

# ETSI TS 100 974 V6.8.0 (2000-11)

---

*Technical Specification*

**Digital cellular telecommunications system (Phase 2+);  
Mobile Application Part (MAP) specification  
(GSM 09.02 version 6.8.0 Release 1997)**

---

**GSM**®

GLOBAL SYSTEM FOR  
MOBILE COMMUNICATIONS



Reference

---

RTS/TSGN-040902Q6R6

Keywords

---

Digital cellular telecommunications system,  
Global System for Mobile communications (GSM)

**ETSI**

650 Route des Lucioles  
F-06921 Sophia Antipolis Cedex - FRANCE

---

Tel.: +33 4 92 94 42 00 Fax: +33 4 93 65 47 16

Siret N° 348 623 562 00017 - NAF 742 C  
Association à but non lucratif enregistrée à la  
Sous-Préfecture de Grasse (06) N° 7803/88

***Important notice***

---

Individual copies of the present document can be downloaded from:

<http://www.etsi.org>

The present document may be made available in more than one electronic version or in print. In any case of existing or perceived difference in contents between such versions, the reference version is the Portable Document Format (PDF). In case of dispute, the reference shall be the printing on ETSI printers of the PDF version kept on a specific network drive within ETSI Secretariat.

Users of the present document should be aware that the document may be subject to revision or change of status. Information on the current status of this and other ETSI documents is available at <http://www.etsi.org/tb/status/>

If you find errors in the present document, send your comment to:  
editor@etsi.fr

***Copyright Notification***

---

No part may be reproduced except as authorized by written permission.  
The copyright and the foregoing restriction extend to reproduction in all media.

© European Telecommunications Standards Institute 2000.  
All rights reserved.

# Contents

Intellectual Property Rights .....	23
Foreword.....	23
1 Scope .....	24
2 References .....	24
3 Abbreviations .....	30
4 Configuration of the mobile network .....	30
4.1 The entities of the mobile system .....	30
4.1.1 The Home Location Register (HLR) .....	31
4.1.2 The Visitor Location Register (VLR) .....	31
4.1.3 The Mobile-services Switching Centre (MSC).....	31
4.1.4 The Base Station System (BSS).....	32
4.1.5 The Gateway MSC (GMSC).....	32
4.1.6 The SMS Gateway MSC.....	32
4.1.7 The SMS Interworking MSC .....	32
4.1.8 The VBS/VGCS Anchor MSC .....	32
4.1.9 The Equipment Identity Register (EIR).....	32
4.1.10 The GSM Service Control Function (gsmSCF).....	32
4.1.11 The VBS/VGCS Relay MSC .....	32
4.1.12 The Group Call Register (GCR) .....	33
4.1.13 The Shared InterWorking Function Server (SIWFS).....	33
4.1.14 The Serving GPRS Support Node (SGSN).....	33
4.1.15 The Gateway GPRS Support Node (GGSN) .....	33
4.2 Void.....	35
4.3 Interconnection between PLMNs .....	35
4.4 The interfaces within the mobile service .....	35
4.4.1 Interface between the HLR and the VLR (D-interface).....	35
4.4.2 Interface between the HLR and the gsmSCF (J-interface) .....	35
4.4.3 Interface between the VLR and its associated MSC(s) (B-interface) .....	35
4.4.4 Interface between VLRs (G-interface).....	35
4.4.5 Interface between the HLR and the MSC (C-interface).....	35
4.4.6 Interface between the MSC and the gsmSCF (L-interface) .....	36
4.4.7 Interface between MSCs (E-interface).....	36
4.4.8 Interface between the MSC and Base Station Systems (A-interface) .....	36
4.4.9 Interface between MSC and EIR (F-interface) .....	36
4.4.10 Interface between VBS/VGCS Anchor MSC and GCR (I-interface) .....	36
4.4.11 Interface between the MSC and the SIWF server (K-interface) .....	36
4.4.12 Interface between SGSN and HLR (Gr-interface) .....	36
4.4.13 Interface between SGSN and SMS-GMSC or SMS-IWMSC (Gd-interface).....	36
4.4.14 Interface between GGSN and HLR (Gc-interface).....	36
4.4.15 Interface between SGSN and EIR (Gf-interface).....	36
4.4.16 Interface between SGSN and BSC (Gb-interface).....	37
4.4.17 Interface between SGSN and MSC/VLR (Gs-interface) .....	37
4.5 Splitting of the data storage .....	37
5 Overload and compatibility overview .....	37
5.1 Overload control.....	37
5.1.1 Overload control for MSC (outside MAP) .....	37
5.1.2 Overload control for MAP entities .....	37
5.1.3 Congestion control for Signalling System No. 7 .....	40
5.2 Compatibility.....	40
5.2.1 General.....	40
5.2.2 Strategy for selecting the Application Context (AC) version .....	41
5.2.2.1 Proposed method.....	41
5.2.2.2 Managing the version look-up table.....	41

5.2.2.3	Optimising the method.....	42
6	Requirements concerning the use of SCCP and TC.....	43
6.1	Use of SCCP.....	43
6.1.1	SCCP Class.....	43
6.1.2	Sub-System Number (SSN).....	43
6.1.3	SCCP addressing.....	43
6.1.3.1	Introduction.....	43
6.1.3.2	The Mobile-services Switching Centre (MSC).....	44
6.1.3.2.1	MSC interaction during handover.....	44
6.1.3.2.2	MSC for short message routing.....	45
6.1.3.3	The Home Location Register (HLR).....	45
6.1.3.3.1	During call set-up.....	45
6.1.3.3.2	Before location updating completion.....	45
6.1.3.3.3	After location updating completion.....	46
6.1.3.3.4	VLR restoration.....	46
6.1.3.3.5	During Network-Requested PDP Context Activation.....	46
6.1.3.3.6	Before GPRS location updating completion.....	46
6.1.3.3.7	After GPRS location updating completion.....	47
6.1.3.4	The Visitor Location Register (VLR).....	47
6.1.3.4.1	Inter-VLR information retrieval.....	47
6.1.3.4.2	HLR request.....	47
6.1.3.5	The Interworking MSC (IWMSC) for Short Message Service.....	47
6.1.3.6	The Equipment Identity Register (EIR).....	47
6.1.3.7	The Shared Inter Working Function (SIWF).....	48
6.1.3.8	The Serving GPRS Support Node (SGSN).....	48
6.1.3.9	The Gateway GPRS Support Node (GGSN).....	48
6.1.3.10	The Gateway MSC (GMSC) for Short Message Service.....	48
6.1.3.11	Summary table.....	48
6.2	Use of TC.....	50
7	General on MAP services.....	51
7.1	Terminology and definitions.....	51
7.2	Modelling principles.....	51
7.3	Common MAP services.....	52
7.3.1	MAP-OPEN service.....	53
7.3.2	MAP-CLOSE service.....	56
7.3.3	MAP-DELIMITER service.....	56
7.3.4	MAP-U-ABORT service.....	56
7.3.5	MAP-P-ABORT service.....	57
7.3.6	MAP-NOTICE service.....	58
7.4	Sequencing of services.....	59
7.5	General rules for mapping of services onto TC.....	60
7.5.1	Mapping of common services.....	60
7.5.2	Mapping of user specific services.....	62
7.6	Definition of parameters.....	62
7.6.1	Common parameters.....	64
7.6.1.1	Invoke Id.....	64
7.6.1.2	Linked Id.....	64
7.6.1.3	Provider error.....	64
7.6.1.4	User error.....	65
7.6.2	Numbering and identification parameter.....	67
7.6.2.1	IMSI.....	67
7.6.2.2	TMSI.....	67
7.6.2.3	IMEI.....	67
7.6.2.4	Previous location area Id.....	67
7.6.2.5	Stored location area Id.....	67
7.6.2.6	Current location area Id.....	68
7.6.2.7	Target location area Id.....	68
7.6.2.8	Target cell Id.....	68
7.6.2.9	Void.....	68
7.6.2.10	Originating entity number.....	68

7.6.2.11	MSC number .....	68
7.6.2.12	Target MSC number .....	68
7.6.2.13	HLR number .....	68
7.6.2.14	VLR number .....	68
7.6.2.15	HLR Id .....	68
7.6.2.16	LMSI .....	68
7.6.2.17	MS ISDN .....	68
7.6.2.18	OMC Id .....	68
7.6.2.19	Roaming number .....	68
7.6.2.20	Void .....	69
7.6.2.21	Handover number .....	69
7.6.2.22	Forwarded-to number .....	69
7.6.2.23	Forwarded-to subaddress .....	69
7.6.2.24	Called number .....	69
7.6.2.25	Calling number .....	69
7.6.2.26	Originally dialled number .....	69
7.6.2.27	Service centre address .....	69
7.6.2.28	Zone Code .....	69
7.6.2.29	MSIsdn-Alert .....	69
7.6.2.30	Location Information .....	69
7.6.2.31	GMSC Address .....	69
7.6.2.32	VMSC Address .....	69
7.6.2.33	Group Id .....	69
7.6.2.34	North American Equal Access preferred Carrier Id .....	70
7.6.2.35	SIWFS Number .....	70
7.6.2.36	B-subscriber address .....	70
7.6.2.37	Serving cell Id .....	70
7.6.2.38	SGSN number .....	70
7.6.2.39	SGSN address .....	70
7.6.2.40	GGSN address .....	70
7.6.2.41	GGSN number .....	70
7.6.2.42	APN .....	70
7.6.2.43	Network Node number .....	70
7.6.2.44	PDP-Type .....	70
7.6.2.45	PDP-Address .....	70
7.6.2.46	Additional number .....	71
7.6.2.47	P-TMSI .....	71
7.6.2.48	B-subscriber number .....	71
7.6.2.49	B-subscriber subaddress .....	71
7.6.3	Subscriber management parameters .....	71
7.6.3.1	Category .....	71
7.6.3.2	Equipment status .....	71
7.6.3.3	Extensible Bearer service .....	71
7.6.3.4	Extensible Teleservice .....	71
7.6.3.5	Extensible Basic Service Group .....	71
7.6.3.6	GSM bearer capability .....	71
7.6.3.7	Subscriber Status .....	71
7.6.3.8	CUG Outgoing Access indicator .....	72
7.6.3.9	Operator Determined Barring General Data .....	72
7.6.3.10	ODB HPLMN Specific Data .....	72
7.6.3.11	Regional Subscription Data .....	72
7.6.3.12	Regional Subscription Response .....	72
7.6.3.13	Roaming Restriction Due To Unsupported Feature .....	73
7.6.3.14	Extensible SS-Info .....	73
7.6.3.15	Extensible Forwarding information .....	73
7.6.3.16	Extensible Forwarding feature .....	73
7.6.3.17	Extensible SS-Status .....	73
7.6.3.18	Extensible Forwarding Options .....	73
7.6.3.19	Extensible No reply condition timer .....	73
7.6.3.20	Extensible Call barring information .....	74
7.6.3.21	Extensible Call barring feature .....	74
7.6.3.22	CUG info .....	74

7.6.3.23	CUG subscription.....	74
7.6.3.24	CUG interlock.....	74
7.6.3.25	CUG index.....	74
7.6.3.26	CUG feature.....	74
7.6.3.27	Inter CUG options.....	75
7.6.3.28	Intra CUG restrictions.....	75
7.6.3.29	Extensible SS-Data.....	75
7.6.3.30	Subscriber State.....	75
7.6.3.31	Requested Info.....	75
7.6.3.32	Suppression of Announcement.....	75
7.6.3.33	Suppress T-CSI.....	75
7.6.3.34	GMSC CAMEL Subscription Info.....	75
7.6.3.35	VLR CAMEL Subscription Info.....	76
7.6.3.36	Supported CAMEL Phases.....	76
7.6.3.37	CUG Subscription Flag.....	76
7.6.3.38	CAMEL Subscription Info Withdraw.....	76
7.6.3.39	Voice Group Call Service (VGCS) Data.....	76
7.6.3.40	Voice Broadcast Service (VBS) Data.....	76
7.6.3.41	ISDN bearer capability.....	76
7.6.3.42	Lower layer Compatibility.....	76
7.6.3.43	High Layer Compatibility.....	76
7.6.3.44	Alerting Pattern.....	76
7.6.3.45	GPRS Subscription Data Withdraw.....	76
7.6.3.46	GPRS Subscription Data.....	76
7.6.3.47	QoS-Subscribed.....	76
7.6.3.48	VPLMN address allowed.....	77
7.6.3.49	Roaming Restricted In SGSN Due To Unsupported Feature.....	77
7.6.3.50	Network Access Mode.....	77
7.6.3.51	Mobile Not Reachable Reason.....	77
7.6.3.52	Cancellation Type.....	77
7.6.3.53	All GPRS Data.....	77
7.6.3.54	Complete Data List Included.....	77
7.6.3.55	PDP Context Identifier.....	77
7.6.4	Supplementary services parameters.....	77
7.6.4.1	SS-Code.....	77
7.6.4.2	SS-Status.....	78
7.6.4.3	SS-Data.....	78
7.6.4.4	Override Category.....	78
7.6.4.5	CLI Restriction Option.....	78
7.6.4.6	Forwarding Options.....	78
7.6.4.7	No reply condition timer.....	79
7.6.4.8-7.6.4.14	Void.....	79
7.6.4.15	Forwarding information.....	79
7.6.4.16	Forwarding feature.....	79
7.6.4.17	Void.....	79
7.6.4.18	Call barring information.....	79
7.6.4.19	Call barring feature.....	79
7.6.4.20	New password.....	79
7.6.4.21	Current password.....	80
7.6.4.22	Guidance information.....	80
7.6.4.23	Void.....	80
7.6.4.24	SS-Info.....	80
7.6.4.25÷7.6.4.35	Void.....	80
7.6.4.36	USSD Data Coding Scheme.....	80
7.6.4.37	USSD String.....	80
7.6.4.38	Bearer service.....	80
7.6.4.39	Teleservice.....	80
7.6.4.40	Basic Service Group.....	81
7.6.4.41	eMLPP information.....	81
7.6.4.42	SS-event.....	81
7.6.4.43	SS-event data.....	81
7.6.5	Call parameters.....	81

7.6.5.1	Call reference number .....	81
7.6.5.2	Interrogation type .....	81
7.6.5.3	OR interrogation .....	81
7.6.5.4	OR capability .....	82
7.6.5.5	Forwarding reason.....	82
7.6.5.6	Forwarding interrogation required .....	82
7.6.5.7	O-CSI.....	82
7.6.5.8	Call Direction.....	82
7.6.5.9	Channel Type.....	82
7.6.5.10	Chosen Channel .....	82
7.6.5.11	CCBS Feature .....	82
7.6.6	Radio parameters .....	82
7.6.6.1 ÷ 7.6.6.6	Void.....	82
7.6.6.7	HO-Number Not Required .....	82
7.6.7	Authentication parameters .....	83
7.6.7.1	Authentication set list.....	83
7.6.7.2	Rand .....	83
7.6.7.3	Sres.....	83
7.6.7.4	Kc.....	83
7.6.7.5	Void.....	83
7.6.7.6	Cksn .....	83
7.6.7.7	Ciphering mode.....	83
7.6.8	Short message parameters.....	83
7.6.8.1	SM-RP-DA.....	83
7.6.8.2	SM-RP-OA.....	84
7.6.8.3	MWD status .....	84
7.6.8.4	SM-RP-UI.....	84
7.6.8.5	SM-RP-PRI.....	84
7.6.8.6	SM Delivery Outcome .....	84
7.6.8.7	More Messages To Send .....	84
7.6.8.8	Alert Reason.....	84
7.6.8.9	Absent Subscriber Diagnostic SM .....	84
7.6.8.10	Alert Reason Indicator .....	84
7.6.8.11	Additional SM Delivery Outcome .....	84
7.6.8.12	Additional Absent Subscriber Diagnostic SM .....	85
7.6.8.13	Delivery Outcome Indicator.....	85
7.6.8.14	GPRS Node Indicator.....	85
7.6.8.15	GPRS Support Indicator.....	85
7.6.8.16	SM-RP-MTI.....	85
7.6.8.17	SM-RP-SMEA .....	85
7.6.9	Access and signalling system related parameters .....	85
7.6.9.1	BSS-apdu .....	85
7.6.9.2	CM service type .....	85
7.6.9.3	Access connection status.....	86
7.6.9.4	External Signal Information .....	86
7.6.9.5	Access signalling information.....	86
7.6.9.6	Location update type .....	86
7.6.9.7	Protocol ID.....	86
7.6.9.8	Network signal information .....	86
7.6.9.9	Call Info .....	87
7.6.10	System operations parameters.....	87
7.6.10.1	Network resources.....	87
7.6.10.2	Trace reference.....	87
7.6.10.3	Trace type.....	87
7.7	Representation of a list of a basic parameter in service-primitives .....	88
8	Mobility services .....	88
8.1	Location management services.....	88
8.1.1	MAP_UPDATE_LOCATION_AREA service.....	88
8.1.1.1	Definition .....	88
8.1.1.2	Service primitives .....	88
8.1.1.3	Parameter definitions and use .....	88

8.1.2	MAP_UPDATE_LOCATION service .....	89
8.1.2.1	Definition .....	89
8.1.2.2	Service primitives .....	90
8.1.2.3	Parameter definitions and use .....	90
8.1.3	MAP_CANCEL_LOCATION service .....	91
8.1.3.1	Definition .....	91
8.1.3.2	Service primitives .....	91
8.1.3.3	Parameter definitions and use .....	91
8.1.4	MAP_SEND_IDENTIFICATION service .....	92
8.1.4.1	Definition .....	92
8.1.4.2	Service primitives .....	92
8.1.4.3	Parameter definitions and use .....	92
8.1.5	MAP_DETACH_IMSI service .....	92
8.1.5.1	Definition .....	92
8.1.5.2	Service primitives .....	93
8.1.5.3	Parameter definitions and use .....	93
8.1.6	MAP_PURGE_MS service .....	93
8.1.6.1	Definition .....	93
8.1.6.2	Service primitives .....	93
8.1.6.3	Parameter definitions and use .....	94
8.1.7	MAP_UPDATE_GPRS_LOCATION service .....	94
8.1.7.1	Definition .....	94
8.1.7.2	Service primitives .....	94
8.1.7.3	Parameter definitions and use .....	95
8.2	Paging and search .....	95
8.2.1	MAP_PAGE service .....	95
8.2.1.1	Definition .....	95
8.2.1.2	Service primitives .....	96
8.2.1.3	Parameter definitions and use .....	96
8.2.2	MAP_SEARCH_FOR_MS service .....	96
8.2.2.1	Definition .....	96
8.2.2.2	Service primitives .....	97
8.2.2.3	Parameter definitions and use .....	97
8.3	Access management services .....	97
8.3.1	MAP_PROCESS_ACCESS_REQUEST service .....	97
8.3.1.1	Definition .....	97
8.3.1.2	Service primitives .....	98
8.3.1.3	Parameter definitions and use .....	98
8.4	Handover services .....	99
8.4.1	MAP_PREPARE_HANDOVER service .....	99
8.4.1.1	Definition .....	99
8.4.1.2	Service primitives .....	99
8.4.1.3	Parameter use .....	99
8.4.2	MAP_SEND_END_SIGNAL service .....	100
8.4.2.1	Definition .....	100
8.4.2.2	Service primitives .....	100
8.4.2.3	Parameter use .....	100
8.4.3	MAP_PROCESS_ACCESS_SIGNALLING service .....	101
8.4.3.1	Definition .....	101
8.4.3.2	Service primitives .....	101
8.4.3.3	Parameter use .....	101
8.4.4	MAP_FORWARD_ACCESS_SIGNALLING service .....	101
8.4.4.1	Definition .....	101
8.4.4.2	Service primitives .....	101
8.4.4.3	Parameter use .....	101
8.4.5	MAP_PREPARE_SUBSEQUENT_HANDOVER service .....	102
8.4.5.1	Definition .....	102
8.4.5.2	Service primitives .....	102
8.4.5.3	Parameter use .....	102
8.4.6	MAP_ALLOCATE_HANDOVER_NUMBER service .....	103
8.4.6.1	Definition .....	103
8.4.6.2	Service primitives .....	103



8.4.6.3	Parameter use .....	103
8.4.7	MAP_SEND_HANOVER_REPORT service.....	103
8.4.7.1	Definition .....	103
8.4.7.2	Service primitives .....	103
8.4.7.3	Parameter use .....	103
8.5	Authentication management services .....	104
8.5.1	MAP_AUTHENTICATE service.....	104
8.5.1.1	Definition .....	104
8.5.1.2	Service primitives .....	104
8.5.1.3	Parameter use .....	104
8.5.2	MAP_SEND_AUTHENTICATION_INFO service.....	105
8.5.2.1	Definition .....	105
8.5.2.2	Service primitives .....	105
8.5.2.3	Parameter use .....	105
8.6	Security management services .....	106
8.6.1	MAP_SET_CIPHERING_MODE service .....	106
8.6.1.1	Definitions.....	106
8.6.1.2	Service primitives .....	106
8.6.1.3	Parameter use .....	106
8.7	International mobile equipment identities management services .....	106
8.7.1	MAP_CHECK_IMEI service .....	106
8.7.1.1	Definition .....	106
8.7.1.2	Service primitives .....	106
8.7.1.3	Parameter use .....	107
8.7.2	MAP_OBTAIN_IMEI service.....	107
8.7.2.1	Definition .....	107
8.7.2.2	Service primitives .....	107
8.7.2.3	Parameter use .....	108
8.8	Subscriber management services.....	108
8.8.1	MAP-INSERT-SUBSCRIBER-DATA service .....	108
8.8.1.1	Definition .....	108
8.8.1.2	Service primitives .....	109
8.8.1.3	Parameter use .....	109
8.8.1.4	Basic service information related to supplementary services.....	115
8.8.2	MAP-DELETE-SUBSCRIBER-DATA service .....	116
8.8.2.1	Definition .....	116
8.8.2.2	Service primitives .....	116
8.8.2.3	Parameter use .....	116
8.9	Identity management services .....	118
8.9.1	MAP-PROVIDE-IMSI service .....	118
8.9.1.1	Definition .....	118
8.9.1.2	Service primitives .....	118
8.9.1.3	Parameter use .....	118
8.9.2	MAP-FORWARD-NEW-TMSI service .....	119
8.9.2.1	Definition .....	119
8.9.2.2	Service primitives .....	119
8.9.2.3	Parameter use .....	119
8.10	Fault recovery services .....	119
8.10.1	MAP_RESET service .....	119
8.10.1.1	Definition .....	119
8.10.1.2	Service primitives .....	119
8.10.1.3	Parameter definition and use .....	119
8.10.2	MAP_FORWARD_CHECK_SS_INDICATION service .....	120
8.10.2.1	Definition .....	120
8.10.2.2	Service primitives .....	120
8.10.2.3	Parameter definition and use .....	120
8.10.3	MAP_RESTORE_DATA service.....	120
8.10.3.1	Definition .....	120
8.10.3.2	Service primitives .....	120
8.10.3.3	Parameter definitions and use .....	121
8.11	Subscriber Information services .....	121
8.11.1	MAP-ANY-TIME-INTERROGATION service.....	121

8.11.1.1	Definition .....	121
8.11.1.2	Service primitives .....	122
8.11.1.3	Parameter definition and use .....	122
8.11.2	MAP-PROVIDE-SUBSCRIBER-Info service .....	122
8.11.2.1	Definition .....	122
8.11.2.2	Service primitives .....	122
8.11.2.3	Parameter definition and use .....	123
9	Operation and maintenance services .....	123
9.1	Subscriber tracing services .....	123
9.1.1	MAP-ACTIVATE-TRACE-MODE service .....	123
9.1.1.1	Definition .....	123
9.1.1.2	Service primitives .....	123
9.1.1.3	Parameter use .....	123
9.1.2	MAP-DEACTIVATE-TRACE-MODE service .....	124
9.1.2.1	Definition .....	124
9.1.2.2	Service primitives .....	124
9.1.2.3	Parameter use .....	124
9.1.3	MAP-TRACE-SUBSCRIBER-ACTIVITY service .....	125
9.1.3.1	Definition .....	125
9.1.3.2	Service primitives .....	125
9.1.3.3	Parameter use .....	125
9.2	Other operation and maintenance services .....	126
9.2.1	MAP-SEND-IMSI service .....	126
9.2.1.1	Definition .....	126
9.2.1.2	Service primitives .....	126
9.2.1.3	Parameter use .....	126
10	Call handling services .....	126
10.1	MAP_SEND_ROUTING_INFORMATION service .....	126
10.1.1	Definition .....	126
10.1.2	Service primitives .....	127
10.1.3	Parameter use .....	127
10.2	MAP_PROVIDE_ROAMING_NUMBER service .....	131
10.2.1	Definition .....	131
10.2.2	Service primitives .....	131
10.2.3	Parameter use .....	131
10.3	MAP_RESUME_CALL_HANDLING service .....	133
10.3.1	Definition .....	133
10.3.2	Service primitives .....	133
10.3.3	Parameter use .....	133
10.4	MAP_PREPARE_GROUP_CALL service .....	134
10.4.1	Definition .....	134
10.4.2	Service primitives .....	134
10.4.3	Parameter definitions and use .....	134
10.5	MAP_PROCESS_GROUP_CALL_SIGNALLING service .....	135
10.5.1	Definitions .....	135
10.5.2	Service primitives .....	135
10.5.3	Parameter definitions and use .....	136
10.6	MAP_FORWARD_GROUP_CALL_SIGNALLING service .....	136
10.6.1	Definitions .....	136
10.6.2	Service primitives .....	136
10.6.3	Parameter definitions and use .....	136
10.7	MAP_SEND_GROUP_CALL_END_SIGNAL service .....	137
10.7.1	Definitions .....	137
10.7.2	Service primitives .....	137
10.7.3	Parameter definitions and use .....	137
10.8	MAP_Provide_SIWFS_Number .....	137
10.8.1	Definition .....	137
10.8.2	Service primitive .....	138
10.8.3	Parameter use .....	138
10.9	MAP_SIWFS_Signalling_Modify .....	139

10.9.1	Definition.....	139
10.9.2	Service primitive.....	139
10.9.3	Parameter use.....	139
10.10	MAP_SET_REPORTING_STATE service .....	140
10.10.1	Definition.....	140
10.10.2	Service primitives .....	140
10.10.3	Parameter use.....	140
10.11	MAP_STATUS_REPORT service.....	141
10.11.1	Definition.....	141
10.11.2	Service primitives .....	141
10.11.3	Parameter use.....	141
10.12	MAP_REMOTE_USER_FREE service.....	142
10.12.1	Definition.....	142
10.12.2	Service primitives .....	142
10.12.3	Parameter use.....	142
11	Supplementary services related services .....	143
11.1	MAP_REGISTER_SS service.....	143
11.1.1	Definition.....	143
11.1.2	Service primitives .....	143
11.1.3	Parameter use.....	144
11.2	MAP_ERASE_SS service .....	145
11.2.1	Definition.....	145
11.2.2	Service primitives .....	145
11.2.3	Parameter use.....	145
11.3	MAP_ACTIVATE_SS service.....	146
11.3.1	Definition.....	146
11.3.2	Service primitives .....	146
11.3.3	Parameter use.....	146
11.4	MAP_DEACTIVATE_SS service .....	147
11.4.1	Definitions .....	147
11.4.2	Service primitives .....	147
11.4.3	Parameter use.....	148
11.5	MAP_INTERROGATE_SS service.....	149
11.5.1	Definitions .....	149
11.5.2	Service primitives .....	149
11.5.3	Parameter use.....	149
11.6	MAP_INVOKE_SS service .....	150
11.6.1	Definitions .....	150
11.6.2	Service primitives .....	151
11.6.3	Parameter use.....	151
11.7	MAP_REGISTER_PASSWORD service .....	151
11.7.1	Definitions .....	151
11.7.2	Service primitives .....	152
11.7.3	Parameter use.....	152
11.8	MAP_GET_PASSWORD service.....	152
11.8.1	Definitions .....	152
11.8.2	Service primitives .....	153
11.8.3	Parameter use.....	153
11.9	MAP_PROCESS_UNSTRUCTURED_SS_REQUEST service.....	153
11.9.1	Definitions .....	153
11.9.2	Service primitives .....	153
11.9.3	Parameter use.....	154
11.10	MAP_UNSTRUCTURED_SS_REQUEST service.....	154
11.10.1	Definitions .....	154
11.10.2	Service primitives .....	155
11.10.3	Parameter use.....	155
11.11	MAP_UNSTRUCTURED_SS_NOTIFY service .....	156
11.11.1	Definitions .....	156
11.11.2	Service primitives .....	156
11.11.3	Parameter use.....	156
11.12	MAP_SS_INVOCATION_NOTIFY .....	157

11.12.1	Definition.....	157
11.12.2	Service primitives .....	157
11.12.3	Parameter use.....	157
11.13	MAP_REGISTER_CC_ENTRY service .....	157
11.13.1	Definition.....	157
11.13.2	Service primitives .....	158
11.13.3	Parameter use.....	158
11.14	MAP_ERASE_CC_ENTRY service .....	159
11.14.1	Definition.....	159
11.14.2	Service primitives .....	159
11.14.3	Parameter use.....	159
12	Short message service management services .....	160
12.1	MAP-SEND-ROUTING-INFO-FOR-SM service .....	160
12.1.1	Definition.....	160
12.1.2	Service primitives .....	160
12.1.3	Parameter use.....	161
12.2	MAP-MO-FORWARD-SHORT-MESSAGE service .....	162
12.2.1	Definition.....	162
12.2.2	Service primitives .....	162
12.2.3	Parameter use.....	162
12.3	MAP-REPORT-SM-DELIVERY-STATUS service.....	163
12.3.1	Definition.....	163
12.3.2	Service primitives .....	163
12.3.3	Parameter use.....	164
12.4	MAP-READY-FOR-SM service.....	165
12.4.1	Definition.....	165
12.4.2	Service primitives .....	165
12.4.3	Parameter use.....	165
12.5	MAP-ALERT-SERVICE-CENTRE service .....	166
12.5.1	Definition.....	166
12.5.2	Service primitives .....	166
12.5.3	Parameter use.....	166
12.6	MAP-INFORM-SERVICE-CENTRE service.....	167
12.6.1	Definition.....	167
12.6.2	Service primitives .....	167
12.6.3	Parameter use.....	167
12.7	MAP-SEND-INFO-FOR-MT-SMS service .....	167
12.7.1	Definition.....	167
12.7.2	Service primitives .....	167
12.7.3	Parameter use.....	168
12.8	MAP-SEND-INFO-FOR-MO-SMS service.....	168
12.8.1	Definition.....	168
12.8.2	Service primitives .....	168
12.8.3	Parameter use.....	169
12.9	MAP-MT-FORWARD-SHORT-MESSAGE service .....	169
12.9.1	Definition.....	169
12.9.2	Service primitives .....	169
12.9.3	Parameter use.....	170
13	Network-Requested PDP Context Activation services .....	171
13.1	MAP_SEND_ROUTING_INFO_FOR_GPRS service.....	171
13.1.1	Definition.....	171
13.1.2	Service primitives .....	171
13.1.3	Parameter definition and use.....	171
13.2	MAP_FAILURE_REPORT service .....	172
13.2.1	Definition.....	172
13.2.2	Service primitives .....	172
13.2.3	Parameter definition and use.....	172
13.3	MAP_NOTE_MS_PRESENT_FOR_GPRS service.....	173
13.3.1	Definition.....	173
13.3.2	Service primitives .....	173

13.3.3	Parameter definition and use.....	173
14	General .....	174
14.1	Overview .....	174
14.2	Underlying services .....	174
14.3	Model .....	174
14.4	Conventions.....	174
15	Elements of procedure.....	175
15.1	Dialogue establishment .....	175
15.1.1	Handling of unknown operations.....	175
15.1.2	Receipt of a MAP-OPEN request primitive.....	176
15.1.3	Receipt of a TC-BEGIN indication.....	176
15.1.4	Receipt of a MAP-OPEN response.....	179
15.1.5	Receipt of the first TC-CONTINUE ind.....	179
15.1.6	Receipt of a TC-END ind .....	179
15.1.7	Receipt of a TC-U-ABORT ind.....	179
15.1.8	Receipt of a TC-P-ABORT ind.....	180
15.2	Dialogue continuation .....	180
15.2.1	Sending entity .....	180
15.2.2	Receiving entity .....	180
15.3	Dialogue termination.....	180
15.3.1	Receipt of a MAP-CLOSE request .....	180
15.3.2	Receipt of a TC-END indication.....	180
15.4	User Abort .....	181
15.4.1	MAP-U-ABORT request .....	181
15.4.2	TC-U-ABORT ind .....	181
15.5	Provider Abort.....	181
15.5.1	MAP PM error situation .....	181
15.5.2	TC-P-ABORT ind.....	181
15.5.3	TC-U-ABORT ind .....	181
15.6	Procedures for MAP specific services .....	182
15.6.1	Service invocation .....	182
15.6.2	Service invocation receipt.....	182
15.6.3	Service response .....	183
15.6.4	Receipt of a response .....	183
15.6.4.1	Receipt of a TC-RESULT-NL indication .....	184
15.6.4.2	Receipt of a TC-RESULT-L indication .....	184
15.6.4.3	Receipt of a TC-U-ERROR indication.....	184
15.6.4.4	Receipt of a TC-INVOKE indication .....	185
15.6.4.5	Receipt of a TC-U-REJECT indication.....	185
15.6.4.6	Receipt of a TC-L-REJECT indication .....	185
15.6.4.7	Receipt of a TC-L-CANCEL indication .....	185
15.6.4.8	Receipt of a TC-NOTICE indication .....	186
15.6.5	Other events.....	186
15.6.5.1	Receipt of a TC-U-REJECT.....	186
15.6.5.2	Receipt of a TC-R-REJECT indication.....	186
15.6.5.3	Receipt of a TC-L-REJECT indication .....	186
15.6.6	Parameter checks .....	186
15.6.7	Returning state machines to idle .....	187
15.6.8	Load control.....	187
16	Mapping on to TC services .....	187
16.1	Dialogue control.....	187
16.1.1	Directly mapped parameters .....	187
16.1.2	Use of other parameters of dialogue handling primitives .....	187
16.1.2.1	Dialogue Id.....	187
16.1.2.2	Application-context-name .....	188
16.1.2.3	User information .....	188
16.1.2.4	Component present.....	188
16.1.2.5	Termination.....	188
16.1.2.6	P-Abort-Cause.....	188
16.1.2.7	Quality of service .....	188

16.2	Service specific procedures .....	189
16.2.1	Directly mapped parameters .....	189
16.2.2	Use of other parameters of component handling primitives .....	189
16.2.2.1	Dialogue Id.....	189
16.2.2.2	Class.....	189
16.2.2.3	Linked Id.....	189
16.2.2.4	Operation.....	189
16.2.2.5	Error.....	191
16.2.2.6	Parameters.....	191
16.2.2.7	Time out.....	191
16.2.2.8	Last component.....	191
16.2.2.9	Problem code.....	191
16.2.2.9.1	Mapping to MAP User Error.....	191
16.2.2.9.2	Mapping to MAP Provider Error parameter.....	191
16.2.2.9.3	Mapping to diagnostic parameter.....	192
16.3	SDL descriptions .....	192
17	Abstract syntax of the MAP protocol.....	219
17.1	General .....	219
17.1.1	Encoding rules .....	219
17.1.2	Use of TC.....	219
17.1.2.1	Use of Global Operation and Error codes defined outside MAP .....	220
17.1.3	Use of information elements defined outside MAP.....	220
17.1.4	Compatibility considerations .....	221
17.1.5	Structure of the Abstract Syntax of MAP .....	221
17.1.6	Application Contexts .....	223
17.2	Operation packages .....	224
17.2.1	General aspects .....	224
17.2.2	Packages specifications.....	225
17.2.2.1	Location updating .....	225
17.2.2.2	Location cancellation .....	225
17.2.2.3	Roaming number enquiry.....	225
17.2.2.4	Information retrieval .....	225
17.2.2.5	Inter-VLR information retrieval.....	226
17.2.2.6	IMSI retrieval.....	226
17.2.2.7	Call control transfer.....	226
17.2.2.8-17.2.2.9	Void.....	226
17.2.2.10	Interrogation.....	226
17.2.2.11	Void.....	227
17.2.2.12	Handover Control.....	227
17.2.2.13	Subscriber Data management stand alone.....	227
17.2.2.14	Equipment management.....	227
17.2.2.15	Subscriber data management.....	227
17.2.2.16	Location register restart.....	228
17.2.2.17	Tracing stand-alone.....	228
17.2.2.18	Functional SS handling .....	228
17.2.2.19	Tracing .....	228
17.2.2.20	Binding.....	229
17.2.2.21	Unstructured SS handling .....	229
17.2.2.22	MO Short message relay services .....	229
17.2.2.23	Short message gateway services .....	230
17.2.2.24	MT Short message relay services.....	230
17.2.2.25	Void.....	230
17.2.2.26	Message waiting data management.....	230
17.2.2.27	Alerting .....	231
17.2.2.28	Data restoration .....	231
17.2.2.29	Purging.....	231
17.2.2.30	Subscriber information enquiry.....	231
17.2.2.31	Any time information enquiry.....	232
17.2.2.32	Group Call Control.....	232
17.2.2.33	Provide SIWFS number .....	232
17.2.2.34	SIWFS Signalling Modify.....	232

17.2.2.35	GPRS location updating .....	232
17.2.2.36	GPRS Interrogation .....	233
17.2.2.37	Failure reporting .....	233
17.2.2.38	GPRS notifying .....	233
17.2.2.39	Supplementary Service invocation notification.....	233
17.2.2.40	Set Reporting State.....	233
17.2.2.41	Status Report .....	234
17.2.2.42	Remote User Free.....	234
17.2.2.43	Call Completion .....	234
17.3	Application contexts.....	234
17.3.1	General aspects .....	234
17.3.2	Application context definitions.....	235
17.3.2.1	Void.....	235
17.3.2.2	Location Updating.....	235
17.3.2.3	Location Cancellation .....	236
17.3.2.4	Roaming number enquiry.....	236
17.3.2.5	Void.....	236
17.3.2.6	Location Information Retrieval.....	236
17.3.2.7	Call control transfer.....	237
17.3.2.8-17.3.2.10	Void.....	237
17.3.2.11	Location registers restart .....	237
17.3.2.12	Handover control.....	237
17.3.2.13	IMSI Retrieval.....	238
17.3.2.14	Equipment Management .....	238
17.3.2.15	Information retrieval .....	238
17.3.2.16	Inter-VLR information retrieval .....	238
17.3.2.17	Stand Alone Subscriber Data Management.....	239
17.3.2.18	Tracing .....	239
17.3.2.19	Network functional SS handling .....	239
17.3.2.20	Network unstructured SS handling .....	240
17.3.2.21	Short Message Gateway .....	240
17.3.2.22	Mobile originating Short Message Relay .....	240
17.3.2.23	Void.....	241
17.3.2.24	Short message alert .....	241
17.3.2.25	Short message waiting data management.....	241
17.3.2.26	Mobile terminating Short Message Relay .....	241
17.3.2.27	MS purging .....	242
17.3.2.28	Subscriber information enquiry.....	242
17.3.2.29	Any time information enquiry.....	242
17.3.2.30	Group Call Control.....	242
17.3.2.31	Provide SIWFS Number .....	243
17.3.2.32	Gprs Location Updating.....	243
17.3.2.33	Gprs Location Information Retrieval .....	243
17.3.2.34	Failure Reporting .....	243
17.3.2.35	GPRS Notifying .....	244
17.3.2.36	Supplementary Service invocation notification.....	244
17.3.2.37	Reporting.....	244
17.3.2.38	Call Completion .....	244
17.3.3	ASN.1 Module for application-context-names .....	244
17.4	MAP Dialogue Information.....	247
17.5	MAP operation and error codes.....	248
17.6	MAP operation and error types .....	254
17.6.1	Mobile Service Operations .....	254
17.6.2	Operation and Maintenance Operations.....	259
17.6.3	Call Handling Operations .....	260
17.6.4	Supplementary service operations .....	262
17.6.5	Short message service operations .....	266
17.6.6	Errors .....	268
17.6.7	Group Call operations.....	273
17.7	MAP constants and data types.....	274
17.7.1	Mobile Service data types.....	274
17.7.2	Operation and maintenance data types.....	287

17.7.3	Call handling data types.....	288
17.7.4	Supplementary service data types.....	293
17.7.5	Supplementary service codes.....	297
17.7.6	Short message data types.....	299
17.7.7	Error data types.....	302
17.7.8	Common data types.....	306
17.7.9	Teleservice Codes.....	312
17.7.10	Bearer Service Codes.....	313
17.7.11	Extension data types.....	315
17.7.12	Group Call data types.....	315
18	General on MAP user procedures.....	317
18.1	Introduction.....	317
18.2	Common aspects of user procedure descriptions.....	317
18.2.1	General conventions.....	317
18.2.2	Naming conventions.....	318
18.2.3	Convention on primitives parameters.....	319
18.2.3.1	Open service.....	319
18.2.3.2	Close service.....	319
18.2.4	Version handling at dialogue establishment.....	320
18.2.4.1	Behaviour at the initiating side.....	320
18.2.4.2	Behaviour at the responding side.....	320
18.2.5	Abort Handling.....	320
18.2.6	SDL conventions.....	320
18.3	Interaction between MAP Provider and MAP Users.....	321
19	Mobility procedures.....	321
19.1	Location management Procedures.....	321
19.1.1	Location updating.....	327
19.1.1.1	General.....	327
19.1.1.2	Detailed procedure in the MSC.....	333
19.1.1.3	Detailed procedure in the VLR.....	337
19.1.1.4	Detailed procedure in the HLR.....	356
19.1.1.5	Send Identification.....	362
19.1.1.5.1	General.....	362
19.1.1.5.2	Detailed procedure in the VLR.....	362
19.1.1.5.3	Detailed procedure in the PVLR.....	362
19.1.1.6	The Process Update Location VLR.....	364
19.1.1.7	The Process Subscriber Present HLR.....	366
19.1.1.8	Detailed procedure in the SGSN.....	368
19.1.2	Location Cancellation.....	371
19.1.2.1	General.....	371
19.1.2.2	Detailed procedure in the HLR.....	371
19.1.2.3	Detailed procedure in the VLR.....	372
19.1.2.4	Detailed procedure in the SGSN.....	375
19.1.3	Detach IMSI.....	378
19.1.3.1	General.....	378
19.1.3.2	Detailed procedure in the MSC.....	378
19.1.3.3	Detailed procedure in the VLR.....	378
19.1.4	Purge MS.....	381
19.1.4.1	General.....	381
19.1.4.2	Detailed procedure in the VLR.....	381
19.1.4.3	Detailed procedure in the HLR.....	382
19.1.4.4	Detailed procedure in the SGSN.....	382
19.2	Handover procedure.....	387
19.2.1	General.....	387
19.2.2	Handover procedure in MSC-A.....	390
19.2.2.1	Basic handover.....	390
19.2.2.2	Handling of access signalling.....	390
19.2.2.3	Other procedures in stable handover situation.....	390
19.2.2.4	Subsequent handover.....	390
19.2.2.5	SDL Diagrams.....	390



19.2.3	Handover procedure in MSC-B .....	404
19.2.3.1	Basic handover .....	404
19.2.3.2	Allocation of handover number.....	404
19.2.3.3	Handling of access signalling.....	404
19.2.3.4	Other procedures in stable handover situation .....	404
19.2.3.5	Subsequent handover .....	404
19.2.3.6	SDL Diagrams.....	405
19.2.4	Handover error handling macro .....	417
19.2.5	Handover procedure in VLR.....	419
19.2.5.1	Allocation of handover number.....	419
19.2.5.2	SDL Diagrams.....	419
19.3	Fault recovery procedures .....	422
19.3.1	VLR fault recovery procedures.....	422
19.3.2	HLR fault recovery procedures.....	424
19.3.3	VLR restoration: the restore data procedure in the HLR .....	432
19.4	Macro Insert_Subst_Data_Framed_HLR .....	434
20	Operation and maintenance procedures.....	438
20.1	General .....	438
20.1.1	Tracing Co-ordinator for the VLR.....	438
20.1.2	Subscriber Data Management Co-ordinator for the VLR .....	440
20.1.3	Tracing Co-ordinator for the SGSN.....	442
20.1.4	Subscriber Data Management Co-ordinator for the SGSN .....	444
20.2	Tracing procedures .....	446
20.2.1	Procedures in the HLR.....	449
20.2.1.1	Subscriber tracing activation procedure.....	449
20.2.1.2	Subscriber tracing deactivation procedure .....	454
20.2.2	Procedures in the VLR.....	459
20.2.2.1	Subscriber tracing activation procedure.....	459
20.2.2.2	Subscriber tracing deactivation procedure .....	461
20.2.2.3	Subscriber tracing procedure.....	463
20.2.3	Procedures in the MSC .....	463
20.2.3.1	Subscriber tracing procedure.....	463
20.2.4	Procedures in the SGSN .....	463
20.2.4.1	Subscriber tracing activation procedure.....	463
20.2.4.2	Subscriber tracing deactivation procedure in SGSN .....	463
20.3	Subscriber data management procedures .....	466
20.3.1	Procedures in the HLR.....	467
20.3.1.1	Subscriber deletion procedure.....	467
20.3.1.2	Subscriber data modification procedure.....	469
20.3.2	Procedures in the VLR.....	474
20.3.2.1	Subscriber deletion procedure.....	474
20.3.2.2	Subscriber data modification procedure.....	474
20.3.3	Procedures in the SGSN .....	477
20.3.3.1	Subscriber deletion procedure.....	477
20.3.3.2	Subscriber data modification procedure.....	477
20.4	Subscriber Identity procedure.....	480
20.4.1	Subscriber identity procedure in the HLR .....	480
20.4.2	Subscriber identity procedure in the VLR .....	482
21	Call handling procedures.....	484
21.1	General .....	484
21.2	Retrieval of routing information.....	485
21.2.1	General.....	485
21.2.2	Process in the GMSC.....	487
21.2.3	Procedures in the HLR.....	490
21.2.4	Process in the VLR to provide a roaming number .....	496
21.2.5	Process in the VLR to restore subscriber data .....	498
21.2.6	Process in the VLR to provide subscriber information .....	500
21.2.7	Process in the HLR for Any Time Interrogation.....	502
21.2.7.1	Process in the gsmSCF.....	502
21.2.3	Process in the HLR .....	502

21.3	Transfer of call handling .....	506
21.3.1	General.....	506
21.3.2	Process in the VMSC.....	507
21.3.3	Process in the GMSC.....	509
21.4	Inter MSC Group Call Procedures .....	511
21.4.1	General.....	511
21.4.2	Process in the Anchor MSC.....	511
21.4.3	Process in the Relay MSC .....	517
21.5	Allocation and modifications of resources in an SIWFS.....	522
21.5.1	General.....	522
21.5.2	Process in the VMSC.....	527
21.5.2.1	Allocation of SIWFS resources.....	527
21.5.2.2	Modification of SIWFS resources initiated by the user .....	528
21.5.2.3	Modification of SIWFS resources initiated by the SIWFS .....	529
21.5.3	Process in the SIWFS .....	536
21.5.3.1	Procedures for allocation of SIWFS resources.....	536
21.5.3.2	Process for modification of SIWFS resources initiated by the user .....	537
21.5.3.3	Process for modification of SIWFS resources initiated by the SIWFS .....	537
21.6	Setting of Reporting State .....	543
21.6.1	General.....	543
21.6.2	Process in the HLR for Set Reporting State stand-alone .....	543
21.6.3	Reporting co-ordinator process in the VLR.....	546
21.6.4	Process in the VLR to set the reporting state .....	548
21.7	Status Reporting .....	551
21.7.1	General.....	551
21.7.2	Process in the VLR for Status Reporting .....	552
21.7.3	Process in the HLR for Status Reporting .....	555
21.8	Remote User Free.....	560
21.8.1	General.....	560
21.8.2	Process in the HLR for Remote User Free.....	560
21.8.3	Process in the VLR for Remote User Free.....	563
22	Supplementary services procedures .....	566
22.1	Functional supplementary service processes .....	566
22.1.1	Functional supplementary service process co-ordinator for MSC .....	566
22.1.2	Functional supplementary service process co-ordinator for VLR.....	568
22.1.3	Functional supplementary service process co-ordinator for HLR.....	571
22.1.4	Call completion supplementary service process co-ordinator for HLR .....	574
22.2	Registration procedure .....	576
22.2.1	General.....	576
22.2.2	Procedures in the MSC .....	577
22.2.3	Procedures in the VLR.....	579
22.2.4	Procedures in the HLR.....	582
22.3	Erasure procedure.....	585
22.3.1	General.....	585
22.3.2	Procedures in the MSC .....	585
22.3.3	Procedures in the VLR.....	586
22.3.4	Procedures in the HLR.....	586
22.4	Activation procedure .....	586
22.4.1	General.....	586
22.4.2	Procedures in the MSC .....	587
22.4.3	Procedures in the VLR.....	589
22.4.4	Procedures in the HLR.....	592
22.5	Deactivation procedure.....	595
22.5.1	General.....	595
22.5.2	Procedures in the MSC .....	596
22.5.3	Procedures in the VLR.....	596
22.5.4	Procedures in the HLR.....	596
22.6	Interrogation procedure .....	596
22.6.1	General.....	596
22.6.2	Procedures in the MSC .....	597
22.6.3	Procedures in the VLR.....	597

22.6.4	Procedures in the HLR.....	602
22.7	Invocation procedure.....	604
22.7.1	General.....	604
22.7.2	Procedures in the MSC.....	605
22.7.3	Procedures in the VLR.....	608
22.8	Password registration procedure.....	610
22.8.1	General.....	610
22.8.2	Procedures in the MSC.....	611
22.8.3	Procedures in the VLR.....	611
22.8.4	Procedures in the HLR.....	611
22.9	Mobile Initiated USSD procedure.....	614
22.9.1	General.....	614
22.9.2	Procedures in the MSC.....	614
22.9.3	Procedures in the VLR.....	618
22.9.4	Procedures in the HLR.....	623
22.10	Network initiated USSD procedure.....	628
22.10.1	General.....	628
22.10.2	Procedure in the MSC.....	628
22.10.3	Procedure in the VLR.....	633
22.10.4	Procedure in the HLR.....	640
22.11	Common macros for clause 22.....	647
22.11.1	SS Password handling macros.....	647
22.11.2	SS Error handling macros.....	650
22.12	Supplementary Service Invocation Notification procedure.....	656
22.12.1	General.....	656
22.12.2	Procedures in the MSC.....	656
22.12.3	Procedures in the gsmSCF.....	658
22.13	Activation of a CCBS request.....	660
22.13.1	General.....	660
22.13.2	Procedure in the VLR.....	660
22.13.3	Procedure in the HLR.....	663
22.14	Deactivation of a CCBS request.....	665
22.14.1	General.....	665
22.14.2	Procedure in the VLR.....	665
22.14.3	Procedure in the HLR.....	668
23	Short message service procedures.....	670
23.1	General.....	670
23.1.1	Mobile originated short message service Co-ordinator for the MSC.....	670
23.1.2	Short message Gateway Co-ordinator for the HLR.....	672
23.1.3	Mobile originated short message service Co-ordinator for the SGSN.....	674
23.2	The mobile originated short message transfer procedure.....	676
23.2.1	Procedure in the servicing MSC.....	677
23.2.2	Procedure in the VLR.....	681
23.2.3	Procedure in the interworking MSC.....	683
23.2.4	Procedure in the servicing SGSN.....	685
23.3	The mobile terminated short message transfer procedure.....	689
23.3.1	Procedure in the Servicing MSC.....	691
23.3.2	Procedures in the VLR.....	700
23.3.3	Procedures in the HLR.....	704
23.3.4	Procedures in the gateway MSC.....	713
23.3.5	Procedure in the Servicing SGSN.....	723
23.4	The Short Message Alert procedure.....	731
23.4.1	Procedures in the Servicing MSC.....	733
23.4.2	Procedures in the VLR.....	735
23.4.2.1	The Mobile Subscriber is present.....	735
23.4.2.2	The Mobile Equipment has memory available.....	735
23.4.3	Procedures in the HLR.....	737
23.4.4	Procedures in the Interworking MSC.....	740
23.4.5	Procedures in the Servicing SGSN.....	742
23.4.5.1	The Mobile Subscriber is present.....	742
23.4.5.2	The Mobile Equipment has memory available.....	742

23.5	The SM delivery status report procedure .....	744
23.5.1	Procedures in the HLR.....	744
23.5.2	Procedures in the gateway MSC .....	746
23.6	Common procedures for the short message clause.....	748
23.6.1	The macro Report_SM_Delivery_Stat_HLR.....	748
24	GPRS process description .....	750
24.1	General .....	750
24.1.1	Process in the HLR for Send Routing Information for GPRS .....	750
24.1.2	Process in the GGSN for Send Routing Information for GPRS.....	752
24.2.1	Process in the HLR for Failure Report.....	754
24.2.2	Process in the GGSN for Failure Report.....	757
24.3.1	Process in the GGSN for Note Ms Present For Gprs .....	759
24.3.2	Process in the HLR for Note Ms Present For Gprs.....	762
25	General macro description.....	764
25.1	MAP open macros .....	764
25.1.1	Macro Receive_Open_Ind .....	764
25.1.2	Macro Receive_Open_Cnf .....	764
25.2	Macros to check the content of indication and confirmation primitives.....	769
25.2.1	Macro Check_Indication.....	769
25.2.2	Macro Check_Confirmation .....	769
25.3	The page and search macros.....	772
25.3.1	Macro PAGE_MSC .....	772
25.3.2	Macro Search_For_MS_MSC .....	773
25.4	Macros for handling an Access Request.....	776
25.4.1	Macro Process_Access_Request_MSC .....	776
25.4.2	Macro Process_Access_Request_VLR.....	781
25.4.3	Macro Identification Procedure .....	783
25.5	Authentication macros and processes.....	788
25.5.1	Macro Authenticate_MSC .....	788
25.5.2	Macro Authenticate_VLR.....	788
25.5.3	Process Obtain_Authentication_Sets_VLR.....	788
25.5.4	Macro Obtain_Authent_Para_VLR .....	788
25.5.5	Process Obtain_Auth_Sets_HLR.....	789
25.5.6	Process Obtain_Authent_Para_SGSN .....	796
25.6	IMEI Handling Macros .....	799
25.6.1	Macro Check_IMEI_MSC.....	799
25.6.2	Macro Check_IMEI_VLR .....	799
25.6.3	Process Check_IMEI_EIR.....	800
25.6.4	Macro Obtain_IMEI_MSC .....	800
25.6.5	Macro Obtain_IMEI_VLR .....	801
25.6.6	Process Check_IMEI_SGSN .....	808
25.7	Insert Subscriber Data Macros .....	811
25.7.1	Macro Insert_Subscriber_Data_VLR.....	811
25.7.2	Process Insert_Subscriber_Data_Stand_Alone_HLR .....	813
25.7.3	Macro Wait_for_Insert_Subscriber_Data_Cnf .....	819
25.7.4	Process Send_Insert_Subscriber_Data .....	821
25.7.5	Macro Insert_Subscriber_Data_SGSN .....	823
25.7.6	Macro Wait_for_Insert_GPRS_Subscriber_Data_Cnf .....	825
25.8	Request IMSI Macros.....	827
25.8.1	Macro Obtain_IMSI_MSC .....	827
25.8.2	Macro Obtain_IMSI_VLR.....	829
25.9	Tracing macros .....	831
25.9.1	Macro Trace_Subscriber_Activity_MSC .....	831
25.9.2	Macro Trace_Subscriber_Activity_VLR.....	833
25.9.3	Macro Activate_Tracing_VLR .....	835
25.9.4	Macro Control_Tracing_HLR .....	837
25.9.5	Macro Trace_Subscriber_Activity_SGSN.....	840
25.9.6	Macro Activate_Tracing_SGSN.....	842
25.10	Short Message Alert procedures.....	844
25.10.1	Subscriber_Present_VLR process.....	844

25.10.2	Macro Alert_Service_Centre_HLR .....	846
25.10.3	The Mobile Subscriber is present .....	849
<b>Annex A (informative):</b>	<b>Cross-reference for abstract syntaxes of MAP .....</b>	<b>851</b>
<b>Annex B (informative):</b>	<b>Fully expanded ASN.1 sources for abstract syntaxes of MAP .....</b>	<b>996</b>
B.1	Fully Expanded ASN.1 Source of MAP-Protocol/TCAPMessages .....	996
B.2	Fully Expanded ASN.1 Source of MAP-DialogueInformation .....	1050
<b>Annex C (informative):</b>	<b>Formal protocol incompatibilities between versions 1 &amp; 2 of MAP .....</b>	<b>1055</b>
C.1	Introduction .....	1055
C.2	Deletion of operations and errors .....	1055
C.2.1	Deletion of operation DeregisterMobileSubscriber .....	1055
C.2.2	Deletion of operation RegisterChargingInfo .....	1055
C.2.3	Deletion of operation ForwardSS-Notification .....	1055
C.2.4	Deletion of operations used only on the B-interface .....	1055
C.2.5	Deletion of error InsufficientBearerCapabilities .....	1055
C.3	Deletion of errors for operations .....	1056
C.3.1	Error NegativePW-Check for operation RegisterSS .....	1056
C.3.2	Error NegativePW-Check for operation EraseSS .....	1056
C.3.3	Error NegativePW-Check for operation InterrogateSS .....	1056
C.3.4	Error CUG-Reject for operation SendRoutingInfoForSM .....	1056
C.4	Changes to definitions of data types .....	1056
C.4.1	CUG-Feature .....	1056
C.4.2	CUG-FeatureList .....	1056
C.4.3	CUG-Info .....	1056
C.4.4	CUG-RejectCause .....	1056
C.4.5	IMSI .....	1057
C.4.6	ISDN-AddressString .....	1057
C.4.7	Password .....	1057
C.4.8	RequestParameter .....	1057
C.4.9	RequestParameterList .....	1057
C.4.10	SentParameter .....	1057
C.4.11	SentParameterList .....	1057
C.4.12	SS-Data .....	1057
C.4.13	SS-Info .....	1057
C.4.14	SS-InfoList .....	1058
C.4.15	SS-SubscriptionOption .....	1058
C.4.16	SubscriberData .....	1058
C.5	Changes to parameters of errors .....	1058
C.5.1	CUG-Reject .....	1058
C.5.2	SS-SubscriptionViolation .....	1058
C.6	Changes to parameters of operations .....	1059
C.6.1	InsertSubscriberData .....	1059
C.6.2	RegisterSS .....	1059
C.6.3	SendParameters .....	1059
C.6.4	SendRoutingInfoForSM .....	1059
C.7	Changes to results of operations .....	1059
C.7.1	ActivateSS .....	1059
C.7.2	DeactivateSS .....	1060
C.7.3	EraseSS .....	1060
C.7.4	GetPassword .....	1060
C.7.5	InterrogateSS .....	1060
C.7.6	RegisterSS .....	1060
C.7.7	SendParameters .....	1061
C.7.8	SendRoutingInfoForSM .....	1061

C.8 Changes to errors of operations.....1061  
C.8.1 ActivateSS .....1061  
C.8.2 DeactivateSS .....1061  
C.8.3 EraseSS .....1061  
C.8.4 RegisterSS .....1062  
C.8.5 SendRoutingInfo .....1062

**Annex D (informative): Clause mapping table .....1063**

D.1 Mapping of Clause numbers.....1063

**Annex E (informative): Change History .....1064**

History .....1067

---

## Intellectual Property Rights

IPRs essential or potentially essential to the present document may have been declared to ETSI. The information pertaining to these essential IPRs, if any, is publicly available for **ETSI members and non-members**, and can be found in ETSI SR 000 314: "*Intellectual Property Rights (IPRs); Essential, or potentially Essential, IPRs notified to ETSI in respect of ETSI standards*", which is available from the ETSI Secretariat. Latest updates are available on the ETSI Web server (<http://www.etsi.org/ipr>).

Pursuant to the ETSI IPR Policy, no investigation, including IPR searches, has been carried out by ETSI. No guarantee can be given as to the existence of other IPRs not referenced in ETSI SR 000 314 (or the updates on the ETSI Web server) which are, or may be, or may become, essential to the present document.

---

## Foreword

This Technical Specification (TS) has been produced by ETSI Technical Committee Special Mobile Group (SMG).

The present document specifies the Mobile Application Part (MAP), the requirements for the signalling system and procedures within the Digital cellular telecommunications system (Phase 2/Phase2+) at application level.

The contents of the present document are subject to continuing work within SMG and may change following formal SMG approval. Should SMG modify the contents of the present document, it will be republished by ETSI with an identifying change of release date and an increase in version number as follows:

Version 6.x.y

where:

- 6 indicates GSM Release 1997 of Phase 2+
- x the second digit is incremented for all changes of substance, i.e. technical enhancements, corrections, updates, etc.
- y the third digit is incremented when editorial only changes have been incorporated in the specification.

# 1 Scope

It is necessary to transfer between entities of a Public Land Mobile Network (PLMN) information specific to the PLMN in order to deal with the specific behaviour of roaming Mobile Stations (MS)s. The Signalling System No. 7 specified by CCITT is used to transfer this information.

This Technical Specification (TS) describes the requirements for the signalling system and the procedures needed at the application level in order to fulfil these signalling needs.

Clauses 1 to 6 are related to general aspects such as terminology, mobile network configuration and other protocols required by MAP.

MAP consists of a set of MAP services that are provided to MAP service-users by a MAP service-provider.

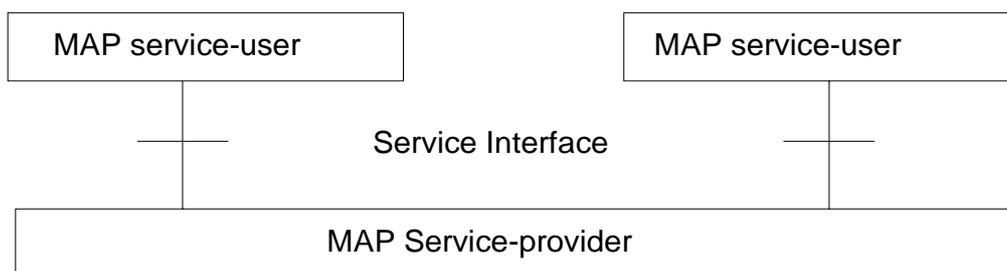

**Figure 1.1/1: Modelling principles**

Clauses 7 to 12 of the present document describe the MAP services.

Clauses 14 to 17 define the MAP protocol specification and the behaviour of service provider (protocol elements to be used to provide MAP services, mapping on to TC service primitives, abstract syntaxes, etc.).

Clauses 18 to 25 describe the MAP user procedures that make use of MAP services.

# 2 References

The following documents contain provisions which, through reference in this text, constitute provisions of the present document.

- References are either specific (identified by date of publication, edition number, version number, etc.) or non-specific.
- For a specific reference, subsequent revisions do not apply.
- For a non-specific reference, the latest version applies.
- A non-specific reference to an ETS shall also be taken to refer to later versions published as an EN with the same number.
- For this Release 1997 document, references to GSM documents are for Release 1997 versions (version 6.x.y).

- [1] GSM 01.04: "Digital cellular telecommunications system (Phase 2+); Abbreviations and acronyms".
- [2] GSM 02.01: "Digital cellular telecommunications system (Phase 2+); Principles of telecommunication services supported by a GSM Public Land Mobile Network (PLMN)".
- [3] GSM 02.02: "Digital cellular telecommunications system (Phase 2+); Bearer Services (BS) Supported by a GSM Public Land Mobile Network (PLMN)".



- [4] GSM 02.03: "Digital cellular telecommunications system (Phase 2+); Teleservices Supported by a GSM Public Land Mobile Network (PLMN)".
- [5] GSM 02.04: "Digital cellular telecommunications system (Phase 2+); General on supplementary services".
- [6] GSM 02.09: "Digital cellular telecommunications system (Phase 2+); Security aspects".
- [7] GSM 02.16: "Digital cellular telecommunications system (Phase 2+); International Mobile station Equipment Identities (IMEI)".
- [8] GSM 02.41: "Digital cellular telecommunications system (Phase 2+); Operator determined barring".
- [9] GSM 02.81: "Digital cellular telecommunications system (Phase 2+); Line identification supplementary services - Stage 1".
- [10] GSM 02.82: "Digital cellular telecommunications system (Phase 2+); Call Forwarding (CF) supplementary services - Stage 1".
- [11] GSM 02.83: "Digital cellular telecommunications system (Phase 2+); Call Waiting (CW) and Call Hold (HOLD) supplementary services - Stage 1".
- [12] GSM 02.84: "Digital cellular telecommunications system (Phase 2+); Multi Party (MPTY) supplementary services - Stage 1".
- [13] GSM 02.85: "Digital cellular telecommunications system (Phase 2+); Closed User Group (CUG) supplementary services - Stage 1".
- [14] GSM 02.86: "Digital cellular telecommunications system (Phase 2+); Advice of charge (AoC) supplementary services - Stage 1".
- [15] GSM 02.88: "Digital cellular telecommunications system (Phase 2+); Call Barring (CB) supplementary services - Stage 1".
- [16] GSM 02.90: "Digital cellular telecommunication system (Phase 2+); Unstructured supplementary services operation - Stage 1".
- [17] GSM 03.03: "Digital cellular telecommunications system (Phase 2+); Numbering, addressing and identification".
- [18] GSM 03.04: "Digital cellular telecommunications system (Phase 2+); Signalling requirements relating to routing of calls to mobile subscribers".
- [19] GSM 03.07: "Digital cellular telecommunications system (Phase 2+); Restoration procedures".
- [20] GSM 03.08: "Digital cellular telecommunications system (Phase 2+); Organisation of subscriber data".
- [21] GSM 03.09: "Digital cellular telecommunications system (Phase 2+); Handover procedures".
- [22] GSM 03.11: "Digital cellular telecommunications system (Phase 2+); Technical realization of supplementary services".

- [23] GSM 03.12: "Digital cellular telecommunications system (Phase 2+); Location registration procedures".
- [24] GSM 03.20: "Digital cellular telecommunications system (Phase 2+); Security related network functions".
- [25] GSM 03.38: "Digital cellular telecommunications system (Phase 2+); Alphabets and language specific information for GSM".
- [26] GSM 03.40: "Digital cellular telecommunications system (Phase 2+); Technical realization of the Short Message Service (SMS) Point to Point (PP)".
- [27] GSM 03.81: "Digital cellular telecommunications system (Phase 2+); Line identification supplementary services - Stage 2".
- [28] GSM 03.82: "Digital cellular telecommunications system (Phase 2+); Call Forwarding (CF) supplementary services - Stage 2".
- [29] GSM 03.83: "Digital cellular telecommunications system (Phase 2+); Call Waiting (CW) and Call Hold (HOLD) supplementary services - Stage 2".
- [30] GSM 03.84: "Digital cellular telecommunications system (Phase 2+); Multi Party (MPTY) supplementary services - Stage 2".
- [31] GSM 03.85: "Digital cellular telecommunications system (Phase 2+); Closed User Group (CUG) supplementary services - Stage 2".
- [32] GSM 03.86: "Digital cellular telecommunications system (Phase 2+); Advice of Charge (AoC) supplementary services - Stage 2".
- [33] GSM 03.88: "Digital cellular telecommunications system (Phase 2+); Call Barring (CB) supplementary services - Stage 2".
- [34] GSM 03.90: "Digital cellular telecommunications system (Phase 2+); Unstructured supplementary services operation - Stage 2".
- [35] GSM 04.08: "Digital cellular telecommunications system (Phase 2+); Mobile radio interface layer 3 specification".
- [36] GSM 04.10: "Digital cellular telecommunications system (Phase 2+); Mobile radio interface layer 3 Supplementary services specification General aspects".
- [37] GSM 04.11: "Digital cellular telecommunications system (Phase 2+); Point-to-Point (PP) Short Message Service (SMS) support on mobile radio interface".
- [38] GSM 04.80: "Digital cellular telecommunications system (Phase 2+); Mobile radio interface layer 3 supplementary services specification Formats and coding".
- [39] GSM 04.81: "Digital cellular telecommunications system (Phase 2+); Line identification supplementary services - Stage 3".
- [40] GSM 04.82: "Digital cellular telecommunications system (Phase 2+); Call Forwarding (CF) supplementary services - Stage 3".

- [41] GSM 04.83: "Digital cellular telecommunications system (Phase 2+); Call Waiting (CW) and Call Hold (HOLD) supplementary services - Stage 3".
- [42] GSM 04.84: "Digital cellular telecommunications system (Phase 2+); Multi Party (MPTY) supplementary services - Stage 3".
- [43] GSM 04.85: "Digital cellular telecommunications system (Phase 2+); Closed User Group (CUG) supplementary services - Stage 3".
- [44] GSM 04.86: "Digital cellular telecommunications system (Phase 2+); Advice of Charge (AoC) supplementary services - Stage 3".
- [45] GSM 04.88: "Digital cellular telecommunications system (Phase 2+); Call Barring (CB) supplementary services - Stage 3".
- [46] GSM 04.90: "Digital cellular telecommunications system (Phase 2+); Unstructured supplementary services operation - Stage 3".
- [47] GSM 08.02: "Digital cellular telecommunications system (Phase 2+); Base Station System - Mobile-services Switching Centre (BSS - MSC) Interface principles".
- [48] GSM 08.06: "Digital cellular telecommunications system (Phase 2+); Signalling transport mechanism specification for the Base Station System - Mobile-services Switching Centre (BSS - MSC) interface".
- [49] GSM 08.08: "Digital cellular telecommunications system (Phase 2+); Mobile Switching Centre - Base Station System (MSC - BSS) interface Layer 3 specification".
- [50] GSM 09.01: "Digital cellular telecommunications system (Phase 2+); General network interworking scenarios".
- [51] GSM 09.02: "Digital cellular telecommunications system (Phase 1); Mobile Application Part (MAP) specification".
- [52] GSM 09.03: "Digital cellular telecommunications system (Phase 2+); Signalling requirements on interworking between the Integrated Services Digital Network (ISDN) or Public Switched Telephone Network (PSTN) and the Public Land Mobile Network (PLMN)".
- [53] GSM 09.04: "Digital cellular telecommunications system (Phase 2+); Interworking between the Public Land Mobile Network (PLMN) and the Circuit Switched Public Data Network (CSPDN)".
- [54] GSM 09.05: "Digital cellular telecommunications system (Phase 2+); Interworking between the Public Land Mobile Network (PLMN) and the Packet Switched Public Data Network (PSPDN) for Packet Assembly/Disassembly facility (PAD) access".
- [55] GSM 09.06: "Digital cellular telecommunications system (Phase 2+); Interworking between a Public Land Mobile Network (PLMN) and a Packet Switched Public Data Network/Integrated Services Digital Network (PSPDN/ISDN) for the support of packet switched data transmission services".
- [56] GSM 09.07: "Digital cellular telecommunications system (Phase 2+); General requirements on interworking between the Public Land Mobile Network (PLMN) and the Integrated Services Digital Network (ISDN) or Public Switched Telephone Network (PSTN)".

- [57] GSM 09.08: "Digital cellular telecommunications system (Phase 2+); Application of the Base Station System Application Part (BSSAP) on the E-interface".
- [58] GSM 09.10: "Digital cellular telecommunications system (Phase 2+); Information element mapping between Mobile Station - Base Station System and BSS - Mobile-services Switching Centre (MS - BSS - MSC) Signalling procedures and the Mobile Application Part (MAP)".
- [59] GSM 09.11: "Digital cellular telecommunications system (Phase 2+); Signalling interworking for supplementary services".
- [60] GSM 09.90: "Digital cellular telecommunications system (Phase 2+); Interworking between Phase 1 infrastructure and Phase 2 Mobile Stations (MS)".
- [61] GSM 12.08: "Digital cellular telecommunications system (Phase 2); Subscriber and Equipment Trace".
- [62] ETS 300 102-1 (1990): "Integrated Services Digital Network (ISDN); User-network interface layer 3 specifications for basic call control".
- [63] ETS 300 136 (1992): "Integrated Services Digital Network (ISDN); Closed User Group (CUG) supplementary service description".
- [64] ETS 300 138 (1992): "Integrated Services Digital Network (ISDN); Closed User Group (CUG) supplementary service Digital Subscriber Signalling System No.One (DSS1) protocol".
- [65] ETS 300 287: "Integrated Services Digital Network (ISDN); Signalling System No.7; Transaction Capabilities (TC) version 2".
- [66] ETR 060: "Signalling Protocols and Switching (SPS); Guide-lines for using Abstract Syntax Notation One (ASN.1) in telecommunication application protocols".
- [67] CCITT Recommendation E.164: "Numbering plan for the ISDN era".
- [68] CCITT Recommendation E.212: "Identification plan for land mobile stations".
- [69] CCITT Recommendation E.213: "Telephone and ISDN numbering plan for land mobile stations".
- [70] CCITT Recommendation E.214: "Structuring of the land mobile global title for the signalling connection control part".
- [71] CCITT Recommendation Q.669: "Interworking between the Digital Subscriber Signalling System Layer 3 protocol and the Signalling System No.7 ISDN User part".
- [72] CCITT Recommendation Q.711: "Specifications of Signalling System No.7; Functional description of the signalling connection control part".
- [73] CCITT Recommendation Q.712: "Definition and function of SCCP messages".
- [74] CCITT Recommendation Q.713: "Specifications of Signalling System No.7; SCCP formats and codes".
- [75] CCITT Recommendation Q.714: "Specifications of Signalling System No.7; Signalling connection control part procedures".

- [76] CCITT Recommendation Q.716: "Specifications of Signalling System No.7; Signalling connection control part (SCCP) performances".
- [77] CCITT Recommendation Q.721 (1988): "Specifications of Signalling System No.7; Functional description of the Signalling System No.7 Telephone user part".
- [78] CCITT Recommendation Q.722 (1988): "Specifications of Signalling System No.7; General function of Telephone messages and signals".
- [79] CCITT Recommendation Q.723 (1988): "Specifications of Signalling System No.7; Formats and codes".
- [80] CCITT Recommendation Q.724 (1988): "Specifications of Signalling System No.7; Signalling procedures".
- [81] CCITT Recommendation Q.725 (1988): "Specifications of Signalling System No.7; Signalling performance in the telephone application".
- [82] CCITT Recommendation Q.761 (1988): "Specifications of Signalling System No.7; Functional description of the ISDN user part of Signalling System No.7".
- [83] CCITT Recommendation Q.762 (1988): "Specifications of Signalling System No.7; General function of messages and signals".
- [84] CCITT Recommendation Q.763 (1988): "Specifications of Signalling System No.7; Formats and codes".
- [85] CCITT Recommendation Q.764 (1988): "Specifications of Signalling System No.7; Signalling procedures".
- [86] CCITT Recommendation Q.767: "Specifications of Signalling System No.7; Application of the ISDN user part of CCITT signalling System No.7 for international ISDN interconnections".
- [87] CCITT Recommendation Q.771: "Specifications of Signalling System No.7; Functional description of transaction capabilities".
- [88] CCITT Recommendation Q.772: "Specifications of Signalling System No.7; Transaction capabilities information element definitions".
- [89] CCITT Recommendation Q.773: "Specifications of Signalling System No.7; Transaction capabilities formats and encoding".
- [90] CCITT Recommendation Q.774: "Specifications of Signalling System No.7; Transaction capabilities procedures".
- [91] CCITT Recommendation Q.775: "Specifications of Signalling System No.7; Guide-lines for using transaction capabilities".
- [92] CCITT Recommendation X.200: "Reference Model of Open systems interconnection for CCITT Applications".
- [93] CCITT Recommendation X.208 (1988): "Specification of Abstract Syntax Notation One (ASN.1)".

- [94] CCITT Recommendation X.209 (1988): "Specification of basic encoding rules for Abstract Syntax Notation One (ASN.1)".
- [95] CCITT Recommendation X.210: "Open systems interconnection layer service definition conventions".
- [96] GSM 09.02: "Digital cellular telecommunications system (Phase 2); Mobile Application Part (MAP) specification".
- [97] GSM 03.18: "Digital cellular telecommunications system (Phase 2+); Basic Call Handling".
- [98] GSM 03.78: "Digital cellular telecommunications system (Phase 2+); Customised Applications for Mobile network Enhanced Logic (CAMEL) - Stage 2".
- [99] GSM 03.79: "Digital cellular telecommunications system (Phase 2+); Support of Optimal Routing (SOR) - Stage 2".
- [100] GSM 03.68: "Digital cellular telecommunications system (Phase 2+); - Stage 2".
- [101] GSM 03.69: "Digital cellular telecommunications system (Phase 2+); - Stage 2".
- [102] ANSI T1.113: "Signalling System No. 7 (SS7) - ISDN User Part".
- [103] GSM 03.54 "Digital cellular telecommunications system (Phase 2+); Stage 2 Description for the use of a Shared Inter Working Function (SIWF) in a GSM PLMN".
- [104] GSM 03.60: "Digital cellular telecommunications system (Phase 2+); General Packet Radio Service (GPRS) Description; Stage 2".
- [105] GSM 09.60: "Digital cellular telecommunications system (Phase 2+), General Packet Radio Service (GPRS); GPRS Tunnelling Protocol (GTP) across the Gn and Gp Interface".
- [106] GSM 09.18: "Digital cellular telecommunications system (Phase 2+); General Packet Radio Service (GPRS); Serving GPRS Support Node (SGSN) - Visitors Location Register (VLR); Gs interface layer 3 specification".
- [107] GSM 03.93: "Digital cellular telecommunications system (Phase 2+); Technical Realization of Completion of Calls to Busy Subscriber (CCBS); Stage 2".

---

## 3 Abbreviations

Abbreviations used in the present document are listed in GSM 01.04.

---

## 4 Configuration of the mobile network

### 4.1 The entities of the mobile system

To provide the mobile service as it is defined, it is necessary to introduce some specific functions. These functional entities can be implemented in different equipment or integrated. In any case, exchanges of data occur between these entities.

### 4.1.1 The Home Location Register (HLR)

This functional entity is a database in charge of the management of mobile subscribers. A PLMN may contain one or several HLRs; it depends on the number of mobile subscribers, on the capacity of the equipment and on the organisation of the network. All subscription data are stored there. The main information stored there concerns the location of each MS in order to be able to route calls to the mobile subscribers managed by each HLR. All management interventions occur on this database. The HLRs have no direct control of MSCs.

Two numbers attached to each mobile subscription are stored in the HLR:

- IMSI;
- MSISDN.

The database contains other information such as:

- location information (VLR number);
- basic telecommunication services subscription information;
- service restrictions (e.g. roaming limitation);
- supplementary services; the tables contain the parameters attached to these services;
- GPRS subscription data and routing information.

The organisation of the subscriber data is detailed in GSM 03.08.

### 4.1.2 The Visitor Location Register (VLR)

An MS roaming in an MSC area is controlled by the Visitor Location Register in charge of this area. When an MS appears in a location area it starts a location updating procedure. The MSC in charge of that area notices this registration and transfers to the Visitor Location Register the identity of the location area where the MS is situated. A VLR may be in charge of one or several MSC areas.

The VLR also contains the information needed to handle the calls set up or received by the MSs registered in its database (in some cases the VLR may have to obtain additional information from the HLR); the following elements can be found in its tables:

- the IMSI;
- the MSISDN;
- the TMSI, if applicable;
- the location area where the MS has been registered. This will be used to call the station;
- supplementary service parameters.

The information is passed between VLR and HLR by the procedures described in GSM 03.12.

The organisation of the subscriber data is detailed in GSM 03.08.

### 4.1.3 The Mobile-services Switching Centre (MSC)

The Mobile-services Switching Centre is an exchange which performs all the switching functions for MSs located in a geographical area designated as the MSC area. The main difference between an MSC and an exchange in a fixed network is that the MSC has to take into account the impact of the allocation of radio resources and the mobile nature of the subscribers and has to perform, for example, the following procedures:

- procedures required for the location registration (see GSM 03.12);
- procedures required for hand-over (see GSM 03.09).

#### 4.1.4 The Base Station System (BSS)

The BSS is the sub-system of Base Station equipment (transceivers, controllers, etc.) which is viewed

- by the MSC through an interface (A-interface) with the functionality described in GSM 08.02;
- by the SGSN through an interface (Gb-interface) with the functionality described in GSM 03.60.

#### 4.1.5 The Gateway MSC (GMSC)

In the case of incoming calls to the PLMN, if the fixed network is unable to interrogate the HLR, the call is routed to an MSC. This MSC will interrogate the appropriate HLR and then route the call to the MSC where the MS is located. The MSC that then performs the routing function to the actual location of the mobile is called the Gateway MSC.

The choice of which MSCs can act as Gateway MSCs is a network operator matter (e.g. all MSCs or some designated MSCs).

If the call is a voice group/broadcast call it is routed directly from the GMSC to the VBS/VGCS Anchor MSC, based on information (VBS/VGCS call reference) contained in the dialled number. See also GSM 03.68 and GSM 03.69.

See also GSM 03.04.

#### 4.1.6 The SMS Gateway MSC

The SMS GMSC is the interface between the Mobile Network and the network that provides access to the Short Message Service Centre, for short messages to be delivered to MSs.

The choice of which MSCs can act as SMS Gateway MSCs is a network operator matter (e.g. all MSCs or some designated MSCs).

#### 4.1.7 The SMS Interworking MSC

The SMS IW MSC is the interface between the Mobile Network and the network that provides access to the Short Message Service Centre, for short messages submitted by MSs.

The choice of which MSCs can act as SMS Interworking MSCs is a network operator matter (e.g. all MSCs or some designated MSCs).

#### 4.1.8 The VBS/VGCS Anchor MSC

The voice broadcast/group call anchor MSC obtains from the associated GCR all relevant attributes and controls in turn all cells in its area, VBS/VGCS Relay-MSCs and dispatchers belonging to a given group call.

#### 4.1.9 The Equipment Identity Register (EIR)

This functional unit is a database in charge of the management of the equipment identities of the MSs (see also GSM 02.16).

#### 4.1.10 The GSM Service Control Function (gsmSCF)

This functional entity contains the CAMEL service logic to implement OSS. It interfaces with the gsmSSF and the HLR; see also TS GSM 03.78.

#### 4.1.11 The VBS/VGCS Relay MSC

The voice broadcast/group call relay MSC obtains from the associated anchor MSC all relevant attributes and controls in turn all cells in its area belonging to a given group call.



### 4.1.12 The Group Call Register (GCR)

This functional unit is a database in charge of the management of attributes related to the establishment of Voice Broadcast Calls and Voice Group Calls

### 4.1.13 The Shared InterWorking Function Server (SIWFS)

A Shared Inter Working Function is a network function that may be used by any MSC in the same PLMN to provide interworking for a data/fax call. Whereas an IWF can only be used by its MSC, the SIWF can be used by several other network nodes e.g. any MSC within the same PLMN (the concept is not limited to a certain number of MSCs). SIWF is applied to data services in GSM Phase 2 and GSM Phase 2+ (as defined in GSM 02.02, GSM 02.03 and GSM 02.34).

The usage of an SIWF requires no additional manipulation at the MS.

An IWF provides specific functions associated with the visited MSC for the interworking with other networks. It comprises signalling and traffic channel related functions. The traffic channel related functions are provided by an Inter Working Unit (IWU).

The SIWF concept is that it provides specific functions for the interworking with other networks. It comprises signalling and traffic channel related functions. Whereas the signalling related functions are associated with the visited MSC, the IWU providing the traffic channel related functions has another physical location.

The entity that contains all additional functions needed in the visited MSC to provide the SIWF is called SIWF Controller (SIWFC). The entity where the IWU is located is called SIWF Server (SIWFS). The Interface between a visited MSC and a SIWFS is called the K Interface.

SIWFS can be provided by a MSC (MSC/SIWFS) or by another network entity (stand alone SIWFS).

### 4.1.14 The Serving GPRS Support Node (SGSN)

This functional unit keeps track of the individual MSs' location and performs security functions and access control; see also GSM 03.60.

### 4.1.15 The Gateway GPRS Support Node (GGSN)

This functional unit provides interworking with external packet-switched networks, network screens and routing of the Network Requested PDP-context activation: see also GSM 03.60.4.2 "Configuration of a Public Land Mobile Network (PLMN)".

The basic configuration of a Public Land Mobile Network is presented in figure 4.2/1. In this figure the most general solution is described in order to define all the possible interfaces which can be found in any PLMN. The specific implementation in each network may be different: some particular functions may be implemented in the same equipment and then some interfaces may become internal interfaces. In any case the configuration of a PLMN must have no impact on the relationship with the other PLMNs.

In this configuration, all the functions are considered implemented in different equipments. Therefore, all the interfaces are external and need the support of the Mobile Application Part of the Signalling System No. 7 to exchange the data necessary to support the mobile service. From this configuration, all the possible PLMN organizations can be deduced.

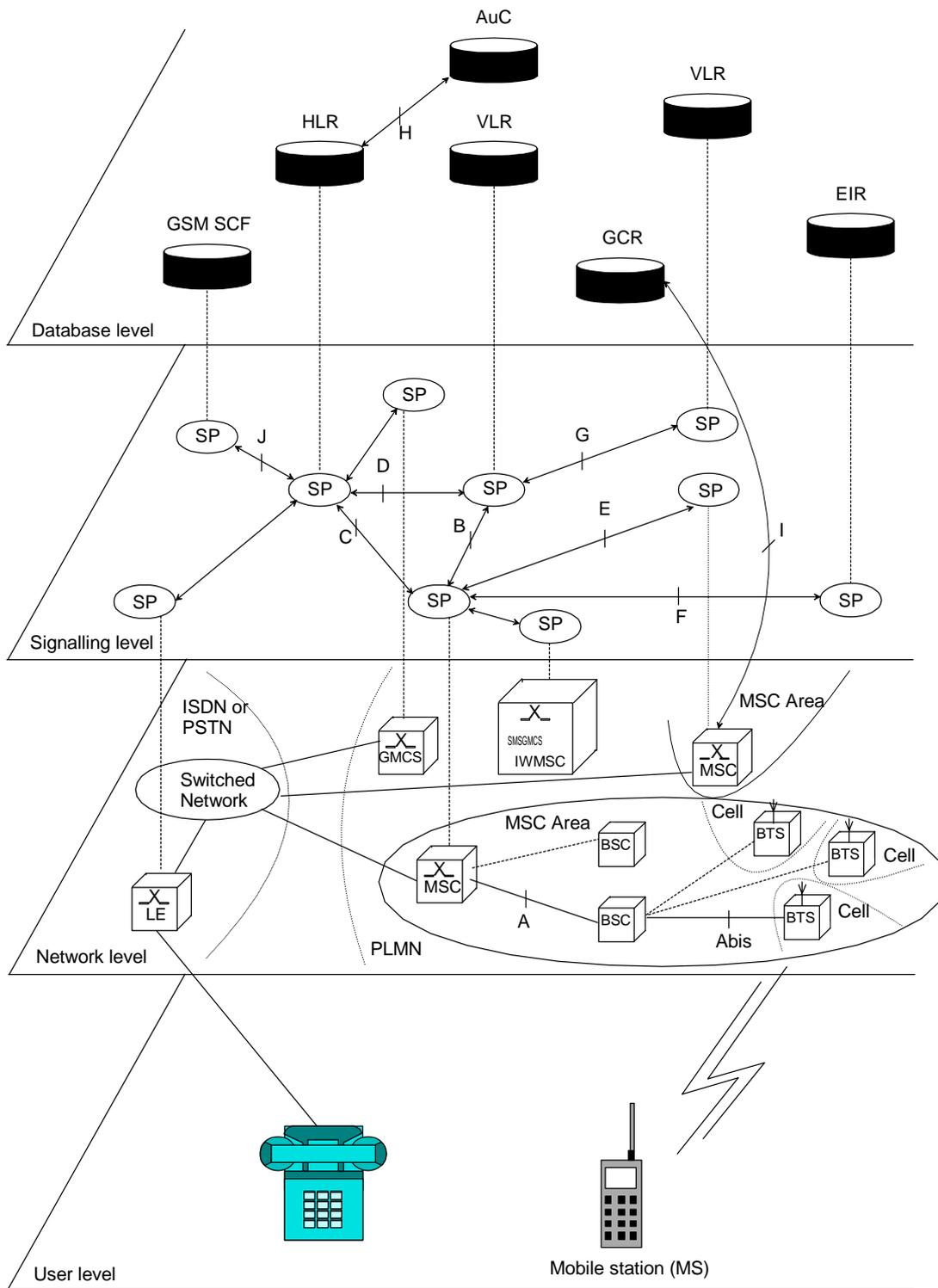

Figure 4.2/1: Configuration of a PLMN

## 4.2 Void

## 4.3 Interconnection between PLMNs

Since the configuration of a PLMN does not have any impact on other PLMNs, the signalling interfaces specified can be implemented both between the entities within a PLMN and between different PLMNs.

## 4.4 The interfaces within the mobile service

### 4.4.1 Interface between the HLR and the VLR (D-interface)

This interface is used to exchange the data related to the location of the MS and to the management of the subscriber. The main service provided to the mobile subscriber is the capability to set up or to receive calls within the whole service area. To support that purpose the location registers have to exchange data. The VLR informs the HLR on the registration of an MS managed by the latter and provides it with the relevant location information. The HLR sends to the VLR all the data needed to support the service to the MS. The HLR then calls the previous VLR to inform it that it can cancel the location registration of this station because of the roaming of the mobile.

Exchanges of data may also occur when the mobile subscriber requires a particular service, when he wants to change some data attached to his subscription or when some parameters of the subscription are modified by administrative means.

### 4.4.2 Interface between the HLR and the gsmSCF (J-interface)

This interface is used by the gsmSCF to request information from the HLR (via the Any-time Interrogation function) or to allow call independent related network- or user-initiated interaction between an MS and the gsmSCF (via the USSD function). Support of the gsmSCF-HLR interface is a network operator option. As a network operator option, the HLR may refuse to provide the information requested by the gsmSCF.

### 4.4.3 Interface between the VLR and its associated MSC(s) (B-interface)

The VLR is the location and management database for the MSs roaming in the area controlled by the associated MSC(s). Whenever the MSC needs data related to a given MS currently located in its area, it interrogates the VLR. When an MS initiates a location updating procedure with an MSC, the MSC informs its VLR which stores the relevant information in its tables. This procedure occurs whenever a mobile roams to another location area. Also, for instance when a subscriber activates a specific supplementary service or modifies some data attached to a service, the MSC transfers (via the VLR) the request to the HLR, which stores these modifications and updates the VLR if required.

However, this interface is not fully operational specified. It is strongly recommended not to implement the B-interface as an external interface.

### 4.4.4 Interface between VLRs (G-interface)

When an MS initiates a location updating using TMSI, the VLR can fetch the IMSI and authentication set from the previous VLR.

### 4.4.5 Interface between the HLR and the MSC (C-interface)

When the fixed network is not able to perform the interrogation procedure needed to set up a call to a mobile subscriber, the Gateway MSC has to interrogate the HLR of the called subscriber to obtain the roaming number of the called MS (see GSM 03.04).

To forward a short message to a mobile subscriber, the SMS Gateway MSC has to interrogate the HLR to obtain the MSC number where the MS is located.

#### 4.4.6 Interface between the MSC and the gsmSCF (L-interface)

When one of the following Supplementary Services, CD, ECT or MPTY, is invoked in the MSC a notification shall be sent towards the gsmSCF.

#### 4.4.7 Interface between MSCs (E-interface)

When an MS moves from one MSC area to another during a call, a handover procedure has to be performed in order to continue the communication. For that purpose the MSCs involved have to exchange data to initiate and then to realise the operation.

This interface is also used to forward short messages.

This interface is also used to transfer information for inter-MSC VBS/VGCS calls.

#### 4.4.8 Interface between the MSC and Base Station Systems (A-interface)

The description of this interface is contained in the GSM 08-series of MSs.

The BSS-MSC interface carries information concerning:

- BSS management;
- call handling;
- location management.

#### 4.4.9 Interface between MSC and EIR (F-interface)

This interface is used when an MSC wants to check an IMEI.

#### 4.4.10 Interface between VBS/VGCS Anchor MSC and GCR (I-interface)

This is an internal interface.

#### 4.4.11 Interface between the MSC and the SIWF server (K-interface)

When an MSC detects that it can not provide the requested IW function, resources from an SIWF server can be used. This interface is used to allocate resources in that SIWF server and establish required physical connections to that server.

#### 4.4.12 Interface between SGSN and HLR (Gr-interface)

The description of this interface is contained in the GSM 03.60.

#### 4.4.13 Interface between SGSN and SMS-GMSC or SMS-IW MSC (Gd-interface)

The description of this interface is contained in the GSM 03.60.

#### 4.4.14 Interface between GGSN and HLR (Gc-interface)

The description of this interface is contained in the GSM 03.60.

#### 4.4.15 Interface between SGSN and EIR (Gf-interface)

The description of this interface is contained in the GSM 03.60.

#### 4.4.16 Interface between SGSN and BSC (Gb-interface)

The description of this interface is contained in the GSM 03.60.

#### 4.4.17 Interface between SGSN and MSC/VLR (Gs-interface)

The description of this interface is contained in the GSM 09.18.

### 4.5 Splitting of the data storage

The data attached to management, operation and location of each MS are stored in the Location Registers. Some data are duplicated in the HLR and in the VLR, but others may be stored only in one place.

A detailed description of the data organisation can be found in GSM 03.08.

---

## 5 Overload and compatibility overview

### 5.1 Overload control

There is a requirement for an overload/congestion control for all entities of the Public Land Mobile Network and the underlying Signalling System No. 7.

#### 5.1.1 Overload control for MSC (outside MAP)

For the entity MSC the following two procedures (outside MAP) may be applied to control the processor load:

- ISDN  
CCITT Recommendation Q.764 (Automatic Congestion Control), applicable to reduce the mobile terminating traffic;
- BSSAP  
GSM 08.08 (A-interface Flow Control), applicable to reduce the mobile originating traffic.

#### 5.1.2 Overload control for MAP entities

For all MAP entities, especially the HLR, the following overload control method is applied:

If overload of a MAP entity is detected requests for certain MAP operations (see tables 5.1/1, 5.1/2 and 5.1/3) may be ignored by the responder. The decision as to which MAP Operations may be ignored is made by the MAP service provider and is based upon the priority of the application context.

Since most of the affected MAP operations are supervised in the originating entity by TC timers (medium) an additional delay effect is achieved for the incoming traffic.

If overload levels are applicable in the Location Registers the MAP operations should be discarded taking into account the priority of their application context (see table 5.1/1 for HLR, table 5.1/2 for MSC/VLR and table 5.1/3 for the SGSN; the lowest priority is discarded first).

The ranking of priorities given in the tables 5.1/1, 5.1/2 and 5.1/3 is not normative. The tables can only be seen as a proposal that might be changed due to network operator/implementation matters.

Table 5.1/1: Priorities of Application Contexts for HLR as Responder

<i>Priority high</i>	<b>Responder = HLR</b>	<b>Initiating Entity</b>
	<u><i>Mobility Management</i></u>	
	networkLocUp (updateLocation), (restoreData/v2), (sendParameters/v1)	VLR
	gprsLocationUpdate (updateGPRSLocation/v3),	SGSN
	infoRetrieval (sendAuthenticationInfo/v2), (sendParameters/v1)	VLR/SGSN
	msPurging (purgeMS/v2/v3)	VLR
	msPurging (purgeMS/v3)	SGSN
	<u><i>Short Message Service</i></u>	
	shortMsgGateway (sendRoutingInfoforSM), (reportSM-DeliveryStatus)	GMSC
	mwdMngt VLR/SGSN (readyForSM/v2/v3), (noteSubscriberPresent/v1)	
	<u><i>Mobile Terminating Traffic</i></u>	
	locInfoRetrieval (sendRoutingInfo)	GMSC
	anyTimeEnquiry (anyTimeInterrogation)	gsmSCF
	reporting (statusReport)	VLR
	<u><i>Subscriber Controlled Inputs (Supplementary Services)</i></u>	
	networkFunctionalSs (registerSS), (eraseSS), (activateSS), (deactivateSS), (interrogateSS), (registerPassword), (processUnstructuredSS-Data/v1), (beginSubscriberActivity/v1)	VLR
	callCompletion (registerCCEntry), (eraseCCEntry)	VLR
	networkUnstructuredSs (processUnstructuredSS-Request/v2)	VLR
	imsiRetrieval (sendIMSI/v2)	VLR
	gprsLocationInfoRetrieval (sendRoutingInfoForGprs/v3)	GGSN/SGSN
	failureReport (failureReport/v3)	GGSN/SGSN
<i>Priority low</i>		

NOTE: The application context name is the last component but one of the object identifier.  
Operation names are given in brackets for information with "/vn" appended to vn only operations.

**Table 5.1/2: Priorities of Application Contexts for MSC/VLR as Responder**

<b>Responder = MSC/VLR</b>	<b>Initiating Entity</b>
<i>Priority high</i>	
<u>Handover</u>	
handoverControl (prepareHandover/v2), (performHandover/v1) Group call and Broadcast call	MSC
groupCallControl (prepareGroupCall/v3)	MSC
<u>Mobility and Location Register Management</u>	
locationCancel (cancelLocation)	HLR
reset (reset)	HLR
interVlrInfoRetrieval (sendIdentification/v2), (sendParameters/v1)	VLR
subscriberDataMngt (insertSubscriberData), (deleteSubscriberData)	HLR
tracing (activateTraceMode), (deactivateTraceMode)	HLR
<u>Short Message Service</u>	
shortMsgMO-Relay (MO-ForwardSM v3) (forwardSM v1/v2)	MSC/SGSN
shortMsgMT-Relay (MT-ForwardSM v3) (forwardSM v1/v2)	MSC
shortMsgAlert (alertServiceCentre/v2), (alertServiceCentreWithoutResult/v1)	HLR
<u>Mobile Terminating Traffic</u>	
roamingNbEnquiry (provideRoamingNumber)	HLR
callControlTransfer (resumeCallHandling)	MSC
subscriberInfoEnquiry (provideSubscriberInformation)	HLR
reporting (remoteUserFree) (SetReportingState)	HLR
<u>Network-Initiated USSD</u>	
networkUnstructuredSs (unstructuredSS-Request/v2), (unstructuredSS-Notify/v2)	HLR
<i>Priority low</i>	

NOTE: The application context name is the last component but one of the object identifier.  
Operation names are given in brackets for information with "/vn" appended to vn only operations.

**Table 5.1/3: Priorities of Application Contexts for SGSN as Responder**

<b>Responder = SGSN</b>	<b>Initiating Entity</b>
<b>Priority high</b>	
<u>Mobility and Location Register Management</u>	
locationCancel (cancelLocation v3)	HLR
reset (reset)	HLR
subscriberDataMngt (insertSubscriberData v3), (deleteSubscriberData v3)	HLR
tracing (activateTraceMode), (deactivateTraceMode)	HLR
<u>Short Message Service</u>	
shortMsgMT-Relay (MT-ForwardSM v3) (forwardSM v1/v2)	MSC
<u>Network-Requested PDP context activation</u>	
gprsNotify (noteMsPresentForGprs v3),	HLR
<b>Priority low</b>	

NOTE: The application context name is the last component but one of the object identifier. Operation names are given in brackets for information with "/vn" appended to vn.

### 5.1.3 Congestion control for Signalling System No. 7

The requirements of SS7 Congestion control have to be taken into account as far as possible.

Means, which could be applied to achieve the required traffic reductions, are described in clauses 5.1.1 and 5.1.2.

## 5.2 Compatibility

### 5.2.1 General

The present document of the Mobile Application Part is designed in such a way that an implementation which conforms to it can also conform to the Mobile Application Part operational version 1 specifications, except on the MSC-VLR interface.

A version negotiation mechanism based on the use of an application-context-name is used to negotiate the protocol version used between two entities for supporting a MAP-user signalling procedure.

When starting a signalling procedure, the MAP-user supplies an application-context-name to the MAP-provider. This name refers to the set of application layer communication capabilities required for this dialogue. This refers to the required TC facilities (e.g. version 1 or 2) and the list of operation packages (i.e. set of operations) from which operations can be invoked during the dialogue.

A version one application-context-name may only be transferred to the peer user in a MAP-U-ABORT to an entity of version two or higher (i.e. to trigger a dialogue which involves only communication capabilities defined for MAP operational version 1).



If the proposed application-context-name can be supported by the responding entity the dialogue continues on this basis otherwise the dialogue is refused and the initiating user needs to start a new dialogue, which involves another application-context-name which requires less communication capabilities but provides similar functionality (if possible).

When a signalling procedure can be supported by several application contexts that differ by their version number, the MAP-User needs to select a name. It can either select the name that corresponds to the highest version it supports or follow a more specific strategy so that the number of protocol fallbacks due to version compatibility problems is minimised.

## 5.2.2 Strategy for selecting the Application Context (AC) version

A method should be used to minimise the number of protocol fall-backs which would occur sometimes if the highest supported AC-Name were always the one selected by GSM entities when initiating a dialogue. The following method is an example that can be used mainly at transitory phase stage when the network is one of mixed phase entities.

### 5.2.2.1 Proposed method

A table (table 1) may be set up by administrative action to define the highest application context (AC) version supported by each destination; a destination may be another node within the same or a different PLMN, or another PLMN considered as a single entity. An E.164 number or an E.214 number derived from an IMSI may define the destination. The table also includes the date when each destination is expected to be able to handle at least one AC of the latest version of the MAP protocol. When this date is reached, the application context supported by the node is marked as "unknown", which will trigger the use of table 2.

A second table (table 2) contains an entry for each destination that has an entry in table 1. For a given entity, the entry in table 2 may be a single application context version or a vector of different versions applying to different application contexts for that entity. Table 2 is managed as described in clause 5.2.2.2.

The data for each destination will go through the following states:

- a) the version shown in table 1 is "version n-1", where 'n' is the highest version existing in this specification; table 2 is not used;
- b) the version shown in table 1 is "unknown"; table 2 is used, and maintained as described in clause 5.2.2.2;
- c) when the PLMN operator declares that an entity (single node or entire PLMN) has been upgraded to support all the MAP version n ACs defined for the relevant interface, the version shown in table 1 is set to "version n" by administrative action; table 2 is no longer used, and the storage space may be recovered.

### 5.2.2.2 Managing the version look-up table

**WHEN** it receives a MAP-OPEN and the MAP-User determines the originating entity number either using the originating address parameter or the originating reference parameter or retrieving it from the subscriber data using the IMSI or the MSISDN.

**IF** the entity number is known

**THEN**

It updates (if required) the associated list of highest supported ACs

**ELSE**

It creates an entry for this entity and includes the received AC-name in the list of highest supported ACs.

**WHEN** starting a procedure, the originating MAP-user looks up its version control table.

**IF** the destination address is known and not timed-out

**THEN**

It retrieves the appropriate AC-name and uses it

**IF** the dialogue is accepted by the peer

**THEN**

It does not modify the version control table

**ELSE** (this should never occur)

It starts a new dialogue with the common highest version supported (based on information implicitly or explicitly provided by the peer).

It replaces the old AC-name by the new one in the list of associated highest AC supported.

**ELSE**

It uses the AC-name that corresponds to the highest version it supports.

**IF** the dialogue is accepted by the peer

**THEN**

It adds the destination node in its version control table and includes the AC-Name in the list of associated highest AC supported.

**ELSE**

It starts a new dialogue with the common highest version supported (based on information implicitly or explicitly provided by the peer).

**IF** the destination node was not known

**THEN**

It adds the destination node in its version control table and includes the new AC-Name in the list of associated highest AC supported.

**ELSE**

It replaces the old AC-name by the new one in the list of highest supported AC and reset the timer.

### 5.2.2.3 Optimising the method

A table look-up may be avoided in some cases if both the HLR and the VLR or both the HLR and the SGSN store for each subscriber the version of the AC-name used at location updating. Then:

- for procedures which make use of the same application-context, the same AC-name (thus the same version) can be selected (without any table look-up) when the procedure is triggered;
- for procedures which make use of a different application-context but which includes one of the packages used by the location updating AC, the same version can be selected (without any table look-up) when the procedure is triggered;

**for HLR:**

- Subscriber data modification (stand alone);

**for VLR:**

- Data Restoration.

---

## 6 Requirements concerning the use of SCCP and TC

### 6.1 Use of SCCP

The Mobile Application Part makes use of the services offered by the Signalling Connection Control Part of signalling System No. 7. CCITT Blue Book or ITU-T (03/93) Recommendations Q.711 to Q.716 should be consulted for the full specification of SCCP.

#### 6.1.1 SCCP Class

MAP will only make use of the connectionless classes (0 or 1) of the SCCP.

#### 6.1.2 Sub-System Number (SSN)

The Application Entities (AEs) defined for MAP consist of several Application Service Elements (ASEs) and are addressed by sub-system numbers (SSNs). The SSN for MAP are specified in GSM 03.03 [17].

When the SGSN emulates MSC behaviour for processing messages (MAP-MO-FORWARD-SHORT-MESSAGE, MAP\_CHECK\_IMEI) towards entities which do not support interworking to SGSNs, it shall use the MSC SSN in the calling party address instead of the SGSN SSN.

#### 6.1.3 SCCP addressing

##### 6.1.3.1 Introduction

Within the GSM System there will be a need to communicate between entities within the same PLMN and in different PLMNs. Using the Mobile Application Part (MAP) for this function implies the use of Transaction Capabilities (TC) and the Signalling Connection Control Part (SCCP) of CCITT Signalling System No. 7.

Only the entities that should be addressed are described below. The format and coding of address parameters carried by the SCCP for that purpose shall comply with CCITT Recommendation Q.713 with the following restrictions:

1) Intra-PLMN addressing

For communication between entities within the same PLMN, a MAP SSN shall always be included in the called and calling party addresses. All other aspects of SCCP addressing are network specific.

2) Inter-PLMN addressing

a) Called Party Address

- SSN indicator = 1 (MAP SSN always included);
- Global title indicator = 0100 (Global title includes translation type, numbering plan, encoding scheme and nature of address indicator);
- the translation type field will be coded "00000000" (Not used);
- Routing indicator = 0 (Routing on global title);

b) Calling Party Address

- SSN indicator = 1 (MAP SSNs always included);
- Point code indicator = 0;
- Global title indicator = 0100 (Global title includes translation type, numbering plan, encoding scheme and nature of address indicator);

- Numbering Plan = 0001 (ISDN Numbering Plan, E.164; In Case of Inter-PLMN Signalling, the dialogue initiating entity and dialogue responding entity shall always include its own E.164 Global Title as Calling Party Address);
- the translation type field will be coded "00000000" (Not used);
- Routing indicator = 0 (Routing on Global Title).

If a Global Title translation is required for obtaining routing information, one of the numbering plans E.164, E.212 and E.214 is applicable.

- E.212 numbering plan

An E.212 number must not be included as Global Title in an SCCP UNITDATA message. The translation of an E.212 number into a Mobile Global Title is applicable in a dialogue initiating VLR, SGSN or GGSN if the routing information towards the HLR is derived from the subscriber's IMSI. When an MS moves from one VLR service area to another, the new VLR may derive the address of the previous VLR from the Location Area Identification provided by the MS in the location registration request. The PLMN where the previous VLR is located is identified by the E.212 numbering plan elements of the Location Area Identification, i.e. the Mobile Country Code (MCC) and the Mobile Network Code (MNC).

- E.214 and E.164 numbering plans

Only address information belonging to either E.214 or E.164 numbering plan is allowed to be included as Global Title in the Called and Calling Party Address.

If the Calling Party Address associated with the dialogue initiating message contains a Global Title, the sending network entity shall include its E.164 entity number.

When receiving an SCCP UNITDATA message, SCCP shall accept either of the valid numbering plans in the Called Party Address and in the Calling Party Address.

When receiving an N-UNITDATA-REQUEST primitive from TC, SCCP shall accept an E.164 number or an E.214 number in the Called Address and in the Calling Address.

The following clauses describe the method of SCCP addressing appropriate for each entity both for the simple intra-PLMN case and where an inter-PLMN communication is required. The following entities are considered:

- the Mobile-services Switching Centre (MSC);
- the Home location Register (HLR);
- the Visitor Location Register (VLR);
- the Gateway Mobile-services Switching Centre (GMSC);
- the GSM Service Control Function (gsmSCF);
- the Interworking Mobile-services Switching Centre (IWMSC);
- the Shared Inter Working Function (SIWF);
- the Serving GPRS Support Node (SGSN);
- the Gateway GPRS Support Node (GGSN).

### 6.1.3.2 The Mobile-services Switching Centre (MSC)

There are several cases where it is necessary to address the MSC.

#### 6.1.3.2.1 MSC interaction during handover

The address is derived from the target Cell id.

### 6.1.3.2.2 MSC for short message routing

When a short message has to be routed to an MS, the GMSC addresses the VMSC by an MSC identity received from the HLR that complies with E.164 rules.

For MS originating short message, the IWMSC address is derived from the Service Centre address.

### 6.1.3.3 The Home Location Register (HLR)

There are several cases where the HLR has to be addressed:

#### 6.1.3.3.1 During call set-up

When a call is initiated the HLR of the called mobile subscriber will be interrogated to discover the whereabouts of the MS. The addressing required by the SCCP will be derived from the MSISDN dialled by the calling subscriber. The dialled number will be translated into either an SPC, in the case of communications within a PLMN, or a Global Title if other networks are involved (i.e. if the communication is across a PLMN boundary).

If the calling subscriber is a fixed network subscriber, the interrogation can be initiated from the Gateway MSC of the home PLMN in the general case. If the topology of the network allows it, the interrogation could be initiated from any Signalling Point that has MAP capabilities, e.g. local exchange, outgoing International Switching Centre (ISC), etc.

#### 6.1.3.3.2 Before location updating completion

When an MS registers for the first time in a VLR, the VLR has to initiate the update location dialogue with the MS's HLR and a preceding dialogue for authentication information retrieval if the authentication information must be retrieved from the HLR. When initiating either of these dialogues, the only data for addressing the HLR that the VLR has available is contained in the IMSI, and addressing information for SCCP must be derived from it. When continuing the established update location dialogue (as with any other dialogue), the VLR must derive the routing information towards the HLR from the Calling Party Address received with the first responding CONTINUE message until the dialogue terminating message is received. This means that the VLR must be able to address the HLR based:

- on an E.214 Mobile Global Title originally derived by the VLR from the IMSI; or
- on an E.164 HLR address; or
- in the case of intra-PLMN signalling, on an SPC.

When answering with Global Title to the VLR, the HLR shall insert its E.164 address in the Calling Party Address of the SCCP message containing the first responding CONTINUE message.

If the HLR is in the same PLMN as the VLR, local translation tables may exist to derive an SPC. For authentication information retrieval and location updating via the international PSTN/ISDN signalling network, the Global title must be derived from the IMSI, using the principles contained in CCITT Recommendation E.214 and the Numbering Plan Indicator (NPI) value referenced by the SCCP Specifications. A summary of the translation from the IMSI (CCITT Recommendation E.212) to Mobile Global Title (described in CCITT Recommendation E.214) is shown below:

- E.212 Mobile Country Code translates to E.164 Country Code;
- E.212 Mobile Network Code translates to E.164 National Destination Code;
- E.212 Mobile Subscriber Identification Number (MSIN) is carried unchanged if within the E.164 number maximum length (15 digits). If the Mobile Global Title is more than 15 digits the number is truncated to 15 by deleting the least significant digits.

This translation will be done either at the application or at SCCP level in the VLR. The Mobile Global Title thus derived will be used to address the HLR.

If location updating is triggered by an MS that roams from one MSC Area into a different MSC Area served by the same VLR, the VLR shall address the HLR in the same way as if the MS registers for the first time in the VLR.

#### 6.1.3.3.3 After location updating completion

In this case, the subscriber's basic MSISDN has been received from the HLR during the subscriber data retrieval procedure as well as the HLR number constituting a parameter of the MAP message indicating successful completion of the update location dialogue. From either of these E.164 numbers the address information for initiating dialogues with the roaming subscriber's HLR can be derived. Also the subscriber's IMSI may be used for establishing the routing information towards the HLR. This may apply in particular if the dialogue with the HLR is triggered by subscriber controlled input.

Thus the SCCP address of the roaming subscriber's HLR may be an SPC, or it may be a Global title consisting of the E.164 MSISDN or the E.164 number allocated to the HLR or the E.214 Mobile Global Title derived from the IMSI.

#### 6.1.3.3.4 VLR restoration

If a roaming number is requested by the HLR for an IMSI that has no data record in the interrogated VLR, the VLR provides the roaming number in the dialogue terminating message. Subsequently the VLR must retrieve the authentication data from the MS's HLR, if required, and must then trigger the restore data procedure. For this purpose, the VLR has to initiate in succession two independent dialogues with the MS's HLR. The MTP and SCCP address information needed for routing to the HLR can be derived from the IMSI received as a parameter of the MAP message requesting the roaming number. In this case, the IMSI received from the HLR in the roaming number request shall be processed in the same way as the IMSI that is received from an MS that registers for the first time within a VLR. Alternatively to the IMSI, the Calling Party Address associated with the roaming number request may be used to obtain the routing information towards the HLR.

#### 6.1.3.3.5 During Network-Requested PDP Context Activation

When receiving a PDP PDU the GGSN may interrogate the HLR of the MS for information retrieval. When initiating such a dialogue, the only data for addressing the HLR that the GGSN has available is contained in the IMSI, and addressing information must be derived from it. The IMSI is obtained from the IP address or the X.25 address in the incoming IP message by means of a translation table. This means that the GGSN shall be able to address the HLR based on an E.214 Mobile Global Title originally derived by the GGSN from the IMSI in the case of inter-PLMN signalling. In the case of intra-PLMN signalling, an SPC may also be used.

If the HLR is in the same PLMN as the GGSN, local translation tables may exist to derive an SPC. For information retrieval via the international PSTN/ISDN signalling network, the Global title must be derived from the IMSI, using the principles contained in CCITT Recommendation E.214 and the Numbering Plan Indicator (NPI) value referenced by the SCCP Specifications. A summary of the translation from the IMSI (CCITT Recommendation E.212) to Mobile Global Title (described in CCITT Recommendation E.214) is shown below:

- E.212 Mobile Country Code translates to E.164 Country Code;
- E.212 Mobile Network Code translates to E.164 National Destination Code;
- E.212 Mobile Subscriber Identification Number (MSIN) is carried unchanged if within the E.164 number maximum length (15 digits). If the Mobile Global Title is more than 15 digits the number is truncated to 15 by deleting the least significant digits.

This translation will be done either at the application or at SCCP level in the GGSN. The Mobile Global Title thus derived will be used to address the HLR.

#### 6.1.3.3.6 Before GPRS location updating completion

When an MS registers for the first time in an SGSN, the SGSN has to initiate the update location dialogue with the MS's HLR and a preceding dialogue for authentication information retrieval if the authentication information must be retrieved from the HLR. When initiating either of these dialogues, the only data for addressing the HLR that the SGSN has available is contained in the IMSI, and addressing information for SCCP must be derived from it. When continuing the established update location dialogue (as with any other dialogue), the SGSN must derive the routing information towards the HLR from the Calling Party Address received with the first responding CONTINUE message until the dialogue terminating message is received. This means that the SGSN must be able to address the HLR based:

- on an E.214 Mobile Global Title originally derived by the SGSN from the IMSI; or
- on an E.164 HLR address; or

- in the case of intra-PLMN signalling, on an SPC.

If the HLR is in the same PLMN as the SGSN, local translation tables may exist to derive an SPC. For authentication information retrieval and location updating via the international PSTN/ISDN signalling network, the Global title must be derived from the IMSI, using the principles contained in CCITT Recommendation E.214 and the Numbering Plan Indicator (NPI) value referenced by the SCCP Specifications. A summary of the translation from the IMSI (CCITT Recommendation E.212) to Mobile Global Title (described in CCITT Recommendation E.214) is shown below:

- E.212 Mobile Country Code translates to E.164 Country Code;
- E.212 Mobile Network Code translates to E.164 National Destination Code;
- E.212 Mobile Subscriber Identification Number (MSIN) is carried unchanged if within the E.164 number maximum length (15 digits). If the Mobile Global Title is more than 15 digits the number is truncated to 15 by deleting the least significant digits.

This translation will be done either at the application or at SCCP level in the SGSN. The Mobile Global Title thus derived will be used to address the HLR.

#### 6.1.3.3.7 After GPRS location updating completion

In this case, the subscriber's Basic MSISDN has been received from the HLR during the subscriber data retrieval procedure as well as the HLR number constituting a parameter of the MAP message indicating successful completion of the update location dialogue. From either of these E.164 numbers the address information for initiating dialogues with the roaming subscriber's HLR can be derived. Also the subscriber's IMSI may be used for establishing the routing information towards the HLR.

Thus the SCCP address of the roaming subscriber's HLR may be an SPC, or it may be a Global title consisting of the E.164 MSISDN or the E.164 number allocated to the HLR or the E.214 Mobile Global Title derived from the IMSI.

#### 6.1.3.4 The Visitor Location Register (VLR)

There are several cases when the VLR needs to be addressed:

##### 6.1.3.4.1 Inter-VLR information retrieval

When an MS moves from one VLR service area to another, the new VLR may request the IMSI and authentication sets from the previous VLR. The new VLR derives the address of the previous VLR from the Location Area Identification provided by the MS in the location registration request.

##### 6.1.3.4.2 HLR request

The HLR will only request information from a VLR if it is aware that one of its subscribers is in the VLR's service area. This means that a location updating dialogue initiated by the VLR has been successfully completed, i.e. the HLR has indicated successful completion of the update location procedure to the VLR.

When initiating dialogues towards the VLR after successful completion of location updating, the routing information used by the HLR is derived from the E.164 VLR number received as a parameter of the MAP message initiating the update location dialogue. If the VLR is in the same PLMN as the HLR, the VLR may be addressed directly by an SPC derived from the E.164 VLR number. For dialogues via the international PSTN/ISDN signalling network, presence of the E.164 VLR number in the Called Party Address is required.

#### 6.1.3.5 The Interworking MSC (IWMSC) for Short Message Service

The IWMSC is the interface between the mobile network and the network to access to the Short Message Service Centre. This exchange has an E.164 address known in the SGSN or in the MSC.

#### 6.1.3.6 The Equipment Identity Register (EIR)

The EIR address is either unique or could be derived from the IMEI. The type of address is not defined.

### 6.1.3.7 The Shared Inter Working Function (SIWF)

When the Visited MSC detects a data or fax call and the IWF in the V-MSC can not handle the required service an SIWF can be invoked. The SIWF is addressed with an E.164 number.

### 6.1.3.8 The Serving GPRS Support Node (SGSN)

The HLR will initiate dialogues towards the SGSN if it is aware that one of its subscribers is in the SGSN's serving area. This means that a GPRS location updating has been successfully completed, i.e, the HLR has indicated successful completion of the GPRS location update to the SGSN. The routing information used by the HLR is derived from the E.164 SGSN number received as parameter of the MAP message initiating the GPRS update location procedure. If the SGSN is in the same PLMN as the HLR, the SGSN may be addressed directly by an SPC derived from the E.164 SGSN number. For dialogues via the international PSTN/ISDN signalling network, the presence of the E.164 SGSN number in the Called Party Address is required.

When the GMSC initiates dialogues towards the SGSN the SGSN (MAP) SSN (See GSM 03.03) shall be included in the called party address. The routing information used by the GMSC is derived from the E.164 SGSN number received as a parameter of the MAP message initiating the forward short message procedure. If the GMSC does not support the GPRS functionality the MSC (MAP) SSN value shall be included in the called party address.

NOTE: Every VMSC and SGSN shall have uniquely identifiable application using E.164 numbers, for the purpose of SMS over GPRS when the GMSC does not support the GPRS functionality.

### 6.1.3.9 The Gateway GPRS Support Node (GGSN)

The GGSN provides interworking with external packet-switched networks, network screens and routing of the Network-Requested PDP Context activation. If a Network-Requested PDP Context activation fails, the HLR will alert the GGSN when the subscriber becomes reachable. The HLR will use the E.164 GGSN number received as parameter of the MAP message reporting the failure.

### 6.1.3.10 The Gateway MSC (GMSC) for Short Message Service

The GMSC provides interworking with the network to access the Short Message Service Centre, the mobile network and routing of Send Routing Info For SM. The GMSC has an E.164 address known in the HLR, SGSN or MSC

### 6.1.3.11 Summary table

The following table summarizes the SCCP address used for invoke operations. As a principle, within a PLMN either an SPC or a GT may be used (network operation option), whereas when addressing an entity outside the PLMN the GT must be used. The address type mentioned in the table (e.g. MSISDN) is used as GT or to derive the SPC.

For a response, the originating address passed in the invoke is used as SCCP Called Party Address. For extra-PLMN addressing the own E.164 entity address is used as SCCP Calling Party Address; for intra-PLMN addressing an SPC derived from the entity number may be used instead. When using an SPC, the SPC may be taken directly from MTP.



Table 6.1/1

to from	fixed net work	HLR	VLR	MSC	EIR	gsmSCF	SIWF	SGSN	GGSN
fixed network	---	E:GT T:MSISDN	---	---	---	---	---	---	---
Home Location Register	---	---	I:SPC/GT E:GT T:VLR NUMBER	---	---	I:SPC/GT E:GT T:gsmSCF NUMBER	---	I:SPC/GT E:GT T:SGSN NUMBER	I:SPC/GT E:GT T:GGSN NUMBER
Visitor Location Register	---	I:SPC/GT E:GT T:MGT/MSI SDN/HLR NUMBER (note)	I:SPC/GT E:GT T:VLR NUMBER	---	---	---	---	---	---
Mobile-services Switching Centre	---	I:SPC/GT E:GT T:MSISDN	I:SPC/GT E:GT T:VLR NUMBER	I:SPC/GT E:GT T:MSC NUMBER	I:SPC/GT E:GT T:EIR NUMBER	I:SPC/GT E:GT T:gsmSCF NUMBER	I:SPC/GT E:GT T:SIWF NUMBER	I:SPC/GT E:GT T:SGSN NUMBER	---
gsm Service Control Function	---	I:SPC/GT E:GT T:MSISDN	---	---	---	---	---	---	---
Shared Inter Working Function	---	---	---	I:SPC/GT E:GT T:MSC NUMBER	---	---	---	---	---
Serving GPRS Support Node	---	I:SPC/GT E:GT T:MGT/ MSISDN/HL R NUMBER	---	I:SPC/GT E:GT T:MSC NUMBER	I:SPC/GT E:GT T:EIR NUMBER	---	---	---	---
Gateway GPRS Support Node	---	I:SPC/GT E:GT T:MGT	---	---	---	---	---	---	---

I: Intra-PLMN      E: Extra(Inter)-PLMN      T: Address Type  
 GT: Global Title      MGT: E.214 Mobile Global Title      SPC: Signalling Point Code

NOTE: For initiating the location updating procedure and an authentication information retrieval from the HLR preceding it, the VLR has to derive the HLR address from the IMSI of the MS. The result can be an SPC or an E.214 Mobile Global Title. When continuing the established update location dialogue (as with any other dialogue) the VLR must derive the routing information towards the HLR from the Calling Party Address received with the first responding CONTINUE message until the dialogue terminating message is received.

For transactions invoked by the VLR after update location completion, the VLR may derive the information for addressing the HLR from addresses received in the course of the update location procedure (MSISDN or HLR number) or from the IMSI.

When invoking the Restore Data procedure and an authentication information retrieval from the HLR preceding it, the VLR must derive the information for addressing the HLR from the address information received in association with the roaming number request. This may be either the IMSI received as a parameter of the MAP message requesting the Roaming Number or the Calling Party Address associated with the MAP message requesting the Roaming Number.

The gsmSCF shall be addressed using more than one Global Title number. The first Global Title number is used to address a gsmSCF for MAP. The second Global Title number is used to address a gsmSCF for CAP.

## 6.2 Use of TC

The Mobile Application part makes use of the services offered by the Transaction Capabilities (TC) of signalling system No. 7. ETS 300 287, which is based on CCITT White Book Recommendations Q.771 to Q.775, should be consulted for the full specification of TC.

The MAP uses all the services provided by TC except the ones related to the unstructured dialogue facility.

From a modelling perspective, the MAP is viewed as a single Application Service Element. Further structuring of it is for further study.

Transaction Capabilities refers to a protocol structure above the network layer interface (i.e. the SCCP service interface) up to the application layer including common application service elements but not the specific application service elements using them.

TC is structured as a Component sub-layer above a Transaction sub-layer.

The Component sub-layer provides two types of application services: services for the control of end-to-end dialogues and services for Remote Operation handling. These services are accessed using the TC-Dialogue handling primitives and TC-Component handling primitives respectively.

Services for dialogue control include the ability to exchange information related to application-context negotiation as well as initialization data.

Services for Remote Operation handling provide for the exchange of protocol data units invoking tasks (operations), and reporting their outcomes (results or errors) plus any non-application-specific protocol errors detected by the component sub-layer. The reporting of application-specific protocol errors by the TC user, as distinct from application process errors, is also provided. The Transaction sub-layer provides a simple end-to-end connection association service over which several related protocol data units (i.e. built by the Component Sub-Layer) can be exchanged. A Transaction termination can be prearranged (no indication provided to the TC user) or basic (indication provided).

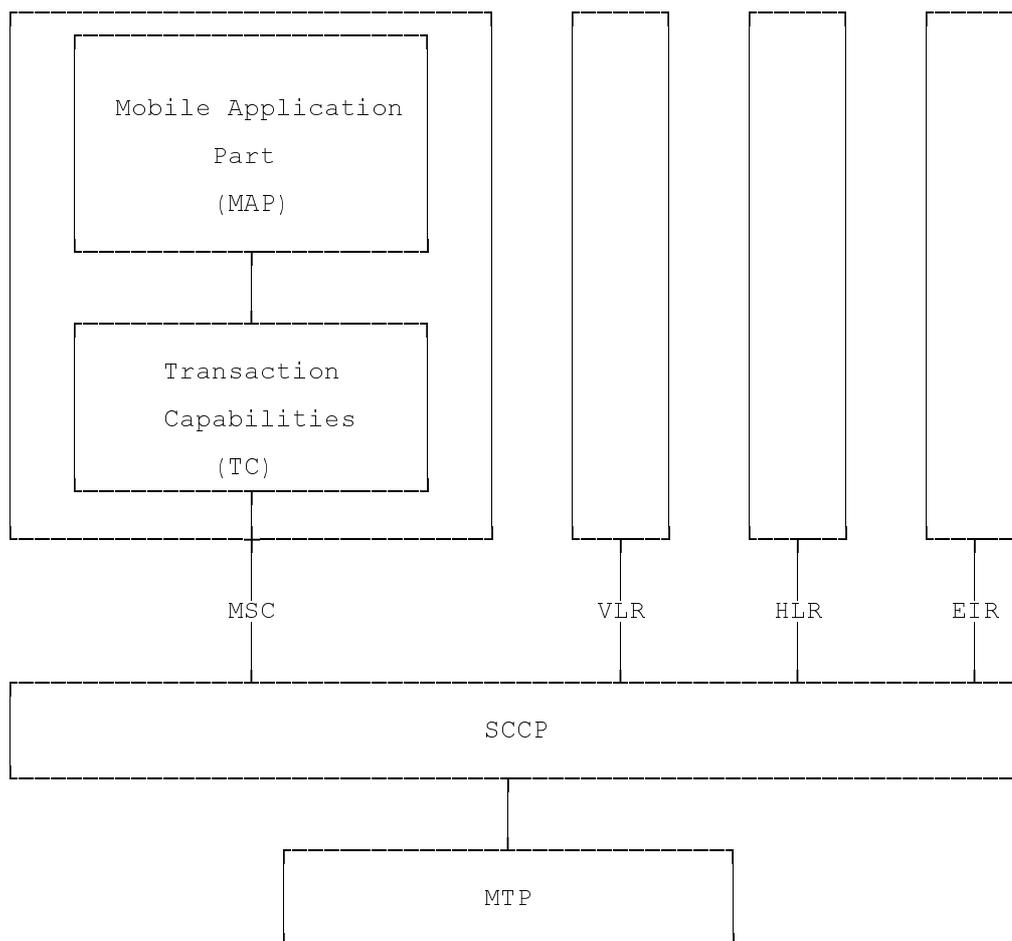

Figure 6.2/1: Facilities for supporting the Mobile Application Part in Signalling System No.7

---

## 7 General on MAP services

### 7.1 Terminology and definitions

The term service is used in clauses 7 to 12 as defined in CCITT Recommendation X.200. The service definition conventions of CCITT Recommendation X.210 are also used.

### 7.2 Modelling principles

MAP provides its users with a specified set of services and can be viewed by its users as a "black box" or abstract machine representing the MAP service-provider. The service interface can then be depicted as shown in figure 7.2/1.

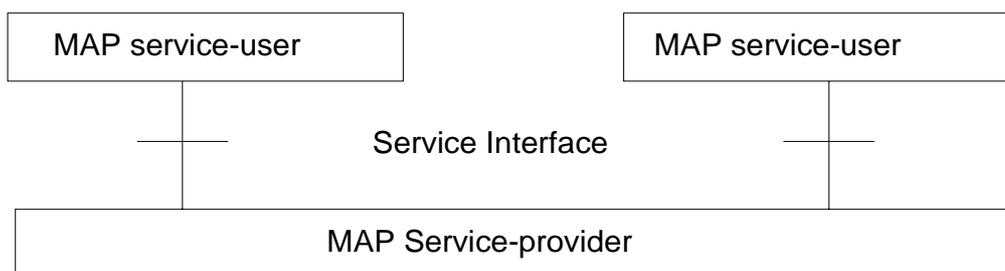

Figure 7.2/1: Modelling principles

The MAP service-users interact with the MAP service-provider by issuing or receiving MAP service-primitives at the service interface.

A MAP service-user may receive services from several instances of the MAP service-provider at the same time. In such cases the overall procedure is synchronised by the service-user.

The MAP service-primitives are named using the following notation:

MAP-ServicePrimitiveName <b>type</b>
--------------------------------------

where **type** can be any of: request (req), indication (ind), response (rsp) or confirm (cnf) (In the user arrow diagrams type is not indicated in the case of req/ind and indicated as "ack" in the case of rsp/cnf).

The services are further classified as unconfirmed-service, confirmed-service and provider-initiated-service where the first two categories refer to whether or not the service is confirmed by the service-provider. The confirmation may or may not correspond to a response provided by the other service-user.

MAP services are also classified as common MAP services which are available to all MAP service-users, and MAP service-user specific services which are services available to one or several, but not all, MAP service-users.

A MAP dialogue is defined as an exchange of information between two MAP users in order to perform a common task. A MAP dialogue will consist of one or several MAP services.

## 7.3 Common MAP services

All MAP service-users require access to services for performing basic application layer functions:

- for establishing and clearing MAP dialogues between peer MAP service-users;
- for accessing functions supported by layers below the applications layer;
- for reporting abnormal situations;
- for handling of different MAP versions;
- for testing whether or not a persistent MAP dialogue is still active at each side.

For these purposes the following common services are defined:

- MAP-OPEN service;
- MAP-CLOSE service;
- MAP-DELIMITER service;
- MAP-U-ABORT service;
- MAP-P-ABORT service;
- MAP-NOTICE service.

In defining the service-primitives the following convention is used for categorising parameters:

- M** the inclusion of the parameter is mandatory. The M category can be used for any primitive type and specifies that the corresponding parameter must be present in the indicated primitive type;
- O** the inclusion of the parameter is a service-provider option. The O category can be used in indication and confirm type primitives and is used for parameters that may optionally be included by the service-provider;
- U** the inclusion of the parameter is a service-user option. The U category can be used in request and response type primitives. The inclusion of the corresponding parameter is the choice of the service-user;

C the inclusion of the parameter is conditional. The C category can be used for the following purposes:

- to indicate that if the parameter is received from another entity it must be included for the service being considered;
- to indicate that the service user must decide whether to include the parameter, based on the context on which the service is used;
- to indicate that one of a number of mutually exclusive parameters must be included (e.g. parameters indicating a positive result versus parameters indicating a negative result);
- to indicate that a service user optional parameter (marked "U") or a conditional parameter (marked "C") presented by the service user in a request or response type primitive is to be presented to the service user in the corresponding indication or confirm type primitive;

(=) when appended to one of the above, this symbol means that the parameter takes the same value as the parameter appearing immediately to its left;

blank the parameter is not present.

A primitive type may also be without parameters, i.e. no parameter is required with the primitive type; in this case the corresponding column of the table is empty.

### 7.3.1 MAP-OPEN service

This service is used for establishing a MAP dialogue between two MAP service-users. The service is a confirmed service with service primitives as shown in table 7.3/1.

**Table 7.3/1: Service-primitives for the MAP-OPEN service**

Parameters	Request	Indication	Response	Confirm
Application context name	M	M(=)	U	C(=)
Destination address	M	M(=)		
Destination reference	U	C(=)		
Originating address	U	O		
Originating reference	U	C(=)		
Specific information	U	C(=)	U	C(=)
Responding address			U	C(=)
Result			M	M(=)
Refuse-reason			C	C(=)
Provider error				O

Application context name:

This parameter identifies the type of application context being established. If the dialogue is accepted the received application context name shall be echoed. In case of refusal of dialogue this parameter shall indicate the highest version supported.

Destination address:

A valid SCCP address identifying the destination peer entity (see also clause 6). As an implementation option, this parameter may also, in the indication, be implicitly associated with the service access point at which the primitive is issued.

Destination-reference:

This parameter is a reference which refines the identification of the called process. It may be identical to Destination address but its value is to be carried at MAP level. Table 7.3/2 describes the MAP services using this parameter. Only these services are allowed to use it.

Table 7.3/2: Use of the destination reference

MAP service	Reference type	Use of the parameter
MAP-REGISTER-SS	IMSI	Subscriber identity
MAP-ERASE-SS	IMSI	Subscriber identity
MAP-ACTIVATE-SS	IMSI	Subscriber identity
MAP-DEACTIVATE-SS	IMSI	Subscriber identity
MAP-INTERROGATE-SS	IMSI	Subscriber identity
MAP-REGISTER-PASSWORD	IMSI	Subscriber identity
MAP-PROCESS-UNSTRUCTURED-SS-REQUEST	IMSI	Subscriber identity
MAP-UNSTRUCTURED-SS-REQUEST	IMSI	Subscriber identity
MAP-UNSTRUCTURED-SS-NOTIFY	IMSI	Subscriber identity
MAP-FORWARD-SHORT-MESSAGE	IMSI (note)	Subscriber identity
MAP-REGISTER-CC-ENTRY	IMSI	Subscriber identity
MAP-ERASE-CC-ENTRY	IMSI	Subscriber identity

NOTE: Only when the IMSI and the LMSI are received together from the HLR in the mobile terminated short message transfer.

Originating address:

A valid SCCP address identifying the requestor of a MAP dialogue (see also clause 6). As an implementation option, this parameter may also, in the request, be implicitly associated with the service access point at which the primitive is issued.

Originating-reference:

This parameter is a reference which refines the identification of the calling process. It may be identical to the Originating address but its value is to be carried at MAP level. Table 7.3/3 describes the MAP services using the parameter. Only these services are allowed to use it. Processing of the Originating-reference shall be performed according to the supplementary service descriptions and other service descriptions, e.g. operator determined barring.

Table 7.3/3: Use of the originating reference

MAP service	Reference type	Use of the parameter
MAP-REGISTER-SS	ISDN-Address-String	Originated entity address
MAP-ERASE-SS	ISDN-Address-String	Originated entity address
MAP-ACTIVATE-SS	ISDN-Address-String	Originated entity address
MAP-DEACTIVATE-SS	ISDN-Address-String	Originated entity address
MAP-INTERROGATE-SS	ISDN-Address-String	Originated entity address
MAP-REGISTER-PASSWORD	ISDN-Address-String	Originated entity address
MAP-PROCESS-UNSTRUCTURED-SS-REQUEST	ISDN-Address-String	Originated entity address
MAP-REGISTER-CC-ENTRY	ISDN-Address-String	Originated entity address
MAP-ERASE-CC-ENTRY	ISDN-Address-String	Originated entity address

Specific information:

This parameter may be used for passing any user specific information. Establishment and processing of the Specific information is not specified by GSM and shall be performed according to operator specific requirements.

Responding address:

An address identifying the responding entity. The responding address is included if required by the context (e.g. if it is different from the destination address).

Result:

This parameter indicates whether the dialogue is accepted by the peer.

Refuse reason:

This parameter is only present if the Result parameter indicates that the dialogue is refused. It takes one of the following values:

- Application-context-not-supported;
- Invalid-destination-reference;
- Invalid-originating-reference;
- No-reason-given;
- Remote node not reachable;
- Potential version incompatibility.

### 7.3.2 MAP-CLOSE service

This service is used for releasing a previously established MAP dialogue. The service may be invoked by either MAP service-user depending on rules defined within the service-user. The service is an unconfirmed service with parameters as shown in table 7.3/4.

**Table 7.3/4: Service-primitives for the MAP-CLOSE service**

Parameters	Request	Indication
Release method	M	
Specific Information	U	C(=)

Release method:

This parameter can take the following two values:

- normal release; in this case the primitive is mapped onto the protocol and sent to the peer;
- prearranged end; in this case the primitive is not mapped onto the protocol. Prearranged end is managed independently by the two users, i.e. only the request type primitive is required in this case.

Specific information:

This parameter may be used for passing any user specific information. Establishment and processing of the Specific information is not specified by GSM GSM and shall be performed according to operator specific requirements.

### 7.3.3 MAP-DELIMITER service

This service is used to explicitly request the transfer of the MAP protocol data units to the peer entities.

See also clause 7.4 and 7.5 for the detailed use of the MAP-DELIMITER service.

The service is an unconfirmed service with service-primitives as shown in table 7.3/5.

**Table 7.3/5: Service-primitives for the MAP-DELIMITER service**

Parameters	Request	Indication

### 7.3.4 MAP-U-ABORT service

This service enables the service-user to request the MAP dialogue to be aborted. The service is an unconfirmed service with service-primitives as shown in table 7.3/6.

**Table 7.3/6: Service-primitives for the MAP-U-ABORT service**

Parameters	Request	Indication
User reason	M	M(=)
Diagnostic information	U	C(=)
Specific information	U	C(=)

User reason:

This parameter can take the following values:

- resource limitation (congestion);  
the requested user resource is unavailable due to congestion;



- resource unavailable;  
the requested user resource is unavailable for reasons other than congestion;
- application procedure cancellation;  
the procedure is cancelled for reason detailed in the diagnostic information parameter;
- procedure error;  
processing of the procedure is terminated for procedural reasons.

Diagnostic information:

This parameter may be used to give additional information for some of the values of the user-reason parameter:

**Table 7.3/7: User reason and diagnostic information**

User reason	Diagnostic information
Resource limitation (congestion)	-
Resource unavailable	
Application procedure cancellation	
	Short term/long term problem
	Handover cancellation/
	Radio Channel release/
	Network path release/
	Call release/
	Associated procedure failure/
	Tandem dialogue released/
	Remote operations failure
Procedure error	-

Specific information:

This parameter may be used for passing any user specific information. Establishment and processing of the Specific information is not specified by GSM and shall be performed according to operator specific requirements.

### 7.3.5 MAP-P-ABORT service

This service enables the MAP service-provider to abort a MAP dialogue. The service is a provider-initiated service with service-primitive as shown in table 7.3/8.

**Table 7.3/8: Service-primitive for the MAP-P-ABORT service**

Parameters	Indication
Provider reason	M
Source	M

Provider reason:

This parameter indicates the reason for aborting the MAP dialogue:

- provider malfunction;
- supporting dialogue/transaction released;
- resource limitation;
- maintenance activity;
- version incompatibility;
- abnormal MAP dialogue.

Source:

This parameter indicates the source of the abort. For Transaction Capabilities (TC) applications the parameter may take the following values:

- MAP problem;
- TC problem;
- network service problem.

**Table 7.3/9: Values of provider reason and source parameters and examples of corresponding events**

Provider reason	Source	Corresponding event
Provider malfunction	MAP	Malfunction at MAP level at peer entity
	TC	"Unrecognised message type" or "Badly formatted transaction portion" or "Incorrect transaction portion" received in TC-P-ABORT "Abnormal dialogue"
	Network service	Malfunction at network service level at peer entity
Supporting dialogue/ transaction released		
	TC	"Unrecognised transaction ID" received in TC-ABORT
Resource limitation	MAP	Congestion towards MAP peer service-user
	TC	"Resource limitation" received in TC-P-ABORT
Maintenance activity	MAP	Maintenance at MAP peer service-user
	Network service	Maintenance at network peer service level
Abnormal MAP dialogue	MAP	MAP dialogue is not in accordance with specified application context
Version incompatibility	TC	A Provider Abort indicating "No common dialogue portion" is received in the dialogue initiated state

### 7.3.6 MAP-NOTICE service

This service is used to notify the MAP service-user about protocol problems related to a MAP dialogue not affecting the state of the protocol machines.

The service is a provider-initiated service with service-primitive as shown in table 7.3/10.

**Table 7.3/10: Service-primitive for the MAP-NOTICE service**

Parameters	Indication
Problem diagnostic	M

Problem diagnostic:

This parameter can take one of the following values:

- abnormal event detected by the peer;
- response rejected by the peer;
- abnormal event received from the peer
- message cannot be delivered to the peer.

## 7.4 Sequencing of services

The sequencing of services is shown in figure 7.4/1 and is as follows:

### Opening:

The MAP-OPEN service is invoked before any user specific service-primitive is accepted. The sequence may contain none, one or several user specific service-primitives. If no user specific service-primitive is contained between the MAP-OPEN and the MAP-DELIMITER primitives, then this will correspond to sending an empty Begin message in TC. If more than one user specific service-primitive is included, all are to be sent in the same Begin message. The sequence ends with a MAP-DELIMITER primitive.

### Continuing:

This sequence may not be present in some MAP dialogues. If it is present, it ends with a MAP-DELIMITER primitive. If more than one user specific service-primitive is included, all are to be included in the same Continue message.

### Closing:

The sequence can only appear after an opening sequence or a continuing sequence. The sequence may contain none, one or several user specific service-primitives if the MAP-CLOSE primitive specifies normal release. If no user specific service-primitive is included, then this will correspond to sending an empty End message in TC. If more than one user specific service-primitive is included, all are to be sent in the same End message. If prearranged end is specified, the sequence cannot contain any user specific service-primitive. The MAP-CLOSE primitive must be sent after all user specific service-primitives have been delivered to the MAP service-provider.

### Aborting:

A MAP service-user can issue a MAP-U-ABORT primitive at any time after the MAP dialogue has been opened or as a response to an attempt to open a MAP dialogue.

The MAP service-provider may issue at any time a MAP-P-ABORT primitive towards a MAP service-user for which a MAP dialogue exists.

MAP-U-ABORT primitives and MAP-P-ABORT primitives terminate the MAP dialogue.

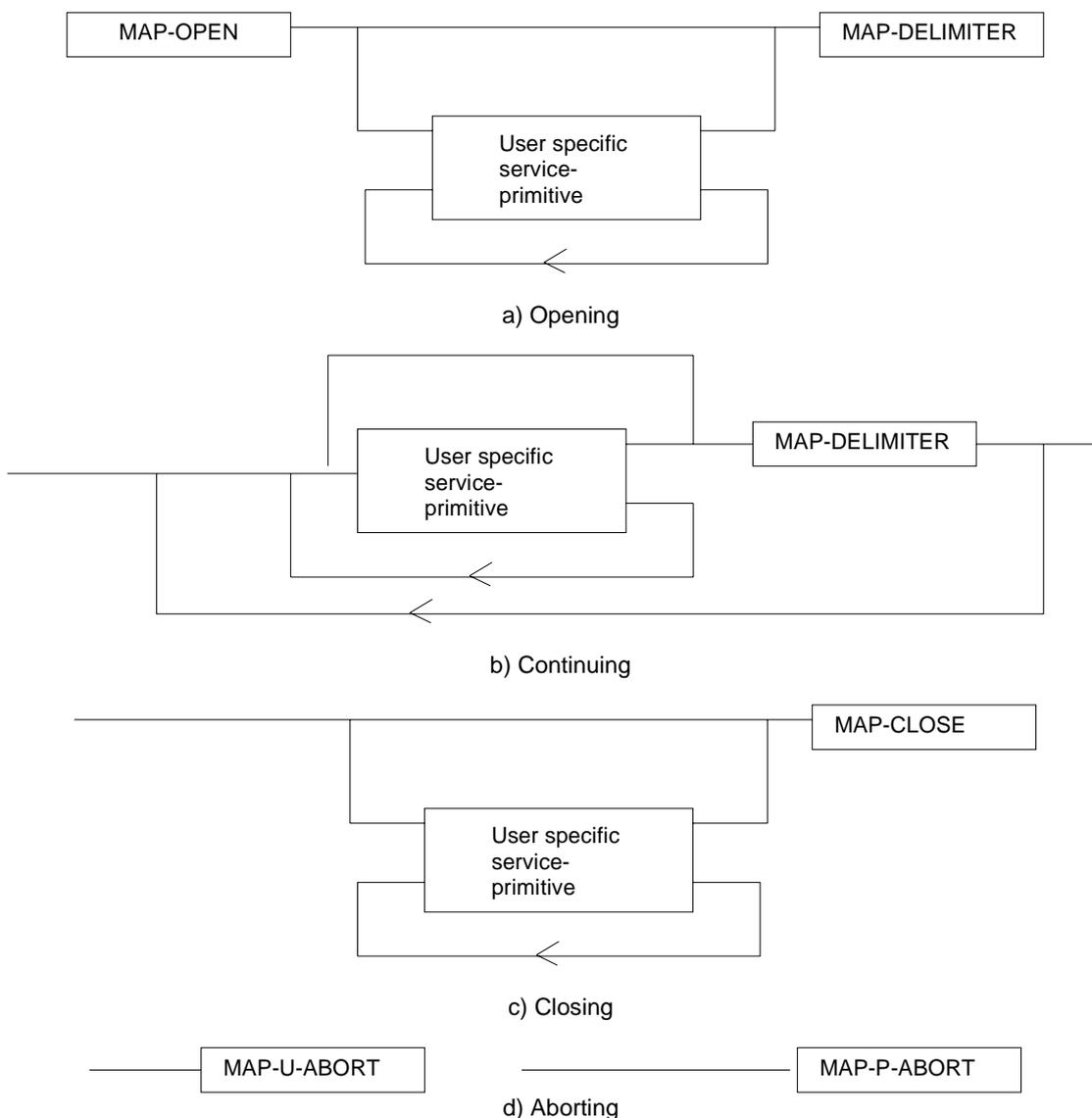

**Figure 7.4/1: Sequencing of services**

If the reason "resource unavailable (short term problem)" is indicated in the MAP-U-ABORT indication primitive, the MAP service-user may decide to attempt a new MAP dialogue establishment immediately.

Sequencing of user specific service-primitives is done by the MAP service-user and based on rules applicable for each MAP service-user instance.

A MAP-NOTICE indication primitive may be received at any time during the active period of a MAP dialogue.

## 7.5 General rules for mapping of services onto TC

### 7.5.1 Mapping of common services

Table 7.5/1 gives an overview of the mapping rules for mapping of common services onto TC-services. Table 7.5/2 gives the mapping rules for mapping of TC-services onto common services.

Protocol machine description is given in clauses 14 to 17.

**Table 7.5/1: Mapping of common services on to TC services**

MAP service-primitive	TC service-primitive
MAP-OPEN request (+ any user specific service primitives) + MAP-DELIMITER request	TC-BEGIN request (+ component handling primitives)
MAP-OPEN response (+ any user specific service primitives) + MAP-DELIMITER request	TC-CONTINUE request (note) (+ component handling primitives)
(any user specific service primitives) + MAP-DELIMITER request	TC-CONTINUE request (+ component handling primitives)
(any user specific service primitives) + MAP-CLOSE request	TC-END request (+ component handling primitives)
MAP-U-ABORT request	TC-U-ABORT request

NOTE: or TC-END if the MAP-CLOSE request has been received before the MAP-DELIMITER request.

**Table 7.5/2: Mapping of TC services on to common service**

TC service-primitive	MAP service-primitive
TC-BEGIN indication (+ component handling primitives)	MAP-OPEN indication (+ user specific service primitives) + MAP-DELIMITER indication (note 1)
TC-CONTINUE indication (+ component handling primitives)	First time: MAP-OPEN confirm (+ user specific service primitives) + MAP-DELIMITER indication (note 1)  Subsequent times: (user specific service primitives) + MAP-DELIMITER indication (note 1)
TC-END indication (+ component handling primitives)	MAP-OPEN confirm (note 6) (user specific service primitives) + MAP-CLOSE indication
TC-U-ABORT indication	MAP-U-ABORT indication or MAP-P-ABORT indication (note 2) MAP-OPEN confirmation (note 3)
TC-P-ABORT indication	MAP-P-ABORT indication (note 4) MAP-OPEN confirmation (note 5)

NOTE 1: It may not be necessary to present this primitive to the user for MAP version 2 applications.

NOTE 2: The mapping depends on whether the TC-U-ABORT indication primitive contains a MAP-abort-PDU from the remote MAP service-provider or a MAP-user-abort-PDU from the remote MAP service-user.

NOTE 3: Only if the opening sequence is pending and if the "Abort Reason" in the TC-U-ABORT indication is set to "Application Context Not Supported".

NOTE 4: If the "Abort Reason" in the TC-P-ABORT indication is set to a value different from "Incorrect Transaction Portion".

NOTE 5: Only if the opening sequence is pending and if the "Abort Reason" in the TC-P-ABORT indication is set to "Incorrect Transaction Portion".

NOTE 6: Only if opening sequence is pending.

## 7.5.2 Mapping of user specific services

Table 7.5/3 gives the general mapping rules which apply to mapping of MAP user specific services onto TC services and table 7.5/4 gives the similar rules for mapping of TC services onto MAP user specific services. Detailed mapping is given in clauses 14 to 17.

**Table 7.5/3: Mapping of MAP user specific services onto TC services**

MAP service-primitive	TC-service-primitive
MAP-xx request	TC-INVOKE request
MAP-xx response (note 1)	TC-RESULT-L request TC-U-ERROR request TC-U-REJECT request TC-INVOKE request (note 2)

**Table 7.5/4: Mapping of TC services onto MAP user specific services**

TC-service-primitive	MAP service-primitive
TC-INVOKE indication	MAP-xx indication
TC-RESULT-L indication (note 4) TC-U-ERROR indication TC-INVOKE indication (note 2) TC-L-CANCEL indication	MAP-xx confirm
TC-U-REJECT indication TC-L-REJECT indication TC-R-REJECT indication	MAP-xx confirm or MAP-NOTICE indication (note 3)

Notes to tables 7.5/3 and 7.5/4:

NOTE 1: The mapping is determined by parameters contained in the MAP-xx response primitive.

NOTE 2: This applies only to TC class 4 operations where the operation is used to pass a result of another class 2 or class 4 operation.

NOTE 3: The detailed mapping rules are given in clause 16.

NOTE 4: If RESULT-NL components are present they are mapped on to the same MAP-xx confirm.

## 7.6 Definition of parameters

Following is an alphabetic list of parameters used in the common MAP-services in clause 7.3:

Application context name	7.3.1	Refuse reason	7.3.1
Destination address	7.3.1	Release method	7.3.2
Destination reference	7.3.1	Responding address	7.3.1
Diagnostic information	7.3.4	Result	7.3.1
Originating address	7.3.1	Source	7.3.5
Originating reference	7.3.1	Specific information	7.3.1/7.3.2/7.3.4
Problem diagnostic	7.3.6	User reason	7.3.4
Provider reason	7.3.5		

Following is an alphabetic list of parameters contained in this clause:

Absent Subscriber Diagnostic SM	7.6.8.9	Invoke Id	7.6.1.1
Access connection status	7.6.9.3	ISDN Bearer Capability	7.6.3.41
Access signalling information	7.6.9.5	Kc	7.6.7.4
Additional Absent Subscriber Diagnostic SM	7.6.8.12	Linked Id	7.6.1.2
Additional number	7.6.2.46	LMSI	7.6.2.16
Additional SM Delivery Outcome	7.6.8.11	Location Information	7.6.2.30
Alert Reason	7.6.8.8	Location update type	7.6.9.6
Alert Reason Indicator	7.6.8.10	Lower Layer Compatibility	7.6.3.42
Alerting Pattern	7.6.3.44	Mobile Not Reachable Reason	7.6.3.51
All GPRS Data	7.6.3.53	More Messages To Send	7.6.8.7
APN	7.6.2.42	MS ISDN	7.6.2.17
Authentication set list	7.6.7.1	MSC number	7.6.2.11
B-subscriber Address	7.6.2.36	MSISdn-Alert	7.6.2.29
B subscriber Number	7.6.2.48	MWD status	7.6.8.3
B subscriber subaddress	7.6.2.49	Network Access Mode	7.6.3.50
Basic Service Group	7.6.4.40	Network node number	7.6.2.43
Bearer service	7.6.4.38	Network resources	7.6.10.1
BSS-apdu	7.6.9.1	Network signal information	7.6.9.8
Call barring feature	7.6.4.19	New password	7.6.4.20
Call barring information	7.6.4.18	No reply condition timer	7.6.4.7
Call Direction	7.6.5.8	North American Equal Access preferred Carrier Id	7.6.2.34
Call Info	7.6.9.9	ODB General Data	7.6.3.9
Call reference	7.6.5.1	ODB HPLMN Specific Data	7.6.3.10
Called number	7.6.2.24	OMC Id	7.6.2.18
Calling number	7.6.2.25	Originally dialled number	7.6.2.26
CAMEL Subscription Info Withdraw	7.6.3.38	Originating entity number	7.6.2.10
Cancellation Type	7.6.3.52	Override Category	7.6.4.4
Category	7.6.3.1	P-TMSI	7.6.2.47
CCBS Feature	7.6.5.8	PDP-Address	7.6.2.45
Channel Type	7.6.5.9	PDP-Context identifier	7.6.3.55
Chosen Channel	7.6.5.10	PDP-Type	7.6.2.44
Ciphering mode	7.6.7.7	Previous location area Id	7.6.2.4
Cksn	7.6.7.5	Protocol Id	7.6.9.7
CLI Restriction	7.6.4.5	Provider error	7.6.1.3
CM service type	7.6.9.2	QoS-Subscribed	7.6.3.47
Complete Data List Included	7.6.3.54	Rand	7.6.7.2
CUG feature	7.6.3.26	Regional Subscription Data	7.6.3.11
CUG index	7.6.3.25	Regional Subscription Response	7.6.3.12
CUG info	7.6.3.22	Requested Info	7.6.3.31
CUG interlock	7.6.3.24	Roaming number	7.6.2.19
CUG Outgoing Access indicator	7.6.3.8	Roaming Restricted In SGSN Due To	7.6.3.49
CUG subscription	7.6.3.23	Unsupported Feature	
CUG Subscription Flag	7.6.3.37	Roaming Restriction Due To	7.6.3.13
Current location area Id	7.6.2.6	Unsupported Feature	
Current password	7.6.4.21	Service centre address	7.6.2.27
eMLPP Information	7.6.4.41	Serving Cell Id	7.6.2.37
Equipment status	7.6.3.2	SGSN address	7.6.2.39
Extensible Basic Service Group	7.6.3.5	SGSN number	7.6.2.38
Extensible Bearer service	7.6.3.3	SIWF Number	7.6.2.35
Extensible Call barring feature	7.6.3.21	SM Delivery Outcome	7.6.8.6
Extensible Call barring information	7.6.3.20	SM-RP-DA	7.6.8.1
Extensible Forwarding feature	7.6.3.16	SM-RP-MTI	7.6.8.16
Extensible Forwarding info	7.6.3.15	SM-RP-OA	7.6.8.2
Extensible Forwarding Options	7.6.3.18	SM-RP-PRI	7.6.8.5
Extensible No reply condition timer	7.6.3.19	SM-RP-SMEA	7.6.8.17
Extensible SS-Data	7.6.3.29	SM-RP-UI	7.6.8.4
Extensible SS-Info	7.6.3.14	Sres	7.6.7.3
Extensible SS-Status	7.6.3.17	SS-Code	7.6.4.1
Extensible Teleservice	7.6.3.4	SS-Data	7.6.4.3
External Signal Information	7.6.9.4	SS-Event	7.6.4.42
Forwarded-to number	7.6.2.22	SS-Event-Data	7.6.4.43
Forwarded-to subaddress	7.6.2.23	SS-Info	7.6.4.24
Forwarding feature	7.6.4.16	SS-Status	7.6.4.2

Forwarding information	7.6.4.15	Stored location area Id	7.6.2.5
Forwarding Options	7.6.4.6	Subscriber State	7.6.3.30
GGSN address	7.6.2.40	Subscriber Status	7.6.3.7
GGSN number	7.6.2.41	Supported CAMEL Phases	7.6.3.36
GMSC CAMEL Subscription Info	7.6.3.34	Suppress T-CSI	7.6.3.33
GPRS Node Indicator	7.6.8.14	Suppression of Announcement	7.6.3.32
GPRS Subscription Data	7.6.3.46	Target cell Id	7.6.2.8
GPRS Subscription Data Withdraw	7.6.3.45	Target location area Id	7.6.2.7
GPRS Support Indicator	7.6.8.15	Target MSC number	7.6.2.12
Group Id	7.6.2.33	Teleservice	7.6.4.39
GSM bearer capability	7.6.3.6	TMSI	7.6.2.2
Guidance information	7.6.4.22	Trace reference	7.6.10.2
Handover number	7.6.2.21	Trace type	7.6.10.3
High Layer Compatibility	7.6.3.43	User error	7.6.1.4
HLR Id	7.6.2.15	USSD Data Coding Scheme	7.6.4.36
HLR number	7.6.2.13	USSD String	7.6.4.37
HO-Number Not Required	7.6.6.7	VBS Data	7.6.3.40
IMEI	7.6.2.3	VGCS Data	7.6.3.39
IMSI	7.6.2.1	VLR CAMEL Subscription Info	7.6.3.35
Inter CUG options	7.6.3.27	VLR number	7.6.2.14
Intra CUG restrictions	7.6.3.28	VPLMN address allowed	7.6.3.48
		Zone Code	7.6.2.28

## 7.6.1 Common parameters

The following set of parameters are used in several MAP service-primitives:

### 7.6.1.1 Invoke Id

This parameter identifies corresponding service primitives. The parameter is supplied by the MAP service-user and must be unique over each service-user/service-provider interface.

### 7.6.1.2 Linked Id

This parameter is used for linked services and it takes the value of the invoke Id of the service linked to.

### 7.6.1.3 Provider error

This parameter is used to indicate a protocol related type of error:

- duplicated invoke Id;
- not supported service;
- mistyped parameter;
- resource limitation;
- initiating release, i.e. the peer has already initiated release of the dialogue and the service has to be released;
- unexpected response from the peer;
- service completion failure;
- no response from the peer;
- invalid response received.



#### 7.6.1.4 User error

This parameter can take values as follows:

NOTE: The values are grouped in order to improve readability; the grouping has no other significance.

a) Generic error:

- system failure, i.e. a task cannot be performed because of a problem in another entity. The type of entity or network resource may be indicated by use of the network resource parameter;
- data missing, i.e. an optional parameter required by the context is missing;
- unexpected data value, i.e. the data type is formally correct but its value or presence is unexpected in the current context;
- resource limitation;
- initiating release, i.e. the receiving entity has started the release procedure;
- facility not supported, i.e. the requested facility is not supported by the PLMN;
- incompatible terminal, i.e. the requested facility is not supported by the terminal.

b) Identification or numbering problem:

- unknown subscriber, i.e. no such subscription exists;
- number changed, i.e. the subscription does not exist for that number any more;
- unknown MSC;
- unidentified subscriber, i.e. if the subscriber is not contained in the database and it has not or cannot be established whether or not a subscription exists;
- unallocated roaming number;
- unknown equipment;
- unknown location area.

c) Subscription problem:

- roaming not allowed, i.e. a location updating attempt is made in an area not covered by the subscription;
- illegal subscriber, i.e. illegality of the access has been established by use of authentication procedure;
- bearer service not provisioned;
- teleservice not provisioned;
- illegal equipment, i.e. the IMEI check procedure has shown that the IMEI is blacklisted or not whitelisted.

d) Handover problem:

- no handover number available;
- subsequent handover failure, i.e. handover to a third MSC failed for some reason.

e) Operation and maintenance problem:

- tracing buffer full, i.e. tracing cannot be performed because the tracing capacity is exceeded.

## f) Call set-up problem:

- no roaming number available, i.e. a roaming number cannot be allocated because all available numbers are in use;
- absent subscriber, i.e. the subscriber has activated the detach service or the system detects the absence condition. This error may be qualified to indicate whether the subscriber was IMSI detached, in a restricted area or did not respond to paging;
- busy subscriber. This error may be qualified to indicate that the subscriber was busy due to CCBS and that CCBS is possible;
- no subscriber reply;
- forwarding violation, i.e. the call has already been forwarded the maximum number of times that is allowed;
- CUG reject, i.e. the call does not pass a CUG check; additional information may also be given in order to indicate rejection due to e.g. incoming call barred or non-CUG membership.
- call barred. Optionally, additional information may be included for indicating either that the call meets a barring condition set by the subscriber or that the call is barred for operator reasons. In case of barring of Mobil Terminating Short Message, the additional information may indicate a barring condition due to « unauthorised Message Originator».
- optimal routeing not allowed, i.e. the entity which sends the error does not support optimal routeing, or the HLR will not accept an optimal routeing interrogation from the GMSC, or the call cannot be optimally routed because it would contravene optimal routeing constraints.
- forwarding failed, i.e. the GMSC interrogated the HLR for forwarding information but the HLR returned an error.

## g) Supplementary services problem:

- call barred;
- illegal SS operation;
- SS error status;
- SS not available;
- SS subscription violation;
- SS incompatibility;
- negative password check;
- password registration failure;
- Number of Password Attempts;
- USSD Busy;
- Unknown Alphabet.
- short term denial;
- long term denial.

For definition of these errors see GSM 04.80.

h) Short message problem:

- SM delivery failure with detailed reason as follows:
  - memory capacity exceeded;
  - MS protocol error;
  - MS not equipped;
  - unknown service centre (SC);
  - SC congestion;
  - invalid SME address;
  - subscriber is not an SC subscriber;
  - and possibly detailed diagnostic information, coded as specified in TS GSM 03.40, under SMS-SUBMIT-REPORT and SMS-DELIVERY-REPORT. If the SM entity which returns the SM Delivery Failure error includes detailed diagnostic information, it shall be forwarded in the MAP\_MO\_FORWARD\_SHORT\_MESSAGE and in the MAP\_MT\_FORWARD\_SHORT\_MESSAGE response.
- message waiting list full, i.e. no further SC address can be added to the message waiting list;
- Subscriber busy for MT SMS, i.e. the mobile terminated short message transfer cannot be completed because:
  - another mobile terminated short message transfer is going on and the delivery node does not support message buffering; or
  - another mobile terminated short message transfer is going on and it is not possible to buffer the message for later delivery; or
  - the message was buffered but it is not possible to deliver the message before the expiry of the buffering time defined in GSM 03.40;
- Absent Subscriber SM, i.e. the mobile terminated short message transfer cannot be completed because the network cannot contact the subscriber. Diagnostic information regarding the reason for the subscriber's absence may be included with this error.

## 7.6.2 Numbering and identification parameter

### 7.6.2.1 IMSI

This parameter is the International Mobile Subscriber Identity defined in GSM 03.03.

### 7.6.2.2 TMSI

This parameter is the Temporary Mobile Subscriber Identity defined in GSM 03.03.

### 7.6.2.3 IMEI

This parameter is the International Mobile Equipment Identity defined in GSM 03.03.

### 7.6.2.4 Previous location area Id

This parameter refers to the identity of the location area from which the subscriber has roamed.

### 7.6.2.5 Stored location area Id

This parameter refers to the location area where the subscriber is assumed to be located.

#### 7.6.2.6 Current location area Id

This parameter is used to indicate the location area in which the subscriber is currently located.

#### 7.6.2.7 Target location area Id

This parameter refers to the location area into which the subscriber intends to roam.

#### 7.6.2.8 Target cell Id

This parameter refers to the identity of the cell to which a call has to be handed over.

#### 7.6.2.9 Void

#### 7.6.2.10 Originating entity number

This parameter refers to an application layer identification of a system component in terms of its associated ISDN number.

#### 7.6.2.11 MSC number

This parameter refers to the ISDN number of an MSC.

#### 7.6.2.12 Target MSC number

This parameter refers to the ISDN number of an MSC to which a call has to be handed over.

#### 7.6.2.13 HLR number

This parameter refers to the ISDN number of an HLR.

#### 7.6.2.14 VLR number

This parameter refers to the ISDN number of a VLR.

#### 7.6.2.15 HLR Id

This parameter refers to the identity of an HLR derived from the IMSI defined in CCITT Recommendation E.212.

#### 7.6.2.16 LMSI

This parameter refers to a local identity allocated by the VLR to a given subscriber for internal management of data in the VLR. LMSI shall not be sent to the SGSN.

#### 7.6.2.17 MS ISDN

This parameter refers to one of the ISDN numbers assigned to a mobile subscriber in accordance with CCITT Recommendation E.213.

#### 7.6.2.18 OMC Id

This parameter refers to the identity of an operation and maintenance centre.

#### 7.6.2.19 Roaming number

This parameter refers to the roaming number as defined in CCITT Recommendation E.213.

**7.6.2.20 Void****7.6.2.21 Handover number**

This parameter refers to the number used for routing a call between MSCs during handover.

**7.6.2.22 Forwarded-to number**

This parameter refers to the address to which a call is to be forwarded. This may include a subaddress. For subscribers having an originating CAMEL Phase 2 subscription this address need not be in non-E.164 international format.

**7.6.2.23 Forwarded-to subaddress**

This parameter refers to the sub-address attached to the address to which a call is to be forwarded.

**7.6.2.24 Called number**

This parameter refers to a called party number as defined in CCITT Recommendation Q.767.

**7.6.2.25 Calling number**

This parameter refers to a calling party number as defined in CCITT Recommendation Q.767.

**7.6.2.26 Originally dialled number**

This parameter refers to the number dialled by the calling party in order to reach a mobile subscriber.

**7.6.2.27 Service centre address**

This parameter represents the address of a Short Message Service Centre.

**7.6.2.28 Zone Code**

This parameter is used to define location areas into which the subscriber is allowed or not allowed to roam (regional subscription). With a complete list of Zone Codes the VLR or the SGSN is able to determine for all its location areas whether roaming is allowed or not.

**7.6.2.29 MSISdn-Alert**

This parameter refers to the MSISDN stored in a Message Waiting Data File in the HLR. It is used to alert the Service Centre when the MS is again attainable.

**7.6.2.30 Location Information**

This parameter indicates the location of the served subscriber as defined in GSM 03.18.

**7.6.2.31 GMSC Address**

This parameter refers to the E.164 address of a GMSC.

**7.6.2.32 VMSC Address**

This parameter refers to the E.164 address of a VMSC.

**7.6.2.33 Group Id**

This parameter is used to describe groups a subscriber can be member of. A subscriber can partake in all group calls (VBS/VGCS) where he subscribed to the respective groups.

#### 7.6.2.34 North American Equal Access preferred Carrier Id

This parameter refers to the carrier identity preferred by the subscriber for calls requiring routing via an interexchange carrier. This identity is used at:

- outgoing calls: when the subscriber does not specify at call setup a carrier identity;
- forwarded calls: when a call is forwarded by the subscriber;
- incoming calls: applicable to the roaming leg of the call.

#### 7.6.2.35 SIWFS Number

This parameter refers to the number used for routing a call between the MSC and the SIWFS (used by ISUP).

#### 7.6.2.36 B-subscriber address

This parameter refers to the address used by the SIWFS to route the outgoing call from the SIWFS to either the B-subscriber in case the non-loop method or back to the VMSC in case of the loop method.

#### 7.6.2.37 Serving cell Id

This parameter indicates the cell currently being used by the served subscriber.

#### 7.6.2.38 SGSN number

This parameter refers to the ISDN number of a SGSN.

#### 7.6.2.39 SGSN address

This parameter refers to the IP-address of a SGSN. This parameter is defined in GSM 03.03.

#### 7.6.2.40 GGSN address

This parameter refers to the IP-address of a GGSN. This parameter is defined in GSM 03.03.

#### 7.6.2.41 GGSN number

This parameter refers to the ISDN number of a GGSN or the ISDN number of the protocol-converter if a protocol-converting GSN is used between the GGSN and the HLR.

#### 7.6.2.42 APN

This parameter refers to the DNS name of a GGSN. This parameter is defined in GSM 03.60.

#### 7.6.2.43 Network Node number

This parameter refers either to the ISDN number of SGSN or to the ISDN number of MSC.

#### 7.6.2.44 PDP-Type

This parameter indicates which type of protocol is used by the MS as defined in GSM 03.60.

#### 7.6.2.45 PDP-Address

This parameter indicates the address of the data protocol as defined in GSM 03.60.

#### 7.6.2.46 Additional number

This parameter can refer either to the SGSN number or to the MSC number.

#### 7.6.2.47 P-TMSI

This parameter is the Packet Temporary Mobile Subscriber Identity defined in GSM 03.03.

#### 7.6.2.48 B-subscriber number

This parameter refers to the number of the destination B dialled by the A user. This may include a subaddress.

#### 7.6.2.49 B-subscriber subaddress

This parameter refers to the sub-address attached to the destination B dialled by the A user.

### 7.6.3 Subscriber management parameters

#### 7.6.3.1 Category

This parameter refers to the calling party category as defined in CCITT Recommendation Q.767.

#### 7.6.3.2 Equipment status

This parameter refers to the status of the mobile equipment as defined in GSM 02.16.

#### 7.6.3.3 Extensible Bearer service

This parameter may refer to a single bearer service, a set of bearer services or to all bearer services as defined in TS GSM 02.02. This parameter is used only for subscriber profile management. Extensible Bearer service values include all values defined for a Bearer service parameter (7.6.4.38).

#### 7.6.3.4 Extensible Teleservice

This parameter may refer to a single teleservice, a set of teleservices or to all teleservices as defined in TS GSM 02.03. This parameter is used only for subscriber profile management. Extensible Teleservice values include all values defined for a Teleservice parameter (7.6.4.39).

#### 7.6.3.5 Extensible Basic Service Group

This parameter refers to the Basic Service Group either as an extensible bearer service (see clause 7.6.3.3) or an extensible teleservice (see clause 7.6.3.4). This parameter is used only for subscriber profile management. The null value (i.e. neither extensible bearer service nor extensible teleservice) is used to denote the group containing all extensible bearer services and all extensible teleservices.

#### 7.6.3.6 GSM bearer capability

This parameter refers to the GSM bearer capability information element defined in GSM 04.08.

#### 7.6.3.7 Subscriber Status

This parameter refers to the barring status of the subscriber:

- service granted;
- Operator Determined Barring.

### 7.6.3.8 CUG Outgoing Access indicator

This parameter represents the Outgoing Access as defined in ETS 300 136.

### 7.6.3.9 Operator Determined Barring General Data

This parameter refers to the set of subscribers features that the network operator or the service provider can regulate. This set only includes those limitations that can be controlled in the VLR or in the SGSN:

- All outgoing calls barred; (\*)
- International outgoing calls barred; (\*)
- International outgoing calls except those to the home PLMN country barred; (\*)
- Interzonal outgoing calls barred; (\*)
- Interzonal outgoing calls except those to the home PLMN country barred; (\*)
- Interzonal outgoing calls AND international outgoing calls except those directed to the home PLMN country barred; (\*)
- Premium rate (information) outgoing calls barred;
- Premium rate (entertainment) outgoing calls barred;
- Supplementary service access barred;
- Invocation of call transfer barred;
- Invocation of chargeable call transfer barred;
- Invocation of internationally chargeable call transfer barred;
- Invocation of interzonally chargeable call transfer barred;
- Invocation of call transfer where both legs are chargeable barred.

(\*) Only these ODBs are supported by the SGSN. The SGSN applies them only for short message transfer.

### 7.6.3.10 ODB HPLMN Specific Data

This parameter refers to the set of subscribers features that the network operator or the service provider can regulate only when the subscriber is registered in the HPLMN. This set only includes those limitations that can be controlled in the VLR or in the SGSN:

- Operator Determined Barring Type 1;
- Operator Determined Barring Type 2;
- Operator Determined Barring Type 3;
- Operator Determined Barring Type 4.

### 7.6.3.11 Regional Subscription Data

This parameter defines the regional subscription area in which the subscriber is allowed to roam. It consists of a list of Zone Codes (see clause 7.6.2.28).

### 7.6.3.12 Regional Subscription Response

This parameter indicates either that the regional subscription data cannot be handled or that the current MSC or SGSN area is entirely restricted because of regional subscription.



### 7.6.3.13 Roaming Restriction Due To Unsupported Feature

This parameter defines that a subscriber is not allowed to roam in the current MSC area. It may be used by the HLR if a feature or service is indicated as unsupported by the VLR.

### 7.6.3.14 Extensible SS-Info

This parameter refers to all the information related to a supplementary service and is a choice between:

- extensible forwarding information (see clause 7.6.3.15);
- extensible call barring information (see clause 7.6.3.20);
- CUG info (see clause 7.6.3.22);
- extensible SS-Data (see clause 7.6.3.29).

### 7.6.3.15 Extensible Forwarding information

This parameter represents the information related to each call forwarding service:

- the SS-Code of the relevant call forwarding service (see clause 7.6.4.1);
- if required, a list of extensible forwarding feature parameters (see clause 7.6.3.16).  
the list may contain one item per Basic Service Group.

### 7.6.3.16 Extensible Forwarding feature

This parameter applies to each combination of call forwarding service and Basic Service Group and contains the following information, as required:

- extensible Basic Service Group (see clause 7.6.3.5);
- extensible SS-Status (see clause 7.6.3.17);
- forwarded-to number (see clause 7.6.2.22);
- forwarded-to subaddress (see clause 7.6.2.23);
- extensible forwarding options (see clause 7.6.3.18);
- extensible no reply condition timer (see clause 7.6.4.19).

### 7.6.3.17 Extensible SS-Status

This parameter refers to the state information of individual supplementary services as defined in TS GSM 03.11.

### 7.6.3.18 Extensible Forwarding Options

This parameter refers to a set of forwarding options attached to a supplementary service. It contains the following informations:

- notification to forwarding party (see TS GSM 02.82 for the meaning of this parameter);
- notification to calling party (see TS GSM 02.82 for the meaning of this parameter);
- Forwarding reason (see TS GSM 02.82 for the meaning of this parameter).

### 7.6.3.19 Extensible No reply condition timer

This parameter refers to the extensible no reply condition timer for call forwarding on no reply.

### 7.6.3.20 Extensible Call barring information

This parameter contains for each call barring service:

- SS-Code (see clause 7.6.4.1);
- a list of extensible call barring feature parameters (see clause 7.6.3.21).  
the list may contain one item per Basic Service Group.

### 7.6.3.21 Extensible Call barring feature

This parameter gives the status of call barring services as applicable to each Basic Service Group. The parameter contains the following information:

- Extensible Basic Service Group (see clause 7.6.3.5);
- provisioned SS-Status (see clause 7.6.3.17).

### 7.6.3.22 CUG info

This parameter refers to the overall information required for operation for each CUG:

- CUG subscriptionList;
- CUG featureList.

### 7.6.3.23 CUG subscription

This parameter refers to the set of basic information for each CUG defined in that subscription. The following information is stored:

- CUG index;
- CUG interlock;
- Intra CUG restrictions;
- Basic Service Group List.

### 7.6.3.24 CUG interlock

This parameter represents the CUG interlock code defined in ETS 300 138.

### 7.6.3.25 CUG index

This parameter represents the CUG index defined in ETS 300 138.

### 7.6.3.26 CUG feature

This parameter contains two parameters which are associated with the Basic Service Group. If the Basic Service Group Code is not present the feature applies to all Basic Services. The following parameters are included:

- Preferential CUG indicator:  
indicates which CUG index is to be used at outgoing call set-up using the associated Basic Service Group;
- Inter CUG Option:  
describes whether it for the associated Basic Service Group is allowed to make calls outside the CUG and whether incoming calls are allowed;
- Basic Service Group.

See TS GSM 02.85 for meaning of this parameter.

### 7.6.3.27 Inter CUG options

This parameter indicates the subscribers ability to make and receive calls outside a specific closed user group. It takes any of the following values:

- CUG only facility (only calls within CUG are allowed);
- CUG with outgoing access (calls outside CUG allowed);
- CUG with incoming access (calls from outside CUG into CUG allowed);
- CUG with both incoming and outgoing access (all calls allowed).

### 7.6.3.28 Intra CUG restrictions

This parameter describes whether or not the subscriber is allowed to originate calls to or to receive calls from within the CUG. It can take any of the following values:

- no CUG restrictions;
- CUG incoming calls barred;
- CUG outgoing calls barred.

### 7.6.3.29 Extensible SS-Data

This parameter refers to the necessary set of information required in order to characterise one supplementary service:

- SS-Code (see clause 7.6.4.1);
- Extensible SS-Status (if applicable) (see clause 7.6.3.17);
- Extensible Override subscription option (if applicable) (see clause 7.6.3.30);
- Extensible CLI Restriction (if applicable) (see clause 7.6.3.31);
- Extensible Basic Service Group Code (see clause 7.6.3.5).

### 7.6.3.30 Subscriber State

This parameter indicates the state of the MS as defined in GSM 03.18.

### 7.6.3.31 Requested Info

This parameter indicates the subscriber information being requested as defined in GSM 03.18.

### 7.6.3.32 Suppression of Announcement

This parameter indicates if the announcement or tones shall be suppressed as defined in GSM 03.78.

### 7.6.3.33 Suppress T-CSI

This parameter is used to suppress the invocation of terminating CAMEL services.

### 7.6.3.34 GMSC CAMEL Subscription Info

This parameter contains CAMEL subscription information, i.e.O-CSI and/or T-CSI, which indicates to the GMSC that originating and/or terminating CAMEL services shall be invoked for the incoming call.

### 7.6.3.35 VLR CAMEL Subscription Info

This parameter identifies the subscriber as having CAMEL services which are invoked in the MSC.

### 7.6.3.36 Supported CAMEL Phases

This parameter indicates which phases of CAMEL are supported.

### 7.6.3.37 CUG Subscription Flag

This parameter indicates a that a subscriber with a T-CSI also has a CUG subscription. It is defined in TS GSM 03.78.

### 7.6.3.38 CAMEL Subscription Info Withdraw

This parameter indicates that CAMEL Subscription Info shall be deleted from the VLR.

### 7.6.3.39 Voice Group Call Service (VGCS) Data

This parameter refers to one or more groups a subscriber may be member of for voice group calls.

### 7.6.3.40 Voice Broadcast Service (VBS) Data

This parameter refers to one or more groups a subscriber may be member of for the voice broadcast service. Per group it is further indicated whether the subscriber is only allowed to listen to respective group calls or whether he is in addition entitled to initiate respective voice broadcast calls.

### 7.6.3.41 ISDN bearer capability

This parameter refers to the ISDN bearer capability information element defined in GSM 09.07.

### 7.6.3.42 Lower layer Compatibility

This parameter refers to the lower layer compatibility information element defined in GSM 04.08.

### 7.6.3.43 High Layer Compatibility

This parameter refers to the high layer compatibility information element defined in GSM 04.08.

### 7.6.3.44 Alerting Pattern

This parameter is an indication that can be used by the MS to alert the user in a specific manner in case of mobile terminating traffic (switched call or USSD). That indication can be an alerting level or an alerting category.

### 7.6.3.45 GPRS Subscription Data Withdraw

This parameter indicates that GPRS Subscription Data shall be deleted from the SGSN.

### 7.6.3.46 GPRS Subscription Data

This parameter refers to the list of PDP-Contexts that subscriber has subscribed to.

### 7.6.3.47 QoS-Subscribed

This parameter indicates the quality of service subscribed for a certain service. It is defined in GSM 03.60.

### 7.6.3.48 VPLMN address allowed

This parameter specifies whether the MS is allowed to use a dynamic address allocated in the VPLMN. It is defined in GSM 03.60.

### 7.6.3.49 Roaming Restricted In SGSN Due To Unsupported Feature

This parameter defines that a subscriber is not allowed to roam in the current SGSN area. It may be used by the HLR if a feature or service is indicated as unsupported by the SGSN.

### 7.6.3.50 Network Access Mode

This parameter is defined in GSM 03.08.

### 7.6.3.51 Mobile Not Reachable Reason

This parameter stores the reason for the MS being absent when an attempt to deliver a short message to an MS fails at the MSC, SGSN or both. It is defined in TS GSM 03.40.

### 7.6.3.52 Cancellation Type

This parameter indicates the reason of location cancellation. It is defined in TS GSM 03.60.

### 7.6.3.53 All GPRS Data

This parameter indicates to the SGSN that all GPRS Subscription Data shall be deleted for the subscriber.

### 7.6.3.54 Complete Data List Included

This parameter indicates to the SGSN that the complete GPRS Subscription Data stored for the Subscriber shall be replaced with the GPRS Subscription Data received.

### 7.6.3.55 PDP Context Identifier

This parameter is used to identify a PDP context for the subscriber.

## 7.6.4 Supplementary services parameters

### 7.6.4.1 SS-Code

This parameter may refer to one supplementary service or a set of supplementary services as defined in TS GSM 02.04. For MAP Release '97 this includes:

- Calling Line Identification Presentation service (CLIP);
- Calling Line Identification Restriction service (CLIR);
- Connected Line Identification Presentation service (COLP);
- Connected Line Identification Restriction service (COLR);
- Calling Name Presentation (CNAP)
- All Call Forwarding services;
- Call Waiting (CW);
- Call Hold (HOLD);
- Multi-Party service (MPTY);

- Closed User Group (CUG);
- All Charging services;
- All Call Restriction services;
- Explicit Call Transfer service (ECT);
- enhanced Multi-Level Precedence and Pre-emption service (eMLPP);
- Completion of Calls to Busy Subscriber, originating side (CCBS-A);
- Completion of Calls to Busy Subscriber, destination side (CCBS-B).

#### 7.6.4.2 SS-Status

This parameter refers to the state information of individual supplementary services as defined in GSM 03.11.

#### 7.6.4.3 SS-Data

This parameter refers to the necessary set of information required in order to characterise one supplementary service:

- SS-Code (see clause 7.6.4.1);
- SS-Status (if applicable) (see clause 7.6.4.2);
- Override subscription option (see clause 7.6.4.4);
- CLI Restriction (see clause 7.6.4.5);
- Basic Service Group Code (see clause 7.6.4.40).

#### 7.6.4.4 Override Category

This parameter refers to the subscription option Override Category attached to a supplementary service. It can take the following two values:

- Enabled;
- Disabled.

#### 7.6.4.5 CLI Restriction Option

This parameter refers to the subscription option Restriction mode attached to the CLIR supplementary service. It can take the following three values:

- Permanent;
- Temporary (Default Restricted);
- Temporary (Default Allowed).

#### 7.6.4.6 Forwarding Options

This parameter refers to a forwarding option attached to a supplementary service. It can take one of the following values:

- notification to forwarding party (see GSM 02.82 for the meaning of this parameter);
- notification to calling party (see GSM 02.82 for the meaning of this parameter);
- Forwarding reason (see GSM 02.82 for the meaning of this parameter).

#### 7.6.4.7 No reply condition timer

This parameter refers to the no reply condition timer for call forwarding on no reply.

#### 7.6.4.8 - 7.6.4.14 Void

#### 7.6.4.15 Forwarding information

This parameter represents the information related to each call forwarding service:

- the SS-Code of the relevant call forwarding service (see clause 7.6.4.1);
- if required, a list of forwarding feature parameters (see clause 7.6.4.16).

The list may contain one item per Basic Service Group.

#### 7.6.4.16 Forwarding feature

This parameter applies to each combination of call forwarding service and Basic Service Group and contains the following information, as required:

- Basic Service Group (see clause 7.6.4.40);
- SS-Status (see clause 7.6.4.2);
- forwarded-to number (see clause 7.6.2.22);
- forwarded-to subaddress (see clause 7.6.2.23);
- forwarding options (see clause 7.6.4.6);
- no reply condition timer (see clause 7.6.4.7).

#### 7.6.4.17 Void

#### 7.6.4.18 Call barring information

This parameter contains for each call barring service:

- SS-Code (see clause 7.6.4.1);
- a list of call barring feature parameters (see clause 7.6.4.19).

The list may contain one item per Basic Service Group.

#### 7.6.4.19 Call barring feature

This parameter gives the status of call barring services as applicable to each Basic Service Group. The parameter contains the following information:

- Basic Service Group (see clause 7.6.4.40);
- SS-Status (see clause 7.6.4.2).

#### 7.6.4.20 New password

This parameter refers to the password which the subscriber just registered in the network.

This parameter refers to a password used by the subscriber for supplementary service control.

#### 7.6.4.21 Current password

This parameter refers to a password used by the subscriber for supplementary service control.

#### 7.6.4.22 Guidance information

This parameter refers to guidance information given to a subscriber who is requested to provide a password. One of the following information may be given:

- "enter password";

This information is used for checking of the old password.

- "enter new password";

This information is used during password registration for the request of the first new password.

- "enter new password again";

This information is used during password registration for the request of the new password again for verification.

#### 7.6.4.23 Void

#### 7.6.4.24 SS-Info

This parameter refers to all the information related to a supplementary service and is a choice between:

- forwarding information (see clause 7.6.4.15);
- call barring information (see clause 7.6.4.18);
- CUG info (see clause 7.6.4.8);
- SS-Data (see clause 7.6.4.3).
- eMLPP information (see clause 7.6.4.41).

#### 7.6.4.25 ÷ 7.6.4.35 Void

#### 7.6.4.36 USSD Data Coding Scheme

This parameter contains the information of the alphabet and the language used for the unstructured information in an Unstructured Supplementary Service Data operation. The coding of this parameter is according to the Cell Broadcast Data Coding Scheme as specified in GSM 03.38.

#### 7.6.4.37 USSD String

This parameter contains a string of unstructured information in an Unstructured Supplementary Service Data operation. The string is sent either by the mobile user or the network. The contents of a string sent by the MS are interpreted by the network as specified in GSM 02.90.

#### 7.6.4.38 Bearer service

This parameter may refer to a single bearer service, a set of bearer services or to all bearer services as defined in TS GSM 02.02. This parameter is used only for supplementary service management.

#### 7.6.4.39 Teleservice

This parameter may refer to a single teleservice, a set of teleservices or to all teleservices as defined in TS GSM 02.03. This parameter is used only for supplementary service management.



#### 7.6.4.40 Basic Service Group

This parameter refers to the Basic Service Group either as a bearer service (see clause 7.6.4.38) or a teleservice (see clause 7.6.4.39). This parameter is used only for supplementary service management. The null value (i.e. neither bearer service nor teleservice) is used to denote the group containing all bearer services and all teleservices.

#### 7.6.4.41 eMLPP information

This parameter contains two parameters which are associated with the eMLPP service. The following two parameters are included:

- maximum entitled priority:  
indicates the highest priority level the subscriber is allowed to apply for an outgoing call set-up;
- default priority:  
defines the priority level which shall be assigned to a call if no explicit priority is indicated during call set-up.

#### 7.6.4.42 SS-event

This parameter indicates the Supplementary Service for which an invocation notification is sent towards the gsmSCF. It can indicate one of the following services:

- Explicit Call Transfer (ECT)
- Call Deflection (CD)
- Multi-Party call (MPTY)

#### 7.6.4.43 SS-event data

This parameter contains additional information related to Supplementary Service invocation. Depending on the service invoked it can contain the following information:

- ECT A list with all Called Party Numbers involved.
- CD The called Party number involved.

### 7.6.5 Call parameters

#### 7.6.5.1 Call reference number

This parameter refers to a call reference number allocated by a call control MSC.

#### 7.6.5.2 Interrogation type

This parameter refers to the type of interrogation for routing information which is sent from a GMSC to an HLR. It can take either of two values:

- basic call (for information to route a call before the call has been extended to the VMSC of the called party);
- forwarding (for information to route the call to the forwarded-to destination after the VMSC of the forwarding party has requested the GMSC to resume handling of the call).

#### 7.6.5.3 OR interrogation

This parameter indicates that the GMSC which interrogated the HLR for routing information is not in the same PLMN as the HLR, and therefore that the call will potentially be optimally routed.

#### 7.6.5.4 OR capability

This parameter indicates the phase of OR which the GMSC supports.

#### 7.6.5.5 Forwarding reason

This parameter indicates the reason for which the call is to be forwarded. It can take one of three values:

- busy subscriber;
- mobile subscriber not reachable;
- no subscriber reply.

#### 7.6.5.6 Forwarding interrogation required

This parameter indicates that if the VMSC of the forwarding subscriber requests the GMSC to resume handling of the call the GMSC shall interrogate the HLR for forwarding information.

#### 7.6.5.7 O-CSI

This parameter identifies the subscriber as having originating CAMEL services as defined in TS GSM 03.78

#### 7.6.5.8 Call Direction

This parameter is used to indicate the direction of the call.

#### 7.6.5.9 Channel Type

This parameter is the result of a Channel Mode Modification for TS61/62. It contains the changed Air Interface User Rate. The information is sent from the SIWFS to the MSC to assign the correct radio resource. This parameter is defined in GSM 08.08.

#### 7.6.5.10 Chosen Channel

This parameter is sent from the MSC to the SIWFS to adjust the interworking unit to the assigned radio resources. This parameter is defined in GSM 08.08.

#### 7.6.5.11 CCBS Feature

This parameter corresponds to the 'CCBS Description' parameter in GSM 03.93. It refers to the necessary set of information required in order to characterise a certain CCBS request. The parameter may contain the following information:

- CCBS Index (see GSM 03.93 for the use of this parameter);
- B-subscriber number (see clause 7.6.2.48);
- B-subscriber subaddress (see clause 7.6.2.49);
- Basic Service Group Code (see clause 7.6.4.40).

### 7.6.6 Radio parameters

#### 7.6.6.1 ÷ 7.6.6.6 Void

#### 7.6.6.7 HO-Number Not Required

This parameter indicates that no handover number allocation is necessary.

## 7.6.7 Authentication parameters

### 7.6.7.1 Authentication set list

This parameter represents a list of sets of authentication parameters for a given subscriber:

- Rand;
- Sres;
- Kc.

### 7.6.7.2 Rand

This parameter represents a random number used for authentication.

### 7.6.7.3 Sres

This parameter represents the response to an authentication request.

### 7.6.7.4 Kc

This parameter refers to a key used for ciphering purposes.

### 7.6.7.5 Void

### 7.6.7.6 Cksn

This parameter refers to a ciphering key sequence number.

### 7.6.7.7 Ciphering mode

This parameter refers to the ciphering mode which is associated with a radio channel. It may take values as follows:

- no encryption;
- identification of specific ciphering algorithm.

## 7.6.8 Short message parameters

### 7.6.8.1 SM-RP-DA

This parameter represents the destination address used by the short message service relay sub-layer protocol. It can be either of the following:

- IMSI (see clause 7.6.2.1);
- LMSI (see clause 7.6.2.16);
- MS-ISDN (see clause 7.6.2.17);
- roaming number (see clause 7.6.2.19);
- service centre address (see clause 7.6.2.27).

### 7.6.8.2 SM-RP-OA

This parameter refers to the originating address used by the short message service relay sub-layer protocol. It can be either of the following:

- MS-ISDN (see clause 7.6.2.17);
- service centre address (see clause 7.6.2.27).

### 7.6.8.3 MWD status

This parameter indicates whether or not the address of the originator service centre is already contained in the Message Waiting Data file. In addition, it contains the status of the Memory Capacity Exceeded Flag (MCEF), the status of the Mobile subscriber Not Reachable Flag (MNRF) and the status of the Mobile station Not Reachable for GPRS flag (MNRG).

### 7.6.8.4 SM-RP-UI

This parameter represents the user data field carried by the short message service relay sub-layer protocol.

### 7.6.8.5 SM-RP-PRI

This parameter is used to indicate whether or not delivery of the short message shall be attempted when a service centre address is already contained in the Message Waiting Data file.

### 7.6.8.6 SM Delivery Outcome

This parameter indicates the cause for setting the message waiting data. It can take one of the following values:

- Absent subscriber;
- MS memory capacity exceeded;
- Successful transfer.

### 7.6.8.7 More Messages To Send

This parameter is used to indicate whether or not the service centre has more short messages to send.

### 7.6.8.8 Alert Reason

This parameter is used to indicate the reason why the service centre is alerted. It can take one of the following values:

- MS present;
- Memory Available.

### 7.6.8.9 Absent Subscriber Diagnostic SM

This parameter is used to indicate the reason why the subscriber is absent. For the values for this parameter see TS GSM 03.40.

### 7.6.8.10 Alert Reason Indicator

This parameter indicates that the alert reason is sent to the HLR due to GPRS activity.

### 7.6.8.11 Additional SM Delivery Outcome

This parameter is used to indicate the GPRS delivery outcome in case a combination between delivery outcome for GPRS and non-GPRS are sent to the HLR.

#### 7.6.8.12 Additional Absent Subscriber Diagnostic SM

This parameter indicates the reason of the additional SM Delivery Outcome.

#### 7.6.8.13 Delivery Outcome Indicator

This parameter indicates that the delivery outcome sent to the HLR is for GPRS.

#### 7.6.8.14 GPRS Node Indicator

This parameter indicates that the Network Node Number sent by the HLR is the SGSN number.

#### 7.6.8.15 GPRS Support Indicator

This parameter indicates that the SMS-GMSC supports GPRS specific procedure of combine delivery of Short Message via MSC and/or via the SGSN.

#### 7.6.8.16 SM-RP-MTI

This parameter represents the RP-Message Type Indicator of the Short Message. It is used to distinguish a SM sent to the mobile station in order to acknowledge an MO-SM initiated by the mobile from a normal MT-SM. This parameter is formatted according to the formatting rules of address fields as described in GSM 03.40.

#### 7.6.8.17 SM-RP-SMEA

This parameter represents the RP-Originating SME-address of the Short Message Entity that has originated the SM. This parameter is used by the short message service relay sub-layer protocol and is formatted according to the formatting rules of address fields as described in GSM 03.40.

### 7.6.9 Access and signalling system related parameters

#### 7.6.9.1 BSS-apdu

This parameter includes one or two concatenated complete 08.06 messages, as described in GSM 03.09 and GSM 09.10. The Protocol ID indicates that the message or messages are according to GSM 08.06. For the coding of the messages see GSM 08.06 and GSM 08.08.

#### 7.6.9.2 CM service type

This parameter identifies the service category being requested by the subscriber:

- mobile originating call;
- emergency call establishment;
- short message service;
- mobile originating call re-establishment;
- mobile terminating call;
- SS request;
- Voice group call setup;
- Voice broadcast setup.

### 7.6.9.3 Access connection status

This parameter represents the following access connection status information:

- RR-connection status (established/not established);
- ciphering mode (on/off);
- authentication status (authenticated/not authenticated).

### 7.6.9.4 External Signal Information

This parameter contains concatenated information elements (including tag and length) which are defined by a common protocol version, preceded by the associated protocol ID. It is used to transport information of the indicated protocol via MAP interfaces.

### 7.6.9.5 Access signalling information

This parameter refers to any set of information elements imported from GSM 04.08.

### 7.6.9.6 Location update type

This parameter refers to the location update type (normal, periodic or IMSI attach) contained in the GSM 04.08 LOCATION REGISTRATION REQUEST message.

### 7.6.9.7 Protocol ID

This parameter refers to the protocol to which the coding of the content of the associated External Signal Information conforms.

The following values are defined:

- 04.08;
- 08.06;
- ETS 300 102-1.

This value indicates the protocol defined by ETS 300 102-1 (EDSS1).

### 7.6.9.8 Network signal information

This parameter is transported as external signal information. The protocol ID shall be set to "ETS 300 102-1".

The network signal information may include the following information elements as defined in GSM 09.07:

- ISDN BC; the tag and length are defined by ETS 300 102-1.  
For the content, see GSM 09.07.
- HLC; the tag and length are defined by ETS 300 102-1.  
For the content, see GSM 09.07.
- LLC; the tag and length are defined by ETS 300 102-1.  
For the content, see GSM 09.07.

They are contained in the Signal Information parameter according to figure 7.6/1 (irrespective of the order):

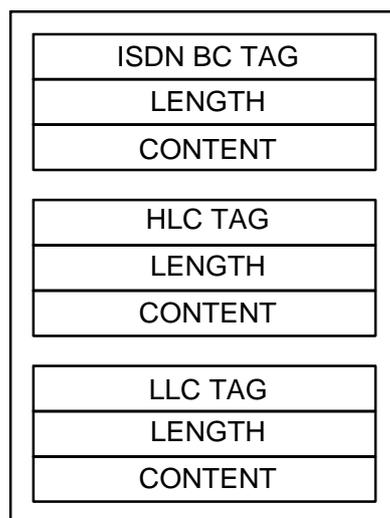

**Figure 7.6/1: Network signal information parameter**

### 7.6.9.9 Call Info

This parameter is transported as external signal information. The protocol ID shall be set to "GSM 04.08".

The Call Info includes the set of information elements from the original SETUP message and is imported from GSM 04.08.

## 7.6.10 System operations parameters

### 7.6.10.1 Network resources

This parameter refers to a class or type of network resource:

- PLMN;
- HLR;
- VLR (current or previous);
- MSC (controlling or current);
- EIR;
- radio sub-system.

### 7.6.10.2 Trace reference

This parameter represents a reference associated with a tracing request. The parameter is managed by OMC.

### 7.6.10.3 Trace type

This parameter identifies the type of trace. Trace types are fully defined in GSM 12.08.

## 7.7 Representation of a list of a basic parameter in service-primitives

In some service-primitives several instances of a basic parameter of clause 7.6 are required. In the service descriptions such cases will be represented as



in the tables where ParameterName refers to one of the parameters defined in clause 7.6. This corresponds to the following construction rule:

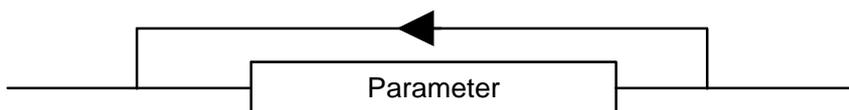

Figure 7.7/1: Construction of Lists

## 8 Mobility services

### 8.1 Location management services

#### 8.1.1 MAP\_UPDATE\_LOCATION\_AREA service

##### 8.1.1.1 Definition

This service is used between MSC and VLR to update location information in the network. It is initiated by an MS when changing the location area or at first registration. The detailed conditions are given in GSM 03.12.

The MAP\_UPDATE\_LOCATION\_AREA service is a confirmed service using the primitives from table 8.1/1.

##### 8.1.1.2 Service primitives

Table 8.1/1: MAP\_UPDATE\_LOCATION\_AREA

Parameter name	Request	Indication	Response	Confirm
Invoke Id	M	M(=)	M(=)	M(=)
Target location area Id	M	M(=)		
Serving cell Id	M	M(=)		
Location update type	M	M(=)		
IMSI	C	C(=)		
TMSI	C	C(=)		
Previous location area Id	C	C(=)		
CKSN	C	C(=)		
User error			C	C(=)
Provider error				O

##### 8.1.1.3 Parameter definitions and use

###### Invoke Id

See definition in clause 7.6.1.

###### Target location area Id

See definition in clause 7.6.2.

###### Serving cell Id



See definition in clause 7.6.2.

#### Location update type

See definition in clause 7.6.9.

#### IMSI

See definition in clause 7.6.2. It is up to the MS to provide either IMSI or TMSI, but one shall be present.

#### TMSI

See definition in clause 7.6.2. It is up to the MS to provide either IMSI or TMSI, but one shall be present.

#### Previous location area Id

See definition in clause 7.6.2. This parameter is provided if the updating is not a first registration.

#### CKSN

See definition in clause 7.6.7. The CKSN is given if TMSI is used.

#### User error

One of the following error causes defined in clause 7.6.1 is sent by the user in case of location area updating failures, depending on the failure reason:

- unknown subscriber;  
This cause is used if the subscriber is not known in the VLR and even a correlated request to the subscriber's HLR gives a negative result (i.e. the IMSI is not allocated to a subscriber).
- unknown location area;  
This cause is used if the target location area identity given is not known in the VLR.
- roaming not allowed;  
This cause is used if the MS is not allowed to roam into the target location area indicated in the MAP\_UPDATE\_LOCATION\_AREA Req. The cause will be qualified according to the roaming restriction reason, i.e. one of "National Roaming Not Allowed", "PLMN Not Allowed", "Location Area Not Allowed", or "Operator Determined Barring".
- illegal subscriber;  
This error is sent if a correlated authentication procedure has not authenticated the subscriber.
- illegal equipment;  
This error is sent if an IMEI check failed, i.e. the IMEI is blacklisted or not white-listed.
- system failure;
- unexpected data value.

#### Provider error

For definition of provider errors see clause 7.6.1.

## 8.1.2 MAP\_UPDATE\_LOCATION service

### 8.1.2.1 Definition

This service is used by the VLR to update the location information stored in the HLR.

The MAP\_UPDATE\_LOCATION service is a confirmed service using the service primitives given in table 8.1/2.

## 8.1.2.2 Service primitives

Table 8.1/2: MAP\_UPDATE\_LOCATION

Parameter name	Request	Indication	Response	Confirm
Invoke Id	M	M(=)	M(=)	M(=)
IMSI	M	M(=)		
MSC Address	M	M(=)		
VLR number	M	M(=)		
LMSI	U	C(=)		
Supported CAMEL Phases	C	C(=)		
HLR number			C	C(=)
User error			C	C(=)
Provider error				O

## 8.1.2.3 Parameter definitions and use

Invoke Id

See definition in clause 5.6.1.

IMSI

See definition in clause 5.6.2.

MSC Address

See definition in clause 5.6.2. The MSC address is used for short message delivery only and for each incoming call set-up attempt the MSRN will be requested from the VLR.

VLR number

See definition in clause 5.6.2.

LMSI

See definition in clause 5.6.2. It is an operator option to provide the LMSI from the VLR; it is mandatory for the HLR to support the LMSI handling procedures.

Supported CAMEL Phases

This parameter indicates which phases of CAMEL are supported. Must be present if a CAMEL phase different from phase 1 is supported. Otherwise may be absent.

HLR number

See definition in clause 5.6.2. The presence of this parameter is mandatory in case of successful HLR updating.

User error

In case of unsuccessful updating, an error cause shall be returned by the HLR. The following error causes defined in clause 5.6.1 may be used, depending on the nature of the fault:

- unknown subscriber;
- roaming not allowed;

This cause will be sent if the MS is not allowed to roam into the PLMN indicated by the VLR number. The cause is qualified by the roaming restriction reason "PLMN Not Allowed" or "Operator Determined Barring". If no qualification is received (HLR with MAP Version 1), "PLMN Not Allowed" is taken as default.

- system failure;
- unexpected data value.

Provider error

For definition of provider errors see clause 5.6.1.

### 8.1.3 MAP\_CANCEL\_LOCATION service

#### 8.1.3.1 Definition

This service is used between HLR and VLR to delete a subscriber record from the VLR. It may be invoked automatically when an MS moves from one VLR area to another, to remove the subscriber record from the old VLR, or by the HLR operator to enforce a location updating from the VLR to the HLR, e.g. on withdrawal of a subscription.

Also this service is used between HLR and SGSN to delete a subscriber record from the SGSN. It may be invoked automatically when an MS moves from one SGSN area to another, to remove the subscriber record from the old SGSN, or by the HLR operator to enforce a location updating from the SGSN to the HLR.

The MAP\_CANCEL\_LOCATION service is a confirmed service using the primitives defined in table 8.1/3.

#### 8.1.3.2 Service primitives

**Table 8.1/3: MAP\_CANCEL\_LOCATION**

Parameter name	Request	Indication	Response	Confirm
Invoke Id	M	M(=)	M(=)	M(=)
IMSI	M	M(=)		
LMSI	C	C(=)		
Cancellation Type	C	C(=)		
User error			C	C(=)
Provider error				O

#### 8.1.3.3 Parameter definitions and use

Invoke Id

See definition in clause 7.6.1.

IMSI

See definition in clause 7.6.2.

LMSI

See definition in clause 7.6.2. The LMSI shall be included if it has been received from VLR. LMSI is not applicable between SGSN and HLR.

Value 0000 0000 can be used to indicate that the LMSI is not in use.

Cancellation Type

See definition in clause 5.6.3. The presence of this parameter is mandatory when the Cancel Location is sent to the SGSN. If the VLR receives this parameter and do not understand it the VLR shall ignore it.

User error

If the cancellation fails, an error cause is to be returned by the VLR or by the SGSN. The one of the following error causes defined in clause 5.6.1 shall be used:

- unexpected data value;
- data missing.

Provider error

For definition of provider errors see clause 7.6.1.

## 8.1.4 MAP\_SEND\_IDENTIFICATION service

### 8.1.4.1 Definition

The MAP\_SEND\_IDENTIFICATION service is used between a VLR and a previous VLR to retrieve IMSI and authentication sets for a subscriber registering afresh in that VLR.

The MAP\_SEND\_IDENTIFICATION service is a confirmed service using the service primitives defined in table 8.1/4.

### 8.1.4.2 Service primitives

**Table 8.1/4: MAP\_SEND\_IDENTIFICATION**

Parameter name	Request	Indication	Response	Confirm
Invoke Id	M	M(=)	M(=)	M(=)
TMSI	M	M(=)		
IMSI			C	C(=)
Authentication set			U	C(=)
User error			C	C(=)
Provider error				O

### 8.1.4.3 Parameter definitions and use

Invoke Id

See definition in clause 7.6.1.

TMSI

See definition in clause 7.6.2.

IMSI

See definition in clause 7.6.2. The IMSI is to be returned if the service succeeds.

Authentication set

See definition in clause 7.6.7. If the service succeeds a list of up to five authentication sets is returned, if there are any available.

User error

This parameter is mandatory if the service fails. The following error cause defined in clause 7.6.1 may be used, depending on the nature of the fault:

- unidentified subscriber.

Provider error

For definition of provider errors see clause 7.6.1.

## 8.1.5 MAP\_DETACH\_IMSI service

### 8.1.5.1 Definition

The MAP\_DETACH\_IMSI service is used by the MSC to indicate to the VLR that an MS is no longer reachable. The network needs this information e.g. to reject an incoming call without initiating paging on the radio path.

The MAP\_DETACH\_IMSI service is a non-confirmed service using the service primitives defined in table 8.1/5.

### 8.1.5.2 Service primitives

**Table 8.1/5: MAP\_DETACH\_IMSI**

Parameter name	Request	Indication
Invoke Id	M	M(=)
Serving cell id	M	M(=)
IMSI	C	C(=)
TMSI	C	C(=)

### 8.1.5.3 Parameter definitions and use

#### Invoke Id

See definition in clause 7.6.1.

#### Serving cell id

See definition in clause 7.6.2.

#### IMSI

See definition in clause 7.6.2. It is up to the MS to provide either IMSI or TMSI as subscriber identity, but one shall be present.

#### TMSI

See definition in clause 7.6.2. It is up to the MS to provide either IMSI or TMSI as subscriber identity, but one shall be present.

## 8.1.6 MAP\_PURGE\_MS service

### 8.1.6.1 Definition

This service is used between the VLR and the HLR to cause the HLR to mark its data for an MS so that any request for routing information for a mobile terminated call or a mobile terminated short message will be treated as if the MS is not reachable. It is invoked when the subscriber record for the MS is to be deleted in the VLR, either by MMI interaction or automatically, e.g. because the MS has been inactive for several days.

Also this service is used between the SGSN and the HLR to cause the HLR to mark its data for an MS so that any request for routing information for a mobile terminated short message or a network requested PDP-context activation will be treated as if the MS is not reachable. It is invoked when the subscriber record for the MS is to be deleted in the SGSN, either by MMI interaction or automatically, e.g. because the MS has been inactive for several days.

The MAP\_PURGE\_MS service is a confirmed service using the primitives defined in table 8.1/6.

### 8.1.6.2 Service primitives

**Table 8.1/6: MAP\_PURGE\_MS**

Parameter name	Request	Indication	Response	Confirm
Invoke Id	M	M(=)	M(=)	M(=)
IMSI	M	M(=)		
VLR number	C	C(=)		
Freeze TMSI			C	C(=)
Freeze P-TMSI			C	C(=)
SGSN number	C	C(=)		
User error			C	C(=)
Provider error				O

### 8.1.6.3 Parameter definitions and use

#### Invoke ID

See definition in clause 7.6.1.

#### IMSI

See definition in clause 7.6.2.

#### VLR number

Shall be present if the sender is VLR. See definition in clause 7.6.2.

#### SGSN number

Shall be present if the sender is SGSN. See definition in clause 7.6.2

#### Freeze TMSI

This parameter is sent to the VLR to indicate that the TMSI has to be frozen. It shall be present if the received VLR number matches the stored VLR number.

#### Freeze P-TMSI

This parameter is sent to the SGSN to indicate that the P-TMSI has to be frozen. It shall be present if the received SGSN number matches the stored SGSN number.

#### User error

This parameter is sent by the responder when an error is detected and if present, takes one of the following values:

- Data Missing;
- Unexpected Data Value;
- UnknownSubscriber.

#### Provider error

See definition of provider errors in clause 7.6.1.

## 8.1.7 MAP\_UPDATE\_GPRS\_LOCATION service

### 8.1.7.1 Definition

This service is used by the SGSN to update the location information stored in the HLR.

The MAP\_UPDATE\_GPRS\_LOCATION service is a confirmed service using the service primitives given in table 8.1/7.

### 8.1.7.2 Service primitives

**Table 8.1/7: MAP\_UPDATE\_GPRS\_LOCATION**

Parameter name	Request	Indication	Response	Confirm
Invoke Id	M	M(=)	M(=)	M(=)
IMSI	M	M(=)		
SGSN number	M	M(=)		
SGSN address	M	M(=)		
HLR number			C	C(=)
User error			C	C(=)
Provider error				O

### 8.1.7.3 Parameter definitions and use

#### Invoke Id

See definition in clause 7.6.1.

#### IMSI

See definition in clause 7.6.2.

#### SGSN number

See definition in clause 7.6.2.

#### SGSN address

See definition in clause 7.6.2.

#### HLR number

See definition in clause 7.6.2. The presence of this parameter is mandatory in case of successful HLR updating.

#### User error

In case of unsuccessful updating, an error cause shall be returned by the HLR. The following error causes defined in clause 7.6.1 may be used, depending on the nature of the fault:

- unknown subscriber;
- roaming not allowed;

This cause will be sent if the MS is not allowed to roam into the PLMN indicated by the SGSN number. The cause is qualified by the roaming restriction reason "PLMN Not Allowed" or "Operator Determined Barring".

- system failure;
- unexpected data value.

The diagnostic in the Unknown Subscriber may indicate "Imsi Unknown" or "Gprs Subscription Unknown".

#### Provider error

For definition of provider errors see clause 7.6.1.

## 8.2 Paging and search

### 8.2.1 MAP\_PAGE service

#### 8.2.1.1 Definition

This service is used between VLR and MSC to initiate paging of an MS for mobile terminated call set-up, mobile terminated short message or unstructured SS notification.

The MAP\_PAGE service is a confirmed service using the primitives from table 8.2/1.

## 8.2.1.2 Service primitives

**Table 8.2/1: MAP\_PAGE**

Parameter name	Request	Indication	Response	Confirm
Invoke Id	M	M(=)	M(=)	M(=)
IMSI	M	M(=)		
Stored location area Id	M	M(=)		
TMSI	U	C(=)		
User error			C	C(=)
Provider error				O

## 8.2.1.3 Parameter definitions and use

### Invoke Id

See definition in clause 7.6.1.

### IMSI

See definition in clause 7.6.2. The IMSI is used to define the paging subgroup. If the TMSI is not supplied, paging on the radio path uses the IMSI as an identifier.

### Stored location area Id

See definition in clause 7.6.2.

### TMSI

See definition in clause 7.6.2. The TMSI is included if paging on the radio channel is to use the TMSI as an identifier.

### User error

The following error causes defined in clause 7.6.1 may be sent by the user in case of a paging error, depending on the failure reason:

- absent subscriber;
- unknown location area;
- busy subscriber;
- system failure;

This corresponds to the case where there is no call associated with the MAP\_PAGE service, i.e. if the call has been released but the dialogue to the VLR has not been aborted.

- unexpected data value.

### Provider error

See definition in clause 7.6.1.

## 8.2.2 MAP\_SEARCH\_FOR\_MS service

### 8.2.2.1 Definition

This service is used between VLR and MSC to initiate paging of an MS in all location areas of that VLR. It is used if the VLR does not hold location area information confirmed by radio contact.

The MAP\_SEARCH\_FOR\_MS service is a confirmed service using the primitives from table 8.2/2.



### 8.2.2.2 Service primitives

**Table 8.2/2: MAP\_SEARCH\_FOR\_MS**

Parameter name	Request	Indication	Response	Confirm
Invoke Id	M	M(=)	M(=)	M(=)
IMSI	M	M(=)		
Current location area Id			C	C(=)
User error			C	C(=)
Provider error				O

### 8.2.2.3 Parameter definitions and use

#### Invoke Id

See definition in clause 7.6.1.

#### IMSI

See definition in clause 7.6.2. The IMSI is used to identify the subscriber when paging on the radio path.

#### Current location area Id

See definition in clause 7.6.2. In case of successful outcome of the service, i.e. if the MS responds to paging, the Location Area Id of the area in which the MS responded is given in the response.

#### User error

The following error causes defined in clause 7.6.1 shall be sent by the user if the search procedure fails, depending on the failure reason:

- absent subscriber;

This error cause is returned by the MSC if the MS does not respond to the paging request.

- system failure;

This corresponds to the case where there is no call associated with the MAP\_SEARCH\_FOR\_MS service, i.e. if the call has been released but the dialogue to the VLR has not been aborted.

- busy subscriber;
- unexpected data value.

#### Provider error

See definition in clause 7.6.1.

## 8.3 Access management services

### 8.3.1 MAP\_PROCESS\_ACCESS\_REQUEST service

#### 8.3.1.1 Definition

This service is used between MSC and VLR to initiate processing of an MS access to the network, e.g. in case of mobile originated call set-up or after being paged by the network.

The MAP\_PROCESS\_ACCESS\_REQUEST service is a confirmed service using the primitives from table 8.3/1.

## 8.3.1.2 Service primitives

Table 8.3/1: MAP\_PROCESS\_ACCESS\_REQUEST

Parameter name	Request	Indication	Response	Confirm
Invoke Id	M	M(=)	M(=)	M(=)
CM service type	M	M(=)		
Access connection status	M	M(=)		
Current Location Area Id	M	M(=)		
Serving cell id	M	M(=)		
TMSI	C	C(=)		
Cksn	C	C(=)		
IMSI	C	C(=)	C	C(=)
IMEI	C	C(=)	C	C(=)
MSISDN			U	C(=)
User error			C	C(=)
Provider error				O

## 8.3.1.3 Parameter definitions and use

Invoke Id

See definition in clause 7.6.1.

CM service type

See definition in clause 7.6.9.

Access connection status

See definition in clause 7.6.9.

Current Location Area Id

See definition in clause 7.6.2. This parameter is used to update the VLR in case of previous VLR failure.

Serving cell id

See definition in clause 7.6.2.

TMSI

See definition in clause 7.6.2. Either TMSI or IMSI as received from the MS are included in the Request/Indication, but one shall be present. In case of CM Service Type "Emergency Call Establishment", the IMEI may replace IMSI/TMSI.

Cksn

See definition in clause 7.6.7. In case of access with TMSI, the Cksn shall be present.

IMSI

See definition in clause 7.6.2. Either TMSI or IMSI as received from the MS are included in the Request/Indication, but one shall be present. In case of CM Service Type "Emergency Call Establishment", the IMEI may replace IMSI/TMSI.

In the Response/Confirmation, the IMSI is to be sent in case of successful outcome of the service. In case of CM Service Type "Emergency Call Establishment", IMEI may replace IMSI.

IMEI

See definition in clause 7.6.2. The IMEI may replace IMSI/TMSI in the Request/Indication and IMSI in the Response/Confirmation only in case the CM Service Type indicates "Emergency Call Establishment".

MSISDN

See definition in clause 7.6.2. The MSISDN is included in case of successful outcome of the service as an operator option, e.g. if it is needed at the MSC for charging purposes in case of call forwarding.

User error

One of the following error causes defined in clause 7.6.1 shall be sent by the user if the access request fails, depending on the failure reason:

- unidentified subscriber;
- illegal subscriber;

This error is sent if a correlated authentication procedure has not authenticated the subscriber.

- illegal equipment;

This error is sent if an IMEI check failed, i.e. the IMEI is blacklisted or not white-listed.

- roaming not allowed;

This cause is used after VLR restart if the subscriber has no subscription for the current location area, e.g. due to regional subscription. The cause will be qualified by "location area not allowed" or "national roaming not allowed", respectively.

- unknown location area;
- system failure;
- unexpected data value.

Provider error

For definition of provider errors see clause 7.6.1.

## 8.4 Handover services

### 8.4.1 MAP\_PREPARE\_HANOVER service

#### 8.4.1.1 Definition

This service is used between MSC-A and MSC-B (E-interface) when a call is to be handed over from MSC-A to MSC-B.

The MAP\_PREPARE\_HANOVER service is a confirmed service using the primitives from table 8.4/1.

#### 8.4.1.2 Service primitives

**Table 8.4/1: MAP\_PREPARE\_HANOVER**

Parameter name	Request	Indication	Response	Confirm
Invoke Id	M	M(=)	M(=)	M(=)
Target Cell Id	C	C(=)		
HO-NumberNotRequired	C	C(=)		
BSS-APDU	C	C(=)	C	C(=)
Handover Number			C	C(=)
User error			C	C(=)
Provider error				O

#### 8.4.1.3 Parameter use

Invoke Id

For definition of this parameter see clause 7.6.1.

Target Cell Id

For definition of this parameter see clause 7.6.2. This parameter is only included if the service is not in an ongoing transaction.

#### HO-Number Not Required

For definition of this parameter see clause 7.6.6.

#### BSS-APDU

For definition of this parameter see clause 7.6.9.

#### Handover Number

For definition of this parameter see clause 7.6.2. This parameter shall be returned, unless the parameter HO-NumberNotRequired is sent.

#### User error

For definition of this parameter see clause 7.6.1. The following errors defined in clause 7.6.1 may be used, depending on the nature of the fault:

- No handover number available;
- System failure;
- Unexpected data value;
- DataMissing.

#### Provider error

See definition of provider errors in clause 7.6.1.

## 8.4.2 MAP\_SEND\_END\_SIGNAL service

### 8.4.2.1 Definition

This service is used between MSC-B and MSC-A (E-interface) indicating that the radio path has been established by MSC-B to the MS. MSC-A retains then the main control of the call until it clears.

The response is used by MSC-A to inform MSC-B that all resources for the call can be released in MSC-B, either because the call has been released in MSC-A or because the call has been successfully handed over from MSC-B to another MSC.

The MAP\_SEND\_END\_SIGNAL service is a confirmed service using the primitives from table 8.4/2.

### 8.4.2.2 Service primitives

**Table 8.4/2: MAP\_SEND\_END\_SIGNAL**

Parameter name	Request	Indication	Response	Confirm
Invoke Id	M	M(=)	M(=)	M(=)
BSS-APDU	M	M(=)		
Provider error				O

### 8.4.2.3 Parameter use

#### Invoke Id

For definition of this parameter see clause 7.6.1.

#### BSS-APDU

For definition of this parameter see clause 7.6.9.

Provider error

For definition of this parameter see clause 7.6.1.

### 8.4.3 MAP\_PROCESS\_ACCESS\_SIGNALLING service

#### 8.4.3.1 Definition

This service is used between MSC-B and MSC-A (E-interface) to pass information received on the A-interface in MSC-B to MSC-A.

The MAP\_PROCESS\_ACCESS\_SIGNALLING service is a non-confirmed service using the primitives from table 8.4/3.

#### 8.4.3.2 Service primitives

**Table 8.4/3: MAP\_PROCESS\_ACCESS\_SIGNALLING**

Parameter name	Request	Indication
Invoke Id	M	M(=)
BSS-APDU	M	M(=)

#### 8.4.3.3 Parameter use

Invoke Id

For definition of this parameter see clause 7.6.1.

BSS-APDU

For definition of this parameter see clause 7.6.9.

### 8.4.4 MAP\_FORWARD\_ACCESS\_SIGNALLING service

#### 8.4.4.1 Definition

This service is used between MSC-A and MSC-B (E-interface) to pass information to be forwarded to the A-interface of MSC-B.

The MAP\_FORWARD\_ACCESS\_SIGNALLING service is a non-confirmed service using the primitives from table 8.4/4.

#### 8.4.4.2 Service primitives

**Table 8.4/4: MAP\_FORWARD\_ACCESS\_SIGNALLING**

Parameter name	Request	Indication
Invoke Id	M	M(=)
BSS-APDU	M	M(=)

#### 8.4.4.3 Parameter use

For the definition and use of all parameters and errors, see clause 7.6.1

Invoke Id

For definition of this parameter see clause 7.6.1.

BSS-APDU

For definition of this parameter see clause 7.6.9.

### 8.4.5 MAP\_PREPARE\_SUBSEQUENT\_HANDOVER service

#### 8.4.5.1 Definition

This service is used between MSC-B and MSC-A (E-interface) to inform MSC-A that it has been decided that a handover to either MSC-A or a third MSC (MSC-B') is required.

The MAP\_PREPARE\_SUBSEQUENT\_HANDOVER service is a confirmed service using the primitives from table 8.4/5.

#### 8.4.5.2 Service primitives

**Table 8.4/5: MAP\_PREPARE\_SUBSEQUENT\_HANDOVER**

Parameter name	Request	Indication	Response	Confirm
Invoke Id	M	M(=)	M(=)	M(=)
Target Cell Id	M	M(=)		
Target MSC Number	M	M(=)		
BSS-APDU	M	M(=)	C	C(=)
User error			C	C(=)
Provider error				O

#### 8.4.5.3 Parameter use

Invoke Id

For definition of this parameter see clause 7.6.1.

Target Cell Id

For definition of this parameter see clause 7.6.2.

Target MSC Number

For definition of this parameter see clause 7.6.2.

BSS-APDU

For definition of this parameter see clause 7.6.9.

User error

For definition of this parameter see clause 7.6.1. The following error causes defined in clause 7.6.1 may be used, depending on the nature of the fault:

- Unknown MSC;
- Subsequent handover failure;
- Unexpected data value;
- Data Missing.

Provider error

For definition of this parameter see clause 7.6.1.

## 8.4.6 MAP\_ALLOCATE\_HANOVER\_NUMBER service

### 8.4.6.1 Definition

This service is used between MSC and VLR (B-interface) to request a handover number.

The MAP\_ALLOCATE\_HANOVER\_NUMBER service is a confirmed service using the primitives from table 8.4/6.

### 8.4.6.2 Service primitives

**Table 8.4/6: MAP\_ALLOCATE\_HANOVER\_NUMBER**

Parameter name	Request	Indication	Response	Confirm
Invoke Id	M	M(=)	M(=)	M(=)
User error			C	C(=)
Provider error				O

### 8.4.6.3 Parameter use

#### Invoke Id

For definition of this parameter see clause 7.6.1.

#### User error

For definition of this parameter see clause 7.6.1. The following errors defined in clause 7.6.1 may be used, depending on the nature of the fault:

- No handover number available.

#### Provider error

For definition of this parameter see clause 7.6.1.

## 8.4.7 MAP\_SEND\_HANOVER\_REPORT service

### 8.4.7.1 Definition

This service is used between VLR and MSC-B (B-interface) to transfer the handover number to be forwarded to and used by MSC-A.

The MAP\_SEND\_HANOVER\_REPORT service is a confirmed service using the primitives from table 8.4/7.

### 8.4.7.2 Service primitives

**Table 8.4/7: MAP\_SEND\_HANOVER\_REPORT**

Parameter name	Request	Indication	Response	Confirm
Invoke Id	M	M(=)	M(=)	M(=)
Handover Number	M	M(=)		Linked Id
M	M(=)	O	Provider error	

### 8.4.7.3 Parameter use

#### Invoke Id

For definition of this parameter see clause 7.6.1.

Handover Number

For definition of this parameter see clause 7.6.2.

Linked Id

For definition of this parameter see clause 7.6.1. This service is linked with MAP\_ALLOCATE\_HANOVER\_NUMBER.

Provider error

For definition of this parameter see clause 7.6.1.

## 8.5 Authentication management services

### 8.5.1 MAP\_AUTHENTICATE service

#### 8.5.1.1 Definition

This service is used between the VLR and the MSC when the VLR receives a MAP service indication from the MSC concerning a location registration, call set-up, operation on a supplementary service or a request from the MSC to initiate authentication.

The service is a confirmed service and consists of four service primitives.

#### 8.5.1.2 Service primitives

The service primitives are shown in table 8.5/1

**Table 8.5/1: MAP\_AUTHENTICATE parameters**

Parameter name	Request	Indication	Response	Confirm
Invoke id	M	M(=)	M(=)	M(=)
RAND	M	M(=)		
CKSN	M	M(=)		
SRES			M	M(=)
Provider error				O

#### 8.5.1.3 Parameter use

Invoke id

See clause 7.6.1 for the use of this parameter.

RAND

See clause 7.6.7 for the use of this parameter.

CKSN

See clause 7.6.7 for the use of this parameter.

SRES

See clause 7.6.7 for the use of this parameter.

Provider error

See clause 7.6.1 for the use of this parameter.



## 8.5.2 MAP\_SEND\_AUTHENTICATION\_INFO service

### 8.5.2.1 Definition

This service is used between the VLR and the HLR for the VLR to retrieve authentication information from the HLR. The VLR requests some sets of RAND/SRES/Kc vectors.

Also this service is used between the SGSN and the HLR for the SGSN to retrieve authentication information from the HLR. The SGSN requests some sets of RAND/SRES/Kc vectors.

If the HLR cannot provide the VLR or the SGSN with triplets, an empty response is returned. The VLR or the SGSN may then re-use old authentication triplets, except where this is forbidden under the conditions specified in GSM 03.20 [24].

If the VLR or SGSN receives a MAP-Send\_AUTHENTICATION\_INFO response containing a User Error parameter as part of the handling of an authentication procedure, the authentication procedure in the VLR or SGSN shall fail.

Security related network functions are further described in GSM 03.20.

The service is a confirmed service and consists of four service primitives.

### 8.5.2.2 Service primitives

The service primitives are shown in table 8.5/2.

**Table 8.5/2: MAP\_SEND\_AUTHENTICATION\_PARAMETERS parameters**

Parameter name	Request	Indication	Response	Confirm
Invoke id	M	M(=)	M(=)	M(=)
IMSI	M	M(=)		
AuthenticationSetList			C	C(=)
User error			C	C(=)
Provider error				O

### 8.5.2.3 Parameter use

#### Invoke id

See clause 7.6.1 for the use of this parameter.

#### IMSI

See clause 7.6.2 for the use of this parameter.

#### AuthenticationSetList

A set of one to five authentication vectors are transferred from the HLR to the VLR or from the HLR to the SGSN, if the outcome of the service was successful.

#### User error

One of the following error causes defined in clause 7.6.1 shall be sent by the user in case of unsuccessful outcome of the service, depending on the respective failure reason:

- unknown subscriber;
- unexpected data value;
- system failure;
- data missing.

#### Provider error

See clause 7.6.1 for the use of this parameter.

## 8.6 Security management services

### 8.6.1 MAP\_SET\_CIPHERING\_MODE service

#### 8.6.1.1 Definitions

This service is used between the VLR and the MSC to set the ciphering mode and to start ciphering if applicable. It is called when another service requires that information is to be sent on the radio path in encrypted form.

The service is a non-confirmed service and consists of two service primitives.

#### 8.6.1.2 Service primitives

The service primitives are shown in table 8.6/1

**Table 8.6/1: MAP\_SET\_CIPHERING\_MODE parameters**

Parameter name	Request	Indication
Invoke id	M	M(=)
Ciphering mode	M	M(=)
Kc	C	C(=)

#### 8.6.1.3 Parameter use

##### Invoke id

See clause 7.6.1 for the use of this parameter.

##### Ciphering mode

See clause 7.6.7 for the use of this parameter.

##### Kc

The Kc parameter should be included when the ciphering mode parameter indicates that ciphering must be performed.

## 8.7 International mobile equipment identities management services

### 8.7.1 MAP\_CHECK\_IMEI service

#### 8.7.1.1 Definition

This service is used between the VLR and the MSC and between the MSC and the EIR and between the SGSN and EIR to request check of IMEI. If the IMEI is not available in the MSC or in the SGSN, it is requested from the MS and transferred to the EIR in the service request.

The service is a confirmed service and consists of four service primitives.

#### 8.7.1.2 Service primitives

The service primitives are shown in table 8.7/1.

Table 8.7/1: MAP\_CHECK\_IMEI parameters

Parameter name	Request	Indication	Response	Confirm
Invoke id	M	M(=)	M(=)	M(=)
IMEI	C	C(=)	C	C(=)
Equipment status			C	C(=)
User error			C	C(=)
Provider error				O

### 8.7.1.3 Parameter use

#### Invoke id

See clause 7.6.1 for the use of this parameter.

#### IMEI

See clause 7.6.2 for the use of this parameter. The parameter shall not be included in the service request between the VLR and the MSC, but is mandatory in the service request from the MSC to the EIR and from the SGSN to the EIR. It is not included in the service response from the EIR to the MSC or to the SGSN, but is mandatory in the service response from the MSC to the VLR on successful outcome.

#### Equipment status

See clause 7.6.4 for the use of this parameter. This parameter is sent by the responder in case of successful outcome of the service.

#### User error

One of the following error causes defined in clause 7.6.1 shall be sent by the user in case of unsuccessful outcome of the service, depending on the respective failure reason:

- unknown equipment;  
This error is returned by the responder when the IMEI is not known in the EIR.
- system failure;
- unexpected data value.

#### Provider error

See clause 7.6.1 for the use of this parameter.

## 8.7.2 MAP\_OBTAIN\_IMEI service

### 8.7.2.1 Definition

This service is used between the VLR and the MSC to request the IMEI. If the IMEI is not available in the MSC, it is requested from the MS.

The service is a confirmed service and consists of four service primitives.

### 8.7.2.2 Service primitives

The service primitives are shown in table 8.7/2.

**Table 8.7/2: MAP\_OBTAIN\_IMEI parameters**

Parameter name	Request	Indication	Response	Confirm
Invoke id	M	M(=)	M(=)	M(=)
IMEI			C	C(=)
User error			C	C(=)
Provider error				O

### 8.7.2.3 Parameter use

#### Invoke id

See clause 7.6.1 for the use of this parameter.

#### IMEI

See clause 7.6.2 for the use of this parameter. The parameter IS included in the service response from the MSC to the VLR on successful outcome of the service.

#### User error

If the service fails, the VLR sends the user error System Failure (see clause 7.6.1) to the MSC.

#### Provider error

See clause 7.6.1 for the use of this parameter.

## 8.8 Subscriber management services

### 8.8.1 MAP-INSERT-SUBSCRIBER-DATA service

#### 8.8.1.1 Definition

This service is used by an HLR to update a VLR with certain subscriber data in the following occasions:

- the operator has changed the subscription of one or more supplementary services, basic services or data of a subscriber. Note that in case of withdrawal of a Basic or Supplementary service this primitive shall not be used;
- the operator has applied, changed or removed Operator Determined Barring;
- the subscriber has changed data concerning one or more supplementary services by using a subscriber procedure;
- the HLR provides the VLR with subscriber parameters at location updating of a subscriber or at restoration. In this case, this service is used to indicate explicitly that a supplementary service is not provisioned, if the supplementary service specification requires it. The only supplementary services which have this requirement are the CLIR and COLR services. Network access mode is provided only in restoration.

Also this service is used by an HLR to update a SGSN with certain subscriber data in the following occasions:

- if the GPRS subscription has changed;
- if the network access mode is changed;
- the operator has applied, changed or removed Operator Determined Barring;
- the HLR provides the SGSN with subscriber parameters at GPRS location updating of a subscriber.

It is a confirmed service and consists of the primitives shown in table 6.8/1.

## 8.8.1.2 Service primitives

Table 8.8/1: MAP-INSERT-SUBSCRIBER-DATA

Parameter name	Request	Indication	Response	Confirm
Invoke Id	M	M(=)	M(=)	M(=)
IMSI	C	C(=)		
MSISDN	C	C(=)		
Category	C	C(=)		
Subscriber Status	C	C(=)		
Bearer service List	C	C(=)	C	C(=)
Teleservice List	C	C(=)	C	C(=)
Forwarding information List	C	C(=)		
Call barring information List	C	C(=)		
CUG information List	C	C(=)		
SS-Data List	C	C(=)		
eMLPP Subscription Data	C	C(=)		
Operator Determined Barring General data	C	C(=)	C	C(=)
Operator Determined Barring HPLMN data	C	C(=)		
Roaming Restriction Due To Unsupported Feature	C	C(=)		
Regional Subscription Data	C	C(=)		
VLR CAMEL Subscription Info	C	C(=)		
Voice Broadcast Data	C	C(=)		
Voice Group Call Data	C	C(=)		
Network access mode	C	C(=)		
GPRS Subscription Data	C	C(=)		
Roaming Restricted In SGSN Due To Unsupported Feature	C	C(=)		
North American Equal Access preferred Carrier Id	U	C(=)		
SS-Code List			C	C(=)
Regional Subscription Response			C	C(=)
Supported CAMEL Phases			C	C(=)
User error			U	C(=)
Provider error				O

## 8.8.1.3 Parameter use

Network access mode

This parameter defines if the subscriber has access to MSC/VLR and/or to SGSN. This parameter is used by SGSN and MSC/VLR. In VLR, the parameter is used only as part of Restore Data Procedure and the parameter is not stored in the VLR. This parameter shall always be sent to the SGSN as part of the GPRS subscriber data at GPRS location updating. It shall be sent to the SGSN if it is changed as a result of administrative action.

All parameters are described in clause 7.6. The following clarifications are applicable:

IMSI

It is only included if the service is not used in an ongoing transaction (e.g. location updating). This parameter is used by the VLR and the SGSN.

MSISDN

It is included either at location updating or when it is changed. The MSISDN sent shall be the basic MSISDN. This parameter is used by the VLR and the SGSN.

Category

It is included either at location updating or when it is changed. This parameter is used only by the VLR and if the SGSN receives this parameter it shall ignore it.

### Subscriber Status

It is included either at location updating or when it is changed.

To apply, remove or update Operator Determined Barring Categories the Subscriber Status is set to Operator Determined Barring. In this case ODB General Data shall also be present. If the Operator Determined Barring applies and the subscriber is registered in the HPLMN and HPLMN specific Operator Determined Barring applies then ODB HPLMN Specific Data shall also be present.

To remove all Operator Determined Barring Categories the Subscriber Status shall be set to "Service Granted". This parameter is used by the VLR and the SGSN.

### Bearer service List

A list of Extensible Bearer service parameters (Extensible Bearer service is defined in clause 7.6). An Extensible Bearer service parameter must be the code for an individual Bearer service, except in the cases described below.

The codes for the Bearer service groups "allAlternateSpeech-DataCDA" and "allAlternateSpeech-DataCDS" shall, if applicable, be sent from the HLR to the VLR as a pair. The codes for the Bearer service groups "allSpeechFollowedByDataCDA" and "allSpeechFollowedByDataCDS" shall, if applicable, be sent from the HLR to the VLR as a pair.

If it is included in the Request/Indication, it includes either all Extensible Bearer services subscribed (at location updating or at restoration) or only the ones added (at subscriber data modification).

If the VLR receives an Indication containing any Extensible Bearer service parameters which it does not support/allocate it returns them in the response to the HLR and discards the unsupported Extensible Bearer services (no error is sent back), except in the cases described below.

If the VLR receives the codes for the Bearer service groups "allSpeechFollowedByDataCDA" and "allSpeechFollowedByDataCDS" and supports one or more of the circuit-switched synchronous or asynchronous data rates specified for simple data bearer services, it shall accept the bearer service codes, and not return them in the response to the HLR. If the VLR does not support any of the circuit-switched synchronous or asynchronous data rates specified for simple data bearer services, and receives the pair of codes for "allAlternateSpeech-DataCDA" and "allAlternateSpeech-DataCDS" or the pair of codes for "allSpeechFollowedByDataCDA" and "allSpeechFollowedByDataCDS", it shall reject the pair of codes by returning them in the response to the HLR. This parameter is used only by the VLR and if the SGSN receives this parameter it shall ignore it.

### Teleservice List

A list of Extensible Teleservice parameters (Extensible Teleservice is defined in clause 7.6). An Extensible Teleservice parameter must be the code for an individual Teleservice.

If it is included in the Request/Indication, it contains either all Extensible Teleservices subscribed (at location updating or at restoration) or the ones added (at subscriber data modification). Only the Extensible Teleservices that are relevant to the node at which the message is received should be included in the Teleservice List.

If the VLR or the SGSN receives an Indication containing any Extensible Teleservice parameters which it does not support/allocate it returns them in the response to the HLR and discards the unsupported Extensible Teleservices (no error is sent back). This parameter is used by the VLR and the SGSN.

### Forwarding information List

A list of Extensible Forwarding information parameters (Extensible Forwarding information is defined in clause 7.6). It includes Call Forwarding services either at location updating or at restoration or when they are changed. Each Extensible Forwarding information parameter shall be treated independently of all other parameters in the primitive.

The Extensible Forwarding information shall include the SS-Code for an individual call forwarding supplementary service. The Extensible Forwarding information shall contain one or more Extensible Forwarding Features (Extensible Forwarding Feature is defined in clause 7.6).

The Extensible Forwarding Feature may include an Extensible Basic Service Group. This shall be interpreted according to the rules in clause 8.8.1.4.

The Extensible Forwarding Feature shall contain an Extensible SS-Status parameter.

If the Extensible SS-Status indicates that call forwarding is registered then (except for call forwarding unconditional) the Extensible Forwarding Feature shall contain a forwarded-to number and, if available, the forwarded-to subaddress. In other states the forwarded-to number and, if applicable, the forwarded-to subaddress shall not be included. For call forwarding unconditional the forwarded-to number and, if applicable, the forwarded-to subaddress shall not be included. If the VLR does not receive a forwarded-to subaddress then it shall assume that a forwarded-to subaddress has not been registered.

The Extensible Forwarding Feature shall contain the extensible forwarding options (except for call forwarding unconditional where the extensible forwarding options shall not be included). Bits 3 and 4 of the extensible forwarding options shall be ignored by the VLR, and may be set to any value by the HLR.

For call forwarding on no reply: If the extensible SS-Status indicates that call forwarding is registered then the Extensible Forwarding Feature shall contain an extensible no reply condition timer. In other states the no reply condition timer shall not be included.

For call forwarding services other than call forwarding on no reply: The Extensible Forwarding Feature shall not contain a no reply condition timer.

If the VLR receives an Indication containing any Call Forwarding service codes which it does not support/allocate it returns them to the HLR in the parameter SS-Code List and discards the unsupported Call Forwarding service codes (no error is sent back). This parameter is used only by the VLR and if the SGSN receives this parameter it shall ignore it.

#### Call barring information List

A list of Extensible Call barring information parameters (Extensible Call barring information is defined in clause 7.6). It includes Call Barring services either at location updating or at restoration or when they are changed. Each Extensible Call barring information parameter shall be treated independently of all other parameters in the primitive.

The Extensible Call barring information shall include the SS-Code for an individual call barring supplementary service. The Extensible Call barring information shall contain one or more Extensible Call Barring Features (Extensible Call Barring Feature is defined in clause 7.6).

The Extensible Call Barring Feature may include an Extensible Basic Service Group. This shall be interpreted according to the rules in clause 8.8.1.4.

The Extensible Call Barring Feature shall contain an extensible SS-Status parameter.

If the VLR receives an Indication containing any Extensible Call Barring service codes which it does not support/allocate it returns them to the HLR in the parameter SS-Code List and discards the unsupported Extensible Call Barring service codes (no error is sent back). This parameter is used only by the VLR and if the SGSN receives this parameter it shall ignore it.

#### CUG information List

A list of CUG information list parameters (CUG information is defined in clause 7.6). It includes CUG information either at location updating or at restoration or when it is changed.

At location updating, restoration or when there is a change in CUG data, the HLR shall include the complete CUG-SubscriptionList and, if there are options per basic group, it shall also include the complete CUG-FeatureList. If there are not options per extensible basic service group the CUG-FeatureList shall not be included.

In any dialogue, the first insertSubscriberData message which contains CUG information shall include a non-empty CUG-SubscriptionList.

When the VLR receives CUG data it shall replace the stored CUG data with the received data set.

If CUG-FeatureList is omitted in the Insert Subscriber Data operation VLR shall interpret that no options per extensible basic service group exist, and then it shall apply the default values i.e. no outgoing access, no incoming access, no preferential CUG exists.

If CUG-Feature is received without preferential CUG, the VLR shall interpret that no preferential CUG applies.

If the VLR detects that there is overlapping in the information received within a dialogue, it shall send the error Unexpected Data Value.

Note that data consistency between CUG subscription data and CUG feature data is the responsibility of the HLR.

If the VLR does not support the CUG service it returns its code to the HLR in the parameter SS-Code List and discards the received information (no error is sent back). This parameter is used only by the VLR and if the SGSN receives this parameter it shall ignore it.

#### SS-Data List

A list of Extensible SS-Data parameters (Extensible SS-Data is defined in clause 7.6). It is sent for any other supplementary service than Call Forwarding, Call Barring, CUG and eMLPP either at location updating or at restoration or when they are changed. Each SS-Data parameter shall be treated independently of all other parameters in the primitive.

The Extensible SS-Data shall include the SS-Code for an individual supplementary service.

The Extensible SS-Data shall contain an Extensible SS-Status parameter and any subscription options that are applicable to the service defined by the SS-Code.

The SS-Data may include a Basic Service Group List. This shall be interpreted according to the rules in clause 8.8.1.4.

If the VLR receives an Indication containing any supplementary service codes which it does not support/allocate it returns them to the HLR in the parameter SS-Code List and therefore discards the unsupported service codes received (no error is sent back). This parameter is used only by the VLR and if the SGSN receives this parameter it shall ignore it.

#### Operator Determined Barring General data

If it is included in a Request/Indication, it includes all the Operator Determined Barring categories that may be applied to a subscriber registered in any PLMN. This parameter is only included in a Request/Indication when the parameter Subscriber Status is set to the value Operator Determined Barring. Note that all General Operator Determined Barring Categories shall be set to their actual status.

If the VLR or the SGSN receives an Indication containing Operator Determined Barring General Data which shows that the subscriber is subject to barring not supported / not allocated by the VLR or by the SGSN, it returns Operator Determined Barring General Data in the response to the HLR to show the barring categories which are not supported / not allocated by the VLR or by the SGSN. This parameter is used by the VLR and the SGSN.

#### Operator Determined Barring HPLMN data

It includes all the Operator Determined Barring categories that may be applied only to a subscriber registered in the HPLMN. Therefore, it shall only be transferred to the VLR or to the SGSN when the subscriber is roaming into the HPLMN and when the parameter Subscriber Status is set to the value Operator Determined Barring. Note that all HPLMN Operator Determined Barring Categories shall be set to their actual status.

If Subscriber Status is set to the value Operator Determined Barring and no Operator Determined Barring HPLMN data is present then the VLR or the SGSN shall not apply any HPLMN specific ODB services to the subscriber. This parameter is used by the VLR and the SGSN.

#### eMLPP Subscription Data

If included in the Insert Subscriber Data request this parameter defines the priorities the subscriber might apply for a call (as defined in clause 7.6). It contains both subparameters of eMLPP.

If the VLR does not support the eMLPP service it returns its code to the HLR in the parameter SS-Code List and therefore discards the received information (no error is sent back).

eMLPP subscription data that have been stored previously in a subscriber data record in the VLR are completely replaced by the new eMLPP subscription data received in a MAP\_INSERT\_SUBSCRIBER\_DATA during either an Update Location or Restore Data procedure or a stand alone Insert Subscriber data procedure. This parameter is used only by the VLR and if the SGSN receives this parameter it shall ignore it.

#### Roaming Restriction Due To Unsupported Feature

The HLR may decide to include this parameter in the request if certain services or features are indicated as not supported by the MSC/VLR (e.g. Advice of Charge Charging Level).

If this parameter is sent to the VLR the MSC area is restricted by the HLR and the VLR. This parameter is used only by the VLR and if the SGSN receives this parameter it shall ignore it.



### Regional Subscription Data

If included in the Insert Subscriber Data request this parameter defines the subscriber's subscription area for the addressed VLR or for the addressed SGSN (as defined in clause 7.6). It contains the complete list of up to 10 Zone Codes that apply to a subscriber in the currently visited PLMN. The HLR shall send only those Zone Codes which are stored against the CC and NDC of the VLR or the CC and NDC of the SGSN to be updated.

NOTE: Support of this parameter is a network operator option and it will not be sent to networks which do not support Regional Subscription.

Regional subscription data that have been stored previously in a subscriber data record in the VLR or in the SGSN are completely replaced by the regional subscription data received in an Insert Subscriber Data indication during either an Update Location or Restore Data procedure or a stand alone Insert Subscriber data procedure.

After the regional subscription data are inserted the VLR or the SGSN shall derive whether its location areas are allowed or not. If the whole MSC or SGSN area is restricted it will be reported to HLR by returning the Regional Subscription Response.

The VLR or the SGSN returns a Regional Subscription Response indicating that a problem with the Zone Code has been detected in one of the following cases:

- Too Many Zone Codes: more than 10 Zone Codes are to be stored in the VLR or in the SGSN;
- Regional Subscription Not Supported by the VLR or the SGSN;
- Zone Codes Conflict: the VLR or the SGSN detects that the zone codes indicate conflicting service permission for a location area.

Zone codes which have no mapping to location areas shall be ignored.

If a sequence of MAP\_INSERT\_SUBSCRIBER\_DATA services is used during a dialogue, Regional Subscription Data shall be accepted only in one service. Regional Subscription Data received in a subsequent service shall be rejected with the error Unexpected Data Value.

If Regional Subscription Data are not included in any MAP\_INSERT\_SUBSCRIBER\_DATA service, there is no restriction of roaming due to Regional Subscription. This parameter is used by the VLR and the SGSN.

### Voice Broadcast Data

This parameter contains a list of group id's a user might have subscribed to; (VBS-Data is defined in clause 7.6). It includes VBS information either at location updating or at restoration or when it is changed.

At location updating, restoration or when there is a change in VBS data, the HLR shall include the complete VBS-Data.

When the VLR receives VBS-Data within a dialogue it shall replace the stored VBS-data with the received data set. All subsequent VBS-data received within this dialogue shall be interpreted as add-on data.

If VBS-data is omitted in the Insert Subscriber Data operation the VLR shall keep the previously stored VBS data.

If the VLR detects that there is overlapping in the information received within a dialogue, it shall send the error Unexpected Data Value. This parameter is used only by the VLR and if the SGSN receives this parameter it shall ignore it.

### Voice Group Call Data

This parameter contains a list of group id's a user might have subscribed to; see clause 7.6.

At location updating, restoration or when there is a change in VGCS data, the HLR shall include the complete VGCS-Data.

When the VLR receives VGCS-Data within a dialogue it shall replace the stored VGCS-Data with the received data set. All VGCS-Data received within this dialogue shall be interpreted as add-on data.

If VBCS-Data is omitted in the Insert Subscriber Data operation the VLR shall keep the previously stored VGCS-Data.

If the VLR detects that there is overlapping in the information received within a dialogue, it shall send the error Unexpected Data Value. This parameter is used only by the VLR and if the SGSN receives this parameter it shall ignore it.

#### North American Equal Access preferred Carrier Id

The preferred carrier identity that is subscribed to.

When the VLR receives this parameter from the HLR, it shall replace the previously stored preferred carrier identity with the received one.

#### SS-Code List

The list of SS-Code parameters that are provided to a subscriber but are not supported/allocated by the VLR (SS-Code is defined in clause 7.6). The list can only include individual SS-Codes that were sent in the service request. This parameter is used only by the VLR.

#### Regional Subscription Response

If included in the response this parameter indicates one of:

- MSC Area Restricted entirely because of regional subscription;
- SGSN Area Restricted entirely because of regional subscription;
- Too Many Zone Codes to be inserted;
- Zone Codes Conflict;
- Regional Subscription not Supported by the VLR or by the SGSN.

If the VLR determines after insertion of Regional Subscription Data that the entire MSC area is restricted, the VLR shall respond with a Regional Subscription Response indicating MSC Area Restricted. Otherwise MSC Area Restricted is not sent. The HLR shall check whether the current MSC area is no longer restricted.

If the SGSN determines after insertion of Regional Subscription Data that the entire SGSN area is restricted, the SGSN shall respond with a Regional Subscription Response indicating SGSN Area Restricted. Otherwise SGSN Area Restricted is not sent. The HLR shall check whether the current SGSN area is no longer restricted. This parameter is used by the VLR and by the SGSN.

#### VLR CAMEL Subscription Info

This parameter is sent for subscribers who have CAMEL services which are invoked in the MSC. In CAMEL phase 1 this parameter contains only the O-CSI. In CAMEL Phase 2 this parameter contains the SS-CSI and/or the O-CSI. If an O-CSI is contained, TDP-Criteria may also be present in CAMEL Phase 2. The VLR CAMEL Subscription Info is sent at location updating or when any information in the applicable CAMEL Subscription Info in the HLR has been changed. The entire set of CAMEL Subscription Info is sent within one dialogue. If a set of CAMEL Subscription Info is already stored in the VLR, i.e received within a previous dialogue, it is replaced by the received data. If the VLR CAMEL Subscription Info is omitted in the Insert Subscriber Data operation the VLR shall keep the previously stored VLR CAMEL Subscription Info. Within one dialogue subsequent received data are interpreted as add-on data. If the VLR detects that there is overlapping in the information received within a dialogue, it shall send the error Unexpected Data Value. This parameter is used only by the VLR and if the SGSN receives this parameter it shall ignore it.

#### Supported CAMEL Phases

The use of this parameter and the requirements for its presence are specified in GSM 03.78. This parameter is used only by the VLR.

A VLR not supporting any CAMEL Phase may omit this parameter.

#### GPRS Subscription Data

This parameter contains a list of PDP-contexts a user has subscribed to; see clause 7.6.

At GPRS location updating the HLR shall include the complete GPRS Subscription Data.

When there is a change in GPRS subscriber data the HLR shall include only the new and/or modified PDP contexts.

When the SGSN receives GPRS Subscription Data within a dialogue it shall check if the received data has to be considered as the entire GPRS subscription data. If so, it shall replace the stored GPRS Subscription Data with the received data set, otherwise it shall replace the data only for the modified PDP contexts (if any) and add the new PDP contexts (if any) to the stored GPRS Subscription Data.

If GPRS Subscription Data is omitted in the Insert Subscriber Data operation the SGSN shall keep the previously stored GPRS Subscription Data.

If the SGSN detects that there is overlapping in the information received within a dialogue, it shall send the error Unexpected Data Value. This parameter is used only by the SGSN and if the VLR receives this parameter it shall ignore it.

#### Roaming Restricted In SGSN Due To Unsupported Feature

The HLR may decide to include this parameter in the request if certain services or features are indicated as not supported by the SGSN. This parameter is used only by the SGSN and if the VLR receives this parameter it shall ignore it.

#### User error

Only one of the following values is applicable:

- Unidentified subscriber;
- Data missing;
- Unexpected data value.

### 8.8.1.4 Basic service information related to supplementary services

A number of parameters that relate to supplementary services can be qualified by a Basic Service Group (or a Basic Service Group List). This clause explains how this information is to be interpreted. Supplementary service parameters to which this clause is applicable only apply to the basic service groups described in this clause, and only those basic service groups shall be overwritten at the VLR.

The Basic Service Group (or Basic Service Group List) is optional.

If present the Basic Service Group (or the elements of the Basic Service Group List) shall be one of:

- an Elementary Basic Service Group for which the supplementary service is applicable to at least one basic service in the group; and to which the subscriber has a subscription to at least one basic service in the group;
- the group "All Teleservices" provided that the service is applicable to at least one teleservice and that the subscriber has a subscription to at least one teleservice that is in the same Elementary Basic Service Group as a teleservice to which the service is applicable;
- the group "All Bearer Services" provided that the service is applicable to at least one bearer service and that the subscriber has a subscription to at least one bearer service that is in the same Elementary Basic Service Group as a basic service to which the service is applicable.

If the Basic Service Group (or Basic Service Group List) is not present then the parameter shall apply to all Basic Service Groups.

If the basic service information is not a single Elementary Basic Service Group then the parameter shall be taken as applying individually to all the Elementary Basic Service Groups for which:

- the supplementary service is applicable to at least one basic service in the Basic Service Group; and
- the subscriber has a subscription to at least one basic service in the Basic Service Group.

The VLR is not required to store supplementary services data for Basic Service Groups that are not supported at the VLR.

## 8.8.2 MAP-DELETE-SUBSCRIBER-DATA service

### 8.8.2.1 Definition

This service is used by an HLR to remove certain subscriber data from a VLR if the subscription of one or more supplementary services or basic services is withdrawn. Note that this service is not used in case of erasure or deactivation of supplementary services.

Also this service is used by an HLR to remove GPRS subscription data from a SGSN.

It is a confirmed service and consists of the primitives shown in table 8.8/2.

### 8.8.2.2 Service primitives

**Table 8.8/2: MAP-DELETE-SUBSCRIBER-DATA**

Parameter name	Request	Indication	Response	Confirm
Invoke Id	M	M(=)	M(=)	M(=)
IMSI	M	M(=)		
Basic service List	C	C(=)		
SS-Code List	C	C(=)		
Roaming Restriction Due To Unsupported Feature	C	C(=)		
Camel Subscription Info Withdraw	C	C(=)		
Regional Subscription Data	C	C(=)		
VBS Group Indication	C	C(=)		
VGCS Group Indication	C	C(=)		
GPRS Subscription Data Withdraw	C	C(=)		
Roaming Restricted In SGSN Due To Unsupported Feature	C	C(=)		
Regional Subscription Response			C	C(=)
User error			C	C(=)
Provider error				O

### 8.8.2.3 Parameter use

All parameters are described in clause 7.6. The following clarifications are applicable:

#### Basic service List

A list of Extensible Basic service parameters (Extensible Basic service is defined in clause 7.6). It is used when one, several or all basic services are to be withdrawn from the subscriber. If the VLR or the SGSN receives a value for an Extensible Basic Service which it does not support, it shall ignore that value. This parameter is used by the VLR and by the SGSN.

#### SS-Code List

A list of SS-Code parameters (SS-Code is defined in clause 7.6). It is used when several or all supplementary services are to be withdrawn from the subscriber.

There are three possible options:

- deletion of basic service(s);

The parameter Basic service List is only included.

- deletion of supplementary service(s);

The parameter SS-Code List is only included.

- deletion of basic and supplementary services;

Both Basic service List and SS-Code List are included.

This parameter is used only by the VLR and if the SGSN receives this parameter it shall ignore it.

#### Roaming Restriction Due To Unsupported Feature

This parameter is used if Roaming Restriction Due To Unsupported Feature is deleted from the subscriber data. This may occur if unsupported features or services are removed from the subscriber data in the HLR.

If this parameter is sent the VLR shall check if the current Location Area is possibly allowed now. This parameter is used only by the VLR and if the SGSN receives this parameter it shall ignore it.

#### CAMEL Subscription Info Withdraw

This parameter is used to indicate that CAMEL Subscription Info shall be deleted from the VLR. All CAMEL Subscription Info for the subscriber shall be deleted. This parameter is used only by the VLR and if the SGSN receives this parameter it shall ignore it.

#### Regional Subscription Identifier

Contains one single Zone Code (as defined clause 7.6) and is used if all Zone Codes shall be deleted from the subscriber data. When all the Zone Codes are deleted, the VLR or the SGSN shall check for its location areas whether they are allowed or not. If the whole MSC area is restricted, VLR will report it to HLR by returning the Regional Subscription Response "MSC Area Restricted". If the whole SGSN area is restricted, SGSN will report it to HLR by returning the Regional Subscription Response "SGSN Area Restricted".

The binary coding of the Zone Code value received in a Delete Subscriber Data request shall not be checked by the VLR or by the SGSN.

Note that support of this parameter is a network operator option and it shall not be sent to networks which do not support Regional Subscription.

If Regional Subscription is not supported by the VLR or by the SGSN, the request for deletion of Zone Codes is refused by sending the Regional Subscription Response "Regional Subscription Not Supported" to the HLR.

If no Zone Codes are stored in the respective subscriber data record, the request for deleting all Zone Code information shall be ignored and no Regional Subscription Response shall be returned. This parameter is used by the VLR and by the SGSN.

#### VBS Group Indication

Contains an indication (flag) which is used if all Group Id's shall be deleted from the subscriber data for the Voice Broadcast teleservice.

If VBS is not supported in the VLR or no Group Ids are stored for VBS in the respective subscriber record, the request for deletion of all Group Ids shall be ignored. This parameter is used only by the VLR and if the SGSN receives this parameter it shall ignore it.

#### VGCS Group Indication

Contains an indication (flag) which is used if all Group Id's shall be deleted from the subscriber data for the Voice Group Call teleservice. This parameter is used only by the VLR and if the SGSN receives this parameter it shall ignore it.

If VGCS is not supported in the VLR or no Group Ids are stored for VGCS in the respective subscriber record, the request for deletion of all Group Ids shall be ignored.

#### GPRS Subscription Data Withdraw

This parameter is used to indicate whether all GPRS Subscription Data for the subscriber shall be deleted or if only a subset of the stored GPRS Subscription Data for the subscriber shall be deleted. In the latter case only those PDP context whose identifiers are included in the subsequent identifier list will be deleted. This parameter is used only by the SGSN and if the VLR receives this parameter it shall ignore it.

Roaming Restricted In SGSN Due To Unsupported Feature

This parameter is used if Roaming Restricted In SGSN Due To Unsupported Feature is deleted from the GPRS subscriber data. This may occur if unsupported features or services are removed from the GPRS subscriber data in the HLR.

If this parameter is sent the SGSN shall check if the current Location Area is possibly allowed now. This parameter is used only by the SGSN and if the VLR receives this parameter it shall ignore it.

Regional Subscription Response

If included in the Delete Subscriber Data response this parameter indicates one of:

- MSC Area Restricted;
- SGSN Area Restricted;
- Regional Subscription Not Supported.

This parameter is used by the VLR and by the SGSN.

User error

Only one of the following values is applicable:

- Unidentified subscriber;
- Data missing;
- Unexpected data value.

## 8.9 Identity management services

### 8.9.1 MAP-PROVIDE-IMSI service

#### 8.9.1.1 Definition

This service is used by a VLR in order to get, via the MSC, the IMSI of a subscriber (e.g. when a subscriber has identified itself with a TMSI not allocated to any subscriber in the VLR).

It is a confirmed service and consists of the primitives shown in table 8.9/1.

#### 8.9.1.2 Service primitives

**Table 8.9/1: MAP-PROVIDE-IMSI**

Parameter name	Request	Indication	Response	Confirm
Invoke Id	M	M(=)	M(=)	M(=)
IMSI			C	C(=)
User error			C	C(=)
Provider error				O

#### 8.9.1.3 Parameter use

All parameters are described in clause 7.6. The following clarifications are applicable:

IMSI

This parameter is received when the request is successfully carried out. It contains the requested IMSI.

User error

Only one of the following values is applicable:

- Absent subscriber.

## 8.9.2 MAP-FORWARD-NEW-TMSI service

### 8.9.2.1 Definition

This service is used by a VLR to allocate, via MSC, a new TMSI to a subscriber during an ongoing transaction (e.g. call set-up, location updating or supplementary services operation).

It is a confirmed service and consists of the primitives shown in table 8.9/2.

### 8.9.2.2 Service primitives

**Table 8.9/2: MAP-FORWARD-NEW-TMSI**

Parameter name	Request	Indication	Response	Confirm
Invoke Id	M	M(=)	M(=)	M(=)
TMSI	M	M(=)	Provider error	
		O		

### 8.9.2.3 Parameter use

The parameter TMSI is described in clause 7.6.

## 8.10 Fault recovery services

### 8.10.1 MAP\_RESET service

#### 8.10.1.1 Definition

This service is used by the HLR, after a restart, to indicate to a list of VLRs or SGSNs that a failure occurred.

The MAP\_RESET service is a non-confirmed service using the service primitives defined in table 8.10/1.

#### 8.10.1.2 Service primitives

**Table 8.10/1: MAP\_RESET**

Parameter name	Request	Indication
Invoke Id	M	M(=)
HLR number	M	M(=)
HLR Id LIST	U	C(=)

#### 8.10.1.3 Parameter definition and use

##### Invoke Id

See definition in clause 7.6.1.

##### HLR number

See definition in clause 7.6.2.

HLR Id LIST

The HLR Id List is a list of HLR Id. If the parameter is present in the indication, the VLR or SGSN may base the retrieval of subscribers to be restored on their IMSI: the subscribers affected by the reset are those whose IMSI leading digits are equal to one of these numbers. If the parameter is absent, subscribers to be restored are those for which the OriginatingEntityNumber received at location updating time matches the equivalent parameter of the Reset Indication.

**8.10.2 MAP\_FORWARD\_CHECK\_SS\_INDICATION service**

**8.10.2.1 Definition**

This service may be used by an HLR as an implementation option, to indicate to a mobile subscriber that supplementary services parameters may have been altered, e.g. due to a restart. If received from the HLR, the VLR shall forward this indication to the MSC, which in turn forwards it to the MS. The HLR only sends this indication after successful completion of the subscriber data retrieval from HLR to VLR that ran embedded in a MAP\_UPDATE\_LOCATION procedure.

The MAP\_FORWARD\_CHECK\_SS\_INDICATION service is a non-confirmed service using the service primitives defined in table 8.10/2.

**8.10.2.2 Service primitives**

**Table 8.10/2: MAP\_FORWARD\_CHECK\_SS\_INDICATION**

Parameter name	Request	Indication
Invoke Id	M	M(=)

**8.10.2.3 Parameter definition and use**

Invoke Id

See definition in clause 7.6.1.

**8.10.3 MAP\_RESTORE\_DATA service**

**8.10.3.1 Definition**

This service is invoked by the VLR on receipt of a MAP\_PROVIDE\_ROAMING\_NUMBER indication for an unknown IMSI, or for a known IMSI with the indicator "Confirmed by HLR" set to "Not confirmed". The service is used to update the LMSI in the HLR, if provided, and to request the HLR to send all data to the VLR that are to be stored in the subscriber's IMSI record.

The MAP\_RESTORE\_DATA service is a confirmed service using the service primitives defined in table 6.10/3.

**8.10.3.2 Service primitives**

**Table 8.10/3: MAP\_RESTORE\_DATA**

Parameter name	Request	Indication	Response	Confirm
Invoke Id	M	M(=)	M(=)	M(=)
IMSI	M	M(=)		
LMSI	U	C(=)		
Supported CAMEL phases	C	C(=)		
HLR number			C	C(=)
MS Not Reachable Flag			C	C(=)
User error			C	C(=)
Provider error				O



### 8.10.3.3 Parameter definitions and use

#### Invoke Id

See definition in clause 5.6.1.

#### IMSI

See definition in clause 5.6.2.

#### LMSI

See definition in clause 5.6.2. It is an operator option to provide the LMSI from the VLR; it is mandatory for the HLR to support the LMSI handling procedures.

#### Supported CAMEL Phases

This parameter indicates which phases of CAMEL are supported. Must be present if a CAMEL phase different from phase 1 is supported. Otherwise may be absent.

#### HLR number

See definition in clause 5.6.2. The presence of this parameter is mandatory in case of successful outcome of the service.

#### MS Not Reachable Flag

See definition in clause 5.6.8. This parameter shall be present in case of successful outcome of the service, if the "MS Not Reachable flag" was set in the HLR.

#### User error

In case of unsuccessful outcome of the service, an error cause shall be returned by the HLR. The following error causes defined in clause 5.6.1 may be used, depending on the nature of the fault:

- unknown subscriber;
- system failure;
- unexpected data value;
- data missing.

#### Provider error

For definition of provider errors see clause 5.6.1.

## 8.11 Subscriber Information services

### 8.11.1 MAP-ANY-TIME-INTERROGATION service

#### 8.11.1.1 Definition

This service is used by the gsmSCF, to request information (e.g. subscriber state and location) from the HLR at any time.

### 8.11.1.2 Service primitives

**Table 8.11/1: Any\_Time\_Interrogation**

Parameter name	Request	Indication	Response	Confirm
Invoke id	M	M(=)	M(=)	M(=)
Requested Info	M	M(=)		
gsmSCF-Address	M	M(=)		
IMSI	C	C(=)		
MSISDN	C	C(=)		
Location Information			C	C(=)
Subscriber State			C	C(=)
User error			C	C(=)
Provider error				O

### 8.11.1.3 Parameter definition and use

All parameters are described in clause 7.6.

The HLR may be able to use the value of the parameter gsmSCF-address to screen an MAP\_Any\_Time\_Interrogation indication.

The use of the parameters and the requirements for their presence are specified in GSM 03.78.

#### User error

This parameter is sent by the responder when an error is detected and if present, takes one of the following values:

- System Failure;
- Any Time Interrogation Not Allowed;
- Data Missing;
- Unexpected Data Value;
- Unknown Subscriber.

#### Provider error

This is defined in clause 7.6.1.

## 8.11.2 MAP-PROVIDE-SUBSCRIBER-Info service

### 8.11.2.1 Definition

This service is used to request information (e.g. subscriber state and location) from the VLR at any time.

### 8.11.2.2 Service primitives

**Table 8.11/2: Provide\_Subscriber\_Information**

Parameter name	Request	Indication	Response	Confirm
Invoke id	M	M(=)	M(=)	M(=)
Requested Info	M	M(=)		
IMSI	M	M(=)		
LMSI	U	O		
Location Information			C	C(=)
Subscriber State			C	C(=)
User error			C	C(=)
Provider error				O

### 8.11.2.3 Parameter definition and use

All parameters are defined in clause 7.6. The use of these parameters and the requirements for their presence are specified in GSM 03.18

#### User error

This parameter is sent by the responder when an error is detected and if present, takes one of the following values:

- Data Missing;
- Unexpected Data Value.

#### Provider error

This is defined in clause 7.6.1.

## 9 Operation and maintenance services

### 9.1 Subscriber tracing services

#### 9.1.1 MAP-ACTIVATE-TRACE-MODE service

##### 9.1.1.1 Definition

This service is used between the HLR and the VLR to activate subscriber tracing in the VLR.

Also this service is used between the HLR and the SGSN to activate subscriber tracing in the SGSN.

The MAP-ACTIVATE-TRACE-MODE service is a confirmed service using the primitives from table 9.1/1.

##### 9.1.1.2 Service primitives

**Table 9.1/1: MAP-ACTIVATE-TRACE-MODE**

Parameter name	Request	Indication	Response	Confirm
Invoke id	M	M(=)	M(=)	M(=)
IMSI	C	C(=)		
Trace reference	M	M(=)		
Trace type	M	M(=)		
OMC Id	U	C(=)		
User error			C	C(=)
Provider error				O

##### 9.1.1.3 Parameter use

#### Invoke id

See definition in clause 7.6.1.

#### IMSI

See definition in clause 7.6.2. The IMSI is a mandatory parameter in a stand-alone operation.

#### Trace reference

See definition in clause 7.6.10.

Trace type

See definition in clause 7.6.10.

OMC Id

See definition in clause 7.6.2. The use of this parameter is an operator option.

User error

The following errors defined in clause 7.6.1 may be used, depending on the nature of the fault:

- Unidentified Subscriber;
- Facility Not Supported;
- Tracing Buffer Full;
- System Failure;
- Unexpected Data Value;
- Data missing.

Provider error

For definition of provider errors see clause 7.6.1.

## 9.1.2 MAP-DEACTIVATE-TRACE-MODE service

### 9.1.2.1 Definition

This service is used between the VLR and the HLR for deactivating subscriber tracing in the VLR.

Also this service is used between the SGSN and the HLR for deactivating subscriber tracing in the SGSN.

The MAP-DEACTIVATE-TRACE-MODE service is a confirmed service using the primitives from table 9.1/2.

### 9.1.2.2 Service primitives

**Table 9.1/2: MAP-DEACTIVATE-TRACE-MODE**

Parameter name	Request	Indication	Response	Confirm
Invoke id	M	M(=)	M(=)	M(=)
IMSI	C	C(=)		
Trace reference	M	M(=)		
User error			C	C(=)
Provider error				O

### 9.1.2.3 Parameter use

Invoke id

See definition in clause 7.6.1.

IMSI

See definition in clause 7.6.2. The IMSI is a mandatory parameter in a stand-alone operation.

Trace reference

See definition in clause 7.6.10.

User error

The following errors defined in clause 7.6.1 may be used, depending on the nature of the fault:

- Unidentified Subscriber;
- Facility Not Supported;
- System Failure;
- Unexpected Data Value;
- Data missing.

Provider error

For definition of provider errors see clause 7.6.1.

### 9.1.3 MAP-TRACE-SUBSCRIBER-ACTIVITY service

#### 9.1.3.1 Definition

This service is used between the VLR and the MSC to activate the subscriber tracing in the MSC.

The MAP-TRACE-SUBSCRIBER-ACTIVITY service is a non-confirmed service using the primitives from table 9.1/3.

#### 9.1.3.2 Service primitives

**Table 9.1/3: MAP-TRACE-SUBSCRIBER-ACTIVITY**

Parameter name	Request	Indication
Invoke id	M	M(=)
IMSI	C	C(=)
Trace reference	M	M(=)
Trace type	M	M(=)
OMC Id	U	C(=)

#### 9.1.3.3 Parameter use

Invoke id

See definition in clause 7.6.1.

IMSI

See definition in clause 7.6.2. The controlling MSC shall provide either the IMSI or the IMEI to the servicing MSC.

Trace reference

See definition in clause 7.6.10.

Trace type

See definition in clause 7.6.10.

OMC Id

See definition in clause 7.6.2. The use of this parameter is an operator option.

## 9.2 Other operation and maintenance services

### 9.2.1 MAP-SEND-IMSI service

#### 9.2.1.1 Definition

This service is used by a VLR in order to fetch the IMSI of a subscriber in case of some Operation & Maintenance procedure where subscriber data are needed in the Visited PLMN and MSISDN is the only subscriber's identity known.

It is a confirmed service and consists of the primitive shown in figure 9.2/1.

#### 9.2.1.2 Service primitives

**Table 9.2/1: MAP-SEND-IMSI**

Parameter name	Request	Indication	Response	Confirm
Invoke Id	M	M(=)	M(=)	M(=)
MSISDN	M	M(=)		
IMSI			C	C(=)
User error			C	C(=)
Provider error				O

#### 9.2.1.3 Parameter use

All parameters are described in clause 7.6. The following clarifications are applicable:

##### User error

Only one of the following values is applicable:

- Unknown subscriber;
- Unexpected data value;
- Data missing.

## 10 Call handling services

### 10.1 MAP\_SEND\_ROUTING\_INFORMATION service

#### 10.1.1 Definition

This service is used between the Gateway MSC and the HLR. The service is invoked by the Gateway MSC to perform the interrogation of the HLR in order to route a call towards the called MS.

This is a confirmed service using the primitives listed in table 10.1/1.

## 10.1.2 Service primitives

**Table 10.1/1: MAP\_SEND\_ROUTING\_INFORMATION parameters**

Parameter name	Request	Indication	Response	Confirm
Invoke Id	M	M(=)	M(=)	M(=)
Interrogation Type	M	M(=)		
GMSC Address	M	M(=)		
MSISDN	M	M(=)		
OR Interrogation	C	C(=)		
OR Capability	C	C(=)		
CUG Interlock	C	C(=)	C	C(=)
CUG Outgoing Access	C	C(=)	C	C(=)
Number of Forwarding	C	C(=)		
Network Signal Info	C	C(=)		
Supported CAMEL Phases	C	C(=)		
Suppress T-CSI	C	C(=)		
Suppression of Announcement	C	C(=)		
Call Reference Number	C	C(=)		
Forwarding Reason	C	C(=)		
Basic Service Group	C	C(=)		
Alerting Pattern	C	C(=)		
CCBS Call	C	C(=)		
Supported CCBS Phase	C	C(=)		
IMSI			C	C(=)
MSRN			C	C(=)
Forwarding Data			C	C(=)
Forwarding Interrogation Required			C	C(=)
VMSC address			C	C(=)
GMSC Camel Subscription Info			C	C(=)
Location Information			C	C(=)
Subscriber State			C	C(=)
Basic Service Code			C	C(=)
CUG Subscription Flag			C	C(=)
North American Equal Access preferred			U	C(=)
Carrier Id				
User error			C	C(=)
SS-List			U	C(=)
CCBS Target			C	C(=)
Keep CCBS Call Indicator			C	C(=)
Provider error				O

## 10.1.3 Parameter use

See clause 7.6 for a definition of the parameters used in addition to the following. Note that:

- a conditional parameter whose use is defined only in GSM 03.78 shall be absent if the sending entity does not support CAMEL;
- a conditional parameter whose use is defined only in GSM 03.79 shall be absent if the sending entity does not support optimal routing;
- a conditional parameter whose use is defined only in GSM 03.78 & GSM 03.79 shall be absent if the sending entity supports neither CAMEL nor optimal routing.

### Interrogation Type

See GSM 03.79 [99] for the use of this parameter.

### GMSC address

The E.164 address of the GMSC.

MSISDN

This is the Mobile Subscriber ISDN number assigned to the called subscriber.

OR Interrogation

See GSM 03.79 [99] for the use of this parameter and the conditions for its presence.

OR Capability

See GSM 03.79 [99] for the use of this parameter and the conditions for its presence.

CUG Interlock

See GSM 03.18 [97] for the use of this parameter and the conditions for its presence.

CUG Outgoing Access

See GSM 03.18 [97] for the use of this parameter and the conditions for its presence.

Number of Forwarding

See GSM 03.18 [97] for the use of this parameter and the conditions for its presence.

Network Signal Info

See GSM 03.18 [97] for the conditions for the presence of the components of this parameter.

Supported CAMEL Phases

The use of this parameter and the requirements for its presence are specified in GSM 03.78

T-CSI Suppression

The use of this parameter and the requirements for its presence are specified in GSM 03.78

Suppression Of Announcement

The use of this parameter and the requirements for its presence are specified in GSM 03.78

Call Reference Number

The use of this parameter and the conditions for its presence are specified in GSM 03.78 [98] and GSM 03.79 [99].

Forwarding Reason

See GSM 03.79 [99] for the use of this parameter and the conditions for its presence.

Basic Service Group

See GSM 03.79 [99] for the use of this parameter and the conditions for its presence.

Alerting Pattern

See GSM 03.18 [97] for the use of this parameter and the conditions for its presence.

CCBS Call

See GSM 03.93 [107] for the use of this parameter and the conditions for its presence.

Supported CCBS Phase

This parameter indicates by its presence that CCBS is supported and the phase of CCBS which is supported.

IMSI

See GSM 03.18 [97] for the use of this parameter and the conditions for its presence.



### MSRN

See GSM 03.18 [97] and GSM 03.79 [99] for the use of this parameter and the conditions for its presence.

### Forwarding Data

This parameter includes the forwarded-to number, the forwarding option Notification to calling party and the forwarding reason, and can include the forwarded-to subaddress. See GSM 03.18 [97] and GSM 03.79 [99] for the conditions for the presence of its components.

### Forwarding Interrogation Required

See GSM 03.79 [99] for the use of this parameter and the conditions for its presence.

### VMSC address

See GSM 03.79 [99] for the use of this parameter and the conditions for its presence.

### GMSC CAMEL Subscription Info

The use of this parameter and the requirements for its presence are specified in GSM 03.78

### Location Information

The use of this parameter and the requirements for its presence are specified in GSM 03.78

### Subscriber State

The use of this parameter and the requirements for its presence are specified in GSM 03.78

### CUG Subscription Flag

The use of this parameter and the requirements for its presence are specified in GSM 03.78.

### North American Equal Access preferred Carrier Id

This parameter is returned to indicate the preferred carrier identity to be used to setup the call (i.e. forwarding the call or establishing the roaming leg).

### SS-List

This parameter includes SS-codes and will be returned as an operator option. The HLR shall not send PLMN-specific SS-codes across PLMN boundaries. However if the GMSC receives PLMN-specific SS-codes from a foreign PLMN's HLR the GMSC may ignore it. If the GMSC attempts to process the PLMN specific SS codes, this may lead to unpredictable behaviour but the GMSC shall continue call processing.

### Basic Service Code

The use of this parameter and the requirements for its presence are specified in GSM 03.78.

If the CAMEL service is not involved, this parameter includes the basic service code and will be returned as an operator option. The HLR shall not send a PLMN-specific Basic Service Code across PLMN boundaries. However if the GMSC receives a PLMN-specific Basic Service Code from a foreign PLMN's HLR the GMSC may ignore it. If the GMSC attempts to process the PLMN specific Basic Service codes, this may lead to unpredictable behaviour but the GMSC shall continue call processing.

### CCBS Target

See GSM 03.93 for the use of this parameter and the conditions for its presence.

### Keep CCBS Call Indicator

See GSM 03.93 for the use of this parameter and the conditions for its presence.

User error

This parameter is sent by the responder when an error is detected and if present, takes one of the following values:

- Unknown Subscriber;
- Number changed;
- Call Barred;

This error will indicate that either incoming calls are barred for this MS or that calls are barred due to Operator Determined Barring (see GSM 02.41 for a definition of this network feature).

- CUG Reject;

The value of this error cause will indicate the reason for CUG Reject.

- Bearer Service Not Provisioned;
- Teleservice Not Provisioned;

A subscription check has been performed and the call has not passed the check due to incompatibility with regard to the requested service. Depending on the nature of the incompatibility, either of these messages will be returned.

- Facility Not Supported;
- Absent Subscriber;

This indicates that the location of the MS is not known (either the station is not registered and there is no location information available or the Provide Roaming Number procedure fails due to IMSI detached flag being set), or the GMSC requested forwarding information with a forwarding reason of not reachable, and the call forwarding on MS not reachable service is not active.

- Busy Subscriber;

This indicates that Call Forwarding on Busy was not active for the specified basic service group when the GMSC requested forwarding information with a forwarding reason of busy.

The error may also indicate that the subscriber is busy due to an outstanding CCBS recall. In the error data it may then be specified that CCBS is possible for the busy encountered call.

- No Subscriber Reply;

This indicates that Call Forwarding on No Reply was not active for the specified basic service group when the GMSC requested forwarding information with a forwarding reason of no reply.

- OR Not Allowed;

This indicates that the HLR is not prepared to accept an OR interrogation from the GMSC, or that calls to the specified subscriber are not allowed to be optimally routed.

- Forwarding Violation;
- System Failure;
- Data Missing;
- Unexpected Data Value.

See clause 7.6 for a definition of these errors.

Provider error

These are defined in clause 7.6.

## 10.2 MAP\_PROVIDE\_ROAMING\_NUMBER service

### 10.2.1 Definition

This service is used between the HLR and VLR. The service is invoked by the HLR to request a VLR to send back a roaming number to enable the HLR to instruct the GMSC to route an incoming call to the called MS.

This is a confirmed service which uses the Primitives described in table 10.2/1.

### 10.2.2 Service primitives

**Table 10.2/1: MAP\_PROVIDE\_ROAMING\_NUMBER parameters**

Parameter name	Request	Indication	Response	Confirm
Invoke Id	M	M(=)	M(=)	M(=)
IMSI	M	M(=)		
MSC Number	M	M(=)		
MSISDN	U	C(=)		
LMSI	C	C(=)		
GSM Bearer Capability	C	C(=)		
Network Signal Info	C	C(=)		
Suppression Of Announcement	C	C(=)		
Call Reference Number	C	C(=)		
GMSC Address	C	C(=)		
OR Interrogation	C	C(=)		
Alerting Pattern	C	C(=)		
CCBS Call	C	C(=)		
Supported CAMEL Phases in GMSC	C	C(=)		
Roaming Number			C	C(=)
User error			C	C(=)
Provider error				O

### 10.2.3 Parameter use

See clause 7.6 for a definition of the parameters used, in addition to the following. Note that:

- a conditional parameter whose use is defined only in GSM 03.78 shall be absent if the sending entity does not support CAMEL;
- a conditional parameter whose use is defined only in GSM 03.79 shall be absent if the sending entity does not support optimal routing;
- a conditional parameter whose use is defined only in GSM 03.78 & GSM 03.79 shall be absent if the sending entity supports neither CAMEL nor optimal routing.

#### IMSI

This is the IMSI of the called Subscriber.

#### MSC Number

This is the ISDN number assigned to the MSC currently serving the MS. The MSC number will have been stored in the HLR as provided at location updating.

#### MSISDN

See GSM 03.18 [97] for the use of this parameter and the conditions for its presence.

#### LMSI

See GSM 03.18 [97] for the use of this parameter and the conditions for its presence.

### GSM Bearer Capability

See GSM 03.18 [97] for the use of this parameter and the conditions for its presence.

This information is passed according to the rules specified in TS GSM 09.07.

There may be two GSM Bearer Capabilities supplied.

### Network Signal Info

See GSM 03.18 [97] for the conditions for the presence of the components of this parameter.

### Suppression Of Announcement

The use of this parameter and the requirements for its presence are specified in GSM 03.78.

### Call Reference Number

The use of this parameter and the conditions for its presence are specified in GSM 03.78 [98] and GSM 03.79 [99].

### GMSC Address

The use of this parameter and the conditions for its presence are specified in GSM 03.78 [98] and GSM 03.79 [99].

### OR Interrogation

See GSM 03.79 [99] for the use of this parameter and the conditions for its presence.

### Supported CAMEL Phases in GMSC

See GSM 03.78 [98] for the use of this parameter and the conditions for its presence.

### Alerting Pattern

See GSM 03.78 [98] for the use of this parameter and the conditions for its presence.

### CCBS Call

See GSM 03.93 [xx] for the use of this parameter and the conditions for its presence.

### Roaming Number

See GSM 03.18 [97] for the use of this parameter and the conditions for its presence.

### User error

This parameter is sent by the responder when an error is detected and if present, takes one of the following values:

- Absent Subscriber;  
This error will be returned if the IMSI detach flag is set.
- No Roaming Number Available;
- OR Not Allowed;  
This indicates that the MAP\_PROVIDE\_ROAMING\_NUMBER indication included the OR interrogation indicator, but the VLR does not support optimal routing.
- Facility Not Supported;
- System Failure;
- Data Missing;
- Unexpected Data Value.

See clause 7.6 for a definition of these reasons.

Provider error

These are defined in clause 7.6.

## 10.3 MAP\_RESUME\_CALL\_HANDLING service

### 10.3.1 Definition

This service is used between the terminating VMSC and the GMSC. The service is invoked by the terminating VMSC to request the GMSC to resume handling the call and forward it to the specified destination.

This is a confirmed service which uses the Primitives listed in table 10.3/1.

### 10.3.2 Service primitives

**Table 10.3/1: MAP\_RESUME\_CALL\_HANDLING parameters**

Parameter name	Request	Indication	Response	Confirm
Invoke Id	M	M(=)	M(=)	M(=)
Call Reference Number	M	M(=)		
Basic Service Group	M	M(=)		
IMSI	M	M(=)		
Forwarding Data	M	M(=)		
CUG Interlock	C	C(=)		
CUG Outgoing Access	C	C(=)		
O-CSI	C	C(=)		
CCBS Target	C	C(=)		
User error			C	C(=)
Provider error				O

### 10.3.3 Parameter use

See clause 7.6 for a definition of the parameters used, in addition to the following.

Call Reference Number

See GSM 03.79 [99] for the use of this parameter.

Basic Service Group

See GSM 03.79 [99] for the use of this parameter.

IMSI

This is the IMSI of the forwarding Subscriber.

Forwarding Data

Includes the forwarded-to number, the forwarding reason, an indication of whether the calling party is to be notified that the call has been forwarded and possibly a forwarded-to subaddress.

CUG Interlock

See GSM 03.79 [99] for the use of this parameter and the conditions for its presence.

CUG Outgoing Access

See GSM 03.79 [99] for the use of this parameter and the conditions for its presence.

O-CSI

See GSM 03.79 [99] for the use of this parameter and the conditions for its presence.

For CAMEL phases 1 & 2, the O-CSI shall contain only one set of O-BCSM TDP data.

#### CCBS Target

See GSM 03.93 [107] for the use of this parameter and the conditions for its presence.

#### User error

This parameter is sent by the responder when an error is detected and if present, takes one of the following values:

- Optimal Routeing not allowed;
- Forwarding failed.

#### Provider error

These are defined in clause 7.6.

## 10.4 MAP\_PREPARE\_GROUP\_CALL service

### 10.4.1 Definition

This service is used by the Anchor\_MSC to inform the Relay\_MSC about a group call setup.

The MAP\_PREPARE\_GROUP\_CALL service is a confirmed service using the service primitives given in table 10.4

### 10.4.2 Service primitives

**Table 10.4/1: MAP\_PREPARE\_GROUP\_CALL service**

Parameter name	Request	Indication	Response	Confirm
Invoke Id	M	M(=)	M(=)	M(=)
Teleservice	M	M(=)		
ASCI Call Reference	M	M(=)		
Ciphering Algorithm	M	M(=)		
Group Key Number	C	C(=)		
Group Key	C	C(=)		
Priority	C	C(=)		
CODEC-Information	M	M(=)		
Uplink Free Indicator	M	M(=)		
Group Call Number			M	M(=)
User Error			C	C(=)
Provider Error				O

### 10.4.3 Parameter definitions and use

#### Invoke Id

See definition in clause 7.6.1

#### Teleservice

Voice Broadcast Service or Voice Group Call Service

#### ASCI Call Reference

Broadcast call reference or group call reference. This item is used to access the VBS-GCR or VGCS-GCR within the Relay\_MSC.

#### Ciphering Algorithm

The ciphering algorithm to be used for the group call.

Group Key Number

This number has to be broadcasted and is used by the mobile station to select the chosen group key.

Shall be present if the ciphering applies.

Group Key

This key is used for ciphering on the radio interface.

Shall be present if the ciphering applies.

Priority

Default priority level related to the call if eMLPP applies.

CODEC-Information

Information on the codecs allowed for this call.

Uplink Free Indicator

A flag indicating whether the call is initiated from a dispatcher.

Group Call Number

This temporary allocated E.164 number is used for routing the call from the Anchor MSC to the Relay MSC.

User Error

For definition of this parameter see clause 7.6.1 The following errors defined in clause 7.6.1 may be used, depending on the nature of the fault:

- No Group Call Number available
- System Failure
- Unexpected Data Value.

Provider Error

See definition of provider error in clause 7.6.1.

## 10.5 MAP\_PROCESS\_GROUP\_CALL\_SIGNALLING service

### 10.5.1 Definitions

This service is used between Relay MSC and Anchor MSC for transmission of Group Call notifications.

The MAP\_PROCESS\_GROUP\_CALL\_SIGNALLING service is a non-confirmed service using the service primitives given in table 10.5

### 10.5.2 Service primitives

**Table 10.5/1: MAP\_PROCESS\_GROUP\_CALL\_SIGNALLING service**

Parameter name	Request	Indication
Invoke Id	M	M(=)
Uplink Request	C	C(=)
Uplink Release Indication	C	C(=)
Release Group Call	C	C(=)

### 10.5.3 Parameter definitions and use

#### Invoke Id

See definition in clause 7.6.1

#### Uplink Request

This information element indicates to the anchor MSC that a service subscriber roaming in the relay MSC area requests access to the uplink.

#### Uplink Release Indication

This information element if included by the Relay MSC indicates to the Anchor MSC that the uplink has become free.

#### Release Group Call

This information element if included by the Relay MSC indicates to the Anchor MSC that the service subscriber who has initiated the call and who currently has access to the uplink terminates the call.

## 10.6 MAP\_FORWARD\_GROUP\_CALL\_SIGNALLING service

### 10.6.1 Definitions

This service is used between Anchor MSC and Relay MSC for transmission of Group Call notifications.

The MAP\_FORWARD\_GROUP\_CALL\_SIGNALLING service is a non-confirmed service using the service primitives given in table 10.6

### 10.6.2 Service primitives

**Table 10.6: MAP\_FORWARD\_GROUP\_CALL\_SIGNALLING service**

Parameter name	Request	Indication
Invoke Id	M	M(=)
IMSI	C	C(=)
Uplink Request Acknowledgement	C	C(=)
Uplink Release Indication	C	C(=)
Uplink Reject Command	C	C(=)
Uplink Seized Command	C	C(=)
Uplink Release Command	C	C(=)

### 10.6.3 Parameter definitions and use

#### IMSI

Identity of the service subscriber who has established the call and who is allowed to terminate the call.

#### Invoke Id

See definition in clause 7.6.1

#### Uplink Request Acknowledgement

This information element is used for positive acknowledgement of an uplink request

#### Uplink Release Indication

This information element if included by the Anchor MSC indicates to the Relay MSC that the uplink has become free.



Uplink Reject Command

This information element is used for negative acknowledgement of an uplink request

Uplink Seized Command

This information element if included by the Anchor MSC indicates to the Relay MSC that the uplink is no longer free.

Uplink Release Command

This information element if included by the Anchor MSC indicates to the Relay MSC that the uplink which is granted to a MS in the relay MSC area shall be released.

## 10.7 MAP\_SEND\_GROUP\_CALL\_END\_SIGNAL service

### 10.7.1 Definitions

This service is used between the Relay MSC and the Anchor MSC indicating that VGCS / VBS channels have been established in the Relay MSC area. The response is used by the Anchor MSC to inform Relay MSC that all resources for the call can be released in Relay MSC because the call has been released in the Anchor MSC.

The MAP\_SEND\_GROUP\_CALL\_END\_SIGNAL service is a confirmed service using the service primitives given in table 10.7.

### 10.7.2 Service primitives

**Table 10.7: MAP\_SEND\_GROUP\_CALL\_END\_SIGNAL service**

Parameter name	Request	Indication	Response	Confirm
Invoke Id	M	M(=)	M(=)	M(=)
IMSI	C	C(=)		
Provider Error				O

### 10.7.3 Parameter definitions and use

IMSI

Identity of the service subscriber who has established the call and who is allowed to terminate the call.

Shall be present if the call was established by a service subscriber roaming in the relay MSC area.

Invoke Id

See definition in clause 7.6.1

Provider Error

See definition of provider error in clause 7.6.1.

## 10.8 MAP\_Provide\_SIWFS\_Number

### 10.8.1 Definition

This service is used between an MSC and SIWFS. It is invoked by an MSC receiving an incoming call (call to or from MS) to request the SIWFS to allocate IWU resources. The service is defined in GSM 03.54.

This is a confirmed service using the primitives described in table 10.8.

## 10.8.2 Service primitive

**Table 10.8: MAP\_Provide\_SIWFS\_Number service**

Parameter name	Request	Indication	Response	Confirm
Invoke ID	M	M(=)	M(=)	M(=)
GSM Bearer Capability	M	M(=)		
ISDN Bearer Capability	M	M(=)		
Call Direction	M	M(=)		
B-subscriber address	M	M(=)		
Chosen Channel	M	M(=)		
Lower Layer Compatibility	C	C(=)		
High Layer Compatibility	C	C(=)		
SIWFS number			C	C(=)
User error			C	C(=)
Provider error				O

## 10.8.3 Parameter use

See clause 7.6 for a definition of the parameter used, in addition to the following.

### GSM Bearer Capability

This information is the result from the negotiation with the mobile station. The information is sent from the MSC to the SIWFS to allocate the correct IWU.

### ISDN Bearer Capability

This parameter refers to the ISDN Bearer Capability information element. For the MTC this parameter is received in the ISUP User Service Information parameter. For the MOC call this parameter is mapped from the GSM BC parameter according to GSM 09.07. The parameter is used by the SIWFS to route the call and to allocate the outgoing circuit.

### Call Direction

This parameter indicates the direction of the call (mobile originated or mobile terminated) at call set-up.

### B-subscriber address

This parameter is sent from the MSC to the SIWFS to inform the SIWFS where to route the call i.e. where to send the IAM. If the loop method is used this parameter will indicate the address to the VMSC. This address is allocated by the VMSC in the same way as a MSRN and is used to correlate the incoming IAM to the corresponding MAP dialogue. If the non-loop method is used this parameter will indicate the address to the B-subscriber.

### Chosen Channel

This parameter is sent from the MSC to the SIWFS to adjust the interworking unit to the assigned radio resources. This parameter is defined in GSM 08.08.

### Lower Layer Compatibility

This parameter is sent from the MSC to the SIWF to allow the interworking unit to perform a compatibility check. This parameter is handled as specified in GSM 09.07. This parameter is defined in GSM 04.08.

### High Layer Compatibility

This parameter is sent from the MSC to the SIWF to allow the interworking unit to perform a compatibility check. This parameter is handled as specified in GSM 09.07. This parameter is defined in GSM 04.08.

### SIWFS number

This parameter is sent from the SIWFS to the MSC. This address is used by the visited MSC to route the call, i.e. the IAM to the SIWFS (similar to MSRN) and will be used by the SIWFS to correlate the incoming IAM to the corresponding MAP message. This parameter must always be sent from the SIWFS when a successful allocation of SIWFS resources has been made.

User error

This parameter is sent by the responder when an error is detected and if present, takes one of the following values:

- Resource limitation;
- Facility Not Supported;
- Unexpected Data Value;
- System Failure.

See clause 7.6 for a definition of these reasons.

Provider error

These are defined in clause 7.6.

## 10.9 MAP\_SIWFS\_Signalling\_Modify

### 10.9.1 Definition

This service is used to transport signalling information between an MSC and an SIWFS in the case of a request to modify the configuration (e.g. HSCSD). It is invoked either by an MSC or by the SIWFS. The service is defined in GSM 03.54.

This is a confirmed service using the primitives described in table 10.9.

### 10.9.2 Service primitive

**Table 10.9: MAP\_SIWFS\_Signalling\_Modify service**

Parameter name	Request	Indication	Response	Confirm
Invoke ID	M	M(=)	M(=)	M(=)
Channel Type	C	C(=)		
Chosen Channel	C	C(=)	C(=)	C(=)
User error			C	C(=)
Provider error				O

### 10.9.3 Parameter use

See clause 7.6 for a definition of the parameter used, in addition to the following.

Channel Type

This parameter is the result of a Channel Mode Modification for TS61/62. It contains the changed Air Interface User Rate. The information is sent from the SIWFS to the MSC to assign the correct radio resource. This parameter is defined in GSM 08.08.

Chosen Channel

This parameter is sent from the MSC to the SIWFS to adjust the interworking unit to the assigned radio resources. This parameter is defined in GSM 08.08.

User error

This parameter is sent by the responder when an error is detected and if present , takes one of the following values:

- Resource limitation;
- Facility Not Supported;

- Data Missing;
- Unexpected Data Value;
- System Failure.

See clause 7.6 for a definition of these reasons.

#### Provider error

These are defined in clause 7.6.

## 10.10 MAP\_SET\_REPORTING\_STATE service

### 10.10.1 Definition

This service is used between the HLR and the VLR to set the reporting state for a requested service. It is a confirmed service using the service primitives shown in table 10.10/1.

### 10.10.2 Service primitives

The service primitives are shown in table 10.10/1.

**Table 10.10/1: MAP\_SET\_REPORTING\_STATE parameters**

Parameter name	Request	Indication	Response	Confirm
Invoke id	M	M(=)	M(=)	M(=)
IMSI	C	C(=)		
LMSI	C	C(=)		
CCBS Monitoring	C	C(=)		
CCBS Subscriber Status			C	C(=)
User error			C	C(=)
Provider error				O

### 10.10.3 Parameter use

See clause 7.6 for a definition of the parameters used, in addition to the following.

#### IMSI

The IMSI is a mandatory parameter if the service is used as the only one in a dialogue.

#### CCBS Monitoring

This parameter indicates whether monitoring for CCBS shall be started or stopped. If it indicates that monitoring shall be started this service corresponds to the message 'Start Reporting' in GSM 03.93; if it indicates that monitoring shall be stopped this service corresponds to the message 'Stop Reporting' in GSM 03.93.

#### CCBS Subscriber Status

See GSM 03.93 for the use of this parameter and the conditions for its presence.

#### User error

This parameter is sent by the responder upon unsuccessful outcome of the service, and then takes one of the following values defined in clause 7.6.1:

- System Failure;
- Unidentified Subscriber;

- Unexpected Data Value;
- Data Missing;
- Resource Limitation;
- Facility Not Supported.

NOTE: This error is reserved for future use.

#### Provider error

These are defined in clause 7.6.

## 10.11 MAP\_STATUS\_REPORT service

### 10.11.1 Definition

This service is used by the VLR to report an event or call outcome to the HLR. It is a confirmed service using the service primitives shown in table 10.11/1.

### 10.11.2 Service primitives

The service primitives are shown in table 10.11/1.

**Table 10.11/1: MAP\_STATUS\_REPORT parameters**

Parameter name	Request	Indication	Response	Confirm
Invoke id	M	M(=)	M(=)	M(=)
IMSI	M	M(=)		
CCBS Subscriber Status	C	C(=)		
Monitoring Mode	C	C(=)		
Call Outcome	C	C(=)		
User error			C	C(=)
Provider error				O

### 10.11.3 Parameter use

See clause 7.6 for a definition of the parameters used, in addition to the following.

#### CCBS Subscriber Status

If this parameter is present without Monitoring Mode and Call Outcome this service corresponds to the message 'Event Report' in GSM 03.93 [107]. See GSM 03.93 [107] for the use of this parameter and the conditions for its presence.

#### Monitoring Mode

If this parameter is present with CCBS Call Outcome this service corresponds to the message 'CCBS Call Report' in GSM 03.93. See GSM 03.93 for the use of this parameter and the conditions for its presence.

#### Call Outcome

See GSM 03.93 for the use of this parameter and the conditions for its presence.

#### User error

This parameter is sent by the responder upon unsuccessful outcome of the service, and then takes one of the following values defined in clause 7.6.1:

- Unknown Subscriber ;

- System Failure;
- Unexpected Data Value;
- Data Missing.

#### Provider error

These are defined in clause 7.6.

## 10.12 MAP\_REMOTE\_USER\_FREE service

### 10.12.1 Definition

This service is used between the HLR and the VLR to report that the B subscriber is now idle and that the A subscriber can be notified. It is a confirmed service using the service primitives shown in table 10.12/1.

### 10.12.2 Service primitives

The service primitives are shown in table 10.12/1.

**Table 10.12/1: MAP\_REMOTE\_USER\_FREE parameters**

Parameter name	Request	Indication	Response	Confirm
Invoke id	M	M(=)	M(=)	M(=)
IMSI	M	M(=)		
Call Info	M	M(=)		
CCBS Feature	M	M(=)		
Translated B Number	M	M(=)		
Replace B Number	C	C(=)		
Alerting Pattern	C	C(=)		
RUF Outcome			C	C(=)
User error			C	C(=)
Provider error				O

### 10.12.3 Parameter use

See clause 7.6 for a definition of the parameters used, in addition to the following.

#### Call Info

See GSM 03.93 for the use of this parameter.

#### CCBS Feature

See GSM 03.93 for the conditions for the presence of the parameters included in the CCBS feature.

#### Translated B Number

See GSM 03.93 for the use of this parameter.

#### Replace B Number

See GSM 03.93 for the use of this parameter and the conditions for its presence.

#### Alerting Pattern

See GSM 03.93 for the use of this parameter and the conditions for its presence.

#### RUF Outcome

See GSM 03.93 for the use of this parameter and the conditions for its presence.

User error

This parameter is sent by the responder upon unsuccessful outcome of the service, and then takes one of the following values defined in clause 7.6.1:

- Unexpected Data Value;
- Data Missing;
- Incompatible Terminal;

This error is returned by the responder when the terminal used for CCBS activation is not compatible with the terminal used for the CCBS recall. For details refer to GSM 04.08.

- Absent Subscriber (IMSI Detach; Restricted Area; No Page Response);
- System Failure;
- Busy Subscriber (CCBS Busy).

Provider error

These are defined in clause 7.6.

## 11 Supplementary services related services

### 11.1 MAP\_REGISTER\_SS service

#### 11.1.1 Definition

This service is used between the MSC and the VLR and between the VLR and the HLR to register data related to a supplementary service. The VLR will relay the message to the HLR.

The service is a confirmed service and consists of four service primitives.

#### 11.1.2 Service primitives

The service primitives are shown in table 11.1/1.

**Table 11.1/1: MAP\_REGISTER\_SS parameters**

Parameter name	Request	Indication	Response	Confirm
Invoke id	M	M(=)	M(=)	M(=)
SS-Code	M	M(=)		
Basic service	C	C(=)		
Forwarded-to number with subaddress	C	C(=)		
No reply condition time	C	C(=)		
EMLPP default priority	C	C(=)	C	C(=)
Forwarding information			C	C(=)
User error			C	C(=)
Provider error				O

### 11.1.3 Parameter use

#### Invoke id

See clause 7.6.1 for the use of this parameter.

#### SS-Code

This parameter indicates the supplementary service which the mobile subscriber wants to register.

#### Basic service

This parameter indicates for which basic service group the supplementary service is to be registered. If it is not included, the registration request applies to all basic services.

#### Forwarded-to number with subaddress

This parameter is obligatory if the registration applies to one or more call forwarding supplementary services. It can optionally include a sub-address.

#### No reply condition time

This parameter is included if the registration applies to the Call Forwarding on No Reply supplementary service (or a superset of this service) and the mobile subscriber supplies a value for this time.

#### EMLPP default priority

This parameter is sent by the initiator to register the eMLPP default priority level and is returned by the responder at successful outcome of the service.

#### Forwarding information

This parameter is returned by the responder at successful outcome of the service, if the registration request concerned one or a group of Call Forwarding supplementary services.

#### User error

This parameter is sent by the responder upon unsuccessful outcome of the service, and then takes one of the following values defined in clause 7.6.1:

- System failure;
- Data missing;
- Unexpected data value;
- Call Barred;
- Bearer service not provisioned;

This error is returned only if not even a subset of the requested bearer service group has been subscribed to.

- Teleservice not provisioned;

This error is returned only if not even a subset of the requested teleservice group has been subscribed to.

- Illegal SS operation;
- SS error status;
- SS incompatibility.

#### Provider error

See clause 7.6.1 for the use of this parameter.



## 11.2 MAP\_ERASE\_SS service

### 11.2.1 Definition

This service is used between the MSC and the VLR and between the VLR and the HLR to erase data related to a supplementary service. The VLR will relay the message to the HLR.

The service is a confirmed service and consists of four service primitives.

### 11.2.2 Service primitives

The service primitives are shown in table 11.2/1.

**Table 11.2/1: MAP\_ERASE\_SS parameters**

Parameter name	Request	Indication	Response	Confirm
Invoke id	M	M(=)	M(=)	M(=)
SS-Code	M	M(=)		
Basic service	C	C(=)		
Forwarding information			C	C(=)
User error			C	C(=)
Provider error				O

### 11.2.3 Parameter use

#### Invoke id

See clause 7.6.1 for the use of this parameter.

#### SS-Code

This parameter indicates the supplementary service which the mobile subscriber wants to erase.

#### Basic service

This parameter indicates for which basic service group the supplementary service should be erased. If it is not included, the erasure request applies to all basic services.

#### Forwarding information

This parameter is returned by the responder at successful outcome of the service, if the erasure request concerned one or a group of Call Forwarding supplementary services.

#### User error

This parameter is sent by the responder upon unsuccessful outcome of the service, and then takes one of the following values, defined in clause 7.6.1:

- System failure;
- Data Missing;
- Unexpected data value;
- Bearer service not provisioned;

This error is returned only if not even a subset of the requested bearer service group has been subscribed to.

- Teleservice not provisioned;

This error is returned only if not even a subset of the requested teleservice group has been subscribed to.

- Call Barred;

- Illegal SS operation;
- SS error status.

#### Provider error

See clause 7.6.1 for the use of this parameter.

## 11.3 MAP\_ACTIVATE\_SS service

### 11.3.1 Definition

This service is used between the MSC and the VLR and between the VLR and the HLR to activate a supplementary service. The VLR will relay the message to the HLR.

The service is a confirmed service and consists of four service primitives.

### 11.3.2 Service primitives

The service primitives are shown in table 11.3/1.

**Table 11.3/1: MAP\_ACTIVATE\_SS parameters**

Parameter name	Request	Indication	Response	Confirm
Invoke id	M	M(=)	M(=)	M(=)
SS-Code	M	M(=)		
Basic service	C	C(=)		
Forwarding information			C	C(=)
Call barring information			C	C(=)
SS-Data			C	C(=)
User error			C	C(=)
Provider error				O

### 11.3.3 Parameter use

#### Invoke id

See clause 7.6.1 for the use of this parameter.

#### SS-Code

This parameter indicates the supplementary service which the mobile subscriber wants to activate.

#### Basic service

This parameter indicates for which basic service groups the requested supplementary service(s) should be activated. If it is not included, the activation request applies to all basic services.

#### Forwarding information

This parameter is returned by the responder at successful outcome of the service, if the activation request concerned Call Forwarding.

#### Call barring information

This parameter is returned by the responder at successful outcome of the service, if the activation request concerned Call Barring.

#### SS-Data

This parameter is returned by the responder at successful outcome of the service, if the activation request concerned for example Call Waiting.

User error

This parameter is sent by the responder upon unsuccessful outcome of the service, and then takes one of the following values, defined in clause 7.6.1:

- System failure;
- Data Missing;
- Unexpected data value;
- Bearer service not provisioned;

This error is returned only if not even a subset of the requested bearer service group has been subscribed to.

- Teleservice not provisioned;

This error is returned only if not even a subset of the requested teleservice group has been subscribed to.

- Call Barred;
- Illegal SS operation;
- SS error status;
- SS subscription violation;
- SS incompatibility;
- Negative PW check;
- Number Of PW Attempts Violation.

Provider error

See clause 7.6.1 for the use of this parameter.

## 11.4 MAP\_DEACTIVATE\_SS service

### 11.4.1 Definitions

This service is used between the MSC and the VLR and between the VLR and the HLR to deactivate a supplementary service. The VLR will relay the message to the HLR.

The service is a confirmed service and consists of four service primitives.

### 11.4.2 Service primitives

The service primitives are shown in table 11.4/1.

**Table 11.4/1: MAP\_DEACTIVATE\_SS parameters**

Parameter name	Request	Indication	Response	Confirm
Invoke id	M	M(=)	M(=)	M(=)
SS-Code	M	M(=)		
Basic service	C	C(=)		
Forwarding information			C	C(=)
Call barring information			C	C(=)
SS-Data			C	C(=)
User error			C	C(=)
Provider error				<b>O</b>

### 11.4.3 Parameter use

#### Invoke id

See clause 7.6.1 for the use of this parameter.

#### SS-Code

This parameter indicates the supplementary service which the mobile subscriber wants to deactivate.

#### Basic service

This parameter indicates for which basic service group the requested supplementary service(s) should be deactivated. If it is not included the deactivation request applies to all basic services.

#### Forwarding information

This parameter is returned by the responder at successful outcome of the service, if the deactivation request concerned one or a group of Call Forwarding supplementary services.

#### Call barring information

This parameter is returned by the responder at successful outcome of the service, if the activation request concerned one or a group of Call Barring supplementary services.

#### SS-Data

This parameter is returned by the responder at successful outcome of the service, for example if the deactivation request concerned the Call Waiting supplementary service.

#### User error

This parameter is sent by the responder upon unsuccessful outcome of the service, and then takes one of the following values, defined in clause 7.6.1:

- System failure;
- Data Missing;
- Unexpected data value;
- Bearer service not provisioned;

This error is returned only if not even a subset of the requested bearer service group has been subscribed to.

- Teleservice not provisioned;

This error is returned only if not even a subset of the requested teleservice group has been subscribed to.

- Call Barred;
- Illegal SS operation;
- SS error status;
- SS subscription violation;
- Negative PW check;
- Number Of PW Attempts Violation.

#### Provider error

See clause 7.6.1 for the use of this parameter.

## 11.5 MAP\_INTERROGATE\_SS service

### 11.5.1 Definitions

This service is used between the MSC and the VLR and between the VLR and the HLR to retrieve information related to a supplementary service. The VLR will relay the message to the HLR if necessary.

The service is a confirmed service and consists of four service primitives.

### 11.5.2 Service primitives

The service primitives are shown in table 11.5/1.

**Table 11.5/1: MAP\_INTERROGATE\_SS parameters**

Parameter name	Request	Indication	Response	Confirm
Invoke id	M	M(=)	M(=)	M(=)
SS-Code	M	M(=)		
Basic service	C	C(=)		
SS-Status			C	C(=)
Basic service Group LIST			C	C(=)
Forwarding feature LIST			C	C(=)
CLI restriction Info			C	C(=)
EMLPP Info			C	C(=)
CCBS Feature LIST			C	C(=)
User error			C	C(=)
Provider error				O

### 11.5.3 Parameter use

For additional information on parameter use refer to the GSM 04.8x and 04.9x-series of technical specifications.

#### Invoke id

See clause 7.6.1 for the use of this parameter.

#### SS-Code

The mobile subscriber can only interrogate a single supplementary service per service request.

#### Basic service

This parameter indicates for which basic service group the given supplementary service is interrogated. If it is not included, the interrogation request applies to all basic services.

#### SS-Status

This parameter is included by the responder if:

- the interrogated supplementary service can only be subscribed for all applicable basic services simultaneously; or
- the interrogated supplementary service is not active for any of the interrogated basic services, or
- the interrogation was for the CCBS supplementary service and no CCBS request is active or the service is not provisioned.

#### Basic service group LIST

This parameter LIST is used to include one or a series of basic service groups for which the interrogated supplementary service is active. If the interrogated supplementary service is not active for any of the interrogated (and provisioned) basic service groups, the SS-Status parameter is returned.

### Forwarding feature LIST

The forwarding feature parameter is described in clause 7.6.4. A list of one or more forwarding features is returned by the responder when the interrogation request applied to Call Forwarding supplementary service.

If no basic service code parameter is provided within this sequence, the forwarding feature parameter applies to all provisioned basic services.

### CLI restriction Info

The CLI-RestrictionInfo parameter is returned by the responder when the interrogation request applies to the CLIR supplementary service.

### EMLPP Info

The eMLPP info (maximum entitled priority and default priority) is returned by the responder if the interrogation request applies to the eMLPP supplementary service.

### CCBS Feature LIST

The CCBS feature parameter is described in clause 7.6. A list of one or more CCBS features is returned by the responder when the interrogation request applied to the CCBS supplementary service. See GSM 03.93 [107] for the conditions for the presence of the parameters included in the CCBS feature.

### User error

This error is sent by the responder upon unsuccessful outcome of the interrogation service, and then takes one of the following values, defined in clause 7.6.1:

- System failure;
- Data Missing;
- Unexpected data value;
- Bearer Service not provisioned;

This error is returned only if not even a subset of the interrogated bearer services are provided.

- Teleservice not provisioned;

This error is returned only if not even a subset of the interrogated teleservices are provided.

- Call Barred;
- Illegal SS operation;
- SS not available.

### Provider error

See clause 7.6.1 for the use of this parameter.

## 11.6 MAP\_INVOKE\_SS service

### 11.6.1 Definitions

This service is used between the MSC and the VLR to check the subscriber's subscription to a given supplementary service in the VLR, in connection with in-call invocation of that supplementary service, i.e. after the call set-up phase is finished. For supplementary service invocation during call set-up phase, please refer to the call handling descriptions.

The service is a confirmed service and consists of four service primitives.

## 11.6.2 Service primitives

The service primitives are shown in table 11.6/1.

**Table 11.6/1: MAP\_INVOKE\_SS parameters**

Parameter name	Request	Indication	Response	Confirm
Invoke id	M	M(=)	M(=)	M(=)
SS-Code	M	M(=)		
Basic service	C	C(=)		
User error			C	C(=)
Provider error				O

## 11.6.3 Parameter use

### Invoke id

See clause 7.6.1 for the use of this parameter.

### SS-Code

This SS-Code can only refer to a single supplementary service, e.g. the Call Hold or Multi Party supplementary services.

### Basic service

This parameter indicates for which basic service the supplementary service invocation is required.

### User error

This parameter is sent by the responder upon unsuccessful outcome of the service, and then takes one of the following values:

- System Failure;
- Data Missing;
- Unexpected data value;
- Call Barred;
- Illegal SS operation;
- SS error status;
- SS not available.

### Provider error

See clause 7.6.1 for the use of this parameter.

## 11.7 MAP\_REGISTER\_PASSWORD service

### 11.7.1 Definitions

This service is used between the MSC and the VLR and between the VLR and the HLR if the mobile subscriber requests to register a new password. The VLR will relay the message to the HLR.

The service is a confirmed service and consists of four service primitives.

## 11.7.2 Service primitives

The service primitives are shown in table 11.7/1.

**Table 11.7/1: MAP\_REGISTER\_PASSWORD parameters**

Parameter name	Request	Indication	Response	Confirm
Invoke id	M	M(=)	M(=)	M(=)
SS-Code	M	M(=)		
New password			C	C(=)
User error			C	C(=)
Provider error				O

## 11.7.3 Parameter use

### Invoke id

See clause 7.6.1 for the use of this parameter.

### SS-Code

This parameter indicates for which supplementary service(s) the password should be registered.

### New Password

See clause 7.6.4 for the use of this parameter.

### User error

This parameter is sent by the responder upon unsuccessful outcome of the service, and then takes one of the following values, defined in clause 7.6.1:

- System failure;
- Data Missing;
- Unexpected data value;
- Call Barred;
- SS subscription violation;
- Password registration failure;
- Negative PW check;
- Number Of PW Attempts Violation.

### Provider error

See clause 7.6.1 for the use of this parameter.

## 11.8 MAP\_GET\_PASSWORD service

### 11.8.1 Definitions

This service is used between the HLR and the VLR and between the VLR and the MSC when the HLR receives a request from the mobile subscriber for an operation on a supplementary service which requires a password from the subscriber. The VLR will relay the message to the MSC.

The service is a confirmed service and consists of four service primitives.



## 11.8.2 Service primitives

The service primitives are shown in table 11.8/1.

**Table 11.8/1: MAP\_GET\_PASSWORD parameters**

Parameter name	Request	Indication	Response	Confirm
Invoke id	M	M(=)	M(=)	M(=)
Linked id	C	C(=)		
Guidance info	M	M(=)		
Current password			M	M(=)
Provider error				O

## 11.8.3 Parameter use

### Invoke id

See clause 7.6.1 for the use of this parameter.

### Linked Id

See clause 7.6.1 for the use of this parameter. If the MAP GET PASSWORD service is used in conjunction with the MAP REGISTER PASSWORD service, this parameter must be present; otherwise it must be absent.

### Guidance info

See clause 7.6.4 for the use of this parameter.

### Current password

See clause 7.6.4 for the use of this parameter.

### Provider error

See clause 7.6.1 for the use of this parameter.

## 11.9 MAP\_PROCESS\_UNSTRUCTURED\_SS\_REQUEST service

### 11.9.1 Definitions

This service is used between the MSC and the VLR, between the VLR and the HLR and between the HLR and gsmSCF to relay information in order to allow unstructured supplementary service operation.

The MAP\_PROCESS\_UNSTRUCTURED\_SS\_REQUEST service is a confirmed service using the primitives from table 11.9/1.

### 11.9.2 Service primitives

**Table 11.9/1: MAP\_PROCESS\_UNSTRUCTURED\_SS\_REQUEST parameters**

Parameter name	Request	Indication	Response	Confirm
Invoke id	M	M(=)	M(=)	M(=)
USSD Data Coding Scheme	M	M(=)	C	C(=)
USSD String	M	M(=)	C	C(=)
MSISDN	U	C(=)		
User error			C	C(=)
Provider error				O

## 11.9.3 Parameter use

### Invoke id

See clause 7.6.1 for the use of this parameter.

### USSD Data Coding Scheme:

See clause 7.6.4 for the use of this parameter. The presence of the parameter in the response is dependent on the unstructured supplementary service application. If this parameter is present, then the USSD String parameter has to be present.

### USSD String:

See clause 7.6.1 for the use of this parameter. The presence of the parameter in the response is dependent on the unstructured supplementary service application. If this parameter is present, then the USSD Data Coding Scheme parameter has to be present.

### MSISDN:

The subscriber's basic MSISDN.

See definition in clause 7.6.2. The MSISDN is included as an operator option, e.g. to allow addressing the subscriber's data in the gsmSCF with the MSISDN.

### User error

This parameter is sent by the responder upon unsuccessful outcome of the service, and then takes one of the following values defined in clause 7.6.1:

- System failure;
- Data missing;
- Unexpected data value;

This error is returned by the responder if it is not able to deal with the contents of the USSD string.

- Call Barred;
- Unknown Alphabet.

### Provider error

See clause 7.6.1 for the use of this parameter.

## 11.10 MAP\_UNSTRUCTURED\_SS\_REQUEST service

### 11.10.1 Definitions

This service is used between the gsmSCF and the HLR, the HLR and the VLR and between the VLR and the MSC when the invoking entity requires information from the mobile user, in connection with unstructured supplementary service handling.

The MAP\_UNSTRUCTURED\_SS\_REQUEST service is a confirmed service using the primitives from table 11.10/1.

## 11.10.2 Service primitives

The service primitives are shown in table 11.10/1.

**Table 11.10/1: MAP\_UNSTRUCTURED\_SS\_REQUEST parameters**

Parameter name	Request	Indication	Response	Confirm
Invoke id	M	M(=)	M(=)	M(=)
USSD Data Coding Scheme	M	M(=)	C	C(=)
USSD String	M	M(=)	C	C(=)
Alerting Pattern	C	C(=)		
User error			C	C(=)
Provider error				O

## 11.10.3 Parameter use

### Invoke id

See clause 7.6.1 for the use of this parameter.

### USSD Data Coding Scheme:

See clause 7.6.4 for the use of this parameter. The presence of the parameter in the response is dependent on the mobile user's MMI input. If this parameter is present, then the USSD String parameter has to be present.

### USSD String:

See clause 7.6.1 for the use of this parameter. The presence of the parameter in the response is dependent on the mobile user's MMI input. If this parameter is present, then the USSD Data Coding Scheme parameter has to be present.

### Alerting Pattern

See clause 7.6.3 for the use of this parameter.

### User error

This parameter is sent by the responder upon unsuccessful outcome of the service, and then takes one of the following values defined in clause 7.6.1:

- System failure;
- Data missing;
- Unexpected data value;

This error is returned by the responder if it is not able to deal with the contents of the USSD string.

- Absent Subscriber;
- Illegal Subscriber;

This error indicates that delivery of the unstructured supplementary service data failed because the MS failed authentication.

- Illegal Equipment;
- USSD Busy;
- Unknown Alphabet.

### Provider error

See clause 7.6.1 for the use of this parameter.

## 11.11 MAP\_UNSTRUCTURED\_SS\_NOTIFY service

### 11.11.1 Definitions

This service is used between the gsmSCF and the HLR, the HLR and the VLR and between the VLR and the MSC when the invoking entity requires a notification to be sent to the mobile user, in connection with unstructured supplementary services handling.

The MAP\_UNSTRUCTURED\_SS\_NOTIFY service is a confirmed service using the primitives from table 11.11/1.

### 11.11.2 Service primitives

The service primitives are shown in table 11.11/1.

**Table 11.11/1: MAP\_UNSTRUCTURED\_SS\_NOTIFY parameters**

Parameter name	Request	Indication	Response	Confirm
Invoke id	M	M(=)	M(=)	M(=)
USSD Data Coding Scheme	M	M(=)		
USSD String	M	M(=)		
Alerting Pattern	C	C(=)		
User error			C	C(=)
Provider error				O

### 11.11.3 Parameter use

#### Invoke id

See clause 7.6.1 for the use of this parameter.

#### USSD Data Coding Scheme:

See clause 7.6.4 for the use of this parameter.

#### USSD String:

See clause 7.6.1 for the use of this parameter.

#### Alerting Pattern

See clause 7.6.3 for the use of this parameter.

#### User error

This parameter is sent by the responder upon unsuccessful outcome of the service, and then takes one of the following values defined in clause 7.6.1:

- System failure;
- Data missing;
- Unexpected data value;

This error is returned by the responder if it is not able to deal with the contents of the USSD string.

- Absent Subscriber;
- Illegal Subscriber;

This error indicates that delivery of the unstructured supplementary service data failed because the MS failed authentication.

- Illegal Equipment;
- USSD Busy;
- Unknown Alphabet.

#### Provider error

See clause 7.6.1 for the use of this parameter.

## 11.12 MAP\_SS\_INVOCATION\_NOTIFY

### 11.12.1 Definition

This service is used between the MSC and the gsmSCF when the subscriber invokes one of the following supplementary services; CD, ECT or MPTY.

### 11.12.2 Service primitives

The service primitives are shown in table 11.12/1.

**Table 11.12/1: SS\_INVOCATION\_NOTIFY parameters**

Parameter name	Request	Indication	Response	Confirm
Invoke id	M	M(=)	M(=)	M(=)
MSISDN	M	M(=)		
IMSI	M	M(=)		
SS- event	M	M(=)		
SS- event data	C	C(=)		
User error			C	C(=)
Provider error				O

### 11.12.3 Parameter use

All parameters are described in clause 7.6. The use of these parameters and the requirements for their presence are specified in GSM 03.78.

#### User error

This parameter is sent by the responder when an error is detected and if present, takes one of the following values:

- Data Missing;
- Unexpected Data Value;
- Unknown Subscriber.

#### Provider error

This is defined in clause 7.6.1.

## 11.13 MAP\_REGISTER\_CC\_ENTRY service

### 11.13.1 Definition

This service is used between the MSC and the VLR and between the VLR and the HLR to register data for a requested call completion supplementary service. The VLR will relay the message to the HLR.

The service is a confirmed service and uses the service primitives shown in table 11.13/1.

## 11.13.2 Service primitives

The service primitives are shown in table 11.13/1.

**Table 11.13/1: MAP\_REGISTER\_CC\_ENTRY parameters**

Parameter name	Request	Indication	Response	Confirm
Invoke id	M	M(=)	M(=)	M(=)
SS Code	M	M(=)		
CCBS Feature	C	C(=)	C	C(=)
Translated B number	C	C(=)		
Service Indicator	C	C(=)		
Call Info	C	C(=)		
Network Signal Info	C	C(=)		
User error			C	C(=)
Provider error				O

## 11.13.3 Parameter use

See clause 7.6 for a definition of the parameters used, in addition to the following.

### SS-Code

This parameter indicates the call completion supplementary service for which the mobile subscriber wants to register an entry.

### CCBS Feature

See GSM 03.93 for the conditions for the presence of the parameters included in the CCBS feature.

### Translated B Number

See GSM 03.93 for the use of this parameter and the conditions for its presence.

### Service Indicator

This parameter corresponds to the parameters 'Presentation Indicator' and 'CAMEL Invoked' in GSM 03.93 [107]. It indicates which services have been invoked for the original call (e.g. CLIR, Camel). See GSM 03.93 [107] for the use of this parameter and the conditions for its presence.

### Call Info

See GSM 03.93 [107] for the use of this parameter and the conditions for its presence.

### Network Signal Info

See GSM 03.93 [107] for the use of this parameter and the conditions for its presence.

### User error

This parameter is sent by the responder upon unsuccessful outcome of the service, and then takes one of the following values, defined in clause 7.6.1:

- System failure;
- Data missing;
- Unexpected data value;
- Call Barred;
- Illegal SS operation;
- SS error status;

- SS incompatibility;
- Short Term Denial;
- Long Term Denial;
- Facility Not Supported.

NOTE: This error is reserved for future use.

Private Extensions shall not be sent with these user errors for this operation.

#### Provider error

See clause 7.6.1 for the use of this parameter.

## 11.14 MAP\_ERASE\_CC\_ENTRY service

### 11.14.1 Definition

This service is used between the MSC and the VLR and between the VLR and the HLR to erase data related to a call completion supplementary service. The VLR will relay the message to the HLR.

The service is a confirmed service and uses the service primitives shown in table 11.14/1.

### 11.14.2 Service primitives

The service primitives are shown in table 11.14/1.

**Table 11.14/1: MAP\_ERASE\_CC\_ENTRY parameters**

Parameter name	Request	Indication	Response	Confirm
Invoke id	M	M(=)	M(=)	M(=)
SS-Code	M	M(=)	C(=)	C(=)
CCBS Index	C	C(=)		
SS-Status			C	C(=)
User error			C	C(=)
Provider error				O

### 11.14.3 Parameter use

See clause 7.6 for a definition of the parameters used, in addition to the following.

#### SS-Code

This parameter indicates the call completion supplementary service for which the mobile subscriber wants to erase an entry/entries.

#### CCBS Index

See GSM 03.93 for the use of this parameter and the condition for its presence.

#### SS-Status

Depending on the outcome of the service request this parameter may indicate either provisioned and active or not provisioned.

User error

This parameter is sent by the responder upon unsuccessful outcome of the service, and then takes one of the following values, defined in clause 7.6.1:

- System failure;
- Data Missing;
- Unexpected data value;
- Call Barred;
- Illegal SS operation;
- SS error status.

Private Extensions shall not be sent with these user errors for this operation.

Provider error

See clause 7.6.1 for the use of this parameter.

## 12 Short message service management services

### 12.1 MAP-SEND-ROUTING-INFO-FOR-SM service

#### 12.1.1 Definition

This service is used between the gateway MSC and the HLR to retrieve the routing information needed for routing the short message to the servicing MSC.

The MAP-SEND-ROUTING-INFO-FOR-SM is a confirmed service using the primitives from table 12.1/1.

#### 12.1.2 Service primitives

The service primitives are shown in table 12.1/1.

**Table 12.1/1: MAP-SEND-ROUTING-INFO-FOR-SM**

Parameter name	Request	Indication	Response	Confirm
Invoke Id	M	M(=)	M(=)	M(=)
MSISDN	M	M(=)		
SM-RP-PRI	M	M(=)		
Service Centre Address	M	M(=)		
SM-RP-MTI	C	C(=)		
SM-RP-SMEA	C	C(=)		
GPRS Support Indicator	C	C(=)		
IMSI			C	C(=)
Network Node Number			C	C(=)
LMSI			C	C(=)
GPRS Node Indicator			C	C(=)
Additional Number			C	C(=)
User error			C	C(=)
Provider error				O



### 12.1.3 Parameter use

**Invoke id:**

See definition in clause 7.6.1.

**MSISDN:**

See definition in clause 7.6.2.

**SM-RP-PRI:**

See definition in clause 7.6.8.

**Service Centre Address:**

See definition in clause 7.6.2.

**SM-RP-MTI :**

See definition in clause 7.6.8. This parameter shall be present when the feature « SM filtering by the HPLMN » is supported by the SMS-GMSC and when the equivalent parameter is received from the short message service relay sub-layer protocol.

**SM-RP-SMEA:**

See definition in clause 7.6.8. This parameter shall be present when the feature « SM filtering by the HPLMN » is supported by the SMS-GMSC and when the equivalent parameter is received from the the short message service relay sub-layer protocol.

**GPRS Support Indicator:**

See definition in clause 7.6.8. The presence of this parameter is mandatory if the SMS-GMSC supports receiving of the two numbers from the HLR.

**IMSI:**

See definition in clause 7.6.2. The presence of this parameter is mandatory in a successful case.

**Network Node Number:**

See definition in clause 7.6.2. This parameter is provided in a successful response.

**LMSI:**

See definition in clause 7.6.2. It is an operator option to provide this parameter from the VLR; it is mandatory for the HLR to include the LMSI in a successful response, if the VLR has used the LMSI.

**GPRS Node Indicator:**

See definition in clause 7.6.8. The presence of this parameter is mandatory if only the SGSN number is sent in the Network Node Number.

**Additional Number:**

See definition in clause 7.6.2. This parameter is provided in a successful response.

**User error:**

The following errors defined in clause 7.6.1 may be used, depending on the nature of the fault:

- Unknown subscriber;
- Call Barred;
- Teleservice Not Provisioned;
- Absent Subscriber\_SM;

- Facility Not Supported;
- System failure;
- Unexpected Data Value;
- Data missing.

**Provider error:**

For definition of provider errors see clause 7.6.1.

## 12.2 MAP-MO-FORWARD-SHORT-MESSAGE service

### 12.2.1 Definition

This service is used between the serving MSC or the SGSN and the SMS Interworking MSC to forward mobile originated short messages.

The MAP-MO-FORWARD-SHORT-MESSAGE service is a confirmed service using the service primitives given in table 12.2/1.

### 12.2.2 Service primitives

The service primitives are shown in table 12.2/1.

**Table 12.2/1: MAP-MO-FORWARD-SHORT-MESSAGE**

Parameter name	Request	Indication	Response	Confirm
Invoke Id	M	M(=)	M(=)	M(=)
SM RP DA	M	M(=)		
SM RP OA	M	M(=)		
SM RP UI	M	M(=)	C	C(=)
User error			C	C(=)
Provider error				O

### 12.2.3 Parameter use

**Invoke id:**

See definition in clause 7.6.1.

**SM RP DA:**

See definition in clause 7.6.8.

In the mobile originated SM transfer this parameter contains the Service Centre address received from the mobile station.

**SM RP OA:**

See definition in clause 7.6.8.

The MSISDN received from the VLR or from the SGSN is inserted in this parameter in the mobile originated SM transfer.

**SM RP UI:**

See definition in clause 7.6.8. The short message transfer protocol data unit received from the Service Centre is inserted in this parameter.

**User error:**

The following errors defined in clause 7.6.1 may be used, depending on the nature of the fault:

- Facility Not Supported;
- System Failure;
- SM Delivery Failure;
  - The reason of the SM Delivery Failure can be one of the following in the mobile originated SM:
    - unknown Service Centre address;
    - Service Centre congestion;
    - invalid Short Message Entity address;
    - subscriber not Service Centre subscriber;
    - protocol error.
- Unexpected Data Value

**Provider error:**

For definition of provider errors see clause 7.6.1.

## 12.3 MAP-REPORT-SM-DELIVERY-STATUS service

### 12.3.1 Definition

This service is used between the gateway MSC and the HLR. The MAP-REPORT-SM-DELIVERY-STATUS service is used to set the Message Waiting Data into the HLR or to inform the HLR of successful SM transfer after polling. This service is invoked by the gateway MSC.

The MAP-REPORT-SM-DELIVERY-STATUS service is a confirmed service using the service primitives given in table 12.3/1.

### 12.3.2 Service primitives

The service primitives are shown in table 12.3/1.

**Table 12.3/1: MAP-REPORT-SM-DELIVERY-STATUS**

Parameter name	Request	Indication	Response	Confirm
Invoke Id	M	M(=)	M(=)	M(=)
MSISDN	M	M(=)		
Service Centre Address	M	M(=)		
SM Delivery Outcome	M	M(=)		
Absent Subscriber	C	C(=)		
Diagnostic SM				
GPRS Support Indicator	C	C(=)		
Delivery Outcome Indicator	C	C(=)		
Additional SM Delivery Outcome	C	C(=)		
Additional Absent Subscriber	C	C(=)		
Diagnostic SM				
MSISdn-Alert			C	C(=)
User error			C	C(=)
Provider error				O

### 12.3.3 Parameter use

**Invoke id:**

See definition in clause 7.6.1.

**MSISDN:**

See definition in clause 7.6.2.

**Service Centre Address:**

See definition in clause 7.6.2.

**SM Delivery Outcome:**

See definition in clause 7.6.8. This parameter indicates the status of the mobile terminated SM delivery.

**Absent Subscriber Diagnostic SM:**

See definition in clause 7.6.8.

**GPRS Support Indicator:**

See definition in clause 7.6.8. The presence of this parameter is mandatory if the SMS-GMSC supports handling of two delivery outcomes.

**Delivery Outcome Indicator:**

See definition in clause 7.6.8.

**Additional SM Delivery Outcome:**

See definition in clause 7.6.8.

**Additional Absent Subscriber Diagnostic SM:**

See definition in clause 7.6.8.

**MSISdn-Alert:**

See definition in clause 7.6.2. This parameter shall be present in case of unsuccessful delivery, when the MSISDN received in the operation is different from the stored MSISdn-Alert; the stored MSISdn-Alert is the value that is returned to the gateway MSC.

**User error:**

The following errors defined in clause 7.6.1 may be used, depending on the nature of the fault:

- Unknown Subscriber;
- Message Waiting List Full;
- Unexpected Data Value;
- Data missing.

**Provider error:**

For definition of provider errors see clause 7.6.1.

## 12.4 MAP-READY-FOR-SM service

### 12.4.1 Definition

This service is used between the MSC and VLR and as well between the VLR and the HLR. The MSC initiates this service if a subscriber indicates memory available situation. The VLR uses the service to indicate this to the HLR.

The VLR initiates this service if a subscriber, whose message waiting flag is active in the VLR, has radio contact in the MSC.

Also this service is used between the SGSN and the HLR. The SGSN initiates this service if a subscriber indicates memory available situation. The SGSN uses the service to indicate this to the HLR.

The SGSN initiates this service if a subscriber, whose message waiting flag is active in the SGSN, has radio contact in the GPRS.

The MAP-READY-FOR-SM service is a confirmed service using the primitives from table 12.4/1.

### 12.4.2 Service primitives

The service primitives are shown in table 12.4/1.

**Table 12.4/1: MAP-READY-FOR-SM**

Parameter name	Request	Indication	Response	Confirm
Invoke Id	M	M(=)	M(=)	M(=)
IMSI	C	C(=)		
TMSI	C	C(=)		
Alert Reason	M	M(=)		
Alert Reason Indicator	C	C(=)		
User error			C	C(=)
Provider error				O

### 12.4.3 Parameter use

#### **Invoke id:**

See definition in clause 7.6.1.

See definition in clause 7.6.2. The IMSI is used always between the VLR and the HLR and between the SGSN and the HLR. Between the MSC and the VLR the identification can be either IMSI or TMSI.

#### **TMSI:**

See definition in clause 7.6.2. The identification can be either IMSI or TMSI between MSC and VLR.

#### **Alert Reason:**

See definition in clause 7.6.8. This parameter indicates if the mobile subscriber is present or the MS has memory available.

#### **Alert Reason Indicator:**

See definition in clause 7.6.8.

**User error:**

The following errors defined in clause 7.6.1 may be used, depending on the nature of the fault:

- Unknown Subscriber;
- Facility Not Supported;
- System Failure;
- Unexpected Data Value;
- Data missing;

**Provider error:**

For definition of provider errors see clause 7.6.1.

## 12.5 MAP-ALERT-SERVICE-CENTRE service

### 12.5.1 Definition

This service is used between the HLR and the interworking MSC. The HLR initiates this service, if the HLR detects that a subscriber, whose MSISDN is in the Message Waiting Data file, is active or the MS has memory available.

The MAP-ALERT-SERVICE-CENTRE service is a confirmed service using the primitives from table 12.5/1.

### 12.5.2 Service primitives

The service primitives are shown in table 12.5/1.

**Table 12.5/1: MAP-ALERT-SERVICE-CENTRE**

Parameter name	Request	Indication	Response	Confirm
Invoke Id	M	M(=)	M(=)	M(=)
MSISdn-Alert	M	M(=)		
Service Centre Address	M	M(=)		
User error			C	C(=)
Provider error				O

### 12.5.3 Parameter use

**Invoke id:**

See definition in clause 7.6.1.

**MSISdn-Alert:**

See definition in clause 7.6.2. The provided MSISDN shall be the one which is stored in the Message Waiting Data file.

**Service Centre Address:**

See definition in clause 7.6.2.

**User error:**

The following errors defined in clause 7.6.1 may be used, depending on the nature of the fault:

- System Failure;
- Unexpected Data Value;
- Data missing.

**Provider error:**

For definition of provider errors see clause 7.6.1.

## 12.6 MAP-INFORM-SERVICE-CENTRE service

### 12.6.1 Definition

This service is used between the HLR and the gateway MSC to inform the Service Centre which MSISDN number is stored in the Message Waiting Data file. If the stored MSISDN number is not the same than the one received from the gateway MSC in the MAP-SEND-ROUTING-INFO-FOR-SM service primitive the stored MSISDN number is included in the message.

Additionally the status of MCEF, MNRF and MNRG flags and the inclusion of the particular Service Centre address in the Message Waiting Data list is informed to the gateway MSC when appropriate.

The MAP-INFORM-SERVICE-CENTRE service is a non-confirmed service using the primitives from table 12.6/1.

### 12.6.2 Service primitives

The service primitives are shown in table 12.6/1.

**Table 12.6/1: MAP-INFORM-SERVICE-CENTRE**

Parameter name	Request	Indication
Invoke Id	M	M(=)
MSIsdn-Alert	C	C(=)
MWD Status	C	C(=)

### 12.6.3 Parameter use

**Invoke id:**

See definition in clause 7.6.1.

**MSIsdn-Alert:**

See definition in clause 7.6.2 This parameter refers to the MSISDN stored in a Message Waiting Data file in the HLR.

**MWD Status:**

See definition in clause 7.6.8. This parameter indicates the status of the MCEF, MNRF and MNRG flags and the status of the particular SC address presence in the Message Waiting Data list.

## 12.7 MAP-SEND-INFO-FOR-MT-SMS service

### 12.7.1 Definition

This service is used between the MSC and the VLR. The service is invoked by the MSC receiving an mobile terminated short message to request subscriber related information from the VLR.

The MAP-SEND-INFO-FOR-MT-SMS service is a confirmed service using the primitives from table 12.7/1.

### 12.7.2 Service primitives

The service primitives are shown in table 12.7/1.

Table 12.7/1: MAP-SEND-INFO-FOR-MT-SMS

Parameter name	Request	Indication	Response	Confirm
Invoke Id	M	M(=)	M(=)	M(=)
SM RP DA	M	M(=)		
MSISDN			C	C(=)
User error			C	C(=)
Provider error				O

### 12.7.3 Parameter use

#### Invoke id:

See definition in clause 7.6.1.

#### SM RP DA:

See definition in clause 7.6.8. This parameter shall contain either an IMSI or a LMSI.

#### MSISDN:

See definition in clause 7.6.2.

#### User error:

The following errors defined in clause 7.6.1 may be used, depending on the nature of the fault:

- Unknown subscriber;
- Unidentified Subscriber;
- Absent subscriber;
- Unexpected Data Value;
- Data Missing;
- Illegal subscriber;
- Illegal equipment;
- Subscriber busy for MT SMS;
- System Failure.

#### Provider error:

For definition of provider errors see clause 7.6.1.

## 12.8 MAP-SEND-INFO-FOR-MO-SMS service

### 12.8.1 Definition

This service is used between the MSC and the VLR. The service is invoked by the MSC which has to handle a mobile originated short message request to request the subscriber related information from the VLR.

The MAP-SEND-INFO-FOR-MO-SMS service is a confirmed service using the primitives from table 12.8/1.

### 12.8.2 Service primitives

The service primitives are shown in table 12.8/1.



Table 12.8/1: MAP-SEND-INFO-FOR-MO-SMS

Parameter name	Request	Indication	Response	Confirm
Invoke Id	M	M(=)	M(=)	M(=)
Service Centre Address	M	M(=)		
MSISDN			C	C(=)
User error			C	C(=)
Provider error				O

### 12.8.3 Parameter use

#### Invoke id:

See definition in clause 7.6.1.

#### Service Centre Address:

See definition in clause 7.6.2.

#### MSISDN:

See definition in clause 7.6.2.

#### User error:

The following errors defined in clause 7.6.1 may be used, depending on the nature of the fault:

- Teleservice Not Provisioned;
- Call Barred;
- Unexpected Data Value;
- Data Missing.

#### Provider error:

For definition of provider errors see clause 7.6.1.

## 12.9 MAP-MT-FORWARD-SHORT-MESSAGE service

### 12.9.1 Definition

This service is used between the gateway MSC and the servicing MSC or the SGSN to forward mobile mobile terminated short messages.

The MAP-MT-FORWARD-SHORT-MESSAGE service is a confirmed service using the service primitives given in table 12.9/1.

### 12.9.2 Service primitives

The service primitives are shown in table 12.9/1.

**Table 12.9/1: MAP-MT-FORWARD-SHORT-MESSAGE**

Parameter name	Request	Indication	Response	Confirm
Invoke Id	M	M(=)	M(=)	M(=)
SM RP DA	M	M(=)		
SM RP OA	M	M(=)		
SM RP UI	M	M(=)	C	C(=)
More Messages To Send	C	C(=)		
User error			C	C(=)
Provider error				O

### 12.9.3 Parameter use

#### **Invoke id:**

See definition in clause 7.6.1.

#### **SM RP DA:**

See definition in clause 7.6.8. This parameter can contain either an IMSI or a LMSI. The use of the LMSI is an operator option. The LMSI can be provided if it is received from the HLR. The IMSI is used if the use of the LMSI is not available.

This parameter is omitted in the mobile terminated subsequent SM transfers.

#### **SM RP OA:**

See definition in clause 7.6.8. The Service Centre address received from the originating Service Centre is inserted in this parameter .

This parameter is omitted in the mobile terminated subsequent SM transfers.

#### **SM RP UI:**

See definition in clause 7.6.8. The short message transfer protocol data unit received from the Service Centre is inserted in this parameter. A short message transfer protocol data unit may also be inserted in this parameter in the message delivery acknowledgment from the MSC or from the SGSN to the Service Centre.

#### **More Messages To Send:**

See definition in clause 7.6.8. The information from the MMS indication received from the Service Centre is inserted in this parameter.

#### **User error:**

The following errors defined in clause 7.6.1 may be used, depending on the nature of the fault:

- Unidentified subscriber;
- Absent Subscriber\_SM;
- Subscriber busy for MT SMS;
- Facility Not Supported;
- Illegal Subscriber indicates that delivery of the mobile terminated short message failed because the mobile station failed authentication;
- Illegal equipment indicates that delivery of the mobile terminated short message failed because an IMEI check failed, i.e. the IMEI was blacklisted or not white-listed;
- System Failure;

- SM Delivery Failure;
  - The reason of the SM Delivery Failure can be one of the following in the mobile terminated SM:
    - memory capacity exceeded in the mobile equipment;
    - protocol error;
    - mobile equipment does not support the mobile terminated short message service.
- Unexpected Data Value;
- Data Missing.

**Provider error:**

For definition of provider errors see clause 7.6.1.

## 13 Network-Requested PDP Context Activation services

### 13.1 MAP\_SEND\_ROUTING\_INFO\_FOR\_GPRS service

#### 13.1.1 Definition

This service is used by the GGSN to request GPRS routing information from the HLR.

#### 13.1.2 Service primitives

**Table 13.1/1: MAP\_SEND\_ROUTING\_INFO\_FOR\_GPRS**

Parameter name	Request	Indication	Response	Confirm
Invoke id	M	M(=)	M(=)	M(=)
IMSI	M	M(=)		
GGSN address	C	C(=)	C	C(=)
GGSN number	M	M(=)		
SGSN address			C	C(=)
Mobile Not Reachable Reason			C	C(=)
User error			C	C(=)
Provider error				O

#### 13.1.3 Parameter definition and use

##### Invoke Id

See definition in clause 7.6.1.

##### IMSI

See definition in clause 7.6.2.

##### GGSN address

This parameter shall be present if the protocol-converting GSN is used between the GGSN and the HLR.

##### GGSN number

See definition in clause 7.6.2.

SGSN address

This parameter shall be present if the outcome of the Send Routing Info For GPRS request to the GPRS application process in the HLR is positive.

Mobile Not Reachable Reason

This parameter shall be present if the outcome of the Send Routing Info For GPRS request to the GPRS application process in the HLR is positive and the MNRG flag in the HLR is set. See definition in clause 7.6.3.51.

User error

This parameter is sent by the responder when an error is detected and if present, takes one of the following values:

- Absent Subscriber;
- System Failure;
- Data Missing;
- Unexpected Data Value;
- UnknownSubscriber.

The diagnostic in the Unknown Subscriber may indicate "Imsi Unknown" or "Gprs Subscription Unknown".

Provider error

These are defined in clause 7.6.1.

## 13.2 MAP\_FAILURE\_REPORT service

### 13.2.1 Definition

This service is used by the GGSN to inform the HLR that network requested PDP-context activation has failed.

### 13.2.2 Service primitives

**Table 13.2/1: MAP\_FAILURE\_REPORT**

Parameter name	Request	Indication	Response	Confirm
Invoke id	M	M(=)	M(=)	M(=)
IMSI	M	M(=)		
GGSN address	C	C(=)		
GGSN number	M	M(=)		
User error			C	C(=)
Provider error				O

### 13.2.3 Parameter definition and use

Invoke Id

See definition in clause 7.6.1.

IMSI

See definition in clause 7.6.2.

GGSN address

This parameter shall be present if the protocol-converting GSN is used between the GGSN and the HLR.

GGSN number

See definition in clause 7.6.2.

User error

This parameter is sent by the responder when an error is detected and if present, takes one of the following values:

- System Failure;
- Data Missing;
- Unexpected Data Value;
- UnknownSubscriber.

Provider error

These are defined in clause 7.6.1.

## 13.3 MAP\_NOTE\_MS\_PRESENT\_FOR\_GPRS service

### 13.3.1 Definition

This service is used by the HLR to inform the GGSN that the MS is present for GPRS again.

### 13.3.2 Service primitives

**Table 13.3/1: MAP\_NOTE\_MS\_PRESENT\_FOR\_GPRS**

Parameter name	Request	Indication	Response	Confirm
Invoke id	M	M(=)	M(=)	M(=)
IMSI	M	M(=)		
GGSN address	C	C(=)		
SGSN address	M	M(=)		
User error			C	C(=)
Provider error				O

### 13.3.3 Parameter definition and use

Invoke Id

See definition in clause 7.6.1.

IMSI

See definition in clause 7.6.2.

GGSN address

This parameter shall be present if the protocol-converting GSN is used between the GGSN and the HLR.

SGSN address

See definition in clause 7.6.2.

### User error

This parameter is sent by the responder when an error is detected and if present, takes one of the following values:

- System Failure;
- Data Missing;
- Unexpected Data Value;
- UnknownSubscriber.

### Provider error

These are defined in clause 7.6.1.

---

## 14 General

### 14.1 Overview

Clause 14 to 17 specify the protocol elements to be used to provide the MAP services described in clause 7.

Clause 15 specifies the elements of procedures for the MAP protocol. Clause 16 specifies the mapping on to TC service primitives. Clause 17 specifies the application contexts, operation packages and abstract syntaxes for the MAP protocol as well as the encoding rules to be applied.

### 14.2 Underlying services

The MAP protocol relies on the services provided by the Transaction Capabilities (TC) of signalling system number 7, as referenced in clause 6.

### 14.3 Model

The MAP Protocol Machine (MAP PM) can be modelled as a collection of service state machines (SSMs) - one per MAP specific service invoked - coordinated by a MAP dialogue control function with its one state machine: MAP dialogue state machine (DSM). There are two types of Service State Machines: Requesting Service State Machines (RSM) and Performing Service State Machines (PSM).

A new invocation of a MAP PM is employed on the receipt of a MAP-OPEN request primitive or a TC-BEGIN indication primitive. Each invocation controls exactly one MAP dialogue. For each MAP specific service invoked during a dialogue, a MAP RSM is created at the requestor's side and a MAP PSM is created at the performer's side.

This modelling is used only to facilitate understanding and the MAP behaviour descriptions and is not intended to suggest any implementation. SDL descriptions are organized according to this model.

How the MAP-service-user and the MAP refer to a MAP dialogue (i.e. a MAP PM invocation) is a local implementation matter.

How TC dialogue identifiers are assigned to a MAP PM invocation is also a local implementation matter.

### 14.4 Conventions

The behaviour of the MAP PM depends on the application-context-name associated with the dialogue. One major difference is that the MAP requests the transfer of the application-context-name by TC only for those contexts which do not belong to the so-called "version one context set".

The "version one context set" is a set of application-contexts which model the behaviour of a MAP V1 implementation according to the latest phase 1 version of GSM 09.02. This set is defined in clause 15.

The procedures described in clause 15 are used when the application-context-name does not refer to a dialogue between an MSC and its VLR. When the application-context-name refers to a dialogue between an MSC and its VLR the MAP PM procedures are a local implementation matter.

---

## 15 Elements of procedure

### 15.1 Dialogue establishment

The establishment of a MAP dialogue involves two MAP-service-users, one that is the dialogue-initiator and one that is the dialogue-responder.

This procedure is driven by the following signals:

- a MAP-OPEN request primitive from the dialogue-initiator;
- a TC-BEGIN indication primitive occurring at the responding side;
- a MAP-OPEN response primitive from the dialogue-responder;
- the first TC-CONTINUE indication primitive occurring at the initiating side.

and under specific conditions:

- a TC-END indication primitive occurring at the initiating side;
- a TC-U-ABORT indication primitive occurring at the initiating side;
- a TC-P-ABORT indication primitive occurring at the initiating side.

#### 15.1.1 Handling of unknown operations

Unknown operations (i.e. a standard operation introduced in a later version of 09.02 or a private operation) can be introduced in MAP in a backwards compatible way. This means, that the receiver of an unknown operation shall, if the dialogue state allows it, send a TC-REJECT component to the sender of the operation indicating 'unrecognised operation' and continue with the processing of further components or messages exchanged within the dialogue as if the unknown operation had not been received.

The standardised structure of a MAP dialogue shall not be affected by the invocation of unknown operations, i.e. if a dialogue uses only a TC-BEGIN message which is acknowledged by a TC-END message, a TC-CONTINUE message shall not be used to invoke an unknown operation. However the standardised structure of a MAP dialogue may be affected by the rejection of unknown operations, i.e. if a dialogue uses only a TC-BEGIN message which is acknowledged by a TC-END message, a TC-CONTINUE message followed by a TC-END message may be used to carry the rejection of an unknown operation and the response to the standardised operation. The entity which initiated a dialogue whose standardised structure is a TC-BEGIN message which is acknowledged by a TC-END message shall not send any messages in that dialogue after the TC-BEGIN.

Note that if the dialogue structure is affected as described in this paragraph the TC-CONTINUE shall include the dialogue portion required to confirm the acceptance of the dialogue.

Unknown operations can be invoked in the following types of messages (there is no restriction as to how many unknown operations can be invoked in a message):

- TC-BEGIN the component to invoke the unknown operation shall follow the component of the standard operation that is included in this message.
- TC-CONTINUE: the component to invoke the unknown operation may be transported as the only component in a stand-alone message or can be grouped with existing operations. In the latter case a specific sequencing of components is not required.
- TC-END: if the component to invoke the unknown operation is grouped with an existing operation a specific sequencing of components is not required.

The TC-REJECT component may be sent in the following messages:

- TC-CONTINUE or TC-END: either as the only component of the message or grouped with an existing component. The choice is up to the MAP-Service User.

If the received message contains only unknown operations the MAP-Service User shall send the TC-REJECT components in a TC-CONTINUE message to the peer entity, if the dialogue state allows it.

If the received message contains unknown operations and standard operations and the standardised structure of the dialogue requires the response to the standard operation to be sent within a TC-END message, then the MAP-Service User may send the response to the standard operations and the TC-REJECT components for the unknown operations in a TC-CONTINUE message followed by a TC-END message. A specific distribution of the components to the TC messages or a specific sequencing of components is not required.

Note that SDLs of clauses 19 - 25 do not show the report to the MAP-Service User about the reception of the unknown operation. This has been done for the sake of simplicity of description; the MAP PM may inform the MAP-Service User.

The sender of the unknown operation shall ensure that there is enough room in the used message for the unknown operation.

### 15.1.2 Receipt of a MAP-OPEN request primitive

On receipt of a MAP-OPEN request primitive the behaviour of the MAP PM shall be as follows:

The MAP PM shall accept zero, one or several user request primitives until a MAP-DELIMITER request primitive is received.

For each user request primitive, the MAP PM shall request the invocation of the associated operation using the TC-INVOKE service. See clause 15.6 for a description of the associated SSMs.

On receipt of the MAP-DELIMITER request primitive the MAP PM shall issue a TC-BEGIN request primitive. The application-context-name as well as the user information parameter (if any) shall be mapped to the corresponding TC-BEGIN parameters.

The requesting MAP PM waits for a TC indication primitive and does not accept any other primitive from its user, except a MAP-U-ABORT request or a MAP-CLOSE request.

### 15.1.3 Receipt of a TC-BEGIN indication

On receipt of a TC-BEGIN indication primitive, the MAP PM shall:

- if no application-context-name is included in the primitive and if the "Components present" indicator indicates "no components", issue a TC-U-ABORT request primitive (note 2). The local MAP-User is not informed.
- if no application-context-name is included in the primitive and if presence of components is indicated, wait for the first TC-INVOKE primitive, and derive a version 1 application-context-name from the operation code according to table 15.1/1 (note 1).

NOTE 1: In some cases, it may be necessary to analyse the operation argument.



Then:

- a) if no application-context-name can be derived (i.e. the operation code does not exist in MAP V1 specifications), the MAP PM shall issue a TC-U-ABORT request primitive (note 2). The local MAP-User is not informed.
- b) if an application-context-name can be derived and if it is acceptable from a load control point of view, the MAP PM shall:
  - i) if this primitive requests the beginSubscriberActivity operation, the MAP PM shall check whether more components have been received associated with this operation. If more components are present, the MAP PM shall issue a MAP-OPEN indication primitive with the version 1 application-context-name "networkFunctionalSsContext-v1". The Destination-reference shall include the IMSI taken from the argument of the beginSubscriberActivity operation; the Originating-reference shall cover the originatingEntityNumber.

A beginSubscriberActivity operation that is not associated with any other Component shall be rejected by the MAP PM by issuing a TC-U-ABORT request primitive (note 2). The local MAP-User shall not be informed.

- ii) otherwise, the MAP PM shall issue a MAP-OPEN indication primitive with the version 1 application-context-name set according to table 15.1/1. DestinationReference and OriginatingReference must not be included in the MAP-OPEN indication primitive.

Then the MAP PM shall function in a way that the dialogue responding MAP behaves as specified in the GSM phase 1 protocol (latest version of TS GSM 09.02 phase 1).

NOTE 2: If no AARQ apdu was included in the BEGIN message, TC (Component Sub-layer) will not include an AARE apdu or an ABRT apdu in a TR-U-ABORT request primitive that is to be issued on receipt of a TC-U-ABORT request primitive from the local MAP service provider.

- c) if an application-context-name can be derived but if it is not acceptable from a load control point of view, the MAP PM shall ignore this dialogue request and not inform the MAP-user;
- if a version 1 application-context-name is included, the MAP PM shall issue a TC-U-ABORT request primitive with abort-reason "User-specific" and user-information "MAP-ProviderAbortInfo" indicating "abnormalDialogue". The local MAP-user shall not be informed.
- if an application-context-name different from version 1 is included in the primitive and if User-information is present, the User-information must constitute a syntactically correct MAP-OPEN dialogue PDU. Otherwise a TC-U-ABORT request primitive with abort-reason "User-specific" and user-information "MAP-ProviderAbortInfo" indicating "abnormalDialogue" shall be issued and the local MAP-user shall not be informed.
- if no User-information is present it is checked whether presence of User Information in the TC-BEGIN indication primitive is required for the received application-context-name. If User Information is required but not present, a TC-U-ABORT request primitive with abort-reason "User-specific" and user-information "MAP-ProviderAbortInfo" indicating "abnormalDialogue" shall be issued. The local MAP-user shall not be informed.
- if an application-context-name different from version 1 is received in a syntactically correct TC-BEGIN indication primitive but is not acceptable from a load control point of view, the MAP PM shall ignore this dialogue request. The MAP-user is not informed.
- if an application-context-name different from version 1 is received in a syntactically correct TC-BEGIN indication primitive and if it is acceptable from a load control point of view, the MAP PM shall check whether the application-context-name is supported.

NOTE 3: Unknown application-context-names are treated like unsupported ones.

If it is, the MAP PM shall issue a MAP-OPEN indication primitive with all parameters (application-context-name included) set according to the value of the corresponding parameter of the TC-BEGIN indication primitive.

The MAP PM shall then process any other indication primitives received from TC as described in clause 15.6. Once all the received components have been processed, the MAP PM shall inform the local MAP service user by a MAP-DELIMITER indication primitive.

If the TC-BEGIN indication primitive is not associated with any component, the MAP PM shall inform the MAP User by a MAP-DELIMITER indication primitive.

Once all the received primitives have been processed, the MAP PM does not accept any primitive from the provider and waits for a MAP-OPEN response primitive from its user.

- if an application-context-name different from version 1 is received in a syntactically correct TC-BEGIN indication primitive and if it is acceptable from a load control point of view but the application-context-name is not supported, the MAP PM shall issue a TC-U-ABORT request primitive with abort-reason indicating "application-context-not-supported". If an alternative application-context-name cannot be offered, the received application-context-name shall be returned in the TC-U-ABORT Req primitive.

In the following cases an alternative application-context can be offered and its name included in the TC-U-ABORT Req primitive:

- a) if an application-context of version 2 or higher is requested, but only version 1 application-context supported, then the v1 application context shall be returned;
- b) if an application-context of version 3 or higher is requested, but only version 2 application-context supported, then the v2 application context shall be returned.
- c) if an application-context of version 4 or higher is requested, but only version 3 application-context supported, then the v3 application context shall be returned.

**Table 15.1/1: Mapping of V1 operation codes on to application-context-names**

Operation	Application-context-name (note 1)
updateLocation	networkLocUpContext-v1
cancelLocation	locationCancellationContext-v1
provideRoamingNumber	roamingNumberEnquiryContext-v1
insertSubscriberData	subscriberDataMngtContext-v1
deleteSubscriberData	subscriberDataMngtContext-v1
sendParameters	infoRetrievalContext-v1
	networkLocUpContext-v1 (note 2)
beginSubscriberActivity	networkFunctionalSsContext-v1
sendRoutingInfo	locationInfoRetrievalContext-v1
performHandover	handoverControlContext-v1
reset	resetContext-v1
activateTraceMode	tracingContext-v1
deactivateTraceMode	tracingContext-v1
sendRoutingInfoForSM	shortMsgGatewayContext-v1
forwardSM	shortMsgRelayContext-v1
reportSM-deliveryStatus	shortMsgGatewayContext-v1
noteSubscriberPresent	mwdMngtContext-v1
alertServiceCentreWithoutResult	shortMsgAlertContext-v1
checkIMEI	EquipmentMngtContext-v1

NOTE 1: These symbolic names refer to the object identifier value defined in clause 17 and allocated to each application-context used for the MAP.

NOTE 2: The choice between the application contexts is based on the parameters received in the operation.

### 15.1.4 Receipt of a MAP-OPEN response

On receipt of a MAP-OPEN response primitive indicating that the dialogue is accepted, the MAP PM shall build a MAP-Accept PDU if the user-information parameter is included in the response primitive and accept any MAP specific service request or service response until a MAP-DELIMITER request or a MAP-CLOSE request is received from the MAP user. The MAP PM shall process the MAP specific primitives as described in clause 15.6. The MAP PM shall then issue a TC-CONTINUE request primitive after it receives the MAP-DELIMITER request primitive if no MAP-CLOSE request primitive has been received, otherwise it shall issue a TC-END request primitive. In both cases the MAP-Accept PDU (if any) is included in the user-information parameter of the TC primitive.

If the dialogue is not associated with a version 1 application context, the MAP PM shall include the application-context-name in the TC primitive.

If no MAP-CLOSE request has been received, the MAP PM waits for a request primitive from its user or an indication primitive from TC.

On receipt of a MAP-OPEN response primitive indicating that the dialogue is not accepted, the MAP PM shall build a MAP-Refuse PDU and request its transfer using the TC-U-ABORT req primitive (abort reason = user specific).

### 15.1.5 Receipt of the first TC-CONTINUE ind

On receipt of the first TC-CONTINUE indication primitive for a dialogue, the MAP PM shall check the value of the application-context-name parameter. If this value matches the one used in the MAP-OPEN request primitive, the MAP PM shall issue a MAP-OPEN confirm primitive with the result parameter indicating "accepted", then process the following TC component handling indication primitives as described in clause 15.6, and then waits for a request primitive from its user or an indication primitive from TC, otherwise it shall issue a TC-U-ABORT request primitive with a MAP-providerAbort PDU indicating "abnormal dialogue" and a MAP-P-ABORT indication primitive with the "provider-reason" parameter indicating "abnormal dialogue".

### 15.1.6 Receipt of a TC-END ind

On receipt of a TC-END indication primitive in the dialogue initiated state, the MAP PM shall check the value of the application-context-name parameter. If this value does not match the one used in the MAP-OPEN request primitive, the MAP PM shall discard any following component handling primitive and shall issue a MAP-P-ABORT indication primitive with the "provider-reason" parameter indicating "abnormal dialogue".

Otherwise it shall issue a MAP-OPEN confirm primitive with the result parameter set to "accepted" and process the following TC component handling indication primitives as described in clause 15.6; then it shall issue a MAP-CLOSE indication primitive and return to idle all state machines associated with the dialogue.

### 15.1.7 Receipt of a TC-U-ABORT ind

On receipt of a TC-U-ABORT indication primitive in the "Dialogue Initiated" state with an abort-reason parameter indicating "ApplicationContextNotSupported", the MAP PM shall issue a MAP-OPEN confirm primitive with the result parameter indicating "Dialogue Refused" and the refuse-reason parameter indicating "ApplicationContextNotSupported".

On receipt of a TC-U-ABORT indication primitive in the "Dialogue Initiated" state with an abort-reason parameter indicating "User Specific" and without user information, the MAP PM shall issue a MAP-OPEN confirm primitive with the result parameter indicating "Dialogue Refused" and the refuse-reason parameter indicating "Potential Version Incompatibility".

On receipt of a TC-U-ABORT indication primitive in the "Dialogue Initiated" state with an abort-reason parameter indicating "User Specific" and a MAP-Refuse PDU included as user information, the MAP PM shall issue a MAP-OPEN confirm primitive with the result set to refused and the refuse reason set as received in the MAP Refuse PDU.

Receipt of a TC-U-ABORT indication primitive with abort-reason "User Specific" and with user information is described as part of abnormal termination (see clause 15.4.2).

### 15.1.8 Receipt of a TC-P-ABORT ind

On receipt of a TC-P-ABORT indication primitive in the "Dialogue Initiated" state with a P-abort parameter indicating "Incorrect Transaction Portion", the MAP PM shall issue a MAP-OPEN confirm primitive with the result parameter indicating "Dialogue Refused" and the refuse reason parameter indicating "Potential Version Incompatibility".

On receipt of a TC-P-ABORT indication primitive in the "Dialogue Initiated" state with a P-abort parameter indicating "No Common Dialogue Portion", the MAP PM shall issue a MAP-P-ABORT indication primitive with the provider reason parameter indicating "Version Incompatibility".

Receipt of a TC-P-ABORT indication primitive with another P-abort parameter value is described as part of abnormal termination (see clause 15.5.2).

## 15.2 Dialogue continuation

Once established the dialogue is said to be in a continuation phase.

Both MAP users can request the transfer of MAP APDUs until one of them requests the termination of the dialogue.

### 15.2.1 Sending entity

The MAP PM shall accept any MAP specific service request or response primitives and process them as described in clause 15.6.

On receipt of a MAP-DELIMITER request primitive, the MAP PM shall issue a TC-CONTINUE request primitive.

### 15.2.2 Receiving entity

On receipt of a TC-CONTINUE indication primitive the MAP PM shall accept zero, one or several TC component handling indication primitives and process them as described in clause 15.6.

## 15.3 Dialogue termination

Both the dialogue-initiator and the dialogue-responder have the ability to request the termination of a dialogue after it has been established.

The dialogue termination procedure is driven by the following events:

- a MAP-CLOSE request primitive;
- a TC-END indication primitive.

### 15.3.1 Receipt of a MAP-CLOSE request

On receipt of a MAP-CLOSE request primitive, the MAP PM shall issue a TC-END request primitive and, if applicable, return to idle the associated active SSMs. Note that if the release method parameter of the MAP-CLOSE request indicates "normal" the TC-END request primitive will trigger the transmission of components associated with any user specific request or response primitives which may have been issued after the last MAP-DELIMITER request.

### 15.3.2 Receipt of a TC-END indication

On receipt of a TC-END indication primitive, the MAP shall accept any component handling indication primitives and process them as described in clause 15.6.

Once all the received primitives have been processed, the MAP PM shall return to idle the associated SSMs and issue a MAP-CLOSE indication primitive.

## 15.4 User Abort

Both the dialogue-initiator and the dialogue-responder have the ability to abort a dialogue at any time.

The user abort procedure is driven by one of the following events:

- a MAP-U-ABORT request primitive;
- a TC-U-ABORT indication primitive carrying a MAP-user-abort PDU.

### 15.4.1 MAP-U-ABORT request

On receipt of a MAP-U-ABORT request the MAP PM shall construct a MAP-user-abort PDU from the user-reason and diagnostic parameters and issue a TC-U-ABORT request primitive. All state machines associated with the dialogue are returned to idle.

### 15.4.2 TC-U-ABORT ind

On receipt of a TC-U-ABORT indication carrying a MAP-user-abort PDU, the MAP PM shall issue a MAP-U-ABORT indication primitive. The user-reason and diagnostic information elements are mapped to the corresponding parameters of the MAP-U-ABORT indication primitive.

All state machines associated with the dialogue are returned to idle.

## 15.5 Provider Abort

The MAP has the ability to abort a dialogue at both the dialogue-initiator side and the dialogue-responder side.

The provider abort procedure is driven by one of the following events:

- a MAP PM error situation;
- a TC-P-ABORT indication primitive;
- a TC-U-ABORT indication primitive carrying a MAP-abort PDU.

### 15.5.1 MAP PM error situation

In the case of an abnormal situation detected at the MAP level during an established dialogue, the MAP PM shall:

- issue a MAP-P-ABORT indication primitive with the appropriate value of the provider-reason parameter;
- construct a MAP-abort PDU from the value of these parameters and request its transfer using a TC-U-ABORT request primitive.

### 15.5.2 TC-P-ABORT ind

On receipt of a TC-P-ABORT indication, the MAP PM shall issue a MAP-P-ABORT indication primitive.

All state machines associated with the dialogue are returned to idle.

### 15.5.3 TC-U-ABORT ind

On receipt of a TC-U-ABORT indication carrying a MAP-abort PDU, the MAP PM shall issue a MAP-P-ABORT indication primitive, with the appropriate value of the provider-reason parameter. The source parameter shall indicate "MAP-provider".

All state machines associated with the dialogue are returned to idle.

## 15.6 Procedures for MAP specific services

This clause describes the MAP procedures for MAP specific services.

These procedures are driven by the following types of events:

- a MAP specific request or a MAP specific MAP response primitive;
- a component handling primitive from TC.

A Service State Machine is activated on receipt of one of the following signals:

- a MAP request primitive, which activates a requesting SSM;
- a TC-INVOKE indication primitive without linked identifier, which activates a responding SSM.

For component handling primitives there are two types of events:

- events which activate a Service State Machine or which can be related to an existing one;

The procedure elements driven by these events are described in clauses 15.6.1 to 15.6.4.

- events which cannot be related to a Service State Machine.

The procedure elements driven by these events are described in clause 15.6.5.

### 15.6.1 Service invocation

The MAP specific procedures are initiated by the MAP request primitives.

On receipt of a MAP request primitive, the MAP PM shall build an operation argument from the parameters received in the request primitive and request the invocation of the associated operation using the TC-INVOKE procedure. If a linked ID parameter is inserted in the primitive this indicates a child service and implies that the operation on which the service is mapped is linked to the operation on which the parent service is mapped.

The mapping of MAP specific services on to remote operations is given in table 16.2/1.

### 15.6.2 Service invocation receipt

On receipt of a TC-INVOKE indication primitive, the MAP PM shall:

- if the invoke ID is already in use by an active service, request the transfer of a reject component using the TC-U-REJECT request primitive with the appropriate problem code (duplicated invokeID) and issue a MAP-NOTICE indication primitive with a diagnostic parameter set to "abnormal event received from the peer";
- if the operation code does not correspond to an operation supported by the application-context, request the transfer of a reject component using the TC-U-REJECT request primitive, with the appropriate problem code (unrecognized operation), and -if the dialogue version is lower than 3- issue a MAP-NOTICE indication primitive with a diagnostic parameter set to „abnormal event received from the peer“;
- if a linked ID is included, perform the following checks: If the operation referred to by the linked ID does not allow linked operations or if the operation code does not correspond to a permitted linked operation, issue a TC-U-REJECT request primitive with the appropriate problem code (linked response unexpected or unexpected linked operation);
- if the type of the argument is not the one defined for the operation, request the transfer of a reject component using the TC-U-REJECT request primitive, with the appropriate problem code (mistyped parameter), and issue a MAP-NOTICE indication primitive with a diagnostic parameter set to "abnormal event from the peer";
- if the type of the argument is correct but the values of the information elements it contains do not permit the type of MAP service being invoked to be determined, request the transfer of an error component using the TC-U-ERROR request primitive with an error code set to "unexpected data value" and issue a MAP-NOTICE indication primitive with a diagnostic parameter set to "abnormal event from the peer";

NOTE 1: These checks are only relevant when there is not a one-to-one mapping between a service and an operation.

- if the type of the argument is correct but information elements required for the service being invoked are missing, request the transfer of an error component using the TC-U-ERROR request primitive with an error code set to "data missing" and issue a MAP-NOTICE indication primitive with a diagnostic parameter set to "abnormal event from the peer";

NOTE 2: These checks are only relevant when there is not a one-to-one mapping between a service and an operation.

- if the type of the argument is correct but contains information elements which are not relevant for the type of MAP service being invoked, request the transfer of an error component using the TC-U-ERROR request primitive with an error code set to "unexpected data value" and issue a MAP-NOTICE indication primitive with a diagnostic parameter set to "abnormal event from the peer";

NOTE 3: These checks are only relevant when there is not a one-to-one mapping between a service and an operation.

- Otherwise, issue the relevant MAP indication primitive to the MAP-service-user. If the service is to be user confirmed, the MAP PM waits for the corresponding response primitive.

### 15.6.3 Service response

For user confirmed services, the MAP PM shall accept a MAP response primitive and shall:

- if no error indication is included in the primitive and the service maps on to a class 1 or 3 operation, construct a result information element from the parameters received and request its transfer using the TC-RESULT-L service and optionally the TC-RESULT-NL service.

The TC-RESULT-NL services shall be used when the user specific parameters of the response primitives cannot be transferred in a single signalling frame and no segmenting mechanism is available from the underlying layers. The MAP PM shall issue one or several TC-RESULT-NL request primitives followed by a TC-RESULT-L primitive. The user parameters shall be split so that each portion contains sufficient information to construct a value compatible with the type defined for the result of the associated operation.

- if no error indication is included in the primitive and the service response maps on to a class 4 linked operation, construct an operation argument from the parameters received and request its transfer using the TC-INVOKE service for this class 4 linked operation. The operation to be invoked is deduced from the value of the result parameter of the service primitive;
- if an error indication is included in the primitive and the service maps on to a class 1 or 2 operation, either issue a TC-U-REJECT request primitive if the user error parameter indicates "resource limitation" or "initiating release", or construct an error parameter from the parameters received and request its transfer using the TC-U-ERROR request primitive. The error code should be the one associated with the value of the user error parameter of the response primitive.

NOTE: The only user errors that a MAP user can generate in addition to the list of errors attached to the operation which is associated with the service are: resource limitation and initiating release. Any other abnormal situation is detected either by the TC entity or by the MAP entity.

- if an error indication is received and the operation maps on to a class 3 operation, or if no error indication is received but the service maps on to a class 2 operation which has no class 4 linked operation, return the local service state machine to idle without requesting any service from TC.

### 15.6.4 Receipt of a response

A component handling indication primitive is considered as driving a response for a confirmed service if the invoke ID parameter value matches the one stored for the service, or if the linked ID parameter value matches the one stored for the service and the operation invoked is a class 4 operation. On receipt of a response (except a TC-L-CANCEL indication) for an unconfirmed service the MAP PM shall issue a MAP-NOTICE indication primitive with the appropriate provider error (return result unexpected or return error unexpected).

#### 15.6.4.1 Receipt of a TC-RESULT-NL indication

If the type of the partial result parameter is not compatible with the one defined for the complete result of this operation, request the transfer of a reject component using the TC-U-REJECT request primitive, with the appropriate problem code (mistyped parameter) and issue a confirm primitive with the provider error parameter set to "invalid response received". The MAP PM shall also issue a TC-U-CANCEL request primitive so that all subsequent result components for this operation are discarded by TC.

Otherwise, store the value of the partial result parameter and wait for subsequent TC-RESULT-NL indication primitives until a TC-RESULT-L indication primitive is received.

#### 15.6.4.2 Receipt of a TC-RESULT-L indication

If the type of the result parameter is not the one defined for the result of this operation, request the transfer of a reject component using the TC-U-REJECT request primitive, with the appropriate problem code (mistyped parameter), and issue a confirm primitive with the provider error parameter set to "invalid response received".

If the type of the result parameter is correct but does not contain all the information elements required by the service associated with the invocation, issue a confirm primitive with the provider error parameter set to "invalid response received".

NOTE 1: These checks are only relevant when there is not a one-to-one mapping between a service and an operation.

If the type of the result parameter is correct but contains information elements which are not relevant for the service associated with the invocation are missing, issue a confirm primitive with the provider error parameter set to "invalid response received".

NOTE 2: These checks are only relevant when there is not a one-to-one mapping between a service and an operation.

Otherwise, issue a MAP confirm primitive to the MAP-service-user mapping the result parameter of the TC-RESULT-L primitive on to the MAP specific parameters.

If partial results have been previously received, the value of the partial result parameters shall also be taken into account before performing the three previous checks.

#### 15.6.4.3 Receipt of a TC-U-ERROR indication

If the error code is not defined for the MAP or is not one associated with the operation referred to by the invoke identifier, request the transfer of a reject component using the TC-U-REJECT request primitive, with the appropriate problem code (unrecognized error or unexpected error), and issue a confirm primitive with the provider error parameter set to "invalid response received".

If the type of the error parameter is not the one defined for this error, request the transfer of a reject component using the TC-U-REJECT request primitive, with the appropriate problem code (mistyped parameter), and issue a confirm primitive with the provider error parameter set to "invalid response received".

If the type of the error parameter is correct but does not contain all the information elements required by the service associated with the invocation, issue a confirm primitive with the provider error parameter set to "invalid response received".

NOTE 1: In some cases, it may be necessary to analyse the operation argument.

If the type of the error parameter is correct but its value includes information elements which are not relevant for the service associated with the invocation, issue a confirm primitive with the provider error parameter set to "invalid response received".

NOTE 2: In some cases, it may be necessary to analyse the operation argument.

Otherwise, issue a MAP confirm primitive to the MAP-service-user with the user error parameter set according to the received error code. If applicable the error parameter is mapped to the diagnostic parameter.



#### 15.6.4.4 Receipt of a TC-INVOKE indication

A TC-INVOKE indication primitive is considered as carrying a possible response to a specific service if the linked ID refers to an active specific service and the associated operation is a class 4 operation. Note that the presence of a linked ID parameter in a TC-INVOKE primitive requesting a non class 4 operation indicates a child service whose procedures are the same as the procedures for the parent service.

On receipt of a TC-INVOKE indication confirming an active service, the MAP PM shall:

- if the operation code is not defined for MAP and the dialogue version is at least 3, issue a TC-U-REJECT request primitive with the appropriate problem code (unrecognized operation).
- if the operation code is not defined for MAP and the dialogue version is lower than 3, or if the operation referred to by the linked ID does not allow linked operations or if the operation code does not correspond to an allowed linked operation, issue a TC-U-REJECT request primitive with the appropriate problem code (unrecognized operation, linked response unexpected or unexpected linked operation). If the service is confirmed, the MAP shall also issue a Confirm primitive with provider error indication "unexpected response from the peer", otherwise it may issue a MAP-NOTICE indication primitive with an appropriate diagnostic "abnormal event received from the peer".
- otherwise issue a confirm primitive mapping the operation argument parameter to the user specific parameters and setting the result parameter according to the operation code of the linked operation.

#### 15.6.4.5 Receipt of a TC-U-REJECT indication

On receipt of a TC-U-REJECT indication primitive which affects a pending service, the MAP PM shall issue a MAP confirm primitive to the MAP-service-user with the appropriate value of the provider error or user error parameter.

The mapping of TC invoke problem codes on to MAP Provider Error and MAP User Error parameter values is described in clause 16.

#### 15.6.4.6 Receipt of a TC-L-REJECT indication

This event occurs when the local TC detects a protocol error in an incoming component which affects an active specific service.

On receipt of a TC-L-REJECT indicating "return result problem, unexpected return result", the MAP shall issue a confirm primitive with the parameter provider error indicating "unexpected response from the peer".

On receipt of a TC-L-REJECT indicating "return error problem, unexpected error result", the MAP shall issue a confirm primitive with the parameter provider error indicating "unexpected response from the peer".

Note that when the problem code indicates a general problem, it is considered that the event cannot be related to an existing SSM even if the invoke Id is provided by TC. This is because whether the invoke Id refers to a local or remote invocation is ambiguous. The behaviour of the MAP PM in such a case is described in clause 15.6.5.3.

#### 15.6.4.7 Receipt of a TC-L-CANCEL indication

On receipt of a TC-L-CANCEL indication, the MAP PM shall:

- if the associated operation is a class 1 operation, issue a confirm primitive with the provider error cause indicating "no response from the peer";
- if the associated operation is a class 2 operation and no linked operations are defined for this operation, issue a confirm primitive without parameter (i.e. indicating implicitly the successful completion of the service);
- if the associated operation is a class 2 operation and has linked operations but none of them has been invoked, issue a confirm primitive with the provider error parameter indicating "service completion failure";
- if the associated operation is a class 2 operation and a linked operation invocation has already been received in response to this operation, ignore the primitive;
- if the associated operation is a class 3 operation, issue a confirm primitive with the provider error cause indicating "service completion failure";

- if the associated operation is a class 4 operation, ignore the primitive.

NOTE: When a TC-L-CANCEL ind primitive is received before the dialogue has been confirmed (i.e. no backward message is received by the dialogue initiator node), the MAP PM shall first issue a MAP-OPEN Cnf primitive with the result parameter indicating "accepted" (which means that the dialogue is considered as being implicitly accepted). Then, as indicated above, the TC-L-CANCEL Indication is interpreted according to the class of the operation to which it refers.

#### 15.6.4.8 Receipt of a TC-NOTICE indication

If a TC-NOTICE indication primitive is received before the dialogue has been confirmed (i.e. no backward message is received by the dialogue initiator node), the MAP PM shall issue a MAP-OPEN Cnf primitive with the result parameter indicating Refused and a refuse reason Remote node not reachable".

If a TC-NOTICE indication primitive is received after the dialogue has been confirmed, the MAP PM shall issue a MAP-NOTICE indication to the user, with a problem diagnostic indicating "message cannot be delivered to the peer".

### 15.6.5 Other events

This clause describes the behaviour of the MAP PM on receipt of a component handling indication primitive which cannot be related to any service or which does not affect a pending one. The MAP user is only informed that an abnormal event occurred during the associated dialogue. It is up to the MAP user to abort, continue or terminate the dialogue.

#### 15.6.5.1 Receipt of a TC-U-REJECT

On receipt of a TC-U-REJECT indication primitive which does not affect an active SSM (i.e. indicating a return result or return error problem), the MAP PM shall issue a MAP-NOTICE indication primitive with the diagnostic parameter set to "response rejected by the peer".

This is also applicable for invoke problems related to a class 4 linked operation.

#### 15.6.5.2 Receipt of a TC-R-REJECT indication

On receipt of a TC-R-REJECT indication (i.e. when a protocol error has been detected by the peer TC entity) which does not affect an active SSM, the MAP PM shall either discard this indication or issue a MAP-NOTICE indication primitive with the provider error indicating "abnormal event detected by the peer".

In case of notification, it is up to the MAP user to continue, abort or terminate the dialogue. Note also that for MAP V1 the reject component is received in an END message and therefore the dialogue is terminated anyway.

#### 15.6.5.3 Receipt of a TC-L-REJECT indication

On receipt of a TC-L-REJECT indication primitive (i.e. when a protocol error has been detected by the local TC entity) which cannot be related to an active SSM, the MAP PM shall either discard this indication or issue a MAP-NOTICE indication primitive with the provider error indicating "abnormal event received from the peer".

In case of notification, it is up to the MAP user to continue, or to terminate the dialogue and implicitly trigger the transmission of the reject component or to abort the dialogue.

### 15.6.6 Parameter checks

As described in the previous clauses, the MAP PM performs a set of checks to ensure the correctness of the information elements received; these are:

- check if the syntax and encoding (note) of the operation argument, result or error parameter are correct.

NOTE: Depending on the implementation, encoding problems on the TC user portion may be detected at TC level or by the MAP user. In the second case the problem is reported in a similar manner to a syntactical problem.

The syntax shall be considered incorrect if a mandatory information element is missing in any constructed element or if the value of an information element is out of the range defined for the type it is supposed to belong to;

- if there is not a one-to-one mapping between a service and an operation:
  - i) check if the value of the information elements (generally a single one) permits the MAP PM to determine the service associated with the operation invocation;
  - ii) check that there are no information elements which are irrelevant for the indication or a confirm primitive to be issued;
- check if all the information elements required to built an indication or a confirm primitive are available.

However some additional checks may have to be performed by the MAP user (see clause 18).

## 15.6.7 Returning state machines to idle

Unlike TC invocation state machines, service state machines exist at both requestor and performer side.

A service state machine at the requestor side is returned to idle when the MAP-specific confirm primitive is issued or when the dialogue terminates.

A service state machine at the performer side is returned to idle on receipt of a MAP-specific response primitive from the MAP user, when the dialogue terminates or at expiry of an implementation dependent watch-dog timer which is started when the state machine is created.

## 15.6.8 Load control

As stated in the previous clauses, before issuing a MAP-OPEN indication primitive the MAP PM performs a check to verify if there are sufficient resources to open the dialogue taking into account possible overload conditions.

The decision is based on the priority allocated to the application-context whose name is explicitly included in the TC-BEGIN indication primitive or implied by the first operation invocation when V1 contexts are in use. How a V1 application-context-name is derived from an operation code is described in table 15.1/1.

The priority level allocated to each application-context is described in clause 3 tables 5.1/1 and 5.1/2.

---

# 16 Mapping on to TC services

## 16.1 Dialogue control

Dialogue control services are mapped to TC dialogue handling services. The TC-UNI service is not used by the MAP PM.

### 16.1.1 Directly mapped parameters

The following parameters of the MAP-OPEN request and indication primitives are directly mapped on to the corresponding parameters of the TC-BEGIN primitives:

- destination address;
- originating address.

### 16.1.2 Use of other parameters of dialogue handling primitives

#### 16.1.2.1 Dialogue Id

The value of this parameter is associated with the MAP PM invocation in an implementation dependent manner.

### 16.1.2.2 Application-context-name

The application-context-name parameter of a MAP primitive is mapped to the application-context-name parameter of TC dialogue handling primitives according to the rules described in clause 15.1.

### 16.1.2.3 User information

The user information parameter of TC dialogue primitives is used to carry the MAP dialogue APDUs.

### 16.1.2.4 Component present

This parameter is used by the MAP PM as described in CCITT Recommendation Q.771. It is not visible to the MAP user.

### 16.1.2.5 Termination

The value of this parameter of the TC-END request primitive is set by the MAP PM on the basis of the release method parameter of the MAP-CLOSE request primitive, except when the dialogue state machine is in the state DIALOGUE INITIATED, in which case the Termination parameter shall always indicate "pre-arranged end".

### 16.1.2.6 P-Abort-Cause

Values of the P-abort-cause parameter are mapped to the values of the provider-reason parameter of the MAP-P-ABORT indication primitive according to table 16.1/1, except in the dialogue initiated phase for the "incorrectTransactionPortion" and "noCommonDialoguePortion" values which are mapped to the "potential incompatibility problem" value of the refuse-reason parameter of the MAP-OPEN cnf primitive. The source parameter in the MAP-P-ABORT ind takes the value "TC problem".

### 16.1.2.7 Quality of service

The quality of service of TC request primitives is set by the MAP as shown below.

- Return option: "Return message on error" or "Discard message on error" as required by the network operator;
- Sequence control: "Sequence guaranteed" or "Sequence result not guaranteed" as required by the network operator;

"Sequence guaranteed" shall be used when a segmented result is to be transferred (e.g. subscriber data in response to SendParameters). It may also be appropriate to use Sequence guaranteed when a series of InsertSubscriberData, ProcessAccessSignalling or ForwardAccessSignalling operations is used.

It is essential that the TC message which indicates acceptance of a dialogue opening request is received by the dialogue initiator before any subsequent message in that dialogue; otherwise the dialogue opening will fail. The dialogue responder shall ensure that this requirement is met by:

- Sending the dialogue acceptance message in a TC-END, if the dialogue structure requires it; or
- Using "Sequence guaranteed", if the dialogue acceptance message is sent in a TC-CONTINUE; or
- Waiting until the dialogue acceptance message has been acknowledged by the dialogue initiator before sending a subsequent message, if the dialogue acceptance message is sent in a TC-CONTINUE.

**Table 16.1/1: Mapping of P-Abort cause in TC-P-ABORT indication on to provider-reason in MAP-P-ABORT indication**

TC P-Abort cause	MAP provider-reason
unrecognized message type	provider malfunction
unrecognized transaction Id	supporting dialogue released
badlyFormattedTransactionPortion	provider malfunction
incorrectTransactionPortion	provider malfunction (note)
resourceLimitation	resource limitation
abnormalDialogue	provider malfunction
noCommonDialoguePortion	version incompatibility

NOTE: Or version incompatibility in the dialogue initiated phase.

## 16.2 Service specific procedures

Specific services are mapped to TC component handling services.

### 16.2.1 Directly mapped parameters

The Invoke Id parameter of the MAP request and indication primitive is directly mapped on to the Invoke Id parameter of the component handling primitives.

### 16.2.2 Use of other parameters of component handling primitives

#### 16.2.2.1 Dialogue Id

The value of this parameter is associated with the MAP PM invocation in an implementation dependent manner.

#### 16.2.2.2 Class

The value of this parameter is set by the MAP PM according to the type of the operation to be invoked.

#### 16.2.2.3 Linked Id

When a service response is mapped to a class 4 operation, the value of this parameter is set by the MAP PM and corresponds to the value assigned by the user to the initial service request (i.e. the value of the invoke ID parameter of the request primitive). Otherwise if such a parameter is included in MAP request/indication primitives it is directly mapped to the linked ID parameter of the associated TC-INVOKE request/indication primitives.

#### 16.2.2.4 Operation

When mapping a request primitive on to a Remote Operations PDU (invoke), the MAP PM shall set the operation code according to the mapping described in table 16.2/1.

When mapping a response primitive on to a Remote Operations service, the MAP PM shall set the operation code of the TC-RESULT-L/NL primitive (if required) to the same value as the one received at invocation time.

Table 16.2/1: Mapping of MAP specific services on to MAP operations

MAP-SERVICE	operation
MAP-ACTIVATE-SS	activateSS
MAP-ACTIVATE-TRACE-MODE	activateTraceMode
MAP-ALERT-SERVICE-CENTRE	alertServiceCentre
MAP-ANY-TIME-INTERROGATION	anyTimeInterrogation
MAP-CANCEL-LOCATION	cancelLocation
MAP-CHECK-IMEI	checkIMEI
MAP-DEACTIVATE-SS	deactivateSS
MAP-DEACTIVATE-TRACE-MODE	deactivateTraceMode
MAP-DELETE-SUBSCRIBER-DATA	deleteSubscriberData
MAP-ERASE-CC-ENTRY	eraseCC-Entry
MAP-ERASE-SS	eraseSS
MAP-FAILURE-REPORT	failureReport
MAP-FORWARD-ACCESS-SIGNALLING	forwardAccessSignalling
MAP-FORWARD-CHECK-SS-INDICATION	forwardCheckSsIndication
MAP-FORWARD-GROUP-CALL-SIGNALLING	forwardGroupCallSignalling
MAP-MT-FORWARD-SHORT-MESSAGE	mt-forwardSM
MAP-MO-FORWARD-SHORT-MESSAGE	mo-forwardSM
MAP-GET-PASSWORD	getPassword
MAP-INFORM-SERVICE-CENTRE	informServiceCentre
MAP-INSERT-SUBSCRIBER-DATA	insertSubscriberData
MAP-INTERROGATE-SS	interrogateSs
MAP-NOTE-MS-PRESENT-FOR-GPRS	noteMsPresentForGprs
MAP-PREPARE-GROUP-CALL	prepareGroupCall
MAP-PREPARE-HANDOVER	prepareHandover
MAP-PREPARE-SUBSEQUENT-HANDOVER	prepareSubsequentHandover
MAP-PROCESS-ACCESS-SIGNALLING	processAccessSignalling
MAP-PROCESS-GROUP-CALL-SIGNALLING	processGroupCallSignalling
MAP-PROCESS-UNSTRUCTURED-SS-REQUEST	processUnstructuredSS-Request
MAP-PROVIDE-ROAMING-NUMBER	provideRoamingNumber
MAP-PROVIDE-SIWFS-NUMBER	provideSIWFSNumber
MAP-PROVIDE-SUBSCRIBER-INFO	provideSubscriberInfo
MAP-PURGE-MS	purgeMS
MAP-READY-FOR-SM	readyForSM
MAP-REGISTER-CC-ENTRY	registerCC-Entry
MAP-REGISTER-PASSWORD	registerPassword
MAP-REGISTER-SS	registerSS
MAP-REMOTE-USER-FREE	remoteUserFree
MAP-REPORT-SM-DELIVERY-STATUS	reportSmDeliveryStatus
MAP-RESET	reset
MAP-RESTORE-DATA	restoreData
MAP-SEND_GROUP_CALL_END_SIGNAL	sendGroupCallEndSignal
MAP-SEND-END-SIGNAL	sendEndSignal
MAP-SEND-AUTHENTICATION-INFO	sendAuthenticationInfo
MAP-SEND-IMSI	sendIMSI
MAP-SEND-IDENTIFICATION	sendIdentification
MAP-SEND-ROUTING-INFO-FOR-SM	sendRoutingInfoForSM
MAP-SEND-ROUTING-INFO-FOR-GPRS	sendRoutingInfoForGprs
MAP-SEND-ROUTING-INFORMATION	sendRoutingInfo
MAP-SET-REPORTING-STATE	setReportingState
MAP-SIWFS-SIGNALLING-MODIFY	SIWFSsignallingModify
MAP-STATUS-REPORT	statusReport
MAP-SUPPLEMENTARY-SERVICE-INVOCATION-NOTIFICATION	ss-Invocation-Notification
MAP-UNSTRUCTURED-SS-NOTIFY	unstructuredSS-Notify
MAP-UNSTRUCTURED-SS-REQUEST	unstructuredSS-Request
MAP-UPDATE-GPRS-LOCATION	updateGprsLocation
MAP-UPDATE-LOCATION	updateLocation

### 16.2.2.5 Error

The error parameter in a TC-U-ERROR indication primitive is mapped to the user error parameter in the MAP confirm primitive of the service associated with the operation to which the error is attached.

The user error parameter in MAP response primitives is mapped to the error parameter of the TC-U-ERROR request primitive, except for "initiating-release" and "resource-limitation" which are mapped to the problem code parameter of the TC-U-REJECT request primitive.

### 16.2.2.6 Parameters

The parameters of MAP specific request and indication primitives are mapped to the argument parameter of TC-INVOKE primitives.

The parameters of MAP specific response and confirm primitives are mapped to the result parameter of TC-RESULT-L primitives, the parameter of TC-U-ERROR primitives or the argument of TC-INVOKE primitives when mapping on linked class 4 operations is used.

### 16.2.2.7 Time out

The value of this parameter is set by the MAP PM according to the type of operation invoked.

### 16.2.2.8 Last component

This parameter is used by the MAP PM as described in CCITT Recommendation Q.711. It is not visible from the MAP user.

### 16.2.2.9 Problem code

#### 16.2.2.9.1 Mapping to MAP User Error

The following values of the user error parameter are mapped as follows to values of the TC problem code parameter. These values are generated by the MAP user. This mapping is valid from the TC-U-REJECT indication primitive to the MAP confirm service primitive and from the MAP response service primitive to the TC-U-REJECT request primitive.

**Table 16.2/2: Mapping of MAP User Error parameter on to TC problem code in TC-U-REJECT primitives**

MAP User Error	TC problem code
resource limitation	resource limitation
initiating release	initiating release

#### 16.2.2.9.2 Mapping to MAP Provider Error parameter

The following values of the TC problem code parameter of the TC-U-REJECT indication primitive are mapped as follows to values of the MAP Provider Error parameter of the MAP confirm primitive.

**Table 16.2/3: Mapping of TC problem code in TC-U-REJECT on to MAP Provider Error parameter**

TC problem code	MAP Provider Error
duplicated invoke Id	duplicated invoke id
unrecognized operation	service not supported
mistyped parameter	mistyped parameter

The following values of the problem code parameters of the TC-L-REJECT primitive are mapped to values of the provider error parameter of the MAP confirm primitive as follows:

**Table 16.2/4: Mapping of TC problem code in TC-L-REJECT on to MAP Provider Error parameter**

TC problem code	MAP Provider Error
return result unexpected	unexpected response from the peer
return error unexpected	unexpected response from the peer

### 16.2.2.9.3 Mapping to diagnostic parameter

The following values of the problem code parameter of the TC-R-REJECT and TC-U-REJECT primitive are mapped to values of the diagnostic parameter of the MAP-NOTICE indication primitive as follows:

**Table 16.2/5: Mapping of TC problem code of TC-R-REJECT and TC-U-REJECT on to diagnostic parameter**

TC problem code	MAP diagnostic
General problem	
abnormal event detected by the peer	
Invoke problem	
- unrecognized linked ID	- abnormal event detected by the peer
- linked response unexpected	- response rejected by the peer
- unexpected linked operation	- response rejected by the peer
Return result problem	
- unrecognized invoke ID	- response rejected by the peer
- return result unexpected	- response rejected by the peer
- mistyped parameter	- response rejected by the peer
Return error problem	
- unrecognized invoke ID	- response rejected by the peer
- return error unexpected	- response rejected by the peer
- unrecognized error	- response rejected by the peer
- unexpected error	- response rejected by the peer
- mistyped parameter	- response rejected by the peer

The following values of the problem code parameter of the TC-L-REJECT primitive are mapped to values of the diagnostic parameter of the MAP-NOTICE indication primitive as follows:

**Table 16.2/6: Mapping of TC problem code of TC-L-REJECT on to diagnostic parameter**

TC problem code	MAP diagnostic
General problems:	- abnormal event received from the peer
Invoke problem:	
- unrecognized linked ID	- abnormal event received from the peer
Return result problem:	
- unrecognized invoke ID	- abnormal event received from the peer
Return error problem:	
- unrecognized invoke ID	- abnormal event received from the peer

## 16.3 SDL descriptions

The following SDL specification describes a system which includes three blocks: MAP-user, MAP-provider and TC.

Such a system resides in each network component supporting MAP and communicates with its peers via the lower layers of the signalling network which are part of the environment.

Only the MAP-provider is fully described in this clause. The various type of processes which form the MAP-User block and the TC block are described respectively in clauses 18 to 25 of the present document and in CCITT Recommendation Q.774.



The MAP-Provider block communicates with the MAP\_USER via two channels U1 and U2. Via U1 the MAP-provider receives the MAP request and response primitives. Via U2 it sends the MAP indication and confirm primitives.

The MAP-Provider block communicates with TC via two channels P1 and P2. Via P1 the MAP-Provider sends all the TC request primitives. Via P2 it receives all the TC indication primitives.

The MAP-Provider block is composed of the four following types of processes:

- a) MAP\_DSM: This type of process handles a dialogue. There exists one process instance per MAP dialogue.
- b) LOAD\_CTRL: This type of process is in charge of load control. There is only one instance of this process in each system.
- c) PERFORMING\_MAP\_SSM: This type of process handle a MAP service performed during a dialogue. An instance of this process is created by the instance of the MAP\_DSM process for each MAP-service to be performed.
- d) REQUESTING\_MAP\_SSM: This type of process handle a MAP service requested during a dialogue. An instance of this process is created by the instance of the MAP\_DSM process for each requested MAP-service.

A process MAP\_DSM exchanges external signals with other blocks as well as internal signals with the other processes of the MAP-Provider block. The external signals are either MAP service primitives or TC service primitives.

The signal routes used by the various processes are organized as follows:

- a) A process MAP\_DSM receives and sends events from/to the MAP\_user via signal route User1/User2. These routes uses respectively channel U1 and U2.
- b) A process MAP\_DSM receives and sends events from/to the TC via signal route Tc1/Tc2. These routes uses respectively channel P1 and P2.
- c) A process MAP\_DSM receives and sends events from/to the LOAD\_CTRL process via signal route Load1/Load2. These routes are internal.
- d) A process MAP\_DSM sends events to the PERFORMING\_MAP\_SSM processes via signal route Intern1. This route is internal.
- e) A process MAP\_DSM sends events to the REQUESTING\_MAP\_SSM processes via signal route Intern2. This route is internal.
- f) A process MAP\_PERFORMING\_SSM sends events to the MAP\_USER via signal route User4. This route uses channel U2.
- g) A process MAP\_PERFORMING\_SSM sends events to TC via signal route Tc3. This route uses channel P1.
- h) A process MAP\_REQUESTING\_SSM sends events to the MAP\_USER via signal route User5. This route uses channel U2.
- j) A process MAP\_REQUESTING\_SSM sends events to TC via signal route Tc4. This route uses channel P1.

09.02 version 6.6.0

System MAP\_STACK

16.2\_1(1)

Figure 16.2/1:

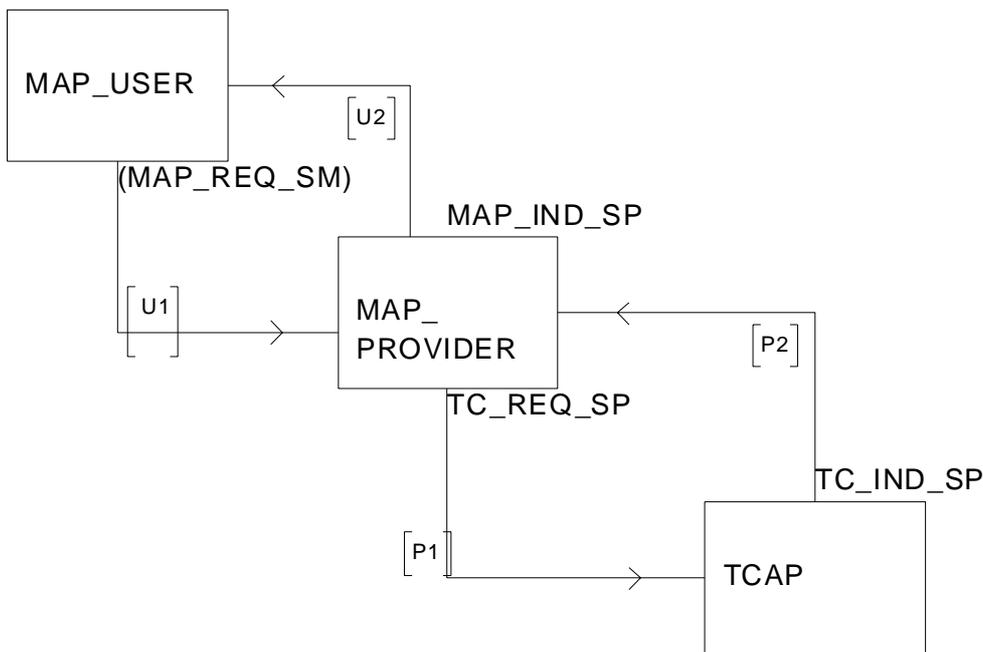

Figure 16.2/1: System MAP\_STACK

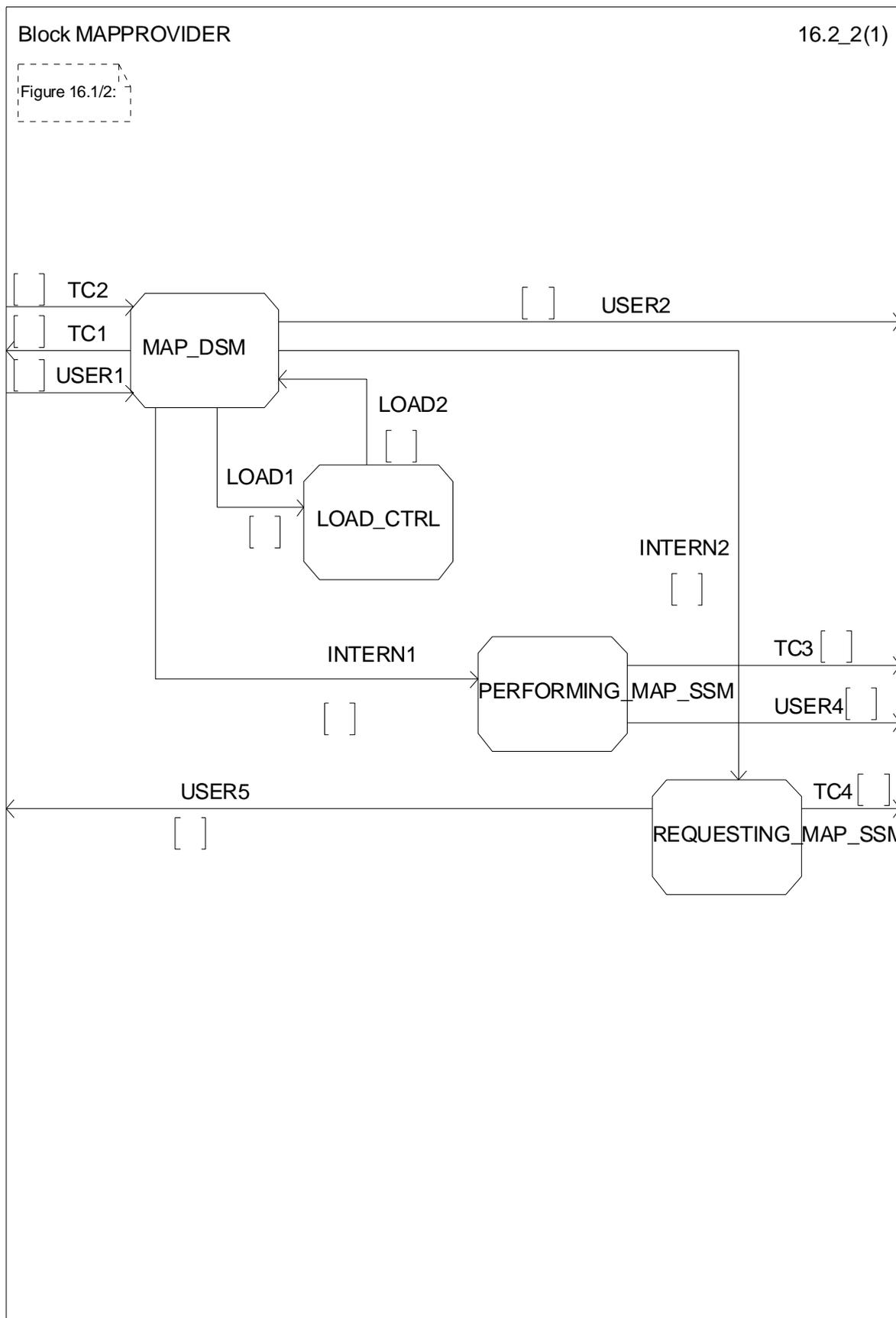

Figure 16.2/2: Block MAPPROVIDER

Process MAP\_DSM

16.2\_3.1(11)

Figure 16.2/3:

Comment 'MAP Dialoges State Maschine':  
DCL  
COMPONENTS\_PRESENT, INVOKEID\_ACTIVE, LAST\_COMPONENT, OP\_EXIST BOOLEAN,  
OP\_CODE INTEGER;

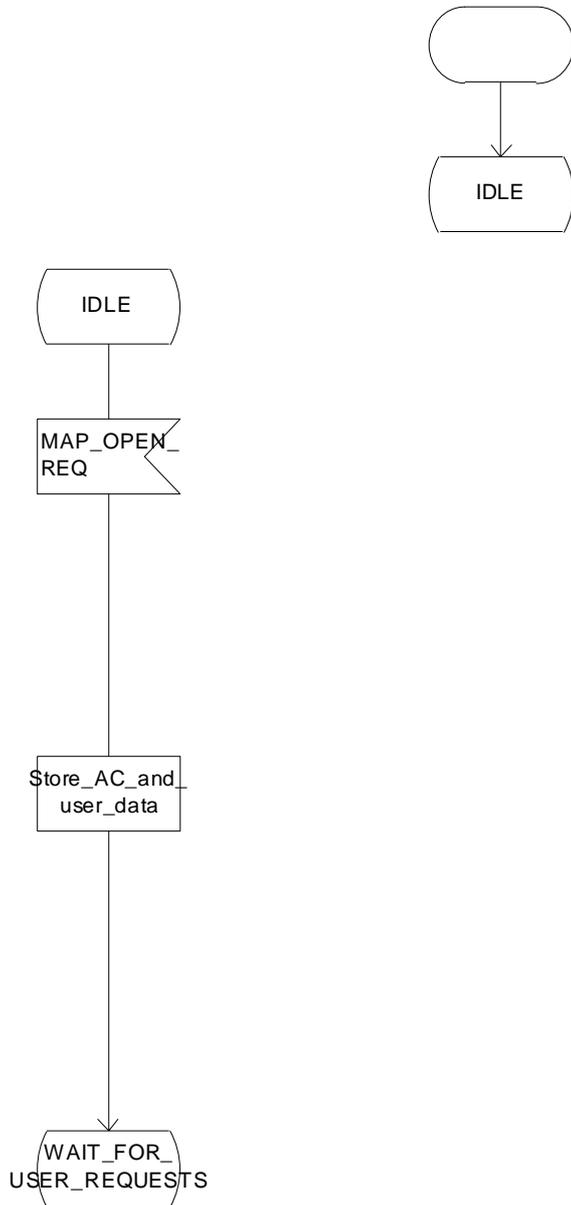

Figure 16.2/3 (sheet 1 of 11): Process MAP\_DSM

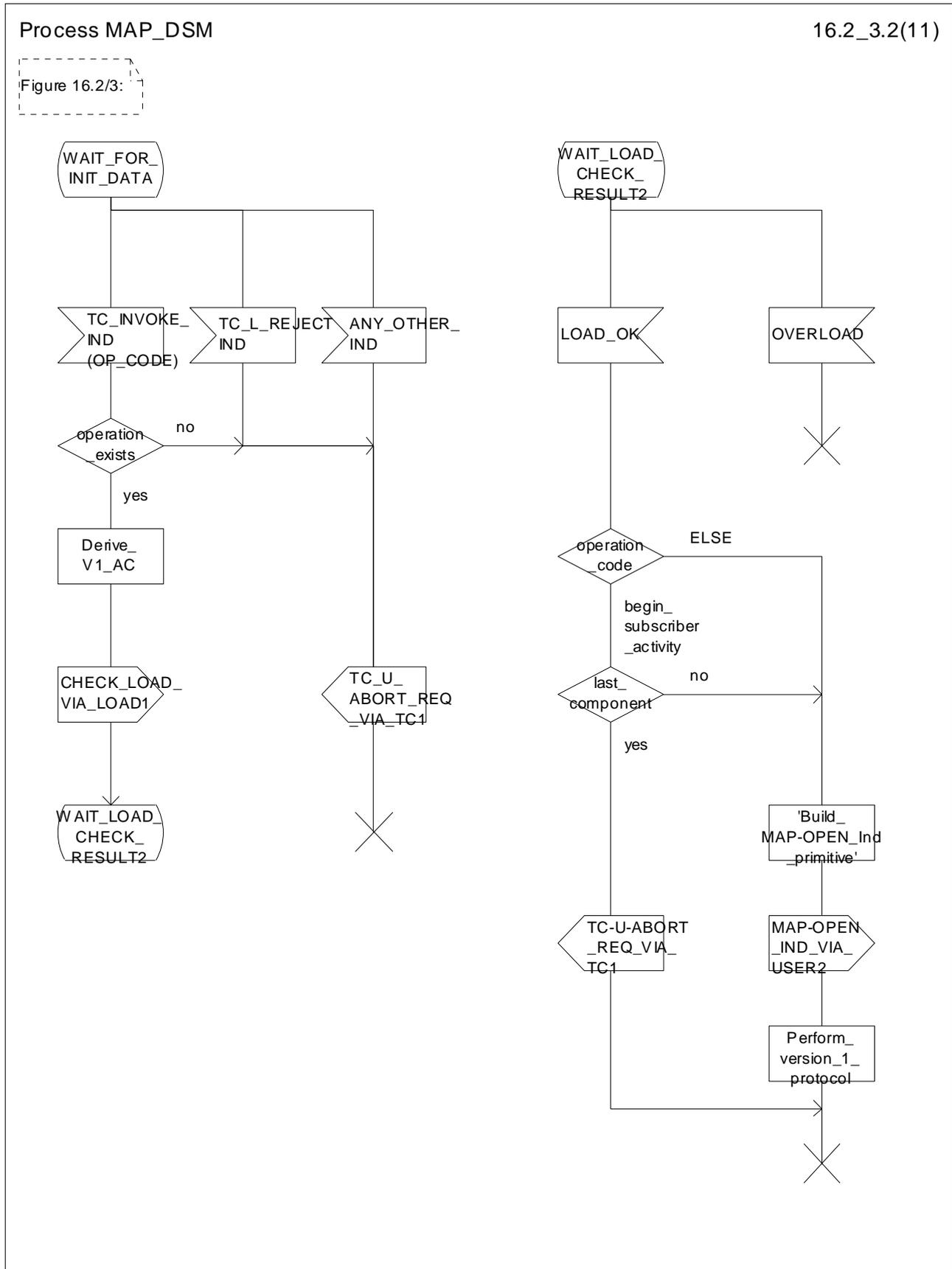

Figure 16.2/3 (sheet 2 of 11): Process MAP\_DSM

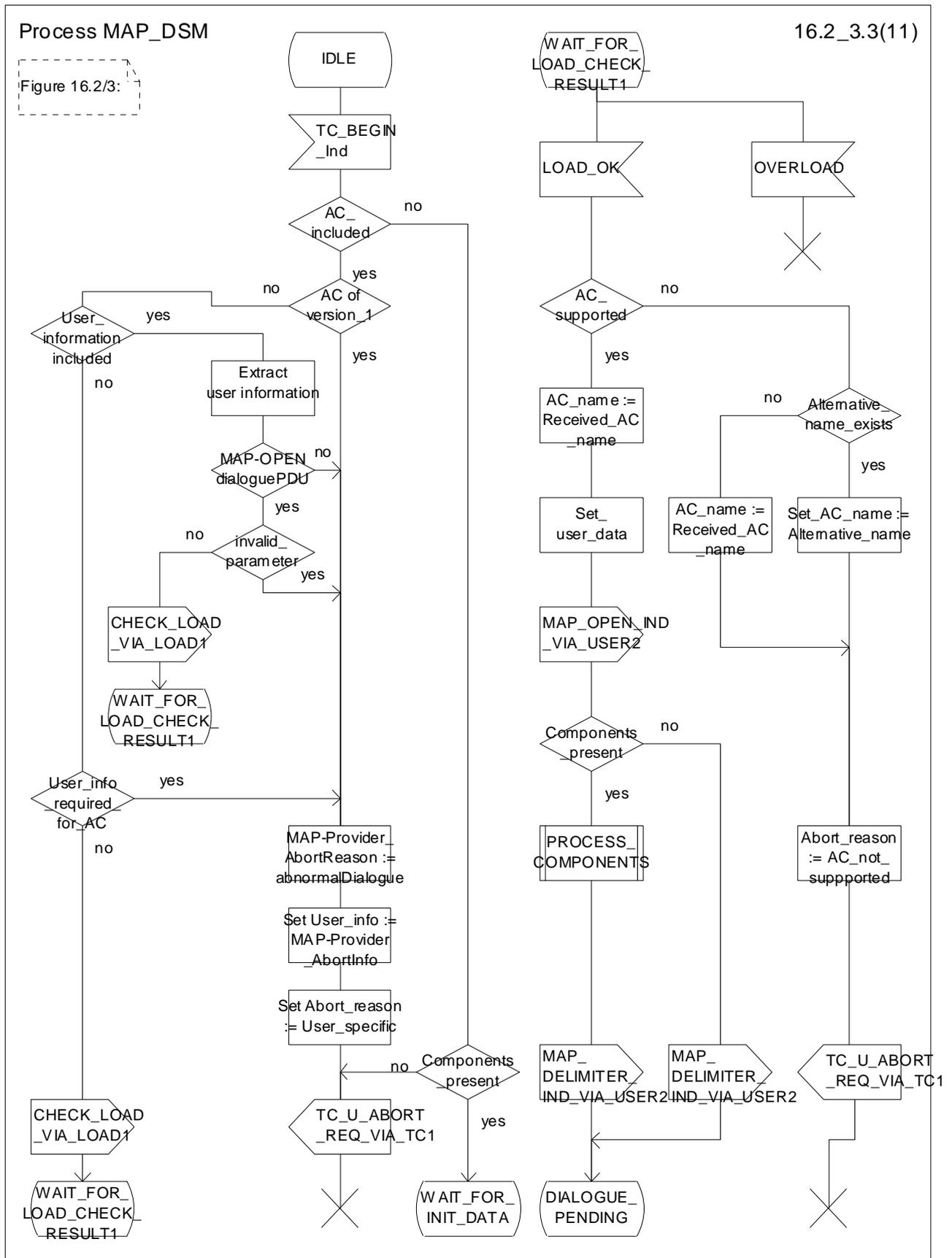

Figure 16.2/3 (sheet 3 of 11): Process MAP\_DSM

Process MAP\_DSM

16.2\_3.4(11)

Figure 16.2/3:

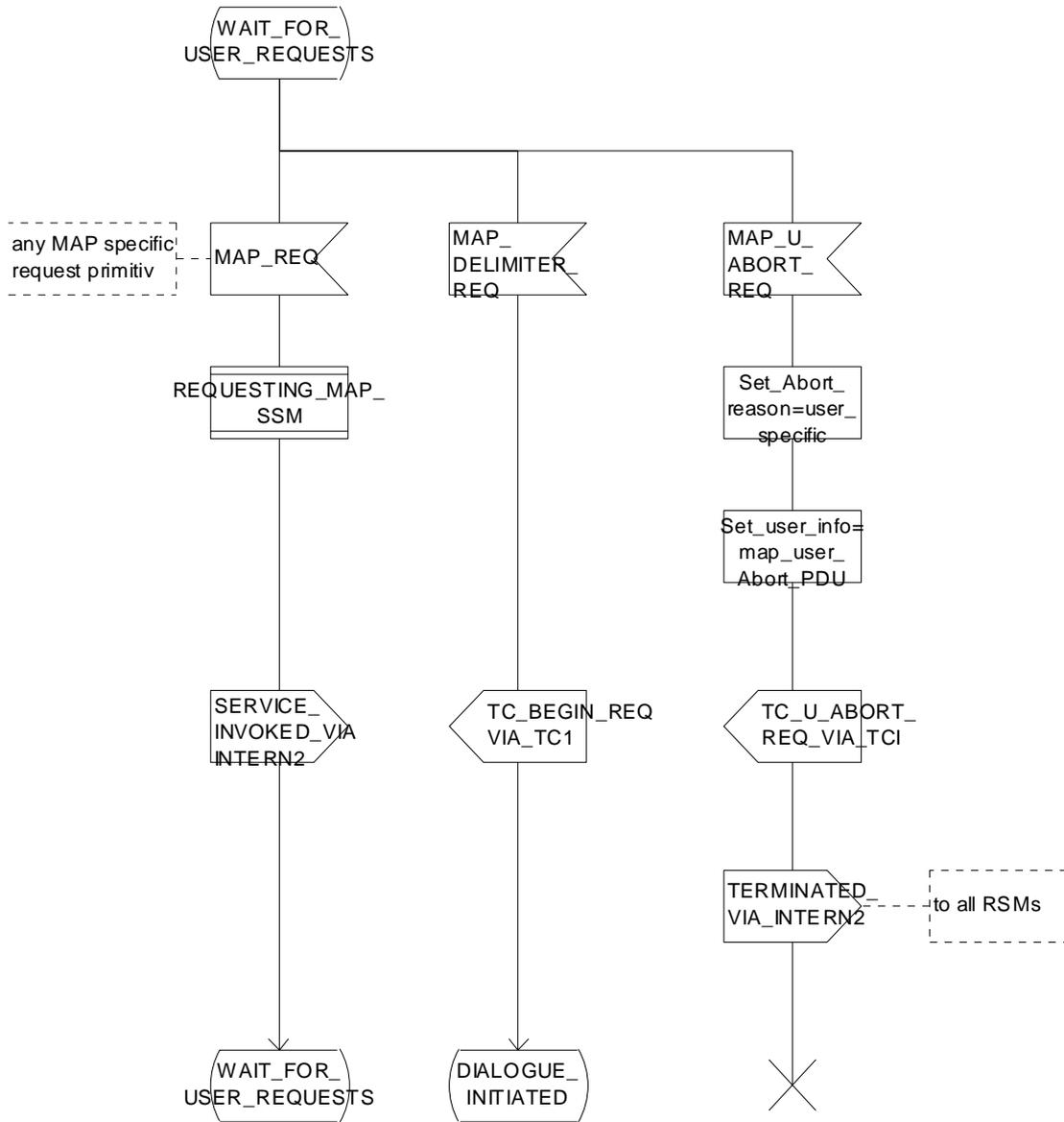

Figure 16.2/3 (sheet 4 of 11): Process MAP\_DSM

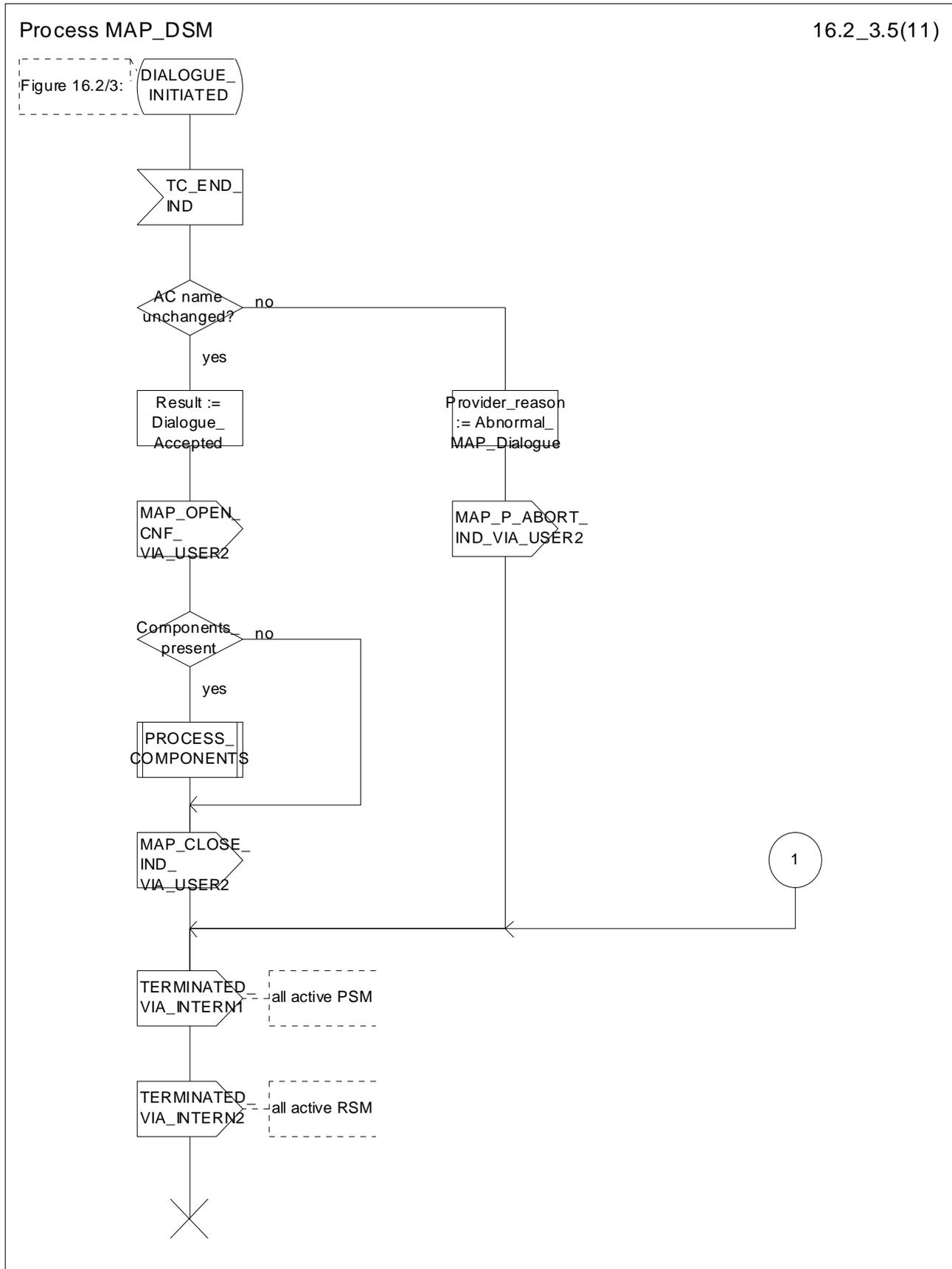

Figure 16.2/3 (sheet 5 of 11): Process MAP\_DSM



Process MAP\_DSM

16.2\_3.6(11)

Figure 16.2/3:

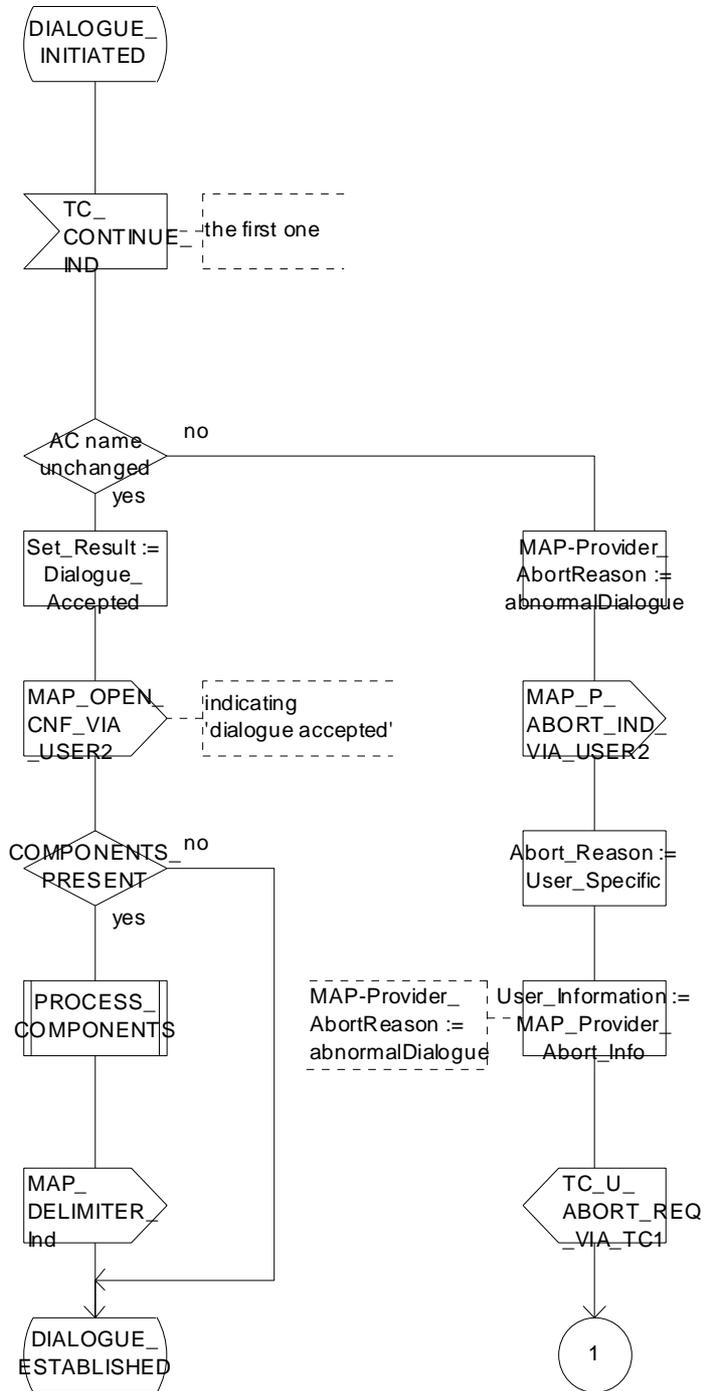

Figure 16.2/3 (sheet 6 of 11): Process MAP\_DSM

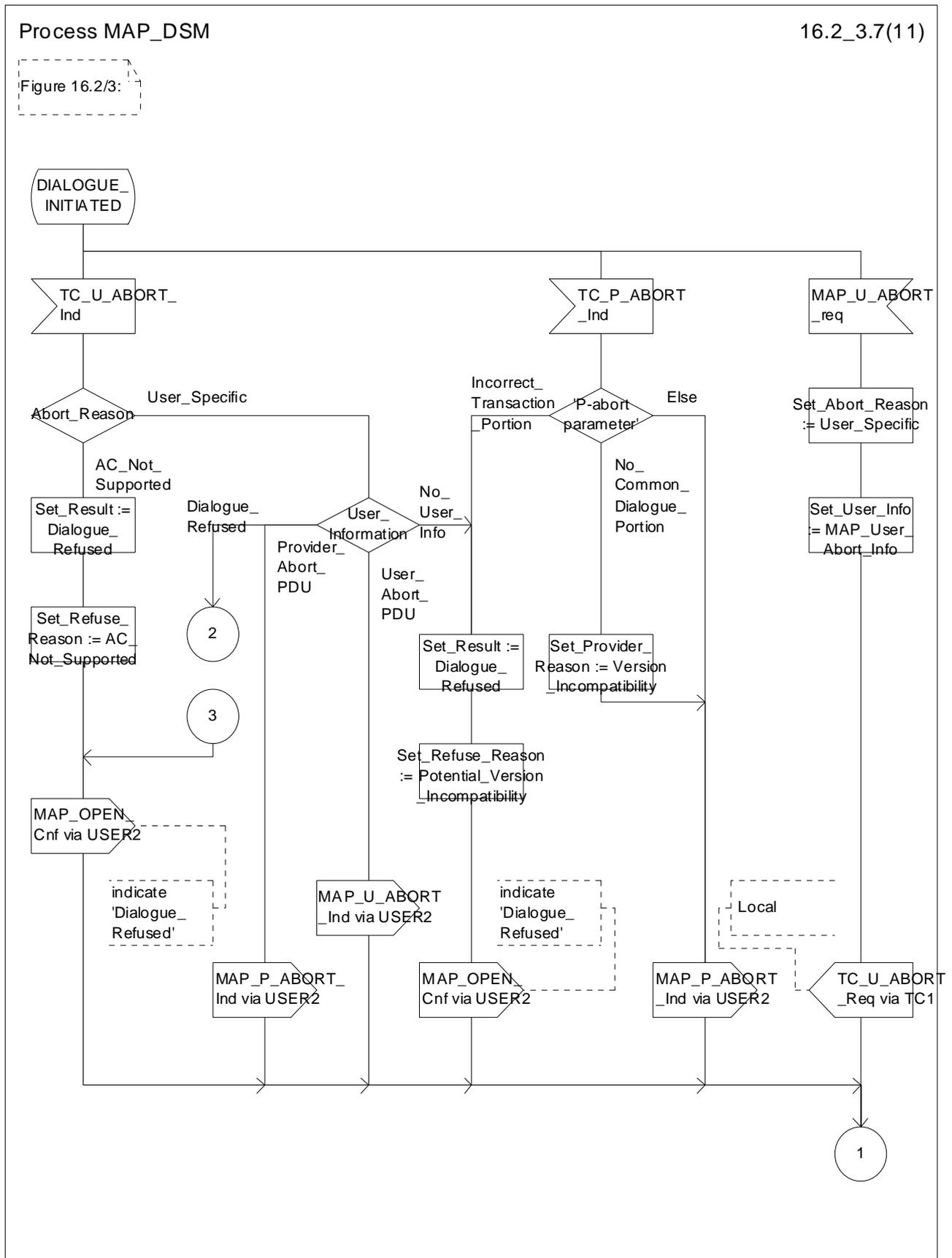

Figure 16.2/3 (sheet 7 of 11): Process MAP\_DSM

Process MAP\_DSM

16.2\_3.8(11)

Figure 16.2/3:

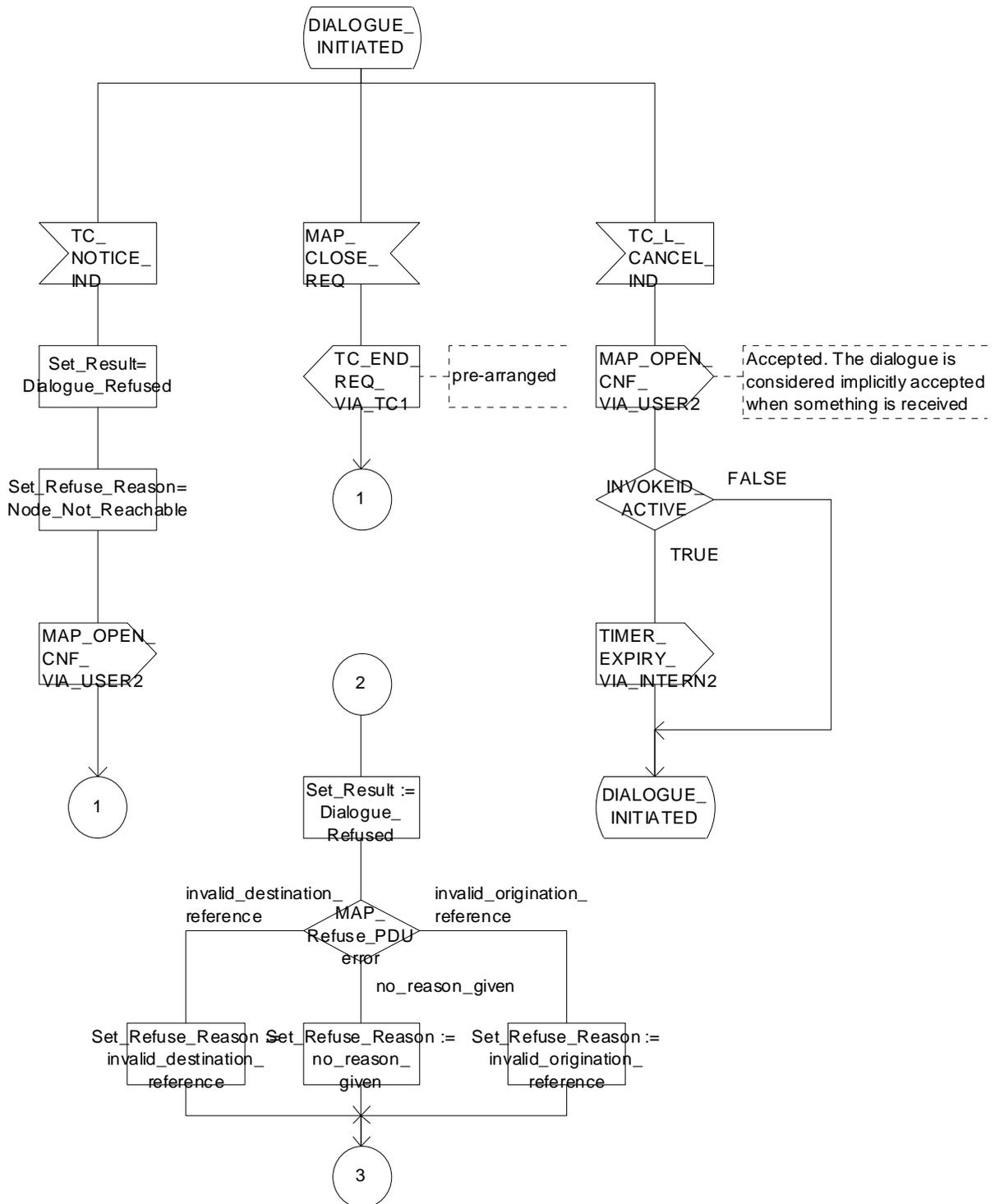

Figure 16.2/3 (sheet 8 of 11): Process MAP\_DSM

Process MAP\_DSM

16.2\_3.9(11)

Figure 16.2/3:

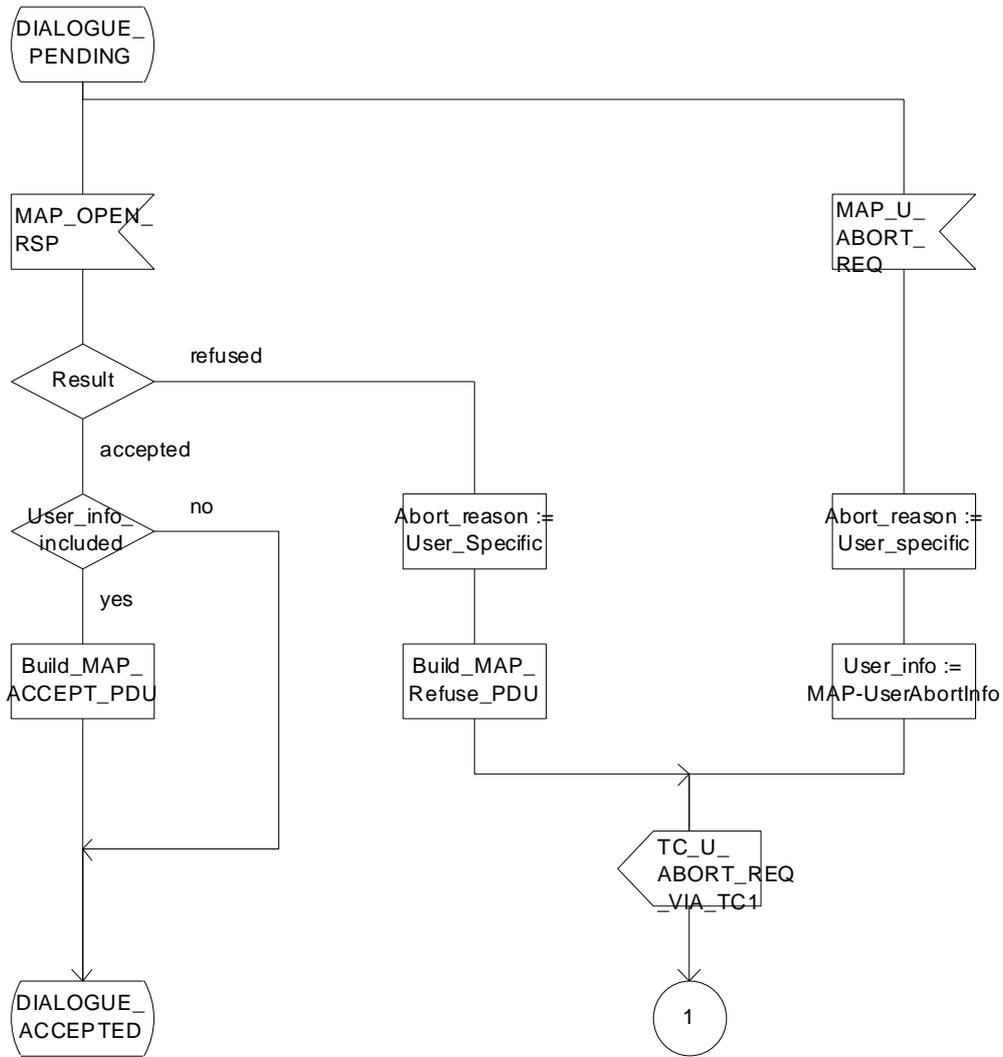

Figure 16.2/3 (sheet 9 of 11): Process MAP\_DSM

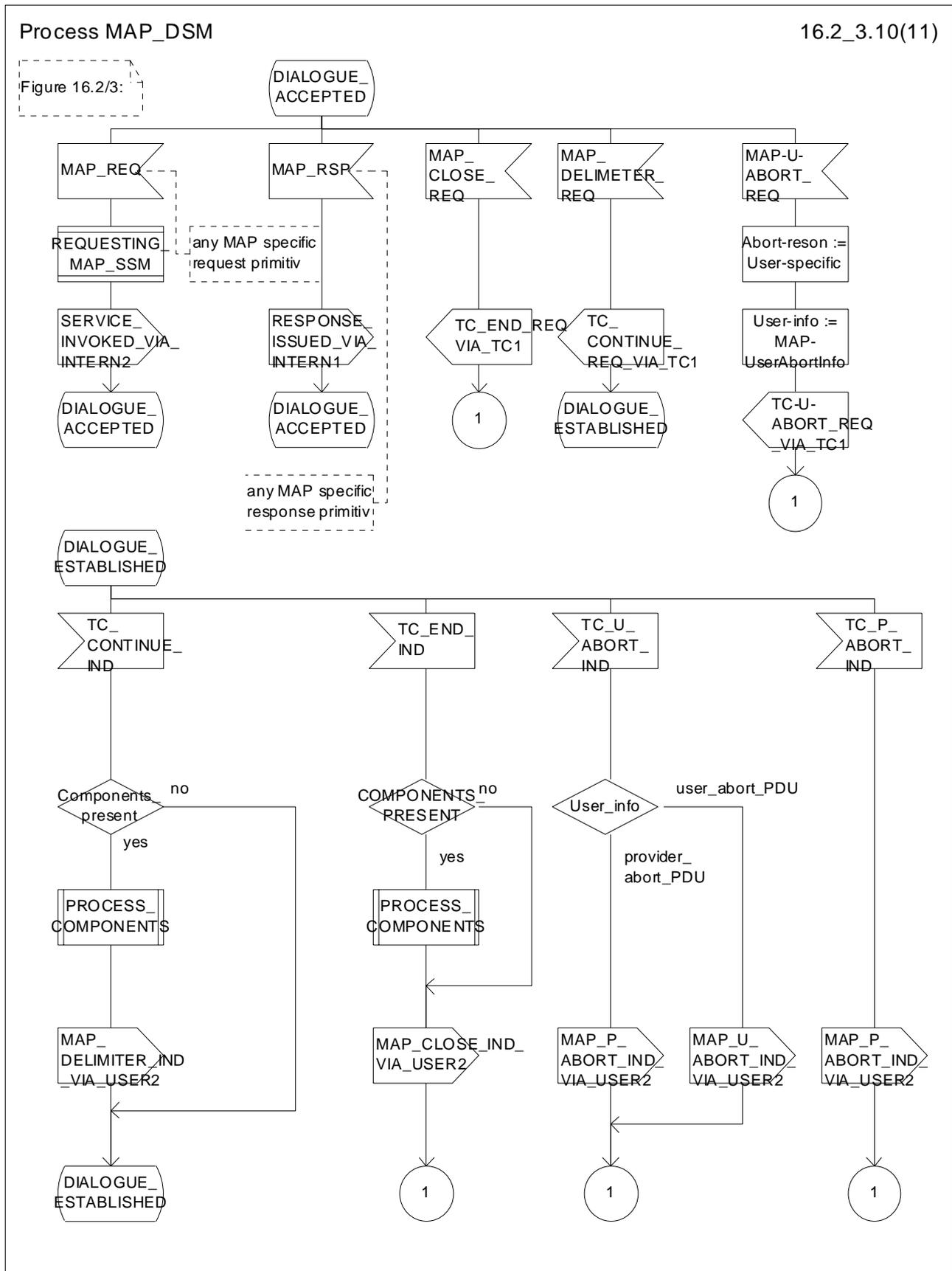

Figure 16.2/3 (sheet 10 of 11): Process MAP\_DSM

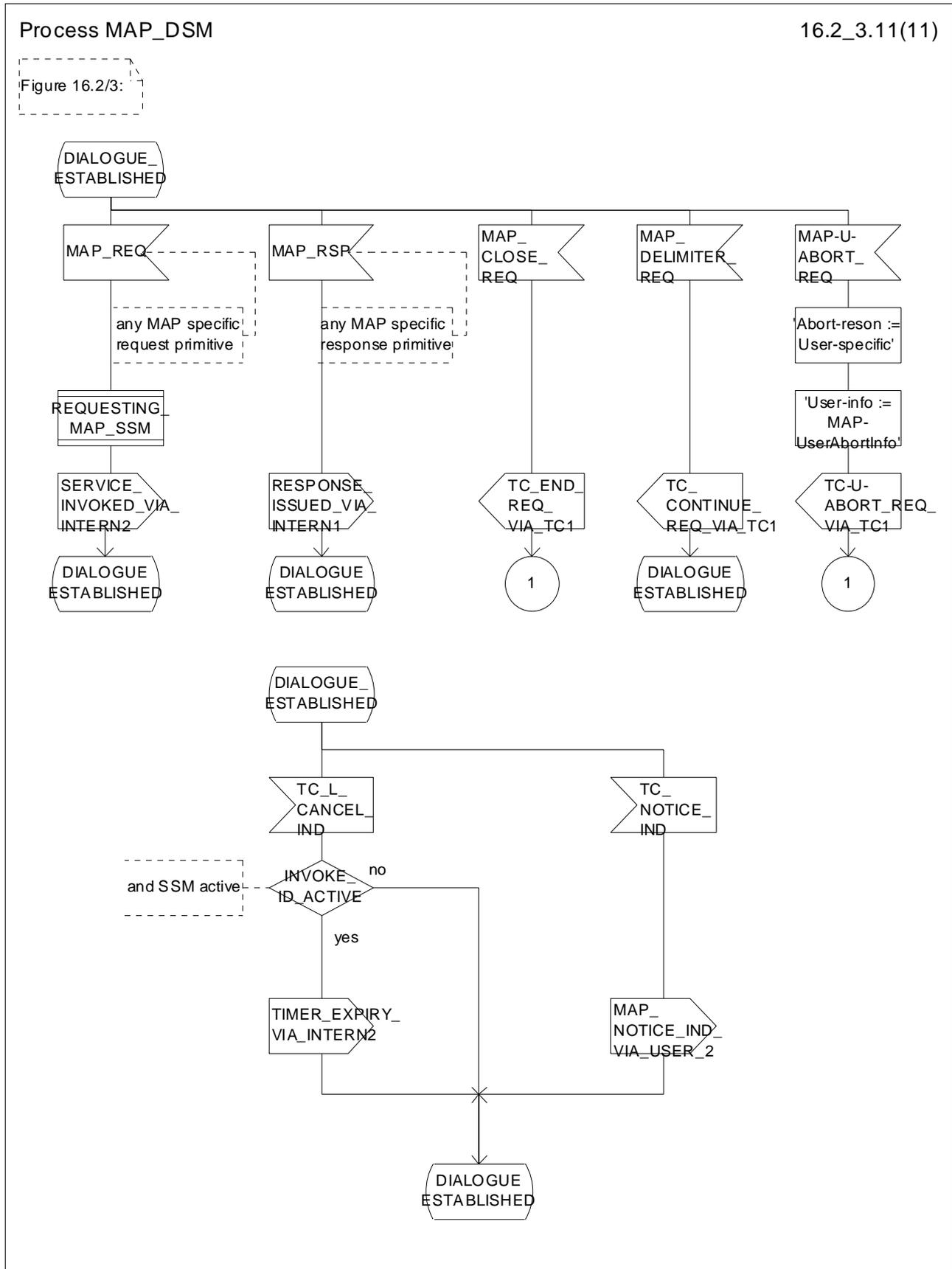

Figure 16.2/3 (sheet 11 of 11): Process MAP\_DSM

Procedure PROCESS\_COMPONENTS

16.2\_4.1(4)

Figure 16.2/4:

Comments: Components from TCAP:  
DCL  
OP\_CODE INTERGER,  
OP\_EXIST, LAST\_COMPONENT, INVOKEID\_ASS, LINKEDID\_PRES, LINKEDID\_ASS BOOLEAN

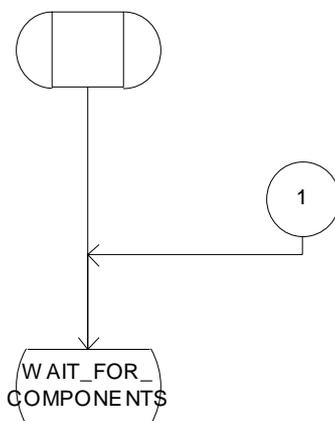

Figure 16.2/4 (sheet 1 of 4): Procedure PROCESS\_COMPONENTS

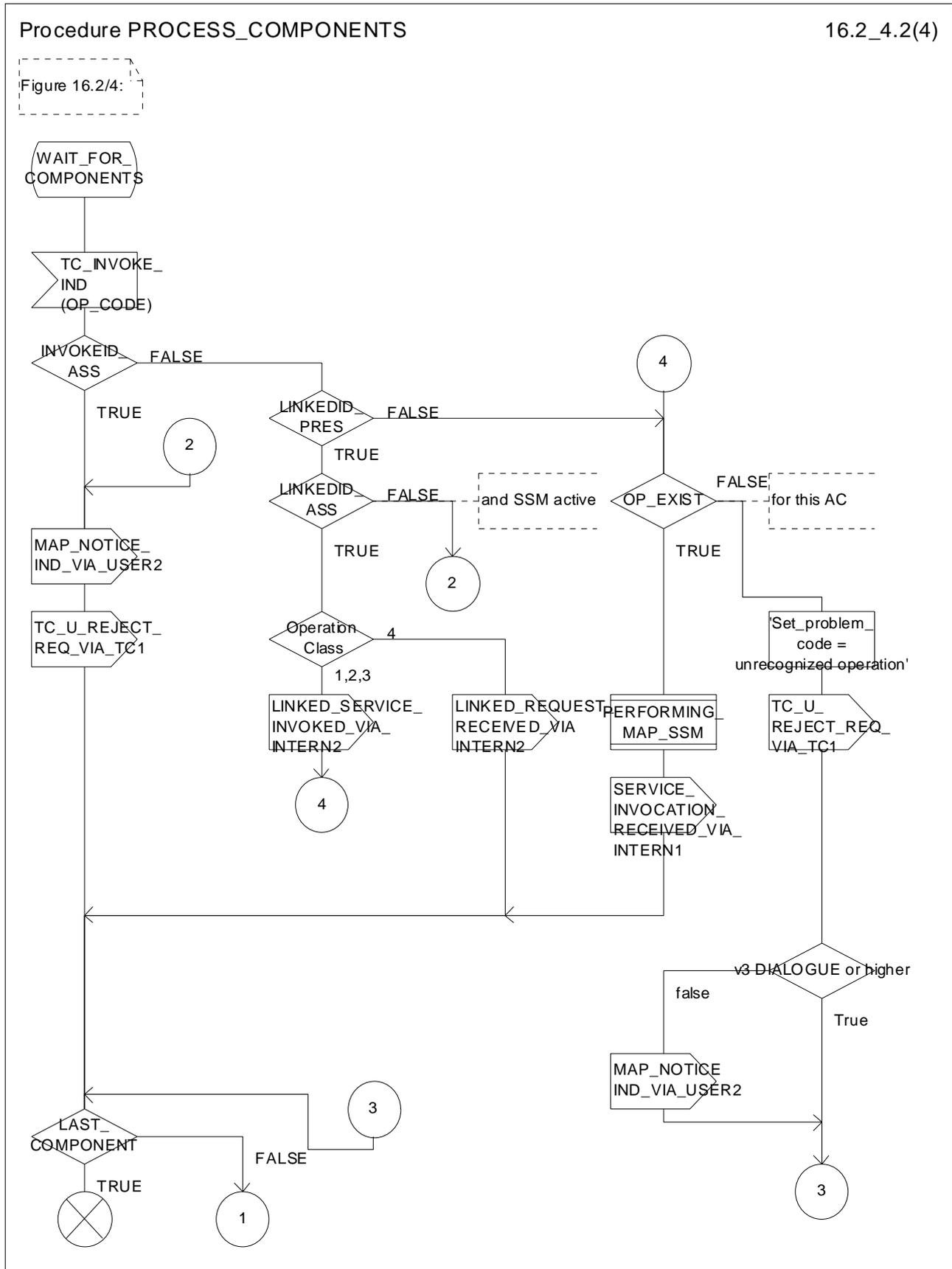

Figure 16.2/4 (sheet 2 of 4): Procedure PROCESS\_COMPONENTS



Procedure PROCESS\_COMPONENTS

16.2\_4.3(4)

Figure 16.2/4:

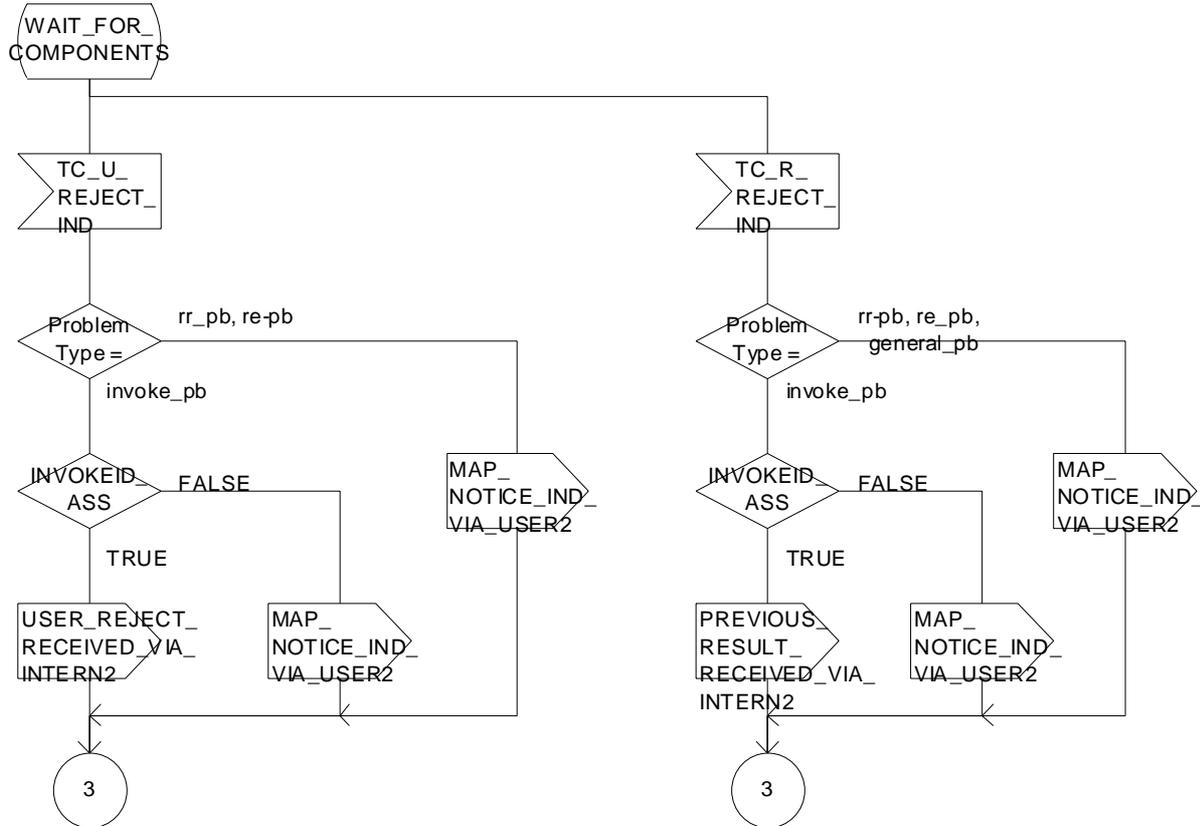
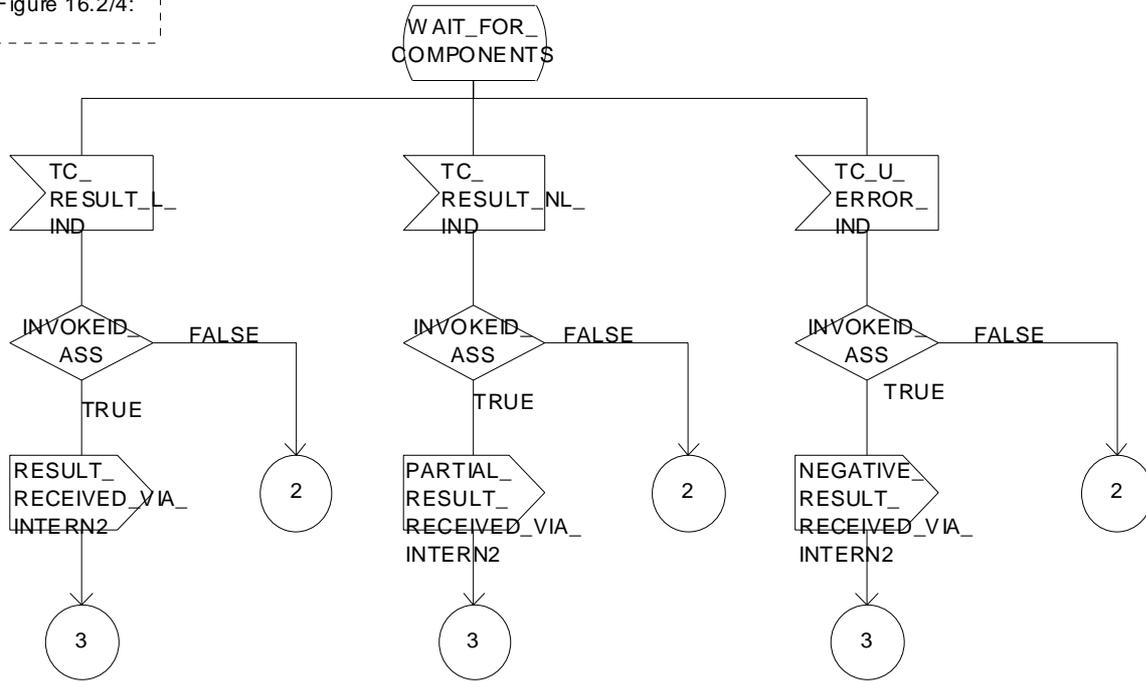

Figure 16.2/4 (sheet 3 of 4): Procedure PROCESS\_COMPONENTS

Procedure PROCESS\_COMPONENTS

16.2\_4.4(4)

Figure 16.2/4:

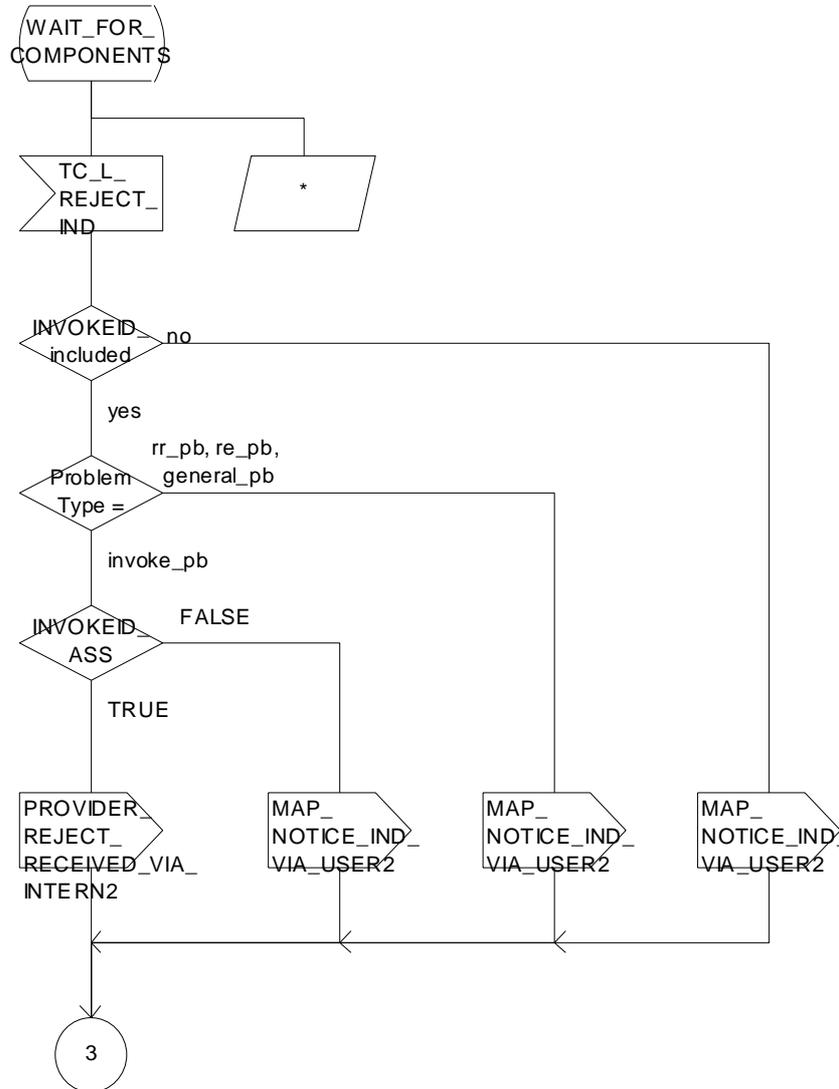

Figure 16.2/4 (sheet 4 of 4): Procedure PROCESS\_COMPONENTS

Process LOAD\_CTRL

16.2\_5(1)

Figure 16.2/5:

Comment 'LOAD CONTROL':  
DCL  
CONGESTION, DIALOGUE\_ACCEPTABLE BOOLEAN;

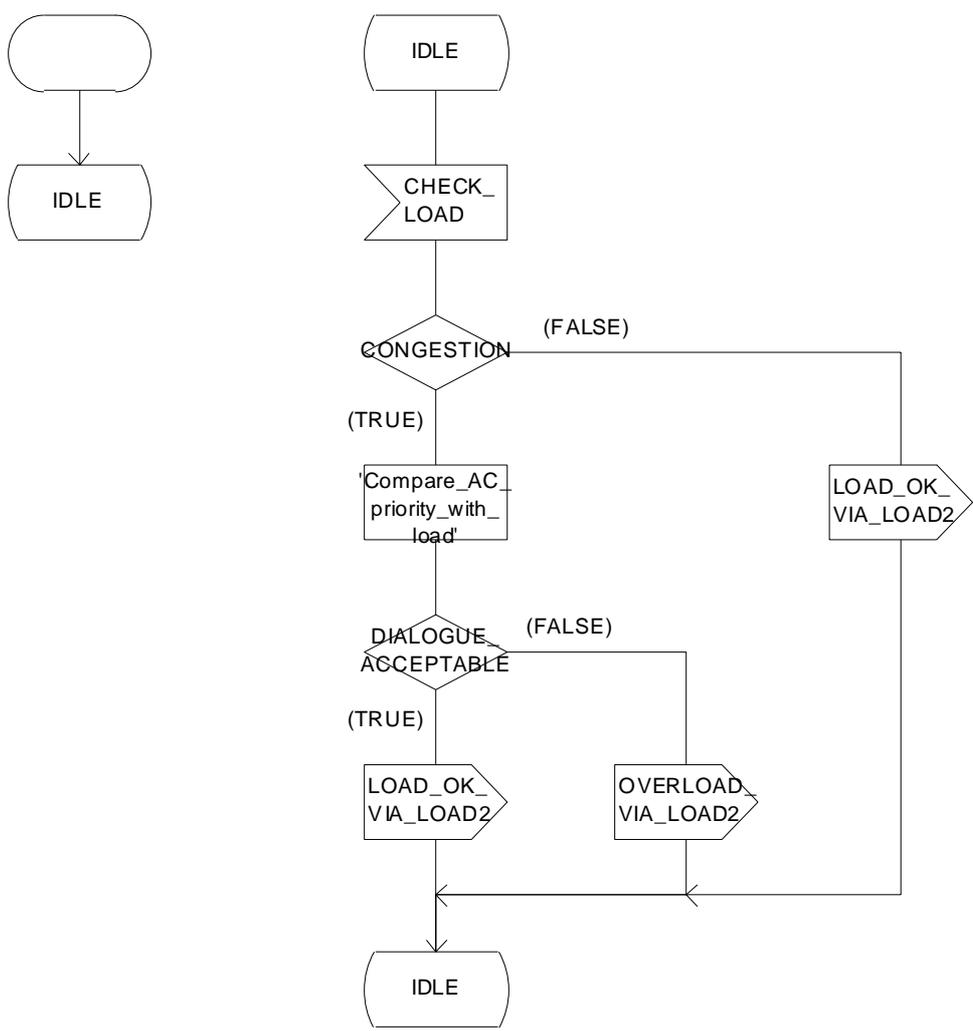

Figure 16.2/5: Process LOAD\_CTRL

Process PERFORMING\_MAP\_SSM

16.2\_6.1(3)

Figure 16.2/6:

Comment 'MAP Service State Machine':  
DCL  
ARGUMENT\_CORRECT, USER\_ERROR\_PRESENT,  
SPECIFIC\_ERROR\_LINKED\_REQUEST, CNF BOOLEAN,  
  
OP\_CLASS INTEGER,  
  
TIMER GUARD\_TIMER COMMENT 'expires if MAP user does not respond';

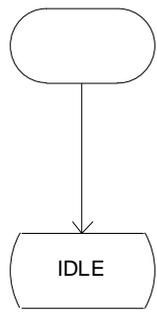

Figure 16.2/6 (sheet 1 of 3): Process PERFORMING\_MAP\_SSM

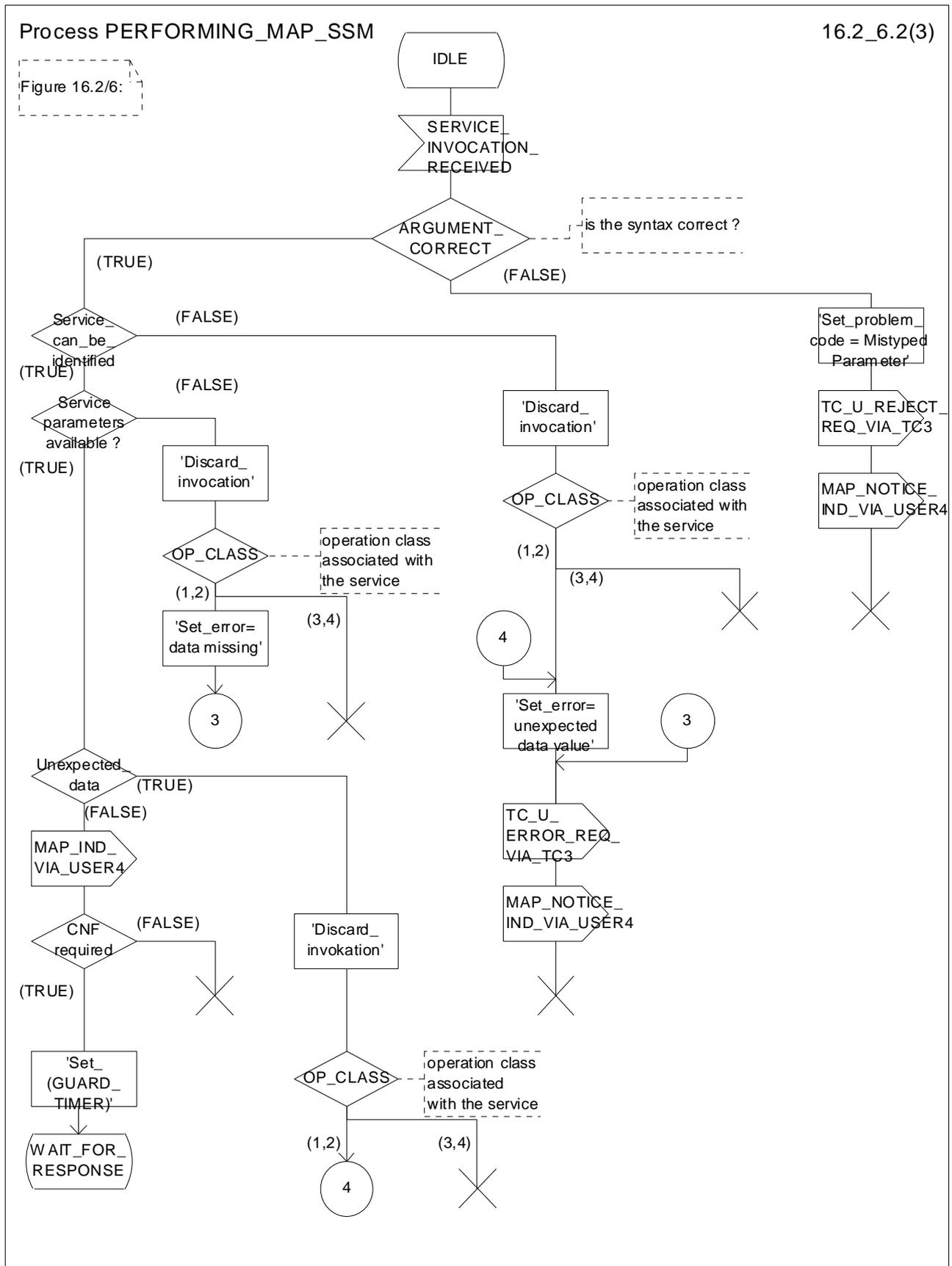

Figure 16.2/6 (sheet 2 of 3): Process PERFORMING\_MAP\_SSM

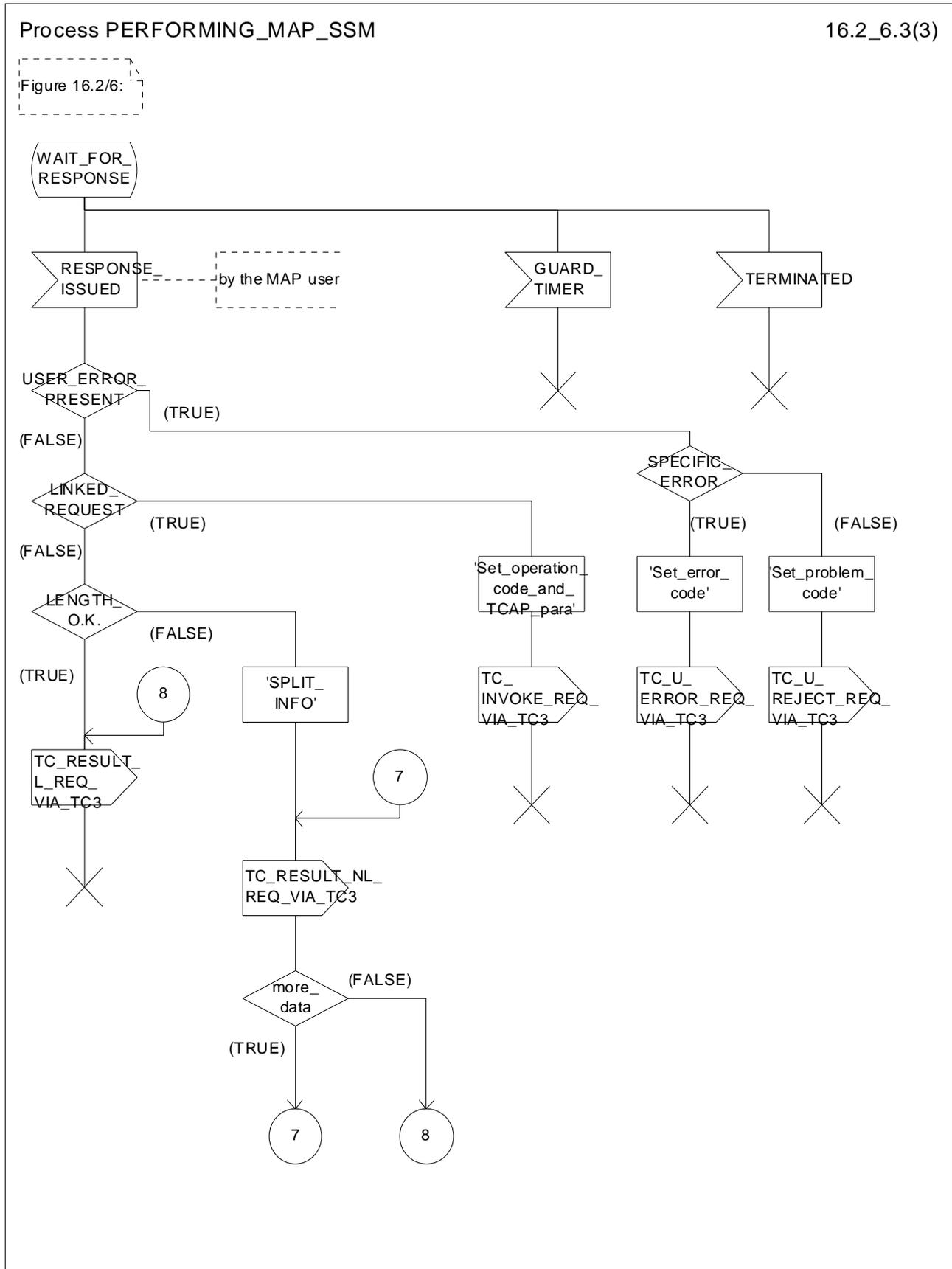

Figure 16.2/6 (sheet 3 of 3): Process PERFORMING\_MAP\_SSM

Process REQUESTING\_MAP\_SSM

16.2\_7.1(4)

Figure 16.2/7:

Comment 'MAP Service State Maschine':  
DCL  
ARGUMENT\_CORRECT, ERROR\_CODE\_CORRECT, LINKED\_REQ\_DEF, SYNTAX\_CORRECT,  
MAP\_INITIATED, CNF, LINKED\_OPERATION\_ALLOWED BOOLEAN,  
OP\_CLASS INTEGER;

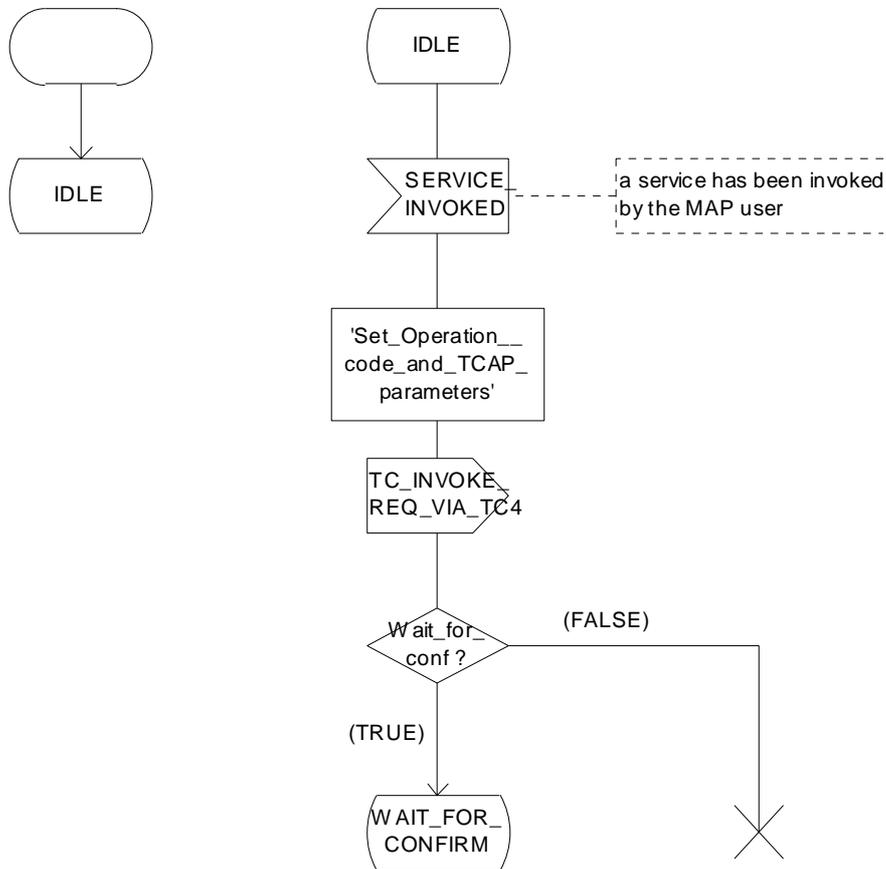

Figure 16.2/7 (sheet 1 of 4): Process REQUESTING\_MAP\_SSM

Process REQUESTING\_MAP\_SSM

16.2\_7.2(4)

Figure 16.2/7:

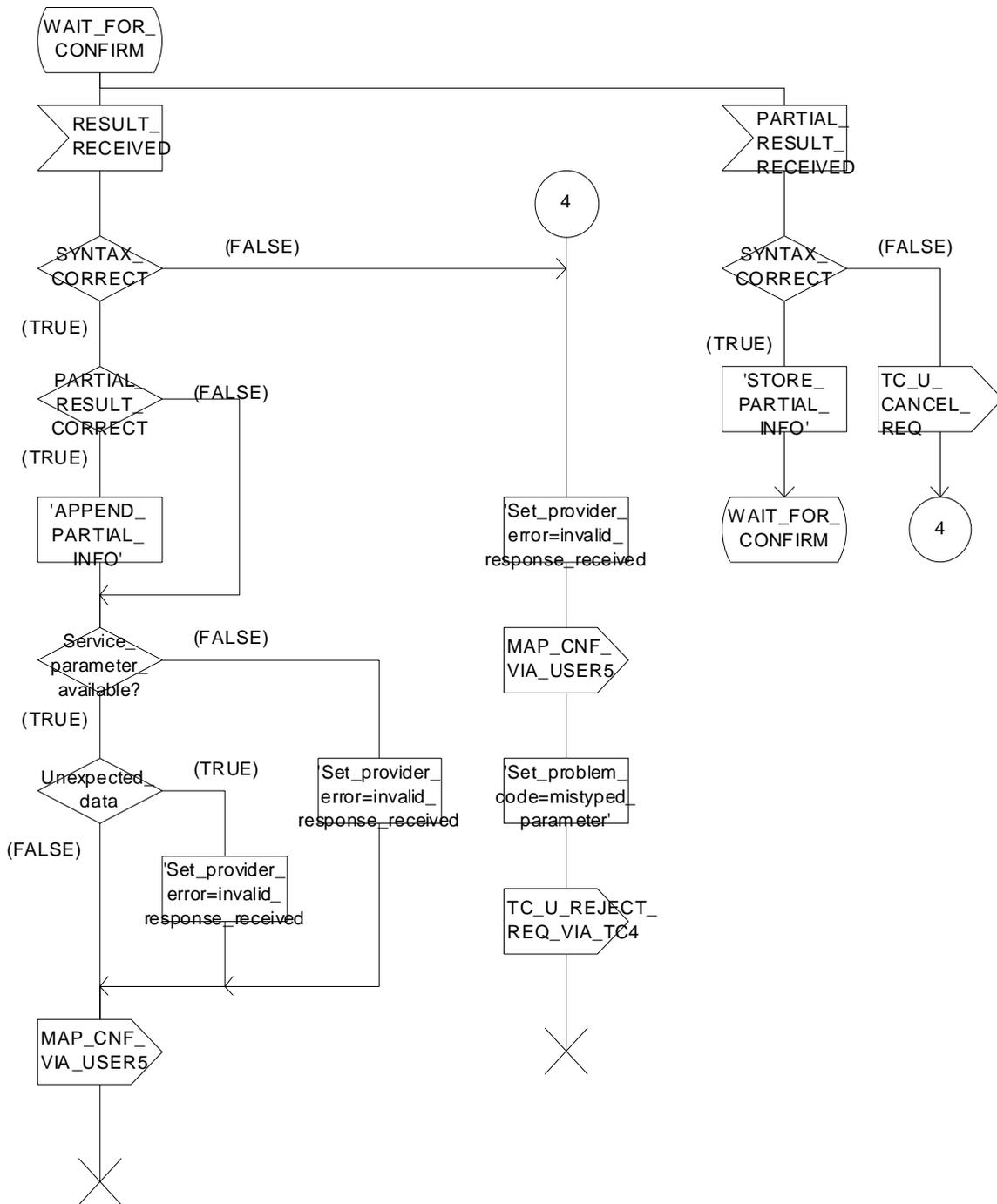

Figure 16.2/7 (sheet 2 of 4): Process REQUESTING\_MAP\_SSM



Process REQUESTING\_MAP\_SSM

16.2\_7.3(4)

Figure 16.2/7:

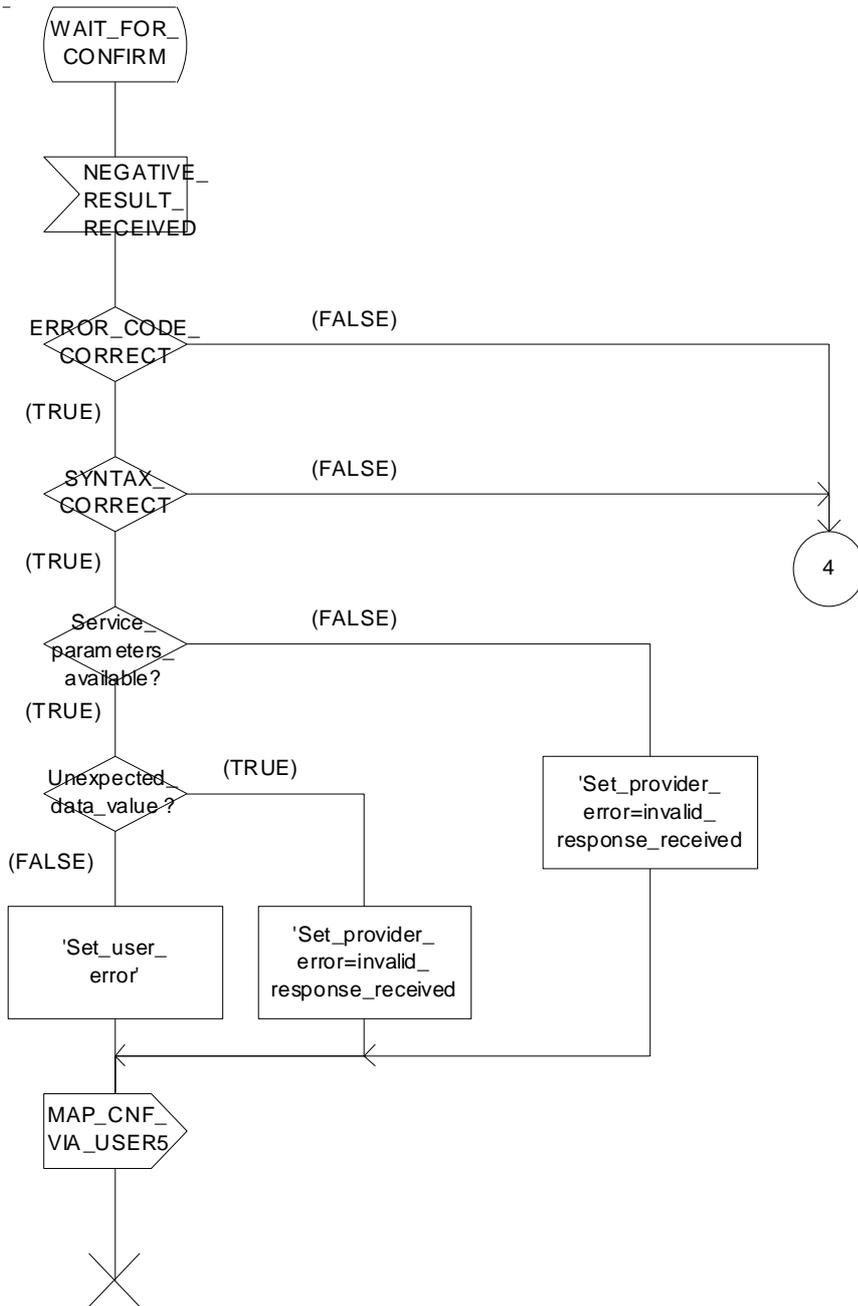

Figure 16.2/7 (sheet 3 of 4): Process REQUESTING\_MAP\_SSM

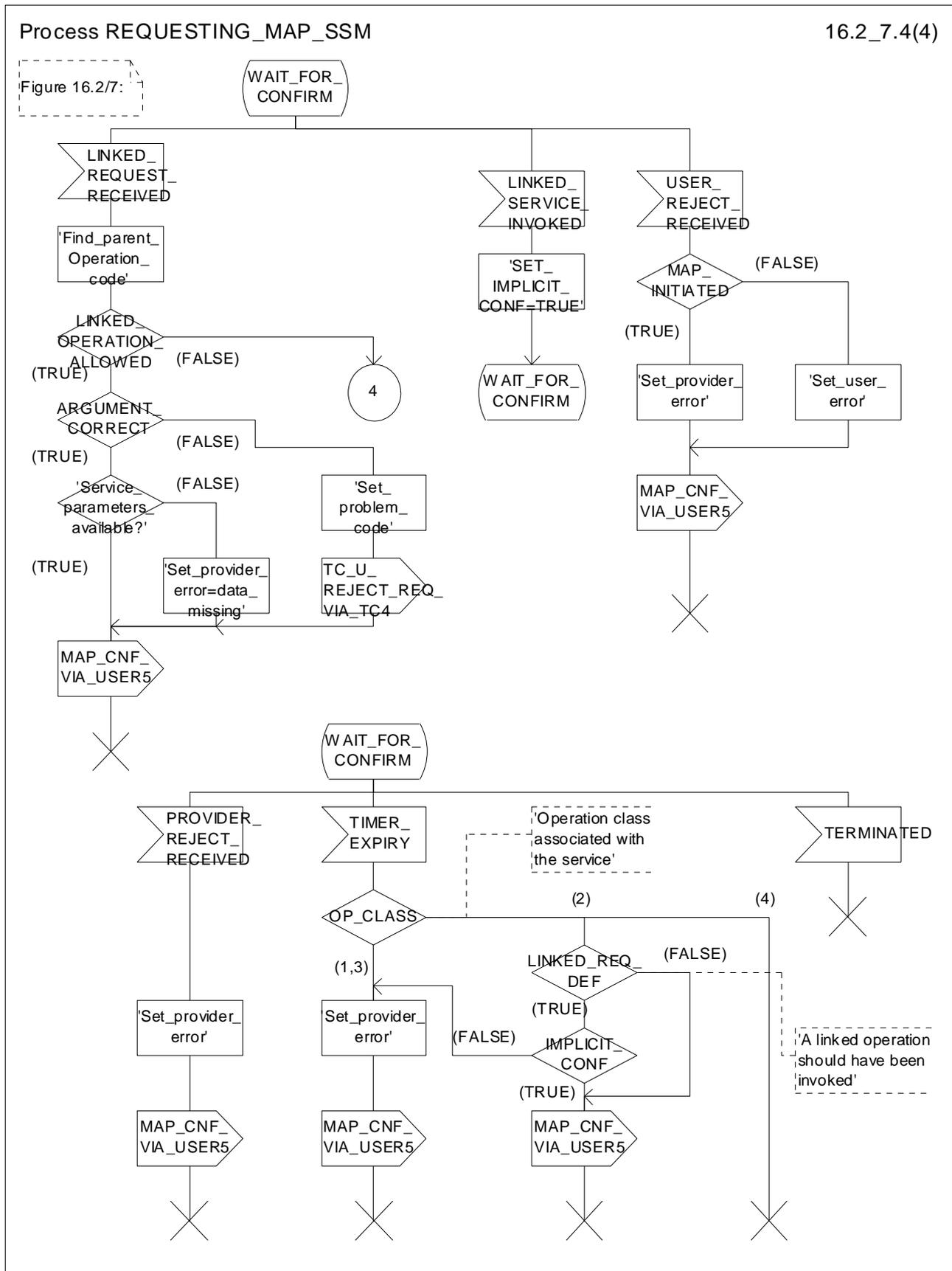

Figure 16.2/7 (sheet 4 of 4): Process REQUESTING\_MAP\_SSM

# 17 Abstract syntax of the MAP protocol

## 17.1 General

This clause specifies the Abstract Syntaxes for the Mobile Application Part as well as the associated set of Operations and Errors, using the Abstract Syntax Notation One (ASN.1), defined in CCITT Recommendation X.208 (1988) or X.680 (1994) with additions as defined in clause 17.1.4 on Compatibility Considerations and the OPERATION and ERROR external MACROs, defined in CCITT Recommendation Q.773.

The Abstract Syntax is defined for all interfaces specified in clause 4.4 except for the A- and B-interfaces.

The Mobile Application Part protocol is defined by two Abstract Syntaxes:

- one Abstract Syntax which encompass all Operations; and
- Errors identified by the various MAP subsystem numbers.

This Abstract Syntax represents the set of values each of which is a value of the ASN.1 type TCAPMessages.MessageType as defined in CCITT Recommendation Q.773 with the ANY DEFINED BY clauses resolved by the operation and error codes included in the ASN.1 module MAP-Protocol. However, only the subset of this abstract syntax which is required by the procedures defined for an entity needs to be supported:

- one Abstract Syntax identified by the OBJECT IDENTIFIER value MAP-DialogueInformation.map-DialogueAS.

This Abstract Syntax represents the set of values each of which is a value of the ASN.1 type MAP-DialogueInformation.MAP-DialoguePDU. Such a value of the ASN.1 single-ASN.1-type element is contained within the user-information element of the TCAPMessages.DialoguePortion ASN.1 type. This Abstract Syntax name is to be used as a direct reference.

### 17.1.1 Encoding rules

The encoding rules which are applicable to the defined Abstract Syntaxes are the Basic Encoding Rules for Abstract Syntax Notation One, defined in CCITT Recommendation X.690 with the same exceptions as in CCITT Recommendation Q.773 clause 4 Message Representation.

When the definite form is used for length encoding, a data value of length less than 128 octets must have the length encoded in the short form.

When the long form is employed to code a length, the minimum number of octets shall be used to code the length field.

OCTET STRING values and BIT STRING values must be encoded in a primitive form.

There is no restriction to the use of empty constructors (e.g. an empty SEQUENCE type). That is, the encoding of the content of any data value shall consist of zero, one or more octets.

### 17.1.2 Use of TC

The mapping of OPERATION and ERROR to TC components is defined in ETS 300 287 (version 2) which is based on CCITT Recommendation Q.773 (1992).

NOTE 1: The class of an operation is not stated explicitly but is specified as well in the ASN.1 operation type definition.

Class 1: RESULT and ERROR appear in ASN.1 operation type definition.

Class 2: only ERROR appears in ASN.1 operation type definition.

Class 3: only RESULT appears in ASN.1 operation type definition.

Class 4: both RESULT and ERROR do not appear in ASN.1 operation type definition.

The ASN.1 data type which follows the keywords "ARGUMENT", "PARAMETER" or "RESULT" (for OPERATION and ERROR) is always optional from a syntactic point of view. However, except when specifically mentioned with the ASN.1 comment «-- optional», the «parameter» part of a component has to be considered as mandatory from a semantic point of view.

When an optional element is missing in an invoke component or in an inner data structure while it is required by the context, an error component is returned if specified in the operation type; the associated type of error is DataMissing. This holds also when the entire parameter of an invoke component is missing while it is required by the context.

NOTE 2: When a mandatory element is missing in the parameter or inner data structure of any component, a reject component is returned (if the dialogue still exists). The problem code to be used is "Mistyped parameter".

The Timer Values used in the operation type definitions are indicated as ASN.1 comment. The Timer Value Ranges are:

s = from 3 seconds to 10 seconds;

m = from 15 seconds to 30 seconds;

ml = from 1 minute to 10 minutes;

l = from 28 hours to 38 hours.

### 17.1.2.1 Use of Global Operation and Error codes defined outside MAP

An entity supporting an application context greater than 2 shall be capable of receiving an operation or error code, within an application context defined in GSM 09.02, encoded as either an Object Identifier (as defined in CCITT Recommendation X.690 (1994)) or an integer value (as defined in clause 17.5). Related restrictions regarding the use of Object Identifiers are as follows:

- The length of the Object Identifier shall not exceed 16 octets and the number of components of the Object Identifier shall not exceed 16.
- Object Identifiers shall be used only for operations or errors defined outside of GSM 09.02.
- Global error codes may be sent only in response to a global operation. If a standard operation is received then a global error code shall not be sent in response.

Handling of an unknown operation codes by the receiving entity is defined in clause 15.1.1.

### 17.1.3 Use of information elements defined outside MAP

An information element or a set of information elements (messages) transparently carried in the Mobile Application Part but defined in other recommendation/technical specifications are handled in one of the following ways:

- i) The contents of each information element (without the octets encoding the identifier and the length in the recommendation/technical specification where it is defined) is carried as the value of an ASN.1 NamedType derived from the OCTET STRING data type. Additionally, the internal structure may be explained by means of comments. In case of misalignment the referred to recommendation/technical specification takes precedence.
- ii) The complete information element (including the octets encoding the identifier and the length in the recommendation/technical specification where it is defined) or set of information elements and the identity of the associated protocol are carried as the value of the ExternalSignalInfo data type defined in the present document. Where more than one information element is carried, the information elements are sent contiguously with no filler octets between them.

## 17.1.4 Compatibility considerations

The following ASN.1 modules conform to CCITT Recommendation X.208 (1988) or X.680 (1994) (the only module which makes use of X.680 is MAP-ExtensionDataTypes), but in addition Ellipsis Notation ("..." - notation) is used as described in ITU-T Recommendation X.680 Amendment 1 (1995) wherever future protocol extensions are foreseen.

The "..." construct applies only to SEQUENCE and ENUMERATED data types. An entity supporting a version greater than 1 shall not reject an unsupported extension following "..." of that SEQUENCE or ENUMERATED data type. The Encoding Rules from clause 17.1.1 apply to every element of the whole Transfer Syntax especially to the ASN.1 type EXTERNAL.

Private extensions shall:

- 1) if included in operations of an AC of V2, follow the extension marker and be tagged using PRIVATE tags up to and including 29.

NOTE: This type of extension is in most cases used only within a PLMN.

- 2) if included in operations of an AC of V3 or higher: be included only in the Private Extension Container that is defined in the specification.

NOTE: This type of extension can be used between PLMNs.

Private extensions shall not be included in v2 supplementary service operations.

Private extensions shall not be included within user error for RegisterCCEnter and EraseCCEnter operations.

PCS extensions shall be included in the PCS Extension Container that is defined in this specification.

In order to improve extensibility, a few error parameters have been defined as a CHOICE between the version 2 description and a SEQUENCE including the version 2 description and an extension container. Operations used in a v2-application-context must consider only the first alternative while operations used in a vn-application-context (n>2) must consider only the second alternative.

## 17.1.5 Structure of the Abstract Syntax of MAP

For each MAP parameter which has to be transferred by a MAP Protocol Data Unit (MAP message), there is a PDU field (an ASN.1 NamedType) whose ASN.1 identifier has the same name as the corresponding parameter, except for the differences required by the ASN.1 notation (blanks between words are removed or replaced by hyphen, the first letter of the first word is lower-case and the first letter of the following words are capitalized, e.g. "no reply condition time" is mapped to "noReplyConditionTime"). Additionally some words may be abbreviated as follows:

bs basic service  
ch call handling  
cug closed user group  
ho handover  
ic incoming call  
id identity  
info information  
ms mobile service  
oc outgoing call  
om operation & maintenance  
pw Password  
sm short message service  
ss supplementary service

The MAP protocol is composed of several ASN.1 modules dealing with either operations, errors, data types, and, if applicable, split into those dealing with mobile services, call handling services, supplementary services and short message services. For operations and errors no values are assigned, but only the operation and error types in order to allow use of the defined types also by other protocols (e.g. TS GSM 04.80). The values (operation codes and error codes) are defined in a separate module. The ASN.1 source lines are preceded by line-numbers at the left margin in order to enable the usage of the cross-reference in annex A.

The module containing the definition of the operation packages for MAP is:

1. MAP-OperationPackages.

The module containing the definition of the application contexts for MAP is:

2. MAP-ApplicationContexts.

The module containing the data types for the Abstract Syntax to be used for TCAPMessages.DialoguePortion for MAP is:

3. MAP-DialogueInformation.

The module containing the operation codes and error codes for MAP is:

4. MAP-Protocol.

The modules containing all operation type definitions for MAP are:

5. MAP-MobileServiceOperations;
6. MAP-OperationAndMaintenanceOperations;
7. MAP-CallHandlingOperations;
8. MAP-SupplementaryServiceOperations;
9. MAP-ShortMessageServiceOperations;
10. MAP-Group-Call-Operations.

The module containing all error type definitions for MAP is:

11. MAP-Errors.

Modules containing all data type definitions for MAP are:

12. MAP-MS-DataTypes;
13. MAP-OM-DataTypes;
14. MAP-CH-DataTypes;
15. MAP-SS-DataTypes;
16. MAP-SS-Code;
17. MAP-SM-DataTypes;
18. MAP-ER-DataTypes;
19. MAP-CommonDataTypes;
20. MAP-TS-Code;
21. MAP-BS-Code;
22. MAP-ExtensionDataTypes;
23. MAP-GR-DataTypes.

References are made also to modules defined outside of the present document. They are defined in the technical specification Mobile Services Domain and technical specification Transaction Capability respectively:

MobileDomainDefinitions;

TCAPMessages;

DialoguePDUs.

### 17.1.6 Application Contexts

The following informative table lists the latest versions of the Application Contexts used in this specification, with the operations used by them and, where applicable, whether or not the operation description is exactly the same as for previous versions. Information in clauses 17.6 & 17.7 relates only to the ACs in this table.

AC Name	AC Version	Operations Used	Comments
locationCancellationContext	v3	cancelLocation	
equipmentMngtContext	v2	checkIMEI	
imsiRetrievalContext	v2	sendIMSI	
infoRetrievalContext	v2	sendAuthenticationInfo	
interVlrInfoRetrievalContext	v2	sendIdentification	
handoverControlContext	v2	prepareHandover forwardAccessSignalling sendEndSignal processAccessSignalling prepareSubsequentHandover	
mwdMngtContext	v3	readyForSM	
msPurgingContext	v3	purgeMS	
shortMsgAlertContext	v2	alertServiceCentre	
resetContext	v2	reset	
networkUnstructuredSsContext	v2	processUnstructuredSS-Request unstructuredSS-Request unstructuredSS-Notify	
tracingContext	v3	activateTraceMode deactivateTraceMode	
networkFunctionalSsContext	v2	registerSS eraseSS activateSS deactivateSS registerPassword interrogateSS getPassword	
shortMsgMO-RelayContext	v3	mo-forwardSM	
shortMsgMT-RelayContext	v3	mt-forwardSM	
shortMsgGatewayContext	v3	sendRoutingInfoForSM reportSM-DeliveryStatus InformServiceCentre	the syntax of this operation has been extended in comparison with release 96 version
networkLocUpContext	v3	updateLocation forwardCheckSs-Indication restoreData insertSubscriberData activateTraceMode	the syntax is the same in v1 & v2
gprsLocationUpdateContext	v3	updateGprsLocation insertSubscriberData activateTraceMode	
subscriberDataMngtContext	v3	insertSubscriberData deleteSubscriberData	
roamingNumberEnquiryContext	v3	provideRoamingNumber	
locationInfoRetrievalContext	v3	sendRoutingInfo	
gprsNotifyContext	v3	noteMsPresentForGprs	
gprsLocationInfoRetrievalContext	v3	sendRoutingInfoForGprs	
failureReportContext	v3	failureReport	

callControlTransferContext	v3	resumeCallHandling	
subscriberInfoEnquiryContext	v3	provideSubscriberInfo	
anyTimeEnquiryContext	v3	anyTimeInterrogation	
ss-InvocationNotificationContext	v3	ss-InvocationNotification	
siWFSAllocationContext	v3	provideSIWFSNumber siWFS signallingModify	
groupCallControlContext	v3	prepareGroupCall processGroupCallSignalling forwardGroupCallSignalling sendGroupCallEndSignal	
reportingContext	v3	setReportingState statusReport remoteUserFree	
callCompletionContext	v3	registerCC-Entry eraseCC-Entry	

NOTE (\*): The syntax of the operations is not the same as in previous versions unless explicitly stated

## 17.2 Operation packages

### 17.2.1 General aspects

This clause describes the operation-packages which are used to build the application-contexts defined in clause 17.3.

Each operation-package is a specification of the roles of a pair of communicating objects (i.e. a pair of MAP-Providers), in term of operations which they can invoke of each other.

The grouping of operations into one or several packages does not necessarily imply any grouping in term of Application Service Elements.

The following ASN.1 MACRO is used to describe operation-packages in this clause:

```
OPERATION-PACKAGE MACRO ::=
BEGIN
TYPE NOTATION ::= Symmetric | ConsumerInvokes SupplierInvokes |
empty
VALUE NOTATION ::= value(VALUE OBJECT IDENTIFIER)
Symmetric ::= "OPERATIONS" "{" OperationList "}"
ConsumerInvokes ::= "CONSUMER INVOKES" "{" OperationList "}"
SupplierInvokes ::= "SUPPLIER INVOKES" "{" OperationList "}" | empty
OperationList ::= Operation | OperationList "," Operation
Operation ::= value(OPERATION)
END
```

Since the application-context definitions provided in clause 17.3 use only an informal description technique, only the type notation is used in the following clauses to define operation-packages.

The following definitions are used throughout this clause (n>=2):

- v1-only operation: An operation which shall be used only in v1 application-contexts;
- vn-only operation: An operation which shall be used only in vn application-contexts;
- v(n-1)-operation: An operation whose specification has not been modified since the MAP v(n-1) specifications or if the modifications are considered as not affecting v(n-1) implementations;
- v(n-1)-equivalent operation: The version of an operation which excludes all the information elements and errors which have been added since the MAP v(n-1) specification;
- vn-only package: An operation package which contains only vn-only operations;



- v(n-1)-package: An operation package which contains only v(n-1)- operations.

The names of vn-packages are suffixed by "-vn" where  $n \geq 2$ .

For each operation package which is not vn-only ( $n \geq 2$ ) and which does not include only v(n-1)-operations, there is a v(n-1)-equivalent package. Except when a definition is explicitly provided in the following clauses, the v(n-1)-equivalent package includes the v(n-1)-equivalent operations of the operations which belong to this package.

## 17.2.2 Packages specifications

### 17.2.2.1 Location updating

This operation package includes the operations required for location management procedures between HLR and VLR.

```
LocationUpdatingPackage-v3 ::= OPERATION-PACKAGE
-- Supplier is HLR if Consumer is VLR
CONSUMER INVOKES {
    updateLocation}
SUPPLIER INVOKES {
    forwardCheckSs-Indication}
```

The v1-equivalent and v2-equivalent packages can be determined according to the rules described in clause 17.2.1.

### 17.2.2.2 Location cancellation

This operation package includes the operations required for location cancellation and MS purging procedures between HLR and VLR and between HLR and SGSN.

```
LocationCancellationPackage-v3 ::= OPERATION-PACKAGE
-- Supplier is VLR or SGSN if Consumer is HLR
CONSUMER INVOKES {
    cancelLocation}
```

The v1-equivalent and v2-equivalent packages can be determined according to the rules described in clause 17.2.1.

### 17.2.2.3 Roaming number enquiry

This operation package includes the operations required for roaming number enquiry procedures between HLR and VLR.

```
RoamingNumberEnquiryPackage-v3 ::= OPERATION-PACKAGE
-- Supplier is VLR if Consumer is HLR
CONSUMER INVOKES {
    provideRoamingNumber}
```

The v1-equivalent and v2-equivalent packages can be determined according to the rules described in clause 17.2.1.

### 17.2.2.4 Information retrieval

This operation package includes the operation required for the authentication information retrieval procedure between HLR and VLR and between HLR and SGSN.

```
InfoRetrievalPackage-v2 ::= OPERATION-PACKAGE
-- Supplier is HLR if Consumer is VLR
-- Supplier is HLR if Consumer is SGSN
CONSUMER INVOKES {
    sendAuthenticationInfo}
```

The v1-equivalent package is defined as follows:

```
InfoRetrievalPackage-v1 ::= OPERATION-PACKAGE
-- Supplier is HLR or VLR if Consumer is VLR
-- Supplier is HLR if Consumer is SGSN
CONSUMER INVOKES {
    sendParameters}
```

### 17.2.2.5 Inter-VLR information retrieval

This operation package includes the operations required for inter VLR information retrieval procedures.

```
InterVlrInfoRetrievalPackage-v2 ::= OPERATION-PACKAGE
-- Supplier is VLR if Consumer is VLR
CONSUMER INVOKES {
    sendIdentification}
```

The v1-equivalent package is : InfoRetrievalPackage-v1

### 17.2.2.6 IMSI retrieval

This operation package includes the operation required for the IMSI retrieval procedure between HLR and VLR.

```
IMSIRetrievalPackage-v2 ::= OPERATION-PACKAGE
-- Supplier is HLR if Consumer is VLR
CONSUMER INVOKES {
    sendIMSI}
```

This package is v2 only.

### 17.2.2.7 Call control transfer

This operation package includes the operation required for the call control transfer procedure between VMSC and GMSC.

```
CallControlTransferPackage-v3 ::= OPERATION-PACKAGE
-- Supplier is GMSC if Consumer is VMSC
CONSUMER INVOKES {
    resumeCallHandling}
```

This package is v3 only.

### 17.2.2.8 - 17.2.2.9 Void

### 17.2.2.10 Interrogation

This operation package includes the operations required for interrogation procedures between MSC and HLR.

```
InterrogationPackage-v3 ::= OPERATION-PACKAGE
-- Supplier is HLR if Consumer is MSC
CONSUMER INVOKES {
    sendRoutingInfo}
```

The v1-equivalent and v2-equivalent packages can be determined according to the rules described in clause 17.2.1.

### 17.2.2.11 Void

### 17.2.2.12 Handover Control

This operation package includes the operations required for handover procedures between MSCs.

```

HandoverControlPackage-v2 ::= OPERATION-PACKAGE
-- Supplier is MSCB if Consumer is MSCA
CONSUMER INVOKES {
    prepareHandover,
    forwardAccessSignalling}
SUPPLIER INVOKES {
    sendEndSignal,
    processAccessSignalling,
    prepareSubsequentHandover}
    
```

The v1-equivalent package is defined as follows.

```

HandoverControlPackage-v1 ::= OPERATION-PACKAGE
-- Supplier is MSCB if Consumer is MSCA
CONSUMER INVOKES {
    performHandover,
    forwardAccessSignalling,
    traceSubscriberActivity}
SUPPLIER INVOKES {
    sendEndSignal,
    noteInternalHandover,
    processAccessSignalling,
    performSubsequentHandover}
    
```

### 17.2.2.13 Subscriber Data management stand alone

This operation package includes the operations required for stand alone subscriber data management procedures between HLR and VLR or between HLR and SGSN.

```

SubscriberDataMngtStandAlonePackage-v3 ::= OPERATION-PACKAGE
-- Supplier is VLR or SGSN if Consumer is HLR
CONSUMER INVOKES {
    insertSubscriberData,
    deleteSubscriberData}
    
```

The v1-equivalent and v2-equivalent packages can be determined according to the rules described in clause 17.2.1.

### 17.2.2.14 Equipment management

This operation package includes the operations required for equipment management procedures between EIR and MSC or between EIR and SGSN.

```

EquipmentMngtPackage-v2 ::= OPERATION-PACKAGE
-- Supplier is EIR if Consumer is MSC
-- Supplier is EIR if Consumer is SGSN
CONSUMER INVOKES {
    checkIMEI}
    
```

The v1-equivalent package can be determined according to the rules described in clause 17.2.1.

### 17.2.2.15 Subscriber data management

This operation package includes the operations required for subscriber data management procedures between HLR and VLR or between HLR and SGSN.

```

SubscriberDataMngtPackage-v3 ::= OPERATION-PACKAGE
-- Supplier is VLR or SGSN if Consumer is HLR
CONSUMER INVOKES {
    insertSubscriberData}
    
```

The v1-equivalent and v2-equivalent packages can be determined according to the rules described in clause 17.2.1.

### 17.2.2.16 Location register restart

This operation package includes the operations required for location register restart procedures between HLR and VLR or between HLR and SGSN.

```
ResetPackage-v2 ::= OPERATION-PACKAGE
-- Supplier is VLR or SGSN if Consumer is HLR
CONSUMER INVOKES {
    reset}
```

The v1-equivalent package can be determined according to the rules described in clause 17.2.1.

### 17.2.2.17 Tracing stand-alone

This operation package includes the operations required for stand alone tracing procedures between HLR and VLR or between HLR and SGSN.

```
TracingStandAlonePackage-v3 ::= OPERATION-PACKAGE
-- Supplier is VLR or SGSN if Consumer is HLR
CONSUMER INVOKES {
    activateTraceMode,
    deactivateTraceMode}
```

The v1-equivalent and v2-equivalent packages can be determined according to the rules described in clause 17.2.1.

### 17.2.2.18 Functional SS handling

This operation package includes the operations required for functional supplementary services procedures between VLR and HLR.

```
FunctionalSsPackage-v2 ::= OPERATION-PACKAGE
-- Supplier is HLR if Consumer is VLR
CONSUMER INVOKES {
    registerSS,
    eraseSS,
    activateSS,
    deactivateSS,
    registerPassword,
    interrogateSS}
SUPPLIER INVOKES {
    getPassword}
```

The v1-equivalent package can be determined according to the rules described in clause 17.2.1.

### 17.2.2.19 Tracing

This operation package includes the operations required for tracing procedures between HLR and VLR or between HLR and SGSN.

```
TracingPackage-v3 ::= OPERATION-PACKAGE
-- Supplier is VLR or SGSN if Consumer is HLR
CONSUMER INVOKES {
    activateTraceMode}
```

The v1-equivalent and v2-equivalent packages can be determined according to the rules described in clause 17.2.1.

### 17.2.2.20 Binding

This operation package includes the operation required to initialize a supplementary service procedure between VLR and HLR or between gsmSCF and HLR.

```

BindingPackage-v1 ::= OPERATION-PACKAGE
  -- Supplier is HLR if Consumer is VLR
  -- Supplier is gsmSCF if Consumer is HLR
  CONSUMER INVOKES {
    beginSubscriberActivity}

```

This package is v1 only.

### 17.2.2.21 Unstructured SS handling

This operation package includes the operations required for unstructured supplementary services procedures between VLR and HLR, and between the HLR and the gsmSCF.

```

UnstructuredSsPackage-v2 ::= OPERATION-PACKAGE
  -- Supplier is HLR if Consumer is VLR
  -- Supplier is gsmSCF if Consumer is HLR
  CONSUMER INVOKES {
    processUnstructuredSS-Request}
  SUPPLIER INVOKES {
    unstructuredSS-Request,
    unstructuredSS-Notify}

```

The v1-equivalent package is defined as follows:

```

UnstructuredSsPackage-v1 ::= OPERATION-PACKAGE
  -- Supplier is HLR if Consumer is VLR
  -- Supplier is gsmSCF if Consumer is HLR
  CONSUMER INVOKES {
    processUnstructuredSS-Data}

```

### 17.2.2.22 MO Short message relay services

This operation package includes the operations required for short message relay service procedures between IWMSC and VMSC or between GMSC and MSC or between SGSN and IWMSC.

```

MOShortMsgRelayPackage-v3 ::= OPERATION-PACKAGE
  -- Supplier is IWMSC if Consumer is MSC
  -- Supplier is IWMSC if Consumer is SGSN
  CONSUMER INVOKES {
    MO-forwardSM}

```

The v2-equivalent package is defined as follows:

```

ShortMsgRelayPackage-v2 ::= OPERATION-PACKAGE
  -- Supplier is IWMSC if Consumer is MSC
  -- Supplier is MSC or SGSN if Consumer is GMSC
  -- Supplier is IWMSC if Consumer is SGSN
  CONSUMER INVOKES {
    forwardSM}

```

The v1-equivalent package can be determined according to the rules described in clause 17.2.1.

### 17.2.2.23 Short message gateway services

This operation package includes the operations required for short message service gateway procedures between MSC and HLR.

```
ShortMsgGatewayPackage-v3 ::= OPERATION-PACKAGE
-- Supplier is HLR if Consumer is GMSC
CONSUMER INVOKES {
    sendRoutingInfoForSM,
    reportSM-DeliveryStatus}
SUPPLIER INVOKES {
    informServiceCentre}
```

The v2-equivalent package can be determined according to the rules described in clause 17.2.1

The v1-equivalent package is defined as follows:

```
ShortMsgGatewayPackage-v1 ::= OPERATION-PACKAGE
-- Supplier is HLR if Consumer is GMSC
CONSUMER INVOKES {
    sendRoutingInfoForSM
    reportSMDeliveryStatus}
```

### 17.2.2.24 MT Short message relay services

This operation package includes the operations required for short message relay service procedures between GMSC and MSC or between GMSC and SGSN.

```
MTShortMsgRelayPackage-v3 ::= OPERATION-PACKAGE
-- Supplier is MSC or SGSN if Consumer is GMSC
CONSUMER INVOKES {
    MT-forwardSM}
```

The v2-equivalent package is: **ShortMsgRelayPackage-v2**

### 17.2.2.25 Void

### 17.2.2.26 Message waiting data management

This operation package includes the operations required for short message waiting data procedures between HLR and VLR, between HLR and SGSN.

```
MwdMngtPackage-v3 ::= OPERATION-PACKAGE
-- Supplier is HLR if Consumer is SGSN
-- Supplier is HLR if Consumer is VLR
CONSUMER INVOKES {
    readyForSM}
```

The v2-equivalent package can be determined according to the rules described in clause 17.2.1.

The v1-equivalent package is defined as follows:

```
MwdMngtPackage-v1 ::= OPERATION-PACKAGE
-- Supplier is HLR if Consumer is VLR
CONSUMER INVOKES {
    noteSubscriberPresent}
```

### 17.2.2.27 Alerting

This operation package includes the operations required for alerting between HLR and IWMSC.

```
AlertingPackage-v2 ::= OPERATION-PACKAGE
-- Supplier is IWMSC if Consumer is HLR
CONSUMER INVOKES {
    alertServiceCentre}
```

The v1-equivalent package is defined as follows.

```
AlertingPackage-v1 ::= OPERATION-PACKAGE
-- Supplier is IWMSC if Consumer is HLR
CONSUMER INVOKES {
    alertServiceCentreWithoutResult}
```

### 17.2.2.28 Data restoration

This operation package includes the operations required for VLR data restoration between HLR and VLR.

```
DataRestorationPackage-v3 ::= OPERATION-PACKAGE
-- Supplier is HLR if Consumer is VLR
CONSUMER INVOKES {
    restoreData}
```

The v2-equivalent package can be determined according to the rules described in clause 17.2.1.

The v1-equivalent package is: InfoRetrievalPackage-v1

### 17.2.2.29 Purging

This operation package includes the operations required for purging between HLR and VLR or between HLR and SGSN.

```
PurgingPackage-v3 ::= OPERATION-PACKAGE
-- Supplier is HLR if Consumer is VLR
-- Supplier is HLR if Consumer is SGSN
CONSUMER INVOKES {
    purgeMS}
```

The v2-equivalent package can be determined according to the rules described in clause 17.2.1.

### 17.2.2.30 Subscriber information enquiry

This operation package includes the operations required for subscriber information enquiry procedures between HLR and VLR.

```
SubscriberInformationEnquiryPackage-v3 ::= OPERATION-PACKAGE
-- Supplier is VLR if Consumer is HLR
CONSUMER INVOKES {
    provideSubscriberInfo}
```

This package is v3 only.

### 17.2.2.31 Any time information enquiry

This operation package includes the operations required for any time information enquiry procedures between gsmSCF and HLR.

```
AnyTimeInformationEnquiryPackage-v3 ::= OPERATION-PACKAGE
-- Supplier is HLR if Consumer is gsmSCF
CONSUMER INVOKES {
    anyTimeInterrogation}
```

This package is v3 only.

### 17.2.2.32 Group Call Control

This operation package includes the operations required for group call and broadcast call procedures between MSCs.

```
GroupCallControlPackage-v3 ::= OPERATION-PACKAGE
-- Supplier is relay MSC if Consumer is anchor MSC
CONSUMER INVOKES {
    prepareGroupCall,
    forwardGroupCallSignalling}
SUPPLIER INVOKES {
    sendGroupCallEndSignal,
    processGroupCallSignalling}
```

This package is v3 only.

### 17.2.2.33 Provide SIWFS number

This operation package includes the operations required between VMSC and SIWF for requesting resources from an SIWF.

```
ProvideSIWFSNumberPackage-v3 ::= OPERATION-PACKAGE
-- Supplier is SIWF if Consumer is VMSC
CONSUMER INVOKES {
    provideSIWFSNumber}
```

This package is v3 only.

### 17.2.2.34 SIWFS Signalling Modify

This operation package includes the operations required for the modification of the resources in an SIWF between the VMSC and SIWF.

```
SIWFSSignallingModifyPackage-v3 ::= OPERATION-PACKAGE
-- Supplier is SIWF if Consumer is VMSC
CONSUMER INVOKES {
    siWFSSignallingModify}
```

This package is v3 only.

### 17.2.2.35 GPRS location updating

This operation package includes the operations required for the gprs location management procedures between HLR and SGSN.

```
GprsLocationUpdatingPackage-v3 ::= OPERATION-PACKAGE
-- Supplier is HLR if Consumer is SGSN
CONSUMER INVOKES {
    updateGprsLocation}
```

This package is v3 only.



### 17.2.2.36 GPRS Interrogation

This operation package includes the operations required for interrogation procedures between HLR and GGSN.

```
GprsInterrogationPackage-v3 ::= OPERATION-PACKAGE
-- Supplier is HLR if Consumer is GGSN
CONSUMER INVOKES {
    sendRoutingInfoForGprs}
```

This package is v3 only.

### 17.2.2.37 Failure reporting

This operation package includes the operations required for failure reporting between HLR and GGSN.

```
FailureReportingPackage-v3 ::= OPERATION-PACKAGE
-- Supplier is HLR if Consumer is GGSN
CONSUMER INVOKES {
    failureReport}
```

This package is v3 only.

### 17.2.2.38 GPRS notifying

This operation package includes the operations required for notifying that GPRS subscriber is present between HLR and GGSN.

```
GprsNotifyingPackage-v3 ::= OPERATION-PACKAGE
-- Supplier is GGSN if Consumer is HLR
CONSUMER INVOKES {
    noteMsPresentForGprs}
```

This package is v3 only.

### 17.2.2.39 Supplementary Service invocation notification

This operation package includes the operations required for Supplementary Service invocation notification procedures between MSC and gsmSCF.

```
SS-InvocationNotificationPackage-v3 ::= OPERATION-PACKAGE
-- Supplier is gsmSCF if Consumer is MSC
CONSUMER INVOKES {
    ss-InvocationNotification}
```

This package is v3 only.

### 17.2.2.40 Set Reporting State

This operation package includes the operation required for procedures between HLR and VLR to set the reporting state.

```
SetReportingStatePackage-v3 ::= OPERATION-PACKAGE
-- Supplier is VLR if Consumer is HLR
CONSUMER INVOKES {
    setReportingState}
```

This package is v3 only.

### 17.2.2.41 Status Report

This operation package includes the operation required for procedures between VLR and HLR to report call results and events.

```
StatusReportPackage-v3 ::= OPERATION-PACKAGE
-- Supplier is HLR if Consumer is VLR
CONSUMER INVOKES {
    statusReport}
```

This package is v3 only.

### 17.2.2.42 Remote User Free

This operation package includes the operation required by the HLR to indicate to the VLR that the remote user is free.

```
RemoteUserFreePackage-v3 ::= OPERATION-PACKAGE
-- Supplier is VLR if Consumer is HLR
CONSUMER INVOKES {
    remoteUserFree}
```

This package is v3 only.

### 17.2.2.43 Call Completion

This operation package includes the operations required for procedures between VLR and HLR for subscriber control of call completion services.

```
CallCompletionPackage-v3 ::= OPERATION-PACKAGE
-- Supplier is HLR if Consumer is VLR
CONSUMER INVOKES {
    registerCC-Entry,
    eraseCC-Entry}
```

This package is v3 only.

## 17.3 Application contexts

### 17.3.1 General aspects

An application-context is assigned for each dialogue established by a MAP-user. In the present document each application-context is assigned a name which is supplied in the MAP-OPEN Req primitive by the MAP-User and transmitted to the peer under certain circumstances.

The following ASN.1 MACRO is used to describe the main aspects of application-contexts in the following clauses:

```
APPLICATION-CONTEXT MACRO ::=
BEGIN
TYPE NOTATION ::= Symmetric | InitiatorConsumerOf
ResponderConsumerOf | empty
VALUE NOTATION ::= value(VALUE OBJECT IDENTIFIER)
Symmetric ::= "OPERATIONS OF" "{" PackageList "}"
InitiatorConsumerOf ::= "INITIATOR CONSUMER OF" "{" PackageList "}"
ResponderConsumerOf ::= "RESPONDER CONSUMER OF" "{" PackageList "}"
| empty
PackageList ::= Package | PackageList "," Package
Package ::= value(OPERATION-PACKAGE)
| type -- shall reference a package type
END
```

The following definitions are used throughout this clause:

- v1-application-context: An application-context which contains only v1-packages and uses only TC v1 facilities;
- v1 context set: the set of v1-application-contexts defined in the present document.
- vn-application-context (n>=2): An application-context which contains only vn-packages;

The names of v1-application-contexts are suffixed by "-v1" while other names are suffixed by "-vn" where n>=2.

Application-contexts which do not belong to the v1 context set use v2 TC facilities.

The last component of each application-context-name (i.e. the last component of the object identifier value) assigned to an application-context which belongs to the v1 context set indicates explicitly "version1".

For each application-context which does not belong to the "v1 context set" there is a v1-equivalent application context. This is a v1-application-context which includes the v1-equivalents of the packages included in the original context.

Each application-context uses the abstract-syntax associated with the operation-packages it includes and uses the transfer-syntax derived from it by applying the encoding rules defined in clause 17.1.1.

ACs which do not belong to the v1 context set require the support of the abstract-syntax identified by the object identifier value: MAP-DialogueInformation.map-Dialogue-AS defined in clause 17.4.

## 17.3.2 Application context definitions

### 17.3.2.1 Void

### 17.3.2.2 Location Updating

This application context is used between HLR and VLR for location updating procedures.

```
networkLocUpContext-v3 APPLICATION-CONTEXT
-- Responder is HLR if Initiator is VLR
INITIATOR CONSUMER OF {
    LocationUpdatingPackage-v3,
    DataRestorationPackage-v3}
RESPONDER CONSUMER OF {
    SubscriberDataMngtPackage-v3
    TracingPackage-v3}
::= {map-ac networkLocUp(1) version3(3)}
```

The following application-context-name is assigned to the v2-equivalent application-context:

```
{map-ac networkLocUp(1) version2(2)}
```

The following application-context-name is assigned to the v1-equivalent application-context:

```
{map-ac networkLocUp(1) version1(1)}
```

### 17.3.2.3 Location Cancellation

This application context is used between HLR and VLR or between HLR and SGSN for location cancellation procedures. For the HLR - SGSN interface only version 3 of this application context is applicable.

```
locationCancellationContext-v3 APPLICATION-CONTEXT
-- Responder is VLR or SGSN if Initiator is HLR
INITIATOR CONSUMER OF {
    LocationCancellationPackage-v3}
 ::= {map-ac locationCancel(2) version3(3)}
```

The following application-context-name is assigned to the v2-equivalent application-context:

```
map-ac locationCancel(2) version2(2)
```

The following application-context-name is assigned to the v1-equivalent application-context:

```
map-ac locationCancel(2) version1(1)
```

### 17.3.2.4 Roaming number enquiry

This application context is used between HLR and VLR for roaming number enquiry procedures.

```
roamingNumberEnquiryContext-v3 APPLICATION-CONTEXT
-- Responder is VLR if Initiator is HLR
INITIATOR CONSUMER OF {
    RoamingNumberEnquiryPackage-v3}
 ::= {map-ac roamingNbEnquiry(3) version3(3)}
```

The following application-context-name is assigned to the v2-equivalent application-context:

```
{map-ac roamingNbEnquiry(3) version2(2)}
```

The following application-context-name is assigned to the v1-equivalent application-context:

```
{map-ac roamingNbEnquiry(3) version1(1)}
```

### 17.3.2.5 Void

### 17.3.2.6 Location Information Retrieval

This application-context is used between GMSC and HLR when retrieving location information.

```
locationInfoRetrievalContext-v3 APPLICATION-CONTEXT
-- Responder is HLR if Initiator is GMSC
INITIATOR CONSUMER OF {
    InterrogationPackage-v3}
 ::= {map-ac locInfoRetrieval(5) version3(3)}
```

The following application-context-name is assigned to the v2-equivalent application-context:

```
{map-ac locInfoRetrieval(5) version2(2)}
```

The following application-context-name is assigned to the v1-equivalent application-context:

```
{map-ac locInfoRetrieval(5) version1(1)}
```

### 17.3.2.7 Call control transfer

This application context is used for the call control transfer procedure between the VMSC and the GMSC.

```
callControlTransferContext-v3 APPLICATION-CONTEXT
-- Responder is GMSC if Initiator is VMSC
INITIATOR CONSUMER OF {
    CallControlTransferPackage-v3}
 ::= {map-ac callControlTransfer(6) version3(3)}
```

This application-context is v3 only.

### 17.3.2.8 - 17.3.2.10 Void

### 17.3.2.11 Location registers restart

This application context is used between HLR and VLR or between HLR and SGSN for location register restart procedures. For the HLR - SGSN interface version 1 and version 2 of this application context are applicable.

```
resetContext-v2 APPLICATION-CONTEXT
-- Responder is VLR or SGSN if Initiator is HLR
INITIATOR CONSUMER OF {
    ResetPackage-v2}
 ::= {map-ac reset(10) version2(2)}
```

The following application-context-name is assigned to the v1-equivalent application-context:

```
{map-ac reset(10) version1(1)}
```

### 17.3.2.12 Handover control

This application context is used for handover procedures between MSCs.

```
handoverControlContext-v2 APPLICATION-CONTEXT
-- Responder is MSCB if Initiator is MSCA
INITIATOR CONSUMER OF {
    HandoverControlPackage-v2}
 ::= {map-ac handoverControl(11) version2(2)}
```

The following application-context-name is assigned to the v1-equivalent application-context:

```
{map-ac handoverControl(11) version1(1)}
```

### 17.3.2.13 IMSI Retrieval

This application context is used for IMSI retrieval between HLR and VLR.

```
imsiRetrievalContext-v2 APPLICATION-CONTEXT
-- Responder is HLR if Initiator is VLR
INITIATOR CONSUMER OF {
    IMSIRetrievalPackage-v2}
 ::= {map-ac imsiRetrieval(26) version2(2)}
```

This application-context is v2 only.

### 17.3.2.14 Equipment Management

This application context is used for equipment checking between MSC and EIR or between SGSN and EIR. For the SGSN - EIR interface version 1 and version 2 of this application context are applicable:

```
equipmentMngtContext-v2 APPLICATION-CONTEXT
-- Responder is EIR if Initiator is MSC
-- Responder is EIR if Initiator is SGSN
INITIATOR CONSUMER OF {
    EquipmentMngtPackage-v2}
 ::= {map-ac equipmentMngt(13) version2(2)}
```

The following application-context-name is assigned to the v1-equivalent application-context:

```
{map-ac equipmentMngt(13) version1(1)}
```

### 17.3.2.15 Information retrieval

This application context is used for authentication information retrieval between HLR and VLR or between HLR and SGSN. For the HLR - SGSN interface version 1 and version 2 of this application context are applicable.

```
infoRetrievalContext-v2 APPLICATION-CONTEXT
-- Responder is HLR if Initiator is VLR
-- Responder is HLR if Initiator is SGSN
INITIATOR CONSUMER OF {
    InfoRetrievalPackage-v2}
 ::= {map-ac infoRetrieval(14) version2(2)}
```

The following application-context-name is assigned to the v1-equivalent application-context:

```
-- Responder is HLR if Initiator is VLR
{map-ac infoRetrieval(14) version1(1)}
```

### 17.3.2.16 Inter-VLR information retrieval

This application context is used for information retrieval between VLRs.

```
interVlrInfoRetrievalContext-v2 APPLICATION-CONTEXT
-- Responder is VLR if Initiator is VLR
INITIATOR CONSUMER OF {
    InterVlrInfoRetrievalPackage-v2}
 ::= {map-ac interVlrInfoRetrieval(15) version2(2)}
```

The v1-equivalent application-context is:

```
-- Responder is VLR if Initiator is VLR
{map-ac infoRetrieval(14) version1(1)}
```

### 17.3.2.17 Stand Alone Subscriber Data Management

This application context is used for stand alone subscriber data management between HLR and VLR or between HLR and SGSN. For the HLR - SGSN interface only version 3 of this application context is applicable:

```
subscriberDataMngtContext-v3 APPLICATION-CONTEXT
-- Responder is VLR or SGSN if Initiator is HLR
INITIATOR CONSUMER OF {
    SubscriberDataMngtStandAlonePackage-v3}
 ::= {map-ac subscriberDataMngt(16) version3(3)}
```

The following application-context-name is assigned to the v2-equivalent application-context:

```
{map-ac subscriberDataMngt(16) version2(2)}
```

The following application-context-name is assigned to the v1-equivalent application-context:

```
{map-ac subscriberDataMngt(16) version1(1)}
```

### 17.3.2.18 Tracing

This application context is used between HLR and VLR or between HLR and SGSN for stand alone tracing control procedures: For the HLR - SGSN interface version 1, version 2 and version 3 of this application context are applicable.

```
tracingContext-v3 APPLICATION-CONTEXT
-- Responder is VLR or SGSN if Initiator is HLR
INITIATOR CONSUMER OF {
    TracingStandAlonePackage-v3}
 ::= {map-ac tracing(17) version3(3)}
```

The following application-context-name is assigned to the v2-equivalent application-context:

```
{map-ac tracing(17) version2(2)}
```

The following application-context-name is assigned to the v1-equivalent application-context:

```
{map-ac tracing(17) version1(1)}
```

### 17.3.2.19 Network functional SS handling

This application context is used for functional-like SS handling procedures between VLR and HLR.

```
networkFunctionalSsContext-v2 APPLICATION-CONTEXT
-- Responder is HLR, Initiator is VLR
INITIATOR CONSUMER OF {
    FunctionalSsPackage-v2}
 ::= {map-ac networkFunctionalSs(18) version2(2)}
```

The v1-equivalent application-context is defined as follows:

```
networkFunctionalSsContext-v1 APPLICATION-CONTEXT
-- Responder is HLR, Initiator is VLR
INITIATOR CONSUMER OF {
    FunctionalSsPackage-v1,
    UnstructuredSsPackage-v1,
    BindingPackage-v1}
 ::= {map-ac networkFunctionalSs(18) version1(1)}
```

### 17.3.2.20 Network unstructured SS handling

This application context is used for handling stimuli-like procedures between HLR and VLR, and between the HLR and gsmSCF.

```
networkUnstructuredSsContext-v2 APPLICATION-CONTEXT
-- Responder is HLR, Initiator is VLR
-- Responder is VLR, Initiator is HLR
-- Responder is gsmSCF, Initiator is HLR
-- Responder is HLR, Initiator is gsmSCF
OPERATIONS OF {
    UnstructuredSsPackage-v2}
 ::= {map-ac networkUnstructuredSs(19) version2(2)}
```

The following application-context-name is assigned to the v1-equivalent application-context:

```
{map-ac networkFunctionalsSs(18) version1(1)}
```

### 17.3.2.21 Short Message Gateway

This application context is used for short message gateway procedures.

```
shortMsgGatewayContext-v3 APPLICATION-CONTEXT
-- Responder is HLR if Initiator is GMSC
INITIATOR CONSUMER OF {
    ShortMsgGatewayPackage-v3}
 ::= {map-ac shortMsgGateway(20) version3(3)}
```

The following application-context-name is assigned to the v2-equivalent application-context:

```
{map-ac shortMsgGateway(20) version2(2)}
```

The following application-context-name is assigned to the v1-equivalent application-context:

```
{map-ac shortMsgGateway(20) version1(1)}
```

### 17.3.2.22 Mobile originating Short Message Relay

This application context is used between MSC and IWMSC or between SGSN and IWMSC for mobile originating short message relay procedures. For the SGSN - IWMSC interface version 1, version 2 and version 3 of this application context are applicable.

```
shortMsgMO-RelayContext-v3 APPLICATION-CONTEXT
-- Responder is IWMSC if Initiator is MSC
-- Responder is IWMSC if Initiator is SGSN
INITIATOR CONSUMER OF {
    MOShortMsgRelayPackage-v3}
 ::= {map-ac shortMsgMO-Relay(21) version3(3)}
```

The following application-context-name is assigned to the v2-equivalent application-context:

```
{map-ac shortMsgMO-Relay(21) version2(2)}
```

The following application-context-name is assigned to the v1-equivalent application-context:

```
{map-ac shortMsg-Relay(21) version1(1)}
```



### 17.3.2.23 Void

### 17.3.2.24 Short message alert

This application context is used for short message alerting procedures.

```
shortMsgAlertContext-v2 APPLICATION-CONTEXT
-- Responder is IWMSC if Initiator is HLR
INITIATOR CONSUMER OF {
    AlertingPackage-v2}
 ::= {map-ac shortMsgAlert(23) version2(2)}
```

The following application-context-name is symbolically assigned to the v1-equivalent application-context:

```
{map-ac shortMsgAlert(23) version1(1)}
```

### 17.3.2.25 Short message waiting data management

This application context is used between VLR and HLR or between SGSN and HLR for short message waiting data management procedures. For the SGSN - HLR interface only version 3 of this application context is applicable.

```
mwdMngtContext-v3 APPLICATION-CONTEXT
-- Responder is HLR if Initiator is SGSN
-- Responder is HLR if Initiator is VLR
INITIATOR CONSUMER OF {
    MwdMngtPackage-v3}
 ::= {map-ac mwdMngt(24) version3(3)}
```

The following application-context-name is assigned to the v2-equivalent application-context:

```
{map-ac mwdMngt(24) version2(2)}
```

The following application-context-name is assigned to the v1-equivalent application-context:

```
{map-ac mwdMngt(24) version1(1)}
```

### 17.3.2.26 Mobile terminating Short Message Relay

This application context is used between GMSC and MSC or between GMSC and SGSN for mobile terminating short message relay procedures. For the GMSC - SGSN interface version 2 and version 3 of this application context and the equivalent version 1 application context are applicable.

```
shortMsgMT-RelayContext-v3 APPLICATION-CONTEXT
-- Responder is MSC or SGSN if Initiator is GMSC
INITIATOR CONSUMER OF {
    MTShortMsgRelayPackage-v3}
 ::= {map-ac shortMsgMT-Relay(25) version3(3)}
```

The following application-context-name is assigned to the v2-equivalent application-context:

```
{map-ac shortMsgMT-Relay(25) version2(2)}
```

The following application-context-name is assigned to the v1-equivalent application-context:

```
{map-ac shortMsgMO-Relay(21) version1(1)}
```

### 17.3.2.27 MS purging

This application context is used between HLR and VLR or between HLR and SGSN for MS purging procedures. For the SGSN - HLR interface only version 3 of this application context is applicable.

```
msPurgingContext-v3 APPLICATION-CONTEXT
-- Responder is HLR if Initiator is VLR
-- Responder is HLR if Initiator is SGSN
INITIATOR CONSUMER OF {
    purgingPackage-v3}
 ::= {map-ac msPurging(27) version3(3)}
```

The following application-context-name is assigned to the v2-equivalent application-context:

```
{map-ac msPurging(27) version2(2)}
```

### 17.3.2.28 Subscriber information enquiry

This application context is used between HLR and VLR for subscriber information enquiry procedures.

```
subscriberInfoEnquiryContext-v3 APPLICATION-CONTEXT
-- Responder is VLR if Initiator is HLR
INITIATOR CONSUMER OF {
    SubscriberInformationEnquiryPackage-v3}
 ::= {map-ac subscriberInfoEnquiry(28) version3(3)}
```

This application-context is v3 only.

### 17.3.2.29 Any time information enquiry

This application context is used between gsmSCF and HLR for any time information enquiry procedures.

```
anyTimeInfoEnquiryContext-v3 APPLICATION-CONTEXT
-- Responder is HLR if Initiator is gsmSCF
INITIATOR CONSUMER OF {
    AnyTimeInformationEnquiryPackage-v3}
 ::= {map-ac anyTimeInfoEnquiry(29) version3(3)}
```

This application-context is v3 only.

### 17.3.2.30 Group Call Control

This application context is used between anchor MSC and relay MSC for group call and broadcast call procedures.

```
groupCallControlContext-v3 APPLICATION-CONTEXT
-- Responder is relay MSC if Initiator is anchor MSC
INITIATOR CONSUMER OF {
    GroupCallControlPackage-v3}
 ::= {map-ac groupCallControl(31) version3(3)}
```

This application-context is v3 only.

### 17.3.2.31 Provide SIWFS Number

This application context is used for activation or modification of SIWF resources.

```

siwfsAllocationContext-v3 APPLICATION-CONTEXT
  -- Responder is SIWF if Initiater is VMSC
  INITIATOR CONSUMER OF {
    ProvideSIWFSNumberPackage-v3,
    SIWFSSignallingModifyPackage-v3}
  ::= {map-ac siwfsAllocation (12) version3(3)}

```

This application-context is v3 only.

### 17.3.2.32 Gprs Location Updating

This application context is used between HLR and SGSN for gprs location updating procedures.

```

gprsLocationUpdateContext-v3 APPLICATION-CONTEXT
  -- Responder is HLR if Initiator is SGSN
  INITIATOR CONSUMER OF {
    GprsLocationUpdatingPackage-v3}
  RESPONDER CONSUMER OF {
    SubscriberDataMngtPackage-v3
    TracingPackage-v3}
  ::= {map-ac gprsLocationUpdate(32) version3(3)}

```

This application-context is v3 only.

### 17.3.2.33 Gprs Location Information Retrieval

This application context is used between HLR and GGSN when retrieving gprs location information.

```

gprsLocationInfoRetrievalContext-v3 APPLICATION-CONTEXT
  -- Responder is HLR if Initiator is GGSN
  INITIATOR CONSUMER OF {
    GprsInterrogationPackage-v3}
  ::= {map-ac gprsLocationInfoRetrieval(33) version3(3)}

```

This application-context is v3 only.

### 17.3.2.34 Failure Reporting

This application context is used between HLR and GGSN to inform that network requested PDP-context activation has failed.

```

failureReportContext-v3 APPLICATION-CONTEXT
  -- Responder is HLR if Initiator is GGSN
  INITIATOR CONSUMER OF {
    FailureReportingPackage-v3}
  ::= {map-ac failureReport(34) version3(3)}

```

This application-context is v3 only.

### 17.3.2.35 GPRS Notifying

This application context is used between HLR and GGSN for notifying that GPRS subscriber is present again.

```
gprsNotifyContext-v3 APPLICATION-CONTEXT
-- Responder is GGSN if Initiator is HLR
INITIATOR CONSUMER OF {
    GprsNotifyingPackage-v3}
 ::= {map-ac gprsNotify(35) version3(3)}
```

This application-context is v3 only.

### 17.3.2.36 Supplementary Service invocation notification

This application context is used between MSC and gsmSCF for Supplementary Service invocation notification procedures.

```
ss-InvocationNotificationContext-v3 APPLICATION-CONTEXT
-- Responder is gsmSCF, Initiator is MSC
INITIATOR CONSUMER OF {
    SS-InvocationNotificationPackage-v3}
 ::= {map-ac ss-InvocationNotification(36) version3(3)}
```

This application-context is v3 only.

### 17.3.2.37 Reporting

This application context is used between HLR and VLR for reporting procedures.

```
reportingContext-v3 APPLICATION-CONTEXT
-- Responder is VLR if Initiator is HLR
-- Responder is HLR if Initiator is VLR
INITIATOR CONSUMER OF {
    SetReportingStatePackage-v3,
    StatusReportPackage-v3,
    RemoteUserFreePackage-v3}
RESPONDER CONSUMER OF {
    SetReportingStatePackage-v3,
    StatusReportPackage-v3}
 ::= {map-ac reporting(7) version3(3)}
```

This application-context is v3 only.

### 17.3.2.38 Call Completion

This application context is used between VLR and the HLR for subscriber control of call completion services.

```
callCompletionContext-v3 APPLICATION-CONTEXT
-- Responder is HLR if Initiator is VLR
INITIATOR CONSUMER OF {
    CallCompletionPackage-v3}
 ::= {map-ac callCompletion(8) version3(3)}
```

This application-context is v3 only.

## 17.3.3 ASN.1 Module for application-context-names

The following ASN.1 module summarizes the application-context-name assigned to MAP application-contexts.

```
MAP-ApplicationContexts {
    ccitt identified-organization (4) etsi (0) mobileDomain (0)
    gsm-Network (1) modules (3) map-ApplicationContexts (2) version4 (4)}
```

DEFINITIONS

```

 ::=
 BEGIN

 -- EXPORTS everything

 IMPORTS
   gsm-NetworkId,
   ac-Id
 FROM MobileDomainDefinitions {
   ccitt (0) identified-organization (4) etsi (0) mobileDomain (0)
   mobileDomainDefinitions (0) version1 (1)}
 ;

 -- application-context-names

map-ac OBJECT IDENTIFIER ::= {gsm-NetworkId ac-Id}

networkLocUpContext-v3 OBJECT IDENTIFIER ::=
  {map-ac networkLocUp(1) version3(3)}

locationCancellationContext-v3 OBJECT IDENTIFIER ::=
  {map-ac locationCancel(2) version3(3)}

roamingNumberEnquiryContext-v3 OBJECT IDENTIFIER ::=
  {map-ac roamingNbEnquiry(3) version3(3)}

locationInfoRetrievalContext-v3 OBJECT IDENTIFIER ::=
  {map-ac locInfoRetrieval(5) version3(3)}

resetContext-v2 OBJECT IDENTIFIER ::=
  {map-ac reset(10) version2(2)}

handoverControlContext-v2 OBJECT IDENTIFIER ::=
  {map-ac handoverControl(11) version2(2)}

equipmentMngtContext-v2 OBJECT IDENTIFIER ::=
  {map-ac equipmentMngt(13) version2(2)}

infoRetrievalContext-v2 OBJECT IDENTIFIER ::=
  {map-ac infoRetrieval(14) version2(2)}

interVlrInfoRetrievalContext-v2 OBJECT IDENTIFIER ::=
  {map-ac interVlrInfoRetrieval(15) version2(2)}

subscriberDataMngtContext-v3 OBJECT IDENTIFIER ::=
  {map-ac subscriberDataMngt(16) version3(3)}

tracingContext-v3 OBJECT IDENTIFIER ::=
  {map-ac tracing(17) version3(3)}

networkFunctionalSsContext-v2 OBJECT IDENTIFIER ::=
  {map-ac networkFunctionalSs(18) version2(2)}

networkUnstructuredSsContext-v2 OBJECT IDENTIFIER ::=
  {map-ac networkUnstructuredSs(19) version2(2)}

shortMsgGatewayContext-v3 OBJECT IDENTIFIER ::=
  {map-ac shortMsgGateway(20) version3(3)}

shortMsgMO-RelayContext-v3 OBJECT IDENTIFIER ::=
  {map-ac shortMsgMO-Relay(21) version3(3)}

shortMsgAlertContext-v2 OBJECT IDENTIFIER ::=
  {map-ac shortMsgAlert(23) version2(2)}

mwdMngtContext-v3 OBJECT IDENTIFIER ::=
  {map-ac mwdMngt(24) version3(3)}

shortMsgMT-RelayContext-v3 OBJECT IDENTIFIER ::=
  {map-ac shortMsgMT-Relay(25) version3(3)}

imsiRetrievalContext-v2 OBJECT IDENTIFIER ::=
  {map-ac imsiRetrieval(26) version2(2)}

```

<b>msPurgingContext-v3</b> OBJECT IDENTIFIER ::=	{map-ac msPurging(27) version3(3)}
<b>subscriberInfoEnquiryContext-v3</b> OBJECT IDENTIFIER ::=	{map-ac subscriberInfoEnquiry(28) version3(3)}
<b>anyTimeInfoEnquiryContext-v3</b> OBJECT IDENTIFIER ::=	{map-ac anyTimeInfoEnquiry(29) version3(3)}
<b>callControlTransferContext-v3</b> OBJECT IDENTIFIER ::=	{map-ac callControlTransfer(6) version3(3)}
<b>ss-InvocationNotificationContext-v3</b> OBJECT IDENTIFIER ::=	{map-ac ss-InvocationNotification(36) version3(3)}
<b>sIWFSAllocationContext-v3</b> OBJECT IDENTIFIER ::=	{map-ac sIWFSAllocation(12) version3(3)}
<b>groupCallControlContext-v3</b> OBJECT IDENTIFIER ::=	{map-ac groupCallControl(31) version3(3)}
<b>gprsLocationUpdateContext-v3</b> OBJECT IDENTIFIER ::=	{map-ac gprsLocationUpdate(32) version3(3)}
<b>gprsLocationInfoRetrievalContext-v3</b> OBJECT IDENTIFIER ::=	{map-ac gprsLocationInfoRetrieval(33) version3(3)}
<b>failureReportContext-v3</b> OBJECT IDENTIFIER ::=	{map-ac failureReport(34) version3(3)}
<b>gprsNotifyContext-v3</b> OBJECT IDENTIFIER ::=	{map-ac gprsNotify(35) version3(3)}
<b>reportingContext-v3</b> OBJECT IDENTIFIER ::=	{map-ac reporting(7) version3(3)}
<b>callCompletionContext-v3</b> OBJECT IDENTIFIER ::=	{map-ac callCompletion(8) version3(3)}

-- The following Object Identifiers are reserved for application-  
 -- contexts existing in previous versions of the protocol

-- AC Name & Version	Object Identifier	
--		
-- networkLocUpContext-v1	map-ac networkLocUp (1)	version1 (1)
-- networkLocUpContext-v2	map-ac networkLocUp (1)	version2 (2)
-- locationCancellationContext-v1	map-ac locationCancellation (2)	version1 (1)
-- locationCancellationContext-v2	map-ac locationCancellation (2)	version2 (2)
-- roamingNumberEnquiryContext-v1	map-ac roamingNumberEnquiry (3)	version1 (1)
-- roamingNumberEnquiryContext-v2	map-ac roamingNumberEnquiry (3)	version2 (2)
-- locationInfoRetrievalContext-v1	map-ac locationInfoRetrieval (5)	version1 (1)
-- locationInfoRetrievalContext-v2	map-ac locationInfoRetrieval (5)	version2 (2)
-- resetContext-v1	map-ac reset (10)	version1 (1)
-- handoverControlContext-v1	map-ac handoverControl (11)	version1 (1)
-- equipmentMngtContext-v1	map-ac equipmentMngt (13)	version1 (1)
-- infoRetrievalContext-v1	map-ac infoRetrieval (14)	version1 (1)
-- subscriberDataMngtContext-v1	map-ac subscriberDataMngt (16)	version1 (1)
-- subscriberDataMngtContext-v2	map-ac subscriberDataMngt (16)	version2 (2)
-- tracingContext-v1	map-ac tracing (17)	version1 (1)
-- tracingContext-v2	map-ac tracing (17)	version2 (2)
-- <i>networkFunctionalSsContext-v1</i>	<i>map-ac networkFunctionalSs (18)</i>	<i>version1 (1)</i>
-- shortMsgGatewayContext-v1	map-ac shortMsgGateway (20)	version1 (1)
-- shortMsgGatewayContext-v2	map-ac shortMsgGateway (20)	version2 (2)
-- shortMsgRelayContext-v1	map-ac shortMsgRelay (21)	version1 (1)
-- shortMsgAlertContext-v1	map-ac shortMsgAlert (23)	version1 (1)
-- <i>mwdMngtContext-v1</i>	<i>map-ac mwdMngt (24)</i>	<i>version1 (1)</i>
-- mwdMngtContext-v2	map-ac mwdMngt (24)	version2 (2)
-- shortMsgMT-RelayContext-v2	map-ac shortMsgMT-Relay (25)	version2 (2)
-- msPurgingContext-v2	map-ac msPurging (27)	version2 (2)

END

# 17.4 MAP Dialogue Information

## MAP-DialogueInformation {

ccitt identified-organization (4) etsi (0) mobileDomain (0)  
gsm-Network (1) modules (3) map-DialogueInformation (3) version4 (4)}

DEFINITIONS

IMPLICIT TAGS

::=

BEGIN

EXPORTS

map-DialogueAS,  
MAP-DialoguePDU

;

IMPORTS

gsm-NetworkId,  
as-Id

FROM MobileDomainDefinitions {

ccitt (0) identified-organization (4) etsi (0) mobileDomain (0)  
mobileDomainDefinitions (0) version1 (1)}

AddressString

FROM MAP-CommonDataTypes {

ccitt identified-organization (4) etsi (0) mobileDomain (0)  
gsm-Network(1) modules (3) map-CommonDataTypes (18) version4 (4)}

ExtensionContainer

FROM MAP-ExtensionDataTypes {

ccitt identified-organization (4) etsi (0) mobileDomain (0)  
gsm-Network (1) modules (3) map-ExtensionDataTypes (21) version4 (4)}

;

-- abstract syntax name for MAP-DialoguePDU

**map-DialogueAS** OBJECT IDENTIFIER ::= {gsm-NetworkId as-Id map-DialoguePDU (1) version1 (1)}

**MAP-DialoguePDU** ::= CHOICE {  
map-open [0] MAP-OpenInfo,  
map-accept [1] MAP-AcceptInfo,  
map-close [2] MAP-CloseInfo,  
map-refuse [3] MAP-RefuseInfo,  
map-userAbort [4] MAP-UserAbortInfo,  
map-providerAbort [5] MAP-ProviderAbortInfo}

**MAP-OpenInfo** ::= SEQUENCE {  
destinationReference [0] AddressString OPTIONAL,  
originationReference [1] AddressString OPTIONAL,  
...,  
extensionContainer ExtensionContainer OPTIONAL  
-- extensionContainer must not be used in version 2  
}

**MAP-AcceptInfo** ::= SEQUENCE {  
...,  
extensionContainer ExtensionContainer OPTIONAL  
-- extensionContainer must not be used in version 2  
}

**MAP-CloseInfo** ::= SEQUENCE {  
...,  
extensionContainer ExtensionContainer OPTIONAL  
-- extensionContainer must not be used in version 2  
}

```

MAP-RefuseInfo ::= SEQUENCE {
    reason Reason,
    ...,
    extensionContainer ExtensionContainer OPTIONAL
    -- extensionContainer must not be used in version 2
}

```

```

Reason ::= ENUMERATED {
    noReasonGiven (0),
    invalidDestinationReference (1),
    invalidOriginatingReference (2)}

```

```

MAP-UserAbortInfo ::= SEQUENCE {
    map-UserAbortChoice MAP-UserAbortChoice,
    ...,
    extensionContainer ExtensionContainer OPTIONAL
    -- extensionContainer must not be used in version 2
}

```

```

MAP-UserAbortChoice ::= CHOICE {
    userSpecificReason [0] NULL,
    userResourceLimitation [1] NULL,
    resourceUnavailable [2] ResourceUnavailableReason,
    applicationProcedureCancellation [3] ProcedureCancellationReason}

```

```

ResourceUnavailableReason ::= ENUMERATED {
    shortTermResourceLimitation (0),
    longTermResourceLimitation (1)}

```

```

ProcedureCancellationReason ::= ENUMERATED {
    handoverCancellation (0),
    radioChannelRelease (1),
    networkPathRelease (2),
    callRelease (3),
    associatedProcedureFailure (4),
    tandemDialogueRelease (5),
    remoteOperationsFailure (6)}

```

```

MAP-ProviderAbortInfo ::= SEQUENCE {
    map-ProviderAbortReason MAP-ProviderAbortReason,
    ...,
    extensionContainer ExtensionContainer OPTIONAL
    -- extensionContainer must not be used in version 2
}

```

```

MAP-ProviderAbortReason ::= ENUMERATED {
    abnormalDialogue (0),
    invalidPDU (1)}

```

END

## 17.5 MAP operation and error codes

```

MAP-Protocol {
    ccitt identified-organization (4) etsi (0) mobileDomain (0)
    gsm-Network (1) modules (3) map-Protocol (4) version4 (4)}

```

DEFINITIONS

::=

BEGIN

IMPORTS

```

    UpdateLocation,
    CancelLocation,
    PurgeMS,
    SendIdentification,
    UpdateGprsLocation,
    PrepareHandover,
    SendEndSignal,
    ProcessAccessSignalling,
    ForwardAccessSignalling,
    PrepareSubsequentHandover,
    SendAuthenticationInfo,
    CheckIMEI,
    InsertSubscriberData,

```



DeleteSubscriberData,  
 Reset,  
 ForwardCheckSS-Indication,  
 RestoreData,  
 ProvideSubscriberInfo,  
 AnyTimeInterrogation,  
 SendRoutingInfoForGprs,  
 FailureReport,  
 NoteMsPresentForGprs

FROM MAP-MobileServiceOperations {  
 ccitt identified-organization (4) etsi (0) mobileDomain (0)  
 gsm-Network (1) modules (3) map-MobileServiceOperations (5)  
 version4 (4)}

ActivateTraceMode,  
 DeactivateTraceMode,  
 SendIMSI

FROM MAP-OperationAndMaintenanceOperations {  
 ccitt identified-organization (4) etsi (0) mobileDomain (0)  
 gsm-Network (1) modules (3) map-OperationAndMaintenanceOperations (6)  
 version4 (4)}

SendRoutingInfo,  
 ProvideRoamingNumber,  
 ResumeCallHandling,  
 ProvideSIWFSNumber,  
 SIWFSSignallingModify,  
 SetReportingState,  
 StatusReport,  
 RemoteUserFree

FROM MAP-CallHandlingOperations {  
 ccitt identified-organization (4) etsi (0) mobileDomain (0)  
 gsm-Network (1) modules (3) map-CallHandlingOperations (7)  
 version4 (4)}

RegisterSS,  
 EraseSS,  
 ActivateSS,  
 DeactivateSS,  
 InterrogateSS,  
 ProcessUnstructuredSS-Request,  
 UnstructuredSS-Request,  
 UnstructuredSS-Notify,  
 RegisterPassword,  
 GetPassword,  
 SS-InvocationNotification,  
 RegisterCC-Entry,  
 EraseCC-Entry

FROM MAP-SupplementaryServiceOperations {  
 ccitt identified-organization (4) etsi (0) mobileDomain (0)  
 gsm-Network (1) modules (3) map-SupplementaryServiceOperations (8)  
 version4 (4)}

SendRoutingInfoForSM,  
 MO-ForwardSM,  
 MT-ForwardSM,  
 ReportSM-DeliveryStatus,  
 AlertServiceCentre,  
 InformServiceCentre,  
 ReadyForSM

FROM MAP-ShortMessageServiceOperations {  
 ccitt identified-organization (4) etsi (0) mobileDomain (0)  
 gsm-Network (1) modules (3) map-ShortMessageServiceOperations (9)  
 version4 (4)}

PrepareGroupCall,  
 ProcessGroupCallSignalling,  
 ForwardGroupCallSignalling,  
 SendGroupCallEndSignal

FROM MAP-Group-Call-Operations {  
 ccitt identified-organization (4) etsi (0) mobileDomain (0)  
 gsm-Network (1) modules (3) map-Group-Call-Operations (22)  
 version4 (4)}

SystemFailure,  
 DataMissing,  
 UnexpectedDataValue,

```

FacilityNotSupported,
UnknownSubscriber,
NumberChanged,
UnknownMSC,
UnidentifiedSubscriber,
UnknownEquipment,
RoamingNotAllowed,
IllegalSubscriber,
IllegalEquipment,
BearerServiceNotProvisioned,
TeleserviceNotProvisioned,
NoHandoverNumberAvailable,
SubsequentHandoverFailure,
TracingBufferFull,
OR-NotAllowed,
NoRoamingNumberAvailable,
AbsentSubscriber,
BusySubscriber,
NoSubscriberReply,
CallBarred,
ForwardingViolation,
ForwardingFailed,
CUG-Reject,
ATI-NotAllowed,
IllegalSS-Operation,
SS-ErrorStatus,
SS-NotAvailable,
SS-SubscriptionViolation,
SS-Incompatibility,
UnknownAlphabet,
USSD-Busy,
PW-RegistrationFailure,
NegativePW-Check,
NumberOfPW-AttemptsViolation,
SubscriberBusyForMT-SMS,
SM-DeliveryFailure,
MessageWaitingListFull,
AbsentSubscriberSM,
ResourceLimitation,
NoGroupCallNumberAvailable,
ShortTermDenial,
LongTermDenial,
IncompatibleTerminal
FROM MAP-Errors {
  ccitt identified-organization (4) etsi (0) mobileDomain (0)
  gsm-Network (1) modules (3) map-Errors (10) version4 (4)}
;

```

-- location registration operation codes

<pre> <b>updateLocation</b> UpdateLocation ::= localValue 2 <b>cancelLocation</b> CancelLocation ::= localValue 3 <b>purgeMS</b> PurgeMS ::= localValue 67 <b>sendIdentification</b> SendIdentification ::= localValue 55 </pre>
--

-- handover operation codes

<pre> <b>prepareHandover</b> PrepareHandover ::= localValue 68 <b>sendEndSignal</b> SendEndSignal ::= localValue 29 <b>processAccessSignalling</b> ProcessAccessSignalling ::= localValue 33 <b>forwardAccessSignalling</b> ForwardAccessSignalling ::= localValue 34 <b>prepareSubsequentHandover</b> PrepareSubsequentHandover ::=   localValue 69 </pre>
---

-- authentication operation codes

<pre> <b>sendAuthenticationInfo</b> SendAuthenticationInfo ::= localValue 56 </pre>
---

-- IMEI MANAGEMENT operation codes

<pre> <b>checkIMEI</b> CheckIMEI ::= localValue 43 </pre>
---

-- subscriber management operation codes

**insertSubscriberData** InsertSubscriberData ::= localValue 7  
**deleteSubscriberData** DeleteSubscriberData ::= localValue 8

-- fault recovery operation codes

**reset** Reset ::= localValue 37  
**forwardCheckSS-Indication** ForwardCheckSS-Indication ::= localValue 38  
**restoreData** RestoreData ::= localValue 57

-- operation and maintenance operation codes

**activateTraceMode** ActivateTraceMode ::= localValue 50  
**deactivateTraceMode** DeactivateTraceMode ::= localValue 51  
**sendIMSI** SendIMSI ::= localValue 58

-- call handling operation codes

**sendRoutingInfo** SendRoutingInfo ::= localValue 22  
**provideRoamingNumber** ProvideRoamingNumber ::= localValue 4  
**resumeCallHandling** ResumeCallHandling ::= localValue 6  
**provideSIWFSNumber** ProvideSIWFSNumber ::= localValue 31  
**SIWFSSignallingModify** SIWFSSignallingModify ::= localValue 32  
**setReportingState** SetReportingState ::= localValue 73  
**statusReport** StatusReport ::= localValue 74  
**remoteUserFree** RemoteUserFree ::= localValue 75

-- supplementary service handling operation codes

**registerSS** RegisterSS ::= localValue 10  
**eraseSS** EraseSS ::= localValue 11  
**activateSS** ActivateSS ::= localValue 12  
**deactivateSS** DeactivateSS ::= localValue 13  
**interrogateSS** InterrogateSS ::= localValue 14  
**processUnstructuredSS-Request** ProcessUnstructuredSS-Request ::= localValue 59  
**unstructuredSS-Request** UnstructuredSS-Request ::= localValue 60  
**unstructuredSS-Notify** UnstructuredSS-Notify ::= localValue 61  
**registerPassword** RegisterPassword ::= localValue 17  
**getPassword** GetPassword ::= localValue 18  
**registerCC-Entry** RegisterCC-Entry ::= localValue 76  
**eraseCC-Entry** EraseCC-Entry ::= localValue 77

-- short message service operation codes

**sendRoutingInfoForSM** SendRoutingInfoForSM ::= localValue 45  
**mo-forwardSM** MO-ForwardSM ::= localValue 46  
**mt-forwardSM** MT-ForwardSM ::= localValue 44  
**reportSM-DeliveryStatus** ReportSM-DeliveryStatus ::= localValue 47  
**informServiceCentre** InformServiceCentre ::= localValue 63  
**alertServiceCentre** AlertServiceCentre ::= localValue 64  
**readyForSM** ReadyForSM ::= localValue 66

-- provide subscriber info operation codes

**provideSubscriberInfo** ProvideSubscriberInfo ::= localValue 70

-- any time interrogation operation codes

**anyTimeInterrogation** AnyTimeInterrogation ::= localValue 71

-- supplementary service invocation notification operation codes

**ss-InvocationNotification** SS-InvocationNotification ::= localValue 72

--Group Call operation codes

```
prepareGroupCall PrepareGroupCall ::= localValue 39
sendGroupCallEndSignal SendGroupCallEndSignal ::= localValue 40
processGroupCallSignalling ProcessGroupCallSignalling ::= localValue 41
forwardGroupCallSignalling ForwardGroupCallSignalling ::= localValue 42
```

-- gprs location updating operation codes

```
updateGprsLocation UpdateGprsLocation ::= localValue 23
```

-- gprs location information retrieval operation codes

```
sendRoutingInfoForGprs SendRoutingInfoForGprs ::= localValue 24
```

-- failure reporting operation codes

```
failureReport FailureReport ::= localValue 25
```

-- GPRS notification operation codes

```
noteMsPresentForGprs NoteMsPresentForGprs ::= localValue 26
```

-- generic error codes

```
systemFailure SystemFailure ::= localValue 34
dataMissing DataMissing ::= localValue 35
unexpectedDataValue UnexpectedDataValue ::= localValue 36
facilityNotSupported FacilityNotSupported ::= localValue 21
incompatibleTerminal IncompatibleTerminal ::= localValue 28
resourceLimitation ResourceLimitation ::= localValue 51
```

-- identification and numbering error codes

```
unknownSubscriber UnknownSubscriber ::= localValue 1
numberChanged NumberChanged ::= localValue 44
unknownMSC UnknownMSC ::= localValue 3
unidentifiedSubscriber UnidentifiedSubscriber ::= localValue 5
unknownEquipment UnknownEquipment ::= localValue 7
```

-- subscription error codes

```
roamingNotAllowed RoamingNotAllowed ::= localValue 8
illegalSubscriber IllegalSubscriber ::= localValue 9
illegalEquipment IllegalEquipment ::= localValue 12
bearerServiceNotProvisioned BearerServiceNotProvisioned ::=
    localValue 10
teleserviceNotProvisioned TeleserviceNotProvisioned ::=
    localValue 11
```

-- handover error codes

```
noHandoverNumberAvailable NoHandoverNumberAvailable ::=
    localValue 25
subsequentHandoverFailure SubsequentHandoverFailure ::=
    localValue 26
```

-- operation and maintenance error codes

```
tracingBufferFull TracingBufferFull ::= localValue 40
```

-- call handling error codes

```
noRoamingNumberAvailable NoRoamingNumberAvailable ::= localValue 39
absentSubscriber AbsentSubscriber ::= localValue 27
busySubscriber BusySubscriber ::= localValue 45
noSubscriberReply NoSubscriberReply ::= localValue 46
callBarred CallBarred ::= localValue 13
forwardingFailed ForwardingFailed ::= localValue 47
or-NotAllowed OR-NotAllowed ::= localValue 48
forwardingViolation ForwardingViolation ::= localValue 14
cug-Reject CUG-Reject ::= localValue 15
```

-- any time interrogation error codes

```
ati-NotAllowed ATI-NotAllowed ::= localValue 49
```

-- Group Call error codes

```
noGroupCallNumberAvailable NoGroupCallNumberAvailable ::= localValue 50
```

-- supplementary service error codes

```
illegalSS-Operation IllegalSS-Operation ::= localValue 16
ss-ErrorStatus SS-ErrorStatus ::= localValue 17
ss-NotAvailable SS-NotAvailable ::= localValue 18
ss-SubscriptionViolation SS-SubscriptionViolation ::= localValue 19
ss-Incompatibility SS-Incompatibility ::= localValue 20
unknownAlphabet UnknownAlphabet ::= localValue 71
ussd-Busy USSD-Busy ::= localValue 72
pw-RegistrationFailure PW-RegistrationFailure ::= localValue 37
negativePW-Check NegativePW-Check ::= localValue 38
numberOfPW-AttemptsViolation NumberOfPW-AttemptsViolation ::=
    localValue 43
shortTermDenial ShortTermDenial ::= localValue 29
longTermDenial LongTermDenial ::= localValue 30
```

-- short message service error codes

```
subscriberBusyForMT-SMS SubscriberBusyForMT-SMS ::= localValue 31
sm-DeliveryFailure SM-DeliveryFailure ::= localValue 32
messageWaitingListFull MessageWaitingListFull ::= localValue 33
absentSubscriberSM AbsentSubscriberSM ::= localValue 6
```

-- The following operation codes are reserved for operations  
 -- existing in previous versions of the protocol

Operation Name	AC used	Oper. Code
-- sendParameters	map-ac infoRetrieval (14) version1 (1)	localValue 9
-- processUnstructuredSS-Data	map-ac networkFunctionalSs (18) version1 (1)	localValue 19
-- performHandover	map-ac handoverControl (11) version1 (1)	localValue 28
-- performSubsequentHandover	map-ac handoverControl (11) version1 (1)	localValue 30
-- noteInternalHandover	map-ac handoverControl (11) version1 (1)	localValue 35
-- noteSubscriberPresent	map-ac mwdMngt (24) version1 (1)	localValue 48
-- alertServiceCentreWithoutResult	map-ac shortMsgAlert (23) version1 (1)	localValue 49
-- traceSubscriberActivity	map-ac handoverControl (11) version1 (1)	localValue 52
-- beginSubscriberActivity	map-ac networkFunctionalSs (18) version1 (1)	localValue 54

-- The following error codes are reserved for errors  
 -- existing in previous versions of the protocol

Error Name	AC used	Error Code
-- unknownBaseStation	map-ac handoverControl (11) version1 (1)	localValue 2
-- invalidTargetBaseStation	map-ac handoverControl (11) version1 (1)	localValue 23
-- noRadioResourceAvailable	map-ac handoverControl (11) version1 (1)	localValue 24

END

## 17.6 MAP operation and error types

### 17.6.1 Mobile Service Operations

```

MAP-MobileServiceOperations {
  ccitt identified-organization (4) etsi (0) mobileDomain (0)
  gsm-Network (1) modules (3) map-MobileServiceOperations (5)
  version4 (4)}

DEFINITIONS

 ::=

BEGIN

EXPORTS

  -- location registration operations
  UpdateLocation,
  CancelLocation,
  PurgeMS,
  SendIdentification,

  -- gprs location registration operations
  UpdateGprsLocation,

  -- subscriber information enquiry operations
  ProvideSubscriberInfo,

  -- any time information enquiry operations
  AnyTimeInterrogation,

  -- handover operations
  PrepareHandover,
  SendEndSignal,
  ProcessAccessSignalling,
  ForwardAccessSignalling,
  PrepareSubsequentHandover,

  -- authentication management operations
  SendAuthenticationInfo,

  -- IMEI management operations
  CheckIMEI,

  -- subscriber management operations
  InsertSubscriberData,
  DeleteSubscriberData,

  -- fault recovery operations
  Reset,
  ForwardCheckSS-Indication,
  RestoreData,

-- gprs location information retrieval operations
  SendRoutingInfoForGprs,

  -- failure reporting operations
  FailureReport,

  -- gprs notification operations
  NoteMsPresentForGprs

;

IMPORTS
  OPERATION
FROM TCAPMessages {
  ccitt recommendation q 773 modules (2) messages (1) version2 (2)}

  SystemFailure,
  DataMissing,
  UnexpectedDataValue,
  UnknownSubscriber,

```

```

UnknownMSC,
UnidentifiedSubscriber,
UnknownEquipment,
RoamingNotAllowed,
ATI-NotAllowed,
NoHandoverNumberAvailable,
SubsequentHandoverFailure,
AbsentSubscriber

```

```

FROM MAP-Errors {
  ccitt identified-organization (4) etsi (0) mobileDomain (0)
  gsm-Network (1) modules (3) map-Errors (10) version4 (4)}

```

```

UpdateLocationArg,
UpdateLocationRes,
CancelLocationArg,
CancelLocationRes,
PurgeMS-Arg,
PurgeMS-Res,
SendIdentificationRes,
UpdateGprsLocationArg,
UpdateGprsLocationRes,
PrepareHO-Arg,
PrepareHO-Res,
PrepareSubsequentHO-Arg,
SendAuthenticationInfoArg,
SendAuthenticationInfoRes,
EquipmentStatus,
InsertSubscriberDataArg,
InsertSubscriberDataRes,
DeleteSubscriberDataArg,
DeleteSubscriberDataRes,
ResetArg,
RestoreDataArg,
RestoreDataRes,
ProvideSubscriberInfoArg,
ProvideSubscriberInfoRes,
AnyTimeInterrogationArg,
AnyTimeInterrogationRes,
SendRoutingInfoForGprsArg,
SendRoutingInfoForGprsRes,
FailureReportArg,
FailureReportRes,
NoteMsPresentForGprsArg,
NoteMsPresentForGprsRes

```

```

FROM MAP-MS-DataTypes {
  ccitt identified-organization (4) etsi (0) mobileDomain (0)
  gsm-Network (1) modules (3) map-MS-DataTypes (11) version4 (4)}

```

```

ExternalSignalInfo,
TMSI,
IMEI

```

```

FROM MAP-CommonDataTypes {
  ccitt identified-organization (4) etsi (0) mobileDomain (0)
  gsm-Network (1) modules (3) map-CommonDataTypes (18) version4 (4)}
;

```

-- location registration operations

<b>UpdateLocation</b> ::= OPERATION	--Timer m
ARGUMENT	
updateLocationArg	UpdateLocationArg
RESULT	
updateLocationRes	UpdateLocationRes
ERRORS {	
SystemFailure,	
DataMissing,	
UnexpectedDataValue,	
UnknownSubscriber,	
RoamingNotAllowed}	

```

CancelLocation ::= OPERATION --Timer m
  ARGUMENT
    cancelLocationArg          CancelLocationArg
  RESULT
    cancelLocationRes          CancelLocationRes
    -- optional
  ERRORS {
    DataMissing,
    UnexpectedDataValue}

```

```

PurgeMS ::= OPERATION --Timer m
  ARGUMENT
    purgeMS-Arg                PurgeMS-Arg
  RESULT
    purgeMS-Res                PurgeMS-Res
    -- optional
  ERRORS{
    DataMissing,
    UnexpectedDataValue,
    UnknownSubscriber}

```

```

SendIdentification ::= OPERATION --Timer s
  ARGUMENT
    tmsi                        TMSI
  RESULT
    sendIdentificationRes       SendIdentificationRes
  ERRORS {
    DataMissing,
    UnidentifiedSubscriber}

```

-- gprs location registration operations

```

UpdateGprsLocation ::= OPERATION --Timer m
  ARGUMENT
    updateGprsLocationArg       UpdateGprsLocationArg
  RESULT
    updateGprsLocationRes       UpdateGprsLocationRes
  ERRORS {
    SystemFailure,
    UnexpectedDataValue,
    UnknownSubscriber,
    RoamingNotAllowed}

```

-- subscriber information enquiry operations

```

ProvideSubscriberInfo ::= OPERATION --Timer m
  ARGUMENT
    provideSubscriberInfoArg     ProvideSubscriberInfoArg
  RESULT
    provideSubscriberInfoRes     ProvideSubscriberInfoRes
  ERRORS {
    DataMissing,
    UnexpectedDataValue}

```

-- any time information enquiry operations

```

AnyTimeInterrogation ::= OPERATION --Timer m
  ARGUMENT
    anyTimeInterrogationArg      AnyTimeInterrogationArg
  RESULT
    anyTimeInterrogationRes      AnyTimeInterrogationRes
  ERRORS {
    SystemFailure,
    ATI-NotAllowed,
    DataMissing,
    UnexpectedDataValue,
    UnknownSubscriber}

```

-- handover operations



<b>PrepareHandover</b> ::= OPERATION	--Timer m
ARGUMENT	
prepareHO-Arg	PrepareHO-Arg
RESULT	
prepareHO-Res	PrepareHO-Res
ERRORS {	
SystemFailure,	
DataMissing,	
UnexpectedDataValue,	
NoHandoverNumberAvailable}	

<b>SendEndSignal</b> ::= OPERATION	--Timer l
ARGUMENT	
bss-APDU	ExternalSignalInfo
RESULT	

<b>ProcessAccessSignalling</b> ::= OPERATION	--Timer s
ARGUMENT	
bss-APDU	ExternalSignalInfo

<b>ForwardAccessSignalling</b> ::= OPERATION	--Timer s
ARGUMENT	
bss-APDU	ExternalSignalInfo

<b>PrepareSubsequentHandover</b> ::= OPERATION	--Timer m
ARGUMENT	
prepareSubsequentHO-Arg	PrepareSubsequentHO-Arg
RESULT	
bss-APDU	ExternalSignalInfo
ERRORS {	
UnexpectedDataValue,	
DataMissing,	
UnknownMSC,	
SubsequentHandoverFailure}	

-- authentication management operations

<b>SendAuthenticationInfo</b> ::= OPERATION	--Timer m
ARGUMENT	
sendAuthenticationInfoArg	SendAuthenticationInfoArg
RESULT	
sendAuthenticationInfoRes	SendAuthenticationInfoRes
-- optional	
ERRORS {	
SystemFailure,	
DataMissing,	
UnexpectedDataValue,	
UnknownSubscriber}	

-- IMEI management operations

<b>CheckIMEI</b> ::= OPERATION	--Timer m
ARGUMENT	
imei	IMEI
RESULT	
equipmentStatus	EquipmentStatus
ERRORS {	
SystemFailure,	
DataMissing,	
UnknownEquipment}	

-- subscriber management operations

<b>InsertSubscriberData</b> ::= OPERATION	--Timer m
ARGUMENT	
insertSubscriberDataArg	InsertSubscriberDataArg
RESULT	
insertSubscriberDataRes	InsertSubscriberDataRes
-- optional	
ERRORS {	
DataMissing,	
UnexpectedDataValue,	
UnidentifiedSubscriber}	

```

DeleteSubscriberData ::= OPERATION --Timer m
  ARGUMENT
    deleteSubscriberDataArg DeleteSubscriberDataArg
  RESULT
    deleteSubscriberDataRes DeleteSubscriberDataRes
    -- optional
  ERRORS {
    DataMissing,
    UnexpectedDataValue,
    UnidentifiedSubscriber}

```

-- fault recovery operations

```

Reset ::= OPERATION --Timer m
  ARGUMENT
    resetArg ResetArg

```

```

ForwardCheckSS-Indication ::= OPERATION --Timer s

```

```

RestoreData ::= OPERATION --Timer m
  ARGUMENT
    restoreDataArg RestoreDataArg
  RESULT
    restoreDataRes RestoreDataRes
  ERRORS {
    SystemFailure,
    DataMissing,
    UnexpectedDataValue,
    UnknownSubscriber}

```

-- gprs location information retrieval operations

```

SendRoutingInfoForGprs ::= OPERATION --Timer m
  ARGUMENT
    sendRoutingInfoForGprsArg SendRoutingInfoForGprsArg
  RESULT
    sendRoutingInfoForGprsRes SendRoutingInfoForGprsRes
  ERRORS {
    AbsentSubscriber,
    SystemFailure,
    DataMissing,
    UnexpectedDataValue,
    UnknownSubscriber}

```

-- failure reporting operations

```

FailureReport ::= OPERATION --Timer m
  ARGUMENT
    failureReportArg FailureReportArg
  RESULT
    failureReportRes FailureReportRes
    -- optional
  ERRORS {
    SystemFailure,
    DataMissing,
    UnexpectedDataValue,
    UnknownSubscriber}

```

-- gprs notification operations

```

NoteMsPresentForGprs ::= OPERATION --Timer m
  ARGUMENT
    noteMsPresentForGprsArg NoteMsPresentForGprsArg
  RESULT
    noteMsPresentForGprsRes NoteMsPresentForGprsRes
    -- optional
  ERRORS {
    SystemFailure,
    DataMissing,
    UnexpectedDataValue,
    UnknownSubscriber}

```

END

## 17.6.2 Operation and Maintenance Operations

```
MAP-OperationAndMaintenanceOperations {
    ccitt identified-organization (4) etsi (0) mobileDomain (0)
    gsm-Network (1) modules (3) map-OperationAndMaintenanceOperations (6)
    version4 (4)}
```

DEFINITIONS

::=

BEGIN

EXPORTS

```
    ActivateTraceMode,
    DeactivateTraceMode,
    SendIMSI
```

;

IMPORTS

OPERATION

FROM TCAPMessages {

```
    ccitt recommendation q 773 modules (2) messages (1) version2 (2)}
```

```
    SystemFailure,
    DataMissing,
    UnexpectedDataValue,
    FacilityNotSupported,
    UnknownSubscriber,
    UnidentifiedSubscriber,
    TracingBufferFull
```

FROM MAP-Errors {

```
    ccitt identified-organization (4) etsi (0) mobileDomain (0)
    gsm-Network (1) modules (3) map-Errors (10) version4 (4)}
```

```
    ActivateTraceModeArg,
    ActivateTraceModeRes,
    DeactivateTraceModeArg,
    DeactivateTraceModeRes
```

FROM MAP-OM-DataTypes {

```
    ccitt identified-organization (4) etsi (0) mobileDomain (0)
    gsm-Network (1) modules (3) map-OM-DataTypes (12) version4 (4)}
```

```
    ISDN-AddressString,
    IMSI
```

FROM MAP-CommonDataTypes {

```
    ccitt identified-organization (4) etsi (0) mobileDomain (0)
    gsm-Network (1) modules (3) map-CommonDataTypes (18) version4 (4)}
```

;

<pre> <b>ActivateTraceMode</b> ::= OPERATION                                --Timer m     ARGUMENT         activateTraceModeArg                ActivateTraceModeArg     RESULT         activateTraceModeRes                ActivateTraceModeRes         -- optional     ERRORS {         SystemFailure,         DataMissing,         UnexpectedDataValue,         FacilityNotSupported,         UnidentifiedSubscriber,         TracingBufferFull}                 </pre>
---

<pre> <b>DeactivateTraceMode</b> ::= OPERATION                            --Timer m     ARGUMENT         deactivateTraceModeArg              DeactivateTraceModeArg     RESULT         deactivateTraceModeRes              DeactivateTraceModeRes         -- optional     ERRORS {         SystemFailure,         DataMissing,         UnexpectedDataValue,         FacilityNotSupported,         UnidentifiedSubscriber}                 </pre>
--

<pre> SendIMSI ::= OPERATION     ARGUMENT         msisdn                ISDN-AddressString     RESULT         imsi                  IMSI     ERRORS {         DataMissing,         UnexpectedDataValue,         UnknownSubscriber} </pre>	<pre> --Timer m </pre>
---	------------------------

END

## 17.6.3 Call Handling Operations

```

MAP-CallHandlingOperations {
    ccitt identified-organization (4) etsi (0) mobileDomain (0)
    gsm-Network (1) modules (3) map-CallHandlingOperations (7)
    version4 (4)}

```

DEFINITIONS

::=

BEGIN

EXPORTS

```

    SendRoutingInfo,
    ProvideRoamingNumber,
    ResumeCallHandling,
    ProvideSIWFSNumber,
    SIWFSSignallingModify,
    SetReportingState,
    StatusReport,
    RemoteUserFree
;

```

IMPORTS

OPERATION

FROM TCAPMessages {

```

    ccitt recommendation q 773 modules (2) messages (1) version2 (2)}

```

```

    SystemFailure,
    DataMissing,
    UnexpectedDataValue,
    FacilityNotSupported,
    OR-NotAllowed,
    UnknownSubscriber,
    NumberChanged,
    BearerServiceNotProvisioned,
    TeleserviceNotProvisioned,
    NoRoamingNumberAvailable,
    AbsentSubscriber,
    BusySubscriber,
    NoSubscriberReply,
    CallBarred,
    ForwardingViolation,
    ForwardingFailed,
    CUG-Reject,
    ResourceLimitation,
    IncompatibleTerminal,
    UnidentifiedSubscriber

```

FROM MAP-Errors {

```

    ccitt identified-organization (4) etsi (0) mobileDomain (0)
    gsm-Network (1) modules (3) map-Errors (10) version4 (4)}

```

```

    SendRoutingInfoArg,
    SendRoutingInfoRes,
    ProvideRoamingNumberArg,
    ProvideRoamingNumberRes,
    ResumeCallHandlingArg,
    ResumeCallHandlingRes,
    ProvideSIWFSNumberArg,
    ProvideSIWFSNumberRes,
    SIWFSSignallingModifyArg,
    SIWFSSignallingModifyRes,
    SetReportingStateArg,
    SetReportingStateRes,
    StatusReportArg,

```

```

StatusReportRes,
RemoteUserFreeArg,
RemoteUserFreeRes
FROM MAP-CH-DataTypes {
ccitt identified-organization (4) etsi (0) mobileDomain (0)
gsm-Network (1) modules (3) map-CH-DataTypes (13) version4 (4)}
;

```

```

SendRoutingInfo ::= OPERATION --Timer m
ARGUMENT
    sendRoutingInfoArg          SendRoutingInfoArg
RESULT
    sendRoutingInfoRes          SendRoutingInfoRes
ERRORS {
    SystemFailure,
    DataMissing,
    UnexpectedDataValue,
    FacilityNotSupported,
    OR-NotAllowed,
    UnknownSubscriber,
    NumberChanged,
    BearerServiceNotProvisioned,
    TeleserviceNotProvisioned,
    AbsentSubscriber,
    BusySubscriber,
    NoSubscriberReply,
    CallBarred,
    CUG-Reject,
    ForwardingViolation}

```

```

ProvideRoamingNumber ::= OPERATION --Timer m
ARGUMENT
    provideRoamingNumberArg      ProvideRoamingNumberArg
RESULT
    provideRoamingNumberRes      ProvideRoamingNumberRes
ERRORS {
    SystemFailure,
    DataMissing,
    UnexpectedDataValue,
    FacilityNotSupported,
    OR-NotAllowed,
    AbsentSubscriber,
    NoRoamingNumberAvailable}

```

```

ResumeCallHandling ::= OPERATION --Timer m
ARGUMENT
    resumeCallHandlingArg        ResumeCallHandlingArg
RESULT
    resumeCallHandlingRes        ResumeCallHandlingRes
ERRORS {
    ForwardingFailed,
    OR-NotAllowed,
    UnexpectedDataValue}

```

```

ProvideSIWFSNumber ::= OPERATION --Timer m
ARGUMENT
    provideSIWFSNumberArg        ProvideSIWFSNumberArg
RESULT
    provideSIWFSNumberRes        ProvideSIWFSNumberRes
ERRORS {
    ResourceLimitation,
    DataMissing,
    UnexpectedDataValue,
    SystemFailure}

```

```

SIWFSSignallingModify ::= OPERATION --Timer m
ARGUMENT
    siWFSSignallingModifyArg      SIWFSSignallingModifyArg
RESULT
    siWFSSignallingModifyRes      SIWFSSignallingModifyRes
    -- optional
ERRORS {
    ResourceLimitation,
    DataMissing,
    UnexpectedDataValue,
    SystemFailure}

```

```

SetReportingState ::= OPERATION --Timer m
  ARGUMENT
    setReportingStateArg          SetReportingStateArg
  RESULT
    setReportingStateRes          SetReportingStateRes
    -- optional
  ERRORS {
    SystemFailure,
    UnidentifiedSubscriber,
    UnexpectedDataValue,
    DataMissing,
    ResourceLimitation,
    FacilityNotSupported}

```

```

StatusReport ::= OPERATION --Timer m
  ARGUMENT
    statusReportArg              StatusReportArg
  RESULT
    statusReportRes              StatusReportRes
    -- optional
  ERRORS {
    UnknownSubscriber,
    SystemFailure,
    UnexpectedDataValue,
    DataMissing}

```

```

RemoteUserFree ::= OPERATION --Timer m1
  ARGUMENT
    remoteUserFreeArg            RemoteUserFreeArg
  RESULT
    remoteUserFreeRes            RemoteUserFreeRes
  ERRORS {
    UnexpectedDataValue,
    DataMissing,
    IncompatibleTerminal,
    AbsentSubscriber,
    SystemFailure,
    BusySubscriber}

```

END

## 17.6.4 Supplementary service operations

```

MAP-SupplementaryServiceOperations {
  ccitt identified-organization (4) etsi (0) mobileDomain (0)
  gsm-Network (1) modules (3) map-SupplementaryServiceOperations (8)
  version4 (4)}

```

DEFINITIONS

::=

BEGIN

EXPORTS

```

  RegisterSS,
  EraseSS,
  ActivateSS,
  DeactivateSS,
  InterrogateSS,
  ProcessUnstructuredSS-Request,
  UnstructuredSS-Request,
  UnstructuredSS-Notify,
  RegisterPassword,
  GetPassword,
  SS-InvocationNotification,
  RegisterCC-Entry,
  EraseCC-Entry
;

```

IMPORTS

```

  OPERATION
  FROM TCAPMessages {
    ccitt recommendation q 773 modules (2) messages (1) version2 (2)}

  SystemFailure,
  DataMissing,
  UnexpectedDataValue,

```

```

UnknownSubscriber,
BearerServiceNotProvisioned,
TeleserviceNotProvisioned,
CallBarred,
IllegalSS-Operation,
SS-ErrorStatus,
SS-NotAvailable,
SS-SubscriptionViolation,
SS-Incompatibility,
PW-RegistrationFailure,
NegativePW-Check,
NumberOfPW-AttemptsViolation,
UnknownAlphabet,
USSD-Busy,
AbsentSubscriber,
IllegalSubscriber,
IllegalEquipment,
ShortTermDenial,
LongTermDenial,
FacilityNotSupported
FROM MAP-Errors {
  ccitt identified-organization (4) etsi (0) mobileDomain (0)
  gsm-Network (1) modules (3) map-Errors (10) version4 (4)}

RegisterSS-Arg,
SS-Info,
SS-ForBS-Code,
InterrogateSS-Res,
USSD-Arg,
USSD-Res,
Password,
GuidanceInfo,
SS-InvocationNotificationArg,
SS-InvocationNotificationRes,
RegisterCC-EntryArg,
RegisterCC-EntryRes,
EraseCC-EntryArg,
EraseCC-EntryRes
FROM MAP-SS-DataTypes {
  ccitt identified-organization (4) etsi (0) mobileDomain (0)
  gsm-Network (1) modules (3) map-SS-DataTypes (14) version4 (4)}

SS-Code
FROM MAP-SS-Code {
  ccitt identified-organization (4) etsi (0) mobileDomain (0)
  gsm-Network (1) modules (3) map-SS-Code (15) version4 (4)}
;

```

-- supplementary service handling operations

<b>RegisterSS</b> ::= OPERATION	--Timer m
ARGUMENT	
registerSS-Arg	RegisterSS-Arg
RESULT	
ss-Info	SS-Info
-- optional	
ERRORS {	
SystemFailure,	
DataMissing,	
UnexpectedDataValue,	
BearerServiceNotProvisioned,	
TeleserviceNotProvisioned,	
CallBarred,	
IllegalSS-Operation,	
SS-ErrorStatus,	
SS-Incompatibility}	

```

EraseSS ::= OPERATION --Timer m
  ARGUMENT
    ss-ForBS SS-ForBS-Code
  RESULT
    ss-Info SS-Info
    -- optional
  ERRORS {
    SystemFailure,
    DataMissing,
    UnexpectedDataValue,
    BearerServiceNotProvisioned,
    TeleserviceNotProvisioned,
    CallBarred,
    IllegalSS-Operation,
    SS-ErrorStatus
  }

```

```

ActivateSS ::= OPERATION --Timer m
  ARGUMENT
    ss-ForBS SS-ForBS-Code
  RESULT
    ss-Info SS-Info
    -- optional
  ERRORS {
    SystemFailure,
    DataMissing,
    UnexpectedDataValue,
    BearerServiceNotProvisioned,
    TeleserviceNotProvisioned,
    CallBarred,
    IllegalSS-Operation,
    SS-ErrorStatus,
    SS-SubscriptionViolation,
    SS-Incompatibility,
    NegativePW-Check,
    NumberOfPW-AttemptsViolation}

```

```

DeactivateSS ::= OPERATION --Timer m
  ARGUMENT
    ss-ForBS SS-ForBS-Code
  RESULT
    ss-Info SS-Info
    -- optional
  ERRORS {
    SystemFailure,
    DataMissing,
    UnexpectedDataValue,
    BearerServiceNotProvisioned,
    TeleserviceNotProvisioned,
    CallBarred,
    IllegalSS-Operation,
    SS-ErrorStatus,
    SS-SubscriptionViolation,
    NegativePW-Check,
    NumberOfPW-AttemptsViolation}

```

```

InterrogateSS ::= OPERATION --Timer m
  ARGUMENT
    ss-ForBS SS-ForBS-Code
  RESULT
    interrogateSS-Res InterrogateSS-Res
  ERRORS {
    SystemFailure,
    DataMissing,
    UnexpectedDataValue,
    BearerServiceNotProvisioned,
    TeleserviceNotProvisioned,
    CallBarred,
    IllegalSS-Operation,
    SS-NotAvailable}

```



```

ProcessUnstructuredSS-Request ::= OPERATION --Timer 10 minutes
    ARGUMENT
        ussd-Arg                USSD-Arg
    RESULT
        ussd-Res                USSD-Res
    ERRORS {
        SystemFailure,
        DataMissing,
        UnexpectedDataValue,
        UnknownAlphabet,
        CallBarred}
    
```

```

UnstructuredSS-Request ::= OPERATION --Timer ml
    ARGUMENT
        ussd-Arg                USSD-Arg
    RESULT
        ussd-Res                USSD-Res
        -- optional
    ERRORS {
        SystemFailure,
        DataMissing,
        UnexpectedDataValue,
        AbsentSubscriber,
        IllegalSubscriber,
        IllegalEquipment,
        UnknownAlphabet,
        USSD-Busy}
    
```

```

UnstructuredSS-Notify ::= OPERATION --Timer ml
    ARGUMENT
        ussd-Arg                USSD-Arg
    RESULT
    ERRORS {
        SystemFailure,
        DataMissing,
        UnexpectedDataValue,
        AbsentSubscriber,
        IllegalSubscriber,
        IllegalEquipment,
        UnknownAlphabet,
        USSD-Busy}
    
```

```

RegisterPassword ::= OPERATION --Timer ml
    ARGUMENT
        ss-Code                SS-Code
    RESULT
        newPassword            Password
    ERRORS {
        SystemFailure,
        DataMissing,
        UnexpectedDataValue,
        CallBarred,
        SS-SubscriptionViolation,
        PW-RegistrationFailure,
        NegativePW-Check,
        NumberOfPW-AttemptsViolation}
    LINKED {
        GetPassword}
    
```

```

GetPassword ::= OPERATION --Timer m
    ARGUMENT
        guidanceInfo            GuidanceInfo
    RESULT
        currentPassword        Password
    
```

```

SS-InvocationNotification ::= OPERATION --Timer m
    ARGUMENT
        ss-InvocationNotificationArg    SS-InvocationNotificationArg
    RESULT
        ss-InvocationNotificationRes    SS-InvocationNotificationRes
        -- optional
    ERRORS {
        DataMissing,
        UnexpectedDataValue,
        UnknownSubscriber}
    
```

```

RegisterCC-Entry ::= OPERATION --Timer m
  ARGUMENT
    registerCC-EntryArg          RegisterCC-EntryArg
  RESULT
    registerCC-EntryRes          RegisterCC-EntryRes
  ERRORS {
    SystemFailure,
    DataMissing,
    UnexpectedDataValue,
    CallBarred,
    IllegalSS-Operation,
    SS-ErrorStatus,
    SS-Incompatibility,
    ShortTermDenial,
    LongTermDenial,
    FacilityNotSupported}

```

```

EraseCC-Entry ::= OPERATION --Timer m
  ARGUMENT
    eraseCC-EntryArg            EraseCC-EntryArg
  RESULT
    eraseCC-EntryRes            EraseCC-EntryRes
  ERRORS {
    SystemFailure,
    DataMissing,
    UnexpectedDataValue,
    CallBarred,
    IllegalSS-Operation,
    SS-ErrorStatus}

```

END

## 17.6.5 Short message service operations

```

MAP-ShortMessageServiceOperations {
  ccitt identified-organization (4) etsi (0) mobileDomain (0)
  gsm-Network (1) modules (3) map-ShortMessageServiceOperations (9)
  version4 (4)}

```

DEFINITIONS

::=

BEGIN

EXPORTS

```

  SendRoutingInfoForSM,
  MO-ForwardSM,
  MT-ForwardSM,
  ReportSM-DeliveryStatus,
  AlertServiceCentre,
  InformServiceCentre,
  ReadyForSM
;

```

IMPORTS

OPERATION

FROM TCAPMessages {

```

  ccitt recommendation q 773 modules (2) messages (1) version2 (2)}

```

```

  SystemFailure,
  DataMissing,
  UnexpectedDataValue,
  FacilityNotSupported,
  UnknownSubscriber,
  UnidentifiedSubscriber,
  IllegalSubscriber,
  IllegalEquipment,
  TeleserviceNotProvisioned,
  AbsentSubscriber,
  CallBarred,
  SubscriberBusyForMT-SMS,
  SM-DeliveryFailure,
  MessageWaitingListFull,
  AbsentSubscriberSM

```

FROM MAP-Errors {

```

  ccitt identified-organization (4) etsi (0) mobileDomain (0)
  gsm-Network (1) modules (3) map-Errors (10) version4 (4)}

```

```

RoutingInfoForSM-Arg,
RoutingInfoForSM-Res,
MO-ForwardSM-Arg,
MO-ForwardSM-Res,
MT-ForwardSM-Arg,
MT-ForwardSM-Res,
ReportSM-DeliveryStatusArg,
ReportSM-DeliveryStatusRes,
AlertServiceCentreArg,
InformServiceCentreArg,
ReadyForSM-Arg,
ReadyForSM-Res
FROM MAP-SM-DataTypes {
  ccitt identified-organization (4) etsi (0) mobileDomain (0)
  gsm-Network (1) modules (3) map-SM-DataTypes (16) version4 (4)}

```

;

```

SendRoutingInfoForSM ::= OPERATION --Timer m
  ARGUMENT
    routingInfoForSM-Arg          RoutingInfoForSM-Arg
  RESULT
    routingInfoForSM-Res          RoutingInfoForSM-Res
  ERRORS {
    SystemFailure,
    DataMissing,
    UnexpectedDataValue,
    FacilityNotSupported,
    UnknownSubscriber,
    TeleserviceNotProvisioned,
    CallBarred,
    AbsentSubscriberSM}

```

```

MO-ForwardSM ::= OPERATION --Timer m1
  ARGUMENT
    mo-forwardSM-Arg              MO-ForwardSM-Arg
  RESULT
    mo-forwardSM-Res              MO-ForwardSM-Res
    -- optional
  ERRORS {
    SystemFailure,
    UnexpectedDataValue,
    FacilityNotSupported,
    SM-DeliveryFailure}

```

```

MT-ForwardSM ::= OPERATION --Timer m1
  ARGUMENT
    mt-forwardSM-Arg              MT-ForwardSM-Arg
  RESULT
    mt-forwardSM-Res              MT-ForwardSM-Res
    -- optional
  ERRORS {
    SystemFailure,
    DataMissing,
    UnexpectedDataValue,
    FacilityNotSupported,
    UnidentifiedSubscriber,
    IllegalSubscriber,
    IllegalEquipment,
    SubscriberBusyForMT-SMS,
    SM-DeliveryFailure,
    AbsentSubscriberSM}

```

```

ReportSM-DeliveryStatus ::= OPERATION --Timer s
  ARGUMENT
    reportSM-DeliveryStatusArg      ReportSM-DeliveryStatusArg
  RESULT
    reportSM-DeliveryStatusRes      ReportSM-DeliveryStatusRes
    -- optional
  ERRORS {
    DataMissing,
    UnexpectedDataValue,
    UnknownSubscriber,
    MessageWaitingListFull}

```

```

AlertServiceCentre ::= OPERATION --Timer s
  ARGUMENT
    alertServiceCentreArg          AlertServiceCentreArg
  RESULT
  ERRORS {
    SystemFailure,
    DataMissing,
    UnexpectedDataValue}

```

```

InformServiceCentre ::= OPERATION --Timer s
  ARGUMENT
    informServiceCentreArg        InformServiceCentreArg

```

```

ReadyForSM ::= OPERATION --Timer m
  ARGUMENT
    readyForSM-Arg                ReadyForSM-Arg
  RESULT
    readyForSM-Res                ReadyForSM-Res
    -- optional
  ERRORS {
    DataMissing,
    UnexpectedDataValue,
    FacilityNotSupported,
    UnknownSubscriber}

```

END

## 17.6.6 Errors

```

MAP-Errors {
  ccitt identified-organization (4) etsi (0) mobileDomain (0)
  gsm-Network (1) modules (3) map-Errors (10) version4 (4)}

```

DEFINITIONS

::=

BEGIN

EXPORTS

```

  -- generic errors
  SystemFailure,
  DataMissing,
  UnexpectedDataValue,
  FacilityNotSupported,
  IncompatibleTerminal,
  ResourceLimitation,

  -- identification and numbering errors
  UnknownSubscriber,
  NumberChanged,
  UnknownMSC,
  UnidentifiedSubscriber,
  UnknownEquipment,

  -- subscription errors
  RoamingNotAllowed,
  IllegalSubscriber,
  IllegalEquipment,
  BearerServiceNotProvisioned,
  TeleserviceNotProvisioned,

  -- handover errors
  NoHandoverNumberAvailable,
  SubsequentHandoverFailure,

```

```

-- operation and maintenance errors
TracingBufferFull,

-- call handling errors
OR-NotAllowed,
NoRoamingNumberAvailable,
BusySubscriber,
NoSubscriberReply,
AbsentSubscriber,
CallBarred,
ForwardingViolation,
ForwardingFailed,
CUG-Reject,

-- any time interrogation errors
ATI-NotAllowed,

-- supplementary service errors
IllegalSS-Operation,
SS-ErrorStatus,
SS-NotAvailable,
SS-SubscriptionViolation,
SS-Incompatibility,
UnknownAlphabet,
USSD-Busy,
PW-RegistrationFailure,
NegativePW-Check,
NumberOfPW-AttemptsViolation,
ShortTermDenial,
LongTermDenial,

-- short message service errors
SubscriberBusyForMT-SMS,
SM-DeliveryFailure,
MessageWaitingListFull,
AbsentSubscriberSM,

-- Group Call errors
NoGroupCallNumberAvailable

;

IMPORTS
  ERROR
FROM TCAPMessages {
  ccitt recommendation q 773 modules (2) messages (1) version2 (2)}

  SS-Status
FROM MAP-SS-DataTypes {
  ccitt identified-organization (4) etsi (0) mobileDomain (0)
  gsm-Network (1) modules (3) map-SS-DataTypes (14) version4 (4)}

  SS-IncompatibilityCause,
  PW-RegistrationFailureCause,
  SM-DeliveryFailureCause,
  SystemFailureParam,
  DataMissingParam,
  UnexpectedDataParam,
  FacilityNotSupParam,
  UnknownSubscriberParam,
  NumberChangedParam,
  UnidentifiedSubParam,
  RoamingNotAllowedParam,
  IllegalSubscriberParam,
  IllegalEquipmentParam,
  BearerServNotProvParam,
  TeleservNotProvParam,
  TracingBufferFullParam,
  NoRoamingNbParam,
  OR-NotAllowedParam,
  AbsentSubscriberParam,
  BusySubscriberParam,
  NoSubscriberReplyParam,
  CallBarredParam,
  ForwardingViolationParam,
  ForwardingFailedParam,
  CUG-RejectParam,
  ATI-NotAllowedParam,

```

SubBusyForMT-SMS-Param,  
 MessageWaitListFullParam,  
 AbsentSubscriberSM-Param,  
 ResourceLimitationParam,  
 NoGroupCallNbParam,  
 IncompatibleTerminalParam,  
 ShortTermDenialParam,  
 LongTermDenialParam

FROM MAP-ER-DataTypes {  
 ccitt identified-organization (4) etsi (0) mobileDomain (0)  
 gsm-Network (1) modules (3) map-ER-DataTypes (17) version4 (4)}  
 ;

-- generic errors

<p><b>SystemFailure</b> ::= ERROR                  PARAMETER                  systemFailureParam                      SystemFailureParam                  -- optional</p>
---

<p><b>DataMissing</b> ::= ERROR                  PARAMETER                  dataMissingParam                      DataMissingParam                  -- optional                  -- dataMissingParam must not be used in version &lt;3</p>
--

<p><b>UnexpectedDataValue</b> ::= ERROR                  PARAMETER                  unexpectedDataParam                      UnexpectedDataParam                  -- optional                  -- unexpectedDataParam must not be used in version &lt;3</p>
---

<p><b>FacilityNotSupported</b> ::= ERROR                  PARAMETER                  facilityNotSupParam                      FacilityNotSupParam                  -- optional                  -- facilityNotSupParam must not be used in version &lt;3</p>
--

<p><b>IncompatibleTerminal</b> ::= ERROR                  PARAMETER                  incompatibleTerminalParam                      IncompatibleTerminalParam                  -- optional</p>
--

<p><b>ResourceLimitation</b> ::= ERROR                  PARAMETER                  resourceLimitationParam                      ResourceLimitationParam                  -- optional</p>
--

-- identification and numbering errors

<p><b>UnknownSubscriber</b> ::= ERROR                  PARAMETER                  unknownSubscriberParam                      UnknownSubscriberParam                  -- optional                  -- unknownSubscriberParam must not be used in version &lt;3</p>
--

<p><b>NumberChanged</b> ::= ERROR                  PARAMETER                  numberChangedParam                      NumberChangedParam                  -- optional</p>
---

<p><b>UnknownMSC</b> ::= ERROR</p>
------------------------------------

<p><b>UnidentifiedSubscriber</b> ::= ERROR                  PARAMETER                  unidentifiedSubParam                      UnidentifiedSubParam                  -- optional                  -- unidentifiedSubParam must not be used in version &lt;3</p>
---

<p><b>UnknownEquipment</b> ::= ERROR</p>
--

-- subscription errors

```
RoamingNotAllowed ::= ERROR
PARAMETER
    roamingNotAllowedParam          RoamingNotAllowedParam
```

```
IllegalSubscriber ::= ERROR
PARAMETER
    illegalSubscriberParam          IllegalSubscriberParam
    -- optional
    -- illegalSubscriberParam must not be used in version <3
```

```
IllegalEquipment ::= ERROR
PARAMETER
    illegalEquipmentParam          IllegalEquipmentParam
    -- optional
    -- illegalEquipmentParam must not be used in version <3
```

```
BearerServiceNotProvisioned ::= ERROR
PARAMETER
    bearerServNotProvParam          BearerServNotProvParam
    -- optional
    -- bearerServNotProvParam must not be used in version <3
```

```
TeleserviceNotProvisioned ::= ERROR
PARAMETER
    teleservNotProvParam           TeleservNotProvParam
    -- optional
    -- teleservNotProvParam must not be used in version <3
```

-- handover errors

```
NoHandoverNumberAvailable ::= ERROR
```

```
SubsequentHandoverFailure ::= ERROR
```

-- operation and maintenance errors

```
TracingBufferFull ::= ERROR
PARAMETER
    tracingBufferFullParam         TracingBufferFullParam
    -- optional
```

-- call handling errors

```
NoRoamingNumberAvailable ::= ERROR
PARAMETER
    noRoamingNbParam              NoRoamingNbParam
    -- optional
```

```
AbsentSubscriber ::= ERROR
PARAMETER
    absentSubscriberParam          AbsentSubscriberParam
    -- optional
```

-- absentSubscriberParam must not be used in version <3

```
BusySubscriber ::= ERROR
PARAMETER
    busySubscriberParam            BusySubscriberParam
    -- optional
```

```
NoSubscriberReply ::= ERROR
PARAMETER
    noSubscriberReplyParam         NoSubscriberReplyParam
    -- optional
```

```
CallBarred ::= ERROR
PARAMETER
    callBarredParam                CallBarredParam
    -- optional
```

```
ForwardingViolation ::= ERROR
PARAMETER
    forwardingViolationParam        ForwardingViolationParam
    -- optional
```

<b>ForwardingFailed</b> ::= ERROR PARAMETER forwardingFailedParam           ForwardingFailedParam -- optional
--

<b>CUG-Reject</b> ::= ERROR PARAMETER cug-RejectParam                CUG-RejectParam -- optional
---

<b>OR-NotAllowed</b> ::= ERROR PARAMETER or-NotAllowedParam            OR-NotAllowedParam -- optional
--

-- any time interrogation errors

<b>ATI-NotAllowed</b> ::= ERROR PARAMETER ati-NotAllowedParam           ATI-NotAllowedParam -- optional
--

-- supplementary service errors

<b>IllegalSS-Operation</b> ::= ERROR
--------------------------------------

<b>SS-ErrorStatus</b> ::= ERROR PARAMETER ss-Status                      SS-Status -- optional
---

<b>SS-NotAvailable</b> ::= ERROR
----------------------------------

<b>SS-SubscriptionViolation</b> ::= ERROR
---

<b>SS-Incompatibility</b> ::= ERROR PARAMETER ss-IncompatibilityCause       SS-IncompatibilityCause -- optional
--

<b>UnknownAlphabet</b> ::= ERROR
----------------------------------

<b>USSD-Busy</b> ::= ERROR
----------------------------

<b>PW-RegistrationFailure</b> ::= ERROR PARAMETER pw-RegistrationFailureCause   PW-RegistrationFailureCause
---

<b>NegativePW-Check</b> ::= ERROR
-----------------------------------

<b>NumberOfPW-AttemptsViolation</b> ::= ERROR
---

<b>ShortTermDenial</b> ::= ERROR PARAMETER shortTermDenialParam           ShortTermDenialParam -- optional
---

<b>LongTermDenial</b> ::= ERROR PARAMETER longTermDenialParam           LongTermDenialParam -- optional
--

-- short message service errors

<b>SubscriberBusyForMT-SMS</b> ::= ERROR PARAMETER subBusyForMT-SMS-Param       SubBusyForMT-SMS-Param -- optional
---

<b>SM-DeliveryFailure</b> ::= ERROR PARAMETER sm-DeliveryFailureCause       SM-DeliveryFailureCause
---



```

MessageWaitingListFull ::= ERROR
  PARAMETER
    messageWaitListFullParam      MessageWaitListFullParam
    -- optional

```

```

AbsentSubscriberSM ::= ERROR
  PARAMETER
    absentSubscriberSM-Param      AbsentSubscriberSM-Param
    -- optional

```

```
-- Group Call errors
```

```

NoGroupCallNumberAvailable ::= ERROR
  PARAMETER
    noGroupCallNbParam           NoGroupCallNbParam
    -- optional

```

```
END
```

## 17.6.7 Group Call operations

```

MAP-Group-Call-Operations {
  ccitt identified-organization (4) etsi (0) mobileDomain (0)
  gsm-Network (1) modules (3) map-Group-Call-Operations (22)
  version4 (4)}

DEFINITIONS

 ::=

BEGIN

EXPORTS
  PrepareGroupCall,
  SendGroupCallEndSignal,
  ForwardGroupCallSignalling,
  ProcessGroupCallSignalling
;

IMPORTS
  OPERATION
FROM TCAPMessages {
  ccitt recommendation q 773 modules (2) messages (1) version2 (2)}

  SystemFailure,
  UnexpectedDataValue,
  NoGroupCallNumberAvailable
FROM MAP-Errors {
  ccitt identified-organization (4) etsi (0) mobileDomain (0)
  gsm-Network (1) modules (3) map-Errors (10) version4 (4)}

  PrepareGroupCallArg,
  PrepareGroupCallRes,
  SendGroupCallEndSignalArg,
  SendGroupCallEndSignalRes,
  ForwardGroupCallSignallingArg,
  ProcessGroupCallSignallingArg
FROM MAP-GR-DataTypes {
  ccitt identified-organization (4) etsi (0) mobileDomain (0)
  gsm-Network (1) modules (3) map-GR-DataTypes (23) version4 (4)}

;

```

```

PrepareGroupCall ::= OPERATION --Timer m
  ARGUMENT
    prepareGroupCallArg          PrepareGroupCallArg
  RESULT
    prepareGroupCallRes          PrepareGroupCallRes
  ERRORS {
    SystemFailure,
    NoGroupCallNumberAvailable,
    UnexpectedDataValue}

```

<b>SendGroupCallEndSignal</b> ::= OPERATION	--Timer 1
ARGUMENT	
sendGroupCallEndSignalArg	SendGroupCallEndSignalArg
RESULT	
sendGroupCallEndSignalRes	SendGroupCallEndSignalRes

<b>ProcessGroupCallSignalling</b> ::= OPERATION	--Timer s
ARGUMENT	
processGroupCallSignallingArg	ProcessGroupCallSignallingArg

<b>ForwardGroupCallSignalling</b> ::= OPERATION	--Timer s
ARGUMENT	
forwardGroupCallSignallingArg	ForwardGroupCallSignallingArg

END

## 17.7 MAP constants and data types

### 17.7.1 Mobile Service data types

```
MAP-MS-DataTypes {
  ccitt identified-organization (4) etsi (0) mobileDomain (0)
  gsm-Network (1) modules (3) map-MS-DataTypes (11) version4 (4)}
```

DEFINITIONS

IMPLICIT TAGS

::=

BEGIN

EXPORTS

```
-- location registration types
UpdateLocationArg,
UpdateLocationRes,
CancelLocationArg,
CancelLocationRes,
PurgeMS-Arg,
PurgeMS-Res,
SendIdentificationRes,
UpdateGprsLocationArg,
UpdateGprsLocationRes,
```

```
-- handover types
PrepareHO-Arg,
PrepareHO-Res,
PrepareSubsequentHO-Arg,
```

```
-- authentication management types
SendAuthenticationInfoArg,
SendAuthenticationInfoRes,
```

```
-- security management types
EquipmentStatus,
Kc,
```

```
-- subscriber management types
InsertSubscriberDataArg,
InsertSubscriberDataRes,
DeleteSubscriberDataArg,
DeleteSubscriberDataRes,
SubscriberData,
ODB-Data,
SubscriberStatus,
ZoneCodeList,
maxNumOfZoneCodes,
O-CSI,
O-BcsmCamelTDPCriteriaList,
SS-CSI,
ServiceKey,
DefaultCallHandling,
```

```

CamelCapabilityHandling,
BasicServiceCriteria,
SupportedCamelPhases,
maxNumOfCamelTDPData,
CUG-Index,
CUG-Interlock,
InterCUG-Restrictions,
IntraCUG-Options,

-- fault recovery types
ResetArg,
RestoreDataArg,
RestoreDataRes,

-- subscriber information enquiry types
ProvideSubscriberInfoArg,
ProvideSubscriberInfoRes,
SubscriberInfo,
LocationInformation,
SubscriberState,

-- any time information enquiry types
AnyTimeInterrogationArg,
AnyTimeInterrogationRes,

-- gprs location information retrieval types
SendRoutingInfoForGprsArg,
SendRoutingInfoForGprsRes,

-- failure reporting types
FailureReportArg,
FailureReportRes,

-- gprs notification types
NoteMsPresentForGprsArg,
NoteMsPresentForGprsRes

;

IMPORTS
    maxNumOfSS,
    SS-SubscriptionOption,
    SS-List
FROM MAP-SS-DataTypes {
    ccitt identified-organization (4) etsi (0) mobileDomain (0)
    gsm-Network (1) modules (3) map-SS-DataTypes (14) version4 (4)}

    SS-Code
FROM MAP-SS-Code {
    ccitt identified-organization (4) etsi (0) mobileDomain (0)
    gsm-Network (1) modules (3) map-SS-Code (15) version4 (4)}

    Ext-BearerServiceCode
FROM MAP-BS-Code {
    ccitt identified-organization (4) etsi (0) mobileDomain (0)
    gsm-Network (1) modules (3) map-BS-Code (20) version4 (4)}

    Ext-TeleserviceCode
FROM MAP-TS-Code {
    ccitt identified-organization (4) etsi (0) mobileDomain (0)
    gsm-Network (1) modules (3) map-TS-Code (19) version4 (4)}

    ISDN-AddressString,
    maxISDN-AddressLength,
    ISDN-SubaddressString,
    ExternalSignalInfo,
    IMSI,
    HLR-List,
    LMSI,
    GlobalCellId,
    CellIdOrLAI,
    Ext-BasicServiceCode,
    NAEA-PreferredCI,
    EMLPP-Info

FROM MAP-CommonDataTypes {

```

```
ccitt identified-organization (4) etsi (0) mobileDomain (0)
gsm-Network (1) modules (3) map-CommonDataTypes (18) version4 (4)}
```

```
ExtensionContainer
FROM MAP-ExtensionDataTypes {
  ccitt identified-organization (4) etsi (0) mobileDomain (0)
  gsm-Network (1) modules (3) map-ExtensionDataTypes (21) version4 (4)}
```

```
AbsentSubscriberDiagnosticSM
FROM MAP-ER-DataTypes {
  ccitt identified-organization (4) etsi (0) mobileDomain (0)
  gsm-Network (1) modules (3) map-ER-DataTypes (17) version4 (4)}
```

;

-- location registration types

<b>UpdateLocationArg ::= SEQUENCE {</b>			
imsi	IMSI,		
msc-Number	[1] ISDN-AddressString,		
vlr-Number	ISDN-AddressString,		
lmsi	[10] LMSI OPTIONAL,		
extensionContainer	ExtensionContainer	OPTIONAL,	
...	,		
vlr-Capability	[6] VLR-Capability	OPTIONAL	}

<b>VLR-Capability ::= SEQUENCE{</b>			
supportedCamelPhases	[0] SupportedCamelPhases	OPTIONAL,	
extensionContainer	ExtensionContainer	OPTIONAL,	
...	}		

<b>UpdateLocationRes ::= SEQUENCE {</b>			
hlr-Number	ISDN-AddressString,		
extensionContainer	ExtensionContainer	OPTIONAL,	
...	}		

<b>CancelLocationArg ::= [3] SEQUENCE {</b>			
identity	Identity,		
cancellationType	CancellationType	OPTIONAL,	
extensionContainer	ExtensionContainer	OPTIONAL,	
...	}		

<b>Identity ::= CHOICE {</b>			
imsi	IMSI,		
imsi-WithLMSI	IMSI-WithLMSI}		

<b>CancellationType ::= ENUMERATED {</b>			
updateProcedure	(0),		
subscriptionWithdraw	(1),		
...	}		
-- The HLR shall not send values other than listed above			

<b>CancelLocationRes ::= SEQUENCE {</b>			
extensionContainer	ExtensionContainer	OPTIONAL,	
...	}		

<b>PurgeMS-Arg ::= [3] SEQUENCE {</b>			
imsi	IMSI,		
vlr-Number	[0] ISDN-AddressString	OPTIONAL,	
sgsn-Number	[1] ISDN-AddressString	OPTIONAL,	
extensionContainer	ExtensionContainer	OPTIONAL,	
...	}		

<b>PurgeMS-Res ::= SEQUENCE {</b>			
freezeTMSI	[0] NULL	OPTIONAL,	
freezeP-TMSI	[1] NULL	OPTIONAL,	
extensionContainer	ExtensionContainer	OPTIONAL,	
...	}		

```
IMSI-WithLMSI ::= SEQUENCE {
    imsi                IMSI,
    lmsi                LMSI,
    -- a special value 00000000 indicates that the LMSI is not in use
    ...}
```

```
SendIdentificationRes ::= SEQUENCE {
    imsi                IMSI,
    authenticationSetList AuthenticationSetList OPTIONAL,
    ...}
```

```
AuthenticationSetList ::= SEQUENCE SIZE (1..5) OF
    AuthenticationSet
```

```
AuthenticationSet ::= SEQUENCE {
    rand                RAND,
    sres                SRES,
    kc                  Kc,
    ...}
```

```
RAND ::= OCTET STRING (SIZE (16))
```

```
SRES ::= OCTET STRING (SIZE (4))
```

```
Kc ::= OCTET STRING (SIZE (8))
```

-- gprs location registration types

```
UpdateGprsLocationArg ::= SEQUENCE {
    imsi                IMSI,
    sgsn-Number        ISDN-AddressString,
    sgsn-Address        GSN-Address,
    extensionContainer ExtensionContainer OPTIONAL,
    ...}
```

```
GSN-Address ::= OCTET STRING (SIZE (5..17))
    -- Octets are coded according to TS GSM 03.03
```

```
UpdateGprsLocationRes ::= SEQUENCE {
    hlr-Number          ISDN-AddressString,
    extensionContainer ExtensionContainer OPTIONAL,
    ...}
```

-- handover types

```
PrepareHO-Arg ::= SEQUENCE {
    targetCellId        GlobalCellId OPTIONAL,
    ho-NumberNotRequired NULL OPTIONAL,
    bss-APDU            ExternalSignalInfo OPTIONAL,
    ...}
```

```
PrepareHO-Res ::= SEQUENCE {
    handoverNumber      ISDN-AddressString OPTIONAL,
    bss-APDU            ExternalSignalInfo OPTIONAL,
    ...}
```

```
PrepareSubsequentHO-Arg ::= SEQUENCE {
    targetCellId        GlobalCellId,
    targetMSC-Number    ISDN-AddressString,
    bss-APDU            ExternalSignalInfo,
    ...}
```

-- authentication management types

```
SendAuthenticationInfoArg ::= IMSI
```

```
SendAuthenticationInfoRes ::= AuthenticationSetList
```

-- security management types

```
EquipmentStatus ::= ENUMERATED {
    whiteListed (0),
    blackListed (1),
    greyListed (2)}
```

-- subscriber management types

```

InsertSubscriberDataArg ::= SEQUENCE {
    imsi                               [0] IMSI                               OPTIONAL,
    COMPONENTS OF                      SubscriberData,
    extensionContainer                  [14] ExtensionContainer           OPTIONAL,
    ... ,
    naea-PreferredCI                    [15] NAEA-PreferredCI           OPTIONAL,
    -- naea-PreferredCI is included at the discretion of the HLR operator.
    gprsSubscriptionData                [16] GPRSSubscriptionData        OPTIONAL,
    roamingRestrictedInSgsnDueToUnsupportedFeature [23]                NULL
    OPTIONAL,
    networkAccessMode                   [24] NetworkAccessMode         OPTIONAL
}
-- If the Network Access Mode parameter is sent, it shall be present only in
-- the first sequence if the segmentation is used

```

```

NetworkAccessMode ::= ENUMERATED {
    bothMSCAndSGSN                      (0),
    onlyMSC                              (1),
    onlySGSN                             (2),
    ...}
-- if unknown values are received in NetworkAccessMode
-- they shall be discarded.

```

```

GPRSDataList ::= SEQUENCE SIZE (1..maxNumOfPDP-Contexts) OF
    PDP-Context

```

```

maxNumOfPDP-Contexts INTEGER ::= 50

```

```

PDP-Context ::= SEQUENCE {
    pdp-ContextId                       ContextId,
    pdp-Type                             [16] PDP-Type,
    pdp-Address                          [17] PDP-Address           OPTIONAL,
    qos-Subscribed                       [18] QoS-Subscribed,
    vplmnAddressAllowed                  [19] NULL OPTIONAL,
    apn                                  [20] APN ,
    extensionContainer                    [21] ExtensionContainer       OPTIONAL,
    ...}

```

```

ContextId ::= INTEGER (1..maxNumOfPDP-Contexts)

```

```

GPRSSubscriptionData ::= SEQUENCE {
    completeDataListIncluded             NULL                               OPTIONAL,
    -- If segmentation is used, completeDataListIncluded may only be present in the
    -- first segment.
    gprsDataList                         [1] GPRSDataList,
    extensionContainer                    [2] ExtensionContainer       OPTIONAL,
    ...}

```

```

APN ::= OCTET STRING (SIZE (2..63))
-- Octets are coded according to TS GSM 03.03

```

```

PDP-Type ::= OCTET STRING (SIZE (2))
-- Octets are coded according to TS GSM 09.60

```

```

PDP-Address ::= OCTET STRING (SIZE (1..16))
-- Octets are coded according to TS GSM 09.60

-- The possible size values are:
-- 1-7 octets X.25 address type
-- 4 octets IPv4 address type
-- 16 octets IPv6 address type

```

```

QoS-Subscribed ::= OCTET STRING (SIZE (3))
-- Octets are coded according to TS GSM 04.08.

```

```
SubscriberData ::= SEQUENCE {
    msisdn                [1] ISDN-AddressString      OPTIONAL,
    category              [2] Category                OPTIONAL,
    subscriberStatus      [3] SubscriberStatus        OPTIONAL,
    bearerServiceList     [4] BearerServiceList        OPTIONAL,
    -- The exception handling for reception of unsupported / not allocated
    -- bearerServiceCodes is defined in clause 6.8.1
    teleserviceList      [6] TeleserviceList          OPTIONAL,
    -- The exception handling for reception of unsupported / not allocated
    -- teleserviceCodes is defined in clause 6.8.1
    provisionedSS        [7] Ext-SS-InfoList          OPTIONAL,
    odb-Data              [8] ODB-Data                OPTIONAL,
    roamingRestrictionDueToUnsupportedFeature [9] NULL      OPTIONAL,
    regionalSubscriptionData [10] ZoneCodeList        OPTIONAL,
    vbsSubscriptionData   [11] VBSDataList            OPTIONAL,
    vgcsSubscriptionData [12] VGCSDataList           OPTIONAL,
    vlrCamelSubscriptionInfo [13] VlrCamelSubscriptionInfo OPTIONAL
}
```

```
Category ::= OCTET STRING (SIZE (1))
-- The internal structure is defined in CCITT Rec Q.763.
```

```
SubscriberStatus ::= ENUMERATED {
    serviceGranted (0),
    operatorDeterminedBarring (1)}
```

```
BearerServiceList ::= SEQUENCE SIZE (1..maxNumOfBearerServices) OF
    Ext-BearerServiceCode
```

```
maxNumOfBearerServices INTEGER ::= 50
```

```
TeleserviceList ::= SEQUENCE SIZE (1..maxNumOfTeleservices) OF
    Ext-TeleserviceCode
```

```
maxNumOfTeleservices INTEGER ::= 20
```

```
ODB-Data ::= SEQUENCE {
    odb-GeneralData          ODB-GeneralData,
    odb-HPLMN-Data          ODB-HPLMN-Data          OPTIONAL,
    extensionContainer       ExtensionContainer      OPTIONAL,
    ...}
```

```
ODB-GeneralData ::= BIT STRING {
    allOG-CallsBarred (0),
    internationalOGCallsBarred (1),
    internationalOGCallsNotToHPLMN-CountryBarred (2),
    interzonalOGCallsBarred (6),
    interzonalOGCallsNotToHPLMN-CountryBarred (7),
    interzonalOGCallsAndInternationalOGCallsNotToHPLMN-CountryBarred (8),
    premiumRateInformationOGCallsBarred (3),
    premiumRateEntertainmentOGCallsBarred (4),
    ss-AccessBarred (5),
    allECT-Barred (9),
    chargeableECT-Barred (10),
    internationalECT-Barred (11),
    interzonalECT-Barred (12),
    doublyChargeableECT-Barred (13),
    multipleECT-Barred (14)} (SIZE (15..32))
-- exception handling: reception of unknown bit assignments in the
-- ODB-GeneralData type shall be treated like unsupported ODB-GeneralData
```

```
ODB-HPLMN-Data ::= BIT STRING {
    plmn-SpecificBarringType1 (0),
    plmn-SpecificBarringType2 (1),
    plmn-SpecificBarringType3 (2),
    plmn-SpecificBarringType4 (3)} (SIZE (4..32))
-- exception handling: reception of unknown bit assignments in the
-- ODB-HPLMN-Data type shall be treated like unsupported ODB-HPLMN-Data
```

```
Ext-SS-InfoList ::= SEQUENCE SIZE (1..maxNumOfSS) OF
    Ext-SS-Info
```

```

Ext-SS-Info ::= CHOICE {
    forwardingInfo           [0] Ext-ForwInfo,
    callBarringInfo         [1] Ext-CallBarInfo,
    cug-Info                 [2] CUG-Info,
    ss-Data                  [3] Ext-SS-Data,
    emlpp-Info               [4] EMLPP-Info}

```

```

Ext-ForwInfo ::= SEQUENCE {
    ss-Code                  SS-Code,
    forwardingFeatureList    Ext-ForwFeatureList,
    extensionContainer       [0] ExtensionContainer OPTIONAL,
    ...}

```

```

Ext-ForwFeatureList ::= SEQUENCE SIZE (1..maxNumOfExt-BasicServiceGroups) OF
    Ext-ForwFeature

```

```

Ext-ForwFeature ::= SEQUENCE {
    basicService             Ext-BasicServiceCode OPTIONAL,
    ss-Status [4] Ext-SS-Status,
    forwardedToNumber        [5] ISDN-AddressString OPTIONAL,
    -- When this data type is sent from an HLR which supports CAMEL Phase 2
    -- to a VLR that supports CAMEL Phase 2 the VLR shall not check the
    -- format of the number
    forwardedToSubaddress    [8] ISDN-SubaddressString OPTIONAL,
    forwardingOptions         [6] Ext-ForwOptions OPTIONAL,
    noReplyConditionTime     [7] Ext-NoRepCondTime OPTIONAL,
    extensionContainer        [9] ExtensionContainer OPTIONAL,
    ...}

```

```

Ext-SS-Status ::= OCTET STRING (SIZE (1..5))

-- OCTET 1:
--
-- bits 8765: 0000 (unused)
-- bits 4321: Used to convey the "P bit", "R bit", "A bit" and "Q bit",
--             representing supplementary service state information
--             as defined in TS GSM 03.11

-- bit 4: "Q bit"

-- bit 3: "P bit"

-- bit 2: "R bit"

-- bit 1: "A bit"

-- OCTETS 2-5: reserved for future use. They shall be discarded if
-- received and not understood.

```

```

Ext-ForwOptions ::= OCTET STRING (SIZE (1..5))

-- OCTET 1:

-- bit 8: notification to forwarding party
-- 0 no notification
-- 1 notification

-- bit 7: 0 (unused)

-- bit 6: notification to calling party
-- 0 no notification
-- 1 notification

-- bit 5: 0 (unused)

-- bits 43: forwarding reason
-- 00 ms not reachable
-- 01 ms busy
-- 10 no reply
-- 11 unconditional

-- bits 21: 00 (unused)

-- OCTETS 2-5: reserved for future use. They shall be discarded if
-- received and not understood.

```



```
Ext-NoRepCondTime ::= INTEGER (1..100)
-- Only values 5-30 are used.
-- Values in the ranges 1-4 and 31-100 are reserved for future use
-- If received:
--     values 1-4 shall be mapped on to value 5
--     values 31-100 shall be mapped on to value 30
```

```
Ext-CallBarInfo ::= SEQUENCE {
    ss-Code                SS-Code,
    callBarringFeatureList Ext-CallBarFeatureList,
    extensionContainer     ExtensionContainer OPTIONAL,
    ...}

```

```
Ext-CallBarFeatureList ::= SEQUENCE SIZE (1..maxNumOfExt-BasicServiceGroups) OF
    Ext-CallBarringFeature
```

```
Ext-CallBarringFeature ::= SEQUENCE {
    basicService           Ext-BasicServiceCode OPTIONAL,
    ss-Status [4] Ext-SS-Status,
    extensionContainer     ExtensionContainer OPTIONAL,
    ...}

```

```
CUG-Info ::= SEQUENCE {
    cug-SubscriptionList  CUG-SubscriptionList,
    cug-FeatureList       CUG-FeatureList OPTIONAL,
    extensionContainer     [0] ExtensionContainer OPTIONAL,
    ...}

```

```
CUG-SubscriptionList ::= SEQUENCE SIZE (0..maxNumOfCUG) OF
    CUG-Subscription
```

```
CUG-Subscription ::= SEQUENCE {
    cug-Index CUG-Index,
    cug-Interlock           CUG-Interlock,
    intraCUG-Options        IntraCUG-Options,
    basicServiceGroupList   Ext-BasicServiceGroupList OPTIONAL,
    extensionContainer     [0] ExtensionContainer OPTIONAL,
    ...}

```

```
CUG-Index ::= INTEGER (0..32767)
-- The internal structure is defined in ETS 300 138.
```

```
CUG-Interlock ::= OCTET STRING (SIZE (4))
```

```
IntraCUG-Options ::= ENUMERATED {
    noCUG-Restrictions (0),
    cugIC-CallBarred (1),
    cugOG-CallBarred (2)}

```

```
maxNumOfCUG INTEGER ::= 10
```

```
CUG-FeatureList ::= SEQUENCE SIZE (1..maxNumOfExt-BasicServiceGroups) OF
    CUG-Feature
```

```
Ext-BasicServiceGroupList ::= SEQUENCE SIZE (1..maxNumOfExt-BasicServiceGroups) OF
    Ext-BasicServiceCode
```

```
maxNumOfExt-BasicServiceGroups INTEGER ::= 32
```

```
CUG-Feature ::= SEQUENCE {
    basicService           Ext-BasicServiceCode OPTIONAL,
    preferentialCUG-Indicator CUG-Index OPTIONAL,
    interCUG-Restrictions  InterCUG-Restrictions,
    extensionContainer     ExtensionContainer OPTIONAL,
    ...}

```

```

InterCUG-Restrictions ::= OCTET STRING (SIZE (1))

-- bits 876543: 000000 (unused)
-- Exception handling:
-- bits 876543 shall be ignored if received and not understood

-- bits 21
-- 00 CUG only facilities
-- 01 CUG with outgoing access
-- 10 CUG with incoming access
-- 11 CUG with both outgoing and incoming access
    
```

```

Ext-SS-Data ::= SEQUENCE {
    ss-Code                               SS-Code,
    ss-Status [4] Ext-SS-Status,
    ss-SubscriptionOption                 SS-SubscriptionOption           OPTIONAL,
    basicServiceGroupList                 Ext-BasicServiceGroupList       OPTIONAL,
    extensionContainer                     [5] ExtensionContainer          OPTIONAL,
    ...}
    
```

```

ZoneCodeList ::= SEQUENCE SIZE (1..maxNumOfZoneCodes)
    OF ZoneCode
    
```

```

ZoneCode ::= OCTET STRING (SIZE (2))
-- internal structure is defined in TS GSM 03.03
    
```

```

maxNumOfZoneCodes INTEGER ::= 10
    
```

```

InsertSubscriberDataRes ::= SEQUENCE {
    teleserviceList                       [1] TeleserviceList             OPTIONAL,
    bearerServiceList                     [2] BearerServiceList          OPTIONAL,
    ss-List                                 [3] SS-List                    OPTIONAL,
    odb-GeneralData                        [4] ODB-GeneralData           OPTIONAL,
    regionalSubscriptionResponse           [5]
        RegionalSubscriptionResponse    OPTIONAL,
    supportedCamelPhases                   [6] SupportedCamelPhases       OPTIONAL,
    extensionContainer                     [7] ExtensionContainer          OPTIONAL,
    ...}
    
```

```

RegionalSubscriptionResponse ::= ENUMERATED {
    networkNode-AreaRestricted             (0),
    tooManyZoneCodes                       (1),
    zoneCodesConflict                       (2),
    regionalSubscNotSupported              (3)}
    
```

```

DeleteSubscriberDataArg ::= SEQUENCE {
    imsi                                    [0] IMSI,
    basicServiceList                       [1] BasicServiceList           OPTIONAL,
    -- The exception handling for reception of unsupported/not allocated
    -- basicServiceCodes is defined in clause 6.8.2
    ss-List                                 [2] SS-List                    OPTIONAL,
    roamingRestrictionDueToUnsupportedFeature [4] NULL                     OPTIONAL,
    regionalSubscriptionIdentifier          [5] ZoneCode                   OPTIONAL,
    vbsGroupIndication                     [7] NULL                       OPTIONAL,
    vgcsGroupIndication                    [8] NULL OPTIONAL,
    camelSubscriptionInfoWithdraw           [9] NULL OPTIONAL,
    extensionContainer                       [6] ExtensionContainer         OPTIONAL,
    ...,
    gprsSubscriptionDataWithdraw            [10] GPRSSubscriptionDataWithdraw OPTIONAL,
    roamingRestrictedInSgsnDueToUnsupportedFeature [11] NULL                 OPTIONAL}
    
```

```

GPRSSubscriptionDataWithdraw ::= CHOICE {
    allGPRSData                            NULL,
    contextIdList                           ContextIdList}
    
```

```

ContextIdList ::= SEQUENCE SIZE (1..maxNumOfPDP-Contexts) OF
    ContextId
    
```

```

BasicServiceList ::= SEQUENCE SIZE (1..maxNumOfBasicServices) OF
    Ext-BasicServiceCode
    
```

```

maxNumOfBasicServices INTEGER ::= 70
    
```

```

DeleteSubscriberDataRes ::= SEQUENCE {
    regionalSubscriptionResponse [0] RegionalSubscriptionResponse OPTIONAL,
    extensionContainer           [1] ExtensionContainer           OPTIONAL,
    ...}

```

```

VlrCamelSubscriptionInfo ::= SEQUENCE {
    o-CSI [0] O-CSI OPTIONAL,
    extensionContainer [1] ExtensionContainer OPTIONAL,
    ...,
    ss-CSI [2] SS-CSI OPTIONAL,
    o-BcsmCamelTDP-CriteriaList [4] O-BcsmCamelTDPCriteriaList OPTIONAL
}

```

```

SS-CSI ::= SEQUENCE {
    ss-CamelData SS-CamelData,
    extensionContainer ExtensionContainer OPTIONAL,
    ...}

```

```

SS-CamelData ::= SEQUENCE {
    ss-EventList SS-EventList,
    gsmSCF-Address ISDN-AddressString,
    extensionContainer [0] ExtensionContainer OPTIONAL,
    ...
}

```

```

SS-EventList ::= SEQUENCE SIZE (1..maxNumOfCamelSSEvents) OF SS-Code
-- Actions for the following SS-Code values are defined in CAMEL Phase 2:
-- ect SS-Code ::= '00110001'B
-- multiPTY SS-Code ::= '01010001'B
-- cd SS-Code ::= '00100100'B
-- all other SS codes shall be ignored

```

```

maxNumOfCamelSSEvents INTEGER ::= 10

```

```

O-CSI ::= SEQUENCE {
    o-BcsmCamelTDPDataList O-BcsmCamelTDPDataList,
    extensionContainer ExtensionContainer OPTIONAL,
    ...,
    camelCapabilityHandling [0] CamelCapabilityHandling OPTIONAL
}

```

```

O-BcsmCamelTDPDataList ::= SEQUENCE SIZE (1..maxNumOfCamelTDPData) OF
O-BcsmCamelTDPData
--- O-BcsmCamelTDPDataList shall not contain more than one instance of O-BcsmCamelTDPData
--- containing the same value for o-BcsmTriggerDetectionPoint.
--- For CAMEL Phase 2, this means that only one instance of O-BcsmCamelTDPData is allowed
--- with o-BcsmTriggerDetectionPoint being equal to DP2.

```

```

maxNumOfCamelTDPData INTEGER ::= 10

```

```

O-BcsmCamelTDPData ::= SEQUENCE {
    o-BcsmTriggerDetectionPoint O-BcsmTriggerDetectionPoint,
    serviceKey ServiceKey,
    gsmSCF-Address [0] ISDN-AddressString,
    defaultCallHandling [1] DefaultCallHandling,
    extensionContainer [2] ExtensionContainer OPTIONAL,
    ...
}

```

```

ServiceKey ::= INTEGER (0..2147483647)

```

```

O-BcsmTriggerDetectionPoint ::= ENUMERATED {
    collectedInfo (2),
    ... }
-- exception handling:
-- For O-BcsmCamelTDPData sequences containing this parameter with any
-- other value than the ones listed the receiver shall ignore the whole
-- O-BcsmCamelTDPData sequence.
-- For O-BcsmCamelTDP-Criteria sequences containing this parameter with any
-- other value than the ones listed the receiver shall ignore the whole
-- O-BcsmCamelTDP-Criteria sequence.

```

```

O-BcsmCamelTDPCriteriaList ::= SEQUENCE SIZE (1..maxNumOfCamelTDPData) OF
O-BcsmCamelTDP-Criteria

```

```
O-BcsmCamelTDP-Criteria ::= SEQUENCE {
  o-BcsmTriggerDetectionPoint      O-BcsmTriggerDetectionPoint,
  destinationNumberCriteria        [0] DestinationNumberCriteria   OPTIONAL,
  basicServiceCriteria             [1] BasicServiceCriteria       OPTIONAL,
  callTypeCriteria                 [2] CallTypeCriteria           OPTIONAL,
  ... }
```

```
DestinationNumberCriteria ::= SEQUENCE {
  matchType                        [0] MatchType,
  destinationNumberList            [1] DestinationNumberList     OPTIONAL,
  destinationNumberLengthList     [2] DestinationNumberLengthList OPTIONAL,
  -- one or both of destinationNumberList and destinationNumberLengthList
  -- shall be present
  ... }
```

```
DestinationNumberList ::= SEQUENCE SIZE (1..maxNumOfCamelDestinationNumbers) OF
  ISDN-AddressString
-- The receiving entity shall not check the format of a number in
-- the dialled number list
```

```
DestinationNumberLengthList ::= SEQUENCE SIZE (1..maxNumOfCamelDestinationNumberLengths) OF
  INTEGER(1..maxNumOfISDN-AddressDigits)
```

```
BasicServiceCriteria ::= SEQUENCE SIZE(1..maxNumOfCamelBasicServiceCriteria) OF
  Ext-BasicServiceCode
```

```
maxNumOfISDN-AddressDigits INTEGER ::= 15
```

```
maxNumOfCamelDestinationNumbers INTEGER ::= 10
```

```
maxNumOfCamelDestinationNumberLengths INTEGER ::= 3
```

```
maxNumOfCamelBasicServiceCriteria INTEGER ::= 5
```

```
CallTypeCriteria ::= ENUMERATED {
  forwarded (0),
  notForwarded (1)}
```

```
MatchType ::= ENUMERATED {
  inhibiting (0),
  enabling (1)}
```

```
DefaultCallHandling ::= ENUMERATED {
  continueCall (0) ,
  releaseCall (1) ,
  ...}
-- exception handling:
-- reception of values in range 2-31 shall be treated as "continueCall"
-- reception of values greater than 31 shall be treated as "releaseCall"
```

```
CamelCapabilityHandling ::= INTEGER(1..16)
-- value 1 = CAMEL phase 1,
-- value 2 = CAMEL phase 2:
-- reception of values greater than 2 shall be treated as CAMEL phase 2
```

```
SupportedCamelPhases ::= BIT STRING {
  phase1 (0),
  phase2 (1) } (SIZE (1..16))
```

-- gprs location information retrieval types

```
SendRoutingInfoForGprsArg ::= SEQUENCE {
  imsi [0] IMSI,
  ggsn-Address [1] GSN-Address OPTIONAL,
  ggsn-Number [2] ISDN-AddressString,
  extensionContainer [3] ExtensionContainer OPTIONAL,
  ... }
```

```
SendRoutingInfoForGprsRes ::= SEQUENCE {
    sgsn-Address          [0] GSN-Address,
    ggsn-Address          [1] GSN-Address          OPTIONAL,
    mobileNotReachableReason [2] AbsentSubscriberDiagnosticSM OPTIONAL,
    extensionContainer    [3] ExtensionContainer  OPTIONAL,
    ...}

```

-- failure report types

```
FailureReportArg ::= SEQUENCE {
    imsi          [0] IMSI,
    ggsn-Number  [1] ISDN-AddressString,
    ggsn-Address [2] GSN-Address          OPTIONAL,
    extensionContainer [3] ExtensionContainer  OPTIONAL,
    ...}

```

```
FailureReportRes ::= SEQUENCE {
    ggsn-Address [0] GSN-Address          OPTIONAL,
    extensionContainer [1] ExtensionContainer  OPTIONAL,
    ...}

```

-- gprs notification types

```
NoteMsPresentForGprsArg ::= SEQUENCE {
    imsi          [0] IMSI,
    sgsn-Address [1] GSN-Address,
    ggsn-Address [2] GSN-Address          OPTIONAL,
    extensionContainer [3] ExtensionContainer  OPTIONAL,
    ...}

```

```
NoteMsPresentForGprsRes ::= SEQUENCE {
    extensionContainer [0] ExtensionContainer  OPTIONAL,
    ...}

```

-- fault recovery types

```
ResetArg ::= SEQUENCE {
    hlr-Number          ISDN-AddressString,
    hlr-List            HLR-List          OPTIONAL,
    ...}

```

```
RestoreDataArg ::= SEQUENCE {
    imsi          IMSI,
    lmsi          LMSI          OPTIONAL,
    extensionContainer ExtensionContainer  OPTIONAL,
    ... ,
    vlr-Capability [6] VLR-Capability  OPTIONAL }

```

```
RestoreDataRes ::= SEQUENCE {
    hlr-Number          ISDN-AddressString,
    msNotReachable     NULL          OPTIONAL,
    extensionContainer  ExtensionContainer  OPTIONAL,
    ...}

```

-- VBS/VGCS types

```
VBSDataList ::= SEQUENCE SIZE (1..maxNumOfVBGroupIds) OF
    VoiceBroadcastData

```

```
VGCSDataList ::= SEQUENCE SIZE (1..maxNumOfVGCSGroupIds) OF
    VoiceGroupCallData

```

```
maxNumOfVBGroupIds INTEGER ::= 50

```

```
maxNumOfVGCSGroupIds INTEGER ::= 50

```

```
VoiceGroupCallData ::= SEQUENCE {
    groupId          GroupId,
    extensionContainer ExtensionContainer  OPTIONAL,
    ...}

```

```
VoiceBroadcastData ::= SEQUENCE {
    groupid          GroupId,
    broadcastInitEntitlement NULL          OPTIONAL,
    extensionContainer ExtensionContainer  OPTIONAL,
    ...}

```

```

GroupId ::= OCTET STRING (SIZE (3))
-- Refers to the Group Identification as specified in GSM TS 03.03
-- and 03.68/ 03.69

```

-- provide subscriber info types

```

ProvideSubscriberInfoArg ::= SEQUENCE {
  imsi      [0] IMSI,
  lmsi      [1] LMSI                OPTIONAL,
  requestedInfo [2] RequestedInfo,
  extensionContainer [3] ExtensionContainer    OPTIONAL,
  ...}

```

```

ProvideSubscriberInfoRes ::= SEQUENCE {
  subscriberInfo      SubscriberInfo,
  extensionContainer  ExtensionContainer    OPTIONAL,
  ...}

```

```

SubscriberInfo ::= SEQUENCE {
  locationInformation [0] LocationInformation    OPTIONAL,
  subscriberState     [1] SubscriberState       OPTIONAL,
  extensionContainer  [2] ExtensionContainer     OPTIONAL,
  ...}

```

```

RequestedInfo ::= SEQUENCE {
  locationInformation [0] NULL                OPTIONAL,
  subscriberState     [1] NULL                OPTIONAL,
  extensionContainer  [2] ExtensionContainer   OPTIONAL,
  ...}

```

```

LocationInformation ::= SEQUENCE {
  ageOfLocationInformation AgeOfLocationInformation    OPTIONAL,
  geographicalInformation  [0] GeographicalInformation  OPTIONAL,
  vlr-number              [1] ISDN-AddressString       OPTIONAL,
  locationNumber          [2] LocationNumber           OPTIONAL,
  cellIdOrLAI             [3] CellIdOrLAI              OPTIONAL,
  extensionContainer      [4] ExtensionContainer        OPTIONAL,
  ...}

```

```

AgeOfLocationInformation ::= INTEGER (0..32767)
-- the value represents the elapsed time in minutes since the last
-- network contact of the mobile station (i.e. the actuality of the
-- location information).
-- value "0" indicates that the MS is currently in contact with the
-- network
-- value "32767" indicates that the location information is at least
-- 32767 minutes old

```

```

GeographicalInformation ::= OCTET STRING (SIZE (8))
-- Refers to geographical Information defined in GSM 03.32.
-- Only the description of an ellipsoid point with uncertainty circle
-- as specified in GSM 03.32 is allowed to be used
-- The internal structure according to GSM 03.32 is as follows:
--   Type of shape (ellipsoid point with uncertainty circle)      1 octet
--   Degrees of Latitude                                           3 octets
--   Degrees of Longitude                                           3 octets
--   Uncertainty code                                              1 octet

```

```

LocationNumber ::= OCTET STRING (SIZE (2..10))
-- the internal structure is defined in CCITT Rec Q.763

```

```

SubscriberState ::= CHOICE {
  assumedIdle [0] NULL,
  camelBusy [1] NULL,
  netDetNotReachable NotReachableReason,
  notProvidedFromVLR [2] NULL}

```

```

NotReachableReason ::= ENUMERATED {
  msPurged (0),
  imsiDetached (1),
  restrictedArea (2),
  notRegistered (3)}

```

-- any time interrogation info types

```

AnyTimeInterrogationArg ::= SEQUENCE {
    subscriberIdentity      [0] SubscriberIdentity,
    requestedInfo           [1] RequestedInfo,
    gsmSCF-Address         [3] ISDN-AddressString,
    extensionContainer     [2] ExtensionContainer      OPTIONAL,
    ...}
    
```

```

AnyTimeInterrogationRes ::= SEQUENCE {
    subscriberInfo          SubscriberInfo,
    extensionContainer     ExtensionContainer      OPTIONAL,
    ...}
    
```

```

SubscriberIdentity ::= CHOICE {
    imsi      [0] IMSI,
    msisdn    [1] ISDN-AddressString
    }
    
```

END

## 17.7.2 Operation and maintenance data types

```

MAP-OM-DataTypes {
    ccitt identified-organization (4) etsi (0) mobileDomain (0)
    gsm-Network (1) modules (3) map-OM-DataTypes (12) version4 (4)}
    
```

DEFINITIONS

IMPLICIT TAGS

::=

BEGIN

EXPORTS

```

    ActivateTraceModeArg,
    ActivateTraceModeRes,
    DeactivateTraceModeArg,
    DeactivateTraceModeRes
    
```

;

IMPORTS

```

    AddressString,
    IMSI
    
```

```

FROM MAP-CommonDataTypes {
    ccitt identified-organization (4) etsi (0) mobileDomain (0)
    gsm-Network (1) modules (3) map-CommonDataTypes (18) version4 (4)}
    
```

```

    ExtensionContainer
    
```

```

FROM MAP-ExtensionDataTypes {
    ccitt identified-organization (4) etsi (0) mobileDomain (0)
    gsm-Network (1) modules (3) map-ExtensionDataTypes (21) version4 (4)}
    
```

;

```

ActivateTraceModeArg ::= SEQUENCE {
    imsi      [0] IMSI      OPTIONAL,
    traceReference [1] TraceReference,
    traceType [2] TraceType,
    omc-Id    [3] AddressString      OPTIONAL,
    extensionContainer [4] ExtensionContainer      OPTIONAL,
    ...}
    
```

```

TraceReference ::= OCTET STRING (SIZE (1..2))
    
```

```

TraceType ::= INTEGER
    (0..255)
    -- Trace types are fully defined in TS GSM 12.08.
    
```

```

ActivateTraceModeRes ::= SEQUENCE {
    extensionContainer [0] ExtensionContainer      OPTIONAL,
    ...}
    
```

<b>DeactivateTraceModeArg</b> ::= SEQUENCE {		
imsi	[0] IMSI	OPTIONAL,
traceReference	[1] TraceReference,	
extensionContainer	[2] ExtensionContainer	OPTIONAL,
...}		

<b>DeactivateTraceModeRes</b> ::= SEQUENCE {		
extensionContainer	[0] ExtensionContainer	OPTIONAL,
...}		

END

### 17.7.3 Call handling data types

```
MAP-CH-DataTypes {
  ccitt identified-organization (4) etsi (0) mobileDomain (0)
  gsm-Network (1) modules (3) map-CH-DataTypes (13) version4 (4)}
```

DEFINITIONS

IMPLICIT TAGS

::=

BEGIN

EXPORTS

```
SendRoutingInfoArg,
SendRoutingInfoRes,
ProvideRoamingNumberArg,
ProvideRoamingNumberRes,
ResumeCallHandlingArg,
ResumeCallHandlingRes,
NumberOfForwarding,
SuppressionOfAnnouncement,
CallReferenceNumber,
ProvideSIWFSNumberArg,
ProvideSIWFSNumberRes,
SIWFSSignallingModifyArg,
SIWFSSignallingModifyRes,
SetReportingStateArg,
SetReportingStateRes,
StatusReportArg,
StatusReportRes,
RemoteUserFreeArg,
RemoteUserFreeRes
```

;

IMPORTS

```
maxNumOfCamelTDPData,
SubscriberInfo,
ServiceKey,
DefaultCallHandling,
SupportedCamelPhases,
CamelCapabilityHandling,
BasicServiceCriteria,
CUG-Interlock,
O-CSI,
O-BcsmCamelTDPCriteriaList
```

```
FROM MAP-MS-DataTypes {
  ccitt identified-organization (4) etsi (0) mobileDomain (0)
  gsm-Network (1) modules (3) map-MS-DataTypes (11) version4 (4)}
```

```
ForwardingOptions,
SS-List,
CCBS-Feature
```

```
FROM MAP-SS-DataTypes {
  ccitt identified-organization (4) etsi (0) mobileDomain (0)
  gsm-Network (1) modules (3) map-SS-DataTypes (14) version4 (4)}
```

```
ISDN-AddressString,
ISDN-SubaddressString,
ExternalSignalInfo,
IMSI,
LMSI,
Ext-BasicServiceCode,
AlertingPattern,
NAEA-PreferredCI
```



```

FROM MAP-CommonDataTypes {
  ccitt identified-organization (4) etsi (0) mobileDomain (0)
  gsm-Network (1) modules (3) map-CommonDataTypes (18) version4 (4)}

ExtensionContainer
FROM MAP-ExtensionDataTypes {
  ccitt identified-organization (4) etsi (0) mobileDomain (0)
  gsm-Network (1) modules (3) map-ExtensionDataTypes (21) version4 (4)}
;
    
```

<b>CUG-CheckInfo ::= SEQUENCE {</b>		
cug-Interlock	CUG-Interlock,	
cug-OutgoingAccess	NULL	OPTIONAL,
extensionContainer	ExtensionContainer	OPTIONAL,
...}		

<b>NumberOfForwarding ::= INTEGER (1..5)</b>
--

<b>SendRoutingInfoArg ::= SEQUENCE {</b>		
msisdn	[0] ISDN-AddressString,	
cug-CheckInfo	[1] CUG-CheckInfo	OPTIONAL,
numberOfForwarding	[2] NumberOfForwarding	OPTIONAL,
interrogationType	[3] InterrogationType,	
or-Interrogation	[4] NULL	OPTIONAL,
or-Capability	[5] OR-Phase	OPTIONAL,
gsmc-Address	[6] ISDN-AddressString,	
callReferenceNumber	[7] CallReferenceNumber	OPTIONAL,
forwardingReason	[8] ForwardingReason	OPTIONAL,
basicServiceGroup	[9] Ext-BasicServiceCode	OPTIONAL,
networkSignalInfo	[10] ExternalSignalInfo	OPTIONAL,
camelInfo [11] CamelInfo	OPTIONAL,	
suppressionOfAnnouncement	[12] SuppressionOfAnnouncement	OPTIONAL,
extensionContainer	[13] ExtensionContainer	OPTIONAL,
...		
alertingPattern	[14] AlertingPattern	OPTIONAL,
ccbs-Call [15] NULL	OPTIONAL,	
supportedCCBS-Phase	[16] SupportedCCBS-Phase	OPTIONAL }

<b>SuppressionOfAnnouncement ::= NULL</b>
---

<b>InterrogationType ::= ENUMERATED {</b>
basicCall (0),
forwarding (1)}

<b>OR-Phase ::= INTEGER (1..127)</b>
--------------------------------------

<b>CallReferenceNumber ::= OCTET STRING (SIZE (1..8))</b>
---

<b>ForwardingReason ::= ENUMERATED {</b>
notReachable (0),
busy (1),
noReply (2)}

<b>SupportedCCBS-Phase ::= INTEGER (1..127)</b>
-- exception handling:
-- Only value 1 is used.
-- Values in the ranges 2-127 are reserved for future use.
-- If received values 2-127 shall be mapped on to value 1.

```

SendRoutingInfoRes ::= [3] SEQUENCE {
  imsi                               [9] IMSI                               OPTIONAL,
  -- IMSI must be present if SendRoutingInfoRes is not segmented.
  -- If the TC-Result-NL segmentation option is taken the IMSI must be
  -- present in one segmented transmission of SendRoutingInfoRes.
  extendedRoutingInfo               ExtendedRoutingInfo             OPTIONAL,
  cug-CheckInfo                     [3] CUG-CheckInfo             OPTIONAL,
  cugSubscriptionFlag               [6] NULL                               OPTIONAL,
  subscriberInfo                    [7] SubscriberInfo         OPTIONAL,
  ss-List                            [1] SS-List                       OPTIONAL,
  basicService                      [5] Ext-BasicServiceCode     OPTIONAL,
  forwardingInterrogationRequired    [4] NULL                               OPTIONAL,
  vmsc-Address                      [2] ISDN-AddressString      OPTIONAL,
  extensionContainer                 [0] ExtensionContainer      OPTIONAL,
  ... ,
  naea-PreferredCI                  [10] NAEA-PreferredCI       OPTIONAL,
  -- naea-PreferredCI is included at the discretion of the HLR operator.
  ccbs-Indicators                   [11] CCBS-Indicators        OPTIONAL
}

```

```

CCBS-Indicators ::= SEQUENCE {
  ccbs-Possible                     [0] NULL                               OPTIONAL,
  keepCCBS-CallIndicator            [1] NULL                               OPTIONAL,
  extensionContainer                 [2] ExtensionContainer            OPTIONAL,
  ...}

```

```

RoutingInfo ::= CHOICE {
  roamingNumber                     ISDN-AddressString,
  forwardingData                    ForwardingData}

```

```

ForwardingData ::= SEQUENCE {
  forwardedToNumber                 [5] ISDN-AddressString           OPTIONAL,
  -- When this datatype is sent from an HLR which supports CAMEL Phase 2
  -- to a GMSC which supports CAMEL Phase 2 the GMSC shall not check the
  -- format of the number
  forwardedToSubaddress             [4] ISDN-SubaddressString       OPTIONAL,
  forwardingOptions                 [6] ForwardingOptions           OPTIONAL,
  extensionContainer                 [7] ExtensionContainer            OPTIONAL,
  ...}

```

```

ProvideRoamingNumberArg ::= SEQUENCE {
  imsi                               [0] IMSI,
  msc-Number                        [1] ISDN-AddressString,
  msisdn                            [2] ISDN-AddressString           OPTIONAL,
  lmsi                               [4] LMSI                               OPTIONAL,
  gsm-BearerCapability              [5] ExternalSignalInfo         OPTIONAL,
  networkSignalInfo                 [6] ExternalSignalInfo         OPTIONAL,
  suppressionOfAnnouncement         [7] SuppressionOfAnnouncement   OPTIONAL,
  gmsc-Address                      [8] ISDN-AddressString           OPTIONAL,
  callReferenceNumber               [9] CallReferenceNumber         OPTIONAL,
  or-Interrogation                  [10] NULL OPTIONAL,
  extensionContainer                 [11] ExtensionContainer            OPTIONAL,
  ... ,
  alertingPattern                   [12] AlertingPattern           OPTIONAL,
  ccbs-Call                         [13] NULL                               OPTIONAL,
  supportedCamelPhasesInGMSC        [15] SupportedCamelPhases     OPTIONAL}

```

```

ProvideRoamingNumberRes ::= SEQUENCE {
  roamingNumber                     ISDN-AddressString,
  extensionContainer                 ExtensionContainer            OPTIONAL,
  ...}

```

```

ResumeCallHandlingArg ::= SEQUENCE {
  callReferenceNumber               [0] CallReferenceNumber,
  basicServiceGroup                 [1] Ext-BasicServiceCode,
  forwardingData                    [2] ForwardingData,
  imsi                               [3] IMSI,
  cug-CheckInfo                     [4] CUG-CheckInfo             OPTIONAL,
  o-CSI                             [5] O-CSI                       OPTIONAL,
  extensionContainer                 [7] ExtensionContainer            OPTIONAL,
  ... ,
  ccbs-Possible                     [8] NULL                               OPTIONAL}

```

```

ResumeCallHandlingRes ::= SEQUENCE {
  extensionContainer                 ExtensionContainer            OPTIONAL,
  ...}

```

```

CamelInfo ::= SEQUENCE {
    supportedCamelPhases          SupportedCamelPhases,
    suppress-T-CSI                NULL,                               OPTIONAL,
    extensionContainer            ExtensionContainer          OPTIONAL,
    ...}
    
```

```

ExtendedRoutingInfo ::= CHOICE {
    routingInfo                  RoutingInfo,
    camelRoutingInfo            [8] CamelRoutingInfo}
    
```

```

CamelRoutingInfo ::= SEQUENCE {
    forwardingData              ForwardingData                OPTIONAL,
    gsmcCamelSubscriptionInfo   [0] GsmcCamelSubscriptionInfo,
    extensionContainer          [1] ExtensionContainer          OPTIONAL,
    ...}
    
```

```

GsmcCamelSubscriptionInfo ::= SEQUENCE {
    t-CSI                       [0] T-CSI OPTIONAL,
    o-CSI                       [1] O-CSI OPTIONAL,
    extensionContainer          [2] ExtensionContainer          OPTIONAL,
    ...,
    o-BcsmCamelTDP-CriteriaList [3] O-BcsmCamelTDPCriteriaList OPTIONAL
}
    
```

```

T-CSI ::= SEQUENCE {
    t-BcsmCamelTDPDataList      T-BcsmCamelTDPDataList,
    extensionContainer          ExtensionContainer              OPTIONAL,
    ...,
    camelCapabilityHandling     [0] CamelCapabilityHandling  OPTIONAL
}
    
```

```

T-BcsmCamelTDPDataList ::= SEQUENCE SIZE (1..maxNumOfCamelTDPData) OF
    T-BcsmCamelTDPData
--- T-BcsmCamelTDPDataList shall not contain more than one instance of T-BcsmCamelTDPData
--- containing the same value for t-BcsmTriggerDetectionPoint.
--- For CAMEL Phase 2, this means that only one instance of T-BcsmCamelTDPData is allowed
--- with t-BcsmTriggerDetectionPoint being equal to DP12.
    
```

```

T-BcsmCamelTDPData ::= SEQUENCE {
    t-BcsmTriggerDetectionPoint T-BcsmTriggerDetectionPoint,
    serviceKey                  ServiceKey,
    gsmSCF-Address              [0] ISDN-AddressString,
    defaultCallHandling         [1] DefaultCallHandling,
    extensionContainer          [2] ExtensionContainer          OPTIONAL,
    ...}
    
```

```

T-BcsmTriggerDetectionPoint ::= ENUMERATED {
    termAttemptAuthorized(12),
    ...}
-- exception handling:
-- For T-BcsmCamelTDPData sequences containing this parameter with any other
-- value than the ones listed the receiver shall ignore the whole
-- T-BcsmCamelTDPData sequence.
    
```

```

ProvidesSIWFSNumberArg ::= SEQUENCE {
    gsm-BearerCapability         [0] ExternalSignalInfo,
    isdn-BearerCapability        [1] ExternalSignalInfo,
    call-Direction              [2] CallDirection,
    b-Subscriber-Address        [3] ISDN-AddressString,
    chosenChannel                [4] ExternalSignalInfo,
    lowerLayerCompatibility     [5] ExternalSignalInfo          OPTIONAL,
    highLayerCompatibility      [6] ExternalSignalInfo          OPTIONAL,
    extensionContainer          [7] ExtensionContainer          OPTIONAL,
    ...}
    
```

```

CallDirection ::= OCTET STRING (SIZE (1))
-- OCTET 1

-- bit 1 (direction of call)
-- 0 Mobile Originated Call (MOC)
-- 1 Mobile Terminated Call (MTC)
    
```

```

ProvidesSIWFSNumberRes ::= SEQUENCE {
  siWFSNumber          [0] ISDN-AddressString,
  extensionContainer   [1] ExtensionContainer   OPTIONAL,
  ...}
    
```

```

SIWFSSignallingModifyArg ::= SEQUENCE {
  channelType          [0] ExternalSignalInfo   OPTIONAL,
  chosenChannel        [1] ExternalSignalInfo   OPTIONAL,
  extensionContainer   [2] ExtensionContainer   OPTIONAL,
  ...}
    
```

```

SIWFSSignallingModifyRes ::= SEQUENCE {
  chosenChannel        [0] ExternalSignalInfo   OPTIONAL,
  extensionContainer   [1] ExtensionContainer   OPTIONAL,
  ...}
    
```

```

SetReportingStateArg ::= SEQUENCE {
  imsi                [0] IMSI                 OPTIONAL,
  lmsi                [1] LMSI                 OPTIONAL,
  ccbs-Monitoring     [2] ReportingState       OPTIONAL,
  extensionContainer   [3] ExtensionContainer   OPTIONAL,
  ...}
    
```

```

ReportingState ::= ENUMERATED {
  stopMonitoring      (0),
  startMonitoring     (1),
  ...}
-- exception handling:
-- reception of values 2-10 shall be mapped to 'stopMonitoring'
-- reception of values > 10 shall be mapped to 'startMonitoring'
    
```

```

SetReportingStateRes ::= SEQUENCE{
  ccbs-SubscriberStatus [0] CCBS-SubscriberStatus   OPTIONAL,
  extensionContainer     [1] ExtensionContainer       OPTIONAL,
  ...}
    
```

```

CCBS-SubscriberStatus ::= ENUMERATED {
  ccbsNotIdle        (0),
  ccbsIdle (1),
  ccbsNotReachable   (2),
  ...}
-- exception handling:
-- reception of values 3-10 shall be mapped to 'ccbsNotIdle'
-- reception of values 11-20 shall be mapped to 'ccbsIdle'
-- reception of values > 20 shall be mapped to 'ccbsNotReachable'
    
```

```

StatusReportArg ::= SEQUENCE{
  imsi                [0] IMSI,
  eventReportData     [1] EventReportData           OPTIONAL,
  callReportdata      [2] CallReportData           OPTIONAL,
  extensionContainer   [3] ExtensionContainer       OPTIONAL,
  ...}
    
```

```

EventReportData ::= SEQUENCE{
  ccbs-SubscriberStatus [0] CCBS-SubscriberStatus   OPTIONAL,
  extensionContainer     [1] ExtensionContainer       OPTIONAL,
  ...}
    
```

```

CallReportData ::= SEQUENCE{
  monitoringMode      [0] MonitoringMode           OPTIONAL,
  callOutcome         [1] CallOutcome              OPTIONAL,
  extensionContainer   [2] ExtensionContainer       OPTIONAL,
  ...}
    
```

```

MonitoringMode ::= ENUMERATED {
  a-side              (0),
  b-side              (1),
  ...}
-- exception handling:
-- reception of values 2-10 shall be mapped 'a-side'
-- reception of values > 10 shall be mapped to 'b-side'
    
```

```

CallOutcome ::= ENUMERATED {
    success                (0),
    failure                 (1),
    busy                   (2),
    ...}
-- exception handling:
-- reception of values 3-10 shall be mapped to 'success'
-- reception of values 11-20 shall be mapped to 'failure'
-- reception of values > 20 shall be mapped to 'busy'
    
```

```

StatusReportRes ::= SEQUENCE {
    extensionContainer      [0] ExtensionContainer      OPTIONAL,
    ...}
    
```

```

RemoteUserFreeArg ::= SEQUENCE{
    imsi                    [0] IMSI,
    callInfo                [1] ExternalSignalInfo,
    ccbs-Feature            [2] CCBS-Feature,
    translatedB-Number      [3] ISDN-AddressString,
    replaceB-Number         [4] NULL                    OPTIONAL,
    alertingPattern         [5] AlertingPattern         OPTIONAL,
    extensionContainer      [6] ExtensionContainer      OPTIONAL,
    ...}
    
```

```

RemoteUserFreeRes ::= SEQUENCE{
    ruf-Outcome             [0] RUF-Outcome,
    extensionContainer      [1] ExtensionContainer      OPTIONAL,
    ...}
    
```

```

RUF-Outcome ::= ENUMERATED{
    accepted (0),
    rejected (1),
    noResponseFromFreeMS (2), -- T4 Expiry
    noResponseFromBusyMS (3), -- T10 Expiry
    udubFromFreeMS (4),
    udubFromBusyMS (5),
    ...}
-- exception handling:
-- reception of values 6-20 shall be mapped to 'accepted'
-- reception of values 21-30 shall be mapped to 'rejected'
-- reception of values 31-40 shall be mapped to 'noResponseFromFreeMS'
-- reception of values 41-50 shall be mapped to 'noResponseFromBusyMS'
-- reception of values 51-60 shall be mapped to 'udubFromFreeMS'
-- reception of values > 60 shall be mapped to 'udubFromBusyMS'
    
```

END

## 17.7.4 Supplementary service data types

```

MAP-SS-DataTypes {
    ccitt identified-organization (4) etsi (0) mobileDomain (0)
    gsm-Network (1) modules (3) map-SS-DataTypes (14) version4 (4)}
    
```

DEFINITIONS

IMPLICIT TAGS

::=

BEGIN

EXPORTS

```

    RegisterSS-Arg,
    SS-Info,
    SS-Status,
    SS-SubscriptionOption,
    SS-ForBS-Code,
    InterrogateSS-Res,
    USSD-Arg,
    USSD-Res,
    Password,
    GuidanceInfo,
    SS-List,
    SS-InfoList,
    OverrideCategory,
    CliRestrictionOption,
    NoReplyConditionTime,
    ForwardingOptions,
    
```

```

maxNumOfSS,
SS-Data,
SS-InvocationNotificationArg,
SS-InvocationNotificationRes,
CCBS-Feature,
RegisterCC-EntryArg,
RegisterCC-EntryRes,
EraseCC-EntryArg,
EraseCC-EntryRes,
USSD-DataCodingScheme,
USSD-String
;

IMPORTS
  AddressString,
  ISDN-AddressString,
  ISDN-SubaddressString,
  IMSI,
  BasicServiceCode,
  AlertingPattern,
  EMLPP-Priority,
  ExternalSignalInfo

FROM MAP-CommonDataTypes {
  ccitt identified-organization (4) etsi (0) mobileDomain (0)
  gsm-Network (1) modules (3) map-CommonDataTypes (18) version4 (4)}

  ExtensionContainer
FROM MAP-ExtensionDataTypes {
  ccitt identified-organization (4) etsi (0) mobileDomain (0)
  gsm-Network (1) modules (3) map-ExtensionDataTypes (21) version4 (4)}

  SS-Code
FROM MAP-SS-Code {
  ccitt identified-organization (4) etsi (0) mobileDomain (0)
  gsm-Network (1) modules (3) map-SS-Code (15) version4 (4)}
;

```

<b>RegisterSS-Arg ::= SEQUENCE{</b>		
ss-Code	SS-Code,	
basicService	BasicServiceCode	OPTIONAL,
forwardedToNumber	[4] AddressString	OPTIONAL,
forwardedToSubaddress	[6] ISDN-SubaddressString	OPTIONAL,
noReplyConditionTime	[5] NoReplyConditionTime	OPTIONAL,
...		
defaultPriority	[7] EMLPP-Priority	OPTIONAL }

**NoReplyConditionTime ::= INTEGER (5..30)**

<b>SS-Info ::= CHOICE {</b>	
forwardingInfo	[0] ForwardingInfo,
callBarringInfo	[1] CallBarringInfo,
ss-Data	[3] SS-Data}

<b>ForwardingInfo ::= SEQUENCE {</b>		
ss-Code	SS-Code	OPTIONAL,
forwardingFeatureList	ForwardingFeatureList,	
...		

**ForwardingFeatureList ::= SEQUENCE SIZE (1..maxNumOfBasicServiceGroups) OF ForwardingFeature**

<b>ForwardingFeature ::= SEQUENCE {</b>		
basicService	BasicServiceCode	OPTIONAL,
ss-Status [4] SS-Status	OPTIONAL,	
forwardedToNumber	[5] ISDN-AddressString	OPTIONAL,
forwardedToSubaddress	[8] ISDN-SubaddressString	OPTIONAL,
forwardingOptions	[6] ForwardingOptions	OPTIONAL,
noReplyConditionTime	[7] NoReplyConditionTime	OPTIONAL,
...		

```

SS-Status ::= OCTET STRING (SIZE (1))

-- bits 8765: 0000 (unused)
-- bits 4321: Used to convey the "P bit", "R bit", "A bit" and "Q bit",
--           representing supplementary service state information
--           as defined in TS GSM 03.11

-- bit 4: "Q bit"

-- bit 3: "P bit"

-- bit 2: "R bit"

-- bit 1: "A bit"
    
```

```

ForwardingOptions ::= OCTET STRING (SIZE (1))

-- bit 8: notification to forwarding party
-- 0 no notification
-- 1 notification

-- bit 7: 0 (unused)

-- bit 6: notification to calling party
-- 0 no notification
-- 1 notification

-- bit 5: 0 (unused)

-- bits 43: forwarding reason
-- 00 ms not reachable
-- 01 ms busy
-- 10 no reply
-- 11 unconditional
-- bits 21: 00 (unused)
    
```

```

CallBarringInfo ::= SEQUENCE {
    ss-Code                SS-Code                OPTIONAL,
    callBarringFeatureList CallBarringFeatureList,
    ...}
    
```

```

CallBarringFeatureList ::= SEQUENCE SIZE (1..maxNumOfBasicServiceGroups) OF
    CallBarringFeature
    
```

```

CallBarringFeature ::= SEQUENCE {
    basicService            BasicServiceCode        OPTIONAL,
    ss-Status [4] SS-Status OPTIONAL,
    ...}
    
```

```

SS-Data ::= SEQUENCE {
    ss-Code                SS-Code                OPTIONAL,
    ss-Status [4] SS-Status OPTIONAL,
    ss-SubscriptionOption  SS-SubscriptionOption  OPTIONAL,
    basicServiceGroupList BasicServiceGroupList  OPTIONAL,
    ...,
    defaultPriority        EMLPP-Priority         OPTIONAL
}
    
```

```

SS-SubscriptionOption ::= CHOICE {
    cliRestrictionOption  [2] CliRestrictionOption,
    overrideCategory      [1] OverrideCategory}
    
```

```

CliRestrictionOption ::= ENUMERATED {
    permanent (0),
    temporaryDefaultRestricted (1),
    temporaryDefaultAllowed (2)}
    
```

```

OverrideCategory ::= ENUMERATED {
    overrideEnabled (0),
    overrideDisabled (1)}
    
```

```

SS-ForBS-Code ::= SEQUENCE {
    ss-Code                SS-Code,
    basicService            BasicServiceCode        OPTIONAL,
    ...}
    
```

```
GenericServiceInfo ::= SEQUENCE {
    ss-Status SS-Status,
    cliRestrictionOption          CliRestrictionOption          OPTIONAL,
    ...,
    maximumEntitledPriority      [0] EMLPP-Priority          OPTIONAL,
    defaultPriority               [1] EMLPP-Priority          OPTIONAL,
    ccbs-FeatureList             [2] CCBS-FeatureList          OPTIONAL }
```

```
CCBS-FeatureList ::= SEQUENCE SIZE (1..maxNumOfCCBS-Requests) OF
    CCBS-Feature
```

```
maxNumOfCCBS-Requests INTEGER ::= 5
```

```
CCBS-Feature ::= SEQUENCE {
    ccbs-Index                   [0] CCBS-Index              OPTIONAL,
    b-subscriberNumber           [1] ISDN-AddressString        OPTIONAL,
    b-subscriberSubaddress       [2] ISDN-SubaddressString     OPTIONAL,
    basicServiceGroup           [3] BasicServiceCode          OPTIONAL,
    ... }
```

```
CCBS-Index ::= INTEGER (1..maxNumOfCCBS-Requests)
```

```
InterrogateSS-Res ::= CHOICE {
    ss-Status [0] SS-Status,
    basicServiceGroupList [2] BasicServiceGroupList,
    forwardingFeatureList [3] ForwardingFeatureList,
    genericServiceInfo [4] GenericServiceInfo }
```

```
USSD-Arg ::= SEQUENCE {
    ussd-DataCodingScheme        USSD-DataCodingScheme,
    ussd-String                  USSD-String,
    ...,
    alertingPattern              AlertingPattern              OPTIONAL,
    msisdn                       [0] ISDN-AddressString        OPTIONAL }
```

```
USSD-Res ::= SEQUENCE {
    ussd-DataCodingScheme        USSD-DataCodingScheme,
    ussd-String                  USSD-String,
    ... }
```

```
USSD-DataCodingScheme ::= OCTET STRING (SIZE (1))
-- The structure of the USSD-DataCodingScheme is defined by
-- the Cell Broadcast Data Coding Scheme as described in
-- TS GSM 03.38
```

```
USSD-String ::= OCTET STRING (SIZE (1..maxUSSD-StringLength))
-- The structure of the contents of the USSD-String is dependent
-- on the USSD-DataCodingScheme as described in TS GSM 03.38.
```

```
maxUSSD-StringLength INTEGER ::= 160
```

```
Password ::= NumericString
(FROM ("0"|"1"|"2"|"3"|"4"|"5"|"6"|"7"|"8"|"9"))
(SIZE (4))
```

```
GuidanceInfo ::= ENUMERATED {
    enterPW (0),
    enterNewPW (1),
    enterNewPW-Again (2)}
-- How this information is really delivered to the subscriber
-- (display, announcement, ...) is not part of this
-- specification.
```

```
SS-List ::= SEQUENCE SIZE (1..maxNumOfSS) OF
    SS-Code
```

```
maxNumOfSS INTEGER ::= 30
```

```
SS-InfoList ::= SEQUENCE SIZE (1..maxNumOfSS) OF
    SS-Info
```

```
BasicServiceGroupList ::= SEQUENCE SIZE (1..maxNumOfBasicServiceGroups) OF
    BasicServiceCode
```

```
maxNumOfBasicServiceGroups INTEGER ::= 13
```



```

SS-InvocationNotificationArg ::= SEQUENCE {
    imsi                [0] IMSI,
    msisdN              [1] ISDN-AddressString,
    ss-Event            [2] SS-Code,
    -- The following SS-Code values are allowed :
    -- ect              SS-Code ::= '00110001'B
    -- multiPTY         SS-Code ::= '01010001'B
    -- cd               SS-Code ::= '00100100'B
    ss-EventSpecification [3] SS-EventSpecification OPTIONAL,
    extensionContainer    [4] ExtensionContainer OPTIONAL,
    ...}

```

```

SS-InvocationNotificationRes ::= SEQUENCE {
    extensionContainer    ExtensionContainer OPTIONAL,
    ...}

```

```

SS-EventSpecification ::= SEQUENCE SIZE (1..maxEventSpecification) OF
    AddressString

```

```

maxEventSpecification INTEGER ::= 2

```

```

RegisterCC-EntryArg ::= SEQUENCE {
    ss-Code              [0] SS-Code,
    ccbs-Data [1]        CCBS-Data OPTIONAL,
    ...}

```

```

CCBS-Data ::= SEQUENCE {
    ccbs-Feature         [0] CCBS-Feature,
    translatedB-Number  [1] ISDN-AddressString,
    serviceIndicator     [2] ServiceIndicator OPTIONAL,
    callInfo             [3] ExternalSignalInfo,
    networkSignalInfo    [4] ExternalSignalInfo,
    ...}

```

```

ServiceIndicator ::= BIT STRING {
    clir-invoked (0),
    camel-invoked (1)} (SIZE(2..32))
-- exception handling:
-- bits 2 to 31 shall be ignored if received and not understood

```

```

RegisterCC-EntryRes ::= SEQUENCE {
    ccbs-Feature         [0] CCBS-Feature OPTIONAL,
    ...}

```

```

EraseCC-EntryArg ::= SEQUENCE {
    ss-Code              [0] SS-Code,
    ccbs-Index           [1] CCBS-Index OPTIONAL,
    ...}

```

```

EraseCC-EntryRes ::= SEQUENCE {
    ss-Code              [0] SS-Code,
    ss-Status [1] SS-Status OPTIONAL,
    ...}

```

END

## 17.7.5 Supplementary service codes

```

MAP-SS-Code {
    ccitt identified-organization (4) etsi (0) mobileDomain (0)
    gsm-Network (1) modules (3) map-SS-Code (15) version4 (4)}

```

DEFINITIONS

::=

BEGIN

```

SS-Code ::= OCTET STRING (SIZE (1))
-- This type is used to represent the code identifying a single
-- supplementary service, a group of supplementary services, or
-- all supplementary services. The services and abbreviations
-- used are defined in TS GSM 02.04. The internal structure is
-- defined as follows:
--
-- bits 87654321: group (bits 8765), and specific service
-- (bits 4321)
    
```

```

allSS SS-Code ::= '00000000'B
-- reserved for possible future use
-- all SS
    
```

```

allLineIdentificationSS SS-Code ::= '00010000'B
-- reserved for possible future use
-- all line identification SS
clip SS-Code ::= '00010001'B
-- calling line identification presentation
clir SS-Code ::= '00010010'B
-- calling line identification restriction
colp SS-Code ::= '00010011'B
-- connected line identification presentation
colr SS-Code ::= '00010100'B
-- connected line identification restriction
mci SS-Code ::= '00010101'B
-- reserved for possible future use
-- malicious call identification

allNameIdentificationSS SS-Code ::= '00011000'B
-- all name identification SS
cnap SS-Code ::= '00011001'B
-- calling name presentation

-- SS-Codes '00011010'B to '00011111'B are reserved for future
-- NameIdentification Supplementary Service use.
    
```

```

allForwardingSS SS-Code ::= '00100000'B
-- all forwarding SS
cfu SS-Code ::= '00100001'B
-- call forwarding unconditional
allCondForwardingSS SS-Code ::= '00101000'B
-- all conditional forwarding SS
cfb SS-Code ::= '00101001'B
-- call forwarding on mobile subscriber busy
cfnry SS-Code ::= '00101010'B
-- call forwarding on no reply
cfnrc SS-Code ::= '00101011'B
-- call forwarding on mobile subscriber not reachable
cd SS-Code ::= '00100100'B
-- call deflection
    
```

```

allCallOfferingSS SS-Code ::= '00110000'B
-- reserved for possible future use
-- all call offering SS includes also all forwarding SS
ect SS-Code ::= '00110001'B
-- explicit call transfer
mah SS-Code ::= '00110010'B
-- reserved for possible future use
-- mobile access hunting
    
```

```

allCallCompletionSS SS-Code ::= '01000000'B
-- reserved for possible future use
-- all Call completion SS
cw SS-Code ::= '01000001'B
-- call waiting
hold SS-Code ::= '01000010'B
-- call hold
ccbs-A SS-Code ::= '01000011'B
-- completion of call to busy subscribers, originating side
ccbs-B SS-Code ::= '01000100'B
-- completion of call to busy subscribers, destination side
-- this SS-Code is used only in InsertSubscriberData and DeleteSubscriberData
    
```

<b>allMultiPartySS</b>	SS-Code ::= '01010000'B
<i>-- reserved for possible future use</i>	
<i>-- all multiparty SS</i>	
<b>multiPTY</b>	SS-Code ::= '01010001'B
<i>-- multiparty</i>	

<b>allCommunityOfInterest-SS</b>	SS-Code ::= '01100000'B
<i>-- reserved for possible future use</i>	
<i>-- all community of interest SS</i>	
<b>cug</b>	SS-Code ::= '01100001'B
<i>-- closed user group</i>	

<b>allChargingSS</b>	SS-Code ::= '01110000'B
<i>-- reserved for possible future use</i>	
<i>-- all charging SS</i>	
<b>aoci</b>	SS-Code ::= '01110001'B
<i>-- advice of charge information</i>	
<b>aocc</b>	SS-Code ::= '01110010'B
<i>-- advice of charge charging</i>	

<b>allAdditionalInfoTransferSS</b>	SS-Code ::= '10000000'B
<i>-- reserved for possible future use</i>	
<i>-- all additional information transfer SS</i>	
<b>uus</b>	SS-Code ::= '10000001'B
<i>-- reserved for possible future use</i>	
<i>-- UUS user-to-user signalling</i>	

<b>allBarringSS</b>	SS-Code ::= '10010000'B
<i>-- all barring SS</i>	
<b>barringOfOutgoingCalls</b>	SS-Code ::= '10010001'B
<i>-- barring of outgoing calls</i>	
<b>baoc</b>	SS-Code ::= '10010010'B
<i>-- barring of all outgoing calls</i>	
<b>boic</b>	SS-Code ::= '10010011'B
<i>-- barring of outgoing international calls</i>	
<b>boicEXHC</b>	SS-Code ::= '10010100'B
<i>-- barring of outgoing international calls except those directed</i>	
<i>-- to the home PLMN</i>	
<b>barringOfIncomingCalls</b>	SS-Code ::= '10011001'B
<i>-- barring of incoming calls</i>	
<b>baic</b>	SS-Code ::= '10011010'B
<i>-- barring of all incoming calls</i>	
<b>bicRoam</b>	SS-Code ::= '10011011'B
<i>-- barring of incoming calls when roaming outside home PLMN</i>	
<i>-- Country</i>	

<b>allPLMN-specificSS</b>	SS-Code ::= '11110000'B
<b>plmn-specificSS-1</b>	SS-Code ::= '11110001'B
<b>plmn-specificSS-2</b>	SS-Code ::= '11110010'B
<b>plmn-specificSS-3</b>	SS-Code ::= '11110011'B
<b>plmn-specificSS-4</b>	SS-Code ::= '11110100'B
<b>plmn-specificSS-5</b>	SS-Code ::= '11110101'B
<b>plmn-specificSS-6</b>	SS-Code ::= '11110110'B
<b>plmn-specificSS-7</b>	SS-Code ::= '11110111'B
<b>plmn-specificSS-8</b>	SS-Code ::= '11111000'B
<b>plmn-specificSS-9</b>	SS-Code ::= '11111001'B
<b>plmn-specificSS-A</b>	SS-Code ::= '11111010'B
<b>plmn-specificSS-B</b>	SS-Code ::= '11111011'B
<b>plmn-specificSS-C</b>	SS-Code ::= '11111100'B
<b>plmn-specificSS-D</b>	SS-Code ::= '11111101'B
<b>plmn-specificSS-E</b>	SS-Code ::= '11111110'B
<b>plmn-specificSS-F</b>	SS-Code ::= '11111111'B

<b>allCallPrioritySS</b>	SS-Code ::= '10100000'B
<i>-- reserved for possible future use</i>	
<i>-- all call priority SS</i>	
<b>emlpp</b>	SS-Code ::= '10100001'B
<i>-- enhanced Multilevel Precedence Pre-emption (EMLPP) service</i>	

END

## 17.7.6 Short message data types

```
MAP-SM-DataTypes {
    ccitt identified-organization (4) etsi (0) mobileDomain (0)
    gsm-Network (1) modules (3) map-SM-DataTypes (16) version4 (4)}
```

DEFINITIONS

IMPLICIT TAGS

::=

BEGIN

EXPORTS

```
RoutingInfoForSM-Arg,
RoutingInfoForSM-Res,
MO-ForwardSM-Arg,
MO-ForwardSM-Res,
MT-ForwardSM-Arg,
MT-ForwardSM-Res,
ReportSM-DeliveryStatusArg,
ReportSM-DeliveryStatusRes,
AlertServiceCentreArg,
InformServiceCentreArg,
ReadyForSM-Arg,
ReadyForSM-Res,
SM-DeliveryOutcome,
AlertReason
```

;

IMPORTS

```
AddressString,
ISDN-AddressString,
SignalInfo,
IMSI,
LMSI
```

```
FROM MAP-CommonDataTypes {
ccitt identified-organization (4) etsi (0) mobileDomain (0)
gsm-Network (1) modules (3) map-CommonDataTypes (18) version4 (4)}
```

AbsentSubscriberDiagnosticSM

```
FROM MAP-ER-DataTypes {
ccitt identified-organization (4) etsi (0) mobileDomain (0)
gsm-Network (1) modules (3) map-ER-DataTypes (17) version4 (4)}
```

ExtensionContainer

```
FROM MAP-ExtensionDataTypes {
ccitt identified-organization (4) etsi (0) mobileDomain (0)
gsm-Network (1) modules (3) map-ExtensionDataTypes (21) version4 (4)}
```

;

```
RoutingInfoForSM-Arg ::= SEQUENCE {
msisdn [0] ISDN-AddressString,
sm-RP-PRI [1] BOOLEAN,
serviceCentreAddress [2] AddressString,
extensionContainer [6] ExtensionContainer OPTIONAL,
... ,
gprsSupportIndicator [7] NULL OPTIONAL,
-- gprsSupportIndicator is set only if the SMS-GMSC supports
-- receiving of two numbers from the HLR
sm-RP-MTI [8] SM-RP-MTI OPTIONAL,
sm-RP-SMEA [9] SM-RP-SMEA OPTIONAL }
```

```
SM-RP-MTI ::= INTEGER (0..10)
-- 0 SMS Deliver
-- 1 SMS Status Report
-- other values are reserved for future use and shall be discarded if
-- received
```

```
SM-RP-SMEA ::= OCTET STRING (SIZE (1..12))
-- this parameter contains an address field which is encoded
-- as defined in GSM 03.40. An address field contains 3 elements :
-- address-length
-- type-of-address
-- address-value
```

```

RoutingInfoForSM-Res ::= SEQUENCE {
    imsi                IMSI,
    locationInfoWithLMSI [0] LocationInfoWithLMSI,
    extensionContainer  [4] ExtensionContainer      OPTIONAL,
    ...}
    
```

```

LocationInfoWithLMSI ::= SEQUENCE {
    networkNode-Number [1] ISDN-AddressString,
    lmsi                LMSI                OPTIONAL,
    extensionContainer  ExtensionContainer   OPTIONAL,
    ...,
    gprsNodeIndicator  [5] NULL            OPTIONAL,
    -- gprsNodeIndicator is set only if the SGSN number is sent as the
    -- Network Node Number
    additional-Number  [6] Additional-Number OPTIONAL
    -- NetworkNode-number can be either msc-number or sgsn-number
}
    
```

```

Additional-Number ::= CHOICE {
    msc-Number          [0] ISDN-AddressString,
    sgsn-Number         [1] ISDN-AddressString}
    -- additional-number can be either msc-number or sgsn-number
    -- if received networkNode-number is msc-number then the
    -- additional number is sgsn-number
    -- if received networkNode-number is sgsn-number then the
    -- additional number is msc-number
    
```

```

MO-ForwardSM-Arg ::= SEQUENCE {
    sm-RP-DA           SM-RP-DA,
    sm-RP-OA           SM-RP-OA,
    sm-RP-UI           SignalInfo,
    extensionContainer ExtensionContainer      OPTIONAL,
    ...}
    
```

```

MO-ForwardSM-Res ::= SEQUENCE {
    sm-RP-UI           SignalInfo            OPTIONAL,
    extensionContainer ExtensionContainer     OPTIONAL,
    ...}
    
```

```

MT-ForwardSM-Arg ::= SEQUENCE {
    sm-RP-DA           SM-RP-DA,
    sm-RP-OA           SM-RP-OA,
    sm-RP-UI           SignalInfo,
    moreMessagesToSend NULL                OPTIONAL,
    extensionContainer ExtensionContainer    OPTIONAL,
    ...}
    
```

```

MT-ForwardSM-Res ::= SEQUENCE {
    sm-RP-UI           SignalInfo            OPTIONAL,
    extensionContainer ExtensionContainer     OPTIONAL,
    ...}
    
```

```

SM-RP-DA ::= CHOICE {
    imsi                [0] IMSI,
    lmsi                [1] LMSI,
    serviceCentreAddressDA [4] AddressString,
    noSM-RP-DA         [5] NULL}
    
```

```

SM-RP-OA ::= CHOICE {
    msisdn              [2] ISDN-AddressString,
    serviceCentreAddressOA [4] AddressString,
    noSM-RP-OA         [5] NULL}
    
```

```

ReportSM-DeliveryStatusArg ::= SEQUENCE {
    msisdn                ISDN-AddressString,
    serviceCentreAddress  AddressString,
    sm-DeliveryOutcome    SM-DeliveryOutcome,
    absentSubscriberDiagnosticSM [0] AbsentSubscriberDiagnosticSM
                                OPTIONAL,
    extensionContainer    [1] ExtensionContainer    OPTIONAL,
    ...,
    gprsSupportIndicator  [2] NULL                  OPTIONAL,
    -- gprsSupportIndicator is set only if the SMS-GMSC supports
    -- handling of two delivery outcomes
    deliveryOutcomeIndicator [3] NULL              OPTIONAL,
    -- DeliveryOutcomeIndicator is set when the SM-DeliveryOutcome
    -- is for GPRS
    additionalSM-DeliveryOutcome [4] SM-DeliveryOutcome    OPTIONAL,
    -- If received, additionalSM-DeliveryOutcome is for GPRS
    -- If DeliveryOutcomeIndicator is set, then AdditionalSM-DeliveryOutcome shall be absent
    additionalAbsentSubscriberDiagnosticSM [5] AbsentSubscriberDiagnosticSM OPTIONAL
    -- If received additionalAbsentSubscriberDiagnosticSM is for GPRS
    -- If DeliveryOutcomeIndicator is set, then AdditionalAbsentSubscriberDiagnosticSM
    -- shall be absent
}
    
```

```

SM-DeliveryOutcome ::= ENUMERATED {
    memoryCapacityExceeded (0),
    absentSubscriber (1),
    successfulTransfer (2)}
    
```

```

ReportSM-DeliveryStatusRes ::= SEQUENCE {
    storedMSISDN          ISDN-AddressString          OPTIONAL,
    extensionContainer    ExtensionContainer          OPTIONAL,
    ...}
    
```

```

AlertServiceCentreArg ::= SEQUENCE {
    msisdn                ISDN-AddressString,
    serviceCentreAddress  AddressString,
    ...}
    
```

```

InformServiceCentreArg ::= SEQUENCE {
    storedMSISDN          ISDN-AddressString          OPTIONAL,
    mw-Status MW-Status  OPTIONAL,
    extensionContainer    ExtensionContainer          OPTIONAL,
    ...}
    
```

```

MW-Status ::= BIT STRING {
    sc-AddressNotIncluded (0),
    mnrf-Set (1),
    mcef-Set (2),
    mnrg-Set (3)} (SIZE (6..16))
    -- exception handling:
    -- bits 4 to 15 shall be ignored if received and not understood
    
```

```

ReadyForSM-Arg ::= SEQUENCE {
    imsi                [0] IMSI,
    alertReason          AlertReason,
    alertReasonIndicator NULL                  OPTIONAL,
    -- alertReasonIndicator is set only when the alertReason
    -- sent to HLR is for GPRS
    extensionContainer  ExtensionContainer          OPTIONAL,
    ...}
    
```

```

ReadyForSM-Res ::= SEQUENCE {
    extensionContainer  ExtensionContainer          OPTIONAL,
    ...}
    
```

```

AlertReason ::= ENUMERATED {
    ms-Present (0),
    memoryAvailable (1)}
    
```

END

### 17.7.7 Error data types

```

MAP-ER-DataTypes {
    ccitt identified-organization (4) etsi (0) mobileDomain (0)
    
```

gsm-Network (1) modules (3) map-ER-DataTypes (17) version4 (4)}

DEFINITIONS

IMPLICIT TAGS

::=

BEGIN

EXPORTS

- RoamingNotAllowedParam,
- CallBarredParam,
- CUG-RejectParam,
- SS-IncompatibilityCause,
- PW-RegistrationFailureCause,
- SM-DeliveryFailureCause,
- SystemFailureParam,
- DataMissingParam,
- UnexpectedDataParam,
- FacilityNotSupParam,
- OR-NotAllowedParam,
- UnknownSubscriberParam,
- NumberChangedParam,
- UnidentifiedSubParam,
- IllegalSubscriberParam,
- IllegalEquipmentParam,
- BearerServNotProvParam,
- TeleservNotProvParam,
- TracingBufferFullParam,
- NoRoamingNbParam,
- AbsentSubscriberParam,
- BusySubscriberParam,
- NoSubscriberReplyParam,
- ForwardingViolationParam,
- ForwardingFailedParam,
- ATI-NotAllowedParam,
- SubBusyForMT-SMS-Param,
- MessageWaitListFullParam,
- AbsentSubscriberSM-Param,
- AbsentSubscriberDiagnosticSM,
- ResourceLimitationParam,
- NoGroupCallNbParam,
- IncompatibleTerminalParam,
- ShortTermDenialParam,
- LongTermDenialParam

;

IMPORTS

SS-Status

FROM MAP-SS-DataTypes {  
 ccitt identified-organization (4) etsi (0) mobileDomain (0)  
 gsm-Network (1) modules (3) map-SS-DataTypes (14) version4 (4)}

SignalInfo,  
 BasicServiceCode,  
 NetworkResource

FROM MAP-CommonDataTypes {  
 ccitt identified-organization (4) etsi (0) mobileDomain (0)  
 gsm-Network (1) modules (3) map-CommonDataTypes (18) version4 (4)}

SS-Code

FROM MAP-SS-Code {  
 ccitt identified-organization (4) etsi (0) mobileDomain (0)  
 gsm-Network (1) modules (3) map-SS-Code (15) version4 (4)}

ExtensionContainer

FROM MAP-ExtensionDataTypes {  
 ccitt identified-organization (4) etsi (0) mobileDomain (0)  
 gsm-Network (1) modules (3) map-ExtensionDataTypes (21) version4 (4)}

;

<b>RoamingNotAllowedParam</b> ::= SEQUENCE {			
roamingNotAllowedCause	RoamingNotAllowedCause,		
extensionContainer	ExtensionContainer		OPTIONAL,
...	}		

```
RoamingNotAllowedCause ::= ENUMERATED {
    plmnRoamingNotAllowed (0),
    operatorDeterminedBarring (3)}
```

```
CallBarredParam ::= CHOICE {
    callBarringCause          CallBarringCause,
    -- call BarringCause must not be used in version 3
    extensibleCallBarredParam ExtensibleCallBarredParam
    -- extensibleCallBarredParam must not be used in version <3
}
```

```
CallBarringCause ::= ENUMERATED {
    barringServiceActive (0),
    operatorBarring (1)}
```

```
ExtensibleCallBarredParam ::= SEQUENCE {
    callBarringCause          CallBarringCause          OPTIONAL,
    extensionContainer        ExtensionContainer        OPTIONAL,
    ... ,
    unauthorisedMessageOriginator [1] NULL          OPTIONAL }
```

```
CUG-RejectParam ::= SEQUENCE {
    cug-RejectCause          CUG-RejectCause          OPTIONAL,
    extensionContainer        ExtensionContainer        OPTIONAL,
    ... }
```

```
CUG-RejectCause ::= ENUMERATED {
    incomingCallsBarredWithinCUG (0),
    subscriberNotMemberOfCUG (1),
    requestedBasicServiceViolatesCUG-Constraints (5),
    calledPartySS-InteractionViolation (7)}
```

```
SS-IncompatibilityCause ::= SEQUENCE {
    ss-Code [1] SS-Code          OPTIONAL,
    basicService BasicServiceCode OPTIONAL,
    ss-Status [4] SS-Status      OPTIONAL,
    ... }
```

```
PW-RegistrationFailureCause ::= ENUMERATED {
    undetermined (0),
    invalidFormat (1),
    newPasswordsMismatch (2)}
```

```
SM-EnumeratedDeliveryFailureCause ::= ENUMERATED {
    memoryCapacityExceeded (0),
    equipmentProtocolError (1),
    equipmentNotSM-Equipped (2),
    unknownServiceCentre (3),
    sc-Congestion (4),
    invalidSME-Address (5),
    subscriberNotSC-Subscriber (6)}
```

```
SM-DeliveryFailureCause ::= SEQUENCE {
    sm-EnumeratedDeliveryFailureCause SM-EnumeratedDeliveryFailureCause,
    diagnosticInfo SignalInfo          OPTIONAL,
    extensionContainer ExtensionContainer OPTIONAL,
    ... }
```

```
AbsentSubscriberSM-Param ::= SEQUENCE {
    absentSubscriberDiagnosticSM AbsentSubscriberDiagnosticSM OPTIONAL,
    -- AbsentSubscriberDiagnosticSM can be either for non-GPRS
    -- or for GPRS
    extensionContainer ExtensionContainer OPTIONAL,
    ... ,
    additionalAbsentSubscriberDiagnosticSM [0] AbsentSubscriberDiagnosticSM OPTIONAL }
    -- if received, additionalAbsentSubscriberDiagnosticSM
    -- is for GPRS and absentSubscriberDiagnosticSM is
    -- for non-GPRS
```

```
AbsentSubscriberDiagnosticSM ::= INTEGER (0..255)
    -- AbsentSubscriberDiagnosticSM values are defined in ETS 300 536 (GSM 03.40)
```



```

SystemFailureParam ::= CHOICE {
    networkResource          NetworkResource,
    -- networkResource must not be used in version 3
    extensibleSystemFailureParam  ExtensibleSystemFailureParam
    -- extensibleSystemFailureParam must not be used in version <3
}
    
```

```

ExtensibleSystemFailureParam ::= SEQUENCE {
    networkResource          NetworkResource          OPTIONAL,
    extensionContainer      ExtensionContainer        OPTIONAL,
    ...
}
    
```

```

DataMissingParam ::= SEQUENCE {
    extensionContainer      ExtensionContainer        OPTIONAL,
    ...
}
    
```

```

UnexpectedDataParam ::= SEQUENCE {
    extensionContainer      ExtensionContainer        OPTIONAL,
    ...
}
    
```

```

FacilityNotSupParam ::= SEQUENCE {
    extensionContainer      ExtensionContainer        OPTIONAL,
    ...
}
    
```

```

OR-NotAllowedParam ::= SEQUENCE {
    extensionContainer      ExtensionContainer        OPTIONAL,
    ...
}
    
```

```

UnknownSubscriberParam ::= SEQUENCE {
    extensionContainer      ExtensionContainer        OPTIONAL,
    ...,
    unknownSubscriberDiagnostic  UnknownSubscriberDiagnostic  OPTIONAL
}
    
```

```

UnknownSubscriberDiagnostic ::= ENUMERATED {
    imsiUnknown (0),
    gprsSubscriptionUnknown (1),
    ...
}
-- if unknown values are received in
-- unknownSubscriberDiagnostic they shall be discarded
    
```

```

NumberChangedParam ::= SEQUENCE {
    extensionContainer      ExtensionContainer        OPTIONAL,
    ...
}
    
```

```

UnidentifiedSubParam ::= SEQUENCE {
    extensionContainer      ExtensionContainer        OPTIONAL,
    ...
}
    
```

```

IllegalSubscriberParam ::= SEQUENCE {
    extensionContainer      ExtensionContainer        OPTIONAL,
    ...
}
    
```

```

IllegalEquipmentParam ::= SEQUENCE {
    extensionContainer      ExtensionContainer        OPTIONAL,
    ...
}
    
```

```

BearerServNotProvParam ::= SEQUENCE {
    extensionContainer      ExtensionContainer        OPTIONAL,
    ...
}
    
```

```

TeleservNotProvParam ::= SEQUENCE {
    extensionContainer      ExtensionContainer        OPTIONAL,
    ...
}
    
```

```

TracingBufferFullParam ::= SEQUENCE {
    extensionContainer      ExtensionContainer        OPTIONAL,
    ...
}
    
```

```

NoRoamingNbParam ::= SEQUENCE {
    extensionContainer      ExtensionContainer        OPTIONAL,
    ...
}
    
```

```

AbsentSubscriberParam ::= SEQUENCE {
    extensionContainer      ExtensionContainer      OPTIONAL,
    ...,
    absentSubscriberReason [0] AbsentSubscriberReason OPTIONAL}
    
```

```

AbsentSubscriberReason ::= ENUMERATED {
    imsiDetach (0),
    restrictedArea (1),
    noPageResponse (2),
    ...}
-- exception handling: at reception of other values than the ones listed the
-- AbsentSubscriberReason shall be ignored.
    
```

```

BusySubscriberParam ::= SEQUENCE {
    extensionContainer      ExtensionContainer      OPTIONAL,
    ...,
    ccbs-Possible          [0] NULL              OPTIONAL,
    ccbs-Busy [1] NULL      OPTIONAL}
    
```

```

NoSubscriberReplyParam ::= SEQUENCE {
    extensionContainer      ExtensionContainer      OPTIONAL,
    ...}
    
```

```

ForwardingViolationParam ::= SEQUENCE {
    extensionContainer      ExtensionContainer      OPTIONAL,
    ...}
    
```

```

ForwardingFailedParam ::= SEQUENCE {
    extensionContainer      ExtensionContainer      OPTIONAL,
    ...}
    
```

```

ATI-NotAllowedParam ::= SEQUENCE {
    extensionContainer      ExtensionContainer      OPTIONAL,
    ...}
    
```

```

SubBusyForMT-SMS-Param ::= SEQUENCE {
    extensionContainer      ExtensionContainer      OPTIONAL,
    ...,
    gprsConnectionSuspended NULL              OPTIONAL }
-- If GprsConnectionSuspended is not understood it shall
-- be discarded
    
```

```

MessageWaitListFullParam ::= SEQUENCE {
    extensionContainer      ExtensionContainer      OPTIONAL,
    ...}
    
```

```

ResourceLimitationParam ::= SEQUENCE {
    extensionContainer      ExtensionContainer      OPTIONAL,
    ...}
    
```

```

NoGroupCallNbParam ::= SEQUENCE {
    extensionContainer      ExtensionContainer      OPTIONAL,
    ...}
    
```

```

IncompatibleTerminalParam ::= SEQUENCE {
    extensionContainer      ExtensionContainer      OPTIONAL,
    ...}
    
```

```

ShortTermDenialParam ::= SEQUENCE {
    ...}
    
```

```

LongTermDenialParam ::= SEQUENCE {
    ...}
    
```

END

## 17.7.8 Common data types

```

MAP-CommonDataTypes {
    ccitt identified-organization (4) etsi (0) mobileDomain (0)
    gsm-Network (1) modules (3) map-CommonDataTypes (18) version4 (4)}
    
```

DEFINITIONS

IMPLICIT TAGS

```
::=
```

```
BEGIN
```

```
EXPORTS
```

```
-- general data types and values
AddressString,
ISDN-AddressString,
maxISDN-AddressLength,
ISDN-SubaddressString,
ExternalSignalInfo,
SignalInfo,
maxSignalInfoLength,
AlertingPattern,

-- data types for numbering and identification
IMSI,
TMSI,
SubscriberId,
IMEI,
HLR-List,
LMSI,
GlobalCellId,
NetworkResource,
NAEA-PreferredCI,
ASCI-CallReference,

-- data types for CAMEL
CellIdOrLAI,

-- data types for subscriber management
BasicServiceCode,
Ext-BasicServiceCode,
EMLPP-Info,
EMLPP-Priority
```

```
;
```

```
IMPORTS
```

```
TeleserviceCode,
Ext-TeleserviceCode
FROM MAP-TS-Code {
ccitt identified-organization (4) etsi (0) mobileDomain (0)
gsm-Network (1) modules (3) map-TS-Code (19) version4 (4)}

BearerServiceCode,
Ext-BearerServiceCode
FROM MAP-BS-Code {
ccitt identified-organization (4) etsi (0) mobileDomain (0)
gsm-Network (1) modules (3) map-BS-Code (20) version4 (4)}

ExtensionContainer
FROM MAP-ExtensionDataTypes {
ccitt identified-organization (4) etsi (0) mobileDomain (0)
gsm-Network (1) modules (3) map-ExtensionDataTypes (21) version4 (4)}
;
```

```
-- general data types
```

```
TBCD-STRING ::= OCTET STRING
```

```
-- This type (Telephony Binary Coded Decimal String) is used to
-- represent several digits from 0 through 9, *, #, a, b, c, two
-- digits per octet, each digit encoded 0000 to 1001 (0 to 9),
-- 1010 (*), 1011 (#), 1100 (a), 1101 (b) or 1110 (c); 1111 used
-- as filler when there is an odd number of digits.
```

```
-- bits 8765 of octet n encoding digit 2n
-- bits 4321 of octet n encoding digit 2(n-1) +1
```

```

AddressString ::= OCTET STRING (SIZE (1..maxAddressLength))
-- This type is used to represent a number for addressing
-- purposes. It is composed of
-- a) one octet for nature of address, and numbering plan
-- indicator.
-- b) digits of an address encoded as TBCD-String.

-- a) The first octet includes a one bit extension indicator, a
-- 3 bits nature of address indicator and a 4 bits numbering
-- plan indicator, encoded as follows:

-- bit 8: 1 (no extension)

-- bits 765: nature of address indicator
-- 000 unknown
-- 001 international number
-- 010 national significant number
-- 011 network specific number
-- 100 subscriber number
-- 101 reserved
-- 110 abbreviated number
-- 111 reserved for extension

-- bits 4321: numbering plan indicator
-- 0000 unknown
-- 0001 ISDN/Telephony Numbering Plan (Rec CCITT E.164)
-- 0010 spare
-- 0011 data numbering plan (CCITT Rec X.121)
-- 0100 telex numbering plan (CCITT Rec F.69)
-- 0101 spare
-- 0110 land mobile numbering plan (CCITT Rec E.212)
-- 0111 spare
-- 1000 national numbering plan
-- 1001 private numbering plan
-- 1111 reserved for extension

-- all other values are reserved.

-- b) The following octets representing digits of an address
-- encoded as a TBCD-STRING.

```

```

maxAddressLength INTEGER ::= 20

```

```

ISDN-AddressString ::=
    AddressString (SIZE (1..maxISDN-AddressLength))
-- This type is used to represent ISDN numbers.

```

```

maxISDN-AddressLength INTEGER ::= 9

```

```

ISDN-SubaddressString ::=
    OCTET STRING (SIZE (1..maxISDN-SubaddressLength))
    -- This type is used to represent ISDN subaddresses.
    -- It is composed of
    -- a) one octet for type of subaddress and odd/even indicator.
    -- b) 20 octets for subaddress information.

    -- a) The first octet includes a one bit extension indicator, a
    --     3 bits type of subaddress and a one bit odd/even indicator,
    --     encoded as follows:

    -- bit 8: 1 (no extension)

    -- bits 765: type of subaddress
    --     000 NSAP (X.213/ISO 8348 AD2)
    --     010 User Specified
    --     All other values are reserved

    -- bit 4: odd/even indicator
    --     0 even number of address signals
    --     1 odd number of address signals
    --     The odd/even indicator is used when the type of subaddress
    --     is "user specified" and the coding is BCD.

    -- bits 321: 000 (unused)

    -- b) Subaddress information.
    -- The NSAP X.213/ISO8348AD2 address shall be formatted as specified
    -- by octet 4 which contains the Authority and Format Identifier
    -- (AFI). The encoding is made according to the "preferred binary
    -- encoding" as defined in X.213/ISO834AD2. For the definition
    -- of this type of subaddress, see CCITT Rec I.334.

    -- For User-specific subaddress, this field is encoded according
    -- to the user specification, subject to a maximum length of 20
    -- octets. When interworking with X.25 networks BCD coding should
    -- be applied.

```

```

maxISDN-SubaddressLength INTEGER ::= 21

```

```

ExternalSignalInfo ::= SEQUENCE {
    protocolId                ProtocolId,
    signalInfo                SignalInfo,
    -- Information about the internal structure is given in
    -- clause 7.6.9.
    extensionContainer        ExtensionContainer OPTIONAL,
    -- extensionContainer must not be used in version 2
    ...}

```

```

SignalInfo ::= OCTET STRING (SIZE (1..maxSignalInfoLength))

```

```

maxSignalInfoLength INTEGER ::= 200
    -- This NamedValue represents the theoretical maximum number of
    -- octets which are available to carry a single data type,
    -- without requiring segmentation to cope with the network layer
    -- service. However, the actual maximum size available for a data
    -- type may be lower, especially when other information elements
    -- have to be included in the same component.

```

```

ProtocolId ::= ENUMERATED {
    gsm-0408 (1),
    gsm-0806 (2),
    gsm-BSSMAP (3),
    -- Value 3 is reserved and must not be used
    ets-300102-1 (4)}

```

```

AlertingPattern ::= OCTET STRING (SIZE (1) )
-- This type is used to represent Alerting Pattern

-- bits 8765 : 0000 (unused)

-- bits 43 : type of Pattern
-- 00 level
-- 01 category
-- 10 category
-- all other values are reserved.

-- bits 21 : type of alerting

alertingLevel-0 AlertingPattern ::= '00000000'B
alertingLevel-1 AlertingPattern ::= '00000001'B
alertingLevel-2 AlertingPattern ::= '00000010'B
-- all other values of Alerting level are reserved
-- Alerting Levels are defined in GSM 02.07

alertingCategory-1 AlertingPattern ::= '00000100'B
alertingCategory-2 AlertingPattern ::= '00000101'B
alertingCategory-3 AlertingPattern ::= '00000110'B
alertingCategory-4 AlertingPattern ::= '00000111'B
alertingCategory-5 AlertingPattern ::= '00001000'B
-- all other values of Alerting Category are reserved
-- Alerting categories are defined in GSM 02.07
    
```

-- data types for numbering and identification

```

IMSI ::= TBCD-STRING (SIZE (3..8))
-- digits of MCC, MNC, MSIN are concatenated in this order.
    
```

```

ASCII-CallReference ::= TBCD-STRING (SIZE (1..8))
-- digits of VGCS/VBC-area,Group-ID are concatenated in this order.
    
```

```

TMSI ::= OCTET STRING (SIZE (1..4))
    
```

```

SubscriberId ::= CHOICE {
    imsi                                [0] IMSI,
    tmsi                                [1] TMSI}
    
```

```

IMEI ::= TBCD-STRING (SIZE (8))
-- Refers to International Mobile Station Equipment Identity
-- and Software Version Number (SVN) defined in TS GSM 03.03.
-- If the SVN is not present the last octet shall contain the
-- digit 0 and a filler.
-- If present the SVN shall be included in the last octet.
    
```

```

HLR-Id ::= IMSI
-- leading digits of IMSI, i.e. (MCC, MNC, leading digits of
-- MSIN) forming HLR Id defined in TS GSM 03.03.
    
```

```

HLR-List ::= SEQUENCE SIZE (1..maxNumOfHLR-Id) OF
    HLR-Id
    
```

```

maxNumOfHLR-Id INTEGER ::= 50
    
```

```

LMSI ::= OCTET STRING (SIZE (4))
    
```

```

GlobalCellId ::= OCTET STRING (SIZE (5..7))
-- Refers to Cell Global Identification defined in TS GSM 03.03.
-- The internal structure is defined as follows:
-- Mobile Country Code:          3 digits according to CCITT Rec E.212
--                               1 digit filler (1111)
-- Mobile Network Code:          2 digits according to CCITT Rec E.212
-- Location Area Code:           2 octets according to TS GSM 04.08
-- Cell Identity:                2 octets (CI) according to TS GSM 04.08
    
```

```

NetworkResource ::= ENUMERATED {
    plmn (0),
    hlr (1),
    vlr (2),
    pvlr (3),
    controllingMSC (4),
    vmsc (5),
    eir (6),
    rss (7)}

```

```

NAEA-PreferredCI ::= SEQUENCE {
    naea-PreferredCIC [0] NAEA-CIC,
    extensionContainer [1] ExtensionContainer OPTIONAL,
    ...}

```

```

NAEA-CIC ::= OCTET STRING (SIZE (3))
-- The internal structure is defined by the Carrier Identification
-- parameter in ANSI T1.113.3. Carrier codes between "000" and "999" may
-- be encoded as 3 digits using "000" to "999" or as 4 digits using
-- "0000" to "0999". Carrier codes between "1000" and "9999" are encoded
-- using 4 digits.

```

-- data types for CAMEL

```

CellIdOrLAI ::= CHOICE {
    cellIdFixedLength [0] CellIdFixedLength,
    laiFixedLength [1] LAIFixedLength}

```

```

CellIdFixedLength ::= OCTET STRING (SIZE (7))
-- Refers to Cell Global Identification defined in TS GSM 03.03.
-- The internal structure is defined as follows:
-- Mobile Country Code: 3 digits according to CCITT Rec E.212
-- 1 digit filler (1111)
-- Mobile Network Code: 2 digits according to CCITT Rec E.212
-- Location Area Code: 2 octets according to TS GSM 04.08
-- Cell Identity: 2 octets (CI) according to TS GSM 04.08

```

```

LAIFixedLength ::= OCTET STRING (SIZE (5))
-- Refers to Location Area Identification defined in TS GSM 03.03.
-- The internal structure is defined as follows:
-- Mobile Country Code: 3 digits according to CCITT Rec E.212
-- 1 digit filler (1111)
-- Mobile Network Code: 2 digits according to CCITT Rec E.212
-- Location Area Code: 2 octets according to TS GSM 04.08

```

-- data types for subscriber management

```

BasicServiceCode ::= CHOICE {
    bearerService [2] BearerServiceCode,
    teleservice [3] TeleserviceCode}

```

```

Ext-BasicServiceCode ::= CHOICE {
    ext-BearerService [2] Ext-BearerServiceCode,
    ext-Teleservice [3] Ext-TeleserviceCode}

```

```

EMLPP-Info ::= SEQUENCE {
    maximumentitledPriority EMLPP-Priority,
    defaultPriority EMLPP-Priority,
    extensionContainer ExtensionContainer OPTIONAL,
    ...}

```

```

EMLPP-Priority ::= INTEGER (0..15)
-- The mapping from the values A,B,0,1,2,3,4 to the integer-value is
-- specified as follows where A is the highest and 4 is the lowest
-- priority level
-- the integer values 7-15 are spare and shall be mapped to value 4

```

```

priorityLevelA EMLPP-Priority ::= 6
priorityLevelB EMLPP-Priority ::= 5
priorityLevel0 EMLPP-Priority ::= 0
priorityLevel1 EMLPP-Priority ::= 1
priorityLevel2 EMLPP-Priority ::= 2
priorityLevel3 EMLPP-Priority ::= 3
priorityLevel4 EMLPP-Priority ::= 4

```

END

## 17.7.9 Teleservice Codes

```
MAP-TS-Code {
  ccitt identified-organization (4) etsi (0) mobileDomain (0)
  gsm-Network (1) modules (3) map-TS-Code (19) version4 (4)}
```

DEFINITIONS

::=

BEGIN

```
TeleserviceCode ::= OCTET STRING (SIZE (1))
-- This type is used to represent the code identifying a single
-- teleservice, a group of teleservices, or all teleservices. The
-- services are defined in TS GSM 02.03.
-- The internal structure is defined as follows:

-- bits 87654321: group (bits 8765) and specific service
-- (bits 4321)
```

```
Ext-TeleserviceCode ::= OCTET STRING (SIZE (1..5))
-- This type is used to represent the code identifying a single
-- teleservice, a group of teleservices, or all teleservices. The
-- services are defined in TS GSM 02.03.
-- The internal structure is defined as follows:

-- OCTET 1:
-- bits 87654321: group (bits 8765) and specific service
-- (bits 4321)

-- OCTETS 2-5: reserved for future use. If received the
-- Ext-TeleserviceCode shall be
-- treated according to the exception handling defined for the
-- operation that uses this type.

-- Ext-TeleserviceCode includes all values defined for TeleserviceCode.
```

```
allTeleservices TeleserviceCode ::= '00000000'B
```

```
allSpeechTransmissionServices TeleserviceCode ::= '00010000'B
telephony TeleserviceCode ::= '00010001'B
emergencyCalls TeleserviceCode ::= '00010010'B
```

```
allShortMessageServices TeleserviceCode ::= '00100000'B
shortMessageMT-PP TeleserviceCode ::= '00100001'B
shortMessageMO-PP TeleserviceCode ::= '00100010'B
```

```
allFacsimileTransmissionServices TeleserviceCode ::= '01100000'B
facsimileGroup3AndAlterSpeech TeleserviceCode ::= '01100001'B
automaticFacsimileGroup3 TeleserviceCode ::= '01100010'B
facsimileGroup4 TeleserviceCode ::= '01100011'B
```

```
-- The following non-hierarchical Compound Teleservice Groups
-- are defined in TS GSM 02.30:
allDataTeleservices TeleserviceCode ::= '01110000'B
-- covers Teleservice Groups 'allFacsimileTransmissionServices'
-- and 'allShortMessageServices'
allTeleservices-ExeptSMS TeleserviceCode ::= '10000000'B
-- covers Teleservice Groups 'allSpeechTransmissionServices' and
-- 'allFacsimileTransmissionServices'
--
-- Compound Teleservice Group Codes are only used in call
-- independent supplementary service operations, i.e. they
-- are not used in InsertSubscriberData or in
-- DeleteSubscriberData messages.
```

```
allVoiceGroupCallServices TeleserviceCode ::= '10010000'B
voiceGroupCall TeleserviceCode ::= '10010001'B
voiceBroadcastCall TeleserviceCode ::= '10010010'B
```



<b>allPLMN-specificTS</b>	TeleserviceCode ::= '11010000'B
<b>plmn-specificTS-1</b>	TeleserviceCode ::= '11010001'B
<b>plmn-specificTS-2</b>	TeleserviceCode ::= '11010010'B
<b>plmn-specificTS-3</b>	TeleserviceCode ::= '11010011'B
<b>plmn-specificTS-4</b>	TeleserviceCode ::= '11010100'B
<b>plmn-specificTS-5</b>	TeleserviceCode ::= '11010101'B
<b>plmn-specificTS-6</b>	TeleserviceCode ::= '11010110'B
<b>plmn-specificTS-7</b>	TeleserviceCode ::= '11010111'B
<b>plmn-specificTS-8</b>	TeleserviceCode ::= '11011000'B
<b>plmn-specificTS-9</b>	TeleserviceCode ::= '11011001'B
<b>plmn-specificTS-A</b>	TeleserviceCode ::= '11011010'B
<b>plmn-specificTS-B</b>	TeleserviceCode ::= '11011011'B
<b>plmn-specificTS-C</b>	TeleserviceCode ::= '11011100'B
<b>plmn-specificTS-D</b>	TeleserviceCode ::= '11011101'B
<b>plmn-specificTS-E</b>	TeleserviceCode ::= '11011110'B
<b>plmn-specificTS-F</b>	TeleserviceCode ::= '11011111'B

END

## 17.7.10 Bearer Service Codes

```
MAP-BS-Code {
  ccitt-identified-organization (4) etsi (0) mobileDomain (0)
  gsm-Network (1) modules (3) map-BS-Code (20) version4 (4)}
```

DEFINITIONS

::=

BEGIN

```
BearerServiceCode ::= OCTET STRING (SIZE (1))
-- This type is used to represent the code identifying a single
-- bearer service, a group of bearer services, or all bearer
-- services. The services are defined in TS GSM 02.02.
-- The internal structure is defined as follows:
--
-- plmn-specific bearer services:
-- bits 87654321: defined by the HPLMN operator
--
-- rest of bearer services:
-- bit 8: 0 (unused)
-- bits 7654321: group (bits 7654), and rate, if applicable
-- (bits 321)
```

```
Ext-BearerServiceCode ::= OCTET STRING (SIZE (1..5))
-- This type is used to represent the code identifying a single
-- bearer service, a group of bearer services, or all bearer
-- services. The services are defined in TS GSM 02.02.
-- The internal structure is defined as follows:
--
-- OCTET 1:
-- plmn-specific bearer services:
-- bits 87654321: defined by the HPLMN operator
--
-- rest of bearer services:
-- bit 8: 0 (unused)
-- bits 7654321: group (bits 7654), and rate, if applicable
-- (bits 321)
--
-- OCTETS 2-5: reserved for future use. If received the
-- Ext-TeleserviceCode shall be
-- treated according to the exception handling defined for the
-- operation that uses this type.
--
-- Ext-BearerServiceCode includes all values defined for BearerServiceCode.
```

```
allBearerServices BearerServiceCode ::= '00000000'B
```

allDataCDA-Services	BearerServiceCode ::= '00010000'B
dataCDA-300bps	BearerServiceCode ::= '00010001'B
dataCDA-1200bps	BearerServiceCode ::= '00010010'B
dataCDA-1200-75bps	BearerServiceCode ::= '00010011'B
dataCDA-2400bps	BearerServiceCode ::= '00010100'B
dataCDA-4800bps	BearerServiceCode ::= '00010101'B
dataCDA-9600bps	BearerServiceCode ::= '00010110'B
general-dataCDA	BearerServiceCode ::= '00010111'B

allDataCDS-Services	BearerServiceCode ::= '00011000'B
dataCDS-1200bps	BearerServiceCode ::= '00011010'B
dataCDS-2400bps	BearerServiceCode ::= '00011100'B
dataCDS-4800bps	BearerServiceCode ::= '00011101'B
dataCDS-9600bps	BearerServiceCode ::= '00011110'B
general-dataCDS	BearerServiceCode ::= '00011111'B

allPadAccessCA-Services	BearerServiceCode ::= '00100000'B
padAccessCA-300bps	BearerServiceCode ::= '00100001'B
padAccessCA-1200bps	BearerServiceCode ::= '00100010'B
padAccessCA-1200-75bps	BearerServiceCode ::= '00100011'B
padAccessCA-2400bps	BearerServiceCode ::= '00100100'B
padAccessCA-4800bps	BearerServiceCode ::= '00100101'B
padAccessCA-9600bps	BearerServiceCode ::= '00100110'B
general-padAccessCA	BearerServiceCode ::= '00100111'B

allDataPDS-Services	BearerServiceCode ::= '00101000'B
dataPDS-2400bps	BearerServiceCode ::= '00101100'B
dataPDS-4800bps	BearerServiceCode ::= '00101101'B
dataPDS-9600bps	BearerServiceCode ::= '00101110'B
general-dataPDS	BearerServiceCode ::= '00101111'B

allAlternateSpeech-DataCDA	BearerServiceCode ::= '00110000'B
----------------------------	-----------------------------------

allAlternateSpeech-DataCDS	BearerServiceCode ::= '00111000'B
----------------------------	-----------------------------------

allSpeechFollowedByDataCDA	BearerServiceCode ::= '01000000'B
----------------------------	-----------------------------------

allSpeechFollowedByDataCDS	BearerServiceCode ::= '01001000'B
----------------------------	-----------------------------------

```

-- The following non-hierarchical Compound Bearer Service
-- Groups are defined in TS GSM 02.30:
allDataCircuitAsynchronous      BearerServiceCode ::= '01010000'B
    -- covers "allDataCDA-Services", "allAlternateSpeech-DataCDA" and
    -- "allSpeechFollowedByDataCDA"
allAsynchronousServices        BearerServiceCode ::= '01100000'B
    -- covers "allDataCDA-Services", "allAlternateSpeech-DataCDA",
    -- "allSpeechFollowedByDataCDA" and "allPadAccessCDA-Services"
allDataCircuitSynchronous      BearerServiceCode ::= '01011000'B
    -- covers "allDataCDS-Services", "allAlternateSpeech-DataCDS" and
    -- "allSpeechFollowedByDataCDS"
allSynchronousServices         BearerServiceCode ::= '01101000'B
    -- covers "allDataCDS-Services", "allAlternateSpeech-DataCDS",
    -- "allSpeechFollowedByDataCDS" and "allDataPDS-Services"
--
-- Compound Bearer Service Group Codes are only used in call
-- independent supplementary service operations, i.e. they
-- are not used in InsertSubscriberData or in
-- DeleteSubscriberData messages.
    
```

allPLMN-specificBS	BearerServiceCode ::= '11010000'B
plmn-specificBS-1	BearerServiceCode ::= '11010001'B
plmn-specificBS-2	BearerServiceCode ::= '11010010'B
plmn-specificBS-3	BearerServiceCode ::= '11010011'B
plmn-specificBS-4	BearerServiceCode ::= '11010100'B
plmn-specificBS-5	BearerServiceCode ::= '11010101'B
plmn-specificBS-6	BearerServiceCode ::= '11010110'B
plmn-specificBS-7	BearerServiceCode ::= '11010111'B
plmn-specificBS-8	BearerServiceCode ::= '11011000'B
plmn-specificBS-9	BearerServiceCode ::= '11011001'B
plmn-specificBS-A	BearerServiceCode ::= '11011010'B
plmn-specificBS-B	BearerServiceCode ::= '11011011'B
plmn-specificBS-C	BearerServiceCode ::= '11011100'B
plmn-specificBS-D	BearerServiceCode ::= '11011101'B
plmn-specificBS-E	BearerServiceCode ::= '11011110'B
plmn-specificBS-F	BearerServiceCode ::= '11011111'B

END

### 17.7.11 Extension data types

```
MAP-ExtensionDataTypes {
    ccitt identified-organization (4) etsi (0) mobileDomain (0)
    gsm-Network (1) modules (3) map-ExtensionDataTypes (21) version4 (4)}
```

DEFINITIONS

IMPLICIT TAGS

::=

BEGIN

EXPORTS

```
    PrivateExtension,
    ExtensionContainer;
```

-- IOC for private MAP extensions

```
MAP-EXTENSION ::= CLASS {
    &ExtensionType                                OPTIONAL,
    &extensionId                                OBJECT IDENTIFIER }
-- The length of the Object Identifier shall not exceed 16 octets and the
-- number of components of the Object Identifier shall not exceed 16
```

-- data types

```
ExtensionContainer ::= SEQUENCE {
    privateExtensionList [0]PrivateExtensionList OPTIONAL,
    pcs-Extensions [1]PCS-Extensions OPTIONAL,
    ...}
```

```
PrivateExtensionList ::= SEQUENCE SIZE (1..maxNumOfPrivateExtensions) OF
    PrivateExtension
```

```
PrivateExtension ::= SEQUENCE {
    extId                                MAP-EXTENSION.&extensionId
                                        ({ExtensionSet}),
    extType                                MAP-EXTENSION.&ExtensionType
                                        ({ExtensionSet}@extId) OPTIONAL}
```

```
maxNumOfPrivateExtensions INTEGER ::= 10
```

```
ExtensionSet                                MAP-EXTENSION ::=
    {...
    -- ExtensionSet is the set of all defined private extensions
    }
-- Unsupported private extensions shall be discarded if received.
```

```
PCS-Extensions ::= SEQUENCE {
    ...}
```

END

### 17.7.12 Group Call data types

```
MAP-GR-DataTypes {
    ccitt identified-organization (4) etsi (0) mobileDomain (0)
    gsm-Network (1) modules (3) map-GR-DataTypes (23) version4 (4)}
```

DEFINITIONS

IMPLICIT TAGS

::=

BEGIN

EXPORTS

```

PrepareGroupCallArg,
PrepareGroupCallRes,
SendGroupCallEndSignalArg,
SendGroupCallEndSignalRes,
ForwardGroupCallSignallingArg,
ProcessGroupCallSignallingArg
;

```

IMPORTS

```

ISDN-AddressString,
IMSI,
EMLPP-Priority,
ASCII-CallReference

```

```

FROM MAP-CommonDataTypes {
ccitt identified-organization (4) etsi (0) mobileDomain (0)
gsm-Network (1) modules (3) map-CommonDataTypes (18) version4 (4)}

```

```

Ext-TeleserviceCode

```

```

FROM MAP-TS-Code {
ccitt identified-organization (4) etsi (0) mobileDomain (0)
gsm-Network (1) modules (3) map-TS-Code (19) version4 (4)}

```

```

Kc

```

```

FROM MAP-MS-DataTypes {
ccitt identified-organization (4) etsi (0) mobileDomain (0)
gsm-Network (1) modules (3) map-MS-DataTypes (11) version4 (4)}

```

```

ExtensionContainer

```

```

FROM MAP-ExtensionDataTypes {
ccitt identified-organization (4) etsi (0) mobileDomain (0)
gsm-Network (1) modules (3) map-ExtensionDataTypes (21) version4 (4)}
;

```

<b>PrepareGroupCallArg ::= SEQUENCE {</b>		
teleservice	Ext-TeleserviceCode,	
asciiCallReference	ASCII-CallReference,	
codec-Info	CODEC-Info,	
cipheringAlgorithm	CipheringAlgorithm,	
groupKeyNumber	[0]GroupKeyNumber	OPTIONAL,
groupKey	[1]Kc	OPTIONAL,
priority	[2]EMLPP-Priority	OPTIONAL,
uplinkFree	[3] NULL	OPTIONAL,
extensionContainer	[4] ExtensionContainer	OPTIONAL,
...}		

<b>PrepareGroupCallRes ::= SEQUENCE {</b>		
groupCallNumber	ISDN-AddressString,	
extensionContainer	ExtensionContainer	OPTIONAL,
...}		

<b>SendGroupCallEndSignalArg ::= SEQUENCE {</b>		
imsi	IMSI	OPTIONAL,
extensionContainer	ExtensionContainer	OPTIONAL,
...}		

<b>SendGroupCallEndSignalRes ::= SEQUENCE {</b>		
extensionContainer	ExtensionContainer	OPTIONAL,
...}		

<b>ForwardGroupCallSignallingArg ::= SEQUENCE {</b>		
imsi	IMSI	OPTIONAL,
uplinkRequestAck	[0] NULL	OPTIONAL,
uplinkReleaseIndication	[1] NULL	OPTIONAL,
uplinkRejectCommand	[2] NULL	OPTIONAL,
uplinkSeizedCommand	[3] NULL	OPTIONAL,
uplinkReleaseCommand	[4] NULL	OPTIONAL,
extensionContainer	ExtensionContainer	OPTIONAL,
...}		

```

ProcessGroupCallSignallingArg ::= SEQUENCE {
    uplinkRequest          [0] NULL          OPTIONAL,
    uplinkReleaseIndication [1] NULL          OPTIONAL,
    releaseGroupCall       [2] NULL          OPTIONAL,
    extensionContainer     ExtensionContainer OPTIONAL,
    ...}

```

```

GroupKeyNumber ::= INTEGER (0..15)

```

```

CODEC-Info ::= OCTET STRING (SIZE (5..10))
-- Refers to channel type
-- coded according to GSM 08.08

```

```

CipheringAlgorithm ::= OCTET STRING (SIZE (1))
-- Refers to 'permitted algorithms' in 'encryption information'
-- coded according to GSM 08.08:

-- Bits 8-1
-- 8765 4321
-- 0000 0001          No encryption
-- 0000 0010          GSM A5/1
-- 0000 0100          GSM A5/2
-- 0000 1000          GSM A5/3
-- 0001 0000          GSM A5/4
-- 0010 0000          GSM A5/5
-- 0100 0000          GSM A5/6
-- 1000 0000          GSM A5/7

```

END

---

## 18 General on MAP user procedures

### 18.1 Introduction

Clauses 18 to 25 describe the use of MAP services for GSM signalling procedures. GSM signalling procedures may involve one or several interfaces running one or several application protocols. The present document addresses only the signalling procedures which require at least the use of one MAP service.

When a signalling procedure takes place in the network, an application process invocation is created in each system component involved. Part of the application process invocation acts as a MAP user and handles one or several MAP dialogues. For each dialogue it employs an instance of the MAP service provider. It may also use other communication services to exchange information on other interfaces, but detailed description of these aspects is outside the scope of the present document.

### 18.2 Common aspects of user procedure descriptions

#### 18.2.1 General conventions

For each signalling procedure the present document provides a brief textual overview accompanied by a flow diagram which represent the functional interactions between system components. Functional interactions are labelled using the MAP service name when the interaction results from a service request or by this service name followed by the symbol "ack" when this interaction results from a service response.

For each of the system components involved, the present document also provides a detailed textual description of the application process behaviour as well as an SDL diagram. SDL diagrams describe the sequence of events, as seen by the MAP-User, which occurs at MAP service provider boundaries as well as external events which occur at other interfaces and which impact on the previous sequence.

External events do not necessarily correspond to the messages of other protocols used in the system component. The MAP-user procedures are described as if a set of interworking functions (IWF) between the MAP-user and the other protocol entities was implemented (see figure 18.2/1). Such interworking functions are assumed to perform either an identity mapping or some processing or translation as required to eliminate information irrelevant to the MAP-user.

The mapping of service primitives on to protocol elements is described in clauses 14 to 17.

GSM signalling procedures are built from one or more sub-procedures (e.g. authentication, ciphering, ....). Sub-procedures from which signalling procedures are built are represented using SDL MACRO descriptions.

In case of any discrepancy between the textual descriptions and the SDL descriptions, the latter take precedence.

## 18.2.2 Naming conventions

Events related to MAP are represented by MAP service primitives. The signal names used in the SDL diagrams are derived from the service primitive names defined in clauses 7 to 12, with some lexical transformations for readability and parsability purposes (blanks between words are replaced by underscores, the first letter of each word is capitalized).

Events received and sent on other interfaces are named by appending the message or signal name to a symbol representing the interface type, with some lexical transformations for readability and parsability purposes (blanks between words are replaced by underscores, the first letter of each word is capitalized).

The following symbols are used to represent the interface types:

- "I": For interfaces to the fixed network. "I" stands for ISUP interface.
- "A": For interfaces to BSS (i.e. A-interfaces);
- "OM": For network management interfaces (communication with OMC, MML interface, ...);
- "SC": For interfaces to a Service Centre;
- "HO\_CA": For internal interfaces to the Handover Control Application.
- "US": For a local USSD application.

These naming conventions can be summarized by the following BNF description:

```

<Event_Name> ::= <MAP_Primitive> | <External_Event>

<MAP_Primitive> ::= <MAP_Open> | <MAP_Close> | <MAP_U_Abort> | <MAP_P_Abort> |
<MAP_Specific> | <MAP_Notice>

<MAP_Open> ::= MAP_Open_Req | MAP_Open_Ind | MAP_Open_Rsp | MAP_Open_Cnf

<MAP_Close> ::= MAP_Close_Req | MAP_Close_Ind

<MAP_U_Abort> ::= MAP_U_Abort_Req | MAP_U_Abort_Ind

<MAP_P_Abort> ::= MAP_P_Abort_Ind

<MAP_Notice> ::= MAP_Notice_Ind

<MAP_Specific> ::= <MAP_Req> | <MAP_Ind> | <MAP_Rsp> | <MAP_Cnf>

<MAP_Req> ::= MAP_<Service_Name>_Req

<MAP_Ind> ::= MAP_<Service_Name>_Ind

<MAP_Rsp> ::= MAP_<Service_Name>_Rsp

<MAP_Cnf> ::= MAP_<Service_Name>_Cnf

<External_Event> ::= <Interface_Type>_<External_Signal>

<Interface_Type> ::= I | A | OM | SC | HO AC | US

```

<External\_Signal> ::= <Lexical\_Unit>  
 <Service\_Name> ::= <Lexical\_Unit>  
 <Lexical\_Unit> ::= <Lexical\_Component> | <Lexical\_Unit>\_<Lexical\_Component>  
 <Lexical\_Component> ::= <Upper\_Case\_Letter><Letter\_Or\_Digit\_List>  
 <Letter\_Or\_Digit\_List> ::= <Letter\_Or\_Digit> | <Letter\_Or\_Digit\_List><Letter\_Or\_Digit>  
 <Letter\_Or\_Digit> ::= <Letter> | <Digit>  
 <Letter> ::= <Lower\_Case\_Letter> | <Upper\_Case\_Letter>  
 <Upper\_Case\_Letter> ::= A|B|C|D|E|F|G|H|I|J|K|L|M|N|O|P|Q|R|S|T|U|V|W|X|Y|Z  
 <Lower\_Case\_Letter> ::= a|b|c|d|e|f|g|h|i|j|k|l|m|n|o|p|q|r|s|t|u|v|w|x|y|z  
 <Digit> ::= 1|2|3|4|5|6|7|8|9|0

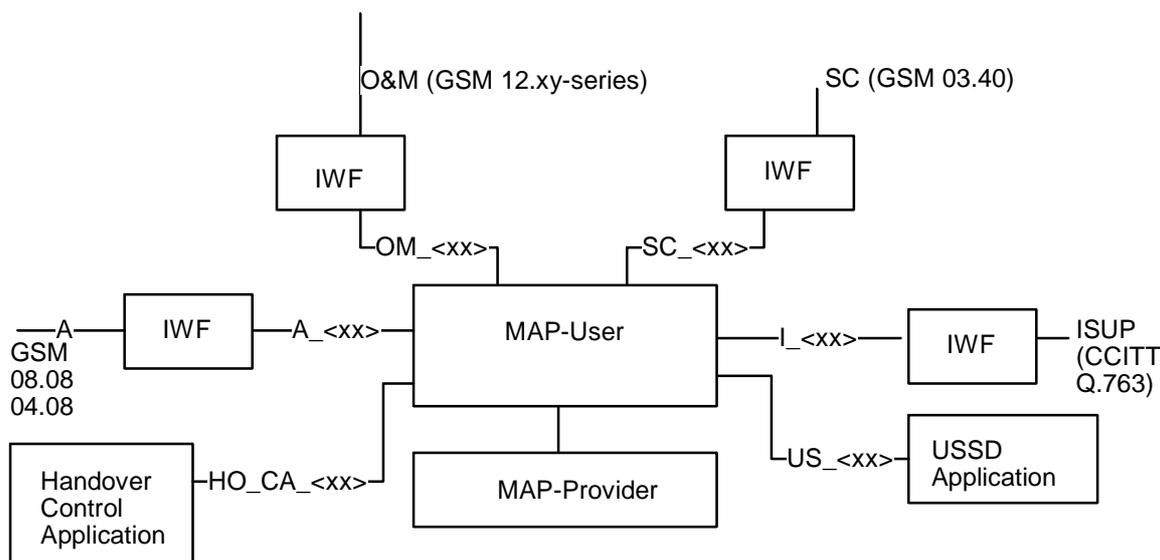

Figure 18.2/1: Interfaces applicable to the MAP-User

## 18.2.3 Convention on primitives parameters

### 18.2.3.1 Open service

When the originating and destination reference parameters shall be included in the MAP-OPEN request primitive, their value are indicated as a comment to the signal which represents this primitive.

### 18.2.3.2 Close service

When a pre-arranged released is requested, a comment is attached to the signal which represents the MAP-CLOSE request primitive. In the absence of comment, a normal release is assumed.

## 18.2.4 Version handling at dialogue establishment

Unless explicitly indicated in subsequent clauses, the following principles regarding version handling procedures at dialogue establishment are applied by the MAP-user:

### 18.2.4.1 Behaviour at the initiating side

When a MAP user signalling procedure has to be executed, the MAP-user issues a MAP-OPEN request primitive with an appropriate application-context-name. If several names are supported (i.e. several versions) a suitable one is selected using the procedures described in clause 5.

If version 2 is selected and a MAP-OPEN Confirm primitive in response to the MAP-OPEN request is received with a result parameter set to "refused" and a diagnostic parameter indicating "application-context-not-supported" or "potential incompatibility problem", the MAP-User issues a new MAP-OPEN request primitive with the equivalent version one context. This is informally represented in the SDL diagrams by a task symbol indicating "Perform Vr procedure".

If version 3 is selected and a MAP-OPEN Confirm primitive in response to the MAP-OPEN request is received with a result parameter set to "refused" and a diagnostic parameter indicating "application-context-not-supported" or "potential incompatibility problem", the MAP-User issues a new MAP-OPEN request primitive with the equivalent version one or version two context. This is informally represented in the SDL diagrams by task symbols indicating "Perform Vr procedure".

### 18.2.4.2 Behaviour at the responding side

On receipt of a MAP-OPEN indication primitive, the MAP-User analyses the application-context-name.

If it refers to a version one context, the associated V1 procedure is executed; if it refers to a version two context, the associated V2 procedure is executed, otherwise the associated V3 procedure is executed.

## 18.2.5 Abort Handling

Unless explicitly indicated in subsequent clauses, the following principles are applied by the MAP-user regarding abort handling procedures:

On receipt of a MAP-P-ABORT indication or MAP-U-ABORT Indication primitive from any MAP-provider invocation, the MAP-User issues a MAP-U-ABORT Request primitive to each MAP-provider invocation associated with the same user procedure.

If applicable a decision is made to decide if the affected user procedure has to be retried or not.

## 18.2.6 SDL conventions

The MAP SDLs make use of a number of SDL concepts and conventions, where not all of them may be widely known. Therefore, this clause outlines the use of a few concepts and conventions to improve understanding of the MAP SDLs.

The MAP User SDLs make use of SDL Processes, Procedures and Macros. Processes are independent from each other even if one process starts another one: The actions of both of them have no ordering in time. SDL Procedures and Macros are just used to ease writing of the specification: They contain parts of a behaviour used in several places, and the corresponding Procedure/Macro definition has to be expanded at the position of the Procedure/Macro call.

All Processes are started at system initialization and live forever, unless process creation/termination is indicated explicitly (i.e. a process is created by some other process).

The direction of Input/Output Signals in the SDL graphs is used to indicate the entity to which/from which communication is directed. If a process A communicates in parallel with processes B and C, all Inputs/Outputs to/from B are directed to one side, whereas communication with C is directed to the other side. However, there has been no formal convention used that communication to a certain entity (e.g. a HLR) will always be directed to a certain side (e.g. right).



In each state all those Input Signals are listed, which result in an action and/or state change. If an Input Signal is not listed in a state, receipt of this input should lead to an implicit consumption without any action or state change (according to the SDL rules). This implicit consumption is mainly used for receipt of the MAP DELIMITER indication and for receipt of a MAP CLOSE indication, except for a premature MAP CLOSE.

## 18.3 Interaction between MAP Provider and MAP Users

Each MAP User is defined by at least one SDL process. On the dialogue initiating side the MAP User will create a new instance of a MAP Provider implicit by issuing a MAP-OPEN request. This instance corresponds to a TC Dialogue and lives as long as the dialogue exists (see also clause 14.3). There is a fix relation between MAP User and this Provider instance, i.e. all MAP service primitives from the MAP User for this dialogue are sent to this instance and all TC components received by this MAP Provider are mapped onto service primitives sent to this MAP User.

On the receiving side a MAP Provider instance is created implicit by receipt of a TC BEGIN indication. The corresponding MAP User is determined by the Application Context name included in this primitive, i.e. each Application Context is associated with one and only one MAP User. An instance of this User will be created implicit by receiving a MAP-OPEN indication. Note that in some cases there exist several SDL Processes for one MAP User (Application Context), e.g. the processes Register\_SS\_HLR, Erase\_SS\_HLR, Activate\_SS\_HLR, Deactivate\_SS\_HLR, Interrogate\_SS\_HLR, and Register\_Password for the AC Network\_Functional\_SS\_Handling. In these cases, a coordinator process is introduced acting as a MAP User, which in turn starts a sub-process depending on the first MAP service primitive received.

---

# 19 Mobility procedures

## 19.1 Location management Procedures

For non-GPRS subscribers, this clause comprises a number of processes to handle the mobile nature of the subscriber. The processes will be addressed by SCCP Sub-System Number (MSC, VLR or HLR) and the Application Context. The following processes are defined in this clause:

Process Update Location Area:

Initiator: Update\_Location\_Area\_MSC, clause 19.1.1.2;

Responder: Update\_Location\_Area\_VLR, clause 19.1.1.3;

Process Update Location:

Initiator: Update\_Location\_Area\_VLR, clause 19.1.1.3, or

Update\_Location\_VLR, clause 19.1.1.6;

Responder: Update\_Location\_HLR, clause 19.1.1.4;

Process Send Identification:

Initiator: Update\_Location\_Area\_VLR, clause 19.1.1.3;

Responder: Send\_Identification\_VLR, clause 19.1.1.5;

Process Subscriber Present HLR:

Initiator: Subscriber\_Present\_HLR, clause 19.1.1.7;

Responder: Short\_Message\_Alert\_IW MSC, clause 23.4.3;

Process Cancel Location:

Initiator: Cancel\_Location\_HLR, clause 19.1.2.2;

Responder: Cancel\_Location\_VLR, clause 19.1.2.3;

Process Detach IMSI:

Initiator: Detach\_IMSI\_MSC, clause 19.1.3.2;

Responder: Detach\_IMSI\_VLR, clause 19.1.3.3.

Process Purge MS:

Initiator: Purge\_MS\_VLR, clause 19.1.4.2;

Responder: Purge\_MS\_HLR, clause 19.1.4.3.

As both the Update Location Area and the Detach IMSI processes use the same application context name, the MAP Provider cannot distinguish between them. Therefore, a Location Management Coordinator Process will act as one user for this application context. This process (one in MSC, one in VLR) will create the Update Location Area or the Detach IMSI process, depending on the first service primitive received in the respective dialogue.

Additionally, a Location Management Coordinator process in the HLR coordinates the two application processes "Update Location HLR" (clause 19.1.1.4) and "RESTORE\_DATA\_HLR" (clause 19.3.3) that are addressed by the same application context.

### **Location Management Coordinator MSC**

On receipt of a request for location updating from the A-interface, the Location Management Coordinator in the MSC will:

- create the process Update\_Location\_Area\_MSC in case the updating type indicated in the A-interface primitive indicates normal updating, periodic updating or IMSI Attach;
- create the process Detach\_IMSI\_MSC in case the updating type indicated in the A-interface primitive indicates IMSI Detach.

The respective primitive is then forwarded to the created process. Henceforth, the coordinator will relay all service primitives from provider to the user and vice versa, until a request or indication for dialogue termination is received. This last primitive will be relayed, too, before the Coordinator process returns to idle state.

### **Location Management Coordinator VLR**

On receipt of a dialogue request for the Location Management Application Context (see Receive\_Open\_Ind macro in clause 25.1), the Location\_Management\_Coordinator will:

- terminate the procedure in case of parameter problems or if the MSC indicated version Vr protocol; or
- continue as below, if the dialogue is accepted.

Depending on the first service primitive received from the MAP Provider in this dialogue, the user process is created:

- Update\_Location\_Area\_VLR in case the primitive is a MAP\_UPDATE\_LOCATION\_AREA indication;
- Detach\_IMSI\_VLR in case the primitive is a MAP\_DETACH\_IMSI indication.

In case a MAP\_U\_ABORT, MAP\_P\_ABORT or a premature MAP\_CLOSE indication is received instead, the process returns to idle state. If a MAP\_NOTICE indication is received, the dialogue towards the MSC is aborted and the process returns to idle state.

After creation of the user process the service primitive received from the provider is passed to the user process. Henceforth, the coordinator will relay all service primitives from provider to the user and vice versa, until a request or indication for dialogue termination is received. This last primitive will be relayed, too, before the Coordinator process returns to idle state.

### **Location Management Coordinator HLR**

On receipt of a dialogue request for the Location Management Application Context (see Receive\_Open\_Ind macro in clause 25.1), the Location\_Management\_Coordinator will:

- terminate the process in case of parameter problems; or

- revert to MAP version Vr protocol if the VLR requests version Vr protocol; or
- continue as described in the following, if the dialogue is accepted.

The user process is created depending on the first service primitive received from the MAP service provider within this dialogue:

- Update\_Location\_HLR if the primitive is a MAP\_UPDATE\_LOCATION indication;
- RESTORE\_DATA\_HLR if the primitive is a MAP\_RESTORE\_DATA indication.

If a MAP\_NOTICE indication is received instead, the dialogue towards the MSC is terminated and the process returns to idle state.

After creation of the user process the service primitive received from the MAP service-provider is passed to the user process. Henceforth, the coordinator will relay all service primitives from MAP service-provider to the MAP service-user and vice versa, until a request or indication for dialogue termination is received. This last primitive will be relayed, too, before the Coordinator process returns to idle state.

For GPRS subscribers, this clause comprises a number of other processes to handle the mobile nature of the subscriber. The processes will be addressed by SCCP Sub-System Number (SGSN or HLR) and the Application Context. The following processes are defined in this clause:

Process GPRS Update Location:

Initiator: GPRS\_Update\_Location\_Area\_VLR, clause 19.1.1.3, or  
SGSN\_Update\_HLR, clause 19.1.1.8,

Responder: Update\_GPRS\_Location\_HLR, clause 19.1.1.4;

Process Cancel Location:

Initiator: Cancel\_GPRS\_Location\_HLR, clause 19.1.2.2;

Responder: Cancel\_Location\_SGSN, clause 19.1.2.4;

Process Purge MS:

Initiator: Purge\_MS\_SGSN, clause 19.1.4.4;

Responder: Purge\_MS\_HLR, clause 19.1.4.3.

The following existing process is also used for GPRS subscribers :

Process Subscriber Present HLR:

Initiator: Subscriber\_Present\_HLR, clause 19.1.1.7;

Responder: Short\_Message\_Alert\_IW MSC, clause 23.4.3;

Process Location\_Management\_Coordinator\_MSC

19.1\_1(1)

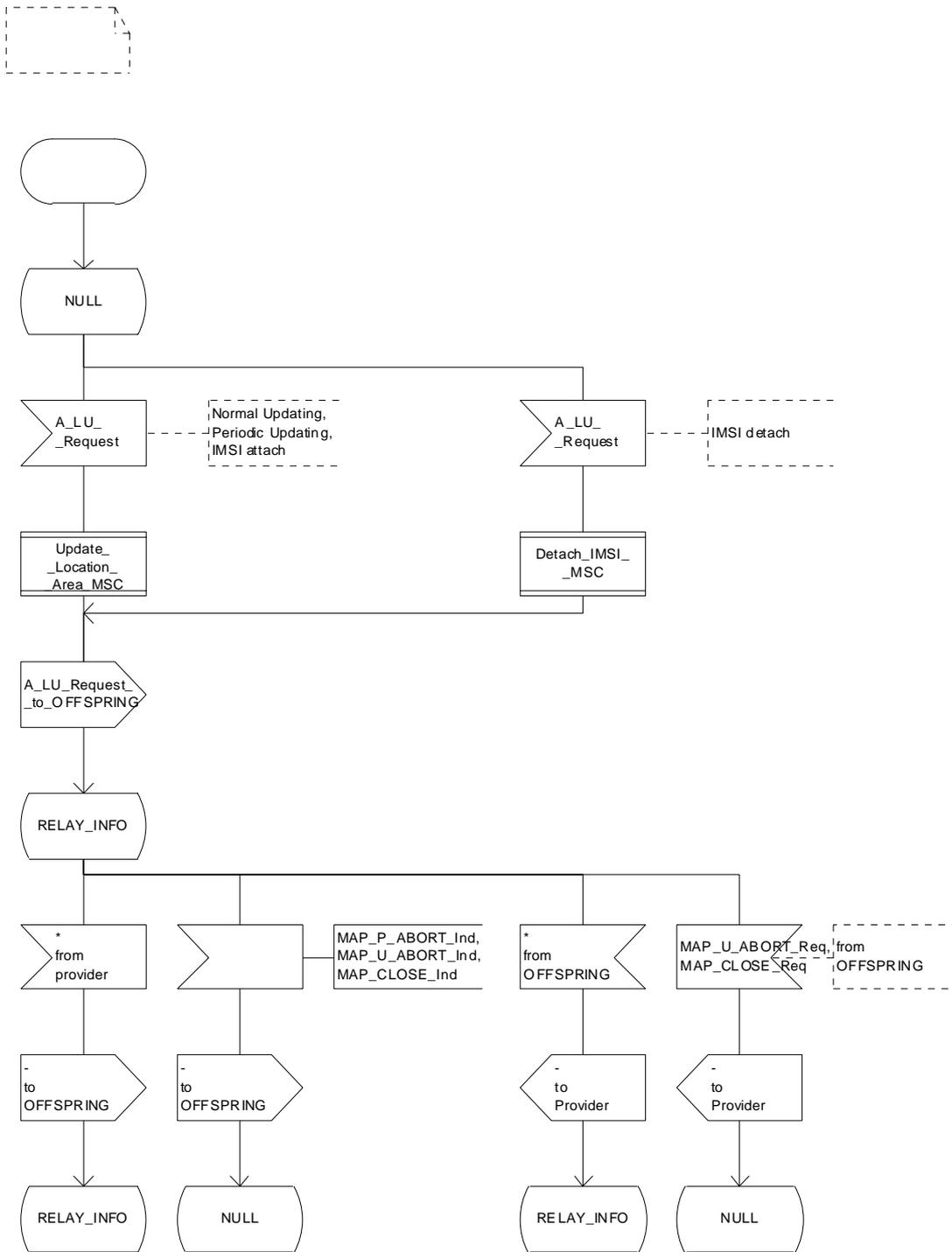

Figure 16.1/1

Figure 19.1/1: Process Location\_Management\_Coordinator\_MSC

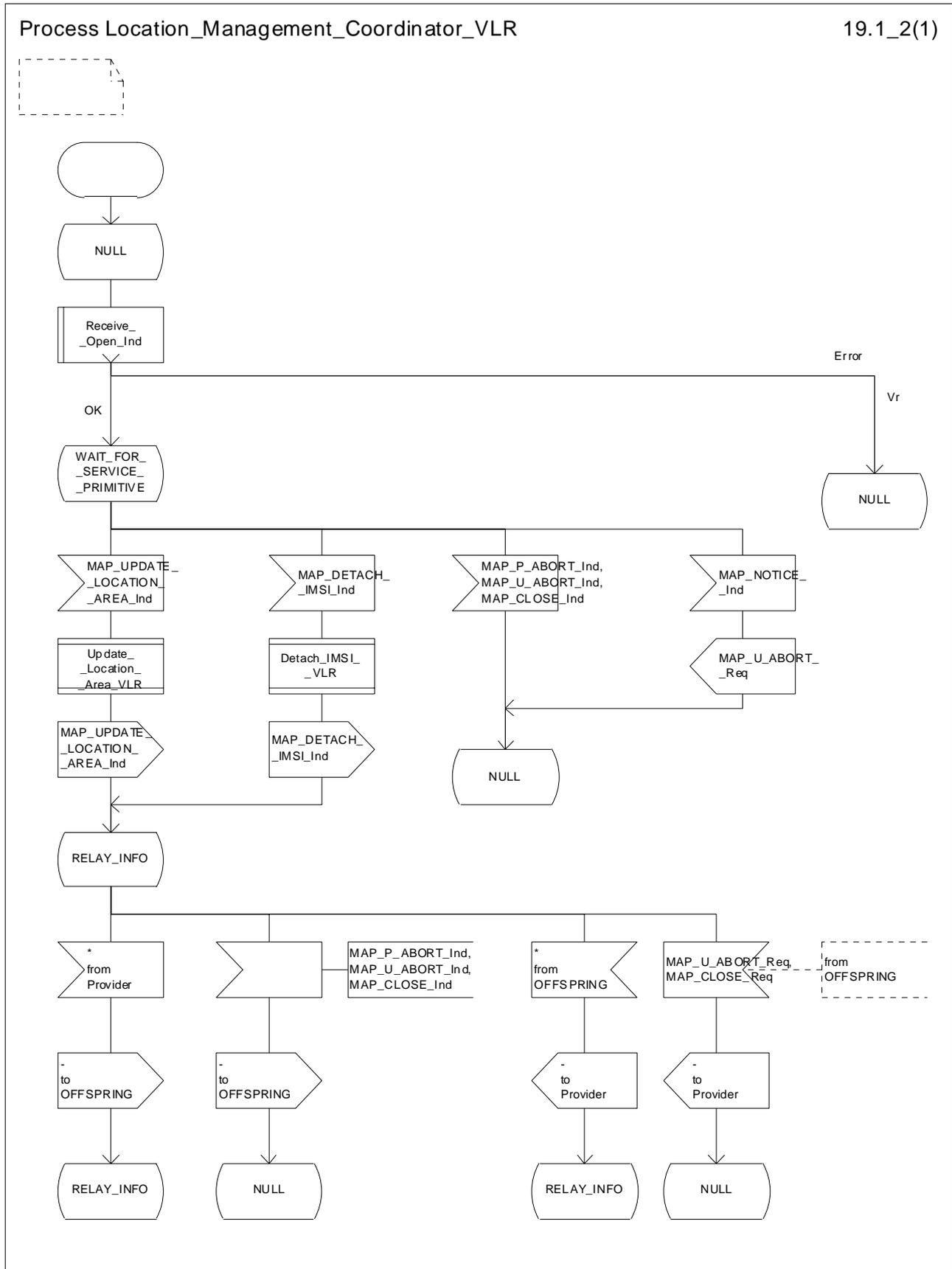

Figure 19.1/2: Process Location\_Management\_Coordinator\_VLR

Process Location\_Management\_Coordinator\_HLR

19.1\_3(1)

Figure 19.1/3  
Location management coordination process in the HLR

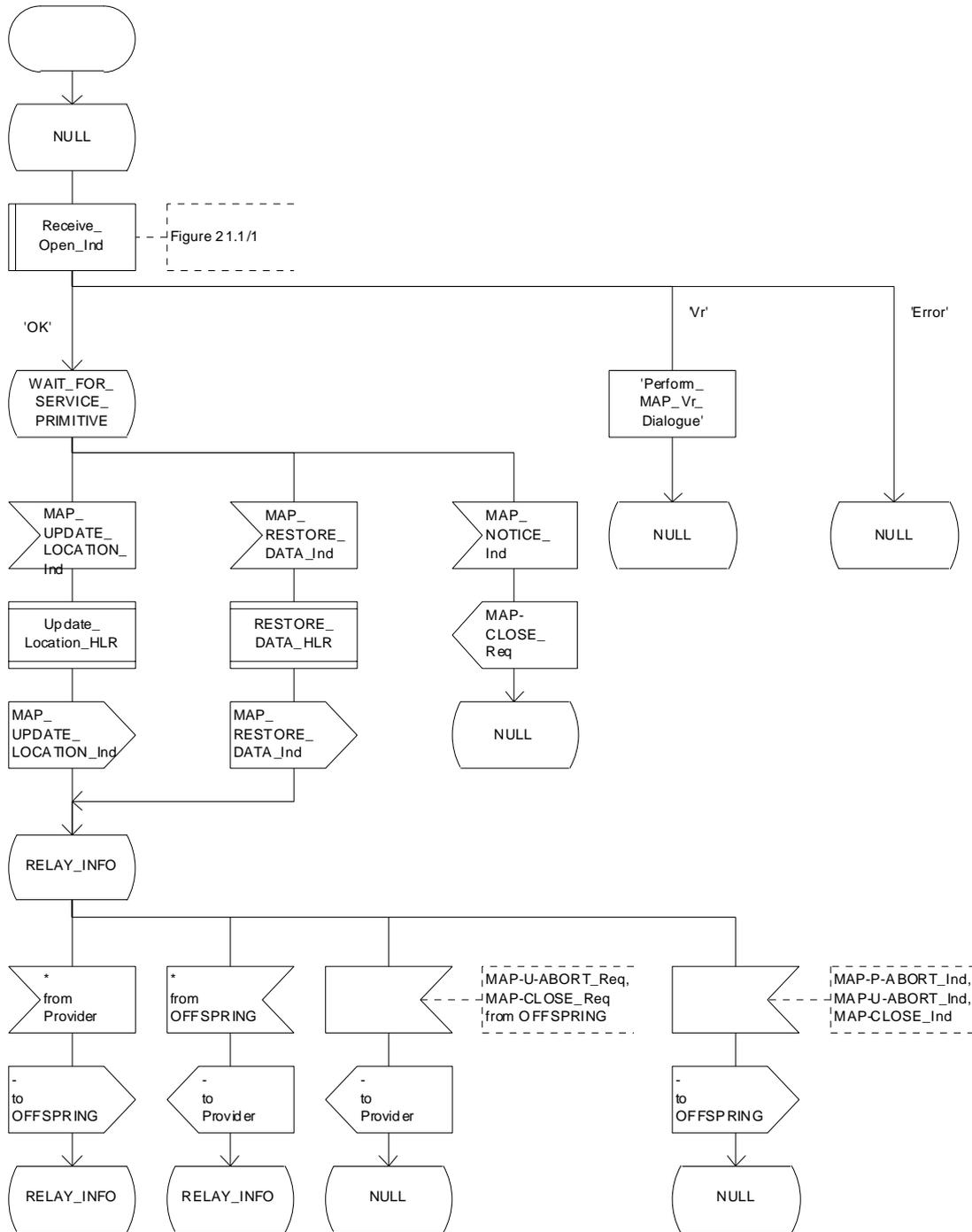

Figure 19.1/3: Process Location\_Management\_Coordinator\_HLR

## 19.1.1 Location updating

### 19.1.1.1 General

The location updating procedure is used to update the location information held in the network. For GPRS subscribers, this procedure describes also updating of the SGSN and, if Gs interface is installed, updating of the VLR in combination with an attach/routing area updating in the SGSN. This location information is used to route incoming calls, packet data, short messages and unstructured supplementary service data to the roaming subscriber. Additionally, this procedure is used to provide the VLR and/or the SGSN with the information that a subscriber already registered, but being detached, is reachable again (IMSI Attach and/or GPRS Attach, see GSM 03.12 and GSM 03.60). The use of the IMSI Detach / Attach feature is optional for the network operator.

To minimize the updates of the subscriber's HLR, the HLR holds only information about the VLR and MSC the subscriber is attached to and, for GPRS subscribers, the SGSN the subscriber is attached to. The VLR and the SGSN contain more detailed location information, i.e. the location area the subscriber is actually roaming in (for the VLR) and the routing area (RA) where the GPRS subscriber is located (for SGSN). Therefore, the VLR needs to be updated at each location area change (see figure 19.1.1/1 for this procedure) and the SGSN needs to be updated at each routing area change. The HLR needs updating only in the following cases:

- when the subscriber registers in a new VLR or SGSN, i.e. the VLR or SGSN has no data for that subscriber;
- when the subscriber registers in a new location area of the same VLR and new routing information is to be provided to the HLR (change of MSC area);
- if the indicator "Confirmed by HLR" or the indicator "Location Information Confirmed in HLR" is set to "Not Confirmed" because of HLR, VLR or SGSN restoration, and the VLR or SGSN receives an indication that the subscriber is present.

If a mobile subscriber registers in a visitor location register (VLR) not holding any information about this subscriber and is identified by a temporary mobile subscriber identity (TMSI) allocated by a previous visitor location register (PVLRL), if the PVLRL identity can be derived from LAI the new VLR must obtain the IMSI from PVLRL to identify the HLR to be updated (see figure 19.1.1/2). If the IMSI cannot be retrieved from PVLRL, it is requested from the MS (see figure 19.1.1/3).

The stage 2 specification for GPRS is in GSM 03.60. The interworking between the MAP signalling procedures and the GPRS procedures in the SGSN is shown by the transfer of signals between these procedures (see clause 19.1.1.8).

The message flow for successful GPRS Attach/ RA update procedure (with Gs interface not installed) is shown in figure 19.1.1/4.

The message flow for successful GPRS Attach/ RA update procedure combined with a successful VLR location updating (Gs interface installed) is shown in figure 19.1.1/5.

The following MAP services are invoked by the location update procedure:

MAP\_UPDATE\_LOCATION\_AREA (see clause 8.1);(\*\*)  
 MAP\_UPDATE\_LOCATION (see clause 8.1);(\*\*)  
 MAP\_UPDATE\_GPRS\_LOCATION (see clause 8.1) (\*);  
 MAP\_CANCEL\_LOCATION (see clause 8.1);  
 MAP\_INSERT\_SUBSCRIBER\_DATA (see clause 8.8);  
 MAP\_SEND\_IDENTIFICATION (see clause 8.1) (\*\*);  
 MAP\_PROVIDE\_IMSI (see clause 8.9) (\*\*);  
 MAP\_AUTHENTICATE (see clause 8.5) (\*\*);  
 MAP\_SET\_CIPHERING\_MODE (see clause 8.6) (\*\*);  
 MAP\_FORWARD\_NEW\_TMSI (see clause 8.9) (\*\*);

MAP\_CHECK\_IMEI (see clause 8.7) (\*\*);  
 MAP\_ACTIVATE\_TRACE\_MODE (see clause 9.2);  
 MAP\_TRACE\_SUBSCRIBER\_ACTIVITY (see clause 9.2) (\*\*).

(\*): only used in SGSN and HLR for GPRS

(\*\*): not used in SGSN

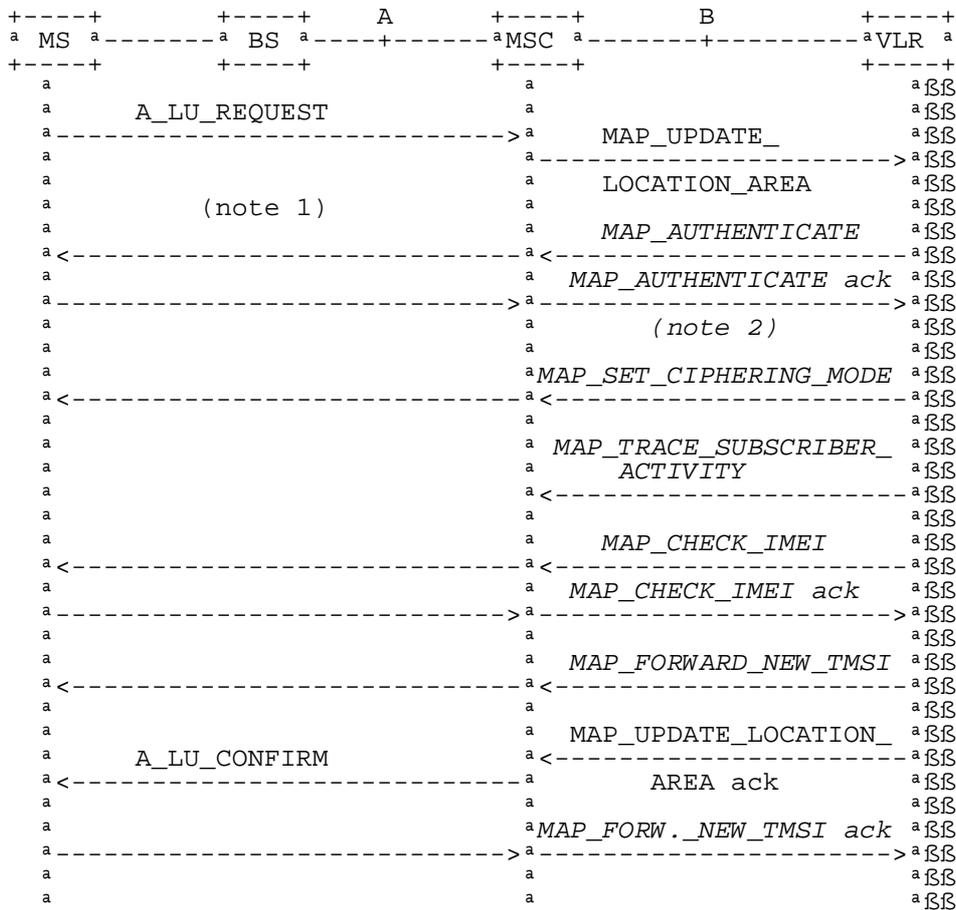

NOTE 1: For details of the procedure on the radio path, see GSM 04.08. The services shown in dotted lines indicate the trigger provided by the signalling on the radio path, and the signalling triggered on the radio path.

NOTE 2: Optional services are printed in *italics*.

**Figure 19.1.1/1: Interface and services for location updating when roaming within an visitor location registers area (without need to update HLR)**





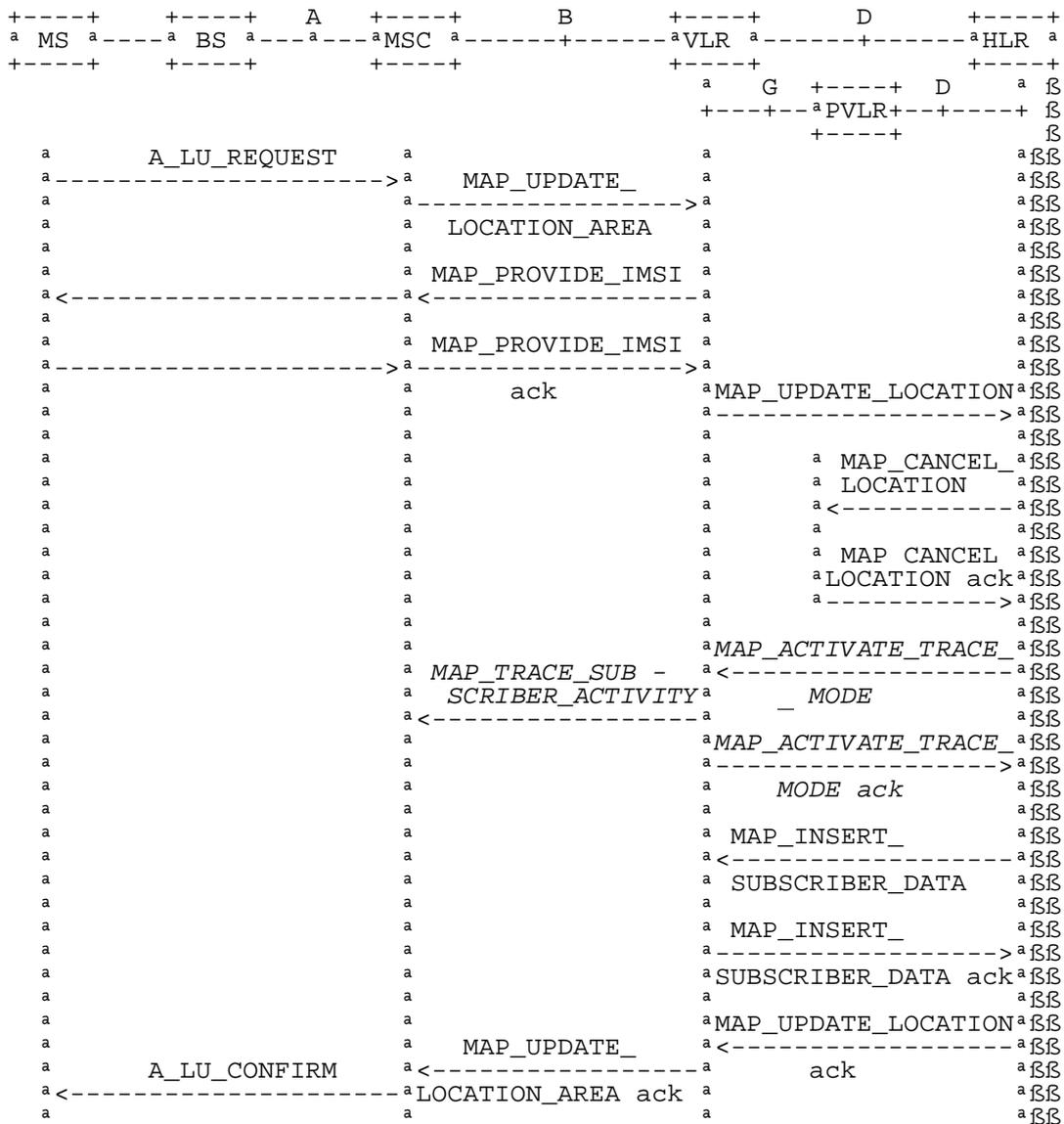

NOTE: The optional procedures in figure 19.1.1/1 apply here respectively.

Figure 19.1.1/3: Interface and services for location updating involving both a VLR and an HLR, when IMSI can not be retrieved from the previous VLR



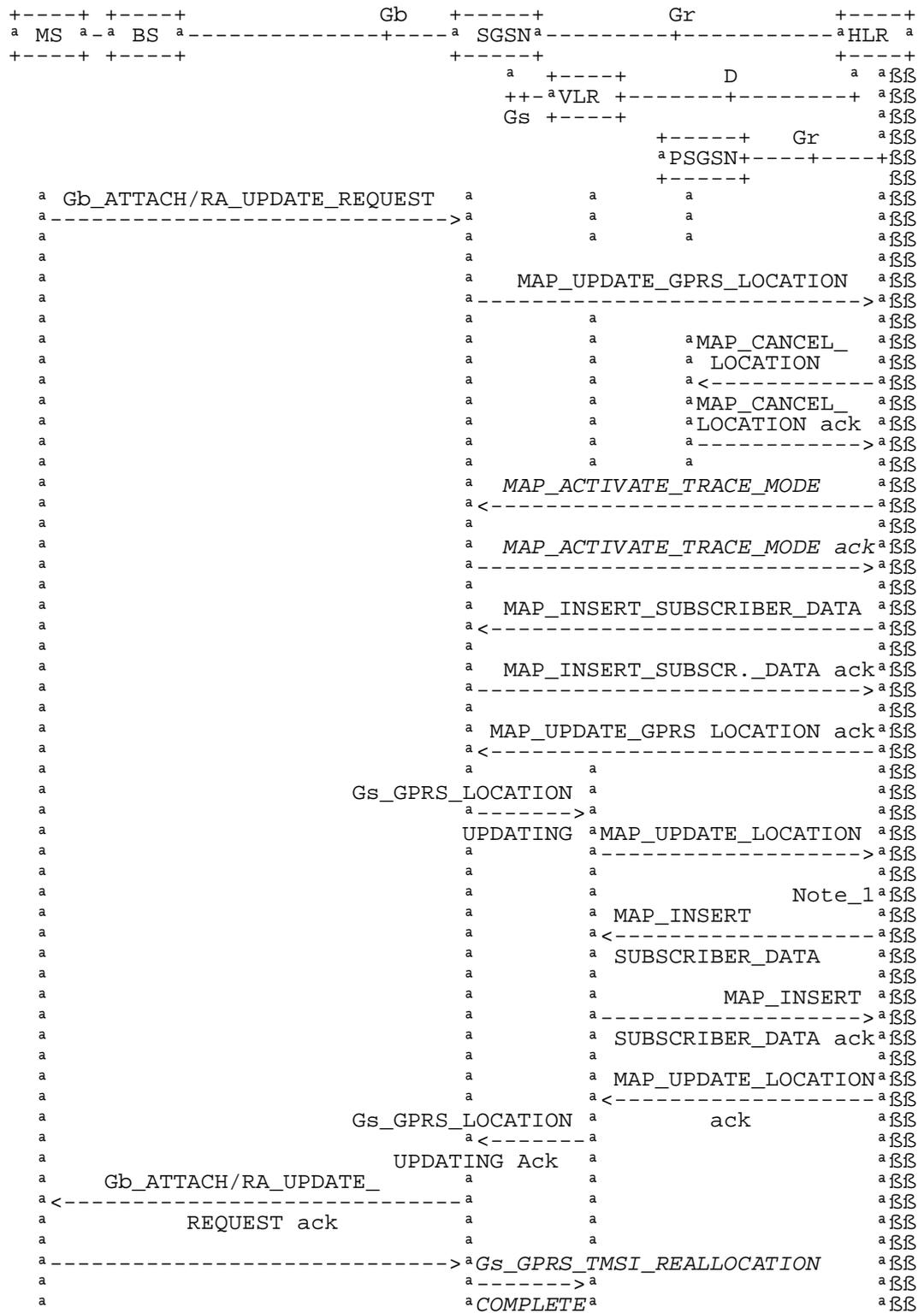

NOTE 1: The optional procedures in figure 19.1.1/14 apply here respectively. For details of the procedure on the Gs-interface, see GSM 09.18.

NOTE 2: Location Cancellation procedure toward the old VLR and optional tracing activation toward the new VLR are not represented on this figure.

**Figure 19.1.1/15: Interface and services for GPRS location updating (Gs-interface installed)**

### 19.1.1.2 Detailed procedure in the MSC

Figure 19.1.1/4 shows the MSC process for location register updating, containing macro calls for:

Receive_Open_Cnf	clause 25.1;
Authenticate_MSC	clause 25.5;
Check_IMEI_MSC	clause 25.6;
Obtain_IMSI_MSC	clause 25.8;
Trace_Subscriber_Activity_MSC	clause 25.9.

For structuring purposes, the second part of the process is placed into the macro Update Location Completion MSC, which is specific to this process (see figure 19.1.1/5).

When the MSC receives an A\_LU\_REQUEST (normal location updating, periodic location updating or IMSI attach) for a subscriber via the radio path, the MSC opens a dialogue to the VLR (MAP\_OPEN request without any user specific parameters) and sends a MAP\_UPDATE\_LOCATION\_AREA request, containing the parameters provided in the A\_LU\_REQUEST by the MS or BSS (for the parameter mapping see GSM 09.10).

If the dialogue is rejected or the VLR indicates a fallback to the version Vr procedure (see Receive\_Open\_Cnf macro in clause 25.1), the MSC will send an A\_LU\_Rej towards the MS and terminate the procedure.

If the dialogue is accepted, the VLR will process this updating request, invoking optionally the MAP\_PROVIDE\_IMSI, MAP\_TRACE\_SUBSCRIBER\_ACTIVITY, MAP\_CHECK\_IMEI or the MAP\_AUTHENTICATE services first (see clause 19.1.1.3 for initiation conditions, clause 25 for macros defining the handling of services in the MSC). For these macros there are two possible outcomes:

- a positive outcome, in which case the process continues waiting for the MAP\_UPDATE\_LOCATION\_AREA confirmation; or
- an error is reported, in which case the process terminates (not applicable for Trace\_Subscriber\_Activity\_MSC, which has only a positive outcome).

After receiving the MAP\_UPDATE\_LOCATION\_AREA indication and handling these optional services, the VLR will decide whether a new TMSI need to be allocated to the subscriber or not.

#### Updating without TMSI reallocation

If the VLR does not reallocate the TMSI, the MSC will receive a MAP\_UPDATE\_LOCATION\_AREA confirmation next (figure 19.1.1/4).

- if there are no parameters with this primitive, updating was successful and a confirmation will be sent to the MS;
- if there is an error cause contained in the received primitive, this cause will be mapped to the corresponding cause in the confirmation sent to the MS (see GSM 09.10 for the mapping of messages and causes).

#### Updating including TMSI reallocation

This case is covered by the macro Update Location Completion MSC given in figure 19.1.1/5. The MSC will upon receipt of a MAP\_SET\_CIPHERING\_MODE request send a ciphering command towards BSS/MS. Thereafter, the MAP\_FORWARD\_NEW\_TMSI indication and the MAP\_UPDATE\_LOCATION\_AREA confirmation are received in arbitrary order, causing a confirmation on the radio path containing both new LAI and new TMSI. If the MAP\_UPDATE\_LOCATION\_AREA confirmation contains any error, the updating request is rejected towards the MS:

- the MS will confirm receipt of the new TMSI, resulting in an empty MAP\_FORWARD\_NEW\_TMSI response terminating the dialogue;
- if there is no confirmation received from the A-interface, the dialogue is terminated locally.

Before receiving a MAP\_UPDATE\_LOCATION\_AREA confirmation, the MSC may receive a MAP\_CHECK\_IMEI indication. Handling of this indication, comprising IMEI request towards the MS and IMEI checking request towards the EIR, is given in the macro description in clause 25.6. The result may either be to return to the state Wait for TMSI or to return to terminate.

**Forwarding the Check SS Indication**

When the VLR receives a MAP\_FORWARD\_CHECK\_SS\_INDICATION\_Ind during the Update LOCATION Area process, this indication is relayed to the MS (see GSM 09.11 for detailed interworking) and the MSC remains in the current state.

**Abort handling**

If the VLR receives a MAP\_U\_ABORT, a MAP\_P\_ABORT or a premature MAP\_CLOSE indication from the VLR during the location update process, the MSC terminates the process by sending an A\_LU\_CONFIRM containing the error cause Updating Failure to the MS. If the MSC had already confirmed the location update towards the MS, the process terminates without notification towards the A-interface.

If the MSC receives a MAP\_NOTICE indication, it issues a MAP\_CLOSE and terminates the A-interface dialogue, and the process terminates.

When the procedure is terminated abnormally on the radio path, the dialogue towards the VLR is aborted with the appropriate diagnostic information, and the procedure terminates.

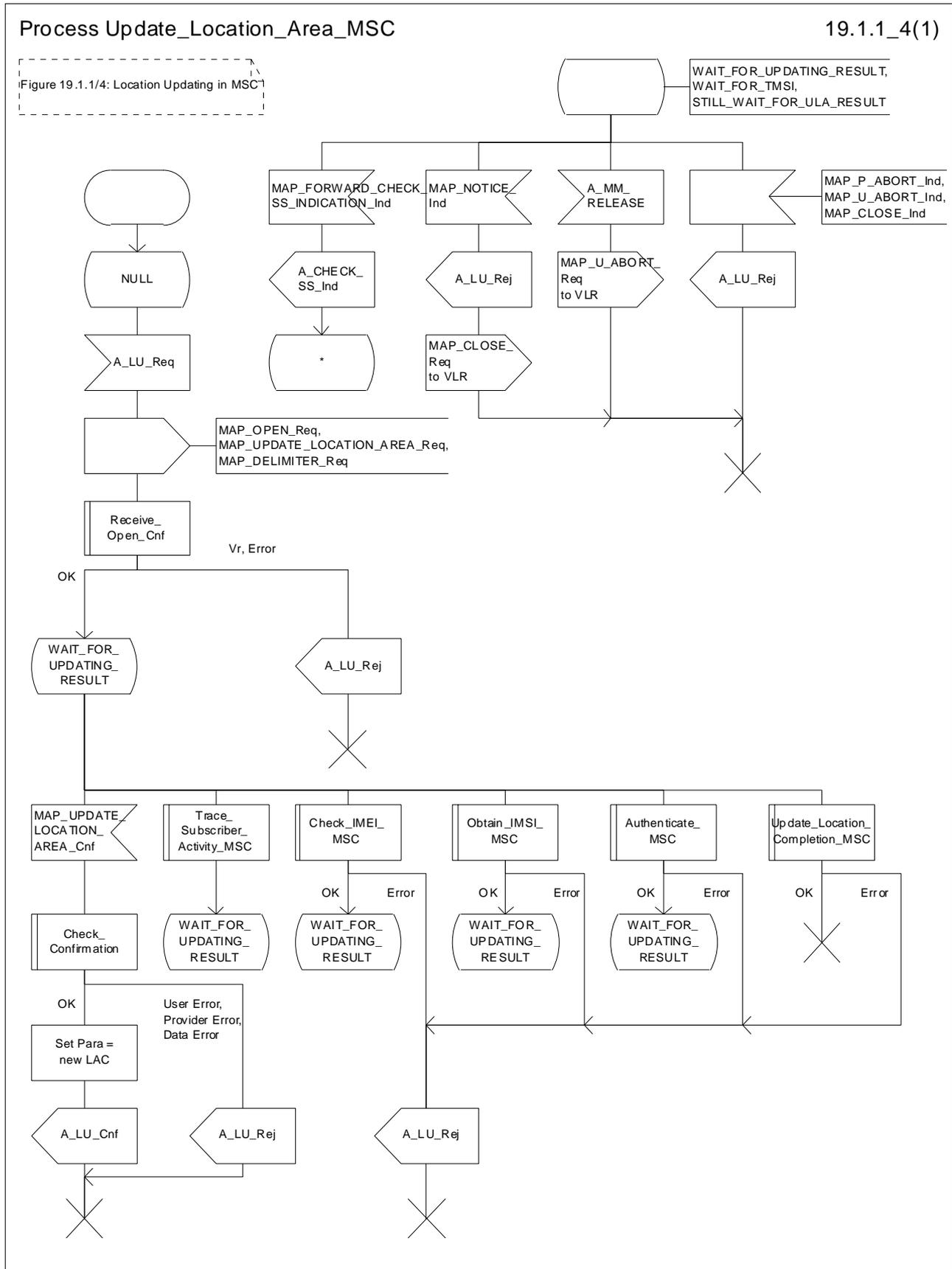

Figure 19.1.1/4: Process Update\_Location\_Area\_MSC

Macrodefinition Update\_Location\_Completion\_MSC

19.1.1\_5(1)

Figure 19.1.1/5: Macro used for Location Updating in MSC

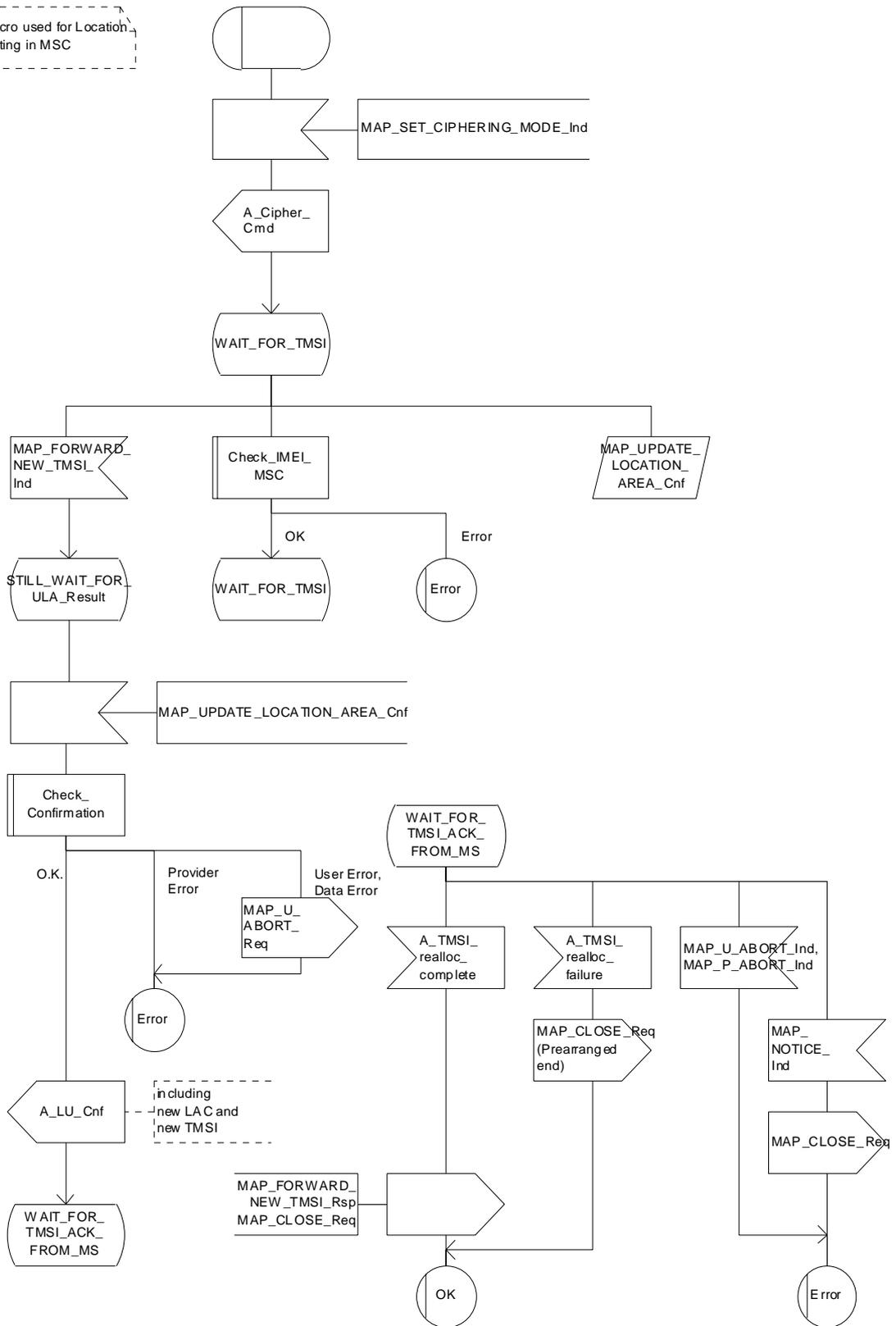

Figure 19.1.1/5: Macro Update\_Location\_Completion\_MSC



### 19.1.1.3 Detailed procedure in the VLR

Figure 19.1.1/6 shows the process for location updating in the VLR. The following general macros are used:

Receive_Open_Ind	clause 25.1;
Receive_Open_Cnf	clause 25.1;
Authenticate_VLR	clause 25.5;
Check_IMEI_VLR	clause 25.6;
Insert_Subscriber_Data_VLR	clause 25.7;
Obtain_IMSI_VLR to request the IMSI for the subscriber	clause 25.8;
Activate_Tracing_VLR and Trace_Subscriber_Activity_VLR	clause 25.9,
Subscriber_Present_VLR	clause 25.10.

Additionally, the process specific macro

Location\_Update\_Completion\_VLR, for optional initiation of Ciphering and TMSI reallocation as for acknowledgement of the MAP\_UPDATE\_LOCATION\_AREA service, see figure 19.1.1/7,

and the optional process specific macro

VLR\_Update\_HLR to update the HLR and download subscriber data from there, see figure 19.1.1/8,

are invoked by this process.

#### Process Initiation

The location area updating process will be activated by receiving a MAP\_UPDATE\_LOCATION\_AREA indication from the MSC. If there are parameter errors in the indication, the process is terminated with the appropriate error sent in the MAP\_UPDATE\_LOCATION\_AREA response to the MSC. Else, The behaviour will depend on the subscriber identity received, either an IMSI or an TMSI.

#### Updating using IMSI

If the subscriber identity is an IMSI, the VLR checks whether the subscriber is unknown (i.e. no IMSI record). If so, the indicator "Location Information Confirmed in HLR" is set to "Not Confirmed" to initiate HLR updating later on. If the IMSI is known, the VLR checks whether the previous location area identification (LAI) provided in the primitive received from the MSC belongs to this VLR. If it does not, the indicator "Location Information Confirmed in HLR" is set to "Not Confirmed" to initiate HLR updating later on. The process may continue in both cases with the authentication check (see below).

#### Updating using TMSI

If the subscriber identity is a TMSI, the VLR checks whether the previous location area identification (LAI) provided in the primitive received from MSC belongs to an area of this VLR:

- if so, the TMSI will be checked. In case of location area change within a VLR, the TMSI should be known and the process may continue with the authentication check. Additionally, the indicator "Location Information Confirmed in HLR" is set to "Not confirmed" and the trace activity status is checked in case the target Location Area Id belongs to a new MSC.
- if the TMSI is not known or the subscriber data stored are incomplete, e.g. because the new LA belongs to a different VLR or due to VLR restoration, the indicator "Confirmed by VLR" is set to "Not Confirmed" to initiate HLR updating later on.

If the subscriber has not already been registered in the VLR, i.e. the previous LAI belongs to a different VLR, the indicators "Confirmed by HLR" and "Location Information Confirmed in HLR" are set to "Not Confirmed" and the VLR checks whether the identity of the Previous VLR (PVLR) is derivable from the previous LAI:

- if so, the IMSI and authentication parameters are requested from that VLR using the MAP\_SEND\_IDENTIFICATION service (see sheet 3 of figure 19.1.1/6), containing the subscriber's TMSI.

- if the dialogue is rejected by the PVLR, the process continues requesting the IMSI from the MS. In case the PVLR reverts to the MAP version Vr dialogue, the VLR will perform the respective procedure of version Vr, too, with outcomes as for the current MAP version dialogue. Else, the process waits for the respective MAP\_SEND\_IDENTIFICATION response from the PVLR:
  - if the IMSI is received in that primitive, the process continues with the authentication check;
  - if the IMSI is not received from the previous VLR for any reason, the dialogue to the PVLR is terminated and the IMSI will be requested from the MS;
  - if a MAP\_NOTICE indication is received from the PVLR, the dialogue will be terminated by sending a MAP\_CLOSE indication, and the process continues requesting the IMSI from the MS;
  - if a MAP\_P\_ABORT or MAP\_U\_ABORT indication is received from the MSC while waiting for the MAP\_SEND\_IDENTIFICATION response, the process is terminated;
  - if a MAP\_NOTICE indication is received from the MSC while waiting for the MAP\_SEND\_IDENTIFICATION response, the dialogue with the PVLR will be aborted by sending a MAP\_U\_ABORT indication (Remote Operations Failure), the dialogue with the MSC will be terminated by sending a MAP\_CLOSE and the process terminates;
- if the identity of the previous VLR cannot be derived, the process continues by requesting the IMSI from the MS.

### Requesting IMSI from the MS

For requesting the IMSI from the MS, the macro Obtain\_IMSI\_VLR described in clause 25.8 is invoked (see figure 19.1.1/6 sheet 3). The outcome will be:

- OK, i.e. receipt of IMSI, in which case the process continues with the authentication check described below; or
- receipt of an Absent Subscriber error, indicating that the MS did not respond. In this case the System Failure error is reported in the MAP\_UPDATE\_LOCATION\_AREA response towards the MSC and the updating process is terminated;
- aborted, i.e. the MSC dialogue has been released while waiting for the IMSI. In this case the updating process is terminated, too.

### Authentication check

After a subscriber identity has been received, either in the service indication or by an explicit request procedure, the VLR checks whether authentication of this identity is required (see figure 19.1.1/6 sheet 2). If so, the authentication macro described in clause 25.5 is invoked. The outcome of this macro can be:

- OK, i.e. the subscriber has been authenticated successfully, in which case the process is continued by setting the indicator "Confirmed by Radio Contact" to "Confirmed" and updating the location information held in the register. Thereafter,
  - if one or both of the indicators "Confirmed by HLR" and "Location Information Confirmed in HLR" is set to "Not Confirmed", HLR updating is invoked first;
  - otherwise the process continues with the Location Update Completion VLR macro described below, and the register is updated after successful completion of this macro.
- Illegal subscriber, i.e. there was a mismatch between expected and received SRES. The VLR checks whether authentication had been performed using the TMSI, in which case a new authentication attempt with IMSI may be started (VLR operator option).
  - if so, the process continues by requesting the IMSI from the MS;
  - else, the Illegal Subscriber error is reported in the MAP\_UPDATE\_LOCATION\_AREA response.
- Unknown Subscriber, i.e. the IMSI given is unknown in the HLR. In this case, the subscriber data are deleted in the VLR and the same error is returned in the MAP\_UPDATE\_LOCATION\_AREA response.

- Procedure error, i.e. the authentication process was unsuccessful for some other reason, e.g. because of a failure while requesting authentication information from the HLR. In this case the System Failure error is reported in the MAP\_UPDATE\_LOCATION\_AREA response.
- Null, indicating impossible dialogue continuation (e.g. termination of the radio path), and leading to procedure termination without any further action.

### Updating the HLR

If the HLR is to be updated, the VLR\_Update\_HLR macro described below is performed, with one of the following results (see sheet 4 of figure 19.1.1/6):

- OK, if HLR updating has been completed successfully. The response will contain the HLR number as parameter. Next, the Location\_Update\_Completion VLR macro is invoked (checking amongst others the roaming restrictions and regional subscription data), and upon successful outcome of this macro the register is updated and the process terminates.
- Roaming Not Allowed, qualified by PLMN Roaming Not Allowed if the location information indicates a PLMN for which the subscriber has no subscription or if the subscribers HLR cannot be reached (e.g. SS7 links to the subscribers HPLMN do not yet exist). In this case, the error Roaming Not Allowed qualified by PLMN Roaming Not Allowed is sent in the MAP\_UPDATE\_LOCATION\_AREA response. The Subscriber Data are deleted in the VLR.
- if Roaming Not Allowed was qualified by the parameter Operator Determined Barring, the same value is sent in the MAP\_UPDATE\_LOCATION\_AREA response to the MSC. The subscriber data are deleted in the VLR.
- Unknown Subscriber, if the subscriber is not known in the HLR. In this case, the subscriber data are deleted in the VLR, and the same error is sent in the MAP\_UPDATE\_LOCATION\_AREA response.
- Procedure error, if there occurs some other error during HLR updating (e.g. abort of the connection to HLR):
  - if the VLR can proceed in stand alone mode (VLR operator option), the Location Update Completion VLR macro is invoked to complete the VLR updating, and the indicator "Confirmed by HLR" remains unchanged;
  - otherwise, the System Failure error is sent in the MAP\_UPDATE\_LOCATION\_AREA response.
- Aborted, indicating that during HLR updating the MSC dialogue has been terminated. In this case, the updating process terminates without any further action.

### The macro Location Update Completion VLR

This macro completes the VLR updating process. First, the VLR checks whether there is a roaming restriction for the subscriber (see figure 19.1.1/7):

- if the target LA is not allowed for the subscriber due to national roaming restrictions, the error Roaming Not Allowed with cause National Roaming Not Allowed is returned in the MAP\_UPDATE\_LOCATION\_AREA response towards the MSC.

The subscriber data are not deleted from VLR, to avoid unnecessary HLR updating when roaming into other LAs of the same MSC. An indication that the subscriber is not allowed to roam is set in the VLR (LA Not Allowed Flag set to not allowed). As a consequence the subscriber is not reachable (checked for MTC, SMS and MT USSD) and cannot perform outgoing actions (checked in Access Management).

- if the target LA is not allowed for the subscriber because of regional subscription data (Zone Code List) or Roaming Restriction Due To Unsupported Feature stored in the VLR, the error Roaming Not Allowed with cause Location Area Not Allowed is returned towards the MSC in the MAP\_UPDATE\_LOCATION\_AREA response.

Also in this case the subscriber data are not deleted from VLR, to avoid unnecessary HLR updating when roaming into other LAs of the same MSC. The LA Not Allowed Flag is set to not allowed in the VLR.

- if, after check of possible roaming restrictions, the subscriber is allowed to roam in the target LA, the LA Not Allowed Flag is set to allowed (if necessary), the IMSI Detached Flag is set to attached and the process SUBSCRIBER\_PRESENT\_VLR is started; this may inform the HLR that the subscriber is present again to retry an SMS delivery (see clause 19.1.1.7). Thereafter, the VLR checks whether TMSI reallocation is required.

- if so, the VLR sends a MAP\_SET\_CIPHERING\_MODE request containing:
  - Ciphering Mode (version 1 GSM); and
  - Kc, the cipher key to be used.
- if IMEI checking is required by the operator, the VLR will invoke the CHECK\_IMEI\_VLR macro (see clause 25.6) to initiate both requesting IMEI from the MS and checking of this IMEI towards the EIR. As result either the service is granted, with process continuation as given below, or the service is rejected, in which case the VLR marks the subscriber as detached and returns an Illegal Equipment error in the MAP\_UPDATE\_LOCATION\_AREA response before the process terminates.
- the VLR then sends a MAP\_FORWARD\_NEW\_TMSI request containing the new TMSI, and the MAP\_UPDATE\_LOCATION\_AREA response containing no parameters. The process will thereafter wait for the MAP\_FORWARD\_NEW\_TMSI confirm. If this indicates a negative outcome, or if a MAP\_P\_ABORT or a MAP\_U\_ABORT primitive is received, the old TMSI is frozen. Subsequent accesses of the MS shall be accepted with both old or new TMSI.
- if TMSI reallocation is not required, the VLR invokes the CHECK\_IMEI\_VLR macro (see clause 25.6) to initiate both requesting IMEI from the MS and checking of this IMEI towards the EIR, if IMEI Checking is required by the operator. As a result, either the service is granted, in which case the MAP\_UPDATE\_LOCATION\_AREA response is sent without any parameters, or the service is rejected, in which case an Illegal Equipment error is returned in the MAP\_UPDATE\_LOCATION\_AREA response, before the process terminates.

In all cases where the VLR sends a MAP\_UPDATE\_LOCATION\_AREA response to the MSC, the dialogue towards the MSC is terminated by a MAP\_CLOSE request with parameter Release Method indicating Normal Release.

#### **The macro VLR Update HLR**

This macro is invoked by the VLR process for location updating or by some other process handling the first subscriber access to the network after a register failure in order to perform HLR updating. If the VLR does not know the subscribers HLR (e.g. no IMSI translation exists as there are not yet any SS7 links to the subscribers HPLMN), the error Roaming Not Allowed with cause PLMN Roaming Not Allowed is returned.

If the subscribers HLR can be reached, the VLR opens a dialogue towards the HLR (see figure 19.1.1/8) by sending a MAP\_OPEN request without any user specific parameters, together with a MAP\_UPDATE\_LOCATION request containing the parameters

- IMSI, identifying the subscriber;
- Location Info, containing the MSC number;
- VLR Number, the E.164 address of the VLR, to be used by the HLR when addressing the VLR henceforth (e.g. when requesting an MSRN);
- the LMSI as an VLR operator option; this is a subscriber identification local to the VLR, used for fast data base access.

In case the HLR rejects dialogue opening (see clause 25.1), the VLR will terminate the procedure indicating procedure error. If the HLR indicates version Vr protocol to be used, the VLR will revert to the version Vr procedure concerning the dialogue with the HLR, with outcomes as for the current MAP version procedure.

If the HLR accepts the dialogue, the HLR will respond with:

- a MAP\_INSERT\_SUBSCRIBER\_DATA indication, handled by the macro Insert\_Sub\_Data\_VLR defined in clause 25.7;

NOTE: The HLR may repeat this service several times depending on the amount of data to be transferred to the VLR and to replace subscription data in case they are not supported by the VLR.

- a MAP\_ACTIVATE\_TRACE\_MODE indication, handled by the macro Activate\_Tracing\_VLR defined in clause 25.9;
- a MAP\_FORWARD\_CHECK\_SS\_INDICATION\_ind. This indication will be relayed to the MSC without any change of the current state.

- the MAP\_UPDATE\_LOCATION confirmation:
  - if this confirmation contains the HLR Number, this indicates that the HLR has passed all information and that updating has been successfully completed. The VLR is updated using the parameters provided in the service and needed by the VLR. If certain parameters are not needed in the VLR, e.g. because some service is not supported, the corresponding data may be discarded. The VLR sets the "Confirmed by HLR" and "Location information confirmed in HLR" indicators to "Confirmed" to indicate successful subscriber data updating;
  - if the confirmation contains an User error cause (Unknown Subscriber, Roaming Not Allowed or some other), the process calling the macro continues accordingly. In the last case, the subscriber data are marked as incomplete by setting the indicators "Confirmed by HLR" and "Location information confirmed in HLR" to "Not Confirmed". The same holds if there is a Provider error or a Data error in the confirmation;
- a MAP\_P\_ABORT, MAP\_U\_ABORT, or MAP\_CLOSE indication. In these cases, the subscriber data are marked to be incomplete and the process continues as in the case of an error reported by the HLR;
- a MAP\_NOTICE indication. Then, the dialogue towards the HLR is terminated, the subscriber data are marked to be incomplete and the process continues as in the case of an error reported by the HLR;
- if during HLR updating the VLR receives a MAP\_P\_ABORT, MAP\_U\_ABORT or a MAP\_CLOSE indication concerning the MSC dialogue, the process is terminated by sending a MAP\_U\_ABORT request towards the HLR, and subscriber data are marked to be incomplete;
- if during HLR updating the VLR receives a MAP\_NOTICE indication concerning the MSC dialogue, the dialogue with the MSC is terminated by sending a MAP\_CLOSE, the dialogue with the HLR is terminated by sending a MAP\_U\_ABORT, subscriber data are marked to be incomplete and the process is terminated.

### Abort Handling

If the VLR receives a MAP\_NOTICE indication from the MSC while waiting for a MAP service primitive, the VLR will terminate the MSC dialogue by sending a MAP\_CLOSE and any pending HLR dialogue by sending a MAP\_U\_ABORT (Remote Operations Failure), and the process is terminated.

### Updating request via the Gs interface (optional for GPRS)

If Gs-interface is installed, the VLR may receive the Gs\_GPRS\_LOCATION\_UPDATING\_Request message from the SGSN for triggering an IMSI Attach or Location Updating procedure (see GSM 03.60 and 09.18).

Figure 19.1.1/16 shows the process for handling this Gs interface message.

The process specific macro

« GPRS\_Location\_Update\_Completion\_VLR » for optional initiation of TMSI reallocation as for acknowledgement of the Gs\_GPRS\_LOCATION\_UPDATING\_Request message (see figure 19.1.1/17),

and the optional process specific macro

« VLR\_Update\_GPRS\_HLR » to update the HLR and download subscriber data from there (see figure 19.1.1/18), are invoked by this process.

On receipt of the Gs\_GPRS\_LOCATION\_UPDATING\_Request message, the VLR checks whether the subscriber is unknown (i.e. no IMSI record). If so, the indicator "Location Information Confirmed in HLR" is set to "Not Confirmed" to initiate HLR updating later on. The indicator "Confirmed by Radio Contact" is set to "Confirmed" and the location information held in the register is updated. If no VLR/SGSN association exists it is created (storage of SGSN address received) otherwise it is updated.

If the HLR is to be updated, the VLR\_Update\_GPRS\_HLR macro described below is performed, with one of the following results (see sheet 2 of figure 19.1.1/18):

- OK, if HLR updating has been completed successfully. The response will contain the HLR number as parameter. Next, the GPRS\_Location\_Update\_Completion\_VLR macro is invoked (checking amongst others the roaming restrictions and regional subscription data), and upon successful outcome of this macro the register is updated and the process terminates.

- Roaming Not Allowed, qualified by PLMN Roaming Not Allowed if the location information indicates a PLMN for which the subscriber has no subscription or if the subscribers HLR cannot be reached (e.g. SS7 links to the subscribers HPLMN do not yet exist). In this case, the appropriate error (see GSM 09.18) is sent to the SGSN in the Gs\_GPRS\_LOCATION\_UPDATING Reject. The Subscriber Data are deleted in the VLR.
- if Roaming Not Allowed was qualified by the parameter Operator Determined Barring, the appropriate error (see GSM 09.18) is sent in the Gs\_GPRS\_LOCATION\_UPDATING Reject to the SGSN. The subscriber data are deleted in the VLR.
- Unknown Subscriber, if the subscriber is not known in the HLR. In this case, the subscriber data are deleted in the VLR, and the appropriate error (see GSM 09.18) is sent in the Gs\_GPRS\_LOCATION\_UPDATING Reject.
- Procedure error, if there occurs some other error during HLR updating (e.g. abort of the connection to HLR). In this case the appropriate error (see GSM 09.18) is sent in the Gs\_GPRS\_LOCATION\_UPDATING Reject.

### The macro GPRS Location Update Completion VLR

This macro completes the VLR updating process. First, the VLR checks whether there is a roaming restriction for the subscriber (see figure 19.1.1/17):

- if the target LA is not allowed for the subscriber due to national roaming restrictions, the appropriate error (see GSM 09.18) is sent in the Gs\_GPRS\_LOCATION\_UPDATING Reject towards the SGSN.

The subscriber data are not deleted from VLR, to avoid unnecessary HLR updating when roaming into other LAs of the same MSC/VLR. An indication that the subscriber is not allowed to roam is set in the VLR (LA Not Allowed Flag set to not allowed). As a consequence the subscriber is not reachable (checked for MTC, SMS and MT USSD) and cannot perform outgoing actions (checked in Access Management).

- if the target LA is not allowed for the subscriber because of regional subscription data (Zone Code List) or Roaming Restriction Due To Unsupported Feature stored in the VLR, the appropriate error (see GSM 09.18) is returned to the SGSN in the Gs\_GPRS\_LOCATION\_UPDATING Reject.

Also in this case the subscriber data are not deleted from VLR, to avoid unnecessary HLR updating when roaming into other LAs of the same MSC. The LA Not Allowed Flag is set to not allowed in the VLR.

- if, after check of possible roaming restrictions, the subscriber is allowed to roam in the target LA, the LA Not Allowed Flag is set to allowed (if necessary), the IMSI Detached Flag is set to attached and the process SUBSCRIBER\_PRESENT\_VLR is started; this may inform the HLR that the subscriber is present again to retry an SMS delivery (see clause 19.1.1.7). Thereafter, the VLR checks whether TMSI reallocation is required.
  - if so, the VLR sends the TMSI within the Gs\_GPRS\_LOCATION\_UPDATING Accept message and Gs\_GPRS\_TMSI\_REALLOCATION\_Complete is expected.
- if TMSI reallocation is not required, the VLR sends the Gs\_GPRS\_LOCATION\_UPDATING Accept message to the SGSN.

### The macro VLR Update GPRS HLR

This macro is invoked by the VLR process for location updating (see GSM 03.60). If the VLR does not know the subscribers HLR (e.g. no IMSI translation exists as there are not yet any SS7 links to the subscribers HPLMN), the error Roaming Not Allowed with cause PLMN Roaming Not Allowed is returned.

If the subscribers HLR can be reached, the VLR opens a dialogue towards the HLR (see figure 19.1.1/18) by sending a MAP\_OPEN request without any user specific parameters, together with a MAP\_UPDATE\_LOCATION request containing the parameters

- IMSI, identifying the subscriber;
- Location Info, containing the MSC number;
- VLR Number, the E.164 address of the VLR, to be used by the HLR when addressing the VLR henceforth (e.g. when requesting an MSRN);
- the LMSI as an VLR operator option; this is a subscriber identification local to the VLR, used for fast data base access.

In case the HLR rejects dialogue opening (see clause 25.1), the VLR will terminate the procedure indicating procedure error. If the HLR indicates version Vr protocol to be used, the VLR will revert to the version Vr procedure concerning the dialogue with the HLR, with outcomes as for the current MAP version procedure.

If the HLR accepts the dialogue, the HLR will respond with:

- a MAP\_INSERT\_SUBSCRIBER\_DATA indication, handled by the macro Insert\_SubData\_VLR defined in clause 25.7;

NOTE: The HLR may repeat this service several times depending on the amount of data to be transferred to the VLR and to replace subscription data in case they are not supported by the VLR.

- a MAP\_ACTIVATE\_TRACE\_MODE indication, handled by the macro Activate\_Tracing\_VLR defined in clause 25.9;
- a MAP\_FORWARD\_CHECK\_SS\_INDICATION\_ind. This indication will not be relayed to the SGSN.
- the MAP\_UPDATE\_LOCATION confirmation:
  - if this confirmation contains the HLR Number, this indicates that the HLR has passed all information and that updating has been successfully completed. The VLR is updated using the parameters provided in the service and needed by the VLR. If certain parameters are not needed in the VLR, e.g. because some service is not supported, the corresponding data may be discarded. The VLR sets the "Confirmed by HLR" and "Location information confirmed in HLR" indicators to "Confirmed" to indicate successful subscriber data updating;
  - if the confirmation contains an User error cause (Unknown Subscriber, Roaming Not Allowed or some other), the process calling the macro continues accordingly. In the last case, the subscriber data are marked as incomplete by setting the indicators "Confirmed by HLR" and "Location information confirmed in HLR" to "Not Confirmed". The same holds if there is a Provider error or a Data error in the confirmation;
- a MAP\_P\_ABORT, MAP\_U\_ABORT, or MAP\_CLOSE indication. In these cases, the subscriber data are marked to be incomplete and the process continues as in the case of an error reported by the HLR;
- a MAP\_NOTICE indication. Then, the dialogue towards the HLR is terminated, the subscriber data are marked to be incomplete and the process continues as in the case of an error reported by the HLR.

### Process Update\_Location\_Area\_VLR

19.1.1\_6.1(4)

Figure 19.1.1/6: Location updating in VLR

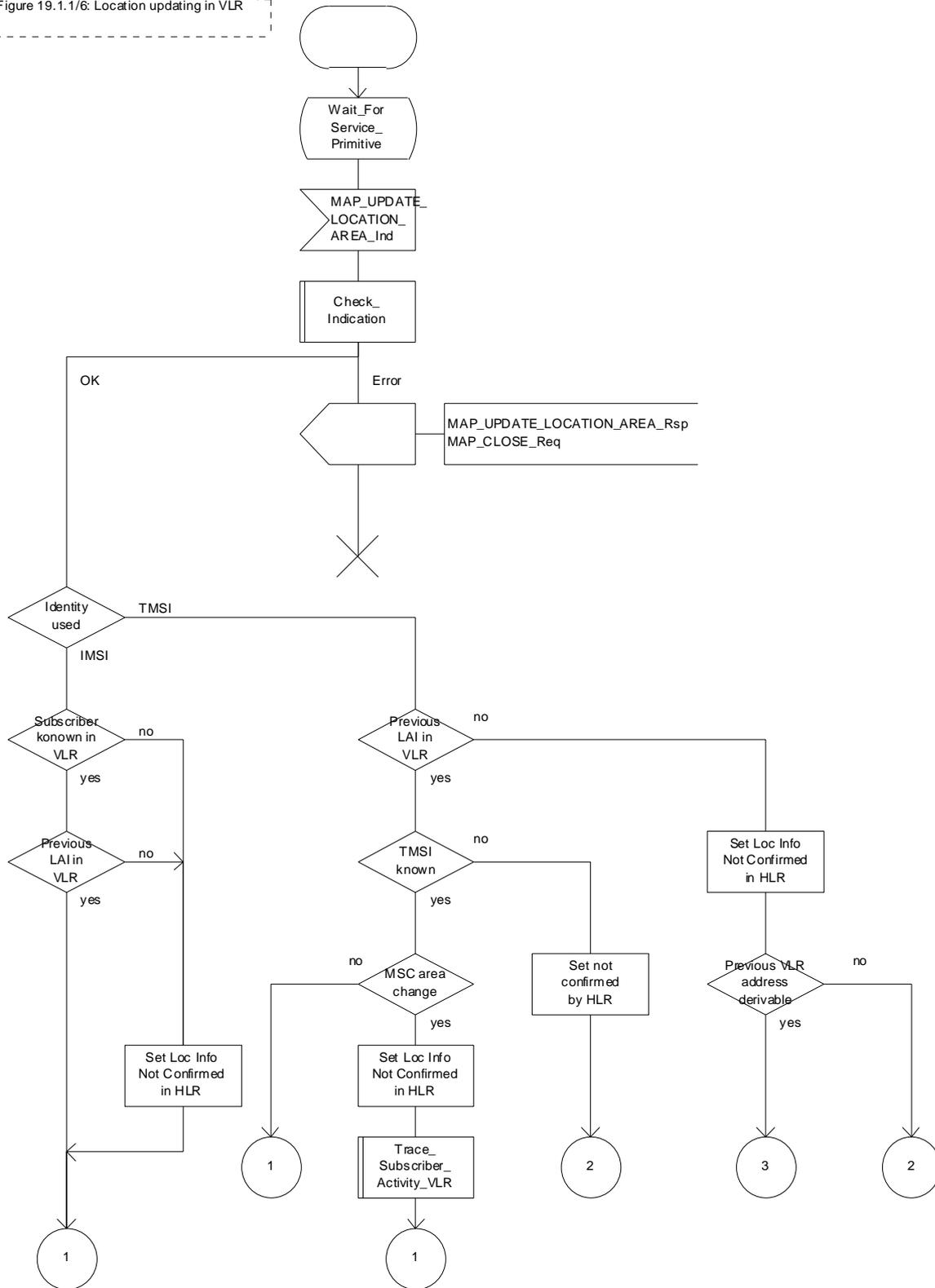

Figure 19.1.1/6 (sheet 1 of 4): Process Update\_Location\_Area\_VLR



Process Update\_Location\_Area\_VLR

19.1.1\_6.2(4)

Figure 19.1.1/6: Location updating in VLR

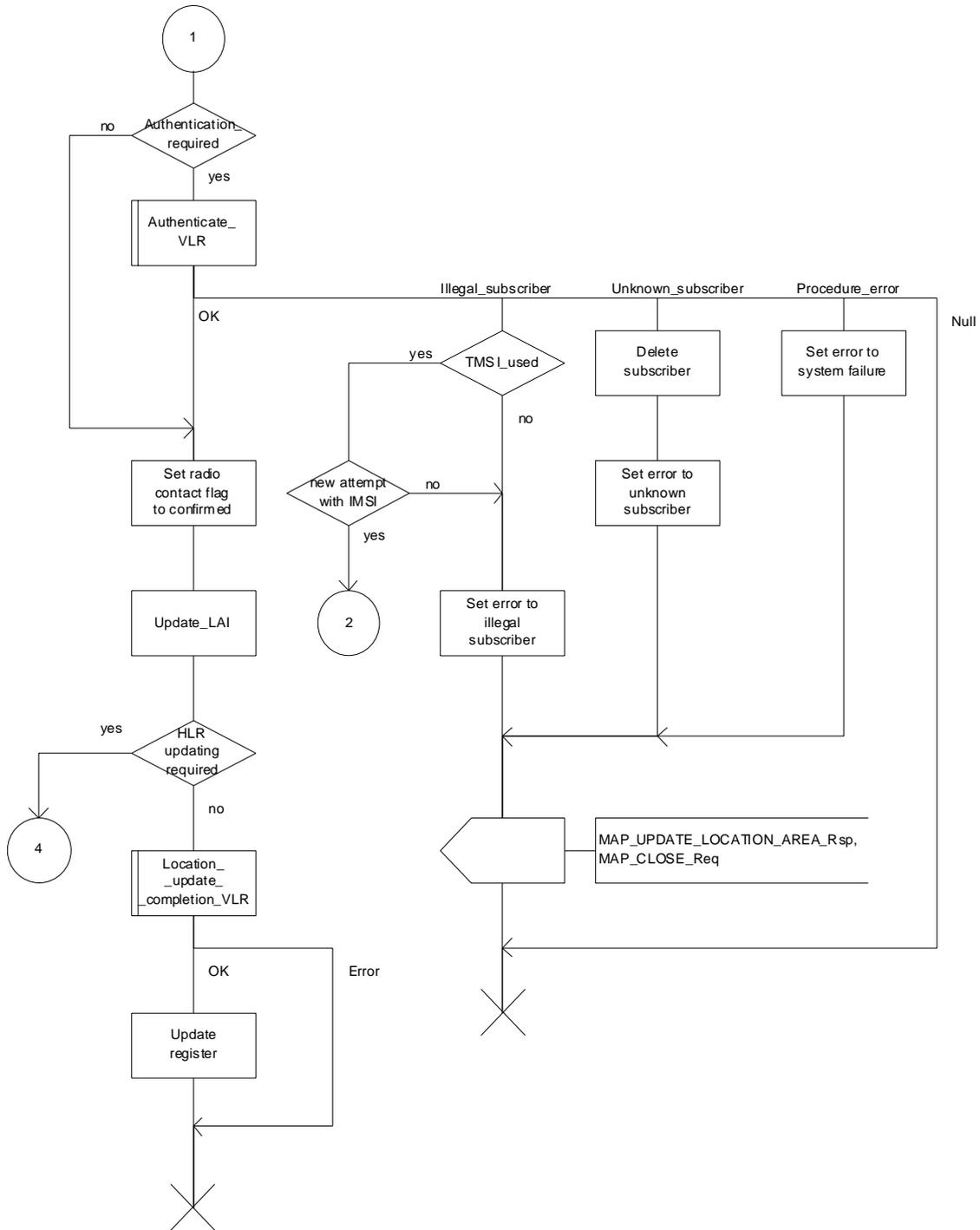

Figure 19.1.1/6 (sheet 2 of 4): Process Update\_Location\_Area\_VLR

Process Update\_Location\_Area\_VLR

19.1.1\_6.3(4)

Figure 19.1.1/6: Location updating in VLR

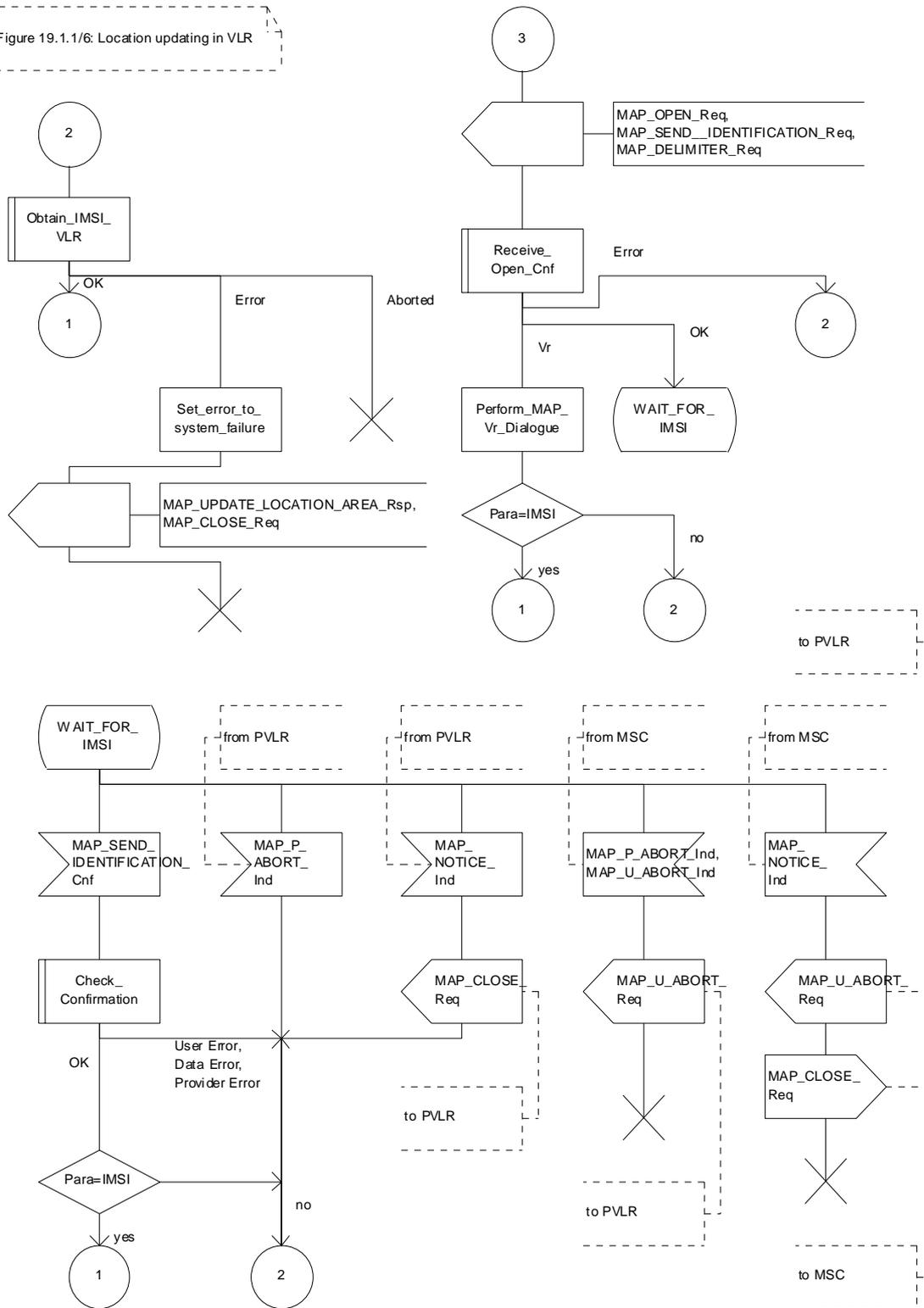

Figure 19.1.1/6 (sheet 3 of 4): Process Update\_Location\_Area\_VLR

Process Update\_Location\_Area\_VLR

19.1.1\_6.4(4)

Figure 19.1.1/6: Location updating in VLR

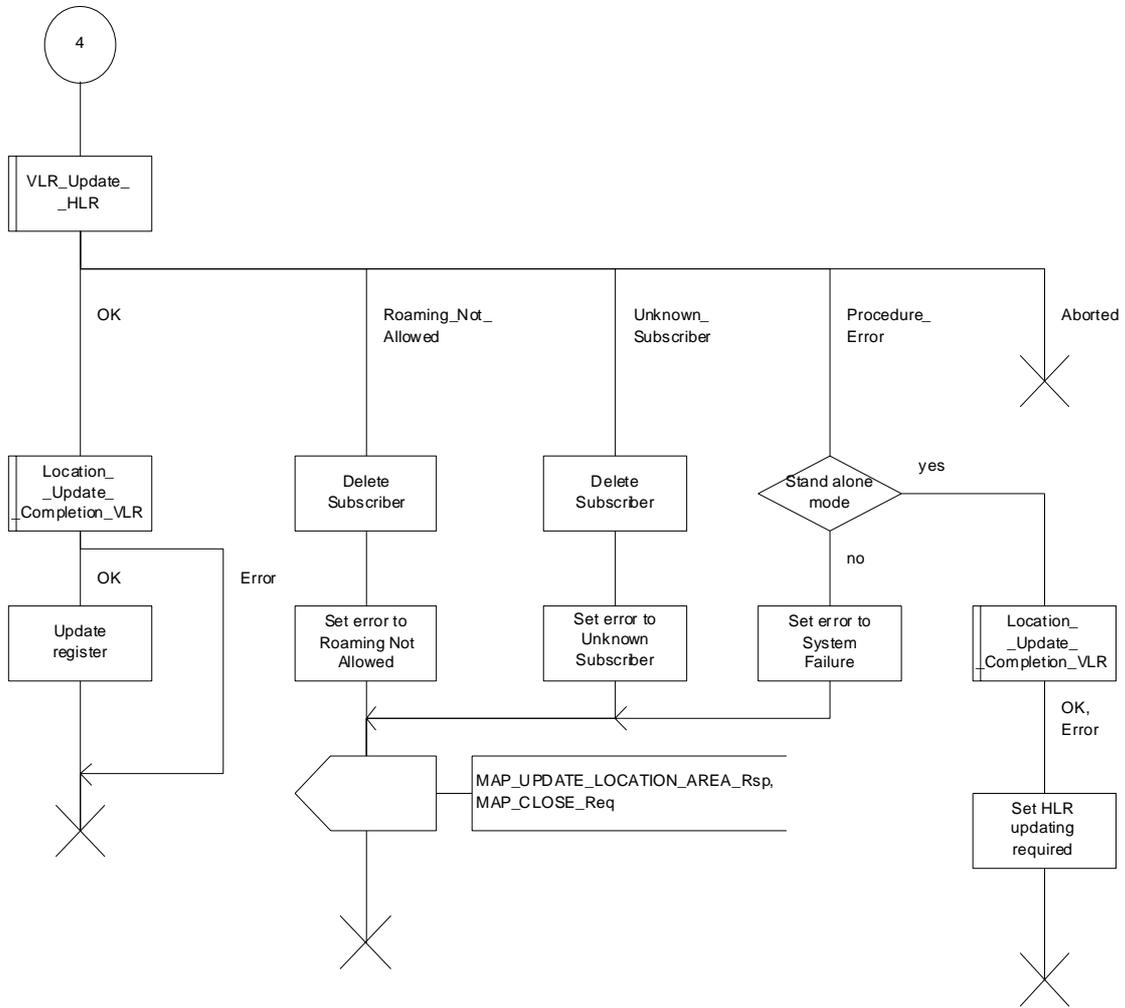

Figure 19.1.1/6 (sheet 4 of 4): Process Update\_Location\_Area\_VLR

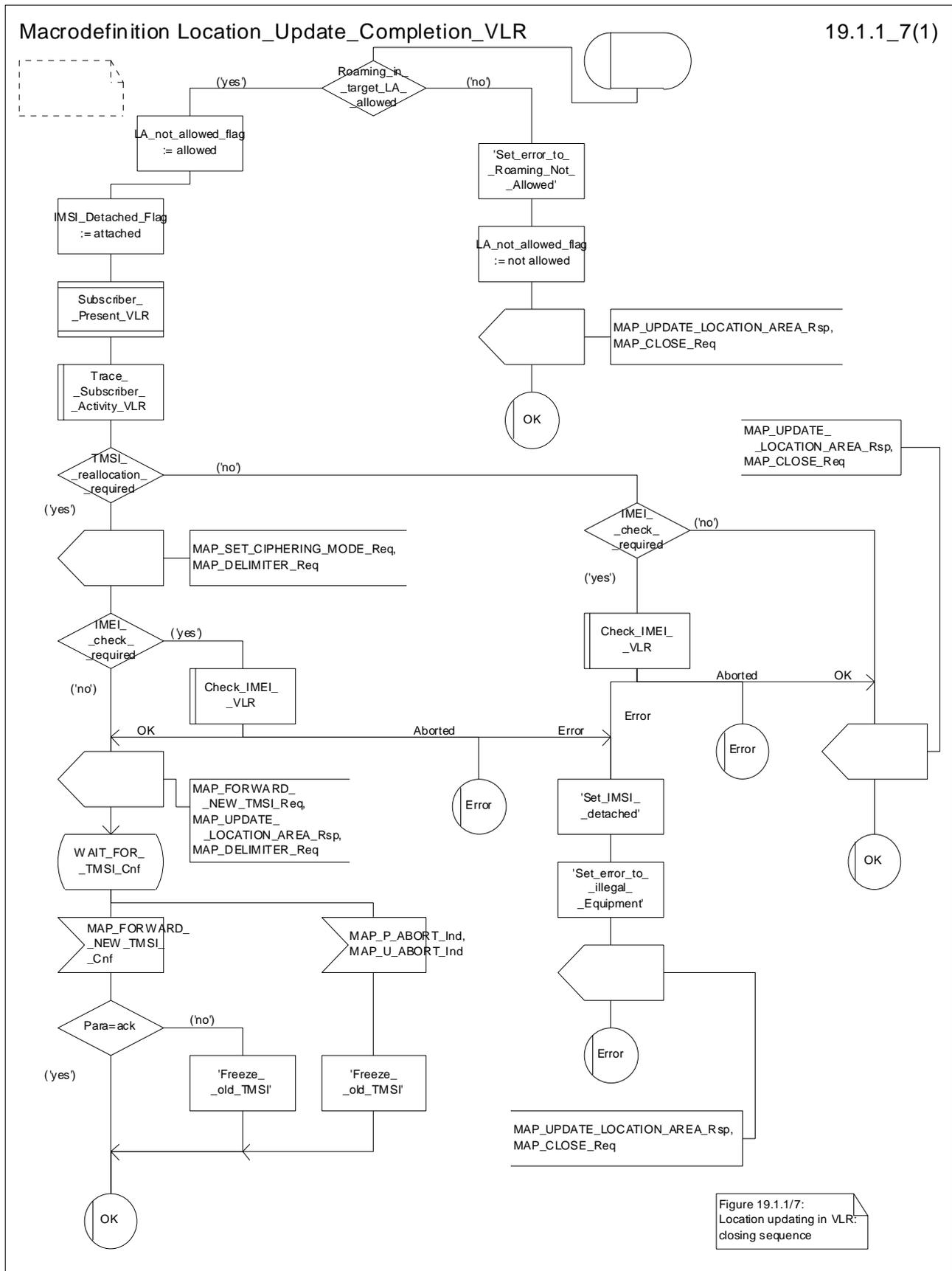

Figure 19.1.1/7: Location updating in VLR: closing sequence

Figure 19.1.1/7: Macro Location\_Update\_Completion\_VLR

Macrodefinition VLR\_Update\_HLR

19.1.1\_8.1(2)

Figure 19.1.1/8:  
HLR updating in VLR

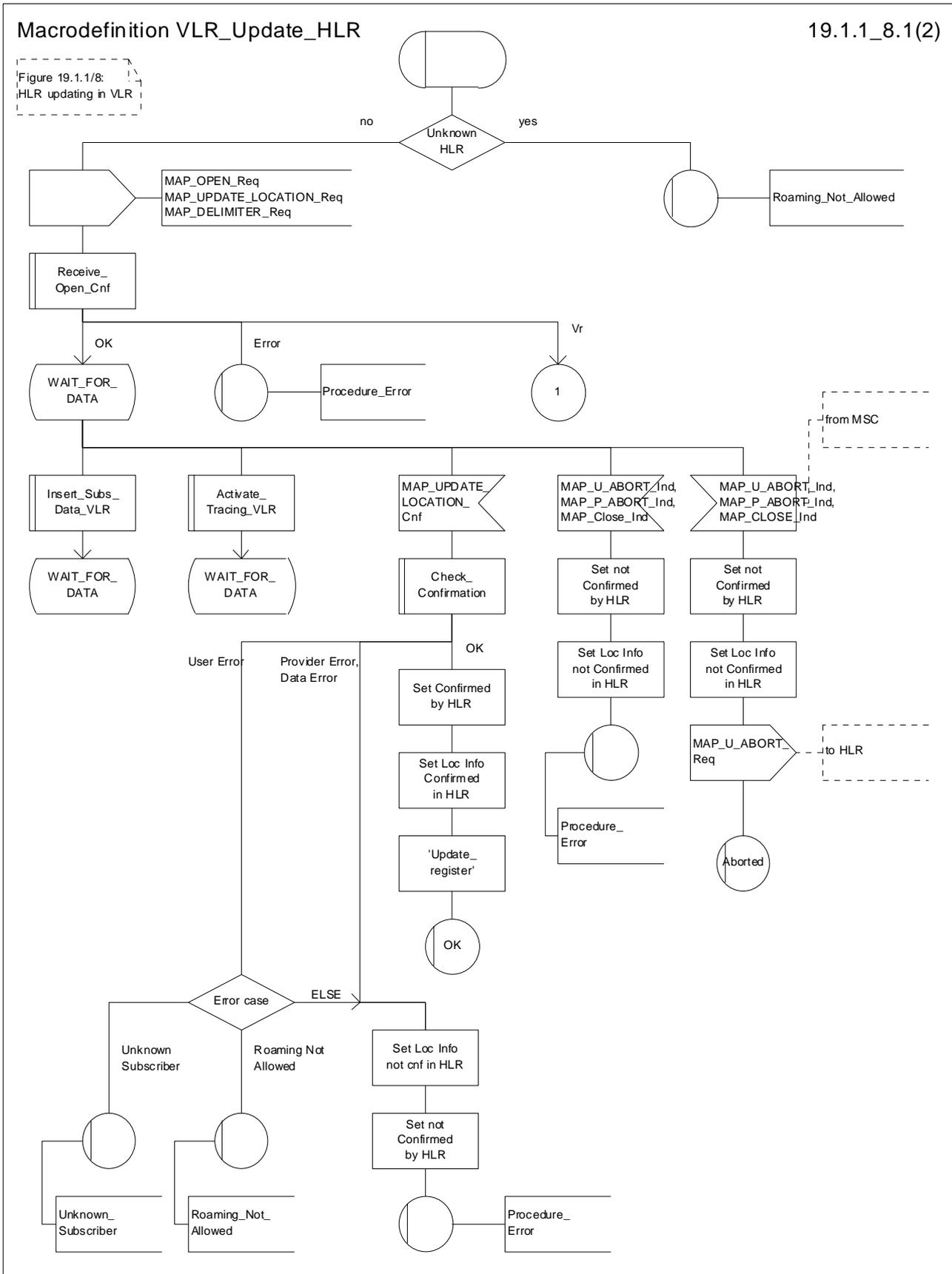

Figure 19.1.1/8 (sheet 1 of 2): Macro VLR\_Update\_HLR

Macrodefinition VLR\_Update\_HLR

19.1.1\_8.2(2)

Figure 19.1.1/8:  
HLR updating in VLR

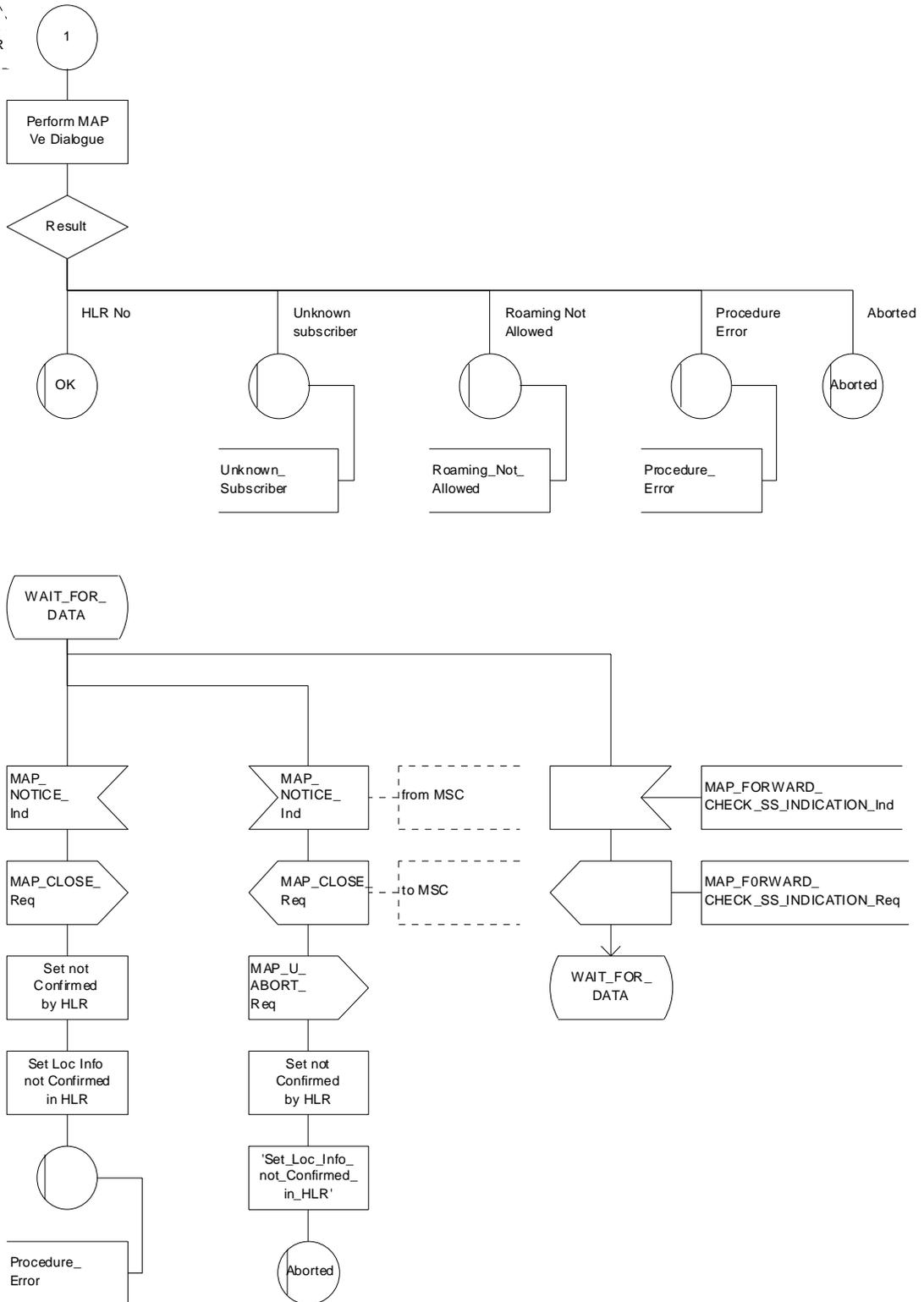

Figure 19.1.1/8 (sheet 2 of 2): Macro VLR\_Update\_HLR

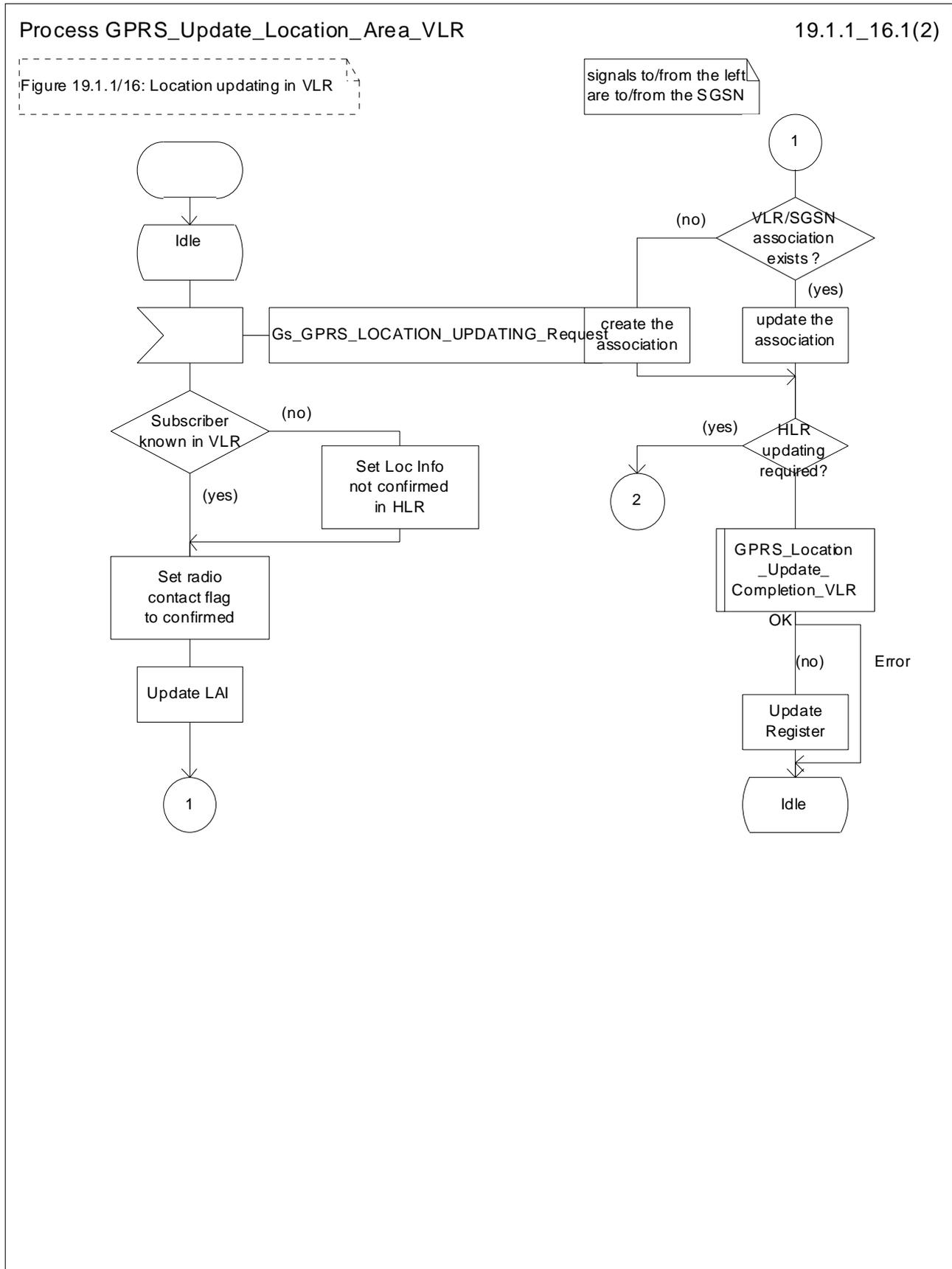

Figure 19.1.1/16 (sheet 1 of 2): Process GPRS\_Update\_Location\_Area\_VLR

Process GPRS\_Update\_Location\_Area\_VLR

19.1.1\_16.2(2)

Figure 19.1.1/16: Location updating in VLR

Signals to/from the left are to/from the SGSN

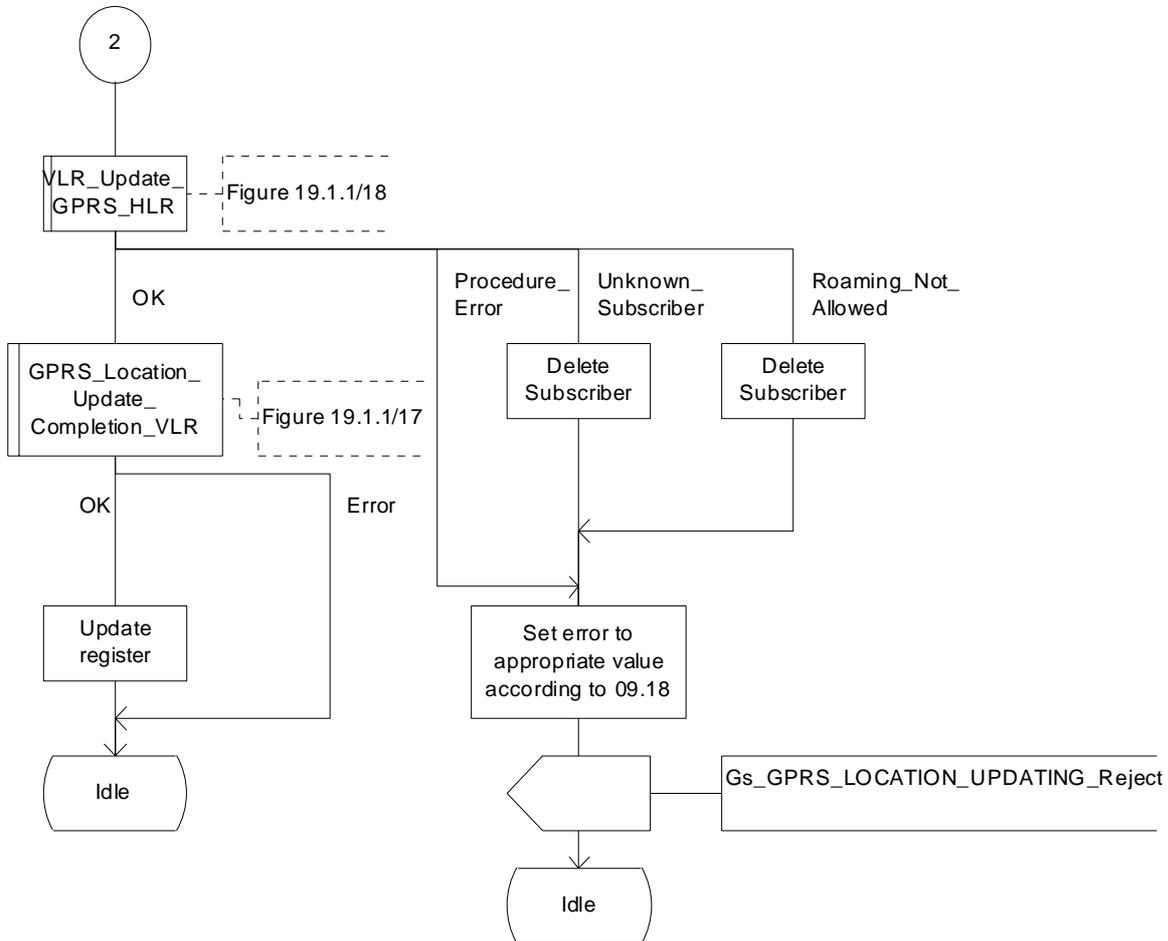

Figure 19.1.1/16 (sheet 2 of 2): Process GPRS\_Update\_Location\_Area\_VLR



Macrodefinition GPRS\_Location\_Update\_Completion\_VLR

19.1.1\_17(1)

Figure 19.1.1/17:  
Location updating in VLR for GPRS;  
closing sequence

Signals to/from the left  
are to/from the SGSN

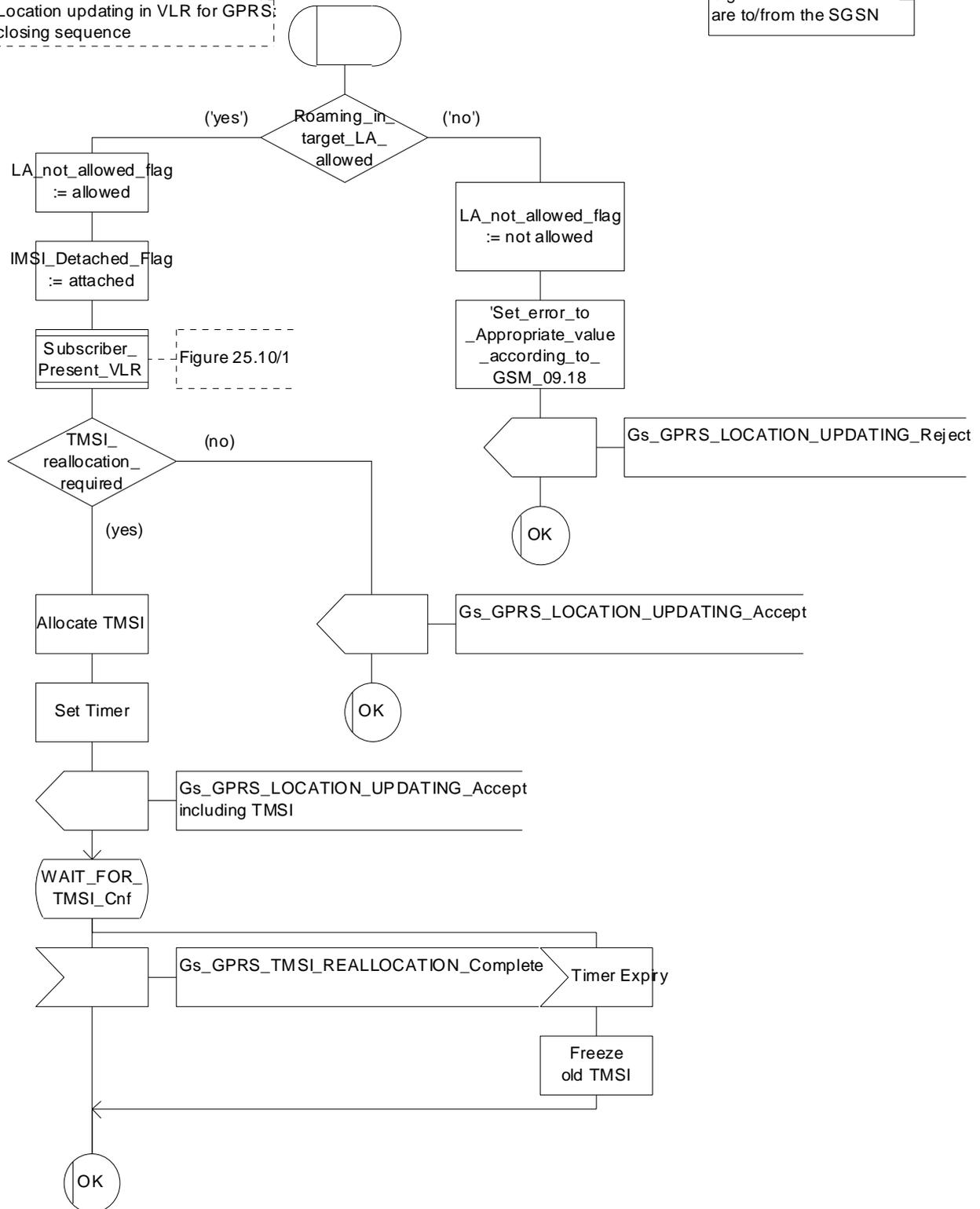

Figure 19.1.1/17: Macro GPRS\_Location\_Update\_Completion\_VLR

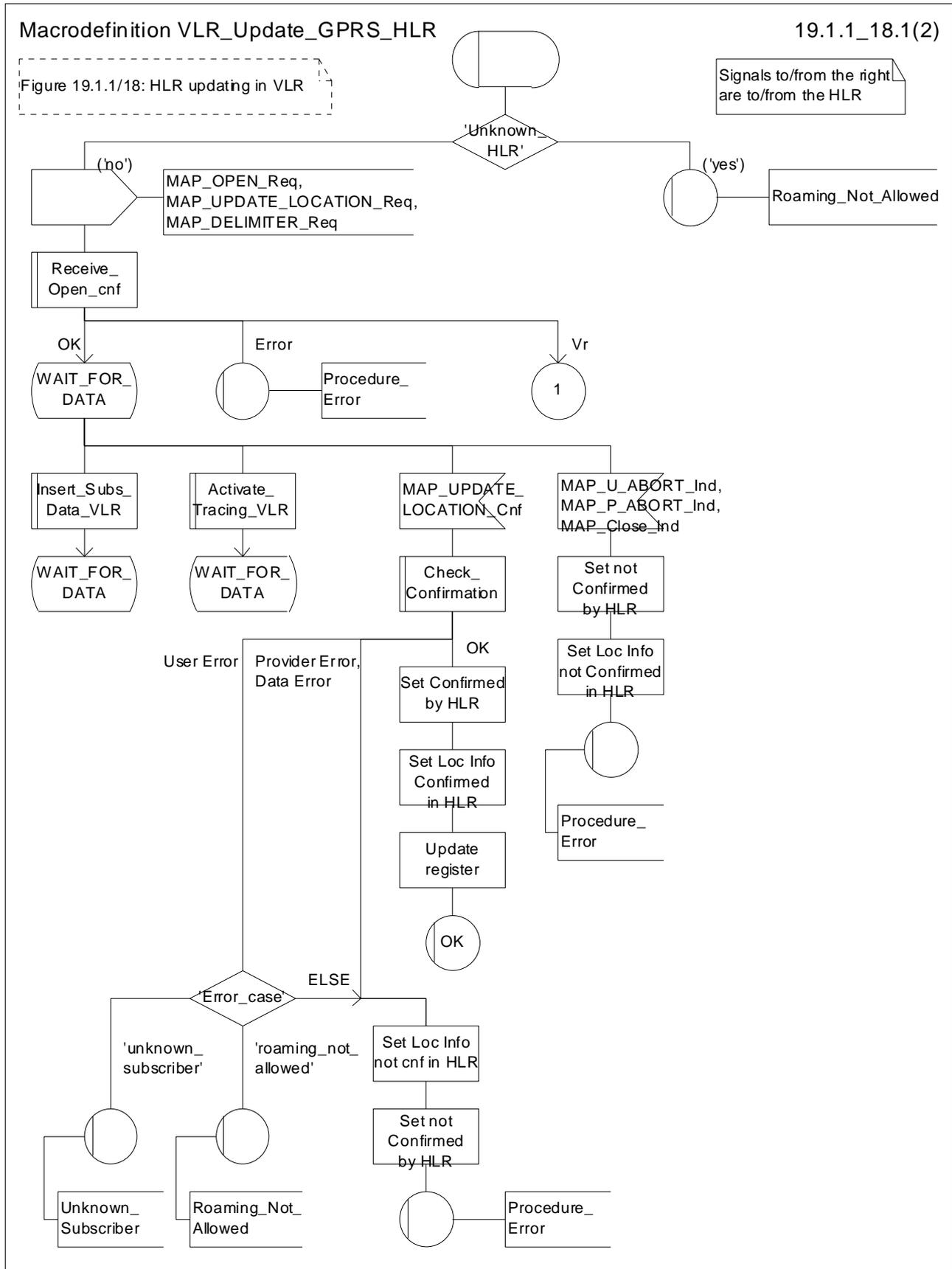

Figure 19.1.1/18 (sheet 1 of 2): Macro VLR\_Update\_GPRS\_HLR

Macrodefinition VLR\_Update\_GPRS\_HLR

19.1.1\_18.2(2)

Figure 19.1.1/18: HLR updating in VLR

Signals to/from the right are to/from the HLR

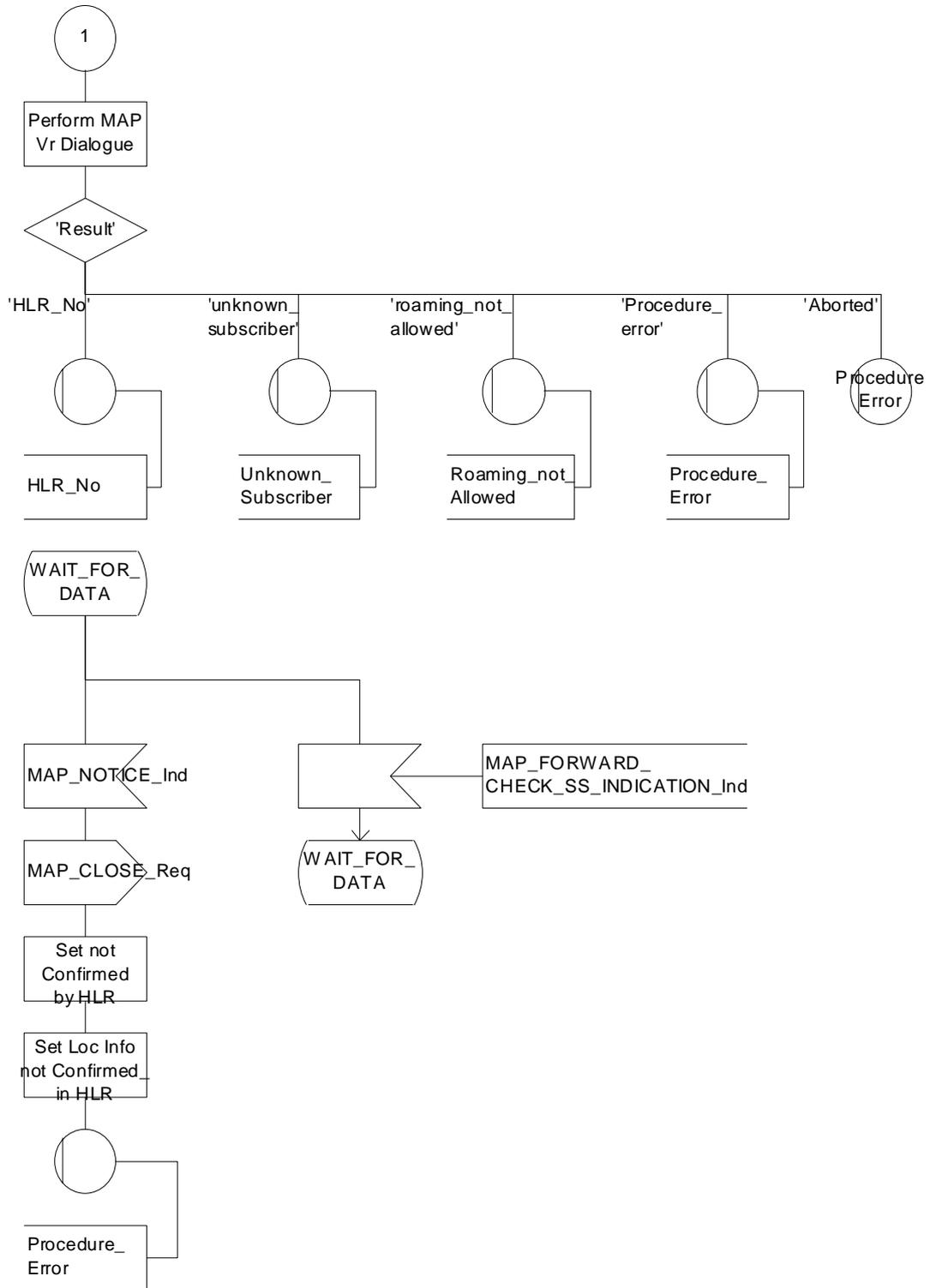

Figure 19.1.1/18 (sheet 2 of 2): Macro VLR\_Update\_GPRS\_HLR

#### 19.1.1.4 Detailed procedure in the HLR

When addressed by the VLR, the following macros are used by the process Update\_Location\_HLR:

- Receive\_Open\_Ind, defined in clause 25.1;
- Check\_indication, defined in clause 25.2;
- Insert\_Subs\_Data\_Framed\_HLR, described in clause 19.4.1;
- Control\_Tracing\_HLR, described in clause 25.9;

and the processes Cancel\_Location\_HLR (see clause 19.1.2) and Subscriber\_Present\_HLR (see clause 19.1.1.7) are invoked.

The location updating process in the HLR is activated by receipt of a MAP\_UPDATE\_LOCATION indication (see figure 19.1.1/9):

- if there is a parameter problem in the indication, the error Unexpected Data Value is returned in the MAP\_UPDATE\_LOCATION response (see Check\_indication macro defined in clause 25.2); if the subscriber is not known in the HLR, the error Unknown Subscriber is returned in the response. In either case the process terminates;
- if Network Access Mode is set to "GPRS only" the error Unknown Subscriber is returned in the response. The process terminates;
- tracing shall be set to deactivate in the VLR
- if the VLR address received in the MAP\_UPDATE\_LOCATION indication differs from the one actually stored against the subscriber, the Cancel\_Location\_HLR process is started to cancel the subscriber data in the stored VLR (see clause 19.1.2).

The next action will be to check whether the subscriber is allowed to roam into the PLMN indicated by the VLR Number given in the MAP\_UPDATE\_LOCATION indication:

- if the subscriber is not allowed to roam into the PLMN, the error Roaming not Allowed with cause PLMN Roaming Not Allowed is returned in the MAP\_UPDATE\_LOCATION response, and the routing information stored (VLR number, MSC Number, LMSI) is deleted (deregistration);
- otherwise the HLR database will be updated with information received in the indication. The HLR sets the "MS purged for non-GPRS" flag to False and checks whether tracing is required for that subscriber. This is handled by the macro Control\_Tracing\_HLR described in clause 25.9.

Thereafter, the macro Insert\_Subs\_Data\_Framed\_HLR described in clause 19.4.1 is invoked. The outcome of this macro may be:

- aborted, in which case the process terminates;
- error, in which case the error System Failure is returned in the MAP\_UPDATE\_LOCATION response and the process terminates;
- OK, indicating successful outcome of downloading the subscriber data to the VLR.

The SUBSCRIBER\_PRESENT\_HLR process is then started to alert the Short Message Service Centre, if required (see clause 19.1.7). Additionally, the MAP\_FORWARD\_CHECK\_SS\_INDICATION request is sent to inform the subscriber about an uncertain state of his SS-Data if this is needed due to previous HLR restoration (use of this service may be omitted as an HLR operator option).

The HLR number is then returned in the MAP\_UPDATE\_LOCATION response.

In all cases where the HLR sends a MAP\_UPDATE\_LOCATION response to the VLR, the dialogue towards the VLR is terminated by a MAP\_CLOSE request with parameter Release Method indicating Normal Release.

Finally the process Update\_Location\_HLR sends a "Location updating complete" message to the process CCBS\_Coordinator\_HLR (specified in GSM 03.93 [107]) and the process terminates.

When addressed by the SGSN, the following macros are used by the process Update\_GPRS\_Location\_HLR:

- Receive\_Open\_indication, defined in clause 25.1;
- Check\_indication, defined in clause 25.2;
- Insert\_Subs\_Data\_In\_SGSN\_Framed\_HLR, described in clause 19.4.x;
- Control\_Tracing\_HLR\_with\_SGSN, described in clause 25.9;

and the processes Cancel\_Location\_HLR (see clause 19.1.2) and Subscriber\_Present\_HLR (see clause 19.1.1.7) are invoked.

The location updating process in the HLR is activated by receipt of a MAP\_UPDATE\_GPRS\_LOCATION indication (see figure 19.1.1/19):

- if there is a parameter problem in the indication, the error Unexpected Data Value is returned in the MAP\_UPDATE\_LOCATION response (see Check\_indication macro defined in clause 25.2); if the subscriber is not known in the HLR, the error Unknown Subscriber (with diagnostic value set to "Imsi Unknown") is returned in the response. In either case the process terminates;
- if Network Access Mode is set to "non-GPRS only" the error Unknown Subscriber (with diagnostic value set to "Gprs Subscription Unknown") is returned in the response. The process terminates;
- tracing shall be set to deactivate in the SGSN.
- if the SGSN number received in the MAP\_UPDATE\_GPRS\_LOCATION indication differs from the one actually stored against the subscriber, the Cancel\_Location\_HLR process is started to cancel the subscriber data in the stored SGSN (see clause 19.1.2).

The next action will be to check whether the subscriber is allowed to roam into the PLMN indicated by the SGSN Number given in the MAP\_UPDATE\_GPRS\_LOCATION indication:

- if the subscriber is not allowed to roam into the PLMN, the error Roaming not Allowed with cause PLMN Roaming Not Allowed or 'Operator determined Barring', depending on the case, is returned in the MAP\_UPDATE\_GPRS\_LOCATION response, and the routing information stored (SGSN number) is deleted (deregistration);
- otherwise the HLR database will be updated with information received in the indication. The HLR sets the "MS purged for GPRS" flag to False and checks whether tracing is required for that subscriber. This is handled by the macro Control\_Tracing\_HLR-with\_SGSN described in clause 25.9.

Thereafter, the macro Insert\_Subs\_Data\_In\_SGSN\_Framed\_HLR described in clause 19.4.x is invoked. The outcome of this macro may be:

- aborted, in which case the process terminates;
- error, in which case the error System Failure is returned in the MAP\_UPDATE\_GPRS\_LOCATION response and the process terminates;
- OK, indicating successful outcome of downloading the subscriber data to the SGSN.

The SUBSCRIBER\_PRESENT\_HLR process is then started to alert the Short Message Service Centre, if required (see clause 19.1.7).

Finally the HLR number is returned in the MAP\_UPDATE\_GPRS\_LOCATION response.

In all cases where the HLR sends a MAP\_UPDATE\_GPRS\_LOCATION response to the SGSN, the dialogue towards the SGSN is terminated by a MAP\_CLOSE request with parameter Release Method indicating Normal Release.

### Process Update\_Location\_HLR

19.1.1\_9.1(2)

Figure 19.1.1/9:  
Location Updating in the HLR

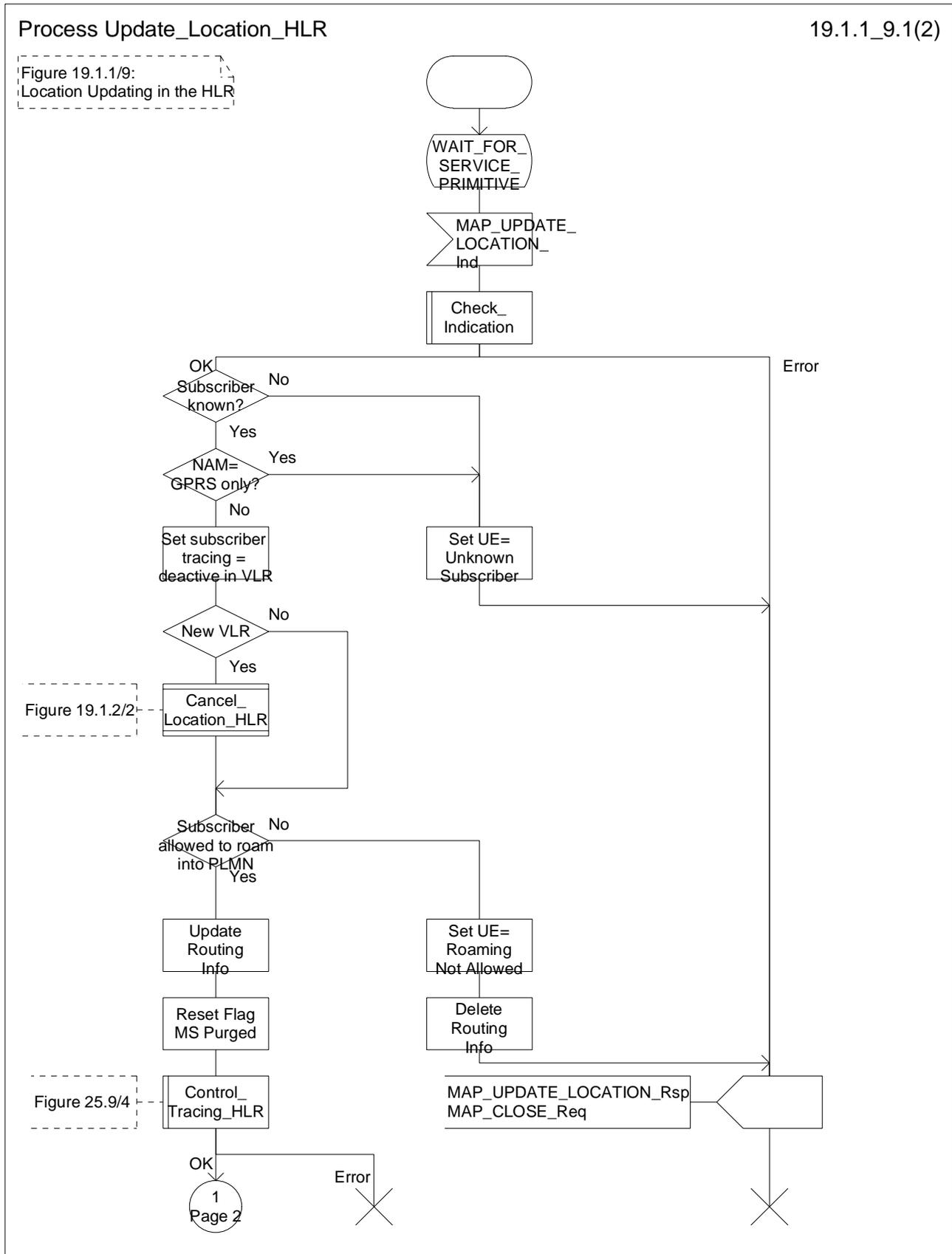

Figure 19.1.1/9 (sheet 1 of 2): Process Update\_Location\_HLR

Process Update\_Location\_HLR

19.1.1\_9.2(2)

Figure 19.1.1/9:  
Location Updating in the HLR

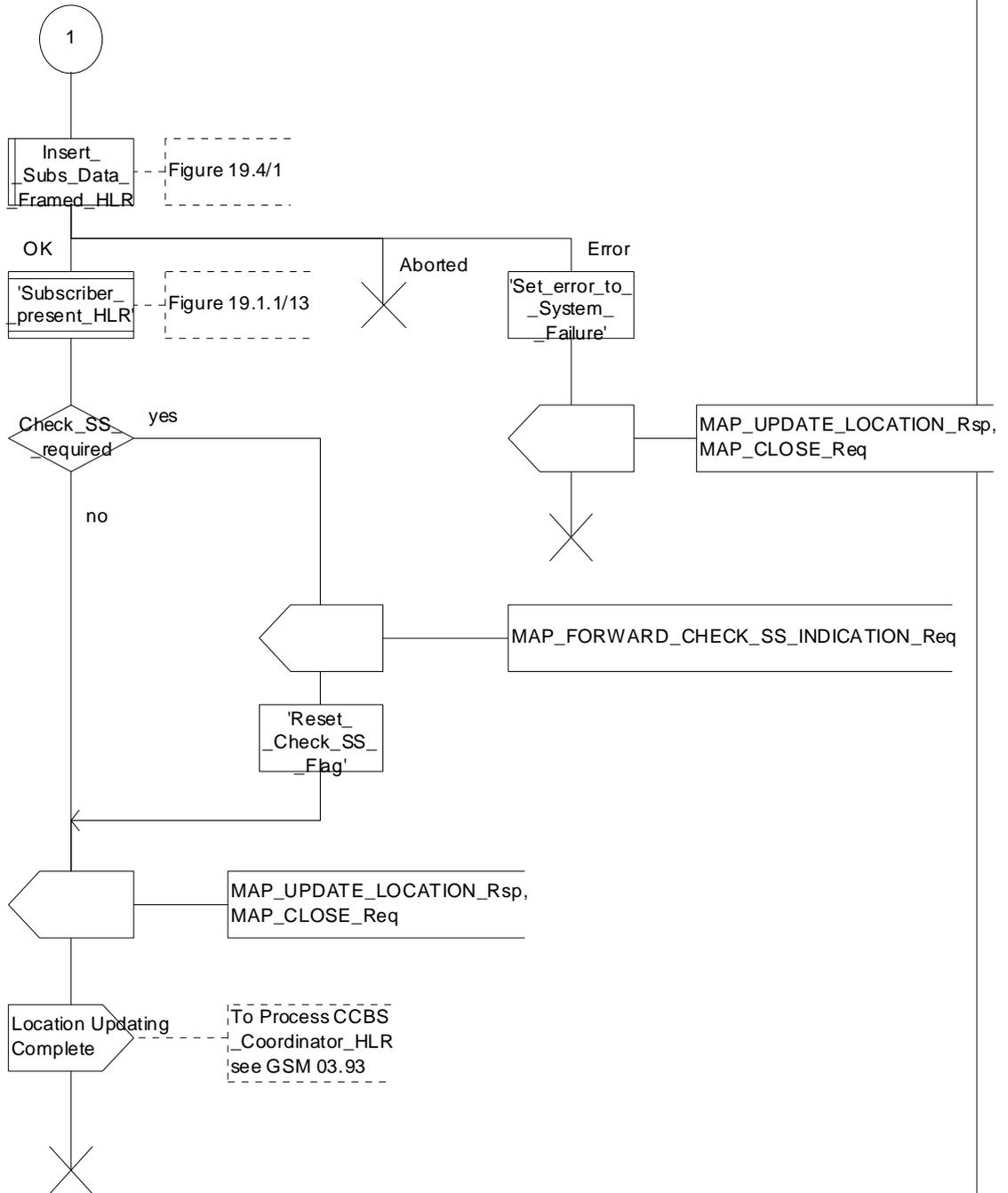

Figure 19.1.1/9 (sheet 2 of 2): Process Update\_Location\_HLR

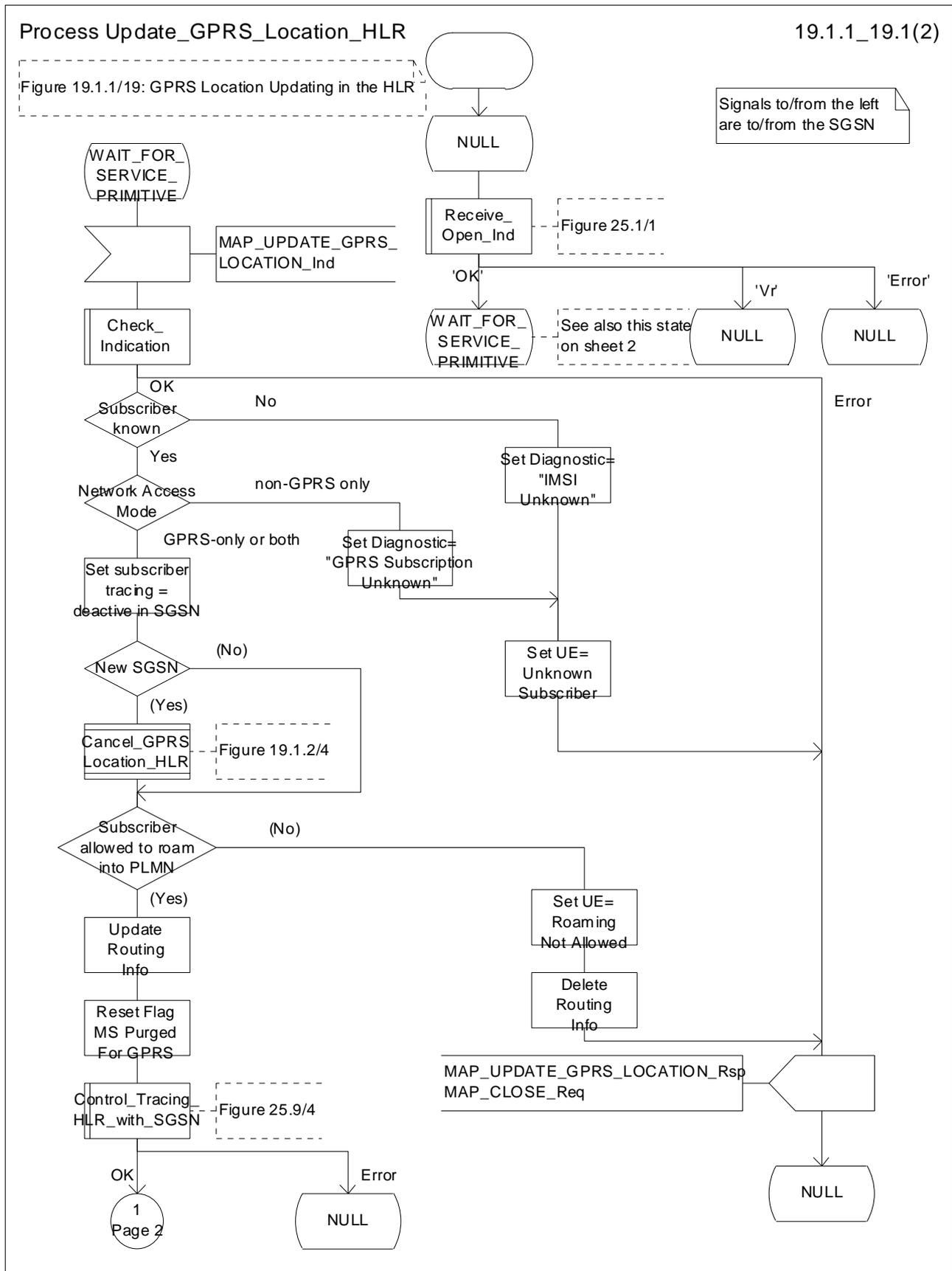

Figure 19.1.1/19 (sheet 1 of 2): Process Update\_GPRS\_Location\_HLR



Process Update\_GPRS\_Location\_HLR

19.1.1\_19.2(2)

Figure 19.1.1/19: GPRS Location Updating in the HLR

Signals to/from the left are to/from the HLR

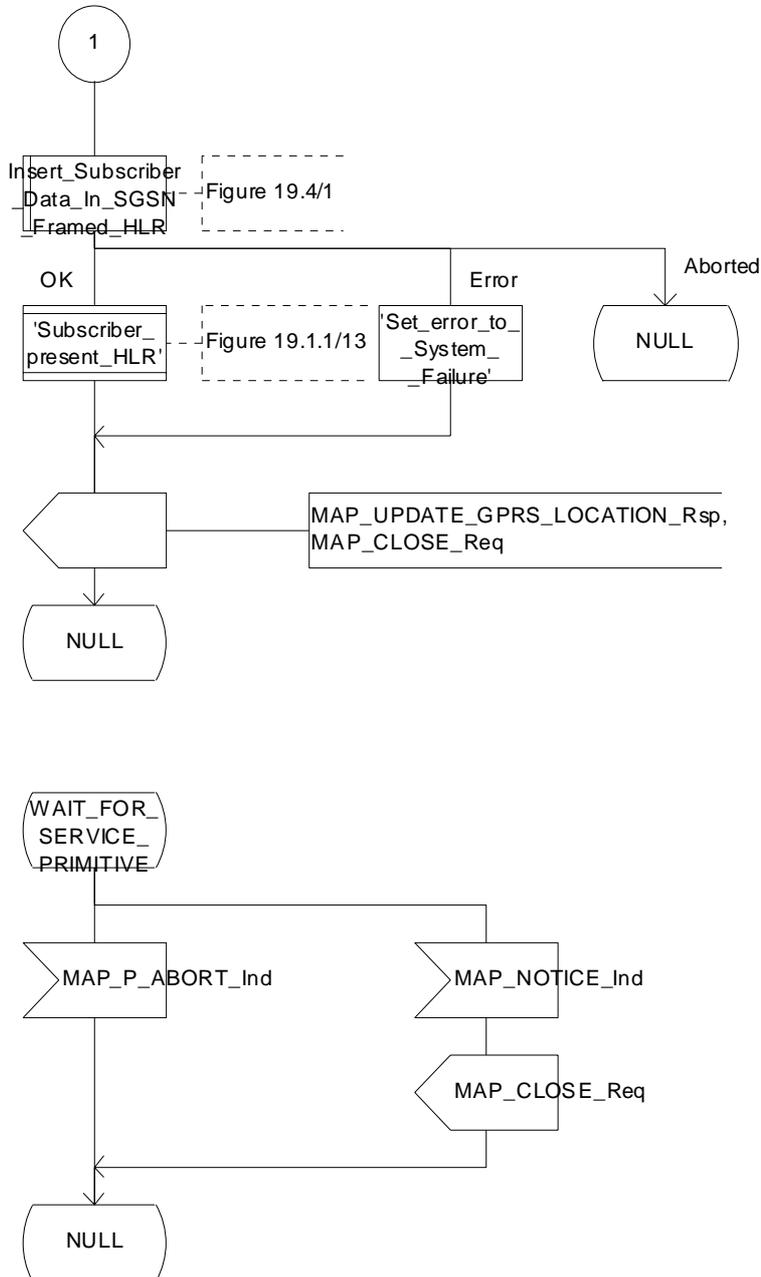
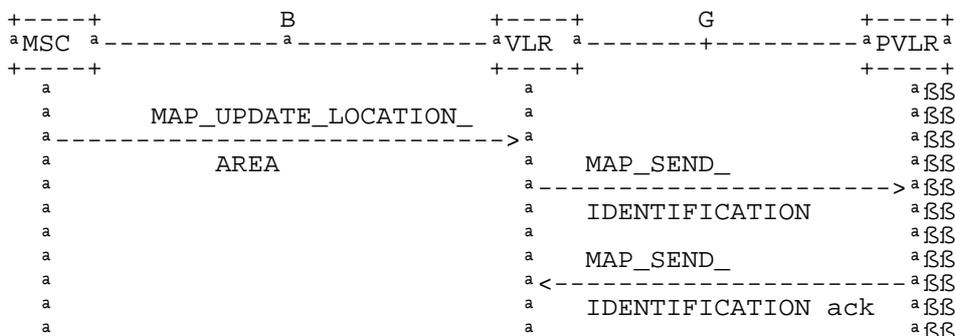

Figure 19.1.1/19 (sheet 2 of 2): Process Update\_GPRS\_Location\_HLR

### 19.1.1.5 Send Identification

#### 19.1.1.5.1 General

This service is invoked by a VLR when it receives a MAP\_UPDATE\_LOCATION\_AREA indication containing a LAI indicating that the subscriber was registered in a different VLR (henceforth called the Previous VLR, PVLR). If the identity of the PVLR is derivable for the VLR (usually if both are within the same network), the IMSI and authentication sets are requested from the PVLR (see clause 19.1.1.3), using the service described in clause 8.1.4.



NOTE: The service shown in dotted lines indicates the trigger provided by other MAP signalling.

**Figure 19.1.1/10: Interface and services for Send Identification**

#### 19.1.1.5.2 Detailed procedure in the VLR

The VLR procedure is part of the location area updating process described in clause 19.1.1.3, see also figure 19.1.1/6 sheet 3.

#### 19.1.1.5.3 Detailed procedure in the PVLR

On receipt of a dialogue request for the Send Identification procedure, (see Receive\_Open\_Ind macro in clause 25.1), the PVLR will:

- terminate the procedure in case of parameter problems;
- revert to the MAP version Vr procedure in case the VLR indicated version Vr protocol; or
- continue as below, if the dialogue is accepted.

If the PVLR process receives a MAP\_NOTICE indication, it terminates the dialogue by sending a MAP\_CLOSE request.

If the PVLR process receives a MAP\_SEND\_IDENTIFICATION indication from the VLR (see figure 19.1.1/11), it checks whether the subscriber identity provided is known:

- if so, the IMSI and - if available - authentication parameters for the subscriber are returned in the MAP\_SEND\_IDENTIFICATION response;
- if not, the error Unidentified Subscriber is returned in the MAP\_SEND\_IDENTIFICATION response.

In all cases where the PVLR sends a MAP\_SEND\_IDENTIFICATION response to the VLR, the dialogue towards the VLR is terminated by a MAP\_CLOSE request with parameter Release Method indicating Normal Release.

Process Send\_Identification\_PVLR

19.1.1\_11(1)

Figure 19.1.1/11: Process in the Previous VLR to handle an identification request

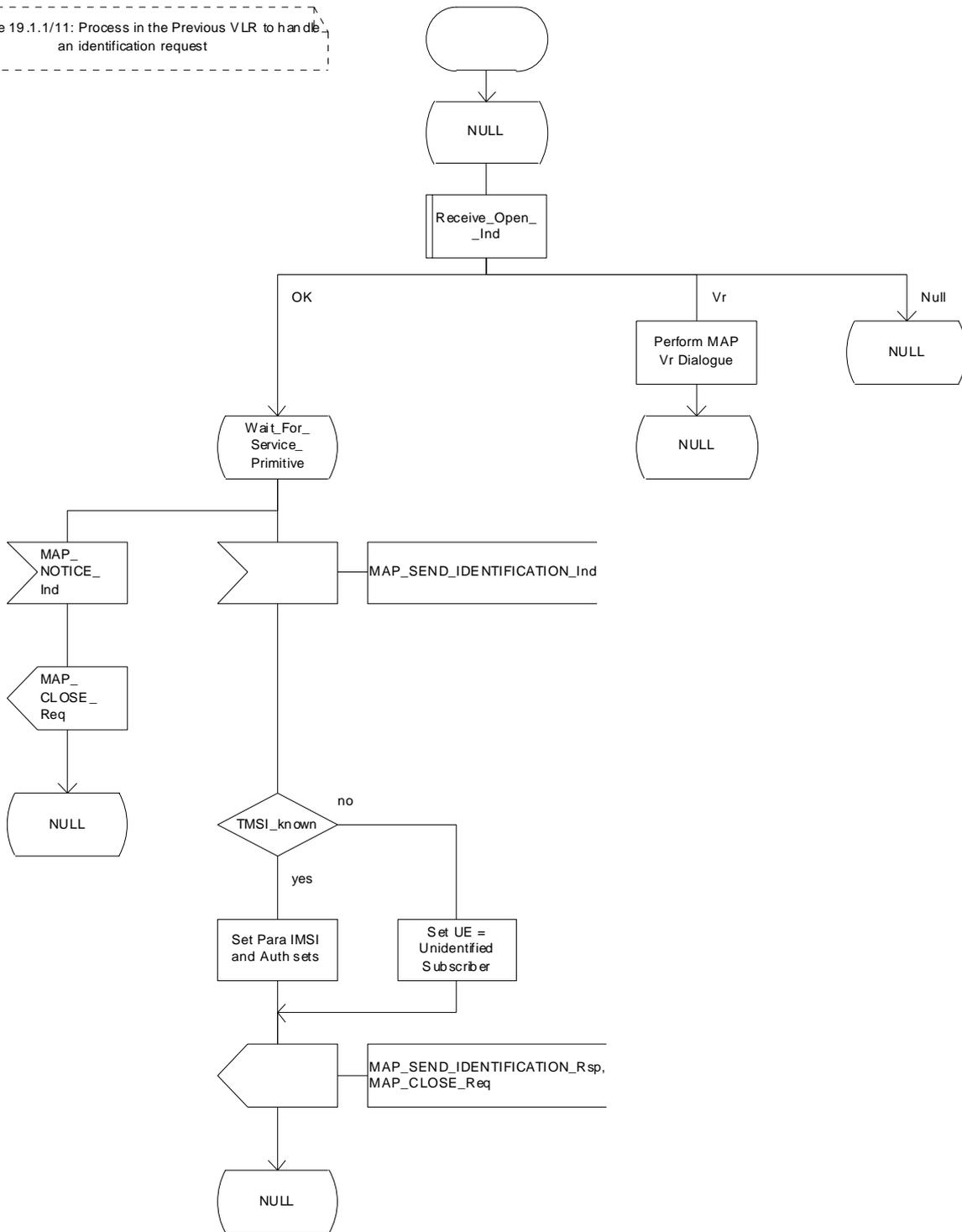

Figure 19.1.1/11: Process Send\_Identification\_PVLR

### 19.1.1.6 The Process Update Location VLR

This process is started by some other MAP user process in case the HLR need to be updated due to previous network failure. It is invoked when the subscriber accesses the network, e.g. for mobile originated call set-up, response to paging or supplementary services handling. Here, location updating consists only of invoking the macro VLR\_Update\_HLR described above (see clause 19.1.1.3), which performs HLR updating and downloading of subscriber data.

If updating is successful (OK) the HLR Number is received in the MAP\_UPDATE\_LOCATION confirm primitive and the process terminates.

If one of the errors Roaming not Allowed or Unknown Subscriber is received instead, all subscriber data are deleted from the VLR before the process terminates.

In case some other error occurs during HLR updating, the process simply terminates. Note, in all error cases the initiating restoration flags in VLR remain false, therefore a new HLR updating attempt will be started later on.

NOTE: This process will be performed independent from the calling process, no coordination is required.

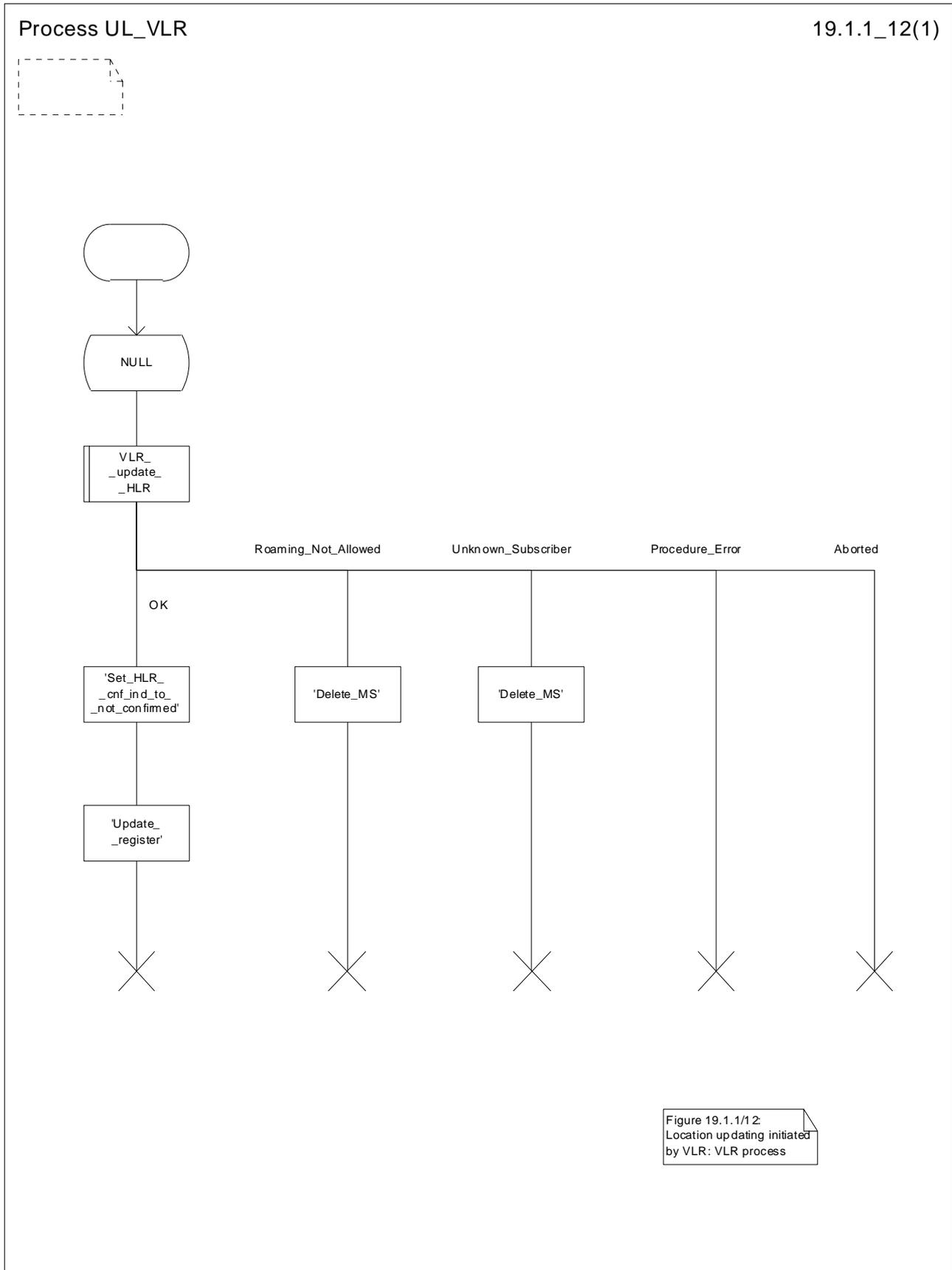

Figure 19.1.1/12: Process UL\_VLR

### 19.1.1.7 The Process Subscriber Present HLR

The process Subscriber Present HLR is started by the location updating process in HLR to perform actions required for short message alerting. The process checks the Message Waiting Data flag, and if this is set, the macro Alert\_Service\_Centre\_HLR defined in clause 25.10 is invoked. This macro will alert all service centres from which there are short messages waiting for this subscriber.

Process Subscriber\_Present\_HLR

19.1.1\_13(1)

Figure 19.1.1/13: Process Subscriber\_Present\_HLR

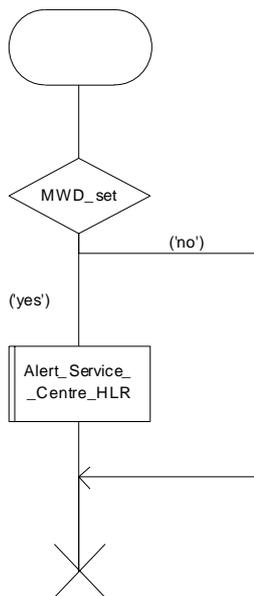

Figure 19.1.1/13: Process Subscriber\_Present\_HLR

### 19.1.1.8 Detailed procedure in the SGSN

Figure 19.1.1/20 shows the MAP process for updating of the SGSN. The following general macros are used:

Receive_Open_Cnf	clause 25.1;
Insert_Subscriber_Data_SGSN	clause 25.7;
Activate_Tracing_SGSN	clause 25.9;

#### The location updating process

The MAP process receives an « Update HLR request » from the relevant process in the SGSN (see GSM 03.60) to perform HLR updating. If the SGSN does not know the subscribers HLR (e.g. no IMSI translation exists as there are not yet any SS7 links to the subscribers HPLMN), the « Update HLR negative response » with error Roaming Not Allowed (cause PLMN Roaming Not Allowed) is returned to the requesting process.

If the subscribers HLR can be reached, the SGSN opens a dialogue towards the HLR by sending a MAP\_OPEN request without any user specific parameters, together with a MAP\_UPDATE\_GPRS\_LOCATION request containing the parameters

- IMSI, identifying the subscriber;
- SGSN Address and SGSN number.

In case the HLR rejects dialogue opening (see clause 25.1) or indicates version Vr protocol to be used, the SGSN will terminate the process indicating « Update HLR negative response » to the requesting process.

If the HLR accepts the dialogue, the HLR will respond with:

- a MAP\_INSERT\_SUBSCRIBER\_DATA indication, handled by the macro Insert\_Subs\_Data\_SGSN defined in clause 25.7;

NOTE: The HLR may repeat this service several times depending on the amount of data to be transferred to the SGSN and to replace subscription data in case they are not supported by the SGSN.

- a MAP\_ACTIVATE\_TRACE\_MODE indication, handled by the macro Activate\_Tracing\_SGSN defined in clause 25.9;
- the MAP\_UPDATE\_GPRS\_LOCATION confirmation:
  - if this confirmation contains the HLR Number, this indicates that the HLR has passed all information and that updating has been successfully completed. The « Update HLR response » message is returned to the requesting process for completion of the SGSN updating (see GSM 03.60).
  - if the confirmation contains an User error cause (Unknown Subscriber, Roaming Not Allowed or some other), the corresponding error is returned to the requesting process in the « Update HLR negative response ».
- a MAP\_P\_ABORT, MAP\_U\_ABORT, or MAP\_CLOSE indication. In these cases, the corresponding error is returned to the requesting process in the « Update HLR negative response ».
- a MAP\_NOTICE indication. Then, the dialogue towards the HLR is terminated, and the « HLR Update negative response » with the appropriate error is returned to the requesting process.



Process SGSN\_Update\_HLR

19.1.1\_20.1(2)

Figure 19.1.1/20: HLR updating in SGSN

Signals from/to the left are from/to requesting process in SGSN  
Signals to/from the right are to/from the HLR

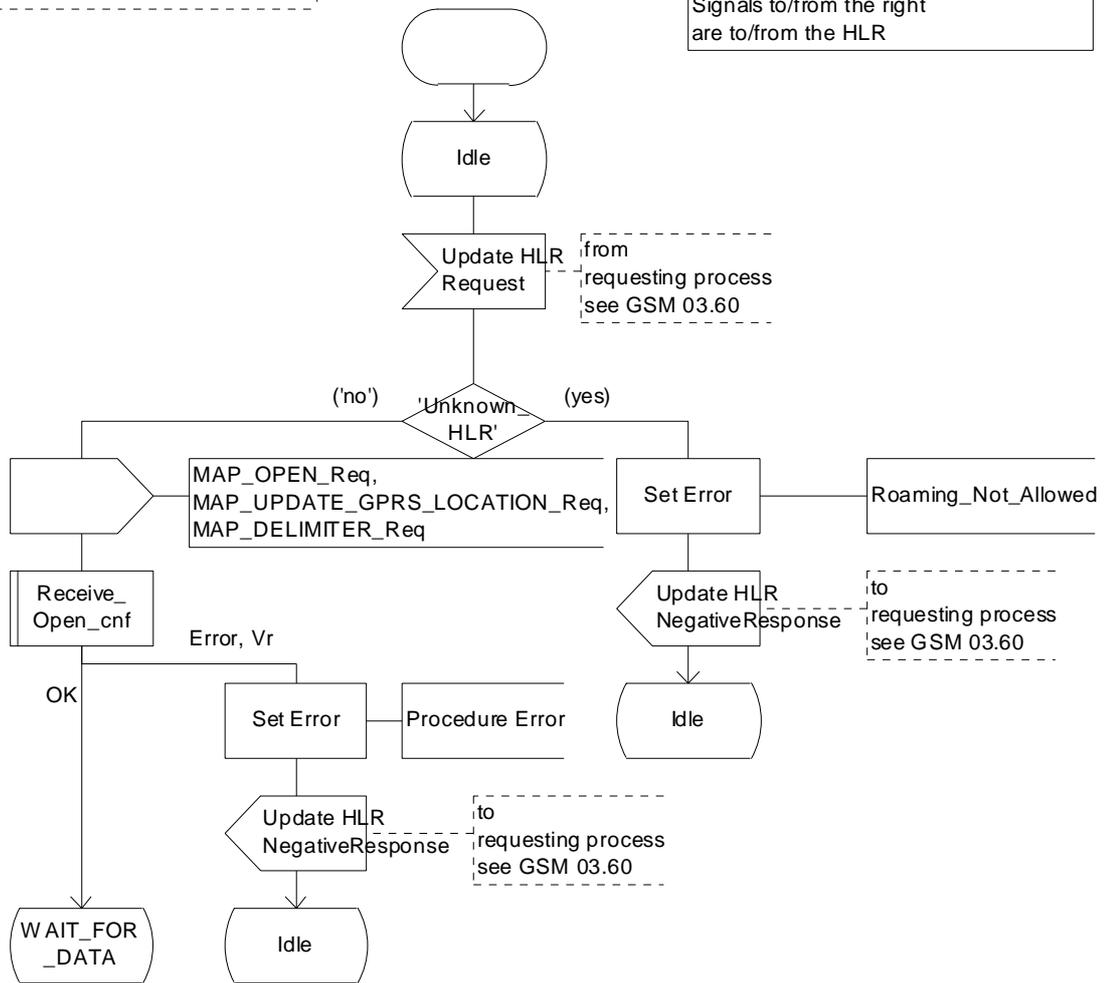

Figure 19.1.1/20 (sheet 1 of 2): Process SGSN\_Update\_HLR

Process SGSN\_Update\_HLR

19.1.1\_20.2(2)

Figure 19.1.1/20: HLR updating in SGSN

Signal from/to the left are from/to requesting process in SGSN  
Signals to/from the right are to/from the HLR

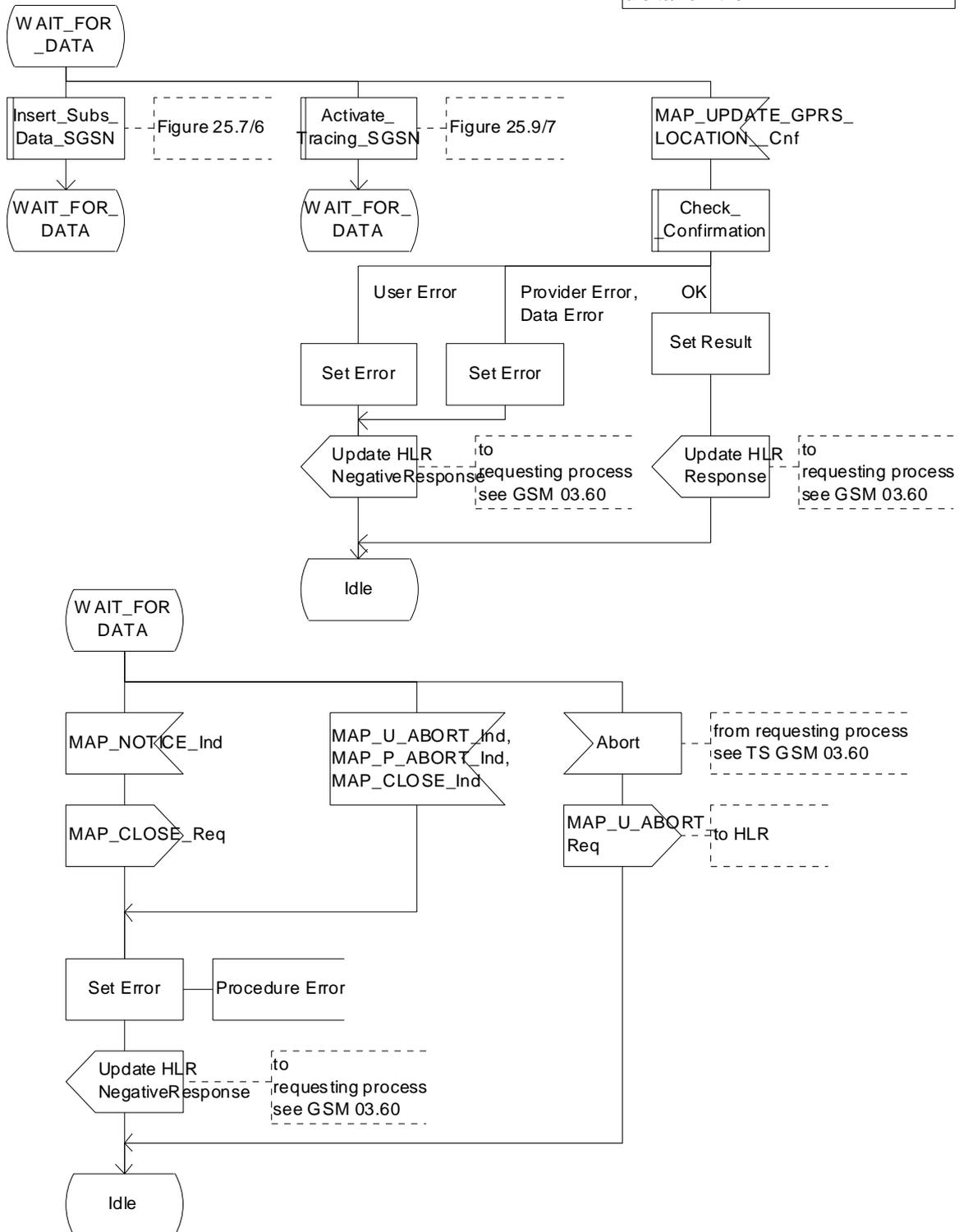

Figure 19.1.1/20 (sheet 2 of 2): Process SGSN\_Update\_HLR

## 19.1.2 Location Cancellation

### 19.1.2.1 General

The purpose of this process is to delete a subscriber's record from a previous visitor location register after she has registered with a new visitor location register. Also this process is used to delete a subscriber's record from a old SGSN after she has registered with a SGSN. The procedure may also be used if the subscriber's record is to be deleted for other operator determined purposes, e.g. withdrawal of subscription, imposition of roaming restrictions or modifications to the subscription which result in roaming restrictions. Location cancellation can be used to enforce location updating including updating of subscriber data in the VLR or in the SGSN at the next subscriber access.

In all cases, the process is performed independently of the invoking process (e.g. Location Updating).

The service as described in clause 8.1.3 is invoked when an HLR receives a MAP\_UPDATE\_LOCATION indication from a VLR other than that stored in its table for this subscriber. Also the MAP\_CANCEL\_LOCATION service is invoked when the HLR receives a MAP\_UPDATE\_GPRS\_LOCATION indication from a SGSN other than stored in its table for this subscriber. Additionally the service may be invoked by operator intervention. The MAP\_CANCEL\_LOCATION service is in any case invoked towards the VLR or the SGSN whose identity is contained in the HLR table.

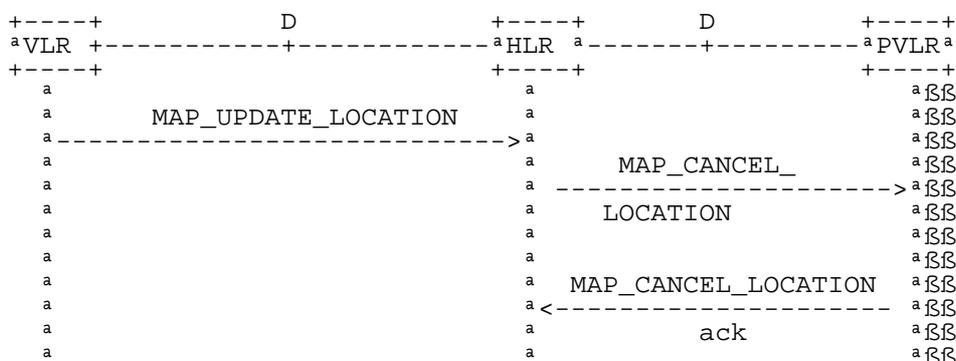

NOTE: The service shown in dotted lines indicates the trigger provided by other MAP signalling.

Figure 19.1.2/1: Interface and services for Location Cancellation

### 19.1.2.2 Detailed procedure in the HLR

The location cancellation process is started by an external process as stated above. The HLR opens a dialogue with the VLR or with the SGSN whose identity is contained in the HLR table (MAP\_OPEN request without any user specific parameters), sending the MAP\_CANCEL\_LOCATION request primitive (see figures 16.1.2/2 and 16.1.2/4), containing the parameters:

- IMSI, to identify the subscriber to be deleted from that VLR or SGSN;
- LMSI, which is included if available in the HLR. LMSI is not applicable between HLR and SGSN;
- Cancellation Type if the Cancel Location is sent to SGSN. Cancellation Type is not applicable between HLR and VLR. If the VLR receives this parameter and do not understand it this parameter shall be ignored.

The HLR then waits for the MAP\_OPEN confirmation (see macro Receive\_Open\_Cnf, clause 21.1), indicating either:

- reject of the dialogue (process terminates);
- reversion to version Vr when the operation is sent to SGSN (process terminates);
- reversion to version Vr when the operation is sent to VLR (process will be performed according to MAP version Vr); or
- dialogue acceptance.

When the VLR or the SGSN accepts the dialogue, it will return a MAP\_CANCEL\_LOCATION confirmation, containing:

- no parameter, indicating successful outcome of the procedure;
- a user error, provider error or a data error indicating unsuccessful outcome of the procedure.

In case of unsuccessful outcome or if a MAP\_P\_ABORT indication has been received, the HLR may repeat the MAP\_CANCEL\_LOCATION request later, where the number of repeat attempts and time in between are HLR operator options, depending on the error returned by the VLR or the SGSN.

### 19.1.2.3 Detailed procedure in the VLR

Opening of the dialogue is described in the macro Receive\_Open\_Ind in clause 25.1, with outcomes:

- reversion to version Vr procedure;
- procedure termination; or
- dialogue acceptance, with processing as below.

If the VLR process receives a MAP\_NOTICE indication, it terminates the dialogue by sending a MAP\_CLOSE request.

If the VLR process receives a MAP\_CANCEL\_LOCATION indication from the HLR (see figure 19.1.2/3), the parameters are checked first (macro Check\_Indication, see clause 25.2). In case of parameter problems the appropriate error is sent in the MAP\_CANCEL\_LOCATION response.

If the MAP\_CANCEL\_LOCATION indication contains both the IMSI and the LMSI, the VLR checks whether the stored IMSI matches the received IMSI. If it does not, the VLR attempts to process the request using the IMSI received from the HLR to define the subscriber record to be deleted.

Thereafter the VLR checks whether the subscriber identity provided is known in the VLR:

- if so, the data of the subscriber are deleted from VLR table and a MAP\_CANCEL\_LOCATION response is returned without any parameters;
- if not, location cancellation is regarded as being successful, too, and the MAP\_CANCEL\_LOCATION response is returned without any parameters.

In either case, after sending the MAP\_CANCEL\_LOCATION response the VLR process releases any TMSI which may be associated with the IMSI of the subscriber, terminates the dialogue (MAP\_CLOSE with Release Method Normal Release) and returns to the idle state.

Process Cancel\_Location\_HLR

19.1.2\_2(1)

Figure 19.1.2/2: Location Cancellation in the HLR

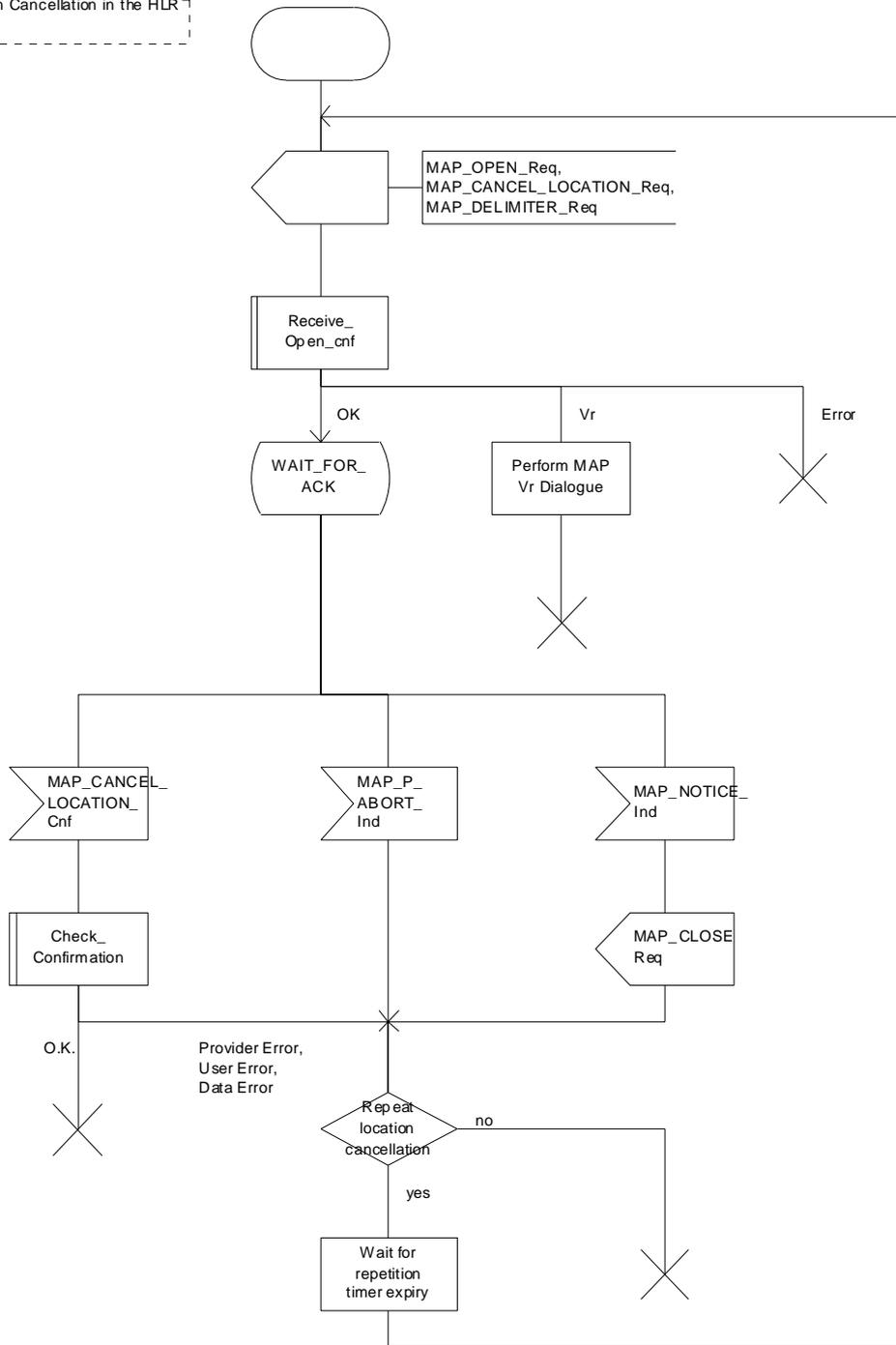

Figure 19.1.2/2: Process Cancel\_Location\_HLR

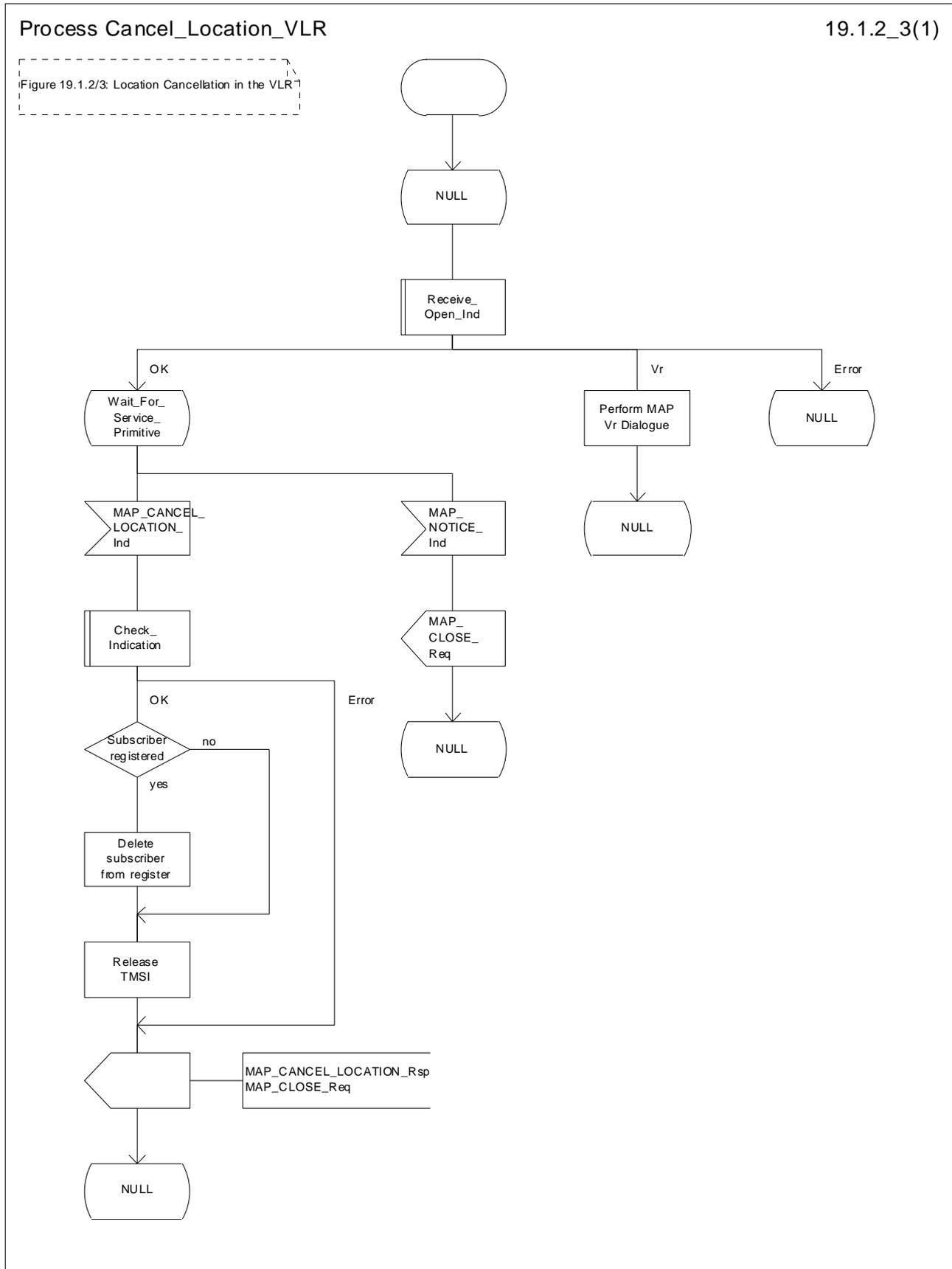

Figure 19.1.2/3: Process Cancel\_Location\_VLR

#### 19.1.2.4 Detailed procedure in the SGSN

Opening of the dialogue is described in the macro Receive\_Open\_Ind in clause 25.1, with outcomes:

- procedure termination; or
- dialogue acceptance, with processing as below.

If the SGSN process receives a MAP\_NOTICE indication, it terminates the dialogue by sending a MAP\_CLOSE request.

If the SGSN process receives a MAP\_CANCEL\_LOCATION indication from the HLR (see figure 19.1.2/4), the parameters are checked first (macro Check\_Indication, see clause 25.2). In case of parameter problems the appropriate error is sent in the MAP\_CANCEL\_LOCATION response.

Thereafter the SGSN checks whether the subscriber identity provided is known in the SGSN:

- if so, the data of the subscriber are deleted from SGSN table and a MAP\_CANCEL\_LOCATION response is returned without any parameters;
- if not, location cancellation is regarded as being successful, too, and the MAP\_CANCEL\_LOCATION response is returned without any parameters.

In either case, after sending the MAP\_CANCEL\_LOCATION response the SGSN process releases any P-TMSI which may be associated with the IMSI of the subscriber, terminates the dialogue (MAP\_CLOSE with Release Method Normal Release) and returns to the idle state.

Process Cancel\_GPRS\_Location\_HLR

19.1.2\_4(1)

Figure 19.1.2/4: Location Cancellation in the HLR for GPRS

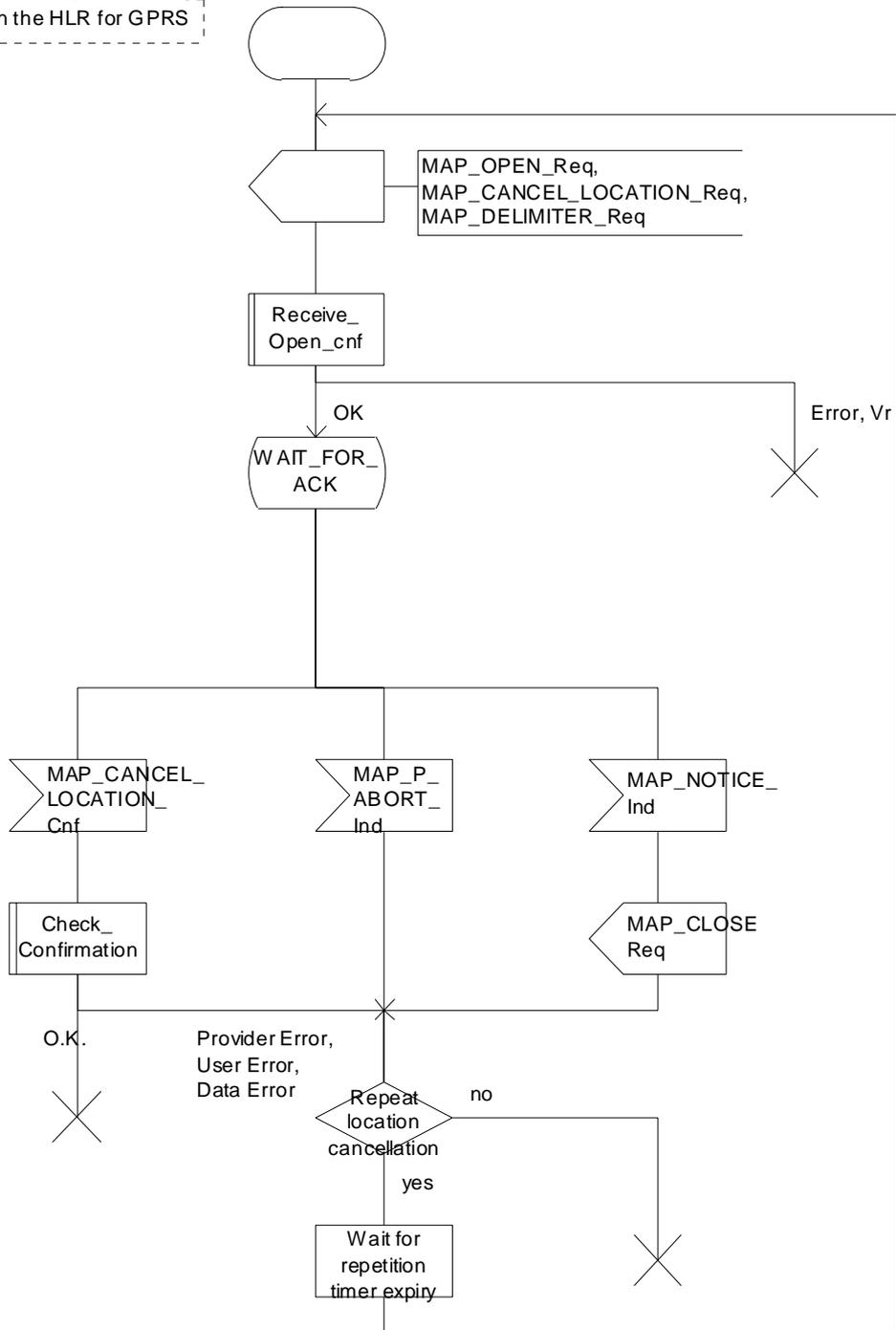

Figure 19.1.2/4: Process Cancel\_GPRS\_Location\_HLR



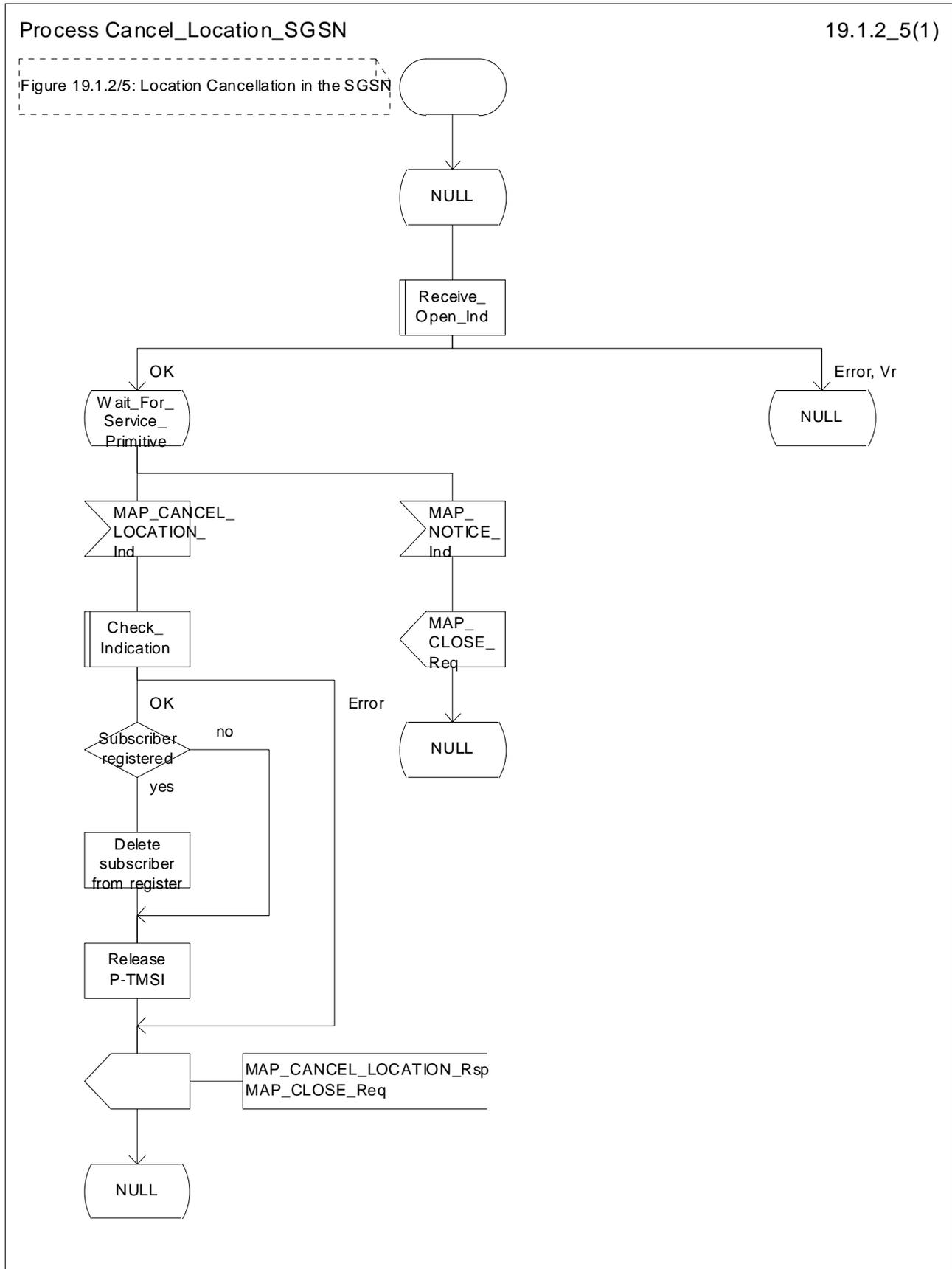

Figure 19.1.2/5: Process Cancel\_Location\_SGSN

### 19.1.3 Detach IMSI

#### 19.1.3.1 General

On receipt of an A\_LU\_REQUEST (DETACH IMSI) indication from the radio interface this procedure invokes the MAP\_DETACH\_IMSI service described in clause 8.1.5 in order to inform the visitor location register that a subscriber is no longer reachable (see figure 19.1.3/1), e.g. due to switched off station. This information is used by the VLR to reject mobile terminating calls or short messages without sending page messages on the radio path. The service is unconfirmed as it is likely that the MS is switched off before receiving a confirmation.

The detach IMSI feature is optional for the network operator. The MS is informed by the network whether detach IMSI is to be used or not.

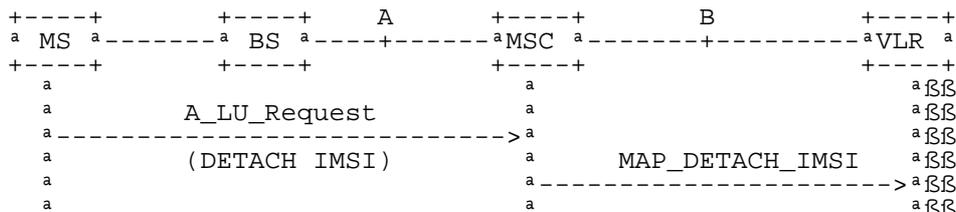

NOTE: The service shown in dotted lines indicates the trigger provided by the radio interface (see GSM 09.10).

**Figure 19.1.3/1: Interface and services for MAP\_DETACH\_IMSI**

If the Gs interface is installed, the procedures to handle an IMSI Detach or a GPRS Detach request from the SGSN via the Gs interface do not require any signalling over the MAP interface. These procedures are specified in GSM 03.60 and 09.18.

#### 19.1.3.2 Detailed procedure in the MSC

The MAP\_DETACH\_IMSI service is invoked by the MSC when receiving an A\_LU\_Request (DETACH IMSI) for a subscriber (see figure 19.1.3/2).

The MSC will open the dialogue to the VLR with a MAP\_OPEN request containing no user specific parameters. The MAP\_DETACH\_IMSI request will contain the following parameter received from the radio side (for the mapping see GSM 09.10):

- Subscriber Id, being either a TMSI or an IMSI.

The MSC then waits for the MAP\_OPEN confirmation (see macro Receive\_Open\_Cnf, clause 25.1), indicating either:

- reject of dialogue (process terminates);
- reversion to version Vr(process terminates); or
- dialogue acceptance.

Thereafter, the dialogue is terminated locally by the MSC (MAP\_CLOSE request with Release Method Prearranged End).

#### 19.1.3.3 Detailed procedure in the VLR

When the VLR receives a MAP\_DETACH\_IMSI indication (see figure 19.1.3/3), it first checks the indication data (macro Check\_Indication, see clause 25.2). Thereafter it is checked whether the subscriber is known:

- if the subscriber is unknown the VLR ignores the indication;
- if the subscriber is known in the VLR, the IMSI detached flag is set.

The VLR process will terminate the dialogue locally (MAP\_CLOSE request with Release Method Prearranged End).

Process Detach\_IMSI\_MSC

19.1.3\_2(1)



Figure 19.1.3/2:  
Detach IMSI in MSC

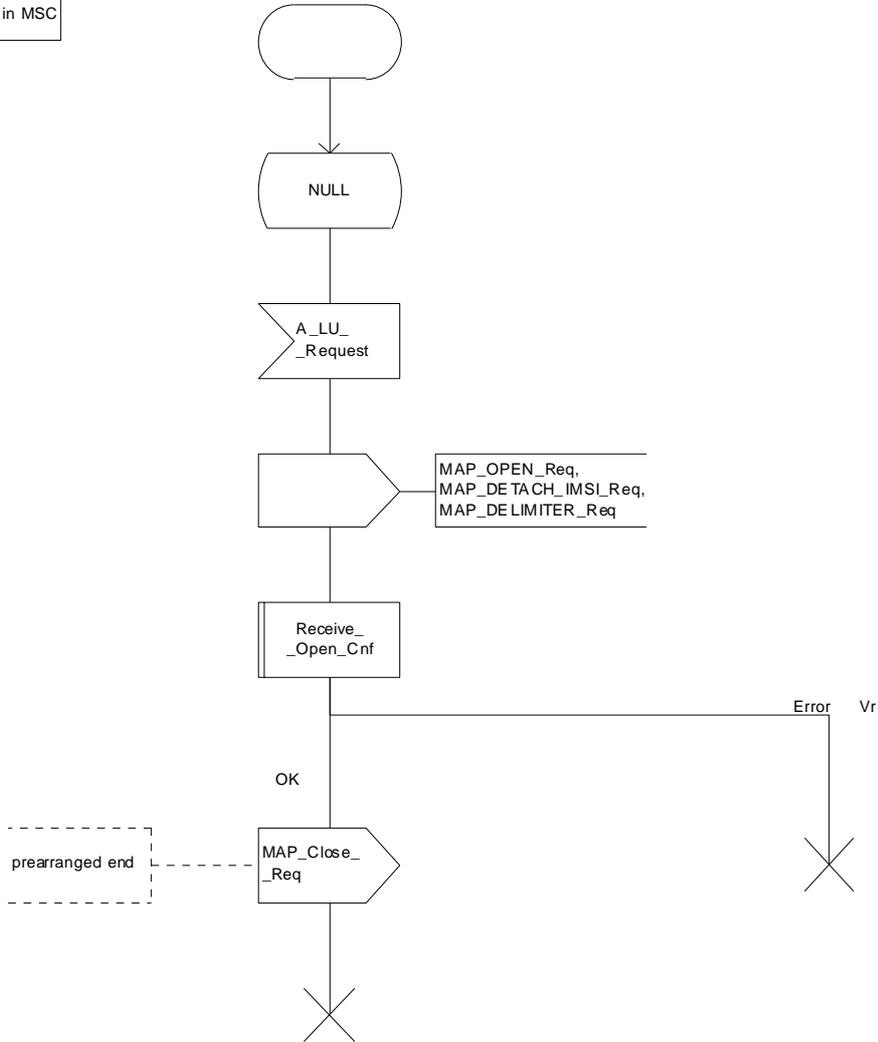

Figure 19.1.3/2: Process Detach\_IMSI\_MSC

Process Detach\_IMSI\_VLR

19.1.3\_3(1)

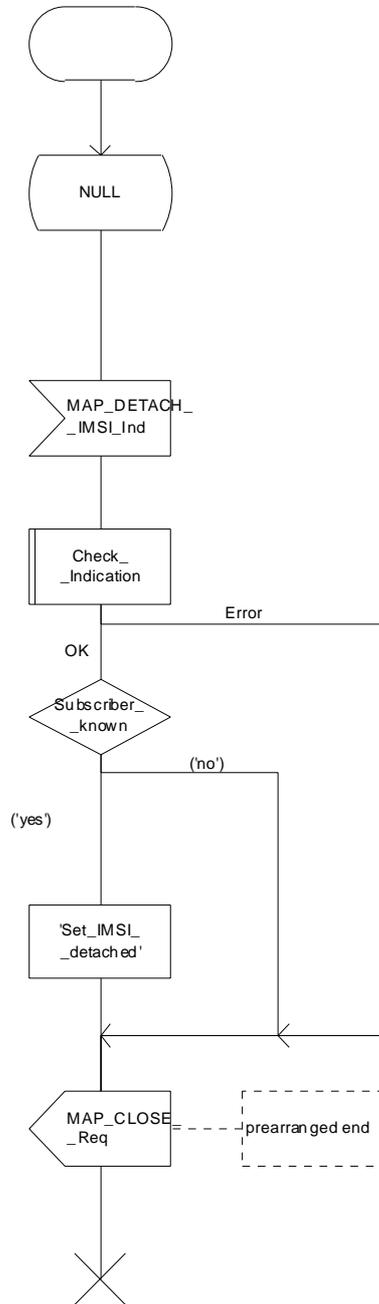

Figure 19.1.3/3:  
Detach IMSI in VLR

Figure 19.1.3/3: Process Detach\_IMSI\_VLR

## 19.1.4 Purge MS

### 19.1.4.1 General

When the VLR or the SGSN receives an indication on the O&M interface that the MS record is to be purged (either because of administrative action or because the MS has been inactive for an extended period), this procedure invokes the MAP\_PURGE\_MS service described in clause 8.1.6 to request the HLR to set the "MS purged for non-GPRS" or the "MS purged for GPRS" flag for the MS so that any request for routing information for a mobile terminated call or a mobile terminated short message will be treated as if the MS is not reachable. The message flows are shown in figures 19.1.4/1 and 19.1.4/5.

It is optional for the network operator to delete MS records from the VLR or from the SGSN, but if the option is used the VLR or the SGSN shall notify the HLR when a record has been deleted.

The O&M process in the VLR or in the SGSN must ensure that during the MS purging procedure any other attempt to access the MS record is blocked, to maintain consistency of data.

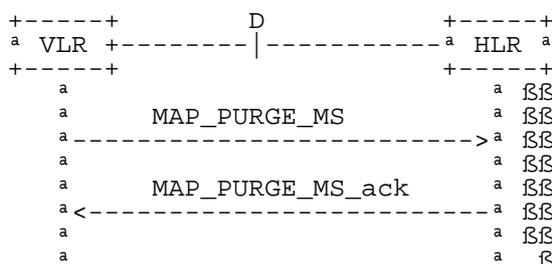

**Figure 19.1.4/1: MAP-D Interface and services for MAP\_PURGE\_MS**

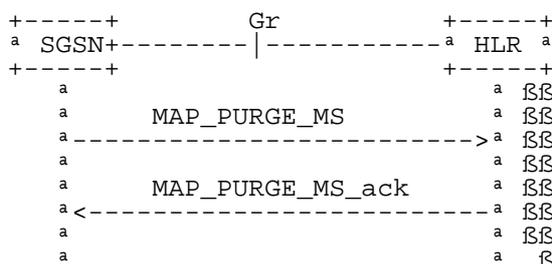

**Figure 19.1.4/5: Gr Interface and services for MAP\_PURGE\_MS**

### 19.1.4.2 Detailed procedure in the VLR

When the VLR receives an indication from O&M that an MS record is to be purged, it invokes the MAP\_PURGE\_MS service (see figure 19.1.4/2).

The VLR opens the dialogue to the HLR with a MAP\_OPEN request containing no user specific parameters. The MAP\_PURGE\_MS request contains the IMSI of the MS which is to be purged and the VLR number.

The VLR then waits for the MAP\_OPEN confirmation (see macro Receive\_Open\_Cnf, clause 25.1), indicating one of:

- rejection of the dialogue (process terminates);
- reversion to version one (process terminates);
- dialogue acceptance.

If the HLR accepts the dialogue it returns a MAP\_PURGE\_MS confirmation, containing no parameter, indicating successful outcome of the procedure.

If a MAP\_PURGE\_MS confirmation containing a provider error, data error or user error, or a MAP\_P\_ABORT, MAP\_NOTICE or premature MAP\_CLOSE indication, has been received, the failure is reported to the O&M interface.

Successful outcome of the procedure leads to deletion of the subscriber data and freezing of the TMSI if so requested by the HLR, and is reported to the O&M interface.

#### 19.1.4.3 Detailed procedure in the HLR

Opening of the dialogue is described in the macro `Receive_Open_Ind` in clause 25.1. The possible outcomes are:

- termination of the procedure if the AC indicates a version 1 dialogue, as this procedure is not defined for version 1;
- termination of the procedure if there is an error;
- dialogue acceptance, in which case the procedure is as described below.

If the HLR receives a `MAP_NOTICE` indication, it terminates the dialogue by sending a `MAP_CLOSE` request.

If the HLR receives a `MAP_PURGE_MS` indication (see figure 19.1.4/3), it first checks the indication data (macro `Check_Indication`, see clause 25.2). If there is a parameter error the HLR terminates the dialogue by sending an appropriate error in the `MAP_PURGE_MS` response in a `MAP_CLOSE` request. If there is no parameter error the HLR then checks whether the subscriber is known.

- if the subscriber is unknown, the HLR reports an error to the O&M interface, the error `Unknown Subscriber` is returned in the `MAP_PURGE_MS` response and the dialogue is terminated by sending a `MAP_CLOSE` request ;
- if the subscriber is known, the HLR checks whether the purging notification came from the VLR or SGSN where the MS was last registered:
  - if the received VLR number and the stored VLR number match, the HLR sets the "MS purged for non-GPRS" flag for the subscriber and sends a `MAP_PURGE_MS` response containing a freeze TMSI indicator to indicate successful outcome;
  - if the received VLR number and the stored VLR number do not match, the HLR sends a `MAP_PURGE_MS` response containing an empty result to indicate successful outcome. Since the MS is known by the HLR to be in a different VLR area, it is not appropriate to block mobile terminated calls or short messages to the MS, but the VLR which initiated the purging procedure can safely purge its record for the MS without freezing the TMSI.
  - if the received SGSN number and the stored SGSN number match, the HLR sets the "MS purged for GPRS" flag for the subscriber and sends a `MAP_PURGE_MS` response containing a freeze P-TMSI indicator to indicate successful outcome;
  - if the received SGSN number and the stored SGSN number do not match, the HLR sends a `MAP_PURGE_MS` response containing an empty result to indicate successful outcome. Since the MS is known by the HLR to be in a different SGSN area, it is not appropriate to block short messages to the MS, but the SGSN which initiated the purging procedure can safely purge its record for the MS without freezing the P-TMSI.

In either cases of successful termination the HLR terminates the dialogue by sending a `MAP_CLOSE` request.

#### 19.1.4.4 Detailed procedure in the SGSN

When the SGSN receives an indication from O&M that an MS record is to be purged, it invokes the `MAP_PURGE_MS` service (see figure 19.1.4/4).

The SGSN opens the dialogue to the HLR with a `MAP_OPEN` request containing no user specific parameters. The `MAP_PURGE_MS` request contains the IMSI of the MS which is to be purged and the SGSN number.

The SGSN then waits for the `MAP_OPEN` confirmation (see macro `Receive_Open_Cnf`, clause 25.1), indicating one of:

- rejection of the dialogue (process terminates);
- reversion to `Vr` (process terminates);
- dialogue acceptance.

If the HLR accepts the dialogue it returns a MAP\_PURGE\_MS confirmation, containing no parameter, indicating successful outcome of the procedure.

If a MAP\_PURGE\_MS confirmation containing a provider error, data error or user error, or a MAP\_P\_ABORT, MAP\_NOTICE or premature MAP\_CLOSE indication, has been received, the failure is reported to the O&M interface. Successful outcome of the procedure leads to deletion of the subscriber data and freezing of the P-TMSI if so requested by the HLR, and is reported to the O&M interface.

Process Purge\_MS\_VLR

19.1.4\_2(1)

Figure 19.1.4/2: Process in the VLR to notify the HLR that an MS record has been purged

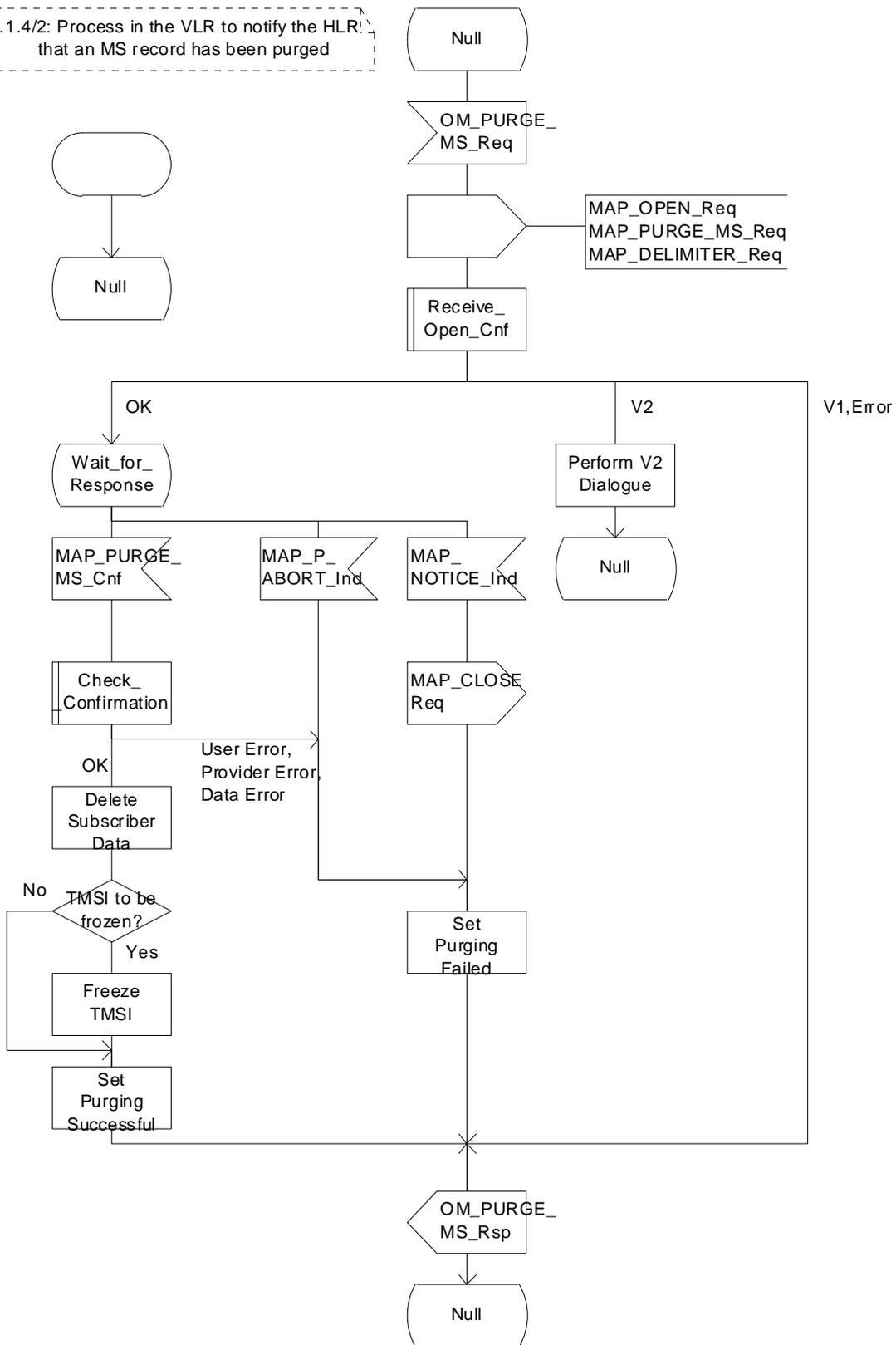

Figure 19.1.4/2: Process Purge\_MS\_VLR



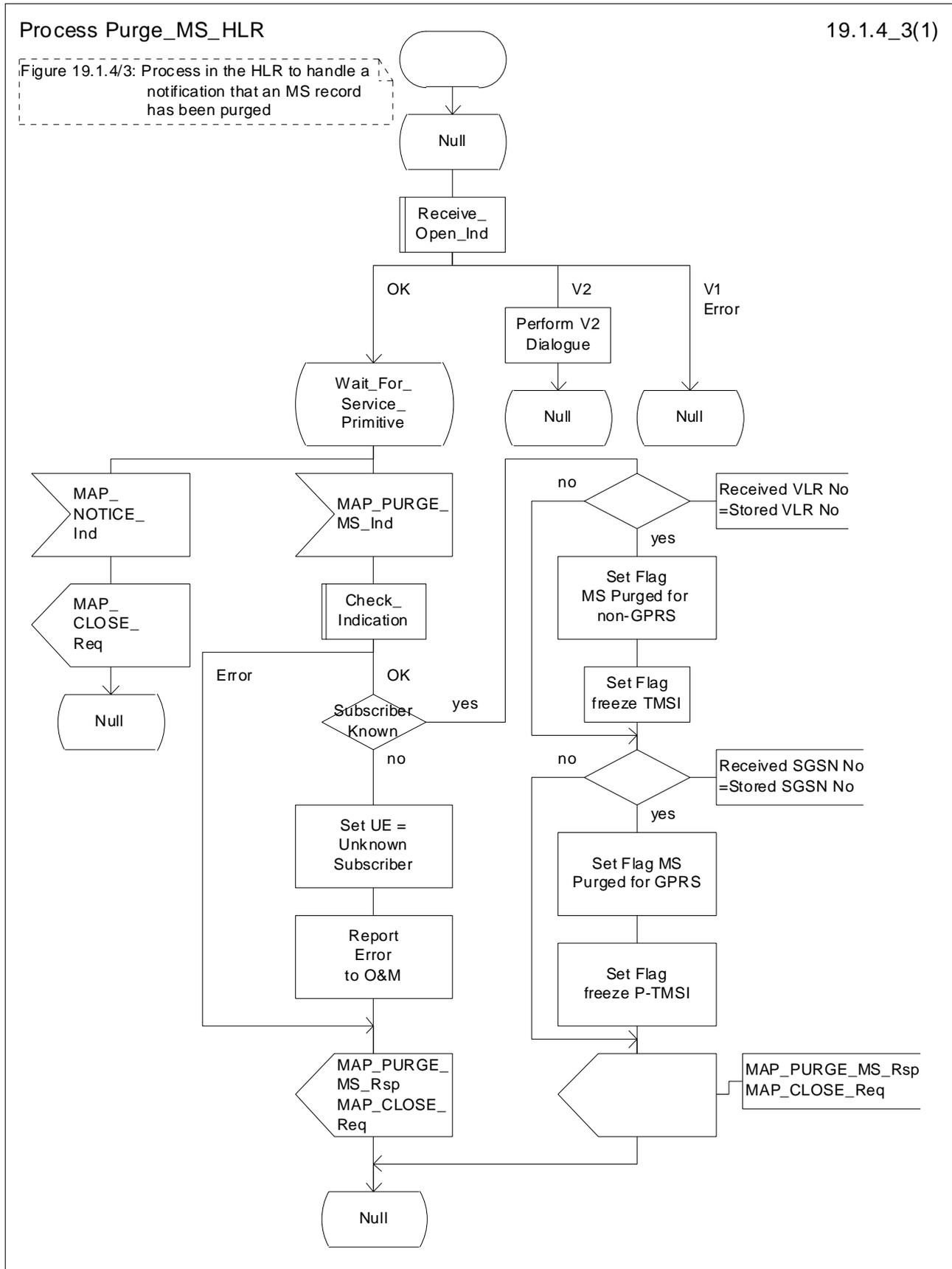

Figure 19.1.4/3: Process Purge\_MS\_HLR

Process Purge\_MS\_SGSN

19.1.4\_4(1)

Figure 19.1.4/4: Process in the SGSN to notify the HLR that an MS record has been purged

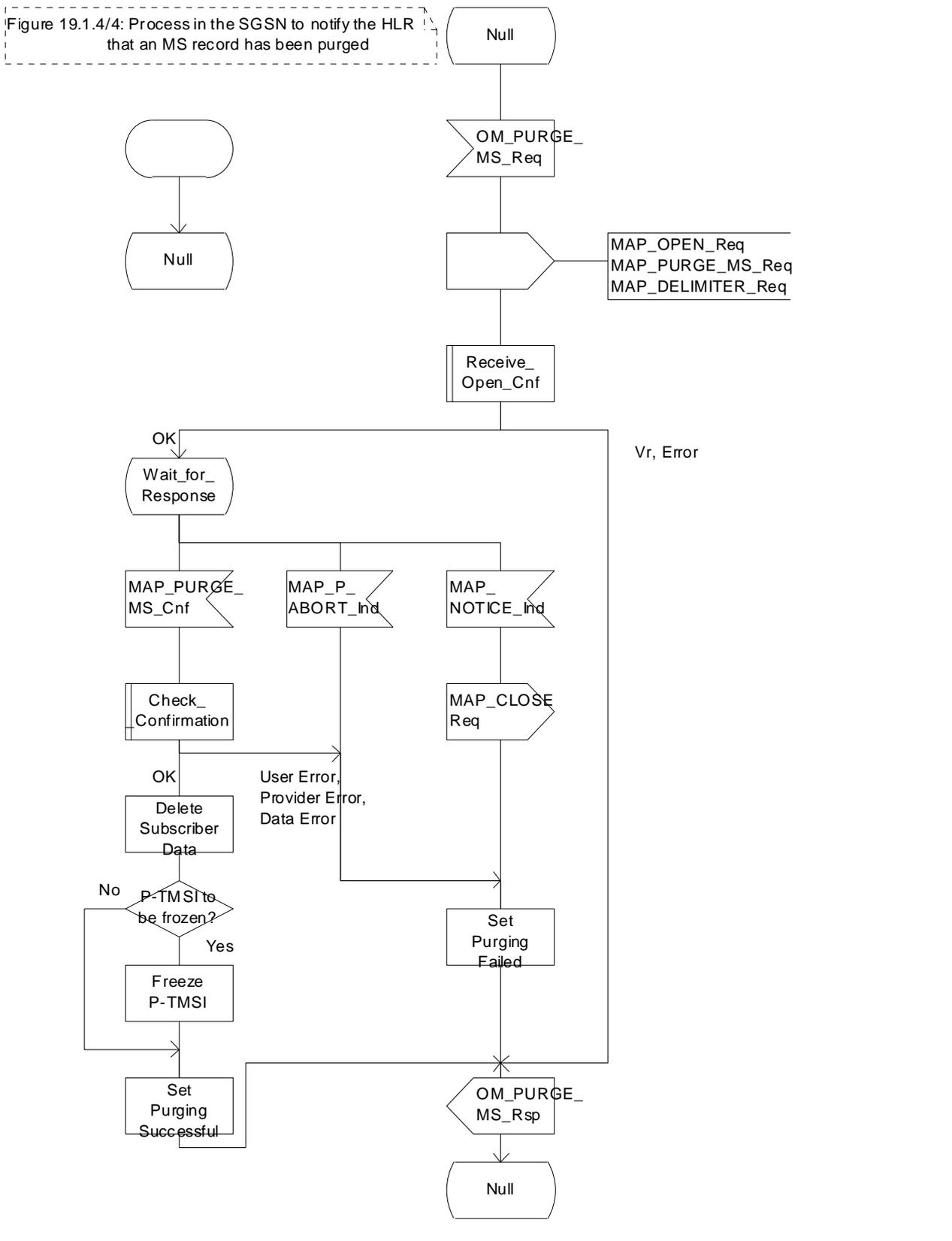

Figure 19.1.4/4: Process Purge\_MS\_SGSN

## 19.2 Handover procedure

### 19.2.1 General

The handover between different MSCs is called Inter-MSC handover. The interfaces involved for Inter-MSC handover are shown in figure 19.2/1. Following two Inter-MSC handover procedures apply:

1) Basic Inter-MSC handover:

The call is handed over from the controlling MSC, called MSC-A to another MSC, called MSC-B (figure 19.2/1a).

Figure 19.2/2 shows a successful handover between MSC-A and MSC-B including a request for handover number allocation by MSC-B to VLR-B.

2) Subsequent Inter-MSC handover:

After the call has been handed over from MSC-A to MSC-B, a handover to either MSC-A (figure 19.2/1a) or to a third MSC (MSC-B') (figure 19.2/1b) is necessary in order to continue the connection.

Figure 19.2/3 shows a successful subsequent handover.



a) Basic handover procedure MSC-A to MSC-B and subsequent handover procedure MSC-B to MSC-A.

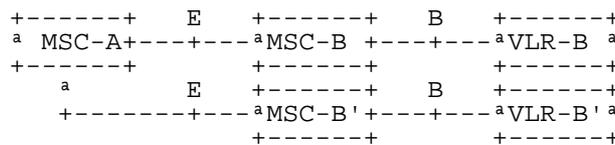

b) Subsequent handover procedure MSC-B to MSC-B'.

**Figure 19.2/1: Interface structure for handover**

The MAP handover procedures achieve the functionality required to set up an MSC-MSC dialogue, to optionally allocate a handover number and to transport BSSAP messages.

The transported BSSAP messages are controlled and handled by the Handover Control Application in the MSCs. This information will be transparent to the MAP protocol. If the MSC receives via the MAP protocol BSSAP messages, this information will be forwarded to the Handover Control Application (shown in the handover SDL diagrams with the internal HO\_CA signalling, it is an internal process in the MSC) and vice versa if the Handover Control Application requires the sending of BSSAP messages via the MAP protocol.

For detailed interworking between the A-interface and MAP procedures, see GSM 03.09 and GSM 09.10.

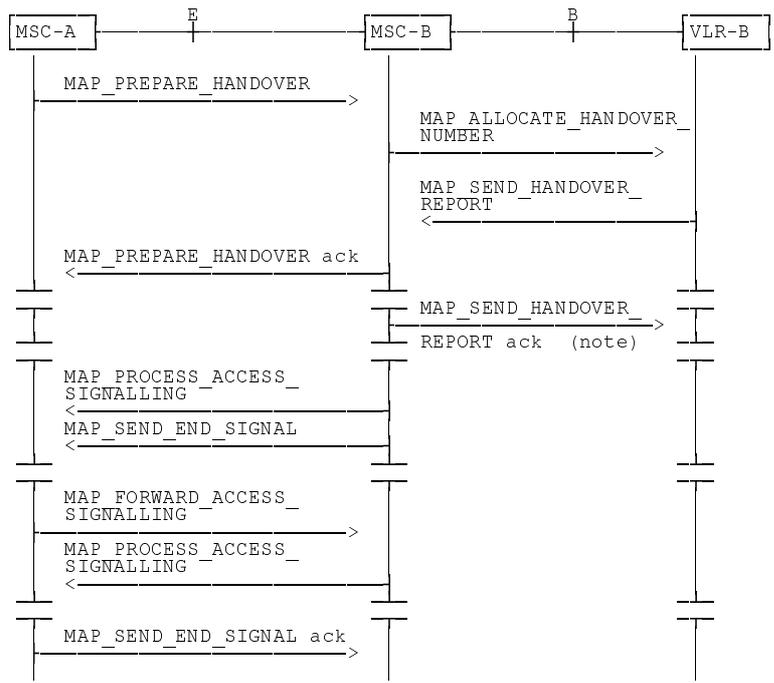

NOTE: This can be sent at any time after the connection between MSC-A and MSC-B is established.

**Figure 19.2/2: Example of a successful basic handover procedure to MSC-B**

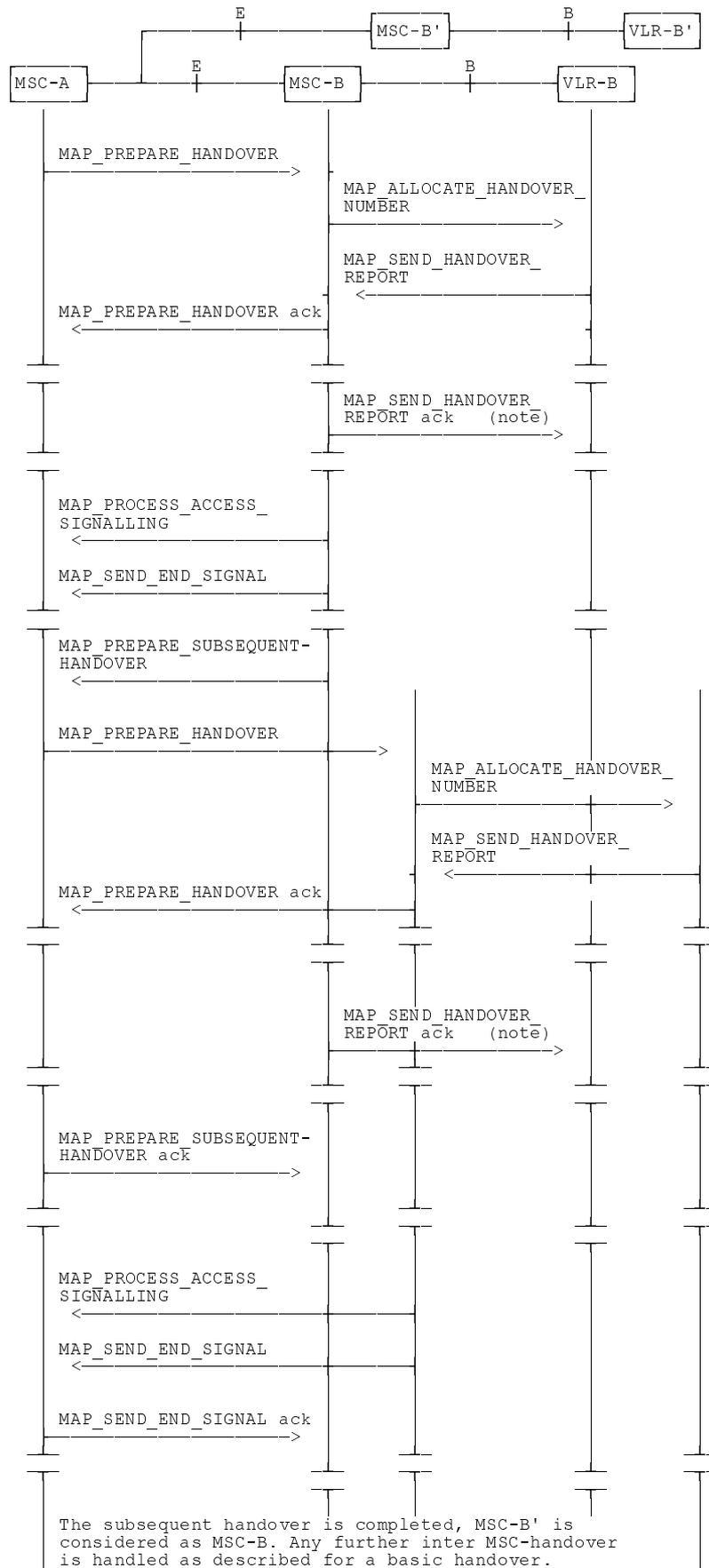

NOTE: This can be sent at any time after the connection between MSC-A and MSC-B is established

Figure 19.2/3: Example of a handover towards a third MSC

## 19.2.2 Handover procedure in MSC-A

This clause describes the handover procedure in MSC-A, including the request for a basic handover to another MSC (MSC-B), subsequent handover to a third MSC (MSC-B') or back to the controlling MSC (MSC-A).

### 19.2.2.1 Basic handover

When MSC-A has decided that a call has to be handed over to MSC-B, the Handover Control Application in MSC-A requests the MAP application to initiate the MAP\_PREPARE\_HANOVER request to MSC-B.

MSC-A opens the dialogue to MSC-B with a MAP\_OPEN request containing no user specific parameters and sends a MAP\_PREPARE\_HANOVER request. This request may optionally contain an indication that a handover number allocation is not required, targetCellId, for compatibility reasons, and all information required by MSC-B to allocate the necessary radio resources.

If MSC-B accepts the dialogue, it returns a MAP\_PREPARE\_HANOVER confirmation containing a handover number, unless the request has included the HO-NumberNotRequired parameter, and BSSAP information which is forwarded to and handled by the Handover Control Application in MSC-A.

Optionally MSC-A can receive, after a MAP\_PREPARE\_HANOVER confirmation, a MAP\_PROCESS\_ACCESS\_SIGNALLING indication containing BSSAP information.

When the connection has been established between the MS and MSC-B, MSC-A will be informed by a MAP\_SEND\_END\_SIGNAL indication.

When MSC-A wants to clear the connection with BSS-B, an indication from the Handover Control Application is received in the Map Application to send the MAP\_SEND\_END-SIGNAL response to MSC-B to close the MAP dialogue.

MSC-A may abort the handover procedure at any time (e.g. if the call is cleared).

### 19.2.2.2 Handling of access signalling

If required, the Handover Control Application in MSC-A requests the MAP application to invoke the MAP\_FORWARD\_ACCESS\_SIGNALLING request containing the information to be transferred to the A-interface of MSC-B (e.g. call control information).

MAP\_FORWARD\_ACCESS\_SIGNALLING is a non-confirmed service.

MSC-B will then forward the required information to the Handover Control Application. The MAP\_FORWARD\_ACCESS\_SIGNALLING is composed in such a way that the information can be passed transparently to the A-interface for call control and mobility management information. Any response received in MSC-B from the A-interface that should be brought to MSC-A will require a new independent request from the Handover Control Application in MSC-B to MSC-A by invoking a MAP\_PROCESS\_ACCESS\_SIGNALLING request.

### 19.2.2.3 Other procedures in stable handover situation

During a call and after handover, a number of procedures between MSC-A and BSS-B controlled by or reported to MSC-A may be initiated in both directions by invoking a MAP\_FORWARD\_ACCESS\_SIGNALLING request and reception of a MAP\_PROCESS\_ACCESS\_SIGNALLING indication.

### 19.2.2.4 Subsequent handover

When MSC-A receives a MAP\_PREPARE\_SUBSEQUENT\_HANOVER request, it will start the procedure of handing the call over to a third MSC (MSC-B'), or back to the controlling MSC (MSC-A). If the new handover procedure towards MSC-B' or MSC-A is successful, the handover control application in MSC-A will request the release of the dialogue towards MSC-B by sending the MAP\_SEND\_END\_SIGNAL confirmation.

### 19.2.2.5 SDL Diagrams

The SDL diagrams on the following pages describe the user processes in MSC-A for the procedures described in this clause.

The services used are defined in clause 8.4.

NOTE: The message primitives HO\_CA\_MESSAGE used in the SDL-Diagrams are used to show the internal co-ordination between the MAP application and the Handover Control Application. For a detailed description of the co-ordination between the applications for the handover procedure, see GSM 03.09.

Note that in case of reception of errors from the MSCs (see the Handover error handling macro), the MAP user reports them to the Handover Control Application and does not take any action except in cases explicitly mentioned in the SDL diagrams.

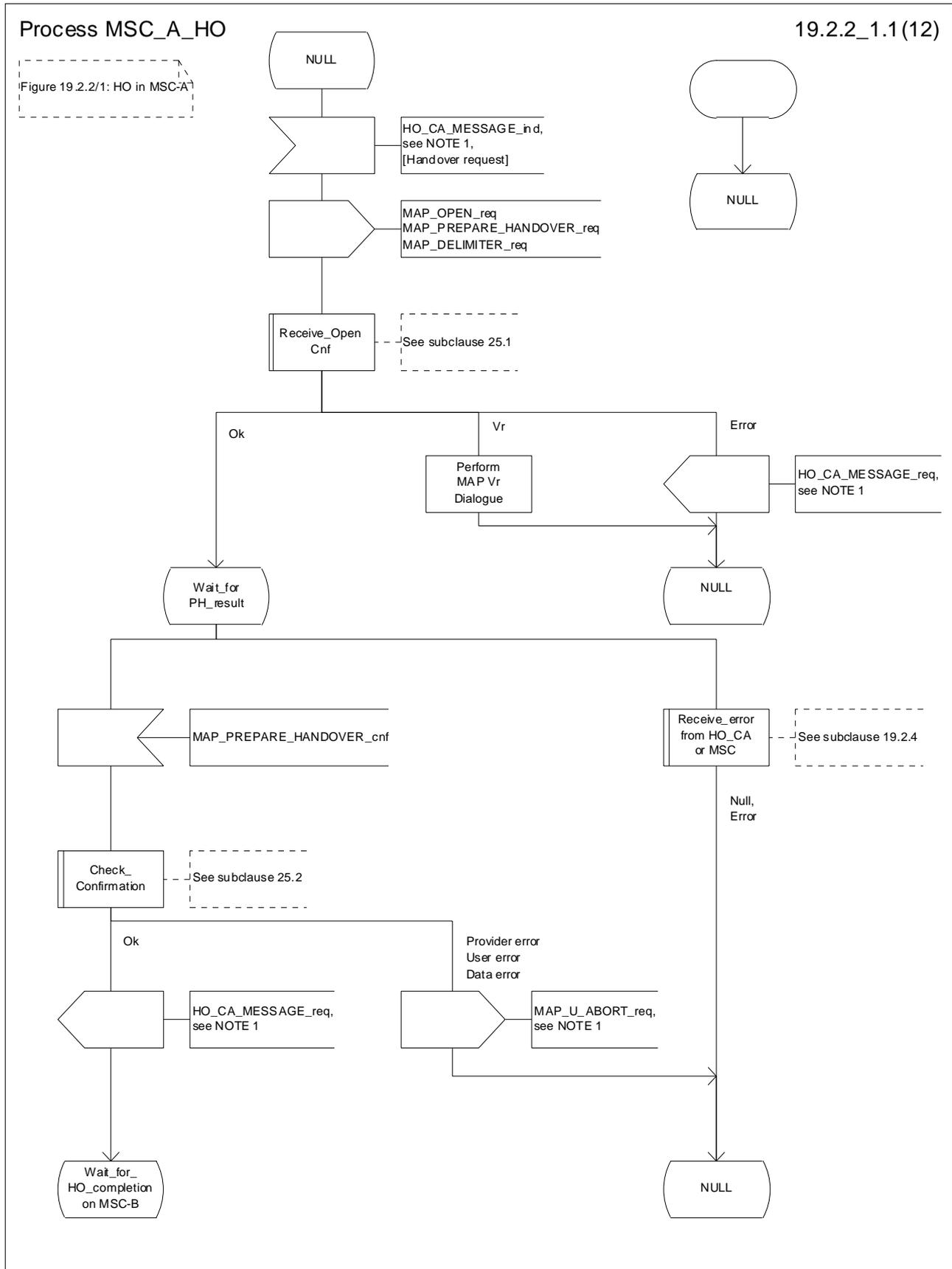

Figure 19.2.2/1 (sheet 1 of 12): Process MSC\_A\_HO



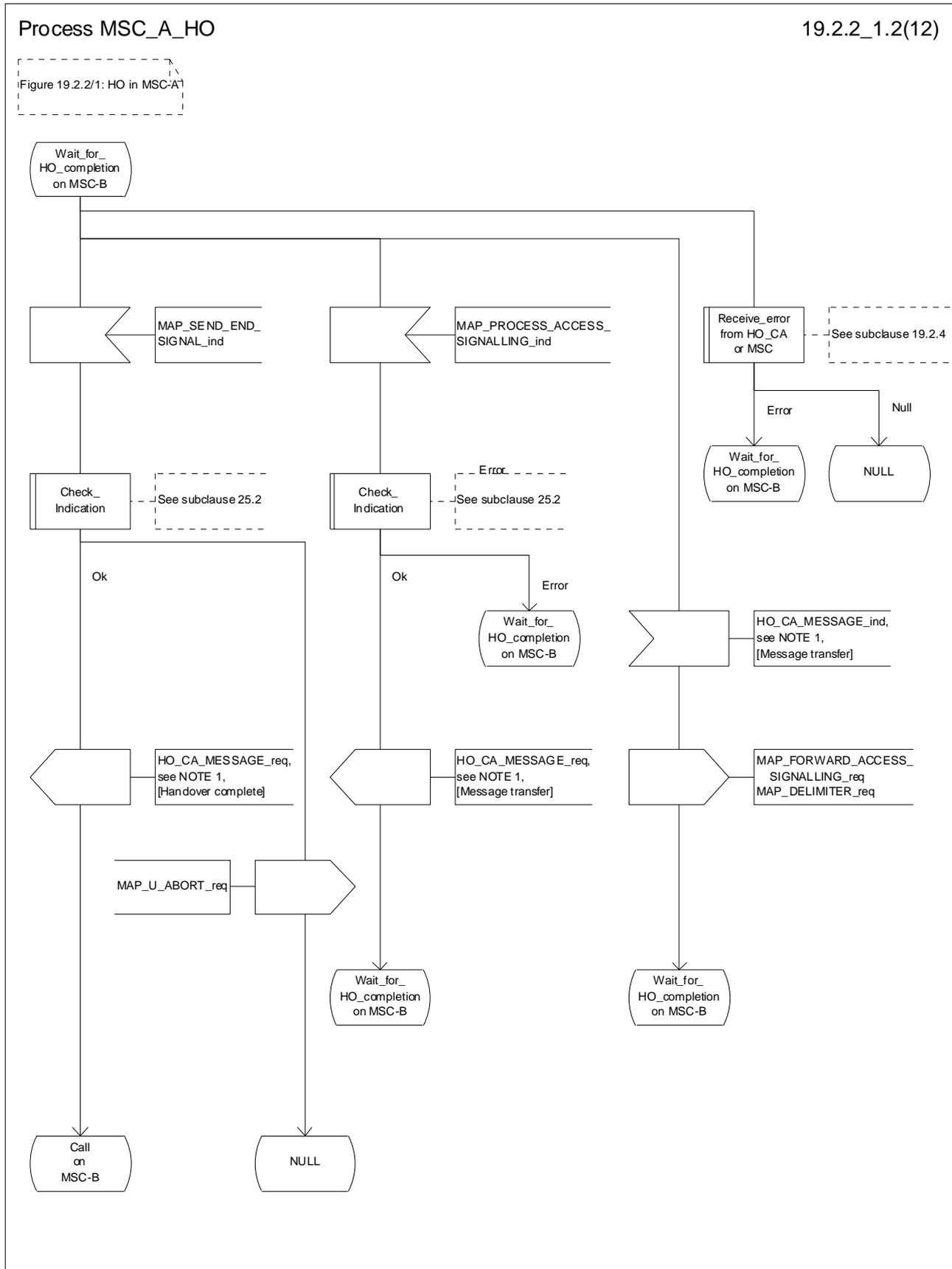

Figure 19.2.2/1 (sheet 2 of 12): Process MSC\_A\_HO

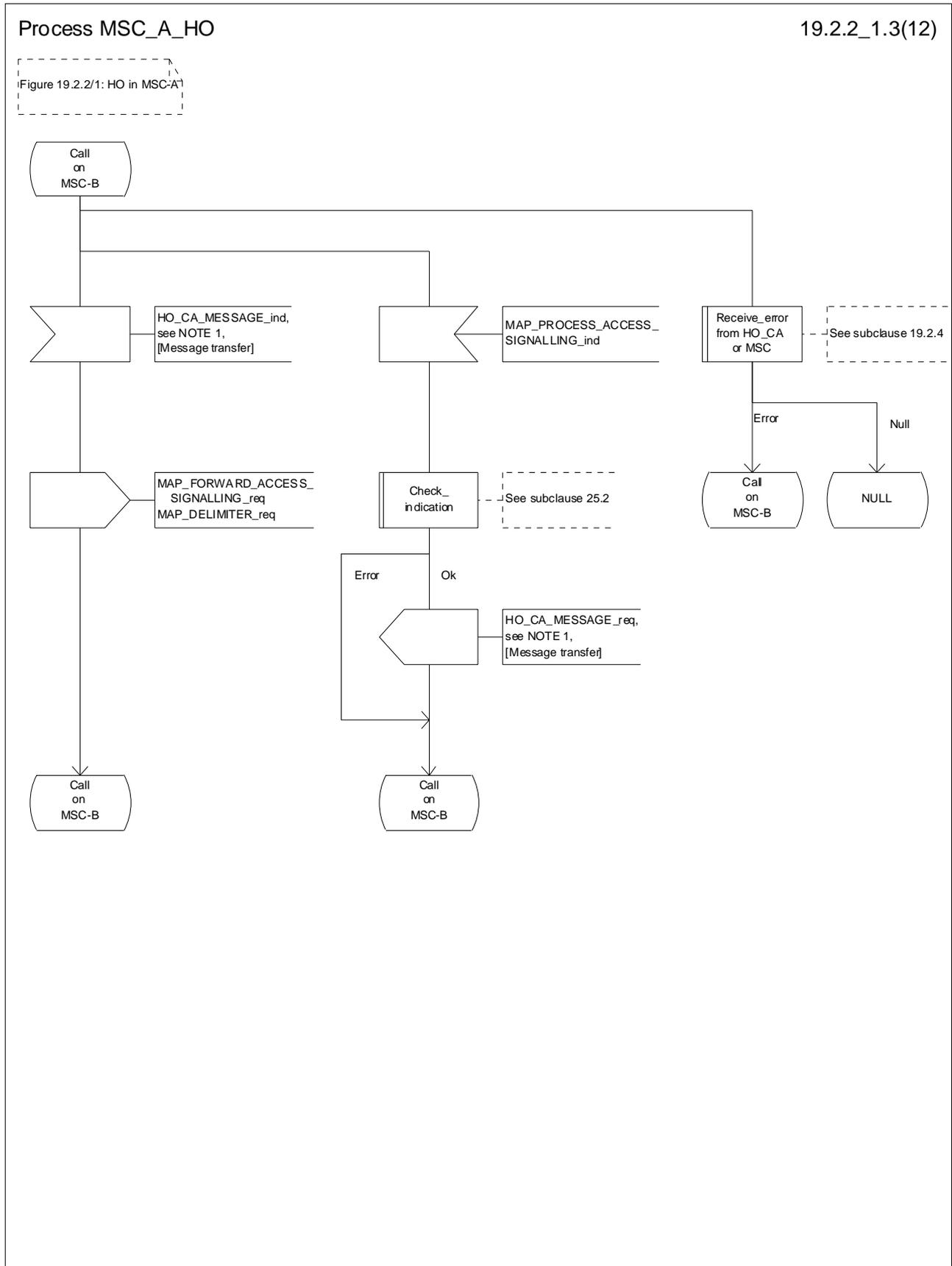

Figure 19.2.2/1 (sheet 3 of 12): Process MSC\_A\_HO

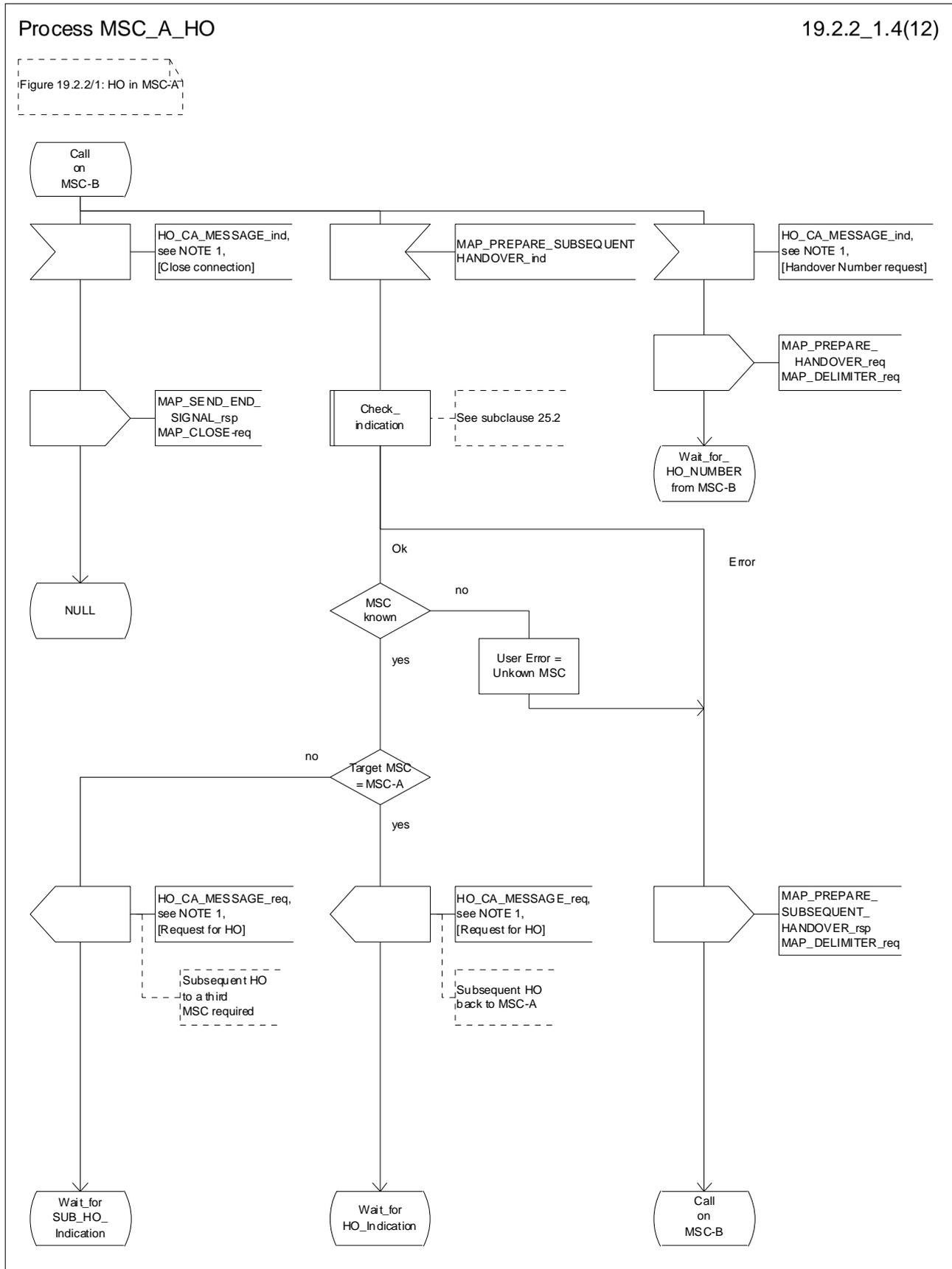

Figure 19.2.2/1 (sheet 4 of 12): Process MSC\_A\_HO

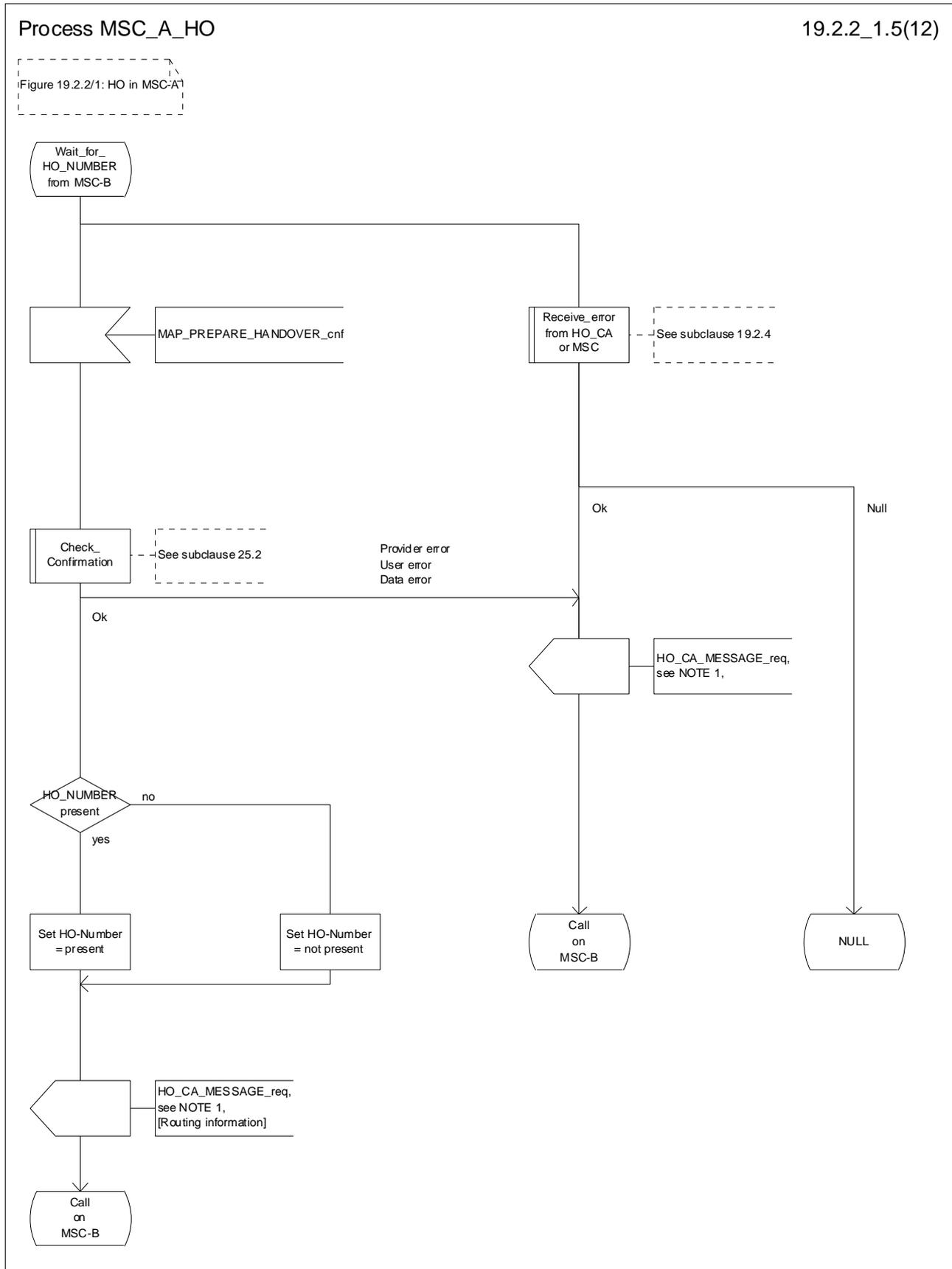

Figure 19.2.2/1 (sheet 5 of 12): Process MSC\_A\_HO

Process MSC\_A\_HO

19.2.2\_1.6(12)

Figure 19.2.2/1: HO in MSC-A

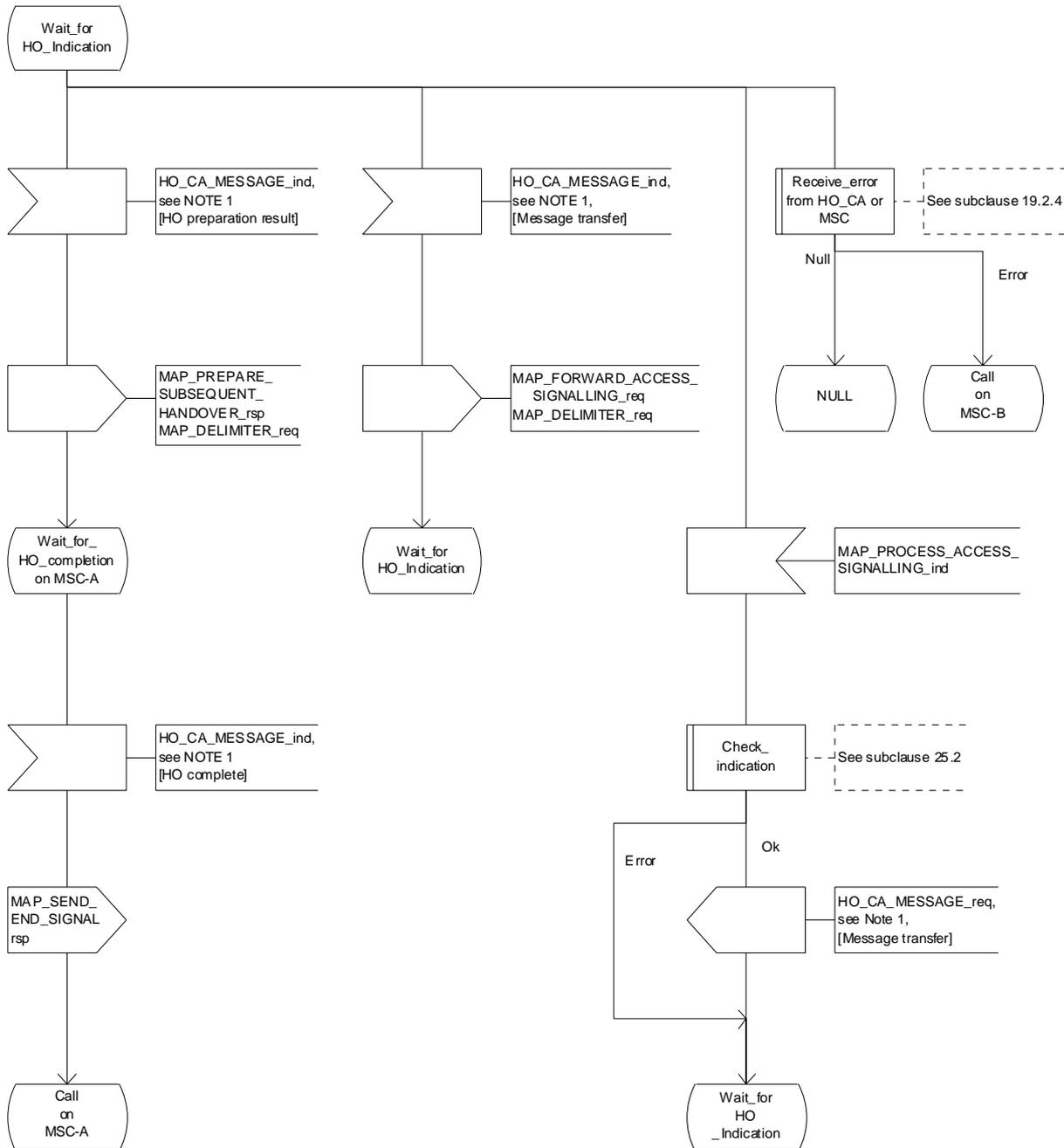

Figure 19.2.2/1 (sheet 6 of 12): Process MSC\_A\_HO

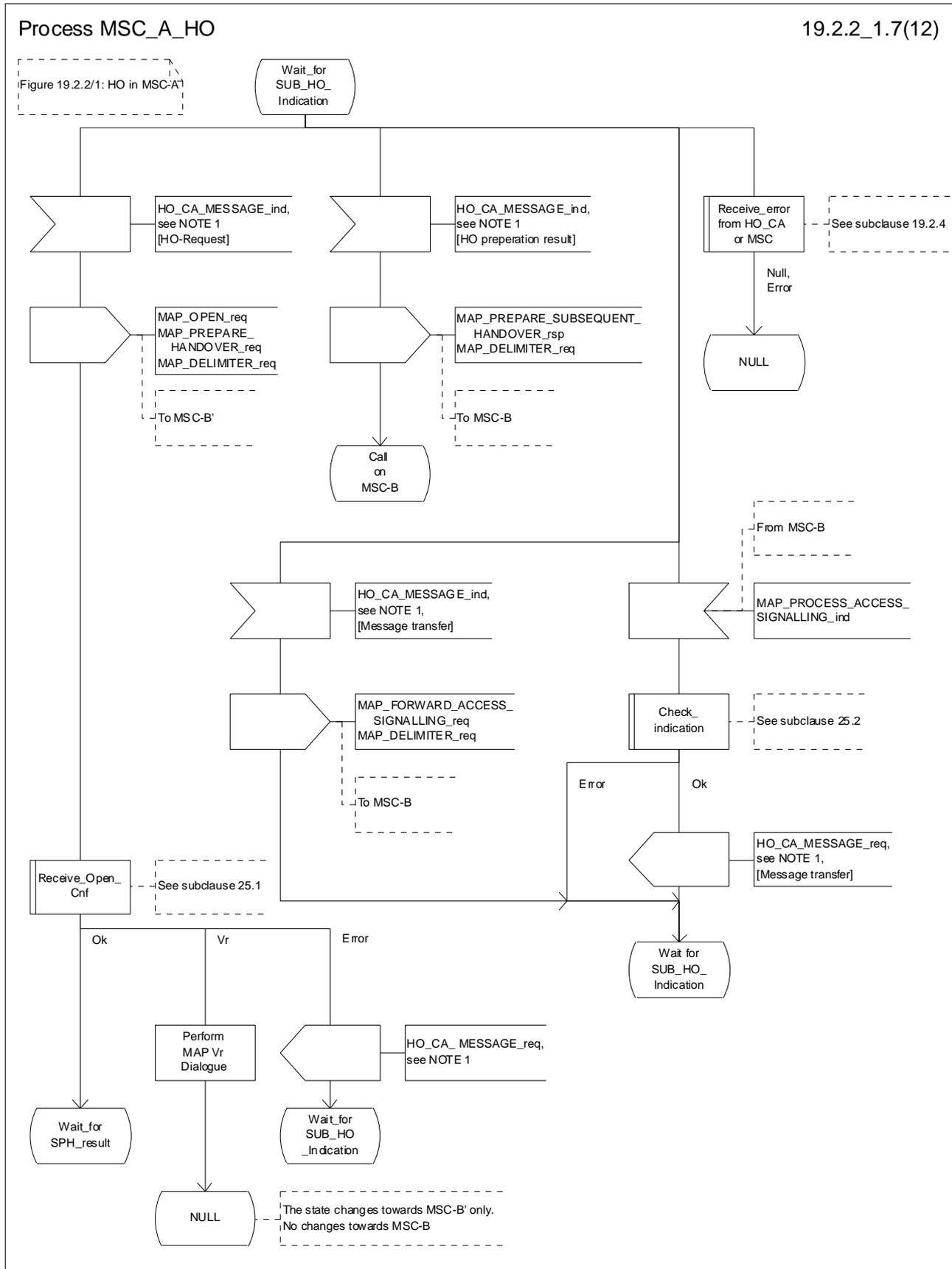

Figure 19.2.2/1 (sheet 7 of 12): Process MSC\_A\_HO

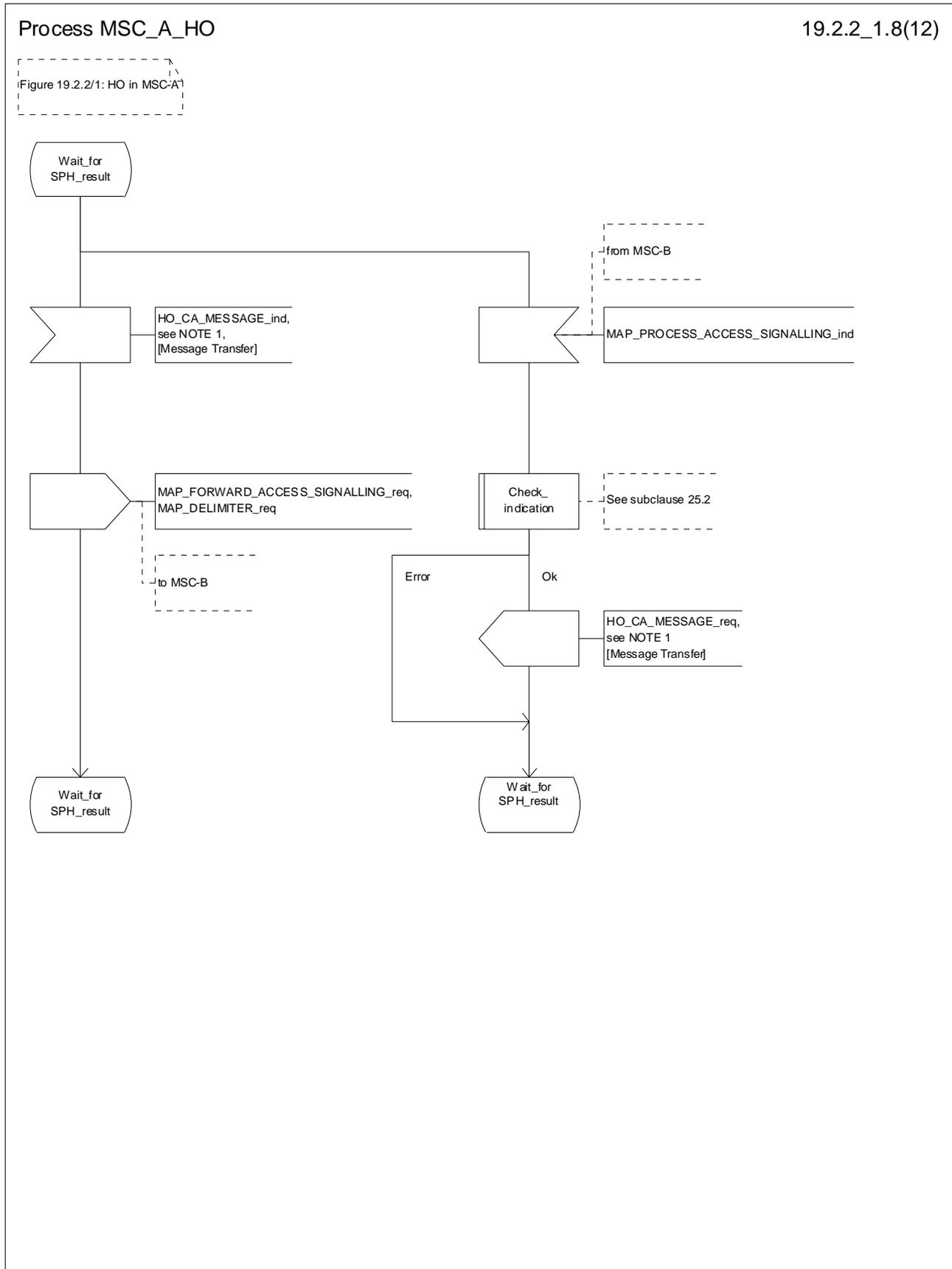

Figure 19.2.2/1 (sheet 8 of 12): Process MSC\_A\_HO

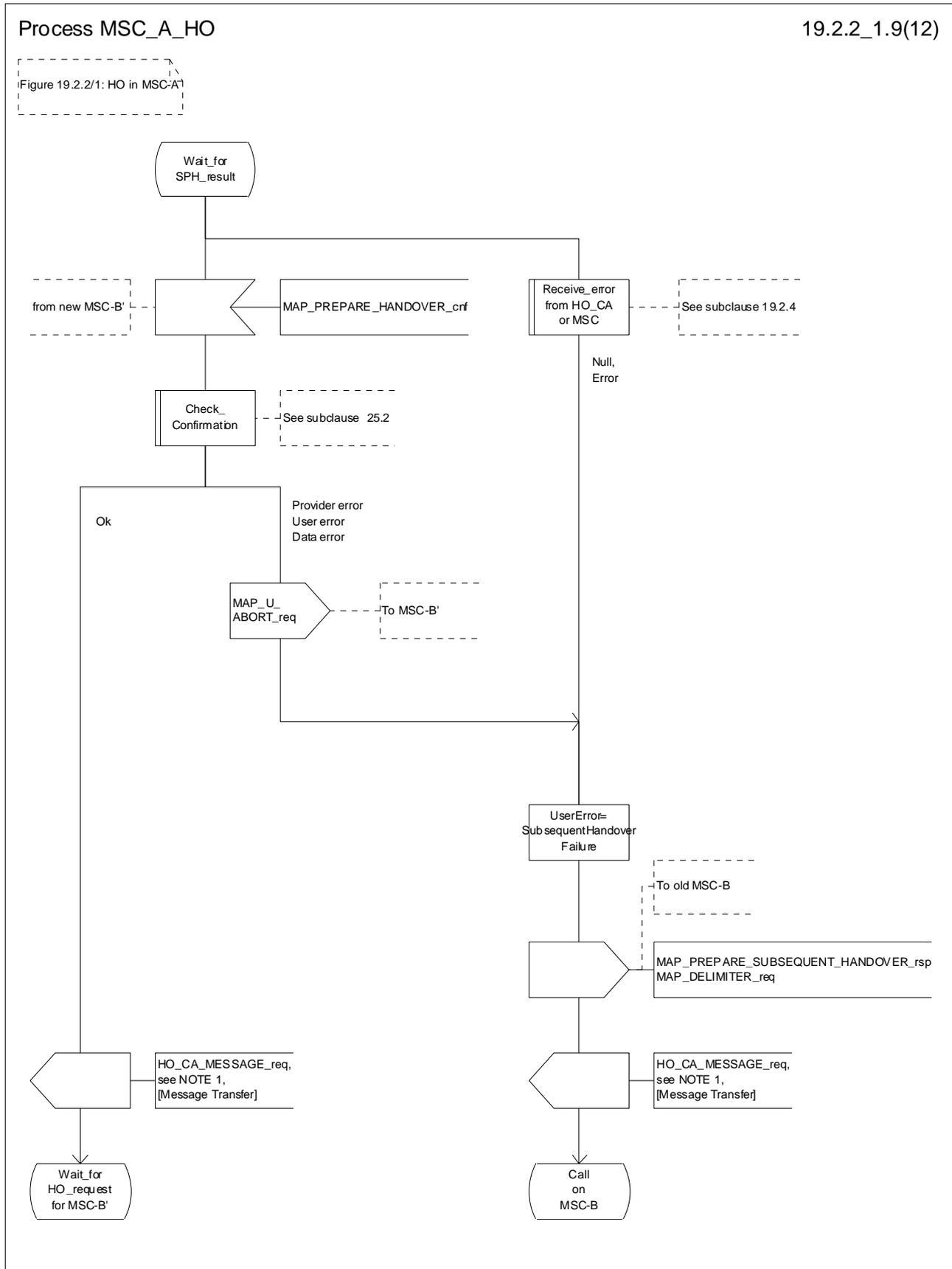

Figure 19.2.2/1 (sheet 9 of 12): Process MSC\_A\_HO



Process MSC\_A\_HO

19.2.2\_1.10(12)

Figure 19.2.2/1: HO in MSC-A'

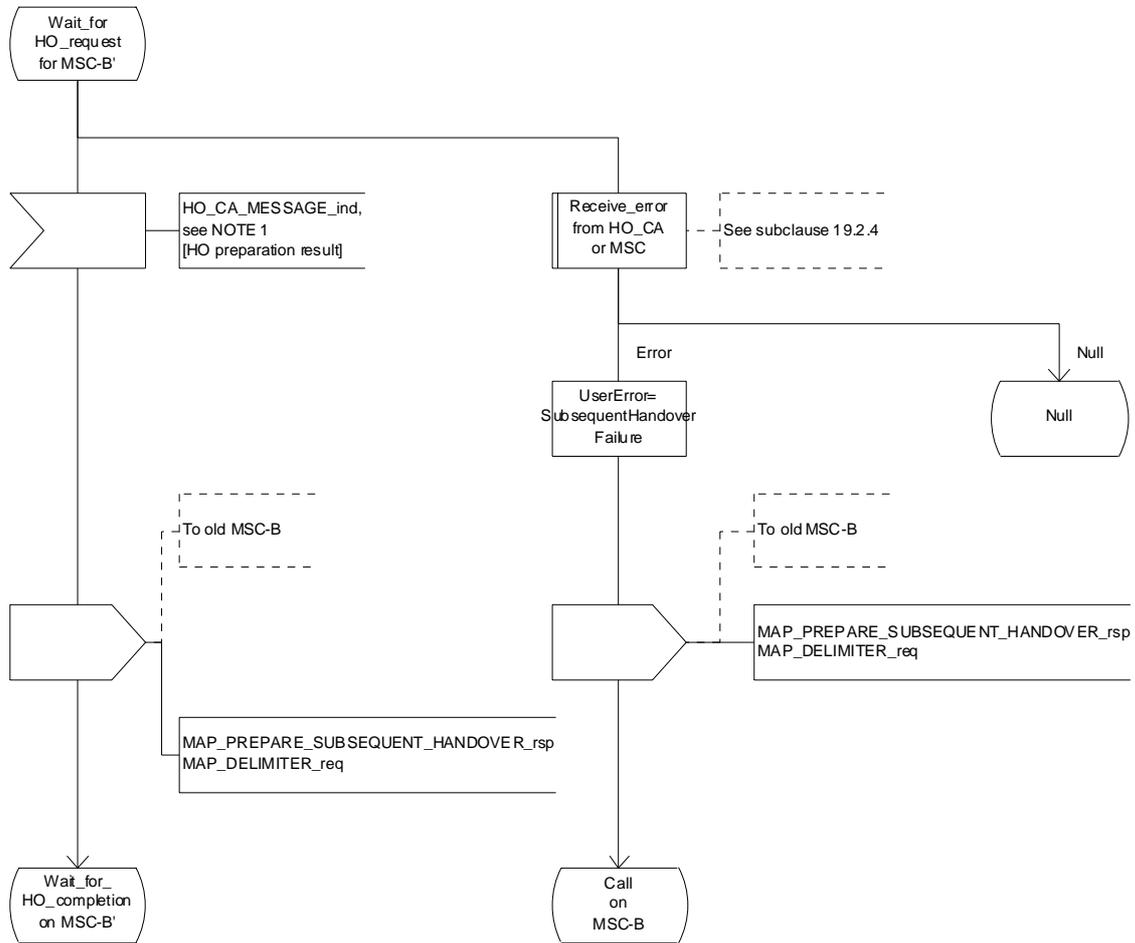

Figure 19.2.2/1 (sheet 10 of 12): Process MSC\_A\_HO

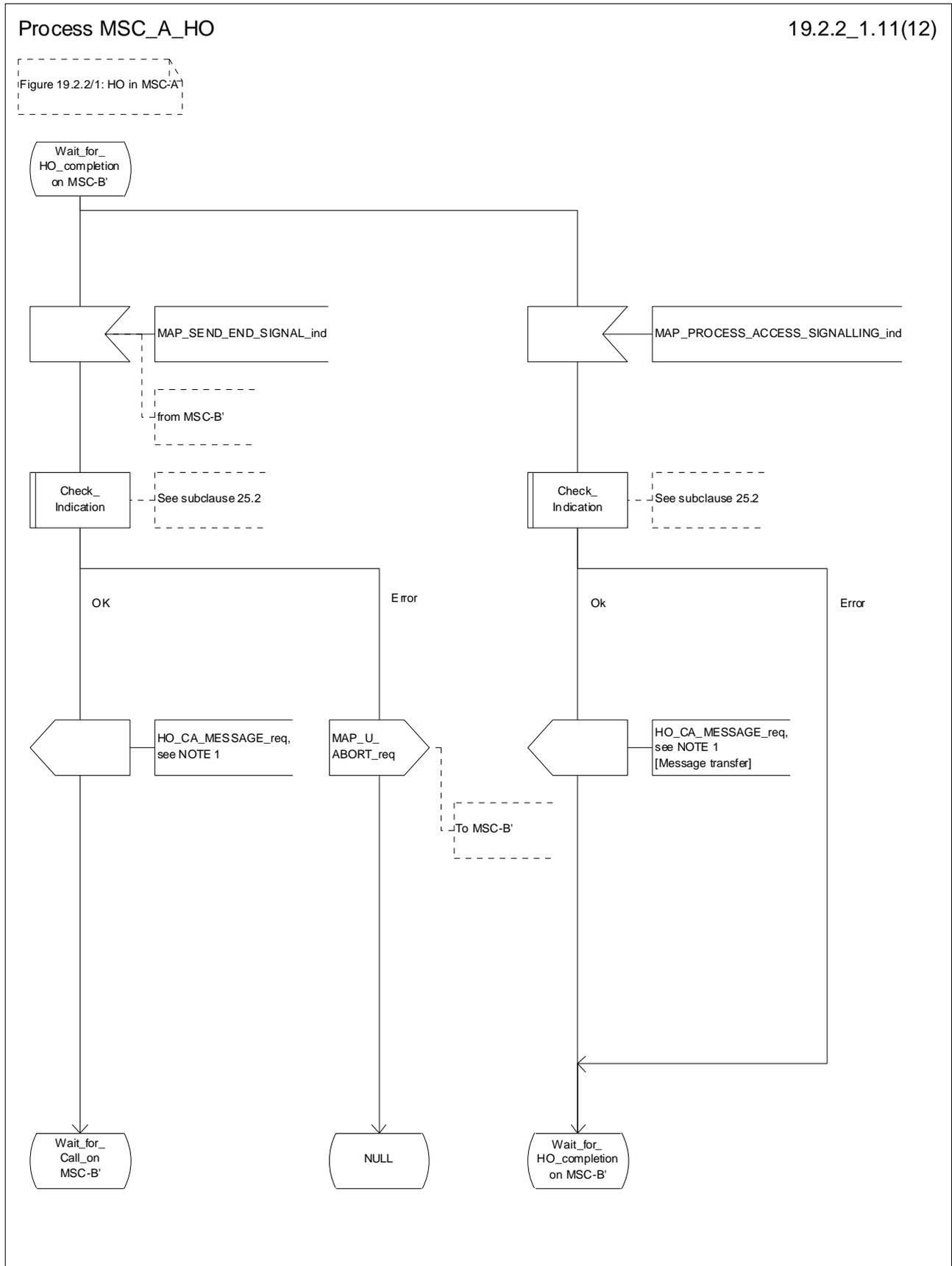

Figure 19.2.2/1 (sheet 11 of 12): Process MSC\_A\_HO

Process MSC\_A\_HO

19.2.2\_1.12(12)

Figure 19.2.2/1: HO in MSC-A

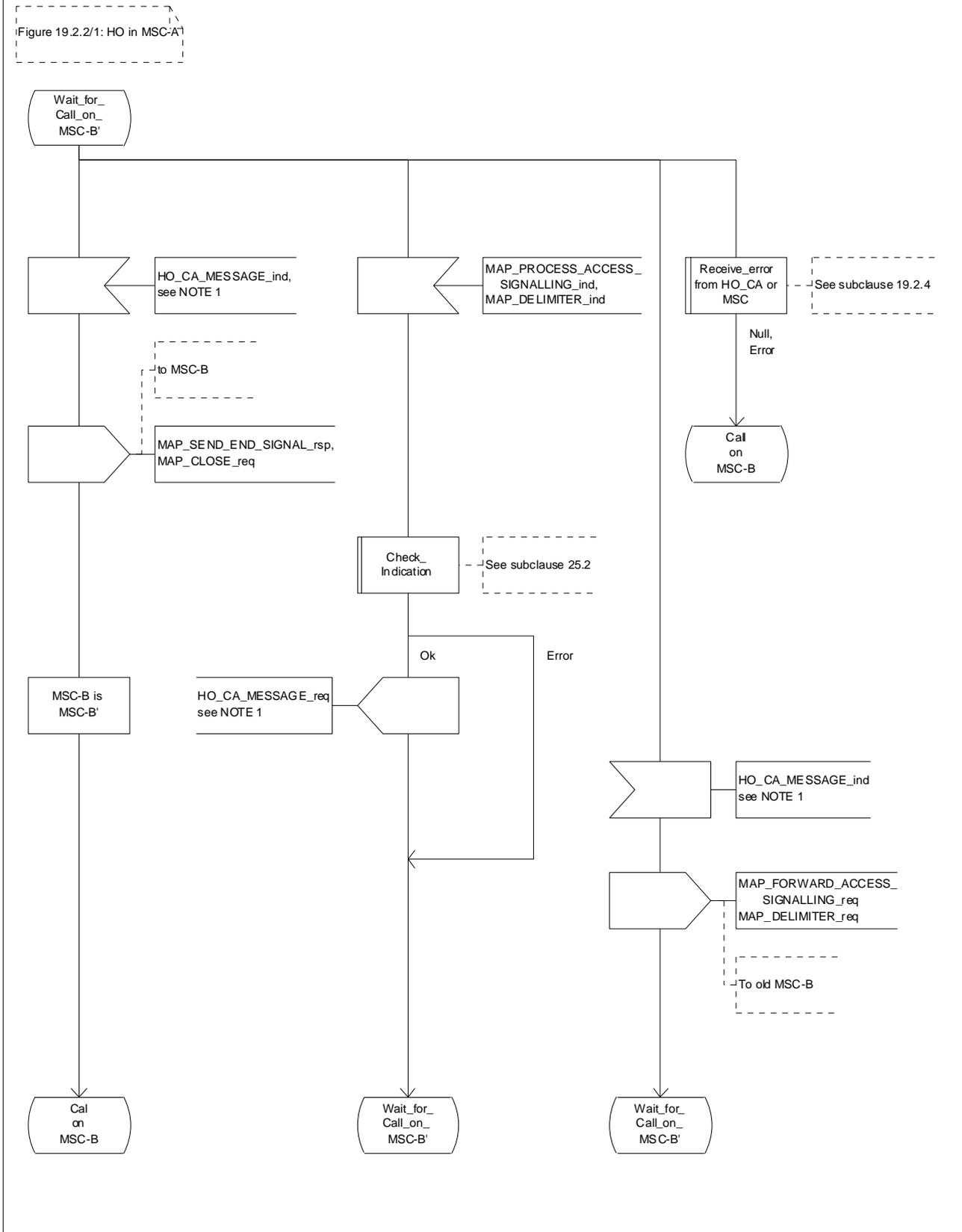

Figure 19.2.2/1 (sheet 12 of 12): Process MSC\_A\_HO

### 19.2.3 Handover procedure in MSC-B

This clause describes the handover procedure in MSC-B, including the request for a handover from another MSC (MSC-A), subsequent handover to a third MSC (MSC-B') or back to the controlling MSC (MSC-A).

#### 19.2.3.1 Basic handover

Opening of the dialogue is described in the macro `Receive_Open_Ind` in clause 25.1.

When MSC-B process receives a `MAP_PREPARE_HANOVER` indication from MSC-A, MSC-B requests its associated VLR to provide a handover number, unless the parameter `HO-NumberNotRequired` is received in the indication.

When the connection between the MS and MSC-B is established on MSC-B, the Handover Control Application will request the MAP application to indicate this event to MSC-A by invoking the `MAP_SEND_END_SIGNAL` request. When a call is released, MSC-A will inform MSC-B by `MAP_SEND_END_SIGNAL` response and the MAP dialogue between MSC-A and MSC-B is closed.

#### 19.2.3.2 Allocation of handover number

When a handover number is required, a `MAP_ALLOCATE_HANOVER_NUMBER` request will be sent to the VLR. The handover number is received in the `MAP_SEND_HANOVER_REPORT` request, and will be included in the `MAP_PREPARE_HANOVER` response to MSC-A.

As soon as the call from MSC-A using the handover number arrives in MSC-B, MSC-B shall release the handover number in the VLR using the `MAP_SEND_HANOVER_REPORT` response.

#### 19.2.3.3 Handling of access signalling

If required by the Handover Control Application, MSC-B invokes the `MAP_PROCESS_ACCESS_SIGNALLING` request containing the information received on the A-interface that should be transferred to MSC-A (e.g. call control information).

`MAP_PROCESS_ACCESS_SIGNALLING` is a non-confirmed service and any response from MSC-A will require a `MAP_FORWARD_ACCESS_SIGNALLING` request.

#### 19.2.3.4 Other procedures in stable handover situation

During a call and after handover, a number of procedures between MSC-A and BSS-B controlled by or reported to MSC-A may be initiated by involving access signalling transfer in both directions.

#### 19.2.3.5 Subsequent handover

The procedure is used when the Handover Control Application in MSC-B has decided that a call is to be handed over to another MSC (either back to the controlling MSC (MSC-A) or to a third MSC (MSC-B')).

After the `MAP_PREPARE_SUBSEQUENT_HANOVER` response is received from MSC-A, MSC-B will await the disconnection of the call. Once the disconnect is complete, MSC-B will inform its VLR by invoking the `MAP_SEND_HANOVER_REPORT` confirmation. VLR-B will then release the allocated handover number.

The subsequent handover procedure is shown in figure 19.2/3.

### 19.2.3.6 SDL Diagrams

The SDL diagrams on the following pages describe the user process in MSC-B for the procedures described in this clause.

The services used are defined in clause 8.4.

NOTE 1: The message primitives HO\_CA\_MESSAGE in the SDL-diagrams are used to show the internal co-ordination between the MAP application and the Handover Control Application. For a detailed description of the co-ordination between the applications for the handover procedure, see GSM 03.09.

NOTE 2: The order in the SDL diagrams to allocate first the handover number and then the radio resources is not binding.

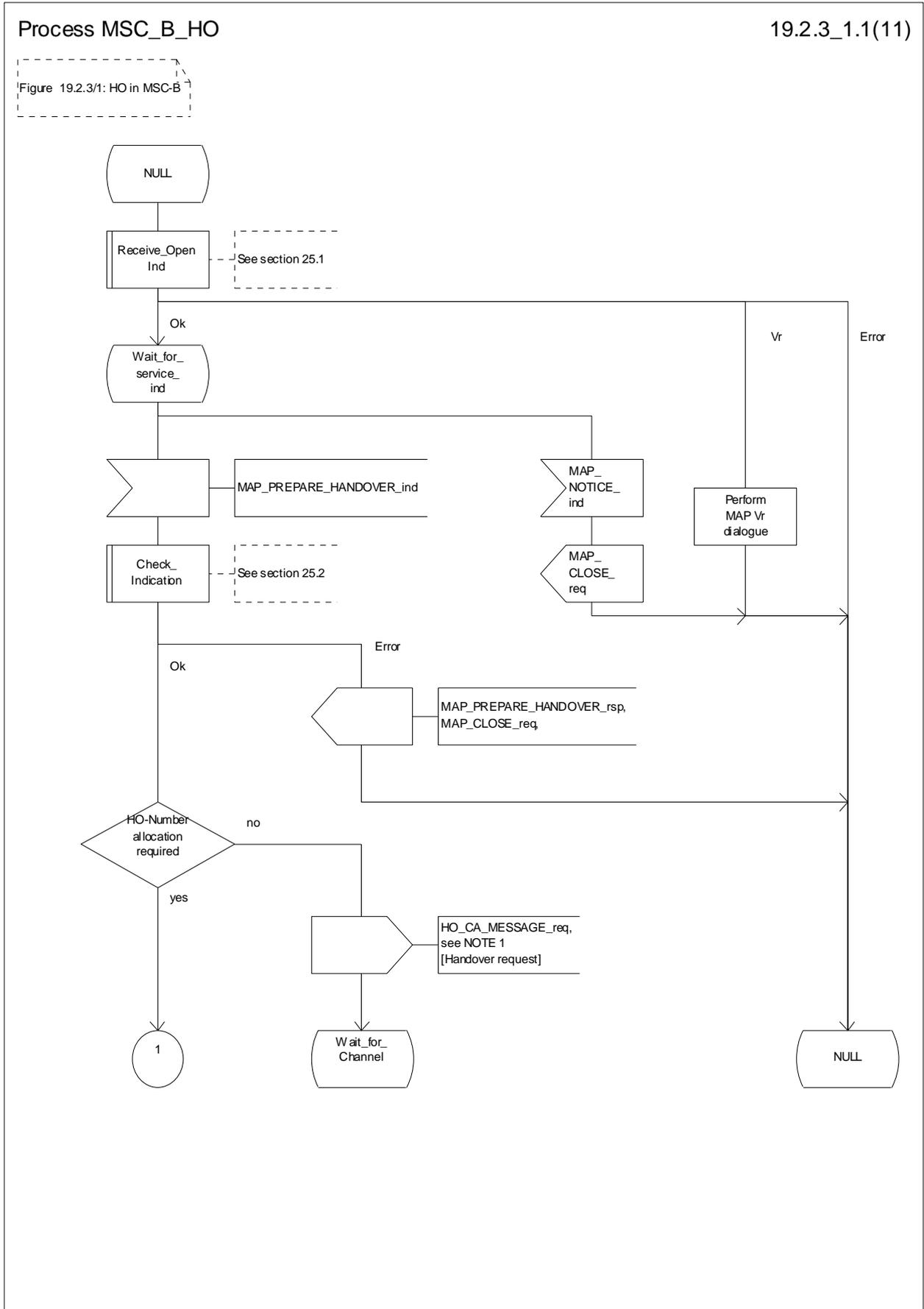

Figure 19.2.3/1 (sheet 1 of 11): Process MSC\_B\_HO

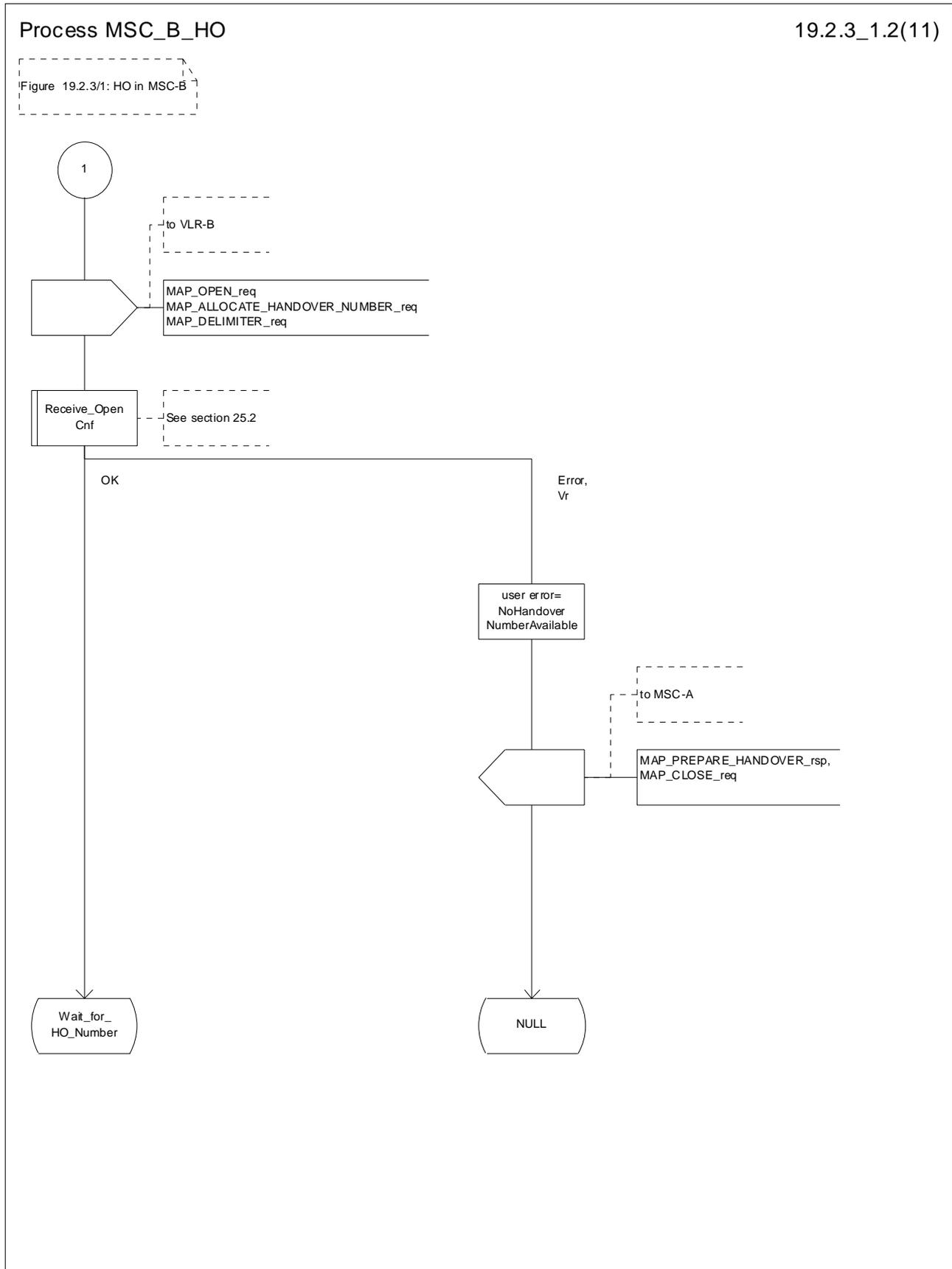

Figure 19.2.3/1 (sheet 2 of 11): Process MSC\_B\_HO

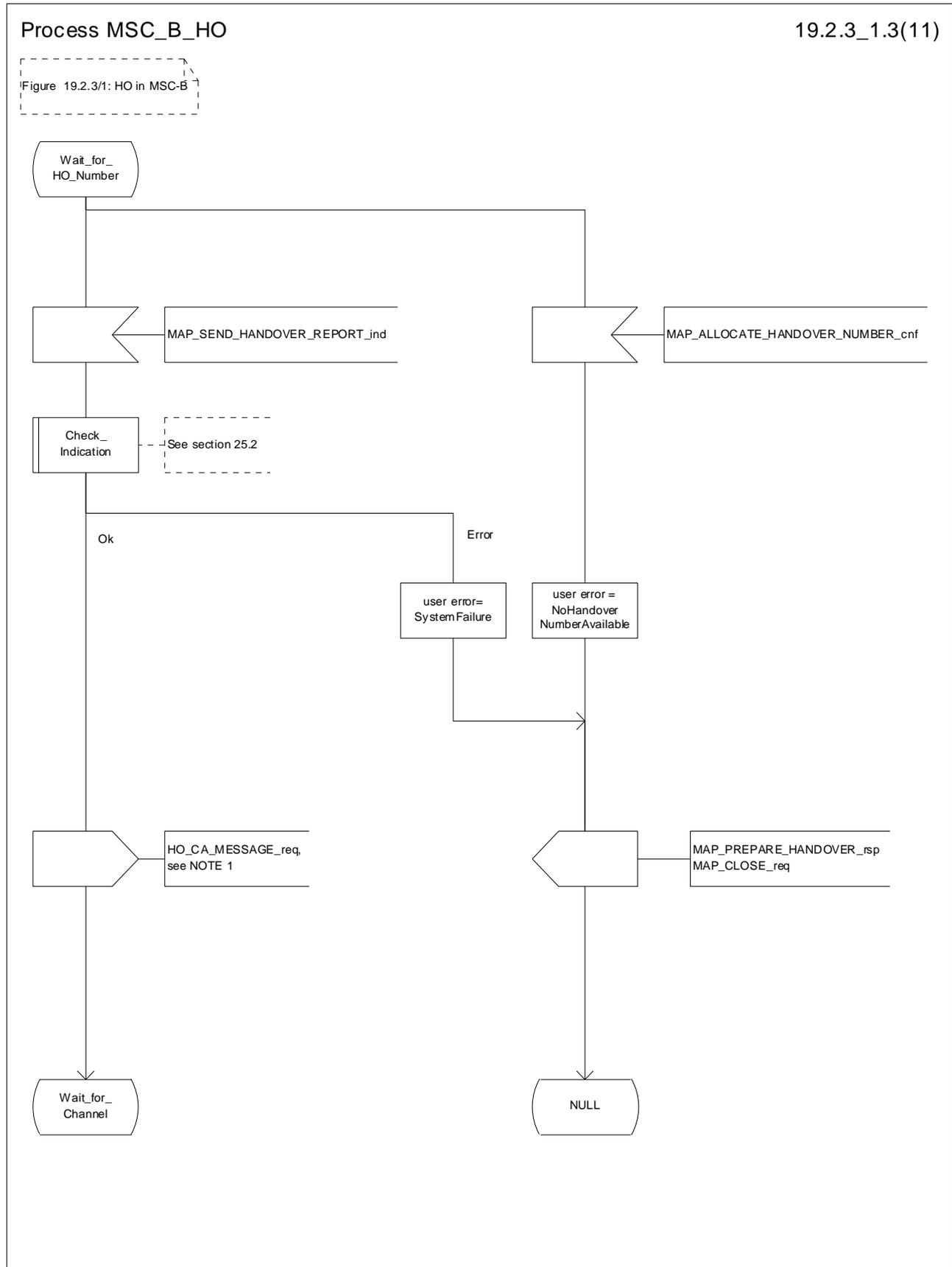

Figure 19.2.3/1 (sheet 3 of 11): Process MSC\_B\_HO



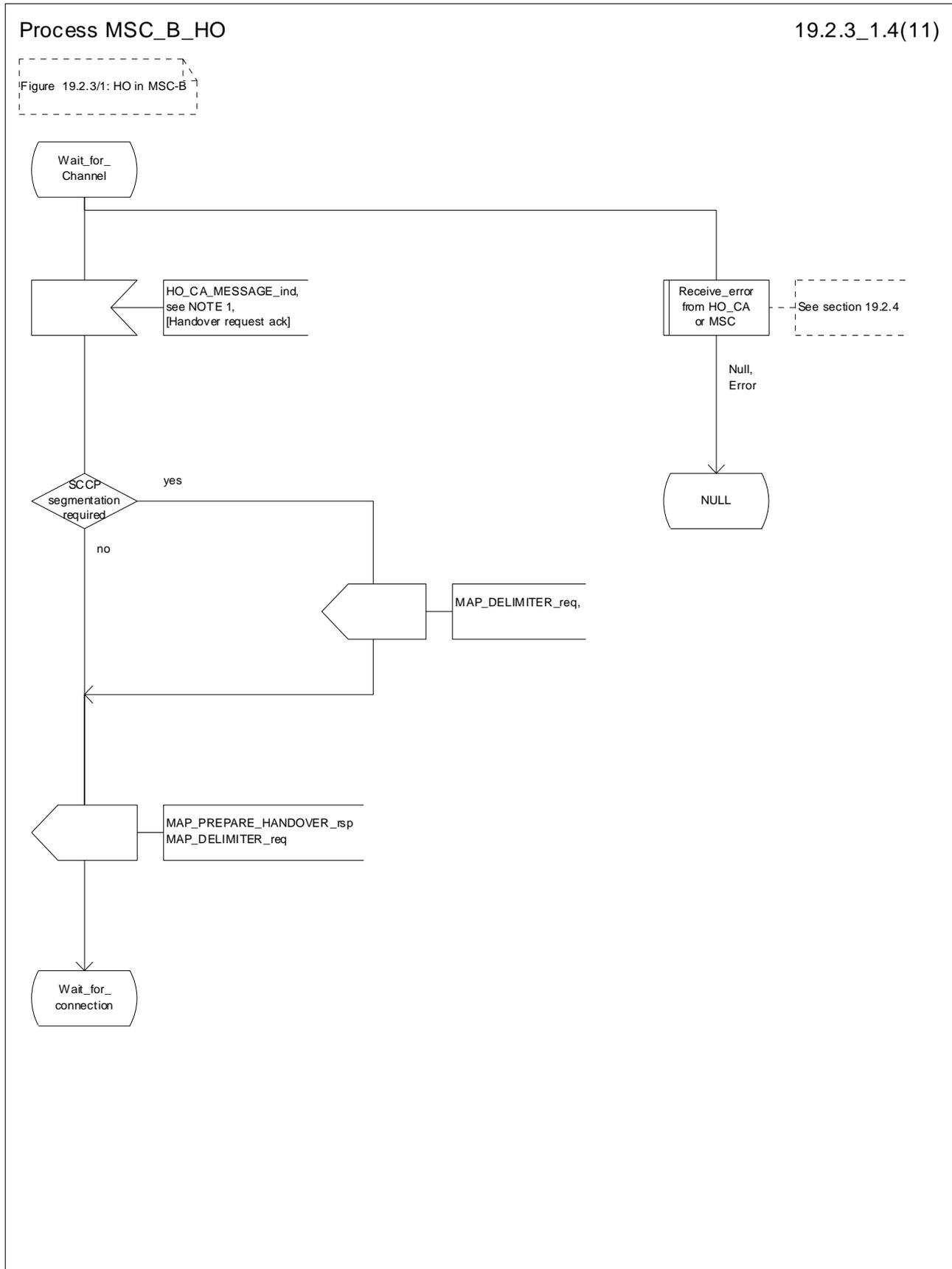

Figure 19.2.3/1 (sheet 4 of 11): Process MSC\_B\_HO

Process MSC\_B\_HO

19.2.3\_1.5(11)

Figure 19.2.3/1: HO in MSC-B

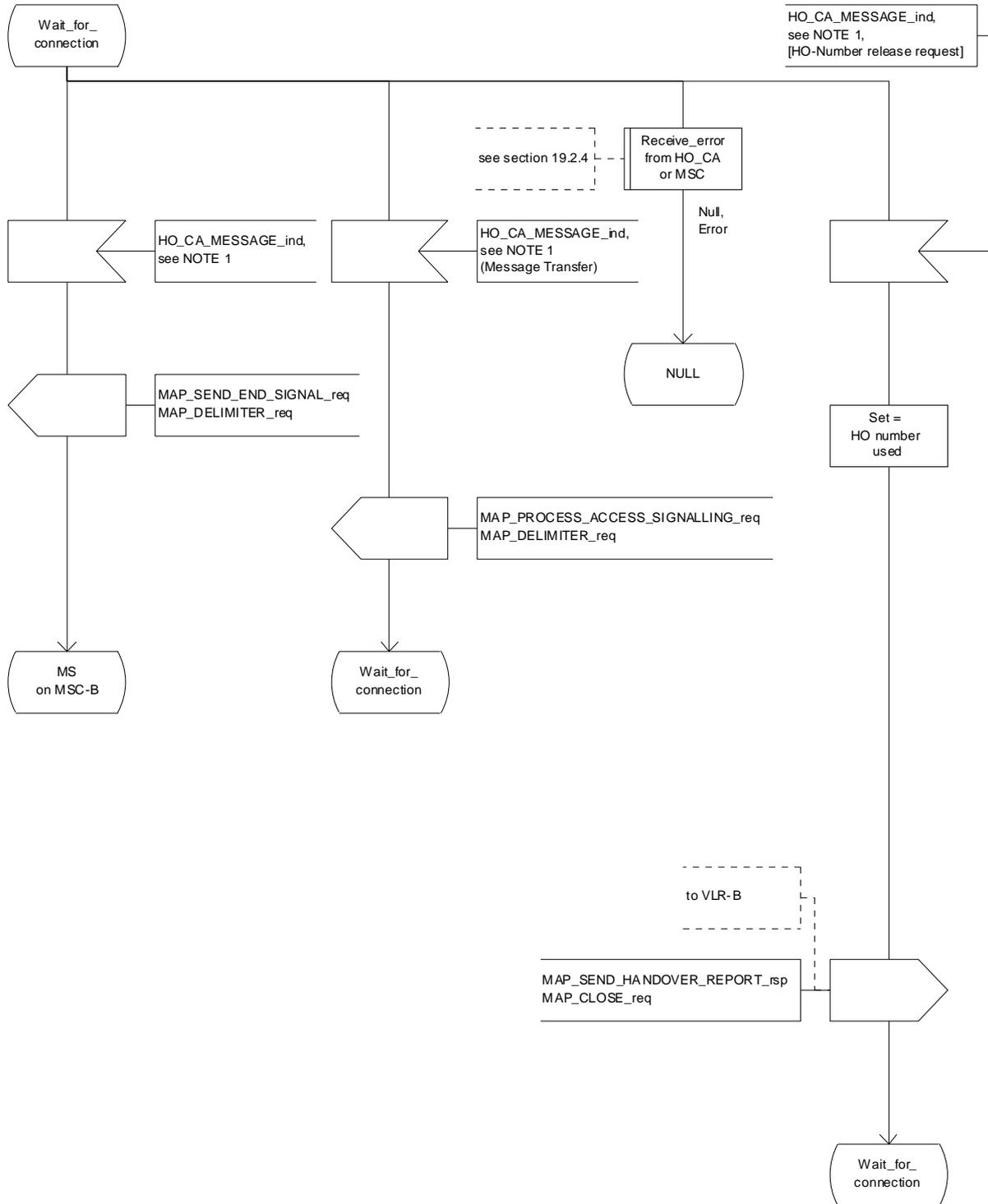

Figure 19.2.3/1 (sheet 5 of 11): Process MSC\_B\_HO

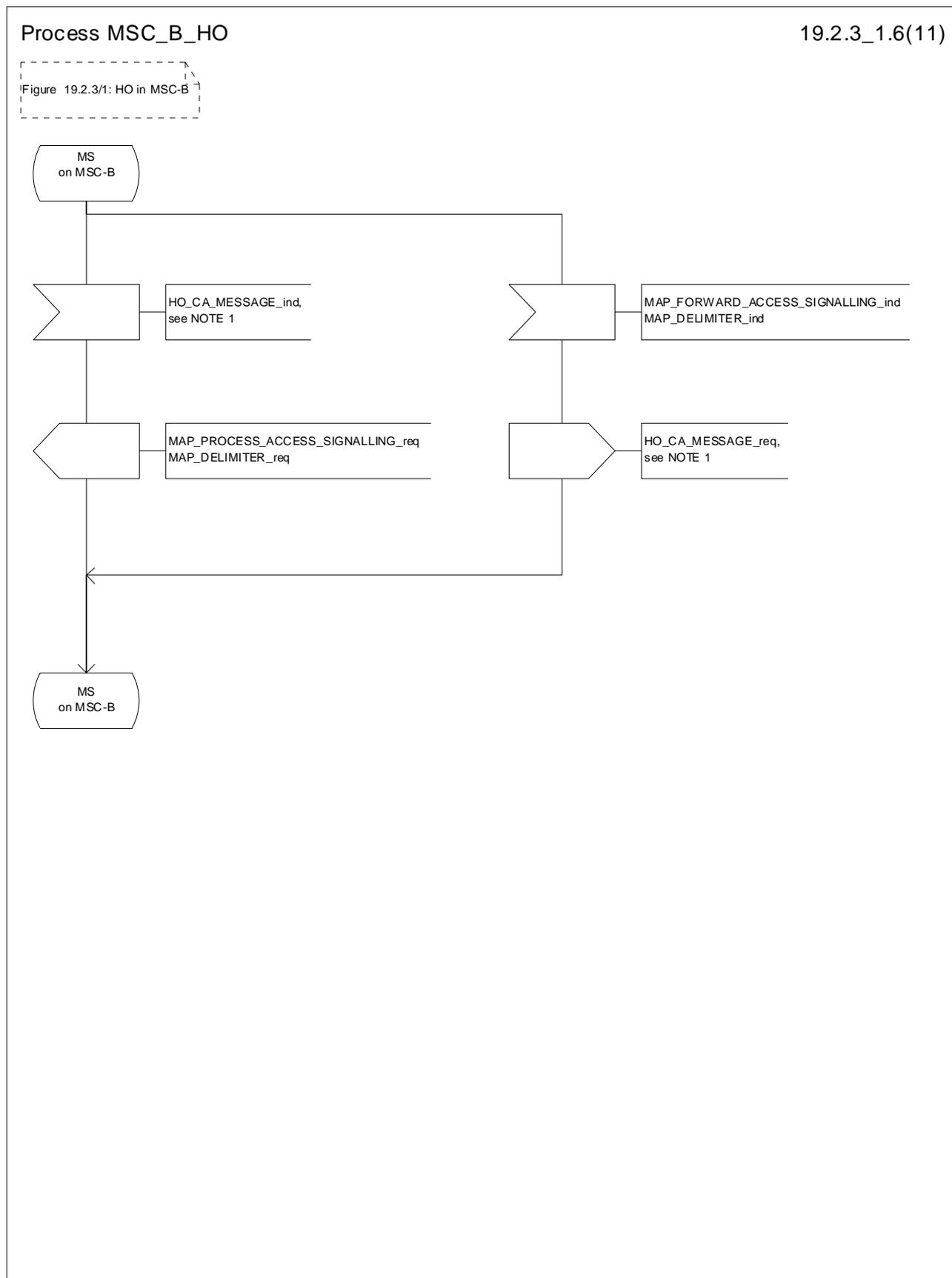

Figure 19.2.3/1 (sheet 6 of 11): Process MSC\_B\_HO

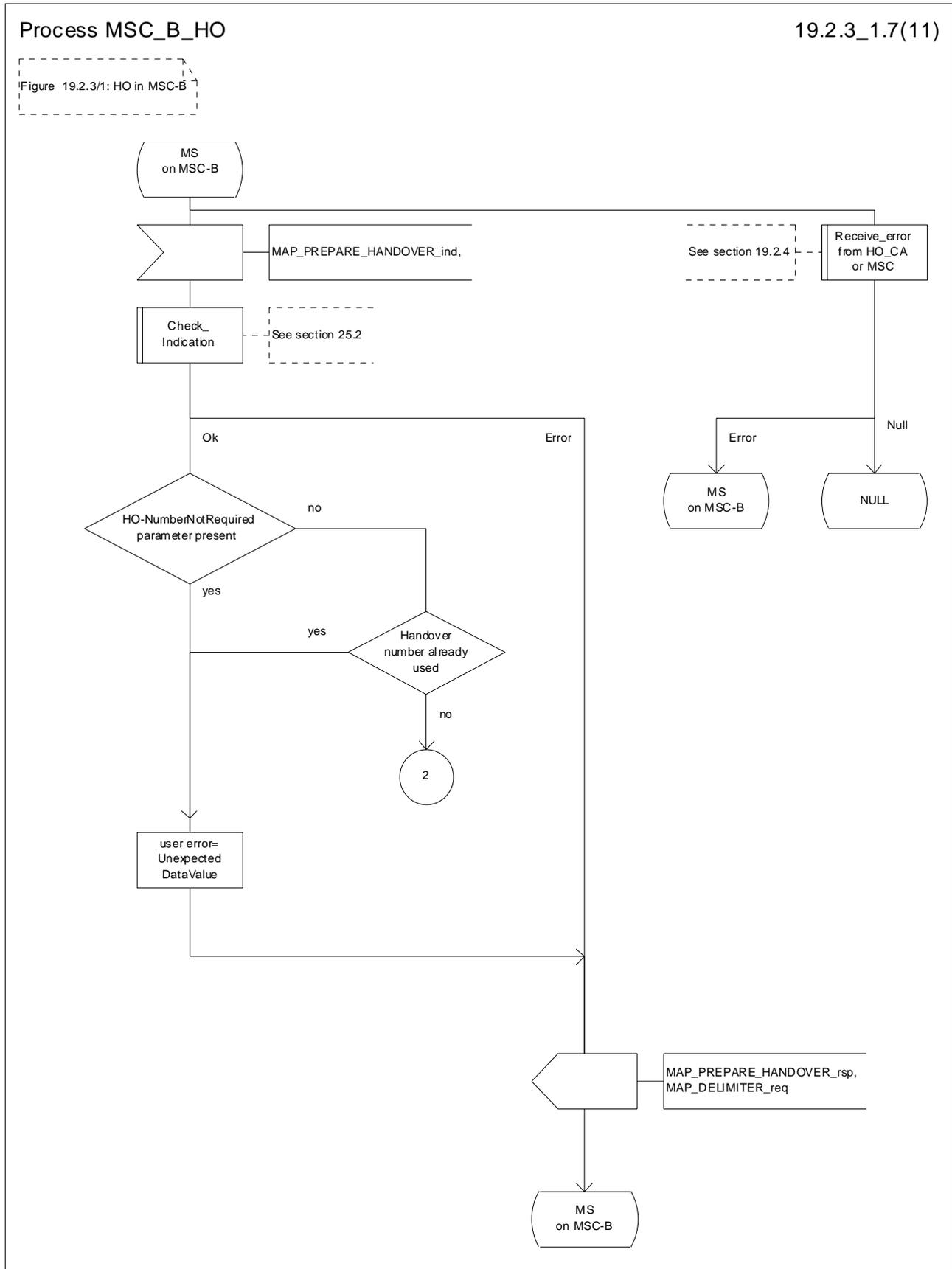

Figure 19.2.3/1 (sheet 7 of 11): Process MSC\_B\_HO

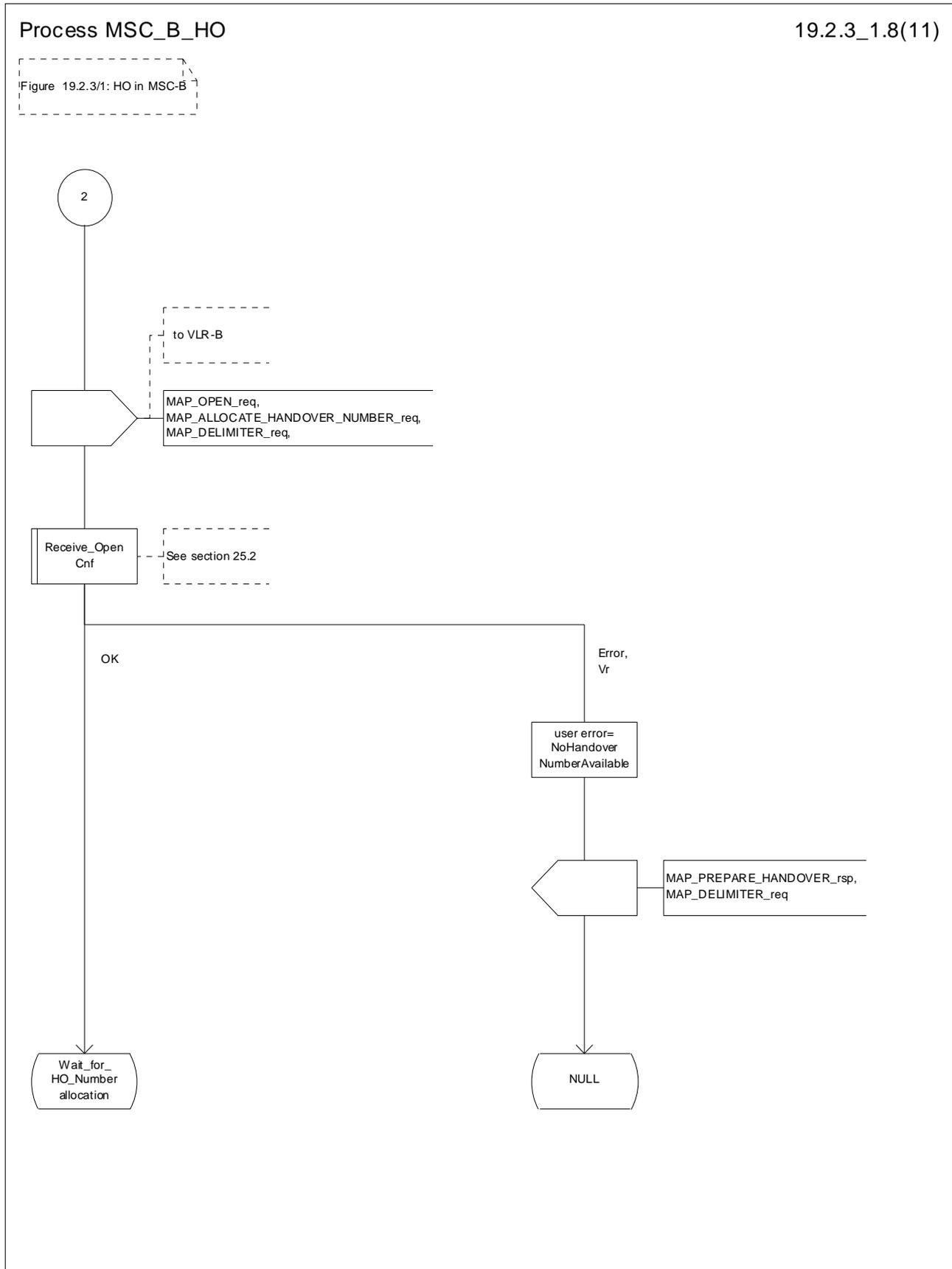

Figure 19.2.3/1 (sheet 8 of 11): Process MSC\_B\_HO

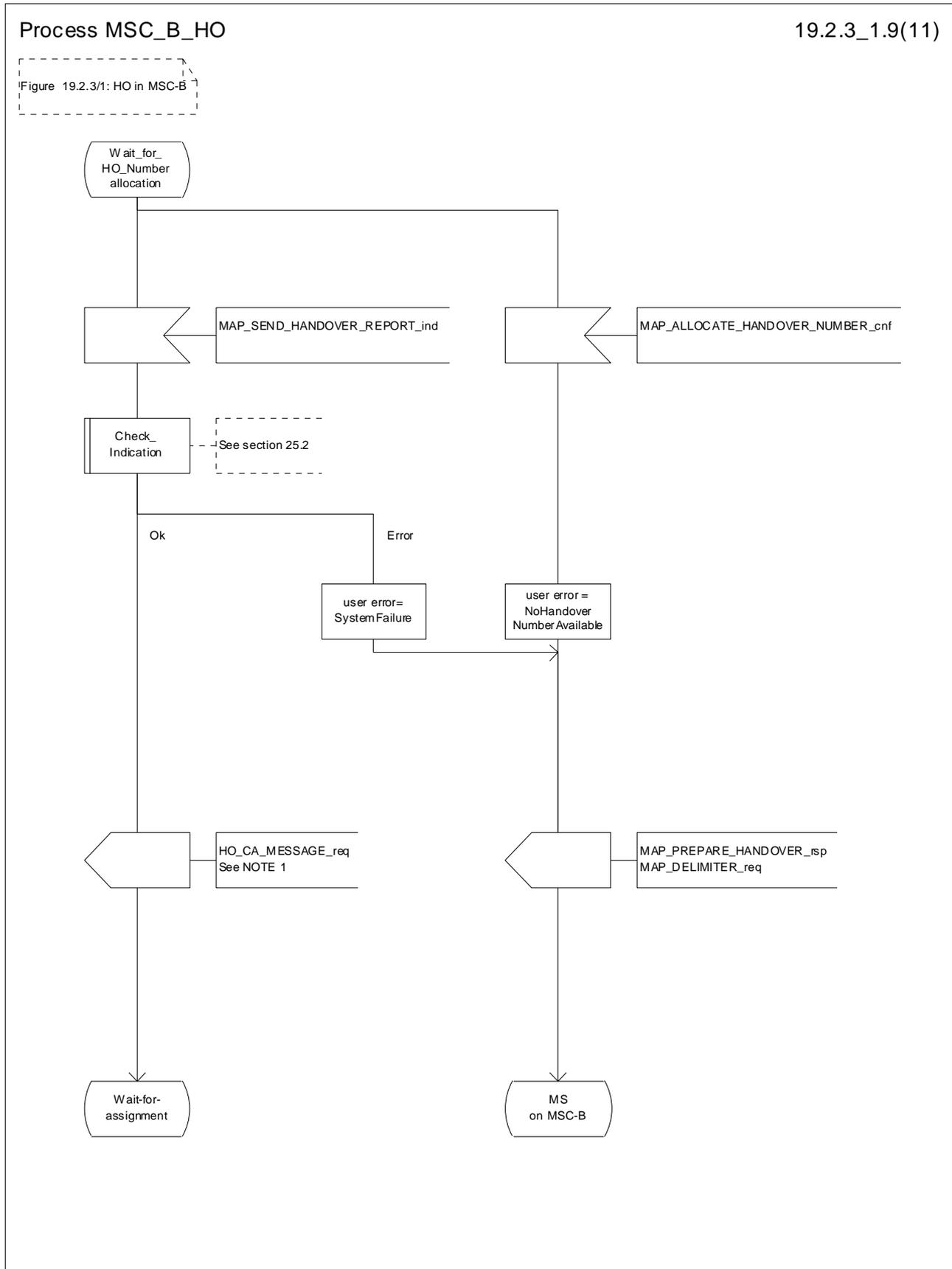

Figure 19.2.3/1 (sheet 9 of 11): Process MSC\_B\_HO

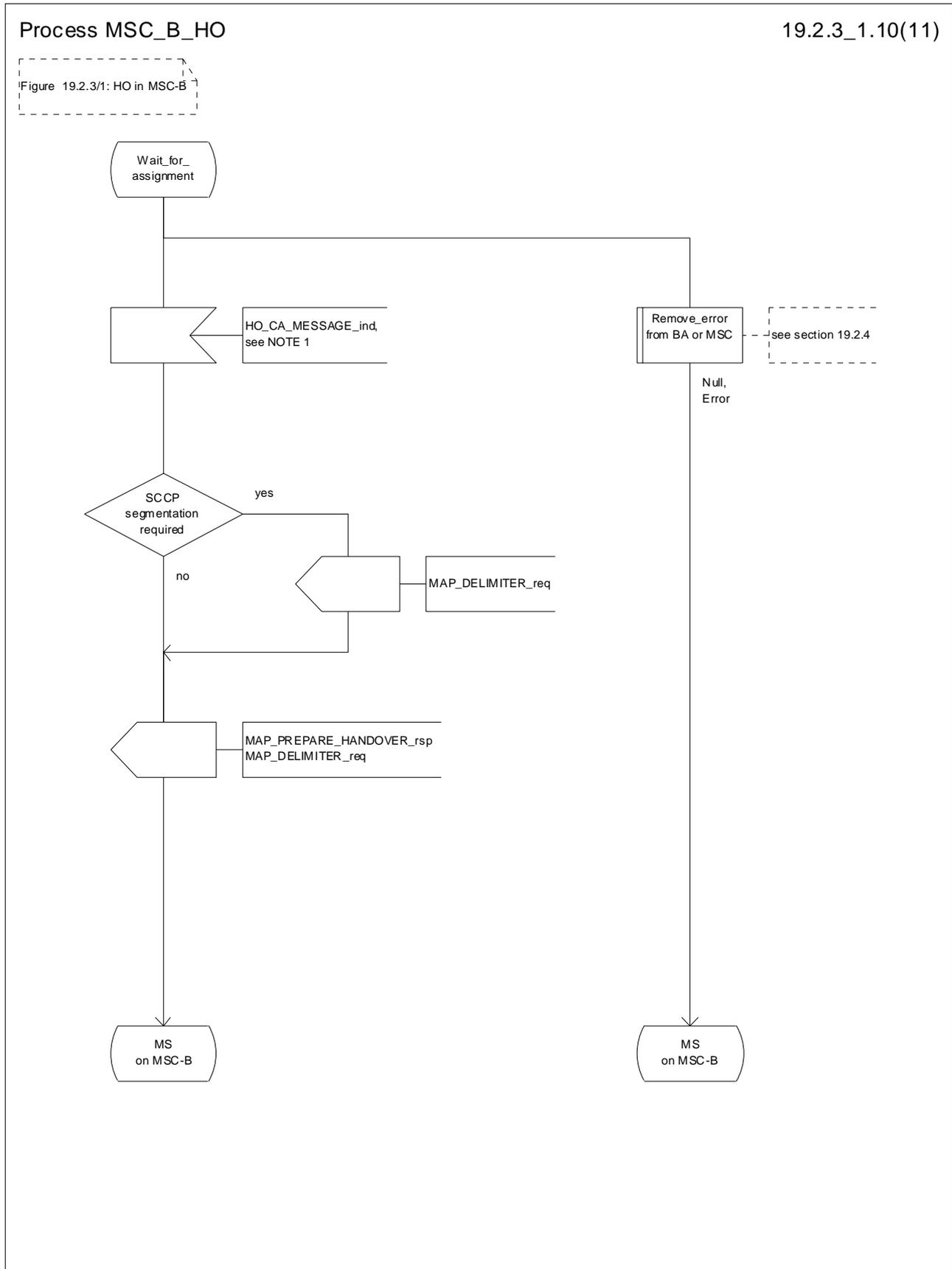

Figure 19.2.3/1 (sheet 10 of 11): Process MSC\_B\_HO

Process MSC\_B\_HO

19.2.3\_1.11(11)

Figure 19.2.3/1: HO in MSC-B

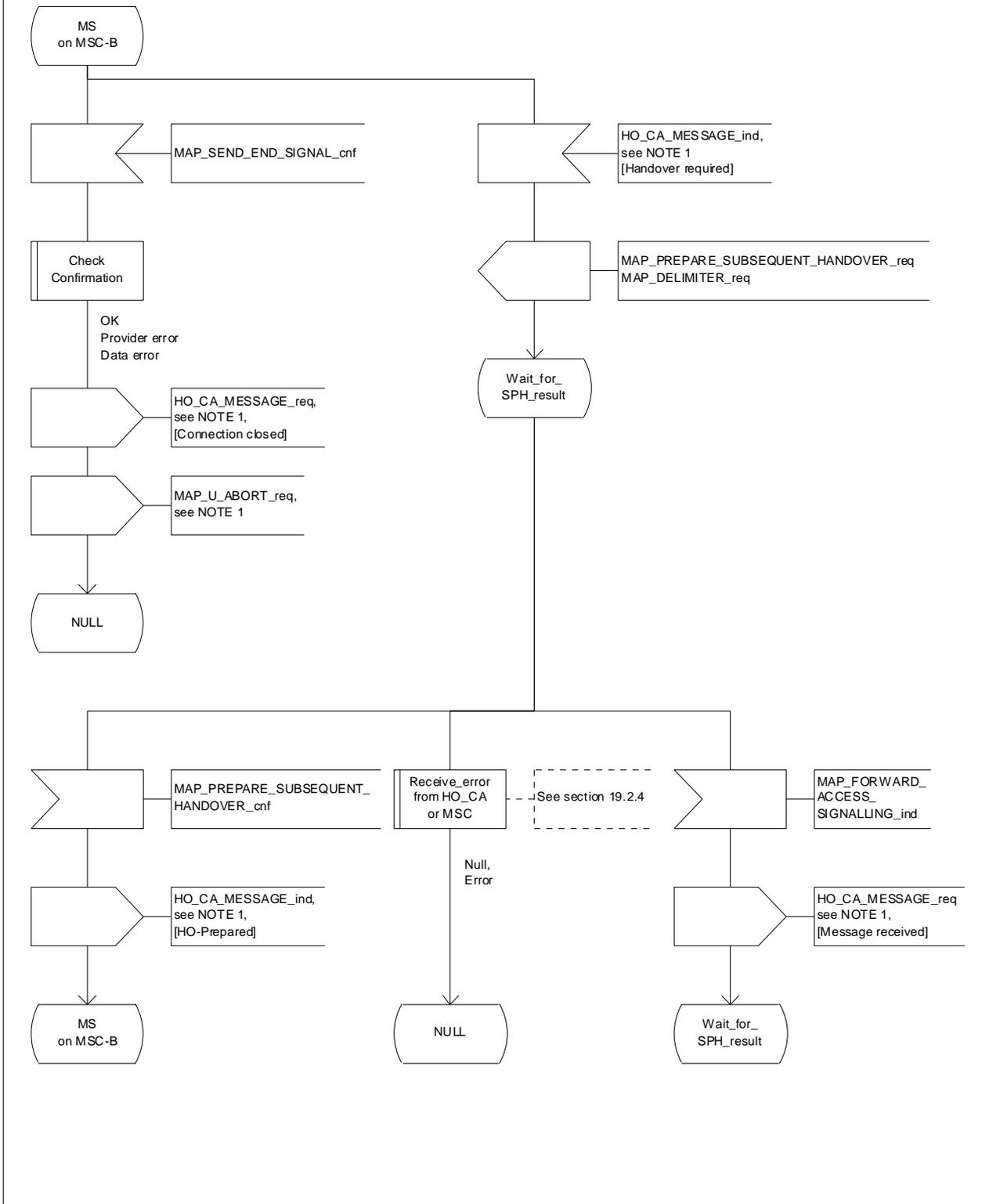

Figure 19.2.3/1 (sheet 11 of 11): Process MSC\_B\_HO



## 19.2.4 Handover error handling macro

This macro is used for the handover procedures to receive errors from the MSCs and from the Handover Control Application at any state of a handover process.

If a MAP\_NOTICE indication is received, the Handover Control Application is informed and the actual situation is kept and the Handover Control Application decides how the handover process should continue. In all other cases the MSC is returned to a "NULL" state.

Macrodefinition Receive\_error\_from\_HO\_CA\_or\_MSC

19.2.4\_1(1)

Figure 19.2.4/1: Macro Receive\_error\_from\_HO\_CA\_or\_MSC

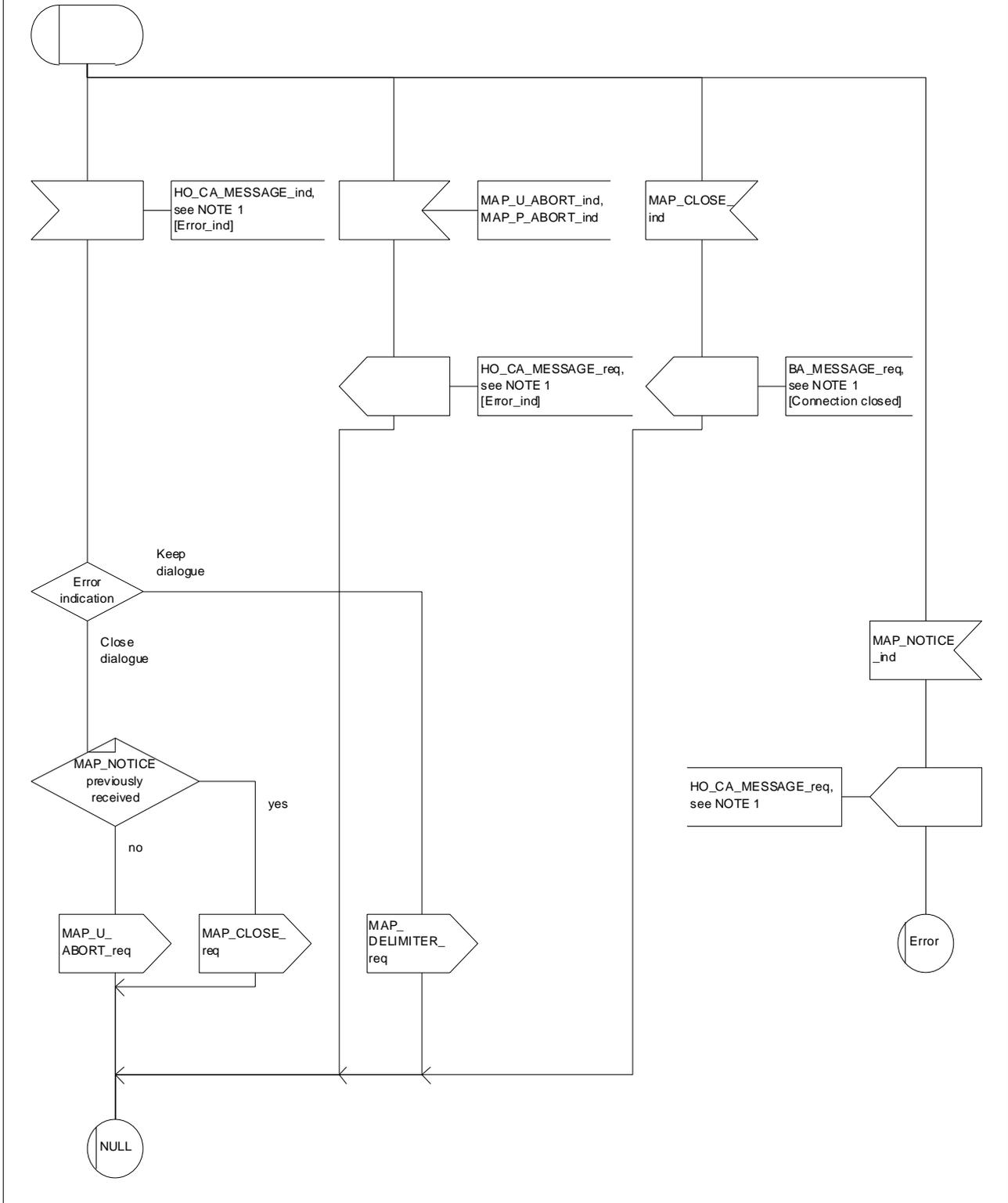

Figure 19.2.4/1: Macro Receive\_error\_from\_HO\_CA\_or\_MSC

## 19.2.5 Handover procedure in VLR

### 19.2.5.1 Allocation of handover number

When receiving the MAP\_ALLOCATE\_HANOVER\_NUMBER indication, the VLR will determine whether a handover number is available. If no handover number is available, this will be indicated by a MAP\_ALLOCATE\_HANOVER\_NUMBER response with the appropriate error.

The handover number allocated will otherwise be returned to MSC-B in the MAP\_SEND\_HANOVER\_REPORT request.

The handover number will be reserved until a MAP\_SEND\_HANOVER\_REPORT confirmation is received from MSC-B.

### 19.2.5.2 SDL Diagrams

The SDL diagrams on the following pages describe the user processes in VLR for the procedures described in this clause.

The services used are defined in clause 8.4.

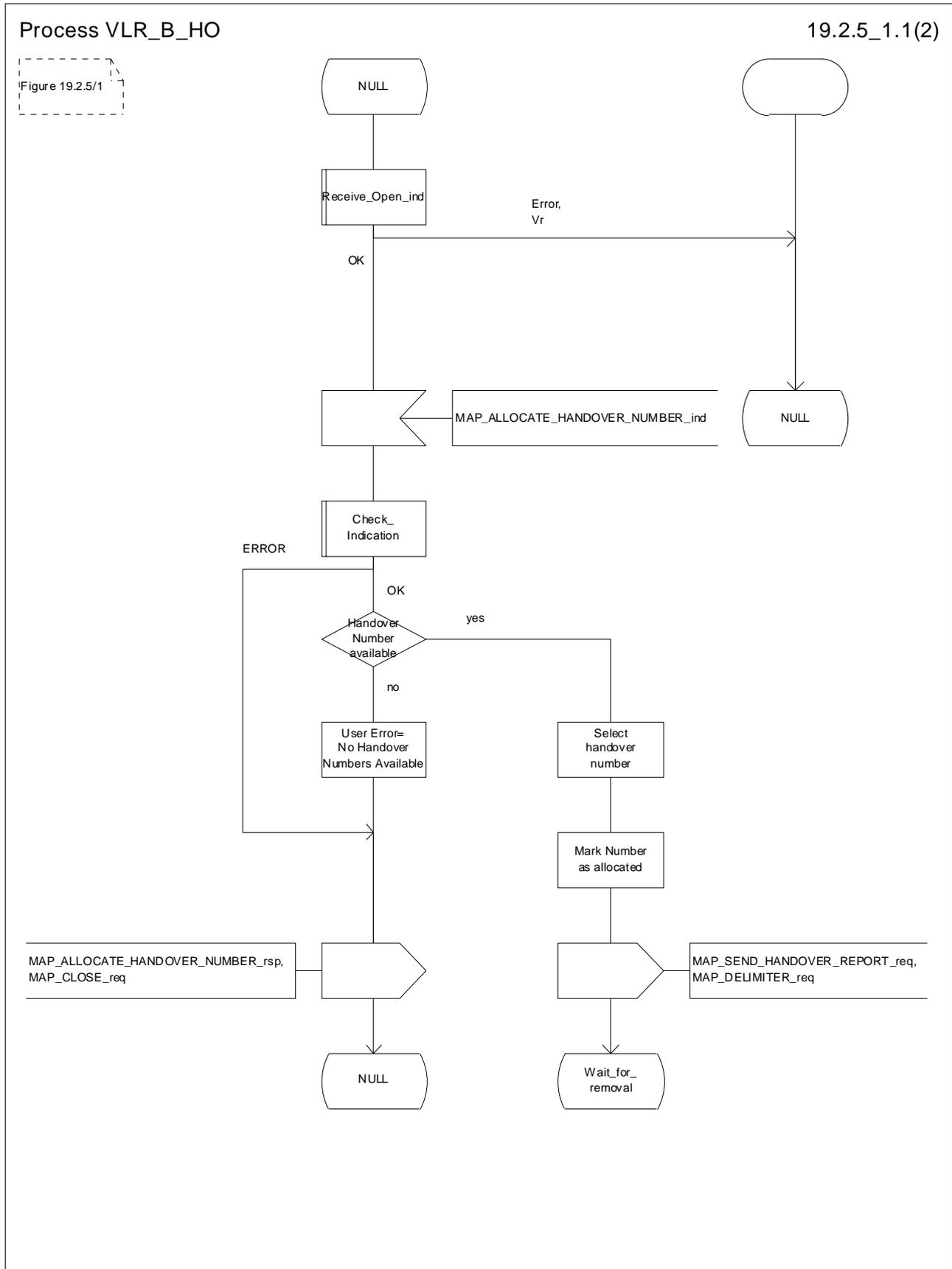

Figure 19.2.5/1 (sheet 1 of 2): Process VLR\_B\_HO

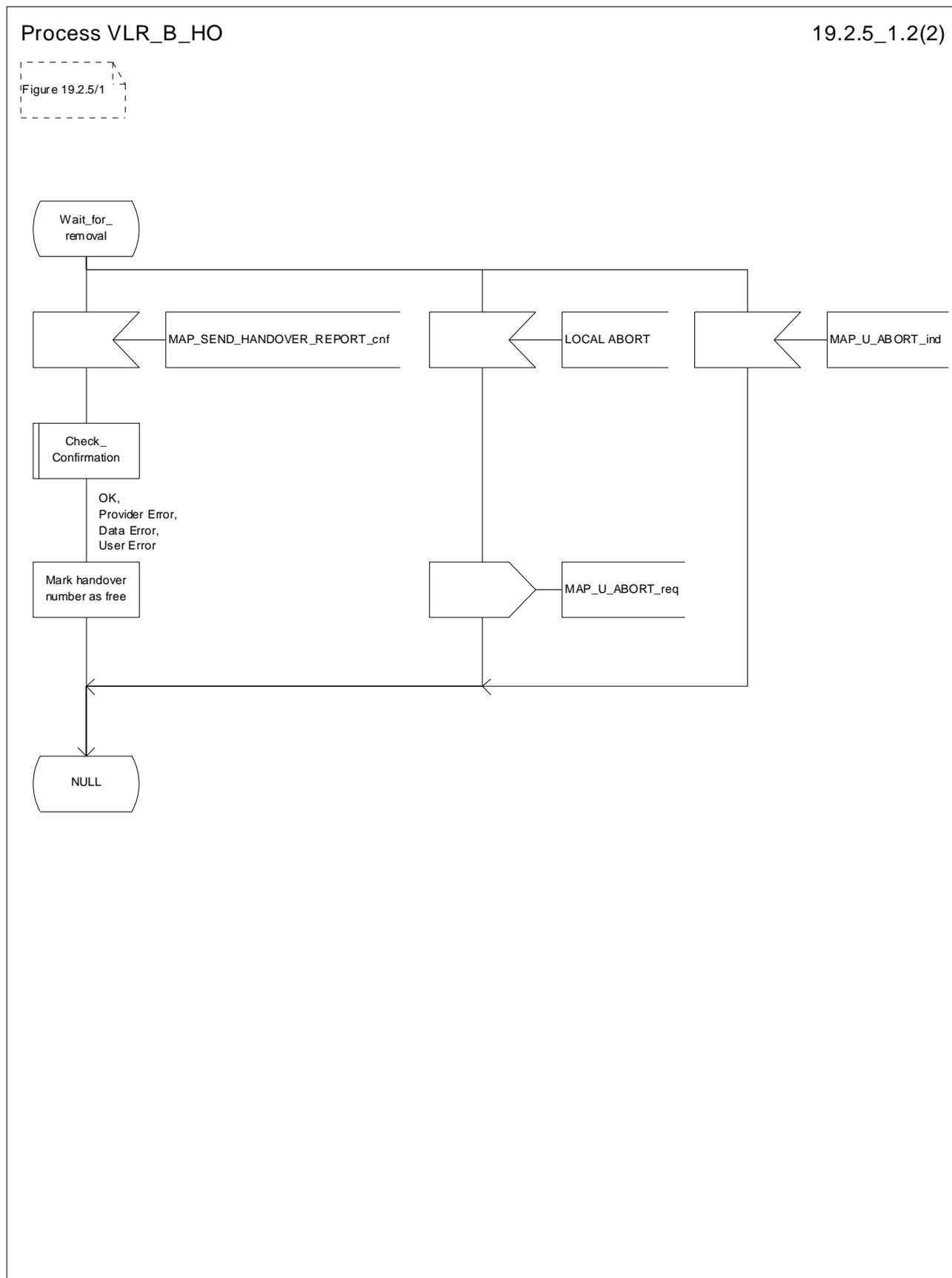

Figure 19.2.5/1 (sheet 2 of 2): Process VLR\_B\_HO

## 19.3 Fault recovery procedures

After a fault of a location register, the fault recovery procedures ensure that the subscriber data in the VLR or in the SGSN become consistent with the subscriber data that are stored in the HLR for the MS concerned and that the location information in HLR, VLR and SGSN reflect accurately the current location of the MS.

The detailed specification of fault recovery procedures of location registers is given in GSM 03.07.

### 19.3.1 VLR fault recovery procedures

The following processes are involved with the restoration of one IMSI record in the VLR:

- In case of a location registration request from the MS:
  - Update\_Location\_Area\_VLR clause 19.1.1.3;
  - Update\_Location\_HLR clause 19.1.1.4.
- In case of a mobile terminated call:
  - PRN\_VLR clause 21.2.4;
  - RESTORE\_DATA\_VLR clause 21.2.4;
  - RESTORE\_DATA\_HLR clause 19.3.3;
  - ICS\_VLR clause 21.3.3.

After a restart, the VLR shall erase all IMSI records affected by the failure and shall cause all affected TMSIs and all affected LMSIs to become invalid. There will be no subscriber data or location information stored for an affected MS until after the VLR has received either a MAP\_PROVIDE\_ROAMING\_NUMBER indication or a MAP\_UPDATE\_LOCATION\_AREA indication for that MS. Restoration of subscriber data in the VLR is triggered individually for each IMSI record by receipt of either of these indications.

Reception of either a MAP\_UPDATE\_LOCATION\_AREA indication or a MAP\_PROVIDE\_ROAMING\_NUMBER indication with an IMSI that is unknown in the VLR causes creation of a skeleton IMSI record that is marked as:

- not confirmed by radio contact by the indicator "Confirmed by Radio Contact" (The function of this indicator is described in GSM 03.07), and
- not confirmed by HLR by the indicator "Confirmed by HLR" (The function of this indicator is described in GSM 03.07).

A third indicator "Location Information Confirmed in HLR" is allocated to each IMSI record in the VLR (The function of this indicator is described in GSM 03.07).

The indicator "Location Information Confirmed in HLR" shall be checked whenever authenticated radio contact with an MS has been established. The status "Not Confirmed" of this indicator shall force the VLR to invoke the MAP\_UPDATE\_LOCATION service but it shall never cause rejection of a mobile originated request. The status is changed from "Not Confirmed" to "Confirmed" only after successful completion of a MAP\_UPDATE\_LOCATION procedure for the MS concerned.

If the VLR serves only one MSC, the indicator "Location Information Confirmed in HLR" is only relevant to the HLR restoration procedure and an initial value must be assigned when an IMSI record is created in the VLR:

- if the IMSI record was created due to a roaming number request, the initial value must be set to "Confirmed";
- if reception of a MAP\_UPDATE\_LOCATION\_AREA indication causes creation of the IMSI record, the initial value must be "Not Confirmed".

If the VLR serves more than one MSC, the indicator "Location Information Confirmed in HLR" is used in the VLR restoration procedure as well as in the HLR restoration procedure. When an IMSI record is created in the VLR, the indicator must be set to "Not Confirmed".

### VLR restoration triggered by a location registration request

Upon receipt of a MAP\_UPDATE\_LOCATION\_AREA indication, the VLR retrieves authentication data from the HLR by using the MAP\_SEND\_AUTHENTICATION\_INFO service if authentication is required and if no authentication data are available in the VLR for the IMSI concerned (see figure 19.1.1/6).

Receipt of a MAP\_UPDATE\_LOCATION\_AREA indication for an MS whose IMSI is unknown in the VLR or whose data stored in the VLR are marked as "Not Confirmed" by the indicator "Confirmed by HLR" and/or by the indicator "Location Information Confirmed in HLR" forces the VLR to invoke the MAP\_UPDATE\_LOCATION service after successful authentication, if required. The location updating procedure is performed as described in clause 19.1.

Any other mobile originated request from an MS whose IMSI is unknown in the VLR or whose subscriber data stored in the VLR are marked as "Not Confirmed" by the indicator "Confirmed by HLR" shall be rejected with error cause "Unidentified Subscriber". This causes the MS to trigger the location registration procedure.

After successful completion of the MAP\_UPDATE\_LOCATION procedure, the indicators "Confirmed by HLR" and "Location Information Confirmed in HLR" are set to "Confirmed".

The indicator "Confirmed by Radio Contact" is set to "Confirmed" when the radio contact with the MS is authenticated.

### VLR restoration triggered by a roaming number request

Figure 19.3/1 illustrates the signalling sequence for restoration of an IMSI record in the VLR triggered by a mobile terminating call set-up.

Upon receipt of a MAP\_PROVIDE\_ROAMING\_NUMBER indication for an IMSI that is unknown in the VLR and for which authentication is required, the VLR retrieves authentication data from the HLR by using the MAP\_SEND\_AUTHENTICATION\_INFO service after an MSRN has been sent to the HLR in the MAP\_PROVIDE\_ROAMING\_NUMBER response.

Receipt of a MAP\_PROVIDE\_ROAMING\_NUMBER indication for an MS whose IMSI is unknown in the VLR or whose data record in the VLR is marked as "Not Confirmed" by the indicator "Confirmed by HLR" forces the VLR to request subscriber data from the HLR by sending a MAP\_RESTORE\_DATA request which triggers one or more INSERT\_SUBSCRIBER\_DATA operations from the HLR. The MAP\_RESTORE\_DATA request may also be used to send the LMSI to the HLR.

The MAP\_RESTORE\_DATA process in the VLR is described in clause 21.2.4.

The MAP\_RESTORE\_DATA process in the HLR is described in clause 19.3.3.

After successful completion of the MAP\_RESTORE\_DATA procedure, the indicator "Confirmed by HLR" is set to "Confirmed".

If restoration of an IMSI record was triggered by a MAP\_PROVIDE\_ROAMING\_NUMBER indication (i.e. by a mobile terminating call), the VLR has no valid Location Area Identity information for the MS concerned before successful establishment of the first authenticated radio contact. Upon receipt of a MAP\_SEND\_INFO\_FOR\_INCOMING\_CALL indication from the MSC (see 5 in figure 19.3/1) for an MS whose subscriber data are marked as "Confirmed" by the indicator "Confirmed by HLR" but not confirmed by radio contact, the VLR shall invoke a "MAP\_SEARCH\_FOR\_MS" instead of a "MAP\_PAGE".

A MAP\_SEARCH\_FOR\_MS shall also be performed if the VLR receives a MAP\_SEND\_INFO\_FOR\_MT\_SMS indication from the MSC for an MS whose IMSI record is marked as "Confirmed" by the indicator "Confirmed by HLR" but not confirmed by radio contact.

The indicator "Confirmed by Radio Contact" is set to "Confirmed" when authenticated radio contact caused by a mobile originated or a mobile terminated activity is established.





- GPRS\_Update\_Location\_Area\_VLR clause 19.1.1.3;
- SGSN\_Update\_HLR clause 19.1.1.8.

In the case of a mobile originated service request, the

- Macro Process\_Access\_Request\_VLR clause 25.4.2; and the
- Process Update\_Location\_HLR clause 19.1.1.4,

are involved with the HLR restoration procedure.

For the HLR, periodic back-up of data to non-volatile memory is mandatory.

Data that have been changed in the period of time after the last back-up storage and before the restart of the HLR cannot be recovered by reload from the non-volatile memory. Therefore, a restoration procedure is triggered individually for each IMSI record that has been affected by the HLR fault at the first authenticated radio contact that is established with the MS concerned.

The HLR restoration procedure forces updating of MSC number, VLR number, SGSN number and, if provided by the VLR, LMSI in the HLR. Consistency of subscriber data that are stored in the VLR or in the SGSN for an MS that has been affected by a HLR fault with the subscriber data stored in the HLR for this MS will be achieved.

As an implementation option, a notification can be forwarded to the MS to alert the subscriber to check the parameters for supplementary services that allow subscriber controlled input (MAP\_FORWARD\_CHECK\_SS\_INDICATION service). If the VLR receives this notification from the HLR it shall forward the notification to the MS. If the Gs-interface is present the VLR shall not forward this notification.

Figures 19.3/2 and 19.3/9 illustrates the signalling sequence for HLR restoration.

After a restart, the home location register performs the following actions for the subscriber data records that have been affected by the HLR fault (see figure 19.3/3):

- reload all data from the non-volatile back-up;
- if the MAP\_FORWARD\_CHECK\_SS\_INDICATION service is implemented, mark each subscriber record "SS Check Required" by setting the "Check SS" indicator;
- set subscriber tracing deactivate in the VLR for each of its Mss;
- reset the "MS Purged" flag for each of its MSs;
- send a MAP\_RESET request to the VLRs where its MSs are located (see figure 19.3/4).
- send a MAP\_RESET request to the SGSNs where its MSs are located (see figure 19.3/7).

The MAP\_RESET request contains the HLR number and optionally the HLR Identity List.

When receiving a MAP\_RESET indication, the VLR or the SGSN will derive all involved MSs of that HLR either from the HLR Identity List (if present), or from the HLR number. The VLR or the SGSN will then mark these MSs with the indicator "Location Information Confirmed in HLR" set to "Not Confirmed" and will deactivate all subscriber tracings for these Mss (see figures 19.3/5 and 19.3/8).

The status "Not Confirmed" of the indicator "Location Information Confirmed in HLR" forces the VLR to invoke the MAP\_UPDATE\_LOCATION service after establishment of authenticated radio contact with the MS concerned.

Also the status "Not Confirmed" of the indicator "Location Information Confirmed in HLR" forces the SGSN to invoke the MAP\_UPDATE\_GPRS\_LOCATION service after establishment of authenticated radio contact with the MS concerned.

The MAP\_UPDATE\_LOCATION procedure is performed as described in clause 19.1.

After receipt of the MAP\_UPDATE\_LOCATION or the MAP\_UPDATE\_GPRS\_LOCATION acknowledge containing the HLR number, the status of the indicator "Location Information Confirmed in HLR" is changed to "Confirmed".

If the MAP\_UPDATE\_LOCATION procedure is unsuccessful for any reason, the status of the indicator "Location Information Confirmed in HLR" remains unchanged except for the case that the IMSI record in the VLR is deleted because either of the errors "Unknown Subscriber" or "Roaming Not Allowed" has been received from the HLR in response to a MAP\_UPDATE\_LOCATION request.

If the MAP\_UPDATE\_GPRS\_LOCATION procedure is unsuccessful for any reason, the status of the indicator "Location Information Confirmed in HLR" remains unchanged except for the case that the IMSI record in the SGSN is deleted because either of the errors "Unknown Subscriber" or "Roaming Not Allowed" has been received from the HLR in response to a MAP\_UPDATE\_GPRS\_LOCATION request.

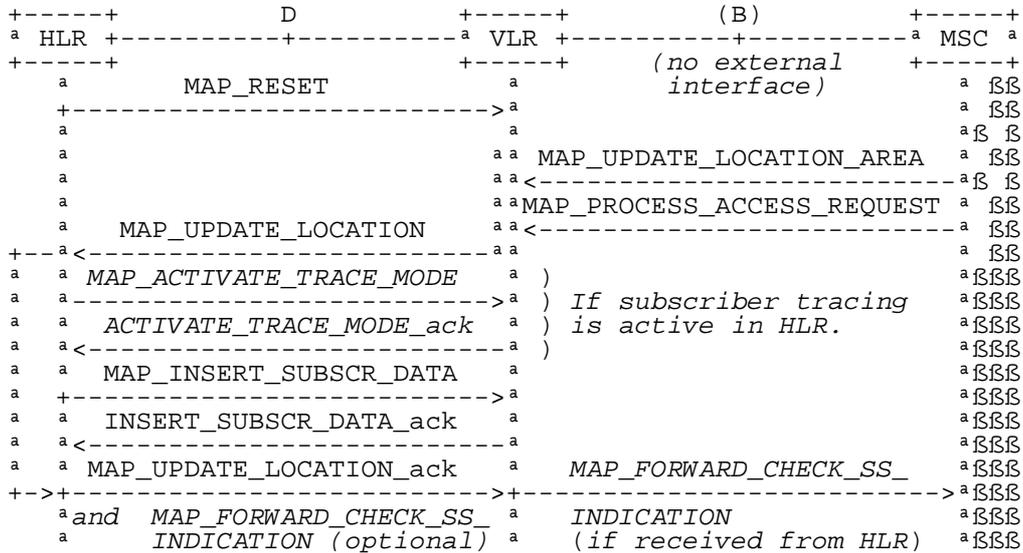

Figure 19.3/2: Procedures related to restoration of HLR

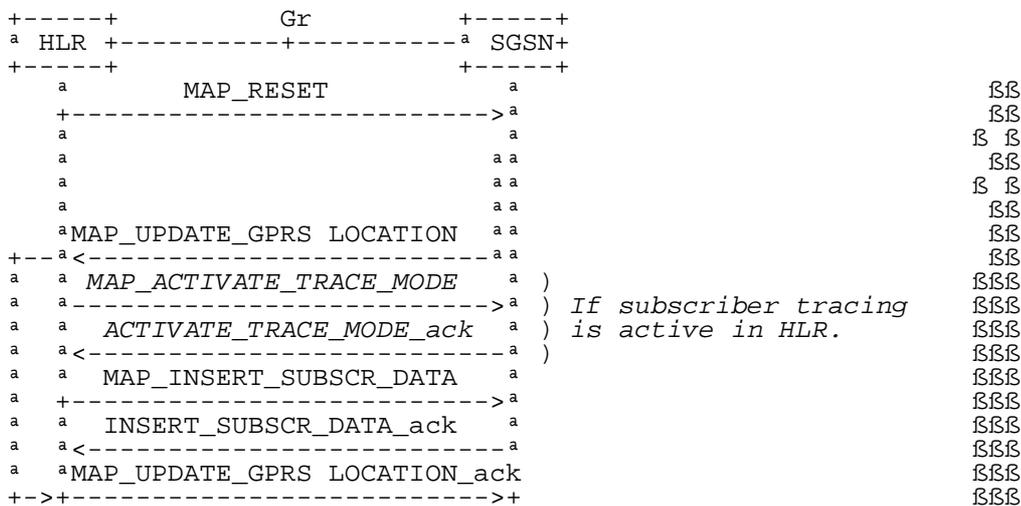

Figure 19.3/9: Procedures related to restoration of HLR for GPRS

Process HLR\_RESTART

19.3\_3(1)

Figure 19.3/3 Restoration of the HLR  
Application process in the HLR for HLR Restart

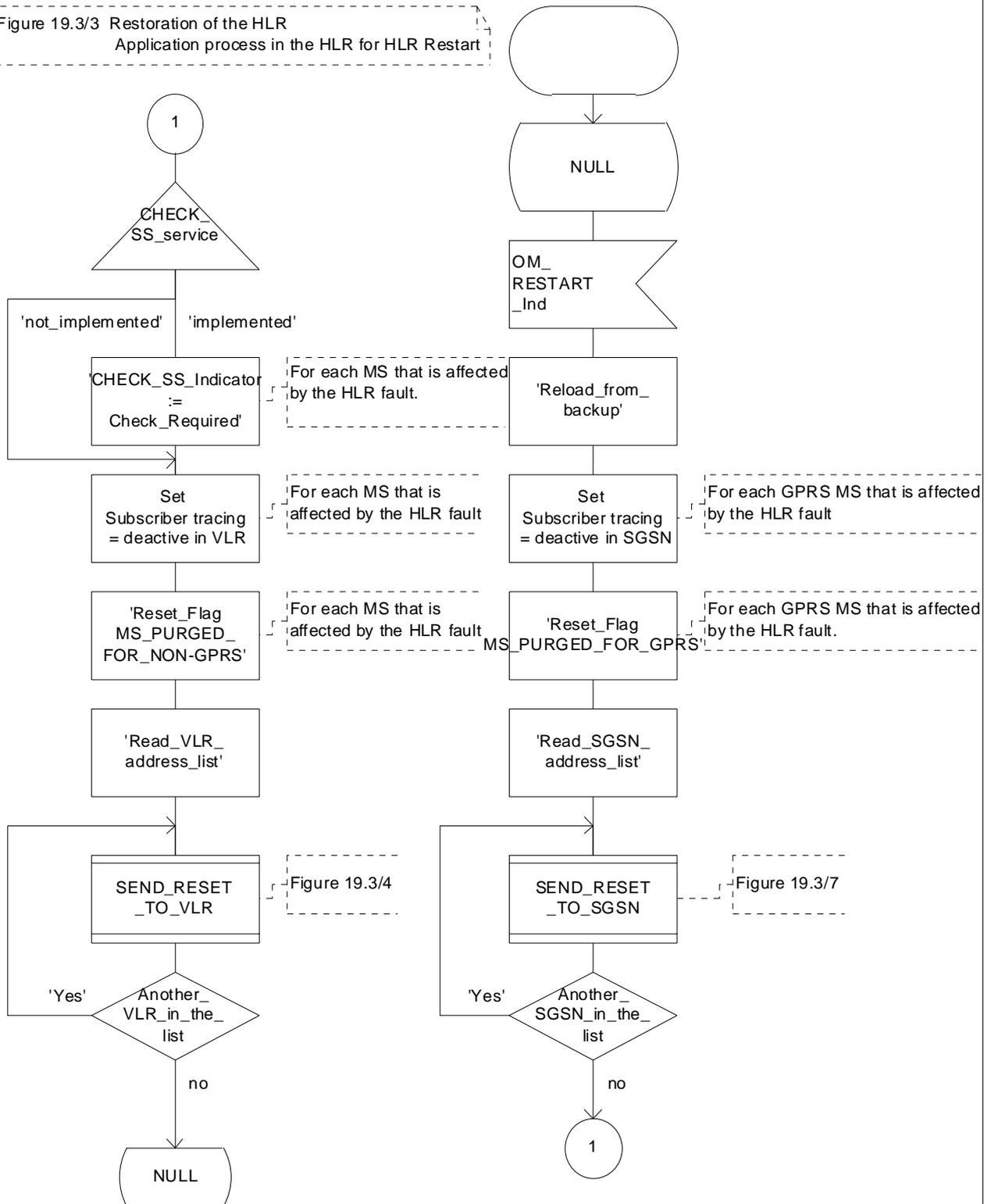

Figure 19.3/3: Process HLR\_RESTART

Process SEND\_RESET\_TO\_VLR

19.3\_4(1)

Figure 19.3/4 Restoration of the HLR  
Process for sending the RESET message  
from HLR to VLR

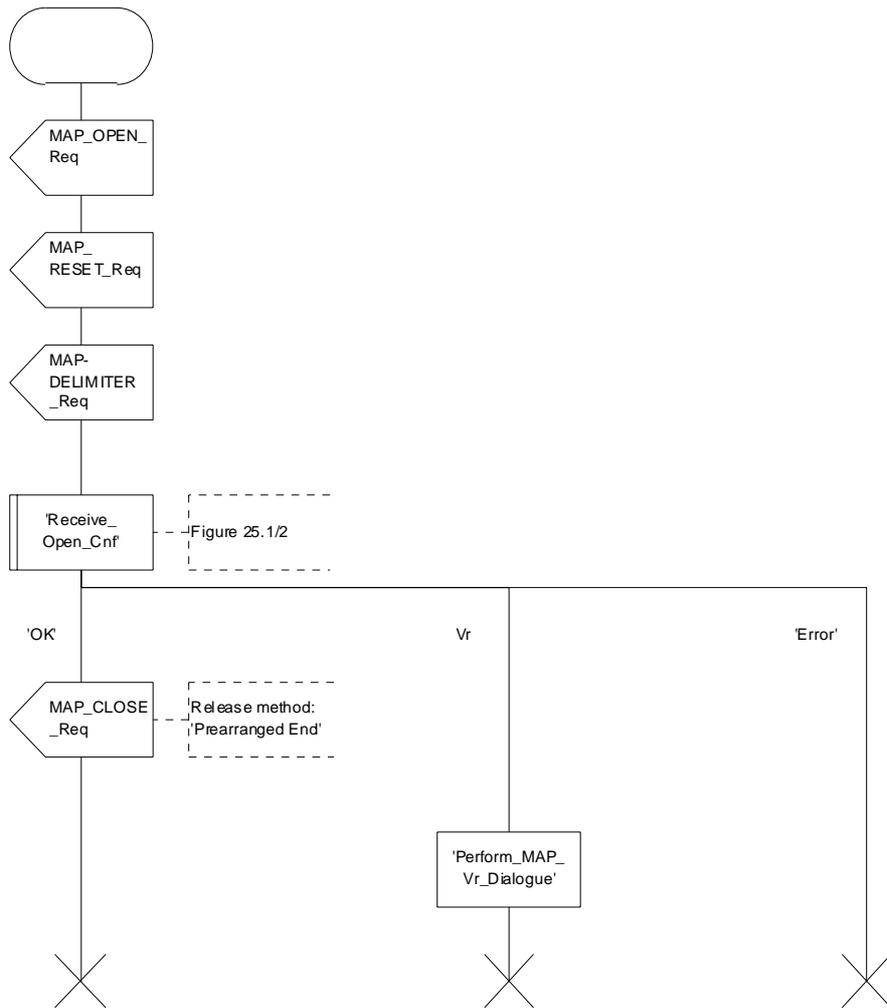

Figure 19.3/4: Process SEND\_RESET\_TO\_VLR

Process REC\_RESET\_IN\_VLR

19.3\_5(1)

Figure 19.3/5 Restoration of the HLR - Application process in the VLR for reception of the RESET message from HLR

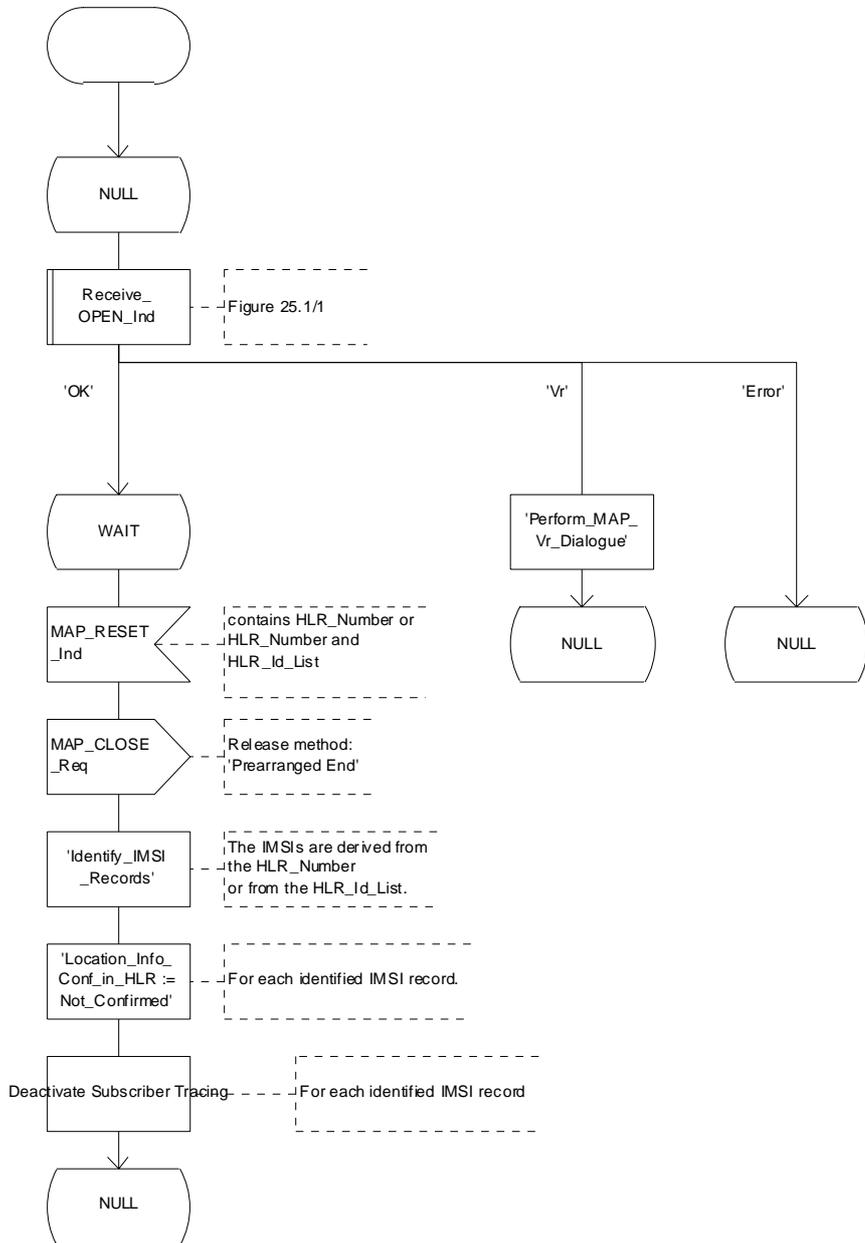

Figure 19.3/5: Process REC\_RESET\_IN\_VLR

Process SEND\_RESET\_TO\_SGSN

19.3\_7(1)

Figure 19.3/7: Restoration of the HLR  
Process for sending the RESET message  
from HLR to SGSN

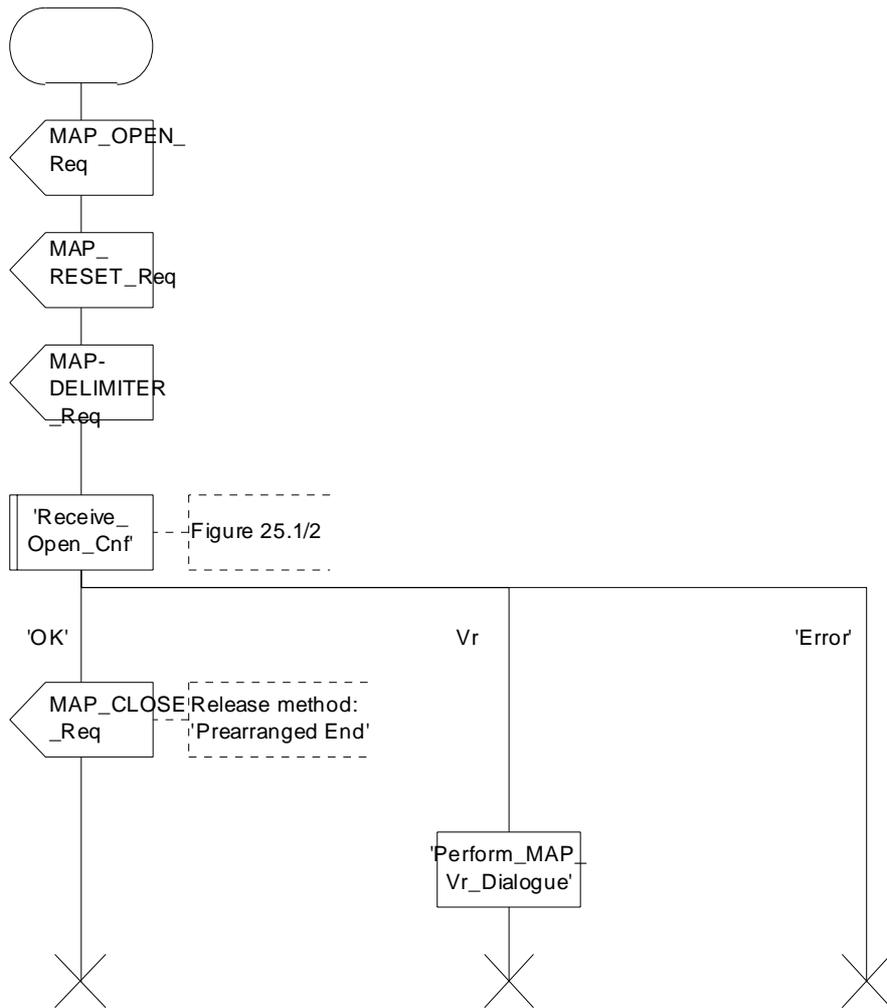

Figure 19.3/7: Process SEND\_RESET\_TO\_SGSN

Process REC\_RESET\_IN\_SGSN

19.3\_8(1)

Figure 19.3/8: Restoration of the HLR - Application process in the SGSN for reception of the RESET message from HLR

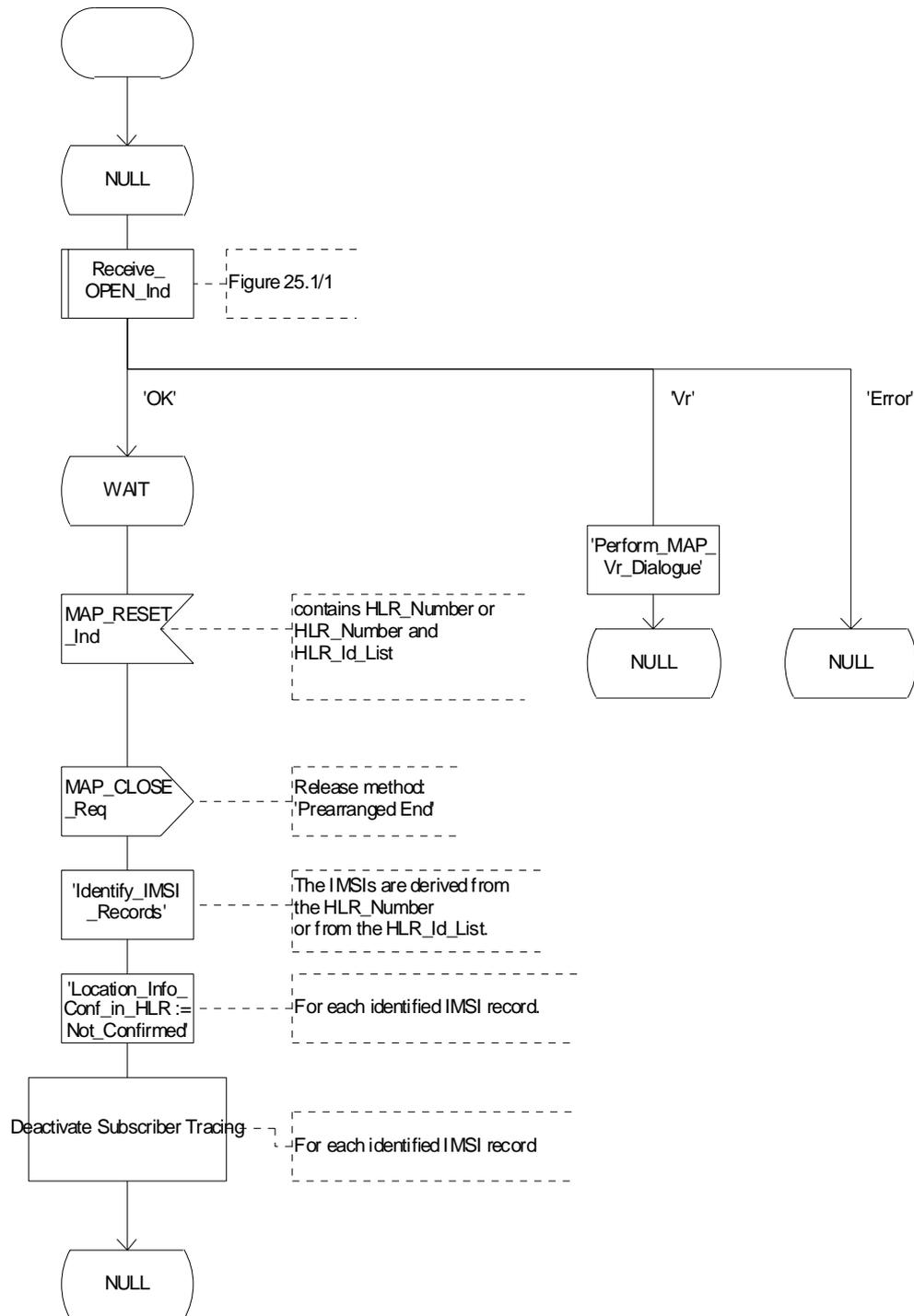

Figure 19.3/8: Process REC\_RESET\_IN\_SGSN

### 19.3.3 VLR restoration: the restore data procedure in the HLR

The MAP\_RESTORE\_DATA procedure in the HLR (Process RESTORE\_DATA\_HLR) is described in this clause; the corresponding procedure in the VLR (RESTORE\_DATA\_VLR) is described in clause 21.2.4.

The process RESTORE\_DATA\_HLR makes use of the following macros:

- Receive\_Open\_Ind                                    clause 25.1.1;
- Check\_Indication                                    clause 25.2.1;
- Insert\_SubData\_Framed\_HLR                        clause 19.4.1.

The MAP\_RESTORE\_DATA service is invoked by the VLR after provision of a roaming number in response to a MAP\_PROVIDE\_ROAMING\_NUMBER indication for an unidentified MS (i.e. IMSI unknown in VLR), or for a known MS whose IMSI record is marked as "Not Confirmed" by the indicator "Confirmed by HLR" (see 4 in figure 19.3/1). The process RESTORE\_DATA\_VLR is shown in figure 21.2/6.

The restore data process in the HLR is activated by receipt of a MAP\_RESTORE\_DATA indication from the VLR (see figure 19.3/6). If there is a parameter problem in the indication, either of the errors "Unexpected Data Value" or "Data Missing" is returned in the MAP\_RESTORE\_DATA response; if the subscriber is not known in the HLR, the error "Unknown Subscriber" is returned in the MAP\_RESTORE\_DATA response. In all of these cases the process in the HLR terminates.

If the MAP\_RESTORE\_DATA indication is accepted and if the LMSI is received, the HLR updates the LMSI for the IMSI received in the MAP\_RESTORE\_DATA indication. For this IMSI the HLR sets "subscriber-tracing-not-active-in-VLR" and checks whether tracing is required. This check is handled by the macro "Control\_Tracing\_HLR" that is described in clause 25.9. Thereafter, the macro "Insert\_SubData\_Framed\_HLR" that is described in clause 19.4.1 is invoked. The outcome of the macro Insert\_SubData\_Framed\_HLR is one of:

- abort, in which case the process terminates;
- error, in which case the HLR returns the error "System Failure" in the MAP\_RESTORE\_DATA response, and the process terminates;
- OK, indicating successful outcome of downloading the subscriber data to the VLR.

After successful completion of the framed MAP\_INSERT\_SUBSCRIBER\_DATA procedure, the HLR Number and, if applicable, the "MS Not Reachable Flag" which is used for SMS, are provided in the MAP\_RESTORE\_DATA response.

Upon receipt of the MAP\_RESTORE\_DATA confirmation, the VLR behaves as described in clause 21.2.4, figure 21.2/6.



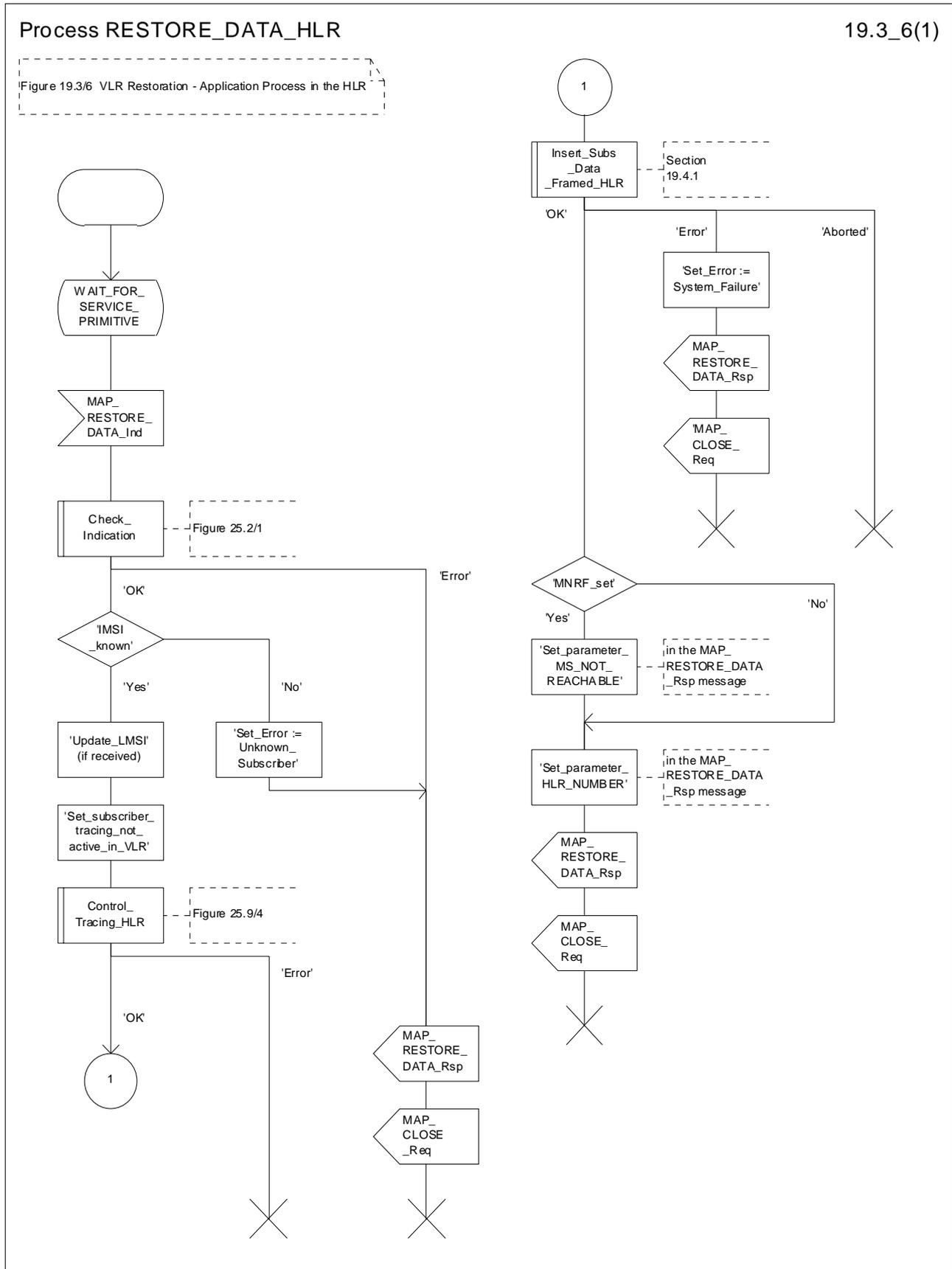

Figure 19.3/6: Process RESTORE\_DATA\_HLR

## 19.4 Macro Insert\_Subscriber\_Data\_Framed\_HLR

This macro is used by any procedure invoked in HLR which requires the transfer of subscriber data by means of the InsertSubscriberData operation (e.g. Update Location or Restore Data).

The invocation of the operation is done in a dialogue already opened by the framing procedure. Therefore the latter is the one that handles the reception of the open indication and sends the dialogue close request.

The macro calls the process "Send\_Insert\_Subscriber\_Data" (see clause 25.7.4) as many times as it is needed for transferring all subscriber data. This process call is meant to describe two possible behaviours of HLR to handle service requests and confirmations:

- either the HLR handles requests and confirmations in parallel; or
- the HLR sends the next request only after receiving the confirmation to the previous one.

Another call is done to the macro "Wait\_for\_Insert\_Subscriber\_Data" (see clause 25.7.3). There the reception and handling of the service confirmations is described.

If certain services required for a subscriber are not supported by the VLR or by the SGSN (e.g. Advice of Charge Charging Level), this may result in one of the following outcomes:

- The HLR stores and sends "Roaming Restriction Due To Unsupported Feature" in a subsequent MAP\_INSERT\_SUBSCRIBER\_DATA service. If "Roaming Restriction Due To Unsupported Feature" is stored in the HLR, the "MSC Area Restricted Flag" shall be set to "restricted". This will prevent MT calls, MT SM and MT USSD from being forwarded to the MSC/VLR;
- The HLR stores and sends other induced subscriber data (e.g. a specific barring program) in a subsequent MAP\_INSERT\_SUBSCRIBER\_DATA service. This will cause rejection of mobile originated service requests, except emergency calls.
- The HLR stores and sends "Roaming Restricted in the SGSN Due To Unsupported Feature" in a subsequent MAP\_INSERT\_SUBSCRIBER\_DATA service. If "Roaming Restricted In SGSN Due To Unsupported Feature" is stored in the HLR, the "SGSN Area Restricted Flag" shall be set to "restricted". This will prevent MT SM from being forwarded to the SGSN and Network Requested PDP-Context Activation;

When the VLR receives regional subscription data (Zone Code List) it may respond with "MSC Area Restricted" in the MAP\_INSERT\_SUBSCRIBER\_DATA response. In this case the "MSC Area Restricted Flag" shall be set to "restricted" in the HLR. This will prevent MT calls, MT SM and MT USSD from being forwarded to the MSC/VLR.

If the HLR neither stores "Roaming Restriction Due To Unsupported Feature" nor receives "MSC Area Restricted" in the MAP\_INSERT\_SUBSCRIBER\_DATA response, the "MSC Area Restricted Flag" in the HLR shall be set to "not restricted".

If subscriber data for CAMEL Phase 2 services are sent to a VLR which does not support CAMEL Phase 2, the service behaviour may be unpredictable or incorrect. The HLR therefore needs to ensure that at the conclusion of a location updating dialogue the data in the VLR do not require a capability that the VLR does not have. Possible mechanisms to ensure this are described in GSM 03.78.

The HLR should send a Forwarded-to number which is not in E.164 international format to the VLR only when the HLR has ascertained that the VLR supports CAMEL Phase 2. Thus, the ISD message containing the Forwarded-to number which is not in E.164 international format shall be sent to the VLR only after the HLR receives confirmation in the first ISD message result that CAMEL Phase 2 is supported.

A Forwarded-to number non-international E.164 format shall only be sent from an HLR to a VLR if the VLR supports CAMEL Phase 2, or a subsequent phase of CAMEL.

When the SGSN receives regional subscription data (Zone Code List) it may respond with "SGSN Area Restricted" in the MAP\_INSERT\_SUBSCRIBER\_DATA response. In this case the "SGSN Area Restricted Flag" shall be set to "restricted" in the HLR. This will prevent MT SM from being forwarded to the SGSN and Network Requested PDP-Context Activation.

If the HLR neither stores "Roaming Restricted In SGSN Due To Unsupported Feature" nor receives "SGSN Area Restricted" in the MAP\_INSERT\_SUBSCRIBER\_DATA response, the "SGSN Area Restricted Flag" in the HLR shall be set to "not restricted".

The SDL diagrams are shown in figures 19.4/1 and 19.4/2.

Macrodefinition Insert\_SubData\_Framed\_HLR

19.4\_1(1)

Figure 19.4/1: Macro to transfer subscriber data from HLR to VLR during an existing dialogue

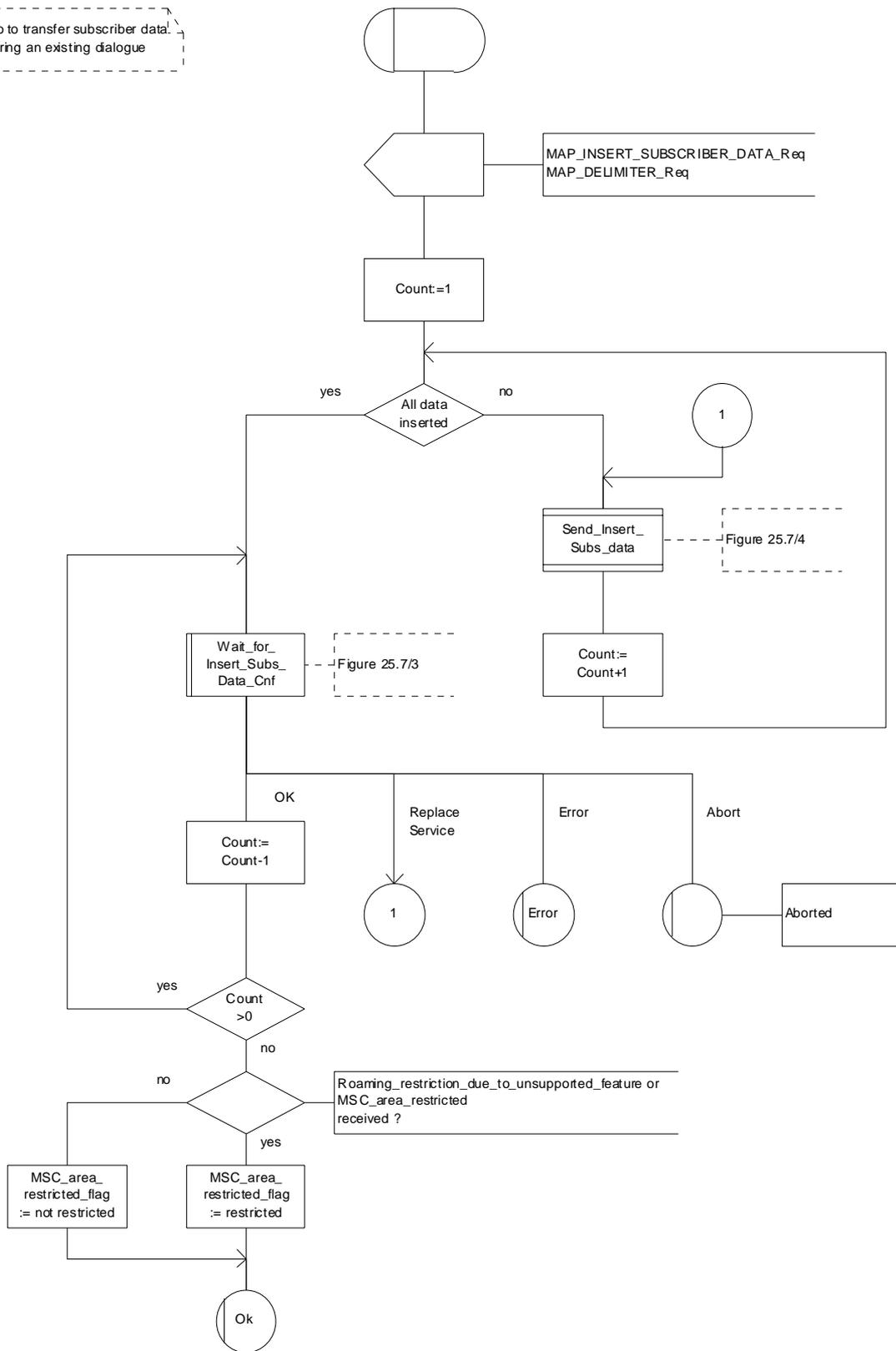

Figure 19.4/1: Macro Insert\_SubData\_Framed\_HLR

Macrodefinition Insert\_Subs\_Data\_In\_SGSN\_Framed\_HLR

19.4\_2(1)

Figure 19.4/2: Macro to transfer subscriber data from HLR to SGSN during an existing dialogue

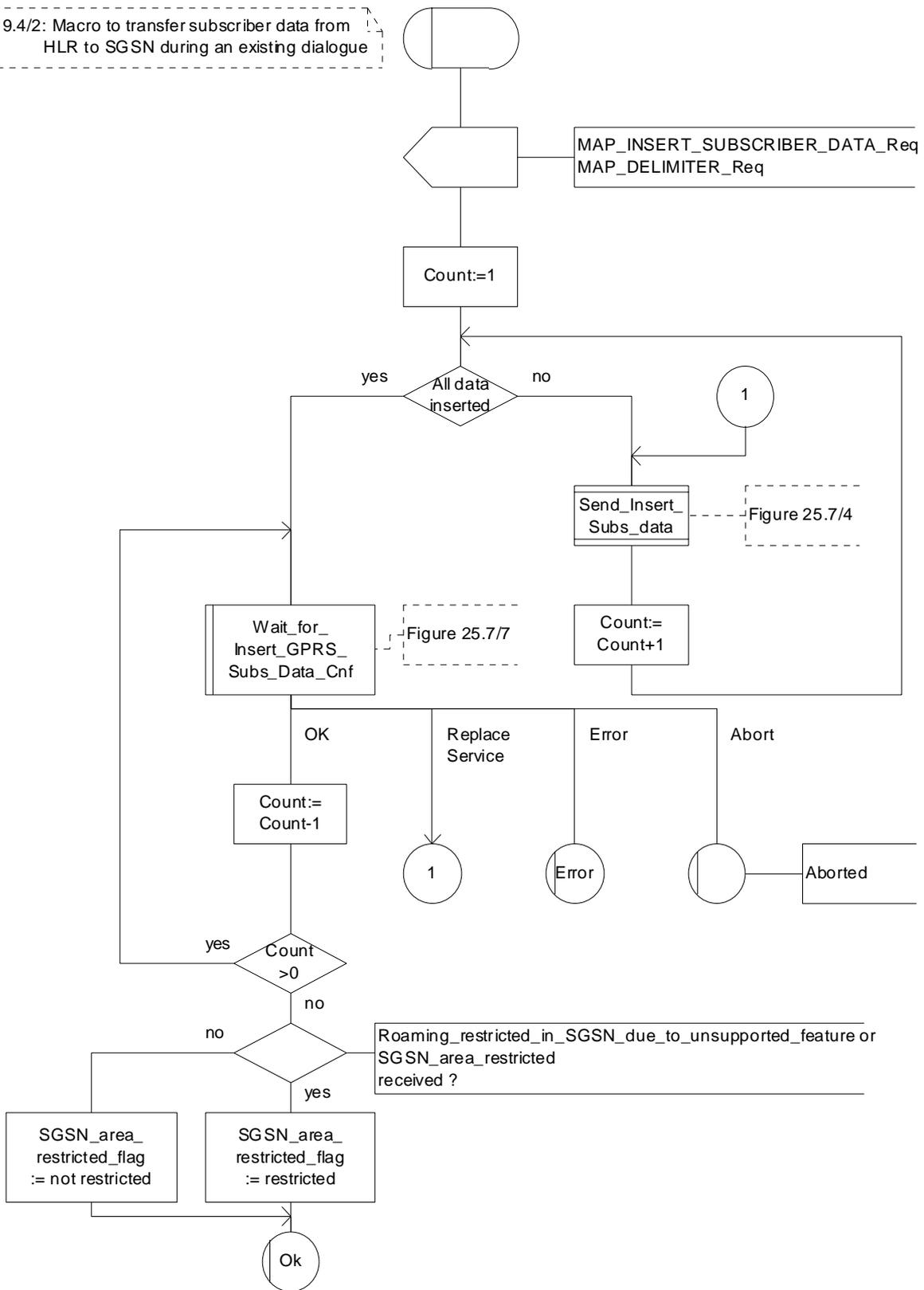

Figure 19.4/2: Macro Insert\_Subs\_Data\_In\_SGSN\_Framed\_HLR

---

## 20 Operation and maintenance procedures

### 20.1 General

The Operation and Maintenance procedures are needed for operating and maintaining the GSM PLMN network.

The following procedures exist for operation and maintenance purposes:

- i) Tracing procedures;
- ii) Subscriber Data Management procedures;
- iii) Subscriber Identity procedures.

The following application contexts refer to complex MAP Users consisting of several processes:

- subscriberDataManagementContext;
- tracingContext.

These two application contexts need a co-ordinating process in the VLR or in the SGSN as described in the following clauses.

#### 20.1.1 Tracing Co-ordinator for the VLR

The MAP\_OPEN indication opens the dialogue for the stand-alone tracing procedure when the application context tracingContext is received. If that service is successful, the Co-ordinator can receive the first service primitive from the MAP\_PM. Depending on the received primitive, the user process is created as follows:

- if the MAP\_ACTIVATE\_TRACE\_MODE indication is received, the process ATM\_VLR\_Standalone is created;
- if the MAP\_DEACTIVATE\_TRACE\_MODE indication is received, the process DTM\_VLR\_Standalone is created.

After creation of the user process the Co-ordinator relays the messages between the MAP\_PM and the invoked process until a request or an indication for dialogue termination is received.

The Tracing Co-ordinator is shown in the figure 20.1/1.

Process Co\_Tracing\_VLR

20.1\_1(1)

Figure 20.1/1: Co-ordinating process for the tracing procedures in the VLR

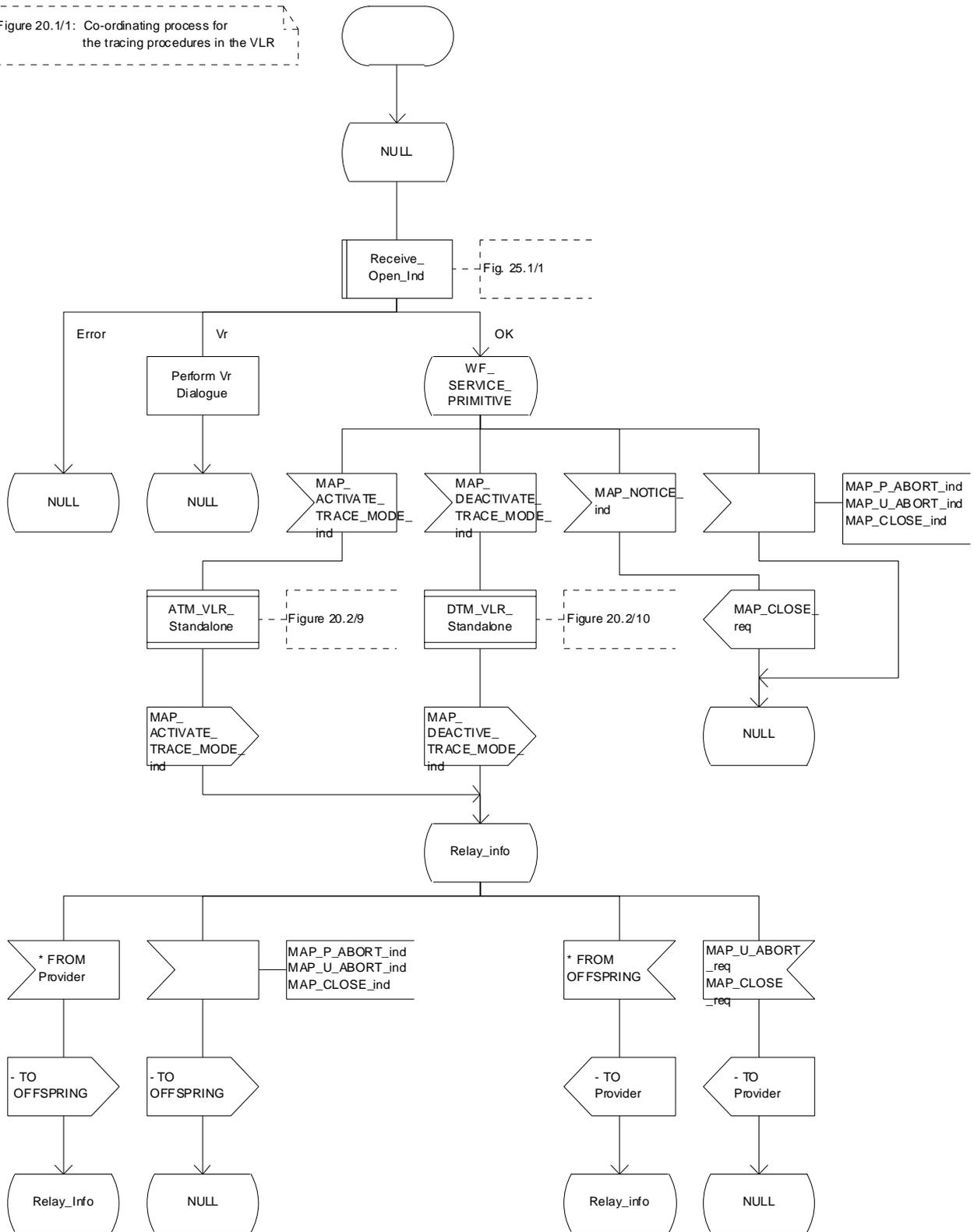

Figure 20.1/1: Process Co\_Tracing\_VLR

## 20.1.2 Subscriber Data Management Co-ordinator for the VLR

The MAP\_OPEN indication opens the dialogue for the stand-alone subscriber data management procedure when the application context subscriberDataManagementContex is received. If that service is successful, the Co-ordinator can receive the first service primitive from the MAP\_PM. Depending on the received primitive, the user process is created as follows:

- if the MAP\_INSERT\_SUBSCRIBER\_DATA indication is received, the process INS\_SUBS\_DATA\_VLR is created;
- if the MAP\_DELETE\_SUBSCRIBER\_DATA indication is received, the process Delete\_Subscriber\_Data\_VLR is created.

After creation of the user process the Co-ordinator relays the messages between the MAP\_PM and the invoked process until a request or an indication for dialogue termination is received.

The Subscriber\_Data\_Management Co-ordinator is shown in the figure 20.1/2.



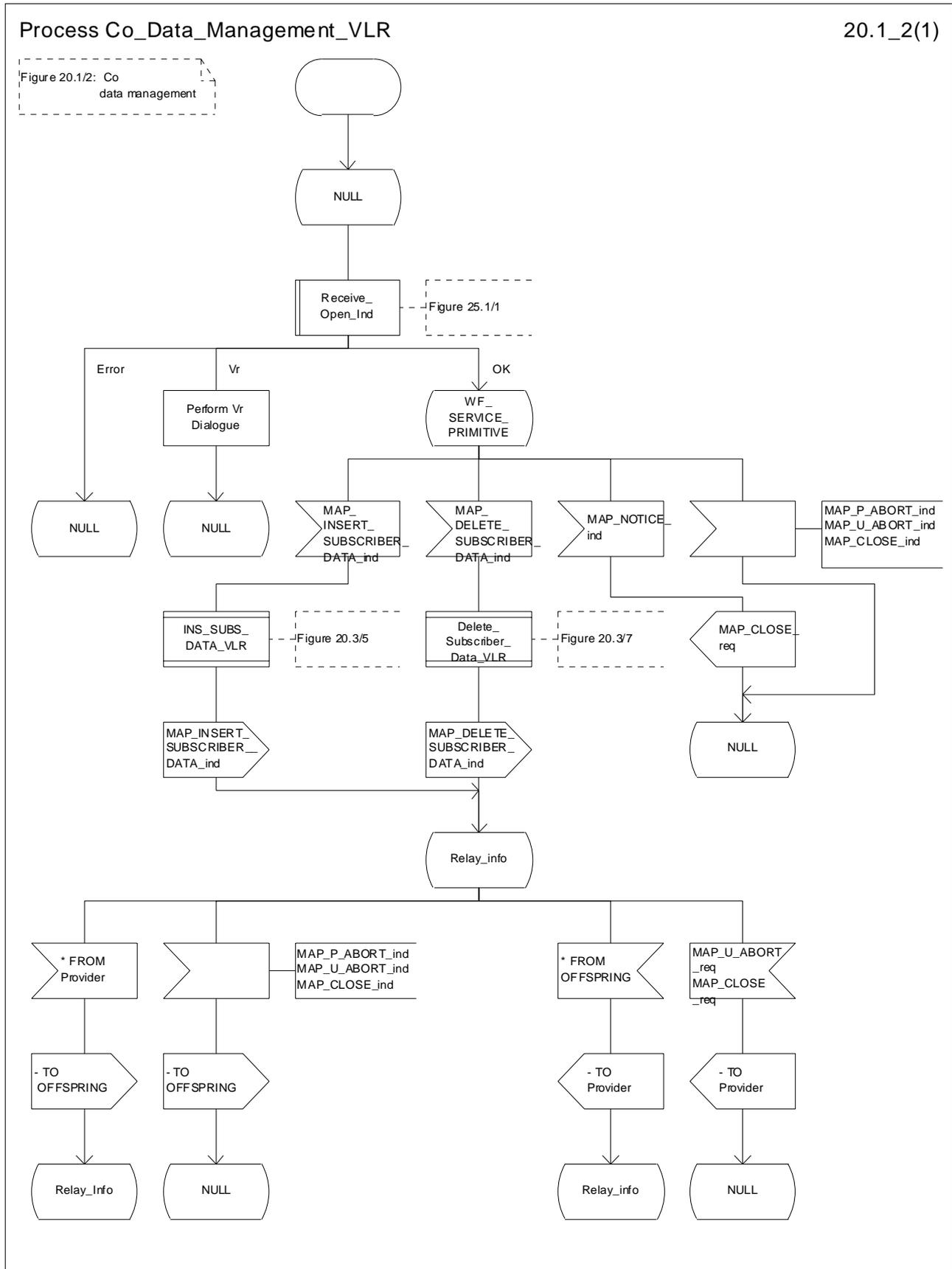

Figure 20.1/2: Process Co\_Data\_Management\_VLR

### 20.1.3 Tracing Co-ordinator for the SGSN

The MAP\_OPEN indication opens the dialogue for the stand-alone tracing procedure when the application context tracingContext is received. If that service is successful, the Co-ordinator can receive the first service primitive from the MAP\_PM. Depending on the received primitive, the user process is created as follows:

- if the MAP\_ACTIVATE\_TRACE\_MODE indication is received, the process ATM\_SGSN\_Standalone is created;
- if the MAP\_DEACTIVATE\_TRACE\_MODE indication is received, the process DTM\_SGSN\_Standalone is created.

After creation of the user process the Co-ordinator relays the messages between the MAP\_PM and the invoked process until a request or an indication for dialogue termination is received.

The Tracing Co-ordinator for the SGSN is shown in the figure 20.1/3.

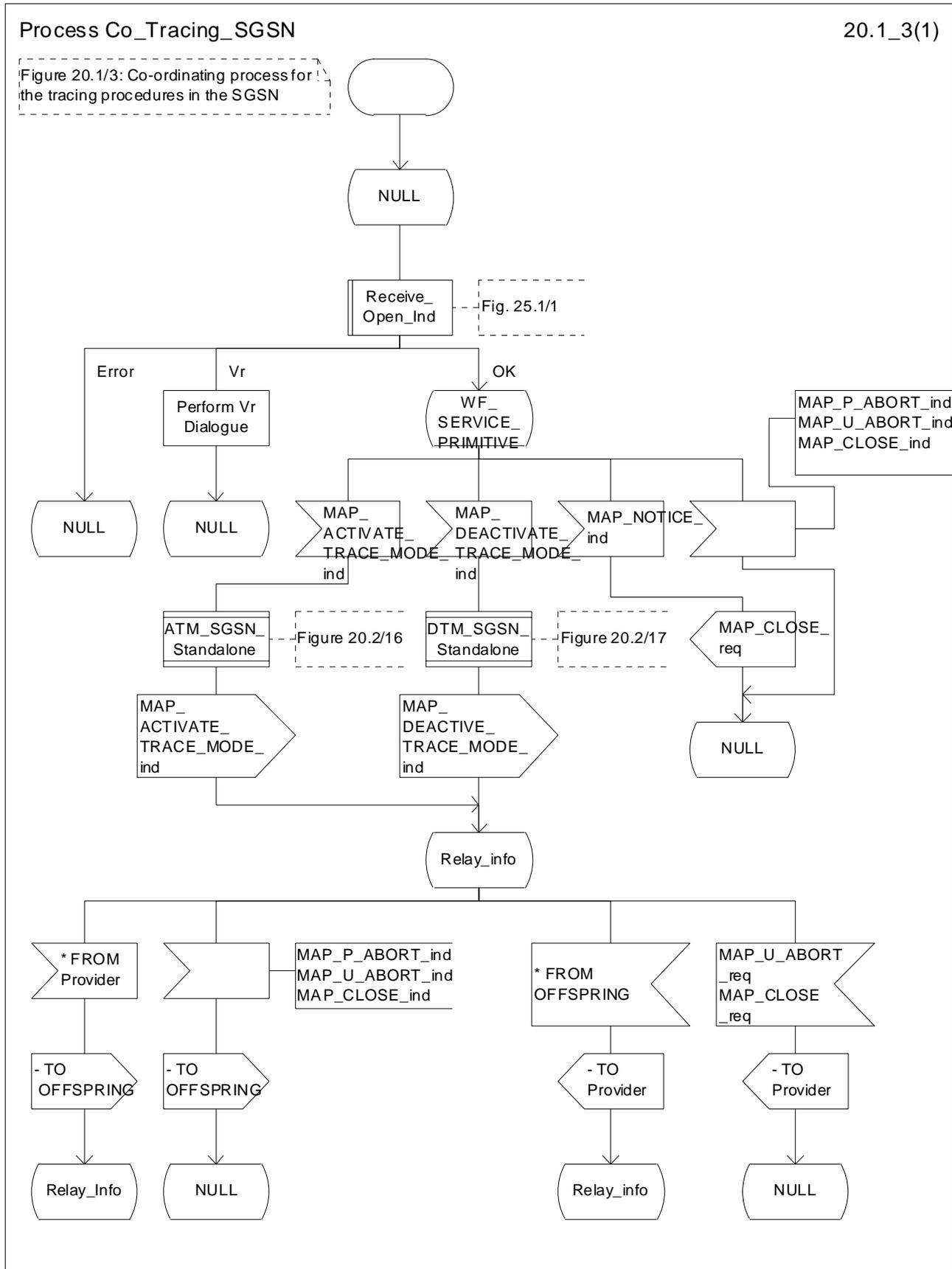

Figure 20.1/3: Process Co\_Tracing\_SGSN

## 20.1.4 Subscriber Data Management Co-ordinator for the SGSN

The MAP\_OPEN indication opens the dialogue for the stand-alone subscriber data management procedure when the application context subscriberDataManagementContext is received. If that service is successful, the Co-ordinator can receive the first service primitive from the MAP\_PM. Depending on the received primitive, the user process is created as follows:

- if the MAP\_INSERT\_SUBSCRIBER\_DATA indication is received, the process INS\_SUBS\_DATA\_SGSN is created;
- if the MAP\_DELETE\_SUBSCRIBER\_DATA indication is received, the process Delete\_Subscriber\_Data\_SGSN is created.

After creation of the user process the Co-ordinator relays the messages between the MAP\_PM and the invoked process until a request or an indication for dialogue termination is received.

The Subscriber\_Data\_Management Co-ordinator is shown in the figure 20.1/4.

Process Co\_Data\_Management\_SGSN

20.1\_4(1)

Figure 20.1/4: Co-ordinating process for the subscriber data management procedures in the SGSN

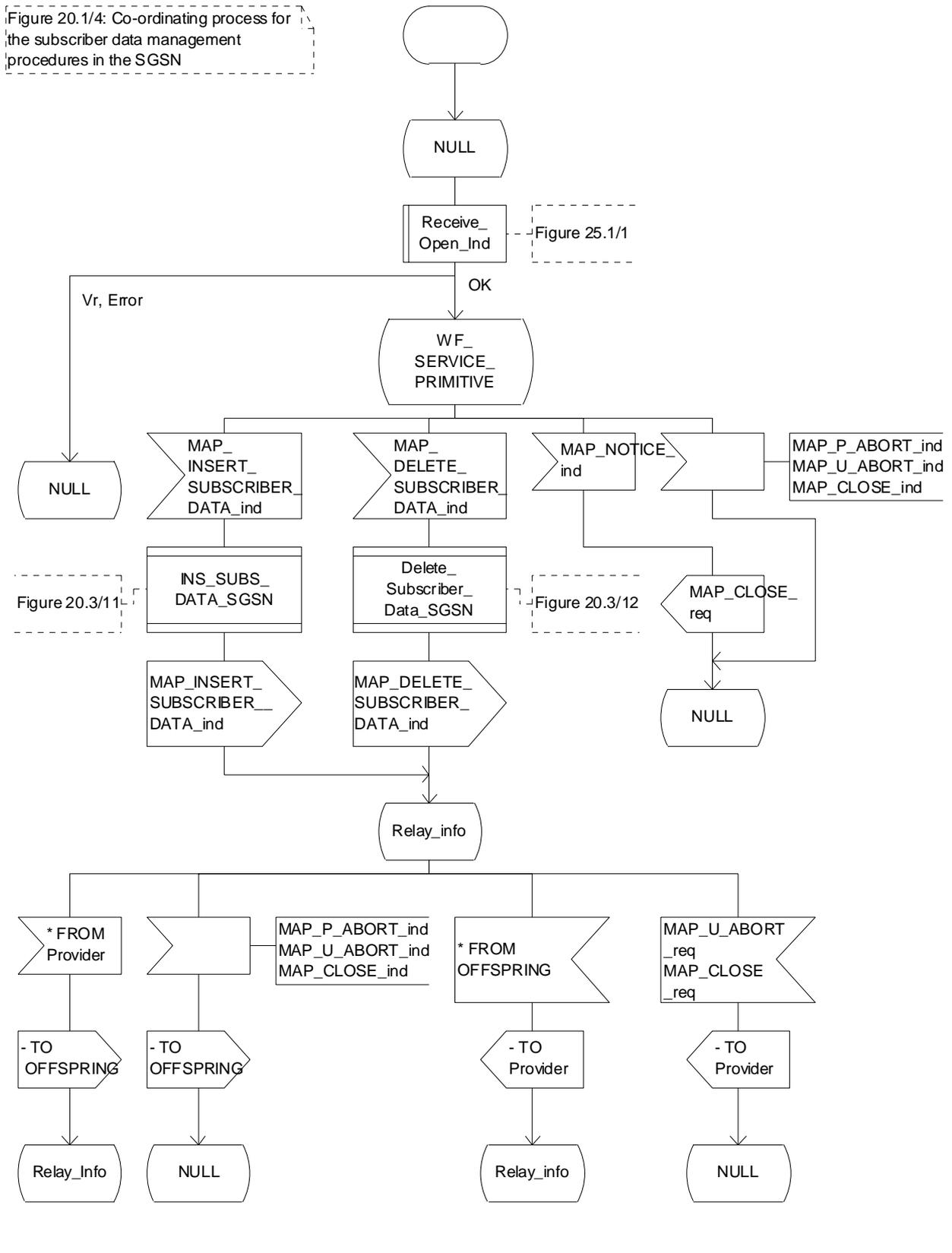

Figure 20.1/4: Process Co\_Data\_Management\_SGSN

## 20.2 Tracing procedures

Three type of tracing procedures exist:

- i) Subscriber tracing management procedures;
- ii) Subscriber tracing procedures;
- iii) Event tracing procedures.

The subscriber tracing management procedures are used for management of the status and the type of the tracing. The subscriber tracing activation procedure is used at location updating or data restoration when the trace mode of a subscriber is set active in the HLR or, as a stand alone procedure, when the subscriber is already registered and the trace mode becomes active in the HLR. The procedures for providing a trace request to the VLR are shown in figures 20.2/1 and 20.2/2. The procedures for providing a trace request to the SGSN are shown in figures 20.2/11 and 20.2/12.

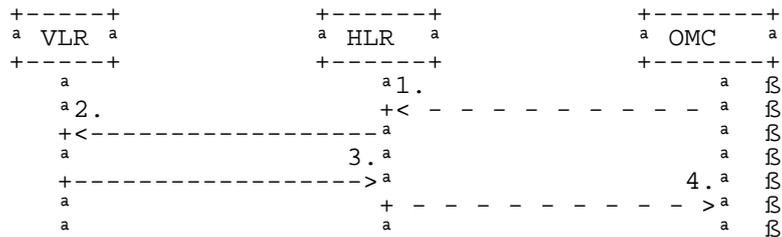

- 1) Subscriber Tracing Activation
- 2) MAP\_ACTIVATE\_TRACE\_MODE
- 3) MAP\_ACTIVATE\_TRACE\_MODE\_ACK
- 4) Subscriber Tracing Activation Accepted

**Figure 20.2/1: Stand alone subscriber tracing activation procedure**

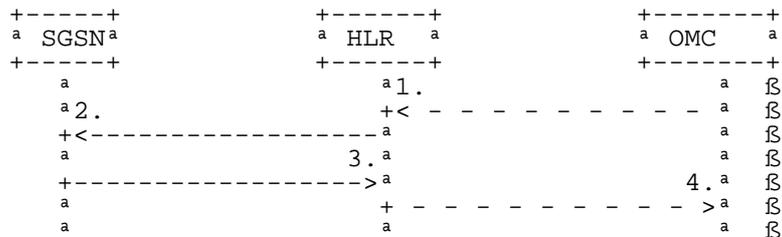

- 1) Subscriber Tracing Activation
- 2) MAP\_ACTIVATE\_TRACE\_MODE
- 3) MAP\_ACTIVATE\_TRACE\_MODE\_ACK
- 4) Subscriber Tracing Activation Accepted

**Figure 20.2/11: Stand alone subscriber tracing activation procedure for GPRS**

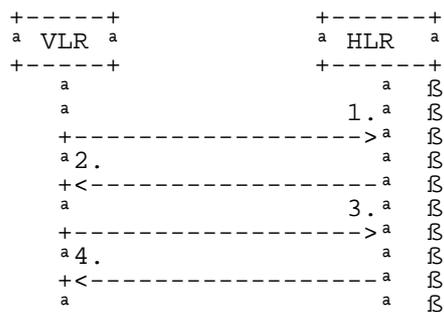

- 1) MAP\_UPDATE\_LOCATION or MAP\_RESTORE\_DATA
- 2) MAP\_ACTIVATE\_TRACE\_MODE
- 3) MAP\_ACTIVATE\_TRACE\_MODE\_ACK
- 4) MAP\_UPDATE\_LOCATION\_ACK or MAP\_RESTORE\_DATA\_ACK

Figure 20.2/2: Subscriber tracing activation procedure at location updating or data restoration

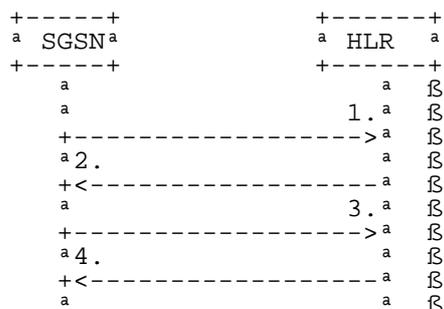

- 1) MAP\_UPDATE\_GPRS\_LOCATION
- 2) MAP\_ACTIVATE\_TRACE\_MODE
- 3) MAP\_ACTIVATE\_TRACE\_MODE\_ACK
- 4) MAP\_UPDATE\_GPRS\_LOCATION\_ACK

Figure 20.2/12: Subscriber tracing activation procedure at gprs location updating

The HLR sends the trace request (IMSI, trace reference, trace type and identity of the OMC) to the VLR or to the SGSN in a MAP\_ACTIVATE\_TRACE\_MODE request. The receipt of this primitive is acknowledged. The acknowledge primitive will indicate that the trace request is accepted by the VLR or by the SGSN. If the request is not accepted, the reason will be reported to the HLR.

The subscriber tracing deactivation procedure is used when the trace request of a subscriber is to be cancelled in the VLR or in the SGSN. The procedures is shown in figures 20.2/3 and 20.2/13.

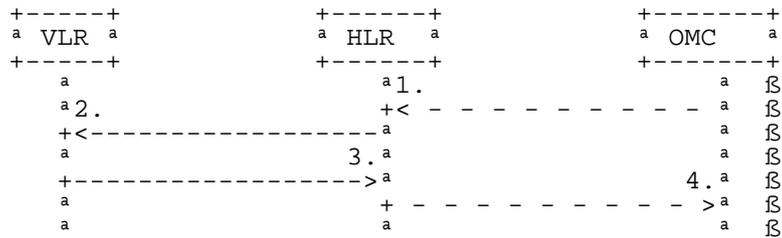

- 1) Subscriber Tracing Deactivation
- 2) MAP\_DEACTIVATE\_TRACE\_MODE
- 3) MAP\_DEACTIVATE\_TRACE\_MODE\_ACK
- 4) Subscriber Tracing Deactivation Accepted

**Figure 20.2/3: Subscriber tracing deactivation procedure**

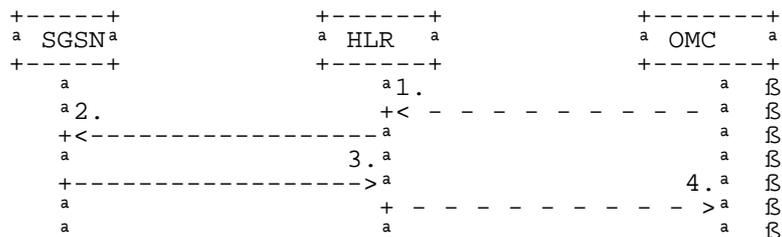

- 1) Subscriber Tracing Deactivation
- 2) MAP\_DEACTIVATE\_TRACE\_MODE
- 3) MAP\_DEACTIVATE\_TRACE\_MODE\_ACK
- 4) Subscriber Tracing Deactivation Accepted

**Figure 20.2/13: Subscriber tracing deactivation procedure for GPRS**



The HLR sends a MAP\_DEACTIVATE\_TRACE\_MODE request to the VLR or to the SGSN. The VLR or the SGSN will acknowledge the deactivation. The acknowledge primitive will indicate that the trace request has been deleted by the VLR or by the SGSN. If the deactivation is not accepted, the reason will be reported to the HLR.

The subscriber tracing procedures are used when the VLR detects any subscriber related activity for which the trace mode is activated, e.g. receives the MAP\_PROCESS\_ACCESS\_REQUEST indication. The procedure is shown in figure 20.2/4.

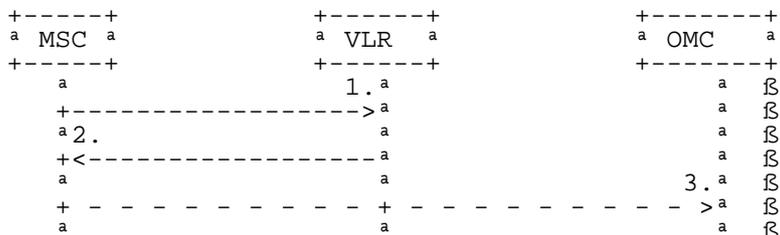

- 1) MAP\_PROCESS\_ACCESS\_REQUEST, MAP\_UPDATE\_LOCATION\_AREA,
- 2) MAP\_TRACE\_SUBSCRIBER\_ACTIVITY
- 3) Subscriber tracing information

**Figure 20.2/4: Subscriber tracing procedure in the servicing MSC**

The VLR will generate the MAP\_TRACE\_SUBSCRIBER\_ACTIVITY indication. The receiving MSC will send the trace record to the OMC.

[Figure numbers 20.2/5 and 20.2/6 are spare.]

## 20.2.1 Procedures in the HLR

### 20.2.1.1 Subscriber tracing activation procedure

When receiving the subscriber tracing mode activation command for a subscriber from the OMC, the HLR will activate tracing, if the subscriber is known and registered in the HLR and the subscriber is roaming in the home PLMN area. The MAP\_ACTIVATE\_TRACE\_MODE request is sent to the VLR or to the SGSN where the subscriber is registered.

If the MAP\_ACTIVATE\_TRACE\_MODE confirmation is received indicating an error situation, the errors are mapped to the OMC interface. The activation request may also be repeated; the number of repeat attempts and the time in between are HLR operator options, depending on the error returned by the VLR or the SGSN.

If the subscriber is known in the HLR, but is deregistered or roaming outside the home PLMN area, the subscriber tracing status is activated in the HLR, but the VLR or the SGSN is not updated.

When receiving a request for location updating or data restoration while the subscriber trace mode is active, the macro Control\_Tracing\_HLR (see figure 25.9/4) shall be initiated by the location updating process in the HLR.

The subscriber tracing activation process in the HLR with VLR is shown in figure 20.2/7.

The subscriber tracing activation process in the HLR with SGSN is shown in figure 20.2/14.

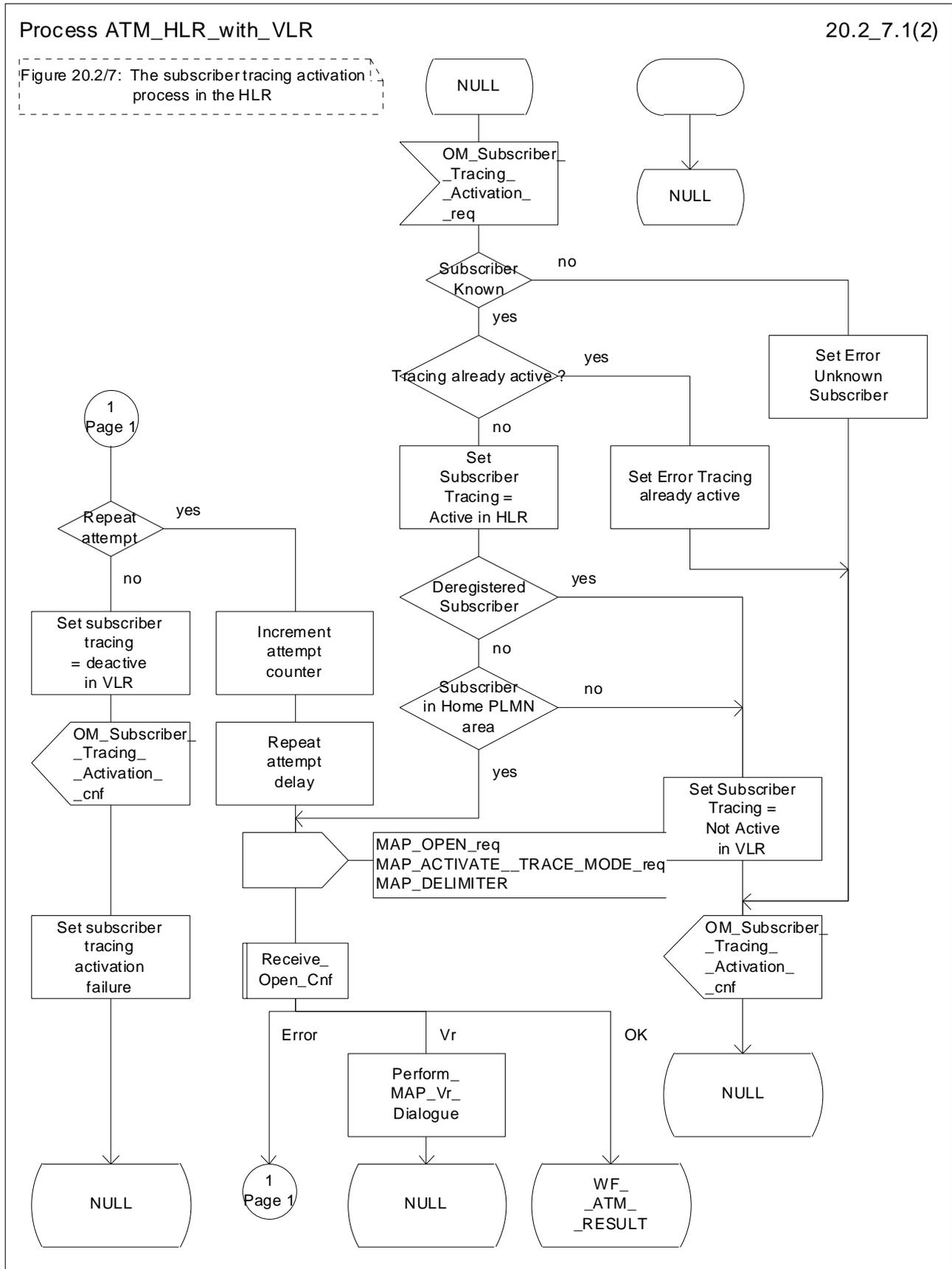

Figure 20.2/7 (sheet 1 of 2): Process ATM\_HLR\_with\_VLR

Process ATM\_HLR\_with\_VLR

20.2\_7.2(2)

Figure 20.2/7: The subscriber tracing activation process in the HLR

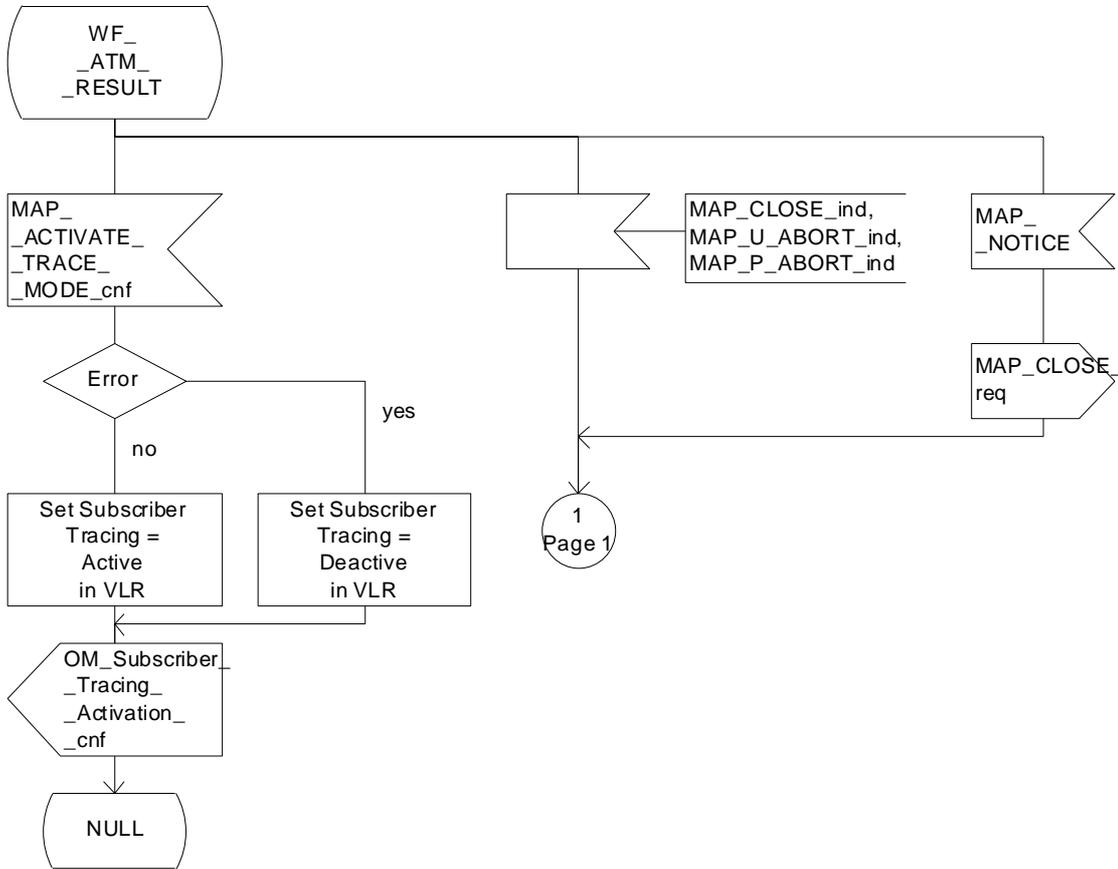

Figure 20.2/7 (sheet 2 of 2): Process ATM\_HLR\_with\_VLR

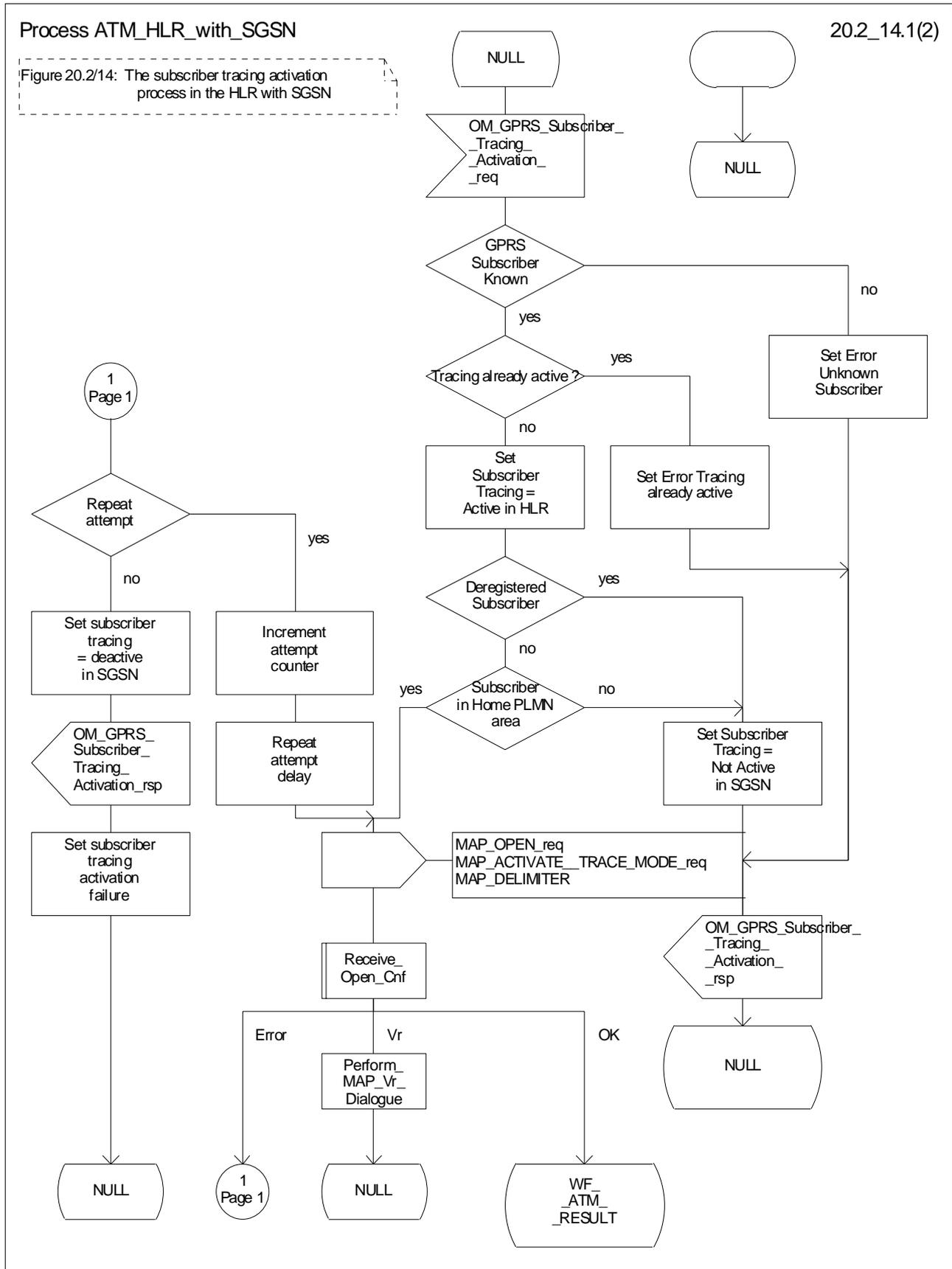

Figure 20.2/14 (sheet 1 of 2): Process ATM\_HLR\_with\_SGSN

Process ATM\_HLR\_with\_SGSN

20.2\_14.2(2)

Figure 20.2/14: The subscriber tracing activation process in the HLR with SGSN

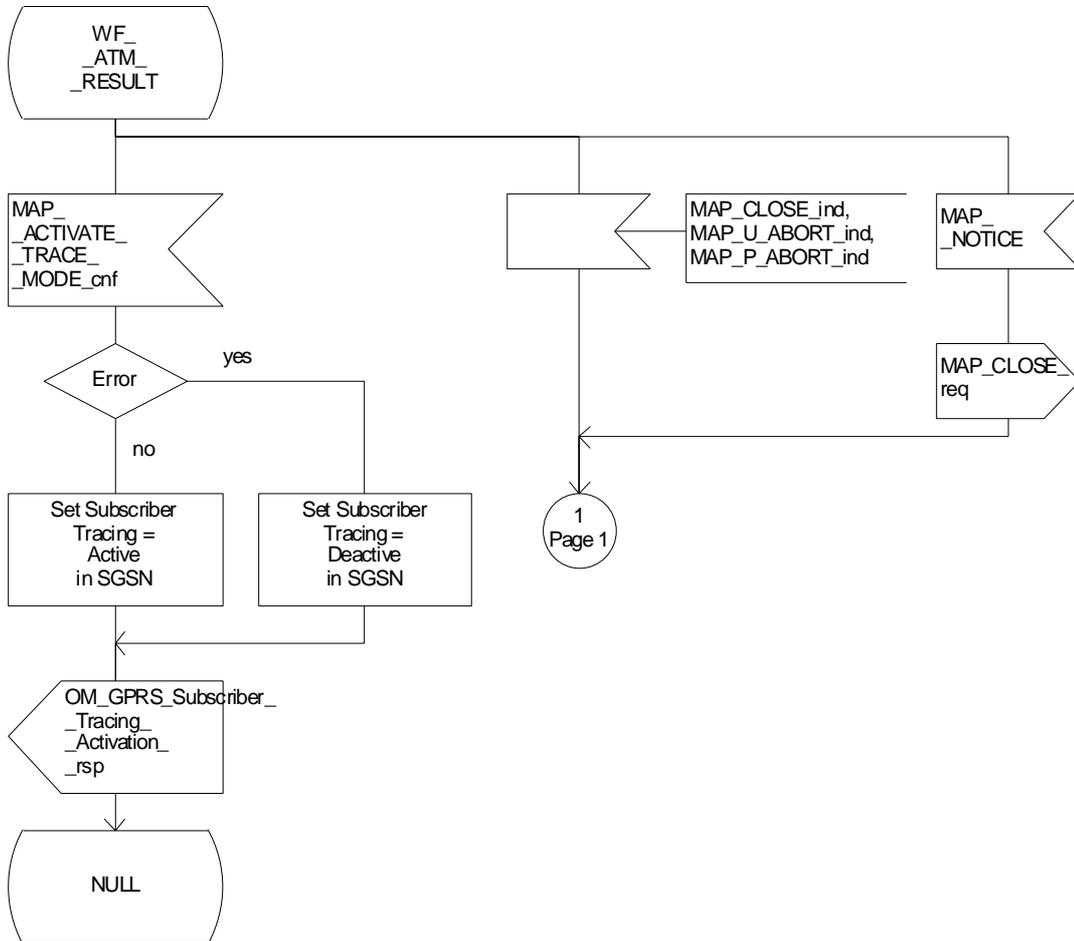

Figure 20.2/14 (sheet 2 of 2): Process ATM\_HLR\_with\_SGSN

### 20.2.1.2 Subscriber tracing deactivation procedure

When receiving the subscriber trace mode deactivation command for a subscriber from the OMC, the HLR will send the MAP\_DEACTIVATE\_TRACE\_MODE request to the VLR or to the SGSN where the subscriber is registered, if the trace mode activation has been carried out. The subscriber tracing in HLR is set to a deactive state.

If the operation is successful, the HLR will set the subscriber tracing in VLR or in SGSN to a deactive state.

If the MAP\_DEACTIVATE\_TRACE\_MODE confirmation is received indicating an error situation, the errors are mapped to the OMC interface. The deactivation request may be also repeated; the number of repeat attempts and the time in between are HLR operator options, depending on the error returned by the VLR or by the SGSN.

The subscriber tracing deactivation procedure with VLR is shown in figure 20.2/8.

The subscriber tracing deactivation procedure with SGSN is shown in figure 20.2/15.

Process DTM\_HLR\_with\_VLR

20.2\_8.1(2)

Figure 20.2/8: The subscriber tracing deactivation process in the HLR

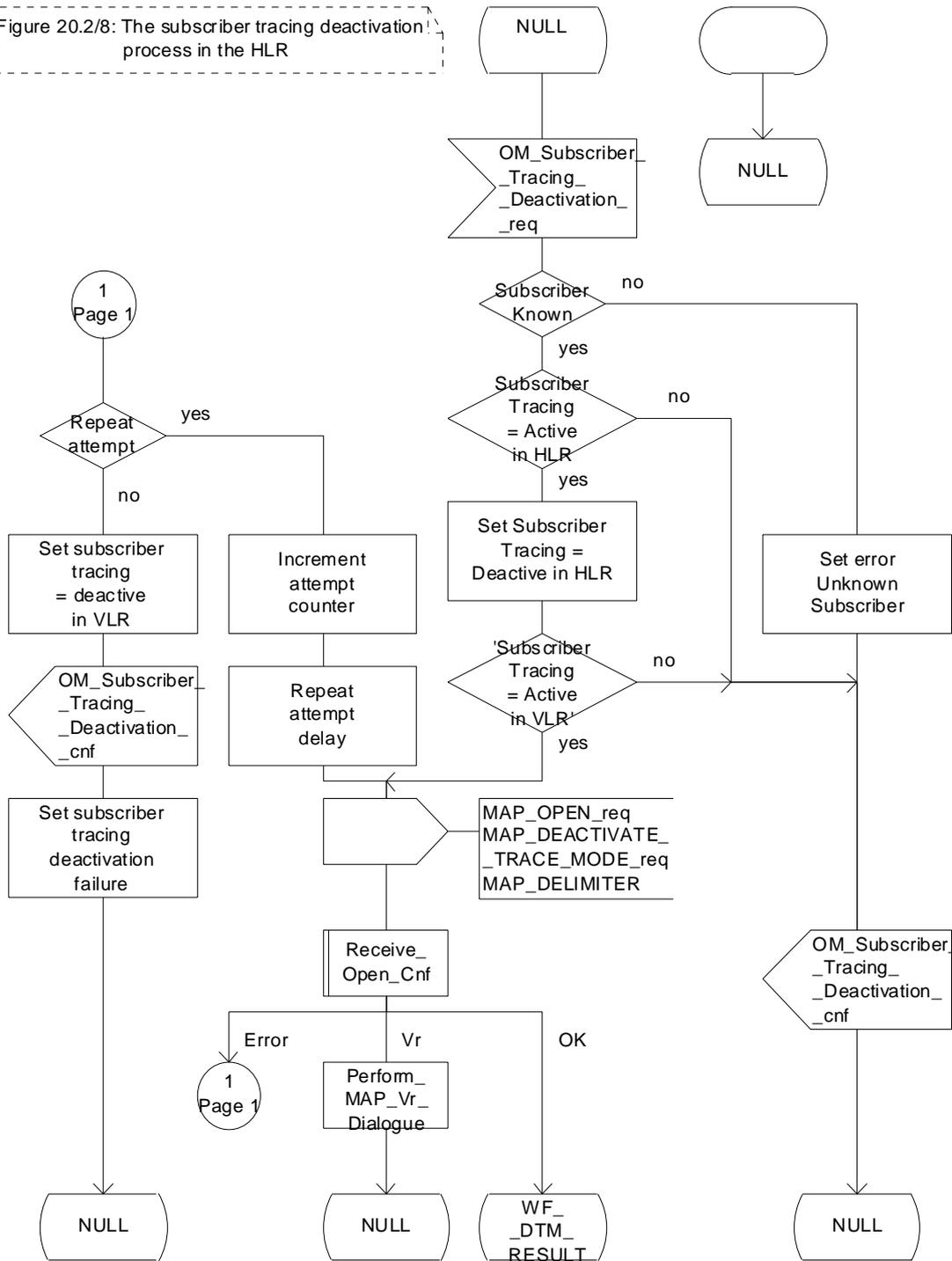

Figure 20.2/8 (sheet 1 of 2): Process DTM\_HLR\_with\_VLR

Process DTM\_HLR\_with\_VLR

20.2\_8.2(2)

Figure 20.2/8: The subscriber tracing deactivation process in the HLR

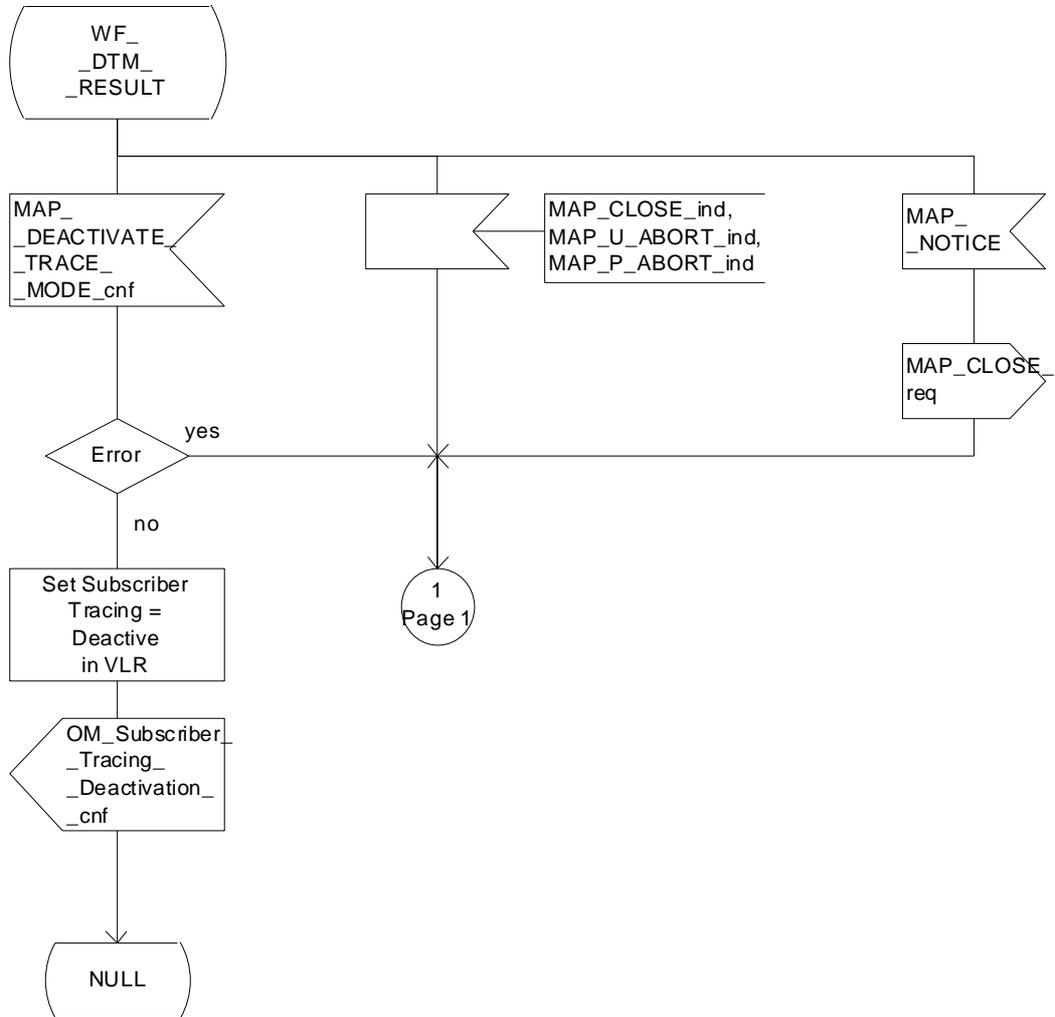

Figure 20.2/8 (sheet 2 of 2): Process DTM\_HLR\_with\_VLR



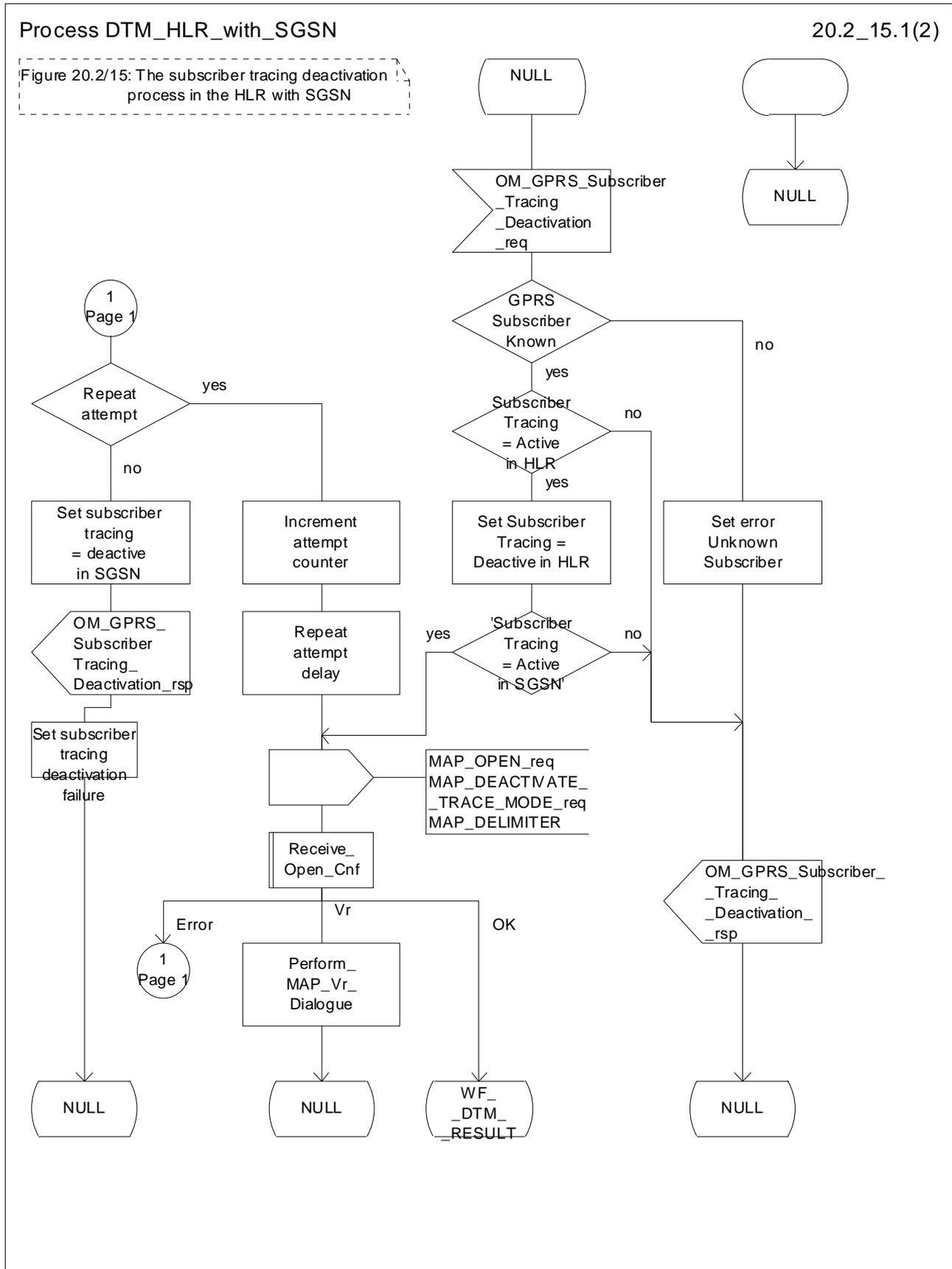

Figure 20.2/15 (sheet 1 of 2): Process DTM\_HLR\_with\_SGSN

Process DTM\_HLR\_with\_SGSN

20.2\_15.2(2)

Figure 20.2/15: The subscriber tracing deactivation process in the HLR with SGSN

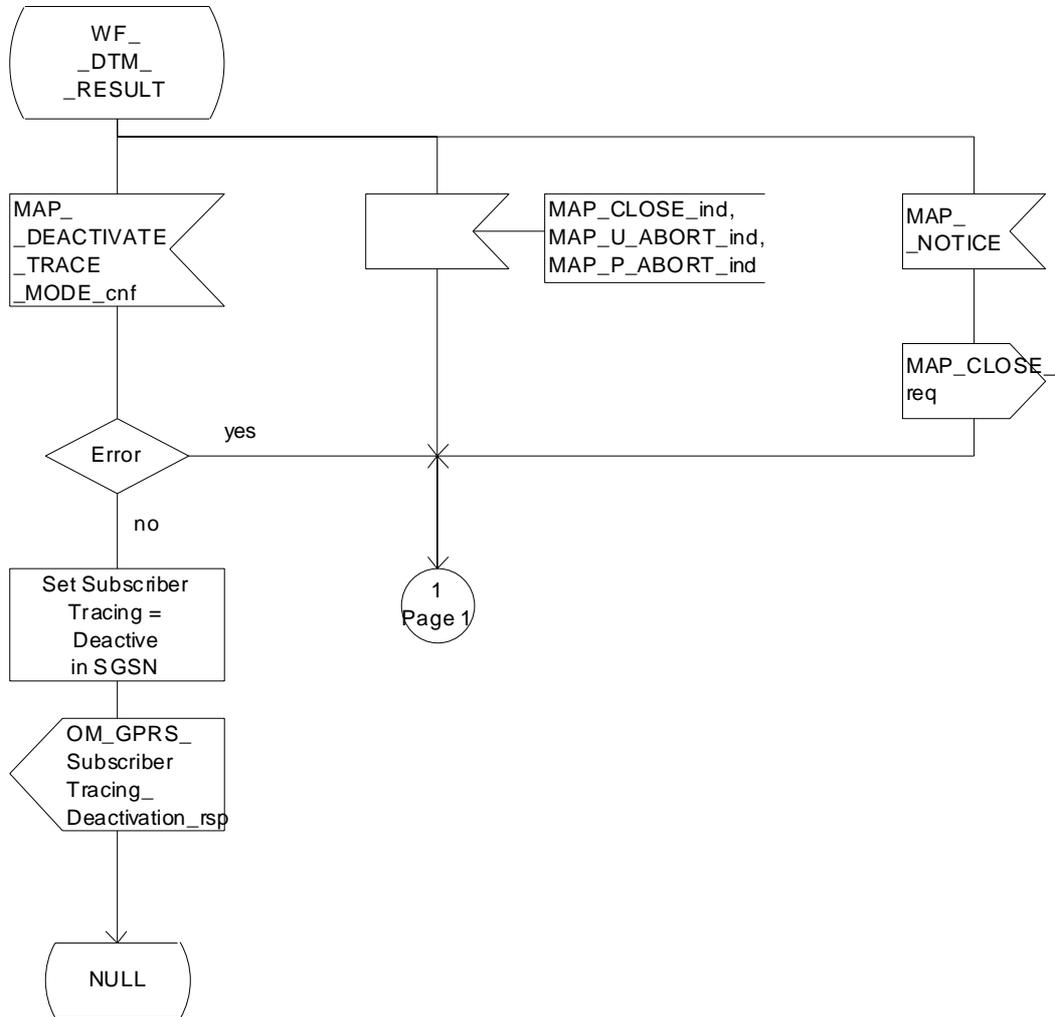

Figure 20.2/15 (sheet 2 of 2): Process DTM\_HLR\_with\_SGSN

## 20.2.2 Procedures in the VLR

The VLR is involved in the following tracing procedures:

- i) Subscriber tracing activation procedure;
- ii) Subscriber tracing deactivation procedure;
- iii) Subscriber tracing procedure.

### 20.2.2.1 Subscriber tracing activation procedure

When receiving a MAP\_ACTIVATE\_TRACE\_MODE indication, the VLR will check the parameters and data in the primitive. Data errors are reported as an unexpected data value error or as a data missing error depending on the nature of the error.

If the subscriber is known, the tracing facility is supported and the tracing capacity is not exceeded, the successful report is sent in the MAP\_ACTIVATE\_TRACE\_MODE response primitive.

The MAP\_ACTIVATE\_TRACE\_MODE indication primitive may be received during a location updating or data restoration procedure, so the location updating or restore data process shall use the macro Activate\_Tracing\_VLR (see figure 25.9/3).

The subscriber tracing activation process in the VLR is shown in figure 20.2/9.

Process ATM\_VLR\_Standalone

20.2\_9(1)

FIGURE 20.2/9 The subscriber tracing activation process for standalone operation in the VLR

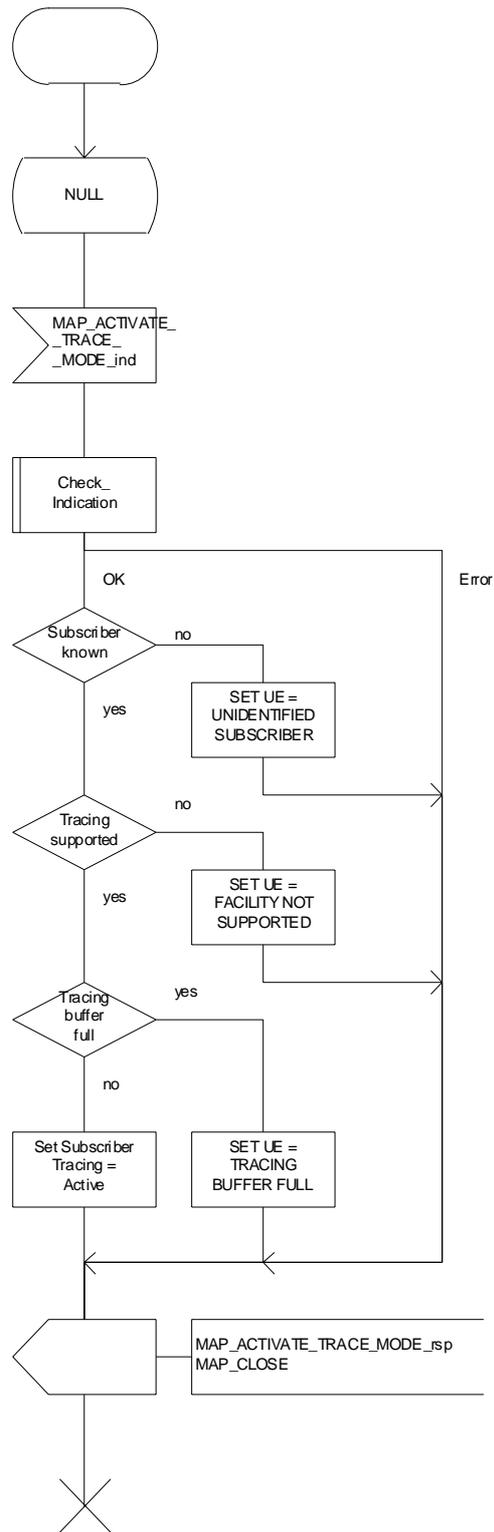

Figure 20.2/9: Process ATM\_VLR\_Standalone

### 20.2.2.2 Subscriber tracing deactivation procedure

When receiving a MAP\_DEACTIVATE\_TRACE\_MODE indication, the VLR will check the parameters and data in the primitive. Data errors are reported as an unexpected data value error or as a data missing error depending on the nature of the error.

If the subscriber is known and the tracing facility is supported, the successful report is sent in the MAP\_DEACTIVATE\_TRACE\_MODE response primitive.

The subscriber tracing deactivation procedure in the VLR is shown in figure 20.2/10.

Process DTM\_VLR\_Standalone

20.2\_10(1)

Figure 20.2/10: The subscriber tracing deactivation process in the VLR

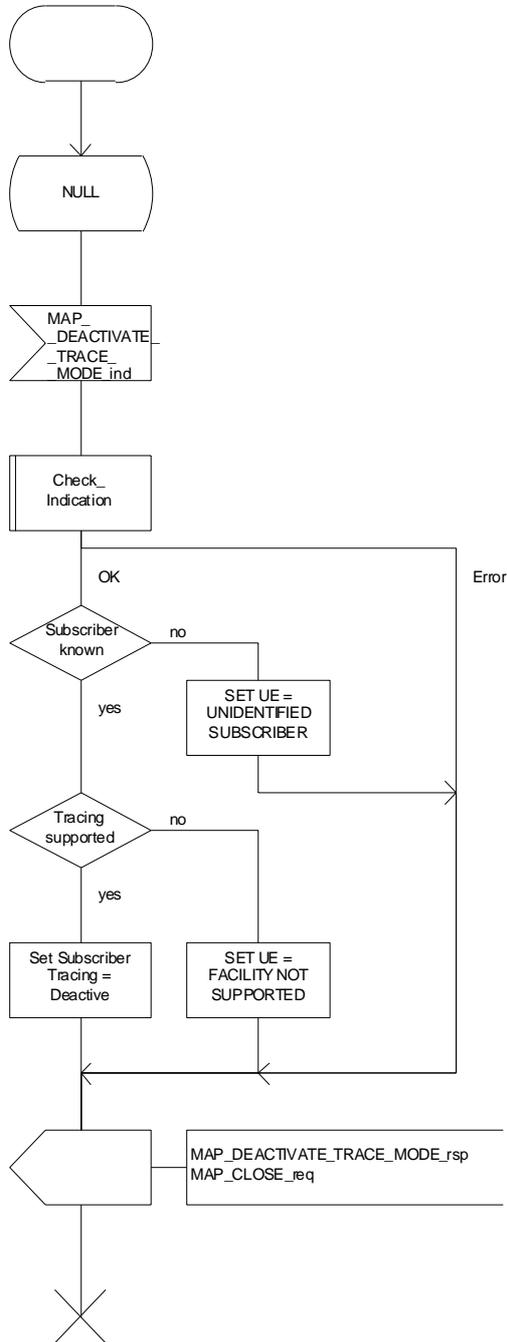

Figure 20.2/10: Process DTM\_VLR\_Standalone

### 20.2.2.3 Subscriber tracing procedure

When the VLR receives a MAP\_PROCESS\_ACCESS\_REQUEST or MAP\_UPDATE\_LOCATION\_AREA indication related to any subscriber activity from the MSC, the subscriber tracing procedure may be carried out. The macro Trace\_Subscriber\_Activity\_VLR is shown in figure 25.9/2.

## 20.2.3 Procedures in the MSC

The MSC is involved in the following tracing procedure:

- i) Subscriber tracing procedure.

### 20.2.3.1 Subscriber tracing procedure

When receiving the MAP\_TRACE\_SUBSCRIBER\_ACTIVITY indication from the VLR, the MSC stores trace reference, trace type and the identity of the OMC in charge of the trace, and the MSC starts to collect the trace information. The MSC will send the trace record to the OMC.

The macro Trace\_Subscriber\_Activity\_MSC is shown in figure 25.9/1.

## 20.2.4 Procedures in the SGSN

The SGSN is involved in the following tracing procedures:

- i) Subscriber tracing activation procedure;
- ii) Subscriber tracing deactivation procedure;

### 20.2.4.1 Subscriber tracing activation procedure

When receiving a MAP\_ACTIVATE\_TRACE\_MODE indication, the SGSN will check the parameters and data in the primitive. Data errors are reported as an unexpected data value error or as a data missing error depending on the nature of the error.

If the subscriber is known, the tracing facility is supported and the tracing capacity is not exceeded, the successful report is sent in the MAP\_ACTIVATE\_TRACE\_MODE response primitive.

The MAP\_ACTIVATE\_TRACE\_MODE indication primitive may be received during a location updating or data restoration procedure, so the location updating or restore data process shall use the macro Activate\_Tracing\_SGSN (see figure 25.9/7).

The subscriber tracing activation process in the SGSN is shown in figure 20.2/16.

### 20.2.4.2 Subscriber tracing deactivation procedure in SGSN

When receiving a MAP\_DEACTIVATE\_TRACE\_MODE indication, the SGSN will check the parameters and data in the primitive. Data errors are reported as an unexpected data value error or as a data missing error depending on the nature of the error.

If the subscriber is known and the tracing facility is supported, the successful report is sent in the MAP\_DEACTIVATE\_TRACE\_MODE response primitive.

The subscriber tracing deactivation procedure in the SGSN is shown in figure 20.2/17.

Process ATM\_SGSN\_Standalone

20.2\_16(1)

FIGURE 20.2/16: The subscriber tracing activation process for standalone operation in the SGSN

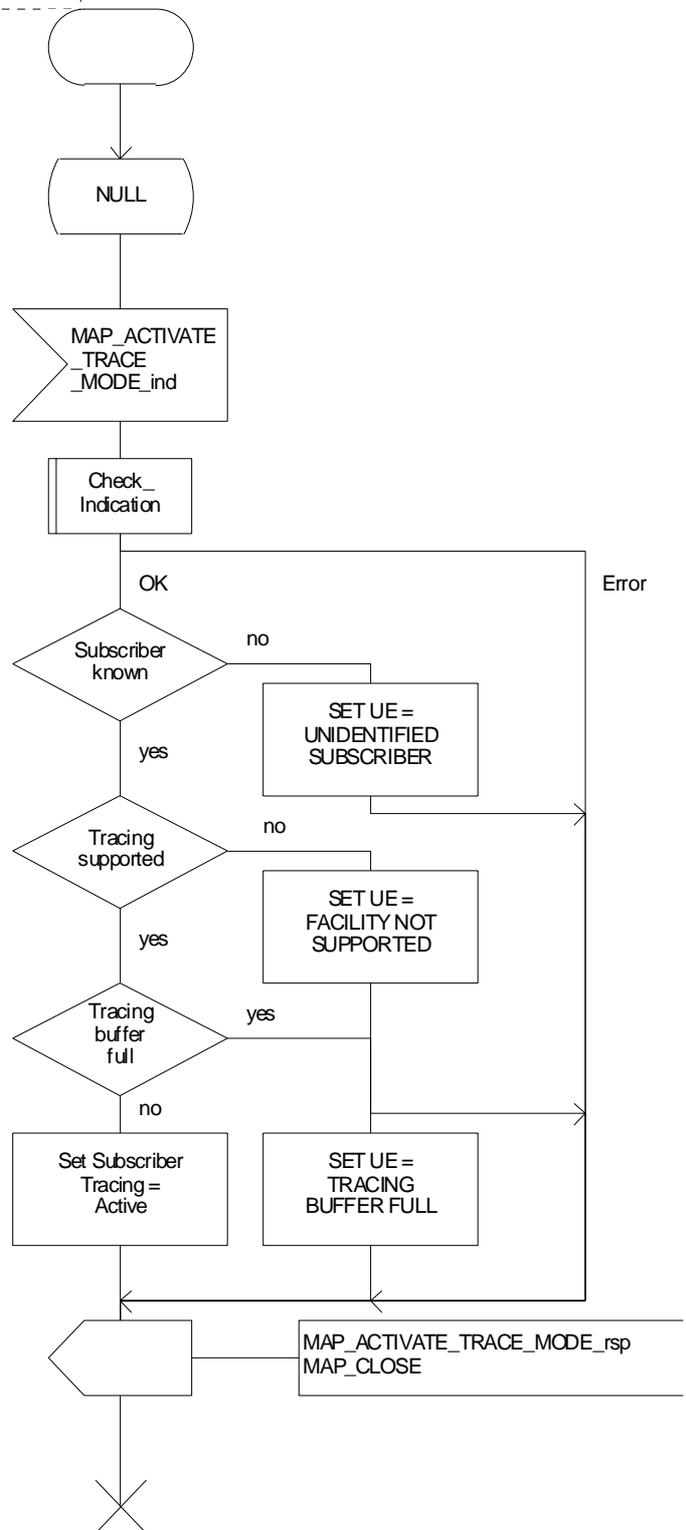

Figure 20.2/16: Process ATM\_SGSN\_Standalone



Process DTM\_SGSN\_Standalone

20.2\_17(1)

Figure 20.2/17: The subscriber tracing deactivation process in the SGSN

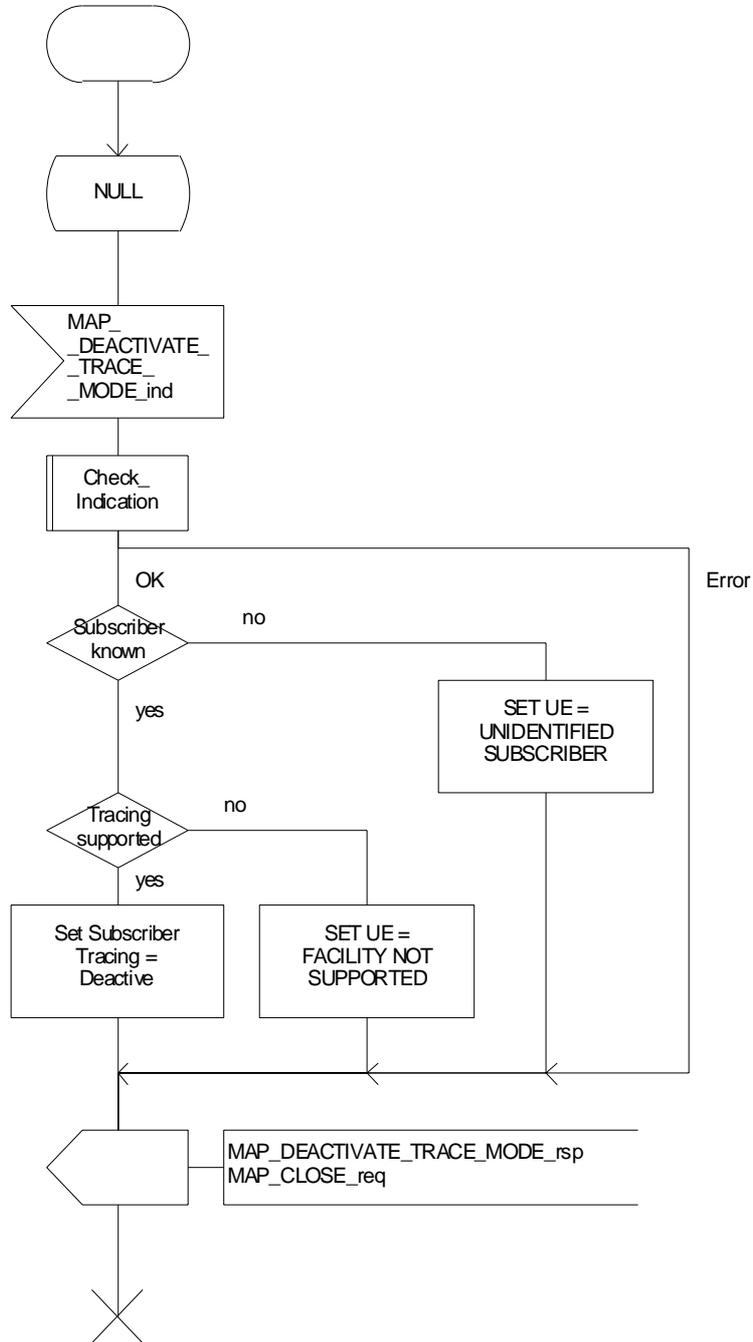

Figure 20.2/17: Process DTM\_SGSN\_Standalone

### 20.3 Subscriber data management procedures

Two types of subscriber data management procedures exist in the Mobile Application Part

- i) Subscriber Deletion;
- ii) Subscriber Data Modification.

No requirements have been identified for the Subscriber creation and subscriber data interrogation procedures.

The subscriber deletion and subscriber data modification procedures are initiated by the OMC (see figures 20.3/1 , 20.3/2, 20.3/8 and 20.3/9).

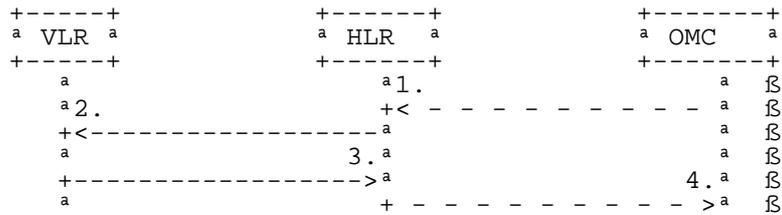

- 1) Delete Subscriber
- 2) MAP\_CANCEL\_LOCATION
- 3) MAP\_CANCEL\_LOCATION\_ACK
- 4) Subscriber Deleted

**Figure 20.3/1: Subscriber deletion procedure**

In the subscriber deletion procedure the subscriber data should be removed from the VLR and from the HLR. The HLR uses the MAP\_CANCEL\_LOCATION service.

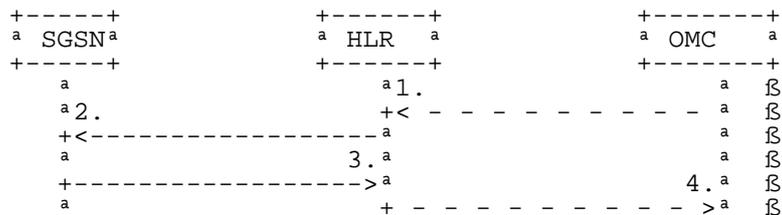

- 1) Delete GPRS Subscriber
- 2) MAP\_CANCEL\_LOCATION
- 3) MAP\_CANCEL\_LOCATION\_ACK
- 4) GPRS Subscriber Deleted

**Figure 20.3/8: Subscriber deletion procedure for GPRS**

In the subscriber deletion procedure the subscriber data should be removed from the SGSN and from the HLR. The HLR uses the MAP\_CANCEL\_LOCATION service.

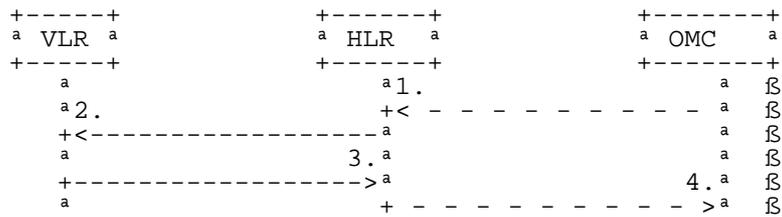

- 1) Modify Subscriber Data
- 2) MAP\_CANCEL\_LOCATION, MAP\_INSERT\_SUBSCRIBER\_DATA or MAP\_DELETE\_SUBSCRIBER\_DATA
- 3) MAP\_CANCEL\_LOCATION\_ACK, MAP\_INSERT\_SUBSCRIBER\_DATA\_ACK or MAP\_DELETE\_SUBSCRIBER\_DATA\_ACK
- 4) Subscriber Data Modified

Figure 20.3/2: Subscriber data modification procedure

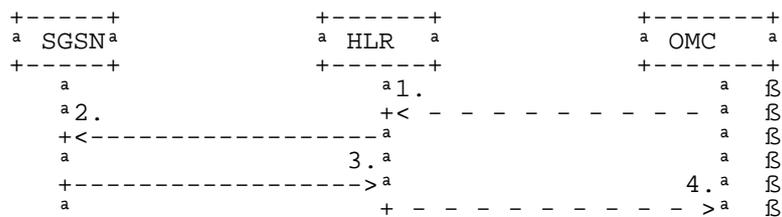

- 1) Modify Subscriber Data
- 2) MAP\_CANCEL\_LOCATION, MAP\_INSERT\_SUBSCRIBER\_DATA or MAP\_DELETE\_SUBSCRIBER\_DATA
- 3) MAP\_CANCEL\_LOCATION\_ACK, MAP\_INSERT\_SUBSCRIBER\_DATA\_ACK or MAP\_DELETE\_SUBSCRIBER\_DATA\_ACK
- 4) Subscriber Data Modified

Figure 20.3/9: Subscriber data modification procedure for GPRS

In the subscriber data modification procedure the subscriber data is modified in the HLR and when necessary also in the VLR or in the SGSN. The HLR initiates either the MAP\_INSERT\_SUBSCRIBER\_DATA, MAP\_DELETE\_SUBSCRIBER\_DATA or MAP\_CANCEL\_LOCATION service depending on the modified data.

### 20.3.1 Procedures in the HLR

#### 20.3.1.1 Subscriber deletion procedure

When the subscriber deletion request is received from the OMC, the HLR shall delete the subscriber data from the HLR and initiate the MAP\_CANCEL\_LOCATION request to the VLR or to the SGSN where the subscriber is registered.

The subscriber deletion procedure in the HLR is shown in the figure 20.3/3.

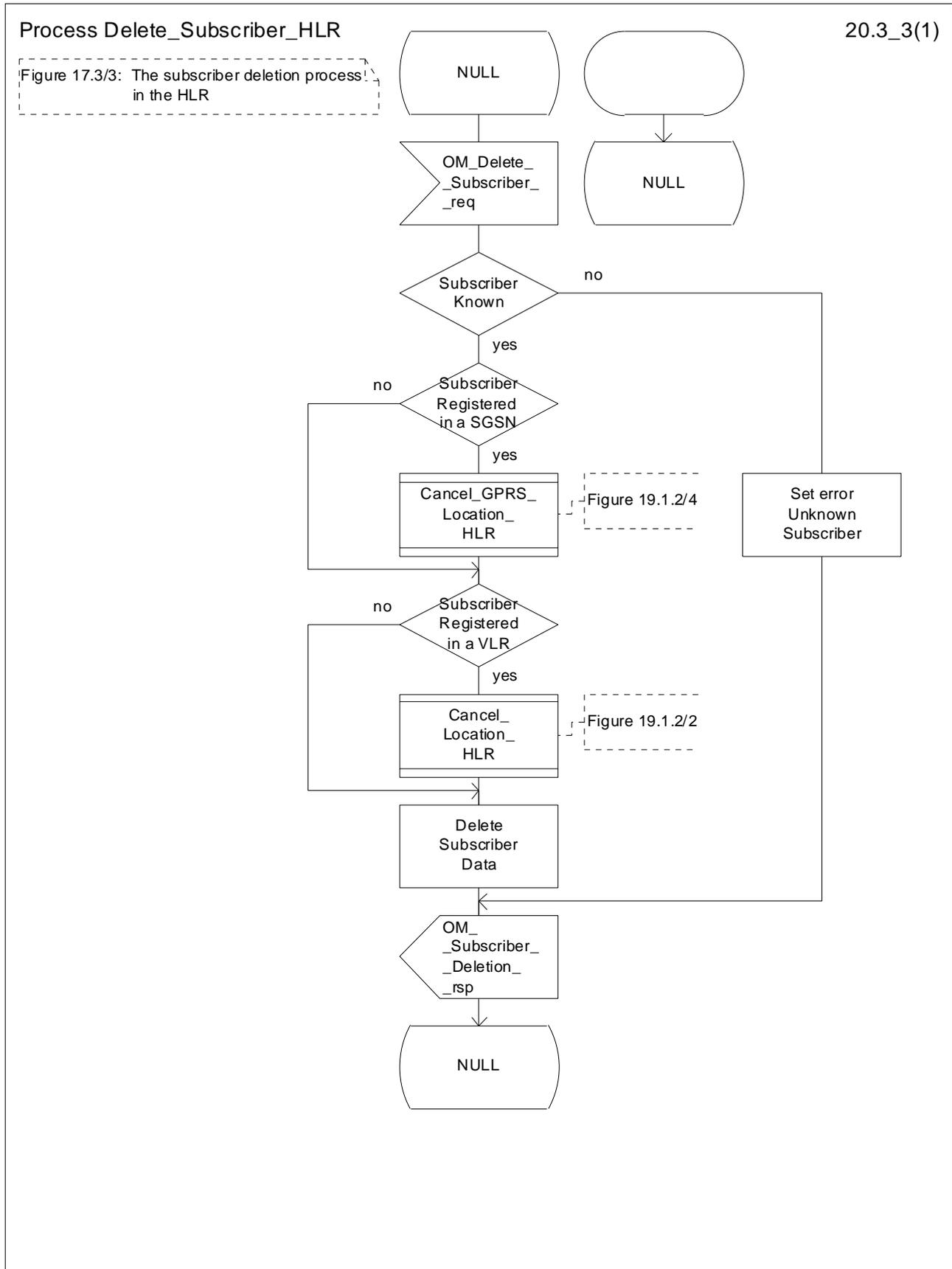

Figure 20.3/3: Process Delete\_Subscriber\_HLR

### 20.3.1.2 Subscriber data modification procedure

The OMC can modify the subscriber data in several different ways. The modifications can be categorized in following groups:

- a) no effect in the VLR;
- b) data shall be modified in both the HLR and the VLR;
- c) withdrawal of a basic service or a supplementary service requiring change to VLR data;
- d) modification affects on the roaming of the subscriber and the subscriber shall be removed from the VLR data base;
- e) authentication algorithm or authentication key of the subscriber is modified;
- f) no effect in the SGSN;
- g) data shall be modified in both the HLR and the SGSN;
- h) withdrawal of a GPRS subscription data or a basic service or both requiring change to SGSN data;
- i) modification affects on the roaming of the subscriber and the subscriber shall be removed from the SGSN data base;
- j) withdrawal of GPRS Subscription related to Network Access Mode;
- k) withdrawal of non-GPRS Subscription related to Network Access Mode;

In case "b" and "g" the MAP\_INSERT\_SUBSCRIBER\_DATA service is initiated in the HLR.

In case "c" and "h" the MAP\_DELETE\_SUBSCRIBER\_DATA service is initiated in the HLR.

In cases "d", "e", "i", "j" and "k" the MAP\_CANCEL\_LOCATION service is initiated in the HLR.

If the result of a primitive received from the VLR or from the SGSN is unsuccessful, the HLR may initiate re-attempts; the number of repeat attempts and the time in between are HLR operator options, depending on the error returned by the VLR or by the SGSN.

The subscriber data modification procedure in the HLR is shown in the figures 20.3/4, 20.3/5 and 25.7/2.

Process Modify\_Data\_HLR

20.3\_4.1(2)

Figure 20.3/4: The subscriber data modification process in the HLR

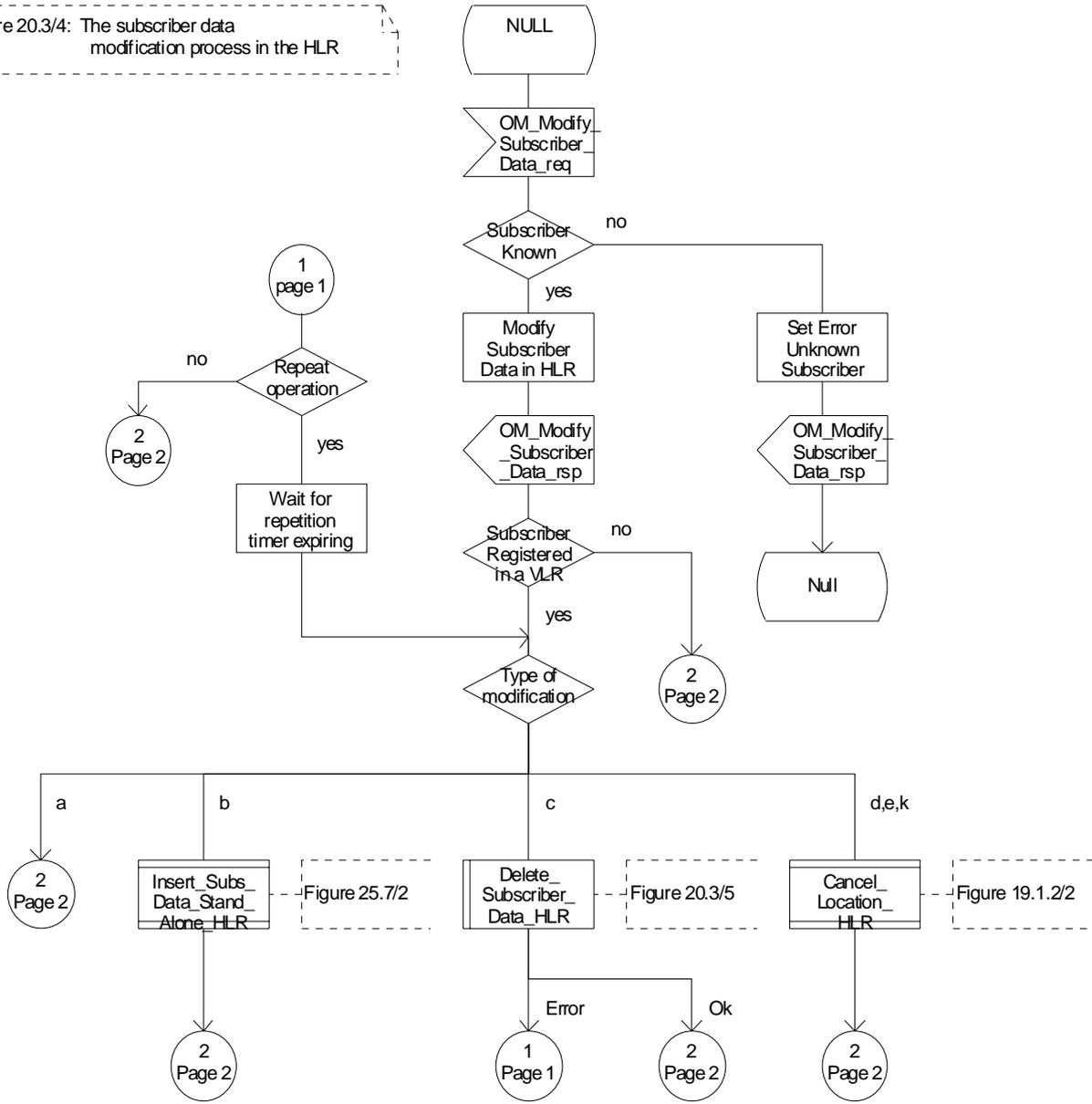

Figure 20.3/4 (sheet 1 of 2): Process Modify\_Data\_HLR

Process Modify\_Data\_HLR

20.3\_4.2(2)

Figure 20.3/4: The subscriber data modification process in the HLR

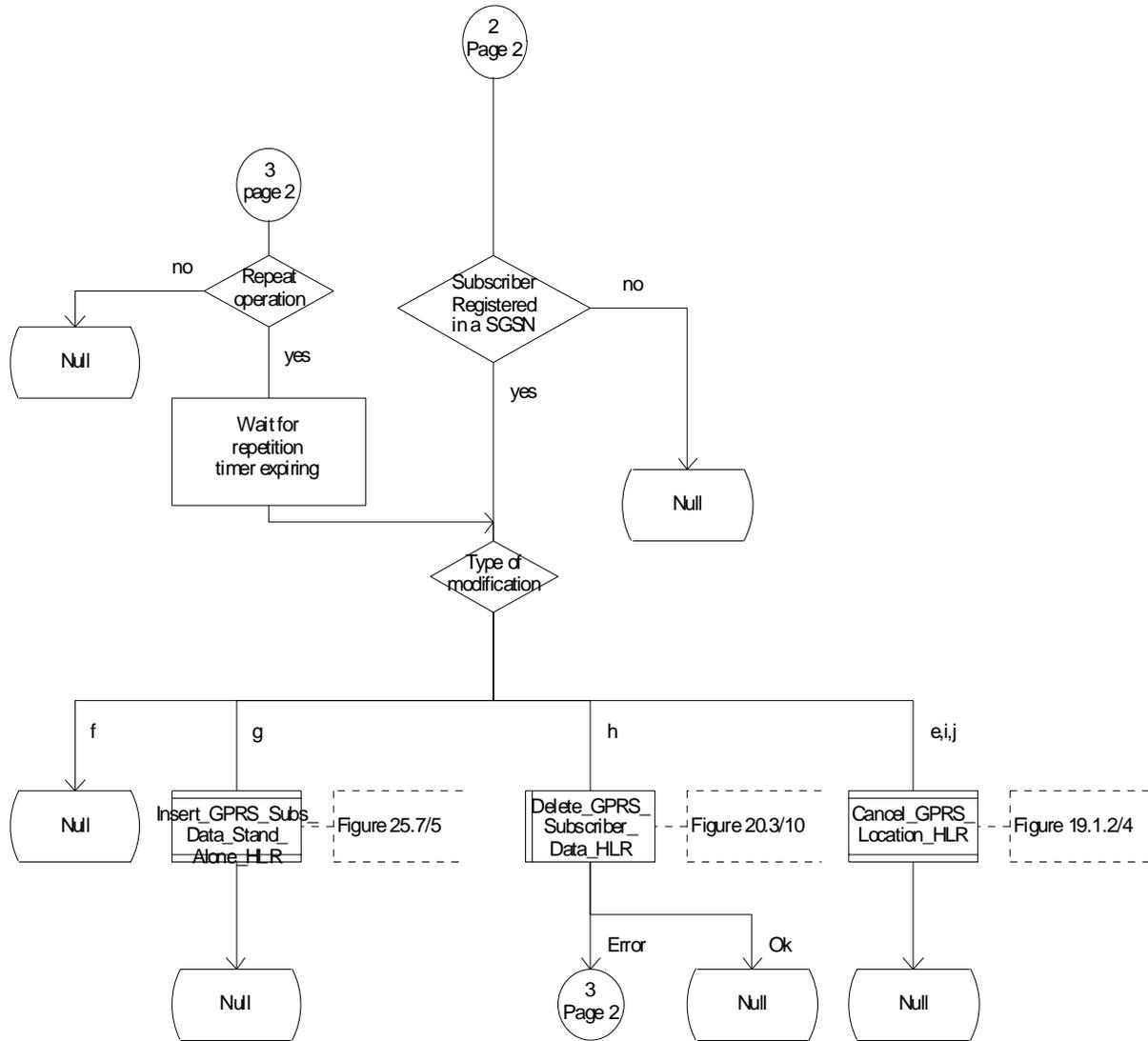

Figure 20.3/4 (sheet 2 of 2): Process Modify\_Data\_HLR

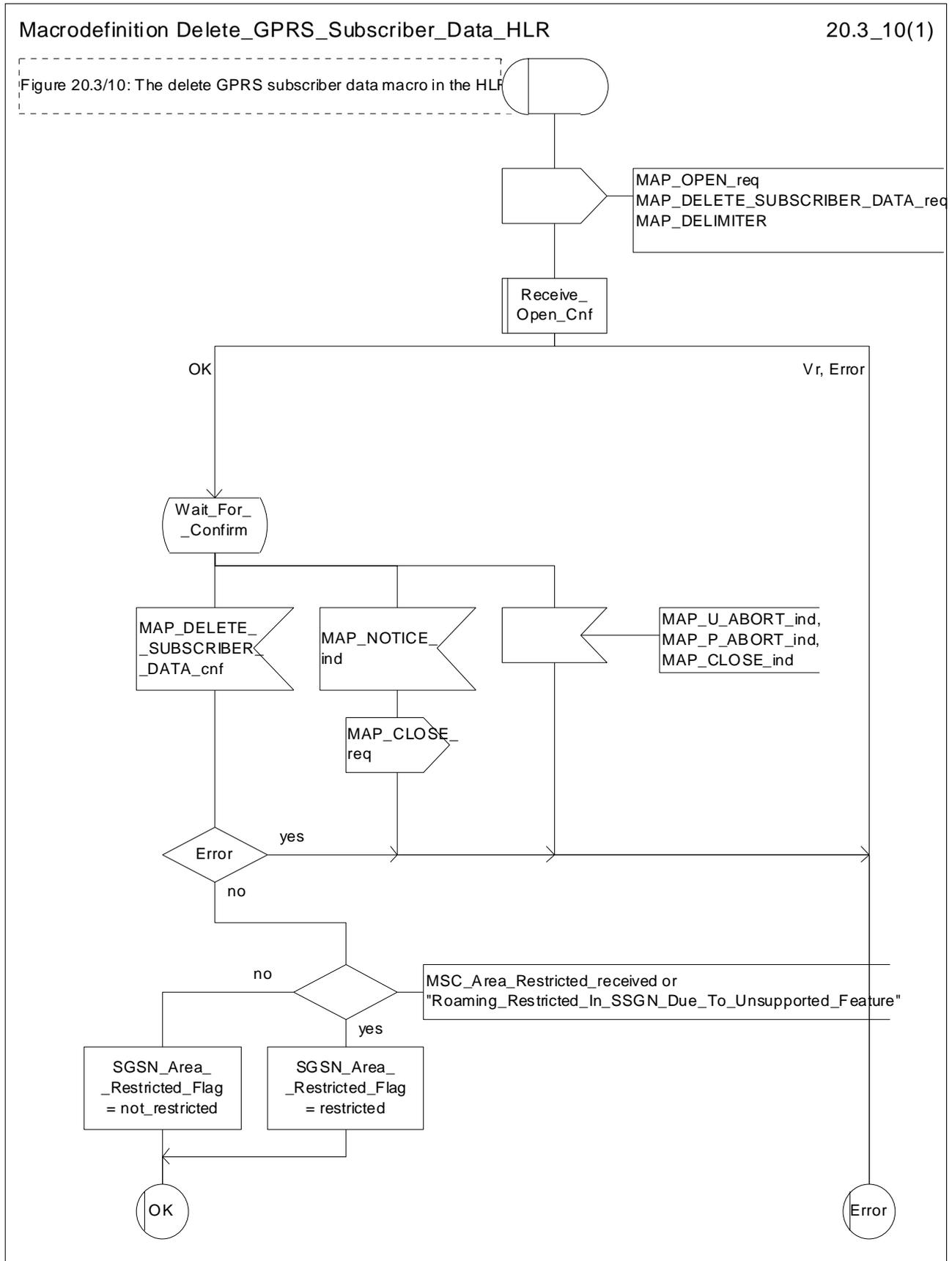

Figure 20.3/10: Macro Delete\_GPRS\_Subscriber\_Data\_HLR



Macrodefinition Delete\_Subscriber\_Data\_HLR

20.3\_5(1)

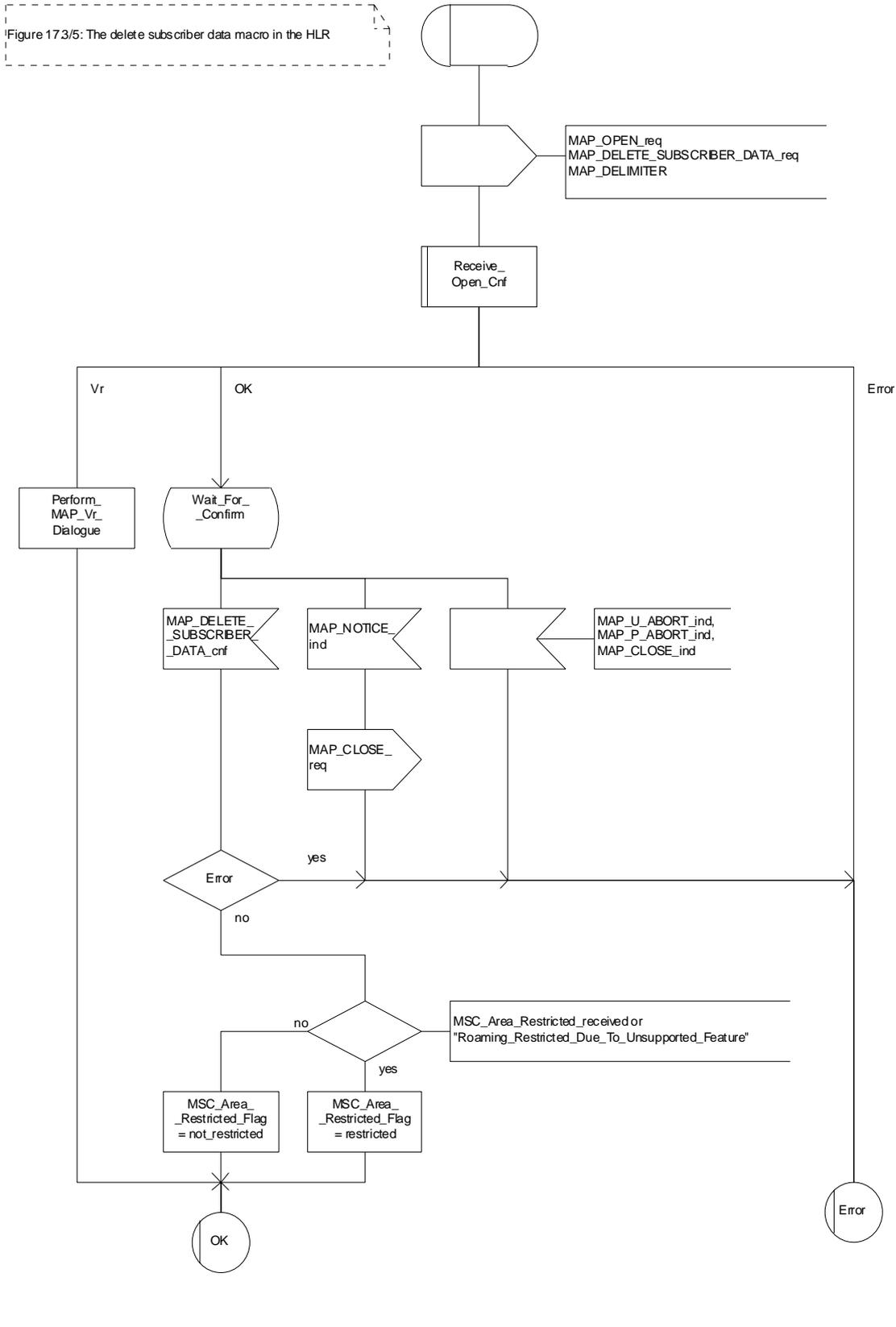

Figure 20.3/5: Macro Delete\_Subscriber\_Data\_HLR

## 20.3.2 Procedures in the VLR

### 20.3.2.1 Subscriber deletion procedure

The subscriber deletion procedure in the VLR is described in the clause 19.1.

### 20.3.2.2 Subscriber data modification procedure

When receiving either the MAP\_INSERT\_SUBSCRIBER\_DATA indication or the MAP\_DELETE\_SUBSCRIBER\_DATA indication, the VLR check the parameters and data in the primitive. Data errors are reported as an unexpected data value error or a data missing error depending on the nature of the error.

After receiving the first MAP\_INSERT\_SUBSCRIBER\_DATA indication, the VLR will check the IMSI that is included in the primitive. If the IMSI is unknown, the error "Unidentified subscriber" is returned.

If the VLR does not support received basic or supplementary services or the network feature Operator Determined Barring, or there is a problem with Regional Subscription Data then it reports it to the HLR.

If the entire MSC area is restricted due to regional subscription, this is reported to the HLR.

If the updating of the subscriber data is not possible, the VLR will initiate the MAP\_U\_ABORT request primitive. If the updating is successful, the MAP\_CLOSE indication is received from the HLR.

The subscriber data modification procedure in the VLR is shown in the figures 20.3/6, 20.3/7 and 25.7/1.

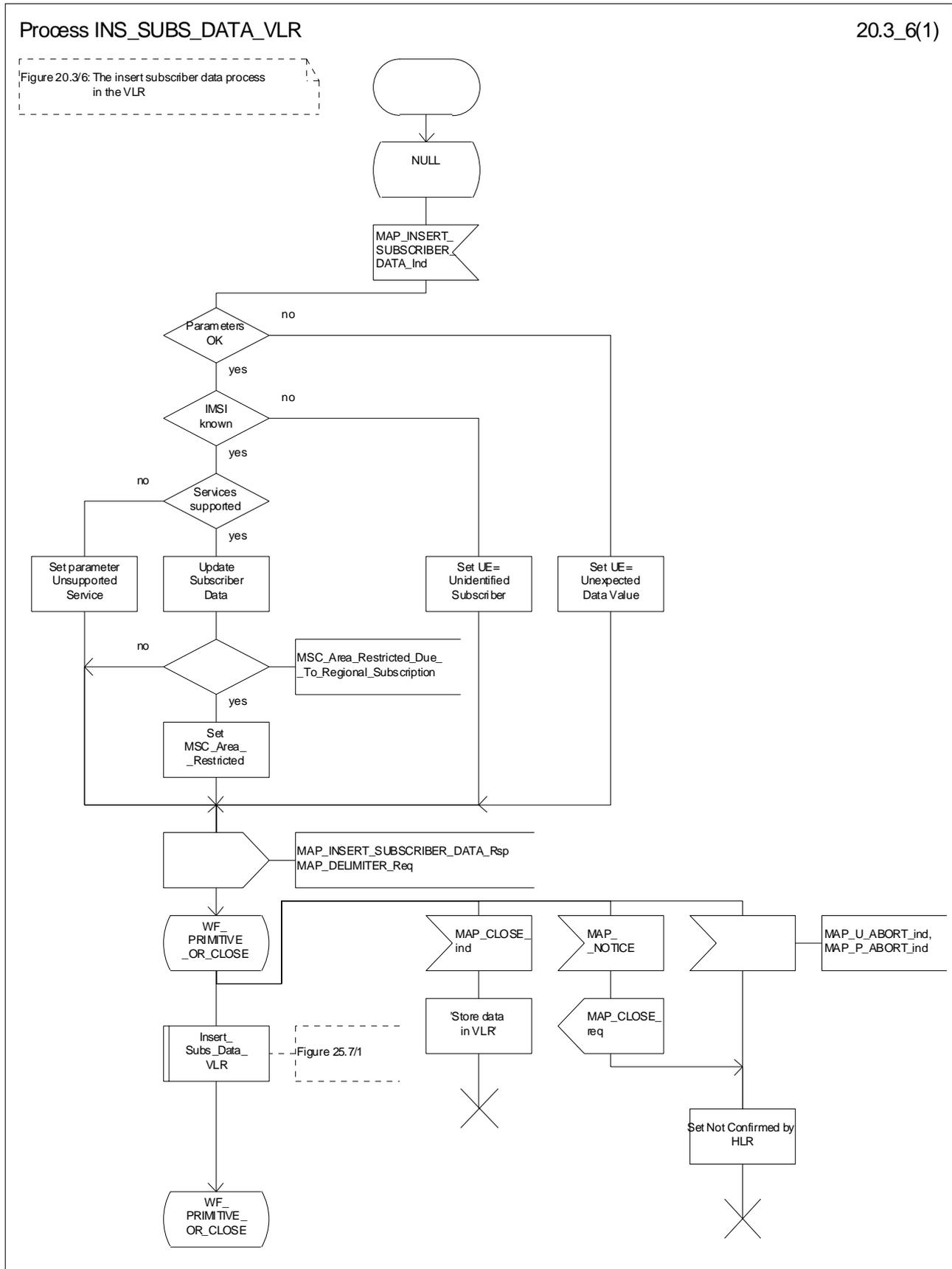

Figure 20.3/6: Process INS\_SUBS\_DATA\_VLR

Process Delete\_Subscriber\_Data\_VLR

20.3\_7(1)

Figure 20.3/7: The delete subscriber data process in the VLR

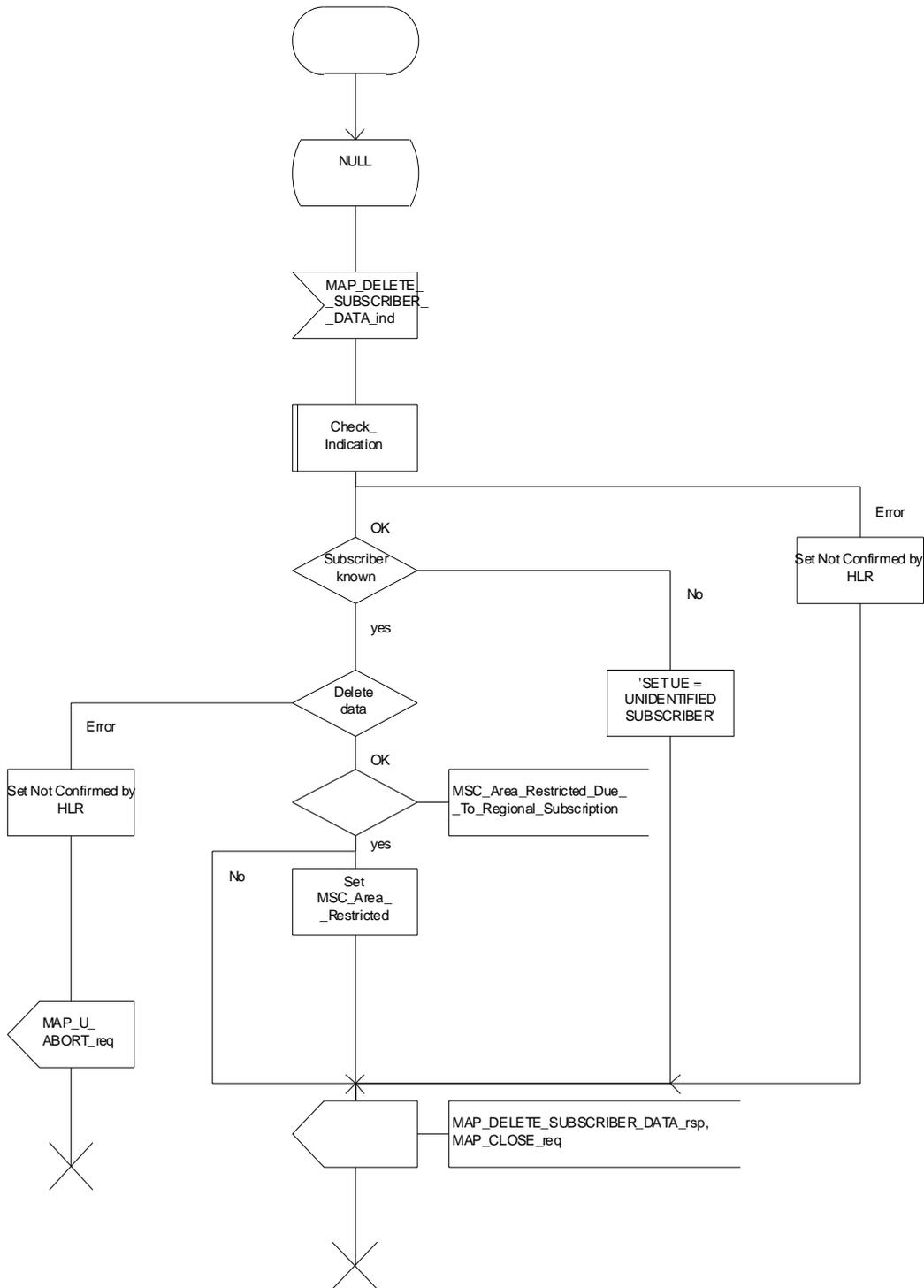

Figure 20.3/7: Process Delete\_Subscriber\_Data\_VLR

## 20.3.3 Procedures in the SGSN

### 20.3.3.1 Subscriber deletion procedure

The subscriber deletion procedure in the SGSN is described in the clause 19.1.

### 20.3.3.2 Subscriber data modification procedure

When receiving either the MAP\_INSERT\_SUBSCRIBER\_DATA indication or the MAP\_DELETE\_SUBSCRIBER\_DATA indication, the SGSN check the parameters and data in the primitive. Data errors are reported as an unexpected data value error or a data missing error depending on the nature of the error.

After receiving the first MAP\_INSERT\_SUBSCRIBER\_DATA indication, the SGSN will check the IMSI that is included in the primitive. If the IMSI is unknown, the error "Unidentified subscriber" is returned.

If the SGSN does not support received basic services or the network feature Operator Determined Barring, or there is a problem with Regional Subscription Data then it reports it to the HLR.

If the entire SGSN area is restricted due to regional subscription, this is reported to the HLR.

If the updating of the subscriber data is not possible, the SGSN will initiate the MAP\_U\_ABORT request primitive. If the updating is successful, the MAP\_CLOSE indication is received from the HLR.

The subscriber data modification procedure in the SGSN is shown in the figures 20.3/11, 20.3/12 and 25.7/5.

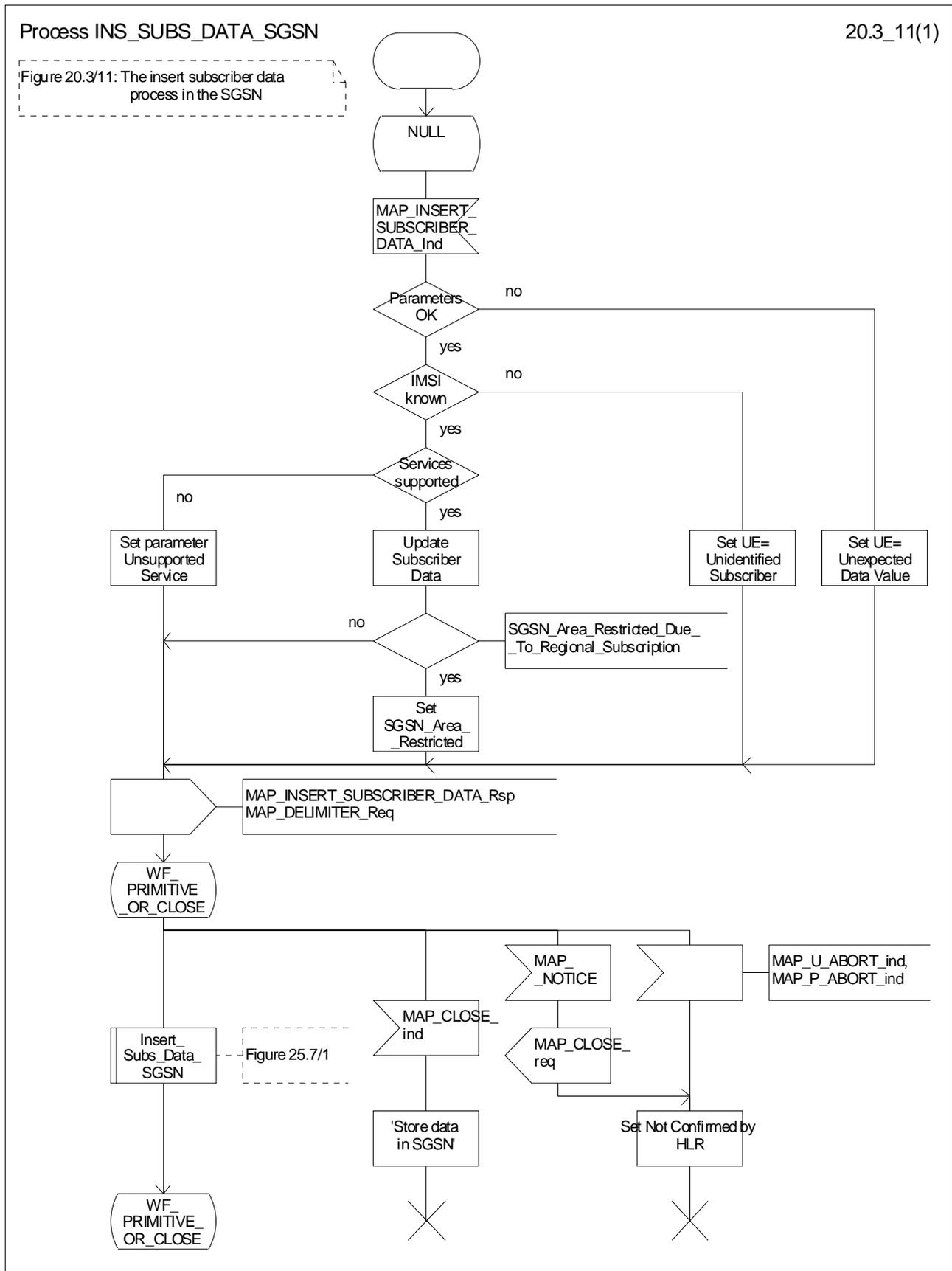

Figure 20.3/11: Process INS\_SUBS\_DATA\_SGSN

Process Delete\_Subscriber\_Data\_SGSN

20.3\_12(1)

Figure 20.3/12: The delete subscriber data process in the SGSN

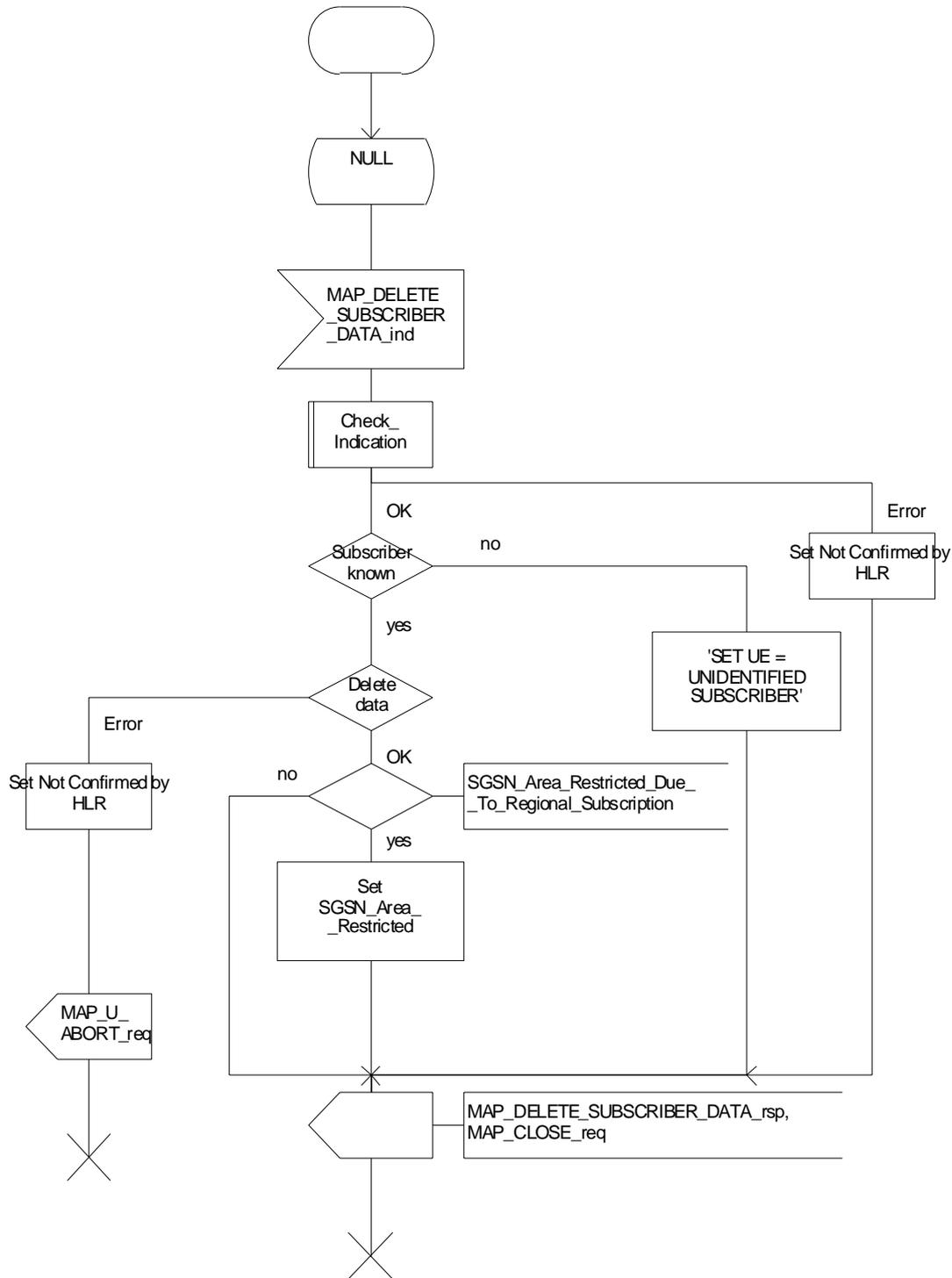
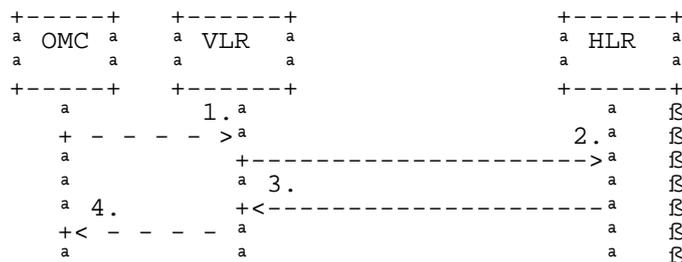

Figure 20.3/12: Process Delete\_Subscriber\_Data\_SGSN

## 20.4 Subscriber Identity procedure

In the subscriber identity procedure the IMSI of the subscriber is retrieved from the HLR. The procedure is shown in figure 20.4/1.



- 1) Identity request
- 2) MAP\_SEND\_IMSI
- 3) MAP\_SEND\_IMSI\_ACK
- 4) Identity confirm

**Figure 20.4/1: The subscriber identity procedure**

### 20.4.1 Subscriber identity procedure in the HLR

Opening of the dialogue is described in the macro Receive\_Open\_Ind in clause 25.1, with outcomes:

- procedure termination; or
- dialogue acceptance, with proceeding as below.

When receiving the MAP\_SEND\_IMSI indication, the HLR will check the parameters and data in the primitive. Data errors are reported as an unexpected data value error or a data missing error depending on the nature of the error.

If the subscriber is known in the HLR, the IMSI is fetched from the database and sent to the VLR. If the MSISDN cannot be identified, unknown subscriber indication is passed to the VLR.

The subscriber identity procedure in the HLR is shown in figure 20.4/2.



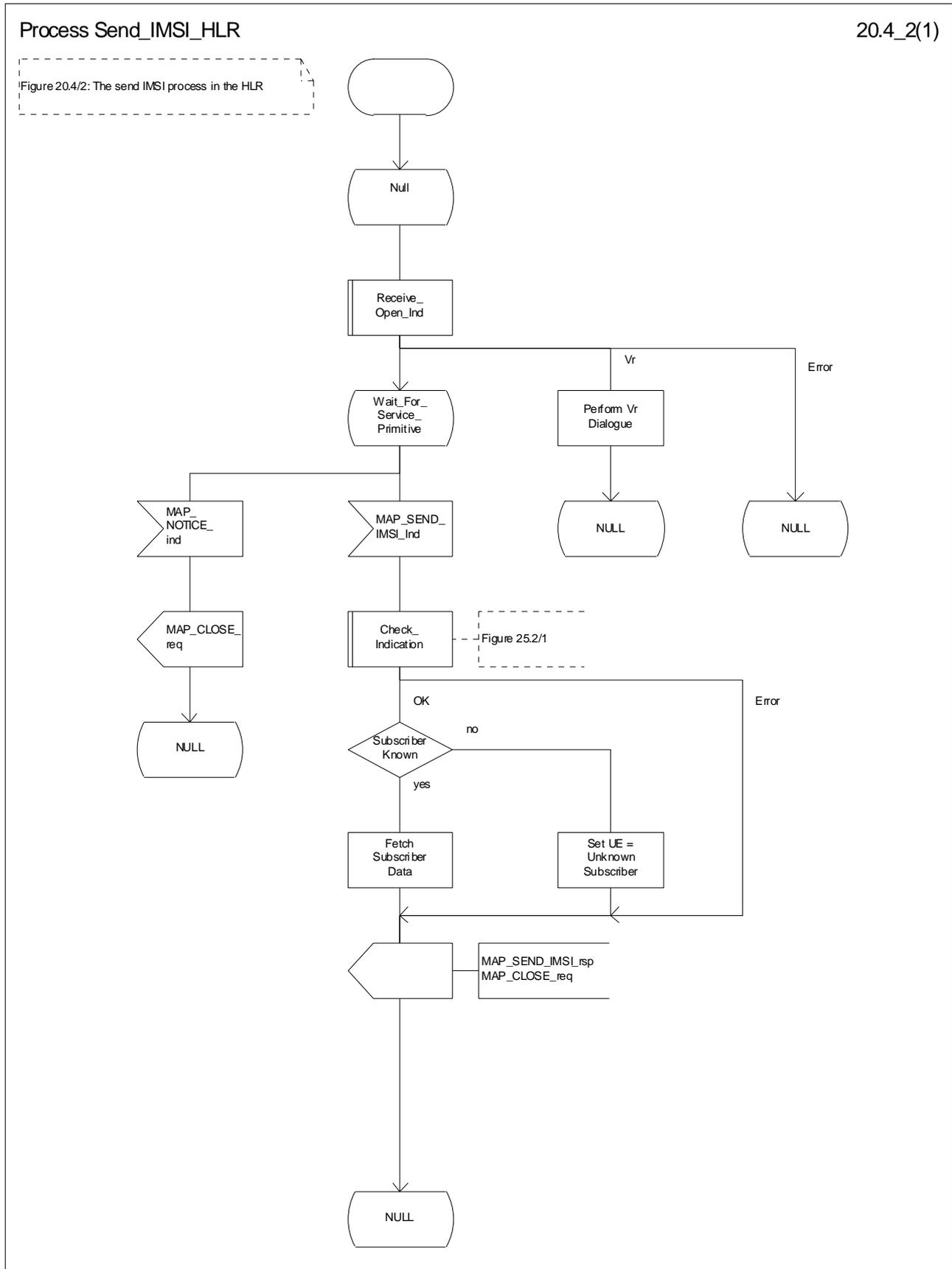

Figure 20.4/2: Process Send\_IMSI\_HLR

## 20.4.2 Subscriber identity procedure in the VLR

When the IMSI request is received from the OMC, the VLR will send the MAP\_SEND\_IMSI request to the HLR. The contents of the response is sent to the OMC.

The subscriber identity procedure in the VLR is shown in figure 20.4/3.

Process Send\_IMSI\_VLR

20.4\_3(1)

Figure 20.4/3: The send IMSI process in the VLR

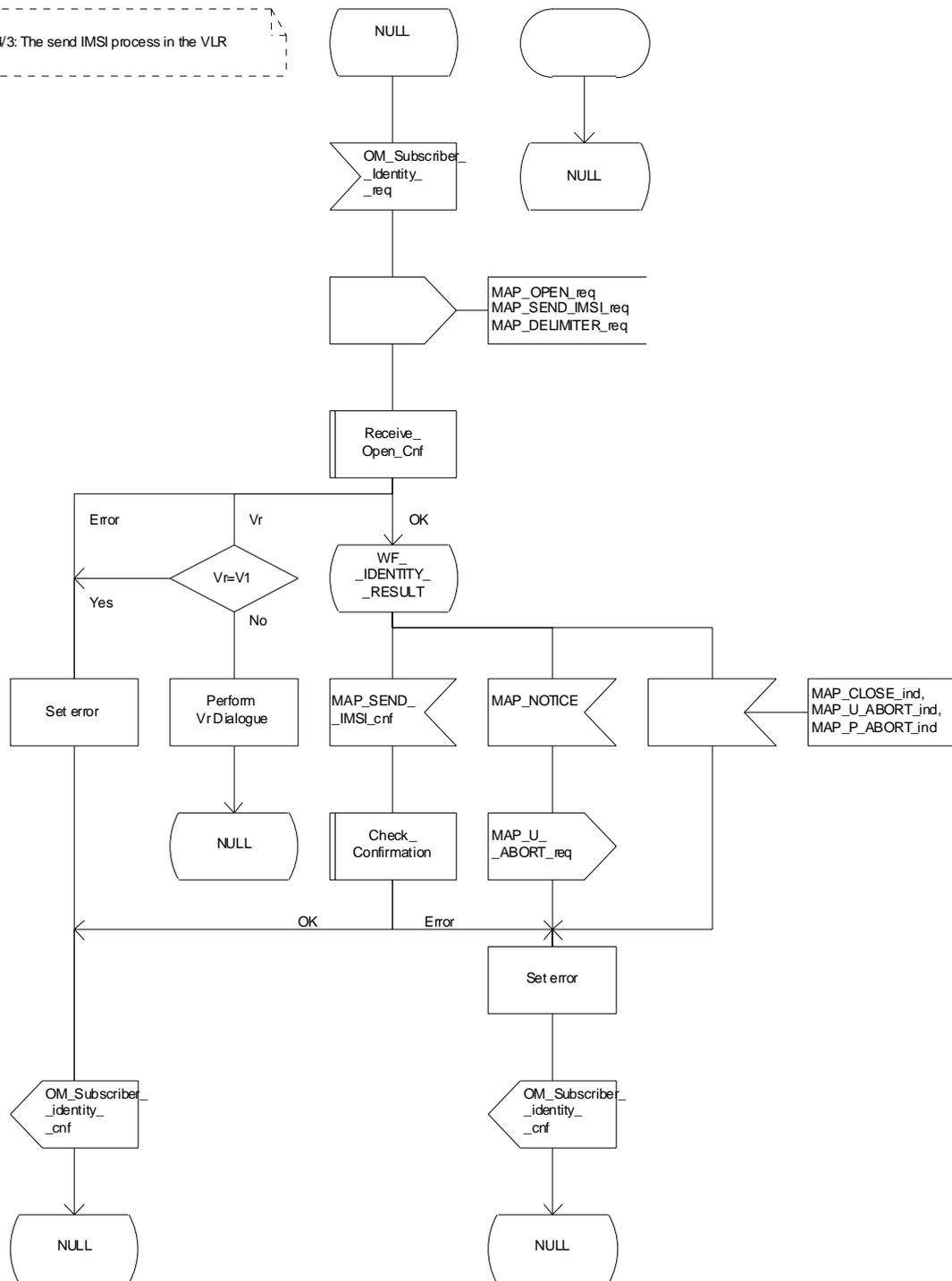

Figure 20.4/3: Process Send\_IMSI\_VLR

---

## 21 Call handling procedures

### 21.1 General

The MAP call handling procedures are used:

- to retrieve routing information to handle a mobile terminating call;
- to transfer control of a call back to the GMSC if the call is to be forwarded;
- to retrieve and transfer information between anchor MSC and relay MSC for inter MSC group calls / broadcast calls;
- to allocate resources in an SIWFS;
- to handle the reporting of MS status for call completion services;
- to handle the notification of remote user free for CCBS.

The procedures to handle a mobile originating call and a mobile terminating call after the call has arrived at the destination MSC do not require any signalling over a MAP interface. These procedures are specified in GSM 03.18 [97].

The stage 2 specification for the retrieval of routing information to handle a mobile terminating call is in GSM 03.18 [97]; modifications to this procedure for CAMEL are specified in GSM 03.78 [98], for optimal routing of a basic mobile-to-mobile call in GSM 03.79 [99] and for CCBS in GSM 03.93. The interworking between the MAP signalling procedures and the call handling procedures for each entity (GMSC, HLR and VLR) is shown by the transfer of signals between these procedures.

The stage 2 specification for the transfer of control of a call back to the GMSC if the call is to be forwarded is in GSM 03.79 [99]. The interworking between the MAP signalling procedures and the call handling procedures for each entity (VMSC and GMSC) is shown by the transfer of signals between these procedures.

The stage 2 specifications for inter MSC group calls / broadcast calls are in GSM 03.68 and GSM 03.69. The interworking between the MAP signalling procedures and the group call /broadcast call procedures for each entity (Anchor MSC and Relay MSC) is shown by the transfer of signals between these procedures.

The stage 2 specification for the allocation of resources in an SIWFS is in GSM 03.54. The interworking between the MAP signalling procedures and the call handling procedures for each entity (VMSC and SIWFS) is shown by the transfer of signals between these procedures.

The interworking between the call handling procedures and signalling protocols other than MAP is shown in GSM 03.18, GSM 03.78 and GSM 03.79.

The stage 2 specification for the handling of reporting of MS status for call completion services and notification of remote user free for CCBS is in GSM 03.93.



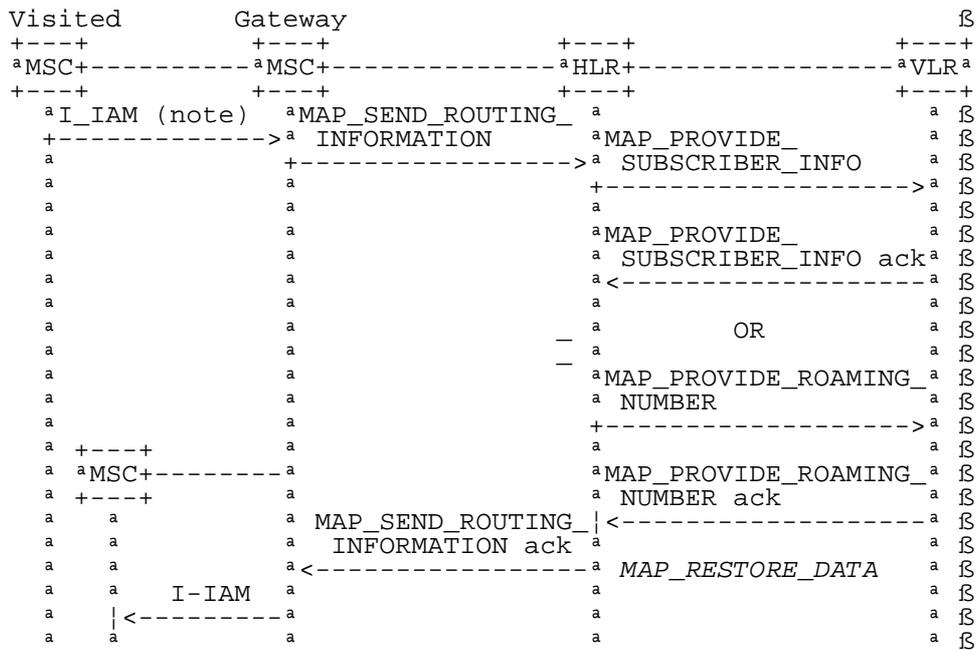

Notes:

xxx = *Optional Procedure*

For Optimal Routing phase 1, only one of the information flows for Provide Subscriber Info and Provide Roaming Number is used. For later phases of Optimal Routing, the HLR may return a MAP\_SEND\_ROUTEING\_INFORMATION ack after the Provide Subscriber Info information flow, and the GMSC may send a second MAP\_SEND\_ROUTEING\_INFORMATION, which will trigger the Provide Roaming Number information flow.

TUP or ISUP may be used in signalling between MSCs, depending on the network type between the MSCs. For further details on the TUP and ISUP procedures refer to the following CCITT Recommendations & ETSI specification:

Q.721-725 - Telephone User Part (TUP);

ETS 300 356-1 - Integrated Services Digital Network (ISDN); Signalling System No.7; ISDN User Part (ISUP) version 2 for the international interface; Part 1: Basic services.

**Figure 21.2/2: Message flow for retrieval of routing information (optimally routed call)**

The following MAP services are used to retrieve routing information:

- MAP\_SEND\_ROUTING\_INFORMATION see clause 10.1;
- MAP\_PROVIDE\_ROAMING\_NUMBER see clause 10.2;
- MAP\_PROVIDE\_SUBSCRIBER\_INFO see clause 8.11.2;
- MAP\_RESTORE\_DATA see clause 8.10.3.

## 21.2.2 Process in the GMSC

The MAP process in the GMSC to retrieve routing information for a mobile terminating call is shown in figure 21.2/3. The MAP process invokes macros not defined in this clause; the definitions of these macros can be found as follows:

Receive_Open_Cnf	see clause 25.1.2;
Check_Confirmation	see clause 25.2.2.

### Successful Outcome

When the MAP process receives a Send Routeing Info request from the call handling process in the GMSC, it requests a dialogue with the HLR whose identity is contained in the Send Routeing Info request by sending a MAP\_OPEN service request, requests routing information using a MAP\_SEND\_ROUTING\_INFORMATION service request and invokes the macro Receive\_Open\_Cnf to wait for the response to the dialogue opening request. If the dialogue opening is successful, the MAP process waits for a response from the HLR.

If the MAP process receives a MAP\_SEND\_ROUTING\_INFORMATION service confirm from the HLR, the MAP process invokes the macro Check\_Confirmation to check the content of the confirm. If the MAP\_SEND\_ROUTING\_INFORMATION confirm from the HLR cannot be carried in a single TC-Result component, it is carried in one or more TC-Result-NL components (each sent in a TC-CONTINUE), followed by a TC-Result-L component in a TC-END message.

If the macro Check\_Confirmation takes the OK exit, the MAP process sends a Send Routeing Info ack containing the routing information received from the HLR to the call handling process in the GMSC and returns to the idle state.

### Earlier version MAP dialogue with the HLR

If the macro Receive\_Open\_Cnf takes the Vr exit, the MAP process checks whether this is an OR interrogation (indicated by the inclusion of the OR interrogation parameter in the MAP\_SEND\_ROUTING\_INFORMATION service request).

If this is not an OR interrogation, the GMSC performs the earlier version MAP dialogue as specified in [51] or [96] and the process returns to the idle state.

If this is an OR interrogation, the MAP process sends a Send Routeing Info negative response indicating OR not allowed to the call handling process in the GMSC and returns to the idle state.

### Dialogue opening failure

If the macro Receive\_Open\_Cnf indicates that the dialogue with the HLR could not be opened, the MAP process sends an Abort to to the call handling process in the GMSC and returns to the idle state.

### Error in MAP\_SEND\_ROUTING\_INFORMATION confirm

If the MAP\_SEND\_ROUTING\_INFORMATION service confirm contains a user error or a provider error, or the macro Check\_Confirmation indicates that there is a data error, the MAP process sends a Send Routeing Info negative response to the call handling process in the GMSC and returns to the idle state.

### Call release

If the call handling process in the GMSC indicates that the call has been aborted (i.e. prematurely released by the calling subscriber), the MAP process returns to the idle state. Any response from the HLR will be discarded.

### Abort of HLR dialogue

After the dialogue with the HLR has been established, the MAP service provider may abort the dialogue by issuing a MAP\_P\_ABORT indication, or the HLR may send a MAP\_U\_ABORT indication or a MAP\_CLOSE indication. In any of these cases, the MAP process sends a Send Routeing Info negative response to the call handling process in the GMSC and returns to the idle state.

If the MAP provider indicates a protocol problem by sending a MAP\_NOTICE indication, the MAP process closes the dialogue with the HLR, sends a Send Routeing Info negative response indicating system failure to the call handling process in the GMSC and returns to the idle state.





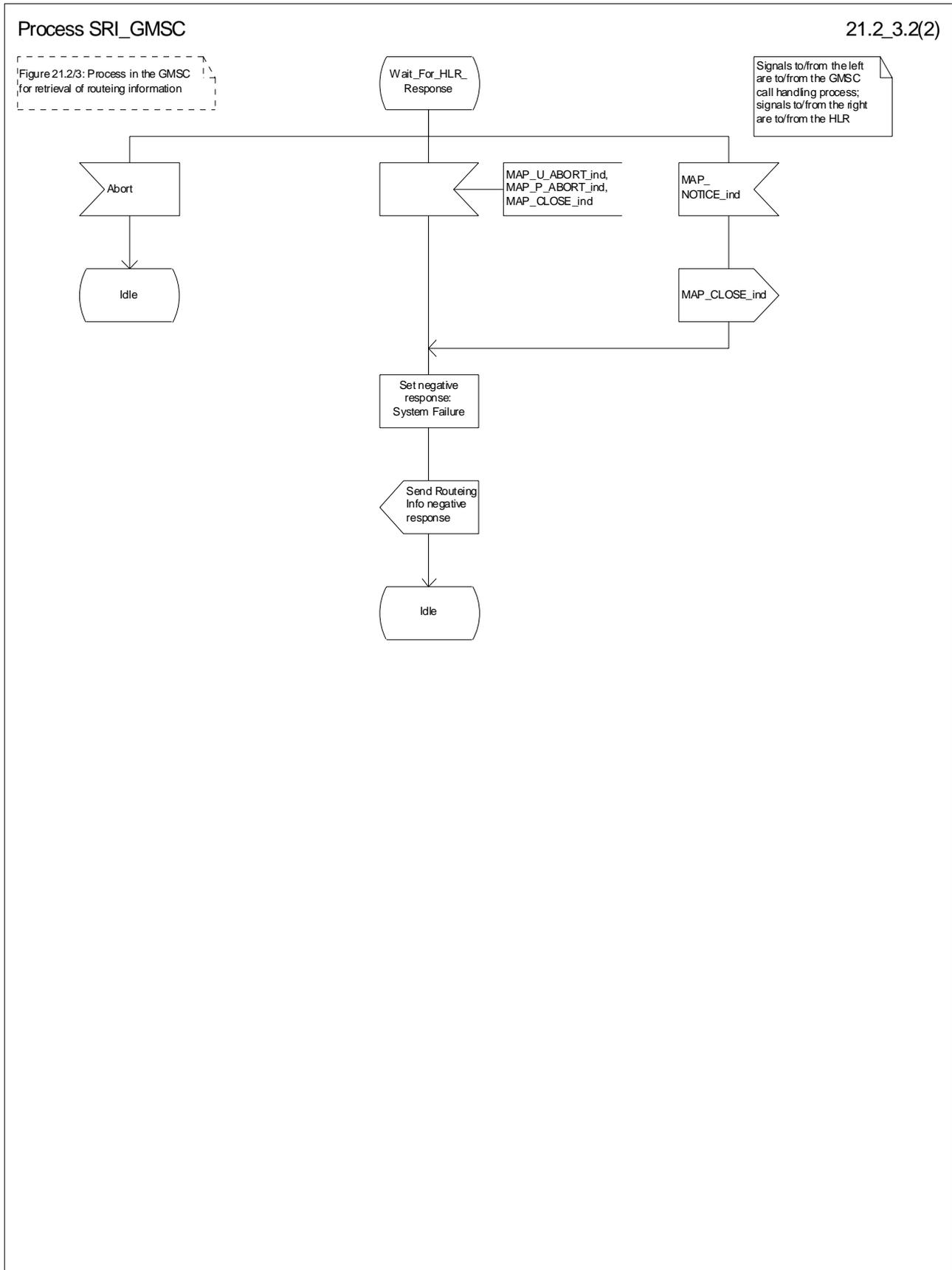

Figure 21.2/3 (sheet 2 of 2): Process SRI\_GMSC

### 21.2.3 Procedures in the HLR

The MAP process in the HLR to retrieve routing information for a mobile terminating call is shown in figure 21.2/4. The MAP process invokes macros not defined in this clause; the definitions of these macros can be found as follows:

Receive_Open_Ind	see clause 25.1.1;
Receive_Open_Cnf	see clause 25.1.2;
Check_Confirmation	see clause 25.2.2.

#### Successful outcome

When the MAP process receives a MAP\_OPEN indication with the application context locInfoRetrieval, it checks it by invoking the macro Receive\_Open\_Ind.

If the macro takes the OK exit, the MAP process waits for a service indication.

If a MAP\_SEND\_ROUTING\_INFORMATION service indication is received, the MAP process sends a Send Routing Info request to the call handling process in the HLR, and waits for a response. The Send Routing Info request contains the parameters received in the MAP\_SEND\_ROUTING\_INFORMATION service indication.

If the call handling process in the HLR returns a Send Routing Info ack, the MAP process constructs a MAP\_SEND\_ROUTING\_INFORMATION service response containing the routing information contained in the Send Routing Info ack, constructs a MAP\_CLOSE service request, sends them to the GMSC and returns to the idle state. If the MAP\_SEND\_ROUTING\_INFORMATION response cannot be carried in a single TC-Result component, it is carried in one or more TC-Result-NL components (each sent in a TC-CONTINUE), followed by a TC-Result-L component in a TC-END message.

If the call handling process in the HLR returns a Provide Subscriber Info request, the MAP process requests a dialogue with the VLR whose identity is contained in the Provide Subscriber Info request by sending a MAP\_OPEN service request, requests the subscriber status using a MAP\_PROVIDE\_SUBSCRIBER\_INFO service request, and invokes the macro Receive\_Open\_Cnf to wait for the response to the dialogue opening request.

If the macro takes the OK exit, the MAP process waits for the response from the VLR.

If the MAP process receives a MAP\_PROVIDE\_SUBSCRIBER\_INFO service confirm, it invokes the macro Check\_Confirmation to check the content of the confirm.

If the Check\_Confirmation macro takes the OK exit, the MAP process sends a Provide Subscriber Info ack containing the information received in the MAP\_PROVIDE\_SUBSCRIBER\_INFO service confirm to the call handling process in the HLR, and waits for a response. The handling of the response from the call handling process in the HLR is described above.

If the MAP\_PROVIDE\_SUBSCRIBER\_INFO service confirm contains a provider error or a data error, the MAP process sends a Provide Subscriber Info negative response indicating the type of error to the call handling process in the HLR, and waits for a response. The handling of the response from the call handling process in the HLR is described above.

NOTE: The 'User Error' exit from the macro Check\_Confirmation is shown for formal completeness; the MAP\_PROVIDE\_SUBSCRIBER\_INFO\_cnf primitive cannot contain a user error.

If the call handling process in the HLR returns a Provide Roaming Number request, the MAP process requests a dialogue with the VLR whose identity is contained in the Provide Roaming Number request by sending a MAP\_OPEN service request, requests a roaming number using a MAP\_PROVIDE\_ROAMING\_NUMBER service request, and invokes the macro Receive\_Open\_Cnf to wait for the response to the dialogue opening request.

If the macro takes the OK exit, the MAP process waits for the response from the VLR.

If the MAP process receives a MAP\_PROVIDE\_ROAMING\_NUMBER service confirm, it invokes the macro Check\_Confirmation to check the content of the confirm.

If the Check\_Confirmation macro takes the OK exit, the MAP process sends a Provide Roaming Number ack containing the MSRN received in the MAP\_PROVIDE\_ROAMING\_NUMBER service confirm to the call handling process in the HLR, and waits for a response. The handling of the response from the call handling process in the HLR is described above.

If the MAP\_PROVIDE\_ROAMING\_NUMBER service confirm contains a user error or a provider error, or the macro Check\_Confirmation indicates that there is a data error, the MAP process sends a Provide Roaming Number negative response indicating the type of error to the call handling process in the HLR, and waits for a response. The handling of the response from the call handling process in the HLR is described above.

#### **Negative response from HLR call handling process**

If the call handling process in the HLR returns a negative response, either before or after a dialogue with the VLR to obtain a roaming number, the MAP process constructs a MAP\_SEND\_ROUTING\_INFORMATION service response containing the appropriate error, constructs a MAP\_CLOSE service request, sends them to the GMSC and returns to the idle state.

#### **Earlier version MAP Provide Roaming Number dialogue with the VLR**

If the macro Receive\_Open\_Cnf takes the Vr exit after the MAP process has requested opening of a Provide Roaming Number dialogue with the VLR, the MAP process checks whether this is an OR interrogation (indicated by the inclusion of the OR interrogation parameter in the MAP\_PROVIDE\_ROAMING\_NUMBER service request).

If this is not an OR interrogation, the HLR performs the earlier version MAP dialogue as specified in [51] or [96], relays the result of the dialogue to the HLR call handling process, and waits for a response. The handling of the response from the call handling process in the HLR is described above.

If this is an OR interrogation, the MAP process sends a Provide Roaming Number negative response indicating OR not allowed to the call handling process in the HLR and waits for a response. The handling of the response from the call handling process in the HLR is described above.

#### **Failure of Provide Subscriber Info dialogue with the VLR**

If the Receive\_Open\_Cnf macro takes the Vr exit or the Error exit after the MAP process has requested opening of a Provide Subscriber Info dialogue with the VLR, the MAP process sends a Provide Subscriber Info negative response indicating system failure to the call handling process in the HLR, and waits for a response. The handling of the response from the call handling process in the HLR is described above.

#### **Failure of Provide Roaming Number dialogue with the VLR**

If the Receive\_Open\_Cnf macro takes the Error exit after the MAP process has requested opening of a Provide Roaming Number dialogue with the VLR, the MAP process sends a Provide Roaming Number negative response indicating system failure to the call handling process in the HLR, and waits for a response. The handling of the response from the call handling process in the HLR is described above.

If the MAP process receives a MAP\_U\_ABORT, a MAP\_P\_ABORT or a premature MAP\_CLOSE from the MAP provider, it sends a Provide Roaming Number negative response indicating system failure to the call handling process in the HLR, and waits for a response. The handling of the response from the call handling process in the HLR is described above.

If the MAP process receives a MAP\_NOTICE from the MAP provider, it returns a MAP\_CLOSE request to the MAP provider, sends a Provide Roaming Number negative response indicating system failure to the call handling process in the HLR, and waits for a response. The handling of the response from the call handling process in the HLR is described above.

#### **Earlier version MAP dialogue with the GMSC**

If the macro Receive\_Open\_Ind takes the Vr exit, the the HLR performs the earlier version MAP dialogue as specified in [51] or [96] and the process returns to the idle state.

### **Failure of dialogue opening with the GMSC**

If the macro Receive\_Open\_Ind takes the Error exit, the MAP process returns to the idle state.

If the MAP provider sends a MAP\_P\_ABORT while the MAP process is waiting for a service indication, the MAP process returns to the idle state.

If the MAP provider sends a MAP\_NOTICE while the MAP process is waiting for a service indication, the MAP process sends a MAP\_CLOSE request to terminate the dialogue and returns to the idle state.

Process SRI\_HLR

21.2\_4.1(3)

Figure 21.2/4: Process in the HLR to respond to a request for routing information

Signals to/from the left are to/from the GMSC; signals to/from the right are to/from the VLR unless specified otherwise

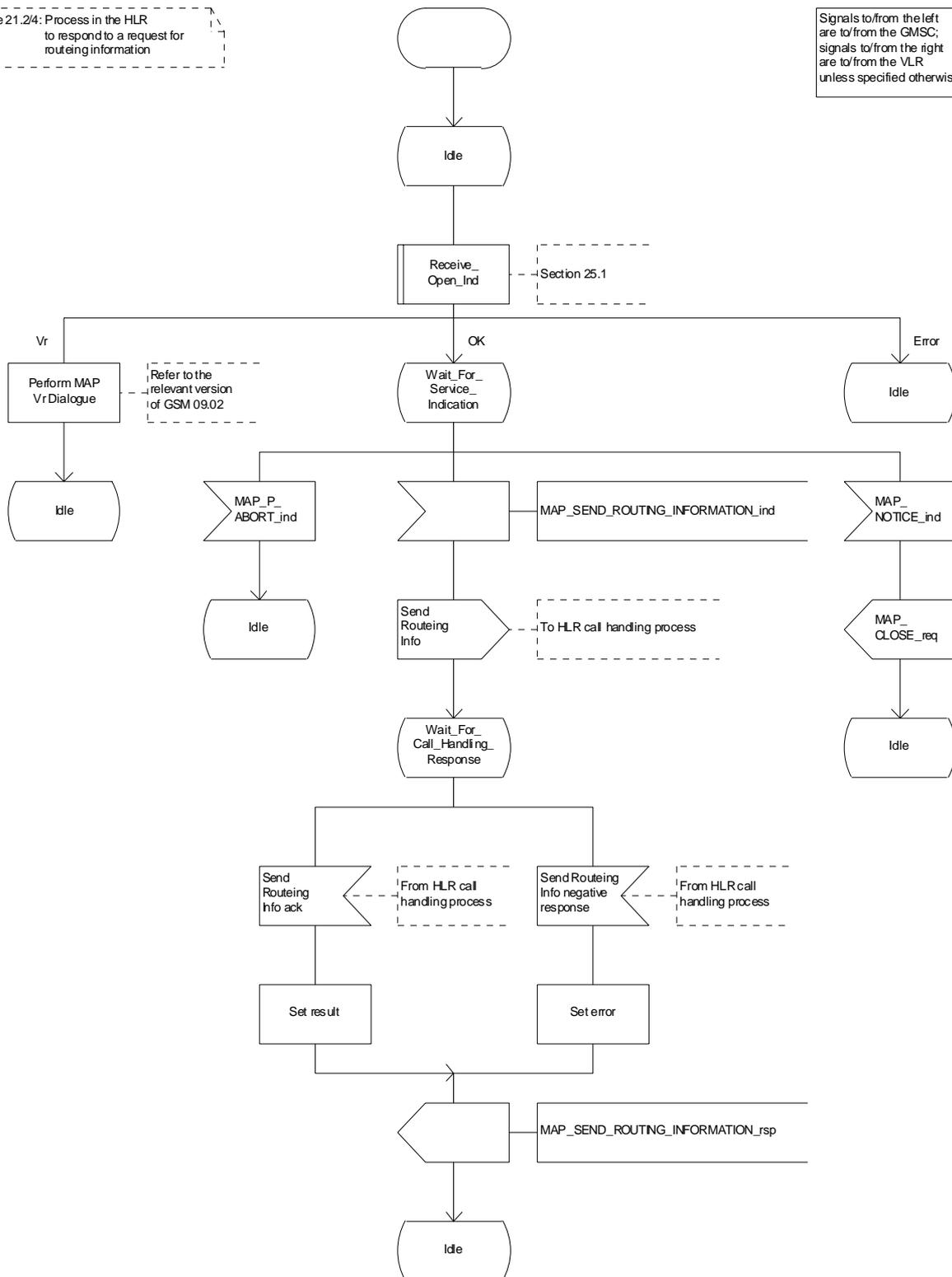

Figure 21.2/4 (sheet 1 of 3): Process SRI\_HLR

Process SRI\_HLR

21.2\_4.2(3)

Figure 21.2/4: Process in the HLR to respond to a request for routing information

Signals to/from the left are to/from the GMSC; signals to/from the right are to/from the VLR unless specified otherwise

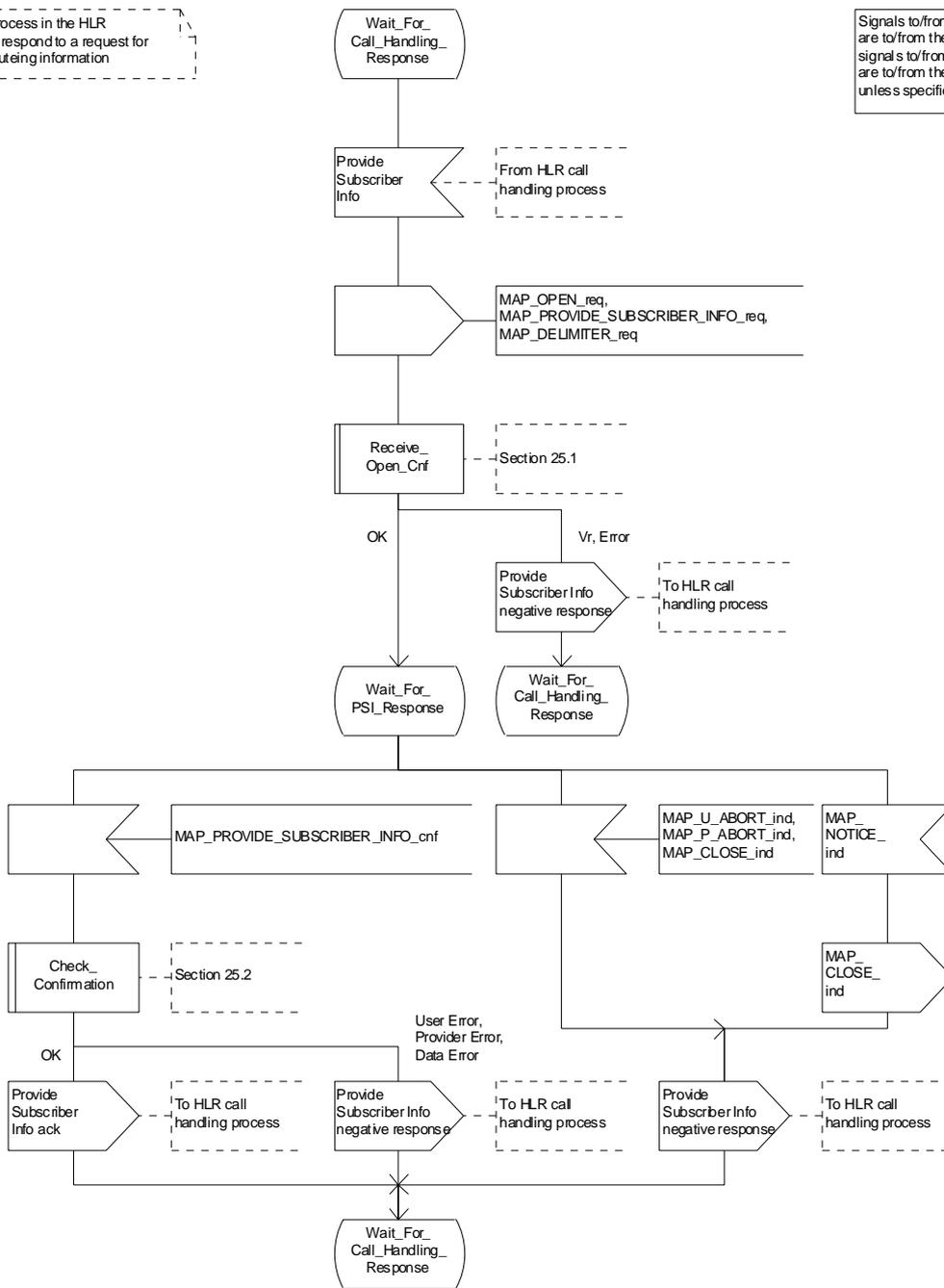

Figure 21.2/4 (sheet 2 of 3): Process SRI\_HLR

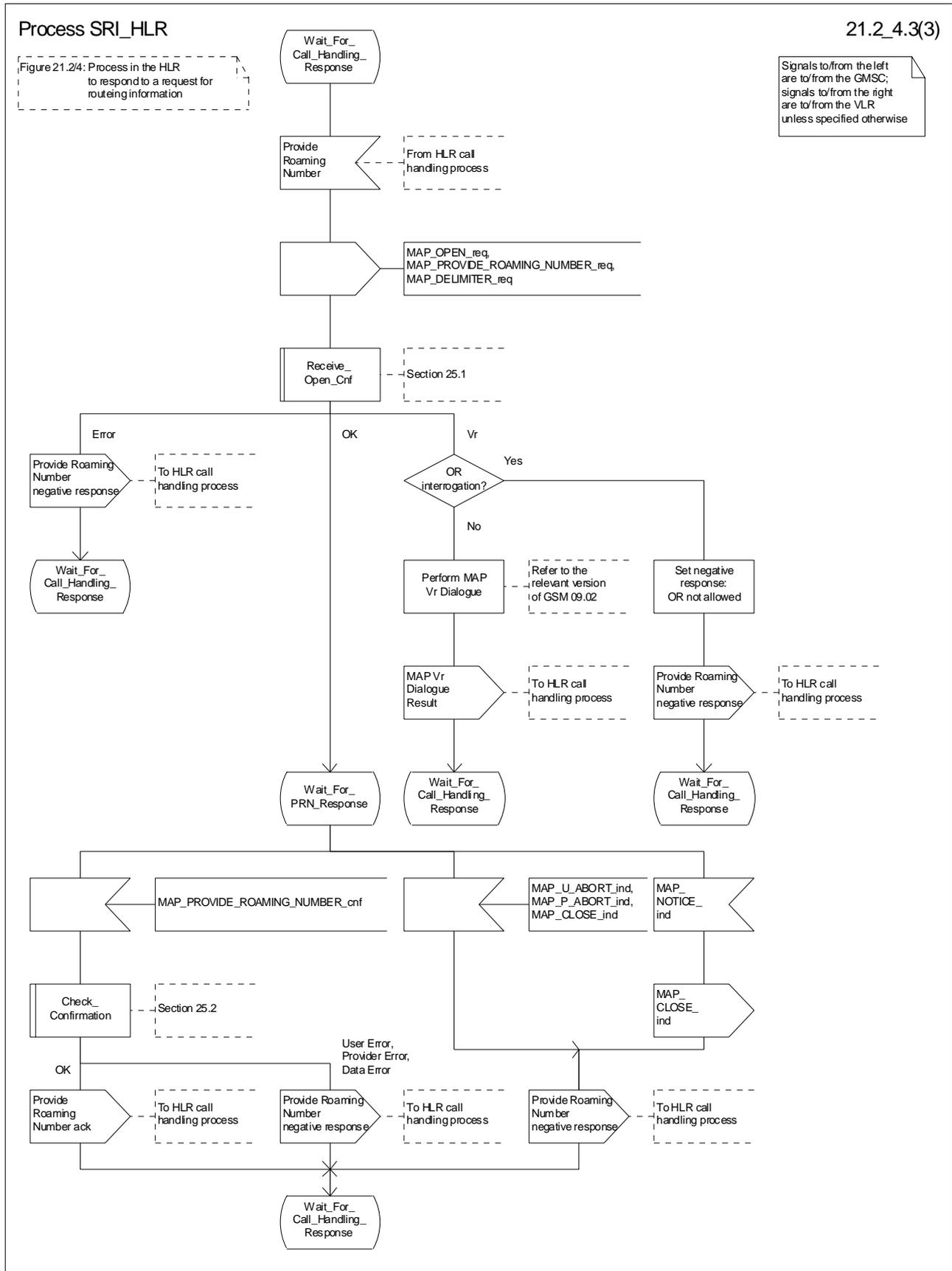

Figure 21.2/4 (sheet 3 of 3): Process SRI\_HLR

## 21.2.4 Process in the VLR to provide a roaming number

The MAP process in the VLR to provide a roaming number for a mobile terminating call is shown in figure 21.2/5. The MAP process invokes a macro not defined in this clause; the definition of this macro can be found as follows:

Receive\_Open\_Ind            see clause 25.1.1;

### Successful outcome

When the MAP process receives a MAP\_OPEN indication with the application context roamingNbEnquiry, it checks it by invoking the macro Receive\_Open\_Ind.

If the macro takes the OK exit, the MAP process waits for a service indication.

If a MAP\_PROVIDE\_ROAMING\_NUMBER service indication is received, the MAP process sends a Provide Roaming Number request to the call handling process in the VLR, and waits for a response. The Provide Roaming Number request contains the parameters received in the MAP\_PROVIDE\_ROAMING\_NUMBER service indication.

If the call handling process in the VLR returns a Provide Roaming Number ack, the MAP process constructs a MAP\_PROVIDE\_ROAMING\_NUMBER service response containing the roaming number contained in the Send Routeing Info ack, constructs a MAP\_CLOSE service request, sends them to the HLR and returns to the idle state.

### Earlier version MAP dialogue with the HLR

If the macro Receive\_Open\_Ind takes the Vr exit, the the VLR performs the earlier version MAP dialogue as specified in [51] or [96] and the process returns to the idle state.

### Failure of dialogue opening with the HLR

If the macro Receive\_Open\_Ind takes the Error exit, the MAP process returns to the idle state.

If the MAP provider sends a MAP\_P\_ABORT while the MAP process is waiting for a service indication, the MAP process returns to the idle state.

If the MAP provider sends a MAP\_NOTICE while the MAP process is waiting for a service indication, the MAP process sends a MAP\_CLOSE request to terminate the dialogue and returns to the idle state.

### Negative response from VLR call handling process

If the call handling process in the HLR returns a negative response, the MAP process constructs a MAP\_PROVIDE\_ROAMING\_NUMBER service response containing the appropriate error, constructs a MAP\_CLOSE service request, sends them to the HLR and returns to the idle state.



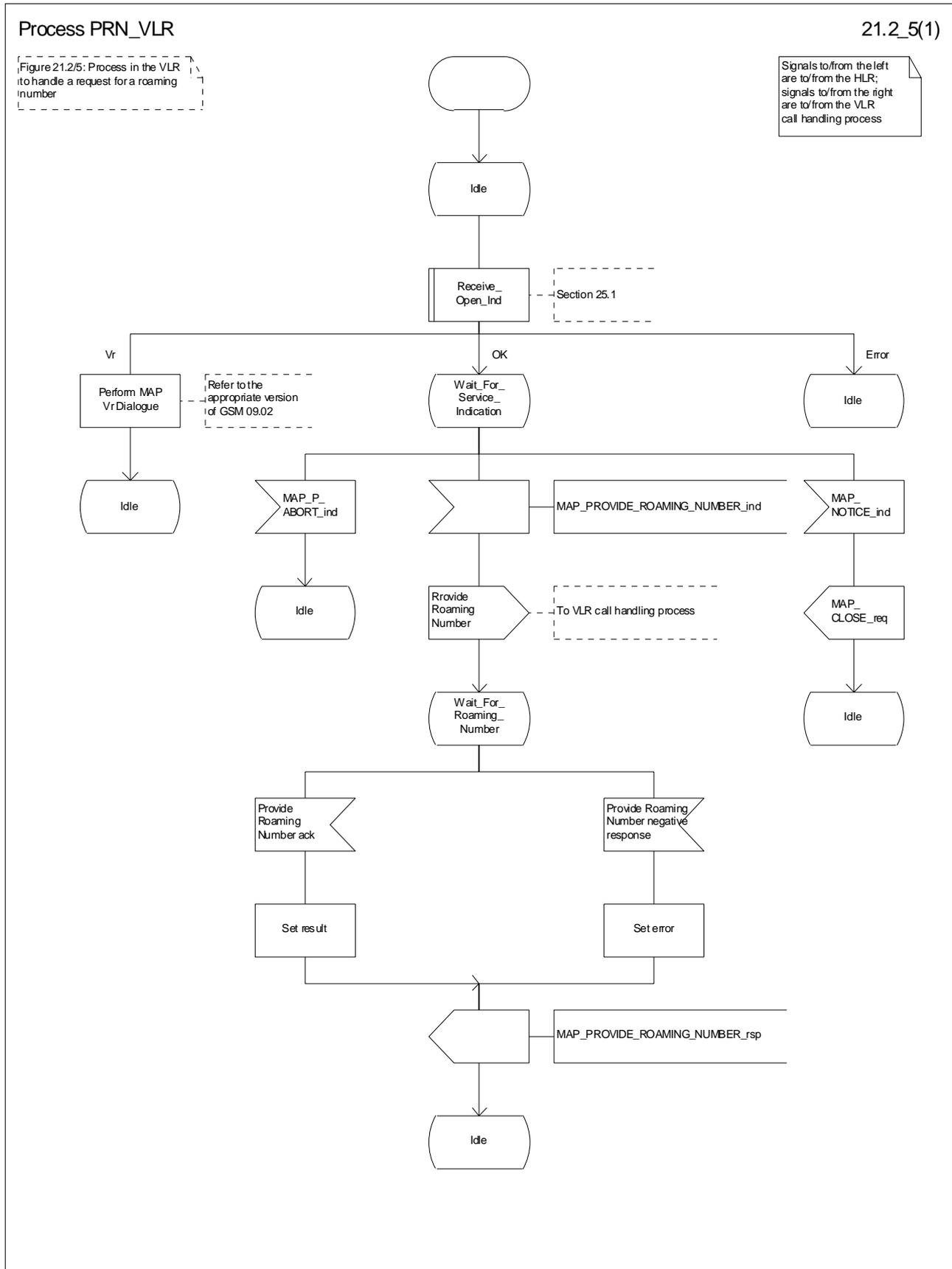

Figure 21.2/5: Process PRN\_VLR

## 21.2.5 Process in the VLR to restore subscriber data

The MAP process in the HLR to restore subscriber data is shown in figure 21.2/6. The MAP process invokes macros not defined in this clause; the definitions of these macros can be found as follows:

Receive_Open_Cnf	see clause 25.1.2;
Check_Confirmation	see clause 25.2.2;
Insert_Subscriber_Data_VLR	see clause 25.7.1;
Activate_Tracing_VLR	see clause 25.9.3.

### Successful outcome

When the MAP process receives a Restore Data request from the data restoration process in the VLR, it requests a dialogue with the HLR whose identity is contained in the Restore Data request by sending a MAP\_OPEN service request, requests data restoration using a MAP\_RESTORE\_DATA service request and invokes the macro Receive\_Open\_Cnf to wait for the response to the dialogue opening request. If the dialogue opening is successful, the MAP process waits for a response from the HLR.

The VLR may receive a MAP\_INSERT\_SUBSCRIBER\_DATA service indication from the HLR; this is handled by the macro Insert\_Subscriber\_Data\_VLR as described in clause 25.7.1, and the MAP process waits for a further response from the HLR.

The VLR may receive a MAP\_ACTIVATE\_TRACE\_MODE service indication from the HLR; this is handled by the macro Activate\_Tracing\_VLR as described in clause 25.9.3, and the MAP process waits for a further response from the HLR.

If the MAP process receives a MAP\_RESTORE\_DATA service confirm, it invokes the macro Check\_Confirmation to check the content of the confirm.

If the Check\_Confirmation macro takes the OK exit, the MAP process sends a Restore Data ack containing the information received from the HLR to the data restoration process in the VLR and returns to the idle state.

### Error in MAP\_RESTORE\_DATA confirm

If the MAP\_RESTORE\_DATA service confirm contains a user error or a provider error, or the macro Check\_Confirmation indicates that there is a data error, the MAP process sends a Restore Data negative response indicating the type of error to the call handling process in the HLR, and returns to the idle state.

### Earlier version MAP dialogue with the HLR

If the macro Receive\_Open\_Cnf takes the Vr exit, the VLR performs the earlier MAP version dialogue as specified in [51] or [96] and the process terminates.

### Dialogue opening failure

If the macro Receive\_Open\_Cnf indicates that the dialogue with the HLR could not be opened, the MAP process sends a negative response indicating system failure to the data restoration process in the GMSC and returns to the idle state.

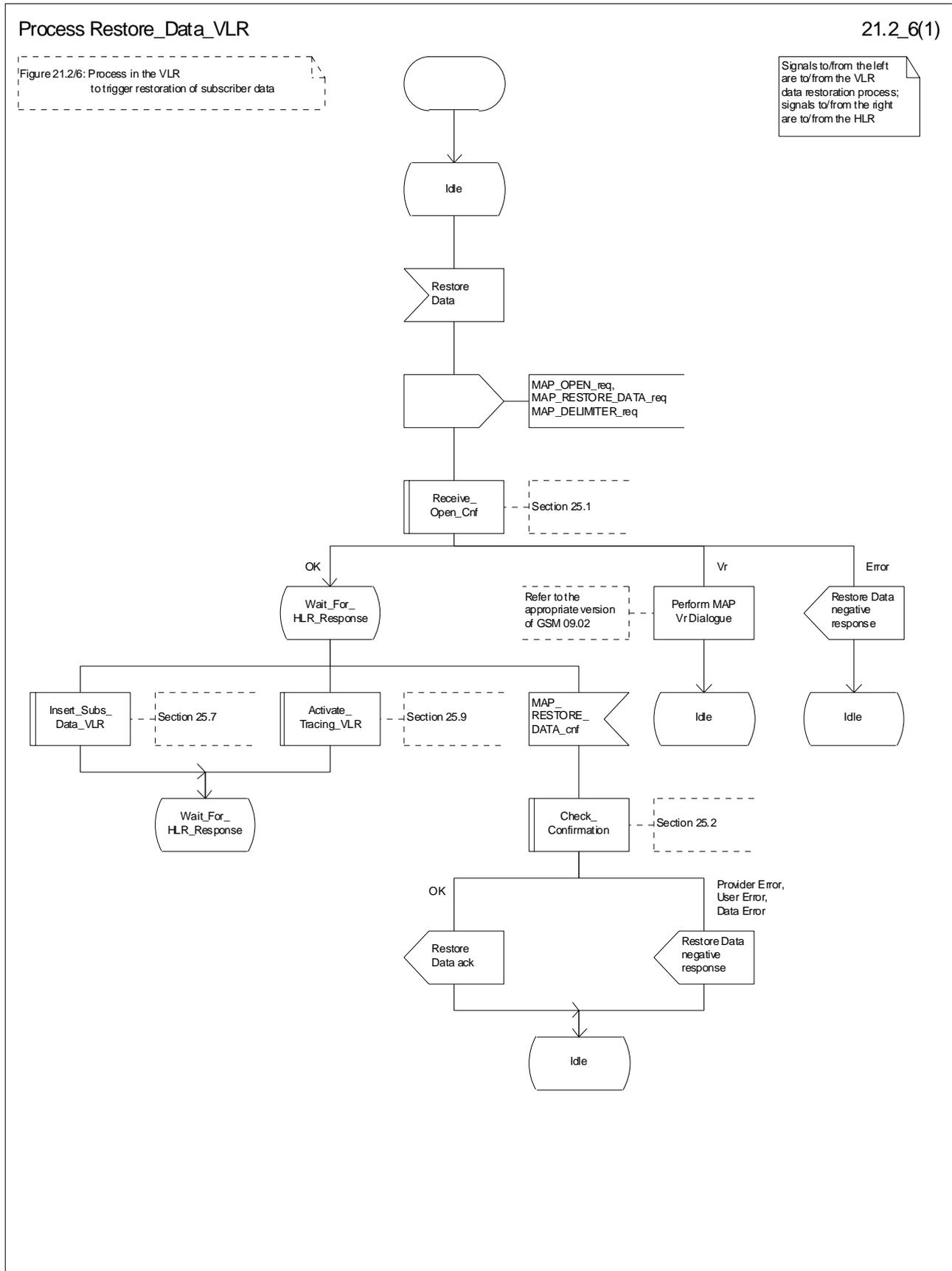

Figure 21.2/6: Process Restore\_Data\_VLR

## 21.2.6 Process in the VLR to provide subscriber information

The MAP process in the VLR to provide subscriber information for a mobile terminating call subject to CAMEL invocation is shown in figure 21.2/6. The MAP process invokes a macro not defined in this clause; the definition of this macro can be found as follows:

Receive\_Open\_Ind            see clause 25.1.1;

### Successful outcome

When the MAP process receives a MAP\_OPEN indication with the application context subscriberInfoEnquiry, it checks it by invoking the macro Receive\_Open\_Ind.

If the macro takes the OK exit, the MAP process waits for a service indication.

If a MAP\_PROVIDE\_SUBSCRIBER\_INFO service indication is received, the MAP process sends a Provide Subscriber Info request to the subscriber information request process in the VLR, and waits for a response. The Provide Subscriber Info request contains the parameters received in the MAP\_PROVIDE\_SUBSCRIBER\_INFO service indication.

If the subscriber information request process in the VLR returns a Provide Subscriber Info ack, the MAP process constructs a MAP\_PROVIDE\_SUBSCRIBER\_INFO service response containing the information contained in the Provide Subscriber Info ack, constructs a MAP\_CLOSE service request, sends them to the HLR and returns to the idle state.

### Failure of dialogue opening with the HLR

If the macro Receive\_Open\_Ind takes the Vr exit or the Error exit, the MAP process returns to the idle state.

If the MAP provider sends a MAP\_P\_ABORT while the MAP process is waiting for a service indication, the MAP process returns to the idle state.

If the MAP provider sends a MAP\_NOTICE while the MAP process is waiting for a service indication, the MAP process sends a MAP\_CLOSE request to terminate the dialogue and returns to the idle state.

Process PSI\_VLR

21.2\_7(1)

Figure 21.2/7: Process in the VLR to handle a request for subscriber information

Signals to/from the left are to/from the HLR; signals to/from the right are to/from the VLR subscriber information request process

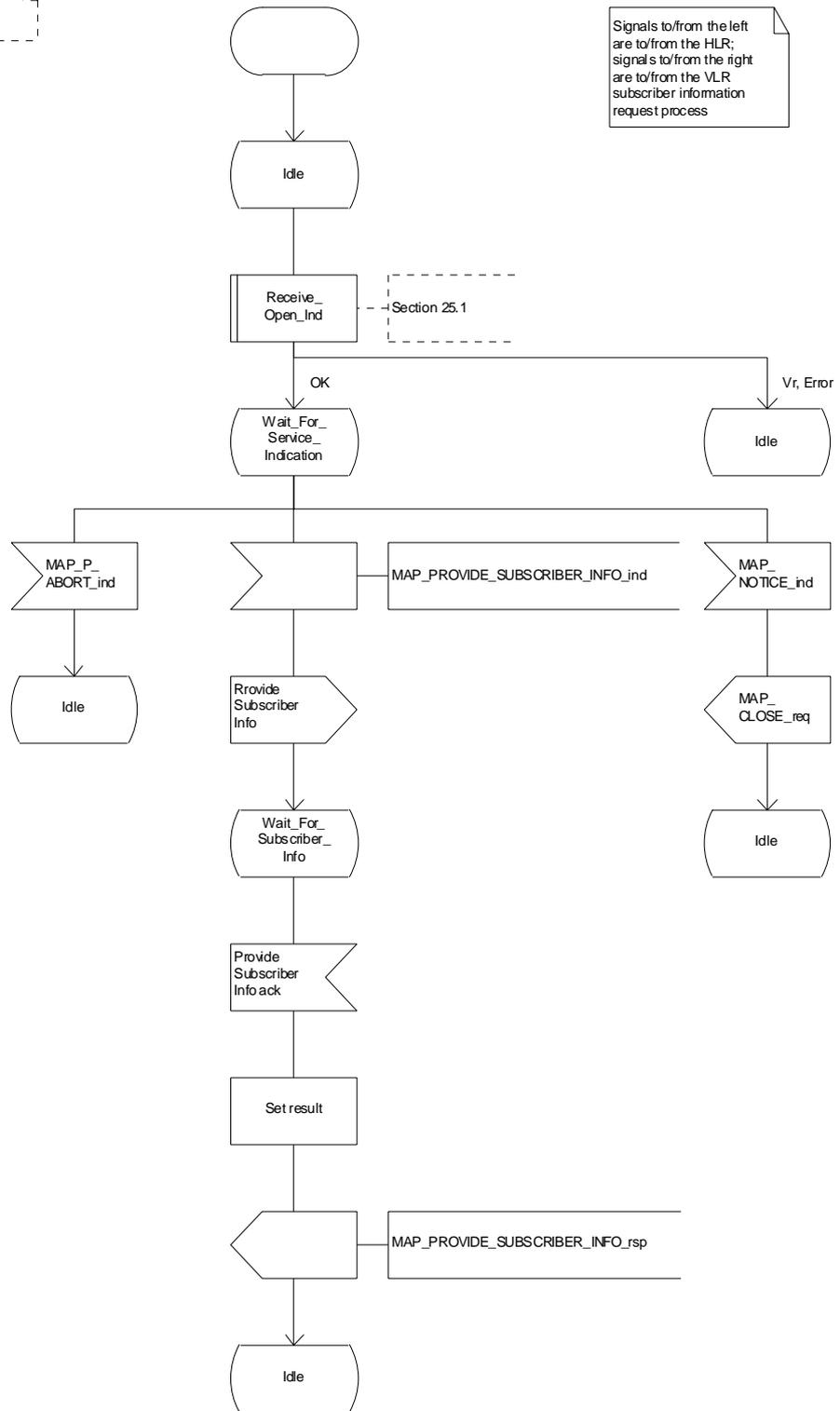
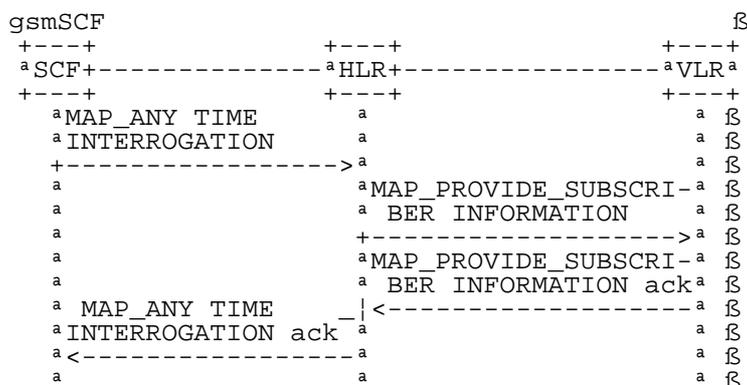

Figure 21.2/7: Process PSI\_VLR

### 21.2.7 Process in the HLR for Any Time Interrogation

The message flows for successful retrieval of subscriber information related to an any time interrogation from the CAMEL server are shown in figure 21.2/8.



**Figure 21.2/8: Message flow for any time interrogation**

The following MAP services are used to retrieve routing information:

- MAP\_ANY\_TIME\_INTERROGATION see clause 8.11.1;
- MAP\_PROVIDE\_SUBSCRIBER\_INFO see clause 8.11.2;

#### 21.2.7.1 Process in the gsmSCF

Out of the scope of the MAP specification.

#### 21.2.3 Process in the HLR

The MAP process in the HLR to provide subscriber information in response to an interrogation from the CAMEL server is shown in figure 21.2/8. The MAP process invokes macros not defined in this clause; the definitions of these macros can be found as follows:

- Receive\_Open\_Ind see clause 25.1.1;
- Receive\_Open\_Cnf see clause 25.1.2;
- Check\_Confirmation see clause 25.2.2.

#### Successful outcome

When the MAP process receives a MAP\_OPEN indication with the application context anyTimeInterrogationEnquiry, it checks it by invoking the macro Receive\_Open\_Ind.

If the macro takes the OK exit, the MAP process waits for a service indication.

If a MAP\_ANY\_TIME\_INTERROGATION service indication is received, the MAP process sends an Any Time Interrogation request to the call handling process in the HLR (described in GSM 03.78), and waits for a response. The Any Time Interrogation request contains the parameters received in the MAP\_ANY\_TIME\_INTERROGATION service indication.

If the call handling process in the HLR returns an Any Time Interrogation response, the MAP process constructs a MAP\_ANY\_TIME\_INTERROGATION service response containing the subscriber information contained in the Any Time Interrogation response, constructs a MAP\_CLOSE service request, sends them to the CAMEL server and returns to the idle state.

If the call handling process in the HLR returns a Provide Subscriber Info request, the MAP process requests a dialogue with the VLR whose identity is contained in the Provide Subscriber Info request by sending a MAP\_OPEN service request, requests the subscriber status using a MAP\_PROVIDE\_SUBSCRIBER\_INFO service request, and invokes the macro Receive\_Open\_Cnf to wait for the response to the dialogue opening request.

If the macro takes the OK exit, the MAP process waits for the response from the VLR.

If the MAP process receives a MAP\_PROVIDE\_SUBSCRIBER\_INFO service confirm, it invokes the macro Check\_Confirmation to check the content of the confirm.

If the Check\_Confirmation macro takes the OK exit, the MAP process sends a Provide Subscriber Info ack containing the information received in the MAP\_PROVIDE\_SUBSCRIBER\_INFO service confirm to the call handling process in the HLR, and waits for a response. The handling of the response from the call handling process in the HLR is described above.

If the MAP\_PROVIDE\_SUBSCRIBER\_INFO service confirm contains a provider error or a data error, the MAP process sends a Provide Subscriber Info negative response indicating the type of error to the call handling process in the HLR, and waits for a response. The handling of the response from the call handling process in the HLR is described above.

NOTE: The 'User Error' exit from the macro Check\_Confirmation is shown for formal completeness; the MAP\_PROVIDE\_SUBSCRIBER\_INFO\_cnf primitive cannot contain a user error.

#### **Negative response from HLR call handling process**

If the call handling process in the HLR returns a negative response, either before or after a dialogue with the VLR to obtain subscriber information, the MAP process constructs a MAP\_ANY\_TIME\_INTERROGATION service response containing the appropriate error, constructs a MAP\_CLOSE service request, sends them to the CAMEL server and returns to the idle state.

#### **Failure of Provide Subscriber Info dialogue with the VLR**

If the Receive\_Open\_Cnf macro takes the Vr exit or the Error exit after the MAP process has requested opening of a Provide Subscriber Info dialogue with the VLR, the MAP process sends a Provide Subscriber Info negative response indicating system failure to the call handling process in the HLR, and waits for a response. The handling of the response from the call handling process in the HLR is described above.

#### **Failure of dialogue opening with the CAMEL server**

If the macro Receive\_Open\_Ind takes the Vr or Error exit, the MAP process returns to the idle state.

If the MAP provider sends a MAP\_P\_ABORT while the MAP process is waiting for a service indication, the MAP process returns to the idle state.

If the MAP provider sends a MAP\_NOTICE while the MAP process is waiting for a service indication, the MAP process sends a MAP\_CLOSE request to terminate the dialogue and returns to the idle state.

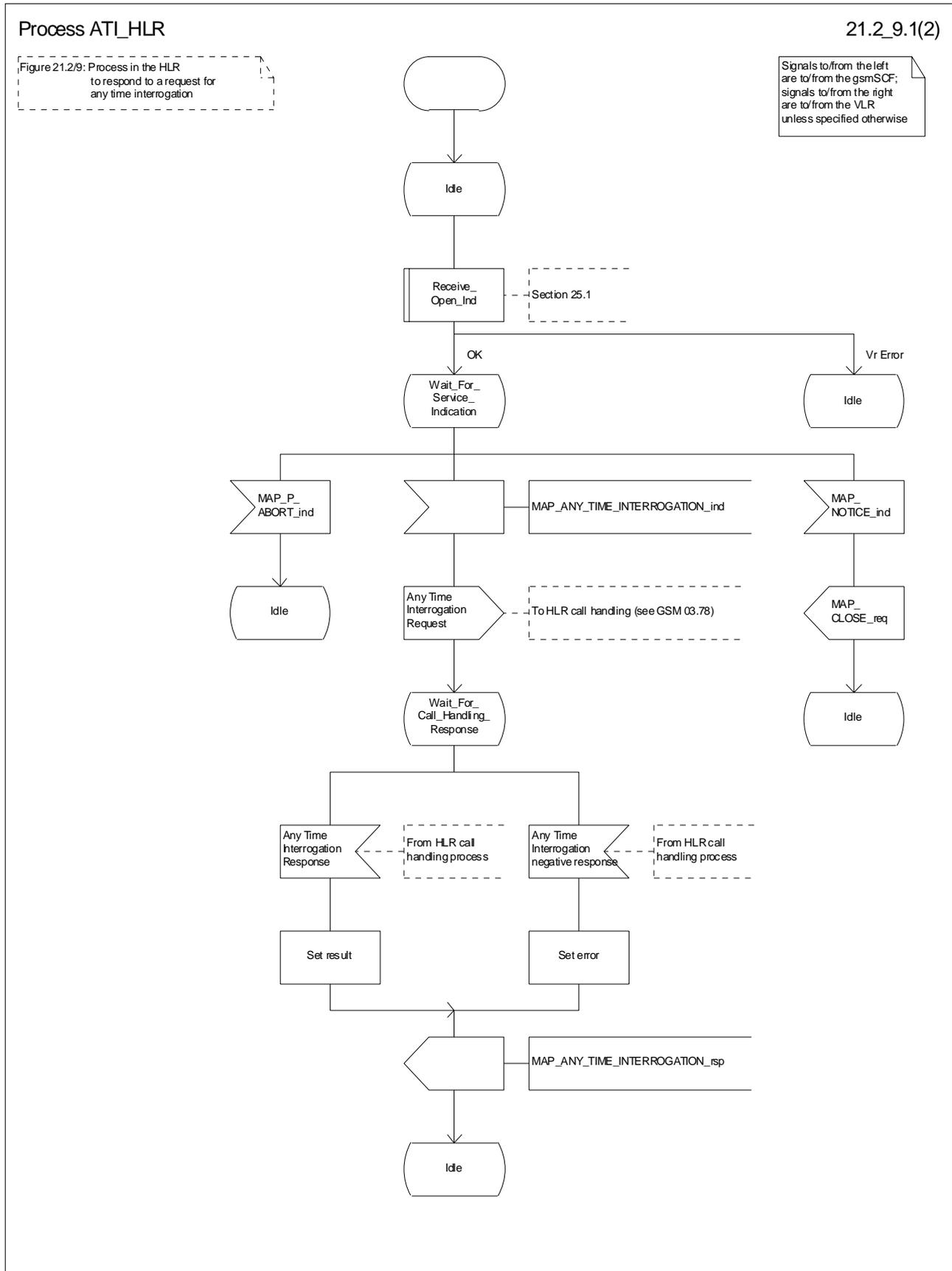

Figure 21.2/9 (sheet 1 of 2): Process ATI\_HLR (New)



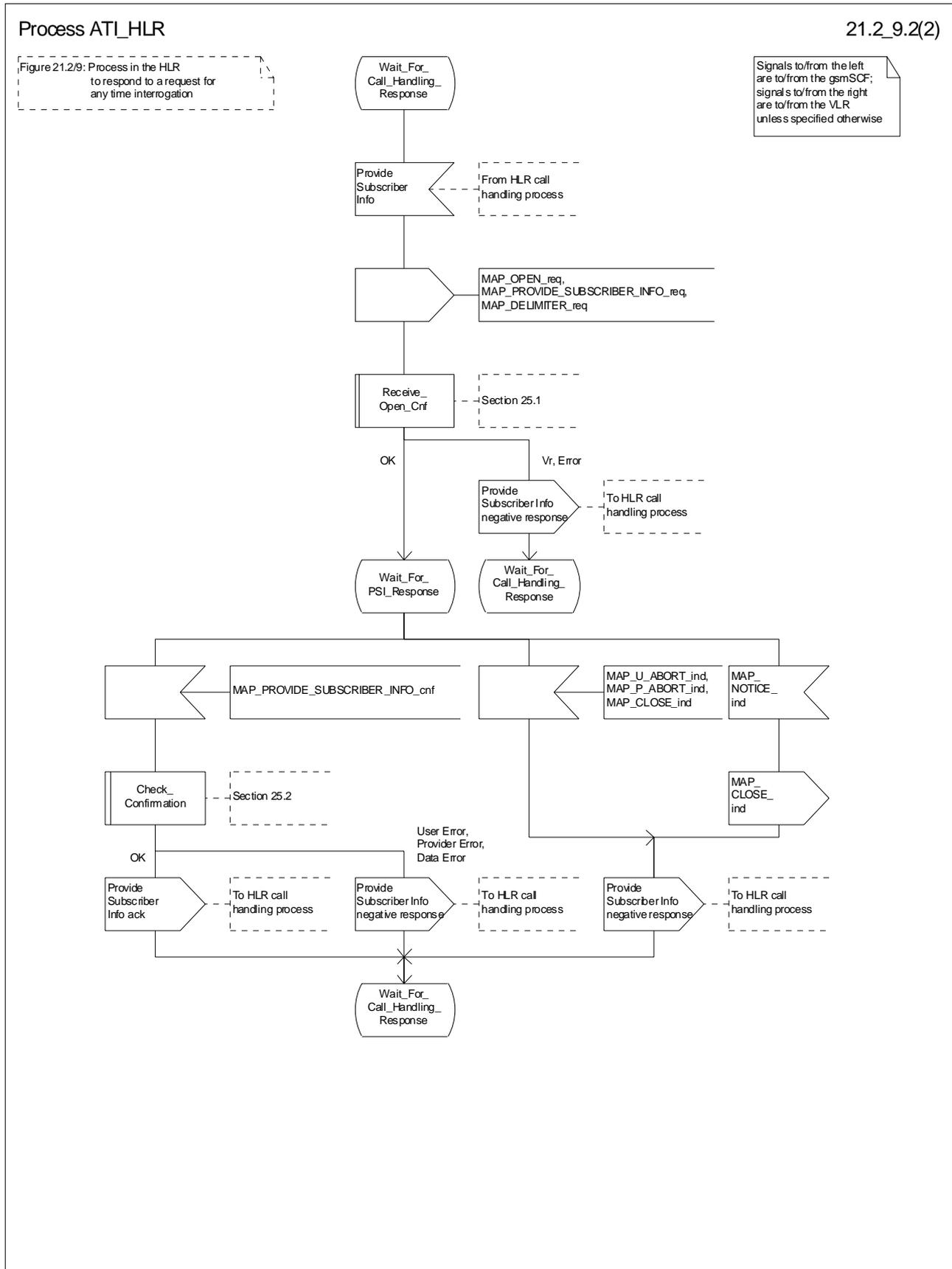
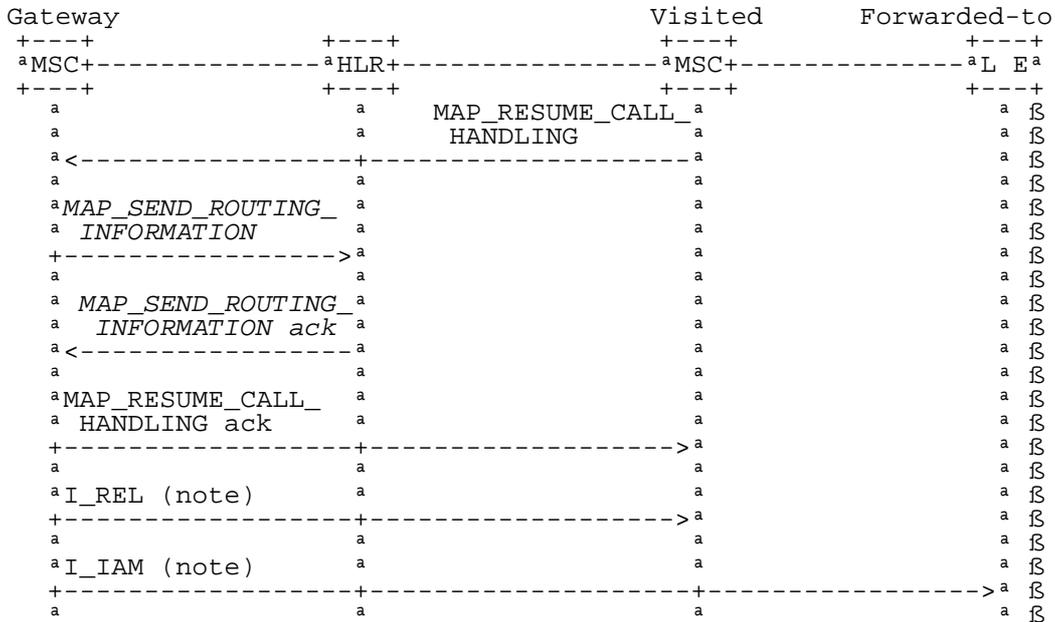

Figure 21.2/9 (sheet 2 of 2): Process ATI\_HLR (New)

## 21.3 Transfer of call handling

### 21.3.1 General

The message flow for successful transfer of call handling to forward a call is shown in figure 21.3/1.



NOTES:

xxx = *Optional Procedure*

TUP or ISUP may be used in signalling between MSCs, depending on the network type between the MSCs. For further details on the TUP and ISUP procedures refer to the following CCITT Recommendations & ETSI specification:

Q.721-725 - Telephone User Part (TUP);

ETS 300 356-1 - Integrated Services Digital Network (ISDN); Signalling System No.7; ISDN User Part (ISUP) version 2 for the international interface; Part 1: Basic services.

**Figure 21.3/1: Message flow for transfer of call handling**

If the HLR indicated in the response to the original request for routing information that forwarding interrogation is required, the GMSC executes the Send Routing Information procedure with the HLR to obtain forwarding information; otherwise the GMSC uses the forwarding data which were sent in the MAP\_RESUME\_CALL\_HANDLING req/ind.

## 21.3.2 Process in the VMSC

The MAP process in the VMSC to retrieve routing information for a mobile terminating call is shown in figure 21.3/2. The MAP process invokes macros not defined in this clause; the definitions of these macros can be found as follows:

Receive_Open_Cnf	see clause 25.1.2;
Check_Confirmation	see clause 25.2.2.

### Successful Outcome

When the MAP process receives a Resume Call Handling request from the call handling process in the VMSC, it requests a dialogue with the GMSC whose identity is contained in the Resume Call Handling request by sending a MAP\_OPEN service request, requests routing information using a MAP\_RESUME\_CALL\_HANDLING service request and invokes the macro Receive\_Open\_Cnf to wait for the response to the dialogue opening request. If the dialogue opening is successful, the MAP process waits for a response from the GMSC.

If the MAP process receives a MAP\_RESUME\_CALL\_HANDLING service confirm from the GMSC, the MAP process invokes the macro Check\_Confirmation to check the content of the confirm.

If the macro Check\_Confirmation takes the OK exit, the MAP process sends a Resume Call Handling ack to the call handling process in the VMSC and returns to the idle state.

### Dialogue opening failure

If the macro Receive\_Open\_Cnf indicates that the dialogue with the GMSC could not be opened or that the dialogue can be opened only at an earlier version, the MAP process sends an Resume Call Handling negative response indicating system failure to the call handling process in the VMSC and returns to the idle state.

### Error in MAP\_RESUME\_CALL\_HANDLING confirm

If the MAP\_RESUME\_CALL\_HANDLING service confirm contains a user error or a provider error, the MAP process sends a Resume Call Handling negative response to the call handling process in the VMSC and returns to the idle state.

NOTE: the 'Data Error' exit from the macro Check\_Confirmation is shown for formal completeness; the result is empty, so the MAP\_PROVIDE\_SUBSCRIBER\_INFO\_cnf primitive cannot contain a data error.]

### Abort of GMSC dialogue

After the dialogue with the GMSC has been established, the MAP service provider may abort the dialogue by issuing a MAP\_P\_ABORT indication, or the GMSC may send a MAP\_CLOSE indication. In either of these cases, the MAP process sends a Resume Call Handling negative response to the call handling process in the GMSC and returns to the idle state.

If the MAP provider indicates a protocol problem by sending a MAP\_NOTICE indication, the MAP process closes the dialogue with the GMSC, sends a Resume Call Handling negative response indicating system failure to the call handling process in the VMSC and returns to the idle state.

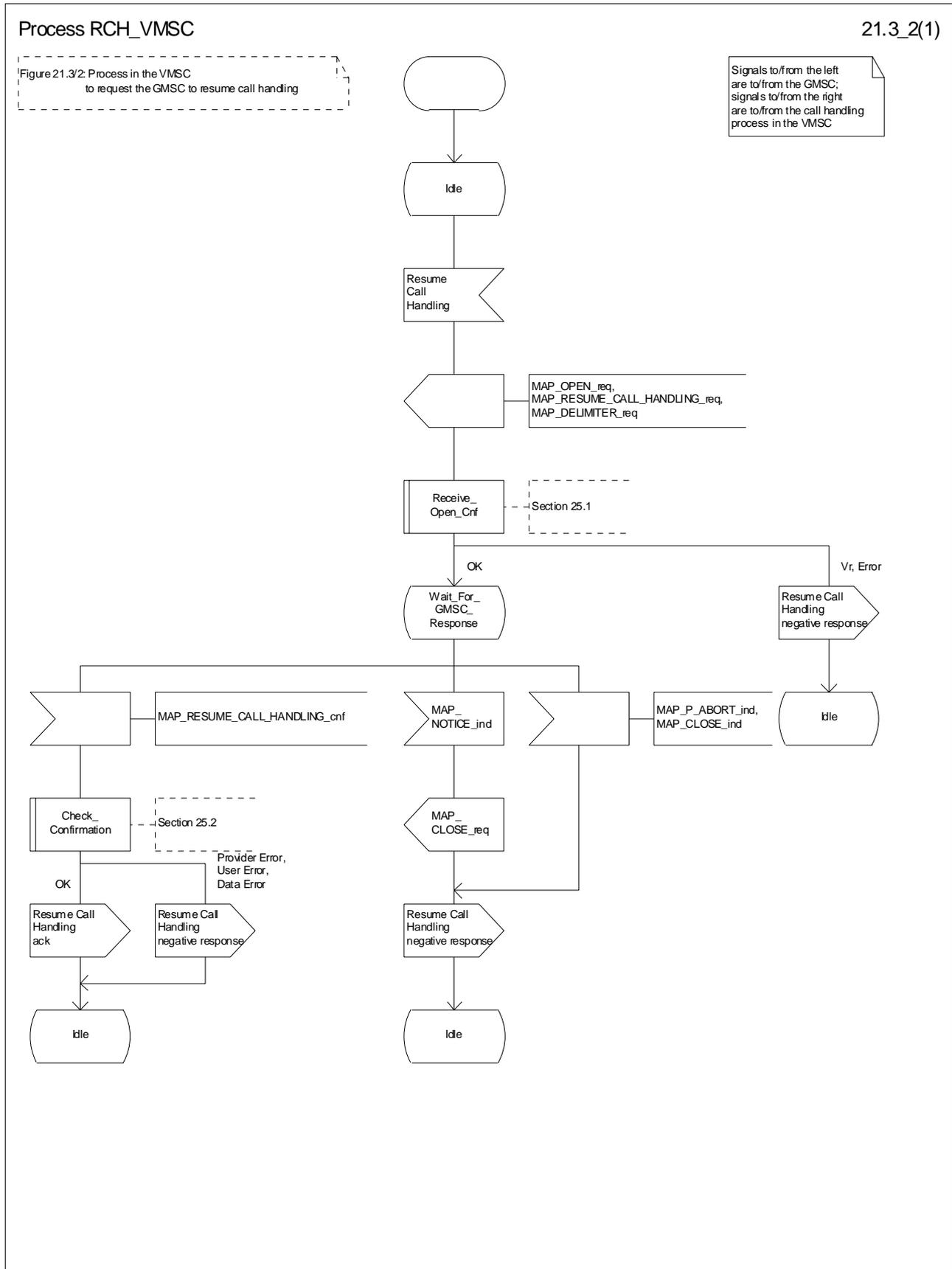

Figure 21.3/2: Process RCH\_VMSC

### 21.3.3 Process in the GMSC

The MAP process in the GMSC to handle a request for the GMSC to resume call handling is shown in figure 21.3/3. The MAP process invokes a macro not defined in this clause; the definition of this macro can be found as follows:

Receive\_Open\_Ind            see clause 25.1.1;

#### **Successful outcome**

When the MAP process receives a MAP\_OPEN indication with the application context callControlTransfer, it checks it by invoking the macro Receive\_Open\_Ind.

If the macro takes the OK exit, the MAP process waits for a service indication.

If a MAP\_RESUME\_CALL\_HANDLING service indication is received, the MAP process sends a Resume Call Handling request to the call handling process in the GMSC, and waits for a response. The Resume Call Handling request contains the parameters received in the MAP\_RESUME\_CALL\_HANDLING service indication.

If the call handling process in the GMSC returns a Resume Call Handling ack, the MAP process constructs a MAP\_RESUME\_CALL\_HANDLING service response, constructs a MAP\_CLOSE service request, sends them to the HLR and returns to the idle state.

#### **Failure of dialogue opening with the VMSC**

If the macro Receive\_Open\_Ind takes the Vr exit or the Error exit, the MAP process returns to the idle state.

If the MAP provider sends a MAP\_P\_ABORT while the MAP process is waiting for a service indication, the MAP process returns to the idle state.

If the MAP provider sends a MAP\_NOTICE while the MAP process is waiting for a service indication, the MAP process sends a MAP\_CLOSE request to terminate the dialogue and returns to the idle state.

Process RCH\_GMSC

21.3\_3(1)

Figure 21.3/3: Process in the GMSC to handle a request to resume call handling

Signals to/from the left are to/from the GMSC call handling process; signals to/from the right are to/from the VMSC

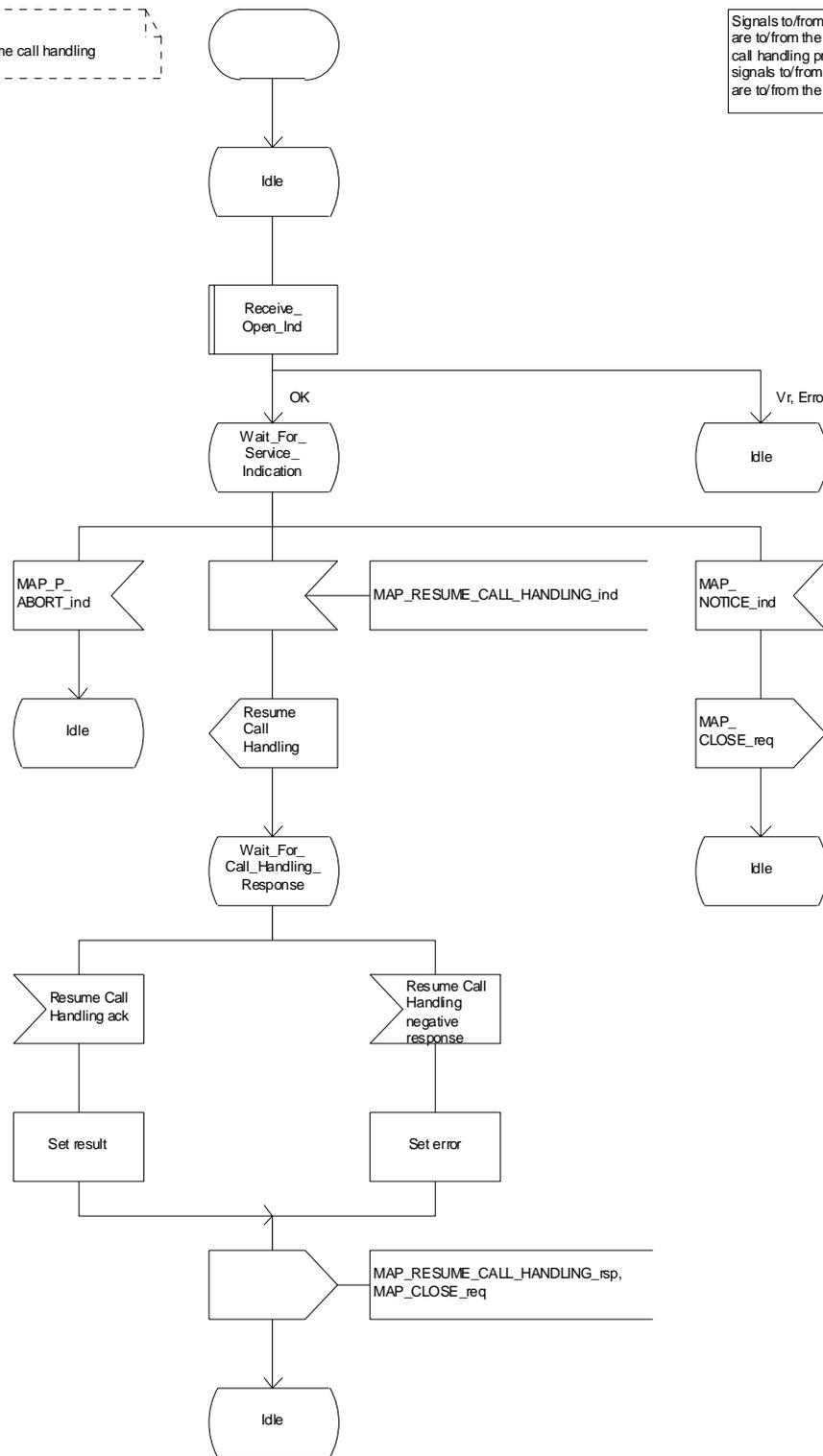
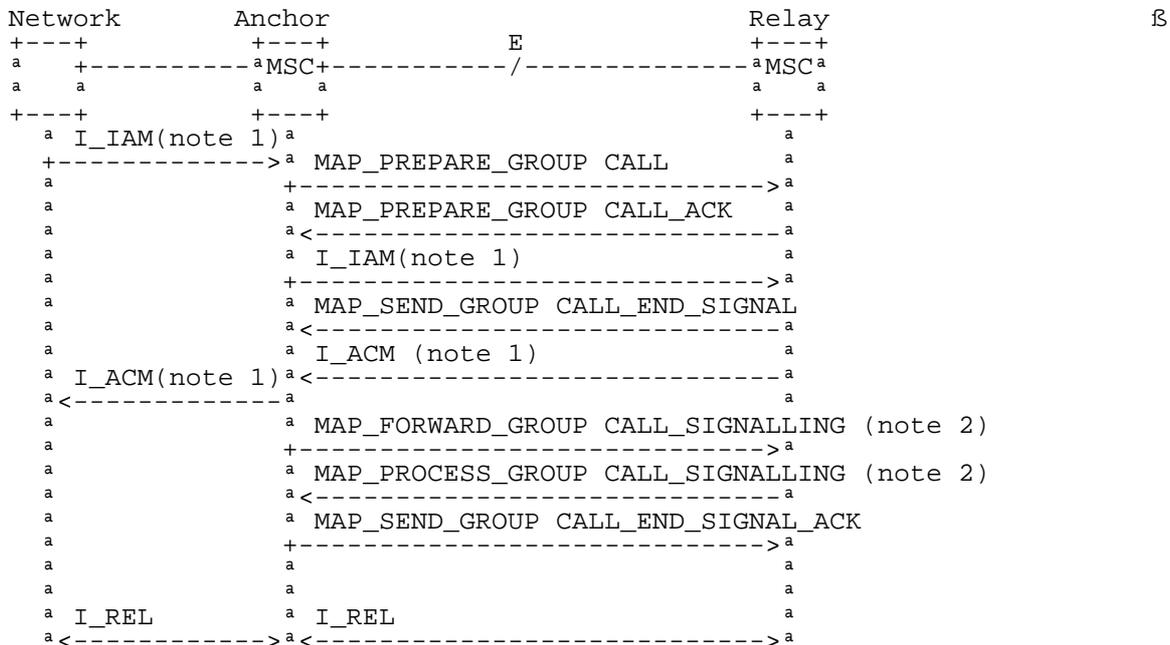

Figure 21.3/3: Process RCH\_GMSC

## 21.4 Inter MSC Group Call Procedures

### 21.4.1 General

The message flows for successful inter MSC group call / broadcast call setup is shown in figure 21.4/1.



NOTE 1: TUP or ISUP may be used in signalling between MSCs, depending on the network type between the MSCs. For further details on the TUP and ISUP procedures refer to the following ITU-T Recommendations and ETSI specification:

Q.721-725 - Telephone User Part (TUP);

ETS 300 356-1 - Integrated Services Digital Network (ISDN); Signalling System No.7; ISDN User Part (ISUP) version 2 for the international interface; Part 1: Basic services.

NOTE 2: The MAP\_FORWARD\_GROUP\_CALL\_SIGNALLING and MAP\_PROCESS\_GROUP\_CALL\_SIGNALLING services are not applicable for voice broadcast calls.

**Figure 21.4/1: Message flow for inter MSC group call / broadcast call**

### 21.4.2 Process in the Anchor MSC

The MAP process in the Anchor MSC to retrieve and transfer information from / to the Relay MSC for VBS and VGCS calls is shown in figure 21.4/2. The MAP process invokes macros not defined in this clause; the definitions of these macros can be found as follows:

- Receive\_Open\_Cnf see clause 25.1.2;
- Check\_Indication see clause 25.2.1;
- Check\_Confirmation see clause 25.2.2.

### Successful Outcome

When the MAP process receives a Prepare Group Call request from the ASCI handling process in the anchor MSC, it requests a dialogue with the relay MSC whose identity is contained in the Prepare Group Call request by sending a MAP\_OPEN service request, requests a Group Call number by using a MAP\_PREPARE\_GROUP\_CALL service request and invokes the macro Receive\_Open\_Cnf to wait for the response to the dialogue opening request. If the dialogue opening is successful, the MAP process waits for a response from the relay MSC.

If the MAP process receives a MAP\_PREPARE\_GROUP\_CALL service confirm from the relay MSC, the MAP process invokes the macro Check\_Confirmation to check the content of the confirm.

If the macro Check\_Confirmation takes the OK exit, the MAP process sends a Prepare Group Call ack containing the Group Call number received from the relay MSC to the ASCI handling process in the anchor MSC and waits for completion of call setup in the relay MSC.

On receipt of a MAP\_SEND\_GROUP\_CALL\_END\_SIGNAL service indication from the relay MSC the MAP process invokes the macro Check\_Indication to check the content of the indication.

If the macro Check\_Indication takes the OK exit, the MAP process sends a Send Group Call End Signal to the ASCI handling process in the anchor MSC and waits for uplink management signals. In this state the following events are processed:

- Reception of a Send Group Call End Signal ack from the ASCI handling process in the anchor MSC;
- Reception of a Forward Group Call Signalling request from the ASCI handling process in the anchor MSC;
- Reception of a MAP\_PROCESS\_GROUP\_CALL\_SIGNALLING service indication from the relay MSC.

On reception of a Send Group Call End Signal ack from the ASCI handling process in the anchor MSC, the MAP process constructs a MAP\_SEND\_GROUP\_CALL\_END\_SIGNAL service response, constructs a MAP\_CLOSE service request, sends them to the relay MSC and returns to the idle state.

On reception of a Forward Group Call Signalling request from the ASCI handling process in the anchor MSC, the MAP process constructs a MAP\_FORWARD\_GROUP\_CALL\_SIGNALLING service request, sends it to the relay MSC and returns to the uplink management state.

On reception of a MAP\_PROCESS\_GROUP\_CALL\_SIGNALLING service indication from the relay MSC, the MAP process invokes the macro Check\_Indication to check the content of the indication.

If the macro Check\_Indication takes the OK exit, the MAP process sends a Process Group Call Signalling to the ASCI handling process in the anchor MSC and returns to the uplink management state.

### Dialogue opening failure

If the macro Receive\_Open\_Cnf indicates that the dialogue with the relay MSC could not be opened, the MAP process sends an Abort to the ASCI handling process and returns to the idle state.

### Error in MAP\_PREPARE\_GROUP\_CALL confirm

If the MAP\_PREPARE\_GROUP\_CALL service confirm contains a user error or a provider error, or the macro Check\_Confirmation indicates that there is a data error, the MAP process sends a Prepare Group Call negative response to the ASCI handling process in the anchor MSC, sends a MAP\_U\_ABORT request to the relay MSC and returns to the idle state.

### Abort of MAP dialogue

After the dialogue with the relay MSC has been established, the MAP service provider may abort the dialogue by issuing a MAP\_P\_ABORT indication, or the relay MSC may send a MAP\_U\_ABORT indication or a MAP\_CLOSE indication. In any of these cases, the MAP process sends an Abort to the ASCI handling process in the anchor MSC and returns to the idle state.

If the MAP provider indicates a protocol problem by sending a MAP\_NOTICE indication, the MAP process closes the dialogue with the relay MSC, sends an Abort to the ASCI handling process in the anchor MSC and returns to the idle state.



Process ASCI\_Anchor\_MSC

21.4\_2.1(4)

Figure 21.4/2: Process in the Anchor MSC for ASCI call handling

Signals to/from the left are to/from the A-MSC ASCI process; signals to/from the right are to/from the R-MSC

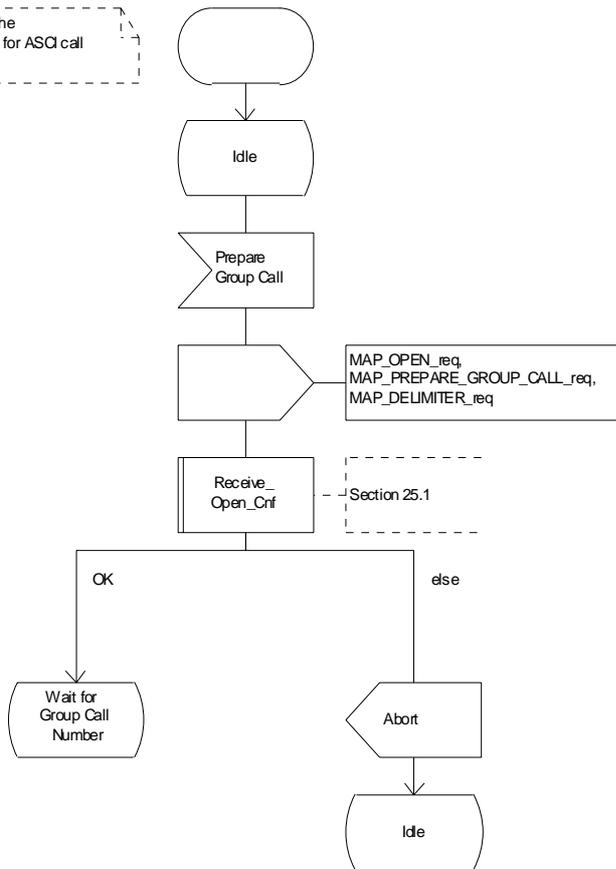

Figure 21.4/2 (sheet 1 of 4): Process ASCI\_Anchor\_MSC

Process ASCI\_Anchor\_MSC

21.4\_2.2(4)

Figure 21.4/2: Process in the Anchor MSC for ASCI call handling

Signals to/from the left are to/from the A-MSC ASCI process; signals to/from the right are to/from the R-MSC

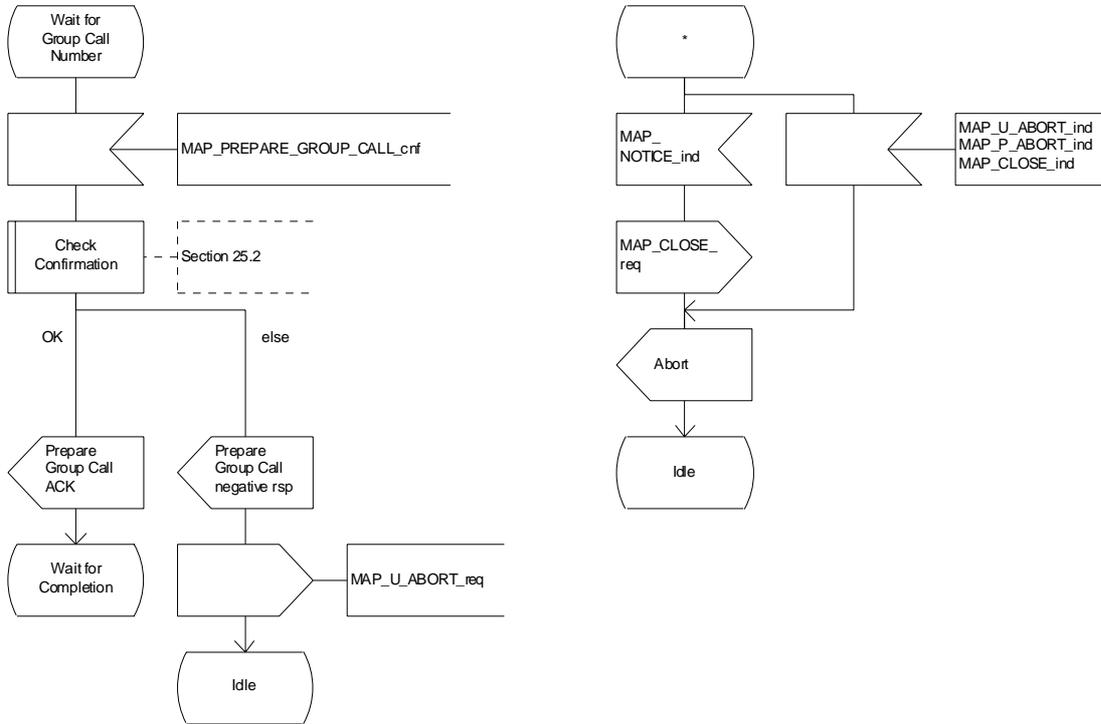

Figure 21.4/2 (sheet 2 of 4): Process ASCI\_Anchor\_MSC

### Process ASCI\_Anchor\_MSC

21.4\_2.3(4)

Figure 21.4/2: Process in the Anchor MSC for ASCI call handling

Signals to/from the left are to/from the A-MSC ASCI process; signals to/from the right are to/from the R-MSC

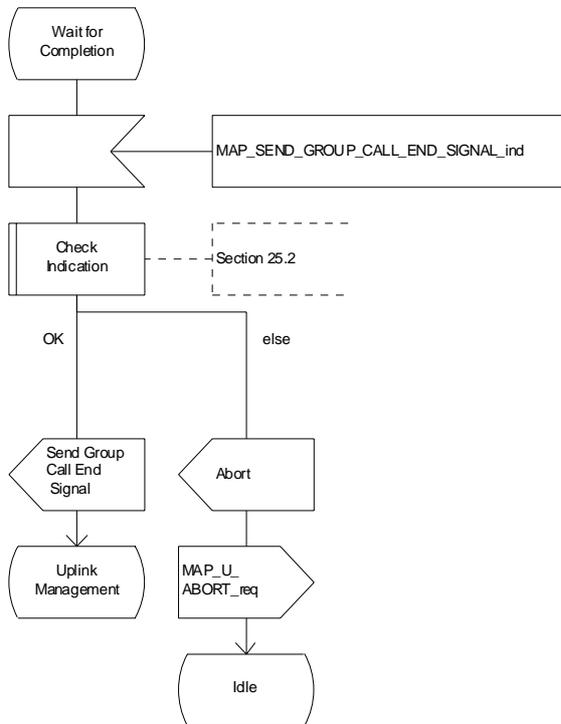

Figure 21.4/2 (sheet 3 of 4): Process ASCI\_Anchor\_MSC

Process ASCI\_Anchor\_MSC

21.4\_2.4(4)

Figure 21.4/2: Process in the Anchor MSC for ASCI call handling

Signals to/from the left are to/from the A-MSC ASCI process; signals to/from the right are to/from the R-MSC

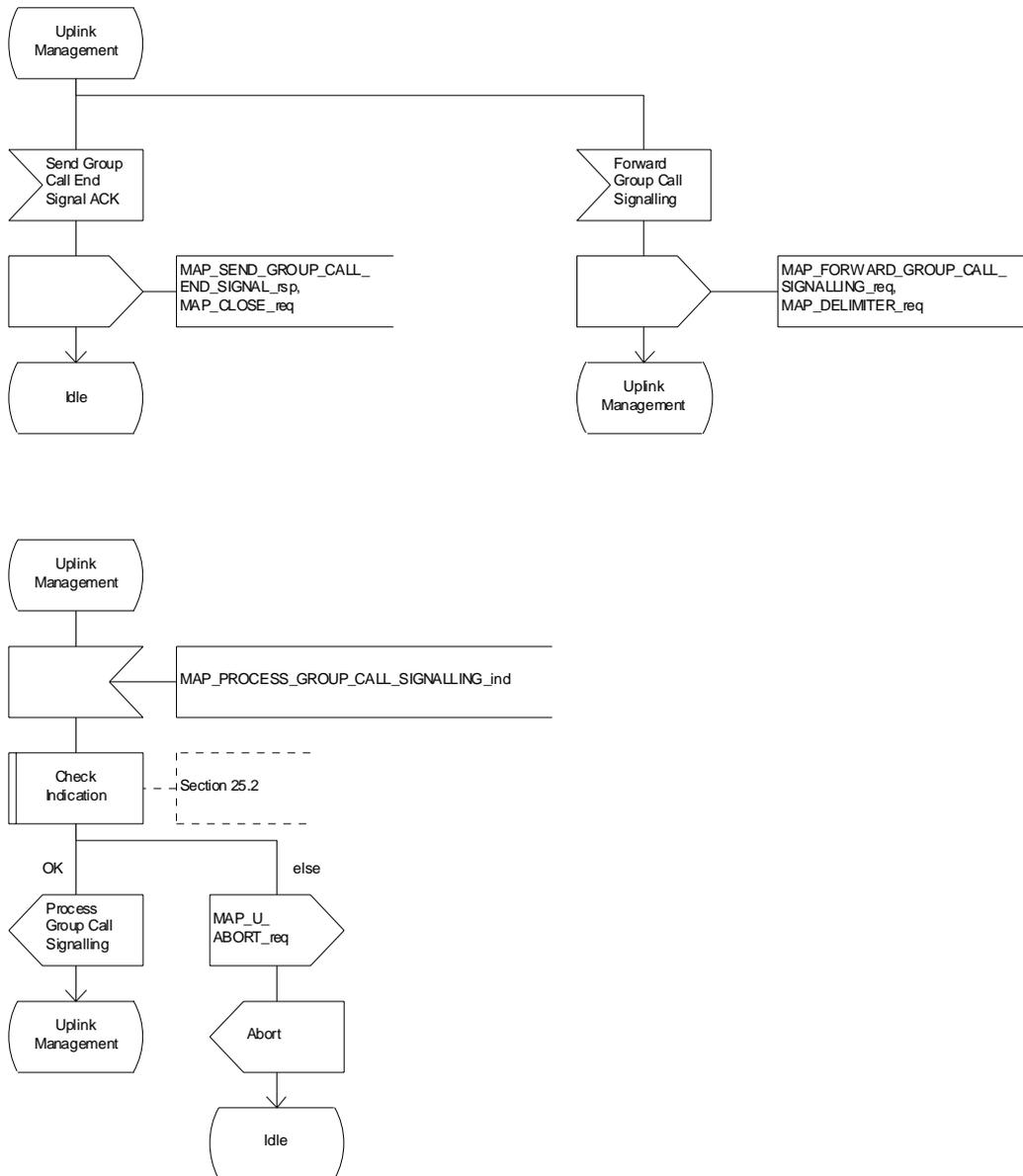

Figure 21.4/2 (sheet 4 of 4): Process ASCI\_Anchor\_MSC

### 21.4.3 Process in the Relay MSC

The MAP process in the Relay MSC to receive and transfer information from / to the Anchor MSC for VBS and VGCS calls is shown in figure 21.4/3. The MAP process invokes macros not defined in this clause; the definitions of these macros can be found as follows:

Receive_Open_Ind	see clause 25.1.2;
Check_Indication	see clause 25.2.1.

#### Successful Outcome

When the MAP process receives a MAP\_OPEN indication with the application context groupCallControl, it checks it by invoking the macro Receive\_Open\_Ind.

If the macro takes the OK exit, the MAP process waits for a service indication.

If a MAP\_PREPARE\_GROUP\_CALL service indication is received, the MAP process invokes the macro Check\_Indication.

If the macro takes the OK exit, the MAP process sends a Prepare Group Call request to the ASCI handling process in the relay MSC and waits for a response. The Prepare Group Call request contains the parameters received in the MAP\_PREPARE\_GROUP\_CALL service indication.

If the ASCI handling process in the relay MSC returns a Prepare Group Call ack, the MAP process constructs a MAP\_PREPARE\_GROUP\_CALL service response containing the information contained in the Prepare Group Call ack, constructs a MAP\_DELIMITER service request, sends them to the anchor MSC and waits for the GROUP CALL END SIGNAL.

If the ASCI handling process in the relay MSC sends a Send Group Call End Signal request to the MAP process, the MAP process constructs a MAP\_SEND\_GROUP\_CALL\_END\_SIGNAL service request containing the information contained in the SEND GROUP CALL End Signal request, constructs a MAP\_DELIMITER service request, sends them to the anchor MSC and waits for uplink management signals. In this state the following events are processed:

- Reception of a MAP\_SEND\_GROUP\_CALL\_END\_SIGNAL service confirmation from the anchor MSC;
- Reception of a MAP\_FORWARD\_GROUP\_CALL\_SIGNALLING service indication from the anchor MSC;
- Reception of a Process Group Call Signalling request from the ASCI handling process in the relay MSC.

On reception of a MAP\_SEND\_GROUP\_CALL\_END\_SIGNAL service confirmation from the anchor MSC, the MAP process returns to the idle state.

On reception of a MAP\_FORWARD\_GROUP\_CALL\_SIGNALLING service indication from the anchor MSC, the MAP process invokes the macro Check Indication. If the macro takes the OK exit, the MAP process sends a Forward Group Call Signalling request to the ASCI handling process in the relay MSC and waits for further uplink management signals.

On reception of a Process Group Call Signalling request from the ASCI handling process in the relay MSC, the MAP process constructs a MAP\_PROCESS\_GROUP\_CALL\_SIGNALLING service request containing the information received in the Process Group Call Signalling request, constructs a MAP\_DELIMITER service request, sends them to the anchor MSC and waits for further uplink management signals.

#### Failure of dialogue opening with the anchor MSC

If the macro Receive\_Open\_Ind takes the Error exit, the MAP process returns to the idle state.

If the MAP provider sends a MAP\_P\_ABORT while the MAP process is waiting for a service indication, the MAP process returns to the idle state.

If the MAP provider sends a MAP\_NOTICE while the MAP process is waiting for a service indication, the MAP process sends a MAP\_CLOSE request to terminate the dialogue and returns to the idle state.

**Error in MAP\_PREPARE\_GROUP\_CALL indication**

If the macro Check Indication takes the Error exit, the MAP process sends a MAP\_U\_ABORT request to the anchor MSC and returns to the idle state.

**Negative response received from the ASCI handling process**

If the ASCI handling process in the relay MSC returns a negative response to the Prepare Group Call request, the MAP process constructs a MAP\_PREPARE\_GROUP\_CALL service response containing the appropriate error, constructs a MAP\_CLOSE service request, sends them to the anchor MSC and returns to the idle state.

**Error in MAP\_FORWARD\_GROUP\_CALL\_SIGNALLING indication**

If the macro Check Indication takes the Error exit, the MAP process sends a MAP\_U\_ABORT request to the anchor MSC, sends an Abort to the ASCI handling process in the relay MSC and returns to the idle state.

**Abort of MAP dialogue**

After the dialogue with the anchor MSC has been established, the MAP service provider may abort the dialogue by issuing a MAP\_P\_ABORT indication, or the anchor MSC may send a MAP\_U\_ABORT indication or a MAP\_CLOSE indication. In any of these cases, the MAP process sends an Abort to the ASCI handling process in the relay MSC and returns to the idle state.

If the MAP provider indicates a protocol problem by sending a MAP\_NOTICE indication, the MAP process closes the dialogue with the anchor MSC, sends an Abort to the ASCI handling process in the anchor MSC and returns to the idle state.

Process ASCI\_Relay\_MSC

21.4\_3.1(3)

Figure 21.4/3: Process in the Relay MSC for ASCI call handling

Signals to/from the left are to/from the A-MSC; Signals to/from the right are to/from the R-MSC ASCI process

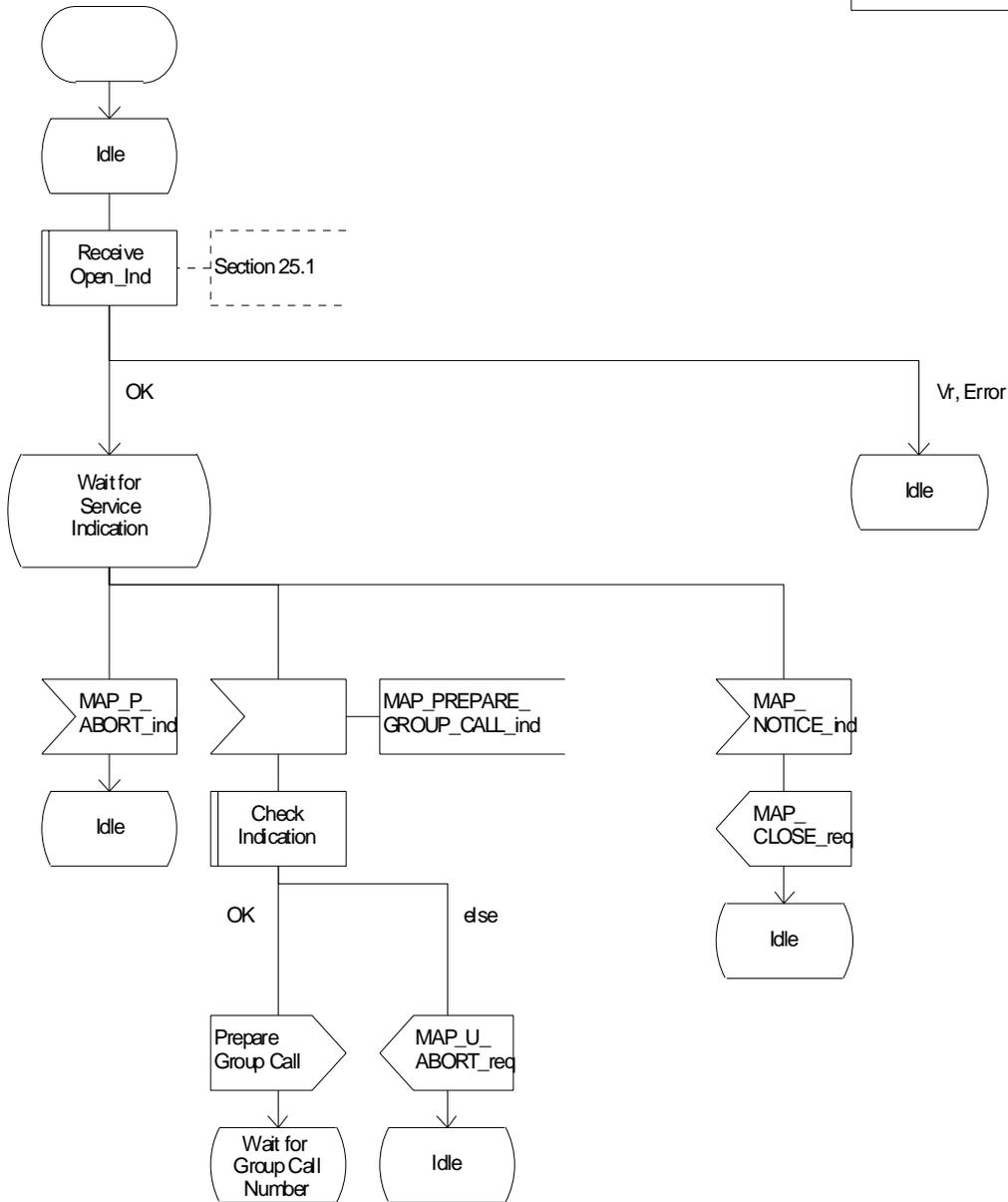

Figure 21.4/3 (sheet 1 of 3): Process ASCI\_Relay\_MSC

Process ASCII\_Relay\_MSC

21.4\_3.2(3)

Figure 21.4/3: Process in the Relay MSC for ASCII call handling

Signals to/from the left are to/from the A-MSC; Signals to/from the right are to/from the R-MSC ASCII process

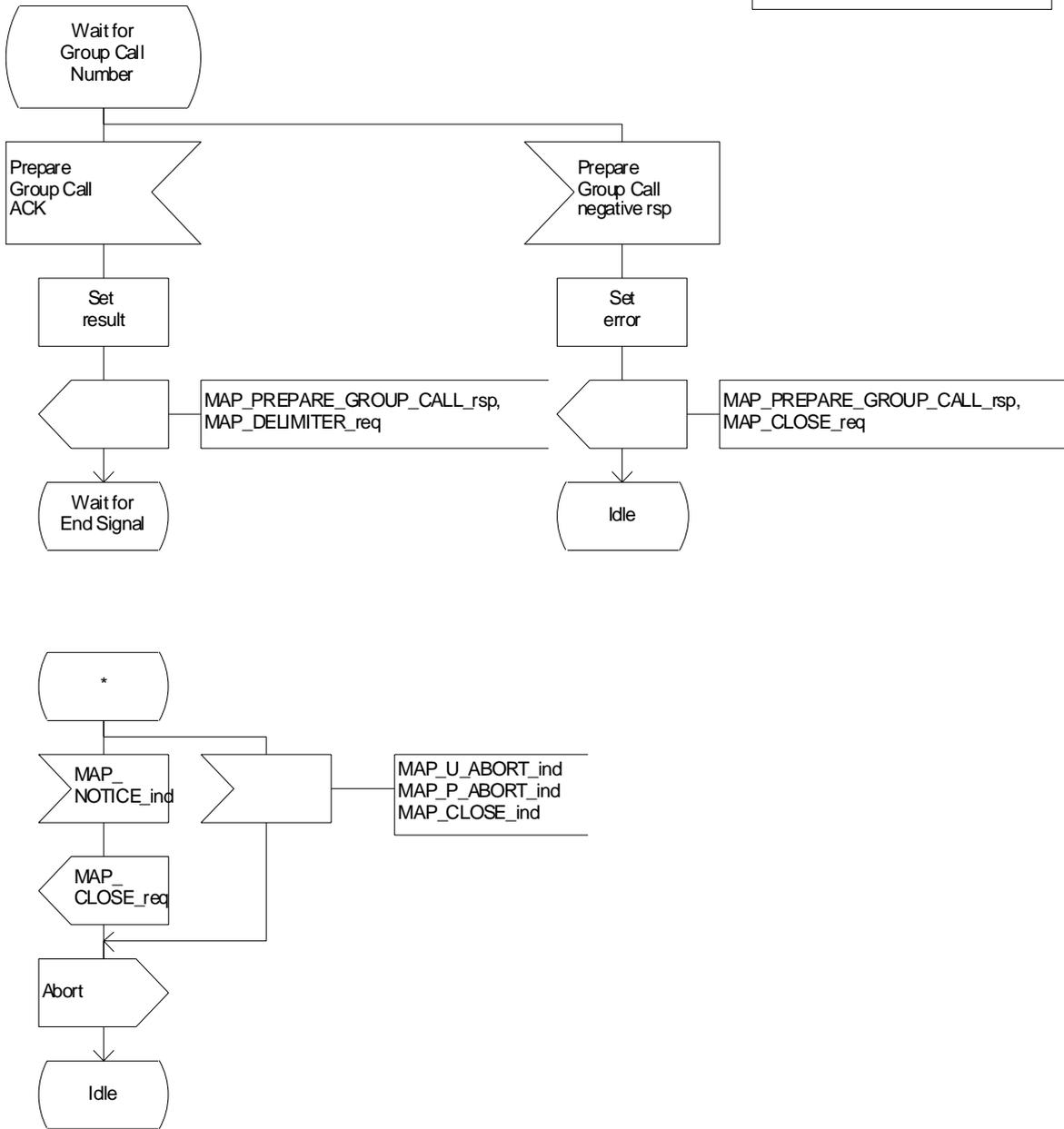

Figure 21.4/3 (sheet 2 of 3): Process ASCII\_Relay\_MSC



Process ASCI\_Relay\_MSC

21.4\_3.3(3)

Figure 21.4/3: Process in the Relay MSC for ASCI call handling

Signals to/from the left are to/from the A-MSC; Signals to/from the right are to/from the R-MSC ASCI process

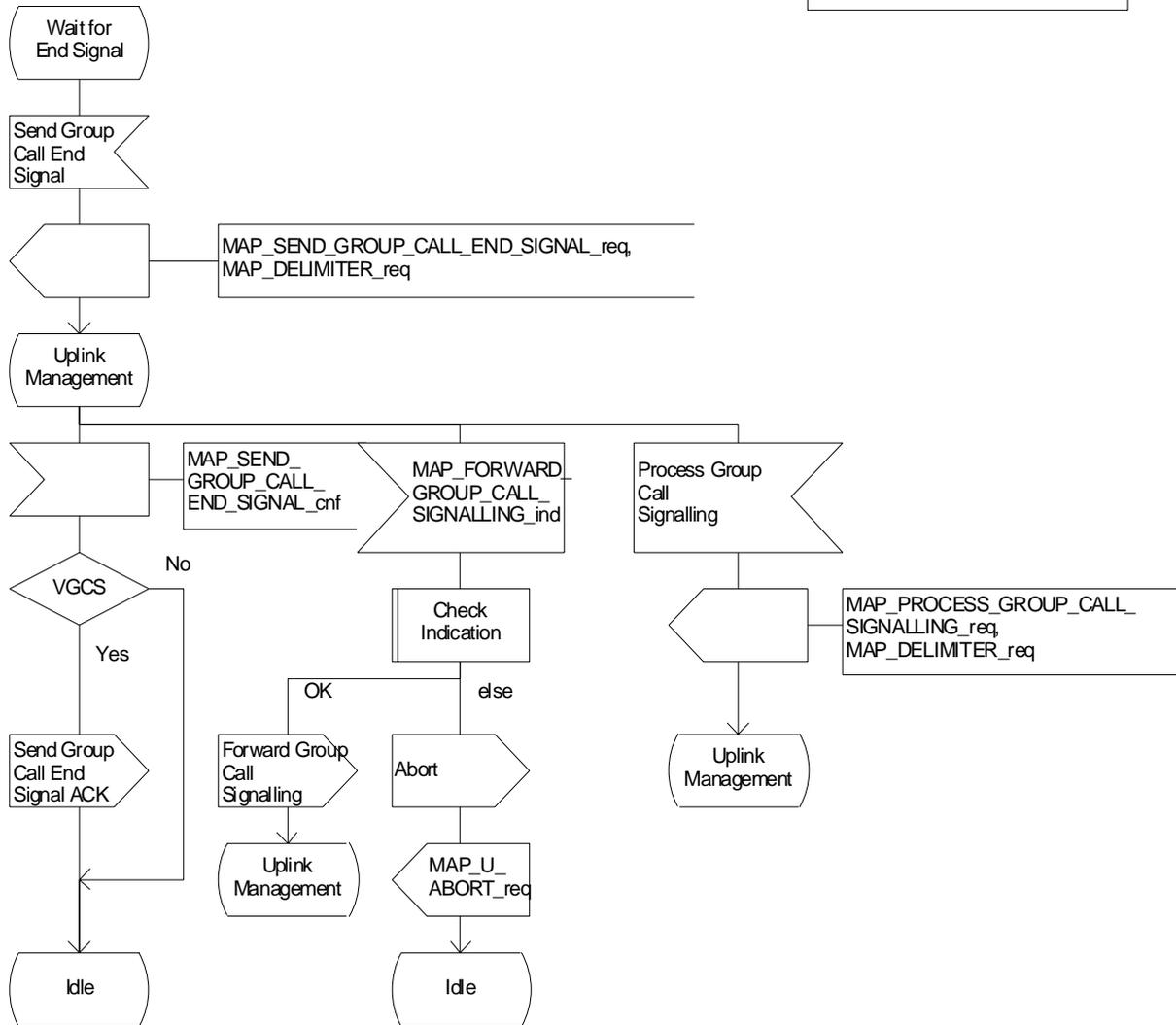
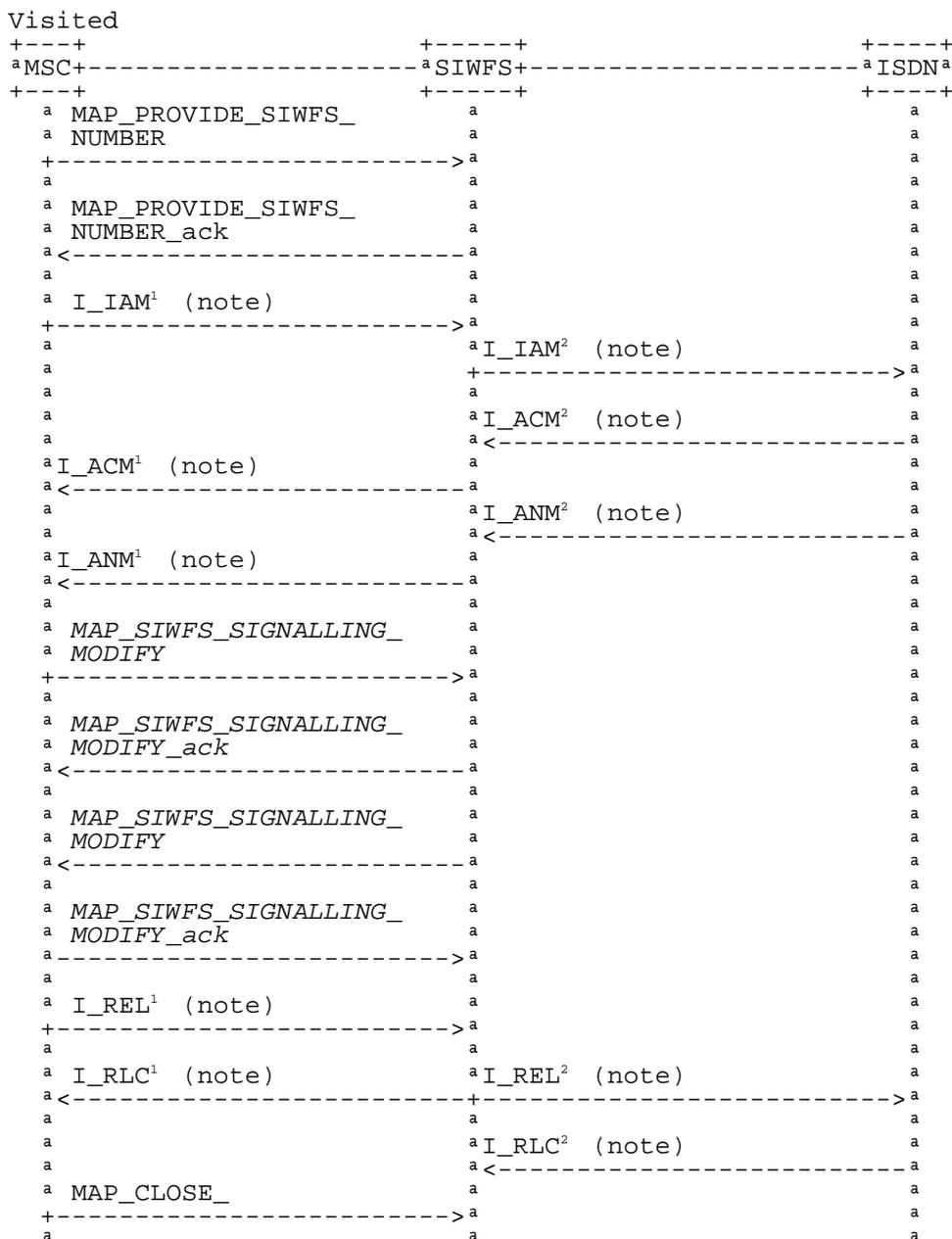

Figure 21.4/3 (sheet 3 of 3): Process ASCI\_Relay\_MSC

## 21.5 Allocation and modifications of resources in an SIWFS

### 21.5.1 General

The message flow for successful allocation and modification of resources in an SIWFS is shown in figure 21.5/1 (mobile originating call non-loop method), 21.5/2 (mobile originating call loop method) and 21.5/3 (mobile terminating call loop method).



NOTES: xxx = Optional Procedure

TUP or ISUP may be used in signalling between MSCs, depending on the network type between the MSCs. The Release message can be initiated either by the calling or called subscriber. For further details on the TUP and ISUP procedures refer to the following CCITT Recommendations & ETSI specification:

Q.721-725 - Telephone User Part (TUP);

ETS 300 356-1 - Integrated Services Digital Network (ISDN); Signalling System No.7; ISDN User Part (ISUP) version 2 for the international interface; Part 1: Basic services.

The number on the ISUP messages have been added to link the messages to respective signalling sequence.

The modification of SIWF resources could be initiated any time during the call either by the VMSC or the SIWFS.

**Figure 21.5/1: Message flow for mobile originating call non-loop method**

Visited

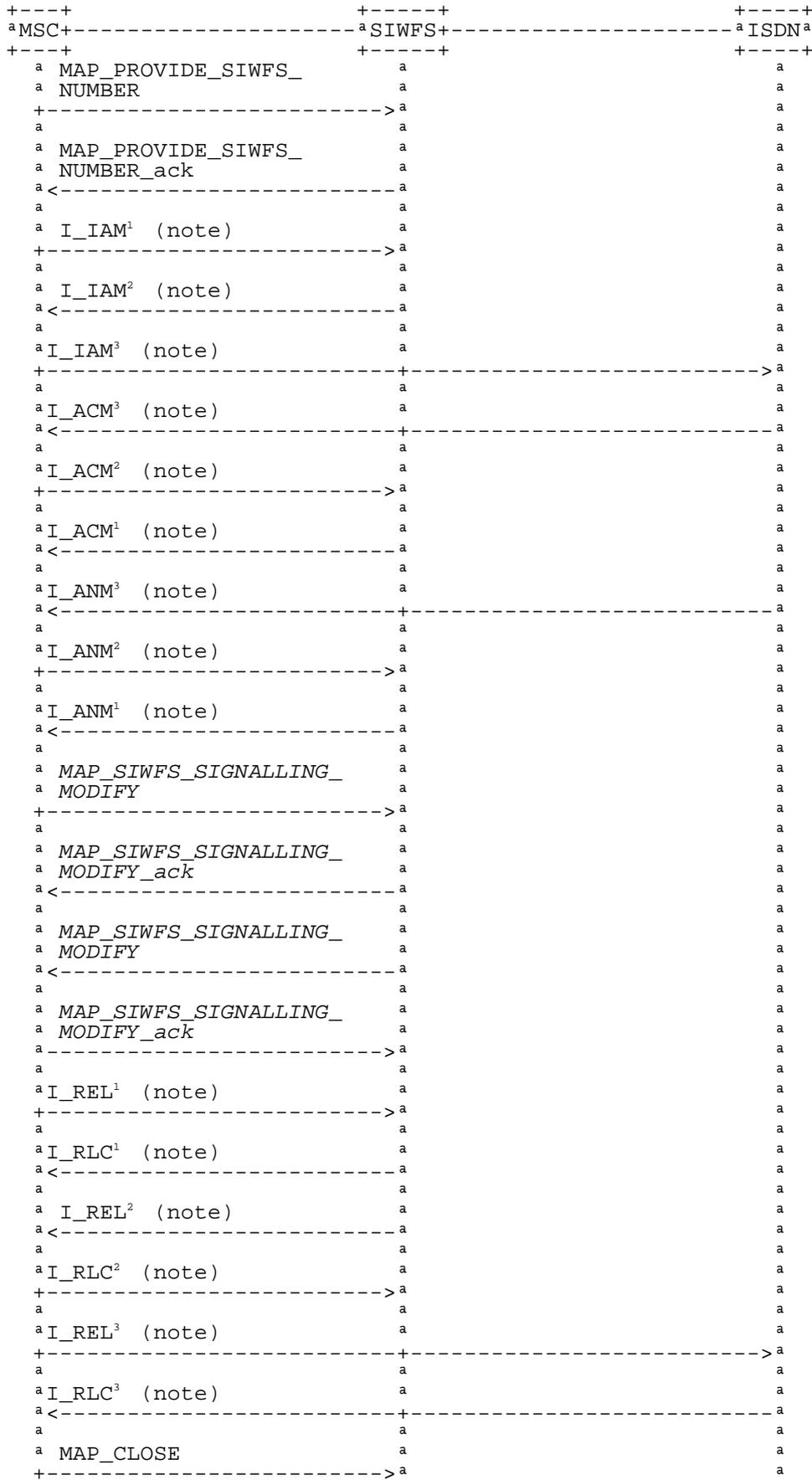

## NOTES:

*xxx = Optional Procedure*

TUP or ISUP may be used in signalling between MSCs, depending on the network type between the MSCs. The Release message can be initiated either by calling or called subscriber. For further details on the TUP and ISUP procedures refer to the following CCITT Recommendations & ETSI specification:

Q.721-725 - Telephone User Part (TUP);

ETS 300 356-1 - Integrated Services Digital Network (ISDN); Signalling System No.7; ISDN User Part (ISUP) version 2 for the international interface; Part 1: Basic services.

The number on the ISUP messages have been added to link the messages to respective signalling sequence.

The modification of SIWF resources could be initiated any time during the call either by the VMSC or the SIWFS.

**Figure 21.5/2: Message flow for mobile originating call loop method**

Visited

```

+---+
aMSC+-----+-----+-----+
+---+          +-----+          +-----+
a I_IAM1 (note)          a          a
a<-----+-----+-----+-----+
a          a          a
a MAP_PROVIDE_SIWFS_          a          a
a NUMBER          a          a
+----->-----+-----+-----+
a          a          a
a MAP_PROVIDE_SIWFS_          a          a
a NUMBER_ack          a          a
a<-----+-----+-----+-----+
a          a          a
a I_IAM2 (note)          a          a
+----->-----+-----+-----+
a          a          a
a I_IAM3 (note)          a          a
a<-----+-----+-----+-----+
a          a          a
a I_ACM3 (note)          a          a
+----->-----+-----+-----+
a          a          a
a I_ACM2 (note)          a          a
a<-----+-----+-----+-----+
a          a          a
a I_ACM1 (note)          a          a
a-----+-----+-----+-----+>
a          a          a
a I_ANM3 (note)          a          a
+----->-----+-----+-----+
a          a          a
a I_ANM2 (note)          a          a
a<-----+-----+-----+-----+
a          a          a
a I_ANM1 (note)          a          a
a-----+-----+-----+-----+>
a          a          a
a MAP_SIWFS_SIGNALLING_          a          a
a MODIFY          a          a
+----->-----+-----+-----+
a          a          a
a MAP_SIWFS_SIGNALLING_          a          a
a MODIFY_ack          a          a
a<-----+-----+-----+-----+
a          a          a
a MAP_SIWFS_SIGNALLING_          a          a
a MODIFY          a          a
a<-----+-----+-----+-----+
a          a          a
a MAP_SIWFS_SIGNALLING_          a          a
a MODIFY_ack          a          a
a-----+-----+-----+-----+>
a          a          a
a I_REL1 (note)          a          a
a<-----+-----+-----+-----+
a          a          a
a I_RLC1 (note)          a          a
+-----+-----+-----+-----+>
a          a          a
a I_REL2 (note)          a          a
+----->-----+-----+-----+
a          a          a
a I_RLC2 (note)          a          a
a<-----+-----+-----+-----+
a          a          a
a I_REL3 (note)          a          a
a<-----+-----+-----+-----+
a          a          a
a I_RLC3 (note)          a          a
+----->-----+-----+-----+
a          a          a
a MAP_CLOSE          a          a
+----->-----+-----+-----+

```

## NOTES:

*xxx = Optional Procedure*

TUP or ISUP may be used in signalling between MSCs, depending on the network type between the MSCs. The Release message can be initiated either by calling or called subscriber. For further details on the TUP and ISUP procedures refer to the following CCITT Recommendations & ETSI specification:

Q.721-725 - Telephone User Part (TUP);

ETS 300 356-1 - Integrated Services Digital Network (ISDN); Signalling System No.7; ISDN User Part (ISUP) version 2 for the international interface; Part 1: Basic services.

The number on the ISUP messages have been added to link the messages to respective signalling sequence.

The modification of SIWF resources could be initiated any time during the call either by the VMSC or the SIWFS.

### Figure 21.5/3: Message flow for mobile terminating call loop method

The following MAP services are used to allocate resources in an SIWFS:

MAP\_PROVIDE\_SIWFS\_NUMBER      see clause 10.4.

The following MAP services are used to modify resources in an SIWFS:

MAP\_SIWFS\_SIGNALLING\_MODIFY      see clause 10.5.

## 21.5.2 Process in the VMSC

The MAP process in the VMSC to allocate and modify resources in an SIWFS for a mobile call is shown in figure 21.5/4. The MAP process invokes macros not defined in this clause; the definitions of these macros can be found as follows:

Receive\_Open\_Cnf      see clause 25.1.2;

Check\_Confirmation      see clause 25.2.2.

### 21.5.2.1 Allocation of SIWFS resources

#### Successful Outcome

When the MAP process receives a Provide SIWFS Number request from the call handling process in the VMSC, it requests a dialogue with the SIWF whose identity is contained in the Provide SIWFS Number request by sending a MAP\_OPEN service request, requests resources in the SIWFS using a MAP\_PROVIDE\_SIWFS\_NUMBER service request and invokes the macro Receive\_Open\_Cnf to wait for the response to the dialogue opening request. If the dialogue opening is successful, the MAP process waits for a response from the SIWFS.

If the MAP process receives a MAP\_PROVIDE\_SIWFS\_NUMBER service confirm from the SIWFS, the MAP process invokes the macro Check\_Confirmation to check the content of the confirm.

If the macro Check\_Confirmation takes the OK exit, the MAP process sends a Provide SIWFS Number ack containing the SIWFS Number received from the SIWFS to the call handling process in the VMSC and go to Wait\_For\_Modification state.

#### Earlier version MAP dialogue with the SIWFS

If the macro Receive\_Open\_Cnf takes the Vr exit, the MAP process sends an Abort to the call handling process in the VMSC and returns to the idle state.

#### Dialogue opening failure

If the macro Receive\_Open\_Cnf indicates that the dialogue with the SIWFS could not be opened, the MAP process sends an Abort to the call handling process in the VMSC and returns to the idle state.

**Error in MAP\_PROVIDE\_SIWFS\_NUMBER confirm**

If the MAP\_PROVIDE\_SIWFS\_NUMBER service confirm contains a user error or a provider error, or the macro Check\_Confirmation indicates that there is a data error, the MAP process sends a Provide SIWFS number negative response to the call handling process in the VMSC and returns to the idle state.

**Call release**

If the call handling process in the VMSC indicates that the call has been aborted, the MAP process returns to the idle state. Any response from the SIWFS will be discarded.

If the call handling process in the VMSC indicates that the traffic channel has been released (i.e. call released by a user) a MAP\_CLOSE\_req is sent and the process is returned to the idle state.

**Abort of SIWFS dialogue**

During the time an answer is expected from the SIWFS, the MAP service provider may abort the dialogue by issuing a MAP\_P\_ABORT indication, or the SIWFS may send a MAP\_U\_ABORT indication or a MAP\_CLOSE indication. In any of these cases, the MAP process sends a Provide SIWFS number negative response to the call handling process in the VMSC and returns to the idle state.

If the MAP provider indicates a protocol problem by sending a MAP\_NOTICE indication, the MAP process closes the dialogue with the SIWFS, sends a Provide SIWFS number negative response indicating system failure to the call handling process in the VMSC and returns to the idle state.

After the dialogue with the SIWFS has been established, the MAP service provider may abort the dialogue by issuing a MAP\_P\_ABORT indication, or the SIWFS may send a MAP\_U\_ABORT indication or a MAP\_CLOSE indication. In any of these cases, the MAP process returns to the idle state.

If the MAP provider indicates a protocol problem by sending a MAP\_NOTICE indication, the MAP process closes the dialogue with the SIWFS, and returns to the idle state.

### 21.5.2.2 Modification of SIWFS resources initiated by the user

**Successful Outcome**

When the MAP process receives an SIWFS Signalling Modify request from the call handling process in the VMSC, it requests a dialogue with the SIWFS whose identity is contained in the SIWFS Signalling Modify request by sending a MAP\_SIWFS\_SIGNALLING\_MODIFY service request and waits for a response from the SIWFS.

If the MAP process receives a MAP\_SIWFS\_SIGNALLING\_MODIFY service confirm from the SIWFS, the MAP process invokes the macro Check\_Confirmation to check the content of the confirm.

If the macro Check\_Confirmation takes the OK exit, the MAP process sends an SIWFS Signalling Modify ack containing the response received from the SIWFS to the call handling process in the VMSC and go to Wait\_For\_Modification state.

**Error in MAP\_SIWFS\_SIGNALLING\_MODIFY confirm**

If the MAP\_SIWFS\_SIGNALLING\_MODIFY service confirm contains a user error or a provider error, or the macro Check\_Confirmation indicates that there is a data error, the MAP process sends an SIWFS Signalling Modify negative response to the call handling process in the VMSC and go to Wait\_For\_Modification state.

**Abort of SIWFS dialogue**

During the time an answer is expected from the SIWFS, the MAP service provider may abort the dialogue by issuing a MAP\_P\_ABORT indication, or the SIWFS may send a MAP\_U\_ABORT indication or a MAP\_CLOSE indication. In any of these cases, the MAP process sends an SIWFS Signalling Modify negative response to the call handling process in the VMSC and returns to the idle state.

If the MAP provider indicates a protocol problem by sending a MAP\_NOTICE indication, the MAP process closes the dialogue with the SIWFS, sends an SIWFS Signalling Modify negative response indicating system failure to the call handling process in the VMSC and returns to the idle state.



### 21.5.2.3 Modification of SIWFS resources initiated by the SIWFS

#### **Successful outcome**

If a MAP\_SIWFS\_SIGNALLING\_MODIFY service indication is received, the MAP process sends an SIWFS signalling modify Info request to the call handling process in the VMSC, and waits for a response. The SIWFS signalling modify request contains the parameters received in the MAP\_SIWFS\_SIGNALLING\_MODIFY service indication.

If the call handling process in the VMSC returns an SIWFS signalling modify ack, the MAP process constructs a MAP\_SIWFS\_SIGNALLING\_MODIFY service response contained in the Provide SIWFS Number ack, send it to the SIWFS and go to Wait\_For\_Modification state.

#### **Negative response from VMSC call handling process**

If the call handling process in the VMSC returns a negative response the MAP process constructs a MAP\_SIWFS\_SIGNALLING\_MODIFY service response containing the appropriate error, send it to the SIWFS and go to Wait\_For\_Modification state.

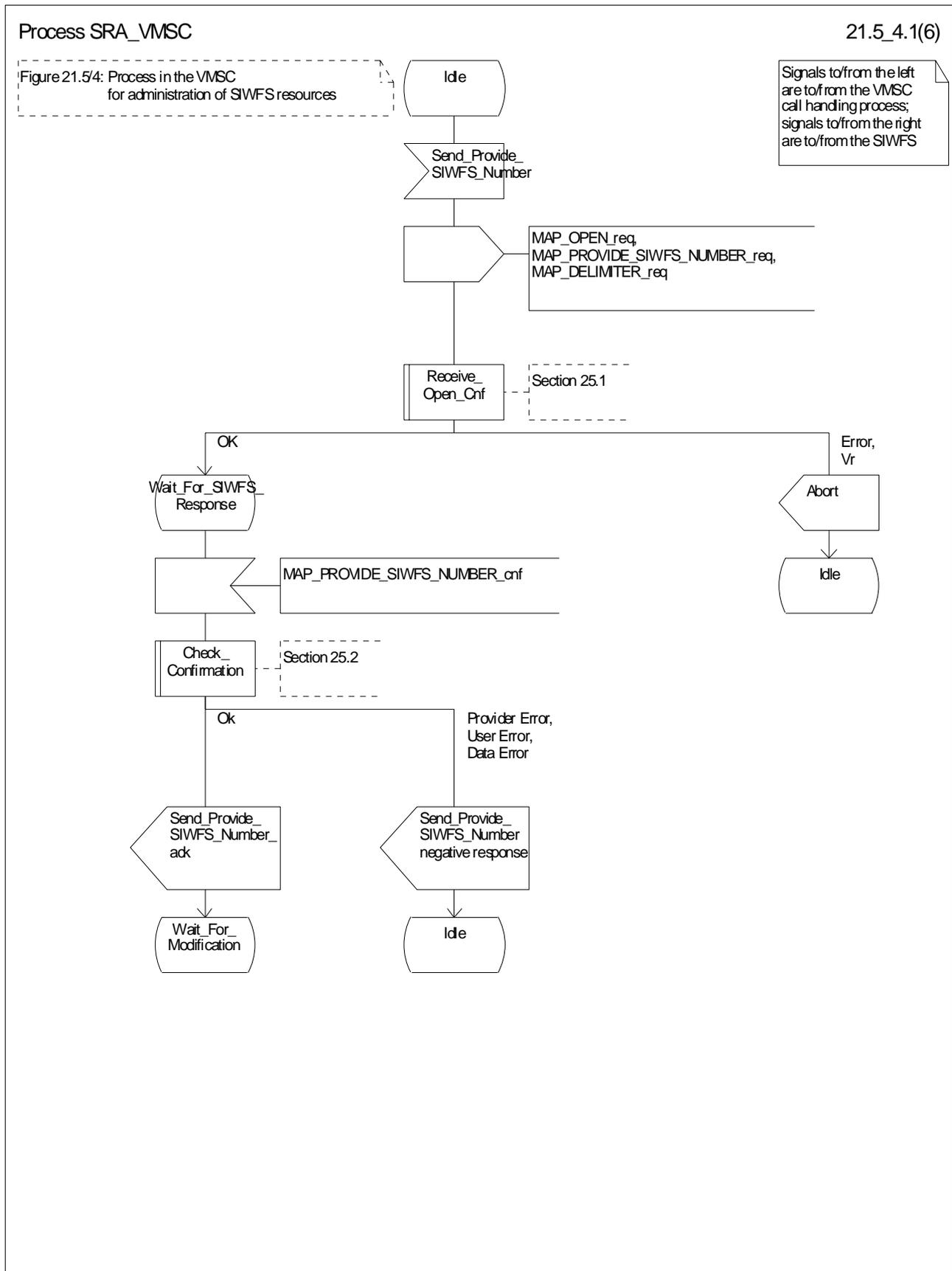

Figure 21.5/4 (sheet 1 of 6): Process SRA (SIWFS\_RESOURCE\_ADMINISTRATION)\_VMSC

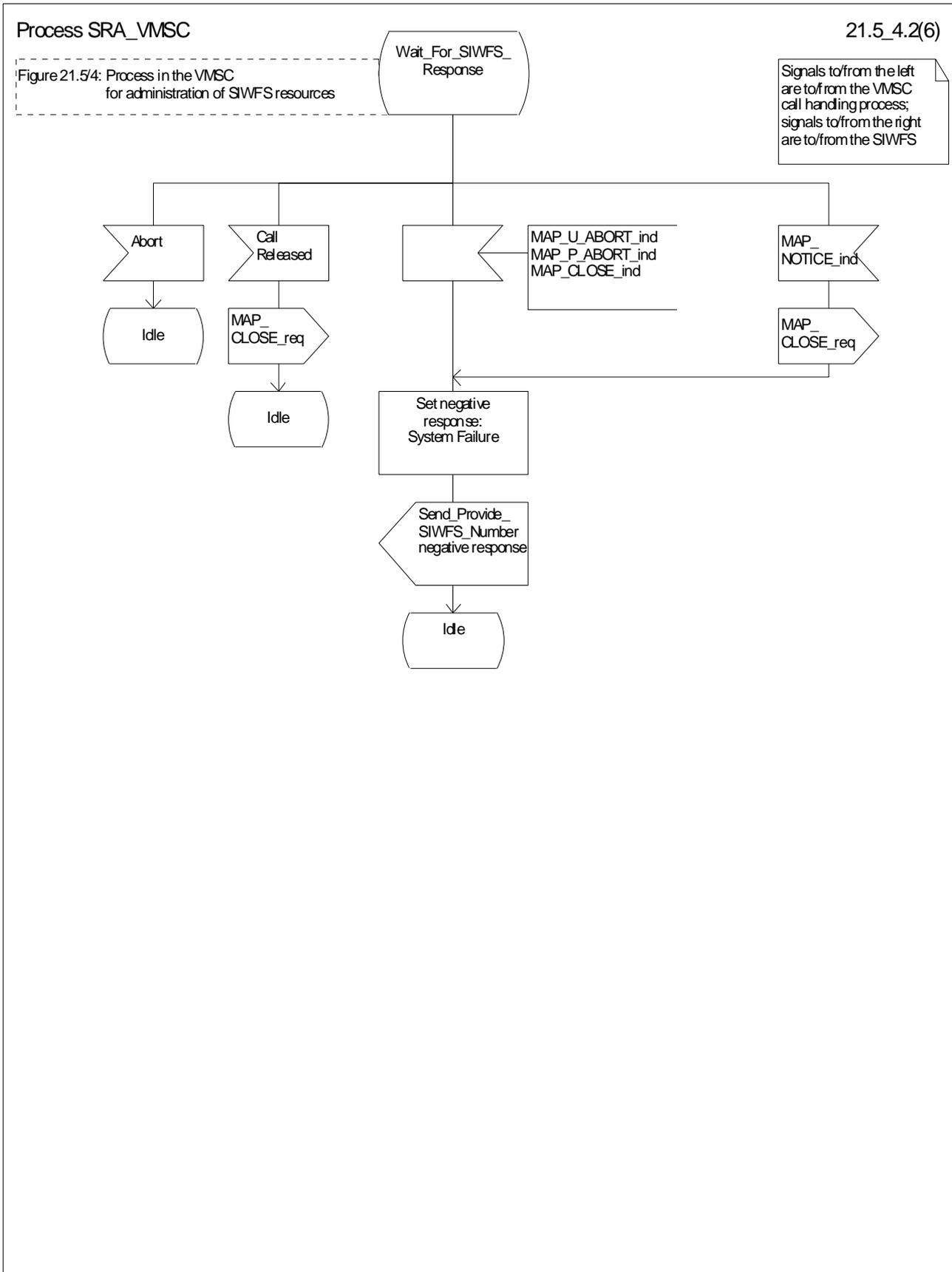

Figure 21.5/4 (sheet 2 of 6): Process SRA\_VMSC

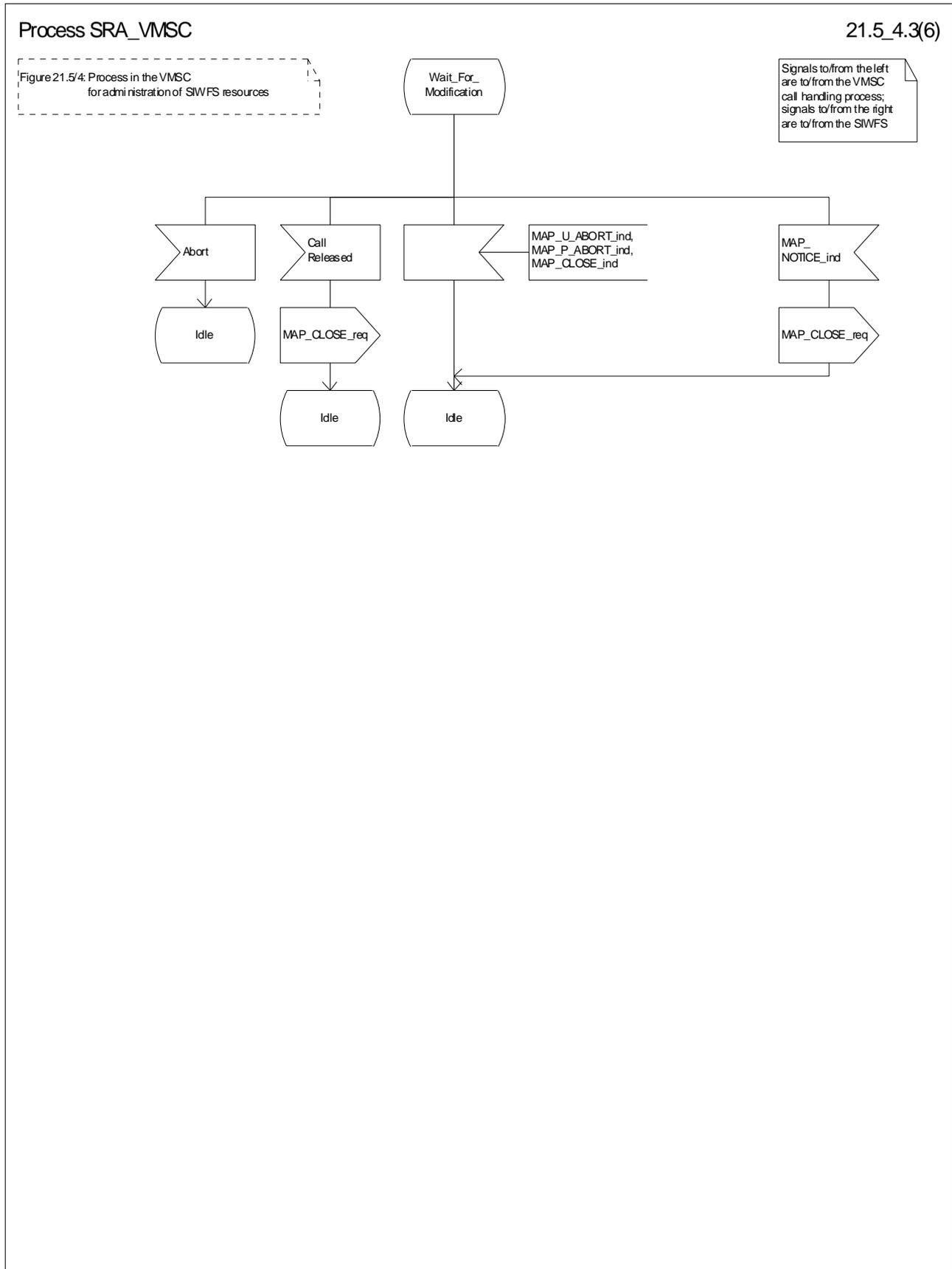

Figure 21.5/4 (sheet 3 of 6): Process SRA\_VMSC

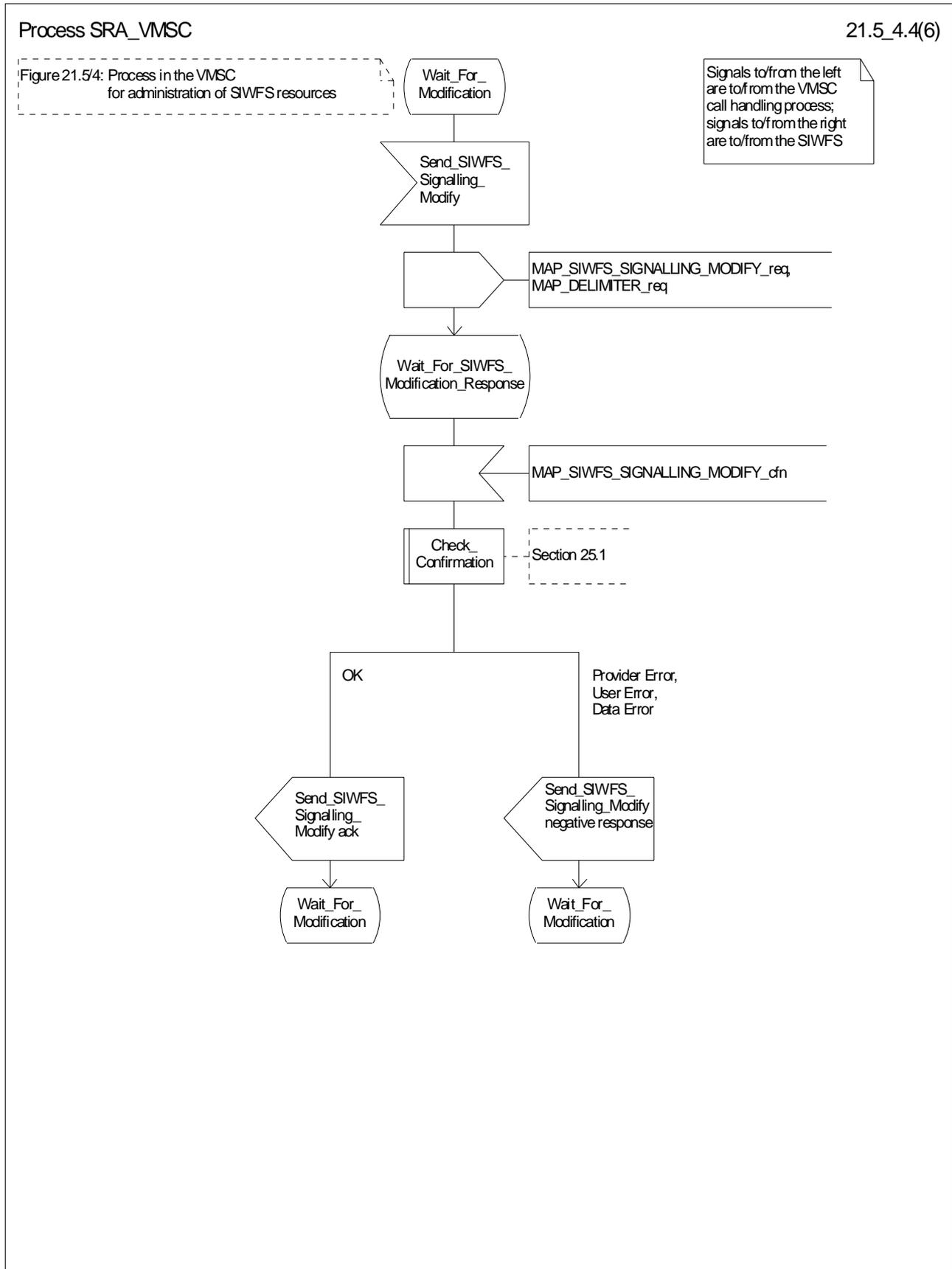

Figure 21.5/4 (sheet 4 of 6): Process SRA\_VMSC

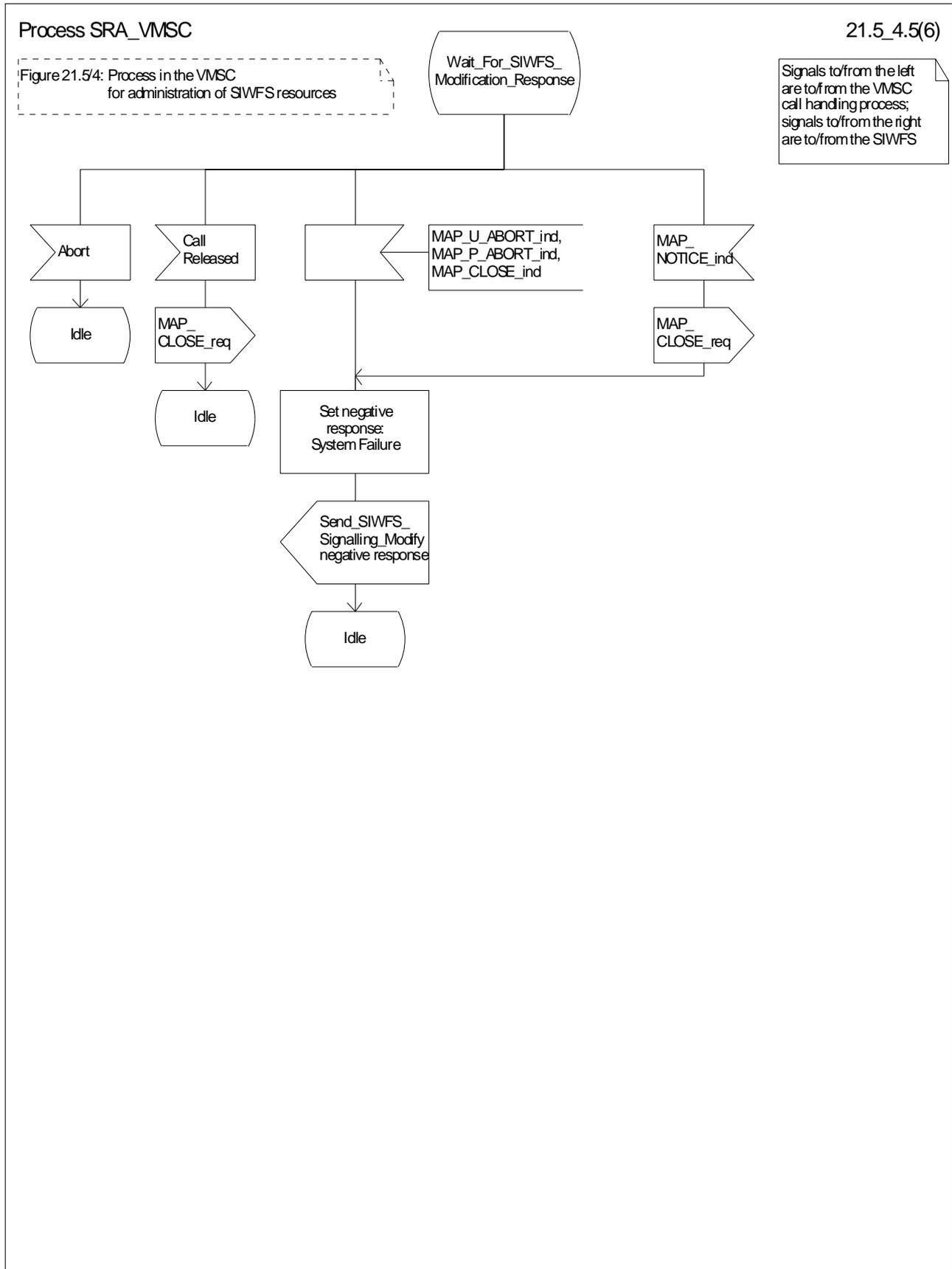

Figure 21.5/4 (sheet 5 of 6): Process SRA\_VMSC

Process SRA\_VMSC

21.5\_4.6(6)

Figure 21.5/4: Process in the VMSC for administration of SIWFS resources

Signals to/from the left are to/from the VMSC call handling process; signals to/from the right are to/from the SIWFS

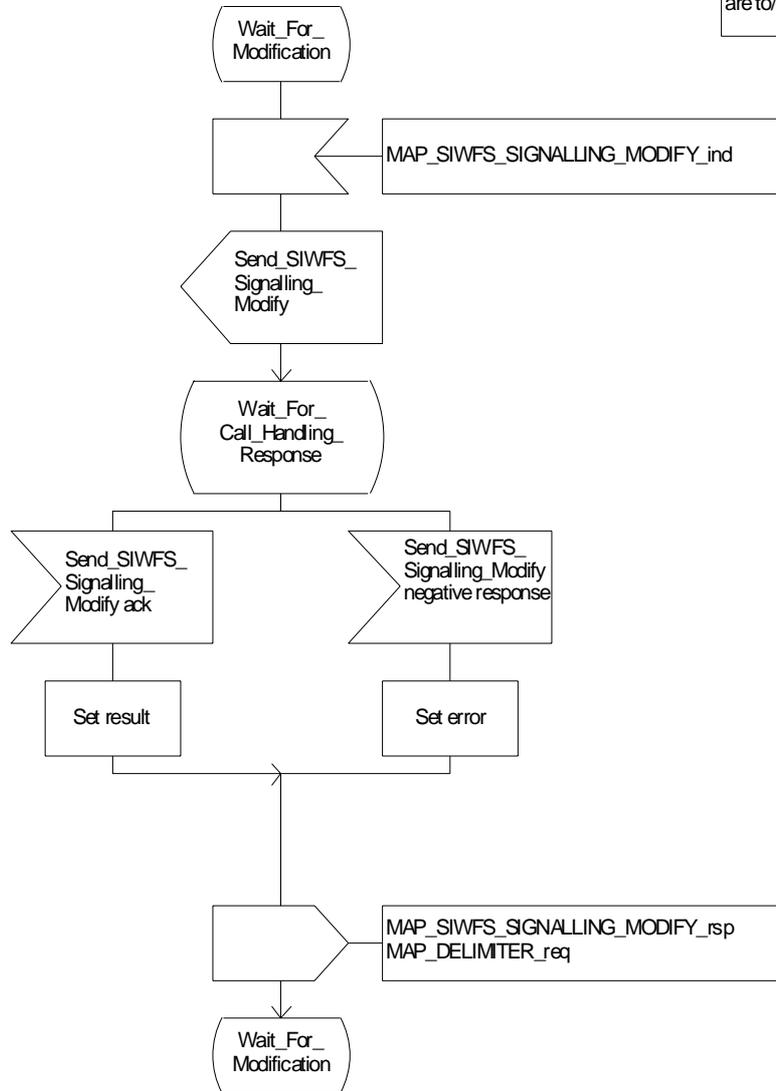

Figure 21.5/4 (sheet 6 of 6): Process SRA\_VMSC

### 21.5.3 Process in the SIWFS

The MAP process in the SIWFS to allocate and modify SIWFS resources for a mobile call is shown in figure 21.5/5. The MAP process invokes macros not defined in this clause; the definitions of these macros can be found as follows:

Receive_Open_Ind	see clause 25.1.1.
Check_Confirmation	see clause 25.2.2.

#### 21.5.3.1 Procedures for allocation of SIWFS resources

##### Successful outcome

When the MAP process receives a MAP\_OPEN indication with the application context locInfoRetrieval, it checks it by invoking the macro Receive\_Open\_Ind.

If the macro takes the OK exit, the MAP process waits for a service indication.

If a MAP\_PROVIDE\_SIWFS\_NUMBER service indication is received, the MAP process sends a Provide SIWFS number Info request to the call handling process in the SIWFS, and waits for a response. The Provide SIWFS number request contains the parameters received in the MAP\_PROVIDE\_SIWFS\_NUMBER service indication.

If the call handling process in the SIWFS returns a Provide SIWFS number ack, the MAP process constructs a MAP\_PROVIDE\_SIWFS\_NUMBER service response containing the routing information contained in the Provide SIWFS Number ack, constructs a MAP\_DELIMITER service request, sends them to the VMSC and go to Wait\_For\_Modification state.

##### Earlier version MAP dialogue with the VMSC

If the macro Receive\_Open\_Ind takes the Vr exit, the MAP process returns to the idle state.

##### Dialogue opening failure

If the macro Receive\_Open\_Ind takes the Error exit, the MAP process returns to the idle state.

If the MAP provider sends a MAP\_P\_ABORT while the MAP process is waiting for a service indication, the MAP process returns to the idle state.

If the MAP provider sends a MAP\_NOTICE while the MAP process is waiting for a service indication, the MAP process sends a MAP\_CLOSE request to terminate the dialogue and returns to the idle state.

##### Negative response from SIWFS call handling process

If the call handling process in the SIWFS returns a negative response the MAP process constructs a MAP\_PROVIDE\_SIWFS\_NUMBER service response containing the appropriate error, constructs a MAP\_CLOSE service request, sends them to the VMSC and returns to the idle state.

##### Call release

If the call handling process in the SIWFS indicates that the call has been aborted, the MAP process returns to the idle state. Any response from the VMSC will be discarded.

If the call handling process in the SIWFS indicates that the traffic channel has been released (i.e. call released by a user) a MAP\_CLOSE\_req is sent and the process is returned to the idle state.

##### Abort of VMSC dialogue

After the dialogue with the VMSC has been established, the MAP service provider may abort the dialogue by issuing a MAP\_P\_ABORT indication, or the VMSC may send a MAP\_U\_ABORT indication or a MAP\_CLOSE indication. In any of these cases, the MAP process returns to the idle state.

If the MAP provider indicates a protocol problem by sending a MAP\_NOTICE indication, the MAP process closes the dialogue with the VMSC, and returns to the idle state.



### 21.5.3.2 Process for modification of SIWFS resources initiated by the user

#### Successful outcome

If a MAP\_SIWFS\_SIGNALLING\_MODIFY service indication is received, the MAP process sends an SIWFS signalling modify Info request to the call handling process in the SIWFS, and waits for a response. The SIWFS signalling modify request contains the parameters received in the MAP\_SIWFS\_SIGNALLING\_MODIFY service indication.

If the call handling process in the SIWFS returns an SIWFS signalling modify ack, the MAP process constructs a MAP\_SIWFS\_SIGNALLING\_MODIFY service response contained in the Provide SIWFS Number ack, send it to the VMSC and go to Wait\_For\_Modification state.

#### Negative response from SIWFS call handling process

If the call handling process in the SIWFS returns a negative response the MAP process constructs a MAP\_SIWFS\_SIGNALLING\_MODIFY service response containing the appropriate error, send it to the VMSC and go to Wait\_For\_Modification state.

### 21.5.3.3 Process for modification of SIWFS resources initiated by the SIWFS

#### Successful Outcome

When the MAP process receives an SIWFS Signalling Modify request from the call handling process in the SIWF, it requests a dialogue with the VMSC whose identity is contained in the VMSC Signalling Modify request by sending a MAP\_DELIMITER service request, requests resources in the VMSC using a MAP\_SIWFS\_SIGNALLING\_MODIFY service request, the MAP process waits for a response from the VMSC.

If the MAP process receives a MAP\_SIWFS\_SIGNALLING\_MODIFY service confirm from the VMSC, the MAP process invokes the macro Check\_Confirmation to check the content of the confirm.

If the macro Check\_Confirmation takes the OK exit, the MAP process sends an SIWFS Signalling Modify ack containing the response received from the VMSC to the call handling process in the SIWF and go to Wait\_For\_Modification state.

#### Error in MAP\_SIWFS\_SIGNALLING\_MODIFY confirm

If the MAP\_SIWFS\_SIGNALLING\_MODIFY service confirm contains a user error or a provider error, or the macro Check\_Confirmation indicates that there is a data error, the MAP process sends an SIWFS Signalling Modify negative response to the call handling process in the SIWFS and go to Wait\_For\_Modification state.

#### Abort of SIWFS dialogue

During the time an answer is expected from the VMSC, the MAP service provider may abort the dialogue by issuing a MAP\_P\_ABORT indication, or the VMSC may send a MAP\_U\_ABORT indication or a MAP\_CLOSE indication. In any of these cases, the MAP process sends an SIWFS Signalling Modify negative response to the call handling process in the SIWFS and returns to the idle state.

If the MAP provider indicates a protocol problem by sending a MAP\_NOTICE indication, the MAP process closes the dialogue with the VMSC, sends an SIWFS Signalling Modify negative response indicating system failure to the call handling process in the SIWFS and returns to the idle state.

Process SRA\_SIWFS

21.5\_5.1(5)

Figure 21.5/5: Process in the SIWFS for administration of SIWFS resources

Signals to/from the left are to/from the SIWFS call handling process; signals to/from the right are to/from the VMSC

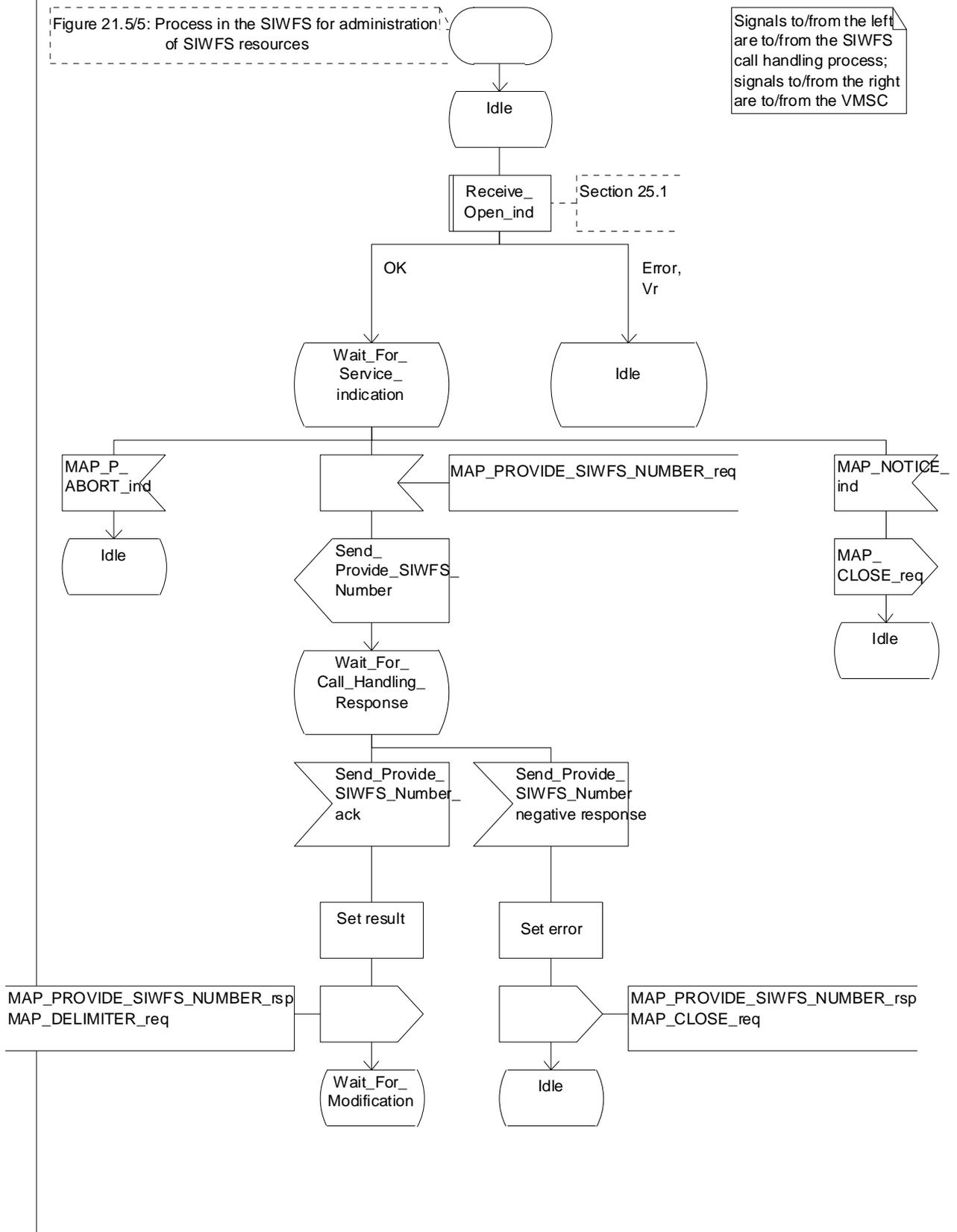

Figure 21.5/5 (sheet 1 of 5): Process SRA\_SIWFS

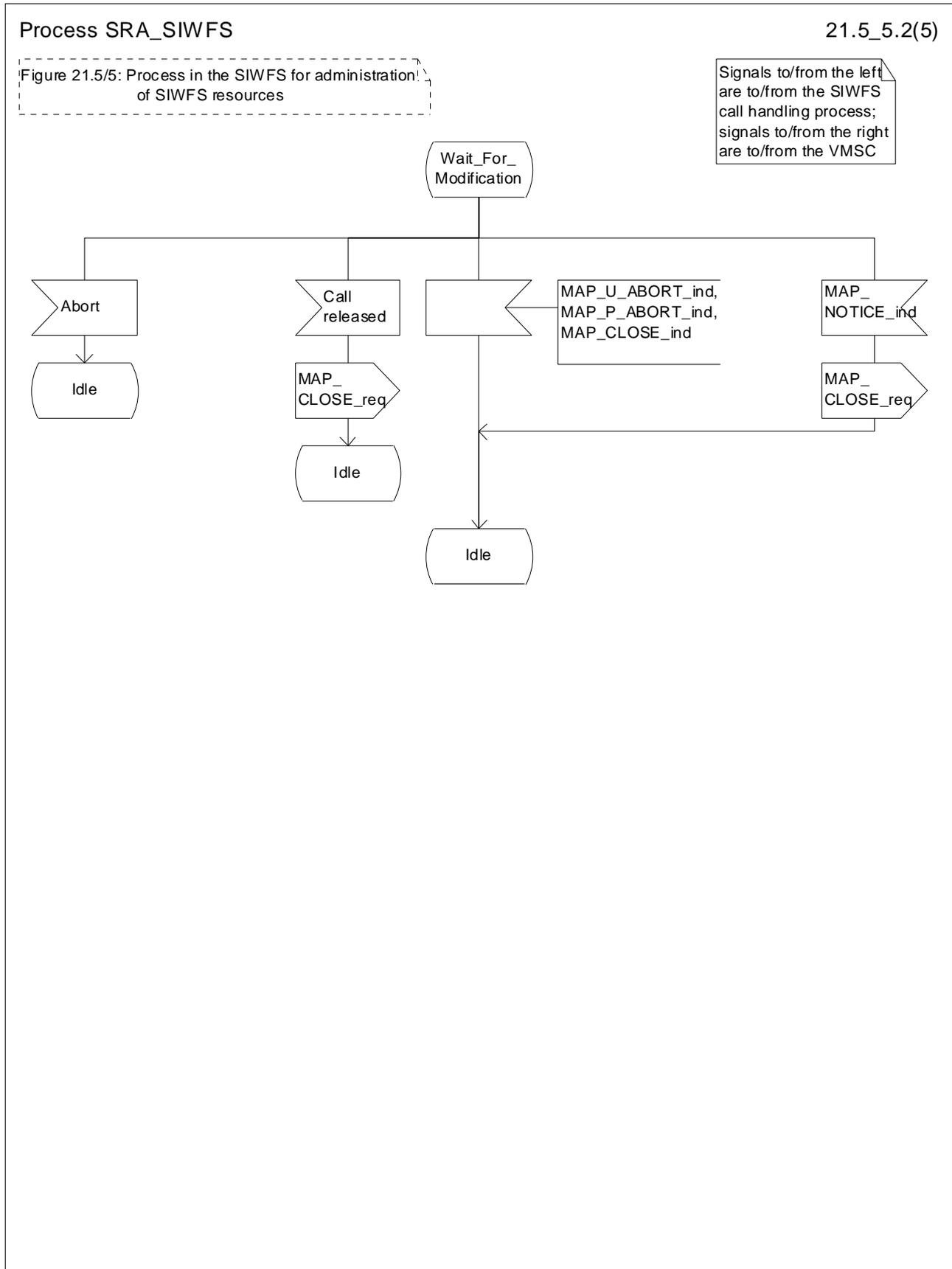

Figure 21.5/5 (sheet 2 of 5): Process SRA\_SIWFS

Process SRA\_SIWFS

21.5\_5.3(5)

Figure 21.5/5: Process in the SIWFS for administration of SIWFS resources

Signals to/from the left are to/from the SIWFS call handling process; signals to/from the right are to/from the VMSC

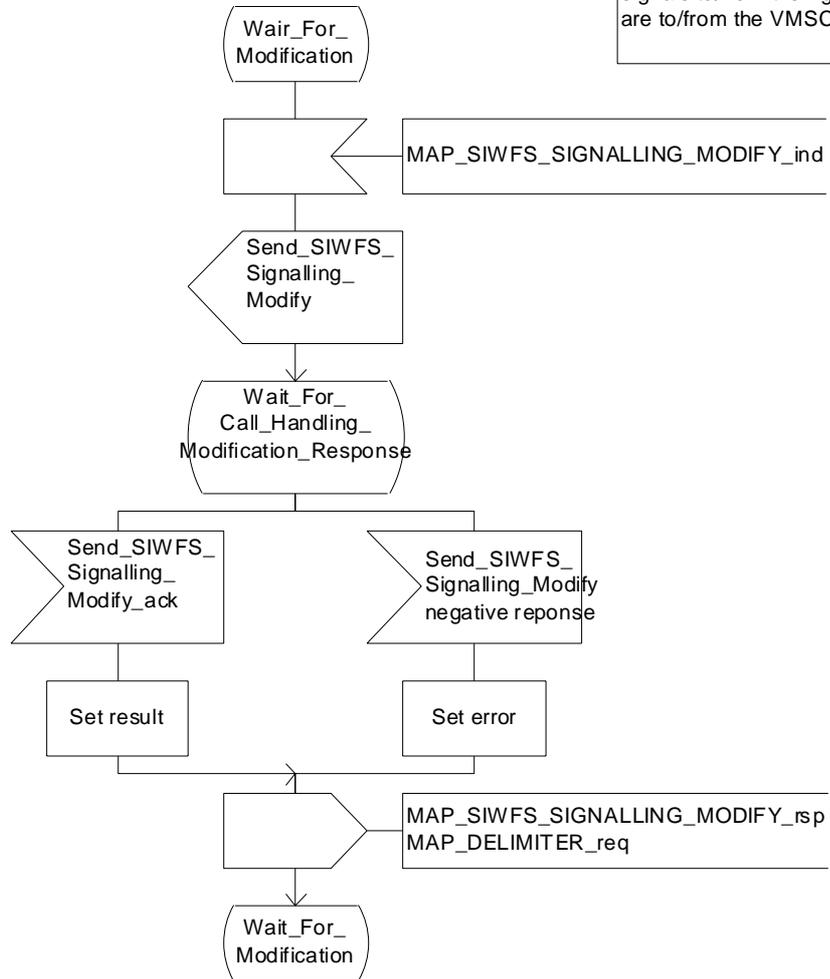

Figure 21.5/5 (sheet 3 of 5): Process SRA\_SIWFS

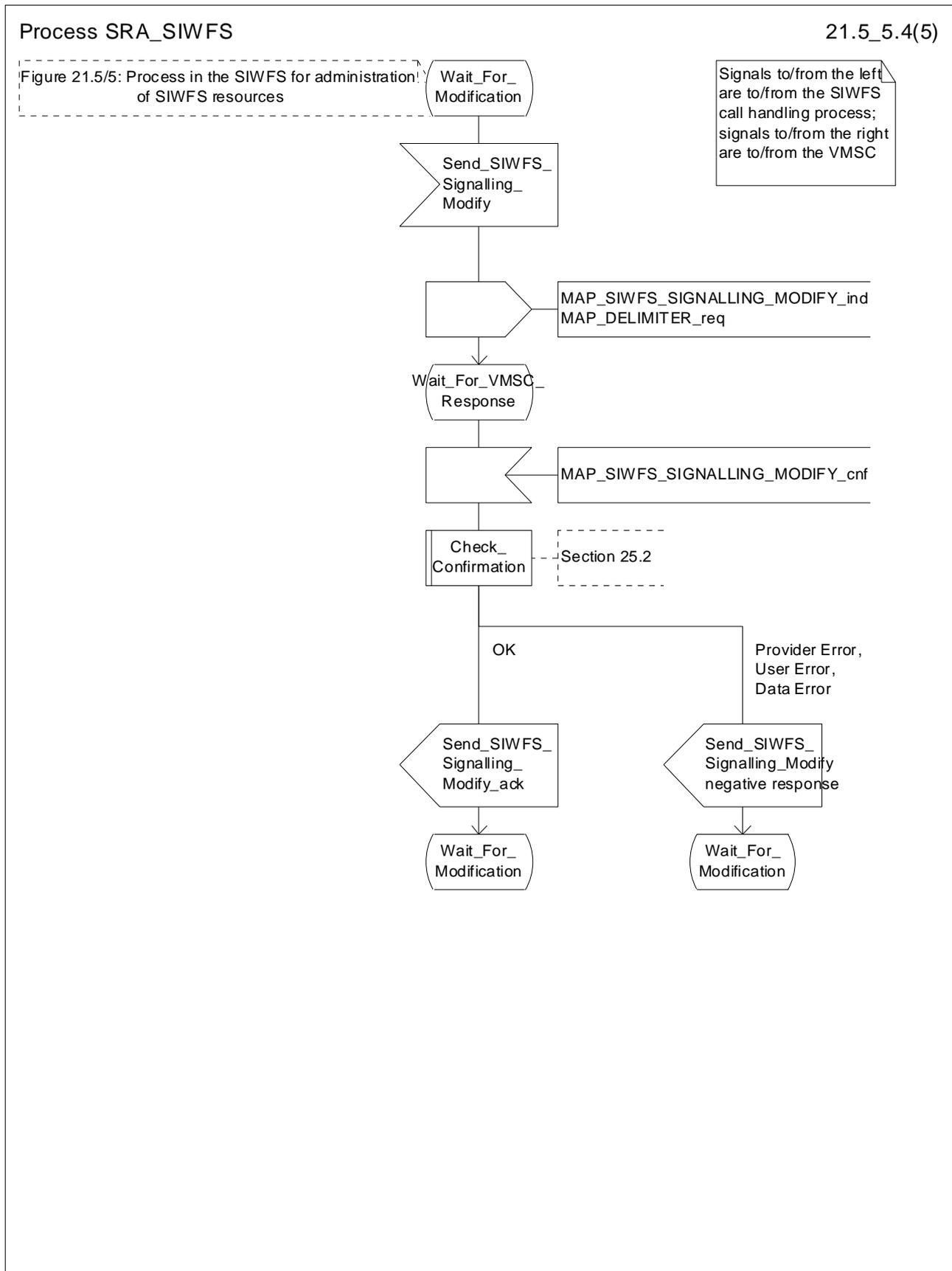

Figure 21.5/5 (sheet 4 of 5): Process SRA\_SIWFS

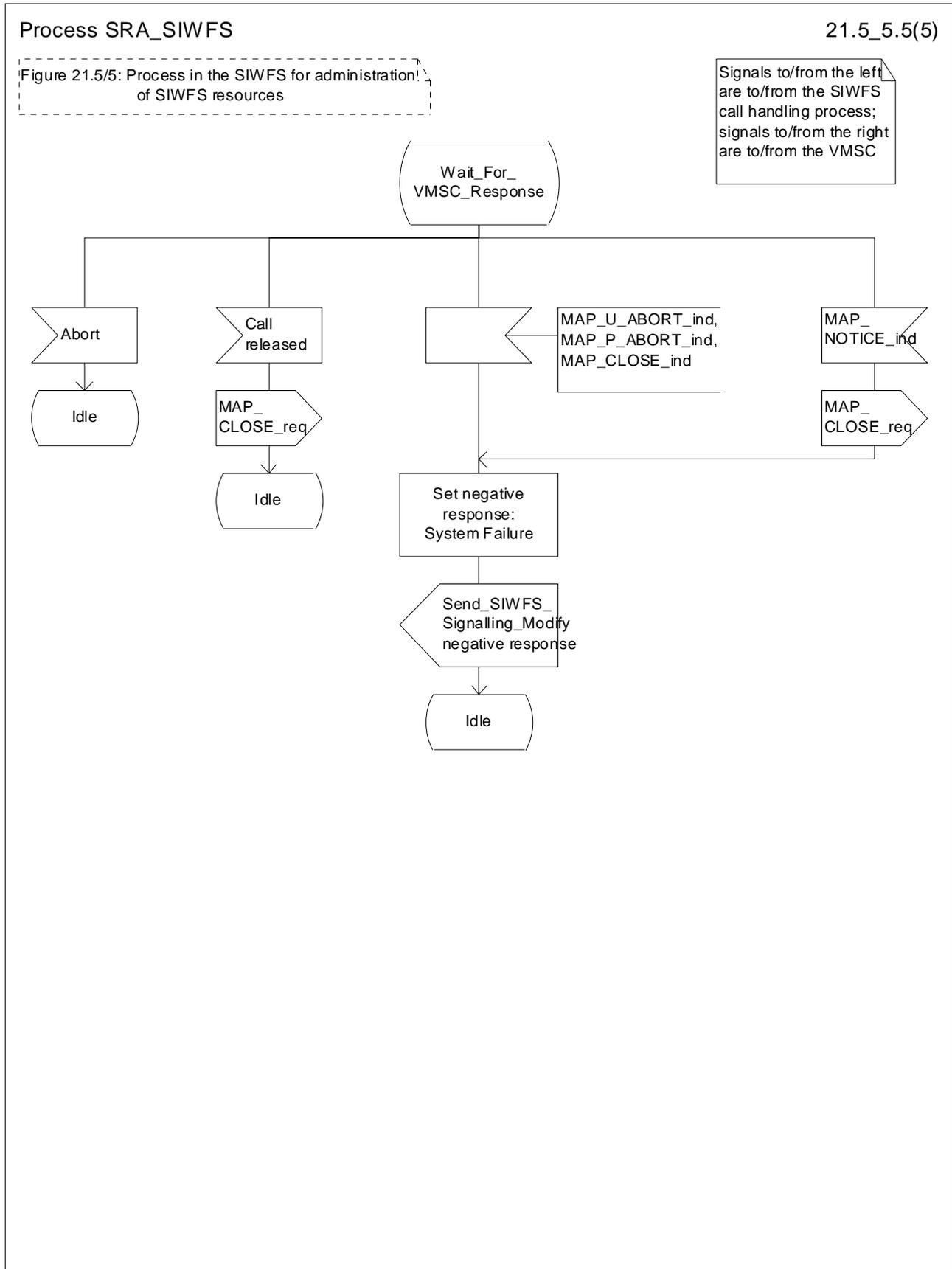
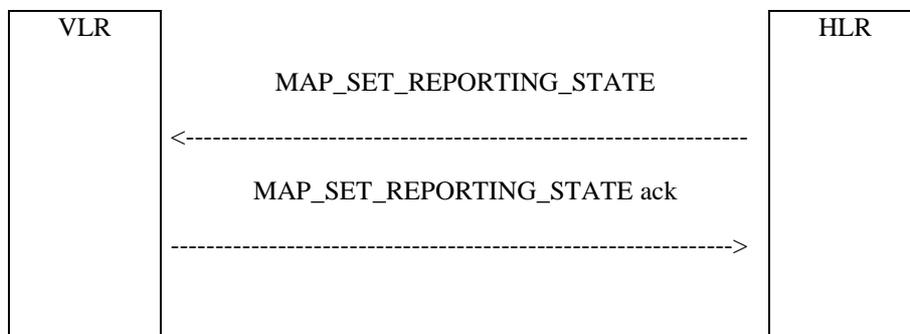

Figure 21.5/5 (sheet 5 of 5): Process SRA\_SIWFS

## 21.6 Setting of Reporting State

### 21.6.1 General

The message flow for setting the reporting state in a stand-alone dialogue is shown in figure 21.6.1/1.



**Figure 21.6/1: Message Flow for Setting the Reporting State**

In Set Reporting State, the HLR can request a start or a stop of monitoring in the VLR.

### 21.6.2 Process in the HLR for Set Reporting State stand-alone

The MAP process in the HLR to set the reporting state in the VLR in a separate stand-alone dialogue is shown in figure 21.6/2. The MAP process invokes macros not defined in this clause; the definitions of these macros can be found as follows:

Receive_Open_Cnf	see clause 25.1.2;
Check_Confirmation	see clause 25.2.2.

#### Successful Outcome

When the MAP process receives a Start Reporting or Stop Reporting request from the CCBS application process in the HLR, it requests a dialogue with the VLR whose identity is contained in the request by sending a MAP\_OPEN service request and sending the necessary information using a MAP\_SET\_REPORTING\_STATE service request. The HLR then invokes the macro Receive\_Open\_Cnf to wait for the response to the dialogue opening request. If the dialogue opening is successful, the MAP process waits for a response from the VLR.

If the MAP process receives a MAP\_SET\_REPORTING\_STATE service confirm from the VLR, the MAP process invokes the macro Check\_Confirmation to check the content of the confirm.

If the macro Check\_Confirmation takes the OK exit and the request was for Start Reporting, the MAP process sends a positive acknowledgement containing the information received from the VLR to the CCBS application process in the HLR and returns to the idle state. In the case of Stop Reporting the CCBS application process returns to the idle state.

#### Failure of dialogue opening with the VLR

If the macro Receive\_Open\_Cnf takes the Vr exit or the Error exit, the MAP process sends (in the case of Start Reporting) a negative response to the CCBS application process in the HLR and returns to the idle state. In the case of Stop Reporting the process returns to the idle state.

#### Error in MAP\_SET\_REPORTING\_STATE confirm

If the MAP\_SET\_REPORTING\_STATE service confirm contains a user error or a provider error, or the macro Check\_Confirmation indicates that there is a data error, the MAP process sends a negative response (in the case of Start Reporting) to the CCBS application process in the HLR and returns to the idle state. In the case of Stop Reporting the CCBS application process returns to the idle state.

**Abort of VLR dialogue**

After the dialogue with the VLR has been established, the MAP service provider may abort the dialogue by issuing a MAP\_P\_ABORT or a MAP\_U\_ABORT indication. If the request was for the Start Reporting, the MAP process sends a Start Reporting negative response to the CCBS application process in the HLR and returns to the idle state.

If the MAP provider indicates a protocol problem by sending a MAP\_NOTICE indication, the MAP process closes the dialogue with the VLR, sends a negative response (in the case of the Start Reporting) indicating system failure to the CCBS application process in the HLR and returns to the idle state. In the case of Stop Reporting the CCBS application process returns to the idle state.



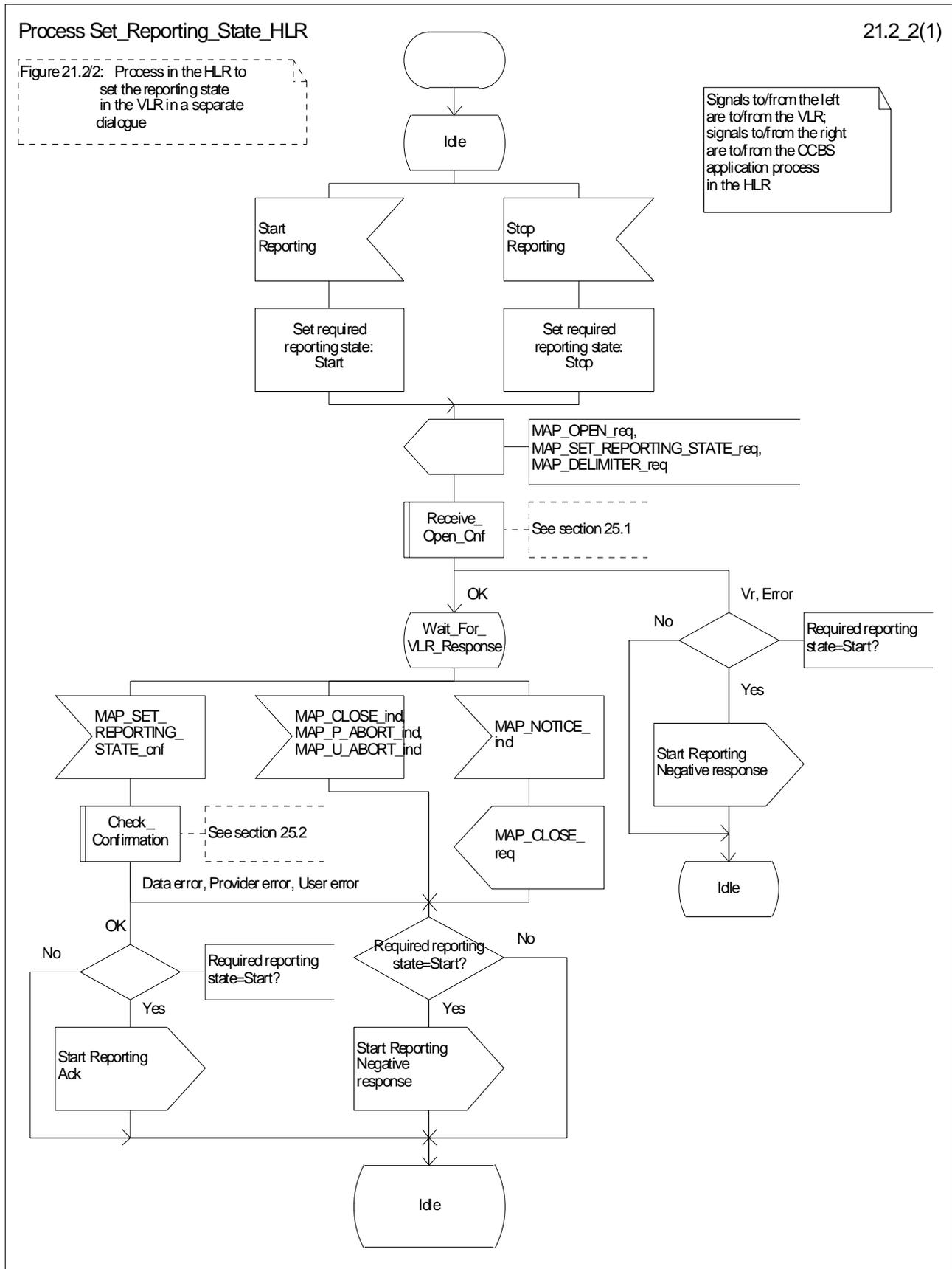

Figure 21.6/2: Process Set\_Reporting\_State\_HLR

### 21.6.3 Reporting co-ordinator process in the VLR

The MAP co-ordinating process in the VLR to handle a dialogue opened with the reporting application context is shown in figure 21.6/3. The MAP process invokes a macro not defined in this clause; the definition of this macro can be found as follows:

Receive\_Open\_Ind            see clause 25.1.1.

Any reporting process in the VLR starts by the VLR receiving a MAP-OPEN service indication. If that service is successful, the VLR can handle reporting indications from the HLR. Table 21.6/1 shows the co-ordinating process' reaction on receipt of specific reporting indications from the HLR. After the relevant process is invoked, the received service indication is sent to that process.

**Table 21.6/1: Relationship between received service indication and invoked process in the VLR**

<b>Service indication received</b>	<b>Process invoked</b>
MAP_REMOTE_USER_FREE_ind	REMOTE_USER_FREE_VLR
MAP_SET_REPORTING_STATE_ind	SET_REPORTING_STATE_VLR

After creation of the user process the co-ordinator relays the messages between the MAP protocol machine and the invoked process until a request or an indication for dialogue termination is received.

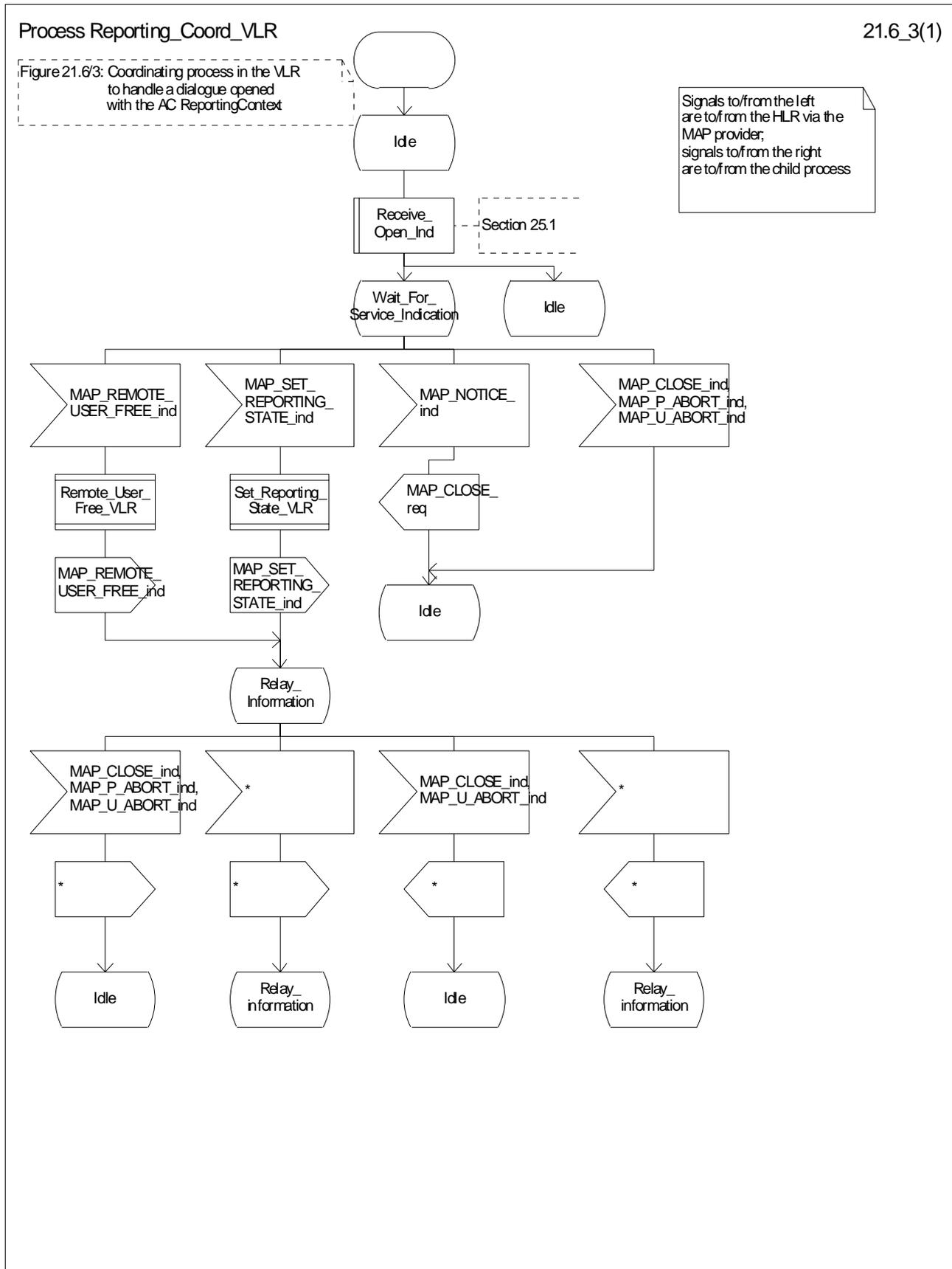

Figure 21.6/3: Process Reporting\_Coord\_VLR

## 21.6.4 Process in the VLR to set the reporting state

The MAP process in the VLR to set the reporting state is shown in figure 21.6/4.

The co-ordinator opens the process. The macro `Receive_Set_Reporting_State_VLR` handles the receipt of the request from the HLR, and the possible response from the CCBS application process in the VLR. When the macro exits, a MAP `CLOSE` is sent to the HLR and the process terminates.

The macro `Set_Reporting_State_VLR` is defined in figure 21.6/5.

When the VLR receives a `MAP_SET_REPORTING_STATE` service indication, it checks whether the required monitoring state is stopped.

If the required monitoring state is stopped, the MAP process sends a Stop Reporting message to the CCBS application in the VLR, sends a `MAP_SET_REPORTING_STATE` response to the HLR and exits from the macro.

If the required monitoring state is started, the MAP process sends a Start Reporting message to the CCBS application in the VLR and waits for a response.

If the CCBS application sends a Start Reporting ack, the MAP process sends a `MAP_SET_REPORTING_STATE` response to the HLR and exits from the macro.

If the CCBS application sends a Start Reporting negative response, the MAP process translates the negative response into a MAP user error, sends a `MAP_SET_REPORTING_STATE` response to the HLR and exits from the macro.

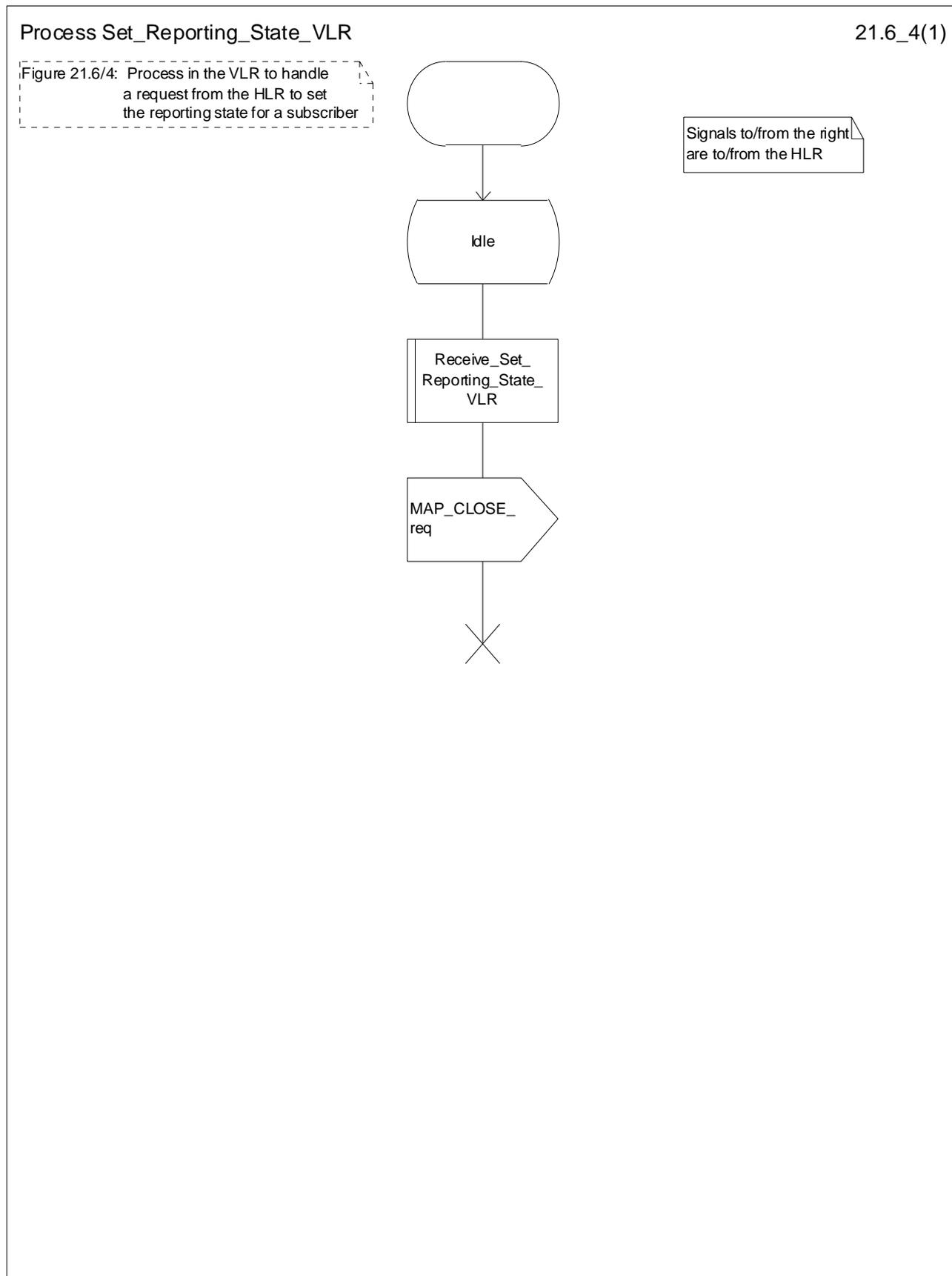

Figure 21.6/4: Process Set\_Reporting\_State\_VLR

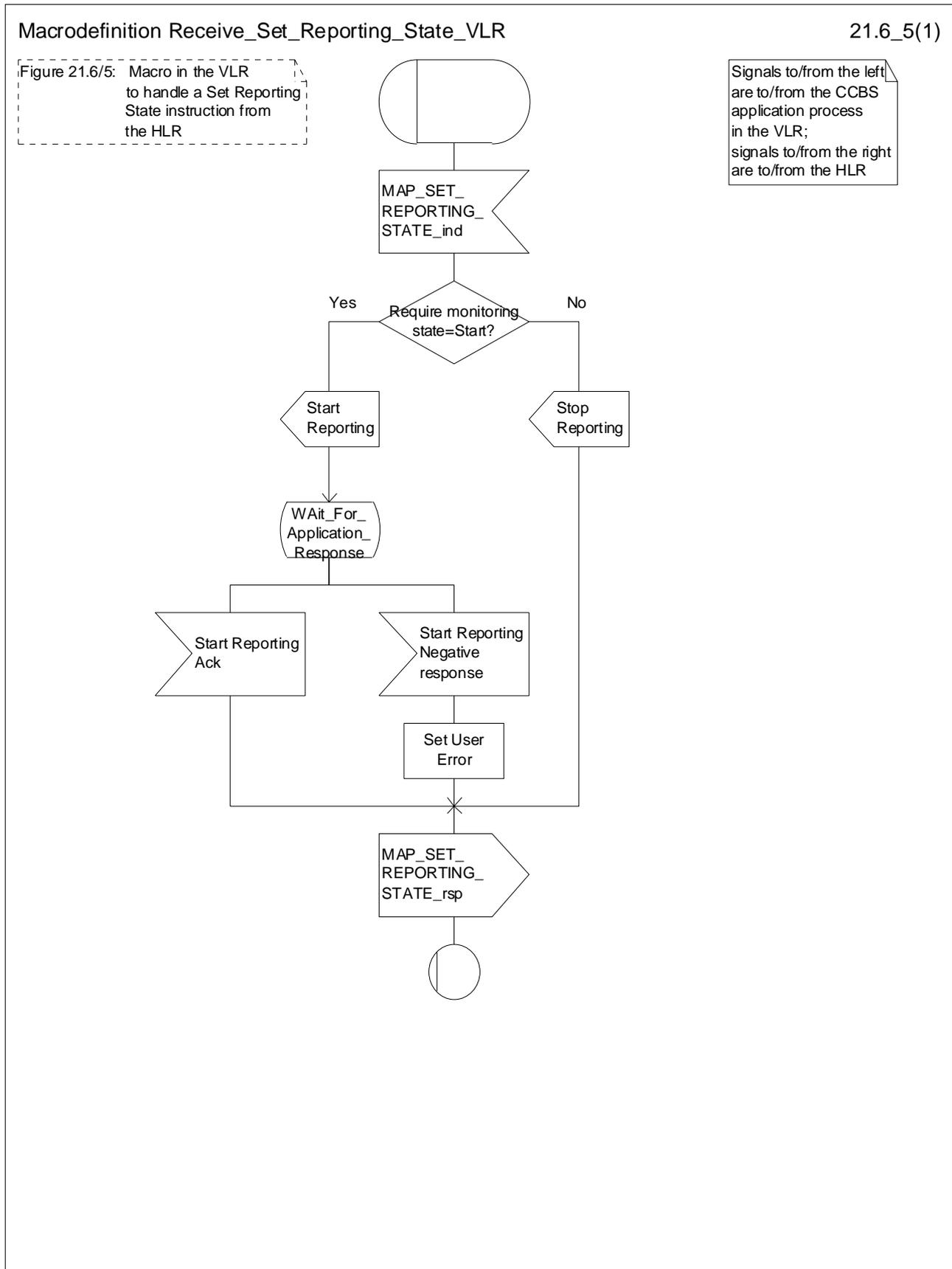
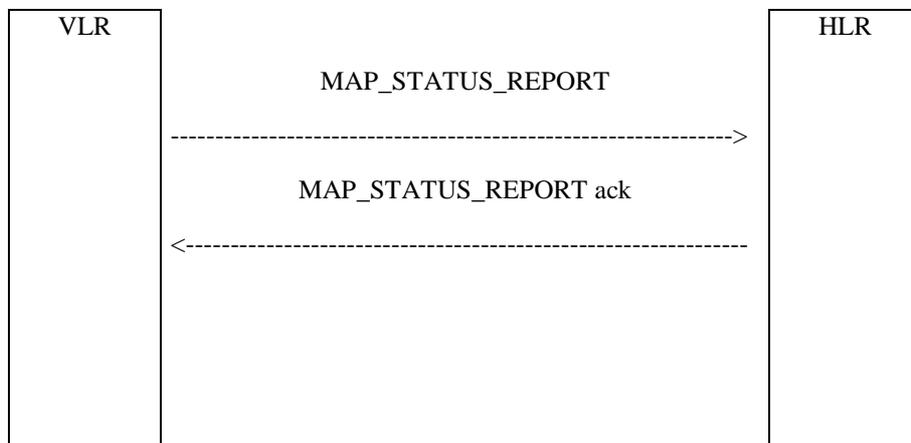

Figure 21.6/5: Macro Receive\_Set\_Reporting\_State\_VLR

## 21.7 Status Reporting

### 21.7.1 General

The message flows for reporting the status of a subscriber are shown in figures 21.7/1 and 21.7/2.



**Figure 21.7/1: Status reporting, when monitoring continues in the VLR**

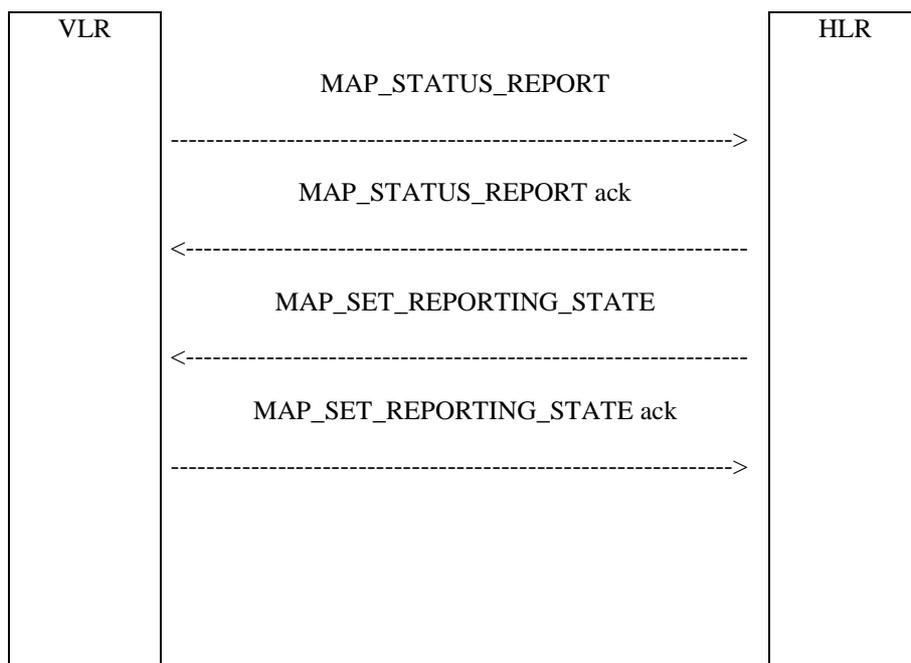

**Figure 21.7/2: Status reporting, when monitoring stops**

When the HLR sends a MAP\_SET\_REPORTING\_STATE, it requests the stop of monitoring in the VLR.

## 21.7.2 Process in the VLR for Status Reporting

The MAP process in the VLR to send a status report to the HLR is shown in figure 21.7/3. The MAP process invokes macros not defined in this clause; the definitions of these macros can be found as follows:

Receive_Open_Cnf	see clause 25.1.2;
Check_Confirmation	see clause 25.2.2.

### Successful Outcome

When the MAP process receives a Event Report or CCBS Call Report from the CCBS application process in the VLR, it requests a dialogue with the HLR whose identity is contained in the request by sending a MAP\_OPEN service request, and requests status report using a MAP\_STATUS\_REPORT service request. The VLR then invokes the macro Receive\_Open\_Cnf to wait for the response to the dialogue opening request. If the dialogue opening is successful, the MAP process waits for a response from the HLR.

If the MAP process receives a MAP\_STATUS\_REPORT service confirm from the HLR, the MAP process invokes the macro Check\_Confirmation to check the content of the confirm.

If the macro Check\_Confirmation takes the OK exit, the MAP process sends an Event Report ack or a CCBS Call Report ack containing the information received from the HLR to the CCBS application process in the VLR and waits for a possible instruction from the HLR to set the reporting state.

If the HLR requests the VLR to set a reporting state (in the macro Receive\_Set\_Reporting\_State\_VLR), the VLR closes the dialogue with the HLR by sending a MAP\_CLOSE to the HLR.

If the HLR requires monitoring in the VLR to continue, it closes the dialogue by sending a MAP\_CLOSE, and the MAP process in the VLR sends Continue Monitoring message to the CCBS application process in the VLR and returns to the idle state.

### Failure of dialogue opening with the HLR

If the macro Receive\_Open\_Cnf takes the Vr exit or the Error exit, the MAP process sends a Event Report negative response or CCBS Call Report negative response to the CCBS application process in the VLR and returns to the idle state.

### Error in MAP\_STATUS\_REPORT confirm

If the MAP\_STATUS\_REPORT service confirm contains a user error or a provider error, or the macro Check\_Confirmation indicates that there is a data error, the MAP process sends an Event Report negative response or CCBS Call Report negative response to the CCBS application process in the VLR and returns to the idle state.

### Abort of HLR dialogue in State Wait\_For\_HLR\_Response

After the dialogue with the HLR has been established, the MAP service provider may abort the dialogue by issuing a MAP\_P\_ABORT or a MAP\_U\_ABORT indication. In this case, the MAP process sends a Event Report or CCBS Call Report negative response to the CCBS application process in the VLR and returns to the idle state.

If the MAP provider indicates a protocol problem by sending a MAP\_NOTICE indication, the MAP process closes the dialogue with the HLR. The VLR sends an Event Report negative response or CCBS Call Report negative response indicating system failure to the CCBS application process in the VLR and returns to the idle state.

### Abort of HLR dialogue in State Wait\_For\_Set\_Reporting

After the dialogue with the HLR has been established, the MAP service provider may abort the dialogue by issuing a MAP\_P\_ABORT or a MAP\_U\_ABORT indication. In this case, the VLR returns to the idle state

If the MAP provider indicates a protocol problem by sending a MAP\_NOTICE indication, the MAP process closes the dialogue with the HLR and returns to the idle state.



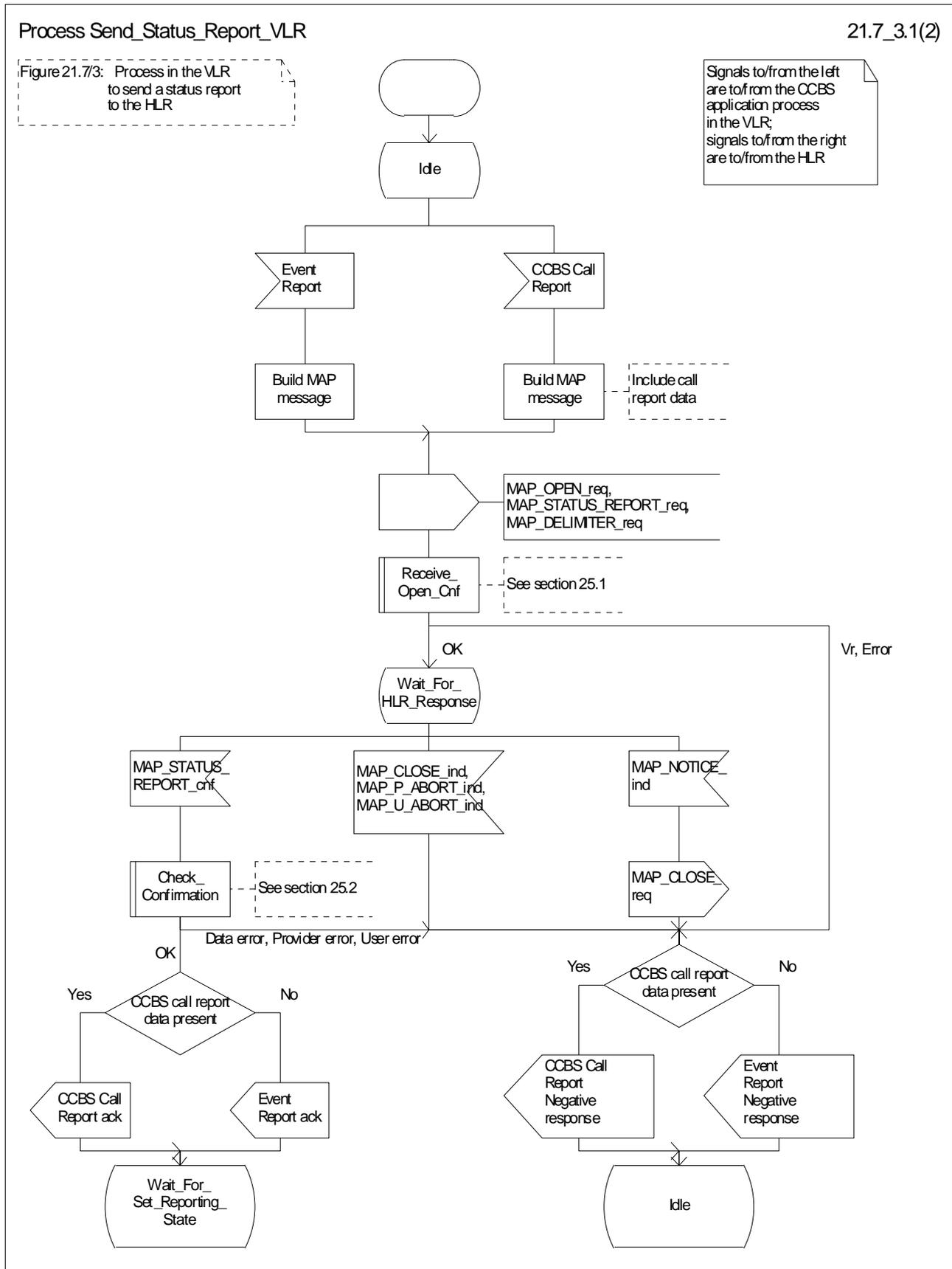

Figure 21.7/3 (sheet 1 of 2): Process Send\_Status\_Report\_VLR

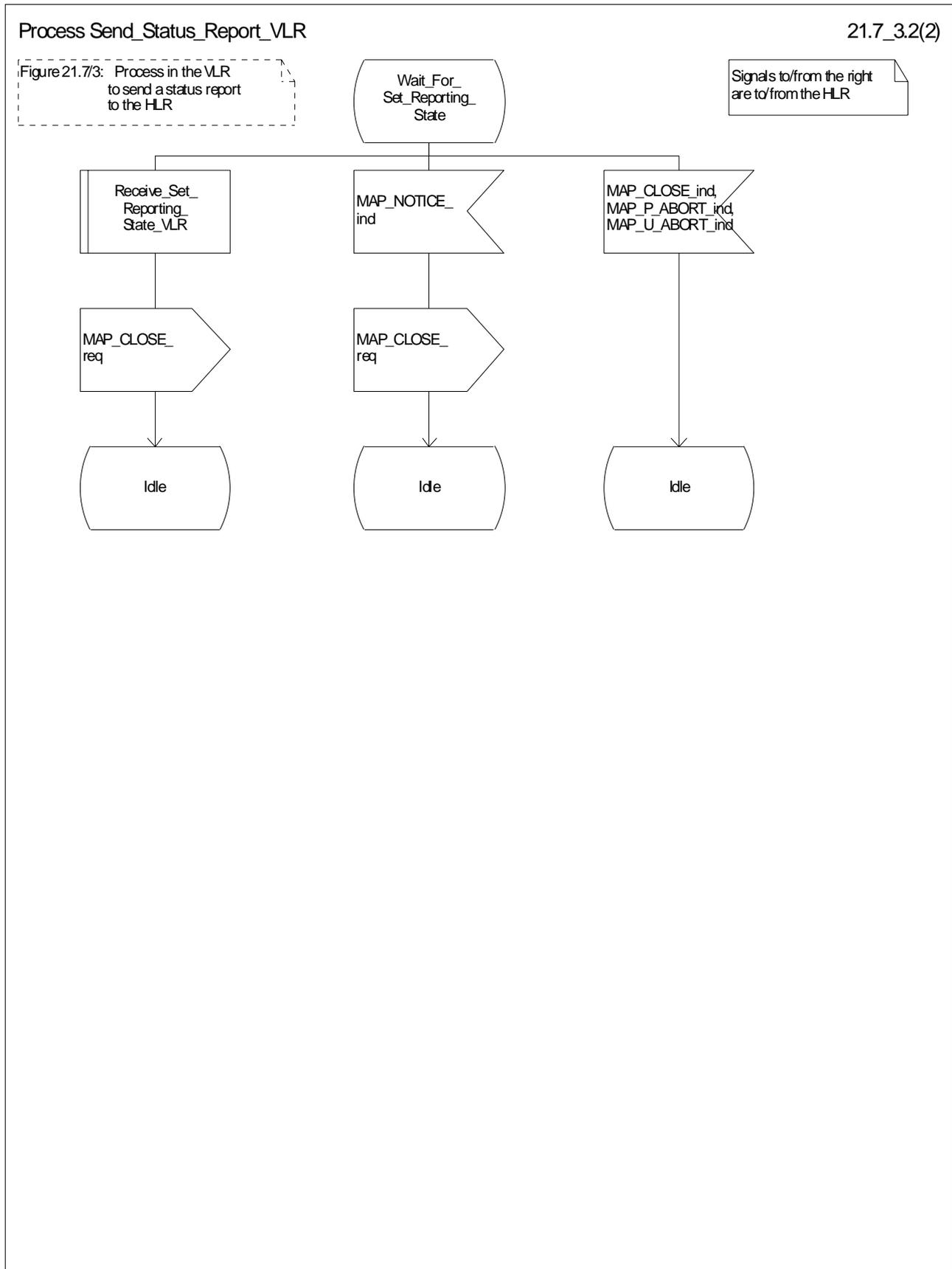

Figure 21.7/3 (sheet 2 of 2): Process Send\_Status\_Report\_VLR

### 21.7.3 Process in the HLR for Status Reporting

The MAP process in the HLR to handle a status report is shown in figure 21.7/4. The MAP process invokes macros not defined in this clause; the definitions of these macros can be found as follows:

Receive_Open_Ind	see clause 25.1.1;
Check_Confirmation	see clause 25.2.2;

#### Successful outcome

When the MAP process receives a MAP\_OPEN indication with the application context reporting, it checks it by invoking the macro Receive\_Open\_Ind.

If the macro takes the OK exit, the MAP process waits for a service indication.

The MAP process invokes the macro Receive\_Status\_Report\_HLR to handle a MAP\_STATUS\_REPORT service indication; this macro is defined in figure 21.7/5. The MAP process then waits for a response from the CCBS application in the HLR.

If the MAP process receives a Stop Reporting message from the CCBS process, it sets the required monitoring state to stop, and may send a MAP\_DELIMITER service request to the VLR. The HLR then invokes the macro Set\_Reporting\_State\_HLR. After exiting the macro, the MAP process returns to the idle state.

If the MAP process receives a Continue Reporting from the CCBS process, it sends a MAP\_CLOSE Request to VLR and returns to the idle state.

#### Failure of dialogue opening with the VLR

If the macro Receive\_Open\_Ind takes the Vr exit or the Error exit, the MAP process returns to the idle state.

#### Abort of VLR dialogue in State Wait\_For\_Service\_Indication

After the dialogue with the HLR has been established, the MAP service provider may abort the dialogue by issuing a MAP\_P\_ABORT indication. In this case, the MAP process returns to the idle state.

If the MAP provider indicates a protocol problem by sending a MAP\_NOTICE indication, the MAP process closes the dialogue with the VLR and returns to the idle state.

#### Macro Receive\_Status\_Report\_HLR

The macro Receive\_Status\_Report\_HLR is shown in figure 21.7/5.

When a MAP\_STATUS\_REPORT service indication is received, the HLR checks whether call report data are present.

If call report data are present, the MAP process sends a CCBS Call Report message to the CCBS application process in the HLR and waits for a response; otherwise it sends an Event Report message to the CCBS application process in the HLR and waits for a response.

If the MAP process receives a CCBS Call Report ack or Event Report ack from the CCBS application process in the HLR, it sends a MAP\_STATUS\_REPORT service confirm to the VLR and exits from the macro.

If the MAP process receives a CCBS Call Report negative response or Event Report negative response from the CCBS application process in the HLR, it sets the User Error according to the negative response, sends a MAP\_STATUS\_REPORT service confirm to the VLR and exits from the macro.

**Macro Set\_Reporting\_State\_HLR**

The macro Set\_Reporting\_State\_HLR is shown in figure 21.7/6.

The MAP process in the HLR sends a MAP\_SET\_REPORTING\_STATE service request to the VLR and waits for a response.

If the MAP process receives a MAP\_SET\_REPORTING\_STATE service confirm from the VLR, it invokes the macro Check\_Confirmation to check the content of the confirm.

If the macro Check\_Confirmation takes the OK exit, the macro Set\_Reporting\_State\_HLR takes the OK exit.

If the macro Check\_Confirmation takes the Data error, Provider error or User error exit, the macro Set\_Reporting\_State\_HLR takes the Error exit.

While the MAP process is waiting for a response from the VLR, the MAP provider may terminate the dialogue by sending a MAP\_CLOSE, MAP\_P\_ABORT or MAP\_U\_ABORT. In this case the macro takes the Aborted exit.

If the MAP provider indicates a protocol problem by sending a MAP\_NOTICE indication, the MAP process closes the dialogue with the VLR and the macro takes the Aborted exit.



Macrodefinition Receive\_Status\_Report\_HLR

21.7\_5(1)

Figure 21.7/5: Macro in the HLR to receive a status report from the VLR

Signals to/from the left are to/from the VLR; signals to/from the right are to/from the CCBS application process in the HLR

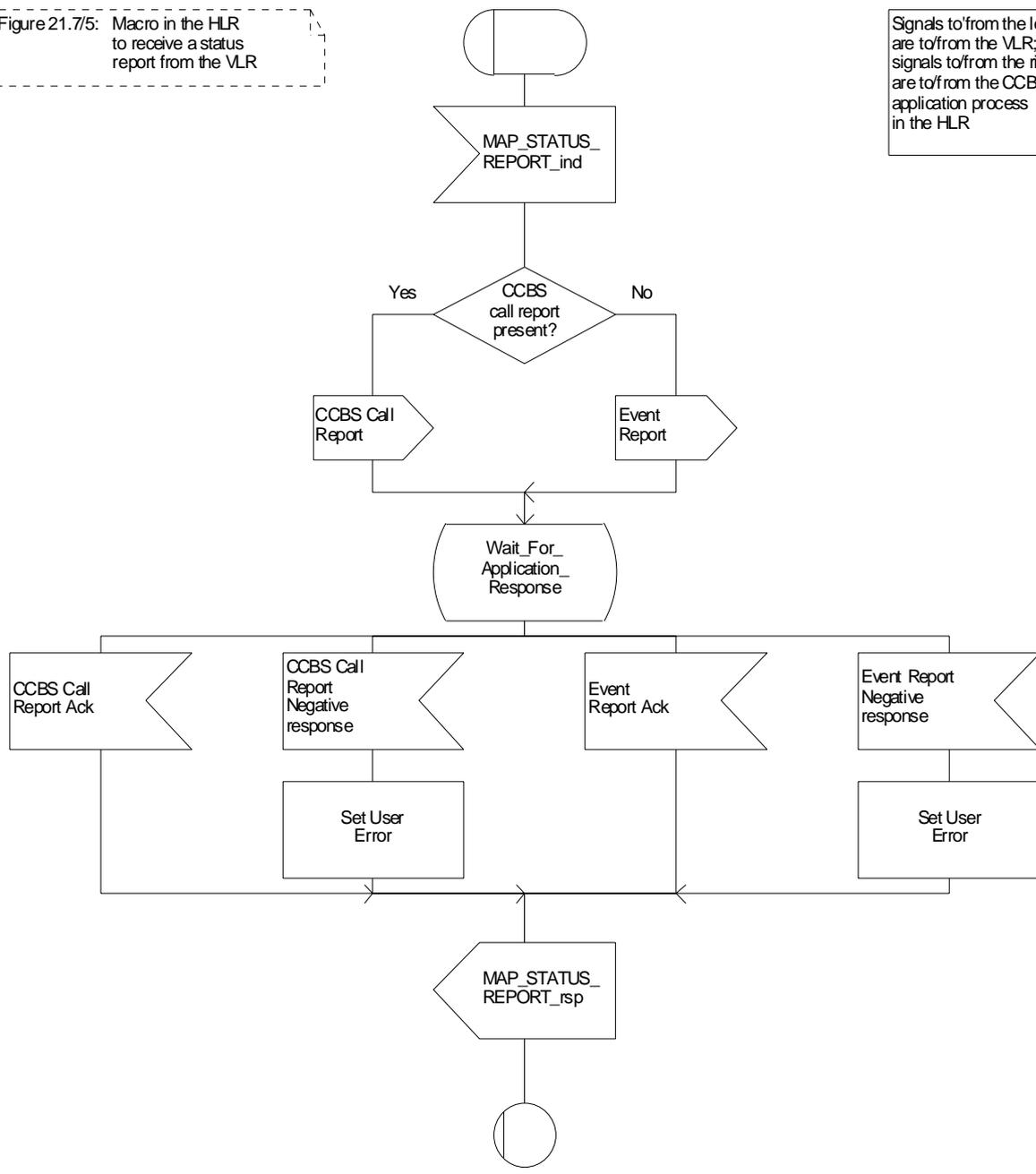

Figure 21.7/5: Macro Receive\_Status\_Report\_HLR

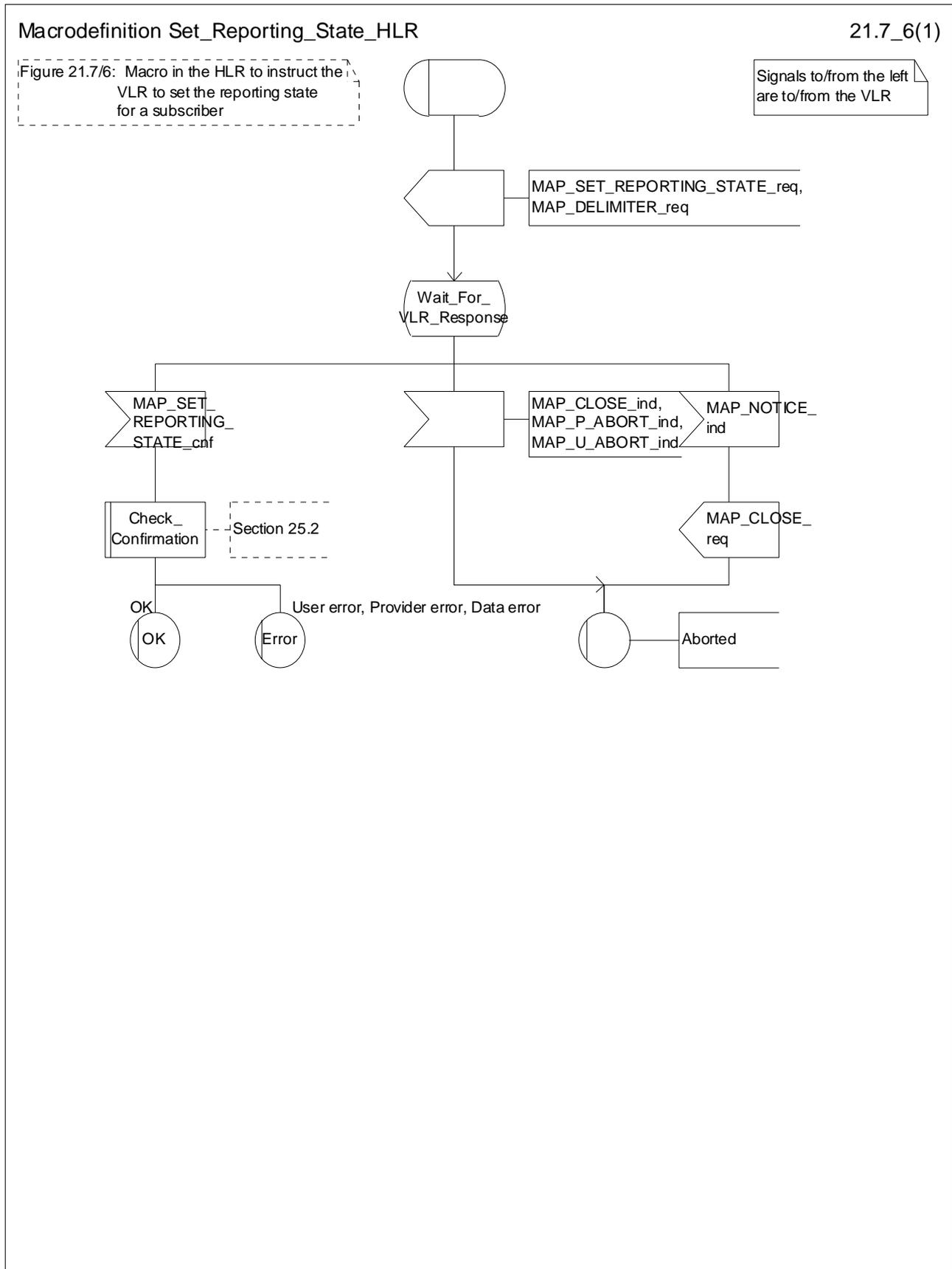

Figure 21.7/6: Macro Set\_Reporting\_State\_HLR

## 21.8 Remote User Free

### 21.8.1 General

The message flows for handling remote user free are shown in figures 21.8/1 and 21.8/2.

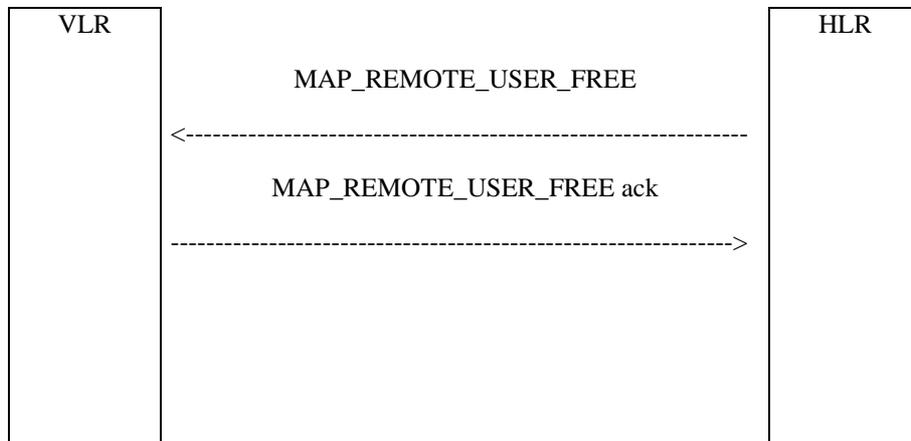

Figure 21.8/1: Remote User Free: recall not accepted

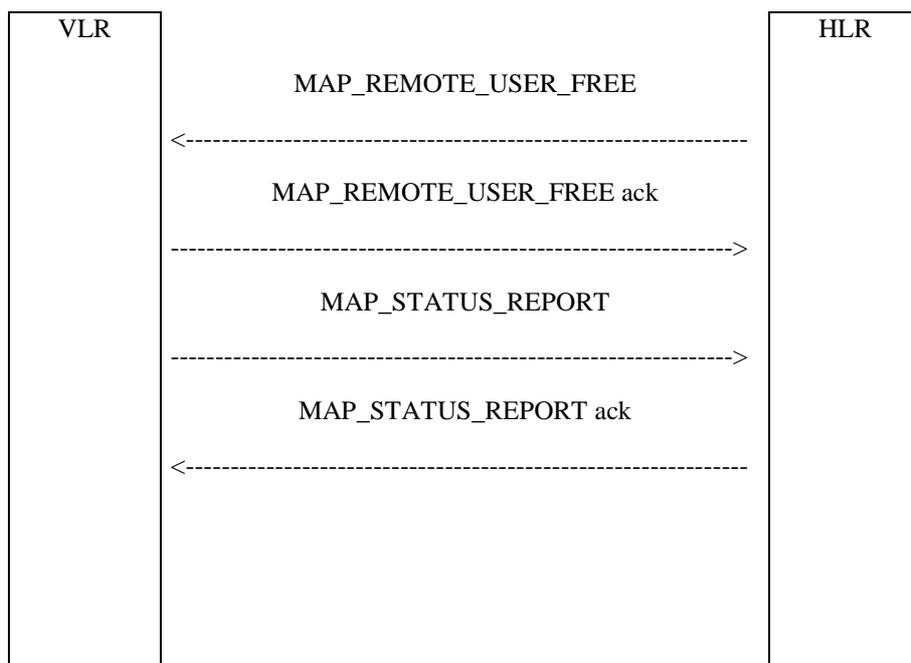

Figure 21.8/2: Remote User Free: recall accepted

### 21.8.2 Process in the HLR for Remote User Free

The MAP process in the HLR to handle Remote User Free is shown in figure 21.8/3. The MAP process invokes macros not defined in this clause; the definitions of these macros can be found as follows:

- Receive\_Open\_Cnf see clause 25.1.2;
- Check\_Confirmation see clause 25.2.2;



### Successful Outcome

When the MAP process receives a CCBS RUF request from the CCBS application process in the HLR, it requests a dialogue with the VLR whose identity is contained in the request by sending a MAP\_OPEN service request and sending the necessary information using a MAP\_REMOTE\_USER\_FREE service request. The HLR then invokes the macro Receive\_Open\_Cnf to wait for the response to the dialogue opening request. If the dialogue opening is successful, the MAP process waits for a response from the VLR.

If the MAP process receives a MAP\_REMOTE\_USER\_FREE service confirm from the VLR, the MAP process invokes the macro Check\_Confirmation to check the content of the confirm.

If the macro Check\_Confirmation takes the OK exit, the MAP process sends a CCBS RUF ack containing the information received from the VLR to the CCBS application process in the HLR and waits for a MAP\_STATUS\_REPORT service indication from the VLR. If in this state a MAP\_CLOSE service indication is received, the MAP process returns to the idle state. If in this state a MAP\_STATUS\_REPORT service indication is received, further processing is described by the macro Receive\_Status\_Report\_HLR (described in clause 21.7.3). When the macro exits, the MAP process constructs a MAP\_CLOSE service request, sends it to the VLR and returns to the idle state.

### Failure of dialogue opening with the VLR

If the macro Receive\_Open\_Cnf takes the Vr exit or the Error exit, the MAP process sends a negative response to the CCBS application process in the HLR and returns to the idle state.

### Error in MAP\_REMOTE\_USER\_FREE confirm

If the MAP\_REMOTE\_USER\_FREE service confirm contains a user error or a provider error, or the macro Check\_Confirmation indicates that there is a data error, the MAP process sends a CCBS RUF negative response to the CCBS application process in the HLR and returns to the idle state.

### Abort of VLR dialogue

When the MAP process is waiting for a VLR response to the MAP\_REMOTE\_USER\_FREE, the MAP service provider may abort the dialogue by issuing a MAP\_CLOSE, a MAP\_P\_ABORT or a MAP\_U\_ABORT indication. In this case, the MAP process sends a CCBS RUF negative response to the CCBS application process in the HLR and returns to the idle state.

If the MAP provider indicates a protocol problem by sending a MAP\_NOTICE indication when the MAP process is waiting for a VLR response to the MAP\_REMOTE\_USER\_FREE, the MAP process closes the dialogue with the VLR, sends a CCBS RUF negative response indicating system failure to the CCBS application process in the HLR and returns to the idle state.

When the MAP process is waiting for a possible MAP\_STATUS\_REPORT from the VLR, the MAP service provider may abort the dialogue by issuing a MAP\_P\_ABORT or a MAP\_U\_ABORT indication. In this case, the MAP process returns to the idle state.

If the MAP provider indicates a protocol problem by sending a MAP\_NOTICE indication when the MAP process is waiting for a possible MAP\_STATUS\_REPORT from the VLR, the MAP process closes the dialogue with the VLR and returns to the idle state.

If the CCBS application in the HLR decides to abort the dialogue, it sends an Abort message to the MAP process, which closes the dialogue with the VLR and returns to the idle state.

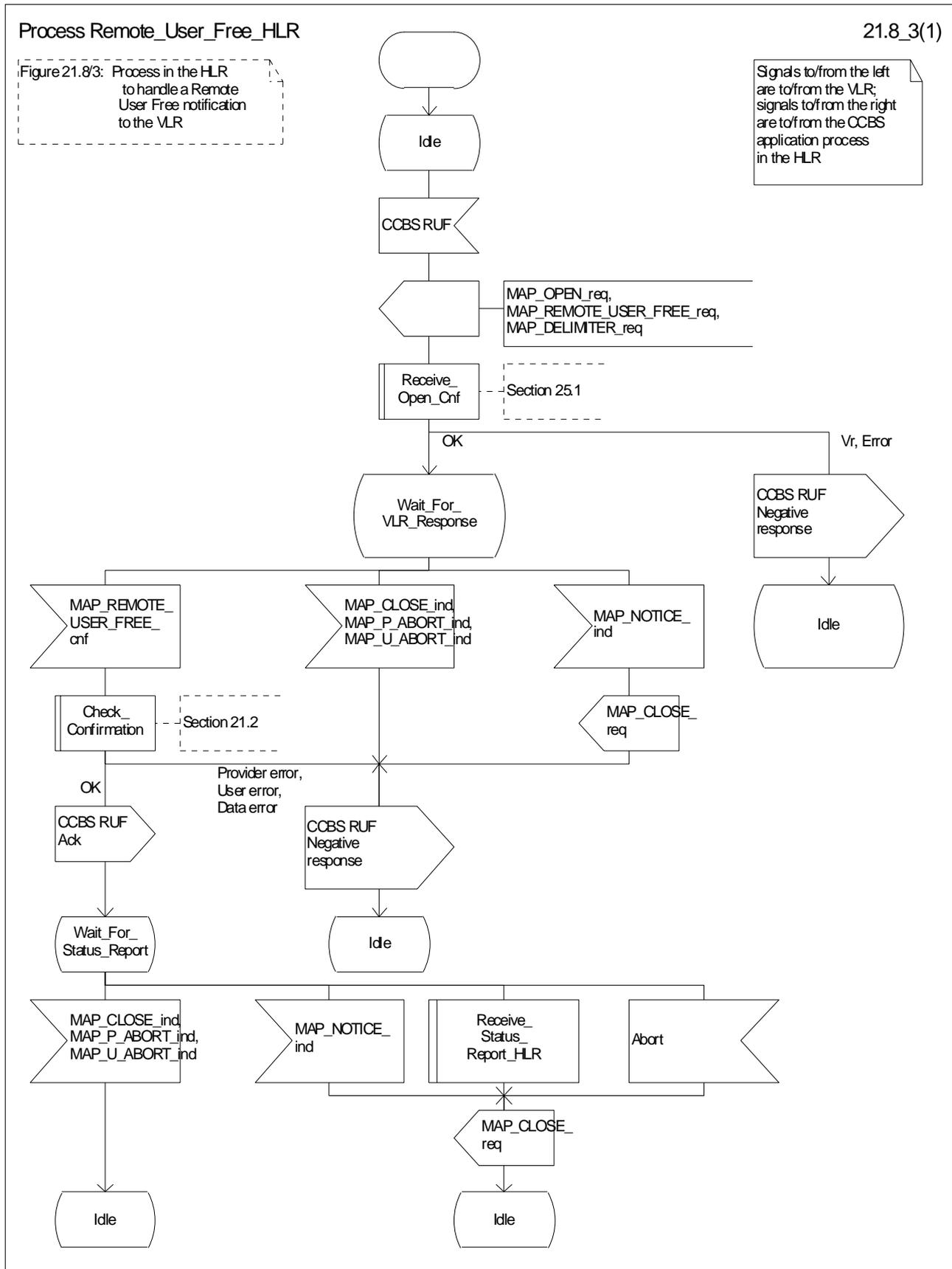

Figure 21.8/3: Process Remote\_User\_Free\_HLR

### 21.8.3 Process in the VLR for Remote User Free

The MAP process in the VLR to handle Remote User Free is shown in figure 21.8/4. The MAP process invokes a macro not defined in this clause; the definitions of this macro can be found as follows:

Check\_Confirmation      see clause 25.2.2;

#### **Successful outcome (Recall accepted)**

When the MAP process receives a MAP\_REMOTE\_USER\_FREE service indication, the VLR sends a CCBS RUF request to the CCBS application process in the VLR, and waits for a response. The request contains the parameters received in the MAP\_REMOTE\_USER\_FREE service indication.

If the CCBS application process in the VLR returns a positive response indicating "recall accepted", the MAP process constructs a MAP\_REMOTE\_USER\_FREE service response and a MAP\_DELIMITER service request, sends them to the VLR and waits for a CCBS Call Report message from the CCBS application process in the VLR. When the MAP process receives the CCBS Call Report from the CCBS application process in the VLR, it constructs a MAP\_STATUS\_REPORT service request and a MAP\_DELIMITER service request, sends them to the HLR and waits for a response. If the MAP process receives a MAP\_STATUS\_REPORT service confirm, the VLR calls the macro Check\_Confirmation. If this macro takes the OK exit, the MAP process sends a CCBS Call Report ack to the CCBS application process in the VLR and the MAP process terminates.

#### **Successful outcome (Recall not accepted)**

If the CCBS application process in the VLR returns a positive response indicating "recall not accepted", the MAP process constructs a MAP\_REMOTE\_USER\_FREE service response and a MAP\_CLOSE service request, sends them to the HLR and terminates.

#### **Negative response from VLR CCBS application process**

If the CCBS application process in the VLR returns a negative response, the MAP process constructs a MAP\_REMOTE\_USER\_FREE service response containing the appropriate error and a MAP\_CLOSE service request, sends them to the HLR and terminates.

#### **Failure of dialogue with the HLR**

When waiting for a response or a call result from the CCBS application process in the VLR, the MAP process may receive a MAP\_CLOSE service indication, a MAP\_U\_ABORT service indication or a MAP\_P\_ABORT service indication from the co-ordinating process, in which case the MAP process terminates.

When waiting for a call result from the CCBS application process in the VLR, the MAP process may receive a MAP\_NOTICE indication from the co-ordinating process, in which case the MAP process constructs a MAP\_CLOSE service request, sends it to the co-ordinating process and terminates.

When waiting for a response from the HLR, the MAP process may receive a MAP\_CLOSE indication, a MAP\_U\_ABORT indication or a MAP\_P\_ABORT indication from the co-ordinating process, in which case the MAP process sends a CCBS Call Report negative response to the CCBS application process in the VLR and terminates.

When waiting for a response from the HLR, the MAP process may receive a MAP\_NOTICE indication from the co-ordinating process, in which case the MAP process constructs a MAP\_CLOSE service request, sends it to the co-ordinating process, sends a CCBS Call Report negative response to the CCBS application process in the VLR and terminates.

#### **Error in MAP\_STATUS\_REPORT confirm**

If the MAP\_STATUS\_REPORT service confirm contains a user error or a provider error, the MAP process sends a CCBS Call Report negative response to the CCBS application process in the VLR and terminates.

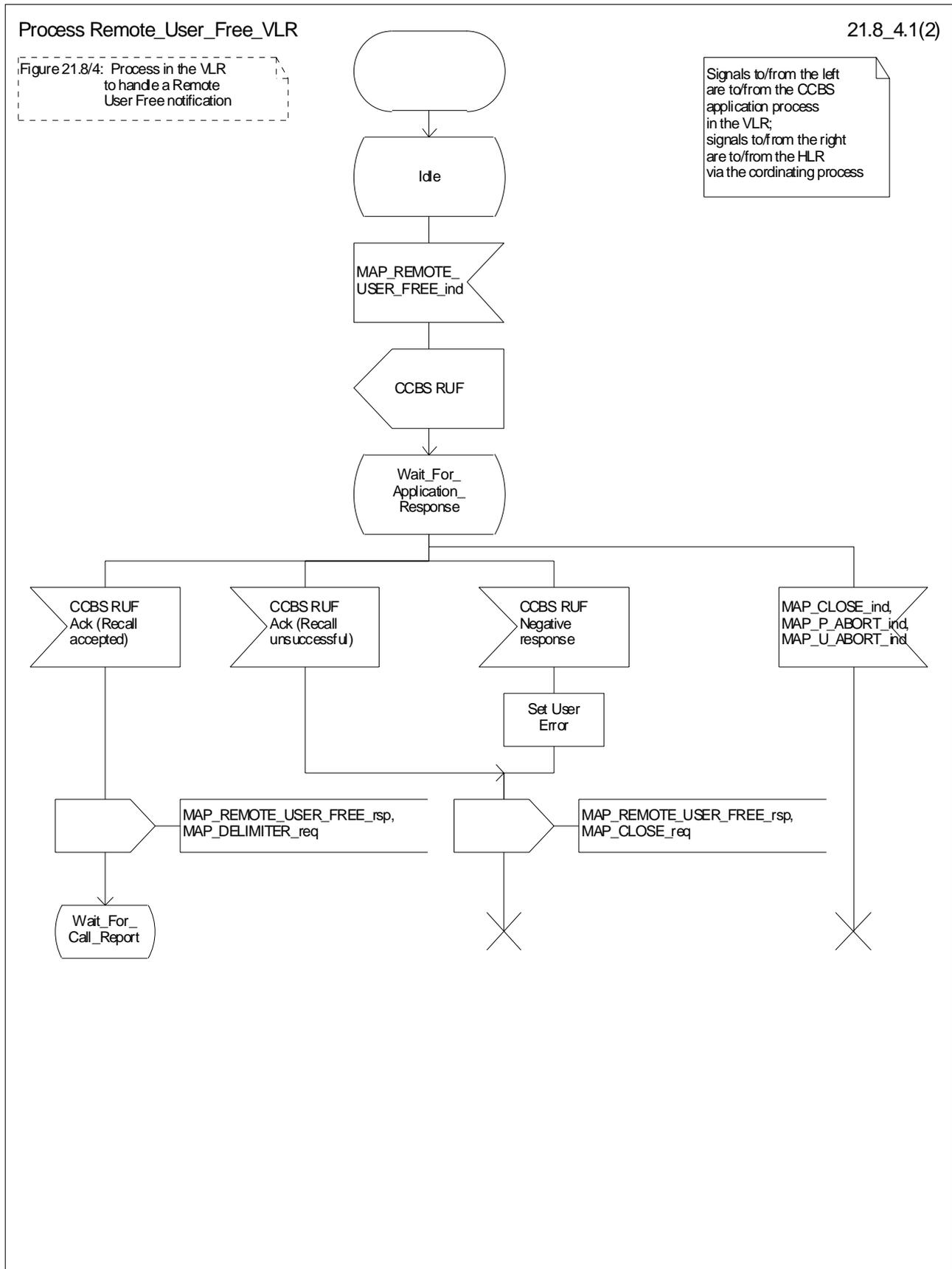

Figure 21.8/4 (sheet 1 of 2): Process Remote\_User\_Free\_VLR

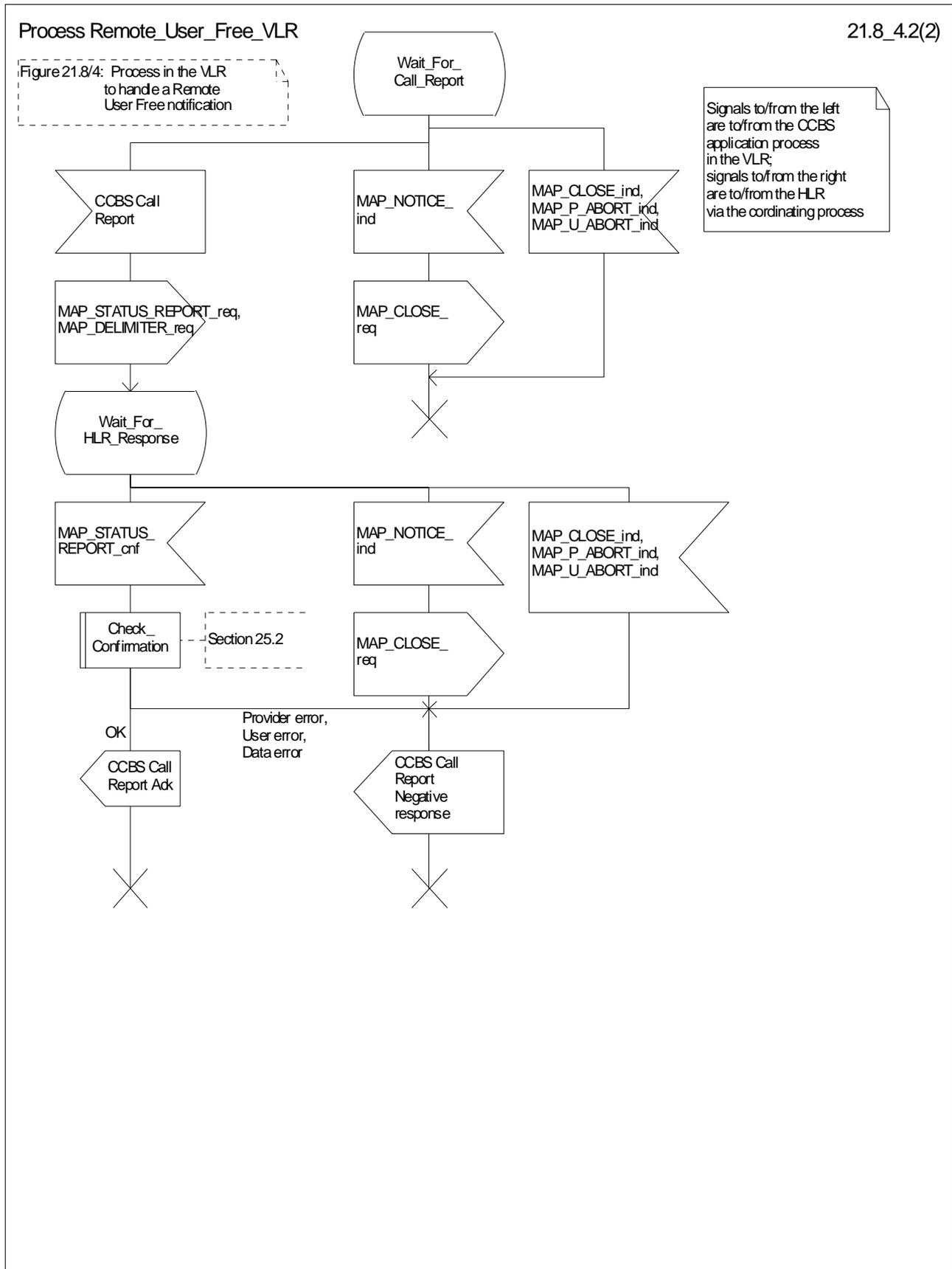

Figure 21.8/4 (sheet 2 of 2): Process Remote\_User\_Free\_VLR

## 22 Supplementary services procedures

The following application contexts exist for handling of supplementary services:

- accessUnstructuredSsContext;
- accessFunctionalSsContext.

The accessUnstructuredSsContext refers to a simple MAP users, for which the corresponding MAP process can be identified by the MAP-Provider directly.

However, the accessFunctionalSsContext refers to a complex MAP-User consisting of several processes. For this user, a process co-ordinator is defined for each network entity, in order to identify the correct process to invoke. These processes open and validate the dialogue, then invoke the necessary operation-specific process. These processes are described below.

### 22.1 Functional supplementary service processes

#### 22.1.1 Functional supplementary service process co-ordinator for MSC

Upon receipt of a CM-Service request with CM-service type = SS, the MSC initiates the process access request procedure towards the VLR as described in clause 25 of the present document.

Once a CM connection is established, the MSC can handle supplementary service indications from the MS. Table 22.1/1 shows the co-ordinating process' reaction on receipt of specific SS service indications on the air interface. After the relevant process is invoked, the received air interface service indication is sent to that process. The creation of service requests on the basis of air interface messages is described in GSM 09.11.

**Table 22.1/1: Relationship between received service indication and invoked process in the MSC**

Service indication received	Process invoked
A_REGISTER_SS_ind	REGISTER_SS_MSC
A_ERASE_SS_ind	ERASE_SS_MSC
A_ACTIVATE_SS_ind	ACTIVATE_SS_MSC
A_DEACTIVATE_SS_ind	DEACTIVATE_SS_MSC
A_INTERROGATE_SS_ind	INTERROGATE_SS_MSC
A_REGISTER_PASSWORD	REGISTER_PASSWORD_MSC

Figure 22.1/1 shows the co-ordinating process in the MSC.

Process SS\_Coordinator\_MSC

22.1\_1(1)

Figure 22.1/1: Supplementary Service Coordination process in the MSC, to identify which functional supplementary service process shall be invoked.

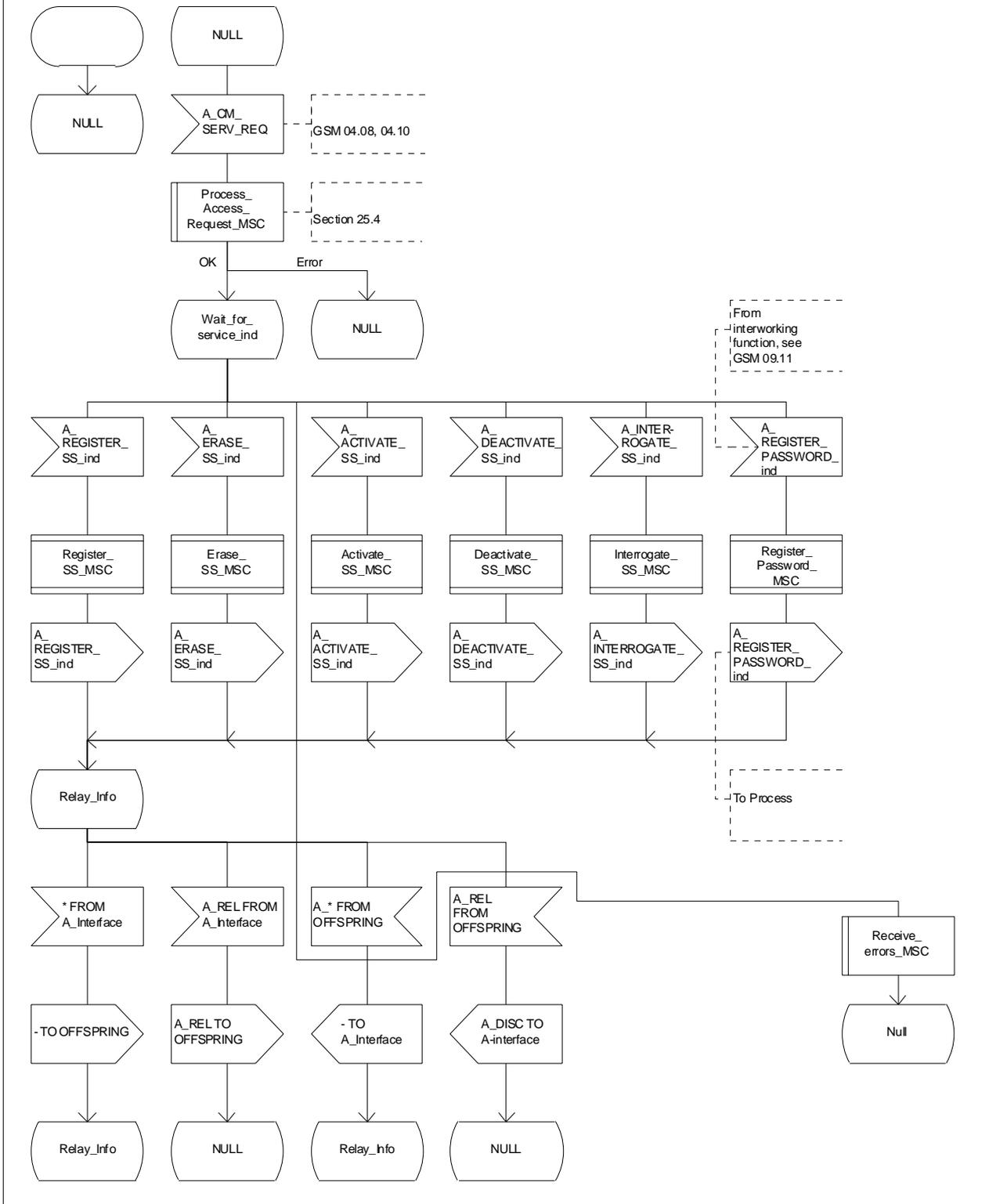

Figure 22.1/1: Process SS\_Coordinator\_MSC

## 22.1.2 Functional supplementary service process co-ordinator for VLR

Any functional SS process in the VLR starts by the VLR receiving the MAP\_PROCESS\_ACCESS\_REQUEST indication. The VLR then acts as described in clause 25 of the present document.

If the Process Access Request was successful, the VLR can handle supplementary service indications from the MSC. Table 22.1/2 shows the co-ordinating process' reaction on receipt of specific SS service indications from the MSC. After the relevant process is invoked, the received service indication is sent to that process, and the co-ordinating process terminates.

**Table 22.1/2: Relationship between received service indication and invoked process in the VLR**

<b>Service indication received</b>	<b>Process invoked</b>
MAP_REGISTER_SS_ind	REGISTER_SS_VLR
MAP_ERASE_SS_ind	ERASE_SS_VLR
MAP_ACTIVATE_SS_ind	ACTIVATE_SS_VLR
MAP_DEACTIVATE_SS_ind	DEACTIVATE_SS_VLR
MAP_INTERROGATE_SS_ind	INTERROGATE_SS_VLR
MAP_REGISTER_PASSWORD	REGISTER_PASSWORD_VLR

Figure 22.1/2 shows the co-ordinating process in the VLR.



### Process SS\_Coordinator\_VLR

22.1\_2.1(2)

Figure 22.1/2: Supplementary Service Coordination process in the VLR, to open and process the access request from the MSC, and then identify which functional supplementary service process shall be invoked.

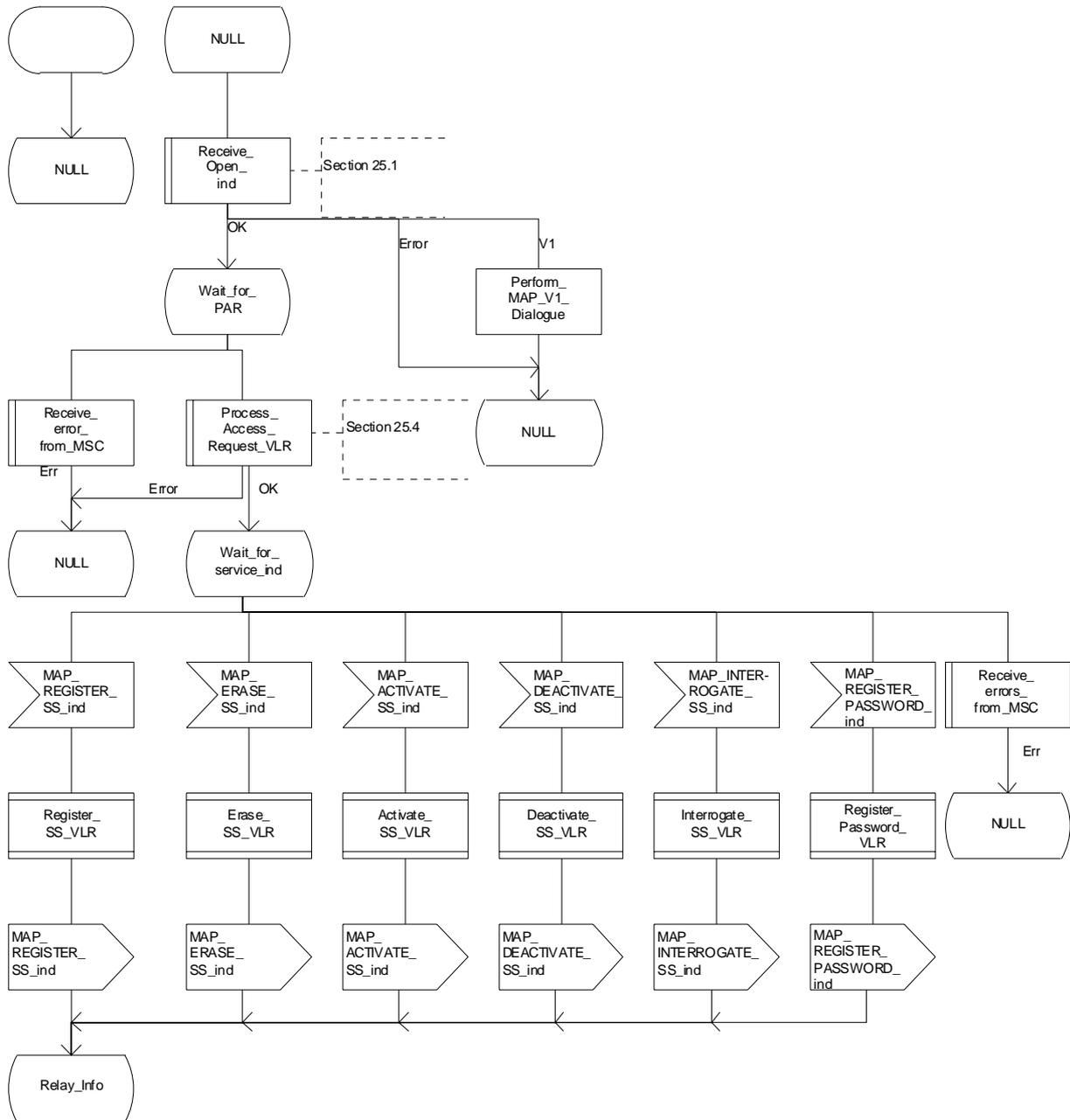

Figure 22.1/2 (sheet 1 of 2): Process SS\_Coordinator\_VLR

Process SS\_Coordinator\_VLR

22.1\_2.2(2)

Figure 22.1/2: Supplementary Service Coordination process in the VLR, to open and process the access request from the MSC, and then identify which functional supplementary service process shall be invoked.

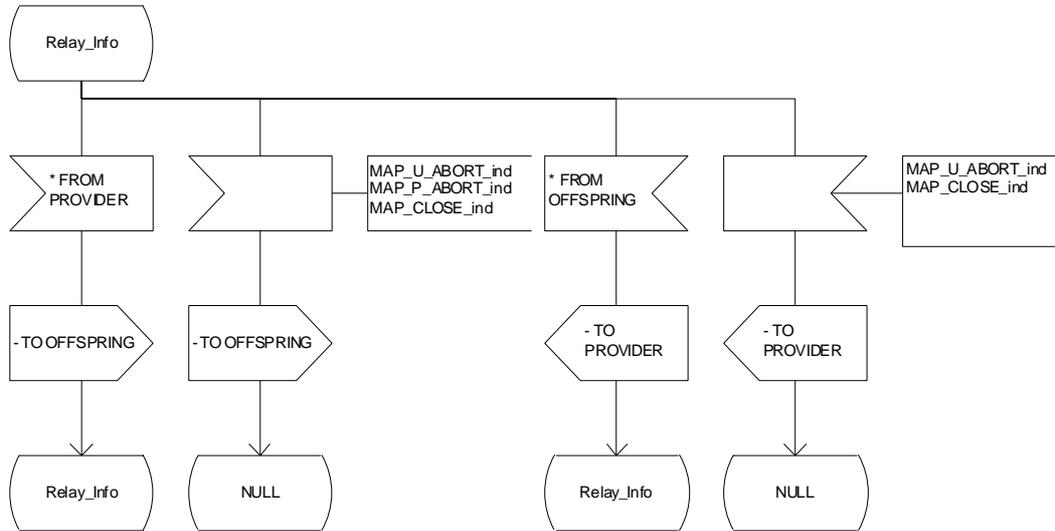

Figure 22.1/2 (sheet 2 of 2): Process SS\_Coordinator\_VLR

### 22.1.3 Functional supplementary service process co-ordinator for HLR

Any functional SS process in the HLR starts by the HLR receiving a MAP-OPEN service indication. If that service is successful, the HLR can handle supplementary service indications from the VLR. Table 22.1/3 shows the co-ordinating process' reaction on receipt of specific SS service indications from the VLR. After the relevant process is invoked, the received service indication is sent to that process, and the co-ordinating process terminates.

**Table 22.1/3: Relationship between received service indication and invoked process in the HLR.**

<b>Service indication received</b>	<b>Process invoked</b>
MAP_REGISTER_SS_ind	REGISTER_SS_HLR
MAP_ERASE_SS_ind	ERASE_SS_HLR
MAP_ACTIVATE_SS_ind	ACTIVATE_SS_HLR
MAP_DEACTIVATE_SS_ind	DEACTIVATE_SS_HLR
MAP_INTERROGATE_SS_ind	INTERROGATE_SS_HLR
MAP_REGISTER_PASSWORD	REGISTER_PASSWORD_HLR

Figure 22.1/3 shows the co-ordinating process in the HLR.

Process SS\_Coordinator\_HLR

22.1\_3.1(2)

Figure 22.1/3: Supplementary Service Coordination process in the HLR, to identify which functional supplementary service process shall be invoked.

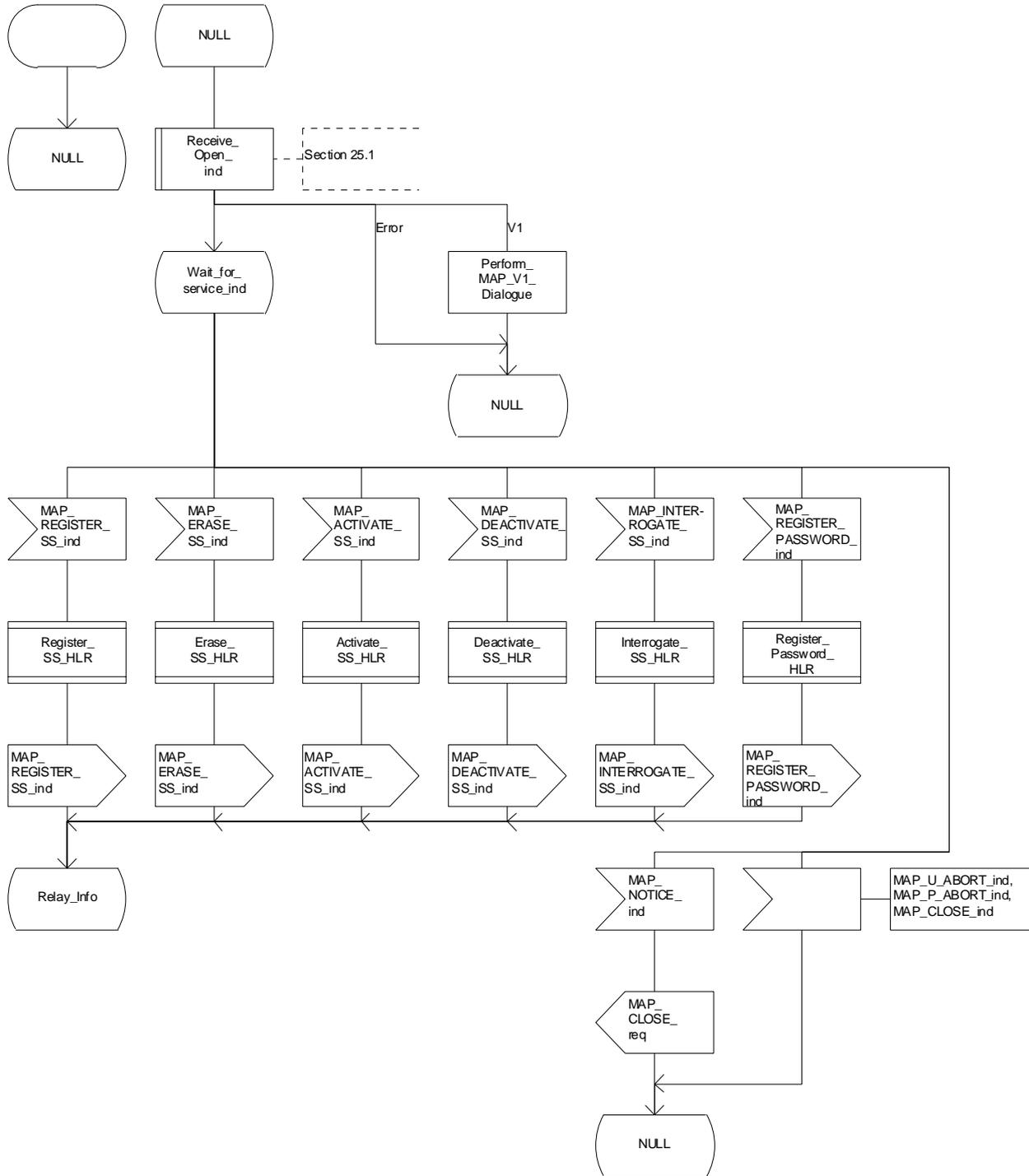

Figure 22.1/3 (sheet 1 of 2): Process SS\_Coordinator\_HLR

### Process SS\_Coordinator\_HLR

22.1\_3.2(2)

Figure 22.1/3: Supplementary Service Coordination process in the HLR, to identify which functional supplementary service process shall be invoked.

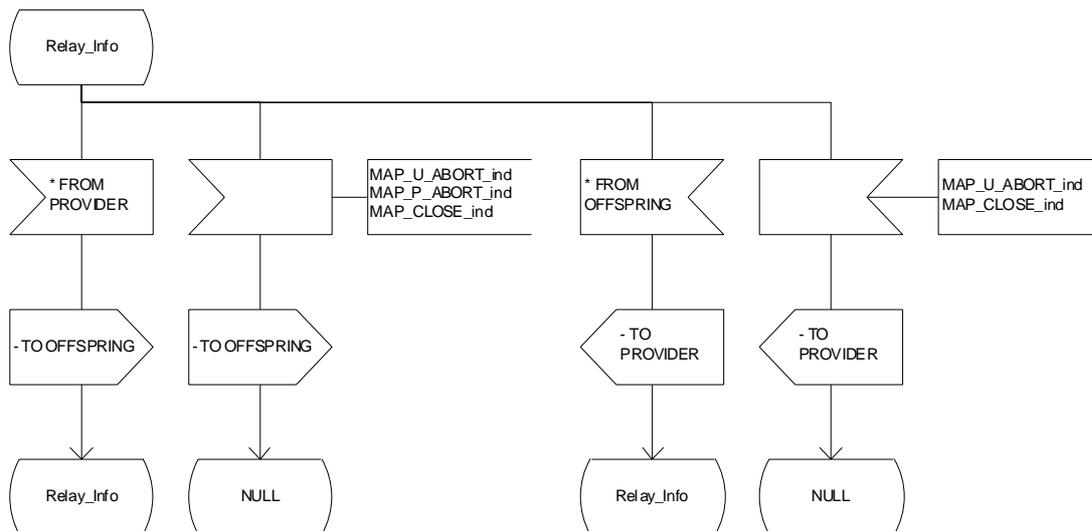

Figure 22.1/3 (sheet 2 of 2): Process SS\_Coordinator\_HLR

## 22.1.4 Call completion supplementary service process co-ordinator for HLR

The MAP co-ordinating process in the HLR to handle a dialogue opened with the callCompletion application context is shown in figure 22.1/4. The MAP process invokes a macro not defined in this clause; the definition of this macro can be found as follows:

Receive\_Open\_Ind            see clause 25.1.1.

Any call completion SS process in the HLR starts by the HLR receiving a MAP-OPEN service indication. If that service is successful, the HLR can handle call completion supplementary service indications from the VLR.

Table 22.1/4 shows the co-ordinating process' reaction on receipt of specific call completion SS service indications from the VLR. After the relevant process is invoked, the received service indication is sent to that process.

**Table 22.1/4: Relationship between received service indication and invoked process in the HLR.**

Service indication received	Process invoked
MAP_REGISTER_CC_ENTRY_ind	REGISTER_CC_ENTRY_HLR
MAP_ERASE_CC_ENTRY_ind	ERASE_CC_ENTRY_HLR

After creation of the user process the Co-ordinator relays the messages between the MAP\_PM and the invoked process until a request or an indication for dialogue termination is received.

The Call\_Completion Co-ordinator is shown in figure 22.1/4.

Process CC\_Coord\_HLR

22.1\_4(1)

Figure 22.1/4: Coordinating process in the HLR to handle a dialogue opened with the AC CallCompletionContext

Signals to/from the left are to/from the VLR via the MAP provider; signals to/from the right are to/from the child process

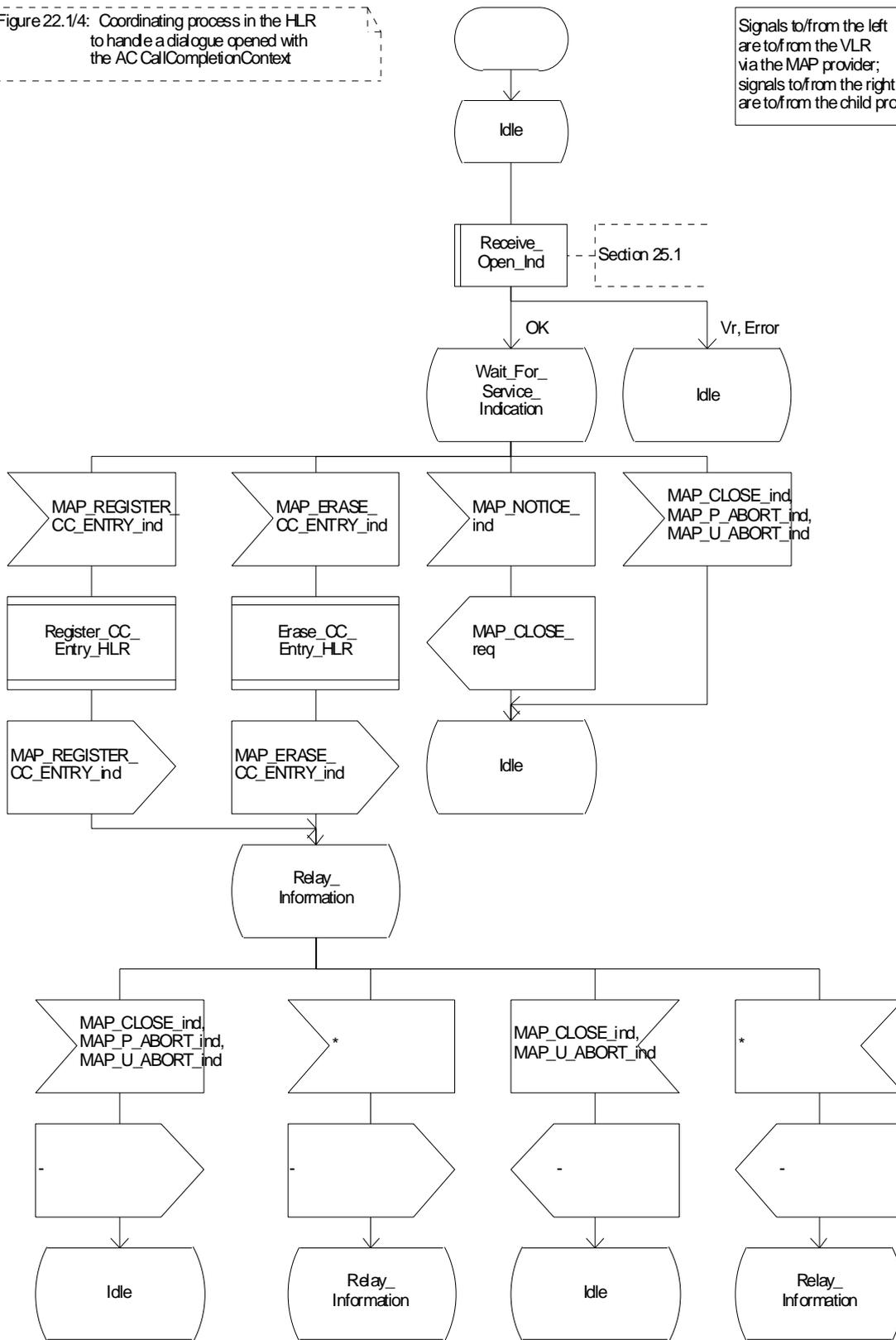

Figure 22.1/4: Process\_CC\_Coord\_HLR

## 22.2 Registration procedure

### 22.2.1 General

The registration procedure is used to register data related to a supplementary service in the HLR. The registration procedure is a fully transparent communication between the MS and the HLR, except that some services may be invoked as a result of the procedure, as described in the clauses below.

The registration procedure is shown in figure 22.2.1/1.

The following services may be used:

- MAP\_PROCESS\_ACCESS\_REQUEST (defined in clauses 8 and 25);
- MAP\_TRACE\_SUBSCRIBER\_ACTIVITY (defined in clauses 9 and 25);
- MAP\_PROVIDE\_IMSI (defined in clauses 8 and 25);
- MAP\_FORWARD\_NEW\_TMSI (defined in clauses 8 and 25);
- MAP\_AUTHENTICATE (defined in clauses 8 and 25);
- MAP\_SET\_CIPHERING\_MODE (defined in clauses 8 and 25);
- MAP\_CHECK\_IMEI (defined in clauses 8 and 25);
- MAP\_READY\_FOR\_SM (defined in clauses 12 and 25);
- MAP\_INSERT\_SUBSCRIBER\_DATA (defined in clauses 8 and 25);
- MAP\_REGISTER\_SS (defined in clause 11).

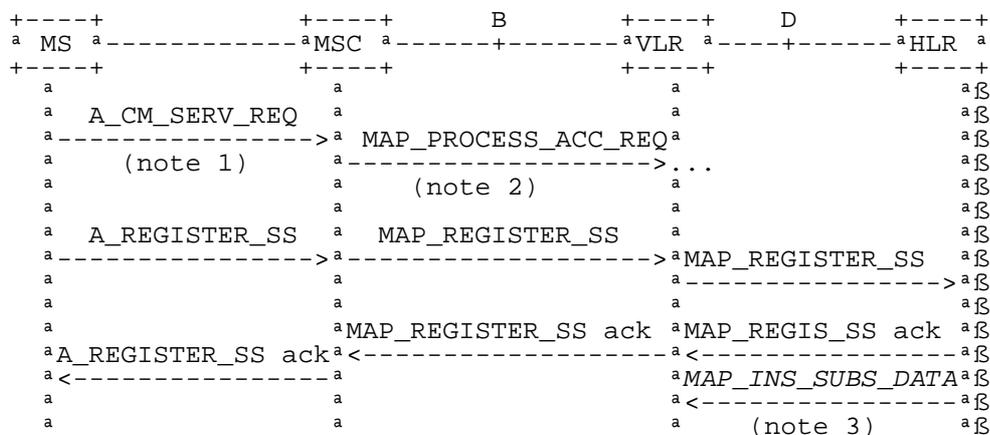

NOTE 1: For details of the procedure on the radio path, see GSM 04.08, 04.10, 04.8x and 04.9x. Services shown in dotted lines indicate the trigger provided by the signalling on the radio path, and the signalling triggered on the radio path.

NOTE 2: For details on the Process Access Request procedure, please refer to clause 25 in the present document.

NOTE 3: Services printed in *italics* are optional.

**Figure 22.2.1/1: Interfaces and services for supplementary service registration**



## 22.2.2 Procedures in the MSC

### Supplementary service registration

The A\_REGISTER\_SS service indication received by the MAP user in the MSC contains the SS-Code and any parameters that are related to the supplementary service.

The MAP user transfers the received information to the VLR in the MAP\_REGISTER\_SS request without checking the contents of the service indication. Rules for the mapping are described in GSM 09.11.

The MSC then awaits the receipt of the MAP\_REGISTER\_SS confirm from the VLR. The outcome of the procedure is reported to the MS in the A\_REGISTER\_SS response message as described in GSM 04.8x, 04.9x and 09.11. Finally the SS-connection is released.

For call independent SS operations, each message shall only contain a single component. Messages which contain more than one component will be stopped at the air interface (as specified in GSM 09.11).

### Error handling

If at any time during the supplementary service part of this procedure a MAP\_P\_ABORT, MAP\_U\_ABORT, MAP\_NOTICE or unexpected MAP\_CLOSE indication is received from the VLR concerning the process, a CM\_RELEASE\_COMPLETE indication is sent to the MS (as specified in GSM 09.11). Upon receipt of a MAP\_NOTICE indication from the VLR, the MSC must close the VLR dialogue by sending a MAP\_CLOSE request. The process is then terminated.

If an A\_CM\_RELEASE indication is received from the MS, all open transactions shall be released using the MAP\_U\_ABORT request indicating application procedure cancellation, and the process is terminated.

The registration procedure in the MSC is shown in figure 22.2.2/1.

Process SS\_REGISTER\_MSC

22.2.2\_1(1)

Figure 22.2.2/1 : Mobile initiated registration of supplementary service in the MSC

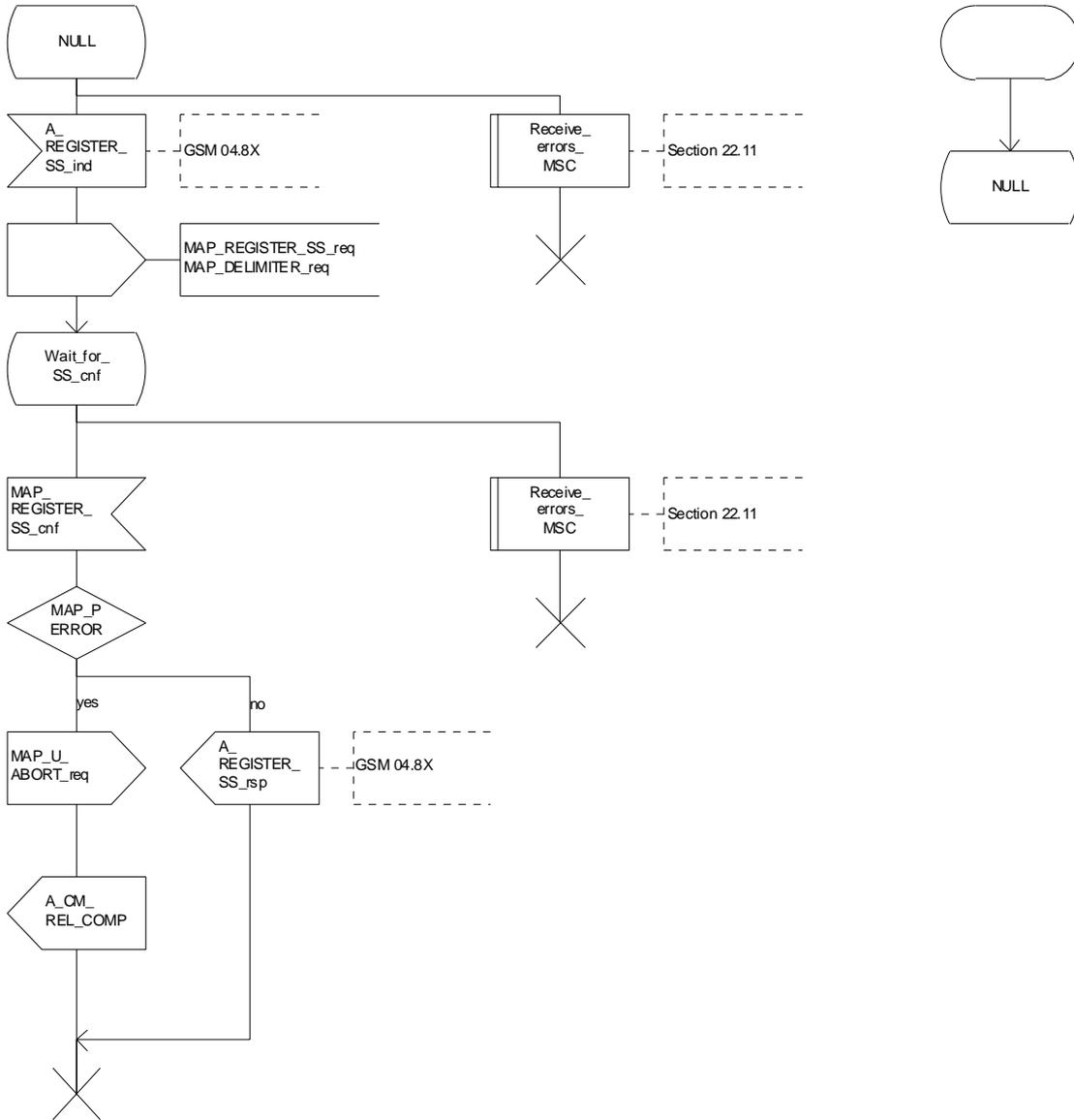

Figure 22.2.2/1: Procedure SS\_Register\_MSC

## 22.2.3 Procedures in the VLR

### Supplementary service registration

When receiving the MAP\_REGISTER\_SS indication, the MAP user in the VLR transfers the information to the HLR in the MAP\_REGISTER\_SS request without checking the contents of the service indication.

The VLR then awaits the receipt of the MAP\_REGISTER\_SS confirm from the HLR. The MAP user in the VLR shall transfer the information contained in this primitive to the MSC in the MAP\_REGISTER\_SS response without checking its contents.

For call independent SS operations, each message shall only contain a single component. Messages which contain more than one component will be stopped at the air interface (as specified in GSM 09.11).

### Error handling

If at any time during this procedure a MAP\_P\_ABORT, MAP\_U\_ABORT, MAP\_NOTICE or unexpected MAP\_CLOSE indication is received from the MSC concerning the process, a MAP\_U\_ABORT request indicating application procedure cancellation is sent to the HLR (if a connection exists). If a MAP\_NOTICE indication was received from the MSC, that dialogue must be closed by sending a MAP\_CLOSE request towards the MSC. The process is terminated.

If a MAP\_P\_ABORT, MAP\_U\_ABORT or MAP\_CLOSE indication is received from the HLR, a MAP\_U\_ABORT request shall be sent to the MSC terminating the process. If a MAP\_NOTICE indication was received from the HLR, that dialogue must be closed by sending a MAP\_CLOSE request towards the HLR. The process terminates.

The registration procedure in the VLR is shown in figure 22.2.3/1.

### Process SS\_REGISTER\_VLR

22.2.3\_1.1(2)

Figure 22.2.3/1: Mobile initiated registration of supplementary services in the VLR

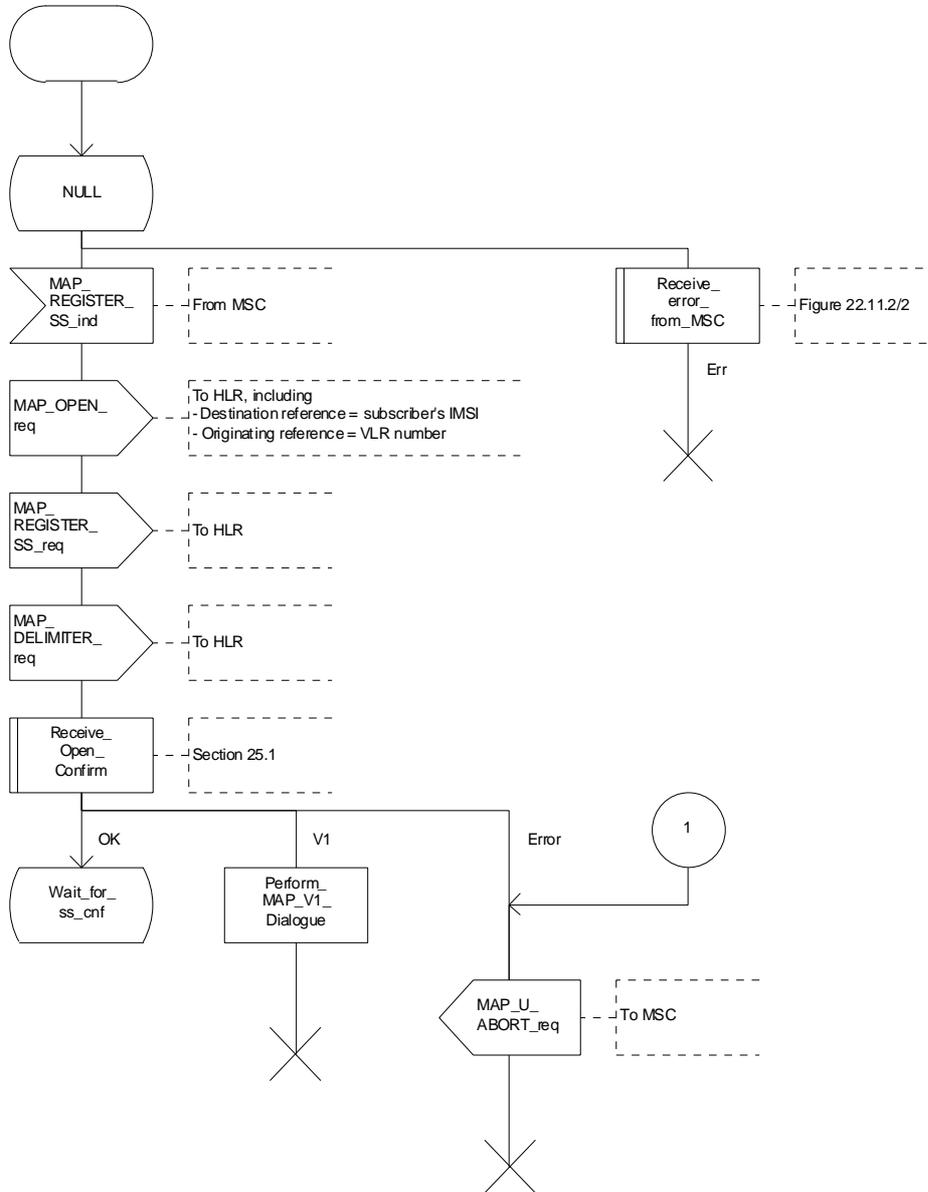

Figure 22.2.3/1 (sheet 1 of 2): Procedure SS\_Register\_VLR

Process SS\_REGISTER\_VLR

22.2.3\_1.2(2)

Figure 22.2.3/1: Mobile initiated registration of supplementary services in the VLR

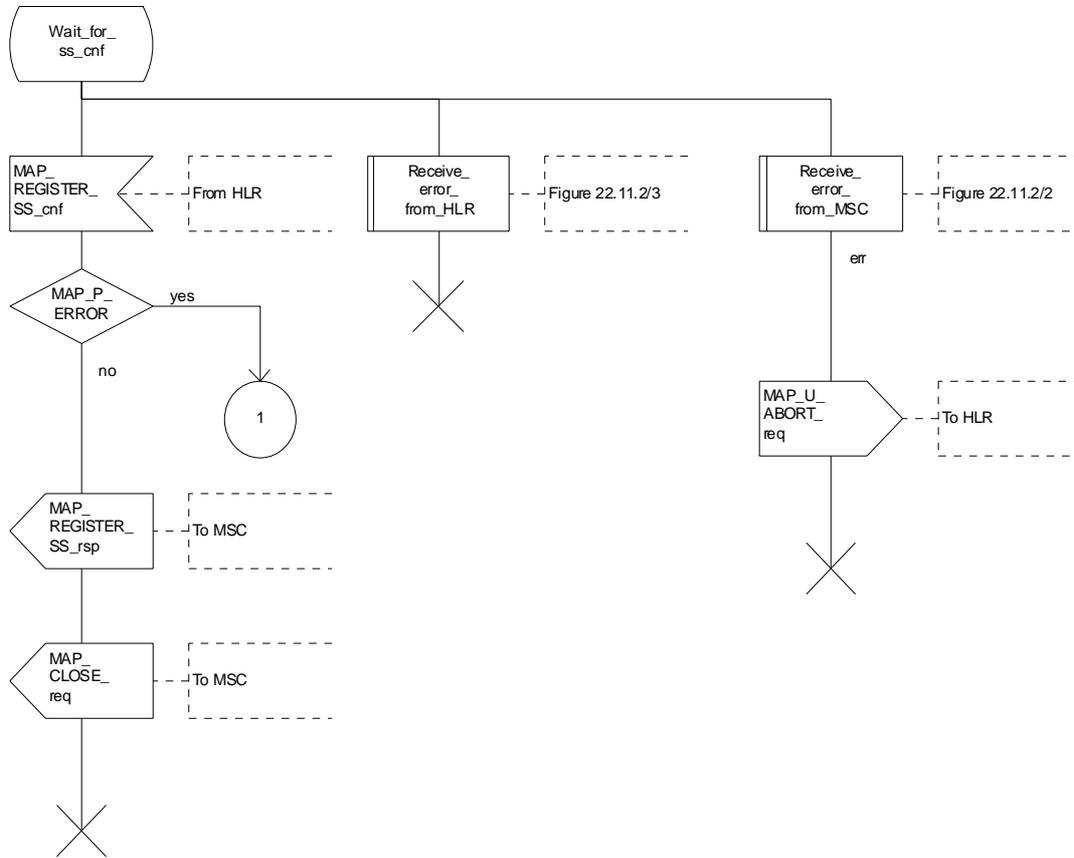

Figure 22.2.3/1 (sheet 2 of 2): Procedure SS\_Register\_VLR

## 22.2.4 Procedures in the HLR

The procedure in the HLR is initiated when it receives a MAP\_REGISTER\_SS indication.

The HLR acts as follows:

- if the operator has barred the subscriber from access to supplementary services, the Call Barred error should be returned to the VLR. The parameter "operatorBarring" shall be included with the error.

The supplementary service request shall then be processed according to GSM 03.11 and the 03.8x and 03.9x-series of technical specifications. This handling may lead to either a successful result, a partially successful result, or an error being returned.

For call independent SS operations, each message shall only contain a single component. Messages which contain more than one component will be stopped at the air interface (as specified in GSM 09.11):

- if the VLR is to be updated after the supplementary service registration, the MAP\_INSERT\_SUBS\_DATA\_HLR process shall be initiated;
- if at any time during this procedure a MAP\_P\_ABORT, MAP\_U\_ABORT or MAP\_CLOSE indication concerning the process is received from the VLR, the process is terminated. If a MAP\_NOTICE indication is received, a MAP\_CLOSE request indicating sent towards the VLR.

The registration procedure in the HLR is shown in figure 22.2.4/1.

Process SS\_REGISTER\_HLR

22.2.4\_1.1(2)

Figure 22.2.4/1: Registration of supplementary services procedure in HLR

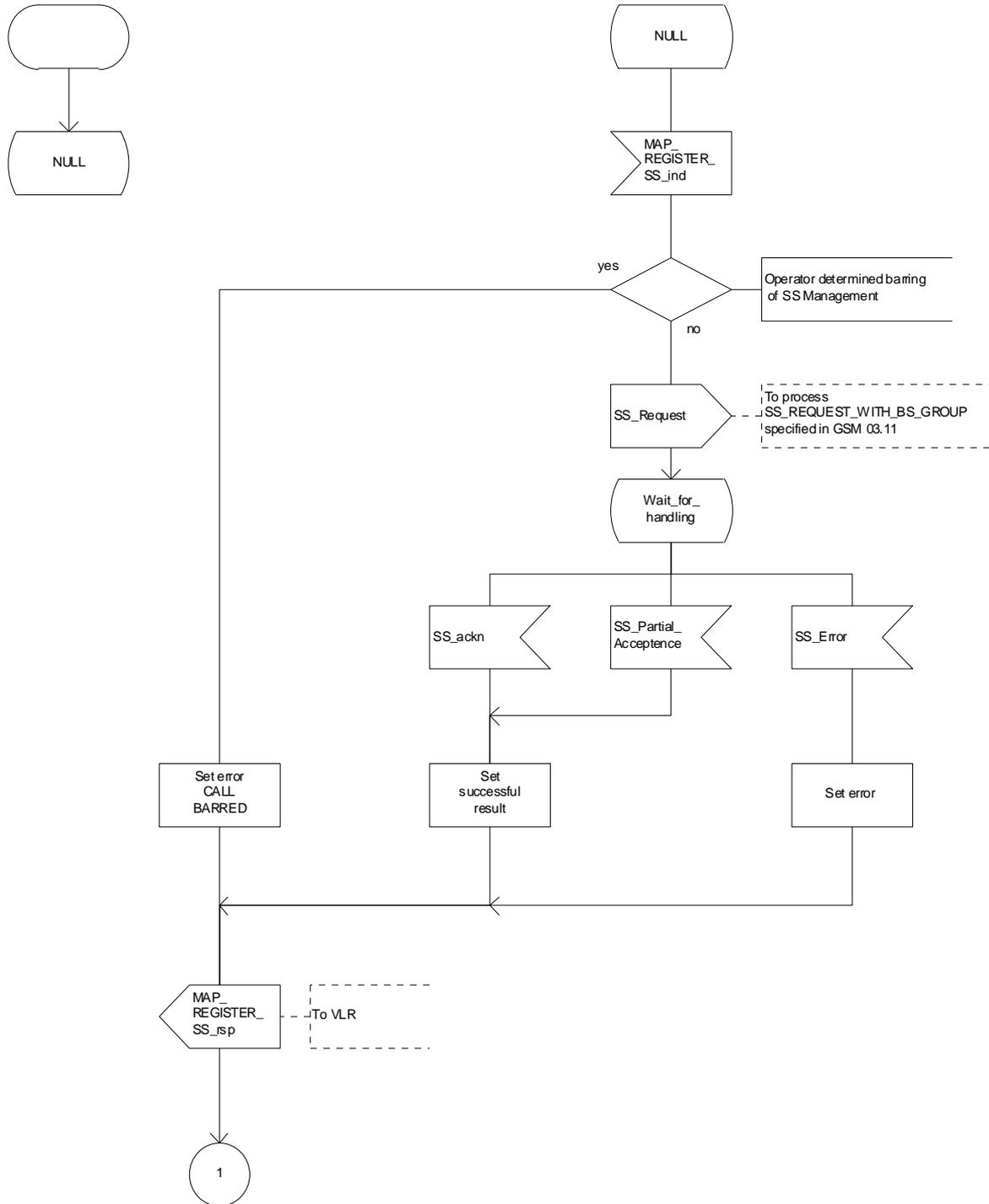

Figure 22.2.4/1 (sheet 1 of 2): Procedure SS\_Register\_HLR

Process SS\_REGISTER\_HLR

22.2.4\_1.2(2)

Figure 22.2.4/1: Registration of supplementary services procedure in HLR

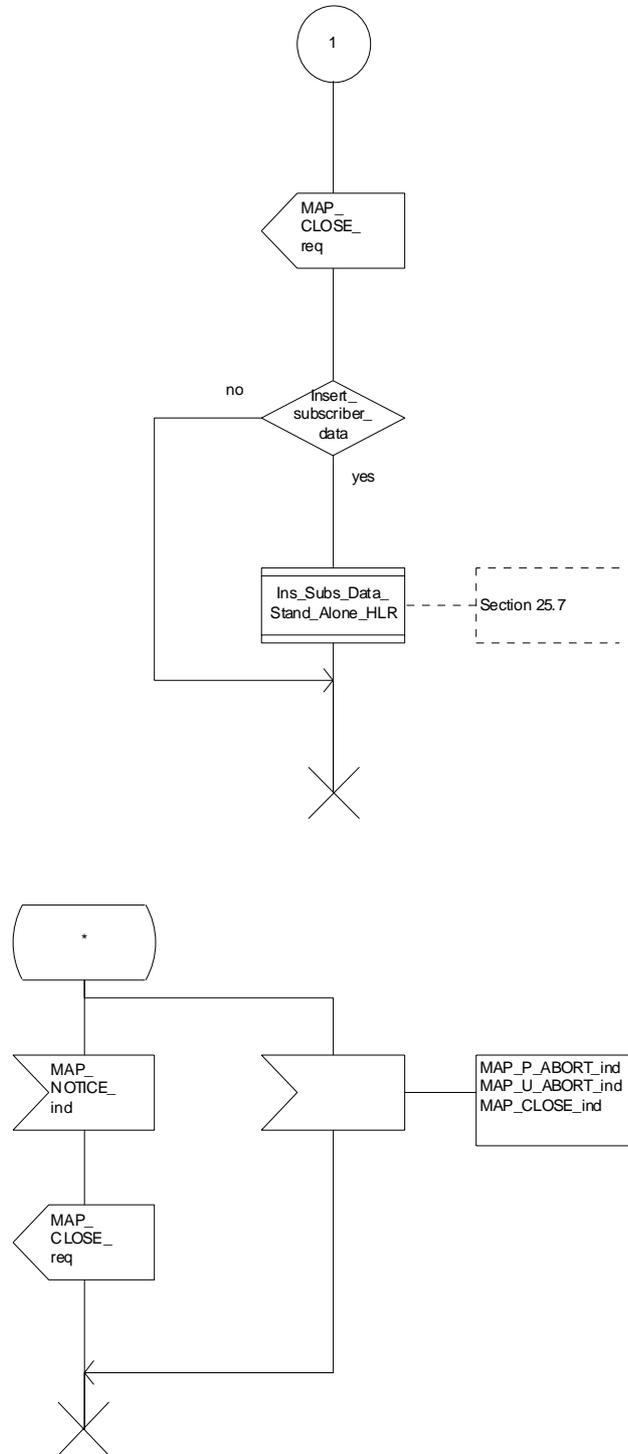

Figure 22.2.4/1 (sheet 2 of 2): Procedure SS\_Register\_HLR



## 22.3 Erasure procedure

### 22.3.1 General

The erasure procedure is used to erase data related to a supplementary service in the HLR. The erasure procedure is a fully transparent communication between the MS and the HLR, except that some services may be invoked as a result of the procedure, as described in the clauses below.

The erasure procedure is shown in figure 22.3.1/1.

The following services may be used:

- MAP\_PROCESS\_ACCESS\_REQUEST (defined in clauses 8 and 25);
- MAP\_TRACE\_SUBSCRIBER\_ACTIVITY (defined in clauses 9 and 25);
- MAP\_PROVIDE\_IMSI (defined in clauses 8 and 25);
- MAP\_FORWARD\_NEW\_TMSI (defined in clauses 8 and 25);
- MAP\_AUTHENTICATE (defined in clauses 8 and 25);
- MAP\_SET\_CIPHERING\_MODE (defined in clauses 8 and 25);
- MAP\_CHECK\_IMEI (defined in clauses 8 and 25);
- MAP\_READY\_FOR\_SM (defined in clauses 12 and 25);
- MAP\_INSERT\_SUBSCRIBER\_DATA (defined in clauses 8 and 25);
- MAP\_ERASE\_SS (defined in clause 11).

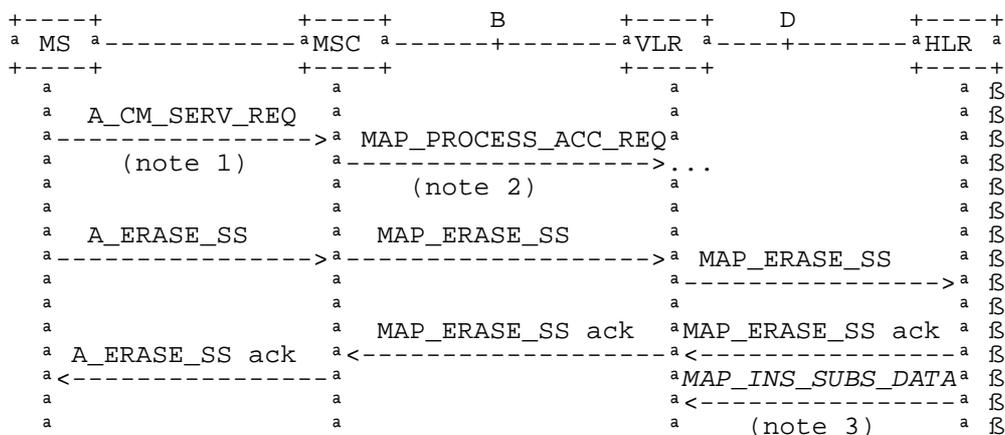

NOTE 1: For details of the procedure on the radio path, see GSM 04.08, 04.10, 04.8x and 04.9x. Services shown in dotted lines indicate the trigger provided by the signalling on the radio path, and the signalling triggered on the radio path.

NOTE 2: For details on the Process Access Request procedure, please refer to clause 25 in the present document.

NOTE 3: Services printed in *italics* are optional.

**Figure 22.3.1/1: Interfaces and services for supplementary service erasure**

### 22.3.2 Procedures in the MSC

The MSC procedures for erasure are identical to those specified for registration in clause 22.2.2. The text and diagrams in clause 22.2.2 apply with all references to registration changed to erasure.

### 22.3.3 Procedures in the VLR

The VLR procedures for erasure are identical to those specified for registration in clause 22.2.3. The text and diagrams in clause 22.2.3 apply with all references to registration changed to erasure.

### 22.3.4 Procedures in the HLR

The HLR procedure for erasure is identical to those specified for registration in clause 22.2.4. The text and diagrams in clause 22.2.4 apply with all references to registration changed to erasure.

## 22.4 Activation procedure

### 22.4.1 General

The activation procedure is used to activate a supplementary service in the HLR. The activation procedure is a fully transparent communication between the MS and the HLR, except that some services may be invoked as a result of the procedure, as described in the clauses below.

The activation procedure is shown in figure 22.4.1/1.

The following services may be used:

MAP_PROCESS_ACCESS_REQUEST	(defined in clauses 8 and 25);
MAP_TRACE_SUBSCRIBER_ACTIVITY	(defined in clauses 9 and 25);
MAP_PROVIDE_IMSI	(defined in clauses 8 and 25);
MAP_FORWARD_NEW_TMSI	(defined in clauses 8 and 25);
MAP_AUTHENTICATE	(defined in clauses 8 and 25);
MAP_SET_CIPHERING_MODE	(defined in clauses 8 and 25);
MAP_CHECK_IMEI	(defined in clauses 8 and 25);
MAP_READY_FOR_SM	(defined in clauses 12 and 25);
MAP_GET_PASSWORD	(defined in clause 11);
MAP_INSERT_SUBSCRIBER_DATA	(defined in clauses 8 and 25);
MAP_ACTIVATE_SS	(defined in clause 11).

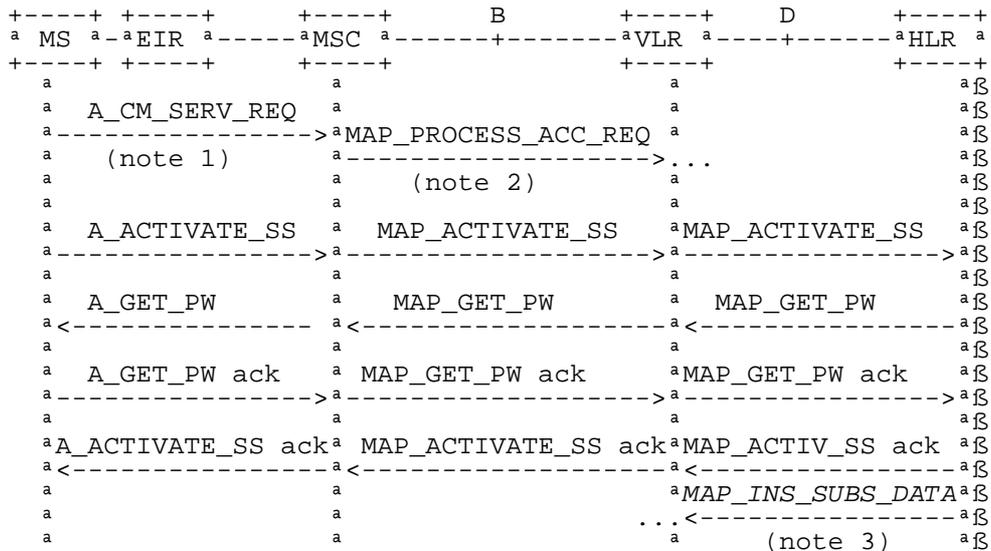

NOTE 1: For details of the procedure on the radio path, see GSM 04.08, 04.10, 04.8x and 04.9x. Services shown in dotted lines indicate the trigger provided by the signalling on the radio path, and the signalling triggered on the radio path.

NOTE 2: For details on the Process Access Request procedure, please refer to clause 25 of this document.

NOTE 3: Services printed in italics are optional.

Figure 22.4.1/1: Interfaces and services for supplementary service activation

### 22.4.2 Procedures in the MSC

The A\_ACTIVATE\_SS service indication received by the MAP user in the MSC contains the SS-Code and any parameters related to the supplementary service.

The MSC transfers the received information to the VLR in the MAP\_ACTIVATE\_SS request without checking the contents of the service indication. Rules for the mapping are described in GSM 09.11.

The MAP user may subsequently receive the MAP\_GET\_PASSWORD indication from the VLR. Upon receipt of this indication, the MSC sends the A\_GET\_PASSWORD message towards the MS and then awaits the response from the MS. When an A\_GET\_PASSWORD confirm message is received from the MS, the MSC initiates the MAP\_GET\_PASSWORD response towards the VLR without checking further the contents of the indication. Also see GSM 09.11.

The MSC will receive a MAP\_ACTIVATE\_SS confirm from the VLR. The outcome of the procedure is reported to the MS in the A\_ACTIVATE\_SS response message, see GSM 04.8x, 04.9x and 09.11. Finally the SS connection is released.

For call independent SS operations, each message shall only contain a single component. Messages which contain more than one component will be stopped at the air interface (as specified in GSM 09.11).

The handling of MAP\_P\_ABORT, MAP\_U\_ABORT, MAP\_NOTICE and unexpected MAP\_CLOSE or A\_CM\_RELEASE in this procedure is identical to the handling in the Registration procedure in the MSC, see clause 22.2.2 of the present document.

The activation procedure in the MSC is shown in figure 22.4.2/1.



## 22.4.3 Procedures in the VLR

### Supplementary service activation

When receiving the MAP\_ACTIVATE\_SS indication, the MAP user in the VLR transfers the information to the HLR in the MAP\_ACTIVATE\_SS request without checking the contents of the service indication.

The VLR may then receive the MAP\_GET\_PASSWORD indication. This information is transferred to the MSC in the MAP\_GET\_PASSWORD request. If a MAP\_GET\_PASSWORD confirm primitive is received from the MSC, the VLR initiates the MAP\_GET\_PASSWORD response towards the HLR.

The VLR will receive the MAP\_ACTIVATE\_SS confirm from the HLR. The MAP user in the VLR shall transfer the information contained in this primitive to the MSC in the MAP\_ACTIVATE\_SS response without checking its contents.

For call independent SS operations, each message shall only contain a single component. Messages which contain more than one component will be stopped at the air interface (as specified in GSM 09.11).

### Error handling

The handling of MAP\_P\_ABORT, MAP\_U\_ABORT, MAP\_NOTICE and unexpected MAP\_CLOSE in this procedure is identical to the handling in the Registration procedure in the VLR, see clause 22.2.3 of the present document.

The activation procedure in the VLR is shown in figure 22.4.3/1.

### Process ACTIVATE\_SS\_VLR

22.4.3\_1.1(2)

Figure 22.4.3/1: Activation of supplementary service procedure in the VLR

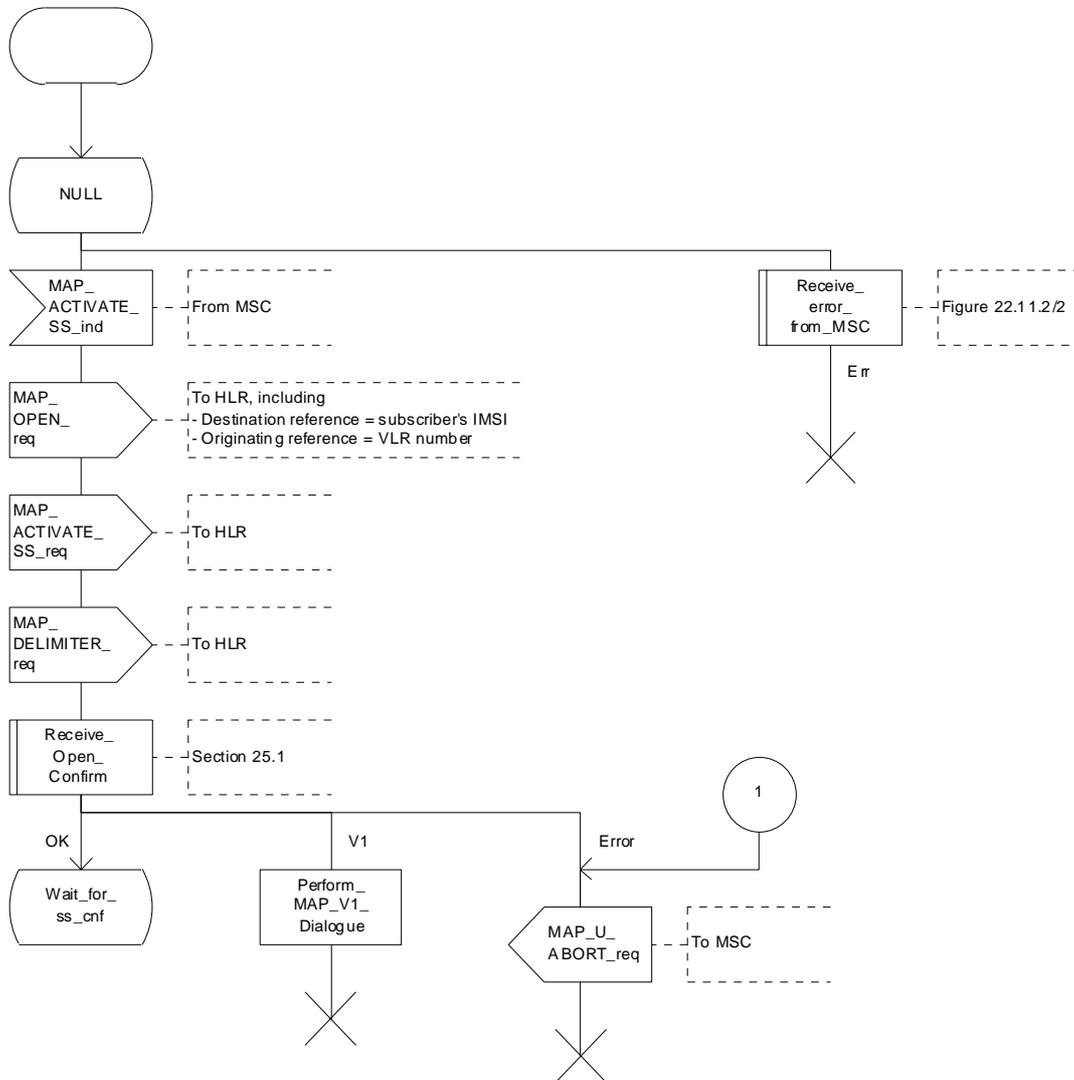

Figure 22.4.3/1 (sheet 1 of 2): Procedure Activate\_SS\_VLR

### Process ACTIVATE\_SS\_VLR

22.4.3\_1.2(2)

Figure 22.4.3/1: Activation of supplementary service procedure in the VLR

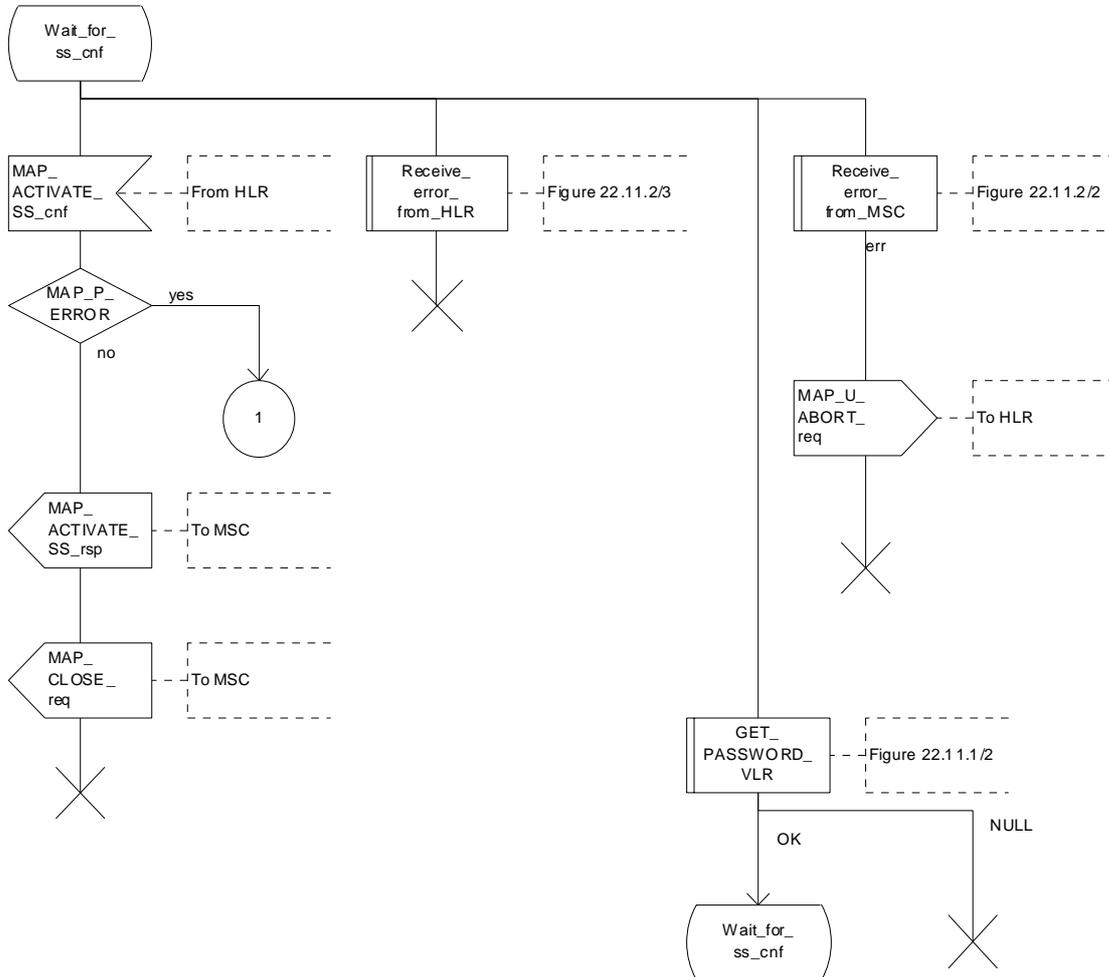

Figure 22.4.3/1 (sheet 2 of 2): Procedure SS\_Activate\_VLR

## 22.4.4 Procedures in the HLR

The procedure in the HLR is initiated when it receives a MAP\_ACTIVATE\_SS indication.

The HLR acts as follows:

- if the operator has barred the subscriber from access to supplementary services, the Call Barred error should be returned to the VLR. The parameter "operatorBarring" shall be included with the error.

The supplementary service request shall then be processed according to GSM 03.11 and the 03.8x and 03.9x-series of technical specifications. This handling may lead to either a successful result, a partially successful result, or an error being returned.

During the handling of activation, the get password procedure may be initiated (as specified in GSM 03.11). This will involve the sending of a MAP\_GET\_PASSWORD request to the VLR.

For call independent SS operations, each message shall only contain a single component. Messages which contain more than one component will be stopped at the air interface (as specified in GSM 09.11):

- if the VLR is to be updated after the supplementary service activation, the MAP\_INSERT\_SUBS\_DATA\_HLR process is initiated;
- handling of receipt of MAP\_P\_ABORT, MAP\_U\_ABORT or MAP\_CLOSE indications from the VLR is identical to their handling in the registration procedure, see clause 22.2.4 above.

The activation procedure in the HLR is shown in figure 22.4.4/1.



Process ACTIVATE\_SS\_HLR

22.4.4\_1.1(2)

Figure 22.4.4/1: Activation of supplementary services procedure in HLR.

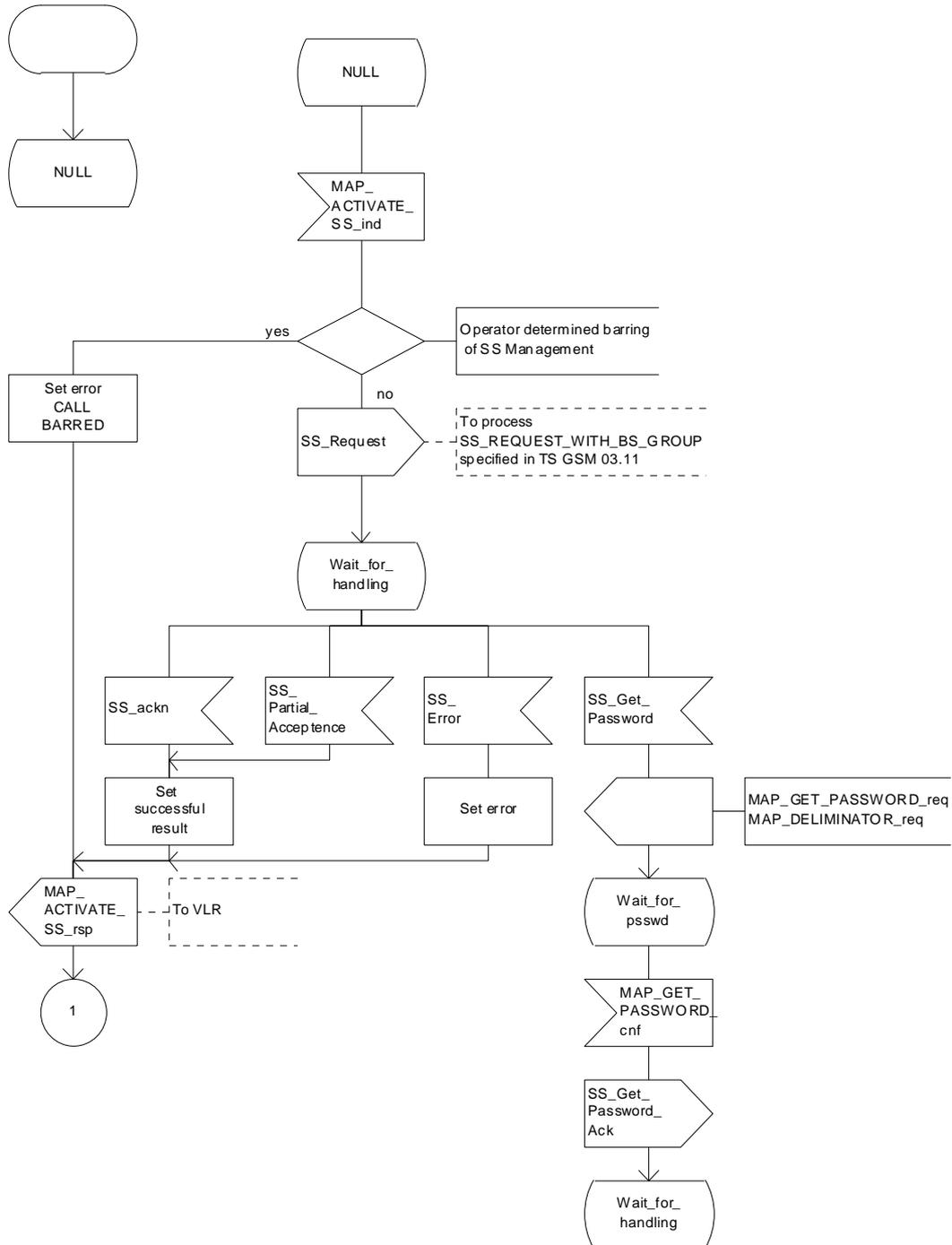

Figure 22.4.4/1 (sheet 1 of 2): Procedure Activate\_SS\_HLR

Process ACTIVATE\_SS\_HLR

22.4.4\_1.2(2)

Figure 22.4.4/1: Activation of supplementary services procedure in HLR.

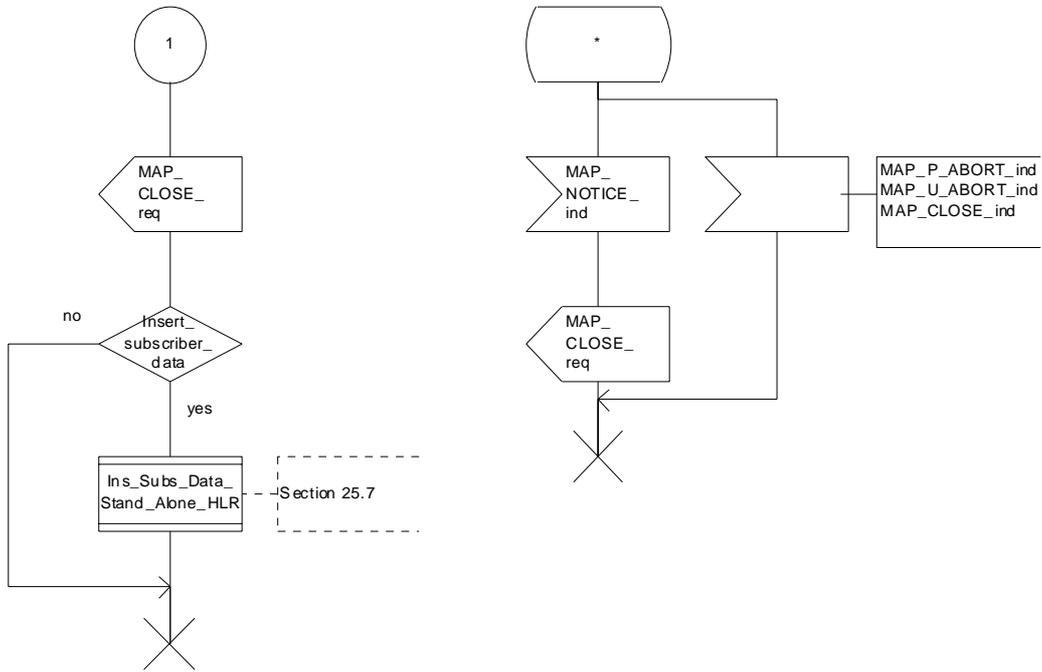

Figure 22.4.4/1 (sheet 2 of 2): Procedure Activate\_SS\_HLR

## 22.5 Deactivation procedure

### 22.5.1 General

The deactivation procedure is used to deactivate a supplementary service in the HLR. The deactivation procedure is a fully transparent communication between the MS and the HLR, except that some services may be invoked as a result of the procedure, as described in the clauses below.

The deactivation procedure is shown in figure 22.5.1/1.

The following services may be used:

- MAP\_PROCESS\_ACCESS\_REQUEST (defined in clauses 8 and 25);
- MAP\_TRACE\_SUBSCRIBER\_ACTIVITY (defined in clauses 9 and 25);
- MAP\_PROVIDE\_IMSI (defined in clauses 8 and 25);
- MAP\_FORWARD\_NEW\_TMSI (defined in clauses 8 and 25);
- MAP\_AUTHENTICATE (defined in clauses 8 and 25);
- MAP\_SET\_CIPHERING\_MODE (defined in clauses 8 and 25);
- MAP\_CHECK\_IMEI (defined in clauses 8 and 25);
- MAP\_READY\_FOR\_SM (defined in clauses 12 and 25);
- MAP\_GET\_PASSWORD (defined in clause 11);
- MAP\_INSERT\_SUBSCRIBER\_DATA (defined in clauses 8 and 25);
- MAP\_DEACTIVATE\_SS (defined in clause 11).

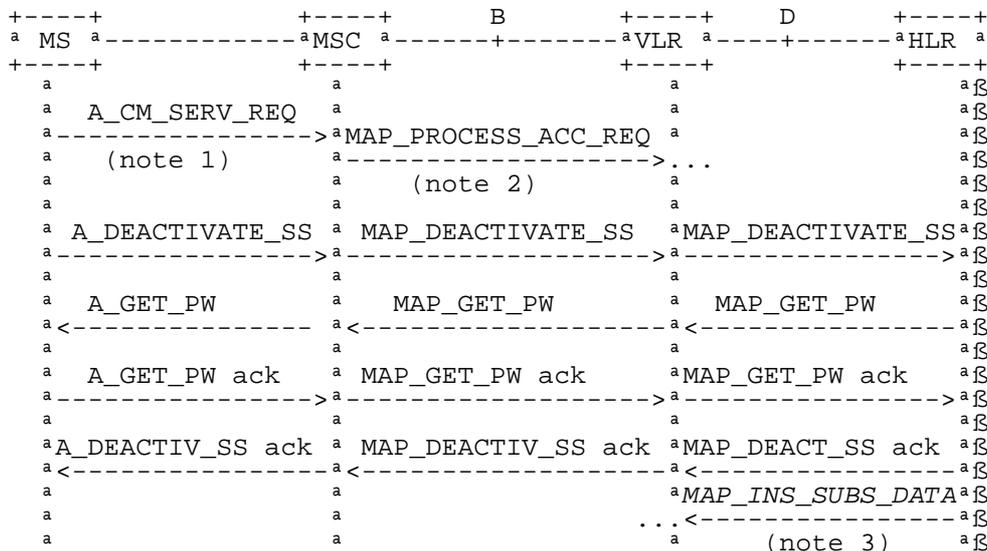

NOTE 1: For details of the procedure on the radio path, see GSM 04.08, 04.10, 04.8x and 04.9x. Services shown in dotted lines indicate the trigger provided by the signalling on the radio path, and the signalling triggered on the radio path.

NOTE 2: For details on the Process Access Request procedure, please refer to clause 25 in the present document.

NOTE 3: Services printed in *italics* are optional.

**Figure 22.5.1/1: Interfaces and services for supplementary service deactivation**

## 22.5.2 Procedures in the MSC

The MSC procedures for deactivation are identical to those specified for activation in clause 22.4.2. The text and diagrams in clause 22.4.2 apply with all references to activation changed to deactivation.

## 22.5.3 Procedures in the VLR

The VLR procedures for deactivation are identical to those specified for activation in clause 22.4.3. The text and diagrams in clause 22.4.3 apply with all references to activation changed to deactivation.

## 22.5.4 Procedures in the HLR

The HLR procedures for deactivation are identical to those specified for activation in clause 22.4.4. The text and diagrams in clause 22.4.4 apply with all references to activation changed to deactivation.

# 22.6 Interrogation procedure

## 22.6.1 General

The interrogation procedure is used to retrieve information related to a supplementary service from the VLR or the HLR. It is the VLR which decides whether an interrogation request should be forwarded to the HLR or not. Some non-supplementary service related services may be invoked as a result of the procedure, as described in the clauses below.

The interrogation procedure is shown in figure 22.6.1/1.

The following services may be used:

MAP_PROCESS_ACCESS_REQUEST	(defined in clauses 8 and 25);
MAP_TRACE_SUBSCRIBER_ACTIVITY	(defined in clauses 9 and 25);
MAP_PROVIDE_IMSI	(defined in clauses 8 and 25);
MAP_FORWARD_NEW_TMSI	(defined in clauses 8 and 25);
MAP_AUTHENTICATE	(defined in clauses 8 and 25);
MAP_SET_CIPHERING_MODE	(defined in clauses 8 and 25);
MAP_CHECK_IMEI	(defined in clauses 8 and 25);
MAP_READY_FOR_SM	(defined in clauses 12 and 25);
MAP_INTERROGATE_SS	(defined in clause 11).

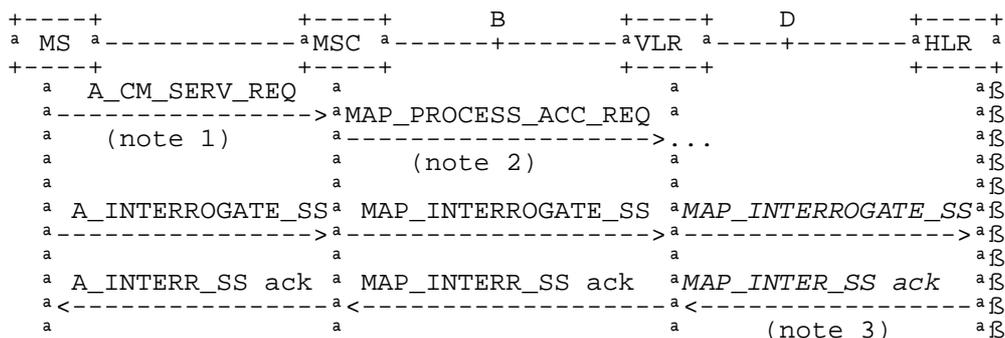

NOTE 1: For details of the procedure on the radio path, see GSM 04.08, 04.10, 04.8x and 04.9x. Services shown in dotted lines indicate the trigger provided by the signalling on the radio path, and the signalling triggered on the radio path.

NOTE 2: For details on the Process Access Request procedure, please refer to clause 25 in the present document.

NOTE 3: Services printed in italics are optional.

**Figure 22.6.1/1: Interfaces and services for supplementary service interrogation**

## 22.6.2 Procedures in the MSC

The MSC procedures for interrogation are identical to those specified for registration in clause 22.2.2. The text and diagrams in clause 22.2.2 apply with all references to registration changed to interrogation.

## 22.6.3 Procedures in the VLR

### Supplementary service interrogation

When receiving the MAP\_INTERROGATE\_SS indication, the MAP user acts as follows:

- if the operator has barred the subscriber from access to supplementary services, the error Call Barred is returned to the MSC. The parameter "operatorBarring" shall be included with the error.

The interrogation is either answered by the VLR or by the HLR, depending on the service interrogated.

#### a) Interrogation to be handled by the VLR

The supplementary service request shall then be processed according to GSM 03.11 and the 03.8x and 03.9x-series of technical specifications. This handling may lead to either a successful result, a partially successful result, or an error being returned.

For call independent SS operations, each message shall only contain a single component. Messages which contain more than one component will be stopped at the air interface (as specified in GSM 09.11).

#### b) Interrogation to be handled by HLR

If the interrogation is to be handled by the HLR, on receiving the MAP\_INTERROGATE\_SS indication, the MAP user in the VLR transfers the information to the HLR in the MAP\_INTERROGATE\_SS request without further checking the contents of the service indication.

The VLR will receive the MAP\_INTERROGATE\_SS confirm from the HLR. The MAP user in the VLR shall transfer the information contained in this primitive to the MSC in the MAP\_INTERROGATE\_SS response without checking its contents.

For call independent SS operations, each message shall only contain a single component. Messages which contain more than one component will be stopped at the air interface (as specified in GSM 09.11).

### **Error handling**

Handling of MAP\_P\_ABORT, MAP\_U\_ABORT, MAP\_NOTICE and unexpected MAP\_CLOSE in this procedure is identical to the handling in the Registration procedure in the VLR, clause 22.2.3. The Interrogation procedure is described in figure 22.6.3/1.

Process INTERROGATE\_SS\_VLR

22.6.3\_1.1(3)

Figure 22.6.3/1: Interrogation of supplementary service procedure in VLR

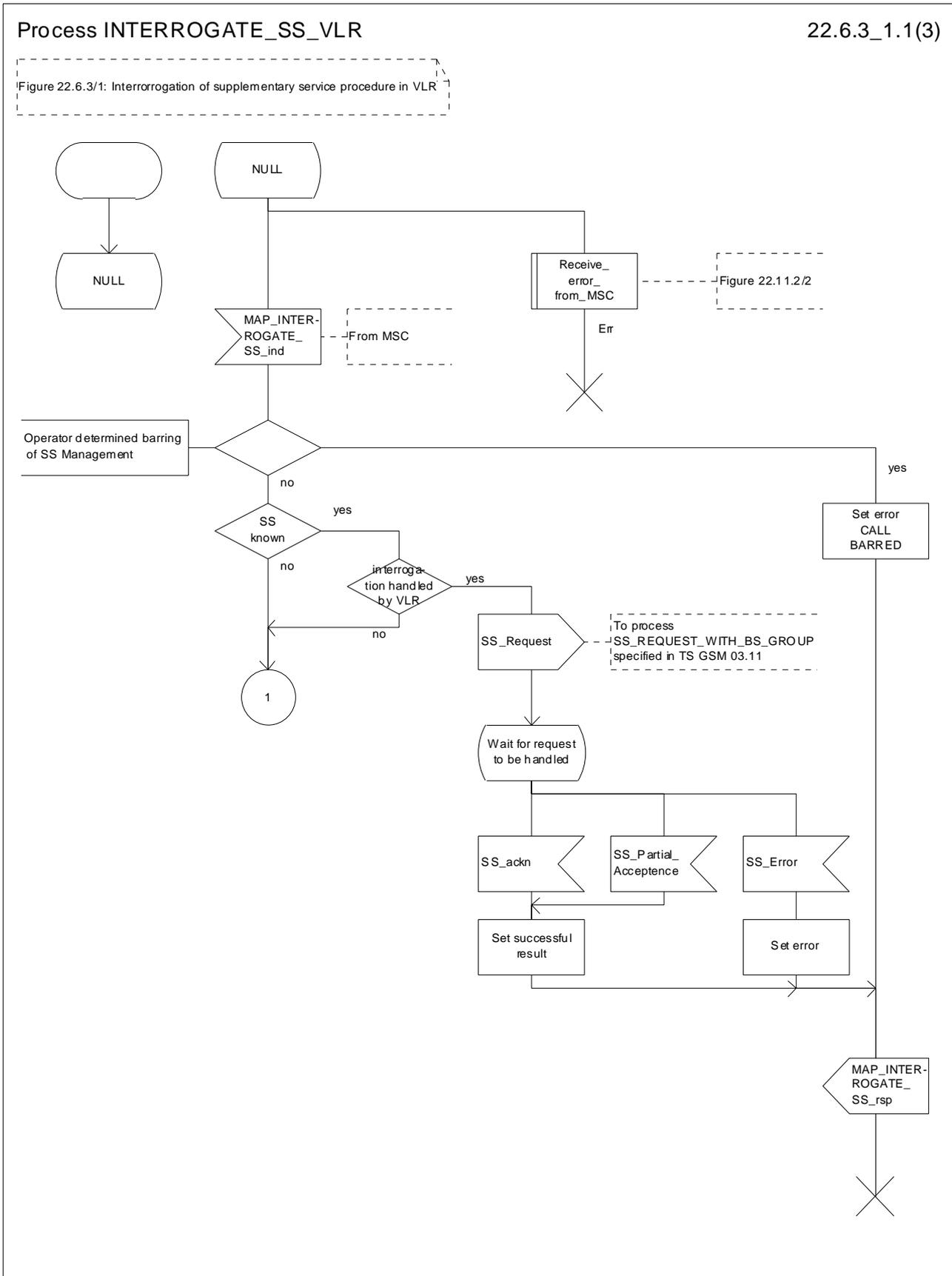

Figure 22.6.3/1 (sheet 1 of 3): Procedure Interrogate\_SS\_VLR

Process INTERROGATE\_SS\_VLR

22.6.3\_1.2(3)

Figure 22.6.3/1: Interrogation of supplementary service procedure in VLR

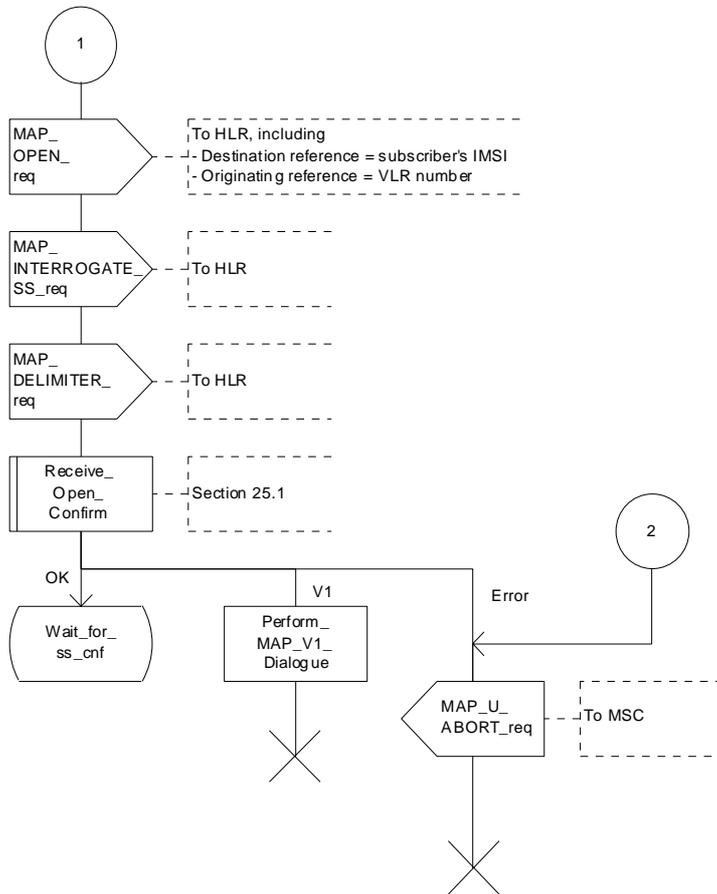

Figure 22.6.3/1 (sheet 2 of 3): Procedure Interrogate\_SS\_VLR



Process INTERROGATE\_SS\_VLR

22.6.3\_1.3(3)

Figure 22.6.3/1: Interrogation of supplementary service procedure in VLR

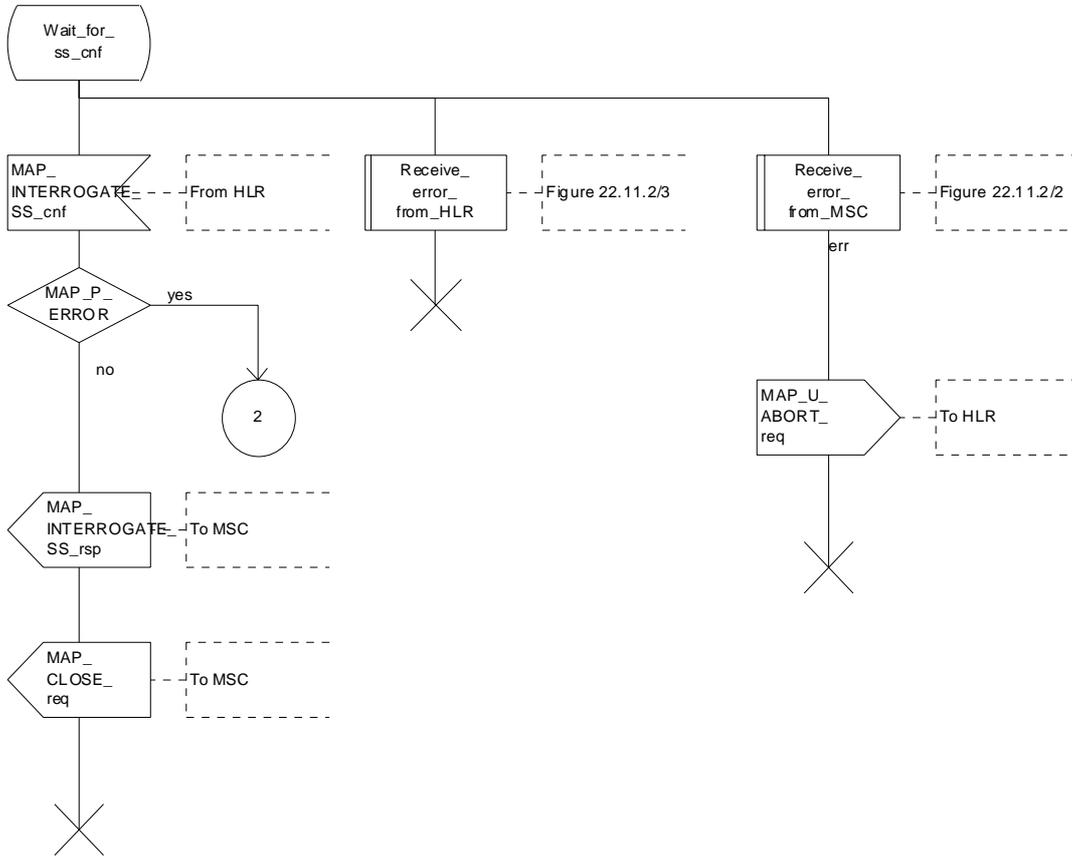

Figure 22.6.3/1 (sheet 3 of 3): Procedure Interrogate\_SS\_VLR

## 22.6.4 Procedures in the HLR

When receiving the MAP\_INTERROGATE\_SS indication, the MAP user acts as follows:

- if the operator has barred the subscriber from access to supplementary services, the error Call Barred is returned to the MSC. The parameter "operatorBarring" shall be included with the error;
- if the supplementary service is not supported in HLR the error Unexpected Data Value is returned to the VLR.

The interrogation is either answered by the VLR or by the HLR, depending on the service interrogated.

### a) Interrogation to be handled by the VLR

If the interrogation procedure should have been answered by the VLR, then the HLR assumes that the VLR does not support the interrogated supplementary service, and returns the SS Not Available error to the VLR.

### b) Interrogation to be handled by HLR

The supplementary service request shall be processed according to GSM 03.11 and the 03.8x and 03.9x-series of technical specifications. This handling may lead to either a successful result or an error being returned.

For call independent SS operations, each message shall only contain a single component.

### Error handling

Handling of MAP\_P\_ABORT, MAP\_U\_ABORT, MAP\_NOTICE and unexpected MAP\_CLOSE in this procedure is identical to the handling in the Registration procedure in the VLR, clause 22.2.3. The Interrogation procedure is described in figure 22.6.4/1.

### Process INTERROGATE\_SS\_HLR

22.6.4\_1(1)

Figure 22.6.4/1: Interrogation of supplementary services procedure in HLR

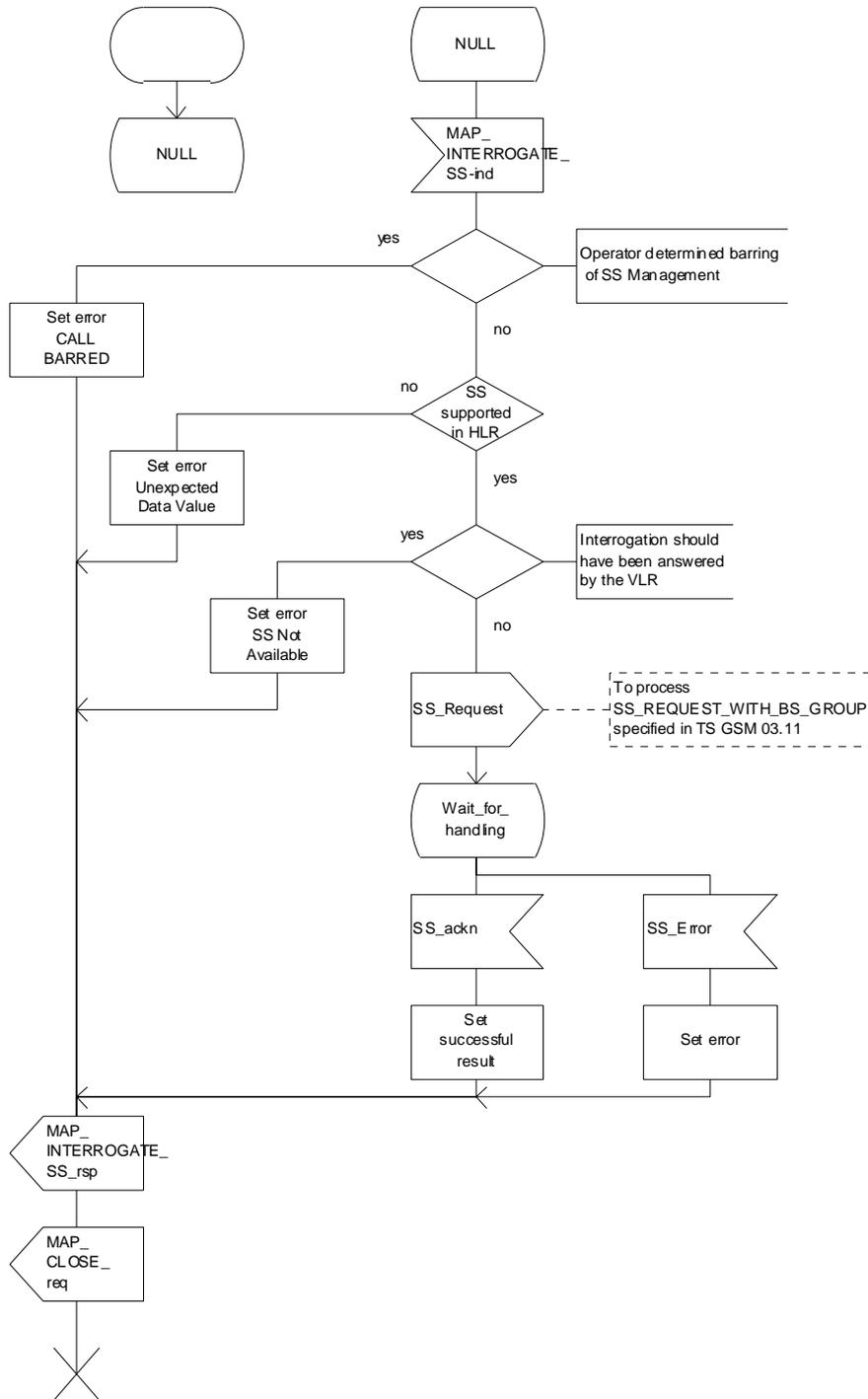

Figure 22.6.4/1: Procedure Interrogate\_SS\_HLR

## 22.7 Invocation procedure

### 22.7.1 General

The invocation procedure is used to check subscription data in the VLR for certain supplementary services which are invoked after the call set-up phase is finished. For invocation of supplementary services which are invoked during the call set-up phase, please refer to the Call Handling procedure descriptions.

The invocation procedure is shown in figure 22.7.1/1. Note that some optional services may be invoked in connection with this procedure, as described in the clause below.

The following services are used:

- MAP\_PROCESS\_ACCESS\_REQUEST (defined in clauses 8 and 25);
- MAP\_TRACE\_SUBSCRIBER\_ACTIVITY (defined in clauses 9 and 25);
- MAP\_PROVIDE\_IMSI (defined in clauses 8 and 25);
- MAP\_FORWARD\_NEW\_TMSI (defined in clauses 8 and 25);
- MAP\_AUTHENTICATE (defined in clauses 8 and 25);
- MAP\_SET\_CIPHERING\_MODE (defined in clauses 8 and 25);
- MAP\_CHECK\_IMEI (defined in clauses 8 and 25);
- MAP\_READY\_FOR\_SM (defined in clauses 12 and 25);
- MAP\_INVOKE\_SS (defined in clause 11).

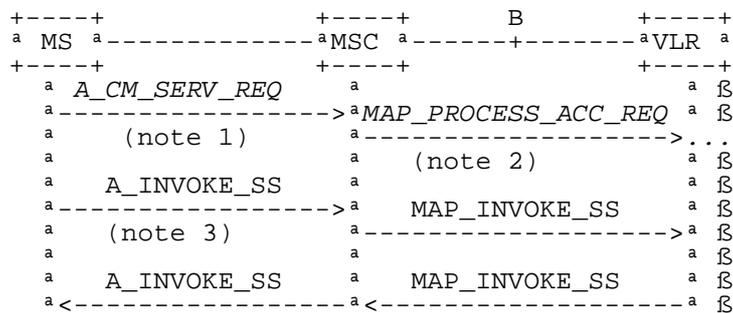

NOTE 1: For details of the procedure on the radio path, see GSM 04.08, 04.10, 04.8x and 04.9x. Services shown in dotted lines indicate the trigger provided by the signalling on the radio path, and the signalling triggered on the radio path.

NOTE 2: For details on the Process Access Request procedure, please refer to clause 25 in the present document.

NOTE 3: A\_INVOKESS is a generic message to illustrate any supplementary service invocation request message on the air interface, e.g. BuildMPTY, see GSM 04.80.

**Figure 22.7.1/1: Interfaces and services for supplementary service invocation**

## 22.7.2 Procedures in the MSC

### Process access request

Before the Call Hold or Multi-Party supplementary services can be invoked, a CC connection must be established between the MS and the MSC as described in GSM 04.08 and the Call Handling procedure descriptions within the present document.

When an A\_INVOKE\_SS request message arrives at the MSC during a call (as described in GSM 04.10, 04.8x and 04.9x-series of technical specifications), then if control of subscription to the invoked supplementary service is required, the MSC initiates the process access request procedure towards the VLR as described in clause 25 of the present document.

### Supplementary service invocation

If the Process Access Request procedure towards the VLR is successful, the MSC shall forward a MAP\_INVOKE\_SS service request towards the VLR. This request shall contain the SS-Code of the supplementary service to be invoked, and possibly the Basic service code. Mapping from the A\_INVOKE\_SS to this service request is described in GSM 09.11.

The MSC will receive a MAP\_INVOKE\_SS confirm from the VLR. If the outcome of the service is successful (i.e. the service confirm is empty), the MSC will invoke the requested supplementary service as described in GSM 02.8x-series, 03.8x and 03.9x-series of technical specifications. If the outcome of the service is unsuccessful, the MSC shall send an appropriate A\_INVOKE\_SS response towards the MS. The structure of this message is described in GSM 09.11 and 04.8x and 04.9x-series of technical specifications.

### Error handling

If at any time during this procedure a MAP\_P\_ABORT, MAP\_U\_ABORT, MAP\_NOTICE or MAP\_CLOSE indication concerning the process is received from the VLR, the process is terminated. If a MAP\_NOTICE indication was received from the VLR, the VLR dialogue must also be aborted by sending a MAP\_U\_ABORT request indicating Procedure error towards the VLR. Possible signalling to the MS is described in GSM 04.10.

If an A\_CM\_RELEASE indication is received from the MS, all open transactions are released using the MAP\_U\_ABORT request indicating application procedure cancellation; the process terminates.

The invocation procedure in the MSC is shown in figure 22.7.2/1.

### Process INVOKE\_SS\_MSC

22.7.2\_1.1(2)

Figure 22.7.2/1: Mobile initiated invocation of supplementary service procedure in the MSC

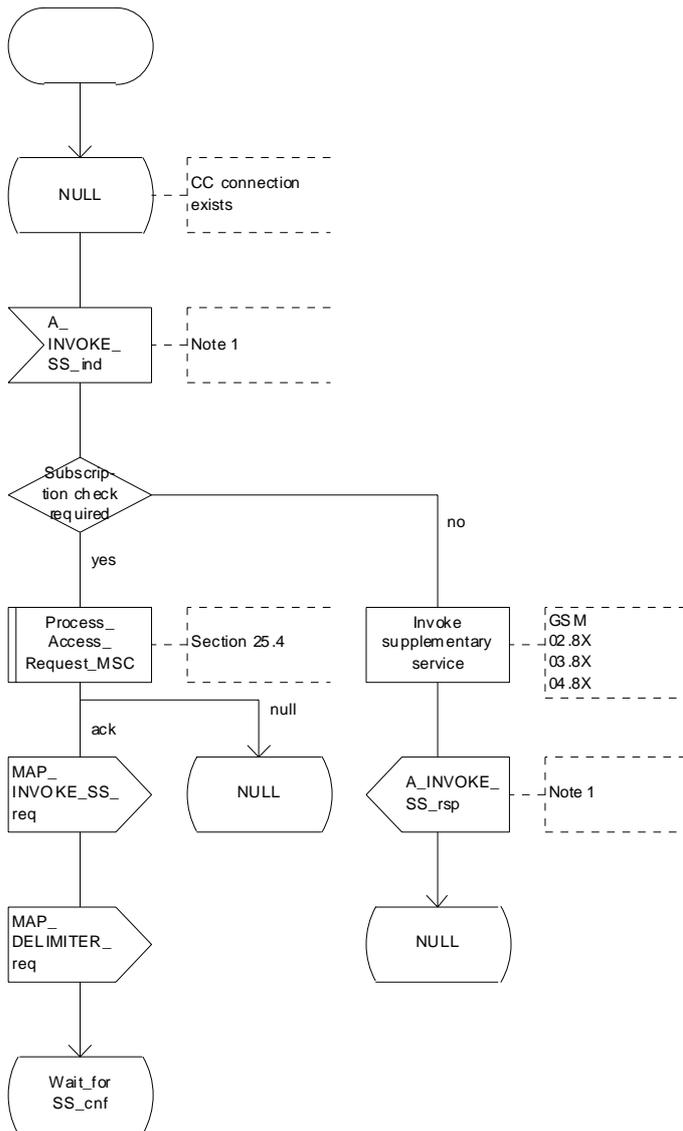

Note 1: Fictitious signal to indicate receipt/sending of SS invocation in voke component on the air interface (eg. BuildMPTY). Described in GSM 04.8X and 09.11.

Figure 22.7.2/1 (sheet 1 of 2): Procedure Invoke\_SS\_MSC

### Process INVOKE\_SS\_MSC

22.7.2\_1.2(2)

Figure 22.7.2/1: Mobile initiated invocation of supplementary service procedure in the MSC

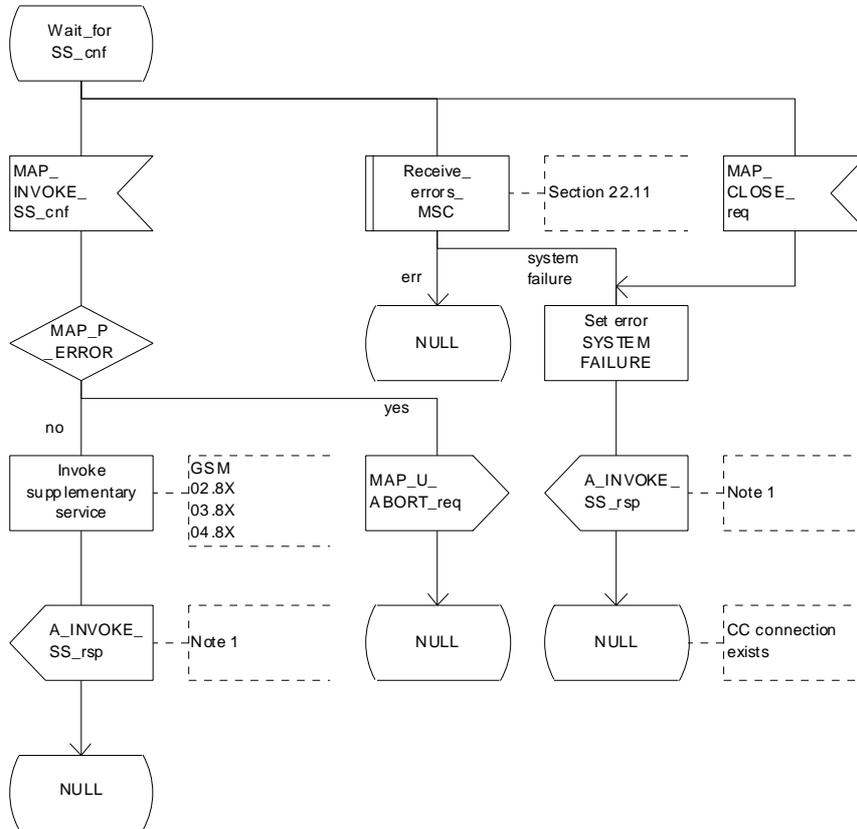

Note 1: Fictitious signal to indicate receipt/ sending of SS invocation invoke component on the air interface, (eg. BuildMPTY). Described in GSM 04.08X and 09.11.

Figure 22.7.2/1 (sheet 2 of 2): Procedure Invoke\_SS\_MSC

## 22.7.3 Procedures in the VLR

### Process Access Request

When receiving the MAP\_PROCESS\_ACCESS\_REQUEST indication, the VLR acts as described in clause 25 of the present document.

### Supplementary service invocation

When receiving the MAP\_INVOKE\_SS indication, the MAP user acts as follows:

- if the operator has barred the subscriber from access to supplementary services, the error "Call Barred" is returned to the MSC. The parameter "operatorBarring" shall be included with the error;
- if any irrelevant information elements (according to the service description) or invalid information element values are present in the service request, then the unexpected data value error is returned to the MSC in the MAP\_INVOKE\_SS response;
- if the VLR does not support the invoked supplementary service then the VLR shall respond with the SS Not Available error;
- if the requested supplementary service cannot be invoked by subscriber actions, then the VLR shall respond with the Illegal SS Operation error;
- if the subscriber is not provided with (i.e. subscribed to) the requested supplementary service, then the SS error status error (possibly including the SS-Status as parameter) is returned to the MSC in the MAP\_INVOKE\_SS response.

If all checks are passed the VLR returns an empty MAP\_INVOKE\_SS response to the MSC, thus indicating that the invocation request was accepted.

If at any time during this procedure a MAP\_P\_ABORT, MAP\_U\_ABORT, MAP\_NOTICE or unexpected MAP\_CLOSE indication concerning the process is received from the MSC, the process terminates. If a MAP\_NOTICE indication was received from the MSC, that dialogue must be aborted by sending a MAP\_U\_ABORT request indicating Procedure error towards the MSC. The process terminates.

The invocation procedure in the VLR is shown in figure 22.7.3/1.



Process INVOKE\_SS\_VLR

22.7.3\_1(1)

Figure 22.7.3/1: Invocation of supplementary service procedure in VLR

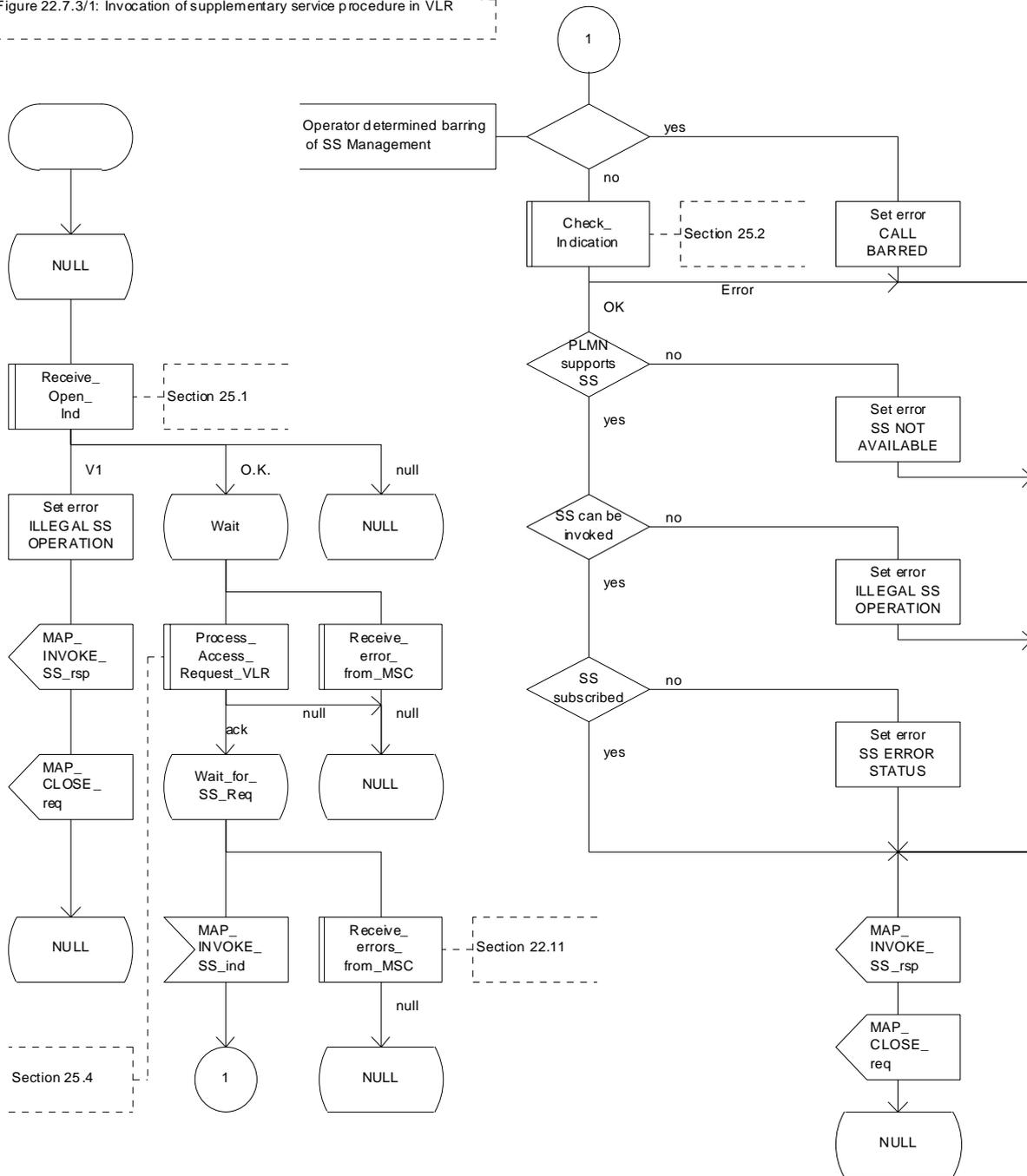

Figure 22.7.3/1: Procedure Invoke\_SS\_VLR

## 22.8 Password registration procedure

### 22.8.1 General

The password registration procedure is used to register a password in the HLR. The password registration procedure is a fully transparent communication between the MS and the HLR, except that some services may be invoked as a result of the procedure, as described below.

The password registration procedure is shown in figure 22.8.1/1.

The following services may be used:

- MAP\_PROCESS\_ACCESS\_REQUEST (defined in clauses 8 and 25);
- MAP\_TRACE\_SUBSCRIBER\_ACTIVITY (defined in clauses 9 and 25);
- MAP\_PROVIDE\_IMSI (defined in clauses 8 and 25);
- MAP\_FORWARD\_NEW\_TMSI (defined in clauses 8 and 25);
- MAP\_AUTHENTICATE (defined in clauses 8 and 25);
- MAP\_SET\_CIPHERING\_MODE (defined in clauses 8 and 25);
- MAP\_CHECK\_IMEI (defined in clauses 8 and 25);
- MAP\_READY\_FOR\_SM (defined in clauses 12 and 25);
- MAP\_GET\_PASSWORD (defined in clause 11).

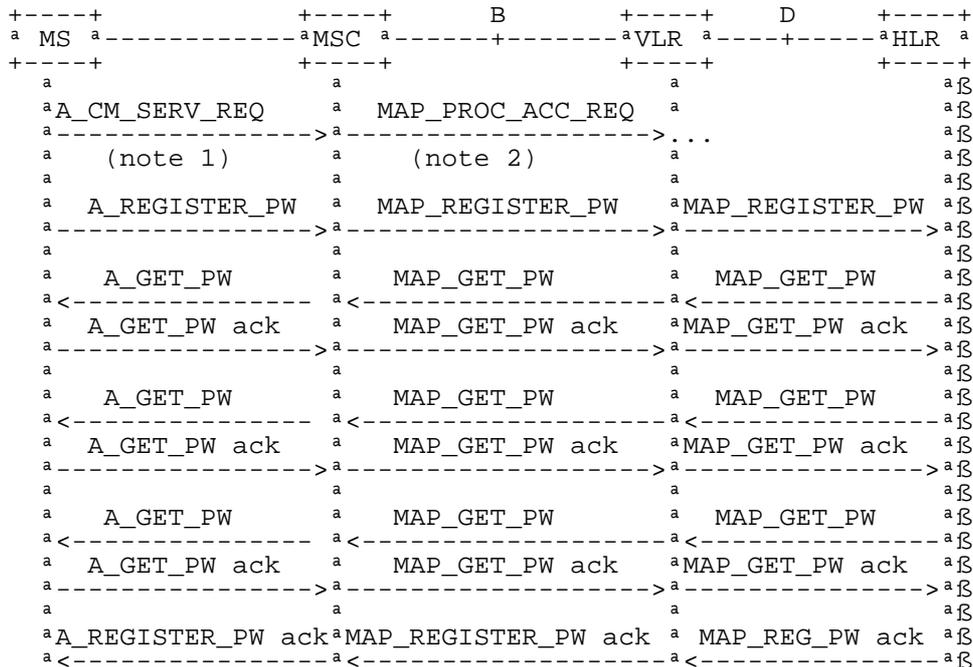

NOTE 1: For details of the procedure on the radio path, see GSM 04.08, 04.10, 04.8x and 04.9x. Services shown in dotted lines are triggers/ triggered signalling on the radio path.

NOTE 2: For details on the Process Access Request procedure, please refer to clause 25 in the present document.

NOTE 3: Use of each of the three MAP\_GET\_PASSWORD operations is described in clause 22.8.4.

**Figure 22.8.1/1: Interfaces and services for supplementary service password registration**

## 22.8.2 Procedures in the MSC

The password registration procedure in the MSC is identical to that for activation specified in clause 22.4.2. All the text and diagrams in clause 22.4.2 apply with all references to activation changed to password registration.

## 22.8.3 Procedures in the VLR

The password registration procedure in the VLR is identical to that for activation specified in clause 22.4.3. All the text and diagrams in clause 22.4.3 apply with all references to activation changed to password registration.

## 22.8.4 Procedures in the HLR

The procedure in the HLR is initiated when it receives a MAP\_REGISTER\_PASSWORD indication.

The HLR acts as follows:

- if the operator has barred the subscriber for access to supplementary services, the Call Barred error is returned to the VLR. The parameter "operatorBarring" shall be included with the error;
- if any irrelevant information elements (according to the service description) or invalid information element values are present, then the unexpected data value error is returned to the VLR in the response. This error should thus be returned if the SS-Code provided by the mobile subscriber is not allocated.

The HLR shall then process the MAP\_REGISTER\_PASSWORD indication as specified in GSM 03.11. During the handling of password registration, the password procedure will be initiated (as specified in GSM 03.11) This will involve the sending of MAP\_GET\_PASSWORD requests to the VLR.

- Handling of receipt of MAP\_P\_ABORT, MAP\_U\_ABORT or MAP\_CLOSE indications from the VLR is identical to their handling in the registration procedure, see clause 22.2.4 above.

The password registration procedure in the HLR is shown in figure 22.8.4/1.

### Process REGISTER\_PASSWORD\_HLR

22.8.4\_1.1(2)

Figure 22.8.4/1: Registration of supplementary service password procedure in HLR

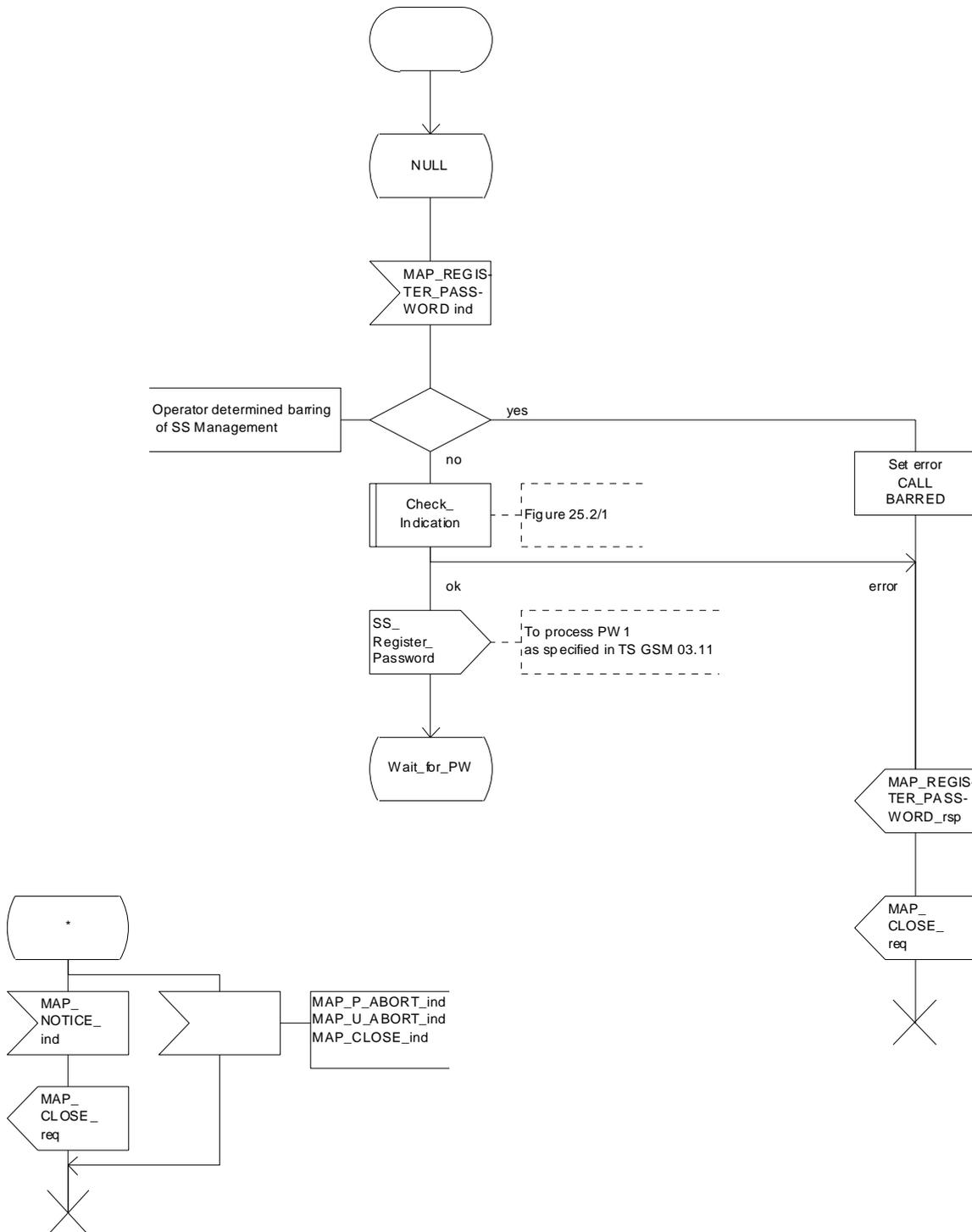

Figure 22.8.4/1 (sheet 1 of 2): Procedure Register\_PW\_HLR

Process REGISTER\_PASSWORD\_HLR

22.8.4\_1.2(2)

Figure 22.8.4/1: Registration of supplementary service password procedure in HLR

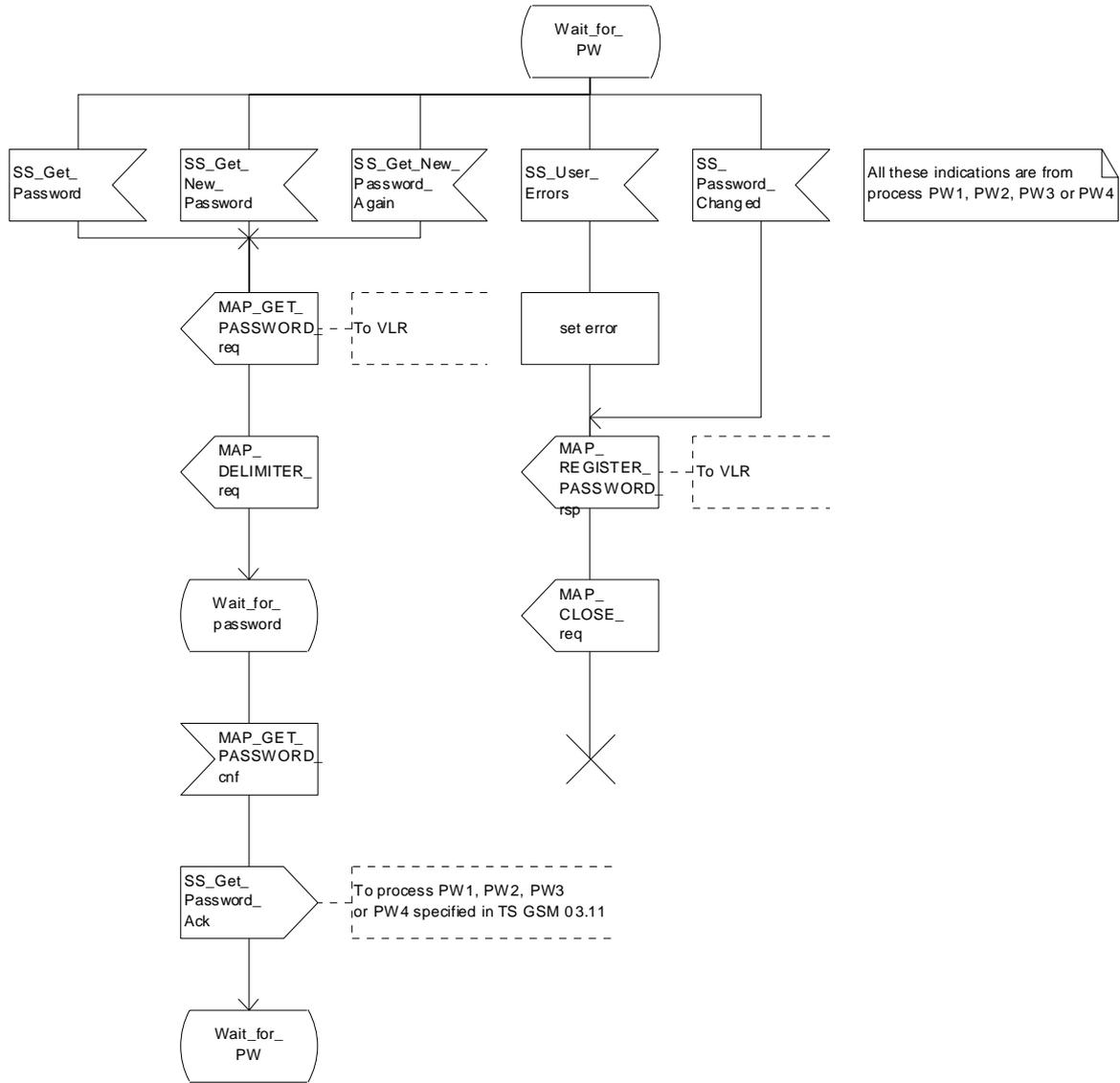

Figure 22.8.4/1 (sheet 2 of 2): Procedure Register\_PW\_HLR

## 22.9 Mobile Initiated USSD procedure

### 22.9.1 General

The procedure supports supplementary service signalling procedures which can allow PLMN specific services to be introduced.

The message flow for the procedure can be found in GSM 03.90.

The following services may be used:

MAP_PROCESS_ACCESS_REQUEST	(defined in clauses 8 and 25);
MAP_TRACE_SUBSCRIBER_ACTIVITY	(defined in clauses 9 and 25);
MAP_PROVIDE_IMSI	(defined in clauses 8 and 25);
MAP_FORWARD_NEW_TMSI	(defined in clauses 8 and 25);
MAP_AUTHENTICATE	(defined in clauses 8 and 25);
MAP_SET_CIPHERING_MODE	(defined in clauses 8 and 25);
MAP_CHECK_IMEI	(defined in clauses 8 and 25);
MAP_READY_FOR_SM	(defined in clauses 12 and 25);
MAP_UNSTRUCTURED_SS_REQUEST	(defined in clause 11);
MAP_UNSTRUCTURED_SS_NOTIFY	(defined in clause 11).

The following service is certainly used:

MAP\_PROCESS\_UNSTRUCTURED\_SS\_REQUEST (defined in clause 11).

### 22.9.2 Procedures in the MSC

Before the Process Unstructured SS Request service can be invoked, a call independent CM connection must be created between the MS and the MSC.

Once a CM-connection is established, the MSC may handle the A\_PROCESS\_UNSTRUCTURED\_SS\_REQUEST from the MS. This message contains information input by the user, the message may be fed to an application contained locally in the MSC or to the VLR. The rules for determining this are specified in GSM 03.90.

#### 1) Message Destined for VLR

If the message is destined for the VLR then the MSC shall transfer the message to the VLR using the mapping specified in detail in GSM 09.11.

The MSC may subsequently receive one or more MAP\_UNSTRUCTURED\_SS\_REQUEST or MAP\_UNSTRUCTURED\_SS\_NOTIFY indications from the VLR. These shall be sent transparently to the MS. When a confirmation is received from the MS this shall be returned to the VLR.

When the MSC receives a MAP\_PROCESS\_UNSTRUCTURED\_SS\_REQUEST confirmation from the VLR then it shall pass this to the MS and initiate release of the CM connection.

## 2) Message Destined for Local Application

If the message is destined for the local USSD application then the MSC shall transfer the message to the application.

The MSC may subsequently receive one or more requests from the application which correspond to the MAP\_UNSTRUCTURED\_SS\_REQUEST or MAP\_UNSTRUCTURED\_SS\_NOTIFY indications. These shall be sent transparently to the MS. When a confirmation is received from the MS this shall be returned to the application.

When the MSC receives the result of the original operation from the application then it shall pass this to the MS and initiate release of the CM connection.

### Error Handling

Both the MS and the VLR or USSD Application may initiate release of the CM-connection at any time. This is handled as shown in the diagrams.

The procedure in the MSC is shown in figure 22.9.2/1.

Process MS\_INIT\_USSD\_MSC

22.9.2\_1.1(2)

Figure 22.9.2/1: Handling of mobile initiated USSD at MSC

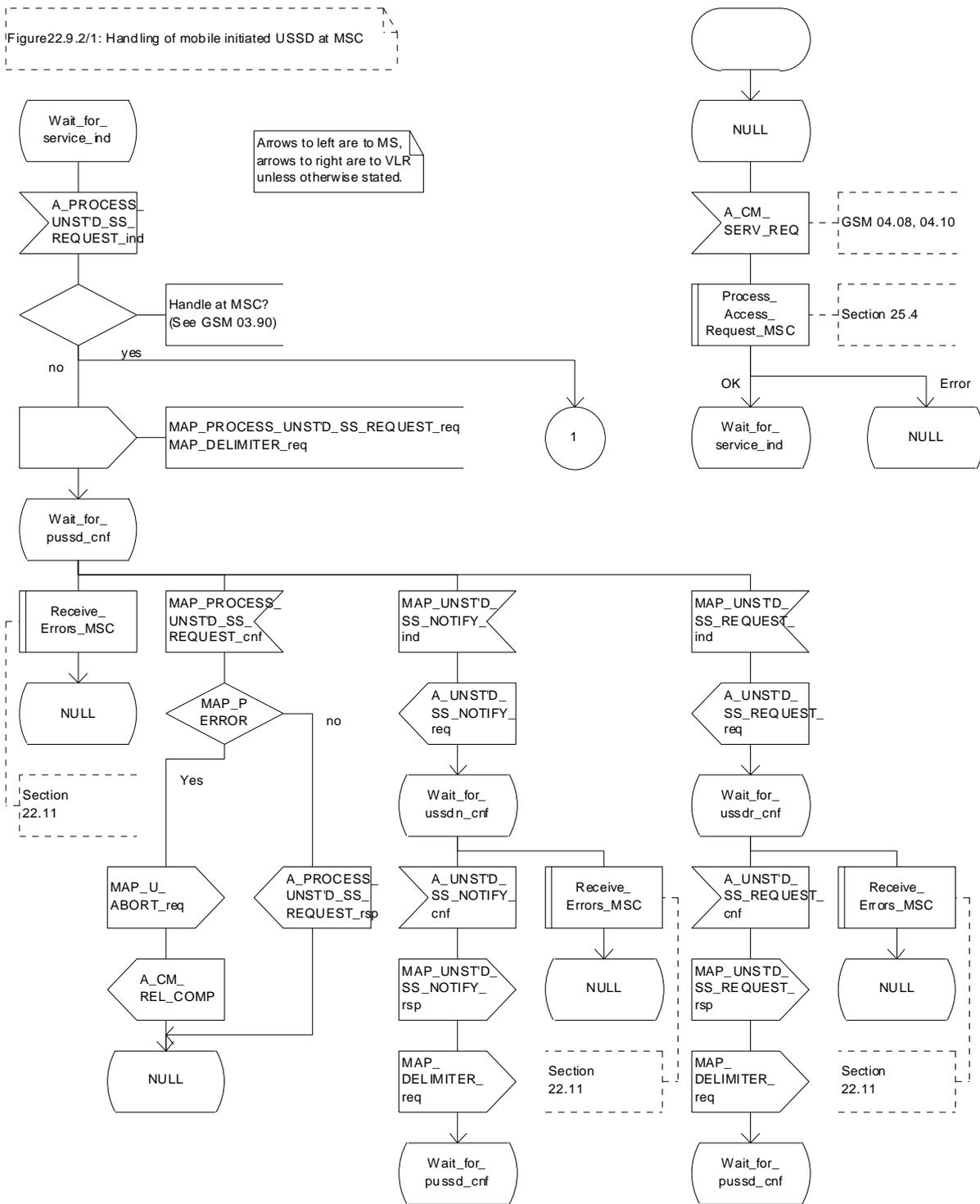

Figure 22.9.2/1 (sheet 1 of 2): Procedure MI\_USSD\_MSC



Process MS\_INIT\_USSD\_MSC

22.9.2\_1.2(2)

Figure 22.9.2/1: Handling of mobile initiated USSD at MSC

Arrows to left are to MS, arrows to right are to USSD application unless otherwise stated.

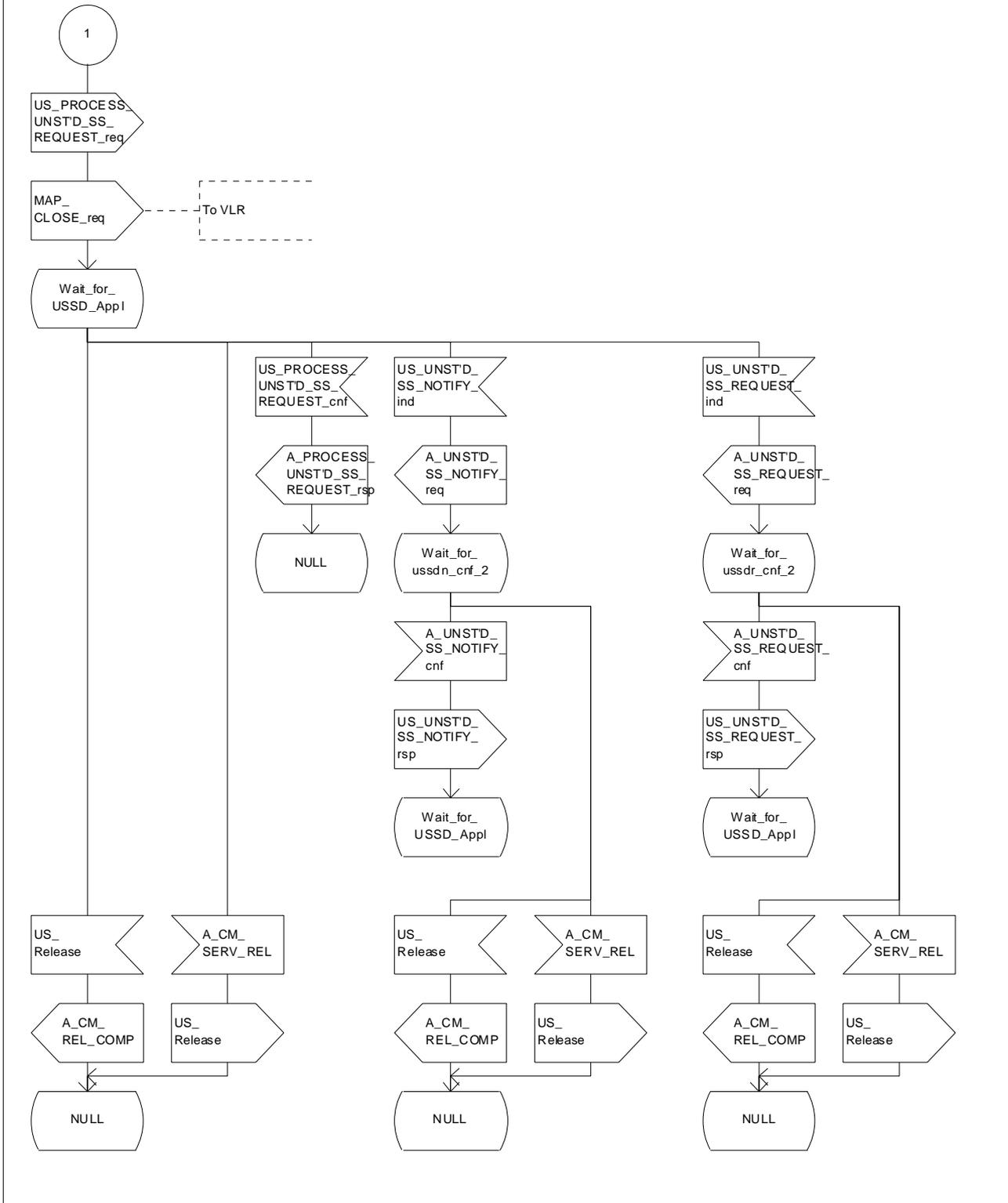

Figure 22.9.2/1 (sheet 2 of 2): Procedure MI\_USSD\_MSC

### 22.9.3 Procedures in the VLR

The initiation of the process is shown in clause 22.1.2.

Once a MAP dialogue is established, the VLR may handle the MAP\_PROCESS\_UNSTRUCTURED\_SS\_REQUEST from the MSC. This message contains information input by the user, the message may be fed to an application contained locally in the VLR or to the HLR. The rules for determining this are specified in GSM 03.90.

#### Message Destined for HLR

If the message is destined for the HLR then the VLR shall transfer the message transparently to the HLR.

The VLR may subsequently receive one or more MAP\_UNSTRUCTURED\_SS\_REQUEST or MAP\_UNSTRUCTURED\_SS\_NOTIFY indications from the HLR. These shall be sent transparently to the MSC. When a confirmation is received from the MSC this shall be returned to the HLR.

When the VLR receives a MAP\_PROCESS\_UNSTRUCTURED\_SS\_REQUEST confirmation from the HLR then it shall pass this to the MS and close the MAP provider service.

#### Message Destined for Local Application

If the message is destined for the local USSD application then the VLR shall transfer the message to the application.

The VLR may subsequently receive one or more requests from the application which correspond to the MAP\_UNSTRUCTURED\_SS\_REQUEST or MAP\_UNSTRUCTURED\_SS\_NOTIFY indications. These shall be sent transparently to the MSC. When a confirmation is received from the MSC this shall be returned to the application.

When the VLR receives the result of the original operation from the application then it shall pass this to the MSC and initiate release of the CM connection.

#### Error Handling

Both the MSC and the HLR or USSD Application may initiate release of the MAP service at any time. This is handled as shown in the diagrams.

The procedure in the VLR is shown in figures 22.9.3/1 and 22.9.3/2.

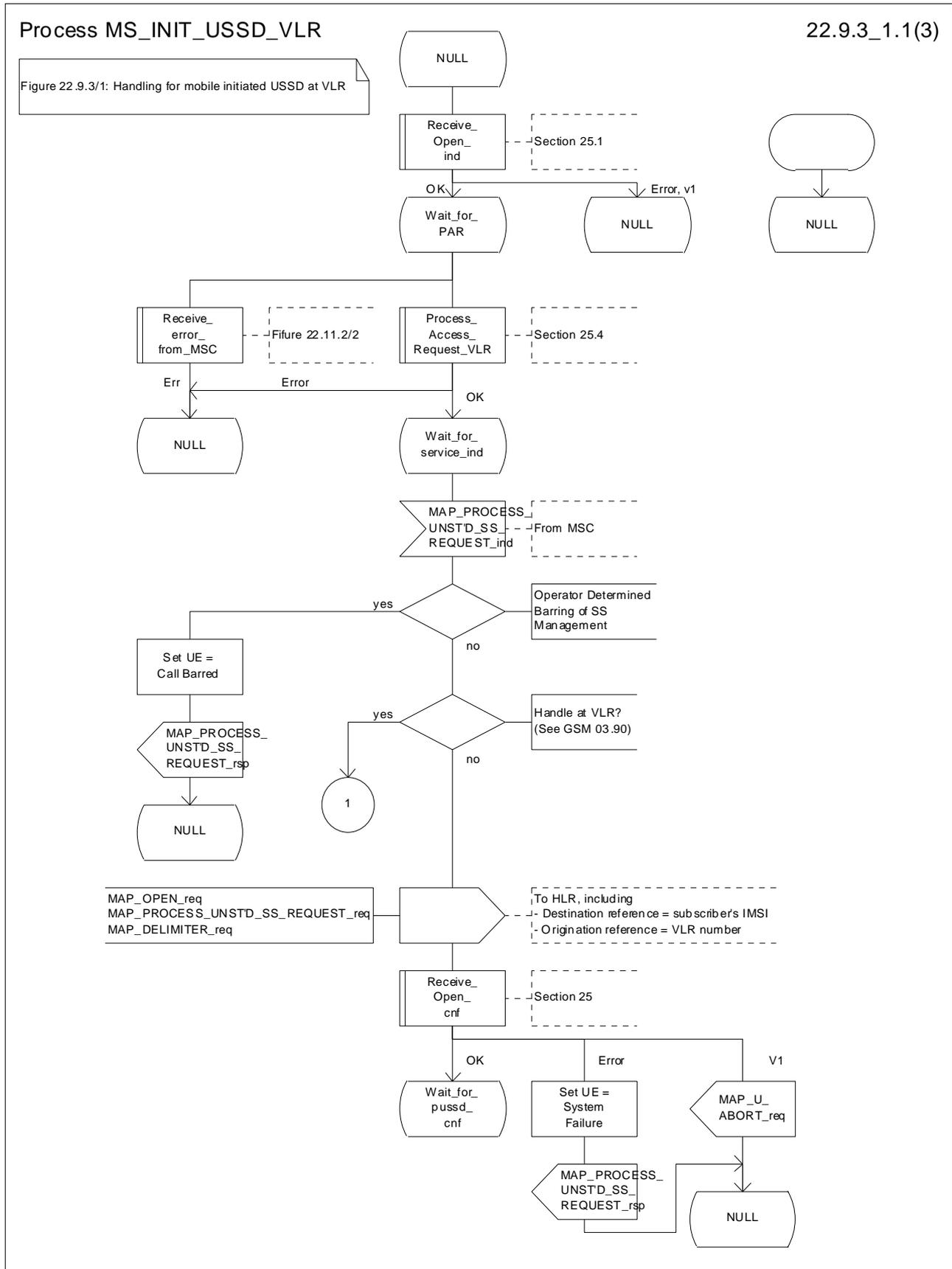

Figure 22.9.3/1 (sheet 1 of 3): Procedure MI\_USSD\_VLR

Process MS\_INIT\_USSD\_VLR

22.9.3\_1.2(3)

Figure 22.9.3/1: Handling for mobile initiated USSD at VLR

Arrows to left are to MSC, arrows to right are to HLR unless otherwise stated.

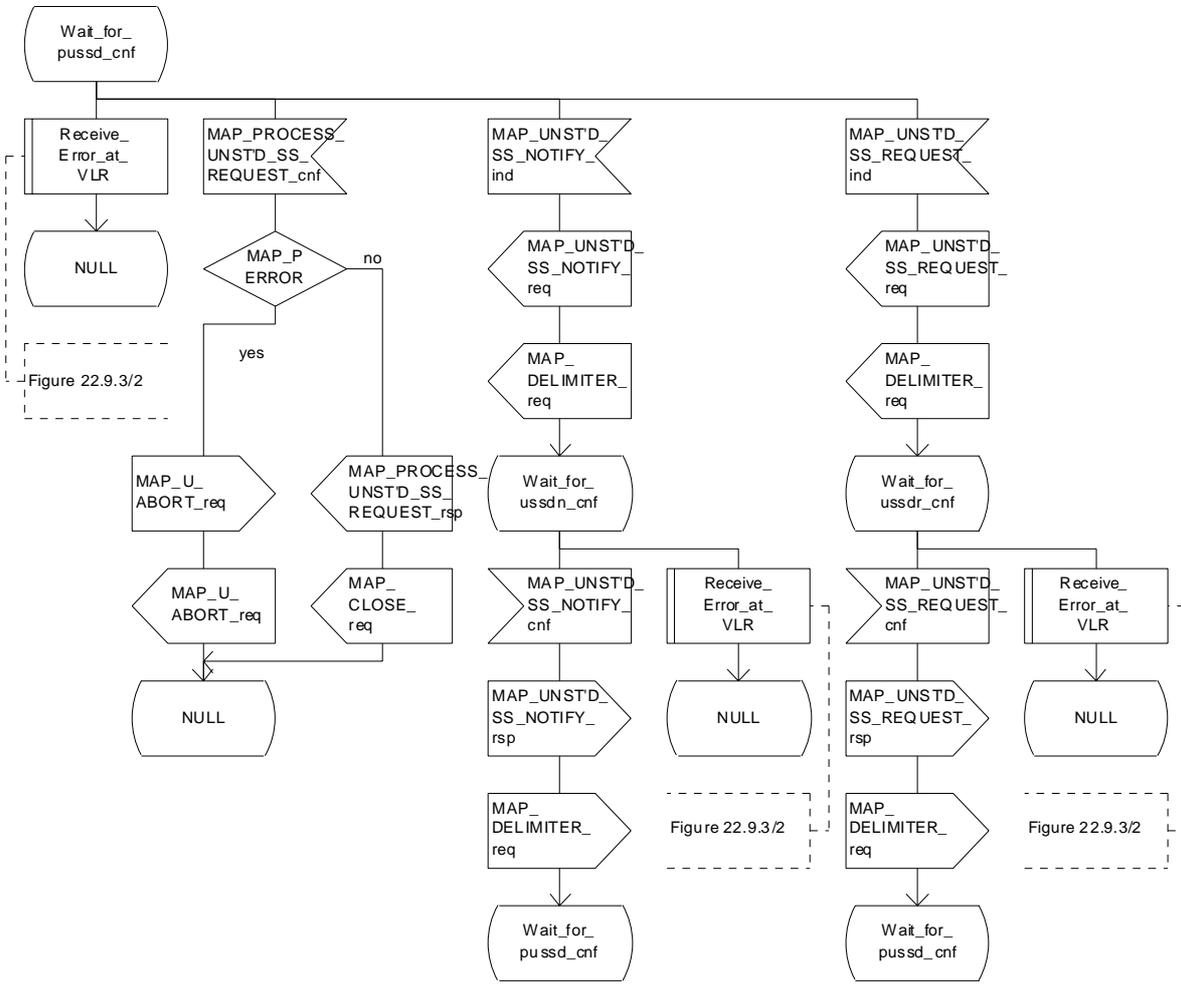

Figure 22.9.3/1 (sheet 2 of 3): Procedure MI\_USSD\_VLR

Process MS\_INIT\_USSD\_VLR

22.9.3\_1.3(3)

Figure 22.9.3/1: Handling for mobile initiated USSD at VLR

Arrows to left are to MSC, arrows to right are to USSD application unless otherwise stated.

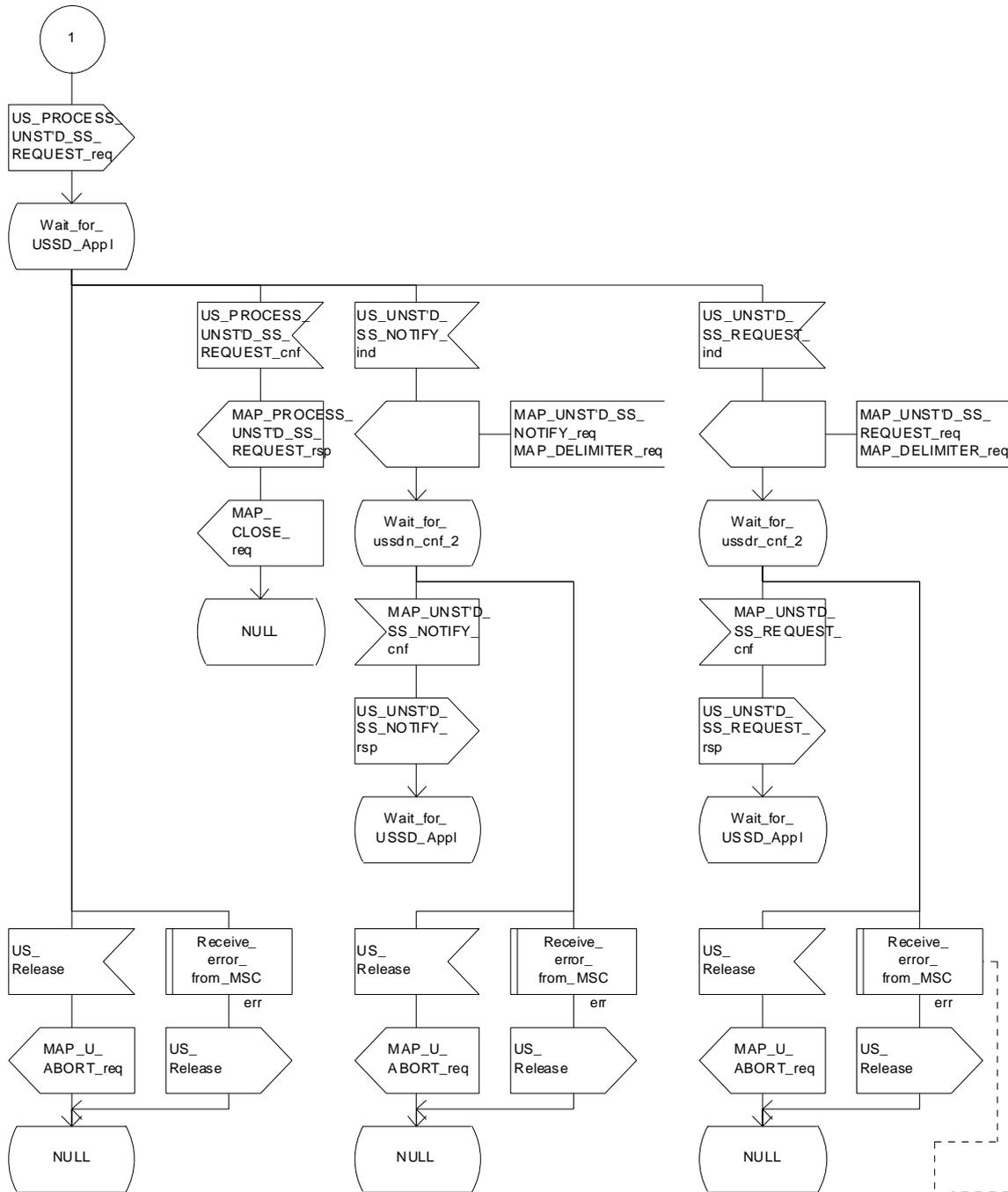

Figure 22.1.1.2/2

Figure 22.9.3/1 (sheet 3 of 3) : Procedure\_MI\_USSD\_VLR

### Macrodefinition Receive\_Error\_at\_VLR

22.9.3\_2(1)

Figure 22.9.3/2: Handling of errors at VLR for USSD

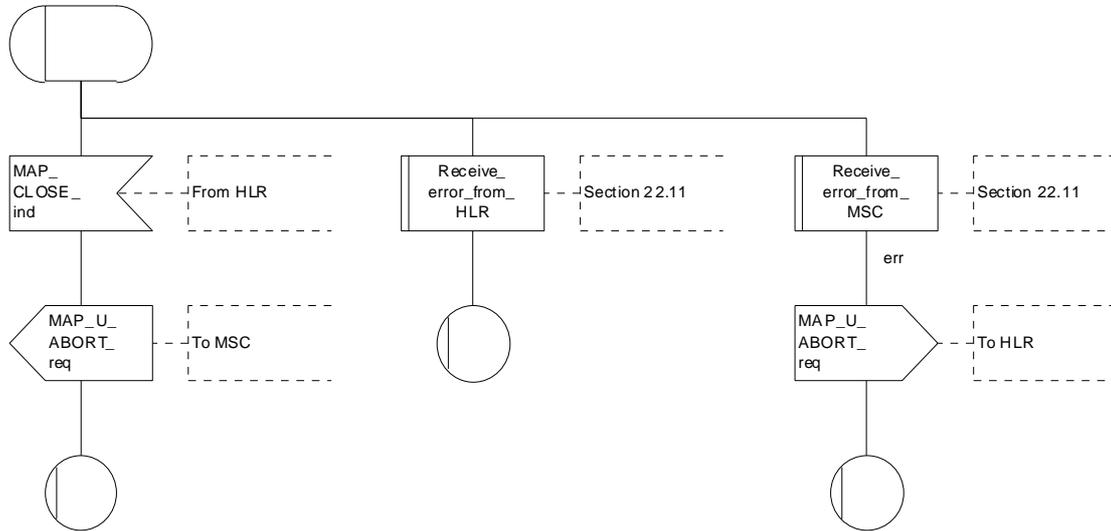

Figure 22.9.3/2: Macro Receive\_Error\_at\_VLR

## 22.9.4 Procedures in the HLR

The initiation of the process is shown in clause 22.1.3.

Once a MAP dialogue is established, the HLR may handle the MAP\_PROCESS\_UNSTRUCTURED\_SS\_REQUEST from the VLR. This message contains information input by the user. If the alphabet used for the message is understood then the message shall either be fed to an application contained locally in the HLR or to the gsmSCF. If the alphabet is not understood then the error "UnknownAlphabet" shall be returned.

### Message Destined for Local Application

If the message is destined for the local USSD application then the HLR shall transfer the message to the local application.

The HLR may subsequently receive one or more requests from the application which correspond to the MAP\_UNSTRUCTURED\_SS\_REQUEST or MAP\_UNSTRUCTURED\_SS\_NOTIFY indications. These shall be sent transparently to the VLR. When a confirmation is received from the VLR this shall be returned to the application.

When the HLR receives the result of the original operation from the application then it shall pass this to the VLR and initiate release of the CM connection.

### Message Destined for gsmSCF

If the message is destined for the gsmSCF then the HLR shall transfer the message transparently to the gsmSCF.

The HLR may subsequently receive one or more MAP\_UNSTRUCTURED\_SS\_REQUEST or MAP\_UNSTRUCTURED\_SS\_NOTIFY indications from the gsmSCF. These shall be sent transparently to the VLR. When a confirmation is received from the VLR this shall be returned to the gsmSCF.

When the HLR receives a MAP\_PROCESS\_UNSTRUCTURED\_SS\_REQUEST confirmation from the gsmSCF then it shall pass this to the VLR and closes the MAP provider service.

### Error Handling

Both the VLR, the USSD Application and the gsmSCF may initiate release of the MAP service at any time. This is handled as shown in the diagrams.

The procedure in the HLR is shown in figure 22.9.4/1.

Process MS\_INIT\_USSD\_HLR

22.9.4\_1.1(4)

Figure 22.9.4/1: Handling of mobile initiated USSD at HLR.

Arrows to left are to VLR unless otherwise stated.  
Arrow to right are to USSD application unless otherwise stated

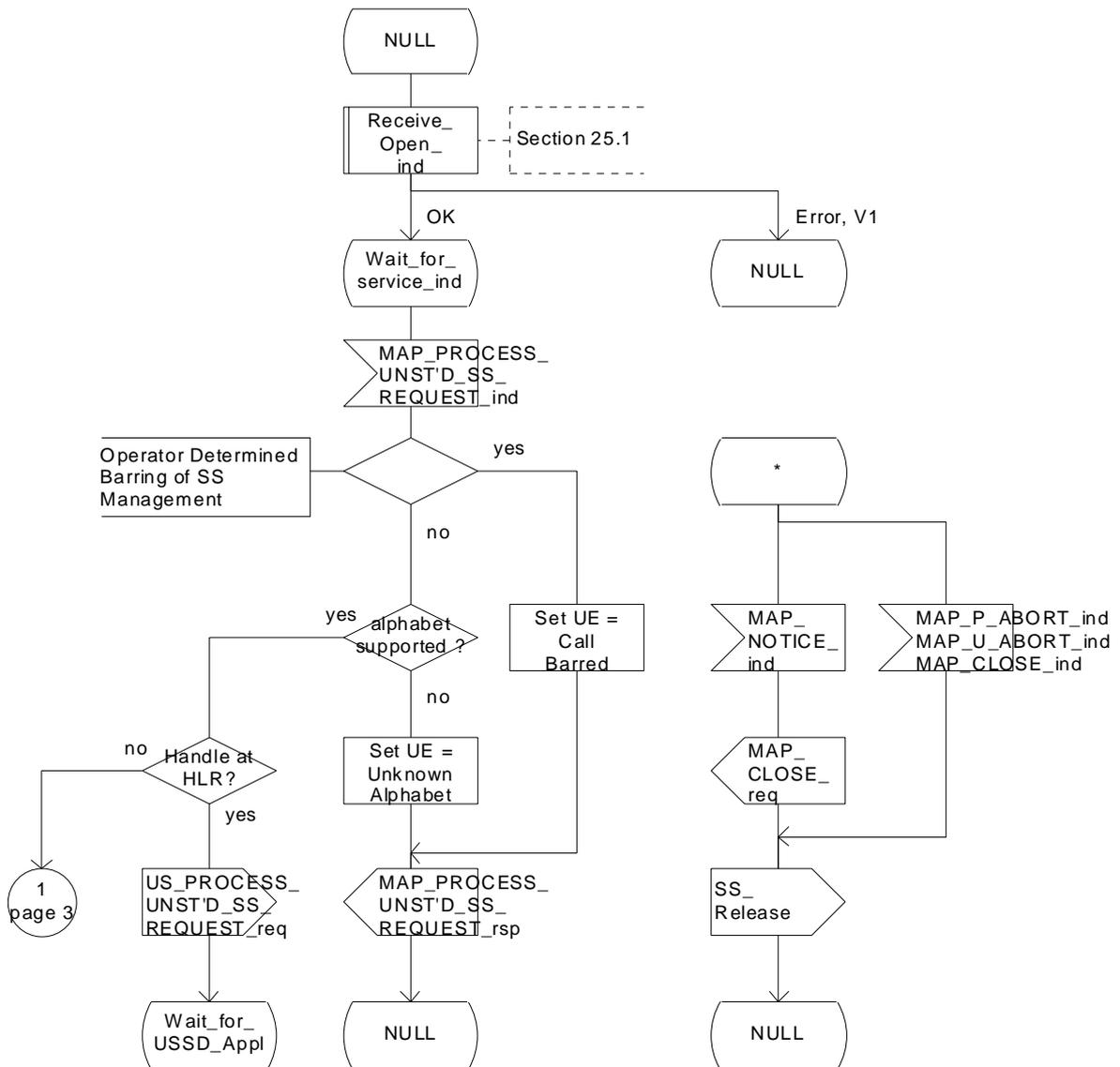

Figure 22.9.4/1 (sheet 1 of 4): Procedure MI\_USSD\_HLR



Process MS\_INIT\_USSD\_HLR

22.9.4\_1.2(4)

Figure 22.9.4/1: Handling of mobile initiated USSD at HLR.

Arrows to left are to VLR, arrows to right are to USSD application unless otherwise stated.

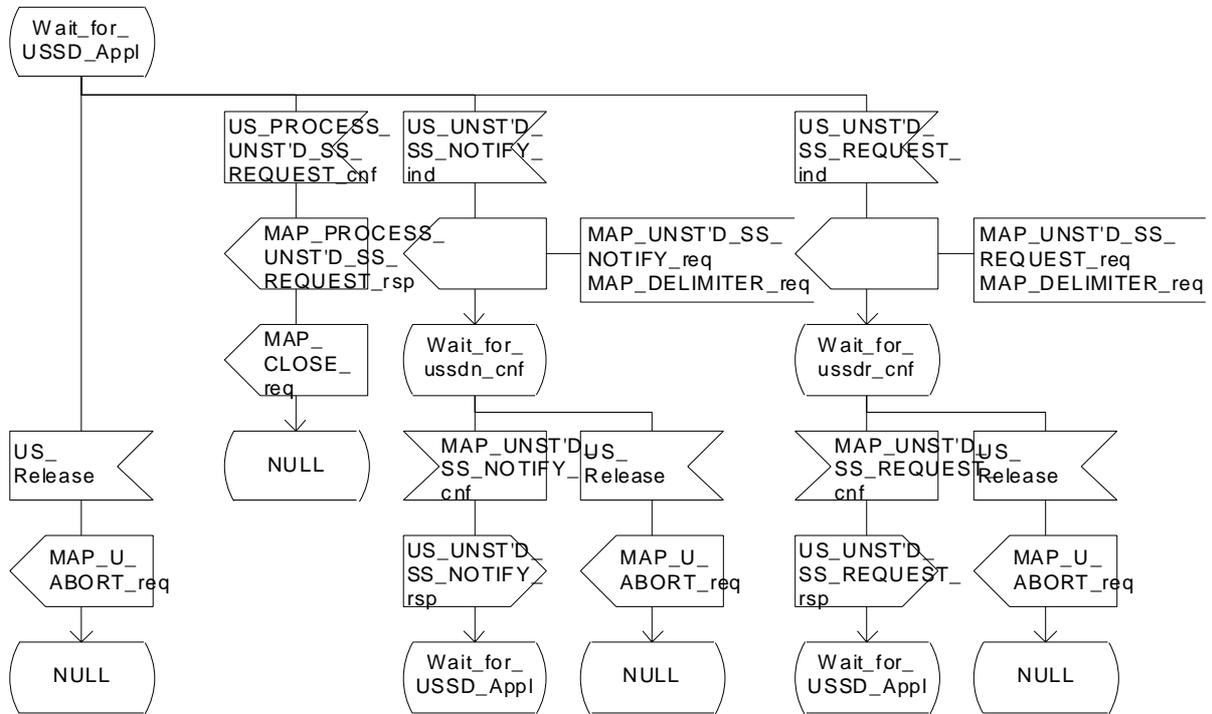

Figure 22.9.4/1 (sheet 2 of 4): Procedure MI\_USSD\_HLR

Process MS\_INIT\_USSD\_HLR

22.9.4\_1.3(4)

Figure 22.9.4/1: Handling of mobile initiated USSD at HLR.

Arrows to left are to VLR, arrows to right are to gsmSCF unless otherwise stated.

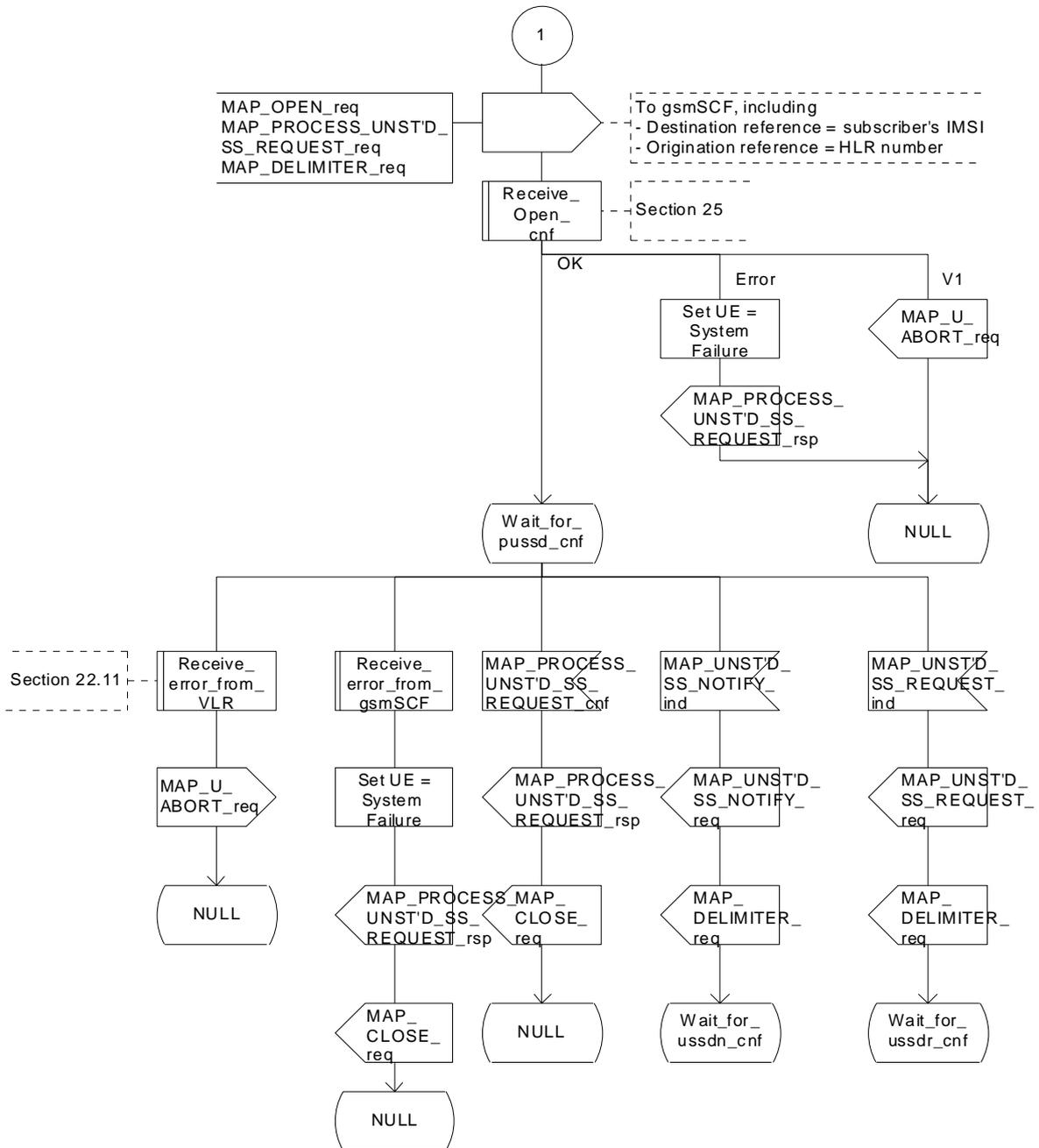

Figure 22.9.4/1 (sheet 3 of 4): Procedure MI\_USSD\_HLR

Process MS\_INIT\_USSD\_HLR

22.9.4\_1.4(4)

Figure 22.9.4/1: Handling of mobile initiated USSD at HLR.

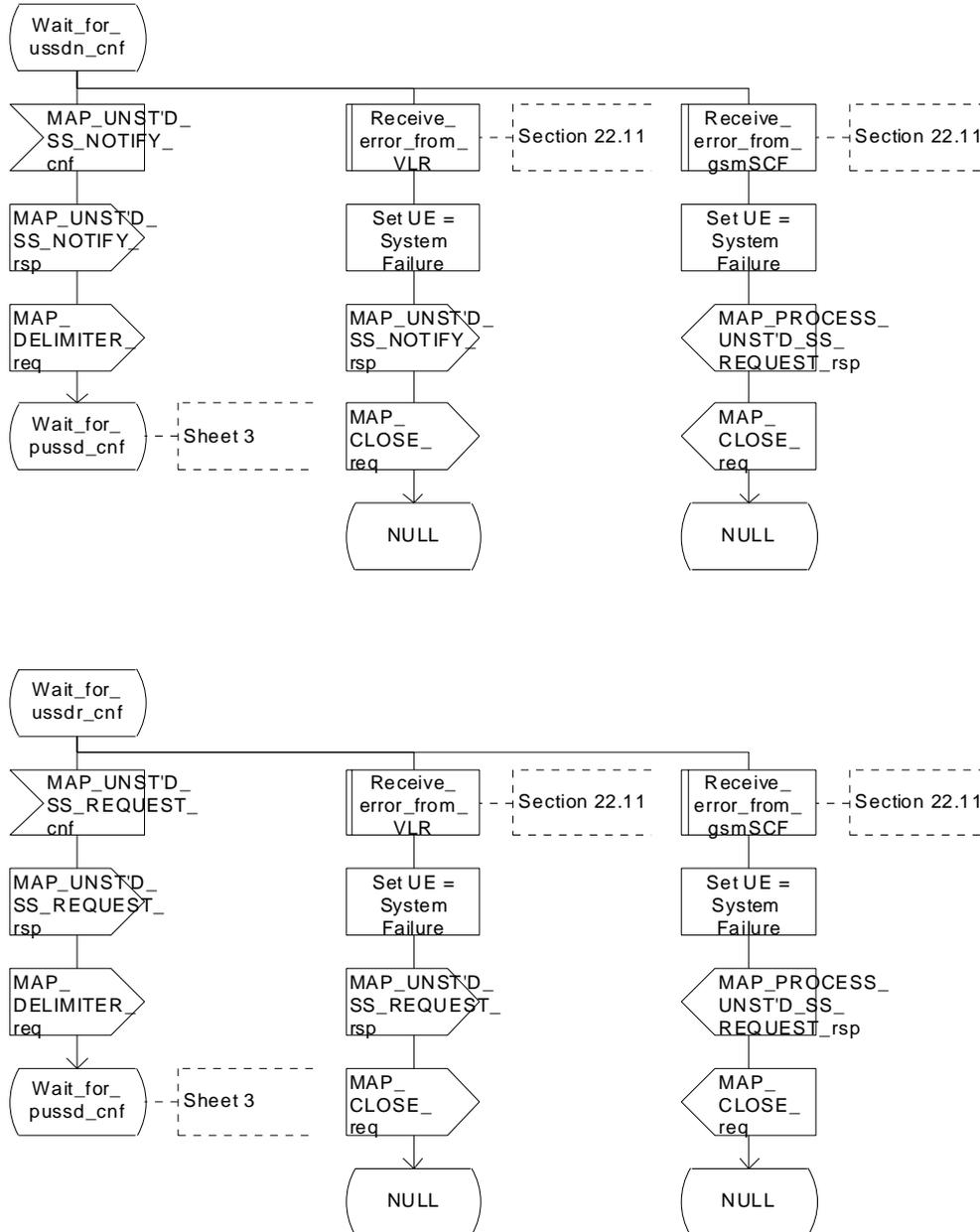

Figure 22.9.4/1 (sheet 4 of 4): Procedure MI\_USSD\_HLR

## 22.10 Network initiated USSD procedure

### 22.10.1 General

The procedure supports supplementary service signalling procedures which can allow PLMN specific services to be introduced.

The message flow for the procedure can be found in GSM 03.90.

The following services may be used:

MAP_PAGE	(defined in clauses 8 and 25);
MAP_SEARCH_FOR_MOBILE_SUBSCRIBER	(defined in clauses 8 and 25);
MAP_PROCESS_ACCESS_REQUEST	(defined in clauses 8 and 25);
MAP_AUTHENTICATE	(defined in clauses 8 and 25);
MAP_SET_CIPHERING_MODE	(defined in clauses 8 and 25);
MAP_FORWARD_NEW_TMSI	(defined in clauses 8 and 25);
MAP_READY_FOR_SM	(defined in clauses 12 and 25).

At least one of the following services will certainly be used, and both may be used:

MAP_UNSTRUCTURED_SS_REQUEST	(defined in clause 11);
MAP_UNSTRUCTURED_SS_NOTIFY	(defined in clause 11).

### 22.10.2 Procedure in the MSC

The procedure may be invoked either by the VLR or by a USSD application local to the MSC. They may start by using either the MAP\_UNSTRUCTURED\_SS\_REQUEST or MAP\_UNSTRUCTURED\_SS\_NOTIFY service. If the request is initiated by a local USSD application then the MSC will open a dialogue with the HLR.

In both cases the MSC will initiate a CM connection to the MS (using the page or search macros defined in clause 25.3). Once the connection is successfully established the message received from the VLR or USSD application will be sent to the MS using the mapping specified in GSM 09.11.

Following transfer of the message the MSC will wait for a confirmation from the MS. This will be sent to the VLR or USSD application as appropriate.

Following this, the MSC may receive further uses of the MAP\_UNSTRUCTURED\_SS\_REQUEST or MAP\_UNSTRUCTURED\_SS\_NOTIFY services, or may receive an indication to release the connection to the MS.

In the event of an error, the connection to the MS shall be released, and the MAP process with the VLR shall be aborted as shown in the diagram.

The procedure in the MSC is shown in figure 22.10.2/1.

### Process NW\_INIT\_USSD\_MSC

22.10.2\_1.1(4)

Figure 22.10.2/1: Handling of network initiated USSD in MSC

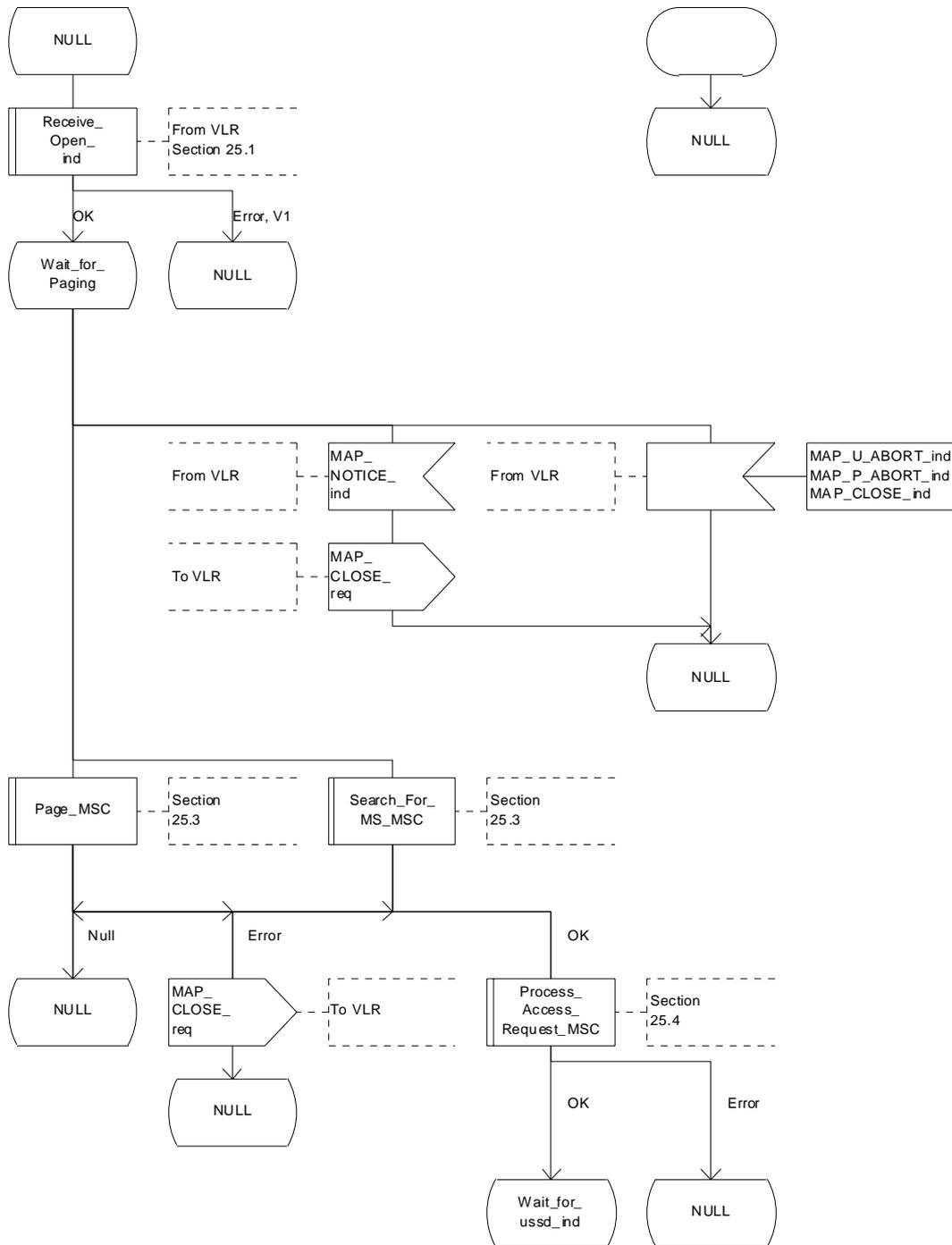

Figure 22.10.2/1 (sheet 1 of 4): Procedure NI\_USSD\_MSC

Process NW\_INIT\_USSD\_MSC

22.10.2\_1.2(4)

Figure 22.10.2/1: Handling of network initiated USSD in MSC

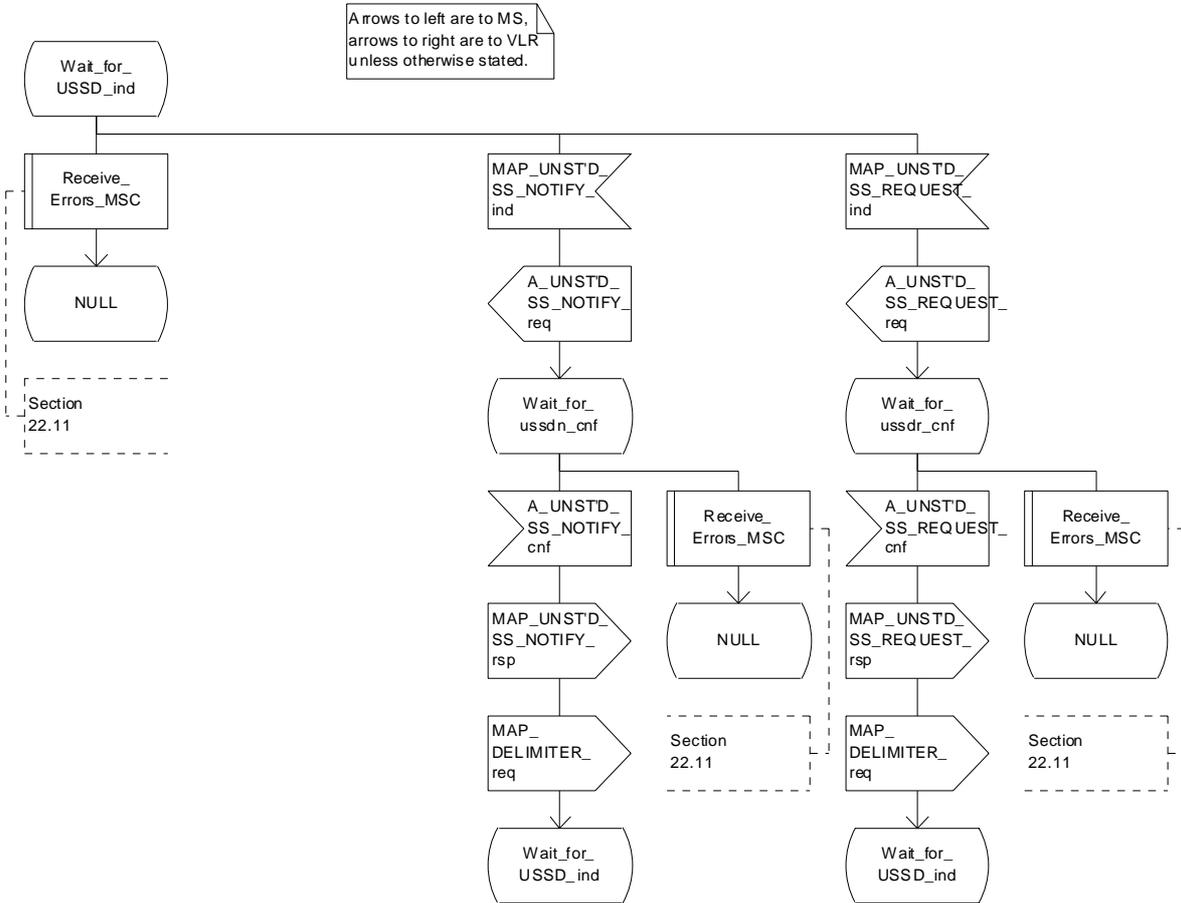

Figure 22.10.2/1 (sheet 2 of 4): Procedure NI\_USSD\_MSC

### Process NW\_INIT\_USSD\_MSC

22.10.2\_1.3(4)

Figure 22.10.2/1: Handling of network initiated USSD in MSC

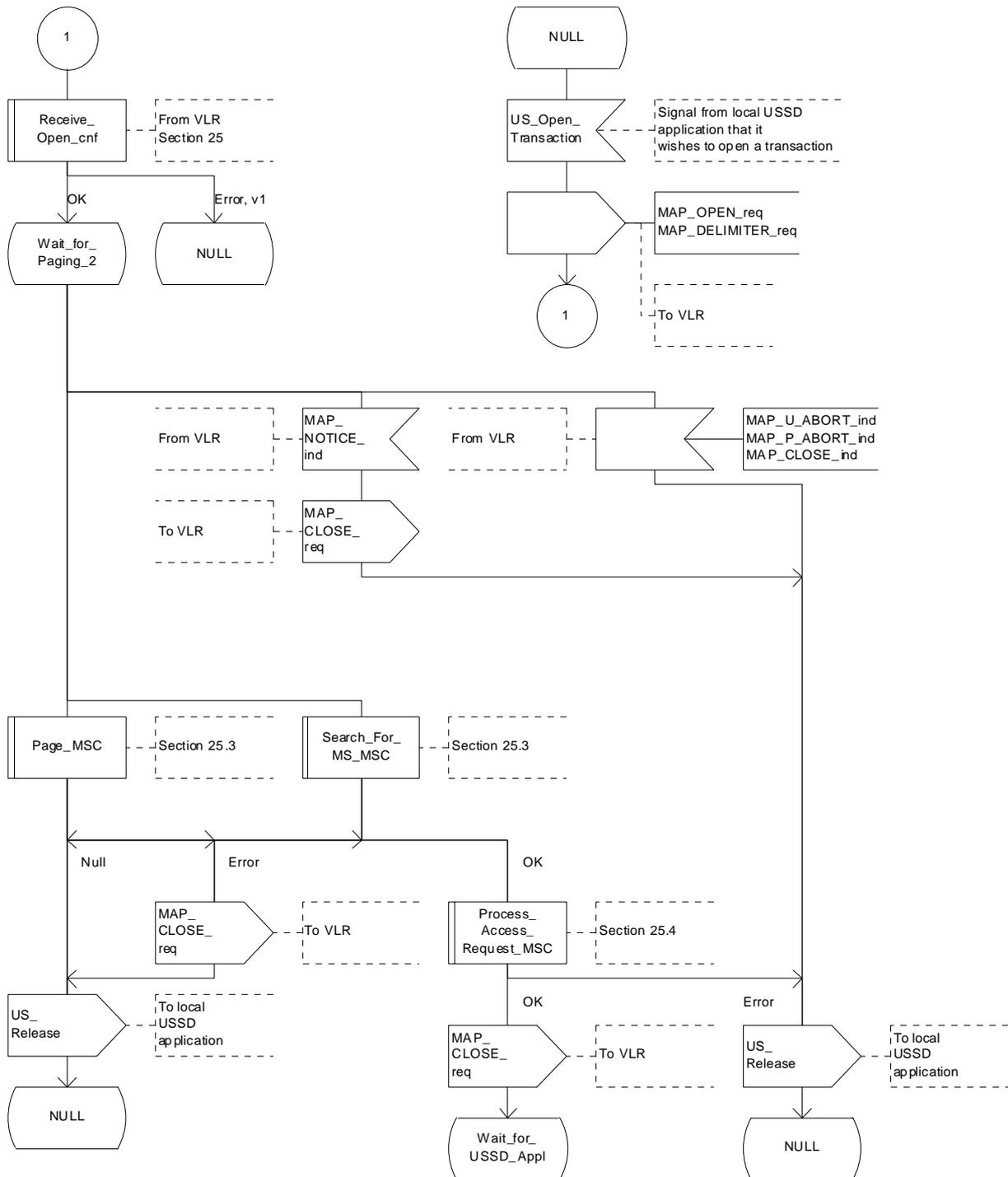

Figure 22.10.2/1 (sheet 3 of 4): Procedure NI\_USSD\_MSC

Process NW\_INIT\_USSD\_MSC

22.10.2\_1.4(4)

Figure 22.10.2/1: Handling of network initiated USSD in MSC

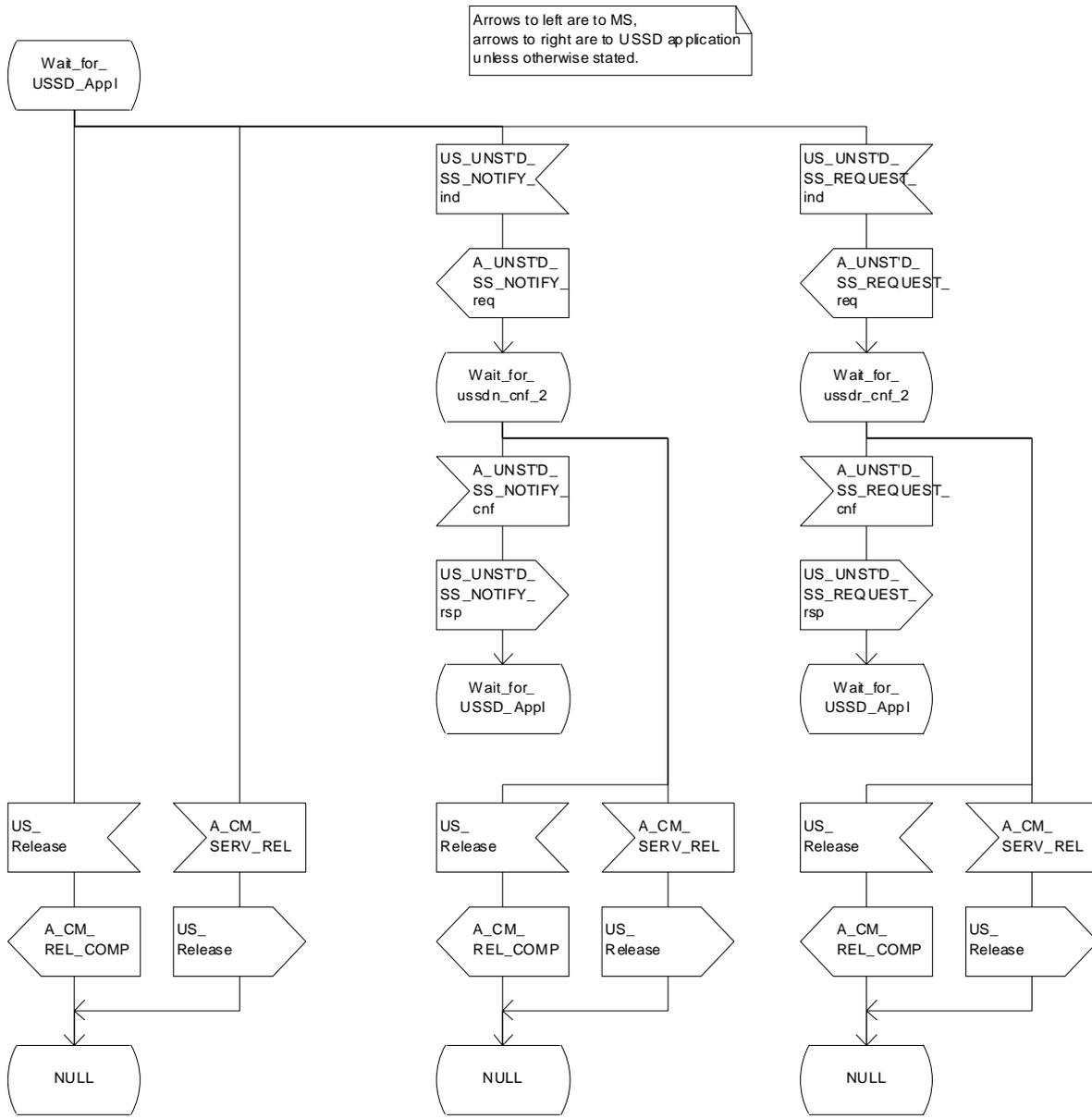

Figure 22.10.2/1 (sheet 4 of 4): Procedure NI\_USSD\_MSC



### 22.10.3 Procedure in the VLR

The procedure may be invoked either by the HLR or by a USSD application local to the VLR. They may start by using either the MAP\_UNSTRUCTURED\_SS\_REQUEST or MAP\_UNSTRUCTURED\_SS\_NOTIFY service.

In both cases the VLR will first initiate a MAP dialogue with the MSC. When the indication for the unstructured SS request or notify is received then the macro Start\_USSD\_VLR will be used to page the MS and open a CM connection. Once the CM connection is successfully established the indication received from the HLR or USSD application will be sent to the MSC.

Following transfer of the message the VLR will wait for a confirmation from the MSC. This will be sent to the HLR or USSD application as appropriate.

Following this, the VLR may receive further uses of the MAP\_UNSTRUCTURED\_SS\_REQUEST or MAP\_UNSTRUCTURED\_SS\_NOTIFY services, or may receive a MAP\_CLOSE\_ind.

In the event of an error, the MAP process with the MSC shall be released, and if necessary the MAP process with the HLR shall be aborted as shown in the diagram.

The procedure in the VLR is shown in figure 22.10.3/1.

#### **MSC Initiated USSD**

If a USSD application in the MSC wishes to use the network initiated USSD procedure, and a connection to the MS does not exist then it shall open a dialogue to the VLR. This dialogue will automatically lead to the VLR performing page and search using the macro Start\_USSD\_VLR.

#### **Macro Start\_USSD\_VLR**

This macro is used to initiate a CM connection with the MS for transfer of network initiated unstructured SS data.

It first checks for correct data in the VLR. If a problem is found then "Err" is returned.

A page or search procedure (as appropriate) will then be used to contact the MS. Following successful page or search the macro Process\_Access\_Request\_VLR specified in clause 25.4 will be used to handle the CM connection establishment.

The macro is shown in figure 22.10.3/2.

Process NW\_INIT\_USSD\_VLR

22.10.3\_1.1(4)

Figure 22.10.3/1: Handling of network initiated USSD at VLR

Arrows to left are to MSC, Arrows to right are to HLR unless otherwise stated.

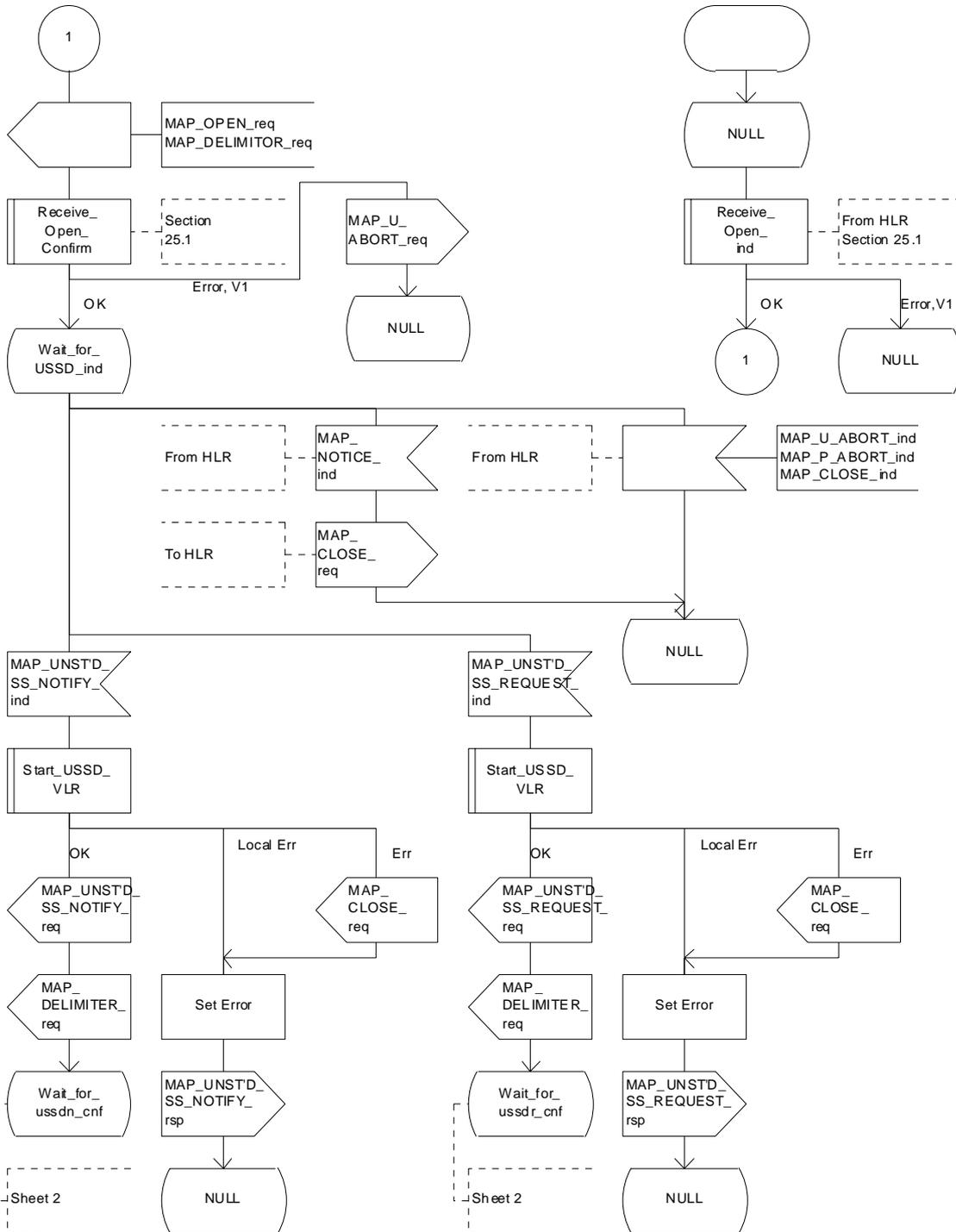

Figure 22.10.3/1 (sheet 1 of 4): Procedure NI\_USSD\_VLR

Process NW\_INIT\_USSD\_VLR

22.10.3\_1.2(4)

Figure 22.10.3/1: Handling of network initiated USSD at VLR

Arrows to left are to MSC, arrows to right are to HLR unless otherwise stated.

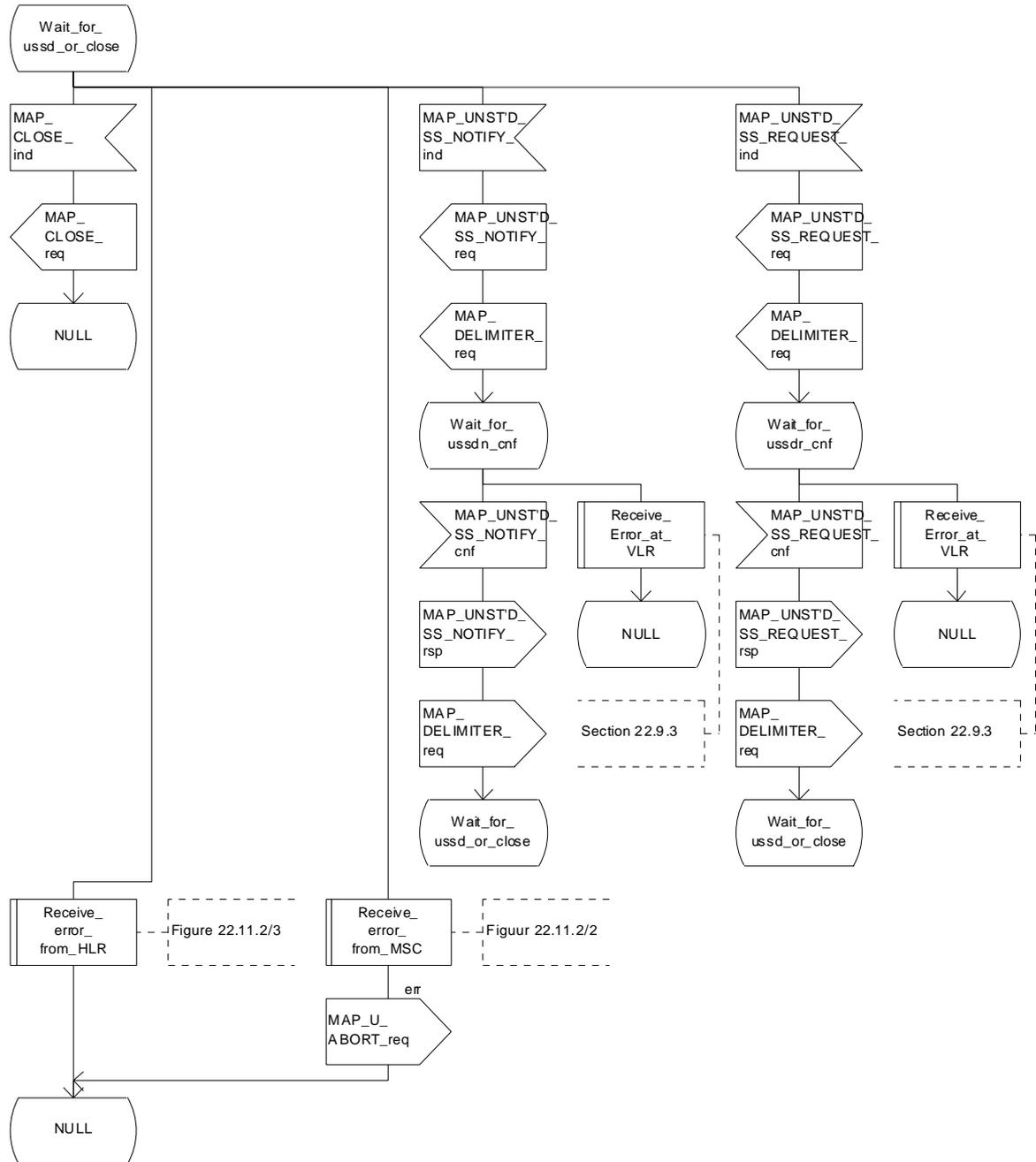

Figure 22.10.3/1 (sheet 2 of 4): Procedure NI\_USSD\_VLR

### Process NW\_INIT\_USSD\_VLR

22.10.3\_1.3(4)

Figure 22.10.3/1: Handling of network initiated USSD at VLR

Arrows to left are to MSC, arrows to right are to USSD application unless otherwise stated.

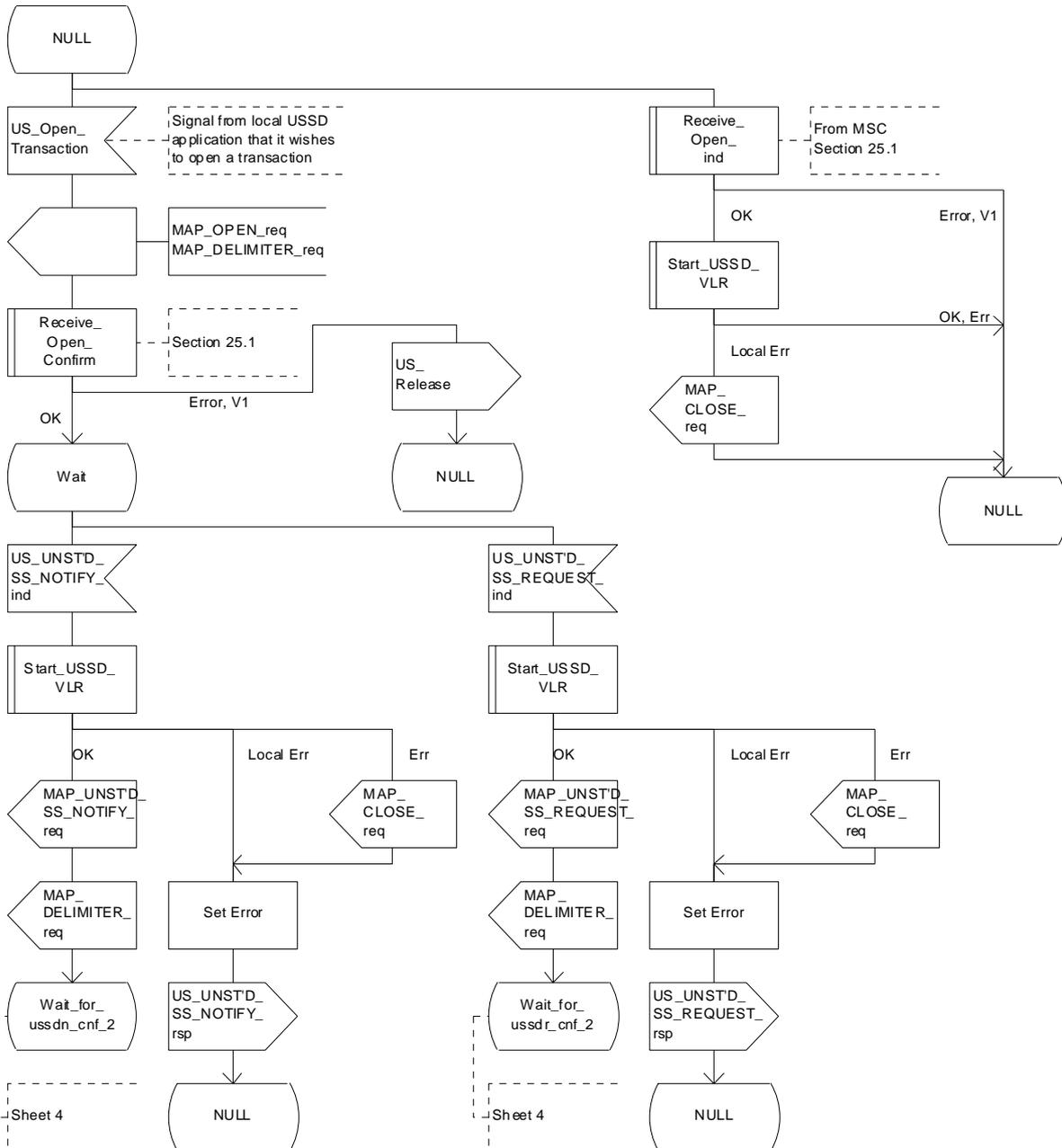

Figure 22.10.3/1 (sheet 3 of 4): Procedure NI\_USSD\_VLR

Process NW\_INIT\_USSD\_VLR

22.10.3\_1.4(4)

Figure 22.10.3/1: Handling of network initiated USSD at VLR

Arrows to left are to MSC, arrows to right are to USSD application unless otherwise stated.

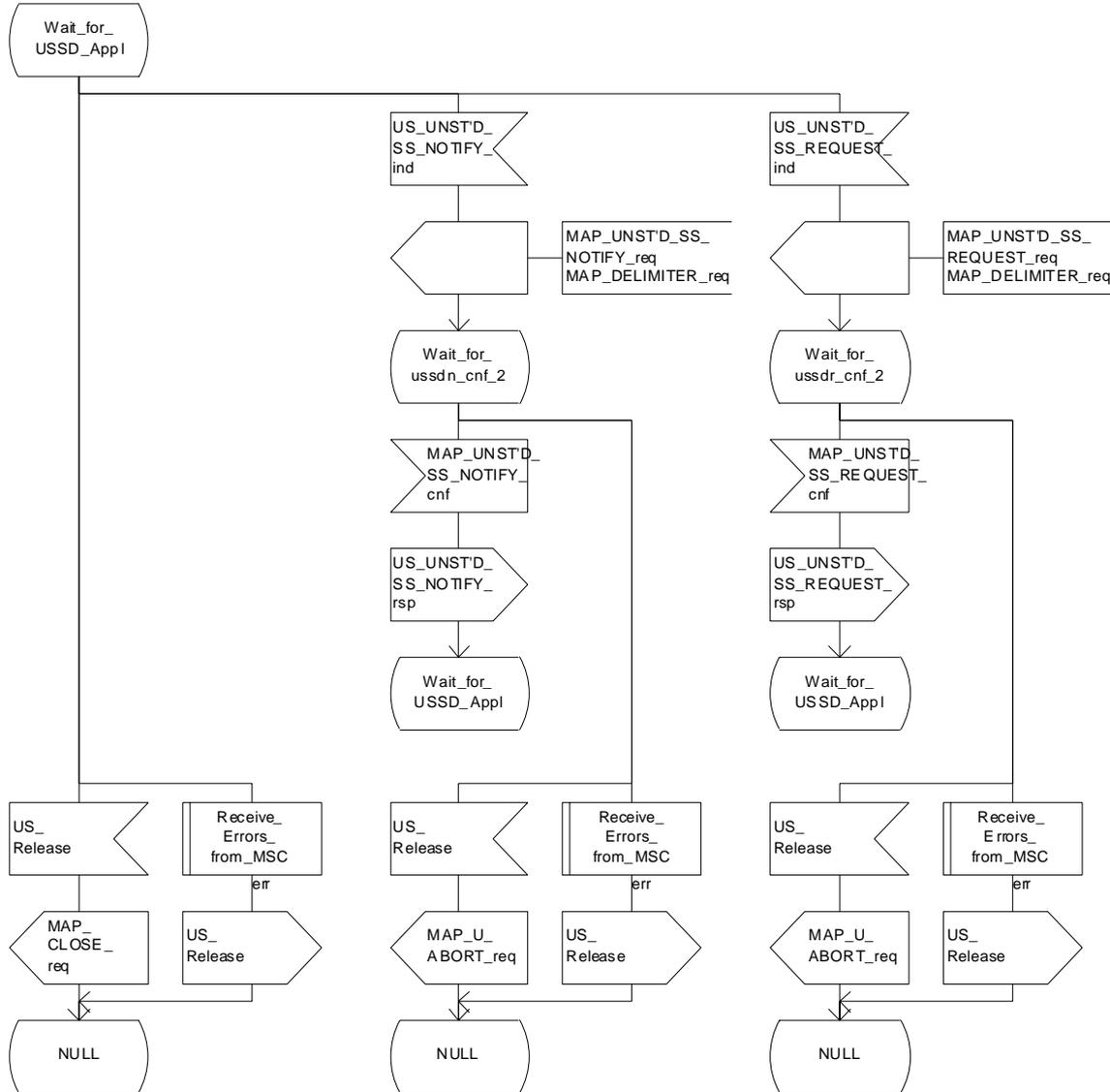

Figure 22.10.3/1 (sheet 4 of 4): Procedure NI\_USSD\_VLR

Macrodefinition Start\_USSD\_VLR

22.10.3\_2.1(2)

Figure 22.10.3/2: Macro to establish a connection to the MS for a network initiated USSD operation.

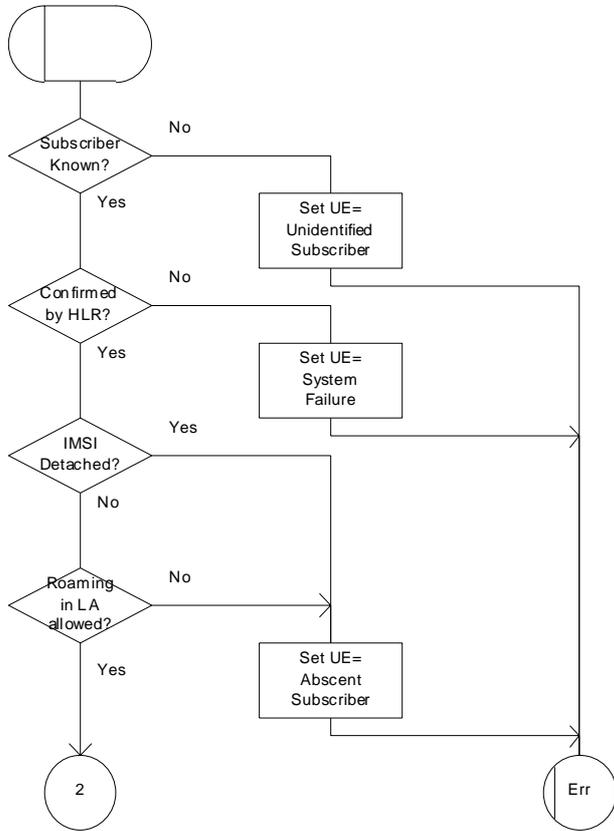

Figure 22.10.3/2 (sheet 1 of 2): Macro Start\_USSD\_VLR

Macrodefinition Start\_USSD\_VLR

22.10.3\_2.2(2)

Figure 22.10.3/2: Macro to establish a connection to the MS for a network initiated USSD operation.

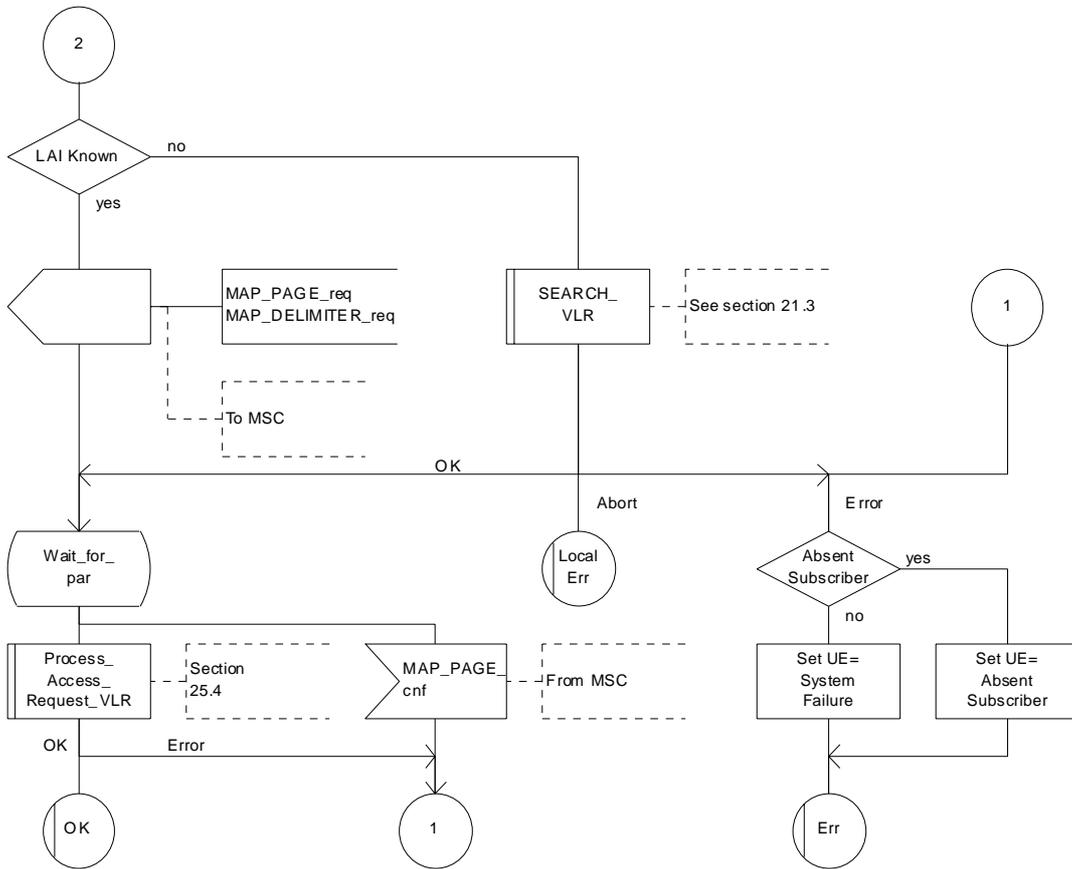

Figure 22.10.3/2 (sheet 2 of 2): Macro Start\_USSD\_VLR

## 22.10.4 Procedure in the HLR

The procedure may be invoked either by the gsmSCF or by a USSD application local to the HLR. It may start by using either the MAP\_UNSTRUCTURED\_SS\_REQUEST or MAP\_UNSTRUCTURED\_SS\_NOTIFY service.

In both cases the HLR will first check whether the MS is reachable.

If the MS is reachable, the HLR will initiate a MAP dialogue with the VLR. Once the dialogue is successfully established the message received from the gsmSCF or USSD application will be sent to the VLR.

Following transfer of the message the HLR will wait for a confirmation from the VLR. This will be sent to the gsmSCF or USSD application as appropriate.

Following this, the HLR may receive further uses of the MAP\_UNSTRUCTURED\_SS\_REQUEST or MAP\_UNSTRUCTURED\_SS\_NOTIFY services, or may receive a MAP\_CLOSE\_ind.

In the event of an error, the MAP process with the VLR shall be released and if necessary the MAP process with the gsmSCF shall be aborted, as shown in the diagram.

### Message Originated by gsmSCF

If the message is originated by the gsmSCF then the HLR shall transfer the message transparently to the VLR.

The HLR may subsequently receive one or more MAP\_UNSTRUCTURED\_SS\_REQUEST\_ind or MAP\_UNSTRUCTURED\_SS\_NOTIFY\_ind indications from the gsmSCF. These shall be sent transparently to the VLR. When a confirmation is received from the VLR this shall be returned to the gsmSCF.

When the HLR receives a MAP\_CLOSE\_ind from the gsmSCF then it shall pass this to the VLR and close the MAP dialogue.

The procedure in the HLR is shown in figure 22.10.4/1 and 22.10.4/2.



Process NW\_INIT\_USSD\_HLR

22.10.4\_1.1(5)

Figure 22.10.4/1 Handling of network initiated USSD at HLR

Arrows to left are to VLR, Arrows to right are to gsmSCF unless otherwise stated.

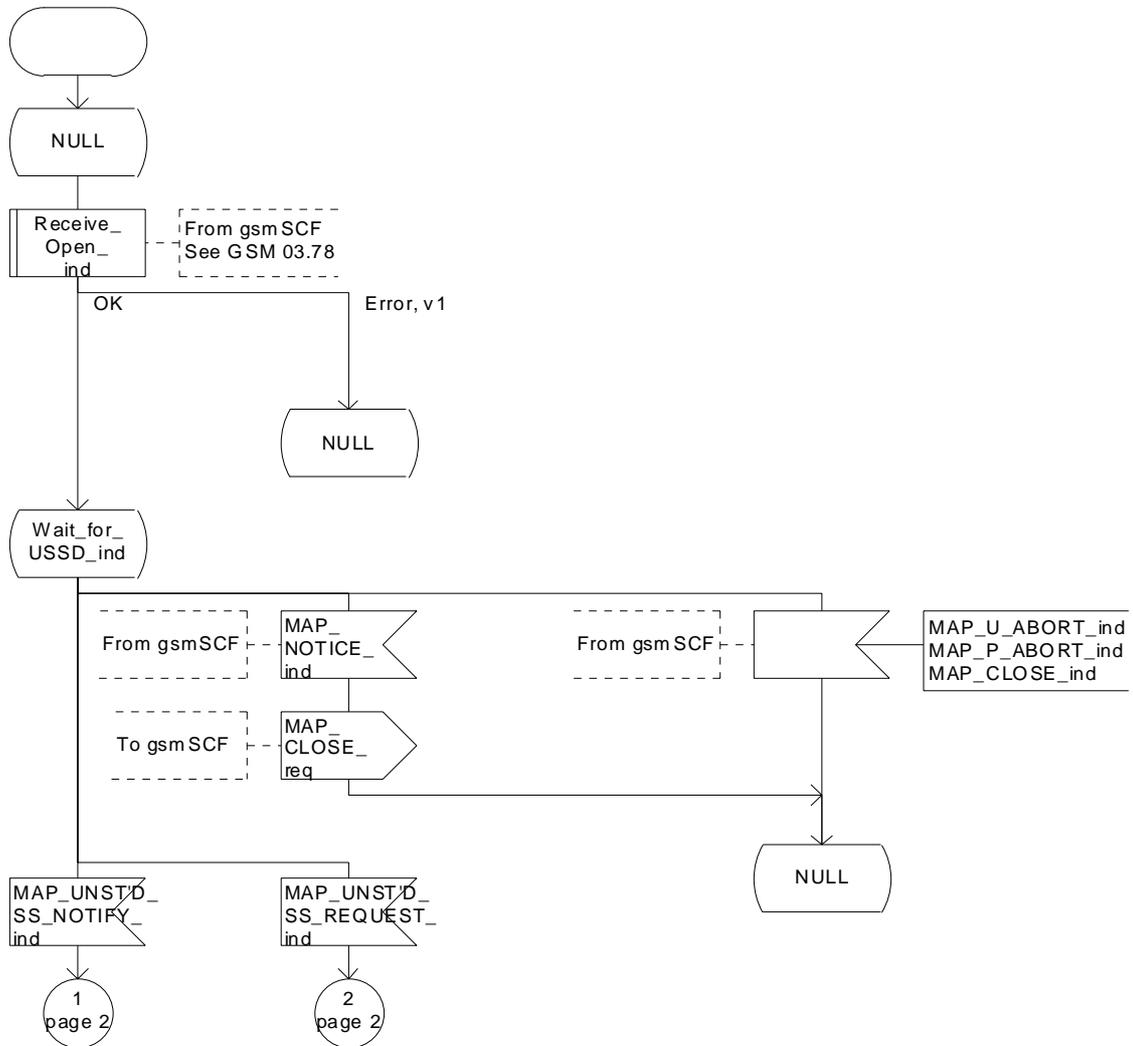

Figure 22.10.4/1 (sheet 1 of 5): Procedure NI\_USSD\_HLR

Process NW\_INIT\_USSD\_HLR

22.10.4\_1.2(5)

Figure 22.10.4/1 Handling of network initiated USSD at HLR

Arrows to left are to VLR, Arrows to right are to gsm SCF unless otherwise stated.

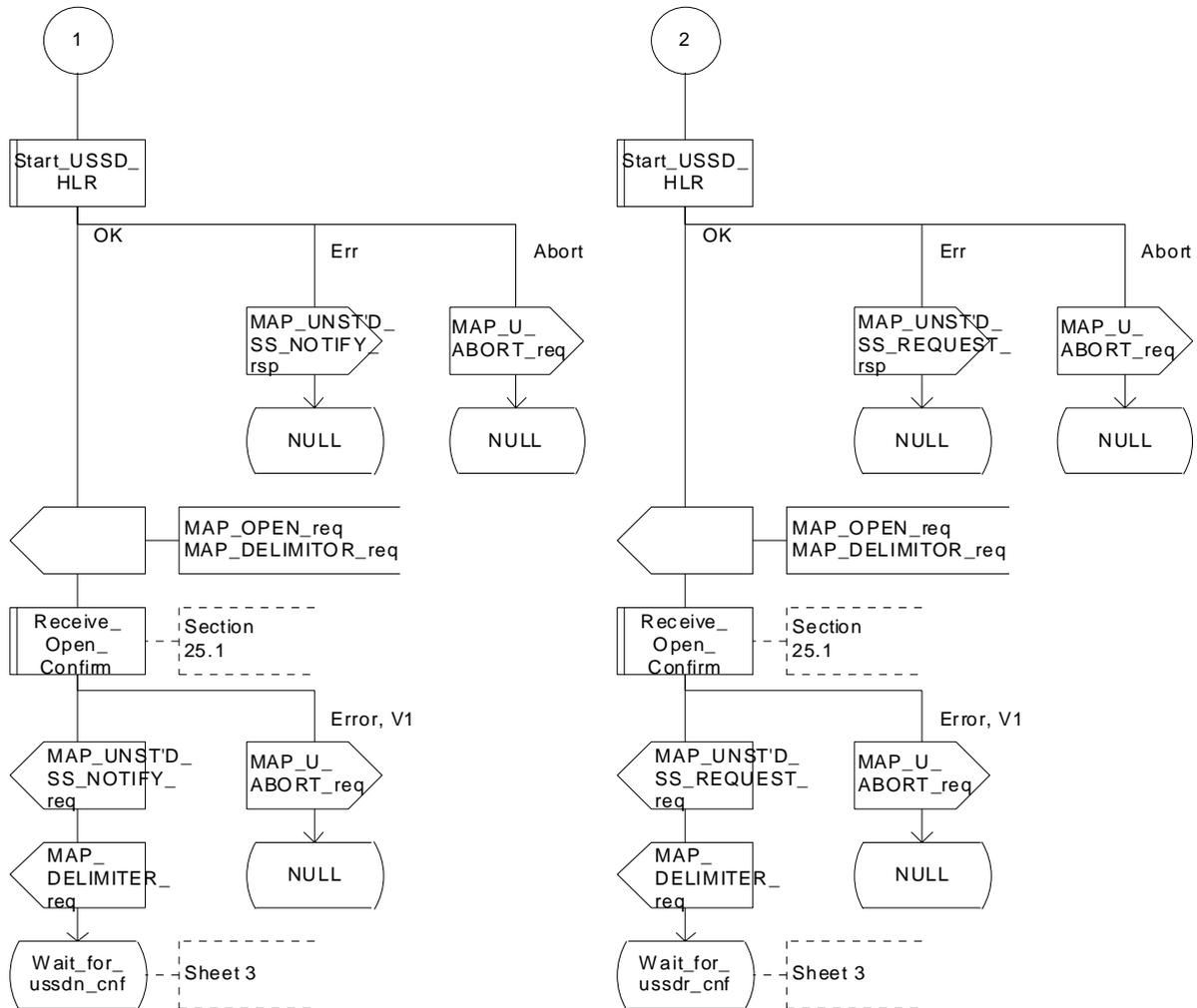

Figure 22.10.4/1 (sheet 2 of 5): Procedure NI\_USSD\_HLR

Process NW\_INIT\_USSD\_HLR

22.10.4\_1.3(5)

Figure 22.10.4/1 Handling of network initiated USSD at HLR

Arrows to left are to VLR, Arrows to right are to gsmSCF unless otherwise stated.

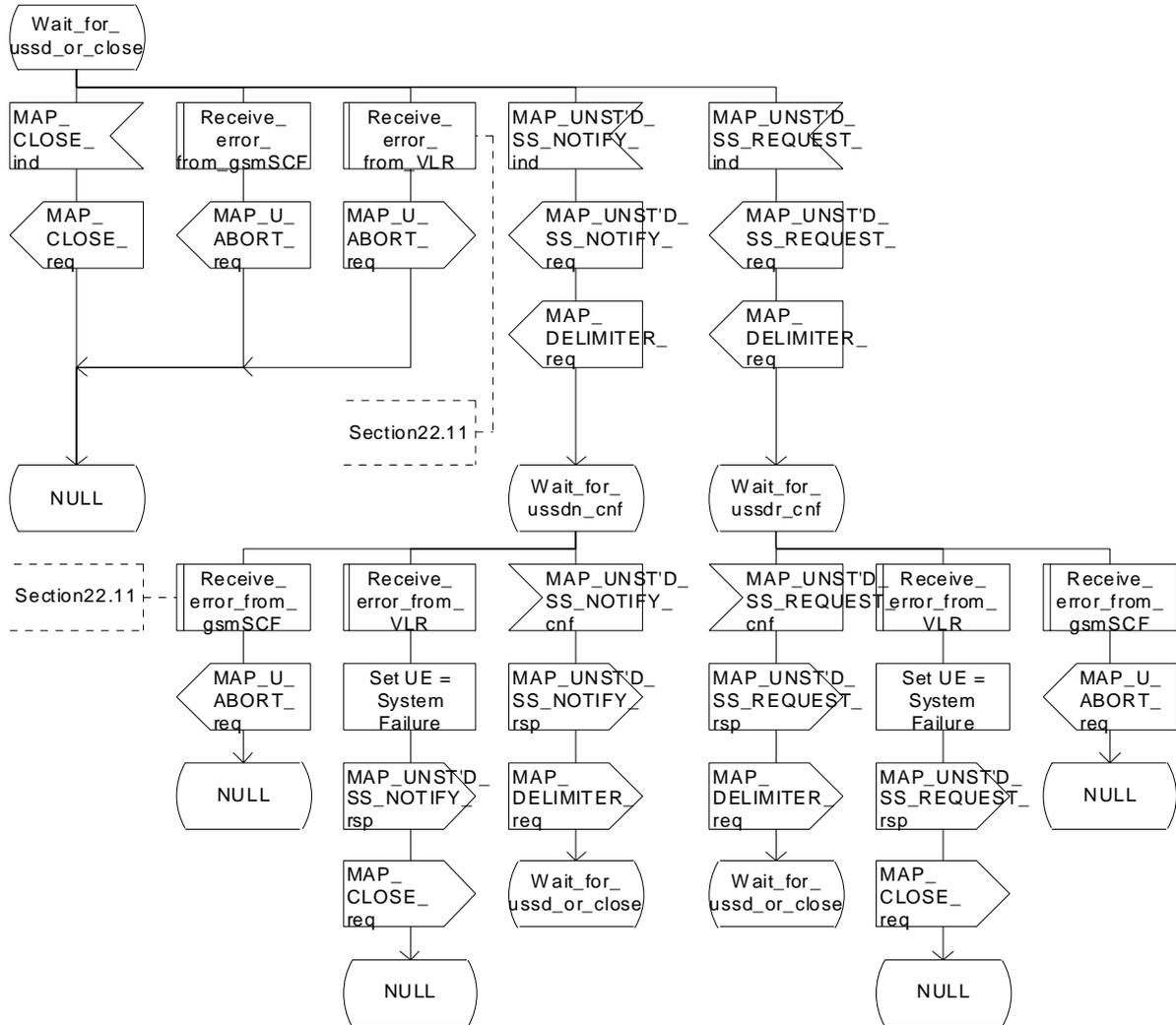

Figure 22.10.4/1 (sheet 3 of 5): Procedure NI\_USSD\_HLR

Process NW\_INIT\_USSD\_HLR

22.10.4\_1.4(5)

Figure 22.10.4/1 Handling of network initiated USSD at HLR

Arrows to left are to VLR, arrows to right are to USSD application unless otherwise stated.

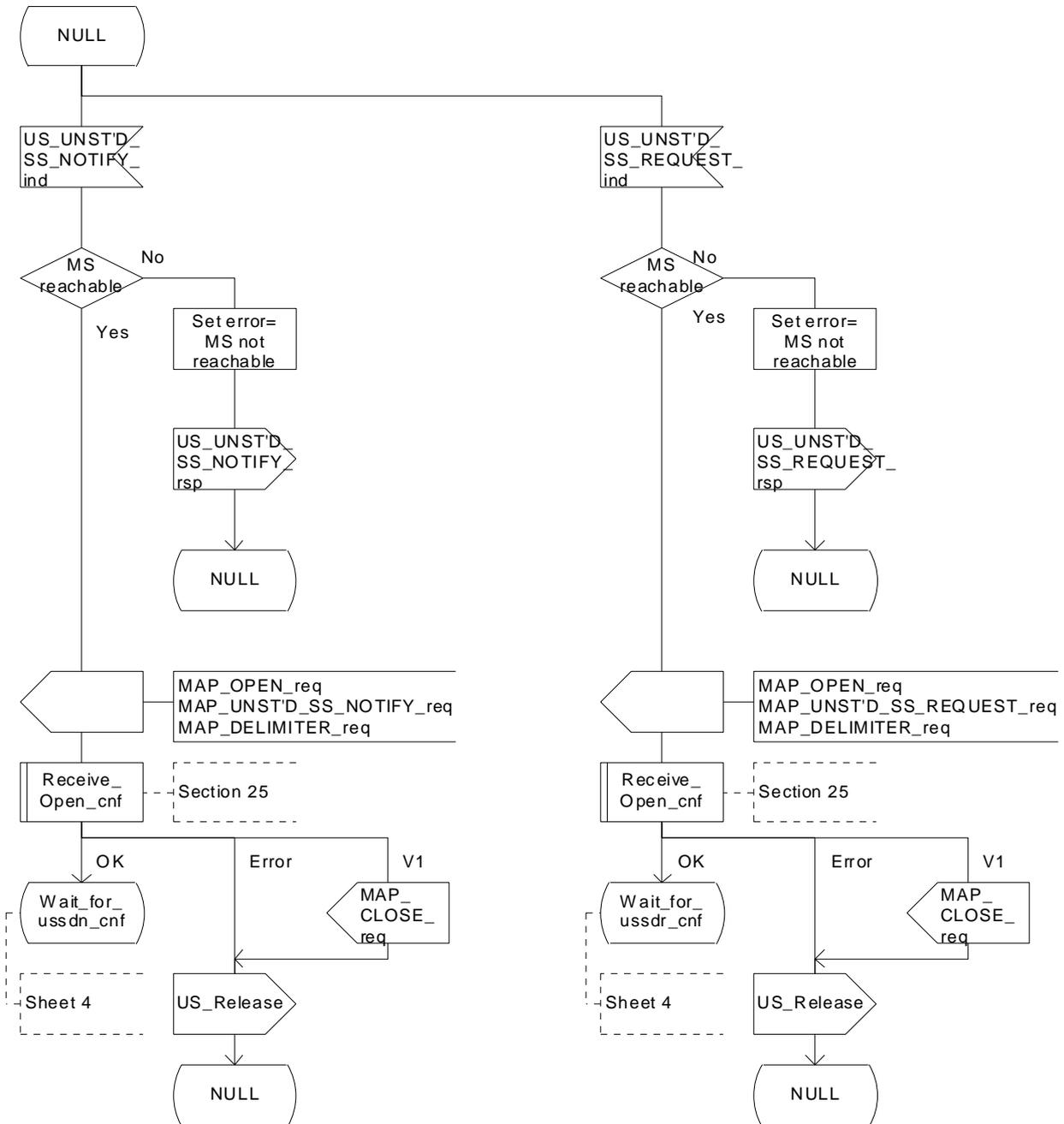

Figure 22.10.4/1 (sheet 4 of 5): Procedure NI\_USSD\_HLR

Process NW\_INIT\_USSD\_HLR

22.10.4\_1.5(5)

Figure 22.10.4/1 Handling of network initiated USSD at HLR

Arrows to left are to VLR, arrows to right are to USSD application unless otherwise stated.

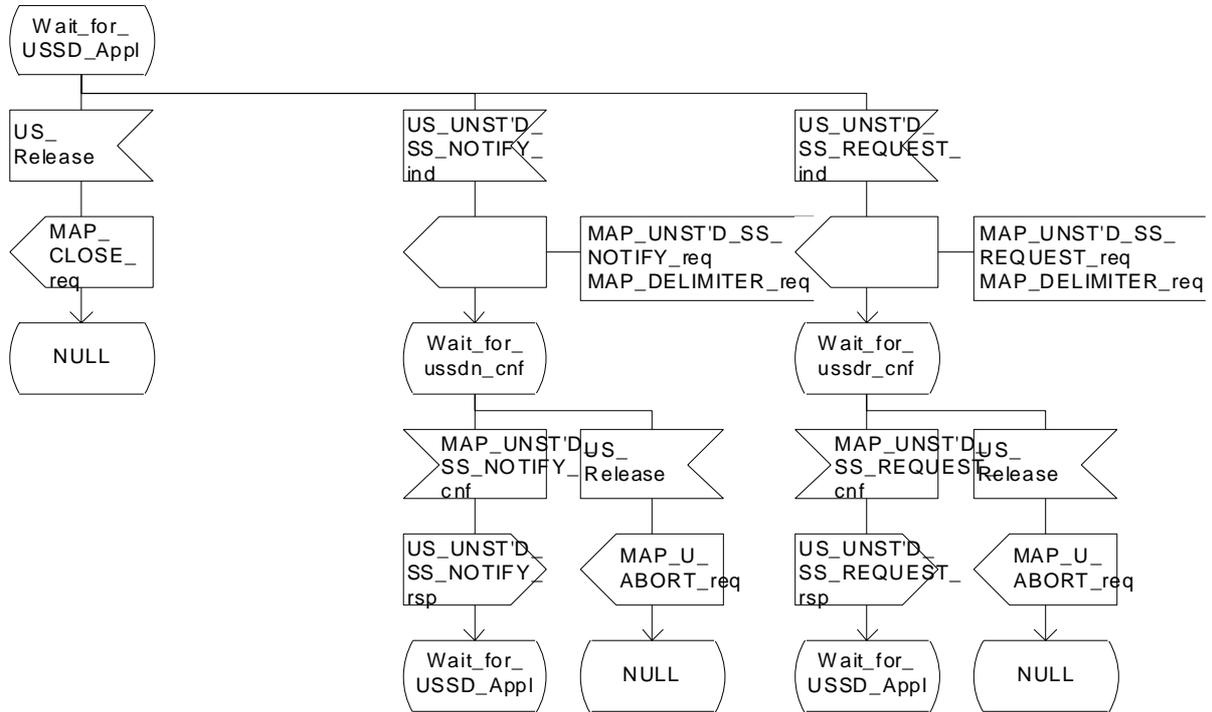

Figure 22.10.4/1 (sheet 5 of 5): Procedure NI\_USSD\_HLR

Macrodefinition Start\_USSD\_HLR

22.10.4\_2.1(1)

Figure 22.10.4/2: Macro to check MS is reachable at the HLR for a network initiated USSD operation

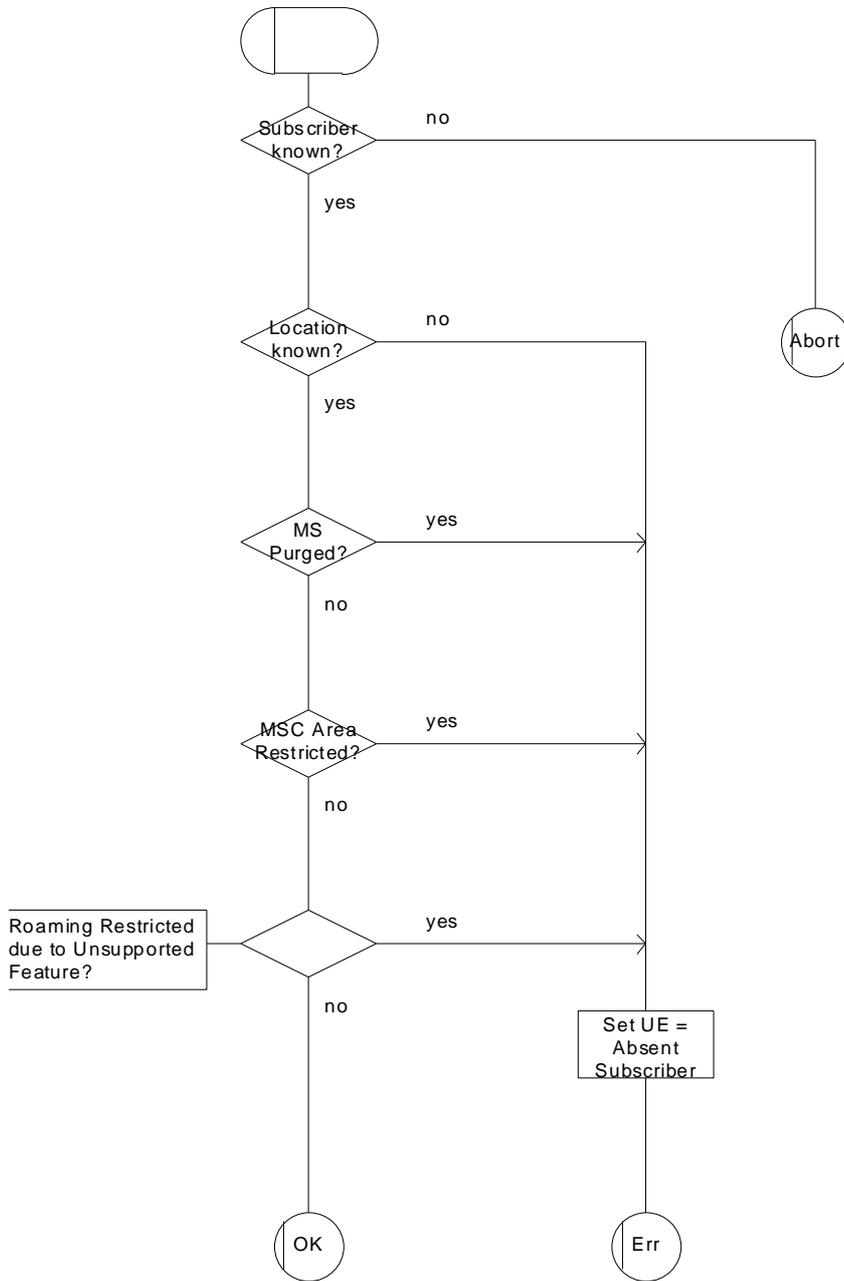

Figure 22.10.4/2: Macro Start\_USSD\_HLR

## 22.11 Common macros for clause 22

The following macros are used for the description of more than one of the supplementary service processes described in clause 22:

### 22.11.1 SS Password handling macros

#### **Macro Get\_Password\_MSC**

This macro is used by the MSC to relay a request for password from the VLR to the MS, and to relay a response from the MS back to the VLR. The macro is described in figure 22.11.1/1.

#### **Macro Get\_Password\_VLR**

This macro is used by the VLR to relay a request for password from the HLR to the MSC, and to relay a response from the MSC back to the HLR. The macro is described in figure 22.11.1/2.

### Macrodefinition GET\_PASSWORD\_MSC

22.11.1\_1(1)

Figure 22.11.1/1: Macro which relays a GetPassword request from the VLR to the MS and relays the GetPassword response from the MS to the VLR

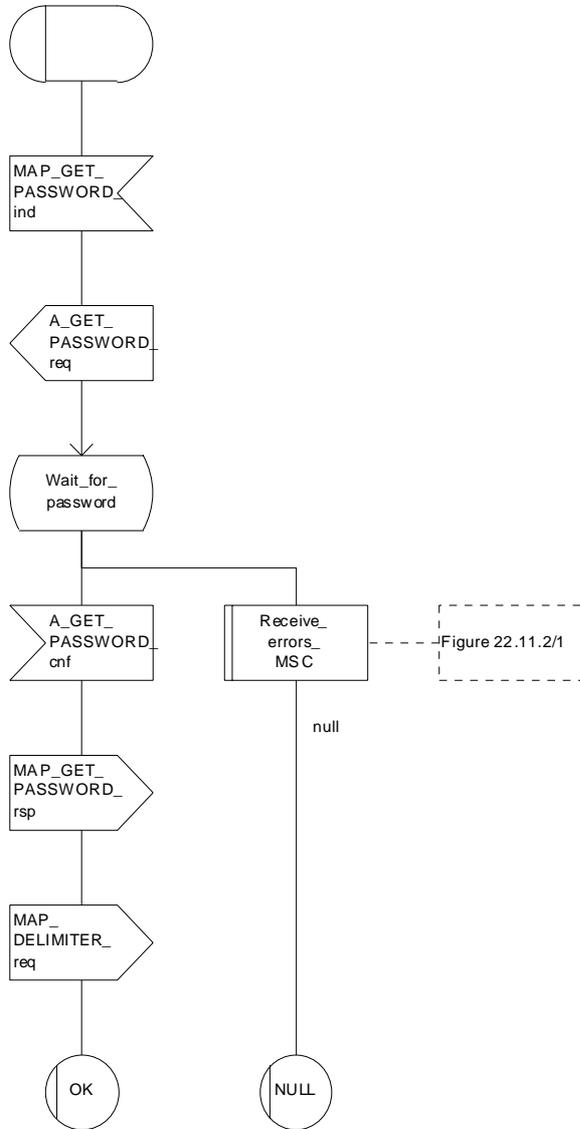

Figure 22.11.1/1: Macro Get\_PW\_MSC



### Macrodefinition GET\_PASSWORD\_VLR

22.11.1\_2(1)

Figure 22.11.1/2: Macro which relay a GetPassword request from the HLR to the VLR and relays the GetPassword response from the VLR to the HLR

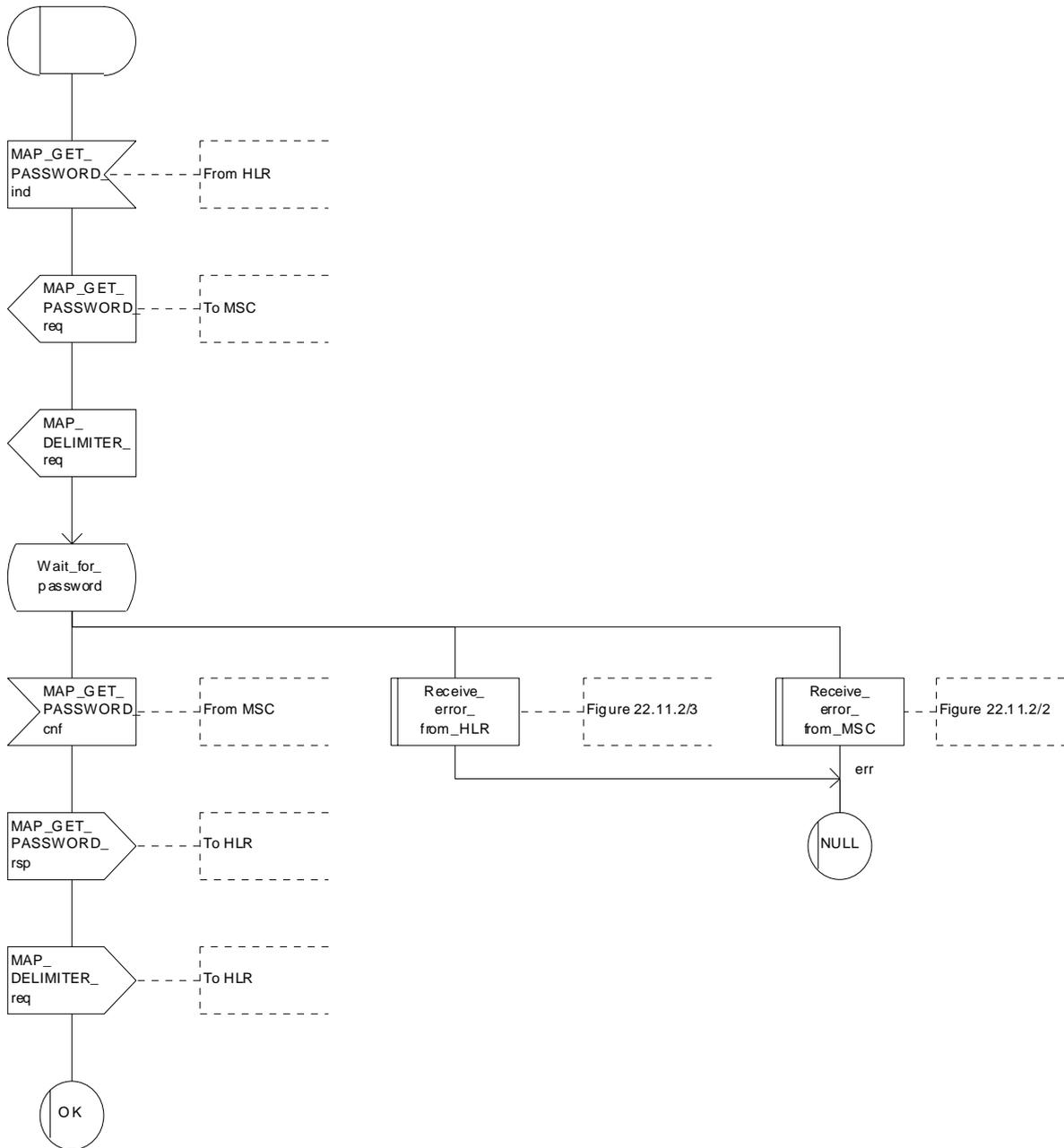

Figure 22.11.1/2: Macro Get\_PW\_VLR

## 22.11.2 SS Error handling macros

### **Macro Receive\_errors\_MSC**

This macro is used by the MSC to receive signals which should lead to failure if received in any state of a supplementary service process. If the air interface connection is released by the MS, the communication towards the VLR is aborted, and the MSC should return to a stable "NULL" state. If a MAP\_NOTICE indication is received from the VLR, or the VLR aborts or unexpectedly closes the connection, then the air interface connection shall be released. The macro is described in figure 22.11.2/1.

### **Macro Receive\_error\_from\_MSC**

This macro is used by the VLR to receive signals from the MSC which should lead to failure if received in any state of a supplementary service process. If a MAP\_NOTICE indication is received from the MSC, that connection is closed before the only outcome of the macro, "err" is reported back to the calling process. The macro is described in figure 22.11.2/2.

### **Macro Receive\_error\_from\_HLR**

This macro is used by the VLR to receive signals from the HLR which should lead to failure if received in any state of a supplementary service process. If a MAP\_NOTICE indication is received from the HLR, that connection is closed. The macro is described in figure 22.11.2/3.

### **Macro Receive\_error\_from\_VLR**

This macro is used by the HLR to receive signals from the VLR that should lead to failure if received in any state of a supplementary service process. If a MAP\_NOTICE indication is received from the VLR, that connection is closed before the only outcome of the macro, "err" is reported back to the calling process. The macro is described in figure 22.11.2/4.

### **Macro Receive\_error\_from\_gsmSCF**

This macro is used by the HLR to receive signals from the gsmSCF that should lead to failure if received in any state of a supplementary service process. If a MAP\_NOTICE indication is received from the gsmSCF, that connection is closed. The macro is described in figure 22.11.2/5.

### Macrodefinition Receive\_errors\_MSC

22.11.2\_1(1)

Figure 22.11.2/1: Macro which handles possible error situations while the MSC is waiting for a confirmation of a supplementary service request to the VLR

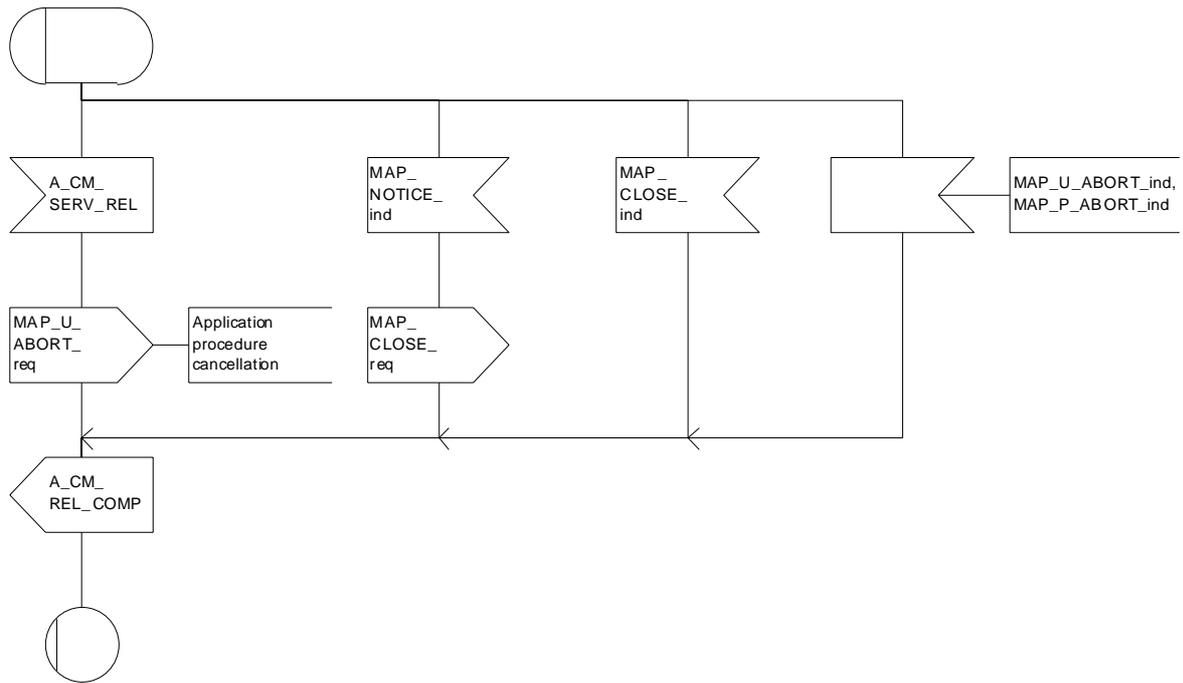

Figure 22.11.2/1: Macro Receive\_Errors\_MSC

### Macrodefinition Receive\_error\_from\_MSC

22.11.2\_2(1)

Figure 22.11.2/2: Macro to receive errors from the MSC during supplementary services procedures in the VLR

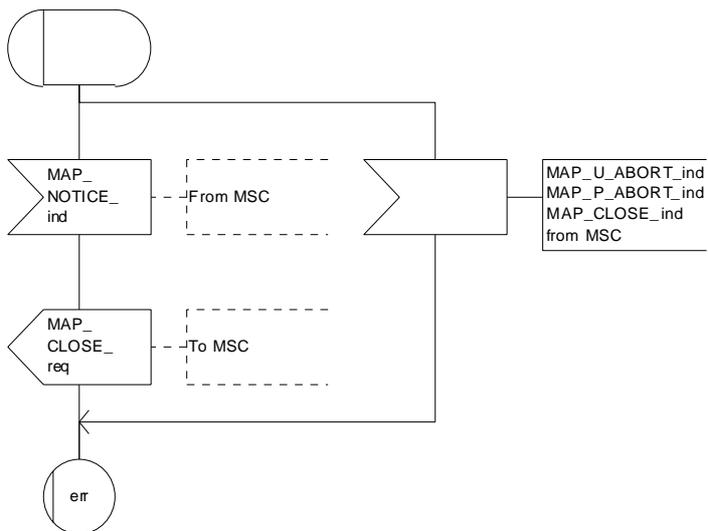

Figure 22.11.2/2: Macro Receive\_Error\_from\_MSC

### Macrodefinition Receive\_error\_from\_HLR

22.11.2\_3(1)

Figure 22.11.2/3: Macro to receive errors from the HLR while the VLR is waiting for a confirmation of a supplementary service request sent to the HLR

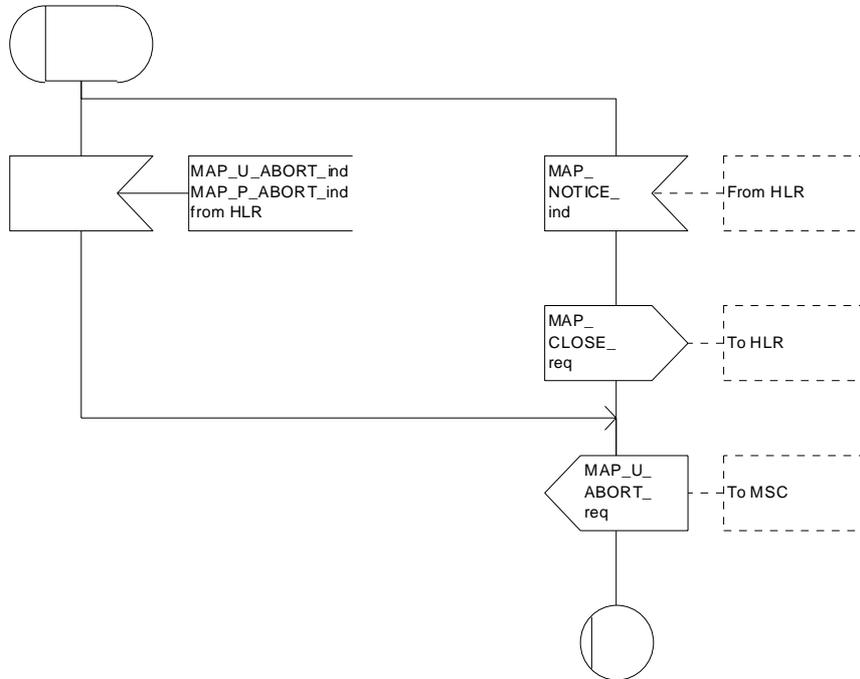

Figure 22.11.2/3: Macro Receive\_Errors\_HLR

Macrodefinition Receive\_error\_from\_VLR

22.11.2\_4(1)

Figure 22.11.2/4: Macro to receive errors from the VLR during supplementary services procedures in the HLR

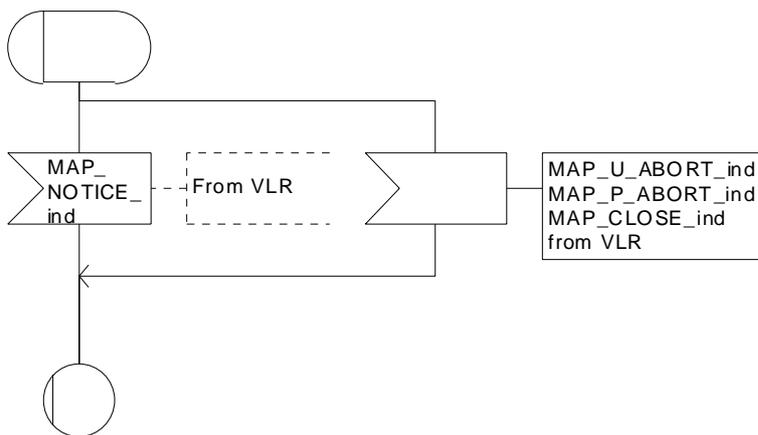

Figure 22.11.2/4: Macro Receive\_error\_from\_VLR

Macrodefinition Receive\_error\_from\_gsmSCF

22.11.2\_5(1)

Figure 22.11.2/5: Macro to receive errors from the gsmSCF while the HLR is waiting for a confirmation of a supplementary service request sent to the gsmSCF

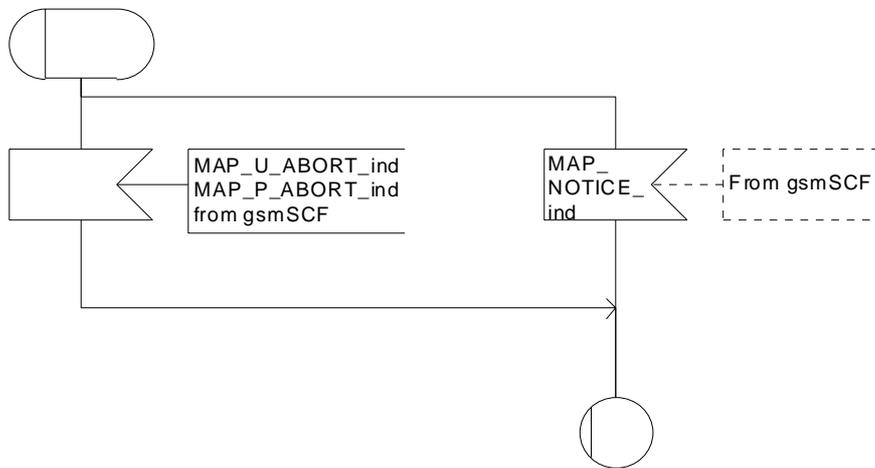

Figure 22.11.2/5: Macro Receive\_error\_from\_gsmSCF

## 22.12 Supplementary Service Invocation Notification procedure

### 22.12.1 General

The Supplementary Service Invocation Notification procedure is used to notify a gsmSCF about the invocation of a GSM Supplementary Service.

The password registration procedure is shown in figure 22.12.1/1.

The following services may be used:



- (1) MAP-SUPPLEMENTARY-SERVICE-INVOCATION-NOTIFICATION (MSC to gsmSCF)
- (2) MAP-SUPPLEMENTARY-SERVICE-INVOCATION-NOTIFICATION-ACK (gsmSCF to MSC)

MAP-SUPPLEMENTARY-SERVICE-INVOCATION-NOTIFICATION (defined in clauses 8 and 25);

**Figure 22.12.1/1: Interfaces and services for supplementary service invocation notification**

### 22.12.2 Procedures in the MSC

The supplementary service invocation notification procedure in the MSC is triggered when the requested supplementary service is invoked at the MSC. The MSC notifies the gsmSCF of a supplementary service invocation the MAP-SUPPLEMENTARY-SERVICE-INVOCATION-NOTIFICATION service. This is sent in a TCAP TC-BEGIN primitive. The MSC then awaits a positive or negative acknowledgement from the gsmSCF to the MAP-SUPPLEMENTARY-SERVICE-INVOCATION-NOTIFICATION. This is received in a TCAP TC-END primitive, and upon receipt the relationship between the MSC and the gsmSCF is terminated. Similarly, the relationship is terminated at the MSC by the sending from or receipt of a TCAP P-ABORT primitive. This is illustrated in Figure 22.12.2.



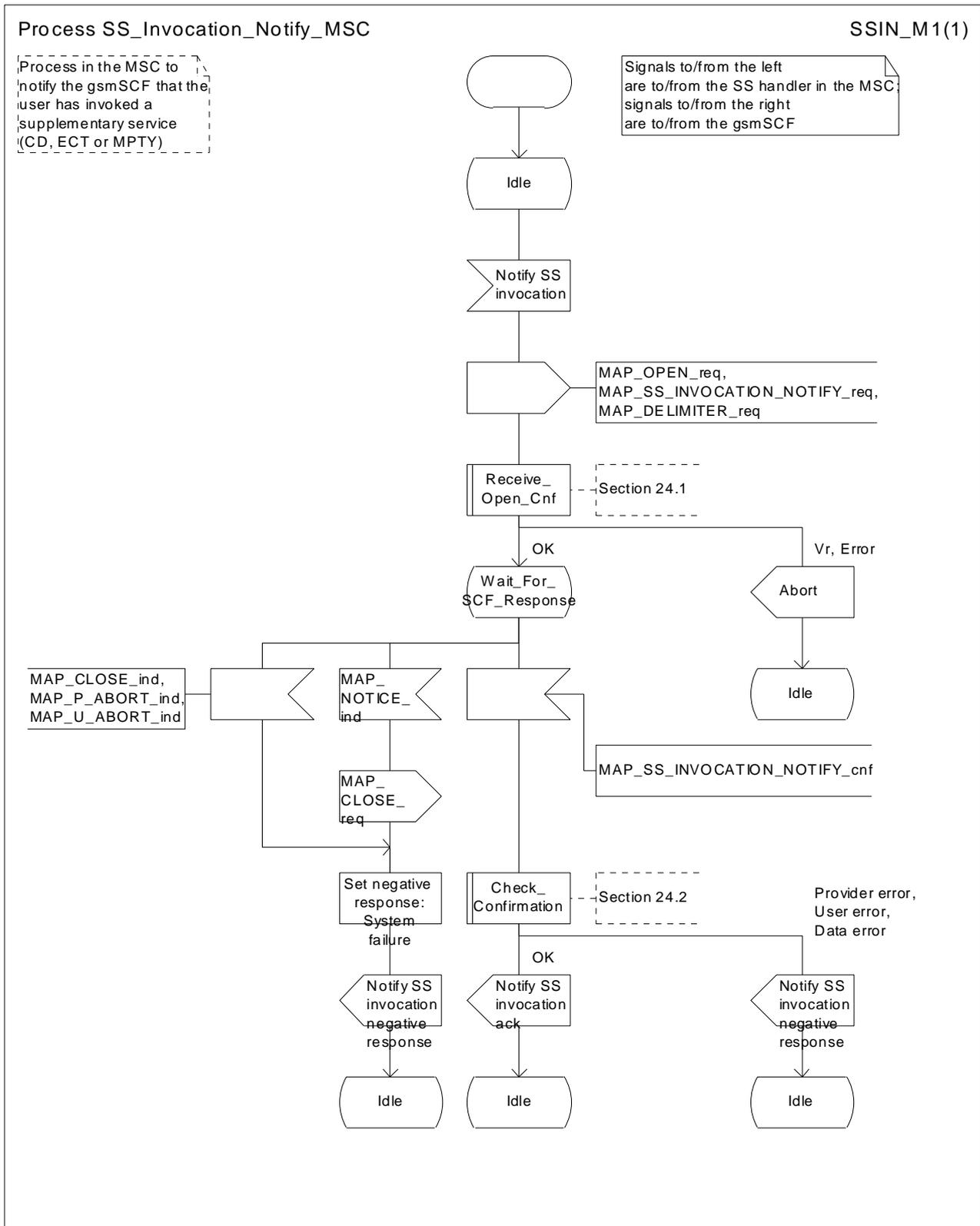

Figure 22.12.2 Process SS\_Invocation\_Notify\_MSC (sheet 1 of 1)

### 22.12.3 Procedures in the gsmSCF

Upon receiving notification of the supplementary service invocation via the MAP-SUPPLEMENTARY-SERVICE-INVOCATION-NOTIFICATION service, the gsmSCF analyses the received information. If the gsmSCF understands the information sent via the the MAP-SUPPLEMENTARY-SERVICE-INVOCATION-NOTIFICATION service then it returns a positive acknowledgement to the MAP-SUPPLEMENTARY-SERVICE-INVOCATION-NOTIFICATION, indicating the success of the service. This is returned in a TCAP TC-END primitive, using the basic end procedure.

Otherwise, a negative acknowledgement to the MAP-SUPPLEMENTARY-SERVICE-INVOCATION-NOTIFICATION is returned. This is also returned in a TCAP TC-END primitive, again using the basic end procedure. The gsmSCF TCAP service may also choose to abort the relationship to the MSC by sending a TCAP P-ABORT primitive. It will immediately terminate processing of a MAP-SUPPLEMENTARY-SERVICE-INVOCATION-NOTIFICATION should a TCAP P-ABORT primitive be received from the MSC. This is illustrated in Figure 22.12.3.



## 22.13 Activation of a CCBS request

### 22.13.1 General

The message flow to activate a CCBS request is shown in figure 22.13.1/1.

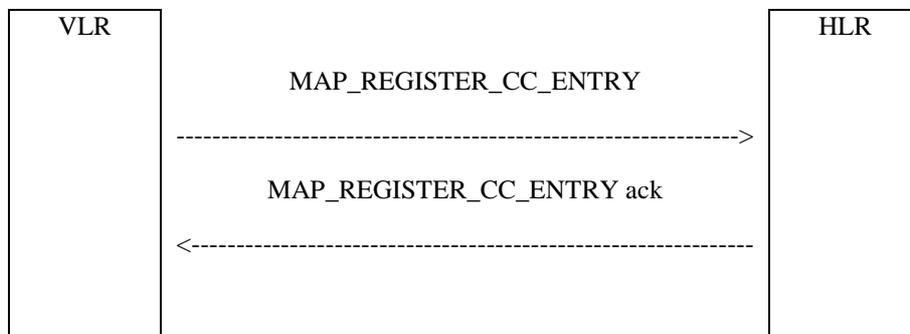

Figure 22.13.1/1: Message flow to activate a CCBS request

### 22.13.2 Procedure in the VLR

The MAP process in the VLR to activate a CCBS request is shown in figure 22.13.2/1. The MAP process invokes macros not defined in this clause; the definitions of these macros can be found as follows:

Receive\_Open\_Cnf      see clause 25.1.2;

Check\_Confirmation    see clause 25.2.2;

#### Successful Outcome

When the MAP process receives a CCBS Request message from the CCBS application process in the VLR, it requests a dialogue with the HLR whose identity is contained in the request by sending a MAP\_OPEN service request and the necessary information in a MAP\_REGISTER\_CC\_ENTRY service request. The VLR then invokes the macro Receive\_Open\_Cnf to wait for the response to the dialogue opening request. If the dialogue opening is successful, the MAP process waits for a response from the HLR.

If the MAP process receives a MAP\_REGISTER\_CC\_ENTRY service confirm from the HLR, the MAP process invokes the macro Check\_Confirmation to check the content of the confirm.

If the macro Check\_Confirmation takes the OK exit, the MAP process sends a CCBS Request Ack message containing the information received from the HLR to the CCBS application process in the VLR and returns to the idle state.

#### Failure of dialogue opening with the HLR

If the macro Receive\_Open\_Cnf takes the Vr exit or the Error exit, the MAP process sends a CCBS Request Negative response message to the CCBS application process in the VLR and returns to the idle state.

#### Error in MAP\_REGISTER\_CC\_ENTRY confirm

If the MAP\_REGISTER\_CC\_ENTRY service confirm contains a user error or a provider error, or the macro Check\_Confirmation indicates that there is a data error, the MAP process sends a CCBS Request Negative response message to the CCBS application process in the VLR and returns to the idle state.

#### Abort of HLR dialogue

After the dialogue with the HLR has been established, the MAP service provider may abort the dialogue by issuing a MAP\_P\_ABORT indication. In this case, the MAP process sends a CCBS Request negative response to the CCBS application process in the VLR and returns to the idle state.

If the MAP provider indicates a protocol problem by sending a MAP\_NOTICE indication, the MAP process closes the dialogue with the HLR, sends a CCBS Request negative response indicating system failure to the CCBS application process in the VLR and returns to the idle state.

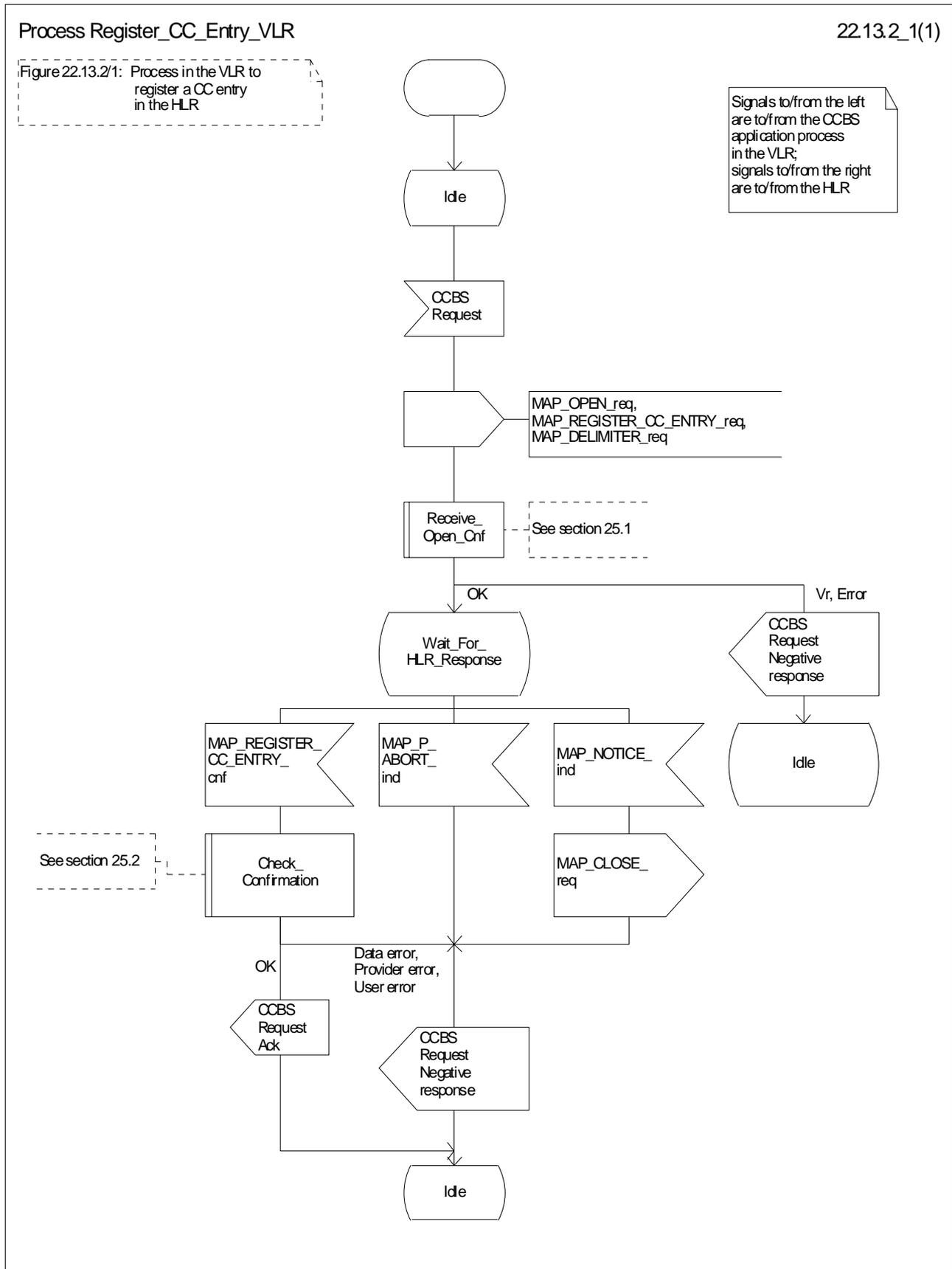

Figure 22.13.2/1: Process Register\_CC\_Entry\_VLR

### 22.13.3 Procedure in the HLR

#### **Successful outcome**

When the MAP process receives a MAP\_REGISTER\_CC\_ENTRY\_indication from the co-ordinating process, it sends a CCBS Request message to the CCBS application process in the HLR, and waits for a response. The request contains the parameters received in the MAP\_REGISTER\_CC\_ENTRY service indication.

If the CCBS application process in the HLR returns a positive response, the MAP process constructs a MAP\_REGISTER\_CC\_ENTRY service response, constructs a MAP\_CLOSE service request, sends them to the co-ordinating process and terminates.

#### **Negative response from HLR CCBS application process**

If the CCBS application process in the HLR returns a negative response, the MAP process constructs a MAP\_REGISTER\_CC\_ENTRY service response containing the appropriate error, constructs a MAP\_CLOSE service request, sends them to the co-ordinating process and terminates.

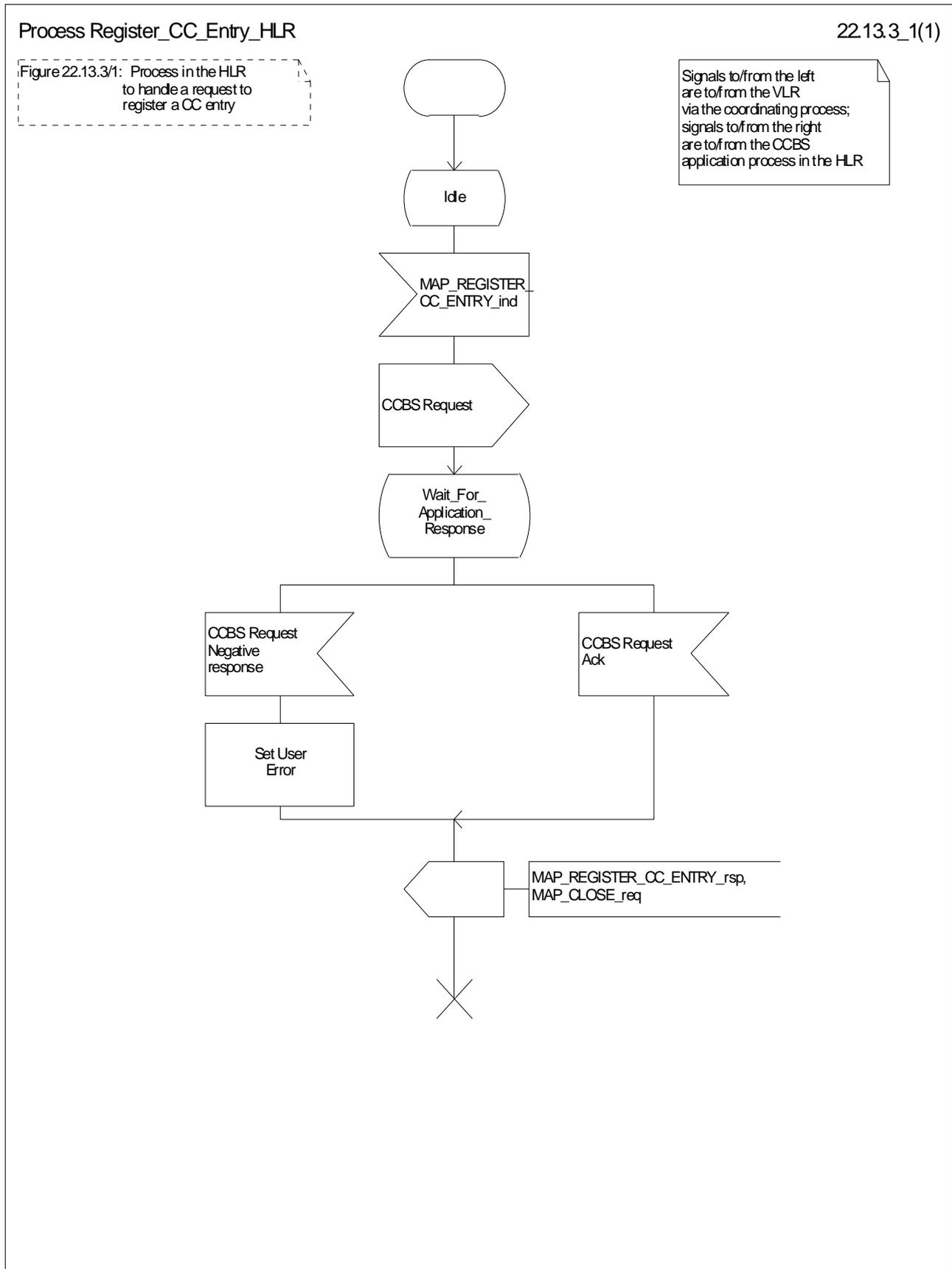

Figure 22.13.3/1: Process Register\_CC\_Entry\_HLR



## 22.14 Deactivation of a CCBS request

### 22.14.1 General

The message flow to deactivate a CCBS request is shown in figure 22.14.1/1.

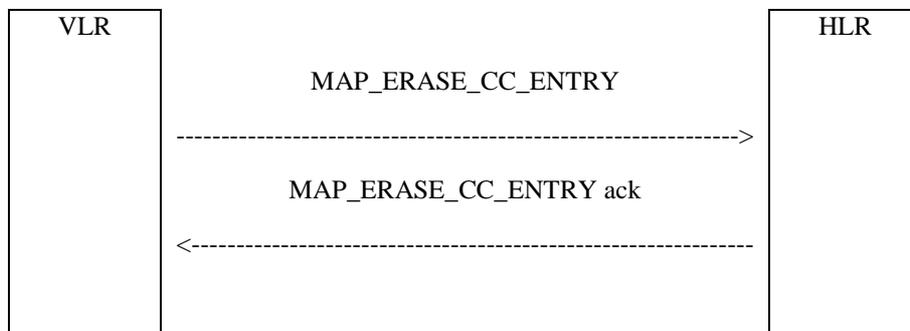

Figure 22.14.1/1: Message flow to deactivate a CCBS request

### 22.14.2 Procedure in the VLR

The MAP process in the VLR to deactivate a CCBS request is shown in figure 22.14.2/1. The MAP process invokes macros not defined in this clause; the definitions of these macros can be found as follows:

Receive\_Open\_Cnf      see clause 25.1.2;

Check\_Confirmation    see clause 25.2.2;

#### Successful Outcome

When the MAP process receives a Deactivate CCBS message from the CCBS application process in the VLR, it requests a dialogue with the HLR whose identity is contained in the request by sending a MAP\_OPEN service request and the necessary information in a MAP\_ERASE\_CC\_ENTRY service request. The VLR then invokes the macro Receive\_Open\_Cnf to wait for the response to the dialogue opening request. If the dialogue opening is successful, the MAP process waits for a response from the HLR.

If the MAP process receives a MAP\_ERASE\_CC\_ENTRY service confirm from the HLR, the MAP process invokes the macro Check\_Confirmation to check the content of the confirm.

If the macro Check\_Confirmation takes the OK exit, the MAP process sends a Deactivate CCBS Ack message containing the information received from the HLR to the CCBS application process in the VLR and returns to the idle state.

#### Failure of dialogue opening with the HLR

If the macro Receive\_Open\_Cnf takes the Vr exit or the Error exit, the MAP process sends a Deactivate CCBS Negative response message to the CCBS application process in the VLR and returns to the idle state.

#### Error in MAP\_ERASE\_CC\_ENTRY confirm

If the MAP\_ERASE\_CC\_ENTRY service confirm contains a user error or a provider error, or the macro Check\_Confirmation indicates that there is a data error, the MAP process sends a Deactivate CCBS Negative response message to the CCBS application process in the VLR and returns to the idle state.

#### Abort of HLR dialogue

After the dialogue with the HLR has been established, the MAP service provider may abort the dialogue by issuing a MAP\_P\_ABORT indication. In this case, the MAP process sends a Deactivate CCBS negative response to the CCBS application process in the VLR and returns to the idle state.

If the MAP provider indicates a protocol problem by sending a MAP\_NOTICE indication, the MAP process closes the dialogue with the HLR, sends a Deactivate CCBS negative response indicating system failure to the CCBS application process in the VLR and returns to the idle state.

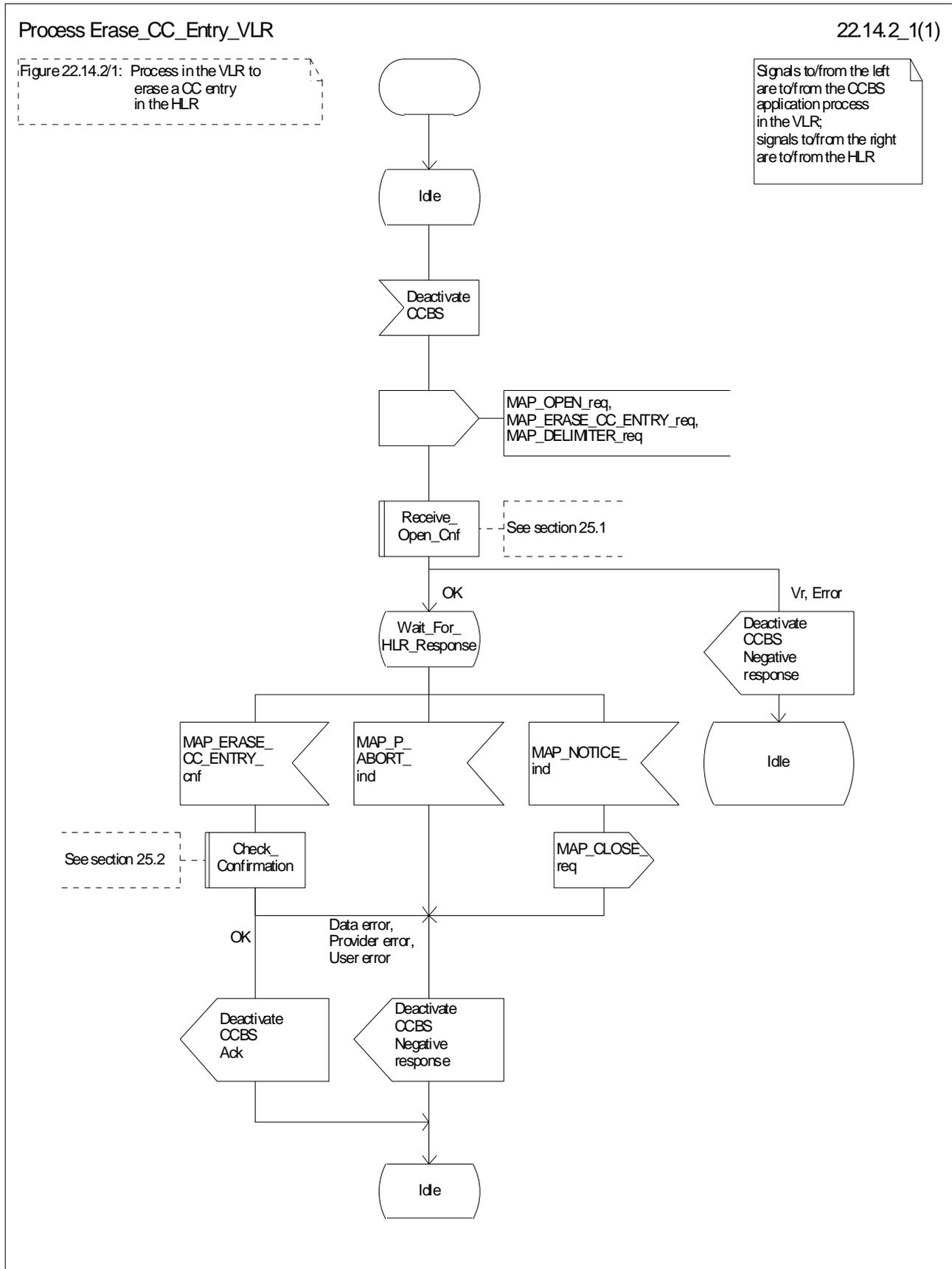

Figure 22.14.2/1: Process Erase\_CC\_Entry\_VLR

### 22.14.3 Procedure in the HLR

#### **Successful outcome**

When the MAP process receives a MAP\_ERASE\_CC\_ENTRY\_indication from the co-ordinating process, it sends a Deactivate CCBS message to the CCBS application process in the HLR, and waits for a response. The message contains the parameters received in the MAP\_ERASE\_CC\_ENTRY service indication.

If the CCBS application process in the HLR returns a positive response, the MAP process constructs a MAP\_ERASE\_CC\_ENTRY service response, constructs a MAP\_CLOSE service request, sends them to the co-ordinating process and terminates.

#### **Negative response from HLR CCBS application process**

If the CCBS application process in the HLR returns a negative response, the MAP process constructs a MAP\_ERASE\_CC\_ENTRY service response containing the appropriate error, constructs a MAP\_CLOSE service request, sends them to the co-ordinating process and terminates.

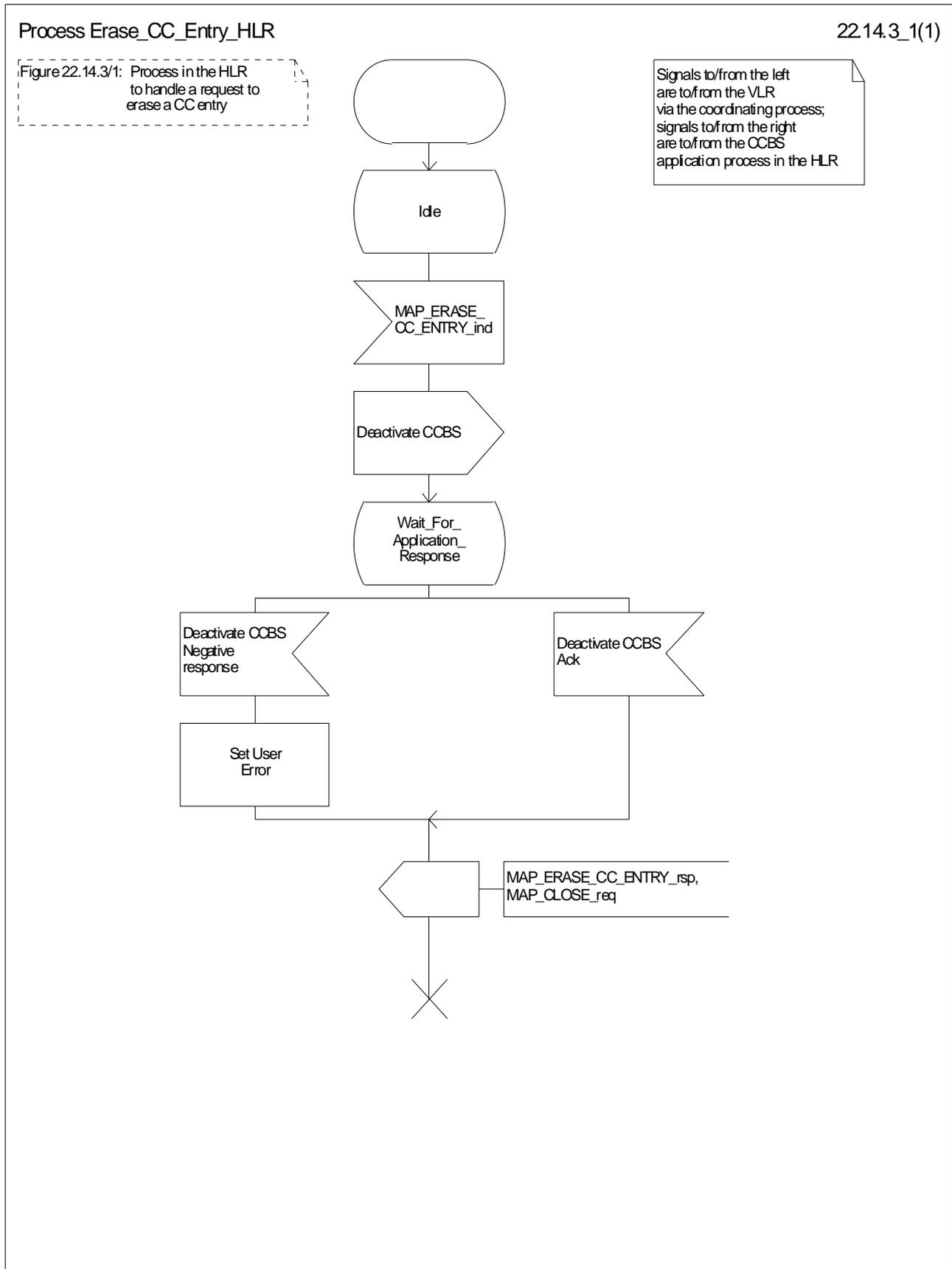

Figure 22.14.3/1: Process Erase\_CC\_Entry\_HLR

---

## 23 Short message service procedures

### 23.1 General

The short message service procedures are used to control both mobile originated and mobile terminated short message transfer.

Four procedures exist for short message services:

- mobile originated short message service transfer;
- mobile terminated short message service transfer;
- short message alert procedure;
- short message waiting data set procedure.

The following application context refers to a complex MAP user consisting of several processes:

- shortMessageGatewayContext.

This application context needs a co-ordinating process in the HLR. Additionally a Co-ordinator has to be defined for the mobile originated situation in the MSC, because the A\_CM\_SERV\_REQ message does not distinguish between mobile originated short message transfer and the short message alert procedures.

NOTE: A\_CM\_SERV\_REQ message is not used for SMS over GPRS.

#### 23.1.1 Mobile originated short message service Co-ordinator for the MSC

The A\_CM\_SERV\_REQ message (GSM 04.08) is received from the A-interface containing the CM service type. This parameter indicates mobile originated short message service. The service MAP\_PROCESS\_ACCESS\_REQUEST is started.

If the MAP\_PROCESS\_ACCESS\_REQUEST service ends successfully, the MS initiates mobile originated short message transfer or alerting indication. Depending on the situation, the appropriate process is initiated as follows:

- if the A\_RP\_MO\_DATA indication is received, the process MOSM\_MSC is initiated (see clause 23.2.1);
- if the A\_RP\_SM\_MEMORY\_AVAILABLE indication is received, the process SC\_Alert\_MSC is initiated (see clause 23.4.1).

After creation of the user process the Co-ordinator relays the messages between the A-interface and the invoked process until a request or an indication for dialogue termination is received.

The SMS process Co-ordinator is shown in the figure 23.1/1.

Process Co\_SMS\_MSC

23.1\_1(1)

Figure 23.1/1: The SMS co-ordinating process in the MSC.

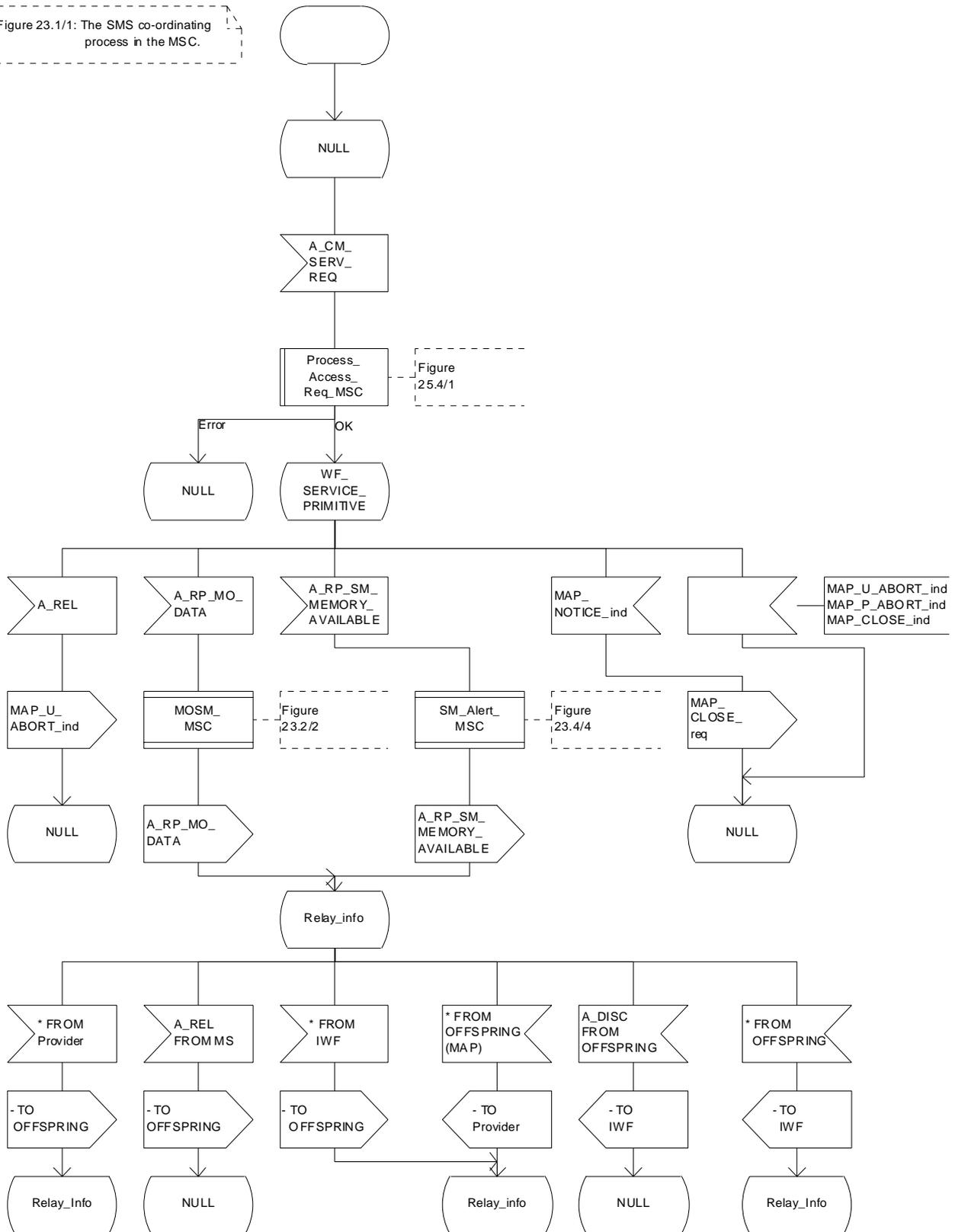

Figure 23.1/1: Process Co\_SMS\_MSC

## 23.1.2 Short message Gateway Co-ordinator for the HLR

The MAP\_OPEN indication opens a dialogue for the short message procedure between the gateway MSC and the HLR when the application context shortMessageGatewayContext is received. If that service is successful, the Co-ordinator can receive the first service primitive from the MAP\_PM. Depending on the received primitive, the user process is created as follows:

- if the MAP\_SEND\_ROUTING\_INFO\_FOR\_SM indication is received, the process Mobile\_Terminated\_MS\_HLR is created;
- if the MAP\_REPORT\_SM\_DELIVERY\_STATUS indication is received, the process Report\_SM\_delivery\_stat\_HLR is created.

After creation of the user process the Co-ordinator relays the messages between the MAP\_PM and the invoked process until a request or an indication for dialogue termination is received.

The SM Gateway Co-ordinator is shown in the figure 23.1/2.

If the Receive\_Open\_Ind macro takes the Vr exit then HLR shall perform the MAP Vr dialogue. But based on the subscriber data, handling at the MAP user application level may be performed as described in release 97 :

- If the subscriber is not a GPRS subscriber then the behaviour of the HLR shall be the same as described in the corresponding MAP Vr release.
- If the subscriber is a GPRS subscriber and a non-GPRS subscriber with the option « transfer of SM via the MSC when GPRS is not supported in the GMSC » then the behaviour of the HLR shall be the same as described in the corresponding MAP Vr release.
- If the subscriber is a GPRS subscriber and a non-GPRS subscriber with the option « transfer of SM via the SGSN when GPRS is not supported in the GMSC » or if the subscriber is a GPRS subscriber only then the behaviour of the HLR shall be the same as for the case transfer over GPRS described in MAP release 97, with the following precision : because GMSC does not support MAP release 97, the previous MAP protocol release is used. When the HLR sends the MAP\_SEND\_ROUTING\_INFO\_FOR\_SM\_Resp, the SGSN number is mapped to the MAP parameter « MSC number ». When the HLR sends the MAP\_INFORM\_SERVICE\_CENTRE\_resp, the MNRG status shall be mapped to the MAP parameter « mnrf-set ». When the HLR receives the MAP\_REPORT\_SM\_DELIVERY\_STATUS\_Ind, it shall interpret the delivery outcome as a GPRS delivery outcome.



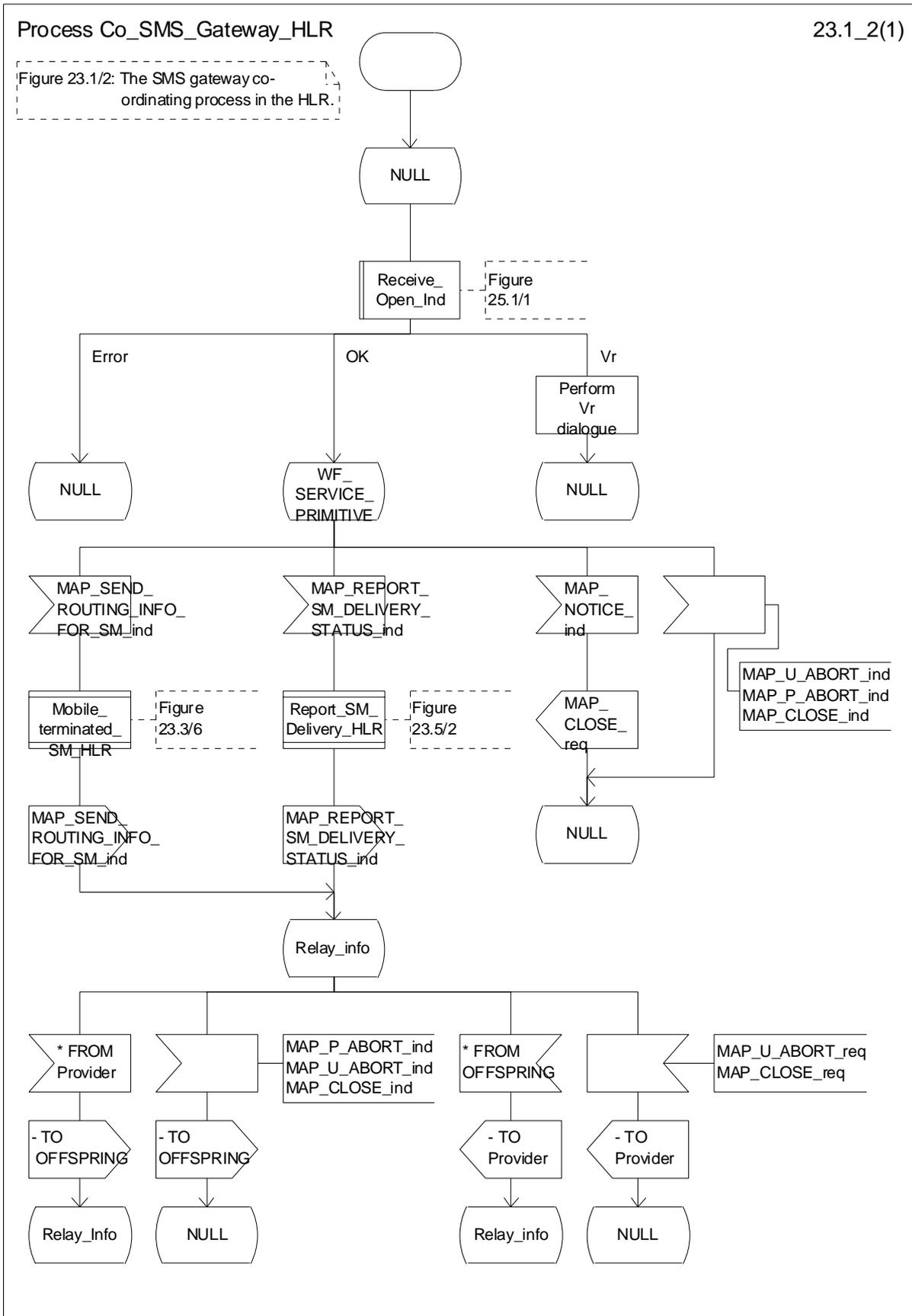

Figure 23.1/2: Process Co\_SMS\_Gateway\_HLR

### 23.1.3 Mobile originated short message service Co-ordinator for the SGSN

The MS initiates mobile originated short message transfer or alerting indication. Depending on the situation, the appropriate process is initiated as follows:

- if the A\_RP\_MO\_DATA indication is received, the process MOSM\_SGSN is initiated (see clause 23.2.4);
- if the A\_RP\_SM\_MEMORY\_AVAILABLE indication is received, the process SC\_Alert\_SGSN is initiated (see clause 23.4.5).

After creation of the user process the Co-ordinator relays the messages between the SGSN and the MS, and the invoked process until a request or an indication for dialogue termination is received.

The SMS process Co-ordinator is shown in the figure 23.1/3.

Process Co\_SMS\_SGSN

23.1\_3(1)

Figure 23.1/3: The SMS co-ordinating process in the SGSN

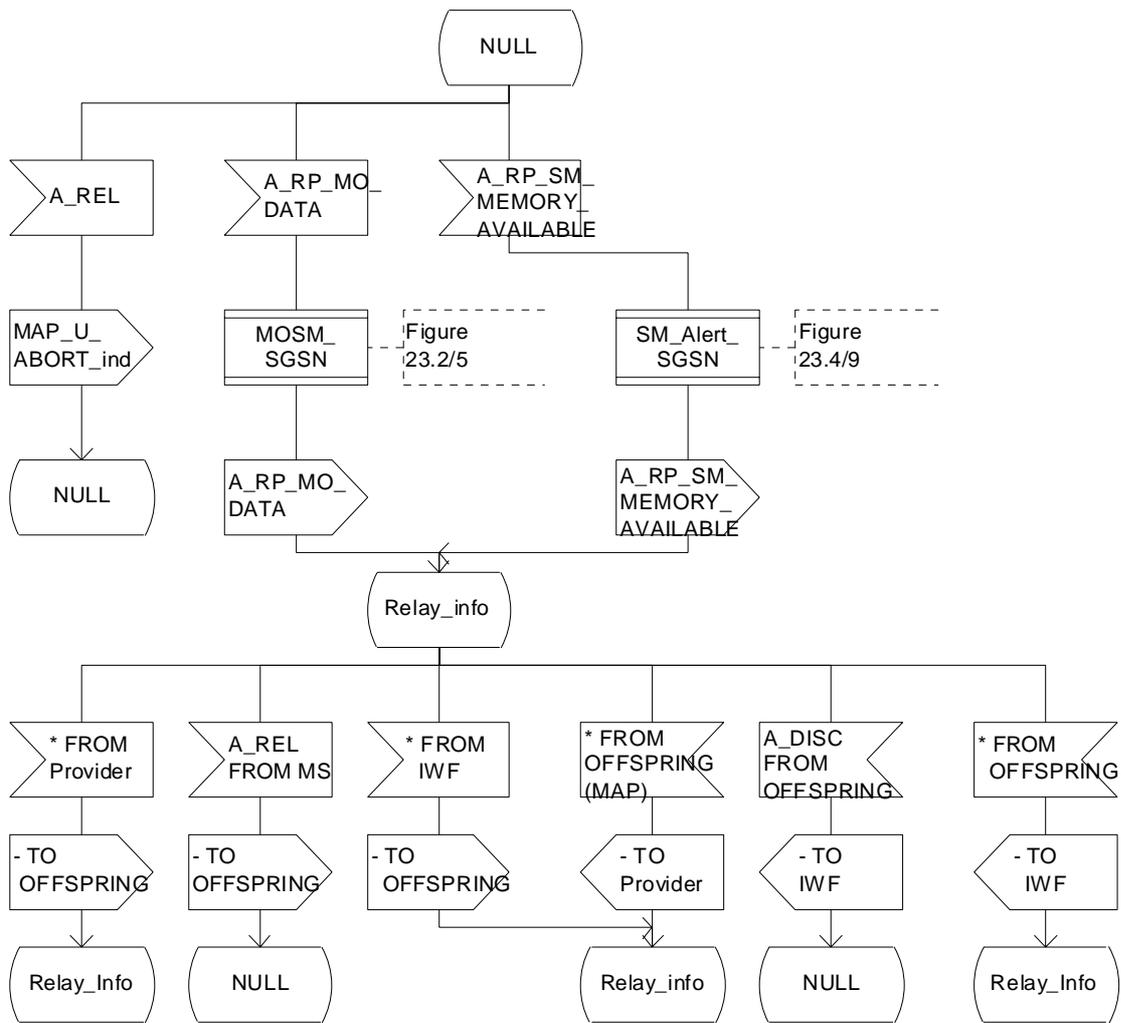
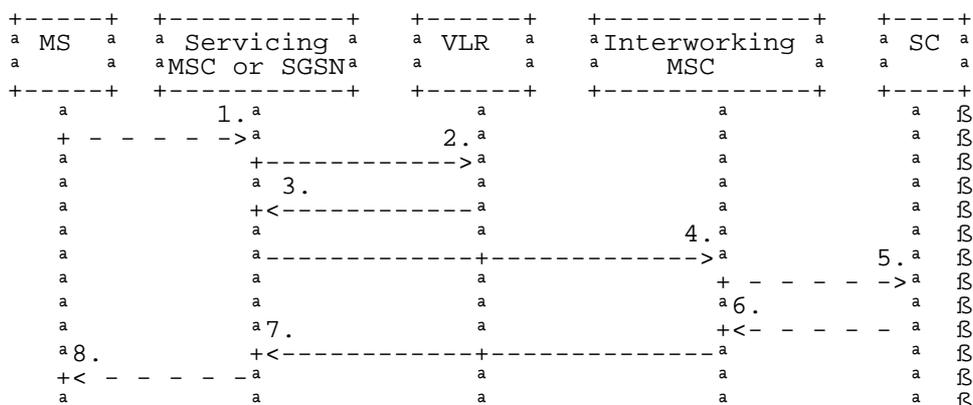

Figure 23.1/3: Process Co\_SMS\_SGSN

## 23.2 The mobile originated short message transfer procedure

The mobile originated short message service procedure is used to forward short message from a mobile subscriber to a Service Centre. The mobile originated short message service procedure is shown in figure 23.2/1.



- 1) Short Message (GSM 04.11)
- 2) MAP\_SEND\_INFO\_FOR\_MO\_SMS (\*)
- 3) MAP\_SEND\_INFO\_FOR\_MO\_SMS\_ACK (\*)
- 4) MAP\_MO\_FORWARD\_SHORT\_MESSAGE
- 5) Short message (TS GSM 03.40)
- 6) Short message Acknowledgement (TS GSM 03.40)
- 7) MAP\_MO\_FORWARD\_SHORT\_MESSAGE\_ACK
- 8) Short Message Acknowledgment (GSM 04.11)

(\*) Messages 2) and 3) are not used by SGSN

**Figure 23.2/1: Mobile originated short message transfer**

In addition the following MAP services are used:

- MAP\_PROCESS\_ACCESS\_REQUEST (see clause 8.3); (\*)
- MAP\_AUTHENTICATE (see clause 8.5); (\*)
- MAP\_SET\_CIPHERING\_MODE (see clause 8.6); (\*)
- MAP\_PROVIDE\_IMSI (see clause 8.9); (\*)
- MAP\_CHECK\_IMEI (see clause 8.7);
- MAP\_FORWARD\_NEW\_TMSI (see clause 8.9); (\*)
- MAP\_TRACE\_SUBSCRIBER\_ACTIVITY (see clause 9.1); (\*)
- MAP\_READY\_FOR\_SM (see clause 12.4).

(\*) Those messages are not used by SGSN.

## 23.2.1 Procedure in the servicing MSC

The activation of the MAP\_PROCESS\_ACCESS\_REQUEST service is described in the clause 25.4.1.

When receiving the short message from the A-interface, the MSC sends the MAP\_SEND\_INFO\_FOR\_MO\_SMS request to the VLR. As a response the MSC will receive the MAP\_SEND\_INFO\_FOR\_MO\_SMS confirmation from VLR indicating that:

- the service ends successfully. If the MSC is not itself the IWMSC, the short message transmission towards the IWMSC is initiated using the MAP\_MO\_FORWARD\_SHORT\_MESSAGE request;
- the service ends unsuccessfully. The error cause in the MAP\_SEND\_INFO\_FOR\_MO\_SMS confirmation indicates the reason for the unsuccessful end. The mapping between MAP error causes and RP\_ERROR causes is described in TS GSM 03.40.

If there are data errors in the MAP\_SEND\_INFO\_FOR\_MO\_SMS confirmation, or there is an operation failure in MAP, the RP\_ERROR cause network out of order is forwarded to the mobile station.

If the service MAP\_MO\_FORWARD\_SHORT\_MESSAGE is started, the MSC will check whether the grouping of MAP\_OPEN request and MAP\_MO\_FORWARD\_SHORT\_MESSAGE request needs segmentation. If this is the case then the MAP\_OPEN request primitive shall be sent first without any associated MAP service request primitive and the dialogue confirmation must be received before the MAP\_MO\_FORWARD\_SHORT\_MESSAGE request is sent. As a response to the procedure, the servicing MSC will receive the MAP\_MO\_FORWARD\_SHORT\_MESSAGE confirmation from the IWMSC indicating that:

- the short message has been successfully delivered to the Service Centre. The acknowledgement is sent to the mobile station;
- one of several error cases has occurred. The mapping between MAP error causes and RP\_ERROR causes is described in TS GSM 03.40. The appropriate indication is provided to the mobile station.

If the procedure failed, a provider error or an abort indication is received. The RP\_ERROR cause network out of order is provided to the mobile station.

If the MSC itself is the interworking MSC, the short message is forwarded to the Service Centre. In that case the service MAP\_MO\_FORWARD\_SHORT\_MESSAGE is not initiated. The acknowledge message from the Service Centre is forwarded to the mobile station (TS GSM 03.40, TS GSM 04.11).

The mobile originated short message service procedure is shown in figure 23.2/2.

Process MOSM\_MSC

23.2\_2.1(3)

Figure 23.2/2: The mobile originated short message service process in the MSC.

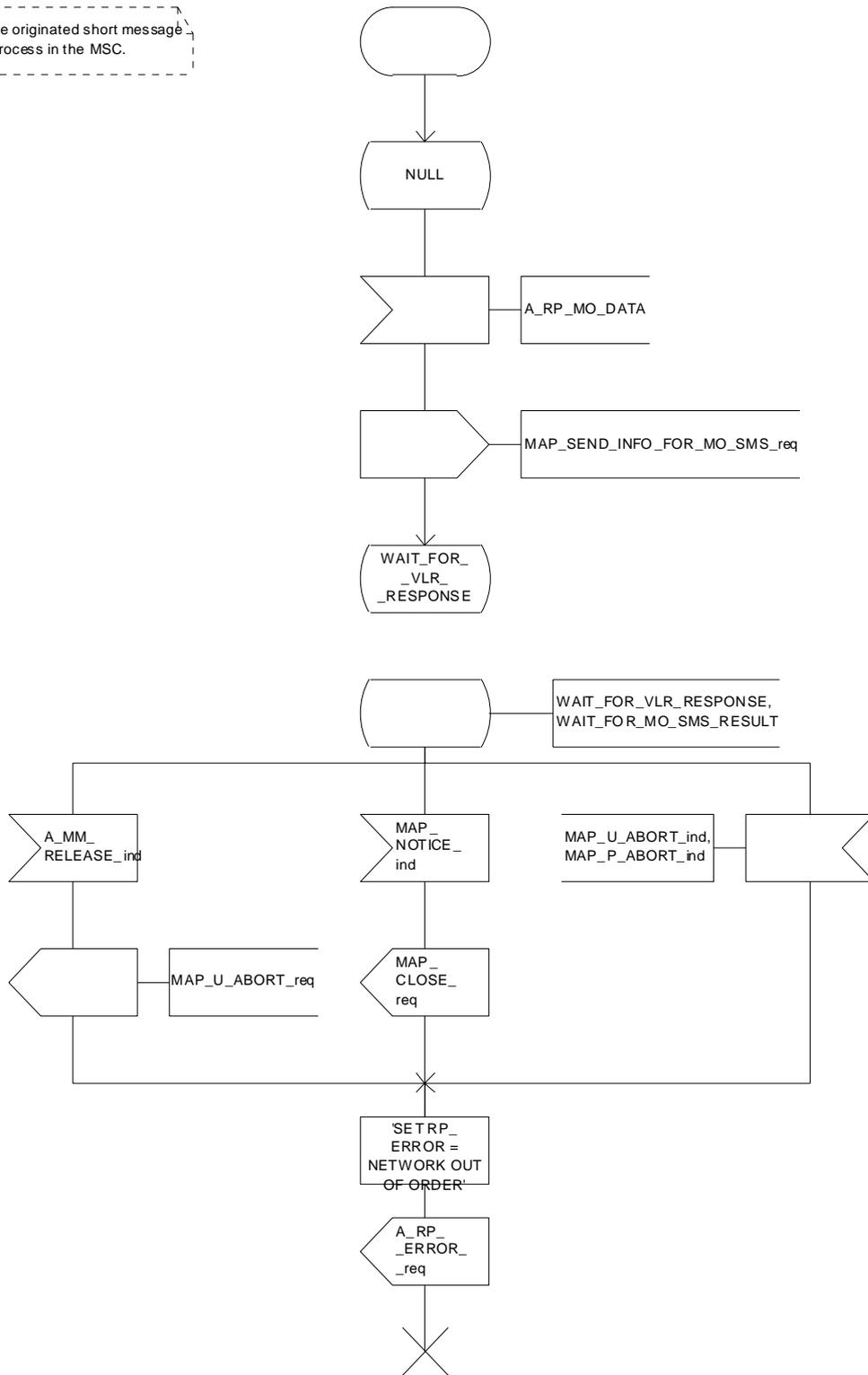

Figure 23.2/2 (sheet 1 of 3): Process MOSM\_MSC

Process MOSM\_MSC

23.2\_2.2(3)

Figure 23.2/2: The mobile originated short message service process in the MSC.

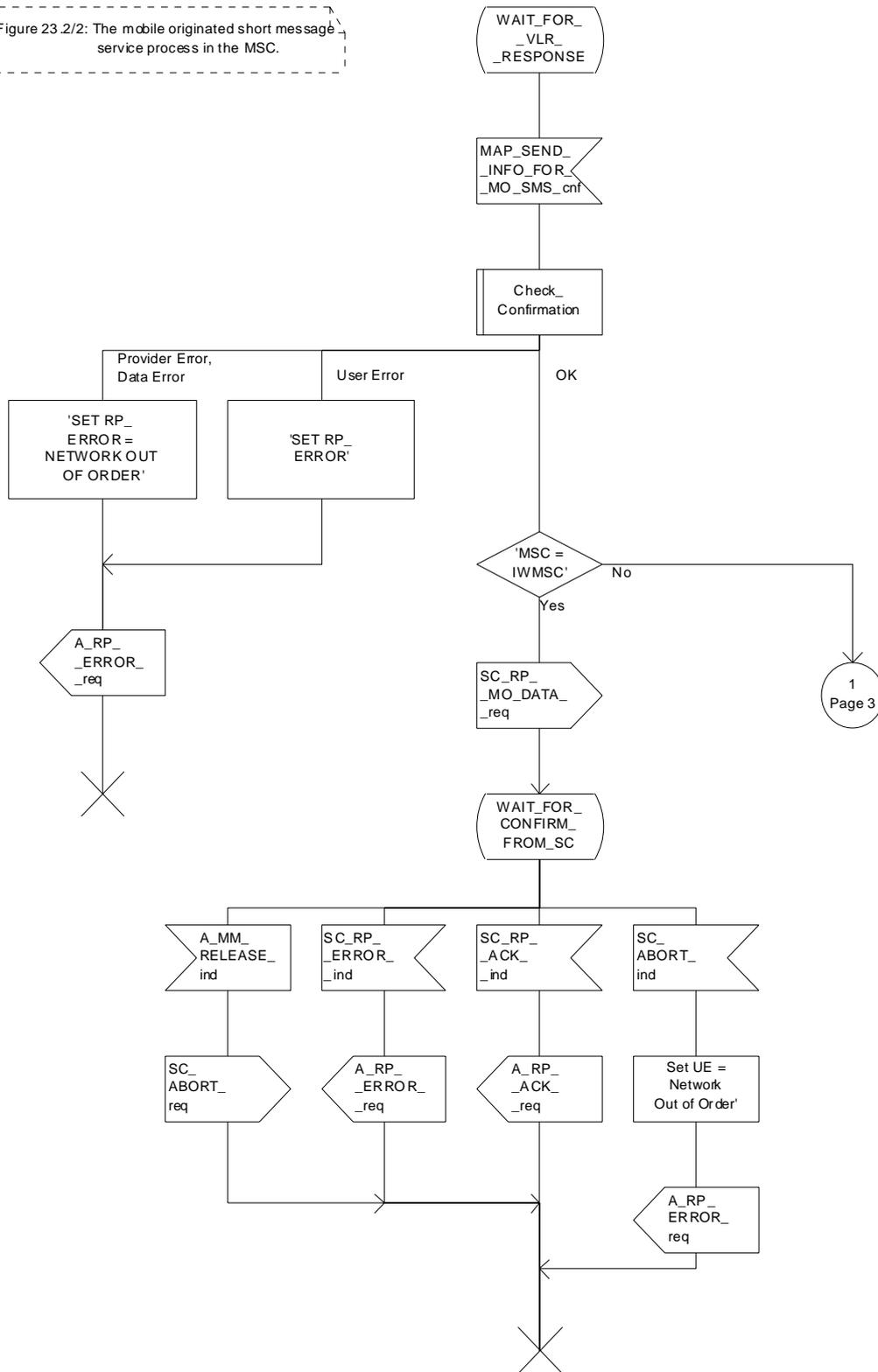

Figure 23.2/2 (sheet 2 of 3): Process MOSM\_MSC

Process MOSM\_MSC

23.2\_2.3(3)

Figure 23.2/2: The mobile originated short message service process in the MSC.

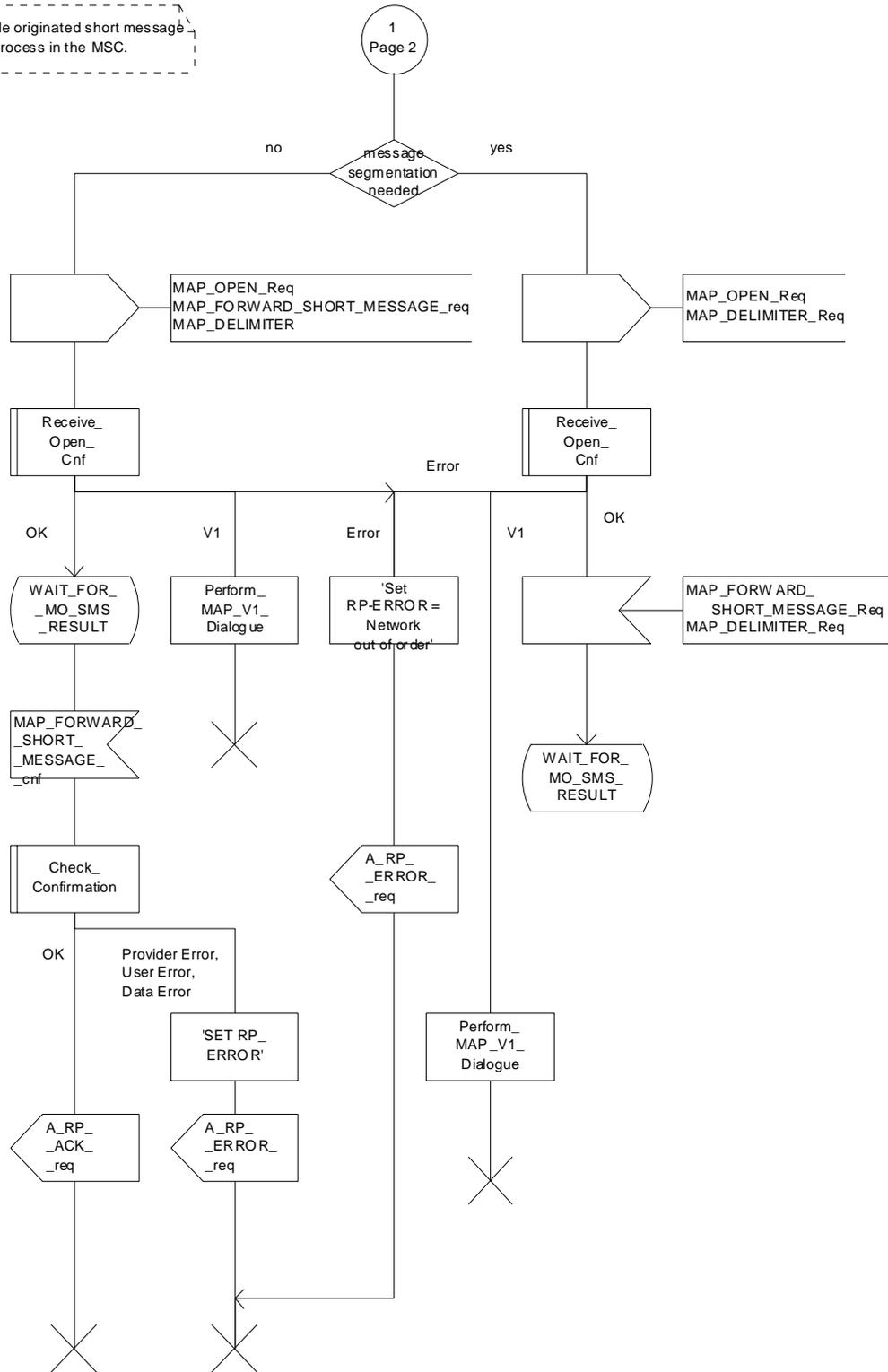

Figure 23.2/2 (sheet 3 of 3): Process MOSM\_MSC



## 23.2.2 Procedure in the VLR

The MAP\_PROCESS\_ACCESS\_REQUEST indication starts the MAP\_PROCESS\_ACCESS\_REQUEST service in the VLR. The application context in the MAP\_OPEN indication is mobile originated short message transfer.

If the service MAP\_PROCESS\_ACCESS\_REQUEST is successful, the VLR waits for the next message from the MSC. When receiving the MAP\_SEND\_INFO\_FOR\_MO\_SMS indication, the VLR acts as follows:

- if there is incompatibility in the subscription check, the error teleservice not provisioned is returned to the MSC;
- if the short message transfer would contravene operator determined barring, the call barred error with cause operator barring is returned;
- if the short message transfer would contravene the supplementary service call barring conditions in the VLR, the call barred error with cause barring service active is returned.

When the mobile subscriber has passed all checks, the MAP\_SEND\_INFO\_FOR\_MO\_SMS response is initiated and the procedure is terminated in the VLR. The mobile originated short message transfer procedure in the VLR is shown in figure 23.2/3.

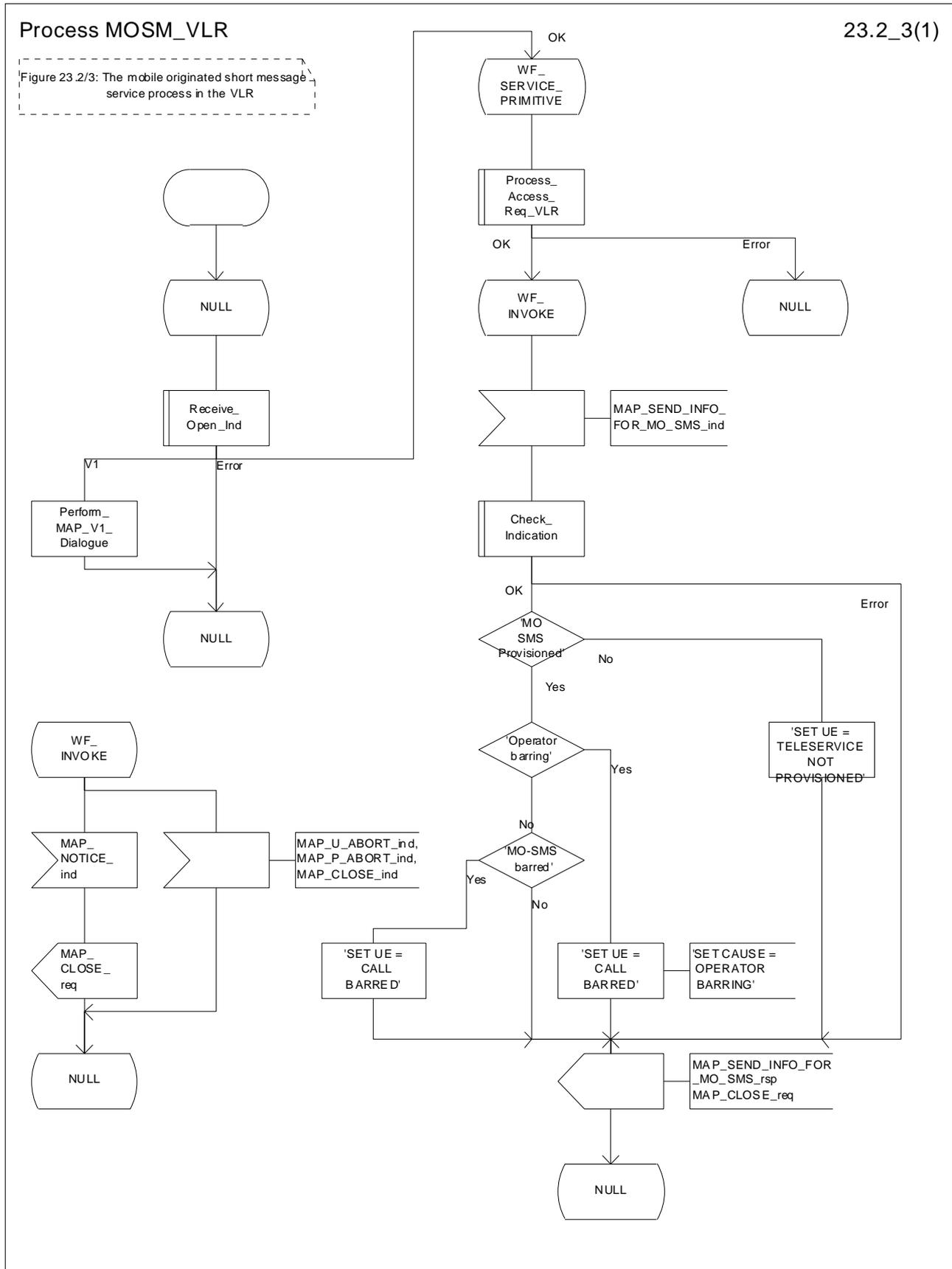

Figure 23.2/3: Process MOSM\_VLR

### 23.2.3 Procedure in the interworking MSC

This procedure applies only when the IWMSC is not the servicing MSC or SGSN.

When receiving a MAP\_OPEN indication primitive that is not associated with any MAP service indication primitive and if the dialogue is accepted, the MAP service-user in the interworking MSC issues a MAP\_DELIMITER request primitive in order to trigger the local MAP service-provider to confirm the dialogue. Then a MAP\_MO\_FORWARD\_SHORT\_MESSAGE indication shall be received.

When a MAP\_MO\_FORWARD\_SHORT\_MESSAGE indication is correctly received, the Interworking MSC invokes forwarding of the short message to the Service Centre. If invalid data content is detected, an unexpected data value error or a data missing error is returned to the servicing MSC or SGSN.

The outcome of the procedure with the Service Centre is awaited before a MAP\_MO\_FORWARD\_SHORT\_MESSAGE response is given back to the servicing MSC or SGSN:

- if a short message is accepted by the Service Centre, an acknowledgement is sent back to the servicing MSC or SGSN;
- if the Service Centre is not identified, the SM Delivery Failure error is returned to the servicing MSC or SGSN;
- if the Service Centre returns an error indication, the SM Delivery Failure error is returned to the servicing MSC with the error cause and any diagnostic information received from the Service Centre;
- if the short message cannot be forwarded to the Service Centre or the procedure towards the Service Centre fails for some reason, a system failure error is sent to the servicing MSC or SGSN.

The mobile originated short message service transfer in the IWMSC is shown in figure 23.2/4.

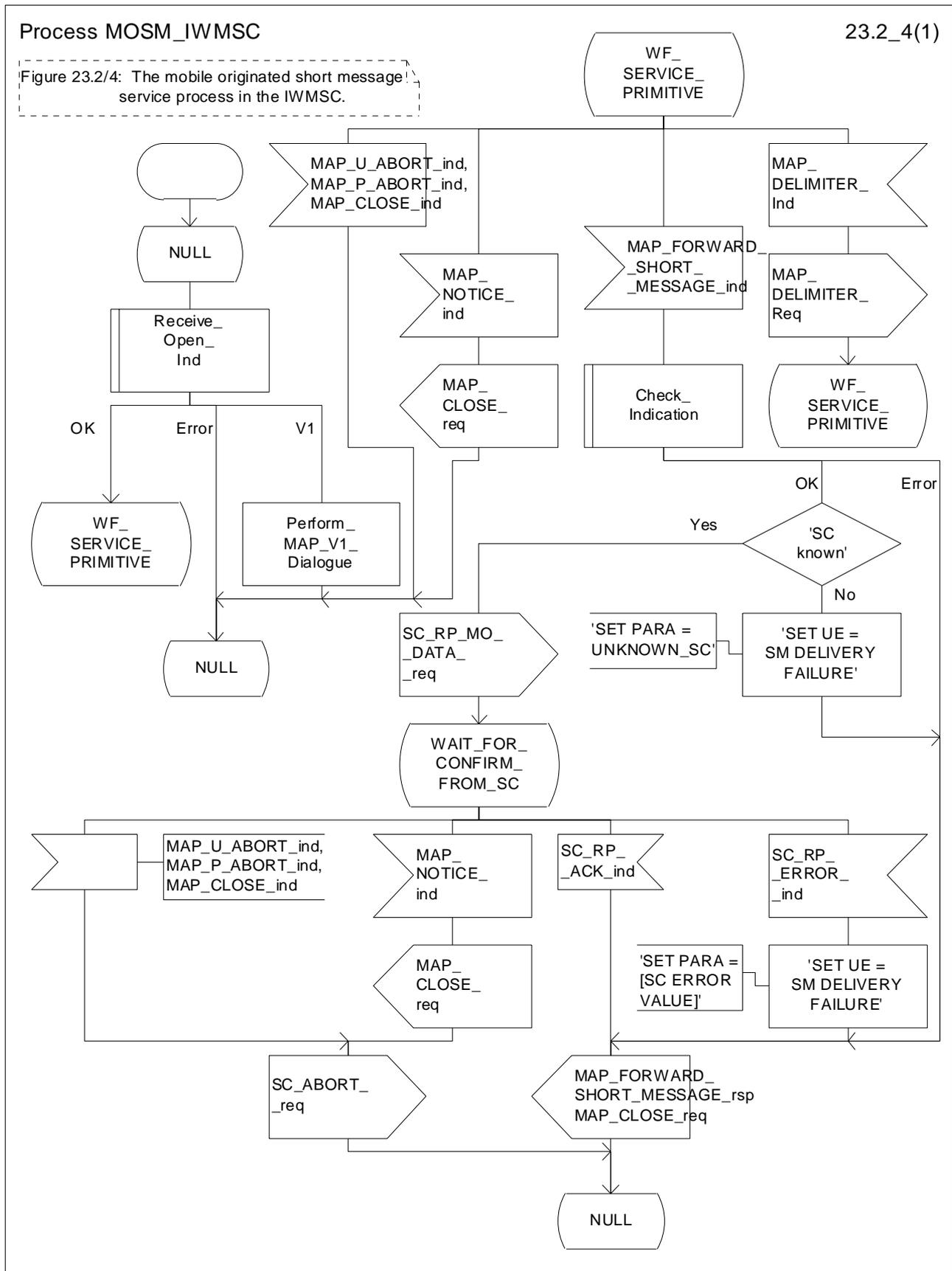

Figure 23.2/4: Process MOSM\_IWMSC

## 23.2.4 Procedure in the servicing SGSN

When receiving the short message from the MS, the SGSN acts as follows:

- if there is incompatibility in the subscription check, the RP\_ERROR cause requested facility not subscribed is provided to the mobile station;
- if the short message transfer would contravene operator determined barring, the RP\_ERROR cause operator determined barring is provided to the mobile station;

NOTE: The RP\_ERROR causes are described in TS GSM 04.11

- if no error is detected, the short message transmission towards the IWMSC is initiated using the MAP\_MO\_FORWARD\_SHORT\_MESSAGE request.

If the service MAP\_MO\_FORWARD\_SHORT\_MESSAGE is started, the SGSN will check whether the grouping of MAP\_OPEN request and MAP\_MO\_FORWARD\_SHORT\_MESSAGE request needs segmentation.

If this is the case then the MAP\_OPEN request primitive shall be sent first without any associated MAP service request primitive and the dialogue confirmation must be received before the MAP\_MO\_FORWARD\_SHORT\_MESSAGE request is sent. As a response to the procedure, the servicing SGSN will receive the MAP\_MO\_FORWARD\_SHORT\_MESSAGE confirmation from the IWMSC indicating that:

- the short message has been successfully delivered to the Service Centre. The acknowledgement is sent to the mobile station;
- one of several error cases has occurred. The mapping between MAP error causes and RP\_ERROR causes is described in TS GSM 03.40. The appropriate indication is provided to the mobile station.

If the procedure failed, a provider error or an abort indication is received. The RP\_ERROR cause network out of order is provided to the mobile station.

The mobile originated short message service procedure is shown in figure 23.2/5.

Process MOSM\_SGSN

23.2\_5.1(3)

Figure 23.2/5: The mobile originated short message service process in the SGSN.

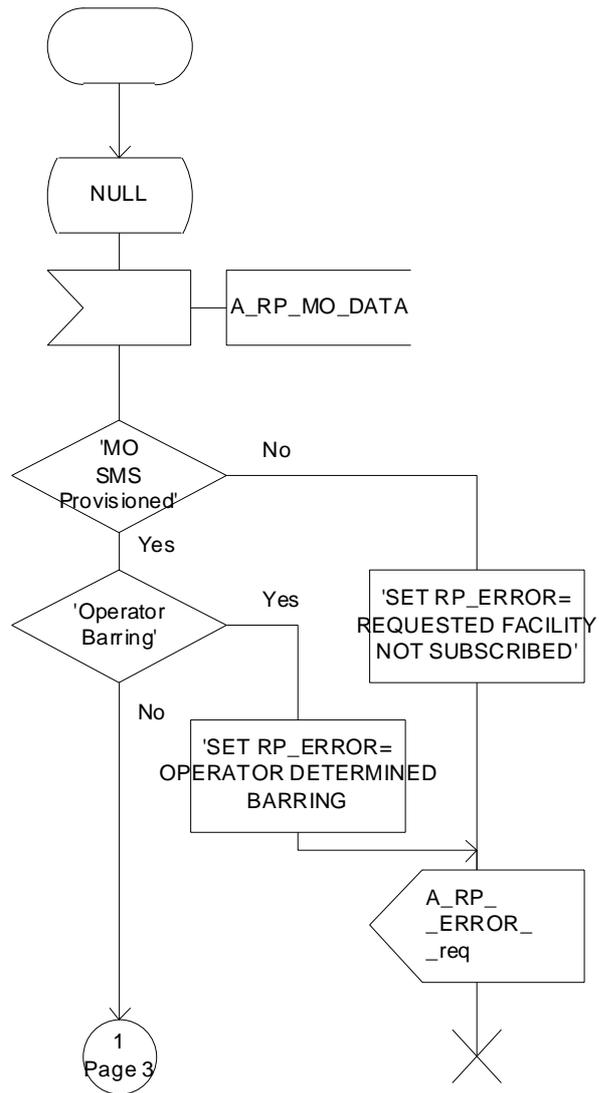

Figure 23.2/5 (sheet 1 of 3): Process MOSM\_SGSN

Process MOSM\_SGSN

23.2\_5.2(3)

Figure 23.2/5: The mobile originated short message service process in the SGSN.

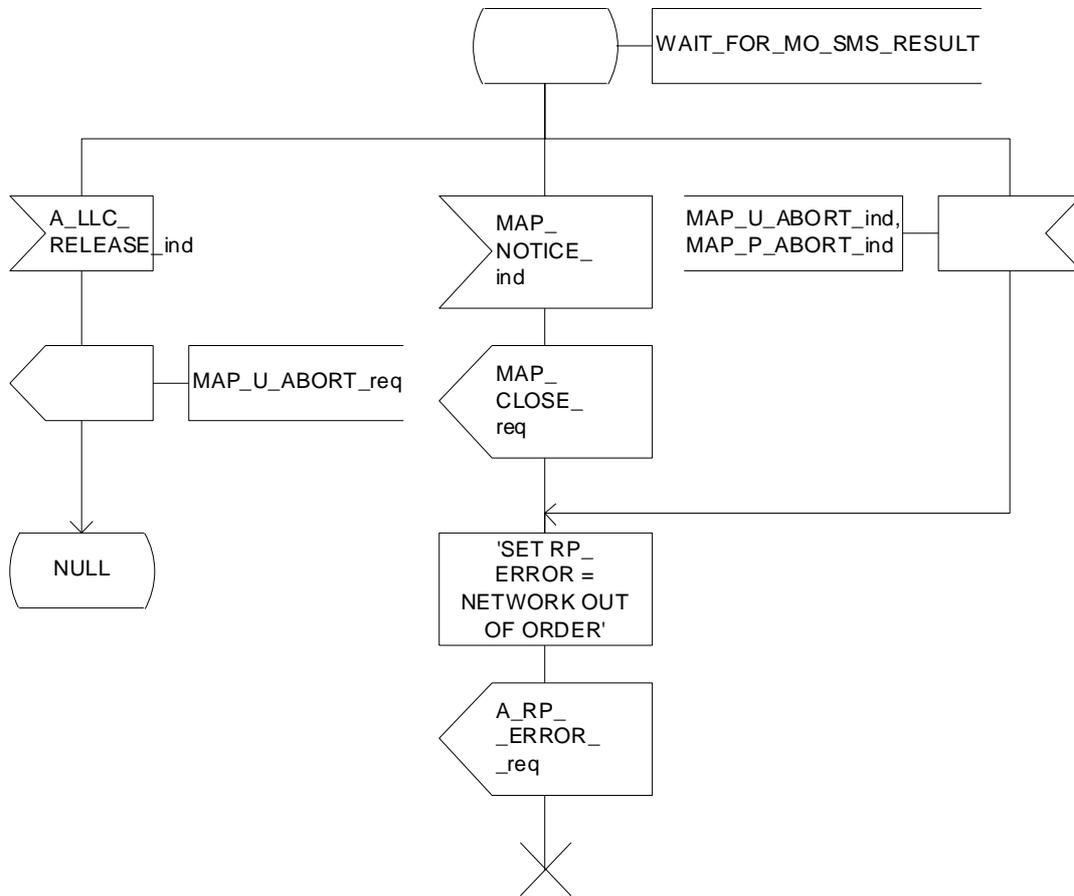

Figure 23.2/5 (sheet 2 of 3): Process MOSM\_SGSN

Process MOSM\_SGSN

23.2\_5.3(3)

Figure 23.2/5: The mobile originated short message service process in the SGSN.

1 Page 1

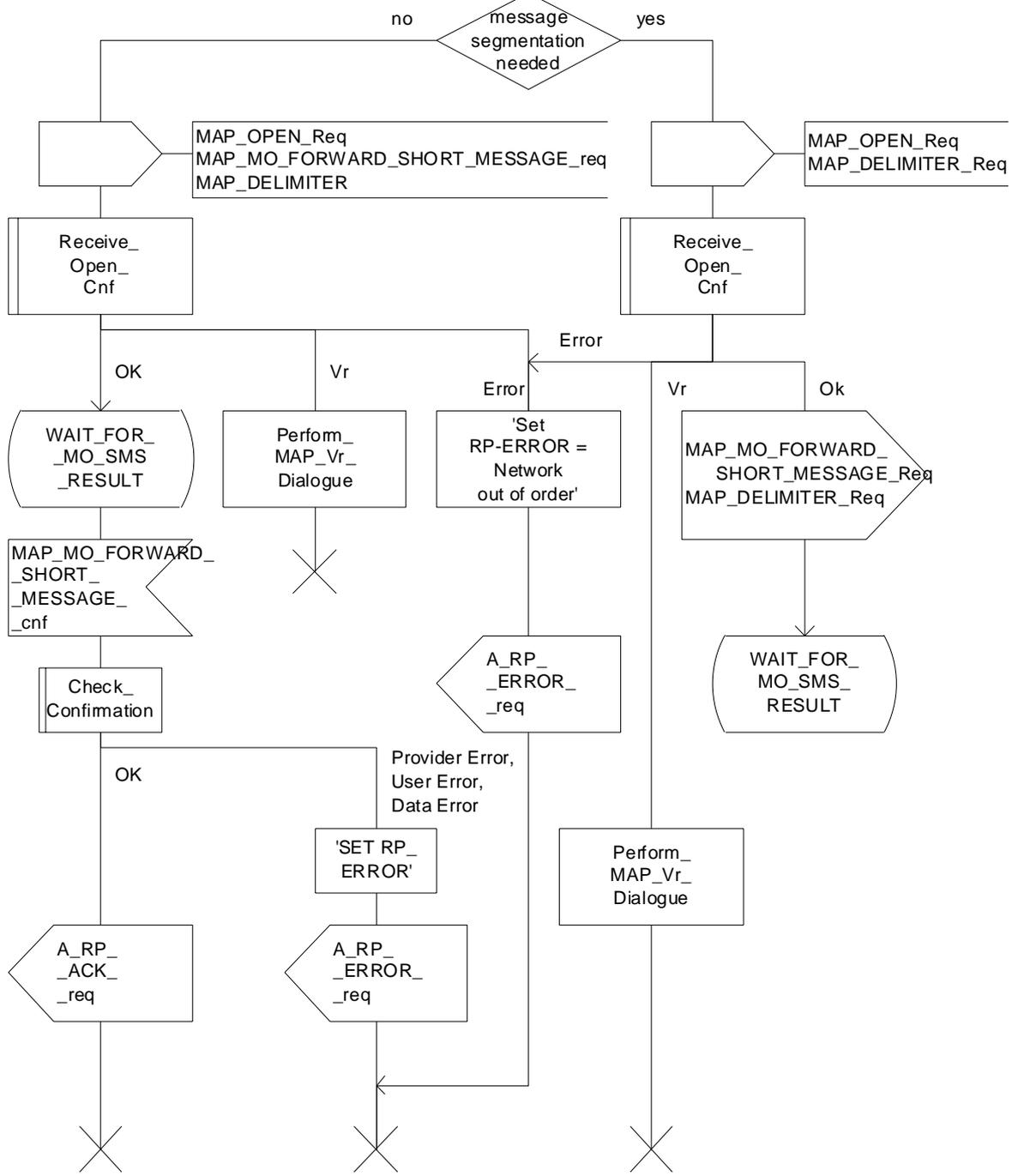
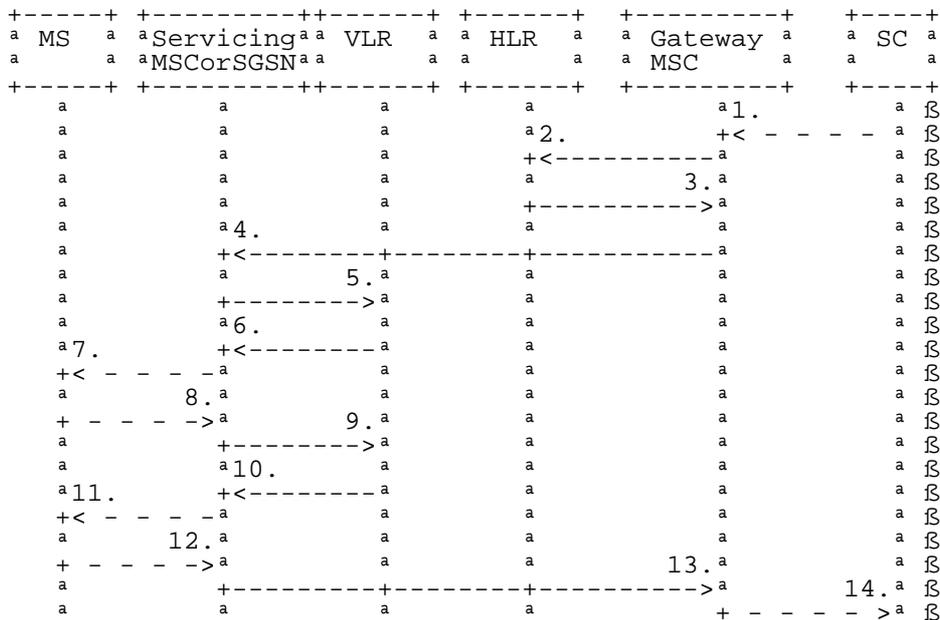

Figure 23.2/5 (sheet 3 of 3): Process MOSM\_SGSN



### 23.3 The mobile terminated short message transfer procedure

The mobile terminated short message transfer procedure is used for forwarding a short message or several short messages from a Service Centre to a mobile subscriber. The mobile terminated short message procedure for a single short message transfer is shown in figure 23.3/1.



- 1) Short Message (GSM 03.40)
  - 2) MAP\_SEND\_ROUTING\_INFO\_FOR\_SM
  - 3) MAP\_SEND\_ROUTING\_INFO\_FOR\_SM\_ACK
  - 4) MAP\_MT\_FORWARD\_SHORT\_MESSAGE
  - 5) MAP\_SEND\_INFO\_FOR\_MT\_SMS (\*)
  - 6) MAP\_PAGE/MAP\_SEARCH\_FOR\_MOBILE\_SUBSCRIBER (\*)
  - 7) Page (GSM 04.08)
  - 8) Page response (GSM 04.08)
  - 9) MAP\_PROCESS\_ACCESS\_REQUEST\_ACK and MAP\_SEARCH\_FOR\_MOBILE\_SUBSCRIBER\_ACK (\*)
  - 10) MAP\_SEND\_INFO\_FOR\_MT\_SMS\_ACK (\*)
  - 11) Short Message (GSM 04.11)
  - 12) Short Message Acknowledgement (GSM 04.11)
  - 13) MAP\_MT\_FORWARD\_SHORT\_MESSAGE\_ACK
  - 14) Short Message Acknowledgment (GSM 03.40)
- (\*) Messages 5), 6), 9), and 10) are not used by SGSN

**Figure 23.3/1: Mobile terminated short message service procedures**

The mobile terminated short message procedure for multiple short message transfer is shown in figure 23.3/2.

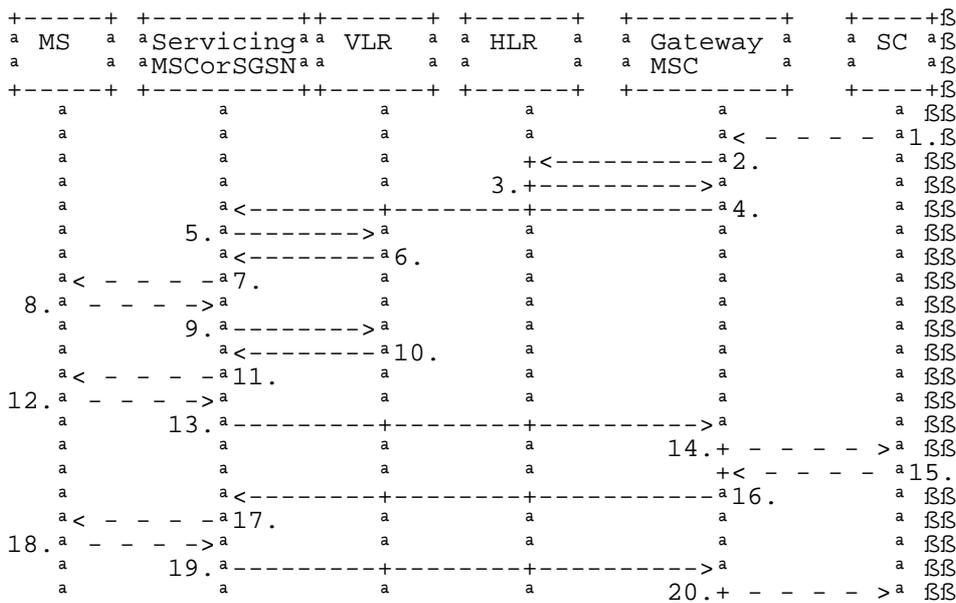

- 1) Short Message (GSM 03.40)
- 2) MAP\_SEND\_ROUTING\_INFO\_FOR\_SM
- 3) MAP\_SEND\_ROUTING\_INFO\_FOR\_SM\_ACK
- 4) MAP\_MT\_FORWARD\_SHORT\_MESSAGE (note 1)
- 5) MAP\_SEND\_INFO\_FOR\_MT\_SMS (\*)
- 6) MAP\_PAGE/MAP\_SEARCH\_FOR\_MOBILE\_SUBSCRIBER (\*)
- 7) Page (GSM 08.08)
- 8) Page response (GSM 04.08)
- 9) MAP\_PROCESS\_ACCESS\_REQUEST\_ACK and MAP\_SEARCH\_FOR\_MOBILE\_SUBSCRIBER\_ACK (\*)
- 10) MAP\_SEND\_INFO\_FOR\_MT\_SMS\_ACK (\*)
- 11) Short Message (GSM 04.11)
- 12) Short Message Acknowledgement (GSM 04.11)
- 13) MAP\_MT\_FORWARD\_SHORT\_MESSAGE\_ACK
- 14) Short Message Acknowledgment (GSM 03.40)
- 15) Short Message (GSM 03.40)
- 16) MAP\_MT\_FORWARD\_SHORT\_MESSAGE (note 2)
- 17) Short Message (GSM 04.11)
- 18) Short Message Acknowledgement (GSM 04.11)
- 19) MAP\_MT\_FORWARD\_SHORT\_MESSAGE\_ACK
- 20) Short Message Acknowledgement (GSM 03.40)

(\*) Messages 5), 6), 9), and 10) are not used by SGSN

NOTE 1: The More Messages To Send flag is TRUE.

NOTE 2: The More Messages To Send flag is FALSE

**Figure 23.3/2: Mobile terminated short message procedure for multiple short message transfer**

In the multiple short message transfer the service MAP\_MT\_FORWARD\_SHORT\_MESSAGE can be used several times. However, the short message transfer is always acknowledged to the Service Centre before the next short message is sent.

In addition the following MAP services are used:

MAP_PROCESS_ACCESS_REQUEST	(see clause 8.3); (*)
MAP_PAGE	(see clause 8.2); (*)
MAP_SEARCH_FOR_MS	(see clause 8.2); (*)
MAP_AUTHENTICATE	(see clause 8.5); (*)
MAP_SET_CIPHERING_MODE	(see clause 8.6); (*)
MAP_CHECK_IMEI	(see clause 8.7);
MAP_FORWARD_NEW_TMSI	(see clause 8.9); (*)
MAP_REPORT_SM_DELIVERY_STATUS	(see clause 12.3);
MAP_INFORM_SERVICE_CENTRE	(see clause 12.6);
MAP_TRACE_SUBSCRIBER_ACTIVITY	(see clause 9.1); (*)
MAP_READY_FOR_SM	(see clause 12.4).

(\*) Those messages are not used by SGSN.

### 23.3.1 Procedure in the Servicing MSC

When initiating the dialogue with the servicing MSC, the SMS Gateway MSC must provide the IMSI of the subscriber to whom the short message is directed.

The IMSI can be included either in the Destination Reference of the MAP\_OPEN indication received from the SMS Gateway MSC or in the sm-RP-DA information field of the MAP\_MT\_FORWARD\_SHORT\_MESSAGE indication.

When receiving a MAP\_OPEN indication primitive that is not associated with any MAP service indication primitive and if the dialogue is accepted, the MAP service-user in the servicing MSC issues a MAP\_DELIMITER request primitive in order to trigger the local MAP service-provider to confirm the dialogue.

When receiving the first MAP\_MT\_FORWARD\_SHORT\_MESSAGE indication from the gateway MSC, the servicing MSC sends the MAP\_SEND\_INFO\_FOR\_MT\_SMS request primitive to the VLR, if the MAP service primitive is accepted and if short message service is supported in the servicing MSC.

The MAP\_MT\_FORWARD\_SHORT\_MESSAGE indication primitive is checked by the macro "Check\_Indication". If the received MAP service primitive contains errors, the service is aborted and an unexpected data value error or data missing error is returned to the GMSC.

If the MSC does not support the short message service, the service is aborted in the servicing MSC and the error "Facility Not Supported" is returned to the GMSC.

The subscriber identity information that may be included in the MAP\_OPEN indication primitive and in the MAP service indication primitive is checked by the macro "Check\_Subscr\_Identity\_For\_MT\_SMS" as follows.

If a Destination Reference has been received in the MAP\_OPEN indication, an LMSI must be present in the sm-RP-DA information field of the MAP\_MT\_FORWARD\_SHORT\_MESSAGE indication. The LMSI shall be included in the sm-RP-DA information field of the MAP\_SEND\_INFO\_FOR\_MT\_SMS request sent to the VLR; the associated MAP\_OPEN request must contain a Destination Reference that carries an IMSI.

Otherwise, if the IMSI is included in the sm-RP-DA information field of the MAP\_MT\_FORWARD\_SHORT\_MESSAGE indication, it is mapped into the sm-RP-DA information field of the MAP\_SEND\_INFO\_FOR\_MT\_SMS request that is sent to the VLR. In this case, the IMSI is not accompanied by an LMSI and neither the MAP\_OPEN indication received from the gateway MSC nor the MAP\_OPEN request sent to the VLR shall include a Destination Reference.

If a Destination Reference has been received in the servicing MSC and the sm-RP-DA information field of the MAP\_MT\_FORWARD\_SHORT\_MESSAGE indication does not include an LMSI or if no Destination Reference has been received and the sm-RP-DA information field does not cover an IMSI the service is aborted in the servicing MSC and the error "Unexpected Data Value" is returned to the SMS GMSC.

The following responses to the MAP\_SEND\_INFO\_FOR\_MT\_SMS request may be received from the VLR:

- unidentified subscriber or system failure error. The error code is forwarded to the GMSC;
- absent subscriber error. The absent subscriber\_SM error is forwarded to the GMSC with the absent subscriber diagnostic indication set to 'IMSI Detached';
- unknown subscriber error. The system failure indication is provided to the GMSC;
- data missing or unexpected data value error. The system failure indication is provided to the GMSC;
- a provider error or an abort indication. The system failure indication is provided to the GMSC;
- subscriber busy for MT SMS. The error code is forwarded to the GMSC;
- paging procedure invocation (see clause 25.3) reporting the successful outcome of the procedure;
- search procedure invocation (see clause 25.3) reporting the successful outcome of the procedure.

The result of the paging or the search procedure is processed as follows:

- if the procedure is completed successfully, the MSC will send the MAP\_PROCESS\_ACCESS\_REQUEST request to the VLR (see clause 25.4);
- if the procedure is completed successfully, but the MS has no mobile terminated short message transfer capability, the procedure is terminated and SM delivery failure indication with cause "equipment not SM equipped" is provided to the GMSC;
- if the procedure ends unsuccessfully, the termination of the procedure is awaited from the VLR. The absent subscriber\_SM error is forwarded to the GMSC with the absent subscriber diagnostic indication set to 'No Paging Response', but the other error causes are reported as a system failure indication.

If the short message transfer is aborted for any reason, the dialogue with the VLR is aborted. If the procedure with the VLR is aborted by the VLR or by the provider, a system failure indication is provided to the GMSC.

The unsuccessful outcome of the MAP\_PROCESS\_ACCESS\_REQUEST service is reported by using the system failure error to the GMSC.

When the service MAP\_PROCESS\_ACCESS\_REQUEST is carried out, the MSC will receive the MAP\_SEND\_INFO\_FOR\_MT\_SMS confirmation indicating:

- the unsuccessful outcome of the procedure. The error indication received from the VLR is forwarded to the GMSC;
- the successful outcome of the procedure. The MSC initiates forwarding of the short message to the MS.

If the primitive itself is badly formatted or data is missing, the system failure error is sent to the GMSC.

If forwarding of the short message is initiated, the MSC awaits the result before one of the following responses is sent back to the GMSC:

- an acknowledge if the short message has been successfully delivered to the mobile subscriber;
- an SM delivery failure error containing a parameter indicating either of the following: there is a MS protocol error or the MS memory capacity is exceeded; detailed diagnostic information (see clause 7.6.1.4) may also be carried;
- a system failure error if the delivery procedure is aborted.

If the More Messages To Send flag was FALSE or the service MAP\_MT\_FORWARD\_SHORT\_MESSAGE ends unsuccessfully, the transaction to the gateway MSC is terminated. Otherwise, the servicing MSC waits for the next short message from the Service Centre.

When receiving the next MAP\_MT\_FORWARD\_SHORT\_MESSAGE indication from the gateway MSC the servicing MSC will act as follows:

- if the received primitive contains errors, the unexpected data value error or data missing error is provided to the gateway MSC;
- if the More Messages To Send flag is FALSE, the servicing MSC will start the short message transfer procedure to the mobile subscriber. The successful or unsuccessful outcome of this procedure is reported to the gateway MSC and the transaction is terminated.
- if the More Messages To Send flag is TRUE, the servicing MSC will start the short message transfer to the mobile subscriber. If the outcome of this procedure is unsuccessful, the reason is reported to the gateway MSC and the procedure is terminated. If the procedure is successful, it is acknowledged to the gateway MSC and more short messages can be received.

The tracing procedure may be activated. It is described in detail in the clause 20.

The mobile terminated short message transfer procedure in the servicing MSC is shown in figures 23.3/3 and 23.3/4. The page and search procedures are shown in figure 25.3/1 and 25.3/2.

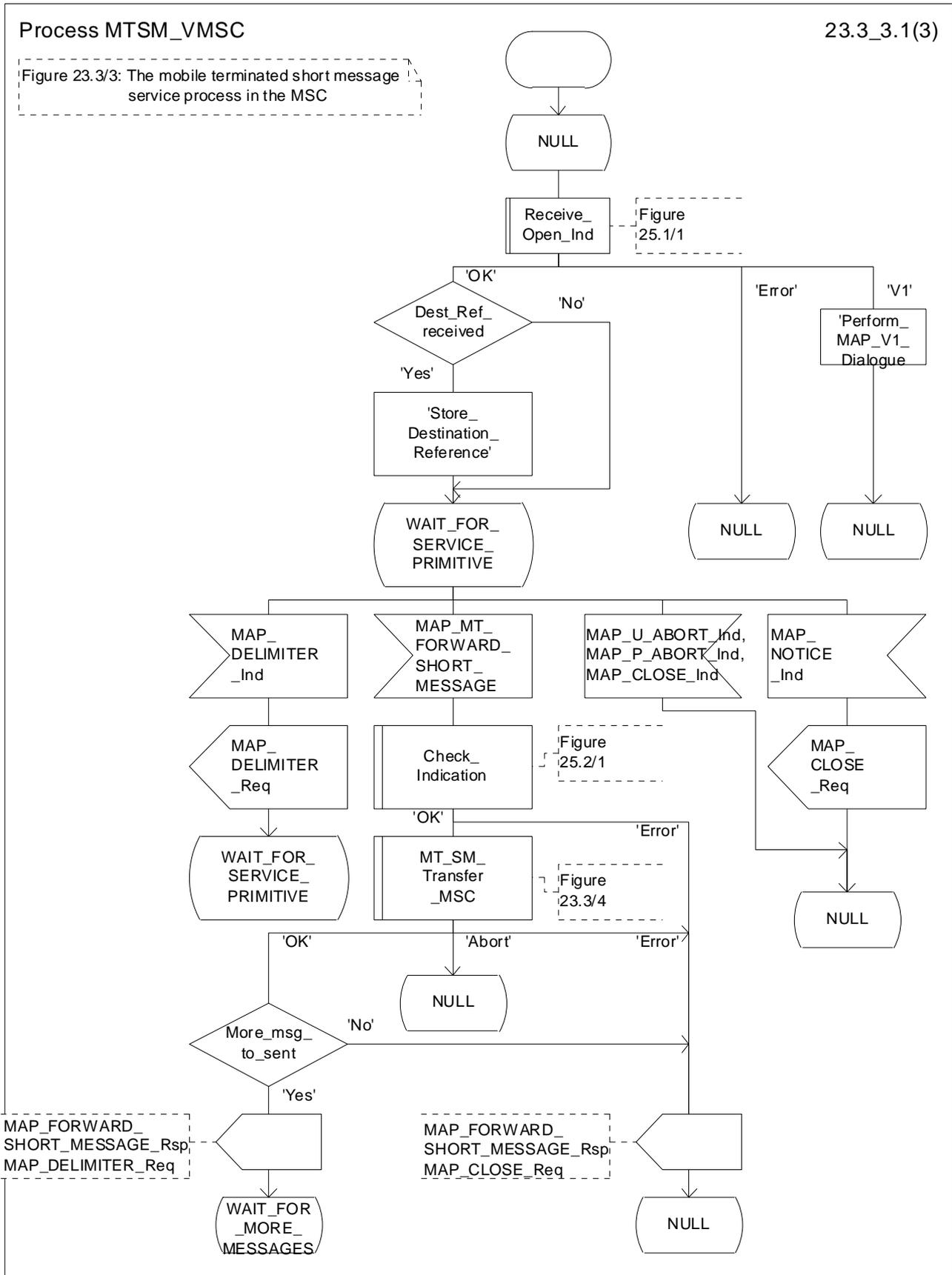

Figure 23.3/3 (sheet 1 of 3): Procedure MTSM\_VMSC

Process MTSM\_VMSC

23.3\_3.2(3)

Figure 23.3/3: The mobile terminated short message service process in the MSC

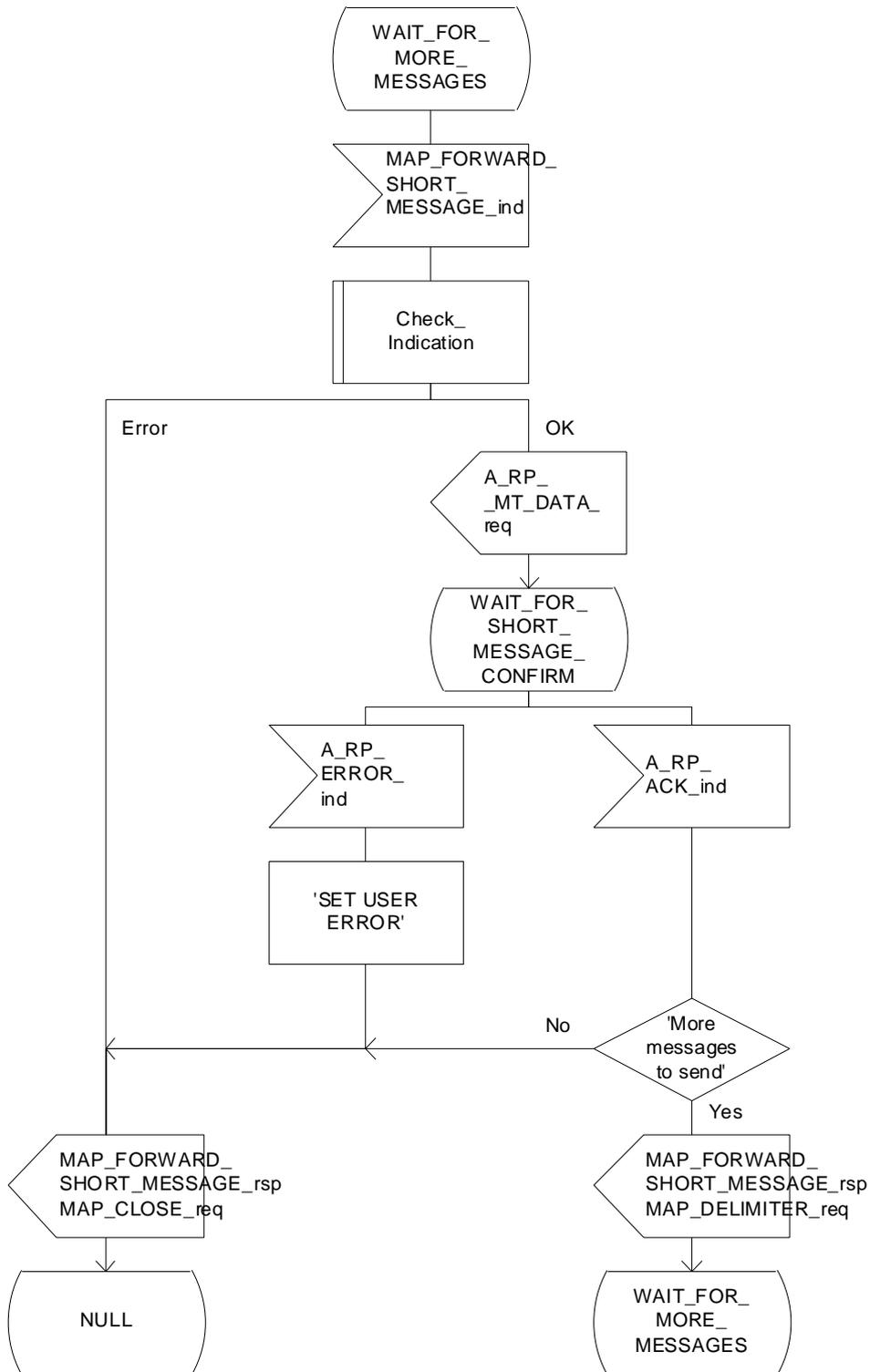

Figure 23.3/3 (sheet 2 of 3): Procedure MTSM\_VMSC

Process MTSM\_VMSC

23.3\_3.3(3)

Figure 23.3/3: The mobile terminated short message service process in the MSC

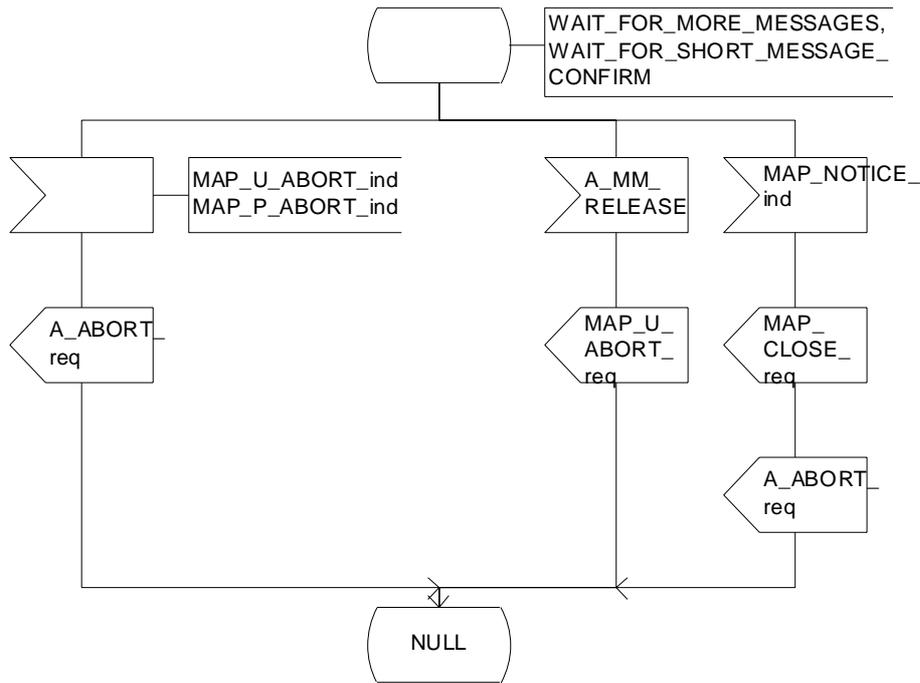

Figure 23.3/3 (sheet 3 of 3): Procedure MTSM\_VMSC



Macrodefinition MT\_SM\_Transfer\_MSC

23.3\_4.1(3)

Figure 23.3/4: The mobile terminated short message transfer macro in the MSC

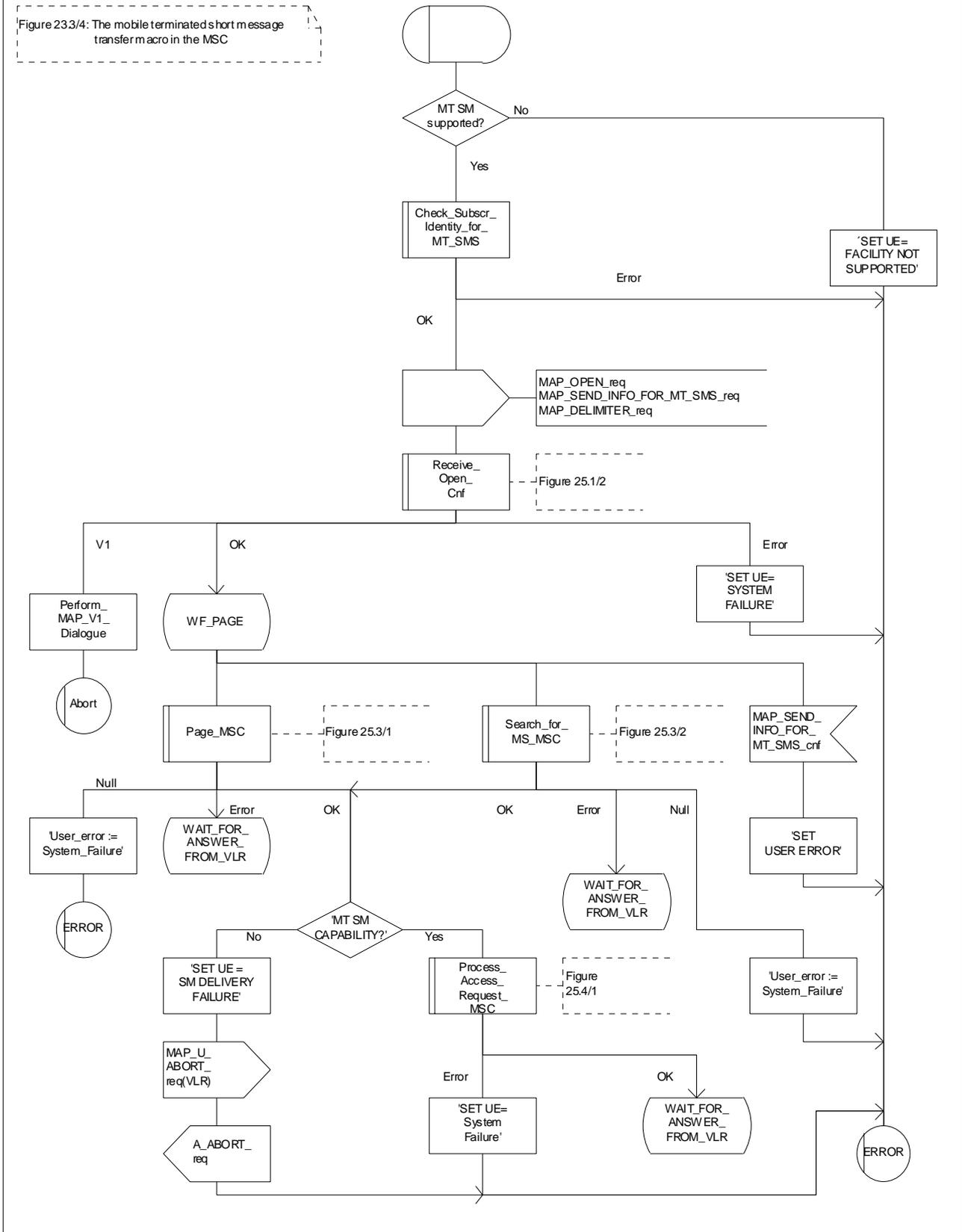

Figure 23.3/4 (sheet 1 of 3): Macro MT\_SM\_Transfer\_MSC

Macrodefinition MT\_SM\_Transfer\_MSC

23.3\_4.2(3)

Figure 23.3/4: The mobile terminated short message transfer macro in the MSC

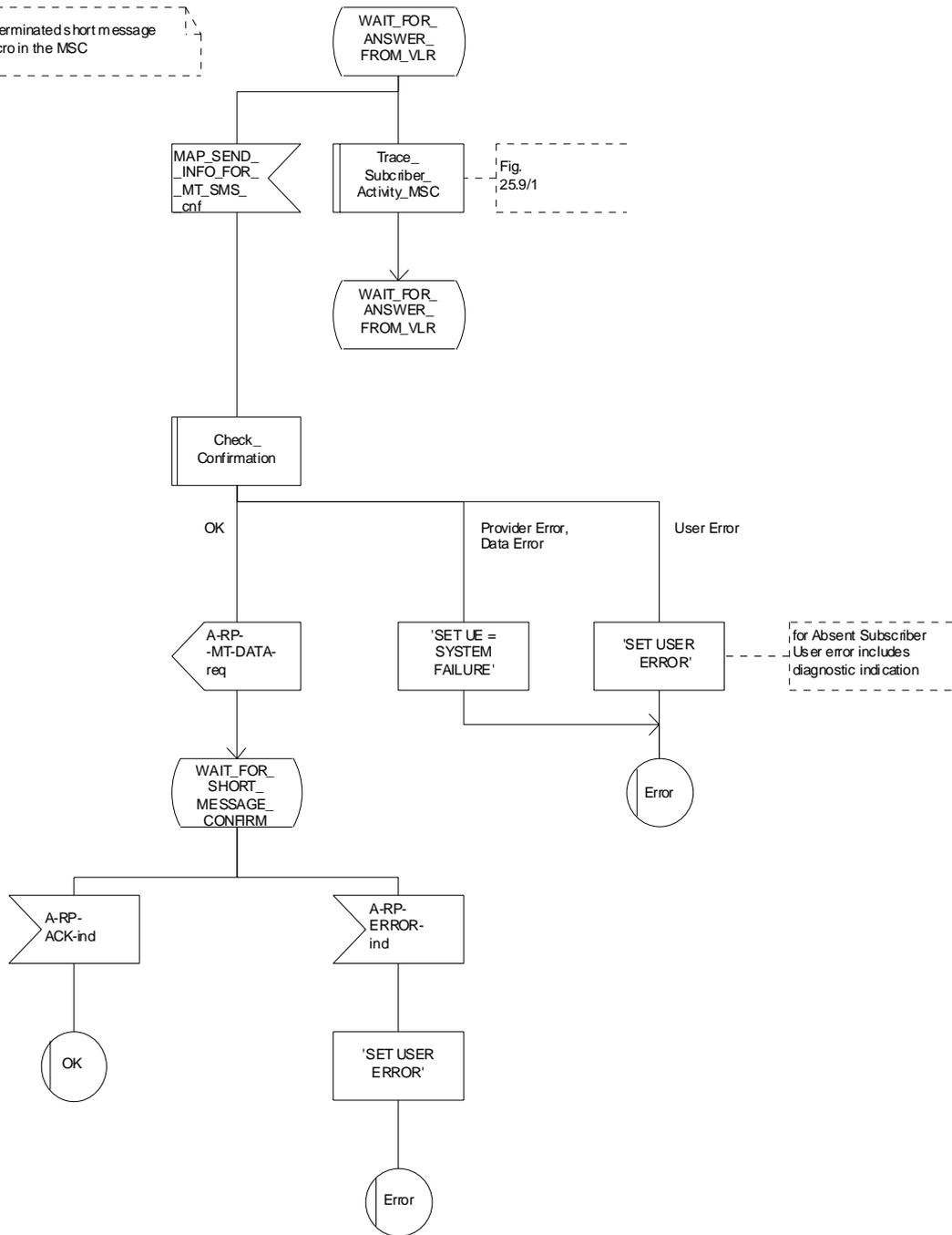

Figure 23.3/4 (sheet 2 of 3): Macro MT\_SM\_Transfer\_MSC

Macrodefinition MT\_SM\_Transfer\_MSC

23.3\_4.3(3)

Figure 23.3/4: The mobile terminated short message transfer macro in the MSC

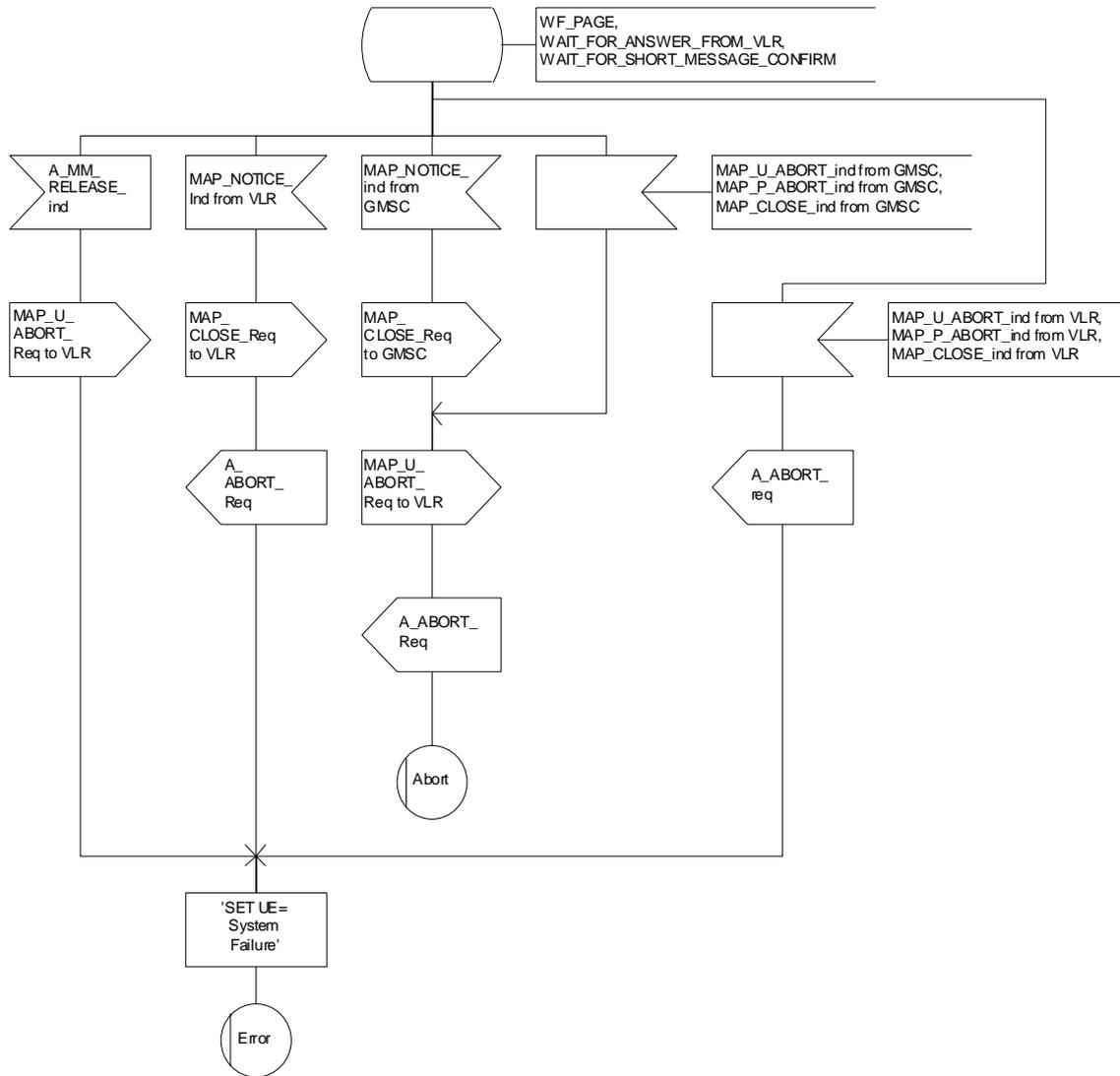

Figure 23.3/4 (sheet 3 of 3): Macro MT\_SM\_Transfer\_MSC

## 23.3.2 Procedures in the VLR

When receiving the MAP\_SEND\_INFO\_FOR\_MT\_SMS indication, the VLR will act as follows:

- the parameters and data in the primitive are checked by the macro "Check\_Indication". A data failure is reported as an unexpected data value error or a data missing error depending on the nature of the failure;
- for mobile terminated short message the mobile subscriber is identified either by the IMSI only or by the IMSI accompanied by the LMSI. The subscriber identity information that may be included in the MAP\_OPEN indication primitive and in the MAP service indication primitive is checked by the macro "Check\_Subscr\_Identity\_For\_MT\_SMS". In the first case, the IMSI is included in the sm-RP-DA information field and the Destination Reference must not be present in the MAP\_OPEN primitive. In the latter case the IMSI must be obtained from the Destination Reference of the MAP\_OPEN indication primitive and an LMSI must be present in the sm-RP-DA information field of the MAP\_SEND\_INFO\_FOR\_MT\_SMS indication. If the mobile subscriber is unknown, the unidentified subscriber error is returned;
- if the "Confirmed by HLR" indicator is set to "Not Confirmed", the unidentified subscriber error is returned;
- if the IMSI Detached Flag is set to detached or the LA Not Allowed Flag is set to not allowed in the VLR, an absent subscriber error with the diagnostic indication set to 'IMSI Detached' is returned and the MS not reachable flag (MNRF) is set;
- if the MAP\_SEND\_INFO\_FOR\_MT\_SMS indication has passed all the tests, the VLR will initiate the paging procedure. If the location area identification is known and the "Confirmed by Radio Contact" indicator is set to "Confirmed", the MAP\_PAGE service is used. Otherwise the MAP\_SEARCH\_FOR\_MOBILE\_SUBSCRIBER service is started.

The following responses to the paging procedure may be received from the MSC:

- the MAP\_SEARCH\_FOR\_MOBILE\_SUBSCRIBER confirmation indicating a successful outcome, if the search procedure is used. After that the VLR awaits the MAP\_PROCESS\_ACCESS\_REQUEST indication from the MSC;
- the MAP\_PAGE confirmation or MAP\_SEARCH\_FOR\_MOBILE\_SUBSCRIBER confirmation indicating unsuccessful outcome. If an absent subscriber error is received, the MS not reachable flag (MNRF) is set in the VLR. The errors are forwarded to the MSC in the MAP\_SEND\_INFO\_FOR\_MT\_SMS response, the absent subscriber error is forwarded with the diagnostic indication set to 'No Paging Response for non GPRS'. If the unexpected data value, or unknown location area error is received, the system failure indication is given to the MSC; if subscriber busy for MT SMS is received, this cause is given to the MSC.
- the MAP\_PROCESS\_ACCESS\_REQUEST indication telling that the outcome of the service MAP\_PAGE is successful.

If the paging procedure or process access request procedure or any other procedure invoked fails, the appropriate error is reported to the MSC.

If the process access request procedure is successful, the VLR will send the MAP\_SEND\_INFO\_FOR\_MT\_SMS response to the MSC and the transaction is terminated in the VLR.

The mobile terminated short message transfer procedure in the VLR is shown in figure 23.3/5.

Process MT\_SM\_VLR

23.3\_5.1(3)

Figure 23.3/5: The mobile terminated short message service process in the VLR

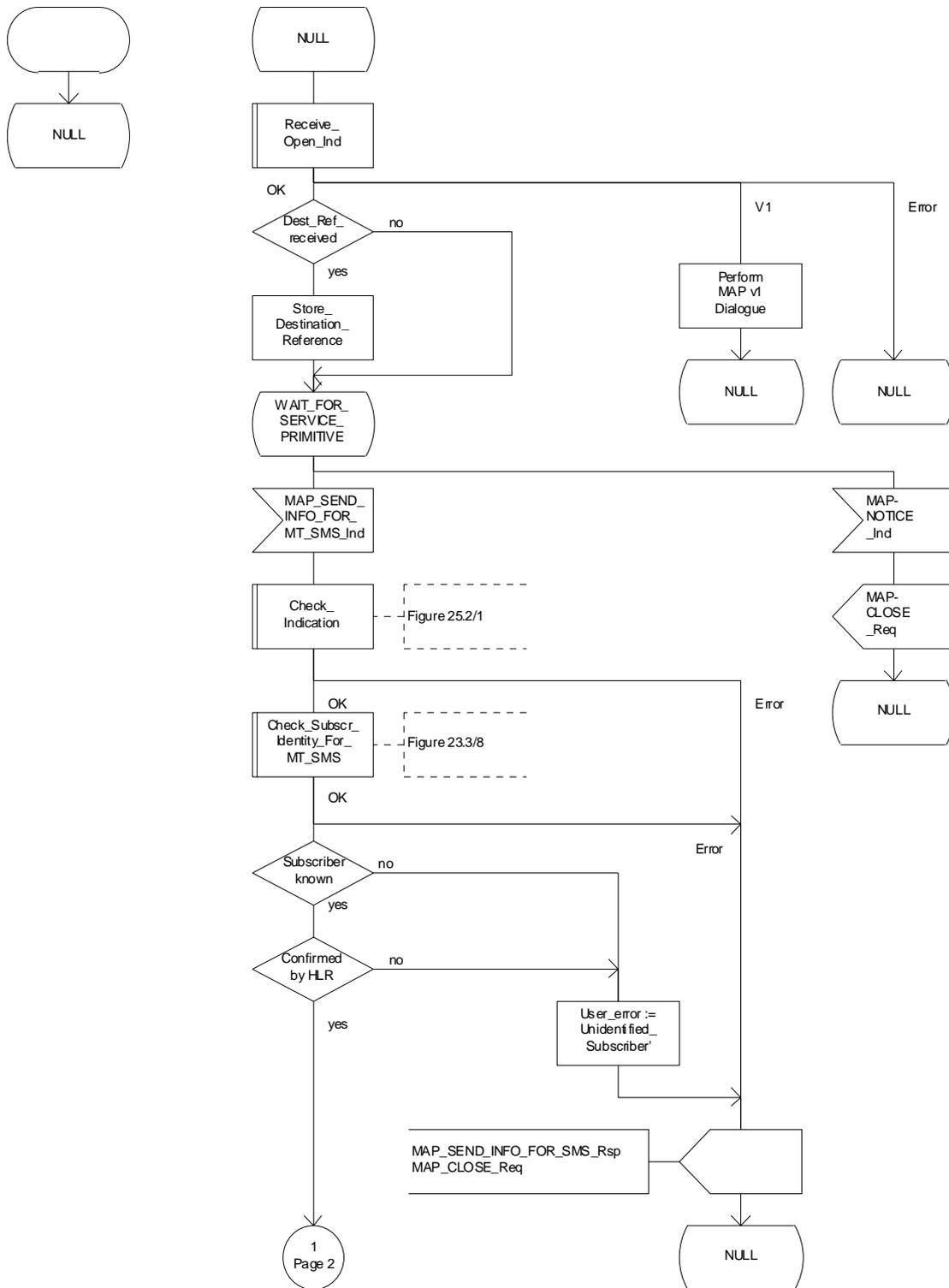

Figure 23.3/5 (sheet 1 of 3): Process MT\_SM\_VLR

Process MT\_SM\_VLR

23.3\_5.2(3)

Figure 23.3/5: The mobile terminated short message service process in the VLR

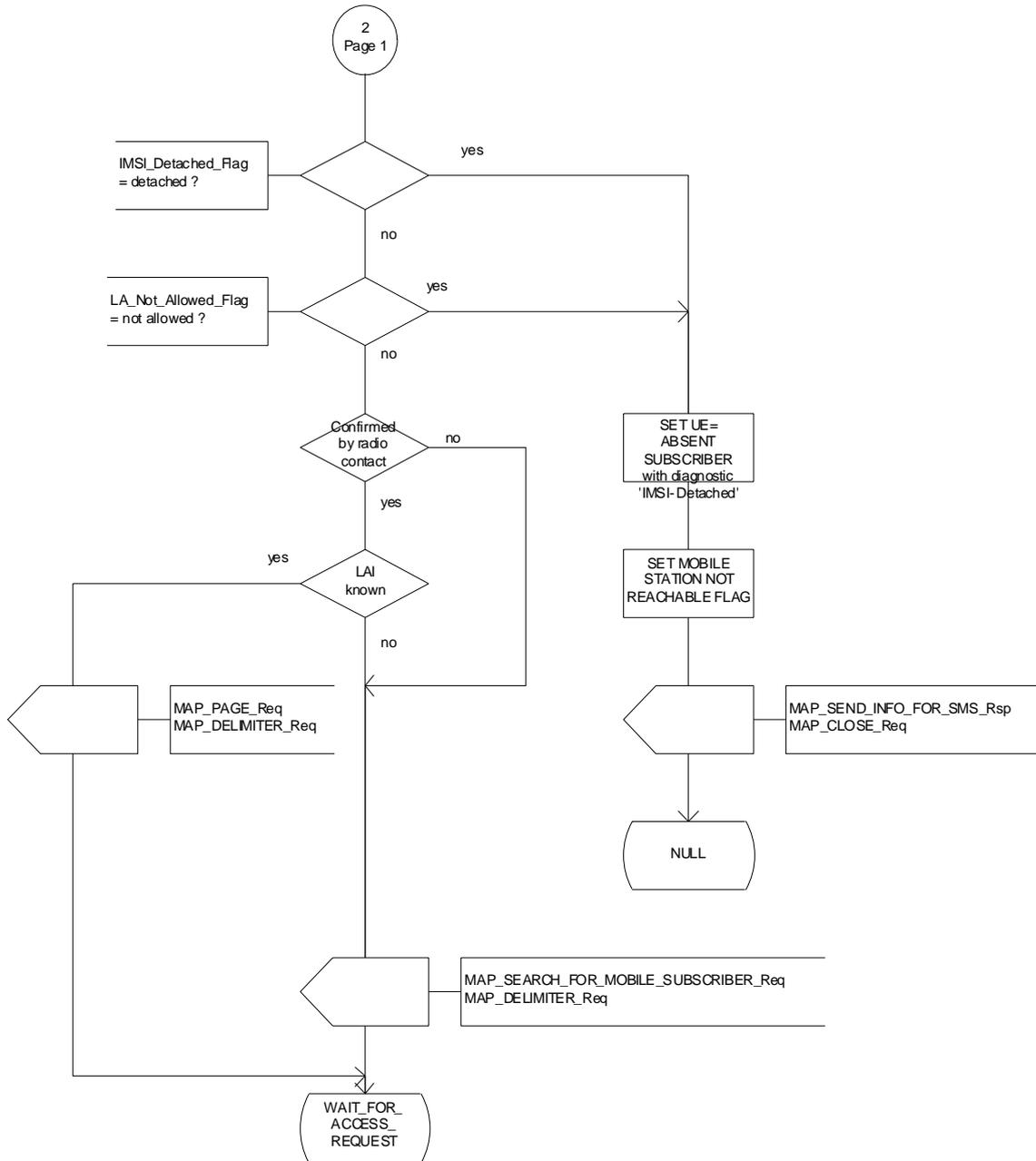

Figure 23.3/5 (sheet 2 of 3): Process MT\_SM\_VLR

Process MT\_SM\_VLR

23.3\_5.3(3)

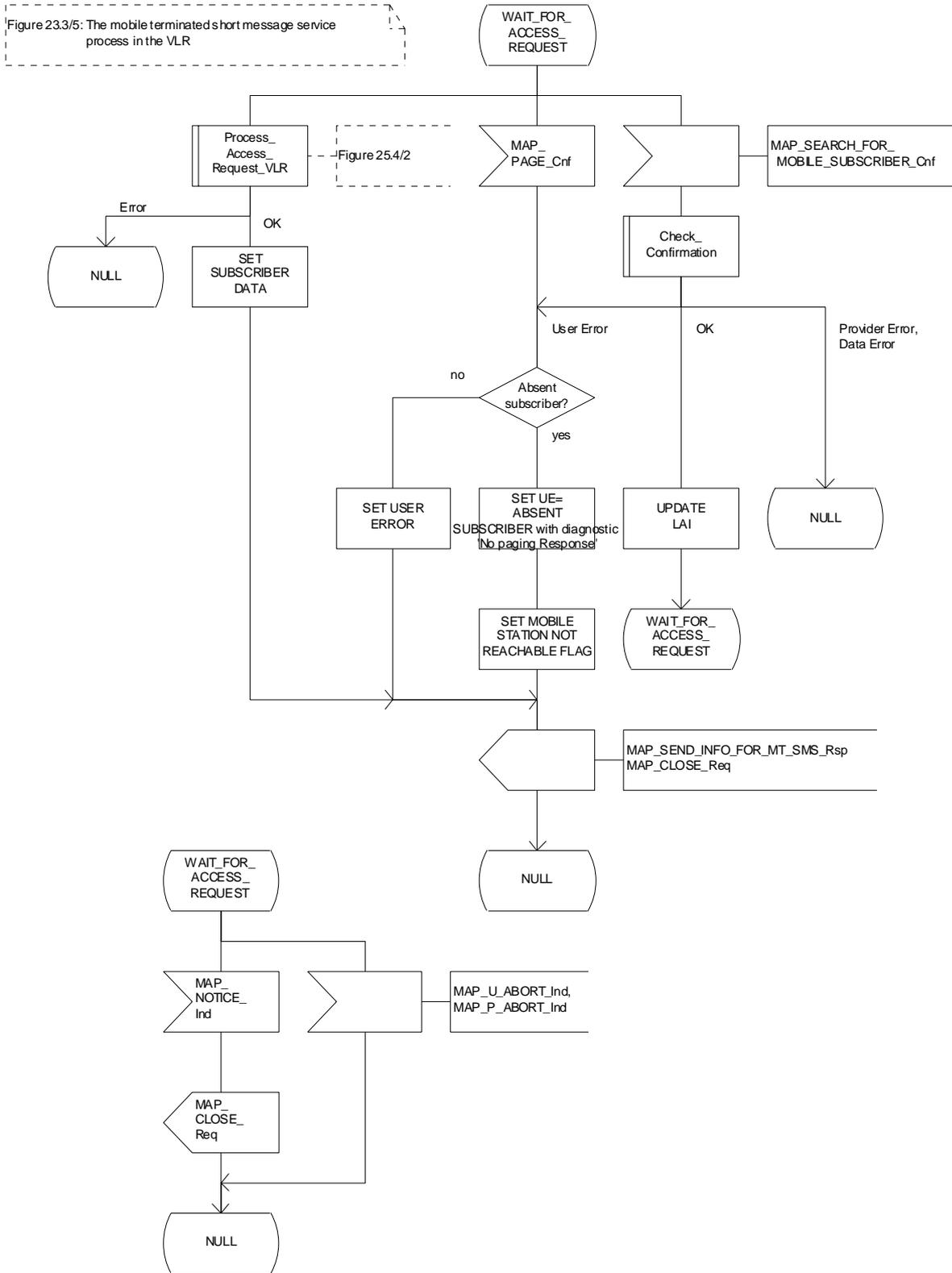

Figure 23.3/5 (sheet 3 to 3): Process MT\_SM\_VLR

### 23.3.3 Procedures in the HLR

The MAP\_SEND\_ROUTING\_INFO\_FOR\_SM indication is received from the GMSC. The following error cases are reported to the GMSC in the MAP\_SEND\_ROUTING\_INFO\_FOR\_SM response as an unsuccessful outcome of the procedure:

- if the necessary parameters and data are not present in the primitive or they are badly formatted, the data missing or unexpected data value error is returned;
- if the mobile subscriber is unknown, i.e. it cannot be identified from the MSISDN given, an unknown subscriber error is returned;
- if the short message transfer would contravene operator determined barring, the call barred error with cause operator barring is returned;
- if the short message transfer would contravene the « SM filtering by the HPLMN » function criteria, the call barred error with cause unauthorised Message Originator is returned (the definition of the filtering function is out of the scope of GSM specification. Filtering may be based on SM-RP-SMEA information element if received from the GMSC) ;
- if the mobile subscription identified by the given MSISDN number does not include the short message service, the teleservice not provisioned error is returned;
- if the GMSC does not support the GPRS functionality, the behaviour of the HLR depends on the following conditions:
  - If the subscriber is not a GPRS subscriber then the behaviour of the HLR shall be the same as for a subscriber only registered as non GPRS and for SMS delivery.
  - If the subscriber is a GPRS subscriber and a non-GPRS subscriber with the option « transfer of SM via the MSC when GPRS is not supported in the GMSC » then the behaviour of the HLR shall be the same as for a subscriber only registered as non GPRS and for SMS delivery.
  - If the subscriber is a GPRS subscriber and a non-GPRS subscriber with the option « transfer of SM via the SGSN when GPRS is not supported in the GMSC » or if the subscriber is a GPRS subscriber only then the behaviour of the HLR shall be the same as for the case transfer over GPRS described in MAP release 97, with the following precision : because GMSC does not support MAP release 97, the previous MAP protocol release is used. When the HLR sends the MAP\_SEND\_ROUTING\_INFO\_FOR\_SM\_Resp, the SGSN number is mapped to the MAP parameter « MSC number ». When the HLR sends the MAP\_INFORM\_SERVICE\_CENTRE\_resp, the MNRG status shall be mapped to the MAP parameter « mnrf-set ».

The HLR may send the MSC, SGSN or both numbers as routing information to SMS-GMSC based on the following:

A) The subscriber may only be registered as non GPRS and for SMS delivery:

- if the short message transfer would contravene the supplementary service barring, the call barred error with cause barring service active is returned;
- if the location registration of the mobile subscriber shows that the VLR in the visited PLMN does not support the MT short message service, the facility not supported error is returned;
- if no MSC identity is stored for the mobile subscriber or the "MSC Area Restricted Flag" is set or the "MS purged for non GPRS" flag is set, i.e. the MS is not reachable, the MSISDN-Alert and the SC address are included in the MWD (if possible), the flag MNRF is set and the "Absent Subscriber\_SM" error is returned with the appropriate absent subscriber diagnostic indication, i.e. 'Deregistered in HLR for non GPRS ', 'Roaming Restricted' or 'MS-Purged for non GPRS '.



The priority parameter (SM\_RP\_PRI) is processed as follows:

- if the priority is low (SM\_RP\_PRI = False) and the mobile station not reachable flag (MNRF) is set, an absent subscriber\_SM error is returned. If a reason for the subscriber's absence for non GPRS is stored in the mobile not reachable reason (MNRR) in the subscriber data, then this is returned with the absent subscriber\_SM error. The SC-address given in the request will be included in the MWD if possible. The service MAP\_INFORM\_SERVICE\_CENTRE including the parameter MW Status is invoked to indicate whether or not the SC address has been included in the MWD list.
- if the priority is low (SM\_RP\_PRI = False), and the MNRF is clear, the routing information with MSC number is retrieved as described below;
- if the priority is high (SM\_RP\_PRI = True) and the MNRF is set, the HLR will send the acknowledge primitive containing the routing information with MSC number to the gateway MSC. In addition the service MAP\_INFORM\_SERVICE\_CENTRE including the parameter MW Status is invoked to indicate whether or not the SC address is already included in the MWD list.

B) The subscriber may only be registered as GPRS and for SMS delivery:

- if the location registration of the mobile subscriber shows that the SGSN in the visited PLMN does not support the MT short message service, the facility not supported error is returned;
- if no SGSN identity is stored for the mobile subscriber or the "SGSN Area Restricted Flag" is set or the "MS purged for GPRS" flag is set, i.e. the MS is not reachable, the MSISDN-Alert and the SC address are included in the MWD (if possible), the flag MNRG is set and the "Absent Subscriber\_SM" error is returned with the appropriate absent subscriber diagnostic indication, i.e. 'Deregistered in HLR for GPRS', 'Roaming Restricted' or 'MS-Purged for GPRS'.

The priority parameter (SM\_RP\_PRI) is processed as follows:

- if the priority is low (SM\_RP\_PRI = False) and the mobile station not reachable for GPRS (MNRG) flag is set, an absent subscriber\_SM error is returned. If a reason for the subscriber's absence for GPRS is stored in the mobile not reachable reason (MNRR) in the subscriber data, then this is returned with the absent subscriber\_SM error. The SC-address given in the request will be included in the MWD if possible. The service MAP\_INFORM\_SERVICE\_CENTRE including the parameter MW Status is invoked to indicate whether or not the SC address has been included in the MWD list.
- if the priority is low (SM\_RP\_PRI = False), and the MNRG is clear, the routing information with SGSN number is retrieved as described below;
- if the priority is high (SM\_RP\_PRI = True) and the MNRG is set, the HLR will send the acknowledge primitive containing the routing information with SGSN number to the gateway MSC. In addition the service MAP\_INFORM\_SERVICE\_CENTRE including the parameter MW Status is invoked to indicate whether or not the SC address is already included in the MWD list.

C) The subscriber may be registered as non GPRS and GPRS and for SMS Delivery:

- if the short message transfer would contravene the supplementary service barring, the behaviour is the same as for a subscriber only registered for GPRS and SMS delivery.
- if the location registration of the mobile subscriber shows that the VLR in the visited PLMN does not support the MT short message service, the behaviour is the same as for a subscriber only registered for GPRS and SMS delivery;
- if the location registration of the mobile subscriber shows that the SGSN in the visited PLMN does not support the MT short message service, the behaviour is the same as for a subscriber only registered for non GPRS and SMS delivery;
- if no MSC and SGSN identities are stored for the mobile subscriber or the "MSC and SGSN Area Restricted Flags" are set or the "MS purged for non GPRS and GPRS" flags are set or a combination of these errors for non GPRS and GPRS are used, i.e. the MS is not reachable, the MSISDN-Alert and the SC address are included in the MWD (if possible), the flags MNRF and MNRG are set and the "Absent Subscriber\_SM" error is returned with the appropriate absent subscriber diagnostic indication, i.e. 'Deregistered in HLR for non GPRS or GPRS', 'Roaming Restricted', 'MS-Purged for non GPRS or GPRS' or both.

The priority parameter (SM\_RP\_PRI) is processed as follows:

- if the priority is low (SM\_RP\_PRI = False), the MNRF and MNRG are set, an absent subscriber\_SM error is returned. If reasons for the subscriber's absence for non GPRS and GPRS are stored in MNRR in the subscriber data, then this is returned with the absent subscriber\_SM error. The SC-address given in the request will be included in the MWD if possible. The service MAP\_INFORM\_SERVICE\_CENTRE including the parameter MW Status is invoked to indicate whether or not the SC address has been included in the MWD list.
- if the priority is low (SM\_RP\_PRI = False), and the MNRF is clear and MNRG is set, the routing information with MSC number is retrieved as described below;
- if the priority is low (SM\_RP\_PRI = False), and the MNRF is set and MNRG is clear, the routing information with SGSN number is retrieved as described below;
- if the priority is low (SM\_RP\_PRI = False), and the MNRF and MNRG are clear, the routing information with MSC and SGSN numbers is retrieved as described below;
- if the priority is high (SM\_RP\_PRI = True) and the MNRF, the MNRG or both are set, the HLR will send the acknowledge primitive containing the routing information with both MSC and SGSN numbers to the gateway MSC. In addition the service MAP\_INFORM\_SERVICE\_CENTRE including the parameter MW Status is invoked to indicate whether or not the SC address is already included in the MWD list.

If the MSISDN-Alert number of the mobile subscriber stored in the MWD is not the same as that received in the MAP\_SEND\_ROUTING\_INFO\_FOR\_SM indication, the HLR will include in the MAP\_INFORM\_SERVICE\_CENTRE request to the GMSC the MSISDN-Alert number stored.

The MAP\_INFORM\_SERVICE\_CENTRE request is sent also when the MCEF, MNRF, MNRG or both are set but the routing information is still sent to the GMSC. The status of the flags is indicated in the parameter MW Status.

The routing information is included in a MAP\_SEND\_ROUTING\_INFO\_FOR\_SM response as follows:

- the IMSI will be returned to the GMSC together with the MSC, SGSN or both numbers and may be optionally accompanied by the LMSI.
- an indication specifying which number belongs the MSC and the SGSN will be returned to the GSMC.

LMSI shall not be used in case only the SGSN number is sent by HLR.

The mobile terminated short message transfer procedure in the HLR is shown in figure 23.3/6.

Process Mobile\_terminated\_SM\_HLR

23.3\_6.1(5)

Figure 23.3/6: The mobile terminated short message service process in the HLR in case the subscriber is registered as non-GPRS and/or GPRS

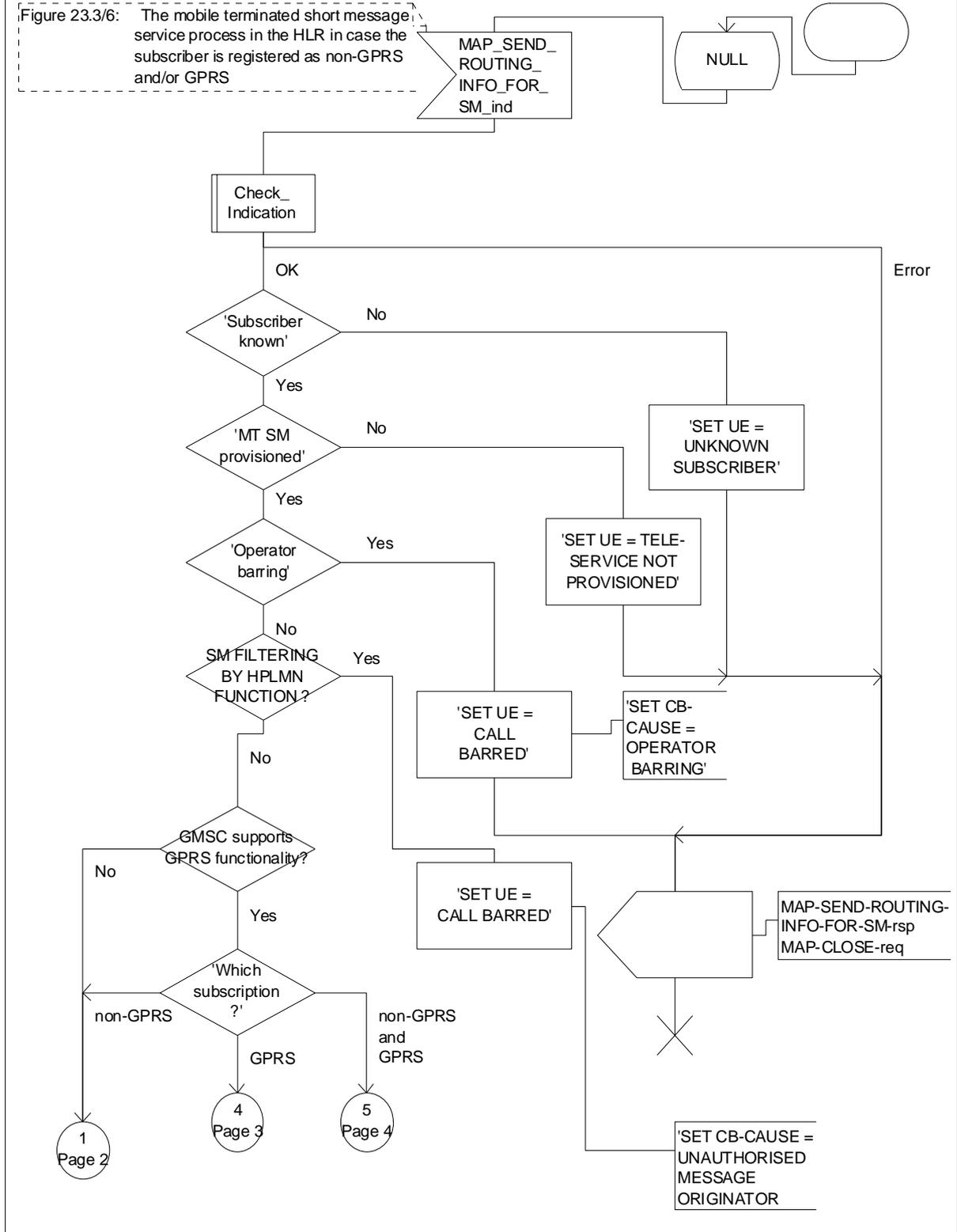

Figure 23.3/6 (sheet 1 of 5): Process Mobile\_terminated\_SM\_HLR



Process Mobile\_terminated\_SM\_HLR

23.3\_6.3(5)

Figure 23.3/6: The mobile terminated short message service process in the HLR in case the subscriber is registered as non-GPRS and/or GPRS

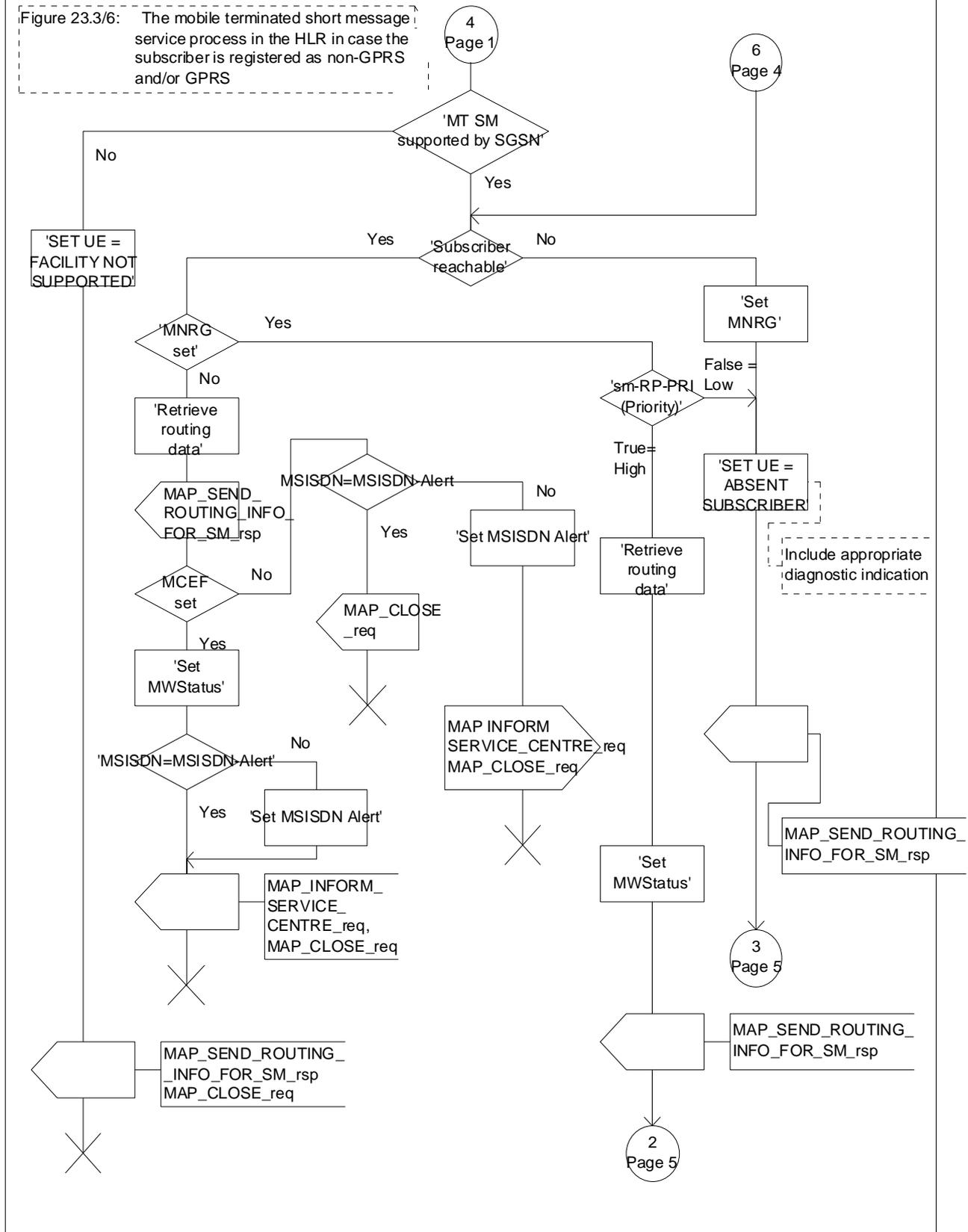

Figure 23.3/6 (sheet 3 of 5): Process Mobile\_terminated\_SM\_HLR

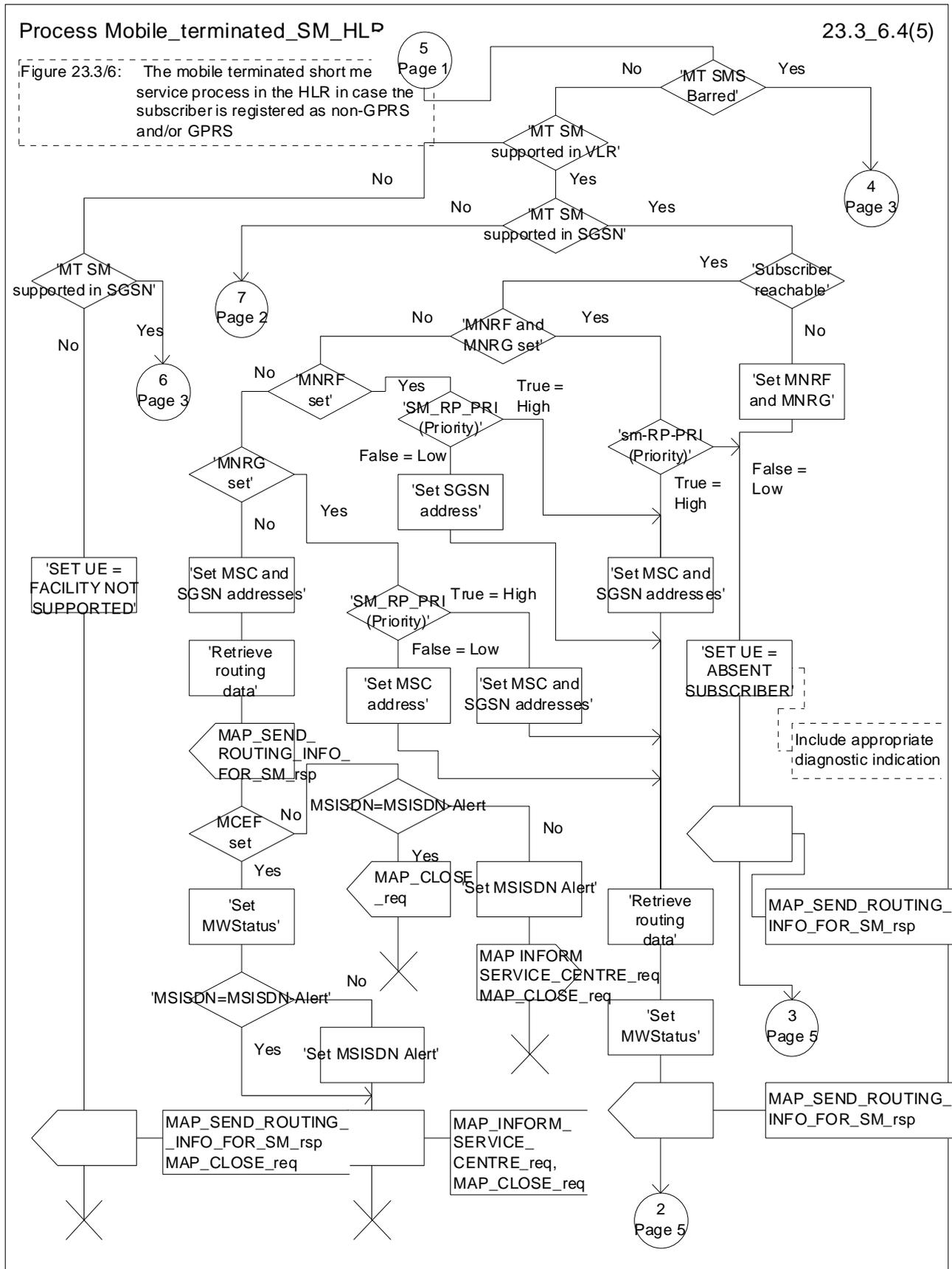

Figure 23.3/6 (sheet 4 of 5): Process Mobile\_terminated\_SM\_HLR

Process Mobile\_terminated\_SM\_HLR

23.3\_6.5(5)

Figure 23.3/6: The mobile terminated short message service process in the HLR in case the subscriber is registered as non-GPRS and/or GPRS

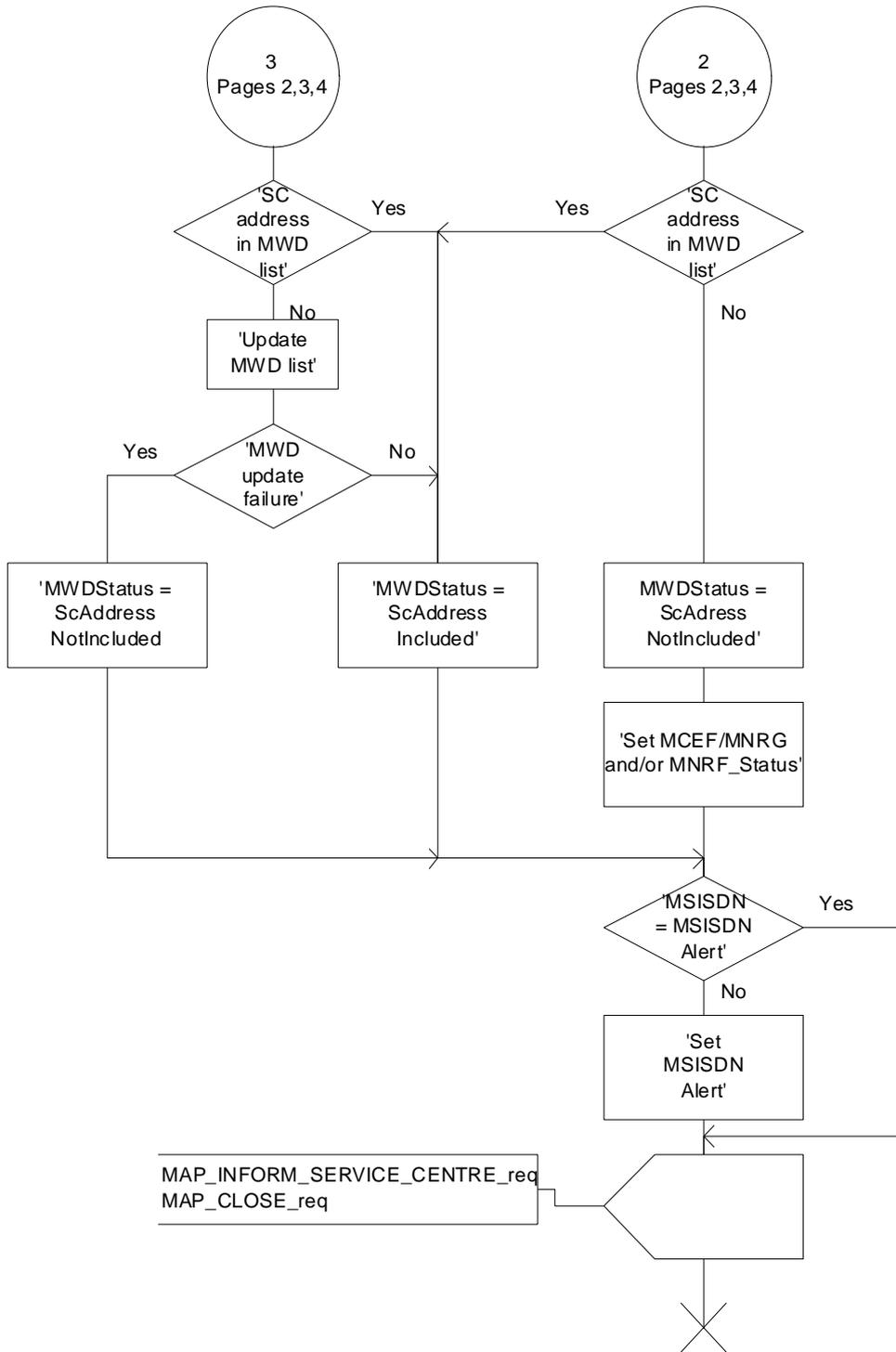

Figure 23.3/6 (sheet 5 of 5): Process Mobile\_terminated\_SM\_HLR

Procedure Select\_Transfer\_Nodes

23.3\_11(1)

Figure 23.3/11: Procedure in the HLR to select the node (MSC or/and SGSN) to which the SMS-GMSC has to send Short Message

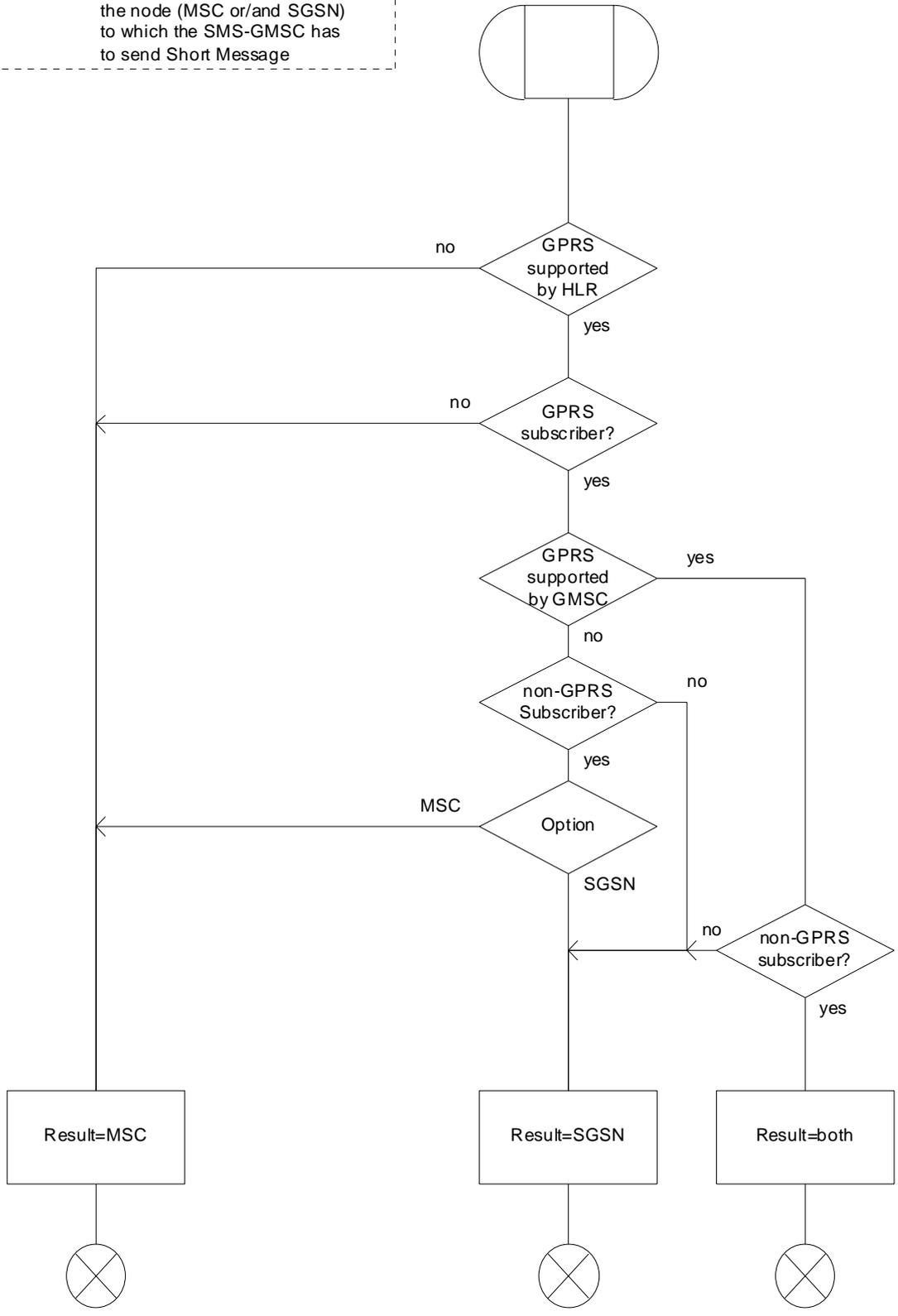

Figure 23.3/11: Procedure Select\_Transfer\_Nodes



### 23.3.4 Procedures in the gateway MSC

The short message handling function of the GMSC will request routing information when a mobile terminated short message is received from a Service Centre. The GMSC sends the MAP\_SEND\_ROUTING\_INFO\_FOR\_SM request to the HLR containing the subscriber data of the mobile subscriber and the indication that the SMS-GMSC supports the GPRS functionality.

As an outcome of the procedure the MAP\_SEND\_ROUTING\_INFO\_FOR\_SM confirmation is received indicating:

- an unsuccessful event indication containing an error;

The mapping between the MAP error causes and the RP\_ERROR causes is explained in TS GSM 03.40.

- a successful event indication containing following parameters:

- an IMSI optionally accompanied by an LMSI; and
- routing addresses (servicing MSC, SGSN or both numbers).

The LMSI shall not be used in case the short message is routed towards the SGSN.

The GMSC may also receive a MAP\_INFORM\_SERVICE\_CENTRE indication after the MAP\_SEND\_ROUTING\_INFO\_FOR\_SM confirmation. The parameter MW Status in the message indicates whether or not the Service Centre address is stored in the Message Waiting Data. It also indicates the status of the MCEF, MNR and MNRG flags in the HLR.

If the MSISDN-Alert stored in the MWD data is not the same as the one sent to the HLR, the MSISDN-Alert is received in the MAP\_INFORM\_SERVICE\_CENTRE indication. This MSISDN number shall be transferred in a delivery failure report to the SC.

In the abnormal end or in the provider error case the system failure error is provided to the SC.

The forward short message procedure is initiated when the GMSC has obtained the routing information needed to forward a mobile terminated short message to the servicing MSC or SGSN.

If both numbers MSC and SGSN are received from HLR as routing information, the SMS-GMSC may choose which path (SGSN or MSC) first the SMS is to be transferred.

If an LMSI has been provided in the MAP\_SEND\_ROUTING\_INFO\_FOR\_SM confirmation, it can be included in the sm-RP-DA information field of the first MAP\_MT\_FORWARD\_SHORT\_MESSAGE request sent to the servicing MSC. In this case, the IMSI must be included in the Destination Reference of the MAP\_OPEN request. If the LMSI is not sent by the SMS Gateway MSC, the sm-RP-DA information field in the first MAP\_MT\_FORWARD\_SHORT\_MESSAGE request sent to the servicing MSC or SGSN shall contain the IMSI and the Destination Reference in the MAP\_OPEN request shall not be present. The Service Centre address is sent in the parameter SM\_RP\_OA. The More Messages To Send flag is set to TRUE or FALSE depending on the information received from the Service Centre.

If the GMSC is the servicing MSC then the MAP service is not initiated. The procedure in the Servicing MSC is described in clause 23.3.1 and in the figure 23.3/4.

If the grouping of MAP\_OPEN request and MAP\_MT\_FORWARD\_SHORT\_MESSAGE request together would need segmenting, these primitives must not be grouped together. The MAP\_OPEN request primitive is sent first without any associated MAP service request primitive and the dialogue confirmation must be received before the MAP\_MT\_FORWARD\_SHORT\_MESSAGE request is sent.

As a response to the procedure, the GMSC will receive the MAP\_MT\_FORWARD\_SHORT\_MESSAGE confirmation indicating:

- a successful forwarding of the short message. This indication is passed to the SC;
- unsuccessful forwarding of the short message:

In case only one number (MSC or SGSN) was received from HLR as routing information, the mapping of the MAP error causes and the RP\_ERROR causes is explained in TS GSM 03.40. The appropriate error indication is sent to the SC.

In case both numbers (MSC and SGSN) were received from HLR as routing information, the transfer of SMS is re-attempted towards the second path only when one of the following errors is received from the unsuccessful transfer over the first path:

Facility Not Supported

Unidentified Subscriber

Absent Subscriber with indication: GPRS or IMSI Detach

Unexpected Data Value

System failure

Data Missing

Subscriber Busy for MT SMS: GPRS Connection Suspended,

otherwise, the mapping of the MAP error causes and the RP\_ERROR causes is performed (see TS GSM 03.40) and the appropriate error indication is sent to the SC.

If second forwarding of short message is unsuccessful, the mapping of the MAP error causes and the RP\_ERROR causes is explained in TS GSM 03.40. The appropriate error indications are sent to the SC.

If second forwarding of short message is successful, the successful indication is passed to the SC.

A provider error is indicated as a system failure error to the SC.

The GMSC invokes the procedure MAP\_REPORT\_SM\_DELIVERY\_STATUS, if an absent subscriber\_SM, an unidentified subscriber or SM delivery failure with error cause MS memory capacity exceeded indication is received from the servicing MSC, SGSN or both, and the corresponding flags received in the MAP\_INFORM\_SC are not already set or the SC address is not yet included in the MWD set.

If absent subscriber diagnostic information (see GSM 03.40) is included with the absent subscriber\_SM error indication then this information is relayed to the HLR using the procedure MAP\_REPORT\_SM\_DELIVERY\_STATUS.

In case the SMS was attempted to be delivered towards the MSC and the SGSN, and both delivery failed with causes described above, the two unsuccessful SMS delivery outcomes for GPRS and non GPRS are sent to the HLR.

In case the SMS was attempted to be delivered towards the MSC and the SGSN, and the first delivery failed with causes described above and the second delivery succeeded, the unsuccessful and successful SMS delivery outcomes for GPRS and non GPRS are sent to HLR.

The gateway MSC may also invoke the procedure when the first SMS delivery was successful towards MSC, if the MNRF, MCEF flags or both were set in the HLR.

The gateway MSC may also invoke the procedure when the first SMS delivery was successful towards SGSN, if the MNRG, MCEF flags or both were set in the HLR.

This procedure is described in detail in clause 23.5.

Unexpected data value, system failure errors are indicated as a system failure to the SC. Other errors are indicated using appropriate cause values and diagnostic information between the GMSC and the SC as described in TS GSM 03.40 and GSM 04.11.

The unidentified subscriber error is indicated to the SC as absent subscriber with diagnostic information set to 'Unidentified subscriber' as described in TS GSM 03.40.

Note that the indication, on which number belongs the SGSN and MSC, received from the HLR at routing information result (see clause 23.3.3) will enable the GMSC to map the causes received from the SGSN, MSC or both into the appropriate causes for non GPRS, GPRS or both, and send them to the SC and HLR.

If there are more short messages to send in the Service Centre and the previous short message transfer succeeded, then the gateway MSC awaits the next short message.

When receiving the next short message from the SC, the gateway MSC sets the More Messages To Send flag according to the information received and starts the service MAP\_MT\_FORWARD\_SHORT\_MESSAGE again.

If the gateway MSC is the servicing MSC, then the short message transfer to mobile subscriber is started as described in the clause 23.3.1.

The mobile terminated short message transfer procedure in the gateway MSC is shown in figure 23.3/7.

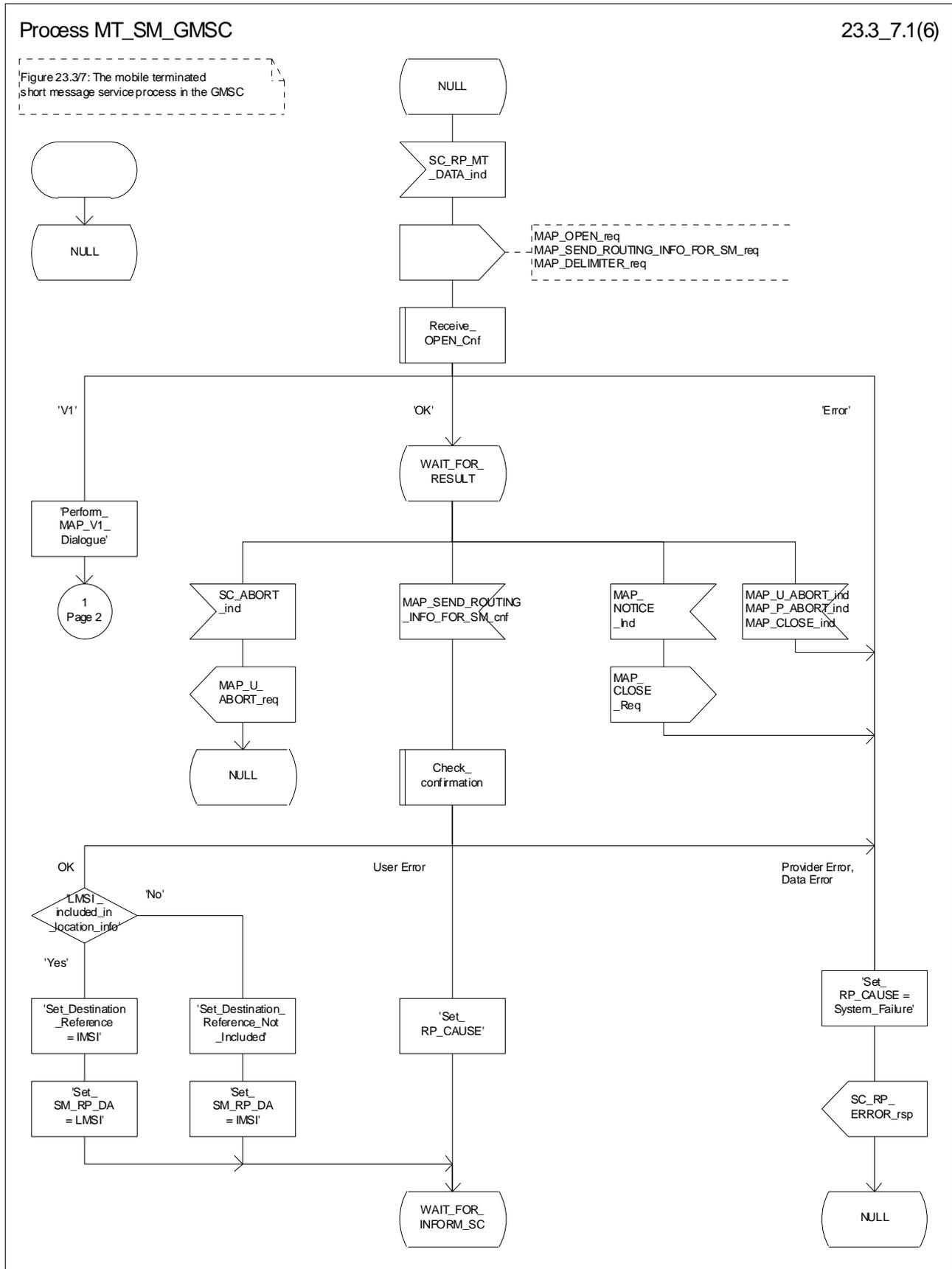

Figure 23.3/7 (sheet 1 of 6): Procedure MT\_SM\_GMSC



Process MT\_SM\_GMSC

23.3\_7.3(6)

Figure 23.37: The mobile terminated short message service process in the GMSC

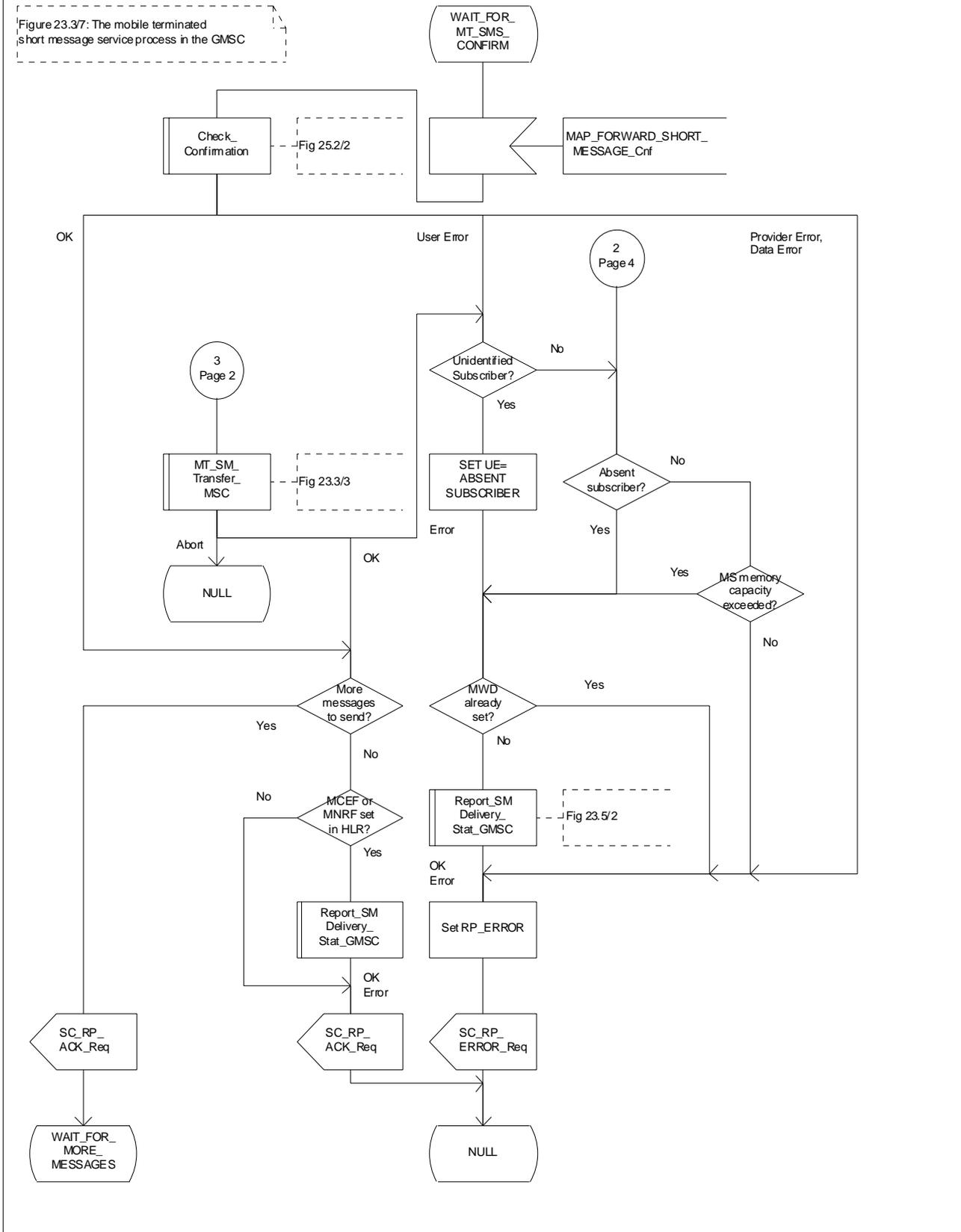

Figure 23.3/7 (sheet 3 of 6): Procedure MT\_SM\_GMSC

Process MT\_SM\_GMSC

23.3\_7.4(6)

Figure 23.3/7: The mobile terminated short message service process in the GMSC

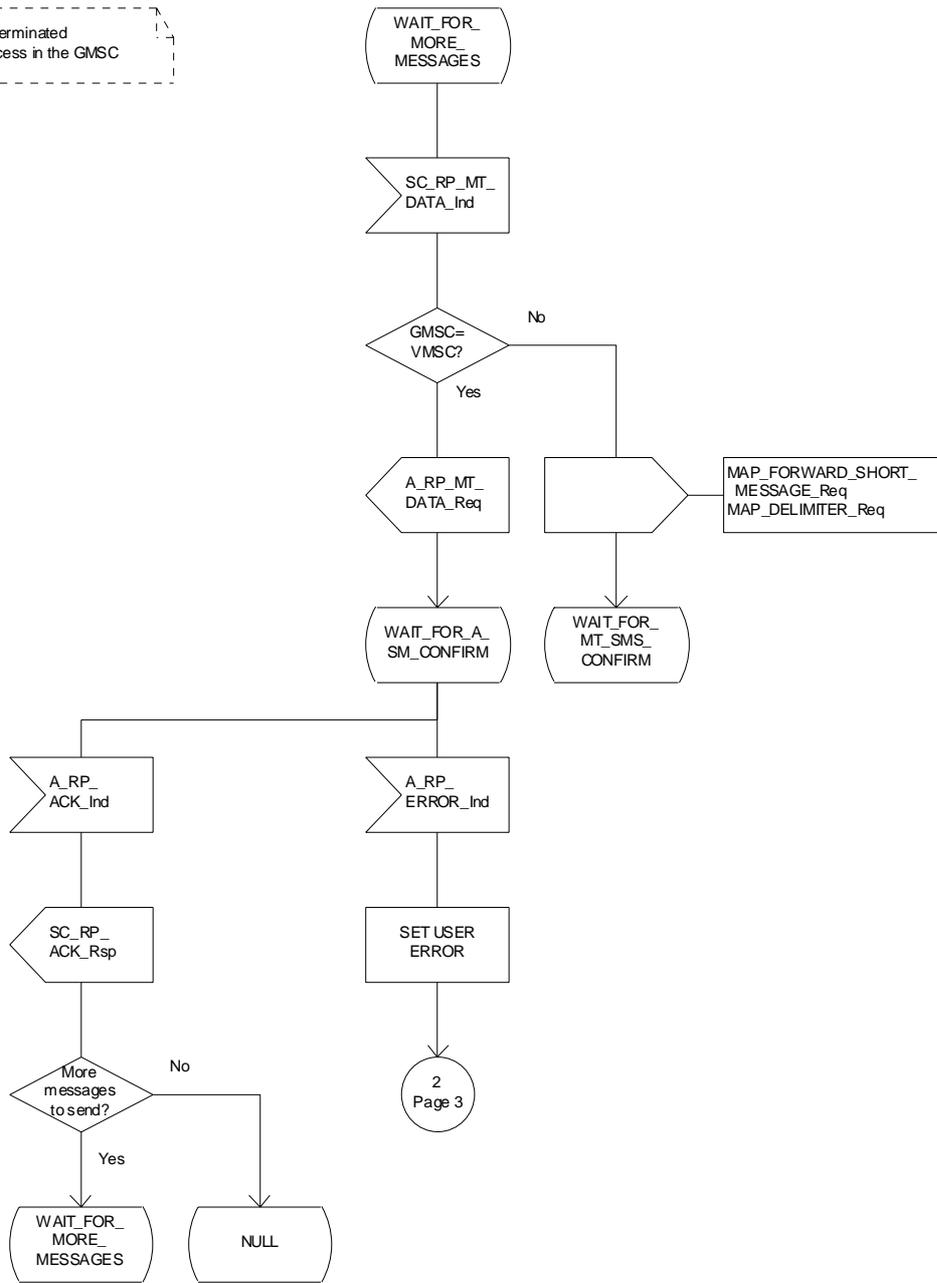

Figure 23.3/7 (sheet 4 of 6): Procedure\_MT\_SM\_GMSC

Process MT\_SM\_GMSC

23.3\_7.5(6)

Figure 23.3/7: The mobile terminated short message service process in the GMSC

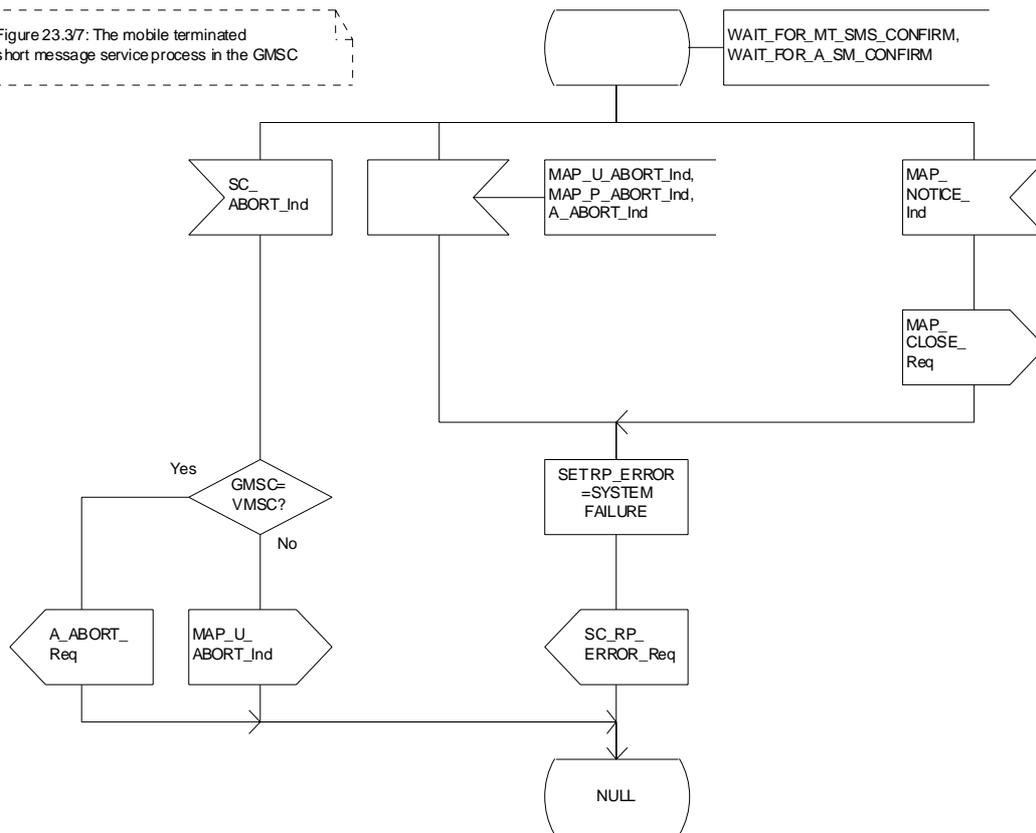

Figure 23.3/7 (sheet 5 to 6): Procedure MT\_SM\_GMSC



Process MT\_SM\_GMSC

23.3\_7.6(6)

Figure 23.37: The mobile terminated short message service process in the GMSC

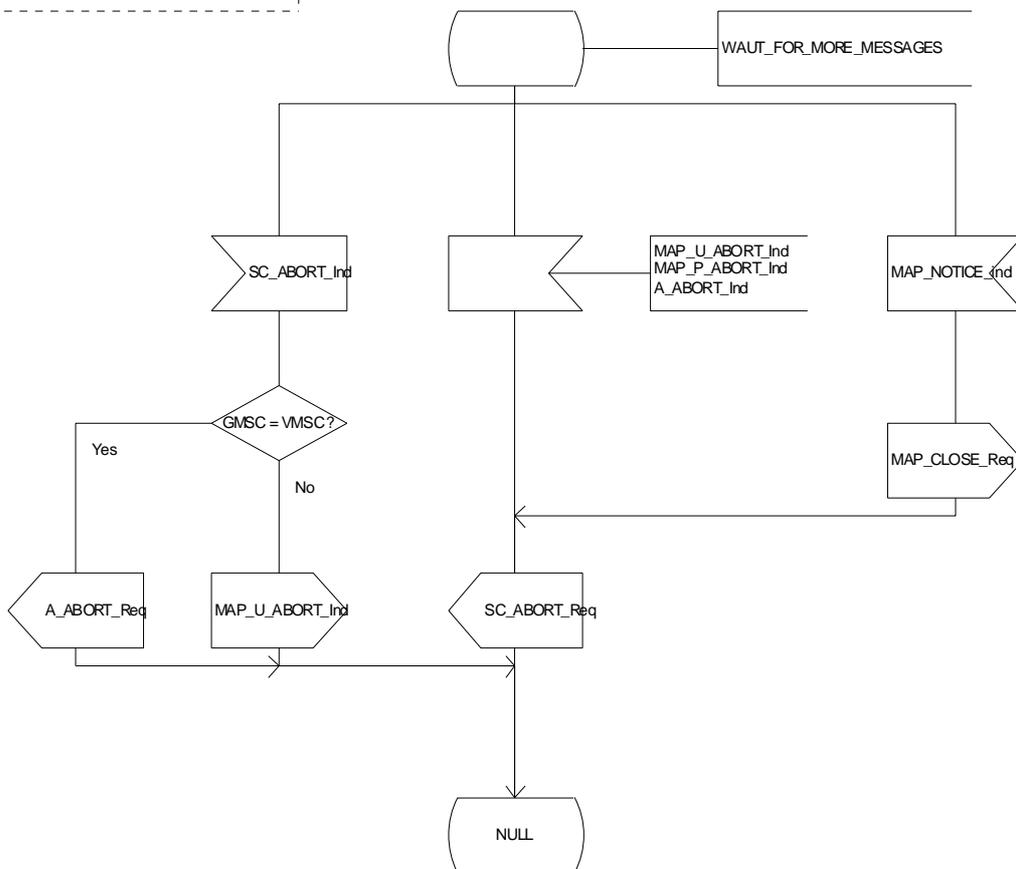

Figure 23.3/7 (sheet 6 of 6): Procedure MT\_SM\_GMSC

Macrodefinition Check\_Subscr\_Identity\_For\_MT\_SMS

23.3\_8(1)

Figure 23.3/8: Check of the subscriber identity for a mobile terminated short message in the servicing MSC and in the VLR

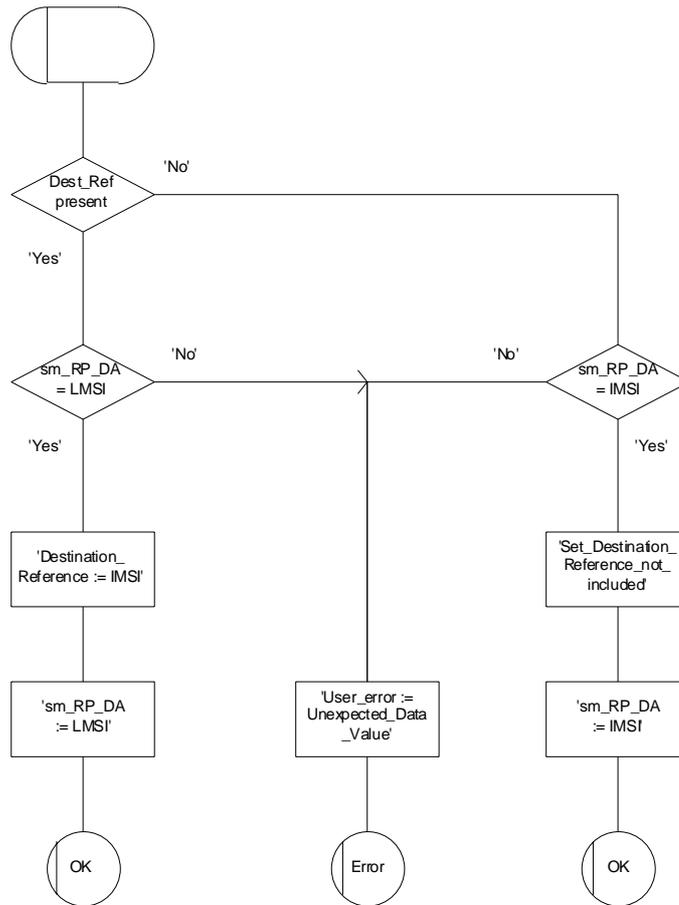

Figure 23.3/8: Macro Check\_Subscr\_Identity\_For\_MT\_SMS

### 23.3.5 Procedure in the Servicing SGSN

When initiating the dialogue with the servicing SGSN, the SMS Gateway MSC must provide the IMSI of the subscriber to whom the short message is directed.

The IMSI is included in the sm-RP-DA information field of the MAP\_MT\_FORWARD\_SHORT\_MESSAGE indication.

When receiving a MAP\_OPEN indication primitive that is not associated with any MAP service indication primitive and if the dialogue is accepted, the MAP service-user in the servicing SGSN issues a MAP\_DELIMITER request primitive in order to trigger the local MAP service-provider to confirm the dialogue.

When receiving the first MAP\_MT\_FORWARD\_SHORT\_MESSAGE indication from the gateway MSC, the servicing SGSN performs some subscriber data checks, if the MAP service primitive is accepted and if short message service is supported in the servicing SGSN.

The MAP\_MT\_FORWARD\_SHORT\_MESSAGE indication primitive is checked by the macro "Check\_Indication". If the received MAP service primitive contains errors, the service is aborted and an unexpected data value error or data missing error is returned to the GMSC.

If the SGSN does not support the short message service, the service is aborted in the servicing SGSN and the error "Facility Not Supported" is returned to the GMSC.

If the connection is GPRS suspended, the SGSN sends to the GMSC an error specifying that the GPRS connection is suspended.

The subscriber identity information that are included in the MAP service indication primitive is checked by the macro "Check\_Subscr\_Identity\_For\_MT\_SMS" as follows:

If the IMSI is included in the sm-RP-DA information field of the MAP\_MT\_FORWARD\_SHORT\_MESSAGE indication, the MAP\_OPEN indication received from the gateway MSC shall not include a Destination Reference.

If no Destination Reference has been received and the sm-RP-DA information field does not cover an IMSI the service is aborted in the servicing SGSN and the error "Unexpected Data Value" is returned to the GMSC.

The following outcomes from the subscriber data checks can occur in SGSN:

- if the mobile subscriber is unknown, the unidentified subscriber error is forwarded to the GMSC;
- if the "Confirmed by HLR" indicator is set to "Not Confirmed", the unidentified subscriber error is forwarded to the GMSC.
- if the GPRS Detached Flag is set to detached or the LA Not Allowed Flag is set to not allowed in the SGSN, an absent subscriber error with the diagnostic indication set to 'GPRS Detached' is forwarded to the GMSC and the MS not reachable for GPRS (MNRG) flag is set;
- If the location area identification is known and the "Confirmed by Radio Contact" indicator is set to "Confirmed", the paging procedure is invoked (see clause 25.3). Otherwise the search procedure is invoked (see clause 25.3).

The result of the paging or the search procedure is processed as follows:

- if the procedure is completed successfully, the SGSN may trigger the Authentication, Ciphering and IMEI check procedures (see clauses 25.4 and 25.5). Then, if the procedure are completed successfully, the SGSN will send the short message to the MS;
- if the procedure is completed successfully, but the MS has no mobile terminated short message transfer capability, the SM delivery failure indication with cause "equipment not SM equipped" is provided to the GMSC;
- if the procedure is ended unsuccessfully because of subscriber already busy for SMS, another paging, emergency call, location updating, inter SGSN routing area update or a call set-up, the subscriber busy for MT SMS is provided to the GMSC.
- if the procedure is ended unsuccessfully, the absent subscriber\_SM error is forwarded to the GMSC with the absent subscriber diagnostic indication set to 'No Paging Response for GPRS', but if the location area is unknown, the system failure indication is provided to the GMSC.

If forwarding of the short message is initiated, the SGSN awaits the result before one of the following responses is sent back to the GMSC:

- an acknowledge if the short message has been successfully delivered to the mobile subscriber;
- an SM delivery failure error containing a parameter indicating either of the following: there is a MS protocol error or the MS memory capacity is exceeded; detailed diagnostic information (see clause 7.6.1.4) may also be carried;
- a system failure error if the delivery procedure is aborted.

If the More Messages To Send flag was FALSE or the service MAP\_MT\_FORWARD\_SHORT\_MESSAGE ends unsuccessfully, the transaction to the gateway MSC is terminated. Otherwise, the servicing SGSN waits for the next short message from the Service Centre.

When receiving the next MAP\_MT\_FORWARD\_SHORT\_MESSAGE indication from the gateway MSC the servicing MSC will act as follows:

- if the received primitive contains errors, the unexpected data value error or data missing error is provided to the gateway MSC;
- if the More Messages To Send flag is FALSE, the servicing SGSN will start the short message transfer procedure to the mobile subscriber. The successful or unsuccessful outcome of this procedure is reported to the gateway MSC and the transaction is terminated.
- if the More Messages To Send flag is TRUE, the servicing SGSN will start the short message transfer to the mobile subscriber. If the outcome of this procedure is unsuccessful, the reason is reported to the gateway MSC and the procedure is terminated. If the procedure is successful, it is acknowledged to the gateway MSC and more short messages can be received.

The mobile terminated short message transfer procedure in the servicing SGSN is shown in figures 23.3/9 and 23.3/10. The page and search procedures are shown in figure 25.3/1 and 25.3/2.

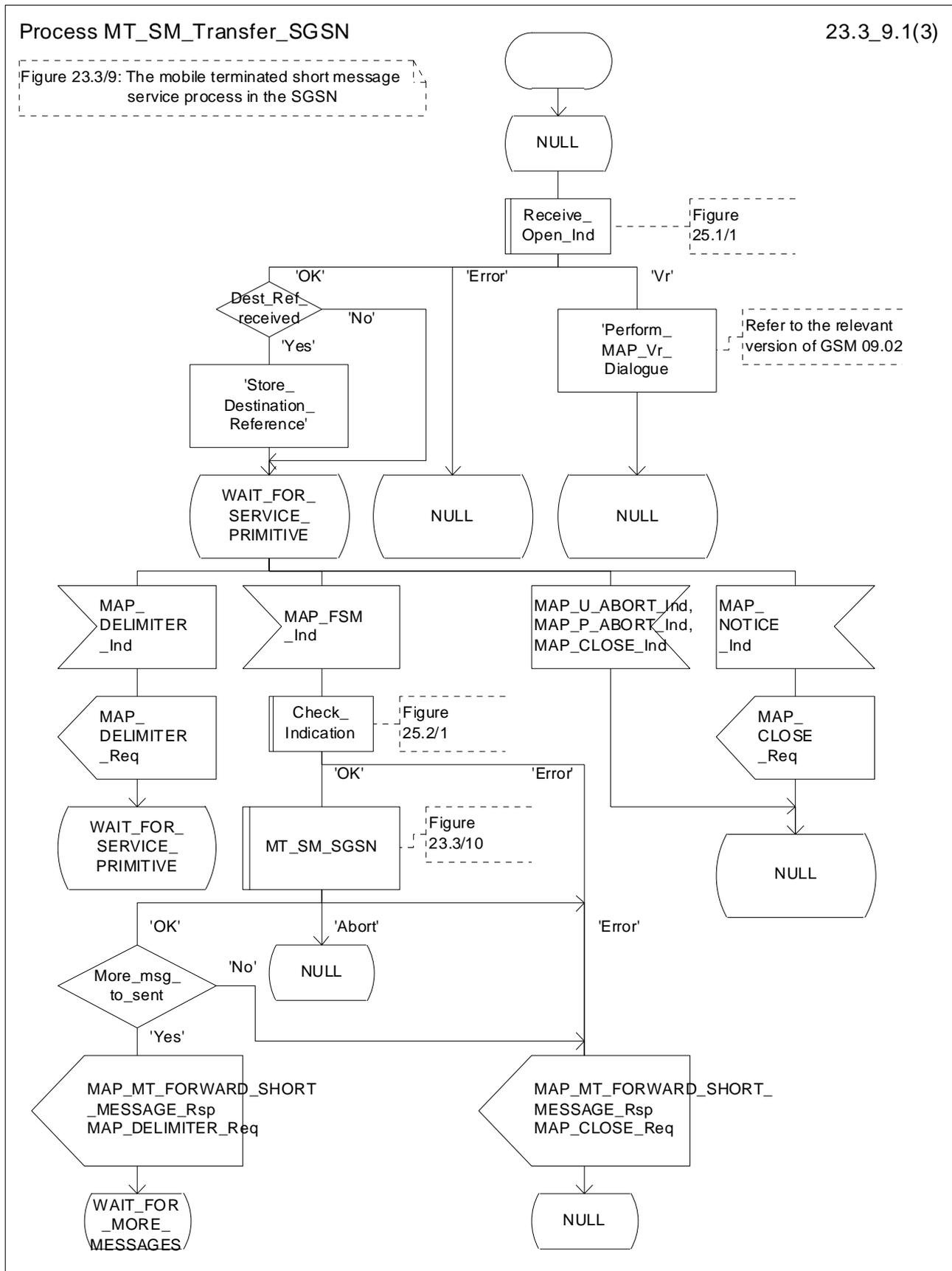

Figure 23.3/9 (sheet 1 of 3): Procedure MT\_SM\_Transfer\_SGSN

Process MT\_SM\_Transfer\_SGSN

23.3\_9.2(3)

Figure 23.3/9: The mobile terminated short message service process in the SGSN

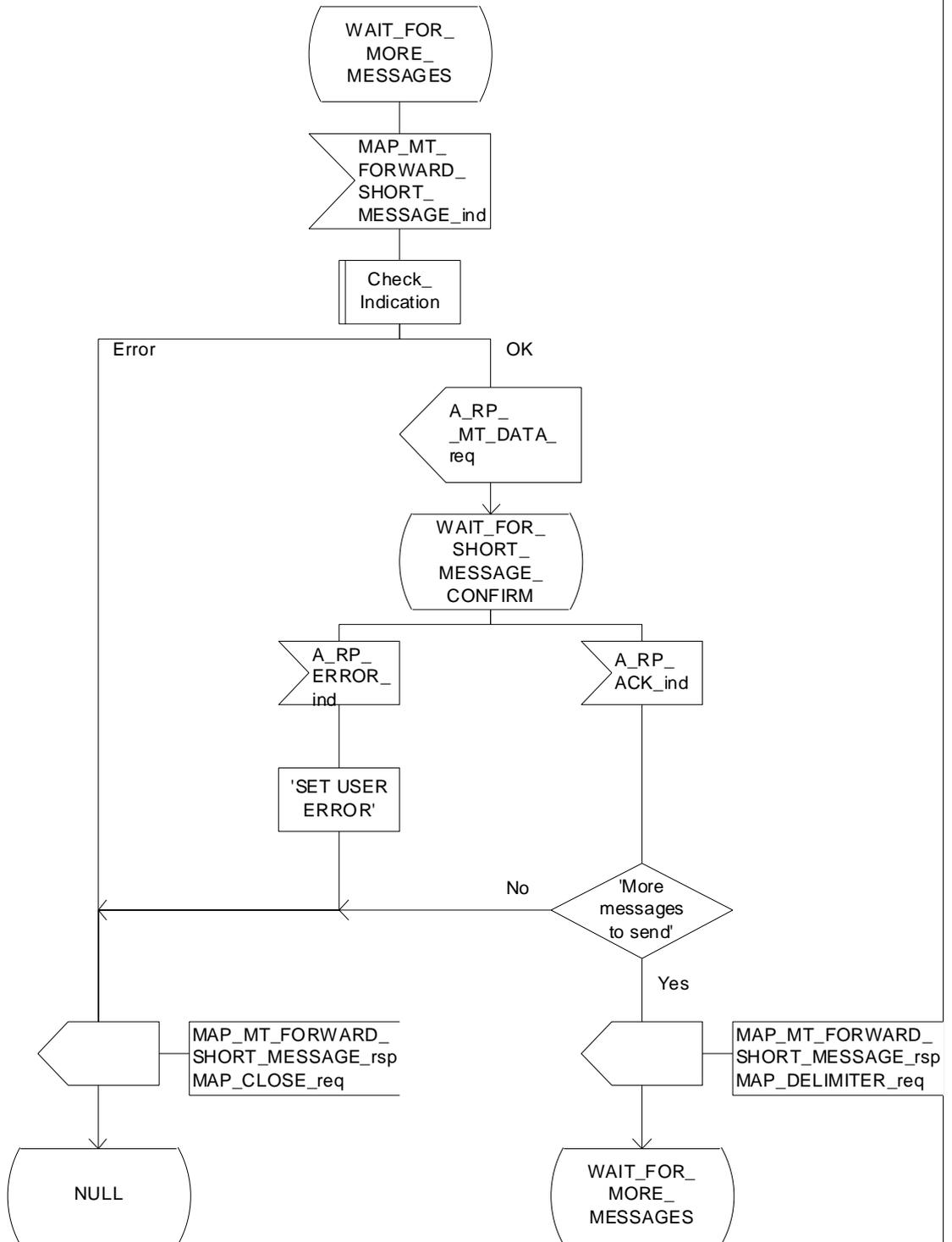

Figure 23.3/9 (sheet 2 of 3): Procedure MT\_SM\_Transfer\_SGSN

Process MT\_SM\_Transfer\_SGSN

23.3\_9.3(3)

Figure 23.3/9: The mobile terminated short message service process in the SGSN

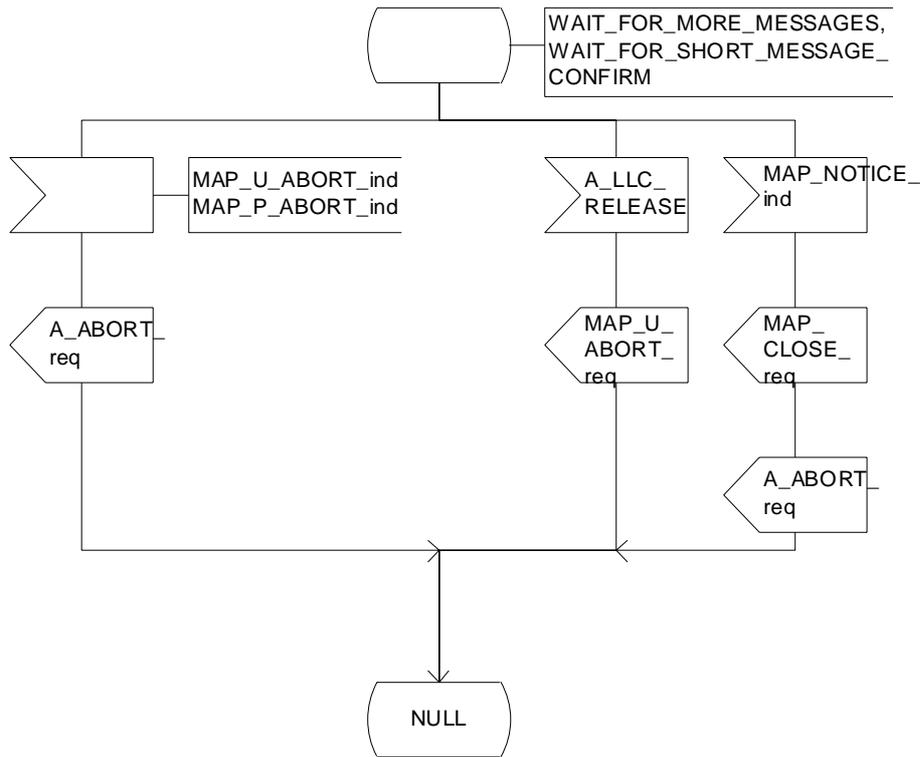

Figure 23.3/9 (sheet 3 of 3): Procedure MT\_SM\_Transfer\_SGSN

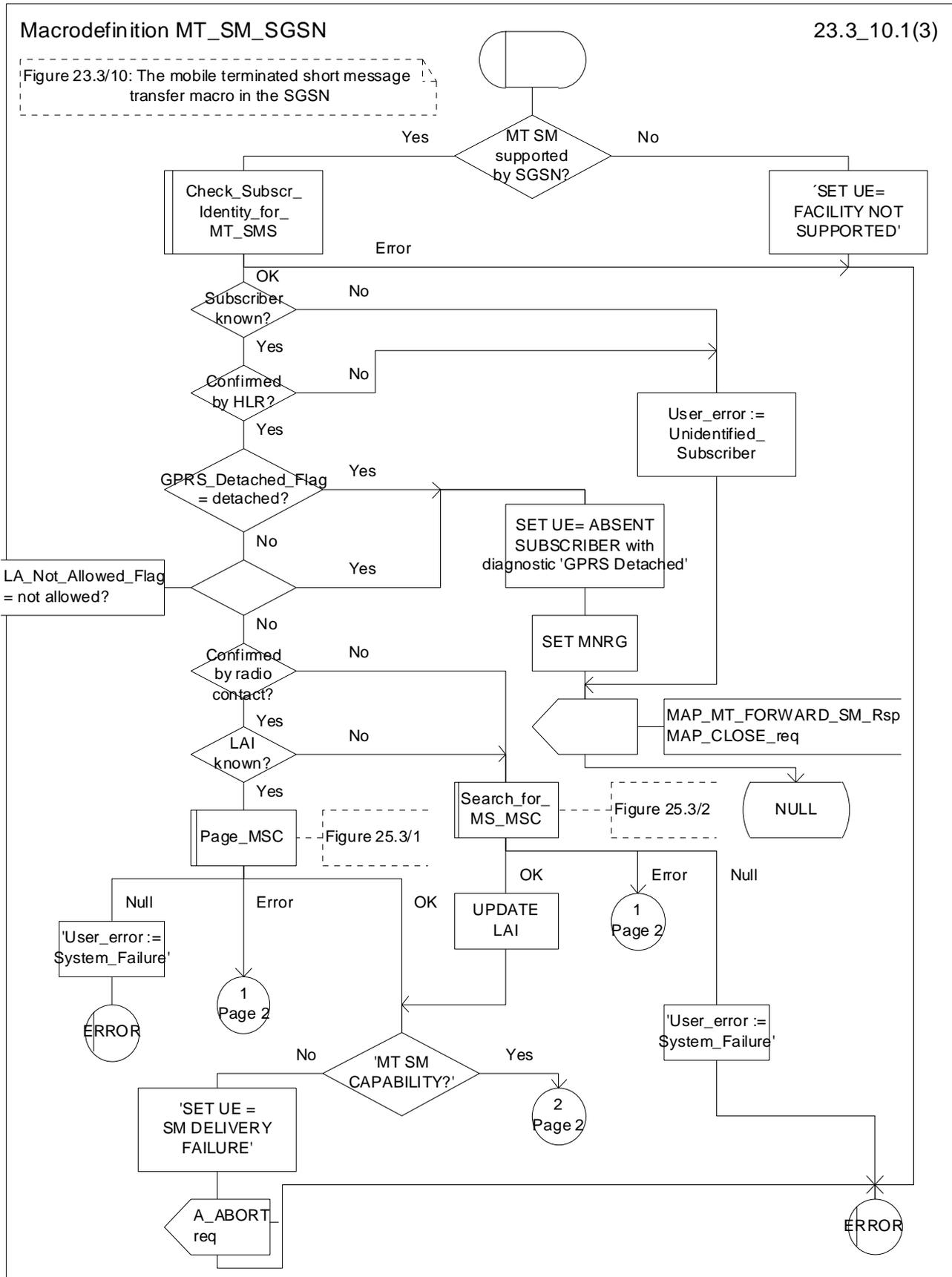

Figure 23.3/10 (sheet 1 of 3): Macro MT\_SM\_SGSN



Macrodefinition MT\_SM\_SGSN

23.3\_10.2(3)

Figure 23.3/10: The mobile terminated short message transfer macro in the SGSN

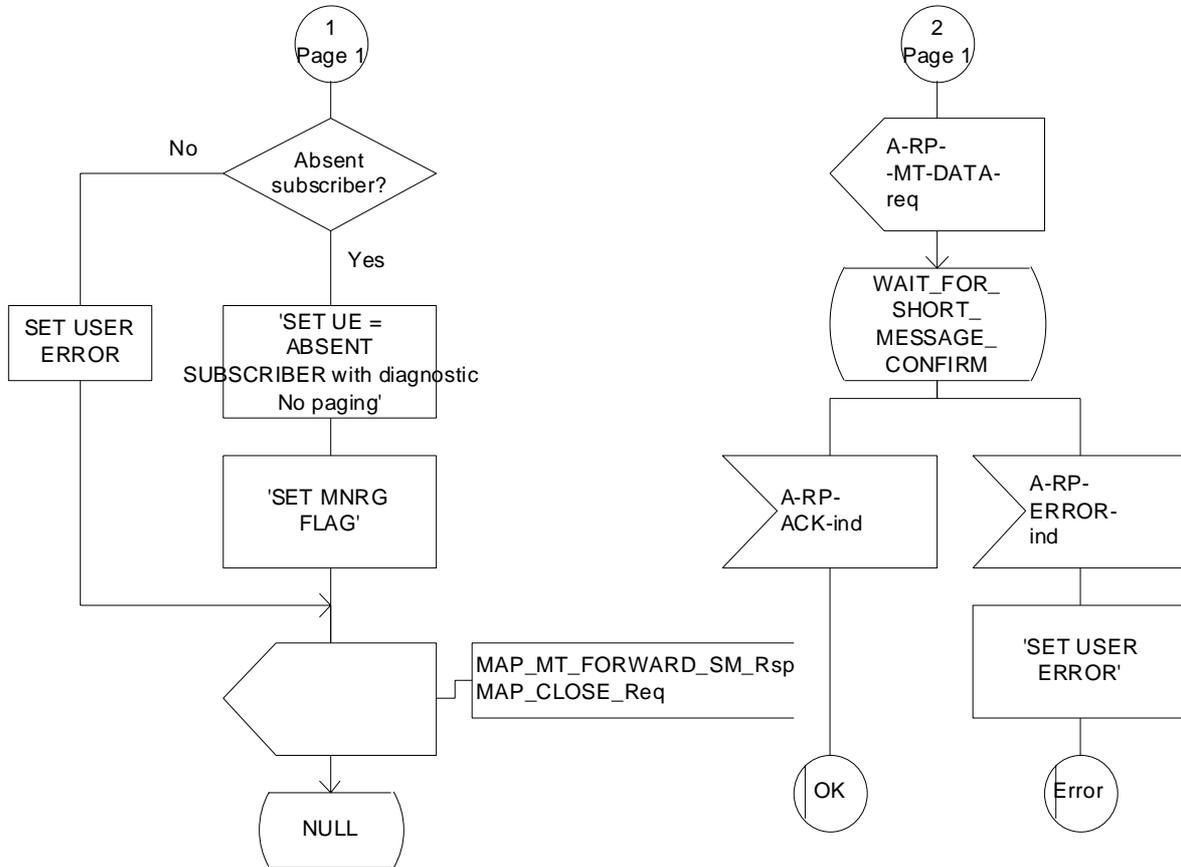

Figure 23.3/10 (sheet 2 of 3): Macro MT\_SM\_SGSN

Macrodefinition MT\_SM\_SGSN

23.3\_10.3(3)

Figure 23.3/10: The mobile terminated short message transfer macro in the SGSN

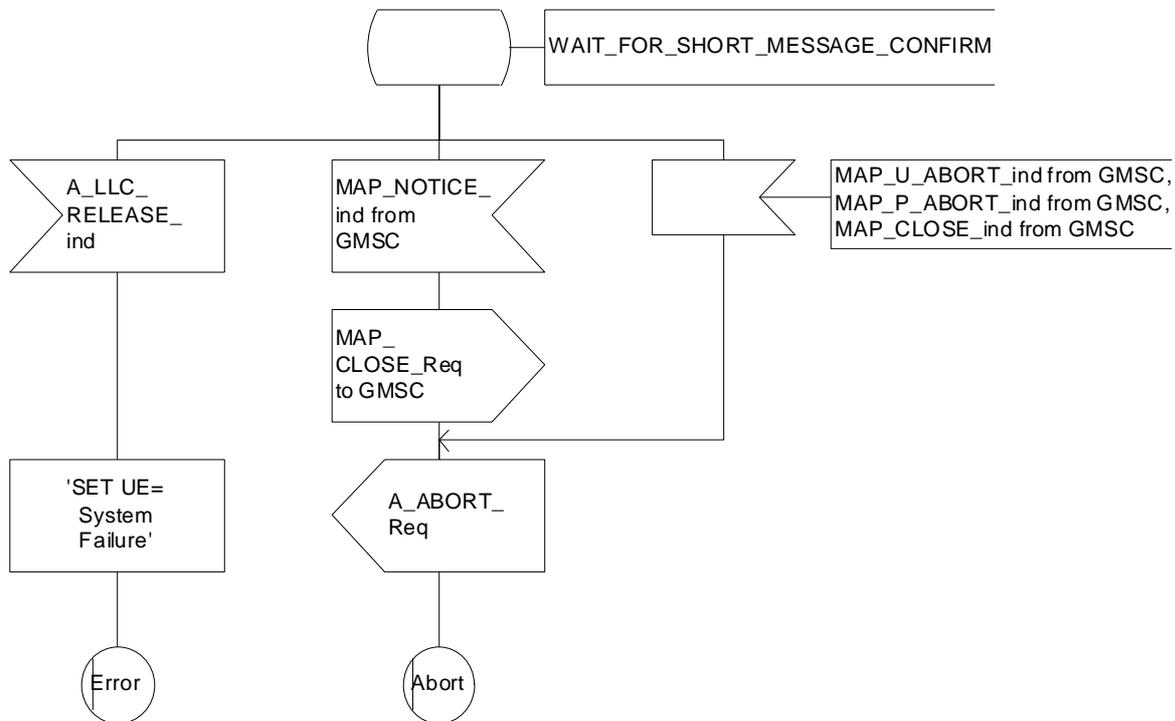
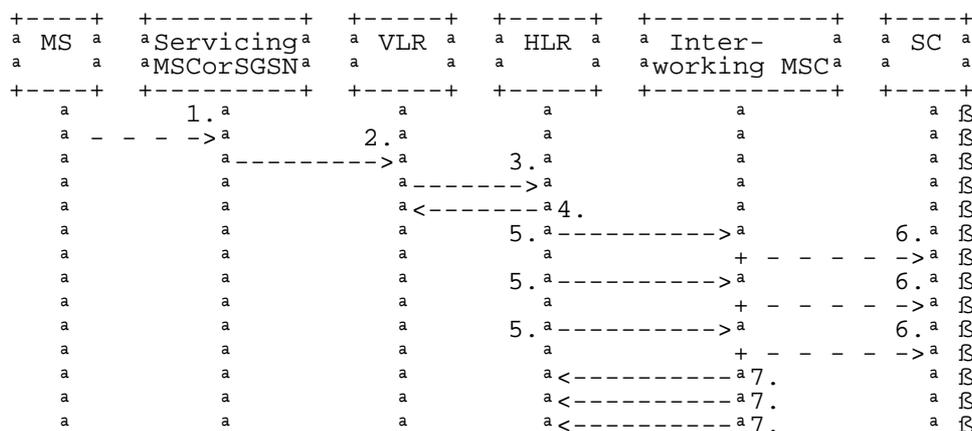

Figure 23.3/10 (sheet 3 of 3): Macro MT\_SM\_SGSN

## 23.4 The Short Message Alert procedure

The Short Message Alert procedure is used for alerting the Service Centre when the mobile subscriber is active after a short message transfer has failed because the mobile subscriber is not reachable or when the MS has indicated that it has memory capacity to accept a short message.

The Short Message Alert procedure for the case when the mobile subscriber was not reachable is shown in figure 23.4/1.



- 1) CM Service Request (\*\*), Page response or Location Updating (GSM 04.08)
- 2) MAP\_PROCESS\_ACCESS\_REQUEST / MAP\_UPDATE\_LOCATION\_AREA (\*\*),
- 3) MAP\_READY\_FOR\_SM (Mobile Present) / MAP\_UPDATE\_LOCATION / Supplementary Service Control Request (\*)
- 4) MAP\_READY\_FOR\_SM\_ACK (\*)
- 5) MAP\_ALERT\_SERVICE\_CENTRE (notes 1 and 2)
- 6) Alert Service Centre (GSM 03.40)
- 7) MAP\_ALERT\_SERVICE\_CENTRE\_ACK

NOTE 1: To all Service Centres in the Message Waiting List.

NOTE 2: The HLR initiates the MAP\_ALERT\_SERVICE\_CENTRE service only if the MS Memory Capacity Exceeded flag is clear.

(\*) In case of GPRS, messages 3) and 4) are sent/received by SGSN

(\*\*) Those messages are not used by SGSN

**Figure 23.4/1: Short message alert procedure (Mobile is present)**

The Short Message Alert procedure for the case where the MS indicates that it has memory capacity to accept one or more short messages is shown in figure 23.4/2.

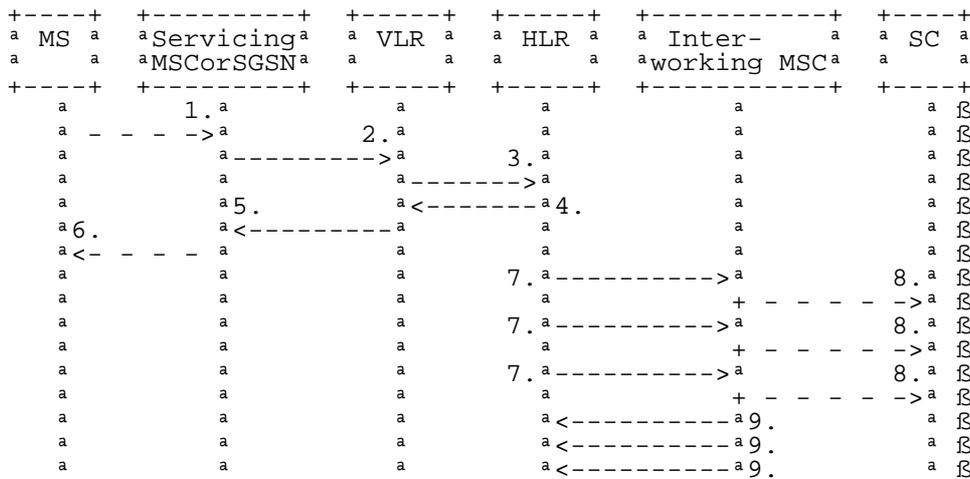

- 1) SM memory capacity available ( GSM 04.11)
- 2) MAP\_READY\_FOR\_SM (Memory Available) (\*)
- 3) MAP\_READY\_FOR\_SM (Memory Available) (\*\*)
- 4) MAP\_READY\_FOR\_SM\_ACK (\*\*)
- 5) MAP\_READY\_FOR\_SM\_ACK (\*)
- 6) SM memory capacity available (Acknowledge) ( GSM 04.11)
- 7) MAP\_ALERT\_SERVICE\_CENTRE (note 1)
- 8) Alert Service Centre (GSM 03.40)
- 9) MAP\_ALERT\_SERVICE\_CENTRE\_ACK

NOTE: To all Service Centres in the Message Waiting List.

- (\*) Message 2) and 5) are not used by SGSN
- (\*\*) In the case of GPRS messages 3) and 4) are sent/received by SGSN

**Figure 23.4/2: Short message alert procedure (MS memory capacity available)**

In addition the following MAP services are used in the MS memory available case:

- MAP\_PROCESS\_ACCESS\_REQUEST (see clause 8.3); (\*)
- MAP\_AUTHENTICATE (see clause 8.5); (\*)
- MAP\_SET\_CIPHERING\_MODE (see clause 8.6); (\*)
- MAP\_PROVIDE\_IMSI (see clause 8.9); (\*)
- MAP\_CHECK\_IMEI (see clause 8.7);
- MAP\_FORWARD\_NEW\_TMSI (see clause 8.9); (\*)
- MAP\_TRACE\_SUBSCRIBER\_ACTIVITY (see clause 9.1). (\*)

(\*) Those messages are not used by SGSN.

The Short Message Alert procedure when the MS indicates successful transfer after polling is shown in figure 23.4/3.

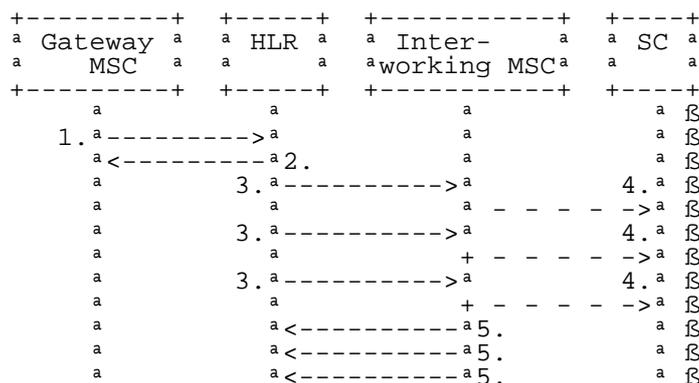

- 1) MAP\_REPORT\_SM\_DELIVERY\_STATUS (Successful Transfer)
- 2) MAP\_REPORT\_SM\_DELIVERY\_STATUS\_ACK
- 3) MAP\_ALERT\_SERVICE\_CENTRE (note)
- 4) Alert Service Centre (GSM 03.40)
- 5) MAP\_ALERT\_SERVICE\_CENTRE\_ACK

NOTE: To all Service Centres in the Message Waiting List.

**Figure 23.4/3: Short message alert procedure (Successful transfer after polling)**

### 23.4.1 Procedures in the Servicing MSC

The activation of the MAP\_PROCESS\_ACCESS\_REQUEST service is described in the clause 23.6.2.

After receiving the SM memory capacity available indication, the servicing MSC sends the MAP\_READY\_FOR\_SM request to the VLR indicating memory available. The outcome of that procedure is one of the following:

- successful acknowledgment. The MSC sends the corresponding message to the MS;
- negative acknowledgment, where the error causes are treated as follows:
  - unexpected data value, data missing and system failure errors are reported as network out of order error to the MS;
  - facility not supported is reported as requested facility not implemented error to the MS;
  - procedure failure, which is reported as network out of order error to the MS if a connection to the MS still exists.

The short message alert procedure in the MSC for the MS memory capacity available case is shown in figure 23.4/4.

Process SM\_Alert\_MSC

23.4\_4(1)

Figure 23.4/4: The short message alert process in the servicing MSC for MS memory capacity available.

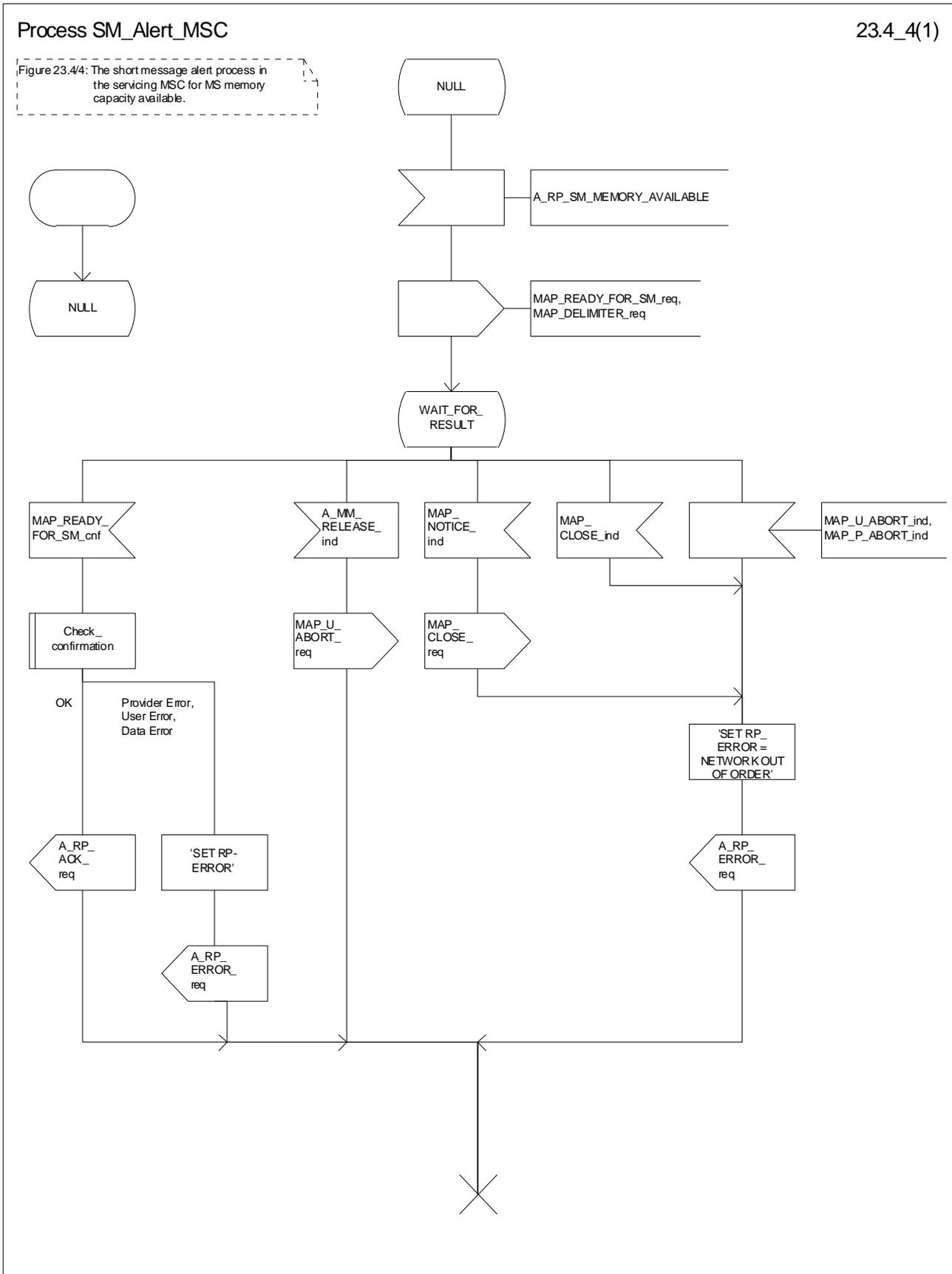

Figure 23.4/4: Procedure SM\_Alert\_MSC

## 23.4.2 Procedures in the VLR

### 23.4.2.1 The Mobile Subscriber is present

When receiving the MAP\_PROCESS\_ACCESS\_REQUEST indication, MAP\_UPDATE\_LOCATION\_AREA indication while the MS not reachable flag (MNRf) is set, the VLR will send the MAP\_READY\_FOR\_SM request towards the HLR. The Alert Reason is set to indicate that the mobile subscriber is present for non GPRS. If the authentication procedure is initiated and it fails, the VLR will not initiate the service. The process in VLR is described in detail in the clause 25.10.

### 23.4.2.2 The Mobile Equipment has memory available

The MAP\_PROCESS\_ACCESS\_REQUEST indication starts the MAP\_PROCESS\_ACCESS\_REQUEST service in the VLR. The application context in the MAP\_OPEN indication refers to the short message alerting procedure.

If the service MAP\_PROCESS\_ACCESS\_REQUEST is successful, the VLR waits for the next message from the MSC. When receiving the MAP\_READY\_FOR\_SM indication from the MSC, the VLR will check the contents. Data errors are reported to the MSC as an unexpected data value or data missing error, depending on the error. If the primitive passes the data check, the VLR forwards it to the HLR and awaits an acknowledgment.

When receiving the MAP\_READY\_FOR\_SM confirmation from the HLR and the Alert Reason is MS memory available, the VLR will act as follows:

- the MAP\_READY\_FOR\_SM response is sent to the MSC as follows:
  - an acknowledge in the positive case;
  - system failure error, if unexpected data value, data missing, or unknown subscriber errors are received, otherwise the error cause received from the HLR;
  - a facility not supported error, if the HLR supports MAP Vr only;
  - procedure failure is reported as a system failure error.

The short message alert procedure in the VLR is shown in figures 23.4/5.

Process SM\_Alert\_VLR

23.4\_5(1)

Figure 23.4/5: The short messages alert process in the VLR for MS memory capacity available

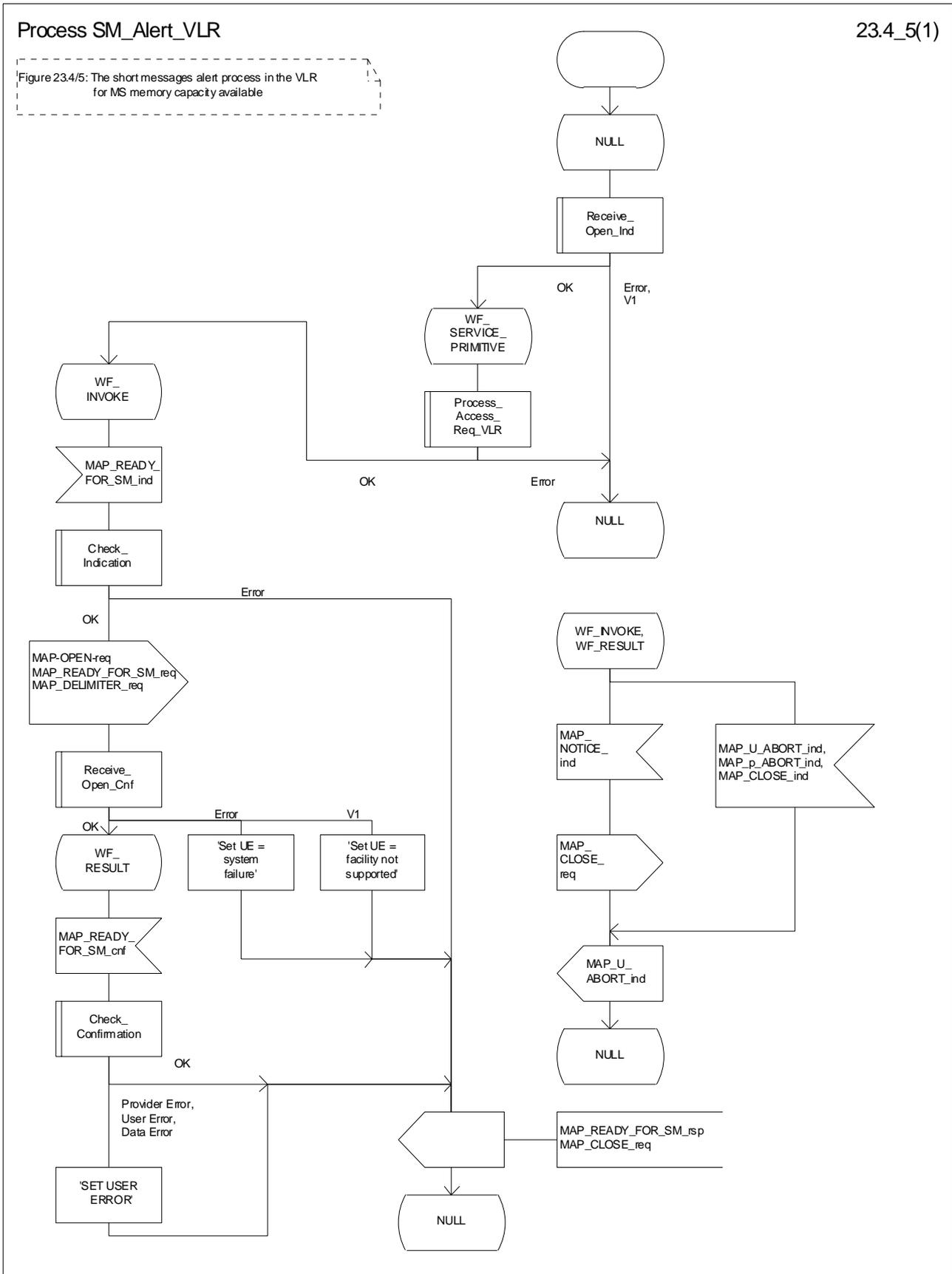

Figure 23.4/5: Procedure SM\_Alert\_VLR



### 23.4.3 Procedures in the HLR

When receiving the MAP\_READY\_FOR\_SM indication, the HLR will check the contents. Data errors are reported to the VLR as an unexpected data value or a data missing error depending on the error. If the HLR does not support the MNRF or MNRG, MCEF, and MWD a facility not supported error is reported to the VLR or SGSN. If the IMSI is unknown an unknown subscriber error is reported to the VLR or SGSN. Otherwise an acknowledgement is returned to the VLR or SGSN.

If neither the MS not reachable flag (MNRF) or the MS not reachable for GPRS (MNRG) flag, nor the memory capacity exceeded flag (MCEF) are set, and MAP\_READY\_FOR\_SM is received from the VLR or SGSN, the HLR sets a timer and waits for it to expire. This ensures that in the race situation the MAP\_REPORT\_SM\_DELIVERY\_STATUS service (as described in the clause 23.6) for the same subscriber can be carried out when delayed in the GMSC.

If the Alert Reason indicates the mobile present for non GPRS situation, or when the update location procedure has been successfully completed or Supplementary Service Control request is received, the MS not reachable flag (MNRF) is cleared and the service centre alert procedure is initiated. If the memory capacity exceeded flag is set, the MS not reachable flag is cleared and stored reason for absence for non GPRS are cleared but the alert procedure is not started.

If the Alert Reason indicates the mobile present for GPRS situation, or when the Update GPRSlocation procedure has been successfully completed, the MS not reachable for GPRS (MNRG) flag is cleared and the service centre alert procedure is initiated. If the memory capacity exceeded flag is set, the MS detach for GPRS flag is cleared and stored reason for absence for GPRS are cleared but the alert procedure is not started.

If the Alert Reason indicates the memory available for non GPRS situation, the HLR initiates the alert procedure. The MS not reachable and memory capacity available flags are cleared.

If the Alert Reason indicates the memory available for GPRS situation, the HLR initiates the alert procedure. The MS detach for GPRS and memory capacity available flags are cleared.

If the MAP\_REPORT\_SM\_DELIVERY\_STATUS indication is received and it indicates the successful transfer of the mobile terminated short message for non GPRS, the HLR initiates the alert procedure described in the clause 25.10 and clears MCEF and MNRF flags and stored reason for absence for non GPRS are cleared.

If the MAP\_REPORT\_SM\_DELIVERY\_STATUS indication is received and it indicates the successful transfer of the mobile terminated short message for GPRS, the HLR initiates the alert procedure described in the clause 25.10 and clears MCEF and MNRG flags and stored reason for absence for GPRS are cleared.

The short message alert procedure in the HLR is shown in figures 23.4/6 and 25.10/2.

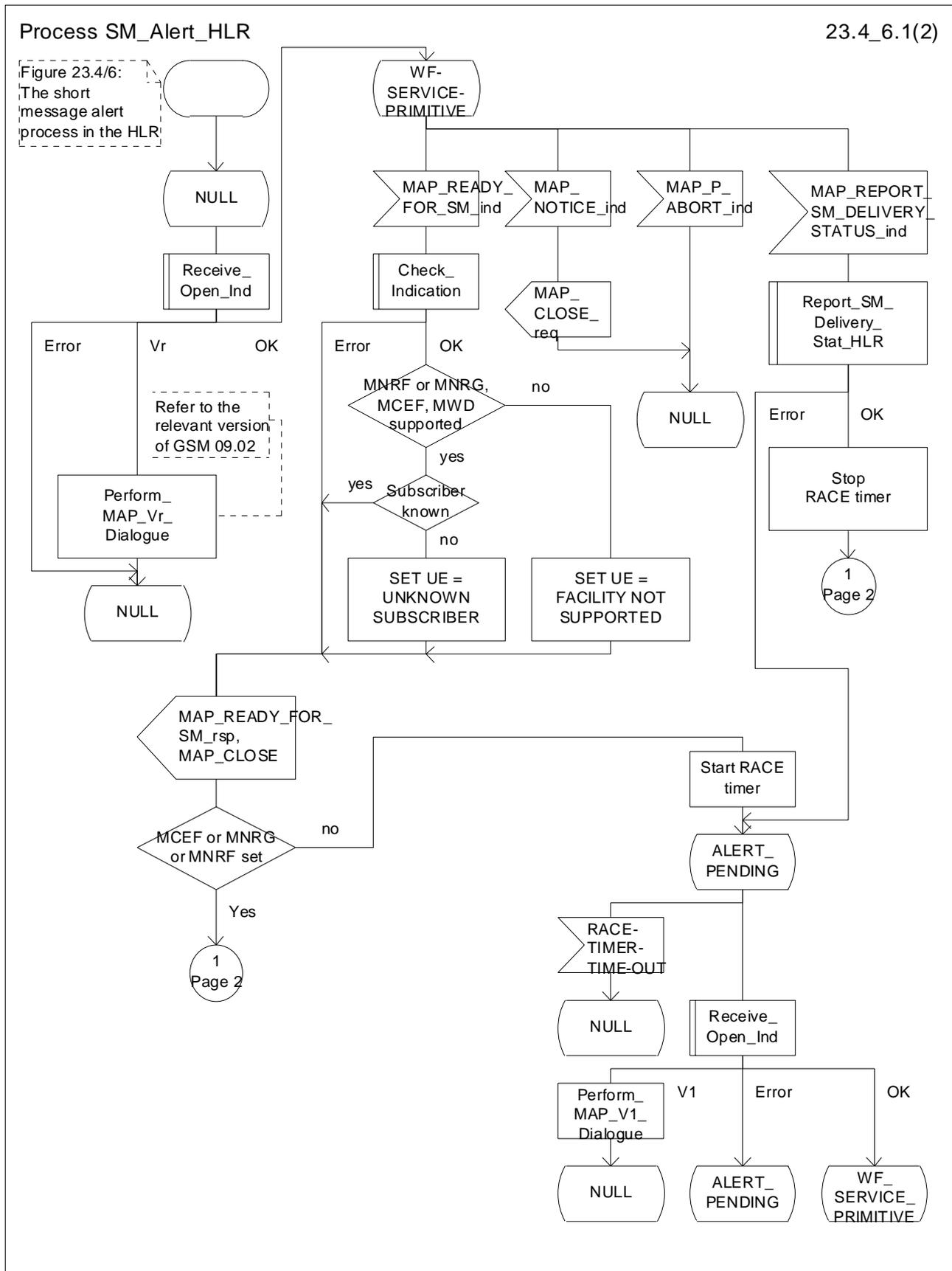

Figure 23.4/6 (sheet 1 of 2): Process SM\_Alert\_HLR

Process SM\_Alert\_HLR

23.4\_6.2(2)

Figure 23.4/6:  
The short message alert process in the HLR

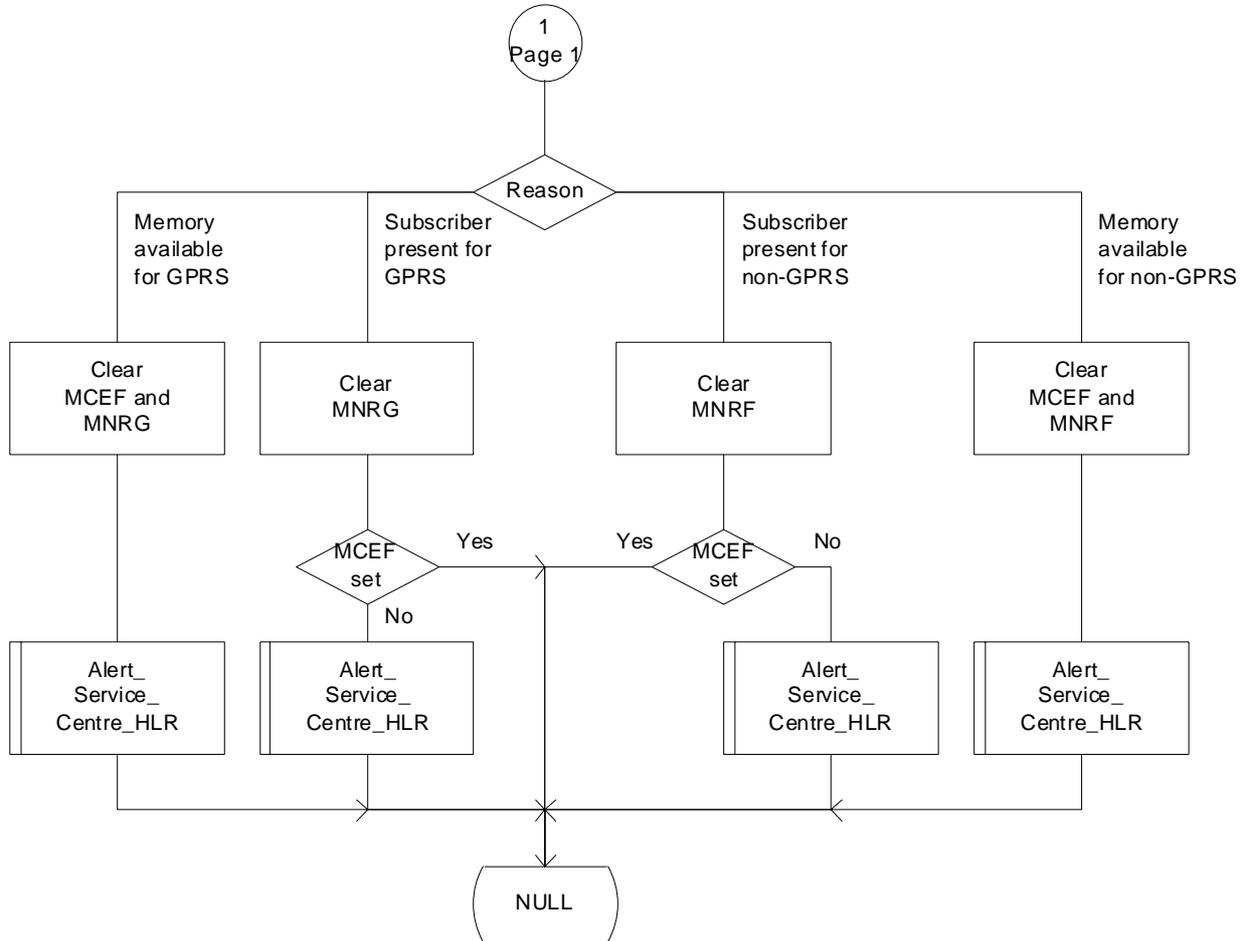

Figure 23.4/6 (sheet 2 of 2): Process SM\_Alert\_HLR

## 23.4.4 Procedures in the Interworking MSC

When a MAP\_ALERT\_SERVICE\_CENTRE indication is correctly received by the IW MSC, the IW MSC will forward the alerting to the given Service Centre if possible.

Data errors are reported to the HLR as an unexpected data value or a data missing error depending on the error.

The short message alert procedure is shown in figure 23.4/7.

Process Alert\_SC\_IWMSC

23.4\_7(1)

Figure 23.4/7: The short message alert message in the IWMSC

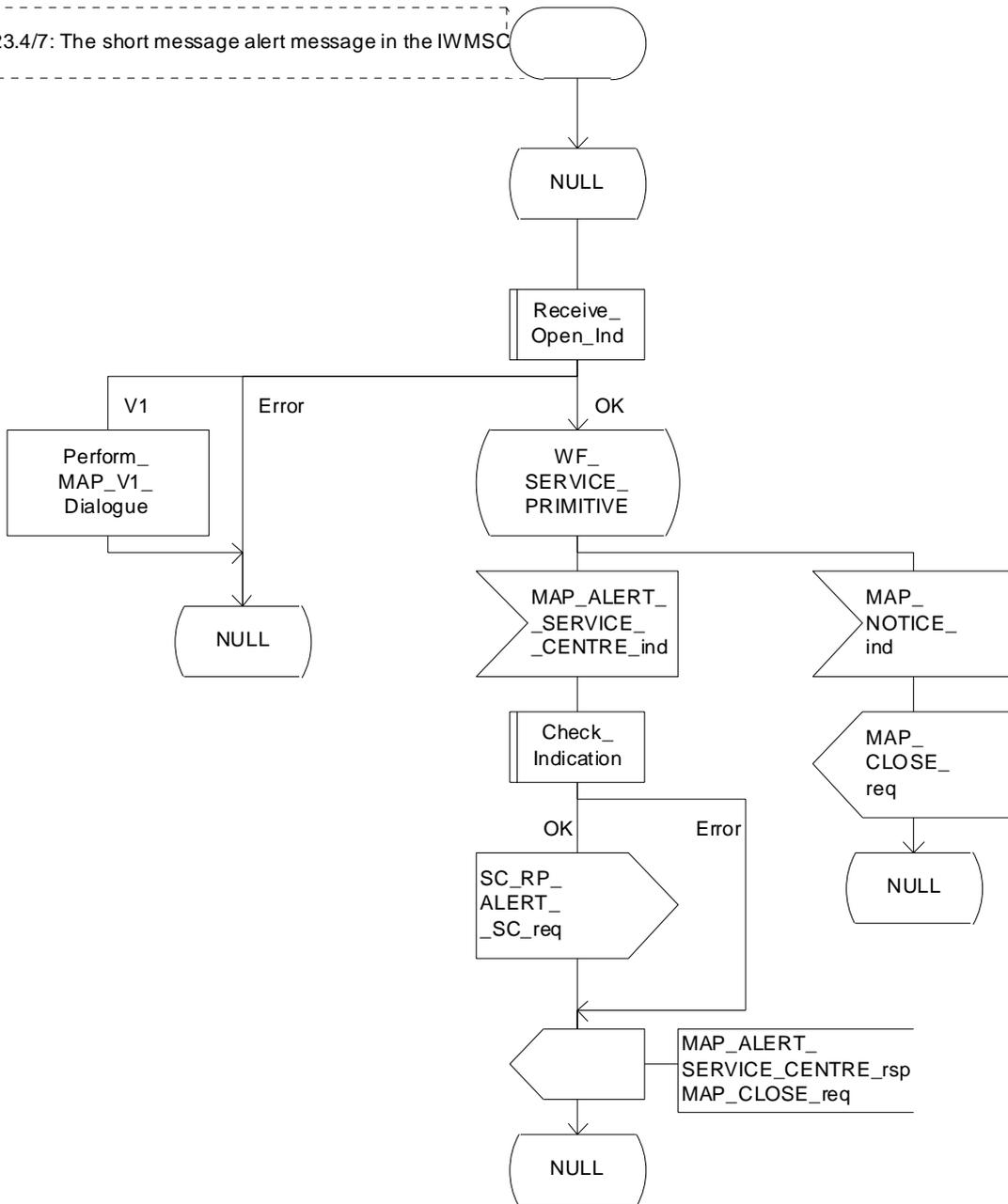

Figure 23.4/7: Process Alert\_SC\_IWMSC

## 23.4.5 Procedures in the Servicing SGSN

### 23.4.5.1 The Mobile Subscriber is present

When receiving Page response, Attach request or Routing area update request messages (TS GSM 04.08), while the MS not reachable for GPRS (MNRG) flag is set, the SGSN will send the MAP\_READY\_FOR\_SM request towards the HLR. The Alert Reason is set to indicate that the mobile subscriber is present for GPRS.

When receiving the answer, the SGSN will act as follows:

- MNRG is cleared if the procedure is successful
- MNRG is not cleared if the procedure is not successful

The process in SGSN is described in detail in the clause 25.10/3.

### 23.4.5.2 The Mobile Equipment has memory available

After receiving the SM memory capacity available indication, the servicing SGSN sends the MAP\_READY\_FOR\_SM request to the HLR indicating memory available for GPRS. The outcome of that procedure is one of the following:

- successful acknowledgment. The SGSN sends the corresponding message to the MS;
- negative acknowledgment, where the error causes are treated as follows:
  - unexpected data value, data missing and system failure errors are reported as network out of order error to the MS;
  - facility not supported is reported as requested facility not implemented error to the MS;
  - procedure failure, which is reported as network out of order error to the MS if a connection to the MS still exists.

The short message alert procedure in the SGSN for the MS memory capacity available case is shown in figure 23.4/8.

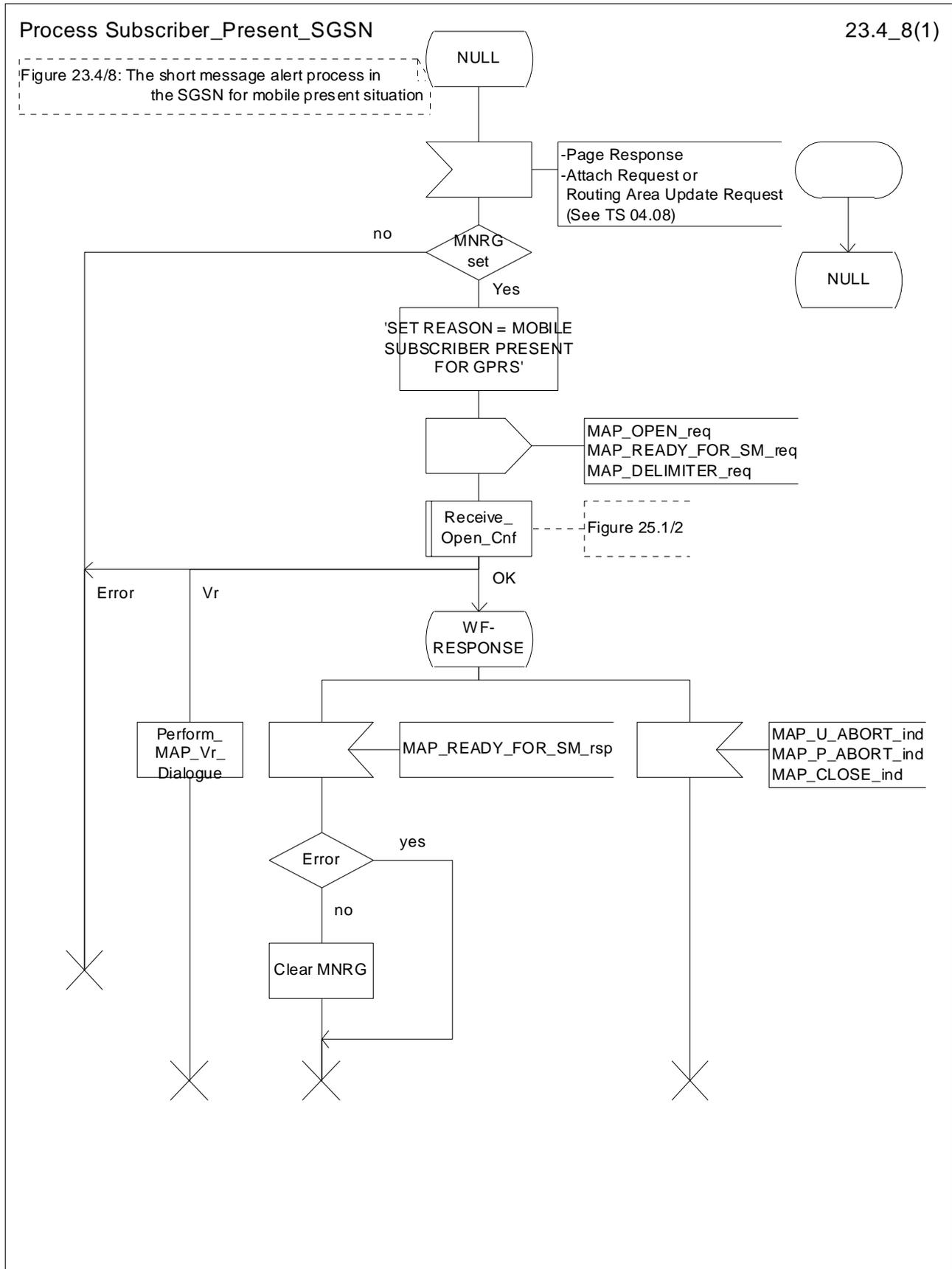

Figure 23.4/8: Process Subscriber\_Present\_SGSN

### 23.5 The SM delivery status report procedure

The SM delivery status report procedure is used to set the Service Centre address into the message waiting list in the HLR because the subscriber is absent or unidentified or the memory capacity is exceeded. The procedure sets

- the memory capacity exceeded flag in the HLR if the MS memory does not have room for more messages
- and/or the MS not reachable flag for non GPRS in the case of unidentified or absent subscriber
- and/or the MS not reachable for GPRS flag in the case of unidentified or absent susbcriber for GPRS

Additionally the procedure is used to report the HLR about the successful transfer for GPRS or non GPRS after the Service Centre has polled the subscriber. This procedure is described also in the clause 23.4.

The SM delivery status report procedure is shown in figure 23.5/1.

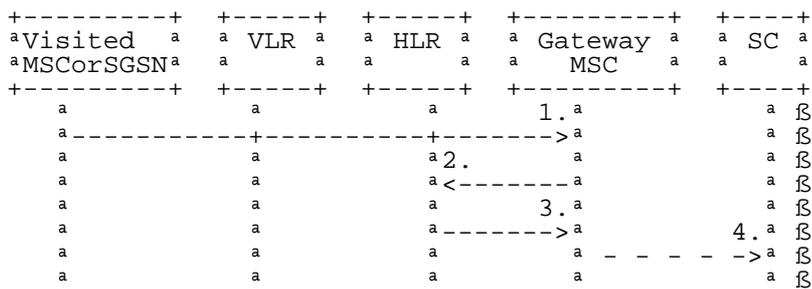

- 1) MAP\_MT\_FORWARD\_SHORT\_MESSAGE\_ACK/\_NACK (Absent subscriber\_SM, unidentified subscriber or memory capacity exceeded)
- 2) MAP\_REPORT\_SM\_DELIVERY\_STATUS
- 3) MAP\_REPORT\_SM\_DELIVERY\_STATUS\_ACK
- 4) Short Message Negative Acknowledgement (GSM 03.40)

**Figure 23.5/1: Short message delivery status report procedure**

#### 23.5.1 Procedures in the HLR

When the HLR receives a MAP\_REPORT\_SM\_DELIVERY\_STATUS indication, it acts as described in the clause 23.6, macro Report\_SM\_Delivery\_Stat\_HLR.

The short message delivery status report process in the HLR is shown in figure 23.5/2.



Process SM\_Delivery\_Status\_Report\_HLR

23.5\_2(1)

Figure 23.5/2: The report SM delivery process in the HLR

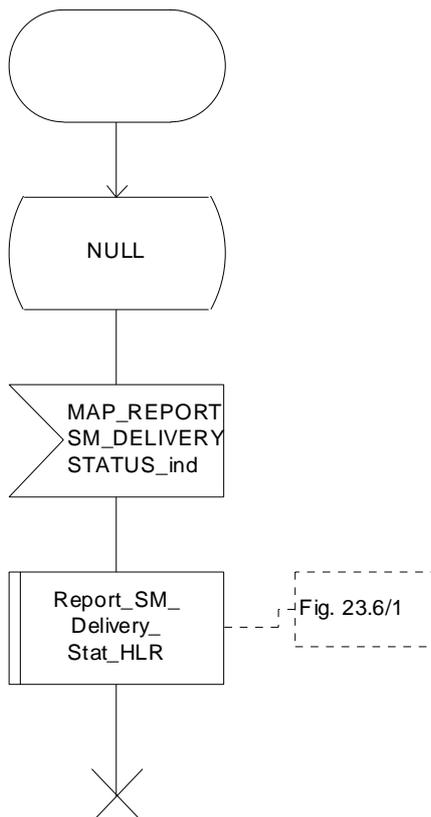

Figure 23.5/2: Process SM\_Delivery\_Status\_Report\_HLR

## 23.5.2 Procedures in the gateway MSC

The GMSC invokes the short message delivery status report procedure if an absent subscriber\_SM indication, unidentified subscriber indication, SM delivery failure error indicating MS memory capacity exceeded or both are received from the servicing MSC, SGSN or both during a mobile terminated short message transfer, and the HLR has not indicated that the SC address is included in the MWD. The unidentified subscriber indication is however processed as the absent subscriber\_SM indication

In case of successful SMS delivery on the second path, the successful SMS Delivery outcome is sent in combination with the unsuccessful SMS Delivery outcome to the HLR.

The service is invoked also when the HLR has indicated that either of the flags MCEF, MNRF or both are set and the first SM delivery was successful from the servicing MSC or, in case of subsequent SM, the last SM delivery was successful from the servicing MSC.

The service is invoked also when the HLR has indicated that either of the flags MCEF, MNRF or both are set and the SM delivery was successful from the servicing SGSN or, in case of subsequent SM, the last SM delivery was successful from the servicing SGSN.

The reason for unsuccessful, successful for GPRS, non GPRS or both deliveries of the short message are included in the SM Delivery Outcome in the MAP\_REPORT\_SM\_DELIVERY\_STATUS request. In the case of an unsuccessful delivery due to the subscriber being absent the absent subscriber diagnostic indication (if available) is also included in the MAP\_REPORT\_SM\_DELIVERY\_STATUS request.

If the reason for unsuccessful delivery is absent subscriber with diagnostic 'Paging failure' for GPRS or non GPRS, the two SM Delivery Outcomes absent subscriber with both diagnostics 'Paging failure' for GPRS and non GPRS is included in the MAP\_REPORT\_SM\_DELIVERY\_STATUS request.

The GMSC sends the MAP\_REPORT\_SM\_DELIVERY\_STATUS request to the HLR. As a response the GMSC will receive the MAP\_REPORT\_SM\_DELIVERY\_STATUS confirmation reporting:

- successful outcome of the procedure. The acknowledge primitive may contain the MSISDN-Alert number which is stored in the MWD List in the HLR;
- unsuccessful outcome of the procedure. The system failure indication is forwarded to the SC. In that case, if the SM Delivery Outcome was successful SMS delivery for GPRS or non GPRS (combined or not with another unsuccessful reason), a successful report is forwarded to the SC.

A provider error is indicated as a system failure to the SC.

Note that the indication, on which number belongs the SGSN and MSC, received from the HLR at routing information result (see clause 23.3.3) will enable the GMSC to map the causes received from the SGSN, MSC or both into the appropriate causes for GPRS, non GPRS or both, and send them to the SC and HLR.

The procedure towards the Service Centre may also be aborted. If so the operation towards the HLR is also aborted.

The short message delivery status report procedure in the GMSC is shown in figure 23.5/3.

Macrodefinition Report\_SM\_Delivery\_Stat\_GMSC

23.5\_3(1)

Figure 23.5/3: The report SM delivery status macro in the GMSC

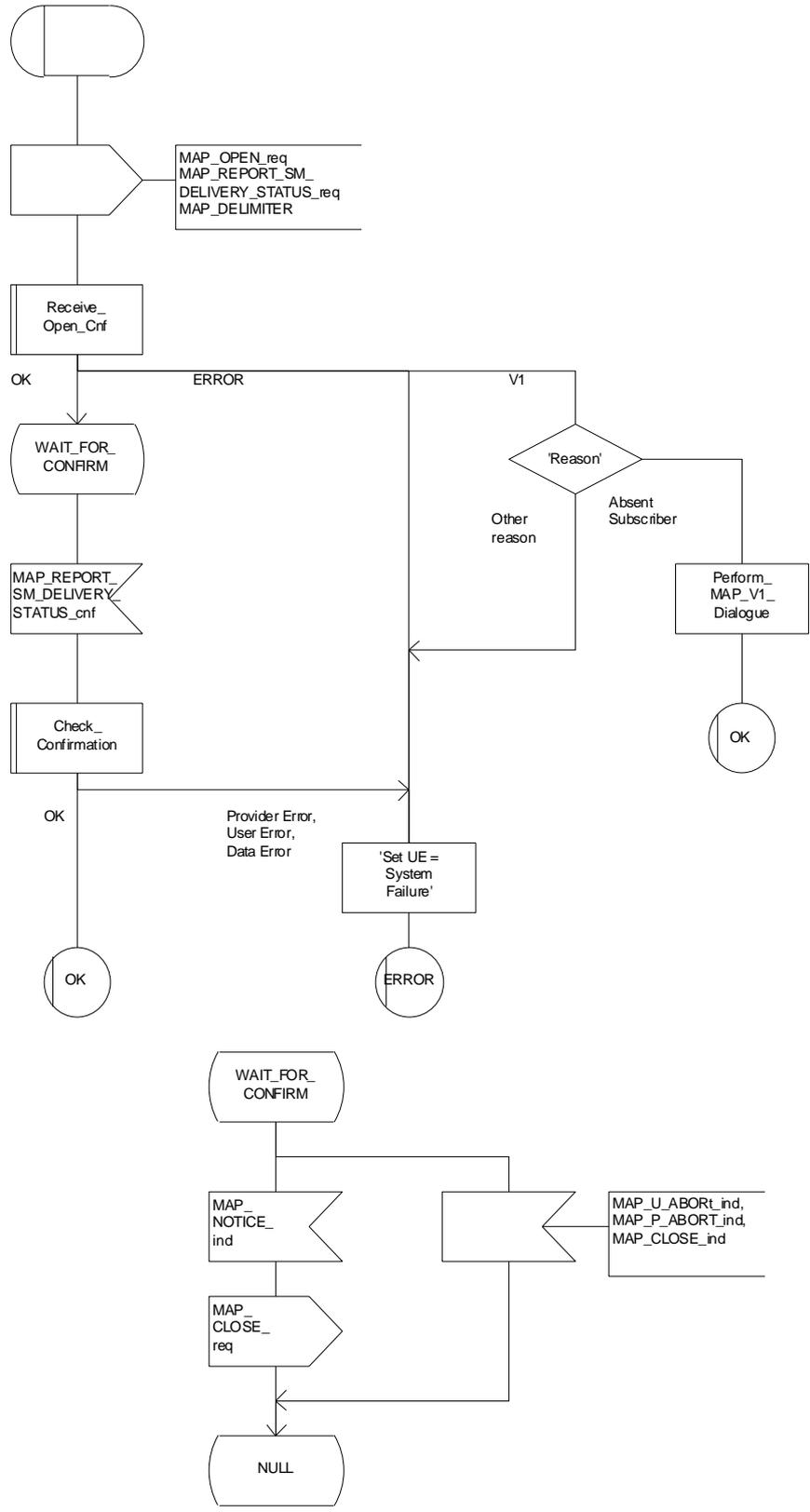

Figure 23.5/3: Macro Report\_SM\_Delivery\_Stat\_GMSC

## 23.6 Common procedures for the short message clause

### 23.6.1 The macro Report\_SM\_Delivery\_Stat\_HLR

This macro is used when the HLR receives a MAP\_REPORT\_SM\_DELIVERY\_STATUS indication from the GMSC. The HLR responses to the indication as follows:

- if the flag « GPRS Support Indicator » is absent then if the subscriber is a GPRS subscriber and a non-GPRS subscriber with the option « transfer of SM via the SGSN when GPRS is not supported in the GMSC » or if the subscriber is a GPRS subscriber only, the HLR shall interpret the delivery outcome as a GPRS delivery outcome.
- if invalid data content is detected, an unexpected data value error or a data missing error is returned to the GMSC;
- if the MSISDN number provided is not recognized by the HLR, an unknown subscriber error is returned to the GMSC;
- if the MAP\_REPORT\_SM\_DELIVERY\_STATUS indication reports a successful SM delivery, the Service Centres in the Message Waiting list are alerted as described in the clause 25.10;
- if the SM Delivery Outcome reports unsuccessful delivery and the inclusion of the SC address in the MWD is not possible, a message waiting list full error is returned to the GMSC;
- if the SM Delivery Outcome reports unsuccessful delivery and the message waiting list is not full, the given Service Centre address is inserted and an acknowledgement is sent to the GMSC. If the MSISDN-Alert stored in the subscriber data is not the same as that received in the MAP\_REPORT\_SM\_DELIVERY\_STATUS indication, the MSISDN-Alert is sent in a response primitive to the GMSC;

The SC address is only stored in the MWD if the unsuccessful SM Delivery Outcome is not received in combination with another successful SM Delivery Outcome

- if the SM Delivery Outcome is MS memory capacity exceeded for non GPRS, the HLR sets the memory capacity exceeded flag in the subscriber data and resets the MNRF;
- if the SM Delivery Outcome is MS memory capacity exceeded for GPRS the HLR sets the memory capacity exceeded flag in the subscriber data and resets the MNRG;
- if the SM Delivery Outcome is absent subscriber for non GPRS, the HLR sets the mobile station not reachable flag in the subscriber data. If a reason for absence is provided by the GMSC then this is stored in the mobile station not reachable reason (MNRR) in the subscriber data.
- if the SM Delivery Outcome is absent subscriber for GPRS, the HLR sets the mobile station not reachable for GPRS flag in the subscriber data. If a reason for absence is provided by the GMSC then this is stored in the mobile station not reachable reason (MNRR) in the subscriber data.

Note that a combination of all the SM Delivery Outcome specified above may be provided to the HLR from the SMS-GMSC.

The short message delivery status report macro in the HLR is shown in figure 23.6/1.

Macrodefinition Report\_SM\_Delivery\_Stat\_HLR

23.6\_1(1)

Figure 23.6/1: The report SM delivery status macro in the HLR

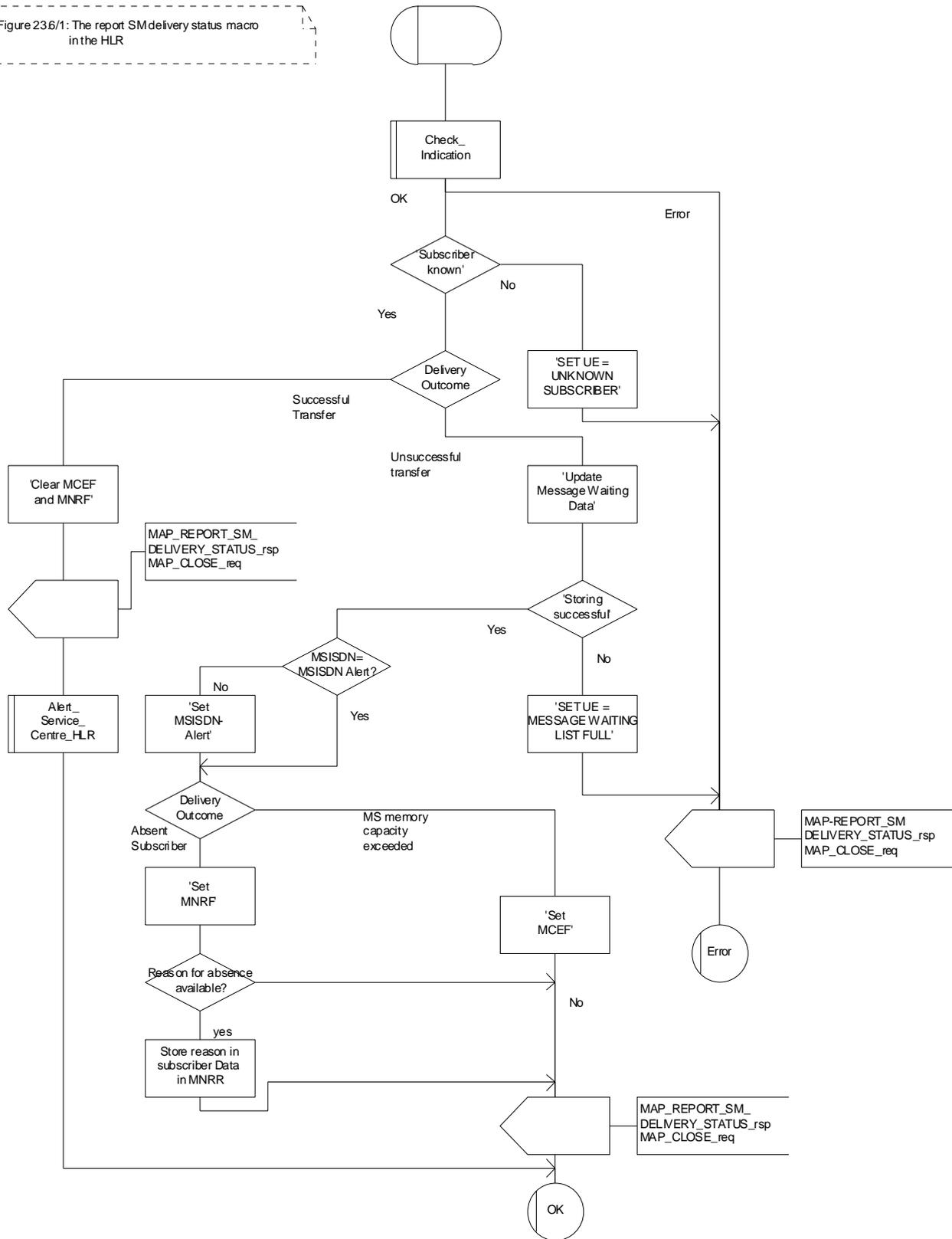

Figure 23.6/1: Macro Report\_SM\_Delivery\_Stat\_HLR

---

## 24 GPRS process description

### 24.1 General

The MAP GPRS procedures are used for the Network Requested PDP-Context Activation procedures.

The stage 2 specification for General Packet Radio Service (GPRS) is in GSM 03.60 [100].

#### 24.1.1 Process in the HLR for Send Routing Information for GPRS

The MAP process in the HLR to provide routing information for a network-requested PDP context activation is shown in figure 24.1/1. The MAP process invokes a macro not defined in this clause; the definition of this macro can be found as follows:

Receive_Open_Ind	see clause 25.1.1;
Check_Indication	see clause 25.2.1.

##### **Successful outcome**

When the MAP process receives a MAP\_OPEN indication with the application context gprsLocationInfoRetrieval, it checks it by invoking the macro Receive\_Open\_Ind.

If the macro takes the OK exit, the MAP process waits for a service indication.

If a MAP\_SEND\_ROUTING\_INFO\_FOR\_GPRS service indication is received, the HLR sends a Send Routing Info For Gprs request to the GPRS application process in the HLR, and wait for a response. The Send Routing Info For Gprs request contains the parameter received in the MAP\_SEND\_ROUTING\_INFO\_FOR\_GPRS service indication

If the GPRS application process in the HLR returns a positive response containing the routing information, the MAP process constructs a MAP\_SEND\_ROUTING\_INFO\_FOR\_GPRS service response containing the routing info, constructs a MAP\_CLOSE service request, sends them to the GGSN and returns to the idle state.

##### **Negative response from HLR GPRS application process**

If the GPRS application process in the HLR returns a negative response, the MAP process constructs a MAP\_SEND\_ROUTING\_INFO\_FOR\_GPRS service response containing the appropriate error, constructs a MAP\_CLOSE service request, sends them to the GGSN and returns to the idle state.

##### **Failure of dialogue opening with the GGSN**

If the macro Receive\_Open\_Ind takes the Vr exit or the Error exit, the MAP process returns to the idle state.

If the MAP provider sends a MAP\_P\_ABORT while the MAP process is waiting for a service indication, the MAP process returns to the idle state.

If the MAP provider sends a MAP\_NOTICE while the MAP process is waiting for a service indication, the MAP process sends a MAP\_CLOSE request to terminate the dialogue and returns to the idle state.

### Process Send\_Routing\_Info\_For\_Gprs\_HLR

24.1\_1(1)

Figure 24.1/1: The Send Routing Info For GPRS process in the HLR

Signals to/from the right are to/from the GPRS application process

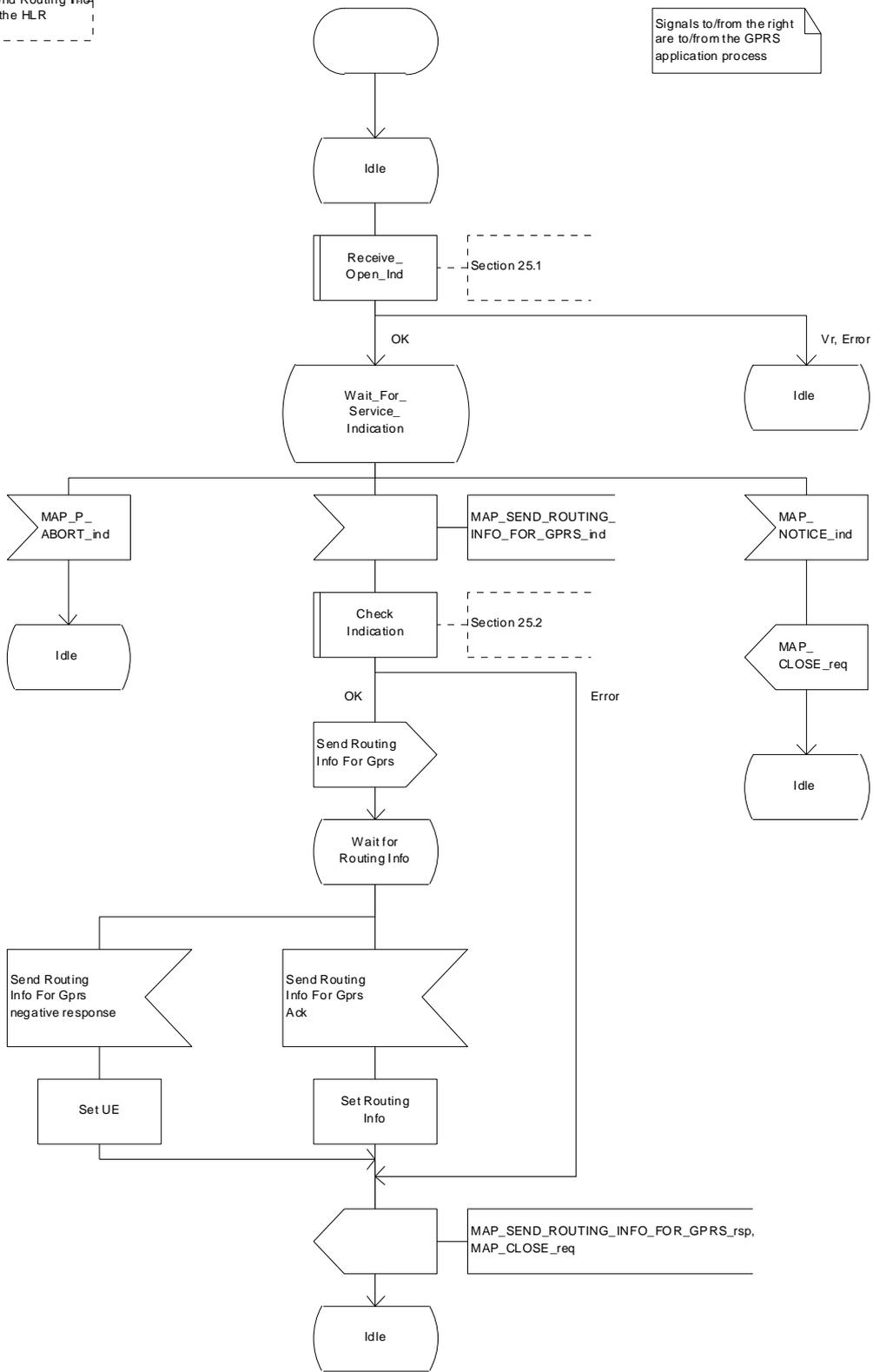

**Figure 24.1/1: Process Send Routing Info For Gprs\_HLR****24.1.2 Process in the GGSN for Send Routing Information for GPRS****Successful Outcome**

When the MAP process receives a Send Routing Info For Gprs request from the GPRS application process in the GGSN, it requests a dialogue with the HLR whose identity is contained in the Send Routing Info For Gprs request by sending a MAP\_OPEN service request, requests routing information using a MAP\_SEND\_ROUTING\_INFO\_FOR\_GPRS service request and invokes the macro Receive\_Open\_Cnf to wait for the response to the dialogue opening request. If the dialogue opening is successful, the MAP process waits for a response from the HLR.

If the MAP process receives a MAP\_SEND\_ROUTING\_INFO\_FOR\_GPRS service confirm from the HLR, the MAP process invokes the macro Check\_Confirmation to check the content of the confirm.

If the macro Check\_Confirmation takes the OK exit, the MAP process sends a Send Routing Info For Gprs ack containing the routing information received from the HLR to the GPRS application process in the GGSN and returns to the idle state.

**Failure of dialogue opening with the HLR**

If the macro Receive\_Open\_Cnf takes the Vr exit or the Error exit, the MAP process sends a negative response to the GPRS application process in the GGSN and returns to the idle state.

**Error in MAP\_SEND\_ROUTING\_INFO\_FOR\_GPRS confirm**

If the MAP\_SEND\_ROUTING\_INFO\_FOR\_GPRS service confirm contains a user error or a provider error, or the macro Check\_Confirmation indicates that there is a data error, the MAP process sends a Send Routing Info For Gprs negative response to the GPRS application process in the GGSN and returns to the idle state.

**Abort of HLR dialogue**

After the dialogue with the HLR has been established, the MAP service provider may abort the dialogue by issuing a MAP\_P\_ABORT or a MAP\_U\_ABORT indication. In this case, the MAP process sends a Send Routing Info For Gprs negative response to the GPRS application process in the GGSN and returns to the idle state.

If the MAP provider indicates a protocol problem by sending a MAP\_NOTICE indication, the MAP process closes the dialogue with the HLR, sends a Send Routing Info For Gprs negative response indicating system failure to the GPRS application process in the GGSN and returns to the idle state.



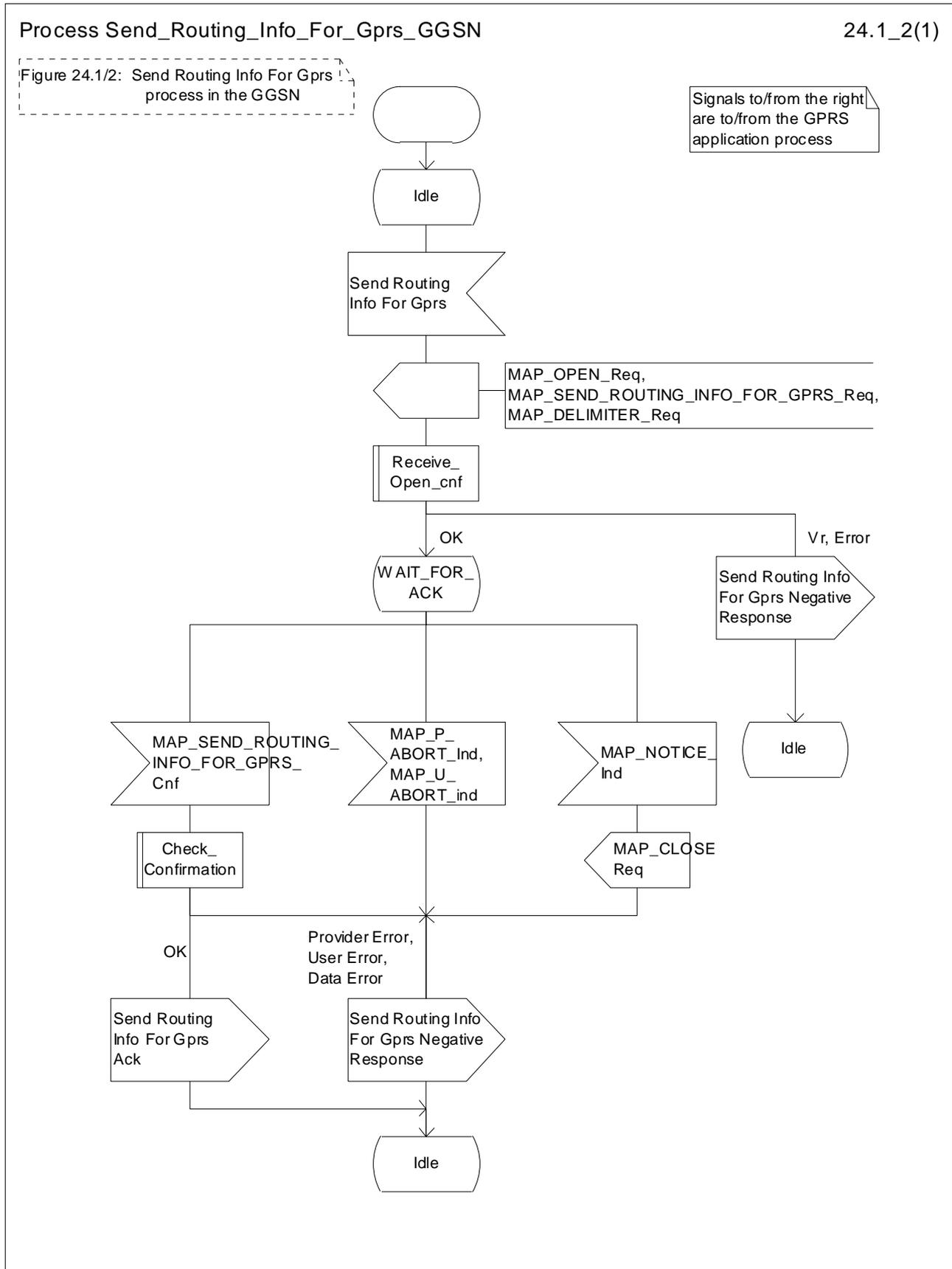

Figure 24.1/2: Process Send\_Routing\_Info\_For\_Gprs\_GGSN

## 24.2.1 Process in the HLR for Failure Report

The MAP process in the HLR to set the MNRG (Mobile station Not Reachable for GPRS) flag for the subscriber is shown in figure 24.2/1. The MAP process invokes a macro not defined in this clause; the definition of this macro can be found as follows:

Receive_Open_Ind	see clause 25.1.1;
Check Indication	see clause 25.2.1.

### Successful outcome

When the MAP process receives a MAP\_OPEN indication with the application context failureReport, it checks it by invoking the macro Receive\_Open\_Ind.

If the macro takes the OK exit, the MAP process waits for a service indication.

If a MAP\_FAILURE\_REPORT service indication is received, the HLR sends a Failure Report request to the GPRS application process in the HLR, and wait for a response. The Failure Report request contains the parameter received in the MAP\_FAILURE\_REPORT service indication.

If a positive response is received, the MAP process constructs a MAP\_FAILURE\_REPORT service response, constructs a MAP\_CLOSE service request, sends them to the GGSN and returns to the idle state.

### Negative response from HLR GPRS application process

If the GPRS application process in the HLR returns a negative response, the MAP process constructs a MAP\_FAILURE\_REPORT service response containing the appropriate error, constructs a MAP\_CLOSE service request, sends them to the GGSN and returns to the idle state.

### Failure of dialogue opening with the GGSN

If the macro Receive\_Open\_Ind takes the Vr exit or the Error exit, the MAP process returns to the idle state.

If the MAP provider sends a MAP\_P\_ABORT while the MAP process is waiting for a service indication, the MAP process returns to the idle state.

If the MAP provider sends a MAP\_NOTICE while the MAP process is waiting for a service indication, the MAP process sends a MAP\_CLOSE request to terminate the dialogue and returns to the idle state.

Process Failure\_Report\_HLR

24.2\_1(1)

Figure 24.2/1: The Failure Report process in the HLR

Signals to/from the right are to/from the GPRS application process

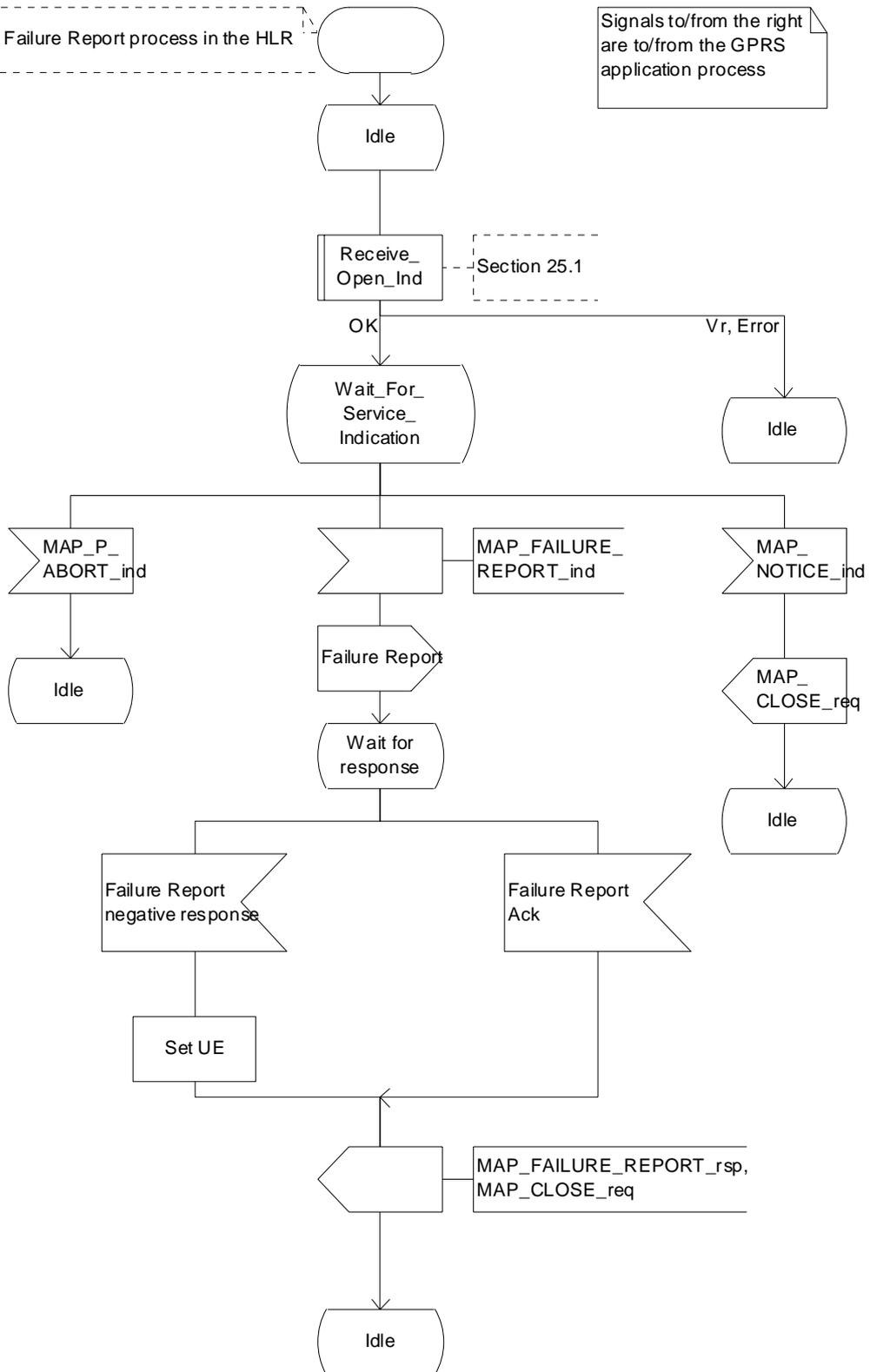

Process Failure\_Report\_HLR

24.2\_1(1)

Figure 24.2/1: The Failure Report process in the HLR

Signals to/from the right are to/from the GPRS application process

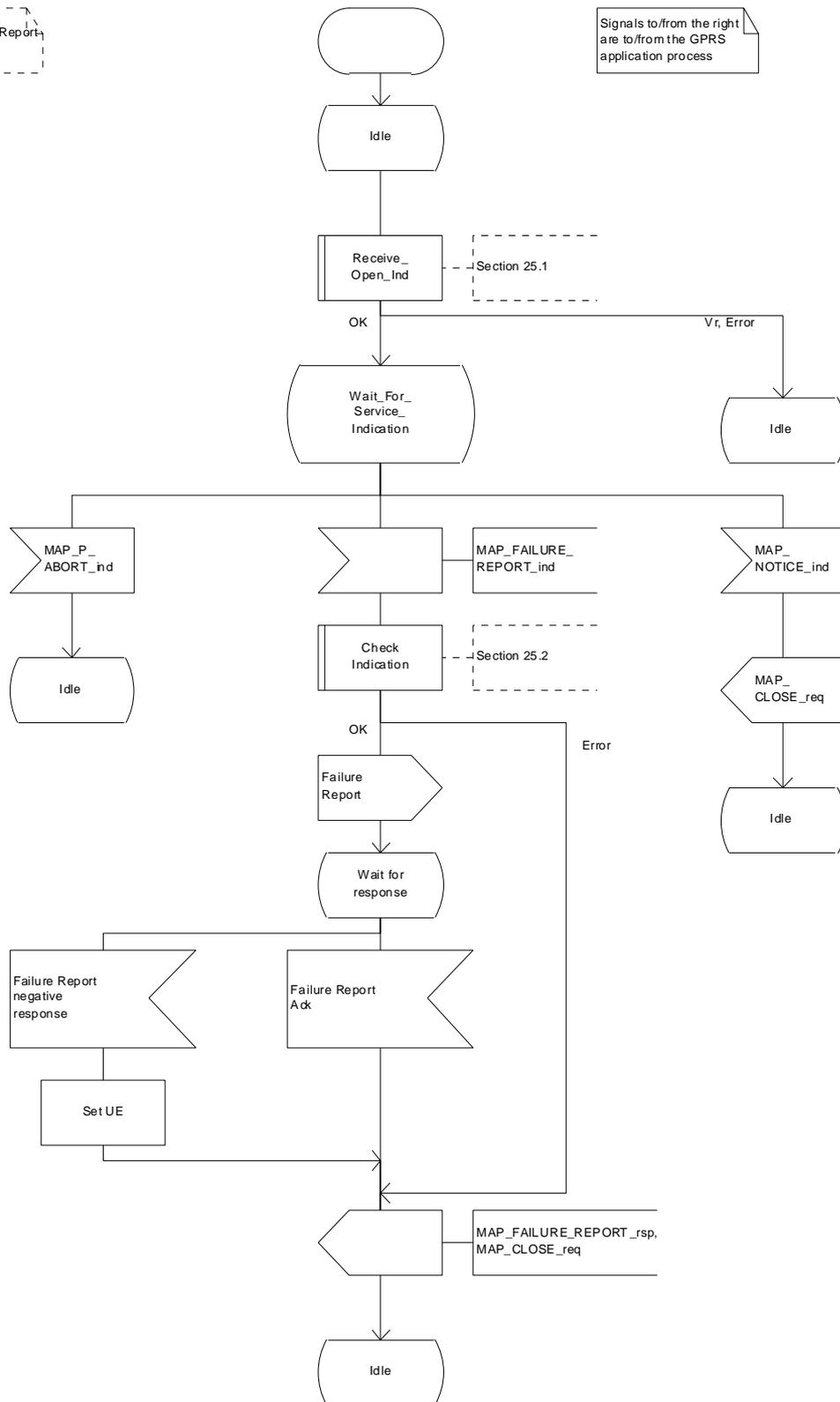

Figure 24.2/1: Process Failure\_Report\_HLR

## 24.2.2 Process in the GGSN for Failure Report

### Successful Outcome

When the MAP process receives a Failure Report request from the GPRS application process in the GGSN, it requests a dialogue with the HLR whose identity is contained in the Failure Report request by sending a MAP\_OPEN service request, sending failure information using a MAP\_FAILURE\_REPORT service request and invokes the macro Receive\_Open\_Cnf to wait for the response to the dialogue opening request. If the dialogue opening is successful, the MAP process waits for a response from the HLR.

If the MAP process receives a MAP\_FAILURE\_REPORT service confirm from the HLR, the MAP process invokes the macro Check\_Confirmation to check the content of the confirm.

If the macro Check\_Confirmation takes the OK exit, the MAP process sends a Failure Report ack containing the information received from the HLR to the GPRS application process in the GGSN and returns to the idle state.

### Failure of dialogue opening with the HLR

If the macro Receive\_Open\_Cnf takes the Vr exit or the Error exit, the MAP process sends a negative response to the GPRS application process in the GGSN and returns to the idle state.

### Error in MAP\_FAILURE\_REPORT confirm

If the MAP\_FAILURE\_REPORT service confirm contains a user error or a provider error, or the macro Check\_Confirmation indicates that there is a data error, the MAP process sends a Failure Report negative response to the GPRS application process in the GGSN and returns to the idle state.

### Abort of HLR dialogue

After the dialogue with the HLR has been established, the MAP service provider may abort the dialogue by issuing a MAP\_P\_ABORT or a MAP\_U\_ABORT indication. In this case, the MAP process sends a Failure Report negative response to the GPRS application process in the GGSN and returns to the idle state.

If the MAP provider indicates a protocol problem by sending a MAP\_NOTICE indication, the MAP process closes the dialogue with the HLR, sends a Failure Report negative response indicating system failure to the GPRS application process in the GGSN and returns to the idle state.

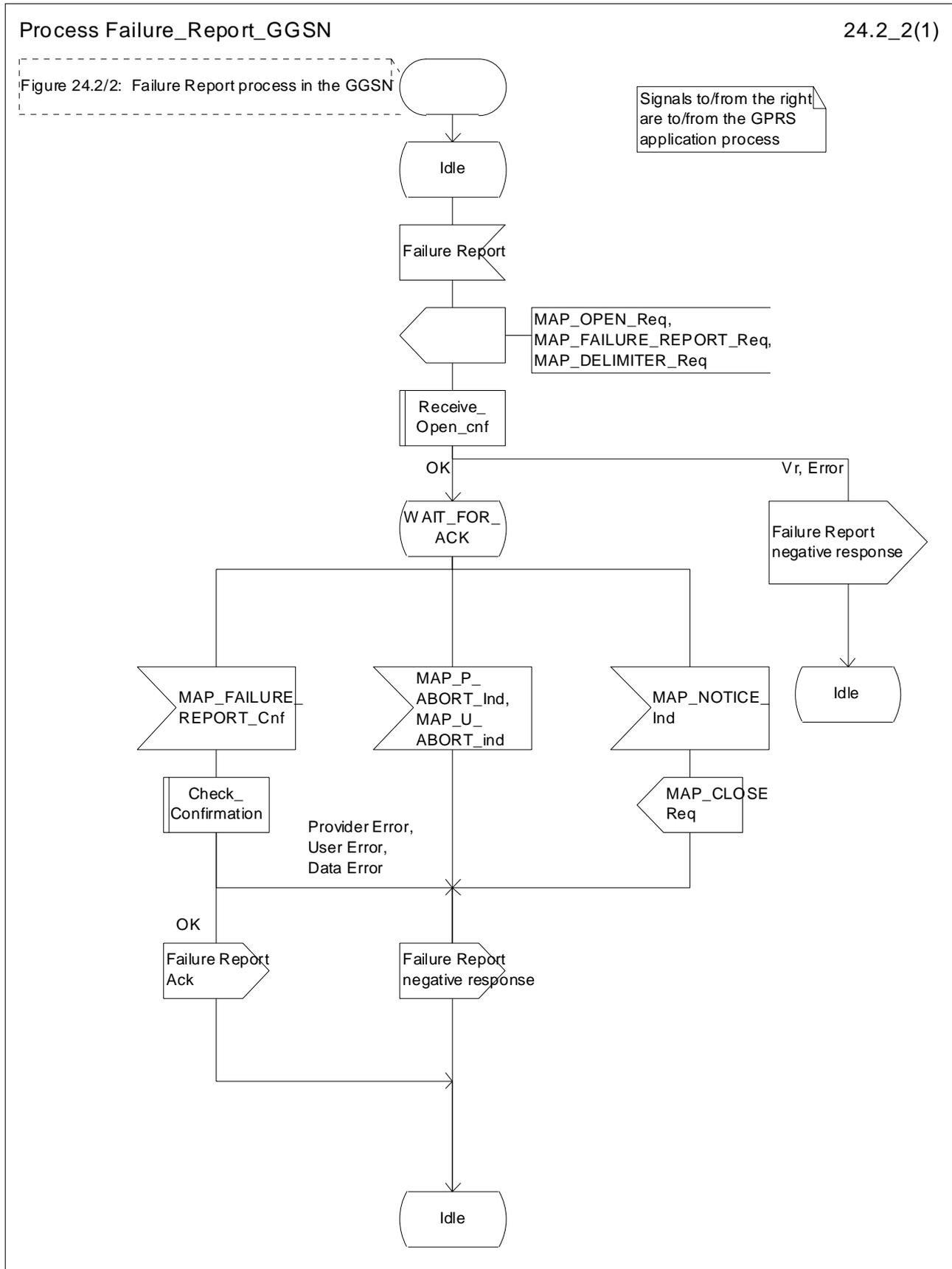

Figure 24.2/2: Process Failure\_Report\_GGSN

### 24.3.1 Process in the GGSN for Note Ms Present For Gprs

The MAP process in the GGSN to inform that the subscriber is present for GPRS again is shown in figure 24.3/1. The MAP process invokes a macro not defined in this clause; the definition of this macro can be found as follows:

Receive\_Open\_Ind            see clause 25.1.1;

Check\_Indication            see clause 25.2.1.

#### **Successful outcome**

When the MAP process receives a MAP\_OPEN indication with the application context gprsNotify, it checks it by invoking the macro Receive\_Open\_Ind.

If the macro takes the OK exit, the MAP process waits for a service indication.

If a MAP\_NOTE\_MS\_PRESENT\_FOR\_GPRS service indication is received, the GGSN sends a Note Ms Present For Gprs request to the GPRS application process in the GGSN, and wait for a response. The Note Ms Present For Gprs request contains the parameter received in the MAP\_NOTE\_MS\_PRESENT\_FOR\_GPRS service indication.

If the GPRS application process in the GGSN returns a positive response, the MAP process constructs a MAP\_NOTE\_MS\_PRESENT\_FOR\_GPRS service response, constructs a MAP\_CLOSE service request, sends them to the HLR and returns to the idle state.

#### **Negative response from GGSN GPRS application process**

If the GPRS application process in the GGSN returns a negative response, the MAP process constructs a MAP\_NOTE\_MS\_PRESENT\_FOR\_GPRS service response containing the appropriate error, constructs a MAP\_CLOSE service request, sends them to the HLR and returns to the idle state.

#### **Failure of dialogue opening with the HLR**

If the macro Receive\_Open\_Ind takes the Vr exit or the Error exit, the MAP process returns to the idle state.

If the MAP provider sends a MAP\_P\_ABORT while the MAP process is waiting for a service indication, the MAP process returns to the idle state.

If the MAP provider sends a MAP\_NOTICE while the MAP process is waiting for a service indication, the MAP process sends a MAP\_CLOSE request to terminate the dialogue and returns to the idle state.

Process Note\_Ms\_Present\_For\_Gprs\_GGSN

24.3\_1(1)

Figure 24.3/1: The Note Ms Present For Gprs process in the HLR

Signals to/from the right are to/from the GPRS application process

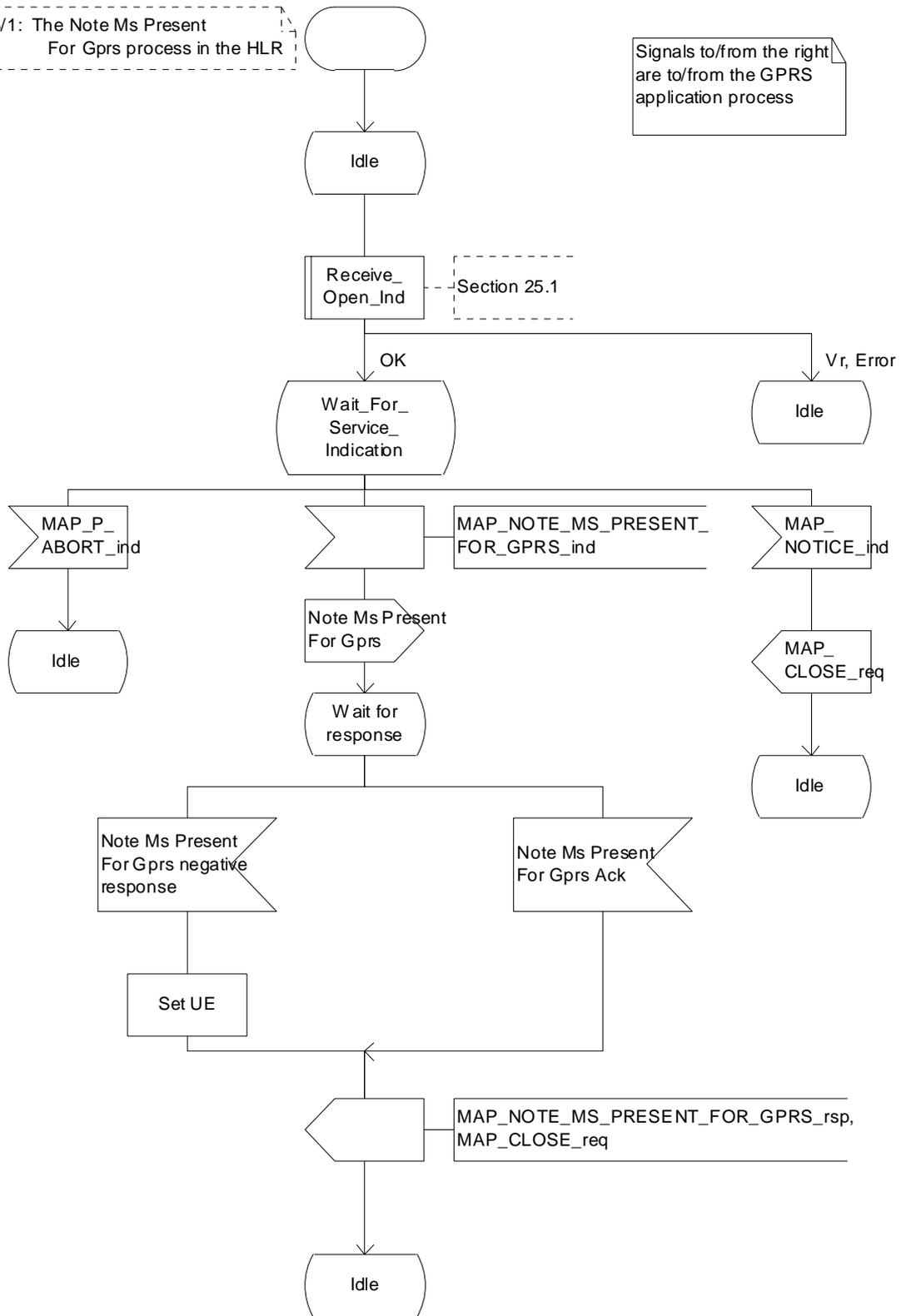



Process Note\_Ms\_Present\_For\_Gprs\_GGSN

24.3\_1(1)

Figure 24.3/1: The Note Ms Present For Gprs process in the HLR

Signals to/from the right are to/from the GPRS application process

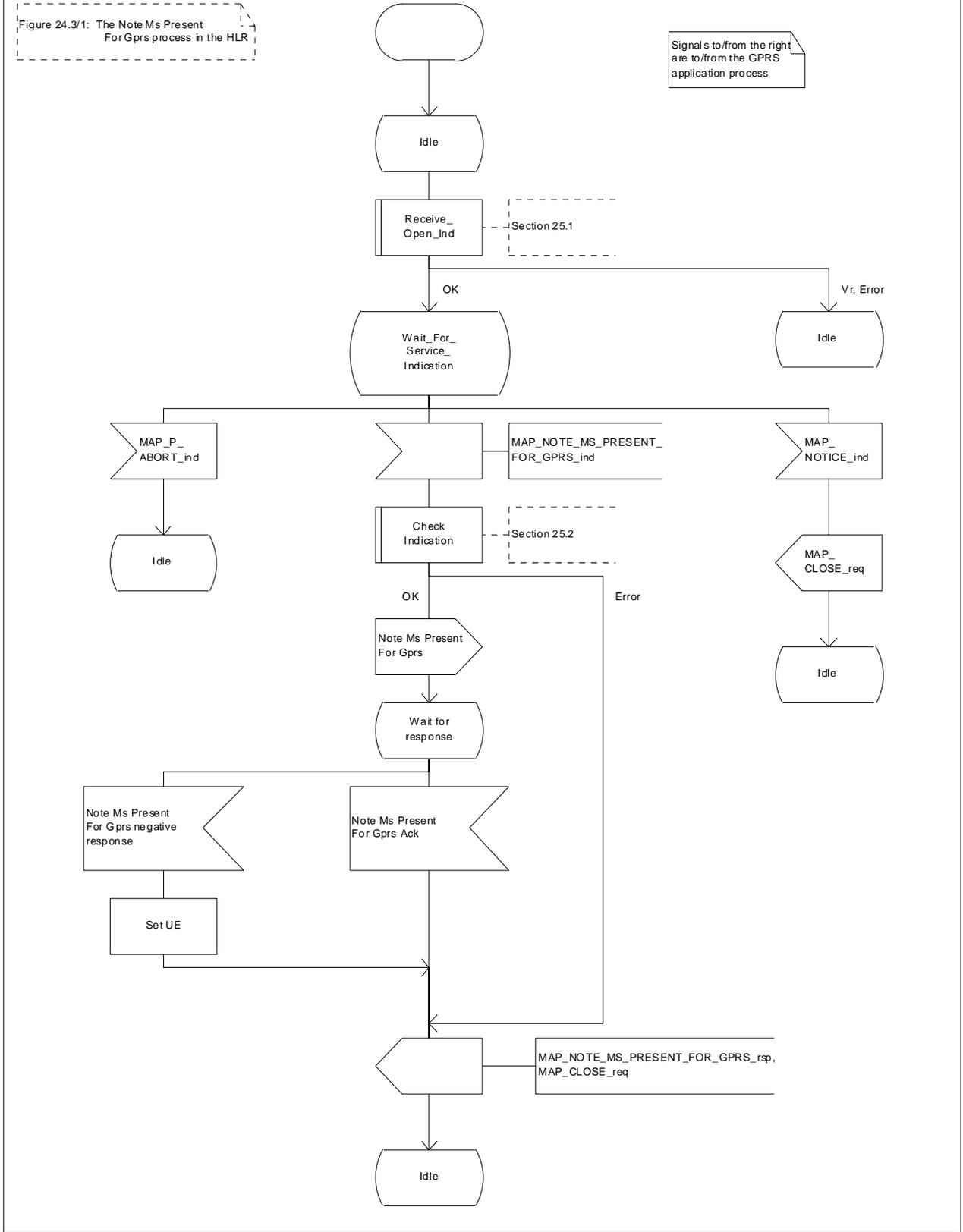

Figure 24.3/1: Process Note\_Ms\_Present\_For\_Gprs\_GGSN

## 24.3.2 Process in the HLR for Note Ms Present For Gprs

### Successful Outcome

When the MAP process receives a Note Ms Present For Gprs request from the GPRS application process in the HLR, it requests a dialogue with the GGSN whose identity is contained in the Note Ms Present For Gprs request by sending a MAP\_OPEN service request, sending necessary information using a MAP\_NOTE\_MS\_PRESENT\_FOR\_GPRS service request and invokes the macro Receive\_Open\_Cnf to wait for the response to the dialogue opening request. If the dialogue opening is successful, the MAP process waits for a response from the GGSN.

If the MAP process receives a MAP\_NOTE\_MS\_PRESENT\_FOR\_GPRS service confirm from the GGSN, the MAP process invokes the macro Check\_Confirmation to check the content of the confirm.

If the macro Check\_Confirmation takes the OK exit, the MAP process sends a Note Ms Present For Gprs ack containing the information received from the GGSN to the GPRS application process in the HLR and returns to the idle state.

### Failure of dialogue opening with the GGSN

If the macro Receive\_Open\_Cnf takes the Vr exit or the Error exit, the MAP process sends a negative response to the GPRS application process in the HLR and returns to the idle state.

### Error in MAP\_NOTE\_MS\_PRESENT\_FOR\_GPRS confirm

If the MAP\_NOTE\_MS\_PRESENT\_FOR\_GPRS service confirm contains a user error or a provider error, or the macro Check\_Confirmation indicates that there is a data error, the MAP process sends a Note Ms Present For Gprs negative response to the GPRS application process in the HLR and returns to the idle state.

### Abort of GGSN dialogue

After the dialogue with the GGSN has been established, the MAP service provider may abort the dialogue by issuing a MAP\_P\_ABORT or a MAP\_U\_ABORT indication. In this case, the MAP process sends a Note Ms Present For Gprs negative response to the GPRS application process in the HLR and returns to the idle state.

If the MAP provider indicates a protocol problem by sending a MAP\_NOTICE indication, the MAP process closes the dialogue with the GGSN, sends a Failure Report negative response indicating system failure to the GPRS application process in the HLR and returns to the idle state.

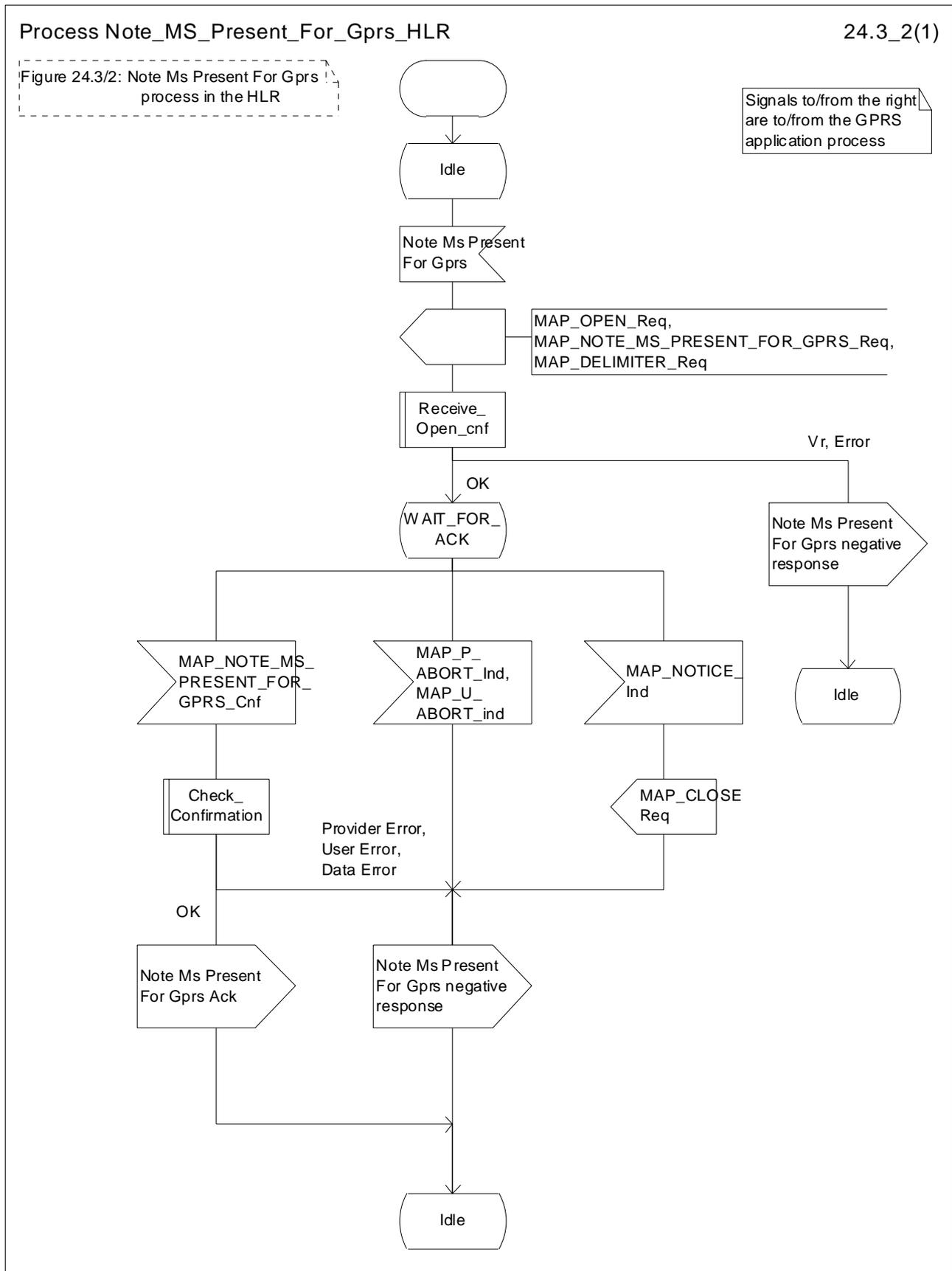

Figure 24.3/2: Process Note\_Ms\_Present\_For\_Gprs\_HLR

---

## 25 General macro description

### 25.1 MAP open macros

#### 25.1.1 Macro Receive\_Open\_Ind

This macro is used by a MAP service-user procedure when a peer entity requests opening of a dialogue.

If the application context received in the MAP-OPEN indication primitive indicates a context name of the MAP version one context set, the macro takes the Vr exit..

If an application-context different from version 1 is received, the presence of MAP\_OPEN information is checked. If no MAP\_OPEN information has been received, the MAP\_OPEN response with:

- Result set to Dialogue Accepted; and
- Application Context Name set to the received value,

is returned

If the received version (Vr) is the one described in this version of MAP, the macro takes the OK exit, otherwise it takes the Vr exit..

If MAP\_OPEN information is received, the macro "CHECK\_REFERENCE" is called in order to check whether the received values for Destination Reference and Originating Reference correspond with the requirements of the received application-context-name. The outcome of this check is an error, the MAP\_OPEN response with:

- Result set to Dialogue Refused;
- Refuse Reason set to Invalid Destination Reference or Invalid Originating Reference;
- Application Context Name set to the highest version supported,

is returned and the macro takes the error exit.

If the data values received for Destination Reference and Originating Reference are accepted for the associated application-context-name it is checked whether the Destination Reference is known if this check is required by the process that calls the macro.

If the Destination Reference (e.g. a subscribers IMSI) is unknown, the MAP\_OPEN response with

- Result set to Dialogue Refused;
- Refuse Reason set to Invalid Destination Reference;
- Application Context Name set to the highest version supported,

is returned and the macro takes the error exit.

Else, if the Destination Reference is accepted or if no check is required, the MAP\_OPEN response with

- Result set to Dialogue Accepted; and
- Application Context Name set to the received value,

is returned and

If the received version (Vr) is the one described in this version of MAP, the macro takes the OK exit, otherwise it takes the Vr exit.

#### 25.1.2 Macro Receive\_Open\_Cnf

This macro is used by a user procedure after it requested opening of a dialogue towards a peer entity.

On receipt of a MAP\_OPEN Confirmation with a "Result" parameter indicating "Dialogue Accepted", the macro takes the OK exit.

If the "Result" parameter indicates "Dialogue Refused", the "Refuse-reason" parameter is examined. If the "Refuse-reason" parameter indicates "Potential Version Incompatibility", the macro terminates in a way that causes restart of the dialogue by using the version 1 protocol.

If the "Refuse-reason" parameter indicates "Application Context Not Supported" and if the received Application Context Name indicates "Version Vr" ( $V_r < V_n$ ), the macro terminates in a way that causes restart of the dialogue by using the version Vr protocol. Otherwise, the macro takes the Error exit.

If the "Refuse-reason" parameter indicates neither "Potential Version Incompatibility" nor "Application Context Not Supported", the macro takes the Error exit.

If a MAP\_U\_ABORT, a MAP\_P\_ABORT or a MAP\_NOTICE Indication is received, the macro takes the Error exit.

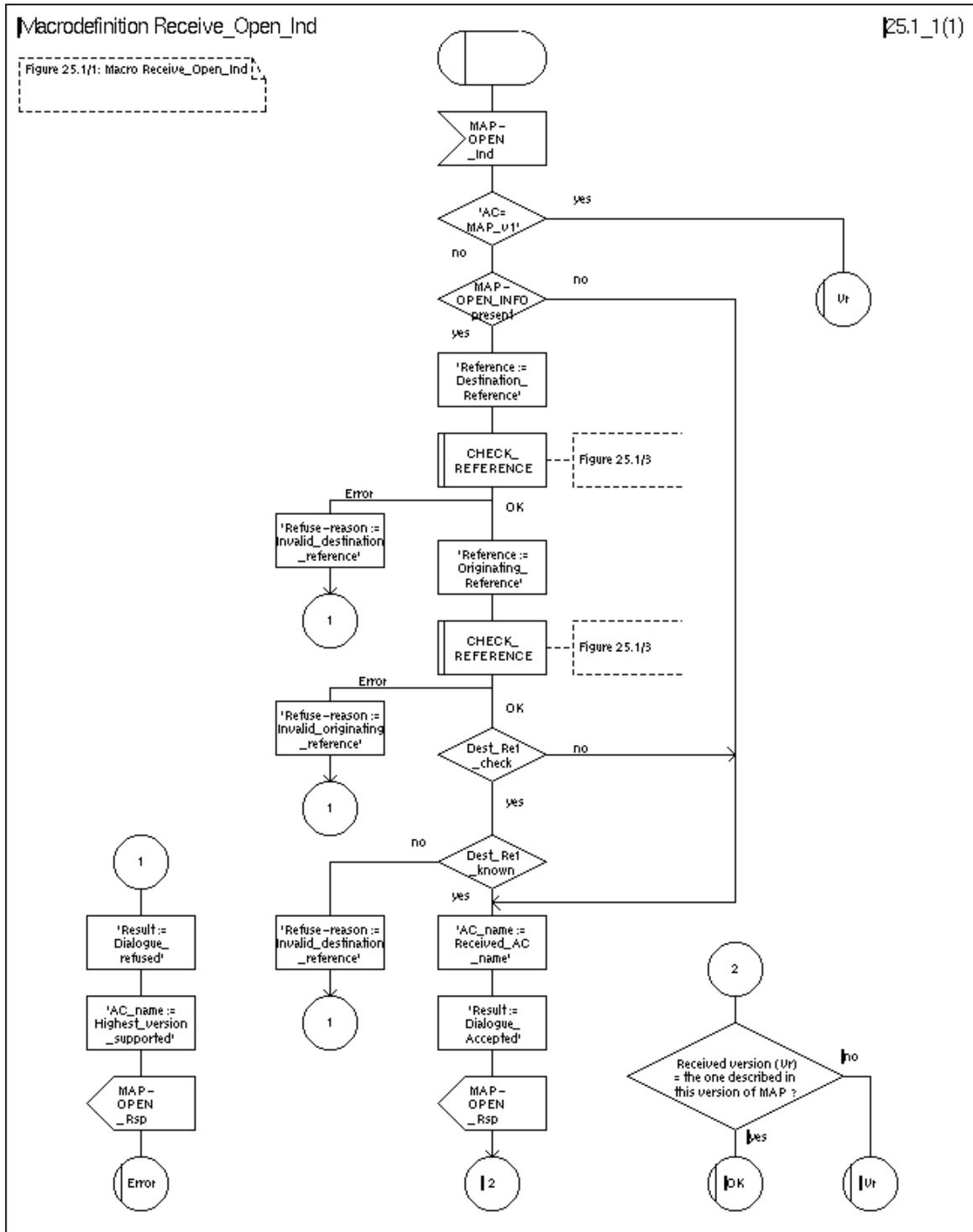

Figure 25.1/1: Macro Receive\_Open\_Ind

Macrodefinition Receive\_Open\_Cnf

25.1\_2(1)

Figure 25.1/2: Macro to receive a MAP\_OPEN\_Cnf

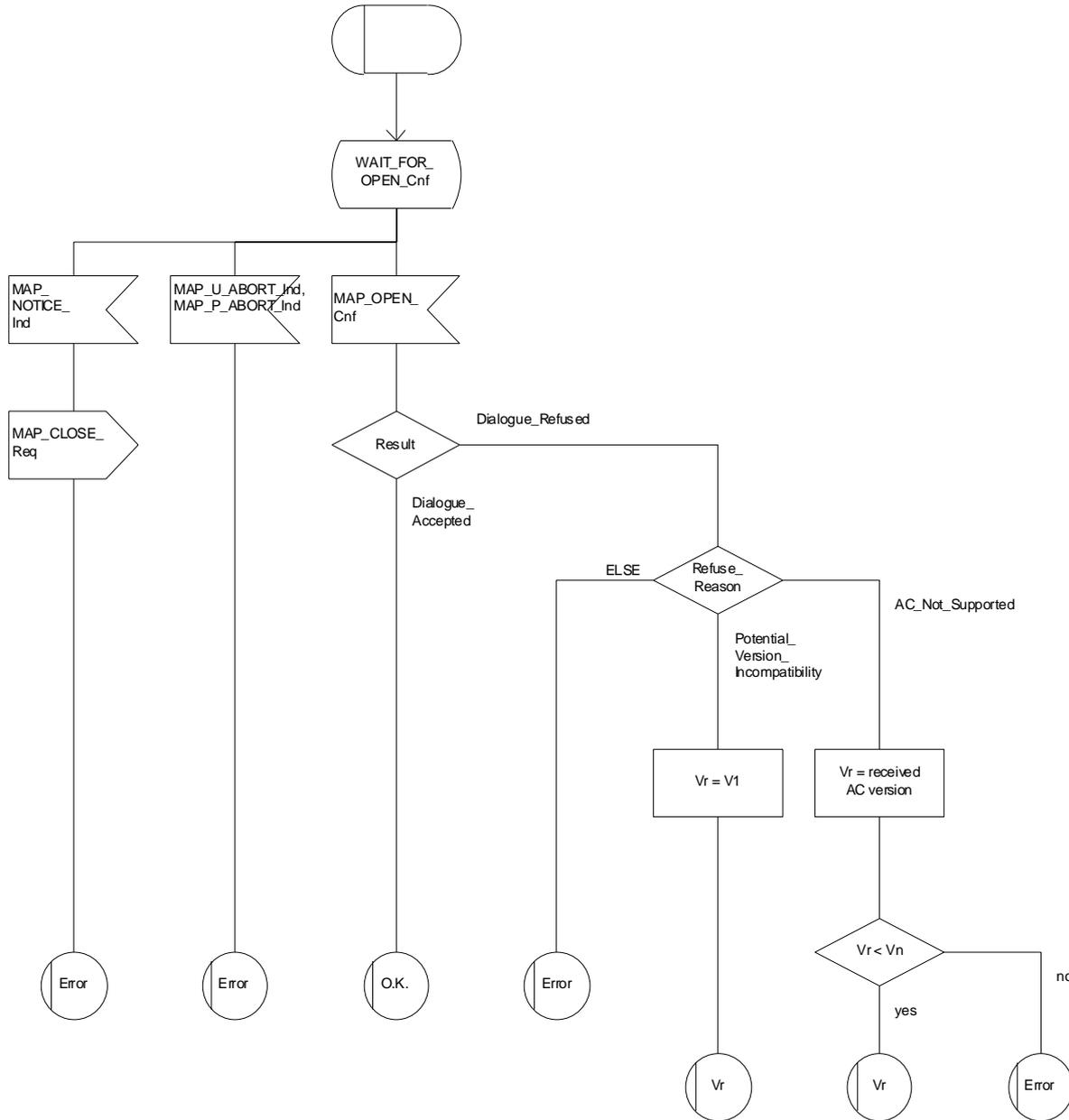

Figure 25.1/2: Macro Receive\_Open\_Cnf

Macrodefinition CHECK\_REFERENCE

25.1\_3(1)

Figure 25.1/3: Check of Destination Reference and Originating Reference received in a MAP-OPEN indication primitive

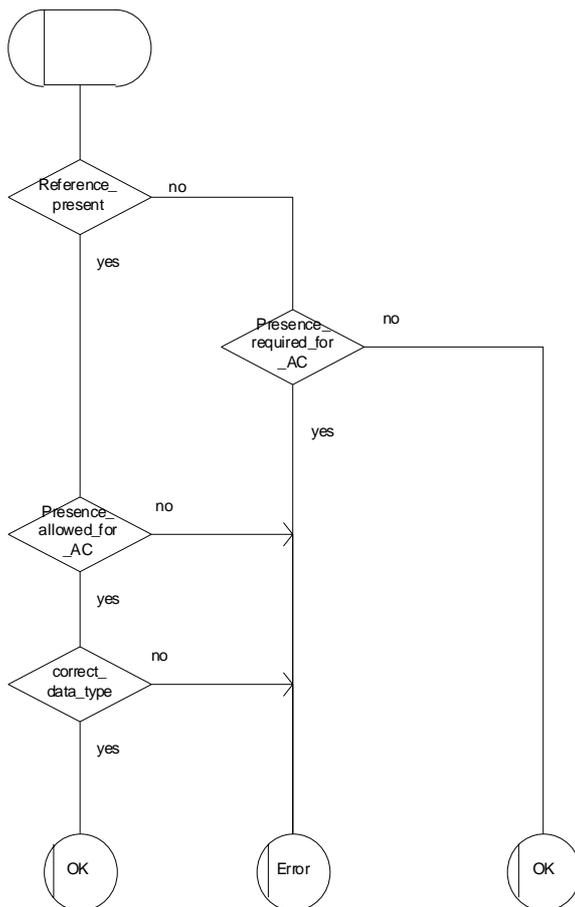

Figure 25.1/3: Macro CHECK\_REFERENCE



## 25.2 Macros to check the content of indication and confirmation primitives

### 25.2.1 Macro Check\_Indication

If a parameter required by the application is missing from the indication, the macro takes the error exit, with a user error of "Data Missing".

If a parameter not expected by the application is present in the indication, or an expected parameter has a value not in the set of values permitted by the application, the macro takes the error exit, with a user error of "Unexpected Data Value".

Otherwise the macro takes the "OK" exit.

The macro is shown in figure 25.2/1.

### 25.2.2 Macro Check\_Confirmation

If the confirmation contains a provider error the macro issues a MAP CLOSE request and takes the provider error exit.

Otherwise, if the confirmation contains a user error the macro takes the user error exit.

Otherwise, if a parameter required by the application is missing from the confirmation, or a parameter not expected by the application is present in the confirmation, or an expected parameter has a value not in the set of values permitted by the application, the macro takes the data error exit.

Otherwise the macro takes the "OK" exit.

The macro is shown in figure 25.2/2.

Macrodefinition Check\_Indication

25.2\_1(1)

Figure 25.2/1: Macro to check the parameters of an indication primitive

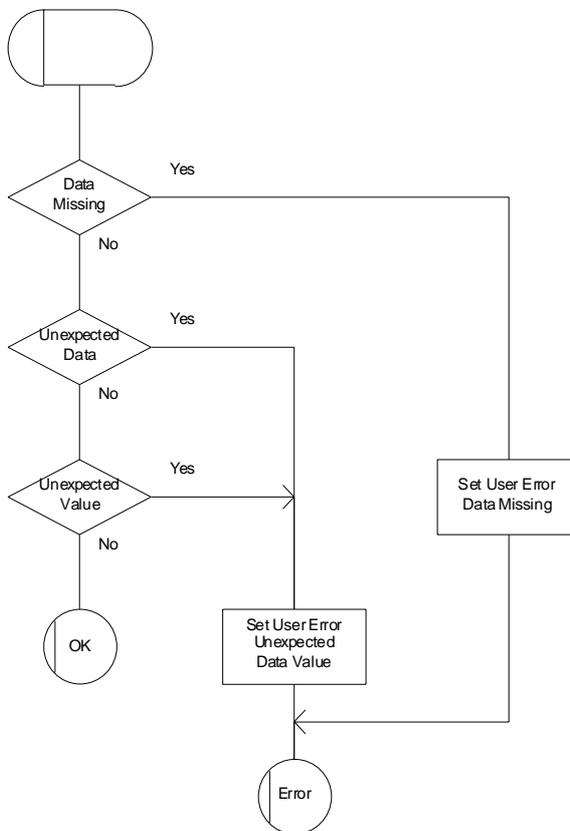

Figure 25.2/1: Macro Check\_Indication

Macrodefinition Check\_Confirmation

25.2\_2(1)

Figure 25.2/2: Macro to check the parameters of a confirmation primitive

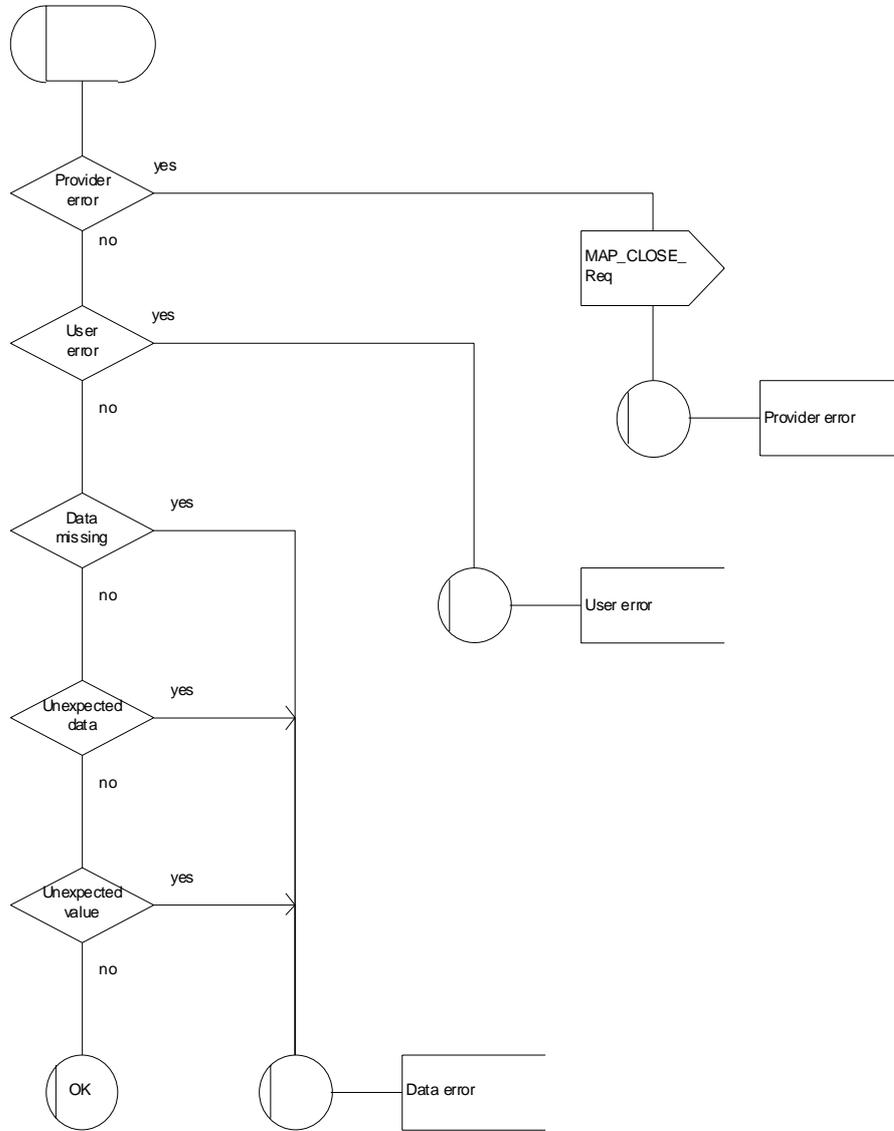

Figure 25.2/2: Macro Check\_Confirmation

## 25.3 The page and search macros

### 25.3.1 Macro PAGE\_MSC

This macro (see figure 25.3/1) is called if a mobile terminating call set-up, an unstructured SS notification, a network-initiated unstructured SS request or a mobile terminating short message is to be delivered to the MS and the current location area identity of the MS is known in the VLR.

When the MSC receives a MAP\_PAGE indication, parameter checks are performed first (macro Check\_Indication, see clause 25.2). If parameter errors are detected, the MSC returns a MAP\_PAGE response containing the appropriate error cause and the macro terminates with unsuccessful outcome.

Thereafter, several checks on the indication content are performed. The macro terminates by returning the MAP\_PAGE response with error:

Unknown Location Area if the LAI is not known in the MSC;

System Failure if the call has been released by the calling subscriber or the SMS or SS transaction for this subscriber has been released by the originating entity in the meantime.

Next, the MSC checks if an MM-connection over the radio link already exists for the given IMSI. If so,

- in the case of mobile terminating call set-up the MSC determines whether the busy condition can be established (see GSM 02.01 for a definition of busy states). If the MSC determines that the MS is busy, it returns a MAP\_PAGE response with error Busy Subscriber, qualified by either More Calls Allowed or No More Calls Allowed. The macro then terminates with unsuccessful outcome.
- if the service requested is short message service or an unstructured SS notification or network-initiated unstructured SS request, or if the service is mobile terminating call set-up, but the existing connection is for signalling purposes only (i.e. a service different from call set-up), the access connection status is set according to the characteristics of the existing connection (i.e. RR-connection established, ciphering mode on/off, MM-connection existing and authenticated or not), and the macro terminates with successful outcome.

If no MM-connection for the given IMSI exists, paging is initiated at the radio interface within all cells of the location area indicated by the VLR. If the VLR provided the TMSI, the MSC uses it to identify the MS at the radio interface; otherwise the MSC uses the IMSI. The IMSI will also be used to determine the page group (see GSM 04.08). There are several possible outcomes of paging:

- the MS responds to paging, causing the access connection status to be set accordingly (i.e. no RR-connection, in which case other values are not significant), and the macro terminates with successful outcome;
- the MS responds with a channel request containing an establishment cause which is not "answer to paging". The MSC sends a MAP\_PAGE response primitive with user error Busy Subscriber before the macro terminates with unsuccessful outcome. This will give priority to the mobile originating request. Alternatively, as an implementation option, the MSC may treat this as a response to paging, which will give priority to the mobile terminating request.
- there is no response from the MS. The MSC sends a MAP\_PAGE response primitive with user error Absent Subscriber before the macro terminates with unsuccessful outcome;
- the call handling connection or MAP transaction on which the call, SMS or unstructured SS transaction is waiting for delivery, is released before a response is received from the MS (indicated in the SDL by the input signal I-REL). The MAP transaction with the VLR will be released in this case by a MAP\_U\_ABORT request, and the unsuccessful macro termination will indicate transaction termination.
- the MAP transaction with the VLR may be released by receiving a MAP\_U\_ABORT or MAP\_P\_ABORT indication. The call handling connection or MAP transaction on which the call, SMS or unstructured SS transaction is waiting for delivery, is released (indicated in the SDL by the output signal I-REL), and the unsuccessful macro termination will indicate transaction termination.

### 25.3.2 Macro Search\_For\_MS\_MSC

This macro (see figure 25.3/2) is called if a mobile terminating call set-up, an unstructured SS notification, a network-initiated unstructured SS request or a mobile terminating short message is to be delivered to the MS and the current location area identity of the MS is not known in VLR.

When the MSC receives a MAP\_SEARCH\_FOR\_MS Indication, parameter checks are performed first (macro Check\_indication, see clause 25.2). If parameter errors are detected, the MSC returns a MAP\_SEARCH\_FOR\_MS response containing the appropriate error cause and the macro terminates with unsuccessful outcome.

Thereafter, the MSC checks whether the call or the SMS or SS transaction still exists in the MSC. If the call or the SMS or SS transaction has been released, the MSC returns a MAP\_SEARCH\_FOR\_MS response with error System Failure and the macro terminates with unsuccessful outcome.

Next, the MSC checks if an MM-connection over the radio link already exists for the given IMSI. If so,

- in the case of mobile terminating call set-up the MSC determines whether the busy condition can be established (see GSM 02.01 for a definition of busy states). If the MSC determines that the MS is busy, it returns a MAP\_SEARCH\_FOR\_MS response with error Busy Subscriber, qualified by either More Calls Allowed or No More Calls Allowed. The macro then terminates with unsuccessful outcome.
- if the service requested is short message service or an unstructured SS notification or network-initiated unstructured SS request, or if the service is mobile terminating call set-up, but the existing connection is for signalling purposes only (i.e. a service different from call set-up), a MAP\_SEARCH\_FOR\_MS response containing the IMSI and current location area identification of the called MS is returned to the VLR. The access connection status is set according to the characteristics of the existing connection (i.e. RR-connection established, ciphering mode on/off, MM-connection existing and authenticated or not), and the macro terminates with successful outcome.

If no MM-connection for the given IMSI exists, paging is initiated at the radio interface within all cells of all location areas of the VLR, using the IMSI to identify the subscriber and the page group (see GSM 04.08). There are several possible outcomes of paging:

- the MS responds to paging, causing a MAP\_SEARCH\_FOR\_MS response containing the IMSI and current location area identification of the called MS to be returned to the VLR. The access connection status will be set accordingly (i.e. no RR-connection, in which case other values are not significant), and the macro terminates with successful outcome.
- the MS responds with a channel request containing an establishment cause which is not "answer to paging". The MSC sends a MAP\_SEARCH\_FOR\_MS response primitive with user error "Busy Subscriber" before the macro terminates with unsuccessful outcome. This will give priority to the mobile originating request. Alternatively, as an implementation option, the MSC may treat this as a response to paging, which will give priority to the mobile terminating request.
- there is no response from the MS. The MSC sends a MAP\_SEARCH\_FOR\_MS response primitive with user error "Absent Subscriber" before the macro terminates with unsuccessful outcome.
- the call handling connection or MAP transaction on which the call, SMS or unstructured SS transaction is waiting for delivery, is released before a response is received from the MS (indicated in the SDL by the input signal I-REL). The MAP transaction with the VLR will be released in this case by a MAP\_U\_ABORT request, and the unsuccessful macro termination will indicate transaction termination.
- the MAP transaction with the VLR may be released by receiving a MAP\_U\_ABORT or MAP\_P\_ABORT indication. The call handling connection or MAP transaction on which the call, SMS or unstructured SS transaction is waiting for delivery, is released (indicated in the SDL by the output signal I-REL), and the unsuccessful macro termination will indicate transaction termination.

Macrodefinition Page\_MSC

25.3\_1(1)

Figure 25.3/1:  
Macro Page\_MSC

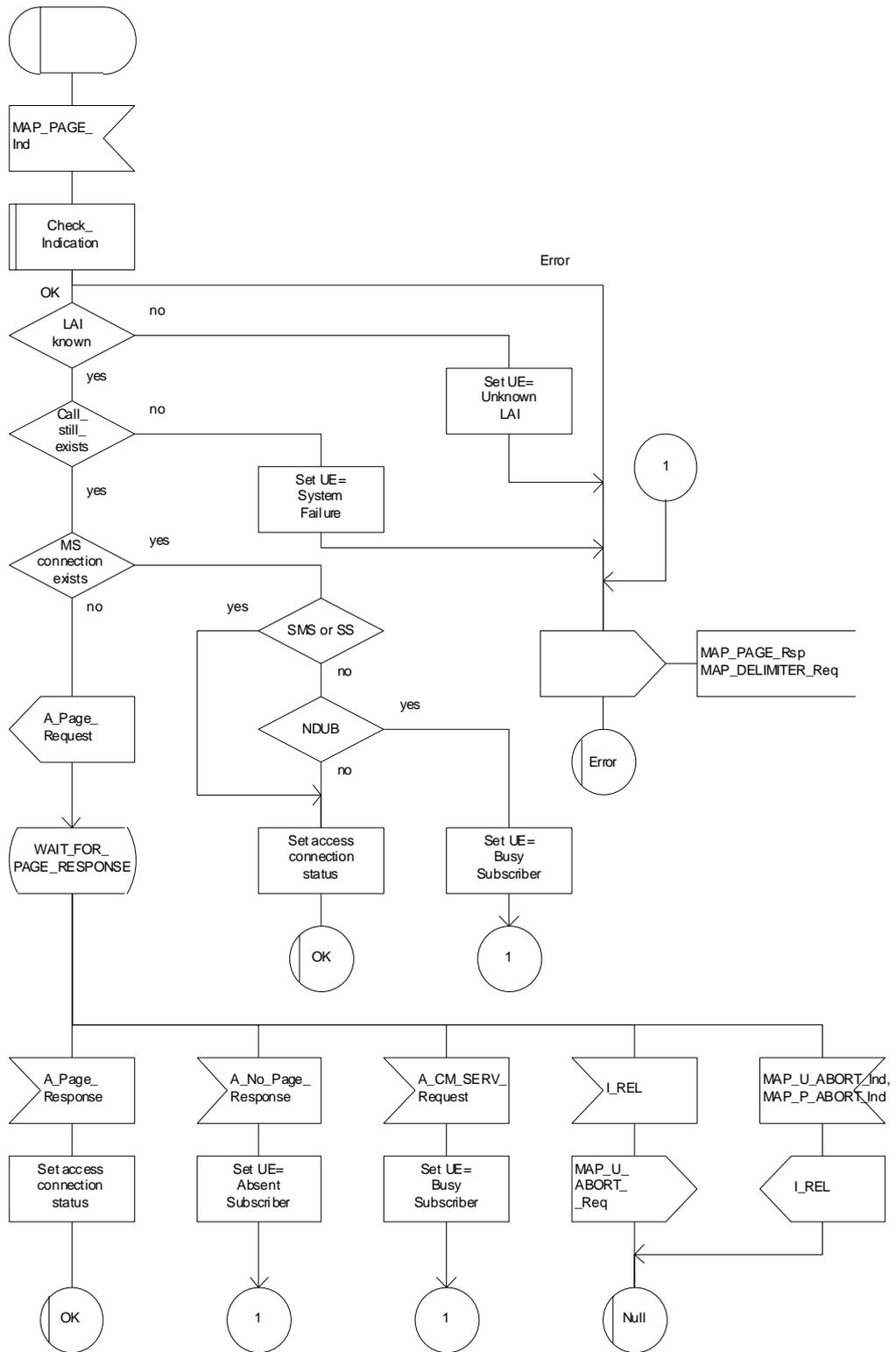

Figure 25.3/1: Macro Page\_MSC

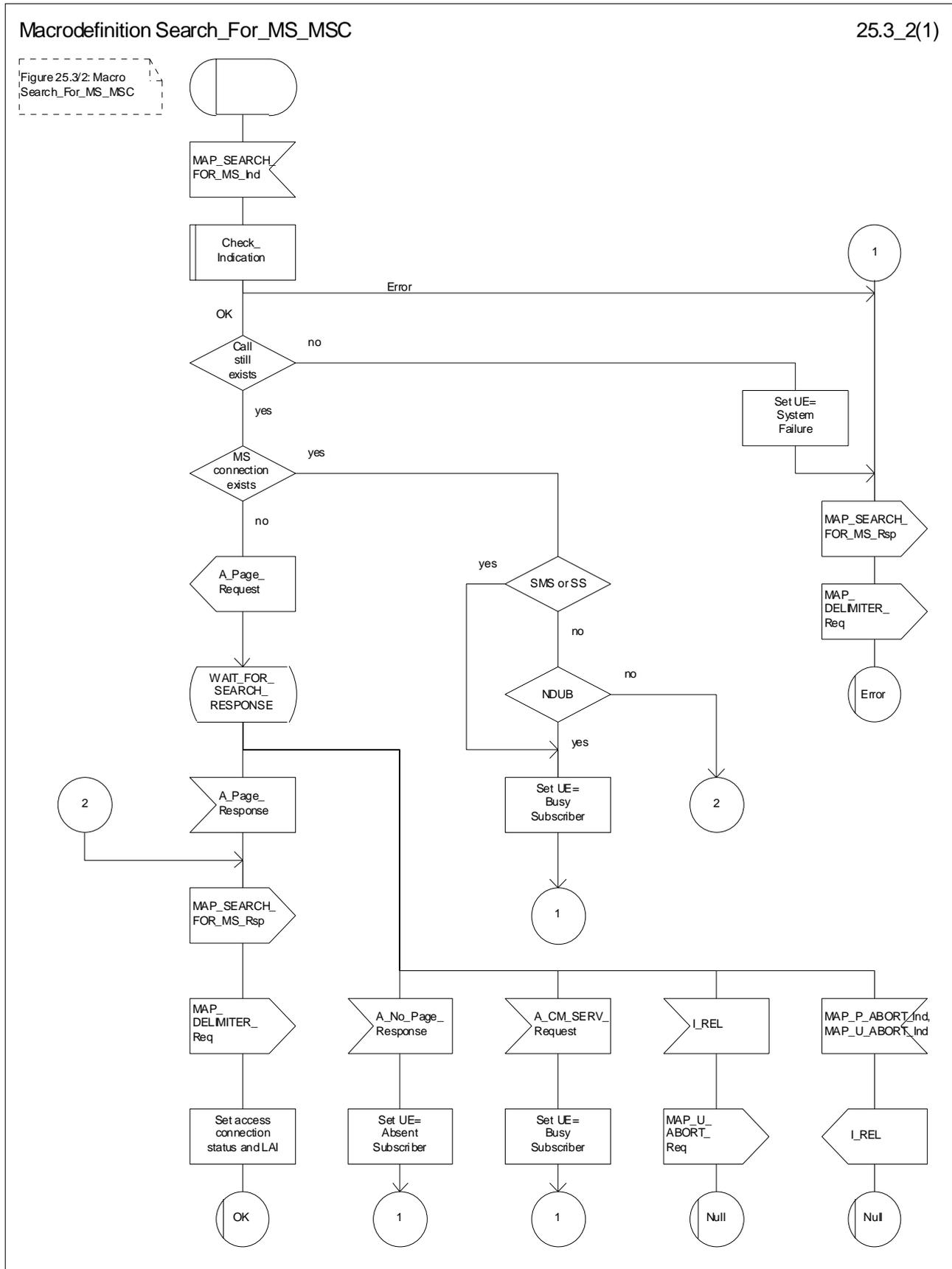

Figure 25.3/2: Macro Search\_for\_MS\_MSC

## 25.4 Macros for handling an Access Request

These macros are invoked when a MS accesses the network, e.g. to set up an outgoing call or when responding to paging. The macro handles identification and authentication of the mobile subscriber as well as invocation of security related features (see GSM 02.09).

### 25.4.1 Macro Process\_Access\_Request\_MSC

This macro is invoked by any procedure receiving an access request from the MS, e.g. the page response at mobile terminating call set-up or the request for outgoing call set-up.

If no dialogue with the VLR exists (e.g. within the procedure for outgoing call set-up), the MSC will open a dialogue towards the VLR by sending a MAP\_OPEN request without any user specific parameters.

In any case, the parameters received from the MS are mapped to a MAP\_PROCESS\_ACCESS\_REQUEST request primitive, containing:

- the received subscriber identification (IMSI, TMSI) or - in case of emergency call set-up - an IMEI;
- the CM service type, indicating the type of request;
- the status of the access connection, i.e. whether a connection to this MS already exists and if so, whether it is already authenticated and ciphered;
- the current location area id of the MS; and
- the CKSN received from the MS.

If opening of the dialogue was required, the MSC will wait for the dialogue confirmation (see macro Receive\_Open\_Confirmation, clause 25.1), leading either to:

- immediate unsuccessful exit from the macro, in case no dialogue is possible;
- reversion to MAP version one dialogue if indicated by the VLR. The macro terminates with unsuccessful outcome, as the complete dialogue will be covered by the version one procedure, so that no further action from the calling process is required;
- continuation as given below, if the dialogue is accepted by the VLR.

The MSC waits then for the MAP\_PROCESS\_ACCESS\_REQUEST confirmation. In between, several other indications may be received from the VLR:

- the MSC may receive a MAP\_PROVIDE\_IMSI indication, handled by the macro Obtain\_IMSI\_MSC defined in clause 25.8. In case of positive outcome, the procedure continues waiting for the MAP\_PROCESS\_ACCESS\_REQUEST confirmation, else the macro terminates with unsuccessful outcome;
- the MSC may receive a MAP\_AUTHENTICATE indication, handled by the macro Authenticate\_MSC defined in clause 25.5. In case of positive outcome, the procedure continues waiting for the MAP\_PROCESS\_ACCESS\_REQUEST confirmation, else the macro terminates with unsuccessful outcome;
- the MSC may receive a MAP\_TRACE\_SUBSCRIBER\_ACTIVITY indication, handled by the macro Trace\_Subscriber\_Activity\_MSC defined in clause 25.9;
- the MSC may receive a MAP\_SET\_CIPHERING\_MODE indication, which will be stored for initiating ciphering later on;
- the MSC may receive a MAP\_CHECK\_IMEI indication, handled by the macro Check\_IMEI\_MSC defined in clause 25.6. In case of positive outcome, the procedure continues waiting for the MAP\_PROCESS\_ACCESS\_REQUEST confirmation, else the macro terminates with unsuccessful outcome;
- the MSC may receive a MAP\_Obtain\_IMEI indication, handled by the macro Obtain\_IMEI\_MSC defined in clause 25.6. In case of positive outcome, the procedure continues waiting for the MAP\_PROCESS\_ACCESS\_REQUEST confirmation, else the macro terminates with unsuccessful outcome;



- the MSC may receive a MAP\_U\_ABORT or MAP\_P\_ABORT indication, or a premature MAP\_CLOSE indication from the VLR. In all these cases, the macro terminates with unsuccessful outcome, after sending the appropriate reject towards the MS (see GSM 09.10);
- the MSC may receive a MAP\_NOTICE indication from the VLR. In this case, the dialogue towards the VLR is terminated by a MAP\_CLOSE primitive, the appropriate reject is sent towards the MS (see GSM 09.10), and the macro terminates with unsuccessful outcome;
- the MSC may receive an indication for release of the radio path, in which case the dialogue towards the VLR will be terminated by a MAP\_U\_ABORT primitive, containing the diagnostic information Radio Channel Release.

When the MAP\_PROCESS\_ACCESS\_REQUEST confirmation is received, the parameters of this primitive are checked first. In case of unsuccessful outcome of the service, the MAP User Error received is mapped onto the appropriate radio interface message (see GSM 09.10), before the macro terminates with unsuccessful outcome.

In case of positive outcome of the service, ciphering is initiated on the radio path, if this had been requested by the VLR (see above). Otherwise, if the access request was not triggered by a page response from the MS, the access request is accepted explicitly by sending a CM\_Service\_Accept message to the MS. If the access request was triggered by a page response from the MS then no CM Service Accept message is sent.

After ciphering has been initiated, the MSC will wait for the MAP\_FORWARD\_NEW\_TMSI indication from the VLR. While waiting, the MSC may receive:

- a MAP\_U\_ABORT or MAP\_P\_ABORT indication, or a premature MAP\_CLOSE indication from the VLR. In these cases, the macro terminates with unsuccessful outcome, after sending a release request towards the MS (see GSM 09.10);
- a MAP\_NOTICE indication from the VLR. In this case, the dialogue towards the VLR is terminated by a MAP\_CLOSE primitive, the appropriate reject is sent towards the MS (see GSM 09.10), and the macro terminates with unsuccessful outcome;
- an indication for release of the radio path, in which case the dialogue towards the VLR will be terminated by a MAP\_U\_ABORT primitive, containing the diagnostic information Radio Channel Release;
- a MAP\_DELIMITER request from the VLR. This will be taken as a successful outcome of the macro (i.e. the VLR did not require TMSI reallocation), and it terminates successfully;
- an A\_SETUP request from the MS. This will be saved for handling by the procedure which invoked the macro Process\_Access\_Request\_MSC after the macro has terminated.

When the MAP\_FORWARD\_NEW\_TMSI indication is received in the MSC, the TMSI Reallocation Command is sent to the MS, and the MSC waits for an acknowledgement from the MS. In case a positive acknowledgement is received, the MSC sends an empty MAP\_FORWARD\_NEW\_TMSI response primitive to the VLR and terminates successfully. Else, the dialogue is terminated locally (MAP\_CLOSE\_Req with Release method Prearranged End) without any further action.

If the MSC receives an A\_SETUP request while it is waiting for the TMSI acknowledgement from the MS, the A\_SETUP is saved for handling by the procedure which invoked the macro Process\_Access\_Request\_MSC after the macro has terminated.

If the dialogue is aborted by the VLR while waiting for the TMSI acknowledgement from the MS, the MSC regards the access request to be failed and terminates with unsuccessful outcome, after sending a release request towards the MS (see GSM 09.10).

Macrodefinition Process\_Access\_Request\_MSC

25.4\_1.1(3)

Figure 25.4/1: Macro for processing the access request in MSC

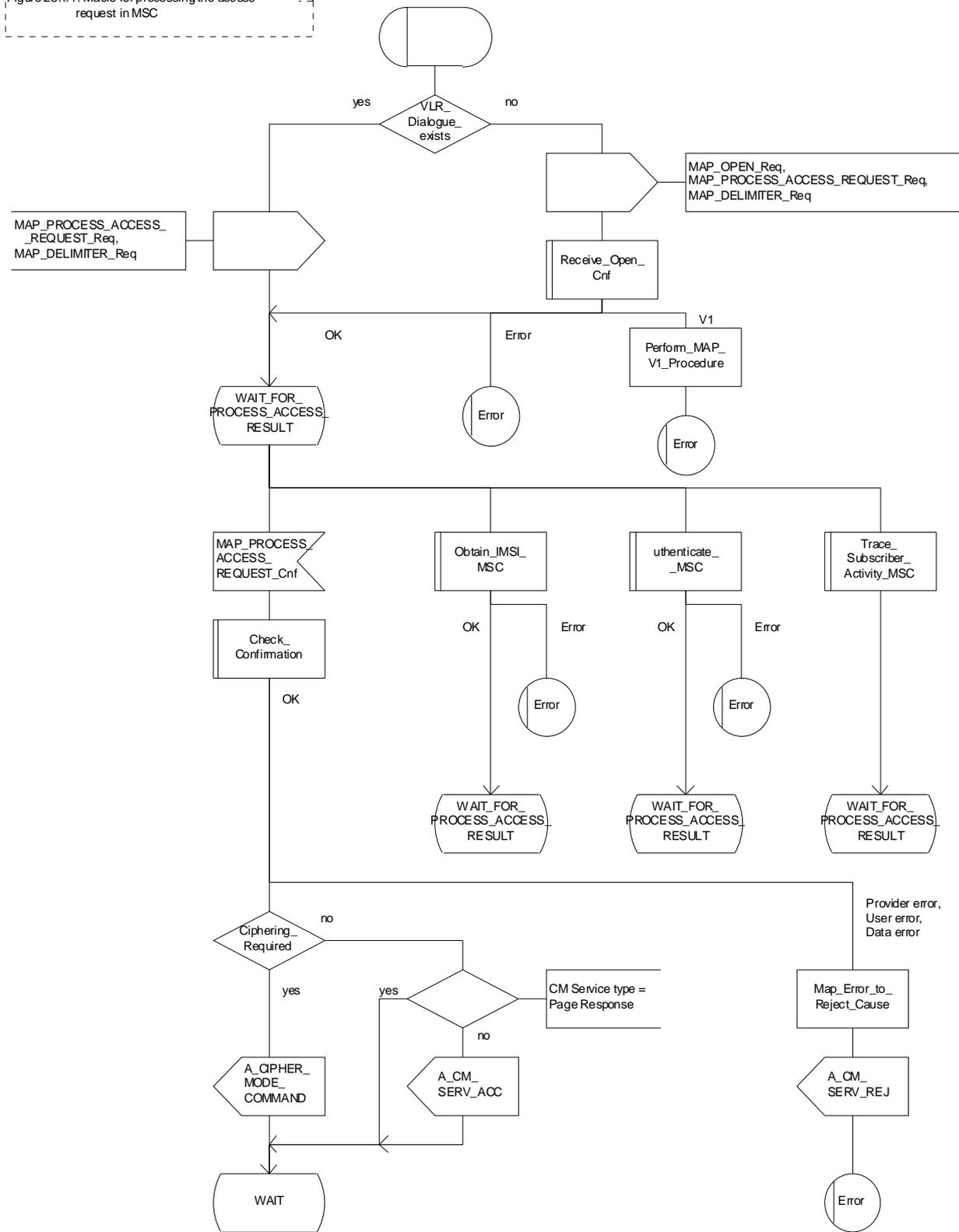

Figure 25.4/1 (sheet 1 of 3): Macro Process\_Access\_Request\_MSC

Macrodefinition Process\_Access\_Request\_MSC

25.4\_1.2(3)

Figure 25.4/1: Macro for processing the access request in MSC

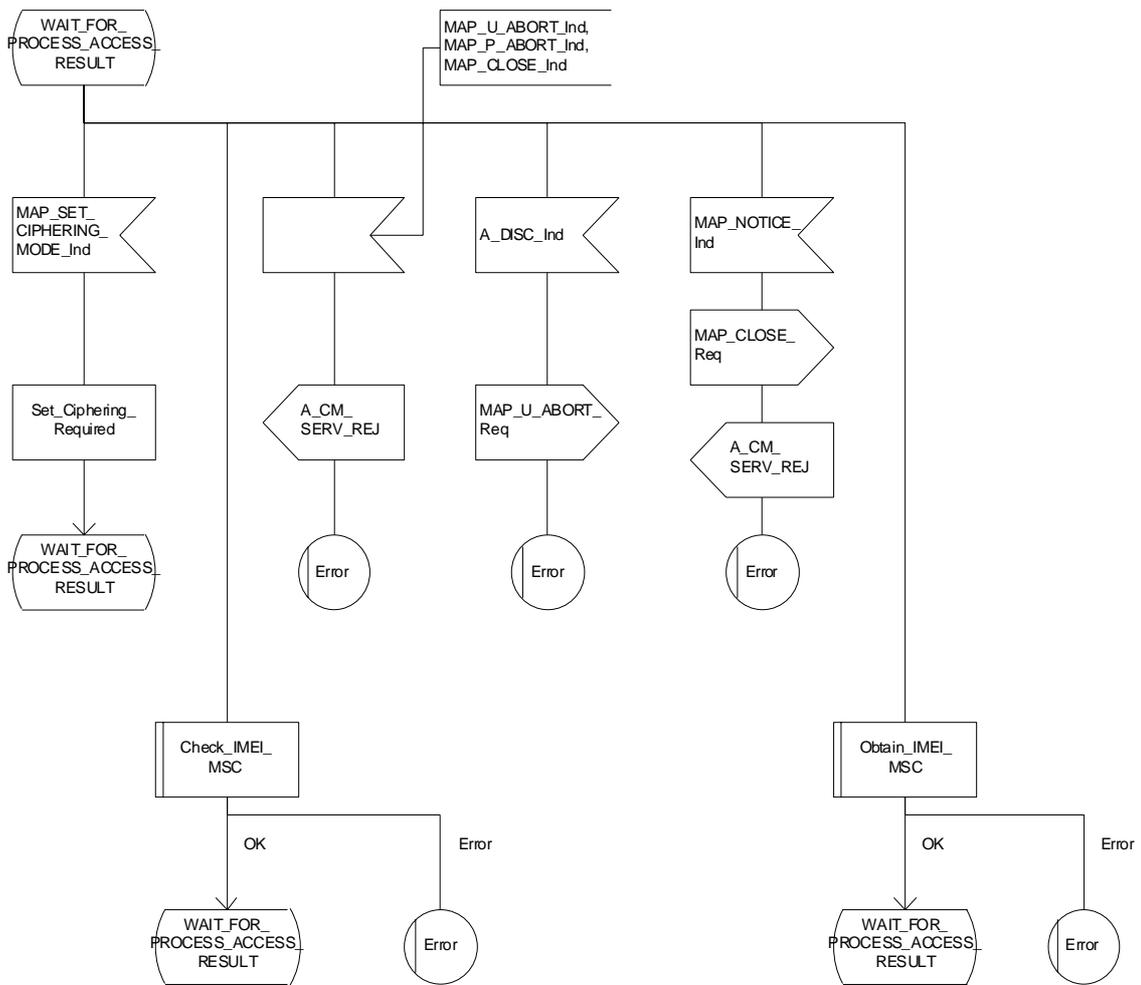

Figure 25.4/1 (sheet 2 of 3): Macro Process\_Access\_Request\_MSC

Macrodefinition Process\_Access\_Request\_MSC

25.4\_1.3(3)

Figure 25.4/1: Macro for processing the access request in MSC

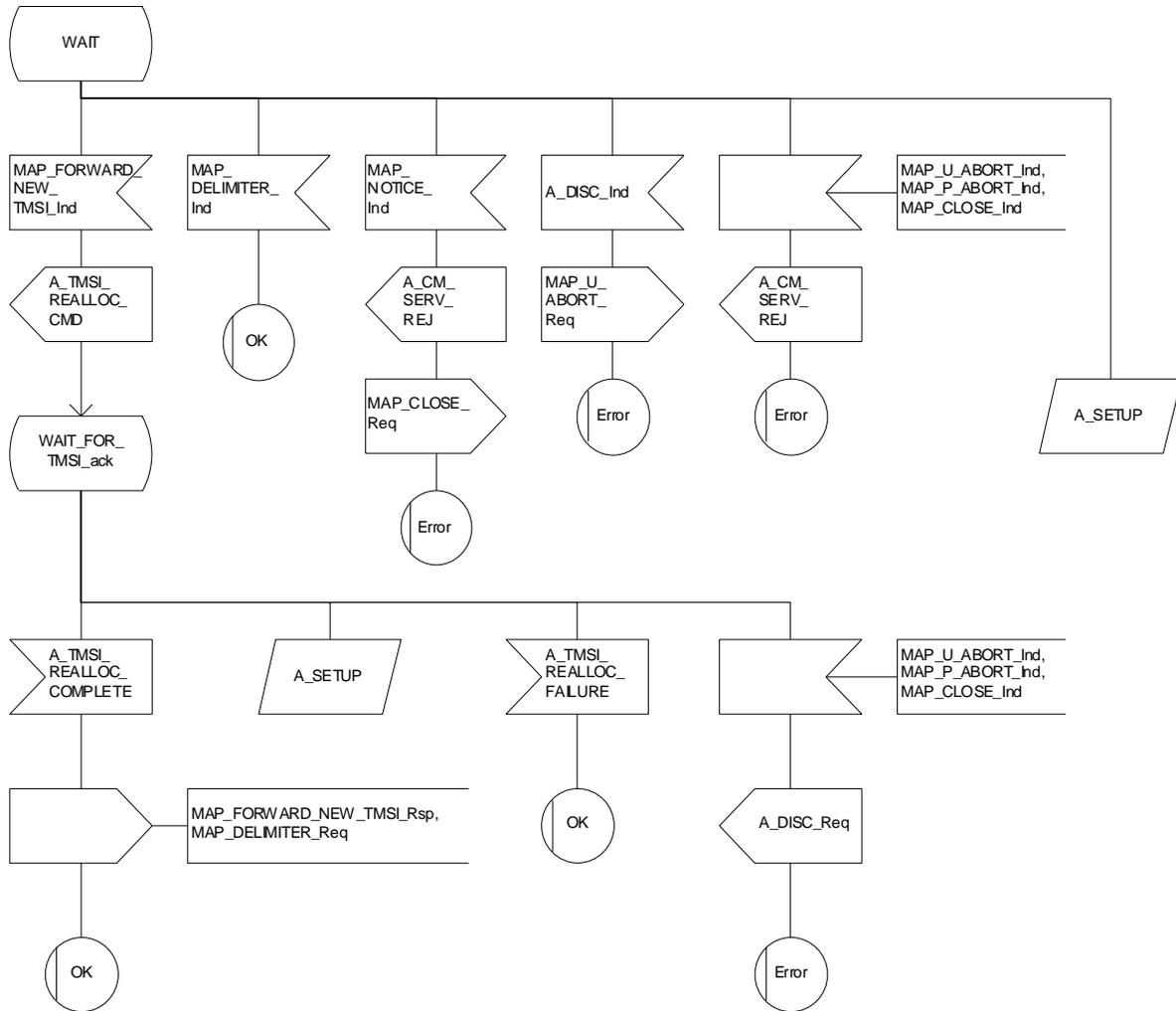

Figure 25.4/1 (sheet 3 of 3): Macro Process\_Access\_Request\_MSC

## 25.4.2 Macro Process\_Access\_Request\_VLR

When the VLR receives a MAP\_PROCESS\_ACCESS\_REQUEST indication, the VLR will check this indication first (macro Check\_Indication, see clause 25.2). In case of negative outcome, the macro will proceed with the error handling described below.

If the indication data are correct, it is checked first whether the subscriber identification (IMSI or TMSI) is known if included:

- if the identification is not known, the IMSI may be requested from the MS, described in the macro Identification\_Procedure (see below) with outcome:
  - OK, if a IMSI known in the VLR has been received;
  - Error, if the VLR did not recognize the subscriber's identity. The macro will proceed with the error handling described below;
  - Aborted, if the transaction to the MSC is released. The macro will terminate immediately with unsuccessful.

In case the identity received is an IMEI, the error System Failure is set and the macro proceeds with the error handling described below.

NOTE: Emergency Call with IMEI may be accepted within the error handling phase.

For a known subscriber the authentication check is performed next (see macro Authenticate\_VLR, clause 25.5), if required. If a negative result is received, the VLR proceeds on receipt of user error:

- illegal subscriber depending on the identity used for authentication;

In case IMSI is already used or no new authentication attempt with IMSI shall not be performed (operator option), the error Illegal Subscriber is set and the macro proceeds with the error handling described below.

If a new authentication attempt with IMSI shall be performed, the IMSI is requested from the MS (macro Obtain\_IMSI\_VLR, see clause 25.8):

- the authentication will be performed again if a IMSI known in the VLR is received;
- the error Unidentified Subscriber is set and the macro proceeds with the error handling described below, if the IMSI received is unknown in VLR;
- if the IMSI request procedure fails for any other reason, the error System Failure is set and the macro proceeds with the error handling described below;
- if the dialogue has been aborted during the IMSI request, the macro terminates immediately with unsuccessful outcome;
- unknown subscriber by setting the error Unidentified Subscriber and proceeding with the error handling described below.

NOTE: This can occur only in case of data inconsistency between HLR and VLR;

- procedure error by setting the error System Failure and proceeding with the error handling described below;
- null (i.e. the dialogue towards the MSC is terminated) by terminating immediately with unsuccessful outcome.

The MS access is accepted if no authentication is required or after successful authentication. Then, the indicator "Confirmed by Radio Contact" is set to "Confirmed". If the indicator "Location Information Confirmed in HLR" is set to "Not Confirmed", HLR updating will be started as an independent process (Update\_Location\_VLR, see clause 19.1.1.6).

If the indicator "Confirmed by HLR" is set to "Not Confirmed", the error Unidentified Subscriber is set and the macro proceeds with the error handling described below.

If roaming is not allowed in the location area indicated in the Current Location Area Id parameter, the error Roaming Not Allowed qualified by the roaming restriction reason is set and the macro proceeds with the error handling described below.

In case roaming is allowed, the IMSI is set to attached and the process for notifying the HLR that the subscriber is present is started if required (Subscriber Present VLR, see clause 25.10).

At next, tracing is invoked if required by the operator (macro Trace\_Subscriber\_Activity\_VLR, see clause 25.9). Thereafter,

if ciphering is not required, IMEI checking is invoked if required by the operator (see macro Check\_IMEI\_VLR defined in clause 25.6).

The error Illegal Equipment is set in case of unsuccessful outcome of the IMEI check, the subscriber is marked as detached and the macro proceeds with the error handling described below.

The macro terminates immediately with unsuccessful outcome if the MSC dialogue has been released during the IMEI check.

Else, the macro terminates successfully by returning the MAP\_PROCESS\_ACCESS\_REQUEST response containing the IMSI to indicate acceptance of the MS access.

if ciphering is required, the MAP\_SET\_CIPHERING\_MODE request containing:

- the cipher mode indicating the cipher algorithm required; and
- the cipher key to be used;

is sent to the MSC.

As a further operator option, IMEI checking may be performed next.

The error Illegal Equipment is set in case of unsuccessful outcome of the IMEI check, the subscriber is marked as detached and the macro proceeds with the error handling described below.

The macro terminates immediately with unsuccessful outcome if the MSC dialogue has been released during the IMEI check.

Else, the macro terminates successfully by returning the MAP\_PROCESS\_ACCESS\_REQUEST response containing the IMSI to indicate acceptance of the MS access.

IF no TMSI reallocation is required (again an operator option), the macro terminates thereafter. Else, TMSI reallocation is performed by sending a MAP\_FORWARD\_NEW\_TMSI request, containing the new TMSI as parameter. The old TMSI will be frozen until an acknowledgement from the MS has been received. Before the macro terminates, the VLR will wait for the MAP\_FORWARD\_NEW\_TMSI response, containing no parameters if reallocation has been confirmed by the MS, or a Provider Error, otherwise, in which case the old TMSI is kept frozen to avoid double allocation. In this case, both the old as the new TMSI are subsequently regarded valid when used by the MS.

### **Error handling**

In case some error is detected during handling the access request, a respective error has been set. Before returning this error cause to the MSC in a MAP\_PROCESS\_ACCESS\_REQUEST response, it need to be checked whether this access is for emergency call set-up, as this will require extra treatment.

If the CM Service type given in the MAP\_PROCESS\_ACCESS\_REQUEST indication is emergency call set-up, it is checked whether EC set-up in the particular error situation is permitted (operator option). If so, it is checked whether the IMEI is required, and if so the IMEI is requested from the MS (macro Obtain\_IMEI\_VLR, see clause 25.6).

The macro will terminate immediately with unsuccessful outcome if the MSC transaction has been aborted during the IMEI retrieval.

In case of an error reported back from IMEI retrieval, MAP\_PROCESS\_ACCESS\_REQUEST response containing the error cause set previously is returned to the MSC, the dialogue is closed (MAP\_CLOSE request indicating normal release) and the macro terminates with unsuccessful outcome.

When a subscriber identity required by the operator (IMSI or IMEI) is available, the user error set previously is deleted, the respective identity is returned in the MAP\_PROCESS\_ACCESS\_REQUEST response to indicate acceptance of emergency call, and the macro terminates with successful outcome.

In all other cases, the MAP\_PROCESS\_ACCESS\_REQUEST response containing the error cause set previously is returned to the MSC, the dialogue is closed (MAP\_CLOSE request indicating normal release) and the macro terminates with unsuccessful outcome.

### 25.4.3 Macro Identification Procedure

This macro is invoked by the macro Process\_Access\_Request\_VLR in case the subscribers identity is not known in the VLR.

If the identity received from the MS is an IMSI, the error Unidentified Subscriber will be set and reported back to the calling macro (to be sent in the MAP\_PROCESS\_ACCESS\_REQUEST response). The same error is used in case a TMSI was received from the MS, but the operator does not allow open identification of the MS.

If open identification of the MS is allowed, the macro Obtain\_IMSI\_VLR is invoked, requesting the subscribers IMSI from the MS (see clause 25.8), with outcome

OK, in which case it is checked whether for the IMSI received there exists a subscriber record in the VLR. If so, the macro terminates successfully, else the error Unidentified Subscriber will be set and reported back to the calling macro.

Error, in which case the error System Failure will be set and reported back to the calling macro.

Aborted, i.e. the MSC transaction is released, in which the macro terminates accordingly.

Macrodefinition Process\_Access\_Request\_VLR

25.4\_2.1(3)

Figure 25.4/2:  
Macro for processing  
on access request  
in VLR

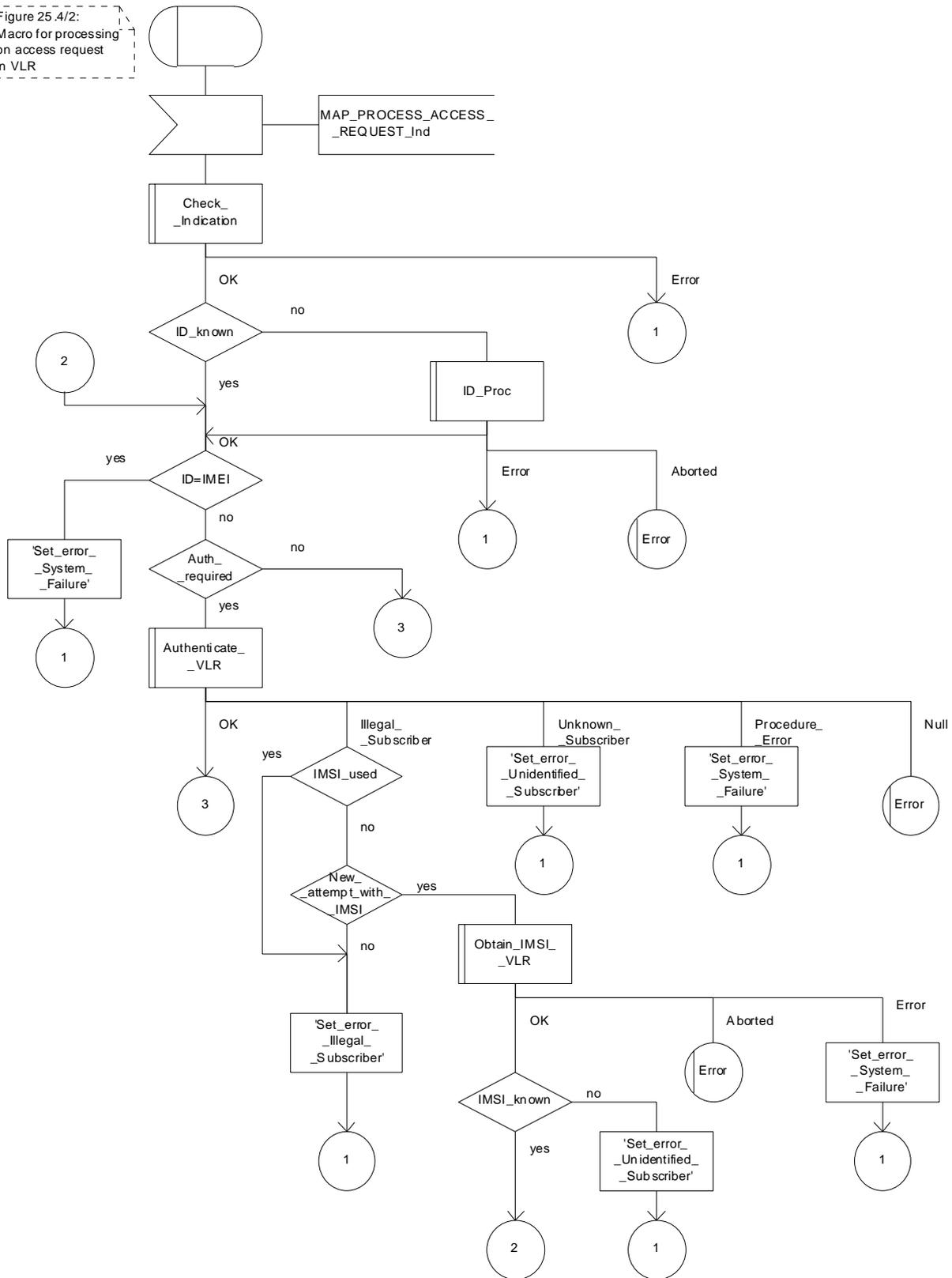

Figure 25.4/2 (sheet 1 of 3): Macro Process\_Access\_Request\_VLR





Macrodefinition Process\_Access\_Request\_VLR

25.4\_2.3(3)

Figure 25.4/2:  
Macro for processing  
on access request  
in VLR

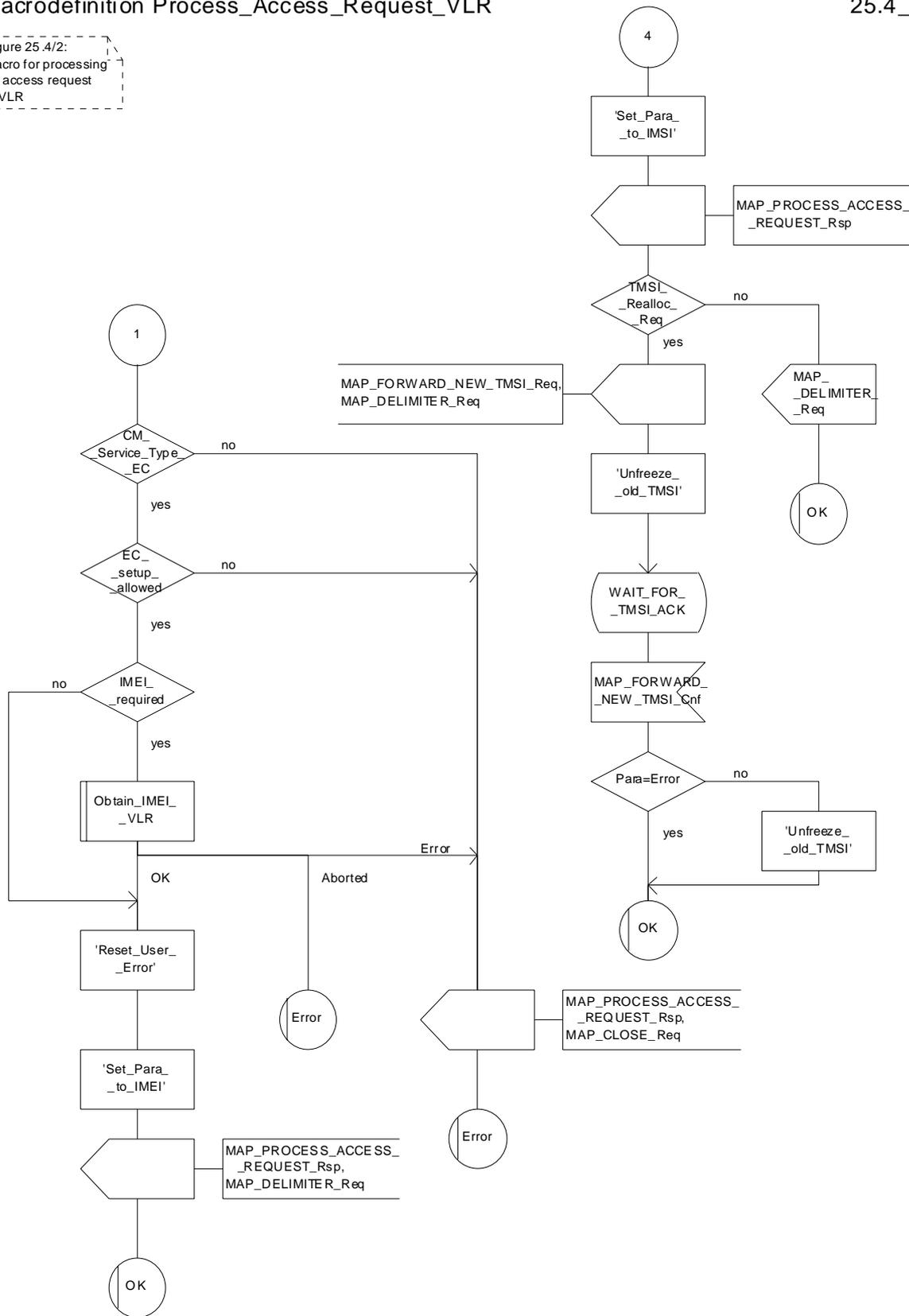

Figure 25.4/2 (sheet 3 of 3): Macro Process\_Access\_Request\_VLR

Macrodefinition ID\_Proc\_VLR

25.4\_3(1)

Figure 25.4/3

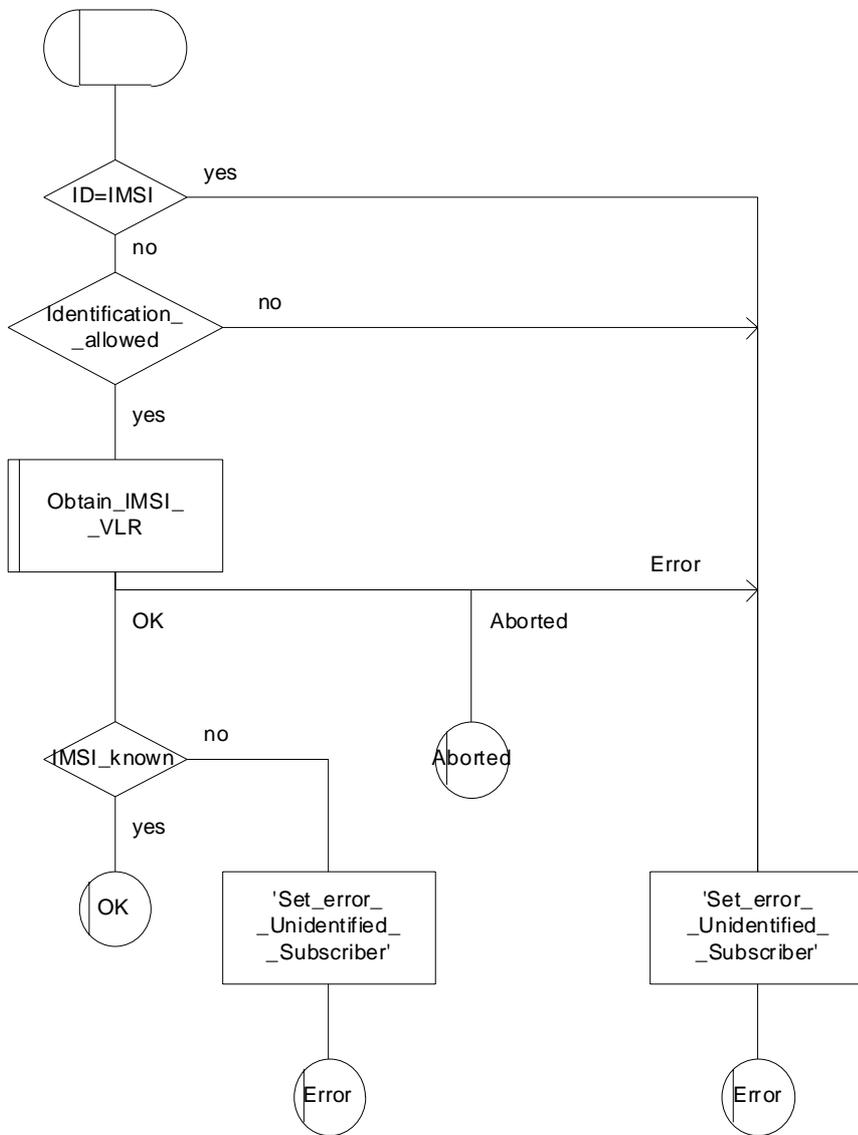

Figure 25.4/3: Macro ID\_Proc\_VLR

## 25.5 Authentication macros and processes

The following macros are used in the GSM network in order to enable authentication of a mobile subscriber.

### 25.5.1 Macro Authenticate\_MSC

This macro is used by the MSC to relay a request for authentication transparently from the VLR to the MS, wait for a response from the MS and to relay the response from the MS back to the VLR. If, while the MSC is waiting for the authentication response, the air interface connection is released or a MAP\_U\_ABORT, MAP\_P\_ABORT or MAP\_CLOSE indication is received from the VLR, then necessary connections are released and the "Error" exit is used. The macro is described in figure 25.5/1.

### 25.5.2 Macro Authenticate\_VLR

This macro is used by the VLR to control the authentication of a subscriber. The macro proceeds as follows:

- if there are not enough authentication triplets in the VLR to perform the authentication, then the macro "Obtain\_Authent\_Para\_VLR" described below is invoked. If this macro fails, then the corresponding error (Unknown Subscriber or Procedure Error) is returned to the calling process;
- if there are enough authentication triplets in the VLR, or the Obtain\_Authent\_Para\_VLR macro was successful, then a MAP\_AUTHENTICATE request is sent to the MSC. This request contains the RAND and CKSN parameters as indicated in the service description;
- the VLR then waits for a response from the MSC;
- if a MAP\_U\_ABORT, MAP\_P\_ABORT or MAP\_CLOSE indication is received from the MSC in this wait state, the VLR checks whether authentication sets are available. If no sets are available the process Obtain\_Authent\_Sets\_VLR is invoked to fetch authentication sets from the HLR. The "Null" exit is then used;
- if a MAP\_NOTICE indication is received from the MSC in this wait state, the VLR closes the dialogue with the MSC, then checks whether authentication sets are available. If no sets are available the process Obtain\_Authent\_Sets\_VLR is invoked to fetch authentication sets from the HLR. The "Null" exit is then used;
- if a MAP\_AUTHENTICATE confirmation is received by the VLR, it checks whether the received Signed Result (SRES) is identical to the stored one (see GSM 03.20). If this is not the case, the "Illegal Subscriber" exit is used. If the SRES values are identical, then the "OK" exit is used;
- before exit, the VLR may fetch a new set of triplets from the HLR. This is done by initiating a separate Obtain\_Authent\_Sets\_VLR process described below.

The macro is described in figure 25.5/2.

### 25.5.3 Process Obtain\_Authentication\_Sets\_VLR

This process is initiated by the VLR to fetch triplets from a subscriber's HLR in a stand-alone, independent manner. The Obtain\_Authent\_Para\_VLR macro described below is simply called; the process is described in figure 25.5/3.

### 25.5.4 Macro Obtain\_Authent\_Para\_VLR

This macro is used by the VLR to request authentication triplets from the HLR. The macro proceeds as follows:

- a connection is opened, and a MAP\_SEND\_AUTHENTICATION\_INFO request sent to the HLR;
- if the HLR indicates that a MAP version 1 dialogue is to be used, the VLR performs the equivalent MAP version 1 dialogue. which can return a positive result containing authentication sets, an empty positive result, or an error;
- if the dialogue opening fails, the "Procedure Error" exit is used. Otherwise, the VLR waits for the response from the HLR;
- if a MAP\_SEND\_AUTHENTICATION\_INFO confirmation is received from the HLR, the VLR checks the received data.

One of the following positive responses may be received from a MAP version 1 or MAP version 2 dialogue with the HLR:

- Authentication triplets, in which case the outcome is successful;
- Empty response, in which case the VLR may re-use old triplets, if allowed by the PLMN operator.

If the VLR cannot re-use old triplets (or no such triplets are available) then the "Procedure Error" exit is used.

If the outcome was successful or re-use of old parameters in the VLR is allowed, then the "OK" exit is used.

If an "Unknown Subscriber" error is included in the MAP\_SEND\_AUTHENTICATION\_INFO confirm or is returned by the MAP version 1 dialogue, then the "Unknown Subscriber" exit is used.

- if a MAP-U-ABORT, MAP\_P\_ABORT, MAP\_NOTICE or unexpected MAP\_CLOSE service indication is received from the MSC, then open connections are terminated, and the macro takes the "Null" exit;
- if a MAP-U-ABORT, MAP\_P\_ABORT or unexpected MAP\_CLOSE service indication is received from the HLR, then the VLR checks whether old authentication parameters can be re-used. If old parameters cannot be re-used the macro takes the "Procedure Error" exit; otherwise it takes the "OK" exit;
- if a MAP\_NOTICE service indication is received from the HLR, then the dialogue with the HLR is closed. The VLR then checks whether old authentication parameters can be re-used. If old parameters cannot be re-used the macro takes the "Procedure Error" exit; otherwise it takes the "OK" exit.

The macro is described in figure 25.5/4.

### 25.5.5 Process Obtain\_Auth\_Sets\_HLR

Opening of the dialogue is described in the macro Receive\_Open\_Ind in clause 25.1, with outcomes:

- reversion to version one procedure;
- procedure termination; or
- dialogue acceptance, with proceeding as below.

This process is used by the HLR to obtain authentication triplets from the AuC, upon request from the VLR or from the SGSN. The process acts as follows:

- a MAP\_SEND\_AUTHENTICATION\_INFO indication is received by the HLR;
- the HLR checks the service indication for errors. If any, they are reported to the VLR or to the SGSN in the MAP\_SEND\_AUTHENTICATION\_INFO response. If no errors are detected, authentication triplets are fetched from the AuC. Further details are found in GSM 03.20;
- if errors are detected they are reported to the VLR or to the SGSN in the MAP\_SEND\_AUTHENTICATION\_INFO response. Otherwise the authentication triplets are returned.

The process is described in figure 25.5/5.



Macrodefinition Authenticate\_VLR

25.5\_2(1)

Figure 21.5/2: Authentication macro in the VLR, controlling the authentication procedure towards the MSC/MS and obtaining authentication triplets from the HLR as applicable.

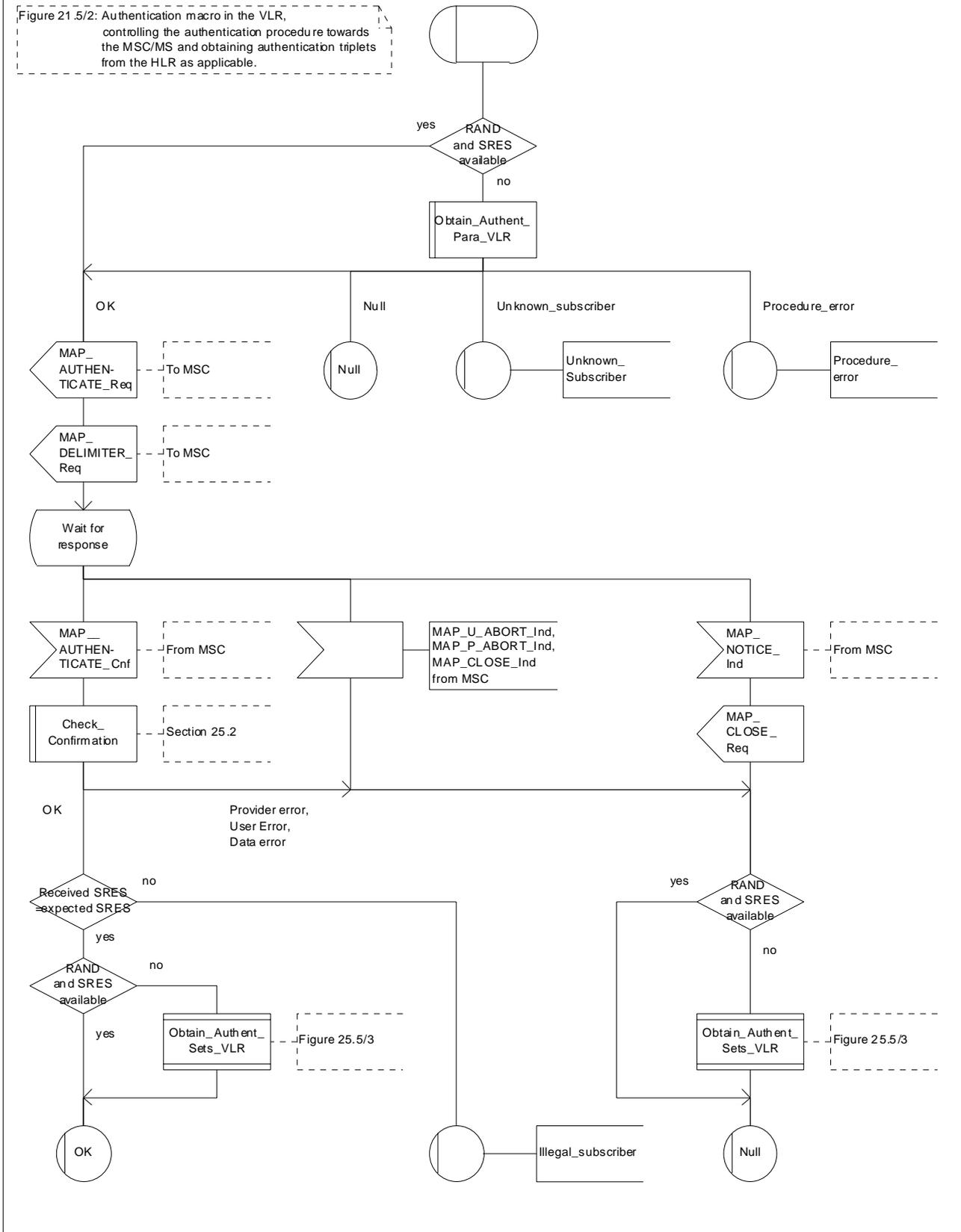

Figure 25.5/2: Macro Authenticate\_VLR

Process Obtain\_Authent\_Sets\_VLR

25.5\_3(1)

Figure 25.5/3: Process to obtain authentication sets from the HLR to the VLR

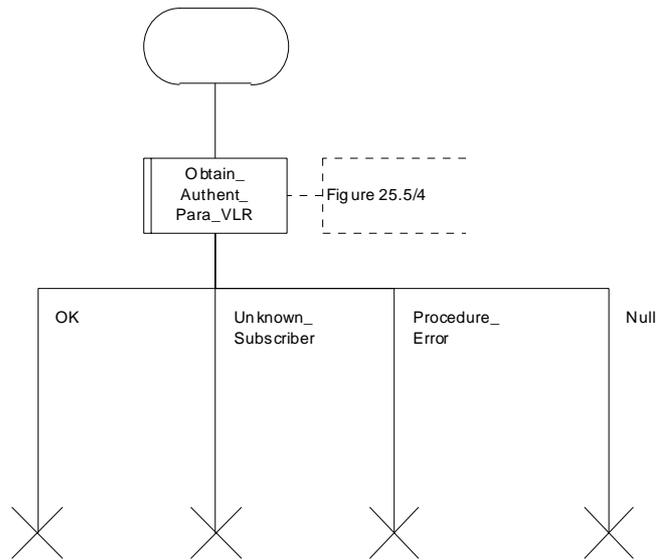

Figure 25.5/3: Process Obtain\_Authentication\_Sets\_VLR



### Macrodefinition Obtain\_Authent\_Para\_VLR

25.5\_4.1(2)

Figure 25.5/4: Macro to obtain authentication parameters from the HLR to the VLR

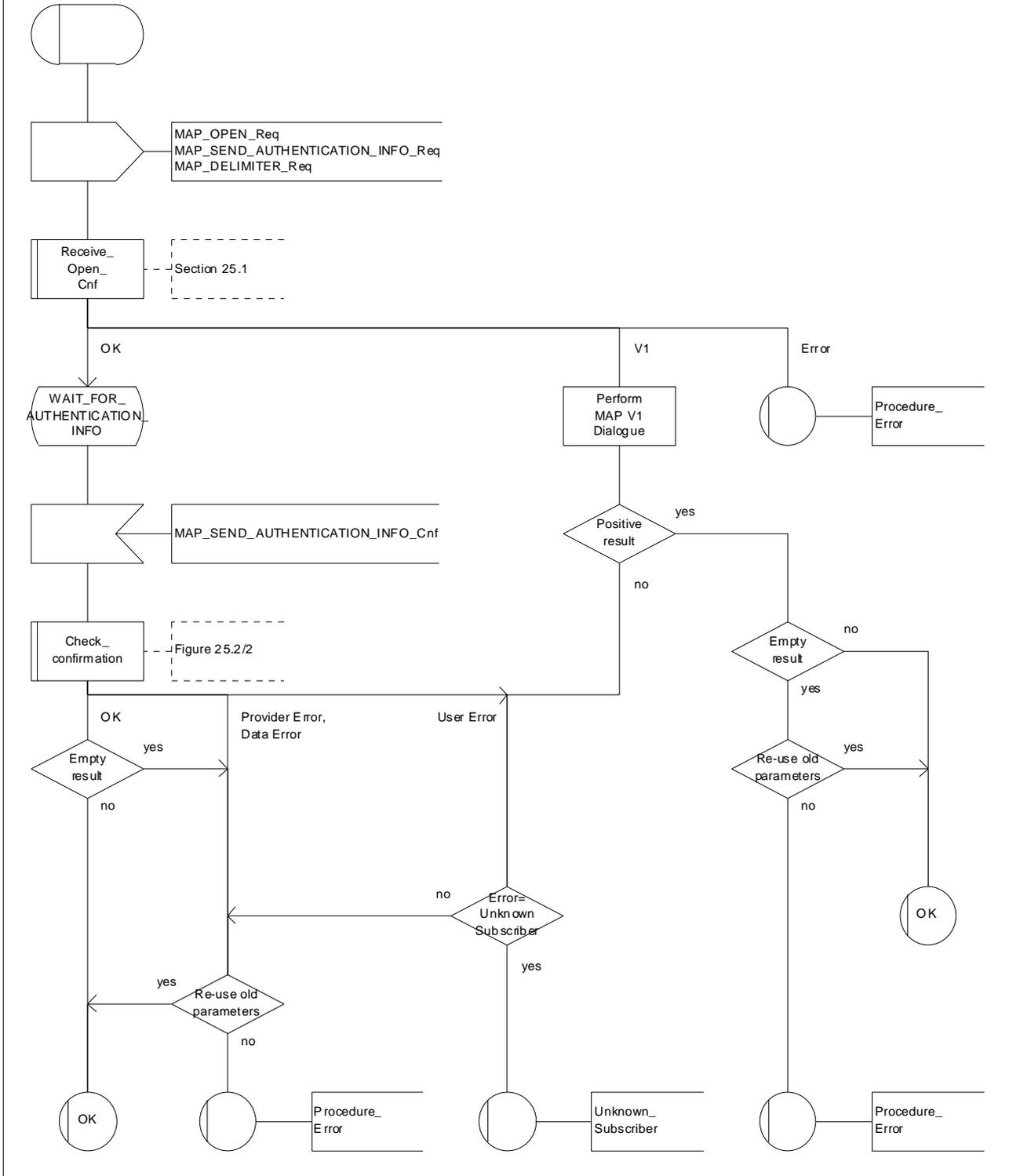

Figure 25.5/4 (sheet 1 of 2): Macro Obtain\_Authent\_Para\_VLR

### Macrodefinition Obtain\_Authent\_Para\_VLR

25.5\_4.2(2)

Figure 25.5/4: Macro to obtain authentication parameters from the HLR to the VLR

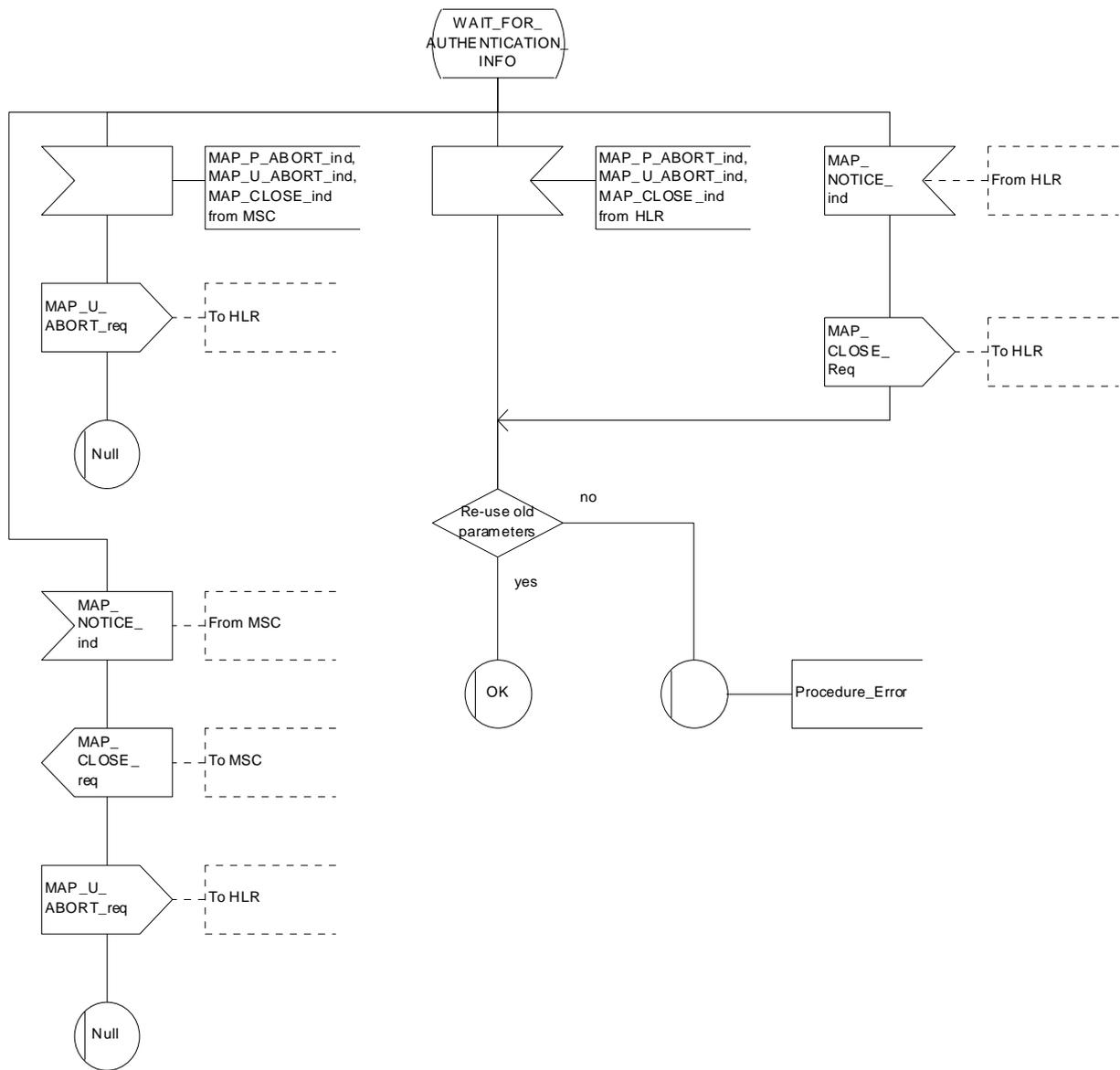

Figure 25.5/4 (sheet 2 of 2): Macro Obtain\_Authent\_Para\_VLR

### Process Obtain\_Auth\_Sets\_HLR

25.5\_5(1)

Figure 25.5/5: Process in the HLR to obtain authentication sets from the AuC and relay them to the VLR

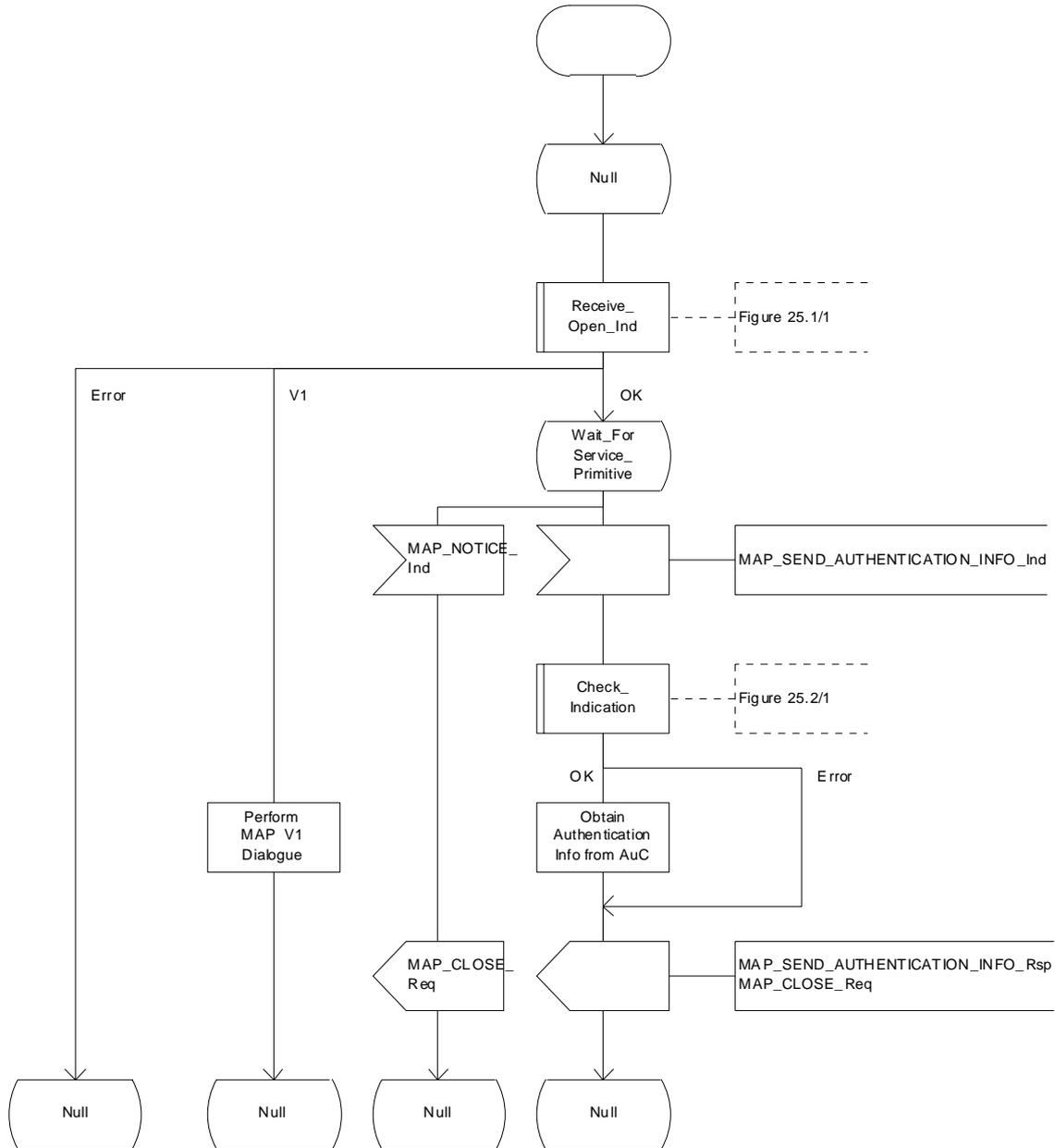

Figure 25.5/5: Process Obtain\_Auth\_Sets\_HLR

## 25.5.6 Process Obtain\_Authent\_Para\_SGSN

For authentication procedure description see GSM 03.60 and GSM 04.08.

This Process is used by the SGSN to request authentication triplets from the HLR. The Process proceeds as follows:

- a connection is opened, and a MAP\_SEND\_AUTHENTICATION\_INFO request sent to the HLR;
- if the HLR indicates that a MAP version 1 dialogue is to be used, the SGSN performs the equivalent MAP version 1 dialogue. which can return a positive result containing authentication sets, an empty positive result, or an error;
- if the dialogue opening fails, the Authentication Parameters negative response with appropriate error is sent to the requesting process. Otherwise, the SGSN waits for the response from the HLR;
- if a MAP\_SEND\_AUTHENTICATION\_INFO confirmation is received from the HLR, the SGSN checks the received data.

One of the following positive responses may be received from a MAP version 1 or MAP version 2 dialogue with the HLR:

- Authentication triplets, in which case the outcome is successful;
- Empty response, in which case the SGSN may re-use old triplets, if allowed by the PLMN operator.

If the SGSN cannot re-use old triplets (or no such triplets are available) then the the Authentication Parameters negative response with appropriate error is sent to the requesting process.

If the outcome was successful or re-use of old parameters in the SGSN is allowed, then the Authentication Parameters response is sent to the requesting process

If an "Unknown Subscriber" error is included in the MAP\_SEND\_AUTHENTICATION\_INFO confirm or is returned by the MAP version 1 dialogue, then the appropriate error is sent to the requesting process in the Authentication Parameters negative response

- if a MAP-U-ABORT, MAP\_P\_ABORT or unexpected MAP\_CLOSE service indication is received from the HLR, then the SGSN checks whether old authentication parameters can be re-used. If old parameters cannot be re-used the Authentication Parameters negative response with appropriate error is sent to the requesting process.
- if a MAP\_NOTICE service indication is received from the HLR, then the dialogue with the HLR is closed. The SGSN then checks whether old authentication parameters can be re-used. If old parameters cannot be re-used the process terminates and the Authentication Parameters negative response with appropriate error is sent to the requesting process; Otherwise the Authentication Parameters response is sent to requesting process.

The process is described in figure 25.5/6.

Process Obtain\_Authen\_Para\_SGSN

25.5\_6.1(2)

Figure 25.5/6: Process to obtain authentication parameters from the HLR to the SGSN

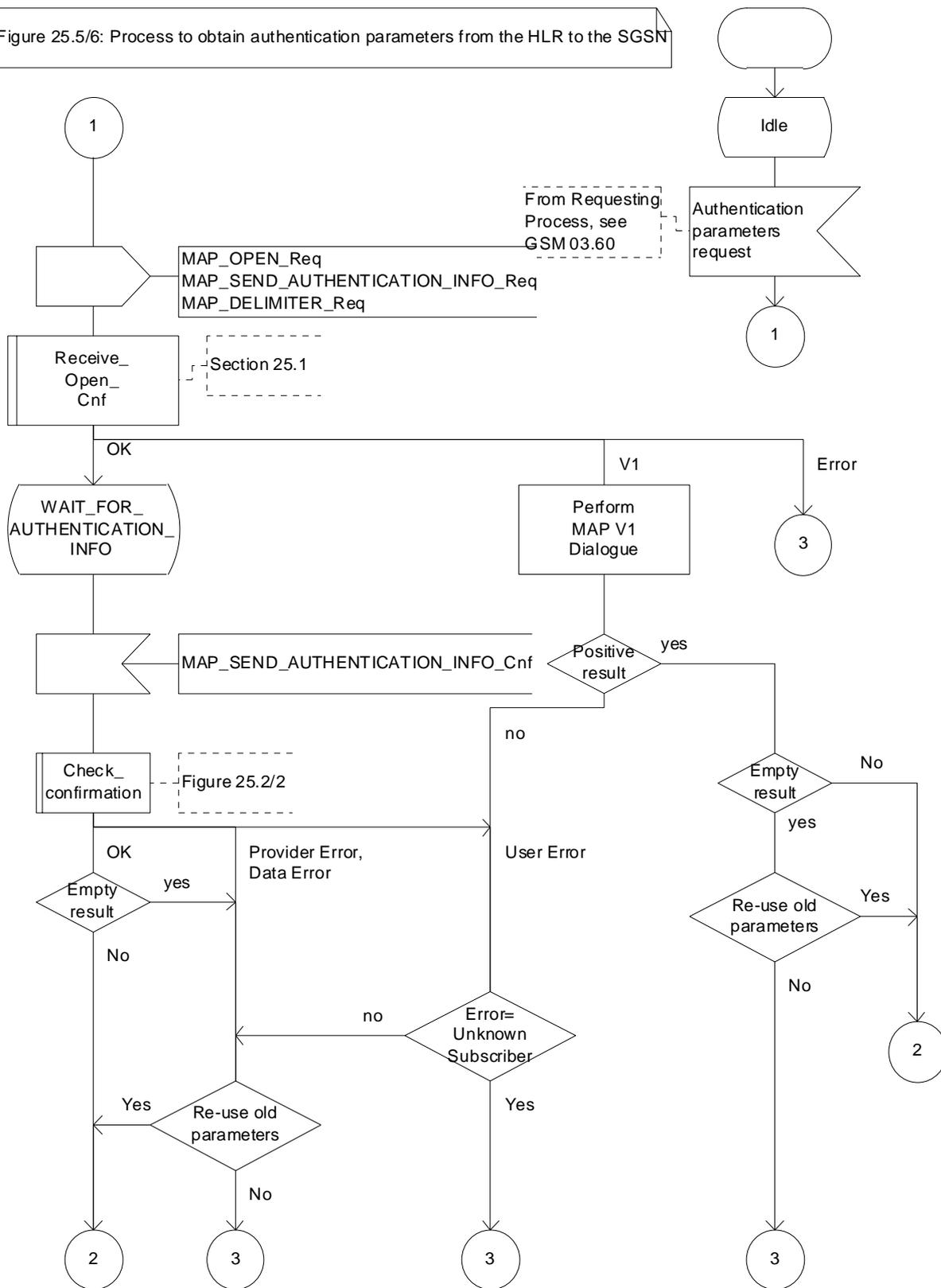

Figure 25.5/6 (sheet 1 of 2): Macro Obtain\_Authen\_Para\_SGSN

Process Obtain\_Authen\_Para\_SGSN

25.5\_6.2(2)

Figure 25.5/6: Process to obtain authentication parameters from the HLR to the SGSN

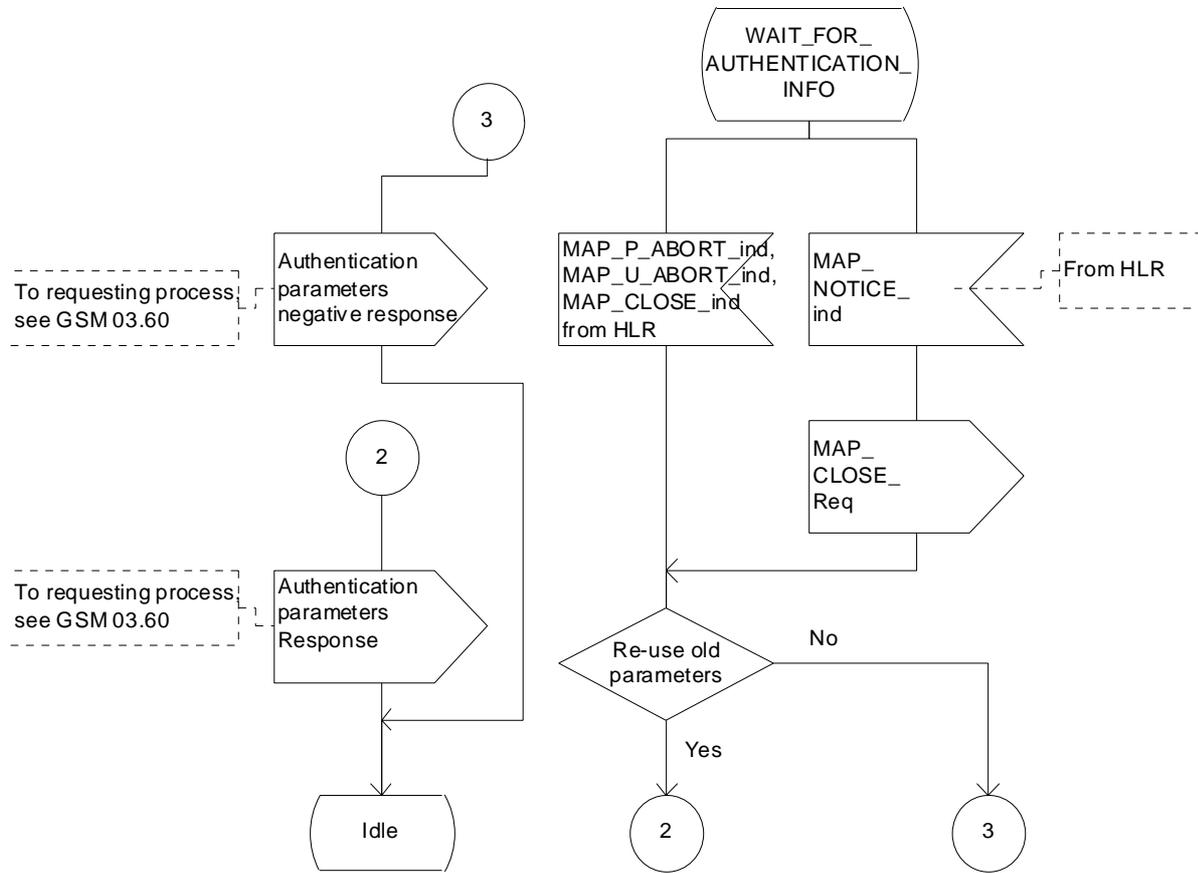

Figure 25.5/6 (sheet 2 of 2): Macro Obtain\_Authen\_Para\_SGSN

## 25.6 IMEI Handling Macros

The following macros are used in the GSM network in order to enable handling and checking of the mobile equipment identity.

### 25.6.1 Macro Check\_IMEI\_MSC

This macro is used by the MSC to receive a request from the VLR, relay it to the EIR, and pass the result from the EIR back to the VLR. The macro proceeds as follows:

- a MAP\_CHECK\_IMEI service indication containing only the Invoke Id is received from the VLR;
- if the IMEI is not available in the MSC, it is requested from the MS using the IDENTITY REQUEST message;
- if the MS releases the radio resources, a MAP\_U\_ABORT request indicating "Application procedure Cancellation" is sent to the VLR, and the "Error" exit of the macro is used;
- when the IMEI is known, a connection is set up towards the EIR, and a MAP\_CHECK\_IMEI service request is sent including the IMEI;
- if the opening of the dialogue fails, a System Failure is reported to the VLR. Otherwise, the MSC waits for a response from the EIR;
- when the MAP\_CHECK\_IMEI service confirm is received, it is checked for errors. Any errors discovered in the MSC lead to the System Failure error to be reported to the VLR in the MAP\_CHECK\_IMEI response. Any errors reported from the EIR are sent directly to the VLR in the MAP\_CHECK\_IMEI service response. If no errors are detected by or reported to the MSC, the IMEI is added to the MAP\_CHECK\_IMEI service response returned to the VLR. The "OK" exit is used in all cases;
- if a MAP\_P\_ABORT, MAP\_U\_ABORT, MAP\_CLOSE or MAP\_NOTICE service indication is received from the EIR, the MSC closes the transaction with the EIR (if necessary), reports a System Failure error back to the VLR in the MAP\_CHECK\_IMEI response, and uses the macro's "OK" exit;
- if a MAP\_P\_ABORT, MAP\_U\_ABORT, MAP\_CLOSE or MAP\_NOTICE indication is received from the VLR, the MSC closes the transaction with the VLR (if necessary) and aborts the connections towards the EIR and the MS; the macro takes the "Error" exit.

If the dialogue with the EIR drops back to version 1, the result or error returned by the EIR is checked. The use of the "Check\_Confirmation" macro in the SDL diagram indicates that the checks carried out on the result returned by the EIR in a MAP v1 dialogue are functionally equivalent to those carried out on the parameters of the MAP\_CHECK\_IMEI confirm received from the EIR in a MAP v2 dialogue.

The macro is described in figure 25.6/1.

### 25.6.2 Macro Check\_IMEI\_VLR

This macro is used by the VLR to control the check of a mobile equipment's IMEI. The macro proceeds as follows:

- a MAP\_CHECK\_IMEI service request is sent to the MSC, including only the Invoke Id;
- the VLR then waits for the response from the MSC;

- if a MAP\_CHECK\_IMEI service confirm including either:
  - the IMEI and the Equipment Status; or
  - an error;
 is received, the VLR checks whether the response requires that an alarm be generated on the Operation and Maintenance interface. The criteria for such alarms are PLMN operator dependent;
- the VLR then checks whether the response from the MSC means that service is granted to the MS. The criteria for granting service depending on the equipment status or errors received in the MAP\_CHECK\_IMEI service response are also PLMN operator dependent;
- if a MAP\_P\_ABORT, MAP\_U\_ABORT, MAP\_CLOSE or MAP\_NOTICE indication is received from the MSC, then the MSC connection is closed (if necessary) and the macro takes the "Aborted" exit.

The macro is described in figure 25.6/2.

### 25.6.3 Process Check\_IMEI\_EIR

This process is used by the EIR to obtain the status of a piece of mobile equipment, upon request from the MSC or from the SGSN. The process acts as follows:

- a MAP\_OPEN service indication is received (macro Receive\_Open\_Ind, clause 25.1.1). If the dialogue opening fails, the process terminates;
- otherwise, a MAP\_CHECK\_IMEI indication is received by the EIR, containing the IMEI to be checked;
- the EIR checks the service indication for errors. If there are any, they are reported to the MSC or to the SGSN in the MAP-CHECK\_IMEI response. If no errors are detected, the EIR data base function is interrogated for the status of the given equipment. Further details are found in GSM 02.16;
- the status of the equipment (white-listed, grey-listed, black-listed or unknown) is returned to the MSC or to the SGSN in the MAP\_CHECK\_IMEI service response;
- if a MAP\_U\_ABORT, MAP\_P\_ABORT, MAP\_NOTICE or MAP\_CLOSE indication is received from the MSC or from the SGSN at any time during this process, the process in the EIR terminates.

The process is described in figure 25.6/3.

### 25.6.4 Macro Obtain\_IMEI\_MSC

This macro is used by the MSC to respond to a request from the VLR to provide the IMEI. The macro proceeds as follows:

- a MAP\_OBTAIN\_IMEI service indication containing only the Invoke Id is received from the VLR;
- if the IMEI is not available in the MSC, it is requested from the MS using the IDENTITY REQUEST message;
- when the IMEI is known, it is returned to the VLR in the MAP\_OBTAIN\_IMEI service response. The macro terminates at the "OK" exit;
- if the IMEI cannot be obtained by the MSC, the System Failure error is reported back to the VLR in the MAP\_OBTAIN\_IMEI service response. The macro terminates at the "OK" exit;
- if a MAP\_P\_ABORT, MAP\_U\_ABORT or MAP\_CLOSE indication is received from the VLR, the macro terminates at the "Error" exit.

The macro is described in figure 25.6/4.



## 25.6.5 Macro Obtain\_IMEI\_VLR

This macro is used by the VLR to obtain the IMEI from the MSC, e.g. to enable handling of emergency calls in case of authentication failure (in which case the IMEI may be used by some operators as an alternative to the IMSI). It proceeds as follows:

- the MAP\_OBTAIN\_IMEI service request is sent to the MSC, including only the Invoke Id;
- the VLR then waits for the response from the MSC;
- if the IMEI is received in the MAP\_OBTAIN\_IMEI service response, the macro terminates at the "OK" exit;
- if the System Failure error is reported in the MAP\_OBTAIN\_IMEI service response, the "Error" exit is used;
- if the MSC terminates the dialogue using a MAP\_P\_ABORT, MAP\_U\_ABORT, MAP\_CLOSE or MAP\_NOTICE service indication, the necessary connections are released, and the "Aborted" exit is used for termination of the macro.

The macro is shown in figure 25.6/5.

Macrodefinition Check\_IMEI\_MSC

25.6\_1.1(2)

Figure 25.6/1: Check IMEI macro in the MSC, relaying the IMEI check indication from the VLR to the MSC and relaying the confirmation from the EIR to the VLR

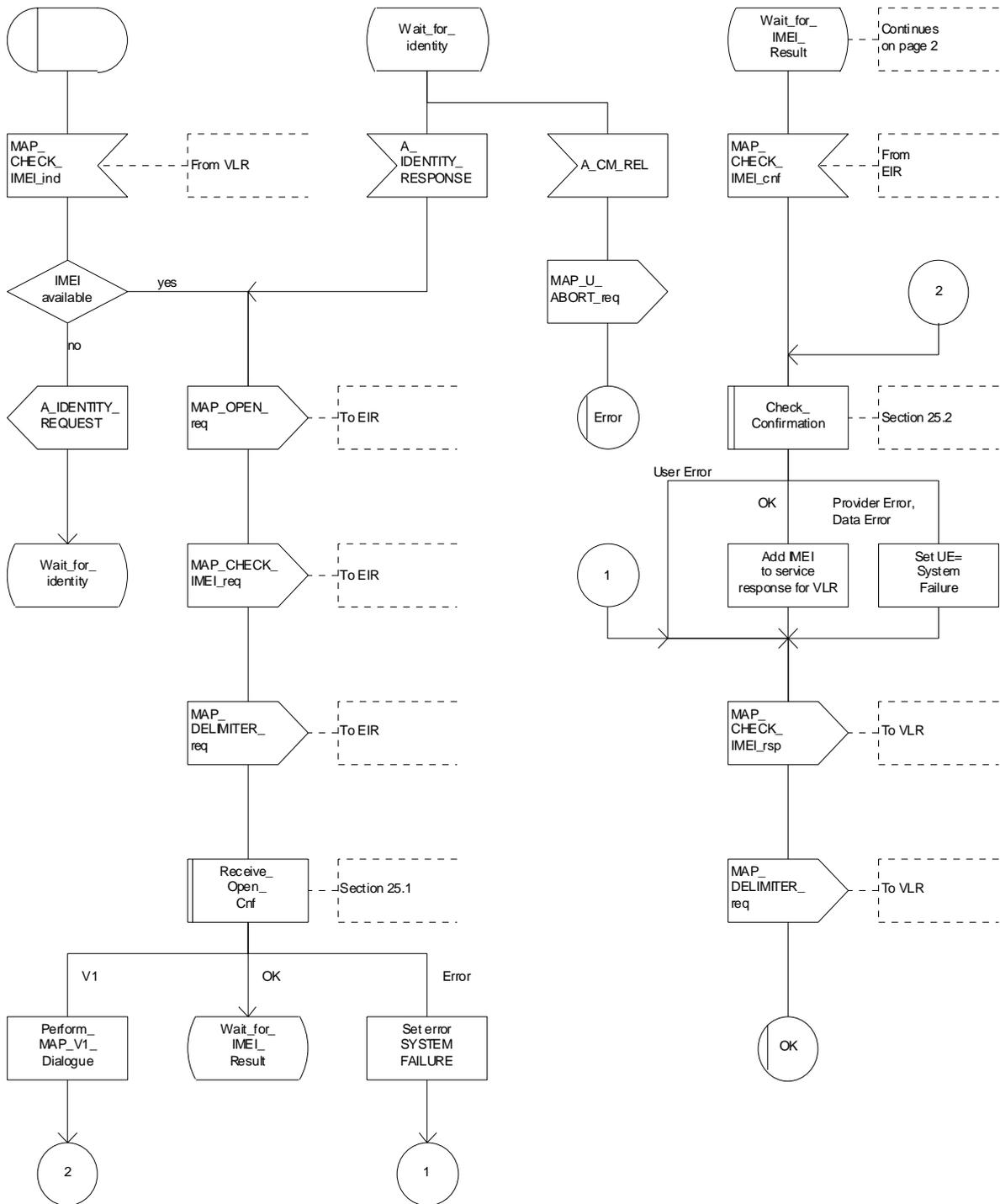

Figure 25.6/1 (sheet 1 of 2): Macro Check\_IMEI\_MSC

Macrodefinition Check\_IMEI\_MSC

25.6\_1.2(2)

Figure 25.6/1: Check IMEI macro in the MSC, relaying the IMEI check indication from the VLR to the MSC and relaying the confirmation from the EIR to the VLR

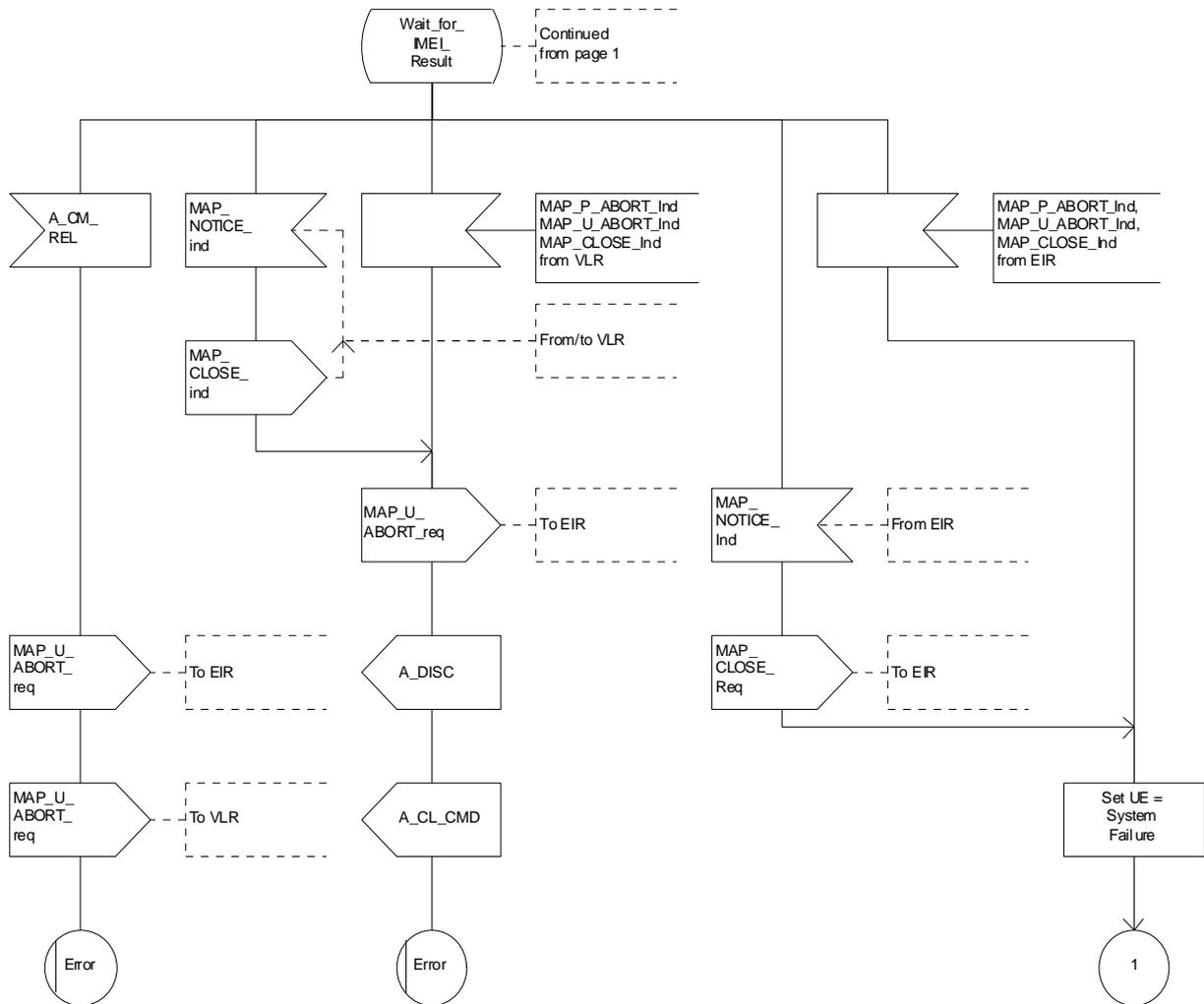

Figure 25.6/1 (sheet 2 of 2): Macro Check\_IMEI\_MSC

Macrodefinition Check\_IMEI\_VLR

25.6\_2(1)

Figure 25.6/2: Check IMEI macro in the VLR, containing the request towards the MSC/EIR

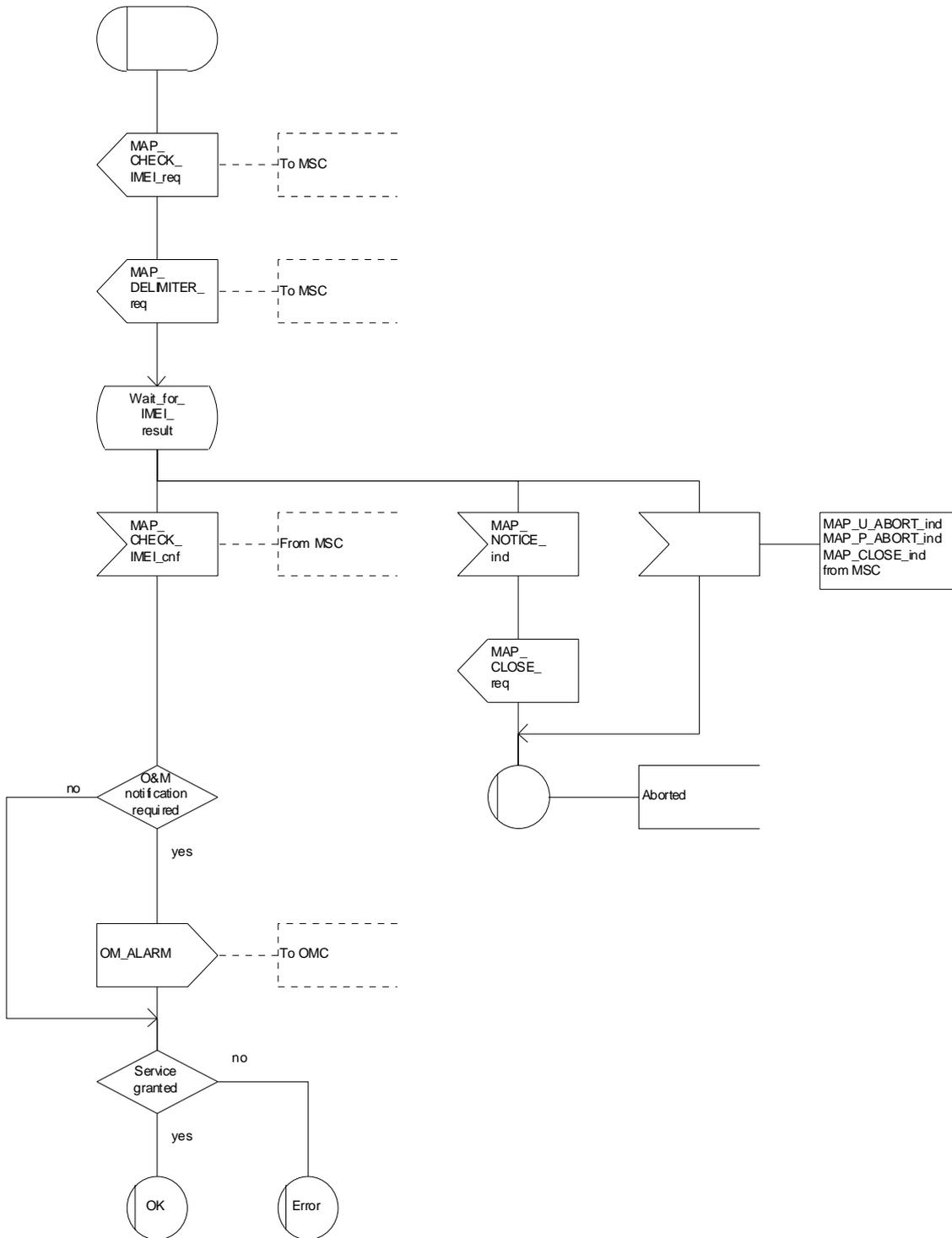

Figure 25.6/2: Macro Check\_IMEI\_VLR

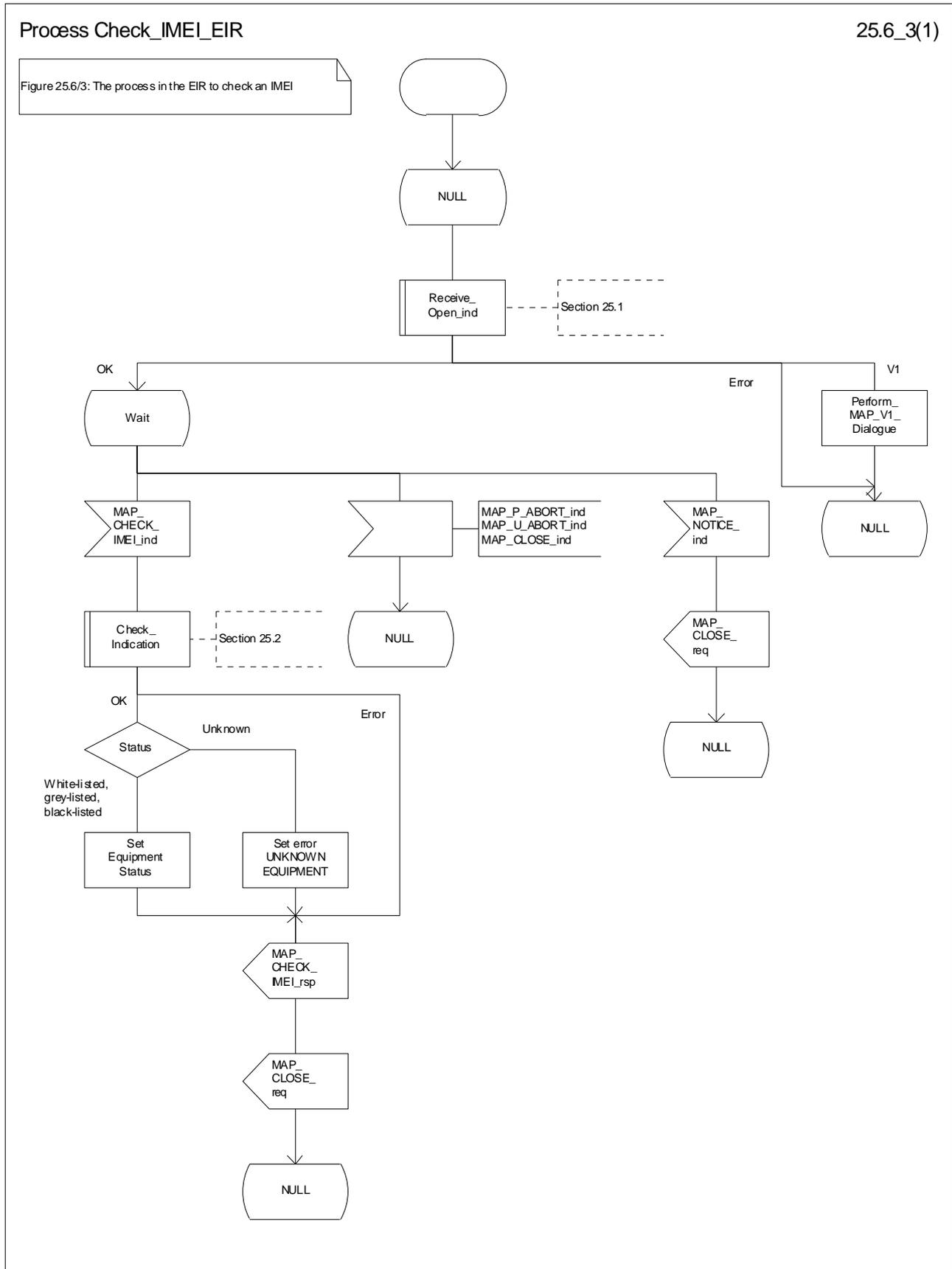

Figure 25.6/3: Process Check\_IMEI\_EIR

Macrodefinition Obtain\_IMEI\_MSC

25.6\_4(1)

Figure 25.6/4: Obtain IMEI macro in the MSC, receiving the Obtain\_IMEI indication from the VLR to the MSC and returning the confirmation to the VLR

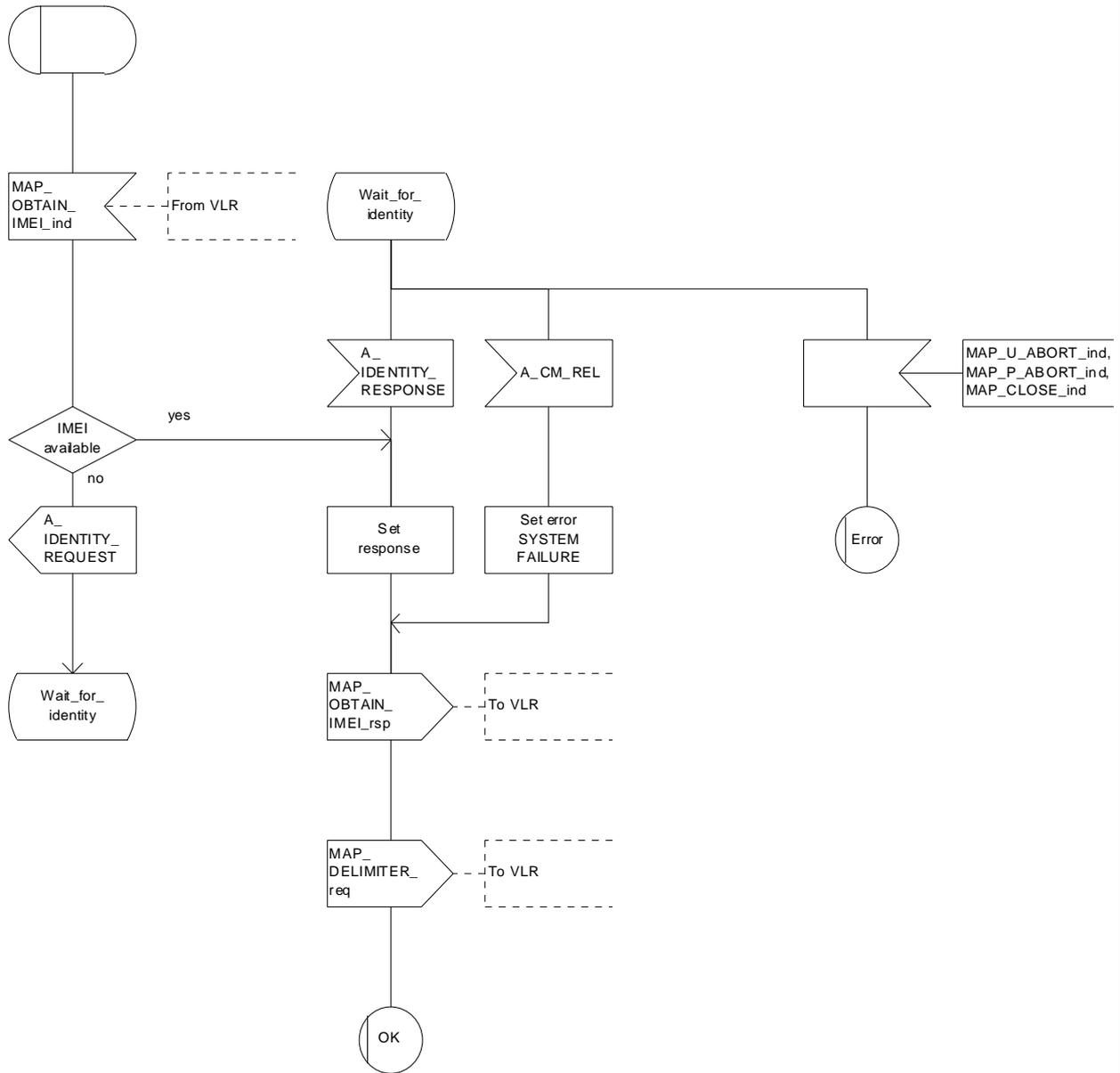

Figure 25.6/4: Macro Obtain\_IMEI\_MSC

Macrodefinition Obtain\_IMEI\_VLR

25.6\_5(1)

Figure 25.6/5: Obtain IMEI macro in the VLR, controlling the request towards the MSC

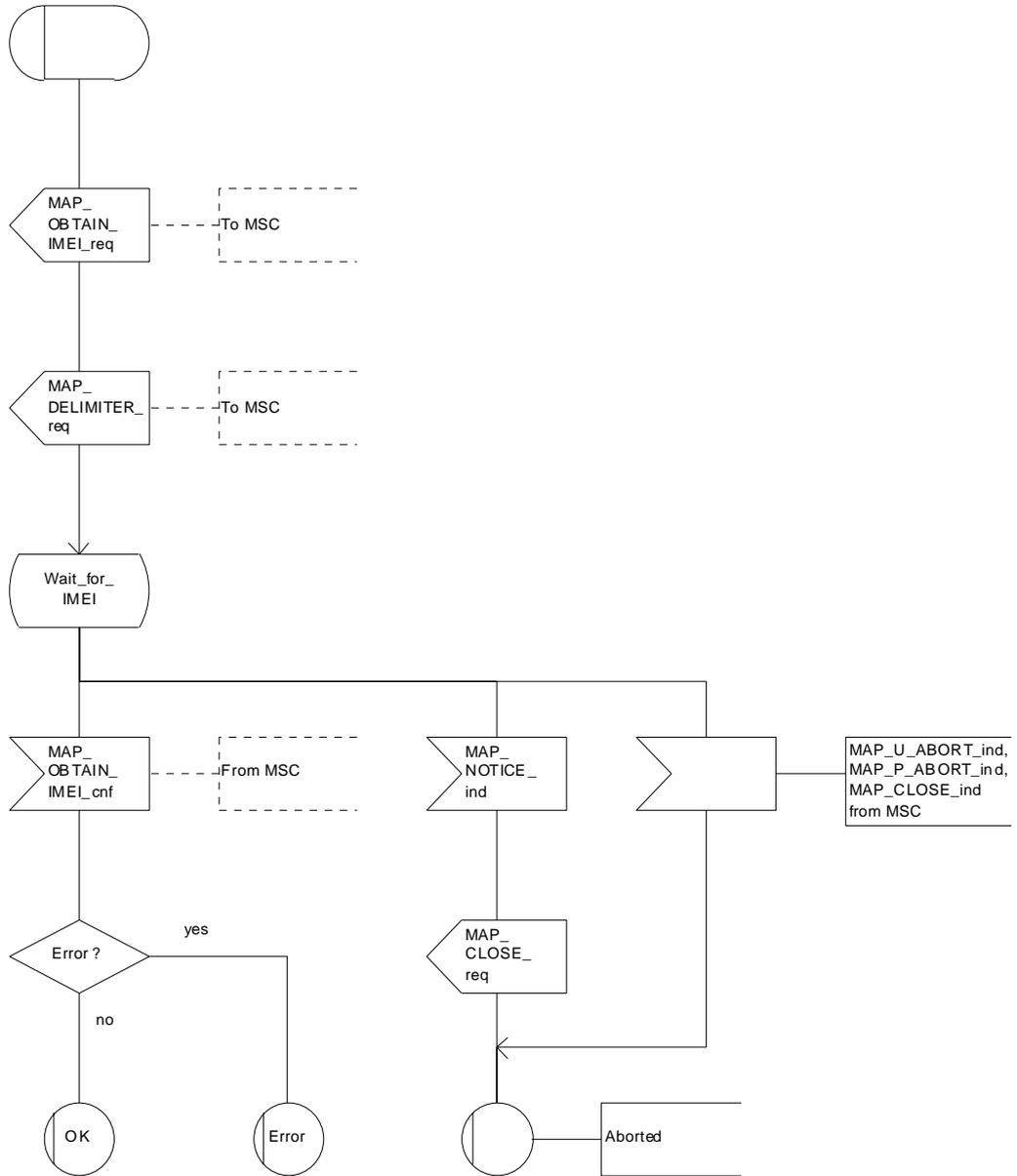

Figure 25.6/5: Macro Obtain\_IMEI\_VLR

## 25.6.6 Process Check\_IMEI\_SGSN

This process is used by the SGSN to control the check of a mobile equipment's IMEI. The process proceeds as follows:

- if the MS does not complete successfully the procedure, the "Error" exit of the macro is used;
- when the IMEI is known, a connection is set up towards the EIR, and a MAP\_CHECK\_IMEI service request is sent including the IMEI;
- if the opening of the dialogue fails, a System Failure is set. Otherwise, the SGSN waits for a response from the EIR;
- if a MAP\_CHECK\_IMEI service confirm including either:
  - the IMEI and the Equipment Status; or
  - an error;is received, the SGSN checks whether the response requires that an alarm be generated on the Operation and Maintenance interface. The criteria for such alarms are PLMN operator dependent;
- the SGSN then checks whether the response from the EIR means that service is granted to the MS. The criteria for granting service depending on the equipment status or errors received in the MAP\_CHECK\_IMEI service response are also PLMN operator dependent;

If the dialogue with the EIR drops back to version 1, the result or error returned by the EIR is checked. The use of the "Check\_Confirmation" macro in the SDL diagram indicates that the checks carried out on the result returned by the EIR in a MAP v1 dialogue are functionally equivalent to those carried out on the parameters of the MAP\_CHECK\_IMEI confirm received from the EIR in a MAP v2 dialogue.

The process is described in figure 25.6/6.



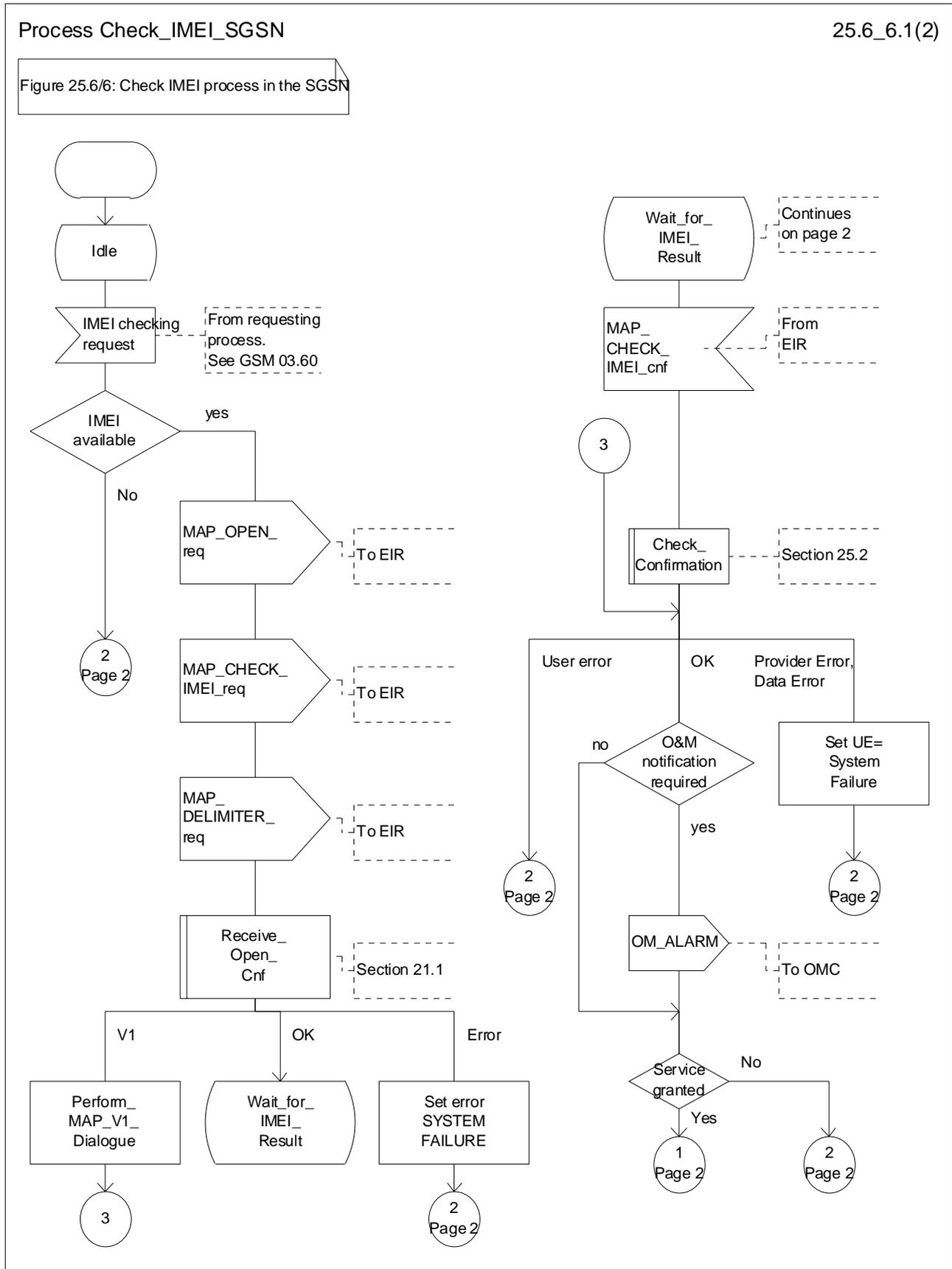

Figure 25.6/6 (sheet 1 of 2): Process Check\_IMEI\_SGSN

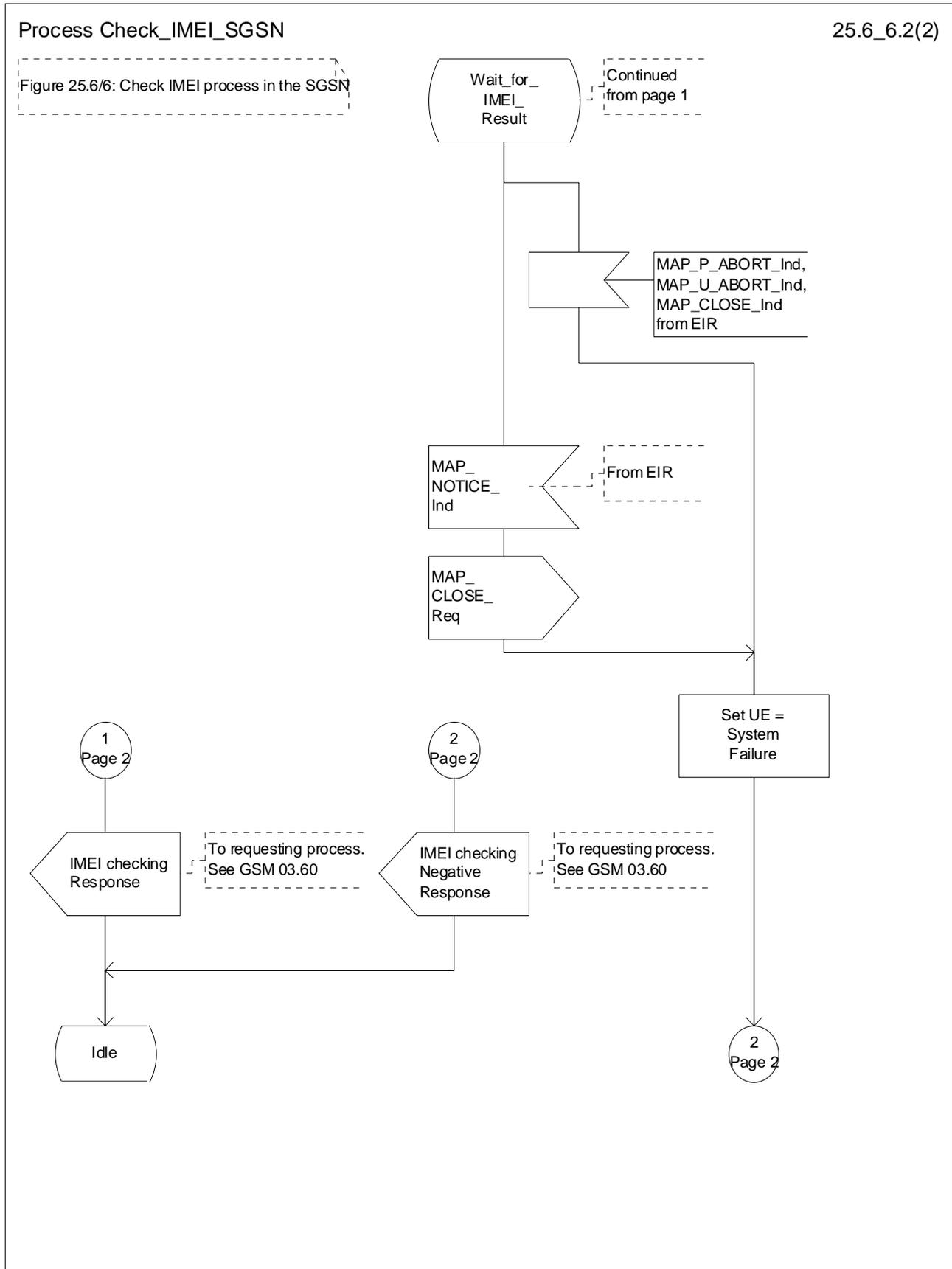

Figure 25.6/6 (sheet 2 of 2): Process Check\_IMEI\_SGSN

## 25.7 Insert Subscriber Data Macros

### 25.7.1 Macro Insert\_SubData\_VLR

This macro describes the reception of the InsertSubscriberData service indication. This macro is used by any procedure that triggers the reception of subscriber data (e.g. Update Location or Restore Data).

If the VLR does not support any basic or supplementary service or the network feature Operator Determined Barring, or there is a problem with Regional Subscription Data then it reports it to the HLR.

If the entire MSC area is restricted due to regional subscription this is reported to the HLR.

The SDL diagram is shown in figure 25.7/1.

Macrodefinition Insert\_Subscriber\_Data\_VLR

25.7\_1(1)

Figure 25.7/1: Macro to receive and store subscriber data in the VLR

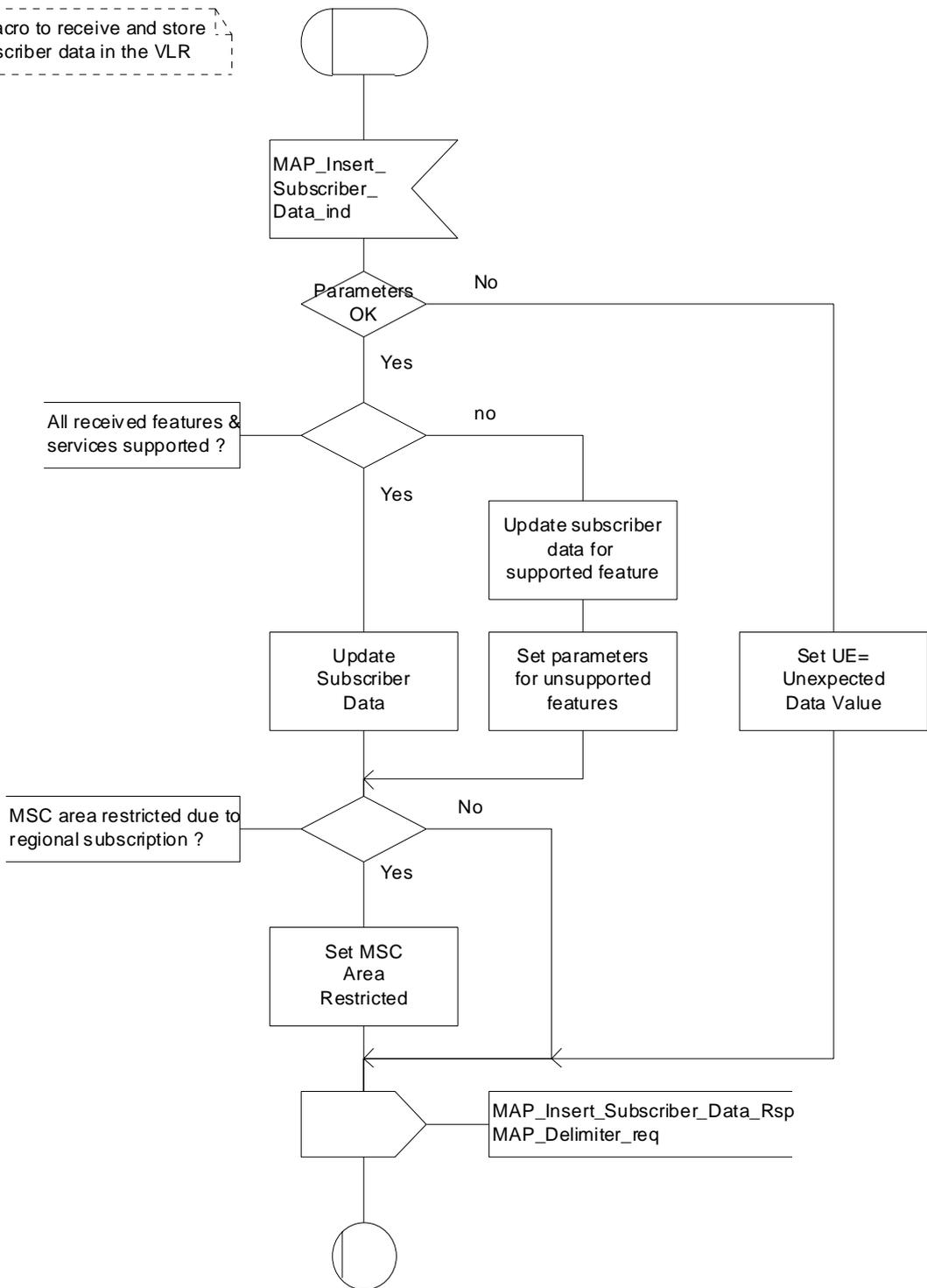

Figure 25.7/1: Macro Insert\_Subscriber\_Data\_VLR

## 25.7.2 Process Insert\_Subscriber\_Data\_Stand\_Alone\_HLR

This process is used by HLR to transfer subscriber data to VLR or to SGSN in a stand alone mode, i.e. in its own dialogue. This is done whenever a change of subscriber data is performed either by the operator or by the subscriber and this change has to be reported to VLR or to SGSN.

The process, after opening the dialogue with VLR or with SGSN, sends as many requests of the InsertSubscriberData service as necessary to transfer the subscriber data. The call to the process "Send\_Insert\_Subscriber\_Data" (see clause 25.7.4) is meant to describe two possible behaviours of the HLR when more than one service request has to be sent:

- either the HLR handles the requests and the confirmations in parallel; or
- the HLR sends every request after receiving the confirmation to the previous one.

The macros "Wait\_for\_Insert\_Subscriber\_Data\_Cnf" and "Wait\_for\_Insert\_GPRS\_Subscriber\_Data\_Cnf" (see clauses 25.7.3 and 25.7.6) are also called in order to handle every single confirmation.

If the result of a primitive received from the VLR or from the SGSN is unsuccessful, the HLR may initiate re-attempts; the number of repeat attempts and the time in between are HLR operator options, depending on the error returned by the VLR or by the SGSN.

If certain services required for a subscriber are not supported by the VLR or by the SGSN (e.g. Advice of Charge Charging Level), this may result in one of the following outcomes:

- the HLR stores and sends "Roaming Restriction Due To Unsupported Feature" in a subsequent MAP\_INSERT\_SUBSCRIBER\_DATA service. If "Roaming Restriction Due To Unsupported Feature" is stored in the HLR, the "MSC Area Restricted Flag" shall be set to "restricted". This will prevent MT calls, MT SM and MT USSD from being forwarded to the MSC/VLR.
- the HLR stores and sends other induced subscriber data (e.g. a specific barring program) in a subsequent MAP\_INSERT\_SUBSCRIBER\_DATA service. This will cause rejection of mobile originated service requests, except emergency calls.
- the HLR stores and sends "Roaming Restricted In SGSN Due To Unsupported Feature" in a subsequent MAP\_INSERT\_SUBSCRIBER\_DATA service. If "Roaming Restricted In SGSN Due To Unsupported Feature" is stored in the HLR, the "SGSN Area Restricted Flag" shall be set to "restricted". This will prevent MT SM from being forwarded to the SGSN and Network Requested PDP-Context activation.

When the VLR receives regional subscription data (Zone Code List) it may respond with "MSC Area Restricted" in the MAP\_INSERT\_SUBSCRIBER\_DATA response. In this case the "MSC Area Restricted Flag" shall be set to "restricted" in the HLR. This will prevent MT calls, MT SM and MT USSD from being forwarded to the MSC/VLR.

When the SGSN receives regional subscription data (Zone Code List) it may respond with "SGSN Area Restricted" in the MAP\_INSERT\_SUBSCRIBER\_DATA response. In this case the "SGSN Area Restricted Flag" shall be set to "restricted" in the HLR. This will prevent MT SM from being forwarded to the SGSN and Network Requested PDP-Context activation.

If subscriber data for CAMEL Phase 2 services are sent to a VLR which does not support CAMEL Phase 2, the service behaviour may be unpredictable or incorrect. The HLR therefore needs to ensure that at the conclusion of a stand alone Insert Subscriber data procedure that the data in the VLR do not require a capability that the VLR does not have. Possible mechanisms to ensure this are described in GSM 03.78.

The HLR should send a Forwarded-to number which is not in E.164 international format to the VLR only when the HLR has ascertained that the VLR supports CAMEL Phase 2. Thus, the ISD message containing the Forwarded-to number which is not in E.164 international format shall be sent to the VLR only if the HLR previously received confirmation from the VLR at Location Update that CAMEL Phase 2 is supported.

A Forwarded-to number in non-international E.164 format shall only be sent from an HLR to a VLR if the VLR supports CAMEL Phase 2, or a subsequent version of CAMEL.

If the HLR does not store "Roaming Restriction Due To Unsupported Feature" as a consequence of the stand alone Insert Subscriber Data procedure and the HLR does not receive "MSC Area Restricted" in the MAP\_INSERT\_SUBSCRIBER\_DATA response and "Roaming Restriction Due To Unsupported Feature" has not been stored in the HLR in the course of a previous subscriber data retrieval procedure, the "MSC Area Restricted Flag" in the HLR shall be set to "not restricted".

If the HLR does not store "Roaming Restricted In SGSN Due To Unsupported Feature" as a consequence of the stand alone Insert Subscriber Data procedure and the HLR does not receive "SGSN Area Restricted" in the MAP\_INSERT\_SUBSCRIBER\_DATA response and "Roaming Restricted In SGSN Due To Unsupported Feature" has not been stored in the HLR in the course of a previous subscriber data retrieval procedure, the "SGSN Area Restricted Flag" in the HLR shall be set to "not restricted".

The SDL diagram of process between HLR and VLR is shown in figure 25.7/2;

The SDL diagram of process between HLR and SGSN is shown in figure 25.7/5.

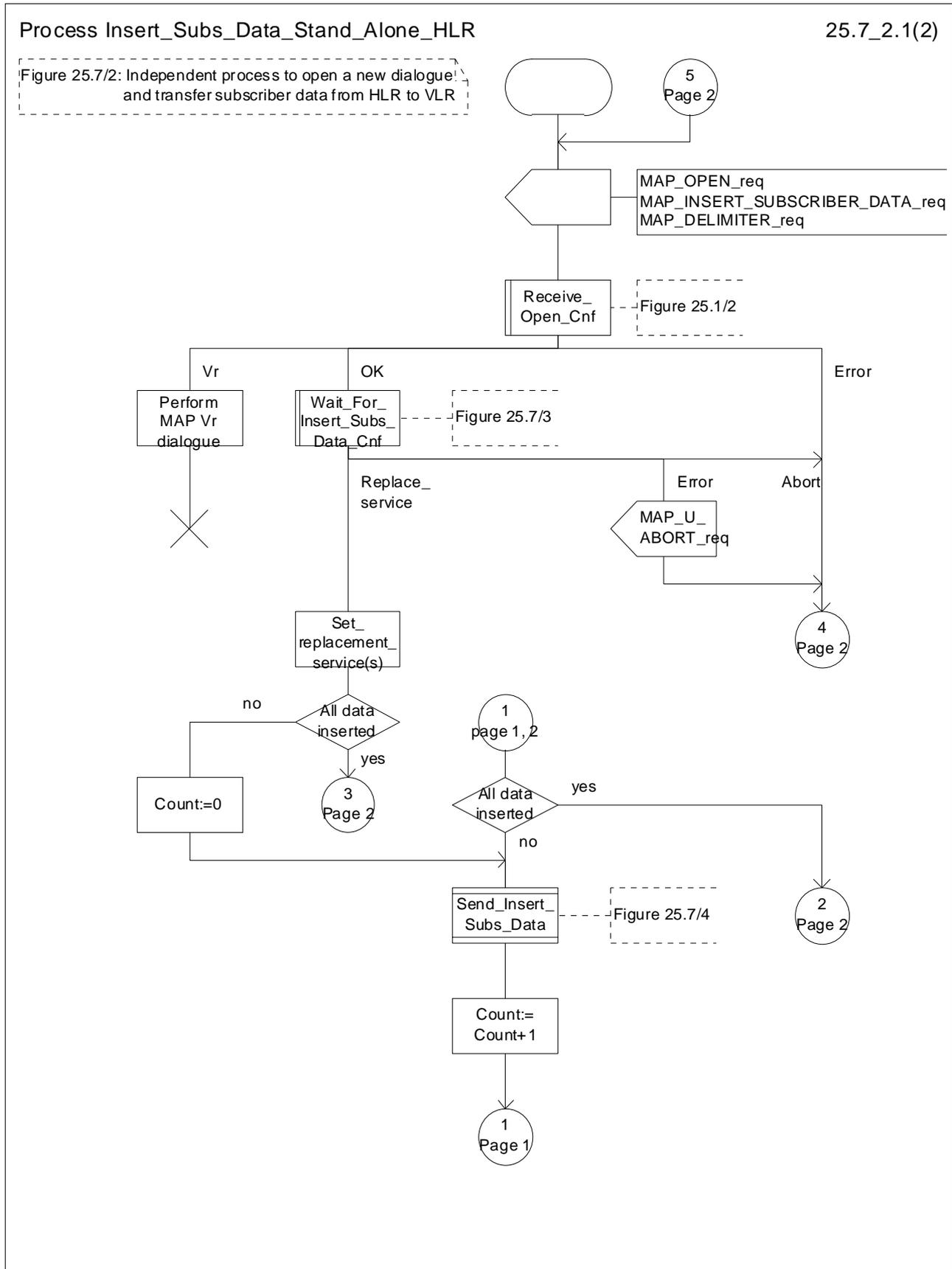

Figure 25.7/2 (sheet 1 of 2): Process Insert\_Subscriber\_Data\_Stand\_Alone\_HLR

### Process Insert\_Subs\_Data\_Stand\_Alone\_HLR

25.7\_2.2(2)

Figure 25.7/2: Independent process to open a new dialogue and transfer subscriber data from HLR to VLR

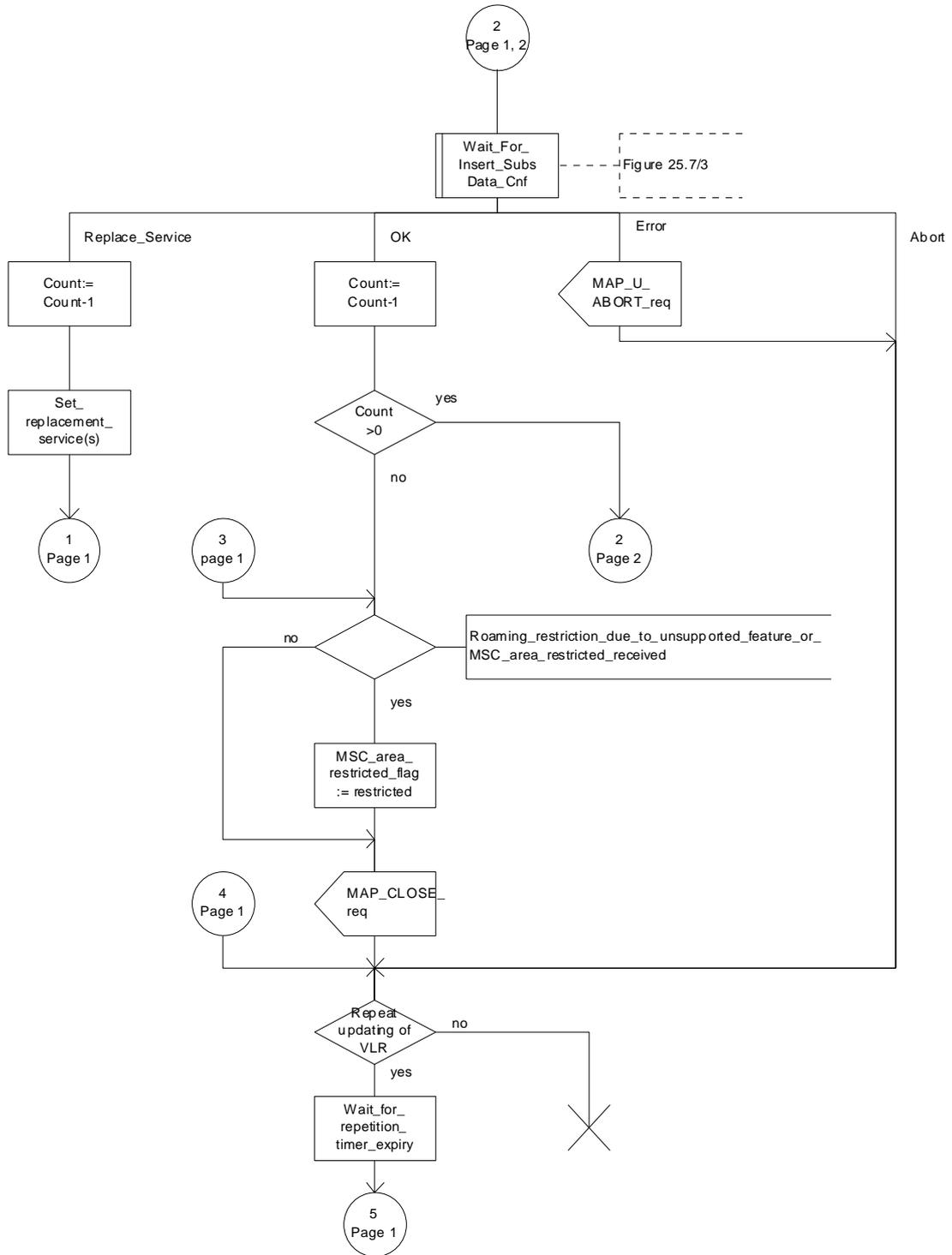

Figure 25.7/2 (sheet 2 of 2): Process Insert\_Subs\_Data\_Stand\_Alone\_HLR



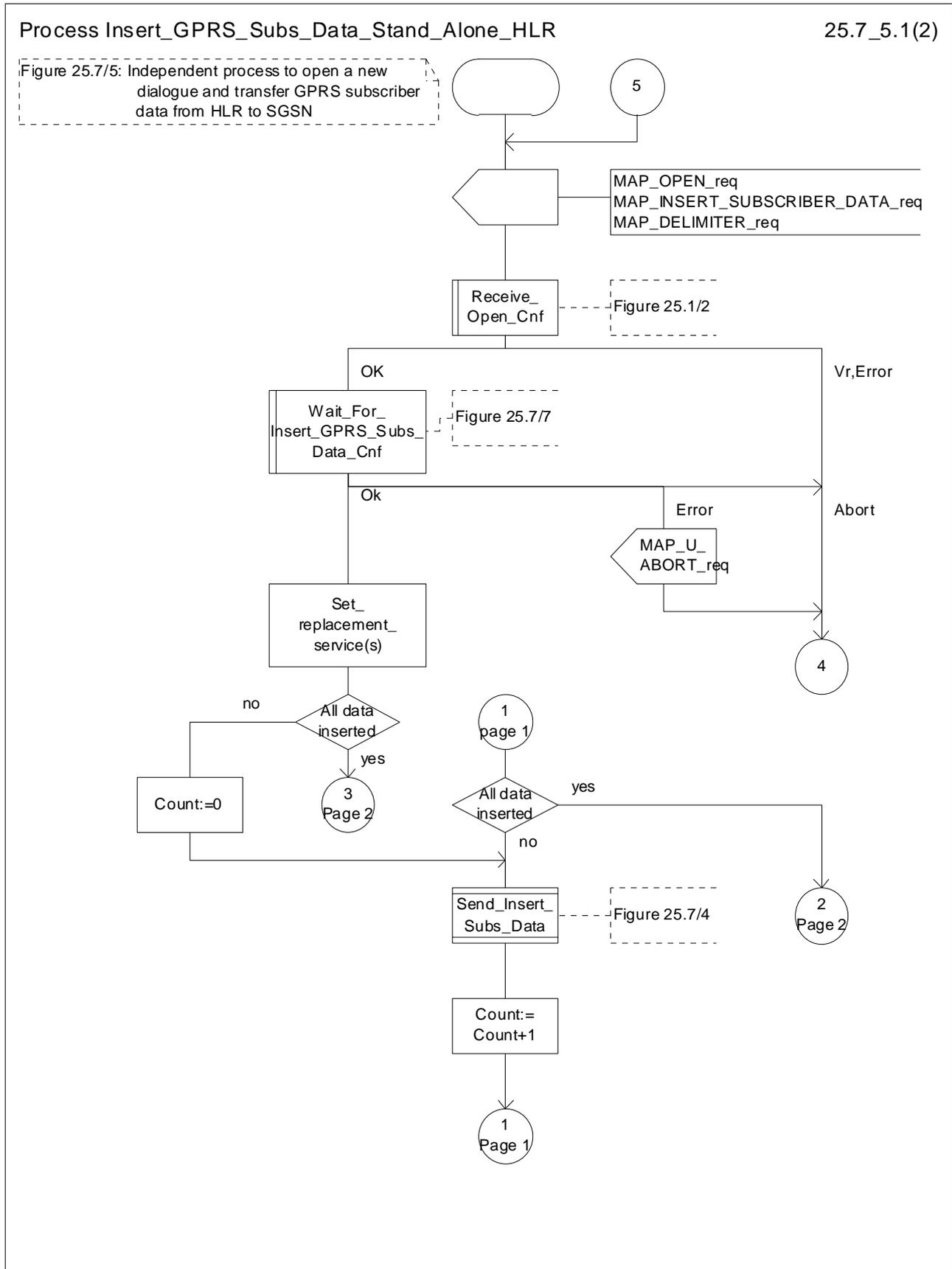

Figure 25.7/5 (sheet 1 of 2): Process Insert\_GPRS\_Subscriber\_Data\_Stand\_Alone\_HLR

Process Insert\_GPRS\_Subscriber\_Data\_Stand\_Alone\_HLR

25.7\_5.2(2)

Figure 25.7/5: Independent process to open a new dialogue and transfer GPRS subscriber data from HLR to SGSN

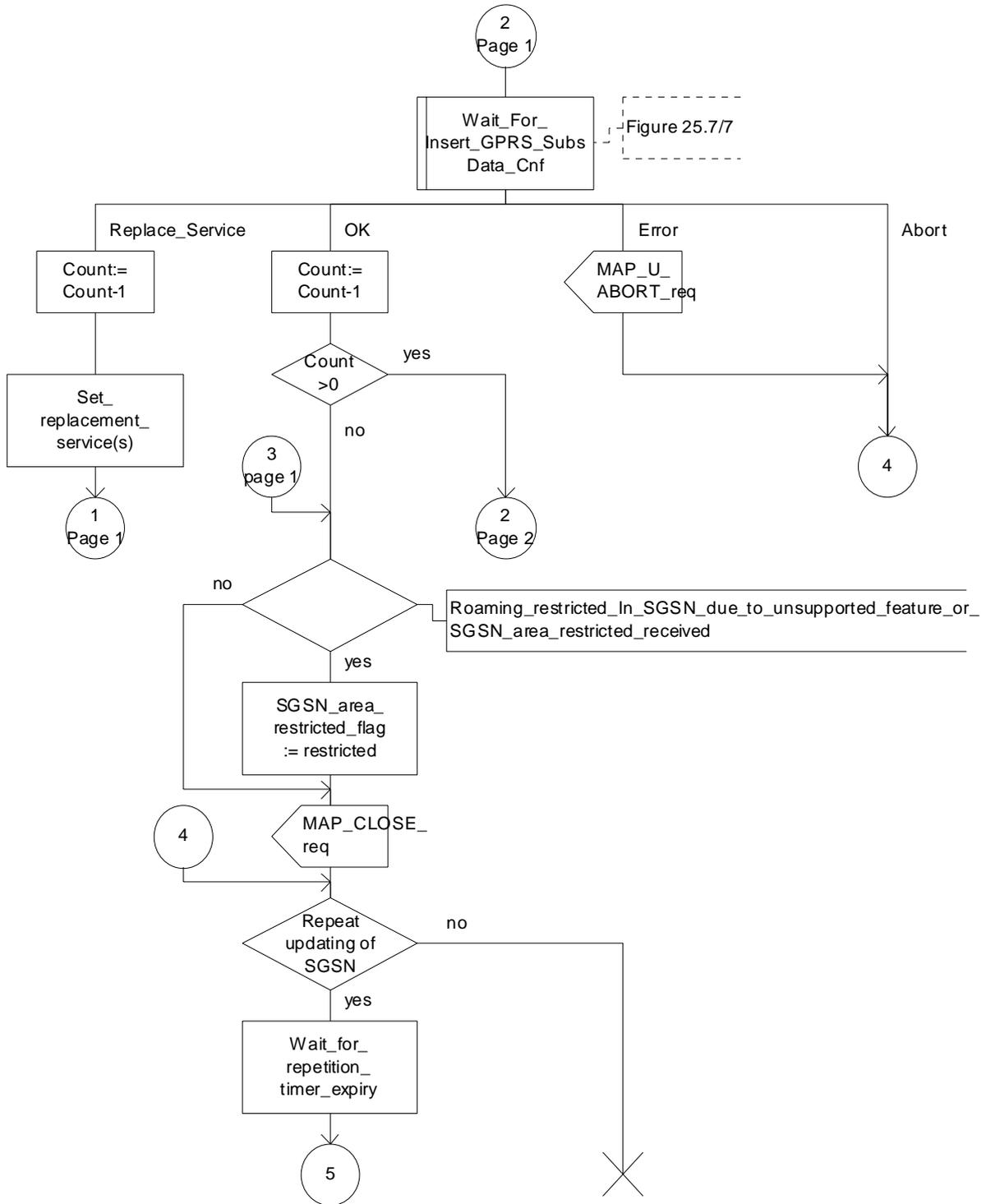

Figure 25.7/5 (sheet 2 of 2): Process Insert\_GPRS\_Subscriber\_Data\_Stand\_Alone\_HLR

### 25.7.3 Macro Wait\_for\_Insert\_Subscriber\_Data\_Cnf

This macro is used by any process or macro that describes the handling of the reception of the Insert\_Subscriber\_Data service in HLR that is coming from VLR (e.g. Update Location or Restore Data).

If the VLR reports the non-support of some basic or supplementary service or the network feature Operator Determined Barring then three actions are possible:

- to ignore the information received;
- to replace the not supported service;
- or to perform any other internal action.

The SDL diagram is shown in figure 25.7/3.

Macrodefinition Wait\_For\_Insert\_Subscriber\_Data\_Cnf

25.7\_3(1)

Figure 25.7/3: Macro to receive confirmation or error indication for MAP\_INSERT\_SUBSCRIBER\_DATA

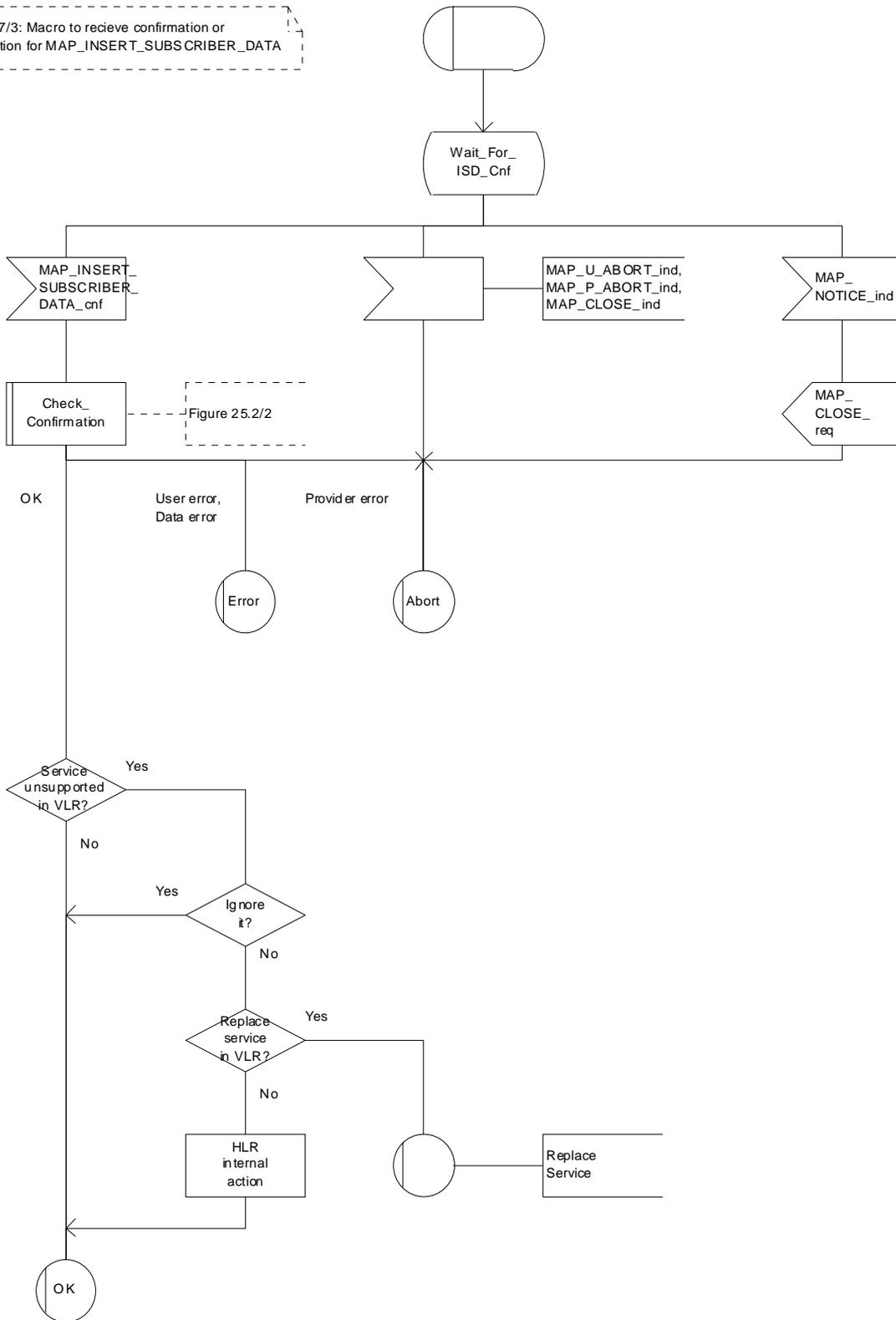

Figure 25.7/3: Macro Wait\_for\_Insert\_Subscriber\_Data\_Cnf

## 25.7.4 Process Send\_Insert\_Subscriber\_Data

This process is used by any process or macro where the Insert\_Subscriber\_Data request is sent to VLR or to SGSN.

The SDL diagram is shown in figure 25.7/4.

Process Send\_Insert\_Subs\_Data

25.7\_4(1)

Figure 25.7/4: Independent process to send a component of subscriber data from HLR to VLR

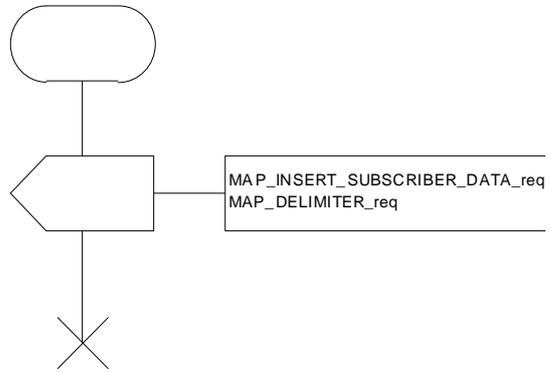

Figure 25.7/4: Process Send\_Insert\_Subs\_Data

## 25.7.5 Macro Insert\_SubscriberData\_SGSN

This macro describes the reception of the InsertSubscriberData service indication. This macro is used by any procedure that triggers the reception of subscriber data (e.g. Update GPRS Location ).

If the SGSN does not support any basic or the network feature Operator Determined Barring, or there is a problem with Regional Subscription Data then it reports it to the HLR.

If the entire SGSN area is restricted due to regional subscription this is reported to the HLR.

The SDL diagram is shown in figure 25.7/6.

Macrodefinition Insert\_Subscriber\_Data\_SGSN

25.7\_6(1)

Figure 25.7/6: Macro to receive and store subscriber data in the SGSN

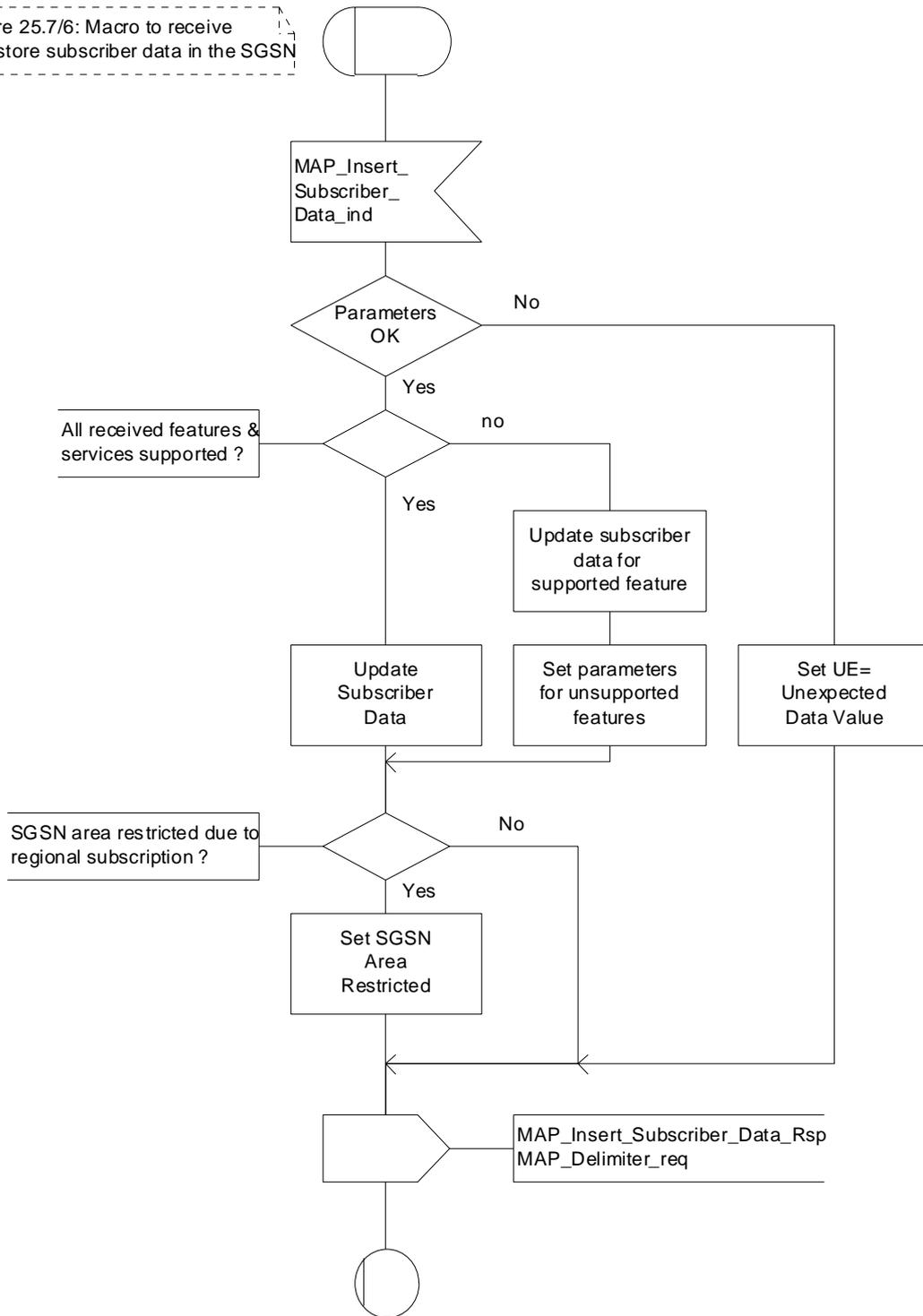

Figure 25.7/6: Macro Insert\_Subscriber\_Data\_SGSN



## 25.7.6 Macro Wait\_for\_Insert\_GPRS\_Subscriber\_Data\_Cnf

This macro is used by any process or macro that describes the handling of the reception of the Insert\_Subscriber\_Data service in HLR that is coming from SGSN (e.g. Update GPRS Location).

If the SGSN reports the non-support of some basic or the network feature Operator Determined Barring then three actions are possible:

- to ignore the information received;
- to replace the not supported service;
- or to perform any other internal action.

The SDL diagram is shown in figure 25.7/7.

Macrodefinition Wait\_For\_Insert\_GPRS\_Subscriber\_Data\_Cnf

25.7\_7(1)

Figure 25.7/7: Macro to receive confirmation or error indication for MAP\_INSERT\_SUBSCRIBER\_DATA from SGSN

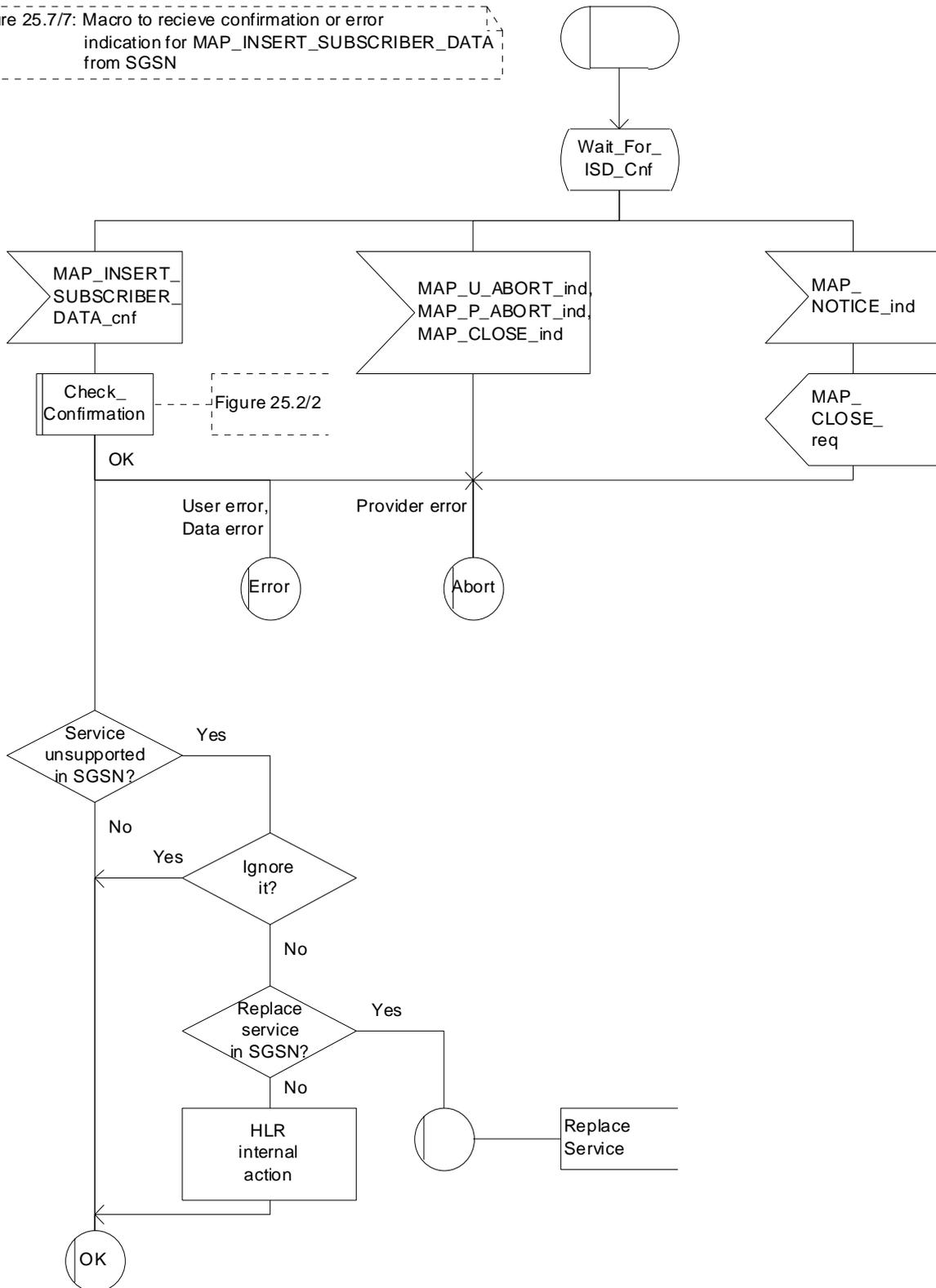

Figure 25.7/7: Macro Wait\_for\_Insert\_GPRS\_Subscriber\_Data\_Cnf

## 25.8 Request IMSI Macros

### 25.8.1 Macro Obtain\_IMSI\_MSC

This macro describes the handling of the request received from the VLR to provide the IMSI of a subscriber (e.g. at Location Updating).

The SDL diagram is shown in figure 25.8/1.

Macrodefinition Obtain\_IMSI\_MSC

25.8\_1(1)

Figure 25.8/1: Macro to relay an IMSI request from the VLR to the MS and return the response to the VLR

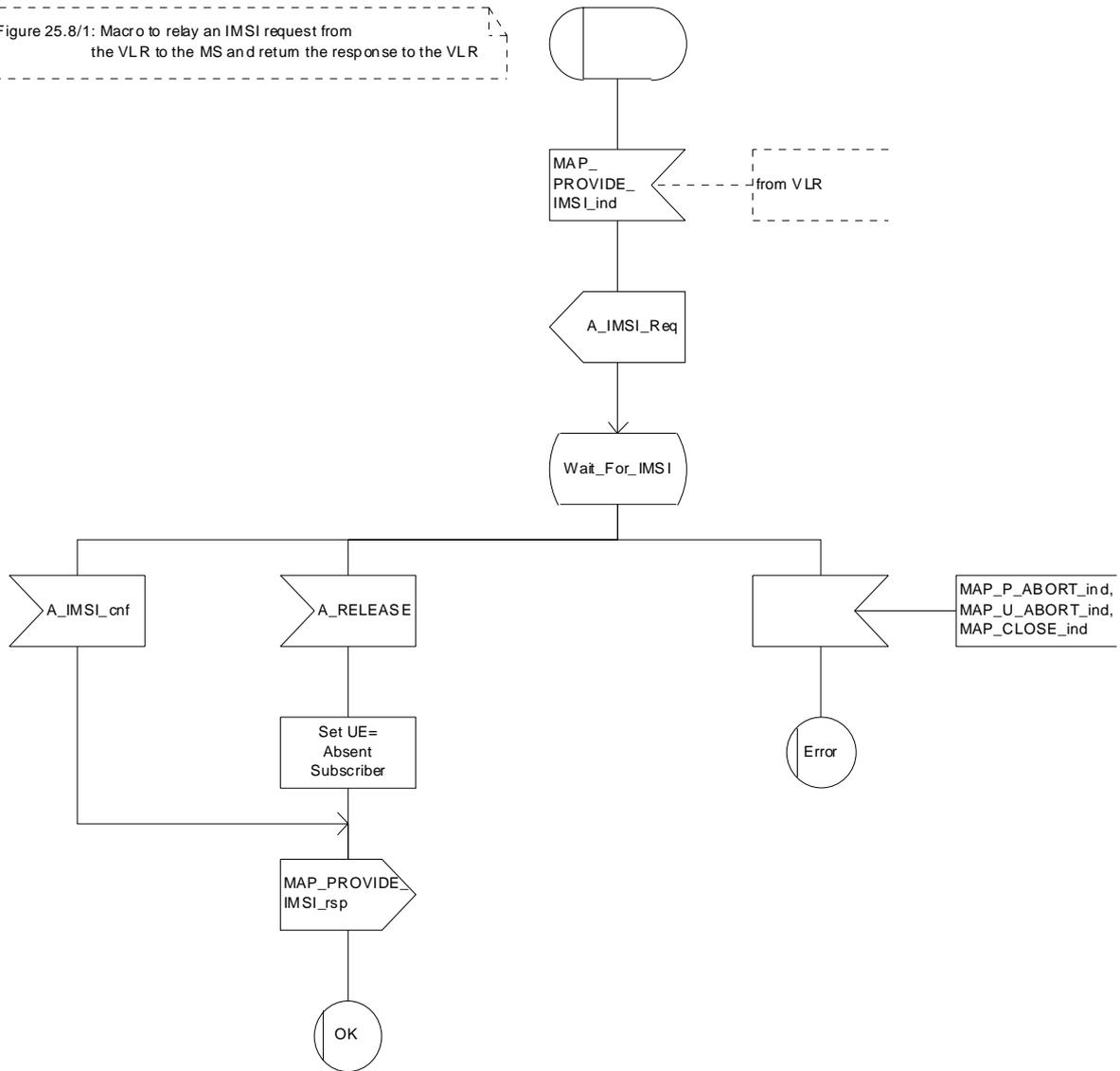

Figure 25.8/1: Macro Obtain\_IMSI\_MSC

## 25.8.2 Macro Obtain\_IMSI\_VLR

This macro describes the way VLR requests the MSC the IMSI of a subscriber (e.g. at Location Updating).

The SDL diagram is shown in figure 25.8/2.

Macrodefinition Obtain\_IMSI\_VLR

25.8\_2(1)

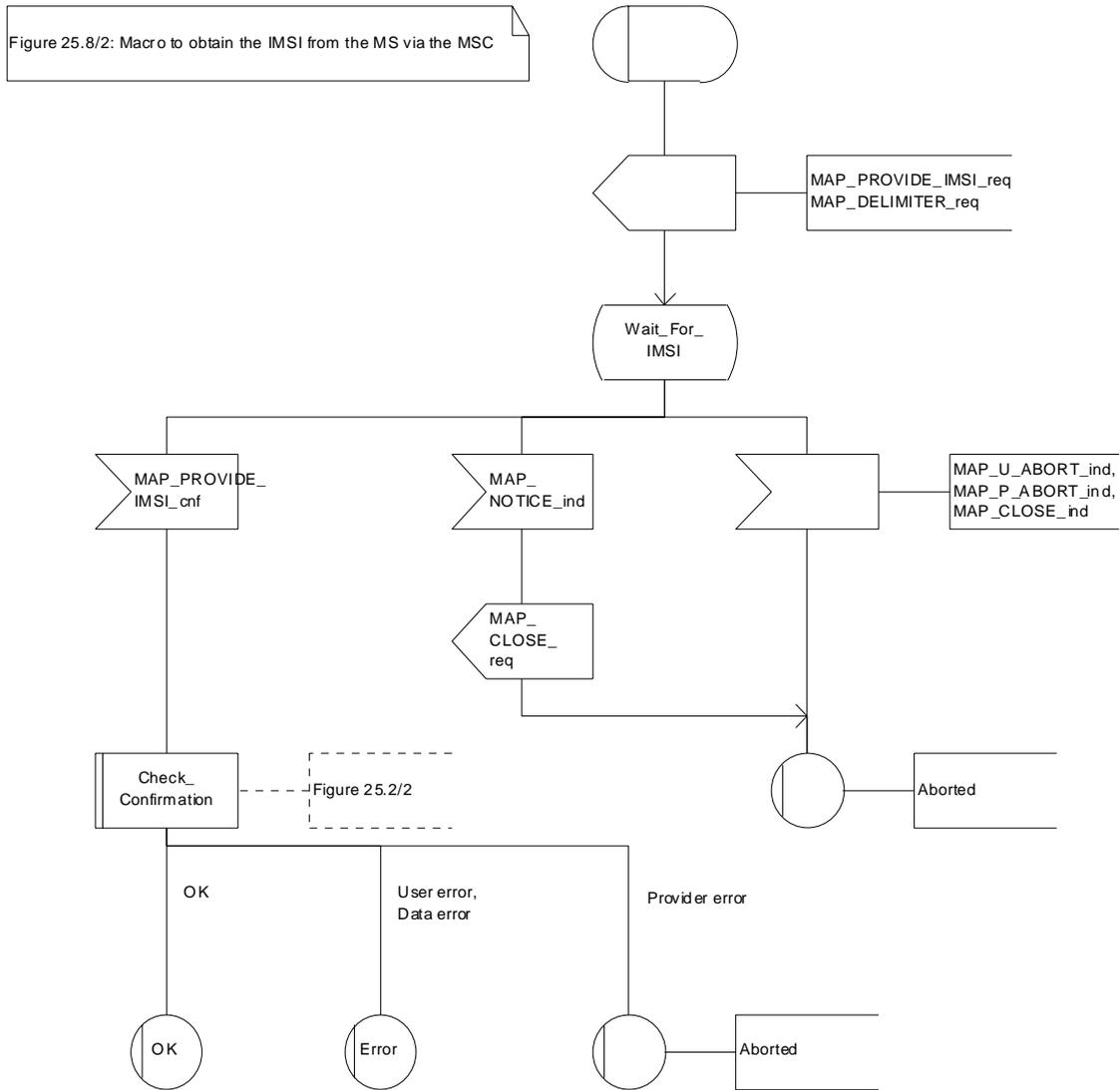

Figure 25.8/2: Macro Obtain\_IMSI\_VLR

## 25.9 Tracing macros

### 25.9.1 Macro Trace\_Subscriber\_Activity\_MSC

The Trace\_Subscriber\_Activity\_MSC is invoked in the MSC, when the MSC receives the MAP\_TRACE\_SUBSCRIBER\_ACTIVITY indication from the VLR. The data of the primitive is checked and the tracing in the MSC is started if the content includes no errors. No response is returned to the VLR.

The Trace\_Subscriber\_Activity\_MSC macro is described in the figure 25.9/1.

Macrodefinition Trace\_Subscriber\_Activity\_MSC

25.9\_1(1)

Figure 25.9/1: The Subscriber tracing macro in the MSC

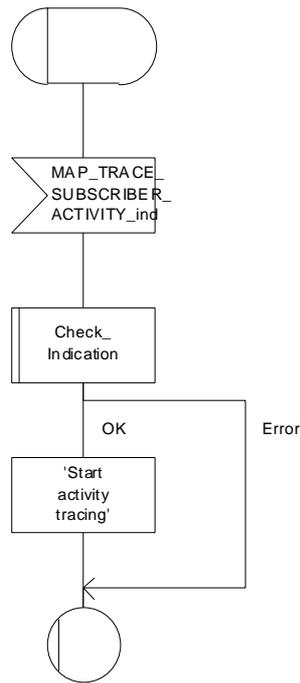

Figure 25.9/1: Macro Trace\_Subscriber\_Activity\_MSC



## 25.9.2 Macro Trace\_Subscriber\_Activity\_VLR

The macro Trace\_Subscriber\_Activity\_VLR is invoked, if the subscriber activity is detected by the VLR and the tracing is active. The VLR sends MAP\_TRACE\_SUBSCRIBER\_ACTIVITY request to the MSC. No answer is awaited from the MSC.

The Trace\_Subscriber\_Activity\_VLR macro is shown in the figure 25.9/2.

Macrodefinition Trace\_Subscriber\_Activity\_VLR

25.9\_2(1)

Figure 25.9/2: The subscriber tracing macro in the VLR

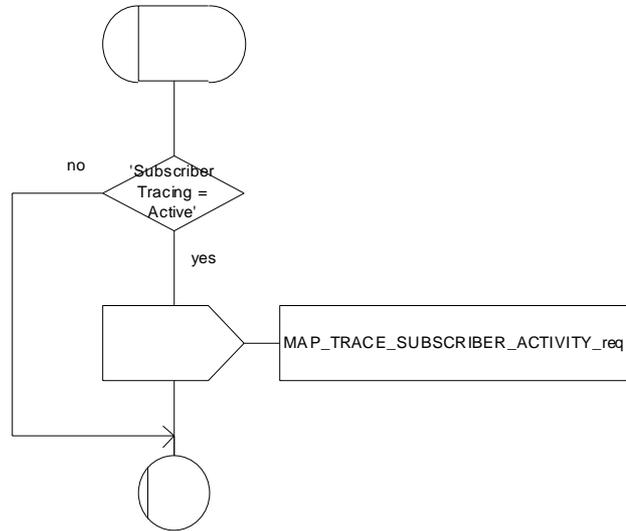

Figure 25.9/2: Macro Trace\_Subscriber\_Activity\_VLR

### 25.9.3 Macro Activate\_Tracing\_VLR

The Activate\_Tracing\_VLR macro is invoked, when the MAP\_ACTIVATE\_TRACE\_MODE indication is received from the HLR. The primitive is processed in the VLR as follows:

- if the data contains errors, a data missing or unexpected data value indication is returned to the HLR;
- if the tracing is not supported, a facility not supported indication is returned to the HLR;
- if the tracing buffer does not have any space left for the data, a tracing buffer full indication is returned to the HLR;
- if no errors is detected, the tracing is set active and a positive acknowledge is returned to the HLR.

The Activate\_Tracing\_VLR macro is described in the figure 25.9/3.

Macrodefinition Activate\_Tracing\_VLR

25.9\_3(1)

Figure 25.9/3: The activate trace mode macro in the VLR

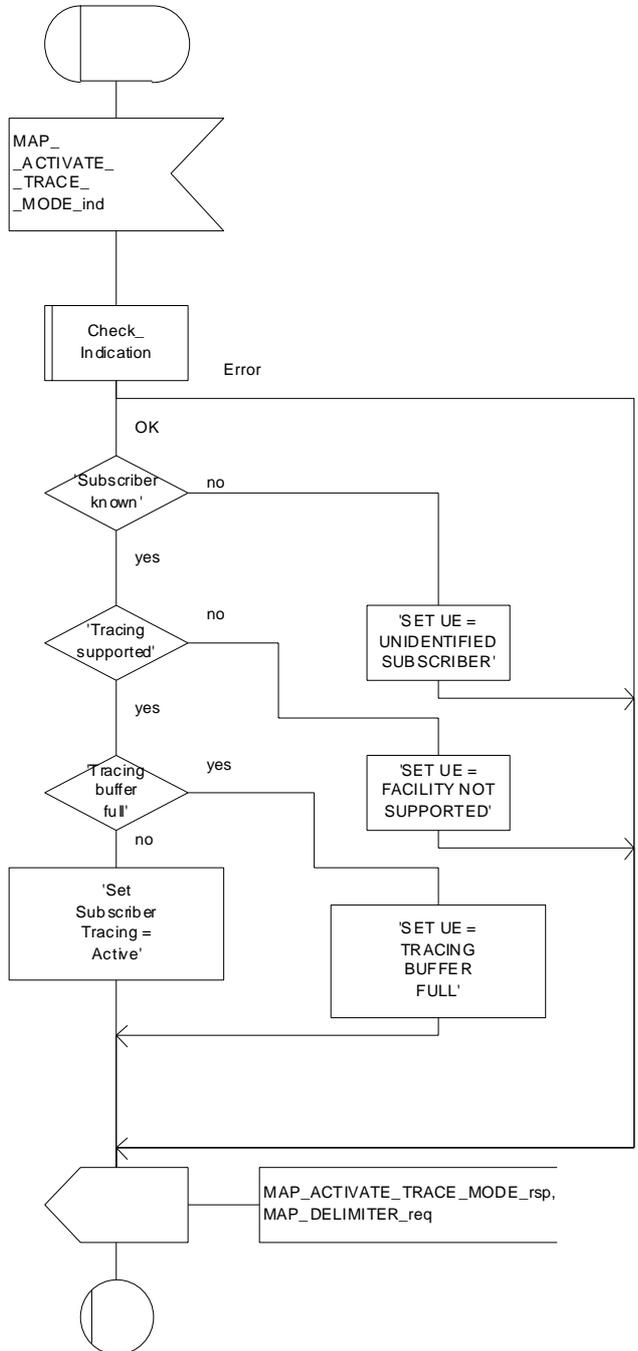

Figure 25.9/3: Macro Activate\_Tracing\_VLR

## 25.9.4 Macro Control\_Tracing\_HLR

The Control\_Tracing\_HLR macro may be invoked in the HLR, if subscriber related activity is detected. If the tracing is active in the HLR and not active in the VLR or in the SGSN, the MAP\_ACTIVATE\_TRACE\_MODE request is sent to the VLR or to the SGSN.

The MAP\_ACTIVATE\_TRACE\_MODE confirmation from the VLR or from the SGSN is processed as follows:

- if the primitive contains a successful acknowledge, the tracing in VLR or in the SGSN is set active;
- if the primitive contains errors, the tracing in VLR or in SGSN is set deactive.

The Control\_Tracing\_HLR macro between HLR and VLR is shown in the figure 25.9/4.

The Control\_Tracing\_HLR\_with\_SGSN macro between HLR and SGSN is shown in the figure 25.9/5.

Macrodefinition Control\_Tracing\_HLR

25.9\_4(1)

Figure 25.9/4: The subscriber tracing activation macro in the HLR

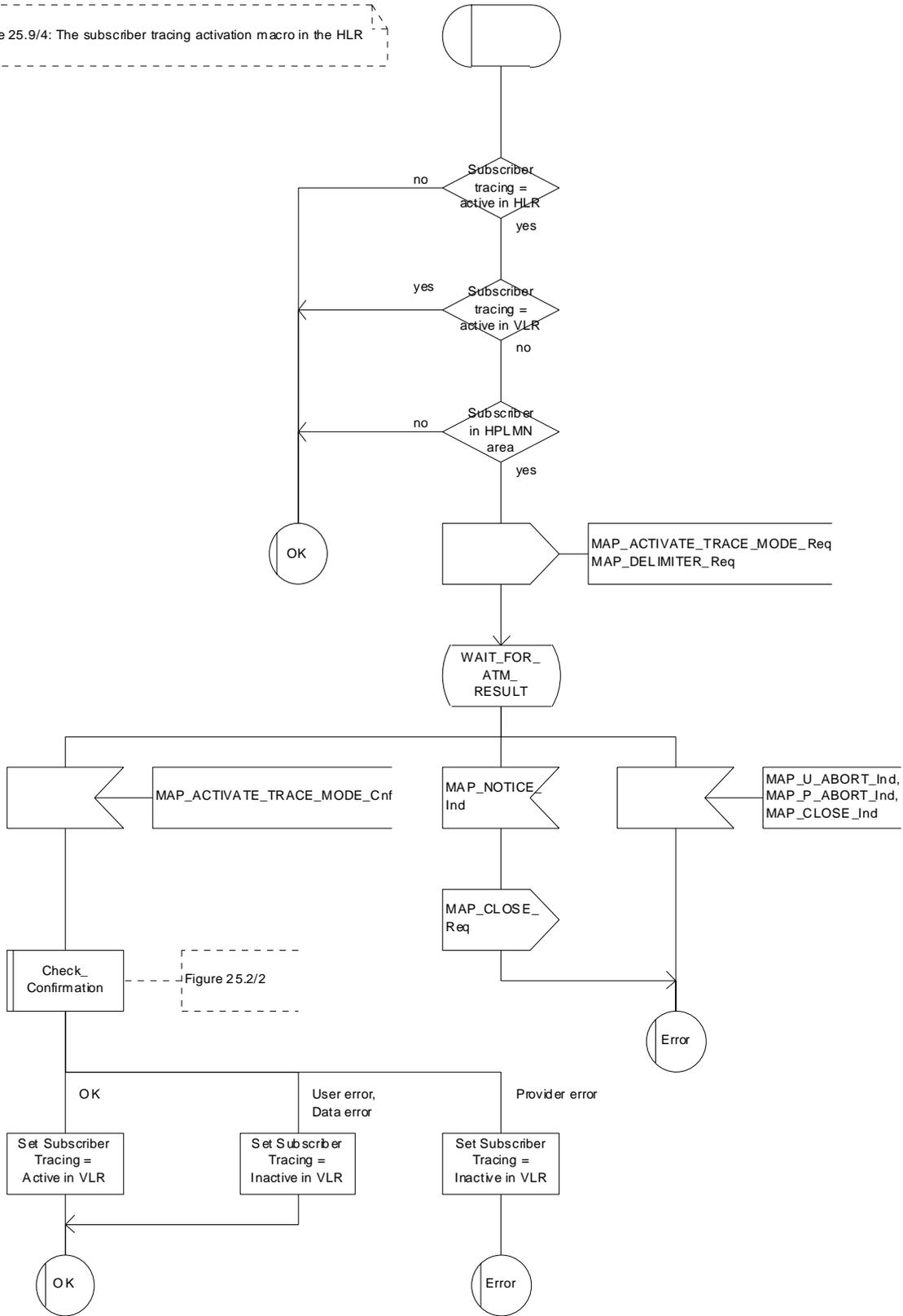

Figure 25.9/4: Macro Control\_Tracing\_HLR

Macrodefinition Control\_Tracing\_HLR\_with\_SGSN

25.9\_5(1)

Figure 25.9/5: The subscriber tracing activation macro in the HLR

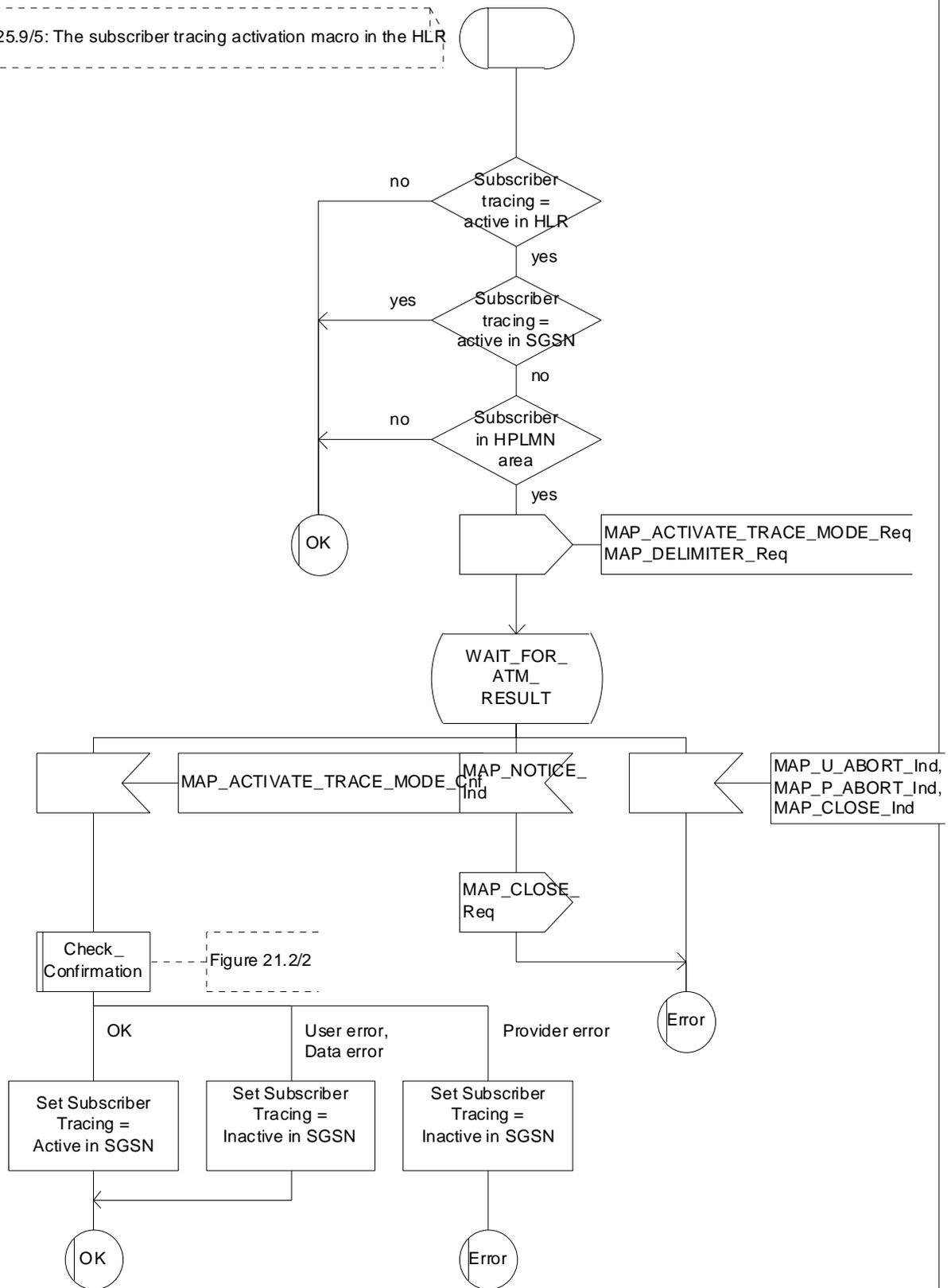

Figure 25.9/5: Macro Control\_Tracing\_HLR\_with\_SGSN

## 25.9.5 Macro Trace\_Subscriber\_Activity\_SGSN

The macro Trace\_Subscriber\_Activity\_SGSN is invoked, if the subscriber activity is detected by the SGSN and the tracing is active.

The Trace\_Subscriber\_Activity\_SGSN macro is shown in the figure 25.9/6.



Macrodefinition Trace\_Subscriber\_Activity\_SGSN

25.9\_6(1)

Figure 25.9/6: The subscriber tracing macro in the SGSN

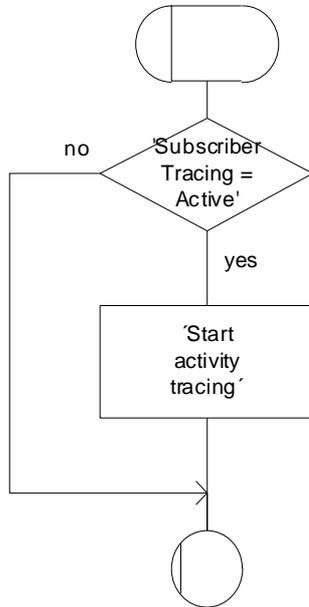

Figure 25.9/6: Macro Trace\_Subscriber\_Activity\_SGSN

## 25.9.6 Macro Activate\_Tracing\_SGSN

The Activate\_Tracing\_SGSN macro is invoked, when the MAP\_ACTIVATE\_TRACE\_MODE indication is received from the HLR. The primitive is processed in the SGSN as follows:

- if the data contains errors, a data missing or unexpected data value indication is returned to the HLR;
- if the tracing is not supported, a facility not supported indication is returned to the HLR;
- if the tracing buffer does not have any space left for the data, a tracing buffer full indication is returned to the HLR;
- if no errors is detected, the tracing is set active and a positive acknowledge is returned to the HLR.

The Activate\_Tracing\_SGSN macro is described in the figure 25.9/7.

Macrodefinition Activate\_Tracing\_SGSN

25.9\_7(1)

Figure 25.9/7: The activate trace mode macro in the SGSN

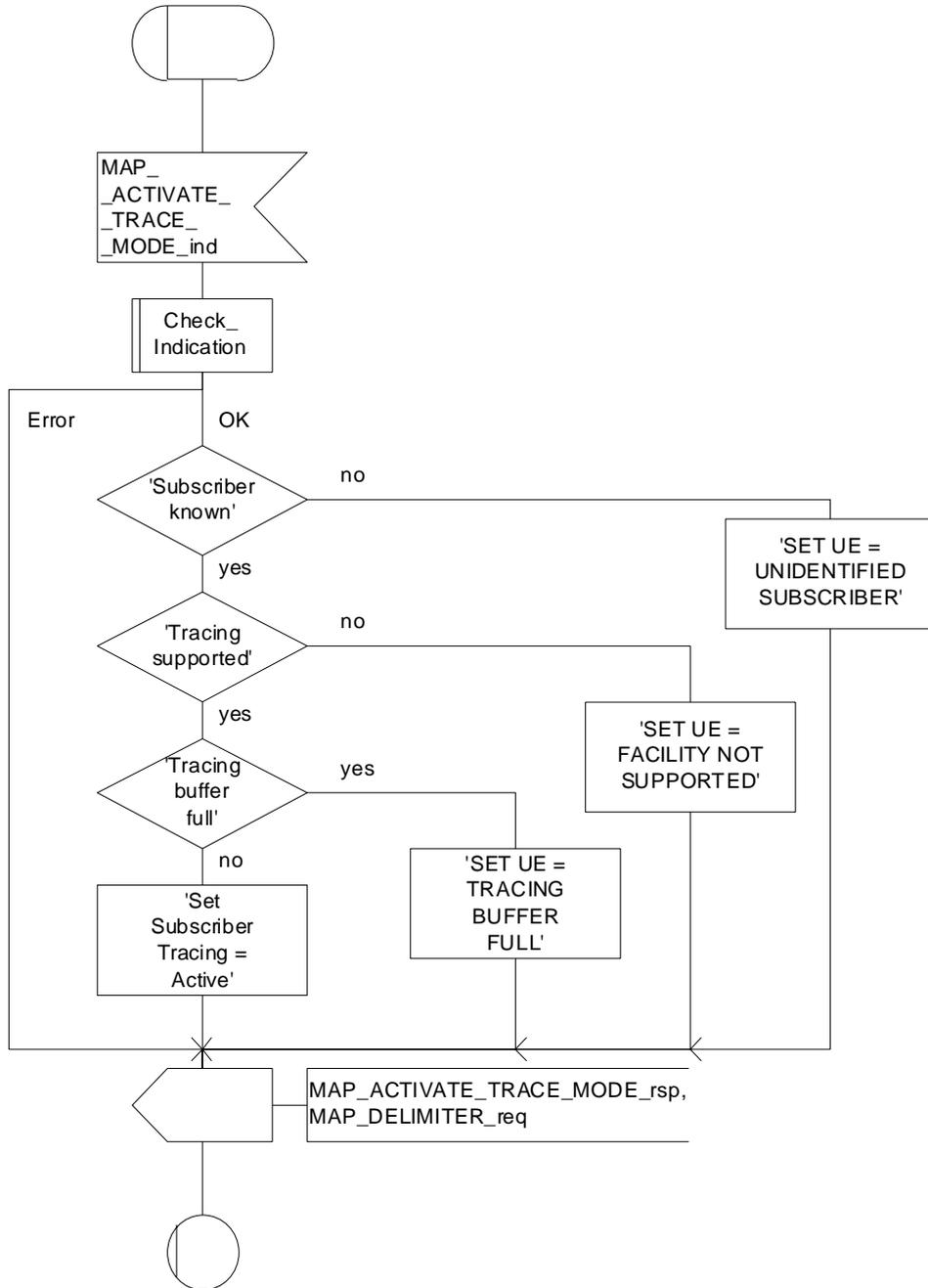

Figure 25.9/7: Macro Activate\_Tracing\_SGSN

## 25.10 Short Message Alert procedures

### 25.10.1 Subscriber\_Present\_VLR process

The Subscriber\_Present\_VLR process is invoked by the VLR, when the mobile subscriber becomes active and the MNRF flag is set. The general description of the short message alert procedures is in the clause 23.4.

The VLR sends the MAP\_READY\_FOR\_SM request to the HLR and waits for the HLR to answer. When receiving the answer, the VLR will act as follows:

- the MNRF flag is cleared if the procedure is successful;
- the MNRF flag is not cleared if the procedure is not successful.

The Subscriber\_Present\_VLR process is shown in the figure 25.10/1.

Process Subscriber\_Present\_VLR

25.10\_1(1)

Figure 25.10/1: The short message alert process in the VLR for mobile present situation

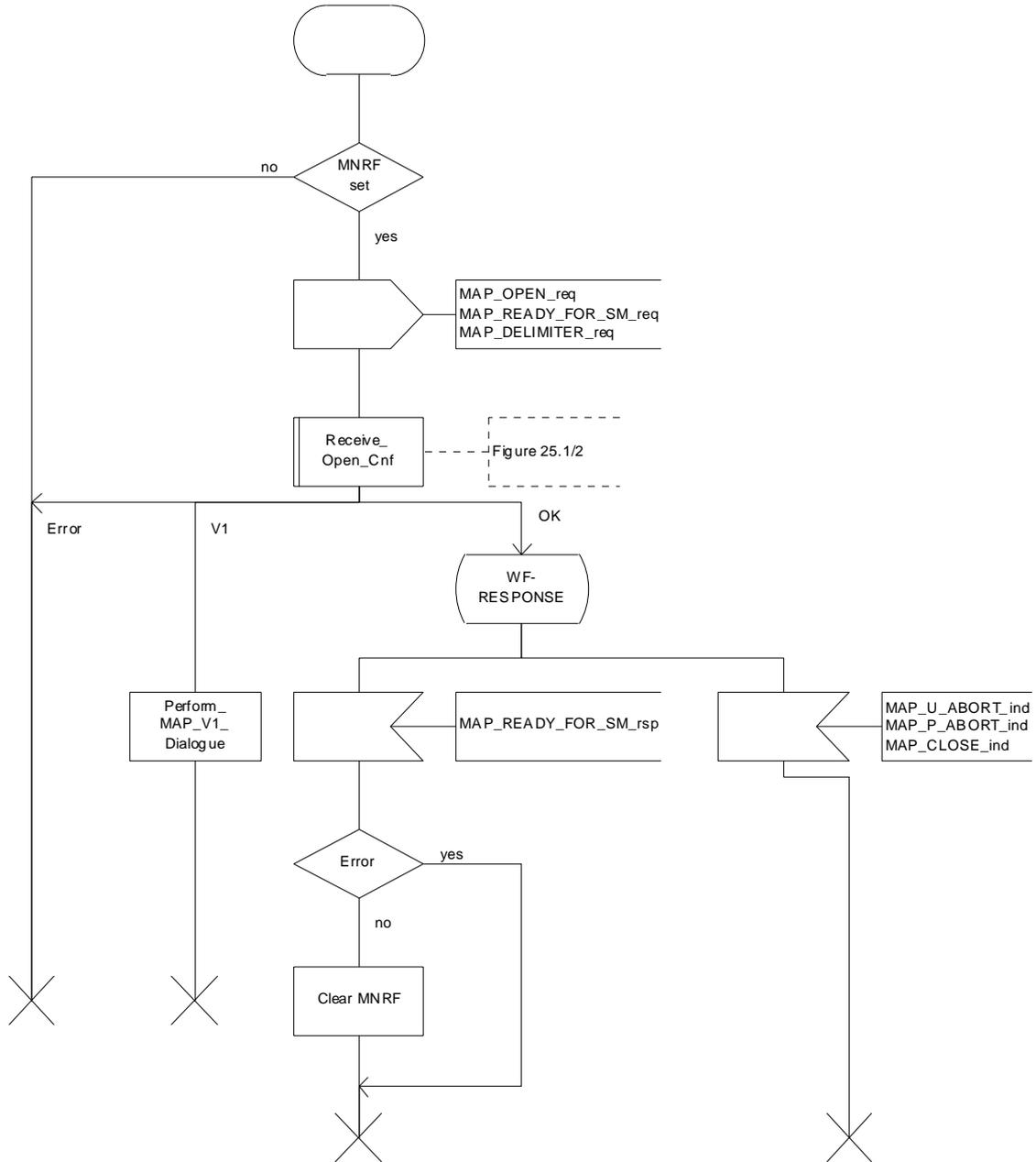

Figure 25.10/1: Process Subscriber\_Present\_VLR

## 25.10.2 Macro Alert\_Service\_Centre\_HLR

The Alert\_Service\_Centre\_HLR macro is initiated when the HLR notices that the Service Centre(s) shall be alerted. The macro starts process Alert\_Service\_Centre\_HLR for every SC address in the MWD list.

In the process Alert\_Service\_Centre\_HLR the HLR sends MAP\_ALERT\_SERVICE\_CENTRE request to the appropriate IWMSC. The MWD entry is deleted when the positive acknowledge is received from the IWMSC. The unsuccessful alert may be repeated. The MWD entry should be purged in the unsuccessful case, at least when a suitable time period has expired.

The Alert\_Service\_Centre\_HLR macro is shown in the figure 25.10/2 and the Alert\_Service\_Centre\_HLR process is shown in the figure 25.10/3.

Macrodefinition Alert\_Service\_Centre\_HLR

25.10\_2(1)

Figure 25.10/2: The short message alert macro in the HLR

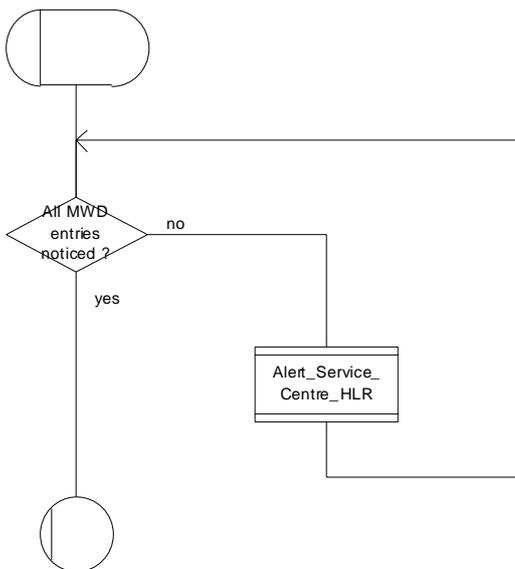

Figure 25.10/2: Macro Alert\_Service\_Centre\_HLR

### Process Alert\_Service\_Centre\_HLR

22.10\_3(1)

Figure 25.10/3: The short message alert process in the HLR

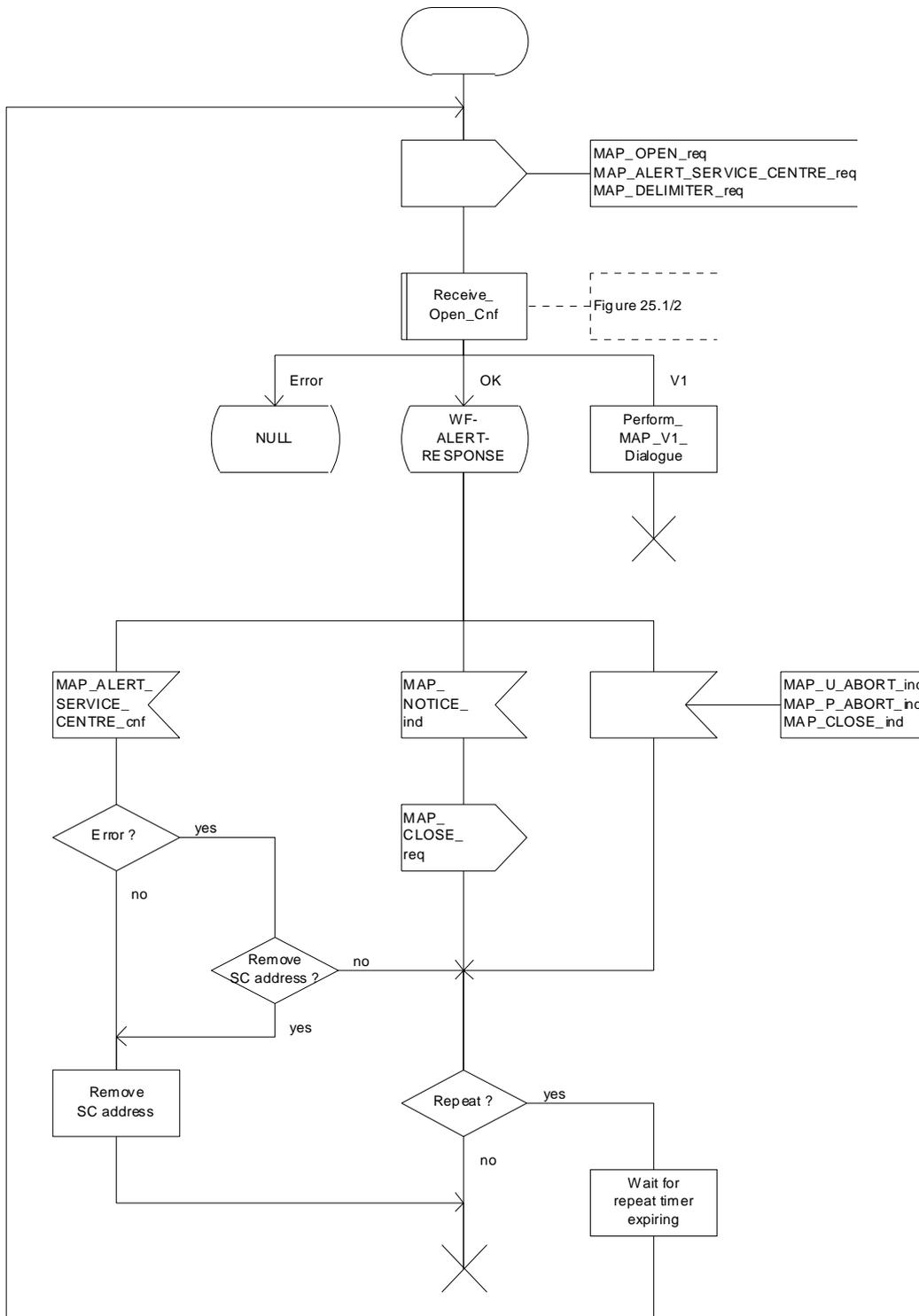

Figure 25.10/3: Process Alert\_Service\_Centre\_HLR



### 25.10.3 The Mobile Subscriber is present

When receiving Page response, Attach request or Routing area update request messages (TS GSM 04.08), while the MS not reachable for GPRS (MNRG) flag is set, the SGSN will send the MAP\_READY\_FOR\_SM request towards the HLR. The Alert Reason is set to indicate that the mobile subscriber is present for GPRS.

When receiving the answer, the SGSN will act as follows:

- MNRG is cleared if the procedure is successful;
- MNRG is not cleared if the procedure is not successful.

The Subscriber\_Present\_SGSN process is shown in the figure 25.10/4.

Process Subscriber\_Present\_SGSN

25.10\_4(1)

Figure 25.10/4: The short message alert process in the SGSN for mobile present situation

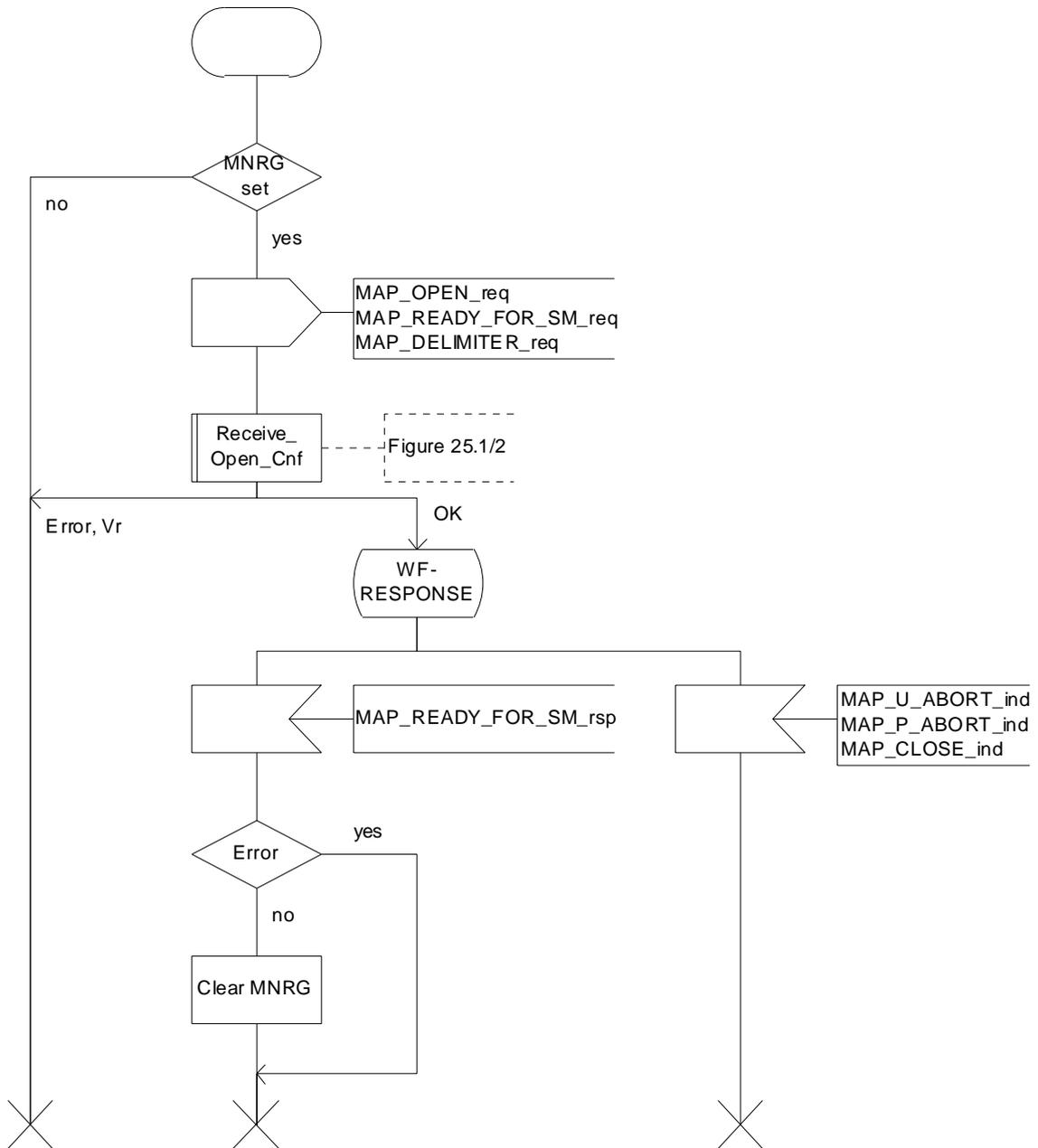

Figure 25.10/4: Process Subscriber\_Present\_SGSN

# Annex A (informative): Cross-reference for abstract syntaxes of MAP

Annex A is not part of the standard, it is included for information purposes only.

For every ASN.1 item such as identifier, type-reference or value-reference the cross-reference allows to locate all occurrences by means of module-name and line numbers. For that purpose line numbers are printed at the left margin in front of each ASN.1 source line starting with 1 for every module.

The items are sorted alphabetically in the cross-reference in a case-insensitive manner. Occurrences of an item are its definition and all its usages such as in exports, imports or within a type or value assignment.

For every item additional information is provided such as kind of item (identifier, value reference, type reference), and tag, associated type and value if applicable.

The cross-reference for a root module includes all modules referred to directly or indirectly via imports. The cross-references for the root modules MAP-Protocol/TCAPMessages and MAP-DialoguePDU are included.

TAG R4.21 Cross Reference Listing for MAP-Protocol 99-12-21 12:08:21 PAGE 1

&extensionId.....	identifier of Fieldspec				
DEFINED in MAP-ExtensionDataTypes	:	24			
USED in MAP-ExtensionDataTypes	:	41			
&ExtensionType.....	identifier of Fieldspec				
DEFINED in MAP-ExtensionDataTypes	:	23			
USED in MAP-ExtensionDataTypes	:	43			
abort.....	identifier of [APPLICATION 7] IMPLICIT Abort				
DEFINED in TCAPMessages	:	56			
Abort.....	type reference SEQUENCE				
DEFINED in TCAPMessages	:	74			
USED in TCAPMessages	:	56			
absentSubscriber.....	value reference AbsentSubscriber, CHOICE VALUE				
DEFINED in MAP-Protocol	:	325			
AbsentSubscriber.....	type reference ERROR				
DEFINED in MAP-Errors	:	244			
USED in MAP-Protocol	:	120	325		
USED in MAP-MobileServiceOpera	:	80	328		
USED in MAP-CallHandlingOperat	:	38	89	107	178
USED in MAP-SupplementaryServi	:	50	197	211	
USED in MAP-ShortMessageServic	:	36			
USED in MAP-Errors	:	47			
absentSubscriber.....	identifier of Named Number, 1				
DEFINED in MAP-SM-DataTypes	:	164			
absentSubscriberDiagnosticSM.....	identifier of [0] AbsentSubscriberDiagnosticSM				
DEFINED in MAP-SM-DataTypes	:	146			
absentSubscriberDiagnosticSM.....	identifier of AbsentSubscriberDiagnosticSM				
DEFINED in MAP-ER-DataTypes	:	141			
AbsentSubscriberDiagnosticSM.....	type reference INTEGER				
DEFINED in MAP-ER-DataTypes	:	151			
USED in MAP-MS-DataTypes	:	143	797		
USED in MAP-SM-DataTypes	:	40	146	158	
USED in MAP-ER-DataTypes	:	43	141	146	
absentSubscriberParam.....	identifier of AbsentSubscriberParam				
DEFINED in MAP-Errors	:	246			
AbsentSubscriberParam.....	type reference SEQUENCE				
DEFINED in MAP-ER-DataTypes	:	227			
USED in MAP-Errors	:	109	246		
USED in MAP-ER-DataTypes	:	34			

absentSubscriberReason.....identifier of [0] AbsentSubscriberReason  
DEFINED in MAP-ER-DataTypes : 230

AbsentSubscriberReason.....type reference ENUMERATED  
DEFINED in MAP-ER-DataTypes : 232  
USED in MAP-ER-DataTypes : 230

absentSubscriberSM.....value reference AbsentSubscriberSM, CHOICE VALUE  
DEFINED in MAP-Protocol : 365

AbsentSubscriberSM.....type reference ERROR  
DEFINED in MAP-Errors : 351  
USED in MAP-Protocol : 141 365  
USED in MAP-ShortMessageService : 41 80 110  
USED in MAP-Errors : 74

absentSubscriberSM-Param.....identifier of AbsentSubscriberSM-Param  
DEFINED in MAP-Errors : 353

AbsentSubscriberSM-Param.....type reference SEQUENCE  
DEFINED in MAP-ER-DataTypes : 140  
USED in MAP-Errors : 119 353  
USED in MAP-ER-DataTypes : 42

accepted.....identifier of Named Number, 0  
DEFINED in MAP-CH-DataTypes : 379

activateSS.....value reference ActivateSS, CHOICE VALUE  
DEFINED in MAP-Protocol : 218

ActivateSS.....type reference OPERATION  
 DEFINED in MAP-SupplementaryServi : 121  
 USED in MAP-Protocol : 64 218  
 USED in MAP-SupplementaryServi : 15

activateTraceMode.....value reference ActivateTraceMode, CHOICE VALUE  
 DEFINED in MAP-Protocol : 197

ActivateTraceMode.....type reference OPERATION  
 DEFINED in MAP-OperationAndMainte : 50  
 USED in MAP-Protocol : 41 197  
 USED in MAP-OperationAndMainte : 13

activateTraceModeArg.....identifier of ActivateTraceModeArg  
 DEFINED in MAP-OperationAndMainte : 52

ActivateTraceModeArg.....type reference SEQUENCE  
 DEFINED in MAP-OM-DataTypes : 36  
 USED in MAP-OperationAndMainte : 34 52  
 USED in MAP-OM-DataTypes : 14

activateTraceModeRes.....identifier of ActivateTraceModeRes  
 DEFINED in MAP-OperationAndMainte : 54

ActivateTraceModeRes.....type reference SEQUENCE  
 DEFINED in MAP-OM-DataTypes : 50  
 USED in MAP-OperationAndMainte : 35 54  
 USED in MAP-OM-DataTypes : 15

additionalAbsentSubscriberDiagnosticSM..identifier of [5] AbsentSubscriberDiagnosticSM  
 DEFINED in MAP-SM-DataTypes : 158

additionalAbsentSubscriberDiagnosticSM..identifier of [0] AbsentSubscriberDiagnosticSM  
 DEFINED in MAP-ER-DataTypes : 146

additionalSM-DeliveryOutcome.....identifier of [4] SM-DeliveryOutcome  
 DEFINED in MAP-SM-DataTypes : 156

additional-Number.....identifier of [6] Additional-Number  
 DEFINED in MAP-SM-DataTypes : 93

Additional-Number.....type reference CHOICE  
 DEFINED in MAP-SM-DataTypes : 97  
 USED in MAP-SM-DataTypes : 93

AddressString.....type reference OCTET STRING  
 DEFINED in MAP-CommonDataTypes : 79  
 USED in MAP-CommonDataTypes : 16 123  
 USED in MAP-OM-DataTypes : 21 40  
 USED in MAP-SS-DataTypes : 44 72 273  
 USED in MAP-SM-DataTypes : 31 55 134 139 144 175

ageOfLocationInformation.....identifier of AgeOfLocationInformation  
 DEFINED in MAP-MS-DataTypes : 902

AgeOfLocationInformation.....type reference INTEGER  
 DEFINED in MAP-MS-DataTypes : 910  
 USED in MAP-MS-DataTypes : 902

alertingCategory-1.....value reference AlertingPattern, '00000100'B  
 DEFINED in MAP-CommonDataTypes : 213

alertingCategory-2.....value reference AlertingPattern, '00000101'B  
 DEFINED in MAP-CommonDataTypes : 214

alertingCategory-3.....value reference AlertingPattern, '00000110'B  
 DEFINED in MAP-CommonDataTypes : 215

alertingCategory-4.....value reference AlertingPattern, '00000111'B  
 DEFINED in MAP-CommonDataTypes : 216

alertingCategory-5.....value reference AlertingPattern, '00001000'B  
 DEFINED in MAP-CommonDataTypes : 217

alertingLevel-0.....value reference AlertingPattern, '00000000'B

```
DEFINED in MAP-CommonDataTypes      :    207
alertingLevel-1.....value reference AlertingPattern, '00000001'B
DEFINED in MAP-CommonDataTypes      :    208
alertingLevel-2.....value reference AlertingPattern, '00000010'B
DEFINED in MAP-CommonDataTypes      :    209
```

3

TAG R4.21 Cross Reference Listing for MAP-Protocol 99-12-21 12:08:21 PAGE

```

AlertingPattern.....type reference OCTET STRING
  DEFINED in MAP-CommonDataTypes : 194
  USED in MAP-CommonDataTypes : 23 207 208 209 213 214 215 216 217
  USED in MAP-CH-DataTypes : 63 102 180 369
  USED in MAP-SS-DataTypes : 49 211

alertingPattern.....identifier of [14] AlertingPattern
  DEFINED in MAP-CH-DataTypes : 102

alertingPattern.....identifier of [12] AlertingPattern
  DEFINED in MAP-CH-DataTypes : 180

alertingPattern.....identifier of [5] AlertingPattern
  DEFINED in MAP-CH-DataTypes : 369

alertingPattern.....identifier of AlertingPattern
  DEFINED in MAP-SS-DataTypes : 211

alertReason.....identifier of AlertReason
  DEFINED in MAP-SM-DataTypes : 194

AlertReason.....type reference ENUMERATED
  DEFINED in MAP-SM-DataTypes : 206
  USED in MAP-SM-DataTypes : 27 194

alertReasonIndicator.....identifier of NULL
  DEFINED in MAP-SM-DataTypes : 195

alertServiceCentre.....value reference AlertServiceCentre, CHOICE VALUE
  DEFINED in MAP-Protocol : 238

AlertServiceCentre.....type reference OPERATION
  DEFINED in MAP-ShortMessageService : 124
  USED in MAP-Protocol : 84 238
  USED in MAP-ShortMessageService : 17

alertServiceCentreArg.....identifier of AlertServiceCentreArg
  DEFINED in MAP-ShortMessageService : 126

AlertServiceCentreArg.....type reference SEQUENCE
  DEFINED in MAP-SM-DataTypes : 173
  USED in MAP-ShortMessageService : 54 126
  USED in MAP-SM-DataTypes : 22

allAdditionalInfoTransferSS.....value reference SS-Code, '10000000'B
  DEFINED in MAP-SS-Code : 105

allAlternateSpeech-DataCDA.....value reference BearerServiceCode, '00110000'B
  DEFINED in MAP-BS-Code : 82

allAlternateSpeech-DataCDS.....value reference BearerServiceCode, '00111000'B
  DEFINED in MAP-BS-Code : 84

allAsynchronousServices.....value reference BearerServiceCode, '01100000'B
  DEFINED in MAP-BS-Code : 95

allBarringSS.....value reference SS-Code, '10010000'B
  DEFINED in MAP-SS-Code : 112

allBearerServices.....value reference BearerServiceCode, '00000000'B
  DEFINED in MAP-BS-Code : 49

allCallCompletionSS.....value reference SS-Code, '01000000'B
  DEFINED in MAP-SS-Code : 72

allCallOfferingSS.....value reference SS-Code, '00110000'B
  DEFINED in MAP-SS-Code : 63

allCallPrioritySS.....value reference SS-Code, '10100000'B
  DEFINED in MAP-SS-Code : 148

allChargingSS.....value reference SS-Code, '01110000'B
  DEFINED in MAP-SS-Code : 97

```

allCommunityOfInterest-SS.....value reference SS-Code, '01100000'B  
DEFINED in MAP-SS-Code : 91

allCondForwardingSS.....value reference SS-Code, '00101000'B  
DEFINED in MAP-SS-Code : 52

allDataCDA-Services.....value reference BearerServiceCode, '00010000'B



4

TAG	R4.21	Cross Reference Listing for MAP-Protocol	99-12-21 12:08:21	PAGE
	DEFINED in MAP-BS-Code	: 51		
allDataCDS-Services	.....value	reference BearerServiceCode, '00011000'B		
	DEFINED in MAP-BS-Code	: 60		
allDataCircuitAsynchronous	.....value	reference BearerServiceCode, '01010000'B		
	DEFINED in MAP-BS-Code	: 92		
allDataCircuitSynchronous	.....value	reference BearerServiceCode, '01011000'B		
	DEFINED in MAP-BS-Code	: 98		
allDataPDS-Services	.....value	reference BearerServiceCode, '00101000'B		
	DEFINED in MAP-BS-Code	: 76		
allDataTeleservices	.....value	reference TeleserviceCode, '01110000'B		
	DEFINED in MAP-TS-Code	: 55		
allECT-Barred	.....identifier	of Named Number, 9		
	DEFINED in MAP-MS-DataTypes	: 411		
allFacsimileTransmissionServices	.....value	reference TeleserviceCode, '01100000'B		
	DEFINED in MAP-TS-Code	: 48		
allForwardingSS	.....value	reference SS-Code, '00100000'B		
	DEFINED in MAP-SS-Code	: 48		
allGPRSData	.....identifier	of NULL		
	DEFINED in MAP-MS-DataTypes	: 637		
allLineIdentificationSS	.....value	reference SS-Code, '00010000'B		
	DEFINED in MAP-SS-Code	: 25		
allMultiPartySS	.....value	reference SS-Code, '01010000'B		
	DEFINED in MAP-SS-Code	: 85		
allNameIdentificationSS	.....value	reference SS-Code, '00011000'B		
	DEFINED in MAP-SS-Code	: 40		
allOG-CallsBarred	.....identifier	of Named Number, 0		
	DEFINED in MAP-MS-DataTypes	: 402		
allPadAccessCA-Services	.....value	reference BearerServiceCode, '00100000'B		
	DEFINED in MAP-BS-Code	: 67		
allPLMN-specificBS	.....value	reference BearerServiceCode, '11010000'B		
	DEFINED in MAP-BS-Code	: 110		
allPLMN-specificSS	.....value	reference SS-Code, '11110000'B		
	DEFINED in MAP-SS-Code	: 131		
allPLMN-specificTS	.....value	reference TeleserviceCode, '11010000'B		
	DEFINED in MAP-TS-Code	: 72		
allShortMessageServices	.....value	reference TeleserviceCode, '00100000'B		
	DEFINED in MAP-TS-Code	: 44		
allSpeechFollowedByDataCDA	.....value	reference BearerServiceCode, '01000000'B		
	DEFINED in MAP-BS-Code	: 86		
allSpeechFollowedByDataCDS	.....value	reference BearerServiceCode, '01001000'B		
	DEFINED in MAP-BS-Code	: 88		
allSpeechTransmissionServices	.....value	reference TeleserviceCode, '00010000'B		
	DEFINED in MAP-TS-Code	: 40		
allSS	.....value	reference SS-Code, '00000000'B		
	DEFINED in MAP-SS-Code	: 21		
allSynchronousServices	.....value	reference BearerServiceCode, '01101000'B		
	DEFINED in MAP-BS-Code	: 101		
allTeleservices	.....value	reference TeleserviceCode, '00000000'B		
	DEFINED in MAP-TS-Code	: 38		
allTeleservices-ExeptSMS	.....value	reference TeleserviceCode, '10000000'B		

```
DEFINED in MAP-TS-Code          :      58
allVoiceGroupCallServices.....value reference TeleserviceCode, '10010000'B
DEFINED in MAP-TS-Code          :      67
anyTimeInterrogation.....value reference AnyTimeInterrogation, CHOICE VALUE
DEFINED in MAP-Protocol         :      247
```

```

AnyTimeInterrogation.....type reference OPERATION
  DEFINED in MAP-MobileServiceOpera : 202
  USED in MAP-Protocol : 30 247
  USED in MAP-MobileServiceOpera : 27

anyTimeInterrogationArg.....identifier of AnyTimeInterrogationArg
  DEFINED in MAP-MobileServiceOpera : 204

AnyTimeInterrogationArg.....type reference SEQUENCE
  DEFINED in MAP-MS-DataTypes : 946
  USED in MAP-MobileServiceOpera : 110 204
  USED in MAP-MS-DataTypes : 78

anyTimeInterrogationRes.....identifier of AnyTimeInterrogationRes
  DEFINED in MAP-MobileServiceOpera : 206

AnyTimeInterrogationRes.....type reference SEQUENCE
  DEFINED in MAP-MS-DataTypes : 953
  USED in MAP-MobileServiceOpera : 111 206
  USED in MAP-MS-DataTypes : 79

aocc.....value reference SS-Code, '01110010'B
  DEFINED in MAP-SS-Code : 102

aoci.....value reference SS-Code, '01110001'B
  DEFINED in MAP-SS-Code : 100

apn.....identifier of [20] APN
  DEFINED in MAP-MS-DataTypes : 325

APN.....type reference OCTET STRING
  DEFINED in MAP-MS-DataTypes : 340
  USED in MAP-MS-DataTypes : 325

asciiCallReference.....identifier of ASCII-CallReference
  DEFINED in MAP-GR-DataTypes : 51

ASCII-CallReference.....type reference TBCD-STRING
  DEFINED in MAP-CommonDataTypes : 227
  USED in MAP-CommonDataTypes : 35
  USED in MAP-GR-DataTypes : 26 51

assumedIdle.....identifier of [0] NULL
  DEFINED in MAP-MS-DataTypes : 933

ati-NotAllowed.....value reference ATI-NotAllowed, CHOICE VALUE
  DEFINED in MAP-Protocol : 336

ATI-NotAllowed.....type reference ERROR
  DEFINED in MAP-Errors : 288
  USED in MAP-Protocol : 127 336
  USED in MAP-MobileServiceOpera : 77 209
  USED in MAP-Errors : 54

ati-NotAllowedParam.....identifier of ATI-NotAllowedParam
  DEFINED in MAP-Errors : 290

ATI-NotAllowedParam.....type reference SEQUENCE
  DEFINED in MAP-ER-DataTypes : 258
  USED in MAP-Errors : 116 290
  USED in MAP-ER-DataTypes : 39

AuthenticationSet.....type reference SEQUENCE
  DEFINED in MAP-MS-DataTypes : 226
  USED in MAP-MS-DataTypes : 224

authenticationSetList.....identifier of AuthenticationSetList
  DEFINED in MAP-MS-DataTypes : 220

AuthenticationSetList.....type reference SEQUENCE OF
  DEFINED in MAP-MS-DataTypes : 223
  USED in MAP-MS-DataTypes : 220 278

automaticFacsimileGroup3.....value reference TeleserviceCode, '01100010'B

```

DEFINED in MAP-TS-Code : 50

a-side.....identifier of Named Number, 0  
DEFINED in MAP-CH-DataTypes : 342

badlyFormattedTransactionPortion.....identifier of Named Number, 2  
DEFINED in TCAPMessages : 105

6

```

badlyStructuredComponent.....identifier of Named Number, 2
  DEFINED in TCAPMessages      :    181

baic.....value reference SS-Code, '10011010'B
  DEFINED in MAP-SS-Code       :    125

baoc.....value reference SS-Code, '10010010'B
  DEFINED in MAP-SS-Code       :    116

barringOfIncomingCalls.....value reference SS-Code, '10011001'B
  DEFINED in MAP-SS-Code       :    123

barringOfOutgoingCalls.....value reference SS-Code, '10010001'B
  DEFINED in MAP-SS-Code       :    114

barringServiceActive.....identifier of Named Number, 0
  DEFINED in MAP-ER-DataTypes   :     93

basicCall.....identifier of Named Number, 0
  DEFINED in MAP-CH-DataTypes    :    109

basicService.....identifier of Ext-BasicServiceCode
  DEFINED in MAP-MS-DataTypes    :    449

basicService.....identifier of Ext-BasicServiceCode
  DEFINED in MAP-MS-DataTypes    :    526

basicService.....identifier of Ext-BasicServiceCode
  DEFINED in MAP-MS-DataTypes    :    569

basicService.....identifier of [5] Ext-BasicServiceCode
  DEFINED in MAP-CH-DataTypes    :    137

basicService.....identifier of BasicServiceCode
  DEFINED in MAP-SS-DataTypes    :     71

basicService.....identifier of BasicServiceCode
  DEFINED in MAP-SS-DataTypes    :     95

basicService.....identifier of BasicServiceCode
  DEFINED in MAP-SS-DataTypes    :    148

basicService.....identifier of BasicServiceCode
  DEFINED in MAP-SS-DataTypes    :    176

basicService.....identifier of BasicServiceCode
  DEFINED in MAP-ER-DataTypes    :    115

BasicServiceCode.....type reference CHOICE
  DEFINED in MAP-CommonDataTypes :    312
  USED in MAP-CommonDataTypes    :     41
  USED in MAP-SS-DataTypes       :     48     71     95     148     176     196     251
  USED in MAP-ER-DataTypes       :     59     115

basicServiceCriteria.....identifier of [1] BasicServiceCriteria
  DEFINED in MAP-MS-DataTypes    :    727

BasicServiceCriteria.....type reference SEQUENCE OF
  DEFINED in MAP-MS-DataTypes    :    747
  USED in MAP-MS-DataTypes       :     57     727
  USED in MAP-CH-DataTypes       :     42

basicServiceGroup.....identifier of [9] Ext-BasicServiceCode
  DEFINED in MAP-CH-DataTypes    :     96

basicServiceGroup.....identifier of [1] Ext-BasicServiceCode
  DEFINED in MAP-CH-DataTypes    :    191

basicServiceGroup.....identifier of [3] BasicServiceCode
  DEFINED in MAP-SS-DataTypes    :    196

basicServiceGroupList.....identifier of Ext-BasicServiceGroupList
  DEFINED in MAP-MS-DataTypes    :    544

```

basicServiceGroupList.....identifier of Ext-BasicServiceGroupList  
DEFINED in MAP-MS-DataTypes : 591

basicServiceGroupList.....identifier of BasicServiceGroupList  
DEFINED in MAP-SS-DataTypes : 156

basicServiceGroupList.....identifier of [2] BasicServiceGroupList

TAG R4.21 Cross Reference Listing for MAP-Protocol 99-12-21 12:08:21 PAGE

7

```

DEFINED in MAP-SS-DataTypes      : 203

BasicServiceGroupList.....type reference SEQUENCE OF
  DEFINED in MAP-SS-DataTypes    : 250
  USED in MAP-SS-DataTypes      : 156 203

basicServiceList.....identifier of [1] BasicServiceList
  DEFINED in MAP-MS-DataTypes    : 622

BasicServiceList.....type reference SEQUENCE OF
  DEFINED in MAP-MS-DataTypes    : 643
  USED in MAP-MS-DataTypes      : 622

bearerService.....identifier of [2] BearerServiceCode
  DEFINED in MAP-CommonDataTypes : 313

BearerServiceCode.....type reference OCTET STRING
  DEFINED in MAP-BS-Code         : 11
  USED in MAP-CommonDataTypes   : 54 313
  USED in MAP-BS-Code           : 49 51 52 53 54 55 56 57 58
                                60 61 62 63 64 65 67 68 69
                                70 71 72 73 74 76 77 78 79
                                80 82 84 86 88 92 95 98 101
                                110 111 112 113 114 115 116 117 118
                                119 120 121 122 123 124 125

bearerServiceList.....identifier of [4] BearerServiceList
  DEFINED in MAP-MS-DataTypes    : 363

BearerServiceList.....type reference SEQUENCE OF
  DEFINED in MAP-MS-DataTypes    : 385
  USED in MAP-MS-DataTypes      : 363 605

bearerServiceList.....identifier of [2] BearerServiceList
  DEFINED in MAP-MS-DataTypes    : 605

bearerServiceNotProvisioned.....value reference BearerServiceNotProvisioned, CHOICE
VALUE
  DEFINED in MAP-Protocol        : 303

BearerServiceNotProvisioned.....type reference ERROR
  DEFINED in MAP-Errors          : 209
  USED in MAP-Protocol          : 113 303
  USED in MAP-CallHandlingOperat : 35 87
  USED in MAP-SupplementaryServi : 37 97 114 131 151 169
  USED in MAP-Errors            : 32

bearerServNotProvParam.....identifier of BearerServNotProvParam
  DEFINED in MAP-Errors          : 211

BearerServNotProvParam.....type reference SEQUENCE
  DEFINED in MAP-ER-DataTypes    : 211
  USED in MAP-Errors            : 104 211
  USED in MAP-ER-DataTypes      : 30

begin.....identifier of [APPLICATION 2] IMPLICIT Begin
  DEFINED in TCAPMessages        : 53

Begin.....type reference SEQUENCE
  DEFINED in TCAPMessages        : 61
  USED in TCAPMessages          : 53

bicRoam.....value reference SS-Code, '10011011'B
  DEFINED in MAP-SS-Code        : 127

blackListed.....identifier of Named Number, 1
  DEFINED in MAP-MS-DataTypes    : 285

boic.....value reference SS-Code, '10010011'B
  DEFINED in MAP-SS-Code        : 118

boicExHC.....value reference SS-Code, '10010100'B
  DEFINED in MAP-SS-Code        : 120

bothMSCAndSGSN.....identifier of Named Number, 0

```

DEFINED in MAP-MS-DataTypes : 307

broadcastInitEntitlement.....identifier of NULL  
DEFINED in MAP-MS-DataTypes : 867

bss-APDU.....identifier of ExternalSignalInfo  
DEFINED in MAP-MobileServiceOpera : 229



```

bss-APDU.....identifier of ExternalSignalInfo
  DEFINED in MAP-MobileServiceOpera : 234

bss-APDU.....identifier of ExternalSignalInfo
  DEFINED in MAP-MobileServiceOpera : 238

bss-APDU.....identifier of ExternalSignalInfo
  DEFINED in MAP-MobileServiceOpera : 244

bss-APDU.....identifier of ExternalSignalInfo
  DEFINED in MAP-MS-DataTypes : 260

bss-APDU.....identifier of ExternalSignalInfo
  DEFINED in MAP-MS-DataTypes : 265

bss-APDU.....identifier of ExternalSignalInfo
  DEFINED in MAP-MS-DataTypes : 271

busy.....identifier of Named Number, 1
  DEFINED in MAP-CH-DataTypes : 118

busy.....identifier of Named Number, 2
  DEFINED in MAP-CH-DataTypes : 352

busySubscriber.....value reference BusySubscriber, CHOICE VALUE
  DEFINED in MAP-Protocol : 326

BusySubscriber.....type reference ERROR
  DEFINED in MAP-Errors : 251
  USED in MAP-Protocol : 121 326
  USED in MAP-CallHandlingOperat : 39 90 180
  USED in MAP-Errors : 45

busySubscriberParam.....identifier of BusySubscriberParam
  DEFINED in MAP-Errors : 253

BusySubscriberParam.....type reference SEQUENCE
  DEFINED in MAP-ER-DataTypes : 240
  USED in MAP-Errors : 110 253
  USED in MAP-ER-DataTypes : 35

b-side.....identifier of Named Number, 1
  DEFINED in MAP-CH-DataTypes : 343

b-subscriberNumber.....identifier of [1] ISDN-AddressString
  DEFINED in MAP-SS-DataTypes : 194

b-subscriberSubaddress.....identifier of [2] ISDN-SubaddressString
  DEFINED in MAP-SS-DataTypes : 195

b-Subscriber-Address.....identifier of [3] ISDN-AddressString
  DEFINED in MAP-CH-DataTypes : 262

callBarred.....value reference CallBarred, CHOICE VALUE
  DEFINED in MAP-Protocol : 328

CallBarred.....type reference ERROR
  DEFINED in MAP-Errors : 261
  USED in MAP-Protocol : 123 328
  USED in MAP-CallHandlingOperat : 41 92
  USED in MAP-SupplementaryServi : 39 99 116 133 153 171 185 226 260
  277
  USED in MAP-ShortMessageServic : 37 79
  USED in MAP-Errors : 48

callBarredParam.....identifier of CallBarredParam
  DEFINED in MAP-Errors : 263

CallBarredParam.....type reference CHOICE
  DEFINED in MAP-ER-DataTypes : 85
  USED in MAP-Errors : 112 263
  USED in MAP-ER-DataTypes : 15

callBarringCause.....identifier of CallBarringCause
  DEFINED in MAP-ER-DataTypes : 86

```

```
CallBarringCause.....type reference ENUMERATED
  DEFINED in MAP-ER-DataTypes      :      92
  USED in MAP-ER-DataTypes         :      86   97

callBarringCause.....identifier of CallBarringCause
  DEFINED in MAP-ER-DataTypes      :      97
```

```

CallBarringFeature.....type reference SEQUENCE
  DEFINED in MAP-SS-DataTypes      : 147
  USED in MAP-SS-DataTypes         : 145

callBarringFeatureList.....identifier of Ext-CallBarFeatureList
  DEFINED in MAP-MS-DataTypes      : 518

callBarringFeatureList.....identifier of CallBarringFeatureList
  DEFINED in MAP-SS-DataTypes      : 141

CallBarringFeatureList.....type reference SEQUENCE OF
  DEFINED in MAP-SS-DataTypes      : 144
  USED in MAP-SS-DataTypes         : 141

callBarringInfo.....identifier of [1] Ext-CallBarInfo
  DEFINED in MAP-MS-DataTypes      : 433

callBarringInfo.....identifier of [1] CallBarringInfo
  DEFINED in MAP-SS-DataTypes      : 82

CallBarringInfo.....type reference SEQUENCE
  DEFINED in MAP-SS-DataTypes      : 139
  USED in MAP-SS-DataTypes         : 82

CallDirection.....type reference OCTET STRING
  DEFINED in MAP-CH-DataTypes      : 269
  USED in MAP-CH-DataTypes         : 261

calledPartySS-InteractionViolation.....identifier of Named Number, 7
  DEFINED in MAP-ER-DataTypes      : 111

callInfo.....identifier of [1] ExternalSignalInfo
  DEFINED in MAP-CH-DataTypes      : 365

callInfo.....identifier of [3] ExternalSignalInfo
  DEFINED in MAP-SS-DataTypes      : 286

callOutcome.....identifier of [1] CallOutcome
  DEFINED in MAP-CH-DataTypes      : 337

CallOutcome.....type reference ENUMERATED
  DEFINED in MAP-CH-DataTypes      : 349
  USED in MAP-CH-DataTypes         : 337

callReferenceNumber.....identifier of [7] CallReferenceNumber
  DEFINED in MAP-CH-DataTypes      : 94

CallReferenceNumber.....type reference OCTET STRING
  DEFINED in MAP-CH-DataTypes      : 114
  USED in MAP-CH-DataTypes         : 22 94 176 190

callReferenceNumber.....identifier of [9] CallReferenceNumber
  DEFINED in MAP-CH-DataTypes      : 176

callReferenceNumber.....identifier of [0] CallReferenceNumber
  DEFINED in MAP-CH-DataTypes      : 190

callReportdata.....identifier of [2] CallReportData
  DEFINED in MAP-CH-DataTypes      : 326

CallReportData.....type reference SEQUENCE
  DEFINED in MAP-CH-DataTypes      : 335
  USED in MAP-CH-DataTypes         : 326

callTypeCriteria.....identifier of [2] CallTypeCriteria
  DEFINED in MAP-MS-DataTypes      : 728

CallTypeCriteria.....type reference ENUMERATED
  DEFINED in MAP-MS-DataTypes      : 758
  USED in MAP-MS-DataTypes         : 728

call-Direction.....identifier of [2] CallDirection
  DEFINED in MAP-CH-DataTypes      : 261

```

camelBusy.....identifier of [1] NULL  
DEFINED in MAP-MS-DataTypes : 934

camelCapabilityHandling.....identifier of [0] CamelCapabilityHandling  
DEFINED in MAP-MS-DataTypes : 687

CamelCapabilityHandling.....type reference INTEGER

10 TAG R4.21 Cross Reference Listing for MAP-Protocol 99-12-21 12:08:21 PAGE

DEFINED in MAP-MS-DataTypes : 775  
 USED in MAP-MS-DataTypes : 56 687  
 USED in MAP-CH-DataTypes : 41 232

camelCapabilityHandling.....identifier of [0] CamelCapabilityHandling  
 DEFINED in MAP-CH-DataTypes : 232

camelInfo.....identifier of [11] CamelInfo  
 DEFINED in MAP-CH-DataTypes : 98

CamelInfo.....type reference SEQUENCE  
 DEFINED in MAP-CH-DataTypes : 204  
 USED in MAP-CH-DataTypes : 98

camelRoutingInfo.....identifier of [8] CamelRoutingInfo  
 DEFINED in MAP-CH-DataTypes : 212

CamelRoutingInfo.....type reference SEQUENCE  
 DEFINED in MAP-CH-DataTypes : 214  
 USED in MAP-CH-DataTypes : 212

camelSubscriptionInfoWithdraw.....identifier of [9] NULL  
 DEFINED in MAP-MS-DataTypes : 630

camel-invoked.....identifier of Named Number, 1  
 DEFINED in MAP-SS-DataTypes : 292

cancellationType.....identifier of CancellationType  
 DEFINED in MAP-MS-DataTypes : 178

CancellationType.....type reference ENUMERATED  
 DEFINED in MAP-MS-DataTypes : 187  
 USED in MAP-MS-DataTypes : 178

cancelLocation.....value reference CancelLocation, CHOICE VALUE  
 DEFINED in MAP-Protocol : 156

CancelLocation.....type reference OPERATION  
 DEFINED in MAP-MobileServiceOpera : 146  
 USED in MAP-Protocol : 13 156  
 USED in MAP-MobileServiceOpera : 16

cancelLocationArg.....identifier of CancelLocationArg  
 DEFINED in MAP-MobileServiceOpera : 148

CancelLocationArg.....type reference [3] SEQUENCE  
 DEFINED in MAP-MS-DataTypes : 176  
 USED in MAP-MobileServiceOpera : 88 148  
 USED in MAP-MS-DataTypes : 18

cancelLocationRes.....identifier of CancelLocationRes  
 DEFINED in MAP-MobileServiceOpera : 150

CancelLocationRes.....type reference SEQUENCE  
 DEFINED in MAP-MS-DataTypes : 194  
 USED in MAP-MobileServiceOpera : 89 150  
 USED in MAP-MS-DataTypes : 19

category.....identifier of [2] Category  
 DEFINED in MAP-MS-DataTypes : 361

Category.....type reference OCTET STRING  
 DEFINED in MAP-MS-DataTypes : 378  
 USED in MAP-MS-DataTypes : 361

ccbsIdle.....identifier of Named Number, 1  
 DEFINED in MAP-CH-DataTypes : 315

ccbsNotIdle.....identifier of Named Number, 0  
 DEFINED in MAP-CH-DataTypes : 314

ccbsNotReachable.....identifier of Named Number, 2  
 DEFINED in MAP-CH-DataTypes : 316

ccbs-A.....value reference SS-Code, '01000011'B

```
DEFINED in MAP-SS-Code          :      79
ccbs-B.....value reference SS-Code, '01000100'B
DEFINED in MAP-SS-Code          :      81
ccbs-Busy.....identifier of [1] NULL
DEFINED in MAP-ER-DataTypes     :     244
```

11

TAG R4.21 Cross Reference Listing for MAP-Protocol 99-12-21 12:08:21 PAGE

```

ccbs-Call.....identifier of [15] NULL
  DEFINED in MAP-CH-DataTypes      :   103

ccbs-Call.....identifier of [13] NULL
  DEFINED in MAP-CH-DataTypes      :   181

ccbs-Data.....identifier of [1] CCBS-Data
  DEFINED in MAP-SS-DataTypes      :   279

CCBS-Data.....type reference SEQUENCE
  DEFINED in MAP-SS-DataTypes      :   282
  USED in MAP-SS-DataTypes        :   279

ccbs-Feature.....identifier of [2] CCBS-Feature
  DEFINED in MAP-CH-DataTypes      :   366

CCBS-Feature.....type reference SEQUENCE
  DEFINED in MAP-SS-DataTypes      :   192
  USED in MAP-CH-DataTypes        :    52   366
  USED in MAP-SS-DataTypes        :    34   188   283   297

ccbs-Feature.....identifier of [0] CCBS-Feature
  DEFINED in MAP-SS-DataTypes      :   283

ccbs-Feature.....identifier of [0] CCBS-Feature
  DEFINED in MAP-SS-DataTypes      :   297

ccbs-FeatureList.....identifier of [2] CCBS-FeatureList
  DEFINED in MAP-SS-DataTypes      :   185

CCBS-FeatureList.....type reference SEQUENCE OF
  DEFINED in MAP-SS-DataTypes      :   187
  USED in MAP-SS-DataTypes        :   185

ccbs-Index.....identifier of [0] CCBS-Index
  DEFINED in MAP-SS-DataTypes      :   193

CCBS-Index.....type reference INTEGER
  DEFINED in MAP-SS-DataTypes      :   199
  USED in MAP-SS-DataTypes        :   193   302

ccbs-Index.....identifier of [1] CCBS-Index
  DEFINED in MAP-SS-DataTypes      :   302

ccbs-Indicators.....identifier of [11] CCBS-Indicators
  DEFINED in MAP-CH-DataTypes      :   144

CCBS-Indicators.....type reference SEQUENCE
  DEFINED in MAP-CH-DataTypes      :   147
  USED in MAP-CH-DataTypes        :   144

ccbs-Monitoring.....identifier of [2] ReportingState
  DEFINED in MAP-CH-DataTypes      :   296

ccbs-Possible.....identifier of [0] NULL
  DEFINED in MAP-CH-DataTypes      :   148

ccbs-Possible.....identifier of [8] NULL
  DEFINED in MAP-CH-DataTypes      :   198

ccbs-Possible.....identifier of [0] NULL
  DEFINED in MAP-ER-DataTypes      :   243

ccbs-SubscriberStatus.....identifier of [0] CCBS-SubscriberStatus
  DEFINED in MAP-CH-DataTypes      :   309

CCBS-SubscriberStatus.....type reference ENUMERATED
  DEFINED in MAP-CH-DataTypes      :   313
  USED in MAP-CH-DataTypes        :   309   331

ccbs-SubscriberStatus.....identifier of [0] CCBS-SubscriberStatus
  DEFINED in MAP-CH-DataTypes      :   331

cd.....value reference SS-Code, '00100100'B

```

DEFINED in MAP-SS-Code : 60

cellIdFixedLength.....identifier of [0] CellIdFixedLength  
DEFINED in MAP-CommonDataTypes : 289

CellIdFixedLength.....type reference OCTET STRING  
DEFINED in MAP-CommonDataTypes : 292



12

TAG R4.21 Cross Reference Listing for MAP-Protocol 99-12-21 12:08:21 PAGE

USED in MAP-CommonDataTypes : 289

cellIdOrLAI.....identifier of [3] CellIdOrLAI  
 DEFINED in MAP-MS-DataTypes : 906

CellIdOrLAI.....type reference CHOICE  
 DEFINED in MAP-CommonDataTypes : 288  
 USED in MAP-MS-DataTypes : 128 906  
 USED in MAP-CommonDataTypes : 38

cfb.....value reference SS-Code, '00101001'B  
 DEFINED in MAP-SS-Code : 54

cfnrc.....value reference SS-Code, '00101011'B  
 DEFINED in MAP-SS-Code : 58

cfnry.....value reference SS-Code, '00101010'B  
 DEFINED in MAP-SS-Code : 56

cfu.....value reference SS-Code, '00100001'B  
 DEFINED in MAP-SS-Code : 50

channelType.....identifier of [0] ExternalSignalInfo  
 DEFINED in MAP-CH-DataTypes : 283

chargeableECT-Barred.....identifier of Named Number, 10  
 DEFINED in MAP-MS-DataTypes : 412

checkIMEI.....value reference CheckIMEI, CHOICE VALUE  
 DEFINED in MAP-Protocol : 178

CheckIMEI.....type reference OPERATION  
 DEFINED in MAP-MobileServiceOpera : 267  
 USED in MAP-Protocol : 23 178  
 USED in MAP-MobileServiceOpera : 40

chosenChannel.....identifier of [4] ExternalSignalInfo  
 DEFINED in MAP-CH-DataTypes : 263

chosenChannel.....identifier of [1] ExternalSignalInfo  
 DEFINED in MAP-CH-DataTypes : 284

chosenChannel.....identifier of [0] ExternalSignalInfo  
 DEFINED in MAP-CH-DataTypes : 289

cipheringAlgorithm.....identifier of CipheringAlgorithm  
 DEFINED in MAP-GR-DataTypes : 53

CipheringAlgorithm.....type reference OCTET STRING  
 DEFINED in MAP-GR-DataTypes : 99  
 USED in MAP-GR-DataTypes : 53

clip.....value reference SS-Code, '00010001'B  
 DEFINED in MAP-SS-Code : 28

clir.....value reference SS-Code, '00010010'B  
 DEFINED in MAP-SS-Code : 30

cliRestrictionOption.....identifier of [2] CliRestrictionOption  
 DEFINED in MAP-SS-DataTypes : 162

CliRestrictionOption.....type reference ENUMERATED  
 DEFINED in MAP-SS-DataTypes : 165  
 USED in MAP-SS-DataTypes : 27 162 181

cliRestrictionOption.....identifier of CliRestrictionOption  
 DEFINED in MAP-SS-DataTypes : 181

clir-invoked.....identifier of Named Number, 0  
 DEFINED in MAP-SS-DataTypes : 291

cnap.....value reference SS-Code, '00011001'B  
 DEFINED in MAP-SS-Code : 42

codec-Info.....identifier of CODEC-Info

```
DEFINED in MAP-GR-DataTypes      :      52
CODEC-Info.....type reference OCTET STRING
  DEFINED in MAP-GR-DataTypes      :      94
  USED in MAP-GR-DataTypes         :      52
collectedInfo.....identifier of Named Number, 2
```

```

DEFINED in MAP-MS-DataTypes      :    711

colp.....value reference SS-Code, '00010011'B
  DEFINED in MAP-SS-Code          :    32

colr.....value reference SS-Code, '00010100'B
  DEFINED in MAP-SS-Code          :    34

completeDataListIncluded.....identifier of NULL
  DEFINED in MAP-MS-DataTypes      :   332

Component.....type reference CHOICE
  DEFINED in TCAPMessages          :   124
  USED in TCAPMessages             :    47   115

ComponentPortion.....type reference [APPLICATION 12] IMPLICIT SEQUENCE OF
  DEFINED in TCAPMessages          :   115
  USED in TCAPMessages             :    59   63   67   72

components.....identifier of ComponentPortion
  DEFINED in TCAPMessages          :    59

components.....identifier of ComponentPortion
  DEFINED in TCAPMessages          :    63

components.....identifier of ComponentPortion
  DEFINED in TCAPMessages          :    67

components.....identifier of ComponentPortion
  DEFINED in TCAPMessages          :    72

ContextId.....type reference INTEGER
  DEFINED in MAP-MS-DataTypes      :   329
  USED in MAP-MS-DataTypes         :   320   641

contextIdList.....identifier of ContextIdList
  DEFINED in MAP-MS-DataTypes      :   638

ContextIdList.....type reference SEQUENCE OF
  DEFINED in MAP-MS-DataTypes      :   640
  USED in MAP-MS-DataTypes         :   638

Continue.....type reference SEQUENCE
  DEFINED in TCAPMessages          :    69
  USED in TCAPMessages             :    55

continueCall.....identifier of Named Number, 0
  DEFINED in MAP-MS-DataTypes      :   768

continue-ME.....identifier of [APPLICATION 5] IMPLICIT Continue
  DEFINED in TCAPMessages          :    55

controllingMSC.....identifier of Named Number, 4
  DEFINED in MAP-CommonDataTypes   :   269

cug.....value reference SS-Code, '01100001'B
  DEFINED in MAP-SS-Code          :    94

cugIC-CallBarred.....identifier of Named Number, 1
  DEFINED in MAP-MS-DataTypes      :   555

cugOG-CallBarred.....identifier of Named Number, 2
  DEFINED in MAP-MS-DataTypes      :   556

cugSubscriptionFlag.....identifier of [6] NULL
  DEFINED in MAP-CH-DataTypes      :   134

CUG-CheckInfo.....type reference SEQUENCE
  DEFINED in MAP-CH-DataTypes      :    78
  USED in MAP-CH-DataTypes         :    88   133   194

cug-CheckInfo.....identifier of [1] CUG-CheckInfo
  DEFINED in MAP-CH-DataTypes      :    88

cug-CheckInfo.....identifier of [3] CUG-CheckInfo

```

DEFINED in MAP-CH-DataTypes : 133

cug-CheckInfo.....identifier of [4] CUG-CheckInfo  
DEFINED in MAP-CH-DataTypes : 194

CUG-Feature.....type reference SEQUENCE  
DEFINED in MAP-MS-DataTypes : 568

14

TAG R4.21 Cross Reference Listing for MAP-Protocol 99-12-21 12:08:21 PAGE

USED in MAP-MS-DataTypes : 561

cug-FeatureList.....identifier of CUG-FeatureList  
 DEFINED in MAP-MS-DataTypes : 533

CUG-FeatureList.....type reference SEQUENCE OF  
 DEFINED in MAP-MS-DataTypes : 560  
 USED in MAP-MS-DataTypes : 533

cug-Index.....identifier of CUG-Index  
 DEFINED in MAP-MS-DataTypes : 541

CUG-Index.....type reference INTEGER  
 DEFINED in MAP-MS-DataTypes : 548  
 USED in MAP-MS-DataTypes : 60 541 570

cug-Info.....identifier of [2] CUG-Info  
 DEFINED in MAP-MS-DataTypes : 434

CUG-Info.....type reference SEQUENCE  
 DEFINED in MAP-MS-DataTypes : 531  
 USED in MAP-MS-DataTypes : 434

cug-Interlock.....identifier of CUG-Interlock  
 DEFINED in MAP-MS-DataTypes : 542

CUG-Interlock.....type reference OCTET STRING  
 DEFINED in MAP-MS-DataTypes : 551  
 USED in MAP-MS-DataTypes : 61 542  
 USED in MAP-CH-DataTypes : 43 79

cug-Interlock.....identifier of CUG-Interlock  
 DEFINED in MAP-CH-DataTypes : 79

cug-OutgoingAccess.....identifier of NULL  
 DEFINED in MAP-CH-DataTypes : 80

cug-Reject.....value reference CUG-Reject, CHOICE VALUE  
 DEFINED in MAP-Protocol : 332

CUG-Reject.....type reference ERROR  
 DEFINED in MAP-Errors : 276  
 USED in MAP-Protocol : 126 332  
 USED in MAP-CallHandlingOperat : 44 93  
 USED in MAP-Errors : 51

cug-RejectCause.....identifier of CUG-RejectCause  
 DEFINED in MAP-ER-DataTypes : 103

CUG-RejectCause.....type reference ENUMERATED  
 DEFINED in MAP-ER-DataTypes : 107  
 USED in MAP-ER-DataTypes : 103

cug-RejectParam.....identifier of CUG-RejectParam  
 DEFINED in MAP-Errors : 278

CUG-RejectParam.....type reference SEQUENCE  
 DEFINED in MAP-ER-DataTypes : 102  
 USED in MAP-Errors : 115 278  
 USED in MAP-ER-DataTypes : 16

CUG-Subscription.....type reference SEQUENCE  
 DEFINED in MAP-MS-DataTypes : 540  
 USED in MAP-MS-DataTypes : 538

cug-SubscriptionList.....identifier of CUG-SubscriptionList  
 DEFINED in MAP-MS-DataTypes : 532

CUG-SubscriptionList.....type reference SEQUENCE OF  
 DEFINED in MAP-MS-DataTypes : 537  
 USED in MAP-MS-DataTypes : 532

currentPassword.....identifier of Password  
 DEFINED in MAP-SupplementaryServi : 238

```
cw.....value reference SS-Code, '01000001'B
  DEFINED in MAP-SS-Code           :      75

dataCDA-1200bps.....value reference BearerServiceCode, '00010010'B
  DEFINED in MAP-BS-Code           :      53

dataCDA-1200-75bps.....value reference BearerServiceCode, '00010011'B
```

15

TAG R4.21 Cross Reference Listing for MAP-Protocol 99-12-21 12:08:21 PAGE

DEFINED in MAP-BS-Code : 54

dataCDA-2400bps.....value reference BearerServiceCode, '00010100'B  
 DEFINED in MAP-BS-Code : 55

dataCDA-300bps.....value reference BearerServiceCode, '00010001'B  
 DEFINED in MAP-BS-Code : 52

dataCDA-4800bps.....value reference BearerServiceCode, '00010101'B  
 DEFINED in MAP-BS-Code : 56

dataCDA-9600bps.....value reference BearerServiceCode, '00010110'B  
 DEFINED in MAP-BS-Code : 57

dataCDS-1200bps.....value reference BearerServiceCode, '00011010'B  
 DEFINED in MAP-BS-Code : 61

dataCDS-2400bps.....value reference BearerServiceCode, '00011100'B  
 DEFINED in MAP-BS-Code : 62

dataCDS-4800bps.....value reference BearerServiceCode, '00011101'B  
 DEFINED in MAP-BS-Code : 63

dataCDS-9600bps.....value reference BearerServiceCode, '00011110'B  
 DEFINED in MAP-BS-Code : 64

dataMissing.....value reference DataMissing, CHOICE VALUE  
 DEFINED in MAP-Protocol : 282

DataMissing.....type reference ERROR  
 DEFINED in MAP-Errors : 139  
 USED in MAP-Protocol : 102 282  
 USED in MAP-MobileServiceOpera : 70 141 153 163 173 197 210 223 247  
 261 274 286 297 316 330 344 358  
 USED in MAP-OperationAndMainte : 24 58 72 83  
 USED in MAP-CallHandlingOperat : 29 81 103 127 139 153 167 176  
 USED in MAP-SupplementaryServi : 34 95 112 129 149 167 182 195 209  
 224 247 258 275  
 USED in MAP-ShortMessageServic : 28 74 102 119 130 144  
 USED in MAP-Errors : 15

dataMissingParam.....identifier of DataMissingParam  
 DEFINED in MAP-Errors : 141

DataMissingParam.....type reference SEQUENCE  
 DEFINED in MAP-ER-DataTypes : 166  
 USED in MAP-Errors : 95 141  
 USED in MAP-ER-DataTypes : 21

dataPDS-2400bps.....value reference BearerServiceCode, '00101100'B  
 DEFINED in MAP-BS-Code : 77

dataPDS-4800bps.....value reference BearerServiceCode, '00101101'B  
 DEFINED in MAP-BS-Code : 78

dataPDS-9600bps.....value reference BearerServiceCode, '00101110'B  
 DEFINED in MAP-BS-Code : 79

deactivateSS.....value reference DeactivateSS, CHOICE VALUE  
 DEFINED in MAP-Protocol : 219

DeactivateSS.....type reference OPERATION  
 DEFINED in MAP-SupplementaryServi : 141  
 USED in MAP-Protocol : 65 219  
 USED in MAP-SupplementaryServi : 16

deactivateTraceMode.....value reference DeactivateTraceMode, CHOICE VALUE  
 DEFINED in MAP-Protocol : 198

DeactivateTraceMode.....type reference OPERATION  
 DEFINED in MAP-OperationAndMainte : 64  
 USED in MAP-Protocol : 42 198  
 USED in MAP-OperationAndMainte : 14

deactivateTraceModeArg.....identifier of DeactivateTraceModeArg

```
DEFINED in MAP-OperationAndMainte :      66
DeactivateTraceModeArg.....type reference SEQUENCE
  DEFINED in MAP-OM-DataTypes :          54
  USED in MAP-OperationAndMainte :      36   66
  USED in MAP-OM-DataTypes :           16
```



```

deactivateTraceModeRes.....identifier of DeactivateTraceModeRes
  DEFINED in MAP-OperationAndMainte : 68

DeactivateTraceModeRes.....type reference SEQUENCE
  DEFINED in MAP-OM-DataTypes : 60
  USED in MAP-OperationAndMainte : 37 68
  USED in MAP-OM-DataTypes : 17

defaultCallHandling.....identifier of [1] DefaultCallHandling
  DEFINED in MAP-MS-DataTypes : 703

DefaultCallHandling.....type reference ENUMERATED
  DEFINED in MAP-MS-DataTypes : 767
  USED in MAP-MS-DataTypes : 55 703
  USED in MAP-CH-DataTypes : 39 246

defaultCallHandling.....identifier of [1] DefaultCallHandling
  DEFINED in MAP-CH-DataTypes : 246

defaultPriority.....identifier of EMLPP-Priority
  DEFINED in MAP-CommonDataTypes : 322

defaultPriority.....identifier of [7] EMLPP-Priority
  DEFINED in MAP-SS-DataTypes : 76

defaultPriority.....identifier of EMLPP-Priority
  DEFINED in MAP-SS-DataTypes : 158

defaultPriority.....identifier of [1] EMLPP-Priority
  DEFINED in MAP-SS-DataTypes : 184

deleteSubscriberData.....value reference DeleteSubscriberData, CHOICE VALUE
  DEFINED in MAP-Protocol : 184

DeleteSubscriberData.....type reference OPERATION
  DEFINED in MAP-MobileServiceOpera : 290
  USED in MAP-Protocol : 25 184
  USED in MAP-MobileServiceOpera : 44

deleteSubscriberDataArg.....identifier of DeleteSubscriberDataArg
  DEFINED in MAP-MobileServiceOpera : 292

DeleteSubscriberDataArg.....type reference SEQUENCE
  DEFINED in MAP-MS-DataTypes : 620
  USED in MAP-MobileServiceOpera : 103 292
  USED in MAP-MS-DataTypes : 44

deleteSubscriberDataRes.....identifier of DeleteSubscriberDataRes
  DEFINED in MAP-MobileServiceOpera : 294

DeleteSubscriberDataRes.....type reference SEQUENCE
  DEFINED in MAP-MS-DataTypes : 648
  USED in MAP-MobileServiceOpera : 104 294
  USED in MAP-MS-DataTypes : 45

deliveryOutcomeIndicator.....identifier of [3] NULL
  DEFINED in MAP-SM-DataTypes : 153

derivable.....identifier of InvokeIdType
  DEFINED in TCAPMessages : 167

destinationNumberCriteria.....identifier of [0] DestinationNumberCriteria
  DEFINED in MAP-MS-DataTypes : 726

DestinationNumberCriteria.....type reference SEQUENCE
  DEFINED in MAP-MS-DataTypes : 731
  USED in MAP-MS-DataTypes : 726

destinationNumberLengthList.....identifier of [2] DestinationNumberLengthList
  DEFINED in MAP-MS-DataTypes : 734

DestinationNumberLengthList.....type reference SEQUENCE OF
  DEFINED in MAP-MS-DataTypes : 744
  USED in MAP-MS-DataTypes : 734

```

destinationNumberList.....identifier of [1] DestinationNumberList  
DEFINED in MAP-MS-DataTypes : 733

DestinationNumberList.....type reference SEQUENCE OF  
DEFINED in MAP-MS-DataTypes : 739  
USED in MAP-MS-DataTypes : 733

```

DestTransactionID.....type reference [APPLICATION 9] IMPLICIT
TransactionID
  DEFINED in TCAPMessages      : 98
  USED in TCAPMessages        : 65 70 74

diagnosticInfo.....identifier of SignalInfo
  DEFINED in MAP-ER-DataTypes  : 136

dialoguePortion.....identifier of DialoguePortion
  DEFINED in TCAPMessages      : 58

dialoguePortion.....identifier of DialoguePortion
  DEFINED in TCAPMessages      : 62

dialoguePortion.....identifier of DialoguePortion
  DEFINED in TCAPMessages      : 66

dialoguePortion.....identifier of DialoguePortion
  DEFINED in TCAPMessages      : 71

dialoguePortion.....identifier of DialoguePortion
  DEFINED in TCAPMessages      : 77

DialoguePortion.....type reference [APPLICATION 11] EXTERNAL
  DEFINED in TCAPMessages      : 82
  USED in TCAPMessages        : 58 62 66 71 77

doublyChargeableECT-Barred.....identifier of Named Number, 13
  DEFINED in MAP-MS-DataTypes  : 415

dtid.....identifier of DestTransactionID
  DEFINED in TCAPMessages      : 65

dtid.....identifier of DestTransactionID
  DEFINED in TCAPMessages      : 70

dtid.....identifier of DestTransactionID
  DEFINED in TCAPMessages      : 74

duplicateInvokeID.....identifier of Named Number, 0
  DEFINED in TCAPMessages      : 183

ect.....value reference SS-Code, '00110001'B
  DEFINED in MAP-SS-Code       : 66

eir.....identifier of Named Number, 6
  DEFINED in MAP-CommonDataTypes : 271

emergencyCalls.....value reference TeleserviceCode, '00010010'B
  DEFINED in MAP-TS-Code       : 42

emlpp.....value reference SS-Code, '10100001'B
  DEFINED in MAP-SS-Code       : 151

emlpp-Info.....identifier of [4] EMLPP-Info
  DEFINED in MAP-MS-DataTypes  : 436

EMLPP-Info.....type reference SEQUENCE
  DEFINED in MAP-CommonDataTypes : 320
  USED in MAP-MS-DataTypes      : 131 436
  USED in MAP-CommonDataTypes  : 43

EMLPP-Priority.....type reference INTEGER
  DEFINED in MAP-CommonDataTypes : 326
  USED in MAP-CommonDataTypes  : 44 321 322 332 333 334 335 336 337
  USED in MAP-SS-DataTypes      : 50 76 158 183 184
  USED in MAP-GR-DataTypes      : 25 56

enabling.....identifier of Named Number, 1
  DEFINED in MAP-MS-DataTypes  : 764

End.....type reference SEQUENCE
  DEFINED in TCAPMessages      : 65
  USED in TCAPMessages        : 54
    
```

end-ME.....identifier of [APPLICATION 4] IMPLICIT End  
DEFINED in TCAPMessages : 54

enterNewPW.....identifier of Named Number, 1  
DEFINED in MAP-SS-DataTypes : 236

enterNewPW-Again.....identifier of Named Number, 2

```

DEFINED in MAP-SS-DataTypes      :    237

enterPW.....identifier of Named Number, 0
  DEFINED in MAP-SS-DataTypes      :    235

equipmentNotSM-Equipped.....identifier of Named Number, 2
  DEFINED in MAP-ER-DataTypes      :    128

equipmentProtocolError.....identifier of Named Number, 1
  DEFINED in MAP-ER-DataTypes      :    127

equipmentStatus.....identifier of EquipmentStatus
  DEFINED in MAP-MobileServiceOpera :    271

EquipmentStatus.....type reference ENUMERATED
  DEFINED in MAP-MS-DataTypes      :    283
  USED in MAP-MobileServiceOpera   :    100 271
  USED in MAP-MS-DataTypes         :     38

eraseCC-Entry.....value reference EraseCC-Entry, CHOICE VALUE
  DEFINED in MAP-Protocol          :    228

EraseCC-Entry.....type reference OPERATION
  DEFINED in MAP-SupplementaryServi :    268
  USED in MAP-Protocol             :     74 228
  USED in MAP-SupplementaryServi   :     25

eraseCC-EntryArg.....identifier of EraseCC-EntryArg
  DEFINED in MAP-SupplementaryServi :    270

EraseCC-EntryArg.....type reference SEQUENCE
  DEFINED in MAP-SS-DataTypes      :    300
  USED in MAP-SupplementaryServi   :     72 270
  USED in MAP-SS-DataTypes         :     37

eraseCC-EntryRes.....identifier of EraseCC-EntryRes
  DEFINED in MAP-SupplementaryServi :    272

EraseCC-EntryRes.....type reference SEQUENCE
  DEFINED in MAP-SS-DataTypes      :    305
  USED in MAP-SupplementaryServi   :     73 272
  USED in MAP-SS-DataTypes         :     38

eraseSS.....value reference EraseSS, CHOICE VALUE
  DEFINED in MAP-Protocol          :    217

EraseSS.....type reference OPERATION
  DEFINED in MAP-SupplementaryServi :    104
  USED in MAP-Protocol             :     63 217
  USED in MAP-SupplementaryServi   :     14

errorCode.....identifier of ERROR
  DEFINED in TCAPMessages          :    158
  USED in TCAPMessages            :    159

ets-300102-1.....identifier of Named Number, 4
  DEFINED in MAP-CommonDataTypes   :    192

eventReportData.....identifier of [1] EventReportData
  DEFINED in MAP-CH-DataTypes      :    325

EventReportData.....type reference SEQUENCE
  DEFINED in MAP-CH-DataTypes      :    330
  USED in MAP-CH-DataTypes         :    325

extendedRoutingInfo.....identifier of ExtendedRoutingInfo
  DEFINED in MAP-CH-DataTypes      :    132

ExtendedRoutingInfo.....type reference CHOICE
  DEFINED in MAP-CH-DataTypes      :    210
  USED in MAP-CH-DataTypes         :    132

extensibleCallBarredParam.....identifier of ExtensibleCallBarredParam
  DEFINED in MAP-ER-DataTypes      :     88

```

ExtensibleCallBarredParam.....type reference SEQUENCE  
  DEFINED in MAP-ER-DataTypes      :    96  
  USED in MAP-ER-DataTypes          :    88

extensibleSystemFailureParam.....identifier of ExtensibleSystemFailureParam  
  DEFINED in MAP-ER-DataTypes      :    157

19

TAG R4.21 Cross Reference Listing for MAP-Protocol 99-12-21 12:08:21 PAGE

ExtensibleSystemFailureParam.....type reference SEQUENCE  
 DEFINED in MAP-ER-DataTypes : 161  
 USED in MAP-ER-DataTypes : 157

extensionContainer.....identifier of ExtensionContainer  
 DEFINED in MAP-MS-DataTypes : 160

extensionContainer.....identifier of ExtensionContainer  
 DEFINED in MAP-MS-DataTypes : 166

extensionContainer.....identifier of ExtensionContainer  
 DEFINED in MAP-MS-DataTypes : 173

extensionContainer.....identifier of ExtensionContainer  
 DEFINED in MAP-MS-DataTypes : 179

extensionContainer.....identifier of ExtensionContainer  
 DEFINED in MAP-MS-DataTypes : 195

extensionContainer.....identifier of ExtensionContainer  
 DEFINED in MAP-MS-DataTypes : 202

extensionContainer.....identifier of ExtensionContainer  
 DEFINED in MAP-MS-DataTypes : 208

extensionContainer.....identifier of ExtensionContainer  
 DEFINED in MAP-MS-DataTypes : 244

extensionContainer.....identifier of ExtensionContainer  
 DEFINED in MAP-MS-DataTypes : 252

extensionContainer.....identifier of [14] ExtensionContainer  
 DEFINED in MAP-MS-DataTypes : 294

extensionContainer.....identifier of [21] ExtensionContainer  
 DEFINED in MAP-MS-DataTypes : 326

extensionContainer.....identifier of [2] ExtensionContainer  
 DEFINED in MAP-MS-DataTypes : 337

extensionContainer.....identifier of ExtensionContainer  
 DEFINED in MAP-MS-DataTypes : 398

extensionContainer.....identifier of [0] ExtensionContainer  
 DEFINED in MAP-MS-DataTypes : 442

extensionContainer.....identifier of [9] ExtensionContainer  
 DEFINED in MAP-MS-DataTypes : 458

extensionContainer.....identifier of ExtensionContainer  
 DEFINED in MAP-MS-DataTypes : 519

extensionContainer.....identifier of ExtensionContainer  
 DEFINED in MAP-MS-DataTypes : 528

extensionContainer.....identifier of [0] ExtensionContainer  
 DEFINED in MAP-MS-DataTypes : 534

extensionContainer.....identifier of [0] ExtensionContainer  
 DEFINED in MAP-MS-DataTypes : 545

extensionContainer.....identifier of ExtensionContainer  
 DEFINED in MAP-MS-DataTypes : 572

extensionContainer.....identifier of [5] ExtensionContainer  
 DEFINED in MAP-MS-DataTypes : 592

extensionContainer.....identifier of [7] ExtensionContainer  
 DEFINED in MAP-MS-DataTypes : 611

extensionContainer.....identifier of [6] ExtensionContainer  
 DEFINED in MAP-MS-DataTypes : 631

extensionContainer.....identifier of ExtensionContainer  
 DEFINED in MAP-MS-DataTypes : 651

extensionContainer.....identifier of [1] ExtensionContainer  
DEFINED in MAP-MS-DataTypes : 656

extensionContainer.....identifier of ExtensionContainer  
DEFINED in MAP-MS-DataTypes : 664



20

TAG R4.21 Cross Reference Listing for MAP-Protocol 99-12-21 12:08:21 PAGE

extensionContainer.....	identifier of [0] ExtensionContainer
DEFINED in MAP-MS-DataTypes	: 670
extensionContainer.....	identifier of ExtensionContainer
DEFINED in MAP-MS-DataTypes	: 685
extensionContainer.....	identifier of [2] ExtensionContainer
DEFINED in MAP-MS-DataTypes	: 704
extensionContainer.....	identifier of [3] ExtensionContainer
DEFINED in MAP-MS-DataTypes	: 791
extensionContainer.....	identifier of [3] ExtensionContainer
DEFINED in MAP-MS-DataTypes	: 798
extensionContainer.....	identifier of [3] ExtensionContainer
DEFINED in MAP-MS-DataTypes	: 807
extensionContainer.....	identifier of [1] ExtensionContainer
DEFINED in MAP-MS-DataTypes	: 811
extensionContainer.....	identifier of [3] ExtensionContainer
DEFINED in MAP-MS-DataTypes	: 820
extensionContainer.....	identifier of [0] ExtensionContainer
DEFINED in MAP-MS-DataTypes	: 824
extensionContainer.....	identifier of ExtensionContainer
DEFINED in MAP-MS-DataTypes	: 838
extensionContainer.....	identifier of ExtensionContainer
DEFINED in MAP-MS-DataTypes	: 845
extensionContainer.....	identifier of ExtensionContainer
DEFINED in MAP-MS-DataTypes	: 862
extensionContainer.....	identifier of ExtensionContainer
DEFINED in MAP-MS-DataTypes	: 868
extensionContainer.....	identifier of [3] ExtensionContainer
DEFINED in MAP-MS-DataTypes	: 881
extensionContainer.....	identifier of ExtensionContainer
DEFINED in MAP-MS-DataTypes	: 886
extensionContainer.....	identifier of [2] ExtensionContainer
DEFINED in MAP-MS-DataTypes	: 892
extensionContainer.....	identifier of [2] ExtensionContainer
DEFINED in MAP-MS-DataTypes	: 898
extensionContainer.....	identifier of [4] ExtensionContainer
DEFINED in MAP-MS-DataTypes	: 907
extensionContainer.....	identifier of [2] ExtensionContainer
DEFINED in MAP-MS-DataTypes	: 950
extensionContainer.....	identifier of ExtensionContainer
DEFINED in MAP-MS-DataTypes	: 955
extensionContainer.....	identifier of ExtensionContainer
DEFINED in MAP-CommonDataTypes	: 173
extensionContainer.....	identifier of [1] ExtensionContainer
DEFINED in MAP-CommonDataTypes	: 276
extensionContainer.....	identifier of ExtensionContainer
DEFINED in MAP-CommonDataTypes	: 323
extensionContainer.....	identifier of [4] ExtensionContainer
DEFINED in MAP-OM-DataTypes	: 41
extensionContainer.....	identifier of [0] ExtensionContainer
DEFINED in MAP-OM-DataTypes	: 51

extensionContainer.....identifier of [2] ExtensionContainer  
DEFINED in MAP-OM-DataTypes : 57

extensionContainer.....identifier of [0] ExtensionContainer  
DEFINED in MAP-OM-DataTypes : 61

extensionContainer.....identifier of ExtensionContainer

```

DEFINED in MAP-CH-DataTypes      :      81
extensionContainer.....identifier of [13] ExtensionContainer
  DEFINED in MAP-CH-DataTypes      :     100
extensionContainer.....identifier of [0] ExtensionContainer
  DEFINED in MAP-CH-DataTypes      :     140
extensionContainer.....identifier of [2] ExtensionContainer
  DEFINED in MAP-CH-DataTypes      :     150
extensionContainer.....identifier of [7] ExtensionContainer
  DEFINED in MAP-CH-DataTypes      :     164
extensionContainer.....identifier of [11] ExtensionContainer
  DEFINED in MAP-CH-DataTypes      :     178
extensionContainer.....identifier of ExtensionContainer
  DEFINED in MAP-CH-DataTypes      :     186
extensionContainer.....identifier of [7] ExtensionContainer
  DEFINED in MAP-CH-DataTypes      :     196
extensionContainer.....identifier of ExtensionContainer
  DEFINED in MAP-CH-DataTypes      :     201
extensionContainer.....identifier of ExtensionContainer
  DEFINED in MAP-CH-DataTypes      :     207
extensionContainer.....identifier of [1] ExtensionContainer
  DEFINED in MAP-CH-DataTypes      :     217
extensionContainer.....identifier of [2] ExtensionContainer
  DEFINED in MAP-CH-DataTypes      :     223
extensionContainer.....identifier of ExtensionContainer
  DEFINED in MAP-CH-DataTypes      :     230
extensionContainer.....identifier of [2] ExtensionContainer
  DEFINED in MAP-CH-DataTypes      :     247
extensionContainer.....identifier of [7] ExtensionContainer
  DEFINED in MAP-CH-DataTypes      :     266
extensionContainer.....identifier of [1] ExtensionContainer
  DEFINED in MAP-CH-DataTypes      :     279
extensionContainer.....identifier of [2] ExtensionContainer
  DEFINED in MAP-CH-DataTypes      :     285
extensionContainer.....identifier of [1] ExtensionContainer
  DEFINED in MAP-CH-DataTypes      :     290
extensionContainer.....identifier of [3] ExtensionContainer
  DEFINED in MAP-CH-DataTypes      :     297
extensionContainer.....identifier of [1] ExtensionContainer
  DEFINED in MAP-CH-DataTypes      :     310
extensionContainer.....identifier of [3] ExtensionContainer
  DEFINED in MAP-CH-DataTypes      :     327
extensionContainer.....identifier of [1] ExtensionContainer
  DEFINED in MAP-CH-DataTypes      :     332
extensionContainer.....identifier of [2] ExtensionContainer
  DEFINED in MAP-CH-DataTypes      :     338
extensionContainer.....identifier of [0] ExtensionContainer
  DEFINED in MAP-CH-DataTypes      :     360
extensionContainer.....identifier of [6] ExtensionContainer
  DEFINED in MAP-CH-DataTypes      :     370
extensionContainer.....identifier of [1] ExtensionContainer

```

DEFINED in MAP-CH-DataTypes : 375

extensionContainer.....identifier of [4] ExtensionContainer  
DEFINED in MAP-SS-DataTypes : 264

extensionContainer.....identifier of ExtensionContainer  
DEFINED in MAP-SS-DataTypes : 268

```

extensionContainer.....identifier of [6] ExtensionContainer
  DEFINED in MAP-SM-DataTypes      :      56

extensionContainer.....identifier of [4] ExtensionContainer
  DEFINED in MAP-SM-DataTypes      :      82

extensionContainer.....identifier of ExtensionContainer
  DEFINED in MAP-SM-DataTypes      :      88

extensionContainer.....identifier of ExtensionContainer
  DEFINED in MAP-SM-DataTypes      :     110

extensionContainer.....identifier of ExtensionContainer
  DEFINED in MAP-SM-DataTypes      :     115

extensionContainer.....identifier of ExtensionContainer
  DEFINED in MAP-SM-DataTypes      :     123

extensionContainer.....identifier of ExtensionContainer
  DEFINED in MAP-SM-DataTypes      :     128

extensionContainer.....identifier of [1] ExtensionContainer
  DEFINED in MAP-SM-DataTypes      :     148

extensionContainer.....identifier of ExtensionContainer
  DEFINED in MAP-SM-DataTypes      :     169

extensionContainer.....identifier of ExtensionContainer
  DEFINED in MAP-SM-DataTypes      :     181

extensionContainer.....identifier of ExtensionContainer
  DEFINED in MAP-SM-DataTypes      :     198

extensionContainer.....identifier of ExtensionContainer
  DEFINED in MAP-SM-DataTypes      :     202

extensionContainer.....identifier of [4] ExtensionContainer
  DEFINED in MAP-GR-DataTypes      :      58

extensionContainer.....identifier of ExtensionContainer
  DEFINED in MAP-GR-DataTypes      :      63

extensionContainer.....identifier of ExtensionContainer
  DEFINED in MAP-GR-DataTypes      :      68

extensionContainer.....identifier of ExtensionContainer
  DEFINED in MAP-GR-DataTypes      :      72

extensionContainer.....identifier of ExtensionContainer
  DEFINED in MAP-GR-DataTypes      :      82

extensionContainer.....identifier of ExtensionContainer
  DEFINED in MAP-GR-DataTypes      :      89

extensionContainer.....identifier of ExtensionContainer
  DEFINED in MAP-ER-DataTypes      :      78

extensionContainer.....identifier of ExtensionContainer
  DEFINED in MAP-ER-DataTypes      :      98

extensionContainer.....identifier of ExtensionContainer
  DEFINED in MAP-ER-DataTypes      :     104

extensionContainer.....identifier of ExtensionContainer
  DEFINED in MAP-ER-DataTypes      :     137

extensionContainer.....identifier of ExtensionContainer
  DEFINED in MAP-ER-DataTypes      :     144

extensionContainer.....identifier of ExtensionContainer
  DEFINED in MAP-ER-DataTypes      :     163

extensionContainer.....identifier of ExtensionContainer
  DEFINED in MAP-ER-DataTypes      :     167

```

extensionContainer.....identifier of ExtensionContainer  
DEFINED in MAP-ER-DataTypes : 171

extensionContainer.....identifier of ExtensionContainer  
DEFINED in MAP-ER-DataTypes : 175

extensionContainer.....	identifier of ExtensionContainer									
DEFINED in MAP-ER-DataTypes	:	179								
extensionContainer.....	identifier of ExtensionContainer									
DEFINED in MAP-ER-DataTypes	:	183								
extensionContainer.....	identifier of ExtensionContainer									
DEFINED in MAP-ER-DataTypes	:	196								
extensionContainer.....	identifier of ExtensionContainer									
DEFINED in MAP-ER-DataTypes	:	200								
extensionContainer.....	identifier of ExtensionContainer									
DEFINED in MAP-ER-DataTypes	:	204								
extensionContainer.....	identifier of ExtensionContainer									
DEFINED in MAP-ER-DataTypes	:	208								
extensionContainer.....	identifier of ExtensionContainer									
DEFINED in MAP-ER-DataTypes	:	212								
extensionContainer.....	identifier of ExtensionContainer									
DEFINED in MAP-ER-DataTypes	:	216								
extensionContainer.....	identifier of ExtensionContainer									
DEFINED in MAP-ER-DataTypes	:	220								
extensionContainer.....	identifier of ExtensionContainer									
DEFINED in MAP-ER-DataTypes	:	224								
extensionContainer.....	identifier of ExtensionContainer									
DEFINED in MAP-ER-DataTypes	:	228								
extensionContainer.....	identifier of ExtensionContainer									
DEFINED in MAP-ER-DataTypes	:	241								
extensionContainer.....	identifier of ExtensionContainer									
DEFINED in MAP-ER-DataTypes	:	247								
extensionContainer.....	identifier of ExtensionContainer									
DEFINED in MAP-ER-DataTypes	:	251								
extensionContainer.....	identifier of ExtensionContainer									
DEFINED in MAP-ER-DataTypes	:	255								
extensionContainer.....	identifier of ExtensionContainer									
DEFINED in MAP-ER-DataTypes	:	259								
extensionContainer.....	identifier of ExtensionContainer									
DEFINED in MAP-ER-DataTypes	:	263								
extensionContainer.....	identifier of ExtensionContainer									
DEFINED in MAP-ER-DataTypes	:	270								
extensionContainer.....	identifier of ExtensionContainer									
DEFINED in MAP-ER-DataTypes	:	274								
extensionContainer.....	identifier of ExtensionContainer									
DEFINED in MAP-ER-DataTypes	:	278								
extensionContainer.....	identifier of ExtensionContainer									
DEFINED in MAP-ER-DataTypes	:	282								
ExtensionContainer.....	type reference SEQUENCE									
DEFINED in MAP-ExtensionDataTypes	:	32								
USED in MAP-MS-DataTypes	:	138	160	166	173	179	195	202	208	244
		252	294	326	337	398	442	458	519	528
		534	545	572	592	611	631	651	656	664
		670	685	704	791	798	807	811	820	824
		838	845	862	868	881	886	892	898	907
		950	955							
USED in MAP-CommonDataTypes	:	60	173	276	323					
USED in MAP-OM-DataTypes	:	27	41	51	57	61				
USED in MAP-CH-DataTypes	:	71	81	100	140	150	164	178	186	196
		201	207	217	223	230	247	266	279	285

**(GSM 09.02 version 6.8.0 Release 1997)**

**896**

**ETSI TS 100 974 V6.8.0 (2000-11)**

		290	297	310	327	332	338	360	370	375
USED in MAP-SS-DataTypes	:	57	264	268						
USED in MAP-SM-DataTypes	:	45	56	82	88	110	115	123	128	148
		169	181	198	202					
USED in MAP-GR-DataTypes	:	42	58	63	68	72	82	89		
USED in MAP-ER-DataTypes	:	70	78	98	104	137	144	163	167	171
		175	179	183	196	200	204	208	212	216



24 TAG R4.21 Cross Reference Listing for MAP-Protocol 99-12-21 12:08:21 PAGE

			220	224	228	241	247	251	255	259	263
			270	274	278	282					
		USED in MAP-ExtensionDataTypes :	16								
		ExtensionSet.....information object set reference MAP-EXTENSION, Information Object									
Set		DEFINED in MAP-ExtensionDataTypes :	48								
		USED in MAP-ExtensionDataTypes :	42	44							
		ExternalSignalInfo.....type reference SEQUENCE									
		DEFINED in MAP-CommonDataTypes :	168								
		USED in MAP-MobileServiceOpera :	123	229	234	238	244				
		USED in MAP-MS-DataTypes :	123	260	265	271					
		USED in MAP-CommonDataTypes :	20								
		USED in MAP-CH-DataTypes :	59	97	172	173	259	260	263	264	265
		USED in MAP-SS-DataTypes :	283	284	289	365					
		USED in MAP-SS-DataTypes :	51	286	287						
		extId.....identifier of InformationObjectClassFieldType									
		DEFINED in MAP-ExtensionDataTypes :	41								
		extType.....identifier of InformationObjectClassFieldType									
		DEFINED in MAP-ExtensionDataTypes :	43								
		Ext-BasicServiceCode.....type reference CHOICE									
		DEFINED in MAP-CommonDataTypes :	316								
		USED in MAP-MS-DataTypes :	129	449	526	564	569	644	748		
		USED in MAP-CommonDataTypes :	42								
		USED in MAP-CH-DataTypes :	62	96	137	191					
		Ext-BasicServiceGroupList.....type reference SEQUENCE OF									
		DEFINED in MAP-MS-DataTypes :	563								
		USED in MAP-MS-DataTypes :	544	591							
		ext-BearerService.....identifier of [2] Ext-BearerServiceCode									
		DEFINED in MAP-CommonDataTypes :	317								
		Ext-BearerServiceCode.....type reference OCTET STRING									
		DEFINED in MAP-BS-Code :	25								
		USED in MAP-MS-DataTypes :	109	386							
		USED in MAP-CommonDataTypes :	55	317							
		Ext-CallBarFeatureList.....type reference SEQUENCE OF									
		DEFINED in MAP-MS-DataTypes :	522								
		USED in MAP-MS-DataTypes :	518								
		Ext-CallBarInfo.....type reference SEQUENCE									
		DEFINED in MAP-MS-DataTypes :	516								
		USED in MAP-MS-DataTypes :	433								
		Ext-CallBarringFeature.....type reference SEQUENCE									
		DEFINED in MAP-MS-DataTypes :	525								
		USED in MAP-MS-DataTypes :	523								
		Ext-ForwFeature.....type reference SEQUENCE									
		DEFINED in MAP-MS-DataTypes :	448								
		USED in MAP-MS-DataTypes :	446								
		Ext-ForwFeatureList.....type reference SEQUENCE OF									
		DEFINED in MAP-MS-DataTypes :	445								
		USED in MAP-MS-DataTypes :	441								
		Ext-ForwInfo.....type reference SEQUENCE									
		DEFINED in MAP-MS-DataTypes :	439								
		USED in MAP-MS-DataTypes :	432								
		Ext-ForwOptions.....type reference OCTET STRING									
		DEFINED in MAP-MS-DataTypes :	482								
		USED in MAP-MS-DataTypes :	456								
		Ext-NoRepCondTime.....type reference INTEGER									
		DEFINED in MAP-MS-DataTypes :	509								
		USED in MAP-MS-DataTypes :	457								
		Ext-SS-Data.....type reference SEQUENCE									

DEFINED in MAP-MS-DataTypes	:	587
USED in MAP-MS-DataTypes	:	435
Ext-SS-Info.....	type reference CHOICE	
DEFINED in MAP-MS-DataTypes	:	431
USED in MAP-MS-DataTypes	:	429
Ext-SS-InfoList.....	type reference SEQUENCE OF	

25

TAG R4.21 Cross Reference Listing for MAP-Protocol 99-12-21 12:08:21 PAGE

DEFINED in MAP-MS-DataTypes : 428  
 USED in MAP-MS-DataTypes : 369

Ext-SS-Status.....type reference OCTET STRING  
 DEFINED in MAP-MS-DataTypes : 461  
 USED in MAP-MS-DataTypes : 450 527 589

ext-Teleservice.....identifier of [3] Ext-TeleserviceCode  
 DEFINED in MAP-CommonDataTypes : 318

Ext-TeleserviceCode.....type reference OCTET STRING  
 DEFINED in MAP-TS-Code : 20  
 USED in MAP-MS-DataTypes : 114 391  
 USED in MAP-CommonDataTypes : 49 318  
 USED in MAP-GR-DataTypes : 31 50

facilityNotSupParam.....identifier of FacilityNotSupParam  
 DEFINED in MAP-Errors : 153

FacilityNotSupParam.....type reference SEQUENCE  
 DEFINED in MAP-ER-DataTypes : 174  
 USED in MAP-Errors : 97 153  
 USED in MAP-ER-DataTypes : 23

facilityNotSupported.....value reference FacilityNotSupported, CHOICE VALUE  
 DEFINED in MAP-Protocol : 284

FacilityNotSupported.....type reference ERROR  
 DEFINED in MAP-Errors : 151  
 USED in MAP-Protocol : 104 284  
 USED in MAP-OperationAndMainte : 26 60 74  
 USED in MAP-CallHandlingOperat : 31 83 105 155  
 USED in MAP-SupplementaryServi : 55 266  
 USED in MAP-ShortMessageServic : 30 76 91 104 146  
 USED in MAP-Errors : 17

facsimileGroup3AndAlterSpeech.....value reference TeleserviceCode, '01100001'B  
 DEFINED in MAP-TS-Code : 49

facsimileGroup4.....value reference TeleserviceCode, '01100011'B  
 DEFINED in MAP-TS-Code : 51

failure.....identifier of Named Number, 1  
 DEFINED in MAP-CH-DataTypes : 351

failureReport.....value reference FailureReport, CHOICE VALUE  
 DEFINED in MAP-Protocol : 272

FailureReport.....type reference OPERATION  
 DEFINED in MAP-MobileServiceOpera : 336  
 USED in MAP-Protocol : 32 272  
 USED in MAP-MobileServiceOpera : 55

failureReportArg.....identifier of FailureReportArg  
 DEFINED in MAP-MobileServiceOpera : 338

FailureReportArg.....type reference SEQUENCE  
 DEFINED in MAP-MS-DataTypes : 803  
 USED in MAP-MobileServiceOpera : 114 338  
 USED in MAP-MS-DataTypes : 86

failureReportRes.....identifier of FailureReportRes  
 DEFINED in MAP-MobileServiceOpera : 340

FailureReportRes.....type reference SEQUENCE  
 DEFINED in MAP-MS-DataTypes : 810  
 USED in MAP-MobileServiceOpera : 115 340  
 USED in MAP-MS-DataTypes : 87

forwardAccessSignalling.....value reference ForwardAccessSignalling, CHOICE VALUE  
 DEFINED in MAP-Protocol : 166

ForwardAccessSignalling.....type reference OPERATION  
 DEFINED in MAP-MobileServiceOpera : 236  
 USED in MAP-Protocol : 20 166

USED in MAP-MobileServiceOpera : 33

forwardCheckSS-Indication.....value reference ForwardCheckSS-Indication, CHOICE

VALUE

DEFINED in MAP-Protocol : 190

ForwardCheckSS-Indication.....type reference OPERATION

DEFINED in MAP-MobileServiceOpera : 307

26 TAG R4.21 Cross Reference Listing for MAP-Protocol 99-12-21 12:08:21 PAGE

USED in MAP-Protocol : 27 190  
 USED in MAP-MobileServiceOpera : 48

forwarded.....identifier of Named Number, 0  
 DEFINED in MAP-MS-DataTypes : 759

forwardedToNumber.....identifier of [5] ISDN-AddressString  
 DEFINED in MAP-MS-DataTypes : 451

forwardedToNumber.....identifier of [5] ISDN-AddressString  
 DEFINED in MAP-CH-DataTypes : 158

forwardedToNumber.....identifier of [4] AddressString  
 DEFINED in MAP-SS-DataTypes : 72

forwardedToNumber.....identifier of [5] ISDN-AddressString  
 DEFINED in MAP-SS-DataTypes : 97

forwardedToSubaddress.....identifier of [8] ISDN-SubaddressString  
 DEFINED in MAP-MS-DataTypes : 455

forwardedToSubaddress.....identifier of [4] ISDN-SubaddressString  
 DEFINED in MAP-CH-DataTypes : 162

forwardedToSubaddress.....identifier of [6] ISDN-SubaddressString  
 DEFINED in MAP-SS-DataTypes : 73

forwardedToSubaddress.....identifier of [8] ISDN-SubaddressString  
 DEFINED in MAP-SS-DataTypes : 98

forwardGroupCallSignalling.....value reference ForwardGroupCallSignalling, CHOICE  
 VALUE  
 DEFINED in MAP-Protocol : 259

ForwardGroupCallSignalling.....type reference OPERATION  
 DEFINED in MAP-Group-Call-Operati : 67  
 USED in MAP-Protocol : 94 259  
 USED in MAP-Group-Call-Operati : 15

forwardGroupCallSignallingArg.....identifier of ForwardGroupCallSignallingArg  
 DEFINED in MAP-Group-Call-Operati : 69

ForwardGroupCallSignallingArg.....type reference SEQUENCE  
 DEFINED in MAP-GR-DataTypes : 75  
 USED in MAP-Group-Call-Operati : 35 69  
 USED in MAP-GR-DataTypes : 18

forwarding.....identifier of Named Number, 1  
 DEFINED in MAP-CH-DataTypes : 110

forwardingData.....identifier of ForwardingData  
 DEFINED in MAP-CH-DataTypes : 155

ForwardingData.....type reference SEQUENCE  
 DEFINED in MAP-CH-DataTypes : 157  
 USED in MAP-CH-DataTypes : 155 192 215

forwardingData.....identifier of [2] ForwardingData  
 DEFINED in MAP-CH-DataTypes : 192

forwardingData.....identifier of ForwardingData  
 DEFINED in MAP-CH-DataTypes : 215

forwardingFailed.....value reference ForwardingFailed, CHOICE VALUE  
 DEFINED in MAP-Protocol : 329

ForwardingFailed.....type reference ERROR  
 DEFINED in MAP-Errors : 271  
 USED in MAP-Protocol : 125 329  
 USED in MAP-CallHandlingOperat : 43 116  
 USED in MAP-Errors : 50

forwardingFailedParam.....identifier of ForwardingFailedParam  
 DEFINED in MAP-Errors : 273

```
ForwardingFailedParam.....type reference SEQUENCE
  DEFINED in MAP-ER-DataTypes      :    254
  USED in MAP-Errors                :    114    273
  USED in MAP-ER-DataTypes         :     38

ForwardingFeature.....type reference SEQUENCE
  DEFINED in MAP-SS-DataTypes      :     94
  USED in MAP-SS-DataTypes         :     92
```

TAG R4.21 Cross Reference Listing for MAP-Protocol 99-12-21 12:08:21 PAGE

forwardingFeatureList.....identifier of Ext-ForwFeatureList  
 DEFINED in MAP-MS-DataTypes : 441

forwardingFeatureList.....identifier of ForwardingFeatureList  
 DEFINED in MAP-SS-DataTypes : 87

ForwardingFeatureList.....type reference SEQUENCE OF  
 DEFINED in MAP-SS-DataTypes : 90  
 USED in MAP-SS-DataTypes : 87 204

forwardingFeatureList.....identifier of [3] ForwardingFeatureList  
 DEFINED in MAP-SS-DataTypes : 204

forwardingInfo.....identifier of [0] Ext-ForwInfo  
 DEFINED in MAP-MS-DataTypes : 432

forwardingInfo.....identifier of [0] ForwardingInfo  
 DEFINED in MAP-SS-DataTypes : 81

ForwardingInfo.....type reference SEQUENCE  
 DEFINED in MAP-SS-DataTypes : 85  
 USED in MAP-SS-DataTypes : 81

forwardingInterrogationRequired.....identifier of [4] NULL  
 DEFINED in MAP-CH-DataTypes : 138

forwardingOptions.....identifier of [6] Ext-ForwOptions  
 DEFINED in MAP-MS-DataTypes : 456

forwardingOptions.....identifier of [6] ForwardingOptions  
 DEFINED in MAP-CH-DataTypes : 163

forwardingOptions.....identifier of [6] ForwardingOptions  
 DEFINED in MAP-SS-DataTypes : 99

ForwardingOptions.....type reference OCTET STRING  
 DEFINED in MAP-SS-DataTypes : 118  
 USED in MAP-CH-DataTypes : 50 163  
 USED in MAP-SS-DataTypes : 29 99

forwardingReason.....identifier of [8] ForwardingReason  
 DEFINED in MAP-CH-DataTypes : 95

ForwardingReason.....type reference ENUMERATED  
 DEFINED in MAP-CH-DataTypes : 116  
 USED in MAP-CH-DataTypes : 95

forwardingViolation.....value reference ForwardingViolation, CHOICE VALUE  
 DEFINED in MAP-Protocol : 331

ForwardingViolation.....type reference ERROR  
 DEFINED in MAP-Errors : 266  
 USED in MAP-Protocol : 124 331  
 USED in MAP-CallHandlingOperat : 42 94  
 USED in MAP-Errors : 49

forwardingViolationParam.....identifier of ForwardingViolationParam  
 DEFINED in MAP-Errors : 268

ForwardingViolationParam.....type reference SEQUENCE  
 DEFINED in MAP-ER-DataTypes : 250  
 USED in MAP-Errors : 113 268  
 USED in MAP-ER-DataTypes : 37

freezeP-TMSI.....identifier of [1] NULL  
 DEFINED in MAP-MS-DataTypes : 207

freezeTMSI.....identifier of [0] NULL  
 DEFINED in MAP-MS-DataTypes : 206

generalProblem.....identifier of [0] IMPLICIT GeneralProblem  
 DEFINED in TCAPMessages : 170

GeneralProblem.....type reference INTEGER

```
DEFINED in TCAPMessages      : 179
USED in TCAPMessages        : 170

general-dataCDA.....value reference BearerServiceCode, '00010111'B
DEFINED in MAP-BS-Code      : 58

general-dataCDS.....value reference BearerServiceCode, '00011111'B
```



28 TAG R4.21 Cross Reference Listing for MAP-Protocol 99-12-21 12:08:21 PAGE

DEFINED in MAP-BS-Code : 65

general-dataPDS.....value reference BearerServiceCode, '00101111'B  
 DEFINED in MAP-BS-Code : 80

general-padAccessCA.....value reference BearerServiceCode, '00100111'B  
 DEFINED in MAP-BS-Code : 74

GenericServiceInfo.....type reference SEQUENCE  
 DEFINED in MAP-SS-DataTypes : 179  
 USED in MAP-SS-DataTypes : 205

genericServiceInfo.....identifier of [4] GenericServiceInfo  
 DEFINED in MAP-SS-DataTypes : 205

geographicalInformation.....identifier of [0] GeographicalInformation  
 DEFINED in MAP-MS-DataTypes : 903

GeographicalInformation.....type reference OCTET STRING  
 DEFINED in MAP-MS-DataTypes : 919  
 USED in MAP-MS-DataTypes : 903

getPassword.....value reference GetPassword, CHOICE VALUE  
 DEFINED in MAP-Protocol : 226

GetPassword.....type reference OPERATION  
 DEFINED in MAP-SupplementaryServi : 234  
 USED in MAP-Protocol : 71 226  
 USED in MAP-SupplementaryServi : 22 232

ggsn-Address.....identifier of [1] GSN-Address  
 DEFINED in MAP-MS-DataTypes : 789

ggsn-Address.....identifier of [1] GSN-Address  
 DEFINED in MAP-MS-DataTypes : 796

ggsn-Address.....identifier of [2] GSN-Address  
 DEFINED in MAP-MS-DataTypes : 806

ggsn-Address.....identifier of [0] GSN-Address  
 DEFINED in MAP-MS-DataTypes : 811

ggsn-Address.....identifier of [2] GSN-Address  
 DEFINED in MAP-MS-DataTypes : 819

ggsn-Number.....identifier of [2] ISDN-AddressString  
 DEFINED in MAP-MS-DataTypes : 790

ggsn-Number.....identifier of [1] ISDN-AddressString  
 DEFINED in MAP-MS-DataTypes : 805

GlobalCellId.....type reference OCTET STRING  
 DEFINED in MAP-CommonDataTypes : 255  
 USED in MAP-MS-DataTypes : 127 258 269  
 USED in MAP-CommonDataTypes : 32

gmscCamelSubscriptionInfo.....identifier of [0] GmscCamelSubscriptionInfo  
 DEFINED in MAP-CH-DataTypes : 216

GmscCamelSubscriptionInfo.....type reference SEQUENCE  
 DEFINED in MAP-CH-DataTypes : 220  
 USED in MAP-CH-DataTypes : 216

gmsc-Address.....identifier of [6] ISDN-AddressString  
 DEFINED in MAP-CH-DataTypes : 93

gmsc-Address.....identifier of [8] ISDN-AddressString  
 DEFINED in MAP-CH-DataTypes : 175

gprsConnectionSuspended.....identifier of NULL  
 DEFINED in MAP-ER-DataTypes : 265

GPRSDataList.....type reference SEQUENCE OF  
 DEFINED in MAP-MS-DataTypes : 314  
 USED in MAP-MS-DataTypes : 336

gprsDataList.....identifier of [1] GPRSDataList  
DEFINED in MAP-MS-DataTypes : 336

gprsNodeIndicator.....identifier of [5] NULL  
DEFINED in MAP-SM-DataTypes : 90

29

TAG	R4.21	Cross Reference Listing for MAP-Protocol	99-12-21 12:08:21	PAGE
gprsSubscriptionData	.....	identifier of [16] GPRSSubscriptionData		
	DEFINED in MAP-MS-DataTypes	:	298	
GPRSSubscriptionData	.....	type reference SEQUENCE		
	DEFINED in MAP-MS-DataTypes	:	331	
	USED in MAP-MS-DataTypes	:	298	
gprsSubscriptionDataWithdraw	.....	identifier of [10] GPRSSubscriptionDataWithdraw		
	DEFINED in MAP-MS-DataTypes	:	633	
GPRSSubscriptionDataWithdraw	.....	type reference CHOICE		
	DEFINED in MAP-MS-DataTypes	:	636	
	USED in MAP-MS-DataTypes	:	633	
gprsSubscriptionUnknown	.....	identifier of Named Number, 1		
	DEFINED in MAP-ER-DataTypes	:	189	
gprsSupportIndicator	.....	identifier of [7] NULL		
	DEFINED in MAP-SM-DataTypes	:	58	
gprsSupportIndicator	.....	identifier of [2] NULL		
	DEFINED in MAP-SM-DataTypes	:	150	
greyListed	.....	identifier of Named Number, 2		
	DEFINED in MAP-MS-DataTypes	:	286	
groupCallNumber	.....	identifier of ISDN-AddressString		
	DEFINED in MAP-GR-DataTypes	:	62	
groupId	.....	identifier of GroupId		
	DEFINED in MAP-MS-DataTypes	:	861	
groupid	.....	identifier of GroupId		
	DEFINED in MAP-MS-DataTypes	:	866	
GroupId	.....	type reference OCTET STRING		
	DEFINED in MAP-MS-DataTypes	:	871	
	USED in MAP-MS-DataTypes	:	861 866	
groupKey	.....	identifier of [1] Kc		
	DEFINED in MAP-GR-DataTypes	:	55	
groupKeyNumber	.....	identifier of [0] GroupKeyNumber		
	DEFINED in MAP-GR-DataTypes	:	54	
GroupKeyNumber	.....	type reference INTEGER		
	DEFINED in MAP-GR-DataTypes	:	92	
	USED in MAP-GR-DataTypes	:	54	
gsmSCF-Address	.....	identifier of ISDN-AddressString		
	DEFINED in MAP-MS-DataTypes	:	669	
gsmSCF-Address	.....	identifier of [0] ISDN-AddressString		
	DEFINED in MAP-MS-DataTypes	:	702	
gsmSCF-Address	.....	identifier of [3] ISDN-AddressString		
	DEFINED in MAP-MS-DataTypes	:	949	
gsmSCF-Address	.....	identifier of [0] ISDN-AddressString		
	DEFINED in MAP-CH-DataTypes	:	245	
gsm-0408	.....	identifier of Named Number, 1		
	DEFINED in MAP-CommonDataTypes	:	188	
gsm-0806	.....	identifier of Named Number, 2		
	DEFINED in MAP-CommonDataTypes	:	189	
gsm-BearerCapability	.....	identifier of [5] ExternalSignalInfo		
	DEFINED in MAP-CH-DataTypes	:	172	
gsm-BearerCapability	.....	identifier of [0] ExternalSignalInfo		
	DEFINED in MAP-CH-DataTypes	:	259	
gsm-BSSMAP	.....	identifier of Named Number, 3		
	DEFINED in MAP-CommonDataTypes	:	190	

```
GSN-Address.....type reference OCTET STRING
  DEFINED in MAP-MS-DataTypes      :    247
  USED in MAP-MS-DataTypes         :    243    789    795    796    806    811    818    819

guidanceInfo.....identifier of GuidanceInfo
  DEFINED in MAP-SupplementaryServi :    236
```

30

TAG R4.21 Cross Reference Listing for MAP-Protocol 99-12-21 12:08:21 PAGE

GuidanceInfo.....type reference ENUMERATED  
 DEFINED in MAP-SS-DataTypes : 234  
 USED in MAP-SupplementaryServi : 67 236  
 USED in MAP-SS-DataTypes : 23

handoverNumber.....identifier of ISDN-AddressString  
 DEFINED in MAP-MS-DataTypes : 264

highLayerCompatibility.....identifier of [6] ExternalSignalInfo  
 DEFINED in MAP-CH-DataTypes : 265

hlr.....identifier of Named Number, 1  
 DEFINED in MAP-CommonDataTypes : 266

HLR-Id.....type reference IMSI  
 DEFINED in MAP-CommonDataTypes : 244  
 USED in MAP-CommonDataTypes : 249

hlr-List.....identifier of HLR-List  
 DEFINED in MAP-MS-DataTypes : 832

HLR-List.....type reference SEQUENCE OF  
 DEFINED in MAP-CommonDataTypes : 248  
 USED in MAP-MS-DataTypes : 125 832  
 USED in MAP-CommonDataTypes : 30

hlr-Number.....identifier of ISDN-AddressString  
 DEFINED in MAP-MS-DataTypes : 171

hlr-Number.....identifier of ISDN-AddressString  
 DEFINED in MAP-MS-DataTypes : 251

hlr-Number.....identifier of ISDN-AddressString  
 DEFINED in MAP-MS-DataTypes : 831

hlr-Number.....identifier of ISDN-AddressString  
 DEFINED in MAP-MS-DataTypes : 843

hold.....value reference SS-Code, '01000010'B  
 DEFINED in MAP-SS-Code : 77

ho-NumberNotRequired.....identifier of NULL  
 DEFINED in MAP-MS-DataTypes : 259

identity.....identifier of Identity  
 DEFINED in MAP-MS-DataTypes : 177

Identity.....type reference CHOICE  
 DEFINED in MAP-MS-DataTypes : 182  
 USED in MAP-MS-DataTypes : 177

illegalEquipment.....value reference IllegalEquipment, CHOICE VALUE  
 DEFINED in MAP-Protocol : 302

IllegalEquipment.....type reference ERROR  
 DEFINED in MAP-Errors : 203  
 USED in MAP-Protocol : 112 302  
 USED in MAP-SupplementaryServi : 52 199 213  
 USED in MAP-ShortMessageServic : 34 107  
 USED in MAP-Errors : 31

illegalEquipmentParam.....identifier of IllegalEquipmentParam  
 DEFINED in MAP-Errors : 205

IllegalEquipmentParam.....type reference SEQUENCE  
 DEFINED in MAP-ER-DataTypes : 207  
 USED in MAP-Errors : 103 205  
 USED in MAP-ER-DataTypes : 29

illegalSS-Operation.....value reference IllegalSS-Operation, CHOICE VALUE  
 DEFINED in MAP-Protocol : 345

IllegalSS-Operation.....type reference ERROR  
 DEFINED in MAP-Errors : 296

USED in MAP-Protocol	:	128	345						
USED in MAP-SupplementaryServi	:	40	100	117	134	154	172	261	278
USED in MAP-Errors	:	57							

illegalSubscriber.....value reference IllegalSubscriber, CHOICE VALUE  
DEFINED in MAP-Protocol : 301

```

IllegalSubscriber.....type reference ERROR
  DEFINED in MAP-Errors      : 197
  USED in MAP-Protocol      : 111 301
  USED in MAP-SupplementaryServi : 51 198 212
  USED in MAP-ShortMessageServic : 33 106
  USED in MAP-Errors      : 30

illegalSubscriberParam.....identifier of IllegalSubscriberParam
  DEFINED in MAP-Errors      : 199

IllegalSubscriberParam.....type reference SEQUENCE
  DEFINED in MAP-ER-DataTypes : 203
  USED in MAP-Errors      : 102 199
  USED in MAP-ER-DataTypes : 28

imei.....identifier of IMEI
  DEFINED in MAP-MobileServiceOpera : 269

IMEI.....type reference TBCD-STRING
  DEFINED in MAP-CommonDataTypes : 237
  USED in MAP-MobileServiceOpera : 125 269
  USED in MAP-CommonDataTypes : 29

imsi.....identifier of IMSI
  DEFINED in MAP-OperationAndMainte : 81

imsi.....identifier of IMSI
  DEFINED in MAP-MS-DataTypes : 155

imsi.....identifier of IMSI
  DEFINED in MAP-MS-DataTypes : 183

imsi.....identifier of IMSI
  DEFINED in MAP-MS-DataTypes : 199

imsi.....identifier of IMSI
  DEFINED in MAP-MS-DataTypes : 213

imsi.....identifier of IMSI
  DEFINED in MAP-MS-DataTypes : 219

imsi.....identifier of IMSI
  DEFINED in MAP-MS-DataTypes : 241

imsi.....identifier of [0] IMSI
  DEFINED in MAP-MS-DataTypes : 292

imsi.....identifier of [0] IMSI
  DEFINED in MAP-MS-DataTypes : 621

imsi.....identifier of [0] IMSI
  DEFINED in MAP-MS-DataTypes : 788

imsi.....identifier of [0] IMSI
  DEFINED in MAP-MS-DataTypes : 804

imsi.....identifier of [0] IMSI
  DEFINED in MAP-MS-DataTypes : 817

imsi.....identifier of IMSI
  DEFINED in MAP-MS-DataTypes : 836

imsi.....identifier of [0] IMSI
  DEFINED in MAP-MS-DataTypes : 878

imsi.....identifier of [0] IMSI
  DEFINED in MAP-MS-DataTypes : 959

IMSI.....type reference TBCD-STRING
  DEFINED in MAP-CommonDataTypes : 224
  USED in MAP-OperationAndMainte : 43 81
  USED in MAP-MS-DataTypes : 124 155 183 199 213 219 241 276 292
  USED in MAP-CommonDataTypes : 26 234 244
  USED in MAP-OM-DataTypes : 22 37 55

```

USED in MAP-CH-DataTypes	:	60	128	168	193	294	324	364
USED in MAP-SS-DataTypes	:	47	256					
USED in MAP-SM-DataTypes	:	34	80	132	193			
USED in MAP-GR-DataTypes	:	24	67	76				
imsi.....identifier of [0] IMSI								
DEFINED in MAP-CommonDataTypes	:	234						



```

imsi.....identifier of [0] IMSI
  DEFINED in MAP-OM-DataTypes      :    37

imsi.....identifier of [0] IMSI
  DEFINED in MAP-OM-DataTypes      :    55

imsi.....identifier of [9] IMSI
  DEFINED in MAP-CH-DataTypes      :   128

imsi.....identifier of [0] IMSI
  DEFINED in MAP-CH-DataTypes      :   168

imsi.....identifier of [3] IMSI
  DEFINED in MAP-CH-DataTypes      :   193

imsi.....identifier of [0] IMSI
  DEFINED in MAP-CH-DataTypes      :   294

imsi.....identifier of [0] IMSI
  DEFINED in MAP-CH-DataTypes      :   324

imsi.....identifier of [0] IMSI
  DEFINED in MAP-CH-DataTypes      :   364

imsi.....identifier of [0] IMSI
  DEFINED in MAP-SS-DataTypes      :   256

imsi.....identifier of IMSI
  DEFINED in MAP-SM-DataTypes      :    80

imsi.....identifier of [0] IMSI
  DEFINED in MAP-SM-DataTypes      :   132

imsi.....identifier of [0] IMSI
  DEFINED in MAP-SM-DataTypes      :   193

imsi.....identifier of IMSI
  DEFINED in MAP-GR-DataTypes      :    67

imsi.....identifier of IMSI
  DEFINED in MAP-GR-DataTypes      :    76

imsiDetach.....identifier of Named Number, 0
  DEFINED in MAP-ER-DataTypes      :   233

imsiDetached.....identifier of Named Number, 1
  DEFINED in MAP-MS-DataTypes      :   940

imsiUnknown.....identifier of Named Number, 0
  DEFINED in MAP-ER-DataTypes      :   188

imsi-WithLMSI.....identifier of IMSI-WithLMSI
  DEFINED in MAP-MS-DataTypes      :   184

IMSI-WithLMSI.....type reference SEQUENCE
  DEFINED in MAP-MS-DataTypes      :   212
  USED in MAP-MS-DataTypes        :   184

incomingCallsBarredWithinCUG.....identifier of Named Number, 0
  DEFINED in MAP-ER-DataTypes      :   108

incompatibleTerminal.....value reference IncompatibleTerminal, CHOICE VALUE
  DEFINED in MAP-Protocol          :   285

IncompatibleTerminal.....type reference ERROR
  DEFINED in MAP-Errors            :   157
  USED in MAP-Protocol             :   146 285
  USED in MAP-CallHandlingOperat  :    46 177
  USED in MAP-Errors              :    18

incompatibleTerminalParam.....identifier of IncompatibleTerminalParam
  DEFINED in MAP-Errors            :   159

IncompatibleTerminalParam.....type reference SEQUENCE

```

DEFINED in MAP-ER-DataTypes	:	281	
USED in MAP-Errors	:	122	159
USED in MAP-ER-DataTypes	:	46	
incorrectTransactionPortion.....identifier of Named Number, 3			
DEFINED in TCAPMessages	:	106	

33

TAG R4.21 Cross Reference Listing for MAP-Protocol 99-12-21 12:08:21 PAGE

informServiceCentre.....value reference InformServiceCentre, CHOICE VALUE  
 DEFINED in MAP-Protocol : 237

InformServiceCentre.....type reference OPERATION  
 DEFINED in MAP-ShortMessageServic : 133  
 USED in MAP-Protocol : 85 237  
 USED in MAP-ShortMessageServic : 18

informServiceCentreArg.....identifier of InformServiceCentreArg  
 DEFINED in MAP-ShortMessageServic : 135

InformServiceCentreArg.....type reference SEQUENCE  
 DEFINED in MAP-SM-DataTypes : 178  
 USED in MAP-ShortMessageServic : 55 135  
 USED in MAP-SM-DataTypes : 23

inhibiting.....identifier of Named Number, 0  
 DEFINED in MAP-MS-DataTypes : 763

initiatingRelease.....identifier of Named Number, 4  
 DEFINED in TCAPMessages : 187

insertSubscriberData.....value reference InsertSubscriberData, CHOICE VALUE  
 DEFINED in MAP-Protocol : 183

InsertSubscriberData.....type reference OPERATION  
 DEFINED in MAP-MobileServiceOpera : 279  
 USED in MAP-Protocol : 24 183  
 USED in MAP-MobileServiceOpera : 43

insertSubscriberDataArg.....identifier of InsertSubscriberDataArg  
 DEFINED in MAP-MobileServiceOpera : 281

InsertSubscriberDataArg.....type reference SEQUENCE  
 DEFINED in MAP-MS-DataTypes : 291  
 USED in MAP-MobileServiceOpera : 101 281  
 USED in MAP-MS-DataTypes : 42

insertSubscriberDataRes.....identifier of InsertSubscriberDataRes  
 DEFINED in MAP-MobileServiceOpera : 283

InsertSubscriberDataRes.....type reference SEQUENCE  
 DEFINED in MAP-MS-DataTypes : 603  
 USED in MAP-MobileServiceOpera : 102 283  
 USED in MAP-MS-DataTypes : 43

interCUG-Restrictions.....identifier of InterCUG-Restrictions  
 DEFINED in MAP-MS-DataTypes : 571

InterCUG-Restrictions.....type reference OCTET STRING  
 DEFINED in MAP-MS-DataTypes : 575  
 USED in MAP-MS-DataTypes : 62 571

internationalECT-Barred.....identifier of Named Number, 11  
 DEFINED in MAP-MS-DataTypes : 413

internationalOGCallsBarred.....identifier of Named Number, 1  
 DEFINED in MAP-MS-DataTypes : 403

internationalOGCallsNotToHPLMN-CountryBaidentifier of Named Number, 2  
 DEFINED in MAP-MS-DataTypes : 404

interrogateSS.....value reference InterrogateSS, CHOICE VALUE  
 DEFINED in MAP-Protocol : 220

InterrogateSS.....type reference OPERATION  
 DEFINED in MAP-SupplementaryServi : 160  
 USED in MAP-Protocol : 66 220  
 USED in MAP-SupplementaryServi : 17

interrogateSS-Res.....identifier of InterrogateSS-Res  
 DEFINED in MAP-SupplementaryServi : 164

InterrogateSS-Res.....type reference CHOICE  
 DEFINED in MAP-SS-DataTypes : 201

```
USED in MAP-SupplementaryServi :    63   164
USED in MAP-SS-DataTypes       :    19
interrogationType.....identifier of [3] InterrogationType
  DEFINED in MAP-CH-DataTypes   :    90
InterrogationType.....type reference ENUMERATED
```

34

TAG	R4.21	Cross Reference Listing for MAP-Protocol	99-12-21	12:08:21	PAGE
	DEFINED in MAP-CH-DataTypes	:	108		
	USED in MAP-CH-DataTypes	:	90		
interzonalECT-Barred.....	identifier of Named Number, 12				
	DEFINED in MAP-MS-DataTypes	:	414		
interzonalOGCallsAndInternationalOGCalls	identifier of Named Number, 8				
	DEFINED in MAP-MS-DataTypes	:	407		
interzonalOGCallsBarred.....	identifier of Named Number, 6				
	DEFINED in MAP-MS-DataTypes	:	405		
interzonalOGCallsNotToHPLMN-CountryBarre	identifier of Named Number, 7				
	DEFINED in MAP-MS-DataTypes	:	406		
intraCUG-Options.....	identifier of IntraCUG-Options				
	DEFINED in MAP-MS-DataTypes	:	543		
IntraCUG-Options.....	type reference ENUMERATED				
	DEFINED in MAP-MS-DataTypes	:	553		
	USED in MAP-MS-DataTypes	:	63 543		
invalidFormat.....	identifier of Named Number, 1				
	DEFINED in MAP-ER-DataTypes	:	121		
invalidSME-Address.....	identifier of Named Number, 5				
	DEFINED in MAP-ER-DataTypes	:	131		
invoke.....	identifier of [1] IMPLICIT Invoke				
	DEFINED in TCAPMessages	:	125		
Invoke.....	type reference SEQUENCE				
	DEFINED in TCAPMessages	:	133		
	USED in TCAPMessages	:	125		
invokeID.....	identifier of InvokeIdType				
	DEFINED in TCAPMessages	:	134		
invokeID.....	identifier of InvokeIdType				
	DEFINED in TCAPMessages	:	145		
invokeID.....	identifier of InvokeIdType				
	DEFINED in TCAPMessages	:	157		
invokeID.....	identifier of CHOICE				
	DEFINED in TCAPMessages	:	166		
InvokeIdType.....	type reference INTEGER				
	DEFINED in TCAPMessages	:	175		
	USED in TCAPMessages	:	47 134 135 145 157 167		
invokeProblem.....	identifier of [1] IMPLICIT InvokeProblem				
	DEFINED in TCAPMessages	:	171		
InvokeProblem.....	type reference INTEGER				
	DEFINED in TCAPMessages	:	183		
	USED in TCAPMessages	:	171		
ISDN-AddressString.....	type reference AddressString				
	DEFINED in MAP-CommonDataTypes	:	122		
	USED in MAP-OperationAndMainte	:	42 79		
	USED in MAP-MS-DataTypes	:	120 157 158 171 200 201 242 251 264		
			270 360 451 669 702 740 790 805 831		
			843 904 949 960		
	USED in MAP-CommonDataTypes	:	17		
	USED in MAP-CH-DataTypes	:	57 87 93 139 154 158 169 170 175		
			185 245 262 278 367		
	USED in MAP-SS-DataTypes	:	45 97 194 212 257 284		
	USED in MAP-SM-DataTypes	:	32 53 86 98 99 138 143 168 174		
			179		
	USED in MAP-GR-DataTypes	:	23 62		
isdn-BearerCapability.....	identifier of [1] ExternalSignalInfo				
	DEFINED in MAP-CH-DataTypes	:	260		

ISDN-SubaddressString.....type reference OCTET STRING  
DEFINED in MAP-CommonDataTypes : 128  
USED in MAP-MS-DataTypes : 122 455  
USED in MAP-CommonDataTypes : 19  
USED in MAP-CH-DataTypes : 58 162  
USED in MAP-SS-DataTypes : 46 73 98 195

35 TAG R4.21 Cross Reference Listing for MAP-Protocol 99-12-21 12:08:21 PAGE

kc.....identifier of Kc  
 DEFINED in MAP-MS-DataTypes : 229

Kc.....type reference OCTET STRING  
 DEFINED in MAP-MS-DataTypes : 236  
 USED in MAP-MS-DataTypes : 39 229  
 USED in MAP-GR-DataTypes : 36 55

keepCCBS-CallIndicator.....identifier of [1] NULL  
 DEFINED in MAP-CH-DataTypes : 149

laiFixedLength.....identifier of [1] LAIFixedLength  
 DEFINED in MAP-CommonDataTypes : 290

LAIFixedLength.....type reference OCTET STRING  
 DEFINED in MAP-CommonDataTypes : 301  
 USED in MAP-CommonDataTypes : 290

linkedID.....identifier of [0] IMPLICIT InvokeIdType  
 DEFINED in TCAPMessages : 135

linkedResponseUnexpected.....identifier of Named Number, 6  
 DEFINED in TCAPMessages : 189

lmsi.....identifier of [10] LMSI  
 DEFINED in MAP-MS-DataTypes : 159

lmsi.....identifier of LMSI  
 DEFINED in MAP-MS-DataTypes : 214

lmsi.....identifier of LMSI  
 DEFINED in MAP-MS-DataTypes : 837

lmsi.....identifier of [1] LMSI  
 DEFINED in MAP-MS-DataTypes : 879

LMSI.....type reference OCTET STRING  
 DEFINED in MAP-CommonDataTypes : 253  
 USED in MAP-MS-DataTypes : 126 159 214 837 879  
 USED in MAP-CommonDataTypes : 31  
 USED in MAP-CH-DataTypes : 61 171 295  
 USED in MAP-SM-DataTypes : 35 87 133

lmsi.....identifier of [4] LMSI  
 DEFINED in MAP-CH-DataTypes : 171

lmsi.....identifier of [1] LMSI  
 DEFINED in MAP-CH-DataTypes : 295

lmsi.....identifier of LMSI  
 DEFINED in MAP-SM-DataTypes : 87

lmsi.....identifier of [1] LMSI  
 DEFINED in MAP-SM-DataTypes : 133

locationInformation.....identifier of [0] LocationInformation  
 DEFINED in MAP-MS-DataTypes : 890

locationInformation.....identifier of [0] NULL  
 DEFINED in MAP-MS-DataTypes : 896

LocationInformation.....type reference SEQUENCE  
 DEFINED in MAP-MS-DataTypes : 901  
 USED in MAP-MS-DataTypes : 74 890

locationInfoWithLMSI.....identifier of [0] LocationInfoWithLMSI  
 DEFINED in MAP-SM-DataTypes : 81

LocationInfoWithLMSI.....type reference SEQUENCE  
 DEFINED in MAP-SM-DataTypes : 85  
 USED in MAP-SM-DataTypes : 81

locationNumber.....identifier of [2] LocationNumber  
 DEFINED in MAP-MS-DataTypes : 905

LocationNumber.....type reference OCTET STRING  
  DEFINED in MAP-MS-DataTypes : 929  
  USED in MAP-MS-DataTypes : 905

longTermDenial.....value reference LongTermDenial, CHOICE VALUE  
  DEFINED in MAP-Protocol : 357



LongTermDenial.....type reference ERROR  
 DEFINED in MAP-Errors : 329  
 USED in MAP-Protocol : 145 357  
 USED in MAP-SupplementaryServi : 54 265  
 USED in MAP-Errors : 68

longTermDenialParam.....identifier of LongTermDenialParam  
 DEFINED in MAP-Errors : 331

LongTermDenialParam.....type reference SEQUENCE  
 DEFINED in MAP-ER-DataTypes : 288  
 USED in MAP-Errors : 124 331  
 USED in MAP-ER-DataTypes : 48

lowerLayerCompatibility.....identifier of [5] ExternalSignalInfo  
 DEFINED in MAP-CH-DataTypes : 264

mah.....value reference SS-Code, '00110010'B  
 DEFINED in MAP-SS-Code : 68

MAP-BS-Code.....module reference  
 DEFINED in MAP-BS-Code : 1  
 USED in MAP-MS-DataTypes : 110  
 USED in MAP-CommonDataTypes : 56

MAP-CallHandlingOperations.....module reference  
 DEFINED in MAP-CallHandlingOperat : 1  
 USED in MAP-Protocol : 57

MAP-CH-DataTypes.....module reference  
 DEFINED in MAP-CH-DataTypes : 1  
 USED in MAP-CallHandlingOperat : 68

MAP-CommonDataTypes.....module reference  
 DEFINED in MAP-CommonDataTypes : 1  
 USED in MAP-MobileServiceOpera : 126  
 USED in MAP-OperationAndMainte : 44  
 USED in MAP-MS-DataTypes : 134  
 USED in MAP-OM-DataTypes : 23  
 USED in MAP-CH-DataTypes : 67  
 USED in MAP-SS-DataTypes : 53  
 USED in MAP-SM-DataTypes : 36  
 USED in MAP-GR-DataTypes : 27  
 USED in MAP-ER-DataTypes : 61

MAP-Errors.....module reference  
 DEFINED in MAP-Errors : 1  
 USED in MAP-Protocol : 147  
 USED in MAP-MobileServiceOpera : 82  
 USED in MAP-OperationAndMainte : 30  
 USED in MAP-CallHandlingOperat : 49  
 USED in MAP-SupplementaryServi : 56  
 USED in MAP-ShortMessageServic : 42  
 USED in MAP-Group-Call-Operati : 27

MAP-ER-DataTypes.....module reference  
 DEFINED in MAP-ER-DataTypes : 1  
 USED in MAP-Errors : 126  
 USED in MAP-MS-DataTypes : 144  
 USED in MAP-SM-DataTypes : 41

MAP-EXTENSION.....information object class reference CLASS  
 DEFINED in MAP-ExtensionDataTypes : 22  
 USED in MAP-ExtensionDataTypes : 41 43 48

MAP-ExtensionDataTypes.....module reference  
 DEFINED in MAP-ExtensionDataTypes : 1  
 USED in MAP-MS-DataTypes : 139  
 USED in MAP-CommonDataTypes : 61  
 USED in MAP-OM-DataTypes : 28  
 USED in MAP-CH-DataTypes : 72  
 USED in MAP-SS-DataTypes : 58  
 USED in MAP-SM-DataTypes : 46  
 USED in MAP-GR-DataTypes : 43  
 USED in MAP-ER-DataTypes : 71

```
MAP-Group-Call-Operations.....module reference
  DEFINED in MAP-Group-Call-Operati :    1
  USED in MAP-Protocol                :   96

MAP-GR-DataTypes.....module reference
  DEFINED in MAP-GR-DataTypes         :    1
```

37

TAG R4.21 Cross Reference Listing for MAP-Protocol 99-12-21 12:08:21 PAGE

USED in MAP-Group-Call-Operati : 37

MAP-MobileServiceOperations.....module reference  
 DEFINED in MAP-MobileServiceOpera : 1  
 USED in MAP-Protocol : 36

MAP-MS-DataTypes.....module reference  
 DEFINED in MAP-MS-DataTypes : 1  
 USED in MAP-MobileServiceOpera : 119  
 USED in MAP-CH-DataTypes : 46  
 USED in MAP-GR-DataTypes : 37

MAP-OM-DataTypes.....module reference  
 DEFINED in MAP-OM-DataTypes : 1  
 USED in MAP-OperationAndMainte : 38

MAP-OperationAndMaintenanceOperations...module reference  
 DEFINED in MAP-OperationAndMainte : 1  
 USED in MAP-Protocol : 44

MAP-Protocol.....module reference  
 DEFINED in MAP-Protocol : 1

MAP-ShortMessageServiceOperations.....module reference  
 DEFINED in MAP-ShortMessageServic : 1  
 USED in MAP-Protocol : 87

MAP-SM-DataTypes.....module reference  
 DEFINED in MAP-SM-DataTypes : 1  
 USED in MAP-ShortMessageServic : 58

MAP-SS-Code.....module reference  
 DEFINED in MAP-SS-Code : 1  
 USED in MAP-SupplementaryServi : 79  
 USED in MAP-MS-DataTypes : 105  
 USED in MAP-SS-DataTypes : 63  
 USED in MAP-ER-DataTypes : 66

MAP-SS-DataTypes.....module reference  
 DEFINED in MAP-SS-DataTypes : 1  
 USED in MAP-SupplementaryServi : 74  
 USED in MAP-Errors : 87  
 USED in MAP-MS-DataTypes : 100  
 USED in MAP-CH-DataTypes : 53  
 USED in MAP-ER-DataTypes : 54

MAP-SupplementaryServiceOperations.....module reference  
 DEFINED in MAP-SupplementaryServi : 1  
 USED in MAP-Protocol : 75

MAP-TS-Code.....module reference  
 DEFINED in MAP-TS-Code : 1  
 USED in MAP-MS-DataTypes : 115  
 USED in MAP-CommonDataTypes : 50  
 USED in MAP-GR-DataTypes : 32

matchType.....identifier of [0] MatchType  
 DEFINED in MAP-MS-DataTypes : 732

MatchType.....type reference ENUMERATED  
 DEFINED in MAP-MS-DataTypes : 762  
 USED in MAP-MS-DataTypes : 732

maxAddressLength.....value reference INTEGER, 20  
 DEFINED in MAP-CommonDataTypes : 120  
 USED in MAP-CommonDataTypes : 79

maxEventSpecification.....value reference INTEGER, 2  
 DEFINED in MAP-SS-DataTypes : 275  
 USED in MAP-SS-DataTypes : 272

maximumentitledPriority.....identifier of EMLPP-Priority  
 DEFINED in MAP-CommonDataTypes : 321

maximumEntitledPriority.....identifier of [0] EMLPP-Priority

```
DEFINED in MAP-SS-DataTypes      :    183
maxISDN-AddressLength.....value reference INTEGER, 9
DEFINED in MAP-CommonDataTypes   :    126
USED in MAP-MS-DataTypes         :    121
USED in MAP-CommonDataTypes     :    18   123
```

38

TAG	R4.21	Cross Reference Listing for MAP-Protocol	99-12-21	12:08:21	PAGE
maxISDN-SubaddressLength.....value	reference	INTEGER, 21			
DEFINED in MAP-CommonDataTypes	:	166			
USED in MAP-CommonDataTypes	:	129			
maxNumOfBasicServiceGroups.....value	reference	INTEGER, 13			
DEFINED in MAP-SS-DataTypes	:	253			
USED in MAP-SS-DataTypes	:	91	144	250	
maxNumOfBasicServices.....value	reference	INTEGER, 70			
DEFINED in MAP-MS-DataTypes	:	646			
USED in MAP-MS-DataTypes	:	643			
maxNumOfBearerServices.....value	reference	INTEGER, 50			
DEFINED in MAP-MS-DataTypes	:	388			
USED in MAP-MS-DataTypes	:	385			
maxNumOfCamelBasicServiceCriteria.....value	reference	INTEGER, 5			
DEFINED in MAP-MS-DataTypes	:	756			
USED in MAP-MS-DataTypes	:	747			
maxNumOfCamelDestinationNumberLengths...value	reference	INTEGER, 3			
DEFINED in MAP-MS-DataTypes	:	754			
USED in MAP-MS-DataTypes	:	744			
maxNumOfCamelDestinationNumbers.....value	reference	INTEGER, 10			
DEFINED in MAP-MS-DataTypes	:	752			
USED in MAP-MS-DataTypes	:	739			
maxNumOfCamelSSEvents.....value	reference	INTEGER, 10			
DEFINED in MAP-MS-DataTypes	:	681			
USED in MAP-MS-DataTypes	:	674			
maxNumOfCamelTDPData.....value	reference	INTEGER, 10			
DEFINED in MAP-MS-DataTypes	:	697			
USED in MAP-MS-DataTypes	:	59	690	721	
USED in MAP-CH-DataTypes	:	36	235		
maxNumOfCCBS-Requests.....value	reference	INTEGER, 5			
DEFINED in MAP-SS-DataTypes	:	190			
USED in MAP-SS-DataTypes	:	187	199		
maxNumOfCUG.....value	reference	INTEGER, 10			
DEFINED in MAP-MS-DataTypes	:	558			
USED in MAP-MS-DataTypes	:	537			
maxNumOfExt-BasicServiceGroups.....value	reference	INTEGER, 32			
DEFINED in MAP-MS-DataTypes	:	566			
USED in MAP-MS-DataTypes	:	445	522	560	563
maxNumOfHLR-Id.....value	reference	INTEGER, 50			
DEFINED in MAP-CommonDataTypes	:	251			
USED in MAP-CommonDataTypes	:	248			
maxNumOfISDN-AddressDigits.....value	reference	INTEGER, 15			
DEFINED in MAP-MS-DataTypes	:	750			
USED in MAP-MS-DataTypes	:	745			
maxNumOfPDP-Contexts.....value	reference	INTEGER, 50			
DEFINED in MAP-MS-DataTypes	:	317			
USED in MAP-MS-DataTypes	:	314	329	640	
maxNumOfPrivateExtensions.....value	reference	INTEGER, 10			
DEFINED in MAP-ExtensionDataTypes	:	46			
USED in MAP-ExtensionDataTypes	:	37			
maxNumOfSS.....value	reference	INTEGER, 30			
DEFINED in MAP-SS-DataTypes	:	245			
USED in MAP-MS-DataTypes	:	97	428		
USED in MAP-SS-DataTypes	:	30	242	247	
maxNumOfTeleservices.....value	reference	INTEGER, 20			
DEFINED in MAP-MS-DataTypes	:	393			
USED in MAP-MS-DataTypes	:	390			
maxNumOfVBSGroupIds.....value	reference	INTEGER, 50			

```
DEFINED in MAP-MS-DataTypes      : 856
USED in MAP-MS-DataTypes          : 850

maxNumOfVGCSGroupIds.....value reference INTEGER, 50
DEFINED in MAP-MS-DataTypes      : 858
USED in MAP-MS-DataTypes          : 853
```

```

maxNumOfZoneCodes.....value reference INTEGER, 10
  DEFINED in MAP-MS-DataTypes      :    601
  USED in MAP-MS-DataTypes         :    50   595

maxSignalInfoLength.....value reference INTEGER, 200
  DEFINED in MAP-CommonDataTypes   :    179
  USED in MAP-CommonDataTypes     :    22   177

maxUSSD-StringLength.....value reference INTEGER, 160
  DEFINED in MAP-SS-DataTypes      :    228
  USED in MAP-SS-DataTypes         :    224

mcef-Set.....identifier of Named Number, 2
  DEFINED in MAP-SM-DataTypes      :    187

mci.....value reference SS-Code, '00010101'B
  DEFINED in MAP-SS-Code          :    36

memoryAvailable.....identifier of Named Number, 1
  DEFINED in MAP-SM-DataTypes     :    208

memoryCapacityExceeded.....identifier of Named Number, 0
  DEFINED in MAP-SM-DataTypes     :    163

memoryCapacityExceeded.....identifier of Named Number, 0
  DEFINED in MAP-ER-DataTypes     :    126

MessageType.....type reference CHOICE
  DEFINED in TCAPMessages         :    51
  USED in TCAPMessages           :    47

messageWaitingListFull.....value reference MessageWaitingListFull, CHOICE VALUE
  DEFINED in MAP-Protocol         :    364

MessageWaitingListFull.....type reference ERROR
  DEFINED in MAP-Errors           :    346
  USED in MAP-Protocol            :    140   364
  USED in MAP-ShortMessageServic :    40   122
  USED in MAP-Errors              :    73

messageWaitListFullParam.....identifier of MessageWaitListFullParam
  DEFINED in MAP-Errors           :    348

MessageWaitListFullParam.....type reference SEQUENCE
  DEFINED in MAP-ER-DataTypes     :    269
  USED in MAP-Errors              :    118   348
  USED in MAP-ER-DataTypes       :    41

mistypedComponent.....identifier of Named Number, 1
  DEFINED in TCAPMessages         :    180

mistypedParameter.....identifier of Named Number, 2
  DEFINED in TCAPMessages         :    185

mistypedParameter.....identifier of Named Number, 2
  DEFINED in TCAPMessages         :    194

mistypedParameter.....identifier of Named Number, 4
  DEFINED in TCAPMessages         :    200

mnrf-Set.....identifier of Named Number, 1
  DEFINED in MAP-SM-DataTypes     :    186

mnrq-Set.....identifier of Named Number, 3
  DEFINED in MAP-SM-DataTypes     :    188

mobileNotReachableReason.....identifier of [2] AbsentSubscriberDiagnosticSM
  DEFINED in MAP-MS-DataTypes     :    797

monitoringMode.....identifier of [0] MonitoringMode
  DEFINED in MAP-CH-DataTypes     :    336

MonitoringMode.....type reference ENUMERATED
  DEFINED in MAP-CH-DataTypes     :    341
  USED in MAP-CH-DataTypes       :    336

```

moreMessagesToSend.....identifier of NULL  
DEFINED in MAP-SM-DataTypes : 122

mo-forwardSM.....value reference MO-ForwardSM, CHOICE VALUE  
DEFINED in MAP-Protocol : 234



40

TAG R4.21 Cross Reference Listing for MAP-Protocol 99-12-21 12:08:21 PAGE

MO-ForwardSM.....type reference OPERATION  
 DEFINED in MAP-ShortMessageServic : 82  
 USED in MAP-Protocol : 81 234  
 USED in MAP-ShortMessageServic : 14

mo-forwardSM-Arg.....identifier of MO-ForwardSM-Arg  
 DEFINED in MAP-ShortMessageServic : 84

MO-ForwardSM-Arg.....type reference SEQUENCE  
 DEFINED in MAP-SM-DataTypes : 106  
 USED in MAP-ShortMessageServic : 48 84  
 USED in MAP-SM-DataTypes : 16

mo-forwardSM-Res.....identifier of MO-ForwardSM-Res  
 DEFINED in MAP-ShortMessageServic : 86

MO-ForwardSM-Res.....type reference SEQUENCE  
 DEFINED in MAP-SM-DataTypes : 113  
 USED in MAP-ShortMessageServic : 49 86  
 USED in MAP-SM-DataTypes : 17

msc-Number.....identifier of [1] ISDN-AddressString  
 DEFINED in MAP-MS-DataTypes : 157

msc-Number.....identifier of [1] ISDN-AddressString  
 DEFINED in MAP-CH-DataTypes : 169

msc-Number.....identifier of [0] ISDN-AddressString  
 DEFINED in MAP-SM-DataTypes : 98

msisdn.....identifier of ISDN-AddressString  
 DEFINED in MAP-OperationAndMainte : 79

msisdn.....identifier of [1] ISDN-AddressString  
 DEFINED in MAP-MS-DataTypes : 360

msisdn.....identifier of [1] ISDN-AddressString  
 DEFINED in MAP-MS-DataTypes : 960

msisdn.....identifier of [0] ISDN-AddressString  
 DEFINED in MAP-CH-DataTypes : 87

msisdn.....identifier of [2] ISDN-AddressString  
 DEFINED in MAP-CH-DataTypes : 170

msisdn.....identifier of [0] ISDN-AddressString  
 DEFINED in MAP-SS-DataTypes : 212

msisdn.....identifier of [1] ISDN-AddressString  
 DEFINED in MAP-SS-DataTypes : 257

msisdn.....identifier of [0] ISDN-AddressString  
 DEFINED in MAP-SM-DataTypes : 53

msisdn.....identifier of [2] ISDN-AddressString  
 DEFINED in MAP-SM-DataTypes : 138

msisdn.....identifier of ISDN-AddressString  
 DEFINED in MAP-SM-DataTypes : 143

msisdn.....identifier of ISDN-AddressString  
 DEFINED in MAP-SM-DataTypes : 174

msNotReachable.....identifier of NULL  
 DEFINED in MAP-MS-DataTypes : 844

msPurged.....identifier of Named Number, 0  
 DEFINED in MAP-MS-DataTypes : 939

ms-Present.....identifier of Named Number, 0  
 DEFINED in MAP-SM-DataTypes : 207

mt-forwardSM.....value reference MT-ForwardSM, CHOICE VALUE  
 DEFINED in MAP-Protocol : 235

```
MT-ForwardSM.....type reference OPERATION
  DEFINED in MAP-ShortMessageService :    94
  USED in MAP-Protocol :    82  235
  USED in MAP-ShortMessageService :    15

mt-forwardSM-Arg.....identifier of MT-ForwardSM-Arg
  DEFINED in MAP-ShortMessageService :    96
```

41

TAG R4.21 Cross Reference Listing for MAP-Protocol 99-12-21 12:08:21 PAGE

MT-ForwardSM-Arg.....type reference SEQUENCE  
 DEFINED in MAP-SM-DataTypes : 118  
 USED in MAP-ShortMessageServic : 50 96  
 USED in MAP-SM-DataTypes : 18

mt-forwardSM-Res.....identifier of MT-ForwardSM-Res  
 DEFINED in MAP-ShortMessageServic : 98

MT-ForwardSM-Res.....type reference SEQUENCE  
 DEFINED in MAP-SM-DataTypes : 126  
 USED in MAP-ShortMessageServic : 51 98  
 USED in MAP-SM-DataTypes : 19

multipleECT-Barred.....identifier of Named Number, 14  
 DEFINED in MAP-MS-DataTypes : 416

multiPTY.....value reference SS-Code, '01010001'B  
 DEFINED in MAP-SS-Code : 88

mw-Status.....identifier of MW-Status  
 DEFINED in MAP-SM-DataTypes : 180

MW-Status.....type reference BIT STRING  
 DEFINED in MAP-SM-DataTypes : 184  
 USED in MAP-SM-DataTypes : 180

NAEA-CIC.....type reference OCTET STRING  
 DEFINED in MAP-CommonDataTypes : 279  
 USED in MAP-CommonDataTypes : 275

naea-PreferredCI.....identifier of [15] NAEA-PreferredCI  
 DEFINED in MAP-MS-DataTypes : 296

NAEA-PreferredCI.....type reference SEQUENCE  
 DEFINED in MAP-CommonDataTypes : 274  
 USED in MAP-MS-DataTypes : 130 296  
 USED in MAP-CommonDataTypes : 34  
 USED in MAP-CH-DataTypes : 64 142

naea-PreferredCI.....identifier of [10] NAEA-PreferredCI  
 DEFINED in MAP-CH-DataTypes : 142

naea-PreferredCIC.....identifier of [0] NAEA-CIC  
 DEFINED in MAP-CommonDataTypes : 275

negativePW-Check.....value reference NegativePW-Check, CHOICE VALUE  
 DEFINED in MAP-Protocol : 353

NegativePW-Check.....type reference ERROR  
 DEFINED in MAP-Errors : 320  
 USED in MAP-Protocol : 136 353  
 USED in MAP-SupplementaryServi : 46 138 157 229  
 USED in MAP-Errors : 65

netDetNotReachable.....identifier of NotReachableReason  
 DEFINED in MAP-MS-DataTypes : 935

networkAccessMode.....identifier of [24] NetworkAccessMode  
 DEFINED in MAP-MS-DataTypes : 301

NetworkAccessMode.....type reference ENUMERATED  
 DEFINED in MAP-MS-DataTypes : 306  
 USED in MAP-MS-DataTypes : 301

networkNode-AreaRestricted.....identifier of Named Number, 0  
 DEFINED in MAP-MS-DataTypes : 615

networkNode-Number.....identifier of [1] ISDN-AddressString  
 DEFINED in MAP-SM-DataTypes : 86

NetworkResource.....type reference ENUMERATED  
 DEFINED in MAP-CommonDataTypes : 264  
 USED in MAP-CommonDataTypes : 33  
 USED in MAP-ER-DataTypes : 60 155 162

```
networkResource.....identifier of NetworkResource
  DEFINED in MAP-ER-DataTypes      :    155

networkResource.....identifier of NetworkResource
  DEFINED in MAP-ER-DataTypes      :    162
```

42	TAG R4.21 Cross Reference Listing for MAP-Protocol	99-12-21 12:08:21 PAGE
	networkSignalInfo.....identifier of [10] ExternalSignalInfo DEFINED in MAP-CH-DataTypes : 97	
	networkSignalInfo.....identifier of [6] ExternalSignalInfo DEFINED in MAP-CH-DataTypes : 173	
	networkSignalInfo.....identifier of [4] ExternalSignalInfo DEFINED in MAP-SS-DataTypes : 287	
	newPassword.....identifier of Password DEFINED in MAP-SupplementaryServi : 221	
	newPasswordsMismatch.....identifier of Named Number, 2 DEFINED in MAP-ER-DataTypes : 122	
	noCUG-Restrictions.....identifier of Named Number, 0 DEFINED in MAP-MS-DataTypes : 554	
	noGroupCallNbParam.....identifier of NoGroupCallNbParam DEFINED in MAP-Errors : 360	
	NoGroupCallNbParam.....type reference SEQUENCE DEFINED in MAP-ER-DataTypes : 277 USED in MAP-Errors : 121 360 USED in MAP-ER-DataTypes : 45	
VALUE	noGroupCallNumberAvailable.....value reference NoGroupCallNumberAvailable, CHOICE DEFINED in MAP-Protocol : 340	
	NoGroupCallNumberAvailable.....type reference ERROR DEFINED in MAP-Errors : 358 USED in MAP-Protocol : 143 340 USED in MAP-Group-Call-Operati : 26 53 USED in MAP-Errors : 77	
VALUE	noHandoverNumberAvailable.....value reference NoHandoverNumberAvailable, CHOICE DEFINED in MAP-Protocol : 311	
	NoHandoverNumberAvailable.....type reference ERROR DEFINED in MAP-Errors : 224 USED in MAP-Protocol : 115 311 USED in MAP-MobileServiceOpera : 78 225 USED in MAP-Errors : 36	
	noPageResponse.....identifier of Named Number, 2 DEFINED in MAP-ER-DataTypes : 235	
	noReply.....identifier of Named Number, 2 DEFINED in MAP-CH-DataTypes : 119	
	noReplyConditionTime.....identifier of [7] Ext-NoRepCondTime DEFINED in MAP-MS-DataTypes : 457	
	noReplyConditionTime.....identifier of [5] NoReplyConditionTime DEFINED in MAP-SS-DataTypes : 74	
	NoReplyConditionTime.....type reference INTEGER DEFINED in MAP-SS-DataTypes : 78 USED in MAP-SS-DataTypes : 28 74 100	
	noReplyConditionTime.....identifier of [7] NoReplyConditionTime DEFINED in MAP-SS-DataTypes : 100	
	noResponseFromBusyMS.....identifier of Named Number, 3 DEFINED in MAP-CH-DataTypes : 382	
	noResponseFromFreeMS.....identifier of Named Number, 2 DEFINED in MAP-CH-DataTypes : 381	
	noRoamingNbParam.....identifier of NoRoamingNbParam DEFINED in MAP-Errors : 241	
	NoRoamingNbParam.....type reference SEQUENCE	

DEFINED in MAP-ER-DataTypes : 223  
USED in MAP-Errors : 107 241  
USED in MAP-ER-DataTypes : 33

noRoamingNumberAvailable.....value reference NoRoamingNumberAvailable, CHOICE

VALUE

DEFINED in MAP-Protocol : 324

NoRoamingNumberAvailable.....type reference ERROR

DEFINED in MAP-Errors : 239

43

TAG R4.21 Cross Reference Listing for MAP-Protocol 99-12-21 12:08:21 PAGE

USED in MAP-Protocol : 119 324  
 USED in MAP-CallHandlingOperat : 37 108  
 USED in MAP-Errors : 44

noSM-RP-DA.....identifier of [5] NULL  
 DEFINED in MAP-SM-DataTypes : 135

noSM-RP-OA.....identifier of [5] NULL  
 DEFINED in MAP-SM-DataTypes : 140

noSubscriberReply.....value reference NoSubscriberReply, CHOICE VALUE  
 DEFINED in MAP-Protocol : 327

NoSubscriberReply.....type reference ERROR  
 DEFINED in MAP-Errors : 256  
 USED in MAP-Protocol : 122 327  
 USED in MAP-CallHandlingOperat : 40 91  
 USED in MAP-Errors : 46

noSubscriberReplyParam.....identifier of NoSubscriberReplyParam  
 DEFINED in MAP-Errors : 258

NoSubscriberReplyParam.....type reference SEQUENCE  
 DEFINED in MAP-ER-DataTypes : 246  
 USED in MAP-Errors : 111 258  
 USED in MAP-ER-DataTypes : 36

noteMsPresentForGprs.....value reference NoteMsPresentForGprs, CHOICE VALUE  
 DEFINED in MAP-Protocol : 276

NoteMsPresentForGprs.....type reference OPERATION  
 DEFINED in MAP-MobileServiceOpera : 350  
 USED in MAP-Protocol : 33 276  
 USED in MAP-MobileServiceOpera : 58

noteMsPresentForGprsArg.....identifier of NoteMsPresentForGprsArg  
 DEFINED in MAP-MobileServiceOpera : 352

NoteMsPresentForGprsArg.....type reference SEQUENCE  
 DEFINED in MAP-MS-DataTypes : 816  
 USED in MAP-MobileServiceOpera : 116 352  
 USED in MAP-MS-DataTypes : 90

noteMsPresentForGprsRes.....identifier of NoteMsPresentForGprsRes  
 DEFINED in MAP-MobileServiceOpera : 354

NoteMsPresentForGprsRes.....type reference SEQUENCE  
 DEFINED in MAP-MS-DataTypes : 823  
 USED in MAP-MobileServiceOpera : 117 354  
 USED in MAP-MS-DataTypes : 91

notForwarded.....identifier of Named Number, 1  
 DEFINED in MAP-MS-DataTypes : 760

notProvidedFromVLR.....identifier of [2] NULL  
 DEFINED in MAP-MS-DataTypes : 936

notReachable.....identifier of Named Number, 0  
 DEFINED in MAP-CH-DataTypes : 117

NotReachableReason.....type reference ENUMERATED  
 DEFINED in MAP-MS-DataTypes : 938  
 USED in MAP-MS-DataTypes : 935

notRegistered.....identifier of Named Number, 3  
 DEFINED in MAP-MS-DataTypes : 942

not-derivable.....identifier of NULL  
 DEFINED in TCAPMessages : 168

numberChanged.....value reference NumberChanged, CHOICE VALUE  
 DEFINED in MAP-Protocol : 292

NumberChanged.....type reference ERROR  
 DEFINED in MAP-Errors : 175

USED in MAP-Protocol	:	106	292
USED in MAP-CallHandlingOperat	:	34	86
USED in MAP-Errors	:	23	

numberChangedParam.....identifier of NumberChangedParam  
DEFINED in MAP-Errors : 177



44 TAG R4.21 Cross Reference Listing for MAP-Protocol 99-12-21 12:08:21 PAGE

NumberChangedParam.....type reference SEQUENCE  
 DEFINED in MAP-ER-DataTypes : 195  
 USED in MAP-Errors : 99 177  
 USED in MAP-ER-DataTypes : 26

NumberOfForwarding.....type reference INTEGER  
 DEFINED in MAP-CH-DataTypes : 84  
 USED in MAP-CH-DataTypes : 20 89

numberOfForwarding.....identifier of [2] NumberOfForwarding  
 DEFINED in MAP-CH-DataTypes : 89

numberOfPW-AttemptsViolation.....value reference NumberOfPW-AttemptsViolation, CHOICE  
 VALUE  
 DEFINED in MAP-Protocol : 354

NumberOfPW-AttemptsViolation.....type reference ERROR  
 DEFINED in MAP-Errors : 322  
 USED in MAP-Protocol : 137 354  
 USED in MAP-SupplementaryServi : 47 139 158 230  
 USED in MAP-Errors : 66

odb-Data.....identifier of [8] ODB-Data  
 DEFINED in MAP-MS-DataTypes : 370

ODB-Data.....type reference SEQUENCE  
 DEFINED in MAP-MS-DataTypes : 395  
 USED in MAP-MS-DataTypes : 47 370

odb-GeneralData.....identifier of ODB-GeneralData  
 DEFINED in MAP-MS-DataTypes : 396

ODB-GeneralData.....type reference BIT STRING  
 DEFINED in MAP-MS-DataTypes : 401  
 USED in MAP-MS-DataTypes : 396 607

odb-GeneralData.....identifier of [4] ODB-GeneralData  
 DEFINED in MAP-MS-DataTypes : 607

odb-HPLMN-Data.....identifier of ODB-HPLMN-Data  
 DEFINED in MAP-MS-DataTypes : 397

ODB-HPLMN-Data.....type reference BIT STRING  
 DEFINED in MAP-MS-DataTypes : 420  
 USED in MAP-MS-DataTypes : 397

omc-Id.....identifier of [3] AddressString  
 DEFINED in MAP-OM-DataTypes : 40

onlyMSC.....identifier of Named Number, 1  
 DEFINED in MAP-MS-DataTypes : 308

onlySGSN.....identifier of Named Number, 2  
 DEFINED in MAP-MS-DataTypes : 309

operationCode.....identifier of OPERATION  
 DEFINED in TCAPMessages : 136  
 USED in TCAPMessages : 137

operationCode.....identifier of OPERATION  
 DEFINED in TCAPMessages : 147  
 USED in TCAPMessages : 148

operatorBarring.....identifier of Named Number, 1  
 DEFINED in MAP-ER-DataTypes : 94

operatorDeterminedBarring.....identifier of Named Number, 1  
 DEFINED in MAP-MS-DataTypes : 383

operatorDeterminedBarring.....identifier of Named Number, 3  
 DEFINED in MAP-ER-DataTypes : 83

OrigTransactionID.....type reference [APPLICATION 8] IMPLICIT  
 TransactionID  
 DEFINED in TCAPMessages : 97

```
USED in TCAPMessages           :      61   69
or-Capability.....identifier of [5] OR-Phase
  DEFINED in MAP-CH-DataTypes   :      92
or-Interrogation.....identifier of [4] NULL
  DEFINED in MAP-CH-DataTypes   :      91
or-Interrogation.....identifier of [10] NULL
```

```

DEFINED in MAP-CH-DataTypes      :    177

or-NotAllowed.....value reference OR-NotAllowed, CHOICE VALUE
  DEFINED in MAP-Protocol          :    330

OR-NotAllowed.....type reference ERROR
  DEFINED in MAP-Errors            :    281
  USED in MAP-Protocol             :   118   330
  USED in MAP-CallHandlingOperat :    32   84  106  117
  USED in MAP-Errors               :    43

or-NotAllowedParam.....identifier of OR-NotAllowedParam
  DEFINED in MAP-Errors            :    283

OR-NotAllowedParam.....type reference SEQUENCE
  DEFINED in MAP-ER-DataTypes      :    178
  USED in MAP-Errors               :   108  283
  USED in MAP-ER-DataTypes         :    24

OR-Phase.....type reference INTEGER
  DEFINED in MAP-CH-DataTypes      :    112
  USED in MAP-CH-DataTypes         :    92

otid.....identifier of OrigTransactionID
  DEFINED in TCAPMessages          :    61

otid.....identifier of OrigTransactionID
  DEFINED in TCAPMessages          :    69

overrideCategory.....identifier of [1] OverrideCategory
  DEFINED in MAP-SS-DataTypes      :   163

OverrideCategory.....type reference ENUMERATED
  DEFINED in MAP-SS-DataTypes      :   170
  USED in MAP-SS-DataTypes         :    26  163

overrideDisabled.....identifier of Named Number, 1
  DEFINED in MAP-SS-DataTypes      :   172

overrideEnabled.....identifier of Named Number, 0
  DEFINED in MAP-SS-DataTypes      :   171

O-BcsmCamelTDPCriteriaList.....type reference SEQUENCE OF
  DEFINED in MAP-MS-DataTypes      :   721
  USED in MAP-MS-DataTypes         :    52  659
  USED in MAP-CH-DataTypes         :    45  225

O-BcsmCamelTDPData.....type reference SEQUENCE
  DEFINED in MAP-MS-DataTypes      :   699
  USED in MAP-MS-DataTypes         :   691

o-BcsmCamelTDPDataList.....identifier of O-BcsmCamelTDPDataList
  DEFINED in MAP-MS-DataTypes      :   684

O-BcsmCamelTDPDataList.....type reference SEQUENCE OF
  DEFINED in MAP-MS-DataTypes      :   690
  USED in MAP-MS-DataTypes         :   684

O-BcsmCamelTDP-Criteria.....type reference SEQUENCE
  DEFINED in MAP-MS-DataTypes      :   724
  USED in MAP-MS-DataTypes         :   722

o-BcsmCamelTDP-CriteriaList.....identifier of [4] O-BcsmCamelTDPCriteriaList
  DEFINED in MAP-MS-DataTypes      :   659

o-BcsmCamelTDP-CriteriaList.....identifier of [3] O-BcsmCamelTDPCriteriaList
  DEFINED in MAP-CH-DataTypes      :   225

o-BcsmTriggerDetectionPoint.....identifier of O-BcsmTriggerDetectionPoint
  DEFINED in MAP-MS-DataTypes      :   700

O-BcsmTriggerDetectionPoint.....type reference ENUMERATED
  DEFINED in MAP-MS-DataTypes      :   710
  USED in MAP-MS-DataTypes         :   700  725

```

o-BcsmTriggerDetectionPoint.....identifier of O-BcsmTriggerDetectionPoint  
DEFINED in MAP-MS-DataTypes : 725

o-CSI.....identifier of [0] O-CSI  
DEFINED in MAP-MS-DataTypes : 655

O-CSI.....type reference SEQUENCE

46

TAG	R4.21	Cross Reference Listing for MAP-Protocol	99-12-21	12:08:21	PAGE
DEFINED	in MAP-MS-DataTypes	:	683		
USED	in MAP-MS-DataTypes	:	51	655	
USED	in MAP-CH-DataTypes	:	44	195	222
o-CSI	.....	identifier of [5] O-CSI			
DEFINED	in MAP-CH-DataTypes	:	195		
o-CSI	.....	identifier of [1] O-CSI			
DEFINED	in MAP-CH-DataTypes	:	222		
padAccessCA-1200bps	.....	value reference BearerServiceCode, '00100010'B			
DEFINED	in MAP-BS-Code	:	69		
padAccessCA-1200-75bps	.....	value reference BearerServiceCode, '00100011'B			
DEFINED	in MAP-BS-Code	:	70		
padAccessCA-2400bps	.....	value reference BearerServiceCode, '00100100'B			
DEFINED	in MAP-BS-Code	:	71		
padAccessCA-300bps	.....	value reference BearerServiceCode, '00100001'B			
DEFINED	in MAP-BS-Code	:	68		
padAccessCA-4800bps	.....	value reference BearerServiceCode, '00100101'B			
DEFINED	in MAP-BS-Code	:	72		
padAccessCA-9600bps	.....	value reference BearerServiceCode, '00100110'B			
DEFINED	in MAP-BS-Code	:	73		
parameter	.....	identifier of ANY DEFINED BY operationCode			
DEFINED	in TCAPMessages	:	137		
parameter	.....	identifier of ANY DEFINED BY operationCode			
DEFINED	in TCAPMessages	:	148		
parameter	.....	identifier of ANY DEFINED BY errorCode			
DEFINED	in TCAPMessages	:	159		
Password	.....	type reference NumericString			
DEFINED	in MAP-SS-DataTypes	:	230		
USED	in MAP-SupplementaryServi	:	66	221	238
USED	in MAP-SS-DataTypes	:	22		
pcs-Extensions	.....	identifier of [1] PCS-Extensions			
DEFINED	in MAP-ExtensionDataTypes	:	34		
PCS-Extensions	.....	type reference SEQUENCE			
DEFINED	in MAP-ExtensionDataTypes	:	56		
USED	in MAP-ExtensionDataTypes	:	34		
pdp-Address	.....	identifier of [17] PDP-Address			
DEFINED	in MAP-MS-DataTypes	:	322		
PDP-Address	.....	type reference OCTET STRING			
DEFINED	in MAP-MS-DataTypes	:	347		
USED	in MAP-MS-DataTypes	:	322		
PDP-Context	.....	type reference SEQUENCE			
DEFINED	in MAP-MS-DataTypes	:	319		
USED	in MAP-MS-DataTypes	:	315		
pdp-ContextId	.....	identifier of ContextId			
DEFINED	in MAP-MS-DataTypes	:	320		
pdp-Type	.....	identifier of [16] PDP-Type			
DEFINED	in MAP-MS-DataTypes	:	321		
PDP-Type	.....	type reference OCTET STRING			
DEFINED	in MAP-MS-DataTypes	:	344		
USED	in MAP-MS-DataTypes	:	321		
permanent	.....	identifier of Named Number, 0			
DEFINED	in MAP-SS-DataTypes	:	166		
phase1	.....	identifier of Named Number, 0			
DEFINED	in MAP-MS-DataTypes	:	781		

phase2.....identifier of Named Number, 1  
DEFINED in MAP-MS-DataTypes : 782

plmn.....identifier of Named Number, 0  
DEFINED in MAP-CommonDataTypes : 265

47 TAG R4.21 Cross Reference Listing for MAP-Protocol 99-12-21 12:08:21 PAGE

plmnRoamingNotAllowed.....	identifier of Named Number, 0
DEFINED in MAP-ER-DataTypes	: 82
plmn-SpecificBarringType1.....	identifier of Named Number, 0
DEFINED in MAP-MS-DataTypes	: 421
plmn-SpecificBarringType2.....	identifier of Named Number, 1
DEFINED in MAP-MS-DataTypes	: 422
plmn-SpecificBarringType3.....	identifier of Named Number, 2
DEFINED in MAP-MS-DataTypes	: 423
plmn-SpecificBarringType4.....	identifier of Named Number, 3
DEFINED in MAP-MS-DataTypes	: 424
plmn-specificBS-1.....	value reference BearerServiceCode, '11010001'B
DEFINED in MAP-BS-Code	: 111
plmn-specificBS-2.....	value reference BearerServiceCode, '11010010'B
DEFINED in MAP-BS-Code	: 112
plmn-specificBS-3.....	value reference BearerServiceCode, '11010011'B
DEFINED in MAP-BS-Code	: 113
plmn-specificBS-4.....	value reference BearerServiceCode, '11010100'B
DEFINED in MAP-BS-Code	: 114
plmn-specificBS-5.....	value reference BearerServiceCode, '11010101'B
DEFINED in MAP-BS-Code	: 115
plmn-specificBS-6.....	value reference BearerServiceCode, '11010110'B
DEFINED in MAP-BS-Code	: 116
plmn-specificBS-7.....	value reference BearerServiceCode, '11010111'B
DEFINED in MAP-BS-Code	: 117
plmn-specificBS-8.....	value reference BearerServiceCode, '11011000'B
DEFINED in MAP-BS-Code	: 118
plmn-specificBS-9.....	value reference BearerServiceCode, '11011001'B
DEFINED in MAP-BS-Code	: 119
plmn-specificBS-A.....	value reference BearerServiceCode, '11011010'B
DEFINED in MAP-BS-Code	: 120
plmn-specificBS-B.....	value reference BearerServiceCode, '11011011'B
DEFINED in MAP-BS-Code	: 121
plmn-specificBS-C.....	value reference BearerServiceCode, '11011100'B
DEFINED in MAP-BS-Code	: 122
plmn-specificBS-D.....	value reference BearerServiceCode, '11011101'B
DEFINED in MAP-BS-Code	: 123
plmn-specificBS-E.....	value reference BearerServiceCode, '11011110'B
DEFINED in MAP-BS-Code	: 124
plmn-specificBS-F.....	value reference BearerServiceCode, '11011111'B
DEFINED in MAP-BS-Code	: 125
plmn-specificSS-1.....	value reference SS-Code, '11110001'B
DEFINED in MAP-SS-Code	: 132
plmn-specificSS-2.....	value reference SS-Code, '11110010'B
DEFINED in MAP-SS-Code	: 133
plmn-specificSS-3.....	value reference SS-Code, '11110011'B
DEFINED in MAP-SS-Code	: 134
plmn-specificSS-4.....	value reference SS-Code, '11110100'B
DEFINED in MAP-SS-Code	: 135
plmn-specificSS-5.....	value reference SS-Code, '11110101'B
DEFINED in MAP-SS-Code	: 136

plmn-specificSS-6.....value reference SS-Code, '11110110'B  
DEFINED in MAP-SS-Code : 137

plmn-specificSS-7.....value reference SS-Code, '11110111'B  
DEFINED in MAP-SS-Code : 138

plmn-specificSS-8.....value reference SS-Code, '11111000'B



48	TAG	R4.21	Cross Reference Listing for MAP-Protocol	99-12-21	12:08:21	PAGE
	DEFINED in MAP-SS-Code	:	139			
	plmn-specificSS-9.....value	reference	SS-Code, '11111001'B			
	DEFINED in MAP-SS-Code	:	140			
	plmn-specificSS-A.....value	reference	SS-Code, '11111010'B			
	DEFINED in MAP-SS-Code	:	141			
	plmn-specificSS-B.....value	reference	SS-Code, '11111011'B			
	DEFINED in MAP-SS-Code	:	142			
	plmn-specificSS-C.....value	reference	SS-Code, '11111100'B			
	DEFINED in MAP-SS-Code	:	143			
	plmn-specificSS-D.....value	reference	SS-Code, '11111101'B			
	DEFINED in MAP-SS-Code	:	144			
	plmn-specificSS-E.....value	reference	SS-Code, '11111110'B			
	DEFINED in MAP-SS-Code	:	145			
	plmn-specificSS-F.....value	reference	SS-Code, '11111111'B			
	DEFINED in MAP-SS-Code	:	146			
	plmn-specificTS-1.....value	reference	TeleserviceCode, '11010001'B			
	DEFINED in MAP-TS-Code	:	73			
	plmn-specificTS-2.....value	reference	TeleserviceCode, '11010010'B			
	DEFINED in MAP-TS-Code	:	74			
	plmn-specificTS-3.....value	reference	TeleserviceCode, '11010011'B			
	DEFINED in MAP-TS-Code	:	75			
	plmn-specificTS-4.....value	reference	TeleserviceCode, '11010100'B			
	DEFINED in MAP-TS-Code	:	76			
	plmn-specificTS-5.....value	reference	TeleserviceCode, '11010101'B			
	DEFINED in MAP-TS-Code	:	77			
	plmn-specificTS-6.....value	reference	TeleserviceCode, '11010110'B			
	DEFINED in MAP-TS-Code	:	78			
	plmn-specificTS-7.....value	reference	TeleserviceCode, '11010111'B			
	DEFINED in MAP-TS-Code	:	79			
	plmn-specificTS-8.....value	reference	TeleserviceCode, '11011000'B			
	DEFINED in MAP-TS-Code	:	80			
	plmn-specificTS-9.....value	reference	TeleserviceCode, '11011001'B			
	DEFINED in MAP-TS-Code	:	81			
	plmn-specificTS-A.....value	reference	TeleserviceCode, '11011010'B			
	DEFINED in MAP-TS-Code	:	82			
	plmn-specificTS-B.....value	reference	TeleserviceCode, '11011011'B			
	DEFINED in MAP-TS-Code	:	83			
	plmn-specificTS-C.....value	reference	TeleserviceCode, '11011100'B			
	DEFINED in MAP-TS-Code	:	84			
	plmn-specificTS-D.....value	reference	TeleserviceCode, '11011101'B			
	DEFINED in MAP-TS-Code	:	85			
	plmn-specificTS-E.....value	reference	TeleserviceCode, '11011110'B			
	DEFINED in MAP-TS-Code	:	86			
	plmn-specificTS-F.....value	reference	TeleserviceCode, '11011111'B			
	DEFINED in MAP-TS-Code	:	87			
	preferentialCUG-Indicator.....identifier of CUG-Index					
	DEFINED in MAP-MS-DataTypes	:	570			
	premiumRateEntertainmentOGCallsBarred..identifier of Named Number, 4					
	DEFINED in MAP-MS-DataTypes	:	409			
	premiumRateInformationOGCallsBarred....identifier of Named Number, 3					

DEFINED in MAP-MS-DataTypes : 408

prepareGroupCall.....value reference PrepareGroupCall, CHOICE VALUE  
DEFINED in MAP-Protocol : 256

PrepareGroupCall.....type reference OPERATION  
DEFINED in MAP-Group-Call-Operati : 46

49 TAG R4.21 Cross Reference Listing for MAP-Protocol 99-12-21 12:08:21 PAGE

USED in MAP-Protocol : 92 256  
 USED in MAP-Group-Call-Operati : 13

prepareGroupCallArg.....identifier of PrepareGroupCallArg  
 DEFINED in MAP-Group-Call-Operati : 48

PrepareGroupCallArg.....type reference SEQUENCE  
 DEFINED in MAP-GR-DataTypes : 49  
 USED in MAP-Group-Call-Operati : 31 48  
 USED in MAP-GR-DataTypes : 14

prepareGroupCallRes.....identifier of PrepareGroupCallRes  
 DEFINED in MAP-Group-Call-Operati : 50

PrepareGroupCallRes.....type reference SEQUENCE  
 DEFINED in MAP-GR-DataTypes : 61  
 USED in MAP-Group-Call-Operati : 32 50  
 USED in MAP-GR-DataTypes : 15

prepareHandover.....value reference PrepareHandover, CHOICE VALUE  
 DEFINED in MAP-Protocol : 163

PrepareHandover.....type reference OPERATION  
 DEFINED in MAP-MobileServiceOpera : 216  
 USED in MAP-Protocol : 17 163  
 USED in MAP-MobileServiceOpera : 30

prepareHO-Arg.....identifier of PrepareHO-Arg  
 DEFINED in MAP-MobileServiceOpera : 218

PrepareHO-Arg.....type reference SEQUENCE  
 DEFINED in MAP-MS-DataTypes : 257  
 USED in MAP-MobileServiceOpera : 95 218  
 USED in MAP-MS-DataTypes : 29

prepareHO-Res.....identifier of PrepareHO-Res  
 DEFINED in MAP-MobileServiceOpera : 220

PrepareHO-Res.....type reference SEQUENCE  
 DEFINED in MAP-MS-DataTypes : 263  
 USED in MAP-MobileServiceOpera : 96 220  
 USED in MAP-MS-DataTypes : 30

prepareSubsequentHandover.....value reference PrepareSubsequentHandover, CHOICE  
 VALUE  
 DEFINED in MAP-Protocol : 167

PrepareSubsequentHandover.....type reference OPERATION  
 DEFINED in MAP-MobileServiceOpera : 240  
 USED in MAP-Protocol : 21 167  
 USED in MAP-MobileServiceOpera : 34

prepareSubsequentHO-Arg.....identifier of PrepareSubsequentHO-Arg  
 DEFINED in MAP-MobileServiceOpera : 242

PrepareSubsequentHO-Arg.....type reference SEQUENCE  
 DEFINED in MAP-MS-DataTypes : 268  
 USED in MAP-MobileServiceOpera : 97 242  
 USED in MAP-MS-DataTypes : 31

priority.....identifier of [2] EMLPP-Priority  
 DEFINED in MAP-GR-DataTypes : 56

priorityLevel0.....value reference EMLPP-Priority, 0  
 DEFINED in MAP-CommonDataTypes : 334

priorityLevel1.....value reference EMLPP-Priority, 1  
 DEFINED in MAP-CommonDataTypes : 335

priorityLevel2.....value reference EMLPP-Priority, 2  
 DEFINED in MAP-CommonDataTypes : 336

priorityLevel3.....value reference EMLPP-Priority, 3  
 DEFINED in MAP-CommonDataTypes : 337

priorityLevel4.....value reference EMLPP-Priority, 4  
DEFINED in MAP-CommonDataTypes : 338

priorityLevelA.....value reference EMLPP-Priority, 6  
DEFINED in MAP-CommonDataTypes : 332

priorityLevelB.....value reference EMLPP-Priority, 5  
DEFINED in MAP-CommonDataTypes : 333

50 TAG R4.21 Cross Reference Listing for MAP-Protocol 99-12-21 12:08:21 PAGE

PrivateExtension.....type reference SEQUENCE  
 DEFINED in MAP-ExtensionDataTypes : 40  
 USED in MAP-ExtensionDataTypes : 15 38

privateExtensionList.....identifier of [0] PrivateExtensionList  
 DEFINED in MAP-ExtensionDataTypes : 33

PrivateExtensionList.....type reference SEQUENCE OF  
 DEFINED in MAP-ExtensionDataTypes : 37  
 USED in MAP-ExtensionDataTypes : 33

problem.....identifier of CHOICE  
 DEFINED in TCAPMessages : 169

processAccessSignalling.....value reference ProcessAccessSignalling, CHOICE VALUE  
 DEFINED in MAP-Protocol : 165

ProcessAccessSignalling.....type reference OPERATION  
 DEFINED in MAP-MobileServiceOpera : 232  
 USED in MAP-Protocol : 19 165  
 USED in MAP-MobileServiceOpera : 32

processGroupCallSignalling.....value reference ProcessGroupCallSignalling, CHOICE  
 VALUE DEFINED in MAP-Protocol : 258

ProcessGroupCallSignalling.....type reference OPERATION  
 DEFINED in MAP-Group-Call-Operati : 63  
 USED in MAP-Protocol : 93 258  
 USED in MAP-Group-Call-Operati : 16

processGroupCallSignallingArg.....identifier of ProcessGroupCallSignallingArg  
 DEFINED in MAP-Group-Call-Operati : 65

ProcessGroupCallSignallingArg.....type reference SEQUENCE  
 DEFINED in MAP-GR-DataTypes : 85  
 USED in MAP-Group-Call-Operati : 36 65  
 USED in MAP-GR-DataTypes : 19

processUnstructuredSS-Request.....value reference ProcessUnstructuredSS-Request, CHOICE  
 VALUE DEFINED in MAP-Protocol : 221

ProcessUnstructuredSS-Request.....type reference OPERATION  
 DEFINED in MAP-SupplementaryServi : 175  
 USED in MAP-Protocol : 67 221  
 USED in MAP-SupplementaryServi : 18

protocolId.....identifier of ProtocolId  
 DEFINED in MAP-CommonDataTypes : 169

ProtocolId.....type reference ENUMERATED  
 DEFINED in MAP-CommonDataTypes : 187  
 USED in MAP-CommonDataTypes : 169

provideRoamingNumber.....value reference ProvideRoamingNumber, CHOICE VALUE  
 DEFINED in MAP-Protocol : 205

ProvideRoamingNumber.....type reference OPERATION  
 DEFINED in MAP-CallHandlingOperat : 96  
 USED in MAP-Protocol : 50 205  
 USED in MAP-CallHandlingOperat : 14

provideRoamingNumberArg.....identifier of ProvideRoamingNumberArg  
 DEFINED in MAP-CallHandlingOperat : 98

ProvideRoamingNumberArg.....type reference SEQUENCE  
 DEFINED in MAP-CH-DataTypes : 167  
 USED in MAP-CallHandlingOperat : 54 98  
 USED in MAP-CH-DataTypes : 16

provideRoamingNumberRes.....identifier of ProvideRoamingNumberRes  
 DEFINED in MAP-CallHandlingOperat : 100

ProvideRoamingNumberRes.....type reference SEQUENCE  
  DEFINED in MAP-CH-DataTypes : 184  
  USED in MAP-CallHandlingOperat : 55 100  
  USED in MAP-CH-DataTypes : 17

provideSIWFSNumber.....value reference ProvideSIWFSNumber, CHOICE VALUE  
  DEFINED in MAP-Protocol : 207

ProvideSIWFSNumber.....type reference OPERATION

51 TAG R4.21 Cross Reference Listing for MAP-Protocol 99-12-21 12:08:21 PAGE

DEFINED in MAP-CallHandlingOperat : 120  
 USED in MAP-Protocol : 52 207  
 USED in MAP-CallHandlingOperat : 16

provideSIWFSNumberArg.....identifier of ProvideSIWFSNumberArg  
 DEFINED in MAP-CallHandlingOperat : 122

ProvideSIWFSNumberArg.....type reference SEQUENCE  
 DEFINED in MAP-CH-DataTypes : 258  
 USED in MAP-CallHandlingOperat : 58 122  
 USED in MAP-CH-DataTypes : 23

provideSIWFSNumberRes.....identifier of ProvideSIWFSNumberRes  
 DEFINED in MAP-CallHandlingOperat : 124

ProvideSIWFSNumberRes.....type reference SEQUENCE  
 DEFINED in MAP-CH-DataTypes : 277  
 USED in MAP-CallHandlingOperat : 59 124  
 USED in MAP-CH-DataTypes : 24

provideSubscriberInfo.....value reference ProvideSubscriberInfo, CHOICE VALUE  
 DEFINED in MAP-Protocol : 243

ProvideSubscriberInfo.....type reference OPERATION  
 DEFINED in MAP-MobileServiceOpera : 191  
 USED in MAP-Protocol : 29 243  
 USED in MAP-MobileServiceOpera : 24

provideSubscriberInfoArg.....identifier of ProvideSubscriberInfoArg  
 DEFINED in MAP-MobileServiceOpera : 193

ProvideSubscriberInfoArg.....type reference SEQUENCE  
 DEFINED in MAP-MS-DataTypes : 877  
 USED in MAP-MobileServiceOpera : 108 193  
 USED in MAP-MS-DataTypes : 71

provideSubscriberInfoRes.....identifier of ProvideSubscriberInfoRes  
 DEFINED in MAP-MobileServiceOpera : 195

ProvideSubscriberInfoRes.....type reference SEQUENCE  
 DEFINED in MAP-MS-DataTypes : 884  
 USED in MAP-MobileServiceOpera : 109 195  
 USED in MAP-MS-DataTypes : 72

provisionedSS.....identifier of [7] Ext-SS-InfoList  
 DEFINED in MAP-MS-DataTypes : 369

purgeMS.....value reference PurgeMS, CHOICE VALUE  
 DEFINED in MAP-Protocol : 157

PurgeMS.....type reference OPERATION  
 DEFINED in MAP-MobileServiceOpera : 156  
 USED in MAP-Protocol : 14 157  
 USED in MAP-MobileServiceOpera : 17

purgeMS-Arg.....identifier of PurgeMS-Arg  
 DEFINED in MAP-MobileServiceOpera : 158

PurgeMS-Arg.....type reference [3] SEQUENCE  
 DEFINED in MAP-MS-DataTypes : 198  
 USED in MAP-MobileServiceOpera : 90 158  
 USED in MAP-MS-DataTypes : 20

purgeMS-Res.....identifier of PurgeMS-Res  
 DEFINED in MAP-MobileServiceOpera : 160

PurgeMS-Res.....type reference SEQUENCE  
 DEFINED in MAP-MS-DataTypes : 205  
 USED in MAP-MobileServiceOpera : 91 160  
 USED in MAP-MS-DataTypes : 21

pvlr.....identifier of Named Number, 3  
 DEFINED in MAP-CommonDataTypes : 268

pw-RegistrationFailure.....value reference PW-RegistrationFailure, CHOICE VALUE

```
DEFINED in MAP-Protocol          :    352
PW-RegistrationFailure.....type reference ERROR
DEFINED in MAP-Errors            :    316
USED in MAP-Protocol             :    135    352
USED in MAP-SupplementaryServi  :     45    228
USED in MAP-Errors               :     64
```



pw-RegistrationFailureCause.....identifier of PW-RegistrationFailureCause  
 DEFINED in MAP-Errors : 318

PW-RegistrationFailureCause.....type reference ENUMERATED  
 DEFINED in MAP-ER-DataTypes : 119  
 USED in MAP-Errors : 92 318  
 USED in MAP-ER-DataTypes : 18

p-abortCause.....identifier of P-AbortCause  
 DEFINED in TCAPMessages : 76

P-AbortCause.....type reference [APPLICATION 10] IMPLICIT INTEGER  
 DEFINED in TCAPMessages : 102  
 USED in TCAPMessages : 76

qos-Subscribed.....identifier of [18] QoS-Subscribed  
 DEFINED in MAP-MS-DataTypes : 323

QoS-Subscribed.....type reference OCTET STRING  
 DEFINED in MAP-MS-DataTypes : 355  
 USED in MAP-MS-DataTypes : 323

rand.....identifier of RAND  
 DEFINED in MAP-MS-DataTypes : 227

RAND.....type reference OCTET STRING  
 DEFINED in MAP-MS-DataTypes : 232  
 USED in MAP-MS-DataTypes : 227

readyForSM.....value reference ReadyForSM, CHOICE VALUE  
 DEFINED in MAP-Protocol : 239

ReadyForSM.....type reference OPERATION  
 DEFINED in MAP-ShortMessageServic : 137  
 USED in MAP-Protocol : 86 239  
 USED in MAP-ShortMessageServic : 19

readyForSM-Arg.....identifier of ReadyForSM-Arg  
 DEFINED in MAP-ShortMessageServic : 139

ReadyForSM-Arg.....type reference SEQUENCE  
 DEFINED in MAP-SM-DataTypes : 192  
 USED in MAP-ShortMessageServic : 56 139  
 USED in MAP-SM-DataTypes : 24

readyForSM-Res.....identifier of ReadyForSM-Res  
 DEFINED in MAP-ShortMessageServic : 141

ReadyForSM-Res.....type reference SEQUENCE  
 DEFINED in MAP-SM-DataTypes : 201  
 USED in MAP-ShortMessageServic : 57 141  
 USED in MAP-SM-DataTypes : 25

reason.....identifier of CHOICE  
 DEFINED in TCAPMessages : 75

regionalSubscNotSupported.....identifier of Named Number, 3  
 DEFINED in MAP-MS-DataTypes : 618

regionalSubscriptionData.....identifier of [10] ZoneCodeList  
 DEFINED in MAP-MS-DataTypes : 372

regionalSubscriptionIdentifier.....identifier of [5] ZoneCode  
 DEFINED in MAP-MS-DataTypes : 627

regionalSubscriptionResponse.....identifier of [5] RegionalSubscriptionResponse  
 DEFINED in MAP-MS-DataTypes : 608

RegionalSubscriptionResponse.....type reference ENUMERATED  
 DEFINED in MAP-MS-DataTypes : 614  
 USED in MAP-MS-DataTypes : 609 650

regionalSubscriptionResponse.....identifier of [0] RegionalSubscriptionResponse  
 DEFINED in MAP-MS-DataTypes : 649

```
registerCC-Entry.....value reference RegisterCC-Entry, CHOICE VALUE
  DEFINED in MAP-Protocol      :      227

RegisterCC-Entry.....type reference OPERATION
  DEFINED in MAP-SupplementaryServi :      251
  USED in MAP-Protocol              :      73      227
```

53

TAG R4.21 Cross Reference Listing for MAP-Protocol 99-12-21 12:08:21 PAGE

```

USED in MAP-SupplementaryServi : 24

registerCC-EntryArg.....identifier of RegisterCC-EntryArg
  DEFINED in MAP-SupplementaryServi : 253

RegisterCC-EntryArg.....type reference SEQUENCE
  DEFINED in MAP-SS-DataTypes : 277
  USED in MAP-SupplementaryServi : 70 253
  USED in MAP-SS-DataTypes : 35

registerCC-EntryRes.....identifier of RegisterCC-EntryRes
  DEFINED in MAP-SupplementaryServi : 255

RegisterCC-EntryRes.....type reference SEQUENCE
  DEFINED in MAP-SS-DataTypes : 296
  USED in MAP-SupplementaryServi : 71 255
  USED in MAP-SS-DataTypes : 36

registerPassword.....value reference RegisterPassword, CHOICE VALUE
  DEFINED in MAP-Protocol : 225

RegisterPassword.....type reference OPERATION
  DEFINED in MAP-SupplementaryServi : 217
  USED in MAP-Protocol : 70 225
  USED in MAP-SupplementaryServi : 21

registerSS.....value reference RegisterSS, CHOICE VALUE
  DEFINED in MAP-Protocol : 216

RegisterSS.....type reference OPERATION
  DEFINED in MAP-SupplementaryServi : 87
  USED in MAP-Protocol : 62 216
  USED in MAP-SupplementaryServi : 13

registerSS-Arg.....identifier of RegisterSS-Arg
  DEFINED in MAP-SupplementaryServi : 89

RegisterSS-Arg.....type reference SEQUENCE
  DEFINED in MAP-SS-DataTypes : 69
  USED in MAP-SupplementaryServi : 60 89
  USED in MAP-SS-DataTypes : 14

reject.....identifier of [4] IMPLICIT Reject
  DEFINED in TCAPMessages : 128

Reject.....type reference SEQUENCE
  DEFINED in TCAPMessages : 165
  USED in TCAPMessages : 128

rejected.....identifier of Named Number, 1
  DEFINED in MAP-CH-DataTypes : 380

releaseCall.....identifier of Named Number, 1
  DEFINED in MAP-MS-DataTypes : 769

releaseGroupCall.....identifier of [2] NULL
  DEFINED in MAP-GR-DataTypes : 88

remoteUserFree.....value reference RemoteUserFree, CHOICE VALUE
  DEFINED in MAP-Protocol : 211

RemoteUserFree.....type reference OPERATION
  DEFINED in MAP-CallHandlingOperat : 169
  USED in MAP-Protocol : 56 211
  USED in MAP-CallHandlingOperat : 20

remoteUserFreeArg.....identifier of RemoteUserFreeArg
  DEFINED in MAP-CallHandlingOperat : 171

RemoteUserFreeArg.....type reference SEQUENCE
  DEFINED in MAP-CH-DataTypes : 363
  USED in MAP-CallHandlingOperat : 66 171
  USED in MAP-CH-DataTypes : 31

remoteUserFreeRes.....identifier of RemoteUserFreeRes

```

```
DEFINED in MAP-CallHandlingOperat : 173
RemoteUserFreeRes.....type reference SEQUENCE
  DEFINED in MAP-CH-DataTypes : 373
  USED in MAP-CallHandlingOperat : 67 173
  USED in MAP-CH-DataTypes : 32
```

TAG R4.21 Cross Reference Listing for MAP-Protocol 99-12-21 12:08:21 PAGE

replaceB-Number.....identifier of [4] NULL  
 DEFINED in MAP-CH-DataTypes : 368

ReportingState.....type reference ENUMERATED  
 DEFINED in MAP-CH-DataTypes : 300  
 USED in MAP-CH-DataTypes : 296

reportSM-DeliveryStatus.....value reference ReportSM-DeliveryStatus, CHOICE VALUE  
 DEFINED in MAP-Protocol : 236

ReportSM-DeliveryStatus.....type reference OPERATION  
 DEFINED in MAP-ShortMessageServic : 112  
 USED in MAP-Protocol : 83 236  
 USED in MAP-ShortMessageServic : 16

reportSM-DeliveryStatusArg.....identifier of ReportSM-DeliveryStatusArg  
 DEFINED in MAP-ShortMessageServic : 114

ReportSM-DeliveryStatusArg.....type reference SEQUENCE  
 DEFINED in MAP-SM-DataTypes : 142  
 USED in MAP-ShortMessageServic : 52 114  
 USED in MAP-SM-DataTypes : 20

reportSM-DeliveryStatusRes.....identifier of ReportSM-DeliveryStatusRes  
 DEFINED in MAP-ShortMessageServic : 116

ReportSM-DeliveryStatusRes.....type reference SEQUENCE  
 DEFINED in MAP-SM-DataTypes : 167  
 USED in MAP-ShortMessageServic : 53 116  
 USED in MAP-SM-DataTypes : 21

requestedBasicServiceViolatesCUG-Constraidentifier of Named Number, 5  
 DEFINED in MAP-ER-DataTypes : 110

requestedInfo.....identifier of [2] RequestedInfo  
 DEFINED in MAP-MS-DataTypes : 880

RequestedInfo.....type reference SEQUENCE  
 DEFINED in MAP-MS-DataTypes : 895  
 USED in MAP-MS-DataTypes : 880 948

requestedInfo.....identifier of [1] RequestedInfo  
 DEFINED in MAP-MS-DataTypes : 948

reset.....value reference Reset, CHOICE VALUE  
 DEFINED in MAP-Protocol : 189

Reset.....type reference OPERATION  
 DEFINED in MAP-MobileServiceOpera : 303  
 USED in MAP-Protocol : 26 189  
 USED in MAP-MobileServiceOpera : 47

resetArg.....identifier of ResetArg  
 DEFINED in MAP-MobileServiceOpera : 305

ResetArg.....type reference SEQUENCE  
 DEFINED in MAP-MS-DataTypes : 830  
 USED in MAP-MobileServiceOpera : 105 305  
 USED in MAP-MS-DataTypes : 66

resourceLimitation.....value reference ResourceLimitation, CHOICE VALUE  
 DEFINED in MAP-Protocol : 286

ResourceLimitation.....type reference ERROR  
 DEFINED in MAP-Errors : 162  
 USED in MAP-Protocol : 142 286  
 USED in MAP-CallHandlingOperat : 45 126 138 154  
 USED in MAP-Errors : 19

resourceLimitation.....identifier of Named Number, 4  
 DEFINED in TCAPMessages : 107

resourceLimitation.....identifier of Named Number, 3  
 DEFINED in TCAPMessages : 186

```
resourceLimitationParam.....identifier of ResourceLimitationParam
  DEFINED in MAP-Errors          :    164

ResourceLimitationParam.....type reference SEQUENCE
  DEFINED in MAP-ER-DataTypes    :    273
  USED in MAP-Errors             :    120  164
  USED in MAP-ER-DataTypes      :     44
```

```

restoreData.....value reference RestoreData, CHOICE VALUE
  DEFINED in MAP-Protocol      :    192

RestoreData.....type reference OPERATION
  DEFINED in MAP-MobileServiceOpera :    309
  USED in MAP-Protocol          :    28   192
  USED in MAP-MobileServiceOpera :    49

restoreDataArg.....identifier of RestoreDataArg
  DEFINED in MAP-MobileServiceOpera :    311

RestoreDataArg.....type reference SEQUENCE
  DEFINED in MAP-MS-DataTypes      :    835
  USED in MAP-MobileServiceOpera   :   106   311
  USED in MAP-MS-DataTypes         :    67

restoreDataRes.....identifier of RestoreDataRes
  DEFINED in MAP-MobileServiceOpera :    313

RestoreDataRes.....type reference SEQUENCE
  DEFINED in MAP-MS-DataTypes      :    842
  USED in MAP-MobileServiceOpera   :   107   313
  USED in MAP-MS-DataTypes         :    68

restrictedArea.....identifier of Named Number, 2
  DEFINED in MAP-MS-DataTypes      :    941

restrictedArea.....identifier of Named Number, 1
  DEFINED in MAP-ER-DataTypes      :    234

result-RR.....identifier of SEQUENCE
  DEFINED in TCAPMessages          :    146

resumeCallHandling.....value reference ResumeCallHandling, CHOICE VALUE
  DEFINED in MAP-Protocol          :    206

ResumeCallHandling.....type reference OPERATION
  DEFINED in MAP-CallHandlingOperat :    110
  USED in MAP-Protocol             :    51   206
  USED in MAP-CallHandlingOperat   :    15

resumeCallHandlingArg.....identifier of ResumeCallHandlingArg
  DEFINED in MAP-CallHandlingOperat :    112

ResumeCallHandlingArg.....type reference SEQUENCE
  DEFINED in MAP-CH-DataTypes      :    189
  USED in MAP-CallHandlingOperat   :    56   112
  USED in MAP-CH-DataTypes         :    18

resumeCallHandlingRes.....identifier of ResumeCallHandlingRes
  DEFINED in MAP-CallHandlingOperat :    114

ResumeCallHandlingRes.....type reference SEQUENCE
  DEFINED in MAP-CH-DataTypes      :    200
  USED in MAP-CallHandlingOperat   :    57   114
  USED in MAP-CH-DataTypes         :    19

returnError.....identifier of [3] IMPLICIT ReturnError
  DEFINED in TCAPMessages          :    127

ReturnError.....type reference SEQUENCE
  DEFINED in TCAPMessages          :    156
  USED in TCAPMessages            :    127

returnErrorProblem.....identifier of [3] IMPLICIT ReturnErrorProblem
  DEFINED in TCAPMessages          :    173

ReturnErrorProblem.....type reference INTEGER
  DEFINED in TCAPMessages          :    196
  USED in TCAPMessages            :    173

returnErrorUnexpected.....identifier of Named Number, 1
  DEFINED in TCAPMessages          :    197

```

```
ReturnResult.....type reference SEQUENCE
  DEFINED in TCAPMessages      :    144
  USED in TCAPMessages         :    126  129

returnResultLast.....identifier of [2] IMPLICIT ReturnResult
  DEFINED in TCAPMessages      :    126
```



```

returnResultNotLast.....identifier of [7] IMPLICIT ReturnResult
  DEFINED in TCAPMessages      :    129

returnResultProblem.....identifier of [2] IMPLICIT ReturnResultProblem
  DEFINED in TCAPMessages      :    172

ReturnResultProblem.....type reference INTEGER
  DEFINED in TCAPMessages      :    192
  USED in TCAPMessages        :    172

returnResultUnexpected.....identifier of Named Number, 1
  DEFINED in TCAPMessages      :    193

roamingNotAllowed.....value reference RoamingNotAllowed, CHOICE VALUE
  DEFINED in MAP-Protocol      :    300

RoamingNotAllowed.....type reference ERROR
  DEFINED in MAP-Errors        :    193
  USED in MAP-Protocol        :    110    300
  USED in MAP-MobileServiceOpera :    76    144    187
  USED in MAP-Errors          :    29

roamingNotAllowedCause.....identifier of RoamingNotAllowedCause
  DEFINED in MAP-ER-DataTypes  :    77

RoamingNotAllowedCause.....type reference ENUMERATED
  DEFINED in MAP-ER-DataTypes  :    81
  USED in MAP-ER-DataTypes    :    77

roamingNotAllowedParam.....identifier of RoamingNotAllowedParam
  DEFINED in MAP-Errors        :    195

RoamingNotAllowedParam.....type reference SEQUENCE
  DEFINED in MAP-ER-DataTypes  :    76
  USED in MAP-Errors          :    101    195
  USED in MAP-ER-DataTypes    :    14

roamingNumber.....identifier of ISDN-AddressString
  DEFINED in MAP-CH-DataTypes  :    154

roamingNumber.....identifier of ISDN-AddressString
  DEFINED in MAP-CH-DataTypes  :    185

roamingRestrictedInSgsnDueToUnsupportedFidentifier of [23] NULL
  DEFINED in MAP-MS-DataTypes  :    299

roamingRestrictedInSgsnDueToUnsuppportedidentifier of [11] NULL
  DEFINED in MAP-MS-DataTypes  :    634

roamingRestrictionDueToUnsupportedFeaturidentifier of [9] NULL
  DEFINED in MAP-MS-DataTypes  :    371

roamingRestrictionDueToUnsupportedFeaturidentifier of [4] NULL
  DEFINED in MAP-MS-DataTypes  :    626

RoutingInfo.....type reference CHOICE
  DEFINED in MAP-CH-DataTypes  :    153
  USED in MAP-CH-DataTypes    :    211

routingInfo.....identifier of RoutingInfo
  DEFINED in MAP-CH-DataTypes  :    211

routingInfoForSM-Arg.....identifier of RoutingInfoForSM-Arg
  DEFINED in MAP-ShortMessageServic :    69

RoutingInfoForSM-Arg.....type reference SEQUENCE
  DEFINED in MAP-SM-DataTypes  :    52
  USED in MAP-ShortMessageServic :    46    69
  USED in MAP-SM-DataTypes    :    14

routingInfoForSM-Res.....identifier of RoutingInfoForSM-Res
  DEFINED in MAP-ShortMessageServic :    71

RoutingInfoForSM-Res.....type reference SEQUENCE
  DEFINED in MAP-SM-DataTypes  :    79

```

```
USED in MAP-ShortMessageServic : 47 71
USED in MAP-SM-DataTypes       : 15

rss.....identifier of Named Number, 7
  DEFINED in MAP-CommonDataTypes : 272

ruf-Outcome.....identifier of [0] RUF-Outcome
```

```

DEFINED in MAP-CH-DataTypes      : 374

RUF-Outcome.....type reference ENUMERATED
  DEFINED in MAP-CH-DataTypes    : 378
  USED in MAP-CH-DataTypes      : 374

sc-AddressNotIncluded.....identifier of Named Number, 0
  DEFINED in MAP-SM-DataTypes    : 185

sc-Congestion.....identifier of Named Number, 4
  DEFINED in MAP-ER-DataTypes    : 130

sendAuthenticationInfo.....value reference SendAuthenticationInfo, CHOICE VALUE
  DEFINED in MAP-Protocol        : 173

SendAuthenticationInfo.....type reference OPERATION
  DEFINED in MAP-MobileServiceOpera : 253
  USED in MAP-Protocol            : 22 173
  USED in MAP-MobileServiceOpera : 37

sendAuthenticationInfoArg.....identifier of SendAuthenticationInfoArg
  DEFINED in MAP-MobileServiceOpera : 255

SendAuthenticationInfoArg.....type reference IMSI
  DEFINED in MAP-MS-DataTypes     : 276
  USED in MAP-MobileServiceOpera  : 98 255
  USED in MAP-MS-DataTypes       : 34

sendAuthenticationInfoRes.....identifier of SendAuthenticationInfoRes
  DEFINED in MAP-MobileServiceOpera : 257

SendAuthenticationInfoRes.....type reference AuthenticationSetList
  DEFINED in MAP-MS-DataTypes     : 278
  USED in MAP-MobileServiceOpera  : 99 257
  USED in MAP-MS-DataTypes       : 35

sendEndSignal.....value reference SendEndSignal, CHOICE VALUE
  DEFINED in MAP-Protocol         : 164

SendEndSignal.....type reference OPERATION
  DEFINED in MAP-MobileServiceOpera : 227
  USED in MAP-Protocol             : 18 164
  USED in MAP-MobileServiceOpera  : 31

sendGroupCallEndSignal.....value reference SendGroupCallEndSignal, CHOICE VALUE
  DEFINED in MAP-Protocol         : 257

SendGroupCallEndSignal.....type reference OPERATION
  DEFINED in MAP-Group-Call-Operati : 56
  USED in MAP-Protocol             : 95 257
  USED in MAP-Group-Call-Operati  : 14

sendGroupCallEndSignalArg.....identifier of SendGroupCallEndSignalArg
  DEFINED in MAP-Group-Call-Operati : 58

SendGroupCallEndSignalArg.....type reference SEQUENCE
  DEFINED in MAP-GR-DataTypes     : 66
  USED in MAP-Group-Call-Operati  : 33 58
  USED in MAP-GR-DataTypes       : 16

sendGroupCallEndSignalRes.....identifier of SendGroupCallEndSignalRes
  DEFINED in MAP-Group-Call-Operati : 60

SendGroupCallEndSignalRes.....type reference SEQUENCE
  DEFINED in MAP-GR-DataTypes     : 71
  USED in MAP-Group-Call-Operati  : 34 60
  USED in MAP-GR-DataTypes       : 17

sendIdentification.....value reference SendIdentification, CHOICE VALUE
  DEFINED in MAP-Protocol         : 158

SendIdentification.....type reference OPERATION
  DEFINED in MAP-MobileServiceOpera : 167
  USED in MAP-Protocol             : 15 158
  USED in MAP-MobileServiceOpera  : 18

```

```
sendIdentificationRes.....identifier of SendIdentificationRes
  DEFINED in MAP-MobileServiceOpera :    171

SendIdentificationRes.....type reference SEQUENCE
  DEFINED in MAP-MS-DataTypes       :    218
  USED in MAP-MobileServiceOpera    :    92   171
```

58

TAG R4.21 Cross Reference Listing for MAP-Protocol 99-12-21 12:08:21 PAGE

USED in MAP-MS-DataTypes : 22

sendIMSI.....value reference SendIMSI, CHOICE VALUE  
 DEFINED in MAP-Protocol : 199

SendIMSI.....type reference OPERATION  
 DEFINED in MAP-OperationAndMainte : 77  
 USED in MAP-Protocol : 43 199  
 USED in MAP-OperationAndMainte : 15

sendRoutingInfo.....value reference SendRoutingInfo, CHOICE VALUE  
 DEFINED in MAP-Protocol : 204

SendRoutingInfo.....type reference OPERATION  
 DEFINED in MAP-CallHandlingOperat : 74  
 USED in MAP-Protocol : 49 204  
 USED in MAP-CallHandlingOperat : 13

sendRoutingInfoArg.....identifier of SendRoutingInfoArg  
 DEFINED in MAP-CallHandlingOperat : 76

SendRoutingInfoArg.....type reference SEQUENCE  
 DEFINED in MAP-CH-DataTypes : 86  
 USED in MAP-CallHandlingOperat : 52 76  
 USED in MAP-CH-DataTypes : 14

sendRoutingInfoForGprs.....value reference SendRoutingInfoForGprs, CHOICE VALUE  
 DEFINED in MAP-Protocol : 268

SendRoutingInfoForGprs.....type reference OPERATION  
 DEFINED in MAP-MobileServiceOpera : 322  
 USED in MAP-Protocol : 31 268  
 USED in MAP-MobileServiceOpera : 52

sendRoutingInfoForGprsArg.....identifier of SendRoutingInfoForGprsArg  
 DEFINED in MAP-MobileServiceOpera : 324

SendRoutingInfoForGprsArg.....type reference SEQUENCE  
 DEFINED in MAP-MS-DataTypes : 787  
 USED in MAP-MobileServiceOpera : 112 324  
 USED in MAP-MS-DataTypes : 82

sendRoutingInfoForGprsRes.....identifier of SendRoutingInfoForGprsRes  
 DEFINED in MAP-MobileServiceOpera : 326

SendRoutingInfoForGprsRes.....type reference SEQUENCE  
 DEFINED in MAP-MS-DataTypes : 794  
 USED in MAP-MobileServiceOpera : 113 326  
 USED in MAP-MS-DataTypes : 83

sendRoutingInfoForSM.....value reference SendRoutingInfoForSM, CHOICE VALUE  
 DEFINED in MAP-Protocol : 233

SendRoutingInfoForSM.....type reference OPERATION  
 DEFINED in MAP-ShortMessageServic : 67  
 USED in MAP-Protocol : 80 233  
 USED in MAP-ShortMessageServic : 13

sendRoutingInfoRes.....identifier of SendRoutingInfoRes  
 DEFINED in MAP-CallHandlingOperat : 78

SendRoutingInfoRes.....type reference [3] SEQUENCE  
 DEFINED in MAP-CH-DataTypes : 127  
 USED in MAP-CallHandlingOperat : 53 78  
 USED in MAP-CH-DataTypes : 15

serviceCentreAddress.....identifier of [2] AddressString  
 DEFINED in MAP-SM-DataTypes : 55

serviceCentreAddress.....identifier of AddressString  
 DEFINED in MAP-SM-DataTypes : 144

serviceCentreAddress.....identifier of AddressString  
 DEFINED in MAP-SM-DataTypes : 175

serviceCentreAddressDA.....identifier of [4] AddressString  
DEFINED in MAP-SM-DataTypes : 134

serviceCentreAddressOA.....identifier of [4] AddressString  
DEFINED in MAP-SM-DataTypes : 139

serviceGranted.....identifier of Named Number, 0

```

DEFINED in MAP-MS-DataTypes      : 382

serviceIndicator.....identifier of [2] ServiceIndicator
  DEFINED in MAP-SS-DataTypes    : 285

ServiceIndicator.....type reference BIT STRING
  DEFINED in MAP-SS-DataTypes    : 290
  USED in MAP-SS-DataTypes      : 285

serviceKey.....identifier of ServiceKey
  DEFINED in MAP-MS-DataTypes    : 701

ServiceKey.....type reference INTEGER
  DEFINED in MAP-MS-DataTypes    : 708
  USED in MAP-MS-DataTypes      : 54 701
  USED in MAP-CH-DataTypes      : 38 244

serviceKey.....identifier of ServiceKey
  DEFINED in MAP-CH-DataTypes    : 244

setReportingState.....value reference SetReportingState, CHOICE VALUE
  DEFINED in MAP-Protocol        : 209

SetReportingState.....type reference OPERATION
  DEFINED in MAP-CallHandlingOperat : 143
  USED in MAP-Protocol            : 54 209
  USED in MAP-CallHandlingOperat : 18

setReportingStateArg.....identifier of SetReportingStateArg
  DEFINED in MAP-CallHandlingOperat : 145

SetReportingStateArg.....type reference SEQUENCE
  DEFINED in MAP-CH-DataTypes      : 293
  USED in MAP-CallHandlingOperat : 62 145
  USED in MAP-CH-DataTypes      : 27

setReportingStateRes.....identifier of SetReportingStateRes
  DEFINED in MAP-CallHandlingOperat : 147

SetReportingStateRes.....type reference SEQUENCE
  DEFINED in MAP-CH-DataTypes      : 308
  USED in MAP-CallHandlingOperat : 63 147
  USED in MAP-CH-DataTypes      : 28

sgsn-Address.....identifier of GSN-Address
  DEFINED in MAP-MS-DataTypes      : 243

sgsn-Address.....identifier of [0] GSN-Address
  DEFINED in MAP-MS-DataTypes      : 795

sgsn-Address.....identifier of [1] GSN-Address
  DEFINED in MAP-MS-DataTypes      : 818

sgsn-Number.....identifier of [1] ISDN-AddressString
  DEFINED in MAP-MS-DataTypes      : 201

sgsn-Number.....identifier of ISDN-AddressString
  DEFINED in MAP-MS-DataTypes      : 242

sgsn-Number.....identifier of [1] ISDN-AddressString
  DEFINED in MAP-SM-DataTypes      : 99

shortMessageMO-PP.....value reference TeleserviceCode, '00100010'B
  DEFINED in MAP-TS-Code          : 46

shortMessageMT-PP.....value reference TeleserviceCode, '00100001'B
  DEFINED in MAP-TS-Code          : 45

shortTermDenial.....value reference ShortTermDenial, CHOICE VALUE
  DEFINED in MAP-Protocol        : 356

ShortTermDenial.....type reference ERROR
  DEFINED in MAP-Errors          : 324
  USED in MAP-Protocol            : 144 356
  USED in MAP-SupplementaryServi : 53 264

```

USED in MAP-Errors : 67

shortTermDenialParam.....identifier of ShortTermDenialParam  
DEFINED in MAP-Errors : 326

ShortTermDenialParam.....type reference SEQUENCE  
DEFINED in MAP-ER-DataTypes : 285



60

TAG	R4.21	Cross Reference Listing for MAP-Protocol	99-12-21	12:08:21	PAGE
	USED in MAP-Errors	: 123	326		
	USED in MAP-ER-DataTypes	: 47			
signalInfo.....	identifier of SignalInfo				
	DEFINED in MAP-CommonDataTypes	: 170			
SignalInfo.....	type reference OCTET STRING				
	DEFINED in MAP-CommonDataTypes	: 177			
	USED in MAP-CommonDataTypes	: 21	170		
	USED in MAP-SM-DataTypes	: 33	109	114	121 127
	USED in MAP-ER-DataTypes	: 58	136		
siWFSNumber.....	identifier of [0] ISDN-AddressString				
	DEFINED in MAP-CH-DataTypes	: 278			
siWFSSignallingModify.....	value reference SIWFSSignallingModify, CHOICE VALUE				
	DEFINED in MAP-Protocol	: 208			
SIWFSSignallingModify.....	type reference OPERATION				
	DEFINED in MAP-CallHandlingOperat	: 131			
	USED in MAP-Protocol	: 53	208		
	USED in MAP-CallHandlingOperat	: 17			
siWFSSignallingModifyArg.....	identifier of SIWFSSignallingModifyArg				
	DEFINED in MAP-CallHandlingOperat	: 133			
SIWFSSignallingModifyArg.....	type reference SEQUENCE				
	DEFINED in MAP-CH-DataTypes	: 282			
	USED in MAP-CallHandlingOperat	: 60	133		
	USED in MAP-CH-DataTypes	: 25			
siWFSSignallingModifyRes.....	identifier of SIWFSSignallingModifyRes				
	DEFINED in MAP-CallHandlingOperat	: 135			
SIWFSSignallingModifyRes.....	type reference SEQUENCE				
	DEFINED in MAP-CH-DataTypes	: 288			
	USED in MAP-CallHandlingOperat	: 61	135		
	USED in MAP-CH-DataTypes	: 26			
sm-DeliveryFailure.....	value reference SM-DeliveryFailure, CHOICE VALUE				
	DEFINED in MAP-Protocol	: 363			
SM-DeliveryFailure.....	type reference ERROR				
	DEFINED in MAP-Errors	: 342			
	USED in MAP-Protocol	: 139	363		
	USED in MAP-ShortMessageServic	: 39	92	109	
	USED in MAP-Errors	: 72			
sm-DeliveryFailureCause.....	identifier of SM-DeliveryFailureCause				
	DEFINED in MAP-Errors	: 344			
SM-DeliveryFailureCause.....	type reference SEQUENCE				
	DEFINED in MAP-ER-DataTypes	: 134			
	USED in MAP-Errors	: 93	344		
	USED in MAP-ER-DataTypes	: 19			
sm-DeliveryOutcome.....	identifier of SM-DeliveryOutcome				
	DEFINED in MAP-SM-DataTypes	: 145			
SM-DeliveryOutcome.....	type reference ENUMERATED				
	DEFINED in MAP-SM-DataTypes	: 162			
	USED in MAP-SM-DataTypes	: 26	145	156	
SM-EnumeratedDeliveryFailureCause.....	type reference ENUMERATED				
	DEFINED in MAP-ER-DataTypes	: 125			
	USED in MAP-ER-DataTypes	: 135			
sm-EnumeratedDeliveryFailureCause.....	identifier of SM-EnumeratedDeliveryFailureCause				
	DEFINED in MAP-ER-DataTypes	: 135			
sm-RP-DA.....	identifier of SM-RP-DA				
	DEFINED in MAP-SM-DataTypes	: 107			
sm-RP-DA.....	identifier of SM-RP-DA				
	DEFINED in MAP-SM-DataTypes	: 119			

```
SM-RP-DA.....type reference CHOICE
  DEFINED in MAP-SM-DataTypes      :    131
  USED in MAP-SM-DataTypes         :    107  119

sm-RP-MTI.....identifier of [8] SM-RP-MTI
  DEFINED in MAP-SM-DataTypes      :     61
```

TAG R4.21 Cross Reference Listing for MAP-Protocol 99-12-21 12:08:21 PAGE

SM-RP-MTI.....type reference INTEGER  
 DEFINED in MAP-SM-DataTypes : 64  
 USED in MAP-SM-DataTypes : 61

sm-RP-OA.....identifier of SM-RP-OA  
 DEFINED in MAP-SM-DataTypes : 108

sm-RP-OA.....identifier of SM-RP-OA  
 DEFINED in MAP-SM-DataTypes : 120

SM-RP-OA.....type reference CHOICE  
 DEFINED in MAP-SM-DataTypes : 137  
 USED in MAP-SM-DataTypes : 108 120

sm-RP-PRI.....identifier of [1] BOOLEAN  
 DEFINED in MAP-SM-DataTypes : 54

sm-RP-SMEA.....identifier of [9] SM-RP-SMEA  
 DEFINED in MAP-SM-DataTypes : 62

SM-RP-SMEA.....type reference OCTET STRING  
 DEFINED in MAP-SM-DataTypes : 71  
 USED in MAP-SM-DataTypes : 62

sm-RP-UI.....identifier of SignalInfo  
 DEFINED in MAP-SM-DataTypes : 109

sm-RP-UI.....identifier of SignalInfo  
 DEFINED in MAP-SM-DataTypes : 114

sm-RP-UI.....identifier of SignalInfo  
 DEFINED in MAP-SM-DataTypes : 121

sm-RP-UI.....identifier of SignalInfo  
 DEFINED in MAP-SM-DataTypes : 127

sres.....identifier of SRES  
 DEFINED in MAP-MS-DataTypes : 228

SRES.....type reference OCTET STRING  
 DEFINED in MAP-MS-DataTypes : 234  
 USED in MAP-MS-DataTypes : 228

ss-AccessBarred.....identifier of Named Number, 5  
 DEFINED in MAP-MS-DataTypes : 410

ss-CamelData.....identifier of SS-CamelData  
 DEFINED in MAP-MS-DataTypes : 663

SS-CamelData.....type reference SEQUENCE  
 DEFINED in MAP-MS-DataTypes : 667  
 USED in MAP-MS-DataTypes : 663

ss-Code.....identifier of SS-Code  
 DEFINED in MAP-SupplementaryServi : 219

ss-Code.....identifier of SS-Code  
 DEFINED in MAP-MS-DataTypes : 440

ss-Code.....identifier of SS-Code  
 DEFINED in MAP-MS-DataTypes : 517

ss-Code.....identifier of SS-Code  
 DEFINED in MAP-MS-DataTypes : 588

ss-Code.....identifier of SS-Code  
 DEFINED in MAP-SS-DataTypes : 70

ss-Code.....identifier of SS-Code  
 DEFINED in MAP-SS-DataTypes : 86

ss-Code.....identifier of SS-Code  
 DEFINED in MAP-SS-DataTypes : 140

ss-Code.....identifier of SS-Code  
DEFINED in MAP-SS-DataTypes : 153

ss-Code.....identifier of SS-Code  
DEFINED in MAP-SS-DataTypes : 175

ss-Code.....identifier of [0] SS-Code

62

```

DEFINED in MAP-SS-DataTypes      :    278

ss-Code.....identifier of [0] SS-Code
  DEFINED in MAP-SS-DataTypes    :    301

ss-Code.....identifier of [0] SS-Code
  DEFINED in MAP-SS-DataTypes    :    306

SS-Code.....type reference OCTET STRING
  DEFINED in MAP-SS-Code         :     11
  USED in MAP-SupplementaryServi :    78   219
  USED in MAP-MS-DataTypes      :   104  440  517  588  674
  USED in MAP-SS-DataTypes      :    62   70   86  140  153  175  243  258  278
                                     301  306
  USED in MAP-SS-Code           :    21   25   28   30   32   34   36   40   42
                                     48   50   52   54   56   58   60   63   66
                                     68   72   75   77   79   81   85   88   91
                                     94   97  100  102  105  108  112  114  116
                                     118  120  123  125  127  131  132  133  134
                                     135  136  137  138  139  140  141  142  143
                                     144  145  146  148  151
  USED in MAP-ER-DataTypes      :    65  114

ss-Code.....identifier of [1] SS-Code
  DEFINED in MAP-ER-DataTypes    :    114

ss-CSI.....identifier of [2] SS-CSI
  DEFINED in MAP-MS-DataTypes    :    658

SS-CSI.....type reference SEQUENCE
  DEFINED in MAP-MS-DataTypes    :    662
  USED in MAP-MS-DataTypes      :    53   658

ss-Data.....identifier of [3] Ext-SS-Data
  DEFINED in MAP-MS-DataTypes    :    435

ss-Data.....identifier of [3] SS-Data
  DEFINED in MAP-SS-DataTypes    :     83

SS-Data.....type reference SEQUENCE
  DEFINED in MAP-SS-DataTypes    :    152
  USED in MAP-SS-DataTypes      :    31   83

ss-ErrorStatus.....value reference SS-ErrorStatus, CHOICE VALUE
  DEFINED in MAP-Protocol        :    346

SS-ErrorStatus.....type reference ERROR
  DEFINED in MAP-Errors          :    298
  USED in MAP-Protocol           :    129  346
  USED in MAP-SupplementaryServi :    41  101  118  135  155  262  279
  USED in MAP-Errors             :     58

ss-Event.....identifier of [2] SS-Code
  DEFINED in MAP-SS-DataTypes    :    258

ss-EventList.....identifier of SS-EventList
  DEFINED in MAP-MS-DataTypes    :    668

SS-EventList.....type reference SEQUENCE OF
  DEFINED in MAP-MS-DataTypes    :    674
  USED in MAP-MS-DataTypes      :    668

ss-EventSpecification.....identifier of [3] SS-EventSpecification
  DEFINED in MAP-SS-DataTypes    :    263

SS-EventSpecification.....type reference SEQUENCE OF
  DEFINED in MAP-SS-DataTypes    :    272
  USED in MAP-SS-DataTypes      :    263

ss-ForBS.....identifier of SS-ForBS-Code
  DEFINED in MAP-SupplementaryServi :   106

ss-ForBS.....identifier of SS-ForBS-Code
  DEFINED in MAP-SupplementaryServi :   123

```

ss-ForBS.....identifier of SS-ForBS-Code  
DEFINED in MAP-SupplementaryServi : 143

ss-ForBS.....identifier of SS-ForBS-Code  
DEFINED in MAP-SupplementaryServi : 162

SS-ForBS-Code.....type reference SEQUENCE

63	TAG	R4.21	Cross Reference Listing for MAP-Protocol	99-12-21	12:08:21	PAGE
			DEFINED in MAP-SS-DataTypes	:	174	
			USED in MAP-SupplementaryServi	:	62	106 123 143 162
			USED in MAP-SS-DataTypes	:	18	
			ss-Incompatibility.....value reference SS-Incompatibility, CHOICE VALUE			
			DEFINED in MAP-Protocol	:	349	
			SS-Incompatibility.....type reference ERROR			
			DEFINED in MAP-Errors	:	307	
			USED in MAP-Protocol	:	132	349
			USED in MAP-SupplementaryServi	:	44	102 137 263
			USED in MAP-Errors	:	61	
			ss-IncompatibilityCause.....identifier of SS-IncompatibilityCause			
			DEFINED in MAP-Errors	:	309	
			SS-IncompatibilityCause.....type reference SEQUENCE			
			DEFINED in MAP-ER-DataTypes	:	113	
			USED in MAP-Errors	:	91	309
			USED in MAP-ER-DataTypes	:	17	
			ss-Info.....identifier of SS-Info			
			DEFINED in MAP-SupplementaryServi	:	91	
			ss-Info.....identifier of SS-Info			
			DEFINED in MAP-SupplementaryServi	:	108	
			ss-Info.....identifier of SS-Info			
			DEFINED in MAP-SupplementaryServi	:	125	
			ss-Info.....identifier of SS-Info			
			DEFINED in MAP-SupplementaryServi	:	145	
			SS-Info.....type reference CHOICE			
			DEFINED in MAP-SS-DataTypes	:	80	
			USED in MAP-SupplementaryServi	:	61	91 108 125 145
			USED in MAP-SS-DataTypes	:	15	248
			SS-InfoList.....type reference SEQUENCE OF			
			DEFINED in MAP-SS-DataTypes	:	247	
			USED in MAP-SS-DataTypes	:	25	
VALUE			ss-InvocationNotification.....value reference SS-InvocationNotification, CHOICE			
			DEFINED in MAP-Protocol	:	251	
			SS-InvocationNotification.....type reference OPERATION			
			DEFINED in MAP-SupplementaryServi	:	240	
			USED in MAP-Protocol	:	72	251
			USED in MAP-SupplementaryServi	:	23	
			ss-InvocationNotificationArg.....identifier of SS-InvocationNotificationArg			
			DEFINED in MAP-SupplementaryServi	:	242	
			SS-InvocationNotificationArg.....type reference SEQUENCE			
			DEFINED in MAP-SS-DataTypes	:	255	
			USED in MAP-SupplementaryServi	:	68	242
			USED in MAP-SS-DataTypes	:	32	
			ss-InvocationNotificationRes.....identifier of SS-InvocationNotificationRes			
			DEFINED in MAP-SupplementaryServi	:	244	
			SS-InvocationNotificationRes.....type reference SEQUENCE			
			DEFINED in MAP-SS-DataTypes	:	267	
			USED in MAP-SupplementaryServi	:	69	244
			USED in MAP-SS-DataTypes	:	33	
			ss-List.....identifier of [3] SS-List			
			DEFINED in MAP-MS-DataTypes	:	606	
			ss-List.....identifier of [2] SS-List			
			DEFINED in MAP-MS-DataTypes	:	625	
			ss-List.....identifier of [1] SS-List			
			DEFINED in MAP-CH-DataTypes	:	136	

```
SS-List.....type reference SEQUENCE OF
  DEFINED in MAP-SS-DataTypes      :    242
  USED in MAP-MS-DataTypes         :    99   606   625
  USED in MAP-CH-DataTypes         :    51   136
  USED in MAP-SS-DataTypes         :    24

ss-NotAvailable.....value reference SS-NotAvailable, CHOICE VALUE
```



```

DEFINED in MAP-Protocol : 347

SS-NotAvailable.....type reference ERROR
  DEFINED in MAP-Errors : 303
  USED in MAP-Protocol : 130 347
  USED in MAP-SupplementaryServi : 42 173
  USED in MAP-Errors : 59

ss-Status.....identifier of SS-Status
  DEFINED in MAP-Errors : 300

ss-Status.....identifier of [4] Ext-SS-Status
  DEFINED in MAP-MS-DataTypes : 450

ss-Status.....identifier of [4] Ext-SS-Status
  DEFINED in MAP-MS-DataTypes : 527

ss-Status.....identifier of [4] Ext-SS-Status
  DEFINED in MAP-MS-DataTypes : 589

ss-Status.....identifier of [4] SS-Status
  DEFINED in MAP-SS-DataTypes : 96

SS-Status.....type reference OCTET STRING
  DEFINED in MAP-SS-DataTypes : 103
  USED in MAP-Errors : 86 300
  USED in MAP-SS-DataTypes : 16 96 149 154 180 202 307
  USED in MAP-ER-DataTypes : 53 116

ss-Status.....identifier of [4] SS-Status
  DEFINED in MAP-SS-DataTypes : 149

ss-Status.....identifier of [4] SS-Status
  DEFINED in MAP-SS-DataTypes : 154

ss-Status.....identifier of SS-Status
  DEFINED in MAP-SS-DataTypes : 180

ss-Status.....identifier of [0] SS-Status
  DEFINED in MAP-SS-DataTypes : 202

ss-Status.....identifier of [1] SS-Status
  DEFINED in MAP-SS-DataTypes : 307

ss-Status.....identifier of [4] SS-Status
  DEFINED in MAP-ER-DataTypes : 116

ss-SubscriptionOption.....identifier of SS-SubscriptionOption
  DEFINED in MAP-MS-DataTypes : 590

ss-SubscriptionOption.....identifier of SS-SubscriptionOption
  DEFINED in MAP-SS-DataTypes : 155

SS-SubscriptionOption.....type reference CHOICE
  DEFINED in MAP-SS-DataTypes : 161
  USED in MAP-MS-DataTypes : 98 590
  USED in MAP-SS-DataTypes : 17 155

ss-SubscriptionViolation.....value reference SS-SubscriptionViolation, CHOICE
VALUE
  DEFINED in MAP-Protocol : 348

SS-SubscriptionViolation.....type reference ERROR
  DEFINED in MAP-Errors : 305
  USED in MAP-Protocol : 131 348
  USED in MAP-SupplementaryServi : 43 136 156 227
  USED in MAP-Errors : 60

startMonitoring.....identifier of Named Number, 1
  DEFINED in MAP-CH-DataTypes : 302

statusReport.....value reference StatusReport, CHOICE VALUE
  DEFINED in MAP-Protocol : 210

StatusReport.....type reference OPERATION

```

```
DEFINED in MAP-CallHandlingOperat : 157
USED in MAP-Protocol : 55 210
USED in MAP-CallHandlingOperat : 19

statusReportArg.....identifier of StatusReportArg
DEFINED in MAP-CallHandlingOperat : 159

StatusReportArg.....type reference SEQUENCE
```

```

DEFINED in MAP-CH-DataTypes      : 323
USED in MAP-CallHandlingOperat  : 64 159
USED in MAP-CH-DataTypes        : 29

statusReportRes.....identifier of StatusReportRes
  DEFINED in MAP-CallHandlingOperat : 161

StatusReportRes.....type reference SEQUENCE
  DEFINED in MAP-CH-DataTypes      : 359
  USED in MAP-CallHandlingOperat  : 65 161
  USED in MAP-CH-DataTypes        : 30

stopMonitoring.....identifier of Named Number, 0
  DEFINED in MAP-CH-DataTypes      : 301

storedMSISDN.....identifier of ISDN-AddressString
  DEFINED in MAP-SM-DataTypes      : 168

storedMSISDN.....identifier of ISDN-AddressString
  DEFINED in MAP-SM-DataTypes      : 179

subBusyForMT-SMS-Param.....identifier of SubBusyForMT-SMS-Param
  DEFINED in MAP-Errors            : 339

SubBusyForMT-SMS-Param.....type reference SEQUENCE
  DEFINED in MAP-ER-DataTypes      : 262
  USED in MAP-Errors              : 117 339
  USED in MAP-ER-DataTypes        : 40

subscriberBusyForMT-SMS.....value reference SubscriberBusyForMT-SMS, CHOICE VALUE
  DEFINED in MAP-Protocol          : 362

SubscriberBusyForMT-SMS.....type reference ERROR
  DEFINED in MAP-Errors            : 337
  USED in MAP-Protocol            : 138 362
  USED in MAP-ShortMessageServic  : 38 108
  USED in MAP-Errors              : 71

SubscriberData.....type reference SEQUENCE
  DEFINED in MAP-MS-DataTypes      : 359
  USED in MAP-MS-DataTypes        : 46 293

SubscriberId.....type reference CHOICE
  DEFINED in MAP-CommonDataTypes  : 233
  USED in MAP-CommonDataTypes     : 28

subscriberIdentity.....identifier of [0] SubscriberIdentity
  DEFINED in MAP-MS-DataTypes      : 947

SubscriberIdentity.....type reference CHOICE
  DEFINED in MAP-MS-DataTypes      : 958
  USED in MAP-MS-DataTypes        : 947

subscriberInfo.....identifier of SubscriberInfo
  DEFINED in MAP-MS-DataTypes      : 885

SubscriberInfo.....type reference SEQUENCE
  DEFINED in MAP-MS-DataTypes      : 889
  USED in MAP-MS-DataTypes        : 73 885 954
  USED in MAP-CH-DataTypes        : 37 135

subscriberInfo.....identifier of SubscriberInfo
  DEFINED in MAP-MS-DataTypes      : 954

subscriberInfo.....identifier of [7] SubscriberInfo
  DEFINED in MAP-CH-DataTypes      : 135

subscriberNotMemberOfCUG.....identifier of Named Number, 1
  DEFINED in MAP-ER-DataTypes      : 109

subscriberNotSC-Subscriber.....identifier of Named Number, 6
  DEFINED in MAP-ER-DataTypes      : 132

subscriberState.....identifier of [1] SubscriberState
  DEFINED in MAP-MS-DataTypes      : 891

```

```
subscriberState.....identifier of [1] NULL
  DEFINED in MAP-MS-DataTypes      :      897

SubscriberState.....type reference CHOICE
  DEFINED in MAP-MS-DataTypes      :      932
  USED in MAP-MS-DataTypes         :      75   891
```

```

subscriberStatus.....identifier of [3] SubscriberStatus
  DEFINED in MAP-MS-DataTypes      :    362

SubscriberStatus.....type reference ENUMERATED
  DEFINED in MAP-MS-DataTypes      :    381
  USED in MAP-MS-DataTypes         :    48    362

subscriptionWithdraw.....identifier of Named Number, 1
  DEFINED in MAP-MS-DataTypes      :    189

subsequentHandoverFailure.....value reference SubsequentHandoverFailure, CHOICE
VALUE
  DEFINED in MAP-Protocol           :    313

SubsequentHandoverFailure.....type reference ERROR
  DEFINED in MAP-Errors             :    226
  USED in MAP-Protocol              :    116    313
  USED in MAP-MobileServiceOpera    :    79    249
  USED in MAP-Errors                :    37

success.....identifier of Named Number, 0
  DEFINED in MAP-CH-DataTypes       :    350

successfulTransfer.....identifier of Named Number, 2
  DEFINED in MAP-SM-DataTypes       :    165

supportedCamelPhases.....identifier of [0] SupportedCamelPhases
  DEFINED in MAP-MS-DataTypes       :    165

supportedCamelPhases.....identifier of [6] SupportedCamelPhases
  DEFINED in MAP-MS-DataTypes       :    610

SupportedCamelPhases.....type reference BIT STRING
  DEFINED in MAP-MS-DataTypes       :    780
  USED in MAP-MS-DataTypes          :    58    165    610
  USED in MAP-CH-DataTypes          :    40    182    205

supportedCamelPhases.....identifier of SupportedCamelPhases
  DEFINED in MAP-CH-DataTypes       :    205

supportedCamelPhasesInGMSC.....identifier of [15] SupportedCamelPhases
  DEFINED in MAP-CH-DataTypes       :    182

supportedCCBS-Phase.....identifier of [16] SupportedCCBS-Phase
  DEFINED in MAP-CH-DataTypes       :    104

SupportedCCBS-Phase.....type reference INTEGER
  DEFINED in MAP-CH-DataTypes       :    121
  USED in MAP-CH-DataTypes          :    104

suppressionOfAnnouncement.....identifier of [12] SuppressionOfAnnouncement
  DEFINED in MAP-CH-DataTypes       :    99

SuppressionOfAnnouncement.....type reference NULL
  DEFINED in MAP-CH-DataTypes       :    106
  USED in MAP-CH-DataTypes          :    21    99    174

suppressionOfAnnouncement.....identifier of [7] SuppressionOfAnnouncement
  DEFINED in MAP-CH-DataTypes       :    174

suppress-T-CSI.....identifier of NULL
  DEFINED in MAP-CH-DataTypes       :    206

systemFailure.....value reference SystemFailure, CHOICE VALUE
  DEFINED in MAP-Protocol           :    281

SystemFailure.....type reference ERROR
  DEFINED in MAP-Errors             :    134
  USED in MAP-Protocol              :    101    281
  USED in MAP-MobileServiceOpera    :    69    140    184    208    222    260    273    315    329
  USED in MAP-OperationAndMainte    :    343    357
  USED in MAP-OperationAndMainte    :    23    57    71
  USED in MAP-CallHandlingOperat    :    28    80    102    129    141    150    165    179
  USED in MAP-SupplementaryServi    :    33    94    111    128    148    166    181    194    208

```

	223	257	274		
USED in MAP-ShortMessageServic :	27	73	89	101	129
USED in MAP-Group-Call-Operati :	24	52			
USED in MAP-Errors :	14				
systemFailureParam.....identifier of SystemFailureParam					
DEFINED in MAP-Errors :	136				

```

SystemFailureParam.....type reference CHOICE
  DEFINED in MAP-ER-DataTypes      : 154
  USED in MAP-Errors                : 94 136
  USED in MAP-ER-DataTypes          : 20

targetCellId.....identifier of GlobalCellId
  DEFINED in MAP-MS-DataTypes       : 258

targetCellId.....identifier of GlobalCellId
  DEFINED in MAP-MS-DataTypes       : 269

targetMSC-Number.....identifier of ISDN-AddressString
  DEFINED in MAP-MS-DataTypes       : 270

TBCD-STRING.....type reference OCTET STRING
  DEFINED in MAP-CommonDataTypes    : 69
  USED in MAP-CommonDataTypes       : 224 227 237

TCAPMessages.....module reference
  DEFINED in TCAPMessages           : 1
  USED in MAP-MobileServiceOpera    : 66
  USED in MAP-OperationAndMainte    : 20
  USED in MAP-CallHandlingOperat    : 25
  USED in MAP-SupplementaryServi    : 30
  USED in MAP-ShortMessageServic    : 24
  USED in MAP-Group-Call-Operati    : 21
  USED in MAP-Errors                : 83

telephony.....value reference TeleserviceCode, '00010001'B
  DEFINED in MAP-TS-Code            : 41

teleservice.....identifier of [3] TeleserviceCode
  DEFINED in MAP-CommonDataTypes    : 314

teleservice.....identifier of Ext-TeleserviceCode
  DEFINED in MAP-GR-DataTypes       : 50

TeleserviceCode.....type reference OCTET STRING
  DEFINED in MAP-TS-Code            : 11
  USED in MAP-CommonDataTypes       : 48 314
  USED in MAP-TS-Code               : 38 40 41 42 44 45 46 48 49
                                     50 51 55 58 67 69 70 72 73
                                     74 75 76 77 78 79 80 81 82
                                     83 84 85 86 87

teleserviceList.....identifier of [6] TeleserviceList
  DEFINED in MAP-MS-DataTypes       : 366

TeleserviceList.....type reference SEQUENCE OF
  DEFINED in MAP-MS-DataTypes       : 390
  USED in MAP-MS-DataTypes         : 366 604

teleserviceList.....identifier of [1] TeleserviceList
  DEFINED in MAP-MS-DataTypes       : 604

teleserviceNotProvisioned.....value reference TeleserviceNotProvisioned, CHOICE
VALUE
  DEFINED in MAP-Protocol            : 305

TeleserviceNotProvisioned.....type reference ERROR
  DEFINED in MAP-Errors              : 215
  USED in MAP-Protocol               : 114 305
  USED in MAP-CallHandlingOperat    : 36 88
  USED in MAP-SupplementaryServi    : 38 98 115 132 152 170
  USED in MAP-ShortMessageServic    : 35 78
  USED in MAP-Errors                : 33

teleservNotProvParam.....identifier of TeleservNotProvParam
  DEFINED in MAP-Errors              : 217

TeleservNotProvParam.....type reference SEQUENCE
  DEFINED in MAP-ER-DataTypes       : 215
  USED in MAP-Errors                : 105 217
  USED in MAP-ER-DataTypes         : 31

```

temporaryDefaultAllowed.....identifier of Named Number, 2  
DEFINED in MAP-SS-DataTypes : 168

temporaryDefaultRestricted.....identifier of Named Number, 1  
DEFINED in MAP-SS-DataTypes : 167

termAttemptAuthorized.....identifier of Named Number, 12  
DEFINED in MAP-CH-DataTypes : 251



```

tmsi.....identifier of TMSI
  DEFINED in MAP-MobileServiceOpera : 169

TMSI.....type reference OCTET STRING
  DEFINED in MAP-CommonDataTypes : 231
  USED in MAP-MobileServiceOpera : 124 169
  USED in MAP-CommonDataTypes : 27 235

tmsi.....identifier of [1] TMSI
  DEFINED in MAP-CommonDataTypes : 235

tooManyZoneCodes.....identifier of Named Number, 1
  DEFINED in MAP-MS-DataTypes : 616

traceReference.....identifier of [1] TraceReference
  DEFINED in MAP-OM-DataTypes : 38

TraceReference.....type reference OCTET STRING
  DEFINED in MAP-OM-DataTypes : 44
  USED in MAP-OM-DataTypes : 38 56

traceReference.....identifier of [1] TraceReference
  DEFINED in MAP-OM-DataTypes : 56

traceType.....identifier of [2] TraceType
  DEFINED in MAP-OM-DataTypes : 39

TraceType.....type reference INTEGER
  DEFINED in MAP-OM-DataTypes : 46
  USED in MAP-OM-DataTypes : 39

tracingBufferFull.....value reference TracingBufferFull, CHOICE VALUE
  DEFINED in MAP-Protocol : 319

TracingBufferFull.....type reference ERROR
  DEFINED in MAP-Errors : 231
  USED in MAP-Protocol : 117 319
  USED in MAP-OperationAndMainte : 29 62
  USED in MAP-Errors : 40

tracingBufferFullParam.....identifier of TracingBufferFullParam
  DEFINED in MAP-Errors : 233

TracingBufferFullParam.....type reference SEQUENCE
  DEFINED in MAP-ER-DataTypes : 219
  USED in MAP-Errors : 106 233
  USED in MAP-ER-DataTypes : 32

TransactionID.....type reference OCTET STRING
  DEFINED in TCAPMessages : 100
  USED in TCAPMessages : 47 97 98

translatedB-Number.....identifier of [3] ISDN-AddressString
  DEFINED in MAP-CH-DataTypes : 367

translatedB-Number.....identifier of [1] ISDN-AddressString
  DEFINED in MAP-SS-DataTypes : 284

T-BcsmCamelTDPData.....type reference SEQUENCE
  DEFINED in MAP-CH-DataTypes : 242
  USED in MAP-CH-DataTypes : 236

t-BcsmCamelTDPDataList.....identifier of T-BcsmCamelTDPDataList
  DEFINED in MAP-CH-DataTypes : 229

T-BcsmCamelTDPDataList.....type reference SEQUENCE OF
  DEFINED in MAP-CH-DataTypes : 235
  USED in MAP-CH-DataTypes : 229

t-BcsmTriggerDetectionPoint.....identifier of T-BcsmTriggerDetectionPoint
  DEFINED in MAP-CH-DataTypes : 243

T-BcsmTriggerDetectionPoint.....type reference ENUMERATED
  DEFINED in MAP-CH-DataTypes : 250

```

USED in MAP-CH-DataTypes : 243

t-CSI.....identifier of [0] T-CSI  
DEFINED in MAP-CH-DataTypes : 221

T-CSI.....type reference SEQUENCE  
DEFINED in MAP-CH-DataTypes : 228

69

TAG R4.21 Cross Reference Listing for MAP-Protocol 99-12-21 12:08:21 PAGE

```

USED in MAP-CH-DataTypes : 221

udubFromBusyMS.....identifier of Named Number, 5
  DEFINED in MAP-CH-DataTypes : 384

udubFromFreeMS.....identifier of Named Number, 4
  DEFINED in MAP-CH-DataTypes : 383

unauthorisedMessageOriginator.....identifier of [1] NULL
  DEFINED in MAP-ER-DataTypes : 100

undetermined.....identifier of Named Number, 0
  DEFINED in MAP-ER-DataTypes : 120

unexpectedDataParam.....identifier of UnexpectedDataParam
  DEFINED in MAP-Errors : 147

UnexpectedDataParam.....type reference SEQUENCE
  DEFINED in MAP-ER-DataTypes : 170
  USED in MAP-Errors : 96 147
  USED in MAP-ER-DataTypes : 22

unexpectedDataValue.....value reference UnexpectedDataValue, CHOICE VALUE
  DEFINED in MAP-Protocol : 283

UnexpectedDataValue.....type reference ERROR
  DEFINED in MAP-Errors : 145
  USED in MAP-Protocol : 103 283
  USED in MAP-MobileServiceOpera : 71 142 154 164 185 198 211 224 246
    262 287 298 317 331 345 359
  USED in MAP-OperationAndMainte : 25 59 73 84
  USED in MAP-CallHandlingOperat : 30 82 104 118 128 140 152 166 175
  USED in MAP-SupplementaryServi : 35 96 113 130 150 168 183 196 210
    225 248 259 276
  USED in MAP-ShortMessageServic : 29 75 90 103 120 131 145
  USED in MAP-Group-Call-Operati : 25 54
  USED in MAP-Errors : 16

unexpectedError.....identifier of Named Number, 3
  DEFINED in TCAPMessages : 199

unexpectedLinkedOperation.....identifier of Named Number, 7
  DEFINED in TCAPMessages : 190

unidentifiedSubParam.....identifier of UnidentifiedSubParam
  DEFINED in MAP-Errors : 184

UnidentifiedSubParam.....type reference SEQUENCE
  DEFINED in MAP-ER-DataTypes : 199
  USED in MAP-Errors : 100 184
  USED in MAP-ER-DataTypes : 27

unidentifiedSubscriber.....value reference UnidentifiedSubscriber, CHOICE VALUE
  DEFINED in MAP-Protocol : 294

UnidentifiedSubscriber.....type reference ERROR
  DEFINED in MAP-Errors : 182
  USED in MAP-Protocol : 108 294
  USED in MAP-MobileServiceOpera : 74 174 288 299
  USED in MAP-OperationAndMainte : 28 61 75
  USED in MAP-CallHandlingOperat : 47 151
  USED in MAP-ShortMessageServic : 32 105
  USED in MAP-Errors : 25

unidirectional.....identifier of [APPLICATION 1] IMPLICIT Unidirectional
  DEFINED in TCAPMessages : 52

Unidirectional.....type reference SEQUENCE
  DEFINED in TCAPMessages : 58
  USED in TCAPMessages : 52

unknownAlphabet.....value reference UnknownAlphabet, CHOICE VALUE
  DEFINED in MAP-Protocol : 350

UnknownAlphabet.....type reference ERROR

```

```
DEFINED in MAP-Errors : 312
USED in MAP-Protocol : 133 350
USED in MAP-SupplementaryServi : 48 184 200 214
USED in MAP-Errors : 62

unknownEquipment.....value reference UnknownEquipment, CHOICE VALUE
DEFINED in MAP-Protocol : 295
```

70

TAG R4.21 Cross Reference Listing for MAP-Protocol 99-12-21 12:08:21 PAGE

UnknownEquipment.....type reference ERROR  
 DEFINED in MAP-Errors : 188  
 USED in MAP-Protocol : 109 295  
 USED in MAP-MobileServiceOpera : 75 275  
 USED in MAP-Errors : 26

unknownMSC.....value reference UnknownMSC, CHOICE VALUE  
 DEFINED in MAP-Protocol : 293

UnknownMSC.....type reference ERROR  
 DEFINED in MAP-Errors : 180  
 USED in MAP-Protocol : 107 293  
 USED in MAP-MobileServiceOpera : 73 248  
 USED in MAP-Errors : 24

unknownServiceCentre.....identifier of Named Number, 3  
 DEFINED in MAP-ER-DataTypes : 129

unknownSubscriber.....value reference UnknownSubscriber, CHOICE VALUE  
 DEFINED in MAP-Protocol : 291

UnknownSubscriber.....type reference ERROR  
 DEFINED in MAP-Errors : 169  
 USED in MAP-Protocol : 105 291  
 USED in MAP-MobileServiceOpera : 72 143 165 186 212 263 318 332 346  
 360  
 USED in MAP-OperationAndMainte : 27 85  
 USED in MAP-CallHandlingOperat : 33 85 164  
 USED in MAP-SupplementaryServi : 36 249  
 USED in MAP-ShortMessageServic : 31 77 121 147  
 USED in MAP-Errors : 22

unknownSubscriberDiagnostic.....identifier of UnknownSubscriberDiagnostic  
 DEFINED in MAP-ER-DataTypes : 185

UnknownSubscriberDiagnostic.....type reference ENUMERATED  
 DEFINED in MAP-ER-DataTypes : 187  
 USED in MAP-ER-DataTypes : 185

unknownSubscriberParam.....identifier of UnknownSubscriberParam  
 DEFINED in MAP-Errors : 171

UnknownSubscriberParam.....type reference SEQUENCE  
 DEFINED in MAP-ER-DataTypes : 182  
 USED in MAP-Errors : 98 171  
 USED in MAP-ER-DataTypes : 25

unrecognizedComponent.....identifier of Named Number, 0  
 DEFINED in TCAPMessages : 179

unrecognizedError.....identifier of Named Number, 2  
 DEFINED in TCAPMessages : 198

unrecognizedInvokeID.....identifier of Named Number, 0  
 DEFINED in TCAPMessages : 192

unrecognizedInvokeID.....identifier of Named Number, 0  
 DEFINED in TCAPMessages : 196

unrecognizedLinkedID.....identifier of Named Number, 5  
 DEFINED in TCAPMessages : 188

unrecognizedMessageType.....identifier of Named Number, 0  
 DEFINED in TCAPMessages : 103

unrecognizedOperation.....identifier of Named Number, 1  
 DEFINED in TCAPMessages : 184

unrecognizedTransactionID.....identifier of Named Number, 1  
 DEFINED in TCAPMessages : 104

unstructuredSS-Notify.....value reference UnstructuredSS-Notify, CHOICE VALUE  
 DEFINED in MAP-Protocol : 224

```
UnstructuredSS-Notify.....type reference OPERATION
  DEFINED in MAP-SupplementaryServi : 203
  USED in MAP-Protocol : 69 224
  USED in MAP-SupplementaryServi : 20

unstructuredSS-Request.....value reference UnstructuredSS-Request, CHOICE VALUE
  DEFINED in MAP-Protocol : 223
```

TAG R4.21 Cross Reference Listing for MAP-Protocol 99-12-21 12:08:21 PAGE

UnstructuredSS-Request.....type reference OPERATION  
 DEFINED in MAP-SupplementaryServi : 187  
 USED in MAP-Protocol : 68 223  
 USED in MAP-SupplementaryServi : 19

updateGprsLocation.....value reference UpdateGprsLocation, CHOICE VALUE  
 DEFINED in MAP-Protocol : 264

UpdateGprsLocation.....type reference OPERATION  
 DEFINED in MAP-MobileServiceOpera : 178  
 USED in MAP-Protocol : 16 264  
 USED in MAP-MobileServiceOpera : 21

updateGprsLocationArg.....identifier of UpdateGprsLocationArg  
 DEFINED in MAP-MobileServiceOpera : 180

UpdateGprsLocationArg.....type reference SEQUENCE  
 DEFINED in MAP-MS-DataTypes : 240  
 USED in MAP-MobileServiceOpera : 93 180  
 USED in MAP-MS-DataTypes : 23

updateGprsLocationRes.....identifier of UpdateGprsLocationRes  
 DEFINED in MAP-MobileServiceOpera : 182

UpdateGprsLocationRes.....type reference SEQUENCE  
 DEFINED in MAP-MS-DataTypes : 250  
 USED in MAP-MobileServiceOpera : 94 182  
 USED in MAP-MS-DataTypes : 24

updateLocation.....value reference UpdateLocation, CHOICE VALUE  
 DEFINED in MAP-Protocol : 155

UpdateLocation.....type reference OPERATION  
 DEFINED in MAP-MobileServiceOpera : 134  
 USED in MAP-Protocol : 12 155  
 USED in MAP-MobileServiceOpera : 15

updateLocationArg.....identifier of UpdateLocationArg  
 DEFINED in MAP-MobileServiceOpera : 136

UpdateLocationArg.....type reference SEQUENCE  
 DEFINED in MAP-MS-DataTypes : 154  
 USED in MAP-MobileServiceOpera : 86 136  
 USED in MAP-MS-DataTypes : 16

updateLocationRes.....identifier of UpdateLocationRes  
 DEFINED in MAP-MobileServiceOpera : 138

UpdateLocationRes.....type reference SEQUENCE  
 DEFINED in MAP-MS-DataTypes : 170  
 USED in MAP-MobileServiceOpera : 87 138  
 USED in MAP-MS-DataTypes : 17

updateProcedure.....identifier of Named Number, 0  
 DEFINED in MAP-MS-DataTypes : 188

uplinkFree.....identifier of [3] NULL  
 DEFINED in MAP-GR-DataTypes : 57

uplinkRejectCommand.....identifier of [2] NULL  
 DEFINED in MAP-GR-DataTypes : 79

uplinkReleaseCommand.....identifier of [4] NULL  
 DEFINED in MAP-GR-DataTypes : 81

uplinkReleaseIndication.....identifier of [1] NULL  
 DEFINED in MAP-GR-DataTypes : 78

uplinkReleaseIndication.....identifier of [1] NULL  
 DEFINED in MAP-GR-DataTypes : 87

uplinkRequest.....identifier of [0] NULL  
 DEFINED in MAP-GR-DataTypes : 86

uplinkRequestAck.....identifier of [0] NULL  
DEFINED in MAP-GR-DataTypes : 77

uplinkSeizedCommand.....identifier of [3] NULL  
DEFINED in MAP-GR-DataTypes : 80

ussd-Arg.....identifier of USSD-Arg



72

TAG R4.21 Cross Reference Listing for MAP-Protocol 99-12-21 12:08:21 PAGE

DEFINED in MAP-SupplementaryServi : 177

ussd-Arg.....identifier of USSD-Arg  
 DEFINED in MAP-SupplementaryServi : 189

ussd-Arg.....identifier of USSD-Arg  
 DEFINED in MAP-SupplementaryServi : 205

USSD-Arg.....type reference SEQUENCE  
 DEFINED in MAP-SS-DataTypes : 207  
 USED in MAP-SupplementaryServi : 64 177 189 205  
 USED in MAP-SS-DataTypes : 20

ussd-Busy.....value reference USSD-Busy, CHOICE VALUE  
 DEFINED in MAP-Protocol : 351

USSD-Busy.....type reference ERROR  
 DEFINED in MAP-Errors : 314  
 USED in MAP-Protocol : 134 351  
 USED in MAP-SupplementaryServi : 49 201 215  
 USED in MAP-Errors : 63

ussd-DataCodingScheme.....identifier of USSD-DataCodingScheme  
 DEFINED in MAP-SS-DataTypes : 208

ussd-DataCodingScheme.....identifier of USSD-DataCodingScheme  
 DEFINED in MAP-SS-DataTypes : 215

USSD-DataCodingScheme.....type reference OCTET STRING  
 DEFINED in MAP-SS-DataTypes : 219  
 USED in MAP-SS-DataTypes : 39 208 215

ussd-Res.....identifier of USSD-Res  
 DEFINED in MAP-SupplementaryServi : 179

ussd-Res.....identifier of USSD-Res  
 DEFINED in MAP-SupplementaryServi : 191

USSD-Res.....type reference SEQUENCE  
 DEFINED in MAP-SS-DataTypes : 214  
 USED in MAP-SupplementaryServi : 65 179 191  
 USED in MAP-SS-DataTypes : 21

ussd-String.....identifier of USSD-String  
 DEFINED in MAP-SS-DataTypes : 209

ussd-String.....identifier of USSD-String  
 DEFINED in MAP-SS-DataTypes : 216

USSD-String.....type reference OCTET STRING  
 DEFINED in MAP-SS-DataTypes : 224  
 USED in MAP-SS-DataTypes : 40 209 216

uus.....value reference SS-Code, '10000001'B  
 DEFINED in MAP-SS-Code : 108

VBSDataList.....type reference SEQUENCE OF  
 DEFINED in MAP-MS-DataTypes : 850  
 USED in MAP-MS-DataTypes : 373

vbsGroupIndication.....identifier of [7] NULL  
 DEFINED in MAP-MS-DataTypes : 628

vbsSubscriptionData.....identifier of [11] VBSDataList  
 DEFINED in MAP-MS-DataTypes : 373

VGCSDataList.....type reference SEQUENCE OF  
 DEFINED in MAP-MS-DataTypes : 853  
 USED in MAP-MS-DataTypes : 374

vgcsGroupIndication.....identifier of [8] NULL  
 DEFINED in MAP-MS-DataTypes : 629

vgcsSubscriptionData.....identifier of [12] VGCSDataList  
 DEFINED in MAP-MS-DataTypes : 374

vlr.....identifier of Named Number, 2  
DEFINED in MAP-CommonDataTypes : 267

vlrCamelSubscriptionInfo.....identifier of [13] VlrCamelSubscriptionInfo  
DEFINED in MAP-MS-DataTypes : 375

73

TAG R4.21 Cross Reference Listing for MAP-Protocol 99-12-21 12:08:21 PAGE

```

VlrCamelSubscriptionInfo.....type reference SEQUENCE
  DEFINED in MAP-MS-DataTypes      : 654
  USED in MAP-MS-DataTypes         : 375

vlr-Capability.....identifier of [6] VLR-Capability
  DEFINED in MAP-MS-DataTypes      : 162

VLR-Capability.....type reference SEQUENCE
  DEFINED in MAP-MS-DataTypes      : 164
  USED in MAP-MS-DataTypes         : 162 840

vlr-Capability.....identifier of [6] VLR-Capability
  DEFINED in MAP-MS-DataTypes      : 840

vlr-Number.....identifier of ISDN-AddressString
  DEFINED in MAP-MS-DataTypes      : 158

vlr-Number.....identifier of [0] ISDN-AddressString
  DEFINED in MAP-MS-DataTypes      : 200

vlr-number.....identifier of [1] ISDN-AddressString
  DEFINED in MAP-MS-DataTypes      : 904

vmsc.....identifier of Named Number, 5
  DEFINED in MAP-CommonDataTypes   : 270

vmsc-Address.....identifier of [2] ISDN-AddressString
  DEFINED in MAP-CH-DataTypes      : 139

voiceBroadcastCall.....value reference TeleserviceCode, '10010010'B
  DEFINED in MAP-TS-Code           : 70

VoiceBroadcastData.....type reference SEQUENCE
  DEFINED in MAP-MS-DataTypes      : 865
  USED in MAP-MS-DataTypes         : 851

voiceGroupCall.....value reference TeleserviceCode, '10010001'B
  DEFINED in MAP-TS-Code           : 69

VoiceGroupCallData.....type reference SEQUENCE
  DEFINED in MAP-MS-DataTypes      : 860
  USED in MAP-MS-DataTypes         : 854

vplmnAddressAllowed.....identifier of [19] NULL
  DEFINED in MAP-MS-DataTypes      : 324

whiteListed.....identifier of Named Number, 0
  DEFINED in MAP-MS-DataTypes      : 284

ZoneCode.....type reference OCTET STRING
  DEFINED in MAP-MS-DataTypes      : 598
  USED in MAP-MS-DataTypes         : 596 627

ZoneCodeList.....type reference SEQUENCE OF
  DEFINED in MAP-MS-DataTypes      : 595
  USED in MAP-MS-DataTypes         : 49 372

zoneCodesConflict.....identifier of Named Number, 2
  DEFINED in MAP-MS-DataTypes      : 617

```

## Annex B (informative): Fully expanded ASN.1 sources for abstract syntaxes of MAP

Annex B is not part of the standard, it is included for information purposes only.

For every (Value)Assignment in the root ASN.1 module all the used defined types and defined values, which are defined within the ASN.1 module or imported from ASN.1 modules, are replaced by the constructs this type or value is composed of.

The fully expanded ASN.1 root module is itself a correct and equivalent representation of the MAP-Protocol.

It allows to see at all the parameters, including all nested ones for a specific operationcode or errorcode at once.

Note that for those operations which use a result without parameters the keyword RESULT is not shown. Empty results are only defined in the ASN.1 description in clause 17.

### B.1 Fully Expanded ASN.1 Source of MAP- Protocol/TCAPMessages

```
--          Expanded ASN1 Module 'MAP-Protocol'
--SIEMENS ASN.1 Compiler      R4.21  (42-00-04)
--          Date: 99-12-21 Time: 12:08:21

MAP-Protocol{ 0 identified-organization (4) etsi (0) mobileDomain (0) gsm-Network (1) modules (3)
map-Protocol (4) version4 (4) }

DEFINITIONS

 ::=

BEGIN

updateLocation OPERATION
  ARGUMENT
    updateLocationArg SEQUENCE {
      imsi                OCTET STRING ( SIZE (3..8) ),
      msc-Number          [1] IMPLICIT OCTET STRING ( SIZE (1..20) ) ( SIZE (1..9) ),
      vlr-Number          OCTET STRING ( SIZE (1..20) ) ( SIZE (1..9) ),
      lmsi                [10] IMPLICIT OCTET STRING ( SIZE (4) ) OPTIONAL,
      extensionContainer SEQUENCE {
        privateExtensionList [0] IMPLICIT SEQUENCE ( SIZE (1..10) ) OF
          SEQUENCE {
            extId          MAP-EXTENSION .&extensionId ( {
              '
              ... } ) ,
            extType       MAP-EXTENSION .&ExtensionType ( {
              '
              ... } { @extId } ) OPTIONAL} OPTIONAL,
            pcs-Extensions [1] IMPLICIT SEQUENCE {
              ... } OPTIONAL,
            ... } OPTIONAL,
          ... ,
        vlr-Capability    [6] IMPLICIT SEQUENCE {
          supportedCamelPhases [0] IMPLICIT BIT STRING {
            phase1 (0 ),
            phase2 (1) } ( SIZE (1..16) ) OPTIONAL,
          extensionContainer SEQUENCE {
            privateExtensionList [0] IMPLICIT SEQUENCE ( SIZE (1..10) ) OF
              SEQUENCE {
                extId          MAP-EXTENSION .&extensionId ( {
                  '
                  ... } ) ,
                extType       MAP-EXTENSION .&ExtensionType ( {
                  '
                  ... } { @extId } ) OPTIONAL} OPTIONAL,
```

```

        pcs-Extensions      [1] IMPLICIT SEQUENCE {
            ... } OPTIONAL,
            ... } OPTIONAL,
            ... } OPTIONAL}
RESULT
updateLocationRes SEQUENCE {
    hlr-Number      OCTET STRING ( SIZE (1..20) ) ( SIZE (1..9) ),
    extensionContainer SEQUENCE {
        privateExtensionList [0] IMPLICIT SEQUENCE ( SIZE (1..10) ) OF
            SEQUENCE {
                extId      MAP-EXTENSION .&extensionId ( {
                    '...'} ) ,
                extType    MAP-EXTENSION .&ExtensionType ( {
                    '...' { @extId } ) OPTIONAL} OPTIONAL,
                pcs-Extensions [1] IMPLICIT SEQUENCE {
                    ... } OPTIONAL,
                    ... } OPTIONAL,
                    ... }
ERRORS {
-- systemFailure -- localValue : 34,
-- dataMissing -- localValue : 35,
-- unexpectedDataValue -- localValue : 36,
-- unknownSubscriber -- localValue : 1,
-- roamingNotAllowed -- localValue : 8}
 ::= localValue : 2

cancelLocation OPERATION
ARGUMENT
cancelLocationArg [3] IMPLICIT SEQUENCE {
    identity      CHOICE {
        imsi      OCTET STRING ( SIZE (3..8) ),
        imsi-WithLMSI SEQUENCE {
            imsi      OCTET STRING ( SIZE (3..8) ),
            lmsi      OCTET STRING ( SIZE (4) ),
            ... }},
    cancellationType ENUMERATED {
        updateProcedure (0),
        subscriptionWithdraw (1),
        ... } OPTIONAL,
    extensionContainer SEQUENCE {
        privateExtensionList [0] IMPLICIT SEQUENCE ( SIZE (1..10) ) OF
            SEQUENCE {
                extId      MAP-EXTENSION .&extensionId ( {
                    '...'} ) ,
                extType    MAP-EXTENSION .&ExtensionType ( {
                    '...' { @extId } ) OPTIONAL} OPTIONAL,
                pcs-Extensions [1] IMPLICIT SEQUENCE {
                    ... } OPTIONAL,
                    ... } OPTIONAL,
                    ... }
RESULT
cancelLocationRes SEQUENCE {
    extensionContainer SEQUENCE {
        privateExtensionList [0] IMPLICIT SEQUENCE ( SIZE (1..10) ) OF
            SEQUENCE {
                extId      MAP-EXTENSION .&extensionId ( {
                    '...'} ) ,
                extType    MAP-EXTENSION .&ExtensionType ( {
                    '...' { @extId } ) OPTIONAL} OPTIONAL,
                pcs-Extensions [1] IMPLICIT SEQUENCE {
                    ... } OPTIONAL,
                    ... } OPTIONAL,
                    ... }
ERRORS {
-- dataMissing -- localValue : 35,
-- unexpectedDataValue -- localValue : 36}
 ::= localValue : 3

purgeMS OPERATION
ARGUMENT
purgeMS-Arg [3] IMPLICIT SEQUENCE {
    imsi      OCTET STRING ( SIZE (3..8) ),

```

```

vlr-Number          [0] IMPLICIT OCTET STRING ( SIZE (1..20 ) ) ( SIZE (1..9 ) ) OPTIONAL,
sgsn-Number         [1] IMPLICIT OCTET STRING ( SIZE (1..20 ) ) ( SIZE (1..9 ) ) OPTIONAL,
extensionContainer  SEQUENCE {
  privateExtensionList [0] IMPLICIT SEQUENCE ( SIZE (1..10 ) ) OF
    SEQUENCE {
      extId          MAP-EXTENSION .&extensionId ( {
        '... } ) ,
      extType        MAP-EXTENSION .&ExtensionType ( {
        '... } { @extId } ) OPTIONAL} OPTIONAL,
  pcs-Extensions    [1] IMPLICIT SEQUENCE {
    ... } OPTIONAL,
    ... } OPTIONAL,
  ... }
RESULT
  purgeMS-Res SEQUENCE {
    freezeTMSI      [0] IMPLICIT NULL OPTIONAL,
    freezeP-TMSI    [1] IMPLICIT NULL OPTIONAL,
    extensionContainer SEQUENCE {
      privateExtensionList [0] IMPLICIT SEQUENCE ( SIZE (1..10 ) ) OF
        SEQUENCE {
          extId          MAP-EXTENSION .&extensionId ( {
            '... } ) ,
          extType        MAP-EXTENSION .&ExtensionType ( {
            '... } { @extId } ) OPTIONAL} OPTIONAL,
          pcs-Extensions [1] IMPLICIT SEQUENCE {
            ... } OPTIONAL,
            ... } OPTIONAL,
          ... }
    ERRORS {
      -- dataMissing -- localValue : 35,
      -- unexpectedDataValue -- localValue : 36,
      -- unknownSubscriber -- localValue : 1}
    ::= localValue : 67

sendIdentification OPERATION
  ARGUMENT
    tmsi          OCTET STRING ( SIZE (1..4 ) )
  RESULT
    sendIdentificationRes SEQUENCE {
      imsi          OCTET STRING ( SIZE (3..8 ) ),
      authenticationSetList SEQUENCE ( SIZE (1..5 ) ) OF
        SEQUENCE {
          rand       OCTET STRING ( SIZE (16 ) ),
          sres       OCTET STRING ( SIZE (4 ) ),
          kc         OCTET STRING ( SIZE (8 ) ),
          ... } OPTIONAL,
        ... }
    ERRORS {
      -- dataMissing -- localValue : 35,
      -- unidentifiedSubscriber -- localValue : 5}
    ::= localValue : 55

prepareHandover OPERATION
  ARGUMENT
    prepareHO-Arg SEQUENCE {
      targetCellId  OCTET STRING ( SIZE (5..7 ) ) OPTIONAL,
      ho-NumberNotRequired NULL OPTIONAL,
      bss-APDU      SEQUENCE {
        protocolId  ENUMERATED {
          gsm-0408   (1 ),
          gsm-0806   (2 ),
          gsm-BSSMAP (3 ),
          ets-300102-1 (4 )},
        signalInfo  OCTET STRING ( SIZE (1..200 ) ),
        extensionContainer SEQUENCE {
          privateExtensionList [0] IMPLICIT SEQUENCE ( SIZE (1..10 ) ) OF
            SEQUENCE {
              extId          MAP-EXTENSION .&extensionId ( {
                '... } ) ,
              extType        MAP-EXTENSION .&ExtensionType ( {
                '... } { @extId } ) OPTIONAL} OPTIONAL,
              pcs-Extensions [1] IMPLICIT SEQUENCE {

```

```

        ... } OPTIONAL,
        ... } OPTIONAL,
        ... } OPTIONAL,
    ... }
RESULT
prepareHO-Res SEQUENCE {
    handoverNumber  OCTET STRING ( SIZE (1..20 ) ) ( SIZE (1..9 ) ) OPTIONAL,
    bss-APDU        SEQUENCE {
        protocolId  ENUMERATED {
            gsm-0408      ( 1 ),
            gsm-0806      ( 2 ),
            gsm-BSSMAP    ( 3 ),
            ets-300102-1  ( 4 )},
        signalInfo    OCTET STRING ( SIZE (1..200 ) ),
        extensionContainer SEQUENCE {
            privateExtensionList [0] IMPLICIT SEQUENCE ( SIZE (1..10 ) ) OF
                SEQUENCE {
                    extId      MAP-EXTENSION .&extensionId ( {
                        '
                        ... } ) ,
                    extType    MAP-EXTENSION .&ExtensionType ( {
                        '
                        ... } { @extId } ) OPTIONAL} OPTIONAL,
            pcs-Extensions [1] IMPLICIT SEQUENCE {
                ... } OPTIONAL,
                ... } OPTIONAL,
                ... } OPTIONAL,
            ... }
ERRORS {
    -- systemFailure -- localValue : 34,
    -- dataMissing -- localValue : 35,
    -- unexpectedDataValue -- localValue : 36,
    -- noHandoverNumberAvailable -- localValue : 25}
 ::= localValue : 68

sendEndSignal OPERATION
ARGUMENT
    bss-APDU SEQUENCE {
        protocolId  ENUMERATED {
            gsm-0408      ( 1 ),
            gsm-0806      ( 2 ),
            gsm-BSSMAP    ( 3 ),
            ets-300102-1  ( 4 )},
        signalInfo    OCTET STRING ( SIZE (1..200 ) ),
        extensionContainer SEQUENCE {
            privateExtensionList [0] IMPLICIT SEQUENCE ( SIZE (1..10 ) ) OF
                SEQUENCE {
                    extId      MAP-EXTENSION .&extensionId ( {
                        '
                        ... } ) ,
                    extType    MAP-EXTENSION .&ExtensionType ( {
                        '
                        ... } { @extId } ) OPTIONAL} OPTIONAL,
            pcs-Extensions [1] IMPLICIT SEQUENCE {
                ... } OPTIONAL,
                ... } OPTIONAL,
            ... }
 ::= localValue : 29

processAccessSignalling OPERATION
ARGUMENT
    bss-APDU SEQUENCE {
        protocolId  ENUMERATED {
            gsm-0408      ( 1 ),
            gsm-0806      ( 2 ),
            gsm-BSSMAP    ( 3 ),
            ets-300102-1  ( 4 )},
        signalInfo    OCTET STRING ( SIZE (1..200 ) ),
        extensionContainer SEQUENCE {
            privateExtensionList [0] IMPLICIT SEQUENCE ( SIZE (1..10 ) ) OF
                SEQUENCE {
                    extId      MAP-EXTENSION .&extensionId ( {
                        '
                        ... } ) ,
                    extType    MAP-EXTENSION .&ExtensionType ( {
                        '
                        ... } { @extId } ) OPTIONAL} OPTIONAL,
            pcs-Extensions [1] IMPLICIT SEQUENCE {

```

```

        ... } OPTIONAL,
        ... } OPTIONAL,
        ... }
 ::= localValue : 33

forwardAccessSignalling OPERATION
ARGUMENT
  bss-APDU SEQUENCE {
    protocolId      ENUMERATED {
      gsm-0408      ( 1 ),
      gsm-0806      ( 2 ),
      gsm-BSSMAP    ( 3 ),
      ets-300102-1  ( 4 )},
    signalInfo      OCTET STRING ( SIZE ( 1..200 ) ),
    extensionContainer SEQUENCE {
      privateExtensionList [0] IMPLICIT SEQUENCE ( SIZE ( 1..10 ) ) OF
        SEQUENCE {
          extId      MAP-EXTENSION .&extensionId ( {
            '... } ) ,
          extType    MAP-EXTENSION .&ExtensionType ( {
            '... } { @extId } ) OPTIONAL} OPTIONAL,
        pcs-Extensions [1] IMPLICIT SEQUENCE {
          ... } OPTIONAL,
          ... } OPTIONAL,
          ... }
    }
 ::= localValue : 34

prepareSubsequentHandover OPERATION
ARGUMENT
  prepareSubsequentHO-Arg SEQUENCE {
    targetCellId      OCTET STRING ( SIZE ( 5..7 ) ),
    targetMSC-Number  OCTET STRING ( SIZE ( 1..20 ) ) ( SIZE ( 1..9 ) ),
    bss-APDU          SEQUENCE {
      protocolId      ENUMERATED {
        gsm-0408      ( 1 ),
        gsm-0806      ( 2 ),
        gsm-BSSMAP    ( 3 ),
        ets-300102-1  ( 4 )},
      signalInfo      OCTET STRING ( SIZE ( 1..200 ) ),
      extensionContainer SEQUENCE {
        privateExtensionList [0] IMPLICIT SEQUENCE ( SIZE ( 1..10 ) ) OF
          SEQUENCE {
            extId      MAP-EXTENSION .&extensionId ( {
              '... } ) ,
            extType    MAP-EXTENSION .&ExtensionType ( {
              '... } { @extId } ) OPTIONAL} OPTIONAL,
          pcs-Extensions [1] IMPLICIT SEQUENCE {
            ... } OPTIONAL,
            ... } OPTIONAL,
            ... }},
        ... }
    }
RESULT
  bss-APDU SEQUENCE {
    protocolId      ENUMERATED {
      gsm-0408      ( 1 ),
      gsm-0806      ( 2 ),
      gsm-BSSMAP    ( 3 ),
      ets-300102-1  ( 4 )},
    signalInfo      OCTET STRING ( SIZE ( 1..200 ) ),
    extensionContainer SEQUENCE {
      privateExtensionList [0] IMPLICIT SEQUENCE ( SIZE ( 1..10 ) ) OF
        SEQUENCE {
          extId      MAP-EXTENSION .&extensionId ( {
            '... } ) ,
          extType    MAP-EXTENSION .&ExtensionType ( {
            '... } { @extId } ) OPTIONAL} OPTIONAL,
        pcs-Extensions [1] IMPLICIT SEQUENCE {
          ... } OPTIONAL,
          ... } OPTIONAL,
          ... }
    }
ERRORS {
  -- unexpectedDataValue -- localValue : 36,

```



```

-- dataMissing -- localValue : 35,
-- unknownMSC -- localValue : 3,
-- subsequentHandoverFailure -- localValue : 26}
 ::= localValue : 69

sendAuthenticationInfo OPERATION
ARGUMENT
  sendAuthenticationInfoArg OCTET STRING ( SIZE (3..8 ) )
RESULT
  sendAuthenticationInfoRes SEQUENCE ( SIZE (1..5 ) ) OF
    SEQUENCE {
      rand      OCTET STRING ( SIZE (16 ) ),
      sres      OCTET STRING ( SIZE (4 ) ),
      kc        OCTET STRING ( SIZE (8 ) ),
      ... }
ERRORS {
  -- systemFailure -- localValue : 34,
  -- dataMissing -- localValue : 35,
  -- unexpectedDataValue -- localValue : 36,
  -- unknownSubscriber -- localValue : 1}
 ::= localValue : 56

checkIMEI OPERATION
ARGUMENT
  imei      OCTET STRING ( SIZE (8 ) )
RESULT
  equipmentStatus ENUMERATED {
    whiteListed (0 ),
    blackListed (1 ),
    greyListed  (2 )}
ERRORS {
  -- systemFailure -- localValue : 34,
  -- dataMissing -- localValue : 35,
  -- unknownEquipment -- localValue : 7}
 ::= localValue : 43

insertSubscriberData OPERATION
ARGUMENT
  insertSubscriberDataArg SEQUENCE {
    imsi [0] IMPLICIT OCTET STRING ( SIZE (3..8 ) )
OPTIONAL,
    msisdn [1] IMPLICIT OCTET STRING ( SIZE (1..20 ) ) (
SIZE (1..9 ) ) OPTIONAL,
    category [2] IMPLICIT OCTET STRING ( SIZE (1 ) )
OPTIONAL,
    subscriberStatus [3] IMPLICIT ENUMERATED {
      serviceGranted (0 ),
      operatorDeterminedBarring (1 )} OPTIONAL,
    bearerServiceList [4] IMPLICIT SEQUENCE ( SIZE (1..50 ) ) OF
      OCTET STRING ( SIZE (1..5 ) ) OPTIONAL,
    teleserviceList [6] IMPLICIT SEQUENCE ( SIZE (1..20 ) ) OF
      OCTET STRING ( SIZE (1..5 ) ) OPTIONAL,
    provisionedSS [7] IMPLICIT SEQUENCE ( SIZE (1..30 ) ) OF
      CHOICE {
        forwardingInfo [0] IMPLICIT SEQUENCE {
          ss-Code OCTET STRING ( SIZE (1 ) ),
          forwardingFeatureList SEQUENCE ( SIZE (1..32 ) ) OF
            SEQUENCE {
              basicService CHOICE {
                ext-BearerService [2] IMPLICIT OCTET STRING ( SIZE (1..5 ) ),
                ext-Teleservice [3] IMPLICIT OCTET STRING ( SIZE (1..5 ) )}
OPTIONAL,
              ss-Status [4] IMPLICIT OCTET STRING ( SIZE (1..5 ) ),
              forwardedToNumber [5] IMPLICIT OCTET STRING ( SIZE (1..20 ) ) ( SIZE
(1..9 ) ) OPTIONAL,
              forwardedToSubaddress [8] IMPLICIT OCTET STRING ( SIZE (1..21 ) )
OPTIONAL,
              forwardingOptions [6] IMPLICIT OCTET STRING ( SIZE (1..5 ) ) OPTIONAL,
              noReplyConditionTime [7] IMPLICIT INTEGER ( 1..100 ) OPTIONAL,
              extensionContainer [9] IMPLICIT SEQUENCE {
                privateExtensionList [0] IMPLICIT SEQUENCE ( SIZE (1..10 ) ) OF
                  SEQUENCE {
                    extId MAP-EXTENSION .&extensionId ( {
                      '
                      ... } ) ,
                    extType MAP-EXTENSION .&ExtensionType ( {
                      '
                      ... } { @extId } ) OPTIONAL} OPTIONAL,

```



```

... },
cug-FeatureList      SEQUENCE ( SIZE (1..32 ) ) OF
  SEQUENCE {
    basicService      CHOICE {
      ext-BearerService [2] IMPLICIT OCTET STRING ( SIZE (1..5 ) ),
      ext-Teleservice   [3] IMPLICIT OCTET STRING ( SIZE (1..5 ) )}
  }
OPTIONAL,

  preferentialCUG-Indicator INTEGER ( 0..32767 ) OPTIONAL,
  interCUG-Restrictions   OCTET STRING ( SIZE ( 1 ) ),
  extensionContainer      SEQUENCE {
    privateExtensionList [0] IMPLICIT SEQUENCE ( SIZE (1..10 ) ) OF
      SEQUENCE {
        extId          MAP-EXTENSION .&extensionId ( {
          '
          ... } ) ,
        extType        MAP-EXTENSION .&ExtensionType ( {
          '
          ... } { @extId } ) OPTIONAL} OPTIONAL,
    pcs-Extensions      [1] IMPLICIT SEQUENCE {
      ... } OPTIONAL,
      ... } OPTIONAL,
      ... } OPTIONAL,
  }
extensionContainer    [0] IMPLICIT SEQUENCE {
  privateExtensionList [0] IMPLICIT SEQUENCE ( SIZE (1..10 ) ) OF
    SEQUENCE {
      extId          MAP-EXTENSION .&extensionId ( {
        '
        ... } ) ,
      extType        MAP-EXTENSION .&ExtensionType ( {
        '
        ... } { @extId } ) OPTIONAL} OPTIONAL,
    pcs-Extensions    [1] IMPLICIT SEQUENCE {
      ... } OPTIONAL,
      ... } OPTIONAL,
      ... } OPTIONAL,
  }
... },
ss-Data              [3] IMPLICIT SEQUENCE {
  ss-Code             OCTET STRING ( SIZE ( 1 ) ),
  ss-Status           [4] IMPLICIT OCTET STRING ( SIZE (1..5 ) ),
  ss-SubscriptionOption CHOICE {
    cliRestrictionOption [2] IMPLICIT ENUMERATED {
      permanent          ( 0 ),
      temporaryDefaultRestricted ( 1 ),
      temporaryDefaultAllowed ( 2 )},
    overrideCategory    [1] IMPLICIT ENUMERATED {
      overrideEnabled    ( 0 ),
      overrideDisabled   ( 1 )}} OPTIONAL,
  basicServiceGroupList SEQUENCE ( SIZE (1..32 ) ) OF
    CHOICE {
      ext-BearerService [2] IMPLICIT OCTET STRING ( SIZE (1..5 ) ),
      ext-Teleservice   [3] IMPLICIT OCTET STRING ( SIZE (1..5 ) )} OPTIONAL,
  extensionContainer   [5] IMPLICIT SEQUENCE {
    privateExtensionList [0] IMPLICIT SEQUENCE ( SIZE (1..10 ) ) OF
      SEQUENCE {
        extId          MAP-EXTENSION .&extensionId ( {
          '
          ... } ) ,
        extType        MAP-EXTENSION .&ExtensionType ( {
          '
          ... } { @extId } ) OPTIONAL} OPTIONAL,
      pcs-Extensions    [1] IMPLICIT SEQUENCE {
        ... } OPTIONAL,
        ... } OPTIONAL,
        ... } OPTIONAL,
    }
  }
... },
emlpp-Info           [4] IMPLICIT SEQUENCE {
  maximumentitledPriority INTEGER ( 0..15 ),
  defaultPriority       INTEGER ( 0..15 ),
  extensionContainer    SEQUENCE {
    privateExtensionList [0] IMPLICIT SEQUENCE ( SIZE (1..10 ) ) OF
      SEQUENCE {
        extId          MAP-EXTENSION .&extensionId ( {
          '
          ... } ) ,
        extType        MAP-EXTENSION .&ExtensionType ( {
          '
          ... } { @extId } ) OPTIONAL} OPTIONAL,
      pcs-Extensions    [1] IMPLICIT SEQUENCE {
        ... } OPTIONAL,
        ... } OPTIONAL,
        ... } OPTIONAL,
    }
  }

```

```

... }} OPTIONAL,
odb-Data [8] IMPLICIT SEQUENCE {
  odb-GeneralData BIT STRING {
    allOG-CallsBarred (0 ),
    internationalOGCallsBarred (1 ),
    internationalOGCallsNotToHPLMN-CountryBarred (2 ),
    interzonalOGCallsBarred (6 ),
    interzonalOGCallsNotToHPLMN-CountryBarred (7 ),
    interzonalOGCallsAndInternationalOGCallsNotToHPLMN-CountryBarred (8 ),
    premiumRateInformationOGCallsBarred (3 ),
    premiumRateEntertainmentOGCallsBarred (4 ),
    ss-AccessBarred (5 ),
    allECT-Barred (9 ),
    chargeableECT-Barred (10 ),
    internationalECT-Barred (11 ),
    interzonalECT-Barred (12 ),
    doublyChargeableECT-Barred (13 ),
    multipleECT-Barred (14 )} ( SIZE (15..32 ) ),
  odb-HPLMN-Data BIT STRING {
    plmn-SpecificBarringType1 (0 ),
    plmn-SpecificBarringType2 (1 ),
    plmn-SpecificBarringType3 (2 ),
    plmn-SpecificBarringType4 (3 )} ( SIZE (4..32 ) ) OPTIONAL,
  extensionContainer SEQUENCE {
    privateExtensionList [0] IMPLICIT SEQUENCE ( SIZE (1..10 ) ) OF
      SEQUENCE {
        extId MAP-EXTENSION .&extensionId ( {
          '
          ... } ) ,
        extType MAP-EXTENSION .&ExtensionType ( {
          '
          ... } { @extId } ) OPTIONAL} OPTIONAL,
    pcs-Extensions [1] IMPLICIT SEQUENCE {
      ... } OPTIONAL,
      ... } OPTIONAL,
      ... } OPTIONAL,
      ... } OPTIONAL,
  roamingRestrictionDueToUnsupportedFeature [9] IMPLICIT NULL OPTIONAL,
  regionalSubscriptionData [10] IMPLICIT SEQUENCE ( SIZE (1..10 ) ) OF
    OCTET STRING ( SIZE (2 ) ) OPTIONAL,
  vbsSubscriptionData [11] IMPLICIT SEQUENCE ( SIZE (1..50 ) ) OF
    SEQUENCE {
      groupId OCTET STRING ( SIZE (3 ) ),
      broadcastInitEntitlement NULL OPTIONAL,
      extensionContainer SEQUENCE {
        privateExtensionList [0] IMPLICIT SEQUENCE ( SIZE (1..10 ) ) OF
          SEQUENCE {
            extId MAP-EXTENSION .&extensionId ( {
              '
              ... } ) ,
            extType MAP-EXTENSION .&ExtensionType ( {
              '
              ... } { @extId } ) OPTIONAL} OPTIONAL,
          pcs-Extensions [1] IMPLICIT SEQUENCE {
            ... } OPTIONAL,
            ... } OPTIONAL,
            ... } OPTIONAL,
            ... } OPTIONAL,
      vgsSubscriptionData [12] IMPLICIT SEQUENCE ( SIZE (1..50 ) ) OF
        SEQUENCE {
          groupId OCTET STRING ( SIZE (3 ) ),
          extensionContainer SEQUENCE {
            privateExtensionList [0] IMPLICIT SEQUENCE ( SIZE (1..10 ) ) OF
              SEQUENCE {
                extId MAP-EXTENSION .&extensionId ( {
                  '
                  ... } ) ,
                extType MAP-EXTENSION .&ExtensionType ( {
                  '
                  ... } { @extId } ) OPTIONAL} OPTIONAL,
              pcs-Extensions [1] IMPLICIT SEQUENCE {
                ... } OPTIONAL,
                ... } OPTIONAL,
                ... } OPTIONAL,
                ... } OPTIONAL,
          vlrCamelSubscriptionInfo [13] IMPLICIT SEQUENCE {
            o-CSI [0] IMPLICIT SEQUENCE {
              o-BcsmCamelTDPDataList SEQUENCE ( SIZE (1..10 ) ) OF
                SEQUENCE {
                  o-BcsmTriggerDetectionPoint ENUMERATED {
                    collectedInfo (2 ),

```



```

... } OPTIONAL,
o-BcsmCamelTDP-CriteriaList [4] IMPLICIT SEQUENCE ( SIZE (1..10 ) ) OF
SEQUENCE {
  o-BcsmTriggerDetectionPoint  ENUMERATED {
    collectedInfo ( 2 ),
    ... },
  destinationNumberCriteria [0] IMPLICIT SEQUENCE {
    matchType [0] IMPLICIT ENUMERATED {
      inhibiting ( 0 ),
      enabling ( 1 )},
    destinationNumberList [1] IMPLICIT SEQUENCE ( SIZE (1..10 ) ) OF
      OCTET STRING ( SIZE (1..20 ) ) ( SIZE (1..9 ) ) OPTIONAL,
    destinationNumberLengthList [2] IMPLICIT SEQUENCE ( SIZE (1..3 ) ) OF
      INTEGER ( 1..15 ) OPTIONAL,
    ... } OPTIONAL,
  basicServiceCriteria [1] IMPLICIT SEQUENCE ( SIZE (1..5 ) ) OF
    CHOICE {
      ext-BearerService [2] IMPLICIT OCTET STRING ( SIZE (1..5 ) ),
      ext-Teleservice [3] IMPLICIT OCTET STRING ( SIZE (1..5 ) )} OPTIONAL,
  callTypeCriteria [2] IMPLICIT ENUMERATED {
    forwarded ( 0 ),
    notForwarded ( 1 )} OPTIONAL,
  ... } OPTIONAL} OPTIONAL,
extensionContainer [14] IMPLICIT SEQUENCE {
  privateExtensionList [0] IMPLICIT SEQUENCE ( SIZE (1..10 ) ) OF
    SEQUENCE {
      extId MAP-EXTENSION .&extensionId ( {
        '
        ... } ) ,
      extType MAP-EXTENSION .&ExtensionType ( {
        '
        ... } { @extId } ) OPTIONAL} OPTIONAL,
  pcs-Extensions [1] IMPLICIT SEQUENCE {
    ... } OPTIONAL,
    ... } OPTIONAL,
... ,
naea-PreferredCI [15] IMPLICIT SEQUENCE {
  naea-PreferredCIC [0] IMPLICIT OCTET STRING ( SIZE ( 3 ) ),
  extensionContainer [1] IMPLICIT SEQUENCE {
    privateExtensionList [0] IMPLICIT SEQUENCE ( SIZE (1..10 ) ) OF
      SEQUENCE {
        extId MAP-EXTENSION .&extensionId ( {
          '
          ... } ) ,
        extType MAP-EXTENSION .&ExtensionType ( {
          '
          ... } { @extId } ) OPTIONAL} OPTIONAL,
    pcs-Extensions [1] IMPLICIT SEQUENCE {
      ... } OPTIONAL,
      ... } OPTIONAL,
      ... } OPTIONAL,
    ... } OPTIONAL,
gprsSubscriptionData [16] IMPLICIT SEQUENCE {
  completeDataListIncluded NULL OPTIONAL,
  gprsDataList [1] IMPLICIT SEQUENCE ( SIZE (1..50 ) ) OF
    SEQUENCE {
      pdp-ContextId INTEGER ( 1..50 ),
      pdp-Type [16] IMPLICIT OCTET STRING ( SIZE ( 2 ) ),
      pdp-Address [17] IMPLICIT OCTET STRING ( SIZE (1..16 ) ) OPTIONAL,
      qos-Subscribed [18] IMPLICIT OCTET STRING ( SIZE ( 3 ) ),
      vplmnAddressAllowed [19] IMPLICIT NULL OPTIONAL,
      apn [20] IMPLICIT OCTET STRING ( SIZE (2..63 ) ),
      extensionContainer [21] IMPLICIT SEQUENCE {
        privateExtensionList [0] IMPLICIT SEQUENCE ( SIZE (1..10 ) ) OF
          SEQUENCE {
            extId MAP-EXTENSION .&extensionId ( {
              '
              ... } ) ,
            extType MAP-EXTENSION .&ExtensionType ( {
              '
              ... } { @extId } ) OPTIONAL} OPTIONAL,
        pcs-Extensions [1] IMPLICIT SEQUENCE {
          ... } OPTIONAL,
          ... } OPTIONAL,
          ... } OPTIONAL,
        ... },
      extensionContainer [2] IMPLICIT SEQUENCE {
        privateExtensionList [0] IMPLICIT SEQUENCE ( SIZE (1..10 ) ) OF
          SEQUENCE {
            extId MAP-EXTENSION .&extensionId ( {

```

```

        '...} ) ,
        extType      MAP-EXTENSION .&ExtensionType ( {
        '...} { @extId } ) OPTIONAL} OPTIONAL,
        pcs-Extensions [1] IMPLICIT SEQUENCE {
        ... } OPTIONAL,
        ... } OPTIONAL,
        ... } OPTIONAL,
        roamingRestrictedInSgsnDueToUnsupportedFeature [23] IMPLICIT NULL OPTIONAL,
        networkAccessMode [24] IMPLICIT ENUMERATED {
        bothMSCAndSGSN (0 ),
        onlyMSC (1 ),
        onlySGSN (2 ),
        ... } OPTIONAL}
RESULT
insertSubscriberDataRes SEQUENCE {
    teleserviceList [1] IMPLICIT SEQUENCE ( SIZE (1..20 ) ) OF
        OCTET STRING ( SIZE (1..5 ) ) OPTIONAL,
    bearerServiceList [2] IMPLICIT SEQUENCE ( SIZE (1..50 ) ) OF
        OCTET STRING ( SIZE (1..5 ) ) OPTIONAL,
    ss-List [3] IMPLICIT SEQUENCE ( SIZE (1..30 ) ) OF
        OCTET STRING ( SIZE (1 ) ) OPTIONAL,
    odb-GeneralData [4] IMPLICIT BIT STRING {
        allOG-CallsBarred (0 ),
        internationalOGCallsBarred (1 ),
        internationalOGCallsNotToHPLMN-CountryBarred (2 ),
        interzonalOGCallsBarred (6 ),
        interzonalOGCallsNotToHPLMN-CountryBarred (7 ),
        interzonalOGCallsAndInternationalOGCallsNotToHPLMN-CountryBarred (8 ),
        premiumRateInformationOGCallsBarred (3 ),
        premiumRateEntertainmentOGCallsBarred (4 ),
        ss-AccessBarred (5 ),
        allECT-Barred (9 ),
        chargeableECT-Barred (10 ),
        internationalECT-Barred (11 ),
        interzonalECT-Barred (12 ),
        doublyChargeableECT-Barred (13 ),
        multipleECT-Barred (14 )} ( SIZE (15..32 ) ) OPTIONAL,
    regionalSubscriptionResponse [5] IMPLICIT ENUMERATED {
        networkNode-AreaRestricted (0 ),
        tooManyZoneCodes (1 ),
        zoneCodesConflict (2 ),
        regionalSubscNotSupported (3 )} OPTIONAL,
    supportedCamelPhases [6] IMPLICIT BIT STRING {
        phase1 (0 ),
        phase2 (1 )} ( SIZE (1..16 ) ) OPTIONAL,
    extensionContainer [7] IMPLICIT SEQUENCE {
        privateExtensionList [0] IMPLICIT SEQUENCE ( SIZE (1..10 ) ) OF
            SEQUENCE {
                extId      MAP-EXTENSION .&extensionId ( {
                '...} ) ,
                extType      MAP-EXTENSION .&ExtensionType ( {
                '...} { @extId } ) OPTIONAL} OPTIONAL,
                pcs-Extensions [1] IMPLICIT SEQUENCE {
                ... } OPTIONAL,
                ... } OPTIONAL,
                ... }
    }
ERRORS {
    -- dataMissing -- localValue : 35,
    -- unexpectedDataValue -- localValue : 36,
    -- unidentifiedSubscriber -- localValue : 5}
 ::= localValue : 7

deleteSubscriberData OPERATION
ARGUMENT
    deleteSubscriberDataArg SEQUENCE {
        imsi [0] IMPLICIT OCTET STRING ( SIZE (3..8 )
    ),
        basicServiceList [1] IMPLICIT SEQUENCE ( SIZE (1..70 ) )
OF
    CHOICE {
        ext-BearerService [2] IMPLICIT OCTET STRING ( SIZE (1..5 ) ),
        ext-Teleservice [3] IMPLICIT OCTET STRING ( SIZE (1..5 ) )} OPTIONAL,
        ss-List [2] IMPLICIT SEQUENCE ( SIZE (1..30 ) )
OF

```

```

    OCTET STRING ( SIZE ( 1 ) ) OPTIONAL,
    roamingRestrictionDueToUnsupportedFeature           [4] IMPLICIT NULL OPTIONAL,
    regionalSubscriptionIdentifier                       [5] IMPLICIT OCTET STRING ( SIZE ( 2 ) )
OPTIONAL,
    vbsGroupIndication                                 [7] IMPLICIT NULL OPTIONAL,
    vgcsGroupIndication                                 [8] IMPLICIT NULL OPTIONAL,
    camelSubscriptionInfoWithdraw                       [9] IMPLICIT NULL OPTIONAL,
    extensionContainer                                  [6] IMPLICIT SEQUENCE {
        privateExtensionList [0] IMPLICIT SEQUENCE ( SIZE ( 1..10 ) ) OF
            SEQUENCE {
                extId      MAP-EXTENSION .&extensionId ( {
                    '
                    ... } ) ,
                extType    MAP-EXTENSION .&ExtensionType ( {
                    '
                    ... } { @extId } ) OPTIONAL} OPTIONAL,
        pcs-Extensions   [1] IMPLICIT SEQUENCE {
            ... } OPTIONAL,
        ... } OPTIONAL,
        ... ,
    gprsSubscriptionDataWithdraw                        [10] CHOICE {
        allGPRSData      NULL,
        contextIdList    SEQUENCE ( SIZE ( 1..50 ) ) OF
            INTEGER ( 1..50 )} OPTIONAL,
        roamingRestrictedInSgsnDueToUnsupportedFeature [11] IMPLICIT NULL OPTIONAL}
RESULT
    deleteSubscriberDataRes SEQUENCE {
        regionalSubscriptionResponse [0] IMPLICIT ENUMERATED {
            networkNode-AreaRestricted ( 0 ),
            tooManyZoneCodes           ( 1 ),
            zoneCodesConflict          ( 2 ),
            regionalSubscNotSupported ( 3 )} OPTIONAL,
        extensionContainer SEQUENCE {
            privateExtensionList [0] IMPLICIT SEQUENCE ( SIZE ( 1..10 ) ) OF
                SEQUENCE {
                    extId      MAP-EXTENSION .&extensionId ( {
                        '
                        ... } ) ,
                    extType    MAP-EXTENSION .&ExtensionType ( {
                        '
                        ... } { @extId } ) OPTIONAL} OPTIONAL,
            pcs-Extensions   [1] IMPLICIT SEQUENCE {
                ... } OPTIONAL,
            ... } OPTIONAL,
            ... }
ERRORS {
    -- dataMissing -- localValue : 35,
    -- unexpectedDataValue -- localValue : 36,
    -- unidentifiedSubscriber -- localValue : 5}
 ::= localValue : 8

reset OPERATION
    ARGUMENT
        resetArg SEQUENCE {
            hlr-Number OCTET STRING ( SIZE ( 1..20 ) ) ( SIZE ( 1..9 ) ),
            hlr-List SEQUENCE ( SIZE ( 1..50 ) ) OF
                OCTET STRING ( SIZE ( 3..8 ) ) OPTIONAL,
            ... }
 ::= localValue : 37

forwardCheckSS-Indication OPERATION
 ::= localValue : 38

restoreData OPERATION
    ARGUMENT
        restoreDataArg SEQUENCE {
            imsi OCTET STRING ( SIZE ( 3..8 ) ),
            lmsi OCTET STRING ( SIZE ( 4 ) ) OPTIONAL,
            extensionContainer SEQUENCE {
                privateExtensionList [0] IMPLICIT SEQUENCE ( SIZE ( 1..10 ) ) OF
                    SEQUENCE {
                        extId      MAP-EXTENSION .&extensionId ( {
                            '
                            ... } ) ,
                        extType    MAP-EXTENSION .&ExtensionType ( {
                            '
                            ... } { @extId } ) OPTIONAL} OPTIONAL,
                pcs-Extensions   [1] IMPLICIT SEQUENCE {
                    ... }

```



```

    ... } OPTIONAL,
    ... } OPTIONAL,
    ...
vlr-Capability      [6] IMPLICIT SEQUENCE {
  supportedCamelPhases [0] IMPLICIT BIT STRING {
    phase1 ( 0 ),
    phase2 ( 1 ) } ( SIZE ( 1..16 ) ) OPTIONAL,
  extensionContainer SEQUENCE {
    privateExtensionList [0] IMPLICIT SEQUENCE ( SIZE ( 1..10 ) ) OF
    SEQUENCE {
      extId      MAP-EXTENSION .&extensionId ( {
        '
        ... } ) ,
      extType    MAP-EXTENSION .&ExtensionType ( {
        '
        ... } { @extId } ) OPTIONAL} OPTIONAL,
    pcs-Extensions [1] IMPLICIT SEQUENCE {
      ... } OPTIONAL,
      ... } OPTIONAL,
      ... } OPTIONAL}
RESULT
restoreDataRes SEQUENCE {
  hlr-Number      OCTET STRING ( SIZE ( 1..20 ) ) ( SIZE ( 1..9 ) ),
  msNotReachable  NULL OPTIONAL,
  extensionContainer SEQUENCE {
    privateExtensionList [0] IMPLICIT SEQUENCE ( SIZE ( 1..10 ) ) OF
    SEQUENCE {
      extId      MAP-EXTENSION .&extensionId ( {
        '
        ... } ) ,
      extType    MAP-EXTENSION .&ExtensionType ( {
        '
        ... } { @extId } ) OPTIONAL} OPTIONAL,
    pcs-Extensions [1] IMPLICIT SEQUENCE {
      ... } OPTIONAL,
      ... } OPTIONAL,
      ... }
ERRORS {
  -- systemFailure -- localValue : 34,
  -- dataMissing -- localValue : 35,
  -- unexpectedDataValue -- localValue : 36,
  -- unknownSubscriber -- localValue : 1}
 ::= localValue : 57

activateTraceMode OPERATION
ARGUMENT
activateTraceModeArg SEQUENCE {
  imsi            [0] IMPLICIT OCTET STRING ( SIZE ( 3..8 ) ) OPTIONAL,
  traceReference  [1] IMPLICIT OCTET STRING ( SIZE ( 1..2 ) ),
  traceType       [2] IMPLICIT INTEGER ( 0..255 ),
  omc-Id          [3] IMPLICIT OCTET STRING ( SIZE ( 1..20 ) ) OPTIONAL,
  extensionContainer [4] IMPLICIT SEQUENCE {
    privateExtensionList [0] IMPLICIT SEQUENCE ( SIZE ( 1..10 ) ) OF
    SEQUENCE {
      extId      MAP-EXTENSION .&extensionId ( {
        '
        ... } ) ,
      extType    MAP-EXTENSION .&ExtensionType ( {
        '
        ... } { @extId } ) OPTIONAL} OPTIONAL,
    pcs-Extensions [1] IMPLICIT SEQUENCE {
      ... } OPTIONAL,
      ... } OPTIONAL,
      ... }
... }
RESULT
activateTraceModeRes SEQUENCE {
  extensionContainer [0] IMPLICIT SEQUENCE {
    privateExtensionList [0] IMPLICIT SEQUENCE ( SIZE ( 1..10 ) ) OF
    SEQUENCE {
      extId      MAP-EXTENSION .&extensionId ( {
        '
        ... } ) ,
      extType    MAP-EXTENSION .&ExtensionType ( {
        '
        ... } { @extId } ) OPTIONAL} OPTIONAL,
    pcs-Extensions [1] IMPLICIT SEQUENCE {
      ... } OPTIONAL,
      ... } OPTIONAL,
      ... }

```

```

... }
ERRORS {
-- systemFailure -- localValue : 34,
-- dataMissing -- localValue : 35,
-- unexpectedDataValue -- localValue : 36,
-- facilityNotSupported -- localValue : 21,
-- unidentifiedSubscriber -- localValue : 5,
-- tracingBufferFull -- localValue : 40}
 ::= localValue : 50

deactivateTraceMode OPERATION
ARGUMENT
  deactivateTraceModeArg SEQUENCE {
    imsi [0] IMPLICIT OCTET STRING ( SIZE (3..8 ) ) OPTIONAL,
    traceReference [1] IMPLICIT OCTET STRING ( SIZE (1..2 ) ),
    extensionContainer [2] IMPLICIT SEQUENCE {
      privateExtensionList [0] IMPLICIT SEQUENCE ( SIZE (1..10 ) ) OF
        SEQUENCE {
          extId MAP-EXTENSION .&extensionId ( {
            '
            ... } ) ,
          extType MAP-EXTENSION .&ExtensionType ( {
            '
            ... } { @extId } ) OPTIONAL} OPTIONAL,
      pcs-Extensions [1] IMPLICIT SEQUENCE {
        ... } OPTIONAL,
        ... } OPTIONAL,
        ... }
    ... }
RESULT
  deactivateTraceModeRes SEQUENCE {
    extensionContainer [0] IMPLICIT SEQUENCE {
      privateExtensionList [0] IMPLICIT SEQUENCE ( SIZE (1..10 ) ) OF
        SEQUENCE {
          extId MAP-EXTENSION .&extensionId ( {
            '
            ... } ) ,
          extType MAP-EXTENSION .&ExtensionType ( {
            '
            ... } { @extId } ) OPTIONAL} OPTIONAL,
      pcs-Extensions [1] IMPLICIT SEQUENCE {
        ... } OPTIONAL,
        ... } OPTIONAL,
        ... }
    ... }
  }
ERRORS {
-- systemFailure -- localValue : 34,
-- dataMissing -- localValue : 35,
-- unexpectedDataValue -- localValue : 36,
-- facilityNotSupported -- localValue : 21,
-- unidentifiedSubscriber -- localValue : 5}
 ::= localValue : 51

sendIMSI OPERATION
ARGUMENT
  msisdn OCTET STRING ( SIZE (1..20 ) ) ( SIZE (1..9 ) )
RESULT
  imsi OCTET STRING ( SIZE (3..8 ) )
ERRORS {
-- dataMissing -- localValue : 35,
-- unexpectedDataValue -- localValue : 36,
-- unknownSubscriber -- localValue : 1}
 ::= localValue : 58

sendRoutingInfo OPERATION
ARGUMENT
  sendRoutingInfoArg SEQUENCE {
    msisdn [0] IMPLICIT OCTET STRING ( SIZE (1..20 ) ) ( SIZE (1..9 ) ),
    cug-CheckInfo [1] IMPLICIT SEQUENCE {
      cug-Interlock OCTET STRING ( SIZE (4 ) ),
      cug-OutgoingAccess NULL OPTIONAL,
      extensionContainer SEQUENCE {
        privateExtensionList [0] IMPLICIT SEQUENCE ( SIZE (1..10 ) ) OF
          SEQUENCE {
            extId MAP-EXTENSION .&extensionId ( {
              '
              ... } ) ,
            extType MAP-EXTENSION .&ExtensionType ( {
              '
              ... } { @extId } ) OPTIONAL} OPTIONAL,
          }
      }
    }
  }

```

```

        pcs-Extensions          [1] IMPLICIT SEQUENCE {
            ... } OPTIONAL,
            ... } OPTIONAL,
            ... } OPTIONAL,
    numberOfForwarding          [2] IMPLICIT INTEGER ( 1..5 ) OPTIONAL,
    interrogationType           [3] IMPLICIT ENUMERATED {
        basicCall      ( 0 ),
        forwarding     ( 1 )},
    or-Interrogation            [4] IMPLICIT NULL OPTIONAL,
    or-Capability               [5] IMPLICIT INTEGER ( 1..127 ) OPTIONAL,
    gsmc-Address                [6] IMPLICIT OCTET STRING ( SIZE ( 1..20 ) ) ( SIZE ( 1..9 ) ),
    callReferenceNumber         [7] IMPLICIT OCTET STRING ( SIZE ( 1..8 ) ) OPTIONAL,
    forwardingReason            [8] IMPLICIT ENUMERATED {
        notReachable  ( 0 ),
        busy          ( 1 ),
        noReply       ( 2 )} OPTIONAL,
    basicServiceGroup           [9] CHOICE {
        ext-BearerService [2] IMPLICIT OCTET STRING ( SIZE ( 1..5 ) ),
        ext-Teleservice  [3] IMPLICIT OCTET STRING ( SIZE ( 1..5 ) )} OPTIONAL,
    networkSignalInfo           [10] IMPLICIT SEQUENCE {
        protocolId       ENUMERATED {
            gsm-0408      ( 1 ),
            gsm-0806      ( 2 ),
            gsm-BSSMAP    ( 3 ),
            ets-300102-1  ( 4 )},
        signalInfo       OCTET STRING ( SIZE ( 1..200 ) ),
        extensionContainer SEQUENCE {
            privateExtensionList [0] IMPLICIT SEQUENCE ( SIZE ( 1..10 ) ) OF
                SEQUENCE {
                    extId         MAP-EXTENSION .&extensionId ( {
                        '
                        ... } ) ,
                    extType      MAP-EXTENSION .&ExtensionType ( {
                        '
                        ... } { @extId } ) OPTIONAL} OPTIONAL,
            pcs-Extensions      [1] IMPLICIT SEQUENCE {
                ... } OPTIONAL,
                ... } OPTIONAL,
                ... } OPTIONAL,
                ... } OPTIONAL,
        camelInfo            [11] IMPLICIT SEQUENCE {
            supportedCamelPhases BIT STRING {
                phase1 ( 0 ),
                phase2 ( 1 )} ( SIZE ( 1..16 ) ),
            suppress-T-CSI      NULL OPTIONAL,
            extensionContainer SEQUENCE {
                privateExtensionList [0] IMPLICIT SEQUENCE ( SIZE ( 1..10 ) ) OF
                    SEQUENCE {
                        extId         MAP-EXTENSION .&extensionId ( {
                            '
                            ... } ) ,
                        extType      MAP-EXTENSION .&ExtensionType ( {
                            '
                            ... } { @extId } ) OPTIONAL} OPTIONAL,
                pcs-Extensions      [1] IMPLICIT SEQUENCE {
                    ... } OPTIONAL,
                    ... } OPTIONAL,
                    ... } OPTIONAL,
                    ... } OPTIONAL,
            suppressionOfAnnouncement [12] IMPLICIT NULL OPTIONAL,
            extensionContainer [13] IMPLICIT SEQUENCE {
                privateExtensionList [0] IMPLICIT SEQUENCE ( SIZE ( 1..10 ) ) OF
                    SEQUENCE {
                        extId         MAP-EXTENSION .&extensionId ( {
                            '
                            ... } ) ,
                        extType      MAP-EXTENSION .&ExtensionType ( {
                            '
                            ... } { @extId } ) OPTIONAL} OPTIONAL,
                pcs-Extensions      [1] IMPLICIT SEQUENCE {
                    ... } OPTIONAL,
                    ... } OPTIONAL,
                    ... } OPTIONAL,
                    ... } OPTIONAL,
            ... ,
            alertingPattern        [14] IMPLICIT OCTET STRING ( SIZE ( 1 ) ) OPTIONAL,
            ccbs-Call              [15] IMPLICIT NULL OPTIONAL,
            supportedCCBS-Phase    [16] IMPLICIT INTEGER ( 1..127 ) OPTIONAL}
RESULT
    sendRoutingInfoRes [3] IMPLICIT SEQUENCE {
        imsi                [9] IMPLICIT OCTET STRING ( SIZE ( 3..8 ) ) OPTIONAL,
        extendedRoutingInfo CHOICE {

```



```

... ,
camelCapabilityHandling [0] IMPLICIT INTEGER ( 1..16 ) OPTIONAL} OPTIONAL,
o-CSI [1] IMPLICIT SEQUENCE {
o-BcsmCamelTDPDataList SEQUENCE ( SIZE (1..10 ) ) OF
SEQUENCE {
o-BcsmTriggerDetectionPoint ENUMERATED {
collectedInfo ( 2 ),
... },
serviceKey INTEGER ( 0..2147483647 ),
gsmSCF-Address [0] IMPLICIT OCTET STRING ( SIZE (1..20 ) )
( SIZE (1..9 ) ),
defaultCallHandling [1] IMPLICIT ENUMERATED {
continueCall ( 0 ),
releaseCall ( 1 ),
... },
extensionContainer [2] IMPLICIT SEQUENCE {
privateExtensionList [0] IMPLICIT SEQUENCE ( SIZE (1..10 ) ) OF
SEQUENCE {
extId MAP-EXTENSION .&extensionId ( {
'...'} ) ,
extType MAP-EXTENSION .&ExtensionType ( {
'...'} { @extId } ) OPTIONAL} OPTIONAL,
pcs-Extensions [1] IMPLICIT SEQUENCE {
... } OPTIONAL,
... } OPTIONAL,
... },
extensionContainer SEQUENCE {
privateExtensionList [0] IMPLICIT SEQUENCE ( SIZE (1..10 ) ) OF
SEQUENCE {
extId MAP-EXTENSION .&extensionId ( {
'...'} ) ,
extType MAP-EXTENSION .&ExtensionType ( {
'...'} { @extId } ) OPTIONAL} OPTIONAL,
pcs-Extensions [1] IMPLICIT SEQUENCE {
... } OPTIONAL,
... } OPTIONAL,
... ,
camelCapabilityHandling [0] IMPLICIT INTEGER ( 1..16 ) OPTIONAL} OPTIONAL,
extensionContainer [2] IMPLICIT SEQUENCE {
privateExtensionList [0] IMPLICIT SEQUENCE ( SIZE (1..10 ) ) OF
SEQUENCE {
extId MAP-EXTENSION .&extensionId ( {
'...'} ) ,
extType MAP-EXTENSION .&ExtensionType ( {
'...'} { @extId } ) OPTIONAL} OPTIONAL,
pcs-Extensions [1] IMPLICIT SEQUENCE {
... } OPTIONAL,
... } OPTIONAL,
... ,
o-BcsmCamelTDP-CriteriaList [3] IMPLICIT SEQUENCE ( SIZE (1..10 ) ) OF
SEQUENCE {
o-BcsmTriggerDetectionPoint ENUMERATED {
collectedInfo ( 2 ),
... },
destinationNumberCriteria [0] IMPLICIT SEQUENCE {
matchType [0] IMPLICIT ENUMERATED {
inhibiting ( 0 ),
enabling ( 1 )},
destinationNumberList [1] IMPLICIT SEQUENCE ( SIZE (1..10 ) ) OF
OCTET STRING ( SIZE (1..20 ) ) ( SIZE (1..9 ) ) OPTIONAL,
destinationNumberLengthList [2] IMPLICIT SEQUENCE ( SIZE (1..3 ) ) OF
INTEGER ( 1..15 ) OPTIONAL,
... } OPTIONAL,
basicServiceCriteria [1] IMPLICIT SEQUENCE ( SIZE (1..5 ) ) OF
CHOICE {
ext-BearerService [2] IMPLICIT OCTET STRING ( SIZE (1..5 ) ),
ext-Teleservice [3] IMPLICIT OCTET STRING ( SIZE (1..5 ) )}
OPTIONAL,
callTypeCriteria [2] IMPLICIT ENUMERATED {
forwarded ( 0 ),
notForwarded ( 1 )} OPTIONAL,
... } OPTIONAL},

```

```

extensionContainer          [1] IMPLICIT SEQUENCE {
  privateExtensionList     [0] IMPLICIT SEQUENCE ( SIZE (1..10 ) ) OF
    SEQUENCE {
      extId                 MAP-EXTENSION .&extensionId ( {
        '...' ) ,
      extType               MAP-EXTENSION .&ExtensionType ( {
        '...' { @extId } ) OPTIONAL} OPTIONAL,
      pcs-Extensions        [1] IMPLICIT SEQUENCE {
        ... } OPTIONAL,
        ... } OPTIONAL,
        ... } OPTIONAL,
        ... } OPTIONAL,
      cug-CheckInfo         [3] IMPLICIT SEQUENCE {
        cug-Interlock       OCTET STRING ( SIZE (4 ) ),
        cug-OutgoingAccess  NULL OPTIONAL,
        extensionContainer  SEQUENCE {
          privateExtensionList [0] IMPLICIT SEQUENCE ( SIZE (1..10 ) ) OF
            SEQUENCE {
              extId          MAP-EXTENSION .&extensionId ( {
                '...' ) ,
              extType        MAP-EXTENSION .&ExtensionType ( {
                '...' { @extId } ) OPTIONAL} OPTIONAL,
              pcs-Extensions [1] IMPLICIT SEQUENCE {
                ... } OPTIONAL,
                ... } OPTIONAL,
                ... } OPTIONAL,
                ... } OPTIONAL,
              cugSubscriptionFlag [6] IMPLICIT NULL OPTIONAL,
              subscriberInfo      [7] IMPLICIT SEQUENCE {
                locationInformation [0] IMPLICIT SEQUENCE {
                  ageOfLocationInformation INTEGER ( 0..32767 ) OPTIONAL,
                  geographicalInformation [0] IMPLICIT OCTET STRING ( SIZE (8 ) ) OPTIONAL,
                  vlr-number            [1] IMPLICIT OCTET STRING ( SIZE (1..20 ) ) ( SIZE (1..9 )
) OPTIONAL,
                  locationNumber       [2] IMPLICIT OCTET STRING ( SIZE (2..10 ) ) OPTIONAL,
                  cellIdOrLAI           [3] CHOICE {
                    cellIdFixedLength [0] IMPLICIT OCTET STRING ( SIZE (7 ) ),
                    laiFixedLength     [1] IMPLICIT OCTET STRING ( SIZE (5 ) ) } OPTIONAL,
                  extensionContainer   [4] IMPLICIT SEQUENCE {
                    privateExtensionList [0] IMPLICIT SEQUENCE ( SIZE (1..10 ) ) OF
                      SEQUENCE {
                        extId          MAP-EXTENSION .&extensionId ( {
                          '...' ) ,
                        extType        MAP-EXTENSION .&ExtensionType ( {
                          '...' { @extId } ) OPTIONAL} OPTIONAL,
                        pcs-Extensions [1] IMPLICIT SEQUENCE {
                          ... } OPTIONAL,
                          ... } OPTIONAL,
                          ... } OPTIONAL,
                          ... } OPTIONAL,
                        subscriberState [1] CHOICE {
                          assumedIdle [0] IMPLICIT NULL,
                          camelBusy    [1] IMPLICIT NULL,
                          netDetNotReachable ENUMERATED {
                            msPurged      (0 ) ,
                            imsiDetached (1 ) ,
                            restrictedArea (2 ) ,
                            notRegistered (3 ) } ,
                          notProvidedFromVLR [2] IMPLICIT NULL} OPTIONAL,
                        extensionContainer [2] IMPLICIT SEQUENCE {
                          privateExtensionList [0] IMPLICIT SEQUENCE ( SIZE (1..10 ) ) OF
                            SEQUENCE {
                              extId          MAP-EXTENSION .&extensionId ( {
                                '...' ) ,
                              extType        MAP-EXTENSION .&ExtensionType ( {
                                  '...' { @extId } ) OPTIONAL} OPTIONAL,
                              pcs-Extensions [1] IMPLICIT SEQUENCE {
                                ... } OPTIONAL,
                                ... } OPTIONAL,
                                ... } OPTIONAL,
                                ... } OPTIONAL,
                              ss-List [1] IMPLICIT SEQUENCE ( SIZE (1..30 ) ) OF
                                OCTET STRING ( SIZE (1 ) ) OPTIONAL,
                              basicService [5] CHOICE {

```

```

    ext-BearerService      [2] IMPLICIT OCTET STRING ( SIZE (1..5 ) ),
    ext-Teleservice        [3] IMPLICIT OCTET STRING ( SIZE (1..5 ) )} OPTIONAL,
forwardingInterrogationRequired [4] IMPLICIT NULL OPTIONAL,
vmsc-Address              [2] IMPLICIT OCTET STRING ( SIZE (1..20 ) ) ( SIZE (1..9
) ) OPTIONAL,
extensionContainer        [0] IMPLICIT SEQUENCE {
  privateExtensionList    [0] IMPLICIT SEQUENCE ( SIZE (1..10 ) ) OF
    SEQUENCE {
      extId                MAP-EXTENSION .&extensionId ( {
        '...'} ) ,
      extType              MAP-EXTENSION .&ExtensionType ( {
        '...'} { @extId } ) OPTIONAL} OPTIONAL,
  pcs-Extensions          [1] IMPLICIT SEQUENCE {
    ... } OPTIONAL,
  ... } OPTIONAL,
... ,
naea-PreferredCI          [10] IMPLICIT SEQUENCE {
  naea-PreferredCIC       [0] IMPLICIT OCTET STRING ( SIZE (3 ) ),
  extensionContainer      [1] IMPLICIT SEQUENCE {
    privateExtensionList  [0] IMPLICIT SEQUENCE ( SIZE (1..10 ) ) OF
      SEQUENCE {
        extId              MAP-EXTENSION .&extensionId ( {
          '...'} ) ,
        extType            MAP-EXTENSION .&ExtensionType ( {
          '...'} { @extId } ) OPTIONAL} OPTIONAL,
    pcs-Extensions        [1] IMPLICIT SEQUENCE {
      ... } OPTIONAL,
      ... } OPTIONAL,
      ... } OPTIONAL,
      ... } OPTIONAL,
ccbs-Indicators           [11] IMPLICIT SEQUENCE {
  ccbs-Possible           [0] IMPLICIT NULL OPTIONAL,
  keepCCBS-CallIndicator [1] IMPLICIT NULL OPTIONAL,
  extensionContainer      [2] IMPLICIT SEQUENCE {
    privateExtensionList  [0] IMPLICIT SEQUENCE ( SIZE (1..10 ) ) OF
      SEQUENCE {
        extId              MAP-EXTENSION .&extensionId ( {
          '...'} ) ,
        extType            MAP-EXTENSION .&ExtensionType ( {
          '...'} { @extId } ) OPTIONAL} OPTIONAL,
    pcs-Extensions        [1] IMPLICIT SEQUENCE {
      ... } OPTIONAL,
      ... } OPTIONAL,
      ... } OPTIONAL,
      ... } OPTIONAL,
ERRORS {
  -- systemFailure -- localValue : 34,
  -- dataMissing -- localValue : 35,
  -- unexpectedDataValue -- localValue : 36,
  -- facilityNotSupported -- localValue : 21,
  -- or-NotAllowed -- localValue : 48,
  -- unknownSubscriber -- localValue : 1,
  -- numberChanged -- localValue : 44,
  -- bearerServiceNotProvisioned -- localValue : 10,
  -- teleserviceNotProvisioned -- localValue : 11,
  -- absentSubscriber -- localValue : 27,
  -- busySubscriber -- localValue : 45,
  -- noSubscriberReply -- localValue : 46,
  -- callBarred -- localValue : 13,
  -- cug-Reject -- localValue : 15,
  -- forwardingViolation -- localValue : 14}
 ::= localValue : 22

provideRoamingNumber OPERATION
ARGUMENT
  provideRoamingNumberArg SEQUENCE {
    imsi                    [0] IMPLICIT OCTET STRING ( SIZE (3..8 ) ),
    msc-Number              [1] IMPLICIT OCTET STRING ( SIZE (1..20 ) ) ( SIZE (1..9 ) ),
    msisdn                  [2] IMPLICIT OCTET STRING ( SIZE (1..20 ) ) ( SIZE (1..9 ) )
OPTIONAL,
  lmsi                     [4] IMPLICIT OCTET STRING ( SIZE (4 ) ) OPTIONAL,
  gsm-BearerCapability      [5] IMPLICIT SEQUENCE {
    protocolId              ENUMERATED {
      gsm-0408              (1 ) ,

```

```

    gsm-0806      ( 2 ),
    gsm-BSSMAP   ( 3 ),
    ets-300102-1 ( 4 )},
signalInfo      OCTET STRING ( SIZE ( 1..200 ) ),
extensionContainer SEQUENCE {
    privateExtensionList [0] IMPLICIT SEQUENCE ( SIZE ( 1..10 ) ) OF
        SEQUENCE {
            extId      MAP-EXTENSION .&extensionId ( {
                '...'} ) ,
            extType    MAP-EXTENSION .&ExtensionType ( {
                '...' { @extId } ) OPTIONAL} OPTIONAL,
            pcs-Extensions [1] IMPLICIT SEQUENCE {
                ... } OPTIONAL,
                ... } OPTIONAL,
                ... } OPTIONAL,
                ... } OPTIONAL,
networkSignalInfo [6] IMPLICIT SEQUENCE {
    protocolId      ENUMERATED {
        gsm-0408      ( 1 ),
        gsm-0806      ( 2 ),
        gsm-BSSMAP   ( 3 ),
        ets-300102-1 ( 4 )},
    signalInfo      OCTET STRING ( SIZE ( 1..200 ) ),
    extensionContainer SEQUENCE {
        privateExtensionList [0] IMPLICIT SEQUENCE ( SIZE ( 1..10 ) ) OF
            SEQUENCE {
                extId      MAP-EXTENSION .&extensionId ( {
                    '...'} ) ,
                extType    MAP-EXTENSION .&ExtensionType ( {
                    '...' { @extId } ) OPTIONAL} OPTIONAL,
                pcs-Extensions [1] IMPLICIT SEQUENCE {
                    ... } OPTIONAL,
                    ... } OPTIONAL,
                    ... } OPTIONAL,
                    ... } OPTIONAL,
suppressionOfAnnouncement [7] IMPLICIT NULL OPTIONAL,
gmsc-Address [8] IMPLICIT OCTET STRING ( SIZE ( 1..20 ) ) ( SIZE ( 1..9 ) )
OPTIONAL,
callReferenceNumber [9] IMPLICIT OCTET STRING ( SIZE ( 1..8 ) ) OPTIONAL,
or-Interrogation [10] IMPLICIT NULL OPTIONAL,
extensionContainer [11] IMPLICIT SEQUENCE {
    privateExtensionList [0] IMPLICIT SEQUENCE ( SIZE ( 1..10 ) ) OF
        SEQUENCE {
            extId      MAP-EXTENSION .&extensionId ( {
                '...'} ) ,
            extType    MAP-EXTENSION .&ExtensionType ( {
                '...' { @extId } ) OPTIONAL} OPTIONAL,
            pcs-Extensions [1] IMPLICIT SEQUENCE {
                ... } OPTIONAL,
                ... } OPTIONAL,
                ... } OPTIONAL,
                ... } OPTIONAL,
    alertingPattern [12] IMPLICIT OCTET STRING ( SIZE ( 1 ) ) OPTIONAL,
    ccbs-Call [13] IMPLICIT NULL OPTIONAL,
    supportedCamelPhasesInGMSC [15] IMPLICIT BIT STRING {
        phase1 ( 0 ),
        phase2 ( 1 )} ( SIZE ( 1..16 ) ) OPTIONAL}
RESULT
    provideRoamingNumberRes SEQUENCE {
        roamingNumber      OCTET STRING ( SIZE ( 1..20 ) ) ( SIZE ( 1..9 ) ),
        extensionContainer SEQUENCE {
            privateExtensionList [0] IMPLICIT SEQUENCE ( SIZE ( 1..10 ) ) OF
                SEQUENCE {
                    extId      MAP-EXTENSION .&extensionId ( {
                        '...'} ) ,
                    extType    MAP-EXTENSION .&ExtensionType ( {
                        '...' { @extId } ) OPTIONAL} OPTIONAL,
                    pcs-Extensions [1] IMPLICIT SEQUENCE {
                        ... } OPTIONAL,
                        ... } OPTIONAL,
                        ... } OPTIONAL,
                        ... } OPTIONAL,
                ... }
ERRORS {
    -- systemFailure -- localValue : 34,

```



```

-- dataMissing -- localValue : 35,
-- unexpectedDataValue -- localValue : 36,
-- facilityNotSupported -- localValue : 21,
-- or-NotAllowed -- localValue : 48,
-- absentSubscriber -- localValue : 27,
-- noRoamingNumberAvailable -- localValue : 39}
 ::= localValue : 4

resumeCallHandling OPERATION
ARGUMENT
  resumeCallHandlingArg SEQUENCE {
    callReferenceNumber [0] IMPLICIT OCTET STRING ( SIZE (1..8) ),
    basicServiceGroup [1] CHOICE {
      ext-BearerService [2] IMPLICIT OCTET STRING ( SIZE (1..5) ),
      ext-Teleservice [3] IMPLICIT OCTET STRING ( SIZE (1..5) )},
    forwardingData [2] IMPLICIT SEQUENCE {
      forwardedToNumber [5] IMPLICIT OCTET STRING ( SIZE (1..20) ) ( SIZE (1..9) )
OPTIONAL,
      forwardedToSubaddress [4] IMPLICIT OCTET STRING ( SIZE (1..21) ) OPTIONAL,
      forwardingOptions [6] IMPLICIT OCTET STRING ( SIZE (1) ) OPTIONAL,
      extensionContainer [7] IMPLICIT SEQUENCE {
        privateExtensionList [0] IMPLICIT SEQUENCE ( SIZE (1..10) ) OF
          SEQUENCE {
            extId MAP-EXTENSION .&extensionId ( {
              '...'} ),
            extType MAP-EXTENSION .&ExtensionType ( {
              '...'} { @extId } ) OPTIONAL} OPTIONAL,
        pcs-Extensions [1] IMPLICIT SEQUENCE {
          ... } OPTIONAL,
          ... } OPTIONAL,
          ... },
        imsi [3] IMPLICIT OCTET STRING ( SIZE (3..8) ),
        cug-CheckInfo [4] IMPLICIT SEQUENCE {
          cug-Interlock OCTET STRING ( SIZE (4) ),
          cug-OutgoingAccess NULL OPTIONAL,
          extensionContainer SEQUENCE {
            privateExtensionList [0] IMPLICIT SEQUENCE ( SIZE (1..10) ) OF
              SEQUENCE {
                extId MAP-EXTENSION .&extensionId ( {
                  '...'} ),
                extType MAP-EXTENSION .&ExtensionType ( {
                  '...'} { @extId } ) OPTIONAL} OPTIONAL,
            pcs-Extensions [1] IMPLICIT SEQUENCE {
              ... } OPTIONAL,
              ... } OPTIONAL,
              ... } OPTIONAL,
            o-CSI [5] IMPLICIT SEQUENCE {
              o-BcsmCamelTDPDataList SEQUENCE ( SIZE (1..10) ) OF
                SEQUENCE {
                  o-BcsmTriggerDetectionPoint ENUMERATED {
                    collectedInfo (2),
                    ... },
                  serviceKey INTEGER ( 0..2147483647 ),
                  gsmSCF-Address [0] IMPLICIT OCTET STRING ( SIZE (1..20) ) ( SIZE
(1..9) ),
                  defaultCallHandling [1] IMPLICIT ENUMERATED {
                    continueCall (0),
                    releaseCall (1),
                    ... },
                  extensionContainer [2] IMPLICIT SEQUENCE {
                    privateExtensionList [0] IMPLICIT SEQUENCE ( SIZE (1..10) ) OF
                      SEQUENCE {
                        extId MAP-EXTENSION .&extensionId ( {
                          '...'} ),
                        extType MAP-EXTENSION .&ExtensionType ( {
                          '...'} { @extId } ) OPTIONAL} OPTIONAL,
                    pcs-Extensions [1] IMPLICIT SEQUENCE {
                      ... } OPTIONAL,
                      ... } OPTIONAL,
                      ... },
                    extensionContainer SEQUENCE {
                      privateExtensionList [0] IMPLICIT SEQUENCE ( SIZE (1..10) ) OF

```

```

SEQUENCE {
    extId      MAP-EXTENSION .&extensionId ( {
        '...' ) ,
    extType    MAP-EXTENSION .&ExtensionType ( {
        '...' { @extId } ) OPTIONAL} OPTIONAL,
    pcs-Extensions [1] IMPLICIT SEQUENCE {
        ... } OPTIONAL,
    ... } OPTIONAL,
    ... ,
    camelCapabilityHandling [0] IMPLICIT INTEGER ( 1..16 ) OPTIONAL} OPTIONAL,
extensionContainer [7] IMPLICIT SEQUENCE {
    privateExtensionList [0] IMPLICIT SEQUENCE ( SIZE (1..10) ) OF
        SEQUENCE {
            extId      MAP-EXTENSION .&extensionId ( {
                '...' ) ,
            extType    MAP-EXTENSION .&ExtensionType ( {
                '...' { @extId } ) OPTIONAL} OPTIONAL,
            pcs-Extensions [1] IMPLICIT SEQUENCE {
                ... } OPTIONAL,
            ... } OPTIONAL,
            ... ,
            ccbs-Possible [8] IMPLICIT NULL OPTIONAL}
RESULT
    resumeCallHandlingRes SEQUENCE {
        extensionContainer SEQUENCE {
            privateExtensionList [0] IMPLICIT SEQUENCE ( SIZE (1..10) ) OF
                SEQUENCE {
                    extId      MAP-EXTENSION .&extensionId ( {
                        '...' ) ,
                    extType    MAP-EXTENSION .&ExtensionType ( {
                        '...' { @extId } ) OPTIONAL} OPTIONAL,
                    pcs-Extensions [1] IMPLICIT SEQUENCE {
                        ... } OPTIONAL,
                    ... } OPTIONAL,
                    ... }
ERRORS {
    -- forwardingFailed -- localValue : 47,
    -- or-NotAllowed -- localValue : 48,
    -- unexpectedDataValue -- localValue : 36}
 ::= localValue : 6

provideSIWFSNumber OPERATION
ARGUMENT
    provideSIWFSNumberArg SEQUENCE {
        gsm-BearerCapability [0] IMPLICIT SEQUENCE {
            protocolId      ENUMERATED {
                gsm-0408      ( 1 ),
                gsm-0806      ( 2 ),
                gsm-BSSMAP     ( 3 ),
                ets-300102-1  ( 4 )},
            signalInfo      OCTET STRING ( SIZE (1..200) ),
            extensionContainer SEQUENCE {
                privateExtensionList [0] IMPLICIT SEQUENCE ( SIZE (1..10) ) OF
                    SEQUENCE {
                        extId      MAP-EXTENSION .&extensionId ( {
                            '...' ) ,
                        extType    MAP-EXTENSION .&ExtensionType ( {
                            '...' { @extId } ) OPTIONAL} OPTIONAL,
                        pcs-Extensions [1] IMPLICIT SEQUENCE {
                            ... } OPTIONAL,
                        ... } OPTIONAL,
                        ... },
                isdn-BearerCapability [1] IMPLICIT SEQUENCE {
                    protocolId      ENUMERATED {
                        gsm-0408      ( 1 ),
                        gsm-0806      ( 2 ),
                        gsm-BSSMAP     ( 3 ),
                        ets-300102-1  ( 4 )},
                    signalInfo      OCTET STRING ( SIZE (1..200) ),
                    extensionContainer SEQUENCE {

```





```

        extId      MAP-EXTENSION .&extensionId ( {
            '... } ) ,
        extType    MAP-EXTENSION .&ExtensionType ( {
            '... } { @extId } ) OPTIONAL} OPTIONAL,
    pcs-Extensions [1] IMPLICIT SEQUENCE {
        ... } OPTIONAL,
    ... } OPTIONAL,
    ... }
RESULT
    siWFSSignallingModifyRes SEQUENCE {
        chosenChannel [0] IMPLICIT SEQUENCE {
            protocolId ENUMERATED {
                gsm-0408 (1 ),
                gsm-0806 (2 ),
                gsm-BSSMAP (3 ),
                ets-300102-1 (4 )},
            signalInfo OCTET STRING ( SIZE (1..200) ),
            extensionContainer SEQUENCE {
                privateExtensionList [0] IMPLICIT SEQUENCE ( SIZE (1..10) ) OF
                    SEQUENCE {
                        extId      MAP-EXTENSION .&extensionId ( {
                            '... } ) ,
                        extType    MAP-EXTENSION .&ExtensionType ( {
                            '... } { @extId } ) OPTIONAL} OPTIONAL,
                    pcs-Extensions [1] IMPLICIT SEQUENCE {
                        ... } OPTIONAL,
                    ... } OPTIONAL,
                    ... } OPTIONAL,
                extensionContainer [1] IMPLICIT SEQUENCE {
                    privateExtensionList [0] IMPLICIT SEQUENCE ( SIZE (1..10) ) OF
                        SEQUENCE {
                            extId      MAP-EXTENSION .&extensionId ( {
                                '... } ) ,
                            extType    MAP-EXTENSION .&ExtensionType ( {
                                '... } { @extId } ) OPTIONAL} OPTIONAL,
                            pcs-Extensions [1] IMPLICIT SEQUENCE {
                                ... } OPTIONAL,
                                ... } OPTIONAL,
                                ... } OPTIONAL,
                                ... }
ERRORS {
    -- resourceLimitation -- localValue : 51,
    -- dataMissing -- localValue : 35,
    -- unexpectedDataValue -- localValue : 36,
    -- systemFailure -- localValue : 34}
 ::= localValue : 32

setReportingState OPERATION
    ARGUMENT
        setReportingStateArg SEQUENCE {
            imsi [0] IMPLICIT OCTET STRING ( SIZE (3..8) ) OPTIONAL,
            lmsi [1] IMPLICIT OCTET STRING ( SIZE (4) ) OPTIONAL,
            ccbs-Monitoring [2] IMPLICIT ENUMERATED {
                stopMonitoring (0 ),
                startMonitoring (1 ),
                ... } OPTIONAL,
            extensionContainer [3] IMPLICIT SEQUENCE {
                privateExtensionList [0] IMPLICIT SEQUENCE ( SIZE (1..10) ) OF
                    SEQUENCE {
                        extId      MAP-EXTENSION .&extensionId ( {
                            '... } ) ,
                        extType    MAP-EXTENSION .&ExtensionType ( {
                            '... } { @extId } ) OPTIONAL} OPTIONAL,
                    pcs-Extensions [1] IMPLICIT SEQUENCE {
                        ... } OPTIONAL,
                        ... } OPTIONAL,
                        ... } OPTIONAL,
                        ... }
RESULT
        setReportingStateRes SEQUENCE {
            ccbs-SubscriberStatus [0] IMPLICIT ENUMERATED {
                ccbsNotIdle (0 ),

```

```

    ccbsIdle          (1 ),
    ccbsNotReachable (2 ),
    ... } OPTIONAL,
extensionContainer   [1] IMPLICIT SEQUENCE {
  privateExtensionList [0] IMPLICIT SEQUENCE ( SIZE (1..10 ) ) OF
    SEQUENCE {
      extId          MAP-EXTENSION .&extensionId ( {
        '
        ... } ) ,
      extType        MAP-EXTENSION .&ExtensionType ( {
        '
        ... } { @extId } ) OPTIONAL} OPTIONAL,
  pcs-Extensions    [1] IMPLICIT SEQUENCE {
    ... } OPTIONAL,
    ... } OPTIONAL,
    ... }
ERRORS {
-- systemFailure -- localValue : 34,
-- unidentifiedSubscriber -- localValue : 5,
-- unexpectedDataValue -- localValue : 36,
-- dataMissing -- localValue : 35,
-- resourceLimitation -- localValue : 51,
-- facilityNotSupported -- localValue : 21}
::= localValue : 73

statusReport OPERATION
ARGUMENT
  statusReportArg SEQUENCE {
    imsi [0] IMPLICIT OCTET STRING ( SIZE (3..8 ) ),
    eventReportData [1] IMPLICIT SEQUENCE {
      ccbs-SubscriberStatus [0] IMPLICIT ENUMERATED {
        ccbsNotIdle (0 ),
        ccbsIdle (1 ),
        ccbsNotReachable (2 ),
        ... } OPTIONAL,
      extensionContainer [1] IMPLICIT SEQUENCE {
        privateExtensionList [0] IMPLICIT SEQUENCE ( SIZE (1..10 ) ) OF
          SEQUENCE {
            extId          MAP-EXTENSION .&extensionId ( {
              '
              ... } ) ,
            extType        MAP-EXTENSION .&ExtensionType ( {
              '
              ... } { @extId } ) OPTIONAL} OPTIONAL,
        pcs-Extensions [1] IMPLICIT SEQUENCE {
          ... } OPTIONAL,
          ... } OPTIONAL,
          ... } OPTIONAL,
          ... } OPTIONAL,
        callReportdata [2] IMPLICIT SEQUENCE {
          monitoringMode [0] IMPLICIT ENUMERATED {
            a-side (0 ),
            b-side (1 ),
            ... } OPTIONAL,
          callOutcome [1] IMPLICIT ENUMERATED {
            success (0 ),
            failure (1 ),
            busy (2 ),
            ... } OPTIONAL,
          extensionContainer [2] IMPLICIT SEQUENCE {
            privateExtensionList [0] IMPLICIT SEQUENCE ( SIZE (1..10 ) ) OF
              SEQUENCE {
                extId          MAP-EXTENSION .&extensionId ( {
                  '
                  ... } ) ,
                extType        MAP-EXTENSION .&ExtensionType ( {
                  '
                  ... } { @extId } ) OPTIONAL} OPTIONAL,
            pcs-Extensions [1] IMPLICIT SEQUENCE {
              ... } OPTIONAL,
              ... } OPTIONAL,
              ... } OPTIONAL,
              ... } OPTIONAL,
            extensionContainer [3] IMPLICIT SEQUENCE {
              privateExtensionList [0] IMPLICIT SEQUENCE ( SIZE (1..10 ) ) OF
                SEQUENCE {
                  extId          MAP-EXTENSION .&extensionId ( {
                    '
                    ... } ) ,
                  extType        MAP-EXTENSION .&ExtensionType ( {

```

```

        '... } { @extId } ) OPTIONAL} OPTIONAL,
    pcs-Extensions [1] IMPLICIT SEQUENCE {
        ... } OPTIONAL,
    ... } OPTIONAL,
    ... }
RESULT
statusReportRes SEQUENCE {
    extensionContainer [0] IMPLICIT SEQUENCE {
        privateExtensionList [0] IMPLICIT SEQUENCE ( SIZE (1..10) ) OF
            SEQUENCE {
                extId MAP-EXTENSION .&extensionId ( {
                    '... } ) ,
                extType MAP-EXTENSION .&ExtensionType ( {
                    '... } { @extId } ) OPTIONAL} OPTIONAL,
        pcs-Extensions [1] IMPLICIT SEQUENCE {
            ... } OPTIONAL,
            ... } OPTIONAL,
            ... }
ERRORS {
    -- unknownSubscriber -- localValue : 1,
    -- systemFailure -- localValue : 34,
    -- unexpectedDataValue -- localValue : 36,
    -- dataMissing -- localValue : 35}
 ::= localValue : 74

remoteUserFree OPERATION
ARGUMENT
remoteUserFreeArg SEQUENCE {
    imsi [0] IMPLICIT OCTET STRING ( SIZE (3..8) ),
    callInfo [1] IMPLICIT SEQUENCE {
        protocolId ENUMERATED {
            gsm-0408 (1 ),
            gsm-0806 (2 ),
            gsm-BSSMAP (3 ),
            ets-300102-1 (4 )},
        signalInfo OCTET STRING ( SIZE (1..200) ),
        extensionContainer SEQUENCE {
            privateExtensionList [0] IMPLICIT SEQUENCE ( SIZE (1..10) ) OF
                SEQUENCE {
                    extId MAP-EXTENSION .&extensionId ( {
                        '... } ) ,
                    extType MAP-EXTENSION .&ExtensionType ( {
                        '... } { @extId } ) OPTIONAL} OPTIONAL,
            pcs-Extensions [1] IMPLICIT SEQUENCE {
                ... } OPTIONAL,
                ... } OPTIONAL,
                ... },
        ccbs-Feature [2] IMPLICIT SEQUENCE {
            ccbs-Index [0] IMPLICIT INTEGER ( 1..5 ) OPTIONAL,
            b-subscriberNumber [1] IMPLICIT OCTET STRING ( SIZE (1..20) ) ( SIZE (1..9) )
OPTIONAL,
            b-subscriberSubaddress [2] IMPLICIT OCTET STRING ( SIZE (1..21) ) OPTIONAL,
            basicServiceGroup [3] CHOICE {
                bearerService [2] IMPLICIT OCTET STRING ( SIZE (1) ),
                teleservice [3] IMPLICIT OCTET STRING ( SIZE (1) )} OPTIONAL,
            ... },
        translatedB-Number [3] IMPLICIT OCTET STRING ( SIZE (1..20) ) ( SIZE (1..9) ),
        replaceB-Number [4] IMPLICIT NULL OPTIONAL,
        alertingPattern [5] IMPLICIT OCTET STRING ( SIZE (1) ) OPTIONAL,
        extensionContainer [6] IMPLICIT SEQUENCE {
            privateExtensionList [0] IMPLICIT SEQUENCE ( SIZE (1..10) ) OF
                SEQUENCE {
                    extId MAP-EXTENSION .&extensionId ( {
                        '... } ) ,
                    extType MAP-EXTENSION .&ExtensionType ( {
                        '... } { @extId } ) OPTIONAL} OPTIONAL,
            pcs-Extensions [1] IMPLICIT SEQUENCE {
                ... } OPTIONAL,
                ... } OPTIONAL,
                ... }
RESULT

```

```

remoteUserFreeRes SEQUENCE {
  ruf-Outcome      [0] IMPLICIT ENUMERATED {
    accepted        ( 0 ),
    rejected        ( 1 ),
    noResponseFromFreeMS ( 2 ),
    noResponseFromBusyMS ( 3 ),
    udubFromFreeMS  ( 4 ),
    udubFromBusyMS  ( 5 ),
    ... },
  extensionContainer [1] IMPLICIT SEQUENCE {
    privateExtensionList [0] IMPLICIT SEQUENCE ( SIZE (1..10) ) OF
      SEQUENCE {
        extId      MAP-EXTENSION .&extensionId ( {
          '... } ) ,
        extType    MAP-EXTENSION .&ExtensionType ( {
          '... } { @extId } ) OPTIONAL} OPTIONAL,
        pcs-Extensions [1] IMPLICIT SEQUENCE {
          ... } OPTIONAL,
          ... } OPTIONAL,
          ... }
  }
}
ERRORS {
  -- unexpectedDataValue -- localValue : 36,
  -- dataMissing -- localValue : 35,
  -- incompatibleTerminal -- localValue : 28,
  -- absentSubscriber -- localValue : 27,
  -- systemFailure -- localValue : 34,
  -- busySubscriber -- localValue : 45}
 ::= localValue : 75

registerSS OPERATION
ARGUMENT
  registerSS-Arg SEQUENCE {
    ss-Code          OCTET STRING ( SIZE ( 1 ) ),
    basicService     CHOICE {
      bearerService [2] IMPLICIT OCTET STRING ( SIZE ( 1 ) ),
      teleservice   [3] IMPLICIT OCTET STRING ( SIZE ( 1 ) )} OPTIONAL,
    forwardedToNumber [4] IMPLICIT OCTET STRING ( SIZE (1..20) ) OPTIONAL,
    forwardedToSubaddress [6] IMPLICIT OCTET STRING ( SIZE (1..21) ) OPTIONAL,
    noReplyConditionTime [5] IMPLICIT INTEGER ( 5..30 ) OPTIONAL,
    ... ,
    defaultPriority [7] IMPLICIT INTEGER ( 0..15 ) OPTIONAL}
RESULT
  ss-Info CHOICE {
    forwardingInfo [0] IMPLICIT SEQUENCE {
      ss-Code          OCTET STRING ( SIZE ( 1 ) ) OPTIONAL,
      forwardingFeatureList SEQUENCE ( SIZE (1..13) ) OF
        SEQUENCE {
          basicService CHOICE {
            bearerService [2] IMPLICIT OCTET STRING ( SIZE ( 1 ) ),
            teleservice   [3] IMPLICIT OCTET STRING ( SIZE ( 1 ) )} OPTIONAL,
          ss-Status      [4] IMPLICIT OCTET STRING ( SIZE ( 1 ) ) OPTIONAL,
          forwardedToNumber [5] IMPLICIT OCTET STRING ( SIZE (1..20) ) ( SIZE (1..9)
) OPTIONAL,
          forwardedToSubaddress [8] IMPLICIT OCTET STRING ( SIZE (1..21) ) OPTIONAL,
          forwardingOptions [6] IMPLICIT OCTET STRING ( SIZE ( 1 ) ) OPTIONAL,
          noReplyConditionTime [7] IMPLICIT INTEGER ( 5..30 ) OPTIONAL,
          ... },
          ... },
    callBarringInfo [1] IMPLICIT SEQUENCE {
      ss-Code          OCTET STRING ( SIZE ( 1 ) ) OPTIONAL,
      callBarringFeatureList SEQUENCE ( SIZE (1..13) ) OF
        SEQUENCE {
          basicService CHOICE {
            bearerService [2] IMPLICIT OCTET STRING ( SIZE ( 1 ) ),
            teleservice   [3] IMPLICIT OCTET STRING ( SIZE ( 1 ) )} OPTIONAL,
          ss-Status      [4] IMPLICIT OCTET STRING ( SIZE ( 1 ) ) OPTIONAL,
          ... },
          ... },
    ss-Data [3] IMPLICIT SEQUENCE {
      ss-Code          OCTET STRING ( SIZE ( 1 ) ) OPTIONAL,
      ss-Status        [4] IMPLICIT OCTET STRING ( SIZE ( 1 ) ) OPTIONAL,
      ss-SubscriptionOption CHOICE {
        cliRestrictionOption [2] IMPLICIT ENUMERATED {
          permanent          ( 0 ),
          temporaryDefaultRestricted ( 1 ),
          temporaryDefaultAllowed ( 2 )},
      ... }
    }
  }
}

```



```

        overrideCategory      [1] IMPLICIT ENUMERATED {
            overrideEnabled    (0 ),
            overrideDisabled   (1 )} OPTIONAL,
        basicServiceGroupList SEQUENCE ( SIZE (1..13 ) ) OF
        CHOICE {
            bearerService      [2] IMPLICIT OCTET STRING ( SIZE (1 ) ),
            teleservice        [3] IMPLICIT OCTET STRING ( SIZE (1 ) )} OPTIONAL,
        ... ,
        defaultPriority        INTEGER ( 0..15 ) OPTIONAL}}
ERRORS {
-- systemFailure -- localValue : 34,
-- dataMissing -- localValue : 35,
-- unexpectedDataValue -- localValue : 36,
-- bearerServiceNotProvisioned -- localValue : 10,
-- teleserviceNotProvisioned -- localValue : 11,
-- callBarred -- localValue : 13,
-- illegalSS-Operation -- localValue : 16,
-- ss-ErrorStatus -- localValue : 17,
-- ss-Incompatibility -- localValue : 20}
 ::= localValue : 10

eraseSS OPERATION
ARGUMENT
    ss-ForBS SEQUENCE {
        ss-Code OCTET STRING ( SIZE (1 ) ),
        basicService CHOICE {
            bearerService [2] IMPLICIT OCTET STRING ( SIZE (1 ) ),
            teleservice [3] IMPLICIT OCTET STRING ( SIZE (1 ) )} OPTIONAL,
        ... }
RESULT
    ss-Info CHOICE {
        forwardingInfo [0] IMPLICIT SEQUENCE {
            ss-Code OCTET STRING ( SIZE (1 ) ) OPTIONAL,
            forwardingFeatureList SEQUENCE ( SIZE (1..13 ) ) OF
            SEQUENCE {
                basicService CHOICE {
                    bearerService [2] IMPLICIT OCTET STRING ( SIZE (1 ) ),
                    teleservice [3] IMPLICIT OCTET STRING ( SIZE (1 ) )} OPTIONAL,
                ss-Status [4] IMPLICIT OCTET STRING ( SIZE (1 ) ) OPTIONAL,
                forwardedToNumber [5] IMPLICIT OCTET STRING ( SIZE (1..20 ) ) ( SIZE (1..9 )
) OPTIONAL,
                forwardedToSubaddress [8] IMPLICIT OCTET STRING ( SIZE (1..21 ) ) OPTIONAL,
                forwardingOptions [6] IMPLICIT OCTET STRING ( SIZE (1 ) ) OPTIONAL,
                noReplyConditionTime [7] IMPLICIT INTEGER ( 5..30 ) OPTIONAL,
                ... },
            ... },
        callBarringInfo [1] IMPLICIT SEQUENCE {
            ss-Code OCTET STRING ( SIZE (1 ) ) OPTIONAL,
            callBarringFeatureList SEQUENCE ( SIZE (1..13 ) ) OF
            SEQUENCE {
                basicService CHOICE {
                    bearerService [2] IMPLICIT OCTET STRING ( SIZE (1 ) ),
                    teleservice [3] IMPLICIT OCTET STRING ( SIZE (1 ) )} OPTIONAL,
                ss-Status [4] IMPLICIT OCTET STRING ( SIZE (1 ) ) OPTIONAL,
                ... },
            ... },
        ss-Data [3] IMPLICIT SEQUENCE {
            ss-Code OCTET STRING ( SIZE (1 ) ) OPTIONAL,
            ss-Status [4] IMPLICIT OCTET STRING ( SIZE (1 ) ) OPTIONAL,
            ss-SubscriptionOption CHOICE {
                cliRestrictionOption [2] IMPLICIT ENUMERATED {
                    permanent (0 ),
                    temporaryDefaultRestricted (1 ),
                    temporaryDefaultAllowed (2 )},
                overrideCategory [1] IMPLICIT ENUMERATED {
                    overrideEnabled (0 ),
                    overrideDisabled (1 )} OPTIONAL,
                basicServiceGroupList SEQUENCE ( SIZE (1..13 ) ) OF
                CHOICE {
                    bearerService [2] IMPLICIT OCTET STRING ( SIZE (1 ) ),
                    teleservice [3] IMPLICIT OCTET STRING ( SIZE (1 ) )} OPTIONAL,
                ... ,
                defaultPriority INTEGER ( 0..15 ) OPTIONAL}}
ERRORS {
-- systemFailure -- localValue : 34,
-- dataMissing -- localValue : 35,
-- unexpectedDataValue -- localValue : 36,
-- bearerServiceNotProvisioned -- localValue : 10,

```

```

-- teleserviceNotProvisioned -- localValue : 11,
-- callBarred -- localValue : 13,
-- illegalSS-Operation -- localValue : 16,
-- ss-ErrorStatus -- localValue : 17}
 ::= localValue : 11

activateSS OPERATION
 ARGUMENT
  ss-ForBS SEQUENCE {
    ss-Code OCTET STRING ( SIZE ( 1 ) ),
    basicService CHOICE {
      bearerService [2] IMPLICIT OCTET STRING ( SIZE ( 1 ) ),
      teleservice [3] IMPLICIT OCTET STRING ( SIZE ( 1 ) )} OPTIONAL,
    ... }
 RESULT
  ss-Info CHOICE {
    forwardingInfo [0] IMPLICIT SEQUENCE {
      ss-Code OCTET STRING ( SIZE ( 1 ) ) OPTIONAL,
      forwardingFeatureList SEQUENCE ( SIZE ( 1..13 ) ) OF
        SEQUENCE {
          basicService CHOICE {
            bearerService [2] IMPLICIT OCTET STRING ( SIZE ( 1 ) ),
            teleservice [3] IMPLICIT OCTET STRING ( SIZE ( 1 ) )} OPTIONAL,
          ss-Status [4] IMPLICIT OCTET STRING ( SIZE ( 1 ) ) OPTIONAL,
          forwardedToNumber [5] IMPLICIT OCTET STRING ( SIZE ( 1..20 ) ) ( SIZE ( 1..9 )
) OPTIONAL,
          forwardedToSubaddress [8] IMPLICIT OCTET STRING ( SIZE ( 1..21 ) ) OPTIONAL,
          forwardingOptions [6] IMPLICIT OCTET STRING ( SIZE ( 1 ) ) OPTIONAL,
          noReplyConditionTime [7] IMPLICIT INTEGER ( 5..30 ) OPTIONAL,
          ... },
        ... },
    callBarringInfo [1] IMPLICIT SEQUENCE {
      ss-Code OCTET STRING ( SIZE ( 1 ) ) OPTIONAL,
      callBarringFeatureList SEQUENCE ( SIZE ( 1..13 ) ) OF
        SEQUENCE {
          basicService CHOICE {
            bearerService [2] IMPLICIT OCTET STRING ( SIZE ( 1 ) ),
            teleservice [3] IMPLICIT OCTET STRING ( SIZE ( 1 ) )} OPTIONAL,
          ss-Status [4] IMPLICIT OCTET STRING ( SIZE ( 1 ) ) OPTIONAL,
          ... },
        ... },
    ss-Data [3] IMPLICIT SEQUENCE {
      ss-Code OCTET STRING ( SIZE ( 1 ) ) OPTIONAL,
      ss-Status [4] IMPLICIT OCTET STRING ( SIZE ( 1 ) ) OPTIONAL,
      ss-SubscriptionOption CHOICE {
        cliRestrictionOption [2] IMPLICIT ENUMERATED {
          permanent ( 0 ),
          temporaryDefaultRestricted ( 1 ),
          temporaryDefaultAllowed ( 2 )},
        overrideCategory [1] IMPLICIT ENUMERATED {
          overrideEnabled ( 0 ),
          overrideDisabled ( 1 )}} OPTIONAL,
      basicServiceGroupList SEQUENCE ( SIZE ( 1..13 ) ) OF
        CHOICE {
          bearerService [2] IMPLICIT OCTET STRING ( SIZE ( 1 ) ),
          teleservice [3] IMPLICIT OCTET STRING ( SIZE ( 1 ) )} OPTIONAL,
          ... ,
      defaultPriority INTEGER ( 0..15 ) OPTIONAL}}
 ERRORS {
  -- systemFailure -- localValue : 34,
  -- dataMissing -- localValue : 35,
  -- unexpectedDataValue -- localValue : 36,
  -- bearerServiceNotProvisioned -- localValue : 10,
  -- teleserviceNotProvisioned -- localValue : 11,
  -- callBarred -- localValue : 13,
  -- illegalSS-Operation -- localValue : 16,
  -- ss-ErrorStatus -- localValue : 17,
  -- ss-SubscriptionViolation -- localValue : 19,
  -- ss-Incompatibility -- localValue : 20,
  -- negativePW-Check -- localValue : 38,
  -- numberOfPW-AttemptsViolation -- localValue : 43}
 ::= localValue : 12

deactivateSS OPERATION
 ARGUMENT
  ss-ForBS SEQUENCE {
    ss-Code OCTET STRING ( SIZE ( 1 ) ),
    basicService CHOICE {

```

```

        bearerService      [2] IMPLICIT OCTET STRING ( SIZE ( 1 ) ),
        teleservice       [3] IMPLICIT OCTET STRING ( SIZE ( 1 ) )} OPTIONAL,
    ... }
RESULT
    ss-Info CHOICE {
        forwardingInfo      [0] IMPLICIT SEQUENCE {
            ss-Code          OCTET STRING ( SIZE ( 1 ) ) OPTIONAL,
            forwardingFeatureList SEQUENCE ( SIZE ( 1..13 ) ) OF
                SEQUENCE {
                    basicService CHOICE {
                        bearerService [2] IMPLICIT OCTET STRING ( SIZE ( 1 ) ),
                        teleservice  [3] IMPLICIT OCTET STRING ( SIZE ( 1 ) )} OPTIONAL,
                        ss-Status    [4] IMPLICIT OCTET STRING ( SIZE ( 1 ) ) OPTIONAL,
                        forwardedToNumber [5] IMPLICIT OCTET STRING ( SIZE ( 1..20 ) ) ( SIZE ( 1..9 )
) OPTIONAL,
                        forwardedToSubaddress [8] IMPLICIT OCTET STRING ( SIZE ( 1..21 ) ) OPTIONAL,
                        forwardingOptions [6] IMPLICIT OCTET STRING ( SIZE ( 1 ) ) OPTIONAL,
                        noReplyConditionTime [7] IMPLICIT INTEGER ( 5..30 ) OPTIONAL,
                        ... },
                    ... },
            callBarringInfo [1] IMPLICIT SEQUENCE {
                ss-Code          OCTET STRING ( SIZE ( 1 ) ) OPTIONAL,
                callBarringFeatureList SEQUENCE ( SIZE ( 1..13 ) ) OF
                    SEQUENCE {
                        basicService CHOICE {
                            bearerService [2] IMPLICIT OCTET STRING ( SIZE ( 1 ) ),
                            teleservice  [3] IMPLICIT OCTET STRING ( SIZE ( 1 ) )} OPTIONAL,
                            ss-Status    [4] IMPLICIT OCTET STRING ( SIZE ( 1 ) ) OPTIONAL,
                            ... },
                        ... },
                ss-Data [3] IMPLICIT SEQUENCE {
                    ss-Code          OCTET STRING ( SIZE ( 1 ) ) OPTIONAL,
                    ss-Status        [4] IMPLICIT OCTET STRING ( SIZE ( 1 ) ) OPTIONAL,
                    ss-SubscriptionOption CHOICE {
                        cliRestrictionOption [2] IMPLICIT ENUMERATED {
                            permanent ( 0 ),
                            temporaryDefaultRestricted ( 1 ),
                            temporaryDefaultAllowed ( 2 )},
                        overrideCategory [1] IMPLICIT ENUMERATED {
                            overrideEnabled ( 0 ),
                            overrideDisabled ( 1 )}} OPTIONAL,
                    basicServiceGroupList SEQUENCE ( SIZE ( 1..13 ) ) OF
                        CHOICE {
                            bearerService [2] IMPLICIT OCTET STRING ( SIZE ( 1 ) ),
                            teleservice  [3] IMPLICIT OCTET STRING ( SIZE ( 1 ) )} OPTIONAL,
                            ... ,
                            defaultPriority INTEGER ( 0..15 ) OPTIONAL}}
        }
    }
ERRORS {
    -- systemFailure -- localValue : 34,
    -- dataMissing -- localValue : 35,
    -- unexpectedDataValue -- localValue : 36,
    -- bearerServiceNotProvisioned -- localValue : 10,
    -- teleserviceNotProvisioned -- localValue : 11,
    -- callBarred -- localValue : 13,
    -- illegalSS-Operation -- localValue : 16,
    -- ss-ErrorStatus -- localValue : 17,
    -- ss-SubscriptionViolation -- localValue : 19,
    -- negativePW-Check -- localValue : 38,
    -- numberOfPW-AttemptsViolation -- localValue : 43}
 ::= localValue : 13

interrogateSS OPERATION
    ARGUMENT
        ss-ForBS SEQUENCE {
            ss-Code          OCTET STRING ( SIZE ( 1 ) ),
            basicService CHOICE {
                bearerService [2] IMPLICIT OCTET STRING ( SIZE ( 1 ) ),
                teleservice  [3] IMPLICIT OCTET STRING ( SIZE ( 1 ) )} OPTIONAL,
            ... }
    RESULT
        interrogateSS-Res CHOICE {
            ss-Status [0] IMPLICIT OCTET STRING ( SIZE ( 1 ) ),
            basicServiceGroupList [2] IMPLICIT SEQUENCE ( SIZE ( 1..13 ) ) OF
                CHOICE {
                    bearerService [2] IMPLICIT OCTET STRING ( SIZE ( 1 ) ),
                    teleservice  [3] IMPLICIT OCTET STRING ( SIZE ( 1 ) )},
            forwardingFeatureList [3] IMPLICIT SEQUENCE ( SIZE ( 1..13 ) ) OF
                SEQUENCE {

```

```

    basicService          CHOICE {
        bearerService     [2] IMPLICIT OCTET STRING ( SIZE ( 1 ) ),
        teleservice       [3] IMPLICIT OCTET STRING ( SIZE ( 1 ) )} OPTIONAL,
    ss-Status             [4] IMPLICIT OCTET STRING ( SIZE ( 1 ) ) OPTIONAL,
    forwardedToNumber     [5] IMPLICIT OCTET STRING ( SIZE ( 1..20 ) ) ( SIZE ( 1..9 ) )
OPTIONAL,
    forwardedToSubaddress [8] IMPLICIT OCTET STRING ( SIZE ( 1..21 ) ) OPTIONAL,
    forwardingOptions     [6] IMPLICIT OCTET STRING ( SIZE ( 1 ) ) OPTIONAL,
    noReplyConditionTime [7] IMPLICIT INTEGER ( 5..30 ) OPTIONAL,
    ... },
genericServiceInfo      [4] IMPLICIT SEQUENCE {
    ss-Status             OCTET STRING ( SIZE ( 1 ) ),
    cliRestrictionOption ENUMERATED {
        permanent         ( 0 ),
        temporaryDefaultRestricted ( 1 ),
        temporaryDefaultAllowed ( 2 )} OPTIONAL,
    ... ,
    maximumEntitledPriority [0] IMPLICIT INTEGER ( 0..15 ) OPTIONAL,
    defaultPriority         [1] IMPLICIT INTEGER ( 0..15 ) OPTIONAL,
    ccbs-FeatureList       [2] IMPLICIT SEQUENCE ( SIZE ( 1..5 ) ) OF
        SEQUENCE {
            ccbs-Index     [0] IMPLICIT INTEGER ( 1..5 ) OPTIONAL,
            b-subscriberNumber [1] IMPLICIT OCTET STRING ( SIZE ( 1..20 ) ) ( SIZE ( 1..9
) ) OPTIONAL,
            b-subscriberSubaddress [2] IMPLICIT OCTET STRING ( SIZE ( 1..21 ) ) OPTIONAL,
            basicServiceGroup [3] CHOICE {
                bearerService [2] IMPLICIT OCTET STRING ( SIZE ( 1 ) ),
                teleservice [3] IMPLICIT OCTET STRING ( SIZE ( 1 ) )} OPTIONAL,
            ... } OPTIONAL}}
ERRORS {
-- systemFailure -- localValue : 34,
-- dataMissing -- localValue : 35,
-- unexpectedDataValue -- localValue : 36,
-- bearerServiceNotProvisioned -- localValue : 10,
-- teleserviceNotProvisioned -- localValue : 11,
-- callBarred -- localValue : 13,
-- illegalSS-Operation -- localValue : 16,
-- ss-NotAvailable -- localValue : 18}
 ::= localValue : 14

```

processUnstructuredSS-Request OPERATION

```

ARGUMENT
    ussd-Arg SEQUENCE {
        ussd-DataCodingScheme OCTET STRING ( SIZE ( 1 ) ),
        ussd-String           OCTET STRING ( SIZE ( 1..160 ) ),
        ... ,
        alertingPattern       OCTET STRING ( SIZE ( 1 ) ) OPTIONAL,
        msisdn                 [0] IMPLICIT OCTET STRING ( SIZE ( 1..20 ) ) ( SIZE ( 1..9 ) )
OPTIONAL}
RESULT
    ussd-Res SEQUENCE {
        ussd-DataCodingScheme OCTET STRING ( SIZE ( 1 ) ),
        ussd-String           OCTET STRING ( SIZE ( 1..160 ) ),
        ... }
ERRORS {
-- systemFailure -- localValue : 34,
-- dataMissing -- localValue : 35,
-- unexpectedDataValue -- localValue : 36,
-- unknownAlphabet -- localValue : 71,
-- callBarred -- localValue : 13}
 ::= localValue : 59

```

unstructuredSS-Request OPERATION

```

ARGUMENT
    ussd-Arg SEQUENCE {
        ussd-DataCodingScheme OCTET STRING ( SIZE ( 1 ) ),
        ussd-String           OCTET STRING ( SIZE ( 1..160 ) ),
        ... ,
        alertingPattern       OCTET STRING ( SIZE ( 1 ) ) OPTIONAL,
        msisdn                 [0] IMPLICIT OCTET STRING ( SIZE ( 1..20 ) ) ( SIZE ( 1..9 ) )
OPTIONAL}
RESULT
    ussd-Res SEQUENCE {
        ussd-DataCodingScheme OCTET STRING ( SIZE ( 1 ) ),
        ussd-String           OCTET STRING ( SIZE ( 1..160 ) ),
        ... }
ERRORS {
-- systemFailure -- localValue : 34,

```

```

-- dataMissing -- localValue : 35,
-- unexpectedDataValue -- localValue : 36,
-- absentSubscriber -- localValue : 27,
-- illegalSubscriber -- localValue : 9,
-- illegalEquipment -- localValue : 12,
-- unknownAlphabet -- localValue : 71,
-- ussd-Busy -- localValue : 72}
 ::= localValue : 60

unstructuredSS-Notify OPERATION
  ARGUMENT
    ussd-Arg SEQUENCE {
      ussd-DataCodingScheme OCTET STRING ( SIZE ( 1 ) ),
      ussd-String OCTET STRING ( SIZE ( 1..160 ) ),
      ... ,
      alertingPattern OCTET STRING ( SIZE ( 1 ) ) OPTIONAL,
      msisdn [0] IMPLICIT OCTET STRING ( SIZE ( 1..20 ) ) ( SIZE ( 1..9 ) )
    }
  OPTIONAL}
  ERRORS {
    -- systemFailure -- localValue : 34,
    -- dataMissing -- localValue : 35,
    -- unexpectedDataValue -- localValue : 36,
    -- absentSubscriber -- localValue : 27,
    -- illegalSubscriber -- localValue : 9,
    -- illegalEquipment -- localValue : 12,
    -- unknownAlphabet -- localValue : 71,
    -- ussd-Busy -- localValue : 72}
 ::= localValue : 61

registerPassword OPERATION
  ARGUMENT
    ss-Code OCTET STRING ( SIZE ( 1 ) )
  RESULT
    newPassword NumericString ( FROM ("0"|"1"|"2"|"3"|"4"|"5"|"6"|"7"|"8"|"9" )|SIZE ( 4 ) )
  ERRORS {
    -- systemFailure -- localValue : 34,
    -- dataMissing -- localValue : 35,
    -- unexpectedDataValue -- localValue : 36,
    -- callBarred -- localValue : 13,
    -- ss-SubscriptionViolation -- localValue : 19,
    -- pw-RegistrationFailure -- localValue : 37,
    -- negativePW-Check -- localValue : 38,
    -- numberOfPW-AttemptsViolation -- localValue : 43}
  LINKED {
    -- getPassword -- localValue : 18}
 ::= localValue : 17

getPassword OPERATION
  ARGUMENT
    guidanceInfo ENUMERATED {
      enterPW ( 0 ),
      enterNewPW ( 1 ),
      enterNewPW-Again ( 2 )}
  RESULT
    currentPassword NumericString ( FROM ("0"|"1"|"2"|"3"|"4"|"5"|"6"|"7"|"8"|"9" )|SIZE ( 4 ) )
 ::= localValue : 18

registerCC-Entry OPERATION
  ARGUMENT
    registerCC-EntryArg SEQUENCE {
      ss-Code [0] IMPLICIT OCTET STRING ( SIZE ( 1 ) ),
      ccbs-Data [1] IMPLICIT SEQUENCE {
        ccbs-Feature [0] IMPLICIT SEQUENCE {
          ccbs-Index [0] IMPLICIT INTEGER ( 1..5 ) OPTIONAL,
          b-subscriberNumber [1] IMPLICIT OCTET STRING ( SIZE ( 1..20 ) ) ( SIZE ( 1..9 ) )
        }
      }
    }
  OPTIONAL,
    b-subscriberSubaddress [2] IMPLICIT OCTET STRING ( SIZE ( 1..21 ) ) OPTIONAL,
    basicServiceGroup [3] CHOICE {
      bearerService [2] IMPLICIT OCTET STRING ( SIZE ( 1 ) ),
      teleservice [3] IMPLICIT OCTET STRING ( SIZE ( 1 ) )} OPTIONAL,
      ... },
    translatedB-Number [1] IMPLICIT OCTET STRING ( SIZE ( 1..20 ) ) ( SIZE ( 1..9 ) ),
    serviceIndicator [2] IMPLICIT BIT STRING {
      clir-invoked ( 0 ),
      camel-invoked ( 1 )} ( SIZE ( 2..32 ) ) OPTIONAL,
    callInfo [3] IMPLICIT SEQUENCE {
      protocolId ENUMERATED {
        gsm-0408 ( 1 ),

```

```

        gsm-0806          ( 2 ),
        gsm-BSSMAP       ( 3 ),
        ets-300102-1    ( 4 )},
    signalInfo           OCTET STRING ( SIZE ( 1..200 ) ),
    extensionContainer   SEQUENCE {
        privateExtensionList [0] IMPLICIT SEQUENCE ( SIZE ( 1..10 ) ) OF
            SEQUENCE {
                extId      MAP-EXTENSION .&extensionId ( {
                    '...'} ) ,
                extType    MAP-EXTENSION .&ExtensionType ( {
                    '...'} { @extId } ) OPTIONAL} OPTIONAL,
        pcs-Extensions   [1] IMPLICIT SEQUENCE {
            ... } OPTIONAL,
            ... } OPTIONAL,
        ... },
    networkSignalInfo   [4] IMPLICIT SEQUENCE {
        protocolId       ENUMERATED {
            gsm-0408     ( 1 ),
            gsm-0806     ( 2 ),
            gsm-BSSMAP   ( 3 ),
            ets-300102-1 ( 4 )},
        signalInfo       OCTET STRING ( SIZE ( 1..200 ) ),
        extensionContainer SEQUENCE {
            privateExtensionList [0] IMPLICIT SEQUENCE ( SIZE ( 1..10 ) ) OF
                SEQUENCE {
                    extId      MAP-EXTENSION .&extensionId ( {
                        '...'} ) ,
                    extType    MAP-EXTENSION .&ExtensionType ( {
                        '...'} { @extId } ) OPTIONAL} OPTIONAL,
            pcs-Extensions   [1] IMPLICIT SEQUENCE {
                ... } OPTIONAL,
                ... } OPTIONAL,
            ... },
        ... } OPTIONAL,
        ... }
    RESULT
        registerCC-EntryRes SEQUENCE {
            ccbs-Feature [0] IMPLICIT SEQUENCE {
                ccbs-Index [0] IMPLICIT INTEGER ( 1..5 ) OPTIONAL,
                b-subscriberNumber [1] IMPLICIT OCTET STRING ( SIZE ( 1..20 ) ) ( SIZE ( 1..9 ) )
OPTIONAL,
                b-subscriberSubaddress [2] IMPLICIT OCTET STRING ( SIZE ( 1..21 ) ) OPTIONAL,
                basicServiceGroup [3] CHOICE {
                    bearerService [2] IMPLICIT OCTET STRING ( SIZE ( 1 ) ),
                    teleservice [3] IMPLICIT OCTET STRING ( SIZE ( 1 ) )} OPTIONAL,
                ... } OPTIONAL,
            ... }
    ERRORS {
        -- systemFailure -- localValue : 34,
        -- dataMissing -- localValue : 35,
        -- unexpectedDataValue -- localValue : 36,
        -- callBarred -- localValue : 13,
        -- illegalSS-Operation -- localValue : 16,
        -- ss-ErrorStatus -- localValue : 17,
        -- ss-Incompatibility -- localValue : 20,
        -- shortTermDenial -- localValue : 29,
        -- longTermDenial -- localValue : 30,
        -- facilityNotSupported -- localValue : 21}
 ::= localValue : 76

eraseCC-Entry OPERATION
    ARGUMENT
        eraseCC-EntryArg SEQUENCE {
            ss-Code [0] IMPLICIT OCTET STRING ( SIZE ( 1 ) ),
            ccbs-Index [1] IMPLICIT INTEGER ( 1..5 ) OPTIONAL,
            ... }
    RESULT
        eraseCC-EntryRes SEQUENCE {
            ss-Code [0] IMPLICIT OCTET STRING ( SIZE ( 1 ) ),
            ss-Status [1] IMPLICIT OCTET STRING ( SIZE ( 1 ) ) OPTIONAL,
            ... }
    ERRORS {
        -- systemFailure -- localValue : 34,
        -- dataMissing -- localValue : 35,

```

```

-- unexpectedDataValue -- localValue : 36,
-- callBarred -- localValue : 13,
-- illegalSS-Operation -- localValue : 16,
-- ss-ErrorStatus -- localValue : 17}
 ::= localValue : 77

sendRoutingInfoForSM OPERATION
ARGUMENT
  routingInfoForSM-Arg SEQUENCE {
    msisdn [0] IMPLICIT OCTET STRING ( SIZE (1..20) ) ( SIZE (1..9) ),
    sm-RP-PRI [1] IMPLICIT BOOLEAN,
    serviceCentreAddress [2] IMPLICIT OCTET STRING ( SIZE (1..20) ),
    extensionContainer [6] IMPLICIT SEQUENCE {
      privateExtensionList [0] IMPLICIT SEQUENCE ( SIZE (1..10) ) OF
        SEQUENCE {
          extId MAP-EXTENSION .&extensionId ( {
            '...'} ) ,
          extType MAP-EXTENSION .&ExtensionType ( {
            '...'} { @extId } ) OPTIONAL} OPTIONAL,
      pcs-Extensions [1] IMPLICIT SEQUENCE {
        ... } OPTIONAL,
      ... } OPTIONAL,
      ... ,
    gprsSupportIndicator [7] IMPLICIT NULL OPTIONAL,
    sm-RP-MTI [8] IMPLICIT INTEGER ( 0..10 ) OPTIONAL,
    sm-RP-SMEA [9] IMPLICIT OCTET STRING ( SIZE (1..12) ) OPTIONAL}
RESULT
  routingInfoForSM-Res SEQUENCE {
    imsi OCTET STRING ( SIZE (3..8) ),
    locationInfoWithLMSI [0] IMPLICIT SEQUENCE {
      networkNode-Number [1] IMPLICIT OCTET STRING ( SIZE (1..20) ) ( SIZE (1..9) ),
      lmsi OCTET STRING ( SIZE (4) ) OPTIONAL,
      extensionContainer SEQUENCE {
        privateExtensionList [0] IMPLICIT SEQUENCE ( SIZE (1..10) ) OF
          SEQUENCE {
            extId MAP-EXTENSION .&extensionId ( {
              '...'} ) ,
            extType MAP-EXTENSION .&ExtensionType ( {
              '...'} { @extId } ) OPTIONAL} OPTIONAL,
        pcs-Extensions [1] IMPLICIT SEQUENCE {
          ... } OPTIONAL,
        ... } OPTIONAL,
        ... ,
      gprsNodeIndicator [5] IMPLICIT NULL OPTIONAL,
      additional-Number [6] CHOICE {
        msc-Number [0] IMPLICIT OCTET STRING ( SIZE (1..20) ) ( SIZE (1..9) ),
        sgsn-Number [1] IMPLICIT OCTET STRING ( SIZE (1..20) ) ( SIZE (1..9) )}
OPTIONAL},
      extensionContainer [4] IMPLICIT SEQUENCE {
        privateExtensionList [0] IMPLICIT SEQUENCE ( SIZE (1..10) ) OF
          SEQUENCE {
            extId MAP-EXTENSION .&extensionId ( {
              '...'} ) ,
            extType MAP-EXTENSION .&ExtensionType ( {
              '...'} { @extId } ) OPTIONAL} OPTIONAL,
        pcs-Extensions [1] IMPLICIT SEQUENCE {
          ... } OPTIONAL,
        ... } OPTIONAL,
        ... }
ERRORS {
  -- systemFailure -- localValue : 34,
  -- dataMissing -- localValue : 35,
  -- unexpectedDataValue -- localValue : 36,
  -- facilityNotSupported -- localValue : 21,
  -- unknownSubscriber -- localValue : 1,
  -- teleserviceNotProvisioned -- localValue : 11,
  -- callBarred -- localValue : 13,
  -- absentSubscriberSM -- localValue : 6}
 ::= localValue : 45

mo-forwardSM OPERATION
ARGUMENT

```

```

mo-forwardSM-Arg SEQUENCE {
  sm-RP-DA CHOICE {
    imsi [0] IMPLICIT OCTET STRING ( SIZE ( 3..8 ) ),
    lmsi [1] IMPLICIT OCTET STRING ( SIZE ( 4 ) ),
    serviceCentreAddressDA [4] IMPLICIT OCTET STRING ( SIZE ( 1..20 ) ),
    noSM-RP-DA [5] IMPLICIT NULL},
  sm-RP-OA CHOICE {
    msisdn [2] IMPLICIT OCTET STRING ( SIZE ( 1..20 ) ) ( SIZE ( 1..9 ) ),
    serviceCentreAddressOA [4] IMPLICIT OCTET STRING ( SIZE ( 1..20 ) ),
    noSM-RP-OA [5] IMPLICIT NULL},
  sm-RP-UI OCTET STRING ( SIZE ( 1..200 ) ),
  extensionContainer SEQUENCE {
    privateExtensionList [0] IMPLICIT SEQUENCE ( SIZE ( 1..10 ) ) OF
      SEQUENCE {
        extId MAP-EXTENSION .&extensionId ( {
          '...'} ) ,
        extType MAP-EXTENSION .&ExtensionType ( {
          '...'} { @extId } ) OPTIONAL} OPTIONAL,
    pcs-Extensions [1] IMPLICIT SEQUENCE {
      ... } OPTIONAL,
    ... } OPTIONAL,
    ... }
RESULT
mo-forwardSM-Res SEQUENCE {
  sm-RP-UI OCTET STRING ( SIZE ( 1..200 ) ) OPTIONAL,
  extensionContainer SEQUENCE {
    privateExtensionList [0] IMPLICIT SEQUENCE ( SIZE ( 1..10 ) ) OF
      SEQUENCE {
        extId MAP-EXTENSION .&extensionId ( {
          '...'} ) ,
        extType MAP-EXTENSION .&ExtensionType ( {
          '...'} { @extId } ) OPTIONAL} OPTIONAL,
    pcs-Extensions [1] IMPLICIT SEQUENCE {
      ... } OPTIONAL,
    ... } OPTIONAL,
    ... }
ERRORS {
  -- systemFailure -- localValue : 34,
  -- unexpectedDataValue -- localValue : 36,
  -- facilityNotSupported -- localValue : 21,
  -- sm-DeliveryFailure -- localValue : 32}
 ::= localValue : 46

mt-forwardSM OPERATION
ARGUMENT
mt-forwardSM-Arg SEQUENCE {
  sm-RP-DA CHOICE {
    imsi [0] IMPLICIT OCTET STRING ( SIZE ( 3..8 ) ),
    lmsi [1] IMPLICIT OCTET STRING ( SIZE ( 4 ) ),
    serviceCentreAddressDA [4] IMPLICIT OCTET STRING ( SIZE ( 1..20 ) ),
    noSM-RP-DA [5] IMPLICIT NULL},
  sm-RP-OA CHOICE {
    msisdn [2] IMPLICIT OCTET STRING ( SIZE ( 1..20 ) ) ( SIZE ( 1..9 ) ),
    serviceCentreAddressOA [4] IMPLICIT OCTET STRING ( SIZE ( 1..20 ) ),
    noSM-RP-OA [5] IMPLICIT NULL},
  sm-RP-UI OCTET STRING ( SIZE ( 1..200 ) ),
  moreMessagesToSend NULL OPTIONAL,
  extensionContainer SEQUENCE {
    privateExtensionList [0] IMPLICIT SEQUENCE ( SIZE ( 1..10 ) ) OF
      SEQUENCE {
        extId MAP-EXTENSION .&extensionId ( {
          '...'} ) ,
        extType MAP-EXTENSION .&ExtensionType ( {
          '...'} { @extId } ) OPTIONAL} OPTIONAL,
    pcs-Extensions [1] IMPLICIT SEQUENCE {
      ... } OPTIONAL,
    ... } OPTIONAL,
    ... }
RESULT
mt-forwardSM-Res SEQUENCE {
  sm-RP-UI OCTET STRING ( SIZE ( 1..200 ) ) OPTIONAL,
  extensionContainer SEQUENCE {

```



```

privateExtensionList  [0] IMPLICIT SEQUENCE ( SIZE (1..10) ) OF
  SEQUENCE {
    extId      MAP-EXTENSION .&extensionId ( {
      '
      ... } ) ,
    extType    MAP-EXTENSION .&ExtensionType ( {
      '
      ... } { @extId } ) OPTIONAL} OPTIONAL,
  pcs-Extensions [1] IMPLICIT SEQUENCE {
    ... } OPTIONAL,
    ... } OPTIONAL,
  ... }
ERRORS {
  -- systemFailure -- localValue : 34,
  -- dataMissing -- localValue : 35,
  -- unexpectedDataValue -- localValue : 36,
  -- facilityNotSupported -- localValue : 21,
  -- unidentifiedSubscriber -- localValue : 5,
  -- illegalSubscriber -- localValue : 9,
  -- illegalEquipment -- localValue : 12,
  -- subscriberBusyForMT-SMS -- localValue : 31,
  -- sm-DeliveryFailure -- localValue : 32,
  -- absentSubscriberSM -- localValue : 6}
 ::= localValue : 44

reportSM-DeliveryStatus OPERATION
  ARGUMENT
    reportSM-DeliveryStatusArg SEQUENCE {
      msisdn OCTET STRING ( SIZE (1..20) ) ( SIZE (1..9) ),
      serviceCentreAddress OCTET STRING ( SIZE (1..20) ),
      sm-DeliveryOutcome ENUMERATED {
        memoryCapacityExceeded (0 ),
        absentSubscriber (1 ),
        successfulTransfer (2 )},
      absentSubscriberDiagnosticSM [0] IMPLICIT INTEGER ( 0..255 ) OPTIONAL,
      extensionContainer [1] IMPLICIT SEQUENCE {
        privateExtensionList [0] IMPLICIT SEQUENCE ( SIZE (1..10) ) OF
          SEQUENCE {
            extId      MAP-EXTENSION .&extensionId ( {
              '
              ... } ) ,
            extType    MAP-EXTENSION .&ExtensionType ( {
              '
              ... } { @extId } ) OPTIONAL} OPTIONAL,
          pcs-Extensions [1] IMPLICIT SEQUENCE {
            ... } OPTIONAL,
            ... } OPTIONAL,
          ... ,
          gprsSupportIndicator [2] IMPLICIT NULL OPTIONAL,
          deliveryOutcomeIndicator [3] IMPLICIT NULL OPTIONAL,
          additionalSM-DeliveryOutcome [4] IMPLICIT ENUMERATED {
            memoryCapacityExceeded (0 ),
            absentSubscriber (1 ),
            successfulTransfer (2 )} OPTIONAL,
          additionalAbsentSubscriberDiagnosticSM [5] IMPLICIT INTEGER ( 0..255 ) OPTIONAL}
      RESULT
        reportSM-DeliveryStatusRes SEQUENCE {
          storedMSISDN OCTET STRING ( SIZE (1..20) ) ( SIZE (1..9) ) OPTIONAL,
          extensionContainer SEQUENCE {
            privateExtensionList [0] IMPLICIT SEQUENCE ( SIZE (1..10) ) OF
              SEQUENCE {
                extId      MAP-EXTENSION .&extensionId ( {
                  '
                  ... } ) ,
                extType    MAP-EXTENSION .&ExtensionType ( {
                  '
                  ... } { @extId } ) OPTIONAL} OPTIONAL,
              pcs-Extensions [1] IMPLICIT SEQUENCE {
                ... } OPTIONAL,
                ... } OPTIONAL,
              ... }
          ... }
        ERRORS {
          -- dataMissing -- localValue : 35,
          -- unexpectedDataValue -- localValue : 36,
          -- unknownSubscriber -- localValue : 1,
          -- messageWaitingListFull -- localValue : 33}
        ::= localValue : 47

```

informServiceCentre OPERATION

ARGUMENT

```

informServiceCentreArg SEQUENCE {
  storedMSISDN      OCTET STRING ( SIZE (1..20 ) ) ( SIZE (1..9 ) ) OPTIONAL,
  mw-Status         BIT STRING {
    sc-AddressNotIncluded ( 0 ),
    mnrf-Set ( 1 ),
    mcef-Set ( 2 ),
    mnrg-Set ( 3 ) } ( SIZE (6..16 ) ) OPTIONAL,
  extensionContainer SEQUENCE {
    privateExtensionList [0] IMPLICIT SEQUENCE ( SIZE (1..10 ) ) OF
      SEQUENCE {
        extId      MAP-EXTENSION .&extensionId ( {
          '
          ... } ) ,
        extType    MAP-EXTENSION .&ExtensionType ( {
          '
          ... } { @extId } ) OPTIONAL} OPTIONAL,
    pcs-Extensions [1] IMPLICIT SEQUENCE {
      ... } OPTIONAL,
      ... } OPTIONAL,
      ... }
}
 ::= localValue : 63

```

alertServiceCentre OPERATION

ARGUMENT

```

alertServiceCentreArg SEQUENCE {
  msisdn           OCTET STRING ( SIZE (1..20 ) ) ( SIZE (1..9 ) ),
  serviceCentreAddress OCTET STRING ( SIZE (1..20 ) ),
  ... }

```

ERRORS {

```

-- systemFailure -- localValue : 34,
-- dataMissing -- localValue : 35,
-- unexpectedDataValue -- localValue : 36}

```

::= localValue : 64

readyForSM OPERATION

ARGUMENT

```

readyForSM-Arg SEQUENCE {
  imsi             [0] IMPLICIT OCTET STRING ( SIZE (3..8 ) ),
  alertReason      ENUMERATED {
    ms-Present ( 0 ),
    memoryAvailable ( 1 ) },
  alertReasonIndicator NULL OPTIONAL,
  extensionContainer SEQUENCE {
    privateExtensionList [0] IMPLICIT SEQUENCE ( SIZE (1..10 ) ) OF
      SEQUENCE {
        extId      MAP-EXTENSION .&extensionId ( {
          '
          ... } ) ,
        extType    MAP-EXTENSION .&ExtensionType ( {
          '
          ... } { @extId } ) OPTIONAL} OPTIONAL,
    pcs-Extensions [1] IMPLICIT SEQUENCE {
      ... } OPTIONAL,
      ... } OPTIONAL,
      ... }
}

```

RESULT

```

readyForSM-Res SEQUENCE {
  extensionContainer SEQUENCE {
    privateExtensionList [0] IMPLICIT SEQUENCE ( SIZE (1..10 ) ) OF
      SEQUENCE {
        extId      MAP-EXTENSION .&extensionId ( {
          '
          ... } ) ,
        extType    MAP-EXTENSION .&ExtensionType ( {
          '
          ... } { @extId } ) OPTIONAL} OPTIONAL,
    pcs-Extensions [1] IMPLICIT SEQUENCE {
      ... } OPTIONAL,
      ... } OPTIONAL,
      ... }
}

```

ERRORS {

```

-- dataMissing -- localValue : 35,
-- unexpectedDataValue -- localValue : 36,
-- facilityNotSupported -- localValue : 21,
-- unknownSubscriber -- localValue : 1}

```

::= localValue : 66

provideSubscriberInfo OPERATION

ARGUMENT

```

provideSubscriberInfoArg SEQUENCE {
  imsi                [0] IMPLICIT OCTET STRING ( SIZE ( 3..8 ) ),
  lmsi                [1] IMPLICIT OCTET STRING ( SIZE ( 4 ) ) OPTIONAL,
  requestedInfo       [2] IMPLICIT SEQUENCE {
    locationInformation [0] IMPLICIT NULL OPTIONAL,
    subscriberState     [1] IMPLICIT NULL OPTIONAL,
    extensionContainer  [2] IMPLICIT SEQUENCE {
      privateExtensionList [0] IMPLICIT SEQUENCE ( SIZE ( 1..10 ) ) OF
        SEQUENCE {
          extId          MAP-EXTENSION .&extensionId ( {
            '...'} ) ,
          extType        MAP-EXTENSION .&ExtensionType ( {
            '...' { @extId } ) OPTIONAL} OPTIONAL,
          pcs-Extensions [1] IMPLICIT SEQUENCE {
            ... } OPTIONAL,
            ... } OPTIONAL,
            ... },
      extensionContainer [3] IMPLICIT SEQUENCE {
        privateExtensionList [0] IMPLICIT SEQUENCE ( SIZE ( 1..10 ) ) OF
          SEQUENCE {
            extId          MAP-EXTENSION .&extensionId ( {
              '...'} ) ,
            extType        MAP-EXTENSION .&ExtensionType ( {
              '...' { @extId } ) OPTIONAL} OPTIONAL,
            pcs-Extensions [1] IMPLICIT SEQUENCE {
              ... } OPTIONAL,
              ... } OPTIONAL,
              ... }
        }
      }
    }
  }
}

```

RESULT

```

provideSubscriberInfoRes SEQUENCE {
  subscriberInfo SEQUENCE {
    locationInformation [0] IMPLICIT SEQUENCE {
      ageOfLocationInformation INTEGER ( 0..32767 ) OPTIONAL,
      geographicalInformation [0] IMPLICIT OCTET STRING ( SIZE ( 8 ) ) OPTIONAL,
      vlr-number             [1] IMPLICIT OCTET STRING ( SIZE ( 1..20 ) ) ( SIZE ( 1..9 )
    ) OPTIONAL,
    locationNumber          [2] IMPLICIT OCTET STRING ( SIZE ( 2..10 ) ) OPTIONAL,
    cellIdOrLAI             [3] CHOICE {
      cellIdFixedLength [0] IMPLICIT OCTET STRING ( SIZE ( 7 ) ),
      laiFixedLength    [1] IMPLICIT OCTET STRING ( SIZE ( 5 ) )} OPTIONAL,
    extensionContainer      [4] IMPLICIT SEQUENCE {
      privateExtensionList [0] IMPLICIT SEQUENCE ( SIZE ( 1..10 ) ) OF
        SEQUENCE {
          extId          MAP-EXTENSION .&extensionId ( {
            '...'} ) ,
          extType        MAP-EXTENSION .&ExtensionType ( {
            '...' { @extId } ) OPTIONAL} OPTIONAL,
          pcs-Extensions [1] IMPLICIT SEQUENCE {
            ... } OPTIONAL,
            ... } OPTIONAL,
            ... } OPTIONAL,
            ... }
        }
      }
    }
  }
  subscriberState [1] CHOICE {
    assumedIdle [0] IMPLICIT NULL,
    camelBusy   [1] IMPLICIT NULL,
    netDetNotReachable ENUMERATED {
      msPurged ( 0 ),
      imsiDetached ( 1 ),
      restrictedArea ( 2 ),
      notRegistered ( 3 )},
    notProvidedFromVLR [2] IMPLICIT NULL} OPTIONAL,
  extensionContainer [2] IMPLICIT SEQUENCE {
    privateExtensionList [0] IMPLICIT SEQUENCE ( SIZE ( 1..10 ) ) OF
      SEQUENCE {
        extId          MAP-EXTENSION .&extensionId ( {
          '...'} ) ,
        extType        MAP-EXTENSION .&ExtensionType ( {
          '...' { @extId } ) OPTIONAL} OPTIONAL,

```

```

        pcs-Extensions          [1] IMPLICIT SEQUENCE {
            ... } OPTIONAL,
            ... } OPTIONAL,
            ... },
    extensionContainer SEQUENCE {
        privateExtensionList [0] IMPLICIT SEQUENCE ( SIZE (1..10) ) OF
        SEQUENCE {
            extId      MAP-EXTENSION .&extensionId ( {
                '
                ... } ) ,
            extType    MAP-EXTENSION .&ExtensionType ( {
                '
                ... } { @extId } ) OPTIONAL} OPTIONAL,
        pcs-Extensions [1] IMPLICIT SEQUENCE {
            ... } OPTIONAL,
            ... } OPTIONAL,
            ... }
    ERRORS {
        -- dataMissing -- localValue : 35,
        -- unexpectedDataValue -- localValue : 36}
    ::= localValue : 70

anyTimeInterrogation OPERATION
ARGUMENT
    anyTimeInterrogationArg SEQUENCE {
        subscriberIdentity [0] CHOICE {
            imsi [0] IMPLICIT OCTET STRING ( SIZE (3..8) ),
            msisdn [1] IMPLICIT OCTET STRING ( SIZE (1..20) ) ( SIZE (1..9) )},
        requestedInfo [1] IMPLICIT SEQUENCE {
            locationInformation [0] IMPLICIT NULL OPTIONAL,
            subscriberState [1] IMPLICIT NULL OPTIONAL,
            extensionContainer [2] IMPLICIT SEQUENCE {
                privateExtensionList [0] IMPLICIT SEQUENCE ( SIZE (1..10) ) OF
                SEQUENCE {
                    extId      MAP-EXTENSION .&extensionId ( {
                        '
                        ... } ) ,
                    extType    MAP-EXTENSION .&ExtensionType ( {
                        '
                        ... } { @extId } ) OPTIONAL} OPTIONAL,
                pcs-Extensions [1] IMPLICIT SEQUENCE {
                    ... } OPTIONAL,
                    ... } OPTIONAL,
                    ... },
            gsmSCF-Address [3] IMPLICIT OCTET STRING ( SIZE (1..20) ) ( SIZE (1..9) ) ,
            extensionContainer [2] IMPLICIT SEQUENCE {
                privateExtensionList [0] IMPLICIT SEQUENCE ( SIZE (1..10) ) OF
                SEQUENCE {
                    extId      MAP-EXTENSION .&extensionId ( {
                        '
                        ... } ) ,
                    extType    MAP-EXTENSION .&ExtensionType ( {
                        '
                        ... } { @extId } ) OPTIONAL} OPTIONAL,
                pcs-Extensions [1] IMPLICIT SEQUENCE {
                    ... } OPTIONAL,
                    ... } OPTIONAL,
                    ... }
        }
    RESULT
        anyTimeInterrogationRes SEQUENCE {
            subscriberInfo SEQUENCE {
                locationInformation [0] IMPLICIT SEQUENCE {
                    ageOfLocationInformation INTEGER ( 0..32767 ) OPTIONAL,
                    geographicalInformation [0] IMPLICIT OCTET STRING ( SIZE (8) ) OPTIONAL,
                    vlr-number [1] IMPLICIT OCTET STRING ( SIZE (1..20) ) ( SIZE (1..9) )
                ) OPTIONAL,
                locationNumber [2] IMPLICIT OCTET STRING ( SIZE (2..10) ) OPTIONAL,
                cellIdOrLAI [3] CHOICE {
                    cellIdFixedLength [0] IMPLICIT OCTET STRING ( SIZE (7) ) ,
                    laiFixedLength [1] IMPLICIT OCTET STRING ( SIZE (5) ) } OPTIONAL,
                extensionContainer [4] IMPLICIT SEQUENCE {
                    privateExtensionList [0] IMPLICIT SEQUENCE ( SIZE (1..10) ) OF
                    SEQUENCE {
                        extId      MAP-EXTENSION .&extensionId ( {
                            '
                            ... } ) ,
                        extType    MAP-EXTENSION .&ExtensionType ( {
                            '

```

```

        ... } { @extId } ) OPTIONAL} OPTIONAL,
    pcs-Extensions [1] IMPLICIT SEQUENCE {
        ... } OPTIONAL,
        ... } OPTIONAL,
        ... } OPTIONAL,
subscriberState [1] CHOICE {
    assumedIdle [0] IMPLICIT NULL,
    camelBusy [1] IMPLICIT NULL,
    netDetNotReachable ENUMERATED {
        msPurged (0 ),
        imsiDetached (1 ),
        restrictedArea (2 ),
        notRegistered (3 )},
    notProvidedFromVLR [2] IMPLICIT NULL} OPTIONAL,
extensionContainer [2] IMPLICIT SEQUENCE {
    privateExtensionList [0] IMPLICIT SEQUENCE ( SIZE (1..10 ) ) OF
        SEQUENCE {
            extId MAP-EXTENSION .&extensionId ( {
                '
                ... } ) ,
            extType MAP-EXTENSION .&ExtensionType ( {
                '
                ... } { @extId } ) OPTIONAL} OPTIONAL,
        pcs-Extensions [1] IMPLICIT SEQUENCE {
            ... } OPTIONAL,
            ... } OPTIONAL,
        ... },
extensionContainer SEQUENCE {
    privateExtensionList [0] IMPLICIT SEQUENCE ( SIZE (1..10 ) ) OF
        SEQUENCE {
            extId MAP-EXTENSION .&extensionId ( {
                '
                ... } ) ,
            extType MAP-EXTENSION .&ExtensionType ( {
                '
                ... } { @extId } ) OPTIONAL} OPTIONAL,
        pcs-Extensions [1] IMPLICIT SEQUENCE {
            ... } OPTIONAL,
            ... } OPTIONAL,
        ... }
ERRORS {
-- systemFailure -- localValue : 34,
-- ati-NotAllowed -- localValue : 49,
-- dataMissing -- localValue : 35,
-- unexpectedDataValue -- localValue : 36,
-- unknownSubscriber -- localValue : 1}
 ::= localValue : 71

ss-InvocationNotification OPERATION
ARGUMENT
    ss-InvocationNotificationArg SEQUENCE {
        imsi [0] IMPLICIT OCTET STRING ( SIZE (3..8 ) ),
        msisdn [1] IMPLICIT OCTET STRING ( SIZE (1..20 ) ) ( SIZE (1..9 ) ),
        ss-Event [2] IMPLICIT OCTET STRING ( SIZE (1 ) ),
        ss-EventSpecification [3] IMPLICIT SEQUENCE ( SIZE (1..2 ) ) OF
            OCTET STRING ( SIZE (1..20 ) ) OPTIONAL,
        extensionContainer [4] IMPLICIT SEQUENCE {
            privateExtensionList [0] IMPLICIT SEQUENCE ( SIZE (1..10 ) ) OF
                SEQUENCE {
                    extId MAP-EXTENSION .&extensionId ( {
                        '
                        ... } ) ,
                    extType MAP-EXTENSION .&ExtensionType ( {
                        '
                        ... } { @extId } ) OPTIONAL} OPTIONAL,
                pcs-Extensions [1] IMPLICIT SEQUENCE {
                    ... } OPTIONAL,
                    ... } OPTIONAL,
                ... }
        ... }
RESULT
    ss-InvocationNotificationRes SEQUENCE {
        extensionContainer SEQUENCE {
            privateExtensionList [0] IMPLICIT SEQUENCE ( SIZE (1..10 ) ) OF
                SEQUENCE {
                    extId MAP-EXTENSION .&extensionId ( {
                        '
                        ... } ) ,
                    extType MAP-EXTENSION .&ExtensionType ( {

```

```

        '... } { @extId } ) OPTIONAL} OPTIONAL,
    pcs-Extensions [1] IMPLICIT SEQUENCE {
        ... } OPTIONAL,
    ... } OPTIONAL,
    ... }
ERRORS {
    -- dataMissing -- localValue : 35,
    -- unexpectedDataValue -- localValue : 36,
    -- unknownSubscriber -- localValue : 1}
 ::= localValue : 72

prepareGroupCall OPERATION
ARGUMENT
    prepareGroupCallArg SEQUENCE {
        teleservice OCTET STRING ( SIZE (1..5) ),
        asciiCallReference OCTET STRING ( SIZE (1..8) ),
        codec-Info OCTET STRING ( SIZE (5..10) ),
        cipheringAlgorithm OCTET STRING ( SIZE (1) ),
        groupKeyNumber [0] IMPLICIT INTEGER ( 0..15 ) OPTIONAL,
        groupKey [1] IMPLICIT OCTET STRING ( SIZE (8) ) OPTIONAL,
        priority [2] IMPLICIT INTEGER ( 0..15 ) OPTIONAL,
        uplinkFree [3] IMPLICIT NULL OPTIONAL,
        extensionContainer [4] IMPLICIT SEQUENCE {
            privateExtensionList [0] IMPLICIT SEQUENCE ( SIZE (1..10) ) OF
                SEQUENCE {
                    extId MAP-EXTENSION .&extensionId ( {
                        '... } ) ,
                    extType MAP-EXTENSION .&ExtensionType ( {
                        '... } { @extId } ) OPTIONAL} OPTIONAL,
                pcs-Extensions [1] IMPLICIT SEQUENCE {
                    ... } OPTIONAL,
                ... } OPTIONAL,
                ... }
        ... }
RESULT
    prepareGroupCallRes SEQUENCE {
        groupCallNumber OCTET STRING ( SIZE (1..20) ) ( SIZE (1..9) ),
        extensionContainer SEQUENCE {
            privateExtensionList [0] IMPLICIT SEQUENCE ( SIZE (1..10) ) OF
                SEQUENCE {
                    extId MAP-EXTENSION .&extensionId ( {
                        '... } ) ,
                    extType MAP-EXTENSION .&ExtensionType ( {
                        '... } { @extId } ) OPTIONAL} OPTIONAL,
                pcs-Extensions [1] IMPLICIT SEQUENCE {
                    ... } OPTIONAL,
                ... } OPTIONAL,
                ... }
        ... }
ERRORS {
    -- systemFailure -- localValue : 34,
    -- noGroupCallNumberAvailable -- localValue : 50,
    -- unexpectedDataValue -- localValue : 36}
 ::= localValue : 39

sendGroupCallEndSignal OPERATION
ARGUMENT
    sendGroupCallEndSignalArg SEQUENCE {
        imsi OCTET STRING ( SIZE (3..8) ) OPTIONAL,
        extensionContainer SEQUENCE {
            privateExtensionList [0] IMPLICIT SEQUENCE ( SIZE (1..10) ) OF
                SEQUENCE {
                    extId MAP-EXTENSION .&extensionId ( {
                        '... } ) ,
                    extType MAP-EXTENSION .&ExtensionType ( {
                        '... } { @extId } ) OPTIONAL} OPTIONAL,
                pcs-Extensions [1] IMPLICIT SEQUENCE {
                    ... } OPTIONAL,
                ... } OPTIONAL,
                ... }
        ... }
RESULT
    sendGroupCallEndSignalRes SEQUENCE {
        extensionContainer SEQUENCE {

```

```

privateExtensionList [0] IMPLICIT SEQUENCE ( SIZE (1..10) ) OF
  SEQUENCE {
    extId      MAP-EXTENSION .&extensionId ( {
      '...'} ) ,
    extType    MAP-EXTENSION .&ExtensionType ( {
      '...'} { @extId } ) OPTIONAL} OPTIONAL,
  pcs-Extensions [1] IMPLICIT SEQUENCE {
    ... } OPTIONAL,
  ... } OPTIONAL,
  ... }
 ::= localValue : 40

processGroupCallSignalling OPERATION
ARGUMENT
  processGroupCallSignallingArg SEQUENCE {
    uplinkRequest [0] IMPLICIT NULL OPTIONAL,
    uplinkReleaseIndication [1] IMPLICIT NULL OPTIONAL,
    releaseGroupCall [2] IMPLICIT NULL OPTIONAL,
    extensionContainer SEQUENCE {
      privateExtensionList [0] IMPLICIT SEQUENCE ( SIZE (1..10) ) OF
        SEQUENCE {
          extId      MAP-EXTENSION .&extensionId ( {
            '...'} ) ,
          extType    MAP-EXTENSION .&ExtensionType ( {
            '...'} { @extId } ) OPTIONAL} OPTIONAL,
        pcs-Extensions [1] IMPLICIT SEQUENCE {
          ... } OPTIONAL,
        ... } OPTIONAL,
        ... }
      ::= localValue : 41

forwardGroupCallSignalling OPERATION
ARGUMENT
  forwardGroupCallSignallingArg SEQUENCE {
    imsi OCTET STRING ( SIZE (3..8) ) OPTIONAL,
    uplinkRequestAck [0] IMPLICIT NULL OPTIONAL,
    uplinkReleaseIndication [1] IMPLICIT NULL OPTIONAL,
    uplinkRejectCommand [2] IMPLICIT NULL OPTIONAL,
    uplinkSeizedCommand [3] IMPLICIT NULL OPTIONAL,
    uplinkReleaseCommand [4] IMPLICIT NULL OPTIONAL,
    extensionContainer SEQUENCE {
      privateExtensionList [0] IMPLICIT SEQUENCE ( SIZE (1..10) ) OF
        SEQUENCE {
          extId      MAP-EXTENSION .&extensionId ( {
            '...'} ) ,
          extType    MAP-EXTENSION .&ExtensionType ( {
            '...'} { @extId } ) OPTIONAL} OPTIONAL,
        pcs-Extensions [1] IMPLICIT SEQUENCE {
          ... } OPTIONAL,
        ... } OPTIONAL,
        ... }
      ::= localValue : 42

updateGprsLocation OPERATION
ARGUMENT
  updateGprsLocationArg SEQUENCE {
    imsi OCTET STRING ( SIZE (3..8) ),
    sgsn-Number OCTET STRING ( SIZE (1..20) ) ( SIZE (1..9) ),
    sgsn-Address OCTET STRING ( SIZE (5..17) ),
    extensionContainer SEQUENCE {
      privateExtensionList [0] IMPLICIT SEQUENCE ( SIZE (1..10) ) OF
        SEQUENCE {
          extId      MAP-EXTENSION .&extensionId ( {
            '...'} ) ,
          extType    MAP-EXTENSION .&ExtensionType ( {
            '...'} { @extId } ) OPTIONAL} OPTIONAL,
        pcs-Extensions [1] IMPLICIT SEQUENCE {
          ... } OPTIONAL,
        ... } OPTIONAL,
        ... }
  }

```

```

RESULT
  updateGprsLocationRes SEQUENCE {
    hlr-Number      OCTET STRING ( SIZE (1..20) ) ( SIZE (1..9) ),
    extensionContainer SEQUENCE {
      privateExtensionList [0] IMPLICIT SEQUENCE ( SIZE (1..10) ) OF
        SEQUENCE {
          extId      MAP-EXTENSION .&extensionId ( {
            '
            ... } ) ,
          extType    MAP-EXTENSION .&ExtensionType ( {
            '
            ... } { @extId } ) OPTIONAL} OPTIONAL,
          pcs-Extensions [1] IMPLICIT SEQUENCE {
            ... } OPTIONAL,
            ... } OPTIONAL,
            ... }
    }
  }
  ERRORS {
    -- systemFailure -- localValue : 34,
    -- unexpectedDataValue -- localValue : 36,
    -- unknownSubscriber -- localValue : 1,
    -- roamingNotAllowed -- localValue : 8}
  ::= localValue : 23

sendRoutingInfoForGprs OPERATION
  ARGUMENT
    sendRoutingInfoForGprsArg SEQUENCE {
      imsi [0] IMPLICIT OCTET STRING ( SIZE (3..8) ),
      ggsn-Address [1] IMPLICIT OCTET STRING ( SIZE (5..17) ) OPTIONAL,
      ggsn-Number [2] IMPLICIT OCTET STRING ( SIZE (1..20) ) ( SIZE (1..9) ),
      extensionContainer [3] IMPLICIT SEQUENCE {
        privateExtensionList [0] IMPLICIT SEQUENCE ( SIZE (1..10) ) OF
          SEQUENCE {
            extId      MAP-EXTENSION .&extensionId ( {
              '
              ... } ) ,
            extType    MAP-EXTENSION .&ExtensionType ( {
              '
              ... } { @extId } ) OPTIONAL} OPTIONAL,
            pcs-Extensions [1] IMPLICIT SEQUENCE {
              ... } OPTIONAL,
              ... } OPTIONAL,
              ... }
        }
      }
  }
  RESULT
    sendRoutingInfoForGprsRes SEQUENCE {
      sgsn-Address [0] IMPLICIT OCTET STRING ( SIZE (5..17) ),
      ggsn-Address [1] IMPLICIT OCTET STRING ( SIZE (5..17) ) OPTIONAL,
      mobileNotReachableReason [2] IMPLICIT INTEGER ( 0..255 ) OPTIONAL,
      extensionContainer [3] IMPLICIT SEQUENCE {
        privateExtensionList [0] IMPLICIT SEQUENCE ( SIZE (1..10) ) OF
          SEQUENCE {
            extId      MAP-EXTENSION .&extensionId ( {
              '
              ... } ) ,
            extType    MAP-EXTENSION .&ExtensionType ( {
              '
              ... } { @extId } ) OPTIONAL} OPTIONAL,
            pcs-Extensions [1] IMPLICIT SEQUENCE {
              ... } OPTIONAL,
              ... } OPTIONAL,
              ... }
        }
      }
    }
  }
  ERRORS {
    -- absentSubscriber -- localValue : 27,
    -- systemFailure -- localValue : 34,
    -- dataMissing -- localValue : 35,
    -- unexpectedDataValue -- localValue : 36,
    -- unknownSubscriber -- localValue : 1}
  ::= localValue : 24

failureReport OPERATION
  ARGUMENT
    failureReportArg SEQUENCE {
      imsi [0] IMPLICIT OCTET STRING ( SIZE (3..8) ),
      ggsn-Number [1] IMPLICIT OCTET STRING ( SIZE (1..20) ) ( SIZE (1..9) ),
      ggsn-Address [2] IMPLICIT OCTET STRING ( SIZE (5..17) ) OPTIONAL,
      extensionContainer [3] IMPLICIT SEQUENCE {
        privateExtensionList [0] IMPLICIT SEQUENCE ( SIZE (1..10) ) OF
          SEQUENCE {
            extId      MAP-EXTENSION .&extensionId ( {

```



```

        '...} ) ,
        extType      MAP-EXTENSION .&ExtensionType ( {
        '...} { @extId  } ) OPTIONAL} OPTIONAL,
    pcs-Extensions   [1] IMPLICIT SEQUENCE {
        ... } OPTIONAL,
        ... } OPTIONAL,
        ... }
RESULT
failureReportRes SEQUENCE {
    ggsn-Address      [0] IMPLICIT OCTET STRING ( SIZE (5..17 ) ) OPTIONAL,
    extensionContainer [1] IMPLICIT SEQUENCE {
        privateExtensionList [0] IMPLICIT SEQUENCE ( SIZE (1..10 ) ) OF
            SEQUENCE {
                extId      MAP-EXTENSION .&extensionId ( {
                    '...} ) ,
                extType    MAP-EXTENSION .&ExtensionType ( {
                    '...} { @extId  } ) OPTIONAL} OPTIONAL,
                pcs-Extensions [1] IMPLICIT SEQUENCE {
                    ... } OPTIONAL,
                    ... } OPTIONAL,
                    ... }
            }
ERRORS {
    -- systemFailure -- localValue : 34,
    -- dataMissing -- localValue : 35,
    -- unexpectedDataValue -- localValue : 36,
    -- unknownSubscriber -- localValue : 1}
 ::= localValue : 25

noteMsPresentForGprs OPERATION
ARGUMENT
noteMsPresentForGprsArg SEQUENCE {
    imsi                [0] IMPLICIT OCTET STRING ( SIZE (3..8 ) ),
    sgsn-Address        [1] IMPLICIT OCTET STRING ( SIZE (5..17 ) ),
    ggsn-Address        [2] IMPLICIT OCTET STRING ( SIZE (5..17 ) ) OPTIONAL,
    extensionContainer  [3] IMPLICIT SEQUENCE {
        privateExtensionList [0] IMPLICIT SEQUENCE ( SIZE (1..10 ) ) OF
            SEQUENCE {
                extId      MAP-EXTENSION .&extensionId ( {
                    '...} ) ,
                extType    MAP-EXTENSION .&ExtensionType ( {
                    '...} { @extId  } ) OPTIONAL} OPTIONAL,
                pcs-Extensions [1] IMPLICIT SEQUENCE {
                    ... } OPTIONAL,
                    ... } OPTIONAL,
                    ... }
            }
        ... }
RESULT
noteMsPresentForGprsRes SEQUENCE {
    extensionContainer [0] IMPLICIT SEQUENCE {
        privateExtensionList [0] IMPLICIT SEQUENCE ( SIZE (1..10 ) ) OF
            SEQUENCE {
                extId      MAP-EXTENSION .&extensionId ( {
                    '...} ) ,
                extType    MAP-EXTENSION .&ExtensionType ( {
                    '...} { @extId  } ) OPTIONAL} OPTIONAL,
                pcs-Extensions [1] IMPLICIT SEQUENCE {
                    ... } OPTIONAL,
                    ... } OPTIONAL,
                    ... }
            }
        ... }
ERRORS {
    -- systemFailure -- localValue : 34,
    -- dataMissing -- localValue : 35,
    -- unexpectedDataValue -- localValue : 36,
    -- unknownSubscriber -- localValue : 1}
 ::= localValue : 26

systemFailure ERROR
PARAMETER
systemFailureParam CHOICE {
    networkResource          ENUMERATED {
        plmn                ( 0 ) ,

```

```

    hlr          (1 ),
    vlr          (2 ),
    pvlr         (3 ),
    controllingMSC (4 ),
    vmsc         (5 ),
    eir          (6 ),
    rss          (7 )},
extensibleSystemFailureParam SEQUENCE {
  networkResource ENUMERATED {
    plmn          (0 ),
    hlr           (1 ),
    vlr           (2 ),
    pvlr          (3 ),
    controllingMSC (4 ),
    vmsc          (5 ),
    eir           (6 ),
    rss           (7 )} OPTIONAL,
  extensionContainer SEQUENCE {
    privateExtensionList [0] IMPLICIT SEQUENCE ( SIZE (1..10 ) ) OF
      SEQUENCE {
        extId          MAP-EXTENSION .&extensionId ( {
          '
          ... } ) ,
        extType        MAP-EXTENSION .&ExtensionType ( {
          '
          ... } { @extId } ) OPTIONAL} OPTIONAL,
    pcs-Extensions    [1] IMPLICIT SEQUENCE {
      ... } OPTIONAL,
      ... } OPTIONAL,
      ... } }
  ::= localValue : 34

dataMissing ERROR
PARAMETER
  dataMissingParam SEQUENCE {
    extensionContainer SEQUENCE {
      privateExtensionList [0] IMPLICIT SEQUENCE ( SIZE (1..10 ) ) OF
        SEQUENCE {
          extId          MAP-EXTENSION .&extensionId ( {
            '
            ... } ) ,
          extType        MAP-EXTENSION .&ExtensionType ( {
            '
            ... } { @extId } ) OPTIONAL} OPTIONAL,
          pcs-Extensions [1] IMPLICIT SEQUENCE {
            ... } OPTIONAL,
            ... } OPTIONAL,
            ... }
        }
      ::= localValue : 35

unexpectedDataValue ERROR
PARAMETER
  unexpectedDataParam SEQUENCE {
    extensionContainer SEQUENCE {
      privateExtensionList [0] IMPLICIT SEQUENCE ( SIZE (1..10 ) ) OF
        SEQUENCE {
          extId          MAP-EXTENSION .&extensionId ( {
            '
            ... } ) ,
          extType        MAP-EXTENSION .&ExtensionType ( {
            '
            ... } { @extId } ) OPTIONAL} OPTIONAL,
          pcs-Extensions [1] IMPLICIT SEQUENCE {
            ... } OPTIONAL,
            ... } OPTIONAL,
            ... }
        }
      ::= localValue : 36

facilityNotSupported ERROR
PARAMETER
  facilityNotSupParam SEQUENCE {
    extensionContainer SEQUENCE {
      privateExtensionList [0] IMPLICIT SEQUENCE ( SIZE (1..10 ) ) OF
        SEQUENCE {
          extId          MAP-EXTENSION .&extensionId ( {
            '
            ... } ) ,
          extType        MAP-EXTENSION .&ExtensionType ( {

```

```

        '... } { @extId } ) OPTIONAL} OPTIONAL,
pcs-Extensions [1] IMPLICIT SEQUENCE {
    ... } OPTIONAL,
    ... } OPTIONAL,
    ... }
 ::= localValue : 21

incompatibleTerminal ERROR
PARAMETER
incompatibleTerminalParam SEQUENCE {
    extensionContainer SEQUENCE {
        privateExtensionList [0] IMPLICIT SEQUENCE ( SIZE (1..10) ) OF
        SEQUENCE {
            extId MAP-EXTENSION .&extensionId ( {
                '... } ) ,
            extType MAP-EXTENSION .&ExtensionType ( {
                '... } { @extId } ) OPTIONAL} OPTIONAL,
        pcs-Extensions [1] IMPLICIT SEQUENCE {
            ... } OPTIONAL,
            ... } OPTIONAL,
            ... }
 ::= localValue : 28

resourceLimitation ERROR
PARAMETER
resourceLimitationParam SEQUENCE {
    extensionContainer SEQUENCE {
        privateExtensionList [0] IMPLICIT SEQUENCE ( SIZE (1..10) ) OF
        SEQUENCE {
            extId MAP-EXTENSION .&extensionId ( {
                '... } ) ,
            extType MAP-EXTENSION .&ExtensionType ( {
                '... } { @extId } ) OPTIONAL} OPTIONAL,
        pcs-Extensions [1] IMPLICIT SEQUENCE {
            ... } OPTIONAL,
            ... } OPTIONAL,
            ... }
 ::= localValue : 51

unknownSubscriber ERROR
PARAMETER
unknownSubscriberParam SEQUENCE {
    extensionContainer SEQUENCE {
        privateExtensionList [0] IMPLICIT SEQUENCE ( SIZE (1..10) ) OF
        SEQUENCE {
            extId MAP-EXTENSION .&extensionId ( {
                '... } ) ,
            extType MAP-EXTENSION .&ExtensionType ( {
                '... } { @extId } ) OPTIONAL} OPTIONAL,
        pcs-Extensions [1] IMPLICIT SEQUENCE {
            ... } OPTIONAL,
            ... } OPTIONAL,
            ... ,
            unknownSubscriberDiagnostic ENUMERATED {
                imsiUnknown (0 ),
                gprsSubscriptionUnknown (1 ),
                ... } OPTIONAL}
 ::= localValue : 1

numberChanged ERROR
PARAMETER
numberChangedParam SEQUENCE {
    extensionContainer SEQUENCE {
        privateExtensionList [0] IMPLICIT SEQUENCE ( SIZE (1..10) ) OF
        SEQUENCE {
            extId MAP-EXTENSION .&extensionId ( {
                '... } ) ,
            extType MAP-EXTENSION .&ExtensionType ( {
                '... } { @extId } ) OPTIONAL} OPTIONAL,

```

```

        pcs-Extensions          [1] IMPLICIT SEQUENCE {
            ... } OPTIONAL,
            ... } OPTIONAL,
            ... }
 ::= localValue : 44

unknownMSC ERROR
 ::= localValue : 3

unidentifiedSubscriber ERROR
PARAMETER
    unidentifiedSubParam SEQUENCE {
        extensionContainer SEQUENCE {
            privateExtensionList [0] IMPLICIT SEQUENCE ( SIZE (1..10) ) OF
                SEQUENCE {
                    extId          MAP-EXTENSION .&extensionId ( {
                        '
                        ... } ) ,
                    extType        MAP-EXTENSION .&ExtensionType ( {
                        '
                        ... } { @extId } ) OPTIONAL} OPTIONAL,
                    pcs-Extensions [1] IMPLICIT SEQUENCE {
                        ... } OPTIONAL,
                        ... } OPTIONAL,
                        ... }
                ::= localValue : 5

unknownEquipment ERROR
 ::= localValue : 7

roamingNotAllowed ERROR
PARAMETER
    roamingNotAllowedParam SEQUENCE {
        roamingNotAllowedCause ENUMERATED {
            plmnRoamingNotAllowed (0 ),
            operatorDeterminedBarring (3 )},
        extensionContainer SEQUENCE {
            privateExtensionList [0] IMPLICIT SEQUENCE ( SIZE (1..10) ) OF
                SEQUENCE {
                    extId          MAP-EXTENSION .&extensionId ( {
                        '
                        ... } ) ,
                    extType        MAP-EXTENSION .&ExtensionType ( {
                        '
                        ... } { @extId } ) OPTIONAL} OPTIONAL,
                    pcs-Extensions [1] IMPLICIT SEQUENCE {
                        ... } OPTIONAL,
                        ... } OPTIONAL,
                        ... }
                ::= localValue : 8

illegalSubscriber ERROR
PARAMETER
    illegalSubscriberParam SEQUENCE {
        extensionContainer SEQUENCE {
            privateExtensionList [0] IMPLICIT SEQUENCE ( SIZE (1..10) ) OF
                SEQUENCE {
                    extId          MAP-EXTENSION .&extensionId ( {
                        '
                        ... } ) ,
                    extType        MAP-EXTENSION .&ExtensionType ( {
                        '
                        ... } { @extId } ) OPTIONAL} OPTIONAL,
                    pcs-Extensions [1] IMPLICIT SEQUENCE {
                        ... } OPTIONAL,
                        ... } OPTIONAL,
                        ... }
                ::= localValue : 9

illegalEquipment ERROR
PARAMETER
    illegalEquipmentParam SEQUENCE {
        extensionContainer SEQUENCE {
            privateExtensionList [0] IMPLICIT SEQUENCE ( SIZE (1..10) ) OF
                SEQUENCE {
                    extId          MAP-EXTENSION .&extensionId ( {
                        '
                        ... } ) ,

```

```

        extType      MAP-EXTENSION .&ExtensionType ( {
            '... } { @extId } ) OPTIONAL} OPTIONAL,
    pcs-Extensions  [1] IMPLICIT SEQUENCE {
        ... } OPTIONAL,
        ... } OPTIONAL,
    ... }
 ::= localValue : 12

bearerServiceNotProvisioned ERROR
PARAMETER
    bearerServNotProvParam SEQUENCE {
        extensionContainer SEQUENCE {
            privateExtensionList [0] IMPLICIT SEQUENCE ( SIZE (1..10) ) OF
                SEQUENCE {
                    extId      MAP-EXTENSION .&extensionId ( {
                        '... } ) ,
                    extType    MAP-EXTENSION .&ExtensionType ( {
                        '... } { @extId } ) OPTIONAL} OPTIONAL,
                pcs-Extensions [1] IMPLICIT SEQUENCE {
                    ... } OPTIONAL,
                    ... } OPTIONAL,
                ... }
 ::= localValue : 10

teleserviceNotProvisioned ERROR
PARAMETER
    teleservNotProvParam SEQUENCE {
        extensionContainer SEQUENCE {
            privateExtensionList [0] IMPLICIT SEQUENCE ( SIZE (1..10) ) OF
                SEQUENCE {
                    extId      MAP-EXTENSION .&extensionId ( {
                        '... } ) ,
                    extType    MAP-EXTENSION .&ExtensionType ( {
                        '... } { @extId } ) OPTIONAL} OPTIONAL,
                pcs-Extensions [1] IMPLICIT SEQUENCE {
                    ... } OPTIONAL,
                    ... } OPTIONAL,
                ... }
 ::= localValue : 11

noHandoverNumberAvailable ERROR
 ::= localValue : 25

subsequentHandoverFailure ERROR
 ::= localValue : 26

tracingBufferFull ERROR
PARAMETER
    tracingBufferFullParam SEQUENCE {
        extensionContainer SEQUENCE {
            privateExtensionList [0] IMPLICIT SEQUENCE ( SIZE (1..10) ) OF
                SEQUENCE {
                    extId      MAP-EXTENSION .&extensionId ( {
                        '... } ) ,
                    extType    MAP-EXTENSION .&ExtensionType ( {
                        '... } { @extId } ) OPTIONAL} OPTIONAL,
                pcs-Extensions [1] IMPLICIT SEQUENCE {
                    ... } OPTIONAL,
                    ... } OPTIONAL,
                ... }
 ::= localValue : 40

noRoamingNumberAvailable ERROR
PARAMETER
    noRoamingNbParam SEQUENCE {
        extensionContainer SEQUENCE {
            privateExtensionList [0] IMPLICIT SEQUENCE ( SIZE (1..10) ) OF
                SEQUENCE {
                    extId      MAP-EXTENSION .&extensionId ( {
                        '... } ) ,

```

```

        extType      MAP-EXTENSION .&ExtensionType ( {
            '... } { @extId } ) OPTIONAL} OPTIONAL,
    pcs-Extensions  [1] IMPLICIT SEQUENCE {
        ... } OPTIONAL,
        ... } OPTIONAL,
    ... }
 ::= localValue : 39

absentSubscriber ERROR
PARAMETER
    absentSubscriberParam SEQUENCE {
        extensionContainer SEQUENCE {
            privateExtensionList [0] IMPLICIT SEQUENCE ( SIZE (1..10) ) OF
                SEQUENCE {
                    extId      MAP-EXTENSION .&extensionId ( {
                        '... } ) ,
                    extType    MAP-EXTENSION .&ExtensionType ( {
                        '... } { @extId } ) OPTIONAL} OPTIONAL,
                pcs-Extensions [1] IMPLICIT SEQUENCE {
                    ... } OPTIONAL,
                    ... } OPTIONAL,
                ... ,
            absentSubscriberReason [0] IMPLICIT ENUMERATED {
                imsiDetach      (0 ),
                restrictedArea  (1 ),
                noPageResponse  (2 ),
                ... } OPTIONAL}
 ::= localValue : 27

busySubscriber ERROR
PARAMETER
    busySubscriberParam SEQUENCE {
        extensionContainer SEQUENCE {
            privateExtensionList [0] IMPLICIT SEQUENCE ( SIZE (1..10) ) OF
                SEQUENCE {
                    extId      MAP-EXTENSION .&extensionId ( {
                        '... } ) ,
                    extType    MAP-EXTENSION .&ExtensionType ( {
                        '... } { @extId } ) OPTIONAL} OPTIONAL,
                pcs-Extensions [1] IMPLICIT SEQUENCE {
                    ... } OPTIONAL,
                    ... } OPTIONAL,
                ... ,
            ccbs-Possible      [0] IMPLICIT NULL OPTIONAL,
            ccbs-Busy         [1] IMPLICIT NULL OPTIONAL}
 ::= localValue : 45

noSubscriberReply ERROR
PARAMETER
    noSubscriberReplyParam SEQUENCE {
        extensionContainer SEQUENCE {
            privateExtensionList [0] IMPLICIT SEQUENCE ( SIZE (1..10) ) OF
                SEQUENCE {
                    extId      MAP-EXTENSION .&extensionId ( {
                        '... } ) ,
                    extType    MAP-EXTENSION .&ExtensionType ( {
                        '... } { @extId } ) OPTIONAL} OPTIONAL,
                pcs-Extensions [1] IMPLICIT SEQUENCE {
                    ... } OPTIONAL,
                    ... } OPTIONAL,
                ... }
 ::= localValue : 46

callBarred ERROR
PARAMETER
    callBarredParam CHOICE {
        callBarringCause      ENUMERATED {
            barringServiceActive (0 ),
            operatorBarring      (1 )},
        extensibleCallBarredParam SEQUENCE {
            callBarringCause      ENUMERATED {

```

```

        barringServiceActive      ( 0 ),
        operatorBarring           ( 1 ) } OPTIONAL,
        extensionContainer        SEQUENCE {
        privateExtensionList      [0] IMPLICIT SEQUENCE ( SIZE ( 1..10 ) ) OF
            SEQUENCE {
                extId              MAP-EXTENSION .&extensionId ( {
                    '...' ) ,
                extType            MAP-EXTENSION .&ExtensionType ( {
                    '...' { @extId } ) OPTIONAL } OPTIONAL,
        pcs-Extensions            [1] IMPLICIT SEQUENCE {
            ... } OPTIONAL,
            ... } OPTIONAL,
        ... ,
        unauthorisedMessageOriginator [1] IMPLICIT NULL OPTIONAL}}
 ::= localValue : 13

forwardingFailed ERROR
PARAMETER
    forwardingFailedParam SEQUENCE {
        extensionContainer SEQUENCE {
            privateExtensionList [0] IMPLICIT SEQUENCE ( SIZE ( 1..10 ) ) OF
                SEQUENCE {
                    extId          MAP-EXTENSION .&extensionId ( {
                        '...' ) ,
                    extType        MAP-EXTENSION .&ExtensionType ( {
                        '...' { @extId } ) OPTIONAL } OPTIONAL,
            pcs-Extensions        [1] IMPLICIT SEQUENCE {
                ... } OPTIONAL,
                ... } OPTIONAL,
            ... }
        ::= localValue : 47

or-NotAllowed ERROR
PARAMETER
    or-NotAllowedParam SEQUENCE {
        extensionContainer SEQUENCE {
            privateExtensionList [0] IMPLICIT SEQUENCE ( SIZE ( 1..10 ) ) OF
                SEQUENCE {
                    extId          MAP-EXTENSION .&extensionId ( {
                        '...' ) ,
                    extType        MAP-EXTENSION .&ExtensionType ( {
                        '...' { @extId } ) OPTIONAL } OPTIONAL,
            pcs-Extensions        [1] IMPLICIT SEQUENCE {
                ... } OPTIONAL,
                ... } OPTIONAL,
            ... }
        ::= localValue : 48

forwardingViolation ERROR
PARAMETER
    forwardingViolationParam SEQUENCE {
        extensionContainer SEQUENCE {
            privateExtensionList [0] IMPLICIT SEQUENCE ( SIZE ( 1..10 ) ) OF
                SEQUENCE {
                    extId          MAP-EXTENSION .&extensionId ( {
                        '...' ) ,
                    extType        MAP-EXTENSION .&ExtensionType ( {
                        '...' { @extId } ) OPTIONAL } OPTIONAL,
            pcs-Extensions        [1] IMPLICIT SEQUENCE {
                ... } OPTIONAL,
                ... } OPTIONAL,
            ... }
        ::= localValue : 14

cug-Reject ERROR
PARAMETER
    cug-RejectParam SEQUENCE {
        cug-RejectCause          ENUMERATED {
            incomingCallsBarredWithinCUG          ( 0 ),
            subscriberNotMemberOfCUG              ( 1 ),

```

```

        requestedBasicServiceViolatesCUG-Constraints      ( 5 ),
        calledPartySS-InteractionViolation                ( 7 )} OPTIONAL,
    extensionContainer SEQUENCE {
        privateExtensionList [0] IMPLICIT SEQUENCE ( SIZE ( 1..10 ) ) OF
            SEQUENCE {
                extId      MAP-EXTENSION .&extensionId ( {
                    '...'} ) ,
                extType    MAP-EXTENSION .&ExtensionType ( {
                    '...'} { @extId } ) OPTIONAL} OPTIONAL,
        pcs-Extensions    [1] IMPLICIT SEQUENCE {
            ... } OPTIONAL,
        ... } OPTIONAL,
        ... }
 ::= localValue : 15

ati-NotAllowed ERROR
PARAMETER
    ati-NotAllowedParam SEQUENCE {
        extensionContainer SEQUENCE {
            privateExtensionList [0] IMPLICIT SEQUENCE ( SIZE ( 1..10 ) ) OF
                SEQUENCE {
                    extId      MAP-EXTENSION .&extensionId ( {
                        '...'} ) ,
                    extType    MAP-EXTENSION .&ExtensionType ( {
                        '...'} { @extId } ) OPTIONAL} OPTIONAL,
            pcs-Extensions    [1] IMPLICIT SEQUENCE {
                ... } OPTIONAL,
            ... } OPTIONAL,
            ... }
 ::= localValue : 49

noGroupCallNumberAvailable ERROR
PARAMETER
    noGroupCallNbParam SEQUENCE {
        extensionContainer SEQUENCE {
            privateExtensionList [0] IMPLICIT SEQUENCE ( SIZE ( 1..10 ) ) OF
                SEQUENCE {
                    extId      MAP-EXTENSION .&extensionId ( {
                        '...'} ) ,
                    extType    MAP-EXTENSION .&ExtensionType ( {
                        '...'} { @extId } ) OPTIONAL} OPTIONAL,
            pcs-Extensions    [1] IMPLICIT SEQUENCE {
                ... } OPTIONAL,
            ... } OPTIONAL,
            ... }
 ::= localValue : 50

illegalSS-Operation ERROR
 ::= localValue : 16

ss-ErrorStatus ERROR
PARAMETER
    ss-Status OCTET STRING ( SIZE ( 1 ) )
 ::= localValue : 17

ss-NotAvailable ERROR
 ::= localValue : 18

ss-SubscriptionViolation ERROR
 ::= localValue : 19

ss-Incompatibility ERROR
PARAMETER
    ss-IncompatibilityCause SEQUENCE {
        ss-Code [1] IMPLICIT OCTET STRING ( SIZE ( 1 ) ) OPTIONAL,
        basicService CHOICE {
            bearerService [2] IMPLICIT OCTET STRING ( SIZE ( 1 ) ),
            teleservice [3] IMPLICIT OCTET STRING ( SIZE ( 1 ) )} OPTIONAL,
        ss-Status [4] IMPLICIT OCTET STRING ( SIZE ( 1 ) ) OPTIONAL,
        ... }
 ::= localValue : 20

```



```

unknownAlphabet ERROR
 ::= localValue : 71

ussd-Busy ERROR
 ::= localValue : 72

pw-RegistrationFailure ERROR
 PARAMETER
   pw-RegistrationFailureCause ENUMERATED {
     undetermined (0 ),
     invalidFormat (1 ),
     newPasswordsMismatch (2 )}
 ::= localValue : 37

negativePW-Check ERROR
 ::= localValue : 38

numberOfPW-AttemptsViolation ERROR
 ::= localValue : 43

shortTermDenial ERROR
 PARAMETER
   shortTermDenialParam SEQUENCE {
     ... }
 ::= localValue : 29

longTermDenial ERROR
 PARAMETER
   longTermDenialParam SEQUENCE {
     ... }
 ::= localValue : 30

subscriberBusyForMT-SMS ERROR
 PARAMETER
   subBusyForMT-SMS-Param SEQUENCE {
     extensionContainer SEQUENCE {
       privateExtensionList [0] IMPLICIT SEQUENCE ( SIZE (1..10 ) ) OF
         SEQUENCE {
           extId MAP-EXTENSION .&extensionId ( {
             '...'} ) ,
           extType MAP-EXTENSION .&ExtensionType ( {
             '...'} { @extId } ) OPTIONAL} OPTIONAL,
       pcs-Extensions [1] IMPLICIT SEQUENCE {
         ... } OPTIONAL,
         ... } OPTIONAL,
       ... ,
       gprsConnectionSuspended NULL OPTIONAL}
 ::= localValue : 31

sm-DeliveryFailure ERROR
 PARAMETER
   sm-DeliveryFailureCause SEQUENCE {
     sm-EnumeratedDeliveryFailureCause ENUMERATED {
       memoryCapacityExceeded (0 ),
       equipmentProtocolError (1 ),
       equipmentNotSM-Equipped (2 ),
       unknownServiceCentre (3 ),
       sc-Congestion (4 ),
       invalidSME-Address (5 ),
       subscriberNotSC-Subscriber (6 )},
     diagnosticInfo OCTET STRING ( SIZE (1..200 ) ) OPTIONAL,
     extensionContainer SEQUENCE {
       privateExtensionList [0] IMPLICIT SEQUENCE ( SIZE (1..10 ) ) OF
         SEQUENCE {
           extId MAP-EXTENSION .&extensionId ( {
             '...'} ) ,
           extType MAP-EXTENSION .&ExtensionType ( {
             '...'} { @extId } ) OPTIONAL} OPTIONAL,
       pcs-Extensions [1] IMPLICIT SEQUENCE {
         ... } OPTIONAL,
         ... } OPTIONAL,
       ... }
 ::= localValue : 32

```

```

messageWaitingListFull ERROR
PARAMETER
  messageWaitListFullParam SEQUENCE {
    extensionContainer SEQUENCE {
      privateExtensionList [0] IMPLICIT SEQUENCE ( SIZE (1..10 ) ) OF
        SEQUENCE {
          extId MAP-EXTENSION .&extensionId ( {
            '...'} ) ,
          extType MAP-EXTENSION .&ExtensionType ( {
            '...'} { @extId } ) OPTIONAL} OPTIONAL,
      pcs-Extensions [1] IMPLICIT SEQUENCE {
        ... } OPTIONAL,
        ... } OPTIONAL,
        ... }
  ::= localValue : 33

absentsubscriberSM ERROR
PARAMETER
  absentSubscriberSM-Param SEQUENCE {
    absentSubscriberDiagnosticSM INTEGER ( 0..255 ) OPTIONAL,
    extensionContainer SEQUENCE {
      privateExtensionList [0] IMPLICIT SEQUENCE ( SIZE (1..10 ) ) OF
        SEQUENCE {
          extId MAP-EXTENSION .&extensionId ( {
            '...'} ) ,
          extType MAP-EXTENSION .&ExtensionType ( {
            '...'} { @extId } ) OPTIONAL} OPTIONAL,
      pcs-Extensions [1] IMPLICIT SEQUENCE {
        ... } OPTIONAL,
        ... } OPTIONAL,
        ... ,
      additionalAbsentSubscriberDiagnosticSM [0] IMPLICIT INTEGER ( 0..255 ) OPTIONAL}
  ::= localValue : 6

END

```

---

## B.2 Fully Expanded ASN.1 Source of MAP-DialogueInformation

```

-- Expanded ASN1 Module 'MAP-DialogueInformation'
--SIEMENS ASN.1 Compiler R4.21 (42-00-04)
-- Date: 99-12-21 Time: 12:08:21

MAP-DialogueInformation{ 0 identified-organization (4) etsi (0) mobileDomain (0) gsm-Network (1)
modules (3) map-DialogueInformation (3) version4 (4) }

DEFINITIONS
 ::=

BEGIN

EXPORTS
  map-DialogueAS,
  MAP-DialoguePDU;

map-DialogueAS OBJECT IDENTIFIER ::= { ccitt (0) identified-organization (4) etsi (0) mobileDomain
(0) gsm-Network (1) 1 map-DialoguePDU (1) version1 (1) }

MAP-DialoguePDU ::= CHOICE {
  map-open [0] IMPLICIT SEQUENCE {
    destinationReference [0] IMPLICIT OCTET STRING ( SIZE (1..20 ) ) OPTIONAL,
    originationReference [1] IMPLICIT OCTET STRING ( SIZE (1..20 ) ) OPTIONAL,
    ... ,
    extensionContainer SEQUENCE {
      privateExtensionList [0] IMPLICIT SEQUENCE ( SIZE (1..10 ) ) OF
        SEQUENCE {
          extId MAP-EXTENSION .&extensionId ( {
            '

```

```

        ... } ) ,
        extType      MAP-EXTENSION .&ExtensionType ( {
            '... } { @extId } ) OPTIONAL } OPTIONAL,
        pcs-Extensions [1] IMPLICIT SEQUENCE {
            ... } OPTIONAL,
            ... } OPTIONAL},
map-accept          [1] IMPLICIT SEQUENCE {
    ... ,
    extensionContainer SEQUENCE {
        privateExtensionList [0] IMPLICIT SEQUENCE ( SIZE (1..10 ) ) OF
        SEQUENCE {
            extId      MAP-EXTENSION .&extensionId ( {
                '... } ) ,
            extType      MAP-EXTENSION .&ExtensionType ( {
                '... } { @extId } ) OPTIONAL } OPTIONAL,
            pcs-Extensions [1] IMPLICIT SEQUENCE {
                ... } OPTIONAL,
                ... } OPTIONAL},
map-close          [2] IMPLICIT SEQUENCE {
    ... ,
    extensionContainer SEQUENCE {
        privateExtensionList [0] IMPLICIT SEQUENCE ( SIZE (1..10 ) ) OF
        SEQUENCE {
            extId      MAP-EXTENSION .&extensionId ( {
                '... } ) ,
            extType      MAP-EXTENSION .&ExtensionType ( {
                '... } { @extId } ) OPTIONAL } OPTIONAL,
            pcs-Extensions [1] IMPLICIT SEQUENCE {
                ... } OPTIONAL,
                ... } OPTIONAL},
map-refuse         [3] IMPLICIT SEQUENCE {
    reason          ENUMERATED {
        noReasonGiven          ( 0 ),
        invalidDestinationReference ( 1 ),
        invalidOriginatingReference ( 2 )},
    ... ,
    extensionContainer SEQUENCE {
        privateExtensionList [0] IMPLICIT SEQUENCE ( SIZE (1..10 ) ) OF
        SEQUENCE {
            extId      MAP-EXTENSION .&extensionId ( {
                '... } ) ,
            extType      MAP-EXTENSION .&ExtensionType ( {
                '... } { @extId } ) OPTIONAL } OPTIONAL,
            pcs-Extensions [1] IMPLICIT SEQUENCE {
                ... } OPTIONAL,
                ... } OPTIONAL},
map-userAbort      [4] IMPLICIT SEQUENCE {
    map-UserAbortChoice CHOICE {
        userSpecificReason          [0] IMPLICIT NULL,
        userResourceLimitation      [1] IMPLICIT NULL,
        resourceUnavailable         [2] IMPLICIT ENUMERATED {
            shortTermResourceLimitation ( 0 ),
            longTermResourceLimitation ( 1 )},
        applicationProcedureCancellation [3] IMPLICIT ENUMERATED {
            handoverCancellation ( 0 ),
            radioChannelRelease ( 1 ),
            networkPathRelease ( 2 ),
            callRelease ( 3 ),
            associatedProcedureFailure ( 4 ),
            tandemDialogueRelease ( 5 ),
            remoteOperationsFailure ( 6 )}},
    ... ,
    extensionContainer SEQUENCE {
        privateExtensionList [0] IMPLICIT SEQUENCE ( SIZE (1..10 ) ) OF
        SEQUENCE {
            extId      MAP-EXTENSION .&extensionId ( {
                '... } ) ,
            extType      MAP-EXTENSION .&ExtensionType ( {
                '... } { @extId } ) OPTIONAL } OPTIONAL,

```

```

        pcs-Extensions          [1] IMPLICIT SEQUENCE {
            ... } OPTIONAL,
        ... } OPTIONAL},
map-providerAbort             [5] IMPLICIT SEQUENCE {
    map-ProviderAbortReason    ENUMERATED {
        abnormalDialogue      ( 0 ),
        invalidPDU             ( 1 )},
    ... ,
    extensionContainer         SEQUENCE {
        privateExtensionList    [0] IMPLICIT SEQUENCE ( SIZE (1..10 ) ) OF
            SEQUENCE {
                extId           MAP-EXTENSION .&extensionId ( {
                    '...'} ) ,
                extType         MAP-EXTENSION .&ExtensionType ( {
                    '...'} { @extId } ) OPTIONAL} OPTIONAL,
        pcs-Extensions          [1] IMPLICIT SEQUENCE {
            ... } OPTIONAL,
        ... } OPTIONAL}}

MAP-OpenInfo ::= SEQUENCE {
    destinationReference        [0] IMPLICIT OCTET STRING ( SIZE (1..20 ) ) OPTIONAL,
    originationReference        [1] IMPLICIT OCTET STRING ( SIZE (1..20 ) ) OPTIONAL,
    ... ,
    extensionContainer          SEQUENCE {
        privateExtensionList    [0] IMPLICIT SEQUENCE ( SIZE (1..10 ) ) OF
            SEQUENCE {
                extId           MAP-EXTENSION .&extensionId ( {
                    '...'} ) ,
                extType         MAP-EXTENSION .&ExtensionType ( {
                    '...'} { @extId } ) OPTIONAL} OPTIONAL,
        pcs-Extensions          [1] IMPLICIT SEQUENCE {
            ... } OPTIONAL,
        ... } OPTIONAL}

MAP-AcceptInfo ::= SEQUENCE {
    ... ,
    extensionContainer          SEQUENCE {
        privateExtensionList    [0] IMPLICIT SEQUENCE ( SIZE (1..10 ) ) OF
            SEQUENCE {
                extId           MAP-EXTENSION .&extensionId ( {
                    '...'} ) ,
                extType         MAP-EXTENSION .&ExtensionType ( {
                    '...'} { @extId } ) OPTIONAL} OPTIONAL,
        pcs-Extensions          [1] IMPLICIT SEQUENCE {
            ... } OPTIONAL,
        ... } OPTIONAL}

MAP-CloseInfo ::= SEQUENCE {
    ... ,
    extensionContainer          SEQUENCE {
        privateExtensionList    [0] IMPLICIT SEQUENCE ( SIZE (1..10 ) ) OF
            SEQUENCE {
                extId           MAP-EXTENSION .&extensionId ( {
                    '...'} ) ,
                extType         MAP-EXTENSION .&ExtensionType ( {
                    '...'} { @extId } ) OPTIONAL} OPTIONAL,
        pcs-Extensions          [1] IMPLICIT SEQUENCE {
            ... } OPTIONAL,
        ... } OPTIONAL}

MAP-RefuseInfo ::= SEQUENCE {
    reason                      ENUMERATED {
        noReasonGiven          ( 0 ),
        invalidDestinationReference ( 1 ),
        invalidOriginatingReference ( 2 )},
    ... ,
    extensionContainer          SEQUENCE {
        privateExtensionList    [0] IMPLICIT SEQUENCE ( SIZE (1..10 ) ) OF
            SEQUENCE {
                extId           MAP-EXTENSION .&extensionId ( {

```

```

        '... } ) ,
        extType      MAP-EXTENSION .&ExtensionType ( {
        '... } { @extId } ) OPTIONAL} OPTIONAL,
pcs-Extensions      [1] IMPLICIT SEQUENCE {
    ... } OPTIONAL,
    ... } OPTIONAL}

Reason ::= ENUMERATED {
    noReasonGiven          ( 0 ),
    invalidDestinationReference ( 1 ),
    invalidOriginatingReference ( 2 )}

MAP-UserAbortInfo ::= SEQUENCE {
    map-UserAbortChoice CHOICE {
        userSpecificReason          [0] IMPLICIT NULL,
        userResourceLimitation       [1] IMPLICIT NULL,
        resourceUnavailable          [2] IMPLICIT ENUMERATED {
            shortTermResourceLimitation ( 0 ),
            longTermResourceLimitation ( 1 )},
        applicationProcedureCancellation [3] IMPLICIT ENUMERATED {
            handoverCancellation ( 0 ),
            radioChannelRelease ( 1 ),
            networkPathRelease ( 2 ),
            callRelease ( 3 ),
            associatedProcedureFailure ( 4 ),
            tandemDialogueRelease ( 5 ),
            remoteOperationsFailure ( 6 )}},
    ... ,
    extensionContainer SEQUENCE {
        privateExtensionList [0] IMPLICIT SEQUENCE ( SIZE ( 1..10 ) ) OF
            SEQUENCE {
                extId      MAP-EXTENSION .&extensionId ( {
                    '... } ) ,
                    extType      MAP-EXTENSION .&ExtensionType ( {
                        '... } { @extId } ) OPTIONAL} OPTIONAL,
                pcs-Extensions [1] IMPLICIT SEQUENCE {
                    ... } OPTIONAL,
                    ... } OPTIONAL}

MAP-UserAbortChoice ::= CHOICE {
    userSpecificReason          [0] IMPLICIT NULL,
    userResourceLimitation       [1] IMPLICIT NULL,
    resourceUnavailable          [2] IMPLICIT ENUMERATED {
        shortTermResourceLimitation ( 0 ),
        longTermResourceLimitation ( 1 )},
    applicationProcedureCancellation [3] IMPLICIT ENUMERATED {
        handoverCancellation ( 0 ),
        radioChannelRelease ( 1 ),
        networkPathRelease ( 2 ),
        callRelease ( 3 ),
        associatedProcedureFailure ( 4 ),
        tandemDialogueRelease ( 5 ),
        remoteOperationsFailure ( 6 )}}

ResourceUnavailableReason ::= ENUMERATED {
    shortTermResourceLimitation ( 0 ),
    longTermResourceLimitation ( 1 )}

ProcedureCancellationReason ::= ENUMERATED {
    handoverCancellation ( 0 ),
    radioChannelRelease ( 1 ),
    networkPathRelease ( 2 ),
    callRelease ( 3 ),
    associatedProcedureFailure ( 4 ),
    tandemDialogueRelease ( 5 ),
    remoteOperationsFailure ( 6 )}

MAP-ProviderAbortInfo ::= SEQUENCE {
    map-ProviderAbortReason ENUMERATED {
        abnormalDialogue ( 0 ),
        invalidPDU ( 1 )},
    ... ,
    extensionContainer SEQUENCE {
        privateExtensionList [0] IMPLICIT SEQUENCE ( SIZE ( 1..10 ) ) OF

```

```
SEQUENCE {
  extId      MAP-EXTENSION .&extensionId ( {
    '...}' ) ,
  extType    MAP-EXTENSION .&ExtensionType ( {
    '...}' { @extId } ) OPTIONAL} OPTIONAL,
  pcs-Extensions [1] IMPLICIT SEQUENCE {
    ... } OPTIONAL,
  ... } OPTIONAL}
```

```
MAP-ProviderAbortReason ::= ENUMERATED {
  abnormalDialogue (0 ),
  invalidPDU (1 )}
```

END

---

## Annex C (informative): Formal protocol incompatibilities between versions 1 & 2 of MAP

### C.1 Introduction

Annex C is not normative; it presents for information those parts of the MAP version 2 protocol which are not backward compatible with (i.e. a true superset of) the MAP version 1 protocol. For each incompatibility there is a commentary on the impact on the interworking of MAP version 1 and MAP version 2 entities.

SMG have decided that the MAP specification should include the operations and procedures used on the B interface (MSC/VLR) only for modelling purposes; the B interface cannot be implemented as an open interface. Hence any incompatibilities which affect operations used only on the B interface have no impact on the interworking of MAP version 1 and MAP version 2 entities.

---

### C.2 Deletion of operations and errors

This clause lists the operations and errors which have been completely removed from the MAP protocol.

#### C.2.1 Deletion of operation DeregisterMobileSubscriber

Although it is defined in the protocol in the MAP version 1 specification, this operation is not used (see clause 1.2 of the latest phase 1 version of GSM 09.02).

#### C.2.2 Deletion of operation RegisterChargingInfo

There is no known implementation of MAP version 1 which supports this operation. The deletion has been approved by SMG.

#### C.2.3 Deletion of operation ForwardSS-Notification

There is no known implementation of MAP version 1 which supports this operation. The deletion has been approved by SMG.

#### C.2.4 Deletion of operations used only on the B-interface

The following operations (listed in alphabetical order) are not defined in the MAP version 2 protocol, because they are used only on the B-interface:

AllocateHandoverNumber; AttachIMSI; Authenticate; CompleteCall; DetachIMSI; ForwardNewTMSI; InvokeSS; Page; ProcessAccessRequest; ProvideIMSI; SearchForMobileSubscriber; SendHandoverReport; SendInfoForIncomingCall; SendInfoForOutgoingCall; SetCipherringMode; UpdateLocationArea.

#### C.2.5 Deletion of error InsufficientBearerCapabilities

This error is defined in the MAP version 1 protocol, but it is not specified for use with any operation.

---

## C.3 Deletion of errors for operations

This clause lists the cases where an error which is specified for use with an operation in the MAP version 1 specification is not specified for use with the same operation in the MAP version 2 specification.

### C.3.1 Error NegativePW-Check for operation RegisterSS

Password checking is not used for the supplementary services to which registration applies.

### C.3.2 Error NegativePW-Check for operation EraseSS

Password checking is not used for the supplementary services to which erasure applies.

### C.3.3 Error NegativePW-Check for operation InterrogateSS

Password checking is not used for the interrogation of supplementary services.

### C.3.4 Error CUG-Reject for operation SendRoutingInfoForSM

Closed User Group does not apply to the short message service.

---

## C.4 Changes to definitions of data types

This clause lists in alphabetical order those data types whose definitions have been directly or indirectly changed. For constructed data types, only the components which have been changed are mentioned. The commentary on the end effect of each change is given in clauses C.6 (parameters of operations), C.7 (results of operations) or C.8 (errors of operations).

### C.4.1 CUG-Feature

The type CUG-Feature was a sequence of four components; these have been deleted and replaced by three new components. It is used for the components of the type CUG-FeatureList.

### C.4.2 CUG-FeatureList

The type CUG-FeatureList is a sequence of components of type CUG-Feature. It is used for a component of the type CUG-Info.

### C.4.3 CUG-Info

The type CUG-Info is a sequence. One component of the sequence has been replaced by a component of a new type; the other component was a choice between a `cug-Feature` and a `cug-FeatureList`, and is now an optional `cug-FeatureList`. The type CUG-Info is used for a component of the type SS-Info.

### C.4.4 CUG-RejectCause

The range of permitted values of the enumerated type CUG-RejectCause has been extended. The type is used for the parameter of the error CUG-Reject.



## C.4.5 IMSI

The lower limit of the length of an IMSI has been increased from 2 octets to 3 octets. It is not possible to code a minimum length IMSI (MCC+MNC+MSIN) in 2 octets, so the theoretical lower limit of 2 octets should never be used by a MAP version 1 entity to send an IMSI; if it is, a MAP version 2 entity will treat it as a protocol error. Since this change has no practical impact it is not discussed further.

## C.4.6 ISDN-AddressString

The upper limit of the length of an ISDN-AddressString has been reduced from 10 octets to 9 octets. The maximum length of an E.164 number is 15 digits; this can be encoded as a TBCD-string in 8 octets, plus a further octet to hold the type of number and number plan indicator. The cases where the ISDN-AddressString type was used in MAP version 1 to carry anything other than an E.164 number are described in clause C.6; the other cases are not discussed further.

## C.4.7 Password

In MAP version 1 the type Password was a choice between a printable string of length 4 to 8 octets or a numeric string of length 4 octets. It is now a numeric string of length 4 octets. The type Password is used for the result of the operation GetPassword.

## C.4.8 RequestParameter

The enumerated type RequestParameter is no longer allowed to take the value requestCUG-Info. It is used as a component of the type RequestParameterList.

## C.4.9 RequestParameterList

The type RequestParameterList is a sequence of components of type RequestParameter. The parameter of the operation SendParameters is a sequence of which one component is of type RequestParameterList.

## C.4.10 SentParameter

The type SentParameter is a choice of which one component is of type SubscriberData. It is used as a component of the type SentParameterList.

## C.4.11 SentParameterList

The type SentParameterList is a sequence whose components are of type SentParameter. The maximum number of components in the sequence has been reduced from 10 to 6.

The type SentParameterList is used for the result of the operation SendParameters.

## C.4.12 SS-Data

The type SS-Data is a sequence of which one component is of type SS-SubscriptionOption. It is used for a component of the type SS-Info.

## C.4.13 SS-Info

The type SS-Info is a choice of which one component is of type CUG-Info and another component is of type SS-Data. It is used for the result of the operations RegisterSS, EraseSS, ActivateSS and DeactivateSS, and for components of the type SS-InfoList.

## C.4.14 SS-InfoList

The type SS-InfoList is a sequence of components of type SS-Info. It is used for a component of the type SubscriberData.

## C.4.15 SS-SubscriptionOption

The type SS-SubscriptionOption was a choice from five components: perCallBasis (used for the CLIR supplementary service); notificationToHeldRetrievedParty (used for the Call Transfer supplementary service); userToUserServiceIndicator (used for the User to User Signalling supplementary service); maximumConfereesNumber (used for the Conference Calling supplementary service); and huntGroupAccessSelectionOrder (used for the Mobile Access Hunting supplementary service. It has been replaced by a choice from two components: cliRestrictionOption (used for the CLIR supplementary service); and overrideCategory (used for the CLIP and COLP supplementary services).

The Call Transfer, User to User Signalling, Conference Calling and Mobile Access Hunting supplementary services are not specified for GSM Phase 1 or GSM Phase 2, so data for these services should not be transferred in a dialogue involving a MAP version 1 entity. These cases will therefore not be discussed further.

The type SS-SubscriptionOption is used for a component of SS-Data and for the parameter of the error SS-SubscriptionViolation.

## C.4.16 SubscriberData

The type SubscriberData is a sequence of which one component is of type SS-InfoList. Components of SubscriberData are used as a component of the parameter of the operation InsertSubscriberData; the type is also used for a component of the type SentParameter.

---

# C.5 Changes to parameters of errors

This clause lists in alphabetical order the errors whose parameters have changed.

## C.5.1 CUG-Reject

The error CUG-Reject has an optional parameter of type CUG-RejectCause. The error CUG-Reject is used for the operation SendRoutingInfo.

## C.5.2 SS-SubscriptionViolation

The error SS-SubscriptionViolation has an optional parameter of type SS-SubscriptionOption. The error SS-SubscriptionViolation is used for the operations ActivateSS, DeactivateSS, EraseSS and RegisterSS.

---

## C.6 Changes to parameters of operations

This clause lists in alphabetical order the operations whose parameters have changed, and gives a commentary on the effect of the changes on each operation.

### C.6.1 InsertSubscriberData

The parameter of the operation InsertSubscriberData is a sequence of which one component is a sequence of components of SubscriberData. The components of SubscriberData which are affected by the changes listed in clause C.4 are cug-Info and ss-SubscriptionOption.

The CUG supplementary service is not supported by MAP version 1; CUG-Info should therefore not be used as a component of SubscriberData in a dialogue involving a MAP version 1 entity.

The replacement of the perCallBasis (type BOOLEAN) subscription option by the cliRestrictionOption (type ENUMERATED) for the CLIR supplementary service means that full support for the CLIR supplementary service is not possible if either entity involved can support only MAP version 1.

### C.6.2 RegisterSS

The forwardedToNumber component of the parameter of the operation RegisterSS had a maximum length of 10 octets in MAP version 1, as it was of the type ISDN-AddressString. In MAP version 2 the maximum length is 20 octets, as the type is AddressString. The maximum length (9 octets) of the ISDN-AddressString type in MAP version 2 may not be adequate to hold the forwardedToNumber, which is not necessarily an E.164 number; the user may enter the number using the digits for international access rather than the "+" key.

### C.6.3 SendParameters

The operation SendParameters uses as its parameter a sequence of which one component is of type RequestParameter. The value requestCUG-Info can no longer be used for this component. The SendParameters operation is used only when interworking with a MAP version 1 entity, and MAP version 1 does not support the GSM Phase 2 CUG supplementary service, so the SendParameters operation should in any case not be used to request CUG information.

### C.6.4 SendRoutingInfoForSM

The cug-Interlock component of the parameter of the operation SendRoutingInfoForSM has been deleted. Closed User Group does not apply to the short message service.

---

## C.7 Changes to results of operations

This clause lists in alphabetical order the operations whose results have changed, and gives a commentary on the effect of the changes on each operation.

### C.7.1 ActivateSS

The result of the operation ActivateSS is of type SS-Info. Two data types used for components of SS-Info have suffered incompatible changes: CUG-Info and SS-SubscriptionOption.

The ActivateSS operation does not apply to the CUG supplementary service, so the cug-Info component of SS-Info should never be present in the result of the operation ActivateSS.

The ActivateSS operation does not apply to the CLIP, CLIR or COLP supplementary services, for which the type SS-SubscriptionOption is used, so the ss-SubscriptionOption component of SS-Info should never be present in the result of the operation ActivateSS.

## C.7.2 DeactivateSS

The result of the operation DeactivateSS is of type SS-Info. Two data types used for components of SS-Info have suffered incompatible changes: CUG-Info and SS-SubscriptionOption.

The DeactivateSS operation does not apply to the CUG supplementary service, so the cug-Info component of SS-Info should never be present in the result of the operation DeactivateSS.

The DeactivateSS operation does not apply to the CLIP, CLIR or COLP supplementary services, for which the type SS-SubscriptionOption is used, so the ss-SubscriptionOption component of SS-Info should never be present in the result of the operation DeactivateSS.

## C.7.3 EraseSS

The result of the operation EraseSS is of type SS-Info. Two data types used for components of SS-Info have suffered incompatible changes: CUG-Info and SS-SubscriptionOption.

The EraseSS operation does not apply to the CUG supplementary service, so the cug-Info component of SS-Info should never be present in the result of the operation EraseSS.

The EraseSS operation does not apply to the CLIP, CLIR or COLP supplementary services, for which the type SS-SubscriptionOption is used, so the ss-SubscriptionOption component of SS-Info should never be present in the result of the operation EraseSS.

## C.7.4 GetPassword

The result of the operation GetPassword is of type Password. In MAP version 1 this was a choice between a printable string of length 4 to 8 octets or a numeric string of length 4 octets. It is now a numeric string of length 4 octets. The printable string option was never used in MAP version 1, as indicated by a comment in the ASN.1 in the latest phase 1 version of GSM 09.02.

## C.7.5 InterrogateSS

The result of the InterrogateSS operation is a CHOICE; one of the components of the CHOICE is a list of basic services to which the supplementary service applies, which is used for the Call Barring supplementary service. In MAP version 1 this list can in principle have up to 70 members, the number of individual basic services. However Call Barring can apply to only 13 basic service groups. In MAP version 2 the length of the list of basic service codes which can be returned in the result of the InterrogateSS operation is reduced to 13 to reflect this.

## C.7.6 RegisterSS

The result of the operation RegisterSS is of type SS-Info. Two data types used for components of SS-Info have suffered incompatible changes: CUG-Info and SS-SubscriptionOption.

The RegisterSS operation does not apply to the CUG supplementary service, so the cug-Info component of SS-Info should never be present in the result of the operation RegisterSS.

The RegisterSS operation does not apply to the CLIP, CLIR or COLP supplementary services, for which the type SS-SubscriptionOption is used, so the ss-SubscriptionOption component of SS-Info should never be present in the result of the operation RegisterSS.

## C.7.7 SendParameters

The result of the operation SendParameters is of type SentParameterList, which is a sequence of components of type SentParameter. The maximum number of components in the sequence has been reduced from 10 to 6. MAP version 1 could in principle send 10 sets of CUG-Information, but the supplementary service Closed User Group is not defined for GSM Phase 1, and the MAP version 1 signalling protocol will not support Closed User Group as defined for GSM Phase 2, so a MAP version 1 entity should never request parameters for CUG. The maximum number of sent parameters therefore consists of an IMSI and 5 AuthenticationSets - a total of 6.

The type SentParameter is a choice of which one component is of type SubscriberData. The components of SubscriberData which are affected by the changes listed in clause C.4 are CUG-Info and ss-SubscriptionOption.

The CUG supplementary service is not supported by MAP version 1; CUG-Info should therefore not be used as a component of SubscriberData in a dialogue involving a MAP version 1 entity.

The replacement of the perCallBasis (type BOOLEAN) subscription option by the cliRestrictionOption (type ENUMERATED) for the CLIR supplementary service means that full support for the CLIR supplementary service is not possible if either entity involved can support only MAP version 1.

## C.7.8 SendRoutingInfoForSM

The result of the operation SendRoutingInfoForSM is a sequence of which one component was a choice between location information (optionally with an associated LMSI) and forwarding data; the choice of forwarding data has been removed. Call Forwarding does not apply to the short message service.

---

# C.8 Changes to errors of operations

This clause lists in alphabetical order the operations whose errors have changed, and gives a commentary on the effect of the changes on each operation.

## C.8.1 ActivateSS

The definition of the type SS-SubscriptionOption used for the optional parameter of the error SS-SubscriptionViolation has been changed. However the only use defined for the error SS-SubscriptionViolation is when the user attempts to activate or deactivate a Call Barring supplementary service and the subscription option "Control by Service Provider" has been taken. The MAP version 1 protocol does not define this subscription option, so there is no case when the error SS-SubscriptionViolation will be used with the optional parameter.

## C.8.2 DeactivateSS

The definition of the type SS-SubscriptionOption used for the optional parameter of the error SS-SubscriptionViolation has been changed. However the only use defined for the error SS-SubscriptionViolation is when the user attempts to activate or deactivate a Call Barring supplementary service and the subscription option "Control by Service Provider" has been taken. The MAP version 1 protocol does not define this subscription option, so there is no case when the error SS-SubscriptionViolation will be used with the optional parameter.

## C.8.3 EraseSS

The definition of the type SS-SubscriptionOption used for the optional parameter of the error SS-SubscriptionViolation has been changed. However the only use defined for the error SS-SubscriptionViolation is when the user attempts to activate or deactivate a Call Barring supplementary service and the subscription option "Control by Service Provider" has been taken, so there is no case when the error SS-SubscriptionViolation will be used for the operation EraseSS.

## C.8.4 RegisterSS

The definition of the type SS-SubscriptionOption used for the optional parameter of the error SS-SubscriptionViolation has been changed. However the only use defined for the error SS-SubscriptionViolation is when the user attempts to activate or deactivate a Call Barring supplementary service and the subscription option "Control by Service Provider" has been taken, so there is no case when the error SS-SubscriptionViolation will be used for the operation RegisterSS.

## C.8.5 SendRoutingInfo

The definition of the type (CUG-RejectCause) used for the optional parameter of the error CUG-Reject has been changed. However the supplementary service Closed User Group is not defined for GSM Phase 1, and the MAP version 1 signalling protocol will not support Closed User Group as defined for GSM Phase 2, so the error CUG-Reject should not be used in a dialogue involving a MAP version 1 entity.

## Annex D (informative): Clause mapping table

### D.1 Mapping of Clause numbers

The clause numbers have been modified according to table D.1.

**Table D.1: Clause mapping from Version 5.9.0 to Version 6.0.0**

Old Clause No (V5.9.0)	New Clause No (V6.0.0)	Old Clause No (V5.9.0)	New Clause No (V6.0.0)
1.1	2	17.*	20.*
1.2	3	18.*	21.*
2.*	4.*	19.*	22.*
3.*	5.*	19.0.*	22.1.*
4.*	6.*	19.1.*	22.2.*
5.*	7.*	19.2.*	22.3.*
6.*	8.*	19.3.*	22.4.*
7.*	9.*	19.4.*	22.5.*
8.*	10.*	19.5.*	22.6.*
9.*	11.*	19.6.*	22.7.*
10.*	12.*	19.7.*	22.8.*
new11.*	13.*	19.8.*	22.9.*
old11.*	14.*	19.9.*	22.10.*
12.*	15.*	19.10.*	22.11.*
13.*	16.*	19.11.*	22.12.*
14.*	17.*	20.*	23.*
15.*	18.*	new22.*	24.*
16.*	19.*	old21.*	25.*

## Annex E (informative): Change History

SMG#	TDoc	SPEC	VERS	CR	R E V	PHAS E	C A T	SUBJECT	NEW_VERS	WORKITEM
s22	372/97	09.02	5.9.0	A087		R97	B	Allocation of an SS-code for the Calling Name Presentation SS. {based on 5.5.0}	6.0.0d1.0	CNAP R97
s23	97-689	09.02	5.9.0	A095	1	R97	B	Support of NAEA {based on 5.6.0}	6.0.0d1.0	NAEA
s24	97-971	09.02	5.9.0	A084	3	R97	B	Network's indication of alerting {based on 5.7.0}	6.0.0d1.0	NIAlerting in MS
s24	97-989	09.02	5.9.0	A094	2	R97	B	Modifications due to ASCII phase 2 {based on 5.7.0}	6.0.0d1.0	ASCII R97
s24	97-912	09.02	5.9.0	A103	6	R97	B	Introduction of SIWFS {based on 5.7.0}	6.0.0d1.0	SIWF
s25	98-0093	09.02	5.9.0	A105	9	R97	B	MAP changes for GPRS	6.0.0	GPRS
s25	98-0152	09.02	5.9.0	A109		R97	B	SMS Screening	6.0.0	SMS Enh.: Filtering
s25	98-0083	09.02	5.9.0	A111	4	R97	B	CAMEL phase 2	6.0.0	CAMEL R97
s25	98-0088	09.02	5.9.0	A114		R97	B	Introduction of description of VBS/VGSC Relay MSC in ASCII R97	6.0.0	ASCII R97
s25	98-0085	09.02	5.9.0	A115	1	R97	C	Introduction of Alerting categories	6.0.0	CAMEL R97, NetworkIA
s26	98-0413	09.02	6.0.0	A104	1	R97	F	SMS interworking with GPRS	6.1.0	
s26	98-0413	09.02	6.0.0	A123	2	R97	C	Subscription withdrawn from SGSN	6.1.0	
s26	98-0413	09.02	6.0.0	A124		R97	F	SMS interworking with GPRS	6.1.0	
s26	98-0413	09.02	6.0.0	A124	2	R97	C	Modification of Insert Subscriber Data and Delete Subscriber Data Procedures for GPRS	6.1.0	
s26	98-0413	09.02	6.0.0	A130	1	R97	C	Network access mode in the Insert-Subscriber-data to SGSN and VLR	6.1.0	
s26	98-0408	09.02	6.0.0	A120		R97	C	Modification of CUG-Info	6.1.0	
s26	98-0411	09.02	6.0.0	A113	2	R97	C	Support of CAMEL Phase 2	6.1.0	
s26	98-0407	09.02	6.0.0	A127	2	R97	A	Queuing of short messages at the VMSC and SGSN	6.1.0	
s26	98-0355	09.02	6.0.0	A097	8	R97	B	MAP impacts for CCBS	6.1.0	
s27		09.02	6.1.1	A136		R97	F	Correction to the Status Reporting procedure	6.2.0	
s27		09.02	6.1.1	A138		R97	F	Extending the applicability of GMSC Address in ProvideRoamingNumber	6.2.0	
s27		09.02	6.1.1	A140		R97	F	Minor corrections to SMS over GPRS	6.2.0	
s27		09.02	6.1.1	A129	1	R97	A	E.214 addressing of the HLR	6.2.0	
s27		09.02	6.1.1	A132	1	R97	F	09.02 Corrections	6.2.0	
s27		09.02	6.1.1	A133	1	R97	F	Clarification on applicability of application contexts	6.2.0	
s27		09.02	6.1.1	A139	2	R97	D	Clarification of GSM 09.02 when the SMS over GPRS functionality is not supported by SMS-GMSC	6.2.0	
s27		09.02	6.1.1	A147	1	R97	F	Correction to the Status Reporting process in the VLR	6.2.0	
s27		09.02	6.1.1	A149		R97	F	Clarification of limit on length of O-CSI in MAP_RESUME_CALL-HANDLING	6.2.0	
s27		09.02	6.1.1	A152	1	R97	C	Support of CAMEL Phase 2	6.2.0	
s27		09.02	6.1.1	A151		R97	F	Removal of CCBS-feature from SS-Data	6.2.0	
s27		09.02	6.1.1	A158	1	R97	F	Restricting the use of extension containers in RegisterCCEnter and Erase CCEnter user errors	6.2.0	
s27		09.02	6.1.1	A153	1	R97	F	Correction in overload control tables for GPRS operations applicability	6.2.0	
s27		09.02	6.1.1	A154		R97	F	Usage of ShortMsgRelayPackage-v2 in GPRS	6.2.0	
s27		09.02	6.1.1	A150	1	R97	F	ASN.1 corrections	6.2.0	
s28		09.02	6.2.0	A159		R97	F	ASN.1 corrections	6.3.0	
s28		09.02	6.2.0	A161	1	R97	C	Clarification on the use of SCCP addresses in response	6.3.0	
s28		09.02	6.2.0	A162		R97	C	Removal of unused ST parameters	6.3.0	
s28		09.02	6.2.0	A164	1	R97	A	Use of SCCP Class 1	6.3.0	



s28		09.02	6.2.0	A167	1	R97	A	Corrections and updating of the 09.02	6.3.0	
s28		09.02	6.2.0	A170		R97	A	Optionality of sm-RP-UI in MO-ForwardSM-Res	6.3.0	
s28		09.02	6.2.0	A171	2	R97	F	Inclusion of "Check Indication" macro in GPRS SDLs	6.3.0	
s28		09.02	6.2.0	A172		R97	D	Editorial corrections of the GPRS enhancement of MAP	6.3.0	
s28		09.02	6.2.0	A173	1	R97	F	Alignment of the Failure Report-Arg message with GS	6.3.0	
s28		09.02	6.2.0	A174		R97	F	Correction on ODB applicability for GPRS ph 1	6.3.0	
s28		09.02	6.2.0	A179	1	R97	F	Alignment of the GSN-Address GSM 09.02 ASN.1 def	6.3.0	
s28		09.02	6.2.0	A180		R97	F	Applicability of SS Binding package	6.3.0	
s28		09.02	6.2.0	A181		R97	F	Definition of DestinationNumberLength	6.3.0	
s28		09.02	6.2.0	A185		R97	F	Clarification for MNRR	6.3.0	
s28		09.02	6.2.0	A188	1	R97	F	Correction of ASN.1 definition of PDP address	6.3.0	
s28		09.02	6.2.0	A192		R97	A	Re-use of security related information	6.3.0	
s28		09.02	6.2.0	A195		R97	F	ASN.1 coding for Access Point name	6.3.0	
s28		09.02	6.2.0	A159	2	R97	B	Introduction of 3-digit MNCs	6.3.0	
s29	N2-99643	09.02	6.3.0	A235	1	R97	F	Modification of the O-CSI ASN.1 structure	6.4.0	CAMEL phase 2
s29	N2-99667	09.02	6.3.0	A233		R97	F	Correction of mapping from MAP service to TC service	6.4.0	TEI
s29	N2-99560	09.02	6.3.0	A230		R97	F	Correction to the Purge MS "Detailed procedure in the HLR"	6.4.0	GPRS
s29	N2-99583	09.02	6.3.0	A229		R97	F	Removal of 3-digit MNCs	6.4.0	TEI
s29	N2b99518	09.02	6.3.0	A221		R97	A	VBS data	6.4.0	TEI
s29	N2-99270	09.02	6.3.0	A213	1	R97	C	Introduction of MSISDN in USSD operation	6.4.0	CAMEL phase 2
s29	N2-99179	09.02	6.3.0	A207		R97	D	Clarification in ASN.1 encoding of O-CSI and T-CSI	6.4.0	CAMEL phase 2
s29	N2-99 169	09.02	6.3.0	A206		R97	D	Use of E interface	6.4.0	ASCI phase 2
s29	N2-99168	09.02	6.3.0	A205		R97	F	Alignment with GSM 04.80	6.4.0	TEI
s29	N2-99249	09.02	6.3.0	A203	1	R97	F	Adding of MAP_DELIMITER_req to the Status Report operation	6.4.0	CCBS
CN#5	N2-99727	09.02	6.4.0	A239		R97	F	Corrections related to GGSN-HLR Interface	6.5.0	GPRS phase 1
CN#5	N2-99757	09.02	6.4.0	A241		R97	F	Clarification on VLR CAMEL Subscription Info	6.5.0	CAMEL phase 2
CN#5	N2-99914	09.02	6.4.0	A243	1	R97	D	Clarification on DestinationNumberCriteria	6.5.0	CAMEL Phase 2
CN#5	N2-99763	09.02	6.4.0	A247		R97	F	Removal of TDP-Criteria from RCH	6.5.0	CAMEL phase 2
CN#05	N2-99827	09.02	6.4.0	A250	1	R97	F	Update Location handling for GPRS-only subscription	6.5.0	GPRS Phase 1
CN#5	N2-99828	09.02	6.4.0	A251	1	R97	F	Correction of OP & AC definitions for NoteMS-PresentForGPRS	6.5.0	GPRS phase 1
CN#5	N2-99960	09.02	6.4.0	A260	1	R97	F	GMSC-CAMEL phase 2 support IE in PRN	6.5.0	CAMEL Phase 2
CN#5	N2-99A17	09.02	6.4.0	A262		R97	F	Alignment of 09.02 with 02.67	6.5.0	eMLPP
CN#5	N2-99C25	09.02	6.4.0	A267		R97	A	Clarification on 'Supported CAMEL Phases' in ISD ack	6.5.0	CAMEL Phase 2
CN#5	N2-99D02	09.02	6.4.0	A269	1	R97	F	Addition of exception handling to the CancellationType	6.5.0	GPRS
CN#6	N2-99G48	09.02	6.5.0	A278		R97	F	Addition of GGSN number for the SRIforGPRS	6.6.0	GPRS
CN#6	N2-99G82	09.02	6.5.0	A236	1	R97	F	Correction of the USSD procedure in the HLR	6.6.0	USSD
CN#6	N2-99K08	09.02	6.5.0	A276	1	R97	F	Use of SSN for GPRS	6.6.0	GPRS
CN#07	N2B000036	09.02	6.6.0	A283		R97	F	Prioritisation of MAP application context related to VGCS/VBS	6.7.0	ASCI phase 2
CN#08	N4-000092	09.02	6.7.0	A286	1	R97	F	Using DSD to delete CCBS-B from the subscriber	6.8.0	CCBS
CN#08	N4-000214	09.02	6.7.0	A290		R97	A	Correction of version handling at dialogue establishment	6.8.0	TEI
CN#08	N4-000218	09.02	6.7.0	A292		R97	F	Correction of errors in Figure 25.1/1: Macro Receive_Open_Ind	6.8.0	TEI
CN#08	N4-000274	09.02	6.7.0	A296		R97	F	Clarification for ReportSM-DeliveryStatus operation	6.8.0	GPRS

CN#08	N4-000376	09.02	6.7.0	A298	1	R97	F	Use of NAM parameter with MAP-INSERT-SUBSCRIBER-DATA service between HLR and SGSN	6.8.0	GPRS
CN#08	N4-000372	09.02	6.7.0	A302		R97	A	Correction to the description of MAP-MO-Forward-Short-Message service	6.8.0	TEI

NOTE: CR 09.02 A109r3 was not completely implemented in v6.0.0 and v6.1.1 so is introduced in v6.2.0. SDL changes to figure 23.3/6 (sheet 1 of 5) "Process Mobile\_terminated\_SM\_HLR".

---

# History

<b>Document history</b>		
V6.1.1	August 1998	Publication
V6.2.0	November 1998	Publication
V6.4.0	August 1999	Publication
V6.6.0	February 2000	Publication
V6.7.0	September 2000	Publication
V6.8.0	November 2000	Publication