

ETSI TS 100 927 V6.8.0 (2003-09)

Technical Specification

**Digital cellular telecommunications system (Phase 2+);
Numbering, addressing and identification
(3GPP TS 03.03 version 6.8.0 Release 1997)**



Reference

RTS/TSGN-040303v680

Keywords

GSM

ETSI

650 Route des Lucioles
F-06921 Sophia Antipolis Cedex - FRANCE

Tel.: +33 4 92 94 42 00 Fax: +33 4 93 65 47 16

Siret N° 348 623 562 00017 - NAF 742 C
Association à but non lucratif enregistrée à la
Sous-Préfecture de Grasse (06) N° 7803/88

Important notice

Individual copies of the present document can be downloaded from:

<http://www.etsi.org>

The present document may be made available in more than one electronic version or in print. In any case of existing or perceived difference in contents between such versions, the reference version is the Portable Document Format (PDF). In case of dispute, the reference shall be the printing on ETSI printers of the PDF version kept on a specific network drive within ETSI Secretariat.

Users of the present document should be aware that the document may be subject to revision or change of status. Information on the current status of this and other ETSI documents is available at

<http://portal.etsi.org/tb/status/status.asp>

If you find errors in the present document, send your comment to:

editor@etsi.org

Copyright Notification

No part may be reproduced except as authorized by written permission.
The copyright and the foregoing restriction extend to reproduction in all media.

© European Telecommunications Standards Institute 2003.
All rights reserved.

DECTTM, **PLUGTESTS**TM and **UMTS**TM are Trade Marks of ETSI registered for the benefit of its Members.
TIPHONTM and the **TIPHON logo** are Trade Marks currently being registered by ETSI for the benefit of its Members.
3GPPTM is a Trade Mark of ETSI registered for the benefit of its Members and of the 3GPP Organizational Partners.

Intellectual Property Rights

IPRs essential or potentially essential to the present document may have been declared to ETSI. The information pertaining to these essential IPRs, if any, is publicly available for **ETSI members and non-members**, and can be found in ETSI SR 000 314: "*Intellectual Property Rights (IPRs); Essential, or potentially Essential, IPRs notified to ETSI in respect of ETSI standards*", which is available from the ETSI Secretariat. Latest updates are available on the ETSI Web server (<http://webapp.etsi.org/IPR/home.asp>).

Pursuant to the ETSI IPR Policy, no investigation, including IPR searches, has been carried out by ETSI. No guarantee can be given as to the existence of other IPRs not referenced in ETSI SR 000 314 (or the updates on the ETSI Web server) which are, or may be, or may become, essential to the present document.

Foreword

This Technical Specification (TS) has been produced by ETSI 3rd Generation Partnership Project (3GPP).

The present document may refer to technical specifications or reports using their 3GPP identities, UMTS identities or GSM identities. These should be interpreted as being references to the corresponding ETSI deliverables.

The cross reference between GSM, UMTS, 3GPP and ETSI identities can be found under <http://webapp.etsi.org/key/queryform.asp>.

Contents

| | |
|---|----|
| Intellectual Property Rights | 2 |
| Foreword..... | 2 |
| Foreword..... | 5 |
| 1 Scope | 6 |
| 1.1 References | 6 |
| 1.2 Abbreviations | 7 |
| 1.3 General comments to references | 7 |
| 1.4 Conventions on bitordering | 7 |
| 2 Identification of mobile subscribers | 8 |
| 2.1 General | 8 |
| 2.2 Composition of IMSI..... | 8 |
| 2.3 Allocation principles | 9 |
| 2.4 Structure of TMSI | 9 |
| 2.5 Structure of LMSI | 9 |
| 2.6 Structure of TLLI | 9 |
| 3 Numbering plan for mobile stations | 10 |
| 3.1 General | 10 |
| 3.2 Numbering plan requirements | 11 |
| 3.3 Structure of MS international PSTN/ISDN number (MSISDN) | 11 |
| 3.4 Mobile Station Roaming Number (MSRN) for PSTN/ISDN routing | 12 |
| 3.5 Structure of Mobile Station International Data Number | 12 |
| 3.6 Handover Number | 12 |
| 3.7 Structure of an IP v4 address | 12 |
| 3.8 Structure of an IP v6 address | 12 |
| 4 Identification of location areas and base stations | 12 |
| 4.1 Composition of the Location Area Identification (LAI)..... | 12 |
| 4.2 Composition of the Routing Area Identification (RAI)..... | 13 |
| 4.3 Base station identification | 13 |
| 4.3.1 Cell Identity (CI) and Cell Global Identification (CGI)..... | 13 |
| 4.3.2 Base Station Identify Code (BSIC)..... | 14 |
| 4.4 Regional Subscription Zone Identity (RSZI)..... | 14 |
| 4.5 Location Number..... | 15 |
| 5 Identification of MSCs and location registers | 15 |
| 5.1 Identification for routing purpose | 15 |
| 5.2 Identification of HLR for HLR restoration application | 16 |
| 6 International Mobile Station Equipment Identity and Software Version Number | 16 |
| 6.1 General | 16 |
| 6.2 Composition of IMEI and IMEISV | 16 |
| 6.2.1 Composition of IMEI..... | 16 |
| 6.2.2 Composition of IMEISV | 17 |
| 6.3 Allocation principles | 17 |
| 7 Identification of Voice Group Call and Voice Broadcast Call Entities | 17 |
| 7.1 Group Identities | 17 |
| 7.2 Group Call Area Identification | 18 |
| 7.3 Voice Group Call and Voice Broadcast Call References | 18 |
| 8 SCCP subsystem numbers | 18 |
| 8.1 Globally standardised subsystem numbers used for GSM | 18 |
| 8.2 National network subsystem numbers used for GSM | 19 |
| 9 Definition of Access Point Name | 19 |
| 9.1 Structure of APN | 19 |

| | | |
|--|---|-----------|
| 9.1.1 | Format of APN Network Identifier | 20 |
| 9.1.2 | Format of APN Operator Identifier | 20 |
| 9.2 | Definition of the Wild Card APN | 20 |
| 9.2.1 | Coding of the Wild Card APN | 20 |
| Annex A (informative): Colour Codes | | 21 |
| A.1 | Utilization of the BSIC | 21 |
| A.2 | Guidance for planning | 21 |
| A.3 | Example of PLMN Colour Codes (NCCs) for the European region | 22 |
| Annex B (informative): Change history | | 23 |
| History | | 24 |

Foreword

This Technical Specification has been produced by the 3rd Generation Partnership Project (3GPP).

The contents of the present document are subject to continuing work within the TSG and may change following formal TSG approval. Should the TSG modify the contents of the present document, it will be re-released by the TSG with an identifying change of release date and an increase in version number as follows:

Version x.y.z

where:

- x the first digit:
 - 1 presented to TSG for information;
 - 2 presented to TSG for approval;
 - 3 or greater indicates TSG approved document under change control.
- y the second digit is incremented for all changes of substance, i.e. technical enhancements, corrections, updates, etc.
- z the third digit is incremented when editorial only changes have been incorporated in the document.

1 Scope

The present document defines:

- a) an identification plan for mobile subscribers in the GSM system;
- b) principles of assigning telephone and ISDN numbers to MSs in the country of registration of the MS;
- c) principles of assigning Mobile Station (MS) roaming numbers to visiting MSs;
- d) an identification plan for location areas, routing areas, and base stations in the GSM system;
- e) an identification plan for MSCs, SGSNs, GGSNs, and location registers in the GSM system;
- f) principles of assigning international mobile equipment identities;
- g) principles of assigning zones for regional subscription;
- h) an identification plan for groups of subscribers to the Voice Group Call Service (VGCS) and to the Voice Broadcast Service (VBS); and identification plan for voice group calls and voice broadcast calls; an identification plan for group call areas;
- i) principles for assigning Packet Data Protocol (PDP) addresses to mobile stations;
- j) an identification plan for point-to-multipoint data transmission groups.

1.1 References

The following documents contain provisions which, through reference in this text, constitute provisions of the present document.

- References are either specific (identified by date of publication, edition number, version number, etc.) or non-specific.
- For a specific reference, subsequent revisions do not apply.
- For a non-specific reference, the latest version applies.
- A non-specific reference to an ETS shall also be taken to refer to later versions published as an EN with the same number.
- For this Release 1997 document, references to GSM documents are for Release 1997 versions (version 6.x.y).

- [1] GSM 01.04: "Digital cellular telecommunications system (Phase 2+); Abbreviations and acronyms".
- [2] GSM 03.08: "Digital cellular telecommunications system (Phase 2+); Organization of subscriber data".
- [3] GSM 03.20: "Digital cellular telecommunications system (Phase 2+); Security related network functions".
- [4] GSM 03.70: "Digital cellular telecommunications system (Phase 2+); Routing of calls to/from Public Data Networks (PDN)".
- [5] GSM 04.08: "Digital cellular telecommunications system (Phase 2+); Mobile radio interface layer 3 specification".
- [6] GSM 09.03: "Digital cellular telecommunications system (Phase 2+); Signalling requirements on interworking between the Integrated Services Digital Network (ISDN) or Public Switched Telephone Network (PSTN) and the Public Land Mobile Network (PLMN)".

- [6a] GSM 09.60: "Digital cellular telecommunications system (Phase 2+); General Packet Radio Service (GPRS); GPRS Tunnelling Protocol (GTP) across the Gn and Gp Interface".
- [7] GSM 11.11: "Digital cellular telecommunications system (Phase 2+); Specification of the Subscriber Identity Module - Mobile Equipment (SIM - ME) interface".
- [8] CCITT Recommendation E.164: "Numbering plan for the ISDN era".
- [9] CCITT Recommendation E.212: "Identification plan for land MSs".
- [10] CCITT Recommendation E.213: "Telephone and ISDN numbering plan for land MSs in public land mobile networks (PLMN)".
- [11] CCITT Recommendation X.121: "International numbering plan for public data networks".
- [12] RFC 791: "Internet Protocol".
- [13] RFC 1883: "Internet Protocol, Version 6 (IPv6) Specification".
- [14] GSM 04.68 (ETS 100 948): "Group Call Control (GCC) protocol".
- [15] GSM 04.69 (ETS 100 949): "Broadcast Call Control (BCC) Protocol".
- [16] GSM 09.02: "Mobile Application Part (MAP) specification".

1.2 Abbreviations

Abbreviations used in the present document are listed in GSM 01.04.

1.3 General comments to references

The identification plan for mobile subscribers defined below is that defined in CCITT Recommendation E.212.

The ISDN numbering plan for MSs and the allocation of mobile station roaming numbers is that defined in CCITT Recommendation E.213. Only one of the principles for allocating ISDN numbers is proposed for GSM PLMNs. Only the method for allocating MS roaming numbers contained in the main text of CCITT Recommendation E.213 is recommended for use in GSM PLMNs. If there is any difference between this Technical Specification and the CCITT Recommendations, the former shall prevail.

For terminology, see also CCITT Recommendations E.164 and X.121.

1.4 Conventions on bitordering

The following conventions hold for the coding of the different identities appearing in this Technical Specification and in other GSM Technical Specifications if not indicated otherwise:

- the different parts of an identity are shown in the figures in order of significance;
- the most significant part of an identity is on the left part of the figure and the least significant on the right.

When an identity appears in other Technical Specifications, the following conventions hold if not indicated otherwise:

- digits are numbered by order of significance, with digit 1 being the most significant;
- bits are numbered by order of significance, with the lowest bit number corresponding to the least significant bit.

2 Identification of mobile subscribers

2.1 General

A unique International Mobile Subscriber Identity (IMSI) shall be allocated to each mobile subscriber in the GSM system.

NOTE: This IMSI is the concept referred to by CCITT as "International Mobile Station Identity".

In order to support the subscriber identity confidentiality service the VLRs and SGSNs may allocate Temporary Mobile Subscriber Identities (TMSI) to visiting mobile subscribers. The VLR and SGSNs must be capable of correlating an allocated TMSI with the IMSI of the MS to which it is allocated.

An MS may be allocated two TMSIs, one for services provided through the MSC, and the other for services provided through the SGSN (P-TMSI for short).

For addressing on resources used for GPRS, a Temporary Logical Link Identity (TLLI) is used. The TLLI to use is built by the MS either on the basis of the P-TMSI (local or foreign TLLI), or directly (random TLLI).

In order to speed up the search for subscriber data in the VLR a supplementary Local Mobile Station Identity (LMSI) is defined.

The LMSI may be allocated by the VLR at location updating and is sent to the HLR together with the IMSI. The HLR makes no use of it but includes it together with the IMSI in all messages sent to the VLR concerning that MS.

2.2 Composition of IMSI

IMSI is composed as shown in figure 1.

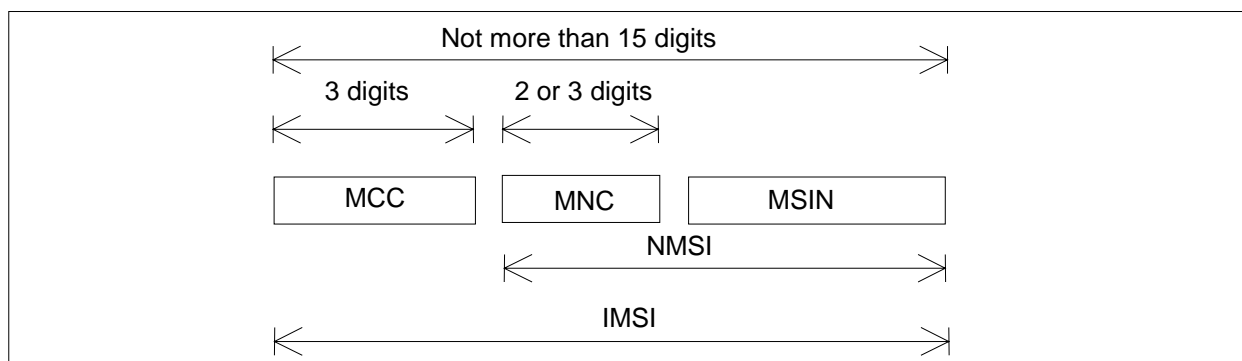

Figure 1: Structure of IMSI

IMSI is composed of three parts:

- i) Mobile Country Code (MCC) consisting of three digits. The MCC identifies uniquely the country of domicile of the mobile subscriber;
- ii) Mobile Network Code (MNC) consisting of two or three digits for GSM applications. The MNC identifies the home GSM PLMN of the mobile subscriber;
- iii) Mobile Subscriber Identification Number (MSIN) identifying the mobile subscriber within a GSM PLMN.

The National Mobile Subscriber Identity (NMSI) consists of the Mobile Network Code and the Mobile Subscriber Identification Number.

NOTE: Three digit MNC is for use with GPRS only.

2.3 Allocation principles

IMSI shall consist of numerical characters (0 through 9) only.

The overall number of digits in IMSI shall not exceed 15 digits.

The allocation of Mobile Country Codes (MCCs) is administered by the CCITT and is given in annex A to CCITT Blue Book Recommendation E.212.

The allocation of National Mobile Subscriber Identity (NMSI) is the responsibility of each administration.

If more than one GSM PLMN exist in a country, a unique Mobile Network Code should be assigned to each of them.

The allocation of IMSIs should be such that not more than the digits MCC + MNC of the IMSI have to be analysed in a foreign GSM PLMN for information transfer.

2.4 Structure of TMSI

Since the TMSI has only local significance (i.e. within a VLR and the area controlled by a VLR, or within an SGSN and the area controlled by an SGSN), the structure and coding of it can be chosen by agreement between operator and manufacturer in order to meet local needs.

The TMSI consists of 4 octets. It can be coded using a full hexadecimal representation.

In order to avoid double allocation of TMSIs after a restart of an allocating node, some part of the TMSI may be related to the time when it was allocated or contain a bit field which is changed when the allocating node has recovered from the restart.

In areas where both MSC-based services and SGSN-based services are provided, some discrimination is needed between the allocation of TMSIs for MSC-based services and the allocation of TMSIs for SGSN-based services. The discrimination shall be done on the 2 most significant bits, with values 00, 01, and 10 being used by the VLR, and 11 being used by the SGSN.

The TMSI shall only be allocated in ciphered form. See also GSM 03.20.

The network shall not allocate a TMSI with all 32 bits equal to 1 (this is because the TMSI must be stored in the SIM, and the SIM uses 4 octets with all bits equal to 1 for indicating that no valid TMSI is available).

To allow for eventual modifications of the management of the TMSI code space management, MSs shall not check if an allocated TMSI belongs to the range allocated to the allocating node. MSs shall use an allocated TMSI according to the specifications, whatever its value.

2.5 Structure of LMSI

The LMSI consists of 4 octets and may be allocated by the VLR.

2.6 Structure of TLLI

A TLLI is built by the MS or by the SGSN either on the basis of the P-TMSI (local or foreign TLLI), or directly (random or auxiliary TLLI), according to the following rules.

The TLLI consists of 32 bits, numbered from 0 to 31 by order of significance, with bit 0 being the LSB.

A local TLLI is built by a MS which has a valid P-TMSI as follows:

- bits 31 down to 30 are set to 1; and
- bits 29 down to 0 are set equal to bits 29 to 0 of the P-TMSI.

A foreign TLLI is built by a MS which has a valid P-TMSI as follows:

- bit 31 is set to 1 and bit 30 is set to 0; and
- bits 29 down to 0 are set equal to bits 29 to 0 of the P-TMSI.

A random TLLI is built by an MS as follows:

- bit 31 is set to 0;
- bits 30 down to 27 are set to 1; and
- bits 0 to 26 are chosen randomly.

An auxiliary TLLI is built by the SGSN as follows:

- bit 31 is set to 0;
- bits 30 down to 28 are set to 1;
- bit 27 is set to 0; and
- bits 0 to 26 can be assigned independently.

Other types of TLLI may be introduced in the future.

The structure of the TLLI is then summarised by table 1.

Table 1: TLLI structure

| 31 | 30 | 29 | 28 | 27 | 26 to 0 | Type of TLLI |
|----|----|----|----|----|---------|----------------|
| 1 | 1 | T | T | T | T | Local TLLI |
| 1 | 0 | T | T | T | T | Foreign TLLI |
| 0 | 1 | 1 | 1 | 1 | R | Random TLLI |
| 0 | 1 | 1 | 1 | 0 | A | Auxiliary TLLI |
| 0 | 1 | 1 | 0 | X | X | Reserved |
| 0 | 1 | 0 | X | X | X | Reserved |
| 0 | 0 | X | X | X | X | Reserved |

'T', 'R', 'A' and 'X' indicate bits which can take any value for the type of TLLI. More precisely, 'T' indicates bits derived from a P-TMSI, 'R' indicates bits chosen randomly, 'A' indicates bits chosen by the SGSN and 'X' bits in reserved ranges.

3 Numbering plan for mobile stations

3.1 General

Below the structure of the numbers used by a subscriber of a fixed (or mobile) network for calling a mobile station of a GSM PLMN is defined. The network addresses used for packet data communication between a mobile station and a fixed (or mobile) station are also defined below.

Also the structure of mobile station roaming numbers is defined.

One or more numbers of the ISDN numbering plan shall be assigned to a mobile station to be used for all calls to that station, i.e. the assignment of an MSISDN to a mobile station is mandatory.

NOTE: For card operated stations the ISDN number should be assigned to the holder of the card (personal number).

3.2 Numbering plan requirements

In principle, it should be possible for any subscriber of the ISDN or PSTN to call any MS in a GSM PLMN. This implies that ISDN numbers for MSs should comply with the ISDN numbering plan in each country.

The ISDN numbers of MSs should be composed in such a way that standard ISDN/PSTN charging can be used for calls to MSs.

It should be possible for each administration to develop its own independent numbering/addressing plan for MSs.

The numbering/addressing plan should not limit the possibility for MSs to roam among GSM PLMNs.

It should be possible to change the IMSI without changing the ISDN number allocated to a MS and vice versa.

In principle, it should be possible for any subscriber of the CSPDN/PSPDN to call any MS in a GSM PLMN. This implies that it may be necessary for an MS to have a X.121 number.

In principle, it should be possible for any fixed or mobile terminal to communicate with a mobile terminal using an IP v4 address.

3.3 Structure of MS international PSTN/ISDN number (MSISDN)

The MS international ISDN numbers are allocated from the CCITT Recommendation E.164 numbering plan, see also CCITT Recommendation E.213. The MS international ISDN number will then be as shown in figure 2.

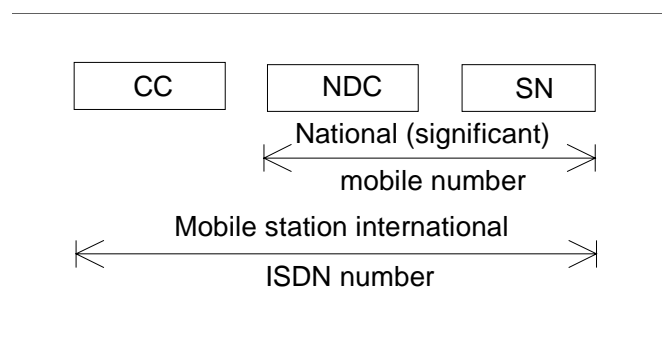

Figure 2: Number Structure of MSISDN

The number consists of:

- Country Code (CC) of the country in which the MS is registered, followed by
- National (significant) mobile number which consists of National Destination Code (NDC) and Subscriber Number (SN).

For GSM applications, a National Destination Code is allocated to each GSM PLMN. In some countries more than one NDC may be required for each GSM PLMN.

The composition of the MS international ISDN number should be such that it can be used as a global title address in the Signalling Connection Control Part (SCCP) for routing messages to the home location register of the MS. The country code (CC) and the national destination code (NDC) will provide such routing information. If further routing information is required, it should be contained in the first few digits of the subscriber number (SN).

A sub-address may be appended to an ISDN number for use in call setup and in supplementary service operations where an ISDN number is required (see CCITT Recommendations E.164, section 11.2 and X.213 annex A). The sub-address is transferred to the terminal equipment denoted by the ISDN number.

The maximum length of a sub-address is 20 octets, including one octet to identify the coding scheme for the sub-address (see CCITT Recommendation X.213, annex A). All coding schemes described in CCITT Recommendation X.213, annex A are supported in GSM.

3.4 Mobile Station Roaming Number (MSRN) for PSTN/ISDN routing

The Mobile Station Roaming Number (MSRN) is used to route calls directed to a MS. On request from the Gateway MSC via the HLR it is temporarily allocated to a MS by the VLR with which the MS is registered it addresses the Visited MSC collocated with the assigning VLR. More than one MSRN may be assigned simultaneously to a MS.

The MSRN is passed by the HLR to the Gateway MSC for routing calls to the MS.

The Mobile Station Roaming Number for PSTN/ISDN routing shall have the same structure as international ISDN numbers in the area in which the roaming number is allocated, i.e.:

- the country code of the country in which the visitor location register is located;
- the national destination code of the visitor GSM PLMN or numbering area;
- a subscriber number with the appropriate structure for that numbering area.

The MSRN must not be used for subscriber dialling. It should be noted that the MSRN can be identical to the MSISDN (section 3.3) in certain circumstances. In order to discriminate between subscriber generated access to these numbers and rerouting performed by the network, rerouting or redirection indicators or other signalling means should be used, if available (see GSM 09.03).

3.5 Structure of Mobile Station International Data Number

The structure of MS international data numbers should comply with the data numbering plan of CCITT Recommendation X.121 as applied in the home country of the mobile subscriber. Implications on numbering interworking functions which may need to be provided by the PLMN (if the use of X.121 numbers is required) are indicated in GSM 03.70.

3.6 Handover Number

The handover number is used for establishment of a circuit between MSCs to be used for a call being handed over. The handover number may be reused in the same way as the MSRN.

3.7 Structure of an IP v4 address

One or more IP address domains could be allocated to each PLMN. The IP v4 address structure is defined in RFC 791.

An IP v4 address may be allocated to an MS either permanently or on a temporary basis during a connection with the network.

3.8 Structure of an IP v6 address

One or more IP address domains could be allocated to each PLMN. The IP v6 address structure is defined in RFC 1883.

An IP v6 address may be allocated to an MS either permanently or on a temporary basis during a connection with the network

4 Identification of location areas and base stations

4.1 Composition of the Location Area Identification (LAI)

The Location Area Identification shall be composed as shown in figure 3.

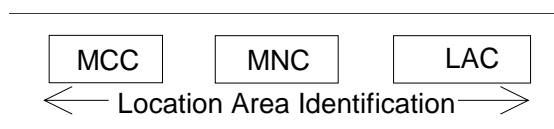

Figure 3: Structure of Location Area Identification

The LAI is composed of the following elements:

- Mobile Country Code (MCC) identifies the country in which the GSM PLMN is located. The value of the MCC is the same as the three digit MCC contained in international mobile subscriber identity (IMSI);
- Mobile Network Code (MNC) is a code identifying the GSM PLMN in that country. The MNC takes the same value as the two digit MNC contained in IMSI;
- Location Area Code (LAC) which is a fixed length code (of 2 octets) identifying a location area within a GSM PLMN. This part of the location area identification can be coded using a full hexadecimal representation except for the following reserved hexadecimal values:
 - 0000, and
 - FFFE.
- These reserved values are used in some special cases when no valid LAI exists in the MS (see GSM 04.08 and GSM 11.11).

4.2 Composition of the Routing Area Identification (RAI)

The Routing Area Identification shall be composed as shown in figure 4.

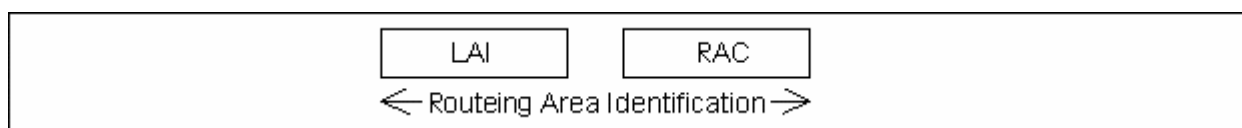

Figure 4: Structure of Routing Area Identification

The RAI is composed of the following elements:

- a valid Location Area Identity (LAI) as defined in section 4.1. Invalid LAI values are used in some special cases when no valid RAI exists in the mobile station (see GSM 04.08 and GSM 11.11);
- Routing Area Code (RAC) which is a fixed length code (of 1 octets) identifying a routing area within a location area.

4.3 Base station identification

4.3.1 Cell Identity (CI) and Cell Global Identification (CGI)

The BSS and cell within the BSS is identified within a location or routing area by adding a Cell Identity (CI) to the location or routing area identification, as shown in figure 5. The CI is of fixed length with 2 octets and it can be coded using a full hexadecimal representation.

The Cell Global Identification is the concatenation of the Location Area Identification and the Cell Identity. Cell Identity must be unique within a location area.

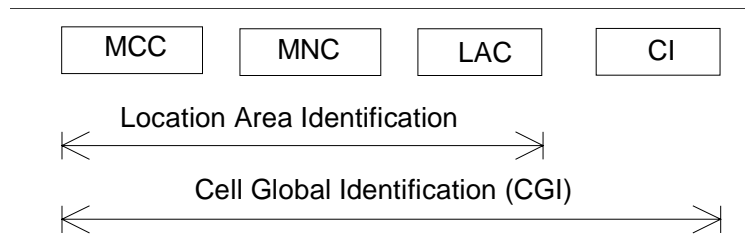

Figure 5: Structure of Cell Global Identification

4.3.2 Base Station Identify Code (BSIC)

The base station identity code is a local colour code that allows a MS to distinguish between different neighbouring base stations. BSIC is a 6 bit length code which is structured in the following way.

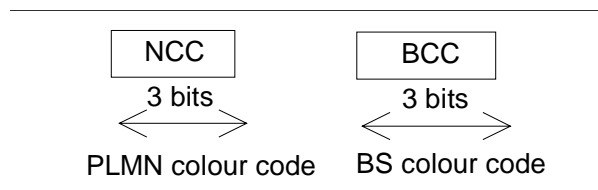

Figure 6: Structure of BSIC

In the definition of the NCC, care needs to be taken to ensure that the same NCC is not used in adjacent PLMNs which may use the same BCCH carrier frequencies in neighbouring areas. Therefore, to prevent potential deadlocks, a definition of the NCC appears in annex A. This annex will be reviewed in a co-ordinated manner when a PLMN is created.

4.4 Regional Subscription Zone Identity (RSZI)

A PLMN specific regional subscription defines unambiguously for the entire PLMN the regions in which roaming is allowed. It consists of one or more regional subscription zones. The regional subscription zone is identified by Regional Subscription Zone Identity (RSZI). A regional subscription zone identity is composed as shown in figure 7.

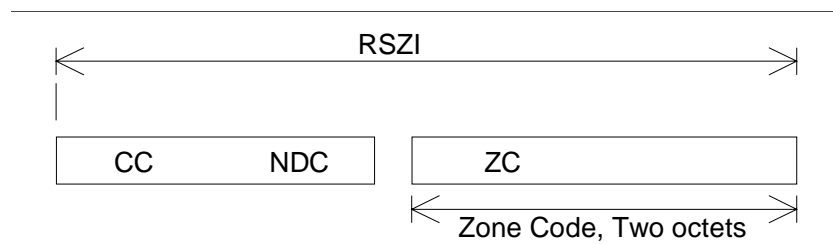

Figure 7: Structure of Regional Subscription Zone Identity (RSZI)

The elements of the regional subscription zone identity are:

- the Country Code (CC) which identifies the country in which the GSM PLMN is located;
- the National Destination Code (NDC) which identifies the GSM PLMN in that country;
- the Zone Code (ZC) which identifies a regional subscription zone as a pattern of allowed and not allowed location areas uniquely within that PLMN.

CC and NDC are those of a CCITT Recommendation E.164 VLR or SGSN number (see section 5.1) of the PLMN and are coded with a tailing filler, if required. ZC has fixed length of two octets and is coded in full hexadecimal representation.

RSZIs including the zone codes are assigned by the VPLMN operator. The zone code is evaluated in the VLR or SGSN by information stored in the VLR or SGSN as a result of administrative action. If a zone code is received by a VLR or

SGSN during updating by the HLR and this zone code is related to that VLR or SGSN, the VLR or SGSN shall be able to decide for all its MSC or SGSN areas and all its location areas whether they are allowed or not allowed.

For details of assignment of RSZI and of ZC as subscriber data see GSM 03.08.

For selection of RSZI at location updating by comparison with the leading digits of the VLR or SGSN number and for transfer of ZC from the HLR to VLR and SGSN see GSM 09.02.

4.5 Location Number

A location number is a number which defines a specific location within a GSM PLMN. The Location number is formatted according to CCITT Recommendation E.164, as shown in figure 8. The country code (CC) and national destination code (NDC) fields of the location number are those which define the GSM PLMN of which the location is part.

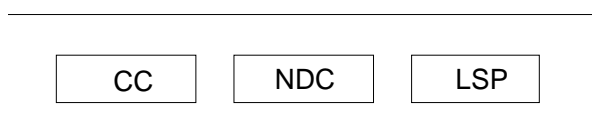

Figure 8: Location Number Structure

The structure of the locally significant part (LSP) of the location number is a matter for agreement between the PLMN operator and the national numbering authority in the PLMN's country. It is desirable that the location number can be interpreted without the need for detailed knowledge of the internal structure of the PLMN; the LSP should therefore include the national destination code in the national numbering plan for the fixed network which defines the geographic area in which the location lies.

The set of location numbers for a GSM PLMN must be chosen so that a location number can be distinguished from the MSISDN of a subscriber of the PLMN. This will allow the PLMN to trap attempts by users to dial a location number.

5 Identification of MSCs and location registers

5.1 Identification for routing purpose

MSCs, GSNs and location registers are identified by international PSTN/ISDN numbers and/or Signalling Point Codes ("entity number", i.e., "HLR number", "VLR number", "MSC number", "SGSN number" and "GGSN number") in each GSM PLMN.

Additionally SGSN, GGSN are identified by GSN Addresses. These are the SGSN Address and the GGSN Address.

A GSN Address shall be composed as shown in figure 9.

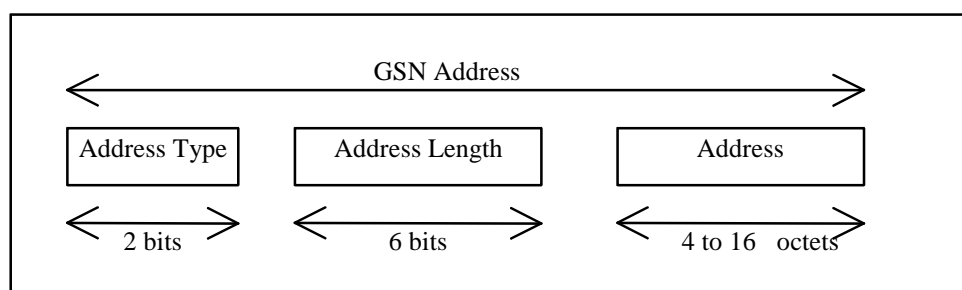

Figure 9: Structure of GSN Address

The GSN Address is composed of the following elements:

- the Address Type which is a fixed length code (of 2 bits) identifying the type of address that is used in the Address field;

- address Length which is a fixed length code (of 6 bits) identifying the length of the Address field;
- address is a variable length field with either an IPv4 address or an IPv6 address.

Address Type 0 and Address Length 4 are used when Address is an IPv4 address.

Address Type 1 and Address Length 16 are used when Address is an IPv6 address.

The IP v4 address structure is defined in RFC 791.

The IP v6 address structure is defined in RFC 1883.

5.2 Identification of HLR for HLR restoration application

HLR may also be identified by one or several "HLR id(s)", consisting of the leading digits of the IMSI (MCC + MNC + leading digits of MSIN).

6 International Mobile Station Equipment Identity and Software Version Number

6.1 General

Below the structure and allocation principles of the International Mobile station Equipment Identity and Software Version Number (IMEISV) and the International Mobile station Equipment Identity (IMEI) are defined.

The Mobile Station Equipment is uniquely defined by the IMEI or the IMEISV.

6.2 Composition of IMEI and IMEISV

6.2.1 Composition of IMEI

The International Mobile station Equipment Identity (IMEI) is composed as shown in figure 10.

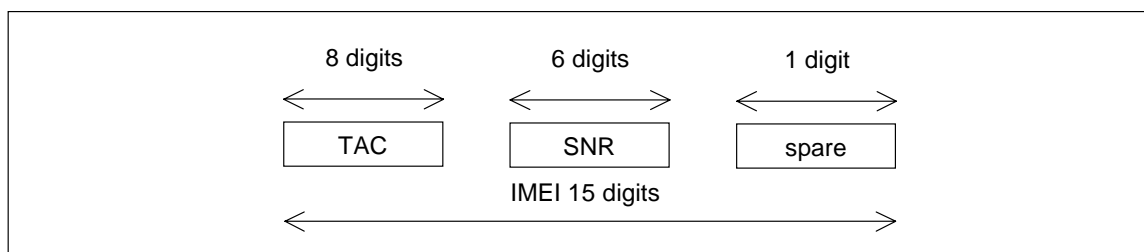

Figure 10: Structure of IMEI

The IMEI is composed of the following elements (each element shall consist of decimal digits only):

- Type Allocation Code (TAC). Its length is 8 digits;
- Serial Number (SNR) is an individual serial number uniquely identifying each equipment within each TAC. Its length is 6 digits.
- Spare digit: this digit shall be zero, when transmitted by the MS.

The security requirements of the IMEI are defined in TS GSM 02.16.

6.2.2 Composition of IMEISV

The International Mobile station Equipment Identity and Software Version Number (IMEISV) is composed as shown in figure 11.

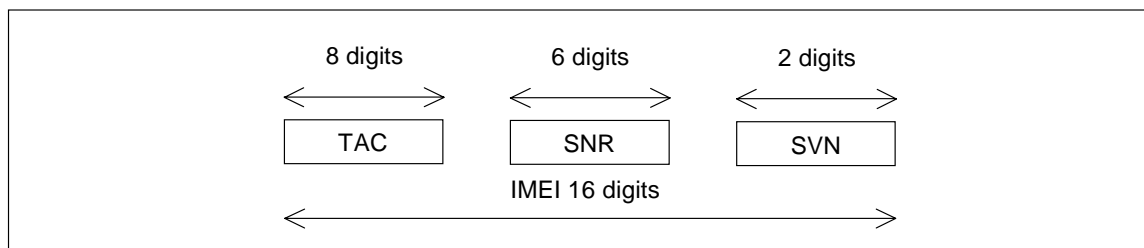

Figure 11: Structure of IMEISV

The IMEISV is composed of the following elements (each element shall consist of decimal digits only):

- Type Allocation Code (TAC). Its length is 8 digits;
- Serial Number (SNR) is an individual serial number uniquely identifying each equipment within each TAC. Its length is 6 digits.
- Software Version Number (SVN) identifies the software version number of the mobile equipment. Its length is 2 digits.

Regarding updates of the IMEISV: The security requirements of TS GSM 02.16 apply only to the TAC and SNR, but not to the SVN part of the IMEISV.

6.3 Allocation principles

The Type Allocation Code (TAC) is issued by a central body.

Manufacturers shall allocate individual serial numbers (SNR) in a sequential order.

For a given ME, the combination of TAC and SNR used in the IMEI shall duplicate the combination of TAC and SNR used in the IMEISV.

The Software Version Number is allocated by the manufacturer. SVN value 99 is reserved for future use.

7 Identification of Voice Group Call and Voice Broadcast Call Entities

7.1 Group Identities

Logical groups of subscribers to the Voice Group Call Service or to the Voice Broadcast Service are known by a Group Identity (Group ID). Group IDs for VGCS are unique within a PLMN. Likewise, Group IDs for VBS are unique within a PLMN. However, no uniqueness is required between the sets of Group IDs. These sets may be intersecting or even identical, at the option of the network operator.

The Group ID is a number with a maximum value depending on the composition of the voice group call reference or voice broadcast call reference defined in section 7.3.

For definition of Group ID on the radio interface, A interface and Abis interface, see GSM 04.68 [14] and GSM 04.69 [15].

For definition of Group ID coding on MAP protocol interfaces, see GSM 09.02 [16].

VGCS or VBS shall also be provided in case of roaming. If this applies, certain Group IDs shall be defined as supra-PLMN Group IDs which have to be co-ordinated between the network operators and which shall be known in the networks and in the SIM.

The format of the Group ID is identical for VBS and VGCS.

7.2 Group Call Area Identification

Groupings of cells into specific group call areas occurs in support of both the Voice Group Call Service and the Voice Broadcast Service. These service areas are known by a "Group Call Area Identity" (Group Call Area Id). No restrictions are placed on what cells may be grouped into a given group call area.

The Group Call Area ID is a number uniquely assigned to a group call area in one network and with a maximum value depending on the composition of the voice group call reference or voice broadcast reference defined under 7.3.

The formats of the Group Call Area ID for VGCS and the Group Call Area ID for VBS are identical.

7.3 Voice Group Call and Voice Broadcast Call References

Specific instances of voice group calls (VGCS) and voice broadcast calls (VBS) within a given group call area are known by a "Voice Group Call Reference" or by a "Voice Broadcast Call Reference" respectively.

Each voice group call or voice broadcast call in one network is uniquely identified by its Voice Group Call Reference or Voice Broadcast Call Reference. The Voice Group Call Reference or Voice Broadcast Call Reference is composed of the Group ID and the Group Call Area ID. The composition of the group call area ID and the group ID can be specific for each network operator.

For definition of Group Call Reference (with leading zeros inserted as necessary) on the radio interface, A interface and Abis interface, see GSM 04.08 [7], GSM 04.68 [15] and GSM 04.69 [15].

For definition of Group Call Reference (also known as ASCII Call Reference, Voice Group Call Reference or Voice Broadcast Call Reference) coding on MAP protocol interfaces, see GSM 09.02 [16].

The format is given in figure 12.

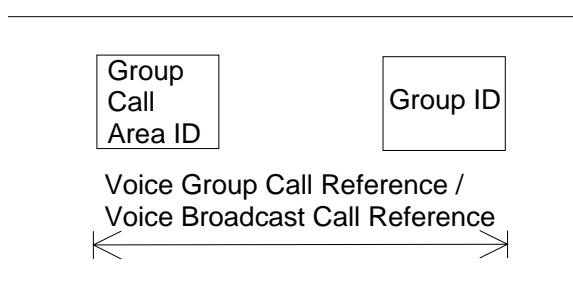

Figure 12: Voice Group Call Reference / Voice Broadcast Call Reference

8 SCCP subsystem numbers

Subsystem numbers are used to identify applications within network entities which use SCCP signalling. In GSM, subsystem numbers may be used between PLMNs, in which case they are taken from the globally standardised range (1 to 31) or the part of the national network range (129 to 150) reserved for GSM use between PLMNs, or within a PLMN, in which case they are taken from the part of the national network range (32 to 128 and 151 to 254).

8.1 Globally standardised subsystem numbers used for GSM

The following globally standardised subsystem numbers have been allocated for use by GSM:

0000 0110HLR (MAP);

0000 0111VLR (MAP);
0000 1000MSC (MAP);
0000 1001EIR (MAP);
0000 1010is allocated for evolution (possible Authentication centre).

8.2 National network subsystem numbers used for GSM

The following national network subsystem numbers have been allocated for use within GSM networks:

1111 1101BSS O&M (A interface);
1111 1110BSSAP (A interface).

The following national network subsystem numbers have been allocated for use within and between GSM networks:

1001 0010CAP;
1001 0011gsmSCF(MAP);
1001 0100SIWF(MAP);
1001 0101SGSN(MAP);
1001 0110GGSN(MAP).

9 Definition of Access Point Name

In the GPRS backbone, an Access Point Name (APN) is a reference to a GGSN. To support inter-PLMN roaming, the internal GPRS DNS functionality is used to translate the APN into the IP address of the GGSN.

9.1 Structure of APN

The APN is composed of two parts as follows:

- The APN Network Identifier which defines to which external network the GGSN is connected to. This part of the APN is mandatory.
- The APN Operator Identifier which defines in which PLMN GPRS backbone the GGSN is located. This part of the APN is optional.

The APN Operator Identifier is placed after the APN Network Identifier. An APN consisting of both the Network Identifier and Operator Identifier corresponds to a DNS name of a GGSN and has a maximum length of 100 octets.

The syntax of the APN shall follow the Name Syntax defined in RFC 2181 [14] and RFC 1035 [15]. The APN consists of one or more labels. Each label is coded as one octet length field followed by that number of octets coded as 8 bit ASCII characters. Following RFC 1035 [15] the labels should consist only of the alphabetic characters (A-Z and a-z), digits (0-9) and the dash (-). The case of alphabetic characters is not significant. The APN is not terminated by a length byte of zero.

Note: A length byte of zero is added by the SGSN at the end of the APN before interrogating a DNS server.

For the purpose of presentation, an APN is usually displayed as a string in which the labels are separated by dots (e.g. "Label1.Label2.Label3").

9.1.1 Format of APN Network Identifier

The APN Network Identifier shall contain at least one label and shall have a maximum length of 63 octets. An APN Network Identifier shall not start with the strings "rac", "lac" or "sgsn" and it shall not end in ".gprs". It shall also not take the value "*".

In order to guarantee uniqueness of APN Network Identifier within the GPRS PLMN(s), an APN Network Identifier containing more than one label corresponds to an Internet domain name. This name should only be allocated by the PLMN to an organisation that has officially reserved this name in the Internet domain. Other types of APN Network Identifiers are not guaranteed to be unique within the GPRS PLMN(s).

9.1.2 Format of APN Operator Identifier

The APN Operator Identifier is composed of three labels. The last label shall be "gprs". The first and second labels together shall uniquely identify the GPRS PLMN (e.g. "<operator-name>.<operator-group>.gprs").

For each operator, there is a default APN Operator Identifier (i.e. domain name). This default APN Operator Identifier is derived from the IMSI as follows:

```
"mnc<MNC>.mcc<MCC>.gprs"
```

where:

"mnc" and "mcc" serve as invariable identifiers for the following digits.

<MNC> and <MCC> are derived from the components of the IMSI defined in section 2.2.

This default APN Operator Identifier is used in inter-PLMN roaming situations when attempting to translate an APN consisting of Network Identifier only into the IP address of the GGSN residing in the HPLMN. The PLMN may provide DNS translations for other, more human-readable, APN Operator Identifiers in addition to the default Operator Identifier described above.

In order to guarantee inter-PLMN DNS translation possibility, the <MNC> and <MCC> coding to be used in the "mnc<MNC>.mcc<MCC>.gprs" format of the APN OI shall be:

- <MNC> = 3 digits
- <MCC> = 3 digits

If there are less than 3 significant digits in MNC, one or more "0" digit(s) is/are inserted at the left side to fill the 3 digits coding of MNC in the APN OI.

As an example, the APN OI for MCC 345 and MNC 12 shall be coded in the DNS as mnc012.mcc345.gprs.

9.2 Definition of the Wild Card APN

The APN field in the HLR may contain a wild card APN if the HPLMN operator allows the subscriber to access any network of a given PDP Type. If an SGSN has received such a wild card APN, it may either choose the APN Network Identifier received from the Mobile Station or a default APN Network Identifier for addressing the GGSN when activating a PDP context.

9.2.1 Coding of the Wild Card APN

The wild card APN is coded as an APN with "*" as its single label, (i.e. a length octet with value one, followed by the ASCII code for the asterisks).

Annex A (informative): Colour Codes

A.1 Utilization of the BSIC

To each cell is allocated a BSIC, within 64 values. In each cell its BSIC is broadcast in each burst sent on the SCH, and is then known by all MSs which get the synchronization with this cell. The BSIC is used by the MS for several purposes, all aiming of avoiding ambiguity or interference which can arise when a MS in a given position can receive two cells *using the same BCCH frequency*.

Some of the utilizations of the BSIC relate to cases where the MS is attached to one of the cells. Other utilizations relates to cases where the MS is attached to third cell, usually somewhere between the two cells in question.

The first category of utilizations includes:

- The three least significant bits of the BSIC indicate which of the 8 training sequences is used in the bursts sent on the downlink common channels of the cell. Different training sequences allow for a better transmission in case of interference. The group of the three least significant bits of the BSIC is called the BCC (Base station Colour Code).
- The BSIC is used to modify the bursts sent by the MSs on the access bursts. This aims to avoid one cell decoding correctly access bursts sent to another cell.

The second category of utilizations includes:

- When in connected mode, the MSs measure and report the level they receive on a number of frequencies, corresponding to the BCCH frequencies of neighbouring cells in the same network as the used cell. Along with the measurement result, the MS provides the network with the BSIC it has received on the frequency. This enables the network to discriminate between several cells happening to use the same BCCH frequency. Bad discrimination might result in faulty handovers.
- The contents of the measurement report messages is limited to 6 neighbour cells. It is then useful to limit the reported cells to those to which handovers are accepted. To this avail, each cell provides a list of the values of the three most significant bits of the BSICs that are allocated to the cells that are useful to consider for handovers (usually excluding cells in other PLMNs). This information enables the MS to put aside cells with non-conformant BSIC and not to report about them. The group of the three most significant bits of the BSIC is called the NCC (Network Colour Code).

It should be noted that when in idle mode, the MS identifies a cell (for cell selection purposes) according to the cell identity broadcast on the BCCH and *not* by the BSIC.

A.2 Guidance for planning

From these utilizations, the following planning rule can be derived:

If there exist places where MSs can receive two cells, whether in the same PLMN or in different ones, that use the same BCCH frequency, it is highly preferable that these two cells have different BSICs.

Where the coverage areas of two PLMNs overlap, the rule above is respected if:

- i) The PLMNs uses different sets of BCCH frequencies. This is in particular the case if no frequency is common to the two PLMNs. This usually holds for PLMNs in the same country.
- ii) The PLMNS use different sets of NCCs.
- iii) BSIC and BCCH frequency planning is co-ordinated.

Recognizing that method iii) is more cumbersome than method ii), and that method i) is too constraining, it is suggested that overlapping PLMNs using common part of spectrum agree on different NCCs to be used in overlapping area. As an example, a preliminary NCC allocation for countries in the European region can be found in section A.3 of this annex.

This example can be used as basis for bilateral agreements. However, the usage of the NCCs allocated in section A.3 is not compulsory. PLMN operators can agree on different BSIC allocation rules in border areas. The usage of BSICs is not constrained in non overlapping areas, or if ambiguities are resolved by using different sets of BCCH frequencies.

A.3 Example of PLMN Colour Codes (NCCs) for the European region

| | | |
|---------------|---|-------------------------|
| Austria | : | 0 |
| Belgium | : | 1 |
| Cyprus | : | 3 |
| Denmark | : | 1 |
| Finland | : | 0 |
| France | : | 0 |
| Germany | : | 3 |
| Greece | : | 0 |
| Iceland | : | 0 |
| Ireland | : | 3 |
| Italy | : | 2 |
| Liechtenstein | : | 2 |
| Luxembourg | : | 2 |
| Malta | : | 1 |
| Monaco | : | 3 (possibly 0(=France)) |
| Netherlands | : | 0 |
| Norway | : | 3 |
| Portugal | : | 3 |
| San Marino | : | 0 (possibly 2(= Italy)) |
| Spain | : | 1 |
| Sweden | : | 2 |
| Switzerland | : | 1 |
| Turkey | : | 2 |
| UK | : | 2 |
| Vatican | : | 1 (possibly 2(=Italy)) |
| Yugoslavia | : | 3 |

This allows for each country a second operator by allocating the colour codes n (in the table) and $n + 4$. More than 2 colour codes per country may be used provided that in border areas only the values n and/or $n+4$ are used.

Annex B (informative): Change history

| SMG# | SPEC | CR | PH | VER | NEW_VE | SUBJECT |
|-------|-------|--------|-----|-------|--------|---|
| s25 | 03.03 | A004 | R96 | 5.0.2 | 5.1.0 | Definitions of SCCP subsystem numbers |
| s25 | 03.03 | A003 | R97 | 5.0.2 | 6.0.0 | Numbering, addressing, and identification |
| s26 | 03.03 | A006 | R97 | 6.0.0 | 6.1.0 | Mandatory assignment of MSISDN to an MS for GPRS; removal of Ipv6 address for GPRS MSs. |
| s26 | 03.03 | A007 | R97 | 6.0.0 | 6.1.0 | Clarification of TLLI used for anonymous access |
| s28 | 03.03 | A016 | R97 | 6.1.0 | 6.2.0 | Correction of the APN wildcard coding |
| s28 | 03.03 | A015 | R97 | 6.1.0 | 6.2.0 | Introduction of IPv6 addresses for GPRS MSs (C99-117) |
| S28 | 03.03 | A014 | R97 | 6.1.0 | 6.2.0 | Alignment of GSM 03.03 with GSM 09.02 |
| S29 | 03.03 | A026r1 | R97 | 6.2.0 | 6.3.0 | SSN reallocation for CAP, gsmSCF, SIWF, GGSN and SGSN |
| S29 | 03.03 | A030 | R97 | 6.2.0 | 6.3.0 | Correction of VGC/VBC reference |
| CN#05 | 03.03 | A033r1 | R97 | 6.3.0 | 6.4.0 | ASCII coding of <MNC> and <MCC> in APN OI |
| S30 | 03.03 | | | | 6.4.0 | Version 6.4.0 approved |
| CN#07 | 03.03 | A039r1 | R97 | 6.4.0 | 6.5.0 | Modification of section 6.2 to enhance IMEI security |
| CN#08 | 03.03 | A044r1 | R97 | 6.5.0 | 6.6.0 | Editorial Modification of section 6.2.2 |
| CN#08 | 03.03 | A050 | R97 | 6.5.0 | 6.6.0 | Use of 3 Digit MNCs in GTP for R'97 |
| CN#16 | 03.03 | A055 | R97 | 6.6.0 | 6.7.0 | Restructuring the IMEI to combine the TAC and FAC |
| CN#21 | 03.03 | A060r1 | R97 | 6.7.0 | 6.8.0 | Correction to definition of Group-ID, Group call area ID and Group |

History

| Document history | | |
|-------------------------|----------------|-------------|
| V6.1.0 | July 1998 | Publication |
| V6.2.0 | April 1999 | Publication |
| V6.3.0 | July 1999 | Publication |
| V6.4.0 | November 1999 | Publication |
| V6.5.0 | June 2000 | Publication |
| V6.6.0 | July 2000 | Publication |
| V6.7.0 | June 2002 | Publication |
| V6.8.0 | September 2003 | Publication |