

# ETSI TS 100 927 V5.5.0 (2003-09)

---

*Technical Specification*

**Digital cellular telecommunications system (Phase 2+);  
Numbering, addressing and identification  
(3GPP TS 03.03 version 5.5.0 Release 1996)**

---

**GSM**®  
GLOBAL SYSTEM FOR  
MOBILE COMMUNICATIONS

**3GPP**™

**ETSI** 

---

Reference

RTS/TSGN-040303v550

---

Keywords

GSM

**ETSI**

650 Route des Lucioles  
F-06921 Sophia Antipolis Cedex - FRANCE

Tel.: +33 4 92 94 42 00 Fax: +33 4 93 65 47 16

Siret N° 348 623 562 00017 - NAF 742 C  
Association à but non lucratif enregistrée à la  
Sous-Préfecture de Grasse (06) N° 7803/88

---

**Important notice**

Individual copies of the present document can be downloaded from:

<http://www.etsi.org>

The present document may be made available in more than one electronic version or in print. In any case of existing or perceived difference in contents between such versions, the reference version is the Portable Document Format (PDF). In case of dispute, the reference shall be the printing on ETSI printers of the PDF version kept on a specific network drive within ETSI Secretariat.

Users of the present document should be aware that the document may be subject to revision or change of status. Information on the current status of this and other ETSI documents is available at

<http://portal.etsi.org/tb/status/status.asp>

If you find errors in the present document, send your comment to:

[editor@etsi.org](mailto:editor@etsi.org)

---

**Copyright Notification**

No part may be reproduced except as authorized by written permission.  
The copyright and the foregoing restriction extend to reproduction in all media.

© European Telecommunications Standards Institute 2003.  
All rights reserved.

DECT™, PLUGTESTS™ and UMTS™ are Trade Marks of ETSI registered for the benefit of its Members.  
TIPHON™ and the TIPHON logo are Trade Marks currently being registered by ETSI for the benefit of its Members.  
3GPP™ is a Trade Mark of ETSI registered for the benefit of its Members and of the 3GPP Organizational Partners.

---

## Intellectual Property Rights

IPRs essential or potentially essential to the present document may have been declared to ETSI. The information pertaining to these essential IPRs, if any, is publicly available for **ETSI members and non-members**, and can be found in ETSI SR 000 314: *"Intellectual Property Rights (IPRs); Essential, or potentially Essential, IPRs notified to ETSI in respect of ETSI standards"*, which is available from the ETSI Secretariat. Latest updates are available on the ETSI Web server (<http://webapp.etsi.org/IPR/home.asp>).

Pursuant to the ETSI IPR Policy, no investigation, including IPR searches, has been carried out by ETSI. No guarantee can be given as to the existence of other IPRs not referenced in ETSI SR 000 314 (or the updates on the ETSI Web server) which are, or may be, or may become, essential to the present document.

---

## Foreword

This Technical Specification (TS) has been produced by ETSI 3rd Generation Partnership Project (3GPP).

The present document may refer to technical specifications or reports using their 3GPP identities, UMTS identities or GSM identities. These should be interpreted as being references to the corresponding ETSI deliverables.

The cross reference between GSM, UMTS, 3GPP and ETSI identities can be found under <http://webapp.etsi.org/key/queryform.asp>.

# Contents

Intellectual Property Rights .....	2
Foreword.....	2
Foreword.....	5
1 Scope .....	6
1.1 References .....	6
1.2 Abbreviations .....	7
1.3 General comments to references .....	7
1.4 Conventions on bitordering .....	7
2 Identification of mobile subscribers .....	7
2.1 General .....	7
2.2 Composition of IMSI.....	8
2.3 Allocation principles .....	8
2.4 Structure of TMSI .....	8
2.5 Structure of LMSI .....	9
3 Numbering plan for mobile stations .....	9
3.1 General .....	9
3.2 Numbering plan requirements .....	9
3.3 Structure of MS international PSTN/ISDN number (MSISDN) .....	9
3.4 Mobile Station Roaming Number (MSRN) for PSTN/ISDN routing.....	10
3.5 Structure of Mobile Station International Data Number .....	11
3.6 Handover Number .....	11
4 Identification of location areas and base stations .....	11
4.1 Composition of the Location Area Identification (LAI).....	11
4.2 Base station identification .....	11
4.2.1 Cell Identity (CI) and Cell Global Identification (CGI).....	11
4.2.2 Base Station Identify Code (BSIC).....	12
4.3 Regional Subscription Zone Identity (RSZI).....	12
4.4 Location Number.....	13
5 Identification of MSCs and location registers .....	13
5.1 Identification for routing purpose.....	13
5.2 Identification of HLR for HLR restoration application .....	13
6 International Mobile Station Equipment Identity and Software Version Number .....	13
6.1 General .....	13
6.2 Composition of IMEI and IMEISV .....	14
6.2.1 Composition of IMEI.....	14
6.2.2 Composition of IMEISV .....	14
6.3 Allocation principles .....	15
7 Identification of Voice Group Call and Voice Broadcast Call Entities.....	15
7.1 Group Identities .....	15
7.2 Group Call Area Identification.....	15
7.3 Voice Group Call and Voice Broadcast Call References .....	15
8 SCCP subsystem numbers .....	16
8.1 Globally standardised subsystem numbers used for GSM .....	16
8.2 National network subsystem numbers used for GSM .....	16
8.3 National network subsystem numbers used for CAP .....	17
<b>Annex A (informative): Colour Codes .....</b>	<b>18</b>
A.1 Utilization of the BSIC.....	18
A.2 Guidance for planning.....	18

A.3 Example of PLMN Colour Codes (NCCs) for the European region.....19

**Annex B (informative): Change history .....20**

History .....21

---

# Foreword

This Technical Specification has been produced by the 3<sup>rd</sup> Generation Partnership Project (3GPP).

The contents of the present document are subject to continuing work within the TSG and may change following formal TSG approval. Should the TSG modify the contents of the present document, it will be re-released by the TSG with an identifying change of release date and an increase in version number as follows:

Version x.y.z

where:

- x the first digit:
  - 1 presented to TSG for information;
  - 2 presented to TSG for approval;
  - 3 or greater indicates TSG approved document under change control.
- y the second digit is incremented for all changes of substance, i.e. technical enhancements, corrections, updates, etc.
- z the third digit is incremented when editorial only changes have been incorporated in the document.

---

# 1 Scope

The present document defines:

- a) an identification plan for mobile subscribers in the GSM system;
- b) principles of assigning telephone and ISDN numbers to MSs in the country of registration of the MS;
- c) principles of assigning Mobile Station (MS) roaming numbers to visiting MSs;
- d) an identification plan for location areas and base stations in the GSM system;
- e) an identification plan for MSCs and location registers in the GSM system;
- f) principles of assigning international mobile equipment identities;
- g) principles of assigning zones for regional subscription;
- h) an identification plan for groups of subscribers to the Voice Group Call Service (VGCS) and to the Voice Broadcast Service (VBS); and identification plan for voice group calls and voice broadcast calls; an identification plan for group call areas.

## 1.1 References

The following documents contain provisions which, through reference in this text, constitute provisions of the present document.

- References are either specific (identified by date of publication, edition number, version number, etc.) or non-specific.
- For a specific reference, subsequent revisions do not apply.
- For a non-specific reference, the latest version applies.
- A non-specific reference to an ETS shall also be taken to refer to later versions published as an EN with the same number.
- For this Release 1996 document, references to GSM documents are for Release 1996 versions (version 5.x.y).

- [1] GSM 01.04 (ETR 350): "Digital cellular telecommunications system (Phase 2+); Abbreviations and acronyms".
- [2] GSM 03.08: "Digital cellular telecommunications system (Phase 2+); Organization of subscriber data".
- [3] GSM 03.20 (ETS 300 929): "Digital cellular telecommunications system (Phase 2+); Security related network functions".
- [4] GSM 03.70: "Digital cellular telecommunications system (Phase 2+); Routing of calls to/from Public Data Networks (PDN)".
- [5] GSM 04.08 (ETS 300 940): "Digital cellular telecommunications system (Phase 2+); Mobile radio interface layer 3 specification".
- [6] GSM 09.03: "Digital cellular telecommunications system (Phase 2+); Signalling requirements on interworking between the Integrated Services Digital Network (ISDN) or Public Switched Telephone Network (PSTN) and the Public Land Mobile Network (PLMN)".
- [7] GSM 11.11 (ETS 300 977): "Digital cellular telecommunications system (Phase 2+); Specification of the Subscriber Identity Module - Mobile Equipment (SIM - ME) interface".
- [8] CCITT Recommendation E.164: "Numbering plan for the ISDN era".

- [9] CCITT Recommendation E.212: "Identification plan for land MSs".
- [10] CCITT Recommendation E.213: "Telephone and ISDN numbering plan for land MSs in public land mobile networks (PLMN)".
- [11] CCITT Recommendation X.121: "International numbering plan for public data networks".
- [12] GSM 04.68 (ETS 100 948): "Group Call Control (GCC) protocol".
- [13] GSM 04.69 (ETS 100 949): "Broadcast Call Control (BCC) Protocol".
- [14] GSM 09.02: "Mobile Application Part (MAP) specification".

## 1.2 Abbreviations

Abbreviations used in the present document are listed in GSM 01.04.

## 1.3 General comments to references

The identification plan for mobile subscribers defined below is that defined in CCITT Recommendation E.212.

The ISDN numbering plan for MSs and the allocation of mobile station roaming numbers is that defined in CCITT Recommendation E.213. Only one of the principles for allocating ISDN numbers is proposed for GSM PLMNs. Only the method for allocating MS roaming numbers contained in the main text of CCITT Recommendation E.213 is recommended for use in GSM PLMNs. If there is any difference between this Technical Specification and the CCITT Recommendations, the former shall prevail.

For terminology, see also CCITT Recommendations E.164 and X.121.

## 1.4 Conventions on bitordering

The following conventions hold for the coding of the different identities appearing in this Technical Specification and in other GSM Technical Specifications if not indicated otherwise:

- the different parts of an identity are shown in the figures in order of significance;
- the most significant part of an identity is on the left part of the figure and the least significant on the right.

When an identity appears in other Technical Specifications, the following conventions hold if not indicated otherwise:

- digits are numbered by order of significance, with digit 1 being the most significant;
- bits are numbered by order of significance, with the lowest bit number corresponding to the least significant bit.

---

# 2 Identification of mobile subscribers

## 2.1 General

A unique International Mobile Subscriber Identity (IMSI) shall be allocated to each mobile subscriber in the GSM system.

NOTE: This IMSI is the concept referred to by CCITT as "International Mobile Station Identity".

In order to support the subscriber identity confidentiality service the VLRs may allocate a unique Temporary Mobile Subscriber Identity (TMSI) to visiting mobile subscribers. The VLR must be capable of correlating the IMSI of an MS and the current TMSI for that MS.

In order to speed up the search for subscriber data in the VLR a supplementary Local Mobile Station Identity (LMSI) is defined.



The LMSI may be allocated by the VLR at location updating and is sent to the HLR together with the IMSI. The HLR makes no use of it but includes it together with the IMSI in all messages sent to the VLR concerning that MS.

## 2.2 Composition of IMSI

IMSI is composed as shown in figure 1.

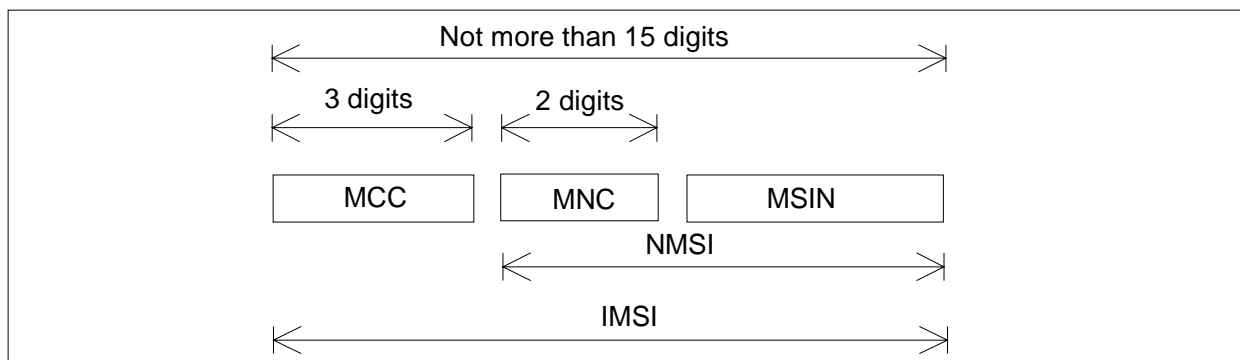

**Figure 1: Structure of IMSI**

IMSI is composed of three parts:

- i) Mobile Country Code (MCC) consisting of three digits. The MCC identifies uniquely the country of domicile of the mobile subscriber;
- ii) Mobile Network Code (MNC) consisting of two digits for GSM applications. The MNC identifies the home GSM PLMN of the mobile subscriber;
- iii) Mobile Subscriber Identification Number (MSIN) identifying the mobile subscriber within a GSM PLMN.

The National Mobile Subscriber Identity (NMSI) consists of the Mobile Network Code and the Mobile Subscriber Identification Number.

## 2.3 Allocation principles

IMSI shall consist of numerical characters (0 through 9) only.

The overall number of digits in IMSI shall not exceed 15 digits.

The allocation of Mobile Country Codes (MCCs) is administered by the CCITT and is given in annex A to CCITT Blue Book Recommendation E.212.

The allocation of National Mobile Subscriber Identity (NMSI) is the responsibility of each administration.

If more than one GSM PLMN exist in a country, a unique Mobile Network Code should be assigned to each of them.

The allocation of IMSIs should be such that not more than the digits MCC + MNC of the IMSI have to be analysed in a foreign GSM PLMN for information transfer.

## 2.4 Structure of TMSI

Since the TMSI has only local significance (i.e. within the VLR and the area controlled by the VLR), the structure and coding of it can be chosen by agreement between operator and manufacturer in order to meet local needs.

The TMSI consists of 4 octets. It can be coded using a full hexadecimal representation.

In order to avoid double allocation of TMSIs after a restart of a VLR, some part of the TMSI may be related to the time when it was allocated or contain a bit field which is changed when the VLR has recovered from the restart.

The TMSI shall only be allocated in ciphered form. See also GSM 03.20.

The network shall not allocate a TMSI with all 32 bits equal to 1 (this is because the TMSI must be stored in the SIM, and the SIM uses 4 octets with all bits equal to 1 for indicating that no valid TMSI is available).

## 2.5 Structure of LMSI

The LMSI consists of 4 octets and may be allocated by the VLR.

---

# 3 Numbering plan for mobile stations

## 3.1 General

Below the structure of the numbers used by a subscriber of a fixed (or mobile) network for calling a MS of a GSM PLMN is defined.

Also the structure of MS roaming numbers is defined.

One or more numbers of the ISDN numbering plan shall be assigned to a MS to be used for all calls to that station.

There may be a need for Mobile Stations (MS) to have a X.121 number. Because the MS has to have in any case a number from the ISDN numbering plan, the X.121 number will be in addition. Implications on numbering interworking functions which may need to be provided by the PLMN (if the use of X.121 numbers is required) are indicated in GSM 03.70.

NOTE: For card operated stations the ISDN number should be assigned to the holder of the card (personal number).

## 3.2 Numbering plan requirements

In principle, it should be possible for any subscriber of the ISDN or PSTN to call any MS in a GSM PLMN. This implies that ISDN numbers for MSs should comply with the ISDN numbering plan in each country.

The ISDN numbers of MSs should be composed in such a way that standard ISDN/PSTN charging can be used for calls to MSs.

It should be possible for each administration to develop its own independent numbering plan for MSs.

The numbering plan should not limit the possibility for MSs to roam among GSM PLMNs.

It should be possible to change the IMSI without changing the ISDN number allocated to a MS and vice versa.

In principle, it should be possible for any subscriber of the CSPDN/PSPDN to call any MS in a GSM PLMN. This implies that it may be necessary for an MS to have a X.121 number.

## 3.3 Structure of MS international PSTN/ISDN number (MSISDN)

The MS international ISDN numbers are allocated from the CCITT Recommendation E.164 numbering plan, see also CCITT Recommendation E.213. The MS international ISDN number will then be as shown in figure 2.

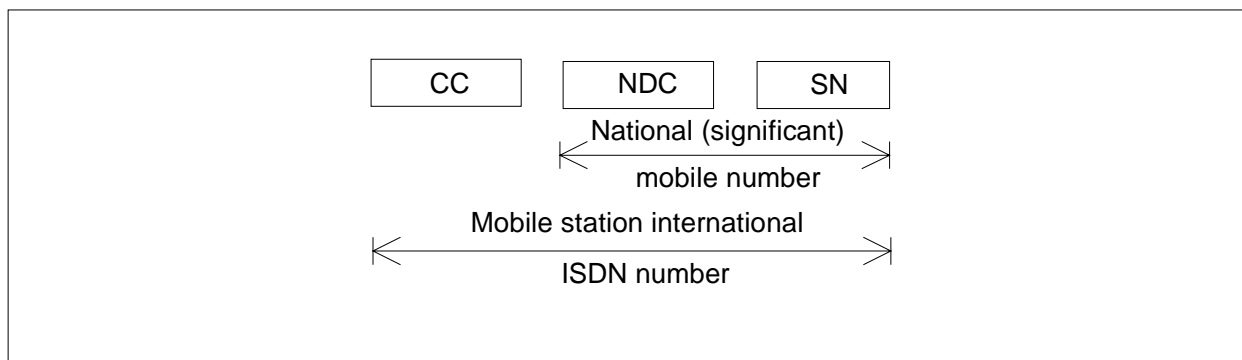

**Figure 2: Number Structure of MSISDN**

The number consists of:

- Country Code (CC) of the country in which the MS is registered, followed by
- National (significant) mobile number which consists of National Destination Code (NDC) and Subscriber Number (SN).

For GSM applications, a National Destination Code is allocated to each GSM PLMN. In some countries more than one NDC may be required for each GSM PLMN.

The composition of the MS international ISDN number should be such that it can be used as a global title address in the Signalling Connection Control Part (SCCP) for routing messages to the home location register of the MS. The country code (CC) and the national destination code (NDC) will provide such routing information. If further routing information is required, it should be contained in the first few digits of the subscriber number (SN).

A sub-address may be appended to an ISDN number for use in call setup and in supplementary service operations where an ISDN number is required (see CCITT Recommendations E.164, section 11.2 and X.213 annex A). The sub-address is transferred to the terminal equipment denoted by the ISDN number.

The maximum length of a sub-address is 20 octets, including one octet to identify the coding scheme for the sub-address (see CCITT Recommendation X.213, annex A). All coding schemes described in CCITT Recommendation X.213, annex A are supported in GSM.

### 3.4 Mobile Station Roaming Number (MSRN) for PSTN/ISDN routing

The Mobile Station Roaming Number (MSRN) is used to route calls directed to a MS. On request from the Gateway MSC via the HLR it is temporarily allocated to a MS by the VLR with which the MS is registered it addresses the Visited MSC collocated with the assigning VLR. More than one MSRN may be assigned simultaneously to a MS.

The MSRN is passed by the HLR to the Gateway MSC for routing calls to the MS.

The Mobile Station Roaming Number for PSTN/ISDN routing shall have the same structure as international ISDN numbers in the area in which the roaming number is allocated, i.e.:

- the country code of the country in which the visitor location register is located;
- the national destination code of the visitor GSM PLMN or numbering area;
- a subscriber number with the appropriate structure for that numbering area.

The MSRN must not be used for subscriber dialling. It should be noted that the MSRN can be identical to the MSISDN (section 3.3) in certain circumstances. In order to discriminate between subscriber generated access to these numbers and rerouting performed by the network, rerouting or redirection indicators or other signalling means should be used, if available (see GSM 09.03).

## 3.5 Structure of Mobile Station International Data Number

The structure of MS international data numbers should comply with the data numbering plan of CCITT Recommendation X.121 as applied in the home country of the mobile subscriber.

## 3.6 Handover Number

The handover number is used for establishment of a circuit between MSCs to be used for a call being handed over. The handover number may be reused in the same way as the MSRN.

---

# 4 Identification of location areas and base stations

## 4.1 Composition of the Location Area Identification (LAI)

The Location Area Identification shall be composed as shown in figure 3:

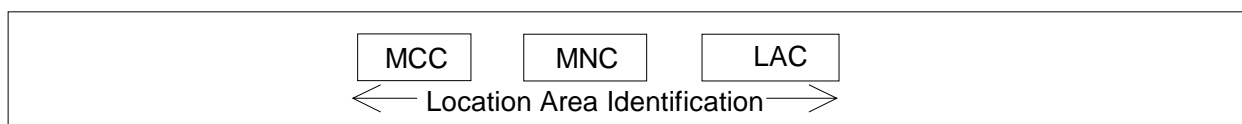

**Figure 3: Structure of Location Area Identification**

The LAI is composed of the following elements:

- Mobile Country Code (MCC) identifies the country in which the GSM PLMN is located. The value of the MCC is the same as the three digit MCC contained in international mobile subscriber identity (IMSI);
- Mobile Network Code (MNC) is a code identifying the GSM PLMN in that country. The MNC takes the same value as the two digit MNC contained in IMSI;
- Location Area Code (LAC) which is a fixed length code (of 2 octets) identifying a location area within a GSM PLMN. This part of the location area identification can be coded using a full hexadecimal representation except for the following reserved hexadecimal values:

0000, and

FFFE

These reserved values are used in some special cases when no valid LAI exists in the MS (see GSM 04.08 and GSM 11.11).

## 4.2 Base station identification

### 4.2.1 Cell Identity (CI) and Cell Global Identification (CGI)

The BSS and cell within the BSS is identified within a location area by adding a Cell Identity (CI) to the location area identification, as shown in figure 4. The CI is of fixed length with 2 octets and it can be coded using a full hexadecimal representation.

The Cell Global Identification is the concatenation of the Location Area Identification and the Cell Identity.

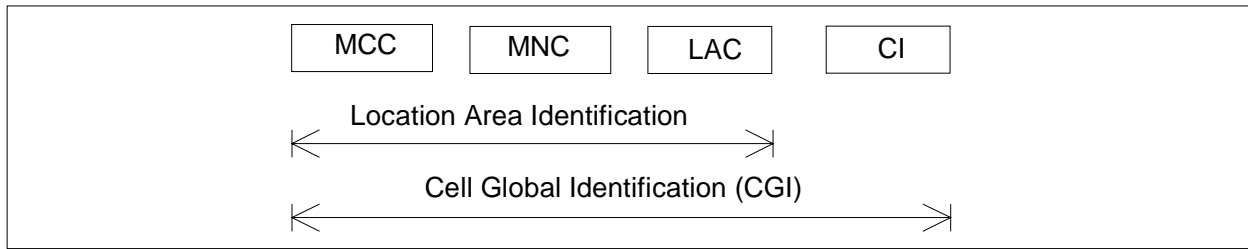

**Figure 4: Structure of Cell Global Identification**

### 4.2.2 Base Station Identify Code (BSIC)

The base station identity code is a local colour code that allows a MS to distinguish between different neighbouring base stations. BSIC is a 6 bit length code which is structured in the following way.

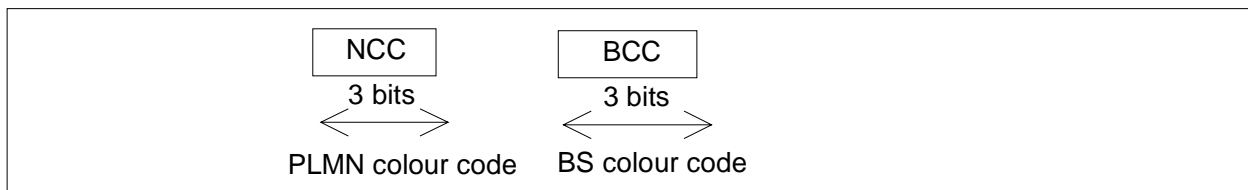
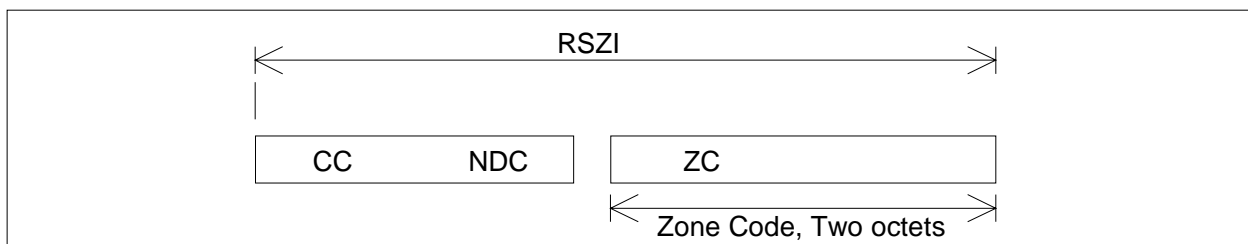

**Figure 5: Structure of BSIC**

In the definition of the NCC, care needs to be taken to ensure that the same NCC is not used in adjacent PLMNs which may use the same BCCH carrier frequencies in neighbouring areas. Therefore, to prevent potential deadlocks, a definition of the NCC appears in annex A. This annex will be reviewed in a co-ordinated manner when a PLMN is created.

### 4.3 Regional Subscription Zone Identity (RSZI)

A PLMN specific regional subscription defines unambiguously for the entire PLMN the regions in which roaming is allowed. It consists of one or more regional subscription zones. The regional subscription zone is identified by Regional Subscription Zone Identity (RSZI). A regional subscription zone identity is composed as shown in figure 6.



**Figure 6: Structure of Regional Subscription Zone Identity (RSZI)**

The elements of the regional subscription zone identity are:

- the Country Code (CC) which identifies the country in which the GSM PLMN is located;
- the National Destination Code (NDC) which identifies the GSM PLMN in that country;
- the Zone Code (ZC) which identifies a regional subscription zone as a pattern of allowed and not allowed location areas uniquely within that PLMN.

CC and NDC are those of a CCITT E.164 VLR number (see section 5.1) of the PLMN and are coded with a tailing filler, if required. ZC has fixed length of two octets and is coded in full hexadecimal representation.

RSZIs including the zone codes are assigned by the VLR operator. The zone code is evaluated in the VLR by information stored in the VLR as a result of administrative action. If a zone code is received by a VLR during updating by the HLR and this zone code is related to that VLR, the VLR shall be able to decide for all its MSC areas and all its location areas whether they are allowed or not allowed.

For details of assignment of RSZI and of ZC as subscriber data see GSM 03.08.

For selection of RSZI at location updating by comparison with the leading digits of the VLR number and for transfer of ZC from the HLR to VLR see GSM 09.02.

## 4.4 Location Number

A location number is a number which defines a specific location within a GSM PLMN. The Location number is formatted according to CCITT Recommendation E.164, as shown in figure 7. The country code (CC) and national destination code (NDC) fields of the location number are those which define the GSM PLMN of which the location is part.



**Figure 7: Location Number Structure**

The structure of the locally significant part (LSP) of the location number is a matter for agreement between the PLMN operator and the national numbering authority in the PLMN's country. It is desirable that the location number can be interpreted without the need for detailed knowledge of the internal structure of the PLMN; the LSP should therefore include the national destination code in the national numbering plan for the fixed network which defines the geographic area in which the location lies.

The set of location numbers for a GSM PLMN must be chosen so that a location number can be distinguished from the MSISDN of a subscriber of the PLMN. This will allow the PLMN to trap attempts by users to dial a location number.

## 5 Identification of MSCs and location registers

### 5.1 Identification for routing purpose

MSCs and location registers are identified by international PSTN/ISDN numbers and/or Signalling Point Codes ("entity number", i.e. "HLR number", "VLR number", "MSC number") in each GSM PLMN.

### 5.2 Identification of HLR for HLR restoration application

HLR may also be identified by one or several "HLR id(s)", consisting of the leading digits of the IMSI (MCC + MNC + leading digits of MSIN).

## 6 International Mobile Station Equipment Identity and Software Version Number

### 6.1 General

Below the structure and allocation principles of the International Mobile station Equipment Identity and Software Version Number (IMEISV) and the International Mobile station Equipment Identity (IMEI) are defined.

The Mobile Station Equipment is uniquely defined by the IMEI or the IMEISV.

## 6.2 Composition of IMEI and IMEISV

### 6.2.1 Composition of IMEI

The International Mobile station Equipment Identity (IMEI) is composed as shown in figure 8.

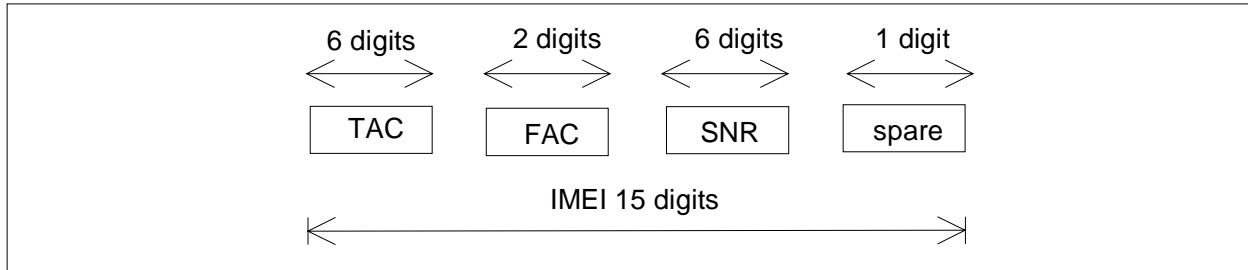

**Figure 8: Structure of IMEI**

The IMEI is composed of the following elements (each element shall consist of decimal digits only):

- Type Approval Code (TAC). Its length is 6 digits;
- Final Assembly Code (FAC) identifies the place of manufacture/final assembly. Its length is 2 digits;
- Serial Number (SNR) is an individual serial number uniquely identifying each equipment within each TAC and FAC. Its length is 6 digits.
- Spare digit: this digit shall be zero, when transmitted by the MS.

The security requirements of the IMEI are defined in TS GSM 02.16.

### 6.2.2 Composition of IMEISV

The International Mobile station Equipment Identity and Software Version Number (IMEISV) is composed as shown in figure 9.

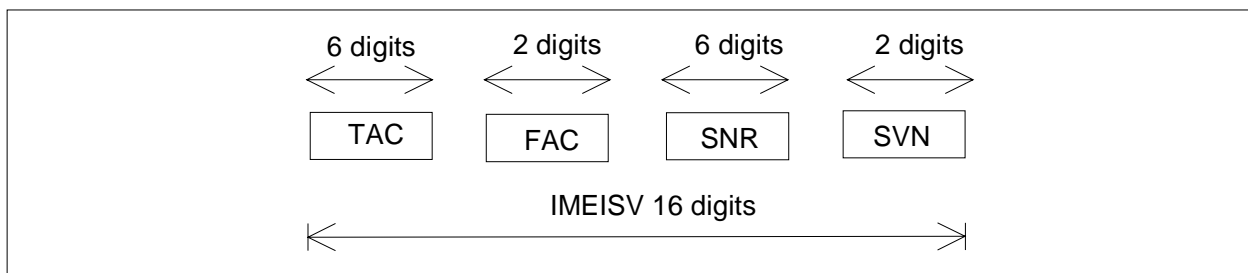

**Figure 9: Structure of IMEISV**

The IMEISV is composed of the following elements (each element shall consist of decimal digits only):

- Type Approval Code (TAC). Its length is 6 digits;
- Final Assembly Code (FAC) identifies the place of manufacture/final assembly. Its length is 2 digits;
- Serial Number (SNR) is an individual serial number uniquely identifying each equipment within each TAC and FAC. Its length is 6 digits.
- Software Version Number (SVN) identifies the software version number of the mobile equipment. Its length is 2 digits.

Regarding updates of the IMEISV: the security requirements of TS GSM 02.16 apply only to the TAC, FAC and SNR, but not to the SVN part of the IMEISV.

## 6.3 Allocation principles

The Type Approval Code (TAC) is issued by a central body.

The place of final assembly (FAC) is encoded by the manufacturer.

Manufacturers shall allocate individual serial numbers (SNR) in a sequential order.

For a given ME, the combination of TAC, FAC and SNR used in the IMEI shall duplicate the combination of TAC, FAC and SNR used in the IMEISV.

The Software Version Number is allocated by the manufacturer after authorization by the type approval authority. SVN value 99 is reserved for future use.

---

# 7 Identification of Voice Group Call and Voice Broadcast Call Entities

## 7.1 Group Identities

Logical groups of subscribers to the Voice Group Call Service or to the Voice Broadcast Service are known by a Group Identity (Group ID). Group IDs for VGCS are unique within a PLMN. Likewise, Group IDs for VBS are unique within a PLMN. However, no uniqueness is required between the sets of Group IDs. These sets may be intersecting or even identical, at the option of the network operator.

The Group ID is a number with a maximum value depending on the composition of the voice group call reference or voice broadcast call reference defined in section 7.3.

For definition of Group ID on the radio interface, A interface and Abis interface, see GSM 04.68 [12] and GSM 04.69 [12].

For definition of Group ID coding on MAP protocol interfaces, see GSM 09.02 [14].

VGCS or VBS shall also be provided in case of roaming. If this applies, certain Group IDs shall be defined as supra-PLMN Group IDs which have to be co-ordinated between the network operators and which shall be known in the networks and in the SIM.

The formats of the Group ID is identical for VBS and VGCS.

## 7.2 Group Call Area Identification

Groupings of cells into specific group call areas occurs in support of both the Voice Group Call Service and the Voice Broadcast Service. These service areas are known by a "Group Call Area Identity" (Group Call Area Id). No restrictions are placed on what cells may be grouped into a given group call area.

The Group Call Area ID is a number uniquely assigned to a group call area in one network and with a maximum value depending on the composition of the voice group call reference or voice broadcast reference defined under 7.3.

The formats of the Group Call Area ID for VGCS and the Group Call Area ID for VBS are identical.

## 7.3 Voice Group Call and Voice Broadcast Call References

Specific instances of voice group calls (VGCS) and voice broadcast calls (VBS) within a given group call area are known by a "Voice Group Call Reference" or by a "Voice Broadcast Call Reference" respectively.



Each voice group call or voice broadcast call in one network is uniquely identified by its Voice Group Call Reference or Voice Broadcast Call Reference. The Voice Group Call Reference or Voice Broadcast Call Reference is composed of the Group ID and the Group Call Area ID. The composition of the group call area ID and the group ID can be specific for each network operator.

For definition of Group Call Reference (with leading zeros inserted as necessary) on the radio interface, A interface and Abis interface, see GSM 04.08 [7], GSM 04.68 [12] and GSM 04.69 [13].

For definition of Group Call Reference (also known as ASCII Call Reference, Voice Group Call Reference or Voice Broadcast Call Reference) coding on MAP protocol interfaces, see GSM 09.02 [14].

The format is given in figure 10.



Figure 10: Voice Group Call Reference / Voice Broadcast Call Reference

## 8 SCCP subsystem numbers

Subsystem numbers are used to identify applications within network entities which use SCCP signalling. In GSM, subsystem numbers may be used between PLMNs, in which case they are taken from the globally standardised range (1 - 31) or the part of the national network range (129 – 150) reserved for GSM use between PLMNs, or within a PLMN, in which case they are taken from the part of the national network range (32 – 128 & 151 - 254) not reserved for GSM use between PLMNs.

### 8.1 Globally standardised subsystem numbers used for GSM

The following globally standardised subsystem numbers have been allocated for use by GSM:

0000 0110HLR (MAP);

0000 0111VLR (MAP);

0000 1000MSC (MAP);

0000 1001EIR (MAP);

0000 1010is allocated for evolution (possible Authentication centre).

### 8.2 National network subsystem numbers used for GSM

The following national network subsystem numbers have been allocated for use within GSM networks:

1111 1101BSS O&M (A interface);

1111 1110BSSAP (A interface).

The following national network subsystem numbers have been allocated for use within and between GSM networks:

1001 0010CAP;

1001 0011gsmSCF(MAP).

## 8.3 National network subsystem numbers used for CAP

The following principles shall be applied in order to allow a correct migration:

1. From 1-1-2000 and until the 31-3-2001, the gsmSCF shall accept the subsystem number 0000 0101 as well as the subsystem number 1001 0010 to identify CAP. After the 31-3-2001, the gsmSCF may accept only 1001 0010 for CAP.
2. The migration phase for the gsmSSF shall start at the earliest the 1-1-2000 and end at the latest the 31-3-2001. For CAP, either subsystem numbers 0000 0101 or 1001 0010 (but not both) may be used by the gsmSSF during the migration phase. After the migration phase, only 1001 0010 shall be used by gsmSSF for CAP.
3. The gsmSCF shall reply with the SSN which was sent by the gsmSSF in the operation. As the gsmSSF is always initiating the dialogue with the InitialDP operation, the SSN used by the gsmSSF and the gsmSCF will be the SSN used for transfer of the InitialDP operation. Note: this includes both SSNs in the calling and called address in the SCCP.

---

## Annex A (informative): Colour Codes

### A.1 Utilization of the BSIC

To each cell is allocated a BSIC, within 64 values. In each cell its BSIC is broadcast in each burst sent on the SCH, and is then known by all MSs which get the synchronization with this cell. The BSIC is used by the MS for several purposes, all aiming of avoiding ambiguity or interference which can arise when a MS in a given position can receive two cells *using the same BCCH frequency*.

Some of the utilizations of the BSIC relate to cases where the MS is attached to one of the cells. Other utilizations relates to cases where the MS is attached to third cell, usually somewhere between the two cells in question.

The first category of utilizations includes:

- The three least significant bits of the BSIC indicate which of the 8 training sequences is used in the bursts sent on the downlink common channels of the cell. Different training sequences allow for a better transmission in case of interference. The group of the three least significant bits of the BSIC is called the BCC (Base station Colour Code).
- The BSIC is used to modify the bursts sent by the MSs on the access bursts. This aims to avoid one cell decoding correctly access bursts sent to another cell.

The second category of utilizations includes:

- When in connected mode, the MSs measure and report the level they receive on a number of frequencies, corresponding to the BCCH frequencies of neighbouring cells in the same network as the used cell. Along with the measurement result, the MS provides the network with the BSIC it has received on the frequency. This enables the network to discriminate between several cells happening to use the same BCCH frequency. Bad discrimination might result in faulty handovers.
- The contents of the measurement report messages is limited to 6 neighbour cells. It is then useful to limit the reported cells to those to which handovers are accepted. To this avail, each cell provides a list of the values of the three most significant bits of the BSICs that are allocated to the cells that are useful to consider for handovers (usually excluding cells in other PLMNs). This information enables the MS to put aside cells with non-conformant BSIC and not to report about them. The group of the three most significant bits of the BSIC is called the NCC (Network Colour Code).

It should be noted that when in idle mode, the MS identifies a cell (for cell selection purposes) according to the cell identity broadcast on the BCCH and *not* by the BSIC.

---

### A.2 Guidance for planning

From these utilizations, the following planning rule can be derived:

*If there exist places where MSs can receive two cells, whether in the same PLMN or in different ones, that use the same BCCH frequency, it is highly preferable that these two cells have different BSICs.*

Where the coverage areas of two PLMNs overlap, the rule above is respected if:

- i) The PLMNs uses different sets of BCCH frequencies. This is in particular the case if no frequency is common to the two PLMNs. This usually holds for PLMNs in the same country.
- ii) The PLMNS use different sets of NCCs.
- iii) BSIC and BCCH frequency planning is co-ordinated.

Recognizing that method iii) is more cumbersome than method ii), and that method i) is too constraining, it is suggested that overlapping PLMNs using common part of spectrum agree on different NCCs to be used in overlapping area. As an example, a preliminary NCC allocation for countries in the European region can be found in section A.3 of this annex.

This example can be used as basis for bilateral agreements. However, the usage of the NCCs allocated in section A.3 is not compulsory. PLMN operators can agree on different BSIC allocation rules in border areas. The usage of BSICs is not constrained in non overlapping areas, or if ambiguities are resolved by using different sets of BCCH frequencies.

---

## A.3 Example of PLMN Colour Codes (NCCs) for the European region

Austria	:	0
Belgium	:	1
Cyprus	:	3
Denmark	:	1
Finland	:	0
France	:	0
Germany	:	3
Greece	:	0
Iceland	:	0
Ireland	:	3
Italy	:	2
Liechtenstein	:	2
Luxembourg	:	2
Malta	:	1
Monaco	:	3 (possibly 0(=France))
Netherlands	:	0
Norway	:	3
Portugal	:	3
San Marino	:	0 (possibly 2(= Italy))
Spain	:	1
Sweden	:	2
Switzerland	:	1
Turkey	:	2
UK	:	2
Vatican	:	1 (possibly 2(=Italy))
Yugoslavia	:	3

This allows for each country a second operator by allocating the colour codes  $n$  (in the table) and  $n + 4$ . More than 2 colour codes per country may be used provided that in border areas only the values  $n$  and/or  $n+4$  are used.

## Annex B (informative): Change history

SMG#	SPEC	CR	PH	VERS	NEW_VE	SUBJECT
s25	03.03	A004	R96	5.0.2	5.1.0	Definitions of SCCP subsystem numbers
	03.03			5.1.0	5.1.1	Version update for publication
S29	03.03	A028r2	R96	5.1.1	5.2.0	SSN reallocation for CAP and gsmSCF
S29	03.03	A029	R96	5.1.1	5.2.0	Correction of VGC/VBC reference
	03.03			5.2.0	5.2.1	Update to Version 5.2.1 for Publication
CN#07	03.03	A040r1	R96	5.2.1	5.3.0	Modification of section 6.2 to enhance IMEI security
CN#08	03.03	A043r1	R96	5.3.0	5.4.0	Editorial Modification of section 6.2.2
	03.03			5.4.0	5.4.1	Update to Version 5.4.1 for Publication
CN#21	03.03	A059r1	R96	5.4.1	5.5.0	Correction to definition of Group-ID, Group call area ID and Group Call Reference

## History

<b>Document history</b>		
V5.0.0	March 1996	Publication as GTS 03.03
Edition 1	November 1996	Unified Approval Procedure UAP 59: 1996-11-25 to 1997-03-21
Edition 1	April 1997	Publication as ETS 300 927
Edition 2	May 1998	One-step Approval Procedure OAP 9841: 1998-05-20 to 1998-10-16
Edition 2	October 1998	Publication as ETS 300 927
Edition 3	July 1999	One-step Approval Procedure OAP 9950: 1999-07-14 to 1999-11-12
Edition 3	November 1999	Publication as ETS 300 927
V5.3.0	July 2000	One-step Approval Procedure OAP 20001103: 2000-07-05 to 2000-11-03
V5.4.0	August 2000	One-step Approval Procedure OAP 20001201: 2000-08-02 to 2000-12-01
V5.3.1	November 2000	Publication as EN 300 927
V5.4.1	December 2000	Publication as EN 300 927
V5.5.0	September 2003	Publication