

ETSI TS 100 605 V6.1.0 (1999-07)

Technical Specification

**Digital cellular telecommunications system (Phase 2+);
Information element mapping between
Mobile Station - Base Station System (MS - BSS) and Base
Station System - Mobile-services Switching Centre
(BSS - MSC);
Signalling procedures and the Mobile Application Part (MAP)
(GSM 09.10 version 6.1.0 Release 1997)**



GSM®
GLOBAL SYSTEM FOR
MOBILE COMMUNICATIONS

ETSI 

Reference

RTS/SMG-030910Q6R1 (5lo030c3.PDF)

Keywords

Digital cellular telecommunications system,
Global System for Mobile communications (GSM)

ETSI

Postal address

F-06921 Sophia Antipolis Cedex - FRANCE

Office address

650 Route des Lucioles - Sophia Antipolis
Valbonne - FRANCE
Tel.: +33 4 92 94 42 00 Fax: +33 4 93 65 47 16
Siret N° 348 623 562 00017 - NAF 742 C
Association à but non lucratif enregistrée à la
Sous-Préfecture de Grasse (06) N° 7803/88

Internet

secretariat@etsi.fr
Individual copies of this ETSI deliverable
can be downloaded from
<http://www.etsi.org>
If you find errors in the present document, send your
comment to: editor@etsi.fr

Copyright Notification

No part may be reproduced except as authorized by written permission.
The copyright and the foregoing restriction extend to reproduction in all media.

© European Telecommunications Standards Institute 1999.
All rights reserved.

Contents

Intellectual Property Rights.....	4
Foreword	4
1 Scope.....	5
1.1 References.....	5
1.2 Abbreviations.....	6
2 Classification of interworking cases	6
2.1 Transparent procedures.....	6
2.2 Non-transparent procedures	6
3 Interworking in the MSC, Transparent case	7
3.1 General.....	7
3.2 Location area updating.....	9
3.3 Detach IMSI.....	10
3.4 Routeing area updating	11
3.5 Authentication.....	12
3.6 Retrieval of the IMSI from the MS	13
3.7 Reallocation of TMSI	13
3.8 Retrieval of the IMEI from the MS.....	14
3.9 Tracing subscriber activity.....	14
4 Non-transparent cases	15
4.1 General.....	15
4.2 Outgoing call set-up (MS originating call).....	15
4.3 Incoming call set-up (MS terminating call).....	19
4.4 Cipher mode setting	21
4.5 Inter-MSC Handover	21
4.5.1 Basic Inter-MSC Handover	22
4.5.2 Subsequent Inter-MSC Handover back to MSC-A.....	27
4.5.3 Subsequent Inter-MSC Handover to third MSC.....	31
4.5.4 BSSAP Messages transfer on E-Interface	35
4.5.5 Processing in MSC-B, and information transfer on E-interface	36
4.5.5.1 Encryption Information.....	36
4.5.5.2 Channel Type.....	37
4.5.5.3 Classmark	37
4.5.5.4 Downlink DTX-Flag.....	38
4.5.5.5 Priority.....	38
4.5.5.6 MSC/BSC-Invoke Trace Information Elements	38
4.5.6 Overview of the Technical Specifications GSM interworking for the Inter-MSC Handover.....	38
Annex A (informative): Document change history.....	40
History	41

Intellectual Property Rights

IPRs essential or potentially essential to the present document may have been declared to ETSI. The information pertaining to these essential IPRs, if any, is publicly available for **ETSI members and non-members**, and can be found in SR 000 314: *"Intellectual Property Rights (IPRs); Essential, or potentially Essential, IPRs notified to ETSI in respect of ETSI standards"*, which is available **free of charge** from the ETSI Secretariat. Latest updates are available on the ETSI Web server (<http://www.etsi.org/ipr>).

Pursuant to the ETSI IPR Policy, no investigation, including IPR searches, has been carried out by ETSI. No guarantee can be given as to the existence of other IPRs not referenced in SR 000 314 (or the updates on the ETSI Web server) which are, or may be, or may become, essential to the present document.

Foreword

This Technical Specification (TS) has been produced by the Special Mobile Group (SMG).

The present document specifies Information element mapping between Mobile Station - Base Station System (MS - BSS) and Base Station System - Mobile-services Switching Centre (BSS - MSC) Signalling procedures and the Mobile Application Part (MAP) within the digital cellular telecommunications system.

The contents of the present document is subject to continuing work within SMG and may change following formal SMG approval. Should SMG modify the contents of the present document, it will be re-released by SMG with an identifying change of release date and an increase in version number as follows:

Version 6.x.y

where:

- 6 indicates GSM Phase 2+ Release 1997;
- x the second digit is incremented for all other types of changes, i.e. technical enhancements, corrections, updates, etc.;
- y the third digit is incremented when editorial only changes have been incorporated in the specification.

1 Scope

The scope of the present document is:

- i) to provide a detailed specification for the interworking between information elements contained in layer 3 messages sent on the MS-MSC interface (Call Control and Mobility Management parts of GSM 04.08) and parameters contained in MAP services sent over the MSC-VLR interface (GSM 09.02) where the MSC acts as a transparent relay of information;
- ii) to provide a detailed specification for the interworking between information elements contained in BSSMAP messages sent on the BSC-MSC interface (GSM 08.08) and parameters contained in MAP services sent over the MSC-VLR interface (GSM 09.02) where the MSC acts as a transparent relay of information;
- iii) to provide a detailed specification for the interworking as in i) and ii) above when the MSC also processes the information.

Interworking for supplementary services is given in GSM 09.11. Interworking for the short message service is given in GSM 03.40 and GSM 04.11. Interworking between the call control signalling of GSM 04.08 and the PSTN/ISDN is given in GSM 09.03, GSM 09.07 and GSM 09.08. Interworking between the 'A' and 'E' interfaces for inter-MSC handover signalling is given in GSM 09.07 and 09.08.

1.1 References

The following documents contain provisions which, through reference in this text, constitute provisions of the present document.

- References are either specific (identified by date of publication, edition number, version number, etc.) or non-specific.
- For a specific reference, subsequent revisions do not apply.
- For a non-specific reference, the latest version applies.
- A non-specific reference to an ETS shall also be taken to refer to later versions published as an EN with the same number.
- For this Release 1997 document, references to GSM documents are for Release 1997 versions (version 6.x.y).

- [1] GSM 01.04: "Digital cellular telecommunications system (Phase 2+); Abbreviations and acronyms".
- [2] GSM 03.09: "Digital cellular telecommunications system (Phase 2+); Handover procedures".
- [3] GSM 03.40: "Digital cellular telecommunications system (Phase 2+); Technical realization of the Short Message Service (SMS) Point to Point (PP)".
- [4] GSM 04.08: "Digital cellular telecommunications system (Phase 2+); Mobile radio interface layer 3 specification".
- [5] GSM 04.10: "Digital cellular telecommunications system (Phase 2+); Mobile radio interface layer 3 Supplementary services specification General aspects".
- [6] GSM 04.11: "Digital cellular telecommunications system (Phase 2+); Point-to-Point (PP) Short Message Service (SMS) support on mobile radio interface".
- [7] GSM 08.08: "Digital cellular telecommunications system (Phase 2+); Mobile Switching Centre - Base Station System (MSC - BSS) interface Layer 3 specification".
- [8] GSM 09.02: "Digital cellular telecommunications system (Phase 2+); Mobile Application Part (MAP) specification".

- [9] GSM 09.03: "Digital cellular telecommunications system (Phase 2+); Signalling requirements on interworking between the Integrated Services Digital Network (ISDN) or Public Switched Telephone Network (PSTN) and the Public Land Mobile Network (PLMN)".
- [10] GSM 09.07: "Digital cellular telecommunications system (Phase 2+); General requirements on interworking between the Public Land Mobile Network (PLMN) and the Integrated Services Digital Network (ISDN) or Public Switched Telephone Network (PSTN)".
- [11] GSM 09.08: "Digital cellular telecommunications system (Phase 2+); Application of the Base Station System Application Part (BSSAP) on the E-interface".
- [12] GSM 09.11: "Digital cellular telecommunications system (Phase 2+); Signalling interworking for supplementary services".

1.2 Abbreviations

Abbreviations used in the present document are listed in GSM 01.04.

2 Classification of interworking cases

2.1 Transparent procedures

The following MSC procedures require transparent mapping of BSSAP information elements into MAP parameters and vice versa (see GSM 09.02 for definitions and the use of the procedures):

- update location area;
- detach IMSI;
- forward new TMSI;
- provide IMSI;
- obtain IMEI;
- check IMEI;
- authenticate;
- trace subscriber activity.

2.2 Non-transparent procedures

Procedures in this class require processing in the MSC and information element mapping. These procedures include those related to:

- outgoing call set-up;
- incoming call set-up;
- handover;
- cipher mode setting.

3 Interworking in the MSC, Transparent case

3.1 General

When the MSC receives a forward message from the BSS (possibly forwarded transparently from the MS), it will invoke the desired MAP service and establish a cross reference between the BSSAP procedure and the MAP procedure in order to return the result of the operation to the BSS (which may forward it transparently to the MS). The cross reference is deleted when the MSC terminates the MAP procedure.

Positive or negative results of the MAP procedure are returned in the appropriate BSSAP message.

The parameters of the forward BSSAP message are mapped by a one-to-one mapping into the parameters of the MAP service. However, in some cases parameters received on the radio path may be suppressed at the MSC because they are related to another protocol entity, e.g. information related to RR-management may be included in MM-management messages. Similarly, parameters received in the (positive) MAP service response are mapped one-to-one into parameters of the corresponding backward BSSAP message.

A negative outcome, as carried in various MAP services (MAP specific service response, MAP_U_ABORT, MAP_P_ABORT, MAP_NOTICE and premature MAP_CLOSE, see GSM 09.02 for definitions) is mapped into a cause value in the required backward BSSAP message. In this case several negative results of MAP may be mapped into the same BSSAP cause value, i.e. without discrimination between these negative results.

NOTE: For O & M purposes, the MAP procedure entity in the MSC may require a more detailed overview of negative results than the MS.

These principles are illustrated in figure 1.

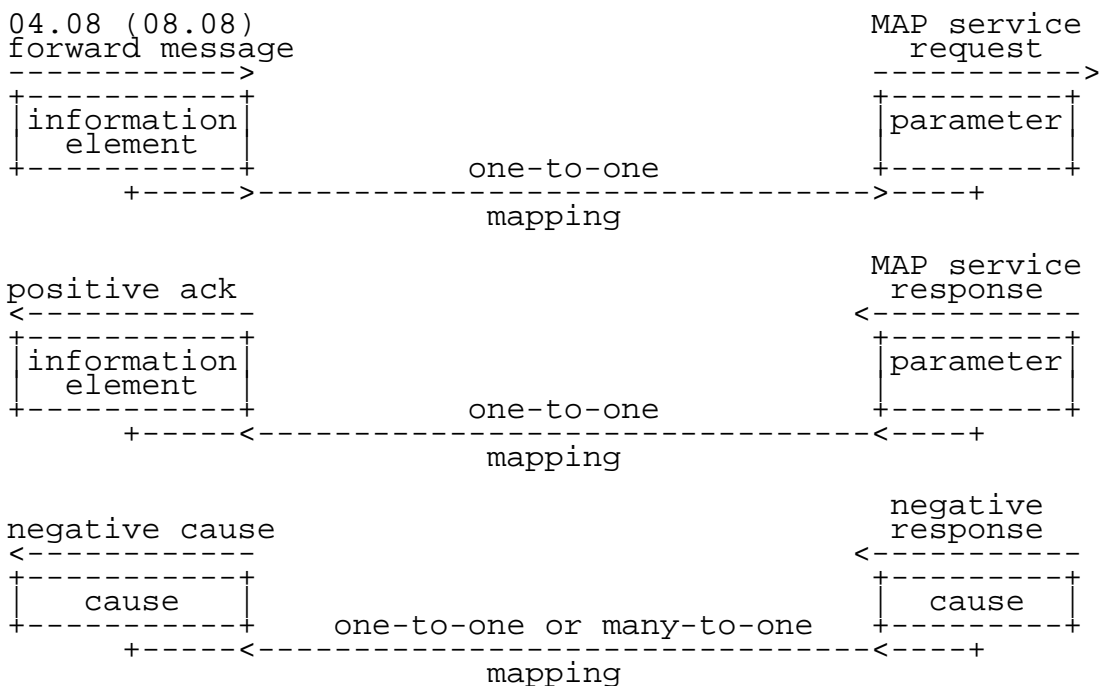

Figure 1: Illustration of mapping principles in the MSC

For each of the transparent operations listed in subclause 2.1, the following format is used to show the mapping.

	04.08 or 08.08		09.02	Notes
Forward message	MS/BSS to MSC message name information element 1 information element 2	<---> <--->	MSC to VLR MAP service request parameter 1 parameter 2	
Positive result	MSC to MS/BSS message name information element 1 information element 2	<---> <--->	VLR to MSC positive response parameter 1 parameter 2	
Negative result	MSC to MS/BSS message name cause 1 cause 2 cause 3 cause 3 cause 3	<---> <---> <---> <---> <--->	VLR to MSC negative response cause 1 cause 2 MAP U/P_ABORT MAP_NOTICE MAP_CLOSE	

Equivalent mapping principles apply for operations invoked by the VLR towards the BSS/MS. However, negative results are generally not received from the BSS/MS but are generated in the MSC. Therefore, for such operations the interworking for negative results is not normally shown.

3.2 Location area updating

	08.08/04.08	09.02	Notes
Forward message	COMPLETE LAYER 3 INFO (LOCATION UPDATING REQUEST) Location area id Mobile identity Mobile station classmark 1 Ciphering key seq number Location update type Cell identifier Chosen channel	MAP_UPDATE_LOCATION_AREA request Previous LA Id IMSI or TMSI CKSN Location update type Target LA Id -	4 3 1
Positive results	DTAP (LOCATION UPDATING ACCEPT) Location area identity Mobile identity Follow on proceed	MAP_UPDATE_LOCATION_AREA response - - -	5
Negative results	DTAP (LOCATION UPDATING REJECT) IMSI unknown in HLR Network failure PLMN not allowed LA not allowed Roaming not allowed in this LA PLMN not allowed Illegal MS Illegal ME Network failure Network failure Network failure Network failure Network failure	MAP_UPDATE_LOCATION_AREA response Unknown subscriber Unknown LA Roaming not allowed: PLMN not allowed LA not allowed National Roaming not allowed Operator determined barring Illegal subscriber Illegal equipment System Failure Unexpected data value MAP_U/P_ABORT MAP_NOTICE MAP_CLOSE	6 2

NOTE 1: The Target LA Id parameter is derived by the MSC from the Cell identifier information element.

NOTE 2: The Unknown LA error is only generated as a result of incorrect information being inserted by the MSC or BSS.

NOTE 3: This parameter can be used by the VLR to decide whether (e.g.) Authentication or IMEI checking is needed.

NOTE 4 As the mobile station classmark (1 or 2) is received by the MSC at the establishment of every RR connection, this information need not be stored in the VLR, but it is stored in the MSC as long as the RR connection exists.

NOTE 5 The mobile identity is inserted by the MSC if it is received in a MAP_FORWARD_NEW_TMSI service. If a TMSI is included, the MS should respond with a TMSI REALLOCATION COMPLETE message.

NOTE 6 The HLR shall also send this error if there is an error in the type of subscription (i.e. VLR requests service for a GPRS only subscriber)

3.3 Detach IMSI

	04.08	09.02	Notes
Forward message	IMSI DETACH INDICATION Mobile identity Mobile Station classmark 1	MAP_DETACH_IMSI request IMSI or TMSI -	
Positive result			1
Negative result			

NOTE 1: The forward message is not acknowledged.

Depending on the state of the MS, the IMSI DETACH INDICATION may be carried in either a DTAP message or a BSSMAP COMPLETE LAYER 3 INFORMATION message.

3.4 Routeing area updating

	04.08	09.02	Notes
Forward message	GMM (ROUTEING AREA UPDATE REQUEST) MS classmark 1 MS classmark 4 GPRS Cipherring key seq number Mobile station identity Old routeing area identification	MAP_UPDATE_GPRS LOCATION request - - - IMSI -	-
Positive results	GMM (ROUTEING AREA UPDATE ACCEPT) Routeing area identification Mobile station identity C Mobile station C Reject: IMSI unknown in HLR C Reject: MSC temporarily not reacheable	MAP_UPDATE_GPRS LOCATION response - - - - -	1 2 3 4
Negative results	GMM (ROUTEING AREA UPDATE REJECT) Network failure GPRS services not allowed GPRS services and non GPRS services not allowed C GPRS services not allowed C GPRS services and non-GPRS services not allowed MS identity cannot be derived by the network PLMN not allowed LA not allowed Roaming not allowed in this LA PLMN not allowed Illegal MS Illegal ME Network failure Network failure Network failure Network failure Network failure	MAP_UPDATE_GPRS LOCATION response - Unknown subscriber (no GPRS subscription) Unknown subscriber (IMSI unknowkn) Unknown subscriber (no GPRS subscription) Unknown subscriber (IMSI unknown) - Roaming not allowed: PLMN not allowed - - Operator determined barring - - System Failure Unexpected data value MAP_U/P_ABORT MAP_NOTICE MAP_CLOSE	5 6 7 8 9 10

NOTE 1: The mobile station identity is inserted by the SGSN if the SGSN wants to deallocate or re-allocate a P-TMSI. If the SGSN wants to deallocate the P-TMSI it shall include the IMSI. If the SGSN wants to re-allocate the P-TMSI it shall include the new P-TMSI. If a P-TMSI is included, the MS shall respond with a ROUTEING AREA UPDATE COMPLETE message.

NOTE 2: The mobile station identity is inserted by the SGSN if it is received in a BSSAP+ LOCATION UPDATE ACCEPT message from the VLR. If a TMSI is included, the MS shall respond with a ROUTEING AREA UPDATE COMPLETE message. Only used in the Combined Routeing and Location Area procedure.

- NOTE 3: This reject cause is inserted on the positive response by the SGSN if the SGSN receives a BSSAP+ LOCATION UPDATE REJECT message from the VLR indicating in the reject cause IMSI unknown in HLR. Only used in the Combined Routeing and Location Area procedure.
- NOTE 4: This reject cause is inserted on the positive response by the SGSN if the SGSN does not receive any response from the VLR to a previous BSSAP+ LOCATION UPDATE REQUEST message. Only used in the Combined Routeing and Location Area procedure.
- NOTE 5: The Unknown RA error is only generated as a result of incorrect information being inserted by the BSS.
- NOTE 6: The HLR shall send Unknown subscriber with diagnostic value No GPRS subscription if the HLR indicates that there is an error in the type of subscription (i.e. SGSN requests service for a non-GPRS only subscriber).
- NOTE 7: The HLR shall send Unknown subscriber with diagnostic value IMSI unknown if the HLR indicates that the IMSI provided by the SGSN is unknown.
- NOTE 8: The HLR shall send Unknown subscriber with diagnostic value No GPRS subscription if the HLR indicates that there is an error in the type of subscription (i.e. SGSN requests service for a non-GPRS only subscriber). Used in the Combined Routeing and Location Area procedure.
- NOTE 9: This reject cause is inserted if the SGSN receives a MAP GPRS UPDATE LOCATION negative response message indicating IMSI unknown. Used in the Combined Routeing and Location Area procedure.
- NOTE 10: This reject cause is inserted if the SGSN does not receive any response from the old SGSN to a previous SGSN CONTEXT REQUEST message.

3.5 Authentication

The message flow for the authentication procedure is shown in figure 2.

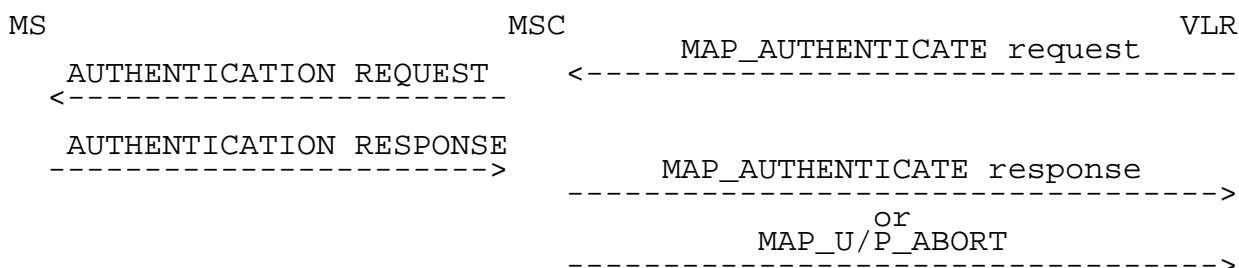

Figure 2: Authentication operation

The MSC can only act on a MAP_AUTHENTICATE request if an RR connection exists with the MS. If such a connection does not exist, the MSC shall terminate the MAP procedure with a MAP_U_ABORT. The same applies if the MS does not respond to an AUTHENTICATION REQUEST message.

	04.08	09.02	Notes
Forward message	AUTHENTICATION REQUEST	MAP_AUTHENTICATE request	
	RAND	RAND	
	Ciphering key seq number	CKSN	
Backward result	AUTHENTICATION REQUEST	MAP_AUTHENTICATE response	
	SRES	SRES	

If the SRES parameter does not match the value stored in the VLR, then the ongoing MAP procedure shall be terminated with a cause 'illegal subscriber'. This shall cause the MSC to send an AUTHENTICATION REJECT message.

3.6 Retrieval of the IMSI from the MS

The VLR may request open identification of an MS with a MAP_PROVIDE_IMSI request.

The mapping of information elements is as follows:

	04.08	09.02	Notes
Forward message	IDENTITY REQUEST	MAP_PROVIDE_IMSI request	
	Identity type set to: IMSI		1
Backward result	IDENTITY RESPONSE	MAP_PROVIDE_IMSI response	
	Mobile Identity (IMSI)		

NOTE 1: The INVOKE does not carry any parameters. The identity type is inferred from the invoke name.

The MSC shall return a MAP_PROVIDE_IMSI response with user error "absent subscriber" if:

- there is no RR connection with the MS when the MAP service request is received;
- there is no response from the MS.

3.7 Reallocation of TMSI

This operation is invoked by the VLR. The MAP_FORWARD_NEW_TMSI request contains the new TMSI which is forwarded to the MS in the TMSI REALLOCATION COMMAND. When the MS acknowledges the receipt of the new TMSI, the MSC will return a MAP_FORWARD_NEW_TMSI response to the VLR.

If there is no radio connection to the MS when the MSC receives the MAP service request, the MSC shall ignore the message.

	04.08	09.02	Notes
Forward message	TMSI REALLOCATION COMMAND Mobile identity Location area identification	MAP_FORWARD_NEW_TMSI request TMSI -	
Backward result	TMSI REALLOCATION COMPLETE	MAP_FORWARD_NEW_TMSI response	

3.8 Retrieval of the IMEI from the MS

The VLR may use the MAP_OBTAIN_IMEI service to request the MS to supply its IMEI , or may use the MAP_CHECK_IMEI service to request the MSC to check the MS's IMEI. For either MAP service the BSSAP signalling is the same.

The mapping of information elements is as follows:

	04.08	09.02	Notes
Forward message	IDENTITY REQUEST Identity type set to: IMEI	{ MAP_CHECK_IMEI request or MAP_OBTAIN_IMEI request	1
Backward result	IDENTITY RESPONSE Mobile Identity (IMEI)	{ MAP_CHECK_IMEI response or MAP_OBTAIN_IMEI response IMEI	2

NOTE 1: The MAP service request does not carry any parameters. The identity type is inferred from the service name.

NOTE 2: If the MAP_CHECK_IMEI service was used, the MSC also returns the equipment status to the VLR in the MAP_CHECK_IMEI response, after a successful dialogue with the EIR using the IMEI received from the MS.

The MSC shall terminate the MAP dialogue with the VLR using a MAP_U_ABORT if:

- there is no RR connection with the MS when the MAP service request is received;
- there is no response from the MS.

NOTE: The MSC can also obtain the IMEI from a phase 2 MS by including appropriate information in the BSSMAP Cipher Mode Command.

3.9 Tracing subscriber activity

The VLR may request the MSC and/or BSS to record data about the current transaction with an MS.

	08.08	09.02	Notes
Forward message	MSC INVOKE TRACE	MAP TRACE_SUBSCRIBER_ACTIVITY request	
	Trace type	Trace type	
	TriggerId	-	
	Trace reference	Trace reference	
	TransactionId	-	
	Mobile identity(IMSI)	IMSI	1
	Mobile identity(IMEI)	IMEI	1
	OMCId	OMCId	
Backward result	none	none	

NOTE 1: The VLR may provide either an IMSI or IMEI, but not both.

4 Non-transparent cases

4.1 General

For interworking other than the mapping of information fields, see GSM 09.08.

4.2 Outgoing call set-up (MS originating call)

Figure 3 shows those elements of a call set-up sequence which require interworking between BSSAP and MAP. BSSAP messages which do not require interworking with MAP are not shown.

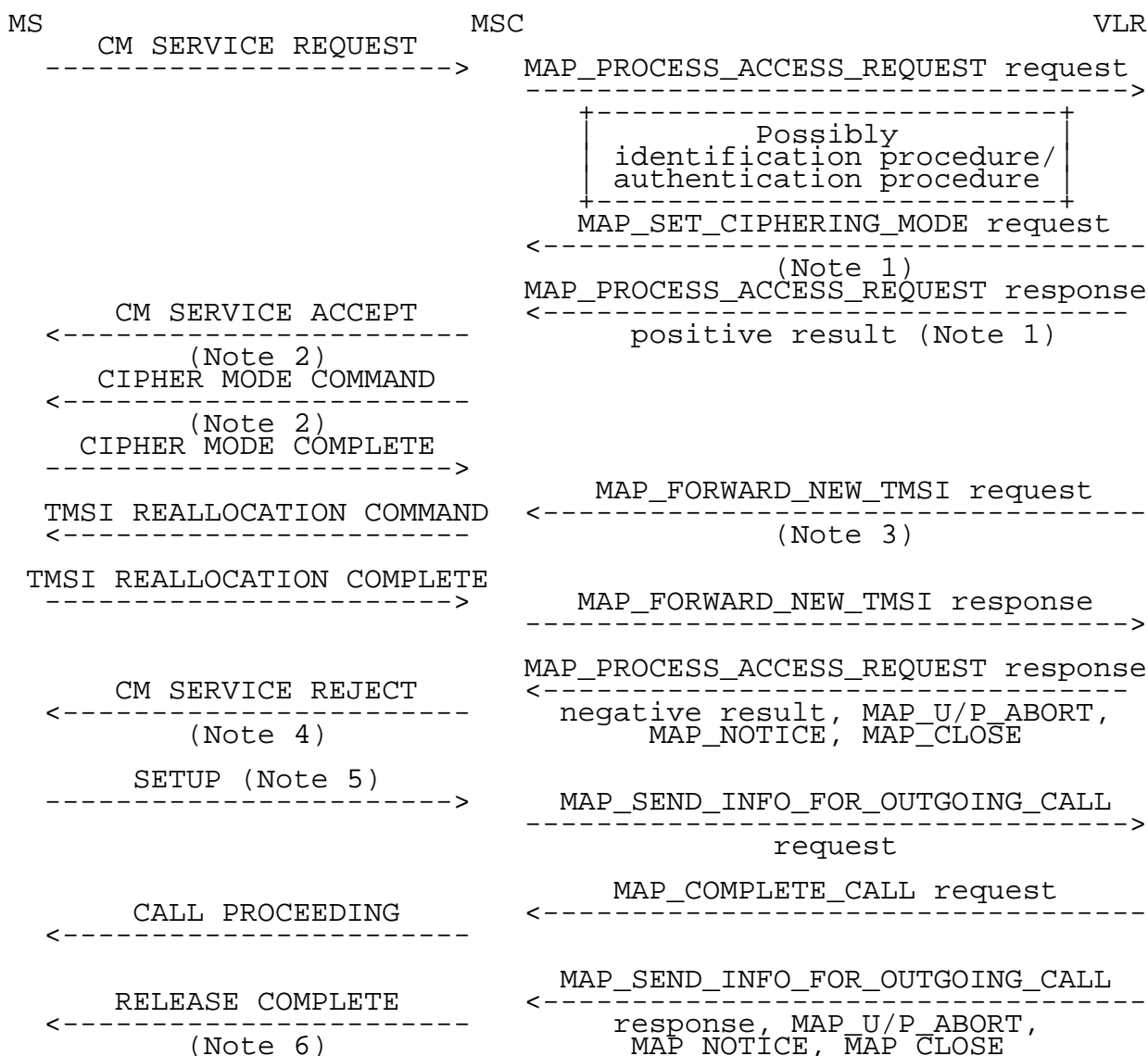

Figure 3: Part of outgoing call set-up sequence

NOTE 1: If the MSC received a MAP_SET_CIPHERING_MODE request, it stores it until it receives the MAP_PROCESS_ACCESS_REQUEST response.

NOTE 2: CM SERVICE ACCEPT is sent only if the ciphering procedure is not invoked.

NOTE 3: TMSI reallocation need not be sequenced with other messages, but should be sent after ciphering.

NOTE 4: CM SERVICE REJECT is sent as a result of a user error parameter in the MAP_PROCESS_ACCESS_REQUEST response, or termination of the MAP dialogue.

NOTE 5: The SETUP message is sent after the MS has either received a CM SERVICE ACCEPT or sent a CIPHER MODE COMPLETE.

NOTE 6: RELEASE COMPLETE is sent as a result of a user error parameter in the MAP_SEND_INFO_FOR_OUTGOING_CALL response, or termination of the MAP dialogue.

The procedure can be considered in two parts: the handling of the CM SERVICE REQUEST and the handling of the SETUP request.

The procedure is initiated by the MS sending a CM SERVICE REQUEST message. The MSC will forward the service request to the VLR in the MAP_PROCESS_ACCESS_REQUEST request. The VLR may then invoke other operations, e.g. authentication and identification. These operations are defined in subclauses 3.4 and 3.5.

If there is a positive outcome for the CM SERVICE REQUEST procedure, the VLR always sends a MAP_PROCESS_ACCESS_REQUEST response. If the request is for a first MM-connection and ciphering is required, the MAP_PROCESS_ACCESS_REQUEST response is preceded by a MAP_SET_CIPHERING_MODE request. In this case the MSC sends a CIPHER MODE COMMAND towards the MS. The interworking for cipher mode setting is described in subclause 4.4. If the request is for an additional MM-connection or for a first MM-connection where ciphering is not required, then the positive MAP_PROCESS_ACCESS_REQUEST response causes the MSC to send a CM SERVICE ACCEPT message to the MS. After cipher mode setting has been completed or the CM SERVICE ACCEPT message has been returned, the MS will send the SETUP (or EMERGENCY SETUP) message and information retrieval takes place as shown.

A negative outcome for the MAP_PROCESS_ACCESS_REQUEST procedure can be signalled by a MAP_PROCESS_ACCESS_REQUEST response containing a user error parameter, or by terminating the MAP dialogue between the MSC and the VLR.

A positive outcome for the call setup procedure is indicated by a MAP_COMPLETE_CALL request from the VLR to the MSC, which causes the MSC to send a CALL PROCEEDING message towards the MS.

A negative outcome for the call setup procedure can be signalled by a MAP_SEND_INFO_FOR_INCOMING_CALL response or by terminating the dialogue between the MSC and the VLR.

Information element mapping is required between the messages:

- CM SERVICE REQUEST to MAP_PROCESS_ACCESS_REQUEST request;
- SETUP to MAP_SEND_INFO_FOR_OUTGOING_CALL request;
- MAP_SEND_INFO_FOR_OUTGOING_CALL response, MAP_U/P_ABORT, MAP_NOTICE or premature MAP_CLOSE to RELEASE COMPLETE or CM SERVICE REJECT.

The information contained in the MAP_COMPLETE_CALL request is not transmitted on the radio interface but is used in the MSC for connecting the call.

The conversion of information elements is as follows:

	08.08/04.08	09.02	Notes
Forward	COMPLETE LAYER 3 INFO (CM SERVICE REQUEST)	MAP_PROCESS_ACCESS_REQUEST request	
	CM Service type Ciphering key sequence number	CM Service type CKSN	1
	Mobile identity Mobile station Classmark 2	TMSI or IMSI or IMEI -	
	Cell identifier Chosen channel -	Current LA Id - Access Connection Status	4 3
Positive result	DTAP(CM SERVICE ACCEPT)	MAP_PROCESS_ACCESS_REQUEST response	2
Negative result	DTAP(CM SERVICE REJECT)	MAP_PROCESS_ACCESS_REQUEST response	
	IMSI unknown in VLR Requested service option not subscribed Illegal ME Network failure Network failure Network failure Network failure	Unidentified Subscriber ?????? Illegal equipment System failure MAP_U/P_ABORT MAP_NOTICE MAP_CLOSE]
	DTAP(AUTHENTICATION REJECT)	MAP_PROCESS_ACCESS_REQUEST response Illegal subscriber	

NOTE 1: Indicates, in this case, a mobile originating call establishment or an emergency call establishment.

NOTE 2: The CM SERVICE ACCEPT is sent when the ciphering procedure is not invoked.

NOTE 3: Indicates whether or not an RR-connection exists and whether or not ciphering has been started.

NOTE 4: The Current LA Id parameter is derived by the MSC from the Cell identifier information element.

	04.08	09.02	Notes
Forward message	SETUP	MAP_SEND_INFO_FOR_OUTGOING_CALL request	
	BC repeat indicator	-	
	Bearer capability 1	-	3
	Bearer capability 2	-	3
	Calling party subaddress	-	
	Called party BCD number	Called Number	
	Called party subaddress	-	
	LLC repeat indicator	-	
	Low layer compatibility I	-	
	Low layer compatibility II	-	
	HLC repeat indicator	-	
	High layer compatibility i	-	
	High layer compatibility ii	-	
	-	Bearer service	3
	-	Teleservice	3
	Facility	-	1
	-	CUG index	4
	-	Suppress pref CUG	4
	-	Suppress CUG OA	4
	User-user	-	
	SS version	-	
	CLIRO flag	-	
Positive result			2
Negative result	RELEASE COMPLETE	MAP_SEND_INFO_FOR_OUTGOING_CALL response	
	TS GSM 04.10	Call Barred	
		Barring Service Active	
	Operator determined barring	Call Barred Operator Determined Barring	
	Network out of order	Data Missing	
	Network out of order	Unexpected Data Value	
	Network out of order	System Failure	
	Bearer capability not authorized	Bearer service not provisioned	
	Bearer capability not authorized	Teleservice not provisioned	
	[User not member of CUG]	CUG reject	
	Network out of order	MAP_U/P_ABORT	
	Network out of order	MAP_NOTICE	
	Network out of order	MAP_CLOSE	

NOTE 1: If the Facility IE contains CUG information, the CUG information is transferred to the VLR in the MAP_SEND_INFO_FOR_OUTGOING_CALL service; any other information contained in a Facility IE is transferred to the VLR in a MAP Supplementary Services related service.

NOTE 2: The call setup parameters retrieved from the VLR are not sent to the MS. The parameters are carried in the MAP_COMPLETE_CALL service.

NOTE 3: The bearer capabilities can be used to derive the bearer/tele service.

NOTE 4: CUG information is derived from the contents of the Facility IE.

4.3 Incoming call set-up (MS terminating call)

Figure 4 shows those elements of the procedure which require interworking between MAP and GSM 04.08 procedures.

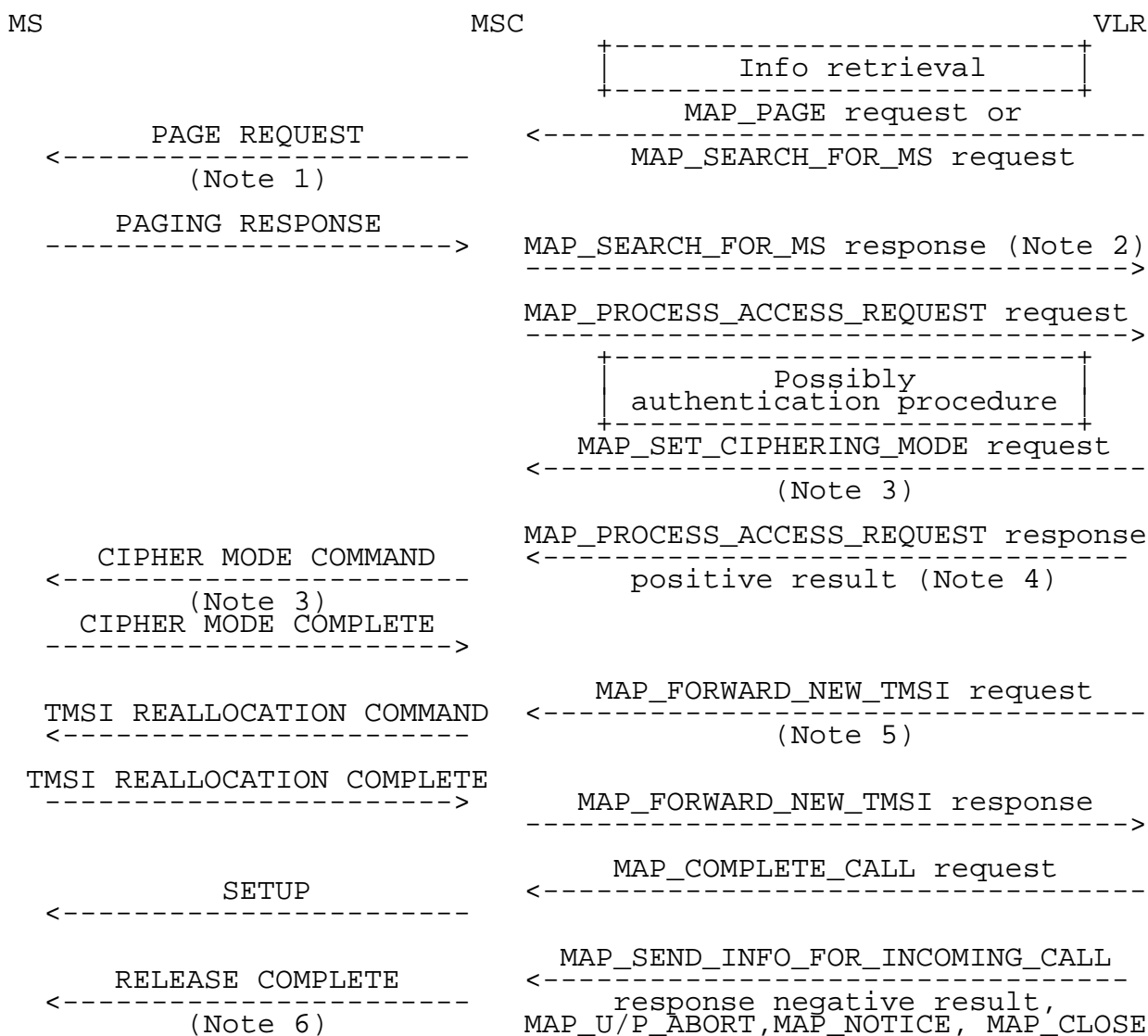
**Figure 4: Incoming call set-up**

NOTE 1: If an MM connection already exists, the PAGE REQUEST is not sent. If the call can be accepted, the MSC sends a MAP_PROCESS_ACCESS_REQUEST request in response to the MAP_PAGE request. If the call cannot be accepted the MSC sends a MAP_PAGE response containing the error 'busy subscriber'.

NOTE 2: Sent only if MAP_SEARCH_FOR_MS was used.

NOTE 3: Needed only if a ciphered MM-connection does not exist already.

NOTE 4: If the MSC received a MAP_SET_CIPHERING_MODE request, it stores it until it receives the MAP_PROCESS_ACCESS_REQUEST response.

NOTE 5: TMSI reallocation need not be sequenced with other messages, but should be sent after ciphering.

NOTE 6: RELEASE COMPLETE is sent as a result of a user error parameter in the MAP_SEND_INFO_FOR_OUTGOING_CALL response, or termination of the MAP dialogue.

The paging procedure is controlled by the VLR. It may be followed by authentication (subclause 3.4), ciphering (subclause 4.4) and reallocation of TMSI(subclause 3.6). The SETUP message is sent when the MAP_COMPLETE_CALL request is received.

Normally there is no interworking between the MAP_COMPLETE_CALL request and the SETUP message. However, the MAP_COMPLETE_CALL request may contain a bearer service indication which will be used to establish the bearer capabilities at the MSC. The interworking between the MAP_PAGE request or MAP_SEARCH_FOR_MS request and the BSSMAP PAGING REQUEST message is as follows:

	08.08/04.08	09.02	Notes
Forward message	PAGING REQUEST	MAP_PAGE request or MAP_SEARCH_FOR_MS request	
	IMSI TMSI Cell identifier list	IMSI TMSI Stored LA Id	1
Backward message	COMPLETE LAYER 3 INFO (PAGING RESPONSE)	MAP_PROCESS_ACCESS_REQUEST request	
	- Ciphering key sequence number	CM service type CKSN	2
	Mobile identity Mobile station classmark 2 Cell Identifier - Chosen channel	TMSI or IMSI - Current LA Id Access connection status -	3

NOTE 1: If TMSI is included, the TMSI is used as the mobile identity in the GSM 04.08 PAGE REQUEST message, otherwise the IMSI is used as the mobile identity.

NOTE 2: In this case the MAP CM service type is set to 'mobile terminating call'.

NOTE 3: The Target LA Id parameter is derived by the MSC from the Cell identifier information element.

4.4 Cipher mode setting

The interworking is as follows:

	08.08	09.02	Notes
Forward	CIPHER MODE COMMAND	MAP_SET_CIPHERING_MODE request	
	Cipher mode setting Encryption information	Ciphering mode Kc	1
Positive result	CIPHER MODE COMPLETE	None	
Negative result	CIPHER MODE REJECT	None	

NOTE 1: The key Kc is passed through the BSS to the BTS, but is not passed to the MS.

4.5 Inter-MSC Handover

The general principles of the handover procedures are given in Technical Specification GSM 03.09. GSM 09.10 gives the necessary information for interworking between the GSM 08.08 handover protocol and the GSM 09.02 MAP protocol.

4.5.1 Basic Inter-MSC Handover

When a Mobile Station is handed over between two MSCs, the establishment of a connection between them (described in GSM 03.09) requires interworking between A-Interface and E-Interface.

The signalling at initiation, execution, completion of the Basic Inter-MSC handover procedure is shown in figures 5 to 10 with both possible positive or negative outcomes.

Additionally figures 5b and 5c show the possible interworking when trace related messages are transparently transferred on the E-Interface at Basic Inter-MSC Handover initiation.

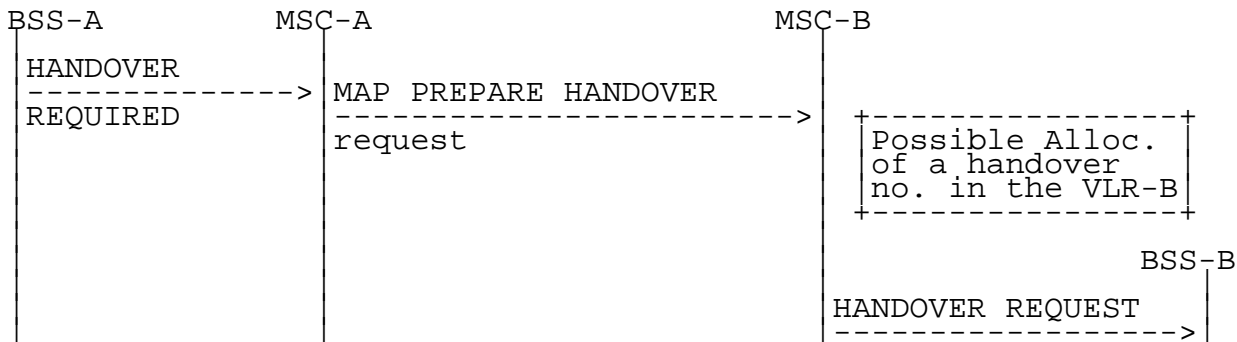

Figure 5a: Signalling for Basic Inter-MSC Handover initiation (no trace related messages transferred)

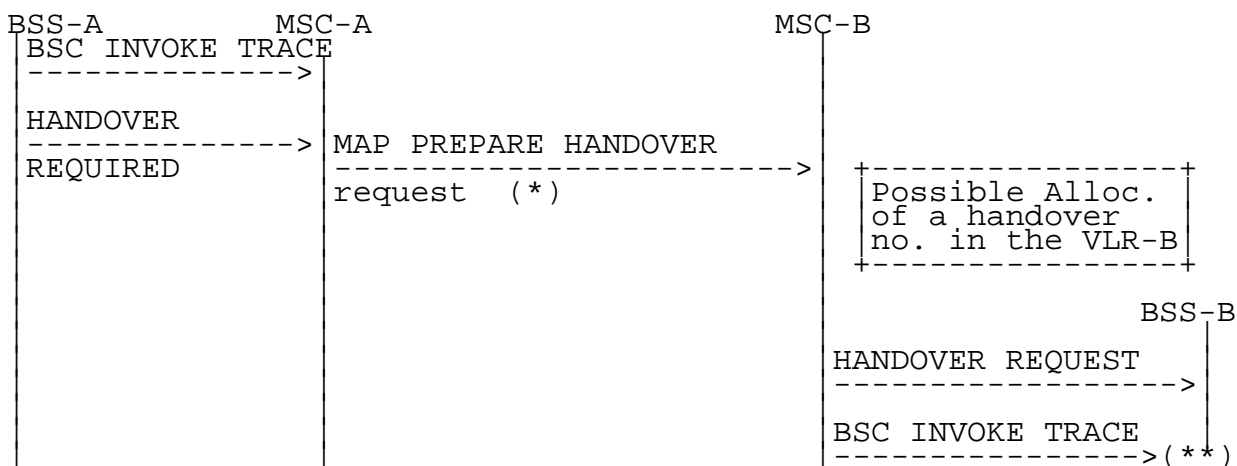

Figure 5b: Signalling for Basic Inter-MSC Handover initiation (BSC invoke trace message transferred)

(*): In that case, **HANDOVER REQUEST** and **BSC INVOKE TRACE** messages are included within the BSS-apdu parameter.

(**): **BSC INVOKE TRACE** is forwarded to BSS-B if supported by MSC-B.

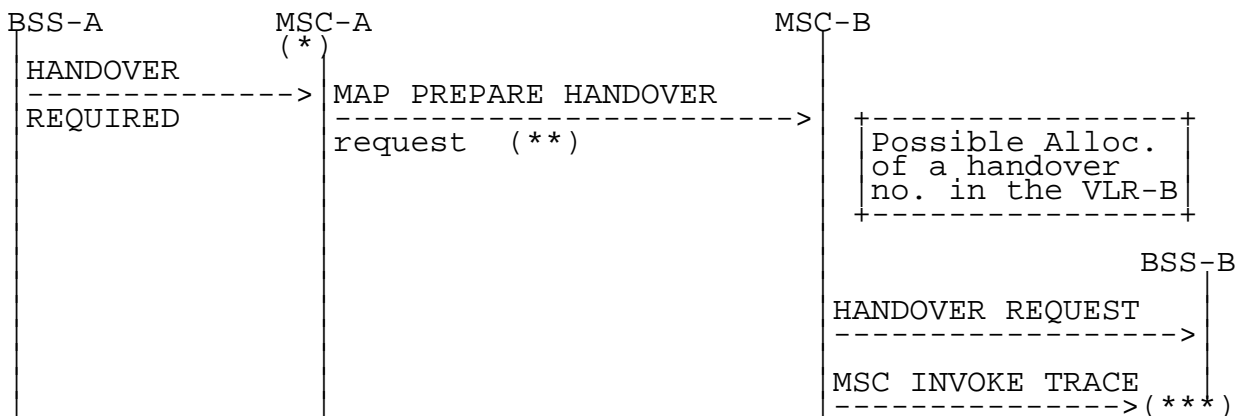
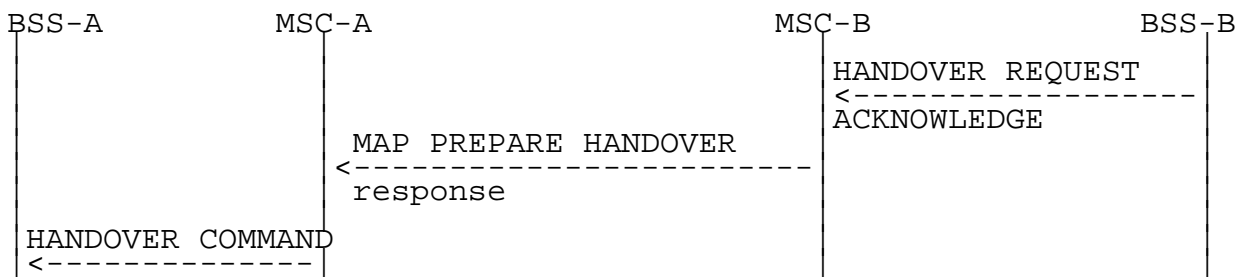

Figure 5c: Signalling for Basic Inter-MSC Handover initiation (MSC invoke trace message transferred)

- (*): Tracing invocation has been received from VLR.
- (**): In that case, HANDOVER REQUEST and MSC INVOKE TRACE messages are included within the BSS-apdu parameter.
- (***): MSC INVOKE TRACE is forwarded to BSS-B if supported by MSC-B.

Possible Positive outcomes

- a) successful radio resources allocation and handover number allocation (if performed):



- b) radio resources allocation queued and successful handover number allocation (if performed). Later successful radio resources allocation indication:

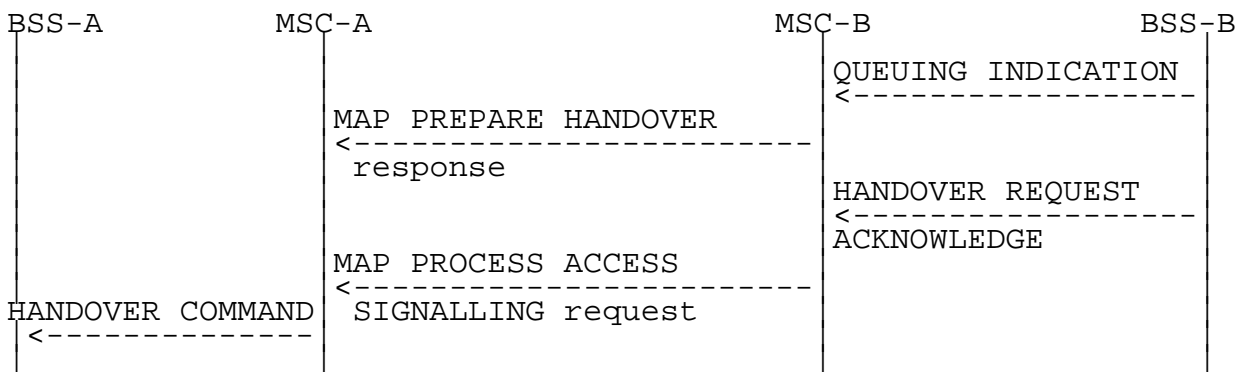
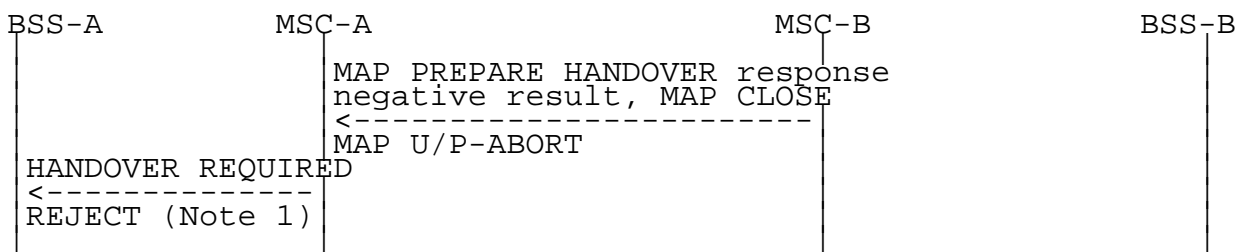

Figure 6: Signalling for Basic Inter-MSC Handover execution (Positive outcomes)

Possible Negative outcomes

- c) user error detected, or handover number allocation unsuccessful (if performed), or component rejection or dialogue abortion performed by MSC-B:



- d) radio resources allocation failure:

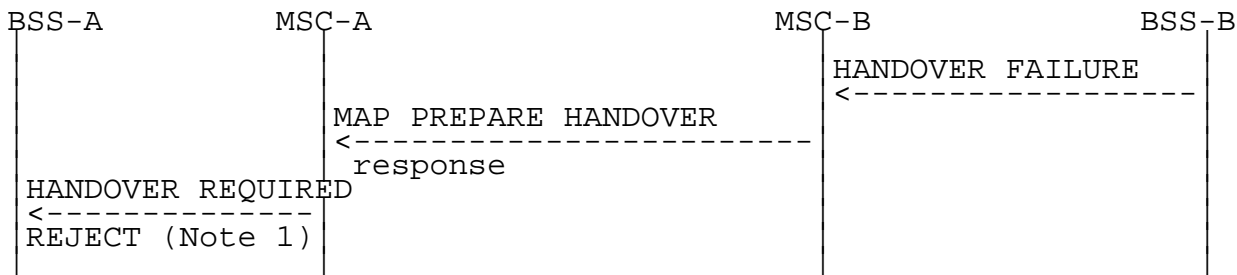

e) radio resources allocation queued and successful handover number allocation (if performed). Later unsuccessful radio resources allocation:

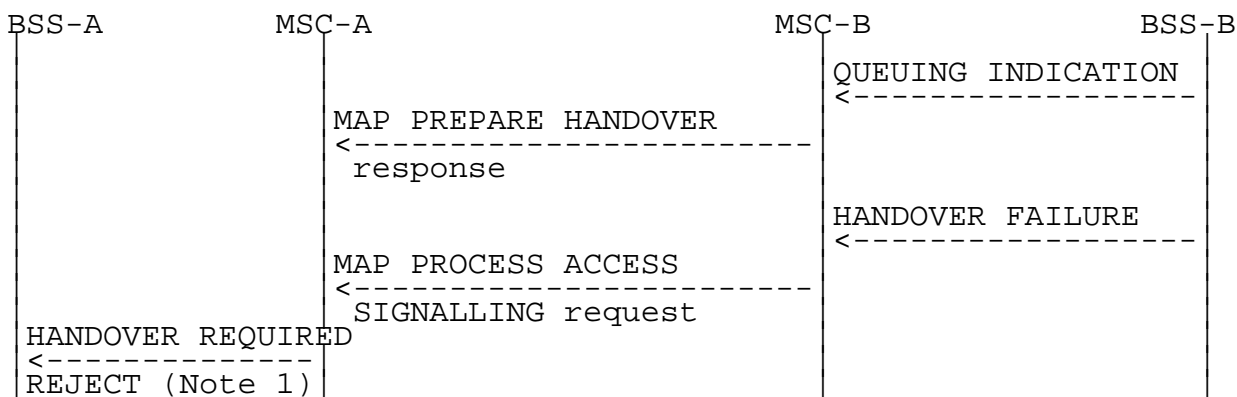

f) unsuccessful handover execution (Reversion to the old channel):

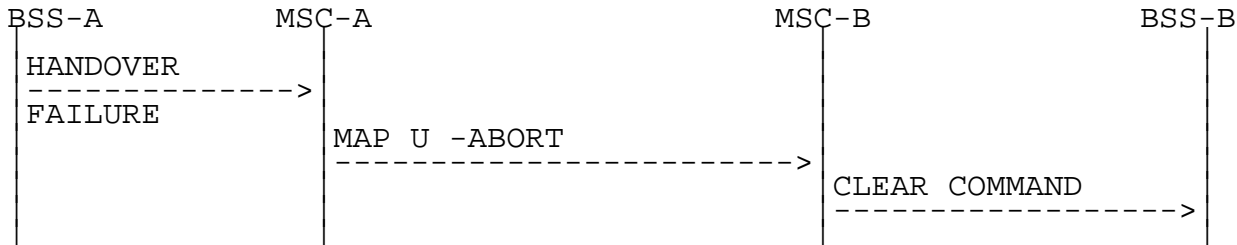

Figure 7: Signalling for Basic Inter-MSC Handover execution (Negative outcomes)

NOTE: Possible rejection of the handover because of the negative outcome of MAP or BSSMAP procedure.

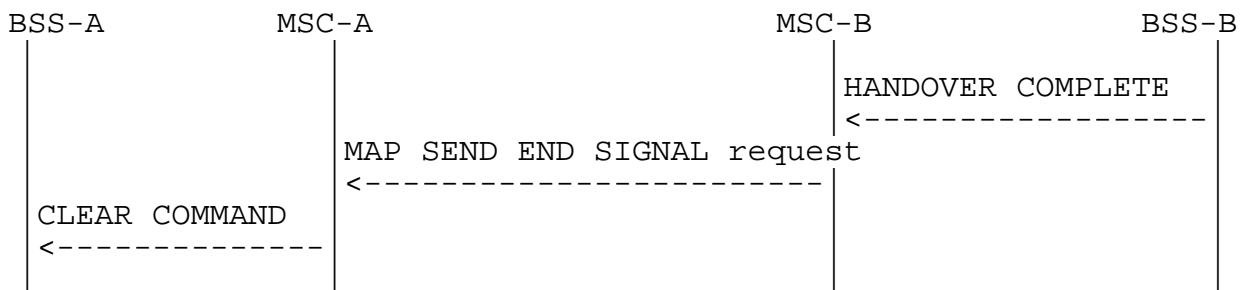

Figure 8: Signalling for Basic Inter-MSC Handover completion

Positive outcome

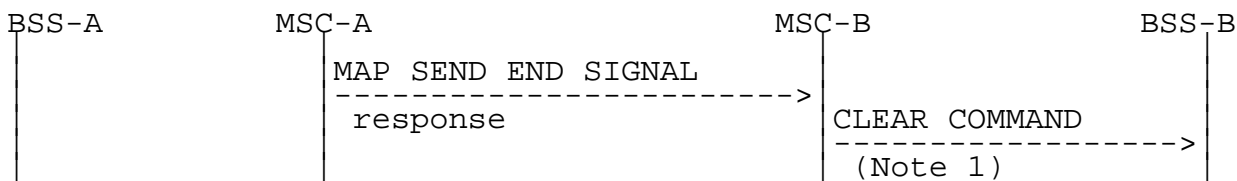

Figure 9: Signalling for Basic Inter-MSC Handover completion (Positive outcome)

Negative outcome

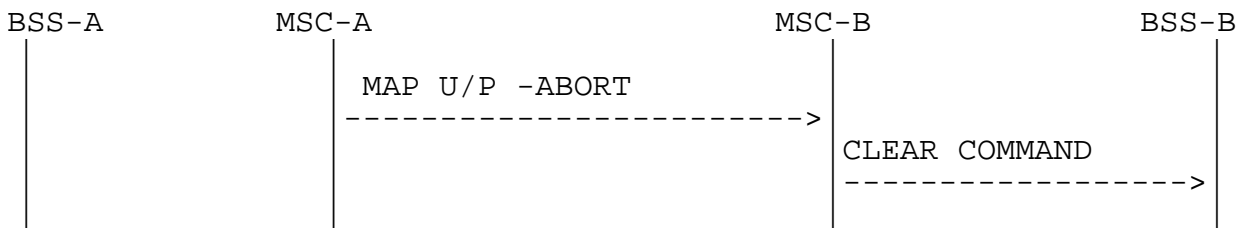

Figure 10: Signalling for Basic Inter-MSC Handover completion (Negative outcome)

NOTE: From interworking between MAP and BSSMAP point of view.

The handover procedure is normally triggered by BSS-A by sending a HANOVER REQUIRED message on A-Interface to MSC-A. The invocation of the Basic Inter-MSC handover procedure is performed and controlled by MSC-A. The sending of the MAP Prepare-Handover request to MSC-B is triggered in MSC-A upon receipt of the HANOVER REQUIRED message. For compatibility reason, the cell identity of the cell where the call is to be handed over in MSC-B area, provided in the HANOVER REQUIRED message, is mapped into targetCellId MAP parameter and the HANOVER REQUEST message is encapsulated in the bss-APDU MAP parameter of the Prepare-Handover MAP request. MSC-B can invoke another operation towards the VLR-B (allocation of the handover number described in GSM 09.02).

Additionally, if tracing activity has been invoked, the trace related messages can be transferred on the E-Interface encapsulated in the bss-APDU MAP parameter of the Prepare-Handover Request. If transferred, one complete trace related message at a time shall be included in the bss-APDU MAP parameter after the HANOVER REQUEST message.

The interworking between Prepare Handover and HANOVER REQUIRED is as follows:

	08.08		09.02	Notes
Forward message	HANDOVER REQUIRED	MAP PREPARE HANDOVER request		
	BSSMAP information elements		-ho-NumberNotRequired	1
			-targetCellId -bss-APDU(HANDOVER REQUEST, BSC INVOKE TRACE, or MSC INVOKE TRACE)	2 3
Positive result		MAP PREPARE HANDOVER response		4
Negative result	HANDOVER REQUIRED REJECT	MAP PREPARE HANDOVER		5
	equipment failure		System Failure	
	equipment failure		No Handover Number available	
	equipment failure		UnexpectedDataValue	
	equipment failure		Data Missing	
	equipment failure		MAP CLOSE	
	equipment failure		MAP U/P -ABORT	

NOTE 1: The ho-NumberNotRequired parameter is included by MSC-A, when MSC-A decides not to use any circuit connection with MSC-B. No handover number shall be present in the positive result. Any negative response from MSC-B shall not be due to handover number allocation problem.

NOTE 2: The process performed on the BSSMAP information elements received in the HANDOVER REQUIRED message is described in the GSM Recommendation 08.08.

NOTE 3: The process performed on the BSSMAP information elements received in the MSC or BSC INVOKE TRACE message is described in subclause 4.5.6.6.

NOTE 4: The response to the Prepare-Handover request can include in its bss-APDU parameter, identifying the GSM-0806 protocol, either a BSSMAP QUEUING INDICATION, or a BSSMAP HANDOVER REQUEST ACKNOWLEDGE or a BSSMAP HANDOVER FAILURE.

In the first case, MSC-A shall wait for the radio resources allocation response from MSC-B, transmitted to MSC-A as described in subclause 4.5.4.

In the second case, the positive result triggers in MSC-A the sending on A-Interface of the HANDOVER COMMAND.

In the third case, the positive result triggers in MSC-A one of the following:

- another handover attempt is initiated by MSC-A
- optionally the sending of the HANDOVER REQUIRED REJECT.

(The possible sending of the HANDOVER REQUIRED REJECT message upon receipt of the HANDOVER FAILURE is out of the scope of the GSM 09.10 and lies in the GSM 08.08).

NOTE 5: The possible sending of the HANDOVER REQUIRED REJECT message is described in the GSM 08.08.

The interworking between Send End Signal and HANDOVER COMPLETE in MSC-B is as follows:

	08.08	09.02	Notes
Forward message	HANDOVER COMPLETE	MAP SEND END SIGNAL request -bss-APDU(HANDOVER COMPLETE)	
Positive result	CLEAR COMMAND -Call Control release	MAP SEND END SIGNAL response	1
Negative result	CLEAR COMMAND -Call Control release	MAP CLOSE MAP U/P -ABORT	2

NOTE 1: The positive empty result triggers the clearing of the Radio Resources on the A-Interface and the release of the SCCP connection between MSC-B and BSS-B. If a circuit connection is used between MSC-A and MSC-B, the 'Call Control release' clearing cause shall only be given to BSS-B when MSC-B has received a clearing indication on its circuit connection with MSC-A.

NOTE 2: The abortion of the dialogue or the rejection of the component triggers in MSC-B the clearing of its circuit connection with MSC-A, if any, of the Radio Resources on the A-Interface and the release of the SCCP connection between MSC-B and BSS-B.

The interworking between Send End Signal and CLEAR COMMAND in MSC-A is as follows:

	09.02	08.08	Notes
Forward message	MAP SEND END SIGNAL response -bss-APDU(HANDOVER COMPLETE)	CLEAR COMMAND - Handover Successful	
Positive result			
Negative result			

The interworking between HANDOVER FAILURE in case of reversion to old channel of the MS and User Abort in MSC-A is as follows:

	08.08	09.02	Notes
Forward message	HANDOVER FAILURE - Reversion to old channel	MAP U -ABORT	
Positive result			
Negative result			

4.5.2 Subsequent Inter-MSC Handover back to MSC-A

When a Mobile Station is being handed over back to MSC-A, the procedure (described in GSM 03.09) requires interworking between A-Interface and E-Interface.

The signalling at initiation, execution and completion of the Subsequent Inter-MSC handover procedure is shown in figures 11 to 15.

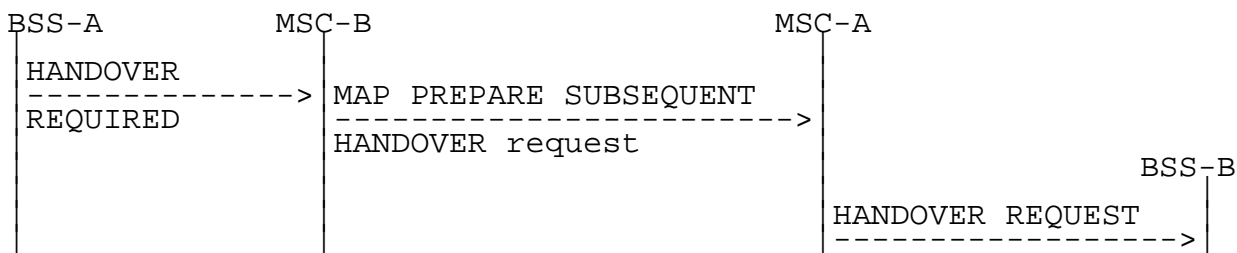
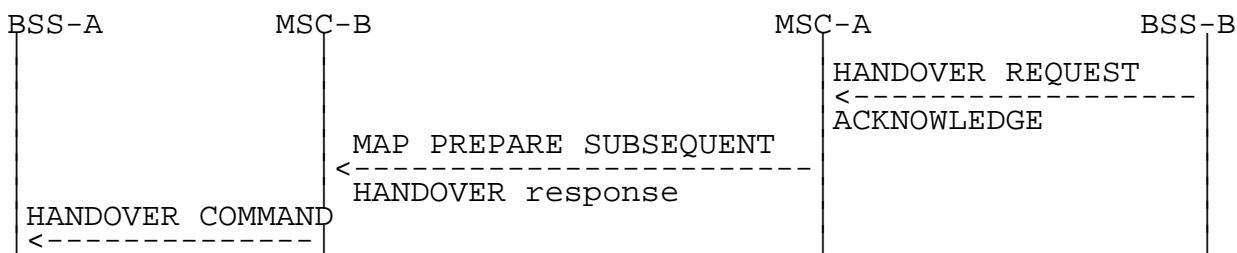

Figure 11: Signalling for Subsequent Inter-MSC Handover back to MSC-A initiation

Possible Positive outcomes

a) successful radio resources allocation:



b) radio resources allocation queued. Later successful radio resources allocation indication:

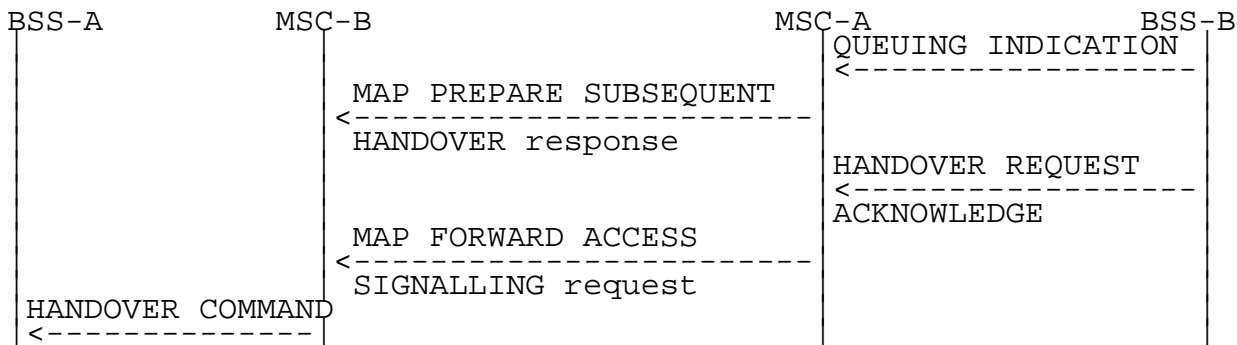
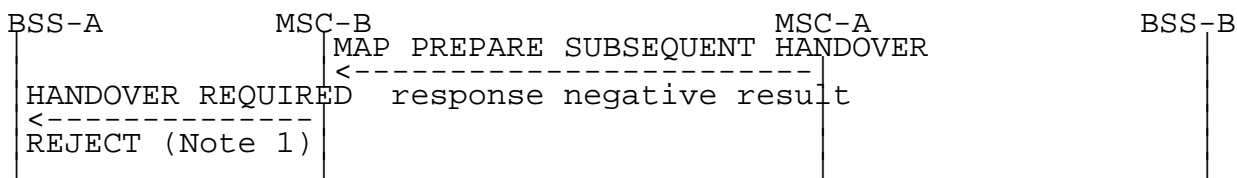

Figure 12: Signalling for Subsequent Inter-MSC Handover back to MSC-A execution (Positive outcome)

Possible Negative outcomes

c) user error detected, or component rejection or dialogue abortion performed by MSC-A:



d) component rejection or dialogue abortion performed by MSC-A:

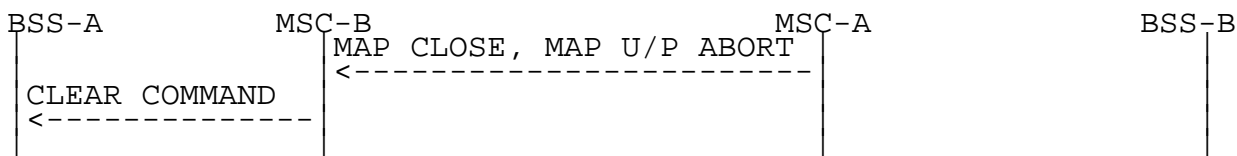

e) radio resources allocation failure:

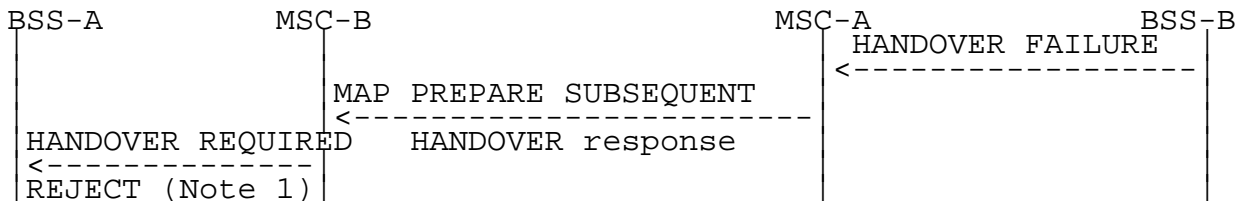

f) radio resources allocation queued. Later unsuccessful radio resources allocation:

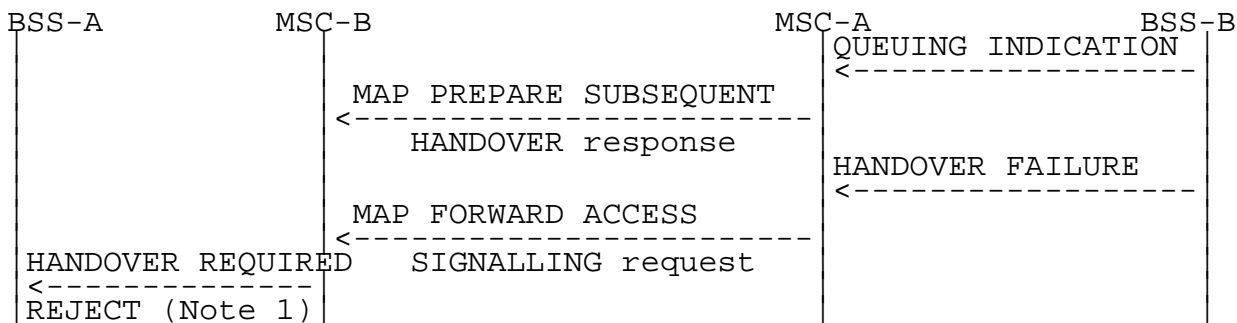

Figure 13: Signalling for Subsequent Inter-MSC Handover back to MSC-A execution (Negative outcome)

NOTE 1: Possible rejection of the handover because of the negative outcome of MAP or BSSMAP procedure.

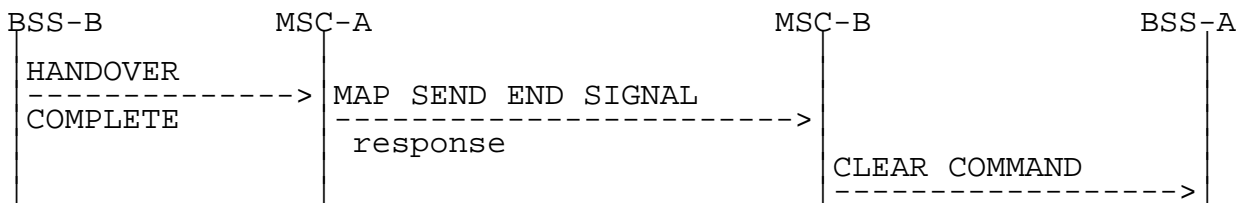

Figure 14: Signalling for Subsequent Inter-MSC Handover back to MSC-A completion (Successful completion of the procedure)

NOTE: Positive outcome case shown in figure 9.

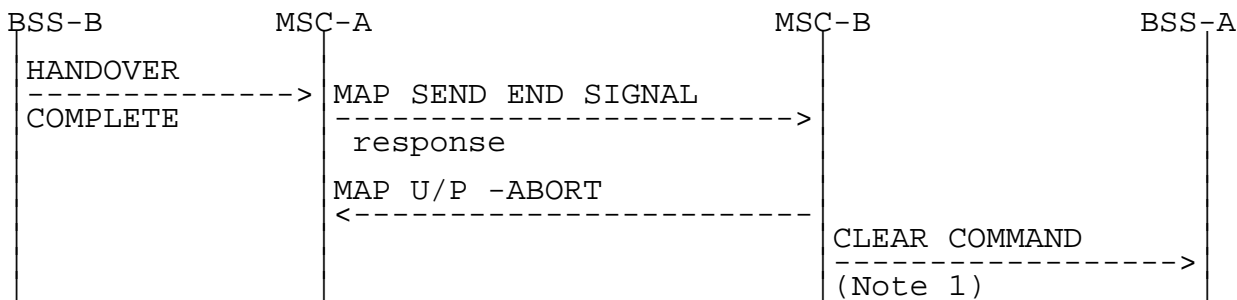

Figure 15: Signalling for Subsequent Inter-MSC Handover back to MSC-A completion (Unsuccessful completion of the procedure)

NOTE 1: Abnormal end of the procedure which triggers the clearing of all resources in MSC-B.

The interworking between Prepare Subsequent Handover and HANOVER REQUIRED is as follows:

	08.08	09.02	Notes
Forward message	HANOVER REQUIRED MAP PREPARE	SUBSEQUENT HANOVER request -target MSC number -targetCellId -bss-APDU(HANOVER REQUEST)	1
Positive result	HANOVER REQUIRED MAP PREPARE	SUBSEQUENT HANOVER response -bss-APDU(QUEUING INDICATION or HANOVER REQUEST ACKNOWLEDGE or HANOVER FAILURE)	2
Negative result	HANOVER REQUIRED REJECT equipment failure equipment failure equipment failure equipment failure CLEAR COMMAND equipment failure equipment failure	MAP PREPARE SUBSEQUENT HANOVER response Unknown MSC Subsequent Handover Failure UnexpectedDataValue Data Missing MAP CLOSE MAP U/P -ABORT	3

NOTE 1: The processing performed on the BSSMAP information elements received in the HANOVER REQUIRED message is out of the scope of this TS. The target MSC number is provided to MSC-A by MSC-B based on the information received from BSS-B.

NOTE 2: The response to the Prepare-Subsequent-Handover request can include in its bss-APDU parameter, identifying the GSM-0806 protocol, either a BSSMAP QUEUING INDICATION, or a BSSMAP HANOVER REQUEST ACKNOWLEDGE or a BSSMAP HANOVER FAILURE.

In the first case, MSC-B shall wait for the radio resources allocation response from MSC-A, transmitted to MSC-B as described in subclause 4.5.4.

In the second case, the positive result triggers in MSC-B the sending on A-Interface of the HANOVER COMMAND.

In the third case, the positive result triggers in MSC-B one of the following:

- another handover attempt is initiated by MSC-B;
- optionally the sending of the HANOVER REQUIRED REJECT.

(The possible sending of the HANOVER REQUIRED REJECT message upon receipt of the HANOVER FAILURE is out of the scope of the GSM 09.10 and lies in the GSM 08.08).

NOTE 3: The possible sending of the HANOVER REQUIRED REJECT message is described in the GSM 08.08.

The interworking between Send End Signal Result and HANOVER COMPLETE in MSC-A is as follows:

	08.08	09.02	Notes
Forward message	HANDOVER COMPLETE	MAP SEND END SIGNAL response	
Positive result			
Negative result		MAP U/P -ABORT	1

NOTE 1: The abortion of the dialogue ends the handover procedure with MSC-B.

4.5.3 Subsequent Inter-MSC Handover to third MSC

When a Mobile Station is being handed over to a third MSC, the procedure (described in GSM 03.09) does require one specific interworking case in MSC-A (figure 20) between E-Interface from MSC-B and E-Interface from MSC-B' other than the combination of the ones described in the subclause 4.5.1 and 4.5.2.

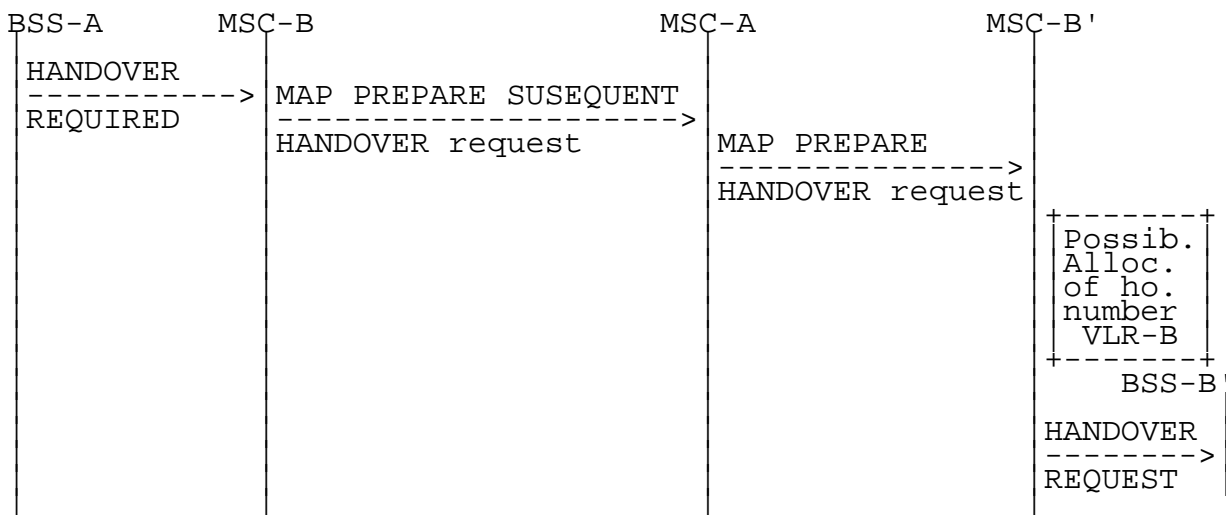
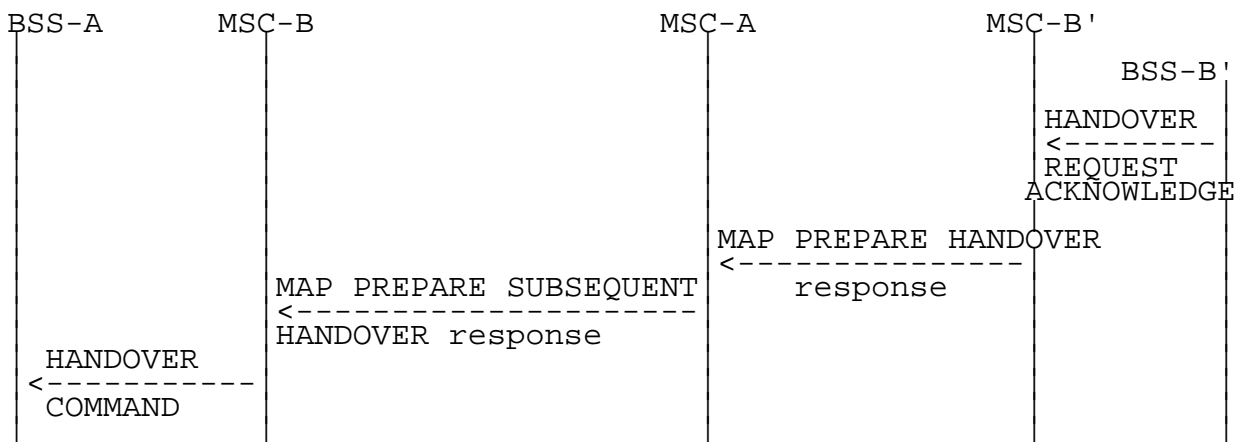

Figure 16: Signalling for Subsequent Inter-MSC Handover to third MSC (MSC-B') initiation

Possible Positive outcomes

a) successful radio resources allocation:



b) radio resources allocation queued and successful handover number allocation, if performed. Later successful radio resources allocation indication:

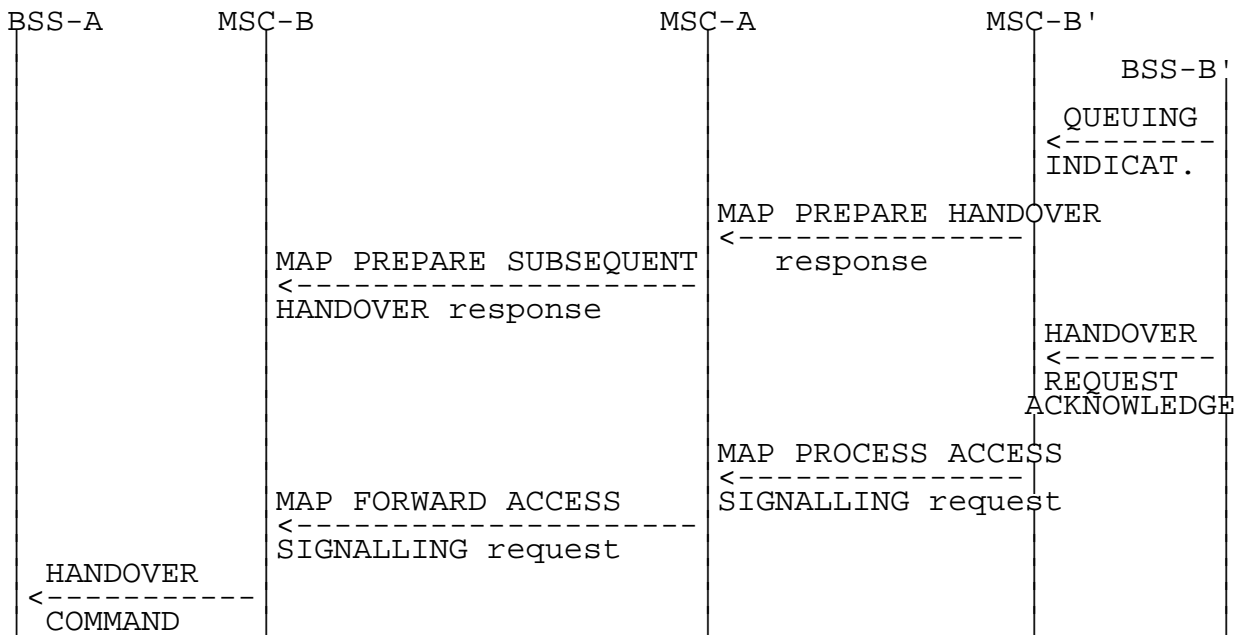
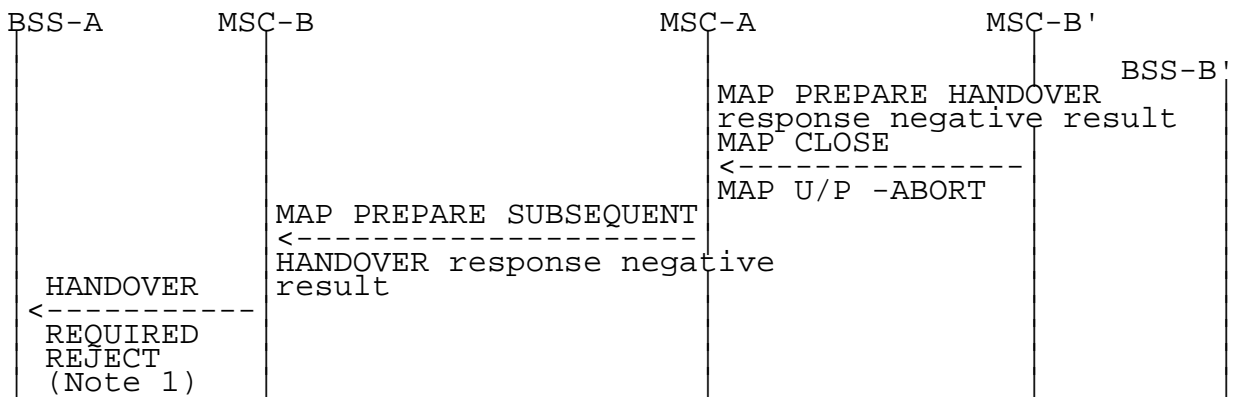

Figure 17: Signalling for Subsequent Inter-MSC Handover to third MSC (MSC-B') execution (Positive outcome)

Possible Negative outcomes

c) user error detected, or component rejection or dialogue abortion performed by MSC-B':



d) radio resources allocation failure:

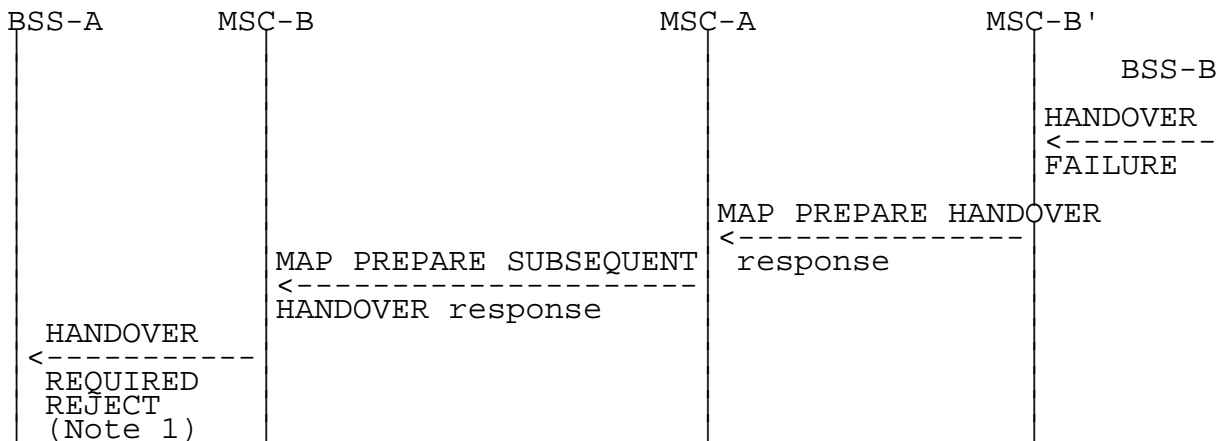

e) radio resources allocation queued and successful handover number allocation (if performed). Later unsuccessful radio resources allocation:

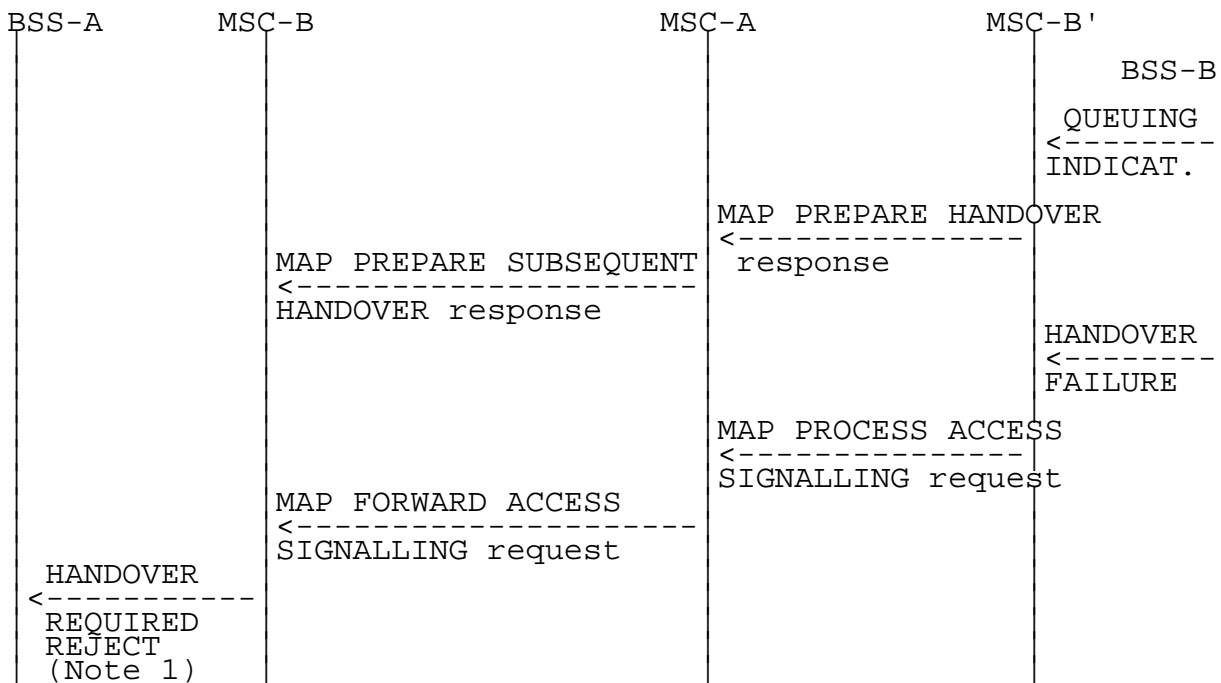

Figure 18: Signalling for Subsequent Inter-MSC Handover to third MSC (MSC-B') execution (Negative outcome)

NOTE 1: Possible rejection of the handover because of the negative outcome of MAP or BSSMAP procedure.

Positive outcome

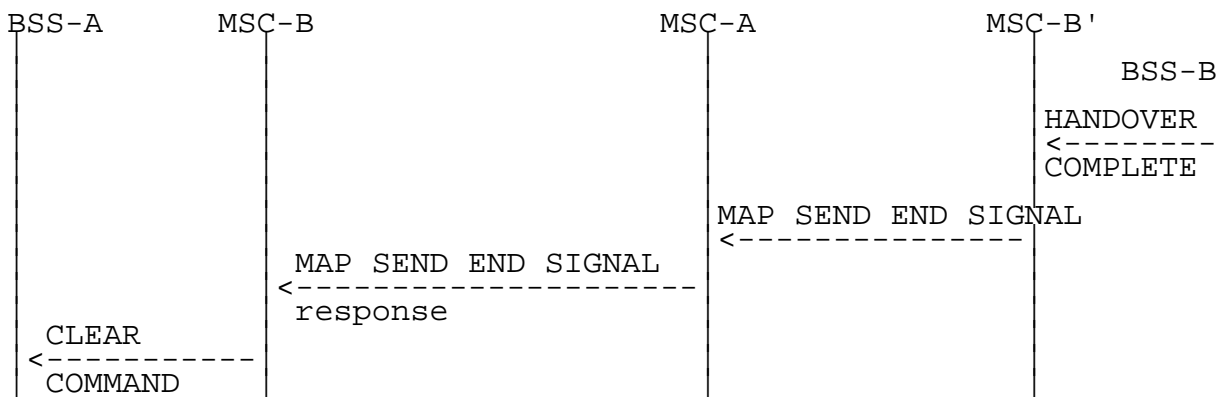

Figure 19: Signalling for Subsequent Inter-MSC Handover to third MSC (MSC-B') completion (Successful completion of the procedure)

Negative outcome

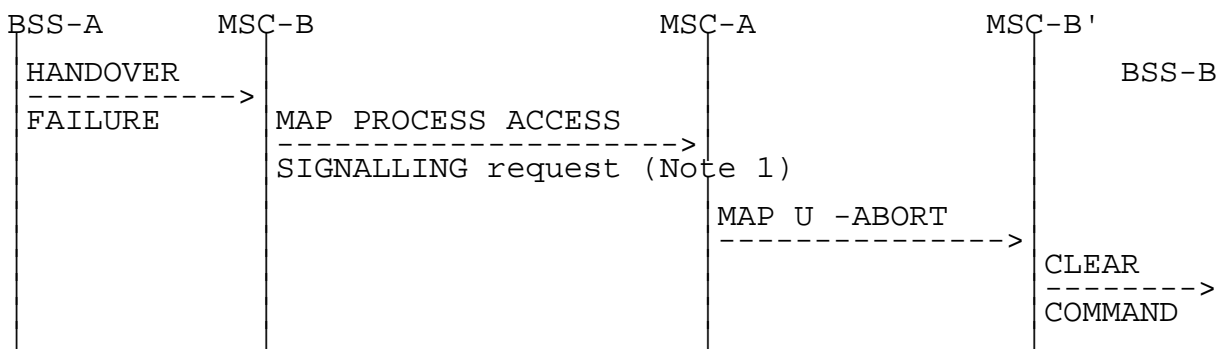

Figure 20: Signalling for Subsequent Inter-MSC Handover to third MSC (MSC-B') completion (Unsuccessful completion of the procedure)

NOTE 1: Specific interworking case detailed below.

The specific interworking case in MSC-A compared to the subclauses 4.5.1 and 4.5.2 occurs between HANDOVER FAILURE encapsulated in a Process Access Signalling from MSC-B and the abortion of the dialogue with MSC-B' in the case of a reversion to old channel of the MS:

	09.02	09.02	Notes
Forward message	MAP PROCESS-SIGNALLING request -bss-APDU(HANDOVER FAILURE)	MAP U -ABORT	1
Positive result			
Negative result		MAP U/P -ABORT	2

NOTE 1: The abortion of the dialogue triggers in MSC-B' the clearing of the circuit connection with MSC-A, if any, and of the Resources between MSC-B' and BSS-B'. The abortion of the dialogue ends the handover procedure with MSC-B'.

NOTE 2: The abortion of the dialogue ends the handover procedure with MSC-B.

4.5.4 BSSAP Messages transfer on E-Interface

The following mapping applies to the encapsulation performed in MSC-A.

	04.08/08.08	09.02	Notes
Forward message	BSSAP messages	MAP FORWARD ACCESS SIGNALLING request -bss-APDU (BSSAP messages)	1
Positive result			2
Negative result		MAP CLOSE MAP U/P -ABORT	

NOTE 1: Complete BSSAP messages to be sent on MSC-B - BSS-B interface (BSSMAP or DTAP messages) are embedded into the bss-APDU parameter (see Annex A of GSM 08.08 for the description of the set of BSSMAP messages).

NOTE 2: The Return Result does not apply. If MSC-B returns a message, this message will arrive in an Invoke: Process Access Signalling.

The following mapping applies to the encapsulation performed in MSC-B.

	04.08/08.08	09.02	Notes
Forward message	BSSAP messages	MAP PROCESS ACCESS SIGNALLING request -bss-APDU (BSSAP messages)	1
Positive result			2
Negative result	CLEAR COMMAND equipment failure	MAP CLOSE MAP U/P -ABORT	3

NOTE 1: Complete BSSAP messages to be sent to MSC-A (BSSMAP or DTAP messages) are embedded into the bss-APDU parameter (see GSM 09.08 for the description of the set of BSSMAP messages).

NOTE 2: The Return Result does not apply. If MSC-A returns a message, this message will arrive in an Invoke: Forward Access Signalling.

NOTE 3: The abortion of the dialogue triggers the clearing of the circuit connection with MSC-A, if any, of the Radio Resources on the A-Interface and the release of the SCCP connection between MSC-B and BSS-B. The clearing of the Radio Resources (the clearing indication received from BSS-B is transmitted to MSC-A) or the loss of the SCCP connection between MSC-B and BSS-B, triggers in MSC-B the abortion of the dialogue on the E-Interface and the clearing of the circuit connection with MSC-A, if any.

4.5.5 Processing in MSC-B, and information transfer on E-interface

The following parameters require processing (e.g. to store the parameter, to internally generate the parameter) in MSC-B. The relevant BSSMAP procedures are mentioned to ease the comprehension, their detailed description is the scope of the GSM 08.08. Each BSSMAP message listed in GSM 09.08 being transferred on E-interface shall use the mechanisms given in subclause 4.5.4 and is described in GSM 08.08.

4.5.5.1 Encryption Information

A sequence of possible encryption algorithms can be sent to a BSS in Cipher Mode Command or Handover Request. The BSS chooses one of the listed algorithms and reports this back to the MSC in Cipher Mode Complete or Handover Request Acknowledge respectively.

The list of algorithms, the ciphering key and the chosen algorithm shall be stored by MSC-B, and the chosen value sent to MSC-A.

Transfer of Information

If ciphering has not been performed before Inter-MSC Handover, this will be controlled by MSC-A after the completion of Inter-MSC Handover.

Ciphering control towards MSC-B:

If Ciphering has been performed before Inter-MSC Handover:

- in the Handover Request BSSMAP message (information included)

The Handover Request Acknowledge should in this case contain the indication of the chosen algorithm.

If Ciphering has NOT been performed before Inter-MSD Handover:

- in the Cipher Mode Command procedure between MSC-A and MSC-B.

If the encryption algorithm is changed at an intra-BSS handover in BSS-B this must be reported to MSC-A in:

- the BSSMAP Handover Performed procedure.

If the encryption algorithm is changed at an intra-MSD handover in MSC-B this must be reported to MSC-A in:

- the BSSMAP Handover Performed procedure which shall be initiated by MSC-B on reception from BSS-B of the Handover Complete message (the information being previously received in the Handover Request Acknowledge message).

Note also that the chosen encryption value may be contained in the BSSMAP Assignment Complete message. This may happen if the encryption value changes e.g. at a second assignment during a call (e.g. from TCH to SDCCH).

4.5.5.2 Channel Type

Assignment Request and Handover Request (BSSMAP) may give the BSS a choice, in the same way as the Encryption Algorithm above. Depending on the Channel Type Info, the chosen channel may have impact on subsequent handovers, internal in MSC-B and inter-MSD controlled by MSC-A. Some values in channel Type Info indicate that if a particular channel once has been chosen, the same type must be used for the rest of the call.

The Channel Type, and the characteristics of the chosen channel shall be stored by MSC-B, and the Chosen Channel and/or Speech Version information elements transferred to MSC-A.

Transfer of Information

Independently of the type of resource (Signalling only (e.g. SDCCH) or TCH) assigned to the MS, the Channel Type Information is transferred to MSC-B in:

- the Handover Request BSSMAP message, and the Chosen Channel and/or Speech Version should be reported back to MSC-A in the Handover Request Acknowledge.

If a new type of resource is to be assigned after Inter-MSD Handover, this can be made with:

- the BSSMAP Assignment procedure between MSC-A and MSC-B (Chosen Channel and/or Speech Version in Assignment Complete).

If the Channel Type (the chosen channel and/or chosen speech version) is changed at an intra-BSS handover in BSS-B this must be reported to MSC-A in:

- the BSSMAP Handover Performed procedure.

If the Channel Type (the chosen channel or chosen speech version) is changed at an intra-MSD handover in MSC-B this must be reported to MSC-A in:

- the BSSMAP Handover Performed procedure which shall be initiated by MSC-B on reception from BSS-B of the Handover Complete message (the information being previously received in the Handover Request Acknowledge message).

4.5.5.3 Classmark

This information shall be stored by MSC-B and might be received either from MSC-A, or from the MS when the MS initiates a Classmark Update.

Transfer of Information due to Classmark received from MSC-A:

This information shall be stored by MSC-B and is received:

- in the Handover Request BSSMAP message

If a new type of resource is to be assigned after Inter-MSC Handover, Classmark Information MAY be included:

- in the BSSMAP Assignment procedure

Transfer of Information, due to "Classmark Signalling Procedures"

This information shall be stored by MSC-B and can be received:

- Due to a classmark update, either requested from MSC-A (Classmark Request, Classmark Update), or an MS-Initiated Classmark Update.

This can be carried out either with:

- the BSSMAP Classmark procedure(s).

Apart from these cases there is the "odd" case where a Classmark Update can be received during an Inter-MSC Handover by MSC-B, i.e. before the MS has moved to the new channel controlled by MSC-B. This can be made with transparent transfer of BSSMAP Classmark Update.

4.5.5.4 Downlink DTX-Flag

The parameter shall be stored by MSC-B to be used at internal Handover in MSC-B.

Transfer of Information

Received by MSC-B from MSC-A in either:

If the MS has already been assigned to a TCH for speech before the Inter-MSC Handover, the DTX-flag should be sent in:

- the Handover Request BSSMAP message

(If the type of resource is not TCH for speech, the DTX-flag shall not be included).

If a new assignment to a TCH for speech after an Inter-MSC Handover is to be performed, this can be made with:

- the BSSMAP Assignment procedure.

4.5.5.5 Priority

The parameter shall be stored by MSC-B and is received according to below:

Transfer of Information

Received by MSC-B from MSC-A in:

- the Handover Request BSSMAP message

If a change is needed after an Inter-MSC Handover with:

- the BSSMAP Assignment procedure.

4.5.5.6 MSC/BSC-Invoke Trace Information Elements

The process to be performed by MSC-B on the information elements of the MSC or BSC Invoke Trace BSSMAP messages is left for further study.

4.5.6 Overview of the Technical Specifications GSM interworking for the Inter-MSC Handover

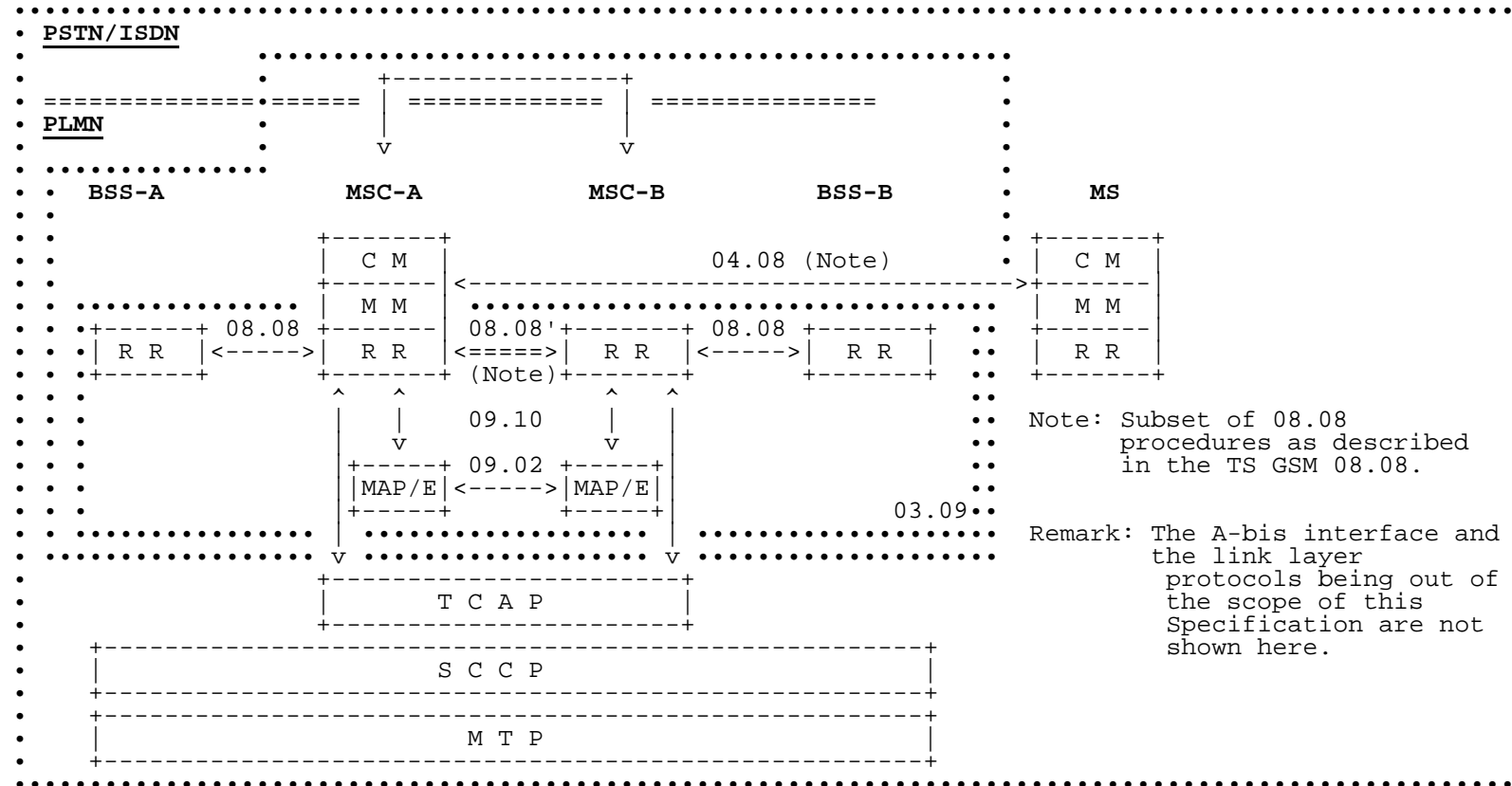

Annex A (informative): Document change history

SMG#	CR	PHASE	VERS	NEW_VERS	SUBJECT
s25	A008	R97	5.2.0	6.0.0	Addition of the mapping of the Routeing area update procedure in GPRS
s26			6.0.0	6.0.1	Publication as part of R97
S29	A009	R97	6.0.1	6.1.0	GPRS ATTACH Reject cause when 'IMSI unknown'

History

Document history		
V6.0.1	July 1998	Publication
V6.1.0	July 1999	Publication