

# ETSI TS 100 548 V7.0.0 (1999-08)

---

*Technical Specification*

**Digital cellular telecommunications system (Phase 2+);  
Call Barring (CB) supplementary services - Stage 2  
(GSM 03.88 version 7.0.0 Release 1998)**

---

The GSM logo consists of the letters 'GSM' in a bold, blue, sans-serif font. The 'G' and 'S' are connected, and the 'M' has a small red square above its top right corner. A registered trademark symbol (®) is located to the right of the 'M'.

**GSM**®

GLOBAL SYSTEM FOR  
MOBILE COMMUNICATIONS



Reference

---

RTS/SMG-030388Q7 (52o03i03.PDF)

Keywords

---

Digital cellular telecommunications system,  
Global System for Mobile communications (GSM)

**ETSI**

Postal address

---

F-06921 Sophia Antipolis Cedex - FRANCE

Office address

---

650 Route des Lucioles - Sophia Antipolis  
Valbonne - FRANCE  
Tel.: +33 4 92 94 42 00 Fax: +33 4 93 65 47 16  
Siret N° 348 623 562 00017 - NAF 742 C  
Association à but non lucratif enregistrée à la  
Sous-Préfecture de Grasse (06) N° 7803/88

Internet

---

[secretariat@etsi.fr](mailto:secretariat@etsi.fr)  
Individual copies of this ETSI deliverable  
can be downloaded from  
<http://www.etsi.org>  
If you find errors in the present document, send your  
comment to: [editor@etsi.fr](mailto:editor@etsi.fr)

---

**Copyright Notification**

---

No part may be reproduced except as authorized by written permission.  
The copyright and the foregoing restriction extend to reproduction in all media.

© European Telecommunications Standards Institute 1999.  
All rights reserved.

# Contents

Intellectual Property Rights .....	<b>Error! Bookmark not defined.</b>
Foreword .....	4
0 Scope .....	5
0.1 References .....	5
0.2 Abbreviations .....	5
0.3 Cross-Phase compatibility .....	6
1 Barring of outgoing calls .....	6
1.1 Handling of barring of outgoing calls .....	6
1.1.1 Registration .....	6
1.1.2 Activation .....	6
1.1.2.1 General .....	6
1.1.2.2 Interactions between barring of outgoing call programs .....	7
1.1.2.3 Interactions with call forwarding supplementary services .....	7
1.1.3 Deactivation .....	11
1.1.4 Interrogation .....	12
1.2 Functions and information flows .....	13
1.3 Information stored in the HLR .....	17
1.4 State transition model .....	18
1.5 Transfer of information from HLR to VLR .....	19
1.6 Information stored in the VLR .....	19
1.7 Handover .....	20
1.8 Cross Phase compatibility .....	20
1.8.1 MS, MSC, VLR or HLR only support Phase 1 control of SS by the subscriber .....	20
1.8.2 HLR only support Phase 1 updating of subscriber information .....	20
2 Barring of incoming calls .....	21
2.1 Handling of barring of incoming calls .....	21
2.1.1 Registration .....	21
2.1.2 Activation .....	21
2.1.2.1 General .....	21
2.1.2.2 Interactions between barring of incoming call programs .....	21
2.1.2.3 Interactions with call forwarding supplementary services .....	21
2.1.3 Deactivation .....	24
2.1.4 Interrogation .....	25
2.2 Functions and information flows .....	26
2.3 Information stored in the HLR .....	29
2.4 State transition model .....	30
2.5 Transfer of information from HLR to VLR .....	31
2.6 Information stored in the VLR .....	31
2.7 Handover .....	31
2.8 Cross Phase compatibility .....	31
2.8.1 MS, MSC, VLR or HLR only support Phase 1 control of SS by the subscriber .....	31
2.8.2 HLR only supports Phase 1 updating of subscriber information .....	32
<b>Annex A (informative): Change Request History .....</b>	<b>33</b>
History .....	34

---

## Intellectual Property Rights

IPRs essential or potentially essential to the present document may have been declared to ETSI. The information pertaining to these essential IPRs, if any, is publicly available for **ETSI members and non-members**, and can be found in SR 000 314: "*Intellectual Property Rights (IPRs); Essential, or potentially Essential, IPRs notified to ETSI in respect of ETSI standards*", which is available **free of charge** from the ETSI Secretariat. Latest updates are available on the ETSI Web server (<http://www.etsi.org/ipr>).

Pursuant to the ETSI IPR Policy, no investigation, including IPR searches, has been carried out by ETSI. No guarantee can be given as to the existence of other IPRs not referenced in SR 000 314 (or the updates on the ETSI Web server) which are, or may be, or may become, essential to the present document.

---

## Foreword

This Technical Specification (TS) has been produced by the Special Mobile Group (SMG).

The present document defines the stage 2 of the call barring services within the digital cellular telecommunications system.

The contents of the present document is subject to continuing work within SMG and may change following formal SMG approval. Should SMG modify the contents of the present document it will be re-released with an identifying change of release date and an increase in version number as follows:

Version 7.x.y

where:

- 7 indicates Release 1998 of GSM Phase 2+
- x the second digit is incremented for all changes of substance, i.e. technical enhancements, corrections, updates, etc.
- y the third digit is incremented when editorial only changes have been incorporated in the specification.

## 0 Scope

The present document gives the stage 2 description of the call barring services.

The possibility for a mobile subscriber to have certain categories of calls barred originated from or terminated at his access:

Barring of outgoing calls	(clause 1):	
- Barring of all outgoing calls	(BAOC)	(Barring program 1);
- Barring of outgoing international calls	(BOIC)	(Barring program 2);
- Barring of outgoing international calls EXCEPT those directed to the home PLMN country	(BOIC-exHC)	(Barring program 3).
Barring of incoming calls	(clause 2):	
- Barring of all incoming calls	(BAIC)	(Barring program 1);
- Barring of incoming calls when roaming outside the home PLMN country	(BIC-Roam)	(Barring program 2).

NOTE: The call barring program "incoming calls when roaming outside the home PLMN country" (clause 2) is only relevant if as a general rule the called mobile subscriber pays the charges for the forwarded part of the call from his home PLMN country to any other country.

## 0.1 References

The following documents contain provisions which, through reference in this text, constitute provisions of the present document.

- References are either specific (identified by date of publication, edition number, version number, etc.) or non-specific.
- For a specific reference, subsequent revisions do not apply.
- For a non-specific reference, the latest version applies.
- A non-specific reference to an ETS shall also be taken to refer to later versions published as an EN with the same number.
- For this Release 1998 document, references to GSM documents are for Release 1998 versions (version 7.x.y).

- [1] GSM 01.04: "Digital cellular telecommunications system (Phase 2+); Abbreviations and acronyms".
- [2] GSM 02.82: "Digital cellular telecommunications system (Phase 2+); Call Forwarding (CF) Supplementary Services - Stage 1".
- [3] GSM 03.11: "Digital cellular telecommunications system (Phase 2+); Technical realization of supplementary services".

## 0.2 Abbreviations

Abbreviations used in the present document are listed in GSM 01.04.

## 0.3 Cross-Phase compatibility

For the following supplementary services, a number of changes exist between the present document and the Phase 1 specification:

- Barring of outgoing calls;
- Barring of incoming calls.

The main body of the present document assumes that all network entities comply with this version of the service. In each case an additional subclause (subclauses 1.6 and 2.6) defines the additional requirements for when one or more network entities or the MS complies with the Phase 1 specifications for the supplementary service procedures.

---

# 1 Barring of outgoing calls

## 1.1 Handling of barring of outgoing calls

### 1.1.1 Registration

If the served mobile subscriber at provision time has selected the subscription option "control of barring services by subscriber using password", he has to register a password at provision time. Furthermore the served mobile subscriber can change the password by an appropriate control procedure at any time. The control procedure consists of three steps: first, the old password has to be provided. Secondly, the new password has to be given, after which it has to be verified by providing it once more, see GSM 03.11.

If the served mobile subscriber at provision time has selected the subscription option "control of barring services by the service provider" an attempt to register a password will be denied and the served mobile subscriber should receive a notification.

The subscriber can register a new password, thus causing the previous registration to be overridden, see GSM 03.11.

### 1.1.2 Activation

#### 1.1.2.1 General

If the served mobile subscriber at provision time has selected the subscription option "control of barring services by subscriber using password" the supplementary service is activated if the subscriber provides the following information to the network:

- 1) password;
- 2) information as to whether the activation applies to all basic services or a specific basic service group;
- 3) selected barring program.

Activation can take place with an appropriate control procedure by the subscriber.

If the served mobile subscriber at provision time has selected the subscription option "control of barring services by the service provider", the supplementary service cannot be activated by the subscriber. The activation has to be performed by the service provider. An attempt to activate the service will be denied and the served mobile subscriber should receive a notification.

If the served mobile subscriber at provision time has selected the subscription option "control of barring services by subscriber using password", and if a wrong password is entered to activate the service the supplementary service will not be activated and the served mobile subscriber is notified.

The information flow for activation of barring of outgoing calls is shown in figure 1.4. For more details see GSM 03.11.

### 1.1.2.2 Interactions between barring of outgoing call programs

In case the served mobile subscriber activates barring of outgoing international calls except those directed to the home PLMN country and this service is not supported by the PLMN in which the served mobile subscriber currently roams, the VPLMN will activate barring of outgoing international calls instead. The SDL diagram in figure 1.1 shows the function to be performed in the VLR in order to deal with this interaction. This function is performed upon receiving the "insert subscriber data" message from the HLR.

In case the mobile subscriber activates one of the call barring programs and another call barring program was already activated, this program will be deactivated and the requested call barring program will be activated. The SDL diagram in figure 1.2 shows the function to be performed in the HLR in order to deal with this interaction between call barring programs.

### 1.1.2.3 Interactions with call forwarding supplementary services

For interactions with call forwarding supplementary services see GSM 02.82.

The SDL diagram in figure 1.3 shows the function to be performed in the HLR in order to deal with the interactions with call forwarding supplementary services.

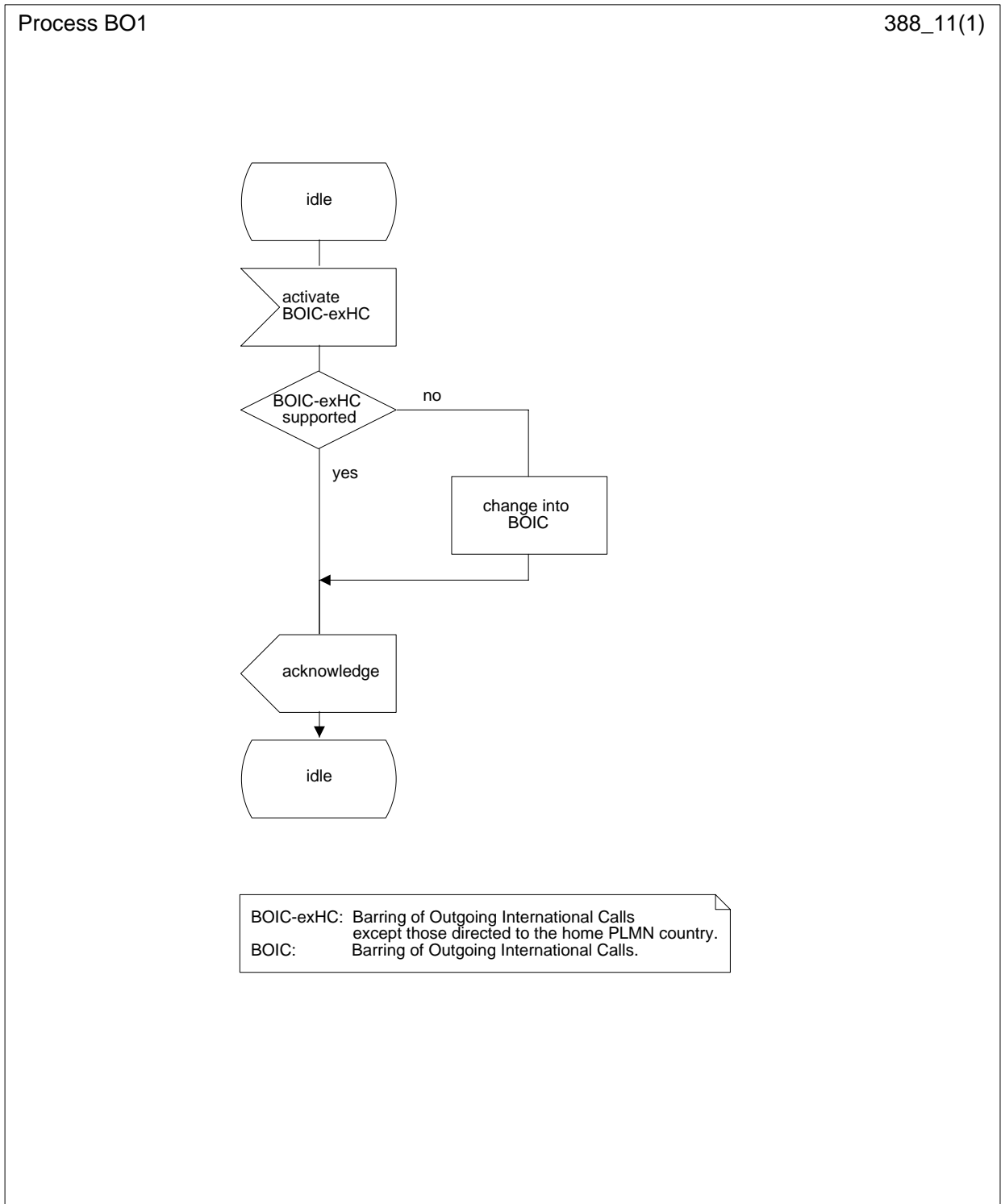

**Figure 1.1: BO1 Possible change of barring of outgoing international calls except those directed to the home PLMN country into barring of outgoing international calls**



Process BO2

388\_12(1)

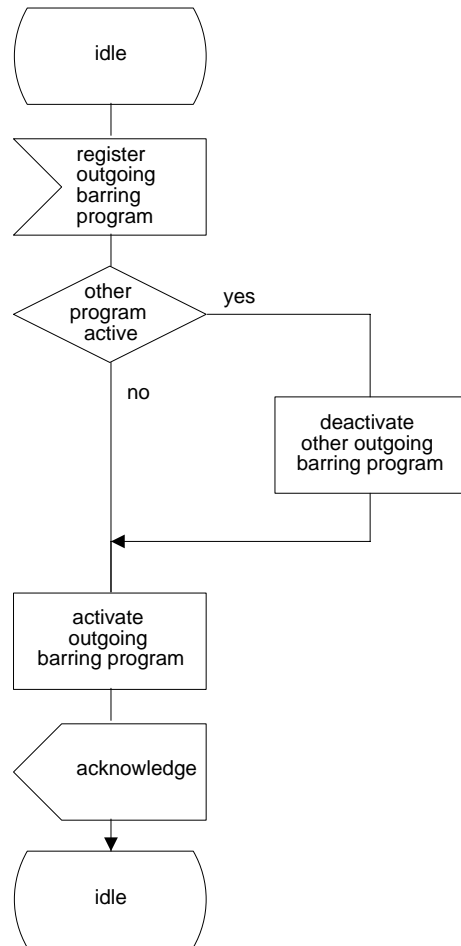

Figure 1.2: BO2 Interaction between call barring programs

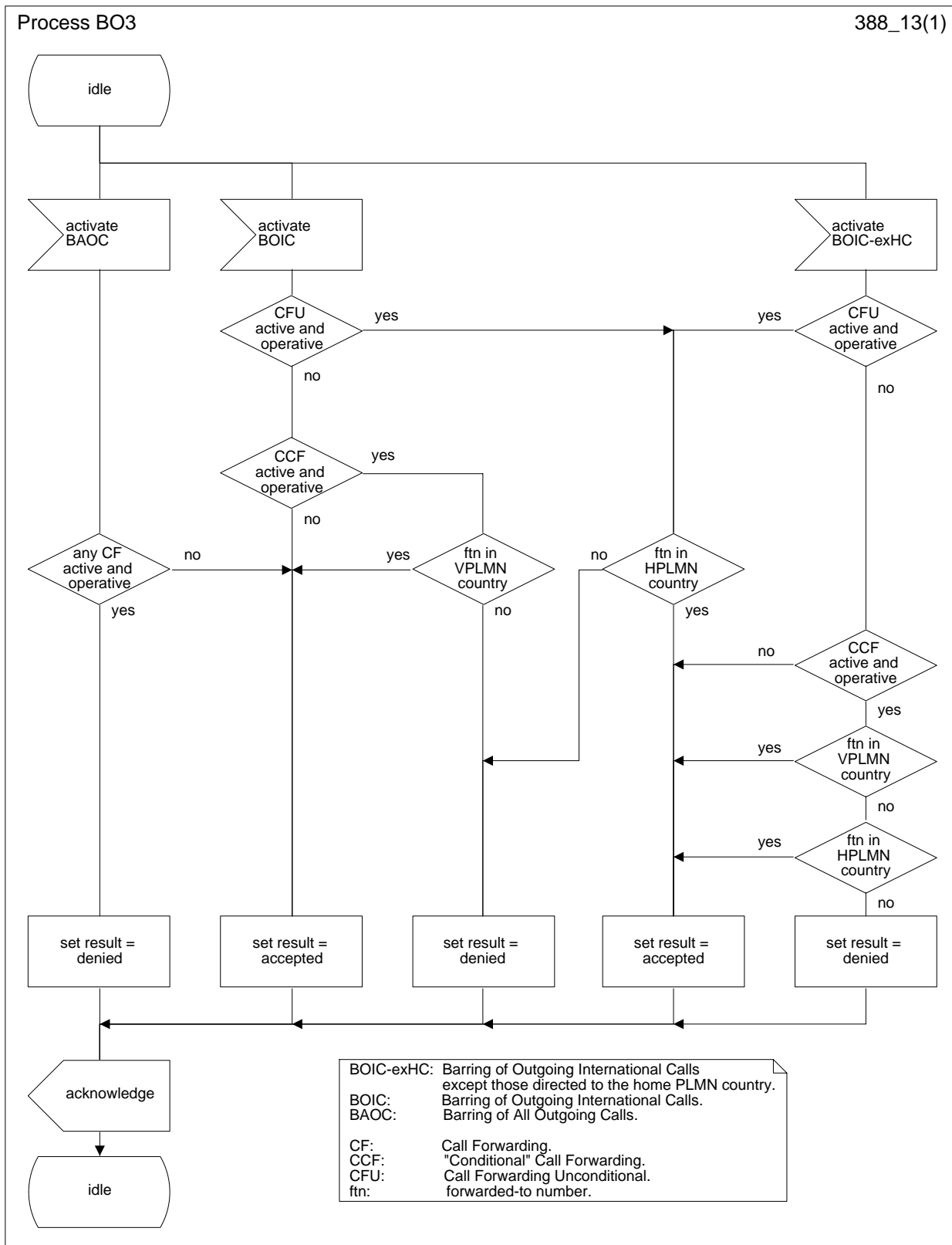
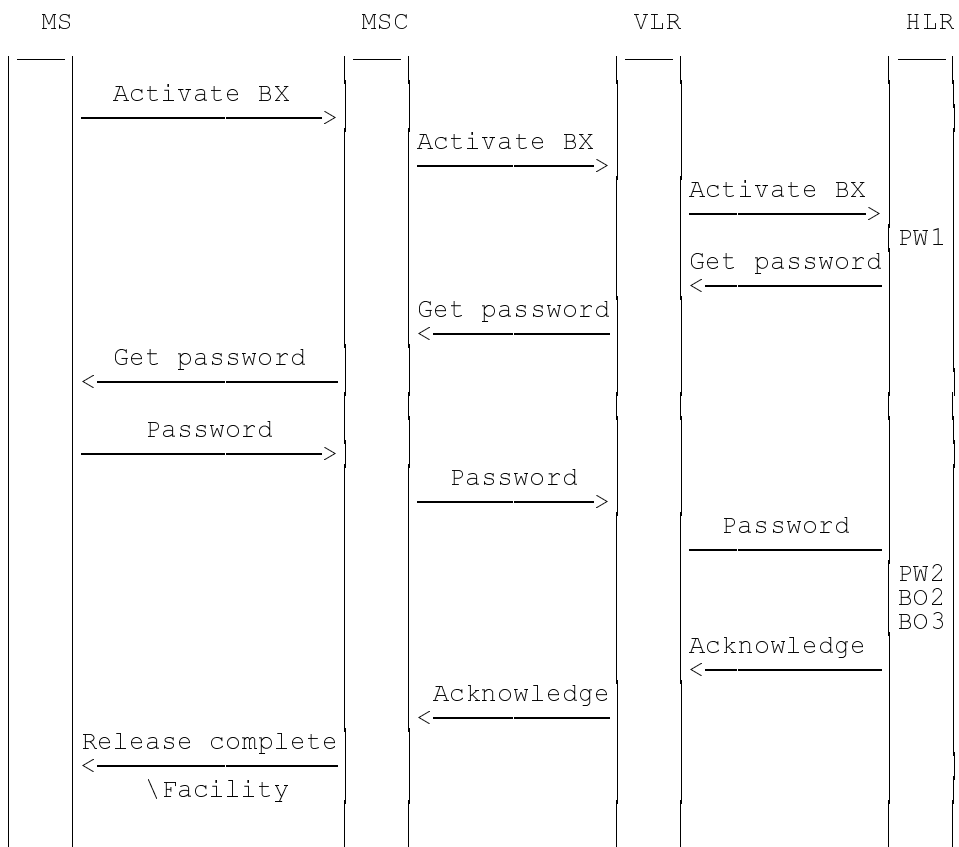

Figure 1.3: BO3 Interaction between call forwarding supplementary services and barring of outgoing calls programs



NOTE: BX indicates any of the barring programs. PW1 and PW2 indicate password handling programs, see GSM 03.11.

Figure 1.4: Activation of barring of outgoing calls

### 1.1.3 Deactivation

The procedure for activation, described in subclause 1.1.2.1, is valid also correspondingly for deactivation with the addition that a barring supplementary service, i.e. the Outgoing barring service, or All barring services can be signalled.

The information flow for deactivation of barring of outgoing calls is shown in figure 1.5. For more details see GSM 03.11.

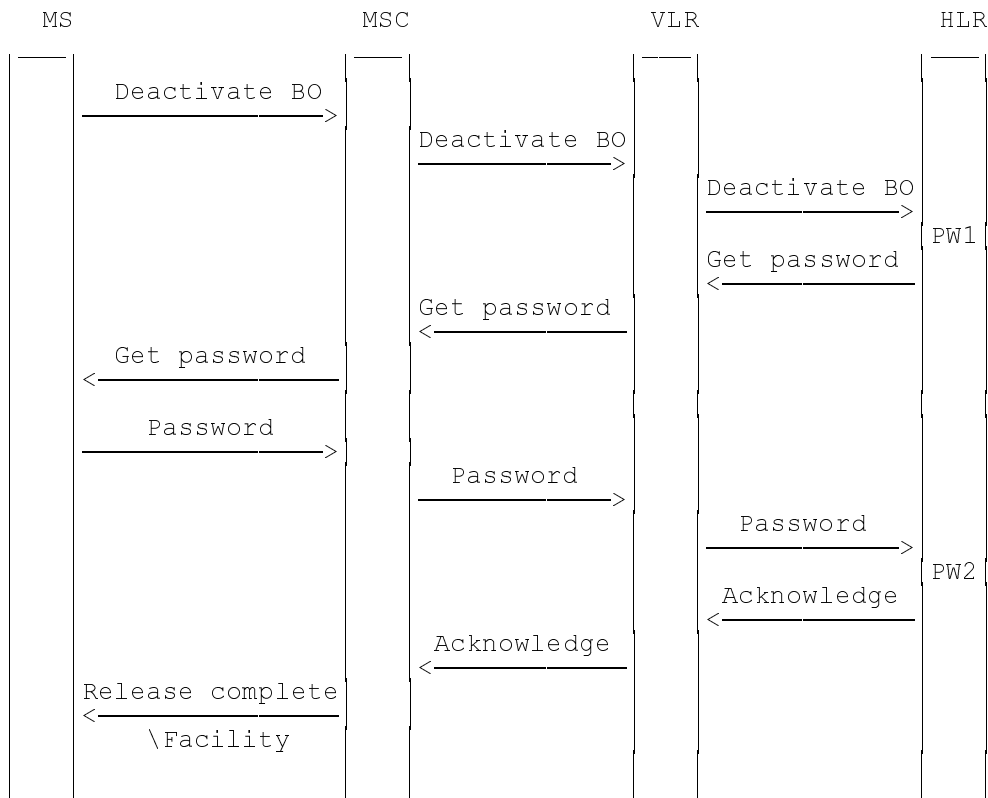

NOTE: BO indicates the general code for barring of outgoing calls. PW1 and PW2 indicate password handling programs, see GSM 03.11.

Figure 1.5: Deactivation of barring of outgoing calls

### 1.1.4 Interrogation

The interrogation procedure enables the mobile subscriber to obtain information about the data stored in the PLMN. After having requested this procedure the network shall return a list of all basic services to which the given barring program is active.

The information flow for interrogation of barring of outgoing calls is shown in figure 1.6.

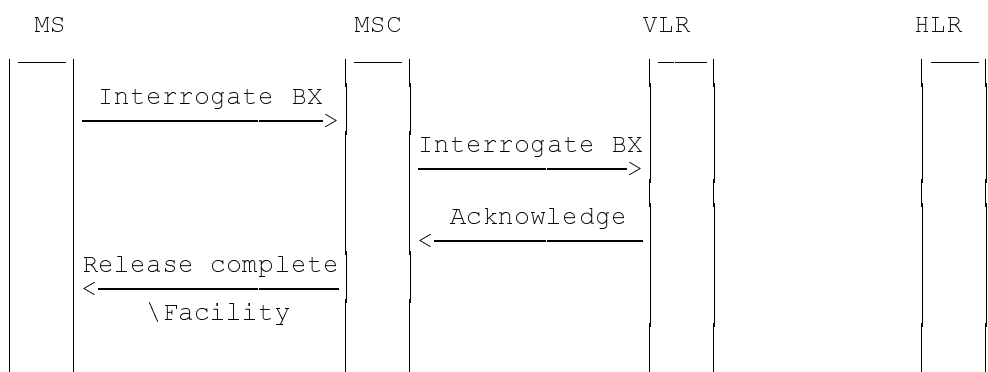

NOTE: BX indicates any of the barring programs.

Figure 1.6: Interrogation of barring of outgoing calls

## 1.2 Functions and information flows

The following Mobile Additional Functions have been identified:

### MAF017

Barring of all outgoing calls related authorizations examination

The ability of a PLMN component to determine the authorizations relating to barring of all outgoing calls. See figure 1.7.

Location: VLR

### MAF018

Barring of outgoing international calls related authorizations examination

The ability of a PLMN component to determine the authorizations relating to barring of outgoing international calls. See figure 1.8.

Location: VLR

### MAF020

Barring of outgoing international calls except those directed to the home PLMN country related authorizations examination

The ability of a PLMN component to determine the authorizations relating to barring of outgoing international calls except those directed to the home PLMN country. See figure 1.9.

Location: VLR

The information flow for barring of outgoing calls is shown in figure 1.10.

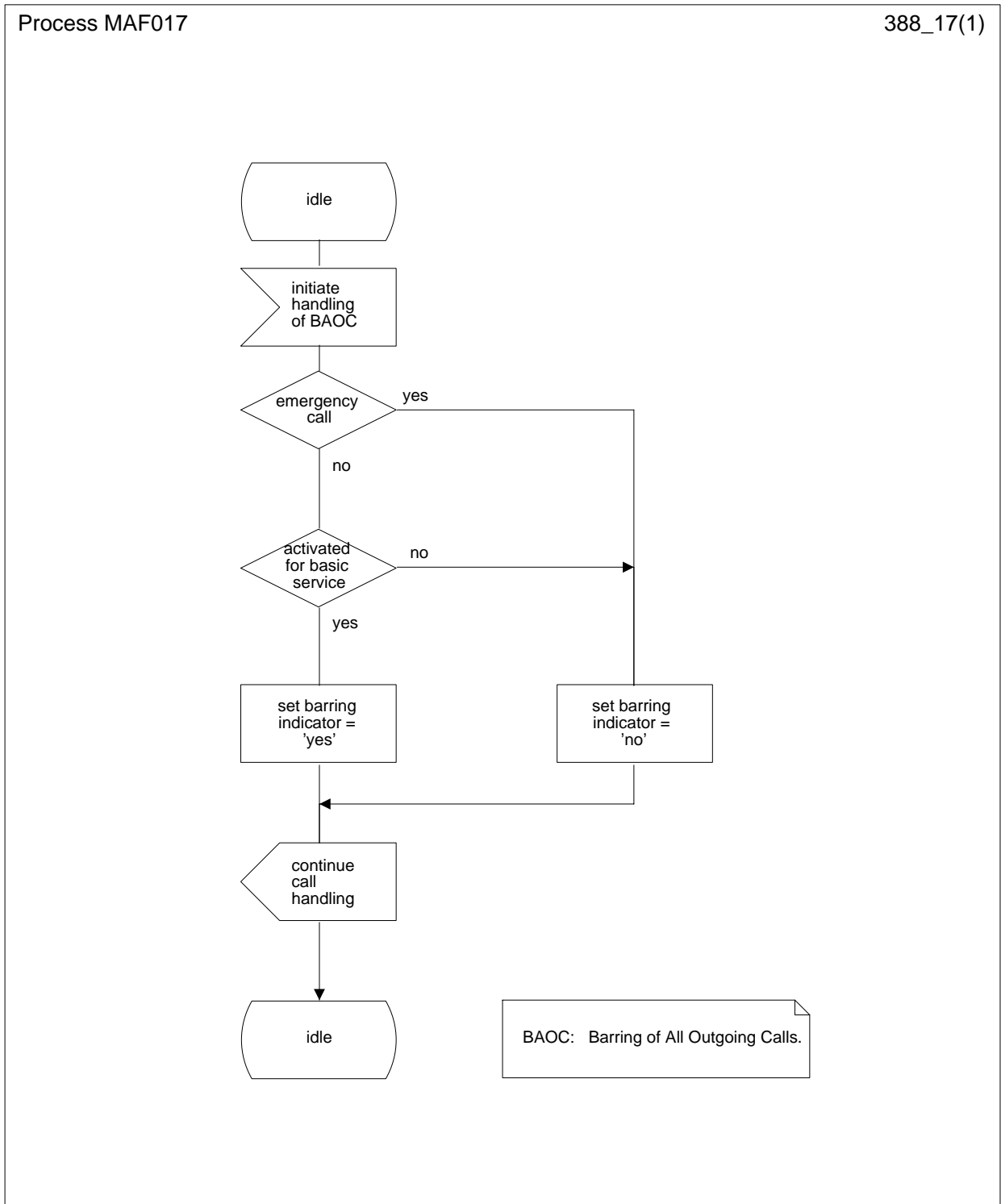

Figure 1.7: MAF017 Barring of all outgoing calls related authorisations examination (VLR)

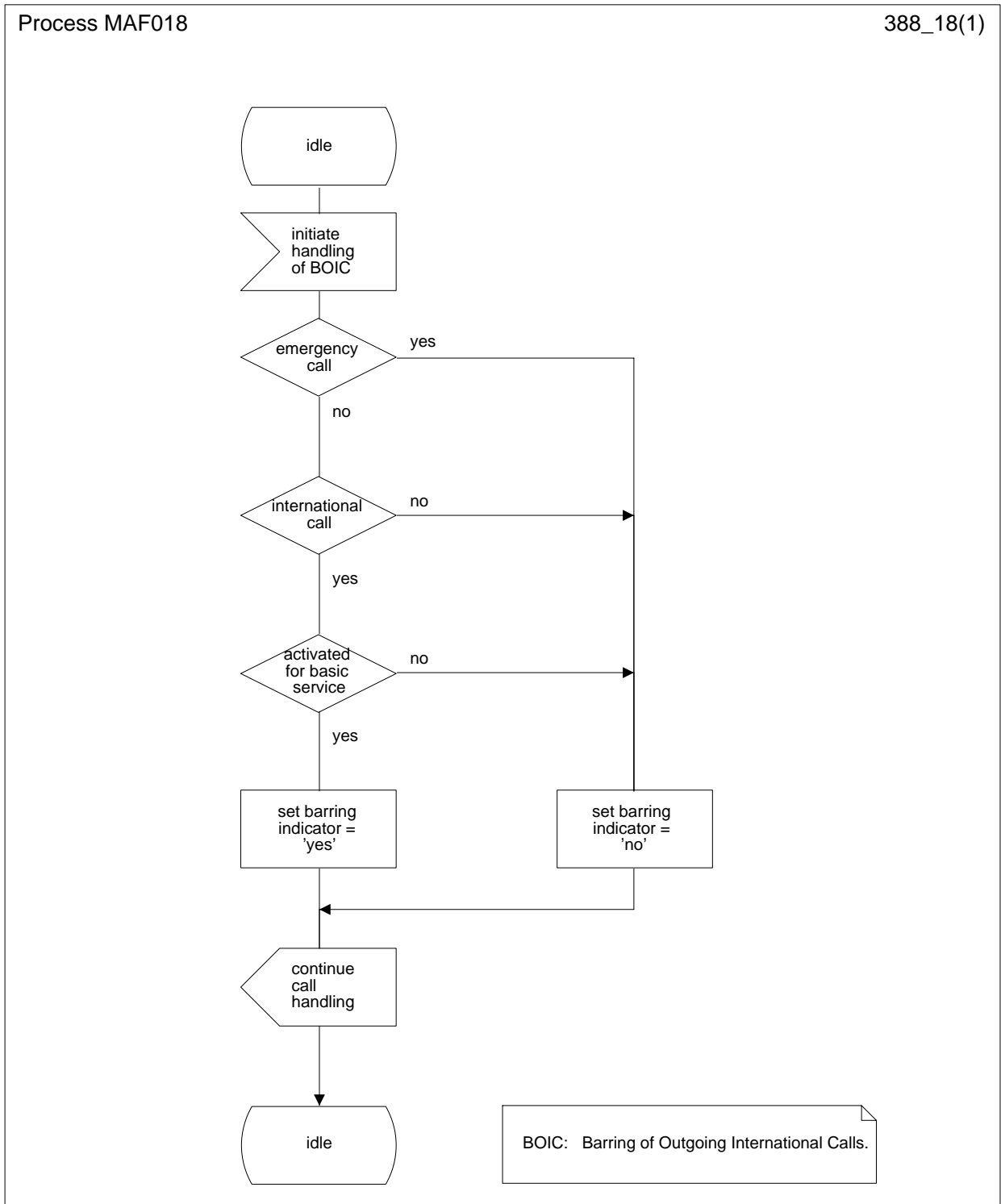

Figure 1.8: MAF018 Barring of all outgoing international calls related authorisations examination (VLR)

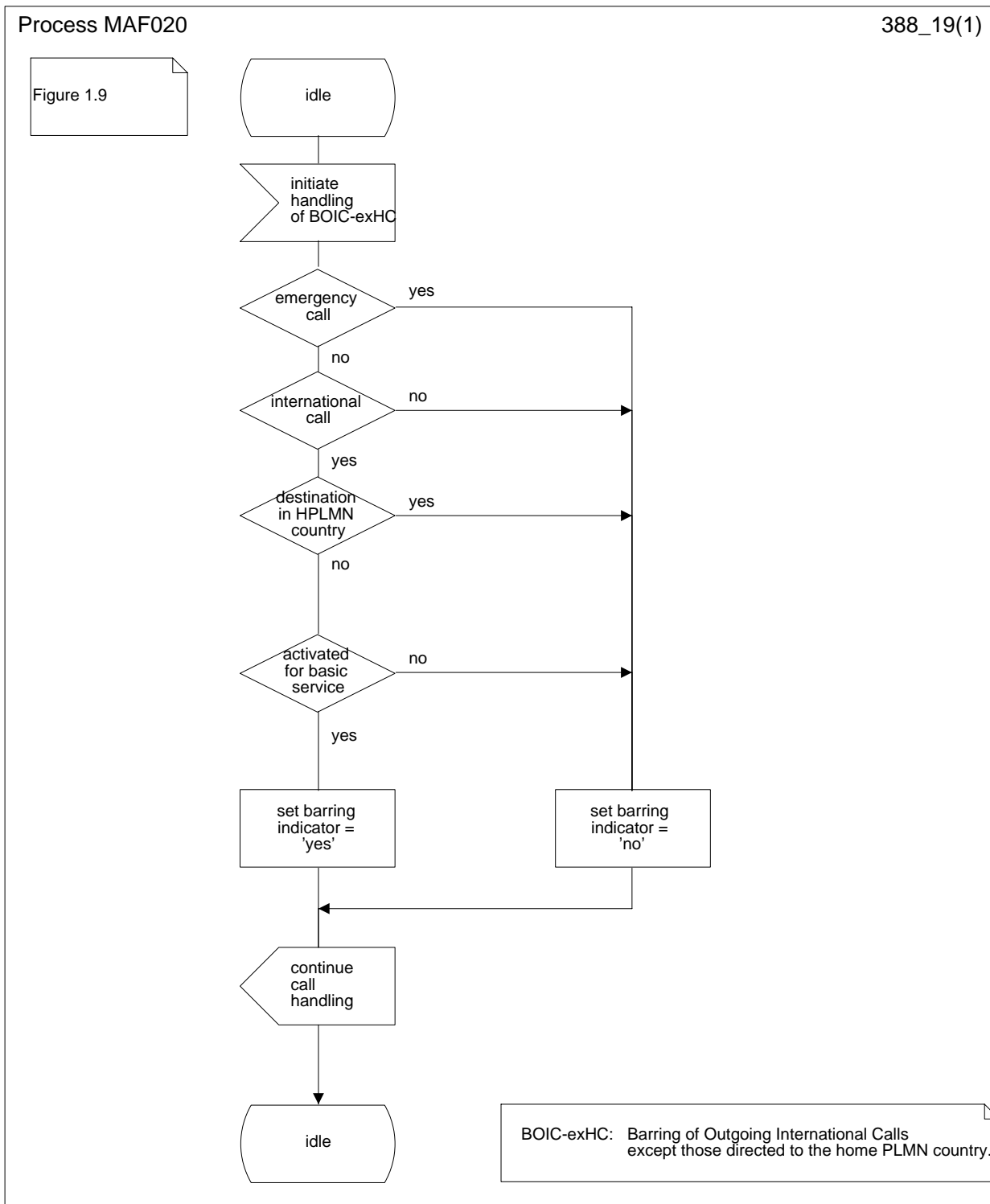
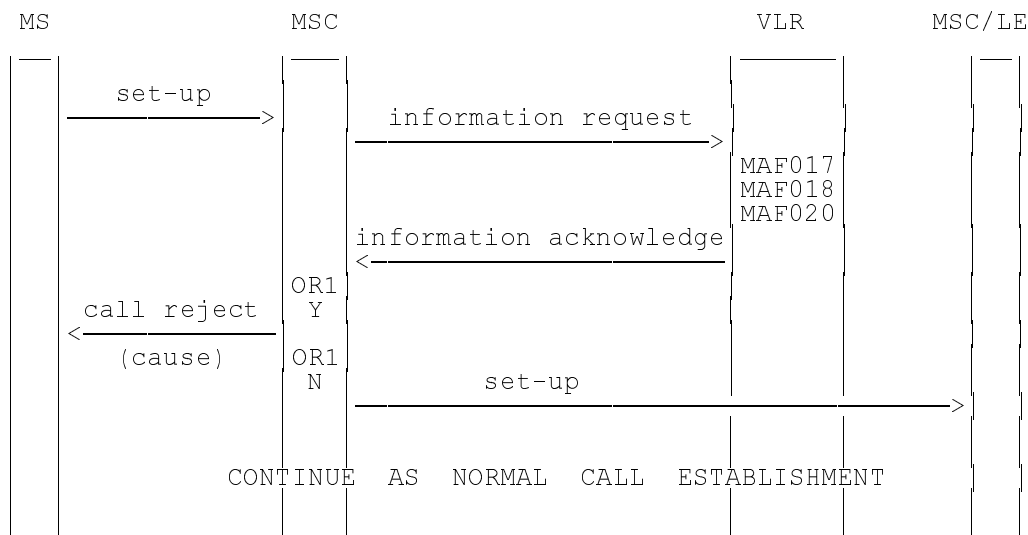

Figure 1.9: MAF020 Barring of outgoing international calls except those directed to the home PLMN country related authorisations examination (VLR)





NOTE: OR1: call barred Y: yes  
N: no

Figure 1.10: Information flow for barring of outgoing calls

### 1.3 Information stored in the HLR

For all call barring supplementary services in the HLR must be stored:

- the subscription option "control of barring services" on per subscriber basis.

This subscription option takes one of the following values:

- by subscriber using password;
- by the service provider.

If the subscription option "control of barring services" has been set to "by subscriber using password" for barring of outgoing calls in the HLR must be stored on per subscriber basis:

- the registration parameter "call barring password"

The password is valid for all basic services to which barring of outgoing calls applies;

- the status parameter "wrong password attempts counter" associated with the password.

Note that the subscription option and the call barring password are parameters which are associated with all call barring services.

The outgoing calls barring program may have the following logical states (refer to GSM 03.11 for an explanation of the notation):

<b>Provisioning State</b>	<b>Registration State</b>	<b>Activation State</b>	<b>HLR Induction State</b>
(Not Provisioned,	Not Applicable,	Not Active,	Not Induced)
(Provisioned,	Not Applicable,	Not Active,	Not Induced)
(Provisioned,	Not Applicable,	Active and Operative,	Not Induced)
(Not Provisioned,	Not Applicable,	Not Active,	Induced)
(Provisioned,	Not Applicable,	Not Active,	Induced)
(Provisioned,	Not Applicable,	Active and Operative,	Induced)

The activation and HLR induction states may be different for each applicable elementary basic service group.

The provisioning state shall be on a per subscriber basis, and hence the same for all basic service groups.

The HLR shall also store the logical state of the outgoing calls barring program (which shall be one of the valid states listed above) for each applicable elementary basic service group.

## 1.4 State transition model

The following figure shows the successful cases of transition between the applicable logical states of the barring of outgoing call program. The state changes are either caused by actions of the service provider, the mobile user or the network.

Note that error cases are not shown in the diagram as they normally do not cause a state change. Additionally, some successful requests may not cause a state change. Hence, they are not shown in diagram.

The diagram only shows operations on an elementary basic service group.

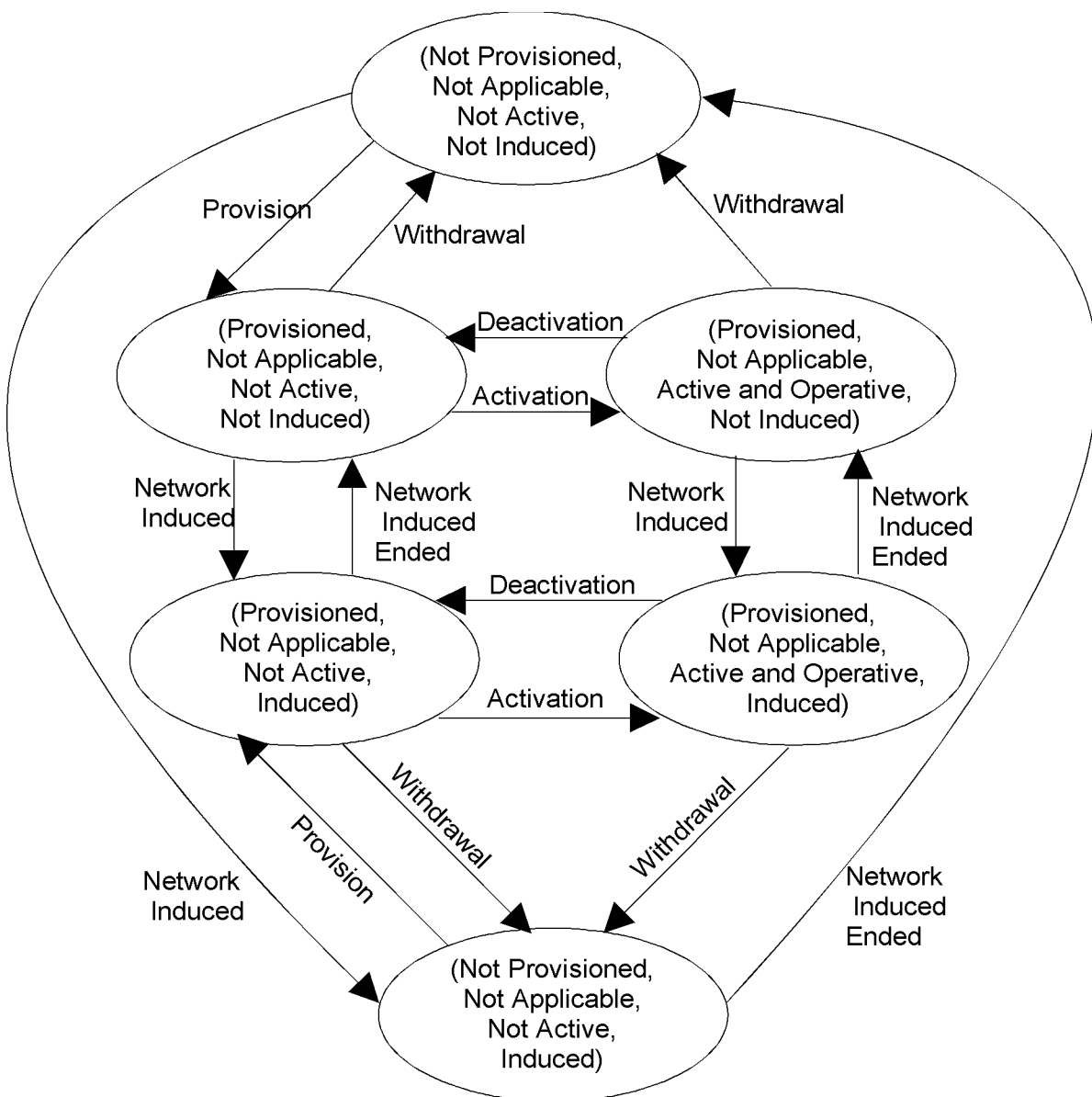

Figure 1.11: State transition model for BAOC, BOIC and BOIC-exHC

## 1.5 Transfer of information from HLR to VLR

If the provisioning state for the outgoing calls barring program is "Provisioned" then when the subscriber registers on a VLR the HLR shall send that VLR information about the logical state of the program for all relevant elementary basic service groups.

If the HLR induction state for the outgoing calls barring program is "Induced" then when the subscriber registers on a VLR the HLR shall send that VLR information about the logical state of the program for all relevant elementary basic service groups.

If the logical state of the outgoing calls barring program is changed while a subscriber is registered on a VLR then for the affected basic service groups, the HLR shall inform the VLR of the new logical state of the program.

## 1.6 Information stored in the VLR

For each barring of outgoing calls program the VLR shall store the service state information received from the HLR.

## 1.7 Handover

Handover will have no impact on the control procedures and the operation of the service.

## 1.8 Cross Phase compatibility

### 1.8.1 MS, MSC, VLR or HLR only support Phase 1 control of SS by the subscriber

In response to a Barring of outgoing calls interrogation request, if the MS or any network element involved is of Phase 1, only information concerning basic service groups for which the activation state has the value "Active and Operative" will be returned.

### 1.8.2 HLR only support Phase 1 updating of subscriber information

If the VLR receives the SS-status parameter from a Phase 1 HLR it shall act as if it has received the SS-Status parameter with the values shown in the following:

- 1) Activated           => P bit = 1, R bit = 0 or 1, A bit = 1, Q bit = 0;
- 2) Deactivated       => P bit = 1, R bit = 0 or 1, A bit = 0, Q bit = 0 or 1.

---

## 2 Barring of incoming calls

### 2.1 Handling of barring of incoming calls

#### 2.1.1 Registration

If the served mobile subscriber at provision time has selected the subscription option "control of barring services by subscriber using password", he has to register a password at provision time. Furthermore the served mobile subscriber can change the password by an appropriate control procedure at any time. The control procedure consists of three steps: first, the old password has to be provided. Secondly, the new password has to be given, after which it has to be verified by providing it once more, see GSM 03.11.

If the served mobile subscriber at provision time has selected the subscription option "control of barring services by the service provider" an attempt to register a password will be denied and the served mobile subscriber should receive a notification.

The subscriber can register a new password, thus causing the previous registration to be overridden, see GSM 03.11.

#### 2.1.2 Activation

##### 2.1.2.1 General

The procedure for activation of Barring of outgoing calls, described in subclause 1.1.2.1, is valid also for activation of Barring of incoming calls.

The information flow for activation of barring of incoming calls is shown in figure 2.3. For more details see GSM 03.11.

##### 2.1.2.2 Interactions between barring of incoming call programs

In case the mobile subscriber activates barring of all incoming calls and barring of incoming calls when roaming outside the home PLMN country was already activated, barring of incoming calls when roaming outside the home PLMN country will be deactivated and barring of all incoming calls will be activated.

The SDL diagram in figure 2.1 shows the function to be performed in the HLR in order to deal with this interaction between call barring services.

##### 2.1.2.3 Interactions with call forwarding supplementary services

For interactions with call forwarding supplementary services see GSM 02.82.

The SDL diagram in figure 2.2 shows the function to be performed in the HLR in order to deal with the interactions with call forwarding services.

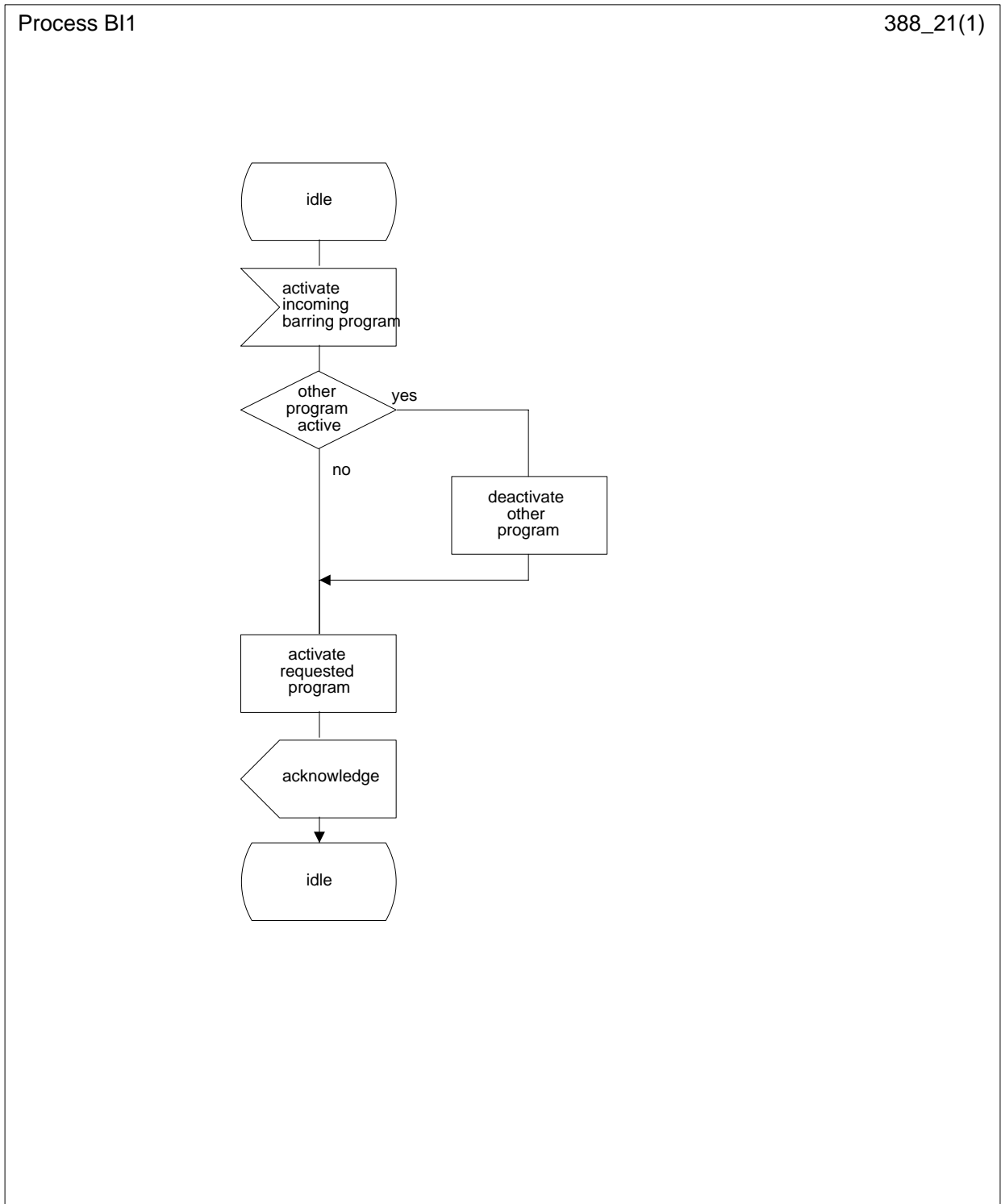

Figure 2.1: BI1 Interaction between call barring programs

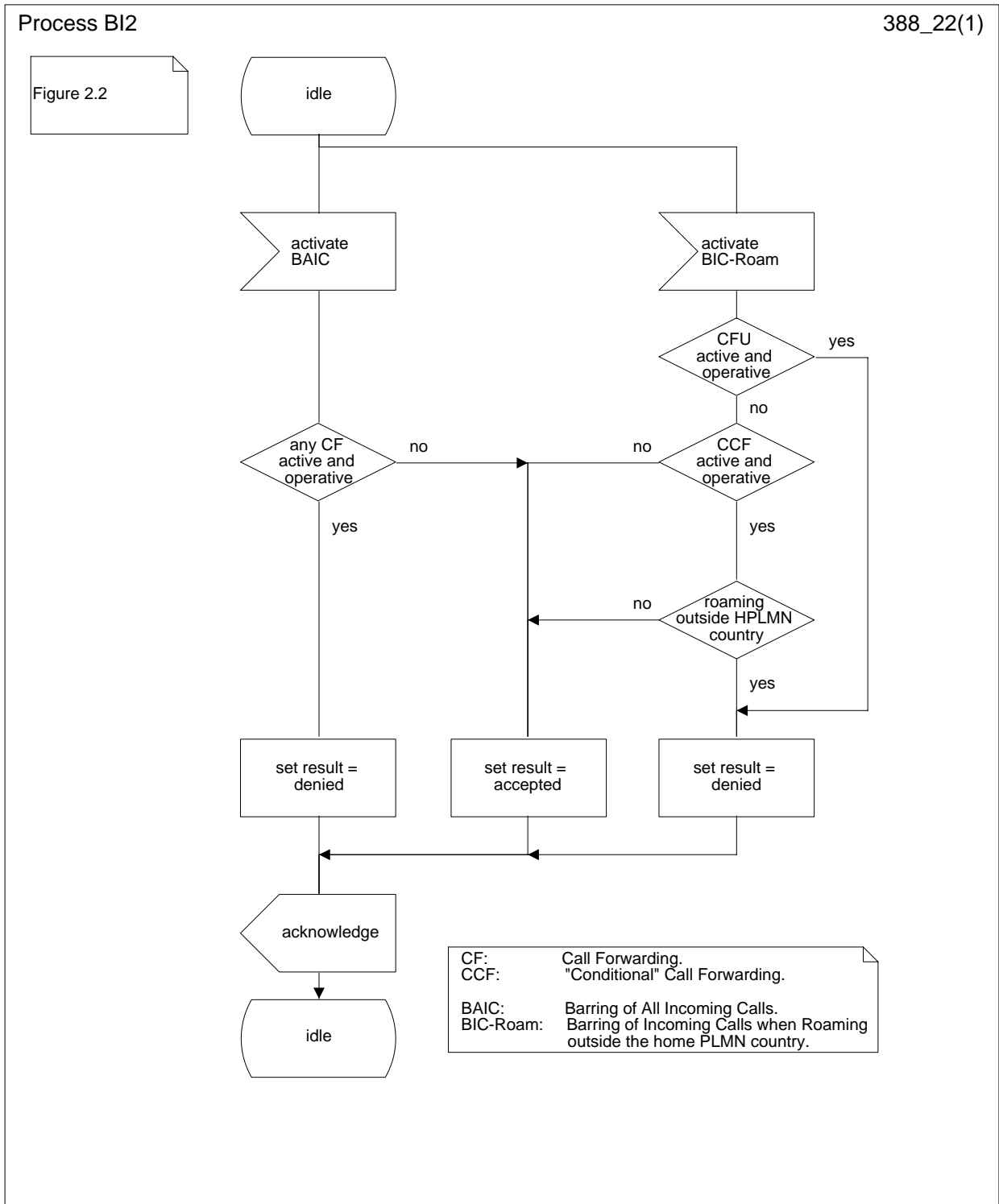
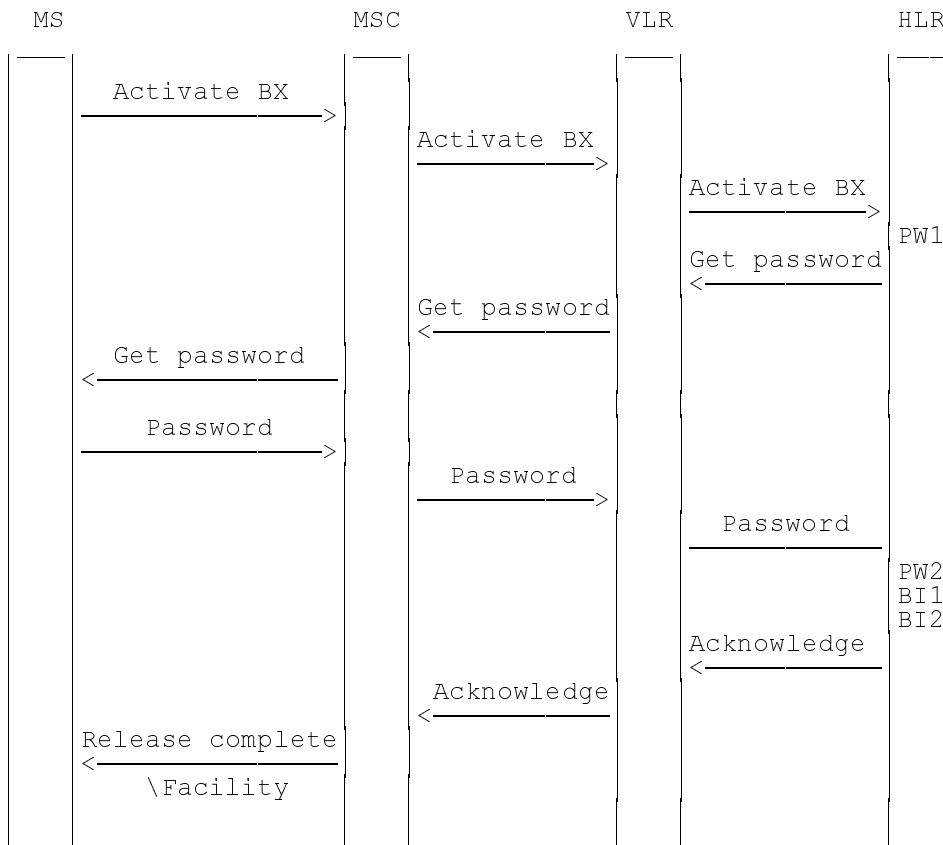

Figure 2.2: BI2 Interaction between call forwarding supplementary services and barring of incoming calls programs



NOTE: BX indicates any of the barring programs.  
PW1 and PW2 indicate password handling programs, see GSM 03.11.

Figure 2.3: Activation of barring of incoming calls

### 2.1.3 Deactivation

The procedure for activation of Barring of outgoing calls, described in subclause 1.1.2.1, is valid also correspondingly for deactivation of Barring of incoming calls with the addition that a barring supplementary service, i.e. the Incoming barring service, or All barring services can be signalled.

The information flow for deactivation of barring of incoming calls is shown in figure 2.4. For more details see GSM 03.11.



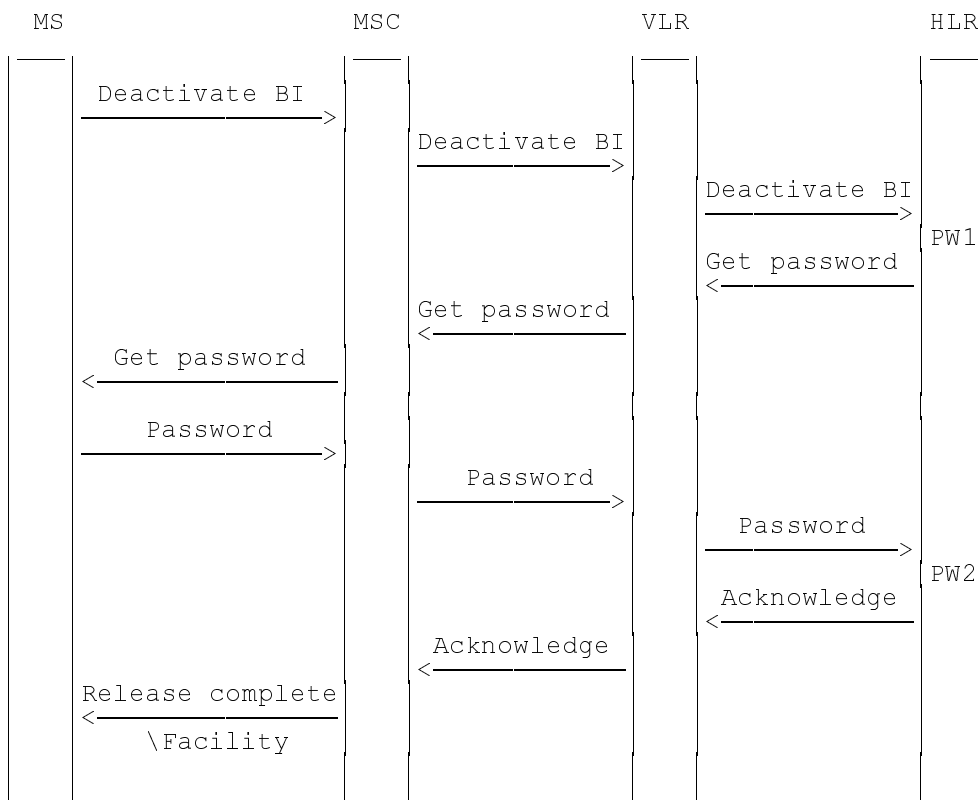

NOTE: BI indicates the general code for barring of incoming calls.  
PW1 and PW2 indicate password handling programs, see GSM 03.11.

Figure 2.4: Deactivation of barring of incoming calls

### 2.1.4 Interrogation

The interrogation procedure enables the mobile subscriber to obtain information about the data stored in the PLMN. After having requested this procedure the network shall return a list of all basic services to which the given program is active.

The information flow for interrogation of barring of incoming calls is shown in figure 2.5.

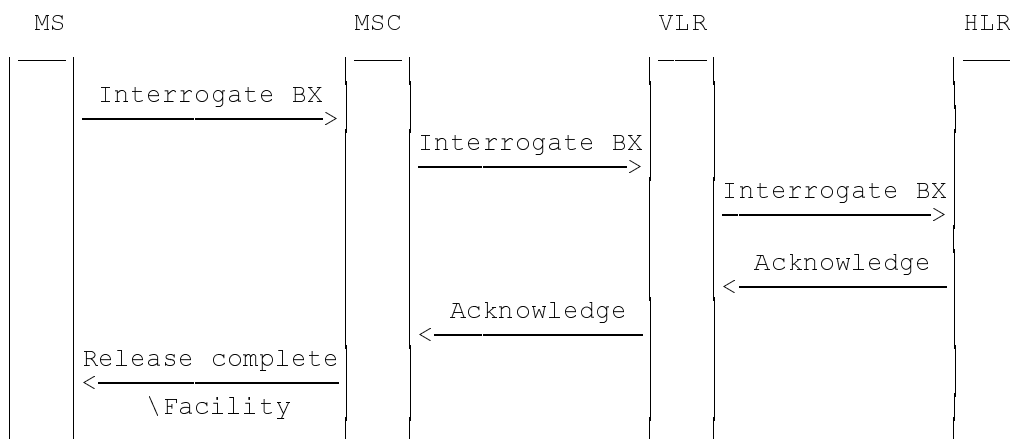

NOTE: BX indicates any of the barring programs.

Figure 2.5: Interrogation of barring of incoming calls

## 2.2 Functions and information flows

The following Mobile Additional Functions have been identified:

### MAF022

Barring of all incoming calls related authorizations examination

The ability of a PLMN component to determine the authorizations relating to barring of incoming calls. See figure 2.6.

Location: HLR

### MAF023

Barring of incoming calls when roaming outside the home PLMN country related authorizations examination

The ability of a PLMN component to determine the authorizations relating to barring of incoming calls when roaming outside the home PLMN country. See figure 2.7.

Location: HLR

The information flow for barring of incoming calls is shown in figure 2.8.

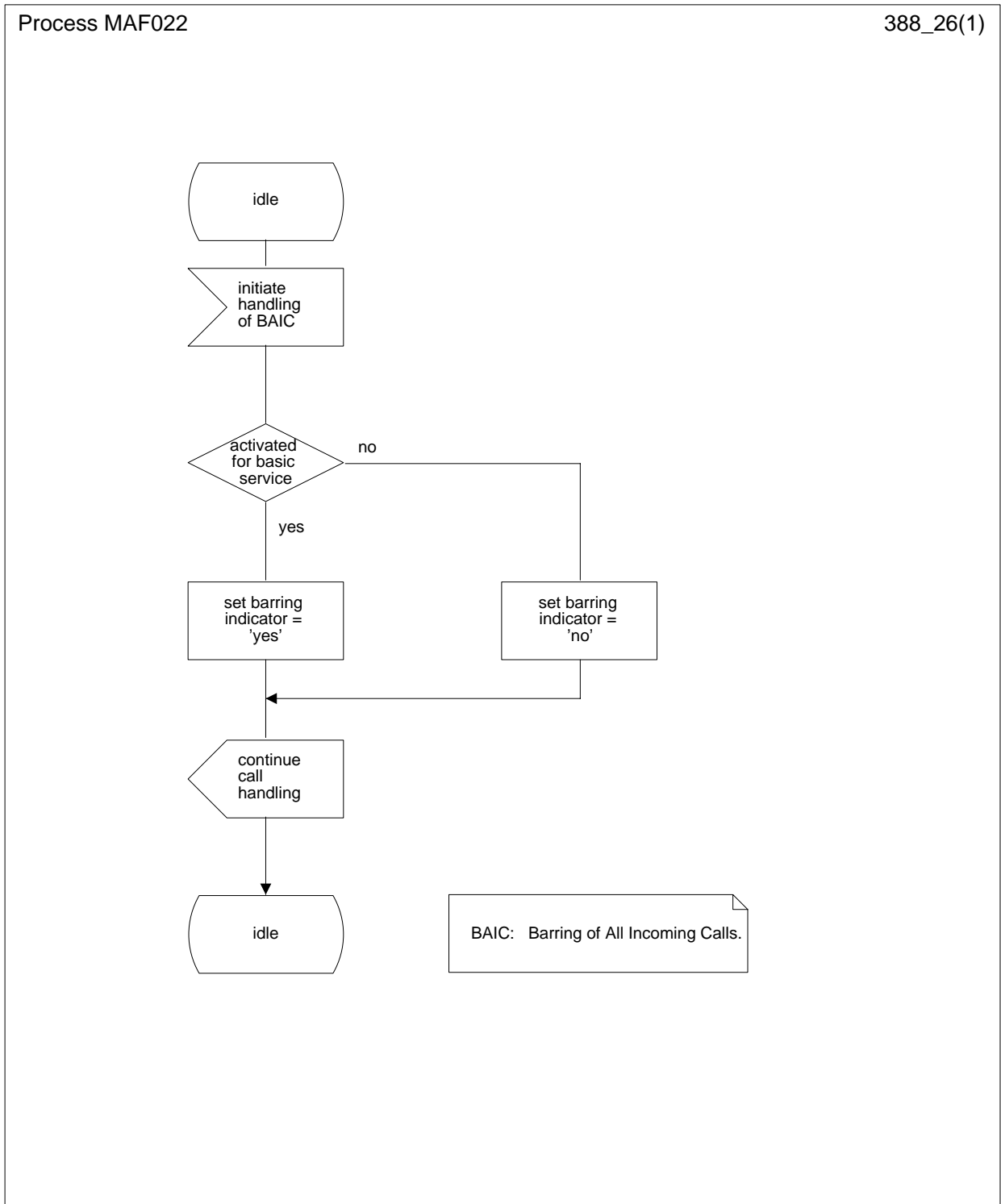

Figure 2.6: MAF022 Barring of all incoming calls related authorisations examination (HLR)

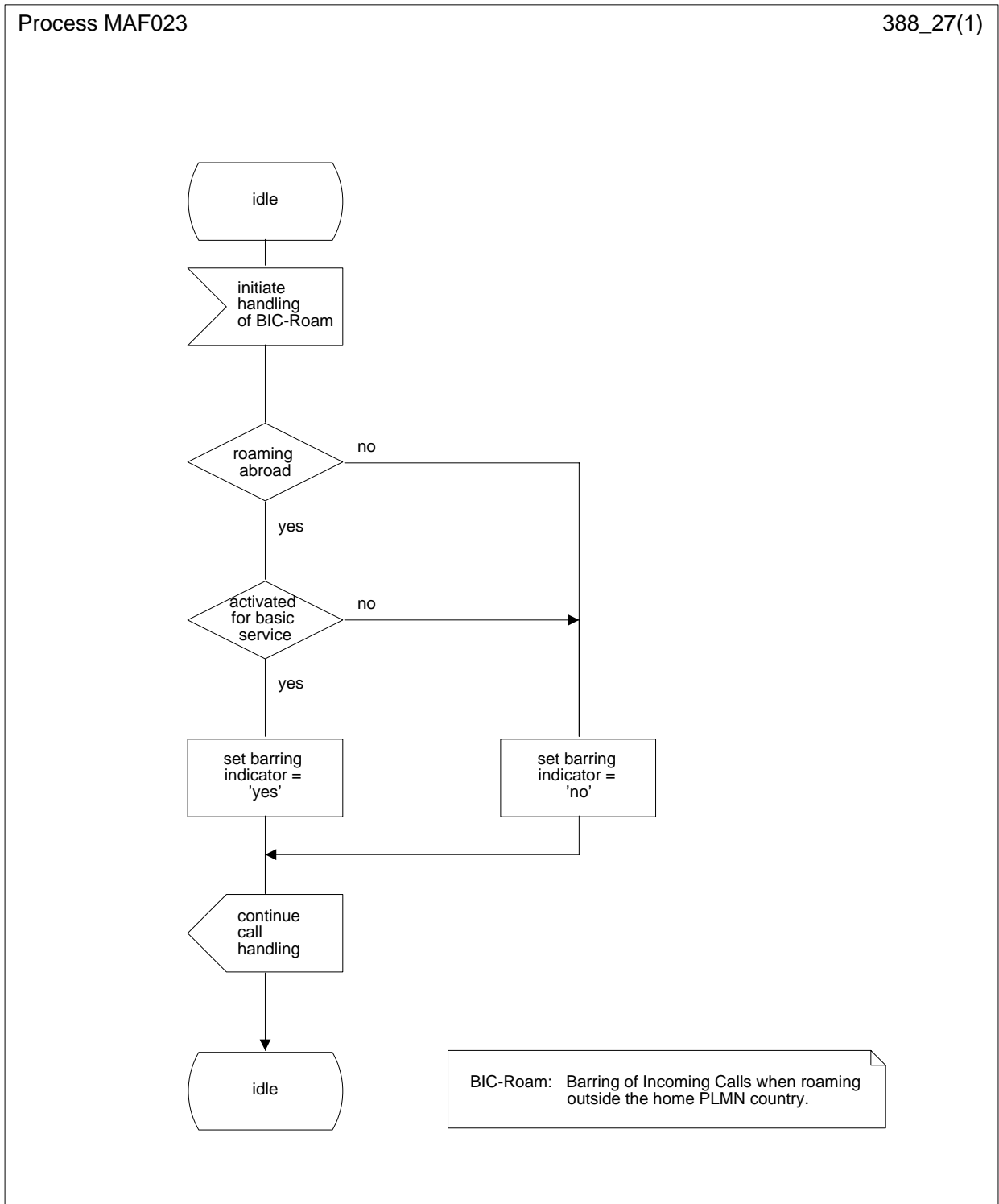
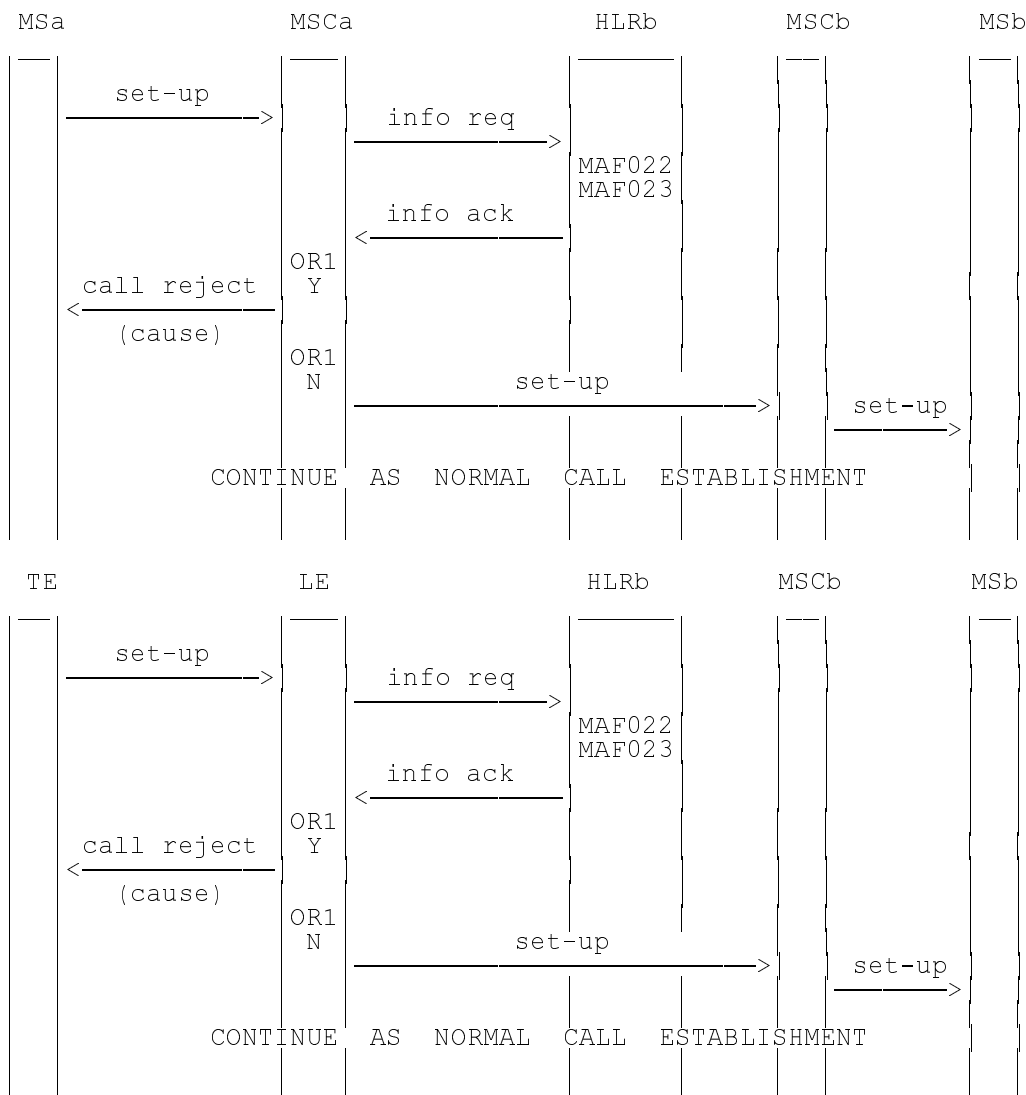

Figure 2.7: MAF023 Barring of incoming calls when roaming outside the home PLMN country related authorisations examination (HLR)



NOTE: info req: information request  
 info ack: information acknowledge  
 OR1: call barred Y: yes  
 N: no.

Figure 2.8: Information flow for barring of incoming calls

## 2.3 Information stored in the HLR

For all call barring supplementary services in the HLR must be stored:

- the subscription option "control of barring services" on per subscriber basis.

This subscription option takes one of the following values:

- by subscriber using password;
- by the service provider.

If the subscription option "control of barring services" has been set to "by subscriber using password" for barring of incoming calls in the HLR must be stored on a per subscriber basis:

- the registration parameter "call barring password".

The password is valid for all basic services to which barring of incoming calls applies;

- the status parameter "wrong password attempts counter" associated with the password.

Note that the subscription option and the call barring password are parameters which are associated with all call barring services.

The incoming calls barring program may have the following logical states (refer to GSM 03.11 for an explanation of the notation):

Provisioning State	Registration State	Activation State	HLR Induction State
(Not Provisioned,	Not Applicable,	Not Active,	Not Induced)
(Provisioned,	Not Applicable,	Not Active,	Not Induced)
(Provisioned,	Not Applicable,	Active and Operative,	Not Induced)

The program of barring of incoming call when roaming outside the home PLMN country may also have the following logical state:

Provisioning State	Registration State	Activation State	HLR Induction State
(Provisioned,	Not Applicable,	Active and Quiescent,	Not Induced)

The activation and HLR induction states may be different for each applicable elementary basic service group.

The provisioning state shall be on a per subscriber basis, and hence the same for all basic service groups.

The HLR shall also store the logical state of the incoming calls barring program (which shall be one of the valid states listed above) for each applicable elementary basic service group.

## 2.4 State transition model

The following figures show the successful cases of transition between the applicable logical states of the call barring program. The state changes are either caused by actions of the service provider, the mobile user or the network.

Note that error cases are not shown in the diagrams as they normally do not cause a state change. Additionally, some successful requests may not cause a state change. Hence, they are not shown in the diagrams.

The diagrams only show operations on an elementary basic service group.

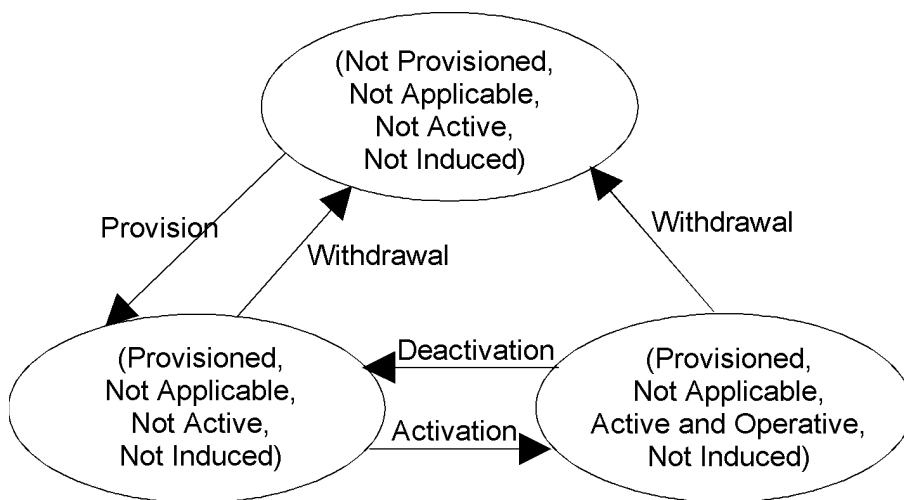
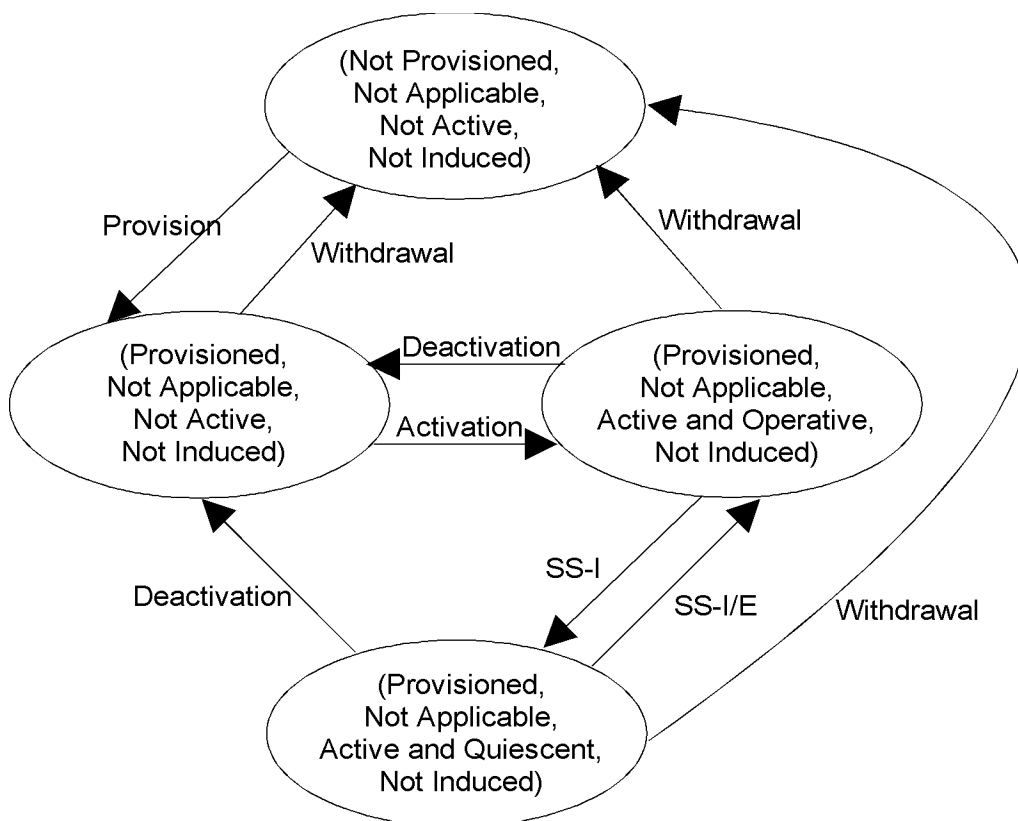

Figure 2.9: State transition model for BAIC



NOTE: SS-I: SS Interaction started or Subscriber in HPLMN country

SS-I/E: SS Interaction ended or Subscriber not in HPLMN country

**Figure 2.10: State transition model for BIC-Roam**

## 2.5 Transfer of information from HLR to VLR

No information is transferred from HLR to VLR for the incoming calls barring program

## 2.6 Information stored in the VLR

No information is stored in the VLR.

## 2.7 Handover

Handover will have no impact on the control procedures and the operation of the service.

## 2.8 Cross Phase compatibility

### 2.8.1 MS, MSC, VLR or HLR only support Phase 1 control of SS by the subscriber

In response to a Barring of incoming calls interrogation request, if the MS or any network element involved is of Phase 1, only information concerning basic service groups for which Barring of incoming calls is active will be returned.

In Phase 1 the state active and quiescent is not used in the HLR.

In Phase 2 the HLR will support the quiescent state.

As this quiescent state is only relevant within the HLR a Phase 1 MSC/VLR and a Phase 1 MS can support the Phase 2 interrogation even if the service becomes quiescent, i.e. there is no functional cross Phase compatibility problem.

Note that the interrogation result received by the user will be in Phase 1 and 2 a list of basic services. The only difference is that in Phase 1 it contains the active basic services irrespective of whether it is operative or quiescent.

## 2.8.2 HLR only supports Phase 1 updating of subscriber information

In Phase 1 the VLR stores the activation status also for barring of incoming calls.

In Phase 2 no information is stored in the VLR in case of barring of incoming calls. The VLR may receive subscription information for barring of incoming calls from a Phase 1 HLR. In this case the VLR shall ignore this information.



## Annex A (informative): Change Request History

<b>Status of Technical Specification GSM 03.88</b>		
<b>Date</b>	<b>Version</b>	<b>Remarks</b>
	version 3.2.0	Last common phase 1/phase 2 version
Release 92	version 3.2.1	only differing in layout, not in content
June 1991	version 4.0.0	CR 03.88-17 rev 1 (category D) approved by GSM#31 CR 03.88-19 rev 2 (category B) CR 03.88-20 rev 1 (category D) CR 03.88-21 (category D) CR 03.88-22 (category D) CR 03.88-23 (category D)
January 1992	version 4.0.1	CR 03.88-24 (category D) approved by SMG#01
April 1992	version 4.1.0	CR 03.88-25 rev 1 (category B) approved by SMG#02 CR 03.88-26 (category B)
June 1992	version 4.1.1	CR 03.88-27 (category D) approved by SMG#03
January 1993	version 4.2.0	CR 03.88-30 rev 1 (category C) approved by SMG#05 CR 03.88-32 (category C)
April 1993	version 4.3.0	CR 03.88-33 rev 1 (category C) approved by SMG#06 TS frozen for phase 2 by SMG#06
June 1993	version 4.4.0	CR 03.88-34 rev 2 (category F) approved by SMG#07 (!!! CR-34 rev 2 in Tdoc SMG3 249/93; Tdoc SMG 383/93 is not completely correct!!!) CR 03.88-35 (category F)
October 1993	version 4.4.1	Changed to draft prETS 300 548
April 1994	version 4.5.0	CR 03.88-36 (category F) approved by SMG#10 CR 03.88-37 (category F) CR 03.88-38 (category F)
October 1994	version 4.6.0	CR 03.88-39 (category D) approved by SMG#12 CR 03.88-40 rev 2 (category F) CR 03.88-41 rev 1 (category F) CR 03.88-42 (category F) CR 03.88-43 (category F) Changed to final draft prETS 300 548
January 1995	version 4.6.1	TS changed to ETS 300 548 First edition
December 1996	version 5.0.0	ETS changed to GTS for release '96
SMG#27	version 6.0.0	Release 1997 version
SMG#29	version 7.0.0	Release 1998 version
<b>Text and flows: WinWord6 Stylesheet: etsiw_70.dot</b>		

---

# History

<b>Document history</b>		
V7.0.0	August 1999	Publication