

**Digital cellular telecommunications system (Phase 2+);  
Circuit switched voice capacity evolution for GSM/EDGE Radio  
Access Network (GERAN)  
(3GPP TR 45.914 version 9.1.1 Release 9)**

---



---

**Reference**

RTR/TSGG-0145914v911

---

**Keywords**

GSM

**ETSI**

---

650 Route des Lucioles  
F-06921 Sophia Antipolis Cedex - FRANCE

Tel.: +33 4 92 94 42 00 Fax: +33 4 93 65 47 16

Siret N° 348 623 562 00017 - NAF 742 C  
Association à but non lucratif enregistrée à la  
Sous-Préfecture de Grasse (06) N° 7803/88

---

**Important notice**

Individual copies of the present document can be downloaded from:

<http://www.etsi.org>

The present document may be made available in more than one electronic version or in print. In any case of existing or perceived difference in contents between such versions, the reference version is the Portable Document Format (PDF). In case of dispute, the reference shall be the printing on ETSI printers of the PDF version kept on a specific network drive within ETSI Secretariat.

Users of the present document should be aware that the document may be subject to revision or change of status. Information on the current status of this and other ETSI documents is available at

<http://portal.etsi.org/tb/status/status.asp>

If you find errors in the present document, please send your comment to one of the following services:

[http://portal.etsi.org/chaicor/ETSI\\_support.asp](http://portal.etsi.org/chaicor/ETSI_support.asp)

---

**Copyright Notification**

No part may be reproduced except as authorized by written permission.  
The copyright and the foregoing restriction extend to reproduction in all media.

© European Telecommunications Standards Institute 2010.  
All rights reserved.

**DECT™**, **PLUGTESTS™**, **UMTS™**, **TIPHON™**, the TIPHON logo and the ETSI logo are Trade Marks of ETSI registered for the benefit of its Members.

**3GPP™** is a Trade Mark of ETSI registered for the benefit of its Members and of the 3GPP Organizational Partners.

**LTE™** is a Trade Mark of ETSI currently being registered

for the benefit of its Members and of the 3GPP Organizational Partners.

**GSM®** and the GSM logo are Trade Marks registered and owned by the GSM Association.

---

## Intellectual Property Rights

IPRs essential or potentially essential to the present document may have been declared to ETSI. The information pertaining to these essential IPRs, if any, is publicly available for **ETSI members and non-members**, and can be found in ETSI SR 000 314: *"Intellectual Property Rights (IPRs); Essential, or potentially Essential, IPRs notified to ETSI in respect of ETSI standards"*, which is available from the ETSI Secretariat. Latest updates are available on the ETSI Web server (<http://webapp.etsi.org/IPR/home.asp>).

Pursuant to the ETSI IPR Policy, no investigation, including IPR searches, has been carried out by ETSI. No guarantee can be given as to the existence of other IPRs not referenced in ETSI SR 000 314 (or the updates on the ETSI Web server) which are, or may be, or may become, essential to the present document.

---

## Foreword

This Technical Report (TR) has been produced by ETSI 3rd Generation Partnership Project (3GPP).

The present document may refer to technical specifications or reports using their 3GPP identities, UMTS identities or GSM identities. These should be interpreted as being references to the corresponding ETSI deliverables.

The cross reference between GSM, UMTS, 3GPP and ETSI identities can be found under <http://webapp.etsi.org/key/queryform.asp>.

# Contents

Intellectual Property Rights .....	2
Foreword.....	2
Foreword.....	10
Introduction .....	10
1 Scope .....	12
2 References .....	12
3 Definitions, symbols and abbreviations .....	13
3.1 Definitions .....	13
3.2 Symbols.....	13
3.3 Abbreviations .....	13
4 Objectives.....	14
4.1 Performance Objectives .....	14
4.1.1 Capacity Improvements at the BTS .....	14
4.1.2 Capacity Improvements at the Air Interface .....	15
4.2 Compatibility Objectives.....	15
4.2.1 Maintainance of Voice Quality .....	15
4.2.2 Support of Legacy Mobile Stations .....	15
4.2.3 Implementation Impacts to new Mobile Stations.....	15
4.2.4 Implementation Impacts to BSS .....	15
4.2.5 Impacts to Network Planning.....	16
5 Common Working Assumptions for Candidates Evaluation .....	16
5.1 General parameters.....	16
5.2 Definition of Model for External Interferers for Link Level Evaluations .....	18
5.2.1 Synchronous Network Mode .....	18
5.2.2 Asynchronous Network Mode .....	19
5.2.2.1 Interferer delay profiles.....	20
5.2.3 Sensitivity limited scenarios .....	20
5.2.4 Frequency Offsets .....	20
5.2.5 Uplink Interferer Profiles .....	20
5.3 Network Configurations .....	21
5.4 Channel Mode Adaptation.....	21
5.5 System Performance Evaluation Method .....	22
5.5.1 Definition of Effective Frequency Load for Mixed Frequency Reuse.....	23
5.6 Definition of Minimum Call Quality Performance .....	23
5.7 Link-to-System Mapping .....	24
5.8 Impairments of the Mobile Station.....	24
5.8.1 Subchannel power imbalance ratio on DL.....	24
5.8.2 Frequency Offset Impairment Model in UL .....	24
5.9 Reference BTS Receiver .....	25
6 Speech Capacity Enhancement using DARP .....	25
6.1 Concept Description .....	25
6.1.1 Principle.....	25
6.1.2 Downlink signal modulation schemes .....	26
6.1.2.1 Equal power level between two desired users .....	26
6.1.2.2 Spectrum analysis .....	28
6.1.2.3 Different power levels between two desired users .....	28
6.1.3 Power control in co-TCH MUROS operation.....	29
6.1.4 BTS changes for co-TCH MUROS operation .....	30
6.1.5 Adaptive pulse shapping for MUROS modulation .....	31
6.2 Performance Characterization .....	35
6.2.1 Link Level Performance .....	35

6.2.1.1	Sensitivity performance .....	35
6.2.1.2	Interference performance .....	37
6.2.1.2.1	MTS-1 configuration .....	37
6.2.1.2.2	MTS-2 configuration .....	38
6.2.1.2.3	MTS-3 configuration .....	39
6.2.1.2.4	MTS-4 configuration .....	40
6.2.1.3	Link level performance with power imbalance .....	41
6.2.1.4	SACCH performance on MUROS and non-MUROS .....	46
6.2.1.4.1	Non-MUROS and MUROS Sensitivity Performance .....	46
6.2.1.4.2	Non-MUROS and MUROS Interference Performance .....	47
6.2.2	Network Level Performance .....	51
6.2.2.1	System Setup and Configurations .....	51
6.2.2.1.1	Enabled features for system simulations .....	52
6.2.2.1.2	Simulated Channel Mode Adaptations .....	52
6.2.2.2	Simulation Results .....	53
6.2.2.2.1	MUROS-1 with 100% penetration .....	53
6.2.2.2.1.1	TU 50km/hr channel model .....	53
6.2.2.2.1.2	TU 3km/hr channel model .....	54
6.2.2.2.2	MUROS-2 with 100% penetration .....	54
6.2.2.2.2.1	TU 50km/hr channel model .....	54
6.2.2.2.3	MUROS-3A with 100% penetration .....	56
6.2.2.2.3.1	TU 50km/hr channel model .....	56
6.2.2.2.3.2	TU 3km/hr channel model .....	56
6.2.2.2.4	MUROS-3B with 100% penetration.....	57
6.2.2.2.4.1	TU 50km/hr channel model .....	57
6.2.2.2.4.2	TU 3km/hr channel model .....	58
6.2.2.2.5	MUROS-2 with less than 100% penetration.....	58
6.2.2.2.5.1	TU 3km/hr channel model .....	58
6.2.2.2.6	Summary .....	59
6.2.2.3	Performance Summary .....	59
6.2.3	Performance Summary .....	60
6.2.4	Verification of Link to System Mapping .....	60
6.3	Impacts on the Mobile Station.....	60
6.4	Impacts on the BSS .....	60
6.4.1	Impact on BTS transmitter.....	60
6.4.2	Impact on BTS receiver .....	61
6.4.3	Impact on Radio Resource Management .....	61
6.5	Impacts on Network Planning .....	61
6.6	Impacts on the Specification .....	61
6.7	Summary of Evaluation versus Objectives.....	62
6.7.1	Performance objectives.....	62
6.7.2	Compatibility objectives .....	63
6.8	References .....	64
7	Orthogonal Sub Channels for Circuit Switched Voice Capacity Evolution.....	64
7.1	Concept description .....	64
7.1.1	Overview .....	64
7.1.2	Downlink concept .....	64
7.1.2.1	Basic OSC concept.....	64
7.1.2.1.1	Mapping of user bits using QPSK modulation .....	64
7.1.2.1.2	Burst structure, training sequence, tail and guard bits .....	65
7.1.2.1.3	Tx pulse shaping filter .....	66
7.1.2.1.3.1	Investigated Candidate TX Pulse Shapes.....	66
7.1.2.1.3.1.1	Candidate Pulse Shape 1 .....	66
7.1.2.1.3.1.2	Candidate Pulse Shape 2 .....	68
7.1.2.1.3.2	Comparison of Filter Characteristics .....	69
7.1.2.1.4	Symbol rotation .....	70
7.1.2.1.5	DTX handling when one sub channel is inactive .....	70
7.1.2.1.6	FACCH signalling.....	70
7.1.2.1.7	SACCH signalling.....	70
7.1.2.2	Enhanced OSC concept.....	71
7.1.2.2.1	Sub channel specific power control.....	71

7.1.2.2.2	Power Balancing.....	72
7.1.2.2.3	Soft Stealing for FACCH with sub channel specific power control.....	72
7.1.2.2.4	Soft Stealing for SACCH with sub channel specific power control.....	73
7.1.2.2.5	User Diversity.....	73
7.1.2.2.5.1	Basic User Diversity.....	73
7.1.2.2.5.2	Optimized User Diversity.....	74
7.1.2.2.5.3	Support of Optimized User Diversity for scenarios with mixed MS types.....	75
7.1.2.2.5.4	Benefits of Optimized User Diversity.....	81
7.1.3	Uplink concept.....	82
7.1.3.1	Modulation and burst structure.....	82
7.1.3.2	Usage of new training sequences.....	82
7.1.3.3	Tx pulse shape.....	82
7.1.3.4	Associated control channels.....	82
7.1.3.5	User diversity.....	82
7.1.3.6	BTS receiver.....	82
7.1.4	RR signalling.....	82
7.2	Performance Characterization.....	83
7.2.1	Link Level Performance.....	83
7.2.1.1	Sensitivity Performance.....	83
7.2.1.1.1	Sensitivity in downlink.....	83
7.2.1.1.1.1	Sensitivity in downlink without sub channel specific power control.....	83
7.2.1.1.1.2	Sensitivity in downlink with subchannel specific power control.....	86
7.2.1.1.2	Sensitivity in uplink.....	87
7.2.1.2	Interference Performance.....	88
7.2.1.2.1	Interference limited performance in downlink.....	88
7.2.1.2.1.1	Interference performance in downlink without subchannel specific power control.....	88
7.2.1.2.1.1.1	Performance for MUROS Test Scenario 1.....	88
7.2.1.2.1.1.2	Performance for MUROS Test Scenario 2.....	88
7.2.1.2.1.1.3	Performance for Using Optimized TX Pulse Shapes.....	90
7.2.1.2.1.2	Interference performance in downlink with subchannel specific power control.....	91
7.2.1.3	Results from: MUROS – Performance of Legacy MS.....	93
7.2.1.3.1	Simulation Assumptions.....	93
7.2.1.3.1.1	Legacy Terminals.....	93
7.2.1.3.1.2	Transmitted MUROS Signal.....	94
7.2.1.3.1.3	MUROS Interference Models.....	94
7.2.1.3.1.4	Other Simulation Parameter.....	94
7.2.1.3.2	Downlink Performance Results.....	94
7.2.1.3.2.1	Sensitivity Performance.....	94
7.2.1.3.2.2	MTS-1 Performance.....	95
7.2.1.3.2.3	MTS-2 Performance.....	96
7.2.1.3.2.4	MTS-3 Performance.....	97
7.2.1.3.2.5	MTS-4 Performance.....	98
7.2.1.3.2.6	ACI Performance.....	99
7.2.1.3.3	Summary of results.....	100
7.2.2	Network Level Performance.....	100
7.2.2.1	Network Configurations.....	100
7.2.2.2	Performance results.....	101
7.2.2.2.1	MUROS-1.....	102
7.2.2.2.2	MUROS-2.....	102
7.2.2.2.3	MUROS-3.....	102
7.2.2.2.4	OSC capacity gains and HW efficiency.....	103
7.2.2.2.5	Performance of optimized user diversity.....	104
7.2.2.2.6	Performance applying Sub Channel Specific Power Control for OSC.....	105
7.2.2.2.7	Performance for Usage of Optimized TX Pulse Shape in Downlink.....	106
7.2.2.2.7.1	Setup for System Performance Evaluation.....	106
7.2.2.2.7.2	System Performance Results.....	106
7.2.2.2.7.2.1	MUROS-1.....	106
7.2.2.2.7.2.2	MUROS-2.....	108
7.2.2.2.7.2.3	MUROS-3a).....	111
7.2.2.2.7.2.4	MUROS-3b).....	113
7.2.2.2.7.3	Summary of EFL gains for optimized pulse shapes versus legacy LGMSK pulse shape.....	116
7.2.2.2.7.4	Conclusions.....	117

7.2.3	Performance Summary .....	118
7.2.4	Verification of Link to System Mapping .....	118
7.2.4.1	Introduction .....	118
7.2.4.2	Verification methodology .....	118
7.2.4.3	Verification for single antenna non-SAIC receivers .....	120
7.2.4.3.1	Verification scenarios .....	120
7.2.4.3.2	Simulation assumptions .....	120
7.2.4.3.3	Mapping verification .....	120
7.2.4.4	Verification for single antenna SAIC receivers.....	122
7.2.4.4.1	Verification scenarios .....	122
7.2.4.4.2	Simulation assumptions .....	122
7.2.4.4.3	Mapping verification .....	123
7.2.4.5	Conclusion .....	125
7.3	Impacts on the Mobile Station.....	125
7.4	Impacts on the BSS .....	126
7.4.1	BTS Transmitter .....	126
7.4.2	BTS Receiver.....	126
7.4.3	Radio Resource Management (RRM).....	126
7.4.3.1	Power Control .....	126
7.4.3.2	Dynamic Channel Allocation (DCA).....	126
7.4.3.3	AMR Channel Rate and Codec Mode Adaptation .....	127
7.5	Impacts on Network Planning .....	127
7.5.1	Impacts to Abis interface .....	127
7.5.1.1	Impact of OSC on Abis allocation strategy.....	127
7.5.1.2	Impact of OSC on bandwidth consumption .....	128
7.5.1.3	Abis migration paths .....	128
7.5.2	Impacts on Frequency Planning.....	129
7.6	Impacts on the Specifications.....	129
7.7	Summary of Evaluation versus Objectives.....	129
7.7.1	Performance objectives .....	130
7.7.2	Compatibility objectives .....	131
7.8	References .....	132
8	Adaptive symbol constellation .....	133
8.1	Concept Description .....	133
8.1.1	Symbol Constellation for the Downlink .....	133
8.1.2	$\alpha$ -QPSK Modulator .....	134
8.1.3	Choice of Symbol Constellation .....	135
8.1.4	Adaptive Constellation Rotation.....	136
8.1.5	Frequency hopping .....	138
8.1.5.1	Legacy support .....	141
8.1.5.2	Additional signaling .....	141
8.1.6	SAM - Single Antenna MIMO - for VAMOS .....	141
8.1.6.1	Concept description.....	141
8.1.6.1.1	Computational Complexity.....	143
8.2	Performance Characterization .....	143
8.2.1	Link Level Performance .....	143
8.2.1.1	Simulation assumptions .....	144
8.2.1.2	Sensitivity Performance .....	145
8.2.1.2.1	SAIC receiver .....	145
8.2.1.2.1.1	Support of legacy mobiles .....	147
8.2.1.2.2	MUROS receiver .....	148
8.2.1.2.2.1	Symbol Constellation Detection .....	148
8.2.1.2.2.2	Constellation Rotation Detection.....	149
8.2.1.2.3	SIC receiver .....	150
8.2.1.2.3.1	Investigations by Telefon AB LM Ericsson.....	150
8.2.1.2.3.1.1	Simulation assumptions.....	150
8.2.1.2.3.1.2	Performance Plots .....	151
8.2.1.2.3.2	Investigations by ST-NXP Wireless France .....	152
8.2.1.2.3.2.1	Simulation Assumptions .....	152
8.2.1.2.3.2.1	Simulation Results for Downlink .....	153
8.2.1.3	Interference Performance .....	155

8.2.1.3.1	non-SAIC receiver .....	155
8.2.1.3.2	SAIC receiver .....	157
8.2.1.3.2.1	Adaptive Constellation Rotation .....	165
8.2.1.3.3	MUROS receiver .....	167
8.2.1.3.3.1	Constellation Rotation Detection .....	167
8.2.1.3.4	SIC receiver .....	168
8.2.1.3.4.1	Investigations by Telefon AB LM Ericsson .....	168
8.2.1.3.4.1.1	Simulation assumptions .....	168
8.2.1.3.4.1.2	Performance Plots for MTS Test Scenarios .....	169
8.2.1.3.4.2	Investigations by ST-NXP Wireless France .....	172
8.2.1.3.4.2.1	Introduction .....	172
8.2.1.3.4.2.2	Simulation Assumptions for Uplink .....	173
8.2.1.3.4.2.3	Simulation Results for Uplink .....	174
8.2.1.3.4.2.4	Simulation Assumptions for Downlink .....	177
8.2.1.3.4.2.5	Simulation Results for Downlink .....	177
8.2.1.3.4.2.6	Conclusions .....	181
8.2.1.3.5	SAM Receiver for VAMOS .....	181
8.2.1.3.5.1	Simulation assumptions .....	181
8.2.1.3.5.2	Performance plots .....	182
8.2.1.4	Results from: MUROS - Performance of Alpha-QPSK with Legacy DARP MS .....	187
8.2.1.4.1	Simulation Assumptions .....	187
8.2.1.4.1.1	Legacy Terminals .....	187
8.2.1.4.1.2	Transmitted MUROS Signal .....	188
8.2.1.4.1.3	Alpha-QPSK .....	188
8.2.1.4.1.4	MUROS Interference Models .....	189
8.2.1.4.1.5	Other Simulation Parameters .....	189
8.2.1.4.2	Downlink Performance Results .....	189
8.2.1.4.2.1	Sensitivity Performance .....	189
8.2.1.4.2.2	MTS-1 Performance .....	190
8.2.1.4.2.3	MTS-2 Performance .....	191
8.2.1.4.2.4	MTS-3 Performance .....	192
8.2.1.4.2.5	MTS-4 Performance .....	193
8.2.1.4.3	Summary of Results .....	194
8.2.2	Network Level Performance .....	194
8.2.2.1	Adaptive constellation rotation .....	194
8.2.2.2	Support of legacy non-DARP Phase I receivers using $\alpha$ -QPSK .....	195
8.2.2.2a	Downlink power control using $\alpha$ -QPSK .....	196
8.2.2.2.1	SCPIR distributions in different system simulations .....	197
8.2.2.3	Evaluation of VAMOS MAIO hopping .....	198
8.2.3	Verification of Link to System Mapping .....	199
8.2.3.1	Methodology, DL .....	199
8.2.3.1.1	Interference scenarios .....	200
8.2.3.1.2	Raw BER verification levels .....	201
8.2.3.1.3	Interference statistics .....	201
8.2.3.1.4	Adjacent channel interference .....	201
8.2.3.1.5	Mappings .....	202
8.2.3.2	Verification, DL .....	204
8.2.3.2.1	SAIC .....	204
8.2.3.2.2	non-SAIC .....	206
8.2.3.2.3	SAM .....	207
8.3	Impacts on the Mobile Station .....	209
8.3.1	Legacy mobile stations .....	209
8.3.2	Mobile stations supporting Adaptive symbol constellation .....	209
8.4	Impacts on the BSS .....	210
8.5	Impacts on Network Planning .....	210
8.6	Impacts on the Specification .....	210
8.7	Summary of Evaluation versus Objectives .....	211
8.7.1	Performance objectives .....	211
8.7.2	Compatibility objectives .....	211
8.8	References .....	214
9	Higher Order Modulations for MUROS .....	216



9.1	Concept Description .....	216
9.1.1	Downlink .....	216
9.1.1.1	Speech multiplexing .....	216
9.1.1.1.1	Speech Multiplexing and Interleaving .....	217
9.1.1.2	Modulation Schemes and Training Sequences .....	217
9.1.1.3	Legacy GMSK MS Support .....	218
9.1.1.4	Codecs support and Achievable Code Rates .....	219
9.1.1.5	DTX .....	220
9.1.1.5.1	DTX Configuration Signaling .....	220
9.1.1.5.1.1	Examples .....	221
9.1.1.5.2	Signalling Rate and Signaling Channel Coding .....	222
9.1.1.5.3	Average Channel Usage .....	222
9.1.1.6	Hopping .....	222
9.1.1.7	Power Control .....	223
9.1.1.8	SACCH .....	225
9.1.1.9	FACCH .....	225
9.1.2	Uplink .....	225
9.1.2.1	Speech multiplexing .....	225
9.1.2.1.1	Legacy Support .....	226
9.1.2.2	Training Sequences .....	227
9.1.2.3	Burst Format Signaling .....	228
9.1.2.4	DTX .....	228
9.1.2.5	Hopping .....	228
9.1.2.6	Codecs support and Achievable Code Rates .....	229
9.1.2.7	Power Control .....	229
9.1.2.8	SACCH .....	229
9.1.3	Dynamic Channel Allocation .....	229
9.2	Performance Characterization .....	230
9.2.1	Link Level Performance .....	230
9.2.1.1	Sensitivity Performance .....	230
9.2.1.2	Interference Performance .....	232
9.2.1.2.1	Co-channel Performance .....	232
9.2.1.2.2	MTS-x Performance .....	234
9.2.1.2.2.1	Downlink .....	235
9.2.1.2.3	Co-Channel Performance with Power Control .....	239
9.2.1.3	MTS-1 to MTS-4 Performance .....	244
9.2.1.4	Adjacent Interference Performance .....	252
9.2.2	Network Level Performance .....	252
9.2.3	Verification of Link to System Mapping .....	253
9.3	Impacts on the Mobile Station .....	253
9.4	Impacts on the BSS .....	253
9.5	Impacts on Network Planning .....	253
9.6	Impacts on the Specification .....	253
9.7	Summary of Evaluation versus Objectives .....	254
9.7.1	Performance Objectives .....	254
9.7.2	Compatibility Objectives .....	254
9.8	References .....	255
10	New Training Sequences .....	256
10.1	Training sequence candidates proposed .....	256
10.1.1	TSC Set proposed by Nokia [10-1] .....	256
10.1.2	TSC Set proposed by Motorola [10-2] .....	257
10.1.3	TSC Set proposed by China Mobile [10-3] .....	257
10.1.4	TSC Set proposed by Research in Motion Ltd [10-4] .....	258
10.1.5	TSC Set proposed by Telefon AB LM Ericsson [10-5] .....	258
10.1.6	TSC Set proposed by Huawei Technologies Ltd [10-6] .....	259
10.1.7	TSC Set-2 proposed by Research in Motion Ltd [10-7] .....	259
10.1.8	TSC Set-2 proposed by Huawei Technologies Ltd [10-8] .....	260
10.1.9	TSC Set-2 proposed by Motorola [10-9] .....	260
10.2	Training sequence evaluation and selection .....	260
10.3	References .....	261

11	Associated Control Channel Design.....	262
11.1	Shifted SACCH.....	262
11.1.1	Concept Description .....	262
11.1.2	Performance Characterization.....	263
11.1.2.1	Link Level Performance.....	263
11.1.2.1.1	Degradation of SACCH Performance introduced by MUROS .....	263
11.1.2.1.1.1	Simulation assumptions .....	263
11.1.2.1.1.2	SACCH Performance in MTS-1 .....	264
11.1.2.1.1.3	SACCH Performance in MTS-2 .....	265
11.1.2.1.2	Degradation of Relative Performance between SACCH and TCH introduced by MUROS .....	265
11.1.2.1.2.1	Simulation assumptions .....	265
11.1.2.1.2.2	Performance of SACCH and TCH in legacy DARP .....	266
11.1.2.1.2.3	Performance of SACCH and TCH in MUROS.....	266
11.1.2.1.2.4	Performance Analysis .....	268
11.1.2.1.3	Performance of Shifted SACCH with different SCPIRs .....	269
11.1.2.1.3.1	Simulation assumptions .....	269
11.1.2.1.3.2	SACCH Performance in MTS-1 .....	269
11.1.2.1.3.3	SACCH performance in MTS-2 .....	270
11.1.2.1.3.4	TCH/AHS5.9 performance in MTS-1.....	271
11.1.2.1.3.5	TCH/AHS5.9 MUROS performance in MTS-2.....	271
11.1.2.1.3.6	Performance analysis .....	271
11.1.2.1.4	Performance of Shifted SACCH in DTX .....	272
11.1.2.1.4.1	Performance evaluation methods in DTX.....	272
11.1.2.1.4.2	Simulation assumptions .....	273
11.1.2.1.4.3	SACCH and AHS4.75 Performance in MTS-1.....	274
11.1.2.1.4.4	SACCH and AHS4.75 performance in MTS-2.....	275
11.1.2.1.4.5	Performance analysis .....	275
11.1.2.1.5	Performance of Shifted SACCH for VAMOS level II and non-SAIC receivers .....	276
11.1.2.1.5.1	Simulation assumptions .....	276
11.1.2.1.5.2	VAMOS level II receiver.....	276
11.1.2.1.5.3	Non-SAIC receiver .....	279
11.1.2.1.5.4	Shifted SACCH without DTX .....	280
11.1.2.1.5.5	Performance analysis .....	281
11.1.3	Impacts on the Mobile Station .....	281
11.1.3.1	Legacy mobile stations.....	281
11.1.3.2	Mobile stations supporting Shifted SACCH .....	281
11.1.4	Impacts on the BSS.....	281
11.2	References .....	282
12	Summary of Evaluation versus Objectives for each Candidate Technique.....	283
12.1	Performance Objectives .....	283
12.2	Compatibility Objectives.....	284
13	Conclusions .....	285
<b>Annex A:</b>	<b>Change history .....</b>	<b>286</b>
History .....		287

---

## Foreword

This Technical Report has been produced by the 3<sup>rd</sup> Generation Partnership Project (3GPP).

The contents of the present document are subject to continuing work within the TSG and may change following formal TSG approval. Should the TSG modify the contents of the present document, it will be re-released by the TSG with an identifying change of release date and an increase in version number as follows:

Version x.y.z

where:

- x the first digit:
  - 1 presented to TSG for information;
  - 2 presented to TSG for approval;
  - 3 or greater indicates TSG approved document under change control.
- y the second digit is incremented for all changes of substance, i.e. technical enhancements, corrections, updates, etc.
- z the third digit is incremented when editorial only changes have been incorporated in the document.

---

## Introduction

Recently, the GSM network is seeing its greatest expansion due to the increased demand for mobile voice services in emerging markets. Furthermore, most of these emerging markets have densely populated cities and limited radio spectrum. Thus the increase of voice capacity in the circuit switched domain in an evolutionary manner is a key issue for operators in these markets.

To help operators in these scenarios to alleviate the strain on their networks, new techniques are required to improve the voice capacity on the basis of reusing existing network equipment and radio resource. These have been investigated during the MUROS feasibility study and candidate solutions proposed in this feasibility study are based on multiplexing two or more users onto one time slot without degrading the speech quality. These solutions are unlike the speech codec approach to increase network capacity by increasing speech compression, e.g. multiplexing two GSM-HR mobiles onto one time slot but rather to maintain the same speech encoding by multiplexing four GSM-HR mobiles onto one time slot.

The Technical Report is structured in the following way:

Chapter 1 elaborates the scope of the MUROS feasibility study.

Chapter 2 and 3 contain usual elements like References, Definitions, Symbols and Abbreviations.

Chapter 4 lists the defined performance and compatibility objectives for MUROS.

Chapter 5 depicts the common working assumptions for the performance evaluation of MUROS candidate solutions.

Chapter 6 to 9 contain the four candidate solutions for MUROS, in particular:

the candidate solution “Speech Capacity Enhancement using DARP” in Chapter 6

the candidate solution “Orthogonal Sub Channels for Circuit Switched Voice Capacity Evolution” in Chapter 7

the candidate solution “Adaptive symbol constellation” in Chapter 8

the candidate solution “Higher Order Modulations for MUROS” in Chapter 9

Chapter 10 lists the proposed candidates for the new set of training sequences.

Chapter 11 depicts aspects related to associated control channel design for MUROS.

Chapter 12 provides a summary of the evaluation versus defined objectives for each of the candidate solutions.

Chapter 13 finally draws conclusions.

---

# 1 Scope

The present document is an output of the 3GPP study item "Multi-User Reusing-One-Slot" (MUROS) [11].

It contains a section describing the objectives of the Circuit Switched Voice Capacity Evolution, and further sections presenting candidate techniques, which are evaluated according to their potential related to voice capacity improvement in GERAN. For this the design of a new set of training sequences with improved cross correlation properties to the existing set of training sequences is foreseen and expected to be evaluated. The study will also include the investigation of different optimised pulse shapes for MUROS for both the uplink and the downlink.

---

# 2 References

The following documents contain provisions which, through reference in this text, constitute provisions of the present document.

- References are either specific (identified by date of publication, edition number, version number, etc.) or non-specific.
- For a specific reference, subsequent revisions do not apply.
- For a non-specific reference, the latest version applies. In the case of a reference to a 3GPP document (including a GSM document), a non-specific reference implicitly refers to the latest version of that document *in the same Release as the present document*.

- [1] 3GPP TR 21.905: "Vocabulary for 3GPP Specifications".
- [2] GP-080393: "Outcome of MUROS session", WI Rapporteur, 3GPP GERAN#37".
- [3] P.T. Brady, A model for generating on-off speech patterns in two-way conversation, Bell Systems Technical Journal (Sept. 1969), p. 2445-2472
- [4] AHG1-080064: "WI Rapporteur", GERAN.
- [5] 3GPP T3GPP TR 45.903, v.7.0.1, Feasibility Study on Single Antenna Interference Cancellation (SAIC) for GSM networks (Release 7)
- [6] GP-080947: "Summary of MUROS Offline Session", WI Rapporteur, 3GPP GERAN#38.
- [7] GP-081130: "MUROS Uplink Performance", Telefon AB LM Ericsson, 3GPP GERAN#39.
- [8] GP-081024: "Link to System mapping method for power imbalanced MUROS", Huawei Technologies Co., LTD., 3GPP GERAN#39.
- [9] GP-081132: "Link-2-System mapping for SAIC and non-SAIC mobiles MUROS", Telefon AB LM Ericsson, 3GPP GERAN#39.
- [10] GP-081131: "Effect of Frequency Offsets in the Link Performance of MUROS UL", Telefon AB LM Ericsson, 3GPP GERAN#39.
- [11] GP-072033, WID: "Multi-User Reusing-One-Slot (MUROS)", China Mobile, Ericsson, Nokia Siemens Networks, Nokia, Nortel Networks, NXP, Qualcomm, Telecom Italia, Vodafone, 3GPP GERAN#36.

## 3 Definitions, symbols and abbreviations

### 3.1 Definitions

For the purposes of the present document, the terms and definitions given in TR 21.905 [1] and the following apply. A term defined in the present document takes precedence over the definition of the same term, if any, in TR 21.905 [1].

### 3.2 Symbols

For the purposes of the present document, the following symbols apply:

$\alpha$	angle specifying constellation of $\alpha$ -QPSK
A	Offered Traffic
$B_p$	Blocking Probability
C/I	Carrier to Interference Ratio
C/I1	Carrier to First (Strongest) Interferer Ratio
IQ, I-Q	In Phase/Quadrature Phase
$\chi$	cross power ratio between sub channels

### 3.3 Abbreviations

For the purposes of the present document, the abbreviations given in TR 21.905 [1] and the following apply. An abbreviation defined in the present document takes precedence over the definition of the same abbreviation, if any, in TR 21.905 [1].

ACI	Adjacent Channel Interference
AFS	Adaptive Multi-Rate Full Slot
AHS	Adaptive Multi-Rate Half Slot
AMR	Adaptive Multi-Rate
ARFCN	Absolute Radio Frequency Carrier Number
AWGN	Average White Gaussian Noise
BCCH	Broadcast Control Channel
BER	Bit Error Rate
BSC	Base Station Controller
BSS	Base Station Subsystem
BTS	Base Transceiver Station
CCI	Co-channel Interference
CIR, C/I	Carrier-to-Interference Ratio
DARP	Downlink Advanced Receiver Performance
DTS	DARP Test Scenario
DTx, DTX	Discontinuous Transmission
EFL	Effective Frequency Load
EGPRS	EDGE General Packet Radio Service
FACCH	Fast Associated Control Channel
FER	Frame Erasure Rate
FH	Frequency Hopping
FR	Full Rate
GMSK	Gaussian Minimum Shift Keying
HR	Half Rate
HSN	Hopping Sequence Number
ICI	Inter Channel Interference
IRC	Interference Rejection Combining
ISI	Inter Symbol Interference
JD	Joint Detection
L2S	Link to System mapping
MA	Mobile Allocation
MAIO	Mobile Allocation Index Offset
MAIOA	MAIO Allocation

MAIOHSN	MAIO Hopping Sequence Number
MAIOPN	MAIO Permutation Number
MIMO	Multiple Input Multiple Output
MRC	Maximal Ratio Combining
MSRD	Mobile Station Receive Diversity
MTS	MUROS Test Scenario
MUROS	Multi-User Reusing One Slot
PA	Power Amplifier
PAR	Peak to Average Ratio
PC	Power Control
PSK	Phase Shift Keying
QAM	Quadrature Amplitude Modulation
QPSK	Quarternary Phase Shift Keying
RMS	Root Mean Square
RR	Radio Resource
RRC	Root Raised Cosine
SACCH	Slow Associated Control Channel
SAIC	Single Antenna Interference Cancellation
SCPIR	Sub Channel Power Imbalance Ratio
SIC	Successive Interference Cancellation
SNR	Signal-to-Noise Ratio
TCH/EFS	Traffic channel employing enhanced full rate GSM speech codec
TCH/FS	Traffic channel employing full rate GSM speech codec
TCH/HS	Traffic channel employing half rate GSM speech codec
TCH/AFS	Traffic channel employing AMR full rate codec
TCH/AHS	Traffic channel employing AMR half rate codec
TCH/WFS	Traffic channel employing Wideband AMR full rate codec based on GMSK
TRX	Transceiver
TSC	Training Sequence Code
VAD	Voice Activity Detection

---

## 4 Objectives

The increase in user amount and voice traffic puts a huge pressure on operators especially within populous countries. Furthermore, as voice service price gets cheaper, most operators face the challenge to obtain efficient utilization of hardware and spectrum resource. The following performance and compatibility objectives are therefore defined for each MUROS candidate technique.

### 4.1 Performance Objectives

Two performance objectives are defined.

#### 4.1.1 Capacity Improvements at the BTS

**Objective P1:** The candidate techniques proposed under MUROS is expected to increase voice capacity of GERAN in order of a factor of two per BTS transceiver. The channels under interest for doubled voice capacity are both full rate and half rate channels: TCH/FS, TCH/HS, TCH/EFS, TCH/AFS, TCH/AHS and TCH/WFS with related associated signaling channels.

## 4.1.2 Capacity Improvements at the Air Interface

**Objective P2:** The objective is to further enhance the voice capacity of GERAN by means of multiplexing at least two users simultaneously on the same radio resource both in downlink and in uplink. The channels under interest for doubled voice capacity are both full rate and half rate channels: TCH/FS, TCH/HS, TCH/EFS, TCH/AFS, TCH/AHS and TCH/WFS with related associated signaling channels.

The co-channel and adjacent channel interference increase with number of users, which leads to the decrease of C/I and frequency reuse. The balance between low frequency reuse and high timeslot reuse should be considered carefully.

## 4.2 Compatibility Objectives

Five compatibility objectives are defined.

### 4.2.1 Maintenance of Voice Quality

**Objective C1:** The introduction of the candidate techniques proposed under MUROS should not decrease voice quality as perceived by the user. In particular a voice quality better than for GSM HR should be ensured. This is due to the fact that in case of sub-channels, being allocated in the same time slot within the same radio frequency, the influence of the inevitable inter-channel interference (ICI) on voice quality and actual proportion of the subscribers sharing the same time slot cannot be ignored.

### 4.2.2 Support of Legacy Mobile Stations

**Objective C2:** Support of legacy MS by candidate techniques proposed under MUROS identifies a further MS related objective. No implementation impacts shall be required for legacy MS types. First priority has the support of legacy DARP phase 1 capable terminals, whilst second priority is given the support of legacy GMSK terminals not supporting DARP phase 1 capability.

### 4.2.3 Implementation Impacts to new Mobile Stations

**Objective C3:** The introduction of the candidate techniques proposed under MUROS should change MS hardware as little as possible. Additional complexity in terms of processing power and memory should be kept to a minimum for a new MS.

### 4.2.4 Implementation Impacts to BSS

**Objective C4:** The introduction of the candidate techniques proposed under MUROS should change BSS hardware as little as possible and HW upgrades to the BSS should be avoided.

Any TRX hardware capable of multiplexing more than one user on a single ARFCN time slot shall support legacy GMSK mobiles, this includes non-SAIC mobiles and SAIC mobiles.

Impacts to dimensioning of resources on Abis interface shall be minimised.



## 4.2.5 Impacts to Network Planning

**Objective C5:** The impacts to network planning and frequency reuse shall be minimised. Impacts to legacy MS interfered on downlink by the MUROS candidate technique should be avoided in case of usage of a wider transmit pulse shape on downlink. Furthermore investigations shall be dedicated into the usage at the band edge, at the edge of an operator's band allocation and in country border regions where no frequency coordination are in place.

# 5 Common Working Assumptions for Candidates Evaluation

This section lists the common working assumptions for the performance evaluation of MUROS candidate techniques that were discussed and agreed at GERAN#37 and are reflected in summary report [2].

## 5.1 General parameters

In this subsection general parameters for the evaluation of MUROS candidate techniques are listed.

**Table 5-1: General agreed evaluation parameters**

Aspect	Working Assumption
Definition of legacy MS type	<ul style="list-style-type: none"> <li>- First Priority: evaluation of DARP phase I MS.</li> <li>- Second Priority: evaluation of legacy MS without DARP phase I capability.</li> </ul>
Definition of new MS type	Single antenna mobiles. No consideration of DARP phase II mobiles.
Penetration level of certain MS types	Share of legacy MS: $S_{\text{NON-MUROS}}$ Legacy MS include both: <ul style="list-style-type: none"> <li>- legacy MS without DARP phase I (share <math>S_{\text{NON-DARP}}</math>)</li> <li>- legacy MS with DARP phase I (share <math>S_{\text{DARP}}</math>)</li> <li>- constant ratio assumed for <math>S_{\text{DARP}} / S_{\text{NON-DARP}} = 30 \% / 70 \%</math></li> <li>- total share of legacy MS: <math>S_{\text{NON-MUROS}} = S_{\text{DARP}} + S_{\text{NON\_DARP}}</math></li> </ul> Share of new MUROS mobiles: $S_{\text{MUROS}}$ with $S_{\text{MUROS}} = 0\%, 25\%, 50\%, 75\%, 100\%$ and $S_{\text{MUROS}} + S_{\text{NON-MUROS}} = 100\%$ . <sup>1</sup>
Propagation Environment	Typical Urban.
Training Sequences Optimisation	<ul style="list-style-type: none"> <li>- Usage of legacy TSC's only to allow early adoption of MUROS</li> <li>- Usage of combination of existing and new TSC's with improved cross correlation properties</li> <li>- Usage of new TSC's with improved cross correlation properties only</li> </ul>
Interference cancellation methods	Specific interference cancellation methods are to be studied for DL and for UL.
Transmit Pulse Shapes	First Priority: legacy linearized GMSK pulse shape Second Priority: optimised pulse shape up to 270 kHz BW.
Mobility	Both 3 km/h and 50 km/h
Speech codecs	GSM HR, AFS 12.2, AFS 5.9 and AHS 5.9

<sup>1</sup> For example for a share of new MUROS mobiles of 50 % remaining 50 % are legacy MS. Hence a share of 35 % is assumed for legacy MS without DARP phase I and 15 % for MS supporting DARP phase I.

AMR codec mode adaptation	Not required for MUROS study. Left optional to companies to provide results including AMR codec mode adaptation.
Frequency Hopping	Activated. Case no FH is FFS.
Voice Call Model	Voice calls are generated in the system simulator based on Poisson call arrivals and exponential call durations. The call arrival rate is set according to the load that is to be simulated in the network. The mean call duration is assumed to be 90 seconds, with a minimum call duration of 5 seconds.
DTX	<p>The channel activity time in DTX on DL and on UL, comprising active voice periods and all types of GSM specific signalling blocks is modelled as follows:</p> <ul style="list-style-type: none"> <li>▪ activity factor of 60 % with independent channel activity on DL and UL.</li> <li>▪ mean channel activity time is 1826 ms. Note, the channel activity duration is exponentially distributed. <sup>2</sup></li> <li>▪ minimum channel activity time is 60 ms. <sup>3</sup></li> <li>▪ minimum channel inactivity time is 185 ms. <sup>4</sup> Note, the channel inactivity duration is also exponentially distributed.</li> <li>▪ both the actual channel activity time and channel inactivity time shall be rounded to next lower or next higher multiple of 20 ms than the selected value from the distribution to enable sending of complete speech blocks. By this rounding the channel activity should be maintained close to the activity factor.</li> </ul>
HW configuration per cell	4 TRX/cell and 6 TRX/cell
BCCH resource utilization	<p>For MUROS-1 and MUROS-2 network configurations, the resource utilization on BCCH carrier is specified as follows:</p> <ul style="list-style-type: none"> <li>- Timeslots for voice: 3</li> <li>- Timeslots for data: 4</li> </ul> <p>According to [4], data channels are modelled by the simplified modelling assumption of the presence of GMSK dummy bursts in these time slots.</p>
Network Synchronisation Mode	<p>First Priority: synchronous networks.</p> <p>Second Priority: asynchronous networks</p> <p>All network configurations (see subclause 5.3) will be first evaluated in synchronous mode. Network configuration MUROS-2 will also be evaluated in asynchronous mode. In case of major performance impact due to network synchronization mode at link level, all network configurations need to be evaluated in asynchronous network mode.</p>
Multiplexing of Mobiles	Optimum multiplexing of mobiles on the same physical resource will be studied for downlink and for uplink.
Power Control	Both DL and UL PC will be enabled (vendor specific). PC management needs to be performed jointly for all sub channels.

<sup>2</sup> Assuming a mean talkspurt duration of 1197 ms and mean silence duration of 1846 ms as defined by the Brady model [3], the total mean periodicity as the sum of mean talkspurt duration and mean silence duration is 3043 ms. Hence the activity factor of 60% yields the mean channel activity time of 1826 ms, which includes GSM specific signalling blocks (SID FIRST, ONSET, SID\_UPDATE, NO\_DATA).

<sup>3</sup> The duration of 60 ms corresponds to a minimum talkspurt duration including SID FIRST and ONSET blocks (40 ms from VAD model + 20 ms signalling).

<sup>4</sup> This corresponds to minimum silence duration of 205 ms from VAD model reduced by 20 ms signalling blocks due to SID FIRST and ONSET.

- Evaluation Output
- Maximum network capacity gain as defined in 3.4
  - FER statistics
  - SNR statistics
  - Information on call drop rate (if available)

## 5.2 Definition of Model for External Interferers for Link Level Evaluations

In this subsection the interferer models specifying the profiles related to **external interferers** are described. External interferers are generated outside the serving cell.

Note, absolute performance characterization is given preference for the comparison to legacy TCH channel type for link performance evaluation.

As in [5] the link performance shall be evaluated for FER := 1%. Other FER ratios may also be considered.

### 5.2.1 Synchronous Network Mode

The link performance per each MUROS candidate technique shall be specified for the following synchronous interferer scenarios:

- a) for a new MTS-1 (MUROS test) scenario with synchronous interferer.

**Table 5-2: MUROS Test Scenario 1 (MTS-1) with single synchrons interferer**

Reference Test Scenario	Interfering Signal	Interferer relative power level	TSC	Interferer Delay range
1) MTS-1	1) Co-channel 1	1) 0 dB	1) None	1) no delay

Whereby the modulation for co-channel 1 will be either: GMSK or MUROS type.

It should be noted, that at MUROS telco#3 the working assumption was agreed to remove single 8-PSK interferer profile since the results by different vendors did not show a major difference in performance compared to the case of a MUROS type interferer. The same applies for scenarios under b) , c) and d).

Interference performance shall be based on C/I for single external cochannel inteferer, where C is related to the received power accumulated from all subchannels in the serving cell and I to the received power of the single external cochannel interferer.

- b) for a new MTS-2 (MUROS test) scenario with multiple synchronous interferers.

**Table 5-3: MUROS Test Scenario 2 (MTS-2) with multiple synchronous interferers.**

Reference Test Scenario	Interfering Signal	Interferer relative power level	TSC	Interferer Delay range
1) MTS-2	1) Co-channel 1	1) 0 dB	1) none	1) no delay
		2) -10 dB	2) none	2) no delay
		3) 3 dB	3) none	3) no delay

	3) Adjacent 1	4) -17 dB	4) -	4) -
	4) AWGN			

Whereby the modulation for co-channel 1 will be either: GMSK or MUROS type. The modulation for co-channel 2 will be either: GMSK or MUROS type. The modulation for adjacent 1 will be either: GMSK or MUROS. Only configurations, where all interferers are using the same modulation type, are considered.

Interference performance shall be based on C/I1 for multiple external cochannel interfezers, where C is related to the received power accumulated from all subchannels in the serving cell and I1 to the received power of the dominant external cochannel interferer.

## 5.2.2 Asynchronous Network Mode

The link performance per each MUROS candidate technique shall be specified for the following asynchronous interferer scenarios:

- a) for a new MTS-3 (MUROS test) scenario with asynchronous interferer.

**Table 5-4: MUROS Test Scenario 3 (MTS-3) with single asynchronous interferer.**

Reference Test Scenario	Interfering Signal	Interferer relative power level	TSC	Interferer Delay
1) MTS-3	1) Co-channel 1	1) 0 dB *)	1) None	1) 74 symbols

\*) The power of the delayed interferer burst, averaged over the active part of the wanted signal burst. The power of the delayed interferer burst, averaged over the active part of the delayed interferer burst is 3 dB higher.

Whereby the modulation for co-channel 1 will be either: GMSK or MUROS type.

Interference performance shall be based on C/I for single external cochannel interfezer, where C is related to the received power accumulated from all subchannels in the serving cell and I to the received power of the single external cochannel interferer.

- b) for a new MTS-4 (MUROS test) scenario with multiple asynchronous interferers.

**Table 5-5: MUROS Test Scenario 4 (MTS-4) with multiple asynchronous interferers**

Reference Test Scenario	Interfering Signal	Interferer relative power level	TSC	Interferer Delay
MTS-4	Co-channel 1	0 dB *)	none	74 symbols
	Co-channel 2	-10 dB	none	no delay
	Adjacent 1	3 dB	none	no delay
	AWGN	-17 dB	-	-

\*) The power of the delayed interferer burst, averaged over the active part of the wanted signal burst. The power of the delayed interferer burst, averaged over the active part of the delayed interferer burst is 3 dB higher.

Whereby the modulation for co-channel 1 will be either: GMSK or MUROS type .

The modulation for co-channel 2 will be either: GMSK or MUROS type. The modulation for adjacent 1 will be either: GMSK or MUROS. Only configurations, where all interferers are using the same modulation type, are considered.

Interference performance shall be based on C/I1 for multiple external cochannel interfezers, where C is related to the received power accumulated from all subchannels in the serving cell and I1 to the received power of the dominant external cochannel interferer.

### 5.2.2.1 Interferer delay profiles

Interferer delay profiles for asynchronous network operation are foreseen to be specified to model the asynchronous network operation merely on link level in order to generate a specific link to system mapping table used by the network simulator running in synchronous mode. This is aligned to the proceeding in the SAIC Feasibility Study [5] as agreed at GERAN#38. The specification of these interferer delay profiles is FFS.

A proposal on interferer delay profiles has been submitted to the GERAN 1 Adhoc Meeting on MUROS on 8<sup>th</sup>/9<sup>th</sup> April in AHG1-080049. The discussion on these interferer delay profiles is ongoing.

### 5.2.3 Sensitivity limited scenarios

The link performance per each MUROS candidate shall be specified for sensitivity with AWGN included both in DL and in UL. As agreed at GERAN#38 [6] the SNR is used both for downlink and uplink for sensitivity performance. Power backoff resulting from modulation specific peak to average ratio should be taken into account and be included in the performance results. In order to allow for a direct comparison with the reference case performance results should be calibrated in such way that the power of all subchannels will be accumulated and this total power then is used to define the SNR, both for DL and for UL.

### 5.2.4 Frequency Offsets

In addition a distribution function for frequency offsets shall be taken into account for each external interferer on DL. It shall be applied in alignment to [5] as follows:

Normal distribution with  $N(50 \text{ Hz}, 17 \text{ Hz})$  for low band (850/900 MHz).

Normal distribution with  $N(100 \text{ Hz}, 33 \text{ Hz})$  for high band (1800/1900 MHz).

### 5.2.5 Uplink Interferer Profiles

In uplink the same profiles MTS-1 through MTS-4 for external interferers are used. In addition the subchannels need to be modelled as described below:

The link level analysis shall be performed for discrete values of the subchannel power imbalance ratios:

SCPIR = -15 dB, -10 dB, -5 dB, 0 dB, 5 dB, 10 dB, 15 dB.

Note at least the performance for the worst subchannel is to be shown.

In addition distributions shall be taken into account for the timing alignment error of both subchannel transmissions and the frequency offset of paired subchannel and of external interferers:

Timing alignment error: a distribution function based on 0.0, 0.5 and 1.0 symbol is used as follows:

- a) Probability (0 symbols) = 50%.
- b) Probability (0.5 symbols) = 25%.
- c) Probability (1 symbol) = 25%.

Note for b) and c) in half of the cases the interferer on the paired subchannel is advanced, and in half of the cases it is postponed related to the signal in the wanted subchannel. Timing alignment error is selected on a burst basis, i.e. independent between successive bursts.

Frequency offset for the paired subchannel and for each external uplink interferer:

A distribution function for the frequency offset shall be taken into account since the MS frequency accuracy is  $\pm 0.1 \text{ ppm}$  on UL as follows:

- a) Normal distribution with  $N(45 \text{ Hz}, 10 \text{ Hz})$  for low band (850/900 MHz).
- b) Normal distribution with  $N(90 \text{ Hz}, 17 \text{ Hz})$  for high band (1800 MHz).
- c) Normal distribution with  $N(95 \text{ Hz}, 17 \text{ Hz})$  for high band (1900 MHz).

Note, the CIR on uplink is defined as a relative figure for the wanted sub channel under consideration as proposed in [7] and agreed at 3GPP GERAN#39.

## 5.3 Network Configurations

Both blocking limited and interference limited scenarios are being evaluated to assess the performance of each MUROS candidate technique on system level. Three network configurations named MUROS-1, MUROS-2 and MUROS-3 are depicted in Table 5-6. Additional parameters for system performance evaluation are contained in Table 5-7.

**Table 5-6: Selected Network Configurations for MUROS (revised after MUROS telco#1).**

Parameter	MUROS-1	MUROS-2	MUROS-3
Frequency band (MHz)	900	900	1800
Cell radius	500 m	500 m	500 m
Bandwidth	4.4 MHz	11.6 MHz	2.6 MHz
Guard band	0.2 MHz	0.2 MHz	0.2 MHz
# channels excluding guard band	21	57	12
# TRX	4	6	4
BCCH frequency re-use	4/12	4/12	N.A.
TCH frequency re-use	1/1	3/9 (***)	1/3 ; 1/1 (**)
Frequency Hopping	Synthesized	Baseband	Synthesized
Length of MA (# FH frequencies)	9	5 (BCCH non-hopping)	4 ; 12 (**)
Fast fading type	Flat / TU	TU	TU
BCCH or TCH under interest	Both	Both	TCH
Network sync mode	sync (async*)	sync / async	sync (async*)

(\*): depending on MUROS-2.

(\*\*): reuse 1/1 with 12 frequencies requested by Vodafone post telco#1.

(\*\*\*): Alternative TCH reuse 3/5.625 with Synthesized FH, MA length 8 and BCCH inclusion requested by China Mobile post telco#1 was removed at GERAN#38 [6].

**Table 5-7: Parameters for Evaluation of MUROS system performance.**

Parameter	Value	Unit
Sector Antenna Pattern	1) UMTS 30.03, 90° H-plane, max transmitter gain: 13 dBi and 2) 65° H-plane, max transmitter gain: 18 dBi agreed at 3GPP GERAN#39	-
Propagation Model	UMTS 30.03, vehicular path loss model	-
Log-Normal Fading: Standard Deviation	8	dB
Log-Normal Fading: Correlation Distance	110	m
Log-Normal Fading: Inter-Site Correlation	50	%
Handover Margin	3	dB

## 5.4 Channel Mode Adaptation

Channel mode adaptation is often used in real networks, e.g. when channel conditions become worse at the cell boundary and switching to full rate mode becomes necessary. It makes use of an intracell handover, which may in case of MUROS be initiated more often due to bad signal quality than due to insufficient signal power, and is based on the specified speech codecs in Table 5-1. According to [4] a sophisticated channel mode adaptation comprising switching between full rate and half rate channels is not required for the purpose of comparing candidate techniques. Instead the following approach has been agreed:

- a) For comparison of the candidate techniques a non-MUROS / MUROS adaptation as depicted in Table 5-8 below is applied:

**Table 5-8: Channel Mode Adaptation for comparison of candidate techniques**

Channel Mode Adaptation	Channel modes
Type A0	GSM HR (Reference case)
Type A1	GSM HR <-> MUROS (GSM HR)
Type B0	AFS 12.2 (Reference case)
Type B1	AFS 12.2 <-> MUROS (AFS 12.2)
Type C0	AFS 5.9 (Reference case)
Type C1	AFS 5.9 <-> MUROS (AFS 5.9)
Type D0	AHS 5.9 (Reference case)
Type D1	AHS 5.9 <-> MUROS (AHS 5.9)

- b) For the complete candidate technique to be standardised, a channel rate change between full rate, half rate and MUROS channel type and vice versa as depicted in Table 5-9 needs to be evaluated:

**Table 5-9: Channel Mode Adaptation for specification of the candidate technique**

Channel Mode Adaptation	Channel modes
Type E0	AFS 12.2 <-> GSM HR (Reference case)
Type E1	AFS 12.2 <-> GSM HR <-> MUROS (GSM HR)
Type E2	AFS 12.2 <-> MUROS (AMR 12.2) <-> MUROS (GSM HR)
Type F0	AFS 5.9 <-> AHS 5.9 (Reference case)
Type F1	AFS 5.9 <-> AHS 5.9 <-> MUROS (AHS 5.9)
Type F2	AFS 5.9 <-> MUROS (AFS 5.9) <-> MUROS (AHS 5.9)

The impact on speech FER due to the usage of channel mode adaptation is required to be taken into account in a vendor specific way.

## 5.5 System Performance Evaluation Method

The following proceeding was agreed to assess the maximum network capacity gain:

- Step 1: The system is loaded without usage of MUROS candidate technique until minimum call quality performance is not anymore ensured.
- Step 2: The system is loaded with usage of MUROS candidate technique until minimum call quality performance is not anymore ensured.
- Step 3: The performance in terms of network capacity is compared against each other according to the definition:

$$\text{Network Capacity Gain} = \frac{\text{Capacity}(\text{with\_MUROS})}{\text{Capacity}(\text{without\_MUROS})}$$

Two system performance capacity metrics listed in Table 5-10 are defined. These will be used for BCCH layer, for TCH layer and for total capacity.

**Table 5-10: Capacity metrics for MUROS evaluation**

Capacity metric	Unit
Spectral efficiency	Erl / MHz / Site
HW Efficiency	Erl / TRX

Note, results should be given in terms of gains relative to the reference case using legacy channel types only, as specified above in Table 5-8 and 5-9.

The evaluation should be done in such way, that switching between non-MUROS and MUROS channel modes based on vendor specific channel mode adaptation thresholds shall be optimized for each channel mode adaptation type and in addition for each network configuration as specified above in Table 5-8 and Table 5-9.

### 5.5.1 Definition of Effective Frequency Load for Mixed Frequency Reuse

The following definition is provided to clarify calibration of system performance in terms of EFL in case of a mixed frequency reuse. This refers to the case that both hard blocking and soft blocking performance of MUROS are provided as function of EFL. A unique definition of EFL should be used throughout the vendors for performance comparison. This is needed in particular for network configurations like MUROS-1 and MUROS-2 including TCH channels for MUROS on BCCH and hence employing a mixed frequency reuse based on TCH layer and BCCH layer. This section proposes a unique definition for EFL in case of mixed frequency reuse, given in the equation below.

$$EFL = \frac{A}{N_{Freq} * av(N_{TS\_per\_TRX})} * 100\% \quad ,$$

with  $A$  being the supported traffic in Erl as determined by the simulation (the equation is valid for FR and HR channel modes, taking into account either full rate or half rate channel capacity as the number of supported simultaneous connections for HR channel modes A and D is supposed to be higher than for FR channel modes B and C in most cases),  $N_{Freq}$  the number of total frequencies composed of the TCH layer and the BCCH layer and  $av(N_{TS\_per\_TRX})$  the average number of available full rate channels or time slots per TRX derived from the total available timeslots for MUROS usage in both layers and the total number of TRX.

An exemplary determination of  $EFL$  is given hereafter.

Let us assume the network configuration MUROS-1 with 1 BCCH carrier and 3 TCH carriers. In this configuration the TCH layer uses a frequency reuse 1/1 with 9 frequencies equivalent to the length of the Mobile Allocation, whilst the BCCH layer utilizes 12 frequencies based on frequency reuse 4/12. Further assume both cases.

- a) legacy full rate channel mode (e.g. C0) and
- b) MUROS full rate channel mode (e.g. C1).

For both cases the average number of timeslots per TRX is given by

$$av(N_{TS\_per\_TRX}) = \frac{N_{total\_TS}}{N_{total\_TRX}} = \frac{3*8 + 3}{3 + 1} = \frac{27}{4} = 6.75$$

and the total number of frequencies is  $N_{Freq}=12+9=21$ .

This yields for both cases

$$EFL = \frac{A}{21 * 6.75} * 100\% = 0.7055\% * A \quad ,$$

with  $A_a$  being the simulated supported number of simultaneous connections for case a) and  $A_b$  the correspondent one for case b) for evaluation against the hard blocking limit of 2% or against the soft blocking limit (average FER for MUROS FR  $\leq 2\%$ , for MUROS HR  $\leq 3\%$ ).

Note: Evaluation of EFL performance is optional in MUROS feasibility study.

## 5.6 Definition of Minimum Call Quality Performance

The following criteria for definition of minimum call quality performance were agreed:

- 1st Criterion: blocked calls  $< 2\%$



- 2nd Criterion: satisfied user criterion fulfilled.
  - average call FER < 2 % for at least 95% users in case of FR channel type i.e. for channel mode adaptation types Bx and Cx in Table 5-8.
  - average call FER < 3 % for at least 95% users in case of HR channel type, i.e. for channel mode adaptation types Ax and Dx in Table 5-8.
- 3rd Criterion: the relative performance of associated signalling channels compared against the traffic channel as derived in link performance evaluation for a reference scenario shall be maintained for MUROS channel types.
  - The reference scenario is defined as follows: DTS-2, DARP receiver, definition of mean performance offset of FACCH and SACCH channels.
    - applying corresponding fullrate codec type in case of MUROS fullrate codec.
    - applying corresponding half-rate codec type in case of MUROS half-rate codec.

Note that the criterion on dropped calls has not been included, as the study is targeting on voice quality under the restriction of sufficient performance of associated signalling channels. Nevertheless it is left open to the proponents of a candidate technique to add information on call dropped call rate. Note the average call FER threshold has been relaxed from 1% to the above values according to [6] at GERAN#38.

## 5.7 Link-to-System Mapping

An agreement has been achieved at 3GPP GERAN#39 not to investigate further for DL and for UL the approach of a common Link to System Mapping approach based on some proposals such as provided in [8] and [9].

Instead verification of L2S mapping in the MTS-1 to MTS 4 scenarios shall be performed by each vendor.

- The SCPIR envisaged for the operation of the candidate technique shall be taken into account.
- The evaluation shall be based on uncoded BER only.

The link to system mapping should be verified by the vendor through link level simulations. All modulations used in the system simulations should be verified.

## 5.8 Impairments of the Mobile Station

### 5.8.1 Subchannel power imbalance ratio on DL

Discussion at 3GPP GERAN#39 was based on contributions from different vendors reporting performance degradation for legacy SAIC mobiles beyond a certain sub channel power imbalance ratio. The reported range was about 8 to 10 dB.

Since performance was believed to be different for all mobile receivers, vendors believed that it was difficult to agree on a specific value for the maximum power imbalance. Taking this account in system simulations was felt to be complicated as call quality is used as criterion for handovers and not the power imbalance.

Mobile vendors were invited to report any limitations on the SCPIR at the next MUROS telco#6. At MUROS telco#6 it was agreed to not specify a general constraint on limitations related to acceptable subchannel power imbalance ratios on terminal side and to take into account terminal performance in a vendor specific manner.

### 5.8.2 Frequency Offset Impairment Model in UL

A proposal in [10] to define a lower figure than the current frequency offset of 100 Hz was discussed based on the statement that 40 Hz would be a more realistic assumption for the average frequency offset of each of both mobiles in uplink subchannels. Mobile vendors were invited to report more realistic figures for the expected frequency offset at the next MUROS telco#6. At MUROS telco#6 a refined frequency offset impairment model on UL was agreed. This is depicted in section 5.2.5.

## 5.9 Reference BTS Receiver

Discussion on introducing a reference BTS receiver type such as dual antenna MRC or IRC during the MUROS feasibility study took place at 3GPP GERAN#39.

Different network vendors preferred the usage of different BTS receiver types. It is agreed that a statement regarding the complexity of the evaluated BTS receiver type for each vendor is included in the Technical Report. It was considered as a limitation to the feasibility study to focus on a single BTS receiver types, as some receiver types may serve one candidate technique better than others. It was also agreed to identify the MUROS performance benefit related to the reference based on the same BTS receiver type.

---

## 6 Speech Capacity Enhancement using DARP

### 6.1 Concept Description

#### 6.1.1 Principle

DARP was specified to provide improved reception on the mobile station side when there is ACI or CCI. However, with good downlink signal quality there is little benefit from DARP. This concept uses this fact to enhance speech capacity.

DARP can work quite successfully with CCI of 0dB. Therefore the network can assign the same physical resources to two mobile stations but allocating them different training sequence codes as depicted in Figure 6-1. Each mobile will receive its own signal (shown in black in the figure) and that intended for the other co-TCH user (shown in red in the figure).

On the downlink, each mobile station will consider the signal intended for the other mobile station as a CCI. The receiving mobile station does not need to support any other enhancements than DARP. For optimum DARP performance, the two signals intended for the two different mobile stations should ideally be phase shifted by  $\pi/2$  for their channel impulse response but less than this will also provide adequate performance.

On the uplink each mobile station would use a different training sequence code. The network may use techniques such as joint detection to separate the two users on the uplink.

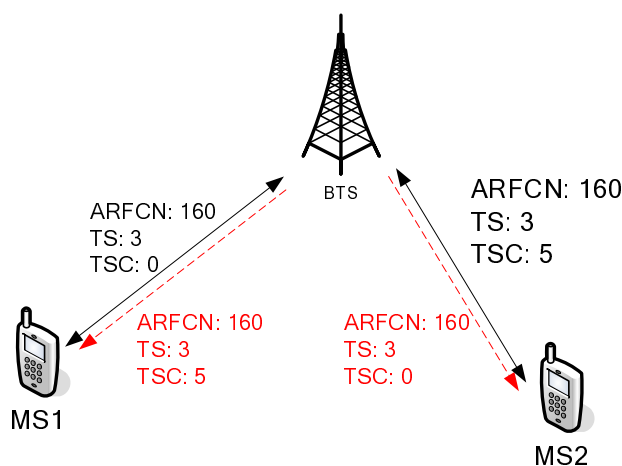

**Figure 6-1 Channel assignment for co-TCH operation**

The above scheme is applicable to OSC signals (QPSK or alpha-QPSK) MUROS signals. This is referred to in chapter 7 for OSC and in chapter 8 for alpha-QPSK.

## 6.1.2 Downlink signal modulation schemes

DARP based co-TCH proposal is based on combining two base-band signals [6-1], although RF combining also works for feasibility demo [6-2].

For future MUROS deployment one way of generating the DL signal is to linearly combine the two GMSK baseband modulated signals and then feed into the RF modulator and power amplifier for transmission as shown in Figure 6-2.

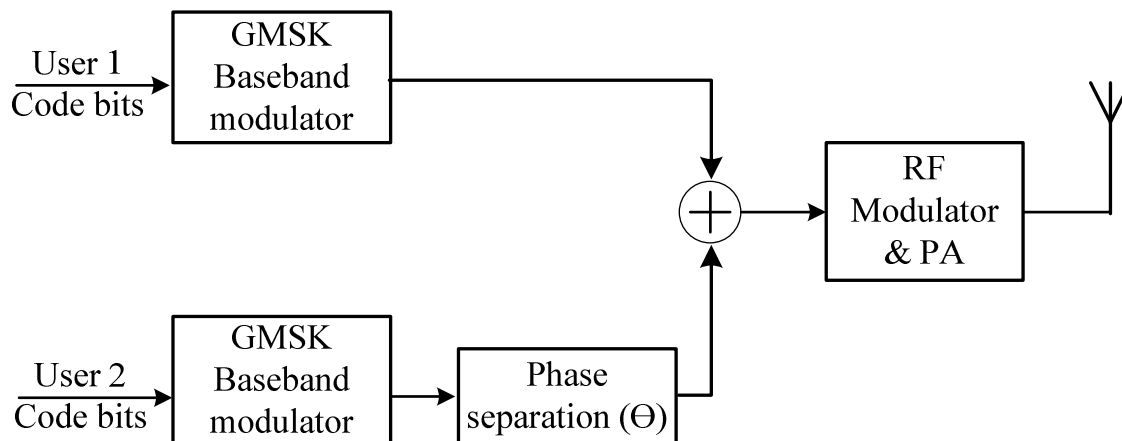

**Figure 6-2 Linear baseband combining for co-TCH**

The DARP based co-TCH MUROS method also works with QPSK as well as GMSK modulation schemes.

In this section a case analysis of three different types of MUROS modulation schemes for DL signals and their spectrums is presented. They are

1. Linear sum of two GMSK signals (90 degree phase separation),
2. QPSK with liner Gaussian filter, and
3. QPSK with RRC (roll off 0.3) filter.

### 6.1.2.1 Equal power level between two desired users

When two DARP phones with similar path loss are paired as MUROS callers, the power level provided to them should be the same.

The I-Q plots for the three modulations schemes are shown in Figure 6-3.

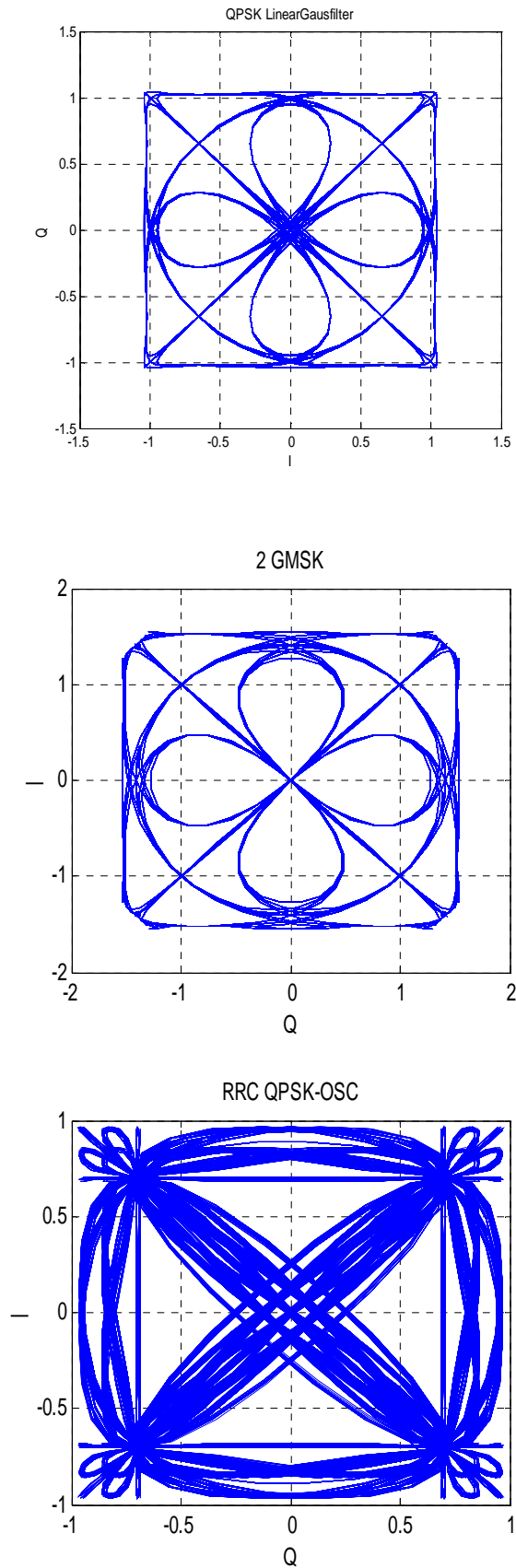
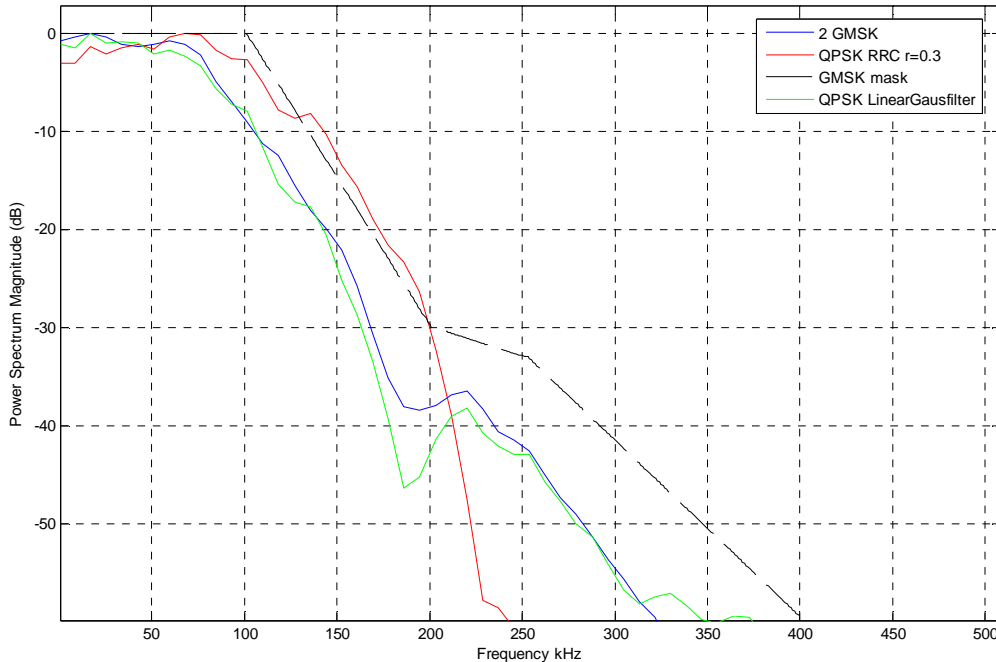

**Figure 6-3 Baseband IQ plots for three MUROS DL modulation schemes**

It can be seen that two GMSK linear combination and QPSK with Linear Gaussian filter have very similar I-Q plots.

### 6.1.2.2 Spectrum analysis

The spectrum analysis of the above three MUROS DL schemes are shown in Figure 6-4. Some difference is observed when compared with reference [6-3] and need further clarification.



**Figure 6-4 Spectrum analysis for three MUROS DL signal modulation schemes**

The plots in Figure 6-4 show:

1. QPSK with RRC filter (roll off 0.3) spectrum is 10 dB higher than the GMSK spectrum between 140-200 kHz, which could have advert effect for capacity enhancement. It is also wider than the spec defined GMSK mask for useful part of the burst, and will increase ACI interference.
2. The linear combination of two GMSK signals has the same spectrum (curve overlapping) as normal GMSK signals as expected. It is within the spec defined GMSK mask for useful part of the burst.
3. QPSK with Linear Gaussian filter (8PSK pulse shaping) is similar to GMSK.

Based on these observations, it is proposed that two GMSK linear combination and QPSK with Linear Gaussian filter should be the candidates for MUROS DL modulation scheme.

### 6.1.2.3 Different power levels between two desired users

It has been found that when the two desired signal have different RF strengths, non-zero crossing can be achieved. For example, linear combination of two GMSK signals with different separation angles the IQ plots are as shown in Figure 6-5.

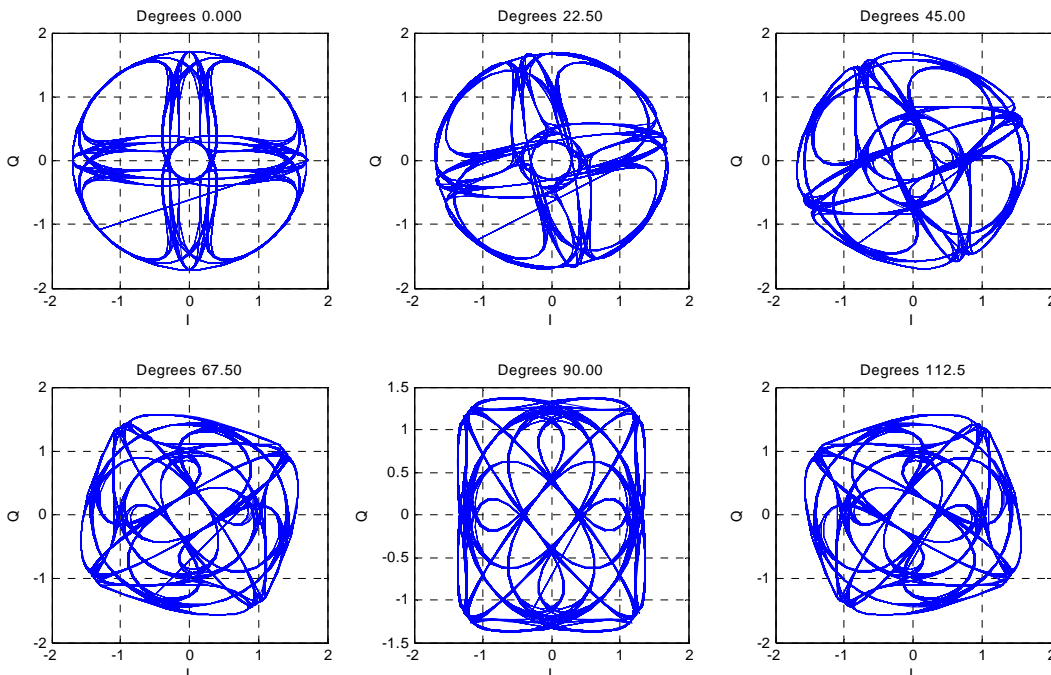
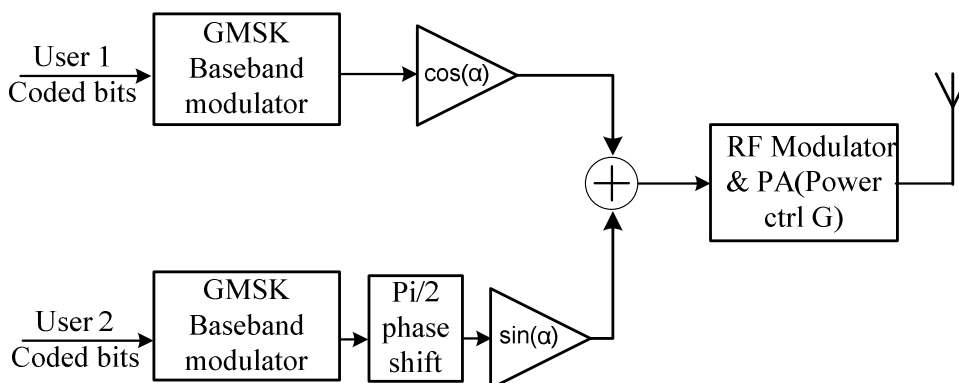

**Figure 6-5 I-Q plots for linear combination of two GMSK signals with different phase separation and 3dB power difference between the two MUROS signals**

This could be very useful for pairing a high performance DARP phone with a non-DARP phone. We propose to use 90 degrees phase separation as simulation showed that this achieves the best performance for two MUROS users.

### 6.1.3 Power control in co-TCH MUROS operation

In MUROS mode the power given to each user is based on their need, provided that the power difference is within a suitable range (i.e. 10dB) to provide sufficient signal quality for reliable reception by each mobile. As an illustration of the MUROS concept based on DARP phase I mobile we can consider the MUROS DL signal as a linear sum of two independent GMSK modulated signals. Further more the modulation can be done at baseband as shown in Figure 6-6 below. Each baseband GMSK modulated signal is individually power controlled by their gains ( $\sin\alpha$  and  $\cos\alpha$ ) and added together at baseband with relative phase reference of  $\pi/2$ . Then the MUROS baseband signal is modulated with the carrier as MUROS DL RF signal with a gain of G.



**Figure 6-6: MUROS signal format concept with sub user power control**

## 6.1.4 BTS changes for co-TCH MUROS operation

For baseband modulation the following changes are required:

Input port needs to have optional second voice channel, so that two voice streams can be modulated to form MUROS DL signals.

The baseband modulator must be able to handle one- and two-channel binary stream. The one-channel is the same as before. The two-channel function is needed when MUROS mode is on, so that the RF output is effectively two legacy RF signals, possibly of different power levels, linearly added together with one rotated by 90 degree.

There are various ways of implementing the above requirements. In the examples given below BTS needs the following two key parameters when sending downlink RF bursts in MUROS mode:

1. IQ stream of normalised scale, which suits the resolution and dynamic range of the DAC, and
2. Appropriate power level of the burst, which drives the PA.

Here is an example what MUROS BTS needs to do based on Figure 6-6:

1. From the path-loss of each of the two co-TCH mobiles, derive the required power level  $P_1$  for user 1 and  $P_2$  for user 2. Both  $P_1$  and  $P_2$  are linear quantities.
2. Using  $P_1$  and  $P_2$ , obtain the IQ amplitude ratio of the two users as follows:  $R = \sqrt{P_2/P_1}$  ( $P_1 > 0, P_2 > 0$ ).
3. Determine the digital gains for each of the two co-TCH mobiles:  
For user 1,  $G_1 = \cos(\alpha)$ , and  
For user 2,  $G_2 = \sin(\alpha)$ ,  
where  $\alpha = \arctan(R)$  and  $\alpha \in [0, \pi/2]$
4. Decide the Tx RF gain for the PA so that the Tx power level is  $P = P_1 + P_2$

Another example of achieving the same effect is:

1. Align the two bursts, and map user 1 and 2's burst level coded bits to I and Q respectively. On I-axis  $0 \rightarrow kG_1$ ,  $1 \rightarrow -kG_1$ . On Q-axis  $0 \rightarrow kG_2$ ,  $1 \rightarrow -kG_2$ , where  $k$  is a scalar factor represents  $G_1$  and  $G_2$  in fix point format with a satisfactory resolution.

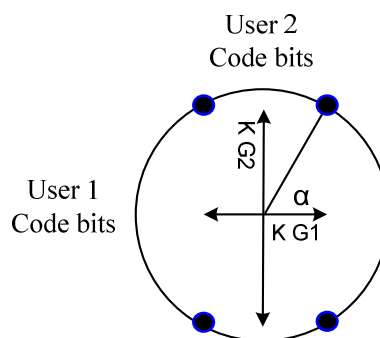

**Figure 6-7: Map two users'  $i$ th bits on to QPSK considering power control of both users**

2. Apply  $\pi/2$  phase rotation on every symbol progressively (just like EGPRS  $3\pi/8$  rotation on every symbol).
3. Apply Gaussian linear filter to satisfy the GSM spectrum mask.

Both of the above approaches give the same spectrum. Simulations based on both above schemes have the same performance.

Examples of baseband IQ trajectory have been described in section 6.1.2.3.

In the case of one mobile in DTx mode, the corresponding gain control ( $G_1$  or  $G_2$ ) is simply set to 0 (in linear term, not dB) while the other gain control is set to 1. If both users are in DTx mode then both gain controls are set to 0.

### 6.1.5 Adaptive pulse shapping for MUROS modulation

The MUROS study has showed that the VAMOS mode of operation needs adaptation of a few parameters to make reliable and good voice services when two users are on one slot. These adaptations are, but not limited to, codecs (AMR, FR, HR etc), FH to introduce user diversity, power imbalance to give suitable levels of RF signal to each VAMOS user and increase the pairing range and providing suitable RF condition for legacy handsets (both DARP and non-DARP) to perform. This section proposes a further VAMOS physical layer adaptation scheme, *an adaptation of pulse shaping while keeping the VAMOS signal within the GMSK mask*. The benefit is that *both users can improve their performance* by a couple of dB in the example of 5 dB power imbalance on FR.

Two VAMOS paired handsets could have different need of RF power, and require different C/I. Therefore their power ratio could be different from unity. Hence the BTS would send VAMOS signal with the power imbalance (+10 dB to -10 dB per MUROS working assumption) intended for the two users.

As shown in Figure 6-7a, is an improvement of the second approach. It has the same mapping shown in Figure 6-6, and introduces different pulse shaping on the two paired users' baseband signal. The Pulse shaping A and B are related with the power imbalance and adaptive to the  $\beta$  parameter. For the low RF power user, the pulse shaping can be root raised cosine (RRC) filter and with broader bandwidth than the high powered user, while the sum of the two is still within the existing GMSK mask.

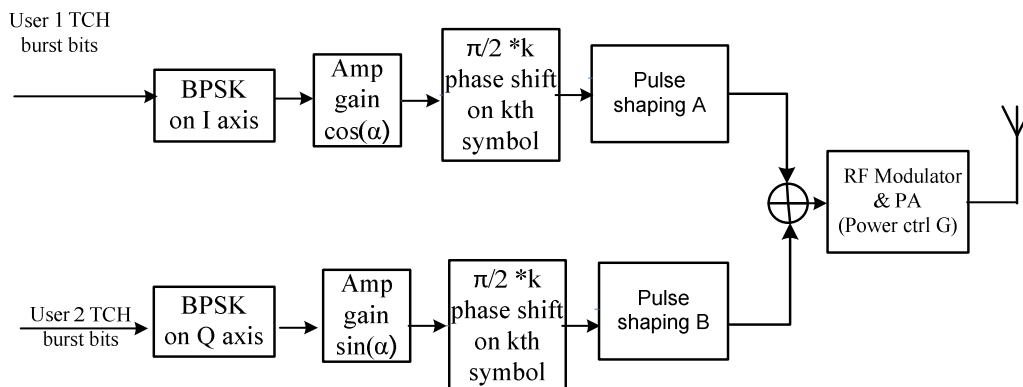

**Figure 6-7a - Adaptive QPSK modulation with pulse shaping adaptation (A and B)**

For a simple example, if user 2 is further away from the BTS than user 1, and user 2 has 5 dB more power than user 1, the power imbalance is user 1/user 2 = -5 dB, then pulse shaping A for user 1 can be RRC with broader bandwidth than shaping B for user 2, as user 1 has weaker RF signal than user 2.

VAMOS signals can use a family of RRC pulse shapes (filters) that have different bandwidths to adapt to different power imbalance cases. LGF/GMSK can be considered as the default pulse shaping/modulation. The principle of adaptive pulse shaping is that the user with weak RF signal can use broader bandwidth pulse shaping, while the user with strong RF signal has narrow bandwidth pulse shaping when suitable. It is suggested that the total sum satisfies the GMSK mask as the cell planning is based on that. In this way VAMOS can make better use of allocated resource more efficiently and improve their performance without introducing considerable CCI or ACI to others without considering other users in the heavily loaded areas.

The benefits of the above adaptation scheme benefit both VAMOS users:

1. For a weaker one that has broader bandwidth it will have better performance. This is because the RF energy per symbol is stronger than a narrow one, e.g. the conventional method (GMSK or LGF) on the user with less intended Tx power (the weak RF user with DARP handset);
2. The user with big intended Tx power (the strong RF user, in the worst case without DARP handset) will have better performance, as the RRC will minimize the ISI to the intended user and the interference to the other



user.

Our link level simulation results showed that it has double benefits. Numerous verifications have been made to come to the above conclusions.

To illustrate the points above, one example of VAMOS pulse shaping adaptation can be a broader RRC on weak user and one LGF on strong user, where both VAMOS users have their performance improved by a couple of dBs. Simulations have been carried out with and without pulse shaping adaptation.

Pulse Shaping Adaptation has following conditions:

1. User 1, with greater RF power (say 5dB) than user 2, on LGF pulse shaping, and
2. User 2, with less RF power (correspondingly -5 dB) than user 1, on RRC pulse shaping.

Figure 6-7b shows the two pulses considered in time domain.

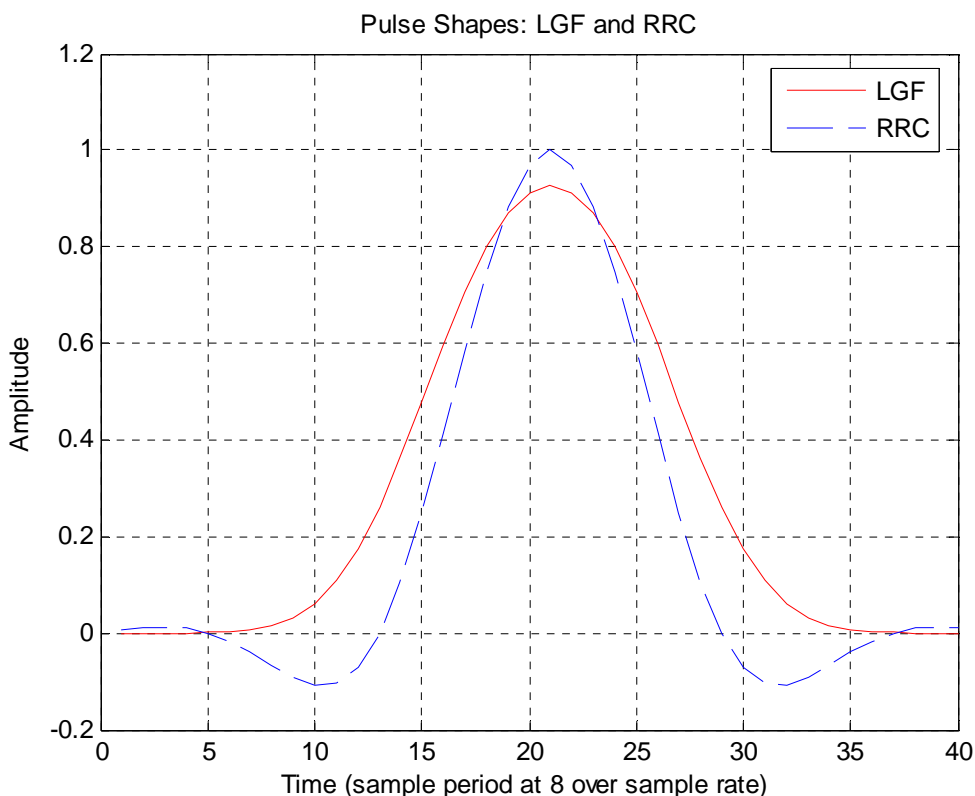

**Figure 6-7b - Two pulse shaping used in VAMOS adaptation**

Figure 6-7c shows the spectrum of relevant aspects, from which we can see that this VAMOS pulse shaping adaptation satisfies the GMSK mask.

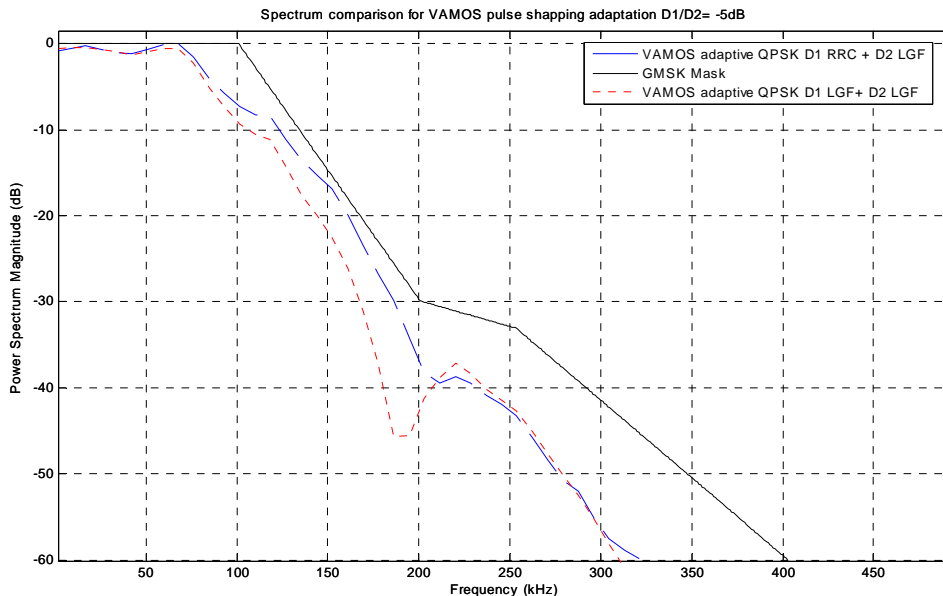

**Figure 6-7c - VAMOS spectrum satisfies the GMSK mask: Spectrum of adaptive QPSK VAMOS signal with a RRC pulse shaping on weak signal and a linearised Gaussian pulse shaping (LGF) on strong signal – power imbalance 5dB.**

Figure 6-7c shows the performances of both VAMOS users on the two schemes: one with VAMOS pulse shaping adaptation (the red curves - dots and diamonds), and the one only apply LGF, without VAMOS pulse shaping adaptation (the blue curves – stars and crosses).

The pulse shaping adaptation shows that both VAMOS users have improved their performance by about 3 dB when comparing with VAMOS LGF pulse shaping (see the two red curves are better than the two blue ones).

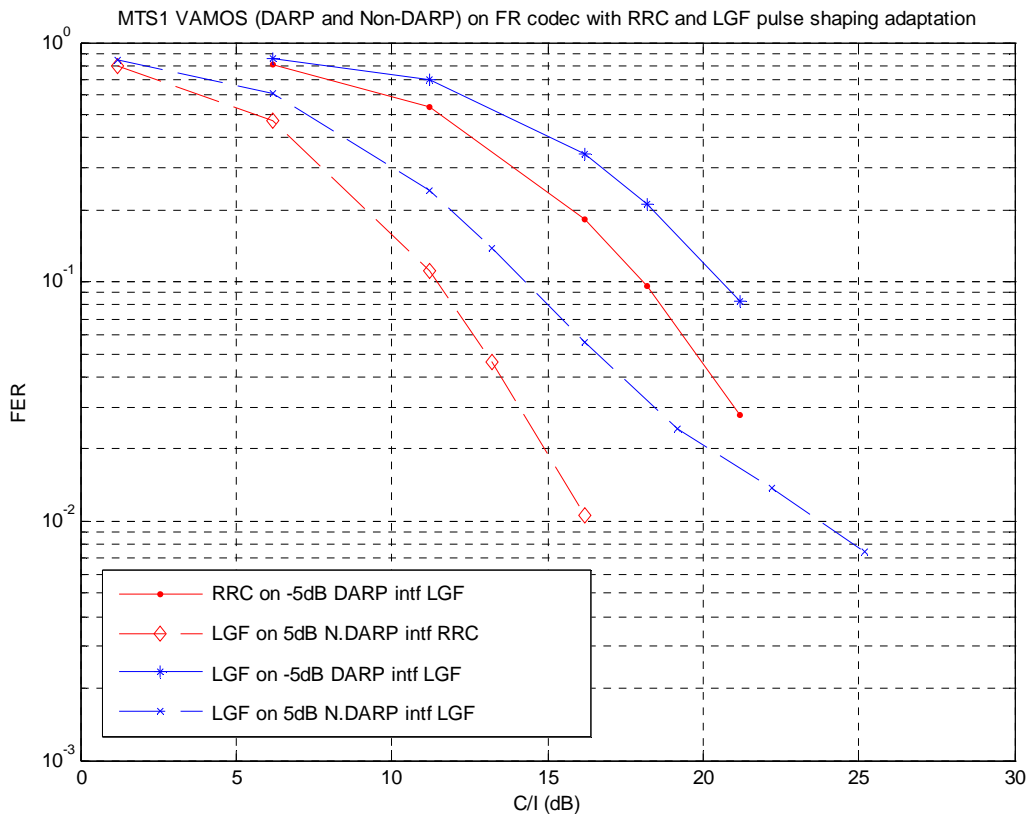

**Figure 6-7d - MTS1 Performance improvement between the cases with and without VAMOS pulse shaping adaptation**

In general the widths of the pulse shaping functions can be linked to the power imbalance ratio. The bigger the power imbalance, the broader the weak one can have. The adaptation is to use RRC and the sum of the two has a spectrum (with PA impairment) that respects the GMSK mask.

In practice a series of pulse shapes can be stored and indexed with the power imbalance decision made by the RRM (radio resource manager). It needs just hundreds of words of memory to hold the coefficients of different pulse shapes, and employs a pointer that changes with the power imbalance decision made by the BTS between the two VAMOS users.

In theory the pulse shaping adaptation on DL can be changed every frame. This may be used in frequency hopping case when user diversity is introduced. However in non-FH cases it may change based on SACCH report period, and then the adaptation may happen every 480 ms or 120 ms with enhanced report mechanism. The actual rate of adaption is flexible, from every frame to keeping them constant as it is currently. It is related with the two handsets RF conditions at the time of voice services as well.

This contribution proposes that the a few RRC filters together with LGF and GMSK can be stored and adaptively used with different power imbalance cases on adaptive QPSK VAMOS modulation signal. The scheme will keep the total spectrum of the two inside the GMSK mask. Simulation shows that both users will benefit from this adaptation. In the example of worst case (legacy DARP and non-DARP), both have been improved by 3 to 4 dB in MTS1.

Since this scheme make better use of allocated spectrum in certain cases it may introduce slightly more CCI and ACI, especially to the next sector on the same site. However the point of adaptation is to explore the option so that optimum benefit can be obtained. It should be noted that the pulse shaping can be narrower as well as broader than the conventional one. So the CCI and ACI are managed in adaptive way to reach a better performance for both VAMOS users and beyond.

Although the simulation result presented has not taken PA impairment into the consideration, the area where PA impairment happens are deliberately left with a realistic margin. It is expected that the adaptation concept introduced here would adapt to the situation in practice. While a small offset might be expected due to reality limitations,

adaptation will improve the relative performance of the same situation, as shown in this contribution for the case presented.

Since there are clear benefits on both VAMOS users, it is proposed that VAMOS modulation adaptation should include the use of different RRC pulse shapes together with GMSK/LGF with regard to different level of power imbalance while the GMSK mask is respected. We hope other companies to verify this proposal and work together to explore the benefit of pulse shaping adaptation.

## 6.2 Performance Characterization

### 6.2.1 Link Level Performance

The performance of a DARP Phase 1 receiver is evaluated under the various configurations defined in chapter 5. The legacy training sequence set and the Nokia training sequence (section 10.1.1) set was used in these simulations. A MUROS capable mobile is assumed to support new training sequence codes, in this case the new TSC set proposed in section 10.1.1. The legacy DARP Phase 1 mobile is assumed to support the legacy TSC set.

Configuration for link level simulations

The simulation configuration for MTS and sensitivity scenarios is shown in Table 6-1 below. In this configuration both co-TCH users have the same power level.

**Table 6-1 Link level simulation configuration for MTS scenarios**

Parameter	Value
MUROS Test Scenario	MTS-1, MTS-2, MTS-3, MTS-4 and Sensitivity
TSC	NSN 4 (desired) and Legacy 4
Audio Codec	GSM HR, GSM FR, AFS 12.2, AFS 5.9 and AHS 5.9
Frequency Hopping	Ideal Hopping and without hopping
Propagation environment	TU3 and TU50
DTX	Not used
Interferer Modulation	GMSK

#### 6.2.1.1 Sensitivity performance

The link level sensitivity performance of MUROS (two user relative power of 0dB) is shown with and without ideal frequency hopping where it applies. However it should be noted that with restricted bandwidth the frequency hopping improvement can be far less.

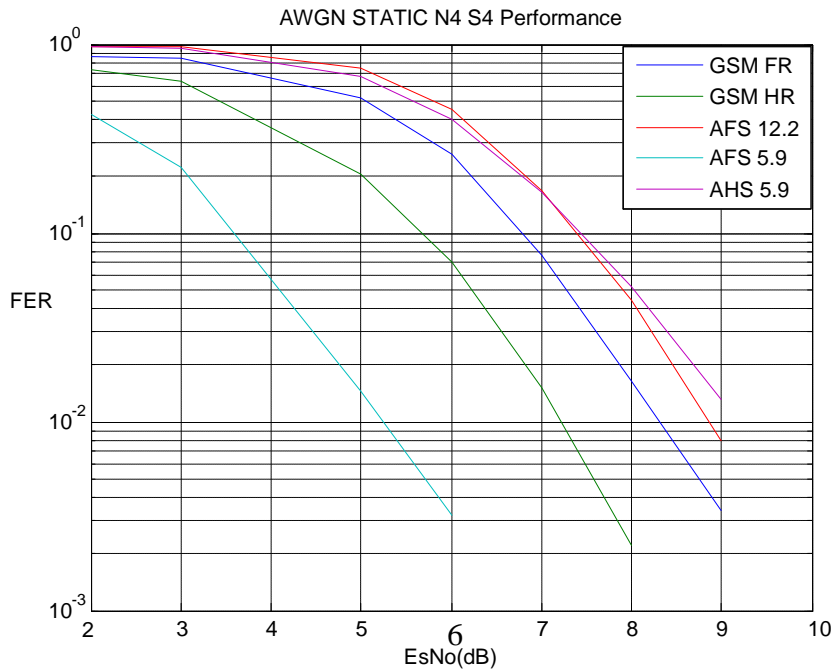

**Figure 6-8: DARP Phase 1 mobile performance in sensitivity condition with static channel**

This shows a good performance in static AWGN case, where mobile station can work in most places in a cell with conventional cell planning.

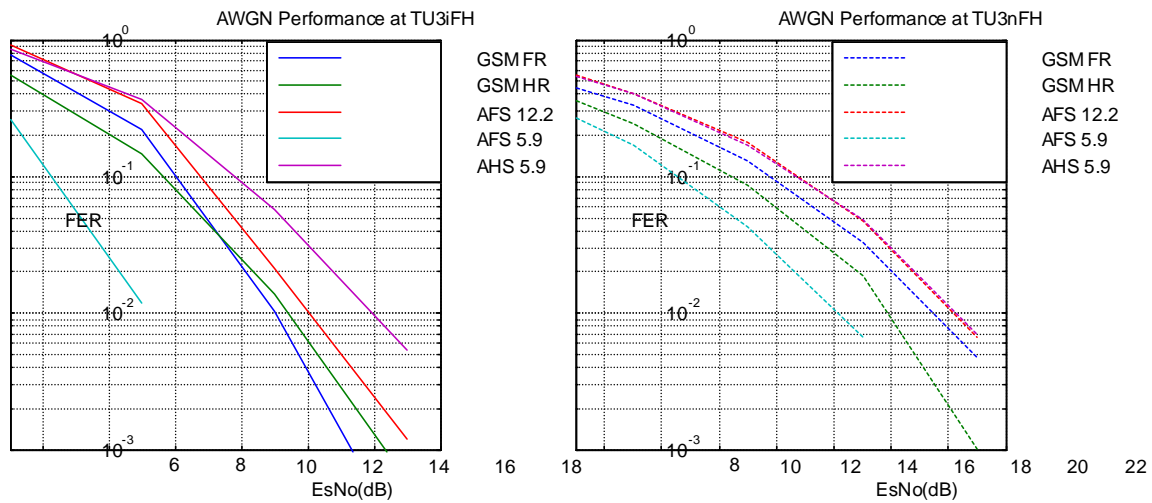

**Figure 6-9: DARP Phase 1 mobile performance in sensitivity condition with TU3**

The results show, as expected, that TU3 introduces 10dB degradation to static case, a major impact to sensitivity performance. However ideal FH improve it by 5 to 7dB.

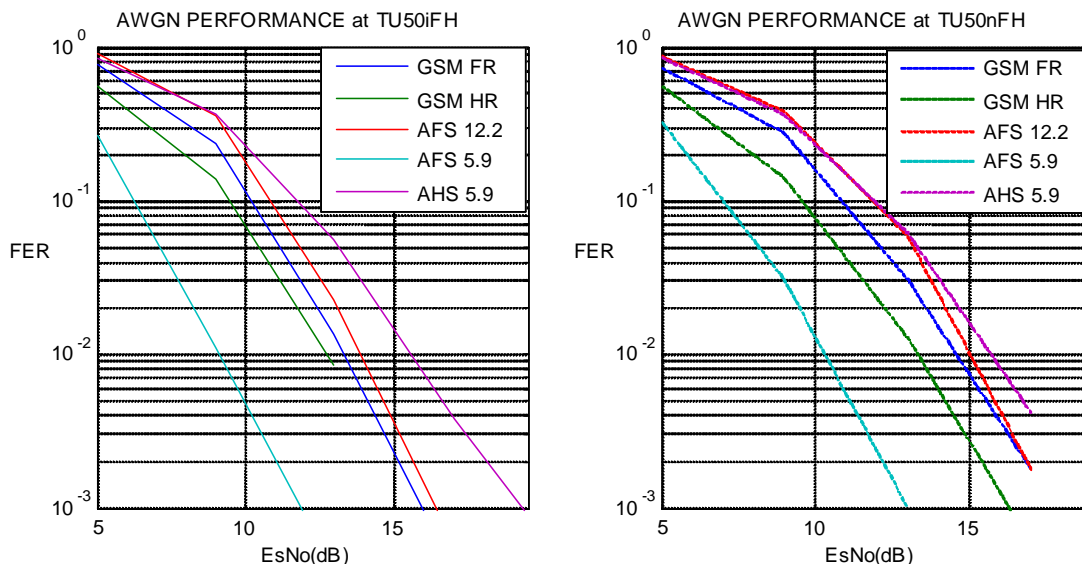

Figure 6-10: DARP Phase 1 mobile performance in sensitivity condition with TU50

TU50 introduces 5 to 7 dB degradation to static case and ideal FH improves by 1 dB, not as much as with TU3.

The conclusion is that MUROS works well in static condition but will have 10dB degradation for worst fading channel which means TU3 does need frequency hopping.

6.2.1.2 Interference performance

6.2.1.2.1 MTS-1 configuration

The link level performance for MTS-1 configuration is shown in Figure 6-11 and Figure 6-12.

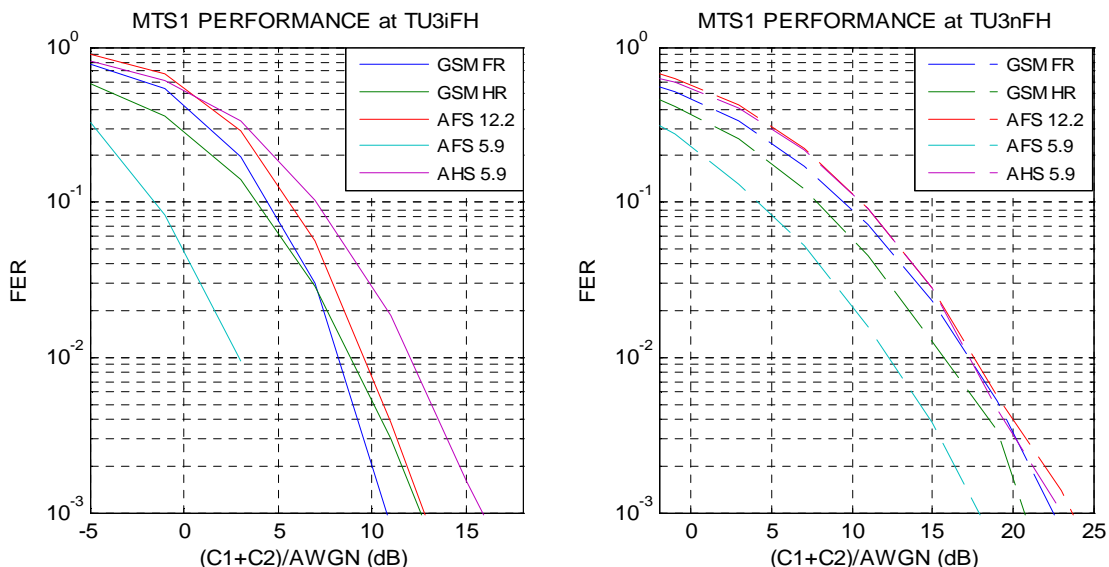

Figure 6-11 DARP Phase 1 mobile performance in MTS-1 scenario with TU3

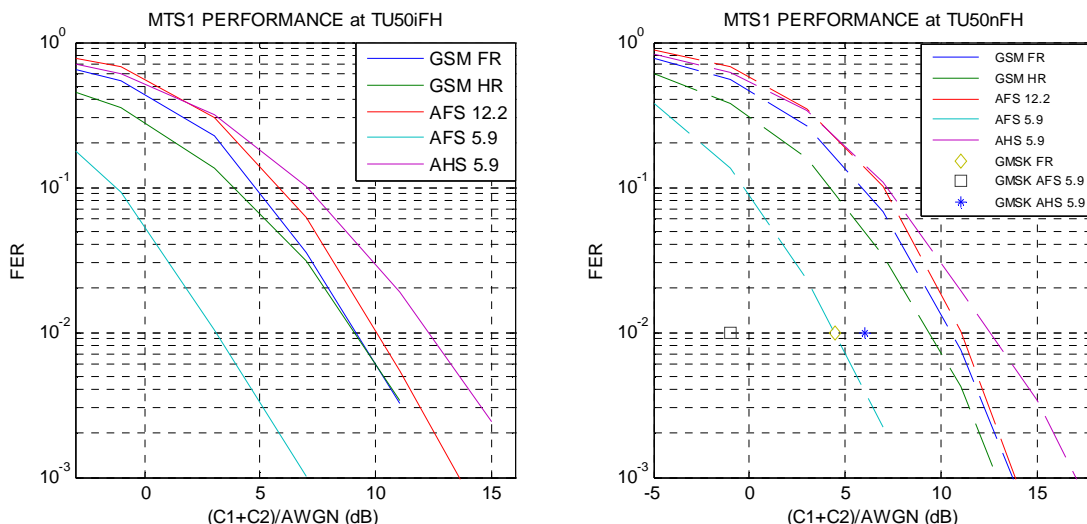

Figure 6-12: DARP Phase 1 mobile performance in MTS-1 scenario with TU50

The spec point for a DARP Phase 1 receiver with GMSK modulated signal is also shown on the second graph in Figure 6-12. As can be seen that the performance of a DARP Phase 1 receiver with MUROS signal is around 3-4dB worse for GSM FR, AFS5.9 and AHS5.9 codecs with iFH, which is reasonable as two users are supported simultaneously by the same radio.

It is clear that even in MUROS mode DARP mobile can still suppress CCI by further 4 to 6 dBs compared with AWGN as MTS-1 has coloured noise.

As expected with ideal frequency hopping, both TU3 and TU50 performing equally well. Without frequency hopping, on the other hand, TU3 degrades by 6 to 10 dB, and TU50 by 2 dB compared to the static case.

6.2.1.2.2 MTS-2 configuration

The link level performance for MTS-2 configuration is shown in Figure 6-13 and Figure 6-14.

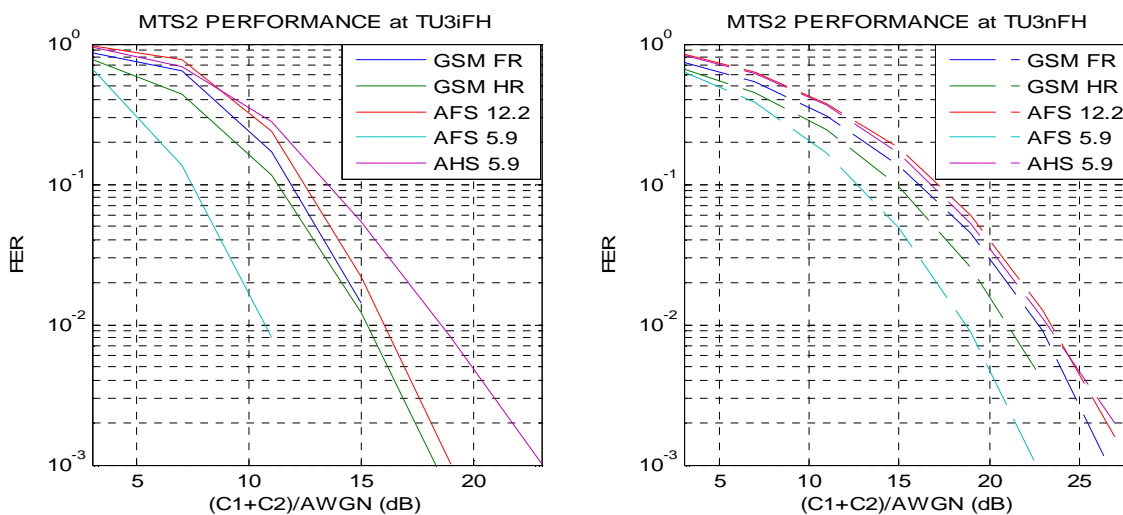

Figure 6-13: DARP Phase 1 mobile performance in MTS-2 scenario with TU3

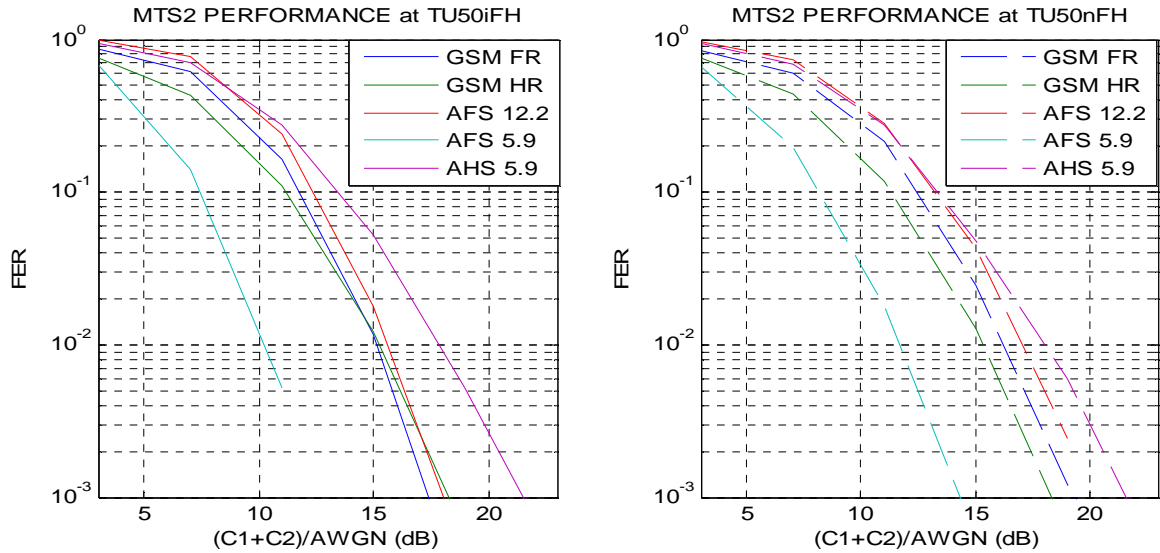

Figure 6-14: DARP Phase 1 mobile performance in MTS-2 scenario with TU50

The results show that MTS-2 is about 1 to 2 dB worse than AWGN, this means that when the interference type is mixed CCIs and ACIs, it is even harder than AWGN for DARP receiver to deal with. As usual, iFH would provide 4 to 9 dB improvement in TU3 channel.

6.2.1.2.3 MTS-3 configuration

The link level performance for MTS-3 configuration is shown in Figure 6-15 and Figure 6-16.

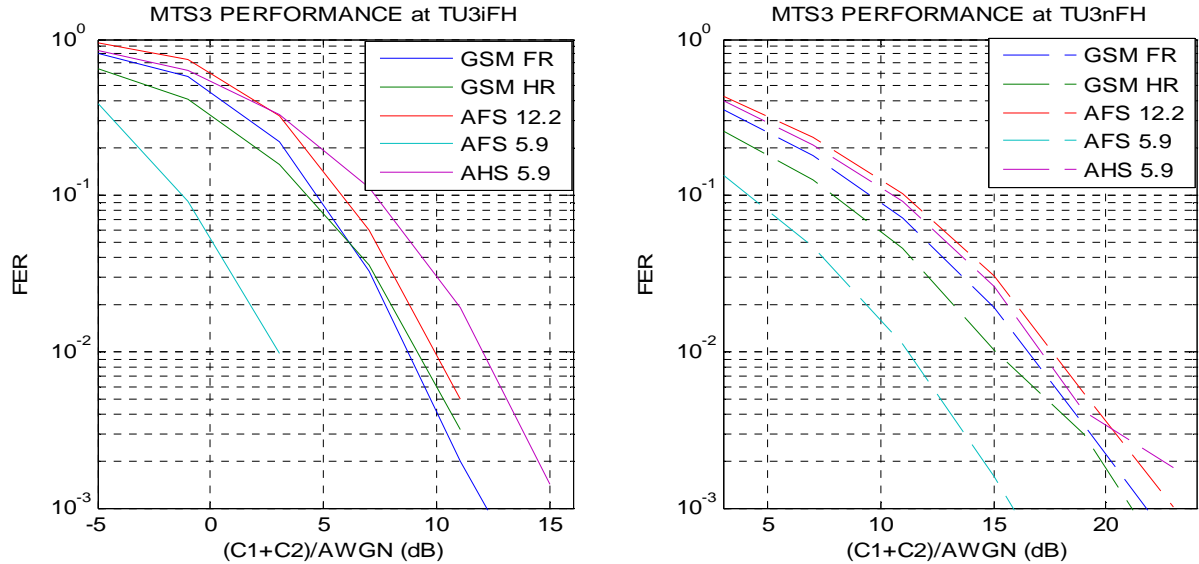

Figure 6-15: DARP Phase 1 mobile performance in MTS-3 scenario with TU3



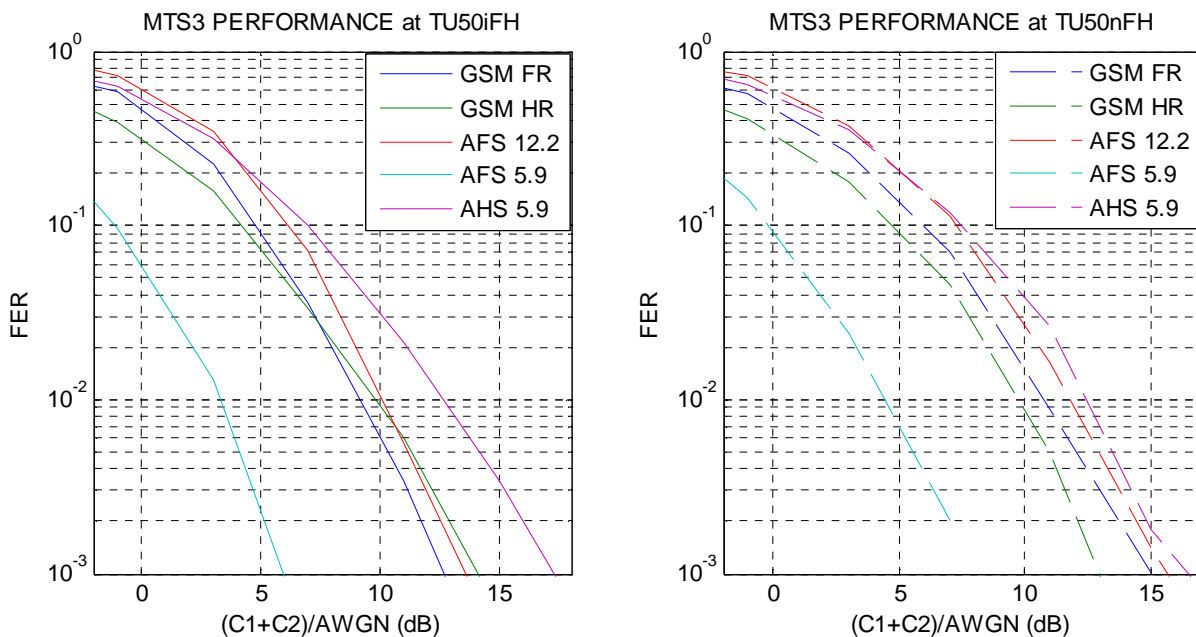

Figure 6-16: DARP Phase 1 mobile performance in MTS-3 scenario with TU50

The link level results for MTS-3 are similar to MTS-1 for our receiver implementation.

6.2.1.2.4 MTS-4 configuration

The link level performance for MTS-4 configuration is shown in Figure 6-17 and Figure 6-18.

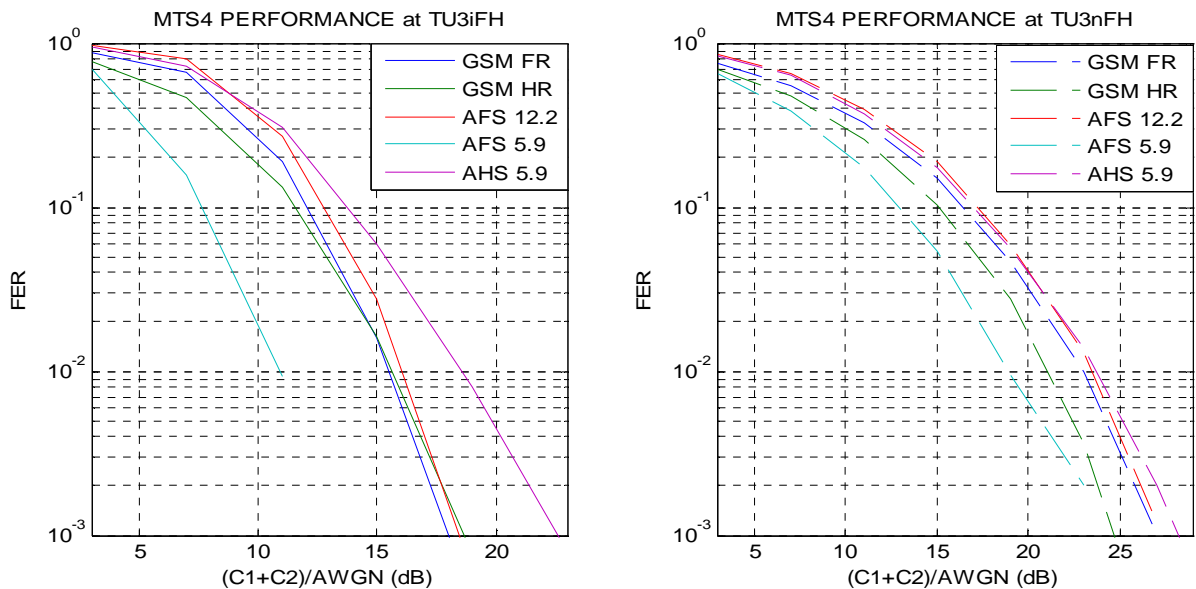
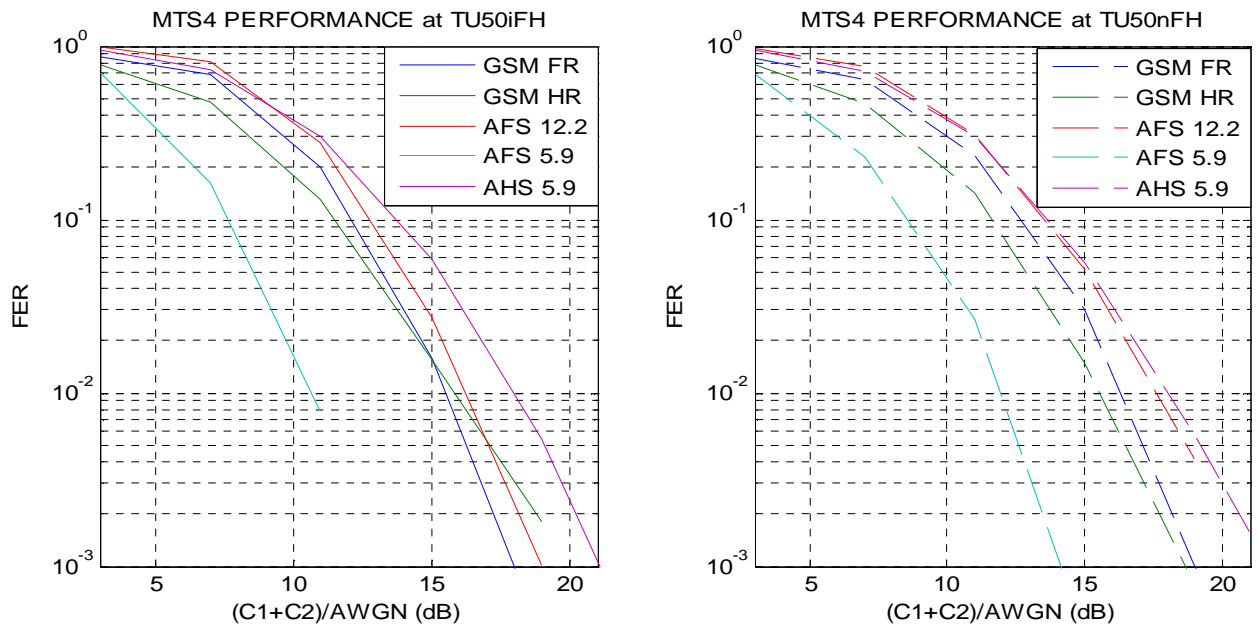

Figure 6-17: DARP Phase 1 mobile performance in MTS-4 scenario with TU3



**Figure 6-18: DARP Phase 1 mobile performance in MTS-4 scenario with TU50**

The link level results for MTS-4 are similar to MTS-2 for our receiver implementation.

### 6.2.1.3 Link level performance with power imbalance

This section shows the link level performance with power imbalance for the two co-TCH users. Following effects have been studied:

1. On both paired users, both DARP with DARP and DARP with non-DARP;
2. The different TSCs;
3. Two codecs of AFS5.9 and HR;
4. Different fading channels, including TU50 with iFH;
5. Different cases of sensitivity and MTS1;

The configuration for the link level simulation is shown in Table 6-2.

**Table 6-2: Link level simulation configuration for power imbalance scenarios**

Parameter	Value
MUROS Test Scenario	Sensitivity and MTS1
TSC	NSN 4 and legacy TSC 4
Audio Codec	AFS 5.9 and HR
Frequency Hopping	with hopping
Propagation environment	AWGN and CCI
DTX	Not used
Power imbalance (dB)	0, 2, 4, 6, 8 and 10 for the legacy MS -2, -4, -6, -8 and -10 for the DARP MS

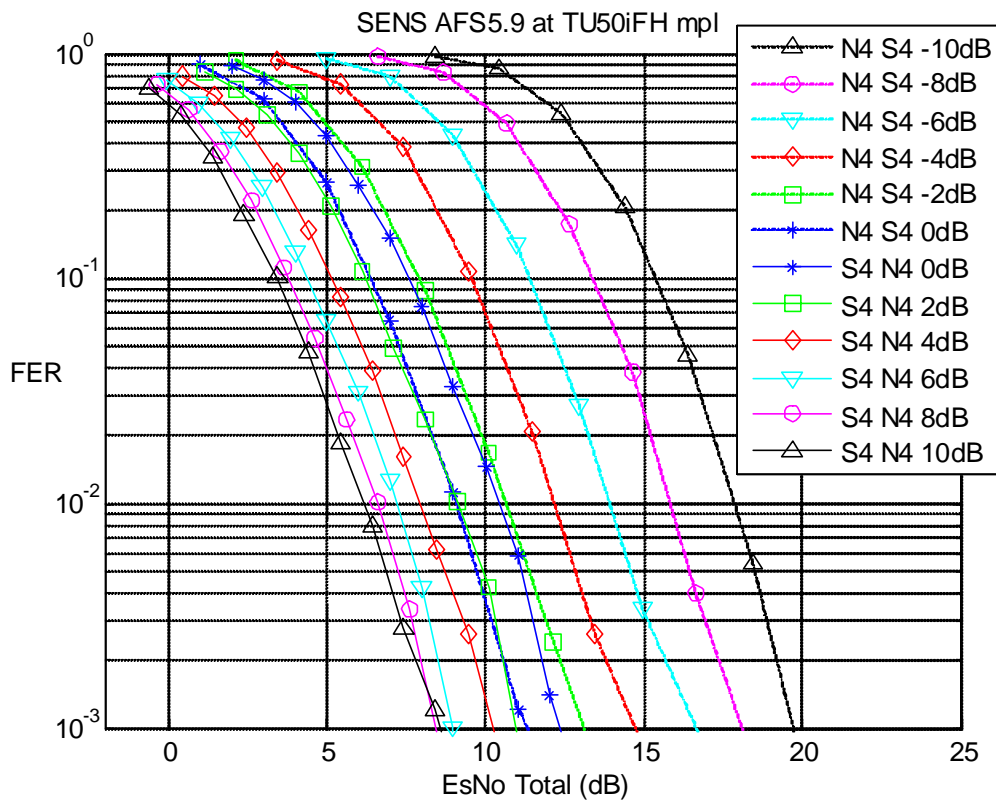

Figure 6-19: MUROS mode performance of DARF mobile with power imbalance in AWGN (AFS 5.9)

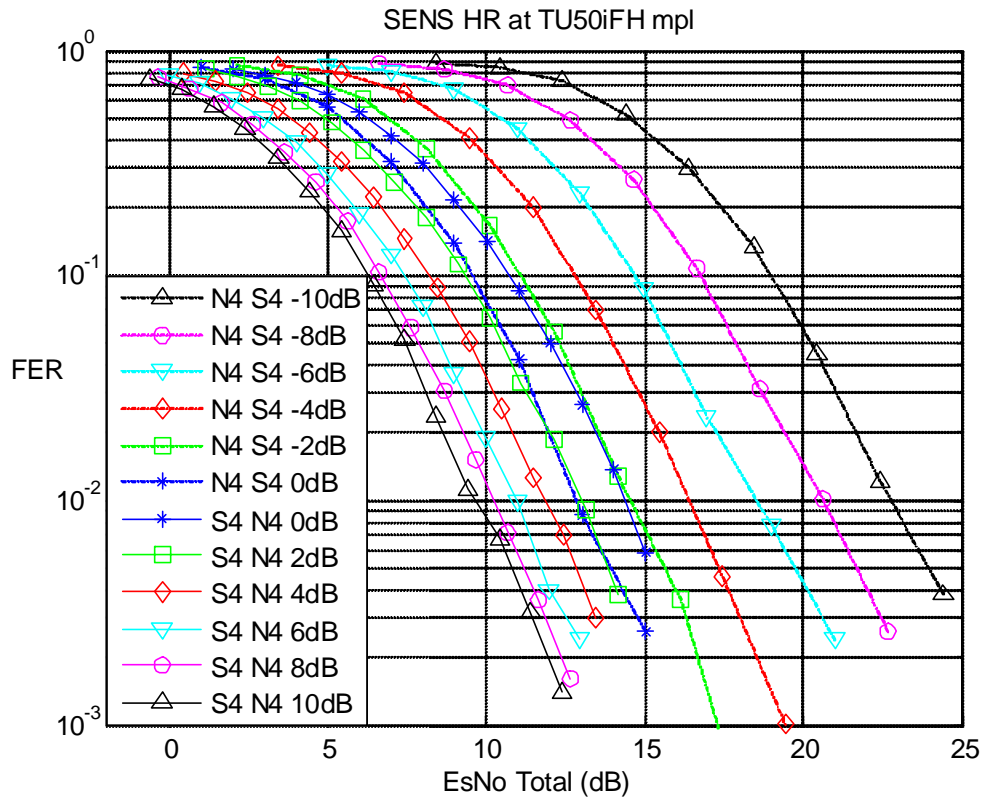

Figure 6-20: MUROS mode performance of DARP mobile with power imbalance in AWGN (GSM HR)

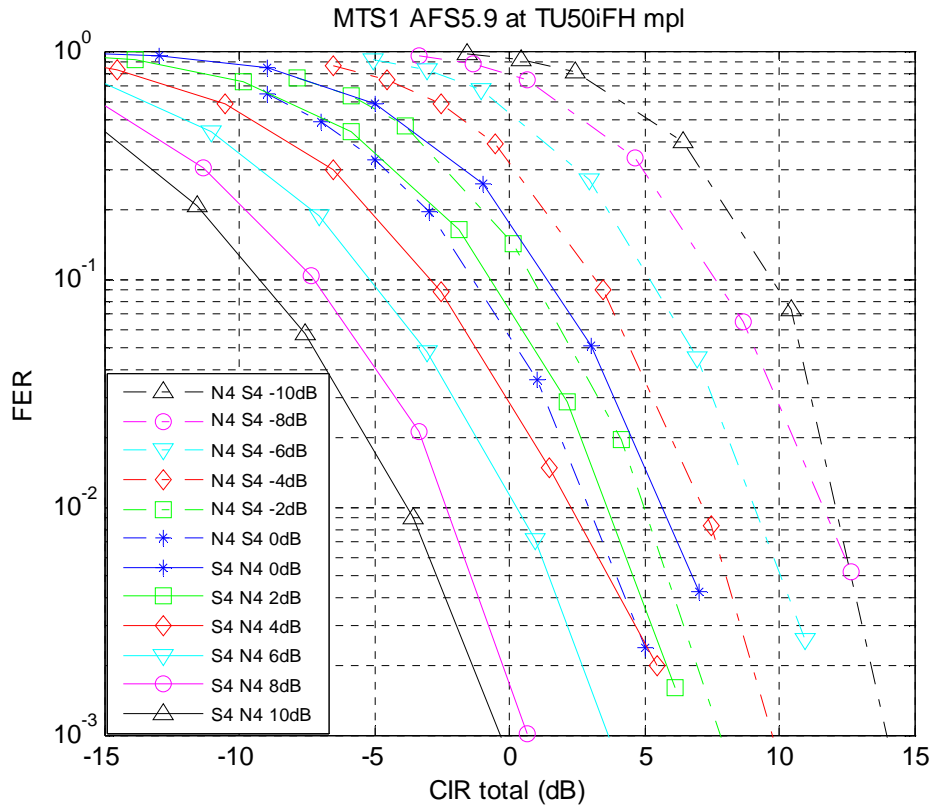

Figure 6-21: MUROS mode performance of DARP mobile with power imbalance in MTS1 (AFS 5.9)

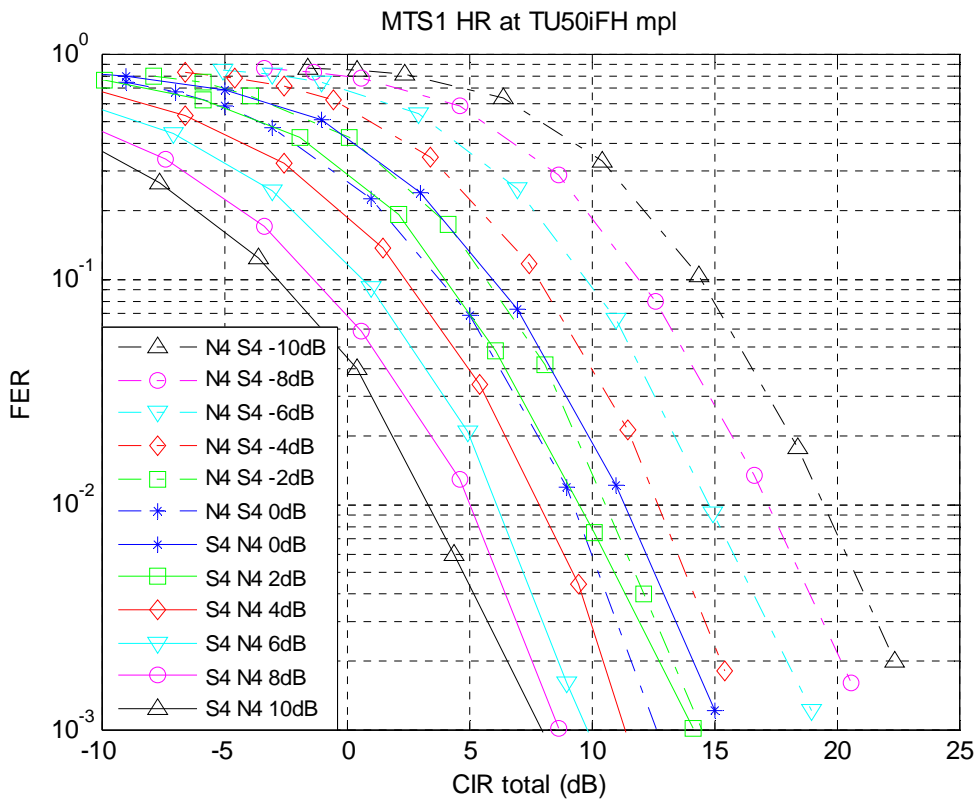

Figure 6-22: MUROS mode performance of DARP mobile with power imbalance in MTS1 (GSM HR)

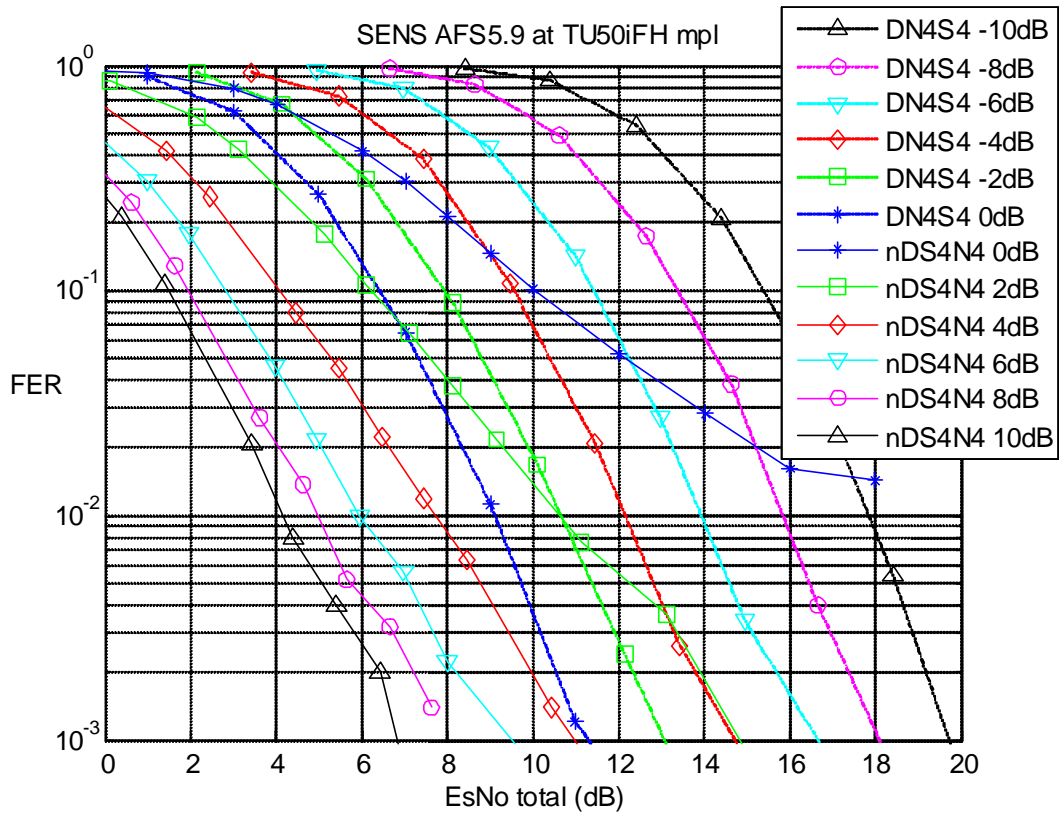

Figure 6-23: MUROS mode performance of DARP mobile with power imbalance in AWGN (AFS5.9)

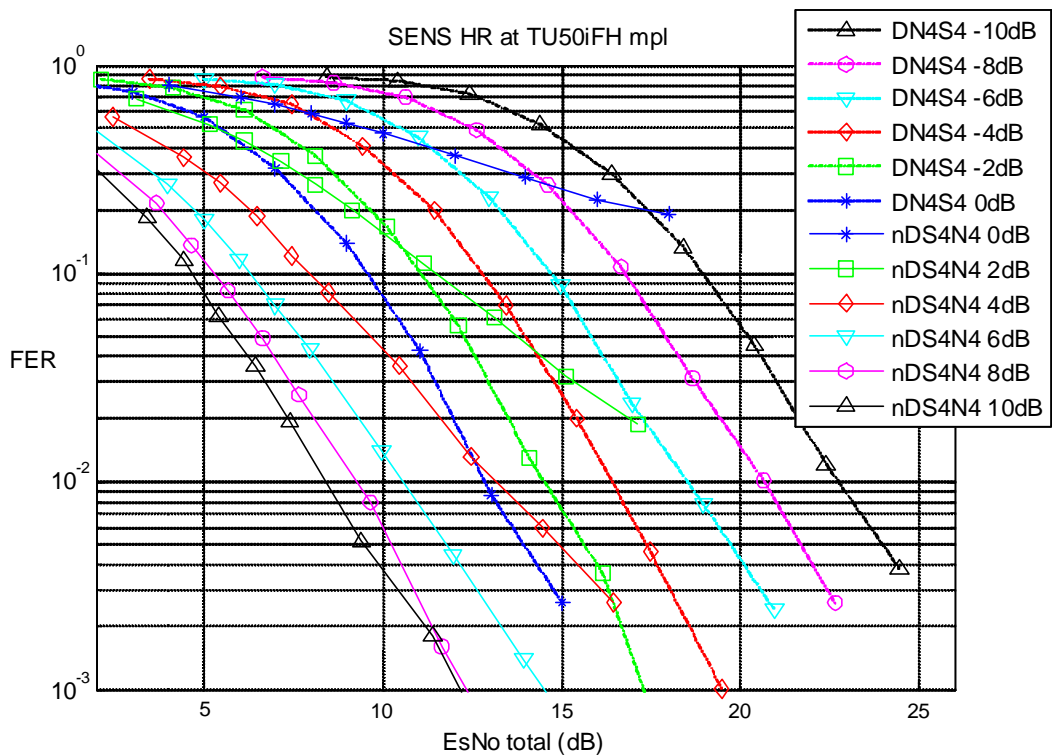

Figure 6-24: MUROS mode performance of DARP mobile with power imbalance in AWGN (GSM HR)

### 6.2.1.4 SACCH performance on MUROS and non-MUROS

Signalling is an important part of MUROS operation. SACCH has a special importance for maintaining the radio link for voice service. For the purposes of comparison, SACCH performance for non-MUROS and MUROS are studied with reference to five other codecs here.

#### 6.2.1.4.1 Non-MUROS and MUROS Sensitivity Performance

Figure 6-25 shows SACCH performance simulated with non-MUROS (Con.) and MUROS (0dB) modes in static, TU50 and TU3 channels with ideal frequency hopping.

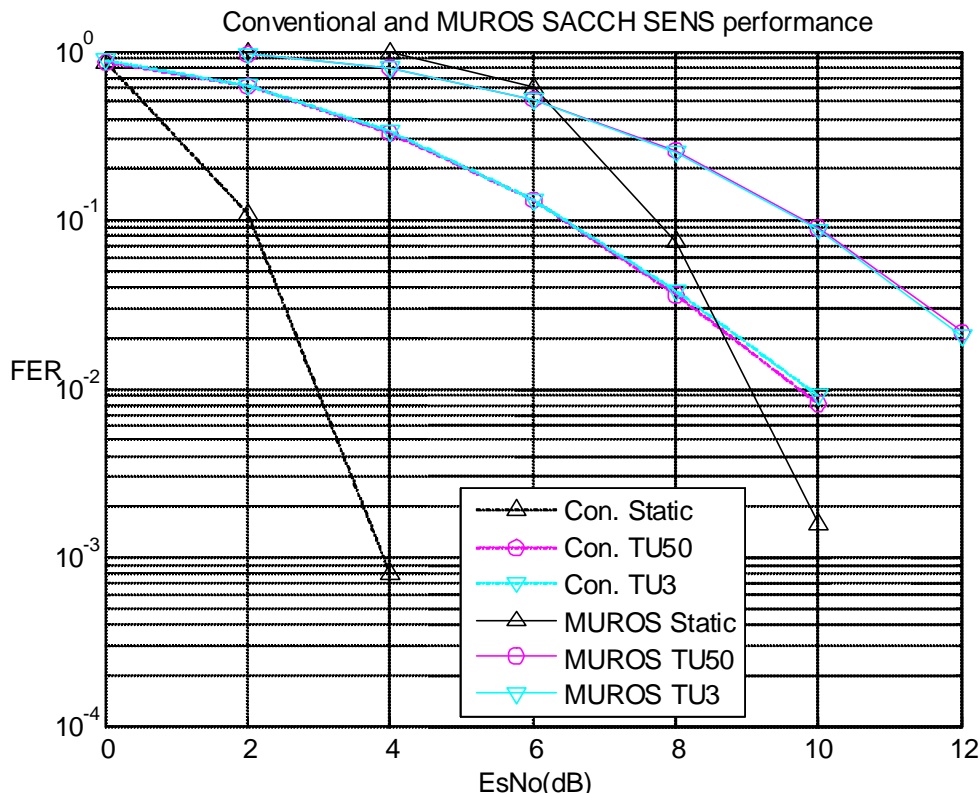

**Figure 6-25: DARP Phase 1 mobile SACCH sensitivity performance with static, TU3, TU50 channels and iFH on non-MUROS and MUROS (C1/AWGN)**

Firstly, as expected with ideal FH, TU3 and TU50 are about the same.

Secondly, SACCH does not have strong FEC, and can degrade pretty quickly with poor RF conditions. This is shown by

1. The 7 dB degradation from static to TU channel in non-MUROS mode.
2. The 6dB degradation on static channel from non-MUROS to MUROS mode.
3. The 3 dB degradation from non-MUROS to MUROS mode on TU channel (with ideal frequency hopping).

For comparison with the non-MUROS case, Figure 6-25 has been plotted without considering the total power, which would be 3 dB more for this case.

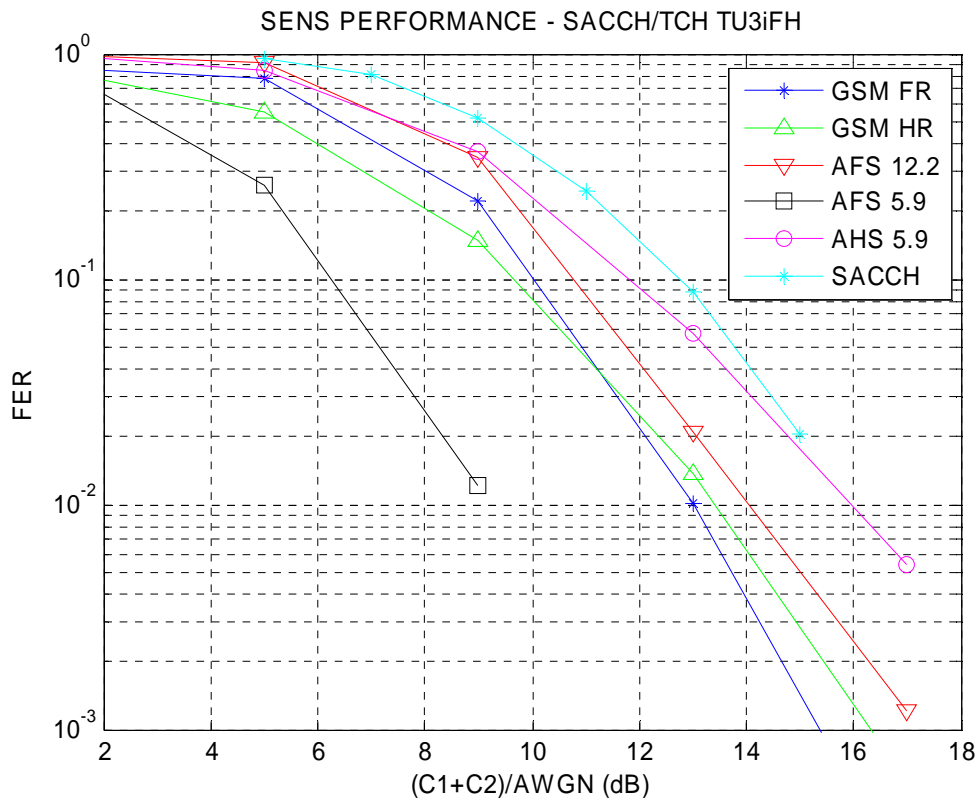

**Figure 6-26: DARP Phase 1 mobile MUROS (0dB) SACCH/TCHes performance comparison in TU3 iFH**

For comparison of SACCH and TCH's Figure 6-26 shows that SACCH with equal power MUROS for the pair would perform slightly worse than AHS5.9, and more than 6 dB worse than AFS5.9. This means that

1. MUROS mode, as expected, near the cell edge is generally not as good as close to the cell centre.
2. If MUROS is used in sensitivity limited case, on AFS, SACCH could be the weakest link. Alternative power imbalance and repeated SACCH would be helpful with 4 to 5 dB gain.
3. SACCH sensitivity performance is similar to AHS5.9 in MUROS mode (15 dB EbNo).

It is expected that HS and AHS are going to be the main focus on MUROS mode and the above shows that it should fine for DARP phone working in MUROS mode when they are not near the cell edge.

#### 6.2.1.4.2 Non-MUROS and MUROS Interference Performance

To understand the relative performance degradation between voice codecs and SACCH in non-MUROS and MUROS mode, DTS-1, DTS-2, MTS-1 and MTS-2 are simulated at link level for five codecs and SACCH. Furthermore, link level simulation results for SACCH, AFS5.9 and AHS5.9 in DTS-1 and DTS2 scenarios have been verified in the lab. All link level MUROS simulations were performed 0dB power imbalance.

In the figures below, the RF conditions are normalised to SACCH 2% FER point in order to see the relative performance of five codecs in both non-MUROS (i.e. DTS) and MUROS (i.e. MTS) modes.

Note that the SACCH performance in each case will be the same irrespective of the speech codec.



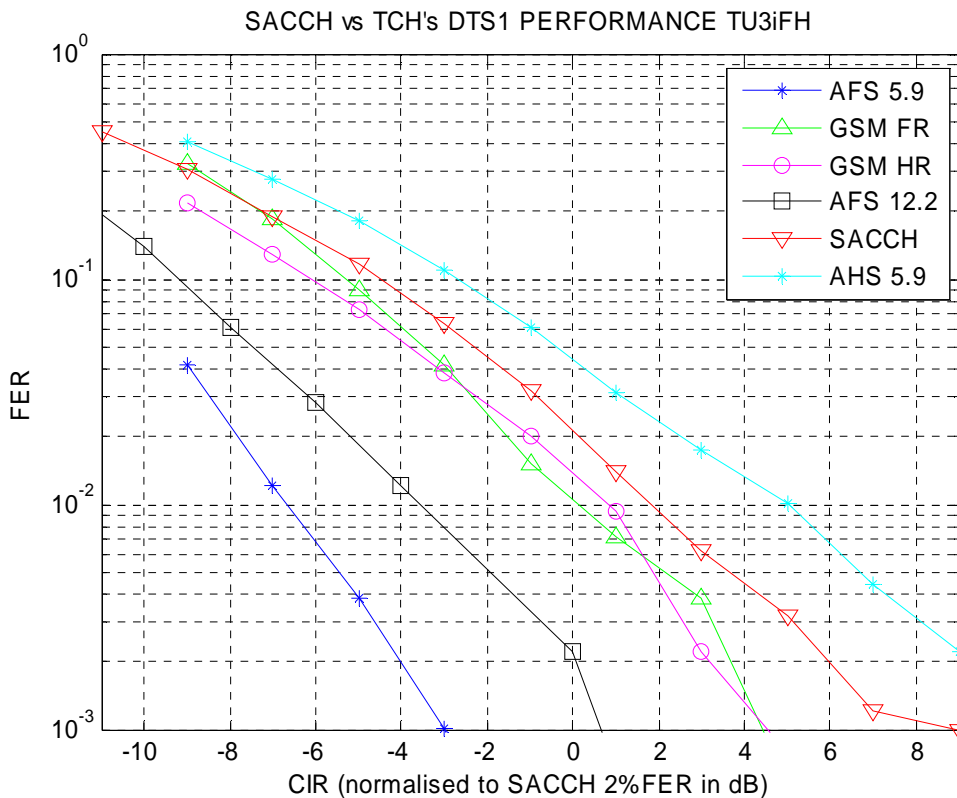
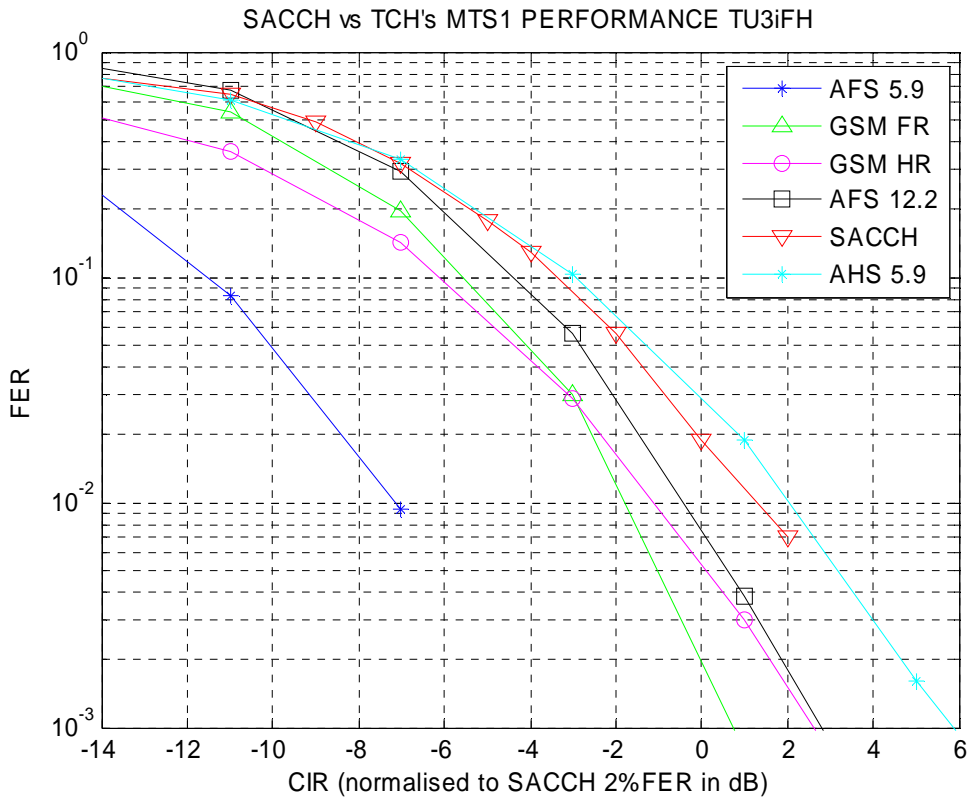

Figure 6-27: DARP Phase 1 mobile SACCH/TCH's performance in DTS-1 scenario with TU3 iFH

In non-MUROS mode, with just one CCI (DTS1), SACCH performance is only 3 dB better than AHS5.9, but worse than other codecs listed above. However for HR it is only about 1 dB worse. This shows the same conclusion: SACCH cannot match some of the good AFS codecs. So in such cases repeated SACCH would be very helpful, as 4 to 5 dB gain can be obtained.



**Figure 6-28: DARP Phase 1 mobile SACCH/TCH's performance in MTS-1 scenario with TU3 iFH**

In the case of MUROS (0dB pairing) MTS1, SACCH performance stays relatively the same (or slightly worse) to other codecs with regards to DTS1. This means that there is no new SACCH issue when MUROS mode is used. In both MTS1 and DTS1 repeated SACCH would help. Compare with AHS5.9 and HR it is not going to cause major issue if RRC does good job on selecting the MUROS pair in the first place.

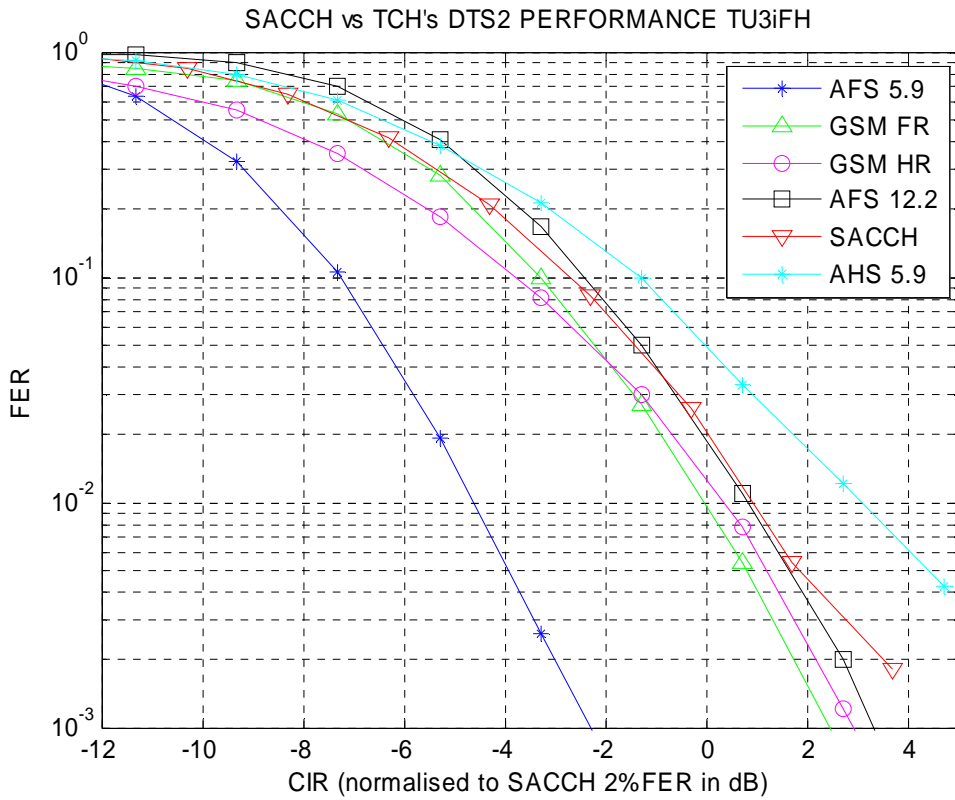

Figure 6-29: DARP Phase 1 mobile SACCH/TCH's performance in DTS-2 scenario with TU3 iFH

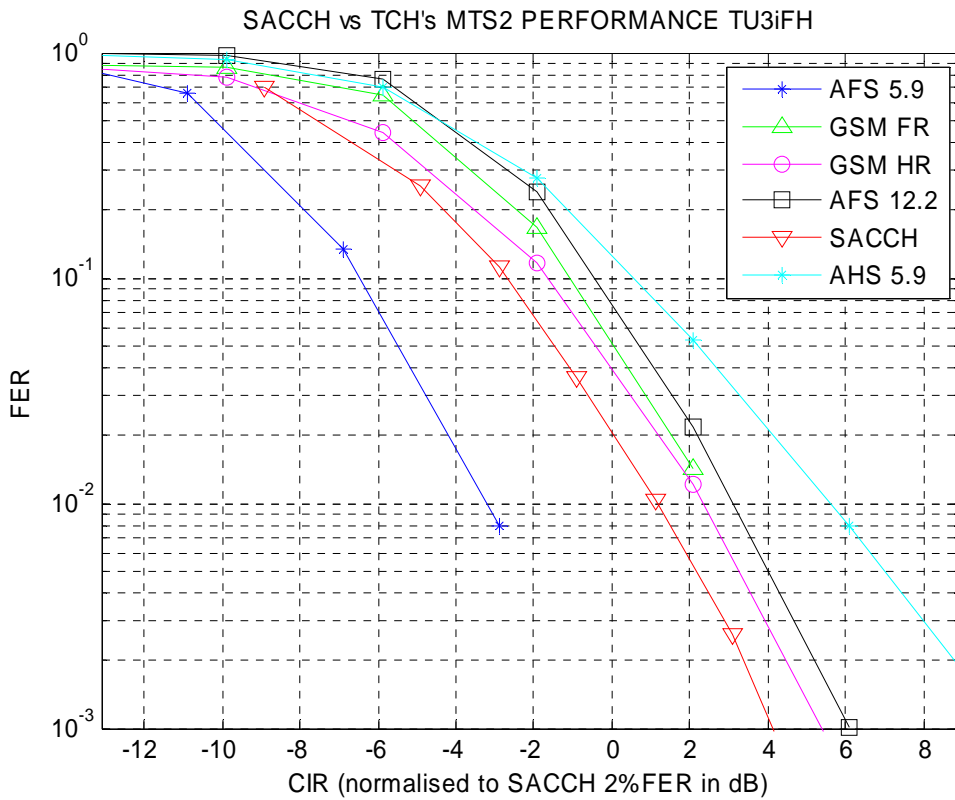

Figure 6-30: DARP Phase 1 mobile SACCH/TCH's performance in MTS-2 scenario with TU3 iFH

When comparing DTS2 with MTS2, SACCH performance seems better relatively to other codecs in MTS2 than DTS2. This is due to the case that DTS2 and MTS2 is not a good case for DARP to perform, and all codecs performance drop more than SACCH, as SACCH does not have very good FEC anyway to take the advantage of better condition.

This shows that in non-MUROS mode (i.e. DTS-2) the SACCH performance is about 6 dB worse than the AFS5.9, while in MUROS mode (i.e. MTS2 ) it is about 4 dB worse than AFS5.9, and becomes better than other four codecs listed above.

Although SACCH may be the weak link, the condition under which MUROS can perform well would have this condition anyway.

It is clear that SACCH performance is not as good as performance of some AMR codecs. But if MUROS is going to be used with HR and AHS, then SACCH is about the same performance and should be fine. In case SACCH needs to be improved, following method can be used:

1. Repeated SACCH could give 4 to 5 dB gain.
2. Alternatively giving high power for SACCH could be used to help the one in trouble.
3. Time offset of SACCH frame between neighbor cells to avoid SACCH shouting together. This could help in this case of synchronized network.

It is also true that SACCH should not be expected to be the same performance in order to maintain the voice service. It has a wider range of acceptance by the network.

## 6.2.2 Network Level Performance

### 6.2.2.1 System Setup and Configurations

The performance of a DARP Phase 1 receiver [6-2] is evaluated via system simulations for the various configurations and working assumptions defined in this TR. The system simulator provides snapshot system performance using a 19 site, 3 cells/site wraparound layout. The simulator completely models both fast and slow fading between each receiver and transmitter. However the simulator does not model mobility and handoff. The simulation results should be interpreted as average snapshot system performance for that particular configuration.

The system parameters of interest are reproduced below in Table 6-3.

**Table 6-3: Different network configurations for MUROS system simulations**

<b>Parameter</b>	<b>MUROS-1</b>	<b>MUROS-2</b>	<b>MUROS-3A</b>	<b>MUROS-3B</b>
Frequency band (MHz)	900	900	1800	1800
Cell radius	500 m	500 m	500 m	500 m
Bandwidth	4.4 MHz	11.6 MHz	2.6 MHz	2.6 MHz
Guard band	0.2 MHz	0.2 MHz	0.2 MHz	0.2 MHz
# channels excluding guard band	21	57	12	12
# TRX	4	6	4	4
BCCH frequency re-use	4/12	4/12	N.A.	N.A.
TCH frequency re-use	1/1	3/9	1/3	1/1
Frequency Hopping	Synthesized	Baseband	Synthesized	Synthesized
Length of MA (# FH frequencies)	9	5	4	12
Fast fading types	TU 50 / TU 3	TU 50 / TU 3	TU 50 / TU 3	TU 50 / TU 3

### 6.2.2.1.1 Enabled features for system simulations

The system simulation was run with the following features included:

**Table 6-4: Common configuration parameters for all MUROS modes**

Feature	Description
Modulation	GMSK (single user), 2-GMSK (MUROS mode)
Audio Codecs	GSM HR, AFS 12.2, AFS 5.9 and AHS 5.9
Frequency Hopping	Randomized (for both Synthesized and Baseband hopping modes)
DTX	60% voice activity period
Antenna pattern	Both 65° and 90° 3dB antenna bandwidth as agreed in GERAN Telco#5
Transmission on BCCH ARFCN	BCCH Frequency is used only for transmission to users with low RXQUAL on TCH; MUROS is not enabled on BCCH
Power Control	Sub-channel specific power adjustment.
MS Receiver Type	For y% penetration of MUROS case, y% : DARP Phase 1, MUROS aware 0.7 (100-y)%: DARP Phase 1 (not MUROS aware) 0.3 (100-y)%: non-DARP Phase 1

For the different scenarios, the system was simulated to determine the maximum number of supportable channels per sector satisfying the FER criterion specified in this TR. The voice call arrival process as specified in this TR is separately accounted for to determine the Erlang capacity. In case of 100% penetration, there is only a single queue of users and the relation between maximum number of supportable channels and Erlang capacity is given by the following equation:

$$B_{\rho} = \frac{(\rho)^N / N!}{\sum_{i=0}^N (\rho)^i / i!},$$

where  $\rho$  is the Erlang capacity,  $N$  is the number of voice channels that can be supported without violating FER constraints (obtained through simulation), and  $B_{\rho}$  is the blocking probability. Erlang capacity is determined for  $B_{\rho} = 0.02$ . In case of less than 100% penetration, there are two queues of users and the arrival process is separately simulated to determine the Erlang capacity based on maximum number of supportable users determined using system simulations.

This approach is relatively simple and has merits over modeling the arrival and departure process in system simulations which are already computationally and memory intensive. Since the mean voice call service time is 90 seconds, simulations would need to be run for extremely long durations to reliably model the statistical arrival/departure processes and to average out the short-term statistical variations. Otherwise the results can be greatly affected by simulation noise.

### 6.2.2.1.2 Simulated Channel Mode Adaptations

Maximum system capacity was determined for each audio codec in both single-user and MUROS modes. For the current set of results being presented, dynamic codec/rate adaptation was not considered.

Table 6-5 Channel mode definitions

Channel Mode Adaptation	Description
Type A0	GSM HR for single-user mode
Type A1	GSM HR for MUROS mode
Type B0	AFS 12.2 for single user mode
Type B1	AFS 12.2 for MUROS mode
Type C0	AFS 5.9 for single user mode
Type C1	AFS 5.9 for MUROS mode
Type D0	AHS 5.9 for single user mode
Type D1	AHS 5.9 for MUROS mode

### 6.2.2.2 Simulation Results

The criteria for minimum call quality used to determine system capacity is described in this TR. The capacity results are presented separately for TU3 and TU50 channel models and for each antenna pattern. The configurations where MUROS shows capacity gains are highlighted in green.

#### 6.2.2.2.1 MUROS-1 with 100% penetration

##### 6.2.2.2.1.1 TU 50km/hr channel model

Table 6-6: Simulation results for MUROS-1, TU50 with 65° Antenna

Channel Mode	Max supportable channels/sector	Spectral Efficiency (Erl/MHz/Site)	Hardware Efficiency (Erl/#TRX)	Limiting Factor
Type A0	54	35.52	10.99	Blocked calls
Type A1	81	56.24	17.40	Call quality (FER > 3%)
Type B0	27	15.56	4.81	Blocked calls
Type B1	35	21.33	6.60	Call quality (FER > 2%)
Type C0	27	15.56	4.81	Blocked calls
Type C1	51	33.25	10.29	Blocked calls
Type D0	54	35.52	10.99	Blocked calls
Type D1	58	38.59	11.94	Call quality (FER > 3%)

Table 6-7: Simulation results for MUROS-1, TU50 with 90° Antenna

Channel Mode	Max supportable channels/sector	Spectral Efficiency (Erl/MHz/Site)	Hardware Efficiency (Erl/#TRX)	Limiting Factor
Type A0	54	35.52	10.99	Blocked calls
Type A1	74	50.83	15.73	Call quality (FER > 3%)
Type B0	27	15.56	4.81	Blocked calls
Type B1	30	17.70	5.47	Call quality (FER > 2%)
Type C0	27	15.56	4.81	Blocked calls
Type C1	51	33.25	10.29	Blocked calls
Type D0	54	35.52	10.99	Blocked calls
Type D1	56	37.05	11.46	Call quality (FER > 3%)

## 6.2.2.2.1.2 TU 3km/hr channel model

**Table 6-8 Simulation results for MUROS-1, TU3 with 65° Antenna**

Channel Mode	Max supportable channels/sector	Spectral Efficiency (Erl/MHz/Site)	Hardware Efficiency (Erl/#TRX)	Limiting Factor
Type A0	54	35.52	10.99	Blocked calls
Type A1	65	43.92	13.59	Call quality (FER > 3%)
Type B0	23	12.73	3.94	Call quality (FER > 2%)
Type B1	23	12.73	3.94	Call quality (FER > 2%)
Type C0	27	15.56	4.81	Blocked calls
Type C1	40	25.01	7.74	Call quality (FER > 2%)
Type D0	46	29.49	9.13	Call quality (FER > 3%)
Type D1	46	29.49	9.13	Call quality (FER > 3%)

**Table 6-9 Simulation results for MUROS-1, TU3 with 90° Antenna**

Channel Mode	Max supportable channels/sector	Spectral Efficiency (Erl/MHz/Site)	Hardware Efficiency (Erl/#TRX)	Limiting Factor
Type A0	54	35.52	10.99	Blocked calls
Type A1	59	39.35	12.18	Call quality (FER > 3%)
Type B0	21	11.31	3.50	Call quality (FER > 2%)
Type B1	21	11.31	3.50	Call quality (FER > 2%)
Type C0	27	15.56	4.81	Blocked calls
Type C1	37	22.83	7.06	Call quality (FER > 2%)
Type D0	41	25.78	7.98	Call quality (FER > 3%)
Type D1	41	25.78	7.98	Call quality (FER > 3%)

The results for MUROS-1 show 30-100% gains in Erlang capacity in the cases of TU50 with 65° antenna pattern. With TU3 however, it is not possible to increase voice capacity with MUROS in cases where users have less resilient codecs (AFS 12.2 and AHS 5.9). The performance under the 90° antenna pattern is marginally worse than that achieved with 65° antenna pattern.

## 6.2.2.2.2 MUROS-2 with 100% penetration

## 6.2.2.2.2.1 TU 50km/hr channel model

**Table 6-10: Simulation results for MUROS-2, TU50 with 65° Antenna**

Channel Type	Max supportable channels/sector	Spectral Efficiency (Erl/MHz/Site)	Hardware Efficiency (Erl/#TRX)	Limiting Factor
Type A0	86	22.26	12.41	Blocked calls
Type A1	166	45.61	25.43	Call quality (FER > 3%)
Type B0	43	10.09	5.62	Blocked calls
Type B1	83	21.39	11.92	Blocked calls
Type C0	43	10.09	5.62	Blocked calls
Type C1	83	21.39	11.92	Blocked calls
Type D0	86	22.26	12.41	Blocked calls
Type D1	166	45.61	25.43	Call quality (FER > 3%)

**Table 6-11: Simulation results for MUROS-2, TU50 with 90° Antenna**

Channel Type	Max supportable channels/sector	Spectral Efficiency (Erl/MHz/Site)	Hardware Efficiency (Erl/#TRX)	Limiting Factor
Type A0	86	22.26	12.41	Blocked calls
Type A1	166	45.61	25.43	Call quality (FER > 3%)
Type B0	43	10.09	5.62	Blocked calls
Type B1	83	21.39	11.92	Blocked calls
Type C0	43	10.09	5.62	Blocked calls
Type C1	83	21.39	11.92	Blocked calls
Type D0	86	22.26	12.41	Blocked calls
Type D1	166	45.61	25.43	Call quality (FER > 3%)

## 6.2.2.2.2.2

TU 3km/hr channel model

**Table 6-12: Simulation results for MUROS-2, TU3 with 65° Antenna**

Channel Type	Max supportable channels/sector	Spectral Efficiency (Erl/MHz/Site)	Hardware Efficiency (Erl/#TRX)	Limiting Factor
Type A0	86	22.26	12.41	Blocked calls
Type A1	166	45.61	25.43	Call quality (FER > 3%)
Type B0	43	10.09	5.62	Blocked calls
Type B1	70	17.67	9.85	Call quality (FER > 2%)
Type C0	43	10.09	5.62	Blocked calls
Type C1	83	21.39	11.92	Blocked calls
Type D0	86	22.26	12.41	Blocked calls
Type D1	166	45.61	25.43	Call quality (FER > 3%)

**Table 6-13: Simulation results for MUROS-2, TU3 with 90° Antenna**

Channel Type	Max supportable channels/sector	Spectral Efficiency (Erl/MHz/Site)	Hardware Efficiency (Erl/#TRX)	Limiting Factor
Type A0	86	22.26	12.41	Blocked calls
Type A1	166	45.61	25.43	Call quality (FER > 3%)
Type B0	43	10.09	5.62	Blocked calls
Type B1	69	17.39	9.69	Call quality (FER > 2%)
Type C0	43	10.09	5.62	Blocked calls
Type C1	83	21.39	11.92	Blocked calls
Type D0	86	22.26	12.41	Blocked calls
Type D1	166	45.61	25.43	Call quality (FER > 3%)

In the MUROS-2 configuration with 100% penetration, gains are possible with all codecs and channel types. With TU50, spectral efficiency gains of greater than 100% are possible and the achievable gains are limited by blocked calls in all cases. With TU3, gains as high as 90% are possible. There is little difference in observed results with different antenna patterns.



## 6.2.2.2.3 MUROS-3A with 100% penetration

## 6.2.2.2.3.1 TU 50km/hr channel model

Table 6-14 Simulation results for MUROS-3a, TU50 with 65° Antenna

Channel Type	Max supportable channels/sector	Spectral Efficiency (Erl/MHz/Site)	Hardware Efficiency (Erl/#TRX)	Limiting Factor
Type A0	64	61.62	13.35	Blocked calls
Type A1	121	125.02	27.09	Call quality (FER > 3%)
Type B0	32	27.35	5.93	Blocked calls
Type B1	49	45.35	9.82	Call quality (FER > 2%)
Type C0	32	27.35	5.93	Blocked calls
Type C1	64	61.62	13.35	Blocked calls
Type D0	64	61.62	13.35	Blocked calls
Type D1	80	79.21	17.16	Call quality (FER > 3%)

Table 6-15 Simulation results for MUROS-3a, TU50 with 90° Antenna

Channel Type	Max supportable channels/sector	Spectral Efficiency (Erl/MHz/Site)	Hardware Efficiency (Erl/#TRX)	Limiting Factor
Type A0	64	61.62	13.35	Blocked calls
Type A1	114	117.17	25.39	Call quality (FER > 3%)
Type B0	32	27.35	5.93	Blocked calls
Type B1	48	44.25	9.59	Call quality (FER > 2%)
Type C0	32	27.35	5.93	Blocked calls
Type C1	64	61.62	13.35	Blocked calls
Type D0	64	61.62	13.35	Blocked calls
Type D1	72	70.38	15.25	Call quality (FER > 3%)

## 6.2.2.2.3.2 TU 3km/hr channel model

Table 6-16: Simulation results for MUROS-3a, TU3 with 65° Antenna

Channel Type	Max supportable channels/sector	Spectral Efficiency (Erl/MHz/Site)	Hardware Efficiency (Erl/#TRX)	Limiting Factor
Type A0	64	61.62	13.35	Blocked calls
Type A1	76	74.83	16.21	Call quality (FER > 3%)
Type B0	23	18.17	3.94	Call quality (FER > 2%)
Type B1	23	18.17	3.94	Call quality (FER > 2%)
Type C0	32	27.35	5.93	Blocked calls
Type C1	50	46.44	10.06	Call quality (FER > 2%)
Type D0	46	42.12	9.13	Call quality (FER > 3%)
Type D1	46	42.12	9.13	Call quality (FER > 3%)

Table 6-17: Simulation results for MUROS-3a, TU3 with 90° Antenna

Channel Type	Max supportable channels/sector	Spectral Efficiency (Erl/MHz/Site)	Hardware Efficiency (Erl/#TRX)	Limiting Factor
Type A0	64	61.62	13.35	Blocked calls
Type A1	68	66.00	14.30	Call quality (FER > 3%)
Type B0	22	17.13	3.71	Call quality (FER > 2%)
Type B1	22	17.13	3.71	Call quality (FER > 2%)
Type C0	32	27.35	5.93	Blocked calls
Type C1	48	44.25	9.59	Call quality (FER > 2%)
Type D0	40	35.71	7.74	Call quality (FER > 3%)
Type D1	40	35.71	7.74	Call quality (FER > 3%)

In MUROS-3a, 60-125% capacity gains are achievable with MUROS for all codecs and channel types with TU 50 channel model. With TU3 capacity gains are observed only in the cases of GSM HR and AFS 5.9. Also worth noting is that MUROS-3a shows the highest achievable spectral efficiency values among all simulated deployment scenarios. This explains why there are cases where all TRX can not be maximally utilized even without MUROS. There are slight differences in performance between 65° and 90° antenna patterns, though the differences are marginal.

#### 6.2.2.2.4 MUROS-3B with 100% penetration

##### 6.2.2.2.4.1 TU 50km/hr channel model

Table 6-18: Simulation results for MUROS-3b, TU50 with 65° Antenna

Channel Type	Max supportable channels/sector	Spectral Efficiency (Erl/MHz/Site)	Hardware Efficiency (Erl/#TRX)	Limiting Factor
Type A0	64	61.62	13.35	Blocked calls
Type A1	90	90.35	19.58	Call quality (FER > 3%)
Type B0	32	27.35	5.93	Blocked calls
Type B1	37	32.60	7.06	Call quality (FER > 2%)
Type C0	32	27.35	5.93	Blocked calls
Type C1	64	61.62	13.35	Blocked calls
Type D0	64	61.62	13.35	Blocked calls
Type D1	65	62.71	13.59	Call quality (FER > 3%)

Table 6-19: Simulation results for MUROS-3b, TU50 with 90° Antenna

Channel Type	Max supportable channels/sector	Spectral Efficiency (Erl/MHz/Site)	Hardware Efficiency (Erl/#TRX)	Limiting Factor
Type A0	64	61.62	13.35	Blocked calls
Type A1	83	82.56	17.89	Call quality (FER > 3%)
Type B0	32	27.35	5.93	Blocked calls
Type B1	34	29.42	6.37	Call quality (FER > 2%)
Type C0	32	27.35	5.93	Blocked calls
Type C1	64	61.62	13.35	Blocked calls
Type D0	60	57.23	12.40	Call quality (FER > 3%)
Type D1	60	57.23	12.40	Call quality (FER > 3%)

6.2.2.2.4.2 TU 3km/hr channel model

**Table 6-20: Simulation results for MUROS-3b, TU3 with 65° Antenna**

Channel Type	Max supportable channels/sector	Spectral Efficiency (Erl/MHz/Site)	Hardware Efficiency (Erl/#TRX)	Limiting Factor
Type A0	63	60.52	13.11	Call quality (FER > 3%)
Type A1	63	60.52	13.11	Call quality (FER > 3%)
Type B0	19	14.19	3.07	Call quality (FER > 2%)
Type B1	19	14.19	3.07	Call quality (FER > 2%)
Type C0	32	27.35	5.93	Blocked calls
Type C1	43	44.25	8.44	Call quality (FER > 2%)
Type D0	36	31.50	6.83	Call quality (FER > 3%)
Type D1	36	31.50	6.83	Call quality (FER > 3%)

**Table 6-21: Simulation results for MUROS-3b, TU3 with 90° Antenna**

Channel Type	Max supportable channels/sector	Spectral Efficiency (Erl/MHz/Site)	Hardware Efficiency (Erl/#TRX)	Limiting Factor
Type A0	55	51.81	11.23	Call quality (FER > 3%)
Type A1	55	51.81	11.23	Call quality (FER > 3%)
Type B0	16	11.31	2.45	Call quality (FER > 2%)
Type B1	16	11.31	2.45	Call quality (FER > 2%)
Type C0	32	27.35	5.93	Blocked calls
Type C1	37	32.60	7.06	Call quality (FER > 2%)
Type D0	33	28.38	6.15	Call quality (FER > 3%)
Type D1	33	28.38	6.15	Call quality (FER > 3%)

With MUROS-3b, modest gains are observed with three of the four codec cases under the TU50 channel model (19 – 125%). With TU3 channel model, however, the capacity gains are seen only in the case of AFS 5.9, depending on the antenna pattern under consideration. The antenna pattern significantly affects performance in MUROS-3b and call quality limitations are observed with lesser numbers of users than in the corresponding cases of MUROS-3a.

6.2.2.2.5 MUROS-2 with less than 100% penetration

In this setup we only consider the 65° antenna pattern with the half rate codecs (GSM HR and AHS 5.9).

6.2.2.2.5.1 TU 3km/hr channel model

**Table 6-22 :Simulation results for MUROS-2, TU3 with 65° Antenna: The penetration levels are related to MUROS/DARP/non-DARP receiver type**

Channel Type	Penetration (0/70/30) (Erl/MHz/Site)	Penetration (25/50/25) (Erl/MHz/Site)	Penetration (50/35/15) (Erl/MHz/Site)	Penetration (75/17.5/7.5) (Erl/MHz/Site)
Type A0	21.38 (Blocking)	21.38 (Blocking)	21.38 (Blocking)	21.38 (Blocking)
Type A1	21.38 (Blocking)	30.50 (Blocking)	38.27 (Blocking)	41.26 (Blocking)
Type D0	21.38 (Blocking)	21.38 (Blocking)	21.38 (Blocking)	21.38 (Blocking)
Type D1	21.38 (Blocking)	30.50 (Blocking)	37.0 (Call Quality)	41.26 (Blocking)

We see gains in all penetration cases with MUROS because DARP receiver types can be paired with MUROS mobiles without loss of performance. Though the channel allocation algorithm avoids pairing of MUROS mobiles with non-DARP mobiles, the random arrival sometimes lead to large number of non-DARP mobiles. In certain scenarios, the channel allocation algorithm even pairs MUROS mobiles with non-DARP mobiles with good received signal strength.

### 6.2.2.2.6 Summary

The percentage increases in voice capacity for the different MUROS configurations with different codecs are summarised in the following Tables.

**Table 6-23: Summary results with 100% penetration for TU50 with 65° Antenna**

Channel Type	MUROS-1	MUROS-2	MUROS-3a	MUROS-3b
Type A	58.4%	104.9%	102.9%	46.6%
Type B	37.1%	112%	65.8%	19.2%
Type C	113.7%	112%	125.3%	125.3%
Type D	8.6%	104.9%	28.6%	1.8%

**Table 6-24: Summary results with 100% penetration for TU50 with 90° Antenna**

Channel Type	MUROS-1	MUROS-2	MUROS-3a	MUROS-3b
Type A	43.1%	104.9%	90.2%	34.0%
Type B	13.7%	112%	61.8%	7.6%
Type C	113.7%	112%	125.3%	125.3%
Type D	4.3%	104.9%	14.2%	0%

**Table 6-25: Summary results with 100% penetration for TU3 with 65° Antenna**

Channel type	MUROS-1	MUROS-2	MUROS-3a	MUROS-3b
Type A	23.7%	104.9%	21.4%	0%
Type B	0%	75.1%	0%	0%
Type C	60.8%	112%	69.8%	42.4%
Type D	0%	104.9%	0%	0%

**Table 6-26: Summary results with 100% penetration for TU3 with 90° Antenna**

Channel type	MUROS-1	MUROS-2	MUROS-3a	MUROS-3b
Type A	10.8%	104.9%	7.1%	0%
Type B	0%	72.3%	0%	0%
Type C	46.7%	112%	61.8%	19.2%
Type D	0%	104.9%	0%	0%

**Table 6-27: Summary results with less than 100% penetration: MUROS-2, TU3 with 65° Antenna: The penetration levels are related to MUROS/DARP/non-DARP receiver type**

Channel type	25% Penetration (25/52.5/22.5)	50% Penetration (50/35/15)	75% Penetration (75/17.5/7.5)
Type A	42.6%	79%	93.0%
Type D	42.6%	67%	93.0%

In calculation of percentage gains in Table 6-27, the reference receiver ratio is always 0/70/30, though we don't expect the legacy performance to change with any mix ratio in MUROS-2 deployment scenario, and so the percentage gains will remain same.

### 6.2.2.3 Performance Summary

Generally, the results for TU-50 channel performance exceed TU-3 performance results for each MUROS configuration and channel mode pair. Significant gains with MUROS are observed in almost all deployment scenarios with TU-50. By comparison, the TU-3 channel lacks short-term time diversity and many users struggle to meet the minimum FER criteria in cases with tight reuse.

We do observe significant MUROS gains even in TU-3 in deployment scenarios which are not inherently interference limited, notably in the low-reuse MUROS-2 configuration. More modest gains are observed in tighter network-planned frequency reuse scenarios such as MUROS-3a, when paired with the AFS 5.9 codec, and to a lesser extent with the GSM HR codec.

MUROS-1 and MUROS-3b are reuse 1:1 deployments, and the system becomes interference limited, especially when less robust codecs (such as AFS 12.2, AHS 5.9) are assigned across all users in the cell. The interference limitations of 1:1 frequency reuse patterns are most acutely seen in the MUROS-3b configurations (which also lack BCCH scheduling). In MUROS-3b, as with MUROS-1, frequency hopping results in interference averaging. However, the antenna patterns used in all configurations do not provide adequate inter-cell interference suppression (maximum of 20 dB from the neighboring cells of same site). The 90° antenna pattern provides worse performance than 65° antenna pattern due to increased inter-cell interference. The DARP receiver provides some interference cancellation but its gains become limited when multiple high interference components are present.

In contrast, the network frequency planning (1:3 reuse) of MUROS-3a provides a measure of intra-site interference avoidance from neighbor cells that the similar MUROS-3b configuration lacks. As a result, for equivalent levels of traffic loading, users across the system suffer significantly in the 1:1 reuse scenarios of MUROS-3b.

We also see that MUROS provides observable benefits when co-existing in deployments with older legacy handsets. For differing levels of MUROS penetration, our results show the general determining factor for system capacity gains remains the channel blocking. The MUROS gains are significant even at lower levels of penetration, with the biggest marginal capacity increase seen between 25% and 50% levels of penetration.

### 6.2.3 Performance Summary

Two GMSK linear combine and QPSK with 8PSK pulse shaping used for EDGE are similar and keep the spectrum unchanged. They should be the candidate for MUROS DL signal modulation.

MUROS operation needs a few dB margin when compared with current GSM spec points. It is necessary for MUROS operation to work under comparatively better RF condition than normal operation (one caller on one slot) as expected. When the condition of the RF channel become less favorable to MUROS, network should switch the DARP phone back to its normal operation in which the DARP capability can be used for cancelling interference from other cells, as it was intended originally.

Together with the originally intended DARP application, MUROS mode will make better use of DARP capability and enhance the capacity by 100% without changing the traditional frequency planning. Network system level study will be necessary to give in-depth indication of capacity gain under various conditions.

### 6.2.4 Verification of Link to System Mapping

This section depicts verification results for the employed Link to System mapping for this candidate technique as agreed at GERAN#41.

## 6.3 Impacts on the Mobile Station

The co-TCH concept requires that one of the two mobile stations must support DARP Phase 1. It is not necessary for the two mobiles to support new training sequence codes provided the network assigns a different TSC to each of the two mobile stations and these two training sequence codes are not used by neighbour cells which use the same frequency (ARFCN).

For new mobiles it is desirable to support the new TSC set in addition to the existing TSC set so that network has more flexibility in selecting TSCs. The new TSC set is required to have minimum cross-correlation properties with legacy TSC set. Therefore, it is proposed that MUROS capable mobiles support new TSC set and legacy TSC set. In order to support the use of this new TSC set, Radio Resource signalling changes would be required.

## 6.4 Impacts on the BSS

### 6.4.1 Impact on BTS transmitter

For MUROS operation, baseband modulator has to have

1. Abis bandwidth that can carry twice as much as the voice data before MUROS deployment.
2. Two voice channel inputs that can be activated with any of four combinations, i.e.
  - a. both user1 and 2 are on (MUROS mode);

- b. both user1 and 2 are off (MUROS mode with both user on DTx);
- c. user1 is on, and user 2 is off (either conventional mode, or user 2 is in DTx); and
- d. user1 is off, and user 2 is on (either conventional mode, or user 1 is in DTx).

If in conventional mode or one user is in DTX mode, then BTS only transmits GMSK for one user only. If both users are in DTx mode, no downlink transmission is needed for this burst.

3. Two different TSCs that are applied to corresponding streams of burst payload when necessary, according to above user 1 and 2 configuration on burst by burst basis.
4. New baseband combining function (could be implemented as FW function).
5. The RF Tx needs linear PA that is capable of handling small percentage of zero crossings. Those BTS that has 8PSK Tx capability would also be suitable.

When both channels are activated, the baseband modulator can take both streams of binary data with two different TSCs applied to corresponding payload streams, and modulate them in such a way that:

1. It satisfies the GMSK mask defined in spec.
2. They are effectively the linear sum of the two independent burst signals that can be well received by legacy mobile stations. For the best channel separation, 90 degrees phase shift between the two independent bursts are needed.

The two signals for each MUROS caller can be of different amplitudes.

## 6.4.2 Impact on BTS receiver

The receiver needs to be able to decode the two GMSK modulated signals that are separated by a TSC. There are number of BTS receiver techniques that can be employed to provide adequate performance on the uplink, such as dual antenna, joint detection. In general BTS receiver performance is better than MS receiver performance.

## 6.4.3 Impact on Radio Resource Management

Radio Resource Management (RRM) is considered the most vital component in voice capacity enhancement. RRM has to:

- Determine the most appropriate users to pair together. This may involve the power requirements of each user; the rate of power change; signal quality
- Power control is a crucial part to provide maximum benefit from MUROS mode of operation. Power control can allow users with varying channel conditions to be kept in MUORS mode for longer. Fast power control (i.e. Enhanced Power Control) can be valuable for MUROS mode operation.
- Determine most appropriate point to un-pair users. This has to be a balance between maintaining call quality and spectral efficiency.

In order to support pairing and un-pairing of users BSS can use existing procedures to move users from one TCH to another (i.e. intra-cell handover command or assignment command). It is down to BSS implementation which is used.

## 6.5 Impacts on Network Planning

With increased air interface capacity there would inevitably be a need to increase Abis bandwidth. The Abis bandwidth would need to be dimensioned to support the maximum air interface users. For example, if air interface supports twice as many full rate users then Abis interface would also need to double the bandwidth. The timeline for upgrading Abis to support additional users depends on the deployment of MUROS capable mobiles, as proportion of MUROS capable mobiles increase, the Abis bandwidth would need to be increased accordingly.

## 6.6 Impacts on the Specification

The impact on specifications is shown in Table 6-28 below.

**Table 6-28: Impact on specification with co-TCH**

3GPP Specification	Impact
TS 44.018 – RR signalling	Signalling changes to support new TSC for use with CS connections.
TS 24.008	Signalling changes for MS to indicate support for new TSC set.
TS 45.002	Define new TSC set.
TS 45.004	Define new modulation scheme for downlink.
TS 45.005	Define performance requirements for MUROS type modulation.
TS 51.010	Define new performance and signalling tests cases for MUROS capable mobiles.

## 6.7 Summary of Evaluation versus Objectives

In this section the candidate technique is evaluated against the defined objectives in chapter 4. Note, this section represents the view of the proponents of this candidate technique.

The following classification is used for the evaluation:

	<b>Fulfilled</b>
	<b>Expected to be fulfilled</b>
	<b>Unclear/FFS</b>
	<b>Not fulfilled</b>

### 6.7.1 Performance objectives

Performance Objectives	Candidate Technique: Co-TCH
<b>P1: Capacity Improvements at the BTS</b> 1) increase voice capacity of GERAN in order of a factor of two per BTS transceiver 2) channels under interest: TCH/FS, TCH/HS, TCH/EFS, TCH/AFS, TCH/AHS and TCH/WFS	1) Gains have been shown to be between 0 and 125 % depending on the system scenario and speech codec.
	2) All voice codecs are supported
<b>P2: Capacity Improvements at the air interface</b> 1) enhance the voice capacity of GERAN by means of multiplexing at least two users simultaneously on the same radio resource both in downlink and in uplink 2) channels under interest: TCH/FS, TCH/HS, TCH/EFS, TCH/AFS, TCH/AHS and TCH/WFS	1) Two users are multiplexed on the same radio resources
	2) All speech codecs are supported

## 6.7.2 Compatibility objectives

Compatibility Objectives	Candidate Technique: Co-TCH
<p><b>C1: Maintainance of Voice Quality</b></p> <p>1) voice quality should not decrease as perceived by the user.</p> <p>2) A voice quality level better than for GSM HR should be ensured.</p>	<p>1) Only users with good RF conditions will be allocated on a channel supporting co-TCH. Simulations have shown that there are no losses in user satisfaction, only gains, when using the new technique.</p> <p>2) Both AMR and GSM HR codecs have been investigated. Given the same RF condition, the voice quality of ARM codecs is better than GSM HR.</p>
<p><b>C2: Support of Legacy Mobile Stations</b></p> <p>1) Support of legacy MS w/o implementation impact.</p> <p>2) First priority on support of legacy DARP phase 1 terminals, second priority on support of legacy GMSK terminals not supporting DARP phase 1.</p>	<p>1) Legacy, DARP Phase I, mobiles can be supported. Downlink power control will support legacy mobiles.</p> <p>2) Legacy DARP Phase I terminals will be supported. Non DARP Phase I terminals have been shown to support the concept on link level. System level studies are still needed to show the gains with non DARP mobile stations.</p>
<p><b>C3: Implementation Impacts to new MS's</b></p> <p>1) change MS hardware as little as possible.</p> <p>2) Additional complexity in terms of processing power and memory should be kept to a minimum.</p>	<p>1) Minimum requirement is to support new training sequences. Impact of new training sequences on complexity and memory requirements is minimal.</p> <p>2) More advanced receiver implementations, such as joint detection, can improve performance and this will have impact on complexity and memory.</p>
<p><b>C4: Implementation Impacts to BSS</b></p> <p>1) Change BSS hardware as little as possible and HW upgrades to the BSS should be avoided.</p> <p>2) Any TRX hardware capable for MUROS shall support legacy non-SAIC mobiles and SAIC mobiles.</p> <p>3) Impacts to dimensioning of resources on Abis interface shall be minimised.</p>	<p>1) Demodulation of two simultaneous signals, support of new training sequences and linear modulator.</p> <p>2) The concept has no impact on TRX to support different type of mobiles.</p> <p>3) The Abis interface capacity needs to be increased in accordance with the increased number of channels supported by MUROS.</p>
<p><b>C5: Impacts to Network Planning</b></p> <p>1) Impacts to network planning and frequency reuse shall be minimised.</p> <p>2) Impacts to legacy MS interfered on downlink by the MUROS candidate technique should be avoided in case of usage of a wider transmit pulse shape on downlink.</p> <p>3) Furthermore investigations shall be dedicated into the usage at the band edge, at the edge of an operator's band allocation and in country border regions where no frequency coordination are in place.</p>	<p>1) No impact on frequency planning or frequency re-use is foreseen.</p> <p>2) A wide pulse shape has only been investigated on link level. System level simulations are needed to investigate the impact of a wider pulse. This proposal does not prevent use of wide pulse.</p> <p>3) If a wide pulse shape is to be deployed it is not expected to be used at the edge of an operator's frequency band.</p>



## 6.8 References

- [6-1] AHG1-080007, Speech capacity enhancements using DARP, QUALCOMM Europe, Ad Hoc on EGPRS2/WIDER/MUROS/MCBTS, Sophia Antipolis, April 8-11, 2008.
- [6-2] GP-071738, Speech capacity enhancements using DARP, QUALCOMM Europe, GERAN #36, Vancouver Nov 12-16 2007
- [6-3] GP-071807, Orthogonal Sub Channel DL performance of DARP capable MS, NXP, GERAN #36, Vancouver Nov 12-16 2007

---

# 7 Orthogonal Sub Channels for Circuit Switched Voice Capacity Evolution

## 7.1 Concept description

### 7.1.1 Overview

A new study item MUROS [7-1] was agreed at GERAN#36 aiming to improve voice efficiency. In this section the orthogonal sub channel (OSC) [7-2] concept is presented. It multiplexes two MSs simultaneously allocated on the same radio resource. OSC is applicable for low end handsets, since the concept is relying on GMSK capability of handsets. Sub channels are separated by using non-correlated training sequences. OSC can considerably increase voice capacity with low impact to handsets as well as to networks. The concept may provide e.g. a double half rate channel providing that 4 users can be allocated to the same radio slot.

The orthogonal sub channel concept in downlink is based on QPSK like modulation, where each of the sub channels is mapped so that it can be received as GMSK signal.

In uplink direction, mobiles allocated to the orthogonal sub channels may use the genuine GMSK modulation with different training sequences. Both orthogonal sub channels are simultaneously received by the BTS that needs to employ e.g. diversity and interference cancellation means to separate the orthogonal sub channels.

In general, the OSC concept relying on GMSK only handsets can offer up to double voice capacity.

The orthogonal sub channel concept by nature doubles the number of channels. One of the key changes is the introduction of new training sequences paired with existing training sequences for lowest cross-correlation to enable separation of sub channels. The first sub channel can use an existing training sequence serving a legacy MS, whilst the second sub channel should preferably use a new training sequence for both downlink and uplink.

OSC can be applied e.g. for TCH/F, TCH/H and related associated control channels (FACCH and SACCH) making it as transparent as possible to deploy it for all GMSK modulated traffic channels.

### 7.1.2 Downlink concept

The downlink concept is depicted in this section. It is splitted into a basic concept and into an enhanced concept.

#### 7.1.2.1 Basic OSC concept

##### 7.1.2.1.1 Mapping of user bits using QPSK modulation

The Basic OSC concept is characterized in downlink in that BTS transmitter uses QPSK type of constellation that may be e.g. a subset of 8PSK constellation used for EGPRS. Modulating bits are mapped to QPSK symbols i.e. "dibits" e.g. so that the first sub channel (OSC-0) is mapped to MSB and the second sub channel (OSC-1) is mapped to LSB as illustrated below.

An example of mapping bits to QPSK like constellation based on 8PSK modulator is shown in Table 7-1 and Figure 7-1. Both sub channels are mapped to QPSK symbol orthogonally.

**Table 7-1: Mapping between OSC modulating bits and the 8PSK symbol parameter *l***

Original Gray mapped 8PSK Modulating bits $d_{3i}, d_{3i+1}, d_{3i+2}$	Mapping of bits for orthogonal sub channels to 8PSK symbols $OSC_0, OSC_1$	Symbol parameter <i>l</i> for rule $s_i = e^{j2\pi l / 8}$
(1,1,1)	-	0
(0,1,1)	(1,1)	1
(0,1,0)	-	2
(0,0,0)	(0,1)	3
(0,0,1)	-	4
(1,0,1)	(0,0)	5
(1,0,0)	-	6
(1,1,0)	(1,0)	7

This is illustrated in Figure 7-1.

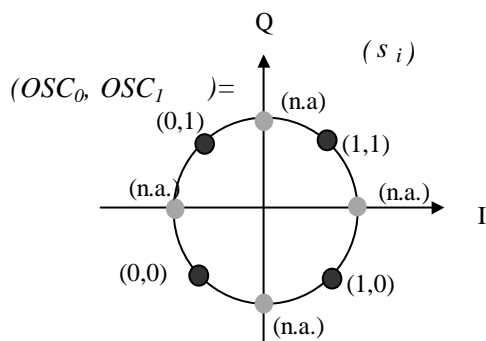

**Figure 7-1: Mapping of OSC modulating bits into 8PSK symbols.**

Both sub channels may use individual ciphering e.g. A5/1 or A5/3. The symbol rotation of  $\pi/2$  used in downlink allows multiplexing with legacy handsets and enables also to use GMSK in case of DTX and FACCH / SACCH signalling, see sections 7.1.2.1.5, 7.1.2.1.6 and 7.1.2.1.7.

**7.1.2.1.2 Burst structure, training sequence, tail and guard bits**

The burst structure should be compatible with the existing bursts. Existing GMSK tail bits and guard bits could be applied for both sub channels separately. The set of new training sequences dedicated to the second sub channel are paired with current training sequences for the lowest cross-correlation with optimal autocorrelation and are listed in Table 7-2. The training sequences have been obtained by performing a full LS channel estimation based computational search [7-2].

**Table 7-2: Set of new training sequences (TSCs) paired with current one**

Training sequence code	Training sequence bits
0	00101101110111010001111011
1	00010001111010010010001000
2	01110100100001000100011110
3	01000100011100001011011101
4	01000101100001011000100000
5	01011111001001110010100000
6	01110111100101111001000101
7	00101011001111110011110101

Figure 7-2 below illustrates cross correlation properties between existing and new training sequences. It can be seen that new training sequences have better cross correlation property in general with all existing training sequences, not only with its pair.

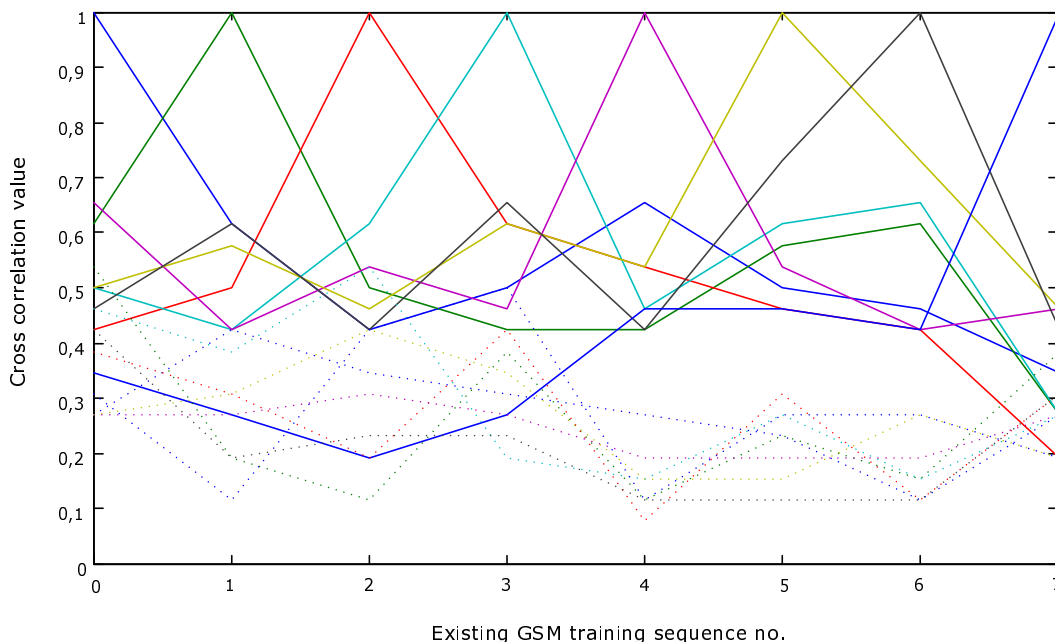

**Figure 7-2 Illustration of Cross correlation properties between existing training sequences (solid line) and between new and existing training sequences (dotted line).**

7.1.2.1.3 Tx pulse shaping filter

Different Tx pulse shaping filters were used in DL simulations such as Hanning windowed Root Raised Cosine with roll-off 0.3 and bandwidth equivalent to symbol rate (270 kHz) and the legacy linearized GMSK pulse. Link performance characterization for above Tx pulse shapes can be found in section 7.2.1.1.1.1.

In addition it is worth to consider further optimisation of the Tx pulse shape with different criteria e.g. system performance and MS receiver performance by defining candidate pulse shapes as depicted below. Performance characterization for these candidates for the optimized Tx pulse shape can be found related to link performance in section 7.2.1.2.1.1.3 and related to system performance in section 7.2.2.2.7 .

7.1.2.1.3.1 Investigated Candidate TX Pulse Shapes

7.1.2.1.3.1.1 Candidate Pulse Shape 1

First investigated pulse shape called here “OPT 1” was a RRC pulse shape with 240 kHz 3 dB bandwidth, rolloff 0.3 and Hanning windowed. Filter length was equivalent to 5 symbols. The pulse shape is depicted in the frequency domain in Figure 7-2a.

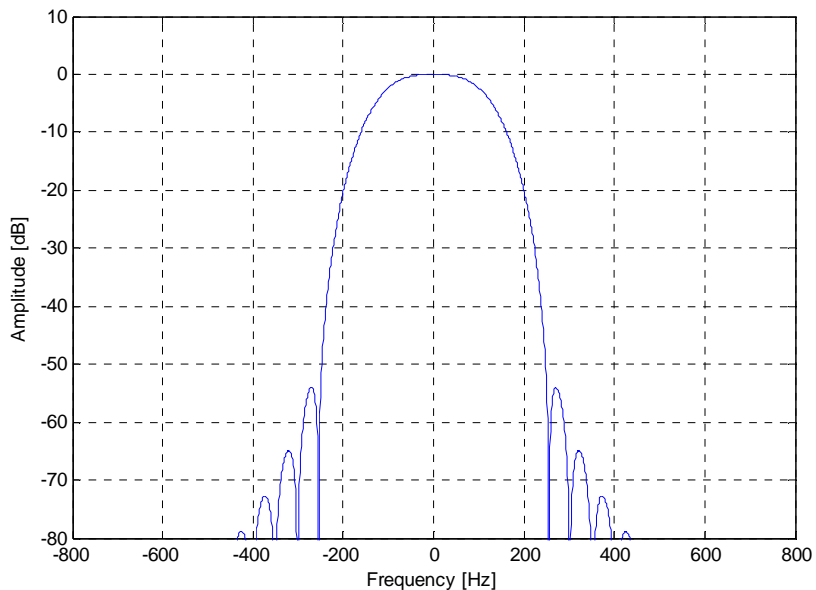

**Figure 7-2a - Spectral power density of candidate pulse shape OPT 1.**

The filter coefficients of the candidate pulse shape OPT 1 are listed below in Table 7-2a. The output signal is normalized to ensure the same energy of the pulse shape as for the reference (LGMSK).

**Table 7-2a - Coefficients of candidate pulse shape OPT 1 using oversampling rate 12.**

Coefficient	Value
0	1.0248550e-005
1	9.8761920e-005
2	4.6907047e-004
3	1.1165667e-003
4	1.8783983e-003
5	2.3321156e-003
6	1.7820497e-003
7	-5.2511264e-004
8	-5.3941600e-003
9	-1.3344621e-002
10	-2.4480981e-002
11	-3.8066912e-002
12	-5.2626525e-002
13	-6.5791939e-002
14	-7.3959972e-002
15	-7.3653112e-002
16	-6.0426548e-002
17	-3.0140358e-002
18	1.9619563e-002
19	9.1343069e-002
20	1.8477091e-001
21	2.9753002e-001
22	4.2599307e-001
23	5.6327282e-001
24	7.0191338e-001
25	8.3333897e-001
26	9.4818832e-001
27	1.0387134e+000
28	1.0981064e+000
29	1.1218391e+000
30	1.1081732e+000
31	1.0581845e+000
32	9.7552623e-001
33	8.6640712e-001
34	7.3884496e-001
35	6.0110815e-001
36	4.6260727e-001

37	3.3127746e-001
38	2.1347172e-001
39	1.1468629e-001
40	3.6963467e-002
41	-1.8853863e-002
42	-5.3863921e-002
43	-7.1541080e-002
44	-7.4983692e-002
45	-6.8551688e-002
46	-5.6516983e-002
47	-4.2004445e-002
48	-2.7957788e-002
49	-1.6084985e-002
50	-7.2331828e-003
51	-1.5633146e-003
52	1.3721554e-003
53	2.2992144e-003
54	2.0647650e-003
55	1.3247141e-003
56	6.1578530e-004
57	1.7365627e-004
58	1.4182217e-005

7.1.2.1.3.1.2 Candidate Pulse Shape 2

The investigated candidate pulse shape 2 is a synthetic pulse shape called here “OPT 2” that has a narrower shape than candidate pulse shape 1. The pulse shape is depicted in the frequency domain in Figure 7-2b.

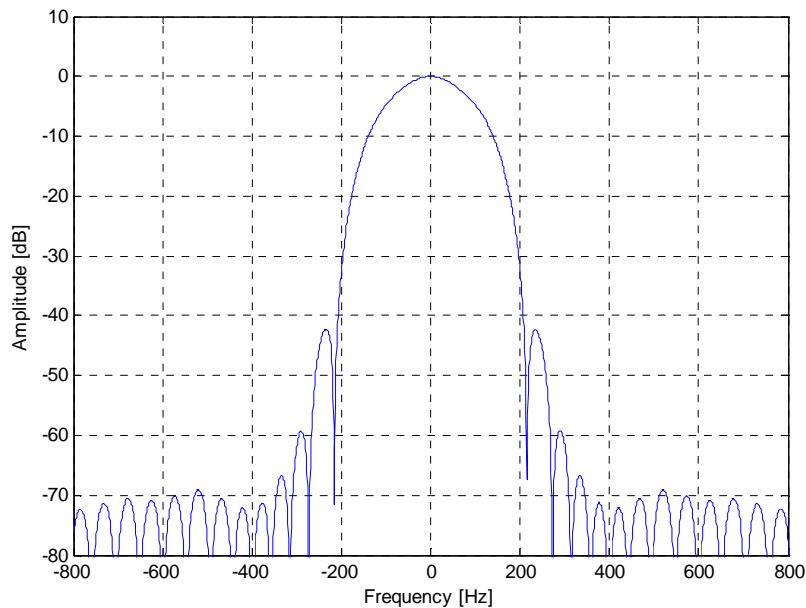

Figure 7-2b - Spectral power density of candidate pulse shape OPT 2.

The filter coefficients of candidate pulse OPT 2 are listed below in Table 7-2b. The output signal is normalized to ensure the same energy of the pulse shape as for the reference (LGMSK).

Table 7-2b Coefficients of candidate pulse shape OPT 2 using oversampling rate 12.

Coefficient	Value
0	9.8323558e-004
1	1.6586564e-003
2	2.4785228e-003
3	3.3787998e-003
4	4.2162118e-003
5	4.8114538e-003
6	5.0146833e-003
7	4.7601965e-003
8	4.1018421e-003
9	3.2356427e-003

10	2.5091905e-003
11	2.4085036e-003
12	3.5191396e-003
13	6.4732195e-003
14	1.1891790e-002
15	2.0325985e-002
16	3.2191485e-002
17	4.7701042e-002
18	6.6811299e-002
19	8.9199464e-002
20	1.1427256e-001
21	1.4120041e-001
22	1.6896279e-001
23	1.9640726e-001
24	2.2231428e-001
25	2.4547834e-001
26	2.6479103e-001
27	2.7931031e-001
28	2.8832023e-001
29	2.9137408e-001
30	2.8832023e-001
31	2.7931031e-001
32	2.6479103e-001
33	2.4547834e-001
34	2.2231428e-001
35	1.9640726e-001
36	1.6896279e-001
37	1.4120041e-001
38	1.1427256e-001
39	8.9199464e-002
40	6.6811299e-002
41	4.7701042e-002
42	3.2191485e-002
43	2.0325985e-002
44	1.1891790e-002
45	6.4732195e-003
46	3.5191396e-003
47	2.4085036e-003
48	2.5091905e-003
49	3.2356427e-003
50	4.1018421e-003
51	4.7601965e-003
52	5.0146833e-003
53	4.8114538e-003
54	4.2162118e-003
55	3.3787998e-003
56	2.4785228e-003
57	1.6586564e-003
58	9.8323558e-004

#### 7.1.2.1.3.2 Comparison of Filter Characteristics

The characteristics of both candidates for the optimized Tx pulse shape and of the reference LGMSK pulse shape are depicted in Table 7-2c.

**Table 7-2c: Filter characteristics for used candidate pulse shapes.**

dB	ACP 1	ACP 2	PAR
Legacy GMSK	18.2	> 50	TBD
Candidate OPT 1	13.8	> 50	TBD
Candidate OPT 2	15.6	> 50	TBD

Note. The second adjacent channel protection for both candidate pulse shapes is below 50 dB, hence fulfilling the requirement of 50 dB in 45.005 (this latter figure was obtained from simulations that used a realistic PA model).

#### 7.1.2.1.4 Symbol rotation

For symbol rotation the compatibility with GMSK makes rotation of  $\pi/2$  the best choice. Thus with above specified RRC filter the peak to average ratio (PAR) is only 2.2 dB, whilst being 3.4 dB for linearised GMSK pulse.

#### 7.1.2.1.5 DTX handling when one sub channel is inactive

When the paired sub channel is inactive due to DTX, it is possible to send normal GMSK bursts instead of QPSK for the active sub channel using the training sequence of the active sub channel. The transmit power can be reduced during that period of time. The change of modulation applies after sending the last burst of the SID\_FIRST message or of the SID\_UPDATE message, respectively, on the paired sub channel. Similarly, the change from GMSK to QPSK applies when the first burst of the SID\_UPDATE or ON\_SET message, respectively, needs to be sent on the paired sub channel. In system point of view this OSC scheme has a different behaviour in DTX mode in downlink. Combined transmitter activity will be higher than for single user, but on the other hand two users are served simultaneously.

#### 7.1.2.1.6 FACCH signalling

Different options exist for transmission of FACCH for orthogonal sub channels in downlink:

- First option is to straightforward apply the FACCH signalling as for legacy channels, but mapped to the sub channels.
- Second option is to steal voice payload bursts from both OSC sub channels to make signalling more robust e.g. for speeding up intra cell handovers. In this case the training sequence of the sub channel, transporting the GMSK modulated FACCH, is being used for discrimination.
- Third option is to employ Repeated DL FACCH per sub channel, which has been standardised for full rate and half rate channels in GERAN Rel-6.
- Fourth option is to use Soft Stealing for FACCH employing sub channel specific power control (see section 7.1.2.2.3).

Performance comparison between all three proposals is FFS.

#### 7.1.2.1.7 SACCH signalling

SACCH performance for OSC full rate traffic channels and OSC half rate channels needs to be designed such that RR signalling carried on downlink gets sufficiently robust.

In case of OSC full rate channels different options exist in downlink:

- First option is to straightforward apply the SACCH signalling as for legacy channels, but mapped to the subchannels. Hence the SACCH blocks of both subchannels are simultaneously transmitted.
- Second option is the usage of Repeated SACCH as standardized in GERAN Rel-7 for full rate traffic channels. This option is suited if legacy mobiles supporting Repeated SACCH are multiplexed on both sub channels, but also in case new OSC aware mobiles are multiplexed or for a mix of legacy mobiles supporting Repeated SACCH and OSC aware mobiles.
- Third option is to shift the SACCH transmission for new OSC aware mobiles by 13 TDMA frames to the current idle frames. Hence new OSC aware mobiles use the SACCH allocation related to the second channel in a half slot channel configuration. This is depicted in section 7.1.2.2.5.3 for the Optimized User Diversity Full Rate Pattern 1. Hence using GMSK modulated bursts for SACCH/F the same performance as for legacy mobiles is achieved.

In case of OSC half rate channels different options exist for SACCH in downlink:

- First option is to straightforward apply the SACCH signalling as for legacy channels, but mapped to the sub channels. Hence the SACCH blocks of both sub channels are simultaneously transmitted.
- Second option is the usage of Repeated SACCH as standardized in GERAN Rel-7 for half rate traffic channels. This option is suited if legacy mobiles supporting Repeated SACCH are multiplexed on both sub channels, but

also in case new OSC aware mobiles are multiplexed or for a mix of legacy mobiles supporting Repeated SACCH and OSC aware mobiles.

- Third option is to use Soft Stealing for SACCH with sub channel specific power control and user diversity (see section 7.1.2.2.4). This option does only exist if at least one OSC aware mobile is multiplexed.

Performance comparison between all three above proposals is FFS.

### 7.1.2.2 Enhanced OSC concept

The Enhanced OSC concept is based on three techniques which complement the Basic OSC concept and thus increase the performance benefits of OSC in that the interworking to legacy mobiles is improved and increased network capacity is achieved.

#### 7.1.2.2.1 Sub channel specific power control

As proposed in [7-3] power control in downlink needs to be performed commonly for both sub channels i.e. based on the highest power demand of two users. Two individual radio path losses or receiver performances may not always be balanced, thus sub channel specific power control needs to be addressed. The enhancement is related to a sub channel specific power control mechanism based on non-square, but rectangular 4QAM constellation provided by 8PSK constellation. The sub channel specific power control utilises normal 8PSK constellation with rotation changed to  $\pi/2$ . Power levels can be adjusted by changing the mapping of users in that different subsets of 4QAM symbols are selected out of the 8PSK constellation diagram as depicted in Figure 7-3.

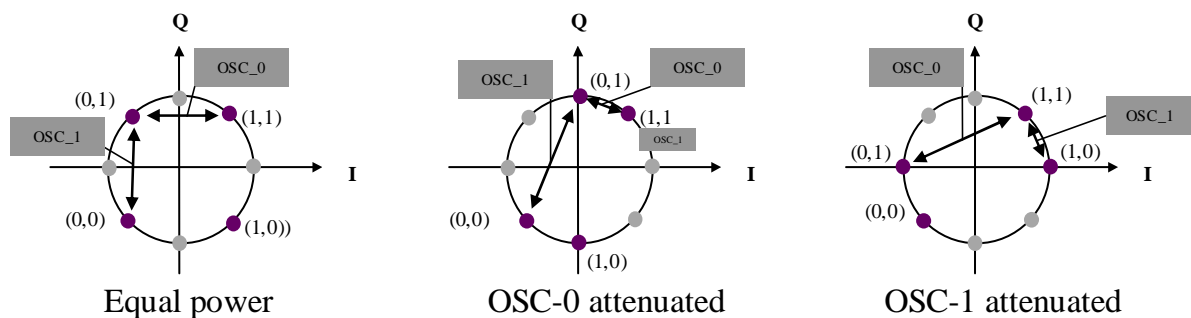

Figure 7-3: Mapping of OSC sub channels with equal or unequal sub channel powers

The OSC sub channel with higher power may experience about 2.3 dB higher power than with equal power OSC and the OSC sub channel with lower power about 5.3 dB lower power, compared to the equal power case, whilst the difference between higher and lower power is 7.7dB. By alternating between 3 different levels from burst to burst it is possible to achieve effectively several level values in within 7.7 dB range. The mapping of encoded bits of both subchannel onto 8PSK constellation points for subchannel specific power control is specified in Table 7-3.

Table 7-3: Mapping between OSC modulating bits and the 8PSK symbol parameter  $l$ .

Original Gray mapped 8PSK Modulating bits $d_{3i}, d_{3i+1}, d_{3i+2}$	Symbol parameter $l$ for rule $s_i = e^{j2\pi l / 8}$	Mapping of bits for orthogonal sub channels to 8PSK symbols $OSC_0, OSC_1$		
		Signal powers: $OSC_0 = OSC_1$	Signal powers: $OSC_0 > OSC_1$	Signal powers: $OSC_0 < OSC_1$
(1,1,1)	0	-	(0,1)	-
(0,1,1)	1	(1,1)	(1,1)	(1,1)
(0,1,0)	2	-	-	(0,1)
(0,0,0)	3	(0,1)	-	-
(0,0,1)	4	-	(1,0)	-
(1,0,1)	5	(0,0)	(0,0)	(0,0)
(1,0,0)	6	-	-	(0,1)
(1,1,0)	7	(1,0)	-	-



The SAIC handset is expected to cancel part of the interference power caused by OSC when applying sub channel specific power control as depicted in Figure 7-4.

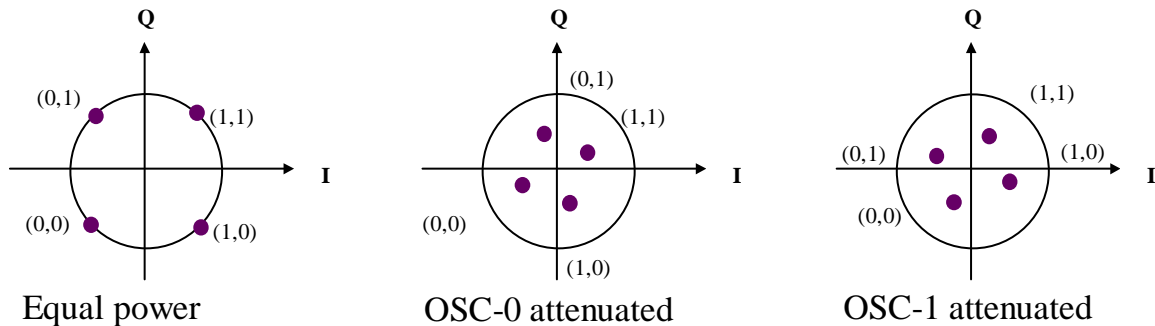

**Figure 7-4: Illustration of OSC signals after SAIC processing by MS in neighbour cell**

Thus SAIC gains could be likely obtained with sub channel specific power control. Performance is characterized in sections 7.2.1.1.1.2 and 7.2.1.2.1.2.

In summary sub channel specific power control is considered beneficial due to several reasons:

- Equal power is not optimal for both OSC sub channels under all radio conditions
- SAIC may be able to successfully cancel part of such an attenuated interference coming from the subchannel user
- FACCH and SACCH may be boosted by a couple of dB without muting possible voice on other sub channel (see section 7.1.2.2.3 and 7.1.2.2.4).

**7.1.2.2.2 Power Balancing**

Power Balancing is an extension of the sub channel specific power control mechanism, in that the selected constellation as depicted in Figure 7-3 and Table 7-3 is modified from burst to burst. Hence the sub channel specific power can be balanced with a higher resolution between both sub channels using different patterns. An exemplary pattern is depicted in Table 7-4. The pattern is selected by the BTS depending on the reported link measurements for both sub channels.

**Table 7-4: Usage of different OSC constellations for power balancing (example).**

TDMA frame mod 8	OSC Constellation
0	Equal Power
1	OSC-0 attenuated
2	OSC-0 attenuated
3	Equal Power
4	Equal Power
5	Equal Power
6	OSC-0 attenuated
7	OSC-0 attenuated

**7.1.2.2.3 Soft Stealing for FACCH with sub channel specific power control**

Sub channel specific power control can be applied when an FACCH needs to be sent on downlink. In this case the FACCH block for the sub channel of interest is carried on the stronger channel. This may improve FACCH, compared to the case of equal power and improves robustness of RR signalling without performing “double stealing” of voice blocks from both sub channels (see section 7.1.2.1.6.).

7.1.2.2.4 Soft Stealing for SACCH with sub channel specific power control

Sub channel specific power control can also be applied for OSC half rate channel when a SACCH needs to be sent on downlink and a TCH channel is active for the paired user. This is proposed in section 7.1.2.2.5.3 for Optimized User Diversity Half Rate Pattern 3. Likewise as for FACCH the SACCH block for the sub channel of interest is carried on the stronger channel and hence robustness of RR signalling (i.e. SYSTEM INFORMATION and MEASUREMENT INFORMATION messages as well as UL power control commands) is improved.

7.1.2.2.5 User Diversity

In order to fully exploit gains of DTX with OSC, this enhancement of the basic OSC concept presented in [7-4] and refined in [7-5] introduces a multiplexing scheme where either 4 users on two HR channels or 4 users on two FR channels are mixed together to increase variance on number of simultaneous active users over an interleaving period. Increased variance is intended to provide better conditions for channel coding to operate. The concept is suited both for downlink and for uplink.

7.1.2.2.5.1 Basic User Diversity

With OSC HR or OSC FR, respectively, and with DTX enabled, bursts are carrying either no, one or two users without any or with low variance on number of simultaneous users over the interleaving period. This can be considered sub-optimal from channel coding point of view. To improve this variance over the interleaving period, 4 users in two HR

channels on one timeslot or 4 users in two FR channels on a timeslot pair can be mixed so that  $\binom{4}{2} = 6$  possible

pairing combinations are evenly used changing frame by frame. This kind of multiplexing exploiting the diversity related to the activity status of each of the 4 users is named **Basic User Diversity** here and is expected to improve the radio performance in both downlink and uplink. Note this feature assumes that the channels carry DTX'ed speech. If DTX is not activated the feature will not yield performance benefits.

One possible way to define the mixing of OSC HR users with DTX activated is given in Table 7-5 below and is based on the specification of a **user diversity pattern**, which is specific for each user and which defines the way how a burst of each frame is mapped to an OSC sub channel and in case of a half rate channel to the (HR) sub channel of a slot. User diversity patterns should be defined so that users are evenly multiplexed with each other users. That pattern may be built with two bits per frame, where the first bit indicates the OSC sub channel and the second bit indicates the used (HR) sub channel. Table 7-5 illustrates how the user diversity pattern could be applied over 12 TDMA frames. The used training sequence may be linked with the OSC sub channel, thus 2 training sequences are shared with 4 users changing according to OSC sub channel.

**Table 7-5: Exemplary “user diversity pattern” to mix 4 OSC HR users [7-4]**

Frame	Active HR SC	User Diversity Pattern (OSC, SC)				User in OSC	
		User 1	User 2	User 3	User 4	OSC-0	OSC-1
0	0	00	01	11	10	User 1	User 4
1	1	10	11	00	01	User 4	User 2
2	0	01	10	11	00	User 4	User 2
3	1	11	00	01	10	User 3	User 1
4	0	00	11	10	01	User 1	User 3
5	1	10	01	11	00	User 2	User 3
6	0	00	01	11	10	User 1	User 4
7	1	10	11	00	01	User 4	User 2
8	0	01	10	11	00	User 4	User 2
9	1	11	00	01	10	User 3	User 1
10	0	00	11	10	01	User 1	User 3
11	1	10	01	11	00	User 2	User 3

active user transmission in TDMA frame  
 time instant related to delivery of speech block

The table could also be extended to differentiate on SACCH and TCH bursts. It might be possible to distribute start of TCH interleaving periods of each user evenly e.g. with offset of one frame. That might be beneficial by offering even distribution of processing load e.g. in channel decoder of BTS. Indeed SACCH bursts could be evenly distributed to provide DTX gains due to mixing also to SACCH performance. If user diversity pattern with length of 12 is repeated periodically it would allow SACCH bursts located every 120ms for the same user.

However, as shown above, the user diversity pattern leads to an irregular delivery of speech blocks for users 1 to 4 taking into account the speech block delivery every other burst in case of HR channel. For example, as can be seen in Table 7-5, for user 1 the speech block is delivered in Frame 3, Frame 6, Frame 10 and Frame 12+3=15, hence the delivery of the speech block experiences a delay between 3 frames and 5 frames and yields a jitter of about  $\pm 5$  ms. This is undesirable considering speech latency performance. The same jitter is present for user 2 whilst user 3 to 4 experience an even higher change of delay between 2 and 5 frames, hence about  $\pm 7.5$  ms.

Thus the *Basic User Diversity* concept as proposed in [7-4] has following drawbacks:

- 1) This kind of statistical multiplexing is based on the assumption that the mobiles know when to transmit and receive in a given TDMA frame and which OSC training sequence to use. Consequently one drawback is that the proposed scheme in [7-4] cannot be applied to legacy mobiles in the field. In other words legacy mobiles operated in OSC channels cannot benefit in terms of reduced interference.
- 2) A second drawback is that the scheme introduces a jitter due to the variable block lengths as shown in Table 7-5 and described above. An additional jitter in the order of  $\pm 5$  ms or even  $\pm 7.5$  ms is introduced which may need some adaptation of network interfaces and identifies an add-on to peak delays for speech.
- 3) Also the concept was merely investigating the OSC half rate case and provided increased interference diversity in one timeslot, whilst it was not considering the OSC full rate case.

#### 7.1.2.2.5.2 Optimized User Diversity

In this section modifications to the *Basic User Diversity* procedure as described in [7-4] are presented in order to mitigate the above mentioned drawbacks. In particular, the described modifications detailed hereafter allow to multiplex legacy mobiles with new OSC aware mobiles in order to let all mobiles benefit from interference diversity and hence mitigates the conceptual drawbacks of the original proposal as sketched in the section above. The ***Optimized User Diversity*** concept also introduces a constant speech delay for each user, avoiding any jitter. Moreover it considers the issue of increasing interference diversity for a full rate channel configuration and is based on the assumption that DTX is in use both for DL and UL operation.

Since OSC is not expected to operate in tight reuse scenarios with high level of external interference, the main interferer in most situations stems from the paired sub channel. Taking into account that DTX is activated, interference diversity can be improved if different users are multiplexed on the paired sub channel. In case of inactivity of either of both sub channels in downlink the BTS can make use of GMSK rather than QPSK and hence transmission can be operated with lower power backoff. In UL reduction of GMSK modulated interference is beneficial in interference limited scenarios and thus will reduce transmit power of mobiles and also increase network capacity.

The enhancements described below are related to the definition of a set of *optimized user diversity* patterns for both OSC half rate and OSC full rate channel configurations. The patterns are optimised for a given mix of mobiles. In order to adapt to the actual mix of mobiles, e.g. share of legacy mobiles and share of new OSC aware mobiles, it is proposed to enable switching between these patterns for OSC half rate channel configuration and for OSC full rate channel configuration, respectively. It has to be noted that the proposed user diversity patterns for enhanced OSC are fixed patterns and not changing in time. Hence it is sufficient to signal the pattern at channel assignment or after channel mode adaptation to the mobile of interest.

For OSC half rate channel configuration legacy mobiles can be included with their legacy transmission behaviour based on the interleaving depth 4 and time diversity of 35 ms. For new OSC aware mobiles the same interleaving depth 4 is selected leading to a time diversity of 30 ms (optimized user diversity half rate pattern 2 and 3).

In addition for OSC half rate channel configuration the SACCH of the second sub channel is advanced by 6 TDMA frames compared to the first sub channel to achieve also interference diversity for this channel (optimized user diversity half rate pattern 3), assuming that the paired sub channel carries DTX'ed speech. The enhancements include also the extension of the user diversity algorithm to paired timeslots as depicted in Figure 7-5.

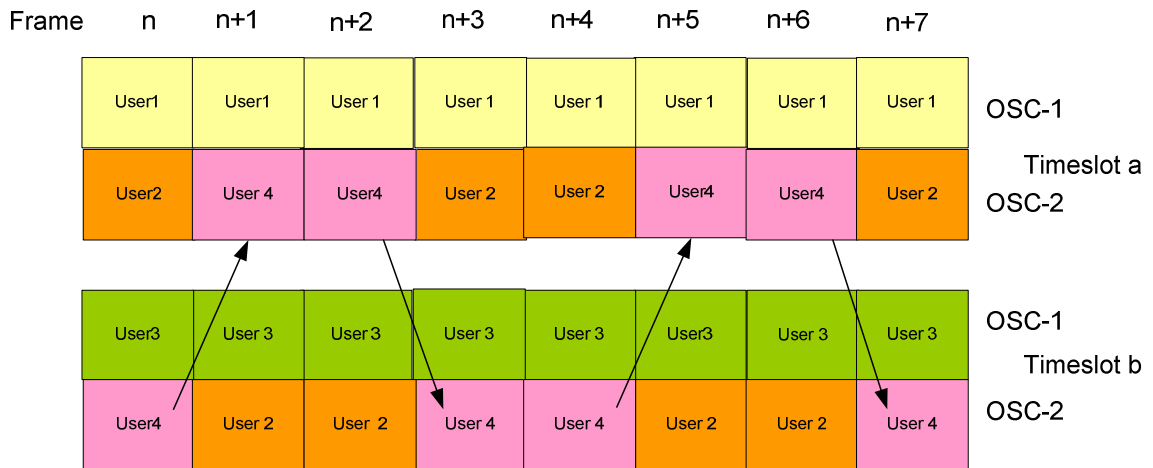

**Figure 7-5: Optimized User Diversity for OSC full rate channel configuration for the case of a timeslot pair**

Interference diversity is achieved here by multiplexing two full rate OSC aware mobiles (User 2 and User 4) on a paired timeslot (timeslot b) to the second sub channel (OSC-2) of the first timeslot (timeslot a).

The concept foresees to allocate two legacy full rate mobiles (User 1 and User 3) on the first sub channel (OSC-1) of the timeslot pair (timeslot a and b), where the time slots need not be adjacent. The remaining OSC aware MS's (User 2 and User 4) are then mandated to hop between the second sub channels (OSC-2) of both timeslots. In case of OSC full rate channel configuration the interleaving depth of 8 is kept for all mobiles, also time diversity of ~ 40 ms is maintained for all mobiles without jitter. As well speech block delivery every 4<sup>th</sup> burst is untouched.

Hence in all cases legacy MS's and new OSC aware mobiles will benefit from the increased interference diversity through the usage of legacy compatible user diversity patterns. The patterns are described in section 7.1.2.2.5.3 . It is intended that the specified *optimized user diversity* patterns are subject to be standardized. intra cell or channel modify HO command, etc.

Signalling support for OSC aware mobiles will then include:

- the specified user diversity pattern (2 bits in case of OSC FR channel configuration and 2 bits in case of OSC HR channel configuration).
- the index for the mobile (2 bits for multiplexing 4 users).
- signalling will be needed if user patterns are switched.
- different signalling methods exist: usage of FACCH to command an intracell HO, usage of inband signalling to transport compressed

**7.1.2.2.5.3 Support of Optimized User Diversity for scenarios with mixed MS types**

For OSC half rate channel configuration and OSC full rate channel configuration three user diversity patterns for each are defined for each to support inclusion of legacy MSs. Half rate configuration is always related to one time slot, whilst full rate configuration is based on two timeslots in two of three configurations in order to obtain a higher interference diversity.

**Optimized User Diversity Half Rate Pattern 1**

The channel configuration depicted in Table 7-6 is related to one timeslot. The configuration supports of up to four users for the following two scenarios:

- a) 4 legacy MS's.
- b) 3 legacy MS's + 1 OSC aware MS.

**Table 7-6: Optimized User Diversity Half Rate Pattern 1 per 26 multiframe**

Frame	Active HR SC	User Diversity Pattern (OSC, SC)				User in OSC	
		User 1	User 2	User 3	User 4	OSC-0	OSC-1
0	0	00	10	01	11	User 1, Bx+B0	User 2, Bx+B0
1	1	00	10	01	11	User 3, Bx+B0	User 4, Bx+B0
2	0	00	10	01	11	User 1, Bx+B0	User 2, Bx+B0
3	1	00	10	01	11	User 3, Bx+B0	User 4, Bx+B0
4	0	00	10	01	11	User 1, B0+B1	User 2, B0+B1
5	1	00	10	01	11	User 3, B0+B1	User 4, B0+B1
6	0	00	10	01	11	User 1, B0+B1	User 2, B0+B1
7	1	00	10	01	11	User 3, B0+B1	User 4, B0+B1
8	0	00	10	01	11	User 1, B1+B2	User 2, B1+B2
9	1	00	10	01	11	User 3, B1+B2	User 4, B1+B2
10	0	00	10	01	11	User 1, B1+B2	User 2, B1+B2
11	1	00	10	01	11	User 3, B1+B2	User 4, B1+B2
12	0	00	10	01	11	User 1, B2+B3	User 2, B2+B3
13	0	00	10	01	11	User 1, B2+B3	User 2, B2+B3
14	1	00	10	01	11	User 3, B2+B3	User 4, B2+B3
15	0	00	10	01	11	User 1, B2+B3	User 2, B2+B3
16	1	00	10	01	11	User 3, B2+B3	User 4, B2+B3
17	0	00	10	01	11	User 1, B3+B4	User 2, B3+B4
18	1	00	10	01	11	User 3, B3+B4	User 4, B3+B4
19	0	00	10	01	11	User 1, B3+B4	User 2, B3+B4
20	1	00	10	01	11	User 3, B3+B4	User 4, B3+B4
21	0	00	10	01	11	User 1, B4+B5	User 2, B4+B5
22	1	00	10	01	11	User 3, B4+B5	User 4, B4+B5
23	0	00	10	01	11	User 1, B4+B5	User 2, B4+B5
24	1	00	10	01	11	User 3, B4+B5	User 4, B4+B5
25	1	00	10	10	11	User 3, SACCH	User 4, SACCH

c) User 1 to User 4: legacy MS or legacy SAIC MS.

d) User 1 to User 3: legacy MS or legacy SAIC MS; User 4: OSC aware MS (one example).

**Optimized User Diversity Half Rate Pattern 2**

The channel configuration depicted in Table 7-7 is related to one timeslot. The configuration supports up to four users for the following three scenarios:

- a) 2 legacy MS's + 2 OSC aware MS's.
- b) 1 legacy MS's + 3 OSC aware MS's.
- c) 4 OSC aware MS's.

**Table 7-7: Optimized User Diversity Half Rate Pattern 2 per 26 multiframe**

Frame	Active HR SC	User Diversity Pattern (OSC, SC)				User in OSC	
		User 1	User 2	User 3	User 4	OSC-0	OSC-1
0	0	00	10	01	11	User 1, Bx+B0	User 2, Bx+B0
1	1	00	11	01	10	User 3, Bx+B0	User 2, Bx+B0
2	0	00	11	01	10	User 1, Bx+B0	User 4, Bx+B0
3	1	00	10	01	11	User 3, Bx+B0	User 4, Bx+B0
4	0	00	10	01	11	User 1, B0+B1	User 2, B0+B1
5	1	00	11	01	10	User 3, B0+B1	User 2, B0+B1
6	0	00	11	01	10	User 1, B0+B1	User 4, B0+B1
7	1	00	10	01	11	User 3, B0+B1	User 4, B0+B1
8	0	00	10	01	11	User 1, B1+B2	User 2, B1+B2
9	1	00	11	01	10	User 3, B1+B2	User 2, B1+B2
10	0	00	11	01	10	User 1, B1+B2	User 4, B1+B2
11	1	00	10	01	11	User 3, B1+B2	User 4, B1+B2
12	0	00	10			User 1, SACCH	User 2, SACCH
13	0	00	10	01	11	User 1, B2+B3	User 2, B2+B3
14	1	00	11	01	10	User 3, B2+B3	User 2, B2+B3
15	0	00	11	01	10	User 1, B2+B3	User 4, B2+B3
16	1	00	10	01	11	User 3, B2+B3	User 4, B2+B3
17	0	00	10	01	11	User 1, B3+B4	User 2, B3+B4
18	1	00	11	01	10	User 3, B3+B4	User 4, B3+B4
19	0	00	11	01	10	User 1, B3+B4	User 4, B3+B4
20	1	00	10	01	11	User 3, B3+B4	User 4, B3+B4
21	0	00	10	01	11	User 1, B4+B5	User 2, B4+B5
22	1	00	11	01	10	User 3, B4+B5	User 4, B4+B5
23	0	00	11	01	10	User 1, B4+B5	User 4, B4+B5
24	1	00	10	01	11	User 3, B4+B5	User 4, B4+B5
25	1	00	10	10	11	User 3, SACCH	User 4, SACCH

- a) User 1 and User 3: legacy MS or legacy SAIC MS; User 2 and User 4: OSC aware MS's.
- b) User 1: legacy MS or legacy SAIC MS; User 2 to User 4: OSC aware MS's.
- c) User 1 to User 4: OSC aware MS's.

**Optimized User Diversity Half Rate Pattern 3**

The channel configuration depicted in Table 7-8 is related to one timeslot. The configuration supports the same scenarios as Pattern 2 and up to four users for the following three scenarios:

- a) 2 legacy MS's + 2 OSC aware MS's.
- b) 1 legacy MS's + 3 OSC aware MS's.
- c) 4 OSC aware MS's.

**Table 7-8: Optimized User Diversity Half Rate Pattern 3 with shift of SACCH per 26 multiframe**

Frame	Active HR SC	User Diversity Pattern (OSC, SC)				User in OSC	
		User 1	User 2	User 3	User 4	OSC-0	OSC-1
0	0	00	10	01	10	User 1, Bx+B0	User 2, Bx+B0
1	1	00	11	01	01	User 3, Bx+B0	User 2, Bx+B0
2	0	00	11	01	10	User 1, Bx+B0	User 4, Bx+B0
3	1	00	10	01	11	User 3, Bx+B0	User 4, Bx+B0
4	0	00	10	01	11	User 1, B0+B1	User 2, B0+B1
5	1	00	11	01	10	User 3, B0+B1	User 2, B0+B1
6	0	00	10	01	11	User 1, B0+B1	User 2, SACCH
7	1	00	10	01	11	User 3, B0+B1	User 4, B0+B1
8	0	00	11	01	10	User 1, B1+B2	User 4, B0+B1
9	1	00	11	01	10	User 3, B1+B2	User 2, B1+B2
10	0	00	10	01	11	User 1, B1+B2	User 2, B1+B2
11	1	00	10	01	11	User 3, B1+B2	User 4, B1+B2
12	0	00	11	01	10	User 1, SACCH	User 4, B1+B2
13	0	00	10	01	10	User 1, B2+B3	User 2, B2+B3
14	1	00	11	01	01	User 3, B2+B3	User 2, B2+B3
15	0	00	11	01	10	User 1, B2+B3	User 4, B2+B3
16	1	00	10	01	11	User 3, B2+B3	User 4, B2+B3
17	0	00	10	01	11	User 1, B3+B4	User 2, B3+B4
18	1	00	11	01	10	User 3, B3+B4	User 2, B3+B4
19	0	00	10	01	10	User 1, B3+B4	User 4, SACCH
20	1	00	10	01	11	User 3, B3+B4	User 4, B3+B4
21	0	00	11	01	10	User 1, B4+B5	User 4, B3+B4
22	1	00	11	01	10	User 3, B4+B5	User 2, B4+B5
23	0	00	10	01	11	User 1, B4+B5	User 2, B4+B5
24	1	00	10	01	11	User 3, B4+B5	User 4, B4+B5
25	1	00	10	01	11	User 3, SACCH	User 4, B4+B5

- a) User 1 and User 3: legacy MS or legacy SAIC MS; User 2 and User 4: OSC aware MS's.
- b) User 1: legacy MS or legacy SAIC MS; User 2 to User 4: OSC aware MS's.
- c) User 1 to User 4: OSC aware MS's.

Note the difference to Pattern 2 is the shift of the SACCH for User 2 and User 4 , i.e. the advance of 6 TDMA frames.

**Optimized User Diversity Full Rate Pattern 1**

The channel configuration depicted in Table 7-9 is related to one timeslot. The configuration supports up to two users for the following three scenarios:

- a) 2 legacy MS's.
- b) 1 legacy MS's + 1 OSC aware MS.
- c) 2 OSC aware MS.

**Table 7-9: Optimized User Diversity Full Rate Pattern 1 per 26 multiframe**

Frame	User Diversity Pattern (OSC)		User in OSC	
	User 1	User 2	OSC-0	OSC-1
0	1	1	User 1, Bx+B0	User 2, Bx+B0
1	1	1	User 1, Bx+B0	User 2, Bx+B0
2	1	1	User 1, Bx+B0	User 2, Bx+B0
3	1	1	User 1, Bx+B0	User 2, Bx+B0
4	1	1	User 1, B0+B1	User 2, B0+B1
5	1	1	User 1, B0+B1	User 2, B0+B1
6	1	1	User 1, B0+B1	User 2, B0+B1
7	1	1	User 1, B0+B1	User 2, B0+B1
8	1	1	User 1, B1+B2	User 2, B1+B2
9	1	1	User 1, B1+B2	User 2, B1+B2
10	1	1	User 1, B1+B2	User 2, B1+B2
11	1	1	User 1, B1+B2	User 2, B1+B2
12	1	0	<b>User 1, SACCH</b>	<b>Legacy User 2, SACCH</b>
13	1	1	User 1, B2+B3	User 2, B2+B3
14	1	1	User 1, B2+B3	User 2, B2+B3
...				
25	0	1	-	<b>OSC User 2, SACCH</b>

- a) User 1 to User 2: legacy MS or legacy SAIC MS with SACCH in Frame 12.
- b) User 1: legacy MS or legacy SAIC MS; User 2: OSC aware MS with SACCH in Frame 25 for User 2.
- c) User 1 to User 2: OSC aware MS with SACCH in Frame 25 for User 2.

**Optimized User Diversity Full Rate Pattern 2**

The channel configuration depicted in Table 7-10 is related to a timeslot pair. The configuration supports up to four users for the following two scenarios:

- a) 4 legacy MS's.
- b) 3 legacy MS's + 1 OSC aware MS.



**Table 7-10: Optimized User Diversity Full Rate Pattern 2 per 26 multiframe.**

Frame	TS	Active SFS	User Diversity Pattern (OSC, SFS)				User in OSC	
			User 1	User 2	User 3	User 4	OSC-0	OSC-1
0	0	0	00	10	01	11	User 1, Bx+B0	User 2, Bx+B0
0	1	1	00	10	01	11	User 3, Bx+B0	User 4, Bx+B0
1	0	0	00	10	01	11	User 1, Bx+B0	User 2, Bx+B0
1	1	1	00	10	01	11	User 3, Bx+B0	User 4, Bx+B0
2	0	0	00	10	01	11	User 1, Bx+B0	User 2, Bx+B0
2	1	1	00	10	01	11	User 3, Bx+B0	User 4, Bx+B0
3	0	0	00	10	01	11	User 1, Bx+B0	User 2, Bx+B0
3	1	1	00	10	01	11	User 3, Bx+B0	User 4, Bx+B0
4	0	0	00	10	01	11	User 1, B0+B1	User 2, B0+B1
4	1	1	00	10	01	11	User 3, B0+B1	User 4, B0+B1
5	0	0	00	10	01	11	User 1, B0+B1	User 2, B0+B1
5	1	1	00	10	01	11	User 3, B0+B1	User 4, B0+B1
6	0	0	00	10	01	11	User 1, B0+B1	User 2, B0+B1
6	1	1	00	10	01	11	User 3, B0+B1	User 4, B0+B1
7	0	0	00	10	01	11	User 1, B0+B1	User 2, B0+B1
7	1	1	00	10	01	11	User 3, B0+B1	User 4, B0+B1
8	0	0	00	10	01	11	User 1, B1+B2	User 2, B1+B2
8	1	1	00	10	01	11	User 3, B1+B2	User 4, B1+B2
9	0	0	00	10	01	11	User 1, B1+B2	User 2, B1+B2
9	1	1	00	10	01	11	User 3, B1+B2	User 4, B1+B2
10	0	0	00	10	01	11	User 1, B1+B2	User 2, B1+B2
10	1	1	00	10	01	11	User 3, B1+B2	User 4, B1+B2
11	0	0	00	10	01	11	User 1, B1+B2	User 2, B1+B2
11	1	1	00	10	01	11	User 3, B1+B2	User 4, B1+B2
12	0	0	00	10	01	11	User 1, SACCH	Legacy User 2, SACCH
12	1	1	00	10	01	11	User 3, SACCH	Legacy User 4, SACCH
13	0	0	00	10	01	11	User 1, B2+B3	User 2, B2+B3
13	1	1	00	10	01	11	User 3, B2+B3	User 4, B2+B3
14	0	0	00	10	01	11	User 1, B2+B3	User 2, B2+B3
14	1	1	00	10	01	11	User 3, B2+B3	User 4, B2+B3
...								
25	0	0	00	10	01	11	-	
25	1	1	00	10	01	11	-	OSC User 4, SACCH

- a) User 1 to User 4: legacy MS or legacy SAIC MS; all users use Frame 12 for SACCH.
- b) User 1 to User 3: legacy MS or legacy SAIC MS; User 4: OSC aware MS (one example); User 4 uses SACCH in Frame 25. Hence the OSC aware user uses Frame 25 for SACCH in this configuration. Instead of User 4, User 2 could identify an OSC aware MS. In this case the SACCH for OSC User 2 is allocated in Frame 25 TS 0.

**Optimized User Diversity Full Rate Pattern 3**

The channel configuration depicted in Table 7-11 is related to a timeslot pair. The configuration supports up to four users for the following three scenarios:

- a) 2 legacy MS's + 2 OSC aware MS's.
- b) 1 legacy MS's + 3 OSC aware MS's.
- c) 4 OSC aware MS's.

**Table 7-11: Optimized User Diversity Full Rate Pattern 3 per 26 multiframe**

Frame	TS	Active SFS	User Diversity Pattern (OSC, SFS)				User in OSC	
			User 1	User 2	User 3	User 4	OSC-0	OSC-1
0	0	0	00	10	01	11	User 1, Bx+B0	User 2, Bx+B0
0	1	1	00	10	01	11	User 3, Bx+B0	User 4, Bx+B0
1	0	0	00	11	01	10	User 1, Bx+B0	User 4, Bx+B0
1	1	1	00	11	01	10	User 3, Bx+B0	User 2, Bx+B0
2	0	0	00	11	01	10	User 1, Bx+B0	User 4, Bx+B0
2	1	1	00	11	01	10	User 3, Bx+B0	User 2, Bx+B0
3	0	0	00	10	01	11	User 1, Bx+B0	User 2, Bx+B0
3	1	1	00	10	01	11	User 3, Bx+B0	User 4, Bx+B0
4	0	0	00	10	01	11	User 1, B0+B1	User 2, B0+B1
4	1	1	00	10	01	11	User 3, B0+B1	User 4, B0+B1
5	0	0	00	11	01	10	User 1, B0+B1	User 4, B0+B1
5	1	1	00	11	01	10	User 3, B0+B1	User 2, B0+B1
6	0	0	00	11	01	10	User 1, B0+B1	User 4, B0+B1
6	1	1	00	11	01	10	User 3, B0+B1	User 2, B0+B1
7	0	0	00	10	01	11	User 1, B0+B1	User 2, B0+B1
7	1	1	00	10	01	11	User 3, B0+B1	User 4, B0+B1
8	0	0	00	10	01	11	User 1, B1+B2	User 2, B1+B2
8	1	1	00	10	01	11	User 3, B1+B2	User 4, B1+B2
9	0	0	00	11	01	10	User 1, B1+B2	User 4, B1+B2
9	1	1	00	11	01	10	User 3, B1+B2	User 2, B1+B2
10	0	0	00	11	01	10	User 1, B1+B2	User 4, B1+B2
10	1	1	00	11	01	10	User 3, B1+B2	User 2, B1+B2
11	0	0	00	10	01	11	User 1, B1+B2	User 2, B1+B2
11	1	1	00	10	01	11	User 3, B1+B2	User 4, B1+B2
12	0	0	00	10	01	11	User 1, SACCH	-
12	1	1	00	10	01	11	User 3, SACCH	-
13	0	0	00	10	01	11	User 1, B2+B3	User 2, B2+B3
13	1	1	00	10	01	11	User 3, B2+B3	User 4, B2+B3
14	0	0	00	11	01	10	User 1, B2+B3	User 4, B2+B3
14	1	1	00	11	01	10	User 3, B2+B3	User 2, B2+B3
...								
25	0	0	00	10	01	11	-	User 2, SACCH
25	1	1	00	10	01	11	-	User 4, SACCH

- a) User 1 and User 3: legacy MS or legacy SAIC MS; User 2 and User 4: OSC aware MS's.
- b) User 1: legacy MS or legacy SAIC MS; User 2 to User 4: OSC aware MS's.
- c) User 1 to User 4: OSC aware MS's.

7.1.2.2.5.4 Benefits of Optimized User Diversity

Optimized User Diversity will mitigate the drawbacks of the Basic User Diversity proposal in the context of impact of variable speech block delivery and of coexistence scenarios with legacy mobiles. Different patterns for full rate and half rate channels have been designed in such way

- that they allow to apply the same constant interleaving depth for full rate channels (8 bursts) as for legacy channels,
- that they allow to apply the same constant interleaving depth for half rate channels (4 bursts) as for legacy channels and an reduced transfer delay by 5ms (30 ms instead of 35 ms) and
- that they can serve a variable mix of legacy and new OSC aware mobiles with least signalling. In particular signalling support for new OSC aware mobiles will be needed to index the user diversity pattern and the position of the user, hence a total of 4 bits per user. The method for this signalling support is FFS.

As outlined in [7-4] the proposed method will yield increased interference diversity both for TCH and SACCH channels in OSC configurations and is independent of employed frequency hopping type. Hence no frequency planning aspects are imposed by the introduction of the user diversity concept. Performance characterization is given in section 7.2.2.5. The described enhancement above is foreseen to be used together with the basic OSC candidate technique. Furthermore it is to be noted, that the concept is equally applicable to other candidates like co-TCH and alpha-QPSK.

### 7.1.3 Uplink concept

The uplink concept for OSC includes a subset of changes for the downlink. In particular two independent uplink transmissions are simultaneously received at the BTS. In the following the aspects of modulation and burst structure, usage of new training sequences and Tx pulse shapes, definition of associated control channel structure and application of the user diversity scheme are considered.

#### 7.1.3.1 Modulation and burst structure

Modulation (i.e. GMSK) and burst structure (normal burst) are the same as for legacy traffic channels.

#### 7.1.3.2 Usage of new training sequences

The mobiles use normal GMSK transmitter with OSC sub channel specific training sequence. Hence both sub channels can be distinguished by their training sequence, similarly as for downlink. A pair of legacy TSCs is used for legacy mobiles, whilst new OSC aware mobiles use new training sequences as depicted in section 7.1.2.1.2 . Training sequence on uplink is always identical to that employed for downlink.

#### 7.1.3.3 Tx pulse shape

Different Tx pulse shapes may be used in uplink as proposed for downlink. Whilst the reuse of the GMSK pulse shape is proposed for the initial OSC concept, investigations on an optimized Tx pulse in uplink are FFS.

#### 7.1.3.4 Associated control channels

FACCH transmission for full rate and halfrate OSC channel is identical to the legacy channel case.

SACCH transmission for full rate OSC channel may use option 1, 2 or 3 as depicted in section 7.1.2.1.7 for downlink.

SACCH transmission for half rate OSC channel may use option 1 or 2 as depicted in section 7.1.2.1.7 for downlink. In addition a third option is to use time shift of the SACCH channel as proposed for user diversity (see section 7.1.2.5.3, optimized user diversity half rate pattern 3).

#### 7.1.3.5 User diversity

The user diversity scheme applied for downlink should also be used in uplink, i.e. the optimized user diversity pattern should be identical. Hence a signalling command referring to the user diversity pattern to be used on DL is also related to UL.

#### 7.1.3.6 BTS receiver

BTS receiver may use e.g. Successive Interference Cancellation (SIC) or Joint Detection (JD) to receive signals from two mobiles on simultaneous sub channels with individual propagation paths. Thus, the uplink scheme can be seen as a 2x2 Multi User MIMO, where different propagation paths from two users provide the basis to fully utilize the degree of freedom of two receive antennas in typical BTS.

### 7.1.4 RR signalling

The following changes to RR signalling are needed:

- MS should provide OSC radio access capability indication.
- Channel assignment should include OSC sub channel information, e.g. in form of the new or the existing training sequence code number (4 bits).
- Channel assignment should include the specified user diversity pattern (2 bits for OSC FR channel and 2 bits for OSC HR channel) and the index for the mobile (2 bits) in case of user diversity support.

## 7.2 Performance Characterization

### 7.2.1 Link Level Performance

Link performance is characterized for sensitivity and for interference limited scenarios [7-2],[7-6],[7-7]. Simulations are performed for full rate and half rate AMR channels using some selected codec rates. Following fading radio channel profiles at GSM900 band are used:

- Typical urban, terminal speed 3 km/h, ideal frequency hopping (TU3iFH),
- Hilly terrain, terminal speed 100 km/h, ideal frequency hopping (HT100iFH).

Sensitivity and DARP test scenario-2 (DTS-2) are considered as noise and interference distortions, respectively. The baseline downlink receiver model is according to a generic DARP Phase 1 mobile station. OSC service is simulated with the same unmodified receiver. OSC signals are generated by mapping the users on QPSK constellation with equal transmission power between the sub channels. Signal rotation of  $\pi/2$  is used. Tx pulse shaping is done according to Linearized GMSK pulse shaping filter, also the performance of alternative pulse shapes is evaluated.

#### 7.2.1.1 Sensitivity Performance

For performance measurement the frame erasure rate (FER) is displayed over the signal to noise ratio (SNR).

##### 7.2.1.1.1 Sensitivity in downlink

Results are presented for the case of equal power on the subchannels (SCPIR = 0 dB) in subsection 7.2.1.1.1.1 and for the case of unequal power on the subchannels in subsection 7.2.1.1.1.2 .

##### 7.2.1.1.1.1 Sensitivity in downlink without sub channel specific power control

Different receiver types have been assumed such as DARP phase 1 with usage of legacy TSC's on both subchannels, with usage of new TSC on paired subchannel and OSC aware receiver benefitting from the knowledge of the training sequences employed on both subchannels.

#### Performance for DARP Phase 1 receiver and legacy training sequences

Legacy training sequence codes are applied to the sub channels, in that legacy training sequence pair TSC0 and TSC2 has been used. In Figure 7-6 and Figure 7-7 the downlink sensitivity performance of OSC is evaluated for some codecs of AMR Full Rate (AFS) and AMR Half Rate (AHS) without and with ideal frequency hopping respectively.

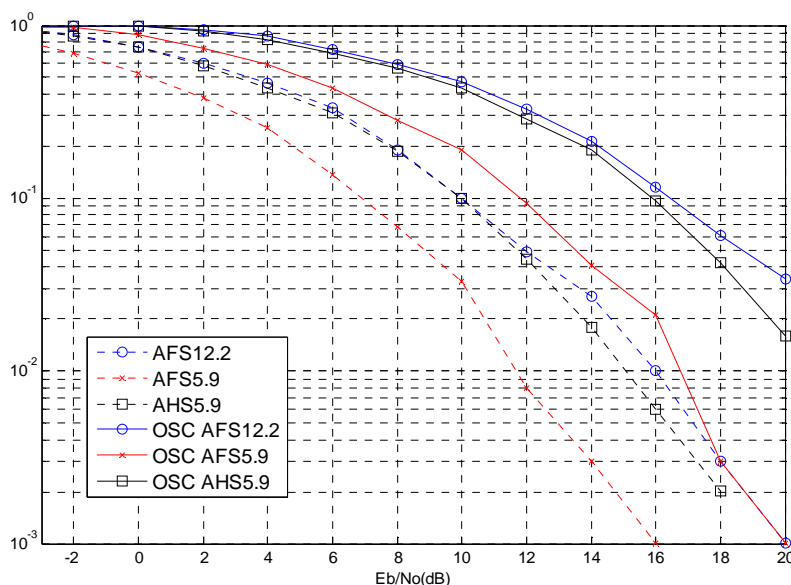
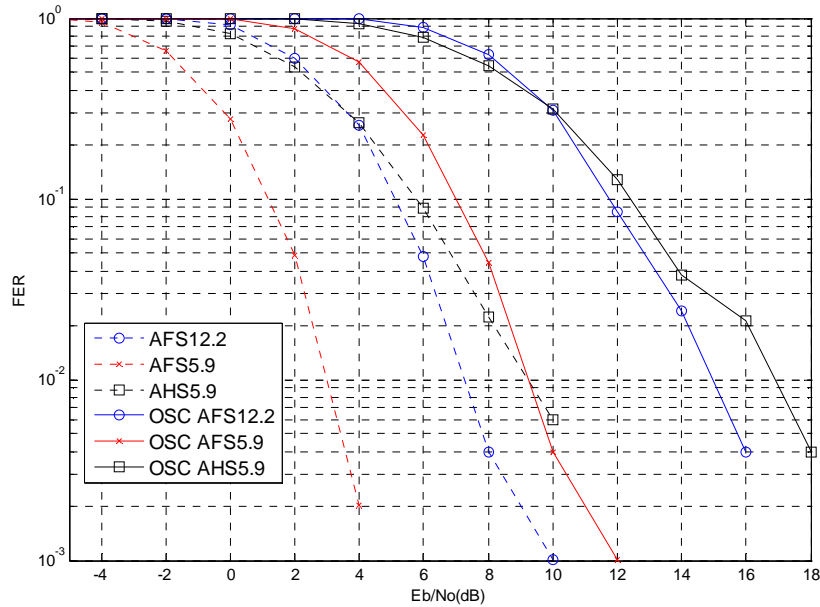
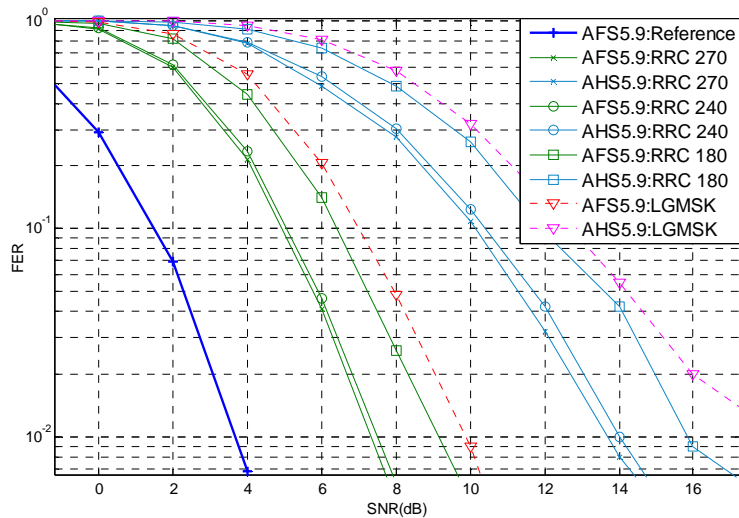

Figure 7-6: DL sensitivity FER performance in TU3nFH of generic DARP phase 1 MS receiving an OSC sub channel with AMR FR 5.9, 12.2 and AMR HR 5.9



**Figure 7-7: DL sensitivity FER performance in TU3iFH of generic DARP phase 1 MS receiving an OSC sub channel with AMR FR 5.9, 12.2 and AMR HR 5.9**

In Figure 7-8 the downlink sensitivity performance of OSC is evaluated for different transmit pulse shaping filters. Simulated pulse shaping filters are Linearized GMSK filter and Root Raised Cosine filters with normalized bandwidths of 180, 240 and 270 kHz. Sensitivity performance is clearly improved with RRC filters.



**Figure 7-8: DL sensitivity FER performance in TU3iFH of generic DARP phase 1 MS receiving an OSC sub channel with AMR FR 5.9 and HR 5.9 with different transmit pulse shaping filters**

In Figure 7-9 the downlink sensitivity performance of OSC in Hilly Terrain 100 km/h radio propagation channel is evaluated against reference.

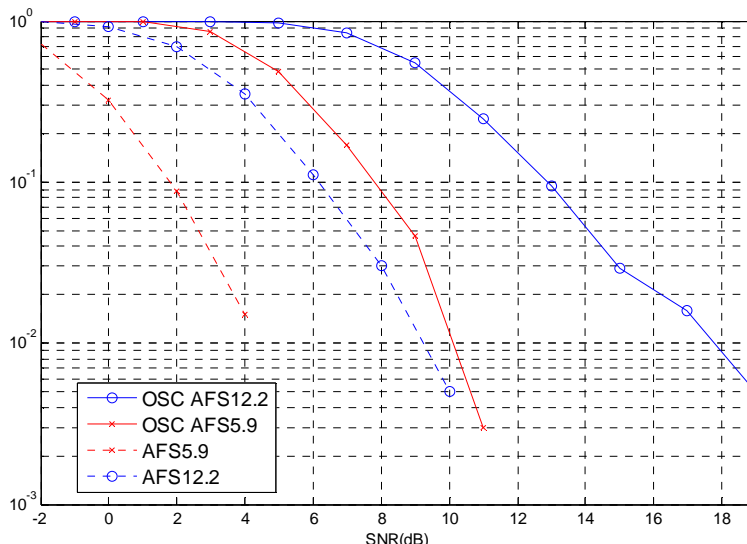
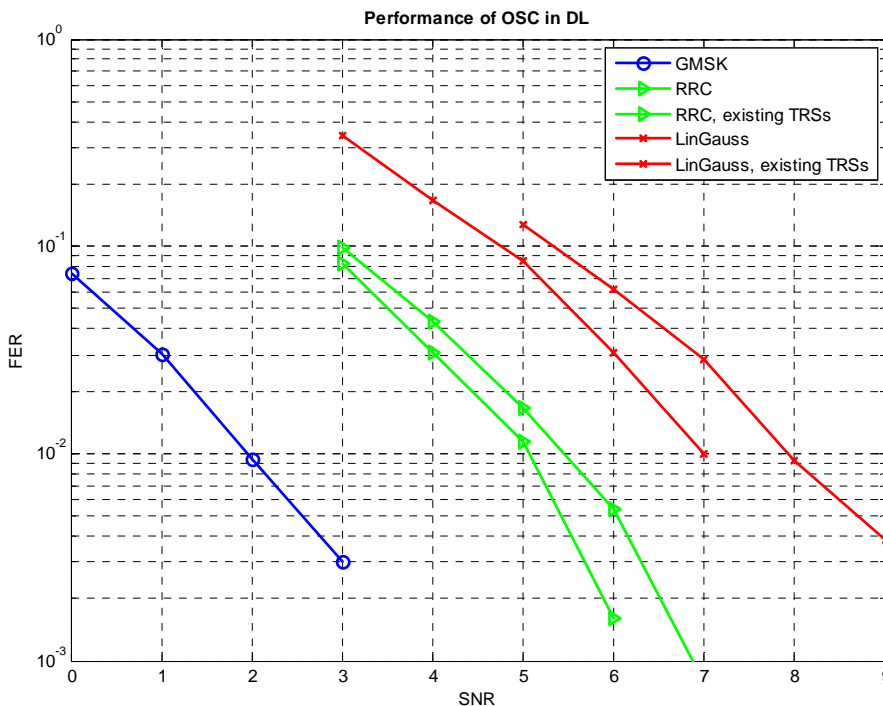

**Figure 7-9: DL sensitivity FER performance in HT100iFH of generic DARP phase 1 MS receiving an OSC sub channel with AMR FR 5.9 and 12.2**

It is shown that the performance of a legacy DARP 1 MS receiving an OSC sub channel is adequate in average network conditions, and more robust AMR channels can also provide sufficient coverage. Sensitivity would be significantly improved by more optimum transmit filter than Linearized GMSK filter. MUROS downlink concept also works in difficult radio propagation conditions, but the usage of high rate AMR codecs is limited to good SNR region.

**Performance for a DARP phase 1 receiver in case of a new training sequence on paired sub channel**

Furthermore investigations with a non-OSC aware type of receiver, such as a DARP phase 1 receiver have been carried out using different Tx pulse shapes (linearized GMSK, RRC 270 kHz) for the case of reusing the existing TSCs and the case using a new set of TSCs as proposed in section 7.1.2.1.2 for the paired sub channel. Results are reported in Figure 7-10.



**Figure 7-10: FER versus SNR for AMR FR 5.9 at TU3 iFH for DARP phase 1 receiver and usage of legacy TSCs only or mix of legacy and new TSC's**

It can be seen that the performance loss related to legacy full rate both depends on the Tx pulse shape and the used set of TSCs for the paired sub channel. The performance loss is depicted in Table 7-12.

**Table 7-12 Link Performance and Loss to Reference for AMR FR 5.9 @ FER=1%**

Configuration	SNR for FER=1%	Loss to Reference
GMSK (Reference)	1.9 dB	-
RRC 270kHz, new TSC pair	5.1 dB	3.2 dB
RRC 270 kHz, existing TSC pair with lowest x-correlation	5.4 dB	3.5 dB
Linearised Gaussian, new TSC pair	7.0 dB	5.1 dB
Linearised Gaussian, existing TSC pair with highest cross-correlation	7.9 dB	6.0 dB

**Performance for OSC aware receiver and usage of new training sequences**

The FER versus SNR is shown in Figure 7-11. It can be seen that OSC would need about 2.6 - 3.2 dB higher Es/No for doubled capacity in sensitivity limited scenarios, i.e. Eb/No is about the same as for related GMSK service, depending on the receiver type (2.6 dB for OSC aware receiver and 3.2 dB for DARP phase 1 receiver).

Since QPSK in downlink may need to reduce transmitter power compared to GMSK due to higher PAR by 2.2 dB in case of RRC pulse shape, further due to the OSC aware receiver, i.e. the receiver which has knowledge about the training sequences of both sub channels using this information for channel estimation of the paired interfering sub channel and which needs 2.6 dB higher Es/No, this yields a 4.8 dB lower link budget for doubled capacity in case of sensitivity limited scenarios. For comparison AMR HR 5.9 needs about 7dB higher Es/No than AMR FR 5.9, thus fullrate orthogonal sub channel could improve HR coverage by about 2 dB in TU3 iFH. Whilst for GMSK legacy AMR, TX pulse shape was assumed to be linearised GMSK, RRC filter with 3 dB double sided bandwidth of 270 kHz was assumed in use for OSC FR, if not otherwise stated. Both receivers, named ‘GMSK’ and ‘GMSK RX for OSC’ in the figures below, are SAIC type receivers. Performance of non-DARP phase 1 legacy MSes is FFS.

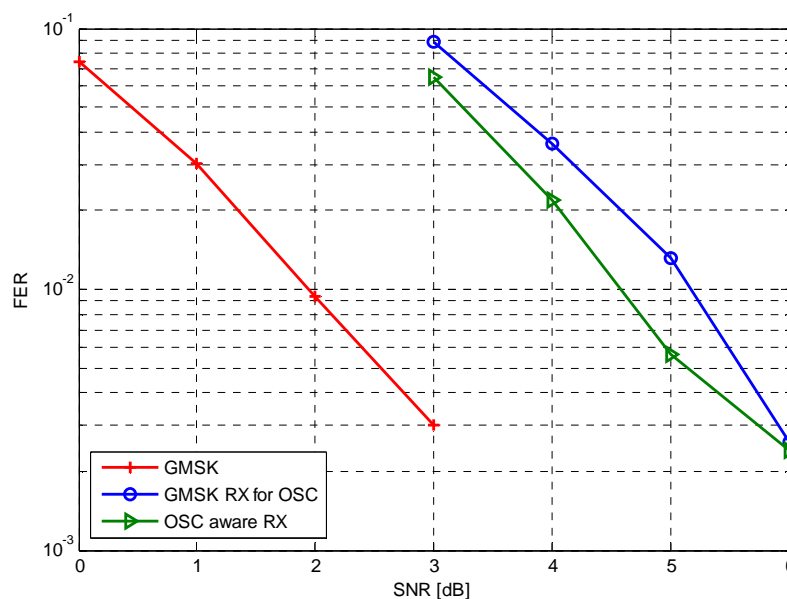

**Figure 7-11: FER versus SNR for AMR FR 5.9 at TU3 iFH for DARP Phase 1 and OSC aware receivers with RRC270 TX pulse shape in case of OSC**

**7.2.1.1.1.2 Sensitivity in downlink with subchannel specific power control**

In this section, simulation results are shown to verify how the SAIC (i.e. DARP phase 1) and non-SAIC mobiles behave in the sensitivity limited cases when receiving signals on downlink with sub-channel power control. TU 3 ideal frequency hopping channel is simulated under sensitivity limited conditions with AWGN noise interferer. It can be seen from Figure 7-12 that the performance of SAIC mobile both on strong and weak channels using the rectangular constellation points possible with 8-PSK modulator is acceptable. Also from Figure 7-13, it can be seen that legacy non-

SAIC mobiles can also decode the OSC signal in downlink if they are multiplexed on the stronger channel. It should be noted that all the bursts used a rectangular constellation here (i.e the case of maximum power imbalance between the subchannels). Further granularity in power control steps could be obtained by varying the constellation diagram as depicted in section 7.1.2.2.2 but this exercise is not repeated here. Further, it can also be noted that as long as the mobiles are multiplexed on the strong channel, the performance of the legacy mobiles with and without SAIC in sensitivity limited scenarios is quite close as seen from the performance of user 2 – who is the stronger user in Figure 7-12 and Figure 7-13.

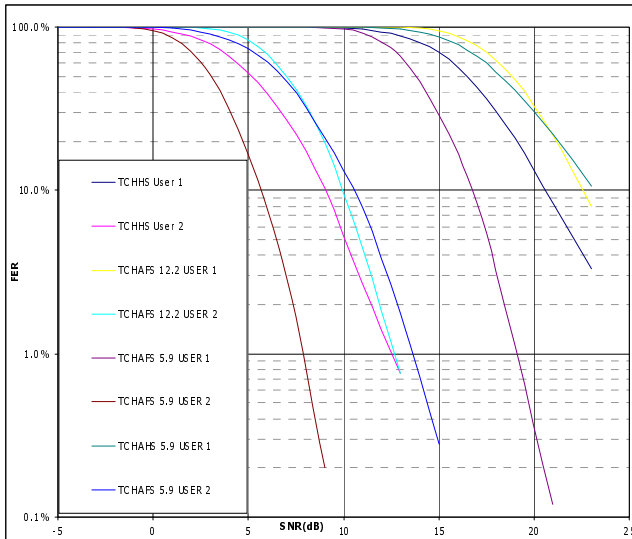

Figure 7-12: Sensitivity performance – SAIC ON

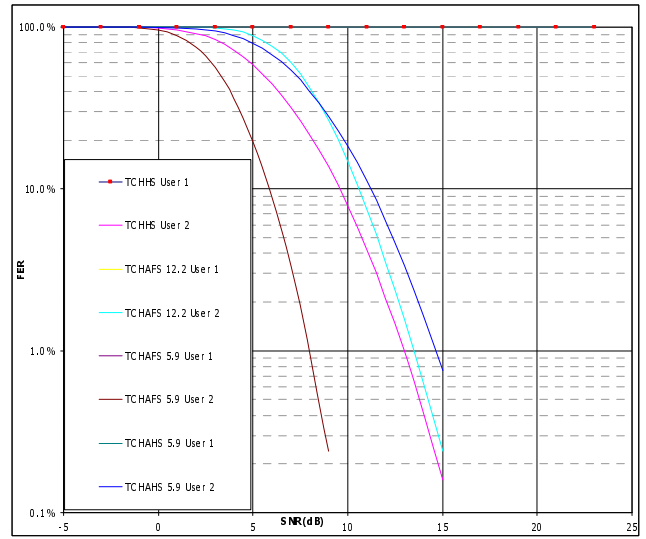
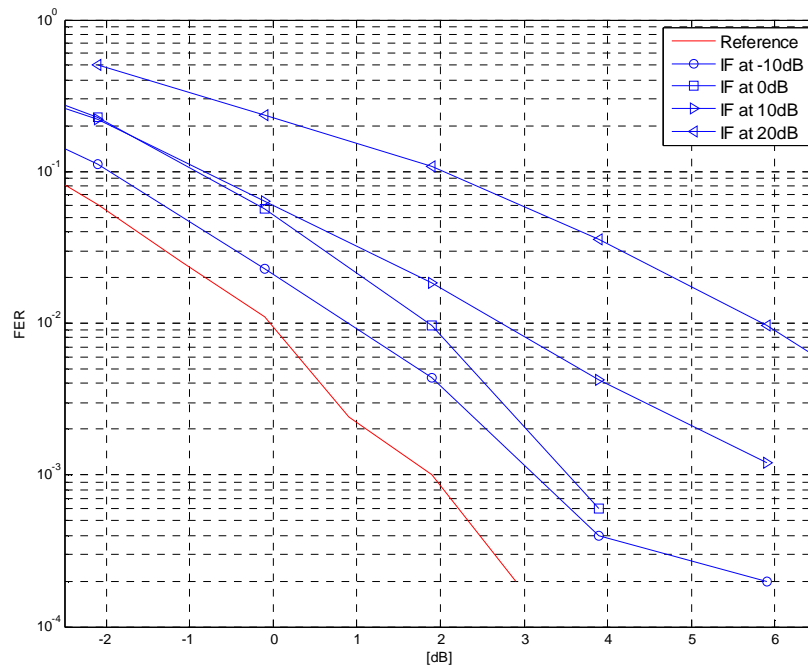

Figure 7-13: Sensitivity performance – SAIC OFF

7.2.1.1.2 Sensitivity in uplink

For uplink sensitivity simulations a SIC receiver has been used (Successive Interference Cancellation). Performance for IRC receiver type (reference) and SIC receiver is shown in Figure 7-14 for different level offsets between coincident users, i.e. SCPIR = -20dB ... +10dB (related to wanted subchannel). FER values are normalized values so that reference AMR HR 7.4 exhibits 1% FER at SNR = 0 dB. It seems that about 2.6 dB loss in coverage is experienced when other orthogonal signal is 10dB higher than wanted signal when SIC receiver is used. At higher SNR levels higher offsets are tolerated. For SCPIR = - 20 dB, a performance loss of almost 6 dB is observed compared to the reference.





**Figure 7-14: UL sensitivity FER performance of a SIC receiver receiving an OSC sub channel with AMR HR 7.4 in dependence of SNR**

OSC concept evaluation in uplink shows that low complexity SIC equalizer can support two subchannels with 2-3 dB difference to the single user uplink channel for SCPIR between -10 dB...10 dB, and even somewhat higher ratios can be tolerated with moderate SNR performance loss.

## 7.2.1.2 Interference Performance

### 7.2.1.2.1 Interference limited performance in downlink

#### 7.2.1.2.1.1 Interference performance in downlink without subchannel specific power control

##### 7.2.1.2.1.1.1 Performance for MUROS Test Scenario 1

See performance evaluation in section 7.2.1.2.1.2 .

##### 7.2.1.2.1.1.2 Performance for MUROS Test Scenario 2

Different receiver types have been assumed such as DARP phase 1 with usage of legacy TSC's on both subchannels, with usage of new TSC on paired subchannel and OSC aware receiver benefitting from the knowledge of the training sequences employed on both subchannels.

#### **Performance for DARP Phase 1 receiver with legacy training sequences**

For performance measurement the frame erasure rate (FER) is displayed over the the carrier to interferer ratio (CIR). The CIR for MTS-2 scenario is related to the dominant interferer designated as  $C/I_0$ . In case of OSC the power of the wanted sub channel is considered. The other orthogonal sub channel is not taken into account in C/I calculation. Performance was compared applying linearized GMSK pulse shape filter.

In Figure 7-15 the downlink performance of MTS-2 is evaluated against reference for some codecs of AMR Full Rate (AFS) and AMR Half Rate (AHS) with ideal frequency hopping.

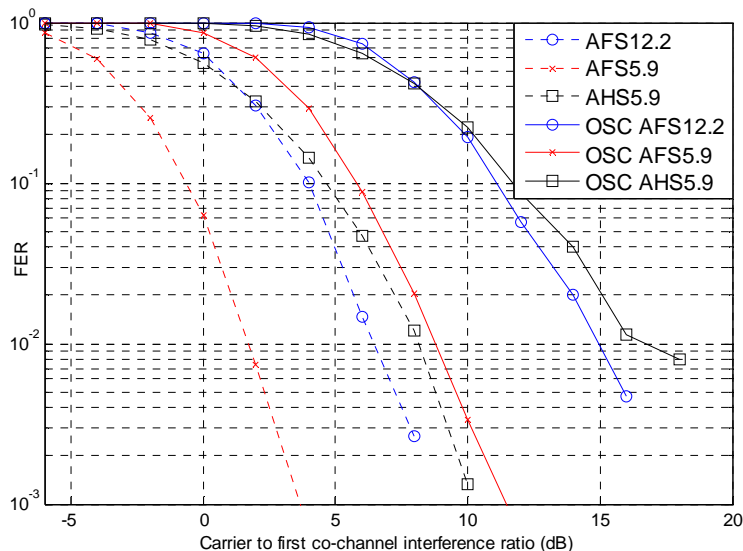

**Figure 7-15: DL MTS-2 FER performance in TU3iFH of generic DARP phase 1 MS receiving an OSC sub channel with AMR FR 5.9, AMR FR 12.2 and AMR HR 5.9**

Performance comparison at FER=1% is captured in Table 7-13 for the three investigated AMR codec types.

**Table 7-13: Link Performance and Loss to Reference for AMR FR 5.9 @ FER=1%**

Configuration	C/I <sub>0</sub> for FER=1%	Loss to Reference
OSC AMR FR 12.2	15.0 dB	8.6 dB
OSC AMR FR 5.9	8.9 dB	7.3 dB
OSC AMR HR 5.9	17.0 dB	8.7 dB

**Performance for OSC aware receiver and usage of new training sequences**

Interference performance shown in Figure 7-16 seems to have about similar 2.6-3.4dB difference as in sensitivity limited case. Again RRC 270 Tx pulse shape was used in this evaluation as well as new TSC for the paired subchannel. Performance is depicted for both a DARP phase 1 (GMSK RX for OSC) and an OSC aware MS. For comparison AMR HR 5.9 needs about 7dB higher C/I than AMR FR 5.9, thus orthogonal sub channel can improve HR performance by about 4 dB in TU3 iFH.

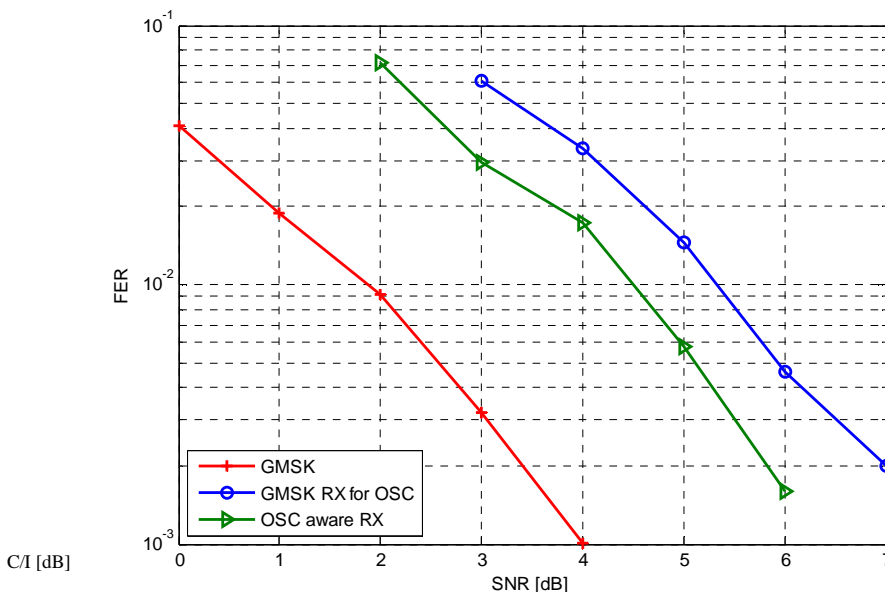

**Figure 7-16: FER for AMR FR 5.9 in TU3 iFH at MTS-2 for DARP phase 1 receiver (GMSK RX for OSC) and OSC aware receiver.**

7.2.1.2.1.1.3 Performance for Using Optimized TX Pulse Shapes

Link Level Performance was investigated for both candidate pulse shapes described in Section 7.1.2.1.3. This is depicted in Figure 7-16a below.

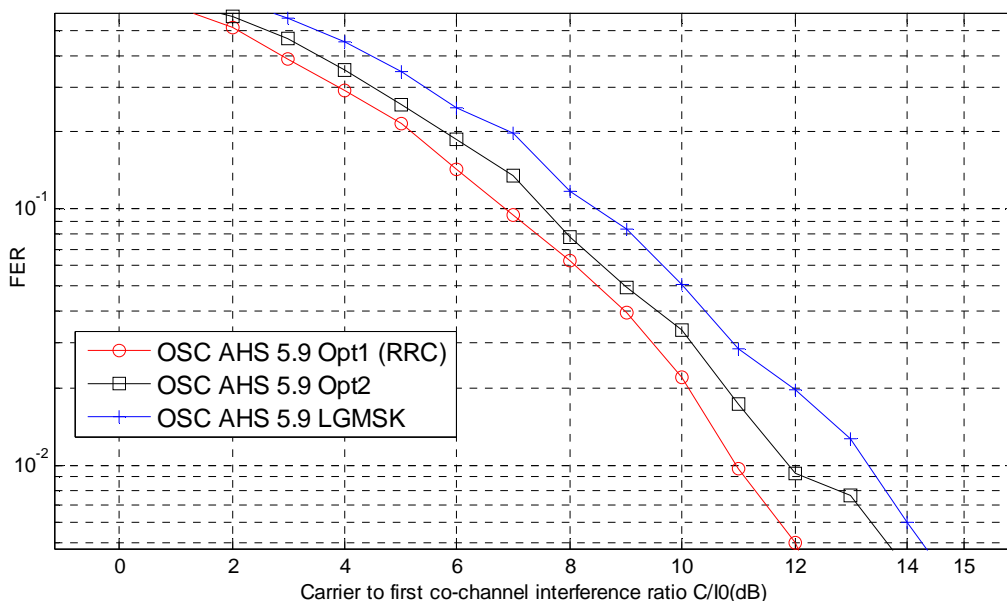

**Figure 7-16a: Link Performance for investigated TX pulse shapes for OSC channels, CCI, DIR=7dB, TU3iFH GSM900.**

The figure above needs to be updated depicting performance for the specified MTS channel profiles.

It can be seen that the link performance is improved by about 2.5 dB for candidate pulse shape OPT 1 and by about 1.5 dB for candidate pulse shape OPT 2 at 1% FER versus the legacy GMSK pulse shape.

## 7.2.1.2.1.2 Interference performance in downlink with subchannel specific power control

Simulation parameters are depicted in Table 7-14.

**Table 7-14: Simulation settings for downlink interference performance with subchannel specific power control**

Parameter	Value
Channel	TU 3
Frequency hopping	Ideal
AMR modes	TCHHS, TCHAFS 12.2, TCHAFS 5.9, TCHAFS 5.9
Antenna diversity (TX and RX)	Off
SAIC	On / Off
External Interference	Single Co-channel (MTS-1)
External Interferer Modulation	GMSK
C/I	Carrier Power (includes both users) / Power of External Interferer
TSCs	TSC-0 legacy and TSC-0 from new set shown in section 1.2.1.2
Number of frames	10000 frames per each C/I point

### Multiplexing a SAIC mobile with a legacy non-SAIC mobile

In this section the case of multiplexing a SAIC mobile with a non-SAIC mobile is studied. It should be noted that one of the two mobiles use the newer TSC hence they are not entirely legacy in that sense. However, apart from the knowledge of the new TSC, nothing else is modified for the SAIC algorithm. Hence, the SAIC mobile with the knowledge of new TSC here might as well represent a OSC aware mobile.

The multiplexing case studied here is the case when the SAIC mobile is on the weaker sub-channel and the legacy non-SAIC mobile is on the stronger sub-channel. This is the typical multiplexing use case to support legacy non-SAIC mobiles in the field using OSC. The results are shown in Figures 7-17, 7-18, 7-19 and 7-20. It can be observed that to multiplex 4 users (2 of which are legacy non-SAIC mobiles) using half rate codecs – TCHHS or TCHAFS 5.9, C/Is around 10 to 20 dB are sufficient in the cell. To multiplex full rate users using TCHAFS 5.9 for instance C/I ratios from 3 to 15 dB are sufficient. Thus it can be seen that multiplexing a legacy non-SAIC mobile with a SAIC mobile using OSC is feasible using both full rate and half rate codec modes. Hence, up to four users including legacy non-SAIC mobiles could be multiplexed using OSC in downlink using the proposed power control strategy.

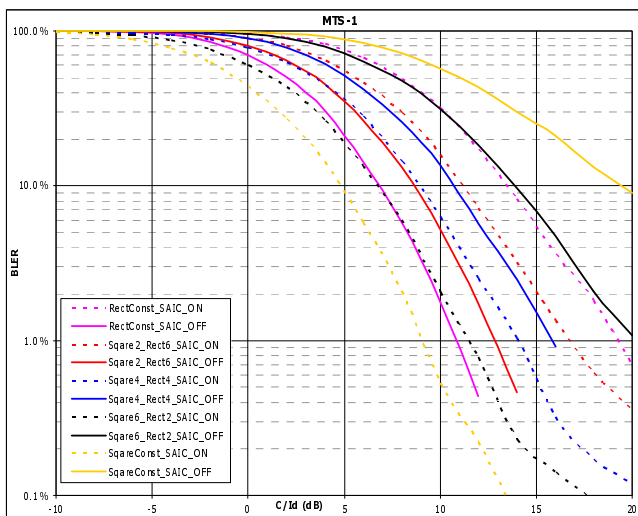

Figure 7-17 TCH:HS

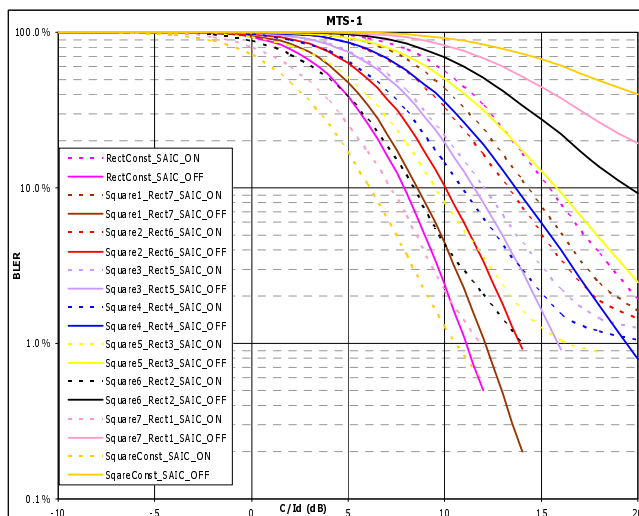

Figure 7-18 TCHAFS 12.2

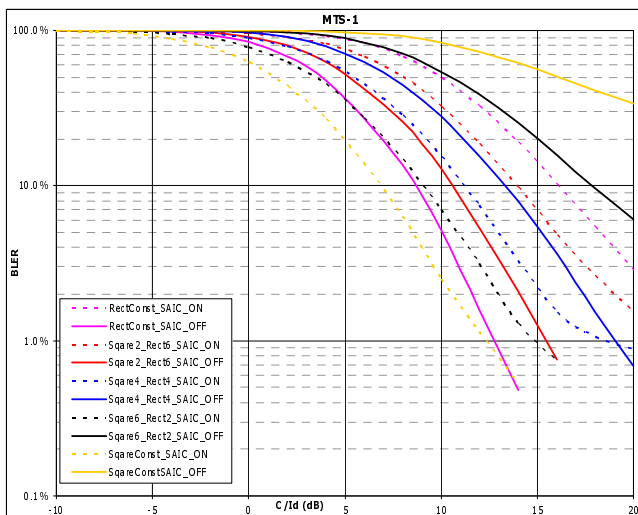

Figure 7-19 TCHAFS 5.9

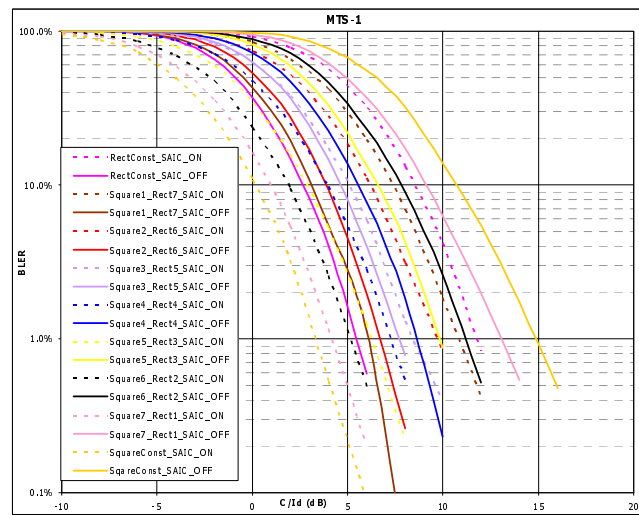

Figure 7-20 TCHAFS 5.9

Legend: In the figures above, the usage of rectangular and square constellations is switched using a predetermined pattern of length 8. For instance, Square1\_Rect7\_SAIC\_ON depicts the performance of a SAIC mobile when the constellation diagram is switched between 1 square (QPSK burst) and 7 rectangular bursts alternatively. It should be noted that when the rectangular burst is used, the signal corresponding to the SAIC mobile is attenuated (by approximately 7.6592 dB). RectConst\_SAIC\_ON refers to the case when all the bursts use the depicted rectangular constellation (performance of SAIC mobile which in this case is always on the weaker channel is depicted) and SquareConst\_SAIC\_OFF refers to the case when all the bursts use QPSK (performance of non SAIC mobile is depicted).

**Multiplexing two SAIC mobiles**

Multiplexing two SAIC mobiles is the easier case compared to the case studied in section above. The advantage of having 2 SAIC mobiles is that multiplexing could be achieved with much lower C/Is in the cell as seen from Figures 7-21, 7-22, 7-23 and 7-24. Here user 2 is always put on the strong channel and user 1 is put on the weaker channel. It can be seen that with 2 SAIC mobiles, C/I ratios in the range of -3 to 12 dB are sufficient to support simultaneous voice call between two mobiles on the downlink using TCHAFS 5.9 codec for instance. It should again be noted that one of the two SAIC mobiles used the orthogonal TSC from the new TSC set and hence can be considered as a OSC aware mobile. Alternatively two TSCs from the legacy set which have good orthogonality could also be chosen thereby multiplexing 2 legacy SAIC mobiles simultaneously. This case however has not been investigated here.

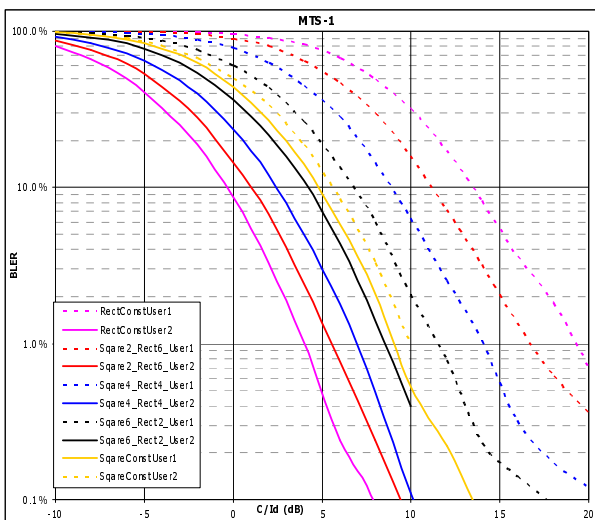

Figure 7-21: TCH:HS

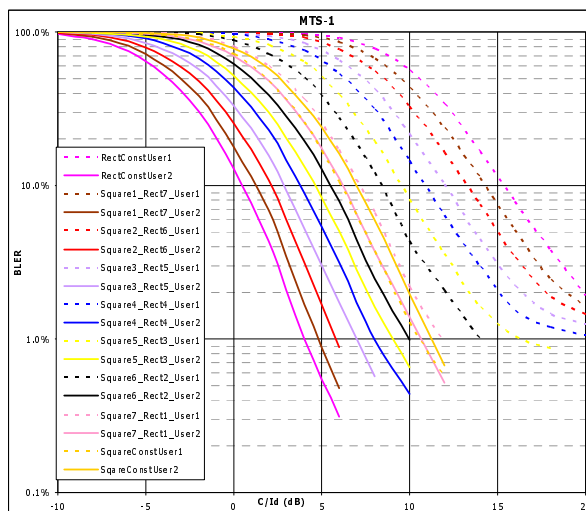

Figure 7-22: TCHAFS 12.2

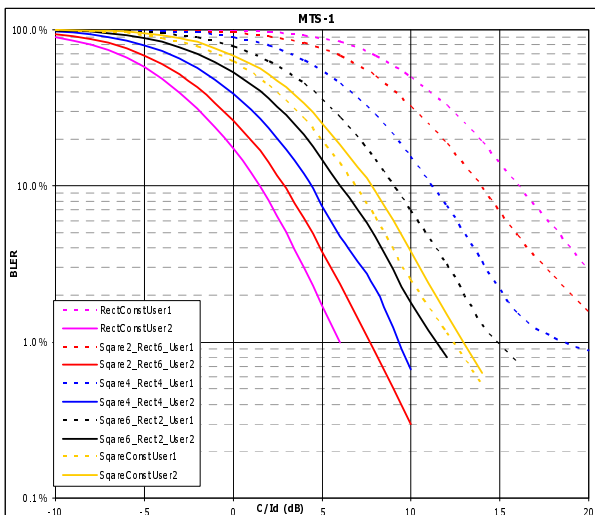

Figure 7-23: TCHAHS 5.9

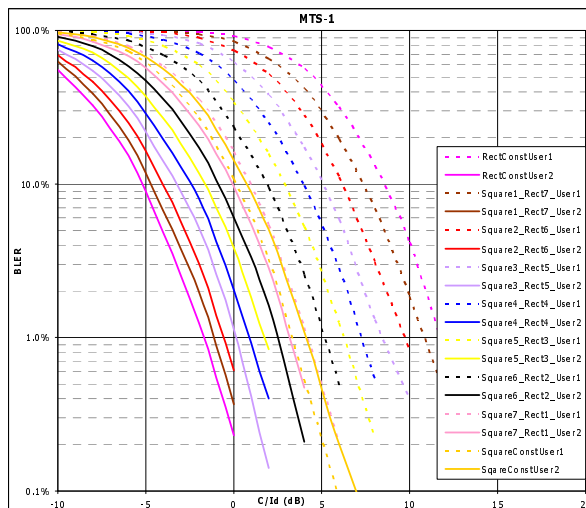

Figure 7-24: TCHAFS 5.9

### 7.2.1.3 Results from: MUROS – Performance of Legacy MS

Text in this section originates by Nokia Corporation in [7-10].

In this section, the sensitivity and interference performance of both legacy non-DARP MS and legacy DARP MS receiving a MUROS sub channel is presented. For interference performance verification the four MUROS Test Scenarios (MTS1-4) described in chapter 5 are used.

#### 7.2.1.3.1 Simulation Assumptions

##### 7.2.1.3.1.1 Legacy Terminals

The legacy DARP receiver applied in this section is a DARP phase I capable terminal. Such DARP terminals are widely present in the market. The legacy non-DARP receiver applied in this section is also present in the market.

### 7.2.1.3.1.2 Transmitted MUROS Signal

In this section, the DL MUROS signal is generated by QPSK symbol mapping with  $\pi/2$  rotation and linearized GMSK TX pulse shape as illustrated in Figure 7-25. This corresponds to the OSC technique presented by NSN in [7-2].

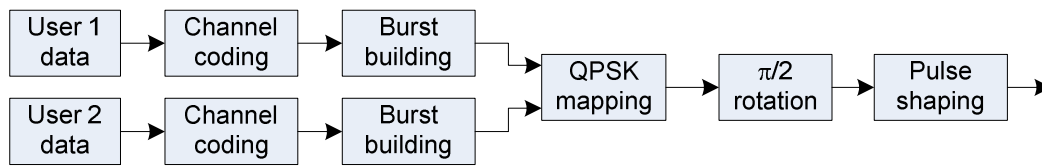

**Figure 7-25: Block diagram of MUROS TX by mapping two users on BB and transmitted as a QPSK modulated signal**

As described above legacy training sequence codes (TSC) are applied to the first MUROS sub channel to make it fully compatible with legacy MS. For the MUROS second sub channel, the orthogonal TSCs proposed in [7-2] are assumed. The pair TSC 0 is chosen from the combined TSC set for the simulations. DTX is not applied.

### 7.2.1.3.1.3 MUROS Interference Models

The four MUROS Test Scenarios (MTS1-4) specified in this TR and Adjacent Channel Interference (ACI) have been used for verifying the interference performance of a legacy non-DARP and legacy DARP MS receiving a MUROS sub channel.

For MTS modulation the GMSK and MUROS modulated interference agreed for MTS1-4 in this TR are included. For ACI both the GMSK and MUROS modulation have been used as well. Only lower band ACI (-200 kHz) is included since the effect of upper band ACI (+200 kHz) is similar.

In [7-11] it was shown that the performance of a legacy DARP MS receiving a MUROS sub channel is more or less independent of the interference modulation type as long as GMSK is not applied for the interferer modulation.

### 7.2.1.3.1.4 Other Simulation Parameter

The performance is presented for TCH/AFS 12.2, TCH/AFS 5.9 and AHS 5.9. A typical urban channel profile, terminal speed 3 km/h (TU3) and frequency hopping (FH) in the 900 MHz band have been used for the DL MUROS simulations. Typical MS impairments are included in the simulations.

### 7.2.1.3.2 Downlink Performance Results

The results in this section cover frame erasure rate (FER) as a function of  $C/I_1$  where  $C$  denotes the total power of the received MUROS signal (i.e. carrying 2 sub channels) and  $I_1$  denotes the power of the strongest co-channel interferer.

The presented performance is for the first MUROS sub channel containing the legacy TSC0. The performance of the second MUROS sub channel is not considered in this section, since changes are required to the MS receiver in order to cope with the orthogonal TSCs presented in [7-2]. However, when the two MUROS sub channels have equal power the performance of the second channel can be assumed to be on par with the first sub channel as noted in [7-12].

First the sensitivity performance is presented in subsection 7.2.1.3.2.1, and then the interference performance for the two synchronous scenarios MTS1+2 are presented in subsection 7.2.1.3.2.2 and 7.2.1.3.2.3 respectively. The performance for the two asynchronous scenarios MTS3+4 are presented in subsection 7.2.1.3.2.4 and 7.2.1.3.2.5 respectively. Finally the ACI performance is presented in subsection 7.2.1.3.2.6.

#### 7.2.1.3.2.1 Sensitivity Performance

The sensitivity performance of a legacy DARP MS receiving a MUROS sub channel is presented in Figure 7-26.

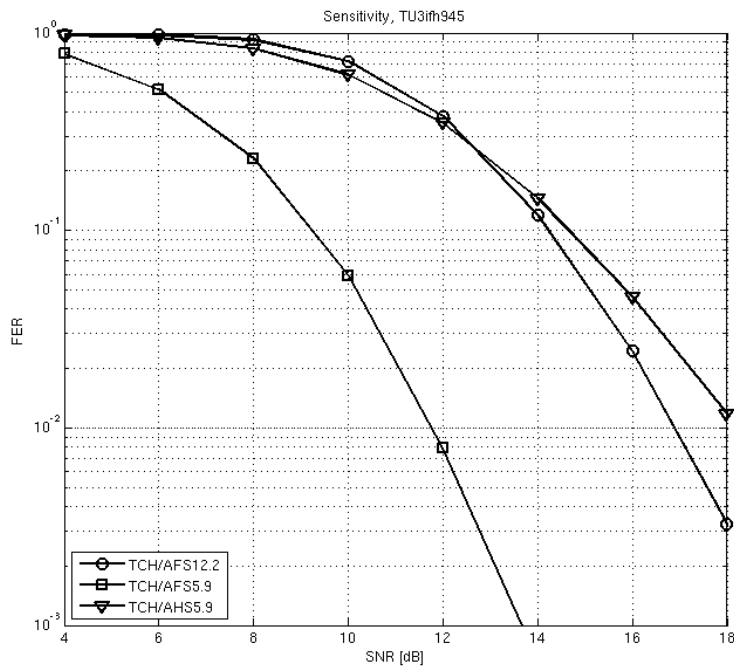

Figure 7-26: DL sensitivity performance of a legacy DARP MS receiving a MUROS sub channel

7.2.1.3.2.2 MTS-1 Performance

The performance of a legacy DARP MS and a legacy non-DARP MS receiving a MUROS sub channel when a single synchronous co-channel interferer is present are shown in Figure 7-27 and Figure 7-28 respectively for AMR half rate 5.9, AMR full rate 12.2 and AMR full rate 5.9.

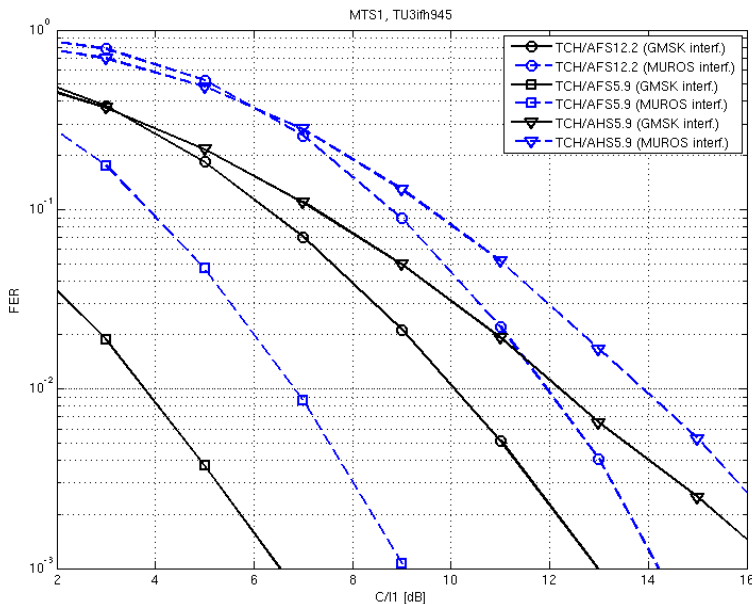

Figure 7-27:DL Co-channel interference performance (MTS1) of a legacy DARP MS receiving a MUROS sub channel using AMR half rate 5.9, AMR full rate 12.2 and AMR full rate 5.9



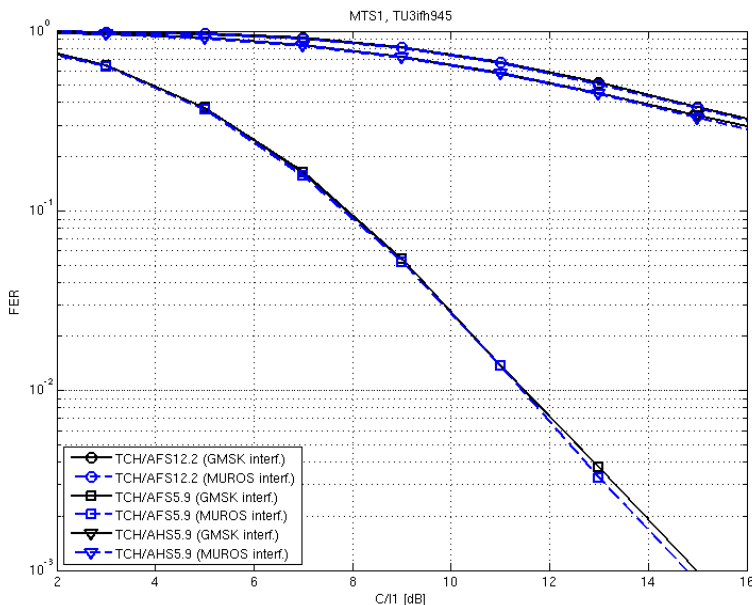

Figure 7-28: DL Co-channel interference performance (MTS1) of a legacy non-DARP MS receiving a MUROS sub channel using AMR half rate 5.9, AMR full rate 12.2 and AMR full rate 5.9

7.2.1.3.2.3 MTS-2 Performance

The performance of a legacy DARP MS and a legacy non-DARP MS receiving a MUROS sub channel when mixed synchronous interference is present are shown in Figure 7-29 and Figure 7-30 respectively for AMR half rate 5.9, AMR full rate 12.2 and AMR full rate 5.9.

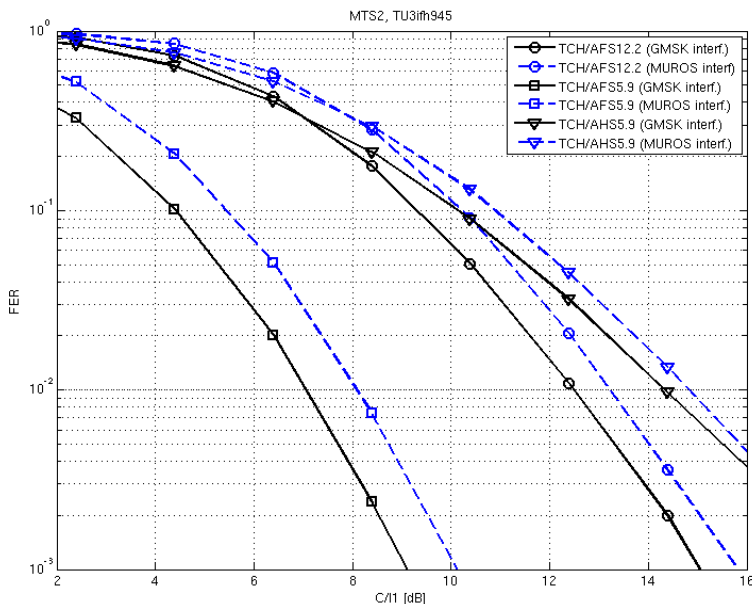

Figure 7-29: DL Mixed interference performance (MTS2) of a legacy DARP MS receiving a MUROS sub channel using AMR half rate 5.9, AMR full rate 12.2 and AMR full rate 5.9

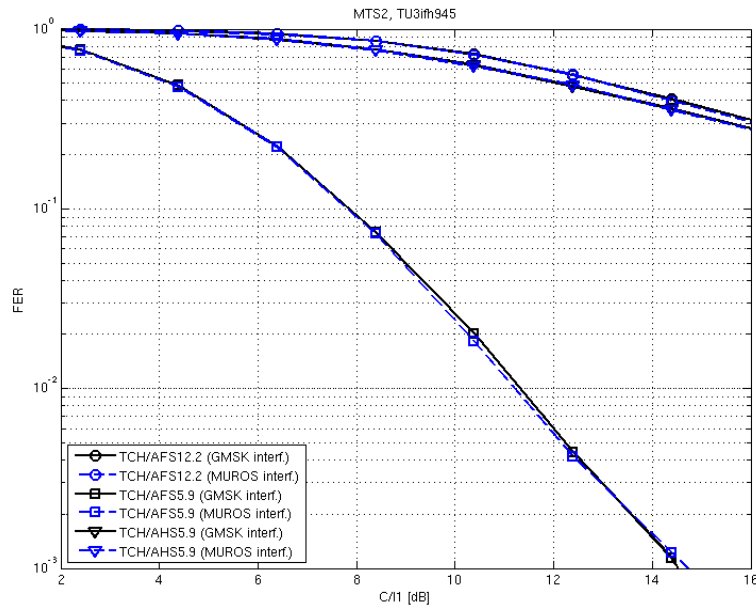

Figure 7-30: DL Mixed interference performance (MTS2) of a legacy non-DARP MS receiving a MUROS sub channel using AMR half rate 5.9, AMR full rate 12.2 and AMR full rate 5.9

7.2.1.3.2.4 MTS-3 Performance

The performance of a legacy DARP MS and a legacy non-DARP MS receiving a MUROS sub channel when a single asynchronous co-channel interference is present are shown in Figure 7-31 and Figure 7-32 respectively for AMR half rate 5.9, AMR full rate 12.2 and AMR full rate 5.9.

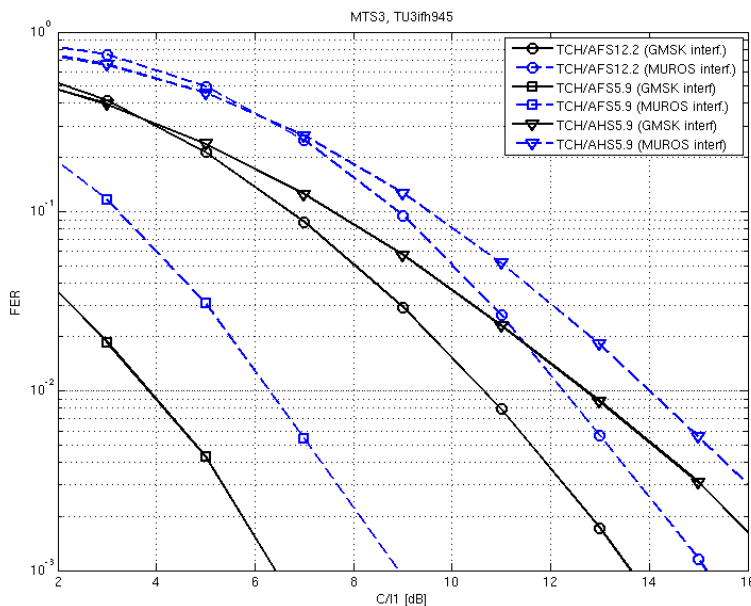

Figure 7-31: DL Asynchronous Co-channel interference performance (MTS3) of a legacy DARP MS receiving a MUROS sub channel using AMR half rate 5.9, AMR full rate 12.2 and AMR full rate 5.9

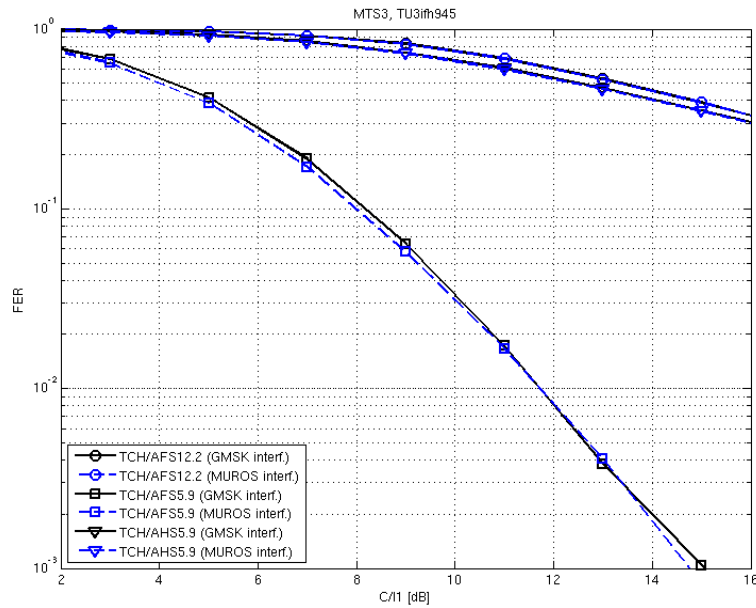

Figure 7-32: DL Asynchronous Co-channel interference performance (MTS3) of a non-legacy DARP MS receiving a MUROS sub channel using AMR half rate 5.9, AMR full rate 12.2 and AMR full rate 5.9

7.2.1.3.2.5 MTS-4 Performance

The performance of a legacy DARP MS and a legacy non-DARP MS receiving a MUROS sub channel when mixed synchronous and asynchronous interference are present are shown in Figure 7-33 and Figure 7-34 respectively for AMR half rate 5.9, AMR full rate 12.2 and AMR full rate 5.9.

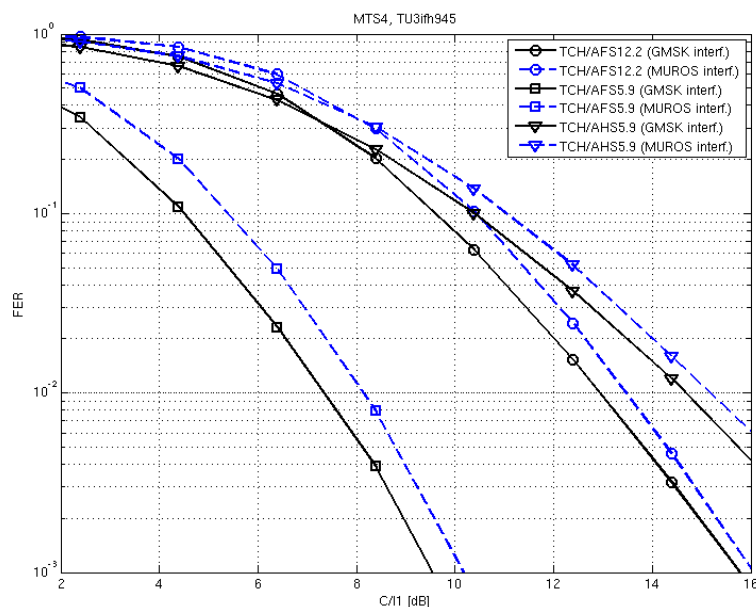

Figure 7-33: DL synchronous and asynchronous mixed interference performance (MTS4) of a legacy DARP MS receiving a MUROS sub channel using AMR half rate 5.9, AMR full rate 12.2 and AMR full rate 5.9

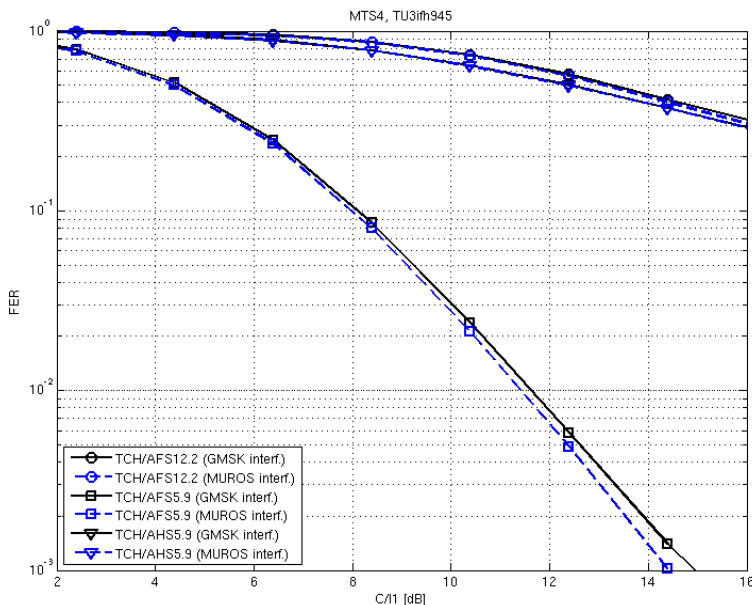

Figure 7-34: DL synchronous and asynchronous mixed interference performance (MTS4) of a legacy non-DARP MS receiving a MUROS sub channel using AMR half rate 5.9, AMR full rate 12.2 and AMR full rate 5.9

7.2.1.3.2.6 ACI Performance

The performance of a legacy DARP MS and a legacy non-DARP MS receiving a MUROS sub channel when lower band adjacent channel interference (-200 kHz) is present are shown in Figure 7-35 and in Figure 7-36 respectively for AMR half rate 5.9, AMR full rate 12.2 and AMR full rate 5.9. The 3GPP ACI performance requirements for the three AMR codecs are indicated in the figures as well by red marks for information.

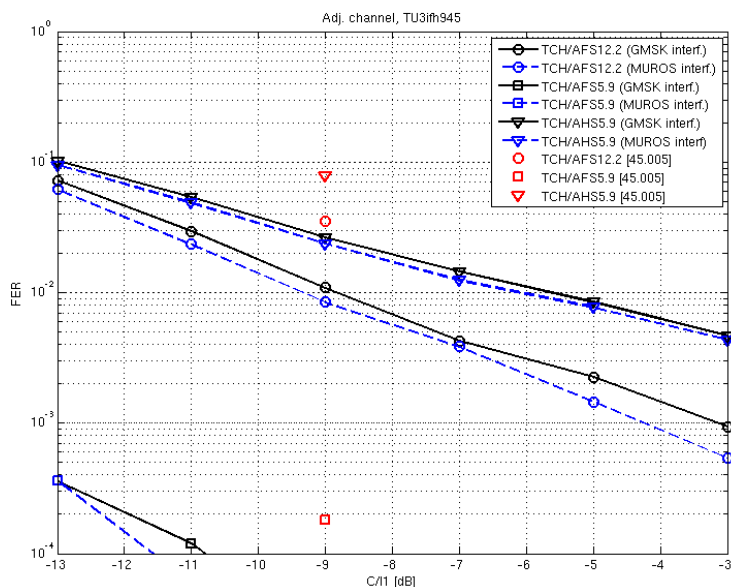
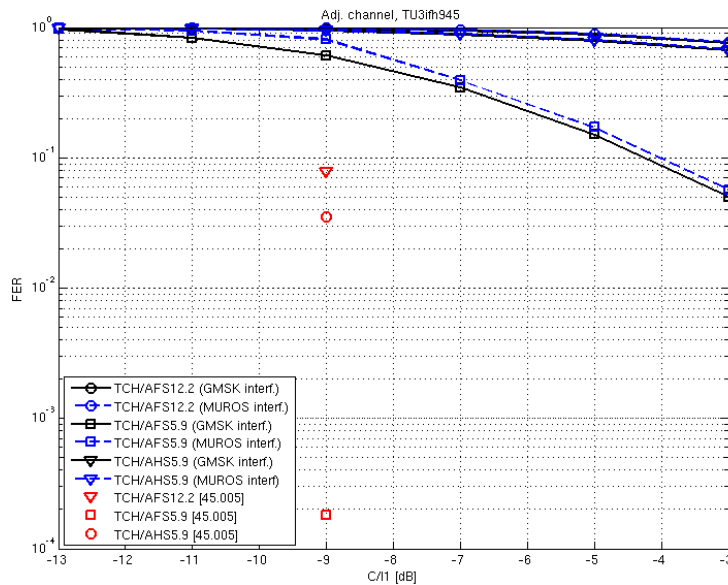

Figure 7-35: Adjacent channel interference performance (lower band) of a legacy DARP MS receiving a MUROS sub channel using AMR half rate 5.9, AMR full rate 12.2 and AMR full rate 5.9



**Figure 7-36: Adjacent channel interference performance (lower band) of a legacy non-DARP MS receiving a MUROS sub channel using AMR half rate 5.9, AMR full rate 12.2 and AMR full rate 5.9**

### 7.2.1.3.3 Summary of results

This section presented the sensitivity and interference performance of a legacy DARP MS and a legacy non-DARP MS receiving a MUROS sub channel. For the interference performances both the MTS1-4 interference scenarios and ACI scenario were used with the interferer modulation type being either: GMSK or MUROS.

As expected it was shown that legacy DARP MS are better to cope with a MUROS sub-channel than legacy non-DARP MS. Furthermore it can be observed that a power balancing between the two MUROS sub-channels are desirable in order to achieve the full benefit of MUROS.

## 7.2.2 Network Level Performance

### 7.2.2.1 Network Configurations

In order to evaluate the system impact of OSC, network simulations for the agreed MUROS network configurations were carried out. Studied network configurations are shown in Table 7-15 and the used channel modes and mode channel adaptation types in Table 7-16. Adaptation between OSC and non-OSC channel was based both on load and quality measurements. DL receiver type was DARP Phase 1. The employed BTS antenna type had a 65° horizontal half power beamwidth [7-8].

**Table 7-15: Studied network configurations**

Parameter	MUROS-1	MUROS-2	MUROS-3 a)	MUROS-3 b)
Frequency band (MHz)	900	900	1800	1800
Cell radius	500 m	500 m	500 m	500 m
Bandwidth	4.4 MHz	11.6 MHz	2.6 MHz	2.6 MHz
Guard band	0.2 MHz	0.2 MHz	0.2 MHz	0.2 MHz
# channels excluding guard band	21	57	12	12
# TRX	4	6	4	4
BCCH frequency reuse	4/12	4/12	N.A.	N.A.
TCH frequency reuse	1/1	3/9	1/3	1/1
Frequency Hopping	Synthesized	Baseband	Synthesized	Synthesized
Length of MA (# FH frequencies)	9	5	4	4
Fast fading type	TU	TU	TU	TU
BCCH or TCH under interest	Both	Both	TCH	TCH
Network sync mode	sync	sync	sync	sync

**Table 7-16: Studied channel modes and channel adaptation types**

Channel Mode Adaptation	Channel modes
Type A0	GSM HR
Type A1	GSM HR <-> OSC HR
Type B0	AFS 12.2
Type B1	AFS 12.2 <-> OSC AFS 12.2
Type C0	AFS 5.9
Type C1	AFS 5.9 <-> OSC AFS 5.9
Type D0	AHS 5.9
Type D1	AHS 5.9 <-> OSC AHS 5.9

Basic OSC employing the QPSK constellation in DL, as described above in this section 7.1.2.1 above, was simulated if not otherwise stated. Adaptation between OSC and non-OSC channel was based both on load and quality measurements. According to the defined mix of mobiles in section 5.3 the DL receiver type was either legacy non-DARP Phase I, legacy DARP Phase I or DARP Phase I updated with the knowledge of the new TSC set ("OSC aware MS") as depicted in the concept description above. Legacy non-DARP Phase I mobiles were not assigned to an OSC subchannel, whilst both other types were assigned.

It is noted that no model for TSC degradation was incorporated, i.e. it has been assumed that always a well suited pair of TSC's is available. Link to system mapping based on CIR and DIR has been used. CIR and DIR are determined taking into account each interferer in adjacent and co-channel frequencies where each interference value is multiplied by one protection value that varies depending on which pulse shape is being used by the interferer, on the receiver type and on whether the interference is received in co-channel or adjacent channel.

### 7.2.2.2 Performance results

System performance results in terms of blocking and DL TCH FER are presented in this section. The following criteria for definition of minimum call quality performance were used:

- blocked calls < 2 %
- call average TCH FER:
  - channels using full rate coding < 2% for at least 95% of the users
  - channels using half rate coding < 3% for at least 95% of the users

In this section the performance evaluation is depicted for applying LGMSK TX pulse shape in DL, if both subchannels are active. Results are compared for penetration of 100 % OSC aware MS either applying the legacy single user channel mode or the MUROS channel mode.

System performance optimisation to fully support the OSC concept including refinements of all RRM procedures, such as Channel Allocation, and AMR Channel Mode Adaptation, has been undertaken.

## 7.2.2.2.1 MUROS-1

MUROS-1 capacity numbers are presented in Table 7-17. A0 (=GSM HR), B0 (=AFS 12.2), C0 (= AFS 5.9) and D0 (= AFS 5.9) were blocking limited, whereas all the other cases were quality limited.

Table 7-17: MUROS-1 performance results

Type	Description	Spectral Efficiency [Users/MHz/site]	Hardware Efficiency [Users/TRX]	EFL [%]	Limiting factor
A0	HR	36.11	12.64	30.10	Blocked calls
A1	MUROS HR	44.79	15.68	37.33	Bad quality calls (3%)
B0	AFS 12.2	15.46	5.41	12.89	Blocked calls
B1	MUROS AFS 12.2	17.31	6.06	14.42	Bad quality calls (2%)
C0	AFS 5.9	15.4	5.39	12.83	Blocked calls
C1	MUROS AFS 5.9	26.18	9.16	21.82	Bad quality calls (2%)
D0	AHS 5.9	36.13	12.65	30.11	Blocked Calls
D1	MUROS AHS 5.9	36.21	12.67	30.17	Bad quality calls (3%)

## 7.2.2.2.2 MUROS-2

MUROS-2 capacity results are shown in Table 7-18. In this loose frequency reuse case (BCCH 4/12 and TCH 3/9) A1, B1 and D1 were quality limited and all the other cases were blocking limited.

Table 7-18: MUROS-2 performance results

Type	Description	Spectral Efficiency [Users/MHz/site]	Hardware Efficiency [Users/TRX]	EFL [%]	Limiting factor
A0	HR	21.16	13.40	17.63	Blocked calls
A1	MUROS HR	37.71	23.88	31.42	Bad quality calls (3%)
B0	AFS 12.2	9.64	6.11	8.03	Blocked calls
B1	MUROS AFS 12.2	12.67	8.02	8.90	Bad quality calls (2%)
C0	AFS 5.9	9.66	6.12	8.05	Blocked calls
C1	MUROS AFS 5.9	20.74	13.13	17.28	Blocked calls
D0	AHS 5.9	21.14	13.39	17.62	Blocked calls
D1	MUROS AHS 5.9	24.50	15.52	20.42	Bad quality calls (3%)

## 7.2.2.2.3 MUROS-3

Capacity results for MUROS-3 are shown in Table 7-19 and Table 7-20. Most of the cases where quality limited in this tight frequency reuse network (TCH reuse 1/3 for MUROS-3 a) or 1/1 for MUROS-3 b), respectively).

Table 7-19: MUROS-3 a) performance results

Type	Description	Spectral Efficiency [Users/MHz/site]	Hardware Efficiency [Users/TRX]	EFL [%]	Limiting factor
A0	HR	73.54	14.71	61.28	Blocked calls
A1	MUROS HR	59.28	12.84	73.36	Bad quality calls (3%)
B0	AFS 12.2	32.86	6.57	27.38	Blocked calls
B1	MUROS AFS 12.2	34.80	6.96	29.00	Bad quality calls (2%)
C0	AFS 5.9	32.85	6.57	37.38	Blocked calls
C1	MUROS AFS 5.9	41.72	8.34	34.77	Bad quality calls (2%)
D0	AHS 5.9	73.01	14.60	60.84	Blocked calls
D1	MUROS AHS 5.9	72.19	14.44	60.16	Bad quality calls (3%)

Table 7-20: MUROS-3 b) performance results

Type	Description	Spectral Efficiency [Users/MHz/site]	Hardware Efficiency [Users/TRX]	EFL [%]	Limiting factor
A0	HR	73.13	14.63	60.94	Blocked calls
A1	MUROS HR	91.93	18.39	76.61	Bad quality calls (3%)
B0	AFS 12.2	32.76	6.55	27.30	Blocked calls
B1	MUROS AFS 12.2	37.92	7.58	31.60	Bad quality calls (2%)
C0	AFS 5.9	32.88	6.58	27.40	Blocked calls
C1	MUROS AFS 5.9	51.10	10.22	42.58	Bad quality calls (2%)
D0	AHS 5.9	72.97	14.59	60.81	Blocked calls
D1	MUROS AHS 5.9	77.67	15.53	64.73	Bad quality calls (3%)

#### 7.2.2.2.4 OSC capacity gains and HW efficiency

Table 7-21 shows the resulting system capacity gains for all MUROS configurations and all channel mode adaptation types as depicted in section 7.2.2.2.3 . Results show very good capacity gains for OSC in MUROS-2 configuration with the mean gain of 55 % for MUROS-2. In the tight reuse cases (MUROS-1 and MUROS-3) OSC provides remarkable gains between 27 % and 70 % for AFS 5.9 codec, still considerable gains between 20 % and 26 % for GSM HR, whilst moderate gains around 10 % are achieved for AFS 12.2 and almost no gains AHS 5.9 for these network configurations.

Table 7-21: Summary of OSC network level capacity gains for LGMSK pulse shape in DL

CMA Type	MUROS-1	MUROS-2	MUROS-3 a)	MUROS-3 b)
<b>A</b>	24 %	78 %	20 %	26 %
<b>B</b>	12 %	11 %	6 %	16 %
<b>C</b>	70 %	115 %	27 %	55 %
<b>D</b>	0 %	16 %	-1 %	6 %

HW efficiency results are shown in Figure 7-37.

Whilst for MUROS-2 all channel mode adaptation types benefit in terms of HW efficiency between 11% and 114%, and for MUROS 3b) likewise between 6 % and 55 %, HW efficiency can only be improved for channel mode adaptation type C (AFS 5.9) throughout all network configurations varying between 70% (MUROS-1), 115% (MUROS-2), 27% (MUROS-3a) and 55% (MUROS-3b)).



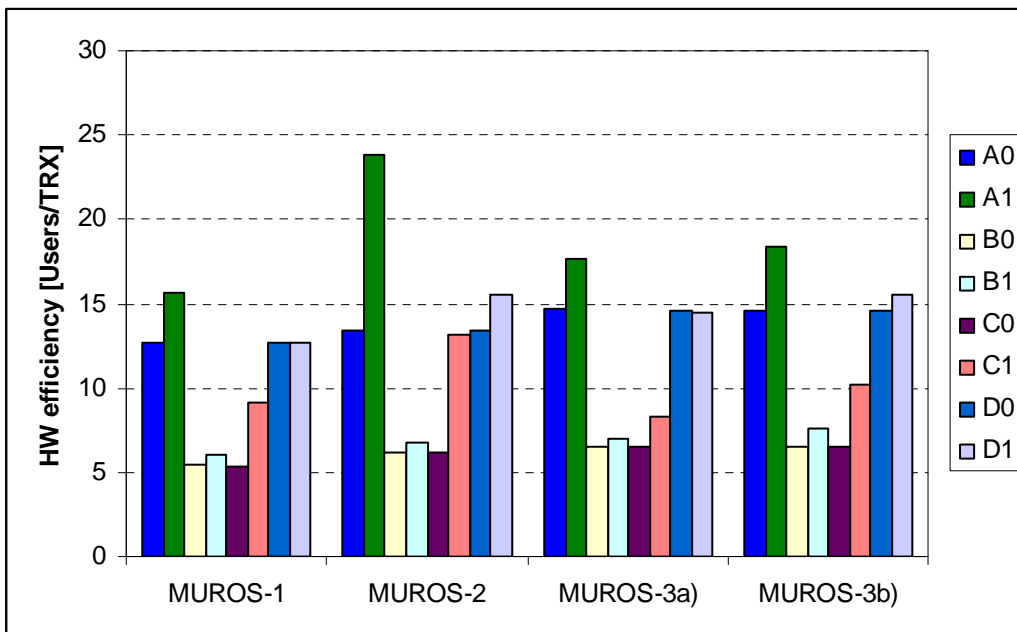

Figure 7-37: HW efficiency for OSC with LGMSK pulse shape in DL for agreed MUROS network configurations

7.2.2.2.5 Performance of optimized user diversity

Performance was investigated for the proposed optimized user diversity half rate patterns 1, 2 and 3 for network configuration MUROS-1 and channel mode adaptation type D1, i.e. usage of AHS 5.9 codec in legacy channel type and in MUROS channel type. Performance was investigated for different percentages of new OSC aware mobiles (25%, 50%, 75% and 100%). Performance results are depicted in Figure 7-38 and in Table 7-22 below.

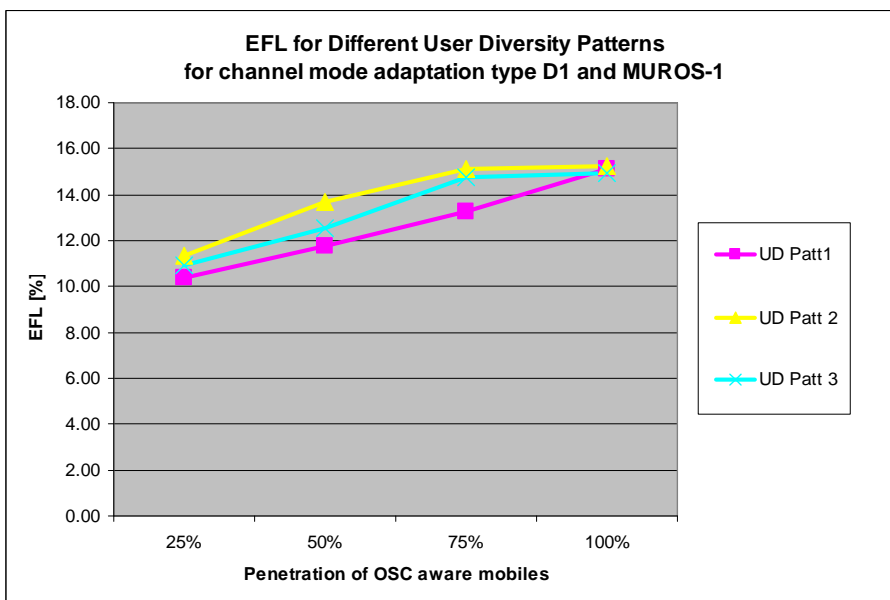

Figure 7-38: EFL for MUROS-1, channel mode adaptation type D1 and different user diversity patterns

**Table 7-22: EFL for MUROS-1, channel mode adaptation type D1, different user diversity patterns and different penetration of OSC aware mobiles**

Type	25%	50%	75%	100%
UD Patt 1	10.41	11.78	13.23	15.11
UD Patt 2	11.35	13.65	15.09	15.23
UD Patt 3	10.89	12.52	14.75	14.91

It has to be noted that only a mix of legacy DARP phase 1 and new OSC aware mobiles was investigated here. We observe that user diversity pattern 2 reveals the best performance, distributing the interference diversity best among different users. Since the signalling channels were not included in the evaluation, user diversity pattern 3 always performs worse than user diversity pattern 2 due to lower interference diversity for TCH. For network configuration MUROS-1 gains of 16% and 14% compared against user diversity pattern 1 (no user diversity) were largest for penetration rates of 50% and 75% of OSC aware mobiles. Gain for 25% penetration was about 9% and only a gain of 1% was evaluated for 100% penetration case. Hence this analysis indicates that optimized user diversity reveals benefits for a mix of different mobile receiver types in the network.

#### 7.2.2.2.6 Performance applying Sub Channel Specific Power Control for OSC

Text from [7-13] is included in this subsection. In [7-14] the sub channel specific power control method for OSC depicted in section 7.1.2.2.1 was proposed. The following configurations depicted in Table 7-22a were evaluated.

**Table 7-22a Simulation Assumptions**

Parameter	Setting A	Setting B
Codec	AFS 5.9 (channel mode type C)	AHS 5.9 (channel mode type D)
Network Configuration	MUROS-2	MUROS-2
Mix of Mobiles	- 35 % non-DARP phase 1 - 15 % DARP phase 1 - 50 % OSC aware	- 35 % non-DARP phase 1 - 15 % DARP phase 1 - 50 % OSC aware
Channel Mode Adaptation	deactivated	deactivated
Subchannel Specific Power Control	activated	activated

Note an OSC aware mobile in this context refers to a mobile that is capable to operate a new TSC. No joint detection capabilities based on the knowledge of the TSC used in the paired sub channel has been assumed for this MS type. The OSC aware MS has got the same receiver filter than the DARP phase I mobile.

Note, in this investigation the multiplexing of legacy DARP phase I mobiles, being assigned the weaker subchannel, with legacy non-DARP mobiles, being assigned the stronger subchannel, on an OSC channel has been assumed. Therefore the results in Table 7-xx cannot directly be compared against those given in Table 7-18.

Table 7-22b below summarizes the observed gains.

**Table 7-22b Observed Capacity Gains due to Subchannel Specific Power Control**

From these results, based on the defined mix of mobiles, it can be seen that subchannel specific power control is able to

Type	EFL [%]	Gains [%]	Limiting Factor
<b>Setting A</b>			
C0	8.13	0	Blocked calls
C1	14.37	76.74	Bad quality calls (2%)
C1 and Sub Channel Specific PC	15.66	92.56	Bad quality calls (2%)
<b>Setting B</b>			
D0	17.38	0	Blocked calls
D1	18.85	8.48	Bad quality calls (3%)
D1 and Sub Channel Specific PC	20.02	15.20	Bad quality calls (3%)

increase further network capacity gains due to OSC in the order of 7% to 16% for MUROS-2. Therefore it is considered to be a viable solution for typical MUROS scenarios as well as for scenarios with a high percentage of legacy users.

#### 7.2.2.2.7 Performance for Usage of Optimized TX Pulse Shape in Downlink

Text from [7-15] is included in this sub-clause.

##### 7.2.2.2.7.1 Setup for System Performance Evaluation

Studied network configurations are MUROS-1, MUROS-2, MUROS-3a) and MUROS-3b) as shown in Table 7-15. The investigation includes analysis of the performance of full rate channel types, i.e. channel mode adaptation type B (AFS 12.2) and channel mode adaptation type C (AFS 5.9) as well as half rate channel types, i.e. channel mode adaptation type A (GSM HR) and channel mode adaptation type D (AHS 5.9), depicted in Table 7-16. Different mix of mobiles as defined in Table 5-1 have been evaluated.

System performance was investigated in case of adoption of different transmit pulse shapes than the legacy linearized GMSK (LGMSK) pulse shape in DL. Two candidates “OPT 1” and “OPT 2” for an optimized TX pulse shape have been considered in the evaluation described in the concept description above. The utilization of the optimized transmit pulse shape has been assumed merely if both users are active in both sub channels. In case of

- a) non-OSC channels or
- b) if only one user is temporarily active in an OSC channel (i.e. paired user has terminated the call or is in DTX mode),

the legacy GMSK pulse shape was employed in DL. On UL the legacy GMSK pulse shape was always in use. Adaptation between OSC and non-OSC channel was based both on load and quality measurements.

MS receiver type was either legacy DARP phase I or DARP Phase I updated with the knowledge of the new TSC set (named “OSC aware MS”). For both types of MS receivers a receiver front-end filter with a 3-dB bandwidth larger than 240 kHz was assumed, which was used both in case of a non-OSC channel and in case of an OSC channel (MUROS mode). For comparison purposes the legacy “LGMSK” pulse shape has been evaluated as well.

##### 7.2.2.2.7.2 System Performance Results

System performance results in terms of blocking and DL TCH FER are presented in this section. Spectral efficiency, HW efficiency and EFL are provided for each network configuration and for each channel mode type.

###### 7.2.2.2.7.2.1 MUROS-1

The EFL is given for the different mix of mobiles in Figures 7-38A1 to 7-38A4 below. MUROS-1 capacity numbers are presented in Table 7-23a to 7-23d thereafter.

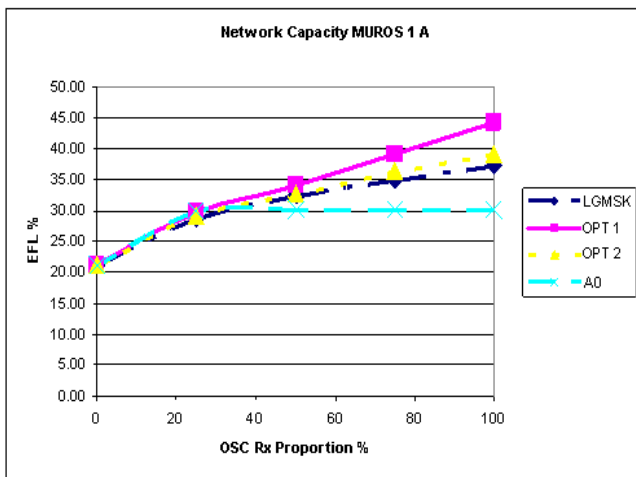

Figure 7-38A1: EFL for investigated TX pulse shapes (MUROS-1, Channel type A) and different penetrations for OSC aware MS.

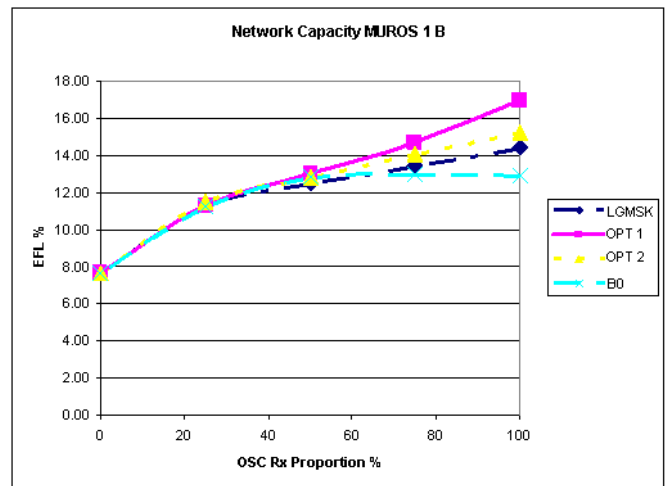

Figure 7-38A2: EFL for investigated TX pulse shapes (MUROS-1, Channel type B) and different penetrations for OSC aware MS.

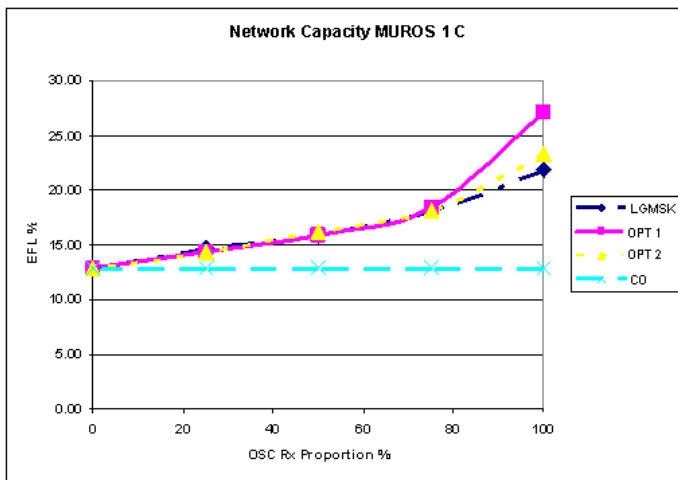

Figure 7-38A3: EFL for investigated TX pulse shapes (MUROS-1, Channel type C) and different penetrations for OSC aware MS.

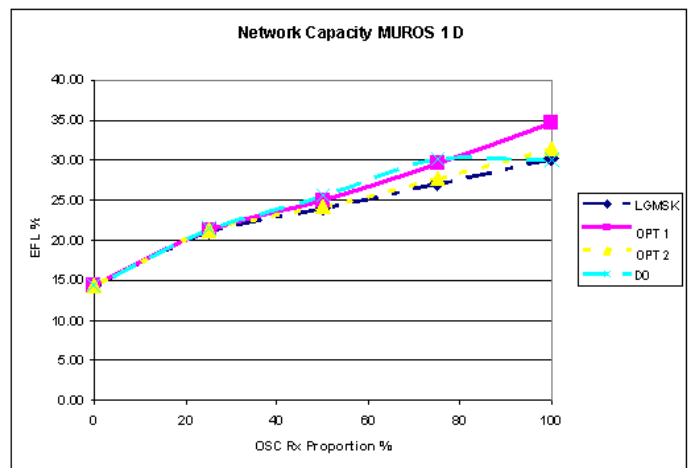

Figure 7-38A4: EFL for investigated TX pulse shapes (MUROS-1, Channel type D) and different penetrations for OSC aware MS.

Table 7-23a MUROS-1 performance results (Channel Type A).

Channel mode type	Channel mode adaptation	OSC Rx proportion	DARP	non-DARP	Wide pulse	Spectral Efficiency [Erl/MHz/site]	Hardware Efficiency [Erl/TRX]	EFL %	OSC Gain %	Limiting Factor
A0	OFF	100	0	0	GMSK	36.11	12.64	30.10	-	Blocked Calls
A1	ON	100	0	0	OPT 1	53.15	18.60	44.29	47%	Bad Quality Calls (3%)
A1	ON	100	0	0	OPT 2	47.07	16.47	39.22	30%	Bad Quality Calls (3%)
A1	ON	100	0	0	LGMSK	44.79	15.68	37.33	24%	Bad Quality Calls (3%)
A0	OFF	75	7.5	17.5	GMSK	36.26	12.69	30.22	-	Blocked Calls
A1	ON	75	7.5	17.5	OPT 1	47.10	16.48	39.25	30%	Bad Quality Calls (3%)
A1	ON	75	7.5	17.5	OPT 2	43.67	15.28	36.39	20%	Bad Quality Calls (3%)
A1	ON	75	7.5	17.5	LGMSK	42.00	14.70	35.00	16%	Bad Quality Calls (3%)
A0	OFF	50	15	35	GMSK	36.22	12.68	30.18	-	Blocked Calls
A1	ON	50	15	35	OPT 1	40.83	14.29	34.02	13%	Bad Quality Calls (3%)
A1	ON	50	15	35	OPT 2	39.40	13.79	32.83	9%	Bad Quality Calls (3%)
A1	ON	50	15	35	LGMSK	38.85	13.60	32.37	7%	Bad Quality Calls (3%)
A0	OFF	25	22.5	52.5	GMSK	35.84	12.54	29.87	-	Bad Quality Calls (3%)
A1	ON	25	22.5	52.5	OPT 1	35.78	12.52	29.82	0%	Bad Quality Calls (3%)
A1	ON	25	22.5	52.5	OPT 2	34.99	12.25	29.16	-2%	Bad Quality Calls (3%)
A1	ON	25	22.5	52.5	LGMSK	34.49	12.07	28.75	-4%	Bad Quality Calls (3%)
A1	ON	0	30	70	LGMSK	25.43	8.90	21.19	-	Bad Quality Calls (3%)

**Table 7-23b MUROS-1 performance results (Channel Type B).**

Channel mode type	Channel mode adaptation	OSC Rx proportion	DARP	non-DARP	Wide pulse	Spectral Efficiency [Erl/MHz/site]	Hardware Efficiency [Erl/TRX]	EFL %	OSC Gain %	Limiting Factor
B0	OFF	100	0	0	GMSK	15.46	5.41	12.89	-	Blocked Calls
B1	ON	100	0	0	OPT 1	20.38	7.13	16.98	32%	Bad Quality Calls (2%)
B1	ON	100	0	0	OPT 2	18.25	6.39	15.21	18%	Bad Quality Calls (2%)
B1	ON	100	0	0	LGMSK	17.31	6.06	14.42	12%	Bad Quality Calls (2%)
B0	OFF	75	7.5	17.5	GMSK	15.57	5.45	12.98	-	Blocked Calls
B1	ON	75	7.5	17.5	OPT 1	17.64	6.18	14.70	13%	Bad Quality Calls (2%)
B1	ON	75	7.5	17.5	OPT 2	16.90	5.92	14.09	9%	Bad Quality Calls (2%)
B1	ON	75	7.5	17.5	LGMSK	16.16	5.66	13.47	4%	Bad Quality Calls (2%)
B0	OFF	50	15	35	GMSK	15.42	5.40	12.85	-	Blocked Calls
B1	ON	50	15	35	OPT 1	15.64	5.47	13.03	1%	Bad Quality Calls (2%)
B1	ON	50	15	35	OPT 2	15.37	5.38	12.81	0%	Bad Quality Calls (2%)
B1	ON	50	15	35	LGMSK	14.97	5.24	12.47	-3%	Bad Quality Calls (2%)
B0	OFF	25	22.5	52.5	GMSK	13.45	4.71	11.21	-	Bad Quality Calls (2%)
B1	ON	25	22.5	52.5	OPT 1	13.59	4.76	11.32	1%	Bad Quality Calls (2%)
B1	ON	25	22.5	52.5	OPT 2	13.83	4.84	11.52	3%	Bad Quality Calls (2%)
B1	ON	25	22.5	52.5	LGMSK	13.55	4.74	11.29	1%	Bad Quality Calls (2%)
B1	ON	0	30	70	LGMSK	9.16	3.21	7.64	-	Bad Quality Calls (2%)

**Table 7-23c MUROS-1 performance results (Channel Type C).**

Channel mode type	Channel mode adaptation	OSC Rx proportion	DARP	non-DARP	Wide pulse	Spectral Efficiency [Erl/MHz/site]	Hardware Efficiency [Erl/TRX]	EFL %	OSC Gain %	Limiting Factor
C0	OFF	100	0	0	GMSK	15.40	5.39	12.83	-	Blocked Calls
C1	ON	100	0	0	OPT 1	32.55	11.39	27.13	111%	Bad Quality Calls (2%)
C1	ON	100	0	0	OPT 2	27.96	9.79	23.30	82%	Bad Quality Calls (2%)
C1	ON	100	0	0	LGMSK	26.18	9.16	21.82	70%	Bad Quality Calls (2%)
C0	OFF	75	7.5	17.5	GMSK	15.48	5.42	12.90	-	Blocked Calls
C1	ON	75	7.5	17.5	OPT 1	22.05	7.72	18.37	42%	Blocked Calls
C1	ON	75	7.5	17.5	OPT 2	21.86	7.65	18.22	41%	Blocked Calls
C1	ON	75	7.5	17.5	LGMSK	21.74	7.61	18.12	40%	Blocked Calls
C0	OFF	50	15	35	GMSK	15.51	5.43	12.92	-	Blocked Calls
C1	ON	50	15	35	OPT 1	18.99	6.65	15.82	22%	Blocked Calls
C1	ON	50	15	35	OPT 2	19.39	6.79	16.16	25%	Blocked Calls
C1	ON	50	15	35	LGMSK	19.05	6.67	15.87	23%	Blocked Calls
C0	OFF	25	22.5	52.5	GMSK	15.39	5.38	12.82	-	Blocked Calls
C1	ON	25	22.5	52.5	OPT 1	17.28	6.05	14.40	12%	Blocked Calls
C1	ON	25	22.5	52.5	OPT 2	17.18	6.01	14.32	12%	Blocked Calls
C1	ON	25	22.5	52.5	LGMSK	17.64	6.17	14.70	15%	Blocked Calls
C1	ON	0	30	70	LGMSK	15.47	5.42	12.90	-	Blocked Calls

**Table 7-23d MUROS-1 performance results (Channel Type D).**

Channel mode type	Channel mode adaptation	OSC Rx proportion	DARP	non-DARP	Wide pulse	Spectral Efficiency [Erl/MHz/site]	Hardware Efficiency [Erl/TRX]	EFL %	OSC Gain %	Limiting Factor
D0	OFF	100	0	0	GMSK	36.13	12.65	30.11	-	Blocked Calls
D1	ON	100	0	0	OPT 1	41.65	14.58	34.71	15%	Bad Quality Calls (3%)
D1	ON	100	0	0	OPT 2	37.78	13.22	31.48	5%	Bad Quality Calls (3%)
D1	ON	100	0	0	LGMSK	36.21	12.67	30.17	0%	Bad Quality Calls (3%)
D0	OFF	75	7.5	17.5	GMSK	36.15	12.65	30.12	-	Blocked Calls
D1	ON	75	7.5	17.5	OPT 1	35.42	12.40	29.52	-2%	Bad Quality Calls (3%)
D1	ON	75	7.5	17.5	OPT 2	33.30	11.66	27.75	-8%	Bad Quality Calls (3%)
D1	ON	75	7.5	17.5	LGMSK	32.50	11.38	27.08	-10%	Bad Quality Calls (3%)
D0	OFF	50	15	35	GMSK	30.63	10.72	25.52	-	Bad Quality Calls (3%)
D1	ON	50	15	35	OPT 1	30.02	10.51	25.01	-2%	Bad Quality Calls (3%)
D1	ON	50	15	35	OPT 2	29.09	10.18	24.24	-5%	Bad Quality Calls (3%)
D1	ON	50	15	35	LGMSK	28.84	10.09	24.03	-6%	Bad Quality Calls (3%)
D0	OFF	25	22.5	52.5	GMSK	25.73	9.01	21.44	-	Bad Quality Calls (3%)
D1	ON	25	22.5	52.5	OPT 1	25.47	8.92	21.23	-1%	Bad Quality Calls (3%)
D1	ON	25	22.5	52.5	OPT 2	25.49	8.92	21.24	-1%	Bad Quality Calls (3%)
D1	ON	25	22.5	52.5	LGMSK	25.43	8.90	21.19	-1%	Bad Quality Calls (3%)
D1	ON	0	30	70	LGMSK	17.36	6.08	14.47	-	Bad Quality Calls (3%)

7.2.2.2.7.2.2 MUROS-2

The EFL is given for the different mix of mobiles in Figures 7-38B1 to 7-38B4 below. MUROS-2 capacity numbers are presented in Table 7-24a to 7-24d thereafter.

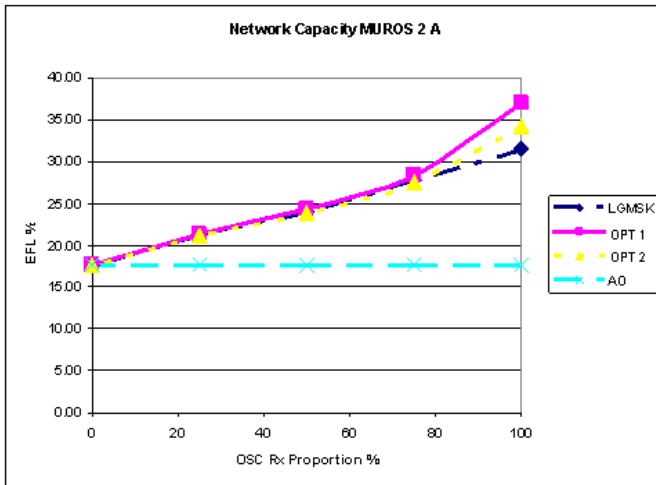

Figure 7-39B1: EFL for investigated TX pulse shapes (MUROS-2, Channel type A) and different penetrations for OSC aware MS

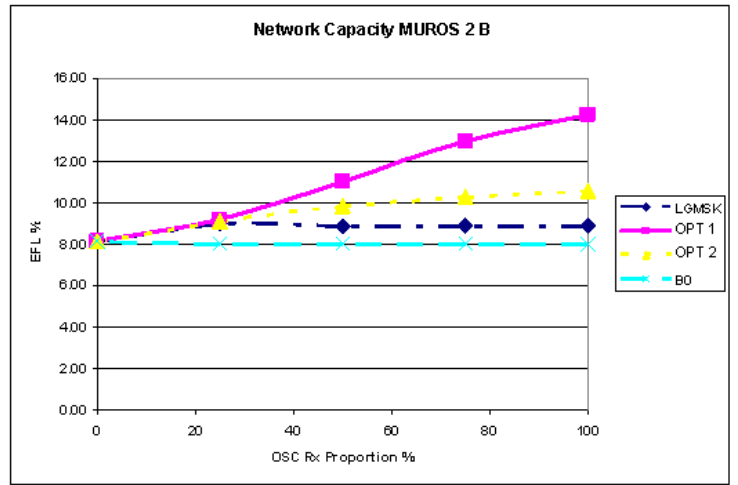

Figure 7-38B2: EFL for investigated TX pulse shapes (MUROS-2, Channel type B) and different penetrations for OSC aware MS.

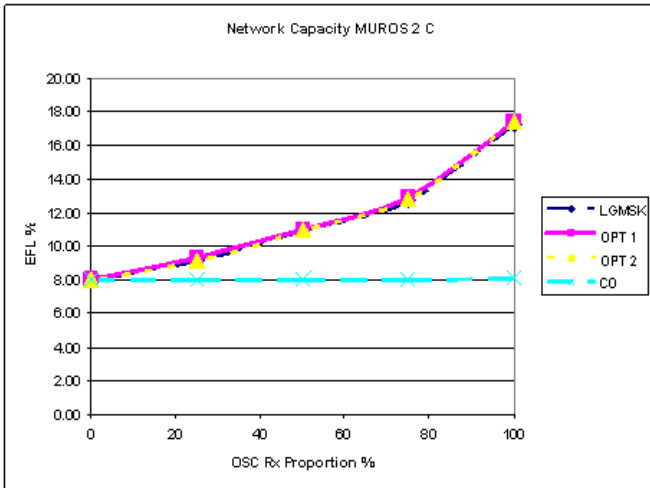

Figure 7-38B3: EFL for investigated TX pulse shapes (MUROS-2, Channel type C) and different penetrations for OSC aware MS.

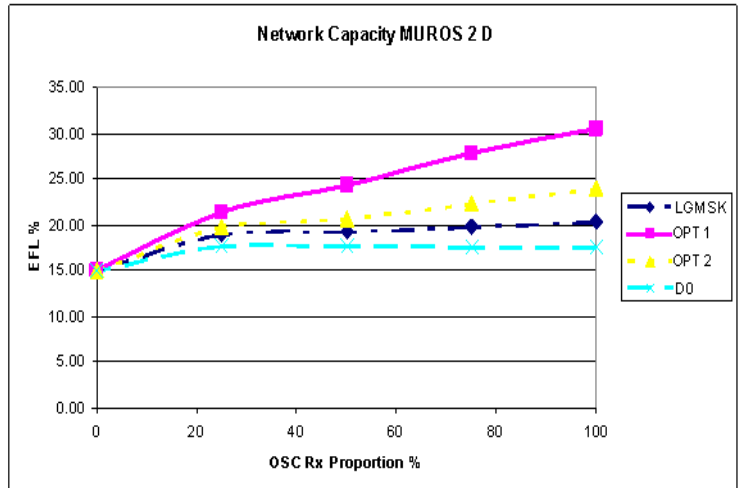

Figure 7-38B4: EFL for investigated TX pulse shapes (MUROS-2, Channel type D) and different penetrations for OSC aware MS.

**Table 7-24a MUROS-2 performance results (Channel Type A).**

Channel mode type	Channel mode adaptation	OSC Rx proportion	DARP	non-DARP	Wide pulse	Spectral Efficiency [Erl/MHz/site]	Hardware Efficiency [Erl/TRX]	EFL %	OSC Gain %	Limiting Factor
A0	OFF	100	0	0	GMSK	21.16	13.40	17.63	-	Blocked Calls
A1	ON	100	0	0	OPT 1	44.31	28.06	36.92	109%	Blocked Calls
A1	ON	100	0	0	LGMSK	37.71	23.88	31.42	78%	Bad Quality Calls (3%)
A1	ON	100	0	0	OPT 2	41.14	26.06	34.29	94%	Bad Quality Calls (3%)
A0	OFF	75	7.5	17.5	GMSK	21.23	13.44	17.69	-	Blocked Calls
A1	ON	75	7.5	17.5	OPT 1	33.93	21.49	28.27	60%	Blocked Calls
A1	ON	75	7.5	17.5	OPT 2	33.36	21.13	27.80	57%	Blocked Calls
A1	ON	75	7.5	17.5	LGMSK	33.07	20.95	27.56	56%	Blocked Calls
A0	OFF	50	15	35	GMSK	21.12	13.38	17.60	-	Blocked Calls
A1	ON	50	15	35	OPT 1	29.12	18.44	24.27	38%	Blocked Calls
A1	ON	50	15	35	OPT 2	28.88	18.29	24.07	37%	Blocked Calls
A1	ON	50	15	35	LGMSK	28.65	18.15	23.88	36%	Blocked Calls
A0	OFF	25	22.5	52.5	GMSK	21.16	13.40	17.63	-	Blocked Calls
A1	ON	25	22.5	52.5	OPT 1	25.52	16.16	21.26	21%	Blocked Calls
A1	ON	25	22.5	52.5	OPT 2	25.46	16.13	21.22	20%	Blocked Calls
A1	ON	25	22.5	52.5	LGMSK	25.40	16.09	21.17	20%	Blocked Calls
A1	ON	0	30	70	GMSK	21.08	13.35	17.57	-	Blocked Calls

**Table 7-24b MUROS-2 performance results (Channel Type B).**

Channel mode type	Channel mode adaptation	OSC Rx proportion	DARP	non-DARP	Wide pulse	Spectral Efficiency [Erl/MHz/site]	Hardware Efficiency [Erl/TRX]	EFL %	OSC Gain %	Limiting Factor
B0	OFF	100	0	0	GMSK	9.64	6.11	8.03	-	Blocked Calls
B1	ON	100	0	0	OPT 1	17.09	10.82	14.24	77%	Bad Quality Calls (2%)
B1	ON	100	0	0	LGMSK	10.69	6.77	8.90	11%	Bad Quality Calls (2%)
B1	ON	100	0	0	OPT 2	12.67	8.02	10.56	31%	Bad Quality Calls (2%)
B0	OFF	75	7.5	17.5	GMSK	9.63	6.10	8.03	-	Blocked Calls
B1	ON	75	7.5	17.5	OPT 1	15.53	9.84	12.95	61%	Blocked Calls
B1	ON	75	7.5	17.5	OPT 2	12.32	7.80	10.27	28%	Bad Quality Calls (2%)
B1	ON	75	7.5	17.5	LGMSK	10.65	6.74	8.87	11%	Bad Quality Calls (2%)
B0	OFF	50	15	35	GMSK	9.60	6.08	8.00	-	Blocked Calls
B1	ON	50	15	35	OPT 1	13.21	8.37	11.01	38%	Blocked Calls
B1	ON	50	15	35	OPT 2	11.84	7.50	9.87	23%	Bad Quality Calls (2%)
B1	ON	50	15	35	LGMSK	10.66	6.75	8.88	11%	Bad Quality Calls (2%)
B0	OFF	25	22.5	52.5	GMSK	9.62	6.09	8.02	-	Blocked Calls
B1	ON	25	22.5	52.5	OPT 1	11.06	7.00	9.22	15%	Blocked Calls
B1	ON	25	22.5	52.5	OPT 2	10.92	6.92	9.10	14%	Blocked Calls
B1	ON	25	22.5	52.5	LGMSK	10.84	6.86	9.03	13%	Bad Quality Calls (2%)
B1	ON	0	30	70	GMSK	9.76	6.18	8.13	-	Blocked Calls

**Table 7-24c MUROS-2 performance results (Channel Type C).**

Channel mode type	Channel mode adaptation	OSC Rx proportion	DARP	non-DARP	Wide pulse	Spectral Efficiency [Erl/MHz/site]	Hardware Efficiency [Erl/TRX]	EFL %	OSC Gain %	Limiting Factor
C0	OFF	100	0	0	GMSK	9.66	6.12	8.05	-	Blocked Calls
C1	ON	100	0	0	OPT 1	20.87	13.21	17.39	116%	Blocked Calls
C1	ON	100	0	0	LGMSK	20.74	13.13	17.28	115%	Blocked Calls
C1	ON	100	0	0	OPT 2	20.89	13.23	17.41	116%	Blocked Calls
C0	OFF	75	7.5	17.5	GMSK	9.63	6.10	8.02	-	Blocked Calls
C1	ON	75	7.5	17.5	OPT 1	15.53	9.83	12.94	61%	Blocked Calls
C1	ON	75	7.5	17.5	OPT 2	15.35	9.72	12.79	59%	Blocked Calls
C1	ON	75	7.5	17.5	LGMSK	15.26	9.66	12.71	58%	Blocked Calls
C0	OFF	50	15	35	GMSK	9.59	6.07	7.99	-	Blocked Calls
C1	ON	50	15	35	OPT 1	13.18	8.35	10.99	38%	Blocked Calls
C1	ON	50	15	35	OPT 2	13.21	8.37	11.01	38%	Blocked Calls
C1	ON	50	15	35	LGMSK	13.22	8.37	11.01	38%	Blocked Calls
C0	OFF	25	22.5	52.5	GMSK	9.64	6.11	8.03	-	Blocked Calls
C1	ON	25	22.5	52.5	OPT 1	11.22	7.10	9.35	16%	Blocked Calls
C1	ON	25	22.5	52.5	OPT 2	10.98	6.95	9.15	14%	Blocked Calls
C1	ON	25	22.5	52.5	LGMSK	11.03	6.99	9.19	14%	Blocked Calls
C1	ON	0	30	70	GMSK	9.62	6.09	8.01	-	Blocked Calls

Table 7-24d MUROS-2 performance results (Channel Type D).

Channel mode type	Channel mode adaptation	OSC Rx proportion	DARP	non-DARP	Wide pulse	Spectral Efficiency [Erl/MHz/site]	Hardware Efficiency [Erl/TRX]	EFL %	OSC Gain %	Limiting Factor
D0	OFF	100	0	0	GMSK	21.14	13.39	17.62	-	Blocked Calls
D1	ON	100	0	0	OPT 1	36.52	23.13	30.44	73%	Bad Quality Calls (3%)
D1	ON	100	0	0	LGMSK	24.50	15.52	20.42	16%	Bad Quality Calls (3%)
D1	ON	100	0	0	OPT 2	28.87	18.28	24.06	37%	Bad Quality Calls (3%)
D0	OFF	75	7.5	17.5	GMSK	21.12	13.38	17.60	-	Blocked Calls
D1	ON	75	7.5	17.5	OPT 1	33.45	21.18	27.87	58%	Bad Quality Calls (3%)
D1	ON	75	7.5	17.5	OPT 2	26.83	16.99	22.36	27%	Bad Quality Calls (3%)
D1	ON	75	7.5	17.5	LGMSK	23.82	15.08	19.85	13%	Bad Quality Calls (3%)
D0	OFF	50	15	35	GMSK	21.18	13.41	17.65	-	Blocked Calls
D1	ON	50	15	35	OPT 1	29.13	18.45	24.28	38%	Blocked Calls
D1	ON	50	15	35	OPT 2	24.82	15.72	20.68	17%	Bad Quality Calls (3%)
D1	ON	50	15	35	LGMSK	23.13	14.65	19.28	9%	Bad Quality Calls (3%)
D0	OFF	25	22.5	52.5	GMSK	21.21	13.43	17.68	-	Blocked Calls
D1	ON	25	22.5	52.5	OPT 1	25.59	16.21	21.33	21%	Blocked Calls
D1	ON	25	22.5	52.5	OPT 2	23.79	15.07	19.83	12%	Bad Quality Calls (3%)
D1	ON	25	22.5	52.5	LGMSK	22.82	14.46	19.02	8%	Bad Quality Calls (3%)
D1	ON	0	30	70	GMSK	18.10	11.46	15.09	-	Bad Quality Calls (3%)

7.2.2.2.7.2.3 MUROS-3a)

The EFL is given for the different mix of mobiles in Figures 7-38C1 to 7-38C4 below. MUROS-3a) capacity numbers are presented in Table 7-25a to 7-25d thereafter.

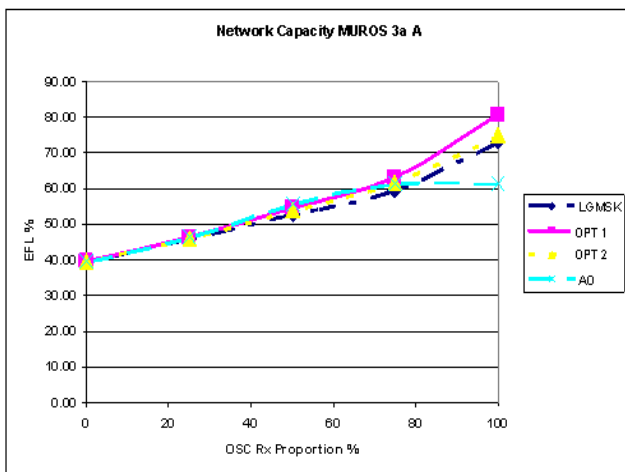

Figure 7-38C1: EFL for investigated TX pulse shapes (MUROS-3a, Channel type A) and different penetrations for OSC aware MS.

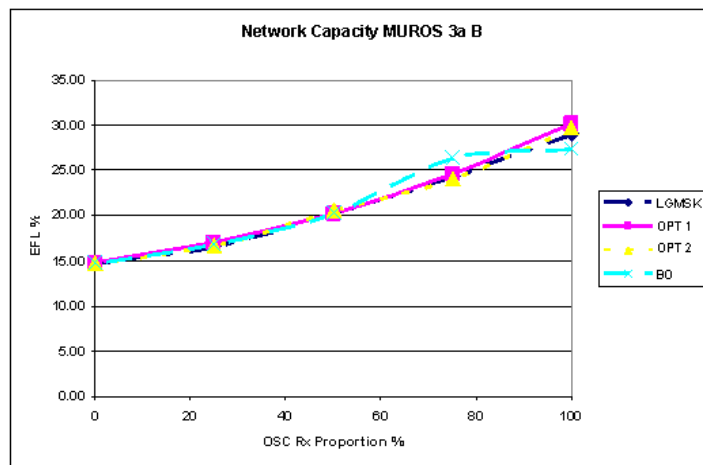

Figure 7-38C2: EFL for investigated TX pulse shapes (MUROS-3a, Channel type B) and different penetrations for OSC aware MS.



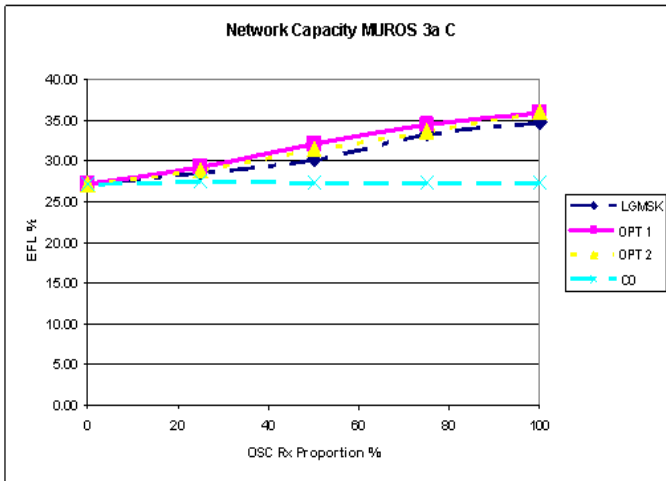

Figure 7-38C3: EFL for investigated TX pulse shapes (MUROS-3a, Channel type C) and different penetrations for OSC aware MS.

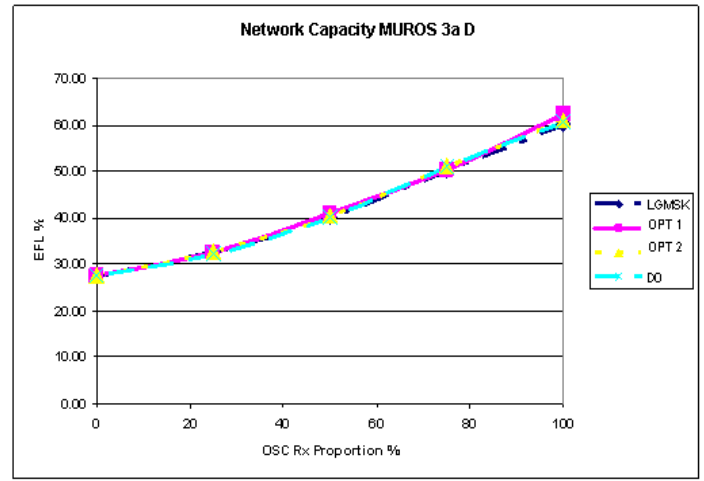

Figure 7-38C4: EFL for investigated TX pulse shapes (MUROS-3a, Channel type D) and different penetrations for OSC aware MS.

Table 7-25a MUROS-3a performance results (Channel Type A).

Channel mode type	Channel mode adaptation	OSC Rx proportion	DARP	non-DARP	Wide pulse	Spectral Efficiency [Erl/MHz/site]	Hardware Efficiency [Erl/TRX]	EFL %	OSC Gain %	Limiting Factor
A0	OFF	100	0	0	GMSK	73.54	14.71	61.28	-	Blocked Calls
A1	ON	100	0	0	LGMSK	88.04	17.61	73.36	20%	Bad Quality Calls (3%)
A1	ON	100	0	0	OPT 1	97.02	19.40	80.85	32%	Bad Quality Calls (3%)
A1	ON	100	0	0	OPT 2	90.09	18.02	75.07	22%	Bad Quality Calls (3%)
A0	OFF	75	7.5	17.5	GMSK	73.65	14.73	61.38	-	Blocked Calls
A1	ON	75	7.5	17.5	LGMSK	71.71	14.34	59.76	-3%	Bad Quality Calls (3%)
A1	ON	75	7.5	17.5	OPT 1	76.01	15.20	63.34	3%	Bad Quality Calls (3%)
A1	ON	75	7.5	17.5	OPT 2	74.11	14.82	61.76	1%	Bad Quality Calls (3%)
A0	OFF	50	15	35	GMSK	66.79	13.36	55.66	-	Bad Quality Calls (3%)
A1	ON	50	15	35	LGMSK	63.59	12.72	52.99	-5%	Bad Quality Calls (3%)
A1	ON	50	15	35	OPT 1	66.77	13.15	54.81	-2%	Bad Quality Calls (3%)
A1	ON	50	15	35	OPT 2	64.52	12.90	53.76	-3%	Bad Quality Calls (3%)
A0	OFF	25	22.5	52.5	GMSK	55.84	11.17	46.53	-	Bad Quality Calls (3%)
A1	ON	25	22.5	52.5	LGMSK	55.26	11.05	46.05	-1%	Bad Quality Calls (3%)
A1	ON	25	22.5	52.5	OPT 1	55.63	11.13	46.35	0%	Bad Quality Calls (3%)
A1	ON	25	22.5	52.5	OPT 2	55.46	11.09	46.22	-1%	Bad Quality Calls (3%)
A0	OFF	0	30	70	GMSK	47.48	9.50	39.57	-	Bad Quality Calls (3%)

Table 7-25b MUROS-3a performance results (Channel Type B).

Channel mode type	Channel mode adaptation	OSC Rx proportion	DARP	non-DARP	Wide pulse	Spectral Efficiency [Erl/MHz/site]	Hardware Efficiency [Erl/TRX]	EFL %	OSC Gain %	Limiting Factor
B0	OFF	100	0	0	GMSK	32.86	6.57	27.38	-	Blocked Calls
B1	ON	100	0	0	LGMSK	34.80	6.96	29.00	6%	Bad Quality Calls (2%)
B1	ON	100	0	0	OPT 1	36.26	7.25	30.21	10%	Bad Quality Calls (2%)
B1	ON	100	0	0	OPT 2	35.75	7.15	29.79	9%	Bad Quality Calls (2%)
B0	OFF	75	7.5	17.5	GMSK	31.78	6.36	26.49	-	Bad Quality Calls (2%)
B1	ON	75	7.5	17.5	LGMSK	29.19	5.84	24.32	-8%	Bad Quality Calls (2%)
B1	ON	75	7.5	17.5	OPT 1	29.52	5.90	24.60	-7%	Bad Quality Calls (2%)
B1	ON	75	7.5	17.5	OPT 2	28.96	5.79	24.14	-9%	Bad Quality Calls (2%)
B0	OFF	50	15	35	GMSK	24.43	4.89	20.36	-	Bad Quality Calls (2%)
B1	ON	50	15	35	LGMSK	24.41	4.88	20.35	0%	Bad Quality Calls (2%)
B1	ON	50	15	35	OPT 1	24.22	4.84	20.19	-1%	Bad Quality Calls (2%)
B1	ON	50	15	35	OPT 2	24.78	4.96	20.65	1%	Bad Quality Calls (2%)
B0	OFF	25	22.5	52.5	GMSK	20.25	4.05	16.87	-	Bad Quality Calls (2%)
B1	ON	25	22.5	52.5	LGMSK	19.97	3.99	16.64	-1%	Bad Quality Calls (2%)
B1	ON	25	22.5	52.5	OPT 1	20.38	4.08	16.98	1%	Bad Quality Calls (2%)
B1	ON	25	22.5	52.5	OPT 2	20.08	4.02	16.73	-1%	Bad Quality Calls (2%)
B0	OFF	0	30	70	GMSK	17.80	3.56	14.83	-	Bad Quality Calls (2%)

**Table 7-25c MUROS-3a performance results (Channel Type C).**

Channel mode type	Channel mode adaptation	OSC Rx proportion	DARP	non-DARP	Wide pulse	Spectral Efficiency [Erl/MHz/site]	Hardware Efficiency [Erl/TRX]	EFL %	OSC Gain %	Limiting Factor
C0	OFF	100	0	0	GMSK	32.85	6.57	27.38	-	Blocked Calls
C1	ON	100	0	0	LGMSK	41.72	8.34	34.77	27%	Blocked Calls
C1	ON	100	0	0	OPT 1	43.00	8.60	35.84	31%	Blocked Calls
C1	ON	100	0	0	OPT 2	43.30	8.66	36.08	32%	Blocked Calls
C0	OFF	75	7.5	17.5	GMSK	32.84	6.57	27.36	-	Blocked Calls
C1	ON	75	7.5	17.5	LGMSK	39.98	8.00	33.31	22%	Blocked Calls
C1	ON	75	7.5	17.5	OPT 1	41.29	8.26	34.40	26%	Blocked Calls
C1	ON	75	7.5	17.5	OPT 2	40.43	8.09	33.69	23%	Blocked Calls
C0	OFF	50	15	35	GMSK	32.82	6.56	27.35	-	Blocked Calls
C1	ON	50	15	35	LGMSK	36.32	7.26	30.26	11%	Bad Quality Calls (2%)
C1	ON	50	15	35	OPT 1	38.52	7.70	32.10	17%	Blocked Calls
C1	ON	50	15	35	OPT 2	37.69	7.54	31.41	15%	Blocked Calls
C0	OFF	25	22.5	52.5	GMSK	33.09	6.62	27.58	-	Blocked Calls
C1	ON	25	22.5	52.5	LGMSK	34.42	6.88	28.68	4%	Bad Quality Calls (2%)
C1	ON	25	22.5	52.5	OPT 1	35.18	7.04	29.32	6%	Blocked Calls
C1	ON	25	22.5	52.5	OPT 2	34.71	6.94	28.92	5%	Bad Quality Calls (2%)
C0	OFF	0	30	70	GMSK	32.67	6.53	27.23	-	Blocked Calls

**Table 7-25d MUROS-3a performance results (Channel Type D).**

Channel mode type	Channel mode adaptation	OSC Rx proportion	DARP	non-DARP	Wide pulse	Spectral Efficiency [Erl/MHz/site]	Hardware Efficiency [Erl/TRX]	EFL %	OSC Gain %	Limiting Factor
D0	OFF	100	0	0	GMSK	73.01	14.60	60.84	-	Blocked Calls
D1	ON	100	0	0	LGMSK	72.19	14.44	60.16	-1%	Bad Quality Calls (3%)
D1	ON	100	0	0	OPT 1	74.94	14.99	62.45	3%	Bad Quality Calls (3%)
D1	ON	100	0	0	OPT 2	73.23	14.65	61.02	0%	Bad Quality Calls (3%)
D0	OFF	75	7.5	17.5	GMSK	61.22	12.24	51.02	-	Bad Quality Calls (3%)
D1	ON	75	7.5	17.5	LGMSK	60.31	12.06	50.26	-1%	Bad Quality Calls (3%)
D1	ON	75	7.5	17.5	OPT 1	60.36	12.07	50.30	-1%	Bad Quality Calls (3%)
D1	ON	75	7.5	17.5	OPT 2	61.46	12.29	51.21	0%	Bad Quality Calls (3%)
D0	OFF	50	15	35	GMSK	48.11	9.62	40.09	-	Bad Quality Calls (3%)
D1	ON	50	15	35	LGMSK	48.31	9.66	40.26	0%	Bad Quality Calls (3%)
D1	ON	50	15	35	OPT 1	49.07	9.81	40.89	2%	Bad Quality Calls (3%)
D1	ON	50	15	35	OPT 2	48.70	9.74	40.59	1%	Bad Quality Calls (3%)
D0	OFF	25	22.5	52.5	GMSK	38.66	7.73	32.21	-	Bad Quality Calls (3%)
D1	ON	25	22.5	52.5	LGMSK	39.34	7.87	32.78	2%	Bad Quality Calls (3%)
D1	ON	25	22.5	52.5	OPT 1	39.20	7.84	32.67	1%	Bad Quality Calls (3%)
D1	ON	25	22.5	52.5	OPT 2	39.35	7.87	32.79	2%	Bad Quality Calls (3%)
D0	OFF	0	30	70	GMSK	33.24	6.65	27.70	-	Bad Quality Calls (3%)

7.2.2.2.7.2.4 MUROS-3b)

The EFL is given for the different mix of mobiles in Figures 7-38D1 to 7-38D4 below. MUROS-3b) capacity numbers are presented in Table 7-26a to 7-26d thereafter.

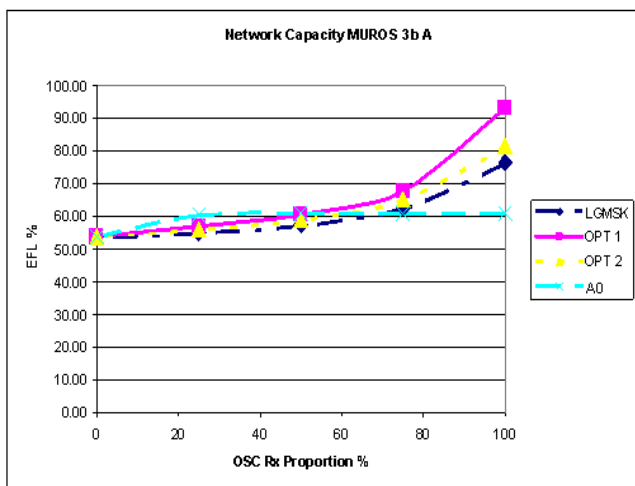

Figure 7-38D1: EFL for investigated TX pulse shapes (MUROS-3b, Channel type A) and different penetrations for OSC aware MS.

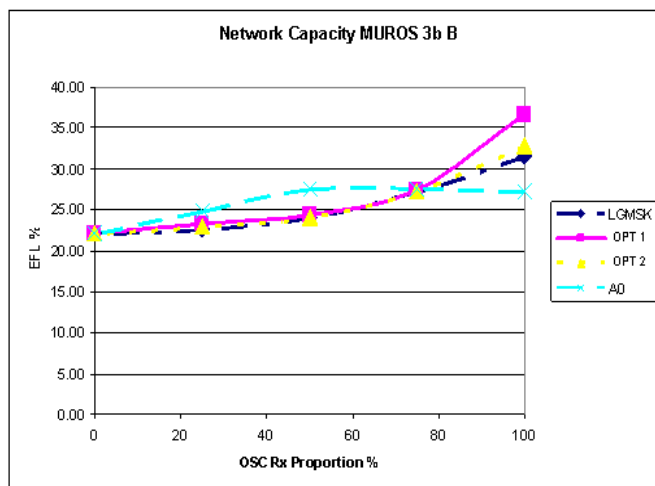

Figure 7-38D2: EFL for investigated TX pulse shapes (MUROS-3b, Channel type B) and different penetrations for OSC aware MS.

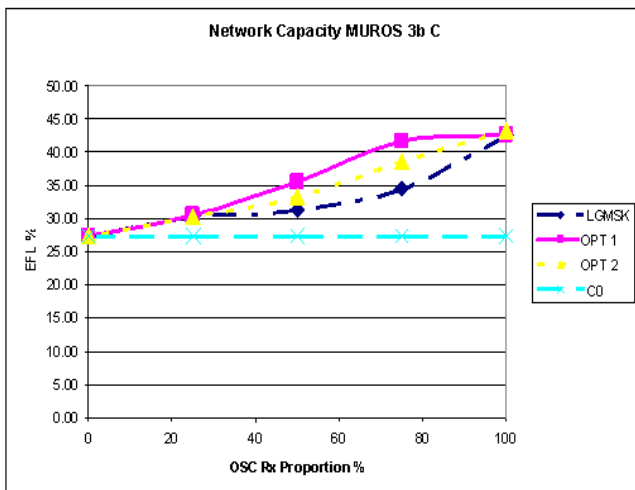

Figure 7-38D3: EFL for investigated TX pulse shapes (MUROS-3b, Channel type C) and different penetrations for OSC aware MS.

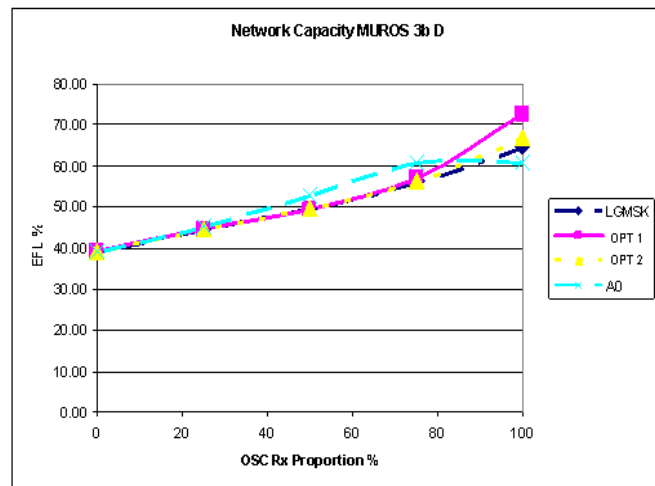

Figure 7-38D4: EFL for investigated TX pulse shapes (MUROS-3b, Channel type D) and different penetrations for OSC aware MS.

Table 7-26a MUROS-3b performance results (Channel Type A).

Channel mode type	Channel mode adaptation	OSC Rx proportion	DARP	non-DARP	Wide pulse	Spectral Efficiency [Erl/MHz/site]	Hardware Efficiency [Erl/TRX]	EFL %	OSC Gain %	Limiting Factor
A0	OFF	100	0	0	GMSK	73.13	14.63	60.94	-	Blocked Calls
A1	ON	100	0	0	LGMSK	91.93	18.39	76.61	26%	Bad Quality Calls (3%)
A1	ON	100	0	0	OPT 1	111.90	22.38	93.25	53%	Blocked Calls
A1	ON	100	0	0	OPT 2	97.99	19.60	81.66	34%	Bad Quality Calls (3%)
A0	OFF	75	7.5	17.5	GMSK	73.31	14.66	61.09	-	Blocked Calls
A1	ON	75	7.5	17.5	LGMSK	75.10	15.02	62.58	2%	Bad Quality Calls (3%)
A1	ON	75	7.5	17.5	OPT 1	81.38	16.28	67.82	11%	Bad Quality Calls (3%)
A1	ON	75	7.5	17.5	OPT 2	78.56	15.71	65.47	7%	Bad Quality Calls (3%)
A0	OFF	50	15	35	GMSK	73.32	14.66	61.10	-	Blocked Calls
A1	ON	50	15	35	LGMSK	68.86	13.77	57.39	-6%	Bad Quality Calls (3%)
A1	ON	50	15	35	OPT 1	72.44	14.49	60.37	-1%	Bad Quality Calls (3%)
A1	ON	50	15	35	OPT 2	70.83	14.17	59.02	-3%	Bad Quality Calls (3%)
A0	OFF	25	22.5	52.5	GMSK	72.49	14.50	60.41	-	Bad Quality Calls (3%)
A1	ON	25	22.5	52.5	LGMSK	66.04	13.21	55.03	-9%	Bad Quality Calls (3%)
A1	ON	25	22.5	52.5	OPT 1	68.29	13.66	56.90	-6%	Bad Quality Calls (3%)
A1	ON	25	22.5	52.5	OPT 2	67.41	13.48	56.18	-7%	Bad Quality Calls (3%)
A0	OFF	0	30	70	GMSK	64.42	12.88	53.69	-	Bad Quality Calls (3%)

Table 7-26b MUROS-3b performance results (Channel Type B).

Channel mode type	Channel mode adaptation	OSC Rx proportion	DARP	non-DARP	Wide pulse	Spectral Efficiency [Erl/MHz/site]	Hardware Efficiency [Erl/TRX]	EFL %	OSC Gain %	Limiting Factor
B0	OFF	100	0	0	GMSK	32.76	6.55	27.30	-	Blocked Calls
B1	ON	100	0	0	LGMSK	37.92	7.58	31.60	16%	Bad Quality Calls (2%)
B1	ON	100	0	0	OPT 1	43.95	8.79	36.62	34%	Bad Quality Calls (2%)
B1	ON	100	0	0	OPT 2	39.45	7.89	32.87	20%	Bad Quality Calls (2%)
B0	OFF	75	7.5	17.5	GMSK	33.08	6.62	27.56	-	Blocked Calls
B1	ON	75	7.5	17.5	LGMSK	32.68	6.54	27.24	-1%	Bad Quality Calls (2%)
B1	ON	75	7.5	17.5	OPT 1	32.96	6.59	27.46	0%	Bad Quality Calls (2%)
B1	ON	75	7.5	17.5	OPT 2	32.75	6.55	27.29	-1%	Bad Quality Calls (2%)
B0	OFF	50	15	35	GMSK	33.17	6.63	27.64	-	Blocked Calls
B1	ON	50	15	35	LGMSK	28.96	5.79	24.13	-13%	Bad Quality Calls (2%)
B1	ON	50	15	35	OPT 1	29.32	5.86	24.43	-12%	Bad Quality Calls (2%)
B1	ON	50	15	35	OPT 2	28.85	5.77	24.04	-13%	Bad Quality Calls (2%)
B0	OFF	25	22.5	52.5	GMSK	29.90	5.98	24.91	-	Bad Quality Calls (2%)
B1	ON	25	22.5	52.5	LGMSK	27.22	5.44	22.69	-9%	Bad Quality Calls (2%)
B1	ON	25	22.5	52.5	OPT 1	27.87	5.57	23.22	-7%	Bad Quality Calls (2%)
B1	ON	25	22.5	52.5	OPT 2	27.54	5.51	22.95	-8%	Bad Quality Calls (2%)
B0	OFF	0	30	70	GMSK	26.54	5.31	22.12	-	Bad Quality Calls (2%)

Table 7-26c MUROS-3b performance results (Channel Type C).

Channel mode type	Channel mode adaptation	OSC Rx proportion	DARP	non-DARP	Wide pulse	Spectral Efficiency [Erl/MHz/site]	Hardware Efficiency [Erl/TRX]	EFL %	OSC Gain %	Limiting Factor
C0	OFF	100	0	0	GMSK	32.88	6.58	27.40	-	Blocked Calls
C1	ON	100	0	0	LGMSK	51.10	10.22	42.58	55%	Blocked Calls
C1	ON	100	0	0	OPT 1	51.19	10.24	42.66	56%	Blocked Calls
C1	ON	100	0	0	OPT 2	51.79	10.36	43.16	57%	Blocked Calls
C0	OFF	75	7.5	17.5	GMSK	32.86	6.57	27.38	-	Blocked Calls
C1	ON	75	7.5	17.5	LGMSK	41.40	8.28	34.50	26%	Bad Quality Calls (2%)
C1	ON	75	7.5	17.5	OPT 1	49.98	10.00	41.65	52%	Bad Quality Calls (2%)
C1	ON	75	7.5	17.5	OPT 2	46.51	9.30	38.76	42%	Bad Quality Calls (2%)
C0	OFF	50	15	35	GMSK	32.97	6.59	27.47	-	Blocked Calls
C1	ON	50	15	35	LGMSK	37.72	7.54	31.43	14%	Bad Quality Calls (2%)
C1	ON	50	15	35	OPT 1	42.59	8.52	35.49	29%	Bad Quality Calls (2%)
C1	ON	50	15	35	OPT 2	40.01	8.00	33.34	21%	Bad Quality Calls (2%)
C0	OFF	25	22.5	52.5	GMSK	32.90	6.58	27.42	-	Blocked Calls
C1	ON	25	22.5	52.5	LGMSK	36.53	7.31	30.44	11%	Blocked Calls
C1	ON	25	22.5	52.5	OPT 1	36.67	7.33	30.56	11%	Blocked Calls
C1	ON	25	22.5	52.5	OPT 2	36.50	7.30	30.42	11%	Blocked Calls
C0	OFF	0	30	70	GMSK	32.91	6.58	27.42	-	Blocked Calls

Table 7-26d MUROS-3b performance results (Channel Type D).

Channel mode type	Channel mode adaptation	OSC Rx proportion	DARP	non-DARP	Wide pulse	Spectral Efficiency [Erl/MHz/site]	Hardware Efficiency [Erl/TRX]	EFL %	OSC Gain %	Limiting Factor
D0	OFF	100	0	0	GMSK	72.97	14.59	60.81	-	Blocked Calls
D1	ON	100	0	0	LGMSK	77.67	15.53	64.73	6%	Bad Quality Calls (3%)
D1	ON	100	0	0	OPT 1	87.31	17.46	72.76	20%	Bad Quality Calls (3%)
D1	ON	100	0	0	OPT 2	80.28	16.06	66.90	10%	Bad Quality Calls (3%)
D0	OFF	75	7.5	17.5	GMSK	73.05	14.61	60.88	-	Blocked Calls
D1	ON	75	7.5	17.5	LGMSK	67.16	13.43	55.96	-8%	Bad Quality Calls (3%)
D1	ON	75	7.5	17.5	OPT 1	68.55	13.71	57.12	-6%	Bad Quality Calls (3%)
D1	ON	75	7.5	17.5	OPT 2	67.60	13.52	56.33	-7%	Bad Quality Calls (3%)
D0	OFF	50	15	35	GMSK	63.44	12.69	52.87	-	Bad Quality Calls (3%)
D1	ON	50	15	35	LGMSK	59.57	11.91	49.64	-6%	Bad Quality Calls (3%)
D1	ON	50	15	35	OPT 1	59.43	11.89	49.52	-6%	Bad Quality Calls (3%)
D1	ON	50	15	35	OPT 2	59.68	11.94	49.73	-6%	Bad Quality Calls (3%)
D0	OFF	25	22.5	52.5	GMSK	54.44	10.89	45.36	-	Bad Quality Calls (3%)
D1	ON	25	22.5	52.5	LGMSK	53.37	10.67	44.48	-2%	Bad Quality Calls (3%)
D1	ON	25	22.5	52.5	OPT 1	53.41	10.68	44.51	-2%	Bad Quality Calls (3%)
D1	ON	25	22.5	52.5	OPT 2	53.73	10.75	44.78	-1%	Bad Quality Calls (3%)
D0	OFF	0	30	70	GMSK	46.91	9.38	39.09	-	Bad Quality Calls (3%)

7.2.2.2.7.3 Summary of EFL gains for optimized pulse shapes versus legacy LGMSK pulse shape

Table 7-27 shows the resulting system capacity gains in case of 100 % OSC aware MS in terms of EFL as derived from Figures 1a to 1d, 2a to 2d, 3a to 3d and 4a to 4d for the investigated network configurations and channel types.

**Table 7-27: OSC network capacity gains for optimized TX pulse shapes and LGMSK pulse shape with 100 % OSC aware MS (blue: quality limited, brown: blocking limited).**

Channel Type	TX Pulse shape	MUROS-1	MUROS-2	MUROS-3a	MUROS-3b
A	Candidate OPT 1	47 %	109 %	32 %	53 %
	Candidate OPT 2	30 %	94 %	22 %	34 %
	LGMSK	24 %	78 %	20 %	26 %
	OPT 1 – LGMSK	23 %	31 %	12 %	27 %
B	Candidate OPT 1	32 %	77 %	6 %	34 %
	Candidate OPT 2	18 %	31 %	10 %	20 %
	LGMSK	12 %	11 %	9 %	16 %
	OPT 1 – LGMSK	20 %	66 %	-3 %	18 %
C	Candidate OPT 1	111 %	116 %	31 %	56 %
	Candidate OPT 2	82 %	116 %	32 %	57 %
	LGMSK	70 %	115 %	27 %	55 %
	OPT 1 – LGMSK	41 %	1 %	4 %	1 %
D	Candidate OPT 1	15 %	73 %	3 %	20 %
	Candidate OPT 2	5 %	37 %	0 %	10 %
	LGMSK	0 %	16 %	-1 %	6 %
	OPT 1 – LGMSK	15 %	57 %	4 %	14 %

The results in Table 7-27 indicate additional gains over the LGMSK pulse shape

- between 15% to 41% that have been observed for MUROS-1,
- between 1% (hard blocking limited) to 66% for MUROS-2,
- between 4% to 12% for MUROS 3a and
- between 2% (hard blocking limited) to 27% for MUROS-3b,

when compared against the non-MUROS reference performance.

In general the gains are higher for GSM legacy HR due to the fact that legacy GSM HR codec is more robust in OSC mode than AMR HR 5.9 and hence frequency of channel mode adaptation to legacy channel mode is reduced. For full rate channel type B clear performance gains of OSC and further for both optimized pulse shapes can be observed for MUROS-1, MUROS-2 and MUROS-3b, whilst the channel type C is mostly hard blocking limited, except MUROS-1, where the optimized pulse shape can as well significantly improve the performance. Note that for all scenarios the UL was simulated as well, but was not identified as the limiting link.

#### 7.2.2.2.7.4 Conclusions

Two candidate pulse shapes for an optimized transmit pulse shape on DL have been investigated and performance was compared against the usage of the linearized GMSK pulse shape. Both candidate pulse shapes outperform the linearized

GMSK pulse shape with somewhat higher gains observed for candidate pulse shape OPT 1, i.e. for RRC 240 pulse shape. Additional gains over the LGMSK pulse shape between 15% to 41% have been observed for MUROS-1, up to 66% for MUROS-2, between 4% and 12% for MUROS 3a and up to 27% for MUROS-3b, compared against the non-MUROS reference performance. These remarkable gains should not be missed when standardizing the selected candidate technique out of the MUROS Feasibility study.

Thus it is proposed to specify candidate pulse shape OPT 1 for the optimized TX pulse shape in DL for VAMOS in addition to the legacy LGMSK TX pulse shape. The MS is supposed to signal its support for the optimized TX pulse shape in DL in the MS classmark 3 IE to the network as suggested in [7-16].

## 7.2.3 Performance Summary

Both link level and system level performance evaluation for the candidate technique OSC have revealed a great potential of OSC to increase network capacity up to 100 %.

System performance of the basic OSC candidate technique as presented to GERAN#36 [7-2] was investigated. Both spectral efficiency and hardware efficiency for OSC were investigated based on the refined minimum quality thresholds of 2% for FR channels and 3% for HR channels for average call FER.

Results related to the usage of legacy linearized TX pulse shape in DL and basic OSC show very good capacity gains for OSC in MUROS-2 configuration with the mean gain of 55 % for MUROS-2. In the tight reuse cases (MUROS-1 and MUROS-3) OSC provides remarkable gains between 27 % and 70 % for AFS 5.9 codec, still considerable gains between 20 % and 26 % for GSM HR, whilst moderate gains around 10 % are achieved for AFS 12.2 and almost no gains AHS 5.9 for these network configurations. With regard to HW efficiency for MUROS-2 all channel mode adaptation types benefit between 11 % and 114%, and for MUROS 3b likewise between 6 % and 55 %. HW efficiency can only be improved for channel mode adaptation type C (AFS 5.9) throughout all network configurations varying between 70 % (MUROS-1), 115% (MUROS-2), 27 % (MUROS-3a) and 55 % (MUROS-3b).

Further enhancements can be achieved through the usage of optimized TX pulse shape in DL for basic OSC.

Results have identified high capacity gains up to 41% for MUROS-1, up to 57 % for MUROS-2, up to 12% for MUROS-3a) and up to 27% for MUROS-3b) compared to the usage of legacy LGMSK TX pulse shape. For moderate reuse scenarios like MUROS-2, the optimized TX pulse shape can considerably increase capacity for HR channel types (57 % gain for AHS 5.9, 31% for GSM HR) and thus leading to a higher robustness against frame erasures. Network configurations employing a tighter frequency reuse can still benefit from the usage of the optimized TX pulse shape especially if robust half rate codecs (e.g. GSM HR) are used and hence up to 27 % gain over the use of LGMSK pulse shape can be achieved, yielding up to around 50 % capacity gain for OSC against non-OSC mode for robust HR codecs like GSM HR in these tighter reuse scenarios.

Further enhancements such as subchannel specific power control on DL and the usage of optimized user diversity patterns have been investigated as well. First investigations show that optimized user diversity improves the performance for different mix of mobiles. Subchannel specific power control is able to increase further network capacity gains due to OSC in the order of 7% to 16% for MUROS-2. Thus it is expected that enhanced OSC will yield a further performance improvement for all network configurations both for the case of 100% of DARP phase I or OSC aware mobiles and for the case of a mix of OSC aware, legacy DARP phase I and legacy non-DARP mobiles.

## 7.2.4 Verification of Link to System Mapping

### 7.2.4.1 Introduction

A link to system (L2S) interface for single antenna non-SAIC receivers and for single antenna SAIC receivers in MUROS study is verified.

As the overall goal of the interface is to produce an expected FER value, the verification of the CIR to BER mapping is based on the average of true CIRs as computed by the link level simulator for a given interference profile.

### 7.2.4.2 Verification methodology

The L2S interface is based on the assumption that the signal to interference ratio (CIR) at the receiver is sufficiently defined as a ratio of interfering in-band powers (i.e. after the RF frontend filter) for the first stage CIR-BER mapping.

System simulation rebuilds the expected BER performance using fast fading sample vector and the L2S CIR-BER distribution. L2S against link simulation can be verified in a same way by rebuilding the raw BER performance using the L2S mapping and CIR. L2S method has been described in the literature in [7-17].

Typical L2S CIR-BER range in system simulation is -20 to 15 dB (receiver inband CIR), but this also depends on the expected dynamic range of the overall mapping from CIR to FER. Simulation has been run for larger range to gain better statistical data.

Figure 7-38E1 shows an exemplary CIR to raw BER relationship for single antenna non-SAIC receivers whilst Figure 7-38E2 treats the case of single antenna SAIC receivers.

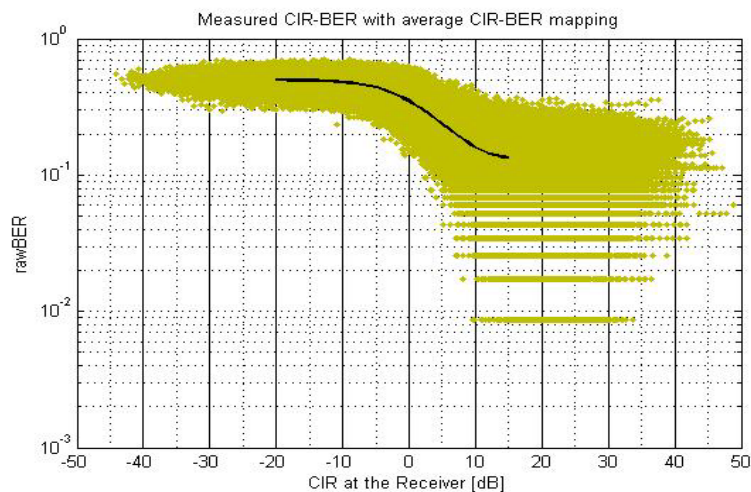

**Figure 7-38E1- Example relationship between the measured burst-wise CIR after the Rx front-end filter and the raw BER distribution for non-SAIC OSC, with average CIR-BER mapping.**

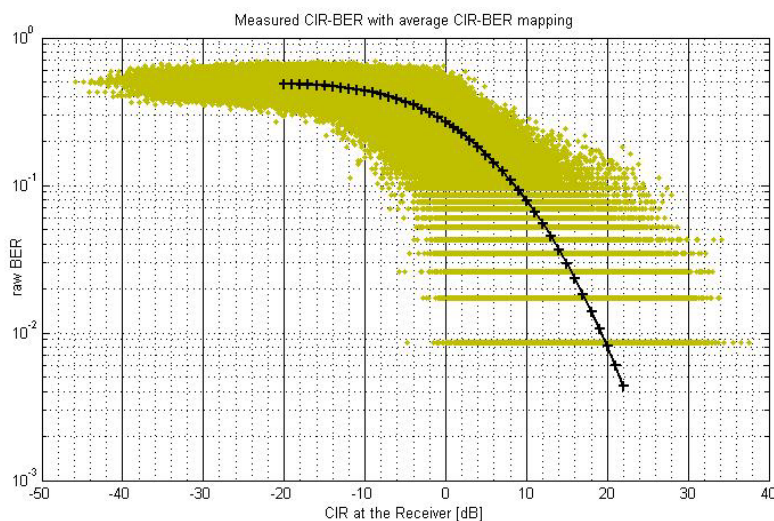

**Figure 7-38E2 - Example relationship between the measured burst-wise CIR after the Rx front-end filter and the raw BER distribution for SAIC OSC, with average CIR-BER mapping.**

Used L2S methodology is verified for,

- The candidate techniques taken into account,
- Uncoded BER only,
- The interference modulation envisaged to be present in the system.



### 7.2.4.3 Verification for single antenna non-SAIC receivers

#### 7.2.4.3.1 Verification scenarios

The verification scenarios are depicted in Table 7-28.

**Table 7-28 - Verification scenarios for single antenna non-SAIC receivers**

Test cases	Modulation, Tx Pulse	Interference scenario	Note
1	GMSK, LGMSK	MTS-1	-
2	GMSK, LGMSK	MTS-2	-
3	QPSK, LGMSK	MTS-1	SCPIR = 0 dB
4	QPSK, LGMSK	MTS-2	SCPIR = 0 dB
5	QPSK, LGMSK	MTS-1	SCPIR = -7.7 dB, S7R1 and S4R4
6	QPSK, LGMSK	MTS-2	SCPIR = -7.7 dB, S7R1 and S4R4

NOTE:

- It has been assumed that all external interference is GMSK. It is expected that DIR has minor impact to the OSC link performance.
- “SCPIR = -7.7 dB, S7R1” means that L2S mapping is verified for SCPIR, where 7 QPSK constellations and one rectangular constellation with SCPIR = -7.7 dB are transmitted over the interleaving period.
- Verification is done for both SubCh 0 (black curves) and SubCh 1 (red curves), also with SCPIR, and both sub-channels have always their own data in the actual L2S mapping.

#### 7.2.4.3.2 Simulation assumptions

The simulation assumptions are summarized in Table 7-29

**Table 7-29 - Simulation assumptions**

Parameter	Value	
Channel profile	Typical Urban (TU)	
Terminal speed	3 km/h	
Frequency band	900 MHz	
Frequency hopping	Ideal	
Antenna diversity	No	
Interference scenario	MTS-1, MTS-2	
Interference modulation	GMSK	
Receiver type	Generic MS non-SAIC receiver	
Frequency offset of interferers	No	
Impairments:	<u>Tx</u>	<u>RX</u>
– Phase noise	0.8 [deg(RMS)]	1.0 [deg(RMS)]
– I/Q gain imbalance	0.05 [dB]	0.2 [dB]
– I/Q phase imbalance	0.2 [deg]	1.5 [deg]
– DC offset	-50 [dBc]	-40 [dBc]
– Frequency error	- [Hz]	25 [Hz]
– PA model	yes	No

#### 7.2.4.3.3 Mapping verification

Mapping verification is depicted in Figures 7-38F1 to 7-38F6 according to the above defined test cases.

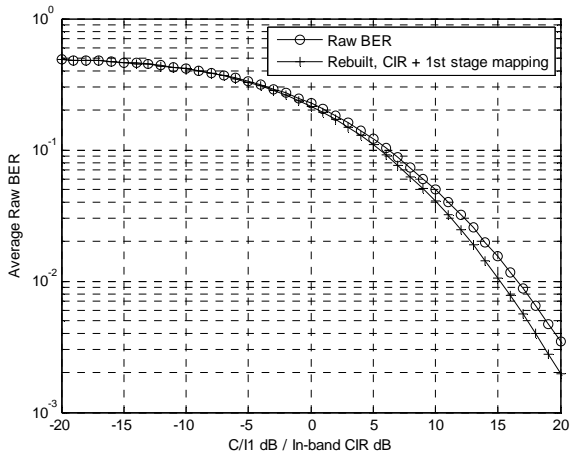

Figure 7-38F1, Test case 1

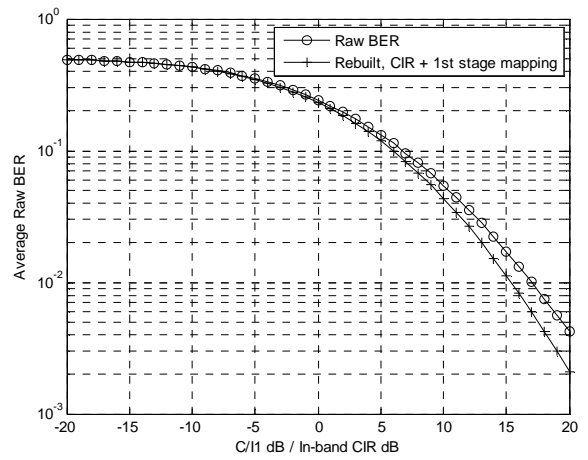

Figure 7-38F2, Test case 2

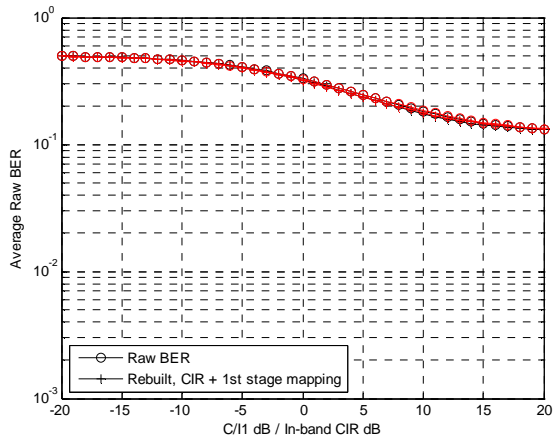

Figure 7-38F3, Test case 3

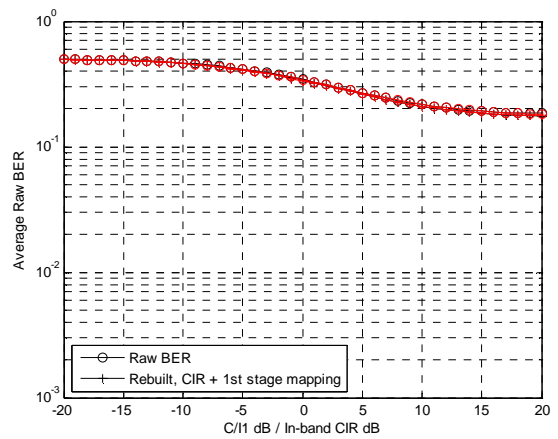

Figure 7-38F4, Test case 4

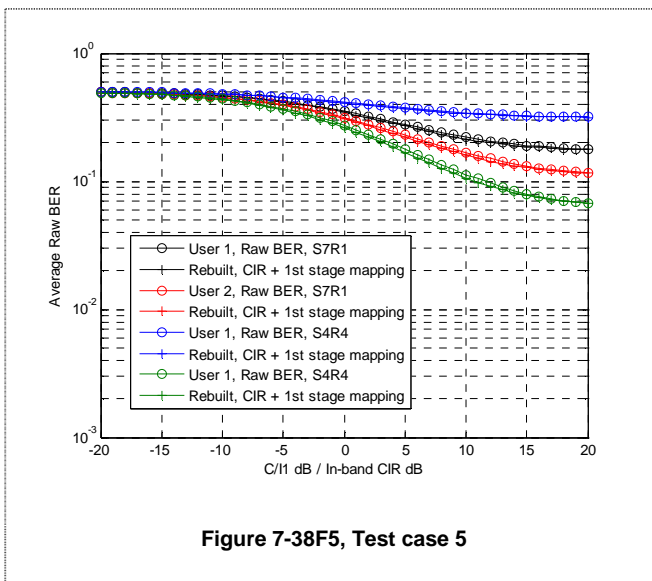

Figure 7-38F5, Test case 5

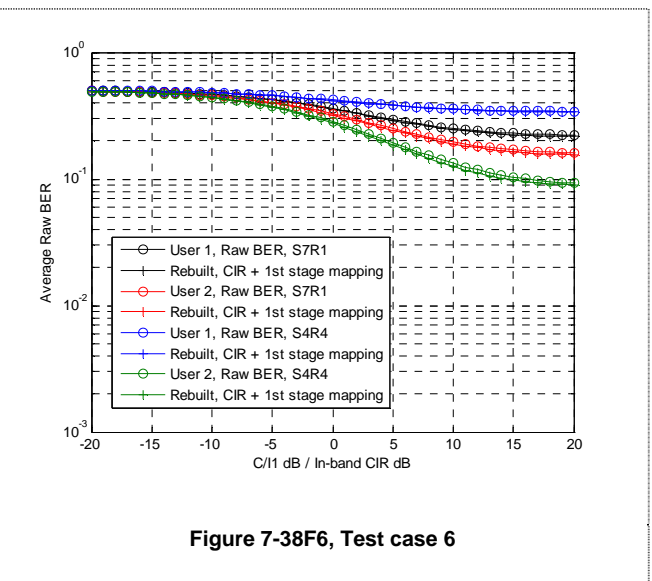

Figure 7-38F6, Test case 6

### 7.2.4.4 Verification for single antenna SAIC receivers

#### 7.2.4.4.1 Verification scenarios

The verification scenarios are depicted in Table 7-30.

**Table 7-30 Verification scenarios for single antenna SAIC receivers**

Test cases	Modulation, Tx Pulse	Interference scenario	Note
1	GMSK, LGMSK	MTS-1	-
2	GMSK, LGMSK	MTS-2	-
3	QPSK, LGMSK	MTS-1	SCPIR = 0 dB
4	QPSK, LGMSK	MTS-2	SCPIR = 0 dB
5	QPSK, Opt1	MTS-1	SCPIR = 0 dB
6	QPSK, Opt1	MTS-2	SCPIR = 0 dB
7	QPSK, Opt1	MTS-1	SCPIR = -7.7 dB, S7R1 and S4R4
8	QPSK, Opt1	MTS-2	SCPIR = -7.7 dB, S7R1 and S4R4
9	QPSK, Opt2	MTS-1	SCPIR = 0 dB
10	QPSK, Opt2	MTS-2	SCPIR = 0 dB

NOTE:

- Tx Pulse shaping option 1 and 2 refer to 3GPP TR 45.914, Orthogonal Sub Channels for Circuit Switched Voice Capacity Evolution, Tx pulse shaping filter.
- It has been assumed that all external interference is GMSK. It is expected that DIR has minor impact to the OSC link performance.
- “SCPIR = -7.7 dB, S7R1” means that L2S mapping is verified for SCPIR, where 7 QPSK constellations and one rectangular constellation with SCPIR = -7.7 dB are transmitted over the interleaving period.
- Verification is done for both SubCh 0 (black curves) and SubCh 1 (red curves), also with SCPIR, and both sub-channels have always their own data in the actual L2S mapping.

#### 7.2.4.4.2 Simulation assumptions

The simulation assumptions are summarized in Table 7-31.

Table 7-31 Simulation assumptions

Parameter	Value	
Channel profile	Typical Urban (TU)	
Terminal speed	3 km/h	
Frequency band	900 MHz	
Frequency hopping	Ideal	
Antenna diversity	No	
Interference scenario	MTS-1, MTS-2	
Interference modulation	GMSK	
Receiver type	SAIC algorithm with IQ-whitening	
Frequency offset of interferers	No	
Impairments:	<u>Tx</u>	<u>RX</u>
– Phase noise	0.8 [deg(RMS)]	1.0 [deg(RMS)]
– I/Q gain imbalance	0.05 [dB]	0.2 [dB]
– I/Q phase imbalance	0.2 [deg]	1.5 [deg]
– DC offset	-50 [dBc]	-40 [dBc]
– Frequency error	- [Hz]	25 [Hz]
– PA model	yes	No

7.2.4.4.3 Mapping verification

Mapping verification is depicted in Figures 7-38G1 to 7-38G10 according to the above defined test cases.

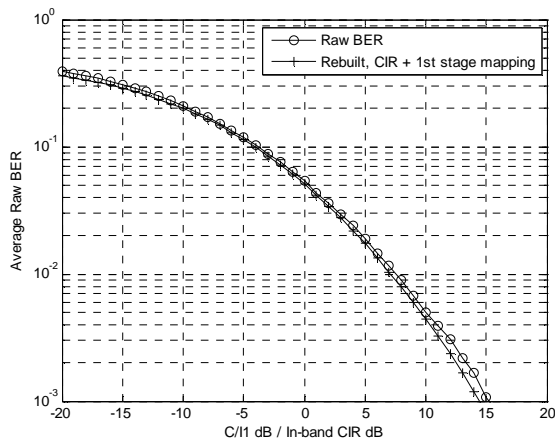

Figure 7-38G1, Test case 1

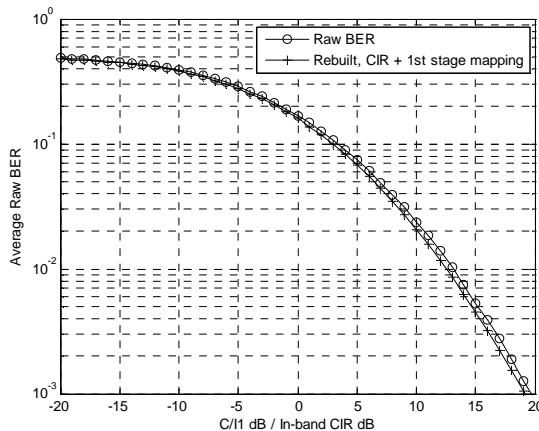

Figure 7-38G2, Test case 2

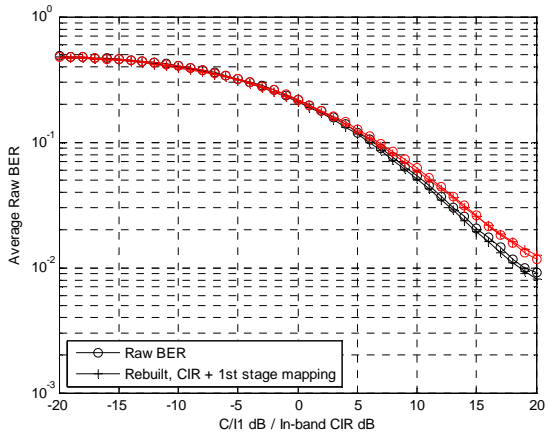

Figure 7-38G3, Test case 3

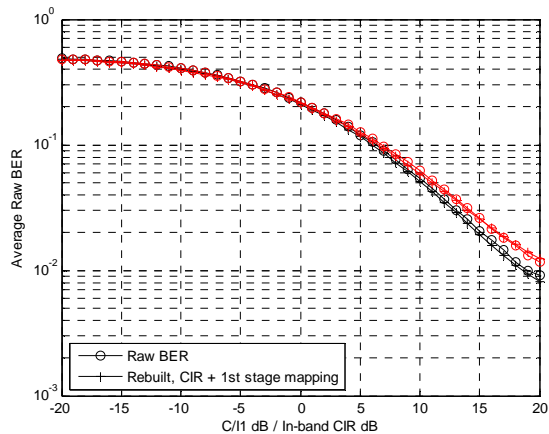

Figure 7-38G4, Test case 4

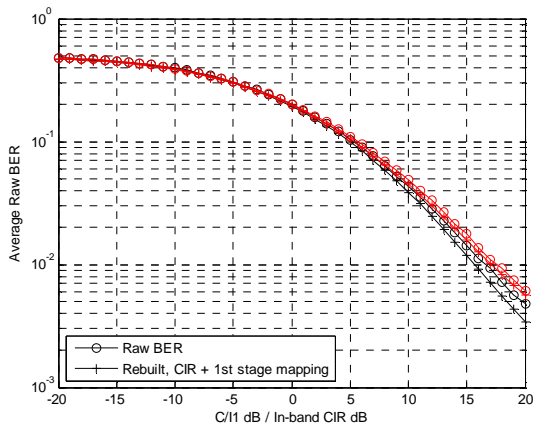

Figure 7-38G5, Test case 5

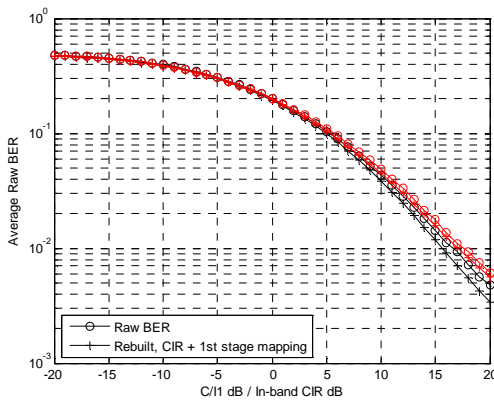
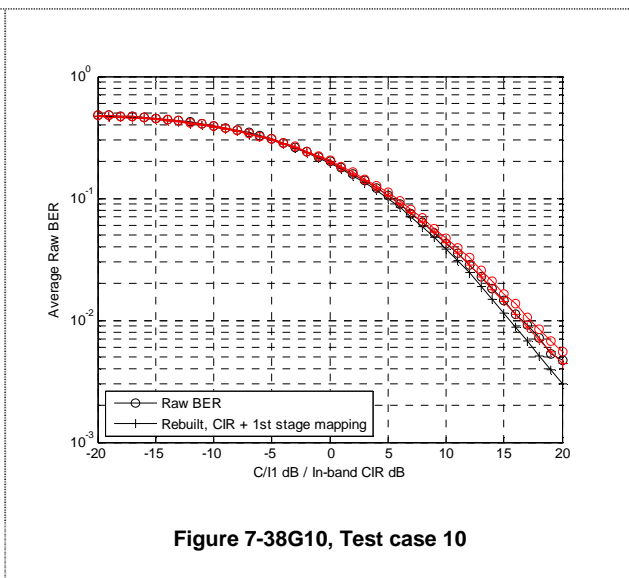
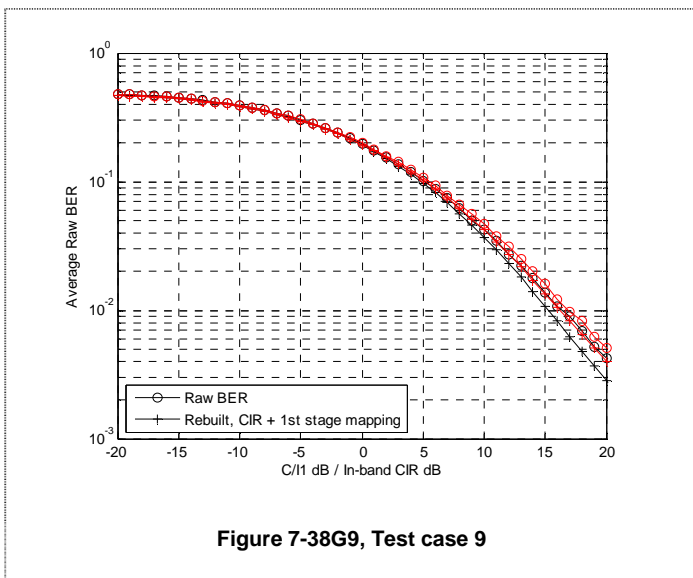
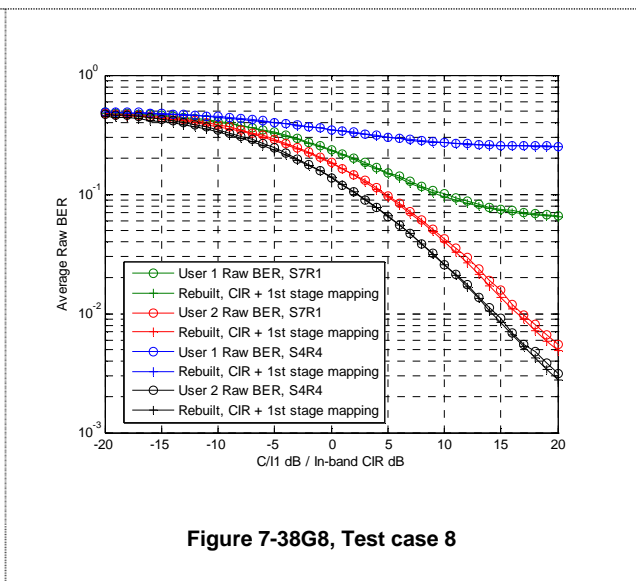
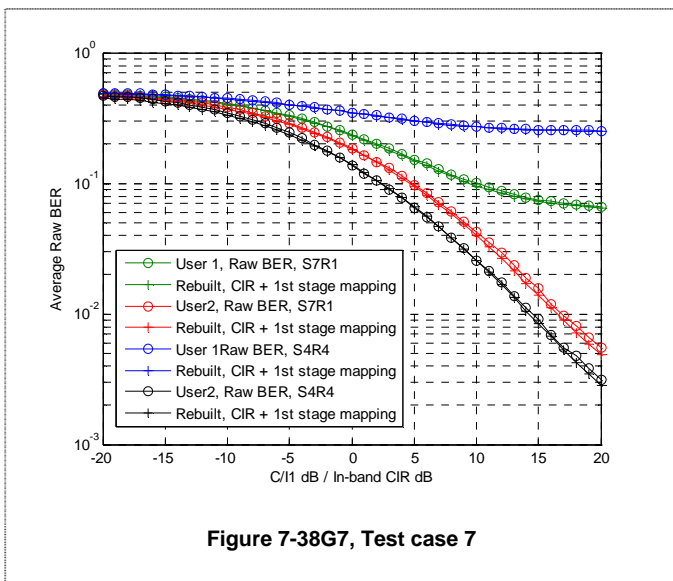

Figure 7-38G6, Test case 6



### 7.2.4.5 Conclusion

The link-2-system mapping method presented in [1] has been verified for scenario MTS-1 and MTS-2 both for single antenna non-SAIC and single antenna SAIC receivers. Mapping from link to system level is done by measuring the burst-wise filtered in-band powers and calculating the resulting raw BER.

Separate verifications for both OSC sub-channels have been done. Test cases with SCPIR have been defined for both users using two different SCPIR settings, i.e. 0 dB and -7.7 dB and combinations of both as an example.

The deviation of L2S mapping from link simulation BER seems to be always below 1dB, typically less than 0.5 dB within the effective range of L2S table in the network simulator.

## 7.3 Impacts on the Mobile Station

Legacy AMR mobiles may be capable to receive sub channel 0, if  $\pi/2$  rotation is applied in downlink for QPSK. For second sub channel the MS should be able to support new training sequences in both downlink and uplink. Indeed the receiver may need to apply e.g. pre-filtering type of receiver to remove ISI for orthogonality.

To improve the accuracy of channel estimation the receiver may also use both binary training sequences of sub channels, denoted as "OSC aware RX", resulting about 0.6 dB gain with QPSK like training sequence, see Figures 7-11 and 7-16.

For sub channel specific PC the MS needs to be coping with unequal power on sub channels. For user diversity the MS needs to support the specified user diversity patterns and the assisted signalling.

For support of an optimised Tx pulse shape on downlink the MS needs to signal its capability to receive it.

## 7.4 Impacts on the BSS

### 7.4.1 BTS Transmitter

The BTS transmitter should support QPSK or QPSK as subset of higher order modulation. Also the symbol rotation of  $\pi/2$  needs to be supported by the BTS.

For sub channel specific PC the BTS needs to be able to change mapping of users to 8PSK constellation based on power control indication.

The Tx pulse shaping filter should also facilitate spectrally wider e.g. RRC pulse shape e.g. with 270 kHz bandwidth in order to provide optimised link and system performance. But linearised GMSK may be applied as well assuming that the new pulse shaping filter is optional.

### 7.4.2 BTS Receiver

The BTS is preferably equipped with 2 receive antennas and uses e.g. either Space Time Interference Rejection Combining (STIRC) or Successive Interference Cancellation (SIC) receiver to receive orthogonal sub channels used by different MSs. Alternatively, the BTS receiver for two GMSK users separated by training sequences could be based e.g. on Joint Detection (JD) of two GMSK users with a JD receiver. A fourth option is to use two independent GMSK receivers for each sub channel.

Indeed BSS should apply uplink power control possibly interworked with Dynamic Channel Allocation (DCA) scheme to keep difference of received uplink signal levels of co-assigned sub channels within e.g.  $\pm 15$  dB window.

### 7.4.3 Radio Resource Management (RRM)

The RRM should balance received uplink signal levels of both sub channels within  $\pm 15$  dB range and should use e.g. current AMR FR or HR traffic channels as a fallback when needed.

With regard to the user diversity procedure, the definition of predefined user diversity patterns as described in the concept section 7.1.2.2.5.3 needs to be undertaken. Thus RRC signalling is needed to indicate during channel assignment the operated user diversity pattern. In addition the sub channel number, the used TSC on this sub channel as well as the new channel type need to be signalled in the channel assignment message.

#### 7.4.3.1 Power Control

Downlink power control may use conditions of the weakest link as criteria. Total power control range for uplink balancing purpose is about 30 dB + 30dB (30 dB range for each multiplexed MS). To make PC four times faster in uplink, Enhanced Power Control may be used.

#### 7.4.3.2 Dynamic Channel Allocation (DCA)

Dynamic channel allocation can sort different OSC voice users to e.g. 30dB windows according to path losses and allocate those to the same resource and balance these further with power control.

Intra Cell Handover for DCA may be triggered for a user having higher or lower level depending on the case. For example a more sensitive user with higher path loss can be left intact, whilst a user with higher level is signalled to perform intra cell HO or vice versa.

### 7.4.3.3 AMR Channel Rate and Codec Mode Adaptation

The switching between e.g. FR, HR and OSC HR, may use similar criteria as in current FR / HR switching, but may take additionally care about sufficient path loss window to maintain operation of SIC in uplink. AMR Codec Mode Adaptation may rely on current parameters.

## 7.5 Impacts on Network Planning

### 7.5.1 Impacts to Abis interface

In order to support OSC, dimensioning aspects on Abis interface have to be considered. In the following impacts on Abis allocation strategy, Abis bandwidth consumption and Abis migration paths are considered in more detail.

#### 7.5.1.1 Impact of OSC on Abis allocation strategy

Introduction of OSC denotes in the context of Abis interface introduction of 2 new transmission modes (in addition to the existing one where 1 radio channel corresponds to 1 Abis sub channel): OSC Full Rate (OSCFR) mode and OSC Half Rate (OSCHR) mode.

As depicted in Figure 7-39, in OSCFR mode it is possible to transmit 2 FR users in a single radio channel which corresponds to simultaneous occupation of 2 Abis sub channels.

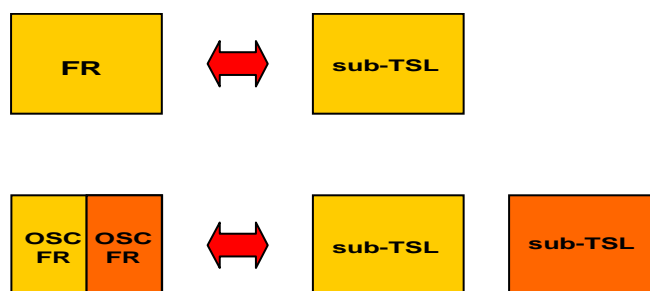

**Figure 7-39: Mapping of FR and OSC FR radio channels onto 16 kbit/s Abis sub channels**

As depicted in Figure 7-40, in OSCHR mode it is possible to transmit 4 HR users in a single radio channel which also corresponds to simultaneous occupation of 2 Abis sub channels. Note that 2 HR users working in OSC HR mode can also be multiplexed in time. In such case they occupy 1 Abis sub channel (just like “non OSC” HR call).



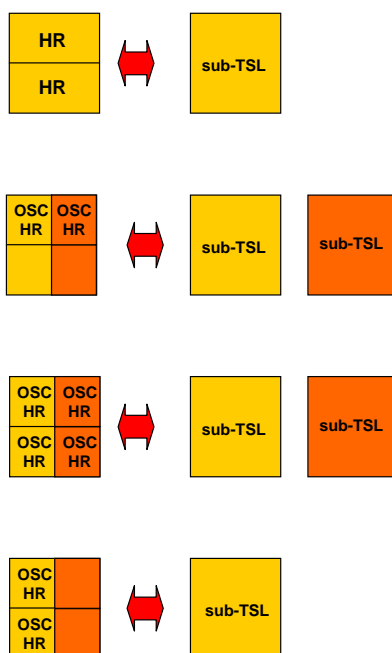

**Figure 7-40: Mapping of HR and OSC HR radio channels onto 16 kbit/s Abis sub timeslots**

Which of the modes (OSCFR only, OSC HR only or both) is to be used depends on the actual implementation.

### 7.5.1.2 Impact of OSC on bandwidth consumption

Theoretically, if all Abis timeslots in all TRXs in the given BTS site work at the same time in “OSC transmission mode” – the Abis bandwidth that would need to be available for CS traffic must be doubled in comparison to “no OSC transmission mode”. Note that Abis bandwidth reserved for signalling must also be adjusted accordingly in such case.

However, unless a 100% penetration of OSC capable mobiles is available in the network, it is unlikely to achieve 100% penetration of OSC channels. Thus a suitable mix of OSC channels and legacy FR and HR channels has to be assumed for Abis dimensioning, taking into account that the mobiles may require OSC channel mode adaptation from OSC HR channel mode or legacy HR channel mode to legacy FR channel mode in case of degrading radio conditions. Hence the actual impact of OSC on the Abis interface depends on penetration of the functionality, i.e. the percentage of radio channels working in “OSC transmission mode”. The greater the penetration of OSC channels the more Abis resources must be reserved for CS domain.

The Abis impact will be studied further in more detail for selected scenarios based on the agreed network configurations.

### 7.5.1.3 Abis migration paths

Implementation of OSC extending CS capacity on radio and consequently on Abis interface as well contributes to the steadily growing requirements concerning bandwidth available in the transport network in particular with regard to Abis interface. On the other hand additional transport network capacity in terms of TDM lines leads to increase of OPEX since leased lines costs’ need to be taken into account. Thus a viable solution is to migrate the transport networks towards packet based ones and to IP based ones as replacement of the existing TDM-based networks. One of the possible migration strategies is the introduction of pseudowire emulation which allows to convert the selected PCM lines into IP packets and then to transmit their content by means of Ethernet network. This allows to smoothly migrate from TDM-based transport to IP-based one in pace depending on availability of reliable IP/Ethernet networks. Final step consists in using “native” IP networks to transmit traffic produced in the RAN. With these solutions further OPEX savings in terms of smaller bandwidth consumption in the transport networks are expected due to additional traffic optimization and statistical multiplexing effects.

## 7.5.2 Impacts on Frequency Planning

OSC channels can be employed both on BCCH carrier and on TCH carrier. In case of usage of the legacy GMSK pulse shape no straight impact on frequency planning is observed. All proposed techniques, such as subchannel specific PC, power balancing, usage of new TSC's and user diversity are operating independent of used frequency hopping scheme. However as performance investigations have shown, OSC can exhibit best performance for HW limited scenarios and loose frequency reuses. For tighter frequency reuses further optimizations of RRM algorithms and application of enhancement techniques need to be executed, before the potential of capacity improvement for OSC can be identified for these scenarios.

Since OSC operates best for loose reuse scenarios, deployment on the BCCH carrier is a viable option. This is also true in case an optimized Tx pulse shape as described in section 7.1.2.1.3 is employed on downlink to minimise ISI. In case an optimized Tx pulse shape is used on the TCH layer, further investigations are required to identify the overall performance gain taking into account impact of the wider pulse on reception of legacy mobiles. Hence this should be studied in the context of an optional enhancement of the OSC feature.

## 7.6 Impacts on the Specifications

In Table 7-23 a list of affected specifications and the respective subjects for introducing OSC into GERAN is shown.





**Table 7-23: Affected existing specifications for OSC**

Spec No.	Subject
24.008	Capability indication for OSC solution
	Capability indication for support of optimized pulse shape
44.018	RR support for OSC solution
45.001	Overview of OSC solution
45.002	New training sequences, multiplexing definitions
45.003	Definition of coding required for OSC
45.004	Modulation definition for OSC in downlink
	Specification of an optimized TX pulse shape on downlink
45.005	Test Scenarios for OSC
	Spectral requirements for downlink
	Performance requirements for legacy GMSK pulse shape on DL
	Performance requirements for optimized TX pulse shape on DL
45.008	Link quality control measurements
48.008	Introduction of the signalling for support of OSC
48.058	Introduction of the signalling for support of OSC

## 7.7 Summary of Evaluation versus Objectives

In this section the candidate technique is evaluated against the defined objectives in chapter 4. Note, this section represents the view of the proponents of this candidate technique.

The following classification is used for the evaluation:

	<b>Fulfilled</b>
	<b>Expected to be fulfilled</b>
	<b>Unclear/FFS</b>
	<b>Not fulfilled</b>

### 7.7.1 Performance objectives

Evaluation of MUROS Candidate Techniques	Orthogonal Sub Channels
Performance Objectives	
<p><b>P1: Capacity Improvements at the BTS</b></p> <p>1) increase voice capacity of GERAN in order of a factor of two per BTS transceiver</p> <p>2) channels under interest: TCH/FS, TCH/HS, TCH/EFS, TCH/AFS, TCH/AHS and TCH/WFS</p>	<p>1) Gains have been shown by system level simulations to be between 20% and 76% dependent on the system scenario and speech codec investigated for OSC. Further gains on top have been shown when utilizing sub channel specific power control in the range of 7% to 16% or are expected related to the usage of optimized Tx pulse shape on DL.</p> <p>2) All codecs are supported.</p>
<p><b>P2: Capacity Improvements at the air interface</b></p> <p>1) enhance the voice capacity of GERAN by means of multiplexing at least two users simultaneously on the same radio resource both in downlink and in uplink</p> <p>2) channels under interest: TCH/FS, TCH/HS, TCH/EFS, TCH/AFS, TCH/AHS and TCH/WFS</p>	<p>1) Two users are multiplexed on the same radio resource both in uplink and downlink.</p> <p>2) All codecs are supported.</p>

## 7.7.2 Compatibility objectives

Evaluation of MUROS Candidate Techniques	Orthogonal Sub Channels
Compatibility Objectives	
<p><b>C1: Maintenance of Voice Quality</b></p> <p>1) voice quality should not decrease as perceived by the user. 2) A voice quality level better than for GSM HR should be ensured.</p>	<p>1) It is assumed that channel mode adaptation (CMA) takes place if quality in OSC channel degrades. Also only users with sufficient quality will be multiplexed on the OSC channel.</p> <p>2) Minimum FER thresholds have been defined in the TR, and these have been taken into account in system level analysis.</p>
<p><b>C2: Support of Legacy Mobile Stations</b></p> <p>1) Support of legacy MS w/o implementation impact. 2) First priority on support of legacy DARP phase 1 terminals, second priority on support of legacy GMSK terminals not supporting DARP phase 1.</p>	<p>1) Link level performance for a mix of SAIC and non-SAIC mobiles were shown at GERAN#39. Results from other vendors do confirm results from Nokia Siemens Networks.</p> <p>2) System level performance for 100 % DARP phase 1 mobiles were shown at GERAN#39, inclusion of legacy non-SAIC MS were studied in based on usage of subchannel specific power control.</p>
<p><b>C3: Implementation Impacts to new MS's</b></p> <p>1) change MS hardware as little as possible. 2) Additional complexity in terms of processing power and memory should be kept to a minimum.</p>	<p>1) Basic SAIC implementation would be sufficient to support the proposal. Only the knowledge of new TSCs is needed.</p> <p>2) For new MS the only additional requirement is the awareness of the new TSCs. Power control in downlink is expected to be transparent to the MS implementation. No additional functionality is needed to support OSC except for SAIC capabilities.</p>
<p><b>C4: Implementation Impacts to BSS</b></p> <p>1) Change BSS hardware as little as possible and HW upgrades to the BSS should be avoided. 2) Any TRX hardware capable for MUROS shall support legacy non-SAIC mobiles and SAIC mobiles. 3) Impacts to dimensioning of resources on Abis interface shall be minimised.</p>	<p>1) No BTS HW change required, since QPSK and 8-PSK are supported on EDGE capable BTS. JD or SIC receiver with IRC needed.</p> <p>2) For EDGE capable BTS this is usually the case.</p> <p>3) Impact is to reserve a higher number of sub channels on Abis interface and possibly use another packet Abis technology.</p>
<p><b>C5: Impacts to Network Planning</b></p> <p>1) Impacts to network planning and frequency reuse shall be minimised. 2) Impacts to legacy MS interfered on downlink by the MUROS candidate technique should be avoided in case of usage of a wider transmit pulse shape on downlink. 3) Furthermore investigations shall be dedicated into the usage at the band edge, at the edge of an operator's band allocation and in country border regions where no frequency coordination are in place.</p>	<p>1) No impact on frequency planning or frequency reuse is foreseen.</p> <p>2) Impacts on legacy MS reception for optimised TX pulse shape need to be further investigated.</p> <p>3) Optimised TX pulse shape is not expected to be used at band edge or at the edge of an operator's allocation.</p>

OSC is believed to have a high potential for voice capacity improvement, as has been shown in this chapter of the TR. Investigations on OSC have confirm the high potential for doubled voice capacity in GERAN networks depending on the frequency reuse of the network under interest. Furthermore a solution by applying subchannel specific power control has been created to allow for efficient multiplexing including legacy mobiles. Further enhancements using new user diversity have been defined to improve interference diversity for traffic channels but also for SACCH control channels. Considering that an urgent need for this improvement has been expressed in particular by asian operators [7-9], it is believed that GERAN should agree to open a work item on the introduction of orthogonal sub channels.

## 7.8 References

- [7-1] GP-072033, WID: Multi-User Reusing-One-Slot (MUROS), China Mobile, Ericsson, Nokia Siemens Networks, Nokia, Nortel Networks, NXP, Qualcomm, Telecom Italia, Vodafone, 3GPP GERAN#36
- [7-2] GP-071792, Voice Capacity Evolution with Orthogonal Sub Channel, Nokia Siemens Networks, Nokia, 3GPP GERAN#36
- [7-3] GP-080171, Sub Channel specific Power Control for Orthogonal Sub Channels, Nokia Siemens Networks, 3GPP GERAN#37
- [7-4] GP-080170, User Diversity with Orthogonal Sub Channels, Nokia Siemens Networks, Nokia, 3GPP GERAN#37
- [7-5] GP-081162 Optimized User Diversity for OSC, Nokia Siemens Networks, Nokia, 3GPP GERAN#39
- [7-6] GP-080769, OSC - Link Level Performance Evaluation - revision 1, Nokia Siemens Networks, 3GPP GERAN#38
- [7-7] GP-081179 Downlink power control with orthogonal sub channels, Nokia Siemens Networks, 3GPP GERAN#39
- [7-8] GP-081161, OSC – System Performance Evaluation, Nokia Siemens Networks, 3GPP GERAN#39
- [7-9] GP-071679, Requirements on evaluation of new techniques for GSM voice capacity enhancements, China Mobile, 3GPP GERAN#36
- [7-10] GP-081917, MUROS – Collection of results for the TR, Nokia Corporation, 3GPP GERAN#40
- [7-11] GP-080572, MUROS – Performance of Legacy DARP MS, Nokia Corp, 3GPP GERAN#38
- [7-12] AHG1-080007, MUROS Interference Performance of DARP capable MS, NXP Semiconductors
- [7-13] GP-090234, “Continued System Performance Evaluation for OSC” source: Nokia Siemens Networks, GERAN#41
- [7-14] GP-081179 Downlink power control with orthogonal sub channels, Nokia Siemens Networks, 3GPP GERAN#39
- [7-15] GP-090871, “Network Performance Evaluation for OSC with Optimized Transmit Pulse Shape in DL” source: Nokia Siemens Networks, NOKIA Corporation, GERAN#42
- [7-16] GP-090742, DRAFT CR 24.008-xxxx “Addition of VAMOS capability to MS Classmark 3”, source Nokia Siemens Networks, NOKIA Corporation, GERAN#42
- [7-17] J. Wigard, T. Nielsen, P. Michaelsen, and P. Mogensen, “BER and FER prediction of control and traffic channels for a GSM type of air-interface,” in Proc. IEEE VTC-Spring, Ottawa, Ontario, May 1998.
- [7-18] GP-080947, “Summary of MUROS offline session”, source: WI Rapporteur, GERAN#38
- [7-19] GP-081180, “Minutes of MUROS telco#5”, source: WI Rapporteur, GERAN#39
- [7-20] GP-081301, “Outcome of TSG GERAN WG1 meeting #39”, source: GERAN1 chairman GERAN#39

## 8 Adaptive symbol constellation

### 8.1 Concept Description

In the uplink the MS shall use GMSK modulation. A different training sequence shall be assigned to each MS. The BSS shall implement a multi-user multiple-input-multiple-output (MU-MIMO) receiver in order to decode the two desired signals.

In the downlink, a linear modulator using a rotating hybrid quaternary complex symbol constellation is proposed. The modulation is adaptive since the signal constellation may be time dependent. The constellation can be chosen according to the capabilities or radio conditions of the MS's. Two sub-channels are created from the real and imaginary parts of the baseband signal. Legacy GMSK MS may be assigned one of the subchannels provided a legacy training sequence is used.

A new set of training sequences with good orthogonality properties shall be designed in order to optimize the link performance both in the uplink and the downlink.

#### 8.1.1 Symbol Constellation for the Downlink

A parameter  $0 \leq \alpha \leq \sqrt{2}$  is chosen to create a quaternary constellation as shown in Table 8-1.

**Table 8-1  $\alpha$ -QPSK Constellation**

$$\alpha\sqrt{\frac{1}{2}} + j\sqrt{2-\alpha^2}\sqrt{\frac{1}{2}} \quad \alpha\sqrt{\frac{1}{2}} - j\sqrt{2-\alpha^2}\sqrt{\frac{1}{2}} \quad -\alpha\sqrt{\frac{1}{2}} + j\sqrt{2-\alpha^2}\sqrt{\frac{1}{2}} \quad -\alpha\sqrt{\frac{1}{2}} - j\sqrt{2-\alpha^2}\sqrt{\frac{1}{2}}$$

The constellation of Table 8-1 shall be called an  $\alpha$ -QPSK constellation. The extreme values  $\alpha = 0$  and  $\alpha = \sqrt{2}$  yield BPSK constellations, while for  $\alpha = 1$  an ordinary QPSK constellation is obtained. Figure 8-1 depicts the case  $\alpha = 0.6$ .

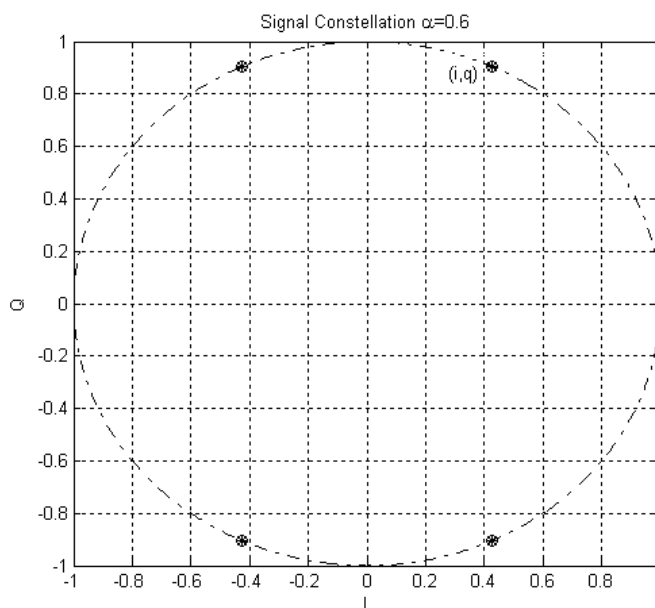

**Figure 8-1: Example  $\alpha$ -QPSK constellation**

As  $\alpha$  changes the power in the  $I$  channel is changed by  $10\log_{10}(\alpha^2)$  dB, relative to the power of the  $I$  channel when using ordinary QPSK. Similarly, the power in the  $Q$  branch is changed by  $10\log_{10}(2 - \alpha^2)$  dB relative to the power of the  $Q$  branch for ordinary QPSK. The cross power ratio  $\chi$ , depicted in Figure 8-2, between the  $I$  and  $Q$  branches is determined by  $\alpha$  as:

$$\chi = 10\log_{10}\left(\frac{\alpha^2}{2 - \alpha^2}\right)$$

It is expected that legacy GMSK mobiles will be able to demodulate one of the sub-channels, provided  $\alpha$  is chosen so that  $|\chi|$  is large enough. This assumption is verified in section 8.2.1.3.1 .

Note that the energy in an  $\alpha$ -QPSK constellation is always 1, independent of  $\alpha$ .

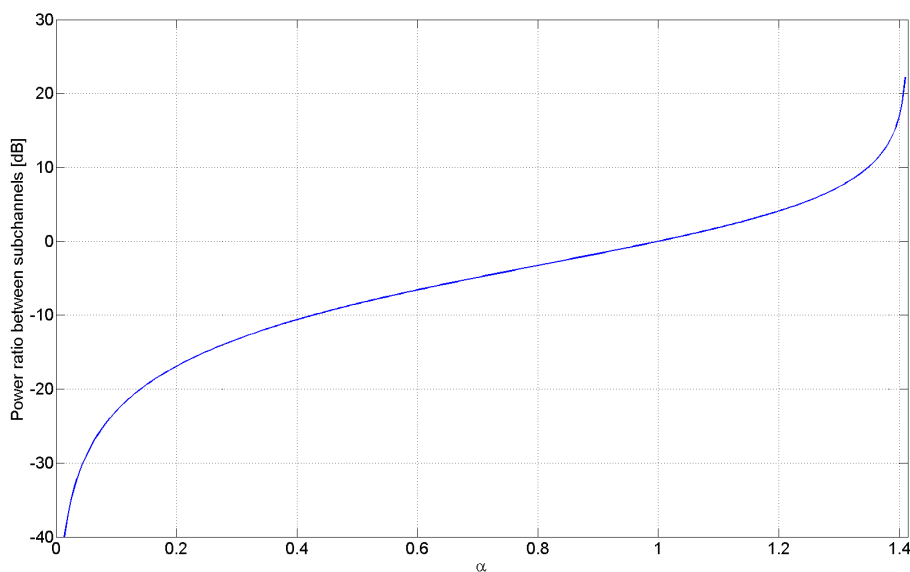

Figure 8-2: Cross power ratio

## 8.1.2 $\alpha$ -QPSK Modulator

The linear modulator required to create the hybrid quaternary symbol constellation of Table 8-1 is depicted in Figure 8-3. The code bits are modulated to binary symbols  $\{-1,+1\}$ . This results in two binary symbol streams  $a_n$  and  $b_n$  that are mapped to one  $\alpha$ -QPSK symbol stream  $c_n$ . The quaternary symbol stream is rotated and passed through a linear pulse shaping filter. Finally the signal is up-mixed to the carrier frequency and amplified.

The two users are separated by means of different training sequences. The use of orthogonal training sequences will improve the performance. Utilizing a pulse shaping filter that satisfies the Nyquist criterion will maintain the orthogonality of the  $I$  and  $Q$  sub-channels. The legacy linearized GMSK pulse may be used in order to comply with the legacy spectral mask.

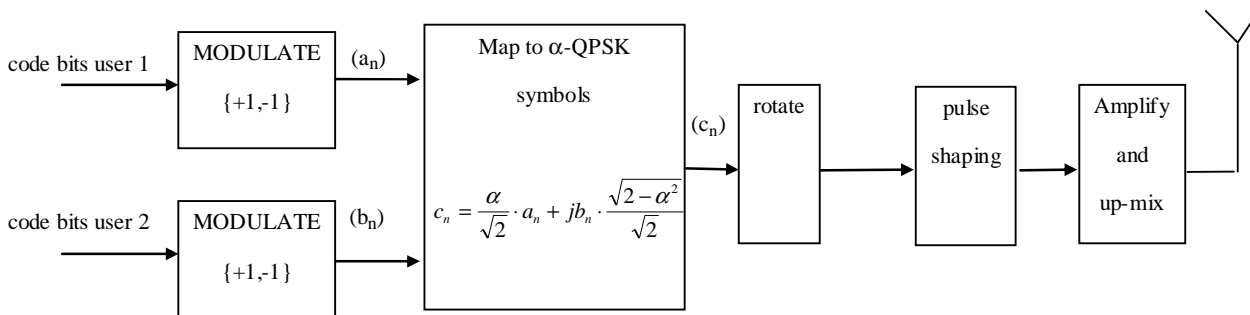

Figure 8-3:  $\alpha$  -QPSK modulator and transmitter

### 8.1.3 Choice of Symbol Constellation

To determine symbol constellation, i.e.  $\alpha$ , the modulator may receive feedback from the MS's. For example  $\alpha$  may depend upon the reported RXQUAL, or upon the capabilities of the MS's, e.g. legacy/legacy SAIC/ $\alpha$  -QPSK-aware. This process is illustrated in Figure 8-4, where the box labeled  $\alpha$  -QPSK modulator contains the modulator described in Figure 8-3. The BSC box represents the Base Station Controller.

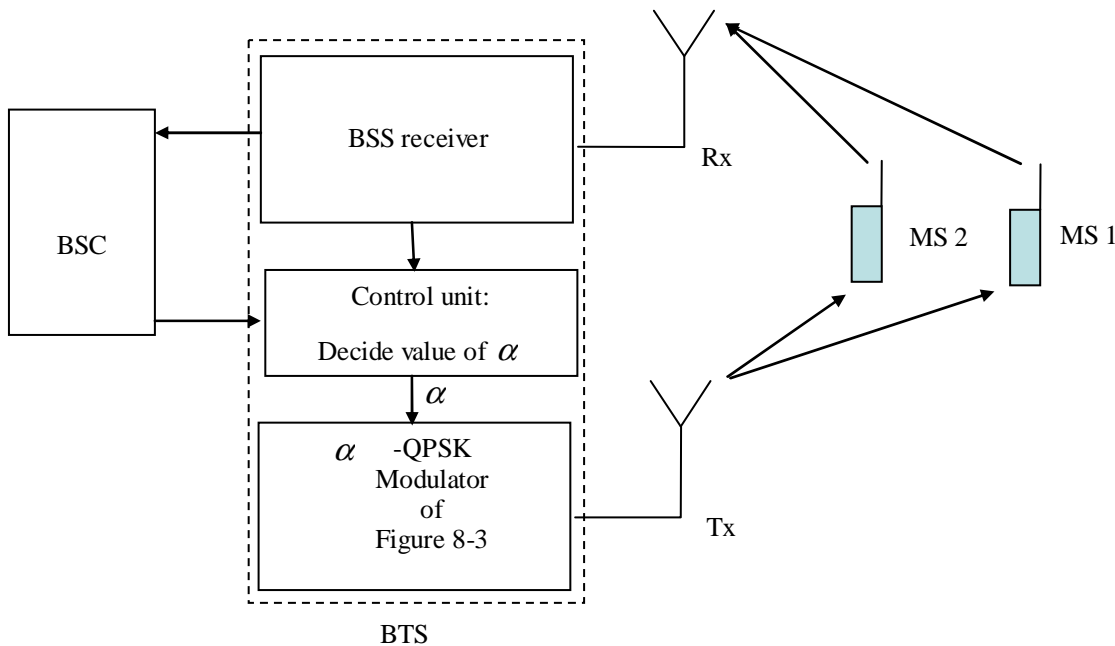

Figure 8-4: Adaptive  $\alpha$  -QPSK modulator

The BSS decides the powers P1 and P2 required for MS1 and MS2 respectively, depending on the reported capabilities, RXQUAL and RXLEV by each MS. The control unit computes a combination of output power P and  $\alpha$  that gives the required combination of P1 and P2. Dynamic Channel Allocation (DCA) may be used to move users from shared radio resources to not shared radio resources and vice versa.

An  $\alpha$  -QPSK-aware mobile may ignore the value of  $\alpha$ . However, it can be advantageous to use it during the demodulation process. Depending on the algorithm used at the control unit, an  $\alpha$  -QPSK-aware MS may not have knowledge of the value of  $\alpha$  used by the modulator in the BTS. If it is unknown then it can be estimated. In section 8.2.1.2.2 simulations are presented to show that the estimation is feasible.



### 8.1.4 Adaptive Constellation Rotation

Since compatibility with legacy mobiles is desired, it has been proposed to rotate the signal by  $\pi/2$ . However, this rotation angle is not optimum in terms of PAR for these symbol constellations. Typical power amplifiers are peak limited, which for a signal with high PAR requires additional power backoff. Hence, as the PAR increases, the coverage of the BTS decreases.

To optimize PAR in the DL it is proposed to adapt the rotation angle to the capabilities of the MS receivers. The penetration of MUROS MSs will increase with time. Eventually two MUROS mobiles will be assigned to two orthogonal sub-channels. In this case, there's no need to continue using the sub-optimal rotation angle. For example, if QPSK modulation is used, then rotation by  $\pi/4$  will result in lower PAR and will eliminate zero crossings. The figures below illustrate this fact. The unit circle is depicted in red and the baseband signal in blue.

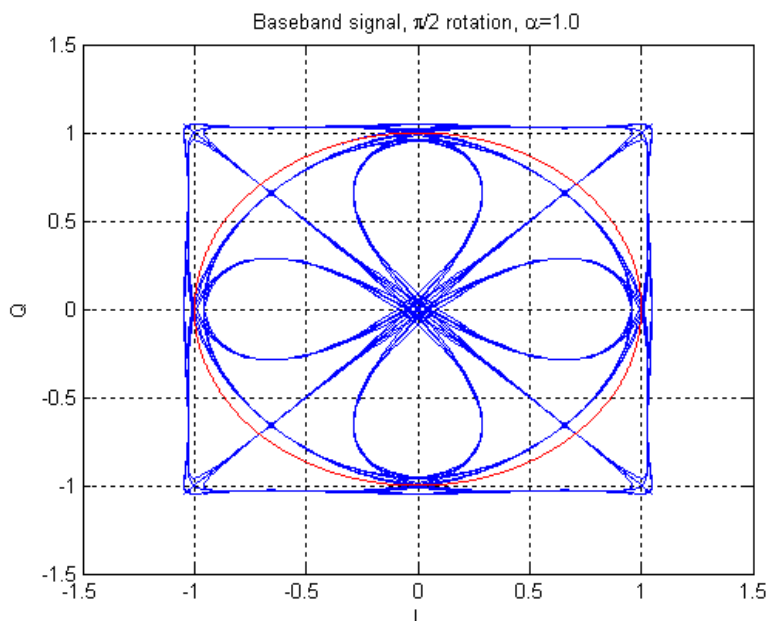
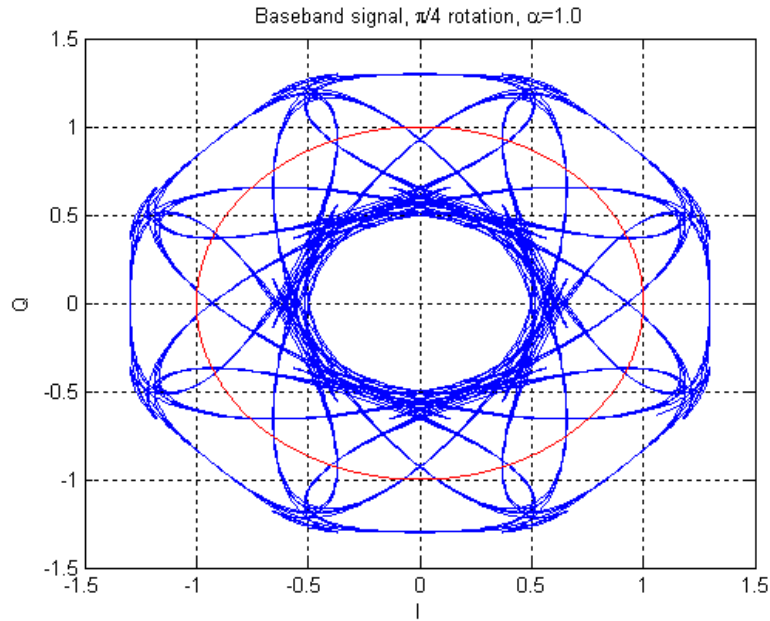
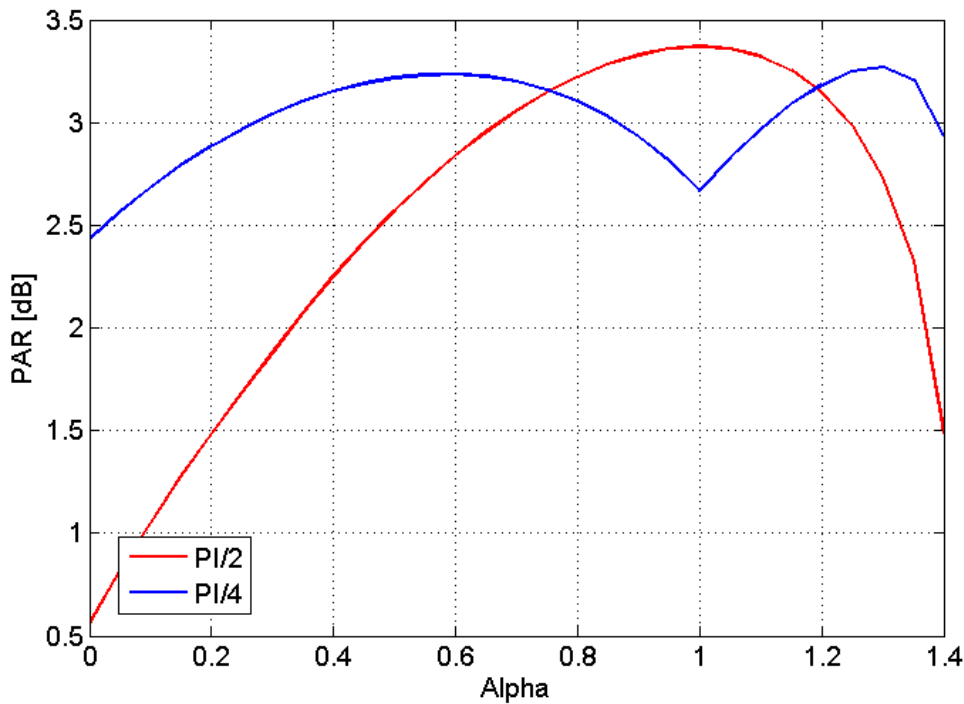

Figure 8-5: Example baseband signal. Ordinary QPSK.  $\pi/2$  rotation. Linearized GMSK Tx pulse



**Figure 8-6: Example baseband signal. Ordinary QPSK.  $\pi/4$  rotation. Linearized GMSK Tx pulse**

The rotation angle shall be chosen so that PAR is minimized. If there is a legacy mobile in at least one of the sub-channels then the BTS modulator rotates the signal by  $\pi/2$ . However, if two  $\alpha$ -QPSK MUROS mobiles are paired together on orthogonal sub-channels, the transmitting base station can choose constellation rotation to minimize PAR. To illustrate the concept Figure 8-7 shows the PAR as a function of alpha for  $\alpha$ -QPSK constellations rotated  $\pi/2$  and  $\pi/4$  radians.



**Figure 8-7: PAR as a function of alpha**

When alpha equals 0.77 and 1.19 the two PAR curves intersect. To minimize the signal PAR a base station would hence adapt its choice of rotation according to the active alpha value:

$$\text{rot}(\alpha) = \begin{cases} \pi/4, & \text{if } (0.77 < \alpha < 1.19) \\ \pi/2 & \text{otherwise.} \end{cases}$$

On the receiver side, the MS performs blind detection of the rotation angle, among a predetermined set of rotation angles. From EGPRS it is known that blind detection of rotation is possible with negligible performance loss and low computational complexity. This assumption is verified in section 8.2.1.2.2.2.

## 8.1.5 Frequency hopping

Since the intra-cell interference is vastly increased by the introduction of multiple users re-using the same time slot it has been considered to increase diversity (i.e., to ensure that a user is not continuously interfered by the same other user). Diversity is achieved by means of frequency hopping. The frequency hopping schemes can be applied both in the uplink and downlink. Initial simulations in the downlink show substantial gains. The performance in the UL is FFS.

Assume that the MAIO takes values in the set  $\{0,1,\dots,N-1\}$ . Denote by  $S_N$  the symmetric group on the set  $\{0,1,\dots,N-1\}$ .  $S_N$  consists of all bijective mappings from  $\{0,1,\dots,N-1\}$  to  $\{0,1,\dots,N-1\}$ . In other words, an element  $\sigma \in S_N$  is a permutation of the set of  $N$  integers  $\{0,1,\dots,N-1\}$ . The length of the MAIO hopping sequence is chosen to be an arbitrary positive integer  $M$ . A MAIO hopping sequence is defined by a set of  $M$  elements  $\sigma_0, \dots, \sigma_{M-1}$  of  $S_N$ . Repetitions are allowed. That is, it is possible to choose  $\sigma_m = \sigma_n$  for  $m \neq n$ . Given a time specified by the counter FN, the MAIO for the  $i$ -th call assigned to the second OSC sub-channel is

$$\text{MAIO}_{\text{FN}}(i) = \sigma_{\text{FN mod } M}(i), \quad 0 \leq i \leq N-1. \quad (1)$$

Here **mod** denotes the arithmetic modulo operator.

Another scheme for MAIO hopping values generation is based on existing pseudo random hopping sequence generation specified in 45.002.

Since the same hopping sequence is used for the different sub channel sets it is guaranteed that at most two users hop onto the same frequency and timeslot at any time instant.

First the case when available frequency hopping is re-used for MUROS.

Assume that two more mobile stations are present in the cell, M4 and M5. They are assigned parameters as shown in Table 8-2.

**Table 8-2: Frequency hopping parameters for case with existing OSC solution**

	<b>M1</b>	<b>M2</b>	<b>M3</b>	<b>M4</b>	<b>M5</b>
MA	{1,4,7,10}	{1,4,7,10}	{1,4,7,10}	{1,4,7,10}	{1,4,7,10}
Basic hopping sequence <sup>5</sup>	[2,3,1,0,2,0,1,3]	[2,3,1,0,2,0,1,3]	[2,3,1,0,2,0,1,3]	[2,3,1,0,2,0,1,3]	[2,3,1,0,2,0,1,3]
MAIO	0	1	2	0	1
Sub-channel	0	0	0	1	1
Frequency sequence	[7,10,4,0,7,0,4,10, ...]	[10,0,7,4,10,4,7, ...]	[0,4,10,7,0,7,10,4, ...]	[7,10,4,0,7,0,4,10, ...]	[10,0,7,4,10,4,7, ...]

Using the frequency sequence in Table 8-2 results in the frequency hopping illustrated in Figure 8-8. It is evident that mobile stations M1 and M4 continuously use the two sub-channels of the same channel and thereby are subject to each other's inter-sub-channel interference. Similarly, M2 and M5 continuously interfere each other. M3, on the other hand, is not subject to any inter-sub-channel interference.

<sup>5</sup> The length of the hopping sequences are assumed to be eight. These hopping sequences are used for illustrative purposes only and do not reflect actual hopping sequences for GSM [8-4].

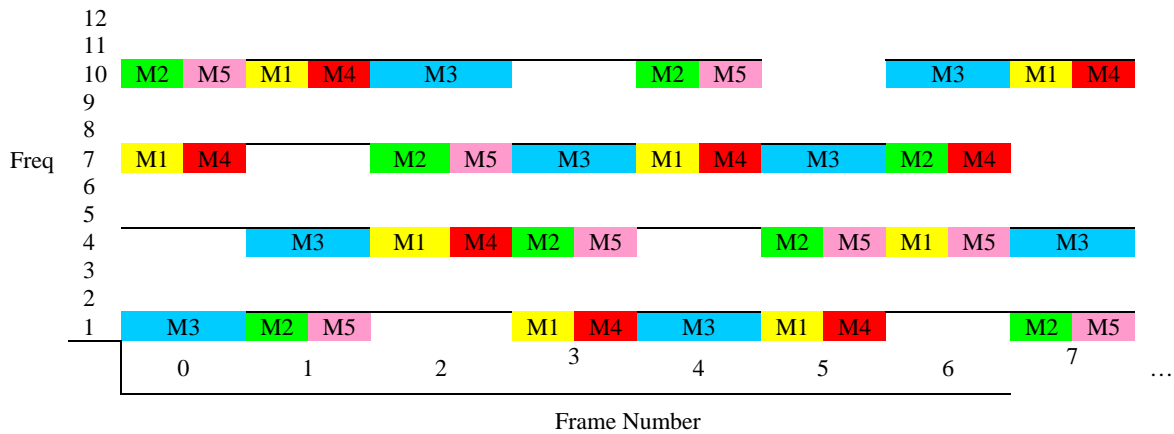

**Figure 8-8: Frequency hopping, with existing OSC solution**

Finally, consider the OSC solution with improved frequency hopping. Assume there are still 5 mobile stations in the cell (on the considered timeslot number). The same parameters are used as in Table 8-2 but users of the second sub-channel, i.e. M4 and M5 will hop between the MAIOs.

A set of permutations giving the MAIO hopping sequences in Table 8-3 is chosen.

**Table 8-3: MAIO Hopping Sequences**

	MAIO							
M4	0	2	2	1	2	0	2	1 ...
M5	1	1	0	0	1	2	0	0 ...
	FN=0	FN=1	FN=2	FN=3	FN=4	FN=5	FN=6	FN=7 ...

The following table shows the resulting assignment of frequencies.

**Table 8-4: Frequency sequences**

	M1	M2	M3	M4	M5
MA	{1,4,7,10}	{1,4,7,10}	{1,4,7,10}	{1,4,7,10}	{1,4,7,10}
Basic hopping sequence <sup>6</sup>	[2,3,1,0,2,0,1,3]	[2,3,1,0,2,0,1,3]	[2,3,1,0,2,0,1,3]	[2,3,1,0,2,0,1,3]	[2,3,1,0,2,0,1,3]
MAIO	0	1	2	from Table 8-3	from Table 8-3
Sub-channel	0	0	0	1	1
Frequency sequence without hopping over MAIOs	[7,10,4,0,7,0,4,10,...]	[10,0,7,4,10,4,7,...]	[7,1,10,4,1,7,10,4,...]	[7,10,4,0,7,0,4,10,...]	[10,0,7,4,10,4,7,...]
Frequency sequence applying cyclic hopping over MAIOs in sub-channel 1	[7,10,4,0,7,0,4,10,...]	[10,0,7,4,10,4,7,...]	[7,1,10,4,1,7,10,4,...]	[7,4,10,4,0,0,10,0 ...]	[10,0,4,0,10,7,4,10,...]

The resulting frequency hopping is illustrated in Figure 8-9. It can be seen that the interference diversity has improved. E.g., mobile station M1 is sometimes interfered by M4, sometimes by M5 and sometimes not interfered at all. A similar improvement is seen for M2. M3, which was never subject to inter-sub-channel interference with the existing OSC solution, is now sometimes interfered by M4 or M5. But the fairness has improved due to the improved frequency hopping. Further, since the channel coding makes the channel robust to a certain amount of interference, it is likely that the speech quality on average has improved in the cell (assuming the network is well dimensioned to handle the given load). No simulation results have been provided in this document but similar gains as shown in [8-3] can be expected.

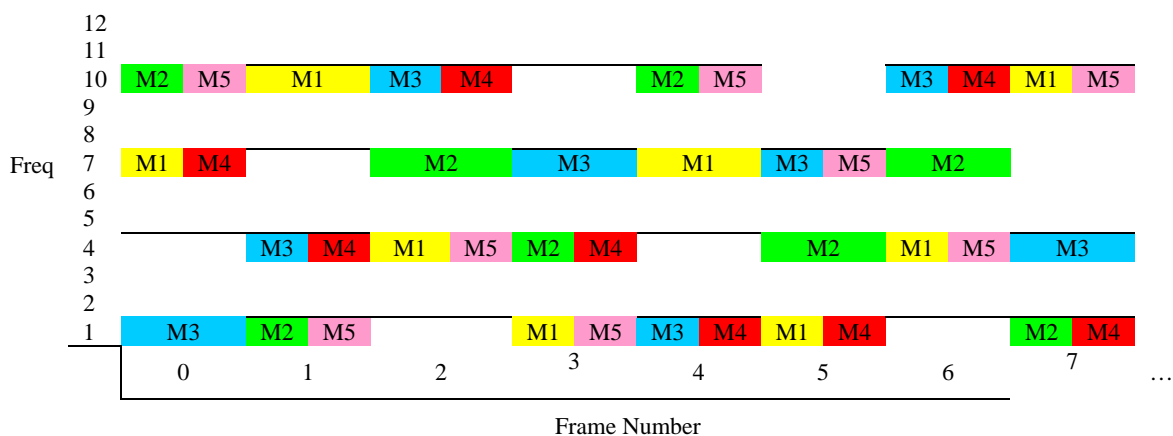

**Figure 8-9: OSC with improved frequency hopping**

<sup>6</sup> The length of the hopping sequences are assumed to be eight. These hopping sequences are used for illustrative purposes only and do not reflect actual hopping sequences for GSM [8-4].

### 8.1.5.1 Legacy support

Since the frequency hopping scheme uses already available MAIO hopping the diversity scheme will support legacy mobiles (given that legacy mobiles can be supported by the MUROS concept and that they are allocated to sub channel one). Note that also legacy mobiles will be able to utilize the gain of the frequency hopping feature, especially when having fractionally loaded TSs.

### 8.1.5.2 Additional signaling

Both the users of the first and second sub-channel will re-use the frequency hopping in GSM is defined in the 3GPP specification 45.002 [8-4]. However, the second set of users will use an additional hopping sequence to hop between MAIOs, which needs to be signaled to the mobile station.

To generate the MAIO hopping sequence, the MS must know the set of allowed MAIOs (the MAIO Allocation, *MAIOA*). Given the MAIOA, the number of MAIOs to hop over is known. Assuming that the permutations are predetermined and stored in the mobile station, the MS selects the permutation corresponding to the size of the MAIOA and an additional parameter determining which MAIO hopping sequence to use (the parameter *I* in the example in section 8.1.5). This is here denoted the *MAIOHSN*.

Optionally, several permutations can be defined for each given MAIOA size. This requires another parameter to be signaled to the mobile station, a MAIO permutation number, MAIOPN.

The MAIOA, the MAIOHSN and optionally the MAIOPN need to be signaled to the mobile station during assignment, handover and reconfiguration. It is necessary to update the relevant signaling messages to convey the new parameters.

Since the resource allocation in the cell can change during a call, it should be possible to change the parameters during a call. Therefore, the signaling messages should also include means for coordinating the change to new hopping parameters between all MS, e.g., a *starting time* after which the new parameters apply.

## 8.1.6 SAM - Single Antenna MIMO - for VAMOS

### 8.1.6.1 Concept description

The  $\alpha$ -QPSK modulated, baseband, received signal ( $r_n$ ) sampled at the symbol rate can be written in terms of an  $L$ -tap complex-valued channel ( $h_k$ ) $_{k=0}^{L-1}$ , the user 1 binary symbols ( $a_n$ ) $_{n=0}^N$ , the binary symbols for user 2, ( $b_n$ ) $_{n=0}^N$ , the rotation angle  $\theta$  ( $\theta = \pi/2$  for backward compatibility with legacy GMSK mobiles) and complex-valued noise plus interference ( $w_n$ ):

$$r_n = \frac{\alpha}{\sqrt{2}} \sum_{k=0}^{L-1} h_k e^{(n-k)j\theta} a_{n-k} + j \frac{\sqrt{2-\alpha^2}}{\sqrt{2}} \sum_{k=0}^{L-1} h_k e^{(n-k)j\theta} b_{n-k} + w_n \quad (1)$$

Equivalently, after de-rotation by  $\theta$ ,

$$r'_n = \frac{\alpha}{\sqrt{2}} \sum_{k=0}^{L-1} h'_k a_{n-k} + j \frac{\sqrt{2-\alpha^2}}{\sqrt{2}} \sum_{k=0}^{L-1} h'_k b_{n-k} + w'_n \quad (2)$$

where the prime indicates that the signal and the channel taps have been de-rotated.

Taking real and imaginary parts in Equation (2), and using the fact that the symbols ( $a_n$ ) $_{n=0}^N$  and ( $b_n$ ) $_{n=0}^N$  are real-valued, we obtain the following pair of equations

$$\begin{aligned}\Re(r'_n) &= \frac{\alpha}{\sqrt{2}} \sum_{k=0}^{L-1} \Re(h'_k) a_{n-k} - \frac{\sqrt{2-\alpha^2}}{\sqrt{2}} \sum_{k=0}^{L-1} \Im(h'_k) b_{n-k} + \Re(w'_n), \\ \Im(r'_n) &= \frac{\alpha}{\sqrt{2}} \sum_{k=0}^{L-1} \Im(h'_k) a_{n-k} + \frac{\sqrt{2-\alpha^2}}{\sqrt{2}} \sum_{k=0}^{L-1} \Re(h'_k) b_{n-k} + \Im(w'_n).\end{aligned}\quad (3)$$

Defining

$$\vec{r}_n = \begin{bmatrix} \Re(r'_n) \\ \Im(r'_n) \end{bmatrix}, H_k = \begin{bmatrix} \frac{\alpha}{\sqrt{2}} \Re(h'_k) & -\frac{\sqrt{2-\alpha^2}}{\sqrt{2}} \Im(h'_k) \\ \frac{\alpha}{\sqrt{2}} \Im(h'_k) & \frac{\sqrt{2-\alpha^2}}{\sqrt{2}} \Re(h'_k) \end{bmatrix}, \vec{w}_n = \begin{bmatrix} \Re(w'_n) \\ \Im(w'_n) \end{bmatrix},$$

we can re-write (3) in matrix form

$$\vec{r}_n = \sum_{k=0}^{L-1} H_k \begin{bmatrix} a_{n-k} \\ b_{n-k} \end{bmatrix} + \vec{w}_n. \quad (4)$$

For the sake of concreteness, let us describe a simple example of interference cancellation based on the model (4). It employs Interference Rejection Combining (IRC). Let  $Q = E[\vec{w}_n \cdot \vec{w}_n^T]$  be the 2x2 spatial covariance matrix of the noise. First, a Cholesky factorization  $Q^{-1} = D^T D$  is performed. Decorrelation of the 2 branches in (4) is achieved by multiplying both sides of (4) by  $D$ .

$$D \cdot \vec{r}_n = \sum_{k=0}^{L-1} D \cdot H_k \begin{bmatrix} a_{n-k} \\ b_{n-k} \end{bmatrix} + D \cdot \vec{w}_n. \quad (5)$$

This simple linear transformation performs interference suppression. Writing  $\vec{y}_n = D \cdot \vec{r}_n$ ,  $G_k = D \cdot H_k$ ,  $\vec{e}_n = D \cdot \vec{w}_n$  (5) becomes

$$\vec{y}_n = \sum_{k=0}^{L-1} G_k \begin{bmatrix} a_{n-k} \\ b_{n-k} \end{bmatrix} + \vec{e}_n, \quad (6)$$

where ( $\vec{e}_n$ ) is a two dimensional white noise and

$$G_k \stackrel{def}{=} \begin{bmatrix} g_{11}^k & g_{12}^k \\ g_{21}^k & g_{22}^k \end{bmatrix} = \begin{bmatrix} d_{11} & d_{12} \\ 0 & d_{22} \end{bmatrix} \begin{bmatrix} \frac{\alpha}{\sqrt{2}} \Re(h'_k) & -\frac{\sqrt{2-\alpha^2}}{\sqrt{2}} \Im(h'_k) \\ \frac{\alpha}{\sqrt{2}} \Im(h'_k) & \frac{\sqrt{2-\alpha^2}}{\sqrt{2}} \Re(h'_k) \end{bmatrix}$$

$$= \begin{bmatrix} \frac{d_{11}\alpha}{\sqrt{2}} \Re e(h'_k) + \frac{d_{12}\alpha}{\sqrt{2}} \Im m(h'_k) & -\frac{d_{11}\sqrt{2-\alpha^2}}{\sqrt{2}} \Im m(h'_k) + \frac{d_{12}\sqrt{2-\alpha^2}}{\sqrt{2}} \Re e(h'_k) \\ \frac{d_{22}\alpha}{\sqrt{2}} \Im m(h'_k) & \frac{d_{22}\sqrt{2-\alpha^2}}{\sqrt{2}} \Re e(h'_k) \end{bmatrix}.$$

Note that the matrix taps  $G_k$  of the whitened channel do not exhibit the symmetries of the original channel taps  $H_k$ .

The signal model

$$\bar{y}_n = \sum_{k=0}^{L-1} \begin{bmatrix} g_{11}^k & g_{12}^k \\ g_{21}^k & g_{22}^k \end{bmatrix} \begin{bmatrix} a_{n-k} \\ b_{n-k} \end{bmatrix} + \bar{e}_n \quad (7)$$

is a time dispersive 2x2 MIMO system with additive Gaussian white noise. Optimum detectors are known for these signals. Hence, this type of receiver is appropriately named Single Antenna MIMO (SAM) receiver.

Please note that we do not advocate the simple IRC technique of (5). It is included just to illustrate the main idea. Better performance is obtained if more sophisticated whitening techniques are used. For example, the SAM receiver used for the simulations in Section 4 models the noise plus interference ( $\bar{w}_n$ ) in (4) as a Vector Auto-Regressive (VAR) process 0.

Note that if there is no interference present then (4) reduces to a model for joint detection, which yields the optimum receiver in sensitivity scenarios. Thus, the signal model (4) provides an accurate representation of  $\alpha$ -QPSK modulated signals in both interference and sensitivity scenarios.

### 8.1.6.1.1 Computational Complexity

The computational complexity of a SAM receiver depends upon subtle implementation details. However, it is possible to make several general observations.

- The number of state transitions required in the trellis in a SAM demodulator with  $L$  MLSE taps is  $4^L$ . Thus, if 3 MLSE taps are used, the number of state transitions will be  $4^3 = 64$ . As a comparison, a typical legacy GMSK demodulator uses 5 MLSE taps and there are  $2^5 = 32$  transitions in the trellis, and in an 8PSK demodulator with 2 MLSE taps there are  $8^2 = 64$  transitions in the trellis.
- Synchronization and estimation (e.g. channel estimation) for SAM are slightly more complex than in legacy SAIC receivers.
- Several well known interference suppression algorithms used in legacy DARP Phase I receivers may be re-used in SAM receivers.

Taking into account the previous observations, a rough estimate of the complexity of SAM can be made:

Complexity SAM with 3 MLSE taps  $\approx 2.5 \times$  Complexity legacy GMSK SAIC.

## 8.2 Performance Characterization

### 8.2.1 Link Level Performance

Link level simulations have been performed in propagation conditions TU3iFH, TU50iFH and TU3nFH using speech codecs AFS/12.20, AFS/5.90 and AHS/5.90.

Interference simulations as well as sensitivity simulations have been performed for the both DL and UL. Interference scenarios MTS-1-4 has been used for the evaluation.

Sub channel power imbalance ratios, SCPIRs, of -8, -4, 0, 4, 8 dB has been investigated for the DL and SCPIRs of 0, -5, -10, -15 have been investigated for the UL.



### 8.2.1.1 Simulation assumptions

In the DL simulations, three different receiver types have been used: non-SAIC receiver, SAIC receiver and MUROS receiver. For the UL a Successive Interference Cancellation, SIC, receiver has been used.

For the sensitivity limited scenarios in DL a backoff of 3.3 dB has been used, based on Figure 8-7. It should be noted that a smaller backoff could be used for alpha values  $\neq 1$ .

Common simulation assumptions for UL and DL are listed in Table 8-5 and assumptions specific for DL and UL are listed in Table 8-6 and Table 8-7 respectively.

**Table 8-5: Common simulations assumptions**

Parameter	Value
Speech codec	TCH/AFS12.2, TCH/AFS5.90, TCH/AHS5.90
Channel profile	Typical Urban (TU)
Terminal speed	3 km/h, 50 km/h
Frequency band	900 MHz
Frequency hopping	Ideal, No
Interference/Noise	MTS-1, MTS-2, MTS-3, MTS-4, Sensitivity

**Table 8-6: DL simulation assumptions**

Parameter	Value
Antenna diversity	No
Frequency offset external interferers	Normal distribution [Hz] N(50,17)
Backoff	3.3 dB
Receiver type	non-SAIC (reference) <u>SAIC</u> The SAIC algorithm used for the receiver utilizes a spatial-temporal Vector Autoregressive (VAR) Model <u>MUROS</u> The MUROS receiver has been implemented as a single antenna QPSK receiver. Aware of the TSC of both sub channels
Impairments: – Phase noise – I/Q gain imbalance – I/Q phase imbalance – DC offset – Frequency error – PA model	Tx / Rx 0.8 / 1.0 [degrees (RMS)] 0.1 / 0.2 [dB] 0.2 / 1.5 [degrees] -45 / -40 [dBc] - / 25 [Hz] Yes/ -

Table 8-7: UL simulation assumptions

Parameter	Value
Antenna diversity	Yes
Frequency offset external interferers and paired sub channel	Normal distribution [Hz] N(100,33)
Receiver type	SIC, spatio-temporal IRC Legacy GMSK, MRC (reference)
Rx filter	RRC <sup>1</sup>
- Bandwidth	240 kHz
- RRC rolloff	0.3
Impairments:	Tx / Rx
- Phase noise	0.8 / 1.0 [degrees (RMS)]
- I/Q gain imbalance	0.1 / 0.2 [dB]
-I/Q phase imbalance	0.2 / 1.5 [degrees]
- DC offset	-45 / -40 [dBc]
Note 1: The 3 dB bandwidth of the RRC filter.	

For the UL the wanted sub-channel is denoted C1, while the paired sub-channel is denoted C2. The two columns in the UL plots show the results of the same simulations. The difference is in the scale of horizontal axis. The total carrier to interference ratio (C/I, where  $C=C1+C2$ ) is shown on the left hand side, while the sub-carrier to interference ratio C1/I is depicted on the right hand side.

NOTE: The agreed working assumption is to present plots for  $(C1+C2)/I$ .

NOTE: The performance for the UL has been normalized so that the reference receiver reaches 1% FER @ 0 dB.

## 8.2.1.2 Sensitivity Performance

### 8.2.1.2.1 SAIC receiver

From the simulations below it can be concluded that:

- The SAIC receiver can handle sub channel power imbalance ratios, SCPIRs,  $\geq -8$  dB.
- The higher the SCPIR, the closer the performance is to a legacy GMSK channel.
- The lower the SCPIR the larger degradation. I.e. the degradation from SCPIR=-4 -> SCPIR=-8 is larger than the degradation from SCPIR=0 -> SCPIR = -4.

AFS/12.20

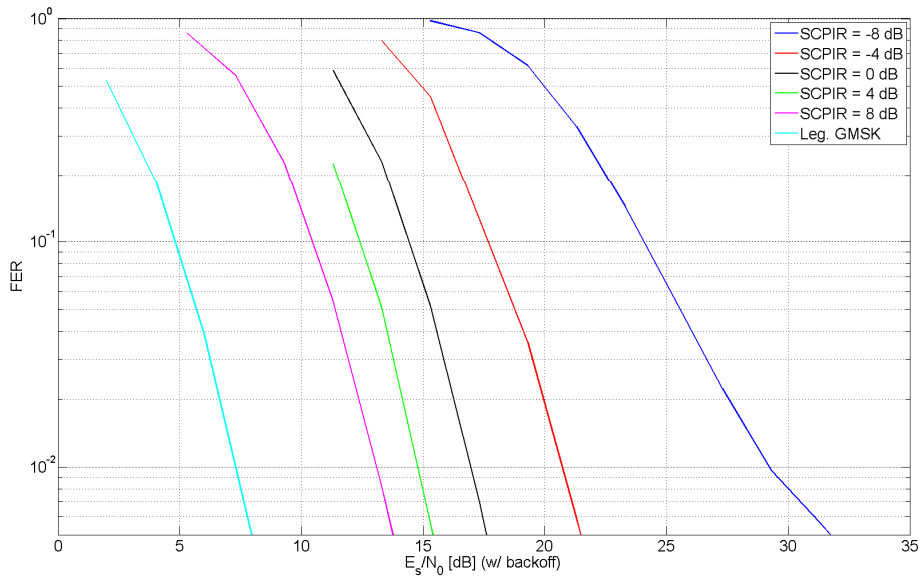

Figure 8-10: AFS/12.20 sensitivity

AFS/5.90

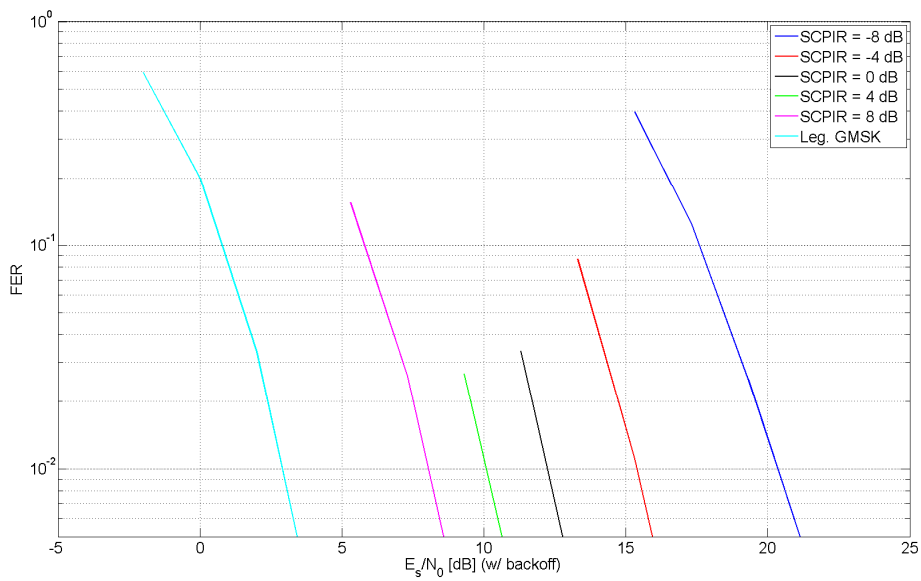

Figure 8-11: AFS/5.90 sensitivity

AHS/5.90

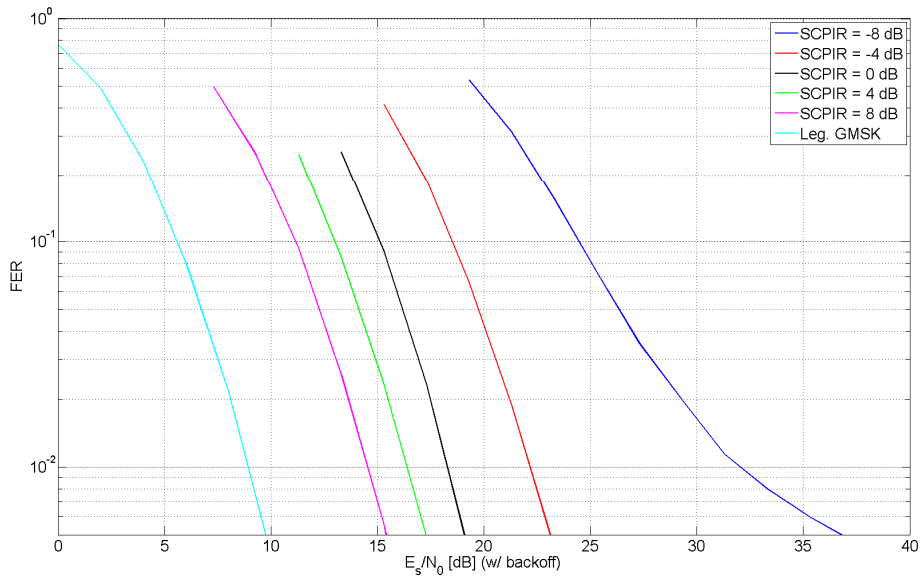

Figure 8-12: AHS/5.90 sensitivity

8.2.1.2.1.1 Support of legacy mobiles

One important objective of the feasibility study is to enable support of legacy mobiles with the new technique. Simulations have been performed by a number of vendors, see [8-5]-[8-9], to investigate the feasibility of using the adaptive symbol constellation concept with legacy SAIC implementations. The simulation results are collected in the following sections. A more detailed description of these findings can be found in [8-10].

It is shown that most SAIC implementations investigated seem to be able to support the concept.

All five references simulated  $\alpha$ -QPSK in sensitivity limited scenarios with different speech codecs. AFS12.2 and AFS5.90 was common to all vendors and has thus been used in the comparison.

The different performance has been compared to SCPIR = 0 dB at 10 % FER. Although 1 % FER would be a more suitable measure for speech performance, 10 % has been chosen since more results are available at this level.

In all simulations a TU3iFH channel has been used.

NOTE: The performance shown estimates the performance presented in [8-5]-[8-9].

Based on [8-5]-[8-9] the SNR performance has been estimated at 10 % FER.

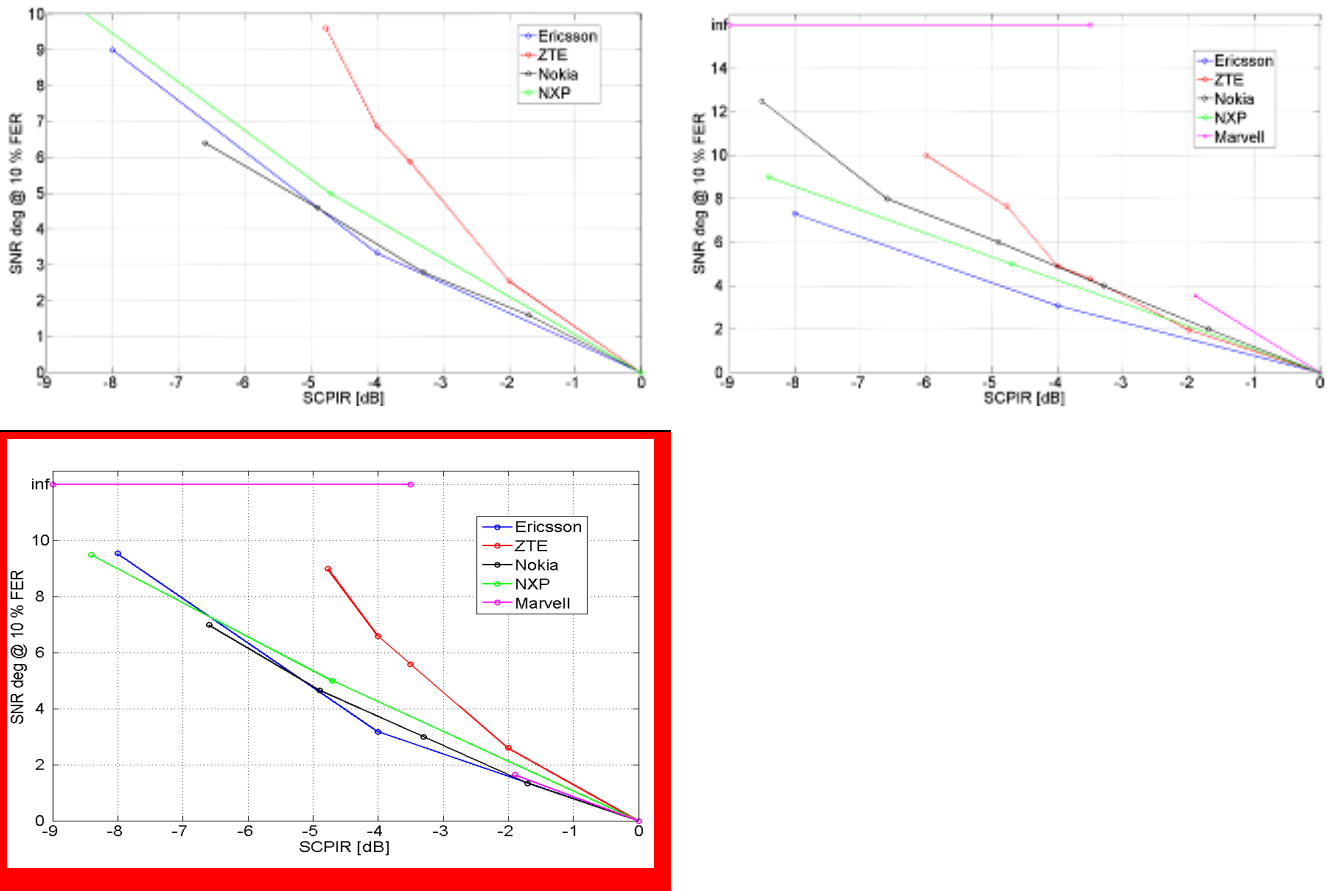

**Figure 8-12a: AHS5.9 performance degradation due to SCPIR for AHS 5.90 (top left), AFS 5.90 (top right) and AFS 12.2 (bottom left)**

In general it can be seen in Figure 8-12a that most legacy SAIC implementations are aligned in performance (Ericsson, Nokia and NXP) with one implementation giving a larger degradation (ZTE). One SAIC implementation performs significantly different (Marvell), experiencing a FER collapse at SCPIR < -3.5 (Shown in the plot as an infinite performance degradation).

Based on the shown results it seems that most SAIC implementations on the market will be able to support the alpha-QPSK concept. Although there is a difference in performance between vendors, given a certain sub channel power imbalance ratio, it is expected that system functionality, such as, MUROS channel mode adaptation will ensure end user performance not to be degraded.

8.2.1.2.2 MUROS receiver

8.2.1.2.2.1 Symbol Constellation Detection

To illustrate the feasibility of MS symbol constellation detection presented in section 8.1.3 . Figure 8-13 shows the DL performance for scenarios:

- Alpha signaled to the MS, i.e. alpha known by the MS (blue line).
- Alpha estimated with a LS estimator (black line).
- Alpha estimated with a LS estimate smoothed over a measurement period of 480ms (red line).

The performance of the *I* channel is presented. Investigated values of  $\alpha$  were selected to make the studied sub-channel both dominant and suppressed, according to Table 8-8.

**Table 8-8: Alpha versus relative sub channel power**

$\alpha$	Power ratio [dB]
0.4	-10.6
0.6	-6.6
1.0	0
1.2	4.1

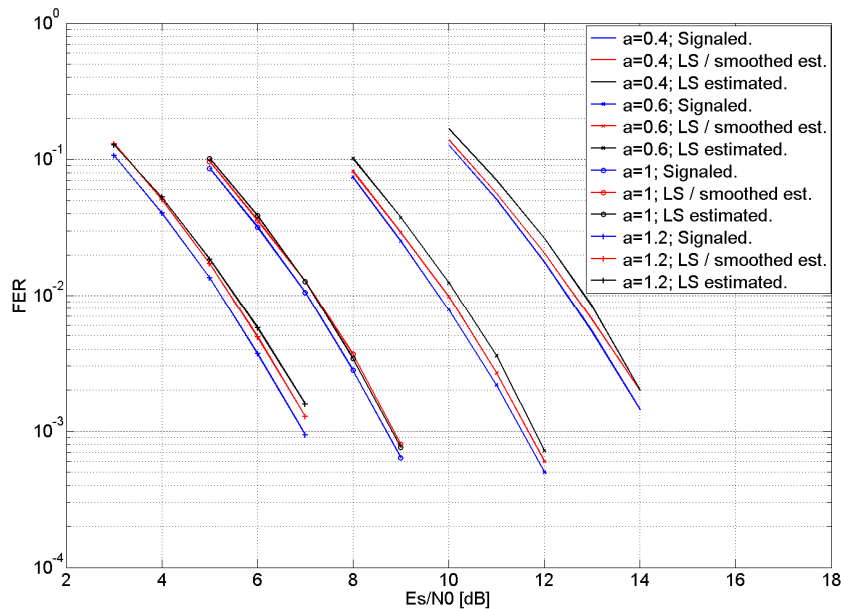

Figure 8-13: AFS5.90 with different receiver information of  $\alpha$

Alpha was restricted to the continuous interval 0.28 - 1.39 to achieve a relative power control range of  $\pm 14$ dB between the two sub channels, as depicted in Figure 8-2. Speech codec AFS 5.90 was utilized during the simulations.

The performance degradation when  $\alpha$  is LS estimated and smoothed over a measurement period is below 0.3 dB at all investigated FER levels. When smoothing is discarded the performance is further degraded, but the total degradation never exceeds 0.5dB.

8.2.1.2.2.2 Constellation Rotation Detection

As described in section 8.1.4 when two  $\alpha$ -QPSK MUROS mobiles are paired together on orthogonal sub-channels, the BSS can choose the constellation rotation to enhance the PAR.

In order to benefit from the PAR enhancement the MUROS MS's must be able to detect the constellation rotation. The simulation results presented in Figure 8-14 illustrates the ability of the MS to do so and simultaneous estimate alpha without deteriorating the receiver performance. The results presented were achieved for  $\alpha$ -QPSK constellation with a symbol rotation of  $\pi/4$  and alpha values according to Table 8-9. For each alpha value three scenarios were simulated:

- Alpha value and symbol rotation known by the MS.
- Alpha value estimated while symbol rotation known by the MS.
- Alpha value estimated and symbol rotation detected by the MS.

For alpha equal to 1.0 an additional scenario was simulated:

- Alpha value known while symbol rotation detected by the MS.

In this scenario the  $\alpha$ -QPSK MUROS constellation takes the form of a QPSK constellation. This is of relevance since it investigates if the adaptive constellation rotation concept is applicable when MUROS is based on a pure QPSK constellation. Speech codec AFS 5.90 was utilized during the simulations.

Table 8-9: Alpha versus relative subchannel power

α	Power ratio [dB]
0.8	-3.3
1.0	0
1.15	2.9

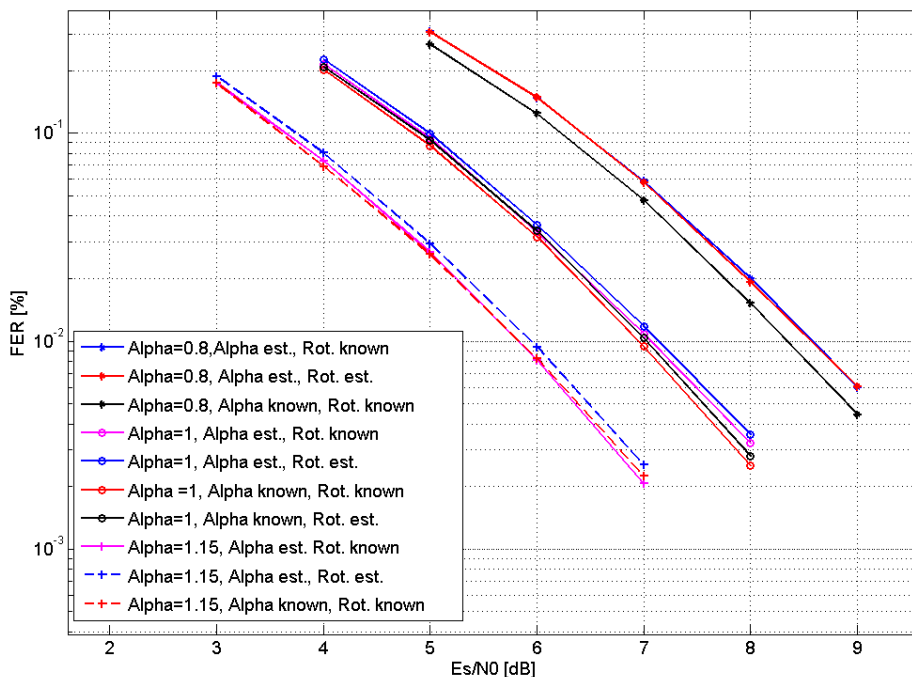

Figure 8-14: MUROS receiver with/without alpha estimation and rotation detection

The receiver performance is dependent on the alpha value. The dominant sub-channel is as expected showing better performance than the suppressed sub-channel. The alpha estimation and rotation detection scenarios are showing a performance degradation of approximately 0.2dB or less compared to the scenarios where both alpha and rotation is known. The same is true when compared to the scenarios where alpha is estimated and rotation is known.

As the degradation due to alpha estimation and rotation detection never exceeds 0.2 dB for any of the studied alpha values it will be compensated by the PAR enhancement presented in Figure 8-7.

8.2.1.2.3 SIC receiver

8.2.1.2.3.1 Investigations by Telefon AB LM Ericsson

8.2.1.2.3.1.1 Simulation assumptions

The reference receiver is a legacy GMSK MRC receiver. The simulation assumptions are shown in Table 8-9a below.

**Table 8-9a Simulation assumptions.**

Parameter	Value
Channel profile	Typical Urban (TU)
Terminal speed	3 km/h
Frequency band	900 MHz
Frequency hopping	Ideal (TU)
Interference modulation	GMSK
Antenna diversity	Yes
Receiver type	SIC, spatio-temporal IRC.
Interference/Noise	Noise
Rx filter	RRC <sup>1</sup>
- Bandwidth	240 kHz
- RRC rolloff	0.3
Impairments:	Typical Tx and Rx impairments
Note 1: The 3 dB bandwidth of the RRC filter.	

8.2.1.2.3.1.2 Performance Plots

The performance has been normalized so that the reference receiver reaches 1% FER @ 0 dB.

From the simulations below it can be concluded that:

- In all test cases the performance of the weakest sub-channel is inferior to the performance of the reference MRC receiver at 1% FER.
- Worst performance is seen for SCPIR = 0 dB.

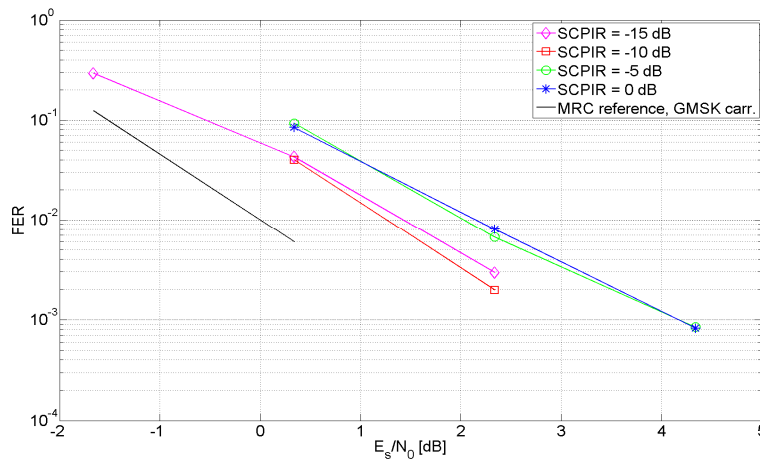



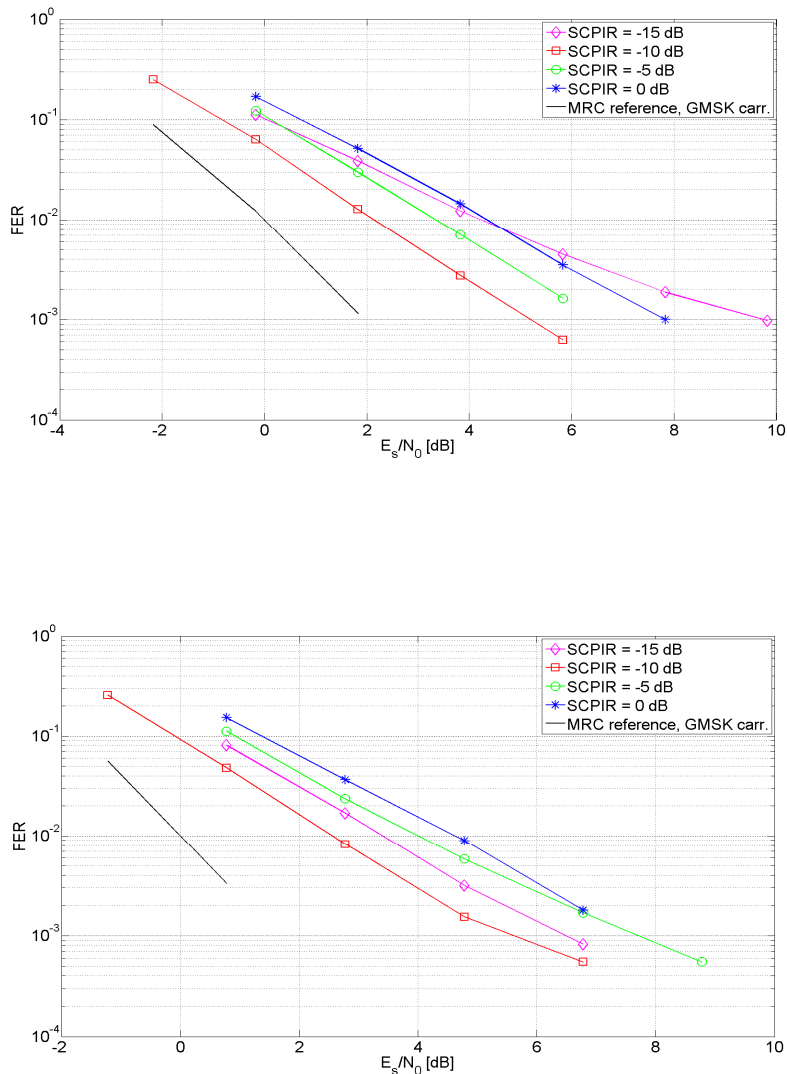

**Figure 8-15 Sensitivity performance for TU3iFH, TCH/AFS5.90 (top left), TCH/AHS5.90 (top right) and TCH/AFS12.2 (bottom left).**

8.2.1.2.3.2 Investigations by ST-NXP Wireless France

8.2.1.2.3.2.1 Simulation Assumptions

Text in this section is based on contributions [8-21] and is related to evaluation of sensitivity performance in downlink. Simulation assumptions can be found in Table 8-9b.

Table 8-9b: Simulation assumptions for Downlink.

Parameter	Value
Channel profile	Typical Urban (TU)
Terminal speed	3 km/h (TU)
Frequency band	900 MHz
Frequency hopping	Ideal (TU)
TSC allocation	User subchannel C1: legacy TSC0 (wanted signal) User subchannel C2: new TSC0 from [8-15]
Interference	MTS-1 and MTS-2 model
Interference modulation	GMSK
MUROS SCPIR	0, -4, -8 dB
C/I	Power of wanted user C1 / dominant external interferer power I1 or Power of total signal C / dominant external interferer power I1
Frequency offset	Not relevant for MIC in DL
Used Codecs	TCH/AFS 12.2, AFS 5.9, AHS 7.95 and AHS 5.9
Antenna diversity	No
Receiver type	- MIC / SAIC - S-MIC (successive MIC)
Receiver implementation	Fixed-point
Frequency offset compensation	Timeslot-based, no outer compensation loop
Simulation time	200 sec (40 000 timeslots) per point
Rx filter Bandwidth	240 kHz (3 dB bandwidth)
Rx-Impairments:	
- Phase noise	2.0 [degrees (RMS)]
- I/Q gain imbalance	0.2 [dB]
- I/Q phase imbalance	1.5 [degrees]
- Noise figure	8 [dB]

8.2.1.2.3.2.1 Simulation Results for Downlink

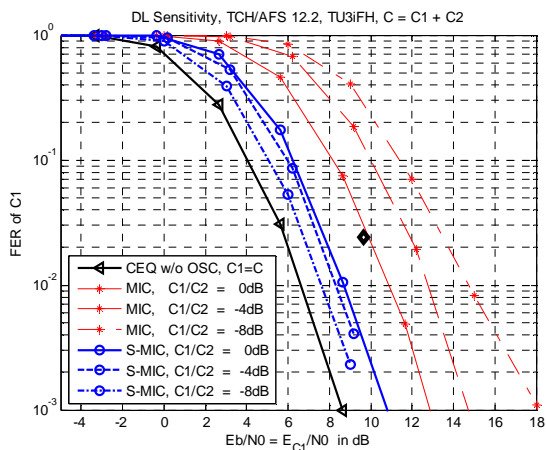

Figure 8-16: Sensitivity for AFS 12.2, power C1

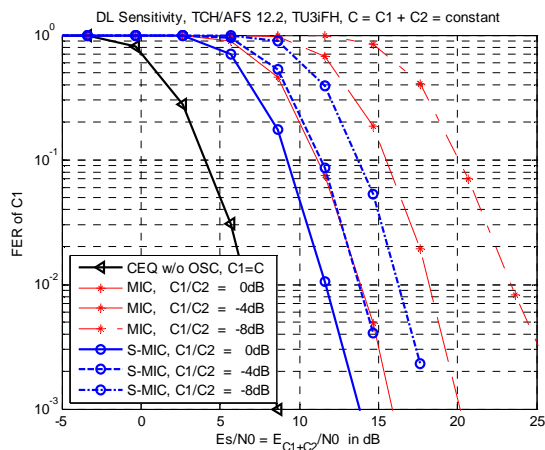

Figure 8-17: Sensitivity for AFS 12.2, power C

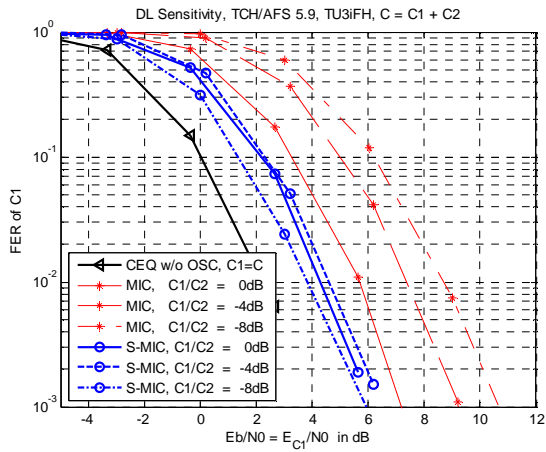

Figure 8-18a: Sensitivity for AFS 5.9, power C1

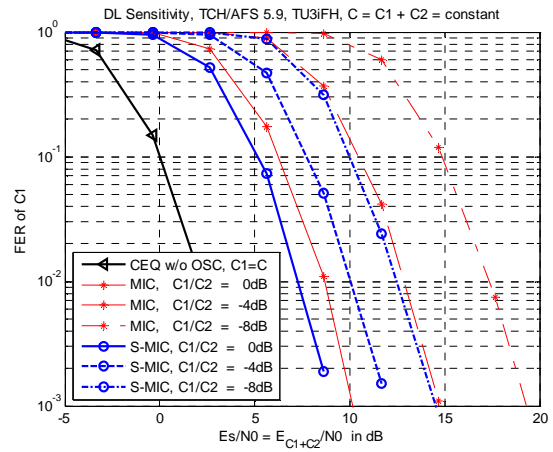

Figure 8-18b: Sensitivity for AFS 5.9, power C

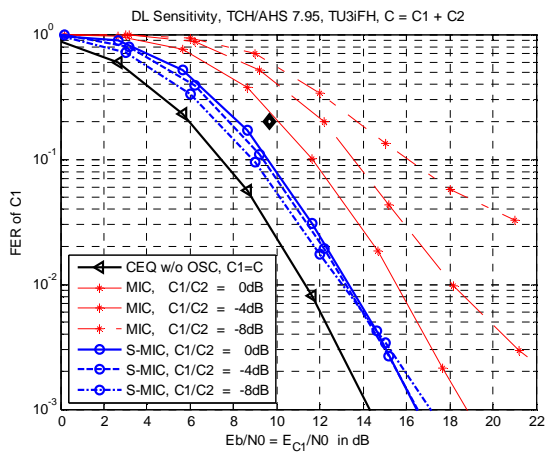

Figure 8-19a: Sensitivity for AHS 7.95, power C1

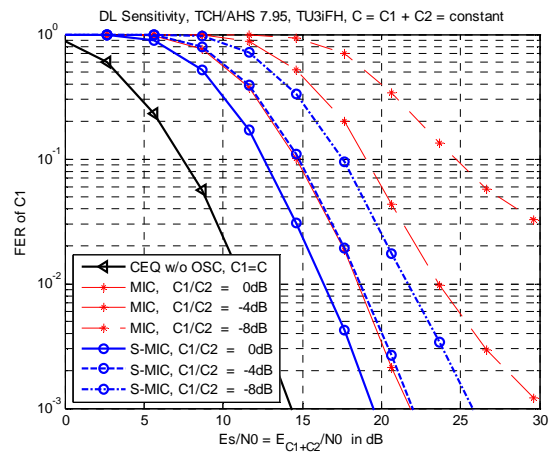

Figure 8-19b: Sensitivity for AHS 7.95, power C

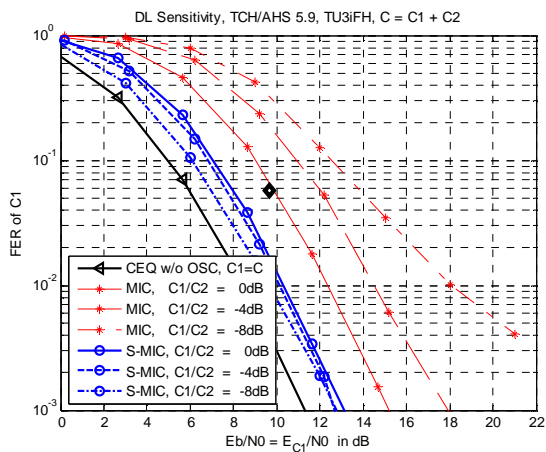

Figure 8-20a: Sensitivity for AHS 5.9, power C1

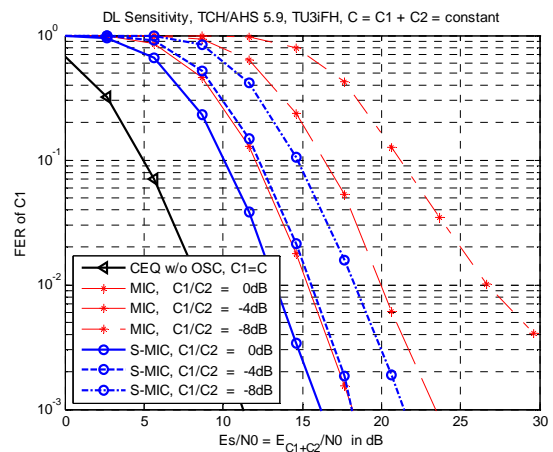

Figure 8-20b: Sensitivity for AHS 5.9, power C

### 8.2.1.3 Interference Performance

#### 8.2.1.3.1 non-SAIC receiver

The non-SAIC legacy GSMK receiver uses a five tap least squares channel estimate. The  $\alpha$ -QPSK-aware receiver uses a quaternary trellis MLSE and  $\alpha$  is assumed to be known. The modulator is as described in Figure 8-3. The x-axis has been normalized so that the reference GSMK reaches 1% FER @ C/I = 0 dB. The legacy and  $\alpha$ -QPSK-aware receiver use orthogonal training sequences consisting of the legacy TSC0 and the corresponding new sequence from [8-2]. Figure 8-21 shows the performance of the OSC concept as described in [8-2]. The Tx filter is a Hanning windowed RRC, rolloff 0.3, with a 3 dB bandwidth (before windowing) of 270 kHz. Speech codec AMR/HR 7.40 was used.

It is seen that even a robust legacy MS is unusable. In fact the FER for the legacy mobile is never lower than 60%, independently of the C/I.

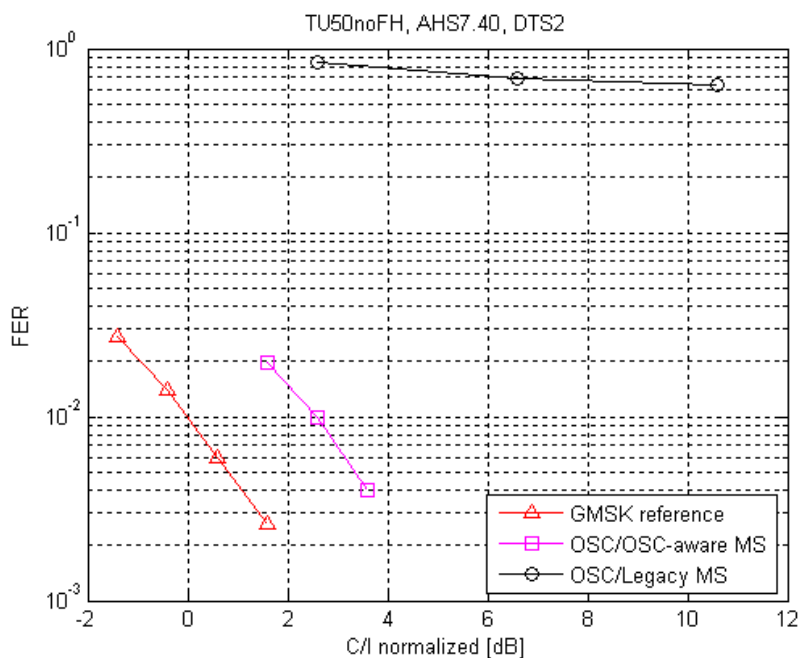

**Figure 8-21: OSC with a legacy GSMK receiver in one sub-channel and OSC-aware receiver in the other sub-channel. Wide Tx Pulse**

Figure 8-22 shows the performance of  $\alpha$ -QPSK modulation. The value of  $\alpha = 0.67$  has been chosen empirically, and is assumed to be known at the  $\alpha$ -QPSK-aware receiver. The simulation settings used are the same as used in Figure 8-21.

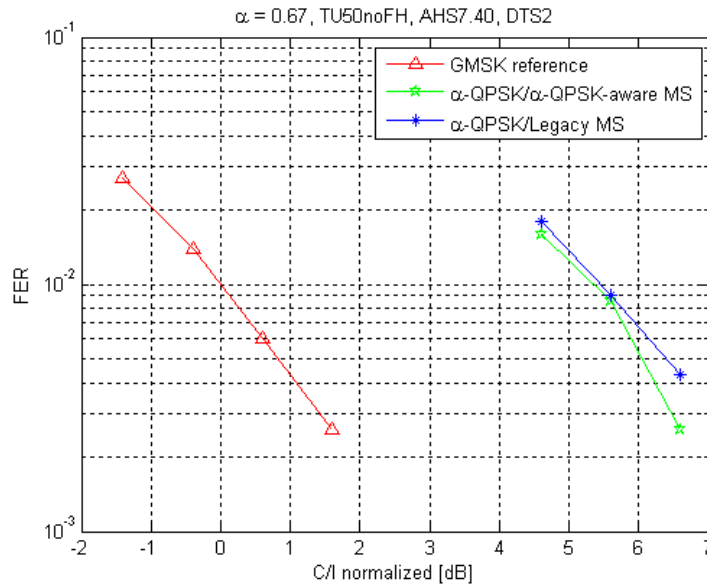

**Figure 8-22:  $\alpha$ -QPSK modulation with a legacy GMSK receiver in one sub-channel and  $\alpha$ -QPSK – aware receiver in the other sub-channel. Wide Tx Pulse**

Figure 8-23 shows the performance of  $\alpha$ -QPSK-aware and legacy receivers when  $\alpha = 0.67$  and the Tx pulse is the linearized GMSK pulse used in EGPRS. The performance is somewhat degraded with respect to the wide Tx pulse performance shown in Figure 8-22.

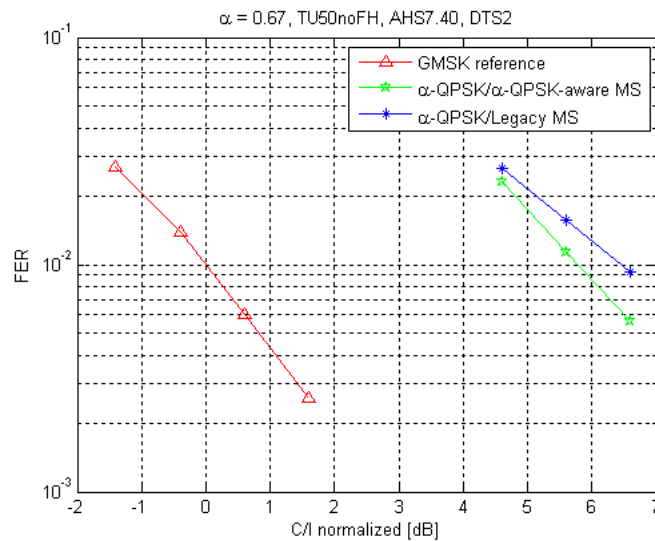

**Figure 8-23:  $\alpha$ -QPSK modulation with a legacy GMSK receiver in one sub-channel and  $\alpha$ -QPSK – aware receiver in the other sub-channel. Linearized GMSK Tx Pulse**

Figure 8-24 shows that even two legacy MS's can be multiplexed using  $\alpha$ -QPSK, as long as one of them has a SAIC receiver. The legacy training sequences TSC0 and TSC3 have been used. Recall that the legacy training sequences are not mutually orthogonal. The value  $\alpha = 0.67$  has been used even though it is not optimal, because it is instructive to make comparisons with Figure 8-22 and Figure 8-23.

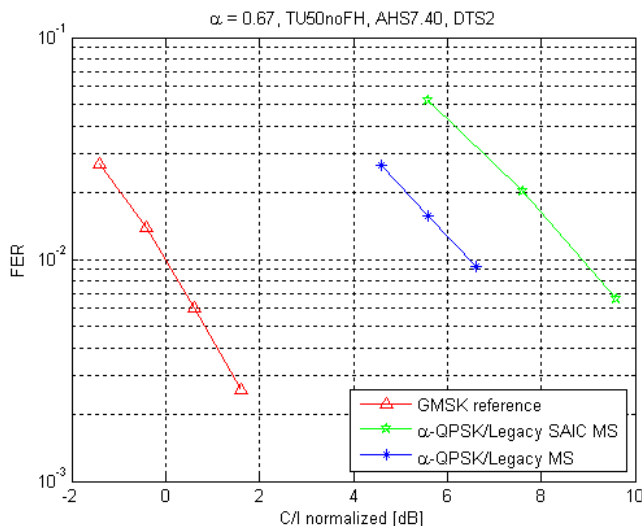

**Figure 8-24: QPSK modulation with legacy GMSK receiver in one sub-channel and legacy SAIC GMSK receiver the other sub-channel. The sub-channel decoded by the Legacy SAIC MS has less power than the other sub-channel. Linearized GMSK Tx Pulse**

8.2.1.3.2 SAIC receiver

From the simulations it can be concluded that:

- The degradation when changing from GMSK modulation to QPSK modulation of the interferer will be larger, the higher the SCPIR since the SAIC algorithm can suppress the external interferers more efficiently when the other sub channel give rise to less interference. This effect is much more evident in the single interferer scenarios, i.e. MTS-1 and MTS-3.
- In general, the lower the SCPIR the larger degradation. I.e. the degradation from SCPIR=-4 -> SCPIR=-8 is larger than the degradation from SCPIR=0 -> SCPIR = -4.
- For TU3 without frequency hopping a FER of 1 % is not met for AHS5.90 using a SCPIR of -8 dB.

AFS/12.20

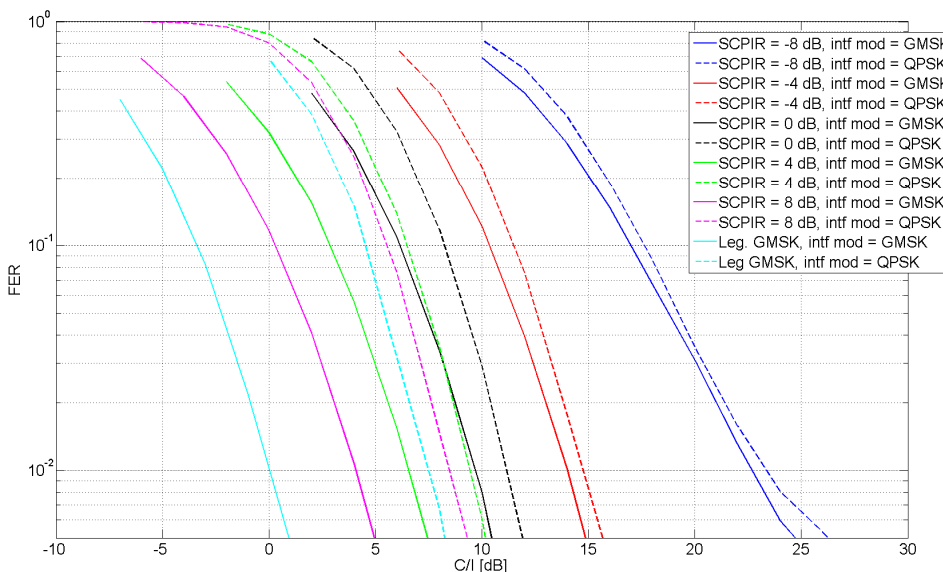

**Figure 8-25: MTS-1, TU3iFH**

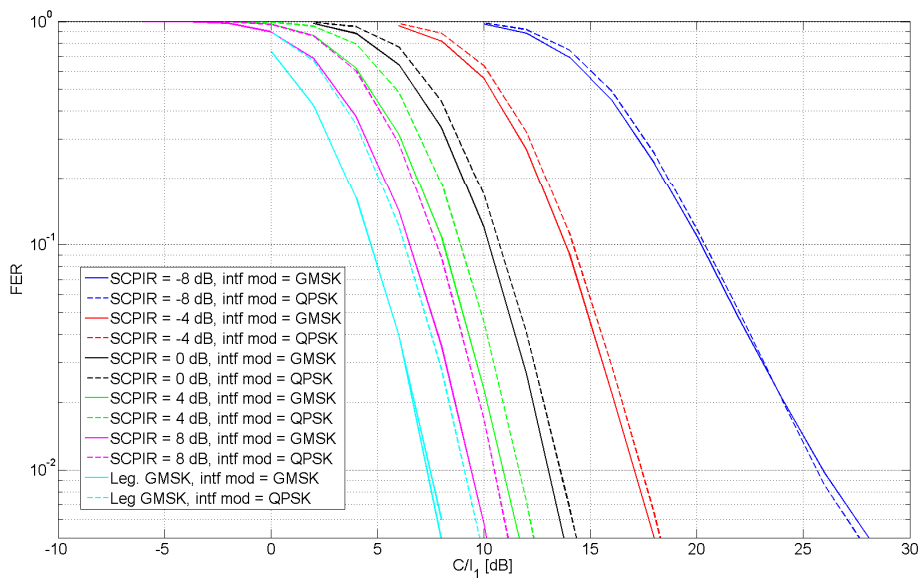

Figure 8-26: MTS-2, TU3iFH

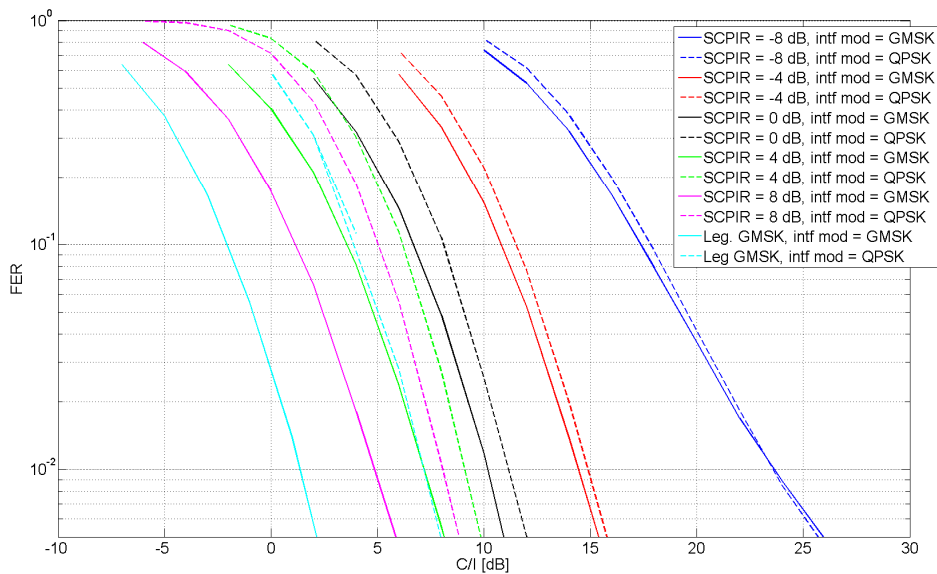

Figure 8-27: MTS-3, TU3iFH

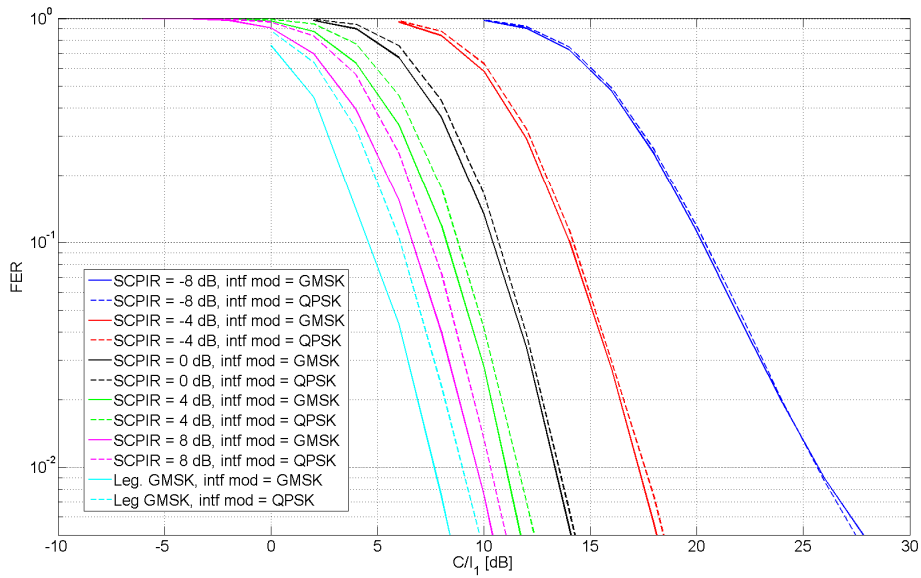

Figure 8-28: MTS-4, TU3iFH

AFS5.90

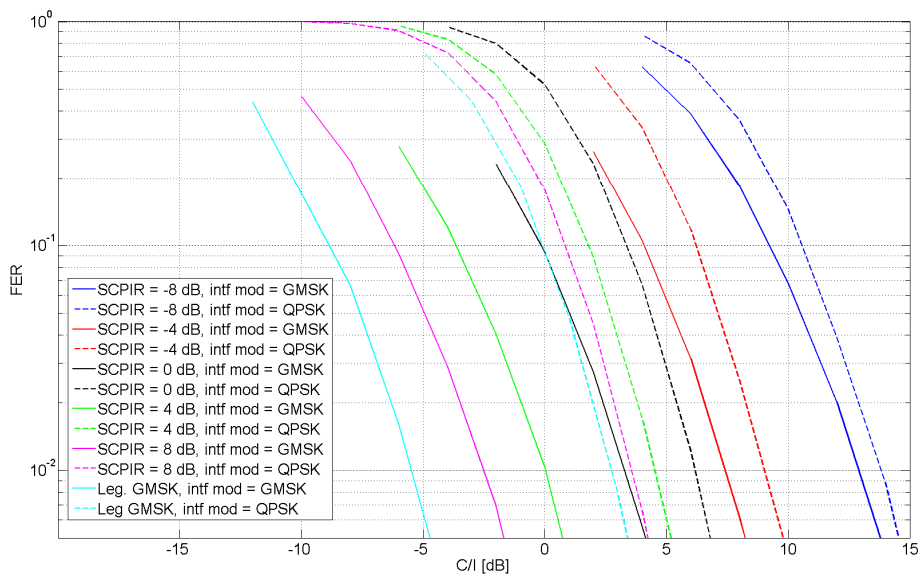

Figure 8-29: MTS-1, TU3iFH



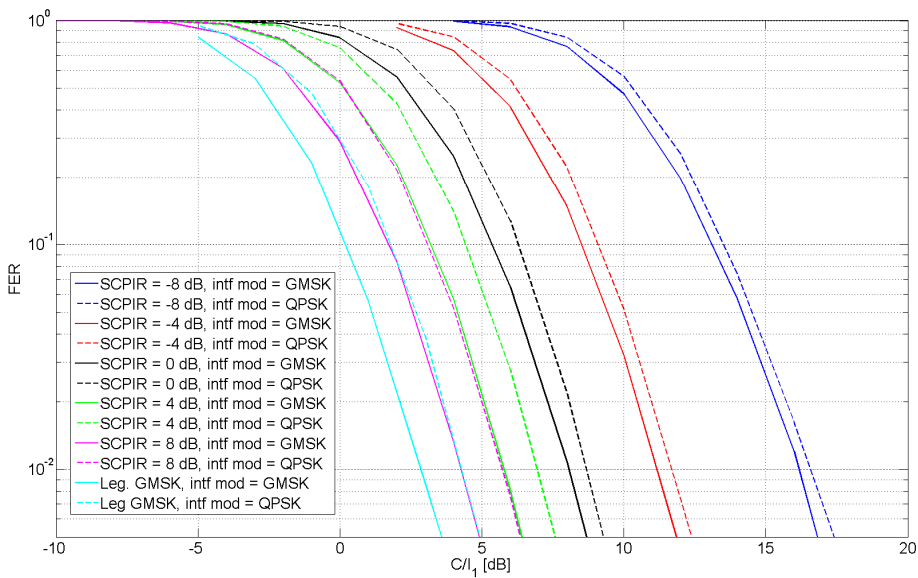

Figure 8-30: MTS-2, TU3iFH

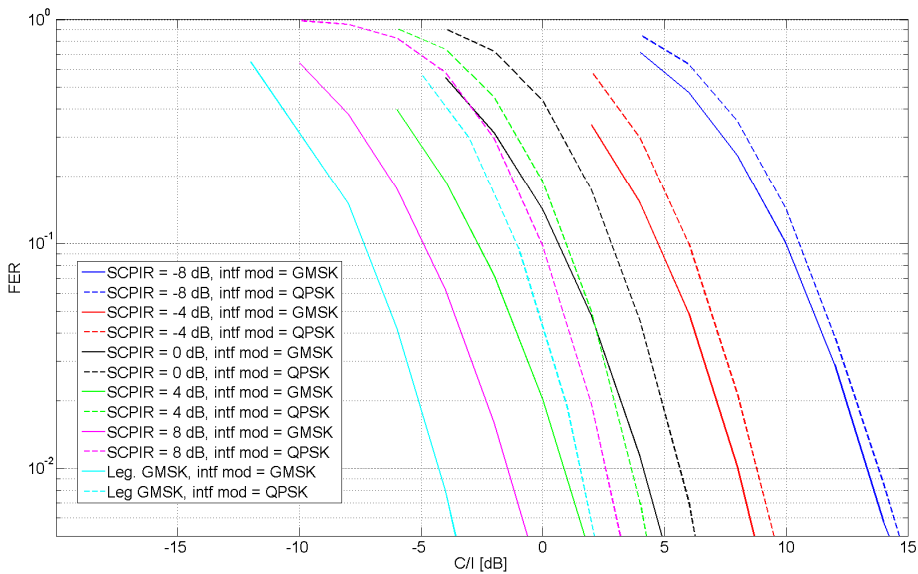

Figure 8-31: MTS-3, TU3iFH

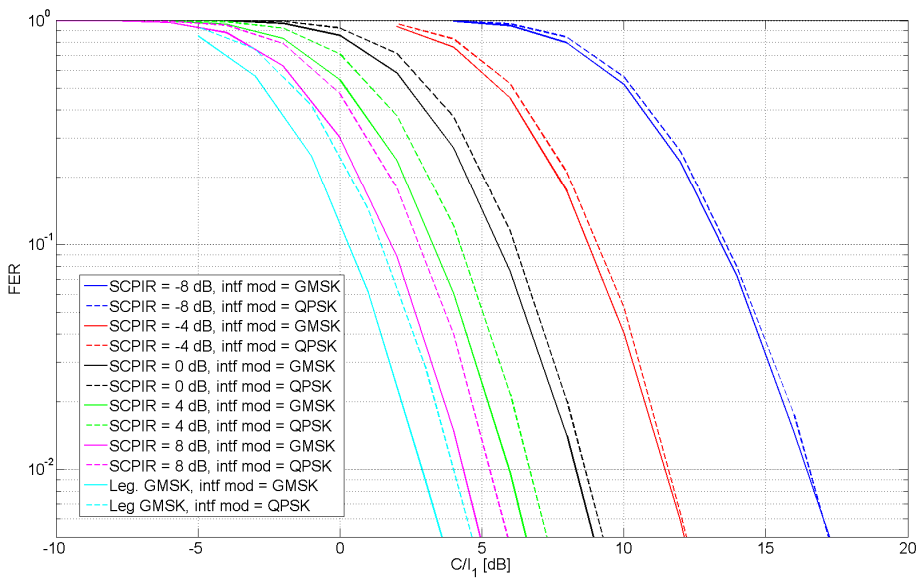

Figure 8-32: MTS-4, TU3iFH

AHS5.90

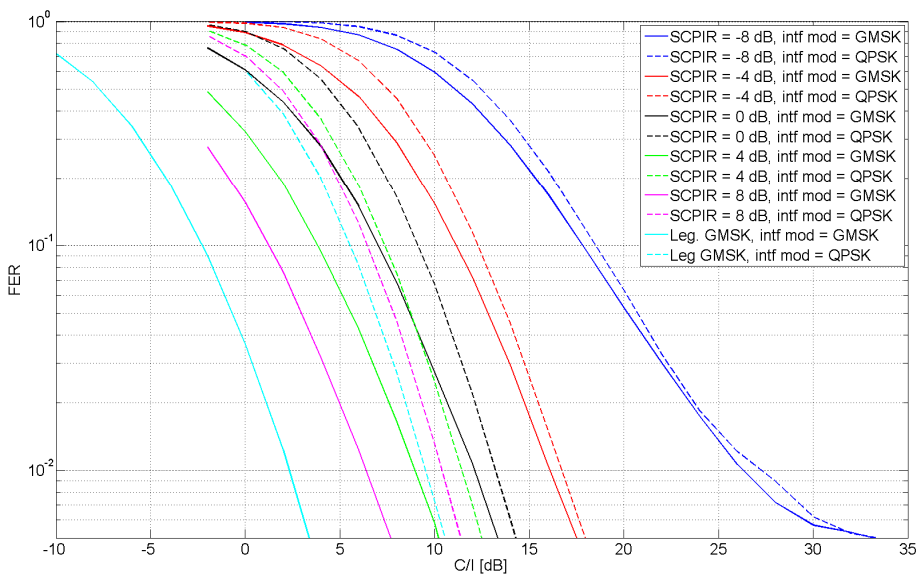

Figure 8-33. MTS-1, TU3iFH

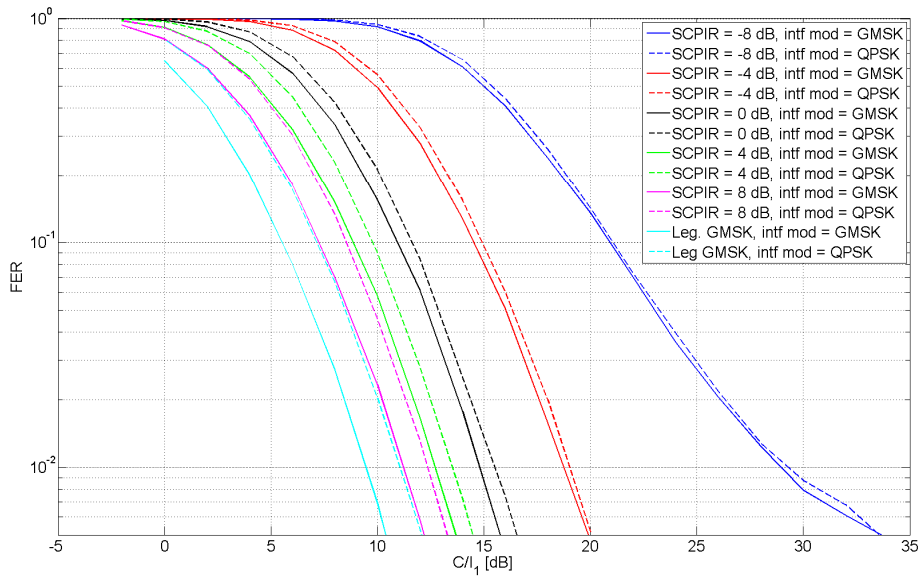

Figure 8-34: MTS-2, TU3iFH

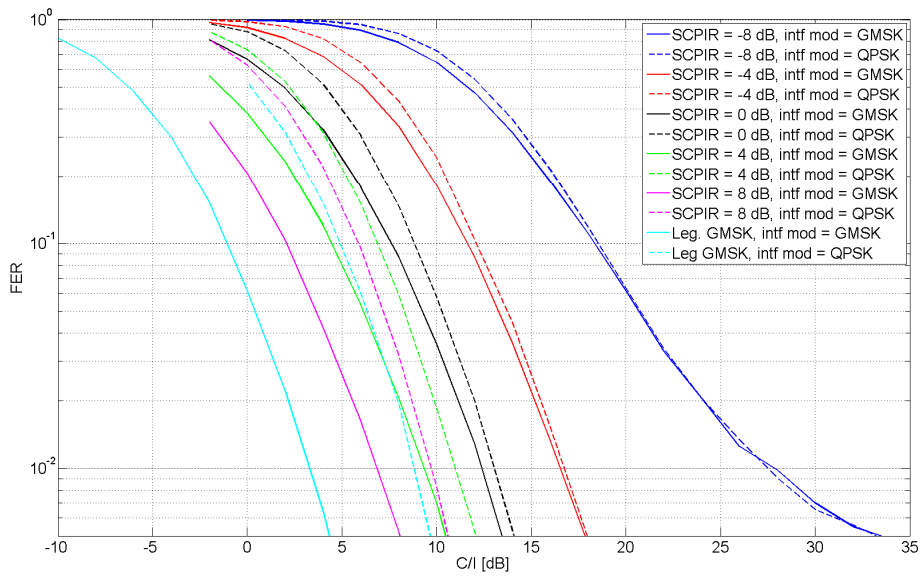

Figure 8-35: MTS-3, TU3iFH

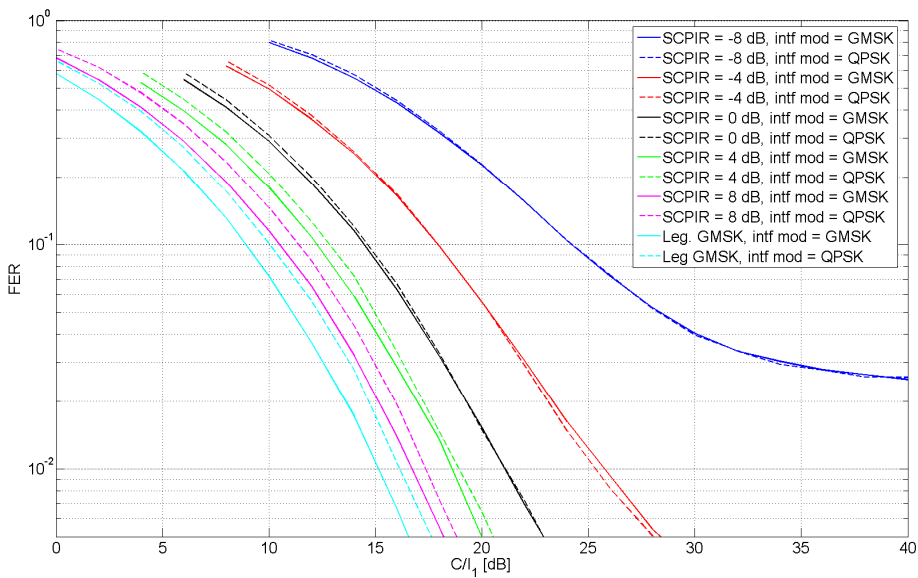

Figure 8-36: MTS-4, TU3iFH

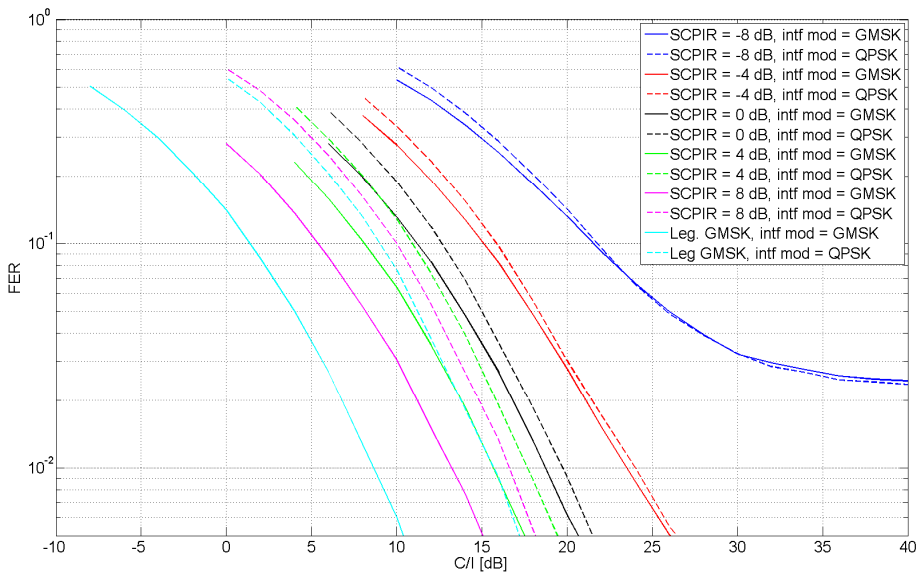

Figure 8-37: MTS-1, TU3nFH

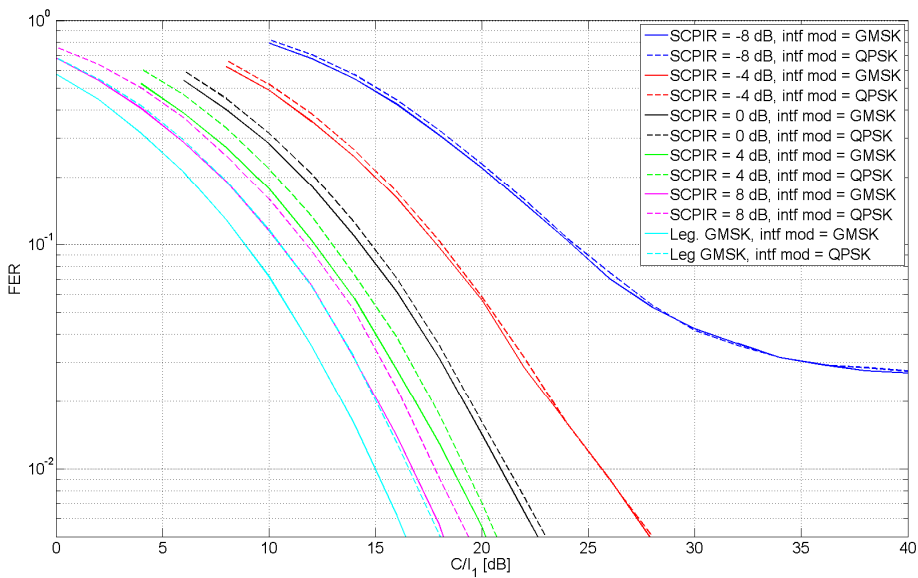

Figure 8-38: MTS-2, TU3nFH

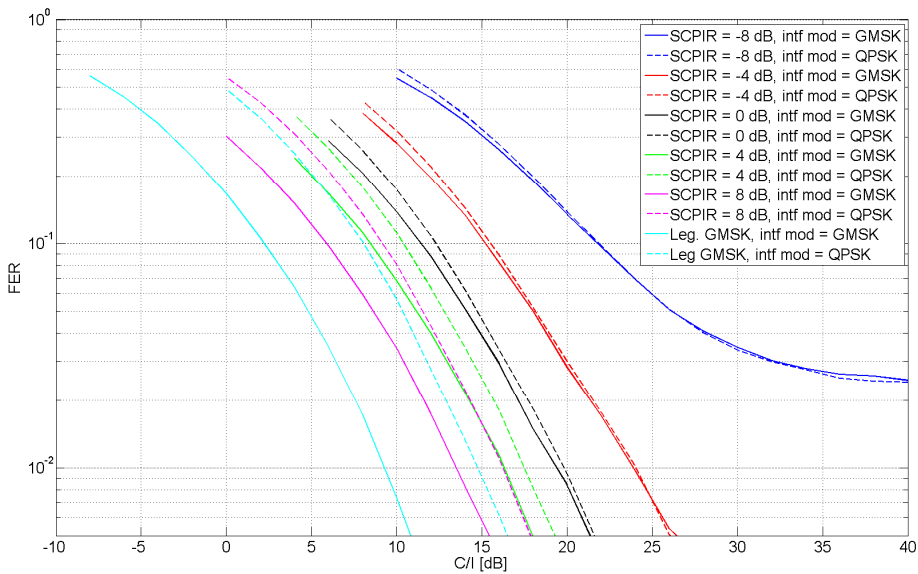

Figure 8-39: MTS-3, TU3nFH

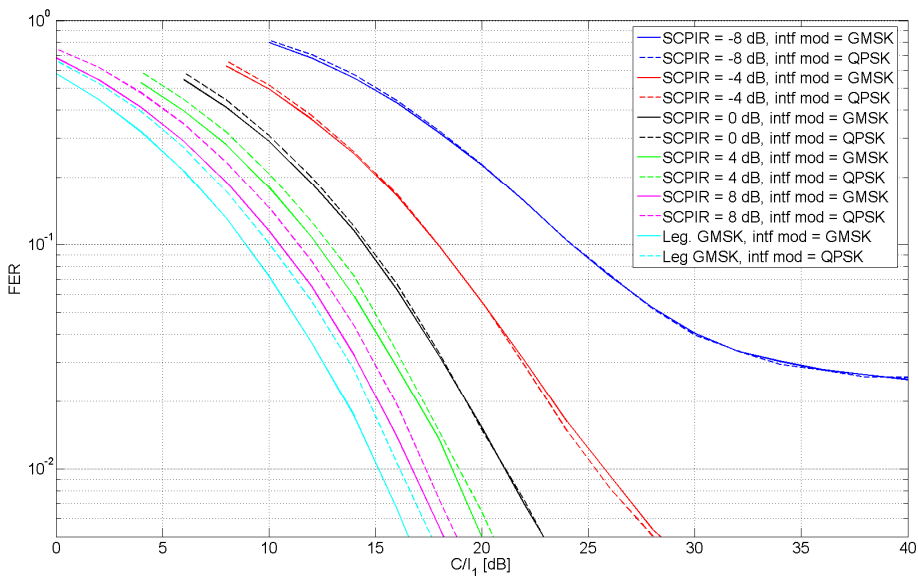

Figure 8-40: MTS-4, TU3nFH

8.2.1.3.2.1 Adaptive Constellation Rotation

Altering alpha or switching the rotation of the  $\alpha$ -QPSK MUROS constellation between  $\pi/2$  and  $\pi/4$  could deteriorate SAIC mobiles' ability to cancel interference caused by MUROS signals. To investigate this, simulations were conducted for both GMSK and  $\alpha$ -QPSK modulated carriers exposed to  $\alpha$ -QPSK modulated interference with varying alpha and a rotation of  $\pi/2$  or  $\pi/4$  as can be seen in the figure below.

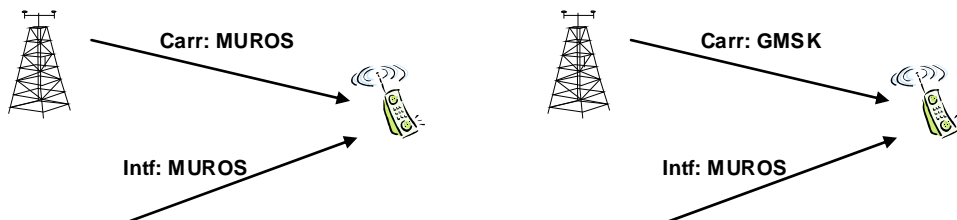

Figure 8-41: Identified interference scenarios

For the  $\alpha$ -QPSK modulated carriers the alpha values were chosen according to Table 8-10. The same  $\alpha$ -value was used by the carrier and interfering signal. The alpha values and constellation rotations used were chosen from Figure 8-9. Alpha equal to 0.77 and 1.19 represents the extreme values where the rotation switches from  $\pi/2$  to  $\pi/4$ . As alpha approaches these values the  $\alpha$ -QPSK modulation approaches a GMSK constellation.

Figure 8-42 presents the results from the simulation when the carrier was  $\alpha$ -QPSK modulated and the interferer either GMSK or  $\alpha$ -QPSK modulated. The  $\alpha$ -QPSK interferers were rotated  $\pi/2$  or  $\pi/4$  while the carrier used a rotation of  $\pi/2$ . The performance degradation due to the change in rotation reaches its maximal value 0.2 dB when  $\alpha$  equals 0.77.

Table 8-10: Alpha versus relative sub channel power

$\alpha$	SCPIR [dB]
0.77	-3.8
0.89	-1.8
1.19	3.8

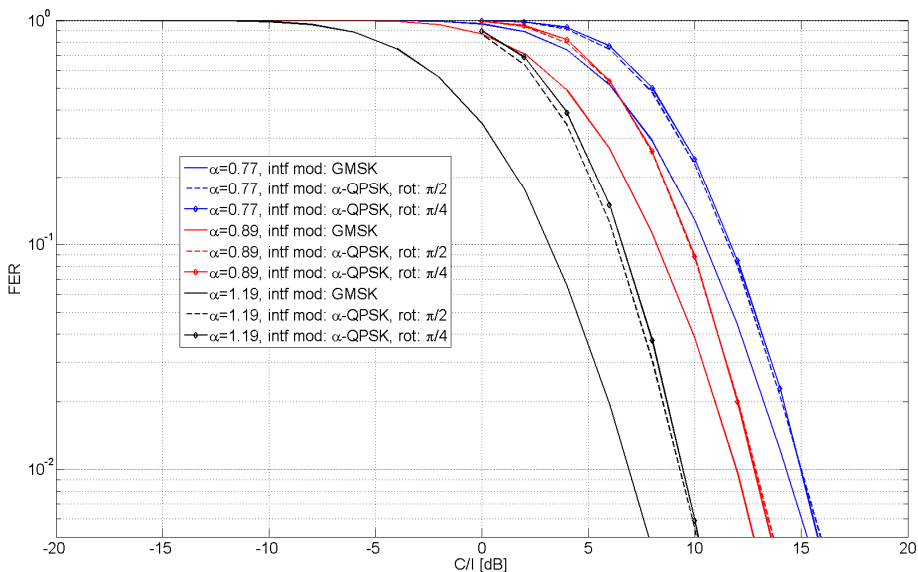

**Figure 8-42: SAIC performance when an  $\alpha$ -QPSK carrier, using AFS/12.2, is exposed to  $\alpha$ -QPSK or GMSK modulated interference**

For the scenario when the carrier is GMSK modulated a more thorough investigation was performed. Figure 8-43 shows the SAIC performance when a GMSK carrier is exposed to MTS-1 or MTS-2 interference. The interferers are  $\alpha$ -QPSK modulated, and the performance is shown for alpha in the range 0.77 to 1.19, which corresponds to a SCPIR of -3.8 to +3.8dB. For each alpha the symbol rotation of the interferers is  $\pi/2$  or  $\pi/4$ .

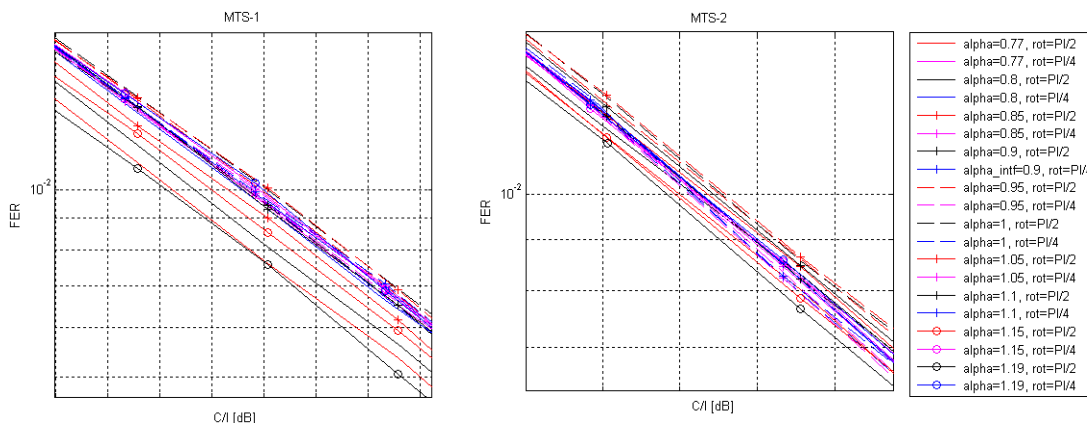

**Figure 8-43: SAIC performance for a GMSK carrier when exposed to MTS-1 (left) and MTS-2 (right) interference, where the interferers are alpha-QPSK modulated. Each tick on the x-axis equals 0.2dB**

By comparing the performance at the different rotations, it is possible to estimate the performance degradation in dB of the SAIC receiver at 1% FER. Figure 8-44 summarizes this degradation over the studied alpha range. The fine resolution on the y-axis is justified since 150 000 frames per point were simulated. The degradation worsens as alpha approaches the theoretical rotation adaptation thresholds of 0.77 and 1.19. For MTS-1 the maximal degradation equals 0.37dB while 0.09 dB for MTS-2.

It can be seen that when the MS experiences a multiple interferer scenario, the degradation due to the modulation rotation is decreased significantly compared to the single interferer case. It should be noted that the MTS-2 multi-interferer case is seen as the relevant system scenario for MUROS.

Figure 8-44 shows, for both scenarios, that symbol rotation  $\pi/4$  is preferred when alpha is close to 1. The reason is that when the interferer modulation constellation is QPSK-like the SAIC receiver has limited, or no, capability to suppress the interference, as can also be seen in [8-12] and [8-13], since the two sub channels are always 90 degree phase shifted.

On the other hand,  $\pi/4$  rotation is used in the transmitter and  $\pi/2$  de-rotation is used in the receiver, resulting in a net rotation of  $-\pi/4$  for the interference. This type of interference causes less performance degradation in the receiver than a BPSK signal rotated  $\pi/2$ . This resembles the case in EGPRS where it is observed that 8PSK interference is less harmful than GMSK interference for a non-SAIC receiver.

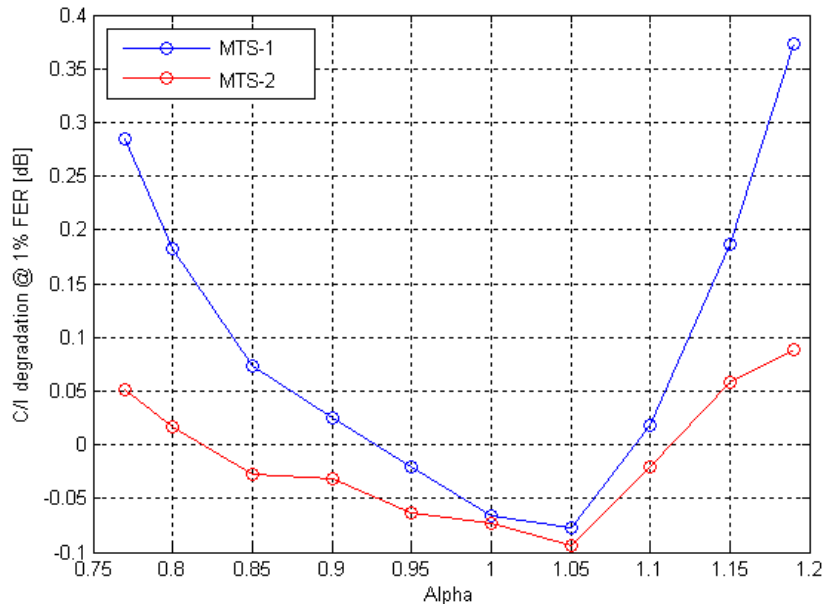

Figure 8-44: C/I degradation at 1% FER

8.2.1.3.3 MUROS receiver

8.2.1.3.3.1 Constellation Rotation Detection

When an additional rotation is introduced for the  $\alpha$ -QPSK modulation, the MS needs to detect it blindly, as mentioned in section 8.1.4. While MUROS receiver performance in sensitivity limited scenario is presented in section 8.2.1.2.2.2, Figure 8-45 depicts the performance degradation of the same receiver when the  $\alpha$ -QPSK carrier is exposed to GMSK modulated MTS-2 interference.

The performance is shown for codecs TCH/HS, TCH/AHS5.9 and TCH/AFS12.2 when the alpha-QPSK modulation constellation is determined by alpha 0.634, 1 and 1.264. The degradation at 1% FER is at most 0.15 dB at SCPIR=+6 dB compared to performance when no modulation needs to be detected. At SCPIR=0 dB and SCPIR=-6 dB no degradation is seen.

As the degradation due rotation detection never exceeds 0.15dB for any of the studied alpha values it will be compensated by the PAR enhancement presented in Figure 8-7.

Table 8-11: Alpha versus relative sub-channel power

$\alpha$	SCPIR [dB]
0.634	-6
1.0	0
1.264	6



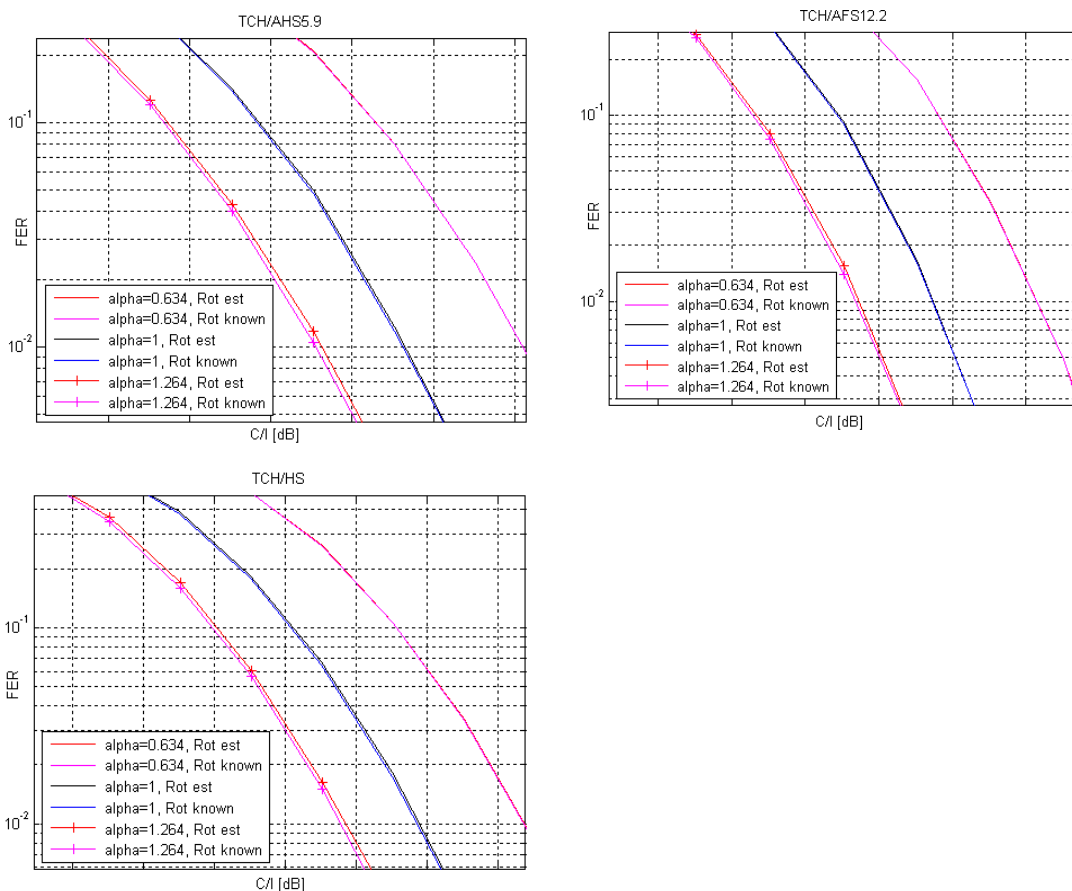

**Figure 8-45: MUROS receiver with/without rotation detection when speech codec TCH/HS, TCH/AHS5.9 and TCH/HS12.2 is used. Each tick on the x-axes corresponds to 2dB**

It should be noted that the MUROS receiver estimates the rotation on a burst-by-burst basis. If the blind rotation detection metric were to be accumulated over several bursts, the performance is expected to be improved.

8.2.1.3.4 SIC receiver

8.2.1.3.4.1 Investigations by Telefon AB LM Ericsson

8.2.1.3.4.1.1 Simulation assumptions

The reference receiver is a legacy GMSK MRC receiver. The wanted sub-channel is denoted  $C_1$ , and the strongest co-channel interferer  $I_1$ .

The simulation assumptions are shown in Table 8-11a below.

**Table 8-11a Simulation assumptions.**

Parameter	Value
Channel profile	Typical Urban (TU)
Terminal speed	3 km/h
Frequency band	900 MHz
Frequency hopping	Ideal (TU)
Interference modulation	GMSK
Antenna diversity	Yes
Receiver type	SIC, spatio-temporal IRC.
Interference/Noise	MTS-1/2/3/4
Rx filter	RRC <sup>1</sup>
- Bandwidth	240 kHz
- RRC rolloff	0.3
Impairments:	Typical Tx and Rx impairments
Note 1: The 3 dB bandwidth of the RRC filter.	

#### 8.2.1.3.4.1.2 Performance Plots for MTS Test Scenarios

The performance has been normalized so that the reference receiver reaches 1% FER @ 0 dB.

From the simulations shown below it can be concluded:

- The performance in the MTS-2 (synchronous, multiple interferers) and MTS-4 (asynchronous, multiple interferers) test cases is very similar, for both reference and SIC receivers.
- In most test cases the performance of the weakest sub-channel is inferior to the performance of the reference MRC receiver at 1% FER. Since a legacy IRC receiver exhibits much better performance than an MRC receiver in interference scenarios, the degradation with respect to a legacy IRC receiver can be very large, roughly from 6 to 20 dB, depending on the IRC algorithms and the test case.

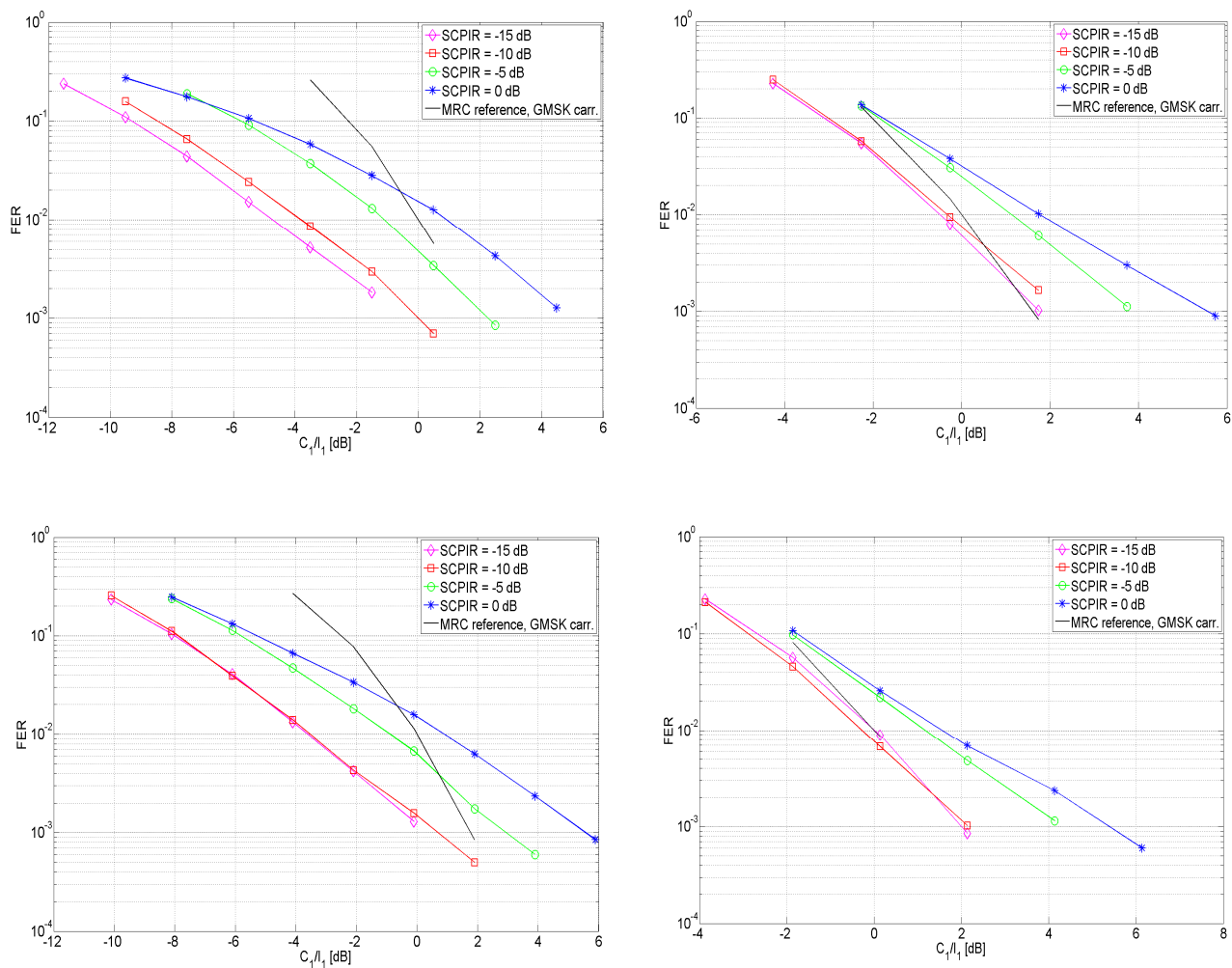

Figure 46 - TCH/AFS5.90, TU3iFH. MTS-1 (top left), MTS-2 (top right), MTS-3 (bottom left), MTS-4 (bottom right).

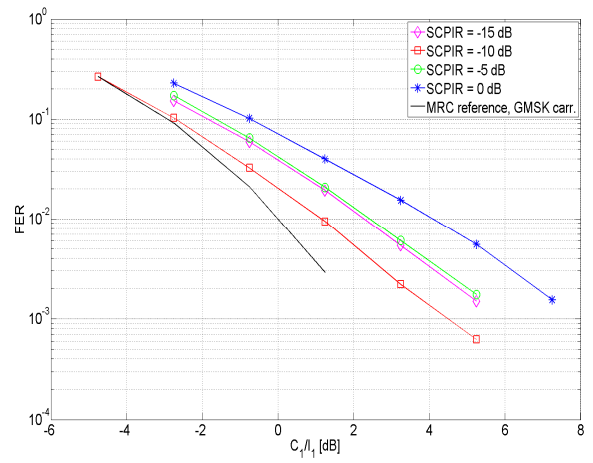
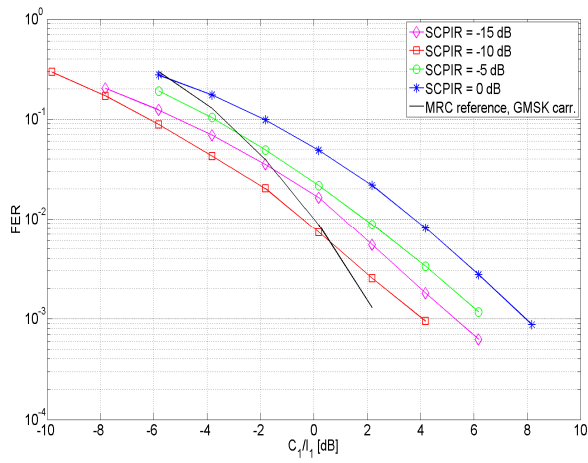
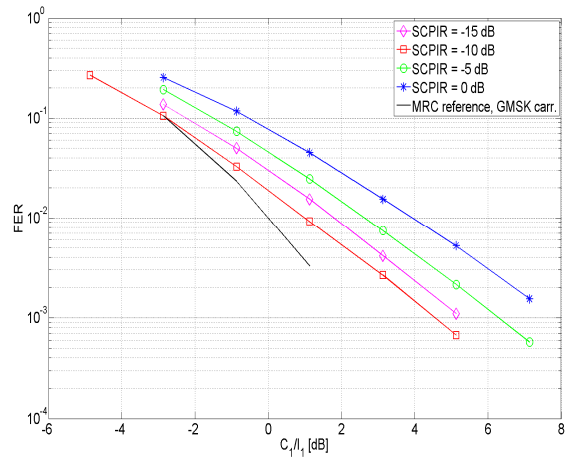
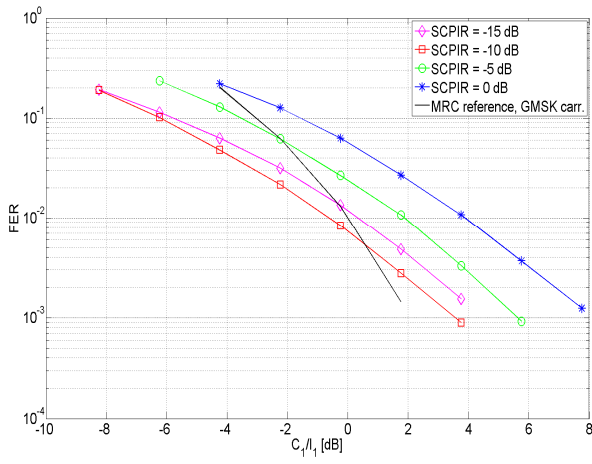
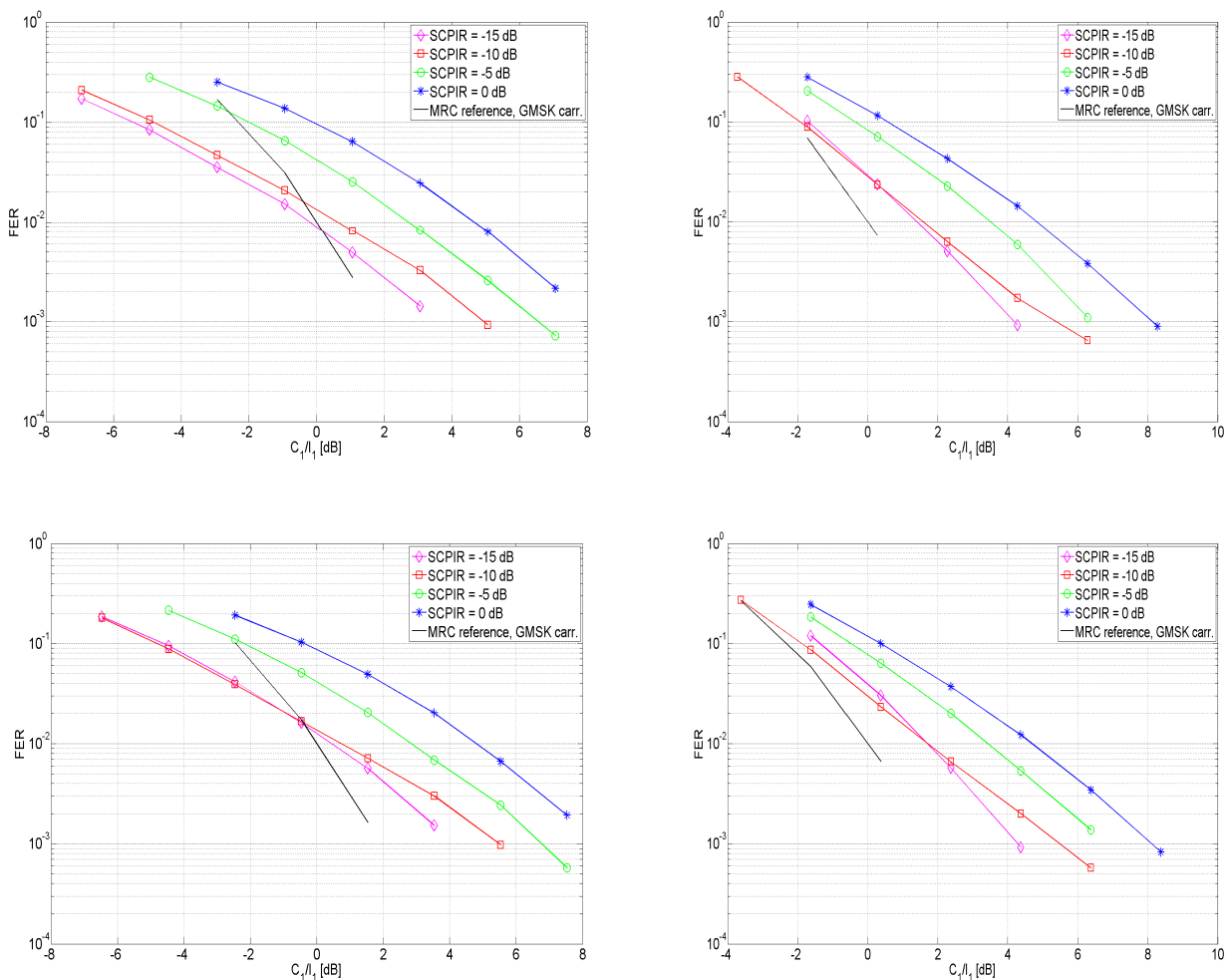

Figure 47 - TCH/AHS5.90, TU3iFH. MTS-1 (top left), MTS-2 (top right), MTS-3 (bottom left), MTS-4 (bottom right)



**Figure 48 - TCH/AFS12.20, TU3iFH. MTS-1 (top left), MTS-2 (top right), MTS-3 (bottom left), MTS-4 (bottom right).**

8.2.1.3.4.2 Investigations by ST-NXP Wireless France

Text in this section is based on contributions [8-20] and [8-21].

8.2.1.3.4.2.1 Introduction

Successive interference cancellation (SIC) receivers have been proposed for the OSC/MUROS uplink, which can be understood as a 2x2 MIMO scheme with 2 users transmitting on separate antennas [8-15]. To take benefit from dual receive antennas available in a typical BTS, SIC can be combined with diversity interference cancellation techniques for MUROS uplink receiver implementations [8-20]. This receiver is considered as a good trade off between complexity and performance, especially when combined with diversity interference cancellation techniques, which can also be denoted as interference rejection combining (IRC) [8-22].

Contrastingly, the MUROS downlink signal is typically sent from a single BTS antenna to both users and received by a single receive antenna in each MS. This situation is expected to persist in the future, at least for the vast majority of phones used by billions of worldwide GSM subscribers. As a result, the downlink is supposed to remain the limiting factor in network planning also with MUROS, even though the signals for both users are transmitted orthogonally to facilitate their separation.

For the MUROS downlink, single antenna interference cancellation (SAIC) as defined by DARP phase 1 capability is already performing quite well to demodulate the MUROS sub channel based on a legacy training sequence [8-28]. For MUROS specification, the VAMOS work item [8-18] approved at GERAN #40 foresees the definition of two different

levels of VAMOS support in new MS. While a first class requires only support of new training sequences in addition to DARP phase 1 capability using SAIC, a second class shall provide more advanced receiver performance specifically for the MUROS/VAMOS downlink signal.

In this section,

- the link performance of a SIC receiver for the uplink is evaluated. Simulations for the AFS 5.9 and AHS 5.9 have been performed for MUROS test scenarios MTS 1 and MTS-2. Simulation assumptions and results have been updated compared to an earlier version presented at MUROS telco #9.
- the link performance of a SIC receiver for the downlink is evaluated, in that the ST-NXP solution of SAIC called mono interference cancellation (MIC) technology is combined with SIC techniques to achieve advanced VAMOS downlink receiver performance (S-MIC). This combination is advantageous especially for downlink power control by adaptive signal constellation, which is foreseen for VAMOS specification. Additionally S-MIC shows significant performance improvements in the case of sensitivity. Both classes of VAMOS capable terminals (MIC and S-MIC) have been simulated for MTS-1, MTS-2 and sensitivity scenarios based on AFS 12.2, AFS 5.9, AHS 7.95 and AHS 5.9 channels.

#### 8.2.1.3.4.2.2 Simulation Assumptions for Uplink

For BTS receive diversity, methods like enhanced diversity interference cancellation can be applied, which have been developed for GMSK modulation, first shown in [8-23]. These methods have been reused for MSRD receivers [8-24]. For MUROS uplink receivers, better radio and baseband conditions at the BTS and specific characteristics of MUROS system definition allow combination with further methods. Good decorrelation of BTS antennas, aligned timing synchronization between the subchannels by timing advance and knowledge of the training sequence of both subchannels can be assumed. This allows exceptionally good performance already in combination with successive interference cancellation, which is still less complex than joint detection. The total complexity of the SIC algorithm considered here (fixed point MIPS) is only about 3 times higher for both users than a conventional diversity IC receiver for a single user.

Simulations have been performed to evaluate the performance of a SIC receiver in combination with IRC. For reference purpose a conventional GMSK MRC receiver is included in the analysis. The simulation assumptions are very similar to [8-22] and summarized in Table 8-11b.

**Table 8-11b: Simulation assumptions for Uplink.**

Parameter	Value
Channel profile	Typical Urban (TU)
Terminal speed	50 km/h (TU)
Frequency band	900 MHz
Frequency hopping	Ideal (TU)
TSC allocation	User subchannel C1: legacy TSC0 (wanted signal) User subchannel C2: new TSC0 from [1]
Interference	MTS-1 and MTS-2 model
Interference modulation	GMSK
MUROS SCPIR	0, -5, -10, -15 dB
C/I	Power of wanted user C1 / dominant external interferer power I1
Timing alignment	Random error model TR 45.914 [10], Section 5.2.5
Frequency offset	C1: 0 Hz, C2: +100 Hz (Fig.1-12) C1: 0 Hz, C2: 0 Hz (Fig. 9-12) C1: -50 Hz, C2: +50 Hz (Fig. 9-12) C1: -150 Hz, C2: +150 Hz (Fig. 9-12)
Used Codecs	TCH/AFS 5.9 and AHS 5.9
Antenna diversity	Yes, uncorrelated antennas
Receiver type	SIC, spatio-temporal IRC
Receiver implementation	fixed-point
Frequency offset compensation	Timeslot-based, no outer compensation loop, range -150 Hz .... 150 Hz (extendable)
Simulation time	200 sec (40 000 timeslots) per point
Rx filter	RRC
– Bandwidth	240 kHz (3 dB bandwidth)
– RRC rolloff	0.3
Rx-Impairments:	
– Phase noise	1.0 [degrees (RMS)]
– I/Q gain imbalance	0.2 [dB]
– I/Q phase imbalance	1.5 [degrees]
– Noise figure	8 [dB]

#### 8.2.1.3.4.2.3 Simulation Results for Uplink

It is preferred to plot absolute FER performance results. These plots, which are all positioned on the left hand side in the following pairs of plots in this subsection below, allow comparison with other UL simulations, which have already started to show absolute performance [8-25].

The performance plots on the right hand side are based on the same simulations, but have been normalized so that the MRC performance becomes 1% FER @ 0 dB, similar to [8-22], [8-26]. The conventional MRC receiver can be expected to provide a better reference basis for comparing simulations results between companies than the IRC receiver, because IRC results are supposed to dependent more strongly on the specific implementation. Therefore comparison with [8-26] would be quite difficult in any case and IRC results are not provided here.

In Figures 53 (a and b) to 54 (a and b) below additional results for varying frequency offset between the subchannels are shown. These can be compared with results in [8-27], but don't show any strong dependency on the frequency offset between the MUROS subchannels reported in that earlier contribution.

In general the uplink performance at 1% FER for interference turns out to be consistently better than MRC, with only few exceptions if the difference between C1 and C2 is 10 dB or more.

MTS-1, AFS/AHS 5.9, frequency offsets: C1 = 0 Hz, C2 = 100 Hz

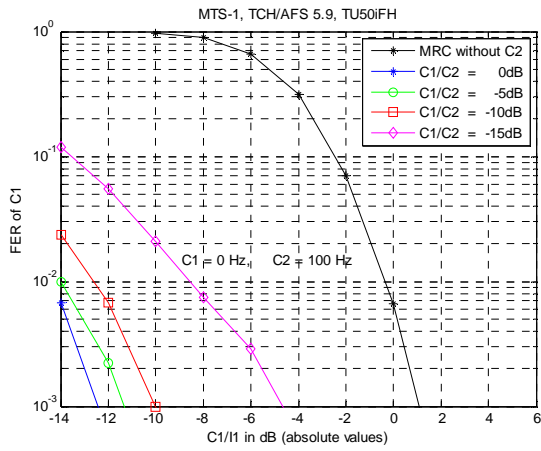

Figure 49a: MTS-1, TCH/AFS 5.9, absolute

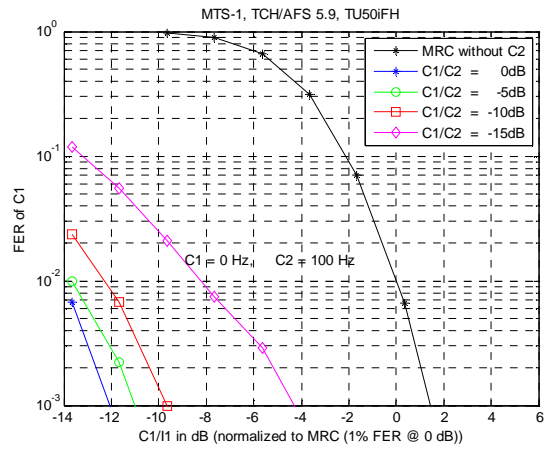

Figure 49b: MTS-1, TCH/AFS 5.9, relative

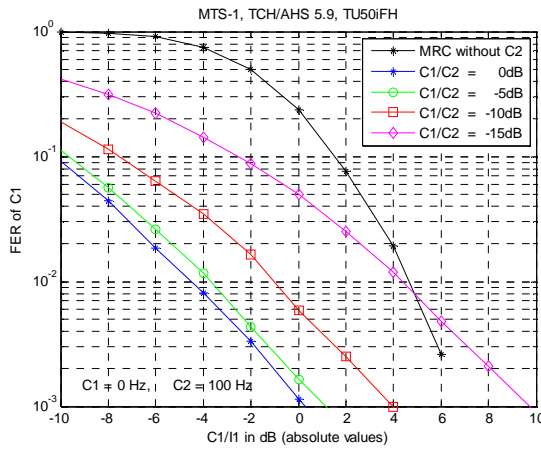

Figure 50a: MTS-1, TCH/AHS 5.9, absolute

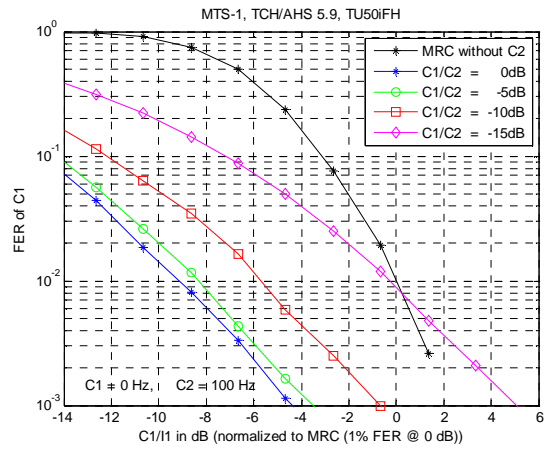

Figure 50b: MTS-1, TCH/AHS 5.9, relative

MTS-2, AFS/AHS 5.9, frequency offsets: C1 = 0 Hz, C2 = 100 Hz

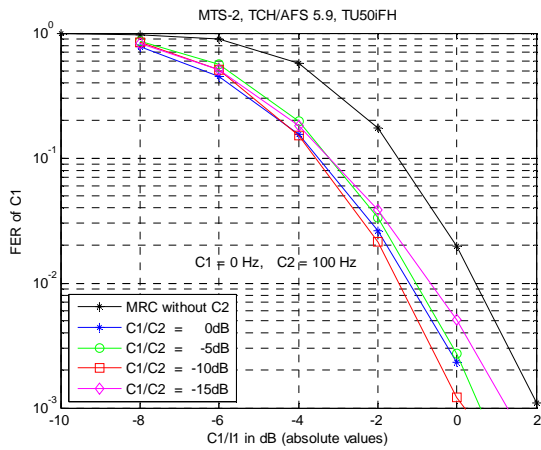

Figure 51a: MTS-2, TCH/AFS 5.9, absolute

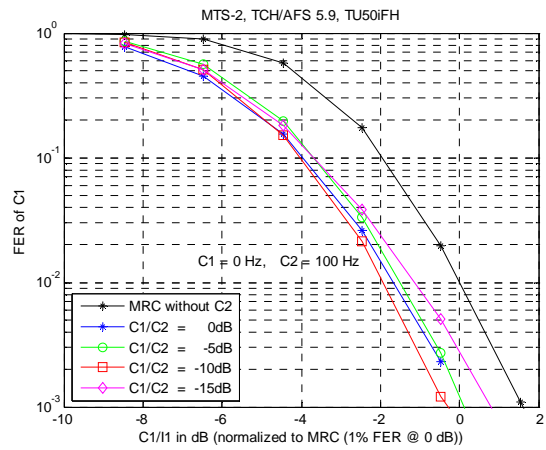

Figure 51b: MTS-2, TCH/AFS 5.9, relative



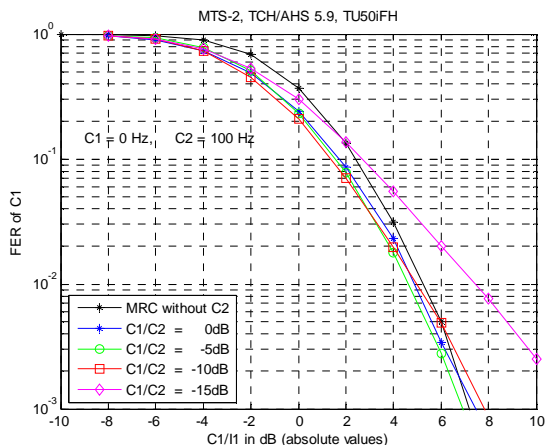

Figure 52a: MTS-2, TCH/AHS 5.9, absolute

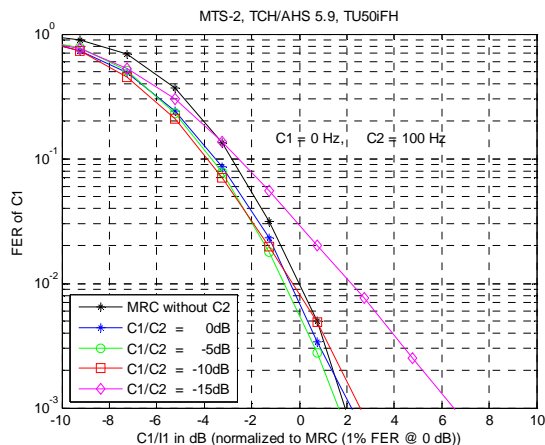

Figure 52b: MTS-2, TCH/AHS 5.9, relative

MTS-1/2, AFS/AHS 5.9 with different frequency offsets

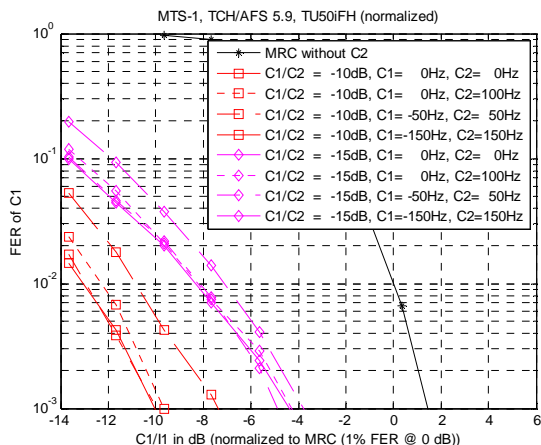

Figure 53a: MTS-1, TCH/AFS 5.9, relative

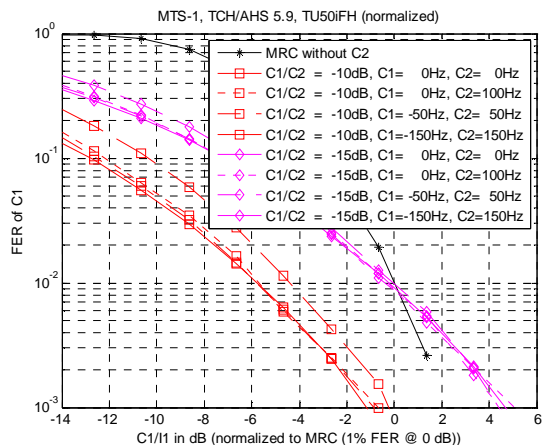

Figure 53b: MTS-1, TCH/AHS 5.9, relative

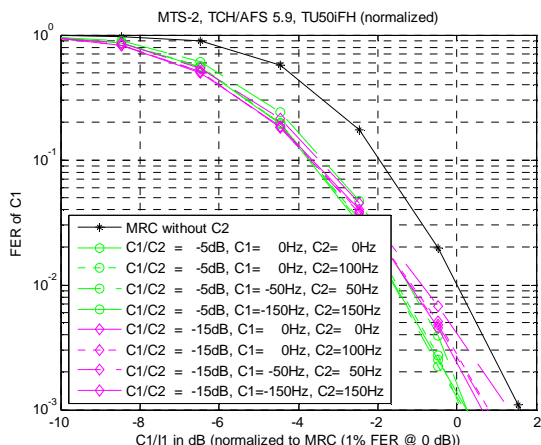

Figure 54a: MTS-2, TCH/AFS 5.9, relative

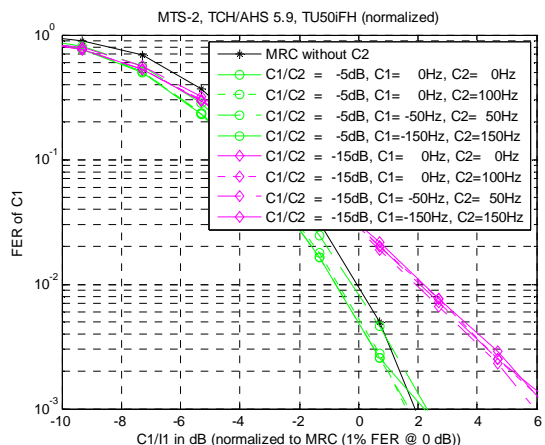

Figure 54b: MTS-2, TCH/AHS 5.9, relative

## 8.2.1.3.4.2.4 Simulation Assumptions for Downlink

Simulations have been performed to evaluate the performance of

- MIC / SAIC (red curves),
- S-MIC (blue curves),
- conventional GMSK equalizer without MUROS (black curves for reference).

The simulation assumptions are summarized in Table 8-11c.

**Table 8-11c: Simulation assumptions for Downlink.**

Parameter	Value
Channel profile	Typical Urban (TU)
Terminal speed	3 km/h (TU)
Frequency band	900 MHz
Frequency hopping	Ideal (TU)
TSC allocation	User subchannel C1: legacy TSC0 (wanted signal) User subchannel C2: new TSC0 from [8-15]
Interference	MTS-1 and MTS-2 model
Interference modulation	GMSK
MUROS SCPIR	0, -4, -8 dB
C/I	Power of wanted user C1 / dominant external interferer power I1 or Power of total signal C / dominant external interferer power I1
Frequency offset	Not relevant for MIC in DL
Used Codecs	TCH/AFS 12.2, AFS 5.9, AHS 7.95 and AHS 5.9
Antenna diversity	No
Receiver type	- MIC / SAIC - S-MIC (successive MIC)
Receiver implementation	Fixed-point
Frequency offset compensation	Timeslot-based, no outer compensation loop
Simulation time	200 sec (40 000 timeslots) per point
Rx filter Bandwidth	240 kHz (3 dB bandwidth)
Rx-Impairments:	
- Phase noise	2.0 [degrees (RMS)]
- I/Q gain imbalance	0.2 [dB]
- I/Q phase imbalance	1.5 [degrees]
- Noise figure	8 [dB]

## 8.2.1.3.4.2.5 Simulation Results for Downlink

FER performance results are shown versus two different carrier-to-interference ratio definitions. Either the wanted sub channel power C1 or the total carrier power  $C = C1 + C2$  of the MUROS downlink signal is considered as the carrier power. In both cases, the interference is defined as the dominating interferer power I1 (in case of MTS-1 this is the total external interference power  $I = I1$ , while the other external interferer contributions of the MTS-2 model increase I according to  $I / I1 = 0.6$  dB [8-29]).

- The plots FER versus C1/I1, which are all positioned on the left hand side in the following pairs of plots, in fact disregard the internal interference power by the second sub channel C2 [8-30].
- The performance plots on the right hand side are based on the same simulations, but are depicted FER versus C/I1, and show the fraction C2 of carrier power C, which does not contribute to the wanted signal for user 1, as an additional degradation [8-28].

Also sensitivity results are shown versus two different signal-to-noise ratio definitions. Either the wanted symbol energy  $E_b$  of sub channel C1 or the total symbol energy  $E_s$  of the total carrier power  $C = C1 + C2$  is considered [8-31].

For reference purpose, the performance of a conventional equalizer for legacy GSMK case  $C = C_1$  is shown in both plots. Furthermore, the reference performance requirements from TS 45.005 for non-DARP capable MS are marked (in case of MTS-2 the reference interference level is increased by 0.6 dB on the  $C_1/I_1$ , resp.  $C/I_1$  scale).

Comparison between results for MTS-1 and MTS-2 interference scenarios does not show really strong dependency of the receiver performance on the interference type. Also the impact of interferer modulation type is expected to be rather limited based on previous analyses for MIC [8-28].

**MTS-1**

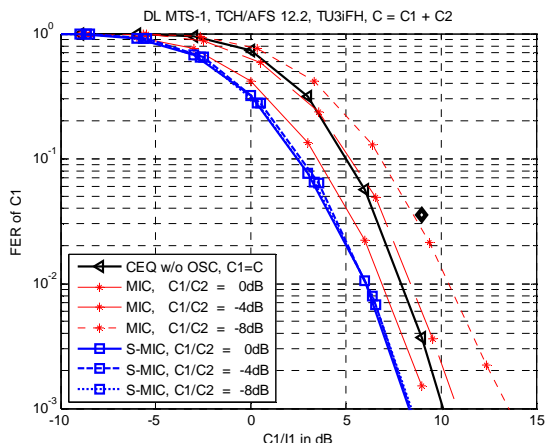

**Figure 55a: MTS-1 for AFS 12.2, power C1**

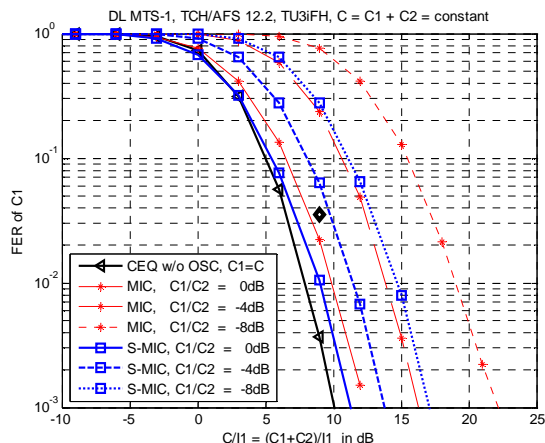

**Figure 55b: MTS-1 for AFS 12.2, power C**

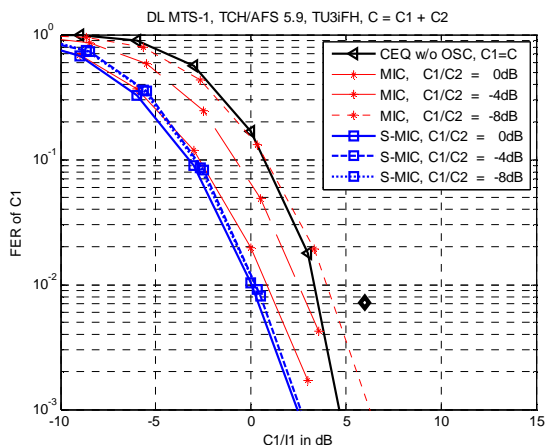

**Figure 56a: MTS-1 for AFS 5.9, power C1**

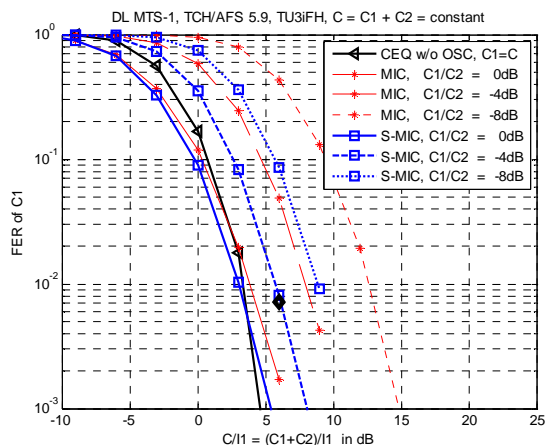

**Figure 56b: MTS-1 for AFS 5.9, power C**

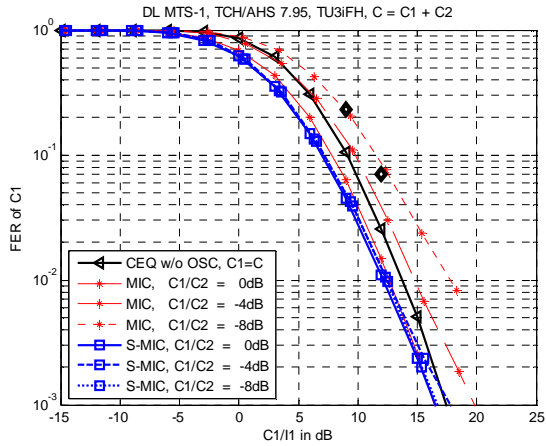

Figure 57a: MTS-1 for AHS 7.95, power C1

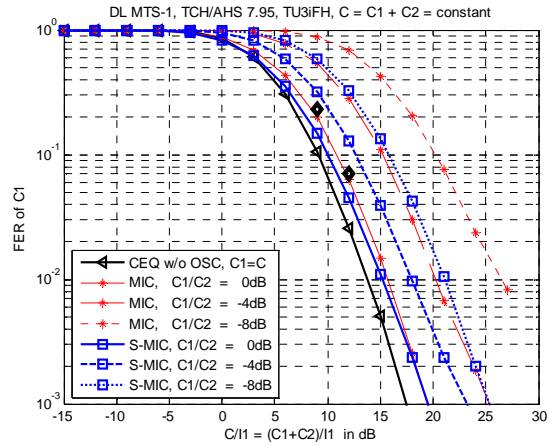

Figure 57b: MTS-1 for AHS 7.95, power C

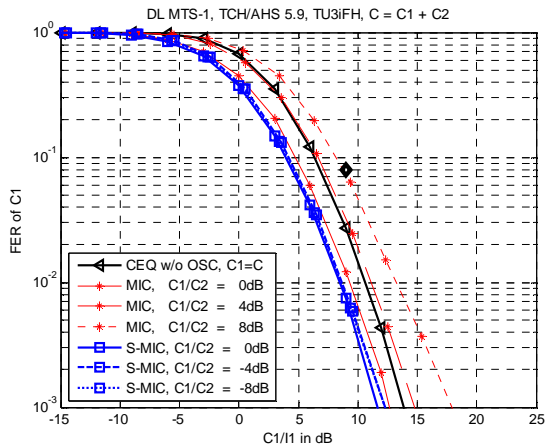

Figure 57c: MTS-1 for AHS 5.9, power C1

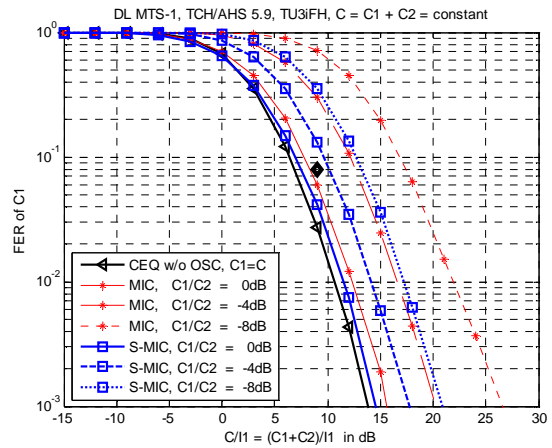

Figure 57d: MTS-1 for AHS 5.9, power C

MTS-2

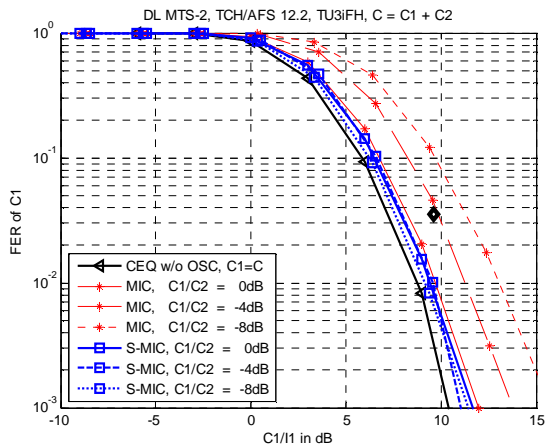

Figure 58a: MTS-2 for AFS 12.2, power C1

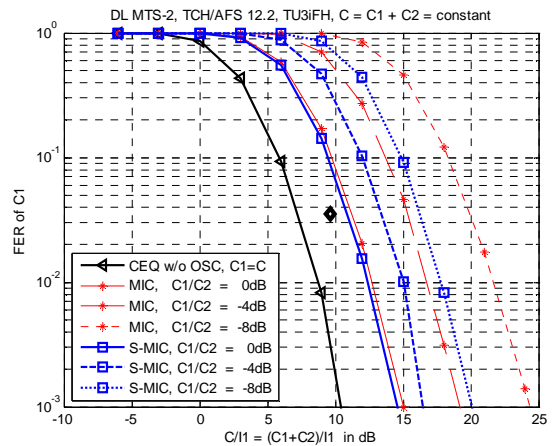

Figure 58b: MTS-2 for AFS 12.2, power C

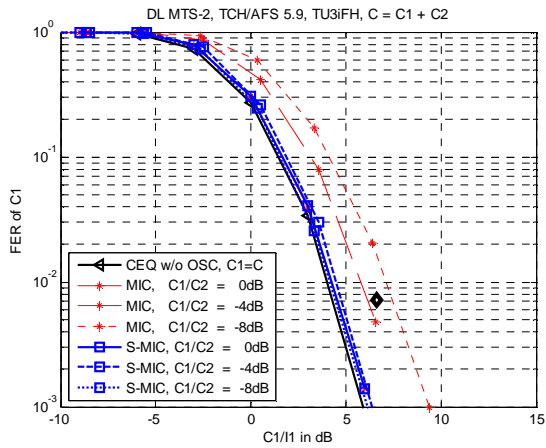

Figure 8-58c: MTS-2 for AFS 5.9, power C1

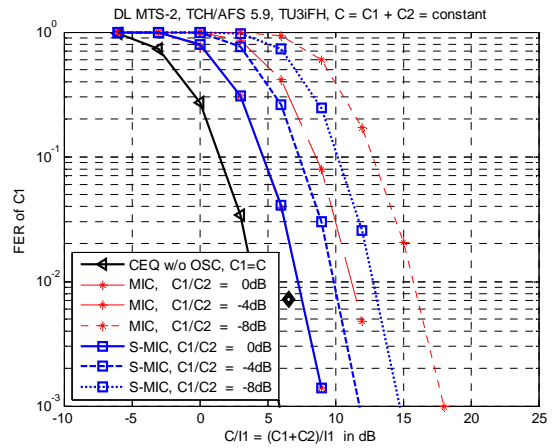

Figure 8-58d: MTS-2 for AFS 5.9, power C

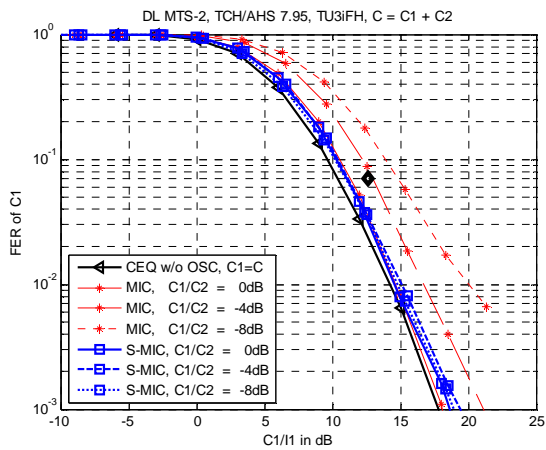

Figure 8-59a: MTS-2 for AHS 7.95, power C1

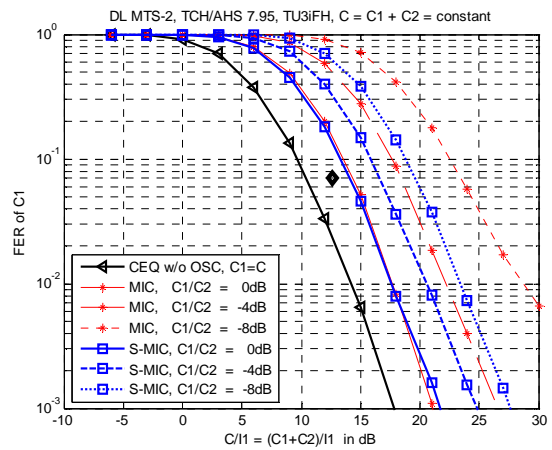

Figure 8-59b: MTS-2 for AHS 7.95, power C

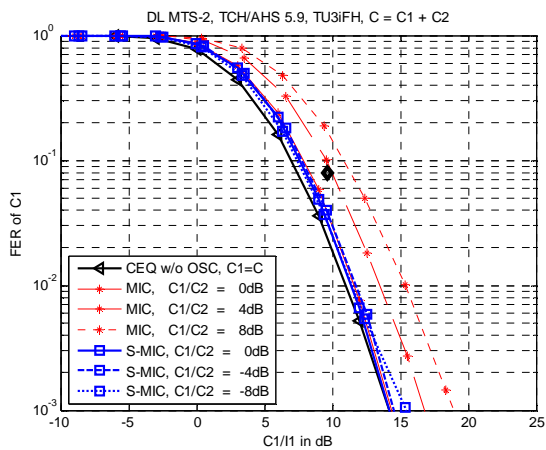

Figure 8-59c: MTS-2 for AHS 5.9, power C1

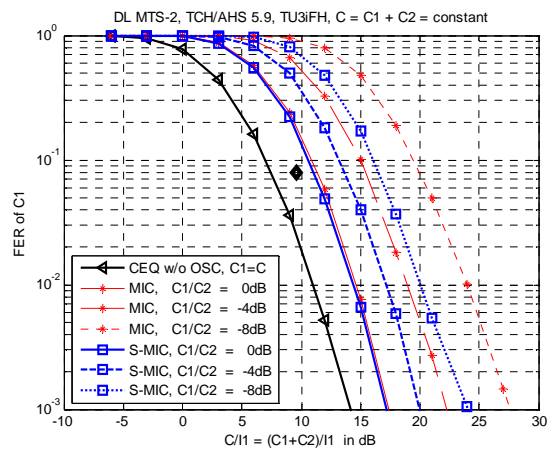

Figure 8-59d: MTS-2 for AHS 5.9, power C

#### 8.2.1.3.4.2.6 Conclusions

The simulation results for uplink presented have been all achieved in fixed point implementation with reasonable complexity, which could also be scaled up or down especially regarding the SIC component. Taking MRC without MUROS as a reference, it becomes evident that the MUROS link performance that can be achieved by efficient combination of advanced receiver techniques is in the same order of magnitude or even better. Since MRC uplink performance is often considered as basis for network planning, this observation supports feasibility of MUROS to provide sufficient uplink performance in these networks even for half rate channels.

The simulation results turn out to be extremely robust with respect to frequency offset, which may be quite high under practical network operation conditions with all variety of MS types. The conclusions presented here for uplink complement similar conclusions from downlink results about the tremendous benefit from MUROS for upgrading existing networks, which has already been shown before [8-28].

The simulation results for downlink show that for a first level of VAMOS capability the MIC / SAIC receiver performs quite well. When compared based on wanted signal power  $C_1$ , some degradation occurs for the weaker sub channel. With an advanced successive MIC receiver (S-MIC), this degradation of the weaker sub channel can mostly be avoided, and also the baseline performance for equally strong sub channels can be improved. The performance improvement is observed consistently for the interference scenarios MTS-1, MTS-2 and also for sensitivity. In summary, S-MIC provides well advanced receiver performance for a second level of VAMOS capability. The results presented herein have been all achieved in fixed point implementation with reasonable complexity. The S-MIC complexity is about 2.5 times higher than for MIC and could also be scaled up or down especially regarding the SIC component. The complexity is supposed affordable in a typical modern MS by SW implementation. Therefore the second level of VAMOS capable MS as defined in the WID is deemed feasible.

Taking into account the total carrier power  $C = C_1 + C_2$  of the MUROS signal, the downlink power is shared by 2 users and especially the performance of the weaker sub channel  $C_1$  degrades in a natural way when reducing  $C_1/C_2$ . However, especially with the advanced successive MIC (S-MIC) receiver, the degradation is basically limited to this natural degradation by reduction of downlink transmit power. For equal power of  $C_1$  and  $C_2$ , only 3 dB are unavoidably lost by power splitting and the interference performance for MUROS signals is not far from the original reference interference performance of the GSM system before introduction of SAIC. This comparison shows the tremendous benefit from MUROS for upgrading existing networks, as already been shown before [8-28]. Further improvements have been achieved by SIC methods in the downlink and fit very well with downlink power control by adaptive signal constellation [8-21].

#### 8.2.1.3.5 SAM Receiver for VAMOS

A SAM receiver prototype based upon the signal model (4) described in section 8.1.6 has been developed. The intention of the present contribution is to provide a proof of concept for SAM. The receiver has not been optimized or tuned. It is only a preliminary version. On the other hand, the reference is an optimized, commercially available, DARF Phase I receiver.

##### 8.2.1.3.5.1 Simulation assumptions

The wanted sub-channel is denoted  $C_1$ , while the paired sub-channel is denoted  $C_2$ . The carrier to interference ratio  $C/I$ , where  $C=C_1+C_2$ , is used in the plots. In multiple interference scenarios the dominant interferer is denoted  $I_1$  and the carrier to dominant interferer  $C/I_1$  is plotted. 10000 frames are used for each point in the graphs.

The simulation assumptions are shown in Table 8-11d below.

Table 8-11d Simulation assumptions

Parameter	Value
Speech codec	TCH/AFS5.90, TCH/AHS5.90
Channel profile	Typical Urban (TU)
Terminal speed	3 km/h
Frequency band	900 MHz
Frequency hopping	Ideal, No
Interference	MTS-1, MTS-2
Antenna diversity	No
Frequency offset external interferers	Normal distribution [Hz] N(50,17)
Receiver type	<u>Legacy SAIC (Reference)</u> The SAIC algorithm used for the receiver utilizes a spatial-temporal Vector Autoregressive (VAR) Model.  <u>SAM</u> 3 MLSE taps, VAR model, $\alpha$ is estimated in the receiver.
Impairments: - Phase noise - I/Q gain imbalance - I/Q phase imbalance - DC offset - Frequency error - PA model	Tx / Rx 0.8 / 1.0 [degrees (RMS)] 0.1 / 0.2 [dB] 0.2 / 1.5 [degrees] -45 / -40 [dBc] - / 25 [Hz] Yes/ -

8.2.1.3.5.2

Performance plots

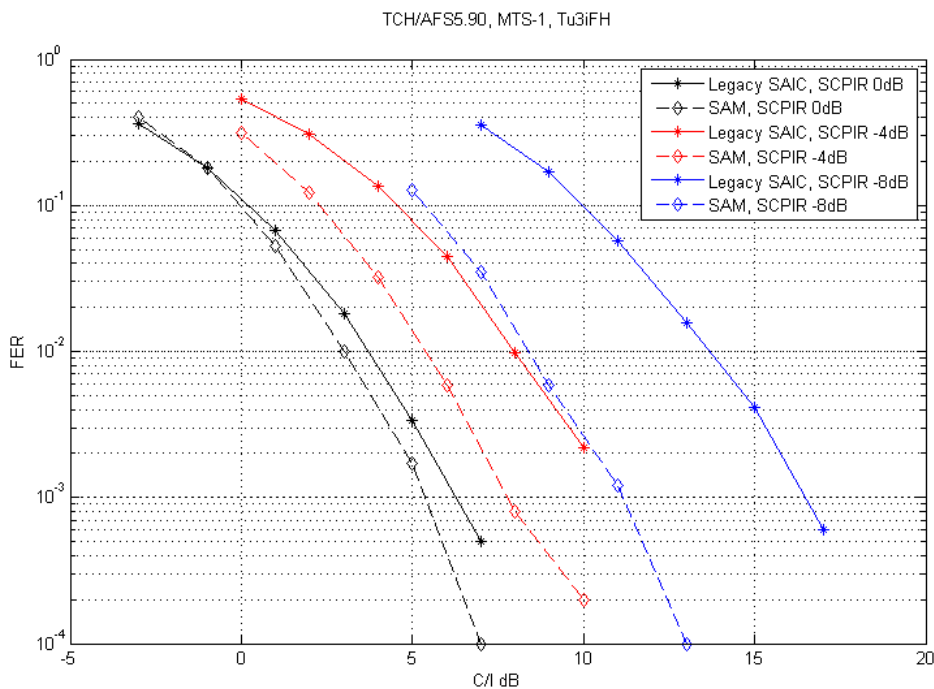

Figure 8-60a - MTS-1, AFS5.90

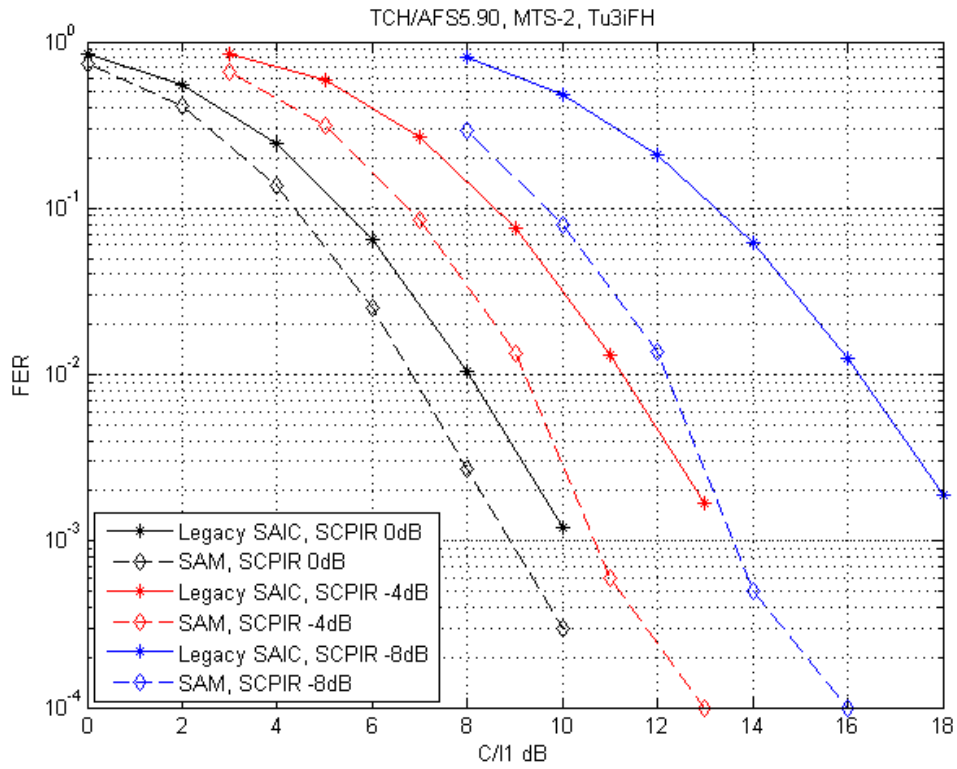

Figure 8-60b - MTS-2, AFS 5.90

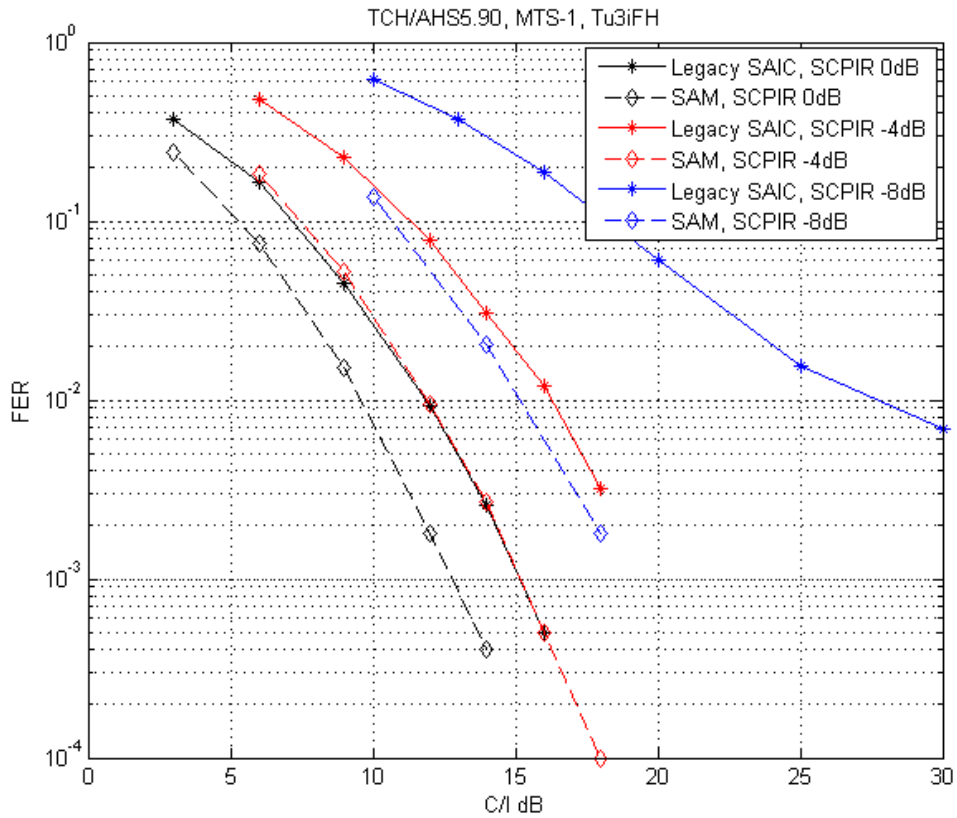

Figure 8-60c - MTS-1, AHS5.90



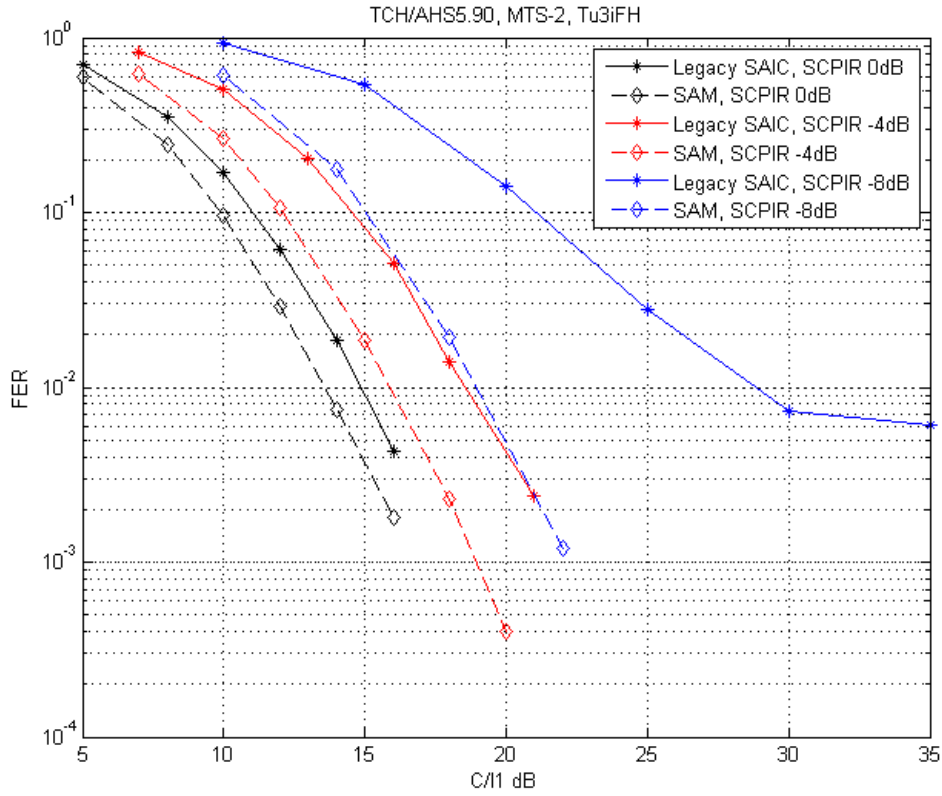

Figure 8-60d - MTS-2, AHS5.90

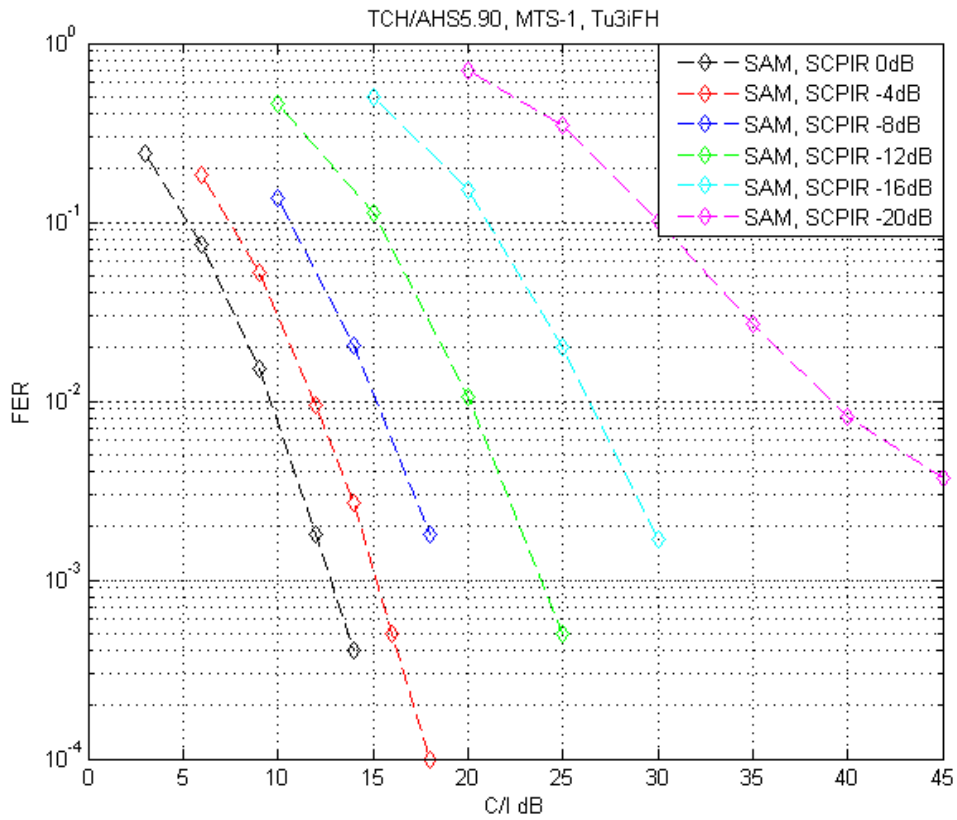

Figure 8-60e - Performance of SAM in MTS-1, AHS5.90 for varying SCPIR

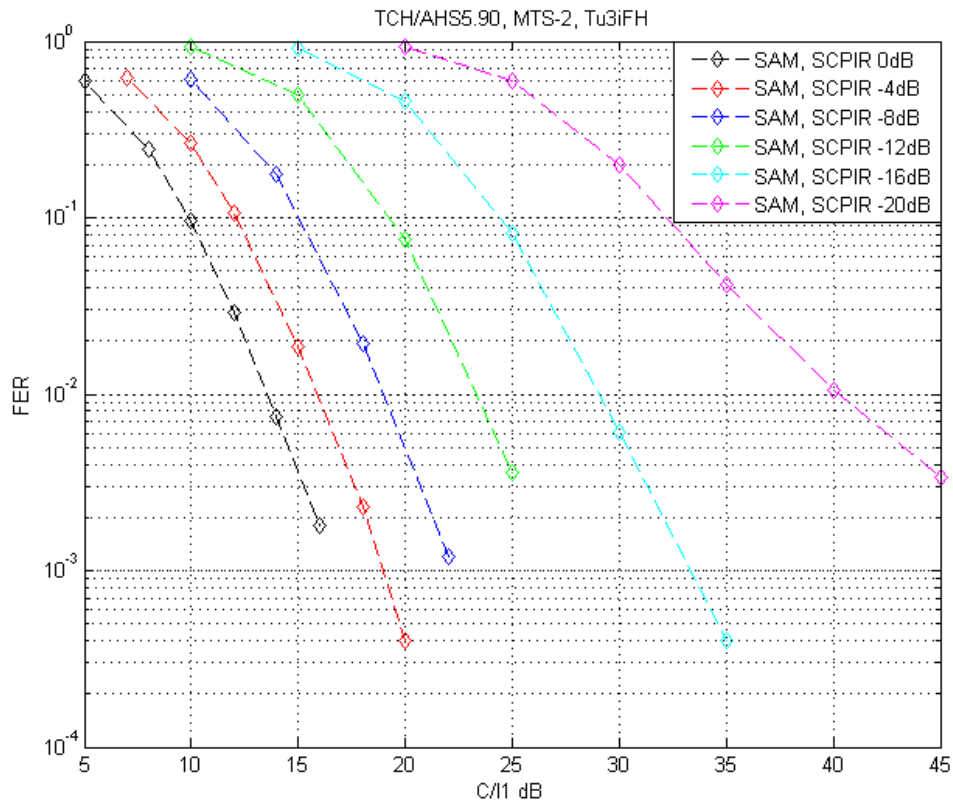

Figure 8-60f - Performance of SAM in MTS-2, AHS5.90 for varying SCPIR

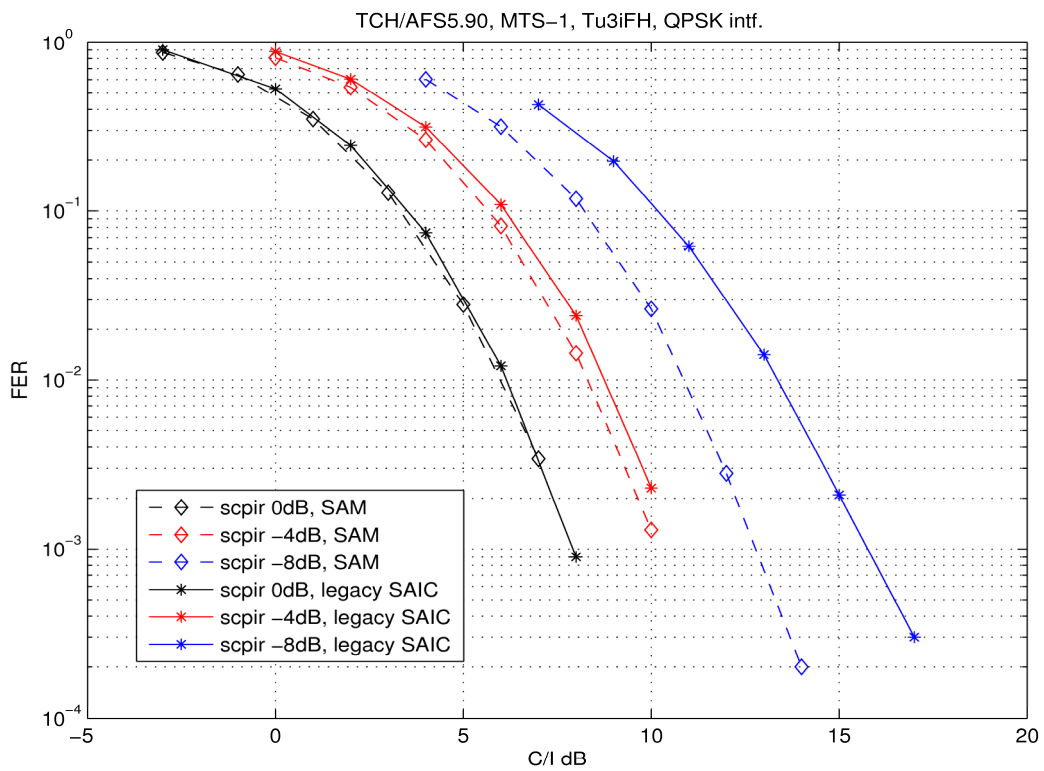

Figure 8-60g - Performance of SAM in MTS-1, AFS5.90 with QPSK modulated interference

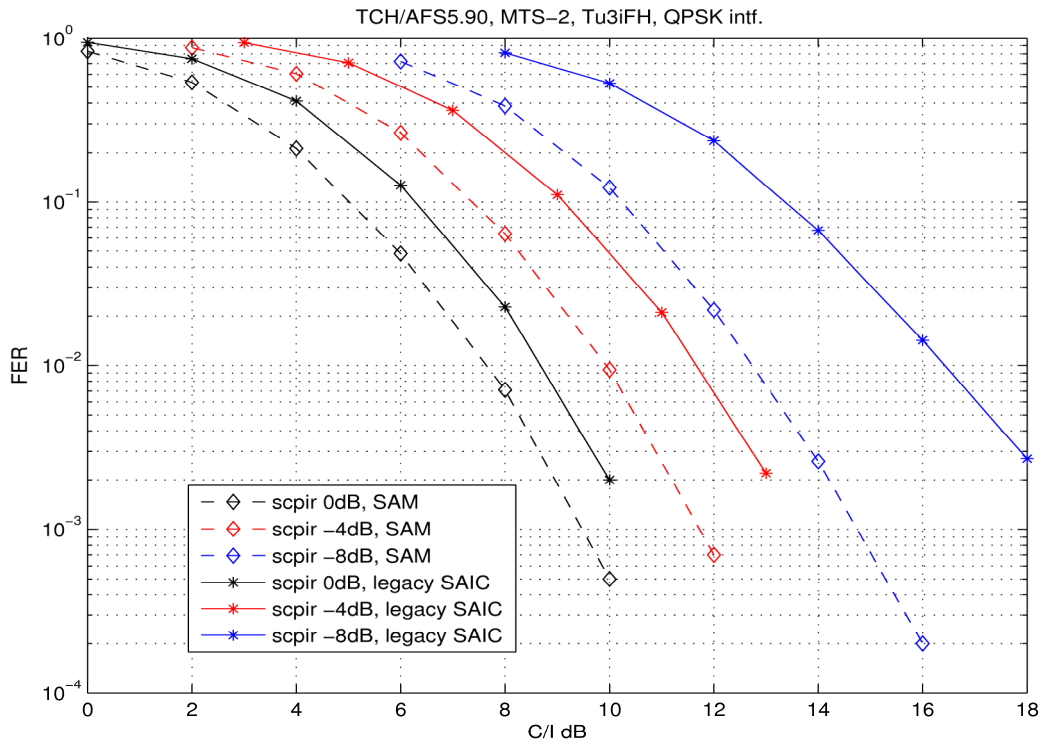

Figure 8-60h - Performance of SAM in MTS-2, AFS5.90 with QPSK modulated interference

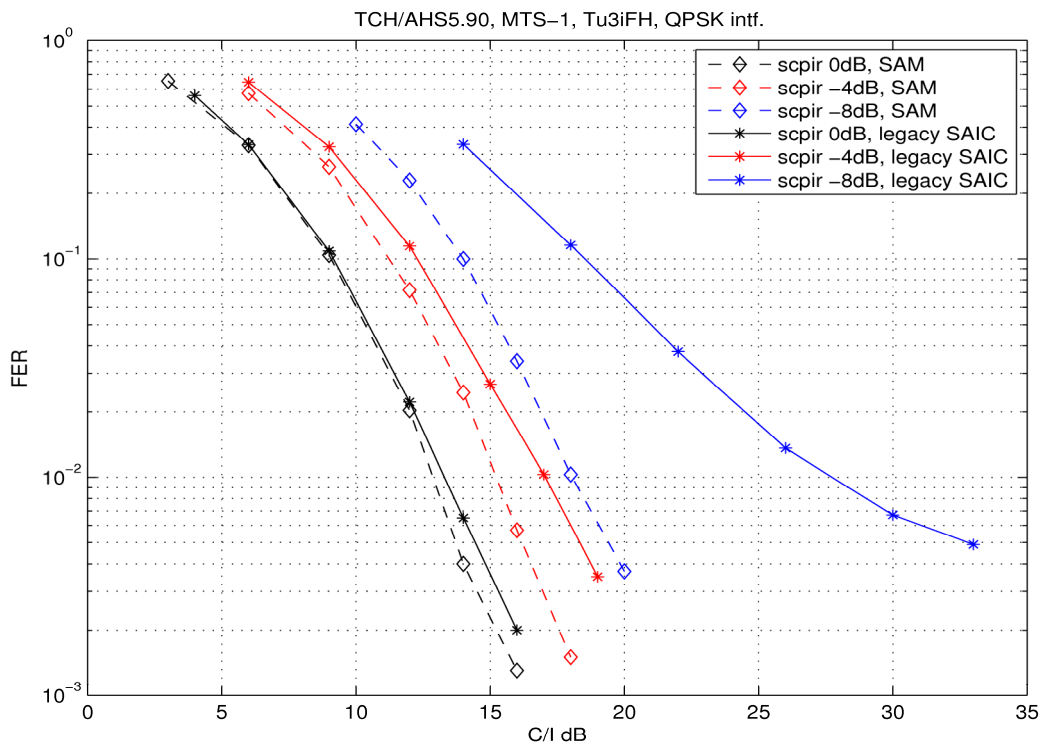

Figure 8-60i - Performance of SAM and SAIC in MTS-1, AHS5.90 with QPSK modulated interference

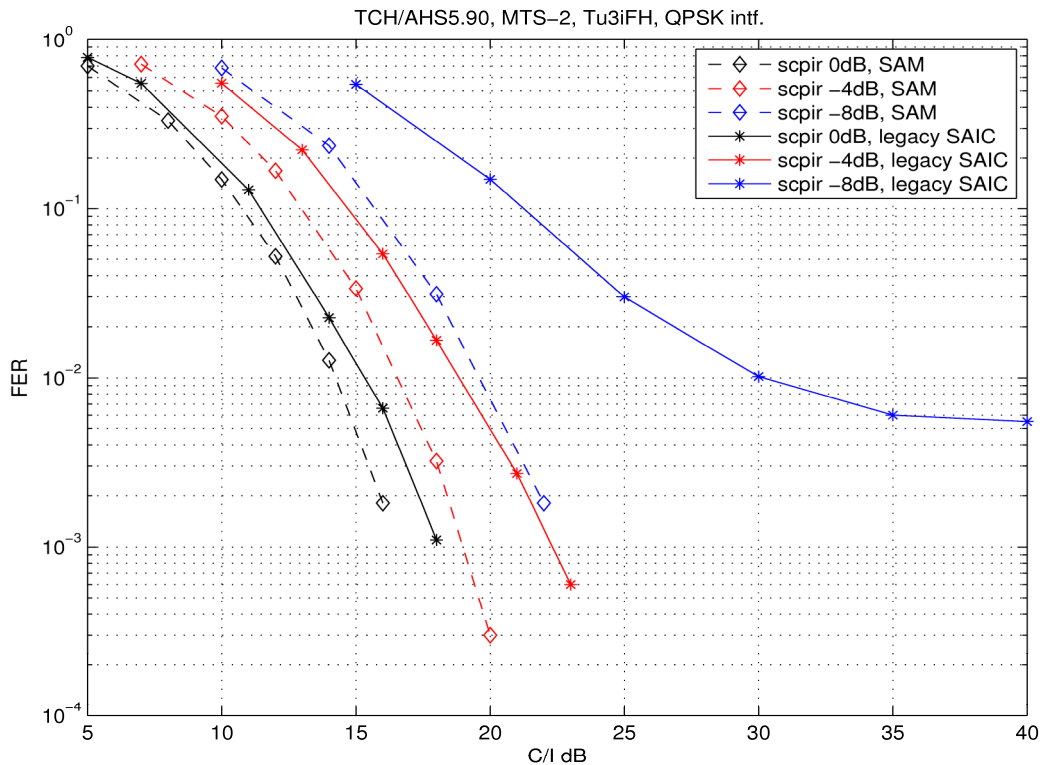

Figure 8-60j - Performance of SAM and SAIC in MTS-2, AHS5.90 with QPSK modulated interference

It can be seen that SAM yields substantial performance gains against a DARP Phase I receiver, in both MTS-1 and MTS-2 interference scenarios, and for SCPIR in the range from 0 down to -20 dB. For example, the performance of SAM with SCPIR = -16 dB is comparable to the performance of legacy SAIC with SCPIR = -8 dB. Thus SAM can cope with much larger power imbalance ratios than legacy SAIC receivers. This is an advantage, especially if legacy non-SAIC mobiles are assigned to the paired sub-channel. It has also been shown that SAM is robust and offers protection against QPSK interference. The degradation compared to GMSK interference has been shown to be less than 0.5 dB for multi-interferer scenarios (MTS-2) while larger degradations are seen when experiencing a single interferer (MTS-1).

The large gains for the weakest subchannel obtained for SCPIR of the order of -8 dB or lower are noteworthy. Advanced VAMOS receivers, and in particular SAM, may be the key to obtain significant capacity increases when non-SAIC legacy mobiles are allowed in one of the VAMOS sub-channels. System simulations with SAM mobiles are for further study.

### 8.2.1.4 Results from: MUROS - Performance of Alpha-QPSK with Legacy DARP MS

Text in this section originates by Nokia Corporation in [8-14].

The text in this section has been contributed by Nokia in [8-14]. This section presents the sensitivity and interference performance of legacy DARP MS receiving an alpha-QPSK [8-16] MUROS sub channel. For interference performance verification the four MUROS Test Scenarios (MTS1-4) described in chapter 5 in this TR are used.

#### 8.2.1.4.1 Simulation Assumptions

##### 8.2.1.4.1.1 Legacy Terminals

The legacy DARP receiver applied in this section is a DARP phase I capable terminal. Such DARP terminals are widely present in the market.

8.2.1.4.1.2 Transmitted MUROS Signal

In this section, the desired DL MUROS signal is generated by alpha-QPSK symbol mapping with  $\pi/2$  rotation and linearized GMSK TX pulse shape as illustrated in Figure 8-61. The receiver is a legacy DARP receiver, i.e. the received signal is being treated as a GMSK modulated signal.

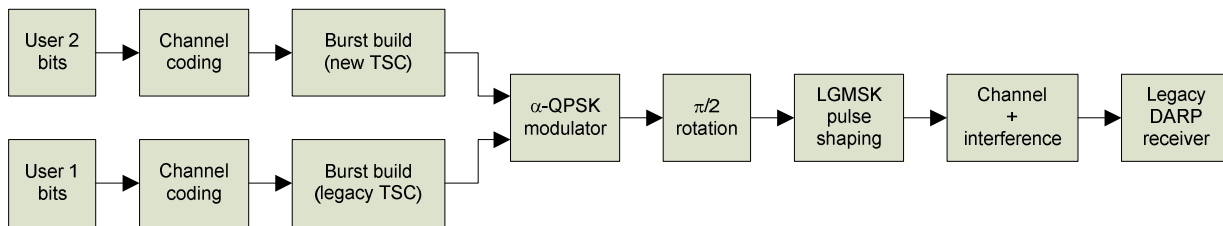

Figure 8-61: Block diagram of MUROS  $\alpha$ -QPSK TX by mapping two users on BB and transmitted as a QPSK modulated signal

As described above in this TR, legacy training sequence codes (TSC) are applied to the first MUROS sub channel to make it fully compatible with legacy MS. For the MUROS second sub channel, the orthogonal TSCs proposed in [8-15] are assumed. The pair TSC 0 is chosen from the combined TSC set for the simulations. DTX is not applied.

8.2.1.4.1.3 Alpha-QPSK

The  $\alpha$ -value can take any value between 0 and  $\sqrt{2}$  and reflects the power ratio between the two users, where the outer values corresponds to BPSK for either user 1 or user 2 (i. e. only one user transmitted), and  $\alpha = 1$  correspond to equal power between the two. The constellation points for different  $\alpha$ -values are shown in Figure 8-62. The red circle (O) correspond to  $\alpha = 1.0$  (which equals OSC presented in [8-15]), and the blue cross (X) corresponds to  $\alpha = 0.2$ . Only performance of user 1 is evaluated and from user 1 point-of-view  $\alpha > 1.0$  will only improve performance over OSC, therefore only  $\alpha \leq 1.0$  is simulated to see the performance loss of different  $\alpha$ -values.

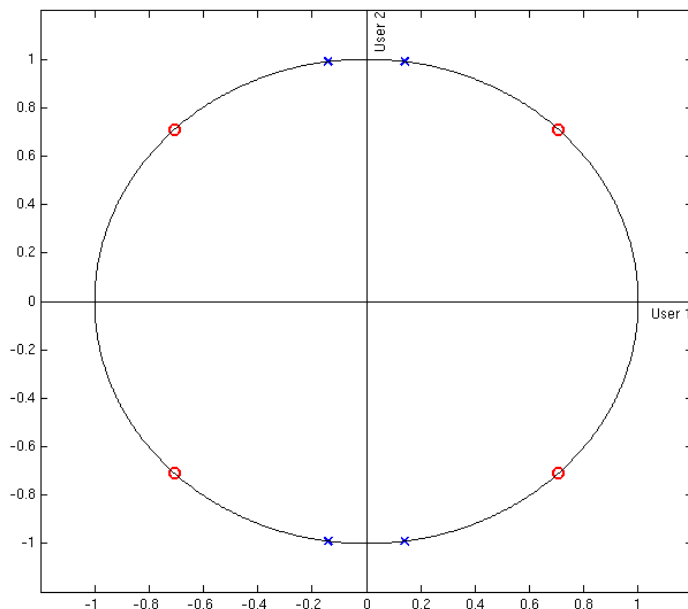

Figure 8-62: Constellation points for various values of  $\alpha$ , (O)  $\alpha = 1.0$  (QPSK), (X)  $\alpha = 0.2$

#### 8.2.1.4.1.4 MUROS Interference Models

Sensitivity and the four MUROS Test Scenarios (MTS1-4) specified in this TR have been used for verifying the interference performance of a legacy DARP MS receiving a MUROS sub channel.

For MTS modulation QPSK modulated interference were used.

#### 8.2.1.4.1.5 Other Simulation Parameters

The performance is presented for TCH/AFS 12.2, TCH/AFS 5.9 and AHS 5.9. A typical urban channel profile, terminal speed 3 km/h (TU3) and frequency hopping (FH) in the 900 MHz band have been used for the DL MUROS simulations. Typical MS impairments are included in the simulations.

#### 8.2.1.4.2 Downlink Performance Results

The results in this section cover frame erasure rate (FER) as a function of  $C/I_1$  where  $C$  denotes the total power of the received MUROS signal (i.e. carrying 2 sub channels) and  $I_1$  denotes the power of the strongest co-channel interferer.

The presented performance is for the first MUROS sub channel containing the legacy TSC0. The performance of the second MUROS sub channel is not considered in this section, since changes are required to the MS receiver in order to cope with the MUROS TSC-pairs. The TSC0-pair proposed in [8-15] is used for the second MUROS sub channel. However, when the two alpha-QPSK MUROS sub channels have equal power (correspond to  $\alpha = 1.0$ ) the performance of the second channel can be assumed to be on par with the first sub channel as noted in [8-17].

First the sensitivity performance is presented in subsection 8.2.1.4.2.1, and then the interference performance for the two synchronous scenarios MTS1+2 are presented in subsection 8.2.1.4.2.2 and 8.2.1.4.2.3 respectively. The performance for the two asynchronous scenarios MTS3+4 are presented in subsection 8.2.1.4.2.4 and 8.2.1.4.2.5 respectively.

##### 8.2.1.4.2.1 Sensitivity Performance

The sensitivity performances of a legacy DARP MS receiving an alpha-QPSK MUROS sub channel is presented in Figure 8-63 for a MUROS sub channel using AMR half rate 5.9, AMR full rate 12.2 and AMR full rate 5.9. The performance is presented for  $\alpha = [0.2, 0.3, \dots, 1.0]$

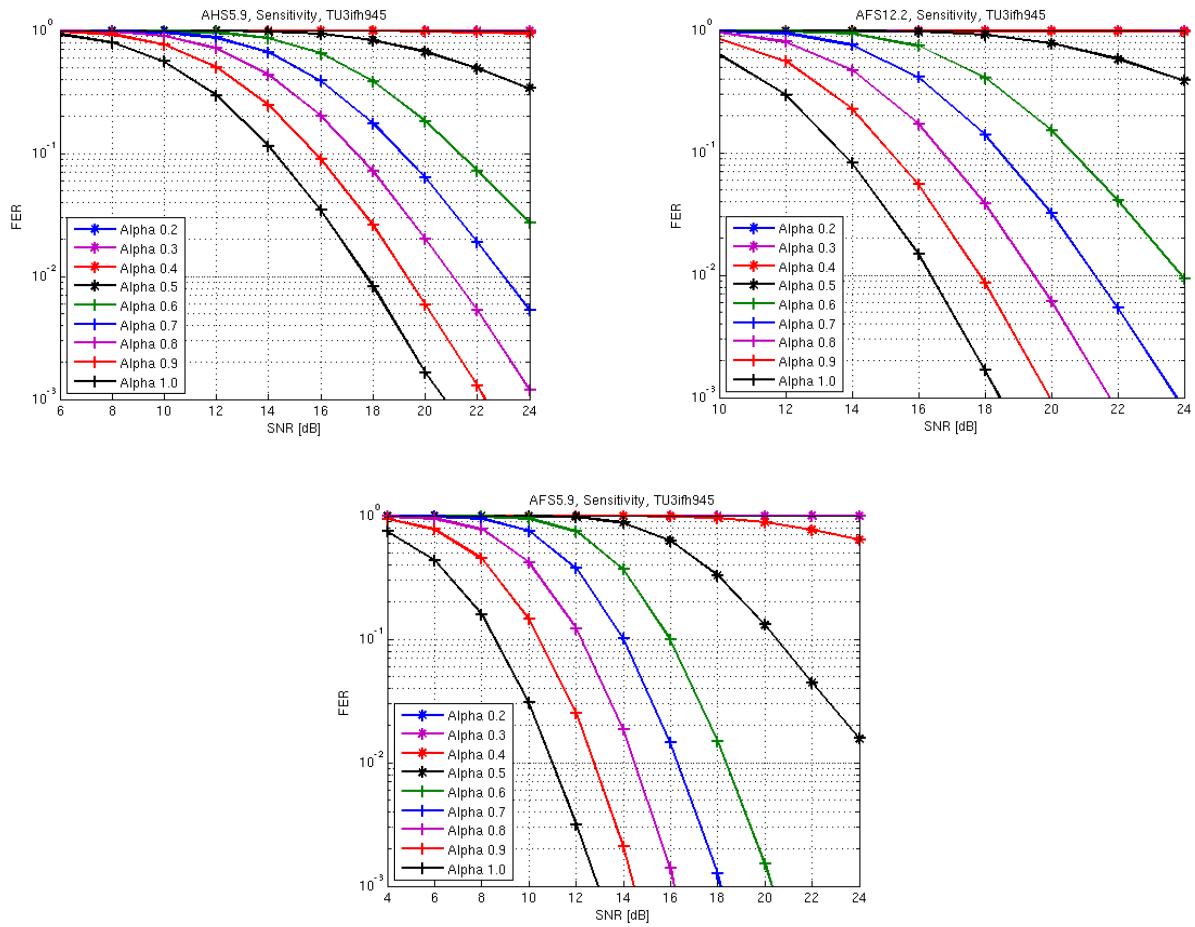

**Figure 8-63: DL sensitivity performance of a legacy DARP MS receiving a alpha-QPSK MUROS sub channel for  $\alpha = [0.2, 0.3, \dots, 1.0]$  using AMR half rate 5.9, AMR full rate 12.2 and AMR full rate 5.9**

8.2.1.4.2.2 MTS-1 Performance

The performance of a legacy DARP MS receiving a alpha-QPSK MUROS sub channel when a single synchronous co-channel interferer is present is shown in Figure 8-64 for AMR half rate 5.9, AMR full rate 12.2 and AMR full rate 5.9. The performance is presented for  $\alpha = [0.2, 0.3, \dots, 1.0]$ .

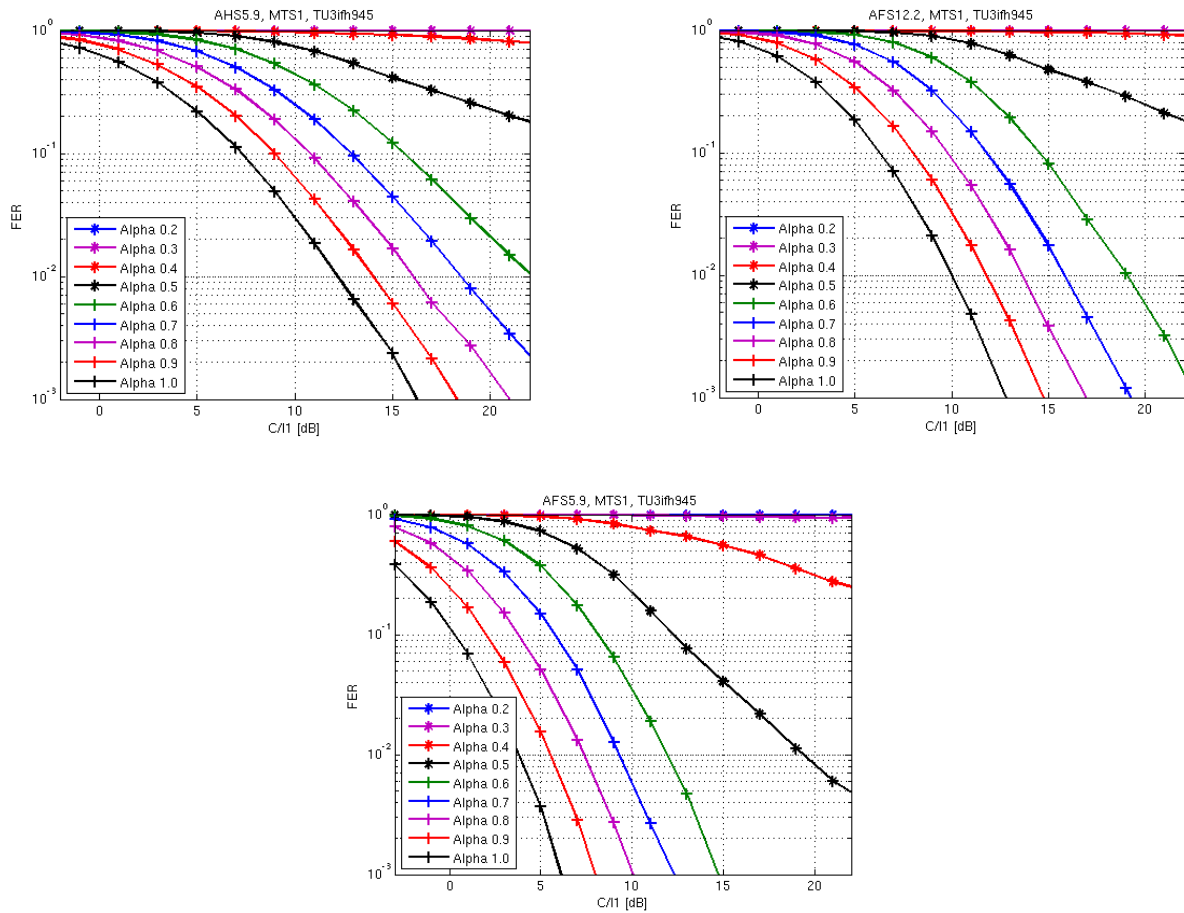
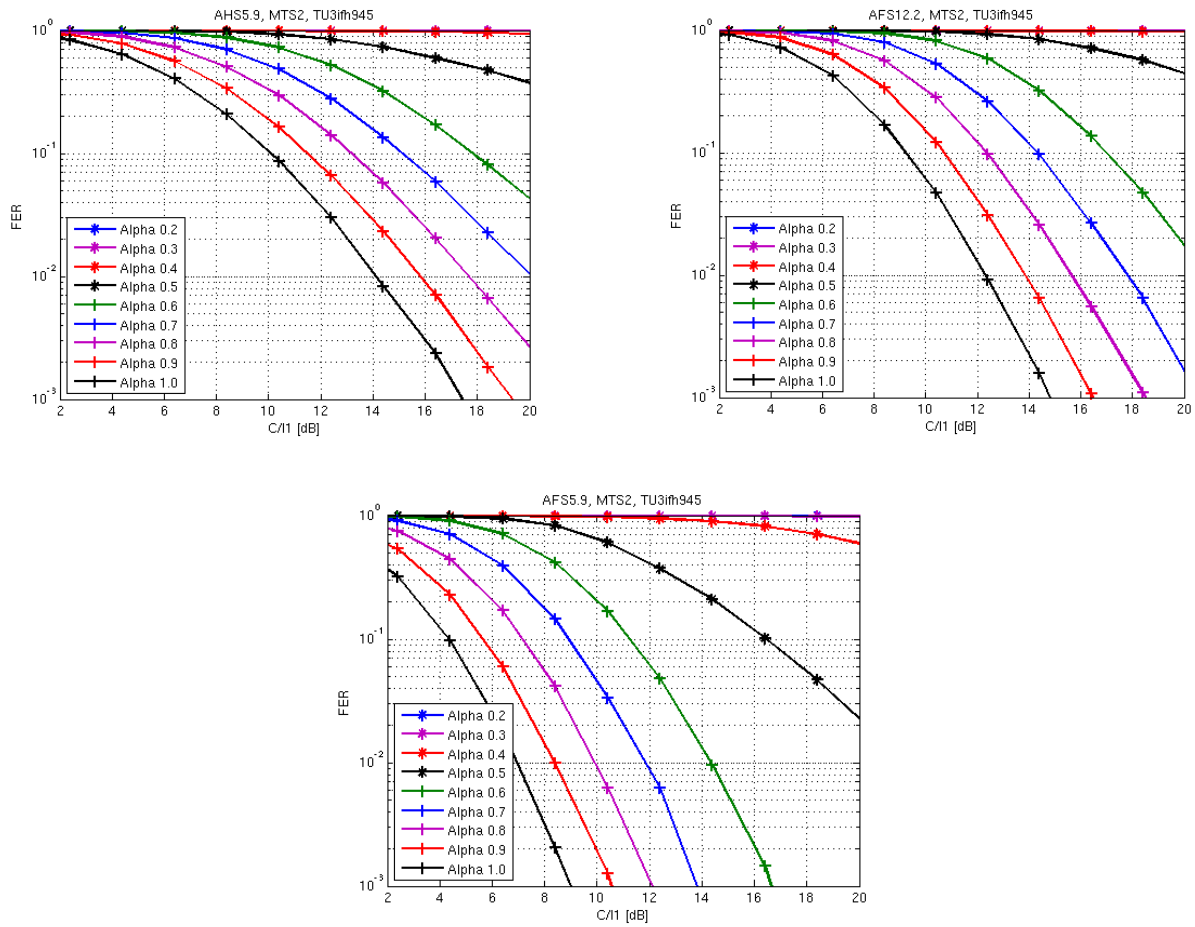

**Figure 8-64: DL Co-channel interference performance (MTS1) of a legacy DARP MS receiving an alpha-QPSK MUROS sub channel for  $\alpha = [0.2, 0.3, \dots, 1.0]$  using AMR half rate 5.9, AMR full rate 12.2 and AMR full rate 5.9**

8.2.1.4.2.3 MTS-2 Performance

The performance of a legacy DARP MS receiving an alpha-QPSK MUROS sub channel when mixed synchronous interference is present is shown in Figure 8-65 for AMR half rate 5.9, AMR full rate 12.2 and AMR full rate 5.9. The performance is presented for  $\alpha = [0.2, 0.3, \dots, 1.0]$ .

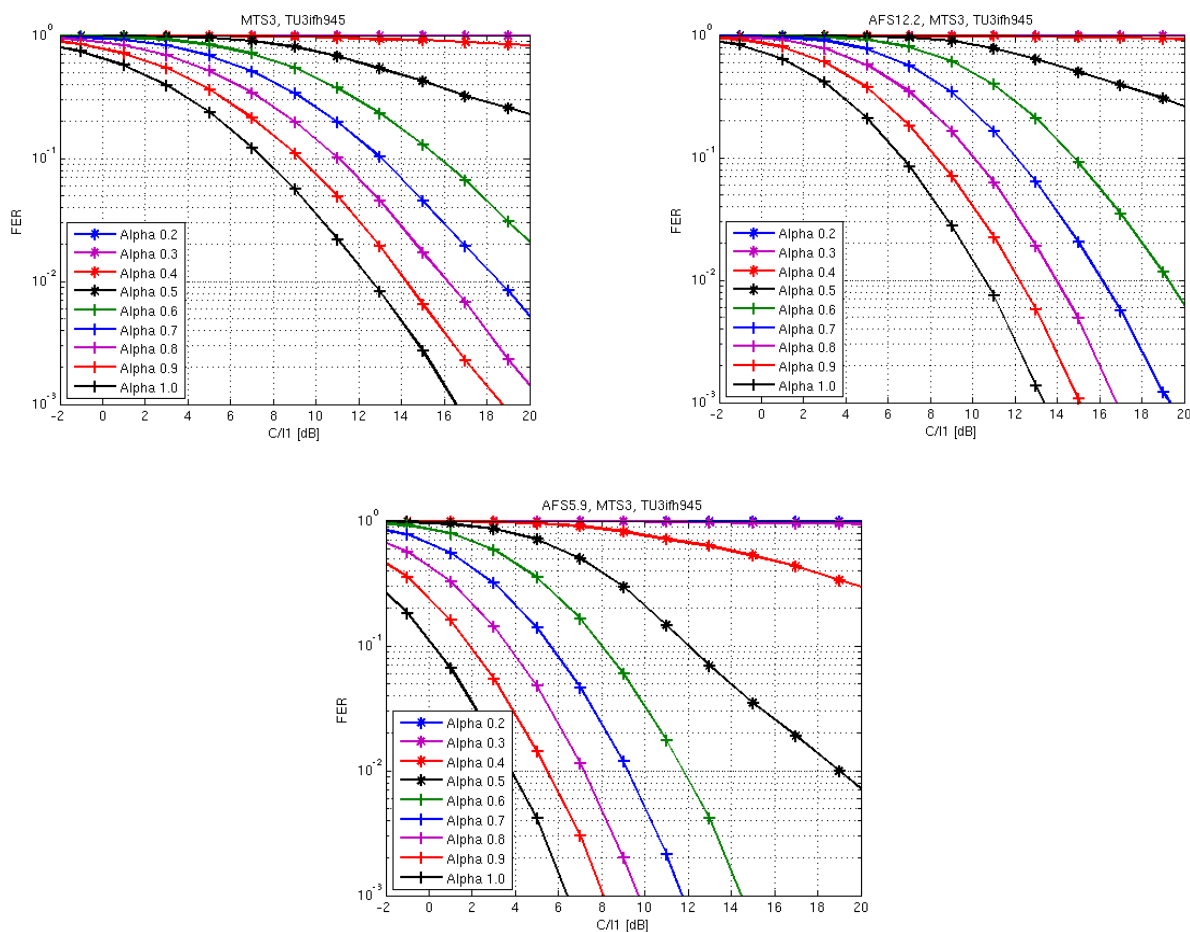



**Figure 8-65: DL Mixed interference performance (MTS2) of a legacy DARP MS receiving an alpha-QPSK MUROS sub channel for  $\alpha = [0.2, 0.3, \dots, 1.0]$  using AMR half rate 5.9, AMR full rate 12.2 and AMR full rate 5.9**

8.2.1.4.2.4 MTS-3 Performance

The performance of a legacy DARP MS receiving an alpha-QPSK MUROS sub channel when a single asynchronous co-channel interference is present is shown in Figure 8-66 for AMR half rate 5.9, AMR full rate 12.2 and AMR full rate 5.9. The performance is presented for  $\alpha = [0.2, 0.3, \dots, 1.0]$ .



**Figure 8-66: DL Asynchronous Co-channel interference performance (MTS3) of a legacy DARP MS receiving an alpha-QPSK MUROS sub channel for  $\alpha = [0.2, 0.3, \dots, 1.0]$  using AMR half rate 5.9, AMR full rate 12.2 and AMR full rate 5.9**

8.2.1.4.2.5 MTS-4 Performance

The performance of a legacy DARP MS receiving an alpha-QPSK MUROS sub channel when mixed synchronous and asynchronous interference are present is shown in Figure 8-67 for AMR half rate 5.9, AMR full rate 12.2 and AMR full rate 5.9. The performance is presented for  $\alpha = [0.2, 0.3, \dots, 1.0]$ .

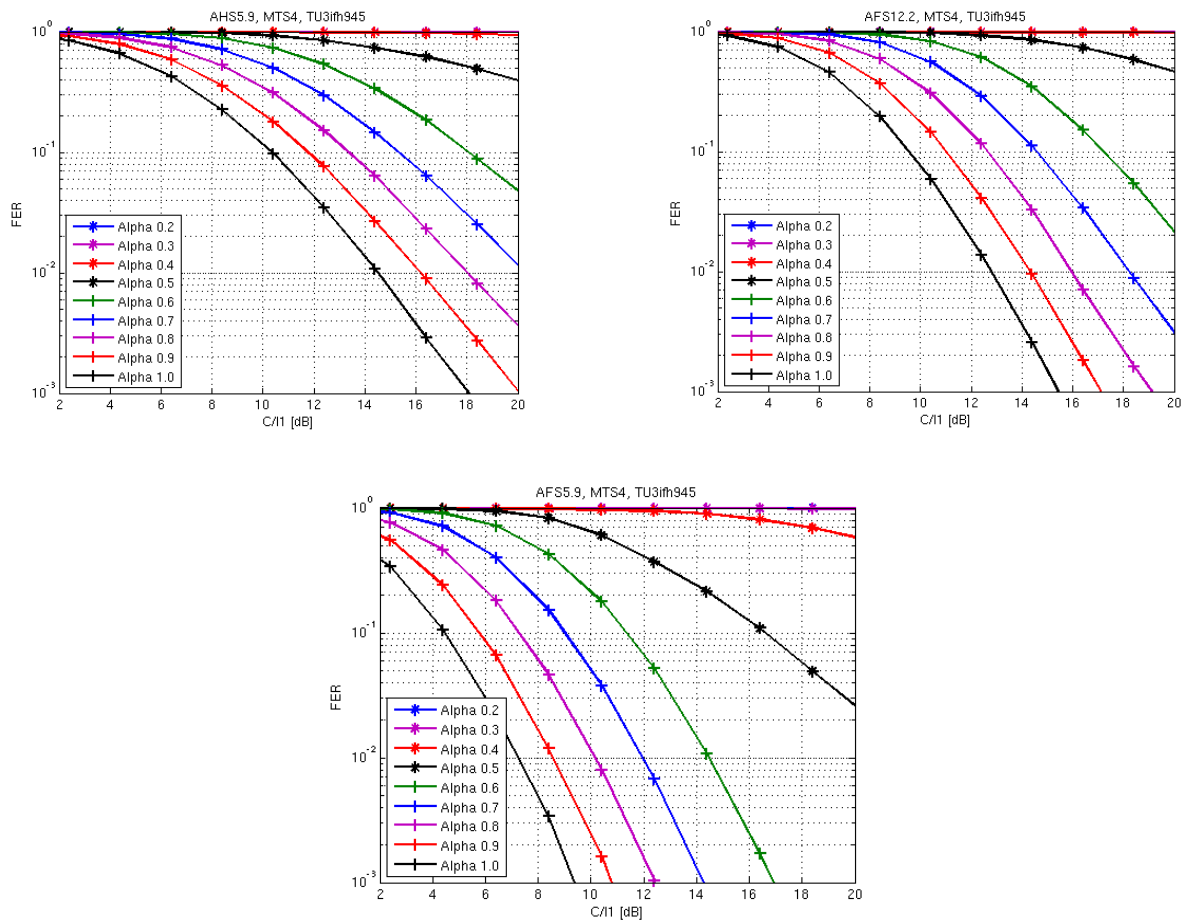

**Figure 8-67: DL synchronous and asynchronous mixed interference performance (MTS4) of a legacy DARP MS receiving an alpha-QPSK MUROS sub channel for  $\alpha = [0.2, 0.3, \dots, 1.0]$  using AMR half rate 5.9, AMR full rate 12.2 and AMR full rate 5.9**

8.2.1.4.3 Summary of Results

This section has presented the sensitivity and interference performance of a legacy DARP MS receiving an alpha-QPSK MUROS sub channel. For the interference performances the MTS1-4 interference scenarios were used with the interferer modulation type being QPSK.

8.2.2 Network Level Performance

8.2.2.1 Adaptive constellation rotation

System simulations have been performed to estimate the possible network gains by the introduction of adaptive symbol constellation rotation.

The investigated scenario is for 100 % MUROS MS penetration.

It should be noted that the adaptive constellation rotation will also give coverage gains in sensitivity limited scenarios, but this has not been evaluated in this investigation.

The investigated scenario is MUROS-2 where a backoff of 3.3 dB and 2.6 dB has been investigated.

The impact on different QPSK backoff is investigated and Figure 8-68 shows the spectral efficiency at the non-MUROS reference case, at 3.3 dB QPSK power backoff and at 2.6 dB QPSK power backoff.

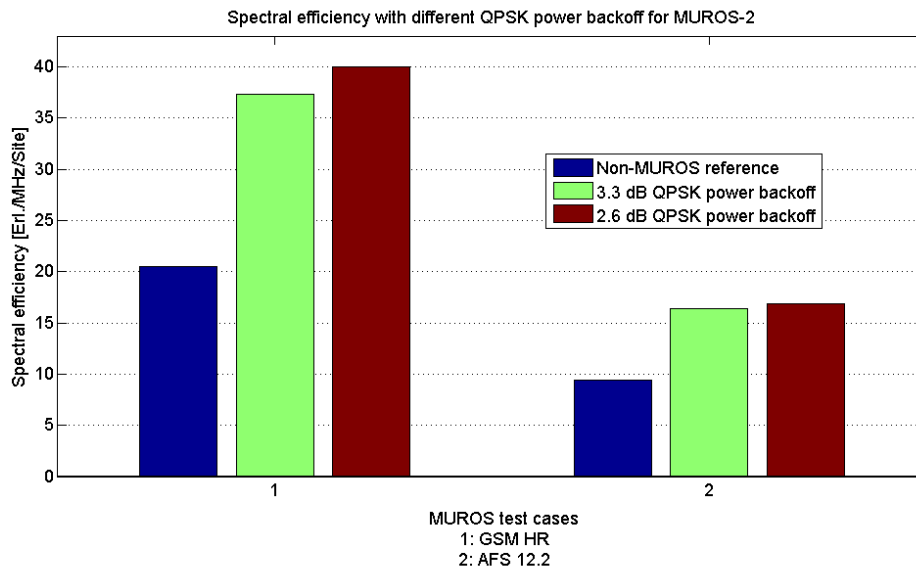

**Figure 8-68: Spectral efficiency MUROS-2**

The gains for test case A and B are presented in Table 8-12. No values are presented for test case C (AFS 5.9) since this case is block limited and will not give any gain. Case D is still left TBD.

**Table 8-12: Capacity gain using different QPSK**

Type	Gain at QPSK power backoff: 3.3 dB	Gain at QPSK power backoff: 2.6 dB
A	82% (*)	95% (*)
B	75%	80%
C	Block limited	-

\* Gain presented at 96% satisfied users

It can be seen that there are gains of approximately 5 - 13 %-units in spectral efficiency by using 2.6 dB backoff compared to the case of using a 3.3 dB backoff.

NOTE 1: The degradation due to the blind modulation detection evaluated in section 8.2.1.3.3.1 has been shown to be 0 dB at  $\alpha=1$ .

NOTE 2: No sub channel power control has been used in the system simulations.

### 8.2.2.2 Support of legacy non-DARP Phase I receivers using $\alpha$ -QPSK

With the right SCPIR between two sub-channels it is possible to support legacy non-SAIC terminals on VAMOS timeslots. See [8-36] for additional information.

Table 8-13a show the spectral and hardware efficiency results for MUROS-2 with 50% VAMOS penetration level (giving 35% legacy non-SAIC and 15% legacy SAIC penetration levels) and speech codec AHS 5.9. D0 is the non-VAMOS reference scenario while the D1 scenario utilizes OSC with legacy non-SAIC capable terminals not allowed on VAMOS TS. Note that with this restriction,  $\alpha$ -QPSK cannot provide better spectral efficiency than OSC since the network is block limited due to lack of resources.

**Table 8-13a: MUROS-2 system performance results (50% VAMOS)**

Type	Description	Spectral efficiency [Erl./MHz/site]	HW efficiency [Erl./TRX]	Call quality limitation
D0	AHS 5.9	19.8	11.9	Block limited
D1, basic OSC	VAMOS I (SAIC) AHS 5.9	29.6	17.8	Block limited
D1 with non-SAIC on VAMOS TS and $\alpha$ -QPSK	VAMOS I (SAIC) AHS 5.9	33.7	20.2	Quality limited
D1 with non-SAIC on VAMOS TS and $\alpha$ -QPSK	VAMOS II (SAM) AHS 5.9	34.8	20.9	Quality limited

Note: "non-SAIC" in the table text refer to legacy non-SAIC capable terminals

Table 8-13b shows the gains for MUROS-2 with 50% VAMOS penetration level (giving 35% legacy non-SAIC penetration level) and speech codec AHS 5.9. The results are compared with the non-VAMOS reference.

**Table 8-13b: Network level gain, MUROS-2, 50% VAMOS penetration**

Simulation setup	Gain
Basic OSC with non-SAIC terminals on VAMOS timeslots not allowed	49% (Block limited)
$\alpha$ -QPSK with non-SAIC on VAMOS TS timeslots allowed (VAMOS I)	70% (Quality limited)
$\alpha$ -QPSK with non-SAIC on VAMOS TS timeslots allowed (VAMOS II)	76% (Quality)

\* The quality requirement of all non-SAIC MSs allocated on VAMOS timeslots is not fulfilled

It has also been shown that  $\alpha$ -QPSK can be used to support legacy non-SAIC terminals to be VAMOS allocated. When this is allowed in the system simulation, the gain increases from 49% to 70% using VAMOS I and from 49% to 76% using VAMOS II terminals.

The following should be noted regarding the results:

- The system is only evaluated on DL. The results are only valid for ideal UL.
- The VAMOS terminals that have been used in the simulations are either SAIC or SAM capable.
- The SAM receiver prototype used in these simulations has not been optimized or tuned (see section 4 in [5]).
- Only MUROS-2 for speech codec AHS 5.9 has been evaluated. Other speech codecs and MUROS-3 is left for FFS.

### 8.2.2.2a Downlink power control using $\alpha$ -QPSK

A summary of system performance results for basic OSC and  $\alpha$ -QPSK (using VAMOS type I and type II receivers) are presented in Table 8-13c, 8-13d and 8-13e. 100% VAMOS penetration have been compared with 100% SAIC penetration. For details in simulation assumptions, system modelling and absolute capacity figure, see [8-35]

**Table 8-13c: Summary of Basic OSC system performance results**

Type	Gain MUROS-2	Gain MUROS-3A	Gain MUROS-3B
A	112%	0%	0%
B	86%	0%	0%
C	110%	44%	23%
D	89%	0%	0%
C+D	89%	0%	0%

**Table 8-13d: Summary of  $\alpha$ -QPSK system performance results for VAMOS I**

VAMOS I (SAIC receiver capability)				
Type	Gain MUROS-2 (50/15/35)	Gain MUROS-2 (100/0/0)	Gain MUROS-3A (100/0/0)	Gain MUROS-3B (100/0/0)
A	-	112%	0%	0%
B	-	94%	0%	0%
C	-	110%	46%	26%
D	70%	97%	0%	0%

**Table 8-13e: Summary of  $\alpha$ -QPSK system performance results for VAMOS II**

VAMOS II (SAM receiver capability)				
Type	Gain MUROS-2 (50/15/35)	Gain MUROS-2 (100/0/0)	Gain MUROS-3A (100/0/0)	Gain MUROS-3B (100/0/0)
A	-	112%	0%	0%
B	-	103%	0%	0%
C	-	110%	60%	36%
D	76%	108%	0%	0%

It is shown that the  $\alpha$ -QPSK candidate technique give large capacity gains in networks using sparse frequency reuse, like MUROS-2. The gains for the AHS 5.90 codec for MUROS-2 are about 8 percentage points using VAMOS I terminals and 19 percentage points using VAMOS II terminals at 100% VAMOS penetration, compared to the basic OSC reference case.

**8.2.2.2.1 SCPIR distributions in different system simulations**

Figure 8-69 shows the SCPIR distributions that are used in the system when the system reaches the quality limit. The left diagram shows the SCPIR distributions for a simulation with non-SAIC, SAIC and VAMOS type I receivers and the right diagram for a simulation with non-SAIC, SAIC and VAMOS type II receivers. It can be seen that the VAMOS type II (SAM) receiver can utilize the discrete alpha values more efficiently, thus providing better support for legacy non-SAIC terminals. The discrete alpha values used in the simulations are described in [8-21].

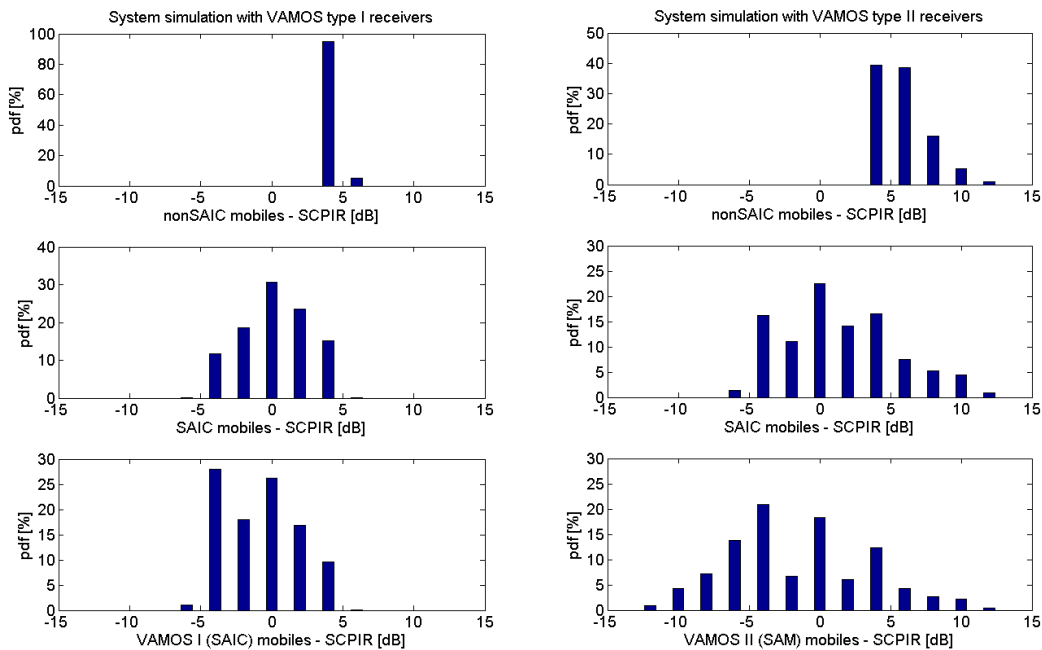

Figure 8-69: SCPIR distributions when using VAMOS I (left) and VAMOS II (right) receivers

8.2.2.3 Evaluation of VAMOS MAIO hopping

This section presents system performance results for the VAMOS specific MAIO hopping schemes. See [8-23] for additional information.

Table 8-14 shows the gain for simulation scenario MUROS-3A and MUROS-3B with and without MAIO hopping. The receiver type is based on SAM and positive effects from MAIO hopping can be observed for both OSC and  $\alpha$ -QPSK.

Table 8-14: MUROS-3 system performance results

Type (codec)	Receiver type	Without MAIO hopping		With MAIO hopping	
		Gain MUROS-3A	Gain MUROS-3B	Gain MUROS-3A	Gain MUROS-3B
C with OSC (AFS 5.9)	VAMOS II (SAM)	54%	46%	73%	56%
C with $\alpha$ -QPSK (AFS 5.9)	VAMOS II (SAM)	69%	68%	81%	79%

Table 8-15 shows spectral efficiency and 8-16 shows hardware efficiency. The non-VAMOS reference spectral efficiency is 26.25 Erl/MHz/Site (blocking limited) for both MUROS-3A and MUROS-3B. All simulations results presented in Table 8-14 are quality limited.

**Table 8-15: MUROS-3 Spectral efficiency [Erl/MHz/Site]**

Type (codec)	Receiver type	Without MAIO hopping		With MAIO hopping	
		MUROS-3A	MUROS-3B	MUROS-3A	MUROS-3B
C with OSC (AFS 5.9)	VAMOS II (SAM)	40.4	38.4	45.4	41.0
C with $\alpha$ -QPSK (AFS 5.9)	VAMOS II (SAM)	44.4	44.1	47.6	46.9

**Table 8-16: MUROS-3 Hardware efficiency [Erl/TRX]**

Type (codec)	Receiver type	Without MAIO hopping		With MAIO hopping	
		MUROS-3A	MUROS-3B	MUROS-3A	MUROS-3B
C with OSC (AFS 5.9)	VAMOS II (SAM)	8.1	7.7	9.1	8.2
C with $\alpha$ -QPSK (AFS 5.9)	VAMOS II (SAM)	8.9	8.8	9.5	9.4

The suggested MAIO hopping technique provide positive gains in high interference system scenarios for the full rate codec AFS 5.90.

The system level gain for the candidate technique OSC goes from 54% to 73% in a 1/3 frequency reuse (MUROS-3A) and from 46% to 56% in a 1/1 frequency reuse (MUROS-3B) compared to the non-VAMOS reference, C0.

For the candidate technique  $\alpha$ -QPSK, the system level gain goes from 69% to 81% in a 1/3 frequency reuse and from 68% to 79% in a 1/1 frequency reuse compared with the non-VAMOS reference, C0.

The following should be noted regarding the results:

- The SAM receiver prototype used in these simulations has not been optimized or tuned
- The impact of MAIO hopping on other half rate speech codecs, such as AHS 5.90, is left FFS.
- The system is only evaluated on DL and the results are only valid for ideal UL. The UL might turn out to be the limiting link with improved DL receiver algorithms and is left FFS.
- System performance results for system scenario MUROS-2 is not included in this contribution since it has already been shown to be block limited for AFS 5.90.

## 8.2.3 Verification of Link to System Mapping

This section depicts verification results for the employed Link to System mapping for this candidate technique as agreed at GERAN#41.

### 8.2.3.1 Methodology, DL

To derive the L2S mapping tables for Adaptive Symbol Constellation the interference is collected burst-wise from a link level simulator and put in bins to get an instantaneous, burst wise C/I mapping to be used in the system simulator.



In addition to C/I also the D/I is collected. The D/I is defined as the ratio between the strongest co-channel interferer and the rest of interference. The strongest co-channel interferer could either be an external GMSK modulated co-channel or the second, unwanted sub channel.

An MS receiver can experience interference from either GMSK modulated external interference, external MUROS interference and/or the unwanted sub channel from the  $\alpha$ -QPSK constellation. The interference from packet data channels are not modeled but if modeled it is expected to perform very similar to MUROS modulation.

For each interferer scenario two different mappings are derived:

#### SAIC and SAM

1. The unwanted sub channel is stronger than the strongest external GMSK modulated co-channel interference.
2. External GMSK modulated co-channel interference is stronger than the unwanted sub channel

#### non-SAIC

1. The unwanted sub channel is stronger than the strongest external interferer.
2. External interference is stronger than the unwanted sub channel.

NOTE: The difference between the two approaches is that the non-SAIC MS does not take into account if the external interference is GMSK or not since it does not have the capability to suppress the interference.

### 8.2.3.1.1 Interference scenarios

Based on the agreed working assumptions that the L2S methodology should be verified for,

1. The SCPIR envisaged for the operation of the candidate technique
2. Uncoded BER only
3. The interference modulation envisaged to be present in the system,

the following scenarios have been identified for a DL MS receiver in synchronous operation:

**Table 8-17: Verification scenarios**

Test case	Carrier mod	Intf. mod	Intf. scenario	SCPIR
1	GMSK	GMSK	MTS-1	-
2	GMSK	QPSK	MTS-1	-
3	GMSK	GMSK	MTS-2	-
4	GMSK	QPSK	MTS-2	-
5	$\alpha$ -QPSK	GMSK	MTS-1	*
6	$\alpha$ -QPSK	QPSK	MTS-1	*
7	$\alpha$ -QPSK	GMSK	MTS-2	*
8	$\alpha$ -QPSK	QPSK	MTS-2	*

\* Dependent on the MS type modeled.

NOTE: It has been assumed that all external MUROS interference is QPSK, and not  $\alpha$ -QPSK, modulated. This is considered a worst case scenario since the more shifted the QPSK constellation is the more easily can the interference be suppressed by a SAIC receiver.

Link simulations have been used to generate the link-2-system mappings while a system simulator has been used for the verification.

### 8.2.3.1.2 Raw BER verification levels

The raw BER has been verified for raw BER levels corresponding to normal operation around 1 % FER for the speech codecs used in the MUROS study.

In the figure below it can be seen that appropriate raw BER levels are 2-20 %.

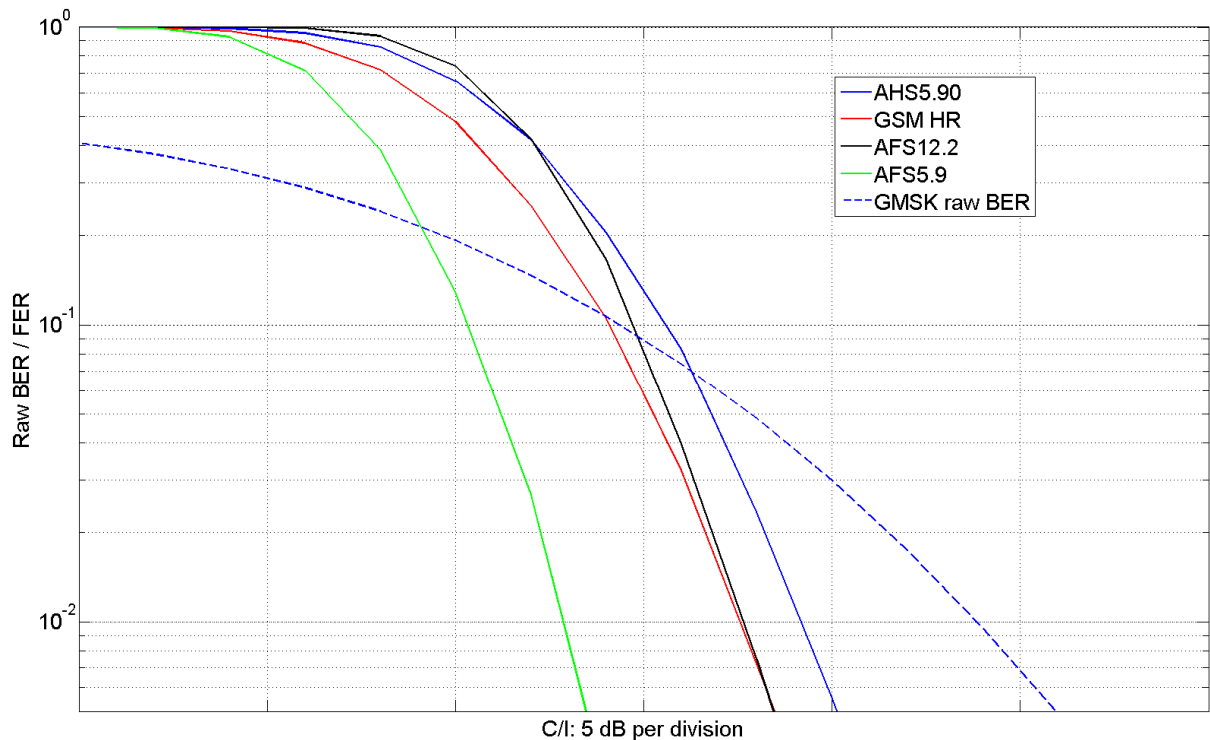

•  
**Figure 8-70: Raw BER and corresponding FER for speech codecs used in the system simulations.**

### 8.2.3.1.3 Interference statistics

Interference is collected for each burst, separating each type of interferer. For each burst the C/I and D/I is identified. The C/I is defined as the carrier/sub carrier power-to-total interference ratio while the D/I is defined as the strongest co-channel interferer to the rest of interferers.

### 8.2.3.1.4 Adjacent channel interference

When calculating the total interference power there is no distinction of whether the signal is an adjacent channel interferer or co channel interferer.

To get a common measure of the interference power irrespective of the type of interferer the C/I needs to be defined at the receiver front end. There is no impact to co channel interference since it will have the same spectral properties as the carrier signal. However, for adjacent channel interference the interference power at the receiver needs to be assessed. Link level simulations have been used to define corresponding co-channel interference for each level of adjacent channel interference. In the simulations QPSK modulated interference is used in order for the SAIC receiver not to suppress the co channel interferer.

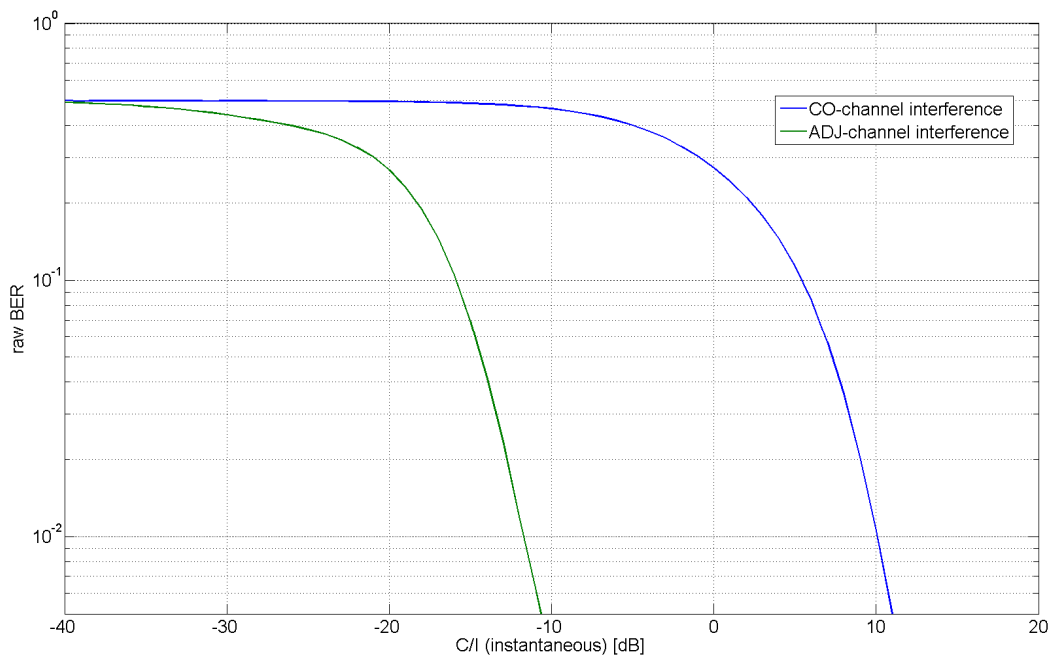

**Figure 8-71: Performance difference between co channel and adjacent channel interference.**

It can be seen that the receiver filter seems to be able to mitigate the adjacent channel interference by approximately 21-22 dB.

For each burst the adjacent channel interference power is mapped to a corresponding co-channel interference power based on the plot above.

### 8.2.3.1.5 Mappings

Examples of L2S mappings used in the evaluation for the SAIC receiver are shown in the figures below.

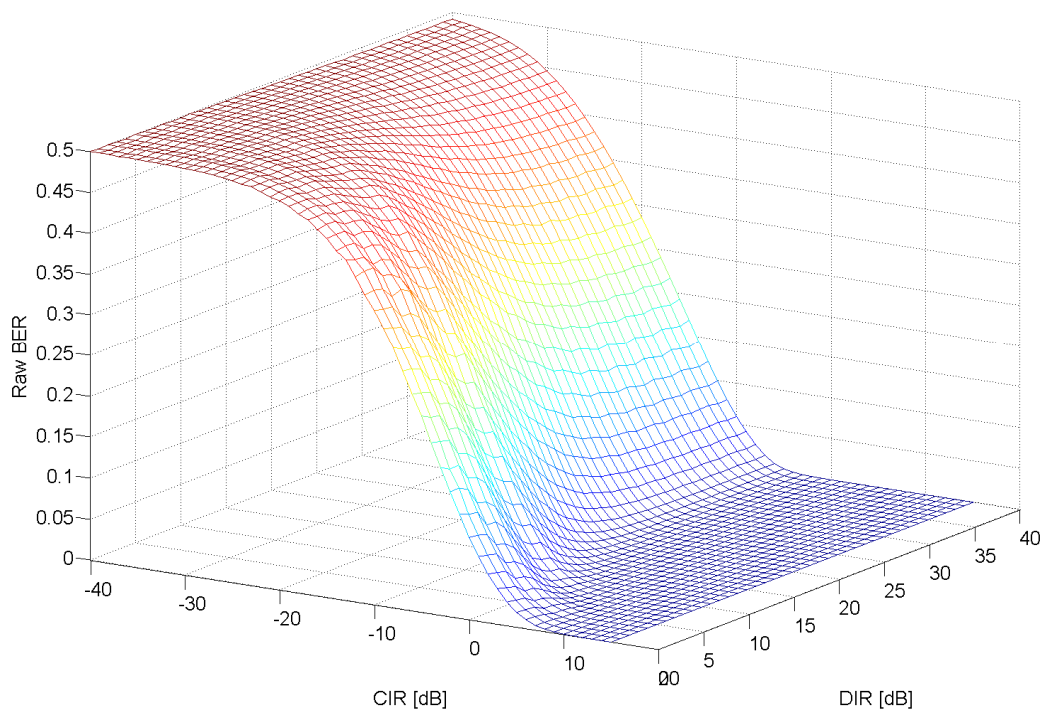

Figure 8-72: L2S mapping for SAIC receiver. 2<sup>nd</sup> sub channel stronger than external GMSK co-channel.

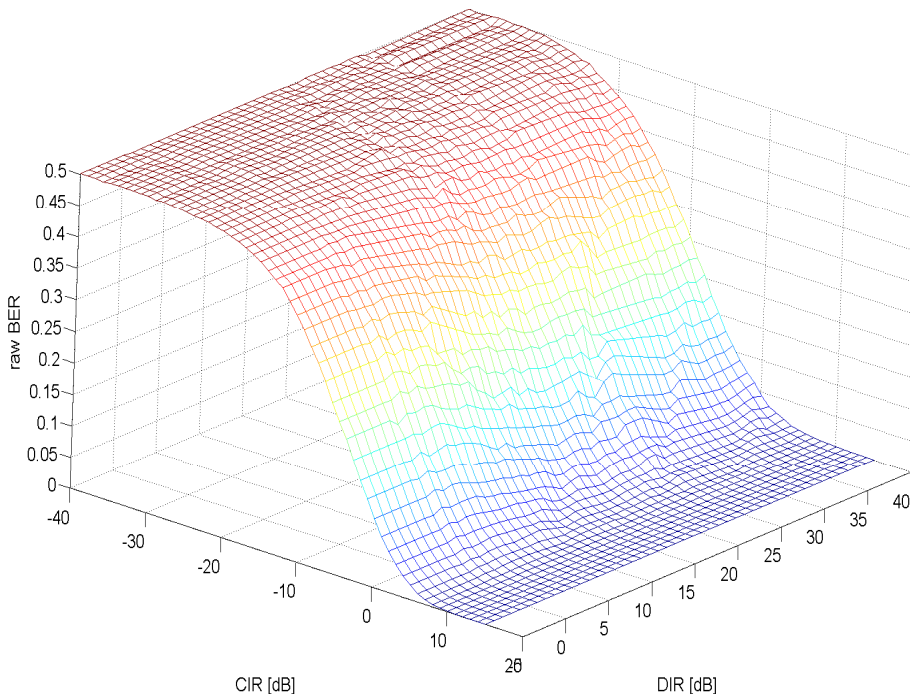

Figure 8-73: L2S mapping for SAIC receiver. External co-channel interferer stronger than 2<sup>nd</sup> sub channel.

It can be seen that it is easier for the SAIC receiver to suppress the unwanted sub channel than external co-channel interference. It is clear from both maps that, given a C/I, the higher the D/I the better the performance.

### 8.2.3.2 Verification, DL

The simulation assumptions are summarized in Table 8-18.

**Table 8-18: Simulation assumptions**

Parameter	Value
Channel profile	Typical Urban (TU)
Terminal speed	3 km/h
Frequency band	900 MHz
Frequency hopping	Ideal
Antenna diversity	No
Interference scenario	MTS-1 MTS-2
Interference modulation	GMSK QPSK
Receiver type	1. The SAIC algorithm used for the receiver utilizes a spatial-temporal Vector Autoregressive (VAR) Model 2. Legacy non-SAIC MS receiver 3. SAM receiver, [5]
Frequency offset of external interferers	N(50 Hz, 17 Hz)
Impairments:	Tx / Rx
– Phase noise	0.8 / 1.0 [degrees (RMS)]
– I/Q gain imbalance	0.1 / 0.2 [dB]
– I/Q phase imbalance	0.2 / 1.5 [degrees]
– DC offset	-45 / -40 [dBc]
– Frequency error	- / 25 [Hz]
– PA model	Yes/ -

#### 8.2.3.2.1 SAIC

The SCPIRs investigated for the SAIC receiver on an  $\alpha$ -QPSK carrier is [-8, -4, 0, 4, 8] which is expected to cover most scenarios possible with a SAIC architecture.

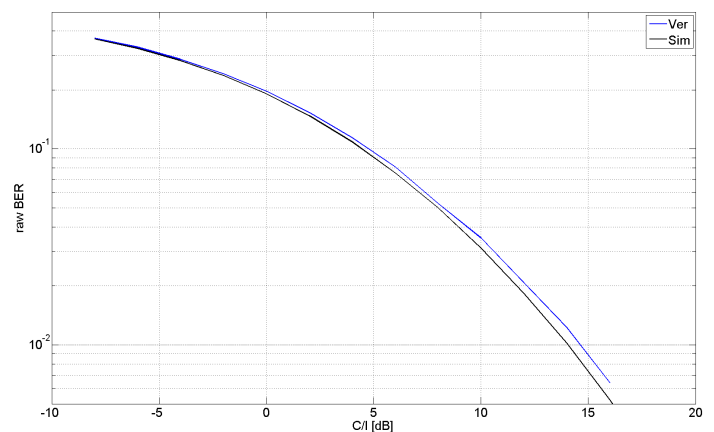
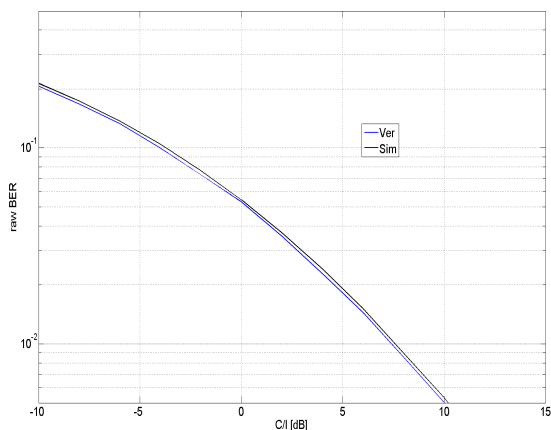

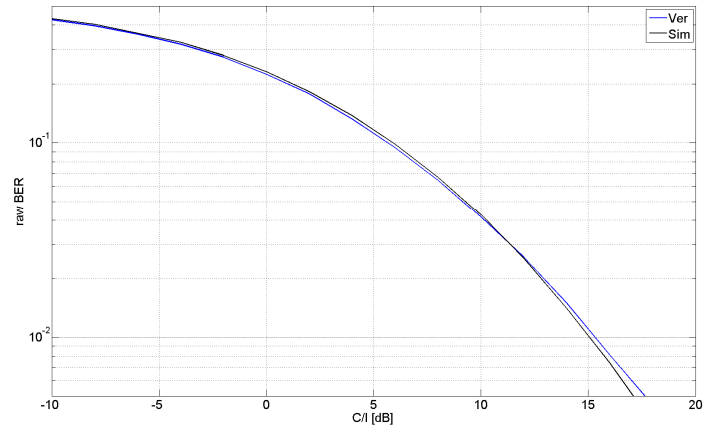
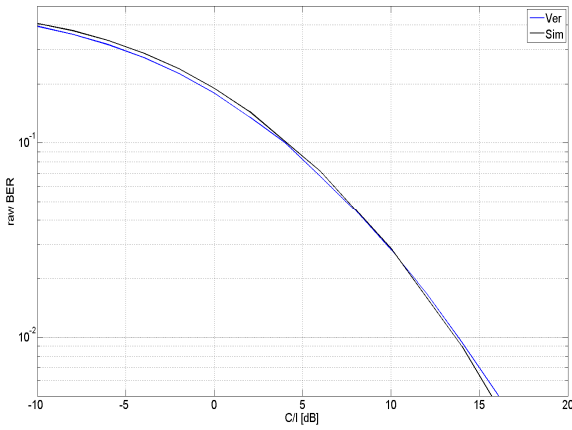

Figure 8-74: GMSK carrier verification. Test case 1 (top left), 2 (top right), 3 (bottom left), 4 (bottom right).

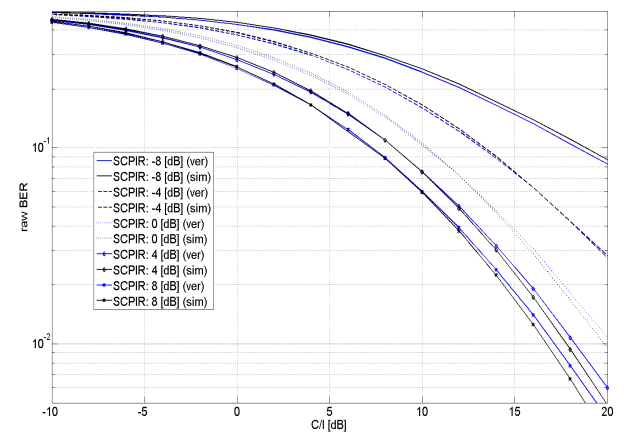
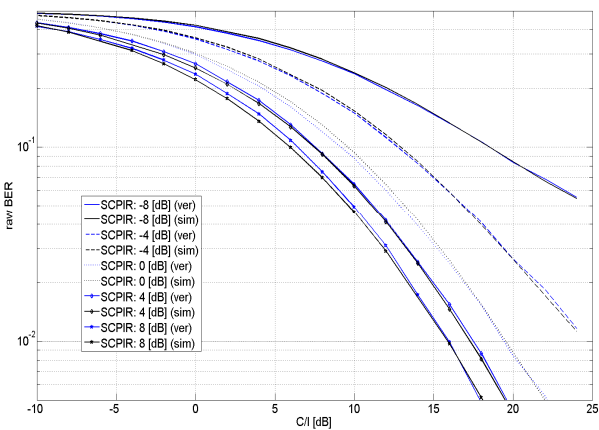
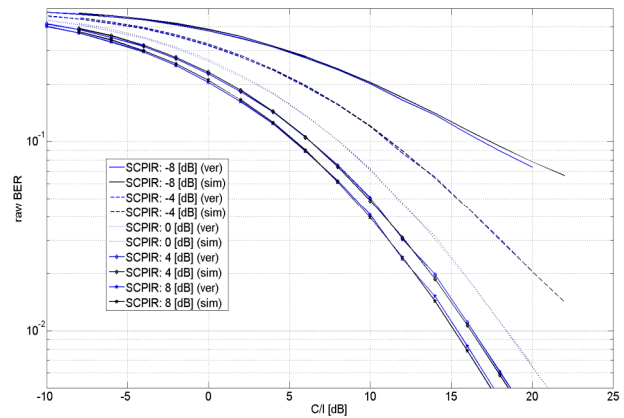
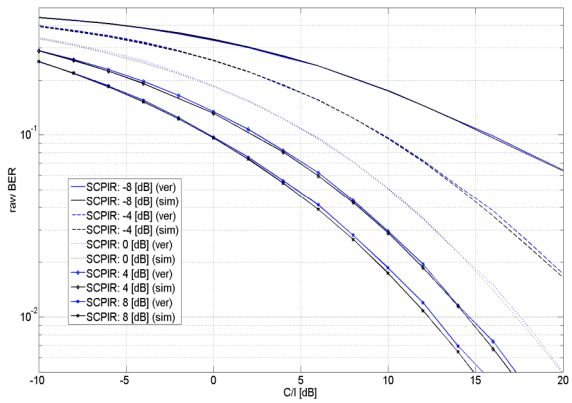

Figure 8-75:  $\alpha$ -QPSK carrier verification. Test case 5 (top left), 6 (top right), 7 (bottom left), 8 (bottom right).

It can be seen that all scenarios there is a good correspondence between the verified and simulated link performance. In rare cases a difference of up to 0.5 dB is observed. However, in most cases the difference in performance is within 0.2 dB.

8.2.3.2.2 non-SAIC

Since the non-SAIC receiver is unable to suppress the interference from the other sub channel, only positive SCPIRs have been considered for this receiver, [0, 4, 8].

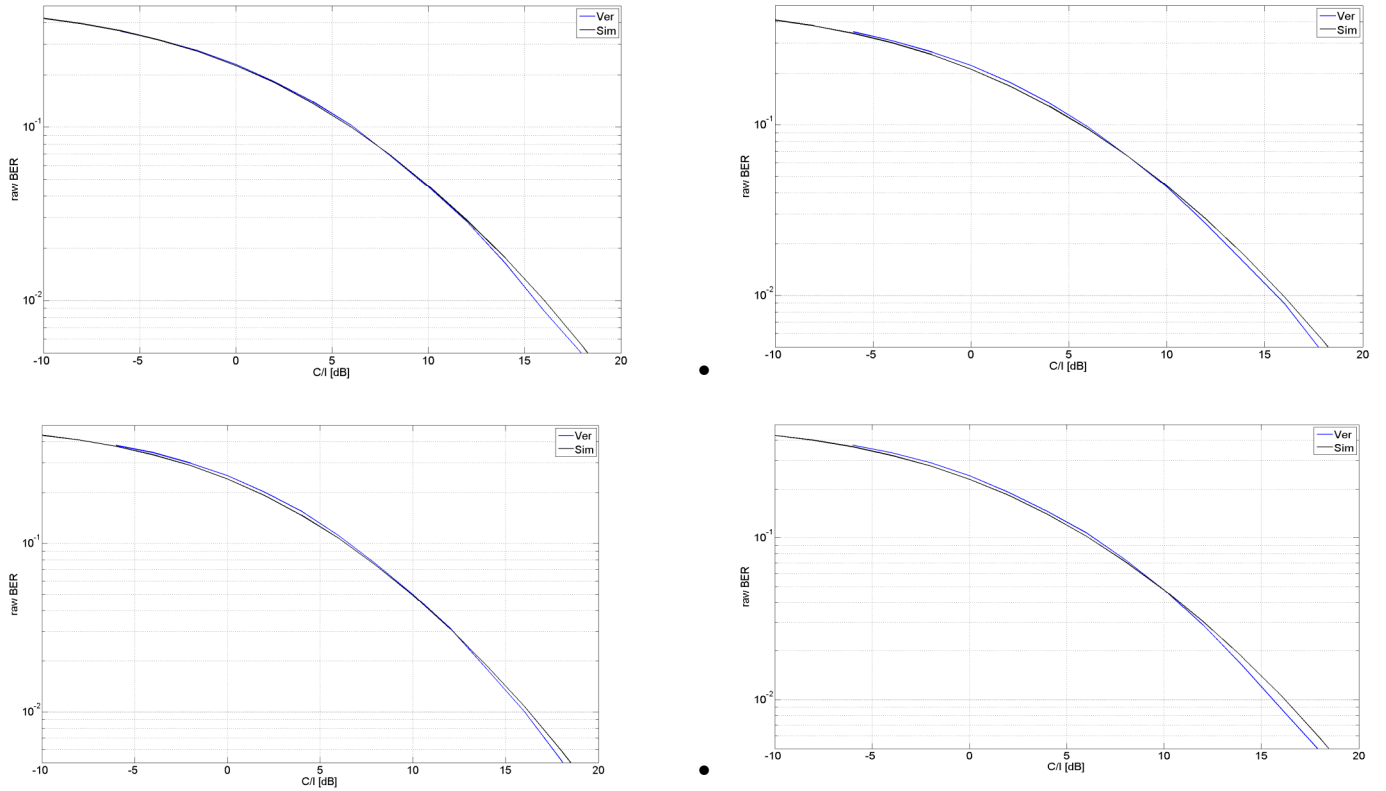
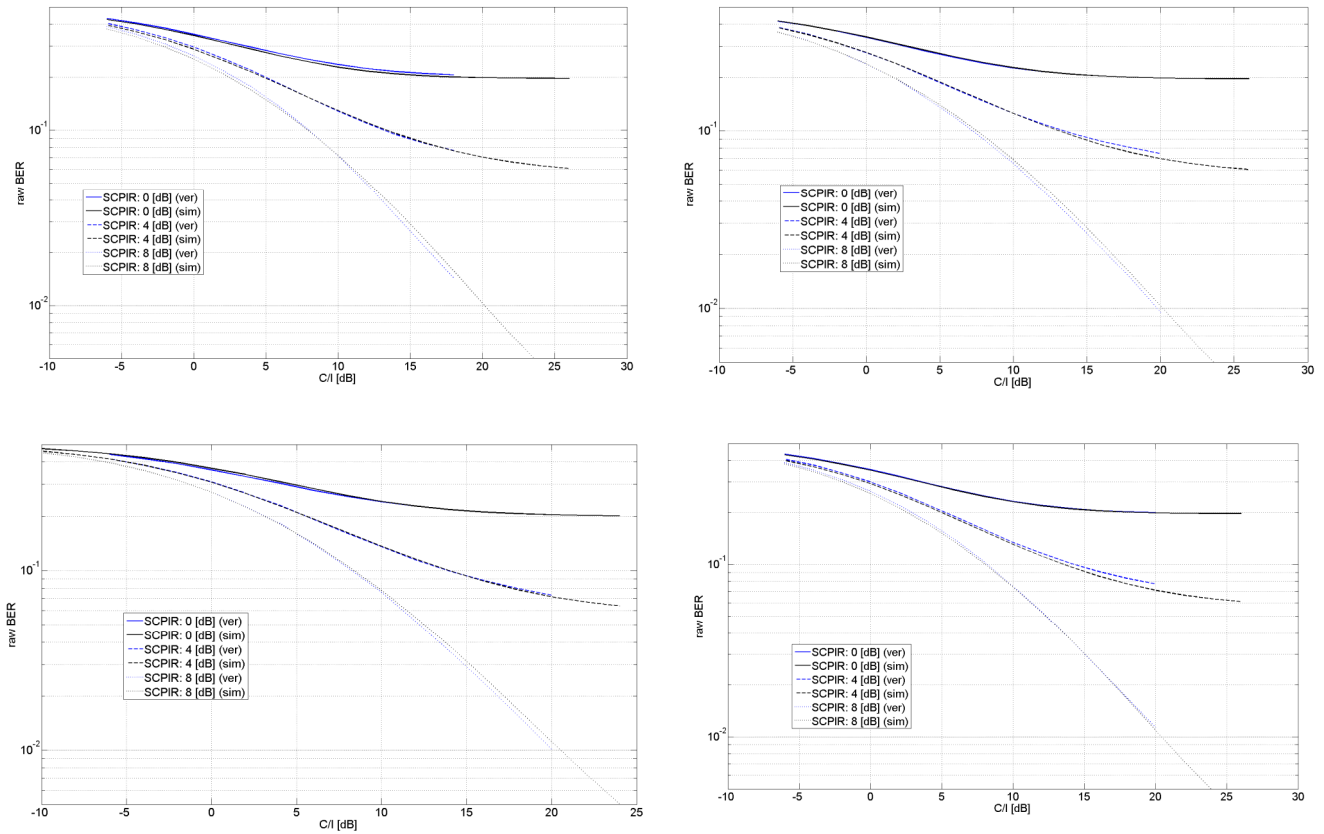

Figure 8-76: GMSK carrier verification. Test case 1 (top left), 2 (top right), 3 (bottom left), 4 (bottom right).



**Figure 8-77:  $\alpha$ -QPSK carrier verification. Test case 5 (top left), 6 (top right), 7 (bottom left), 8 (bottom right).**

It can be seen that all scenarios there is a good correspondence between the verified and simulated link performance. In rare cases a difference of up to 0.5 dB is observed. However, in most cases the difference in performance is within 0.3 dB.

### 8.2.3.2.3 SAM

The SAM receiver has been shown to provide good performance even in the case of large SCPIRs, see [5]. Thus, the receiver has been verified using SCPIRs up to -14 dB.



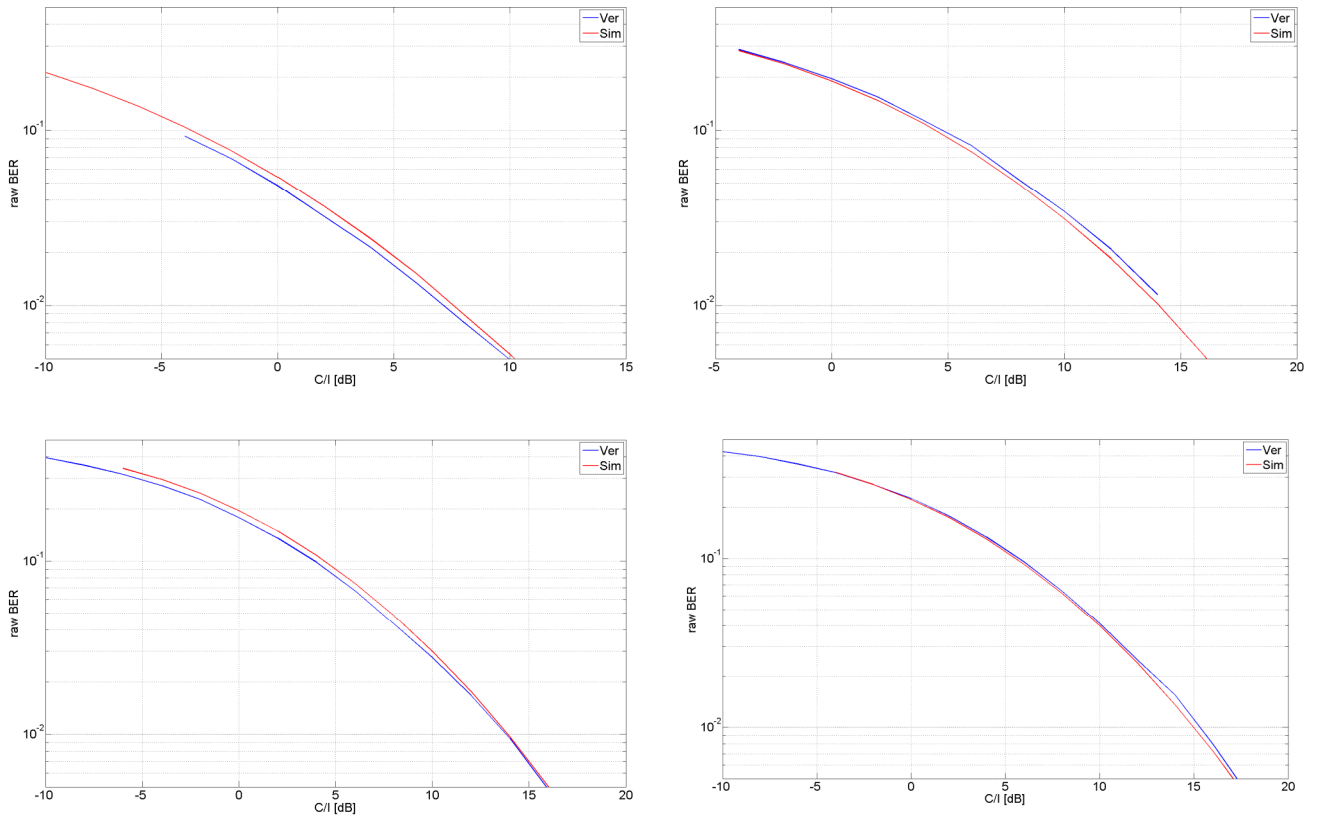

Figure 8-78: GMSK carrier verification. Test case 1 (top left), 2 (top right), 3 (bottom left), 4 (bottom right).

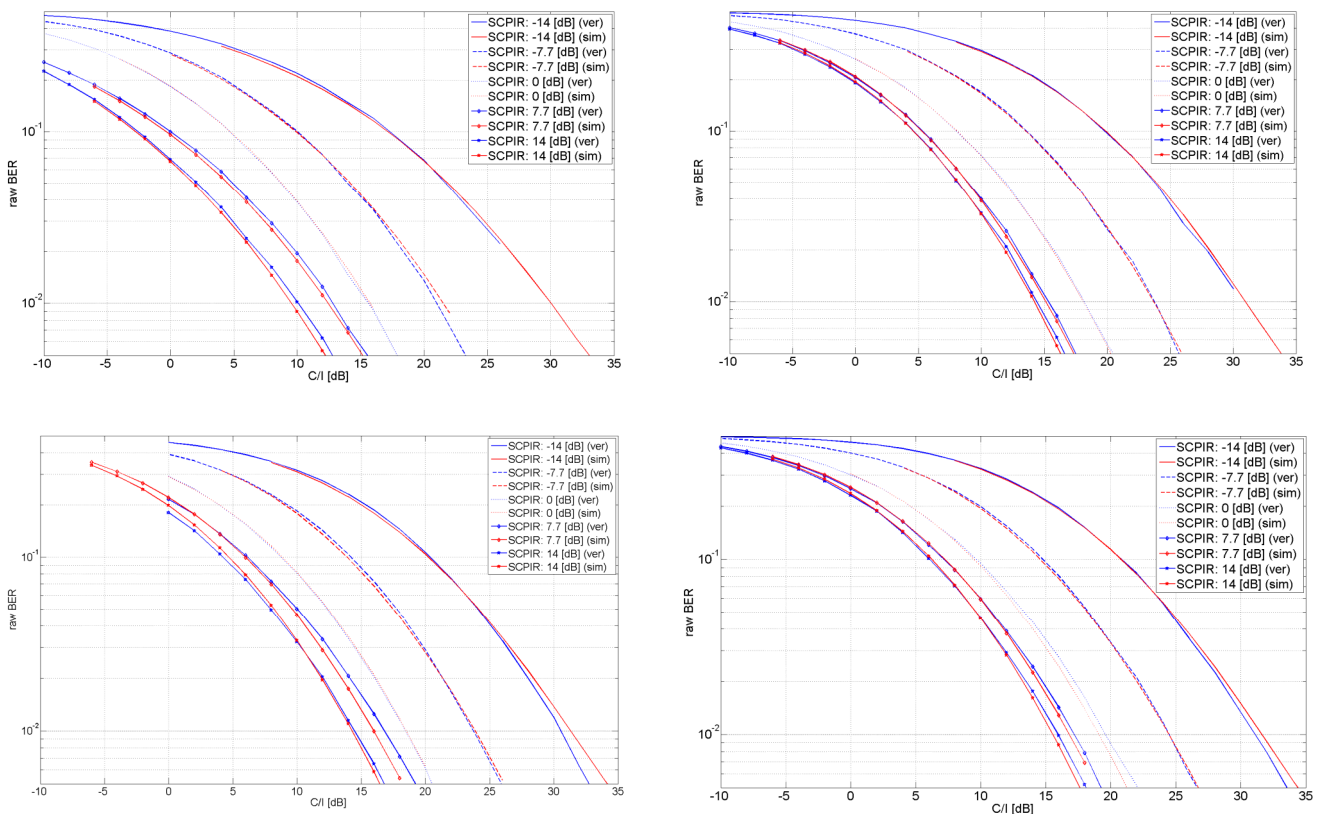

Figure 8-79:  $\alpha$ -QPSK carrier verification. Test case 5 (top left), 6 (top right), 7 (bottom left), 8 (bottom right).

## 8.3 Impacts on the Mobile Station

### 8.3.1 Legacy mobile stations

The presented concept is compatible with legacy MS. No implementation impact is foreseen. In addition, it should be noticed that legacy mobiles will gain from both the sub channel specific power control on the DL and the proposed frequency hopping scheme.

### 8.3.2 Mobile stations supporting Adaptive symbol constellation

Support of new TSCs will help improve link performance, spectral efficiency and network planning. Thus, new training sequence codes must be defined in the MS. The support of the new training sequence codes must be signalled to the network.

In order to improve the link performance and ultimately the spectral efficiency of the network, the MS receiver algorithms should be optimized to cope with inter-sub-channel interference.

#### Sub channel power control on the DL ( $\alpha$ -QPSK)

No additional implementation is needed to support sub channel power control on the DL for an MS detecting its own sub channel, e.g. a SAIC capable MS.

If a joint detection algorithm is used, i.e. the two sub channels are detected jointly, the power control parameter  $\alpha$  needs to be estimated on a burst-by-burst basis or by a filtering over several bursts. Alternatively, signalling could be used to convey  $\alpha$ . NOTE: Estimation of alpha is only needed for joint detection receivers.

#### Adaptive constellation rotation

In order to support adaptive constellation rotation the MS must perform blind detection of the rotation angle.

### Frequency hopping

There is no impact to the legacy mobile allocated on the first sub channel. The user on the second sub channel needs to support additional signalling and the new hopping sequences.

## 8.4 Impacts on the BSS

The transmitter will need to implement a new linear modulation type. A receiver capable of demodulating multiuser MIMO signals is also required. New power control and channel allocation strategies must also be implemented. The following list provides more details:

BSS shall be able to assign different TSC's to the two users. The choice of TSC shall be made based upon the capabilities of the MS.

The transmitter shall implement the linear modulator. If a legacy BSS has support for a linear  $M$ -PSK modulator,  $M \geq 4$ , then  $\alpha$  can be quantized to a set of discrete values and the legacy modulator re-used.

The transmitter should be able to support two rotations, which are used dependent on the value of alpha.

The receiver shall be able to demodulate 2 simultaneous received signals from two antenna branches. (I.e. a 2 user MIMO receiver is needed.).

The transmitter and receiver should support new signalling for frequency hopping and new frequency hopping schemes.

The BSS shall implement new power control algorithms both in the uplink and downlink. In the downlink it is necessary to ensure that each MS has a signal to noise plus interference ratio high enough to successfully demodulate and decode its intended signal. This is achieved by choosing the parameter  $\alpha$  and the output power appropriately.

Adaptive symbol constellation will only impact the radio interface in terms of increased channel capacity. Thus, the capacity of the Abis interface will have to be increased in accordance with the increased number of channels that can be supported by Adaptive Symbol Constellation.

## 8.5 Impacts on Network Planning

No impact on network planning is foreseen. The impact on system performance due to a wider pulse shape is left FFS.

## 8.6 Impacts on the Specification

Below is a list of impacted specifications for the Adaptive Symbol Constellation concept:

3GPP TS	Details
24.008	Capability indication for adaptive symbol constellation
44.018	Layer3, training sequence signalling
45.002	Definition of new training sequence codes
	Frequency hopping impacts
45.004	$\alpha$ -QPSK modulation definition
45.005	Performance requirements for UL and DL
45.008	Impacts on power control
51.010	Introduction of new mobile station test cases
51.021	Introduction of new base station test cases

## 8.7 Summary of Evaluation versus Objectives

In this section the candidate technique is evaluated against the defined objectives in chapter 4. Note, this section represents the view of the proponents of this candidate technique.

The following classification is used for the evaluation:

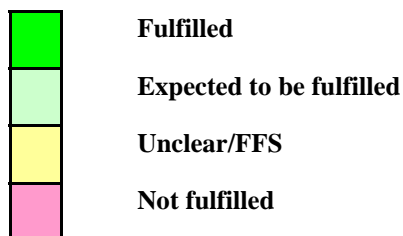

### 8.7.1 Performance objectives

#### Capacity improvements at the BTS (P1)

Gains have been shown in [8-11] to be between 0 and 114 % dependent on the system scenario and speech coded investigated. Further enhancements are expected when utilizing  $\alpha$ -QPSK, frequency hopping and adaptive constellation rotation.

*Expected to be fulfilled*

#### Capacity improvements at the Air interface (P2)

Two users are multiplexed on the same radio resource.

*Fulfilled*

Evaluation of MUROS Candidate Techniques	Candidate Techniques proposed in MUROS
<b>Performance Objectives</b>	<b>Adaptive symbol constellation</b>
<b>P1: Capacity Improvements at the BTS</b> 1) increase voice capacity of GERAN in order of a factor of two per BTS transceiver 2) channels under interest: TCH/FS, TCH/HS, TCH/EFS, TCH/AFS, TCH/AHS and TCH/WFS	1) Gains have been shown to be between 0 and 114 % dependent on the system scenario and speech coded investigated for OSC. Further enhancements are expected when utilizing $\alpha$ -QPSK, frequency hopping and adaptive constellation rotation.
	2) All codecs are supported
<b>P2: Capacity Improvements at the air interface</b> 1) enhance the voice capacity of GERAN by means of multiplexing at least two users simultaneously on the same radio resource both in downlink and in uplink 2) channels under interest: TCH/FS, TCH/HS, TCH/EFS, TCH/AFS, TCH/AHS and TCH/WFS	1) Two users are multiplexed on the same radio resources
	2) All codecs are supported

### 8.7.2 Compatibility objectives

#### Maintenance of Voice Quality (C1)

The capacity gains have been shown when using the same quality target for channels not using adaptive symbol constellation and channels using adaptive symbol constellation. Additionally, GSM HR has been investigated with the same FER threshold as AMR codecs. Given the same FER level, the voice quality is worse for GSM HR than for any AMR codec.

*Fulfilled*

### **Support of legacy mobile stations (C2)**

Legacy, DARP Phase I, mobiles can be supported on the first sub channel, see [8-10], while MS's supporting new training sequence codes are required for the second sub channel.

Both the concept of downlink power control ( $\alpha$ -QPSK) and the concept of frequency hopping will support legacy mobiles. However, legacy mobiles will experience no gains from adaptive constellation rotation.

The support of non DARP Phase I mobiles is still left FFS.

*Fulfilled (DARP Phase I MSs)*

*TBD (Non DARP Phase I MSs)*

### **Implementation Impact to new Mobile Stations (C3)**

Compared to a legacy DARP Phase I receiver, the following additional support is needed.

- new training sequences
- additional detection of rotation. (Note: Algorithms for modulation detection in EDGE capable terminals can be re-used.)
- signaling procedure of frequency hopping
- frequency hopping support,

### **Implementation Impacts to BSS (C4)**

Transmitter:

- additional constellation rotation
- linear modulator for  $\alpha$ -QPSK

Receiver

- Dual antenna receiver becomes mandatory.
- Demodulation algorithm of two simultaneous received signals

Transmitted and Receiver

- new TSC support
- support of frequency hopping concept

Dimensioning aspects of the Abis interface due to the increased channel support needs to be taken into account.

### **Impacts to Network Planning (C5)**

No impact is foreseen when using the linearized GMSK pulse shape. The impact due to a wider pulse shape on the DL is left FFS.

The evaluation against the objectives is summarised in the table below.

The compatibility objectives are summarized below with following colour coding.

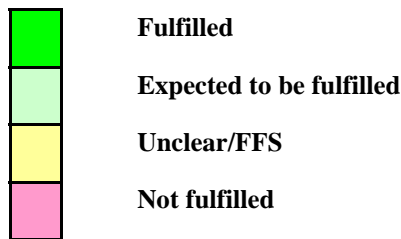

Evaluation of MUROS Candidate Techniques	Candidate Techniques proposed in MUROS
<b>Compatibility Objectives</b>	<b>Adaptive symbol constellation</b>
<p><b>C1: Maintainance of Voice Quality</b></p> <p>1) voice quality should not decrease as perceived by the user.                  2) A voice quality level better than for GSM HR should be ensured.</p>	<p>1) Only users experiencing good enough quality will be allocated on a channel supporting alpha-QPSK. Simulations have shown that there are no losses in user satisfaction, only gains, when using the new technique.</p> <p>2) GSM HR has been investigated with the same FER threshold as AMR codecs. Given the same FER level, the voice quality is worse for GSM HR than for any AMR codec.</p>
<p><b>C2: Support of Legacy Mobile Stations</b></p> <p>1) Support of legacy MS w/o implementation impact.                  2) First priority on support of legacy DARP phase 1 terminals, second priority on support of legacy GMSK terminals not supporting DARP phase 1.</p>	<p>1) Legacy, DARP Phase I, mobiles can be supported on the first sub channel. Both the concept of downlink power control (<math>\alpha</math>-QPSK) and the concept of frequency hopping will support legacy mobiles.</p> <p>2) Legacy DARP Phase I terminals will be supported. Non DARP Phase I terminals have been shown to support the concept on link level. System level studies are still needed to show the feasibility of non DARP Phase I support.</p>
<p><b>C3: Implementation Impacts to new MS's</b></p> <p>1) change MS hardware as little as possible.                  2) Additional complexity in terms of processing power and memory should be kept to a minimum.</p>	<p>1) New training sequences, additional rotation (note that blind modulation detection algorithms from EGPRS can be re-used) and new frequency hopping functionality need to be supported. If joint detection receiver is used, the alpha (in the alpha-QPSK constellation), needs to be estimated.</p> <p>2) Detection of one additional rotation is a low complexity/low memory operation and can be done in the same way as in modulation detection in EGPRS.</p> <p>If joint detection receiver is to be used then the demodulator will be considerably more complex than the GMSK demodulator. In this case the estimation of alpha is also required. Estimation of alpha is slightly more complex than the detection of one additional rotation.</p>
<p><b>C4: Implementation Impacts to BSS</b></p>	<p>1) Demodulation of two simultaneous signals is needed. Additionally support of new training sequences, linear modulator for alpha-QPSK, additional rotation and support of new frequency</p>

<p>1) Change BSS hardware as little as possible and HW upgrades to the BSS should be avoided.</p> <p>2) Any TRX hardware capable for MUROS shall support legacy non-SAIC mobiles and SAIC mobiles.</p> <p>3) Impacts to dimensioning of resources on Abis interface shall be minimised.</p>	<p>hopping scheme needs to be supported.</p>
	<p>2) The concept brings no impact to the support of different type of mobiles for the TRX</p>
	<p>3) The capacity of the Abis interface needs to be increased in accordance with the increased number of channels supported by MUROS.</p>
<p><b>C5: Impacts to Network Planning</b></p> <p>1) Impacts to network planning and frequency reuse shall be minimised.</p> <p>2) Impacts to legacy MS interfered on downlink by the MUROS candidate technique should be avoided in case of usage of a wider transmit pulse shape on downlink.</p> <p>3) Furthermore investigations shall be dedicated into the usage at the band edge, at the edge of an operator's band allocation and in country border regions where no frequency coordination are in place.</p>	<p>1) No impact on frequency planning or frequency reuse is foreseen.</p>
	<p>2) A wide pulse shape has only been investigated on link level. System level simulations are needed to investigate the impact of a wider pulse.</p>
	<p>3) If a wide pulse shape is to be deployed it is not expected to be used at the edge of an operator's frequency band.</p>

## 8.8 References

- [8-1] GP-080658 "Draft TR on Circuit Switched Voice Capacity Evolution for GERAN".
- [8-2] GP-070214, "Voice Capacity Evolution with Orthogonal Sub Channel", source Nokia
- [8-3] AHG1-080019, "Frequency hopping scheme for MUROS", source Telefon AB LM Ericsson. GERAN WG1 Ad Hoc on EGPRS2/WIDER/MUROS/MCBTS.
- [8-4] 3GPP TS 45.002, "Multiplexing and multiple access on the radio path"
- [8-5] GP-081011, "Legacy DARP Phase I performance in  $\alpha$ -QPSK modulation", source Marvell, GERAN#39
- [8-6] GP-081086, "Sensitivity performance of DARP capable MS in power-controlled MUROS downlink", source NXP. GERAN#39
- [8-7] GP-081133 "SAIC performance for Adaptive Symbol constellation", source Telefon AB LM Ericsson. GERAN#39
- [8-8] GP-081145 "MUROS – Performance of Alpha-QPSK with Legacy DARP MS", source Nokia Corporation. GERAN#39
- [8-9] GP-081168 "Legacy SAIC MS Performance in Alpha-QPSK Modulation", source ZTE. GERAN#39
- [8-10] "Alpha-QPSK performance - collected", source Ericsson. 6<sup>th</sup> telephone conference on MUROS.
- [8-11] AHG1-080132 "OSC System performance evaluation DL", source Ericsson, 3GPP GERAN 1 Adhoc on EGPRS2/WIDER/MUROS
- [8-12] GP-080637, "Adaptive constellation rotation for MUROS", source Telefon AB LM Ericsson. GERAN#38
- [8-13] AHG1-080120, "Comparison of MUROS Candidate Techniques in MUROS TR", source Nokia Siemens Networks, Nokia Corporation. GERAN WG1 ad hoc on EGPRS2/WIDER/MUROS, October 2008
- [8-14] GP-081917, "Collected results for MUROS TR", Nokia Corporation, 3GPP GERAN#40
- [8-15] GP-071792, Voice Capacity Evolution with Orthogonal Sub Channel, Nokia Siemens Networks, Nokia, 3GPP GERAN#36
- [8-16] GP-080114, Adaptive Symbol Constellation for MUROS (Downlink), Telefon AB LM Ericsson, 3GPP GERAN#37

- [8-17] AHG1-080007, MUROS Interference Performance of DARP capable MS, NXP Semiconductors
- [8-18] GP-081949, "Work Item Description VAMOS", source China Mobile, Ericsson, Huawei, Motorola, Nokia, Nokia Siemens Networks, Qualcomm, Samsung, STMicroelectronics, Vodafone, Telecom Italia.
- [8-19] MLSE and Spatio-Temporal Interference Rejection Combining With Antenna Arrays, D. Asztely and B. Ottersten, Ninth European Signal Processing Conference Eusipco-98.
- [8-20] GP-090114, "MUROS Uplink Receiver Performance", ST-NXP Wireless, February 2009
- [8-21] GP-090115, "MUROS Downlink Receiver Performance for Interference and Sensitivity", ST-NXP Wireless, February 2009
- [8-22] GP-081130, "MUROS Uplink Performance", Ericsson, GERAN #39, August 2008
- [8-23] GP-010772, "Diversity Interference Cancellation for GSM / EDGE", Lucent, GERAN #4, April 2001
- [8-24] GP-050953, "GERAN Downlink Performance Evolution", Philips, GERAN #24, April 2005
- [8-25] AHG1-080113, "MUROS uplink performance", Nokia Siemens Networks, GERAN1 Ad Hoc October 2008
- [8-26] AHG1-080080, "Performance of MUROS Uplink", Huawei, GERAN1 Ad Hoc October 2008
- [8-27] GP-081131, "Effect of Frequency Offsets in the Link Performance of MUROS UL", Ericsson, GERAN #39, August 2008
- [8-28] GP-080567, "MUROS Interference Performance of DARP capable MS", NXP Semiconductors, GERAN #38, May 2008
- [8-29] GP-081085, "MUROS Test Scenario Performance of DARP capable MS", NXP Semiconductors, GERAN #39, August 2008
- [8-30] GP-071807, "Orthogonal Sub Channel DL performance of DARP capable MS", NXP Semiconductors, GERAN #36, November 2007
- [8-31] GP-081086, "Sensitivity Performance of DARP capbl. MS in power-controlled MUROS DL", NXP Semiconductors, GERAN #39, August 2008
- [8-32] GP-090731, "Discrete alphas for AQPSK", source Telefon AB Ericsson, GERAN#42
- [8-33] GP-090732, "Support of legacy non-DARP Phase I receivers using  $\alpha$ -QPSK – Updated system performance evaluation", source Telefon AB Ericsson, GERAN#42
- [8-34] GP-090733, "System performance evaluation of VAMOS MAIO hopping schemes", source Telefon AB Ericsson, GERAN#42
- [8-35] GP-091306, "Adaptive symbol constellation system performance evaluation DL", source Telefon AB LM Ericsson, GERAN#43
- [8-36] GP-1307, "Updated basic OSC system performance performance evaluation, DL", source Telefon AB LM Ericsson, GERAN#43.



## 9 Higher Order Modulations for MUROS

### 9.1 Concept Description

#### 9.1.1 Downlink

##### 9.1.1.1 Speech multiplexing

For the downlink channel, several speech channels can be transmitted simultaneously over a single physical channel. Each channel can be separately encoded. This technique support all legacy speech codecs (TCH/FS, TCH/EFS, TCH/AFS, TCH/WFS, TCH/HS, TCH/AHS), and separate DTX for each user. In the case that AMR speech encoding is being used for one or more of the users, this allows for independent selection of codec mode for each user, multiplexing of legacy users. A diagram showing the concept of multiplexing four users is shown in Figure 9-1.

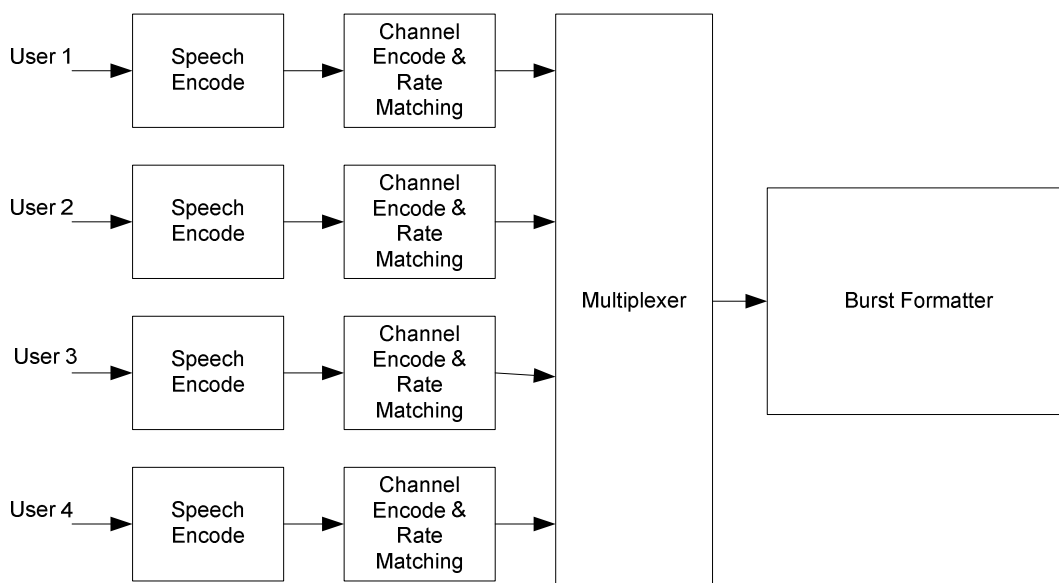

**Figure 9-1: Higher Order Modulation for MUROS in Downlink (4 users)**

As can be seen in Figure 9-1, each user is separately encoded. After rate matching, the users are multiplexed together. There are several policies the multiplexer could take. One option is to fairly divide the resource among the users. For example, by concatenating the users' messages and then bit interleaving, or by allocating separate symbols for every user. In order to allow power control between the users the number of bits the rate matching outputs can be unequal. Another option that can be used is allocating each user a bit (or bits) in the modulation constellation. This option allows inherent power control, as the strength of bits is not equal. This is discussed in more detail in the section on power control.

Using this method, one can multiplex 1 to 4 users on the same slot. As in TCH/AFS, each speech frame is interleaved over 8 physical slots to allow as large as possible time diversity. The four MUROS users are marked as  $M_0, \dots, M_3$ . In each slot, up to 4 users are transmitted, depending on each user's individual DTX status. The modulation level can be varied according to the instantaneous number of users as shown in Figure 9-2.

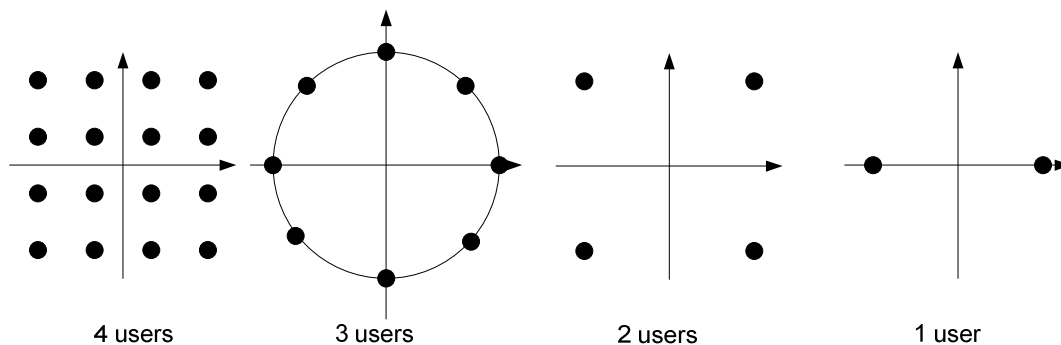

**Figure 9-2: Modulation according to Number of Configured Users**

### 9.1.1.1.1 Speech Multiplexing and Interleaving

The allocation of the symbols on the constellation is done according to the order of bit definition in 45.004. In GMSK, S0 is the only bit in the constellation,  $d_i$ . In QPSK, S0 is mapped to the first bit and S1 to the second bit  $d_{2i}$  and  $d_{2i+1}$  respectively. In 8PSK, S0, S1 and S2 are mapped to bits  $d_{3i}$ ,  $d_{3i+1}$  and  $d_{3i+2}$  respectively, and in 16QAM stream S0 to S3 are mapped to bits  $d_{4i}$ ,  $d_{4i+1}$ ,  $d_{4i+2}$  and  $d_{4i+3}$  respectively. Using this definition, in 8PSK modulation streams S0 and S1 are “strong” streams, as they are mapped to strong bits, while S2 is a “weak” stream, as it mapped to a weak bit. In 16QAM, stream S0 and S1 are the strong streams and stream S2 and S3 are the weak streams.

In case of 4 users, the stream allocation to user allocation is done in the following way: M0 to S0, M1 to S1, M2 to S2 and M3 to S3. In case of only one active user, that user will be mapped to the GMSK S0 stream. In other cases, the mapping will depend on the instantaneous DTX status, as will be described in the DTX subsection.

Each user that is transmitted has an allocated user stream in the constellations. As the number of bits in each stream is equal to the legacy number of bits in the TCH channel, speech multiplexing can be done as currently done in TCH/AFS channels, with the interleaving onto the allocated bits. As with legacy channels, adjacent speech frames are diagonally interleaved in the same way.

The interleaving pattern used by each user is depending on the user number. The interleaving is done in the following way:

Let  $C(k)$ ,  $k=0, \dots, 455$ , be the coded bits after puncturing, and  $I(j)$ ,  $j=0, \dots, 455$  be the coded bits after interleaving.

Define  $j$  as:  $j = 57*(k\%8) + (49*k+14*\text{index})\%57$ , where  $\text{index}$  is the MUROS user index, given in Table 9-0. The interleaving pattern is defined as  $I(j) = C(k)$ .

Using this interleaving, user M0 has the the same legacy interleaving, therefore if only M0 is transmitted, the legacy TCH/AFS slots are achieved.

**Table 9-0: MUROS user interleaving indices**

User	Index
M0	0
M1	1
M2	2
M3	3

### 9.1.1.2 Modulation Schemes and Training Sequences

The proposal will re-use GMSK and 8-PSK modulation training sequences, and 16-QAM modulation training sequences defined for EGPRS2. In addition, 8 training sequences for QPSK modulation at normal symbol rate will need to be defined. This can using the same method of producing the 16QAM/32QAM sequences. A rotation of  $3\pi/4$  can be used to differentiate the modulation scheme for blind modulation detection. The TSCs are summarized in Table 9-0a.

**Table 9-0a: QPSK Training Sequences**

Training Sequence Code (TSC)	Training sequence
0	1,1,1,1,0,0,1,1,1,1,0,0,1,1,0,0,0,0,0,0,1,1,1,1,1,1,1,1,0,0, 1,1,1,1,1,1,0,0,1,1,1,1,0,0,1,1,0,0,0,0,0,0
1	1,1,1,1,0,0,1,1,0,0,0,0,1,1,0,0,0,0,0,0,1,1,0,0,0,0,0,0,0,0, 1,1,1,1,1,1,0,0,1,1,0,0,0,0,1,1,0,0,0,0,0,0
2	1,1,0,0,1,1,1,1,1,1,1,1,0,0,0,0,0,0,1,1,0,0,0,0,0,0,1,1,0,0, 1,1,1,1,0,0,1,1,1,1,1,1,1,1,0,0,0,0,0,0,1,1
3	1,1,0,0,1,1,1,1,1,1,0,0,0,0,0,0,0,0,1,1,0,0,0,0,1,1,0,0,1,1, 1,1,1,1,0,0,1,1,1,1,1,1,0,0,0,0,0,0,0,0,1,1
4	1,1,1,1,1,1,0,0,0,0,1,1,0,0,1,1,0,0,0,0,0,0,1,1,1,1,0,0,1,1, 1,1,1,1,1,1,1,1,0,0,0,0,1,1,0,0,1,1,0,0,0,0
5	1,1,0,0,1,1,1,1,0,0,0,0,0,0,1,1,0,0,1,1,0,0,0,0,1,1,1,1,1,1, 1,1,1,1,0,0,1,1,1,1,0,0,0,0,0,0,1,1,0,0,1,1
6	0,0,1,1,0,0,1,1,1,1,0,0,0,0,0,0,0,0,1,1,0,0,0,0,1,1,1,1,1, 1,1,0,0,1,1,0,0,1,1,1,1,0,0,0,0,0,0,0,0,0,0
7	0,0,0,0,0,0,1,1,0,0,0,0,0,0,0,0,1,1,1,1,1,1,0,0,1,1,1,1,0,0, 1,1,0,0,0,0,0,0,1,1,0,0,0,0,0,0,0,0,1,1,1,1

Constellation rotations can be as for EGPRS2, with the exception of the QPSK configuration to support a legacy GMSK user. This is described in clause 9.1.1.3.

**9.1.1.3 Legacy GMSK MS Support**

Support for legacy GMSK MSs can be provided with a modified QPSK modulation. In this case, the resource can support up to 2 MSs, one of which can be a legacy GMSK MS. The constellation rotation will be compatible with legacy GMSK for transmission of this slot, i.e.  $\pi/2$  per symbol period, as shown in Figure 9-3. Detection of the rotation will be by blind modulation detection, as for detection between different modulation schemes for the regular speech multiplexing. Figure 9-4 shows different configurations for multiplexing legacy MSs, both full rate and half rate.

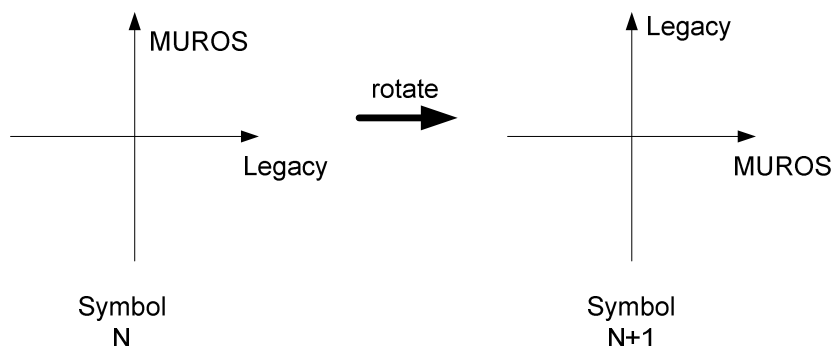

**Figure 9-3:  $\pi/2$  constellation rotation for legacy multiplexing**

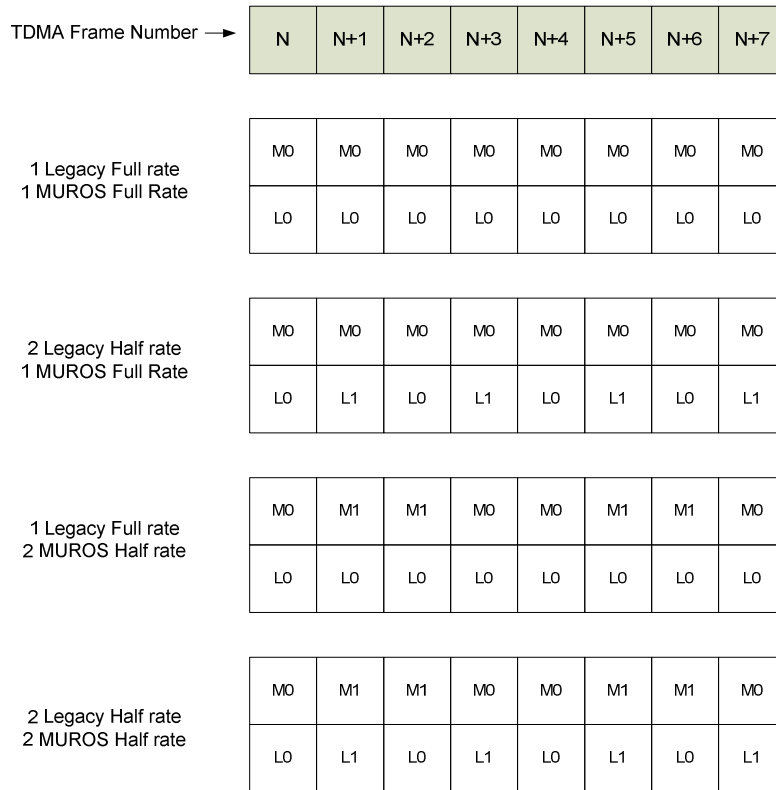

**Figure 9-4: Downlink Configurations of MUROS with Legacy**

**9.1.1.4 Codecs support and Achievable Code Rates**

This HOM technique support all legacy speech codecs (TCH/FS, TCH/EFS, TCH/AFS, TCH/WFS, TCH/HS, TCH/AHS), and separate DTX for each user. In full rate codec is supported in the following way. Every legacy codec produce a payload of 456 bits. This payload is interleaved using the interleaving scheme described in subsection 9.1.1.2. After interleaving, the payload bits are mapped to the user stream over 8 slots as done the legacy full rate channels.

The achievable coding rate are equal to the legacy coding rate, as the same payload size is maintained, i.e. 456 bits.

The support of the legacy codes is done in the following way. Every half rate code produces 228 bits. Those bits are duplicated to produce a total of 456 bits. Ones 456 bits are achieved, we continue as in the full rate codecs, i.e., interleaving and mapping on the appropriate stream.

As explained in the above text, the achievable code rate is the same as achieve in the legacy codec for every modulation. As a reference, Table 9-1 summarized the TCH/AFS code rates for any modulation used.

**Table 9-1: AMR channel coding rates on DL**

AMR	AMR code rate (no header)
TCH/AFS12.2	0.56
TCH/AFS10.2	0.47
TCH/AFS7.95	0.37
TCH/AFS7.4	0.34
TCH/AFS6.7	0.31
TCH/AFS5.9	0.28
TCH/AFS5.15	0.24
TCH/AFS4.75	0.23

### 9.1.1.5 DTX

The decision for each DL user channel to activate DTX is independent, depending on instantaneous speech activity. In the case that one or more users enter DTX, a lower, more robust modulation can be used according to the number of users instantaneously required. For example, where four users use 16-QAM, 3 users can use 8PSK, two users QPSK, and one user GMSK modulation.

Since information about which user or users enter DTX is not known a priori, this information must be provided by signaling as side information. This can be done as for the following example.

Each user of a logical channel is a priori assigned an identifier, so that the user knows where to access the channel encoded bits. So, the user will always know which vector of decoded bits to extract from a received burst. The different DTX configurations are now considered.

#### 9.1.1.5.1 DTX Configuration Signaling

Signaling of the MUROS users that are active for a given slot transmission can be done with a single bit.

Suppose that there 4 MUROS users, numbered for a given TDMA frame as M0, M1, M2, and M3. Each MS is aware a priori of its index for this phase in the hop sequence. This information is signaled at call setup. The interleaving order is preserved also in the case that one or more of the channels enters DTX.

The signaling may then work as follows.

##### *4 users - 16-QAM*

All four users are transmitted. No signaling is required. User M0 is carried on stream S0, M1 on S1, M2 on S2 and M3 on S3.

##### *3 users - 8-PSK*

One user has entered DTX. Four options are possible for transmitted channels. A signal bit is used to indicate the appropriate channel configuration as shown in Table 9-2.

**Table 9-2: Signalled Bit Encoding according to DTX states**

S0 S1 S2	
M0 M1 M2	0
M0 M1 M3	0
M0 M2 M3	1
M1 M2 M3	1

In the 8-PSK slot transmission there are 3 streams S0, S1 and S2, of encoded channel bits, each equivalent in size to the payload carried by a GMSK slot. The four users relate to the signaled bit as shown in Table 9-3. So for example, when the signaled bit is set to 1, the MUROS user with index 2 (M2), reads the third vector of bits, S2.

**Table 9-3: Interpretation of Signaled Bit By MUROS user**

Signalled Bit	M0	M1	M2	M3
0	S0	S1	S2	S2
1	S0	S0	S1	S2

##### *2 users - QPSK*

Two users have entered DTX. Six options are possible for transmitted channels. A signal bit is used to indicate the appropriate channel configuration as shown in Table 9-4.

**Table 9-4: Signalled Bit Encoding according to DTX states**

Transmitted channels	Signalled Bit
S0 S1	
M0 M1	1
M0 M2	0

M0 M3	1
M1 M2	0
M1 M3	0
M2 M3	1

In the QPSK slot transmission there are 2 streams, S0 and S1, of encoded channel bits, equivalent in size to the payload carried by a GMSK slot. The four users relate to the signaled bit as shown in Table 9-5. So for example, when the signaled bit is set to 1, the MUROS user with index 2 (M2), reads the third vector of bits, S2.

**Table 9-5: Interpretation of Signaled Bit By MUROS user**

Signalled Bit	M0	M1	M2	M3
0	S0	S0	S1	S1
1	S0	S1	S0	S1

### *1 user - GMSK*

In the case that only a single user is not in DTX, no signaling is required. All users on this timeslot/frequency will receive the slot, and use it to try to decode a speech frame. However, only the user to whom the data is transmitted will succeed in decoding the speech frame.

#### 9.1.1.5.1.1 Examples

##### *M0 user*

A user allocated M0 always reads the first stream of bits, irrespective of the modulation used. Since the user order is preserved, the first stream S0 will always carry M0 data, irrespective of the DTX state of other users, except in the case that M0 itself has entered DTX. The DTX signaling bit can be ignored by user M0. In the case that M0 is one of the users that is in DTX, the received data will not be decodable, since the encryption scrambling will be different from that for M0.

Note that MEAN\_BEP & CV\_BEP are parameters that are dependent only on uncoded data, not on data at frame level. So frames that are not decoded are not relevant to determining downlink channel quality.

Similarly, a user allocated to M3 always takes bits from the last stream of the transmitted modulation, which is S3 for 16-QAM, S2 for 8-PSK, S1 for QPSK; and, if GMSK is used, then the single stream of bits is used by M3 as the received data for speech frame decoding. The DTX signaling bit can be ignored by user M3.

##### *M2 user*

Suppose a user is allocated identifier M2 at setup together with 3 other users, allocated as M0, M1 and M3. For 16-QAM modulation transmitted on the downlink, M2 reads data bits from stream S2.

At a point in the call, one of the users on the downlink enters DTX. From the start of the next interleaved speech frame, the modulation transmitted is now 8-PSK. At this point, as the next timeslots are received, user M2 is not yet aware which user has entered DTX (including if it is M2 itself). After receiving all the timeslots of the interleaved speech frame, the DTX signaling information for that speech frame can be decoded. If the signaling bit is 0, then bits for M2 are read from stream S2 (per Table 9-3) (corresponding to M3 being in DTX (or M2 itself)). If the signaling bit is 1, then bits for M2 are read from stream S1 (corresponding to either M0 or M1 being in DTX). As for the M0 example above, if it is M2 itself that has entered DTX, then the received data will not be decodable, but since the data is not directed to M2, this is not relevant.

Suppose now that 2 users enter DTX, and QPSK is transmitted on the downlink. If the DTX signaling bit is 0, then M2 reads its bits from the second stream S1 (per Table 9-5) (corresponding to either M0 or M1, plus M3 (or M2)), being in DTX. If the DTX signaling bit is 1, then bits for M2 are read from the first stream S0 (corresponding to both M0 and M1 being in DTX).

In the case that 3 users enter DTX, and GMSK is transmitted on the downlink, then bits for M2 are read from the single stream S0.

### 9.1.1.5.2 Signalling Rate and Signaling Channel Coding

In order to signal the instantaneous user channel configuration for 8-PSK and QPSK slot transmissions, one signaling bit is required. As the DTX status can be changed every speech block, the required rate of the signaling is one signaling bit per 4 slots. In order to make this transmission robust, it must be encoded. A code rate of 1/8 is used. The code words are specified in Table 9-5a.

**Table 9-5a: Signaling Bit Codewords**

Signaling bit	Codeword
0	0 0 0 0 0 0 0 0
1	1 1 1 1 1 1 1 1

In order to convey the signaling codeword, 8 bits per 4 slots are needed to be transmitted, that is 2 bits per slot. In QPSK modulation, this will affect only one bit per user per slot, a total of 4 payload bits in one speech frame. For example, for 12.2kbps AMR channel, this would change the channel encoding rate from  $R=0.56$  (250/448) to  $R=0.563$  (250/444). The impact of this on speech channel performance is expected to be negligible. Note that all simulation results include impact of the signalling.

In 8PSK the same number of bits is needed per slot. In order to improve the signaling performance, strong bits are used. Therefore user on stream S2 is unaffected in the coderate, while user in stream S0 and S1 has the same impact as in QPSK.

The signaling codeword is interleaved over 8 slots using the same way the stealing bits are interleaved. The bits that are used to convey the signaling are the strong bits. The symbol that is used to convey the signaling is symbol number 116, such that in QPSK all the symbol is used and in 8PSK only the two strong bits are used.

### 9.1.1.5.3 Average Channel Usage

The average active part of the DTX of an MS is typically 60%. Assuming that we multiplex 4 users simultaneously onto a physical channel, the distribution of usage among the different modulation schemes can be estimated.

Assume that for a given timeslot, the usage of a given MS, is given by a uniformly distributed variable,  $p(u) = 0.6$ . The usage of DTX by each MS is independent, then the number of channels instantaneously in use is distributed as:

$$P(k) = {}^4C_k (0.6)^k (0.4)^{(4-k)}$$

This gives the modulation probability distribution as shown in Table 9-6. This shows that most of the transmissions use a modulation no higher than 8PSK. Only when none of the 4 users is in DTX, then the modulation rises to 16-QAM.

**Table 9-6: Modulation Usage in DTX**

Modulation	Probability
16-QAM	6%
8PSK	24%
QPSK	30%
GMSK	24%
None	6%

### 9.1.1.6 Hopping

The DTX phase of an MS tends to be for a period of time, and does not change from speech frame to speech frame. So the improvement in channel conditions is localized to certain periods in time.

Some consideration of this has been given for the case where only 2 users are multiplexed [9-8], where adaptive frequency hopping has been proposed to hop between hopping sequences, and so better distribute the improvements available from DTX phases. Although the case for 4 multiplexed users is somewhat better in terms of improvements from DTX, since there are a number of multiplexed users that can each enter DTX, the improvements still remain somewhat localized. The concept presented in [9-8] can also be used for higher modulations. A simple example is

shown in Table 9-7 for 8 MSs, distributed over 2 hopping sequences. Initially, the MSs are distributed {M0,M1,M2,M3} and {M4,M5,M6,M7} over the 2 carriers in frame N. In frame N+1, the allocation is changed to {M0,M1,M2,M7}, {M4,M5,M6,M3}. As can be seen in Table 9-7, the second and third users are set as fixed during 4 frames. This fact is used in the signaling coding that was described in subsection 9.1.1.5. After the 4 frames, users M2 and M6 change location in order to improve the DTX diversity.

**Table 9-7: Example of Adaptive Hopping for Higher Order Modulations**

Frame ->	N	N+1	N+2	N+3	N+4	N+5	N+6	N+7
<b>Hop seq 1</b>	M0	M0	M4	M4	M0	M4	M4	M4
	M1	M1	M1	M1	M1	M1	M1	M1
	M2	M2	M2	M2	M6	M6	M6	M6
	M3	M7	M3	M7	M7	M7	M3	M7
<b>Hop seq 2</b>	M4	M4	M0	M0	M4	M4	M0	M0
	M5	M5	M5	M5	M5	M5	M5	M5
	M6	M6	M6	M6	M2	M2	M2	M2
	M7	M3	M7	M3	M7	M3	M7	M3

### 9.1.1.7 Power Control

Some measure of power control differential between the users supported within the constellation is desirable, in addition to power control for the complete constellation.

A proposal for a modified QPSK constellation was made in [9-9] in order to allow a power differential between 2 users.

As shown in Figure 9-6, for each block of  $k=4$  bits, two of them ( $b_1$  and  $b_2$ ) are mapped to the sub channel I, and the other two bits ( $b_3$  and  $b_4$ ) are mapped to the sub channel Q. Because the two sub channels are independent, different protection of the strong bits and weak bits can be obtained by setting a proper value of  $\mu$  for each sub channel where the distance between the two inner points are denoted by  $d_i$  and  $d_q$  for the subchannel I and Q, respectively, while the distance between an outer point and its neighbour is denoted by  $\mu_i d_i$ , and  $\mu_q d_q$  for the sub channel I and Q, respectively ( $\mu_i$  and  $\mu_q$  are real numbers). In general,  $\mu_q$  is not necessarily equal to  $\mu_i$ , and,  $d_q$  is not necessarily equal to  $d_i$ . These flexibilities make it possible to let all of the four bits have different protection (Note that for  $\mu_i = \mu_q = 1.0$  and  $d_i = d_q$ , Figure 9-6 represents a regular 16-QAM constellation with equal distance between all neighboring points.).

In the receiver, the real part and the imaginary part of the received complex symbol can be separated, and a hard decision can be made for each bit following the rules,

$$\hat{b}_1 = \begin{cases} 0 & \text{if } \text{Re}\{r\} > 0 \\ 1 & \text{otherwise} \end{cases} \quad (1)$$

$$\hat{b}_2 = \begin{cases} 0 & \text{if } |\text{Re}\{r\}| < (\mu_i + 1)d_i/2 \\ 1 & \text{otherwise} \end{cases} \quad (2)$$

$$\hat{b}_3 = \begin{cases} 0 & \text{if } \text{Im}\{r\} > 0 \\ 1 & \text{otherwise} \end{cases} \quad (3)$$

$$\hat{b}_4 = \begin{cases} 0 & \text{if } |\text{Im}\{r\}| < (\mu_q + 1)d_q/2 \\ 1 & \text{otherwise} \end{cases} \quad (4)$$

where  $\text{Re}\{r\}$  and  $\text{Im}\{r\}$  are the real part and the imaginary part of the received symbol, respectively.

The values of  $\mu_i$  and  $\mu_q$  can be estimated in the receiver by observing the received training sequence. Noted that the estimation errors of  $\mu_i$  and/or  $\mu_q$  have no effect on the BEP performance of the strong bits; they affect only the weak bits. Furthermore, the estimation errors only widen the performance gap between the strong and weak bits. This effect can be compensated by adjusting the corresponding values of  $\mu_i$  and/or  $\mu_q$  accordingly. This method can also be used for adapting  $\mu_i$  and/or  $\mu_q$  in response to variation of the channel.



When changing modulation schemes, a number of possibilities can be considered. One is to maintain the carrier power irrespective of modulation. The MSs not in DTX enjoy the improved link performance, although inter cell interference may be increased. This simplifies RSSI measurement within a SACCH multiframe, since all timeslots have the same transmit power. A second option is to transmit the different modulations with a known power differential between them. In this way, similar BEP performance could be possible for the different modulations. However, since the power difference between the modulations is known a priori, the RSSI measurement within a SACCH multiframe can be made as though all slots were transmitted with identical power.



Figure 9-5: Downlink power control on HOM – QPSK

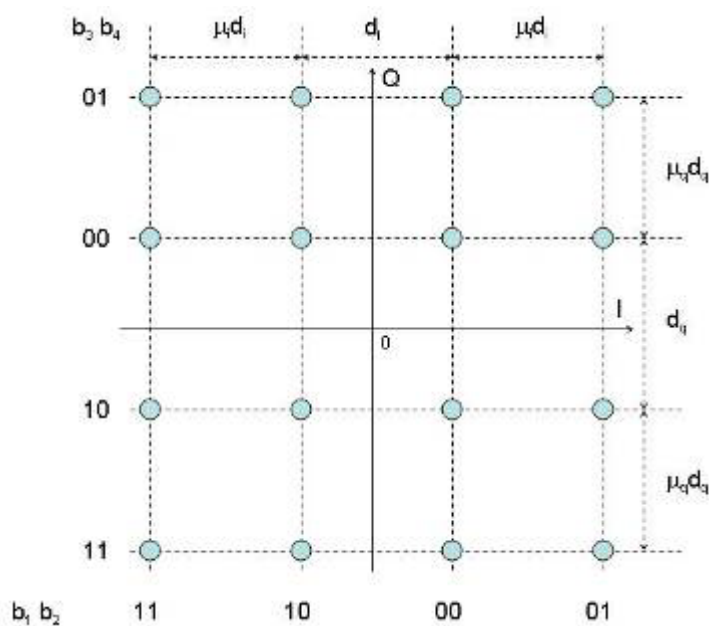

Figure 9-6: Downlink power control on HOM- 16QAM

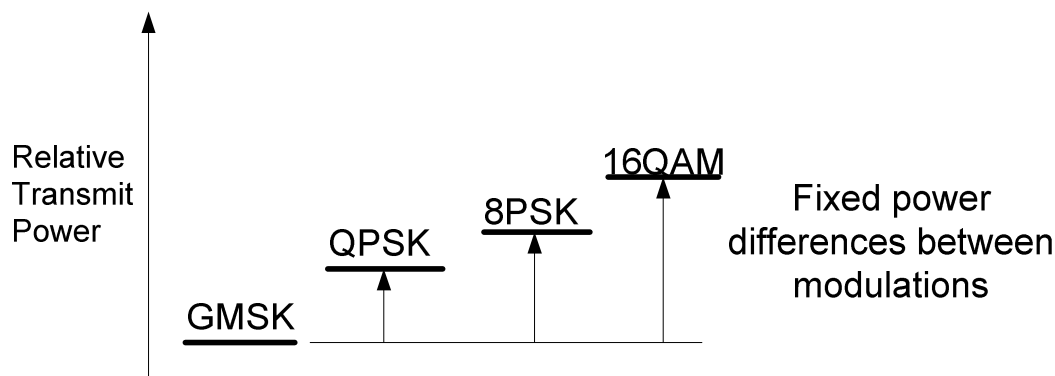

Figure 9-7: Pre-defined Backoff for DTX modulation changes

### 9.1.1.8 SACCH

The SACCH channels are supported in the following manner. Users M0 and M1 SACCH messages are allocated on frame 12. If both users M0 and M1 are allocated, QPSK modulation is used, such that the first stream S0 is the SACCH of user M0, and the second stream S1 is the SACCH of user M1. If only one user out of M0 and M1 is allocated, GMSK modulation is used for the SACCH of that user. Similarly, the SACCH messages for user M2 and M3 are allocated on frame 25. Note that no modification of the SACCH coding is needed, and no signalling is required.

Repeated SACCH can also be supported using this principle for each user independently.

### 9.1.1.9 FACCH

FACCH messages are transmitted, as currently, by replacement of the speech frame bits of that user. This ensures the alignment of the FACCH performance to the speech performance. Note that the transmission of FACCH for one of the users does not impact the other users (e.g. no loss of speech frames).

The performance of the FACCH signaling channel should be aligned with the performance of the speech channels that it supports. With the existing channel coding of the FACCH channel, this can be supported over modulations of similar order to those supporting the speech channels. If each speech user is independently encoded, then the bits relating to that user can be replaced by a FACCH block related to that user, without impacting the other users.

Repeated FACCH can also be supported using this principle for each user independently.

## 9.1.2 Uplink

### 9.1.2.1 Speech multiplexing

Figure 9-10 shows the concept for uplink MUROS support. For the uplink, up to 2 MSs can co-transmit on the same frequency and timeslot. The users are differentiated by the use of different training sequences. The uplink transmissions can use QPSK modulation or GMSK modulation. In order to achieve the coding rates to support high bit rate codecs like AMR (12.2kb/s), TCH/FS and TCH/EFS, uplink modulation will be QPSK. If one of the MSs is legacy GMSK, then its uplink transmission will be with GMSK modulation.

It is assumed that the BTS uses interference rejection combining (IRC) or successive interference cancellation (SIC) in order to receive the data for each of the users.

In order to support 4 users on the uplink, the allocation can be arranged as shown in Figure 9-11. Two users will be allocated to transmit on each alternate frame. The two user MUROS case is a sub-case of 4 users where the first 2 users are allocated so that they transmit on alternate frames, and co-transmission is avoided until at least 3 users are active.

Note: Co-channel interfered higher order modulation was considered in GERAN Release 7 for DARP Phase II [9-10]. An example requirement in the standard is that, for MCS5, using 8PSK modulation with code rate 0.37, with a GMSK or 8-PSK co-channel interferer, the performance requirement must be met at  $C/I = -6.5\text{dB}$ . So, it is expected that good

performance with uplink QPSK modulation with a co-channel interferer will be achievable with conditions of a secondary user transmitted so that each user has a C/I around 0dB.

9.1.2.1.1 Legacy Support

Examples of legacy support configurations are shown in Figure 9-12. These different configurations show how full rate or half rate legacy GSM MSs can be supported on the uplink.

Note that the configurations would allow flexibility such that not all the MSs sharing a physical resource need to be of type full rate or half rate.

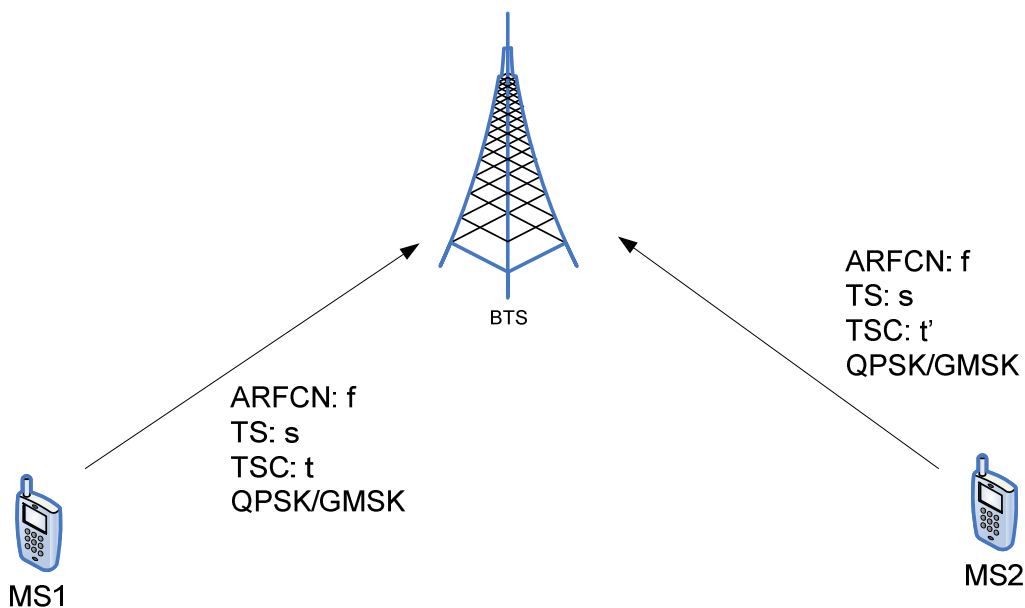

Figure 9-10 : Higher Order Modulation for MUROS in Uplink

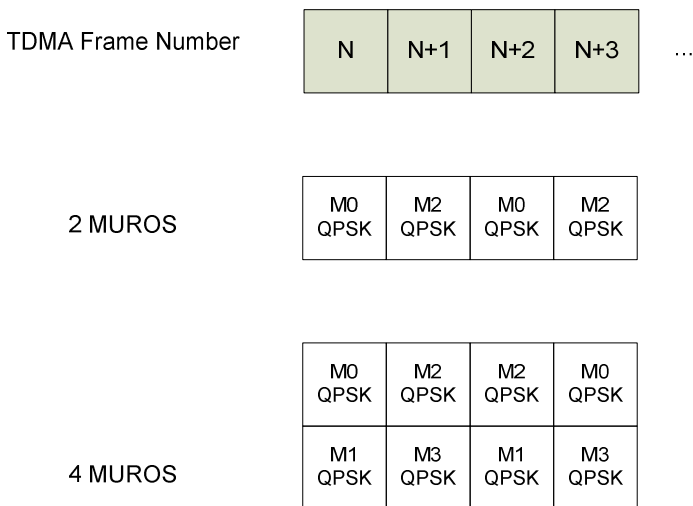
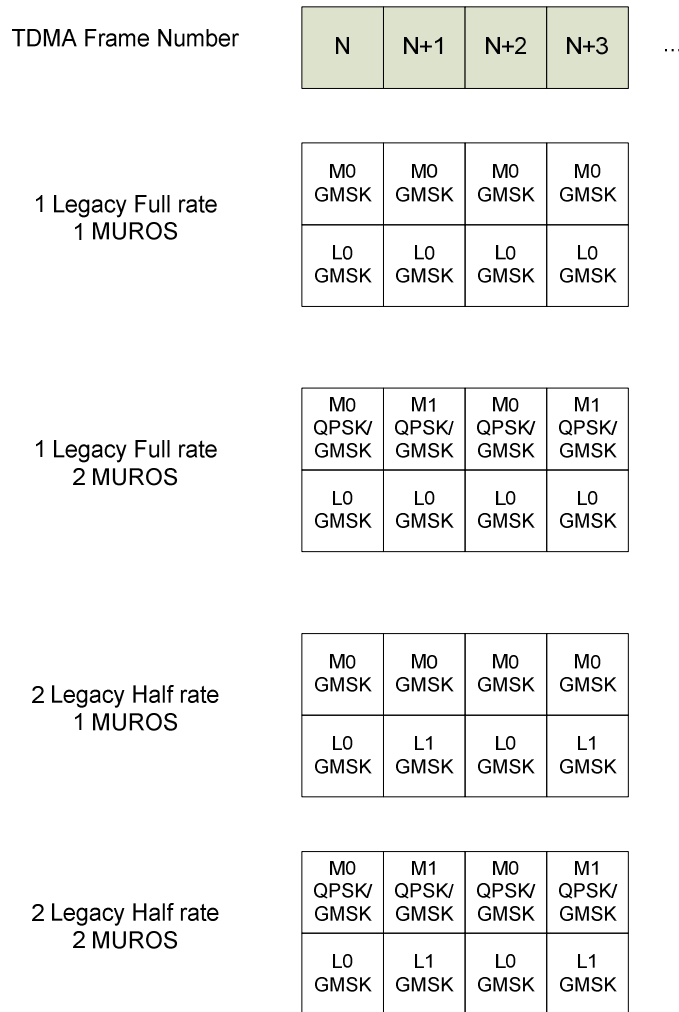

Figure 9-11: Uplink MUROS Configurations



**Figure 9-12: Uplink Configurations of MUROS with Legacy**

### 9.1.2.2 Training Sequences

Two QPSK training sequences will need to be defined for normal symbol rate. The base set defined in Table 9-0a for downlink QPSK modulation can be re-used. The second set is based on the GMSK TSC suggested in [9-11] using two diagonal constellation point of QPSK. The results TSC bit sequences are shown in Table 9-7a.



In terms of allocation of MSs, it is of course preferable to allocate them initially so that they are not transmitting on the same frames, and only once this has been completed, to start allocating the second of the pairs (e.g. {MS0, MS1}).

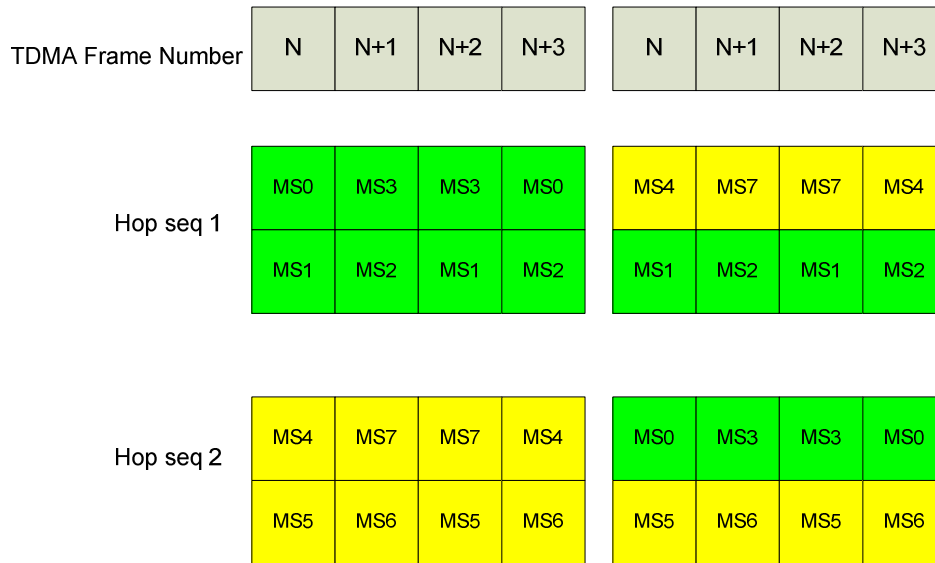

Figure 9-13: Hopping across 2 hopping sequences on Uplink

### 9.1.2.6 Codecs support and Achievable Code Rates

The code rates achievable with multiplexing a speech user over a QPSK modulation with interleaving depth of 4 slots is the same as is achievable for TCH/AFS over GMSK. So the achievable code rates are given in Table 9-1 above.

### 9.1.2.7 Power Control

On the uplink, each uplink independently transmits. The power requested by the network is set for each MS, such that two users' transmissions can be reliably separated.

### 9.1.2.8 SACCH

The SACCH channels are supported in the following manner. Each user transmits its SACCH channel using GMSK modulation, as per legacy. Users M0 and M1 are allocated on frame 12, and users M2 and M3 are allocated on frame 25. Note that no modification of the SACCH coding is needed, and no signalling is required.

Repeated SACCH can also be supported using this principle for each user independently.

## 9.1.3 Dynamic Channel Allocation

In addition to some internal power control, dynamic channel allocation (DCA), can group the users into sets of users that have similar needs, and allocate these to a common resource. As the signal conditions of each user change, these sets can be updated in order to maximize effectiveness.

## 9.2 Performance Characterization

### 9.2.1 Link Level Performance

#### 9.2.1.1 Sensitivity Performance

This section shows the performance of the different speech codecs in sensitivity conditions.

In each plot, the sensitivity performance of the speech channel is shown for relevant physical channel. Lines are shown for 1 user (black), 2 users (blue), 3 users (green) and 4 users (red). For the case of 3 and 4 co-allocated users, 2 curves are shown, corresponding to mapping of the stream to strong bits or weak bits in the modulation constellation. For 3 users, 2 streams are on strong bits, and one on weak bit stream. For 4 users, 2 users are on each of the strong and weak bits.

**Table 9-7b: Simulation Assumptions for sensitivity performance evaluation**

Parameter	Value
Speech codec	TCH/AFS5.9, TCH/AFS12.2, TCH/AHS5.9, TCH/FS, TCH/FS, TCH/EFS
Channel profile	TU3, TU50
Frequency band	900 MHz
Frequency hopping	Ideal
Interference	Sensitivity
Backoff	GMSK 0dB QPSK 2.2dB 8PSK 3.3dB 16-QAM 4.4dB
No. simulated speech frames	10, 000

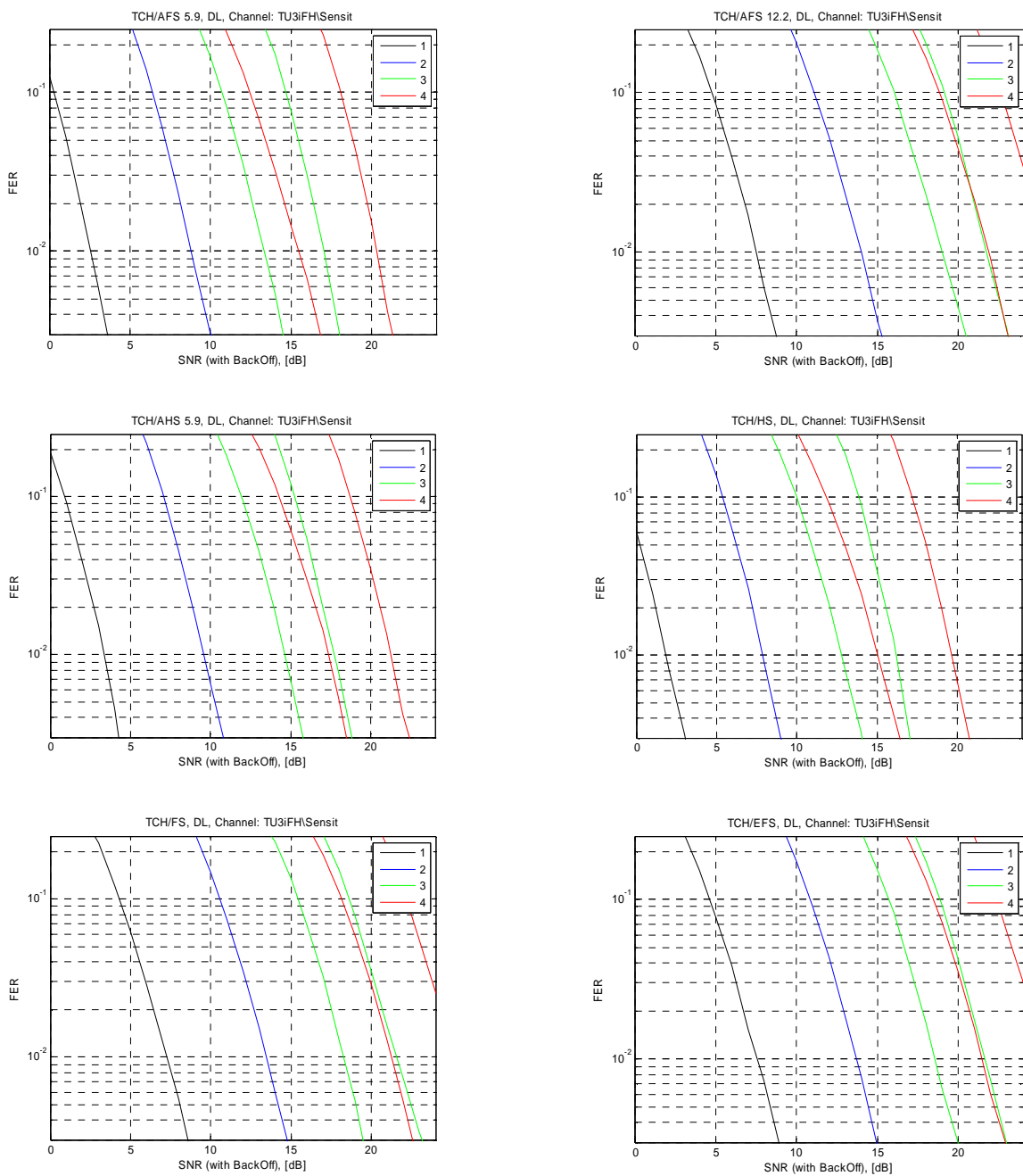
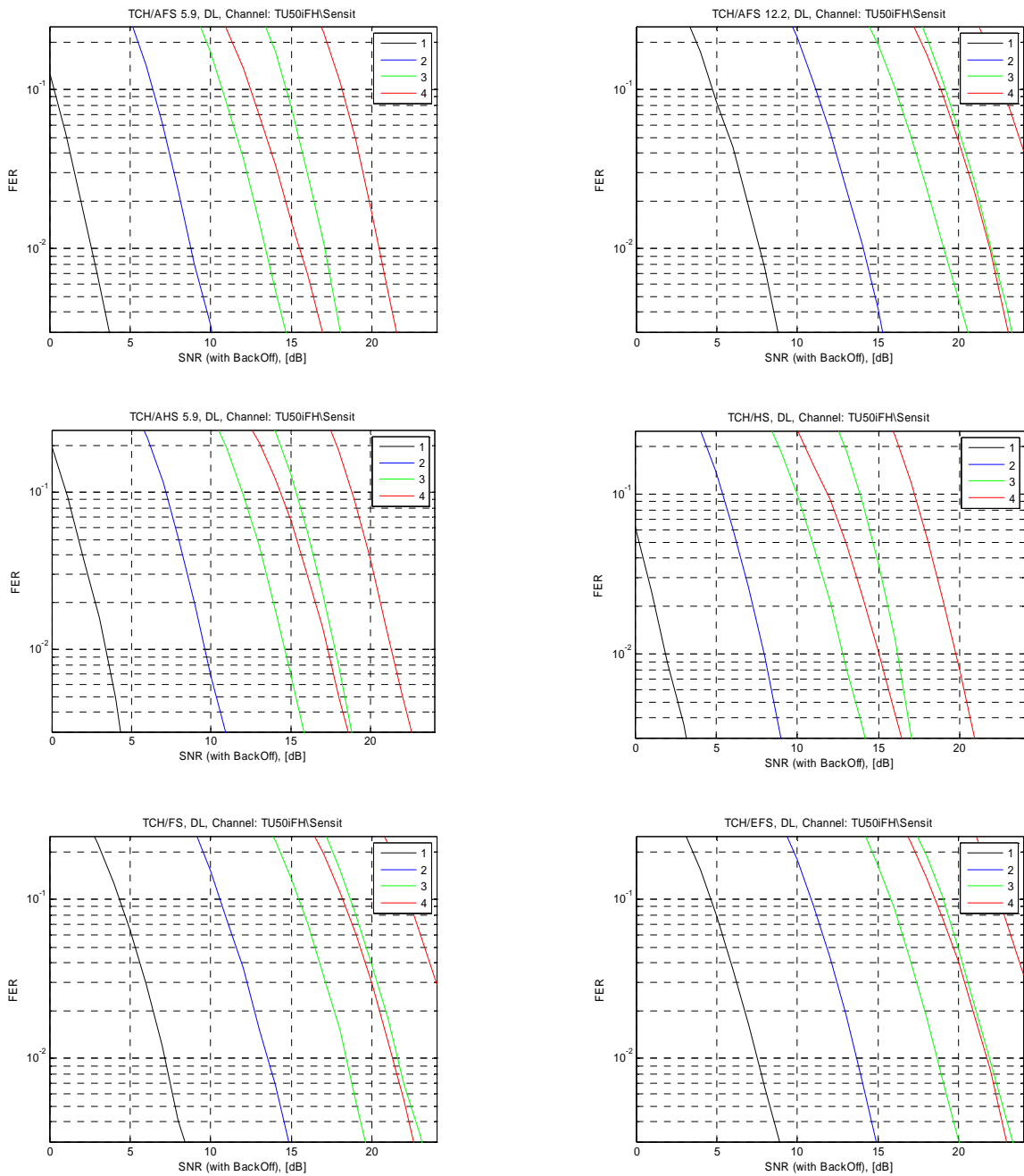

Figure 9-13a: Multiplexed users in DL, Sensitivity/TU3iFH





**Figure 9-13b: Multiplexed users in DL, Sensitivity/TU50iFH**

9.2.1.2 Interference Performance

9.2.1.2.1 Co-channel Performance

This section shows simulation results for two speech users multiplexed on QPSK modulation both in uplink and downlink, and four speech users multiplexed on 16-QAM modulation both in uplink and downlink. The conditions are co-channel interferer with a TU3 iFH channel. For two all users and four users, the legacy AMR coding schemes and puncturing were used.

Figure 9-14 shows the downlink performance achievable with the AMR 5.9kbps codec for 2 and 4 users, as compared to the legacy single user 5.9kbps case. Also shown are the 45.005 requirements for TCH/AFS12.2, TCH/AFS5.9 and TCH/AHS5.9. The 2 user MUROS curve only requires a 1.2dB improvement over the single user legacy case; it also

exceeds the TCH/AFS5.9 requirement in 45.005 by around 3dB. The 4-user MUROS case exceeds the TCH/AHS5.9 requirements by around 2dB. That is, with a 2dB degradation in C/I, double the number of speech users can be supported as compared to the legacy requirements.

Figure 9-15 shows the downlink performance achievable with the AMR 12.2kbps codec for 2 and 4 users, as compared to the legacy single user 12.2 kbps case. Similarly to the 5.9 case, the 2-user MUROS case using the 12.2kbps codec only requires a 0.5dB improvement over the single user legacy case. The 4-user MUROS case can also be supported with a C/I=15.5dB which, based on network measurements done during Release 7 GERAN Evolution work, is very reasonable to occur in networks.

Figure 9-16 shows the downlink performance for the case when only a half rate traffic physical channel is allocated to MUROS users, as for instance when the other half rate is allocated to legacy usage. The performance of 2-user MUROS carrying AMR5.9kbps is compared to TCH/AFS5.9 and TCH/AHS5.9 performance. Also shown are the 45.005 requirements for TCH/AHS5.9. It can be seen that an improvement of only 0.5dB is needed to support 2 users over the half rate resource. Also, the MUROS performance exceeds the TCH/AHS5.9 performance requirement by 1dB. So, allocating part of the resource to a legacy user, does not affect the ability to use the remainder of the resource in an effective way for MUROS.

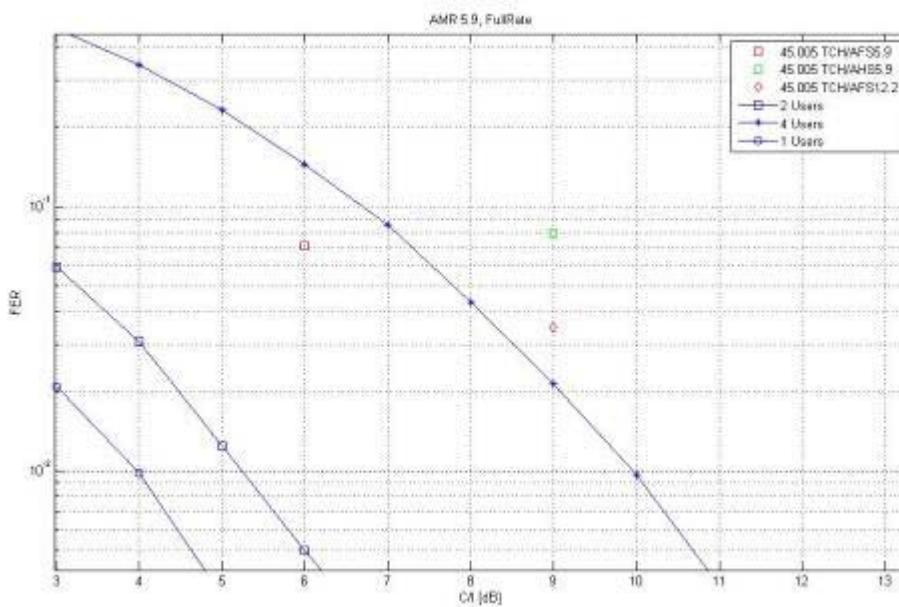

Figure 9-14: Speech user performance of multiplexed users in Downlink, AMR5.9, Co-channel, TU3 iFH

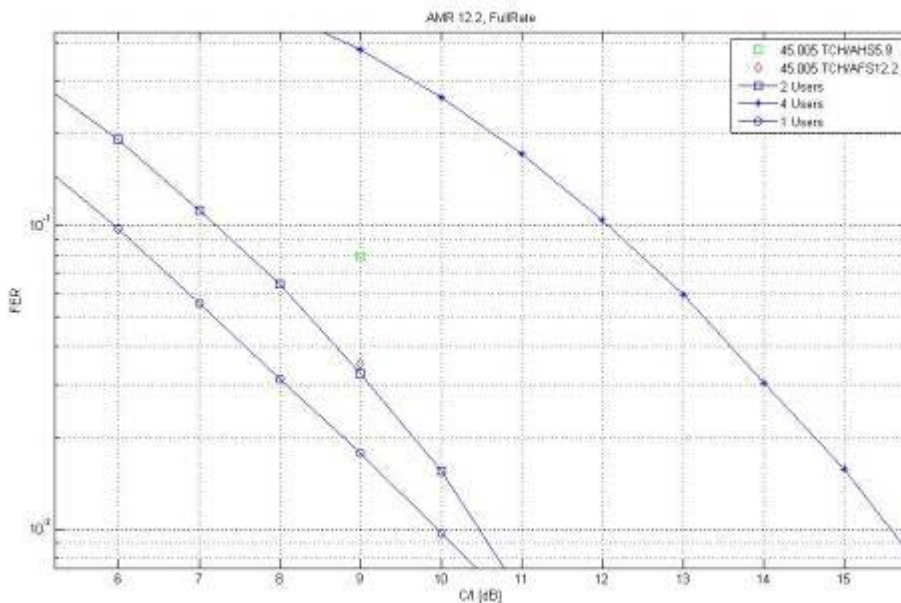

Figure 9-15: Speech user performance of multiplexed users in Downlink, AMR12.2, Co-channel, TU3 iFH

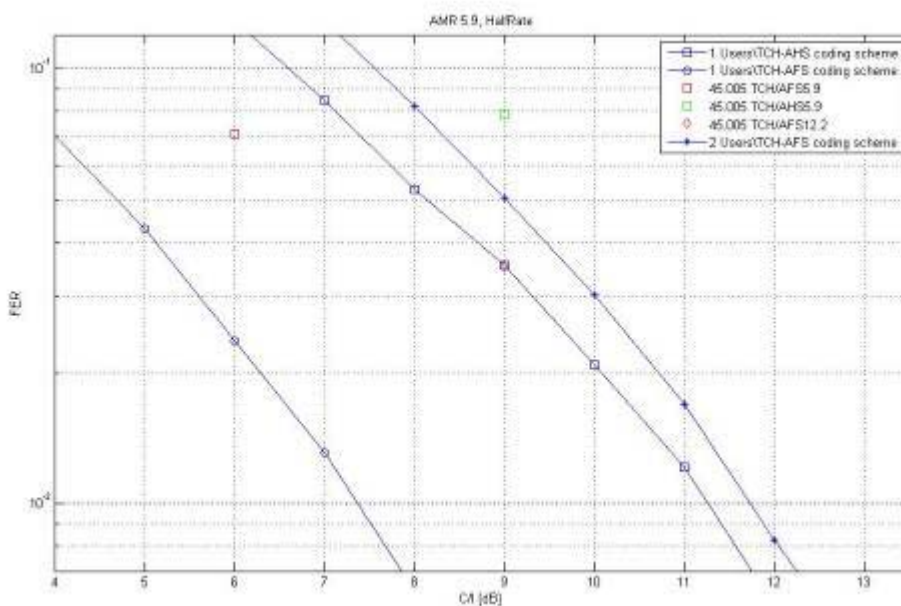

Figure 9-16: Speech user performance of multiplexed users in Downlink, AMR5.9, Co-channel, TU3 iFH (Half Rate Resource)

9.2.1.2.2 MTS-x Performance

This section shows the performance of speech over the defined MUROS channels, under the different types of MUROS interferers that could be present. That is, GMSK, QPSK and 16QAM interferers. Simulations are shown for configurations MTS-1 to MTS-4.

In the Figures 9-17 to 9-24, the line colour indicates the number of users, 1, 2 or 4, and the shape indicates the interferer type. Also shown by the purple and green markers are 3GPP standard requirements of a number of cases.

**Table 9-8 Simulation Assumptions for MTS-x performance evaluation.**

Parameter	Value
Speech codec	AMR 5.9 and 12.2
Channel profile	TU3
Frequency band	900 MHz
Frequency hopping	Ideal
Interference	MTS-1, MTS-2, MTS-3, MTS-4 (GMSK, QPSK, 16QAM)
Receiver type	Conventional
Rx filter	Conventional
No. simulated speech frames	10, 000

9.2.1.2.2.1 Downlink

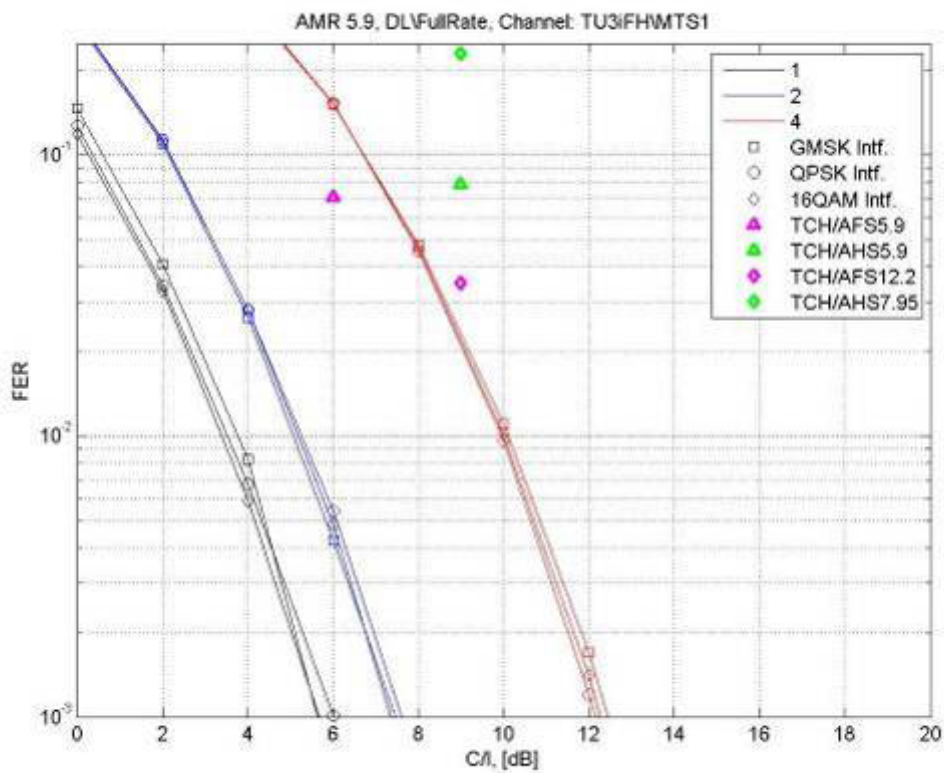

**Figure 9-17: AMR 5.9 performance of multiplexed users in DL, MTS-1**

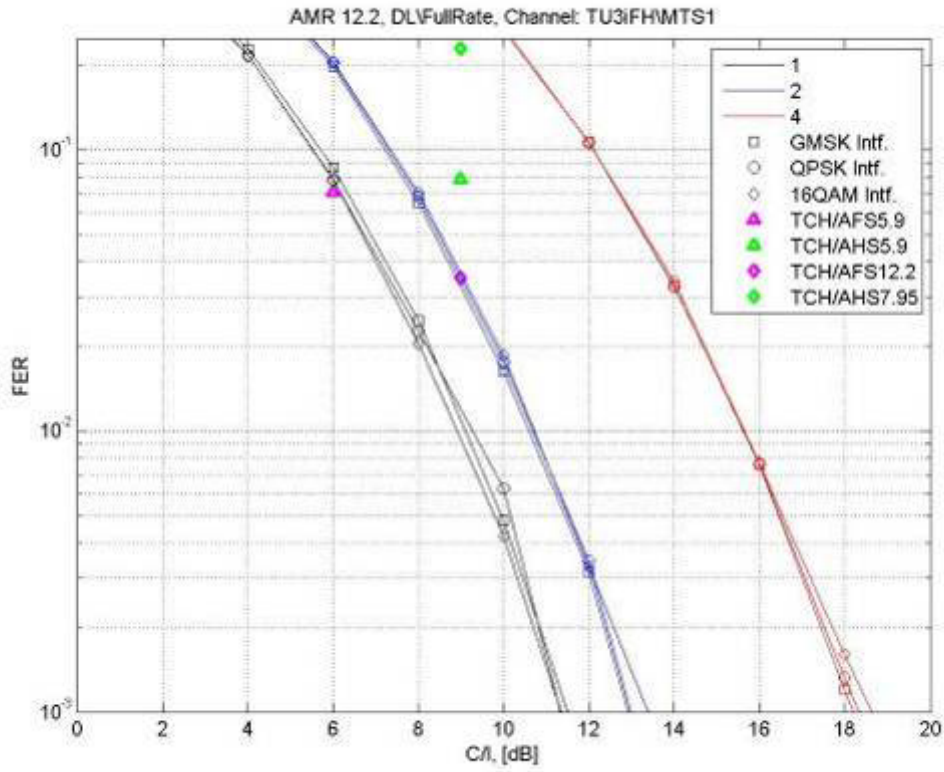

Figure 9-18: AMR 12.2 performance of multiplexed users in DL, MTS-1

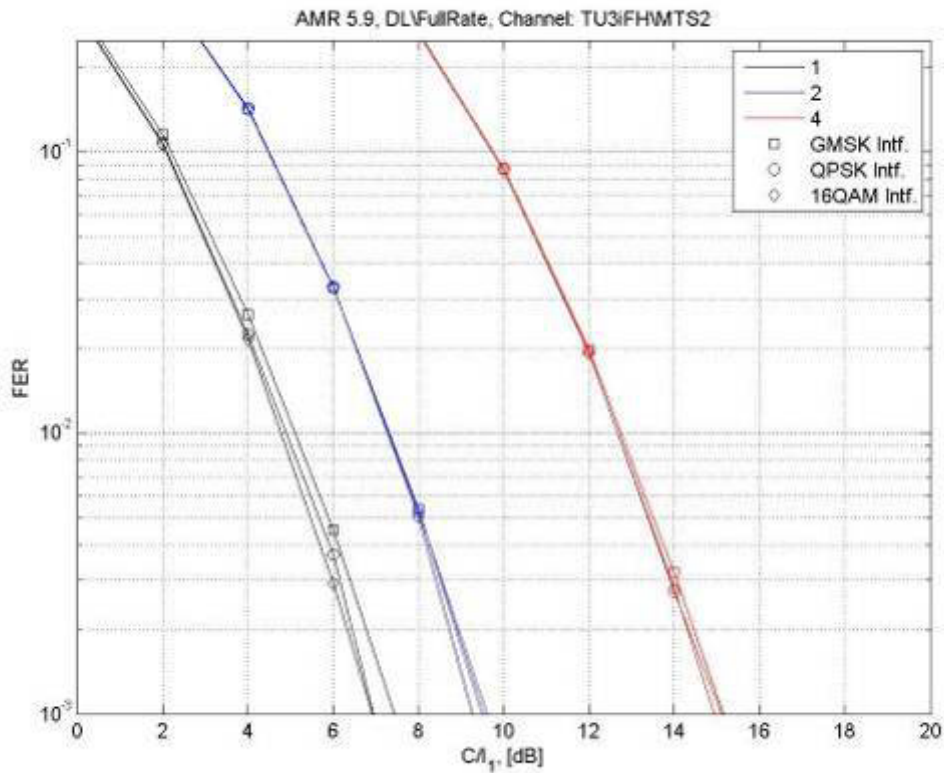

Figure 9-19: AMR 5.9 performance of multiplexed users in DL, MTS-2

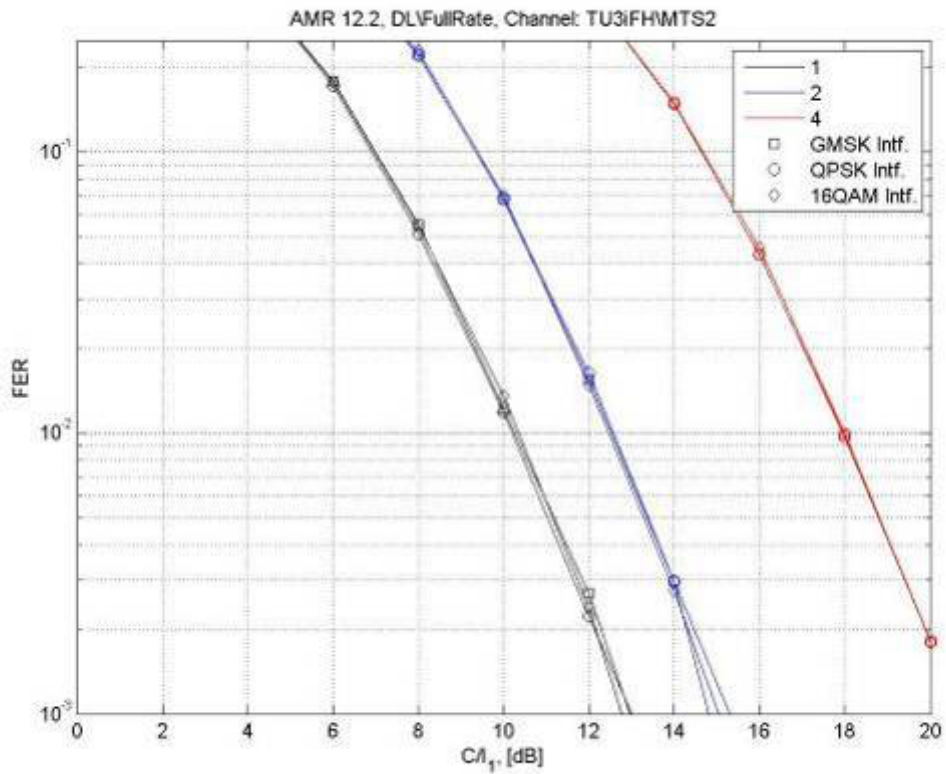

Figure 9-20: AMR 12.2 performance of multiplexed users in DL, MTS-2

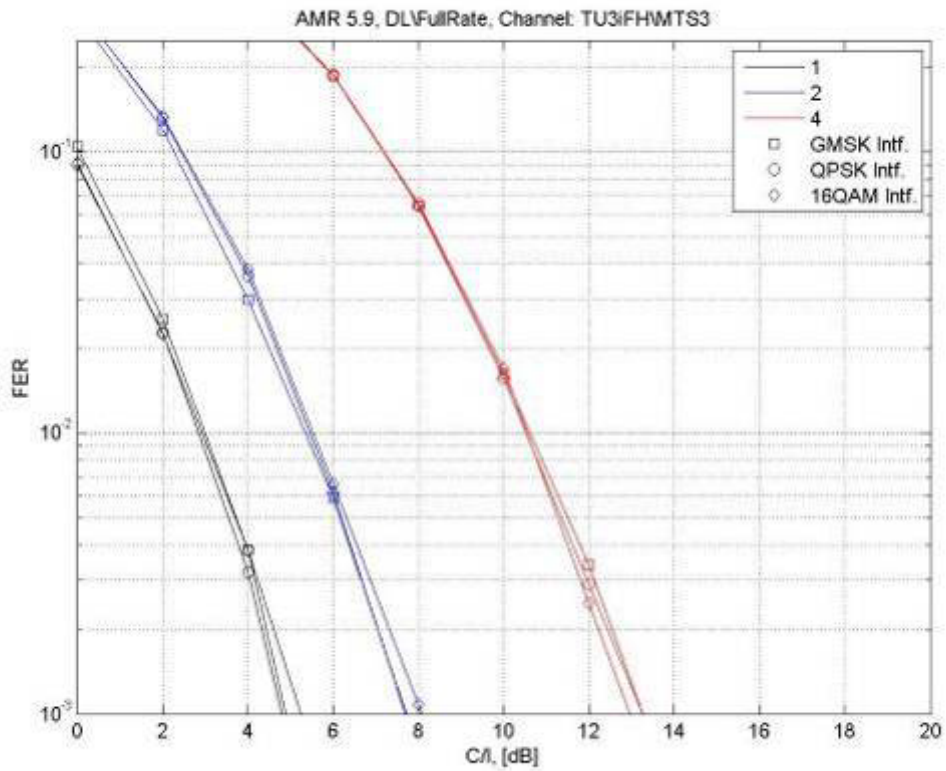

Figure 9-21: AMR 5.9 performance of multiplexed users in DL, MTS-3

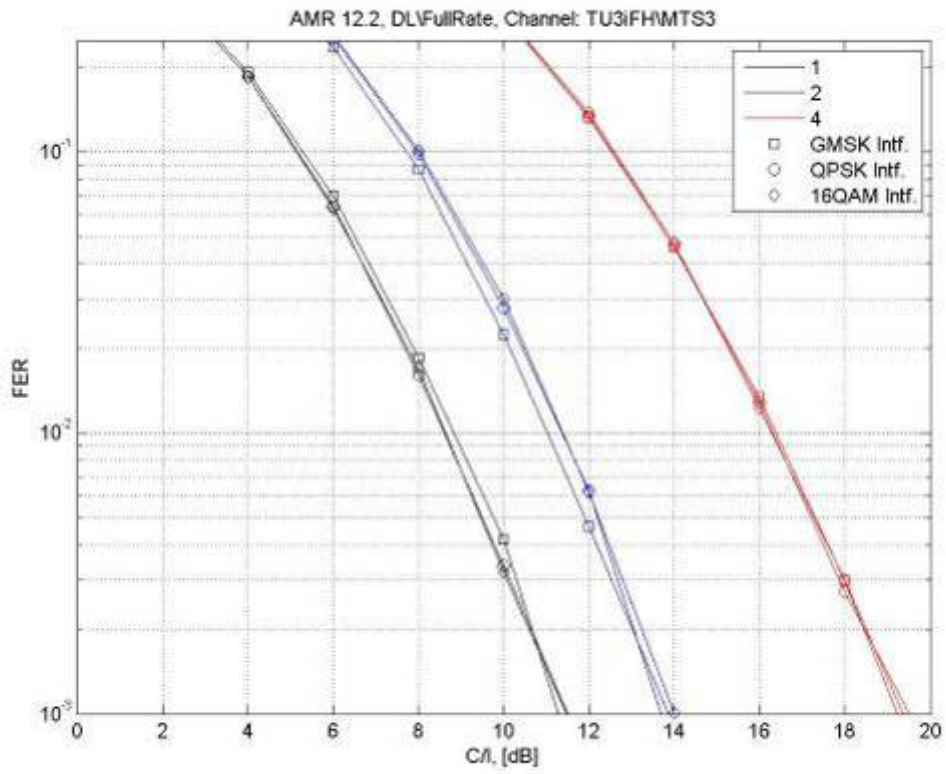

Figure 9-22: AMR 12.2 performance of multiplexed users in DL, MTS-3

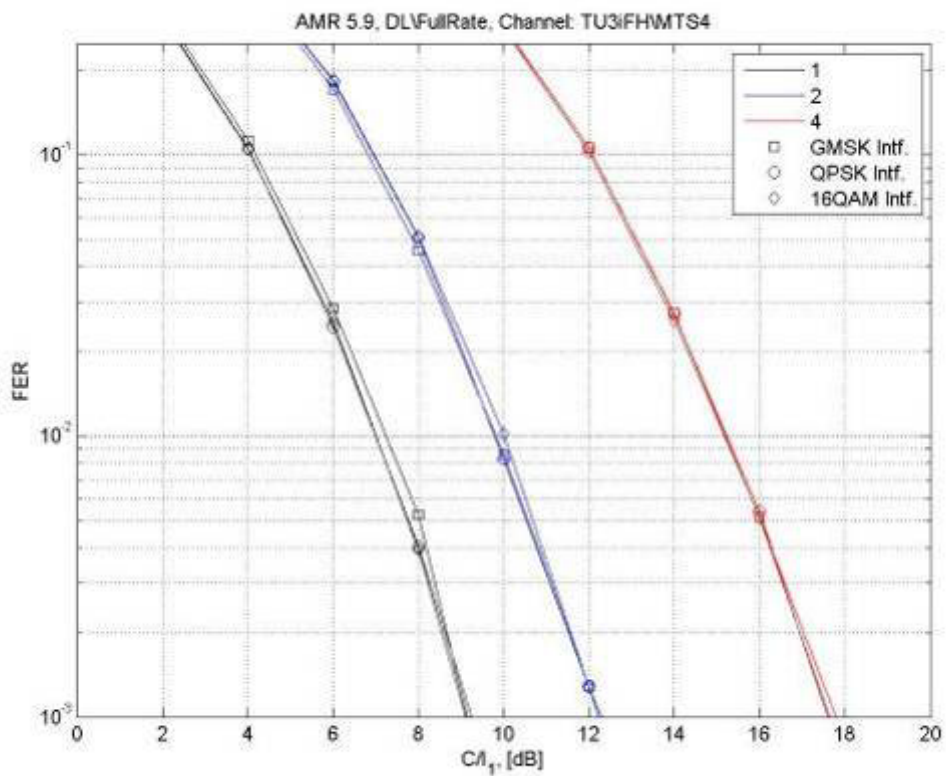

Figure 9-23: AMR 5.9 performance of multiplexed users in DL, MTS-4

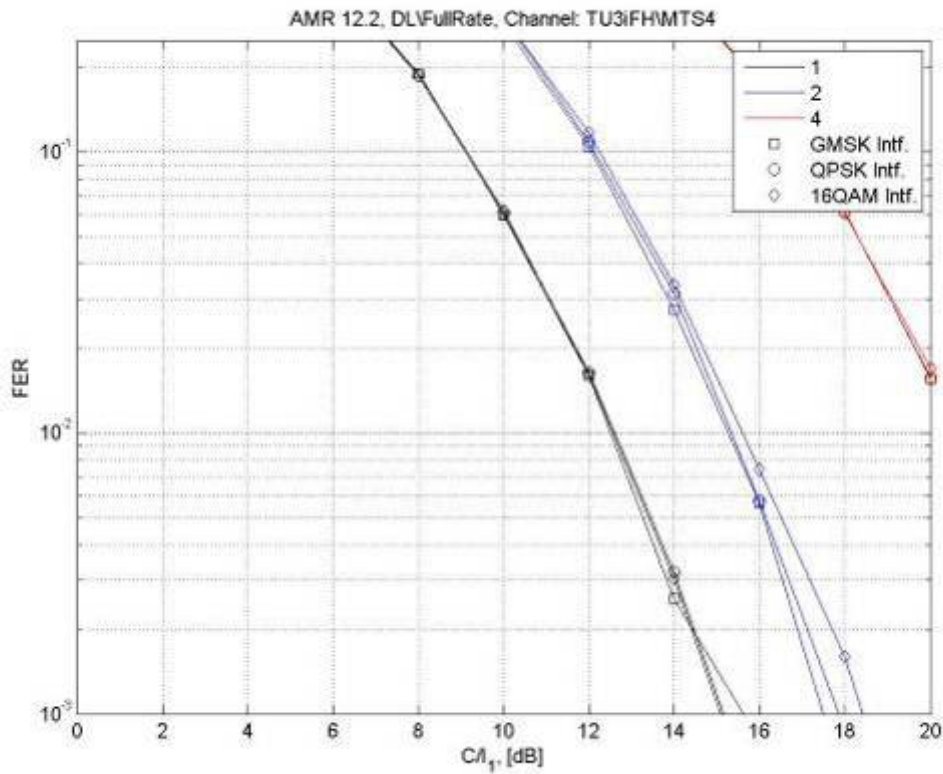

Figure 9-24: AMR 12.2 performance of multiplexed users in DL, MTS-4

9.2.1.2.3 Co-Channel Performance with Power Control

This section shows the range of power control available in the higher modulations by use of mapping the user streams to the different strength bits in the modulation constellation, as described earlier. In addition, this can also be enhanced by modification of the constellation as proposed in Section 9.1.1.7.

The following Figures are shown for the 12.2 and 5.9 AMR full rate codecs, in channel scenarios MTS-1 to MTS-4 with MUROS interference. For 2 users over QPSK, a single line is shown as both bits in the constellation are of same strength. For 3 users over 8-PSK, 2 lines are shown – 2 users are with strong bits, 1 with less strong. For 4 users over 16-QAM, 2 lines are shown – 2 users with strong bits, 2 users with less strong. Additionally, markers indicate 45.005 standard requirements where relevant. It can be seen that performance of 3 and 4 users is quite similar. It can also be seen that by simple mapping, it is possible to support speech users in conditions that are only 6dB worse than legacy speech channels.



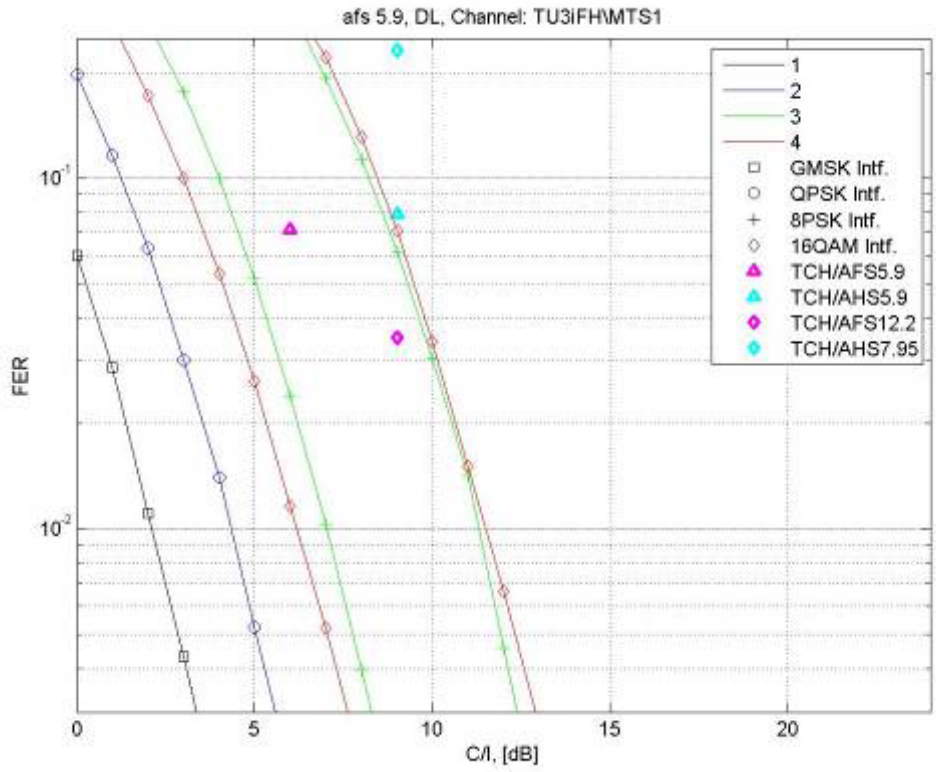

Figure 9-25: AMR 5.9 multiplexed users in DL, MTS-1/TU3iFH

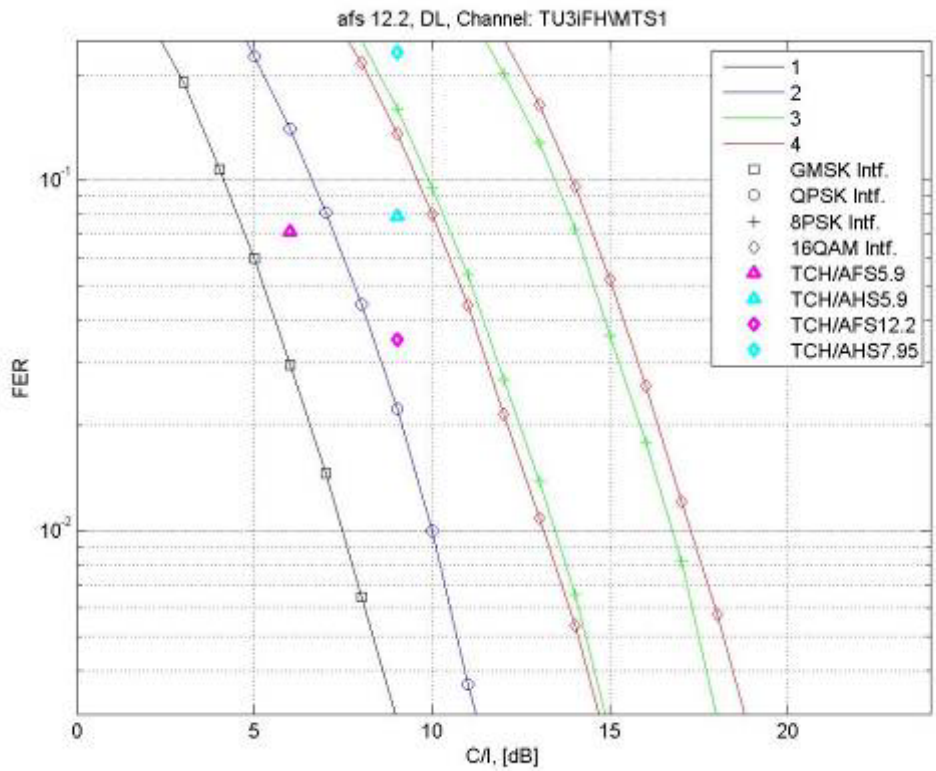

Figure 9-26: AMR 12.2 multiplexed users in DL, MTS-1/TU3iFH

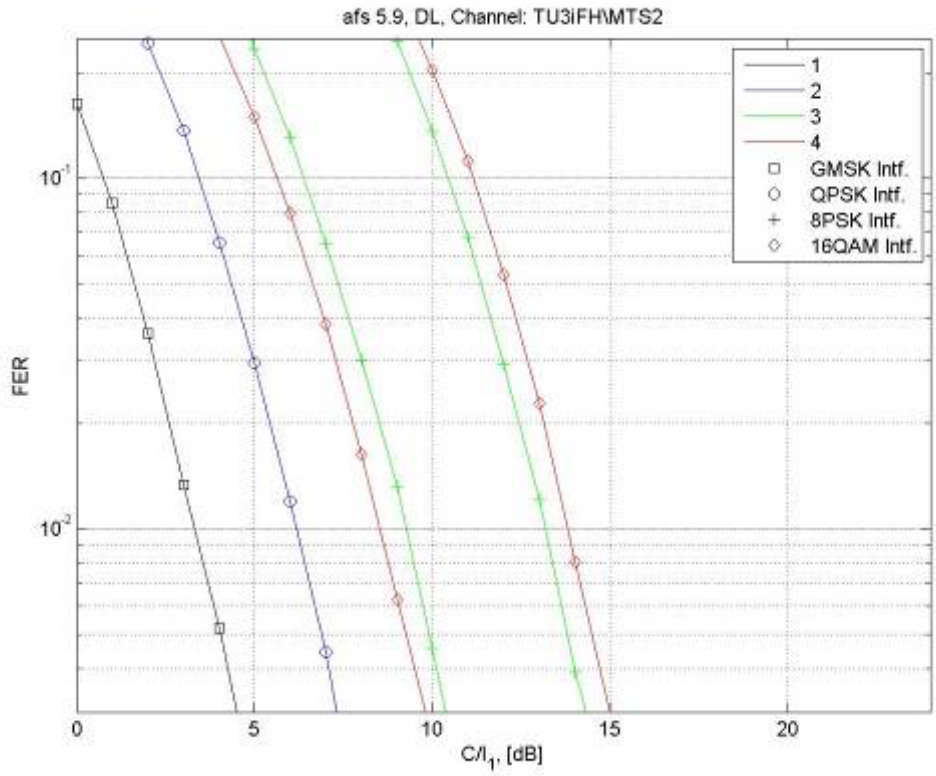

Figure 9-27: AMR 5.9 multiplexed users in DL, MTS-2/TU3iFH

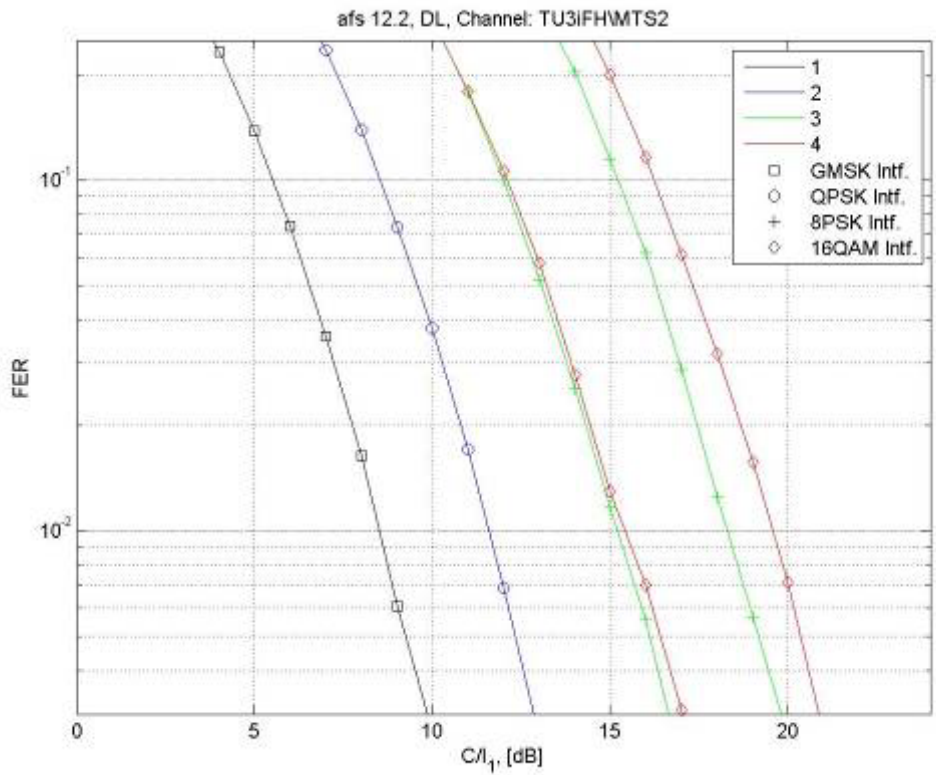

Figure 9-28: AMR 12.2 multiplexed users in DL, MTS-2/TU3iFH

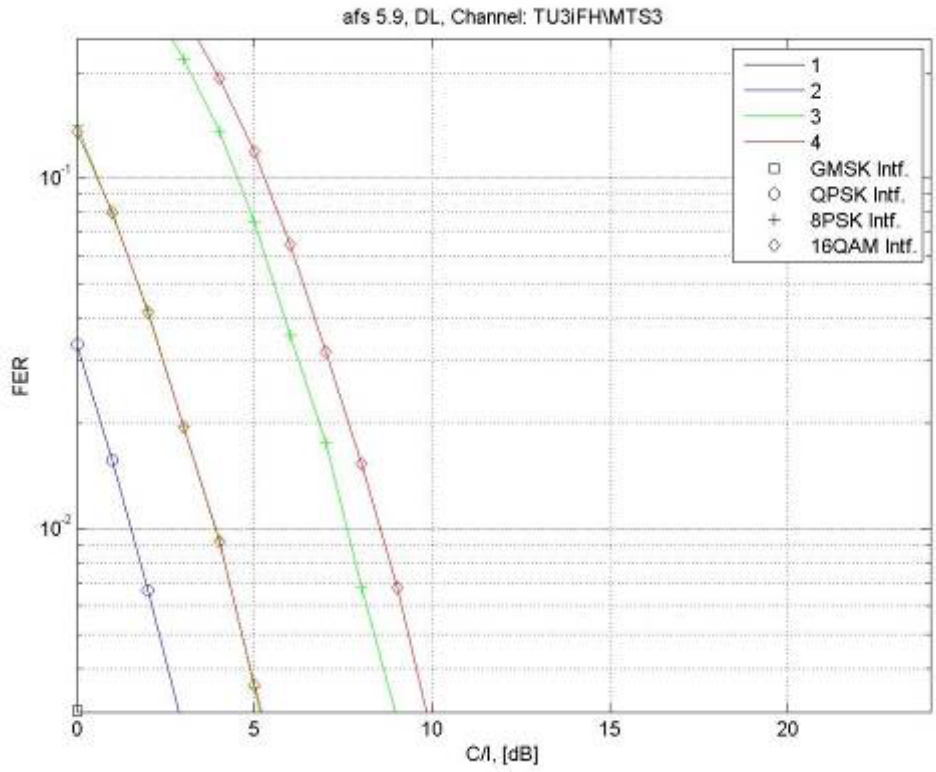

Figure 9-29: AMR 5.9 multiplexed users in DL, MTS-3/TU3iFH

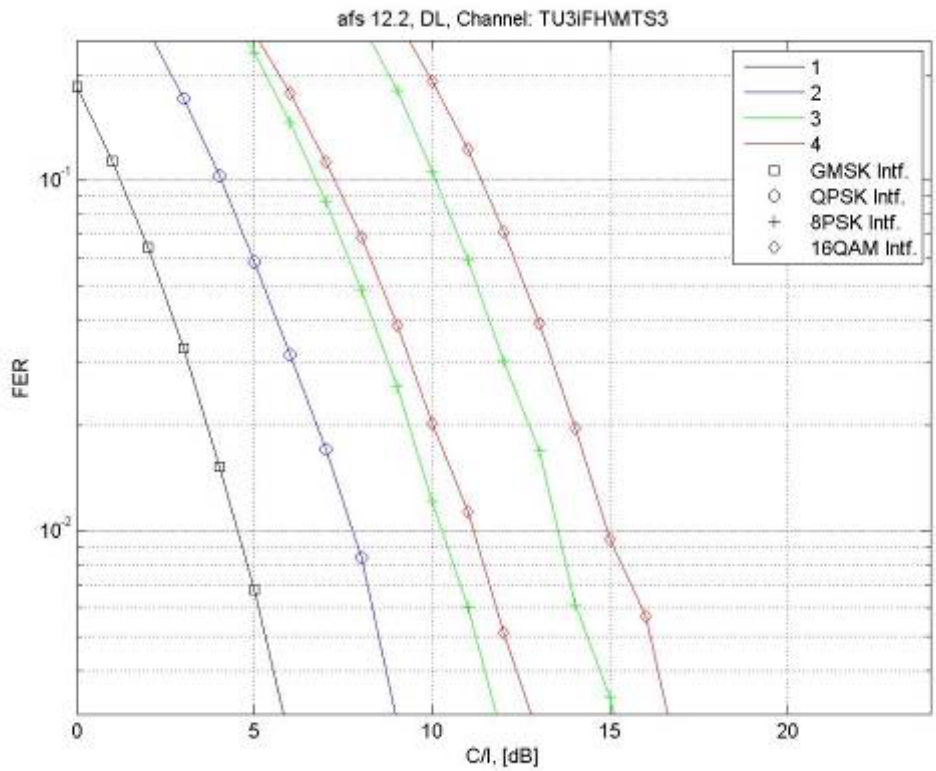

Figure 9-30: AMR 12.2 multiplexed users in DL, MTS-3/TU3iFH

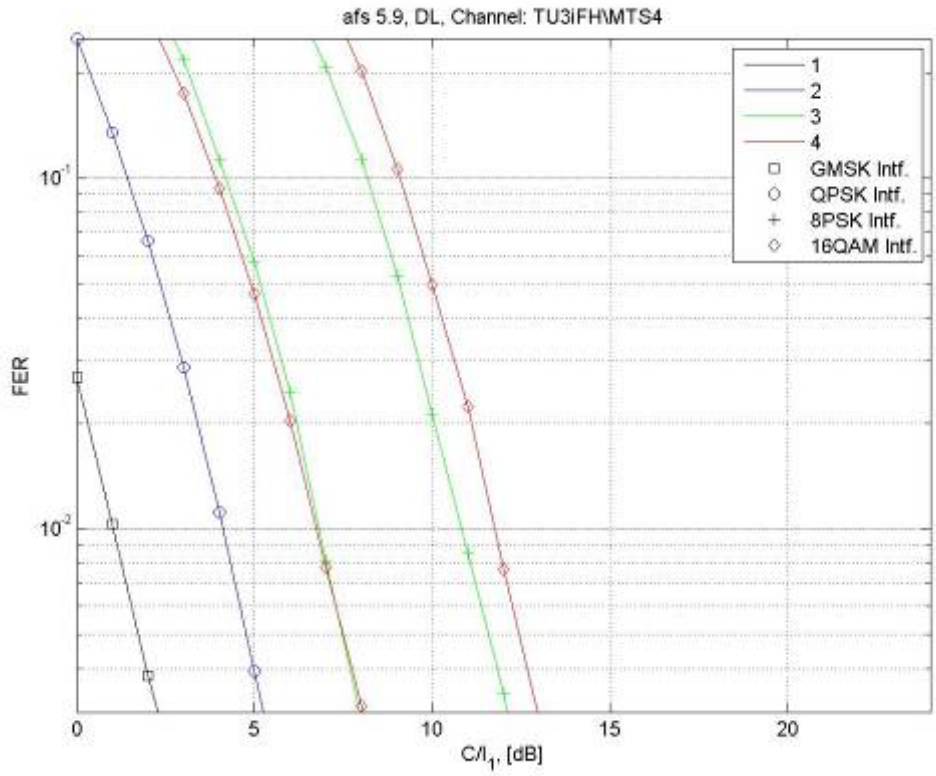

Figure 9-31: AMR 5.9 multiplexed users in DL, MTS-4/TU3iFH

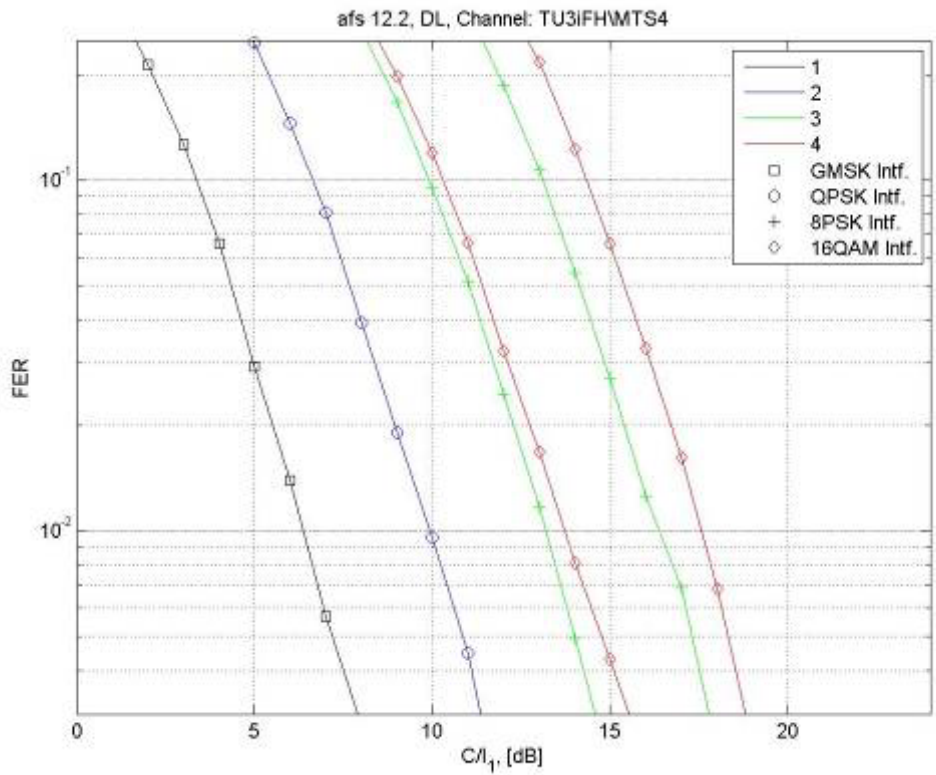

Figure 9-32: AMR 12.2 multiplexed users in DL, MTS-4/TU3iFH

### 9.2.1.3 MTS-1 to MTS-4 Performance

This section shows the performance of the different speech codecs over the defined MUROS channels, MTS-1 to MTS-4.

In each plot, the interferer performance of the speech channel is shown for relevant physical channel. Lines are shown for 1 user (black), 2 users (blue), 3 users (green) and 4 users (red). For the case of 3 and 4 co-allocated users, 2 curves are shown, corresponding to mapping of the stream to strong bits or weak bits in the modulation constellation. For 3 users, 2 streams are on strong bits, and one on weak bit stream. For 4 users, 2 users are on each of the strong and weak bits.

**Table 9-8a Simulation Assumptions for interferer performance evaluation**

Parameter	Value
Speech codec	TCH/AFS5.9, TCH/AFS12.2, TCH/AHS5.9, TCH/FS, TCH/FS, TCH/EFS
Channel profile	TU3, TU50
Frequency band	900 MHz
Frequency hopping	Ideal
Interference	MUROS interferer
No. simulated speech frames	10, 000

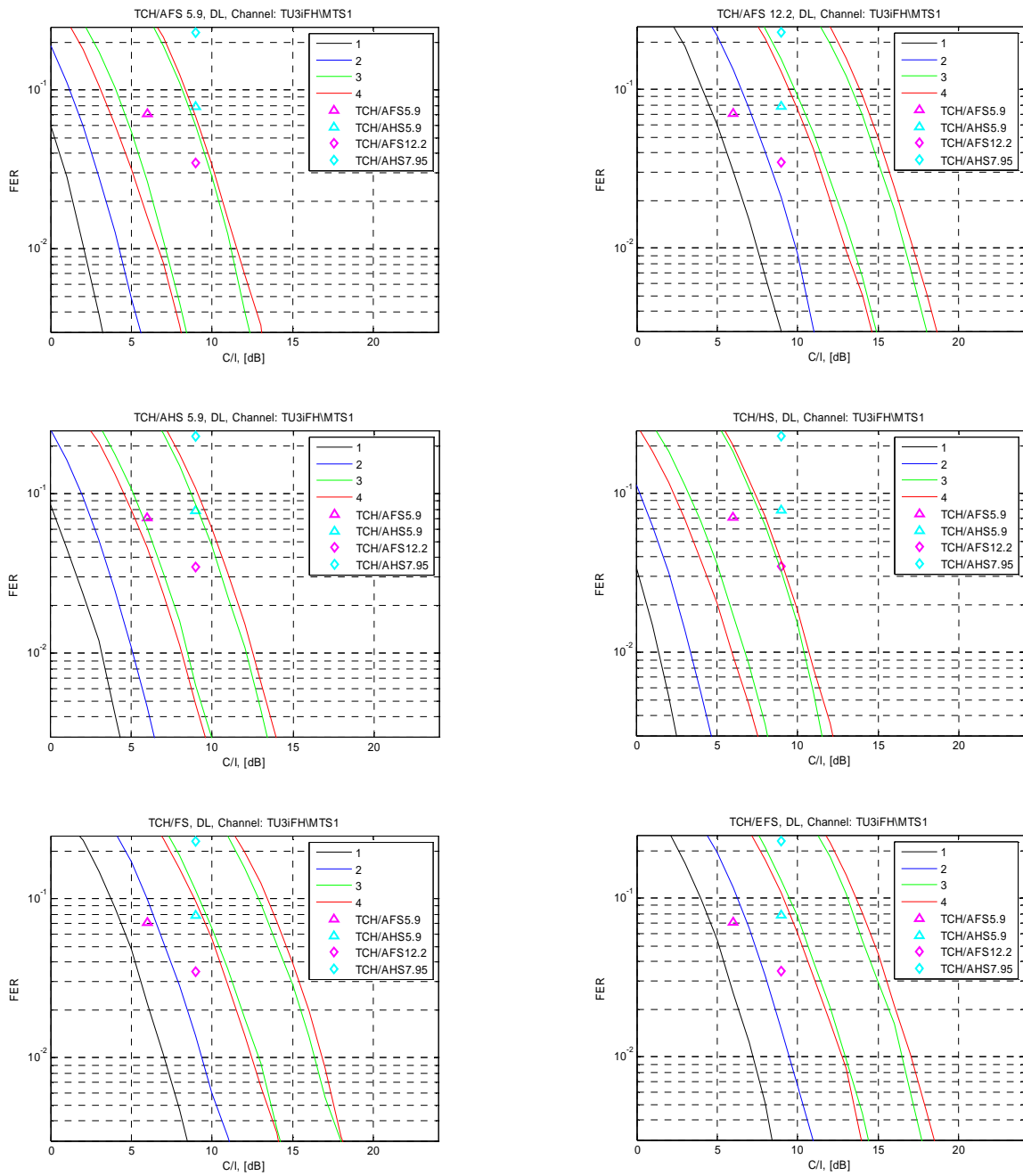

Figure 9-33: Multiplexed users in DL, MTS-1/TU3iFH

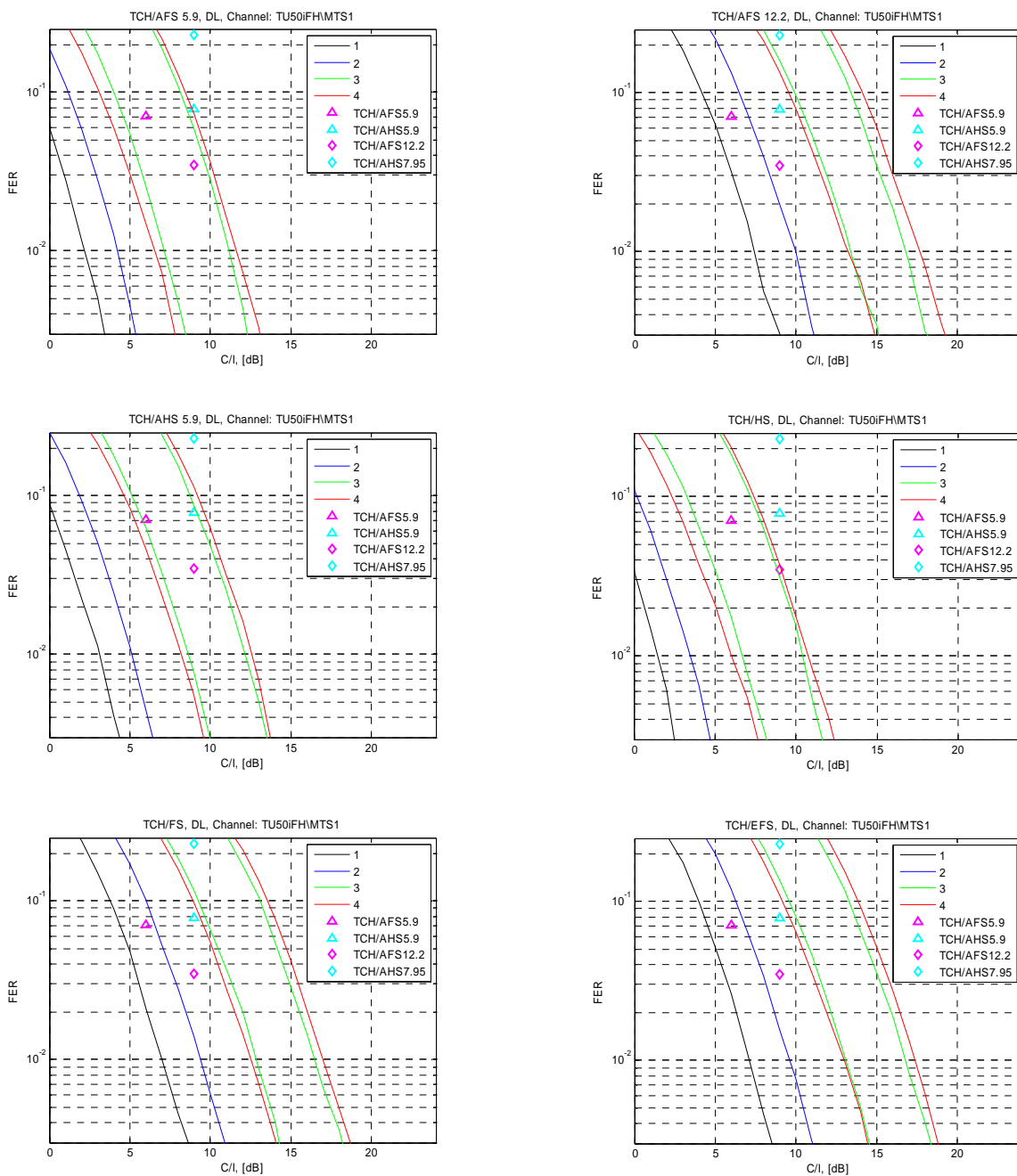

Figure 9-34: Multiplexed users in DL, MTS-1/TU50iFH

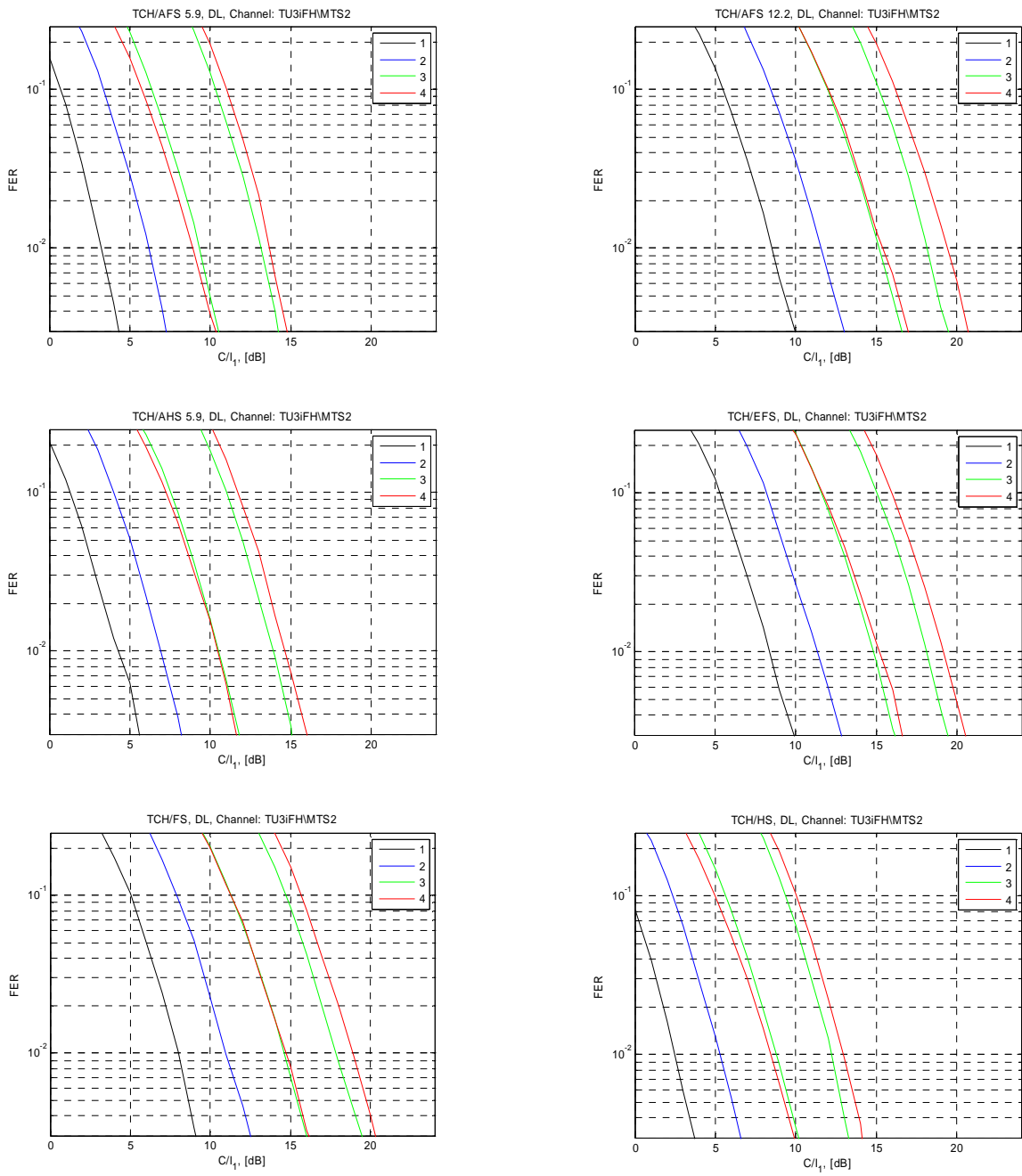

Figure 9-35: Multiplexed users in DL, MTS-2/TU3iFH



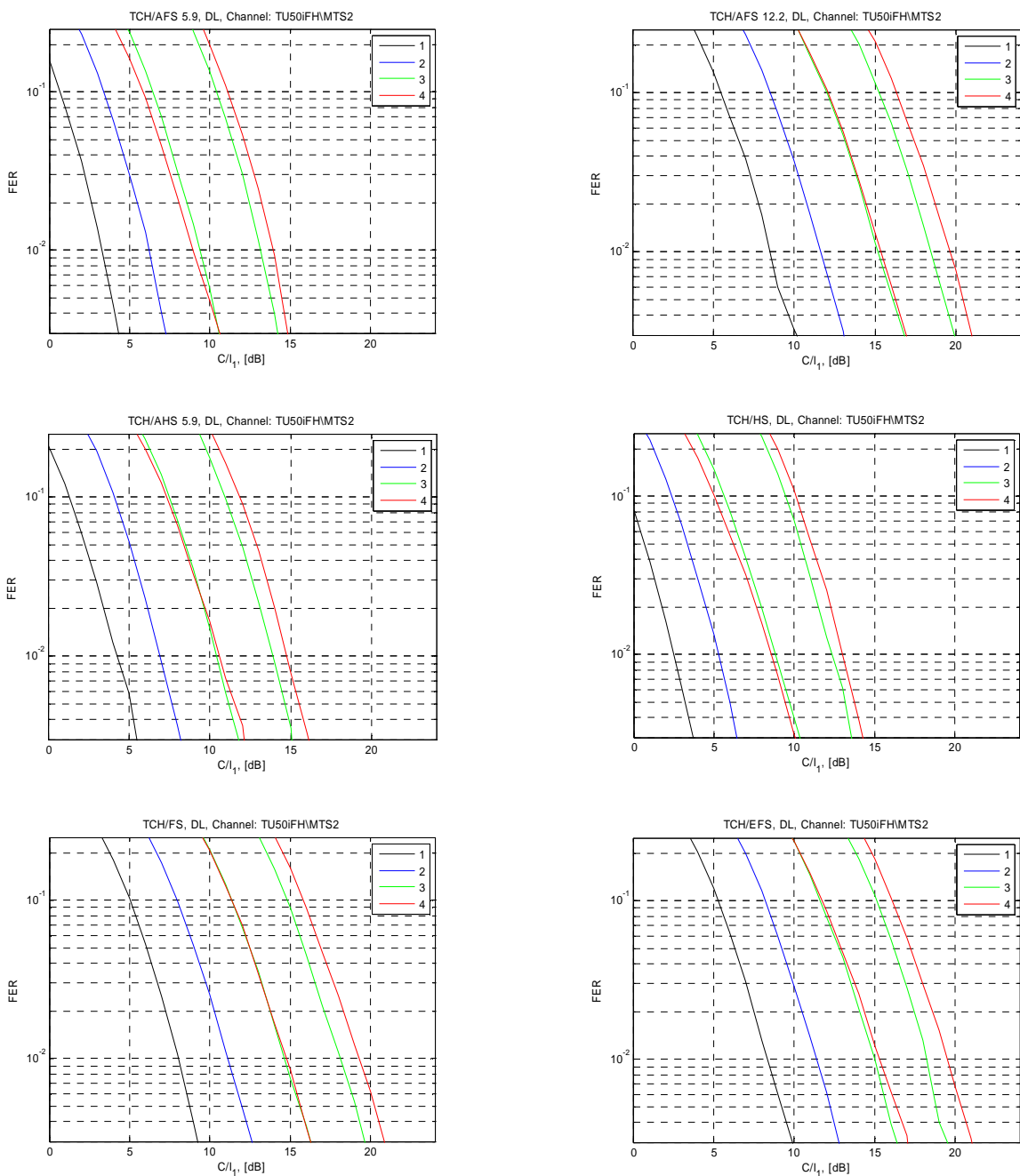

Figure 9-36: Multiplexed users in DL, MTS-2/TU50iFH

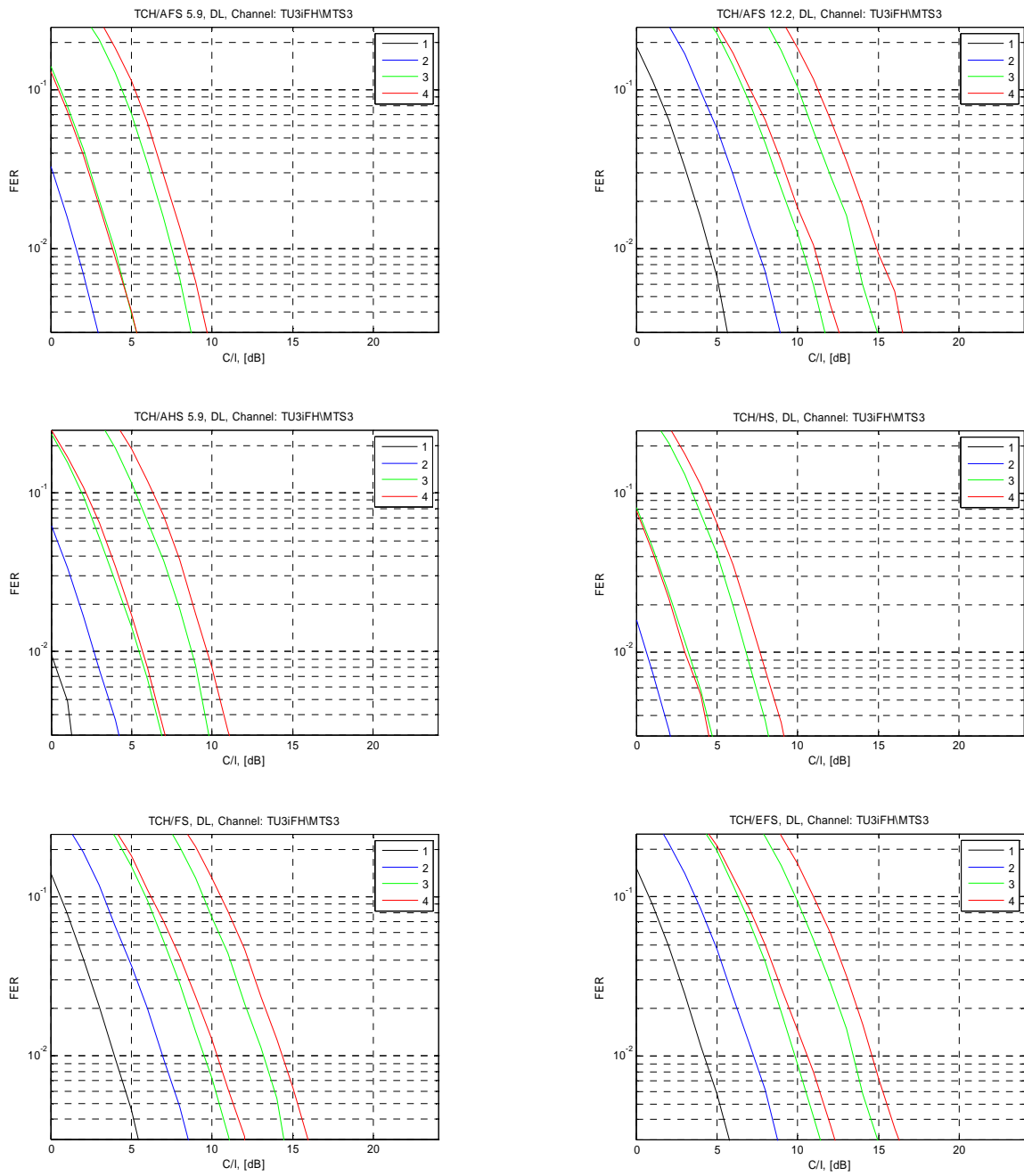

Figure 9-37: Multiplexed users in DL, MTS-3/TU3iFH

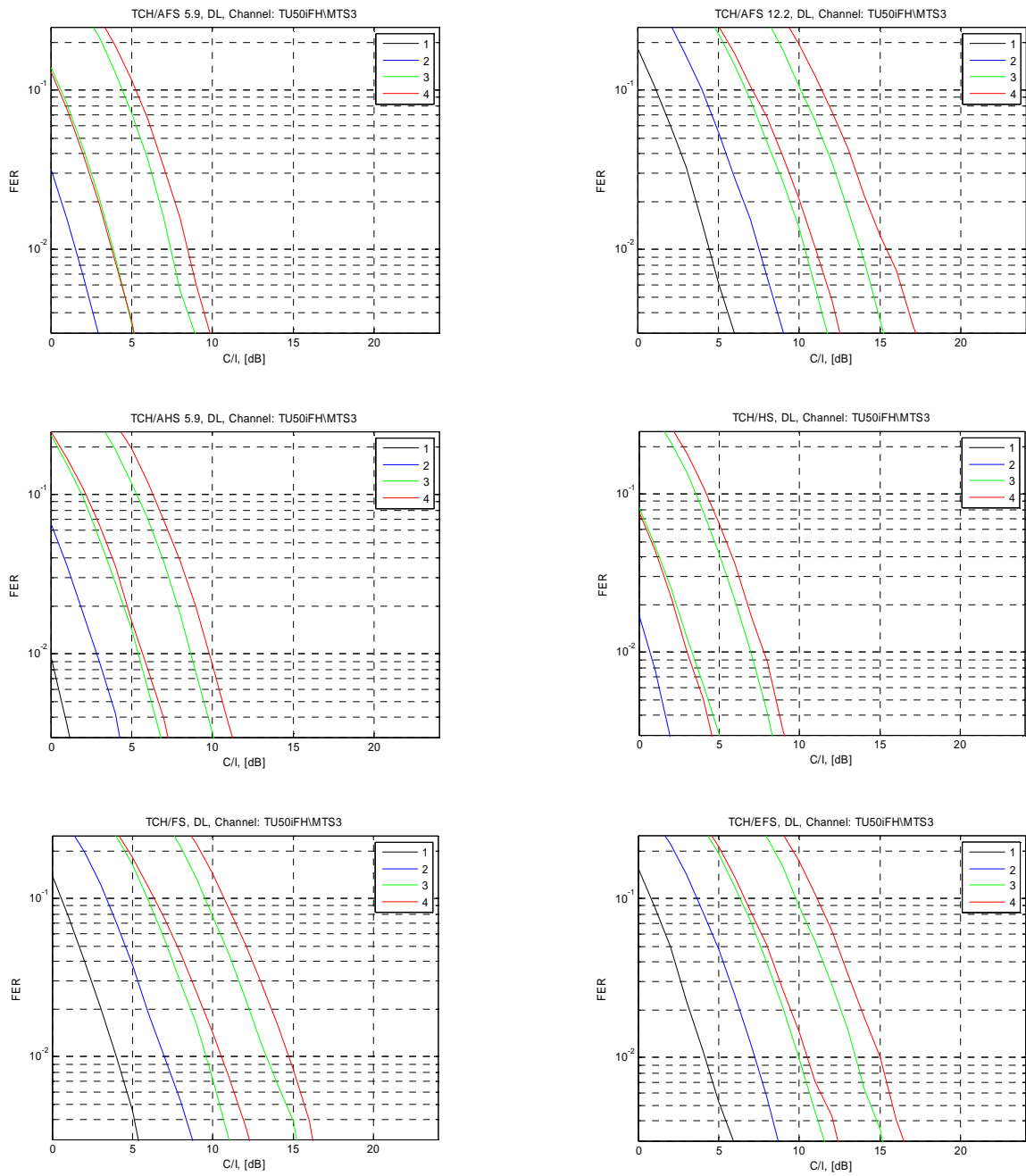

Figure 9-38: Multiplexed users in DL, MTS-3/TU50iFH

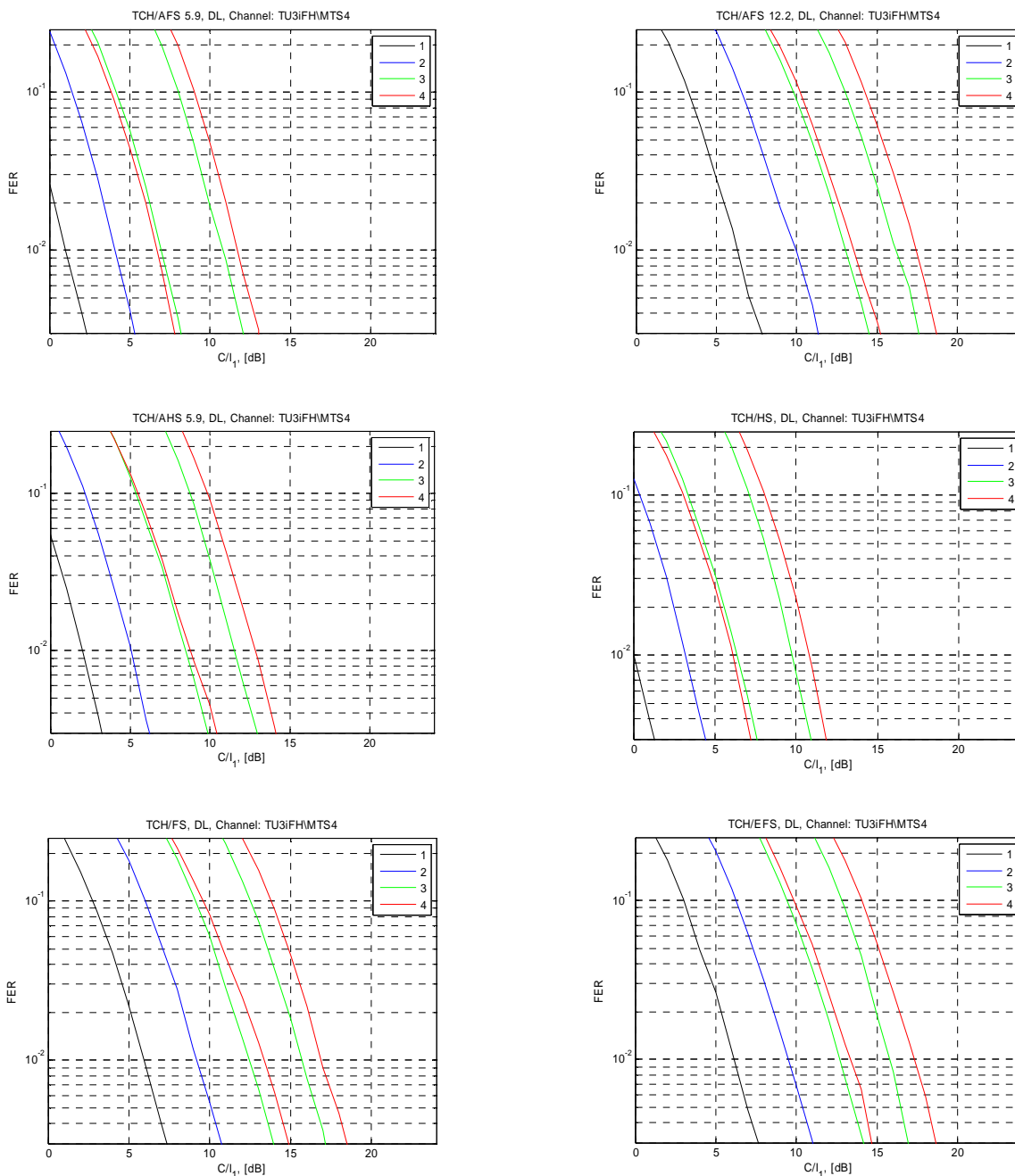

Figure 9-39: Multiplexed users in DL, MTS-4/TU3iFH

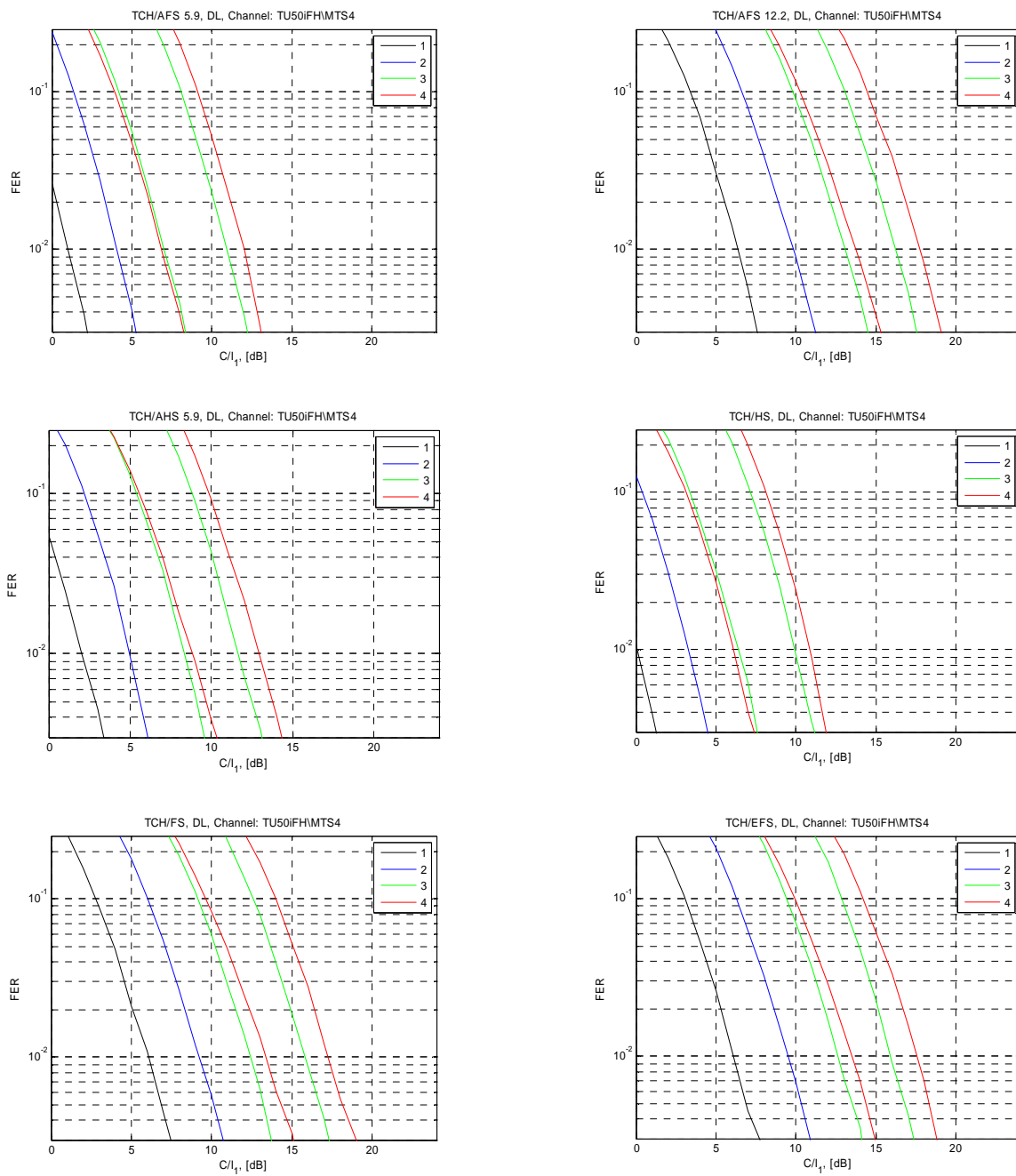

Figure 9-40: Multiplexed users in DL, MTS-4/TU50iFH

### 9.2.1.4 Adjacent Interference Performance

[to be included]

### 9.2.2 Network Level Performance

[tbd]

### 9.2.3 Verification of Link to System Mapping

This section depicts verification results for the employed Link to System mapping for this candidate technique as agreed at GERAN#41.

## 9.3 Impacts on the Mobile Station

The presented concept is compatible with legacy MSs. Legacy MS designs that already support modulations required for Release 7 require the following changes

- Support of new multiplexing schemes for multiuser speech
- Definition of new training sequences, both on downlink and uplink
- Signaling support to indicate new MS capabilities
- Modification of modulation definitions to support QPSK on uplink (at Normal Symbol Rate)

Legacy MSs that support only GMSK modulation are supported

- Multiplexing on a QPSK modulation with  $\pi/2$  constellation rotation, and use of a legacy training sequence on the sub-channel
- Multiplexing of legacy MS on dedicated timeslot

## 9.4 Impacts on the BSS

- Support of new multiplexing schemes for multiuser speech channels
- Support of QPSK Normal Symbol Rate reception
- Signaling support to indicate channel status

## 9.5 Impacts on Network Planning

There should be no impacts on network planning, as the multiplexing schemes take advantage of existing excess C/I available in current typical network layouts.

## 9.6 Impacts on the Specification

The following specification documents are expected to be updated

<u>Specification</u>	<u>Comments</u>
24.008	Capability indication for HOM/MUROS
44.018	RR support for HOM/MUROS
45.002	Definitions of multiple users on MUROS channels
45.003	Channel coding definitions to support HOMUROS
45.004	Modulation definition for QPSK on uplink; QPSK with $\pi/2$ rotation on downlink
45.005	Performance requirements for new HOM/MUROS channels
45.008	Link quality measurements

## 9.7 Summary of Evaluation versus Objectives

In this section the candidate technique is evaluated against the defined objectives in chapter 4. Note, this section represents the view of the proponents of this candidate technique.

The following classification is used for the evaluation:

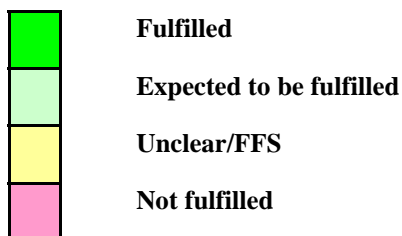

### 9.7.1 Performance Objectives

<b>Evaluation of MUROS Candidate Techniques</b>	<b>Higher Order Modulation</b>
<b>Performance Objectives</b>	
<b>P1: Capacity Improvements at the BTS</b> 1) increase voice capacity of GERAN in order of a factor of two per BTS transceiver 2) channels under interest: TCH/FS, TCH/HS, TCH/EFS, TCH/AFS, TCH/AHS and TCH/WFS	1) Network simulations have not yet been presented to show the available spectral efficiency gain  2) All codecs are supported.
<b>P2: Capacity Improvements at the air interface</b> 1) enhance the voice capacity of GERAN by means of multiplexing at least two users simultaneously on the same radio resource both in downlink and in uplink 2) channels under interest: TCH/FS, TCH/HS, TCH/EFS, TCH/AFS, TCH/AHS and TCH/WFS	1) Up to 4 users are multiplexed on the same radio resource  2) All codecs are supported.

### 9.7.2 Compatibility Objectives

<b>Evaluation of MUROS Candidate Techniques</b>	<b>Higher Order Modulation</b>
<b>Compatibility Objectives</b>	
<b>C1: Maintainance of Voice Quality</b> 1) voice quality should not decrease as perceived by the user. 2) A voice quality level better than for GSM HR should be ensured.	1) Only users experiencing good enough quality will be allocated on a multiuser channel  2) Minimum FER thresholds have been defined in the TR. Given the same FER level, the voice quality for

	any of the defined codecs exceeds that for GSM HR.
<b>C2: Support of Legacy Mobile Stations</b> 1) Support of legacy MS w/o implementation impact. 2) First priority on support of legacy DARP phase 1 terminals, second priority on support of legacy GMSK terminals not supporting DARP phase 1.	1) Legacy, DARP Phase I, mobiles can be supported on the first sub channel by 2-user allocation on a resource.
	2) Legacy non DARP Phase I terminals can be supported on the first sub channel by 2-user allocation on a resource.
<b>C3: Implementation Impacts to new MS's</b> 1) change MS hardware as little as possible. 2) Additional complexity in terms of processing power and memory should be kept to a minimum.	1) Legacy MSs supporting downlink 16-QAM (Rel-7 EGPRS2) can be multiplexed for up to 4 users on a resource. Legacy MSs supporting downlink 8-PSK can be multiplexed for up to 3 users on a resource.
	2) New multiplexing of users on timeslot data.  New QPSK training sequences (possible also to use proposed sequences).  QPSK modulation on uplink – this is a subset of 8PSK for EDGE capable MS.
<b>C4: Implementation Impacts to BSS</b> 1) Change BSS hardware as little as possible and HW upgrades to the BSS should be avoided. 2) Any TRX hardware capable for MUROS shall support legacy non-SAIC mobiles and SAIC mobiles. 3) Impacts to dimensioning of resources on Abis interface shall be minimised.	1) Legacy BTS capable of 8PSK downlink modulation allows up to 3 users multiplexed on a resource, using 16QAM. Legacy BTS capable of 16QAM downlink modulation (already supported on by Rel 7 EDGE2), allows up 4 users multiplexed on a resource.  New QPSK training sequences on uplink.  New multiplexing of users on timeslot data  Demodulation of two simultaneous signals is needed.
	2) The concept has no impact on the support of different types of mobiles for the TRX
	3) Impact is to reserve a higher number of sub channels on Abis interface and possibly use another packet Abis technology.
<b>C5: Impacts to Network Planning</b> 1) Impacts to network planning and frequency reuse shall be minimised. 2) Impacts to legacy MS interfered on downlink by the MUROS candidate technique should be avoided in case of usage of a wider transmit pulse shape on downlink. 3) Furthermore investigations shall be dedicated into the usage at the band edge, at the edge of an operator's band allocation and in country border regions where no frequency coordination are in place.	1) No impact on frequency planning or frequency re-use is foreseen.
	2) Impacts on legacy MS reception for optimised TX pulse shape would require further investigation
	3) Optimised TX pulse shape is not expected to be used at band edge or at the edge of an operator's allocation.

## 9.8 References

- [9-1] GP-072033, "WID: Multi-User Reusing-One-Slot (MUROS)," China Mobile et al
- [9-2] GP-071792, "Voice Capacity Evolution with Orthogonal Sub Channels ," Nokia Siemens Networks, Nokia
- [9-3] GP-071738, "Speech capacity enhancements using DARP," Qualcomm



- [9-4] GP-062488, “New WID on reduced symbol duration, higher order modulation and turbo coding (RED HOT) for downlink,” Ericsson et al
- [9-5] GP-061478, “WID: Higher Uplink Performance for GERAN Evolution (HUGE),” Nokia et al
- [9-6] GP-062124, “Assessment of HOT performance based on EGPRS performance in live networks,” Ericsson
- [9-7] “Higher Order Modulations for MUROS – Concept Description”, Telco#1 on MUROS, Marvell
- [9-8] GP-080636, “Frequency Hopping Schemes for MUROS,” source Ericsson
- [9-9] GP-080114, “Adaptive Symbol Constellation for MUROS”, source Ericsson
- [9-10] 3GPP TS 45.005, “Radio Transmission and Reception,” Release 7, version 7.13.0
- [9-11] GP-081053, “On Training Sequences for MUROS,” source Research in Motion

## 10 New Training Sequences

A number of candidate techniques using a new set of training sequences were proposed for speech capacity enhancement under MUROS study item. In total 7 different sets of new training sequences were proposed. These are enumerated in this section.

### 10.1 Training sequence candidates proposed

#### 10.1.1 TSC Set proposed by Nokia [10-1]

**Table 10-1: Nokia candidate training sequence symbols**

TSC#	Training sequence
0	1 1 -1 1 -1 -1 1 -1 -1 -1 1 -1 -1 -1 1 -1 1 1 1 -1 -1 -1 -1 1 -1 -1
1	1 1 1 -1 1 1 1 -1 -1 -1 -1 1 -1 1 1 -1 1 1 1 -1 1 1 1
2	1 -1 -1 -1 1 -1 1 1 -1 1 1 1 1 -1 1 1 1 -1 1 1 1 -1 -1 -1 -1 1
3	1 -1 1 1 1 -1 1 1 1 -1 -1 -1 1 1 1 1 -1 1 -1 -1 1 -1 -1 -1 1 -1
4	1 -1 1 1 1 -1 1 -1 -1 1 1 1 1 -1 1 -1 -1 1 1 1 -1 1 1 1 1 1
5	1 -1 1 -1 -1 -1 -1 -1 1 1 -1 1 1 -1 -1 -1 1 1 -1 1 -1 1 1 1 1 1
6	1 -1 -1 -1 1 -1 -1 -1 -1 1 1 -1 1 -1 -1 -1 -1 1 1 -1 1 1 1 -1 1 -1
7	1 1 -1 1 -1 1 -1 -1 1 1 -1 -1 -1 -1 -1 -1 1 1 -1 -1 -1 -1 1 -1 1 -1

### 10.1.2 TSC Set proposed by Motorola [10-2]

**Table 10-2: Motorola candidate training sequence symbols**

TSC#	Training sequence
0	-1 -1 1 1 1 -1 1 -1 -1 -1 -1 1 -1 -1 1 -1 -1 -1 1 1 1 -1 1 -1 -1 -1
1	1 1 -1 1 -1 -1 -1 1 1 1 -1 1 1 -1 1 1 1 -1 1 -1 -1 -1 1 1 1
2	-1 1 -1 -1 -1 -1 1 -1 -1 1 -1 -1 -1 1 1 1 -1 1 -1 -1 -1 -1 1 -1 -1 1
3	1 -1 1 1 -1 1 1 1 1 -1 1 -1 -1 -1 1 1 1 -1 1 1 -1 1 1 1 1 -1
4	1 1 -1 1 1 1 -1 1 1 -1 1 -1 -1 -1 -1 1 1 1 -1 1 1 1 -1 1 1 -1
5	-1 -1 -1 -1 1 -1 1 1 -1 1 1 1 -1 1 1 1 -1 -1 -1 -1 1 -1 1 1 -1 1
6	1 -1 1 1 1 -1 1 1 1 -1 -1 -1 -1 1 -1 1 1 -1 1 1 1 -1 1 1 1 -1
7	-1 -1 -1 1 1 1 -1 1 1 -1 1 -1 -1 -1 1 -1 -1 -1 -1 1 1 1 -1 1 1 -1

### 10.1.3 TSC Set proposed by China Mobile [10-3]

**Table 10-3: China Mobile candidate training sequence symbols**

TSC#	Training sequence
0	1 1 1 -1 -1 -1 1 -1 -1 1 -1 1 -1 -1 1 -1 1 1 -1 -1 -1 1 -1 -1 1
1	1 -1 -1 -1 -1 -1 -1 -1 1 -1 1 1 1 -1 -1 1 1 -1 -1 -1 -1 -1 -1 1 -1
2	1 1 1 -1 -1 -1 1 -1 -1 1 -1 -1 1 -1 1 1 1 -1 -1 -1 1 -1 -1 1
3	-1 -1 -1 1 -1 -1 1 -1 -1 -1 1 1 1 -1 1 -1 -1 -1 -1 1 -1 -1 1 -1 -1
4	-1 -1 1 -1 -1 -1 1 -1 -1 1 -1 1 1 1 -1 -1 -1 1 -1 -1 -1 1 -1 -1 1
5	1 -1 -1 -1 1 -1 1 1 1 1 -1 1 1 -1 1 1 1 -1 -1 -1 1 -1 1 1 1 1
6	-1 -1 -1 -1 -1 -1 1 -1 -1 1 -1 1 -1 1 1 1 -1 -1 -1 -1 -1 -1 1 -1 -1 1
7	1 -1 -1 -1 -1 -1 -1 1 -1 -1 -1 1 1 1 -1 1 1 -1 -1 -1 -1 -1 -1 1 -1 -1

### 10.1.4 TSC Set proposed by Research in Motion Ltd [10-4]

**Table 10-4: Research in Motion Ltd candidate training sequence symbols**

TSC#	Training sequence
0	1 1 1 -1 1 1 1 1 -1 1 1 -1 -1 1 -1 1 -1 1 1 1 -1 -1 -1 -1 1 1
1	1 -1 -1 -1 -1 -1 1 -1 1 1 1 1 -1 1 1 -1 -1 1 1 1 -1 1 -1 -1 -1 -1
2	1 1 -1 1 -1 1 1 -1 1 1 1 1 1 1 -1 -1 1 1 1 -1 1 -1 -1 -1 1 -1
3	1 -1 -1 -1 1 -1 -1 1 1 1 -1 -1 -1 -1 -1 -1 1 1 -1 1 -1 1 1 -1 -1 1
4	1 -1 -1 1 1 1 -1 1 1 -1 -1 1 -1 1 -1 1 1 -1 -1 -1 -1 -1 -1 1 1 -1
5	1 1 1 -1 -1 1 1 1 1 1 -1 1 -1 1 1 1 1 -1 -1 1 1 -1 1 -1 -1 -1
6	1 1 -1 -1 1 -1 -1 -1 -1 1 -1 1 -1 -1 -1 -1 -1 1 1 1 -1 1 1 -1 -1 1
7	1 1 -1 1 -1 -1 1 1 -1 -1 -1 -1 -1 -1 1 1 -1 -1 -1 -1 1 -1 1 -1 1 1

### 10.1.5 TSC Set proposed by Telefon AB LM Ericsson [10-5]

**Table 10-5: Telefon AB LM Ericsson Proposed training sequence symbols**

TSC#	Training sequence
0	1 -1 1 1 1 1 1 1 -1 1 1 -1 1 -1 -1 -1 1 1 1 -1 1 1 -1 -1 -1 1
1	-1 1 -1 -1 -1 1 1 -1 1 -1 1 -1 -1 -1 -1 -1 1 -1 1 1 -1 -1 1 1 1 1
2	1 1 1 -1 -1 -1 1 1 -1 -1 -1 -1 -1 -1 1 -1 1 -1 1 1 -1 -1 1 -1 -1 1
3	-1 -1 1 -1 1 1 -1 -1 1 -1 -1 -1 1 1 -1 -1 -1 -1 1 -1 1 -1 1 1 1 1
4	1 1 1 -1 1 1 -1 1 1 1 -1 1 -1 1 1 1 1 -1 -1 1 -1 -1 -1 -1 1 1
5	1 -1 -1 -1 1 1 -1 1 1 1 -1 -1 -1 1 -1 1 1 -1 1 1 1 1 1 1 -1 1
6	-1 -1 -1 -1 1 -1 1 1 1 1 -1 -1 1 -1 1 -1 -1 -1 1 -1 -1 1 -1 -1 -1 1
7	-1 1 1 1 -1 1 -1 1 1 1 -1 1 1 -1 1 -1 1 1 -1 -1 -1 -1 -1 -1 1 1

### 10.1.6 TSC Set proposed by Huawei Technologies Ltd [10-6]

**Table 10-6: Huawei Technologies Proposed training sequence symbols**

TSC#	Training sequence
0	-1 1 -1 1 1 1 -1 1 1 1 1 -1 1 -1 -1 1 1 1 1 -1 -1 -1 1 -1 -1 1
1	1 1 1 1 1 -1 1 1 1 -1 -1 1 -1 -1 1 1 1 -1 -1 1 -1 1 -1 -1 -1 -1
2	1 -1 -1 -1 1 -1 1 -1 -1 1 1 1 1 1 1 -1 -1 1 1 1 -1 1 -1 1 1 -1
3	1 -1 1 -1 1 1 1 1 1 -1 -1 1 -1 1 1 1 1 -1 -1 1 -1 -1 -1 1 -1 1
4	1 -1 -1 -1 1 1 -1 1 1 1 1 1 -1 1 -1 1 1 1 1 1 -1 -1 1 -1 1 -1
5	1 -1 -1 1 1 1 1 -1 1 1 -1 -1 1 -1 1 1 -1 -1 -1 -1 -1 1 -1 1
6	-1 1 1 1 -1 1 1 1 -1 1 -1 -1 -1 -1 1 1 -1 1 -1 -1 1 -1 -1 1 1
7	-1 1 1 1 -1 1 1 -1 -1 -1 -1 -1 1 -1 1 -1 -1 -1 -1 -1 1 -1 -1 1 1 1

### 10.1.7 TSC Set-2 proposed by Research in Motion Ltd [10-7]

**Table 10-7: Research in Motion Ltd candidate training sequence symbols-2**

TSC#	Training sequence
0	1 -1 -1 1 1 1 -1 1 1 1 -1 1 1 -1 1 1 -1 -1 -1 1 -1 1 -1 -1 -1
1	1 -1 1 -1 -1 -1 -1 1 -1 1 1 -1 -1 1 -1 -1 -1 1 -1 -1 1 1 1 -1
2	1 -1 1 1 1 1 1 -1 1 -1 -1 1 1 1 -1 -1 -1 1 -1 -1 -1 1 -1 -1 1
3	1 1 -1 1 -1 -1 1 -1 -1 -1 1 -1 -1 -1 1 1 -1 -1 -1 1 -1 1 1 1
4	1 -1 -1 -1 1 -1 1 1 -1 -1 -1 -1 1 -1 1 1 -1 -1 -1 1 -1 -1 -1 -1 1
5	1 -1 1 1 1 1 1 -1 1 1 -1 -1 1 -1 1 1 -1 -1 -1 -1 1 1 -1 -1
6	1 1 1 -1 1 1 1 1 -1 -1 1 -1 1 1 1 1 -1 -1 1 -1 -1 1 -1 -1
7	1 -1 1 1 1 -1 1 -1 -1 -1 1 1 -1 -1 -1 -1 -1 1 1 -1 1 -1 1 -1

### 10.1.8 TSC Set-2 proposed by Huawei Technologies Ltd [10-8]

**Table 10-8: Huawei Technologies Ltd candidate training sequence symbols-2**

TSC#	New Training Sequences
0	1 -1 -1 1 1 1 1 1 -1 1 1 1 -1 -1 1 1 -1 1 1 1 -1 -1 -1 -1 -1 1 1 -1 1
1	-1 1 1 1 1 -1 1 1 1 -1 -1 -1 -1 -1 1 1 -1 1 1 -1 -1 -1 -1 -1 1 1 -1 1 1 1 1
2	1 -1 -1 -1 1 1 -1 1 1 -1 -1 1 1 1 1 1 1 1 -1 -1 1 1 1 1 -1 1 1 1 1 -1
3	-1 1 1 1 1 -1 1 1 1 1 -1 1 1 -1 -1 -1 -1 1 1 1 -1 1 1 -1 -1 1 1 -1 1 1 1
4	1 -1 1 -1 1 1 1 1 1 1 -1 -1 1 -1 1 1 1 1 1 -1 -1 1 -1 -1 -1 1 1 -1 1
5	1 1 1 1 1 1 -1 1 1 1 1 -1 -1 1 1 -1 -1 1 1 1 1 -1 -1 1 -1 1 1 -1 -1 -1
6	1 -1 -1 -1 1 1 1 -1 1 1 1 1 1 1 1 -1 1 1 -1 1 1 1 1 1 -1 -1 1 1 -1 1 -1
7	-1 1 -1 1 1 1 1 -1 1 1 1 1 1 -1 1 1 -1 -1 1 1 1 1 1 -1 -1 -1 1 1 -1 1 1

10.1.9  
TSC  
Set-2  
propos  
ed by  
Motorol  
a [10-9]

**Table 10-9: Motorola candidate training sequence symbols-2**

TSC#	Motorola Proposed TSC Symbols
0	+1 -1 -1 +1 +1 +1 +1 +1 +1 -1 +1 +1 -1 -1 +1 -1 +1 +1 -1 -1 -1 +1 -1 +1 +1
1	+1 +1 +1 -1 -1 -1 -1 +1 -1 +1 +1 -1 +1 +1 -1 -1 -1 +1 -1 -1 -1 +1 -1 -1 -1 +1
2	+1 -1 -1 -1 -1 +1 -1 -1 +1 -1 -1 -1 -1 +1 +1 -1 -1 -1 +1 -1 +1 -1 +1 +1 -1 -1
3	+1 +1 -1 +1 +1 +1 -1 +1 +1 +1 -1 +1 +1 -1 -1 -1 +1 +1 +1 -1 +1 -1 -1 +1 -1
4	+1 -1 +1 +1 +1 -1 +1 -1 -1 +1 +1 +1 +1 -1 +1 -1 -1 +1 +1 +1 -1 +1 +1 +1 +1
5	+1 -1 -1 +1 +1 +1 +1 -1 +1 +1 -1 -1 +1 -1 +1 -1 +1 -1 -1 -1 -1 -1 +1 -1 -1
6	-1 -1 -1 +1 -1 -1 -1 -1 +1 +1 -1 +1 -1 -1 -1 -1 +1 +1 -1 +1 +1 +1 -1 +1 -1 +1
7	+1 +1 -1 +1 +1 +1 -1 +1 -1 -1 -1 +1 +1 -1 -1 -1 -1 -1 -1 -1 +1 +1 -1 +1 -1 -1 +1

## 10.2 Training sequence evaluation and selection

The criteria for selection of TSC's were agreed at GERAN#39:

- Legacy TSC is used on 1st subchannel
- New proposed TSC is used on 2nd subchannel
- Performance of TSC pairs is evaluated
- Restriction to single interferer scenario MTS-1 with the interferer either using GMSK or MUROS modulation type.
- Both DL and UL will be evaluated.

- Evaluate in addition the cross correlation performance of new TSC's whilst the evaluation method is left open <sup>7</sup>

At GERAN 1 Adhoc on EGPRS2/WIDER/MUROS following agreements were achieved:

- fixed pairs will be used for the training sequence evaluation. There was no agreement to standardise training sequence pairs.
- newly proposed TRS sets will be included in the TR but without corresponding performance simulation results (in order not to overload the TR).
- selection could wait until after a WI is opened.
- no new proposal for new training sequences will be accepted from this point in time, unless it was shown to provide a significant performance improvement of (~0.5 dB).

At MUROS telco#7 following agreements were achieved:

- Contributions can be provided by companies to check the cross correlation properties of unpaired sequences at GERAN#40.
- Voting will be used at GERAN#40 to select the best sequence among the candidate sets.

At GERAN#40 it was agreed to freeze the work related to the evaluation of the best TSC set, until a work item is started. Hence further training sequence evaluation as well as final selection of the TSC set will take place within the successive work item VAMOS.

At GERAN#41 an offline session on further proceeding related to the TSC evaluation work was held [10-10]. In the following GERAN working group 1 meeting it was agreed that the proposed candidate in section 10.1.7 (RIM-2) is selected for VAMOS.

## 10.3 References

- [10-1] GP-070214, "Voice Capacity Evolution with Orthogonal Sub Channel", source Nokia, TSG GERAN #33
- [10-2] GP-080602, "MUROS Intra-Cell Interference and TSC Design", source Motorola, TSG GERAN #38
- [10-3] GERAN Telco #5 on MUROS, "New series of training sequence codes for MUROS", source China Mobile
- [10-4] GP-081053, "On Training Sequences for MUROS", source Research in Motion Ltd, TSG GERAN #39
- [10-5] GP-081134, "Training Sequence Evaluation for MUROS", source Telefon AB LM Ericsson, TSG GERAN #39
- [10-6] "Training Sequences for MUROS", GERAN Telco #6 on MUROS, source Huawei Technologies Ltd
- [10-7] "Evaluation of Training Sequences for MUROS", GERAN Telco #6 on MUROS, source Research in Motion Ltd
- [10-8] AHG1-080133, "On the MUROS TSC Design", GERAN 1 Adhoc on EGPRS2/WIDER/MUROS, source Motorola
- [10-9] AHG1-080079, "Training Sequences for MUROS", GERAN 1 Adhoc on EGPRS2/WIDER/MUROS, source Huawei Technologies Ltd
- [10-10] GP-090473, "Summary of Offline Session on TSC Evaluation for VAMOS (Revision 1)", source WI Rapporteur, 3GPP GERAN#41

---

<sup>7</sup> This additional criterion has been defined in MUROS telco #6 [10-8].

# 11 Associated Control Channel Design

## 11.1 Shifted SACCH

### 11.1.1 Concept Description

The TDMA frame mapping on the second MUROS sub channel is rearranged so that the allocation of the SACCH frame does not collide with that in the first MUROS sub channel where legacy TDMA frame mapping is applied. This can be done both for a full rate channel and for a half rate channel. The new mapping on one MUROS sub channel should be kept once assigned, regardless of the state of the pairing MUROS sub channel.

One approach of designing the new mapping is to simply swap the SACCH frame with a specific TCH frame within a 26-multiframe. To minimize the impacts on both BSS and MS (e.g. frame scheduling, and alignment of measurement reports etc.), the chosen allocation of the SACCH frame is respectively the 13<sup>th</sup> frame for a full rate channel, the 13<sup>th</sup> frame for the 1<sup>st</sup> half rate sub channel, and the 24<sup>th</sup> frame for the 2<sup>nd</sup> half rate sub channel.

Possible channel organizations are shown in Figure 11-1 through Figure 11-5, where only one time slot per TDMA frame is considered. It can be seen that such an allocation scheme nicely keeps the speech block interval the same as that in legacy mapping (i.e. 7 or 8 frames).

	0	1	2	3	4	5	6	7	8	9	10	11	12	13	14	15	16	17	18	19	20	21	22	23	24	25
u1	T	T	T	T	T	T	T	T	T	T	T	T	S	T	T	T	T	T	T	T	T	T	T	T	T	I
u2	T	T	T	T	T	T	T	T	T	T	T	T	S	T	T	T	T	T	T	T	T	T	T	T	T	I

Figure 11-1: Shifted SACCH with two full rate TCHs

	0	1	2	3	4	5	6	7	8	9	10	11	12	13	14	15	16	17	18	19	20	21	22	23	24	25
(a) u1	T	T	T	T	T	T	T	T	T	T	T	T	S	T	T	T	T	T	T	T	T	T	T	T	T	I
u2	T		T		T		T		T		T		T	S		T		T		T		T		T		
(b) u1	T	T	T	T	T	T	T	T	T	T	T	T	S	T	T	T	T	T	T	T	T	T	T	T	T	I
u2		T		T		T		T		T		T			T		T		T		T		T		S	T
(c) u1	T		T		T		T		T		T		S	T		T		T		T		T		T		
u2	T	T	T	T	T	T	T	T	T	T	T	T	S	T	T	T	T	T	T	T	T	T	T	T	T	
(d) u1		T		T		T		T		T		T			T		T		T		T		T		T	S
u2	T	T	T	T	T	T	T	T	T	T	T	T	S	T	T	T	T	T	T	T	T	T	T	T	T	

Figure 11-2: Shifted SACCH with one full rate TCH and one half rate TCH

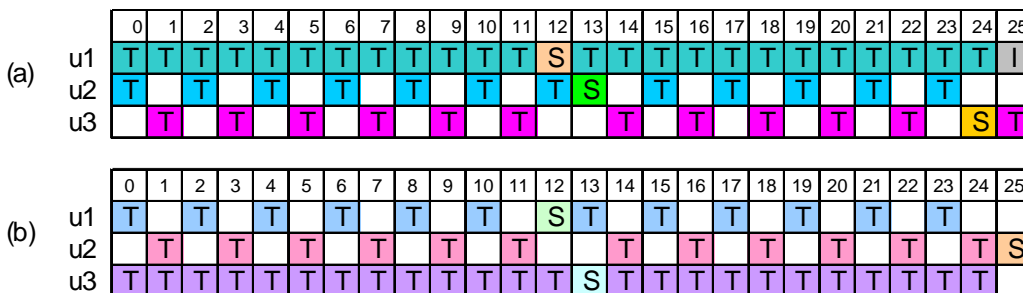

Figure 11-3: Shifted SACCH with one full rate TCH and two half rate TCHs

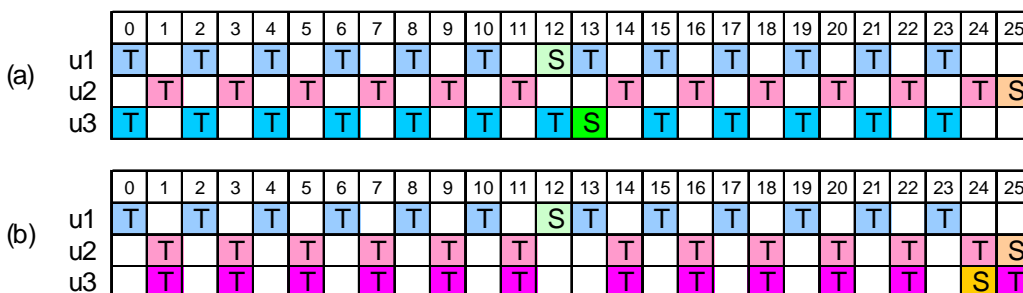

Figure 11-4: Shifted SACCH with three half rate TCHs

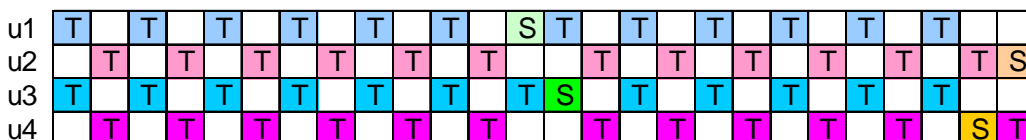

Figure 11-5: Shifted SACCH with four half rate TCHs

With the new TDMA frame mapping, more possibility is given to enhance the SACCH performance and thus maintain the relative performance between SACCH and TCH in MUROS. For example, a SACCH frame on one MUROS sub channel can now benefit from the DTX gains brought by the pairing MUROS sub channel. Furthermore, the network can tune the SCPIR so that the MUROS sub channel carrying a SACCH frame has a larger portion of transmitted power, therefore obtains improved SACCH performance.

The idea can be applied both in the uplink and in the downlink.

## 11.1.2 Performance Characterization

### 11.1.2.1 Link Level Performance

Link level simulations have been performed in three stages. First the degradation of SACCH performance due to the introduction of MUROS is studied. Then the degradation of relative performance between SACCH and TCH due to the introduction of MUROS is presented. Finally the performance of Shifted SACCH is shown both with different SCPIRs and in DTX.

#### 11.1.2.1.1 Degradation of SACCH Performance introduced by MUROS

##### 11.1.2.1.1.1 Simulation assumptions

The simulation assumptions are shown in Table 11-1.

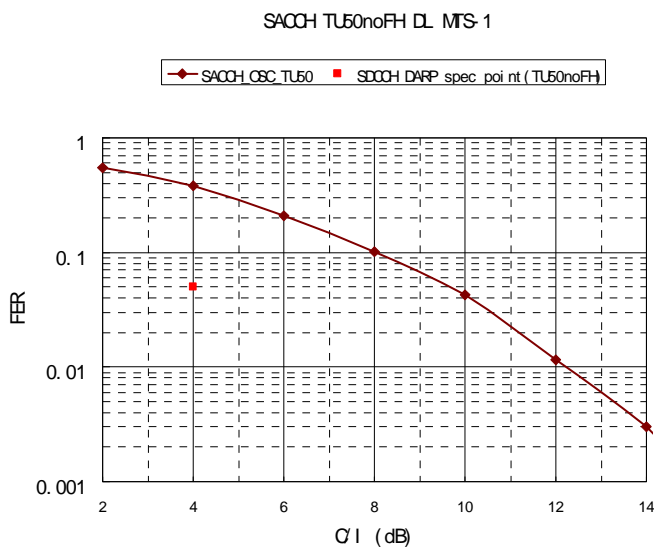

**Table 11-1: Simulation assumptions of link performance**

Parameter	Value
Propagation Environment	Typical Urban (TU)
Terminal speed	50 km/h
Frequency band	900 MHz
Frequency hopping	No
Interference/noise	MTS-1, MTS-2
Antenna diversity	No
DARP receiver	VAR receiver (*)
Tx pulse shape	legacy linearized GMSK pulse shape
Training sequence	Existing sequence and new sequence proposed in [11-2]
Channel type	SACCH
Interference modulation type	GMSK

(\*): The DARP receiver used for the simulation is Vector Autoregressive (VAR) receiver, which is a popular SAIC receiver.

11.1.2.1.1.2 SACCH Performance in MTS-1



**Figure 11-6: Interference performance of SACCH, MTS-1**

11.1.2.1.1.3 SACCH Performance in MTS-2

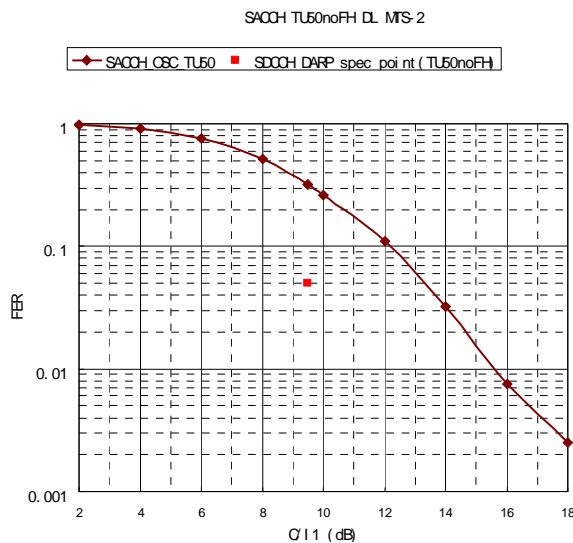

Figure 11-7: Interference performance of SACCH, MTS-2

Figure 11-6 shows that the performance of SACCH in MUROS can not meet the requirement for a DARP receiver in GSM specifications in the MTS-1 scenario. The degradation is 6dB. Figure 11-7 shows the result in MTS-2 scenario, where the degradation is 4dB.

11.1.2.1.2 Degradation of Relative Performance between SACCH and TCH introduced by MUROS

11.1.2.1.2.1 Simulation assumptions

The simulation assumptions are shown in Table 11-2. The performance has been normalized so that the reference reaches 1% FER @ 0dB.

Table 11-2: Simulation assumptions of link performance

Parameter	Value
Propagation Environment	Typical Urban (TU)
Terminal speed	3 km/h
Frequency band	900 MHz
Frequency hopping	Ideal
Interference/noise	MTS-2
Antenna diversity	No
DARP receiver	VAR receiver
Tx pulse shape	legacy linearized GMSK pulse shape
Training sequence	Existing sequence and new sequence proposed in [11-2]
Channel type	SACCH, TCH AFS4.75, TCH AHS4.75
Interference modulation type	GMSK and OSC

11.1.2.1.2.2 Performance of SACCH and TCH in legacy DARP

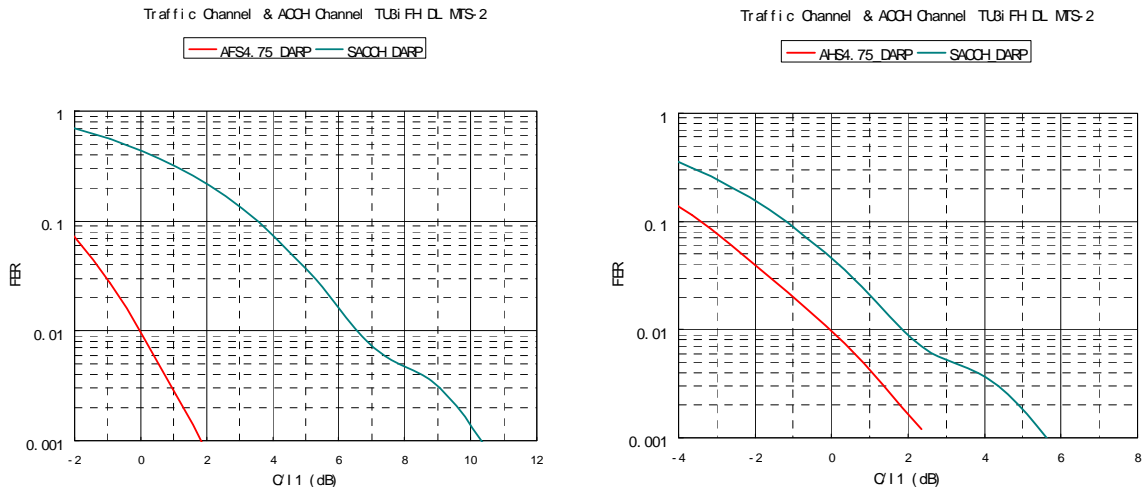

Figure 11-8: Performance of SACCH and AFS4.75/AHS4.75 in legacy DARP, MTS-2

11.1.2.1.2.3 Performance of SACCH and TCH in MUROS

Four scenarios A, B, C and D as shown in Table 11-3 are selected for evaluation. The first two scenarios use an SCPIR value of 0, and the last two scenarios use an SCPIR value of -3dB (i.e. the power level of the wanted sub channel is 3dB lower than that of the pairing sub channel).

Table 11-3: Scenario descriptions

A	B	C	D
OSC_GMSKIntf	OSC_OSCIntf	MUROS_-3dB_GMSKIntf	MUROS_-3dB_OSCIntf

The performance curves are shown from Figure 11-9 to Figure 11-12.

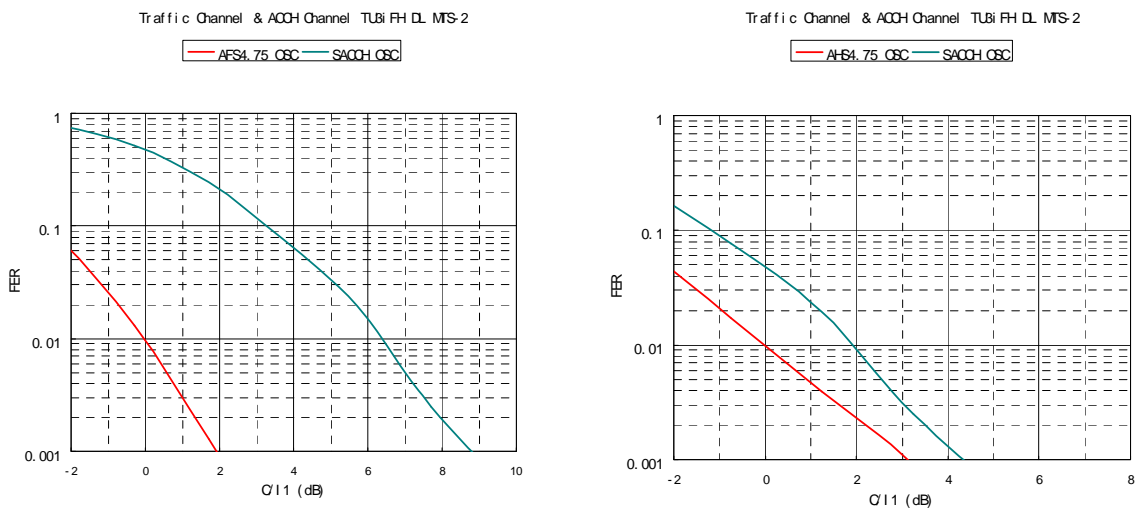

Figure 11-9: Performance of SACCH and AFS4.75/AHS4.75 in Scenario A, MTS-2

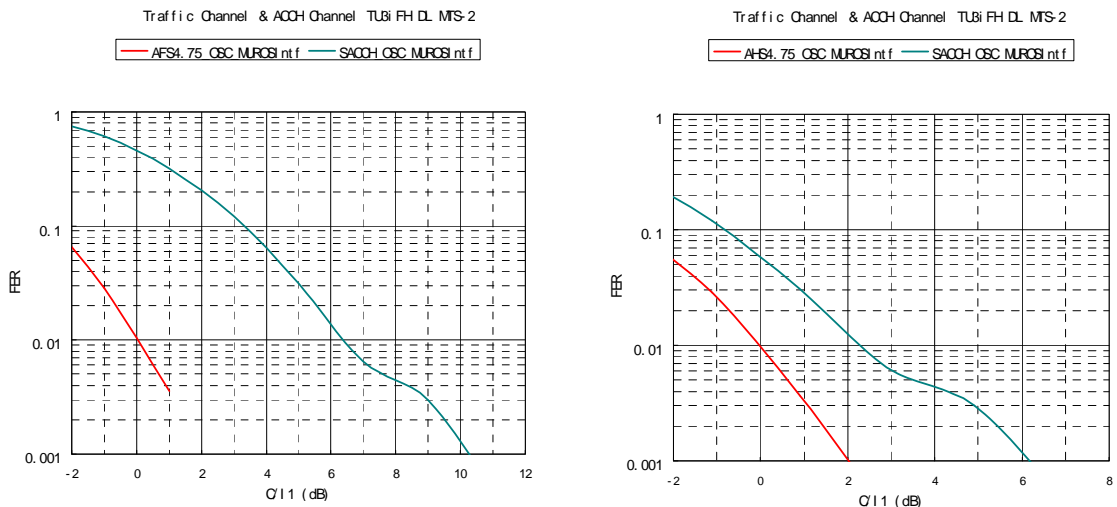

Figure 11-10: Performance of SACCH and AFS4.75/AHS4.75 in Scenario B, MTS-2

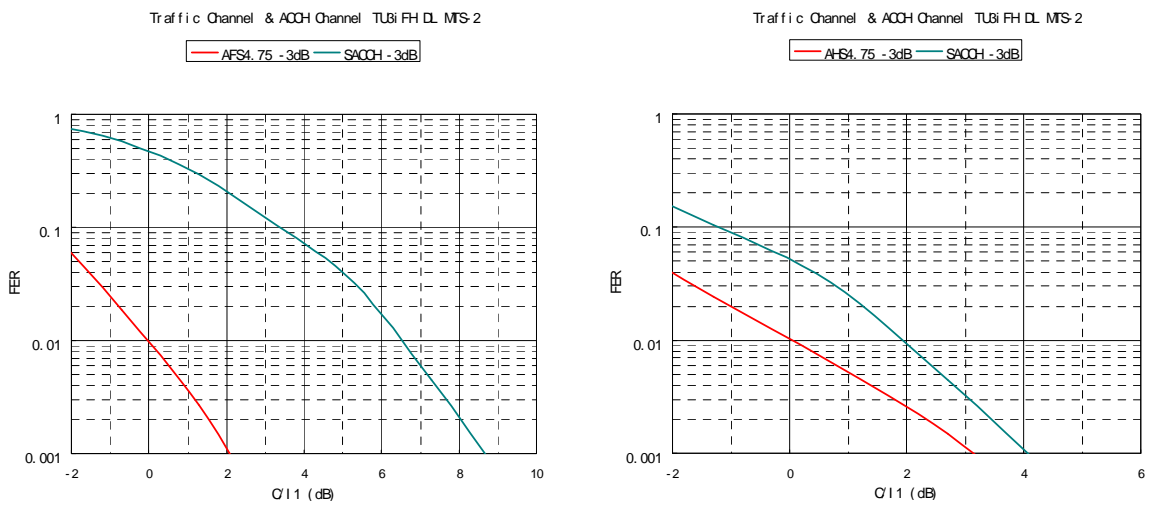

Figure 11-11: Performance of SACCH and AFS4.75/AHS4.75 in Scenario C, MTS-2

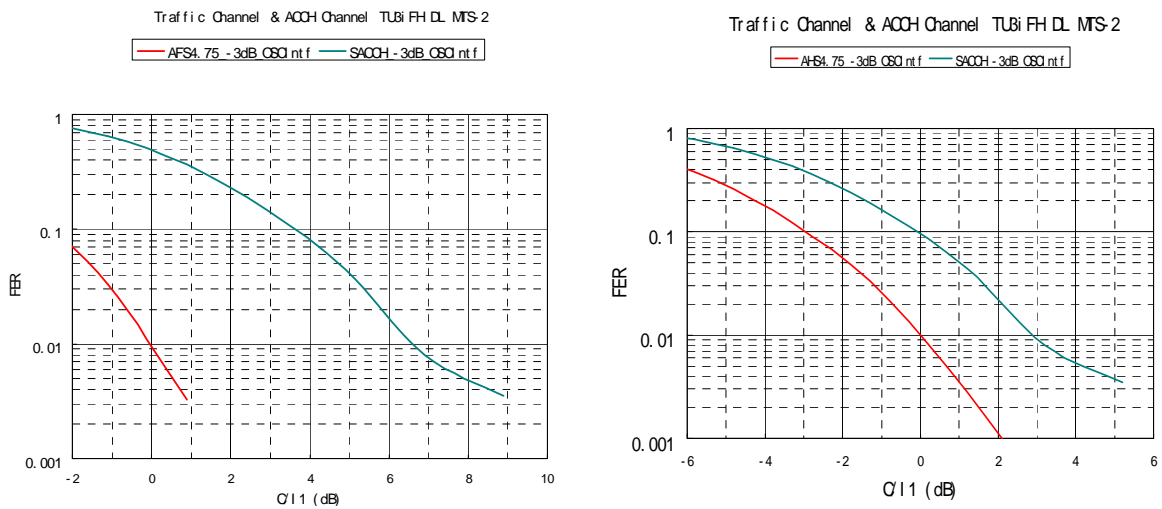

Figure 11-12: Performance of SACCH and AFS4.75/AHS4.75 in Scenario D, MTS-2

11.1.2.1.2.4 Performance Analysis

The relative performance between SACCH and AFS4.75/AHS4.75 in legacy DARP can be derived from Figure 11-8, whilst the relative performance between SACCH and AFS4.75/AHS4.75 for scenario A, B, C and D can be respectively derived from Figure 11-9 to Figure 11-12. These are listed in Table 11-4 for AFS4.75 and Table 11-5 for AHS4.75. It can be seen that the degradation of relative performance between SACCH and AHS4.75 can be up to 1.1dB (in scenario D).

Table 11-4: Degradation of relative performance between SACCH and AFS4.75

	Relative performance between SACCH and AFS4.75	Degradation of relative performance compared with legacy DARP (*)
legacy DARP	6.6	
scenario A	6.4	-0.2
scenario B	6.4	-0.2
scenario C	6.5	-0.1
scenario D	6.7	0.1

(\*): A negative value in this column indicates smaller (i.e. better) gap between SACCH and TCH, whilst a positive value indicates larger (i.e. worse) gap between SACCH and TCH.

Table 11-5: Degradation of relative performance between SACCH and AHS4.75

	Relative performance between	Degradation of relative performance

	SACCH and AHS4.75	compared with legacy DARP (*)
legacy DARP	1.8	
scenario A	1.9	0.1
scenario B	2.4	0.6
scenario C	1.9	0.1
scenario D	2.9	1.1

(\*): A negative value in this column indicates smaller (i.e. better) gap between SACCH and TCH, whilst a positive value indicates larger (i.e. worse) gap between SACCH and TCH.

### 11.1.2.1.3 Performance of Shifted SACCH with different SCPIRs

#### 11.1.2.1.3.1 Simulation assumptions

The simulation assumptions are shown in Table 11-6.

**Table 11-6: Simulation assumptions of link performance**

Parameter	Value
Propagation Environment	Typical Urban (TU)
Terminal speed	50 km/h
Frequency band	900 MHz
Frequency hopping	No
Interference/noise	MTS-1, MTS-2
Antenna diversity	No
DARP receiver	VAR receiver
Tx pulse shape	legacy linearized GMSK pulse shape
Training sequence	Existing sequence and new sequence proposed in [11-2]
Channel type	SACCH TCH AHS5.9
Interference modulation type	GMSK

#### 11.1.2.1.3.2 SACCH Performance in MTS-1

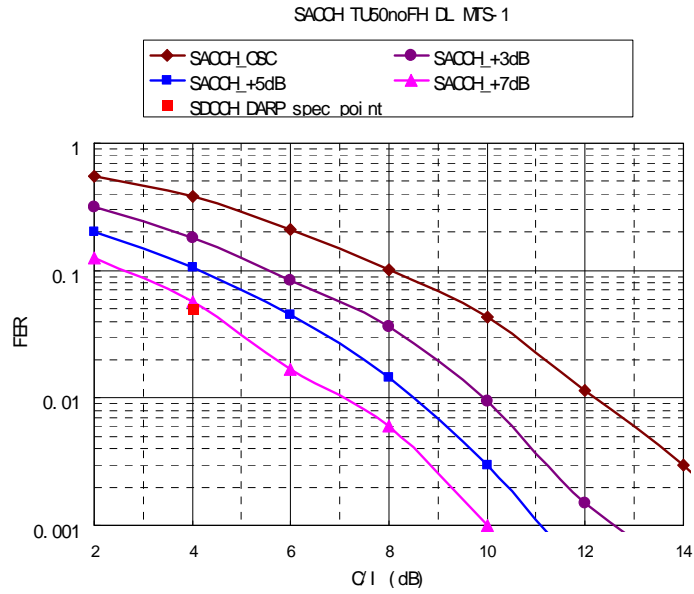

Figure 11-13: Interference performance of SACCH, MTS-1

11.1.2.1.3.3

SACCH performance in MTS-2

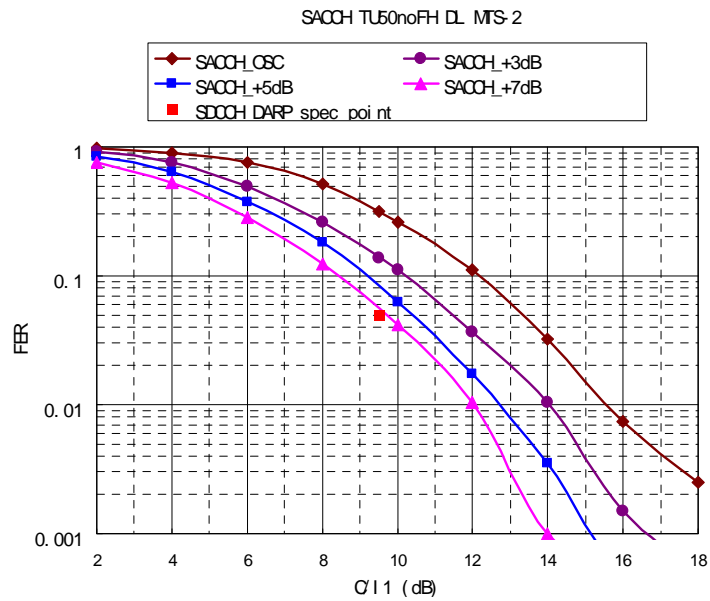

Figure 11-14: Interference performance SACCH, MTS-2

11.1.2.1.3.4 TCH/AHS5.9 performance in MTS-1

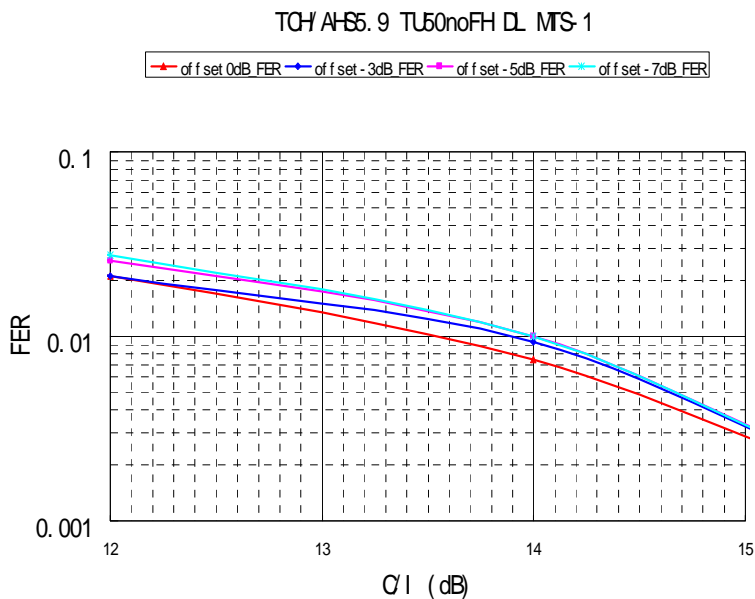

Figure 11-15: Interference performance TCH/AHS5.9, MTS-1

11.1.2.1.3.5 TCH/AHS5.9 MUROS performance in MTS-2

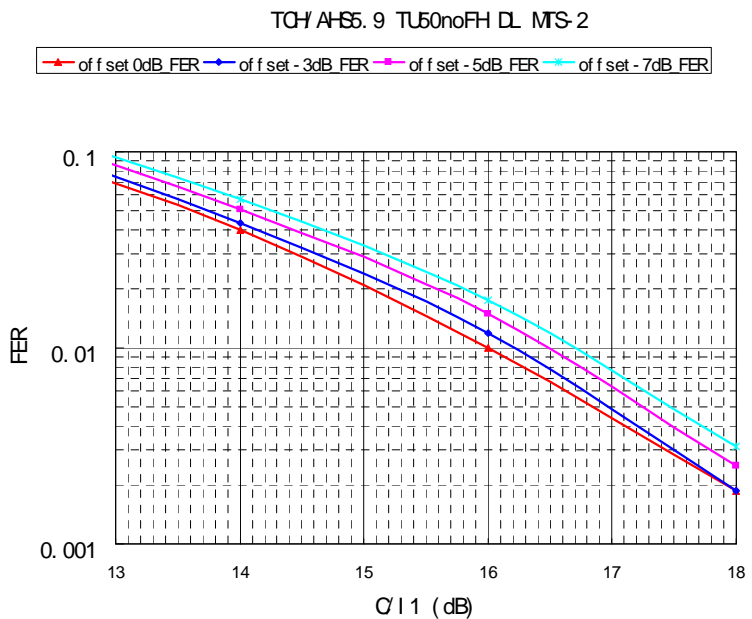

Figure 11-16: Interference performance TCH/AHS5.9, MTS-2

11.1.2.1.3.6 Performance analysis

Figure 11-13 and Figure 11-14 show the simulation results of the interference performance for SACCH with different SCPIRs. Figure 11-15 and Figure 11-16 give the corresponding results for TCH/AHS5.9. Table 11-7 and Table 11-8 provide the C/I<sub>1</sub> at FER=1% and the gain or loss compared with the case of 0dB SCPIR.



**Table 11-7: Interference performance of SACCH @FER=1%**

SCPIR	MTS-1		MTS-2	
	C/I1 (dB)	Gain (dB)	C/I1 (dB)	Gain (dB)
0dB	12.2	0	15.6	0
+3dB	10	2.2	14	1.6
+5dB	8.5	3.7	12.8	2.8
+7dB	7	5.2	12	3.6

**Table 11-8: Interference performance of TCH/AHS5.9 @FER=1%**

SCPIR	MTS-1		MTS-2	
	C/I1 (dB)	Loss (dB)	C/I1 (dB)	Loss (dB)
0dB	13.5	0	16	0
-3dB	13.9	0.4	16.2	0.2
-5dB	14	0.5	16.5	0.5
-7dB	14	0.5	16.7	0.7

It can be seen e.g. that in MTS-1 the performance of SACCH is improved by 5.2dB given an SCPIR of 7dB, whilst the TCH of the pairing sub channel only sees a slight degradation of 0.5dB.

#### 11.1.2.1.4 Performance of Shifted SACCH in DTX

##### 11.1.2.1.4.1 Performance evaluation methods in DTX

Figure 11-17 illustrates how to calculate the performance improvement of Shifted SACCH in the case of DTX. Symbol 'a' denotes the relative performance between SACCH and TCH in legacy DARP when DTX is off. Symbol 'b' denotes the relative performance between SACCH and TCH in MUROS when DTX is off. Symbol 'c' denotes the performance improvement of DTX for TCH. Symbol 'd' denotes the performance improvement of SACCH when it's shifted and the pairing sub channel is in DTX.

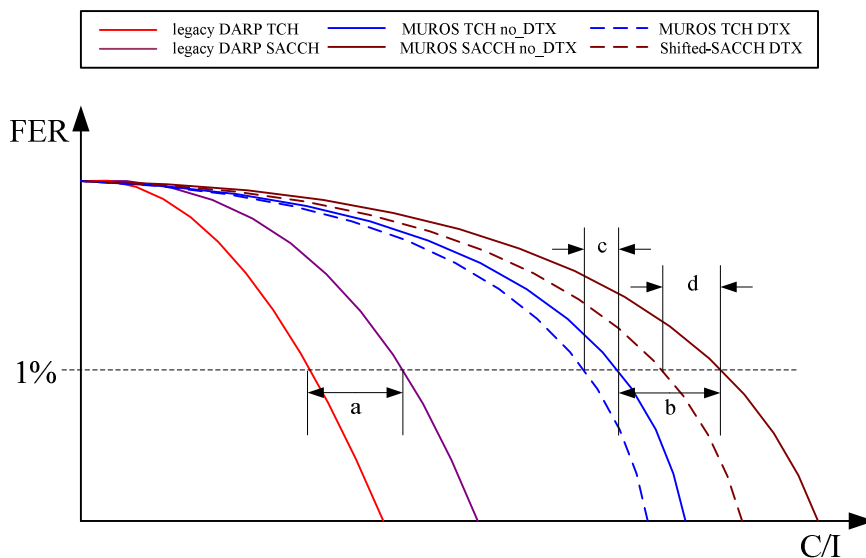

**Figure 11-17: Relative performance between SACCH and TCH with and without DTX**

According to Figure 11-17 three quantities regarding the degradation of relative performance between SACCH and TCH in MUROS are derived and explained as follows:

$$\text{Degrad}_{\text{MUROS\_DTX\_OFF}} = b - a , \text{ when there's no Shifted SACCH, and DTX is off.}$$

$$\text{Degrad}_{\text{MUROS\_DTX\_ON}} = b - a + c , \text{ when there' no Shifted SACCH, and DTX is on.}$$

$$\text{Degrad}_{\text{SHIFTED\_SACCH\_DTX\_ON}} = b - a + c - d , \text{ when there's Shifted SACCH, and DTX is on.}$$

It can be seen that the degradation is worsened by 'c' dB when DTX is on. But this can be improved by 'd' dB if Shifted SACCH is introduced. Since 'c-d' is less than 0 in some scenarios, the degradation introduced by both MUROS and DTX might be completely compensated by Shifted SACCH, making  $\text{Degrad}_{\text{SHIFTED\_SACCH\_DTX\_ON}}$  close to 0.

11.1.2.1.4.2 Simulation assumptions

The simulation assumptions are shown in Table 11-9. The TCH performance without DTX has been normalized so that it reaches 1% FER @ C/I=0 dB. DTX was modelled by a Markov state model with an activity factor of 0.6 and an average activity period of 1s. Scenario A as defined in Table 11-3 was selected to be simulated in MTS-1. Scenario D was selected to be simulated in MTS-2.

**Table 11-9: Simulation assumptions of link performance**

Parameter	Value
Propagation Environment	Typical Urban (TU)
Terminal speed	3 km/h
Frequency band	900 MHz
Frequency hopping	ideal
Interference/noise	MTS-1, MTS-2
Antenna diversity	No
DARP receiver	VAR receiver
Tx pulse shape	legacy linearized GMSK pulse shape
Training sequence	Existing sequence and new sequence proposed in [11-2]
Channel type	TCH AHS4.75, SACCH
Interference modulation type	GMSK, OSC
SCPIR	0, -3dB
DTX	On/Off

11.1.2.1.4.3 SACCH and AHS4.75 Performance in MTS-1

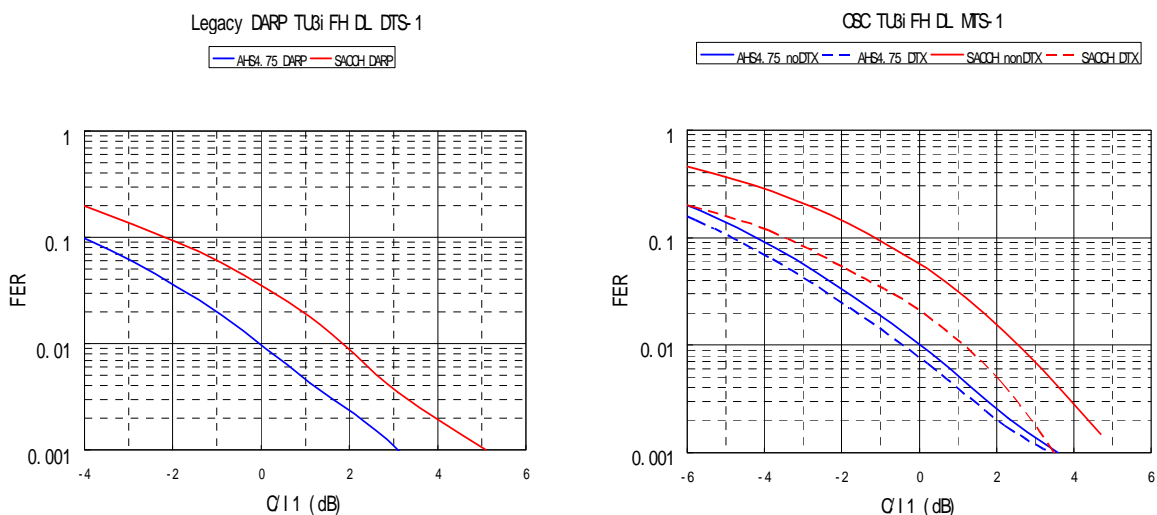

**Figure 11-18: Interference performance of SACCH and AHS4.75, Scenario A, MTS-1**

11.1.2.1.4.4 SACCH and AHS4.75 performance in MTS-2

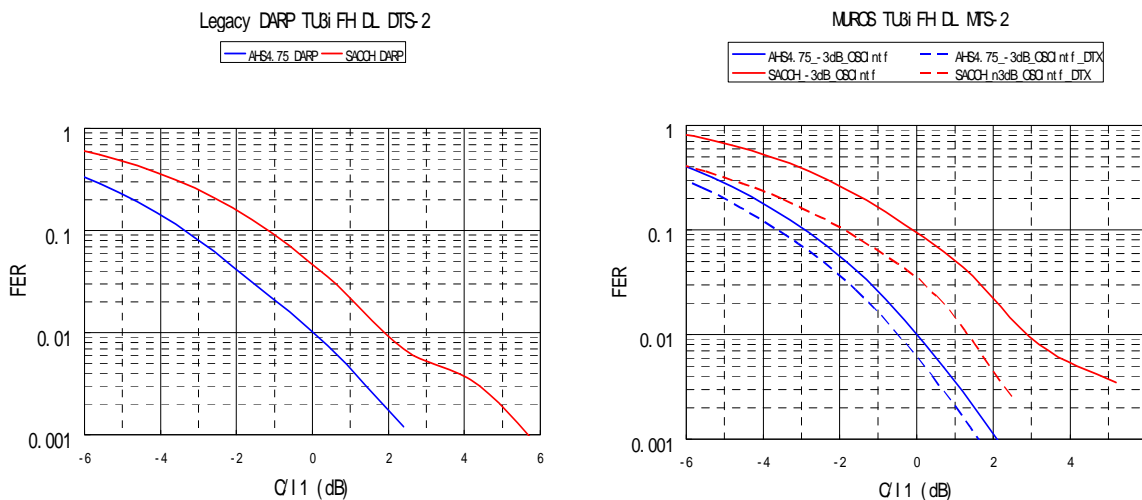

Figure 11-19: Interference performance of SACCH and AHS4.75, Scenario D, MTS-2

11.1.2.1.4.5 Performance analysis

Table 11-10 and Table 11-11 provide the relative performance between SACCH and AHS4.75 in MUROS, and the degradation of relative performance compared with legacy DARP. It can be seen that the degradation is up to 1.3dB in MTS-1 when DTX is on, but is reversed to be -0.1dB when Shifted SACCH is employed. In MTS-2 the results are similar, where the degradation is up to 1.7dB when DTX is on, but is reduced to be only 0.1dB by Shifted SACCH.

Table 11-10: Degradation of relative performance between SACCH and AHS4.75, MTS-1

	Relative performance between SACCH and AHS4.75	Degradation of relative performance compared with legacy DARP
legacy DARP, no DTX	1.8	
scenario A, DTX off	2.6	0.8 (*)
scenario A, DTX on	3.1	1.3 (**)
scenario A, DTX on, with Shifted SACCH	1.7	-0.1 (***)

(\*):  $\text{Degrad}_{\text{MUROS\_DTX\_OFF}}$

(\*\*):  $\text{Degrad}_{\text{MUROS\_DTX\_ON}}$

(\*\*\*):  $\text{Degrad}_{\text{SHIFTED\_SACCH\_DTX\_ON}}$

**Table 11-11: Degradation of relative performance between SACCH and AHS4.75, MTS-2**

	Relative performance between SACCH and AHS4.75	Degradation of relative performance compared with legacy DARP
legacy DARP, DTX off	1.8	
scenario D, DTX off	2.9	1.1 (*)
scenario D, DTX on	3.5	1.7 (**)
scenario D, DTX on, with Shifted SACCH	1.9	0.1 (***)

(\*):  $\text{Degrad}_{\text{MUROS\_DTX\_OFF}}$

(\*\*):  $\text{Degrad}_{\text{MUROS\_DTX\_ON}}$

(\*\*\*):  $\text{Degrad}_{\text{SHIFTED\_SACCH\_DTX\_ON}}$

#### 11.1.2.1.5 Performance of Shifted SACCH for VAMOS level II and non-SAIC receivers

##### 11.1.2.1.5.1 Simulation assumptions

The simulation assumptions are shown in Table 11-12. All simulation curves have been normalized so that the reference reaches 1% FER @ C/I1=0 dB. DTX was modelled by a Markov state model with an activity factor of 0.6.

The relative performance of SACCH refers to the performance gap between SACCH and the most robust TCH in half rate channel AHS4.75 at 1% FER in this document.

**Table 11-12: Simulation assumptions of link performance**

Parameter	Value
Propagation Environment	Typical Urban (TU)
Terminal speed	3 km/h
Frequency band	900 MHz
Frequency hopping	Ideal
Interference/noise	MTS-2
Antenna diversity	No
Receiver	VAMOS level II Non-SAIC
Tx pulse shape	legacy linearized GMSK pulse shape
Training sequence	Existing sequence and new sequence proposed in [11-2]
Channel type	TCH AHS4.75, SACCH
Interference modulation type	GMSK, OSC
SCPIR	0, -4dB, +4dB
DTX	On/Off

##### 11.1.2.1.5.2 VAMOS level II receiver

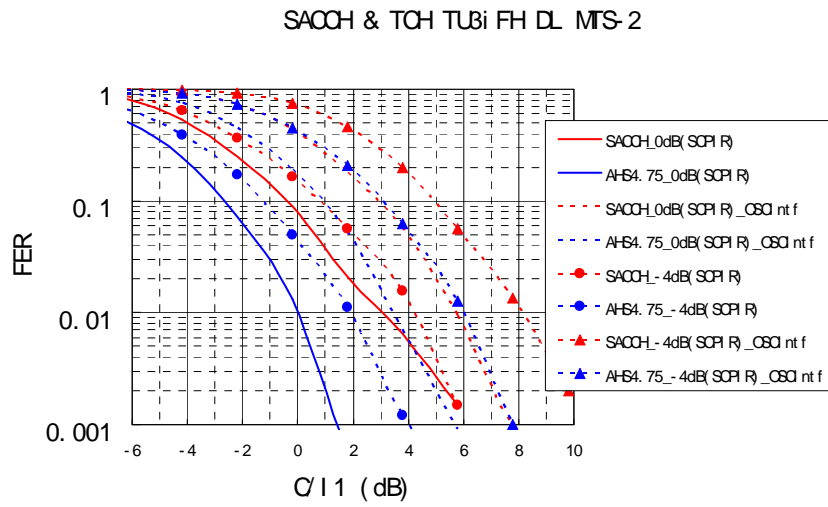

Figure 11-20: SACCH and TCH performance without shifted SACCH, DTX off

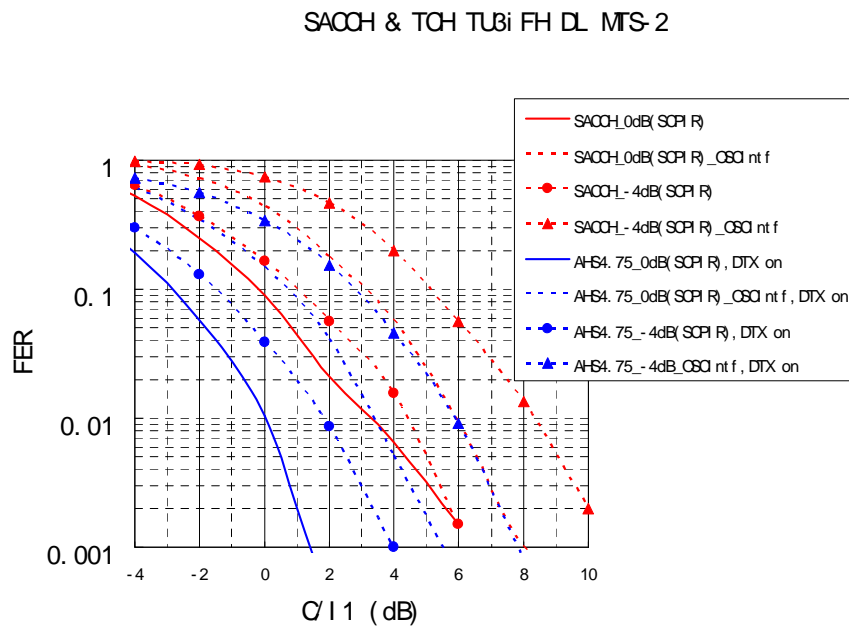

Figure 11-21: SACCH and TCH performance without shifted SACCH, DTX on

Table 11-13: Relative performance without shifted SACCH

	Relative performance DTX off	Relative performance DTX on
0dB_GMSKIntf	3	3.3
0dB_OSCIntf	2.3	2.6

-4dB_GMSKIntf	2.4	2.5
-4dB_OSCIntf	2.1	2.4

SACCH & TCH TUBi FH DL MTS-2

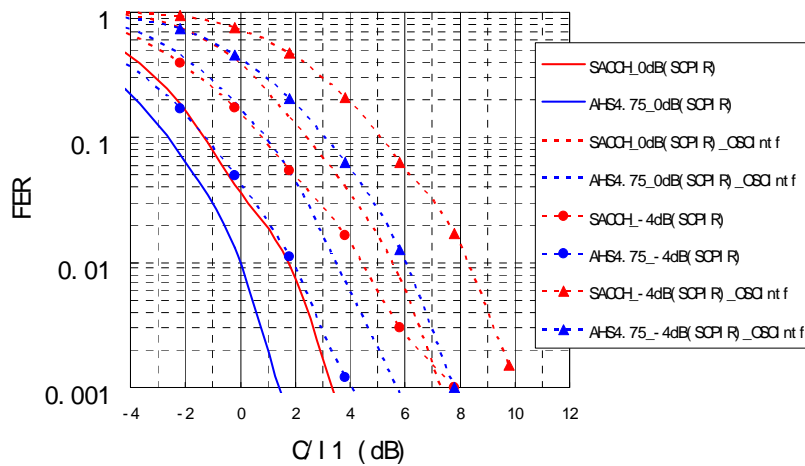

Figure 11-22: SACCH and TCH performance with shifted SACCH, DTX off

SACCH & TCH TUBi FH DL MTS-2

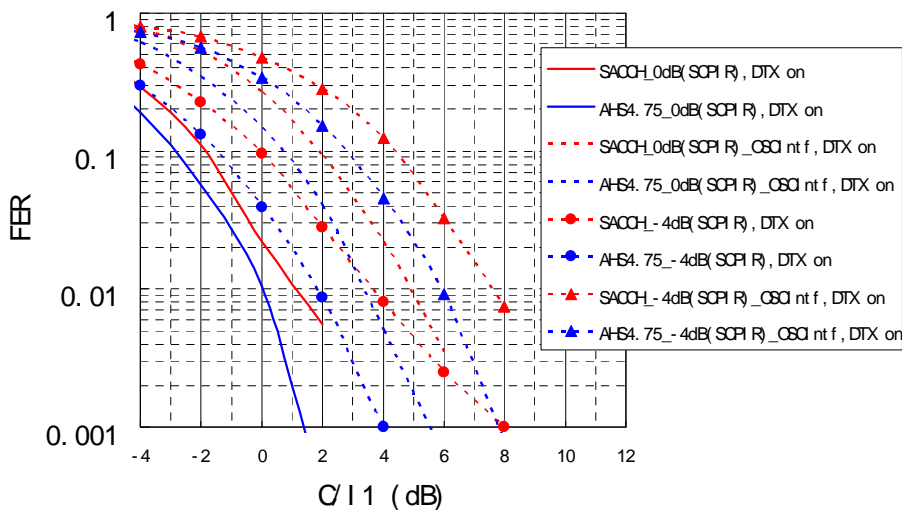

Figure 11-23: SACCH and TCH performance with shifted SACCH, DTX on

**Table 11-14: Relative performance with shifted SACCH**

	Relative performance DTX off	Relative performance DTX on
0dB_GMSKIntf	1.8	1.1
0dB_OSCIntf	2	1.6
-4dB_GMSKIntf	2.6	1.8
-4dB_OSCIntf	2.3	1.7

11.1.2.1.5.3 Non-SAIC receiver

SACCH & TCH TUBi FH DL MTS-2 nonSAIC

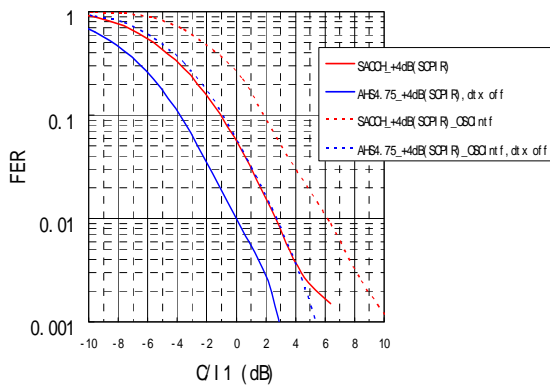

SACCH & TCH TUBi FH DL MTS-2 nonSAIC

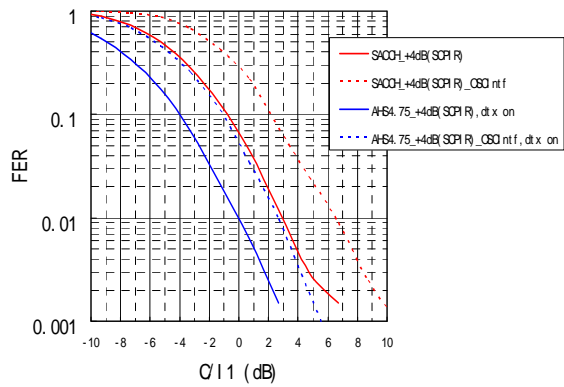

**Figure 11-24: SACCH and TCH performance without shifted SACCH**

**Table 11-15: Relative performance without shifted SACCH**

	Relative performance DTX off	Relative performance DTX on
+4dB_GMSKIntf	2.8	3
+4dB_OSCIntf	3.2	3.7



SACCH & TCH TUBi FH DL MTS-2 nonSAI C

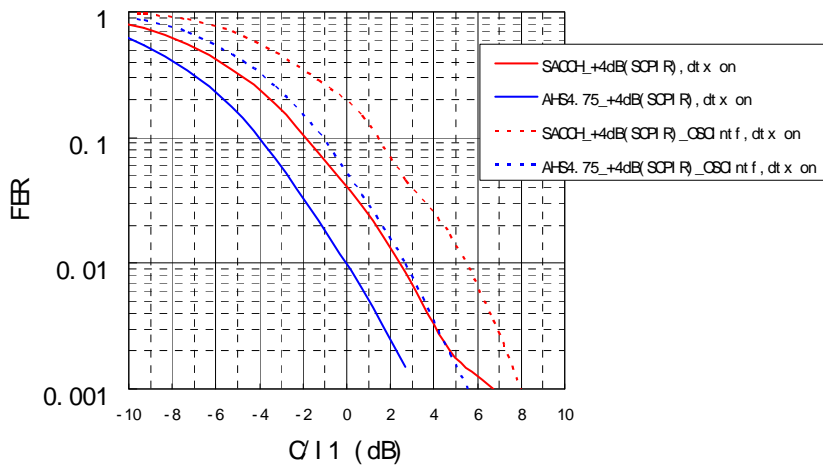

Figure 11-25: SACCH and TCH performance with shifted SACCH, DTX on

Table 11-16: Relative performance with shifted SACCH

	Relative performance DTX on
+4dB_GMSKIntf	2.3
+4dB_OSCIntf	2.6

11.1.2.1.5.4 Shifted SACCH without DTX

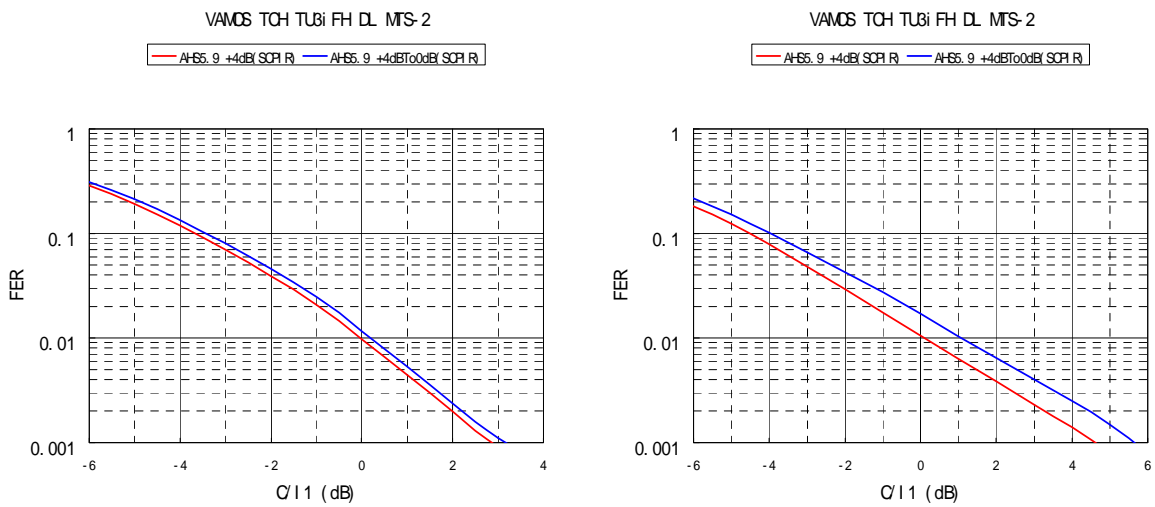

Figure 11-26: Paired TCH degradation with shifted SACCH, DTX off, tuning SCPIR of SACCH

#### 11.1.2.1.5.5 Performance analysis

In order to evaluate the performance improvement of Shifted SACCH for VAMOS level II and legacy non-SAIC receivers, the relative performance of legacy SAIC receiver in non VAMOS mode, 1.8 dB (see [11-7]), is chosen as the reference point. The following comparisons are between the reference point and the simulation results shown above.

As shown in Table 11-13 and Table 11-14, comparing with the reference point, the relative performance degradation of VAMOS level II receiver without shifted SACCH is 0.6dB to 1.5dB while that with shifted SACCH is -0.7dB to 0dB. The negative value here indicates an improvement on the relative performance.

As shown in Table 11-15 and Table 11-16, comparing with the reference point, the relative performance degradation of non-SAIC receiver without shifted SACCH is 1.2dB to 1.9dB while that with shifted SACCH is 0.5dB to 0.8dB.

It is clear that shifted SACCH is a helpful solution to keep the relative performance of SACCH at the legacy non-VAMOS level with the DTX gain.

Even without DTX shifted SACCH also has some gains by tuning SCPIR of the SACCH frame. That means a VAMOS sub channel could have different SCPIRs between TCH and SACCH.

To take Figure 11-22 as an example, if SCPIR in TCH is -4dB and SCPIR in SACCH is 0dB, the relative performance would be 0dB which is much less than that of a legacy SAIC receiver (1.8dB).

It may be argued that the performance of paired user will be degraded. It has also been considered in this evaluation. As shown in Figure 11-26, if the paired user is a SAIC receiver, the degradation is only about 0.2dB. Even if the paired user is a non-SAIC receiver, the degradation is no more than 1dB.

### 11.1.3 Impacts on the Mobile Station

At least one of the mobiles in a MUROS pair will need to support the Shifted SACCH concept.

#### 11.1.3.1 Legacy mobile stations

The presented concept is compatible with legacy MS. No implementation impact is foreseen. In addition, it should be noticed that the SACCH performance of a legacy mobile on one MUROS sub channel will obtain the same gains as that of the mobile on the pairing sub channel where Shifted SACCH is employed.

#### 11.1.3.2 Mobile stations supporting Shifted SACCH

A mobile station supporting Shifted SACCH shall support the new TDMA frame mapping and may be allocated on the second MUROS sub channel. Changes to the scheduling of speech frames should be considered in the implementation, although it is trivial. The support of Shifted SACCH must be signalled to the network, either by the indication of the support of MUROS if Shifted SACCH is mandatory in MUROS or by a stand-alone indicator if Shifted SACCH is optional in MUROS.

The contents of measurement results are not affected by shifting the allocation of SACCH frames.

No impact on hardware implementation of the mobile station is foreseen.

### 11.1.4 Impacts on the BSS

The BTS transmitter and receiver shall support the new TDMA frame mapping.

The misalignment of SACCH frame numbers on the two MUROS sub channels should be taken into account. The BSS may need to synchronize the measurement reports for both sub channels in order to perform sub channel power control. This should be done both for the downlink and for the uplink. No other impact is foreseen on downlink power control. For uplink power control, the PC commands for the two MUROS sub channels may be jointly decided but will not be sent out at the same time. Since the time difference is only several frames (e.g. one frame in Figure 11-2), and the power control period is typically 1.5s, there's almost no impact on the performance of uplink power control.

The performance of TCH is fully maintained if there's no power imbalance. However, the BSS may assign a positive SCPIR to the sub channel containing a SACCH frame. In this case the performance of SACCH is clearly improved but at the same time the performance of TCH on the pairing sub channel will be slightly degraded (see 11.1.2.1.3).

## 11.2 References

- [11-1] “Associated Control Channel Performance of Downlink MUROS, GERAN MUROS Telco #5
- [11-2] GP 071792, Voice Capacity Evolution with Orthogonal Sub Channels, GERAN #36
- [11-3] AHG1-080082, “MUROS Downlink ACCH Relative Performance”, GERAN WG1 ad hoc on EGPRS2/WIDER/MUROS, October 2008
- [11-4] GP-081025, “Associated Control Channel Performance of Downlink MUROS”, GERAN#39
- [11-5] GP-081026, “New strategy on SACCH for Downlink MUROS”, GERAN#39
- [11-6] GP-081499, “Further Analysis of signalling SACCH for MUROS”, GERAN#40
- [11-7] GP-090643, “DTX Performance of SACCH for VAMOS – updated v2”, GERAN#42
- [11-8] GP-091197, “Updated SACCH performance for VAMOS lev2 and nonSAIC receiver”, GERAN#43

## 12 Summary of Evaluation versus Objectives for each Candidate Technique

A number of candidate techniques have been proposed for MUROS and have been included in this Technical Report. This section lists a summary of the evaluation versus the defined performance and compatibility objectives in section 4 for each of the proposed candidate techniques.

### 12.1 Performance Objectives

Table 12-1: Evaluation against performance objectives

Performance Objectives	Co-TCH	Orthogonal Sub Channels	Adaptive Symbol Constellation	Higher Order Modulation
<b>P1: Capacity Improvements at the BTS</b> 1) increase voice capacity of GERAN in order of a factor of two per BTS transceiver	1) Two users are multiplexed on the same BTS resources. For some BTS architectures there might not be a HW efficiency gain.	1) Two users are multiplexed on the same BTS resource both in uplink and downlink.	1) Two users are multiplexed on the same BTS resource.	1) Up to 4 users are expected to be multiplexed per timeslot.
2) channels under interest: TCH/FS, TCH/HS, TCH/EFS, TCH/AFS, TCH/AHS and TCH/WFS	2) All voice codecs are supported	2) All codecs are supported.	2) All codecs are supported	2) All codecs are supported.
<b>P2: Capacity Improvements at the air interface</b> 1) enhance the voice capacity of GERAN by means of multiplexing at least two users simultaneously on the same radio resource both in downlink and in uplink	1) Gains have been shown to be between 0 and 125 % depending on the system scenario and speech codec.	1) Gains have been shown by system level simulations on DL to be between 0% and 76% in GP-081632 dependent on the system scenario and speech codec investigated for OSC. Gains versus reference on top have been shown when utilizing sub channel specific power control in the range of 7% to 16%. Further gains may be possible by the usage of optimized Tx pulse shape on DL.	1) Gains have been shown to be between 0 and 114 % dependent on the system scenario and speech coded investigated for OSC. Gains in the range of 5..13% on top have been observed for adaptive constellation rotation used for new MUROS capable MS. Further enhancements may be possible when utilizing $\alpha$ -QPSK and frequency hopping.	1) Network simulations have not yet been presented to show the available spectral efficiency gain
2) channels under interest: TCH/FS, TCH/HS, TCH/EFS, TCH/AFS, TCH/AHS and TCH/WFS	2) All speech codecs are supported	2) All codecs are supported.	2) All codecs are supported	2) All codecs are supported.

Classification	Not Fulfilled	Unclear/FFS	Expected to be fulfilled.	Fulfilled
----------------	---------------	-------------	---------------------------	-----------

## 12.2 Compatibility Objectives

**Table 12-2: Evaluation against compatibility objectives**

Evaluation of Techniques	Candidate Techniques proposed in MUROS			
	Co-TCH	Orthogonal Sub Channels	Adaptive Symbol Constellation	Higher Order Modulation for MUROS
<b>Objective</b>				
<b>Compatibility Objectives</b>				
<b>C1: Maintenance of Voice Quality</b> 1) voice quality should not decrease as perceived by the user. 2) A voice quality level better than for GSM HR should be ensured.	Fulfilled. 1) It is assumed that channel mode adaptation (CMA) takes place if quality in co-TCH channel degrades. Link performance and system performance evaluations have confirmed that there is no voice quality decrease. 2) Minimum FER thresholds have been defined in the TR, that have been evaluated by system level analysis. References: see performance characterization in chapter 6.	Fulfilled. 1) It is assumed that channel mode adaptation (CMA) takes place if quality in OSC channel degrades. Link performance and system performance evaluations have confirmed that there is no voice quality decrease. 2) Minimum FER thresholds have been defined in the TR, that have been taken into account in system level analysis. References: see performance characterization in chapter 7.	Fulfilled. 1) It is assumed that channel mode adaptation (CMA) takes place if quality in alpha-QPSK channel degrades. Link performance and system performance evaluations have confirmed that there is no voice quality decrease. 2) Minimum FER thresholds have been defined in the TR, that have been taken into account in system level analysis. References: see performance characterization in chapter 8.	Fulfilled. 1) It is assumed that channel mode adaptation (CMA) takes place if quality in HOM for MUROS channel degrades. Link level evaluations have confirmed that there is no voice quality decrease. Link performance performance have confirmed that there is no voice quality decrease. 2) Minimum FER thresholds have been defined in the TR, that have been taken into account in system level analysis. References: see performance characterization in chapter 9.
<b>C2: Support of Legacy Mobile Stations</b> 1) Support of legacy MS w/o implementation impact. 2) First priority on support of legacy DARP phase 1 terminals, second priority on support of legacy GMSK terminals not supporting DARP phase 1.	Fulfilled. 1) With power assignment procedure in DL, both legacy non-DARP MS and legacy-DARP phase 1 MS are expected to be multiplexed. 2) Legacy DARP phase 1 terminals have been shown to be supported with the technique. Non DARP terminals could be supported under fairly good radio conditions.	Fulfilled. 1) With subchannel power control procedure in DL, both legacy non-DARP MS and legacy-DARP phase 1 MS are expected to be multiplexed. 2) Legacy DARP phase 1 terminals have been shown to be supported with the technique. Non DARP terminals could be supported under fairly good radio conditions.	Fulfilled. 1) With downlink power control using alpha-QPSK, both legacy non-DARP MS and legacy-DARP phase 1 MS are expected to be multiplexed. pi/4 rotation is not compatible with legacy mobiles. 2) Legacy DARP phase 1 terminals have been shown to be supported with the technique. Non DARP terminals could be supported under fairly good radio conditions. Evaluations show capacity gains with non-DARP mobiles included in MUROS channels.	Unclear/FFS 1) With downlink power control using QPSK, both legacy non-DARP MS and legacy-DARP phase 1 MS are expected to be multiplexed for up to 2 users. Whilst 3 or 4 user allocation is not compatible with legacy mobiles. 2) Non DARP terminals need to be studied at link and system level.
<b>C3: Implementation Impacts to new MSs</b> 1) change MS hardware as little as possible. 2) Additional complexity in terms of processing power and memory should be kept to a minimum.	1) Minimum requirement is to support new training sequences. Impact of new training sequences on complexity and memory requirements is minimal. 2) More advanced receiver implementations, such as joint detection, can improve performance and this will have impact on complexity and memory. Adaptive pulse shaping may lead to additional complexity.	1) Minimum requirement is to support new training sequences. Impact of new training sequences on complexity and memory requirements is minimal. 2) More advanced receiver implementations, such as joint detection, can improve performance and this will have impact on complexity and memory. For OSC only 3 different constellations are defined which may mitigate the additional complexity. User diversity scheme proposed needs additional timeslot hopping functionality.	1) Minimum requirement is to support new training sequences. Impact of new training sequences on complexity and memory requirements is minimal. Additional rotation (note that blind modulation detection algorithms from EGPRS can be re-used) need to be supported and blindly detected by the mobile. 2) More advanced receiver implementations, such as joint detection, can improve performance and this will have impact on complexity and memory. Detection of one additional rotation might add complexity and can be done in the same way as in modulation detection in EGPRS. Estimation of alpha is slightly more complex than the detection of one additional rotation. Frequency hopping scheme proposed needs additional frequency hopping sequences.	1) Higher order modulations need to be supported in downlink. The impact is likely similar to that of EGPRS2-A. It requires new user multiplexing. New uplink transmission scheme other than GMSK needed. Additional complexity introduced because of the downlink power control.
<b>C4: Implementation Impacts to BSS</b> 1) Change BSS hardware as little as possible and HW upgrades to the BSS should be avoided. 2) Any TRX hardware capable for MUROS shall support legacy non-SAIC mobiles and SAIC mobiles. 3) Impacts to dimensioning of resources on Abis interface shall be minimised.	Expected to be fulfilled. 1) Depending on the implementation, 2 GMSK modulators or a flexible quaternary constellation based modulator is required on the transceiver. Adaptive pulse shaping needs additional complexity. JD or SIC for GMSK receiver needed. 2) For EDGE capable BTS this is usually the case. 3) The capacity of the Abis interface needs to be increased by up to a factor of 2 compared to full rate channels.	Expected to be fulfilled. 1) No BTS HW change required in the transmitter, since QPSK and 8-PSK are supported on EDGE capable BTS. JD or SIC for GMSK receiver needed. 2) For EDGE capable BTS this is usually the case. 3) The capacity of the Abis interface needs to be increased by up to a factor of 2 compared to full rate channels.	Expected to be fulfilled. 1) Linear modulator for alpha-QPSK, additional rotation needed. JD or SIC for GMSK receiver needed. 2) For EDGE capable BTS this is usually the case. The support of Frequency hopping proposal depends on BTS architecture. 3) The capacity of the Abis interface needs to be increased by up to a factor of 2 compared to full rate channels.	Unclear/FFS 1) Higher order Modulation transmitter needed as for EGPRS2-A. JD/SIC receiver capable of receiving upto 2 QPSK users simultaneously on the uplink needed. BTS needs enough processing power to demodulate GMSK or QPSK on up to 4 different resources simultaneously on uplink. 2) This depends on BTS architecture. 3) The capacity of the Abis interface needs to be increased by up to a factor of 4 compared to full rate channels.
<b>C5: Impacts to Network Planning</b> 1) Impacts to network planning and frequency reuse shall be minimised. 2) Impacts to legacy MS interfered on downlink by the MUROS candidate technique should be avoided in case of usage of a wider transmit pulse shape on downlink. 3) Furthermore investigations shall be dedicated into the usage at the band edge, at the edge of an operator's band allocation and in country border regions where no frequency coordination are in place.	Expected to be fulfilled. 1) No impact on frequency planning or frequency re-use is foreseen. 2) A wider Tx pulse shape has only been investigated on link level. System level simulations are needed to investigate the impact of a wider pulse shape. Adaptive pulse shaping using pulse shapes within the spectrum mask may give further gains whilst minimising the impact to other users. 3) If a wider pulse shape is to be deployed it is not expected to be used at the edge of an operator's frequency band.	Expected to be fulfilled. 1) No impact on frequency planning or frequency re-use is foreseen. 2) A wider Tx pulse shape has only been investigated on link level and system level. Impacts on legacy MS reception for wider Tx pulse shape need to be further investigated. 3) If a wider pulse shape is to be deployed it is not expected to be used at the edge of an operator's frequency band.	Expected to be Fulfilled. 1) No impact on frequency planning or frequency re-use is foreseen. 2) A wide pulse shape has only been investigated on link level. System level simulations are needed to investigate the impact of a wider pulse. 3) If a wider pulse shape is to be deployed it is not expected to be used at the edge of an operator's frequency band.	Expected to be Fulfilled. 1) No impact on frequency planning or frequency re-use is foreseen. 2) A wide pulse shape has not been investigated. 3) If a wide pulse shape is to be deployed it is not expected to be used at the edge of an operator's frequency band.
<b>Classification</b>	Not Fulfilled	Unclear/FFS	Expected to be fulfilled.	Fulfilled

---

## 13 Conclusions

During the MUROS feasibility study, opened at GERAN#36, a number of candidate techniques have been investigated that are aimed at increasing voice capacity of GERAN in the CS domain in order of a factor of two per BTS transceiver by creating new types of speech traffic channels in GERAN. These candidate techniques included into this Technical Report are described in chapter 6 to 9, namely

- Speech capacity enhancement using DARP (chapter 6).
- Orthogonal Sub Channels (chapter 7).
- Adaptive Symbol Constellation (chapter 8).
- Higher Order Modulations for MUROS (chapter 9).

The four above listed candidate techniques were evaluated against the defined performance and compatibility objectives defined in chapter 4. The evaluation against performance objectives is reflected in chapter 12 in Table 12-1 and against compatibility objectives in chapter 12 in Table 12-2. .

To summarize this evaluation it was seen that the second and the third candidate technique fulfill the performance and compatibility objectives best, whilst the first three candidate techniques have major conceptual commonalities.

Among these three candidate techniques the Adaptive Symbol Constellation concept has been identified to include techniques common to the co-TCH and the Orthogonal Sub Channels proposals. The solution for the uplink is identical for these three concepts. Voice capacity is increased by multiplexing two users simultaneously on the same radio resource defined by a single time slot, specific ARFCN and specific sequence of TDMA frame numbers as defined for full rate and half rate GSM speech channels.

It is the intention to leave this feasibility study open in order to further investigate enhancements for Rel-9 and beyond. In this context the Higher Order Modulation proposal will be further studied.

## Annex A: Change history

Change history							
Date	TSG #	TSG Doc.	CR	Rev	Subject/Comment	Old	New
2009-02	41	GP-090527			Approved at TSG GERAN#41	2.0.0	8.0.0
2009-05	42	GP-090734	0001		System performance updates for adaptive symbol constellation	8.0.0	8.1.0
2009-05	42	GP-090871	0004		Update of Network Performance Evaluation Results for OSC	8.0.0	8.1.0
2009-05	42	GP-090983	0005	1	Clarification on the System Performance Evaluation Method	8.0.0	8.1.0
2009-05	42	GP-090989	0006	1	Inclusion of Text Proposals agreed at GERAN#41	8.0.0	8.1.0
2009-05	42	GP-090874	0007		Verification of Link to System Mapping for OSC	8.0.0	8.1.0
2009-05	42	GP-091033	0008		VAMOS adaptive pulse shaping	8.0.0	8.1.0
2009-09	43	GP-091308	0002	1	SAM - Single Antenna MIMO – for MUROS	8.1.0	8.2.0
2009-09	43	GP-091309	0003	1	L2S mapping verifications for MUROS	8.1.0	8.2.0
2009-09	43	GP-091196	0009		Updates for Shifted SACCH	8.1.0	8.2.0
2009-09	43	GP-091310	0010		System performance results for adaptive symbol constellation	8.1.0	8.2.0
2009-12	44				Version for Release 9	8.2.0	9.0.0
2010-03	45	GP-100182	0012		MAIO Hopping Methodology	9.0.0	9.1.0
2010-05					Correction to previous line of history table	9.1.0	9.1.1

---

## History

<b>Document history</b>		
V9.0.0	February 2010	Publication
V9.1.1	May 2010	Publication