



**5G;
NR;**

**Derivation of test tolerances and measurement uncertainty for
User Equipment (UE) conformance test cases
(3GPP TR 38.903 version 15.3.0 Release 15)**



Reference

RTR/TSGR-0538903vf30

Keywords

5G

ETSI

650 Route des Lucioles
F-06921 Sophia Antipolis Cedex - FRANCE

Tel.: +33 4 92 94 42 00 Fax: +33 4 93 65 47 16

Siret N° 348 623 562 00017 - NAF 742 C
Association à but non lucratif enregistrée à la
Sous-Préfecture de Grasse (06) N° 7803/88

Important notice

The present document can be downloaded from:

<http://www.etsi.org/standards-search>

The present document may be made available in electronic versions and/or in print. The content of any electronic and/or print versions of the present document shall not be modified without the prior written authorization of ETSI. In case of any existing or perceived difference in contents between such versions and/or in print, the prevailing version of an ETSI deliverable is the one made publicly available in PDF format at www.etsi.org/deliver.

Users of the present document should be aware that the document may be subject to revision or change of status.

Information on the current status of this and other ETSI documents is available at

<https://portal.etsi.org/TB/ETSIDeliverableStatus.aspx>

If you find errors in the present document, please send your comment to one of the following services:

<https://portal.etsi.org/People/CommiteeSupportStaff.aspx>

Copyright Notification

No part may be reproduced or utilized in any form or by any means, electronic or mechanical, including photocopying and microfilm except as authorized by written permission of ETSI.

The content of the PDF version shall not be modified without the written authorization of ETSI.

The copyright and the foregoing restriction extend to reproduction in all media.

© ETSI 2019.

All rights reserved.

DECT™, **PLUGTESTS™**, **UMTS™** and the ETSI logo are trademarks of ETSI registered for the benefit of its Members.

3GPP™ and **LTE™** are trademarks of ETSI registered for the benefit of its Members and of the 3GPP Organizational Partners.

oneM2M™ logo is a trademark of ETSI registered for the benefit of its Members and of the oneM2M Partners.

GSM® and the GSM logo are trademarks registered and owned by the GSM Association.

Intellectual Property Rights

Essential patents

IPRs essential or potentially essential to normative deliverables may have been declared to ETSI. The information pertaining to these essential IPRs, if any, is publicly available for **ETSI members and non-members**, and can be found in ETSI SR 000 314: "*Intellectual Property Rights (IPRs); Essential, or potentially Essential, IPRs notified to ETSI in respect of ETSI standards*", which is available from the ETSI Secretariat. Latest updates are available on the ETSI Web server (<https://ipr.etsi.org/>).

Pursuant to the ETSI IPR Policy, no investigation, including IPR searches, has been carried out by ETSI. No guarantee can be given as to the existence of other IPRs not referenced in ETSI SR 000 314 (or the updates on the ETSI Web server) which are, or may be, or may become, essential to the present document.

Trademarks

The present document may include trademarks and/or tradenames which are asserted and/or registered by their owners. ETSI claims no ownership of these except for any which are indicated as being the property of ETSI, and conveys no right to use or reproduce any trademark and/or tradename. Mention of those trademarks in the present document does not constitute an endorsement by ETSI of products, services or organizations associated with those trademarks.

Legal Notice

This Technical Report (TR) has been produced by ETSI 3rd Generation Partnership Project (3GPP).

The present document may refer to technical specifications or reports using their 3GPP identities. These shall be interpreted as being references to the corresponding ETSI deliverables.

The cross reference between 3GPP and ETSI identities can be found under <http://webapp.etsi.org/key/queryform.asp>.

Modal verbs terminology

In the present document "**should**", "**should not**", "**may**", "**need not**", "**will**", "**will not**", "**can**" and "**cannot**" are to be interpreted as described in clause 3.2 of the [ETSI Drafting Rules](#) (Verbal forms for the expression of provisions).

"**must**" and "**must not**" are **NOT** allowed in ETSI deliverables except when used in direct citation.

Contents

Intellectual Property Rights	2
Legal Notice	2
Modal verbs terminology.....	2
Foreword.....	7
Introduction	7
1 Scope	8
2 References	8
3 Definitions, symbols and abbreviations	9
3.1 Definitions	9
3.2 Symbols.....	9
3.3 Abbreviations	9
4 General Principles	10
4.1 Principle of Superposition	10
4.2 Sensitivity analysis	10
4.3 Statistical combination of uncertainties.....	10
4.4 Correlation between uncertainties	11
4.4.1 Uncorrelated uncertainties	11
4.4.2 Positively correlated uncertainties	11
4.4.3 Negatively correlated uncertainties.....	12
4.4.4 Treatment of uncorrelated uncertainties	13
4.4.5 Treatment of positively correlated uncertainties with adverse effect.....	13
4.4.6 Treatment of positively correlated uncertainties with beneficial effect	13
4.4.7 Treatment of negatively correlated uncertainties	13
5 Determination of Test System Uncertainties.....	13
5.1 General	13
5.2 Uncertainty figures	14
6 Determination of Test Tolerances	14
6.1 General	14
7 Grouping of test cases defined in TS 38.521-4	14
8 Grouping of test cases defined in TS 38.533.....	15
Annex A: Derivation documents for test tolerance	16
A.1 Default uncertainties for conducted test cases defined in TS 38.533 (informative).....	16
A.1.1 AWGN and Fading.....	16
Annex B: Acceptable uncertainty of test system for test cases defined in TS 38.521-2 for radiative testing.....	17
B.1 Uncertainty budget calculation principle.....	17
B.1.1 Uncertainty budget calculation principle for DFF	17
B.1.2 Uncertainty budget calculation principle for IFF	17
B.1.3 Uncertainty budget calculation principle for NFTF	18
B.2 Measurement error contribution descriptions.....	18
B.2.1 Measurement error contribution descriptions for DFF	18
B.2.1.1 Positioning misalignment	18
B.2.1.2 Measure distance uncertainty.....	18
B.2.1.3 Quality of quiet zone.....	18
B.2.1.4 Mismatch	18
B.2.1.5 Standing Wave Between the DUT and measurement antenna.....	20
B.2.1.6 Uncertainty of the RF power measurement equipment.....	20

B.2.1.7	Phase curvature	21
B.2.1.8	Amplifier uncertainties	21
B.2.1.9	Random uncertainty	21
B.2.1.10	Influence of the XPD	22
B.2.1.11	Insertion loss Variation	25
B.2.1.12	RF leakage (from measurement antenna to receiver/transmitter)	25
B.2.1.13	Misalignment of positioning System	25
B.2.1.14	Uncertainty of the Network Analyzer	26
B.2.1.15	Uncertainty of the absolute gain of the calibration antenna	26
B.2.1.16	Positioning and pointing misalignment between the reference antenna and the measurement antenna	26
B.2.1.17	gNB emulator uncertainty	26
B.2.1.18	Phase centre offset of calibration	26
B.2.1.19	Quality of quiet zone for calibration process	27
B.2.1.20	Standing wave between reference calibration antenna and measurement antenna	27
B.2.1.21	Influence of the calibration antenna feed cable (Flexing cables, adapters, attenuators, connector repeatability)	27
B.2.1.22	Influence of TRP measurement grid	27
B.2.1.23	Influence of beam peak search grid	27
B.2.1.24	Systematic error due to TRP calculation/quadrature	27
B.2.1.25	Multiple measurement antenna uncertainty	28
B.2.1.26	DUT repositioning	28
B.2.1.27	Influence of noise	28
B.2.1.28	Systematic error related to beam peak search	28
B.2.1.29	Influence of spherical coverage grid	28
B.2.1.30	Systematic error related to EIS spherical coverage	28
B.2.2	Measurement error contribution descriptions for IFF	29
B.2.2.1	Positioning misalignment	29
B.2.2.2	Measure distance uncertainty	29
B.2.2.3	Quality of Quiet Zone	29
B.2.2.4	Mismatch	29
B.2.2.5	Standing wave between DUT and measurement antenna	29
B.2.2.6	Uncertainty of the RF power measurement equipment	29
B.2.2.7	Phase Curvature	29
B.2.2.8	Amplifier Uncertainties	29
B.2.2.9	Random uncertainty	29
B.2.2.10	Influence of XPD	29
B.2.2.11	Insertion Loss Variation	29
B.2.2.12	RF leakage (from measurement antenna to receiver/transmitter)	29
B.2.2.13	Misalignment of positioning system	29
B.2.2.14	Uncertainty of the Network Analyzer	30
B.2.2.15	Uncertainty of the absolute gain of the calibration antenna	30
B.2.2.16	Positioning and pointing misalignment between the reference antenna and the measurement antenna	30
B.2.2.17	gNB emulator uncertainty	30
B.2.2.18	Phase centre offset of calibration	30
B.2.2.19	Quality of the Quiet Zone for Calibration Process	30
B.2.2.20	Standing wave between reference calibration antenna and measurement antenna	30
B.2.2.21	Influence of the calibration antenna feed cable (Flexing cables, adapters, attenuators, connector repeatability)	30
B.2.2.22	Influence of TRP measurement grid	30
B.2.2.23	Influence of beam peak search grid	30
B.2.2.24	Systematic error due to TRP calculation/quadrature	30
B.2.2.25	Multiple measurement antenna uncertainty	30
B.2.2.26	DUT repositioning	30
B.2.2.27	Influence of noise	31
B.2.2.28	Systematic error related to beam peak search	31
B.2.2.29	Influence of spherical coverage grid	31
B.2.2.30	Systematic error related to EIS spherical coverage	31
B.2.3	Measurement error contribution descriptions for NFTF	31
B.2.3.1	Axes Alignment	31
B.2.3.2	Measurement Distance uncertainty	31
B.2.3.3	Quality of the Quiet Zone	31
B.2.3.4	Mismatch	31

B.2.3.5	Multiple Reflections: Coupling Measurement Antenna and DUT.....	31
B.2.3.6	Uncertainty of the RF power measurement equipment.....	31
B.2.3.7	Phase curvature.....	32
B.2.3.8	Amplifier uncertainties.....	32
B.2.3.9	Random uncertainty.....	32
B.2.3.10	Influence of the XPD.....	32
B.2.3.11	NF to FF truncation.....	32
B.2.3.12	Probe Polarization Amplitude and Phase.....	32
B.2.3.13	Probe Array Uniformity (for multi-probe systems only).....	32
B.2.3.14	Uncertainty of the Network Analyzer.....	32
B.2.3.15	Uncertainty of the absolute gain of the calibration antenna.....	32
B.2.3.16	Phase Recovery Non-Linearity over signal bandwidth.....	32
B.2.3.17	Probe Pattern Effect.....	32
B.2.3.18	Phase centre offset of calibration.....	33
B.2.3.19	Quality of the Quiet Zone for Calibration Process.....	33
B.2.3.20	Phase Drift and Noise.....	33
B.2.3.21	Mismatch in the connection of the calibration antenna.....	33
B.2.3.22	Influence of TRP measurement grid.....	33
B.2.3.23	33
B.2.3.24	33
B.2.3.25	Leakage and Crosstalk.....	33
B.2.3.26	Systematic error due to TRP calculation/quadrature.....	33
B.2.3.27	Multiple measurement antenna uncertainty.....	33
B.2.3.28	DUT repositioning.....	33
B.2.3.29	Influence of noise.....	33
B.3	UE maximum output power.....	33
B.3.1	Uncertainty budget format and assessment for DFF.....	34
B.3.2	Uncertainty budget format and assessment for IFF.....	38
B.3.3	Uncertainty budget format and assessment for NFTF.....	50
B.4 to B7	52
B.8	Transmit OFF power.....	52
B.8.1	Uncertainty budget format and assessment for DFF.....	52
B.8.2	Uncertainty budget format and assessment for IFF.....	56
B.9	61
B.10	Frequency error.....	61
B.10.1	Uncertainty budget format and assessment for DFF.....	61
B.10.2	Uncertainty budget format and assessment for IFF.....	61
B.11 to B.14	61
B.15	Occupied bandwidth.....	61
B.15.1	Uncertainty budget format and assessment for DFF.....	62
B.15.2	Uncertainty budget format and assessment for IFF.....	62
B.16	Spectrum emission mask.....	62
B.16.1	Uncertainty budget format and assessment for DFF.....	62
B.16.2	Uncertainty budget format and assessment for IFF.....	66
B.17	Adjacent Channel Leakage Ratio.....	72
B.17.1	Uncertainty budget format and assessment for DFF.....	72
B.17.2	Uncertainty budget format and assessment for IFF.....	76
B.18	Spurious emissions.....	79
B.18.1	Uncertainty budget format and assessment for DFF.....	80
B.18.2	Uncertainty budget format and assessment for IFF.....	84
B.18.3	Uncertainty budget format and assessment for NFTF.....	113
B.19	Reference Sensitivity.....	113
B.19.1	Uncertainty budget format and assessment for DFF.....	113
B.19.2	Uncertainty budget format and assessment for IFF.....	113

B.20 to B.24.....	119
B.25 Receiver spurious emissions	119
B.25.1 Uncertainty budget format and assessment for DFF	119
B.25.2 Uncertainty budget format and assessment for IFF.....	122
Annex C: Acceptable uncertainty of test system for test cases defined in TS 38.521-3 for radiative testing.....	153
Annex D: Acceptable uncertainty of test system for test cases defined in TS 38.521-4 for radiative testing.....	154
D.1 Uncertainty budget calculation principle.....	155
D.1.1 Uncertainty budget calculation principle for DNF	155
D.1.2 Uncertainty budget calculation principle for DFF.....	155
D.1.3 Uncertainty budget calculation principle for IFF	155
D.2 Measurement error contribution descriptions.....	155
D.2.1 Measurement error contribution descriptions for DNF	155
D.2.1.1 gNB emulator SNR uncertainty	155
D.2.1.2 gNB emulator Downlink EVM.....	155
D.2.1.3 gNB emulator fading model impairments.....	156
D.2.2 Measurement error contribution descriptions for DFF.....	156
D.2.2.1 gNB emulator SNR uncertainty	156
D.2.2.2 gNB emulator Downlink EVM.....	156
D.2.2.3 gNB emulator fading model impairments.....	156
D.2.3 Measurement error contribution descriptions for IFF	156
D.2.3.1 gNB emulator SNR uncertainty	156
D.2.3.2 gNB emulator Downlink EVM.....	156
D.2.3.3 gNB emulator fading model impairments.....	156
Annex E: Acceptable uncertainty of test system for test cases defined in TS 38.533 for radiative testing.....	157
E.1 Uncertainty budget calculation principle.....	157
E.1.1 Uncertainty budget calculation principle for DFF.....	157
E.1.2 Uncertainty budget calculation principle for IFF	157
E.2 Measurement error contribution descriptions.....	157
E.2.1 Measurement error contribution descriptions for DFF.....	157
E.2.1.1 gNB emulator SNR uncertainty	157
E.2.1.2 gNB emulator Downlink EVM.....	157
E.2.1.3 gNB emulator fading model impairments.....	157
E.2.2 Measurement error contribution descriptions for IFF	158
E.2.2.1 gNB emulator SNR uncertainty	158
E.2.2.2 gNB emulator Downlink EVM.....	158
E.2.2.3 gNB emulator fading model impairments.....	158
Annex F: Change history	159
History	160

Foreword

This Technical Report has been produced by the 3rd Generation Partnership Project (3GPP).

The contents of the present document are subject to continuing work within the TSG and may change following formal TSG approval. Should the TSG modify the contents of the present document, it will be re-released by the TSG with an identifying change of release date and an increase in version number as follows:

Version x.y.z

where:

- x the first digit:
 - 1 presented to TSG for information;
 - 2 presented to TSG for approval;
 - 3 or greater indicates TSG approved document under change control.
- y the second digit is incremented for all changes of substance, i.e. technical enhancements, corrections, updates, etc.
- z the third digit is incremented when editorial only changes have been incorporated in the document.

Introduction

FFS

1 Scope

The present document specifies a general method used to derive Measurement Uncertainties and Test Tolerances for UE conformance tests. The acceptable uncertainties for each test case are documented and establish a system for relating the Test Tolerances to the measurement uncertainties of the Test System.

For UE radio transmitting and reception tests, only FR2 is considered in this document. For UE RRM and Demodulation tests, both FR1 and FR2 are considered in this document.

The test cases which have been analysed to determine Test Tolerances are included as .zip files.

The present document is applicable from Release 15 up to the release indicated on the front page of the present Terminal conformance specifications.

2 References

The following documents contain provisions which, through reference in this text, constitute provisions of the present document.

- References are either specific (identified by date of publication, edition number, version number, etc.) or non-specific.
- For a specific reference, subsequent revisions do not apply.
- For a non-specific reference, the latest version applies. In the case of a reference to a 3GPP document (including a GSM document), a non-specific reference implicitly refers to the latest version of that document *in the same Release as the present document*.

- [1] 3GPP TR 21.905: "Vocabulary for 3GPP Specifications".
- [2] 3GPP TR 36.903: " Evolved Universal Terrestrial Radio Access (E-UTRA) and Evolved Universal Terrestrial Radio Access Network (E-UTRAN); Derivation of test tolerances for Radio Resource Management (RRM) conformance tests".
- [3] 3GPP TS 36.904: " Evolved Universal Terrestrial Radio Access (E-UTRA) and Evolved Universal Terrestrial Radio Access Network (E-UTRAN); Derivation of test tolerances for User Equipment (UE) radio reception conformance tests".
- [4] ETSI ETR 273-1-2: "Improvement of radiated methods of measurement (using test sites) and evaluation of the corresponding measurement uncertainties; Part 1: Uncertainties in the measurement of mobile radio equipment characteristics; Sub-part 2: Examples and annexes".
- [5] 3GPP TS 36.521-1: "User Equipment (UE) conformance specification, Radio transmission and reception Part 1: conformance testing".
- [6] 3GPP TS 38.521-1: "NR; User Equipment (UE) conformance specification; Radio transmission and reception; Part 1: Range 1 Standalone".
- [7] 3GPP TS 38.521-2: "NR; User Equipment (UE) conformance specification; Radio transmission and reception; Part 2: Range 2 Standalone".
- [8] 3GPP TS 38.521-3: "NR; User Equipment (UE) conformance specification; Radio transmission and reception; Part 3: NR interworking between NR range1 + NR range2; and between NR and LTE".
- [9] 3GPP TS 38.521-4: "NR; User Equipment (UE) conformance specification; Radio transmission and reception; Part 4: Performance requirements".
- [10] 3GPP TS 38.533: "NR; User Equipment (UE) conformance specification; Radio Resource Management (RRM)".

- [11] ETSI TR 102 273-1-1 V1.2.1 (2001-12): “Electromagnetic compatibility and Radio spectrum Matters (ERM); Improvement on Radiated Methods of Measurement (using test site) and evaluation of the corresponding measurement uncertainties; Part 1: Uncertainties in the measurement of mobile radio equipment characteristics; Sub-part 1: Introduction”.
- [12] 3GPP TR 25.914: “Measurement of Radio Performances for UMTS terminals in speech mode”.
- [13] 3GPP TR 38.810: "Study on test methods for New Radio ".
- [14] CTIA OTA Test Plan version 3.7, <https://www.ctia.org/>.
- [15] 3GPP TS 36.521-3: “User Equipment (UE) conformance specification, Radio transmission and reception Part 3: Radio Resource Management (RRM) conformance testing.”

3 Definitions, symbols and abbreviations

3.1 Definitions

For the purposes of the present document, the terms and definitions given in 3GPP TR 21.905 [1] apply.

3.2 Symbols

For the purposes of the present document, the following symbols apply:

D DUT radiating aperture

3.3 Abbreviations

For the purposes of the present document, the abbreviations given in 3GPP TR 21.905 [1] and the following apply. An abbreviation defined in the present document takes precedence over the definition of the same abbreviation, if any, in 3GPP TR 21.905 [1].

BW	Bandwidth
CA	Carrier Aggregation
DFF	Direct Far Field
DUT	Device Under Test
EIS	Effective Isotropic Sensitivity
EIRP	Effective (or equivalent) isotropic radiated power
EVM	Error Vector Magnitude
FF	Far Field
FR1	Frequency Range 1
FR2	Frequency Range 2
FWA	Fixed Wireless Access
IFF	Indirect Far Field
MBW	Maximum Bandwidth
MU	Measurement Uncertainty
NFTF	Near Field To Far-field
NR	New Radio
OTA	Over The Air
SNR	Signal-to-Noise Ratio
TRP	Total Radiated Power
UE	User Equipment

4 General Principles

4.1 Principle of Superposition

For multi-cell tests there are several cells each generating various Physical channels. In general cells are combined along with AWGN, so the signal and noise seen by the UE may be determined by more than one cell.

Since several cells may contribute towards the overall power applied to the UE, a number of test system uncertainties affect the signal and noise seen by the UE. The aim of the superposition method is to vary each controllable parameter of the test system separately, and to establish its effect on the critical parameters as seen by the UE receiver. The superposition principle then allows the effect of each test system uncertainty to be added, to calculate the overall effect.

The contributing test system uncertainties shall form a minimum set for the superposition principle to be applicable.

4.2 Sensitivity analysis

A change in any one channel level or channel ratio generated at source does not necessarily have a 1:1 effect at the UE. The effect of each controllable parameter of the test system on the critical parameters as seen by the UE receiver shall therefore be established. As a consequence of the sensitivity scaling factors not necessarily being unity, the test system uncertainties cannot be directly applied as test tolerances to the critical parameters as seen by the UE.

EXAMPLE: In many of the tests described, the \hat{E}_s / I_{ot} is one of the critical parameters at the UE. Scaling factors are used to model the sensitivity of the \hat{E}_s / I_{ot} to each test system uncertainty. When the scaling factors have been determined, the superposition principle then allows the effect of each test system uncertainty to be added, to give the overall variability in the critical parameters as seen at the UE.

There are often constraints on several parameters at the UE. The aim of the sensitivity analysis, together with the acceptable test system uncertainties, is to ensure that the variability in each of these parameters is controlled within the limits necessary for the specification to apply. The test has then been conducted under valid conditions.

4.3 Statistical combination of uncertainties

The acceptable uncertainties of the test system are specified as the measurement uncertainty tolerance interval for a specific measurement that contains 95 % of the performance of a population of test equipment. In the RRM and UE radio transmission and reception conformance tests covered by the present document, the Test System shall enable the stimulus signals in the test case to be adjusted to within the specified range, with an uncertainty not exceeding the specified values.

The method given in the present document combines the acceptable uncertainties of the test system, to give the overall variability in the critical parameters as seen at the UE. Since the process does not add any new uncertainties, the method of combination should be chosen to maintain the same tolerance interval for the combined uncertainty as is already specified for the contributing test system uncertainties.

The basic principle for combining uncertainties is in accordance with ETR 273-1-2 [4]. In summary, the process requires 3 steps:

- a) Express the value of each contributing uncertainty as a one standard deviation figure, from knowledge of its numeric value and its distribution.
- b) Combine all the one standard deviation figures as root-sum-squares, to give the one standard deviation value for the combined uncertainty.
- c) Expand the combined uncertainty by a coverage factor, according to the tolerance interval required.

Provided that the contributing uncertainties have already been obtained using this method, using a coverage factor of 2, further stages of combination can be achieved by performing step b) alone, since steps a) and c) simply divide by 2 and multiply by 2 respectively.

The root-sum-squares method is therefore used to maintain the same tolerance interval for the combined uncertainty as is already specified for the contributing test system uncertainties. In some cases where correlation between contributing uncertainties has an adverse effect, the method is modified in accordance with clause 4.4.5 of the present document.

In each analysis, the uncertainties are assumed to be uncorrelated, and are added result root-sum-square unless otherwise stated.

The combination of uncertainties is performed using dB values for simplicity. It has been shown that using dB uncertainty values gives a slightly worse combined uncertainty result than using linear values for the uncertainties. The analysis method therefore errs on the safe side.

4.4 Correlation between uncertainties

The statistical (root-sum-square) addition of uncertainties is based on the assumption that the uncertainties are independent of each other. For realisable test systems, the uncertainties may not be fully independent. The validity of the method used to add uncertainties depends on both the type of correlation and on the way in which the uncertainties affect the test requirements.

Clauses 4.4.1 to 4.4.3 give examples to illustrate different types of correlation.

Clauses 4.4.4 to 4.4.7 show how the scenarios applicable to multi-cell RRM tests are treated.

4.4.1 Uncorrelated uncertainties

The graph shows an example of two test system uncertainties, A and B, which affect a test requirement. Each sample from a population of test systems has a specific value of error in parameter A, and a specific value of error in parameter B. Each dot on the graph represents a sample from a population of test systems, and is plotted according to its error values for parameters A and B.

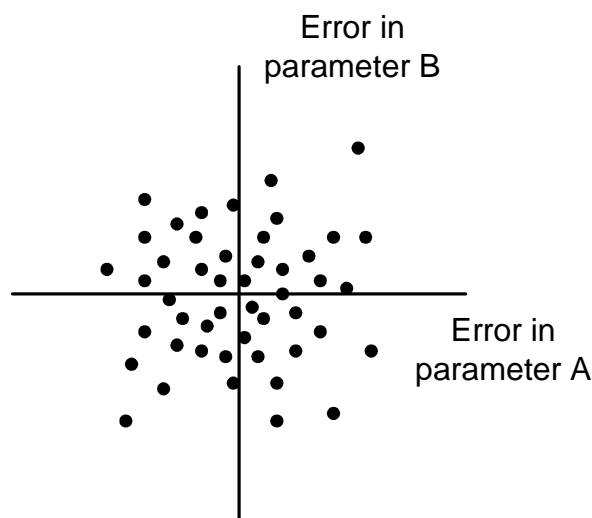

Figure 4.4.1-1: Example of two test system uncertainties affecting a test requirement

It can be seen that a positive value of error in parameter A, for example, is equally likely to occur with either a positive or a negative value of error in parameter B. This is expected when two parameters are uncorrelated, such as two uncertainties which arise from different and unrelated parts of the test system.

4.4.2 Positively correlated uncertainties

The graph shows an example of two test system uncertainties, A and B, which affect a test requirement. Each sample from a population of test systems has a specific value of error in parameter A, and a specific value of error in parameter

B. Each dot on the graph represents a sample from a population of test systems, and is plotted according to its error values for parameters A and B.

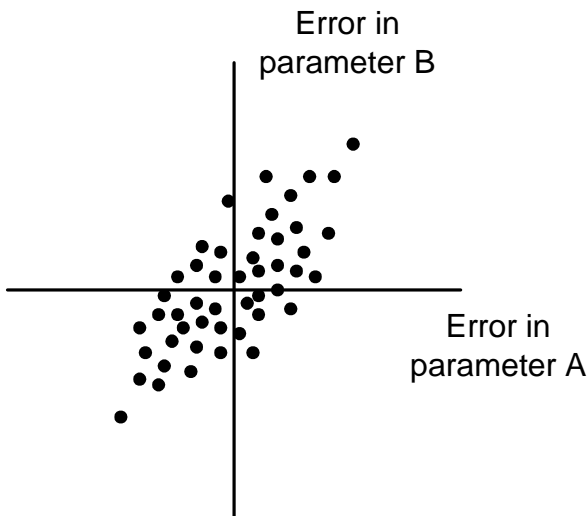

Figure 4.4.2-1: Example of two test system uncertainties affecting a test requirement

It can be seen that a positive value of error in parameter A, for example, is more likely to occur with a positive value of error in parameter B and less likely to occur with a negative value of error in parameter B. This can occur when the two uncertainties arise from similar parts of the test system, or when one component of the uncertainty affects both parameters in a similar way.

In an extreme case, if the error in parameter A and the error in parameter B came from the same sources of uncertainty, and no others, the dots would lie on a straight line of slope +1.

4.4.3 Negatively correlated uncertainties

The graph shows an example of two test system uncertainties, A and B, which affect a test condition. Each sample from a population of test systems has a specific value of error in parameter A, and a specific value of error in parameter B. Each dot on the graph represents a sample from a population of test systems, and is plotted according to its error values for parameters A and B.

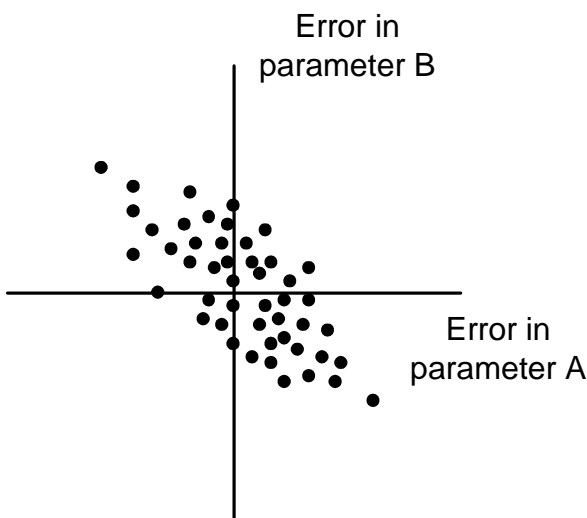

Figure 4.4.3-1: Example of two test system uncertainties affecting a test condition

It can be seen that a positive value of error in parameter A, for example, is more likely to occur with a negative value of error in parameter B and less likely to occur with a positive value of error in parameter B. This effect can theoretically occur, and is included for completeness, but is unlikely in a practical test system.

4.4.4 Treatment of uncorrelated uncertainties

If two uncertainties are uncorrelated, they are added statistically in the analysis. Provided that each uncertainty is already expressed as an expanded uncertainty with coverage factor 2, the contributing uncertainties are added root-sum-squares to give a combined uncertainty which also has coverage factor 2, and the 95% tolerance interval is maintained.

This is the default assumption.

4.4.5 Treatment of positively correlated uncertainties with adverse effect

If two test system uncertainties are positively correlated, and if they affect the value of a critical parameter in the same direction, the combined effect may be greater than predicted by adding the contributing uncertainties root-sum-squares.

In this scenario the two uncertainties are added worst-case in the analysis. Provided that each uncertainty is already expressed as an expanded uncertainty with coverage factor 2, the combined uncertainty will cover a 95% tolerance interval even when the two contributing uncertainties are fully correlated. If the two contributing uncertainties are less than fully correlated, the combined uncertainty will cover a tolerance interval greater than 95%.

4.4.6 Treatment of positively correlated uncertainties with beneficial effect

If two test system uncertainties are positively correlated, and if they affect the value of a critical parameter in opposite directions, the combined effect will be less than predicted by adding the contributing uncertainties root-sum-squares.

In this scenario the two uncertainties are added statistically in the analysis. Provided that each uncertainty is already expressed as an expanded uncertainty with coverage factor 2, the combined uncertainty will cover a 95% tolerance interval when the two contributing uncertainties are uncorrelated. If the two contributing uncertainties are positively correlated, the combined uncertainty will cover a tolerance interval greater than 95%.

4.4.7 Treatment of negatively correlated uncertainties

Negatively correlated uncertainties are excluded by the assumptions. This has been agreed as an acceptable restriction on practical test systems, as the mechanisms which produce correlation generally arise from similarities between two parts of the test system, and therefore produce positive correlation.

5 Determination of Test System Uncertainties

5.1 General

The uncertainty of a test system when making measurements reduces the ability of the test system to distinguish between conformant and non-conformant test subjects. The aim is therefore to minimise uncertainty, subject to a number of practical constraints:

- a) A vendor's test system should be reproducible in the required quantities.
- b) A choice of test systems should be available from different vendors.
- c) The uncertainties should allow reasonable freedom of test system implementation
- d) The test system can be run automatically
- e) The test system may include several radio access technologies

- f) It should be possible to maintain calibration of deployed test systems over reasonable spans of time and environmental conditions

In practice therefore within 3GPP the acceptable uncertainty of the test system is the smallest value that can be agreed between the test system vendors represented, consistent with the above constraints. The uncertainty will not therefore be as low as could be achieved, for example, by a national standards laboratory.

5.2 Uncertainty figures

The actual figures for the acceptable uncertainty of a test system are defined in [Annex TBD of 38.521-1, Annex TBD of 38.521-2, Annex TBD of 38.521-3, Annex TBD of TS 38.521-4 and Annex TBD of TS 38.533]. To avoid maintenance issues with figures in separate specifications, the uncertainties are not formally defined within the present document, but informative guidelines are provided in Annex B to Annex E of the present document.

6 Determination of Test Tolerances

6.1 General

The general principles given in the present document are applied to each test case, according to the applicable uncertainties and requirements to obtain a correct verdict.

The test cases which have been analysed to determine Test Tolerances are included in the present document as .zip files. The name of the zip file indicates the specification and the test cases covered.

Annex A gives the rationale for their inclusion.

7 Grouping of test cases defined in TS 38.521-4

Editor's note: intended to capture grouping of demodulation test cases.

8 Grouping of test cases defined in TS 38.533

Group	Test Case Numbers	.zip file name	Comments
SCell_Activation_01	4.5.3.1 4.5.3.2 4.5.3.3	"38.533 4.5.3.1+4.5.3.2+4.5.3.3 TT.zip"	"2 Inter Frequency NR Cells, 3 time periods, Various number of sub-tests, No fading"
Intra_Freq_Meas_01	4.6.1.1 4.6.1.2 4.6.1.3 4.6.1.4 6.6.1.1 6.6.1.2 6.6.1.3 6.6.1.4 6.6.1.5 6.6.1.6	"38.533 4.6.1.1+4.6.1.2+4.6.1.3+4.6.1.4 TT.zip"	"2 Intra Frequency NR Cells, 2 time periods, Various number of sub-tests, No fading"
Inter_Freq_Meas_01	4.6.2.1 4.6.2.2 4.6.2.5 4.6.2.6 6.6.2.1 6.6.2.2 6.6.2.5 6.6.2.6	"4.6.2.1+4.6.2.2+4.6.2.5+4.6.2.6 TT.zip"	"2 Inter Frequency NR Cells, 2 time periods, Various number of sub-tests, No fading"
Intra_Reselection_01	6.1.1.1	"38.533 6.1.1.1 TT.zip"	"2 Intra Frequency NR Cells, 3 time periods, No fading"
Inter_Reselection_01	6.1.1.2	"38.533 6.1.1.2 TT.zip"	"2 Inter Frequency NR Cells, 3 time periods, No fading"
InterRAT_Higher_Reselection_01	6.1.2.1	"38.533 6.1.2.1 TT.zip"	"1 E-UTRAN Cell, 1 NR Cells, 3 time periods, No fading"
InterRAT_Lower_Reselection_01	6.1.2.2	"38.533 6.1.2.2 TT.zip"	"1 E-UTRAN Cell, 1 NR Cells, 2 time periods, No fading"
InterRAT_Known_Handover_01	6.3.1.4	"38.533 6.3.1.4 TT.zip"	"1 E-UTRAN Cell, 1 NR Cells, 3 time periods, No fading"
InterRAT_Unknown_Handover_01	6.3.1.5	"38.533 6.3.1.5 TT.zip"	"1 E-UTRAN Cell, 1 NR Cells, 2 time periods, No fading"

Annex A: Derivation documents for test tolerance

The documents (and spreadsheets where applicable) used to derive the test tolerances for each test case are included in the present document as zip files.

The aim is to provide a reference to completed test cases, so that test tolerances for similar test cases can be derived on a common basis. The information on test case grouping in section 7 and 8 can be used to identify similarities.

A.1 Default uncertainties for conducted test cases defined in TS 38.533 (informative)

This annex contains suggested uncertainties, grouped according to types of test case for NR cells. The aim is to provide a consistent set of uncertainties across similar test cases to allow efficient implementation.

The suggested uncertainties for LTE cells are specified in TS 36.521-3 [xx] Annex B.

This Annex is informative only, as the acceptable uncertainties of a test system are defined in Annex F of TS 38.533 [10].

A.1.1 AWGN and Fading

The following uncertainties and parameters are suggested for NR AWGN and Fading.

Table A.1-1: Parameters for NR AWGN and Fading

AWGN Bandwidth	FFS
AWGN absolute power uncertainty	Test-specific
AWGN flatness and signal flatness, max deviation for any Resource Block, relative to average over BW_{Config}	± 1.5 dB
AWGN peak to average ratio	FFS
Signal-to noise ratio uncertainty	Test-specific
Fading profile power uncertainty	
- For 1 Tx antenna:	FFS
- For 2 Tx antenna	FFS
Fading profile delay uncertainty, relative to frame timing	FFS

Annex B: Acceptable uncertainty of test system for test cases defined in TS 38.521-2 for radiative testing

This annex contains suggested uncertainties for each test case in TS 38.521-2.

B.1 Uncertainty budget calculation principle

Three permitted test methodologies, DFF, IFF and NFTF, have been identified for UE RF FR2 test cases defined in TS 38.521-2.

This Annex is deriving Total expanded Measurement Uncertainties per test case for each test methodology.

Threshold MU is equivalent to Total expanded uncertainty of the reference methodology which has been defined as IFF.

If the Total expanded Measurement Uncertainty per test case of a permitted test method is lower than or equal to the threshold MU, then that test method is applicable to the respective test cases defined in TS 38.521-2.

NOTE: The reference methodology for spurious emission test cases has not been defined yet.

B.1.1 Uncertainty budget calculation principle for DFF

The uncertainty tables should be presented with two stages:

- Stage 1: the calibration of the absolute level of the DUT measurement results is performed by means of using a calibration antenna whose absolute gain is known at the frequencies of measurement
- Stage 2: the actual measurement with the DUT as either the transmitter or receiver is performed.

The MU budget should comprise the following headings:

- 1) The uncertainty source. Compile a complete list of the individual measurement uncertainty elements that contribute to a measurement. Determine the maximum value of each uncertainty
- 2) Determine the distribution of each uncertainty (rectangular, U-shaped, etc.),
- 3) Calculate (if necessary) the standard deviation of each uncertainty, u_i , for each uncertainty element,
- 4) Convert the units (if necessary) of each uncertainty element into the chosen unit, i.e., dB,,
- 5)
- 6) Combine ALL the standard uncertainties by the root-sum-squares method to derive the 'combined standard uncertainty',
- 7) Multiply the resulting combined standard uncertainty by an expansion factor ' k ' to derive the 'expanded uncertainty' for a given confidence level. All expanded uncertainties are quoted to 95% confidence level, so k is taken as 1.96. This gives 95% confidence that the true value is within 1.96 times the combined standard uncertainty of the measured value to derive the 'expanded uncertainty'.
- 8) Any systematic errors are added to the expanded uncertainty to derive the 'total expanded uncertainty', i.e.,

$$u_{c,\text{total expanded}} = u_{c,\text{expanded}} + u_{c,\text{systematic}} = 1.96 \sqrt{\sum u_i^2} + \sum u_{i,\text{systematic}}$$

B.1.2 Uncertainty budget calculation principle for IFF

The same as defined in B.1.1.

B.1.3 Uncertainty budget calculation principle for NFFT

The same as defined in B.1.1 with the exception of Stage 2, only the measurement of the DUT transmitter is performed.

B.2 Measurement error contribution descriptions

B.2.1 Measurement error contribution descriptions for DFF

B.2.1.1 Positioning misalignment

This contribution originates from the misalignment of the testing direction and the beam peak direction of the measurement antenna due to imperfect rotation operation. The pointing misalignment may happen in both azimuth and vertical directions and the effect of the misalignment depends highly on the beam width of the beam under test. The same level of misalignment results in a larger measurement error for a narrower beam.

B.2.1.2 Measure distance uncertainty

The cause of this uncertainty contributor is due to the reduction of distance between the measurement antenna and the DUT. If the distance of separation is $2D^2/\lambda$ based on D being the entire device size, then the phase variation is 22.5deg. Whether this is the minimum acceptable criteria of phase taper over the entire DUT is FFS and shall be assessed during final MU definition for the test method. Any reduction in the distance of separation increases the phase variation and creates an error which is DUT dependant. Determination of limit of the error shall be done during final MU definition for the test method.

B.2.1.3 Quality of quiet zone

The quality of the quiet zone procedure characterizes the quiet zone performance of the anechoic chamber, specifically the effect of reflections within the anechoic chamber including any positioners and support structures. The MU term additionally includes the amplitude variations effect of offsetting the directive antenna array inside a DUT from the centre of the quiet zone as well as the directivity MU, i.e., the variation of antenna gains in the different direct line-of-sight links. An additional MU term related to phase variation and phase ripple effects which depends on measurement distance is FFS, and shall be assessed during final MU definition for the test method. This might require an augmentation of the quality of the quiet zone validation procedure.

B.2.1.4 Mismatch

Mismatch uncertainty occurs when;

- Changing the signal path between the measurement and calibration procedure
- Evaluating the insertion loss of a signal path

The mismatch uncertainty for a system consisting of a generator, a load and a component in between is defined as

$$\text{Mismatch contribution (standard deviation)} = \frac{|\Gamma_{generator}| \cdot |\Gamma_{load}| \cdot |S_{21}| \cdot |S_{12}| \cdot 100}{\sqrt{2} \cdot 11.5} \text{ dB},$$

Where Γ denotes the reflection coefficient and S_{21} is the transmission coefficient, both in linear voltage ratios.

For a cascade of several components, the interactions between all components have to be evaluated. For example, for four devices in a row (shown in Figure B.2.1.4-1) the following contributions have to be accounted for: AB, BC, CD, ABC, BCD, ABCD. The term ABCD represents the interaction between A and D (generator and load) with the components B and C in between.



Figure B.2.1.4-1: Cascade of components

The combined mismatch uncertainty is given by the root sum square of the individual contributions:

$$combined\ mismatch\ uncertainty = \sqrt{(AB)^2 + (BC)^2 + (CD)^2 + (ABC)^2 + (BCD)^2 + (ABCD)^2}$$

In an optimized test procedure, the overall mismatch uncertainty is smaller when matching pairs of mismatches exist in the calibration and measurement stage since these pairs cancel each other out. Figure B.2.1.4-2 displays a calibration setup, where device D is replaced by device F. The mismatch contributions for this path are AB, BC, CE, ABC, BCE and ABCE. For a result based on the measurement and calibration stage, the mismatch contributions AB, BC, and ABC are matching pairs as they occur both in the measurement and calibration stage. Thus, they can be eliminated [11], and the system mismatch uncertainty is obtained as $\sqrt{(CD)^2 + (CE)^2 + (BCD)^2 + (BCE)^2 + (ABCD)^2 + (ABCE)^2}$

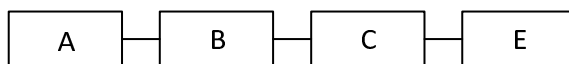

Figure B.2.1.4-2: Sketch of a calibration path

In the following, an example mismatch uncertainty calculation for a TX/RX patch from the measurement equipment to the measurement antenna is performed for a frequency of 43.5GHz. The example path under investigation consists of four SPDT switches, one SP6T switch and one DPDT switch and microwave cable interconnects with PC2.4 mm connectors. The attenuation and reflectance of typical components suitable for frequencies ranging up to 43.5 GHz have been considered in the calculation of the mismatch uncertainty.

Figure B1.1.4.4-3 shows a sample system setup for an EIRP/EIS test case with rather simple complexity of the switch box similar to a current sub 6GHz test setup. It should be noted that the switch unit is significantly less complex than a state-of-the-art switch unit currently used for conformance tests.

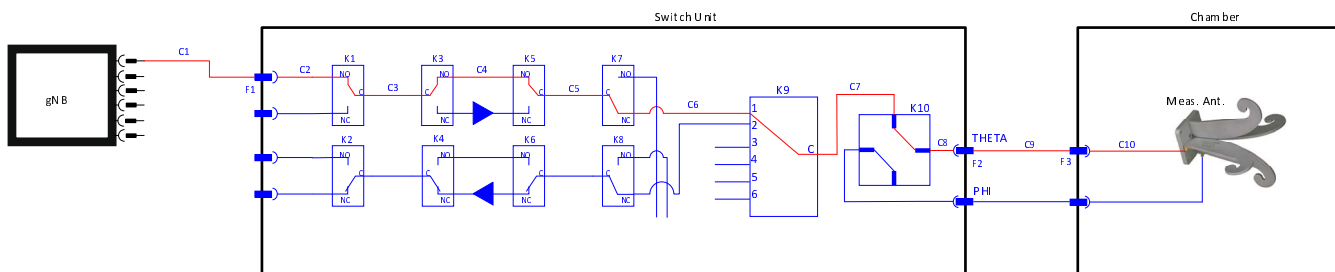

Figure B.2.1.4-3: Block Diagram of an EIRP/EIS test case with components from the gNB to the antenna (only portion of switch unit shown)

Table B.2.1.4-1: comprises the reflection and transmission properties of the components of the example path at a frequency of 43.5 GHz

Device / Component	VSWR	Transmission (dB)	Identifier in Figure B.2.1.4-3	Additional Comment/ Assumption
System Simulator	3.5		gNB	
Cable	1.5	-5.38	C1	Length: 1.5m Loss: 3.59dB/m
Cable	1.5	-0.61	C2, C3, C4, C5, C6, C7, C8	Length: 0.17m Loss: 3.59dB/m
Cable	1.5	-7.18	C9, C10	Length: 2.0m Loss: 3.59dB/m
Feedthrough	1.3	-0.66	F1, F2, F3	
SPDT switch	1.9	-1.10	K1, K3, K5, K7	
SP6T switch	2.2	-1.20	K9	
Transfer switch	2.0	-1.10	K10	
Antenna	2.0		Meas. Ant.	

The calculation of the overall mismatch uncertainty for a frequency of 43.5 GHz results in a value of 2.7 dB for the standard deviation, i.e., the expanded uncertainty is 5.3 dB.

Figure B.2.1.4-4 depicts a possible calibration for a part of the setup.

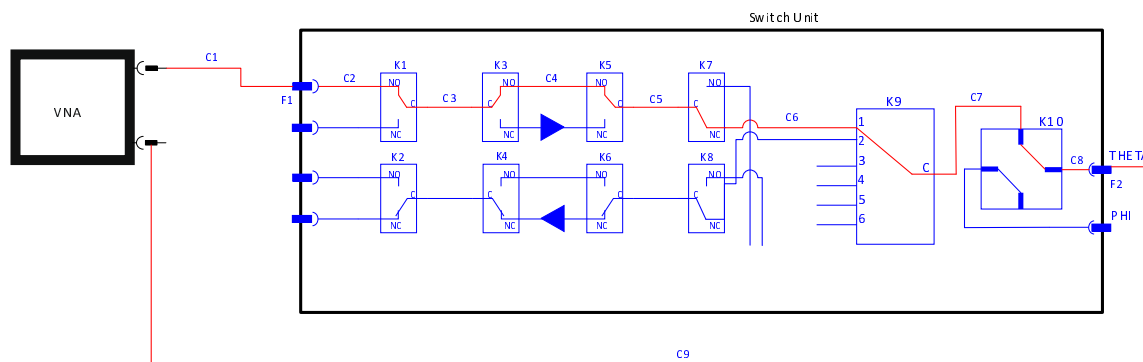

Figure B.2.1.4-4: Block Diagram of the calibration stage

For the VNA a return loss of 30 dB is assumed after a full two-port calibration. The calculation of the system mismatch uncertainty applying the elimination of matching pairs results in a value of 1.0 dB (standard deviation) with an expanded value of 1.9 dB.

Since the overall mismatch uncertainty value is already a standard deviation, which is RSS of values divided by the divisor ($\sqrt{2}$), the overall mismatch uncertainty value should be divided by actual divisor 1 when calculating total mismatch.

B.2.1.5 Standing Wave Between the DUT and measurement antenna

This uncertainty term is related to the amplitude ripple coming from the standing waves between the DUT and measurement antenna. If this term is not considered to be negligible one method to obtain this value is to slide the DUT $\lambda/4$ towards the measurement antenna while measuring the amplitude. The uncertainty term can be derived by performing the standard deviation on the results.

B.2.1.6 Uncertainty of the RF power measurement equipment

The receiving device is used to measure the received signal level in the EIRP tests as an absolute level. These receiving devices are spectrum analysers, communication analysers, or power meters. The uncertainty value will be indicated in the manufacturer's data sheet. It needs to be ensured that appropriate manufacturer's uncertainty contributions are

specified for the settings used such as bandwidth and absolute level. If a power meter is used zero offset, zero drift and measurement noise need to be included.

B.2.1.7 Phase curvature

This contribution originates from the finite far field measurement distance, which causes phase curvature across the antenna of UE/reference antenna. At a measurement distance of $2D^2/\lambda$ the phase curvature is 22.5 degrees. The impact of this factor shall be assessed during final MU definition for the test method.

B.2.1.8 Amplifier uncertainties

Any components in the setup can potentially introduce measurement uncertainty. It is then needed to determine the uncertainty contributors associated with the use of such components. For the case of external amplifiers, the following uncertainties should be considered but the applicability is contingent to the measurement implementation and calibration procedure.

- Stability
 - An uncertainty contribution comes from the output level stability of the amplifier. Even if the amplifier is part of the system for both measurement and calibration, the uncertainty due to the stability shall be considered. This uncertainty can be either measured or determined by the manufacturers' data sheet for the operating conditions in which the system will be required to operate.
- Linearity
 - An uncertainty contribution comes from the linearity of the amplifier since in most cases calibration and measurements are performed at two different input/output power levels. This uncertainty can be either measured or determined by the manufacturers' data sheet.
- Noise Figure
 - When the signal goes into an amplifier, noise is added so that the SNR at the output is reduced with regard to the SNR of the signal at the input. This added noise introduces error on the signal which affects the Error Rate of the receiver thus the EVM (Error Vector Magnitude). An uncertainty can be calculated through the following formula:

$$\varepsilon_{EVM} = 20 \log_{10} \left(1 + 10^{\frac{-SNR}{20}} \right)$$
 - Where SNR is the signal to noise ratio in dB at the signal level used during the sensitivity measurement.
- Mismatch
 - If the external amplifier is used for both stages, measurement and calibration the uncertainty contribution associated with it can be considered systematic and constant -> 0dB. If it is not the case, the mismatch uncertainty at its input and output shall be either measured or determined by the method described in [12].
- Gain
 - If the external amplifier is used for both stages, measurement and calibration the uncertainty contribution associated with it can be considered systematic and constant -> 0dB. If it is not the case, this uncertainty shall be considered.

B.2.1.9 Random uncertainty

This contribution is used to account for all the unknown, unquantifiable, etc. uncertainties associated with the measurements.

Random uncertainty MU contributions are normally distributed.

The random uncertainty term, by definition, cannot be measured, or even isolated completely. However, past system definitions provide an empirical basis for a value. Current LTE SISO OTA measurements have random uncertainty

contributions of ~0.2dB. A value of 0.5dB is suggested due to increased sensitivity to random effects in more complex, higher frequency NR test systems.

B.2.1.10 Influence of the XPD

This factor takes into account the uncertainty caused due to the finite cross polar discrimination (XPD) between the two polarization ports of the measurement probe. The XPD of the probe antenna shall be take into account during final MU definition for the test method.

A typical probe antenna can have XPD of 30dB.

A transmission matrix and calibration setup as shown in Figure B.2.1.10-1 is considered here. Typically, a single-polarized reference antenna with known gain is placed at the centre of the quiet zone and the total attenuation, L , between the reference antenna terminal and the feed antenna terminals is determined as part of the range reference calibration procedure.

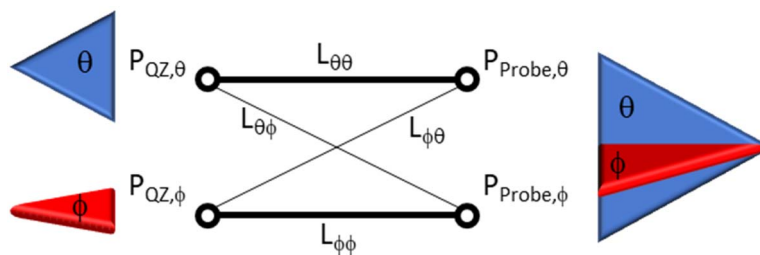

Figure B.2.1.10-1: Calibration Setup

Since the reference antenna is considered a single-polarized antenna, the XPD effect is negligible. Since the measurement probe is assumed to be a dual-linearly polarized antenna, leakage from one terminal/polarization to the other, i.e., XPD, needs to be considered.

The dual-linearly polarized measurement probe has two terminals corresponding to a set of orthogonal polarizations, θ and ϕ which match the orientations of the reference antenna. The most thorough calibration procedure would determine the path losses between the four different combinations of signal paths: $\theta\theta$, $\theta\phi$, $\phi\theta$, and $\phi\phi$, e.g., the power received by the measurement probe at the θ polarization/terminal, $P_{\text{Feed},\theta}$, is attenuated by $L_{\phi\theta}$ with respect to the power delivered to the reference antenna oriented in the ϕ polarization and placed in the centre of quiet zone, $P_{\text{QZ},\phi}$.

The most common calibration approach, however, is based on calibrating the polarization matched paths in Figure B.2.1.10-1 (thick solid lines), i.e., $\theta\theta$ and $\phi\phi$. In this case, as illustrated in Figure B.2.1.10-2, the normalized pathlosses $L_{\theta\theta}$ and $L_{\phi\phi}$ are 1 and the pathlosses of the crossed components become the XPD terms of the measurement probe:

$$\alpha_{\theta\phi} = 10^{\frac{\text{XPD}_{\theta\phi}}{10}} \quad (1.1)$$

and

$$\alpha_{\phi\theta} = 10^{\frac{\text{XPD}_{\phi\theta}}{10}} \quad (1.2)$$

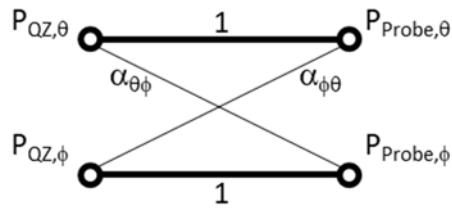

Figure B.2.1.10-2: Common calibration approach based on calibrating the polarization matched signal paths

In the remainder of this analysis, it is assumed that the leakage between the two polarization ports of the measurement probe is assumed to be the same, i.e., $XPD = XPD_{\theta\phi} = XPD_{\phi\theta}$ and $\alpha = \alpha_{\theta\phi} = \alpha_{\phi\theta}$.

The normalized powers at the measurement probe terminals can then be written as

$$P_{Probe,\theta} = P_{QZ,\theta} + \alpha P_{QZ,\phi} \tag{1.3}$$

$$P_{Probe,\phi} = P_{QZ,\phi} + \alpha P_{QZ,\theta} \tag{1.4}$$

The normalized ratio of total powers at measurement probe and the centre of the quiet zone is therefore

$$\frac{P_{Probe}}{P_{QZ}} = \frac{P_{Probe,\theta} + P_{Probe,\phi}}{P_{QZ,\theta} + P_{QZ,\phi}} = \frac{(P_{QZ,\theta} + P_{QZ,\phi})(1 + \alpha)}{P_{QZ,\theta} + P_{QZ,\phi}} = 1 + \alpha \tag{1.5}$$

This simple analysis shows that the XPD of the measurement probe introduces a small error of the total power measured by the measurement probe and that the conservation of measured powers is not guaranteed, i.e., the MU based on the XPD can be expressed as

$$MU_{XPD} [dB] = 10 \log_{10} (1 + \alpha) = 10 \log_{10} \left(1 + 10^{\frac{XPD}{10}} \right) \tag{1.6}$$

This XPD MU is tabulated for different levels of XPD in Table B.2.1.10-1.

Table B.2.1.10-1: XPD MU for different XPD values

XPD [dB]	MU _{XPD} [dB]
-20	0.043
-25	0.014
-30	0.004
-35	0.001
-40	0.000

When the range reference calibration is based on a full matrix-based approach, i.e., all signal paths are calibrated, the conservation of measured powers is guaranteed. As shown in Figure B.2.1.10-3, the polarization-matched signal paths take into account the leakage of power into the cross paths.

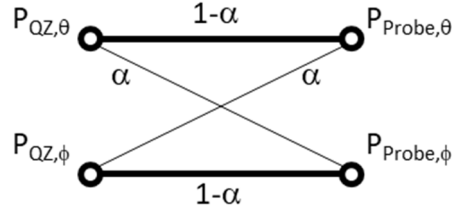

Figure B.2.1.10-3: Calibration approach based on calibrating all signal paths

The powers at the measurement probe can now be written as

$$P_{\text{Probe},\theta} = (1-\alpha)P_{\text{QZ},\theta} + \alpha P_{\text{QZ},\phi} \quad (1.7)$$

$$P_{\text{Probe},\phi} = (1-\alpha)P_{\text{QZ},\phi} + \alpha P_{\text{QZ},\theta} \quad (1.8)$$

The normalized ratio of total powers at measurement probe and the centre of the quiet zone is then

$$\frac{P_{\text{Probe}}}{P_{\text{QZ}}} = \frac{P_{\text{Probe},\theta} + P_{\text{Probe},\phi}}{P_{\text{QZ},\theta} + P_{\text{QZ},\phi}} = \frac{P_{\text{QZ},\theta} + P_{\text{QZ},\phi}}{P_{\text{QZ},\theta} + P_{\text{QZ},\phi}} = 1 \quad (1.9)$$

This simple analysis now shows that for a matrix-based calibration of all signal paths the XPD of the measurement probe no longer introduces any error and that the conservation of measured powers is guaranteed, i.e., the MU based on the XPD is 0dB.

The derivation of the XPD MU based on powers is a more straightforward and less complex approach than with electric fields as attempted in [2]. This annex shows that the same XPU MU result as derived in (1.5) can be derived using electric fields.

The corresponding signal paths are illustrated in Figure B.2.1.10-4.

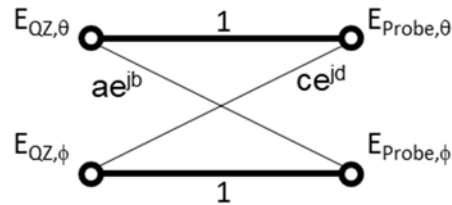

Figure B.2.1.10-4: Signal paths for electric fields (based on calibrating the polarization matched signal paths)

The normalized fields at the measurement probe terminals can then be written as

$$E_{\text{Probe},\theta} = E_{\text{QZ},\theta} + ce^{jd} E_{\text{QZ},\phi} \quad (1.10)$$

$$E_{\text{Probe},\phi} = E_{\text{QZ},\phi} + ae^{jb} E_{\text{QZ},\theta} \quad (1.11)$$

The transmission matrix can be defined as H

$$\begin{bmatrix} E_{\text{Probe},\theta} \\ E_{\text{Probe},\phi} \end{bmatrix} = H \begin{bmatrix} E_{\text{QZ},\theta} \\ E_{\text{QZ},\phi} \end{bmatrix} \quad (1.12)$$

$$H = \begin{bmatrix} 1 & ae^{jb} \\ ce^{jd} & 1 \end{bmatrix} \quad (1.13)$$

The total magnitude component of the electric field including coherence/interference terms at the probe is

$$\begin{aligned} E_{\text{Probe},T} &= \sqrt{|E_{\text{Probe},\theta}|^2 + |E_{\text{Probe},\phi}|^2} = \sqrt{|E_{\text{QZ},\theta} + ce^{jd} E_{\text{QZ},\phi}|^2 + |E_{\text{QZ},\phi} + ae^{jb} E_{\text{QZ},\theta}|^2} \\ &= \sqrt{\left[(E_{\text{QZ},\theta} + cE_{\text{QZ},\phi} \cos(d))^2 + (cE_{\text{QZ},\phi} \sin(d))^2 \right] + \left[(E_{\text{QZ},\phi} + aE_{\text{QZ},\theta} \cos(b))^2 + (aE_{\text{QZ},\theta} \sin(b))^2 \right]} \\ &= \sqrt{\left[E_{\text{QZ},\theta}^2 + 2cE_{\text{QZ},\theta}E_{\text{QZ},\phi} \cos(d) + c^2E_{\text{QZ},\phi}^2 \cos^2(d) + c^2E_{\text{QZ},\phi}^2 \sin^2(d) \right] +} \\ &\quad \sqrt{\left[E_{\text{QZ},\phi}^2 + 2aE_{\text{QZ},\theta}E_{\text{QZ},\phi} \cos(b) + a^2E_{\text{QZ},\theta}^2 \cos^2(b) + a^2E_{\text{QZ},\theta}^2 \sin^2(b) \right]} \\ &= \sqrt{E_{\text{QZ},\theta}^2 (1+a^2) + E_{\text{QZ},\phi}^2 (1+c^2) + 2E_{\text{QZ},\theta}E_{\text{QZ},\phi} (c \cos(d) + a \cos(b))} \end{aligned} \quad (1.14)$$

When it is assumed that leakage between the two polarization ports of the measurement probe is assumed to be the same, then $a=c=10^{\frac{\text{XPD}}{20}}$ in (1.14). Additionally, it has to be assumed that $d=b+\pi$ which guarantees the orthogonality between the two field vectors, i.e., the dot product between the vectors has to be zero. With these assumptions, Equation (1.14) will become

$$E_{\text{Probe},T} = \sqrt{(E_{\text{QZ},\theta}^2 + E_{\text{QZ},\phi}^2)(1+a^2)} \quad (1.15)$$

The normalized ratio of total powers at measurement probe and the centre of the quiet zone is therefore

$$\frac{P_{\text{Probe}}}{P_{\text{QZ}}} \propto \frac{E_{\text{Probe},T}^2}{E_{\text{QZ},T}^2} = 1 + a^2 = 1 + 10^{\frac{2\text{XPD}}{20}} = 1 + 10^{\frac{\text{XPD}}{10}} \quad (1.16)$$

The derived XPD MU based on electric fields which included the coherence/interference terms in (1.16) is the same as in (1.6).

B.2.1.11 Insertion loss Variation

This uncertainty contribution comes from introducing an additional cable which is not present for both the calibration and DUT measurement. If the cables remain the same for the calibration and DUT measurement, then the contribution should be set to zero.

If an additional cable is added for one part of the test, the insertion loss must be accounted for in the measurement results. If the insertion loss is measured the uncertainty contribution will be the combined uncertainty related to the insertion loss measurement. The insertion loss can also be taken from the datasheet and assumed to have a rectangular distribution.

B.2.1.12 RF leakage (from measurement antenna to receiver/transmitter)

This contribution denotes noise leaking in to connector and cable(s) between measurement antenna and receiving/transmitting equipment. The contribution also includes the noise leakage between the connector and cable(s) between reference antenna and transmitting equipment for the calibration phase. This uncertainty contributor is contained in the contributor quality of quiet zone described in clause B.2.1.3 and its value therefore is set to zero.

B.2.1.13 Misalignment of positioning System

This contribution originates from uncertainty in sliding position and turn table angle/tilt accuracy. If the calibration antenna is aligned to the beam peak this contribution can be considered negligible and therefore set to zero.

B.2.1.14 Uncertainty of the Network Analyzer

This contribution originates from all uncertainties involved transmission magnitude measurement with a network analyser, for example: drift, frequency flatness, temperature variation from kit calibration to path losses measurement as well as interpolation of calibration data if test frequencies were not calibrated during path loss characterization. The uncertainty value will be indicated in the manufacturer's data sheet. It needs to be ensured that appropriate manufacturer's uncertainty contribution is specified for the absolute levels measured.

When an end-to-end system calibration approach is used, the absolute levels are related to the total system losses of the measurement path. When a split calibration approach is used, separate MU contributions need to be determined

- `u_cond`: transmission magnitude uncertainty for the conducted portion of the calibration; the absolute levels are related to the total system losses for the portion of the system calibrated
- `u_rad`: transmission magnitude uncertainty for the radiated portion of the calibration; the absolute levels are related to the total system losses for the portion of the system calibrated

The total MU of the network analyser for the split calibration is the RSS'ed value of `u_cond` and `u_rad`.

B.2.1.15 Uncertainty of the absolute gain of the calibration antenna

The calibration antenna only appears in Stage 2. Therefore, the gain uncertainty has to be taken into account. This uncertainty will come from a calibration report with traceability to a National Metrology Institute with measurement uncertainty budgets generated following the guidelines outlined in internationally accepted standards.

B.2.1.16 Positioning and pointing misalignment between the reference antenna and the measurement antenna

This contribution originates from reference antenna alignment and pointing error. In this measurement if the maximum gain direction of the reference antenna and the transmitting antenna are aligned to each other, this contribution can be considered negligible and therefore set to zero.

B.2.1.17 gNB emulator uncertainty

gNB emulator is used to drive a signal to the horn antenna (via multiple external components such as a switch box, an amplifier and a circulator, etc.) in sensitivity tests either as an absolute level or as a relative level. Receiving device used is typically a UE/phablet/tablet/FWA. Generally there occurs uncertainty contribution from absolute level accuracy, non-linearity and frequency characteristic of the gNB emulator.

For practical reasons, in a case that a VNA is used as calibration equipment, gNB emulator is connected to the system after the calibration measurement (Stage 2) is performed by the VNA. Hence, the uncertainty on the absolute level of gNB emulator (transmitter device) cannot be assumed as systematic. This uncertainty should be calculated from the manufacturer's data in logs with a rectangular distribution, unless otherwise informed. Furthermore, the uncertainty of the non-linearity is included in the absolute level uncertainty.

B.2.1.18 Phase centre offset of calibration

Gain is defined at the phase centre of the antenna. If the phase centre of the calibration antenna is not aligned at the centre of the set up during the calibration, then there will be uncertainty related to the measurement distance.

The phase centre of a horn antenna moves with frequency along the taper length of the antenna therefore during the calibration the phase centre of all frequencies will not be aligned with the setup centre. The associated uncertainty term can be estimated using the following formula [14]:

$$\pm 20 \log_{10} \left(\frac{d_m - d_p}{d_m} \right)$$

+/-20log((measurement distance – d)/measurement distance) [14]

Where d_m is the measurement distance and d_p is the maximum positional uncertainty. For a Horn antenna this is equal to 0.5 the length of the taper. This uncertainty is considered to have a rectangular distribution so the standard uncertainty is calculated by dividing the uncertainty by $\sqrt{3}$.

The same equation applies to log periodic antennas with d_m being 0.5 the length of the boom.

For a dipole antenna, given that the phase centre of the antenna is easily aligned with the centre of the set up the measurement uncertainty is zero.

If the calibration antenna (i.e. horn) is adjusted during the calibration to align the phase centre to the setup centre then this uncertainty term can be considered to be zero.

As an example a horn with a taper length of 50 mm, at 43.5 GHz and a measurement distance of 72.55 cm the uncertainty term is 0.62, with a rectangular distribution the standard uncertainty is 0.358 dB.

For DFF systems this uncertainty contribution must be included.

B.2.1.19 Quality of quiet zone for calibration process

During the calibration process the calibration antenna will be placed at the centre of the quiet zone. Therefore, only point P1 from the procedure outlined in B.2.1.3 needs to be considered for the quality of the quiet zone validation measurement.

For gain calibrations, the standard uncertainty of the EIRP results obtained following the method outlined in 2.10 shall be used. For efficiency calibrations, the standard uncertainty of the TRP result obtained following the method outlined in 2.9 shall be used.

B.2.1.20 Standing wave between reference calibration antenna and measurement antenna

This term comes from the amplitude ripple caused by the standing waves between the reference antenna and measurement antenna. This value can be captured by sliding ($\lambda/4$) the reference antenna towards the measurement antenna as the standing waves go in and out of phase causing a ripple in amplitude. The uncertainty term can be derived by performing the standard deviation on the results.

B.2.1.21 Influence of the calibration antenna feed cable (Flexing cables, adapters, attenuators, connector repeatability)

During the calibration measurement a cable (adapters, attenuators) is used to feed the calibration antenna. This uncertainty captures any influence the cable may have on the measurements result. This term can be assessed by repeating measurements while flexing the cables and rotary joints and using the largest difference between the results as the uncertainty. For some calibration test configurations this uncertainty can be considered to be zero.

B.2.1.22 Influence of TRP measurement grid

This contributor describes the uncertainty of the measured TRP value due to the finite number of measurement grid points.

B.2.1.23 Influence of beam peak search grid

This contributor describes the uncertainty of absolute TX power beam peak measurements, e.g., EIRP in beam peak direction, due to the finite number of measurement points in the beam peak search grid.

B.2.1.24 Systematic error due to TRP calculation/quadrature

When calculating TRP using different quadrature of constant step size data, a mean error shall be taken into account. The value of this contributor depends on the number of measurement grid points and the quadrature technique used.

No mean error has to be taken into account for constant density approach (using the charged particle or the golden spiral implementation) for non-sparse antenna arrays.

This measurement uncertainty contributor represents a systematic uncertainty and must not be root sum squared with contributors described by standard deviation.

B.2.1.25 Multiple measurement antenna uncertainty

This contributor describes the uncertainty caused by switching multiple measurement antennas either by mechanically or electrically to measure TRx spurious emission.

A frequency range of spurious tests (e.g. general spurious emission) is defined from 6 GHz to second harmonic of FR2 bands such as 80 GHz. Since that frequency range is quite wide, it is impossible to cover the whole range only by one measurement antenna. Therefore to provide a feature of the spurious emission measurement by FR2 test system, the system has to equip a capability to switch corresponding measurement antennas in an anechoic chamber. One of the mechanical antenna switching methods can be a structure of a slider. Then a repeatability of a bending loss of a feeder cable which is connected to the measurement antennas shall be taken into account. On the other hand for electrical antenna switching, since multiple antennas need to be aligned in a chamber with a different position, the quiet zone characteristics might receive an influence by a displacement from the ideal focal point. In a case of electrical switching system, if the measurement antenna configuration is the same for the quality of the quiet zone measurement and the DUT measurement, then this uncertainty term is encompassed in the quality of the quiet zone results.

B.2.1.26 DUT repositioning

This contributor describes the uncertainty due to a displacement of a DUT. The DUT may need to be re-positioned between measurements, for instance when the battery runs low in charge.

B.2.1.27 Influence of noise

This contributor describes an offset uncertainty factor caused by a noise floor especially in a case of low SNR. This contributor works as a bias to measured results only to a direction to increase values and thus this shall be included in the uncertainty budget table as a systematic uncertainty. The uncertainty value can be derived by the following equation.

$$\text{Influence of noise} = 10 * \log\left(1 + 10^{\left(\frac{SNR}{10}\right)}\right)$$

B.2.1.28 Systematic error related to beam peak search

When calculating beam peak search a systematic error shall be taken into account. The value of this contributor depends on the number of measurement grid points.

This measurement uncertainty contributor represents a systematic uncertainty and must not be root sum squared with contributors described by standard deviation.

B.2.1.29 Influence of spherical coverage grid

This contributor describes the uncertainty of spherical measurements, due to the finite number of measurement points in the spherical coverage grid.

B.2.1.30 Systematic error related to EIS spherical coverage

When calculating EIS spherical coverage, a mean error shall be taken into account. The value of this contributor depends on the DL power step size used for the EIS search and then number of measurement grid points.

This measurement uncertainty contributor represents a systematic uncertainty and must not be root sum squared with contributors described by standard deviation.

B.2.2 Measurement error contribution descriptions for IFF

B.2.2.1 Positioning misalignment

See B.2.1.1.

B.2.2.2 Measure distance uncertainty

See B.2.1.2. For IFF1 this can be considered to be zero.

B.2.2.3 Quality of Quiet Zone

See B.2.1.3.

B.2.2.4 Mismatch

See B.2.1.4.

B.2.2.5 Standing wave between DUT and measurement antenna

See B.2.1.5.

B.2.2.6 Uncertainty of the RF power measurement equipment

See B.2.1.6.

B.2.2.7 Phase Curvature

See B.2.1.7. For IFF1 this can be considered to be zero.

B.2.2.8 Amplifier Uncertainties

See B.2.1.8.

B.2.2.9 Random uncertainty

See B.2.1.9.

B.2.2.10 Influence of XPD

See B.2.1.10.

B.2.2.11 Insertion Loss Variation

See B.2.1.11.

B.2.2.12 RF leakage (from measurement antenna to receiver/transmitter)

See B.2.1.12.

B.2.2.13 Misalignment of positioning system

See B.2.1.13.

B.2.2.14 Uncertainty of the Network Analyzer

See B.2.1.14.

B.2.2.15 Uncertainty of the absolute gain of the calibration antenna

See B.2.1.15.

B.2.2.16 Positioning and pointing misalignment between the reference antenna and the measurement antenna

See B.2.1.16.

B.2.2.17 gNB emulator uncertainty

See B.2.1.17.

B.2.2.18 Phase centre offset of calibration

See B.2.1.18. For IFF1 this can be considered to be zero.

B.2.2.19 Quality of the Quiet Zone for Calibration Process

See B.2.1.19.

B.2.2.20 Standing wave between reference calibration antenna and measurement antenna

See B.2.1.20.

B.2.2.21 Influence of the calibration antenna feed cable (Flexing cables, adapters, attenuators, connector repeatability)

See B.2.1.21.

B.2.2.22 Influence of TRP measurement grid

See B.2.1.22.

B.2.2.23 Influence of beam peak search grid

See B.2.1.23.

B.2.2.24 Systematic error due to TRP calculation/quadrature

See B.2.1.24.

B.2.2.25 Multiple measurement antenna uncertainty

See B.2.1.25.

B.2.2.26 DUT repositioning

See B.2.1.26.

B.2.2.27 Influence of noise

See B.2.1.27.

B.2.2.28 Systematic error related to beam peak search

See B.2.1.28.

B.2.2.29 Influence of spherical coverage grid

See B.2.1.29.

B.2.2.30 Systematic error related to EIS spherical coverage

See B.2.1.30.

B.2.3 Measurement error contribution descriptions for NFTF

B.2.3.1 Axes Alignment

Includes the following mechanical alignment errors:

- The uncertainty related with the lateral displacement between the horizontal and vertical axes of the DUT positioner.
- The differences from 90° of the angle between the horizontal and vertical axes.
- The horizontal mis-pointing of the horizontal axis to the probe reference point for $\Theta=0^\circ$.

These mechanical errors can result in sampling the field on a non-ideal sphere. This uncertainty can be considered to have a normal distribution.

B.2.3.2 Measurement Distance uncertainty

See B.2.1.2.

B.2.3.3 Quality of the Quiet Zone

See B.2.1.3.

B.2.3.4 Mismatch

See B.2.1.4.

B.2.3.5 Multiple Reflections: Coupling Measurement Antenna and DUT

The multiple reflections occur when a portion of the transmitted signal is reflected from the receiving antenna back to the transmitting antenna and re-reflected by the transmitting antenna back to the receiving antenna. This uncertainty can be determined by multiple measurements of the DUT when at different distance from the probes. This uncertainty is assumed to have a U-shaped distribution.

B.2.3.6 Uncertainty of the RF power measurement equipment

See B.2.1.6.

B.2.3.7 Phase curvature

See B.2.1.7.

B.2.3.8 Amplifier uncertainties

See B.2.1.8.

B.2.3.9 Random uncertainty

See B.2.1.9.

B.2.3.10 Influence of the XPD

Refer to B.2.1.10. If the Probe Polarization Amplitude and Phase is measured and corrected for then this uncertainty term can be considered to be zero.

B.2.3.11 NF to FF truncation

The measured near field is expanded using a finite set of spherical modes. The number of modes is linked to number of samples. The filtering effect generated by the finite number of modes can improve measurement results by removing signals from outside the physical area of the DUT. Care must be taken in order to make sure the removed signals are not from the DUT itself. This term also includes the uncertainty related to the scan area truncation. This uncertainty is usually negligible. This uncertainty is assumed to have a normal distribution.

B.2.3.12 Probe Polarization Amplitude and Phase

The amplitude and phase of the probe polarization coefficients should be measured. This uncertainty is assumed to have a normal distribution.

B.2.3.13 Probe Array Uniformity (for multi-probe systems only)

This is the uncertainty due to the fact that different probes are used for each physical position. Different probes have different radiation patterns. Generally, the probe array is calibrated so that the uniformity of the probes is achieved. This uncertainty term must be considered if the amplitude and phase of each probe is not identical or corrected for. This uncertainty is assumed to have a normal distribution

B.2.3.14 Uncertainty of the Network Analyzer

See B.2.1.14.

B.2.3.15 Uncertainty of the absolute gain of the calibration antenna

See B.2.1.15.

B.2.3.16 Phase Recovery Non-Linearity over signal bandwidth

This uncertainty originates from the non-linearity of the phase recovery for wide band signal. The phase recovery can be due to either phase non-linearity of the receiver and/or the DUT itself. The method to quantify the non-linearities is not defined.

B.2.3.17 Probe Pattern Effect

The probe/s pattern/s is assumed to be known so that the DUT measurement in near field can be corrected when performing the near field to far field transform. If the probe pattern is known, then the uncertainty term is zero. There is no direct dependence between the DUT pattern and the probe pattern in near field measurements. This uncertainty is assumed to have a normal distribution.

B.2.3.18 Phase centre offset of calibration

See B.2.1.18.

B.2.3.19 Quality of the Quiet Zone for Calibration Process

See B.2.1.19.

B.2.3.20 Phase Drift and Noise

This uncertainty is due to the noise level and drift of the test range and should be determined or measured at the DUT location. The noise level is usually measured with a Spectrum Analyzer. This uncertainty is assumed to have a normal distribution.

B.2.3.21 Mismatch in the connection of the calibration antenna

See B.2.1.4.

B.2.3.22 Influence of TRP measurement grid

See B.2.1.22.

B.2.3.23

B.2.3.24

B.2.3.25 Leakage and Crosstalk

This uncertainty can be addressed by measurements on the actual system setup. The leakage and crosstalk cannot be separated from the random amplitude and phase errors so that the relative importance should be determined. This uncertainty is assumed to have a normal distribution.

B.2.3.26 Systematic error due to TRP calculation/quadrature

See B.2.1.24.

B.2.3.27 Multiple measurement antenna uncertainty

See B.2.1.25.

B.2.3.28 DUT repositioning

See B.2.1.26.

B.2.3.29 Influence of noise

See B.2.1.27.

B.3 UE maximum output power

Following tables summarize the MU threshold for EIRP and TRP measurements for UE maximum output power. The origin MU values for different test setups with varies parameters can be found in following subclauses.

Table B.3-1: MU threshold for EIRP measurement for UE maximum output power

Frequency	MBW	Power (NOTE2)	Threshold MU value [dB] (NOTE1)
23.45GHz <= f <= 32.125GHz	BW <= 400MHz	P = Max Output Power	4.89
32.125GHz < f <= 40.8GHz			5.09
NOTE 1: Max {Total EIRP Expanded MU for IFF for 15cm in Table B.3.2-2, Total EIRP Expanded MU for IFF for 30cm in Table B.3.2-3}.			
NOTE 2: Max output power level for PC3 device.			

Table B.3-2: MU threshold for TRP measurement for UE maximum output power

Frequency	MBW	Power (NOTE2)	Threshold MU value (NOTE 1)
23.45GHz <= f <= 32.125GHz	BW <= 400MHz	P = Max Output Power	4.42
32.125GHz < f <= 40.8GHz			4.62
NOTE 1: Max {Total TRP Expanded MU for IFF for 15cm in Table B.3.2-2, Total TRP Expanded MU for IFF for 30cm in Table B.3.2-3}			
NOTE 2: Max output power level for PC3 device.			

Table B.3-3: MU threshold for Spherical coverage measurement for UE maximum output power

Frequency	MBW	Power	Threshold MU value (NOTE 1)
23.45GHz <= f <= 32.125GHz	BW <= 400MHz	P = TBD	TBD
32.125GHz < f <= 40.8GHz			TBD
NOTE 1: Max {Total Spherical coverage Expanded MU for IFF for 15cm in Table B.3.2-4, Total Spherical coverage Expanded MU for IFF for 30cm in Table B.3.2-5}			

B.3.1 Uncertainty budget format and assessment for DFF

The uncertainty contributions that may impact the overall MU value are listed in Table B.3.1-1.

Table B.3.1-1: Uncertainty contributions for EIRP and TRP measurement

UID	Description of uncertainty contribution	Details in annex
Stage 2: DUT measurement		
1	Positioning misalignment	B.2.1.1
2	Measure distance uncertainty	B.2.1.2
3	Quality of quiet zone	B.2.1.3
4	Mismatch	B.2.1.4
5	Standing Wave Between the DUT and measurement antenna	B.2.1.5
6	Uncertainty of the RF power measurement equipment	B.2.1.6
7	Phase curvature	B.2.1.7
8	Amplifier uncertainties	B.2.1.8
9	Random uncertainty	B.2.1.9
10	Influence of the XPD	B.2.1.10
11	Insertion Loss Variation	B.2.1.11
12	RF leakage (from measurement antenna to the receiver/transmitter)	B.2.1.12
13	Influence of TRP measurement grid	B.2.1.22
14	Influence of beam peak search grid	B.2.1.23
15	Multiple measurement antenna uncertainty	B.2.1.25
16	DUT repositioning	B.2.1.26
17	Influence of spherical coverage grid	B.2.1.29
Stage 1: Calibration measurement		
18	Mismatch	B.2.1.4
19	Amplifier uncertainties	B.2.1.8
20	Misalignment of positioning System	B.2.1.13
21	Uncertainty of the Network Analyzer	B.2.1.14
22	Uncertainty of the absolute gain of the calibration antenna	B.2.1.15
23	Positioning and pointing misalignment between the reference antenna and the measurement antenna	B.2.1.16
24	Phase centre offset of calibration antenna	B.2.1.18
25	Quality of quiet zone for calibration process	B.2.1.19
26	Standing wave between reference calibration antenna and measurement antenna	B.2.1.20
27	Influence of the calibration antenna feed cable	B.2.1.21
28	Insertion Loss Variation	B.2.1.11
Systematic uncertainties		
29	Systematic error due to TRP calculation/quadrature	B.2.1.24
30	Influence of noise	B.2.1.27
31	Systematic error related to beam peak search	B.2.1.28

The uncertainty assessment tables are organized as follows:

- For the purpose of uncertainty assessment, the radiating antenna aperture of the DUT is denoted as D
- The uncertainty assessment has been derived for the case of $D = [5 \text{ cm}]$, $f = \{22.65\text{GHz}, 31.1\text{GHz}, 45.1\text{GHz}\}$, $P = [\text{maximum output power}]$.
- The uncertainty assessment for EIRP and TRP is provided in Table B.3.1-2.

Table B.3.1-2: Uncertainty assessment for EIRP and TRP measurement (f=TBD, D=TBD)

UID	Uncertainty source	Uncertainty value	Distribution of the probability	Divisor	Standard uncertainty (σ) [dB]
Stage 2: DUT measurement					
1	Positioning misalignment				
2	Measure distance uncertainty				
3	Quality of quiet zone (NOTE 2)				
4	Mismatch (NOTE 3)				
5	Standing Wave Between the DUT and measurement antenna				
6	Uncertainty of the RF power measurement equipment (NOTE 4)				
7	Phase curvature				
8	Amplifier uncertainties				
9	Random uncertainty				
10	Influence of the XPD				
11	Insertion Loss Variation				
12	RF leakage (from measurement antenna to the receiver/transmitter)				
13	Influence of TRP measurement grid (NOTE 5)	0.25	Actual	1	0.25
14	Influence of beam peak search grid (NOTE 6)	0.0	Actual	1	0.0
15	Multiple measurement antenna uncertainty				
16	DUT repositioning				
17	Influence of spherical coverage grid (NOTE 8)	0.12	Actual	1	0.12
Stage 1: Calibration measurement					
18	Mismatch				
19	Amplifier uncertainties				
20	Misalignment of positioning System				
21	Uncertainty of the Network Analyzer				
22	Uncertainty of the absolute gain of the calibration antenna				
23	Positioning and pointing misalignment between the reference antenna and the measurement antenna				
24	Phase centre offset of calibration antenna				
25	Quality of quiet zone for calibration process (NOTE 2)				
26	Standing wave between reference calibration antenna and measurement antenna				
27	Influence of the calibration antenna feed cable				
28	Insertion Loss Variation				
Systematic uncertainties (NOTE 7)					Value
29	Systematic error due to TRP calculation/quadrature (NOTE 5)				0.00
30	Influence of noise				
31	Systematic error related to beam peak search (NOTE 6)				0.5
Total measurement uncertainty					Value
EIRP Expanded uncertainty (1.96 σ - confidence interval of 95 %) [dB]					TBD
TRP Expanded uncertainty (1.96 σ - confidence interval of 95 %) [dB]					TBD

NOTE 1:	The impact of phase variation on EIRP shall be taken into account during final MU definition for the test method..
NOTE 2:	The quality of quiet zone is different for EIRP and TRP. For TRP, the standard uncertainty is FFS; for EIRP, the standard uncertainty of quiet zone is FFS.
NOTE 3:	The analysis was done only for the case of operating at max output power, in-band, non-CA.
NOTE 4:	The assessment assumes maximum DUT output power.
NOTE 5:	This contributor shall only be considered for TRP measurements.
NOTE 6:	This contributor shall only be considered for EIRP measurements.
NOTE 7:	In order to obtain the total measurement uncertainty, systematic uncertainties have to be added to the expanded root sum square of the standard deviations of the Stage 1 and Stage 2 contributors.
NOTE 8:	This contributor shall only be considered for spherical EIRP measurements

B.3.2 Uncertainty budget format and assessment for IFF

The uncertainty contributions that may impact the overall MU value are listed in Table B.3.2-1.

Table B.3.2-1: Uncertainty contributions for EIRP and TRP measurement

UID	Description of uncertainty contribution	Details in annex
Stage 2: DUT measurement		
1	Positioning misalignment	B.2.2.1
2	Measure distance uncertainty	B.2.2.2
3	Quality of Quiet Zone	B.2.2.3
4	Mismatch	B.2.2.4
5	Standing wave between the DUT and measurement antenna	B.2.2.5
6	Uncertainty of the RF power measurement equipment	B.2.2.6
7	Phase curvature	B.2.2.7
8	Amplifier uncertainties	B.2.2.8
9	Random uncertainty	B.2.2.9
10	Influence of the XPD	B.2.2.10
11	Insertion Loss Variation	B.2.2.11
12	RF leakage (from measurement antenna to the receiver/transmitter)	B.2.2.12
13	Influence of TRP measurement grid	B.2.2.22
14	Influence of beam peak search grid	B.2.2.23
15	Multiple measurement antenna uncertainty	B.2.2.25
16	DUT repositioning	B.2.2.26
17	Influence of spherical coverage grid	B.2.2.29
Stage 1: Calibration measurement		
18	Mismatch	B.2.2.4
19	Amplifier Uncertainties	B.2.2.8
20	Misalignment of positioning System	B.2.2.13
21	Uncertainty of the Network Analyzer	B.2.2.14
22	Uncertainty of the absolute gain of the calibration antenna	B.2.2.15
23	Positioning and pointing misalignment between the reference antenna and the measurement antenna	B.2.2.16
24	Phase centre offset of calibration antenna	B.2.2.18
25	Quality of quiet zone for calibration process	B.2.2.19
26	Standing wave between reference calibration antenna and measurement antenna	B.2.2.20
27	Influence of the calibration antenna feed cable	B.2.2.21
28	Insertion Loss Variation	B.2.1.11
Systematic uncertainties		
29	Systematic error due to TRP calculation/quadrature	B.2.2.24
30	Influence of noise	B.2.1.27
31	Systematic error related to beam peak search	B.2.2.28

The uncertainty assessment tables are organized as follows:

- For the purpose of uncertainty assessment, the radiating antenna aperture of the DUT is denoted as D

- The uncertainty assessment has been derived for the case of DUT size = [15 cm and 30 cm], $f = \{23.45\text{GHz}, 32.125\text{GHz}, 40.8\text{GHz}\}$, [P = maximum output power].
- The uncertainty assessment for EIRP and TRP is provided in Table B.3.2-2 and Table B.3.2-3.
- The uncertainty assessment for Spherical coverage is provided in Table B.3.2-4 and Table B.3.2-5.

Table B.3.2-2: Uncertainty assessment for EIRP and TRP measurement (f=23.45GHz, 32.125GHz, 40.8GHz, DUT size = 15 cm)

UID	Uncertainty source	Uncertainty value	Distribution of the probability	Divisor	Standard uncertainty (σ) [dB]
Stage 2: DUT measurement					
1	Positioning misalignment	0.00	Normal	2.00	0.00
2	Measure distance uncertainty	0.00	Rectangular	1.73	0.00
3	Quality of Quiet Zone (NOTE 1)	0.6	Actual	1.00	0.6
4	Mismatch	1.30	Actual	1.00	1.30
5	Standing wave between the DUT and measurement antenna	0.00	U-shaped	1.41	0.00
6	Uncertainty of the RF power measurement equipment (NOTE 3)	2.16	Normal	2.00	1.08
7	Phase curvature	0.00	U-shaped	1.41	0.00
8	Amplifier uncertainties	2.10	Normal	2.00	1.05
9	Random uncertainty	0.50	Normal	2.00	0.25
10	Influence of the XPD	0.01	U-shaped	1.41	0.00
11	Insertion Loss Variation	0.00	Rectangular	1.73	0.00
12	RF leakage (from measurement antenna to the receiver/transmitter)	0.00	Actual	1.00	0.00
13	Influence of TRP measurement grid (NOTE 4)	0.25	Actual	1	0.25
14	Influence of beam peak search grid (NOTE 5)	0.00	Actual	1	0.00
15	Multiple measurement antenna uncertainty (NOTE 9)	0.15	Actual	1	0.15
16	DUT repositioning	0.00 (NOTE 4) 0.08 (NOTE 5)	Rectangular	1.73	0.00 (NOTE 4) 0.05 (NOTE 5)
Stage 1: Calibration measurement					
17	Mismatch	0.00	U-shaped	1.41	0.00
18	Amplifier Uncertainties	0.00	Normal	2.00	0.00
19	Misalignment of positioning System	0.00	Normal	2.00	0.00
20	Uncertainty of the Network Analyzer	0.73	Normal	2.00	0.37
21	Uncertainty of the absolute gain of the calibration antenna	0.60	Normal	2.00	0.30
22	Positioning and pointing misalignment between the reference antenna and the measurement antenna	0.01	Rectangular	1.73	0.00
23	Phase centre offset of calibration antenna	0.00	Rectangular	1.73	0.00
24	Quality of quiet zone for calibration process (NOTE 1)	0.4	Actual	1.00	0.4
25	Standing wave between reference calibration antenna and measurement antenna	0.00	U-shaped	1.41	0.00
26	Influence of the calibration antenna feed cable	0.14	Normal	2.00	0.07
27	Insertion Loss Variation	0.00	Rectangular	1.73	0.00
Systematic uncertainties (NOTE 6)					Value
28	Systematic error due to TRP calculation/quadrature (NOTE 4)				0.00
29	Influence of noise (23.45GHz \leq f \leq 32.125GHz)				0.1
29	Influence of noise (32.125GHz < f \leq 40.8GHz)				0.3
30	Systematic error related to beam peak search (NOTE 5)				0.5
Total measurement uncertainty					Value
EIRP Expanded uncertainty (23.45GHz \leq f \leq 32.125GHz) (1.96 σ - confidence interval of 95 %) [dB]					4.89
EIRP Expanded uncertainty (32.125GHz < f \leq 40.8GHz) (1.96 σ - confidence interval of 95 %) [dB]					5.09
TRP Expanded uncertainty (23.45GHz \leq f \leq 32.125GHz) (1.96 σ - confidence interval of 95 %) [dB]					4.42
TRP Expanded uncertainty (32.125GHz < f \leq 40.8GHz) (1.96 σ - confidence interval of 95 %) [dB]					4.62

- NOTE 1: The quality of quiet zone is the same for EIRP and TRP.
- NOTE 2: The analysis was done only for the case of operating at max output power, in-band, non-CA.
- NOTE 3: The assessment assumes maximum DUT output power.
- NOTE 4: This contributor shall only be considered for TRP measurements.
- NOTE 5: This contributor shall only be considered for EIRP measurements.
- NOTE 6: In order to obtain the total measurement uncertainty, systematic uncertainties have to be added to the expanded root sum square of the standard deviations of the Stage 1 and Stage 2 contributors.
- NOTE 7: Void.
- NOTE 8: Void
- NOTE 9: Applies to the system which has a structure of mechanical feed antenna positioning.

Table B.3.2-3: Uncertainty assessment for EIRP and TRP measurement (f=23.45GHz, 32.125GHz, 40.8GHz, DUT size = 30 cm)

UID	Uncertainty source	Uncertainty value	Distribution of the probability	Divisor	Standard uncertainty (σ) [dB]
Stage 2: DUT measurement					
1	Positioning misalignment	0.00	Normal	2.00	0.00
2	Measure distance uncertainty	0.00	Rectangular	1.73	0.00
3	Quality of Quiet Zone (NOTE 1, NOTE 9)	0.5	Actual	1.00	0.5
4	Mismatch	1.30	Actual	1.00	1.30
5	Standing wave between the DUT and measurement antenna	0.00	U-shaped	1.41	0.00
6	Uncertainty of the RF power measurement equipment (NOTE 3)	2.16	Normal	2.00	1.08
7	Phase curvature	0.00	U-shaped	1.41	0.00
8	Amplifier uncertainties	2.10	Normal	2.00	1.05
9	Random uncertainty	0.50	Normal	2.00	0.25
10	Influence of the XPD	0.01	U-shaped	1.41	0.00
11	Insertion Loss Variation	0.00	Rectangular	1.73	0.00
12	RF leakage (from measurement antenna to the receiver/transmitter)	0.00	Actual	1.00	0.00
13	Influence of TRP measurement grid (NOTE 4)	0.25	Actual	1	0.25
14	Influence of beam peak search grid (NOTE 5)	0.00	Actual	1	0.00
15	Multiple measurement antenna uncertainty (NOTE 10)	0.15	Actual	1	0.15
16	DUT repositioning	0.00 (NOTE 4) 0.08 (NOTE 5)	Rectangular	1.73	0.00 (NOTE 4) 0.05 (NOTE 5)
Stage 1: Calibration measurement					
17	Mismatch	0.00	U-shaped	1.41	0.00
18	Amplifier Uncertainties	0.00	Normal	2.00	0.00
19	Misalignment of positioning System	0.00	Normal	2.00	0.00
20	Uncertainty of the Network Analyzer	0.73	Normal	2.00	0.37
21	Uncertainty of the absolute gain of the calibration antenna	0.60	Normal	2.00	0.30
22	Positioning and pointing misalignment between the reference antenna and the measurement antenna	0.01	Rectangular	1.73	0.00
23	Phase centre offset of calibration antenna	0.00	Rectangular	1.73	0.00
24	Quality of quiet zone for calibration process (NOTE 1, NOTE 9)	0.2	Actual	1.00	0.2
25	Standing wave between reference calibration antenna and measurement antenna	0.00	U-shaped	1.41	0.00
26	Influence of the calibration antenna feed cable	0.14	Normal	2.00	0.07
27	Insertion Loss Variation	0.00	Rectangular	1.73	0.00
Systematic uncertainties (NOTE 6)					Value
28	Systematic error due to TRP calculation/quadrature (NOTE 4)				0.00
29	Influence of noise (23.45GHz \leq f \leq 32.125GHz)				0.1
30	Influence of noise (32.125GHz < f \leq 40.8GHz)				0.3
31	Systematic error related to beam peak search (NOTE 5)				0.5
Total measurement uncertainty					Value
EIRP Expanded uncertainty (23.45GHz \leq f \leq 32.125GHz) (1.96 σ - confidence interval of 95 %) [dB]					4.79
EIRP Expanded uncertainty (32.125GHz < f \leq 40.8GHz) (1.96 σ - confidence interval of 95 %) [dB]					4.99
TRP Expanded uncertainty (23.45GHz \leq f \leq 32.125GHz) (1.96 σ - confidence interval of 95 %) [dB]					4.32

TRP Expanded uncertainty (32.125GHz < f <= 40.8GHz) (1.96 σ - confidence interval of 95 %) [dB]	4.52
NOTE 1: The quality of quiet zone is the same for EIRP and TRP. NOTE 2: The analysis was done only for the case of operating at max output power, in-band, non-CA. NOTE 3: The assessment assumes maximum DUT output power. NOTE 4: This contributor shall only be considered for TRP measurements. NOTE 5: This contributor shall only be considered for EIRP measurements. NOTE 6: In order to obtain the total measurement uncertainty, systematic uncertainties have to be added to the expanded root sum square of the standard deviations of the Stage 1 and Stage 2 contributors. NOTE 7: Void NOTE 8: Void NOTE 9: Value based on procedure defined in Annex D.2 of TR 38.810 for Quiet Zone size of 30 cm. NOTE 10: Applies to the system which has a structure of mechanical feed antenna positioning.	

Table B.3.2-4: Uncertainty assessment for Spherical coverage measurement (f=23.45GHz, 32.125GHz, 40.8GHz, DUT size = 15 cm)

UID	Uncertainty source	Uncertainty value	Distribution of the probability	Divisor	Standard uncertainty (σ) [dB]
Stage 2: DUT measurement					
1	Positioning misalignment	0.00	Normal	2.00	0.00
2	Measure distance uncertainty	0.00	Rectangular	1.73	0.00
3	Quality of Quiet Zone (NOTE 1)	0.6	Actual	1.00	0.6
4	Mismatch	1.30	Actual	1.00	1.30
5	Standing wave between the DUT and measurement antenna	0.00	U-shaped	1.41	0.00
6	Uncertainty of the RF power measurement equipment (NOTE 3)	2.16	Normal	2.00	1.08
7	Phase curvature	0.00	U-shaped	1.41	0.00
8	Amplifier uncertainties	2.1	Normal	2.00	1.05
9	Random uncertainty	0.50	Normal	2.00	0.25
10	Influence of the XPD	0.01	U-shaped	1.41	0.00
11	Insertion Loss Variation	0.00	Rectangular	1.73	0.00
12	RF leakage (from measurement antenna to the receiver/transmitter)	0.00	Actual	1.00	0.00
13	Multiple measurement antenna uncertainty (NOTE 5)	0.15	Actual	1	0.15
14	DUT repositioning	0.00	Rectangular	1.73	0.00
15	Influence of spherical coverage grid	0.12	Actual	1	0.12
Stage 1: Calibration measurement					
16	Mismatch	0.00	U-shaped	1.41	0.00
17	Amplifier Uncertainties	0.00	Normal	2.00	0.00
18	Misalignment of positioning System	0.00	Normal	2.00	0.00
19	Uncertainty of the Network Analyzer	0.73	Normal	2.00	0.37
20	Uncertainty of the absolute gain of the calibration antenna	0.60	Normal	2.00	0.30
21	Positioning and pointing misalignment between the reference antenna and the measurement antenna	0.01	Rectangular	1.73	0.00
22	Phase centre offset of calibration antenna	0.00	Rectangular	1.73	0.00
23	Quality of quiet zone for calibration process (NOTE 1)	0.4	Actual	1.00	0.4
24	Standing wave between reference calibration antenna and measurement antenna	0.00	U-shaped	1.41	0.00
25	Influence of the calibration antenna feed cable	0.14	Normal	2.00	0.07
26	Insertion Loss Variation	0.00	Rectangular	1.73	0.00
Systematic uncertainties (NOTE 4)					Value
27	Influence of noise (23.45GHz \leq f \leq 32.125GHz)				TBD
27	Influence of noise (32.125GHz < f \leq 40.8GHz)				TBD
Total measurement uncertainty					Value
Spherical coverage Expanded uncertainty (23.45GHz \leq f \leq 32.125GHz) (1.96 σ - confidence interval of 95 %) [dB]					TBD
Spherical coverage Expanded uncertainty (32.125GHz < f \leq 40.8GHz) (1.96 σ - confidence interval of 95 %) [dB]					TBD
NOTE 1: The quality of quiet zone is the same for EIRP and TRP.					
NOTE 2: The analysis was done only for the case of operating at max output power, in-band, non-CA.					
NOTE 3: The assessment assumes maximum DUT output power.					
NOTE 4: In order to obtain the total measurement uncertainty, systematic uncertainties have to be added to the expanded root sum square of the standard deviations of the Stage 1 and Stage 2 contributors.					
NOTE 5: Applies to the system which has a structure of mechanical feed antenna positioning.					

Table B.3.2-5: Uncertainty assessment for Spherical coverage measurement (f=23.45GHz, 32.125GHz, 40.8GHz, DUT size = 30 cm)

UID	Uncertainty source	Uncertainty value	Distribution of the probability	Divisor	Standard uncertainty (σ) [dB]
Stage 2: DUT measurement					
1	Positioning misalignment	0.00	Normal	2.00	0.00
2	Measure distance uncertainty	0.00	Rectangular	1.73	0.00
3	Quality of Quiet Zone (NOTE 1, NOTE 5)	0.5	Actual	1.00	0.5
4	Mismatch	1.30	Actual	1.00	1.30
5	Standing wave between the DUT and measurement antenna	0.00	U-shaped	1.41	0.00
6	Uncertainty of the RF power measurement equipment (NOTE 3)	2.16	Normal	2.00	1.08
7	Phase curvature	0.00	U-shaped	1.41	0.00
8	Amplifier uncertainties	2.1	Normal	2.00	1.05
9	Random uncertainty	0.50	Normal	2.00	0.25
10	Influence of the XPD	0.01	U-shaped	1.41	0.00
11	Insertion Loss Variation	0.00	Rectangular	1.73	0.00
12	RF leakage (from measurement antenna to the receiver/transmitter)	0.00	Actual	1.00	0.00
13	Multiple measurement antenna uncertainty (NOTE 6)	0.15	Actual	1	0.15
14	DUT repositioning	0.00	Rectangular	1.73	0.00
15	Influence of spherical coverage grid	0.12	Actual	1	0.12
Stage 1: Calibration measurement					
16	Mismatch	0.00	U-shaped	1.41	0.00
17	Amplifier Uncertainties	0.00	Normal	2.00	0.00
18	Misalignment of positioning System	0.00	Normal	2.00	0.00
19	Uncertainty of the Network Analyzer	0.73	Normal	2.00	0.37
20	Uncertainty of the absolute gain of the calibration antenna	0.60	Normal	2.00	0.30
21	Positioning and pointing misalignment between the reference antenna and the measurement antenna	0.01	Rectangular	1.73	0.0
22	Phase centre offset of calibration antenna	0.00	Rectangular	1.73	0.00
23	Quality of quiet zone for calibration process (NOTE 1, NOTE 5)	0.2	Actual	1.00	0.2
24	Standing wave between reference calibration antenna and measurement antenna	0.00	U-shaped	1.41	0.00
25	Influence of the calibration antenna feed cable	0.14	Normal	2.00	0.07
26	Insertion Loss Variation	0.00	Rectangular	1.73	0.00
Systematic uncertainties (NOTE 4)					Value
27	Influence of noise (23.45GHz \leq f \leq 32.125GHz)				TBD
27	Influence of noise (32.125GHz < f \leq 40.8GHz)				TBD
Total measurement uncertainty					Value
Spherical coverage Expanded uncertainty (23.45GHz \leq f \leq 32.125GHz) (1.96 σ - confidence interval of 95 %) [dB]					TBD
Spherical coverage Expanded uncertainty (32.125GHz < f \leq 40.8GHz) (1.96 σ - confidence interval of 95 %) [dB]					TBD
NOTE 1: The quality of quiet zone is the same for EIRP and TRP.					
NOTE 2: The analysis was done only for the case of operating at max output power, in-band, non-CA.					
NOTE 3: The assessment assumes maximum DUT output power.					
NOTE 4: In order to obtain the total measurement uncertainty, systematic uncertainties have to be added to the expanded root sum square of the standard deviations of the Stage 1 and Stage 2 contributors.					
NOTE 5: Value based on procedure defined in Annex D.2 of TR 38.810 for Quiet Zone size of 30 cm.					
NOTE 6: Applies to the system which has a structure of mechanical feed antenna positioning.					

B.3.3 Uncertainty budget format and assessment for NFTF

The uncertainty contributions that may impact the overall MU value are listed in Table B.3.3-1.

Table B.3.3-1: Uncertainty contributions for EIRP and TRP measurement

UID	Description of uncertainty contribution	Details in paragraph
Stage 2: EIRP Near Field Radiation Pattern Measurement and EIRP Near Field DUT power measurement		
1	Axis Alignment	B.2.3.1
2	Measurement Distance Uncertainty	B.2.3.2
3	Quality of the Quiet Zone	B.2.3.3
4	Mismatch	B.2.3.4
5	Multiple Reflections: Coupling between Measurement Antenna and DUT	B.2.3.5
6	Uncertainty of the RF power measurement equipment	B.2.3.6
7	Phase curvature	B.2.3.7
8	Amplifier uncertainties	B.2.3.8
9	Random uncertainty	B.2.3.9
10	Influence of the XPD	B.2.3.10
11	NF to FF truncation	B.2.3.11
12	Probe Polarization Amplitude and Phase	B.2.3.12
13	Probe Array Uniformity (for multi-probe systems only)	B.2.3.13
14	Phase Recovery Non-Linearity over signal bandwidth	B.2.3.16
15	Probe Pattern Effect	B.2.3.17
16	Phase Drift and Noise	B.2.3.20
17	Leakage and Crosstalk	B.2.3.25
Stage 1: Calibration measurement		
18	Mismatch	B.2.3.4
19	Amplifier uncertainties	B.2.3.8
20	Uncertainty of the Network Analyzer	B.2.3.14
21	Uncertainty of the absolute gain of the calibration antenna	B.2.3.15
22	Phase centre offset of calibration	B.2.3.18
23	Quality of the Quiet Zone for Calibration Process	B.2.3.19
24	Mismatch in the connection of the calibration antenna	B.2.3.21

The uncertainty assessment table is organized as follows:

- For the purpose of uncertainty assessment, the radiating antenna aperture of the DUT is denoted as D
- The uncertainty assessment has been derived for the case of $D = [5 \text{ cm}]$, $f = \{22.65\text{GHz}, 31.1\text{GHz}, 45.1\text{GHz}\}$, $P = [\text{maximum output power}]$.
- The uncertainty assessment for EIRP and TRP is provided in Table B.3.1-2.

Table B.3.3-2: Uncertainty assessment for EIRP and TRP measurement (f=TBD, D=TBD)

UID	Description of uncertainty contribution	Uncertainty Value	Distribution of the probability	Divisor	Standard uncertainty (σ) [dB]
Stage 2: EIRP Near Field Radiation Pattern Measurement and EIRP Near Field DUT power measurement					
1	Axis Alignment				
2	Measurement Distance Uncertainty				
3	Quality of the Quiet Zone				
4	Mismatch				
5	Multiple Reflections: Coupling between Measurement Antenna and DUT				
6	Uncertainty of the RF power measurement equipment				
7	Phase curvature				
8	Amplifier uncertainties				
9	Random uncertainty				
10	Influence of the XPD				
11	NF to FF truncation				
12	Probe Polarization Amplitude and Phase				
13	Probe Array Uniformity (for multi-probe systems only)				
14	Phase Recovery Non-Linearity over signal bandwidth				
15	Probe Pattern Effect				
16	Phase Drift and Noise				
17	Leakage and Crosstalk				
Stage 1: Calibration measurement					
18	Mismatch				
19	Amplifier uncertainties				
20	Uncertainty of the Network Analyzer				
21	Uncertainty of the absolute gain of the calibration antenna				
22	Phase centre offset of calibration				
23	Quality of the Quiet Zone for Calibration Process				
24	Mismatch in the connection of the calibration antenna				
EIRP Expanded uncertainty (1.96σ - confidence interval of 95 %) [dB]					
TRP Expanded uncertainty (1.96σ - confidence interval of 95 %) [dB]					
NOTE 1: The impact of phase variation on EIRP shall be taken into account during final MU definition for the test method.					
NOTE 2: The quality of quiet zone is different for EIRP and TRP. For TRP, the standard uncertainty is FFS; for EIRP FFS.					
NOTE 3: The analysis was done only for the case of operating at max output power, in-band, non-CA,					
NOTE 4: The assessment assumes maximum DUT output power.					
NOTE 5: The Phase Recovery Non-Linearity over signal bandwidth is shall be taken into account during final MU definition for the test method.					

B.4 to B7

B.8 Transmit OFF power

Following tables summarize the MU threshold for TRP measurements for Transmit OFF power. The origin MU values for different test setups can be found in following subclauses.

Table B.8-1: MU threshold for TRP measurement for Transmit OFF power

Frequency	MBW	Power	Threshold MU value (NOTE1)
23.45GHz \leq f \leq 32.125GHz	BW \leq 400MHz	P = Off Power	TBD
32.125GHz < f \leq 40.8GHz			TBD
NOTE 1: Max {Total Expanded MU for IFF for 15cm in Table B.8.2-2, Total Expanded MU for IFF for 30cm in Table B.8.2-3}			

B.8.1 Uncertainty budget format and assessment for DFF

The uncertainty contributions that may impact the overall MU value are listed in Table B.8.1-1.

Table B.8.1-1: Uncertainty contributions for TRP measurement

UID	Description of uncertainty contribution	Details in annex
Stage 2: DUT measurement		
1	Positioning misalignment	B.2.1.1
2	Measure distance uncertainty	B.2.1.2
3	Quality of quiet zone	B.2.1.3
4	Mismatch	B.2.1.4
5	Standing Wave Between the DUT and measurement antenna	B.2.1.5
6	Uncertainty of the RF power measurement equipment	B.2.1.6
7	Phase curvature	B.2.1.7
8	Amplifier uncertainties	B.2.1.8
9	Random uncertainty	B.2.1.9
10	Influence of the XPD	B.2.1.10
11	Insertion Loss Variation	B.2.1.11
12	RF leakage (from measurement antenna to the receiver/transmitter)	B.2.1.12
13	Influence of TRP measurement grid	B.2.1.22
14	Influence of beam peak search grid	B.2.1.23
15	Multiple measurement antenna uncertainty	B.2.1.25
16	DUT repositioning	B.2.1.26
Stage 1: Calibration measurement		
17	Mismatch	B.2.1.4
18	Amplifier uncertainties	B.2.1.8
19	Misalignment of positioning System	B.2.1.13
20	Uncertainty of the Network Analyzer	B.2.1.14
21	Uncertainty of the absolute gain of the calibration antenna	B.2.1.15
22	Positioning and pointing misalignment between the reference antenna and the measurement antenna	B.2.1.16
23	Phase centre offset of calibration antenna	B.2.1.18
24	Quality of quiet zone for calibration process	B.2.1.19
25	Standing wave between reference calibration antenna and measurement antenna	B.2.1.20
26	Influence of the calibration antenna feed cable	B.2.1.21
27	Insertion Loss Variation	B.2.1.11
Systematic uncertainties		
28	Systematic error due to TRP calculation/quadrature	B.2.1.24
29	Influence of noise	B.2.1.27

The uncertainty assessment tables are organized as follows:

- For the purpose of uncertainty assessment, the radiating antenna aperture of the DUT is denoted as D
- The uncertainty assessment has been derived for the case of $D = [5 \text{ cm}]$, $f = \{23.45 \text{ GHz}, 32.125 \text{ GHz}, 40.8 \text{ GHz}\}$, $P = [\text{Off power}]$.
- The uncertainty assessment for TRP is provided in Table B.8.1-2.

Table B.8.1-2: Uncertainty assessment for TRP measurement (f=TBD, D=TBD)

UID	Uncertainty source	Uncertainty value	Distribution of the probability	Divisor	Standard uncertainty (σ) [dB]
Stage 2: DUT measurement					
1	Positioning misalignment				
2	Measure distance uncertainty				
3	Quality of quiet zone (NOTE 2)				
4	Mismatch (NOTE 3)				
5	Standing Wave Between the DUT and measurement antenna				
6	Uncertainty of the RF power measurement equipment (NOTE 4)				
7	Phase curvature				
8	Amplifier uncertainties				
9	Random uncertainty				
10	Influence of the XPD				
11	Insertion Loss Variation				
12	RF leakage (from measurement antenna to the receiver/transmitter)				
13	Influence of TRP measurement grid (NOTE 5)				
14	Influence of beam peak search grid (NOTE 6)				
15	Multiple measurement antenna uncertainty				
16	DUT repositioning		Actual	1	
Stage 1: Calibration measurement					
17	Mismatch				
18	Amplifier uncertainties				
19	Misalignment of positioning System				
20	Uncertainty of the Network Analyzer				
21	Uncertainty of the absolute gain of the calibration antenna				
22	Positioning and pointing misalignment between the reference antenna and the measurement antenna				
23	Phase centre offset of calibration antenna				
24	Quality of quiet zone for calibration process (NOTE 2)				
25	Standing wave between reference calibration antenna and measurement antenna				
26	Influence of the calibration antenna feed cable				
27	Insertion Loss Variation				
TRP Expanded uncertainty (1.96σ - confidence interval of 95 %) [dB]					
Systematic uncertainties (NOTE 7)					Value
28	Systematic error due to TRP calculation/quadrature (NOTE 5)				
29	Influence of noise				
Total measurement uncertainty					
TRP total measurement uncertainty [dB]					
NOTE 1: The impact of phase variation on EIRP is FFS.					
NOTE 2: The quality of quiet zone is different for EIRP and TRP. For TRP, the standard uncertainty is FFS; for EIRP, the standard uncertainty of quiet zone is FFS.					
NOTE 3: The analysis was done only for the case of operating at max output power, in-band, non-CA.					
NOTE 4: The assessment assumes maximum DUT output power.					
NOTE 5: This contributor shall only be considered for TRP measurements.					
NOTE 6: This contributor shall only be considered for EIRP measurements.					
NOTE 7: In order to obtain the total measurement uncertainty, systematic uncertainties have to be added to the expanded root sum square of the standard deviations of the Stage 1 and Stage 2 contributors.					

B.8.2 Uncertainty budget format and assessment for IFF

The uncertainty contributions that may impact the overall MU value are listed in Table B.8.2-1.

Table B.8.2-1: Uncertainty contributions for TRP measurement

UID	Description of uncertainty contribution	Details in annex
Stage 2: DUT measurement		
1	Positioning misalignment	B.2.2.1
2	Measure distance uncertainty	B.2.2.2
3	Quality of Quiet Zone	B.2.2.3
4	Mismatch	B.2.2.4
5	Standing wave between the DUT and measurement antenna	B.2.2.5
6	Uncertainty of the RF power measurement equipment	B.2.2.6
7	Phase curvature	B.2.2.7
8	Amplifier uncertainties	B.2.2.8
9	Random uncertainty	B.2.2.9
10	Influence of the XPD	B.2.2.10
11	Insertion Loss Variation	B.2.2.11
12	RF leakage (from measurement antenna to the receiver/transmitter)	B.2.2.12
13	Influence of TRP measurement grid	B.2.2.22
14	Influence of beam peak search grid	B.2.2.23
15	Multiple measurement antenna uncertainty	B.2.2.25
16	DUT repositioning	B.2.2.26
Stage 1: Calibration measurement		
17	Mismatch	B.2.2.4
18	Amplifier Uncertainties	B.2.2.8
19	Misalignment of positioning System	B.2.2.13
20	Uncertainty of the Network Analyzer	B.2.2.14
21	Uncertainty of the absolute gain of the calibration antenna	B.2.2.15
22	Positioning and pointing misalignment between the reference antenna and the measurement antenna	B.2.2.16
23	Phase centre offset of calibration antenna	B.2.2.18
24	Quality of quiet zone for calibration process	B.2.2.19
25	Standing wave between reference calibration antenna and measurement antenna	B.2.2.20
26	Influence of the calibration antenna feed cable	B.2.2.21
27	Insertion Loss Variation	B.2.2.11
Systematic uncertainties		
28	Systematic error due to TRP calculation/quadrature	B.2.2.24
29	Influence of noise	B.2.2.27

The uncertainty assessment tables are organized as follows:

- For the purpose of uncertainty assessment, the radiating antenna aperture of the DUT is denoted as D
- The uncertainty assessment has been derived for the case of DUT size = [15 cm and 30 cm], $f = \{23.45\text{GHz}, 32.125\text{GHz}, 40.8\text{GHz}\}$, [P = Off power].
- The uncertainty assessment for TRP is provided in Table B.8.2-2 and Table B.8.2-3.

Table B.8.2-2: Uncertainty assessment for TRP measurement (f=23.45GHz, 32.125GHz, 40.8GHz, DUT size = 15 cm)

UID	Uncertainty source	Uncertainty value	Distribution of the probability	Divisor	Standard uncertainty (σ) [dB]
Stage 2: DUT measurement					
1	Positioning misalignment (NOTE 6)				
2	Measure distance uncertainty				
3	Quality of Quiet Zone				
4	Mismatch (NOTE 1, NOTE 6)				
5	Standing wave between the DUT and measurement antenna				
6	Uncertainty of the RF power measurement equipment (NOTE 2)				
7	Phase curvature (NOTE 6)				
8	Amplifier uncertainties (NOTE 6)				
9	Random uncertainty (NOTE 6)				
10	Influence of the XPD (NOTE 6)				
11	Insertion Loss Variation				
12	RF leakage (from measurement antenna to the receiver/transmitter)				
13	Influence of TRP measurement grid (NOTE 3)				
14	Influence of beam peak search grid (NOTE 4)				
15	Multiple measurement antenna uncertainty				
16	DUT repositioning				
Stage 1: Calibration measurement					
17	Mismatch (NOTE 6)				
18	Amplifier Uncertainties (NOTE 6)				
19	Misalignment of positioning System (NOTE 6)				
20	Uncertainty of the Network Analyzer				
21	Uncertainty of the absolute gain of the calibration antenna				
22	Positioning and pointing misalignment between the reference antenna and the measurement antenna (NOTE 6)				
23	Phase centre offset of calibration antenna				
24	Quality of quiet zone for calibration process				
25	Standing wave between reference calibration antenna and measurement antenna (NOTE 6)				
26	Influence of the calibration antenna feed cable (NOTE 6)				
27	Insertion Loss Variation				
TRP Expanded uncertainty (1.96σ - confidence interval of 95 %) [dB]					
Systematic uncertainties (NOTE 5)					Value
28	Systematic error due to TRP calculation/quadrature (NOTE 3)				
29	Influence of noise				
Total measurement uncertainty					Value
TRP total measurement uncertainty [dB]					
NOTE 1: The analysis was done only for the case of operating at max output power, in-band, non-CA.					
NOTE 2: The assessment assumes Off power.					
NOTE 3: This contributor shall only be considered for TRP measurements.					
NOTE 4: This contributor shall only be considered for EIRP measurements.					
NOTE 5: In order to obtain the total measurement uncertainty, systematic uncertainties have to be added to the expanded root sum square of the standard deviations of the Stage 1 and Stage 2 contributors.					
NOTE 6: Values extracted from TR 38.810 v2.6.1 in square brackets pending for further analysis.					
NOTE 7: Void					

Table B.8.2-3: Uncertainty assessment for TRP measurement (f=23.45GHz, 32.125GHz, 40.8GHz, DUT size = 30 cm)

UID	Uncertainty source	Uncertainty value	Distribution of the probability	Divisor	Standard uncertainty (σ) [dB]
Stage 2: DUT measurement					
1	Positioning misalignment (NOTE 6)				
2	Measure distance uncertainty				
3	Quality of Quiet Zone (NOTE 7)				
4	Mismatch (NOTE 1, NOTE 6)				
5	Standing wave between the DUT and measurement antenna				
6	Uncertainty of the RF power measurement equipment (NOTE 2)				
7	Phase curvature (NOTE 6)				
8	Amplifier uncertainties (NOTE 6)				
9	Random uncertainty (NOTE 6)				
10	Influence of the XPD				
11	Insertion Loss Variation				
12	RF leakage (from measurement antenna to the receiver/transmitter)				
13	Influence of TRP measurement grid (NOTE 3)				
14	Influence of beam peak search grid (NOTE 4)				
15	Multiple measurement antenna uncertainty				
16	DUT repositioning				
Stage 1: Calibration measurement					
17	Mismatch (NOTE 6)				
18	Amplifier Uncertainties (NOTE 6)				
19	Misalignment of positioning System (NOTE 6)				
20	Uncertainty of the Network Analyzer				
21	Uncertainty of the absolute gain of the calibration antenna				
22	Positioning and pointing misalignment between the reference antenna and the measurement antenna (NOTE 6)				
23	Phase centre offset of calibration antenna				
24	Quality of quiet zone for calibration process (NOTE 7)				
25	Standing wave between reference calibration antenna and measurement antenna (NOTE 6)				
26	Influence of the calibration antenna feed cable (NOTE 6)				
27	Insertion Loss Variation				
TRP Expanded uncertainty (1.96σ - confidence interval of 95 %) [dB]					
Systematic uncertainties (NOTE 5)					Value
28	Systematic error due to TRP calculation/quadrature (NOTE 3)				
29	Influence of noise				
Total measurement uncertainty					Value
TRP total measurement uncertainty [dB]					
NOTE 1: The analysis was done only for the case of operating at max output power, in-band, non-CA.					
NOTE 2: The assessment assumes Off power.					
NOTE 3: This contributor shall only be considered for TRP measurements.					
NOTE 4: This contributor shall only be considered for EIRP measurements.					
NOTE 5: In order to obtain the total measurement uncertainty, systematic uncertainties have to be added to the expanded root sum square of the standard deviations of the Stage 1 and Stage 2 contributors.					
NOTE 6: Values extracted from TR 38.810 v2.6.1 in square brackets pending for further analysis.					
NOTE 7: Value based on procedure defined in Annex D.2 of TR 38.810 for Quiet Zone size of 30 cm.					
NOTE 8: The quality of quiet zone is 1.0 dB for EIRP and 0.75 dB for TRP.					
NOTE 9: Void					

B.9

B.10 Frequency error

Following tables summarize the MU threshold for EIRP measurements for Frequency error. The origin MU values for different test setups can be found in following subclauses.

Table B.10-1: MU threshold for beam peak measurement for Frequency error

Frequency	MBW	Power	Threshold MU value (NOTE1)
23.45GHz <= f <= 32.125GHz	BW <= 400MHz	P = Max Output Power	+/- 0.01 ppm
32.125GHz < f <= 40.8GHz			+/- 0.01 ppm
NOTE 1: Max {Total Expanded MU for IFF for 15cm in section B.10.2, Total Expanded MU for IFF for 30cm in section B.10.2}			

B.10.1 Uncertainty budget format and assessment for DFF

+/- 0.01 ppm

- The uncertainty assessment has been derived for the case of D = [5 cm], f = {23.45 GHz, 32.125 GHz, 40.8 GHz}, P = [Maximum output power].

B.10.2 Uncertainty budget format and assessment for IFF

+/- 0.01 ppm

- The uncertainty assessment has been derived for the case of DUT size = [15 cm and 30 cm], f = {23.45GHz, 32.125GHz, 40.8GHz}, P = [Maximum output power].

B.11 to B.14

B.15 Occupied bandwidth

Following tables summarize the MU threshold for EIRP measurements for Occupied bandwidth. The origin MU values for different test setups can be found in following subclauses.

Table B.15-1: MU threshold for beam peak measurement for Occupied bandwidth

Frequency	MBW	Power	Threshold MU value (NOTE1)
23.45GHz \leq f \leq 32.125GHz	BW \leq 400MHz	P = Max Output Power	TBD
32.125GHz < f \leq 40.8GHz			TBD
NOTE 1: Max {Total Expanded MU for IFF for 15cm in Table B.15.2, Total Expanded MU for IFF for 30cm in Table B.15.2}			

B.15.1 Uncertainty budget format and assessment for DFF

FFS

- The uncertainty assessment has been derived for the case of $D = [5 \text{ cm}]$, $f = \{23.45 \text{ GHz}, 32.125 \text{ GHz}, 40.8 \text{ GHz}\}$, $P = [\text{Maximum output power}]$.

B.15.2 Uncertainty budget format and assessment for IFF

FFS

- The uncertainty assessment has been derived for the case of DUT size = $[15 \text{ cm and } 30 \text{ cm}]$, $f = \{23.45\text{GHz}, 32.125\text{GHz}, 40.8\text{GHz}\}$, $P = [\text{Maximum output power}]$.

B.16 Spectrum emission mask

Following tables summarize the MU threshold for TRP measurements for Spectrum emission mask. The origin MU values for different test setups can be found in following subclauses.

Table B.16-1: MU threshold for TRP measurement for Spectrum emission mask

Frequency	MBW	Power	Threshold MU value (NOTE 1)
23.45GHz \leq f \leq 32.125GHz	BW \leq 400MHz	P = Max Output Power	4.94
32.125GHz < f \leq 40.8GHz			5.32
NOTE 1: Max {Total Expanded MU for IFF for 15cm in Table B.16.2-2, Total Expanded MU for IFF for 30cm in Table B.16.2-3}			

B.16.1 Uncertainty budget format and assessment for DFF

The uncertainty contributions that may impact the overall MU value are listed in Table B.16.1-1.

Table B.16.1-1: Uncertainty contributions for TRP measurement

UID	Description of uncertainty contribution	Details in annex
Stage 2: DUT measurement		
1	Positioning misalignment	B.2.1.1
2	Measure distance uncertainty	B.2.1.2
3	Quality of quiet zone	B.2.1.3
4	Mismatch	B.2.1.4
5	Standing Wave Between the DUT and measurement antenna	B.2.1.5
6	Uncertainty of the RF power measurement equipment	B.2.1.6
7	Phase curvature	B.2.1.7
8	Amplifier uncertainties	B.2.1.8
9	Random uncertainty	B.2.1.9
10	Influence of the XPD	B.2.1.10
11	Insertion Loss Variation	B.2.1.11
12	RF leakage (from measurement antenna to the receiver/transmitter)	B.2.1.12
13	Influence of TRP measurement grid	B.2.1.22
14	Influence of beam peak search grid	B.2.1.23
15	Multiple measurement antenna uncertainty	B.2.1.25
16	DUT repositioning	B.2.1.26
Stage 1: Calibration measurement		
17	Mismatch	B.2.1.4
18	Amplifier uncertainties	B.2.1.8
19	Misalignment of positioning System	B.2.1.13
20	Uncertainty of the Network Analyzer	B.2.1.14
21	Uncertainty of the absolute gain of the calibration antenna	B.2.1.15
22	Positioning and pointing misalignment between the reference antenna and the measurement antenna	B.2.1.16
23	Phase centre offset of calibration antenna	B.2.1.18
24	Quality of quiet zone for calibration process	B.2.1.19
25	Standing wave between reference calibration antenna and measurement antenna	B.2.1.20
26	Influence of the calibration antenna feed cable	B.2.1.21
27	Insertion Loss Variation	B.2.1.11
Systematic uncertainties		
28	Systematic error due to TRP calculation/quadrature	B.2.1.24
29	Influence of noise	B.2.1.27

The uncertainty assessment tables are organized as follows:

- For the purpose of uncertainty assessment, the radiating antenna aperture of the DUT is denoted as D
- The uncertainty assessment has been derived for the case of $D = [5 \text{ cm}]$, $f = \{23.45 \text{ GHz}, 32.125 \text{ GHz}, 40.8 \text{ GHz}\}$, $P = [\text{Maximum output power}]$.
- The uncertainty assessment for TRP is provided in Table B.16.1-2.

Table B.16.1-2: Uncertainty assessment for TRP measurement (f=TBD, D=TBD)

UID	Uncertainty source	Uncertainty value	Distribution of the probability	Divisor	Standard uncertainty (σ) [dB]
Stage 2: DUT measurement					
1	Positioning misalignment				
2	Measure distance uncertainty				
3	Quality of quiet zone (NOTE 2)				
4	Mismatch (NOTE 3)				
5	Standing Wave Between the DUT and measurement antenna				
6	Uncertainty of the RF power measurement equipment (NOTE 4)				
7	Phase curvature				
8	Amplifier uncertainties				
9	Random uncertainty				
10	Influence of the XPD				
11	Insertion Loss Variation				
12	RF leakage (from measurement antenna to the receiver/transmitter)				
13	Influence of TRP measurement grid (NOTE 5)				
14	Influence of beam peak search grid (NOTE 6)				
15	Multiple measurement antenna uncertainty				
16	DUT repositioning				
Stage 1: Calibration measurement					
17	Mismatch				
18	Amplifier uncertainties				
19	Misalignment of positioning System				
20	Uncertainty of the Network Analyzer				
21	Uncertainty of the absolute gain of the calibration antenna				
22	Positioning and pointing misalignment between the reference antenna and the measurement antenna				
23	Phase centre offset of calibration antenna				
24	Quality of quiet zone for calibration process (NOTE 2)				
25	Standing wave between reference calibration antenna and measurement antenna				
26	Influence of the calibration antenna feed cable				
27	Insertion Loss Variation				
TRP Expanded uncertainty (1.96σ - confidence interval of 95 %) [dB]					
Systematic uncertainties (NOTE 7)					Value
28	Systematic error due to TRP calculation/quadrature (NOTE 5)				
29	Influence of noise				
Total measurement uncertainty					
TRP total measurement uncertainty [dB]					
NOTE 1: The impact of phase variation on EIRP is FFS.					
NOTE 2: The quality of quiet zone is different for EIRP and TRP. For TRP, the standard uncertainty is FFS; for EIRP, the standard uncertainty of quiet zone is FFS.					
NOTE 3: The analysis was done only for the case of operating at max output power, in-band, non-CA.					
NOTE 4: The assessment assumes maximum DUT output power.					
NOTE 5: This contributor shall only be considered for TRP measurements.					
NOTE 6: This contributor shall only be considered for EIRP measurements.					
NOTE 7: In order to obtain the total measurement uncertainty, systematic uncertainties have to be added to the expanded root sum square of the standard deviations of the Stage 1 and Stage 2 contributors.					

B.16.2 Uncertainty budget format and assessment for IFF

The uncertainty contributions that may impact the overall MU value are listed in Table B.16.2-1.

Table B.16.2-1: Uncertainty contributions for TRP measurement

UID	Description of uncertainty contribution	Details in annex
Stage 2: DUT measurement		
1	Positioning misalignment	B.2.2.1
2	Measure distance uncertainty	B.2.2.2
3	Quality of Quiet Zone	B.2.2.3
4	Mismatch	B.2.2.4
5	Standing wave between the DUT and measurement antenna	B.2.2.5
6	Uncertainty of the RF power measurement equipment	B.2.2.6
7	Phase curvature	B.2.2.7
8	Amplifier uncertainties	B.2.2.8
9	Random uncertainty	B.2.2.9
10	Influence of the XPD	B.2.2.10
11	Insertion Loss Variation	B.2.2.11
12	RF leakage (from measurement antenna to the receiver/transmitter)	B.2.2.12
13	Influence of TRP measurement grid	B.2.2.22
14	Influence of beam peak search grid	B.2.2.23
15	Multiple measurement antenna uncertainty	B.2.2.25
16	DUT repositioning	B.2.2.26
Stage 1: Calibration measurement		
17	Mismatch	B.2.2.4
18	Amplifier Uncertainties	B.2.2.8
19	Misalignment of positioning System	B.2.2.13
20	Uncertainty of the Network Analyzer	B.2.2.14
21	Uncertainty of the absolute gain of the calibration antenna	B.2.2.15
22	Positioning and pointing misalignment between the reference antenna and the measurement antenna	B.2.2.16
23	Phase centre offset of calibration antenna	B.2.2.18
24	Quality of quiet zone for calibration process	B.2.2.19
25	Standing wave between reference calibration antenna and measurement antenna	B.2.2.20
26	Influence of the calibration antenna feed cable	B.2.2.21
27	Insertion Loss Variation	B.2.2.11
Systematic uncertainties		
28	Systematic error due to TRP calculation/quadrature	B.2.2.24
29	Influence of noise	B.2.2.27

The uncertainty assessment tables are organized as follows:

- For the purpose of uncertainty assessment, the radiating antenna aperture of the DUT is denoted as D
- The uncertainty assessment has been derived for the case of DUT size = [15 cm and 30 cm], $f = \{23.45\text{GHz}, 32.125\text{GHz}, 40.8\text{GHz}\}$, $P = [\text{Maximum output power}]$.
- The uncertainty assessment for TRP is provided in Table B.16.2-2 and Table B.16.2-3.

Table B.16.2-2: Uncertainty assessment for TRP measurement (f=23.45GHz, 32.125GHz, 40.8GHz, DUT size = 15 cm)

UID	Uncertainty source	Uncertainty value	Distribution of the probability	Divisor	Standard uncertainty (σ) [dB]
Stage 2: DUT measurement					
1	Positioning misalignment	0.00	Normal	2.00	0.00
2	Measure distance uncertainty	0.00	Rectangular	1.73	0.00
3	Quality of Quiet Zone	0.6	Actual	1.00	0.6
4	Mismatch (NOTE 1)	1.30	Actual	1.00	1.30
5	Standing wave between the DUT and measurement antenna	0.00	U-shaped	1.41	0.00
6	Uncertainty of the RF power measurement equipment (NOTE 2)	2.16	Normal	2.00	1.08
7	Phase curvature	0.00	U-shaped	1.41	0.00
8	Amplifier uncertainties	2.1	Normal	2.00	1.05
9	Random uncertainty	0.50	Normal	2.00	0.25
10	Influence of the XPD	0.01	U-shaped	1.41	0.00
11	Insertion Loss Variation	0.00	Rectangular	1.73	0.00
12	RF leakage (from measurement antenna to the receiver/transmitter)	0.00	Actual	1.00	0.00
13	Influence of TRP measurement grid (NOTE 3)	0.25	Actual	1	0.25
14	Influence of beam peak search grid (NOTE 4)	0.00	Actual	1	0.00
15	Multiple measurement antenna uncertainty (NOTE 8)	0.15	Actual	1	0.15
16	DUT repositioning (NOTE 3)	0.00	Rectangular	1.73	0.00
Stage 1: Calibration measurement					
17	Mismatch	0.00	U-shaped	1.41	0.00
18	Amplifier Uncertainties	0.00	Normal	2.00	0.00
19	Misalignment of positioning System	0.00	Normal	2.00	0.00
20	Uncertainty of the Network Analyzer	0.73	Normal	2.00	0.37
21	Uncertainty of the absolute gain of the calibration antenna	0.60	Normal	2.00	0.30
22	Positioning and pointing misalignment between the reference antenna and the measurement antenna	0.01	Rectangular	1.73	0.00
23	Phase centre offset of calibration antenna	0.00	Rectangular	1.73	0.00
24	Quality of quiet zone for calibration process	0.4	Actual	1.00	0.4
25	Standing wave between reference calibration antenna and measurement antenna	0.00	U-shaped	1.41	0.00
26	Influence of the calibration antenna feed cable	0.14	Normal	2.00	0.07
27	Insertion Loss Variation	0.00	Rectangular	1.73	0.00
Systematic uncertainties (NOTE 5)					Value
28	Systematic error due to TRP calculation/quadrature (NOTE 3)				0.00
29	Influence of noise (23.45GHz <= f <= 32.125GHz)				0.62
29	Influence of noise (32.125GHz < f <= 40.8GHz)				1.00
Total measurement uncertainty					Value
TRP total measurement uncertainty (23.45GHz <= f <= 32.125GHz) (1.96 σ - confidence interval of 95 %) [dB]					4.94
TRP total measurement uncertainty (32.125GHz < f <= 40.8GHz) (1.96 σ - confidence interval of 95 %) [dB]					5.32

- NOTE 1: The analysis was done only for the case of operating at max output power, in-band, non-CA.
- NOTE 2: The assessment assumes maximum DUT output power.
- NOTE 3: This contributor shall only be considered for TRP measurements.
- NOTE 4: This contributor shall only be considered for EIRP measurements.
- NOTE 5: In order to obtain the total measurement uncertainty, systematic uncertainties have to be added to the expanded root sum square of the standard deviations of the Stage 1 and Stage 2 contributors.
- NOTE 6: Values extracted from TR 38.810 v2.6.1 in square brackets pending for further analysis.
- NOTE 7: Void.
- NOTE 8: Applies to the system which has a structure of mechanical feed antenna positioning.

Table B.16.2-3: Uncertainty assessment for TRP measurement (f=23.45GHz, 32.125GHz, 40.8GHz, DUT size = 30 cm)

UID	Uncertainty source	Uncertainty value	Distribution of the probability	Divisor	Standard uncertainty (σ) [dB]
Stage 2: DUT measurement					
1	Positioning misalignment	0.00	Normal	2.00	0.00
2	Measure distance uncertainty	0.00	Rectangular	1.73	0.00
3	Quality of Quiet Zone	0.50	Actual	1.00	0.50
4	Mismatch (NOTE 1)	1.30	Actual	1.00	1.30
5	Standing wave between the DUT and measurement antenna	0.00	U-shaped	1.41	0.00
6	Uncertainty of the RF power measurement equipment (NOTE 2)	2.16	Normal	2.00	1.08
7	Phase curvature	0.00	U-shaped	1.41	0.00
8	Amplifier uncertainties	2.1	Normal	2.00	1.05
9	Random uncertainty (NOTE 6)	0.50	Normal	2.00	0.25
10	Influence of the XPD	0.01	U-shaped	1.41	0.00
11	Insertion Loss Variation	0.00	Rectangular	1.73	0.00
12	RF leakage (from measurement antenna to the receiver/transmitter)	0.00	Actual	1.00	0.00
13	Influence of TRP measurement grid (NOTE 3)	0.25	Actual	1.00	0.25
14	Influence of beam peak search grid (NOTE 4)	0.00	Actual	1.00	0.00
15	Multiple measurement antenna uncertainty (NOTE 11)	0.15	Actual	1	0.15
16	DUT repositioning (NOTE 3)	0.00	Rectangular	1.73	0.00
Stage 1: Calibration measurement					
17	Mismatch	0.00	U-shaped	1.41	0.00
18	Amplifier Uncertainties	0.00	Normal	2.00	0.00
19	Misalignment of positioning System	0.00	Normal	2.00	0.00
20	Uncertainty of the Network Analyzer	0.73	Normal	2.00	0.37
21	Uncertainty of the absolute gain of the calibration antenna	0.60	Normal	2.00	0.30
22	Positioning and pointing misalignment between the reference antenna and the measurement antenna	0.01	Rectangular	1.73	0.00
23	Phase centre offset of calibration antenna	0.00	Rectangular	1.73	0.00
24	Quality of quiet zone for calibration process (NOTE 7)	0.20	Actual	1.00	0.20
25	Standing wave between reference calibration antenna and measurement antenna	0.01	Rectangular	1.73	0.00
26	Influence of the calibration antenna feed cable	0.14	Normal	2.00	0.07
27	Insertion Loss Variation	0.00	Rectangular	1.73	0.00
Systematic uncertainties (NOTE 5)					Value
28	Systematic error due to TRP calculation/quadrature (NOTE 3)				0.00
29	Influence of noise (23.45GHz <= f <= 32.125GHz)				0.62
29	Influence of noise (32.125GHz < f <= 40.8GHz)				1.00
Total measurement uncertainty					Value
TRP total measurement uncertainty (23.45GHz <= f <= 32.125GHz) (1.96 σ - confidence interval of 95 %) [dB]					4.84
TRP total measurement uncertainty (32.125GHz < f <= 40.8GHz) (1.96 σ - confidence interval of 95 %) [dB]					5.22

NOTE 1:	The analysis was done only for the case of operating at max output power, in-band, non-CA.
NOTE 2:	The assessment assumes maximum DUT output power.
NOTE 3:	This contributor shall only be considered for TRP measurements.
NOTE 4:	This contributor shall only be considered for EIRP measurements.
NOTE 5:	In order to obtain the total measurement uncertainty, systematic uncertainties have to be added to the expanded root sum square of the standard deviations of the Stage 1 and Stage 2 contributors.
NOTE 6:	Values extracted from TR 38.810 v2.6.1 in square brackets pending for further analysis.
NOTE 7:	Value based on procedure defined in Annex D.2 of TR 38.810 for Quiet Zone size of 30 cm.
NOTE 8:	MU value is derived based on the condition of SNR = 10 dB.
NOTE 9:	MU value is derived based on the condition of SNR = [4.2] dB.
NOTE 10:	Void.
NOTE 11:	Applies to the system which has a structure of mechanical feed antenna positioning.

B.17 Adjacent Channel Leakage Ratio

Editor's Note:

Since ACLR is a relative measurement, assessment of uncertainty budget format and contributions need a further study.

Following terms are yet to be approved to use in the Uncertainty Assessment and needs further technical analysis.

UID 4 Mismatch

UID 6 Uncertainty of the RF power measurement equipment

UID 29 Influence of noise

Following tables summarize the MU threshold for TRP measurements for Adjacent Channel Leakage Ratio. The origin MU values for different test setups can be found in following subclauses.

Table B.17-1: MU threshold for TRP measurement for Spectrum emission mask

Frequency	MBW	Power	Threshold MU value (NOTE 1)
23.45GHz <= f <= 32.125GHz	BW <= 400MHz	P = Max Output Power	TBD
32.125GHz < f <= 40.8GHz			TBD
NOTE 1: Total Expanded MU for IFF in Table B.17.2-2			

B.17.1 Uncertainty budget format and assessment for DFF

The uncertainty contributions that may impact the overall MU value are listed in Table B.17.1-1.

Table B.17.1-1: Uncertainty contributions for TRP measurement

UID	Description of uncertainty contribution	Details in annex
Stage 2: DUT measurement		
1	Positioning misalignment	B.2.1.1
2	Measure distance uncertainty	B.2.1.2
3	Quality of quiet zone	B.2.1.3
4	Mismatch	B.2.1.4
5	Standing Wave Between the DUT and measurement antenna	B.2.1.5
6	Uncertainty of the RF power measurement equipment	B.2.1.6
7	Phase curvature	B.2.1.7
8	Amplifier uncertainties	B.2.1.8
9	Random uncertainty	B.2.1.9
10	Influence of the XPD	B.2.1.10
11	Insertion Loss Variation	B.2.1.11
12	RF leakage (from measurement antenna to the receiver/transmitter)	B.2.1.12
13	Influence of TRP measurement grid	B.2.1.22
14	Influence of beam peak search grid	B.2.1.23
15	Multiple measurement antenna uncertainty	B.2.1.25
16	DUT repositioning	B.2.1.26
Stage 1: Calibration measurement		
17	Mismatch	B.2.1.4
18	Amplifier uncertainties	B.2.1.8
19	Misalignment of positioning System	B.2.1.13
20	Uncertainty of the Network Analyzer	B.2.1.14
21	Uncertainty of the absolute gain of the calibration antenna	B.2.1.15
22	Positioning and pointing misalignment between the reference antenna and the measurement antenna	B.2.1.16
23	Phase centre offset of calibration antenna	B.2.1.18
24	Quality of quiet zone for calibration process	B.2.1.19
25	Standing wave between reference calibration antenna and measurement antenna	B.2.1.20
26	Influence of the calibration antenna feed cable	B.2.1.21
27	Insertion Loss Variation	B.2.1.11
Systematic uncertainties		
28	Systematic error due to TRP calculation/quadrature	B.2.1.24
29	Influence of noise	B.2.1.27

The uncertainty assessment tables are organized as follows:

- For the purpose of uncertainty assessment, the radiating antenna aperture of the DUT is denoted as D
- The uncertainty assessment has been derived for the case of $D = [5 \text{ cm}]$, $f = \{23.45 \text{ GHz}, 32.125 \text{ GHz}, 40.8 \text{ GHz}\}$, $P = [\text{Maximum output power}]$.
- The uncertainty assessment for TRP is provided in Table B.17.1-2.

Table B.17.1-2: Uncertainty assessment for TRP measurement (f=TBD, D=TBD)

UID	Uncertainty source	Uncertainty value	Distribution of the probability	Divisor	Standard uncertainty (σ) [dB]
Stage 2: DUT measurement					
1	Positioning misalignment				
2	Measure distance uncertainty				
3	Quality of quiet zone (NOTE 2)				
4	Mismatch (NOTE 3)				
5	Standing Wave Between the DUT and measurement antenna				
6	Uncertainty of the RF power measurement equipment (NOTE 4)				
7	Phase curvature				
8	Amplifier uncertainties				
9	Random uncertainty				
10	Influence of the XPD				
11	Insertion Loss Variation				
12	RF leakage (from measurement antenna to the receiver/transmitter)				
13	Influence of TRP measurement grid (NOTE 5)				
14	Influence of beam peak search grid (NOTE 6)				
15	Multiple measurement antenna uncertainty				
16	DUT repositioning				
Stage 1: Calibration measurement					
17	Mismatch				
18	Amplifier uncertainties				
19	Misalignment of positioning System				
20	Uncertainty of the Network Analyzer				
21	Uncertainty of the absolute gain of the calibration antenna				
22	Positioning and pointing misalignment between the reference antenna and the measurement antenna				
23	Phase centre offset of calibration antenna				
24	Quality of quiet zone for calibration process (NOTE 2)				
25	Standing wave between reference calibration antenna and measurement antenna				
26	Influence of the calibration antenna feed cable				
27	Insertion Loss Variation				
TRP Expanded uncertainty (1.96σ - confidence interval of 95 %) [dB]					
Systematic uncertainties (NOTE 7)					Value
28	Systematic error due to TRP calculation/quadrature (NOTE 5)				
29	Influence of noise				
Total measurement uncertainty					
TRP total measurement uncertainty [dB]					
NOTE 1: The impact of phase variation on EIRP is FFS.					
NOTE 2: The quality of quiet zone is different for EIRP and TRP. For TRP, the standard uncertainty is FFS; for EIRP, the standard uncertainty of quiet zone is FFS.					
NOTE 3: The analysis was done only for the case of operating at max output power, in-band, non-CA.					
NOTE 4: The assessment assumes maximum DUT output power.					
NOTE 5: This contributor shall only be considered for TRP measurements.					
NOTE 6: This contributor shall only be considered for EIRP measurements.					
NOTE 7: In order to obtain the total measurement uncertainty, systematic uncertainties have to be added to the expanded root sum square of the standard deviations of the Stage 1 and Stage 2 contributors.					
NOTE 8: Void					

B.17.2 Uncertainty budget format and assessment for IFF

The uncertainty contributions that may impact the overall MU value are listed in Table B.17.2-1.

Table B.17.2-1: Uncertainty contributions for TRP measurement

UID	Description of uncertainty contribution	Details in annex
Stage 2: DUT measurement		
1	Positioning misalignment	B.2.2.1
2	Measure distance uncertainty	B.2.2.2
3	Quality of Quiet Zone	B.2.2.3
4	Mismatch	B.2.2.4
5	Standing wave between the DUT and measurement antenna	B.2.2.5
6	Uncertainty of the RF power measurement equipment	B.2.2.6
7	Phase curvature	B.2.2.7
8	Amplifier uncertainties	B.2.2.8
9	Random uncertainty	B.2.2.9
10	Influence of the XPD	B.2.2.10
11	Insertion Loss Variation	B.2.2.11
12	RF leakage (from measurement antenna to the receiver/transmitter)	B.2.2.12
13	Influence of TRP measurement grid	B.2.2.22
14	Influence of beam peak search grid	B.2.2.23
15	Multiple measurement antenna uncertainty	B.2.2.25
16	DUT repositioning	B.2.2.26
Stage 1: Calibration measurement		
17	Mismatch	B.2.2.4
18	Amplifier Uncertainties	B.2.2.8
19	Misalignment of positioning System	B.2.2.13
20	Uncertainty of the Network Analyzer	B.2.2.14
21	Uncertainty of the absolute gain of the calibration antenna	B.2.2.15
22	Positioning and pointing misalignment between the reference antenna and the measurement antenna	B.2.2.16
23	Phase centre offset of calibration antenna	B.2.2.18
24	Quality of quiet zone for calibration process	B.2.2.19
25	Standing wave between reference calibration antenna and measurement antenna	B.2.2.20
26	Influence of the calibration antenna feed cable	B.2.2.21
27	Insertion Loss Variation	B.2.2.11
Systematic uncertainties		
28	Systematic error due to TRP calculation/quadrature	B.2.2.24
29	Influence of noise	B.2.2.27

The uncertainty assessment tables are organized as follows:

- For the purpose of uncertainty assessment, the radiating antenna aperture of the DUT is denoted as D
- The uncertainty assessment has been derived for the case of DUT size = [15 cm and 30 cm], $f = \{23.45\text{GHz}, 32.125\text{GHz}, 40.8\text{GHz}\}$, $P = [\text{Maximum output power}]$.
- The uncertainty assessment for TRP is provided in Table B.17.2-2 and Table B.17.2-3.

Table B.17.2-2: Uncertainty assessment for TRP measurement (f=23.45GHz, 32.125GHz, 40.8GHz, DUT size = 15 cm and 30 cm)

UID	Uncertainty source	Uncertainty value	Distribution of the probability	Divisor	Standard uncertainty (σ) [dB]
Stage 2: DUT measurement					
1	Positioning misalignment	0.00	Normal	2.00	0.00
2	Measure distance uncertainty	0.00	Rectangular	1.73	0.00
3	Quality of Quiet Zone (NOTE 1)	0.5	Actual	1.00	0.5
4	Mismatch (NOTE 2, NOTE 7)	[1.30]	Actual	1.00	[1.30]
5	Standing wave between the DUT and measurement antenna	0.00	U-shaped	1.41	0.00
6	Uncertainty of the RF power measurement equipment (NOTE 3, 7)	[2.16]	Normal	2.00	[1.08]
7	Phase curvature	0.00	U-shaped	1.41	0.00
8	Amplifier uncertainties	2.1	Normal	2.00	1.05
9	Random uncertainty	0.50	Normal	2.00	0.25
10	Influence of the XPD	0.00	U-shaped	1.41	0.00
11	Insertion Loss Variation	0.00	Rectangular	1.73	0.00
12	RF leakage (from measurement antenna to the receiver/transmitter)	0.00	Actual	1.00	0.00
13	Influence of TRP measurement grid (NOTE 4)	0.25	Actual	1	0.25
14	Influence of beam peak search grid (NOTE 5)	0.00	Actual	1	0.00
15	Multiple measurement antenna uncertainty (NOTE 9)	[0.15]	Actual	1	[0.15]
16	DUT repositioning (NOTE 4)	0.00	Rectangular	1.73	0.00
Stage 1: Calibration measurement					
17	Mismatch	0.00	U-shaped	1.41	0.00
18	Amplifier Uncertainties	0.00	Normal	2.00	0.00
19	Misalignment of positioning System	0.00	Normal	2.00	0.00
20	Uncertainty of the Network Analyzer	0.73	Normal	2.00	0.37
21	Uncertainty of the absolute gain of the calibration antenna	0.60	Normal	2.00	0.30
22	Positioning and pointing misalignment between the reference antenna and the measurement antenna	0.00	Normal	2.00	0.00
23	Phase centre offset of calibration antenna	0.00	Rectangular	1.73	0.00
24	Quality of quiet zone for calibration process (NOTE 1)	0.2	Actual	1.00	0.2
25	Standing wave between reference calibration antenna and measurement antenna	0.00	U-shaped	1.41	0.00
26	Influence of the calibration antenna feed cable	0.00	Normal	2.00	0.00
27	Insertion Loss Variation	0.00	Rectangular	1.73	0.00
TRP Expanded uncertainty (1.96 σ - confidence interval of 95 %) [dB]					[4.21]
Systematic uncertainties (NOTE 6)					Value
28	Systematic error due to TRP calculation/quadrature (NOTE 4)				0.00
29	Influence of noise				TBD
30	Beam peak search				0.00
Total measurement uncertainty					Value
TRP total measurement uncertainty [dB]					TBD

NOTE 1:	Void
NOTE 2:	The analysis was done only for the case of operating at max output power, in-band, non-CA.
NOTE 3:	The assessment assumes maximum DUT output power.
NOTE 4:	This contributor shall only be considered for TRP measurements.
NOTE 5:	Void
NOTE 6:	In order to obtain the total measurement uncertainty, systematic uncertainties have to be added to the expanded root sum square of the standard deviations of the Stage 1 and Stage 2 contributors.
NOTE 7:	Values extracted from TR 38.810 v2.6.1 in square brackets pending for further analysis.
NOTE 8:	Void.
NOTE 9:	Applies to the system which has a structure of mechanical feed antenna positioning.

B.18 Spurious emissions

Editor's Note:

- If the TBD Offset value is too high, then consider increasing no. of points on the fine and/or coarse grid to higher value. Total offset value < 10dB is desirable.
- MU value analysis for various test setups in subsection B.18.x is not complete (will account for MU element due to fine TRP measurement grid, which is expected to be <0.25dB)
- Offset value analysis is not complete as it is derived from MU value analysis

Test procedure of general spurious emission comprises 2 stages: coarse TRP measurement and fine TRP measurement BW. Coarse TRP measurement is introduced to reduce the measurement time by applying sparser grids and/or wider measurement BW than fine TRP measurement while having offset dB more stringent test requirement in order not to cause additional misjudgement risk. For the frequency ranges for which coarse TRP measurement does not PASS, the measurement is continued with fine TRP measurement procedure.

Following tables summarize the MU threshold for fine TRP measurements for General spurious emissions. The origin MU values for fine TRP measurement for different test setups can be found in following subclauses.

Table B.18-1: MU threshold for fine TRP measurement for Spurious emissions

Frequency	MBW	Power	Aperture size	MU value
TBD	BW <= 400MHz	P = Maximum Output Power	D <= 5cm	FFS
			5cm < D <= 15cm	FFS
			15cm < D <= 30cm	FFS

Following table provide some valid coarse TRP measurement grids and corresponding offset dB value that may be used for UE Tx spurious emission test case. Coarse TRP measurement grid selection is up to test system implementation but shall meet the criteria shown in TR38.521-2 Table I-3.

Table B.18-2: Coarse TRP measurement grids and offset values for UE Tx spurious emission

Coarse TRP measurement grid	Tx Spurious type	Number of measurement points on the grid	MU contribution (stddev) from coarse TRP measurement grid (dB)	MU contribution from coarse TRP mean error (dB)	Offset value (dB)
Constant step size grid	Measurement of a spur in non- 2nd harmonic frequency range	14 (60deg angular step)	0.36	[TBD]	[TBD]
	Measurement of a spur in 2nd harmonic frequency range	26 (45deg angular step)	3.78	[TBD]	[TBD]
Constant density grid (charged particle based)	Measurement of a spur in non-2nd harmonic frequency range	14	0.06	[TBD]	[TBD]
	Measurement of a spur in 2nd harmonic frequency range	26	1.88	[TBD]	[TBD]

Following table provide some valid fine TRP measurement grids and corresponding MU value that may be used for UE Tx spurious emission test case. Fine TRP measurement grid selection is up to test system implementation but shall meet the criteria shown in TR38.521-2 Table I-3. The origin MU values for different test setups with various parameters can be found in following subclauses.

Table B.18-3: Fine TRP measurement grids for UE Tx spurious emission

Fine TRP measurement grid	Tx Spurious type	Number of measurement points on the grid
Constant step size grid	Measurement of a spur in non-2nd harmonic frequency range	26 (45deg angular step)
	Measurement of a spur in 2nd harmonic frequency range	266 (15deg angular step)
Constant density grid (charged particle based)	Measurement of a spur in non-2nd harmonic frequency range	14
	Measurement of a spur in 2nd harmonic frequency range	140

B.18.1 Uncertainty budget format and assessment for DFF

The uncertainty contributions that may impact the overall MU value are listed in Table B.18.1-1.

Table B.18.1-1: Uncertainty contributions for TRP measurement

UID	Description of uncertainty contribution	Details in annex
Stage 2: DUT measurement		
1	Positioning misalignment	B.2.1.1
2	Measure distance uncertainty	B.2.1.2
3	Quality of quiet zone	B.2.1.3
4	Mismatch	B.2.1.4
5	Standing Wave Between the DUT and measurement antenna	B.2.1.5
6	Uncertainty of the RF power measurement equipment	B.2.1.6
7	Phase curvature	B.2.1.7
8	Amplifier uncertainties	B.2.1.8
9	Random uncertainty	B.2.1.9
10	Influence of the XPD	B.2.1.10
11	Insertion Loss Variation	B.2.1.11
12	RF leakage (from measurement antenna to the receiver/transmitter)	B.2.1.12
13	Influence of TRP measurement grid	B.2.1.22
14	Influence of beam peak search grid	B.2.1.23
15	Multiple measurement antenna uncertainty	B.2.1.25
16	DUT repositioning	B.2.1.26
Stage 1: Calibration measurement		
17	Mismatch	B.2.1.4
18	Amplifier uncertainties	B.2.1.8
19	Misalignment of positioning System	B.2.1.13
20	Uncertainty of the Network Analyzer	B.2.1.14
21	Uncertainty of the absolute gain of the calibration antenna	B.2.1.15
22	Positioning and pointing misalignment between the reference antenna and the measurement antenna	B.2.1.16
23	Phase centre offset of calibration antenna	B.2.1.18
24	Quality of quiet zone for calibration process	B.2.1.19
25	Standing wave between reference calibration antenna and measurement antenna	B.2.1.20
26	Influence of the calibration antenna feed cable	B.2.1.21
27	Insertion Loss Variation	B.2.1.11
Systematic uncertainties		
28	Systematic error due to TRP calculation/quadrature	B.2.1.24
29	Influence of noise	B.2.1.27

The uncertainty assessment tables are organized as follows:

- For the purpose of uncertainty assessment, the radiating antenna aperture of the DUT is denoted as D
- The uncertainty assessment has been derived for the case of $D = [5 \text{ cm}]$, $f = \{6 \text{ GHz to } 80 \text{ GHz}\}$, $P = [\text{Maximum output power}]$.
- The uncertainty assessment for TRP is provided in Table B.18.1-2 to B.18.1-xx

Table B.18.1-2: Uncertainty assessment for TRP measurement (f=TBD, D=TBD)

UID	Uncertainty source	Uncertainty value	Distribution of the probability	Divisor	Standard uncertainty (σ) [dB]
Stage 2: DUT measurement					
1	Positioning misalignment				
2	Measure distance uncertainty				
3	Quality of quiet zone (NOTE 2)				
4	Mismatch (NOTE 3)				
5	Standing Wave Between the DUT and measurement antenna				
6	Uncertainty of the RF power measurement equipment (NOTE 4)				
7	Phase curvature				
8	Amplifier uncertainties				
9	Random uncertainty				
10	Influence of the XPD				
11	Insertion Loss Variation				
12	RF leakage (from measurement antenna to the receiver/transmitter)				
13	Influence of TRP measurement grid (NOTE 5)				
14	Influence of beam peak search grid (NOTE 6)				
15	Multiple measurement antenna uncertainty				
16	DUT repositioning				
Stage 1: Calibration measurement					
17	Mismatch				
18	Amplifier uncertainties				
19	Misalignment of positioning System				
20	Uncertainty of the Network Analyzer				
21	Uncertainty of the absolute gain of the calibration antenna				
22	Positioning and pointing misalignment between the reference antenna and the measurement antenna				
23	Phase centre offset of calibration antenna				
24	Quality of quiet zone for calibration process (NOTE 2)				
25	Standing wave between reference calibration antenna and measurement antenna				
26	Influence of the calibration antenna feed cable				
27	Insertion Loss Variation				
TRP Expanded uncertainty (1.96σ - confidence interval of 95 %) [dB]					
Systematic uncertainties (NOTE 7)					Value
28	Systematic error due to TRP calculation/quadrature (NOTE 5)				
29	Influence of noise				
Total measurement uncertainty					
TRP total measurement uncertainty [dB]					
NOTE 1: The impact of phase variation on EIRP is FFS.					
NOTE 2: The quality of quiet zone is different for EIRP and TRP. For TRP, the standard uncertainty is FFS; for EIRP, the standard uncertainty of quiet zone is FFS.					
NOTE 3: The analysis was done only for the case of operating at max output power, in-band, non-CA.					
NOTE 4: The assessment assumes maximum DUT output power.					
NOTE 5: This contributor shall only be considered for TRP measurements.					
NOTE 6: This contributor shall only be considered for EIRP measurements.					
NOTE 7: In order to obtain the total measurement uncertainty, systematic uncertainties have to be added to the expanded root sum square of the standard deviations of the Stage 1 and Stage 2 contributors.					
NOTE 8: Void					

B.18.2 Uncertainty budget format and assessment for IFF

The uncertainty contributions that may impact the overall MU value are listed in Table B.18.2-1.

Table B.18.2-1: Uncertainty contributions for TRP measurement

UID	Description of uncertainty contribution	Details in annex
Stage 2: DUT measurement		
1	Positioning misalignment	B.2.2.1
2	Measure distance uncertainty	B.2.2.2
3	Quality of Quiet Zone	B.2.2.3
4	Mismatch	B.2.2.4
5	Standing wave between the DUT and measurement antenna	B.2.2.5
6	Uncertainty of the RF power measurement equipment	B.2.2.6
7	Phase curvature	B.2.2.7
8	Amplifier uncertainties	B.2.2.8
9	Random uncertainty	B.2.2.9
10	Influence of the XPD	B.2.2.10
11	Insertion Loss Variation	B.2.2.11
12	RF leakage (from measurement antenna to the receiver/transmitter)	B.2.2.12
13	Influence of TRP measurement grid	B.2.2.22
14	Influence of beam peak search grid	B.2.2.23
15	Multiple measurement antenna uncertainty	B.2.2.25
16	DUT repositioning	B.2.2.26
Stage 1: Calibration measurement		
17	Mismatch	B.2.2.4
18	Amplifier Uncertainties	B.2.2.8
19	Misalignment of positioning System	B.2.2.13
20	Uncertainty of the Network Analyzer	B.2.2.14
21	Uncertainty of the absolute gain of the calibration antenna	B.2.2.15
22	Positioning and pointing misalignment between the reference antenna and the measurement antenna	B.2.2.16
23	Phase centre offset of calibration antenna	B.2.2.18
24	Quality of quiet zone for calibration process	B.2.2.19
25	Standing wave between reference calibration antenna and measurement antenna	B.2.2.20
26	Influence of the calibration antenna feed cable	B.2.2.21
27	Insertion Loss Variation	B.2.2.11
Systematic uncertainties		
28	Systematic error due to TRP calculation/quadrature	B.2.2.24
29	Influence of noise	B.2.2.27

The uncertainty assessment tables are organized as follows:

- For the purpose of uncertainty assessment, the radiating antenna aperture of the DUT is denoted as D
- The uncertainty assessment has been derived for the case of DUT size = [15 cm and 30 cm], f = {6 GHz to 80 GHz}, P = [Maximum output power].
- The uncertainty assessment for TRP is provided from Table B.18.2-2 to Table B.18.2-11.

Table B.18.2-2: Uncertainty assessment for TRP measurement (f= [6] GHz to [12.75] GHz], DUT size = 15 cm)

UID	Uncertainty source	Uncertainty value	Distribution of the probability	Divisor	Standard uncertainty (σ) [dB]
Stage 2: DUT measurement					
1	Positioning misalignment	0.00	Normal	2.00	0.00
2	Measure distance uncertainty	0.00	Rectangular	1.73	0.00
3	Quality of Quiet Zone (NOTE 4)	FFS	Actual	1.00	
4	Mismatch	[1.50]	Actual	1.00	[1.50]
5	Standing wave between the DUT and measurement antenna	0.00	U-shaped	1.41	0.00
6	Uncertainty of the RF power measurement equipment	FFS	Normal	2.00	
7	Phase curvature	0.00	U-shaped	1.41	0.00
8	Amplifier uncertainties	FFS	Normal	2.00	
9	Random uncertainty	FFS	Normal	2.00	
10	Influence of the XPD	0.043	U-shaped	1.41	0.03
11	Insertion Loss Variation	0.00	Rectangular	1.73	0.00
12	RF leakage (from measurement antenna to the receiver/transmitter)	0.00	Actual	1.00	0.00
13	Influence of TRP measurement grid (NOTE 1)	FFS	Actual	1	
14	Influence of beam peak search grid (NOTE 2)	N/A	Actual	1	N/A
15	Multiple measurement antenna uncertainty (NOTE 5)	0.15	Actual	1	0.15
16	DUT repositioning	FFS	Rectangular	1.73	
Stage 1: Calibration measurement					
17	Mismatch	0.00	U-shaped	1.41	0.00
18	Amplifier Uncertainties	0.00	Normal	2.00	0.00
19	Misalignment of positioning System	FFS	Normal	2.00	
20	Uncertainty of the Network Analyzer	[0.40]	Normal	2.00	[0.20]
21	Uncertainty of the absolute gain of the calibration antenna	FFS	Normal	2.00	
22	Positioning and pointing misalignment between the reference antenna and the measurement antenna	FFS	Rectangular	1.73	
23	Phase centre offset of calibration antenna	0.00	Rectangular	1.73	0.00
24	Quality of quiet zone for calibration process (NOTE 4)	FFS	Actual	1.00	
25	Standing wave between reference calibration antenna and measurement antenna	0.00	U-shaped	1.41	0.00
26	Influence of the calibration antenna feed cable	0.14	Normal	2.00	0.07
27	Insertion Loss Variation	0.00	Rectangular	1.73	0.00
Expanded uncertainty (1.96σ - confidence interval of 95 %)					Value
TRP Expanded uncertainty ([6] GHz < f <= [12.75] GHz) [dB] (a)					TBD
Systematic uncertainties (NOTE 3)					Value
28	Systematic error due to TRP calculation/quadrature (NOTE 1) (b)				TBD
29	Influence of noise ([6] GHz < f <= [12.75] GHz) (c)				TBD
30	Systematic error related to beam peak search (NOTE 2)				N/A
Total measurement uncertainty					Value
Total measurement uncertainty (a)+(b)+(c) [dB]					TBD
NOTE 1: This contributor shall only be considered for TRP measurements.					
NOTE 2: This contributor shall only be considered for EIRP measurements.					
NOTE 3: In order to obtain the total measurement uncertainty, systematic uncertainties have to be added to the expanded root sum square of the standard deviations of the Stage 1 and Stage 2 contributors.					
NOTE 4: Value based on procedure defined in Annex D.2 of TR 38.810.					
NOTE 5: Applies to the system which has a structure of mechanical feed antenna positioning.					

Table B.18.2-3: Uncertainty assessment for TRP measurement (f=[6] GHz to [12.75] GHz, DUT size = 30 cm)

UID	Uncertainty source	Uncertainty value	Distribution of the probability	Divisor	Standard uncertainty (σ) [dB]
Stage 2: DUT measurement					
1	Positioning misalignment	0.00	Normal	2.00	0.00
2	Measure distance uncertainty	0.00	Rectangular	1.73	0.00
3	Quality of Quiet Zone (NOTE 4)	FFS	Actual	1.00	
4	Mismatch	[1.50]	Actual	1.00	[1.50]
5	Standing wave between the DUT and measurement antenna	0.00	U-shaped	1.41	0.00
6	Uncertainty of the RF power measurement equipment	FFS	Normal	2.00	
7	Phase curvature	0.00	U-shaped	1.41	0.00
8	Amplifier uncertainties	FFS	Normal	2.00	
9	Random uncertainty	FFS	Normal	2.00	
10	Influence of the XPD	0.043	U-shaped	1.41	0.03
11	Insertion Loss Variation	0.00	Rectangular	1.73	0.00
12	RF leakage (from measurement antenna to the receiver/transmitter)	0.00	Actual	1.00	0.00
13	Influence of TRP measurement grid (NOTE 1)	FFS	Actual	1	
14	Influence of beam peak search grid (NOTE 2)	N/A	Actual	1	N/A
15	Multiple measurement antenna uncertainty (NOTE 5)	0.15	Actual	1	0.15
16	DUT repositioning	FFS	Rectangular	1.73	
Stage 1: Calibration measurement					
17	Mismatch	0.00	U-shaped	1.41	0.00
18	Amplifier Uncertainties	0.00	Normal	2.00	0.00
19	Misalignment of positioning System	FFS	Normal	2.00	
20	Uncertainty of the Network Analyzer	[0.40]	Normal	2.00	[0.20]
21	Uncertainty of the absolute gain of the calibration antenna	FFS	Normal	2.00	
22	Positioning and pointing misalignment between the reference antenna and the measurement antenna	FFS	Rectangular	1.73	
23	Phase centre offset of calibration antenna	0.00	Rectangular	1.73	0.00
24	Quality of quiet zone for calibration process (NOTE 4)	FFS	Actual	1.00	
25	Standing wave between reference calibration antenna and measurement antenna	0.00	U-shaped	1.41	0.00
26	Influence of the calibration antenna feed cable	0.14	Normal	2.00	0.07
27	Insertion Loss Variation	0.00	Rectangular	1.73	0.00
Expanded uncertainty (1.96σ - confidence interval of 95 %)					Value
TRP Expanded uncertainty ([6] GHz < f <= [12.75] GHz) [dB] (a)					TBD
Systematic uncertainties (NOTE 3)					Value
28	Systematic error due to TRP calculation/quadrature (NOTE 1) (b)				TBD
29	Influence of noise ([6] GHz < f <= [12.75] GHz) (c)				TBD
30	Systematic error related to beam peak search (NOTE 2)				N/A

Total measurement uncertainty	Value
Total measurement uncertainty (a)+(b)+(c) [dB]	TBD
<p>NOTE 1: This contributor shall only be considered for TRP measurements.</p> <p>NOTE 2: This contributor shall only be considered for EIRP measurements.</p> <p>NOTE 3: In order to obtain the total measurement uncertainty, systematic uncertainties have to be added to the expanded root sum square of the standard deviations of the Stage 1 and Stage 2 contributors.</p> <p>NOTE 4: Value based on procedure defined in Annex D.2 of TR 38.810.</p> <p>NOTE 5: Applies to the system which has a structure of mechanical feed antenna positioning.</p>	

Table B.18.2-4: Uncertainty assessment for TRP measurement (f= [12.75] GHz to 23.45 GHz, DUT size = 15 cm)

UID	Uncertainty source	Uncertainty value	Distribution of the probability	Divisor	Standard uncertainty (σ) [dB]
Stage 2: DUT measurement					
1	Positioning misalignment	0.00	Normal	2.00	0.00
2	Measure distance uncertainty	0.00	Rectangular	1.73	0.00
3	Quality of Quiet Zone (NOTE 4)	FFS	Actual	1.00	
4	Mismatch	[1.50]	Actual	1.00	[1.50]
5	Standing wave between the DUT and measurement antenna	0.00	U-shaped	1.41	0.00
6	Uncertainty of the RF power measurement equipment	FFS	Normal	2.00	
7	Phase curvature	0.00	U-shaped	1.41	0.00
8	Amplifier uncertainties	FFS	Normal	2.00	
9	Random uncertainty	FFS	Normal	2.00	
10	Influence of the XPD	0.043	U-shaped	1.41	0.03
11	Insertion Loss Variation	0.00	Rectangular	1.73	0.00
12	RF leakage (from measurement antenna to the receiver/transmitter)	0.00	Actual	1.00	0.00
13	Influence of TRP measurement grid (NOTE 1)	FFS	Actual	1	
14	Influence of beam peak search grid (NOTE 2)	N/A	Actual	1	N/A
15	Multiple measurement antenna uncertainty (NOTE 5)	0.15	Actual	1	0.15
16	DUT repositioning	FFS	Rectangular	1.73	
Stage 1: Calibration measurement					
17	Mismatch	0.00	U-shaped	1.41	0.00
18	Amplifier Uncertainties	0.00	Normal	2.00	0.00
19	Misalignment of positioning System	FFS	Normal	2.00	
20	Uncertainty of the Network Analyzer	[0.40]	Normal	2.00	[0.20]
21	Uncertainty of the absolute gain of the calibration antenna	FFS	Normal	2.00	
22	Positioning and pointing misalignment between the reference antenna and the measurement antenna	FFS	Rectangular	1.73	
23	Phase centre offset of calibration antenna	0.00	Rectangular	1.73	0.00
24	Quality of quiet zone for calibration process (NOTE 4)	FFS	Actual	1.00	
25	Standing wave between reference calibration antenna and measurement antenna	0.00	U-shaped	1.41	0.00
26	Influence of the calibration antenna feed cable	0.14	Normal	2.00	0.07
27	Insertion Loss Variation	0.00	Rectangular	1.73	0.00
Expanded uncertainty (1.96σ - confidence interval of 95 %)					Value
TRP Expanded uncertainty ([12.75] GHz < f <= 23.45 GHz) [dB] (a)					TBD
Systematic uncertainties (NOTE 3)					Value
28	Systematic error due to TRP calculation/quadrature (NOTE 1) (b)				TBD
29	Influence of noise ([12.75] GHz < f <= 23.45 GHz) (c)				TBD
30	Systematic error related to beam peak search (NOTE 2)				N/A

Total measurement uncertainty	Value
Total measurement uncertainty (a)+(b)+(c) [dB]	TBD
<p>NOTE 1: This contributor shall only be considered for TRP measurements.</p> <p>NOTE 2: This contributor shall only be considered for EIRP measurements.</p> <p>NOTE 3: In order to obtain the total measurement uncertainty, systematic uncertainties have to be added to the expanded root sum square of the standard deviations of the Stage 1 and Stage 2 contributors.</p> <p>NOTE 4: Value based on procedure defined in Annex D.2 of TR 38.810.</p> <p>NOTE 5: Applies to the system which has a structure of mechanical feed antenna positioning.</p>	

Table B.18.2-5: Uncertainty assessment for TRP measurement (f=[12.75] GHz to 23.45 GHz, DUT size = 30 cm)

UID	Uncertainty source	Uncertainty value	Distribution of the probability	Divisor	Standard uncertainty (σ) [dB]
Stage 2: DUT measurement					
1	Positioning misalignment	0.00	Normal	2.00	0.00
2	Measure distance uncertainty	0.00	Rectangular	1.73	0.00
3	Quality of Quiet Zone (NOTE 4)	FFS	Actual	1.00	
4	Mismatch	[1.50]	Actual	1.00	[1.50]
5	Standing wave between the DUT and measurement antenna	0.00	U-shaped	1.41	0.00
6	Uncertainty of the RF power measurement equipment	FFS	Normal	2.00	
7	Phase curvature	0.00	U-shaped	1.41	0.00
8	Amplifier uncertainties	FFS	Normal	2.00	
9	Random uncertainty	FFS	Normal	2.00	
10	Influence of the XPD	0.043	U-shaped	1.41	0.03
11	Insertion Loss Variation	0.00	Rectangular	1.73	0.00
12	RF leakage (from measurement antenna to the receiver/transmitter)	0.00	Actual	1.00	0.00
13	Influence of TRP measurement grid (NOTE 1)	FFS	Actual	1	
14	Influence of beam peak search grid (NOTE 2)	N/A	Actual	1	N/A
15	Multiple measurement antenna uncertainty (NOTE 5)	0.15	Actual	1	0.15
16	DUT repositioning	FFS	Rectangular	1.73	
Stage 1: Calibration measurement					
17	Mismatch	0.00	U-shaped	1.41	0.00
18	Amplifier Uncertainties	0.00	Normal	2.00	0.00
19	Misalignment of positioning System	FFS	Normal	2.00	
20	Uncertainty of the Network Analyzer	[0.40]	Normal	2.00	[0.20]
21	Uncertainty of the absolute gain of the calibration antenna	FFS	Normal	2.00	
22	Positioning and pointing misalignment between the reference antenna and the measurement antenna	FFS	Rectangular	1.73	
23	Phase centre offset of calibration antenna	0.00	Rectangular	1.73	0.00
24	Quality of quiet zone for calibration process (NOTE 4)	FFS	Actual	1.00	
25	Standing wave between reference calibration antenna and measurement antenna	0.00	U-shaped	1.41	0.00
26	Influence of the calibration antenna feed cable	0.14	Normal	2.00	0.07
27	Insertion Loss Variation	0.00	Rectangular	1.73	0.00
	Expanded uncertainty (1.96σ - confidence interval of 95 %)				Value
	TRP Expanded uncertainty ([12.75] GHz < f <= 23.45 GHz) [dB] (a)				TBD
	Systematic uncertainties (NOTE 3)				Value
28	Systematic error due to TRP calculation/quadrature (NOTE 1) (b)				TBD
29	Influence of noise ([12.75] GHz < f <= 23.45 GHz) (c)				TBD
30	Systematic error related to beam peak search (NOTE 2)				N/A

Total measurement uncertainty	Value
Total measurement uncertainty (a)+(b)+(c) [dB]	TBD
<p>NOTE 1: This contributor shall only be considered for TRP measurements.</p> <p>NOTE 2: This contributor shall only be considered for EIRP measurements.</p> <p>NOTE 3: In order to obtain the total measurement uncertainty, systematic uncertainties have to be added to the expanded root sum square of the standard deviations of the Stage 1 and Stage 2 contributors.</p> <p>NOTE 4: Value based on procedure defined in Annex D.2 of TR 38.810.</p> <p>NOTE 5: Applies to the system which has a structure of mechanical feed antenna positioning.</p>	

Table B.18.2-6: Uncertainty assessment for TRP measurement (f= 23.45 GHz to 40.8 GHz, DUT size = 15 cm)

UID	Uncertainty source	Uncertainty value	Distribution of the probability	Divisor	Standard uncertainty (σ) [dB]
Stage 2: DUT measurement					
1	Positioning misalignment	0.00	Normal	2.00	0.00
2	Measure distance uncertainty	0.00	Rectangular	1.73	0.00
3	Quality of Quiet Zone (NOTE 4)	FFS	Actual	1.00	
4	Mismatch	FFS	Actual	1.00	
5	Standing wave between the DUT and measurement antenna	0.00	U-shaped	1.41	0.00
6	Uncertainty of the RF power measurement equipment	FFS	Normal	2.00	
7	Phase curvature	0.00	U-shaped	1.41	0.00
8	Amplifier uncertainties	FFS	Normal	2.00	
9	Random uncertainty	FFS	Normal	2.00	
10	Influence of the XPD	FFS	U-shaped	1.41	
11	Insertion Loss Variation	0.00	Rectangular	1.73	0.00
12	RF leakage (from measurement antenna to the receiver/transmitter)	0.00	Actual	1.00	0.00
13	Influence of TRP measurement grid (NOTE 1)	FFS	Actual	1	
14	Influence of beam peak search grid (NOTE 2)	N/A	Actual	1	N/A
15	Multiple measurement antenna uncertainty (NOTE 5)	0.15	Actual	1	0.15
16	DUT repositioning	FFS	Rectangular	1.73	
Stage 1: Calibration measurement					
17	Mismatch	0.00	U-shaped	1.41	0.00
18	Amplifier Uncertainties	0.00	Normal	2.00	0.00
19	Misalignment of positioning System	FFS	Normal	2.00	
20	Uncertainty of the Network Analyzer	FFS	Normal	2.00	
21	Uncertainty of the absolute gain of the calibration antenna	FFS	Normal	2.00	
22	Positioning and pointing misalignment between the reference antenna and the measurement antenna	FFS	Rectangular	1.73	
23	Phase centre offset of calibration antenna	0.00	Rectangular	1.73	0.00
24	Quality of quiet zone for calibration process (NOTE 4)	FFS	Actual	1.00	
25	Standing wave between reference calibration antenna and measurement antenna	0.00	U-shaped	1.41	0.00
26	Influence of the calibration antenna feed cable	0.14	Normal	2.00	0.07
27	Insertion Loss Variation	0.00	Rectangular	1.73	0.00
	Expanded uncertainty (1.96σ - confidence interval of 95 %)				Value
	TRP Expanded uncertainty (23.45 GHz < f <= 40.8 GHz) [dB] (a)				TBD
	Systematic uncertainties (NOTE 3)				Value
28	Systematic error due to TRP calculation/quadrature (NOTE 1) (b)				TBD
29	Influence of noise (23.45 GHz < f <= 40.8 GHz) (c)				TBD
30	Systematic error related to beam peak search (NOTE 2)				N/A

Total measurement uncertainty	Value
Total measurement uncertainty (a)+(b)+(c) [dB]	TBD
<p>NOTE 1: This contributor shall only be considered for TRP measurements.</p> <p>NOTE 2: This contributor shall only be considered for EIRP measurements.</p> <p>NOTE 3: In order to obtain the total measurement uncertainty, systematic uncertainties have to be added to the expanded root sum square of the standard deviations of the Stage 1 and Stage 2 contributors.</p> <p>NOTE 4: Value based on procedure defined in Annex D.2 of TR 38.810.</p> <p>NOTE 5: Applies to the system which has a structure of mechanical feed antenna positioning.</p>	

Table B.18.2-7: Uncertainty assessment for TRP measurement (f=23.45 GHz to 40.8 GHz, DUT size = 30 cm)

UID	Uncertainty source	Uncertainty value	Distribution of the probability	Divisor	Standard uncertainty (σ) [dB]
Stage 2: DUT measurement					
1	Positioning misalignment	0.00	Normal	2.00	0.00
2	Measure distance uncertainty	0.00	Rectangular	1.73	0.00
3	Quality of Quiet Zone (NOTE 4)	FFS	Actual	1.00	
4	Mismatch	FFS	Actual	1.00	
5	Standing wave between the DUT and measurement antenna	0.00	U-shaped	1.41	0.00
6	Uncertainty of the RF power measurement equipment	FFS	Normal	2.00	
7	Phase curvature	0.00	U-shaped	1.41	0.00
8	Amplifier uncertainties	FFS	Normal	2.00	
9	Random uncertainty	FFS	Normal	2.00	
10	Influence of the XPD	FFS	U-shaped	1.41	
11	Insertion Loss Variation	0.00	Rectangular	1.73	0.00
12	RF leakage (from measurement antenna to the receiver/transmitter)	0.00	Actual	1.00	0.00
13	Influence of TRP measurement grid (NOTE 1)	FFS	Actual	1	
14	Influence of beam peak search grid (NOTE 2)	N/A	Actual	1	N/A
15	Multiple measurement antenna uncertainty (NOTE 5)	0.15	Actual	1	0.15
16	DUT repositioning	FFS	Rectangular	1.73	
Stage 1: Calibration measurement					
17	Mismatch	0.00	U-shaped	1.41	0.00
18	Amplifier Uncertainties	0.00	Normal	2.00	0.00
19	Misalignment of positioning System	FFS	Normal	2.00	
20	Uncertainty of the Network Analyzer	FFS	Normal	2.00	
21	Uncertainty of the absolute gain of the calibration antenna	FFS	Normal	2.00	
22	Positioning and pointing misalignment between the reference antenna and the measurement antenna	FFS	Rectangular	1.73	
23	Phase centre offset of calibration antenna	0.00	Rectangular	1.73	0.00
24	Quality of quiet zone for calibration process (NOTE 4)	FFS	Actual	1.00	
25	Standing wave between reference calibration antenna and measurement antenna	0.00	U-shaped	1.41	0.00
26	Influence of the calibration antenna feed cable	0.14	Normal	2.00	0.07
27	Insertion Loss Variation	0.00	Rectangular	1.73	0.00
	Expanded uncertainty (1.96σ - confidence interval of 95 %)				Value
	TRP Expanded uncertainty (23.45 GHz < f <= 40.8 GHz) [dB] (a)				TBD
	Systematic uncertainties (NOTE 3)				Value
28	Systematic error due to TRP calculation/quadrature (NOTE 1) (b)				TBD
29	Influence of noise (23.45 GHz < f <= 40.8 GHz) (c)				TBD
30	Systematic error related to beam peak search (NOTE 2)				N/A

Total measurement uncertainty	Value
Total measurement uncertainty (a)+(b)+(c) [dB]	TBD
<p>NOTE 1: This contributor shall only be considered for TRP measurements.</p> <p>NOTE 2: This contributor shall only be considered for EIRP measurements.</p> <p>NOTE 3: In order to obtain the total measurement uncertainty, systematic uncertainties have to be added to the expanded root sum square of the standard deviations of the Stage 1 and Stage 2 contributors.</p> <p>NOTE 4: Value based on procedure defined in Annex D.2 of TR 38.810.</p> <p>NOTE 5: Applies to the system which has a structure of mechanical feed antenna positioning.</p>	

Table B.18.2-8: Uncertainty assessment for TRP measurement (f= 40.8 GHz to 66 GHz, DUT size = 15 cm)

UID	Uncertainty source	Uncertainty value	Distribution of the probability	Divisor	Standard uncertainty (σ) [dB]
Stage 2: DUT measurement					
1	Positioning misalignment	FFS	Normal	2.00	
2	Measure distance uncertainty	0.00	Rectangular	1.73	0.00
3	Quality of Quiet Zone (NOTE 4)	FFS	Actual	1.00	
4	Mismatch	[2.30]	Actual	1.00	[2.30]
5	Standing wave between the DUT and measurement antenna	0.00	U-shaped	1.41	0.00
6	Uncertainty of the RF power measurement equipment	FFS	Normal	2.00	
7	Phase curvature	0.00	U-shaped	1.41	0.00
8	Amplifier uncertainties	FFS	Normal	2.00	
9	Random uncertainty	FFS	Normal	2.00	
10	Influence of the XPD	FFS	U-shaped	1.41	
11	Insertion Loss Variation	0.00	Rectangular	1.73	0.00
12	RF leakage (from measurement antenna to the receiver/transmitter)	0.00	Actual	1.00	0.00
13	Influence of TRP measurement grid (NOTE 1)	FFS	Actual	1	
14	Influence of beam peak search grid (NOTE 2)	N/A	Actual	1	N/A
15	Multiple measurement antenna uncertainty (NOTE 5)	0.15	Actual	1	0.15
16	DUT repositioning	FFS	Rectangular	1.73	
Stage 1: Calibration measurement					
17	Mismatch	0.00	U-shaped	1.41	0.00
18	Amplifier Uncertainties	0.00	Normal	2.00	0.00
19	Misalignment of positioning System	FFS	Normal	2.00	
20	Uncertainty of the Network Analyzer	[0.80]	Normal	2.00	[0.40]
21	Uncertainty of the absolute gain of the calibration antenna	FFS	Normal	2.00	
22	Positioning and pointing misalignment between the reference antenna and the measurement antenna	FFS	Rectangular	1.73	
23	Phase centre offset of calibration antenna	0.00	Rectangular	1.73	0.00
24	Quality of quiet zone for calibration process (NOTE 4)	FFS	Actual	1.00	
25	Standing wave between reference calibration antenna and measurement antenna	0.00	U-shaped	1.41	0.00
26	Influence of the calibration antenna feed cable	0.28	Normal	2.00	0.14
27	Insertion Loss Variation	0.00	Rectangular	1.73	0.00
	Expanded uncertainty (1.96σ - confidence interval of 95 %)				Value
	TRP Expanded uncertainty (40.8 GHz < f <= 66 GHz) [dB] (a)				TBD
	Systematic uncertainties (NOTE 3)				Value
28	Systematic error due to TRP calculation/quadrature (NOTE 1) (b)				TBD
29	Influence of noise (40.8 GHz < f <= 66 GHz) (c)				TBD
30	Systematic error related to beam peak search (NOTE 2)				N/A

Total measurement uncertainty	Value
Total measurement uncertainty (a)+(b)+(c) [dB]	TBD
<p>NOTE 1: This contributor shall only be considered for TRP measurements.</p> <p>NOTE 2: This contributor shall only be considered for EIRP measurements.</p> <p>NOTE 3: In order to obtain the total measurement uncertainty, systematic uncertainties have to be added to the expanded root sum square of the standard deviations of the Stage 1 and Stage 2 contributors.</p> <p>NOTE 4: Value based on procedure defined in Annex D.2 of TR 38.810.</p> <p>NOTE 5: Applies to the system which has a structure of mechanical feed antenna positioning.</p>	

Table B.18.2-9: Uncertainty assessment for TRP measurement (f= 40.8 GHz to 66 GHz, DUT size = 30 cm)

UID	Uncertainty source	Uncertainty value	Distribution of the probability	Divisor	Standard uncertainty (σ) [dB]
Stage 2: DUT measurement					
1	Positioning misalignment	FFS	Normal	2.00	
2	Measure distance uncertainty	0.00	Rectangular	1.73	0.00
3	Quality of Quiet Zone (NOTE 4)	FFS	Actual	1.00	
4	Mismatch	[2.30]	Actual	1.00	[2.30]
5	Standing wave between the DUT and measurement antenna	0.00	U-shaped	1.41	0.00
6	Uncertainty of the RF power measurement equipment	FFS	Normal	2.00	
7	Phase curvature	0.00	U-shaped	1.41	0.00
8	Amplifier uncertainties	FFS	Normal	2.00	
9	Random uncertainty	FFS	Normal	2.00	
10	Influence of the XPD	FFS	U-shaped	1.41	
11	Insertion Loss Variation	0.00	Rectangular	1.73	0.00
12	RF leakage (from measurement antenna to the receiver/transmitter)	0.00	Actual	1.00	0.00
13	Influence of TRP measurement grid (NOTE 1)	FFS	Actual	1	
14	Influence of beam peak search grid (NOTE 2)	N/A	Actual	1	N/A
15	Multiple measurement antenna uncertainty (NOTE 5)	0.15	Actual	1	0.15
16	DUT repositioning	FFS	Rectangular	1.73	
Stage 1: Calibration measurement					
17	Mismatch	0.00	U-shaped	1.41	0.00
18	Amplifier Uncertainties	0.00	Normal	2.00	0.00
19	Misalignment of positioning System	FFS	Normal	2.00	
20	Uncertainty of the Network Analyzer	[0.80]	Normal	2.00	[0.40]
21	Uncertainty of the absolute gain of the calibration antenna	FFS	Normal	2.00	
22	Positioning and pointing misalignment between the reference antenna and the measurement antenna	FFS	Rectangular	1.73	
23	Phase centre offset of calibration antenna	0.00	Rectangular	1.73	0.00
24	Quality of quiet zone for calibration process (NOTE 4)	FFS	Actual	1.00	
25	Standing wave between reference calibration antenna and measurement antenna	0.00	U-shaped	1.41	0.00
26	Influence of the calibration antenna feed cable	0.28	Normal	2.00	0.14
27	Insertion Loss Variation	0.00	Rectangular	1.73	0.00
	Expanded uncertainty (1.96σ - confidence interval of 95 %)				Value
	TRP Expanded uncertainty (40.8 GHz < f <= 66 GHz) [dB] (a)				TBD
	Systematic uncertainties (NOTE 3)				Value
28	Systematic error due to TRP calculation/quadrature (NOTE 1) (b)				TBD
29	Influence of noise (40.8 GHz < f <= 66 GHz) (c)				TBD
30	Systematic error related to beam peak search (NOTE 2)				N/A

Total measurement uncertainty	Value
Total measurement uncertainty (a)+(b)+(c) [dB]	TBD
<p>NOTE 1: This contributor shall only be considered for TRP measurements.</p> <p>NOTE 2: This contributor shall only be considered for EIRP measurements.</p> <p>NOTE 3: In order to obtain the total measurement uncertainty, systematic uncertainties have to be added to the expanded root sum square of the standard deviations of the Stage 1 and Stage 2 contributors.</p> <p>NOTE 4: Value based on procedure defined in Annex D.2 of TR 38.810.</p> <p>NOTE 5: Applies to the system which has a structure of mechanical feed antenna positioning.</p>	

Table B.18.2-10: Uncertainty assessment for TRP measurement (f= 66 GHz to 80 GHz, DUT size = 15 cm)

UID	Uncertainty source	Uncertainty value	Distribution of the probability	Divisor	Standard uncertainty (σ) [dB]
Stage 2: DUT measurement					
1	Positioning misalignment	FFS	Normal	2.00	
2	Measure distance uncertainty	0.00	Rectangular	1.73	0.00
3	Quality of Quiet Zone (NOTE 4)	FFS	Actual	1.00	
4	Mismatch	FFS	Actual	1.00	
5	Standing wave between the DUT and measurement antenna	0.00	U-shaped	1.41	0.00
6	Uncertainty of the RF power measurement equipment	FFS	Normal	2.00	
7	Phase curvature	0.00	U-shaped	1.41	0.00
8	Amplifier uncertainties	FFS	Normal	2.00	
9	Random uncertainty	FFS	Normal	2.00	
10	Influence of the XPD	FFS	U-shaped	1.41	
11	Insertion Loss Variation	0.00	Rectangular	1.73	0.00
12	RF leakage (from measurement antenna to the receiver/transmitter)	0.00	Actual	1.00	0.00
13	Influence of TRP measurement grid (NOTE 1)	FFS	Actual	1	
14	Influence of beam peak search grid (NOTE 2)	N/A	Actual	1	N/A
15	Multiple measurement antenna uncertainty (NOTE 5)	0.15	Actual	1	0.15
16	DUT repositioning	FFS	Rectangular	1.73	
Stage 1: Calibration measurement					
17	Mismatch	0.00	U-shaped	1.41	0.00
18	Amplifier Uncertainties	0.00	Normal	2.00	0.00
19	Misalignment of positioning System	FFS	Normal	2.00	
20	Uncertainty of the Network Analyzer	FFS	Normal	2.00	
21	Uncertainty of the absolute gain of the calibration antenna	FFS	Normal	2.00	
22	Positioning and pointing misalignment between the reference antenna and the measurement antenna	FFS	Rectangular	1.73	
23	Phase centre offset of calibration antenna	0.00	Rectangular	1.73	0.00
24	Quality of quiet zone for calibration process (NOTE 4)	FFS	Actual	1.00	
25	Standing wave between reference calibration antenna and measurement antenna	0.00	U-shaped	1.41	0.00
26	Influence of the calibration antenna feed cable	0.28	Normal	2.00	0.14
27	Insertion Loss Variation	0.00	Rectangular	1.73	0.00
	Expanded uncertainty (1.96σ - confidence interval of 95 %)				Value
	TRP Expanded uncertainty (66 GHz < f <= 80 GHz) [dB] (a)				TBD
	Systematic uncertainties (NOTE 3)				Value
28	Systematic error due to TRP calculation/quadrature (NOTE 1) (b)				TBD
29	Influence of noise (66 GHz < f <= 80 GHz) (c)				TBD
30	Systematic error related to beam peak search (NOTE 2)				N/A

Total measurement uncertainty	Value
Total measurement uncertainty (a)+(b)+(c) [dB]	TBD
<p>NOTE 1: This contributor shall only be considered for TRP measurements.</p> <p>NOTE 2: This contributor shall only be considered for EIRP measurements.</p> <p>NOTE 3: In order to obtain the total measurement uncertainty, systematic uncertainties have to be added to the expanded root sum square of the standard deviations of the Stage 1 and Stage 2 contributors.</p> <p>NOTE 4: Value based on procedure defined in Annex D.2 of TR 38.810.</p> <p>NOTE 5: Applies to the system which has a structure of mechanical feed antenna positioning.</p>	

Table B.18.2-11: Uncertainty assessment for TRP measurement (f= 66 GHz to 80 GHz, DUT size = 30 cm)

UID	Uncertainty source	Uncertainty value	Distribution of the probability	Divisor	Standard uncertainty (σ) [dB]
Stage 2: DUT measurement					
1	Positioning misalignment	FFS	Normal	2.00	
2	Measure distance uncertainty	0.00	Rectangular	1.73	0.00
3	Quality of Quiet Zone (NOTE 4)	FFS	Actual	1.00	
4	Mismatch	FFS	Actual	1.00	
5	Standing wave between the DUT and measurement antenna	0.00	U-shaped	1.41	0.00
6	Uncertainty of the RF power measurement equipment	FFS	Normal	2.00	
7	Phase curvature	0.00	U-shaped	1.41	0.00
8	Amplifier uncertainties	FFS	Normal	2.00	
9	Random uncertainty	FFS	Normal	2.00	
10	Influence of the XPD	FFS	U-shaped	1.41	
11	Insertion Loss Variation	0.00	Rectangular	1.73	0.00
12	RF leakage (from measurement antenna to the receiver/transmitter)	0.00	Actual	1.00	0.00
13	Influence of TRP measurement grid (NOTE 1)	FFS	Actual	1	
14	Influence of beam peak search grid (NOTE 2)	N/A	Actual	1	N/A
15	Multiple measurement antenna uncertainty (NOTE 5)	0.15	Actual	1	0.15
16	DUT repositioning	FFS	Rectangular	1.73	
Stage 1: Calibration measurement					
17	Mismatch	0.00	U-shaped	1.41	0.00
18	Amplifier Uncertainties	0.00	Normal	2.00	0.00
19	Misalignment of positioning System	FFS	Normal	2.00	
20	Uncertainty of the Network Analyzer	FFS	Normal	2.00	
21	Uncertainty of the absolute gain of the calibration antenna	FFS	Normal	2.00	
22	Positioning and pointing misalignment between the reference antenna and the measurement antenna	FFS	Rectangular	1.73	
23	Phase centre offset of calibration antenna	0.00	Rectangular	1.73	0.00
24	Quality of quiet zone for calibration process (NOTE 4)	FFS	Actual	1.00	
25	Standing wave between reference calibration antenna and measurement antenna	0.00	U-shaped	1.41	0.00
26	Influence of the calibration antenna feed cable	0.28	Normal	2.00	0.14
27	Insertion Loss Variation	0.00	Rectangular	1.73	0.00
	Expanded uncertainty (1.96σ - confidence interval of 95 %)				Value
	TRP Expanded uncertainty (66 GHz < f <= 80 GHz) [dB] (a)				TBD
	Systematic uncertainties (NOTE 3)				Value
28	Systematic error due to TRP calculation/quadrature (NOTE 1) (b)				TBD
29	Influence of noise (66 GHz < f <= 80 GHz) (c)				TBD
30	Systematic error related to beam peak search (NOTE 2)				N/A

Total measurement uncertainty	Value
Total measurement uncertainty (a)+(b)+(c) [dB]	TBD
NOTE 1: This contributor shall only be considered for TRP measurements. NOTE 2: This contributor shall only be considered for EIRP measurements. NOTE 3: In order to obtain the total measurement uncertainty, systematic uncertainties have to be added to the expanded root sum square of the standard deviations of the Stage 1 and Stage 2 contributors. NOTE 4: Value based on procedure defined in Annex D.2 of TR 38.810. NOTE 5: Applies to the system which has a structure of mechanical feed antenna positioning.	

B.18.3 Uncertainty budget format and assessment for NFTF

FFS

B.19 Reference Sensitivity

Following tables summarize the MU threshold for EIS measurements for Reference Sensitivity. The origin MU values for different test setups with varies parameters can be found in following subclauses.

Table B.19-1: MU threshold for EIS for Reference Sensitivity

Frequency	MBW	Power	Threshold MU value (NOTE 1)
23.45GHz ≤ f ≤ 32.125GHz	BW ≤ 400MHz	P = Max Output Power	TBD
32.125GHz < f ≤ 40.8GHz			TBD
NOTE 1: Max {Total Expanded MU for IFF for 15cm in Table B.19.2-2, Total Expanded MU for IFF for 30cm in Table B.19.2-3}			

B.19.1 Uncertainty budget format and assessment for DFF

FFS

B.19.2 Uncertainty budget format and assessment for IFF

The uncertainty contributions that may impact the overall MU value are listed in Table B.19.2-1.

Table B.19.2-1: Uncertainty contributions for EIS measurement

UID	Description of uncertainty contribution	Details in annex
Stage 2: DUT measurement		
1	Positioning misalignment	B.2.2.1
2	Measure distance uncertainty	B.2.2.2
3	Quality of Quiet Zone	B.2.2.3
4	Mismatch	B.2.2.4
5	Standing wave between the DUT and measurement antenna	B.2.2.5
6	gNB emulator uncertainty	B.2.2.17
7	Phase curvature	B.2.2.7
8	Amplifier uncertainties	B.2.2.8
9	Random uncertainty	B.2.2.9
10	Influence of the XPD	B.2.2.10
11	Insertion Loss Variation	B.2.2.11
12	RF leakage (from measurement antenna to the receiver/transmitter)	B.2.2.12
13	Multiple measurement antenna uncertainty	B.2.2.25
14	DUT repositioning	B.2.2.26
15	Influence of spherical coverage grid	B.2.2.29
Stage 1: Calibration measurement		
16	Mismatch	B.2.2.4
17	Amplifier Uncertainties	B.2.2.8
18	Misalignment of positioning System	B.2.2.13
19	Uncertainty of the Network Analyzer	B.2.2.14
20	Uncertainty of the absolute gain of the calibration antenna	B.2.2.15
21	Positioning and pointing misalignment between the reference antenna and the measurement antenna	B.2.2.16
22	Phase centre offset of calibration antenna	B.2.2.18
23	Quality of quiet zone for calibration process	B.2.2.19
24	Standing wave between reference calibration antenna and measurement antenna	B.2.2.20
25	Influence of the calibration antenna feed cable	B.2.2.21
26	Insertion Loss Variation	B.2.2.11
Systematic uncertainties		
27	Systematic error related to beam peak search	B.2.2.28
28	Systematic error related to EIS spherical coverage	B.2.2.30

The uncertainty assessment tables are organized as follows:

- For the purpose of uncertainty assessment, the radiating antenna aperture of the DUT is denoted as D
- The uncertainty assessment has been derived for the case of DUT size = [15 cm and 30 cm], $f = \{23.45\text{GHz}, 32.125\text{GHz}, 40.8\text{GHz}\}$, [P = maximum output power].
- The uncertainty assessment for EIS is provided in Table B.19.2-2 and Table B.19.2-3.

Table B.19.2-2: Uncertainty assessment for EIS measurement (f=23.45GHz, 32.125GHz, 40.8GHz, DUT size = 15 cm)

UID	Uncertainty source	Uncertainty value	Distribution of the probability	Divisor	Standard uncertainty (σ) [dB]
Stage 2: DUT measurement					
1	Positioning misalignment	0.00	Normal	2.00	0.00
2	Measure distance uncertainty	0.00	Rectangular	1.73	0.00
3	Quality of Quiet Zone	0.6	Actual	1.00	0.6
4	Mismatch	1.30	Actual	1.00	1.30
5	Standing wave between the DUT and measurement antenna	0.00	U-shaped	1.41	0.00
6	gNB uncertainty on absolute level	2.9	Normal	2.00	1.45
7	Phase curvature	0.00	U-shaped	1.41	0.00
8	Amplifier uncertainties	2.1	Normal	2.00	1.05
9	Random uncertainty	0.50	Normal	2.00	0.25
10	Influence of the XPD	0.01	U-shaped	1.41	0.00
11	Insertion Loss Variation	0.00	Rectangular	1.73	0.00
12	RF leakage (from measurement antenna to the receiver/transmitter)	0.00	Actual	1.00	0.00
13	Multiple measurement antenna uncertainty (NOTE 6)	0.15	Actual	1.00	0.15
14	DUT repositioning	0.00 (NOTE 4) 0.08	Rectangular	1.73	0.00 (NOTE 4) 0.05
15	Influence of spherical coverage grid (NOTE 4)	0.12	Actual	1	0.12
Stage 1: Calibration measurement					
16	Mismatch	0.00	U-shaped	1.41	0.00
17	Amplifier Uncertainties	0.00	Normal	2.00	0.00
18	Misalignment of positioning System	0.00	Normal	2.00	0.00
19	Uncertainty of the Network Analyzer	0.73	Normal	2.00	0.37
20	Uncertainty of the absolute gain of the calibration antenna	0.60	Normal	2.00	0.30
21	Positioning and pointing misalignment between the reference antenna and the measurement antenna	0.01	Rectangular	1.73	0.00
22	Phase centre offset of calibration antenna	0.00	Rectangular	1.73	0.00
23	Quality of quiet zone for calibration process	0.4	Actual	1.00	0.4
24	Standing wave between reference calibration antenna and measurement antenna	0.00	U-shaped	1.41	0.00
25	Influence of the calibration antenna feed cable	0.14	Normal	2.00	0.07
26	Insertion Loss Variation	0.00	Rectangular	1.73	0.00
Systematic uncertainties (NOTE 3)					Value
27	Systematic error related to beam peak search (NOTE 5)				0.5
28	Systematic error related to EIS spherical coverage (NOTE 4)				DL power step size, 0.2
Total measurement uncertainty					Value
EIS Expanded uncertainty (1.96 σ - confidence interval of 95 %) [dB]					5.19
EIS Spherical coverage Expanded uncertainty (1.96 σ - confidence interval of 95 %) [dB]					4.90
NOTE 1: The analysis was done only for the case of operating at max output power, in-band, non-CA.					
NOTE 2: Void.					
NOTE 3: In order to obtain the total measurement uncertainty, systematic uncertainties have to be added to the expanded root sum square of the standard deviations of the Stage 1 and Stage 2 contributors.					
NOTE 4: This contributor shall only be considered for spherical EIS measurements.					
NOTE 5: This contributor shall only be considered for EIS measurements.					
NOTE 6: Applies to the system which has a structure of mechanical feed antenna positioning.					

Table B.19.2-3: Uncertainty assessment for EIS measurement (f=23.45GHz, 32.125GHz, 40.8GHz, DUT size = 30 cm)

UID	Uncertainty source	Uncertainty value	Distribution of the probability	Divisor	Standard uncertainty (σ) [dB]
Stage 2: DUT measurement					
1	Positioning misalignment	0.00	Normal	2.00	0.00
2	Measure distance uncertainty	0.00	Rectangular	1.73	0.00
3	Quality of Quiet Zone (NOTE 3)	0.5	Actual	1.00	0.5
4	Mismatch	1.30	Actual	1.00	1.30
5	Standing wave between the DUT and measurement antenna	0.00	U-shaped	1.41	0.00
6	gNB uncertainty on absolute level	2.9	Normal	2.00	1.45
7	Phase curvature	0.00	U-shaped	1.41	0.00
8	Amplifier uncertainties	2.1	Normal	2.00	1.05
9	Random uncertainty	0.50	Normal	2.00	0.25
10	Influence of the XPD	0.01	U-shaped	1.41	0.00
11	Insertion Loss Variation	0.00	Rectangular	1.73	0.00
12	RF leakage (from measurement antenna to the receiver/transmitter)	0.00	Actual	1.00	0.00
13	Multiple measurement antenna uncertainty (NOTE 7)	0.15	Actual	1.00	0.15
14	DUT repositioning	0.00 (NOTE 5) 0.08	Rectangular	1.73	0.00 (NOTE 5) 0.05
15	Influence of spherical coverage grid (NOTE 5)	0.12	Actual	1	0.12
Stage 1: Calibration measurement					
16	Mismatch	0.00	U-shaped	1.41	0.00
17	Amplifier Uncertainties	0.00	Normal	2.00	0.00
18	Misalignment of positioning System	0.00	Normal	2.00	0.00
19	Uncertainty of the Network Analyzer	0.73	Normal	2.00	0.37
20	Uncertainty of the absolute gain of the calibration antenna	0.60	Normal	2.00	0.30
21	Positioning and pointing misalignment between the reference antenna and the measurement antenna	0.01	Rectangular	1.73	0.00
22	Phase centre offset of calibration antenna	0.00	Rectangular	1.73	0.00
23	Quality of quiet zone for calibration process (NOTE 3)	0.2	Actual	1.00	0.2
24	Standing wave between reference calibration antenna and measurement antenna	0.00	U-shaped	1.41	0.00
25	Influence of the calibration antenna feed cable	0.14	Normal	2.00	0.07
26	Insertion Loss Variation	0.00	Rectangular	1.73	0.00
Systematic uncertainties (NOTE 4)					Value
27	Systematic error related to beam peak search (NOTE 6)				0.5
28	Systematic error related to EIS spherical coverage (NOTE 5)				DL power step size, 0.2
Total measurement uncertainty					Value
EIS Expanded uncertainty (1.96 σ - confidence interval of 95 %) [dB]					5.10
EIS Spherical coverage Expanded uncertainty (1.96 σ - confidence interval of 95 %) [dB]					[4.80]
NOTE 1: The analysis was done only for the case of operating at max output power, in-band, non-CA.					
NOTE 2: Void.					
NOTE 3: Value based on procedure defined in Annex D.2 of TR 38.810 for Quiet Zone size of 30 cm.					
NOTE 4: In order to obtain the total measurement uncertainty, systematic uncertainties have to be added to the expanded root sum square of the standard deviations of the Stage 1 and Stage 2 contributors.					
NOTE 5: This contributor shall only be considered for spherical EIS measurements.					
NOTE 6: This contributor shall only be considered for EIS measurements.					
NOTE 7: Applies to the system which has a structure of mechanical feed antenna positioning.					

B.20 to B.24

B.25 Receiver spurious emissions

Following tables summarize the MU threshold for TRP measurements for Receiver spurious emissions. The origin MU values for different test setups can be found in following subclauses.

Table B.25-1: MU threshold for TRP measurement for General spurious emissions

Frequency	MBW	Power	Aperture size	MU value
TBD	BW <= 400MHz	P = Maximum Output Power	D <= 5cm	FFS
			5cm < D <= 15cm	FFS
			15cm < D <= 30cm	FFS

B.25.1 Uncertainty budget format and assessment for DFF

The uncertainty contributions that may impact the overall MU value are listed in Table B.25.1-1.

Table B.25.1-1: Uncertainty contributions for TRP measurement

UID	Description of uncertainty contribution	Details in annex
Stage 2: DUT measurement		
1	Positioning misalignment	B.2.1.1
2	Measure distance uncertainty	B.2.1.2
3	Quality of quiet zone	B.2.1.3
4	Mismatch	B.2.1.4
5	Standing Wave Between the DUT and measurement antenna	B.2.1.5
6	Uncertainty of the RF power measurement equipment	B.2.1.6
7	Phase curvature	B.2.1.7
8	Amplifier uncertainties	B.2.1.8
9	Random uncertainty	B.2.1.9
10	Influence of the XPD	B.2.1.10
11	Insertion Loss Variation	B.2.1.11
12	RF leakage (from measurement antenna to the receiver/transmitter)	B.2.1.12
13	Influence of TRP measurement grid	B.2.1.22
14	Influence of beam peak search grid	B.2.1.23
15	Multiple measurement antenna uncertainty	B.2.1.25
16	DUT repositioning	B.2.1.26
Stage 1: Calibration measurement		
17	Mismatch	B.2.1.4
18	Amplifier uncertainties	B.2.1.8
19	Misalignment of positioning System	B.2.1.13
20	Uncertainty of the Network Analyzer	B.2.1.14
21	Uncertainty of the absolute gain of the calibration antenna	B.2.1.15
22	Positioning and pointing misalignment between the reference antenna and the measurement antenna	B.2.1.16
23	Phase centre offset of calibration antenna	B.2.1.18
24	Quality of quiet zone for calibration process	B.2.1.19
25	Standing wave between reference calibration antenna and measurement antenna	B.2.1.20
26	Influence of the calibration antenna feed cable	B.2.1.21
27	Insertion Loss Variation	B.2.1.11
Systematic uncertainties		
28	Systematic error due to TRP calculation/quadrature	B.2.1.24
29	Influence of noise	B.2.1.27

The uncertainty assessment tables are organized as follows:

- For the purpose of uncertainty assessment, the radiating antenna aperture of the DUT is denoted as D
- The uncertainty assessment has been derived for the case of $D = [5 \text{ cm}]$, $f = \{6 \text{ GHz to } 80 \text{ GHz}\}$, $P = [\text{Off power}]$.
- The uncertainty assessment for TRP is provided in Table B.25.1-2 to B.25.1-xx

Table B.25.1-2: Uncertainty assessment for TRP measurement (f=TBD, D=TBD)

UID	Uncertainty source	Uncertainty value	Distribution of the probability	Divisor	Standard uncertainty (σ) [dB]
Stage 2: DUT measurement					
1	Positioning misalignment				
2	Measure distance uncertainty				
3	Quality of quiet zone				
4	Mismatch (NOTE 1)				
5	Standing Wave Between the DUT and measurement antenna				
6	Uncertainty of the RF power measurement equipment (NOTE 2)				
7	Phase curvature				
8	Amplifier uncertainties				
9	Random uncertainty				
10	Influence of the XPD				
11	Insertion Loss Variation				
12	RF leakage (from measurement antenna to the receiver/transmitter)				
13	Influence of TRP measurement grid (NOTE 3)				
14	Influence of beam peak search grid (NOTE 4)				
15	Multiple measurement antenna uncertainty				
16	DUT repositioning				
Stage 1: Calibration measurement					
17	Mismatch				
18	Amplifier uncertainties				
19	Misalignment of positioning System				
20	Uncertainty of the Network Analyzer				
21	Uncertainty of the absolute gain of the calibration antenna				
22	Positioning and pointing misalignment between the reference antenna and the measurement antenna				
23	Phase centre offset of calibration antenna				
24	Quality of quiet zone for calibration process				
25	Standing wave between reference calibration antenna and measurement antenna				
26	Influence of the calibration antenna feed cable				
27	Insertion Loss Variation				
TRP Expanded uncertainty (1.96 σ - confidence interval of 95 %) [dB]					
Systematic uncertainties (NOTE 5)					Value
28	Systematic error due to TRP calculation/quadrature (NOTE 3)				
29	Influence of noise				
Total measurement uncertainty					
TRP total measurement uncertainty [dB]					
NOTE 1: The analysis was done only for the case of operating at max output power, in-band, non-CA.					
NOTE 2: The assessment assumes maximum DUT output power.					
NOTE 3: This contributor shall only be considered for TRP measurements.					
NOTE 4: This contributor shall only be considered for EIRP measurements.					
NOTE 5: In order to obtain the total measurement uncertainty, systematic uncertainties have to be added to the expanded root sum square of the standard deviations of the Stage 1 and Stage 2 contributors.					
NOTE 6: Void					

B.25.2 Uncertainty budget format and assessment for IFF

The uncertainty contributions that may impact the overall MU value are listed in Table B.25.2-1.

Table B.25.2-1: Uncertainty contributions for TRP measurement

UID	Description of uncertainty contribution	Details in annex
Stage 2: DUT measurement		
1	Positioning misalignment	B.2.2.1
2	Measure distance uncertainty	B.2.2.2
3	Quality of Quiet Zone	B.2.2.3
4	Mismatch	B.2.2.4
5	Standing wave between the DUT and measurement antenna	B.2.2.5
6	Uncertainty of the RF power measurement equipment	B.2.2.6
7	Phase curvature	B.2.2.7
8	Amplifier uncertainties	B.2.2.8
9	Random uncertainty	B.2.2.9
10	Influence of the XPD	B.2.2.10
11	Insertion Loss Variation	B.2.2.11
12	RF leakage (from measurement antenna to the receiver/transmitter)	B.2.2.12
13	Influence of TRP measurement grid	B.2.2.22
14	Influence of beam peak search grid	B.2.2.23
15	Multiple measurement antenna uncertainty	B.2.2.25
16	DUT repositioning	B.2.2.26
Stage 1: Calibration measurement		
17	Mismatch	B.2.2.4
18	Amplifier Uncertainties	B.2.2.8
19	Misalignment of positioning System	B.2.2.13
20	Uncertainty of the Network Analyzer	B.2.2.14
21	Uncertainty of the absolute gain of the calibration antenna	B.2.2.15
22	Positioning and pointing misalignment between the reference antenna and the measurement antenna	B.2.2.16
23	Phase centre offset of calibration antenna	B.2.2.18
24	Quality of quiet zone for calibration process	B.2.2.19
25	Standing wave between reference calibration antenna and measurement antenna	B.2.2.20
26	Influence of the calibration antenna feed cable	B.2.2.21
27	Insertion Loss Variation	B.2.2.11
Systematic uncertainties		
28	Systematic error due to TRP calculation/quadrature	B.2.2.24
29	Influence of noise	B.2.2.27

The uncertainty assessment tables are organized as follows:

- For the purpose of uncertainty assessment, the radiating antenna aperture of the DUT is denoted as D
- The uncertainty assessment has been derived for the case of DUT size = [15 cm and 30 cm], f = {6 GHz to 80 GHz}, P = [Off power].
- The uncertainty assessment for TRP is provided from Table B.25.2-2 to Table B.25.2-11.

Table B.25.2-2: Uncertainty assessment for TRP measurement (f= [6] GHz to [12.75] GHz, DUT size = 15 cm)

UID	Uncertainty source	Uncertainty value	Distribution of the probability	Divisor	Standard uncertainty (σ) [dB]
Stage 2: DUT measurement					
1	Positioning misalignment	0.00	Normal	2.00	0.00
2	Measure distance uncertainty	0.00	Rectangular	1.73	0.00
3	Quality of Quiet Zone (NOTE 4)	FFS	Actual	1.00	
4	Mismatch	[1.50]	Actual	1.00	[1.50]
5	Standing wave between the DUT and measurement antenna	0.00	U-shaped	1.41	0.00
6	Uncertainty of the RF power measurement equipment	FFS	Normal	2.00	
7	Phase curvature	0.00	U-shaped	1.41	0.00
8	Amplifier uncertainties	FFS	Normal	2.00	
9	Random uncertainty	FFS	Normal	2.00	
10	Influence of the XPD	0.043	U-shaped	1.41	0.03
11	Insertion Loss Variation	0.00	Rectangular	1.73	0.00
12	RF leakage (from measurement antenna to the receiver/transmitter)	0.00	Actual	1.00	0.00
13	Influence of TRP measurement grid (NOTE 1)	FFS	Actual	1	
14	Influence of beam peak search grid (NOTE 2)	N/A	Actual	1	N/A
15	Multiple measurement antenna uncertainty (NOTE 5)	0.15	Actual	1	0.15
16	DUT repositioning	FFS	Rectangular	1.73	
Stage 1: Calibration measurement					
17	Mismatch	0.00	U-shaped	1.41	0.00
18	Amplifier Uncertainties	0.00	Normal	2.00	0.00
19	Misalignment of positioning System	FFS	Normal	2.00	
20	Uncertainty of the Network Analyzer	[0.40]	Normal	2.00	[0.20]
21	Uncertainty of the absolute gain of the calibration antenna	FFS	Normal	2.00	
22	Positioning and pointing misalignment between the reference antenna and the measurement antenna	FFS	Rectangular	1.73	
23	Phase centre offset of calibration antenna	0.00	Rectangular	1.73	0.00
24	Quality of quiet zone for calibration process (NOTE 4)	FFS	Actual	1.00	
25	Standing wave between reference calibration antenna and measurement antenna	0.00	U-shaped	1.41	0.00
26	Influence of the calibration antenna feed cable	0.14	Normal	2.00	0.07
27	Insertion Loss Variation	0.00	Rectangular	1.73	0.00
	Expanded uncertainty (1.96σ - confidence interval of 95 %)				Value
	TRP Expanded uncertainty ([6] GHz < f <= [12.75] GHz) [dB] (a)				TBD
	Systematic uncertainties (NOTE 3)				Value
28	Systematic error due to TRP calculation/quadrature (NOTE 1) (b)				TBD
29	Influence of noise ([6] GHz < f <= [12.75] GHz) (c)				TBD
30	Systematic error related to beam peak search (NOTE 2)				N/A

Total measurement uncertainty	Value
Total measurement uncertainty (a)+(b)+(c) [dB]	TBD
<p>NOTE 1: This contributor shall only be considered for TRP measurements.</p> <p>NOTE 2: This contributor shall only be considered for EIRP measurements.</p> <p>NOTE 3: In order to obtain the total measurement uncertainty, systematic uncertainties have to be added to the expanded root sum square of the standard deviations of the Stage 1 and Stage 2 contributors.</p> <p>NOTE 4: Value based on procedure defined in Annex D.2 of TR 38.810.</p> <p>NOTE 5: Applies to the system which has a structure of mechanical feed antenna positioning.</p>	

Table B.25.2-3: Uncertainty assessment for TRP measurement (f=[6] GHz to [12.75] GHz, DUT size = 30 cm)

UID	Uncertainty source	Uncertainty value	Distribution of the probability	Divisor	Standard uncertainty (σ) [dB]
Stage 2: DUT measurement					
1	Positioning misalignment	0.00	Normal	2.00	0.00
2	Measure distance uncertainty	0.00	Rectangular	1.73	0.00
3	Quality of Quiet Zone (NOTE 4)	FFS	Actual	1.00	
4	Mismatch	[1.50]	Actual	1.00	[1.50]
5	Standing wave between the DUT and measurement antenna	0.00	U-shaped	1.41	0.00
6	Uncertainty of the RF power measurement equipment	FFS	Normal	2.00	
7	Phase curvature	0.00	U-shaped	1.41	0.00
8	Amplifier uncertainties	FFS	Normal	2.00	
9	Random uncertainty	FFS	Normal	2.00	
10	Influence of the XPD	0.043	U-shaped	1.41	0.03
11	Insertion Loss Variation	0.00	Rectangular	1.73	0.00
12	RF leakage (from measurement antenna to the receiver/transmitter)	0.00	Actual	1.00	0.00
13	Influence of TRP measurement grid (NOTE 1)	FFS	Actual	1	
14	Influence of beam peak search grid (NOTE 2)	N/A	Actual	1	N/A
15	Multiple measurement antenna uncertainty (NOTE 5)	0.15	Actual	1	0.15
16	DUT repositioning	FFS	Rectangular	1.73	
Stage 1: Calibration measurement					
17	Mismatch	0.00	U-shaped	1.41	0.00
18	Amplifier Uncertainties	0.00	Normal	2.00	0.00
19	Misalignment of positioning System	FFS	Normal	2.00	
20	Uncertainty of the Network Analyzer	[0.40]	Normal	2.00	[0.20]
21	Uncertainty of the absolute gain of the calibration antenna	FFS	Normal	2.00	
22	Positioning and pointing misalignment between the reference antenna and the measurement antenna	FFS	Rectangular	1.73	
23	Phase centre offset of calibration antenna	0.00	Rectangular	1.73	0.00
24	Quality of quiet zone for calibration process (NOTE 4)	FFS	Actual	1.00	
25	Standing wave between reference calibration antenna and measurement antenna	0.00	U-shaped	1.41	0.00
26	Influence of the calibration antenna feed cable	0.14	Normal	2.00	0.07
27	Insertion Loss Variation	0.00	Rectangular	1.73	0.00
	Expanded uncertainty (1.96σ - confidence interval of 95 %)				Value
	TRP Expanded uncertainty ([6] GHz < f <= [12.75] GHz) [dB] (a)				TBD
	Systematic uncertainties (NOTE 3)				Value
28	Systematic error due to TRP calculation/quadrature (NOTE 1) (b)				TBD
29	Influence of noise ([6] GHz < f <= [12.75] GHz) (c)				TBD
30	Systematic error related to beam peak search (NOTE 2)				N/A

Total measurement uncertainty	Value
Total measurement uncertainty (a)+(b)+(c) [dB]	TBD
<p>NOTE 1: This contributor shall only be considered for TRP measurements.</p> <p>NOTE 2: This contributor shall only be considered for EIRP measurements.</p> <p>NOTE 3: In order to obtain the total measurement uncertainty, systematic uncertainties have to be added to the expanded root sum square of the standard deviations of the Stage 1 and Stage 2 contributors.</p> <p>NOTE 4: Value based on procedure defined in Annex D.2 of TR 38.810.</p> <p>NOTE 5: Applies to the system which has a structure of mechanical feed antenna positioning.</p>	

Table B.25.2-4: Uncertainty assessment for TRP measurement (f= [12.75] GHz to 23.45 GHz, DUT size = 15 cm)

UID	Uncertainty source	Uncertainty value	Distribution of the probability	Divisor	Standard uncertainty (σ) [dB]
Stage 2: DUT measurement					
1	Positioning misalignment	0.00	Normal	2.00	0.00
2	Measure distance uncertainty	0.00	Rectangular	1.73	0.00
3	Quality of Quiet Zone (NOTE 4)	FFS	Actual	1.00	
4	Mismatch	[1.50]	Actual	1.00	[1.50]
5	Standing wave between the DUT and measurement antenna	0.00	U-shaped	1.41	0.00
6	Uncertainty of the RF power measurement equipment	FFS	Normal	2.00	
7	Phase curvature	0.00	U-shaped	1.41	0.00
8	Amplifier uncertainties	FFS	Normal	2.00	
9	Random uncertainty	FFS	Normal	2.00	
10	Influence of the XPD	0.043	U-shaped	1.41	0.03
11	Insertion Loss Variation	0.00	Rectangular	1.73	0.00
12	RF leakage (from measurement antenna to the receiver/transmitter)	0.00	Actual	1.00	0.00
13	Influence of TRP measurement grid (NOTE 1)	FFS	Actual	1	
14	Influence of beam peak search grid (NOTE 2)	N/A	Actual	1	N/A
15	Multiple measurement antenna uncertainty (NOTE 5)	0.15	Actual	1	0.15
16	DUT repositioning	FFS	Rectangular	1.73	
Stage 1: Calibration measurement					
17	Mismatch	0.00	U-shaped	1.41	0.00
18	Amplifier Uncertainties	0.00	Normal	2.00	0.00
19	Misalignment of positioning System	FFS	Normal	2.00	
20	Uncertainty of the Network Analyzer	[0.40]	Normal	2.00	[0.20]
21	Uncertainty of the absolute gain of the calibration antenna	FFS	Normal	2.00	
22	Positioning and pointing misalignment between the reference antenna and the measurement antenna	FFS	Rectangular	1.73	
23	Phase centre offset of calibration antenna	0.00	Rectangular	1.73	0.00
24	Quality of quiet zone for calibration process (NOTE 4)	FFS	Actual	1.00	
25	Standing wave between reference calibration antenna and measurement antenna	0.00	U-shaped	1.41	0.00
26	Influence of the calibration antenna feed cable	0.14	Normal	2.00	0.07
27	Insertion Loss Variation	0.00	Rectangular	1.73	0.00
Expanded uncertainty (1.96σ - confidence interval of 95 %)					Value
TRP Expanded uncertainty ([12.75] GHz < f <= 23.45 GHz) [dB] (a)					TBD
Systematic uncertainties (NOTE 3)					Value
28	Systematic error due to TRP calculation/quadrature (NOTE 1) (b)				TBD
29	Influence of noise ([12.75] GHz < f <= 23.45 GHz) (c)				TBD
30	Systematic error related to beam peak search (NOTE 2)				N/A

Total measurement uncertainty	Value
Total measurement uncertainty (a)+(b)+(c) [dB]	TBD
<p>NOTE 1: This contributor shall only be considered for TRP measurements.</p> <p>NOTE 2: This contributor shall only be considered for EIRP measurements.</p> <p>NOTE 3: In order to obtain the total measurement uncertainty, systematic uncertainties have to be added to the expanded root sum square of the standard deviations of the Stage 1 and Stage 2 contributors.</p> <p>NOTE 4: Value based on procedure defined in Annex D.2 of TR 38.810.</p> <p>NOTE 5: Applies to the system which has a structure of mechanical feed antenna positioning.</p>	

Table B.25.2-5: Uncertainty assessment for TRP measurement (f=[12.75] GHz to 23.45 GHz, DUT size = 30 cm)

UID	Uncertainty source	Uncertainty value	Distribution of the probability	Divisor	Standard uncertainty (σ) [dB]
Stage 2: DUT measurement					
1	Positioning misalignment	0.00	Normal	2.00	0.00
2	Measure distance uncertainty	0.00	Rectangular	1.73	0.00
3	Quality of Quiet Zone (NOTE 4)	FFS	Actual	1.00	
4	Mismatch	[1.50]	Actual	1.00	[1.50]
5	Standing wave between the DUT and measurement antenna	0.00	U-shaped	1.41	0.00
6	Uncertainty of the RF power measurement equipment	FFS	Normal	2.00	
7	Phase curvature	0.00	U-shaped	1.41	0.00
8	Amplifier uncertainties	FFS	Normal	2.00	
9	Random uncertainty	FFS	Normal	2.00	
10	Influence of the XPD	0.043	U-shaped	1.41	0.03
11	Insertion Loss Variation	0.00	Rectangular	1.73	0.00
12	RF leakage (from measurement antenna to the receiver/transmitter)	0.00	Actual	1.00	0.00
13	Influence of TRP measurement grid (NOTE 1)	FFS	Actual	1	
14	Influence of beam peak search grid (NOTE 2)	N/A	Actual	1	N/A
15	Multiple measurement antenna uncertainty (NOTE 5)	0.15	Actual	1	0.15
16	DUT repositioning	FFS	Rectangular	1.73	
Stage 1: Calibration measurement					
17	Mismatch	0.00	U-shaped	1.41	0.00
18	Amplifier Uncertainties	0.00	Normal	2.00	0.00
19	Misalignment of positioning System	FFS	Normal	2.00	
20	Uncertainty of the Network Analyzer	[0.40]	Normal	2.00	[0.20]
21	Uncertainty of the absolute gain of the calibration antenna	FFS	Normal	2.00	
22	Positioning and pointing misalignment between the reference antenna and the measurement antenna	FFS	Rectangular	1.73	
23	Phase centre offset of calibration antenna	0.00	Rectangular	1.73	0.00
24	Quality of quiet zone for calibration process (NOTE 4)	FFS	Actual	1.00	
25	Standing wave between reference calibration antenna and measurement antenna	0.00	U-shaped	1.41	0.00
26	Influence of the calibration antenna feed cable	0.14	Normal	2.00	0.07
27	Insertion Loss Variation	0.00	Rectangular	1.73	0.00
Expanded uncertainty (1.96σ - confidence interval of 95 %)					Value
TRP Expanded uncertainty ([12.75] GHz < f <= 23.45 GHz) [dB] (a)					TBD
Systematic uncertainties (NOTE 3)					Value
28	Systematic error due to TRP calculation/quadrature (NOTE 1) (b)				TBD
29	Influence of noise ([12.75] GHz < f <= 23.45 GHz) (c)				TBD
30	Systematic error related to beam peak search (NOTE 2)				N/A

Total measurement uncertainty	Value
Total measurement uncertainty (a)+(b)+(c) [dB]	TBD
<p>NOTE 1: This contributor shall only be considered for TRP measurements.</p> <p>NOTE 2: This contributor shall only be considered for EIRP measurements.</p> <p>NOTE 3: In order to obtain the total measurement uncertainty, systematic uncertainties have to be added to the expanded root sum square of the standard deviations of the Stage 1 and Stage 2 contributors.</p> <p>NOTE 4: Value based on procedure defined in Annex D.2 of TR 38.810.</p> <p>NOTE 5: Applies to the system which has a structure of mechanical feed antenna positioning.</p>	

Table B.25.2-6: Uncertainty assessment for TRP measurement (f= 23.45 GHz to 40.8 GHz, DUT size = 15 cm)

UID	Uncertainty source	Uncertainty value	Distribution of the probability	Divisor	Standard uncertainty (σ) [dB]
Stage 2: DUT measurement					
1	Positioning misalignment	0.00	Normal	2.00	0.00
2	Measure distance uncertainty	0.00	Rectangular	1.73	0.00
3	Quality of Quiet Zone (NOTE 4)	FFS	Actual	1.00	
4	Mismatch	FFS	Actual	1.00	
5	Standing wave between the DUT and measurement antenna	0.00	U-shaped	1.41	0.00
6	Uncertainty of the RF power measurement equipment	FFS	Normal	2.00	
7	Phase curvature	0.00	U-shaped	1.41	0.00
8	Amplifier uncertainties	FFS	Normal	2.00	
9	Random uncertainty	FFS	Normal	2.00	
10	Influence of the XPD	FFS	U-shaped	1.41	
11	Insertion Loss Variation	0.00	Rectangular	1.73	0.00
12	RF leakage (from measurement antenna to the receiver/transmitter)	0.00	Actual	1.00	0.00
13	Influence of TRP measurement grid (NOTE 1)	FFS	Actual	1	
14	Influence of beam peak search grid (NOTE 2)	N/A	Actual	1	N/A
15	Multiple measurement antenna uncertainty (NOTE 5)	0.15	Actual	1	0.15
16	DUT repositioning	FFS	Rectangular	1.73	
Stage 1: Calibration measurement					
17	Mismatch	0.00	U-shaped	1.41	0.00
18	Amplifier Uncertainties	0.00	Normal	2.00	0.00
19	Misalignment of positioning System	FFS	Normal	2.00	
20	Uncertainty of the Network Analyzer	FFS	Normal	2.00	
21	Uncertainty of the absolute gain of the calibration antenna	FFS	Normal	2.00	
22	Positioning and pointing misalignment between the reference antenna and the measurement antenna	FFS	Rectangular	1.73	
23	Phase centre offset of calibration antenna	0.00	Rectangular	1.73	0.00
24	Quality of quiet zone for calibration process (NOTE 4)	FFS	Actual	1.00	
25	Standing wave between reference calibration antenna and measurement antenna	0.00	U-shaped	1.41	0.00
26	Influence of the calibration antenna feed cable	0.14	Normal	2.00	0.07
27	Insertion Loss Variation	0.00	Rectangular	1.73	0.00
	Expanded uncertainty (1.96σ - confidence interval of 95 %)				Value
	TRP Expanded uncertainty (23.45 GHz < f <= 40.8 GHz) [dB] (a)				TBD
	Systematic uncertainties (NOTE 3)				Value
28	Systematic error due to TRP calculation/quadrature (NOTE 1) (b)				TBD
29	Influence of noise (23.45 GHz < f <= 40.8 GHz) (c)				TBD
30	Systematic error related to beam peak search (NOTE 2)				N/A

Total measurement uncertainty	Value
Total measurement uncertainty (a)+(b)+(c) [dB]	TBD
<p>NOTE 1: This contributor shall only be considered for TRP measurements.</p> <p>NOTE 2: This contributor shall only be considered for EIRP measurements.</p> <p>NOTE 3: In order to obtain the total measurement uncertainty, systematic uncertainties have to be added to the expanded root sum square of the standard deviations of the Stage 1 and Stage 2 contributors.</p> <p>NOTE 4: Value based on procedure defined in Annex D.2 of TR 38.810.</p> <p>NOTE 5: Applies to the system which has a structure of mechanical feed antenna positioning.</p>	

Table B.25.2-7: Uncertainty assessment for TRP measurement (f=23.45 GHz to 40.8 GHz, DUT size = 30 cm)

UID	Uncertainty source	Uncertainty value	Distribution of the probability	Divisor	Standard uncertainty (σ) [dB]
Stage 2: DUT measurement					
1	Positioning misalignment	0.00	Normal	2.00	0.00
2	Measure distance uncertainty	0.00	Rectangular	1.73	0.00
3	Quality of Quiet Zone (NOTE 4)	FFS	Actual	1.00	
4	Mismatch	FFS	Actual	1.00	
5	Standing wave between the DUT and measurement antenna	0.00	U-shaped	1.41	0.00
6	Uncertainty of the RF power measurement equipment	FFS	Normal	2.00	
7	Phase curvature	0.00	U-shaped	1.41	0.00
8	Amplifier uncertainties	FFS	Normal	2.00	
9	Random uncertainty	FFS	Normal	2.00	
10	Influence of the XPD	FFS	U-shaped	1.41	
11	Insertion Loss Variation	0.00	Rectangular	1.73	0.00
12	RF leakage (from measurement antenna to the receiver/transmitter)	0.00	Actual	1.00	0.00
13	Influence of TRP measurement grid (NOTE 1)	FFS	Actual	1	
14	Influence of beam peak search grid (NOTE 2)	N/A	Actual	1	N/A
15	Multiple measurement antenna uncertainty (NOTE 5)	0.15	Actual	1	0.15
16	DUT repositioning	FFS	Rectangular	1.73	
Stage 1: Calibration measurement					
17	Mismatch	0.00	U-shaped	1.41	0.00
18	Amplifier Uncertainties	0.00	Normal	2.00	0.00
19	Misalignment of positioning System	FFS	Normal	2.00	
20	Uncertainty of the Network Analyzer	FFS	Normal	2.00	
21	Uncertainty of the absolute gain of the calibration antenna	FFS	Normal	2.00	
22	Positioning and pointing misalignment between the reference antenna and the measurement antenna	FFS	Rectangular	1.73	
23	Phase centre offset of calibration antenna	0.00	Rectangular	1.73	0.00
24	Quality of quiet zone for calibration process (NOTE 4)	FFS	Actual	1.00	
25	Standing wave between reference calibration antenna and measurement antenna	0.00	U-shaped	1.41	0.00
26	Influence of the calibration antenna feed cable	0.14	Normal	2.00	0.07
27	Insertion Loss Variation	0.00	Rectangular	1.73	0.00
	Expanded uncertainty (1.96σ - confidence interval of 95 %)				Value
	TRP Expanded uncertainty (23.45 GHz < f <= 40.8 GHz) [dB] (a)				TBD
	Systematic uncertainties (NOTE 3)				Value
28	Systematic error due to TRP calculation/quadrature (NOTE 1) (b)				TBD
29	Influence of noise (23.45 GHz < f <= 40.8 GHz) (c)				TBD
30	Systematic error related to beam peak search (NOTE 2)				N/A

Total measurement uncertainty	Value
Total measurement uncertainty (a)+(b)+(c) [dB]	TBD
<p>NOTE 1: This contributor shall only be considered for TRP measurements.</p> <p>NOTE 2: This contributor shall only be considered for EIRP measurements.</p> <p>NOTE 3: In order to obtain the total measurement uncertainty, systematic uncertainties have to be added to the expanded root sum square of the standard deviations of the Stage 1 and Stage 2 contributors.</p> <p>NOTE 4: Value based on procedure defined in Annex D.2 of TR 38.810.</p> <p>NOTE 5: Applies to the system which has a structure of mechanical feed antenna positioning.</p>	

Table B.25.2-8: Uncertainty assessment for TRP measurement (f= 40.8 GHz to 66 GHz, DUT size = 15 cm)

UID	Uncertainty source	Uncertainty value	Distribution of the probability	Divisor	Standard uncertainty (σ) [dB]
Stage 2: DUT measurement					
1	Positioning misalignment	FFS	Normal	2.00	
2	Measure distance uncertainty	0.00	Rectangular	1.73	0.00
3	Quality of Quiet Zone (NOTE 4)	FFS	Actual	1.00	
4	Mismatch	[2.30]	Actual	1.00	[2.30]
5	Standing wave between the DUT and measurement antenna	0.00	U-shaped	1.41	0.00
6	Uncertainty of the RF power measurement equipment	FFS	Normal	2.00	
7	Phase curvature	0.00	U-shaped	1.41	0.00
8	Amplifier uncertainties	FFS	Normal	2.00	
9	Random uncertainty	FFS	Normal	2.00	
10	Influence of the XPD	FFS	U-shaped	1.41	
11	Insertion Loss Variation	0.00	Rectangular	1.73	0.00
12	RF leakage (from measurement antenna to the receiver/transmitter)	0.00	Actual	1.00	0.00
13	Influence of TRP measurement grid (NOTE 1)	FFS	Actual	1	
14	Influence of beam peak search grid (NOTE 2)	N/A	Actual	1	N/A
15	Multiple measurement antenna uncertainty (NOTE 5)	0.15	Actual	1	0.15
16	DUT repositioning	FFS	Rectangular	1.73	
Stage 1: Calibration measurement					
17	Mismatch	0.00	U-shaped	1.41	0.00
18	Amplifier Uncertainties	0.00	Normal	2.00	0.00
19	Misalignment of positioning System	FFS	Normal	2.00	
20	Uncertainty of the Network Analyzer	[0.80]	Normal	2.00	[0.40]
21	Uncertainty of the absolute gain of the calibration antenna	FFS	Normal	2.00	
22	Positioning and pointing misalignment between the reference antenna and the measurement antenna	FFS	Rectangular	1.73	
23	Phase centre offset of calibration antenna	0.00	Rectangular	1.73	0.00
24	Quality of quiet zone for calibration process (NOTE 4)	FFS	Actual	1.00	
25	Standing wave between reference calibration antenna and measurement antenna	0.00	U-shaped	1.41	0.00
26	Influence of the calibration antenna feed cable	0.28	Normal	2.00	0.14
27	Insertion Loss Variation	0.00	Rectangular	1.73	0.00
	Expanded uncertainty (1.96σ - confidence interval of 95 %)				Value
	TRP Expanded uncertainty (40.8 GHz < f <= 66 GHz) [dB] (a)				TBD
	Systematic uncertainties (NOTE 3)				Value
28	Systematic error due to TRP calculation/quadrature (NOTE 1) (b)				TBD
29	Influence of noise (40.8 GHz < f <= 66 GHz) (c)				TBD
30	Systematic error related to beam peak search (NOTE 2)				N/A

Total measurement uncertainty	Value
Total measurement uncertainty (a)+(b)+(c) [dB]	TBD
<p>NOTE 1: This contributor shall only be considered for TRP measurements.</p> <p>NOTE 2: This contributor shall only be considered for EIRP measurements.</p> <p>NOTE 3: In order to obtain the total measurement uncertainty, systematic uncertainties have to be added to the expanded root sum square of the standard deviations of the Stage 1 and Stage 2 contributors.</p> <p>NOTE 4: Value based on procedure defined in Annex D.2 of TR 38.810.</p> <p>NOTE 5: Applies to the system which has a structure of mechanical feed antenna positioning.</p>	

Table B.25.2-9: Uncertainty assessment for TRP measurement (f= 40.8 GHz to 66 GHz, DUT size = 30 cm)

UID	Uncertainty source	Uncertainty value	Distribution of the probability	Divisor	Standard uncertainty (σ) [dB]
Stage 2: DUT measurement					
1	Positioning misalignment	FFS	Normal	2.00	
2	Measure distance uncertainty	0.00	Rectangular	1.73	0.00
3	Quality of Quiet Zone (NOTE 4)	FFS	Actual	1.00	
4	Mismatch	[2.30]	Actual	1.00	[2.30]
5	Standing wave between the DUT and measurement antenna	0.00	U-shaped	1.41	0.00
6	Uncertainty of the RF power measurement equipment	FFS	Normal	2.00	
7	Phase curvature	0.00	U-shaped	1.41	0.00
8	Amplifier uncertainties	FFS	Normal	2.00	
9	Random uncertainty	FFS	Normal	2.00	
10	Influence of the XPD	FFS	U-shaped	1.41	
11	Insertion Loss Variation	0.00	Rectangular	1.73	0.00
12	RF leakage (from measurement antenna to the receiver/transmitter)	0.00	Actual	1.00	0.00
13	Influence of TRP measurement grid (NOTE 1)	FFS	Actual	1	
14	Influence of beam peak search grid (NOTE 2)	N/A	Actual	1	N/A
15	Multiple measurement antenna uncertainty (NOTE 5)	0.15	Actual	1	0.15
16	DUT repositioning	FFS	Rectangular	1.73	
Stage 1: Calibration measurement					
17	Mismatch	0.00	U-shaped	1.41	0.00
18	Amplifier Uncertainties	0.00	Normal	2.00	0.00
19	Misalignment of positioning System	FFS	Normal	2.00	
20	Uncertainty of the Network Analyzer	[0.80]	Normal	2.00	[0.40]
21	Uncertainty of the absolute gain of the calibration antenna	FFS	Normal	2.00	
22	Positioning and pointing misalignment between the reference antenna and the measurement antenna	FFS	Rectangular	1.73	
23	Phase centre offset of calibration antenna	0.00	Rectangular	1.73	0.00
24	Quality of quiet zone for calibration process (NOTE 4)	FFS	Actual	1.00	
25	Standing wave between reference calibration antenna and measurement antenna	0.00	U-shaped	1.41	0.00
26	Influence of the calibration antenna feed cable	0.28	Normal	2.00	0.14
27	Insertion Loss Variation	0.00	Rectangular	1.73	0.00
Expanded uncertainty (1.96σ - confidence interval of 95 %)					Value
TRP Expanded uncertainty (40.8 GHz < f <= 66 GHz) [dB] (a)					TBD
Systematic uncertainties (NOTE 3)					Value
28	Systematic error due to TRP calculation/quadrature (NOTE 1) (b)				TBD
29	Influence of noise (40.8 GHz < f <= 66 GHz) (c)				TBD
30	Systematic error related to beam peak search (NOTE 2)				N/A

Total measurement uncertainty	Value
Total measurement uncertainty (a)+(b)+(c) [dB]	TBD
<p>NOTE 1: This contributor shall only be considered for TRP measurements.</p> <p>NOTE 2: This contributor shall only be considered for EIRP measurements.</p> <p>NOTE 3: In order to obtain the total measurement uncertainty, systematic uncertainties have to be added to the expanded root sum square of the standard deviations of the Stage 1 and Stage 2 contributors.</p> <p>NOTE 4: Value based on procedure defined in Annex D.2 of TR 38.810.</p> <p>NOTE 5: Applies to the system which has a structure of mechanical feed antenna positioning.</p>	

Table B.25.2-10: Uncertainty assessment for TRP measurement (f= 66 GHz to 80 GHz, DUT size = 15 cm)

UID	Uncertainty source	Uncertainty value	Distribution of the probability	Divisor	Standard uncertainty (σ) [dB]
Stage 2: DUT measurement					
1	Positioning misalignment	FFS	Normal	2.00	
2	Measure distance uncertainty	0.00	Rectangular	1.73	0.00
3	Quality of Quiet Zone (NOTE 4)	FFS	Actual	1.00	
4	Mismatch	FFS	Actual	1.00	
5	Standing wave between the DUT and measurement antenna	0.00	U-shaped	1.41	0.00
6	Uncertainty of the RF power measurement equipment	FFS	Normal	2.00	
7	Phase curvature	0.00	U-shaped	1.41	0.00
8	Amplifier uncertainties	FFS	Normal	2.00	
9	Random uncertainty	FFS	Normal	2.00	
10	Influence of the XPD	FFS	U-shaped	1.41	
11	Insertion Loss Variation	0.00	Rectangular	1.73	0.00
12	RF leakage (from measurement antenna to the receiver/transmitter)	0.00	Actual	1.00	0.00
13	Influence of TRP measurement grid (NOTE 1)	FFS	Actual	1	
14	Influence of beam peak search grid (NOTE 2)	N/A	Actual	1	N/A
15	Multiple measurement antenna uncertainty (NOTE 5)	0.15	Actual	1	0.15
16	DUT repositioning	FFS	Rectangular	1.73	
Stage 1: Calibration measurement					
17	Mismatch	0.00	U-shaped	1.41	0.00
18	Amplifier Uncertainties	0.00	Normal	2.00	0.00
19	Misalignment of positioning System	FFS	Normal	2.00	
20	Uncertainty of the Network Analyzer	FFS	Normal	2.00	
21	Uncertainty of the absolute gain of the calibration antenna	FFS	Normal	2.00	
22	Positioning and pointing misalignment between the reference antenna and the measurement antenna	FFS	Rectangular	1.73	
23	Phase centre offset of calibration antenna	0.00	Rectangular	1.73	0.00
24	Quality of quiet zone for calibration process (NOTE 4)	FFS	Actual	1.00	
25	Standing wave between reference calibration antenna and measurement antenna	0.00	U-shaped	1.41	0.00
26	Influence of the calibration antenna feed cable	0.28	Normal	2.00	0.14
27	Insertion Loss Variation	0.00	Rectangular	1.73	0.00
	Expanded uncertainty (1.96σ - confidence interval of 95 %)				Value
	TRP Expanded uncertainty (66 GHz < f <= 80 GHz) [dB] (a)				TBD
	Systematic uncertainties (NOTE 3)				Value
28	Systematic error due to TRP calculation/quadrature (NOTE 1) (b)				TBD
29	Influence of noise (66 GHz < f <= 80 GHz) (c)				TBD
30	Systematic error related to beam peak search (NOTE 2)				N/A

Total measurement uncertainty	Value
Total measurement uncertainty (a)+(b)+(c) [dB]	TBD
<p>NOTE 1: This contributor shall only be considered for TRP measurements.</p> <p>NOTE 2: This contributor shall only be considered for EIRP measurements.</p> <p>NOTE 3: In order to obtain the total measurement uncertainty, systematic uncertainties have to be added to the expanded root sum square of the standard deviations of the Stage 1 and Stage 2 contributors.</p> <p>NOTE 4: Value based on procedure defined in Annex D.2 of TR 38.810.</p> <p>NOTE 5: Applies to the system which has a structure of mechanical feed antenna positioning.</p>	

Table B.25.2-11: Uncertainty assessment for TRP measurement (f= 66 GHz to 80 GHz, DUT size = 30 cm)

UID	Uncertainty source	Uncertainty value	Distribution of the probability	Divisor	Standard uncertainty (σ) [dB]
Stage 2: DUT measurement					
1	Positioning misalignment	FFS	Normal	2.00	
2	Measure distance uncertainty	0.00	Rectangular	1.73	0.00
3	Quality of Quiet Zone (NOTE 4)	FFS	Actual	1.00	
4	Mismatch	FFS	Actual	1.00	
5	Standing wave between the DUT and measurement antenna	0.00	U-shaped	1.41	0.00
6	Uncertainty of the RF power measurement equipment	FFS	Normal	2.00	
7	Phase curvature	0.00	U-shaped	1.41	0.00
8	Amplifier uncertainties	FFS	Normal	2.00	
9	Random uncertainty	FFS	Normal	2.00	
10	Influence of the XPD	FFS	U-shaped	1.41	
11	Insertion Loss Variation	0.00	Rectangular	1.73	0.00
12	RF leakage (from measurement antenna to the receiver/transmitter)	0.00	Actual	1.00	0.00
13	Influence of TRP measurement grid (NOTE 1)	FFS	Actual	1	
14	Influence of beam peak search grid (NOTE 2)	N/A	Actual	1	N/A
15	Multiple measurement antenna uncertainty (NOTE 5)	0.15	Actual	1	0.15
16	DUT repositioning	FFS	Rectangular	1.73	
Stage 1: Calibration measurement					
17	Mismatch	0.00	U-shaped	1.41	0.00
18	Amplifier Uncertainties	0.00	Normal	2.00	0.00
19	Misalignment of positioning System	FFS	Normal	2.00	
20	Uncertainty of the Network Analyzer	FFS	Normal	2.00	
21	Uncertainty of the absolute gain of the calibration antenna	FFS	Normal	2.00	
22	Positioning and pointing misalignment between the reference antenna and the measurement antenna	FFS	Rectangular	1.73	
23	Phase centre offset of calibration antenna	0.00	Rectangular	1.73	0.00
24	Quality of quiet zone for calibration process (NOTE 4)	FFS	Actual	1.00	
25	Standing wave between reference calibration antenna and measurement antenna	0.00	U-shaped	1.41	0.00
26	Influence of the calibration antenna feed cable	0.28	Normal	2.00	0.14
27	Insertion Loss Variation	0.00	Rectangular	1.73	0.00
	Expanded uncertainty (1.96σ - confidence interval of 95 %)				Value
	TRP Expanded uncertainty (66 GHz < f <= 80 GHz) [dB] (a)				TBD
	Systematic uncertainties (NOTE 3)				Value
28	Systematic error due to TRP calculation/quadrature (NOTE 1) (b)				TBD
29	Influence of noise (66 GHz < f <= 80 GHz) (c)				TBD
30	Systematic error related to beam peak search (NOTE 2)				N/A

Total measurement uncertainty	Value
Total measurement uncertainty (a)+(b)+(c) [dB]	TBD
<p>NOTE 1: This contributor shall only be considered for TRP measurements.</p> <p>NOTE 2: This contributor shall only be considered for EIRP measurements.</p> <p>NOTE 3: In order to obtain the total measurement uncertainty, systematic uncertainties have to be added to the expanded root sum square of the standard deviations of the Stage 1 and Stage 2 contributors.</p> <p>NOTE 4: Value based on procedure defined in Annex D.2 of TR 38.810.</p> <p>NOTE 5: Applies to the system which has a structure of mechanical feed antenna positioning.</p>	

Annex C: Acceptable uncertainty of test system for test cases defined in TS 38.521-3 for radiative testing

FFS

Annex D: Acceptable uncertainty of test system for test cases defined in TS 38.521-4 for radiative testing

This annex contains suggested uncertainties for each test case in TS 38.521-4.

D.1 Uncertainty budget calculation principle

D.1.1 Uncertainty budget calculation principle for DNF

The uncertainty tables cover the actual measurement using the DUT receiver. If applicable, any uncertainty arising from a calibration or alignment process before the measurements should also be included.

The MU budget should comprise of a minimum 5 headings:

- 1) The uncertainty source,
- 2) Uncertainty value,
- 3) Distribution of the probability,
- 4) Divisor based on distribution shape,
- 5) Calculated standard uncertainty (based on uncertainty value and divisor).

D.1.2 Uncertainty budget calculation principle for DFF

The same as defined in D.1.1.

D.1.3 Uncertainty budget calculation principle for IFF

The same as defined in D.1.1.

D.2 Measurement error contribution descriptions

D.2.1 Measurement error contribution descriptions for DNF

D.2.1.1 gNB emulator SNR uncertainty

This contribution originates from setting the ratio of signal and noise in the conducted part of the test system. It is estimated to be the same as for LTE conducted testing in TS 36.521-1 Annex F, which is ± 0.3 dB. The default for values in 36.521-1 Annex F is 95% confidence interval, normal distribution.

D.2.1.2 gNB emulator Downlink EVM

When simulations of demodulation performance are run, the downlink signal is modelled with a defined EVM, representing imperfections in the signal transmitted by the gNB. This EVM value is agreed across companies to align simulations, and is normally lower than the gNB EVM requirement, to represent “typical” conditions. The EVM used for simulations is therefore built in to the requirement points, normally specified as the SNR required to meet a specified throughput, with a defined modulation and Reference channel, under defined propagation conditions.

For a conformance test, the EVM defined for the simulations is taken as a maximum allowed value for the test system, as a worse gNB emulator EVM would make the signal harder to demodulate, and disadvantage the UE. In a test system the EVM cannot normally be set to a specific value, but is specified to be no higher than a defined value.

Following this approach, the uncertainty from gNB emulator Downlink EVM is a one-sided distribution, with beneficial effect. Without treating the positive and negative uncertainties separately, and as it would not make the SNR worse, the effective uncertainty is 0dB.

D.2.1.3 gNB emulator fading model impairments

This contribution originates from imperfections in the gNB emulator fading model, compared to the applied fading model. It is estimated to be the same as for LTE conducted testing in TS 36.521-1 Annex F, which is ± 0.5 dB. The default for values in 36.521-1 Annex F is 95% confidence interval, normal distribution.

D.2.2 Measurement error contribution descriptions for DFF

D.2.2.1 gNB emulator SNR uncertainty

See D.2.1.1.

D.2.2.2 gNB emulator Downlink EVM

See D.2.1.2.

D.2.2.3 gNB emulator fading model impairments

See D.2.1.3.

D.2.3 Measurement error contribution descriptions for IFF

The Measurement uncertainty contributions and uncertainty assessment are expected to be the same as for the Direct near field (DNF) setup in D.2.1.

D.2.3.1 gNB emulator SNR uncertainty

See D.2.1.1.

D.2.3.2 gNB emulator Downlink EVM

See D.2.1.2.

D.2.3.3 gNB emulator fading model impairments

See D.2.1.3.

Annex E: Acceptable uncertainty of test system for test cases defined in TS 38.533 for radiative testing

This annex contains suggested uncertainties for each test case in TS 38.533.

E.1 Uncertainty budget calculation principle

E.1.1 Uncertainty budget calculation principle for DFF

The uncertainty tables cover the actual measurement using the DUT. In some cases, uncertainty may also arise from a calibration or alignment process before the measurements.

When a calibration process is used before the measurements, the uncertainty tables should be presented with two stages:

- Stage 1: the calibration of the absolute level of the DUT measurement results is performed by means of using a calibration antenna whose absolute gain is known at the frequencies of measurement
- Stage 2: the actual measurement with the DUT as either the transmitter or receiver is performed.

The MU budget should comprise of a minimum 5 headings:

- 1) The uncertainty source,
- 2) Uncertainty value,
- 3) Distribution of the probability,
- 4) Divisor based on distribution shape,
- 5) Calculated standard uncertainty (based on uncertainty value and divisor).

E.1.2 Uncertainty budget calculation principle for IFF

The same as defined in E.1.1.

E.2 Measurement error contribution descriptions

E.2.1 Measurement error contribution descriptions for DFF

E.2.1.1 gNB emulator SNR uncertainty

See D.2.1.1.

E.2.1.2 gNB emulator Downlink EVM

See D.2.1.2.

E.2.1.3 gNB emulator fading model impairments

See D.2.1.3.

E.2.2 Measurement error contribution descriptions for IFF

E.2.2.1 gNB emulator SNR uncertainty

See D.2.1.1.

E.2.2.2 gNB emulator Downlink EVM

See D.2.1.2.

E.2.2.3 gNB emulator fading model impairments

See D.2.1.3.

Annex F: Change history

Change history							
Date	Meeting	TDoc	CR	Rev	Cat	Subject/Comment	New version
2017-09	RAN5 #76	R5-174706				Initial skeleton	0.0.1
2018-04	RAN5 #2-5G-NR-Adhoc	R5-182093				Implementation of pCRs to TS 38.903 V0.0.1	0.1.0
2018-05	RAN5#79	R5-182670				Editorial update of TR 38.903.	0.2.0
2018-09	RAN5#80	R5-185213				Making Measurement Uncertainty Terms Common between methods in TR 38.90	1.0.0
2018-09	RAN5#80	R5-185214				TP on Measurement Uncertainty Contributions in FR2	1.0.0
2018-09	RAN5#80	R5-185212				Adding MU values for EIRPTRP measurements with Near Field test range (NFTF) at mmWave	1.0.0
2018-09	RAN#81	-	-	-	-	raised to v15.0.0 with editorial changes only	15.0.0
2018-12	RAN#82	R5-187023	0010	-	F	Editorial update of Annex B	15.1.0
2018-12	RAN#82	R5-187024	0011	-	F	Addition of MU contribution for demodulation test cases	15.1.0
2018-12	RAN#82	R5-187025	0012	-	F	Addition of MU contribution for RRM test cases	15.1.0
2018-12	RAN#82	R5-187148	0013	-	F	General clauses updated for TR38.903	15.1.0
2018-12	RAN#82	R5-187848	0008	1	F	FR2 Spurious Emission measurement grids and offset values	15.1.0
2018-12	RAN#82	R5-188060	0019	1	F	Update of MU budget and contributor description to TR 38.903	15.1.0
2018-12	RAN#82	R5-188224	0009	1	F	Update MU budget in TR 38.903	15.1.0
2018-12	RAN#82	R5-188225	0016	1	F	Update of MU budget tables in TR 38.903	15.1.0
2018-12	RAN#82	R5-188226	0017	2	F	Addition of descriptions on new MU contributions	15.1.0
2019-03	RAN#83	R5-192476	0030	1	F	Addition of Test Tolerance analysis for FR1 PRACH Test cases	15.2.0
2019-03	RAN#83	R5-192504	0038	1	F	Addition of TT analysis for Transmit timing accuracy Tests	15.2.0
2019-03	RAN#83	R5-192505	0031	1	F	Addition common text for RRM	15.2.0
2019-03	RAN#83	R5-192534	0039	-	F	Addition of TT Analysis for Timing Advance Adjustment Accuracy 4.4.3.1	15.2.0
2019-03	RAN#83	R5-192671	0033	1	F	Addition of TT analysis for event triggered test cases	15.2.0
2019-03	RAN#83	R5-192679	0036	1	F	Addition of TT analysis for handover with known cell	15.2.0
2019-03	RAN#83	R5-192845	0029	1	F	CR to update TR 38.903	15.2.0
2019-06	RAN#84	R5-193799	0048	-	F	FR1 Test tolerance analysis for intra re-selection 6.1.1.1	15.3.0
2019-06	RAN#84	R5-193800	0049	-	F	FR1 Test tolerance analysis for inter re-selection 6.1.1.2	15.3.0
2019-06	RAN#84	R5-193801	0050	-	F	FR1 Test tolerance analysis for interRAT higher priority re-selection 6.1.2.1	15.3.0
2019-06	RAN#84	R5-193802	0051	-	F	FR1 Test tolerance analysis for interRAT lower priority re-selection 6.1.2.2	15.3.0
2019-06	RAN#84	R5-193803	0052	-	F	FR1 Test tolerance analysis for interRAT known handover 6.3.1.4	15.3.0
2019-06	RAN#84	R5-194027	0057	-	F	CR on spurious emission MU in FR2	15.3.0
2019-06	RAN#84	R5-194123	0058	-	F	Definition of MU terminologies in TR 38.903	15.3.0
2019-06	RAN#84	R5-195014	0054	1	F	FR1 Test tolerance analysis for EN-DC SCell activation 4.5.3.1-4.5.3.3	15.3.0
2019-06	RAN#84	R5-195015	0060	1	F	Test Tolerance analysis for Inter-Freq measurement Test Cases	15.3.0
2019-06	RAN#84	R5-195159	0059	1	F	CR to update TR 38.903 after RAN5#5-5G NR Adhoc	15.3.0
2019-06	RAN#84	R5-195181	0055	1	F	FR1 Test tolerance analysis for EN-DC measurement reporting 4.6.1.1-4.6.1.4	15.3.0

History

Document history		
V15.0.0	October 2018	Publication
V15.1.0	April 2019	Publication
V15.2.0	April 2019	Publication
V15.3.0	July 2019	Publication