



**Universal Mobile Telecommunications System (UMTS);
LTE;
Measurement of radiated performance for
Multiple Input Multiple Output (MIMO) and
multi-antenna reception for
High Speed Packet Access (HSPA) and LTE terminals
(3GPP TR 37.976 version 13.0.0 Release 13)**



Reference

RTR/TSGR-0437976vd00

Keywords

LTE,UMTS

ETSI

650 Route des Lucioles
F-06921 Sophia Antipolis Cedex - FRANCE

Tel.: +33 4 92 94 42 00 Fax: +33 4 93 65 47 16

Siret N° 348 623 562 00017 - NAF 742 C
Association à but non lucratif enregistrée à la
Sous-Préfecture de Grasse (06) N° 7803/88

Important notice

The present document can be downloaded from:
<http://www.etsi.org/standards-search>

The present document may be made available in electronic versions and/or in print. The content of any electronic and/or print versions of the present document shall not be modified without the prior written authorization of ETSI. In case of any existing or perceived difference in contents between such versions and/or in print, the only prevailing document is the print of the Portable Document Format (PDF) version kept on a specific network drive within ETSI Secretariat.

Users of the present document should be aware that the document may be subject to revision or change of status. Information on the current status of this and other ETSI documents is available at
<http://portal.etsi.org/tb/status/status.asp>

If you find errors in the present document, please send your comment to one of the following services:
<https://portal.etsi.org/People/CommiteeSupportStaff.aspx>

Copyright Notification

No part may be reproduced or utilized in any form or by any means, electronic or mechanical, including photocopying and microfilm except as authorized by written permission of ETSI.

The content of the PDF version shall not be modified without the written authorization of ETSI.
The copyright and the foregoing restriction extend to reproduction in all media.

© European Telecommunications Standards Institute 2016.
All rights reserved.

DECT™, **PLUGTESTS™**, **UMTS™** and the ETSI logo are Trade Marks of ETSI registered for the benefit of its Members.
3GPP™ and **LTE™** are Trade Marks of ETSI registered for the benefit of its Members and of the 3GPP Organizational Partners.
GSM® and the GSM logo are Trade Marks registered and owned by the GSM Association.

Intellectual Property Rights

IPRs essential or potentially essential to the present document may have been declared to ETSI. The information pertaining to these essential IPRs, if any, is publicly available for **ETSI members and non-members**, and can be found in ETSI SR 000 314: *"Intellectual Property Rights (IPRs); Essential, or potentially Essential, IPRs notified to ETSI in respect of ETSI standards"*, which is available from the ETSI Secretariat. Latest updates are available on the ETSI Web server (<https://ipr.etsi.org/>).

Pursuant to the ETSI IPR Policy, no investigation, including IPR searches, has been carried out by ETSI. No guarantee can be given as to the existence of other IPRs not referenced in ETSI SR 000 314 (or the updates on the ETSI Web server) which are, or may be, or may become, essential to the present document.

Foreword

This Technical Report (TR) has been produced by ETSI 3rd Generation Partnership Project (3GPP).

The present document may refer to technical specifications or reports using their 3GPP identities, UMTS identities or GSM identities. These should be interpreted as being references to the corresponding ETSI deliverables.

The cross reference between GSM, UMTS, 3GPP and ETSI identities can be found under <http://webapp.etsi.org/key/queryform.asp>.

Modal verbs terminology

In the present document "**shall**", "**shall not**", "**should**", "**should not**", "**may**", "**need not**", "**will**", "**will not**", "**can**" and "**cannot**" are to be interpreted as described in clause 3.2 of the [ETSI Drafting Rules](#) (Verbal forms for the expression of provisions).

"**must**" and "**must not**" are **NOT** allowed in ETSI deliverables except when used in direct citation.

Contents

Intellectual Property Rights	2
Foreword.....	2
Modal verbs terminology.....	2
Foreword.....	5
1 Scope	6
2 References	6
3 Definitions, symbols and abbreviations	7
3.1 Definitions	7
3.2 Symbols.....	7
3.3 Abbreviations	7
4 Introduction	8
4.1 Background	8
4.2 Study item objective.....	8
4.3 High Level Requirements.....	8
4.4 Proposed work plan	8
5 Performance Metrics	11
5.1 Figure of Merits.....	11
5.1.1 Definition of MIMO Throughput.....	11
5.1.2 Definition of SNR.....	11
5.1.2.1 Multiple probe antenna based method.....	12
5.1.2.2 Reverberation chamber based method	13
5.1.2.3 Two-stage method.....	13
5.2 Receiver Performance Metrics	13
6 Measurement Methodologies	13
6.1 Fixed Reference Measurement Channels (FRCs).....	13
6.2 MIMO Channel Models	13
6.3 Downlink Measurement Methodologies	17
6.3.1 Methodologies based on Anechoic RF Chamber.....	18
6.3.1.1 Candidate Solution 1	18
6.3.1.1.1 Concept and Configuration.....	19
6.3.1.1.2 Test Conditions.....	20
6.3.1.2 Candidate Solution 2.....	21
6.3.1.2.1 Concept and Configuration.....	22
6.3.1.2.1A Scalability of the methodology.....	23
6.3.1.2.2 Test Conditions.....	24
6.3.1.3 Candidate Solution 3	25
6.3.1.3.1 Concept and Configuration.....	25
6.3.1.3.2 Test Conditions.....	26
6.3.1.4 Candidate Solution 4	27
6.3.1.4.1 Concept and Configuration.....	27
6.3.1.5 Candidate Solution 5	28
6.3.1.5.1 Concept and Configuration.....	28
6.3.1.5.2 Test Conditions.....	31
6.3.1.Y Downlink Transmission Modes	32
6.3.2 Methodologies based on Reverberation Chamber	32
6.3.2.1 Candidate Solution 1	32
6.3.2.1.1 Concept and Configuration.....	33
6.3.2.1.2 Test Conditions.....	34
6.3.2.2 Candidate Solution 2	35
6.3.2.2.1 Concept and Configuration.....	36
6.3.2.2.2 Test Conditions.....	36

6.3.2.Y	Downlink Transmission Modes	37
7	Measurement Results from COST2100	37
7.1	Reference Measurement Channels	37
8	Measurement Results from CTIA	37
8.1	Reference Measurement Channels	37
9	Conclusions	38
9.1	Comparison of Candidate Methodologies	38
9.1.1	Definitions of rows in the table.....	41
9.2	Lessons learnt and conclusions	42
10	Recommendations	43
Annex A (Informative): Test Plan for Anechoic Chamber based candidate methodologies with 3 or more probe antennas.....		45
A.1	Introduction	45
A.2	Test setup.....	45
A.2.1	Calibration	46
A.2.1.1	Calibration Check	46
A.2.2	Radio Channel Conditions.....	47
A.2.2.1	Average channel power	47
A.3	Test Procedure.....	48
A.3.1	HSDPA connection settings	48
A.3.1.1	FRC.....	48
A.3.2	Method of test.....	49
Annex B (Informative): LTE MIMO OTA Test Plan		51
B.1	Test Objectives	51
B.2	Test Setup.....	51
B.2.1	Figure of Merits (FOMs)	54
B.2.2	Channel Models.....	55
B.2.3	Antenna Probes	55
B.2.4	eNodeB Emulator Parameter Settings	56
B.2.5	Reference DUTs Configurations	57
B.3	Calibration of Test System	58
B.3.1	Calibration Procedure for Anechoic-chamber based methodologies.....	58
B.3.1.1	Probe power calibration	58
B.3.1.2	Channel power calibration	59
B.3.1.3	Calibration check	59
B.3.2	Calibration Procedure for Reverberation-chamber based methodologies	60
B.3.2.1.	Tuning Reverberation Chamber to Specific Channel Model	61
B.3.2.2.1	Reverberation Chamber Combined with Channel Emulator.....	61
B.3.2.2	Average Path Loss Measurement.....	61
B.3.3	Calibration Procedure for 2-Stage methodologies.....	62
B.3.3.1	Antenna pattern measurement calibration in stage I.....	62
B.3.3.3	Power calibration for results comparison from different OTA test methods	64
B.3.4	Calibration Procedure for antenna pattern based methodologies	64
B.3.5	Calibration Procedure for two-channel method.....	65
B.4	Test Procedure.....	65
B.4.1	Test Procedure 1	65
B.4.1A	Test Procedure 1A (Reverberation Chamber Based Methodologies).....	67
B.4.2	Test Procedure 2.....	67
B.4.3	Test Procedure 3 (Antenna spatial correlation measurement)	68
B.4.4	Test Procedure 4 (Two-stage throughput)	69
B.4.5	Test Procedure 5 for two-channel method.....	71
Annex C (informative): Change history		72
History		75

Foreword

This Technical Report has been produced by the 3rd Generation Partnership Project (3GPP).

The contents of the present document are subject to continuing work within the TSG and may change following formal TSG approval. Should the TSG modify the contents of the present document, it will be re-released by the TSG with an identifying change of release date and an increase in version number as follows:

Version x.y.z

where:

- x the first digit:
 - 1 presented to TSG for information;
 - 2 presented to TSG for approval;
 - 3 or greater indicates TSG approved document under change control.
- y the second digit is incremented for all changes of substance, i.e. technical enhancements, corrections, updates, etc.
- z the third digit is incremented when editorial only changes have been incorporated in the document.

1 Scope

The present document is the technical report for the study item on MIMO OTA, which was approved at TSG RAN#43 [2]. The scope of the SI is to define a 3GPP methodology for measuring the radiated performance of multiple antenna reception and MIMO receivers in the UE. The test methodology should be relevant for HSPA and LTE technologies, with particular focus on handheld devices and devices embedded in laptop computers.

2 References

The following documents contain provisions which, through reference in this text, constitute provisions of the present document.

- References are either specific (identified by date of publication, edition number, version number, etc.) or non-specific.
- For a specific reference, subsequent revisions do not apply.
- For a non-specific reference, the latest version applies. In the case of a reference to a 3GPP document (including a GSM document), a non-specific reference implicitly refers to the latest version of that document *in the same Release as the present document*.

- [1] 3GPP TR 21.905: "Vocabulary for 3GPP Specifications".
- [2] RP-090352, 'Proposed new study item: Measurement of radiated performance for MIMO and multi-antenna reception for HSPA and LTE terminals.'
- [3] TD(09) 766, COST2100 SWG 2.2, Braunschweig, Germany, Pekka Kyösti et. al. 'Proposal for standardized test procedure for OTA testing of multi-antenna terminals', Elektrobitt.
- [4] 3GPP TS 34.114: 'User Equipment (UE) / Mobile Station (MS) Over The Air (OTA) Antenna Performance Conformance Testing'.
- [5] 3GPP TS 25.214, 'Physical Layer Procedures (FDD)'
- [6] TD(09) 742, COST 2100 SWG 2.2, Braunschweig, Germany, February 2009, J. Takada, 'Handset MIMO Antenna Testing Using a RF-controlled Spatial Fading Emulator'.
- [7] 3GPP TS 36.212, 'Evolved Universal Terrestrial Radio Access (E-UTRA); Multiplexing and channel coding'.
- [8] 3GPP TS 36.213, 'Evolved Universal Terrestrial Radio Access (E-UTRA); Physical layer procedures'.
- [9] CTIA, 'Test Plan for Mobile Station Over the Air Performance - Method of Measurement for Radiated RF Power and Receiver Performance', Revision 3.0, 4/30/2009.
- [10] 3GPP TS 36.101, 'User Equipment (UE) radio transmission and reception'.
- [11] 3GPP TR 25.914, 'Measurements of radio performances for UMTS terminals in speech mode'.
- [12] 3GPP TS 36.521-1, 'Evolved Universal Terrestrial Radio Access (E-UTRA); User Equipment (UE) conformance specification Radio transmission and reception; Part 1: Conformance Testing'

3 Definitions, symbols and abbreviations

3.1 Definitions

For the purposes of the present document, the terms and definitions given in TR 21.905 [1] and the following apply. A term defined in the present document takes precedence over the definition of the same term, if any, in TR 21.905 [1].

3.2 Symbols

For the purposes of the present document, the following symbols apply:

H	Channel matrix
ϕ	Adjacent probe separation angle
θ	Zenith angle in the spherical co-ordinate system
ϕ	Azimuth angle in the spherical co-ordinate system

3.3 Abbreviations

For the purposes of the present document, the abbreviations given in TR 21.905 [1] and the following apply. An abbreviation defined in the present document takes precedence over the definition of the same abbreviation, if any, in TR 21.905 [1].

AoA	Angle of Arrival
AoD	Angle of Departure
BS	Base Station
BSE	Base Station Emulator
BTS	Base Transceiver Station
COST	Cooperation of Scientific and Technical
CTIA	Cellular and Telecommunication Industry Association
DL	Downlink
DUT	Device Under Test
FRC	Fixed Reference Measurement Channel
FTP	File Transfer Protocol
HSPA	High Speed Packet Access
HTTP	HyperText Transfer Protocol
LTE	Long Term Evolution
MCS	Modulation and Coding Scheme
MIMO	Multiple Input Multiple Output
OTA	Over-the-Air
SCM	Spatial Channel Model
SCME	Spatial Channel Model Extension
SI	Study Item
SISO	Single Input Single Output
SNR	Signal-to-Noise Ratio
SS	System Simulator
TBS	Transport Block Size
TTI	Transmission Time Interval
UE	User Equipment
UDP	User Datagram Protocol
UL	Uplink
VRC	Variable Reference Measurement Channel

4 Introduction

4.1 Background

The use of MIMO and receiver diversity in the UE is expected to give large gains in downlink throughput performance for HSPA and LTE devices. 3GPP already defined conducted tests for MIMO and multiple antenna receivers (type 1 and type 3 in TS25.101 for HSPA demodulation), but it is clear that the ability to duplicate these gains in the field is highly dependent on the performance of the receive-antenna system.

At TSG RAN#41, it was indicated that there is a need for a test methodology to be created with the aim of measuring and verifying the radiated performance of multi-antenna and MIMO receiver in UEs for both HSPA and LTE devices. As an outcome of the discussion, an LS was sent to COST 2100 SWG2.2 and CTIA ERP to ask them for feedback on their plans/ongoing work in this area, and also the timescales for which such work could be completed to define such a methodology, with particular focus on handheld devices and devices embedded in laptop computers.

Since then, feedback from COST 2100 and CTIA has suggested they are happy to work on this topic. However given that 3GPP is the customer for this work as well as being a potential contributor, it is important to aim for commonly-accepted measurement and test methodology to be used across the industry.

4.2 Study item objective

The high level objective of this study item is to define a 3GPP methodology for measuring the radiated performance of multiple antenna reception and MIMO receivers in the UE. The test methodology should be relevant for HSPA and LTE technologies, with particular focus on handheld devices and devices embedded in laptop computers.

The steps intended to achieve this involve the following:

- 1) Identify the performance metrics and clarify the requirements of operators for defining such a methodology.
- 2) Review of potential solutions also considering input from CTIA ERP and COST 2100.
- 3) Agree the final solution, and detail the agreed 3GPP solution in a technical report to be reported to RAN plenary.
- 4) Maintain ongoing communication with COST 2100 and CTIA ERP to ensure industry coordination on this topic.

TSG RAN should contact TSG GERAN to get feedback on the applicability of such a test methodology for GERAN.

4.3 High Level Requirements

The following high level requirements are agreed by RAN4:

1. Measurement of radiated performance for MIMO and multi-antenna reception for HSPA and LTE terminals must be performed over-the-air, i.e. without RF cable connections to the DUT.
 - NOTE 1: DUTs to the test house will have accessibility to temporary antenna port for conducted purposes.
 - NOTE 2: Temporary antenna port is used to assess to DUT receiver.
 - NOTE 3: UE special function to measure antenna pattern is not desirable for MIMO OTA purposes.
2. The MIMO OTA method(s) must be able to differentiate between a good terminal and a bad terminal in terms of MIMO OTA performance.
3. The desired primary Figure of Merit (FOM) is throughput.

4.4 Proposed work plan

Figure 4.4-1 illustrates the work plan for MIMO OTA.

Figure 4.4-2 illustrates the extended work plan for MIMO OTA due to the SI extension.

Figure 4.4-3 illustrates the extended work plan for MIMO OTA as a result of further extension of the SI.

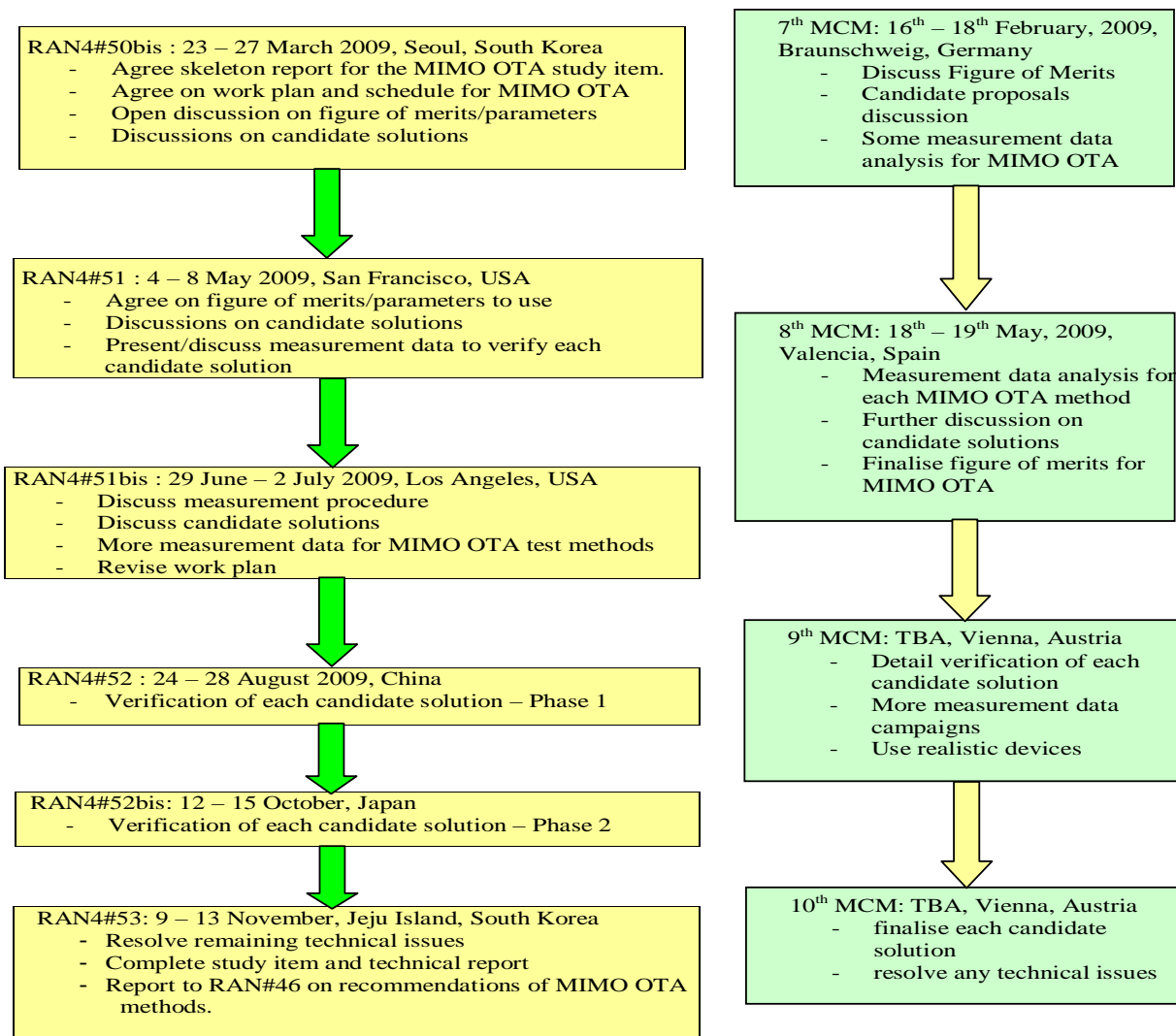

Figure 4.4-1: MIMO OTA work plan

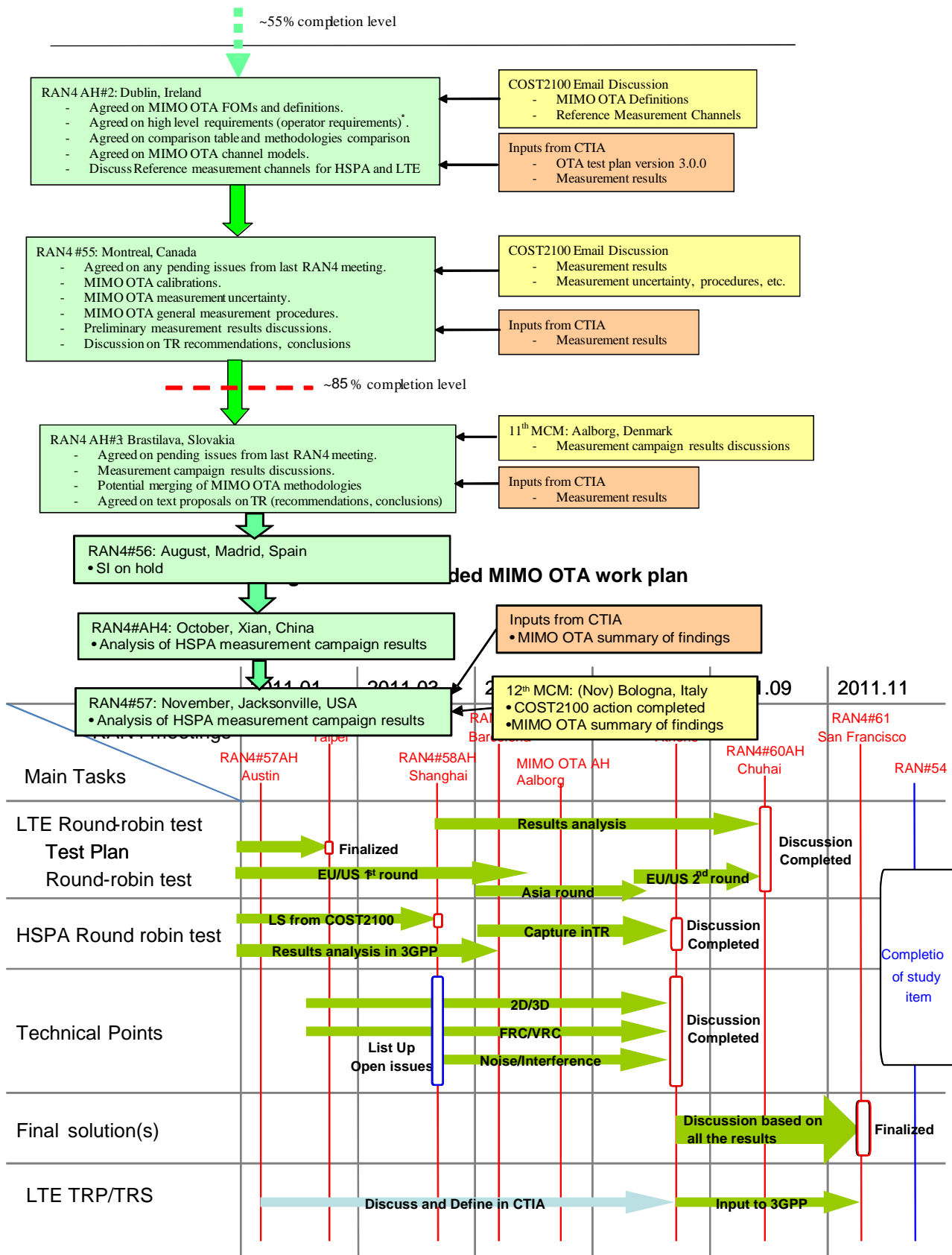

Figure 4.4-3: Further extension of MIMO OTA work plan

5 Performance Metrics

<Editor: list down the essential parameters to be measured, metrics of measuring OTA performance>

5.1 Figure of Merits

The performance metrics applies to both HSPA and LTE system.

Table 5-1: Categories of Figure of Merits

Category	I	II	III	IV	V
FOMs	MIMO Throughput CQI (FRC)	TRP TRS	Gain Imbalance Spatial correlation MIMO Capacity	Antenna Efficiency MEG	MIMO Throughput (VRC)
Type	OTA	OTA	MIMO antennas	MIMO antennas	OTA
Methodology	Active (with fading)	Active (with fading)	Passive/Active (with fading)	Passive/Active (without fading)	Active (with fading)
NOTE 1: Category V MIMO throughput measurement is performed over active communication link with DUT by using the variable reference channel. This is FFS.					
NOTE 2: FOMs can be measured either by establishing active communication link with the DUT (similar to current SISO OTA) incorporating realistic fading propagation channel models (Active methodology), or by simply transmitting RF signal in uplink or downlink, with or without the fading effect included in the measurement setup (Passive methodology).					

5.1.1 Definition of MIMO Throughput

MIMO Throughput is defined here as the time-averaged number of correctly received transport blocks in a communication system running an application, where a Transport Block is defined in the reference measurement channel. From OTA perspective, this is also called MIMO OTA throughput.

The MIMO OTA throughput is measured at the top of physical layer of HSPA and LTE system. Therefore, this is also measured at the same point as in the conductive measurement setup: under the use of FRC, the SS transmit fixed-size payload bits to the DUT. The DUT signals back either ACK or NACK to the SS. The SS then records the following:

- Number of ACKs,
- Number of NACKs, and
- Number of DTX TTIs

Hence the MIMO (OTA) throughput can be calculated as

$$\text{MIMO (OTA) Throughput} = \frac{\text{Transmitted TBS} \times \text{Num of ACKs}}{\text{MeasurementTime}}$$

where Transmitted TBS is the Transport Block Size transmitted by the SS, which is fixed for a FRC during the measurement period. MeasurementTime is the total composed of successful TTIs (ACK), unsuccessful TTIs (NACK) and DTX-TTIs.

The time-averaging is to be taken over a time period sufficiently long to average out the variations due to the fading channel. Therefore, this is also called the average MIMO OTA throughput. The throughput should be measured at a time when eventual start-up transients in the system have evanesced.

5.1.2 Definition of SNR

The typical configuration of a MIMO handset under real channel with co-channel interference is shown in Figure 5.1.2-1. As a first step the interference can be simplified to use non-directional AWGN with no fading. More realistic noise including narrowband statistical scheduling and directional aspects is for further study.

To evaluate the MIMO antenna's influence, a multipath channel needs to be applied to the downlink signal. This configuration can still be illustrated by Figure 5.1.2-1.

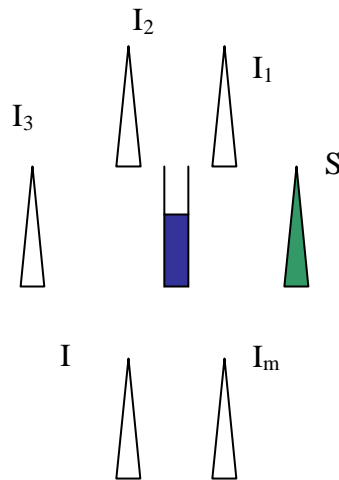

Figure 5.1.2-1: MIMO Handset under co-channel interference

Suppose a reference dipole antenna is placed in the center of configuration, then the received signal power by one element of the handset antenna is

$P = P_s H_s G_{dipole}$, where H is the channel gain for the transmitted signal under given configuration, G_{dipole} is the antenna gain of the dipole antenna.

The received interference signal is

$$P_I = \sum_i P_{I_i} H_i G_{dipole}$$

The SNR is defined to be $SNR = P / P_I$ when there is a co-channel interferer. If the co-channel interferer is removed by setting the power of the interferer zero, then the test configuration corresponds to the test case where the device under test self noise will be the major noise influencing the performance. It is not possible to know the actual SNR for this case without knowing details of the handset design. From the MIMO OTA test perspective, it is not necessary to know the actual SNR for this case. What is needed for the test is to control the downlink signal power to search for the lowest power level at which the DUT achieves a pre-defined throughput. This power corresponds to potential improvement in coverage.

The SNR definition is applied to the three main MIMO radiated test methods as follows:

5.1.2.1 Multiple probe antenna based method

For the multiple probe antenna based methods, the AWGN is applied to a full circle of antennas surrounding the DUT with equal angle interval. On each probe antenna, equal power AWGN is applied. Equal power AWGN is applied to both vertical polarization and horizontal polarization.

The AWGN can be super-imposed on the probe antennas for signal generation or can be on independent probe antennas. The number of probe antennas for AWGN noise generation is at least 3 to have a good approximation of spatial AWGN.

When testing MIMO antenna design with the throughput figure of merits, the AWGN interferer's power level is set to a constant level. The downlink power level is changed to vary the SNR. The measured throughput under different SNR will be used to evaluate the different MIMO antenna design. When testing the coverage improvement, the AWGN interferers are turned off. The downlink signal power is changed to find the power level where a given throughput is achieved. The measured signal power with a dipole for this case will be a measure of potential coverage improvement for the MIMO downlink.

5.1.2.2 Reverberation chamber based method

For the reverberation chamber based method, the way of applying AWGN is to apply it to the test signal before it is radiated through the test antenna. When testing MIMO antenna design with the throughput figure of merits, the AWGN interferer's power level is set to a constant level. The downlink power level is changed to vary the SNR. The measured throughput under different SNR will be used to evaluate the different MIMO antenna design. When testing the coverage improvement, the AWGN interferers are turned off. The downlink signal power is changed to find the power level where a given throughput is achieved. The measured signal power with a dipole for this case will be a measure of coverage improvement.

5.1.2.3 Two-stage method

The spatial AWGN is integrated over the antenna pattern and the resulting noise power is used to generate the noise power for the second stage throughput test. The first stage antenna pattern measurement does not require AWGN. The output power of the channel emulator is set to ensure the power received by the DUT with RF connection is comparable to the power received through the DUT's antenna. The SNR is emulated by setting the power of the AWGN correctly when measuring the throughput for the given MIMO antenna design. When measuring for coverage improvement, the AWGN interference is turned off.

5.2 Receiver Performance Metrics

<Editor: add texts>

6 Measurement Methodologies

6.1 Fixed Reference Measurement Channels (FRCs)

<Editor: add texts>

6.2 MIMO Channel Models

The following channel models are used in evaluation of MIMO OTA methodologies. The same models are also potential candidates for final MIMO OTA UE tests (WI).

There are three different clustered delay line (CDL) models, and one simplified (single cluster) model.

The generic models are

- SCME Urban micro-cell,
- Modified SCME Urban micro-cell,
- SCME Urban macro-cell, and
- WINNER II Outdoor-to-indoor.

The single cluster models are based on

- SCME Urban micro-cell and
- Extended Pedestrian A (EPA)

The uniform models are based on

- Extended Pedestrian A (EPA) and
- Exponential decay.

The emulated base station antennas may be assumed to be one of the following:

- 1) Vertically polarized elements
 - a.) with a fixed 4λ separation, specified at the center frequency, or
 - b) are uncorrelated, i.e. to allow the UE to be measured independently from BS effects
- 2) Dual polarized equal power elements that are uncorrelated with a fixed 0λ separation, 45 degrees slanted.

In the following we define the cross polarization power ratio a propagation channel as $XPR = XPR_V = XPR_H$, where

$$XPR_V = \frac{S_{VV}}{S_{HV}} \quad \text{and} \quad XPR_H = \frac{S_{HH}}{S_{VH}}$$

and

- S_{VV} is the coefficient for scattered/reflected power on V-polarization and incident power on V-polarization
- S_{VH} is the coefficient for scattered/reflected power on V-polarization and incident power on H-polarization
- S_{HV} is the coefficient for scattered/reflected power on H-polarization and incident power on V-polarization
- S_{HH} is the coefficient for scattered/reflected power on H-polarization and incident power on H-polarization

Note: for Vertical only measurements, the powers per delay are used without regard to the specified XPR values.

Table 6.2-1: SCME urban micro-cell channel model

SCME Urban micro-cell								
Cluster #	Delay [ns]			Power [dB]			AoD [°]	AoA [°]
1	0	5	10	-3.0	-5.2	-7.0	6.6	0.7
2	285	290	295	-4.3	-6.5	-8.3	14.1	-13.2
3	205	210	215	-5.7	-7.9	-9.7	50.8	146.1
4	660	665	670	-7.3	-9.5	-11.3	38.4	-30.5
5	805	810	815	-9.0	-11.2	-13.0	6.7	-11.4
6	925	930	935	-11.4	-13.6	-15.4	40.3	-1.1
Delay spread [ns]								294
Cluster AS AoD / AS AoA [°]								5 / 35
Cluster PAS shape								Laplacian
Total AS AoD / AS AoA [°]								18.2 / 67.8
Mobile speed [km/h] / Direction of travel [°]								3, 30 / 120
XPR								9 dB
NOTE: V & H components based on assumed BS antennas								
Mid-paths Share Cluster parameter values for:								AoD, AoA, AS, XPR

The following Modified SCME Urban Micro-cell channel model has the same PDP as the original one, but angle spread is smaller.

Table 6.2-2: Modified SCME urban micro-cell channel model

Modified SCME Urban micro-cell								
Cluster #	Delay [ns]			Power [dB]			AoD [°]	AoA [°]
	0	5	10	-3.0	-5.2	-7.0		
1	0	5	10	-3.0	-5.2	-7.0	6.6	-2.3
2	285	290	295	-4.3	-6.5	-8.3	14.1	42.6
3	205	210	215	-5.7	-7.9	-9.7	50.8	-49.5
4	660	665	670	-7.3	-9.5	-11.3	38.4	24.7
5	805	810	815	-9.0	-11.2	-13.0	6.7	61.7
6	925	930	935	-11.4	-13.6	-15.4	40.3	10.6
Delay spread [ns]								294
Cluster AS AoD / AS AoA [°]								5 / 35
Cluster PAS shape								Laplacian
Total AS AoD / AS AoA [°]								18.2 / 49.0
Mobile speed [km/h] / Direction of travel [°]								3, 30 / 120
XPR								9dB
NOTE: V & H components based on assumed BS antennas								
Mid-paths Share Cluster parameter values for:								AoD, AoA, AS, XPR

The following SCME Urban Macro-cell is unchanged from the original SCME paper, with added XPR values, Direction of Travel, and Velocity.

Table 6.2-3: SCME urban macro-cell channel model

SCME Urban macro-cell								
Cluster #	Delay [ns]			Power [dB]			AoD [°]	AoA [°]
	0	5	10	-3	-5.2	-7		
1	0	5	10	-3	-5.2	-7	82	66
2	360	365	370	-5.2	-7.4	-9.2	81	46
3	255	260	265	-4.7	-6.9	-8.7	80	143
4	1040	1045	1050	-8.2	-10.4	-12.2	99	33
5	2730	2735	2740	-12.1	-14.3	-16.1	102	-91
6	4600	4605	4610	-15.5	-17.7	-19.5	107	-19
Delay spread [ns]								839.5
Cluster AS AoD / AS AoA [°]								2 / 35
Cluster PAS shape								Laplacian
Total AS AoD / AS AoA [°]								7.8 / 62.6
Mobile speed [km/h] / Direction of travel [°]								3, 30 / 120
XPR								9 dB
NOTE: V & H components based on assumed BS antennas								
Mid-paths Share Cluster parameter values for:								AoD, AoA, AS, XPR

The following Winner II Outdoor-to-Indoor is modified from the original Winner II report, with the following Angle Spread, XPR values, Direction of Travel, and Velocity.

Table 6.2-4: Modified WINNER II outdoor-to-indoor channel model

Modified Winner II Outdoor-to-Indoor								
Cluster #	Delay [ns]			Power [dB]			AoD [°]	AoA [°]
	1	0	5	10	-3	-5.2		
2	0			-8.7			32	101.5
3	5			-3.7			-21	66.2
4	10			-11.9			37	-118.7
5	35			-16.2			-43	138.5
6	35			-6.9			28	-90.4
7	65	70	75	-3.9	-6.1	-7.9	-49	32.7
8	120			-10.3			-34	10.5
9	125			-20.7			-49	156.6
10	195			-16.0			43	137.7
11	250			-21.0			49	-157.7
12	305			-22.9			51	-164.7
Delay spread [ns]								40.5
Cluster AS AoD / AS AoA [°]								5 / 25
Cluster PAS shape								Laplacian
Total AS AoD / AS AoA [°]								28.6 / 56
Mobile speed [km/h] / Direction of travel [°]								3 / 120
XPR								9dB
NOTE: V & H components based on assumed BS antennas								
Mid-paths Share Cluster parameter values for:								AoD, AoA, AS, XPR _V and XPR _H

The following Single Cluster model is based on the SCME Urban Micro-cell model with all AoAs assumed to be zero degrees. XPR values, Direction of Travel, and Velocity were specified. An option allows a cluster angle spread to be specified with $\sigma_{AS} = 35^\circ$ or with $\sigma_{AS} = 25^\circ$ to enable a range of spatial correlation for different types of devices.

Table 6.2-5: Single spatial cluster model with multi-path based on SCME urban micro-cell channel model

Single Spatial Cluster Model with Multi-path based on SCME Urban micro-cell								
Cluster #	Delay [ns]			Power [dB]			AoD [°]	AoA [°]
	1	0	5	10	-3.0	-5.2		
2	285	290	295	-4.3	-6.5	-8.3	14.1	0
3	205	210	215	-5.7	-7.9	-9.7	50.8	0
4	660	665	670	-7.3	-9.5	-11.3	38.4	0
5	805	810	815	-9.0	-11.2	-13.0	6.7	0
6	925	930	935	-11.4	-13.6	-15.4	40.3	0
Delay spread [ns]								294
Cluster AS AoD / AS AoA [°]								5 / 25 or 35
Cluster PAS shape								Laplacian
Total AS AoD / AS AoA [°]								18.2 / 25 or 35
Mobile speed [km/h] / Direction of travel [°]								3, 30/ 120
XPR								9 dB
NOTE: V & H components based on assumed BS antennas								
Mid-paths Share Cluster parameter values for:								AoD, AoA, AS, XPR

For some techniques, which cannot control the channel model a 3D uniform channel model is assumed. For comparison purpose, a 2D uniform channel model is specified as follows for other methods which can control the channel model.

Table 6.2-6: 3D uniform channel model

3D uniform channel model	
PDP	Exponential decay
PAS	3D uniform
XPR	0 dB

Table 6.2-7: 2D uniform multipath channel model

2D Uniform Multipath Model				
Cluster #	Delay [ns]	Power [dB]	AoD [°]	AoA [°]
1	0	0.0	N/A	0
2	30	-1.0	N/A	0
3	70	-2.0	N/A	0
4	90	-3.0	N/A	0
5	110	-8.0	N/A	0
6	190	-17.2	N/A	0
7	410	-20.8	N/A	0
Delay spread [ns]				45
Cluster AS AoD / AS AoA [°]				N/A/104
Cluster PAS shape				Uniform
Total AS AoD / AS AoA [°]				N/A/104
XPR NOTE: No depolarization based on XPR Equal power transmitted in V & H, $P_V = 0.5$, $P_H = 0.5$ V & H components based on assumed BS antennas				0 dB
Mobile speed [km/h] / Direction of travel [°]				3 or 30 / N/A

For comparison purpose, a single cluster multi-path channel model is specified to compare the test results with the reverberation chamber based method as follows

Table 6.2-8: single cluster multipath channel model

Single Cluster Multipath Model				
Cluster #	Delay [ns]	Power [dB]	AoD [°]	AoA [°]
1	0	0.0	N/A	0
2	30	-1.0	N/A	0
3	70	-2.0	N/A	0
4	90	-3.0	N/A	0
5	110	-8.0	N/A	0
6	190	-17.2	N/A	0
7	410	-20.8	N/A	0
Delay spread [ns]				45
Cluster AS AoD / AS AoA [°]				N/A/70
Cluster PAS shape				Laplacian
Total AS AoD / AS AoA [°]				N/A/70
XPR NOTE: No depolarization based on XPR Equal power transmitted in V & H, $P_V = 0.5$, $P_H = 0.5$ V & H components based on assumed BS antennas				0 dB
Mobile speed [km/h] / Direction of travel [°]				3 or 30 / 120

The parameters of the channel models are the expected parameters for the MIMO OTA channel models. However, the final channel model achieved for different methods could be a combined effect of the chamber and the channel emulator.

How the Rayleigh fading is implemented in the channel emulator or in the MIMO OTA test for different test methods is implementation specific and should be appropriate as long as the statistics of the generated Rayleigh fading are within standard requirement on Rayleigh fading statistics.

6.3 Downlink Measurement Methodologies

The methodologies defined in this subclause are candidate methodologies being studied for the purpose of defining procedures for conformance testing of over the air performance.

6.3.1 Methodologies based on Anechoic RF Chamber

An OTA method based on the use of an Anechoic RF Chamber is described consisting of a number of test antenna probes located in the chamber transmitting signals with temporal and spatial characteristics for testing multiple antenna devices.

This section describes the methodologies based on Anechoic RF Chamber, where a number of test antennas are located in different positions of the chamber, and the device under test (DUT) is located at center position. The DUT is tested over the air without RF cables.

6.3.1.1 Candidate Solution 1

An Anechoic Chamber technique is defined, consisting of a number of source elements at one end or surrounding the DUT to create a realistic geometric based spatio-temporal radio channel for testing MIMO performance. The latter implementation is illustrated in Figure 6.3.1.1-1.

By utilizing specific geometries of the test probes in the chamber, a range of possible channels are emulated. The exact number and positioning of the source antenna probes will be fixed in a final design; however they may be optimized for the best performance when the OTA channel models are defined. In other words, depending on the types of channel models required and the range of parameters needed for testing, the number of probes may be optimized to produce the best performance with the fewest number of probes. For example, based on the range of channels defined by the SCM, SCME, Winner I & II channel models, the optimized number of probes may vary from 6 to 8 for a given polarization. In general, the most flexible configurations require the higher number of probes.

Azimuth spread is created by energizing sets of probes separated in azimuth with signals that will combine over the air at a specific delay to emulate a path or cluster. Elevation spread may be created by installing probes at different elevations, however doing this tends to constrain their flexibility.

The components of the solution include:

- Anechoic Chamber
- System Simulator (SS)
- N channel RF emulator, with OTA Channel Generation Features
- N antenna elements configured with V, H or co-located V&H or slant X polarizations
- K azimuthally separated antenna positions with predefined angles at radius R
- Channel Model definition for each test case

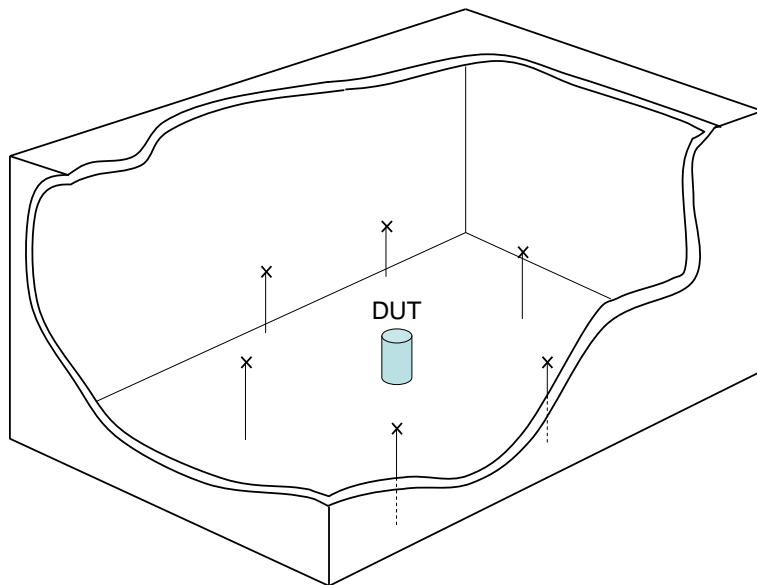

Figure 6.3.1.1-1: N-Element Anechoic Chamber Approach (Absorbing tiles and cabling not shown)

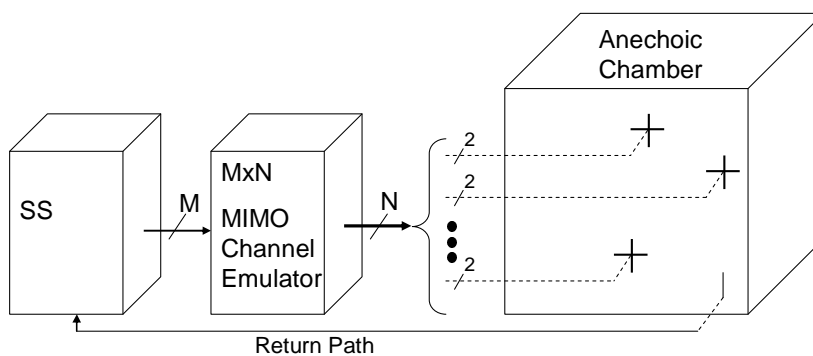

Figure 6.3.1.1-2: OTA System Level Block Diagram

A system level block diagram is shown in Figure 6.3.1.1-2, which includes the SS to generate the M branch MIMO signal, and an RF Channel Emulator with an OTA Channel Generation Feature to properly correlate, fade, scale, delay, and distribute the signal to each test probe in the chamber.

For research purposes, a range of possible channel models and parameterizations will be used to specify the most generic and versatile antenna test probe configuration. For performance and conformance testing, the channel model is expected to be limited in scope or simplified, which may allow an optimized design to reduce the number of test probes required. Thus the number of test probes will be selected to best meet the requirements of the test so that the most efficient and economical design can be achieved.

6.3.1.1.1 Concept and Configuration

6.3.1.1.1.1 Emulating Spatial Channels

Spatial channel models, including SCM, SCME, Winner I & II, and ITU-A, were developed from measured data, and attempt to preserve the measured behaviour of the channel at the path (cluster) level, including spatial, temporal, polarization, and delay characteristics. Reference [3] described a technique for reproducing the spatial characteristics of a narrow angle spread signal with a reduced number of antenna probes. This technique uses pre-faded signals at each

probe wherein the power-adjusted signals from the multiple probes, i.e. typically 2-4 or more, are combined over the air to produce an accurate narrow angle spread representation of the signal for each delay. This technique is able to maintain its close match to an ideal narrow angle spread signal even for severe antenna variations.

The spacing of the antenna probes in the chamber are constrained by the range of angle spreads being emulated, and therefore the channel model is a key determining factor in optimizing an OTA chamber design. For the angle spreads defined by SCM, SCME, Winner I & II, and the ITU-A channel models, the optimum number of probes may vary from 6 to 8 for a given polarization, depending on the device type, and for large devices the number of probes may increase. In general, the most flexible configurations will tend to require the higher number of probes. Once the design of parameters of the system are decided, it is expected that the number of probes will be fixed to a value that works for all channel models and devices being simulated. Figure 6.3.1.1.1-1 illustrates some practical antenna probe configurations to support devices such as handsets and laptops. The single cluster approach can be performed using probes distributed over a portion of a circle or in a full ring-like distribution.

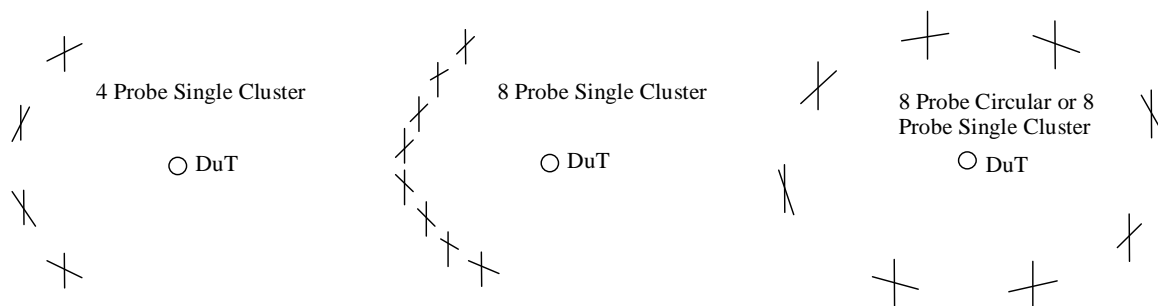

Figure 6.3.1.1.1-1: Some Practical Antenna Probe Configurations, (shown with dual polarization)

The probe separation angle, ϕ used in the Chamber design, shown in Figure 6.3.1.1.1-1, will be defined in conjunction with the channel models as described below. In general, the angles will not be exact even integer fractions of π , to avoid symmetries. i.e. exact symmetry will produce convergence problems due to correlated Doppler, e.g. $\cos(\alpha) = -\cos(\alpha + \pi)$.

6.3.1.1.1.2 Joint Selection of a Channel Model and a Chamber Design

Since link modelling is usually associated with a single 'drop' or single 'channel realization' from the channel model, a few specific channel realizations will likely be specified and standardized for evaluation purposes. From a testing standpoint, only a few channel realizations will be measured in an OTA performance/conformance system, and it would be useful to align the channel model clusters with the probe locations in an optimized chamber design. However, there is enough flexibility inherent in these probe configurations to emulate clusters from arbitrary angles if desired.

Specifically, since the chamber layout has probes at specific angles, and since most spatial channel models draw channel AoAs randomly from specified distributions, it is reasonable that specific AoAs are chosen to align with the chamber layout for these few test channels.

For research purposes, a more generic OTA chamber design is possible, but generally at the cost of having the maximum number of probes. Also, there is a trade-off in modelling signals with arbitrary AoA while controlling the signals Angle Spread at the same time. By selecting specific AoAs within a valid channel realization, a more precise AS can be obtained. Thus performance of the OTA design is closely tied to the channel modelling assumptions used, and can be specified more completely when the channel model and its associated parameters are specified.

6.3.1.1.2 Test Conditions

For performance and conformance testing purposes, only a small number of channel realizations is practical due to the nature of the OTA measurements. Based on this, it is reasonable to define a range of conditions for testing that can be represented in 2-3 channel realizations. It is anticipated that these channel realizations would represent a Low, Medium, and High correlation cases, which generally align to the ability of the channel to support MIMO operation.

These channels may also be used to optimize the design and layout of the chamber to reduce the number of probes and achieve the most efficient and cost effective design.

6.3.1.2 Candidate Solution 2

The MIMO OTA test setup is composed of a number of OTA chamber antennas, a multidimensional fading emulator, an anechoic chamber, communication tester / BS emulator and a device under test (DUT). The following figure depicts an example of the OTA concept. The purpose of the figure is not to restrict the implementation, but rather to clarify the general idea of the MIMO OTA concept. For simplicity, uplink cabling is not drawn here.

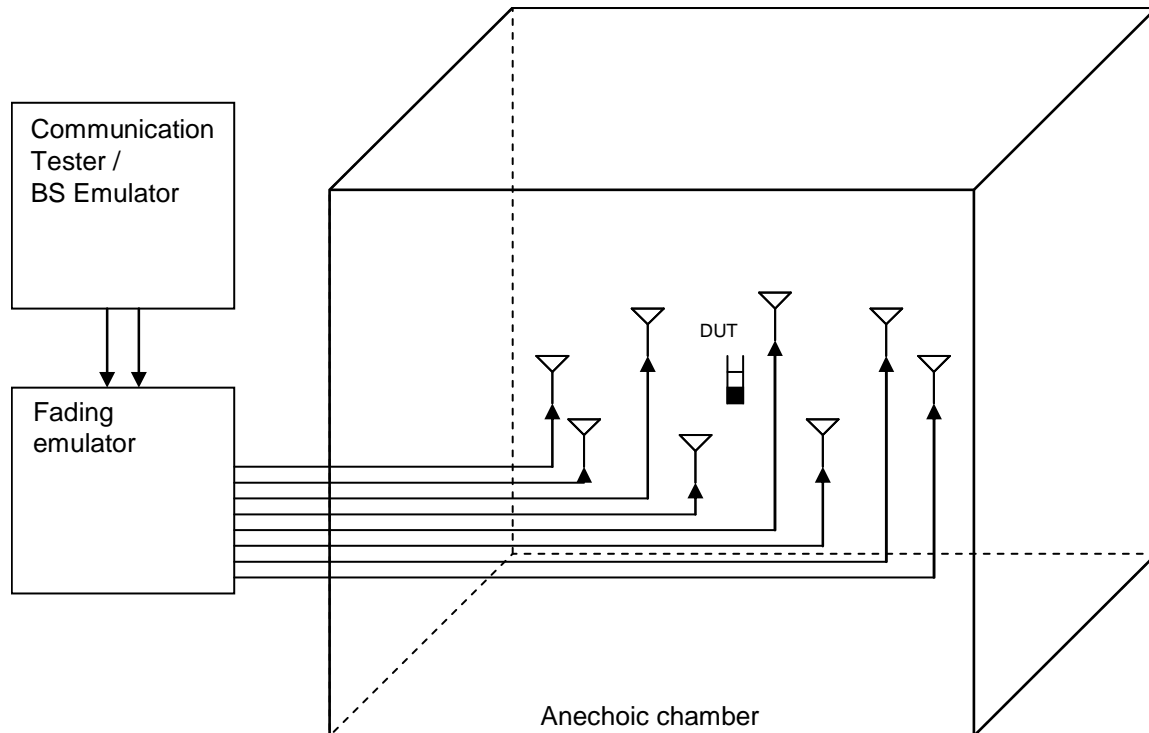

Figure 6.3.1.2-1: Example of MIMO/Multiantenna OTA test setup (Uplink signal path omitted in the figure)

The DUT is located at center of the anechoic chamber. The idea of locating DUT into center provides a possibility to create a radio channel environment where the signal can arrive from various possible directions simultaneously to the DUT. This is the key aspect of the wideband MIMO radio channel models implemented today.

The proposed test setup is composed of a transmitter, a multidimensional radio channel emulator, an anechoic chamber equipped with OTA antennas and a DUT with multiple antennas. The crucial challenge is to generate realistic angular and polarization behavior within the anechoic chamber. The family of geometry-based stochastic channel models (GSCM) is well suitable for MIMO OTA testing. The GSCM include 3GPP SCM, SCME, WINNER and IMT-Advanced channel models. This angular and polarization behavior creates appropriate correlation at the DUT antennas. The correlation is defined implicitly via the per-path angle of arrival and real antennas. Correlation matrix based model is not suitable for this, because it includes the antenna information in the model itself.

Geometry based channel modeling methodology models BS and UE antenna arrays and the propagation between them (including angular power spectra). The parameters that are included are Doppler, Angle of Arrival, Angle of Departure, delay and polarization. The parameters are based mainly on measurements. The measurements define certain statistics and radio channel realizations are then created by these statistical properties.

The geometrical models are divided in to three parts:

- 1) BS antenna arrangement and the angular power spectrum as well as the AoD from the BS are modeled in the channel emulator.
- 2) AoA is created by dividing the appropriate clusters based on their original AoA to corresponding OTA antennas. The user terminal is not physically in a motion, thus the fading and Doppler spectrum are built in the channel model.

3) The angular power spectrum at DUT is created by radiating the signal from multiple OTA antennas.

UE (DUT) antenna characteristics are assumed unknown. In other words we do not use this information in the OTA modeling.

6.3.1.2.1 Concept and Configuration

The idea of the MIMO OTA modelling is that the geometric channel models are mapped into the fading emulator. The mapping process covers all the required mathematics when converting the traditional geometric channel model to fading emulator tap coefficients as well as the calibration. The modeling process is shown in Figure 6.3.1.2.1-1.

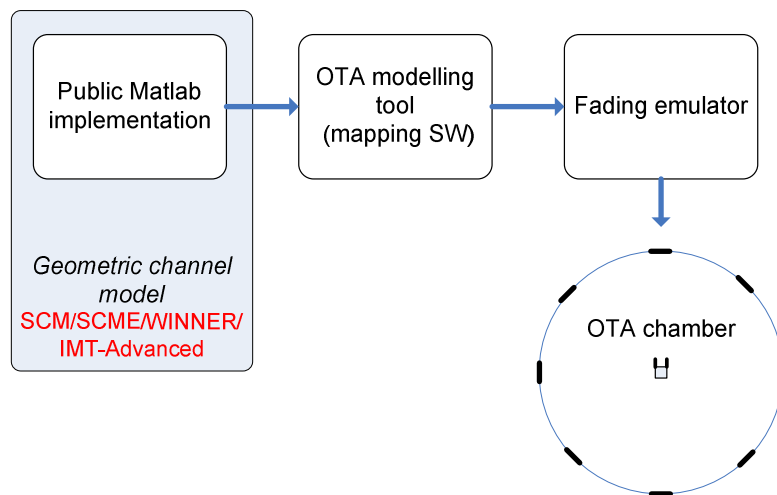

Figure 6.3.1.2.1-1: Modelling process

The setup of OTA chamber antennas with eight antenna elements is depicted in Figure 6.3.1.2.1-2. DUT is at center and the antennas are on a circle around DUT with uniform spacing (e.g. 45° with 8 elements). Let us denote directions of K OTA antennas with $\theta_k, k = 1, \dots, K$, and antenna spacing in the angle domain with $\Delta\theta$. Each antenna is connected to a single fading emulator output port. If single antenna BS is considered the fading emulator configuration is 1x8 SIMO, with two BS antennas 2x8 MIMO etc. If dual polarized OTA antennas are used like in Figure 6.3.1.2.1-3 the fading emulator configuration will be with 1 BS antenna 1x16 SIMO, with two BS antennas 2x16 MIMO etc. In the figure for example antenna A_{1V} denotes the first OTA antenna position and vertically (V) polarized element, A_{8H} denotes the eight OTA antenna position and horizontally (H) polarized element, etc.

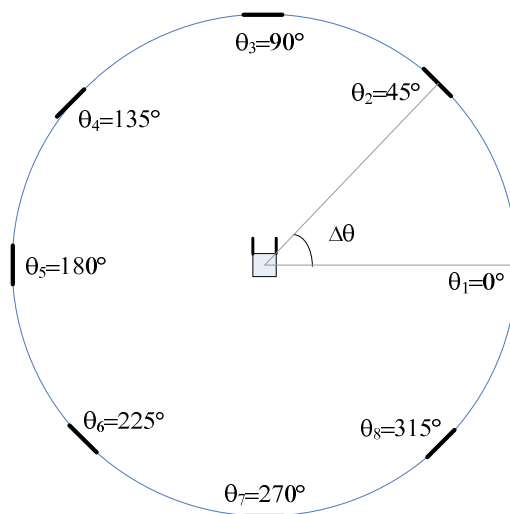

Figure 6.3.1.2.1-2: OTA chamber antenna setup with eight uniformly spaced chamber antennas

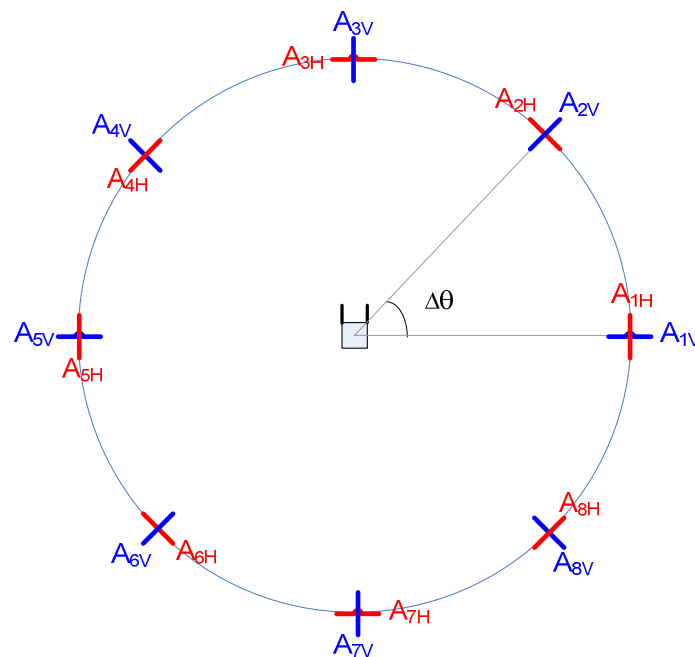

Figure 6.3.1.2.1-3: OTA chamber antenna setup with eight uniformly spaced dual polarized chamber antennas. In the drawing the V-polarized elements are actually orthogonal to the paper (azimuth plane)

6.3.1.2.1A Scalability of the methodology

The number of antennas is scalable. In theory, there is no upper limit and the lower limit is one. The required number of channels depends on three main aspects: channel model, DUT size, and polarization. The key question is how accurately the channel model is emulated. Based on the quiet zone discussion, it was proposed to use 8 antennas in the case of single polarization and 16 antennas in the case of dual polarization. However, for single cluster case, less antennas may be enough. On the other hand, if elevation is needed, the antenna number will be higher. Additionally, the antenna positions can be adjusted to optimize the accuracy with limited number of antennas.

Other aspect is the channel model. Most of the geometry-based stochastic channel models (GSCMs) are two-dimensional, i.e. azimuth plane only, but the proposed MIMO OTA concept is not limited into azimuth plane. It can also be extended to elevation plane, when we talk about 3D MIMO OTA. However, the 3D MIMO OTA is rather complex and it does not provide very much additional information about the DUT. Therefore, 3D MIMO OTA can be considered as one future development, but it is not the recommended solution in the beginning of MIMO OTA testing.

Downscaling of the proposed method is more attractive due to the possibility to save the cost of the test system. Full SCME requires at least 8 probe antennas, but single cluster SCME can be implemented with lower number of antennas. The difference between full SCME and Single Cluster model is depicted in Figure 6.3.1.2.1A-1. Basically the only difference is that the mean Angle-of-Arrival (AoA) of each cluster is turned to the same direction. Obviously, one AoA requires lower number of antennas than multiple AoAs especially when angular spread is narrow, e.g., 35 degrees. The number of fading channels is the same as the number of antennas. Therefore, single cluster SCME would require less fading channels as well.

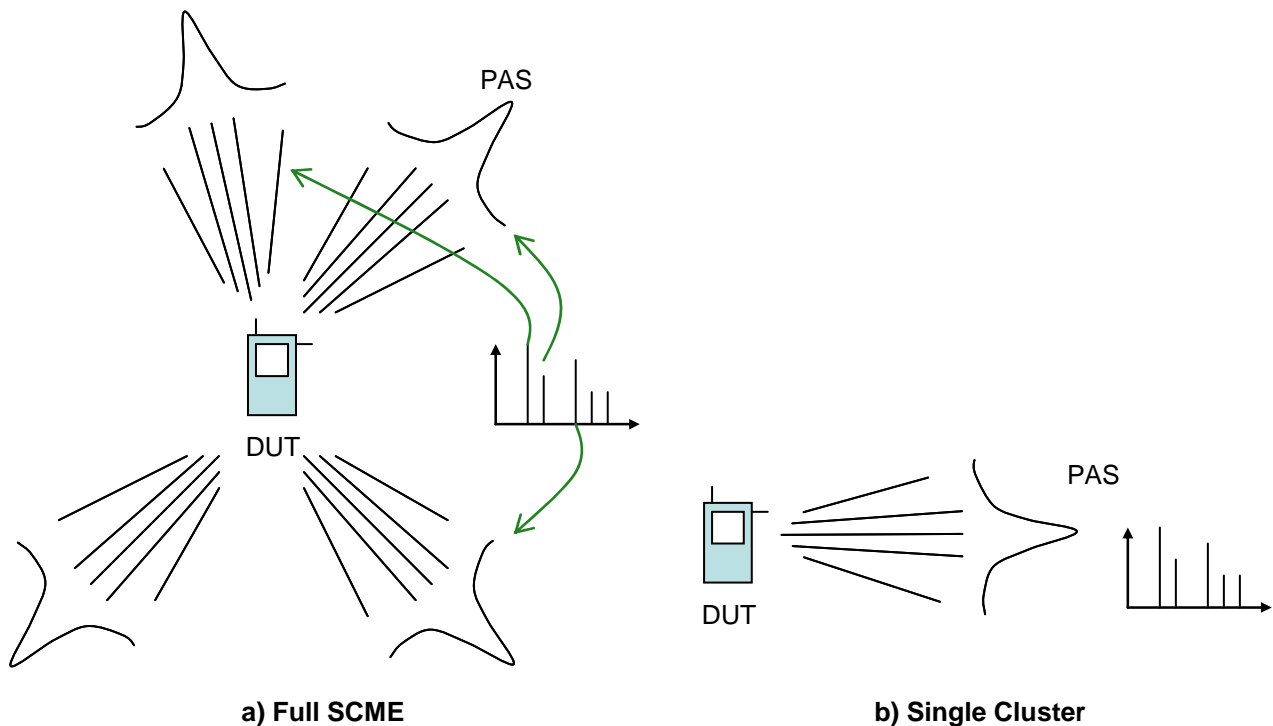

Figure 6.3.1.2.1A-1: Full SCME vs. Single Cluster model.

6.3.1.2.2 Test Conditions

This candidate solution supports testing of different figure of merits. It is also applicable for any 3GPP Release, and even for other standards. It supports different channel models from SCM to IMT-Advanced. Due to its generality, it does not restrict the test conditions. However, for simplicity, it is good to start from downlink throughput testing.

The downlink throughput testing can be done e.g. in following manner.

BS transmits signal through a radio channel emulator. This signal is routed to several antennas in anechoic chamber. The DUT is placed at center of the chamber and the performance is measured from the DUT.

- OTA antennas are located along a circle around the DUT.
- The circular geometry is needed because we need signal from many directions at the same time (requirement from the channel models)

The test steps can be, e.g., according to [3] or as follows:

- 1) Calibrate the full system with a test signal.
- 2) Set the first test case (e.g. channel model) to the fading emulator.
- 3) Generate test signal by the communication tester / BS emulator.
- 4) Measure the DUT performance (downlink throughput).
- 5) If the performance exceeds the specified limit, the DUT passes the test case.
- 6) If all test cases done, go to step 7. Otherwise, set the next test case (e.g. channel model) to the fading emulator and go back to step 3.
- 7) If DUT passed all the test cases, the DUT passes the full MIMO OTA test.
- 8) If DUT failed in at least one test case, the DUT failed the full MIMO OTA test.

6.3.1.3 Candidate Solution 3

The principle of two-stage MIMO OTA method is based on the assumption that the far-field antenna radiation pattern will contain all the necessary information for evaluation the antenna's performance like radiation power, efficiency and correlation and that with channel model approaches, the influence of antenna radiation pattern can be correctly incorporated into the channel model. Thus the method will first measure the MIMO antenna patterns and then incorporate the measurement antenna patterns with chosen MIMO OTA channel models for real-time emulation. In order to accurately measure the antenna pattern of the intact device, the chipset needs to support amplitude and relative phase measurements of the antennas. If the EUT has dynamic antenna tuning elements, detailed information on the implementation is required to understand the consequences for the pattern measurement. The BTS and DUT can then be connected to the real-time channel emulator through the standard temporary antenna connectors to do the test on throughput, etc., to test how the MIMO antennas will influence the performance.

It should be noted that should this methodology be chosen for conformance testing, the method for antenna gain and phase measurement would require to be standardized. The details for proposed antenna gain and phase measurements are FFS. Further details will be provided before the RAN4 evaluation of this methodology can progress.

6.3.1.3.1 Concept and Configuration

The assumption of the two-stage MIMO OTA method is that the measured far field antenna pattern of the multiple antennas can fully capture the mutual coupling of the multiple antenna arrays and their influence. Thus to do the two-stage MIMO OTA test, the antenna patterns of the antenna array needs to be measured accurately in the first stage. In order to accurately measure the antenna pattern of the intact device, the chipset needs to support amplitude and relative phase measurements of the antennas.

Stage 1: Test multiple antennas system in a traditional anechoic chamber. The chamber for antenna pattern measurement is set up as described in Annex A.2 in [4], where the DUT is put into a chamber and each antenna element's far zone pattern is measured. Section B.4.3 gives description on how to measure each antenna element's pattern using non-intrusive method. The influence of human body loss can be measured by attaching the DUT to a SAM head and or hand when doing the antenna pattern measurements. The DUT is placed against a SAM phantom, and the characteristics of the SAM phantom are specified in Annex A.1 of [4]. The chamber is equipped with a positioner, which makes it possible to perform full 3-D far zone pattern measurements for both Tx and Rx radiated performance. The measurement antenna should be able to measure two orthogonal polarizations (typically linear theta (θ) and phi (ϕ) polarizations as shown in Figure 6.3.1.3.1-1).

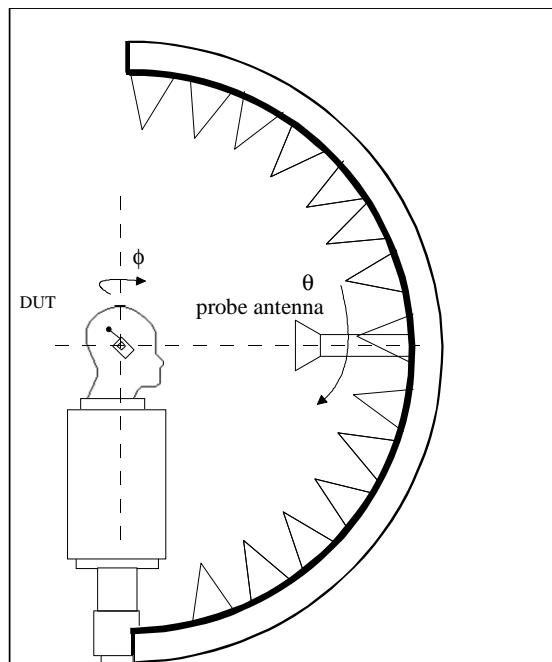

Figure 6.3.1.3.1-1: The coordinate system used in the measurements

Stage 2: Combine the antenna patterns measured in stage 1 into MIMO channel model, emulate the MIMO channel model with the measured antenna patterns incorporated in the commercial channel emulator and perform the OTA test in conducted approach.

The MIMO OTA method based on the above mentioned two-stage method is illustrated in Figure 6.3.1.3.1-2. The integrated channel model with both MIMO antenna effect and the multipath channel effect can be emulated with a commercial MIMO channel emulator. The BS emulator is connected to the MIMO channel emulator and then to the MIMO device's temporary antenna ports via approved RF cables. These ports are the standard ones provided for conducted conformance tests. By controlling the power settings of the channel emulator and also the integrated channel model, the end-to-end throughput with the MIMO antenna radiation influence can be measured.

There are two different approaches to combine the antenna patterns with MIMO channel model.

- a) Apply antenna patterns to Ray-based channel models. Ray-based models are capable to support arbitrary antenna patterns under predefined channel modes in a natural way as described above. If Ray-based model like SCM model is specified to be used for MIMO OTA test, then the channel emulator needs to be able to support SCM channel model emulation and support loading measured antenna patterns.
- b) Apply antenna patterns to correlation-based channel models. MIMO channel model. With a correlation matrix calculation method for arbitrary antenna patterns under multipath channel conditions, the correlation matrix and the antenna imbalance can be calculated and then emulated by the channel emulator.
- c) This method can be used to measure the following figure of merit:
 - 1) Throughput
 - 2) TRP and TRS
 - 3) CQI, BLER
 - 4) Antenna efficiency and MEG
 - 5) Antenna correlation, MIMO channel capacity.

The coupling between the UE antenna and internal spurious emission of the UE might be characterized during the antenna pattern measurement stage inside the chamber by lowering down the signal power and is for further research.

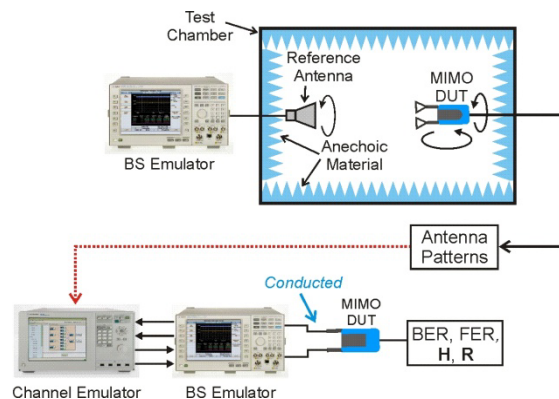

Figure 6.3.1.3.1-2: Proposed two-stage test methodology for MIMO OTA test

6.3.1.3.2 Test Conditions

This candidate solution supports testing of different figure of merits. It is also applicable for any 3GPP Release, and even for other standards.

This method can reuse existing SISO OTA anechoic chambers to make the antenna pattern measurements; the channel emulator number is required to match the number of device receiver inputs regardless of the complexity of the chosen channel model, the method is consequently easily scalable to higher order MIMO due to the reduced number of instruments required; the channel models are highly accurate due to being implemented electronically and are also fully

flexible and can be altered to suit any desired operating conditions such as indoor-outdoor, high or low Doppler spread, high or low delay spread, beam width, in 2D or full 3D etc.

This method requires the chipset in DUT to support amplitude and relative phase measurements of the antennas, and it cannot directly measure self-desensitization since the antenna pattern measurement does not take account of possible signal leakage from the device transmit antennas into the receive antennas.

The detailed test procedure can be found in Annex B.

6.3.1.4 Candidate Solution 4

In this method an assessment of the antenna's performance in MIMO or Diversity operation is performed. Several simplifications are used in order to optimise the testing.

A test of the UE in an anechoic environment with the help of a base station emulator is proposed, with a limited number of faded channels and transmitting antennas, and in a simple geometrical set-up.

The underlying principle is to decompose the task for evaluating MIMO performance. Since in the conformance test many properties of the DUT are already tested in a conducted environment, the OTA test only has to add information not achievable by a cabled set-up.

For that reason it then is sufficient to define some abstract channel environment during the test which does not need to be very close to reality. Abstraction on the environment makes it easier to interpret the obtained results.

The channel information available in the UE can be used to deliver a quick answer to the test system about the current receive quality. Such a measurement is much faster than the evaluation of a throughput figure, but it is nevertheless closely related to it. If necessary, an explicit scaling from one quantity onto the other one can be made.

6.3.1.4.1 Concept and Configuration

The test set-up uses an anechoic chamber. In case of an RX diversity measurement the signal from the base station emulator is routed via a two-channel fading to two antennas in the chamber. For an RX MIMO measurement, the two signals from the base station emulator can undergo a 2x2 channel fading simulation before reaching the antennas in the chamber, or can be routed directly to the probe antennas with some chosen polarization.

Figure 6.3.1.4.1-1 is a sketch of the chamber set-up. For obtaining various angles of arrival (AoA) at the EUT, two antennas A1 and A2 can be rotated in a vertical plane and can be put to angles θ_1 and θ_2 . The UE is placed on a turntable rotating around the vertical axis by some angle φ . In addition, the UE may be tilted by some additional rotation around the horizontal axis, not shown in the figure. By this arrangement the two antennas A1 and A2 can send the signals from the base station emulator to any position on the unit sphere around the UE, thus creating arbitrary AoA.

As an alternative to moving the antennas by mechanically rotating them it is possible to arrange the antennas in a horizontal plane and to move one antenna with respect to the other in order to vary the angle difference between the two. In that case the positioner rotating the UE will be designed in a more complex way.

Typically, the antennas are dual-polarised ones. In the usual configuration each antenna is sending its signal in one polarization only. Tests are made for the various combinations of antenna polarizations in order to generate either co-polarized or cross-polarized signals. As a special case it is also possible to test with one antenna where each polarization is transmitting one MIMO data stream. This will lead to identical AoAs for the two data streams.

If one wants to extend this method to 3D AoA, a third antenna outside the plane can be used.

The figure does not show an additional antenna used for the uplink communication. This antenna may be placed in the vicinity of the UE, for example in the φ positioner. It is common practise to use circularly polarized antennas for this purpose, and to use a limiting amplifier in the path towards the BSE in order to get a good and constant UL level.

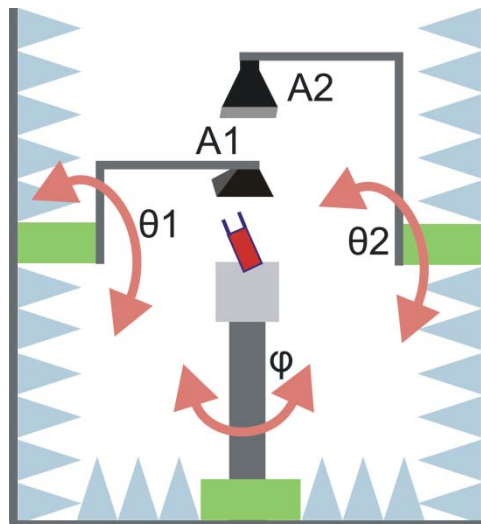

Figure 6.3.1.4.1-1: 2 Channel Method, antenna arrangement in anechoic chamber

A test point is described by:

- 1) Signal from BSE, e.g. frequency, MCS, data rate, MIMO mode, ...
- 2) Fading characteristics (if applicable) and antenna polarisations
- 3) Antenna positions
- 4) UE position elevation, azimuth

The detailed settings for the various parameters describing a test point are for further study.

The measurement then uses the quantities CQI, RI and PMI for a quick evaluation of the channel characteristics for each given test point. More precisely, the DL power will be changed until a change in the returned channel information is observed.

In case the required figure of merit is some other quantity such as throughput, some mapping from the channel information onto the figure of merit can be made. This mapping of course depends on the signal settings on the BSE and possibly on other parameters. The mapping can be derived in a series of measurements where changes to the channel parameters lead to different channel information values and to different corresponding values of the figure of merit. It is also possible but more time-consuming to measure the figure of merit for each test point.

The OTA performance can better be described by taking statistical evaluations into account. If, for example, for each test point a relative throughput value is obtained as function of subcarrier power, one can plot the results for different points in a histogram and to obtain some CCDF indicating the conditions for getting at least a given TP value.

6.3.1.5 Candidate Solution 5

The RF-controlled spatial fading emulator can directly reproduce a multipath radio propagation environment by radio waves emitted from antenna-probe units arranged around a handset tested. Moreover, the emulator has an advantage of measuring radiation characteristics of a handset antenna for the present OTA testing in 3GPP as well as the multipath testing because of its RF operation [6].

6.3.1.5.1 Concept and Configuration

The RF-controlled spatial fading emulator can directly reproduce multipath radio propagation environments both in line-of-sight (LOS) and non line-of-sight (NLOS) situations by radio waves emitted from antenna probes arranged around a DUT. Thus, the emulator can be easily used for measurement of the MIMO characteristics of a HSPA/LTE multiple antenna device in a multipath fading environment.

Figure 6.3.1.5.1-1 (a) and (b) show the configuration and arrangement of the antenna probes of the RF spatial fading emulator in an anechoic chamber. In this method, the DUT is designated as any device that possesses multiple antennas, including a HSPA or LTE device.

The height of DUT from the floor of the anechoic chamber is H . The DUT can also be placed at a rotatable turn-table in order to set and vary the horizontal angle of the DUT. The DUT is surrounded by N numbers of antenna probes. The distance between DUT and each antenna probe is r . The antenna probe consists of two antennas. The one is a half-wavelength dipole set vertically for emitting the vertically-polarized wave and the other is a horizontally-located half-wavelength dipole for the horizontally-polarized wave. This configuration of the antenna-probe unit can represent a cross polarization power ratio, XPR, of incoming wave. The separation between vertical and horizontal antennas is d . The height of the antenna probe from the anechoic chamber floor is h . The distance between the ring of antenna probes and the walls of anechoic chamber is D . (Note if the anechoic chamber is not square, then D_1 and D_2 are used).

A reference antenna probe is designated so that it can be used to determine the direction of motion of DUT. This parameter is designated as ϕ_{shift} . The circular angle between antenna probes from the centre of the ring (i.e. DUT) is ϕ_i with respect to the reference antenna probe.

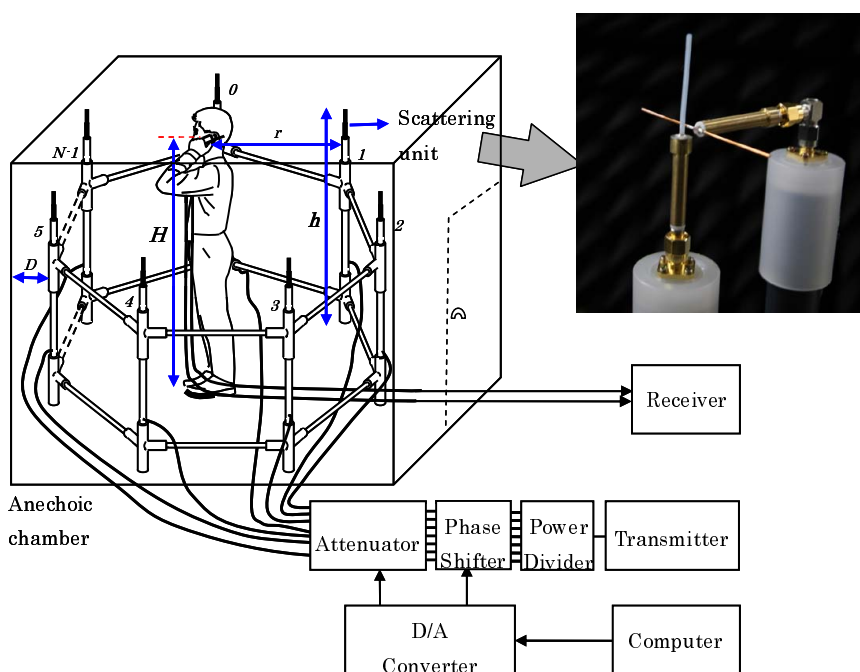

(a) Experimental Setup

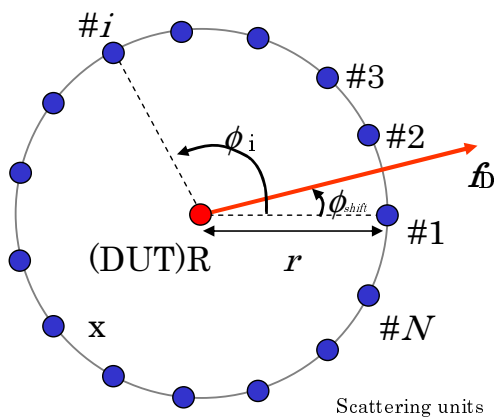

(b) Arrangement of the antenna probes

Figure 6.3.1.5.1-1: Experimental setup of the spatial fading emulator

The key features of this method are that it does not use the sophisticated commercial channel emulator. By using the combination of phase shifters, power dividers and attenuators, operating in the RF band, it has been shown that a realistic fading channel environment can be emulated. To reduce the influence from the measurement equipment, the receiver, phase shifter, power divider, transmitter and computer are set outside of the anechoic chamber. Firstly, we describe channel response between the m^{th} base station, BS, antenna and the n^{th} handset antenna for M -by- N MIMO radio communication system. The channel response is calculated by following equation:

$$h_{nm} = \sum_{i=1}^N E_n(\phi_i) \sqrt{\Omega(\phi_i)} \frac{\lambda}{4\pi \cdot r} \exp[-j\{kr + 2\pi \cdot t \cdot f_D \cos(\phi_0 - \phi_i) + \alpha_{mi}\}] \quad (1)$$

where E_n and f_D are radiation component of the n -th handset antenna and the Doppler frequency respectively. ϕ_0 is the direction of motion and ϕ_i is the direction of the i -th antenna probe. α_{mi} is initial phase of the signal radiated from the i -th antenna probe. The waves radiated from each base station (BS) antenna are uncorrelated each other. For the investigation of MIMO antennas, the waves from different BS antenna are represented by different sets of initial phases, α_{mi} , of the waves. According to the propagation models, such as SCM and SCME, the angular power spectrum Ω of the spatial cluster of incoming waves in the horizontal plane can be modelled by a Laplacian distribution in the following, for instance:

$$\Omega(\phi) = \frac{P}{2\sigma} \exp\left\{-\frac{|\phi - \mu_\phi|}{\sigma}\right\} \quad (2)$$

where P and μ_ϕ are power and average direction of angle of the cluster. σ is a standard deviation of the APS. In this case, the spatial distribution in the vertical plane is modelled by a delta function.

In addition, the strongest point of the spatial fading emulator is to be capable of evaluating radiation characteristics of a handset antenna for the present OTA testing in 3GPP as well as the multipath-fading evaluation since the emulator is operated in a radio frequency (RF) band.

A calibration of the RF-controlled spatial fading emulator is carried out using the following procedure:

- 1) Firstly a half-wavelength dipole for the receiving antenna is vertically placed at the center of a circle arranging the antenna probes.
- 2) A radio wave with vertical polarization is radiated only from a vertical dipole of the antenna probe # i ($i=1, 2, \dots, L$), and then, the dipole at the center of the emulator can receive the wave. From this, we can obtain amplitude and phase of the RF signal from the transmitter to the receiver via the vertical dipole of the antenna probe # i .
- 3) The attenuator and phase shifter are adjusted so that the RF signals received by the dipole at the center have the same values in amplitude and phase.
- 4) Secondly the slotted cylindrical antenna is placed at the center of the antenna probes located on the circle.
- 5) A radio wave with horizontal polarization is radiated only from a horizontally-located dipole of the antenna probe # i ($i=1, 2, \dots, L$). From the received signal from the antenna probe # i , we also obtain amplitude and phase of the RF signal from the transmitter to the receiver via the horizontal dipole of the antenna probe # i .
- 6) The attenuator and phase shifter are adjusted so that the RF signals received by the slotted cylindrical antenna at the center have the same values in amplitude and phase.

The calibration procedure above mentioned can be performed by using an electrical-controlled RF switch. Thus, the calibration of the emulator can be done automatically using a computer in our system. Once the calibration is finished, we can vary the attenuators in order to produce a special distribution of the incoming wave and to make a cross polarization power ratio (XPR). Moreover, we can set an initial phase to each antenna probe to create a multipath fading channel.

With regard to the signal-to-noise power ratio, SNR, of incoming wave, the signal power can be determined by an average value of faded signal powers received by a half-wavelength dipole antenna for the vertical polarization and a slotted cylindrical antenna for the horizontal polarization. Both antennas have an omni-directional radiation pattern. Thus, SNR can be obtained as the following equation:

$$SNR = \frac{S_V + S_H}{N_0} \quad (3)$$

where S_V and S_H are the average signal powers received by the dipole and slotted cylindrical antennas, respectively. N_0 is the noise power that was calculated as a thermal noise within the frequency bandwidth of the radio communication.

6.3.1.5.2 Test Conditions

In this method, all signals are operated and controlled at RF level. A computer (either a laptop or relatively powerful computer) is used to provide the followings:

- 1) Graphical user interface (GUI) to set the input parameters, determine the measured parameters to be collected, setting of calibration parameters and setting of DUT parameters.
- 2) Generating control signals to manipulate the phase angle of each Phase Shifter.
- 3) Collecting measured raw data obtained via the DUT.
- 4) Post-processing the measured raw data to derive the desired figure of merits (i.e. minimum requirements for DUT).
- 5) To initiate the BS emulator and start the testing session (by establishing a communication session with DUT)

The RF signals transmitted from the BS emulator's antenna connector are fed to a bank of Power Dividers. Each power divider provides identical RF signal from each of the output ports. The number of Power Dividers required is determined by N .

Each Power Divider output is then fed to a Phase Shifter. The Phase Shifter is used to change the phase of the RF signal according to the parameter setting input to the computer earlier. Note that the control signal from the computer is digital-to-analogue, D/A, converted, before used to control the Phase Shifter. By controlling the phase of each RF signal, a Rayleigh distributed or other relevant multipath distribution can be obtained. The number of Phase Shifters required is determined by N .

The output of the Phase Shifters is connected to the antenna probes. The signal from each Phase Shifter is fed to the vertical and horizontal antennas and radiates toward the DUT. The DUT then measures the signals from each antenna probe and the measurement data is reported back to the computer. The amount of measurement data to be collected can be controlled by the computer by setting the sampling rate, R .

An example below illustrated the principle of creating Rayleigh faded signal by control the phase of each component wave in Figure 6.3.1.5.2-1.

Number of antenna probes N : 15

Direction of motion ϕ_0 : 10 deg.

Doppler frequency f_D : 20 Hz

Sampling frequency f_s : 400 Hz

Radius of circle arranging antenna probes r : 1.0 m

Operating frequency : 2.14 GHz

Receiving antenna (Rx) : half-wavelength Dipole

Radiation pattern of Rx $E_n(\phi)$: omni

APS, $\Omega(\phi)$: Uniform

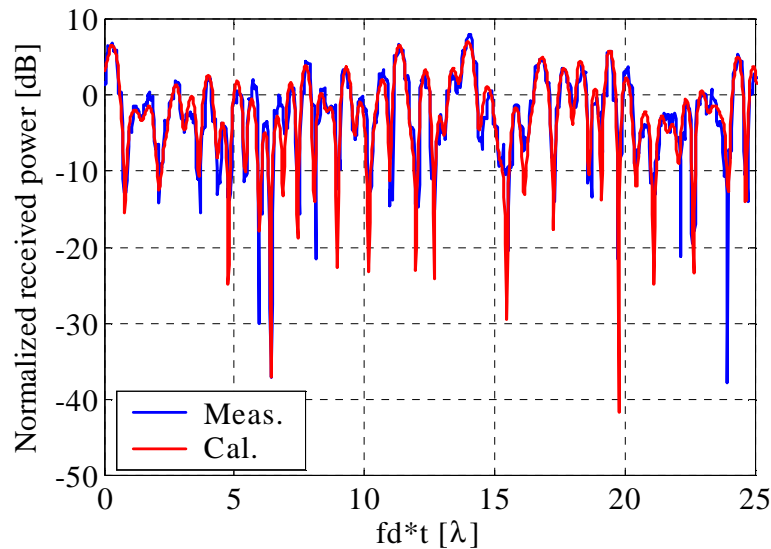

Figure 6.3.1.5.2-1: Rayleigh faded signal by control the phase of each component wave

6.3.1.Y Downlink Transmission Modes

<Editor: add texts>

6.3.2 Methodologies based on Reverberation Chamber

6.3.2.1 Candidate Solution 1

The reverberation chamber is a metallic cavity or cavities that can emulate an isotropic multi-path environment which represents a reference environment for systems designed to work during fading, similar to how the free space 'anechoic' reference environment is used for tests of Line-Of-Sight systems. The Rayleigh environment in a reverberation chamber is well known as a good reference for urban and indoor environments, but does not well represent rural and suburban environments.

For a future Multi-antenna OTA measurement standard it is important to have a fast and repeatable test method to evaluate and compare multi-antenna devices in the environments and under the conditions where most people will use them. The overwhelming majority of calls/data connections with mobile phones are made indoors and in urban areas which can be very well represented by the reverberation chamber. These environments are well characterised by multi-path and 3D distribution of the communication signals and it makes sense to use the reverberation chamber for optimizing/evaluating devices with both single and multiple antenna configurations to be used indoors and in urban areas.

The test setup for testing UE receiver diversity performance is composed of a base station emulator, a reverberation chamber equipped with fixed BS wall-mounted antennas, a switch to direct the base station signal to/from one of the BS wall mounted antennas, mechanical metallic stirrers and a rotating platform to hold the DUT (Figure 6.3.2.1-1). Alternatively, the chamber may contain one or more cavities coupled through waveguides or slotted plates (Figure 7.1-2).

Reverberation chambers have no quiet zone. As long as the DUT is placed at least 0.5 wavelengths from the wall or metallic stirrers the result will be the same within the standard deviation of the chamber.

Mechanical stirrers and switching among different fixed BS wall-mounted antennas (monopoles used for polarization stirring) allow simulating the Rayleigh fading at each antenna of the terminal inside the chamber. Accuracy can even be increased by rotating the platform holding the device.

Each position of the mechanical stirrers for each position of the platform and each fixed BS antenna, represents a point of the Rayleigh distribution in terms of receive power on the device antennas. In that way a Rayleigh fading is artificially created.

In that way, several UE metrics can be measured: throughput with RX-DIV, TRP, TIS (Total isotropic sensitivity), etc.

For each point of the Rayleigh distribution created by the different configurations of the chamber, the metric is noted. This method can be used to measure UE sensitivity and UE radiated power.

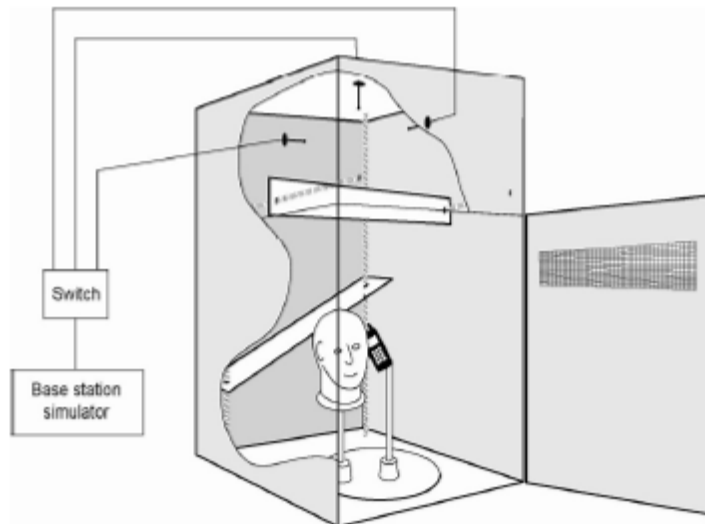

Figure 6.3.2.1-1: Reverberation chamber setup for devices testing with Single Cavity [source: Bluetest AB]

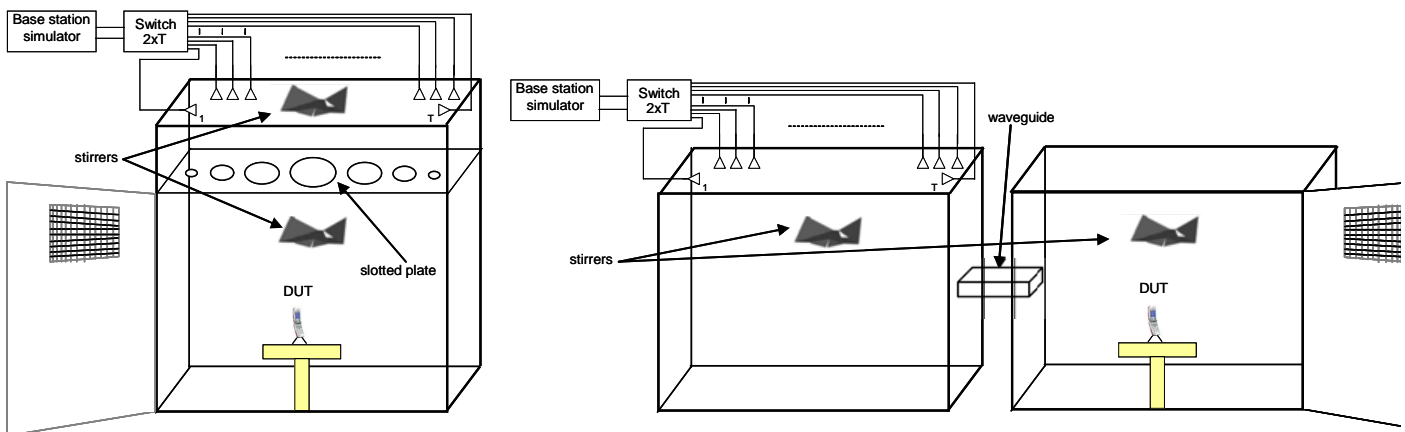

Figure 6.3.2.1-2 Reverberation Chambers with Multiple Cavities [source: EMITE Ing]

6.3.2.1.1 Concept and Configuration

In order to calibrate the reverberation chamber a broadband antenna can be used to measure the losses in the chamber with a network analyzer. This takes < 10 minutes. CTIA RCSG is working on a standard methodology for reverberation chamber calibration.

There are no active electronics in the measurement path that needs to be calibrated.

Reflections in turntables, cables, doors, etc, do not degrade accuracy. Reflections increase the richness of the channel in the reverberation chamber.

Existing studies show that low standard deviation (good accuracy) can be achieved by measuring the DUT in sufficient number of different positions and calculate the average of the values. Some analysis (see relevant references in [2]) show a typical standard deviation less than 0.5 dB at about 800 MHz, in a reverberation chamber with a size of 1.2m x 1.75m x 1.8m and continuous mode stirring. At higher frequencies or with a chamber of larger dimensions the standard deviation decreases and accuracy increases.

The following figure presents an example for an HSDPA receive diversity test configuration in a reverberation chamber.

For these tests we emulate an HSDPA call with a Node B emulator. The latter is connected to one of the 3 BS wall-mounted antennas through a switch. A fourth antenna allows measuring the DL received signal in the chamber with a spectrum analyzer.

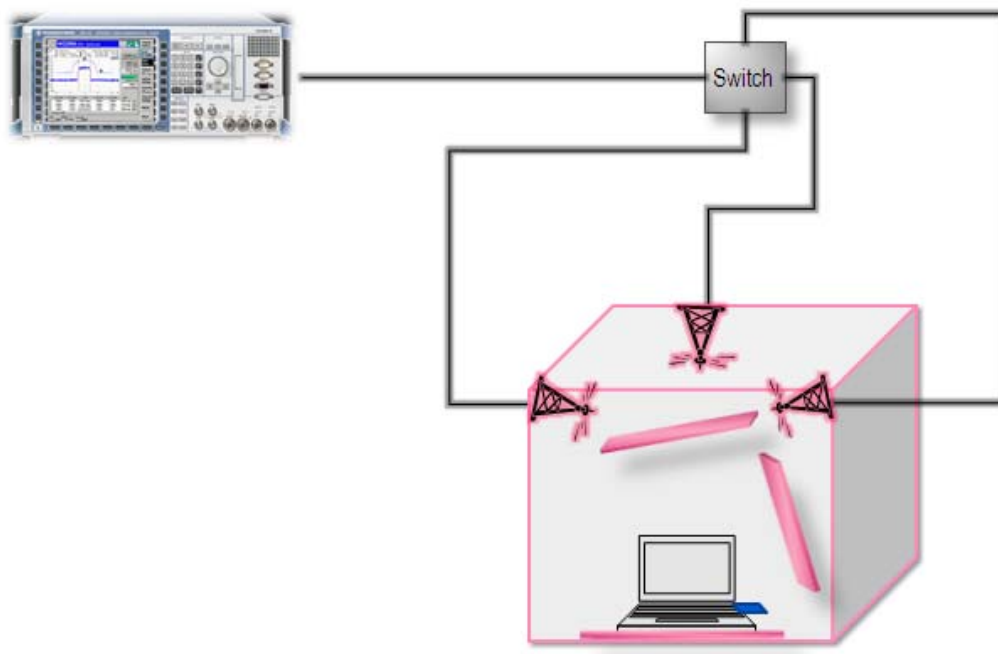

Figure 6.3.2.1.1-1: Test bench configuration for testing in reverberation chamber

In order to create a Rayleigh fading environment, we've got 3 types of parameters that can be set using a tool on a computer plugged to the chamber:

- Antenna among the 3, installed at the top of the cavity with different polarizations, is chosen
- Turning the platform that holds the DUT
- The 2 metallic stirrers near the walls can be moved on their axes

6.3.2.1.2 Test Conditions

Once the chamber is calibrated, the downlink throughput testing can be performed as follows to get one throughput averaged measurement:

- The DUT is placed in the chamber at least 0.5 wavelengths from the wall or from the metallic stirrers
- An HSDPA call is emulated using the NodeB emulator with a pre-defined BS TX power.
- To get one measurement sample we set up one of the following possible combinations: position of the rotating platform {0, $\pi/2$, π , $3\pi/2$, etc.} + position of the metallic stirrers {0, 25, 50, 75, 100, etc.} + antenna from {1, 2, 3}.

- For each one of these combinations we can record CQI, DL Throughput and DL Power in the chamber. The latter is measured using a fourth antenna and a spectrum analyzer. This constitutes one measurement sample. For each measurement sample, the link adaptation is performed manually or automatically on the NodeB emulator as follows: the HS-DSCH is configured (modulation, transport block size, number of HS-DSCH) depending on the CQI (Channel Quality Indicator) reported by the UE (User Equipment) according to the mapping table in [5].
- Once enough different DL throughput measurement samples (ideally ≥ 100), corresponding to different Antenna, rotating platform's position and stirrers' position combinations, are recorded for the same NodeB emulator DL TX power, they can be averaged to have the averaged DL throughput measurement.

The test duration can be significantly reduced if all these steps are automated. With a variable reference channel (VRC) and continuous mode stirring total measurement time of less than 10 minutes could be possible.

6.3.2.2 Candidate Solution 2

The reverberation chamber by itself has a limited range of channel modeling capabilities. Specifically,

- The power/delay profile is limited to a single decaying exponential
- The Doppler spectrum and maximum Doppler is limited by the relatively slow motion of the stirrers
- It is difficult to impart a specific, repeatable MIMO fading correlation on the downlink waveform

These limitations can be overcome when a MIMO channel emulator and reverberation chamber are cascaded.

The power/delay profile (PDP) can be enhanced beyond the single decaying exponential by programming the channel emulator with fading taps set at the desired excess delays. The resulting PDP will be the convolution of the taps provided by the channel.

The fading taps provided by the channel emulator allow much higher Doppler spreads than from the reverberation chamber alone. If a classical fading spectrum with a maximum Doppler of 100 Hz is desired, the channel emulator is configured to provide this. The resulting overall Doppler spectrum that results is the convolution of the channel emulator's Doppler spectrum with that of the reverberation chamber.

The fading produced by the cascaded channel emulator and reverberation chamber has a double-Rayleigh amplitude distribution. Because performance simulations generally use Rayleigh fading, simulation results for the double-Rayleigh case are not available.

The benefit is testing with a much higher maximum Doppler, on the order of 100 Hz or higher, than is possible with the reverberation chamber alone. Under these conditions, the reverberation chamber-induced fading will effectively be constant while the channel emulator-induced fading will dominate. Therefore, while a receiver's performance under such circumstances will definitely be different than under normal Rayleigh fading conditions, it should not undermine the receiver's ability to demodulate. Tests have shown that this is indeed the case. However, due to the lack of double-Rayleigh simulation results, measured results should only be compared with other devices using these same test conditions.

The correlation of fading between the downlink MIMO transmission paths can be adjusted using the channel emulator. This is also known as 'BS correlation,' reflecting the fact that it is controlled on the BS side of the link. The way to set this correlation using the channel emulator is as follows: using the Kronecker model of fading correlation, set the desired correlation of the transmit or BS correlation matrix. The receiver or MS correlation matrix should be set to identity. An example is given for a 2x2 MIMO system:

$$R_{BS} = \begin{bmatrix} 1 & \rho \\ \rho & 1 \end{bmatrix}, \quad R_{MS} = \begin{bmatrix} 1 & 0 \\ 0 & 1 \end{bmatrix}, \quad R_{chan} = R_{BS} \otimes R_{MS}$$

The value for ρ is the desired correlation between the two downlink paths. Note that it is not possible to control the phase of the correlation, only the amplitude.

The downlink antennas in the chamber are typically referred to as 'wall' antennas. There should be a number of them equal to the number of spatial streams supported by the DUT. The spacing of the wall antennas is not very important. Tests have shown that as the spacing between them is changed over a range between 6 and 80 mm, the measured correlation changes very little, on the order of 5% to 10%.

6.3.2.2.1 Concept and Configuration

The general configuration to be used for testing is shown in Figure 6.3.2.2.1-1. The specific example show there is for two BS antennas. If higher order MIMO devices are to be tested, additional antennas are required. The channel emulator is placed between the (e)NodeB emulator and the reverberation chamber. Two calibrations are performed:

- 1) Calibration of reverberation chamber loading to set the proper chamber impulse response. Most of the time, the chamber will be loaded to produce a specific, desired chamber RMS delay spread. This is achieved using such devices as a phantom head, tank filled with liquid, and RF absorbing foam. For use with the channel emulator, it is desirable to set the chamber RMS delay spread as low as is allowable (approximately 55 ns)¹, although higher RMS delay spreads are also legitimate, depending on the desired overall PDP.

NOTE 1: If the delay spread is reduced to below this point, the chamber's ability to produce the desired Rayleigh amplitude distribution at the DUT is degraded.

- 2) Calibration of the losses from (e)NodeB emulator to DUT location. This is already described in the test methodology for the reverberation chamber alone (subclause 6.3.2.1).

The calibrations are performed in this order, using a test antenna as the DUT antenna, and with the DUT in the chamber as it will be during the test. The contents of the chamber should not be disturbed after the calibration is complete. More information about the calibration procedures are found in a later section.

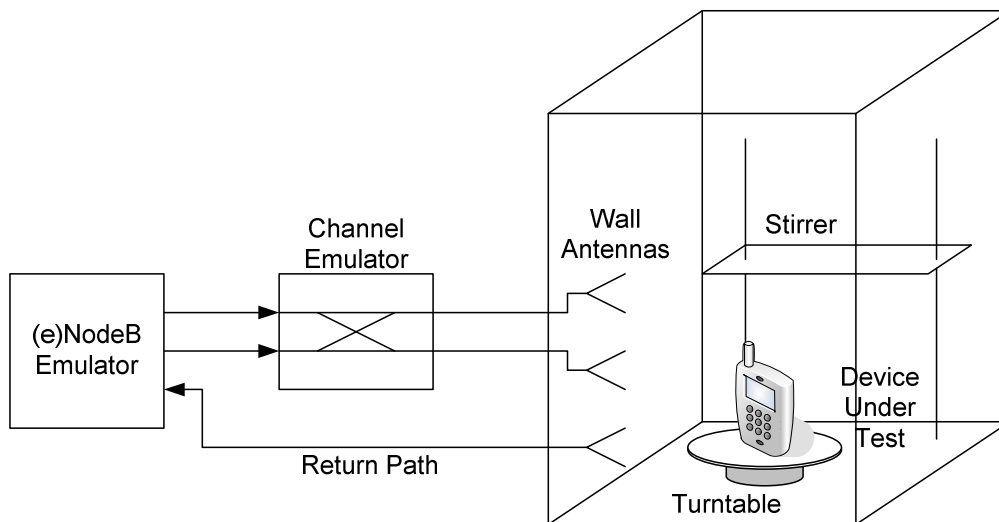

Figure 6.3.2.2.1-1: Test bench configuration for test using channel emulator and reverberation chamber for a 2x2 MIMO configuration

6.3.2.2.2 Test Conditions

After the chamber is calibrated, the emulator is configured for the desired channel model, including the end-to-end PDP, the desired fading spectrum and Doppler spread, and the MIMO fading correlation. At this point, the system is ready to test the DUT, and a procedure appropriate to the FOM being measured is carried out.

There are two basic operating methods, dependent on the motion of the stirrers and the state of the fading in the channel emulator, the 'dynamic' and the 'move-and-stop' methods.

In the dynamic method, the stirrers, turntable and channel emulator to operate continuously while the specific FOM is measured. A good example of this use would be throughput measurements under the conditions of a high Doppler rate, or, measured while the signal levels are varied over a wide range.

In the move-and-stop method, the stirrers and turntable are positioned in a number of combinations as described in 6.3.2.1.2. The channel emulator is allowed to run for a fixed length of time (usually 1 or 2 seconds is enough) and paused. The FOM is measured while the stirrers and turntable are not in motion, and the channel emulator is paused. In this method, the number of fixed positions and emulator states must be at least enough to guarantee the proper amplitude distribution. Automation of this entire procedure will significantly reduce the test time.

6.3.2.Y Downlink Transmission Modes

<Editor: Text to be added>

7 Measurement Results from COST2100

7.1 Reference Measurement Channels

<Editor: Text to be added>

8 Measurement Results from CTIA

8.1 Reference Measurement Channels

<Editor: Text to be added>

9 Conclusions

In section 9.1 the different candidate methodologies are compared. In section 9.2 lessons learnt after round robin test campaign together with final conclusions are given.

9.1 Comparison of Candidate Methodologies

The candidate methodologies for MIMO OTA can be broadly classified into 3 categories:

- 1) Anechoic Chamber
- 2) Reverberation Chamber
- 3) Multi-stage Method

It is recognized that the content of the table is preliminary and based on currently available information. Many of the attributes of the candidate methodologies require further study/proof and are subject to change.

Attribute	Reverberation Chamber		Anechoic Chamber Based			Multi-stage methods	
	RC	RC + CE	Single Cluster	Ring	2 channel method	2 stage method ⁷	Antenna method ⁶
Setup							
Major components	Reverberation chamber	Channel Emulator, Reverberation Chamber	Channel emulator, probe antennas, anechoic chamber	Channel emulator, probe antennas, anechoic chamber	Channel emulator, probe antenna	Channel emulator, probe antenna, anechoic chamber	Probe Antenna, Anechoic Chamber
Number of probe antennas	2-9	2 – 9	3-16 (varies)	8-32 (varies)	2-3	1	1
Operating bands							
Supported 3GPP bands	All	All	All	All	All	All	All
Bandwidths supported: HSPA/LTE	Yes/Yes	Yes/Yes	Yes/Yes	Yes/Yes	Yes/Yes	Yes/Yes	Yes/Yes
Channel Modelling aspects							
2D/3D	3D	3D	2D/3D (varies)	2D/3D ¹ (varies)	2D/3D	2D/3D	2D/3D ¹
Number of spatial clusters	1	1	1	1-24 (varies)	1-2	1-24	1-No upper bound
Power angular spectrum per cluster	Uniform	Uniform	Controllable	Controllable	Controllable	Controllable	Controllable
Angular spread	Random ⁸	Random ⁸	Controllable	Controllable	Partly Controllable	Controllable	Controllable
Power delay profile	Exponential decay	Controllable + Exponential	Controllable	Controllable	Controllable	Controllable	Controllable
Delay spread	Slightly controllable decay	Controllable	Controllable	Controllable	Controllable	Controllable	Controllable
Doppler shift	Limited	Controllable	Controllable	Controllable	Controllable	Controllable	Controllable
Supported channel models	Uniform ⁵	Uniform spatial, controllable multipath	Single cluster, multipath (varies)	SCME, Single Cluster, Uniform, Arbitrary	SCME, Single cluster, uniform, arbitrary	SCME, Single cluster, uniform, arbitrary	SCME, Single cluster, uniform, arbitrary
Controllable spatial characteristics of BS antennas	FFS	Controllable	Controllable	Controllable	Controllable	Controllable	Controllable
XPR	Constant	Constant	Controllable	Controllable	Controllable	Controllable	Controllable
Other MIMO OTA attributes							
Supported 3GPP transmission modes [7]	1 – 7	1 – 7	1 – 7	1 – 7	1 – 7	1 – 7	1-7

Ability to control interference direction	No	No	Limited – Yes	Yes	Yes	Yes	FFS
SNR control ³	FFS	Yes	Yes	Yes	Yes	Yes	N/A (Part of channel capacity calculation)
DUT size constraints	None	None	0.5 – 4 lambda, (varies)	0.5 – 4 lambda (varies)	FFS	None	None
Measurements & Results							
Supported FOM ² (Categories in Sec 5.1)	I, II, part of IV (except MEG), V	I, II, part of IV (except MEG), V	I-V +Throughput(θ) + other antenna characteristics ¹⁰	I-V +Throughput(θ) + other antenna characteristics ¹⁰	I-V +Throughput(θ) + other antenna characteristics ¹⁰	I-V +Throughput(θ) + other antenna characteristics ¹⁰	II, III, IV + other antenna characteristics ¹¹
Demonstration results available	Yes	Yes	Yes	Yes	Yes	Yes	Partial
System/Hardware Details							
Calibration equipment/method	2-Port VNA ⁴	2-Port VNA ⁴	Joint OTA link calibration using 2-port VNA ⁴	Joint OTA link calibration using 2-port VNA ⁴	Range calibration by 2-port VNA ⁴ , for example	Chamber calibration by 2-port VNA ⁴ , second stage calibration	Chamber calibration by 2-port VNA ⁴
Use this method in SISO OTA	Yes	Yes	Yes	Yes	Yes	Yes	Yes
Re-use potential existing SISO OTA systems	High	High	High	High	High	High	High
Other Considerations							
Requires non-intrusive test mode for antenna pattern measurement	N/A ⁹	N/A ⁹	No	No	No	Yes	Yes
Throughput measurement method	OTA	OTA	OTA	OTA	OTA	Conducted via temporary antenna connector	N/A (Capacity metric calculated from antenna parameters)

NOTES:

Note 1: 3D is feasible if 3D channel model is used.

Note 2: Metrics supported: the measurement metrics supported by the test method like throughput, TRP/TRS, antenna pattern, gain imbalance, etc

Note 3: SNR control: explicit SNR, implicit SNR, etc

Note 4: VNA is an abbreviation of Vector Network Analyzer.

Note 5: random AoA, uniform average

- Note 6: antenna-based method uses stage 1 from the 2 stage method and derive from this, a MIMO channel capacity FOM
- Note 7: 2 stage method does not require channel capacity metric, but measures throughput using second stage in a conducted test
- Note 8: The angular spread observed in a reverberation chamber depends on the duration of observation. For short durations, it is random. For long durations, the angle spread converges to a fixed value based on a uniform angular distribution.
- Note 9: the antenna pattern cannot be measured, if needed
- Note 10: The throughput, branch imbalance, spatial correlation, antenna gain can be measured as a function of DUT rotation
- Note 11: The branch imbalance, spatial correlation, antenna gain can be measured as a function of DUT rotation

9.1.1 Definitions of rows in the table

Setup

Major components: List of main hardware components required

Number of probe antennas: self-explanatory

Operating bands

Supported bands: Which frequency bands does the method support (TS 36.101, TS 25.101)

Bandwidths supported: HSPA/LTE: Does the method support at least 20 MHz

Channel Modelling

2D/3D: ability of method to support 2D/3D modelling of environment

Number of clusters: number of taps/multipath components supported by method. This determines how "spread out" the arriving signal is spatially.

Power angular spectrum per cluster: Types of power angular (azimuth) spectrum distributions supported by method. The distributions should be settable for each cluster.

Angular spread: Ability to set the amount of angle spread. This determines how "spread out" the arriving signal corresponding to each cluster is spatially.

Power Delay Profile: Types of power delay profiles supported. Ability to control the powers and delays of each of the clusters.

Delay spread: ability to support different delay spreads.

Doppler shift: types of Doppler spectra that can be supported. This determines the frequency domain (and by duality, the time domain) characteristics of the wireless channel emulated.

Supported channel models: channel models supported by method.

Controllable spatial characteristics of BS antennas: ability to set the spatial correlation of the BS antennas.

XPR: Cross-polarization ratio values supported.

Other MIMO OTA attributes

Supported 3GPP transmission modes: self-explanatory. Refer to [7].

Ability to control interference direction: ability to model the direction from which interference arrives

SNR control: Explicit SNR, Implicit SNR

DUT size constraints: range of DUT size supported. (quiet zone dependency on channel model and number of antennas)

Measurements and Results

Supported FOM (subclause 5.1): The figures of merit listed in subclause 5.1 that are supported. Does the method provide any other enhancements to the FOM measured?

Demonstration results available: Are demonstration results available?

System/Hardware Details

Calibration equipment/method: list of main equipment required for calibration of system with some insight into the calibration approach.

Use this method in SISO OTA: Can this same method be used in SISO OTA too?

Re-use potential existing SISO OTA systems: Can this method be re-used in existing SISO OTA systems?

Other considerations

Requires non-intrusive test mode for antenna pattern measurement: Does the method require a special mode (hardware/software capability) in the UE to make antenna pattern measurements

Throughput measurement method: Are the throughput measurements made over the air or in a conducted setup?

9.2 Lessons learnt and conclusions

After round robin testing campaign the following conclusions have been reached and agreed, and taken as lessons learnt:

Test Result Agreement within a Methodology

- Anechoic chamber based OTA typically shows good level of agreement when using UMi and UMa channel propagation models.
- Reverberation chamber based OTA typically shows good level of agreement when using NIST, UMi and UMa channel propagation models.
- Uncertainties in the measurements and different lab setups prevent full comparison in some cases.
- It can be seen from the comparison that Nokia's two stage results and Agilent two-stage results from Pool 4 USB-dongle are comparable with a 3dB difference. One possible reason for the difference related to measurement setup is that the Nokia setup selected cross polarized BS antennas and the Agilent setup selected uncorrelated BS antennas. Apart from this difference the setups should be comparable and any difference in results likely to be due to the achievable accuracy of calibration between two separate labs. In some cases, results within a methodology were corrupted by inadvertent errors in test equipment settings or changes to the DUT's operating environment.

Test Result Agreement between Methodologies

- Results show that several test methods were proven to be able to show a clear ranking between DUTs.
- In several cases, very good agreement between anechoic (multiprobe, single cluster and two-channel methods), reverberation chamber and two-stage results were observed for a single device, however uncertainties in the measurements and in the labs setups prevent to take any conclusion regarding any inter-methodology comparison.
- For some other test cases, big differences among the test method results are still to be further understood.
- It's not obvious as to how different methodologies can be directly compared due to the fact that there are many different variables between the methods.

The following issues were identified which made a true comparison difficult:

- Test configuration issues: lack of clearly defined test environment (Base Station antenna correlation settings, channel model details, not all labs had access to all DUTs, and DUT configuration varied between labs.

- Reference UE issues: Instability of DUTs over test duration, laptop noise affected throughput results, and receiver (antenna and baseband) characteristics of each test UE were unknown so difficult to verify specifically what caused differences in results.
- Propagation Environment Aspects: SCME channel models are two-dimensional only; maybe there are (or there will be) more appropriate channel models for us to consider, 1 drop/instance of a channel model unlikely to be enough to verify real-world performance.
- Test equipment aspects: eNode B emulators were not mature and even today labs have found UE performance differences between them.

It is understood to be feasible to specify a test methodology to measure multiple antenna receiver performance, but the different types of methods need further technical analysis before agreement can be made on what methodology(ies) are finally selected.

In chapter 10, recommendations are given on how to scope the work so that the standardization of a method (s) can progress in the most effective and efficient way.

10 Recommendations

Recommendation is to close current SI and open a WI which basically will take all the lessons learnt in the SI phase in order to conclude in a method (s) able to accurately provide MIMO OTA performance that is meaningful compared to MIMO end user experience.

After Round Robin testing campaign it has been proven that the different candidate methodologies are able to provide a measure of MIMO OTA performance, nevertheless it is recognized that there are a number of pending issues that need to be technically treated in order to be able to conclude a final test methodology(ies). The following list of items are suggested to be considered within the scope of the WI:

1. The initial focus shall be on over-the-air testing of LTE MIMO terminals (with expansion to LTE SIMO and HSPA SIMO/MIMO afterwards).
2. Deploy reference antennas and reference device(s)
 - a. Realize and validate reference antennas
 - b. Agree on a reduced set of devices to be tested across all labs.
 - c. Reference devices will be selected such that they represent as well several chipset manufacturers.
3. Create reference environment (standardization of RF environment):
 - a. RF environment shall consider all key radio link aspects, including, for example, downlink power levels, SNR, (e)Node B transmission modes, reference channel types and channel rank. In order to minimize variables and uncertainty during the initial phase, tests shall use of LTE Transmission Mode 3, Fixed Reference Channel, and forced Rank 2.
 - b. Standardize eNB, channel emulator
 - i. Agree on eNodeB emulator settings (begin with same s/w version, MCS settings, etc.). emulator parameters shall be evaluated and standardized for MIMO OTA performance evaluation, ensuring alignment with the configurations used in real-life deployments.
 - ii. Define BS antenna parameters
 - iii. Standardize channel emulator, validation of channel emulator.
 - c. Use channel model from TR

- i. Clearly select the channel models from the TR and specify all the parameters used to ensure consistent test results within and across methodologies. The selection shall be done to reflect likely field conditions.
 - ii. Therefore, validation procedures shall be developed to ensure that any given channel model has been correctly implemented within each methodology.
 - d. Utilize reference antennas in combination with a known UE baseband receiver (verified via conducted RF tests with and without channel impairments). This is intended to verify whether the characteristics of the receive antenna design (i.e. correlation, gain imbalance, etc) affecting receiver performance can be accurately distinguished by proposed test methods
 - i. Measure conducted reference sensitivity unimpaired.
 - ii. Measure conducted performance (power and noise levels need to be defined) using an agreed channel model with direct connections (no antenna impact).
 - iii. Measure conducted performance (power and noise levels need to be defined) using simulated or measured reference antenna and agreed channel model.
 - e. Validate channel model implementation in chamber
4. Simulation of expected UE performance in chosen channel model
 5. Identify the repeatability, reliability and level of measurement uncertainty of each proposed methodology.
 6. Evaluate the use of statistical performance analysis in order to minimize test time and help ensure accurate performance assessment.
 7. Consider whether any additional MIMO performance metrics are necessary.
 8. For a final selection of the method(s) cost, time and other implications should be considered.

Also it is noted that the standardisation of multiple test methodologies may be one eventual outcome but, during the WI, RAN4 shall avoid fragmentation of the absolute measurement result that is output as part of the 3GPP test framework for any given tested device. 3GPP shall also ensure that all devices can be comparably tested. Currently throughput is the figure of merit to be used as to compare the different results across the different methods. Absolute throughput is agreed as the only figure of merit that will be used for comparable testing across different methods.

Annex A (Informative): Test Plan for Anechoic Chamber based candidate methodologies with 3 or more probe antennas

A.1 Introduction

This annex describes the test plan for OTA throughput comparison measurements. This test plan is focused on anechoic chamber based methodologies with 3 or more probe antennas. The plan has previously been presented in COST2100 and CTIA.

The aim of the comparison measurement campaign is to study how well an OTA throughput measurement in a predefined propagation channel can be reproduced in different labs. Testing time and challenges in system calibration are also matters of interest. There is a risk that labs participating in the measurement campaign use different setups, different channel model realizations, and different Node-B Emulator settings. This may lead into some inconsistent results. Therefore, the goal of this test plan is to define the radio channel conditions and the throughput measurement in such detail that the results are as comparable as practically possible.

To be able to compare throughput results between labs one of the challenges of this test plan has been to define an absolute power level in the center of the test volume of the used chamber.

One of the important aspects for further study is to implement horizontal polarization to the test system. Because the aim of this contribution was to study calibration and repeatability, it was left out. However to create a realistic radio channel to the chamber, both vertical and horizontal polarizations have to be taken in to account.

A.2 Test setup

Testing is done in an anechoic chamber. A number of vertically polarized antennas are located in a horizontal plane in respect to the UE. The typical number of antennas is at least eight in a full circle and at least three for a single cluster test. The probe distance from the UE will vary from lab to lab. The fading channel is generated by using a channel emulator/simulator which is fed by a Node-B Emulator. The UE will be rotated around its vertical centre line by using a turntable or manually. Figure A.2-1 depicts the test setup. The requirement on the probe antenna is FFS.

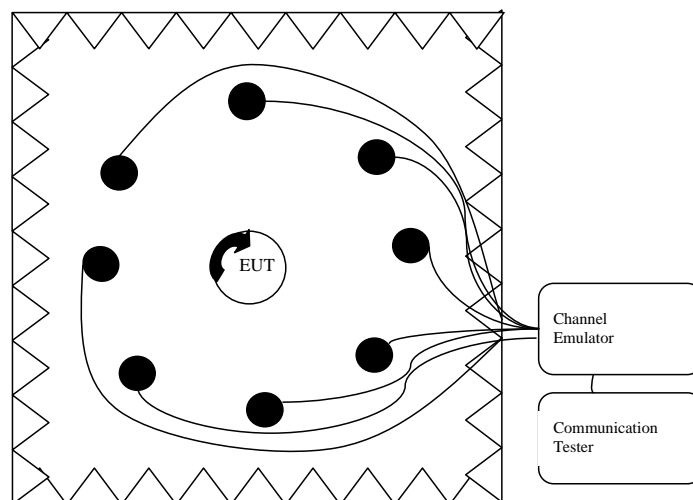

Figure A.2-1: Test Setup (Communication Tester here means Node-B Emulator)

A.2.1 Calibration

The test system shall be calibrated using the setup in Figure A.2.1-1. The UE is replaced by a reference antenna with known gain characteristics. A CW non-faded calibration signal is fed to one probe at a time and received by the reference antenna. Based on the known properties of the reference antenna, the path loss from the input of the channel emulator to the UE location will be calculated.

The settings (except fading model) of the channel emulator during the calibration and measurement phases should be identical. The channel model used in the calibration is static propagation conditions (1 tap, no fading, max. output power). Signal is routed to one probe antenna at a time. Each path (antenna probe) is calibrated separately.

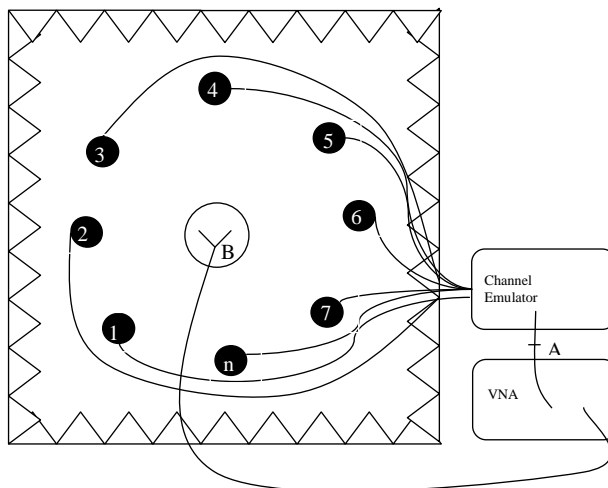

Figure A.2.1-1: Calibration Setup (VNA stands for Vector Network Analyzer)

Calibration steps:

- Measure the attenuation between points A and B through each probe. Point A is the input to the channel emulator and point B is the UE location represented by the reference antenna.
- Compensate for path loss differences. This can be done for example by adjusting the channel emulator outputs by the factor:

$$Path_{compensation_i} = Attn_i - \max(Attn)$$

where

$Path_{compensation_i}$ is the compensation factor for probe i to be adjusted by channel emulator.

$Attn_i$ is the measured attenuation via probe i, and,

$\max(Attn)$ is the highest attenuation over all probes.

- Calculate the path loss of each route as follows:

$$PathLoss = \max(Attn) - G_{ref\ antenna}$$

A.2.1.1 Calibration Check

A UE sensitivity measurement is performed for each probe antenna using the static propagation conditions model. The result of this check can be used to verify that the probe antennas have been properly calibrated.

Configure the test system according to section B.3 with the following exceptions:

- 1) The channel model is single tap, non faded

2) Only one probe antenna is used at a time

Rotate the UE using an angle step of 45° and measure the UE reference sensitivity which is the highest transmit power resulting in a throughput of between 1499 kbps and 1999 kbps for each probe antenna. Note: These throughput values are for H-Set 3, 16QAM. For H-Set 6, the values are FFS.

For each probe and angle of rotation, record the UE reference sensitivity in Table A.2.1.1-1.

Table A.2.1.1-1: Calibration check table

Reference sensitivity/ Angle	Path 1 [dBm]	Path 2 [dBm]	Path 3 [dBm]	Path 4 [dBm]	Path 5 [dBm]	Path 6 [dBm]	Path 7 [dBm]	Path 8 [dBm]
0°								
45°								
90°								
135°								
180°								
225°								
270°								
315°								
Path Average								

$$PathAverage_n = 10 * \log_{10} \left(\frac{8}{\sum 1/10^{(Path_n/10)}} \right)$$

The path loss compensation is considered successful if the path average results are within ±1 dB.

A.2.2 Radio Channel Conditions

The desired radio channel models are the same as described in the main part of this TR (subclause 6.2). The recommended sub-set of channel models for anechoic chamber based measurements are listed below.

For full circle testing:

- SCME Urban micro-cell,
- SCME Urban macro-cell, and

For single cluster testing:

- Single Spatial Cluster Model with Multi-path based on SCME Urban micro-cell, or
- Single Cluster Multi-Path Model based on Extended Pedestrian A (EPA)

The channel model used in the test is independent of implementation. When/if the sum of sinusoids based implementation of SCME channel models is used, the number of sub-paths per cluster is 20.

NOTE: The Doppler spectrum is based on the geometry (AoA and DoT).

A.2.2.1 Average channel power

During the calibration phase the static propagation condition was used with one probe antenna at a time.

For the measurement phase using faded channel conditions, the signal is transmitted via several probe antennas at a time. Therefore, the per-path calibration information gained from the path loss measurements needs to be used to adjust the signal level when using multiple antennas and a fading channel.

Composite loss is the loss between point A and point B. The average channel power is defined as the signal level in the centre of the probe array (location B). The power at location B is the sum of signal powers via a number of calibrated probe antennas. The total power should be determined for each channel model separately. The average channel power at

location B is the Node-B Emulator output power (location A) minus the composite loss. The average channel power level is defined to be the measured power in the centre of the probe array, averaged over 30 seconds, for the selected channel model when a HSDPA link is applied. [An example step by step procedure is necessary to explain how to take the calibrated individual static paths from the calibration phase and turn this into a calibrated composite faded signal at point B. The example step by step procedure will be completed by proponents].

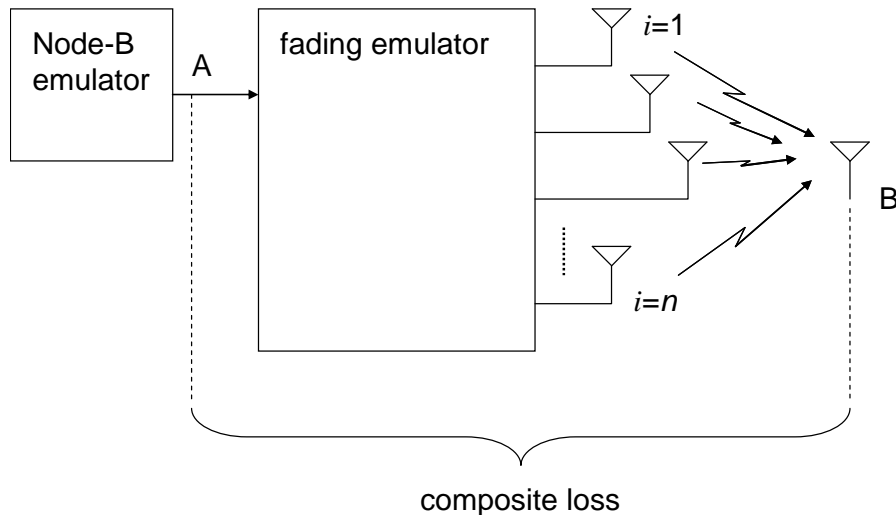

Figure A.2.2.1-1. Signal level in fading radio channel conditions

A.3 Test Procedure

The following UE device detail refers only to the COST2100 measurement campaign.

The USB modem will be tested with the provided laptop. Due to practical reasons the lid is kept closed during measurements. The laptop has two USB ports, use the one close to the lid for testing i.e. the higher one. The laptop will be powered by battery and following power management settings should be used:

Turn off monitor - never

Turn off hard disks - never

System standby - never

WLAN and Bluetooth radios – off

A.3.1 HSDPA connection settings

Working assumptions:

- 1) HSDPA category 8
- 2) FRC (Fixed Reference Channel) H-Set 3 (16QAM)
- 3) Single Link Performance
- 4) DL channel 10562 is used for testing. Other DL channels can also be used, but this needs to be described in the measurement report.

A.3.1.1 FRC

H-Set3 from 34.121-1 is chosen as the FRC. During the FRC tests the behaviour of the Node-B Emulator in response to the ACK/NACK signalling field of the HS-DPCCH is specified in Table A.3.1.1-1.

Table A.3.1.1-1: Behaviour of Node-B Emulator in response to ACK/NACK/DTX

HS-DPCCH ACK/NACK Field State	Node-B Emulator Behaviour
ACK	ACK: new transmission using 1 st redundancy and constellation version (RV)
NACK	NACK: retransmission using the next RV (up to the maximum permitted number or RV"s)
DTX	DTX: retransmission using the RV previously transmitted to the same H-ARQ process

A.3.2 Method of test

The average throughput is measured by varying the average channel power by 8 dB either side of the 50% point of the FRC maximum throughput. The example steps for doing that are shown below.

Table A.3.2-1: Physical channel levels for HSDPA connections set up

Parameter During Measurement	Unit	Value
P-CPICH E_c/lor	dB	-9.9
P-CCPCH and SCH E_c/lor	dB	-11.9
PICH E_c/lor	dB	-14.9
HS-PDSCH	dB	-5.9
HS-SCCH_1	dB	-7.4
DPCH E_c/lor	dB	-5
OCNS E_c/lor	dB	-13.3

Table A.3.2-2: Test parameters for testing 16QAM H-set 3

Parameter	Unit	Test 1	Test 2	Test 3	Test 4
Phase reference	dBm/3.84 MHz	P-CPICH			
Redundancy and constellation version coding sequence		{6,2,1,5}			
Maximum number of HARQ transmission		4			
NOTE: The HS-SCCH-1 and HS-PDSCH shall be transmitted continuously with constant power. HS-SCCH-1 shall only use the identity of the UE under test for those TTI intended for the UE.					

- 1) Set up fading conditions defined in section A.2.1.1.
- 2) Establish an HSDPA connection according to subclause A.3.1 with the UE in angular position 0 degrees.
- 3) Set the SS behaviour according to Table A.3.1.1-1.
- 4) Set test parameters on the SS according to Table A.3.2-2.
- 5) Set up number of frames to 5000, and repetition to 'Single Shot'.
- 6) Select inner loop power control algorithm 2, power continuously up.
- 7) Adjust the average channel power to achieve roughly 50% of the FRC maximum throughput (DUT rotation 0°). Note this power.

Throughput is calculated with the following formula:

$$\text{Throughput} = \text{Transmitted blocks size} \times \text{Number of blocks acknowledged} / \text{Measuring time}$$

- 8) Set the average channel power 8 dB below the level recorded in step 7).

- 9) Measure the throughput of the UE and record in the result in Table A.3.2-3.
- 10) Increase the average channel power by 2 dB.
- 11) Repeat steps 9) and 10) until the throughput has been measured at 8 dB above the level in step 7).
- 12) Rotate the UE by 45 degrees and repeat steps 8 to 11 until all 8 angles have been measured.
- 13) Calculate the average throughput for each power step.

Table A.3.2-3: Throughput result table

Device:			
Channel Model:			
	Average channel power		
	[dBm]	[dBm]	etc.
Rotation Angle	Throughput [kbps]		
0°			
45°			
90°			
135°			
180°			
225°			
270°			
315°			
Average			

Annex B (Informative): LTE MIMO OTA Test Plan

B.1 Test Objectives

- 1) To measure a set of figure of merits by using the same reference DUTs for the candidate methodologies,
- 2) To compare the OTA figure of merits results between the candidate methodologies, and
- 3) To determine and prove whether the candidate test methodology can be used to differentiate a good and bad DUT

B.2 Test Setup

The test system setup is shown in Figure B.2 for the proposed methodologies in 6.3. For anechoic chamber based methodologies in Figure B.2-1, a number of vertically and horizontally polarized antennas are located on a plane with respect to the DUT. The typical number of antennas is at least eight in a full circle and at least three for a single cluster test. The antenna probes' distance from the DUT, r , will vary from lab to lab. In the candidate solution 4 typically two antennas will be used. The DUT will be rotated around its centre line by using the electronically-controlled turntable system or using a manual turning approach. The angle of turning is designated as θ . An anechoic chamber of sufficient size ($W \times L$) m is used and this will vary from lab to lab. Some uplink signal amplifier may be used to ensure good isolation between Tx and Rx port of eNodeB emulator.

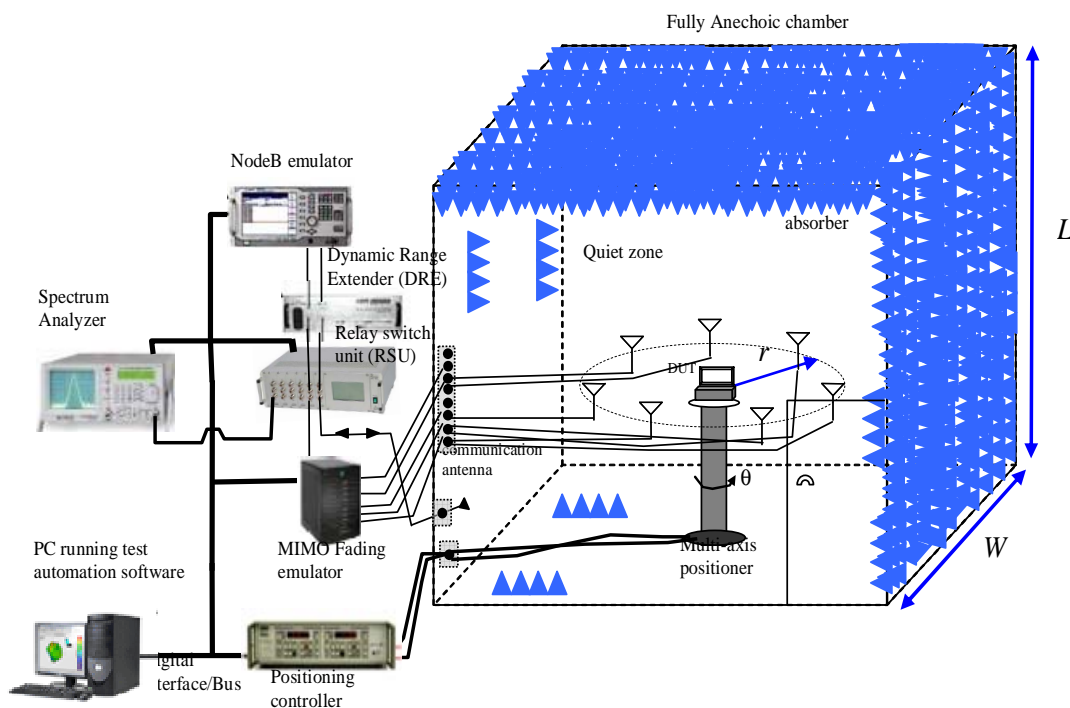

Figure B.2-1: Anechoic-chamber based methodologies

Figure B.2-2 shows the setup for the reverberation-chamber based methodologies. Several measurement antennas can be used to transmit the RF signals to the DUT. The DUT is inserted in a position inside the chamber. The mode stirrers are used to create scattering waves that mimic certain propagation conditions. The uplink antennas are used to establish active communication link between the eNodeB emulator and the DUT. A reverberation chamber is equipped with

mode stirrers and can create a statistically isotropic distribution of incoming waves to the UE (User Equipment). When in the isotropic mimic, there are no restrictions for aligning the UE in a certain direction, but the UE must be placed at a minimum distance of 0.7 wavelengths from any other conducting object or RF absorbing material in the chamber. The reverberation chamber may be loaded with absorbing objects in order to tune the power-delay-profile to fit the channel models described below.

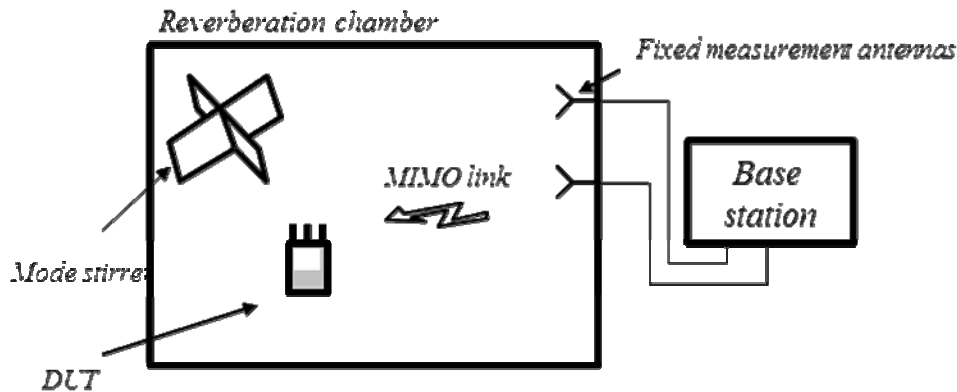

Figure B.2-2: MIMO measurement setup for baseline configuration with reverberation chamber only. Several measurement antennas can be used to transmit the RF signals to the DUT

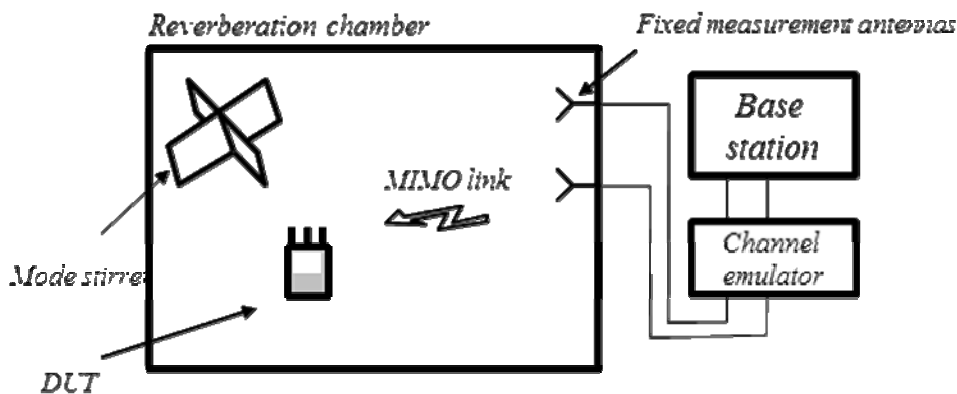

Figure B.2-2A: MIMO measurement setup for extended configuration with reverberation chamber paired with channel emulator.

The measurement setup with reverberation chamber can be combined with a channel emulator to produce more specific power delay profiles. Figure B.2-2A shows the measurement setup with added channel emulator. Configuration of the channel emulator and the reverberation chamber is slightly different from the reverberation chamber alone. Note that the intent is to mimic the channel model created by the emulator as much as possible. Since the chamber introduces its own decaying exponential PDP, the chamber must be tuned to as low a delay spread as possible without compromising the desired statistics. Provisionally, 90 ns has been selected as the target value. For everything else related to the setup in the reverberation chamber, the same considerations as in the previous section about reverberation chamber only should be followed.

For the two-stage methodologies shown in Figure B.2-3, this method divides the MIMO OTA test into two stages:

- 1) Measure the device antenna pattern inside an anechoic chamber. In order to accurately measure the antenna pattern of the intact device, the chipset needs to support amplitude and relative phase measurements of the antennas. Section B.4.3 gives a description on how to measure each antenna element's pattern using a non-intrusive method.

- 2) Use a commercial MIMO channel emulator to convolve the measured antenna pattern with the desired channel model to provide the stimulus for a conducted throughput test on the DUT.

The chamber for antenna pattern measurement is set up as described in Annex A.2 of [4], where the DUT is put into a chamber and each antenna element's far zone pattern is measured. The influence of human body loss can be measured by attaching the DUT to a SAM head and or hand when doing the antenna pattern measurements. The antenna pattern can be measured using non-intrusive methods as described in B.4.3. The integrated channel model with both MIMO antenna effect and the multipath channel effect can then be emulated with a commercial MIMO channel emulator. The Node B emulator is connected to the MIMO channel emulator and then to the MIMO device's temporary antenna ports via approved RF cables. These ports are the standard ones provided for conducted conformance tests. By controlling the power settings of the channel emulator and also the integrated channel model, the end-to-end throughput with the MIMO antenna radiation influence can be measured.

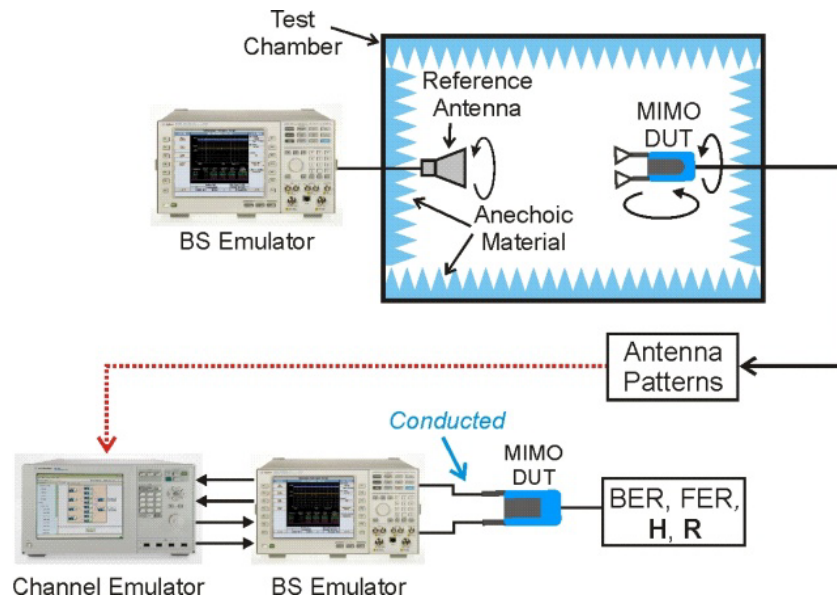

Figure B.2-3: Two-stage based methodology Test Setup

NOTE: Detailed test setup should be presented together with the measurement results.

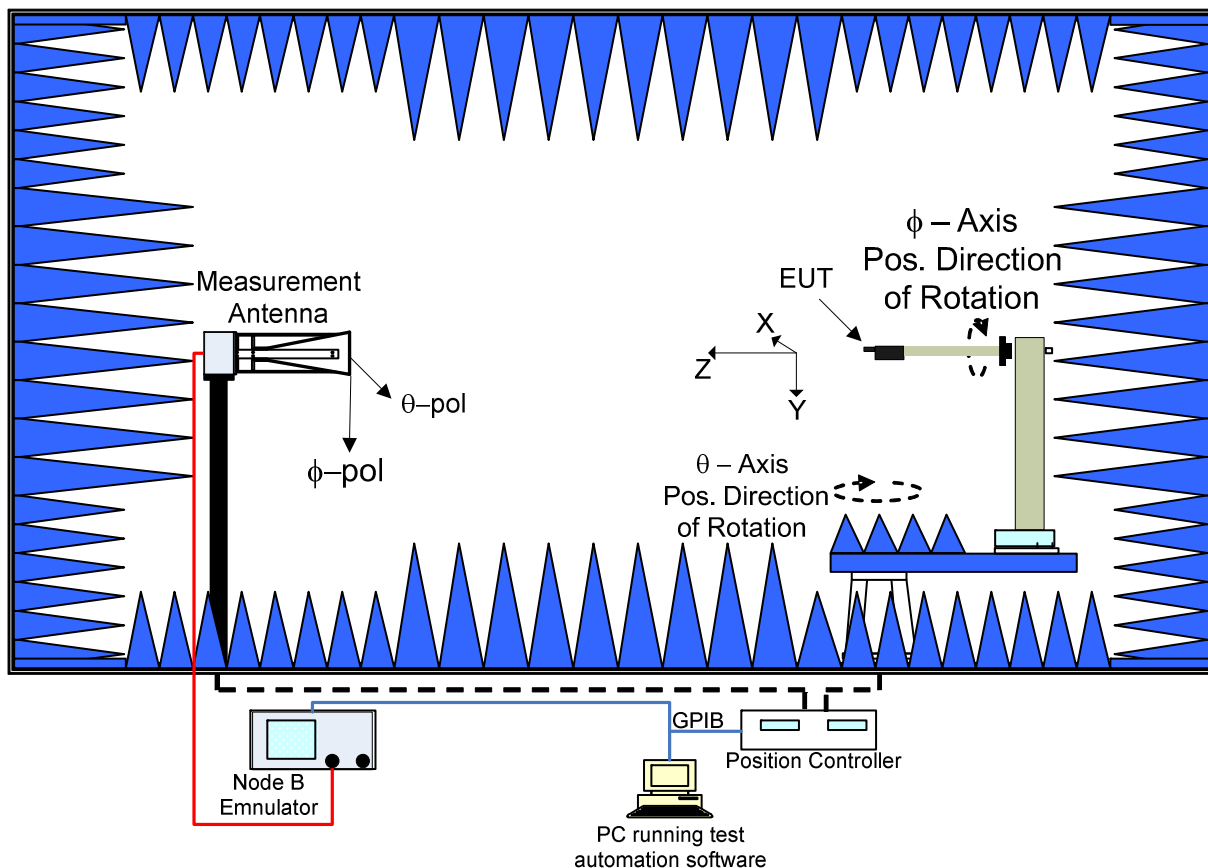

Figure B.2.4: Test setup for antenna pattern measurement in anechoic chamber

Set up

- a) LTE Node B emulator.
- b) Anechoic chamber with position controller capable of moving the DUT and antenna probe relative to each other in theta (θ) and phi (ϕ). Anechoic chamber designed and calibrated to support desired test frequencies.
- c) The DUT is capable of measuring complex antenna pattern data (i.e. both magnitude and phase) for both antennas used in the reception of LTE signals. A diagnostic tool may be used to capture the data. Devices that connect to the USB port of the laptop shall be connected directly to a USB port on the left or right side of the laptop.
- d) PC running test automation software.

B.2.1 Figure of Merits (FOMs)

The figure of merits or test parameters in Table B.2.1-1 must be measured.

Table B.2.1-1: Figure of Merits

Category	I
FOMs	MIMO Throughput CQI (FRC)
Type	OTA
Methodology	Active (with fading)

CQI – Channel Quality Indicator (This FOM is optional but where possible it should be measured)

From the FOMs, the second-order statistics can also be derived to assess the OTA performance of the DUT. For OTA throughput, the PDF and CDF of throughput should be generated.

B.2.2 Channel Models

The desired radio channel models that can be used for the measurement campaign are described in 6.2. The recommended sub-set of channel models for the measurement campaign is listed below:

For full circle testing:

- SCME Urban micro-cell,
- SCME Urban macro-cell, and

For single cluster testing:

- Single Spatial Cluster Model with Multi-path based on SCME Urban micro-cell (Angle spread : 35 deg)
- Single Cluster Multi-Path Model based on Extended Pedestrian A (EPA) (Angle spread : 35 deg)

For uniform model testing:

- Extended Pedestrian A (EPA)

The channel model used in the test is independent of implementation. When/if the sum of sinusoids based implementation of SCME channel models is used, the number of sub-paths per cluster is 20. The Doppler spectrum is based on the geometry (AoA and DoT). The mobile speed of the channel models is 3 km/h.

The candidate solution 4 (two-channel method) does not require a channel model to be applied.

B.2.3 Antenna Probes

This setup is only applicable to anechoic-chamber based methodologies.

The measurement antennas or antenna probes should be based on orthogonally polarised antennas that are capable of transmitting the vertical and horizontal component of the RF transmitted signals.

Different types of antenna probes can be used, depending on the test methodology. However, antenna probes should be able to support the 3GPP LTE frequency bands, at various centre frequencies. The number of antenna probes needed in an anechoic chamber will depend on the methodology employed.

For measurement campaign purpose, the antenna probes should be calibrated where possible and the following additional information about the antenna probes should be recorded:

- The antenna pattern of the antenna probes.
- The cross-polarisation of the antenna probes. The cross-polarisation of an antenna probe is defined using Cross Polarisation Purity (AntennaCrossPolarisation). AntennaCrossPolarisation is used to ensure quality/controllability of polarisation effect. The vertical and horizontal gain component of antenna probe can be measured separately or simultaneously to define the XPR. The cross polarisation of the measurement antennas should be ≥ 20 dB for the operating carrier frequency.
- The mutual coupling between vertical and horizontal antenna probe element. The mutual coupling between horizontal and vertical antenna probe element should be minimised (1 dB).

For the round robin measurement campaign, measurements have to be done for horizontal and vertical polarization of the probe antennas. If applicable, mixing polarizations for different antennas is recommended as an additional test. This test will be especially important to verify performance for polarization diversity transmissions.

B.2.4 eNodeB Emulator Parameter Settings

The eNodeB emulator parameters are set according to the Table B.2.4.1-2. Testing with 64QAM is considered to be done optionally. The settings for DL stream 1 and stream 2 are the same.

Table B.2.4.1-2: Parameter settings for eNodeB emulator

Parameters (Note 1)	Unit	Value	
		Signal level (Note 2)	
Parameters	Unit	middle	high
Physical channel			
Connection mode of UE		Connection established	
DL MIMO mode		2 x 2 open loop spatial multiplexing	
Duplex mode		FDD	
Operating band (UL channel, DL channel)		band 7 (21100, 3100) band 20 (24300, 6300)	
Schedule tyoe		Reference Measurement Channel (RMC)	
Reference Channel		R.11 (Note 3)	not applicable (Note 4)
Bandwidth DL	MHz	10	
Number of RBs DL		50	
Start RB DL		0	
Modulation DL		16QAM	64QAM
TBS Idx DL		13 (RMC defined)	24 (RMC defined)
Bandwidth UL	MHz	10	
Number of RBs UL		50	
Start RB UL		0	
Modulation UL		QPSK	16QAM
TBS Idx UL		6 (RMC defined)	19 (RMC defined)
Transmit power control	dBm	-10, open loop (Note 5)	
PDSCH power offset relative to RS EPRE	dB	$\rho_A = -3$ $\rho_B = -3$	
Number of HARQ transmissions		1 (no HARQ re-transmissions)	
AWGN		OFF	
DL power level (RS EPRE)	dBm / 15 kHz	Set at eNodeB simulator with correction from calibration	
Number of subframes for FOM measurement		2000 minimum for static channel 20000 minimum for faded channel (Note 6)	

Note 1: This set of parameters is aligned with R&S CMW500, Anritsu MTC8820C, AT4 S3110B, and Agilent E6621A (to be confirmed).

Note 2: The indications for the signal level to be middle or high are describing the channel conditions under which either a 16QAM or a 64QAM modulation, as selected for the test, usually would be applied.

Note 3: This RMC is defined in 3GPP TS 36.521-1, subclause 8.2.1.3.1

Note 4: This RMC is not yet given a name in RAN5.

Note 5: No uplink power control

Note 6: These values might need to be increased for frequency and mobile speed reasons.

B.2.5 Reference DUTs Configurations

A set of reference DUTs consists of:

- 1) Laptops with LTE embedded modules (not yet available)
- 2) LTE USB dongles
- 3) [Other LTE devices with different form factors]

These DUTs are used for the purpose of round-robin measurement campaign.

The reference DUTs shall be treated as commercial off-the-shell MIMO devices.

The test SIM requirement to establish the communication links between DUT and the BS emulator should be provided by each proponent of methodology. The SIMs are only used to set up communication link and therefore it should not impact the measurement results.

Note that the DUTs are usually equipped with RF connectors which allow conducted testing.

USB Dongles

For USB dongle or modem type DUTs, a laptop (non-MIMO capable) will be used to connect to them. A spare laptop will also be provided to charge up the battery. The laptop shall be battery powered during the test.

The USB dongle will be tested with the provided laptop. The lid is kept open in a 110 degree position during measurements. Use the USB port labelled for USB connection. The following power management settings should be used:

On the Dell E6400 notebook, the USB port to be used is the upper one on the left side. On the Dell D430 it is the one most to the right side.

<u>Configurations</u>	<u>Settings</u>
Turn off monitor	never
Turn off hard disks	never
System standby	never
WLAN	off
Bluetooth radio	off

For LTE USB dongles that are attached to the laptops for the purpose of measurement, the laptops shall be positioned with respect to the turn-table and anechoic chamber coordinate system as outlined in Appendix L.9 in [9].

For LTE DUT, if the DUT is capable of 90 degrees mechanical mode, then such mechanical mode shall be used if the host laptop allows doing so. Otherwise, the horizontal (0 degree) mechanical mode shall be used.

The support of engineering software for DUTs is not needed during the measurement process of the DUTs.

B.3 Calibration of Test System

B.3.1 Calibration Procedure for Anechoic-chamber based methodologies

The calibration procedure is composed of following three steps.

1. Probe power calibration
2. Channel power calibration
3. Calibration check

B.3.1.1 Probe power calibration

The test system shall be calibrated using the setup in Figure B.3.1-1. The UE is replaced by a reference antenna (shown in green) with known gain characteristics. A CW non-faded calibration signal is fed to one probe at a time and received by the reference antenna. Based on the known properties of the reference antennas, the pathloss from the input of the fading emulator to the UE location will be calculated.

The settings (except fading model) of the channel emulator during the calibration and measurement phases should be identical. The channel model used in the calibration is static propagation conditions (1 tap, no fading, maximum channel output power). Signal is routed to one antenna probe at a time. Each path (antenna probe) is calibrated separately.

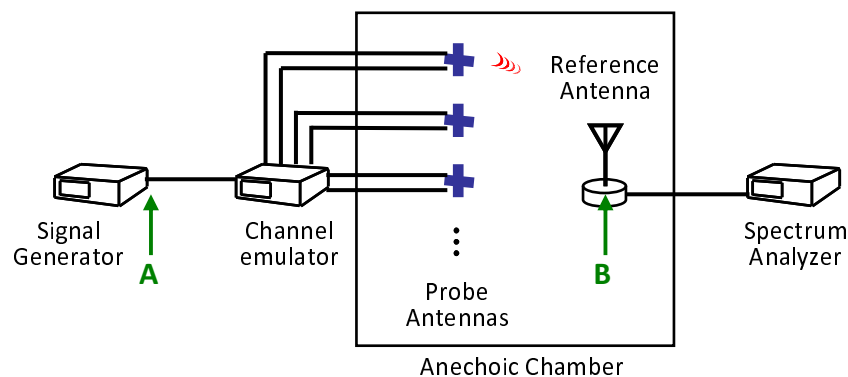

Figure B.3.1-1: Probe Power Calibration Setup

The calibration steps are given as follows:

- 1) Measure the attenuation between points A and B (shown in Figure B.3.1-1) through the antenna probe. Point A is the input to the channel emulator and point B is the UE location represented by the reference antenna for the first polarization. The reference antenna has to be aligned with the antenna probe in order to have the antenna probe within the main lobe of the reference antenna, and with the correct polarization.
- 2) Calculate pathloss compensation factor as below:

$$Path_{compensation_i} = Attn_i - \max(Attn)$$

where

$Path_{compensation_i}$ is the compensation factor for antenna probe i to be adjusted by channel emulator.

$Attn_i$ is the measured attenuation via antenna probe i , and,

$\max(Attn)$ is the highest attenuation over all antenna probes.

- 3) Adjust the channel emulator outputs by the compensation factor.
- 4) Calculate the pathloss of each route as follows:

$$Pathloss = \max(Attn) - G_{ref\ antenna}$$

where $G_{ref\ antenna}$ is the reference antenna gain.

- 5) Repeat the above procedure for the other polarization.

B.3.1.2 Channel power calibration

During the calibration phase the static propagation channel condition is used with one probe antenna at a time. For the measurement phase using faded channel conditions, the signal is transmitted via several probe antennas at a time. Therefore, the per-path calibration information gained from the pathloss measurements needs to be used to adjust the signal level when using multiple antennas and a fading channel.

The composite loss is the loss between point A and point B, as shown in Figure B.3.1-2. The average channel power is defined as the measured signal power level in the center of the probe array (Point B) using an omnidirectional reference antenna for the vertical or the horizontal polarization respectively. The power at location B is the sum of signal powers via a number of calibrated probe antennas and averaged over 30 seconds. The total power should be determined for each channel model, and polarization separately. The average channel power at Point B is also the eNodeB Emulator output power (Point A) minus the composite loss. The average channel power at the reference antenna for both vertical and horizontal polarization should be set as the target received power respectively, for example -60 dBm for the initial power for each polarization.

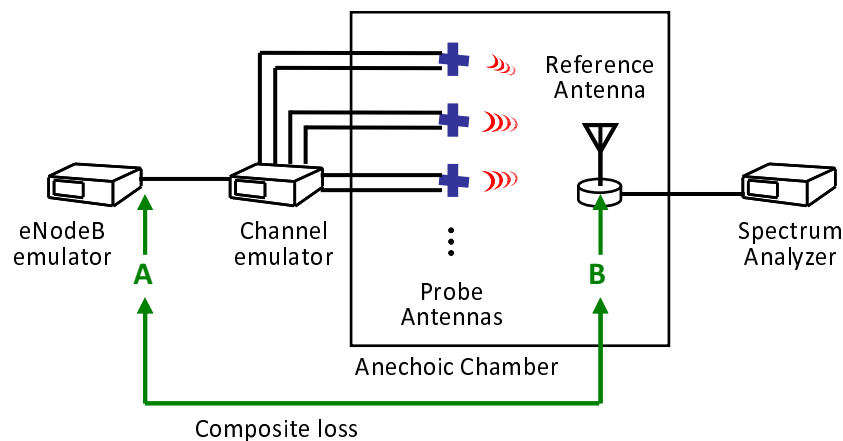

Figure B.3.1-2: Channel Power Calibration Setup

B.3.1.3 Calibration check

In order to verify that each antenna probe has been properly calibrated, a UE sensitivity measurement is performed for each antenna probe using the static propagation channel model. The result of this check can be used to verify that the probe antennas have been properly calibrated.

The test system is configured as in Figure B.1-1 according to the test procedure described in the 'Test Procedure' section below, but with the following exceptions:

- 1) The channel model is a single tap and non-faded (AWGN) channel.

2) Only one probe antenna is used at a time.

Rotate the UE using an angle step, θ of 45° and measure the UE reference sensitivity. For each antenna probe and angle of step, θ , and polarization, record the UE reference sensitivity in Table B.3.1-1.

Table B.3.1-1: Calibration check table

Reference sensitivity/Angle	Path 1 [dBm]	Path 2 [dBm]	Path 3 [dBm]	Path 4 [dBm]	Path 5 [dBm]	Path 6 [dBm]	----	Path n [dBm]
0°								
45°								
90°								
135°								
180°							---	
225°								
270°								
315°								
Path Average								

$$PathAverage_{\theta} = 10 * \log_{10} \left(\frac{N_{\theta}}{\sum_{\theta} 1/10^{(Path_{\theta}/10)}} \right)$$

where θ is the rotation angle,

$N_{\theta} = 8$ for angle step of 45° , and,

$Path_{\theta}$ is the recorded reference sensitivity for each angle step θ .

The pathloss compensation is considered successful if the path average results are within ± 1 dB.

B.3.2 Calibration Procedure for Reverberation-chamber based methodologies

The calibration of reverberation-chamber based methodologies should be based on Appendix E.3 in [11], which has been devised to support SISO-type device OTA measurement.

For MIMO OTA, additional considerations on calibration procedure of reverberation-chamber based methodologies should be made. The S-parameters should be obtained using the standard vector network analyser that can support multiple port connections. These S-parameters are

$$S_{11}(i, n), S_{22}(i, n), S_{21}(i, n) \quad \text{for } n = 1, 2, 3, \dots, N$$

for i^{th} measurement antenna installed inside the chamber. N is the total number of stirrer positions.

During the calibration, several essential parameters should be recorded: Chamber Q-factor or average power received from a lossless antenna, propagation channel-related parameters such as RMC delay, coherence bandwidth and Doppler spread. A proposed calibration setup for reverberation chamber type methodologies is shown in Figure B.3.2-1.

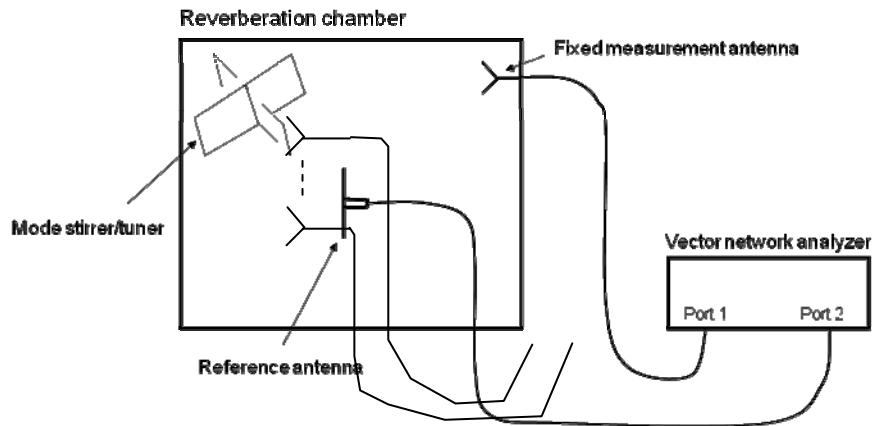

Figure B.3.2-1: Generic setup for calibration measurement in reverberation chamber

B.3.2.1. Tuning Reverberation Chamber to Specific Channel Model

Since the power-delay-profile (PDP) in a reverberation chamber can take the shape of exponential decay, the RMS delay spread is the only parameter needed to characterize the chamber PDP. From calibration data the RMS delay spread of the current setup can be calculated. This should be used to tune the RMS delay spread to what is specified.

For tuning of the reverberation chamber to a specific radio channel condition, the RMS delay spread can be calculated in either of two ways. The first alternative is the direct method where the frequency response of the chamber is Fourier transformed to the time domain and a standard calculation of RMS delay spread is performed on the time domain data. The second alternative is the simplified method where the relationship between RMS delay spread, coherence bandwidth, and average power transfer function of the chamber is used. The relationship between RMS delay spread and average power transfer function of the chamber is given by

$$\sigma_{\tau} = \frac{8\pi f^2 V G_{ch}}{c_0^3}$$

B.3.2.2.1 Reverberation Chamber Combined with Channel Emulator

For the case when a channel emulator is used in combination with a reverberation chamber, the total power available for the UE is dependent on the output power available from the channel emulator.

The calibration of the reverberation chamber part of the system should be carried out as stated in the section above about calibration of the reverberation chamber only. The total path loss should then be adjusted so as to appropriately account for the channel emulator path loss.

B.3.2.2 Average Path Loss Measurement

Based on Figure B.3.1-3 and Appendix E.3 in **Error! Reference source not found.**[11], the following calibration procedure can be used:

- 1) Place all objects, which will be used during the measurements, into the RC. These objects could include a head phantom, hand phantom and fixture for the EUT, if applicable. The purpose of this step is to ensure that the loss in the chamber is the same during both calibration and measurements later.
- 2) Place the calibration or reference antenna inside the RC. The calibration antenna is preferably mounted on a low-loss dielectric fixture, to avoid effects from the fixture itself which may affect the EUT's radiation efficiency and mismatch factor. The calibration antenna must be placed in the chamber in such a way that it is far enough from any walls, mode-stirrers, head phantom, or other object, such that the environment for the calibration antenna (taken over the complete stirring sequence) resembles a free space environment. 'Far enough away' depends on the type of calibration antenna used. For low-gain, nearly omni-directional antennas like dipoles it is normally sufficient to ensure that this spacing is larger than 0.5 wavelengths. More directive calibration antennas should be directed towards the center of the chamber.

- 3) Connect the first fixed measurement antenna and measure the S-parameters between port of fixed measurement antenna and the calibration antenna. The network analyser should be calibrated (by manufacturer) so that the S-parameter can be measured accurately.
- 4) Repeat Step 3 for each stirrer position and carrier frequency.
- 5) Connect the next fixed measurement antenna and repeat Step 3 – 4.
- 6) Repeat Step 5 until all the fixed measurement antennas have been installed and calibrated in the chamber.

Note that the frequency dependency of the S-parameters is suppressed in this formulation. The number of stirrer positions N in the chosen stirring sequence, i.e. the number of S-parameter samples at each frequency point, should be chosen in such a way that it is large enough to yield an acceptable statistical contribution to the total measurement uncertainty. As a guideline it should be in the range of 200 – 400 to ensure that the number of independent samples is not severely limited by the total number of samples measured. The number of independent samples, which is a subset of all samples, determines the statistical contribution to the expanded measurement uncertainty. This should be larger than 100 to ensure an expanded uncertainty less than 1 dB.

Note also that the number of independent samples depends on the frequency, size of chamber, quality of stirrers, the level of loading by absorbing objects, and whether or not frequency stirring is used. A good chamber can provide 100 independent samples down to a lower frequency of operation than a bad chamber. The sequence of moving the stirrers to different positions may be either step-wise (stopping stirrer for each sample) or continuous (sampling on-the-fly). With continuous stirring it may not be possible to characterize the chamber over a wide frequency band at the same time.

An uplink signal amplifier may be required to ensure good isolation between Tx and Rx port of eNodeB emulator.

B.3.3 Calibration Procedure for 2-Stage methodologies

B.3.3.1 Antenna pattern measurement calibration in stage I

The DUT antenna patterns are measured in a calibrated certified anechoic chamber. The anechoic chamber constraints can be found in Annex A.2 in [4]. The preferred measurement is based on the assumption that the chipset in device has the capability to support amplitude and relative phase measurements of the antennas. Less integrated devices such as those providing cabled access to the antenna and receiver After the antenna pattern measurement using non-intrusive methods as described in B.4.3, the antenna pattern absolute gain calibration is carried out by using a reference dipole with known gain to measure the path loss, which means that the path loss is calibrated out from the measured pattern. The detailed path loss L_{total} calibration process is as below, which is from Annex B in [4].

Path loss calibration process

L_{total} is the attenuation between P and B, see figure B.3-1.

$$L_{total} = (L_{AB} - L_{AC} + E_{cal})$$

Where L_{AC} is cable loss from A to B. The cable AC connecting the substitution antenna should be such that its influence upon radiation pattern measurements is minimal. L_{AB} is the attenuation between points A and B. E_{cal} is the efficiency or gain of the calibration antenna at the frequency of interest.

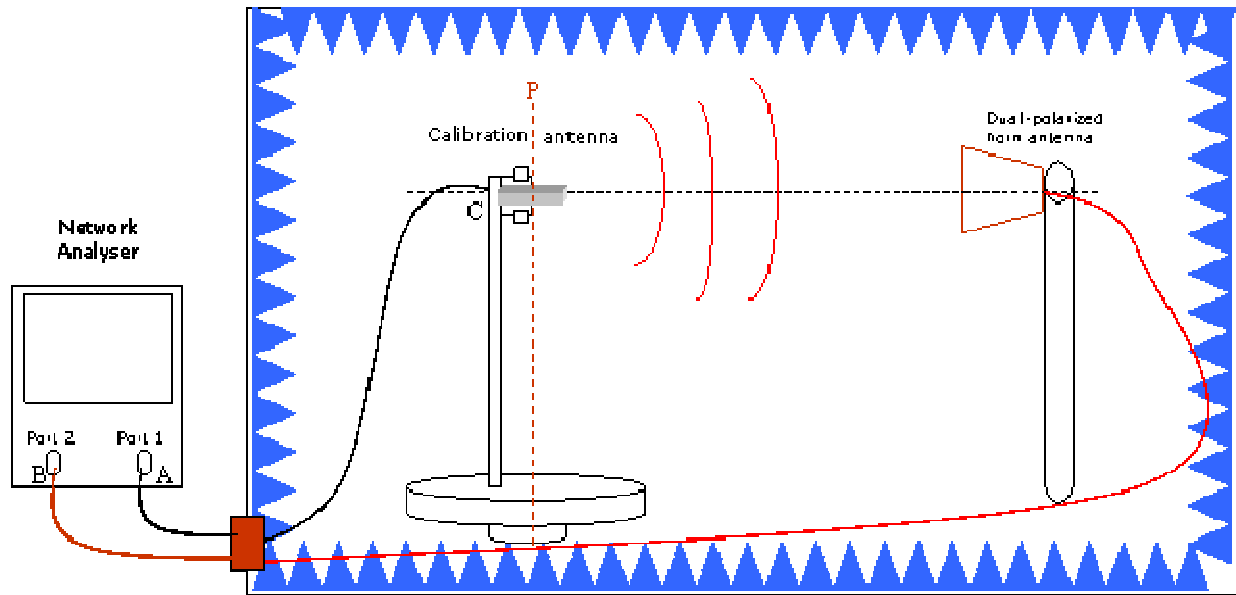

Figure B.3.3.1-1 Calibration/substitution procedures using a vector network analyzer from Annex B in TS 34.114 V.9.0.0

If the calibration is based on known efficiency of the calibration antenna, a full spherical scanning is performed to determine L_{AB} .

This procedure has to be done at each frequency of interest.

To achieve measurements with an uncertainty as low as possible, it is absolutely necessary to exactly keep the same P to B configuration (cables, dual-polarized antenna and cables positions, etc).

Calibration shall be performed yearly or if any equipment in the measurement system is changed.

B.3.3.2 Antenna pattern change compensation

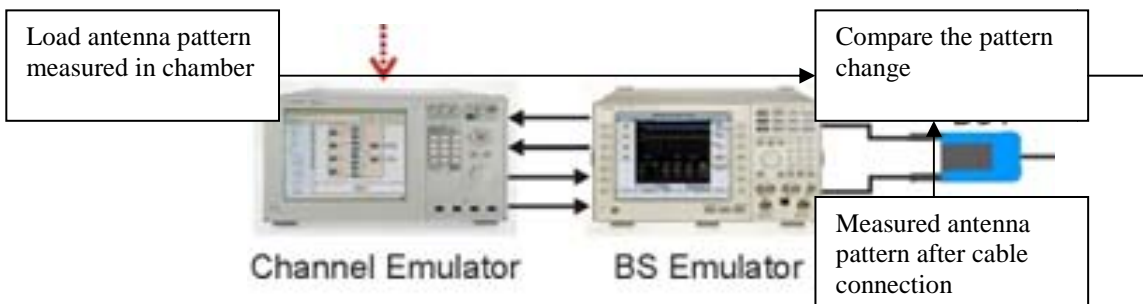

Figure B.3.3.2-1 Calibration antenna pattern change introduced by test platform

Compensate the pattern change
 throughput measurement in stage II, we should calibrate out the antenna pattern change introduced
 calibration process is below:
 1) Set up the conducted throughput test platform as shown in Figure B.3-2.

- 2) Load antenna pattern measured in chamber into channel emulator, and configure the channel to one Line of Sight (LOS) path without fading.
- 3) Using device's non-intrusive pattern measurement capability to measure the emulated pattern under this connection and compare this result with the loaded one to get the pattern change introduced by test platform

- 4) Compensate the pattern change from the original pattern file to get the calibrated pattern file, and make sure the measured pattern from this test platform is same as that measured in the chamber. Assume the original pattern measured in chamber is A, and the measured emulated-pattern under cable connection in step 3 is B, then the compensated pattern should be $A + (A - B)$

B.3.3.3 Power calibration for results comparison from different OTA test methods

To meaningfully compare the throughput results for different MIMO OTA test methods, it is essential to ensure the incident power level is independent of the test method. Using the multi-probe test method as an example: the reference power is defined as the total received power on the minimum sphere surface surrounding the DUT antenna. The transmitted power is measured from the i^{th} probe antenna over all N antennas as P_i , and the measured path loss between each probe antenna and the DUT as P_{loss} (this method can be found in Vodafone, 'Detailed Test Plan of MIMO/multiple receiver antennas OTA measurement campaign for COST2100 and CTIA'). The total received power on the minimum sphere surface surrounding the DUT antenna is $\sum_{i=1}^N P_i - P_{\text{loss}}$. To compare the two-stage method results with the multi-probe method, the power at the temporary antenna connectors is set to be the same as would have been received when using the multi-probe method.

B.3.4 Calibration Procedure for antenna pattern based methodologies

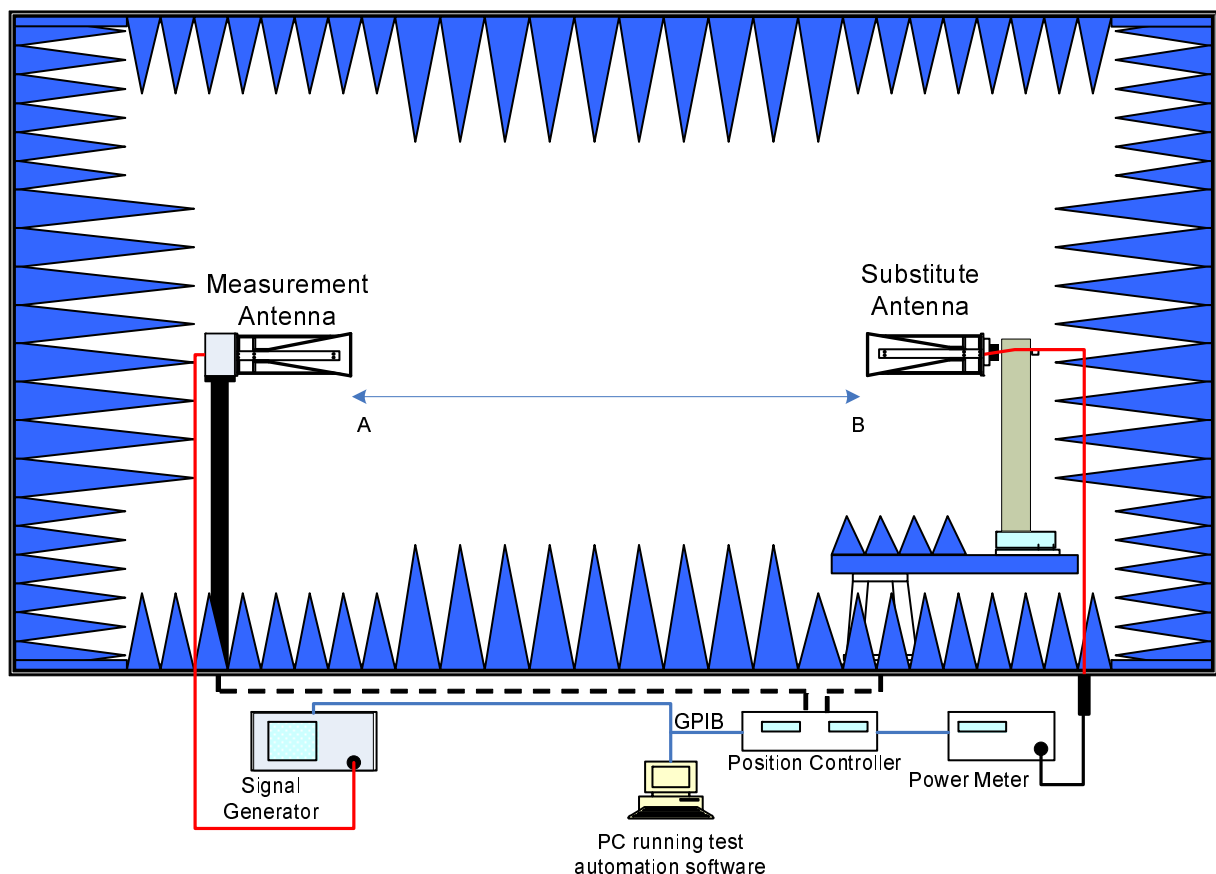

Figure B.3.4-1: Generic setup for calibration measurement in anechoic chamber

- 1) Set up: An anechoic chamber with signal generator, reference antenna supporting the test frequencies of interest, probe antenna as shown in Figure B.3.4-1. Free space path loss from point A to point B can be measured using measurement methods described in CTIA OTA Test Plan version 3.0, section 4 [2].

- 2) The UE is replaced by a reference antenna with known gain characteristics. A CW non-faded calibration signal is fed to the probe antenna and received by the reference antenna. Based on the known properties of the reference antenna, the pathloss from the input of the the UE location will be calculated.
- 3) Repeat this measurement for both horizontal and vertical polarization path losses and record these values. Use these values to account for the path loss from the Node B emulator to the DUT.

B.3.5 Calibration Procedure for two-channel method

The calibration in the case of candidate solution 4 (two-channel method) is similar to the calibration of power levels in the SISO case. Attenuation of cables as well as free space attenuation are measured to determine the path loss between an RF output of the eNodeB emulator and the output of an ideally isotropic radiator placed at the centre of the quiet zone. The radiator is co-polarized with the utilized test antenna. The measurement can be achieved using a signal generator, a power meter and a calibrated reference antenna, for example.

The attenuation values obtained by means of this method are then used in the following way:

For the power level at the quiet zone due to antenna 1, the power level of the eNodeB emulator is taken and the total attenuation for that path is subtracted in order to obtain the power level at the UE's position. Since there are usually different paths involved, one for each polarization, the correction for the appropriate polarization has to be taken.

The power level at the quiet zone due to antenna 2 then is set to the same level by adjusting the power level in the eNodeB emulator. The power level going into the first antenna is taken and shifted by the difference in attenuations of the two paths involved.

The resulting uncertainty is determined by the uncertainty of the attenuation measurement and the uncertainty of the eNodeB emulator output.

B.4 Test Procedure

B.4.1 Test Procedure 1

The following test procedure is used to measure MIMO throughput and CQI given in Table B.2.1-1. The FOM is measured by varying the average channel power. The steps for doing that are shown below:

- 1) Set up fading test conditions defined in section B.2 and appropriate probe antenna polarizations.
- 2) Establish an LTE connection according to [12] with the UE in angular position 0 degrees.
- 3) Ensure and check that the eNodeB emulator behaviour is according to Table B.2.4.1-1.
- 4) Set eNodeB emulator parameters according to Table B.2.4.1-2 depending on the DUT type.
- 5) Set up number of subframes to 2000, and repetition to 'Single Shot'.
- 6) Adjust the average channel power to a level approximately 1 dB higher than the point where throughput degradation starts to occur. Record this power level.

Throughput is calculated with the following formula:

$$\text{Throughput} = \frac{\text{Transmitted TBS} \times \text{No. of ACKs}}{\text{MeasurementTime}}$$

- 7) Measure the FOM and record the FOM result in a new row below row #21, as shown in Table B.4.1-1
- 8) Reduce the power level in steps of 0.5 dB and record the throughput / power levels accordingly, until the throughput value is less than 10 % of the maximum throughput of step 6.
- 9) Rotate the DUT by θ degrees and repeat steps 6 to 8 until all rotation angles have been measured
- 10) Calculate the average value of the FOM for each power step over all rotation angles.

Table B.4.1-1: Throughput and CQI FOM result table

Row	Col A	Col B	Col C	Col D	Col E	Description
1	Setup ID					An identifier that indicates the conditions of the test setup; this ID is unique for each measurement result submitted by a company
2	Lab	R&S				lab where the test has been made (text)
3	ID	10001				unique identifier of form nnnmmm; nn is the lab, mmmm is consecutive number freely assigned by the lab nn (see schedule): 01=R&S, 02=SATIMO, 03=Nokia, 04=EMITE, 05=Bluetest, 06=ETS-Lindgren, 07=Azimuth 08=Spirent, 09=Qualcomm, 10=NTT DCM, 11=Agilent, 12=Huawei, 13=CATR, 14=Samsung
4	Method	2-chan				any of anechoic, reverb, 2-chan, 2-stage
5	Ch model	0	TR 37.976 6.2-2			Column B may be any of Umi, Uma; 0 means no additional channel model. Column C defines the channel model drop (e.g. specific reference to TR 37.976)
6	Test ant.	2				number of test antennas * polarizations; e.g. 8 dual-pol antennas with 16 signals --> 16
7	Constellations	10° to 150°	averaged			circle, cluster, any other information describing the test antenna constellations if col C contains "averaged", data are taken for different constellations and are then averaged
8	Polarization	4 comb.	averaged			hor, ver, hor+ver (2 signals per antenna), n/a, 4 comb. 4 comb: one measurement for each of h+h, h+v, v+h, v+v, and then averaged
9	Positions	7	averaged or elevation & azimuth			number of UE positions / antenna relocations (typically 8) Column C specifies if FoM was averaged over all positions or if the data specifies elevation and azimuth information
10	eNodeB	CMW500	SW ver	HW ver	FW ver	CMW500, MT8820C, ... Columns C, D, E: SW, HW, FW versions respectively
11	Modulation	16QAM				16QAM or 64QAM, all other parameters as per table B.2.4.1-2 of TR 37.976
12	Subframes	2000				number of subframes for averaging the throughput values
13	Host	E6400	p1			E6400 or D430, col c = p1 (pool 1) or p2 (pool 2) etc.
14	UE	E398	p1ue2			E398 (Huawei) / B3710, B3740 (Samsung GT-...), AL621 (ZTE), ... col c: p1ue1=E398, p1ue2=B3740, p1ue4=B3710; p2ue1=E398, p2ue4=B3710, p2ue2=AL621; p3ue1=E398, p3ue2=AL621
15	Orientation	vertical				UE arrangement: horizontal, vertical, Styrofoam, see fig.
16	UE Ant	internal				internal, external (in this case use col c for additional info like "crosspol", "copol" etc.)
17	Comments					short comment or reference to footnote or to other location for additional information
18	Legend	Huawei E398				will be the data set name in the legend
19						this row intentionally left blank
20	Level	Throughput	TP rel	Az. Ang.	Ev. Ang.	Headers for the signal level, throughput, relative throughput, azimuth angle, and elevation angle columns of data
21	dBm	kBit/s	%	degree	degree	Units for each column of data

For comparison purposes the same test should be made using an external antenna. The connection to the modem is done by means of short cables. See figure B.4.1-1 how the mounting of the antenna shall be made.

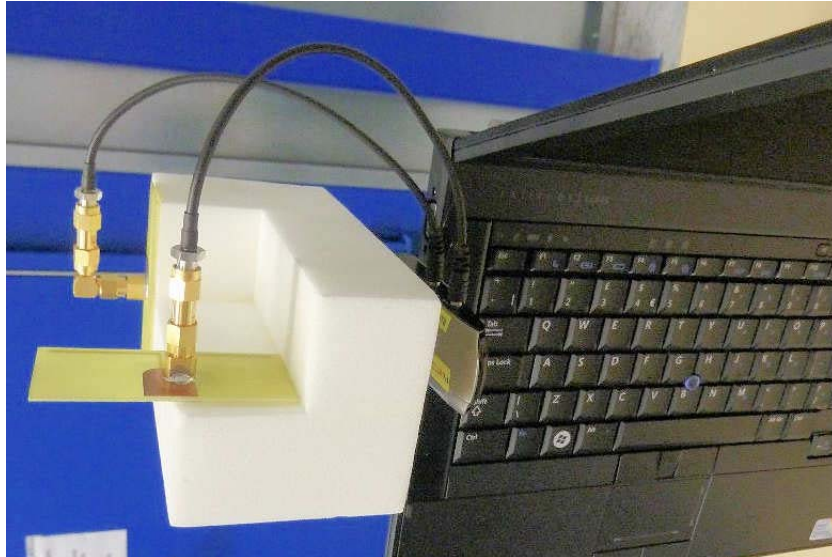

Figure B.4.1-1: Mounting of external antenna on USB modem

In addition a test in conducted mode has to be made with similar settings, but of course using the much smaller attenuation of the conducted setup.

B.4.1A Test Procedure 1A (Reverberation Chamber Based Methodologies)

1. Set up the fading conditions defined in Section B.2.
2. Set the eNodeB behavior according to Table B.2.4.1-2.
3. Establish a connection according to the settings called for in [12] with the UE placed in the chamber.
4. Adjust the output power so that the average power available for the UE is equal to [-50 dBm].
5. Measure the average throughput during a full mode-stirrer sequence, with either step-wise or continuous stirrer movement:
 - Step-wise stirring: Sample the throughput in each fixed stirrer position by using 50 frames for each sample, then calculate the average over the complete set of samples. The number of samples should be 150 or more.
 - Continuous stirring: Set the number of subframes to [5000] and make the stirrers to move continuously for as long as it takes to measure the throughput for this number of frames.

Throughput is calculated with the following formula:

$$\text{Throughput} = \text{Transmitted blocks size} \times (\text{Number of blocks acknowledged} / \text{Measuring time})$$

6. Repeat steps 6 and 7, each time with a 2 dB lower output power of the eNodeB until the average throughput is equal to zero or measurement cannot be continued due to disconnection of the UE.
7. Record the average power setting and the average throughput measurement at each repetition of steps 6 and 7.

B.4.2 Test Procedure 2

The following test procedure is used to measure TRS/TIS given in Table B.2.1-1. Detailed steps are FFS.

B.4.3 Test Procedure 3 (Antenna spatial correlation measurement)

The following test procedure is used to measure Spatial correlation, given in Table B.2.1-1.

For the purposes of the antenna amplitude and relative phase measurement the conditions under which the measurements are required to operate are in the received power range of REFSENS + 10 dBm or higher in a static channel with one dominant angle of arrival. The amplitude and phase measurements should be computed from the same period of time which should be sufficient for the result to represent the power and phase of the static signal, with an upper limit of [10] ms is provisionally proposed FFS. An absolute power accuracy of +/- [6] dB is considered sufficient for this study phase investigation and the figure for relative phase accuracy is [2] degrees.

The test setup is according to Figure B.2.4.

eNodeB Emulator Parameter Settings

The eNodeB emulator parameters are set according to the type of DUT to be tested.

Table B.4.3-1: Test Parameters for Channel Bandwidths

Test Parameters for Channel Bandwidths						
Ch BW	Downlink Configuration			Uplink Configuration		
	Mod"n	RB allocation		Mod"n	RB allocation	
		FDD	TDD		FDD	TDD
1.4MHz	QPSK	6	6	QPSK	6	6
3MHz	QPSK	15	15	QPSK	15	15
5MHz	QPSK	25	25	QPSK	25	25
5MHz	QPSK	25	N/A	QPSK	20	N/A
10MHz	QPSK	50	50	QPSK	50	50
10MHz	QPSK	50	N/A	QPSK	25	N/A
10MHz	QPSK	50	N/A	QPSK	20	N/A
15MHz	QPSK	75	75	QPSK	75	75
15MHz	QPSK	75	N/A	QPSK	50	N/A
15MHz	QPSK	75	N/A	QPSK	25	N/A
20MHz	QPSK	100	100	QPSK	100	100
20MHz	QPSK	100	N/A	QPSK	75	N/A
20MHz	QPSK	100	N/A	QPSK	50	N/A
20MHz	QPSK	100	N/A	QPSK	25	N/A

Note 1: Test Channel Bandwidths are checked separately for each E-UTRA band, which applicable channel bandwidths are specified in Table 5.4.2.1-1 of TS36.521-1.

Note 2: Depending on E-UTRA band, only the appropriate Uplink RB allocation value according to table 7.3.3-2 is tested per Test Channel Bandwidth. TS36.521-1

Note 3: For the DL signal one sided dynamic OCNG Pattern OP.1 FDD/TDD is used.

- 1) Set initial position of DUT with respect to probe antenna.
- 2) Set up eNode B conditions defined in Table B.4.3-1, as per section 7.3.4.1 of [12].
- 3) Set the downlink signal level to REFSENS + 45 dB, above reference sensitivity level of DUT.
- 4) Inner loop power control shall be enabled for the uplink.
- 5) Establish an LTE connection according to 3GPP 36.521-1 section 7.3.4.2 of [12].
- 6) Enable the DUT to measure complex antenna pattern data, Received for each DUT receive antenna and the relative phase between the antennas.

The details of the received signal strength and phase measurements are to be elaborated but at this time it is assumed that these are based on the downlink RS as a non-limiting example.

[editor's note: Details for complex antenna pattern data, Received Signal Strength (RSS) and phase and how their obtained are FFS. Further details shall be provided before test plan for this candidate method can progress]

- 7) Rotate the DUT/antenna probe to measure complex antenna pattern data over a spherical space around the DUT. Data points are taken every 3 degrees in theta (θ) and phi (ϕ).
- 8) Linearize the RSS pattern measurements using the procedure in section 6.16.2 of [9]. The downlink signal strength in shall be adjusted as needed.
- 9) Extract the measured complex antenna pattern data per each measured theta (θ) and phi (ϕ) position.
- 10) Calculate the antenna correlation coefficient ρ_e . For each theta (θ) and phi (ϕ), indexed as i and j for discrete elevation and azimuth positions, the antenna correlation coefficient, ρ_e can be calculated using the following expressions:

For antenna pair (1, 2),

$$\rho = \frac{R_{12}}{\sqrt{\sigma_1 \cdot \sigma_2}}, \text{ where}$$

$$R_{12} = \sum_{j=1}^{N\phi} \sum_{i=1}^{N\theta} (XPR \cdot E_{\theta_1^{i,j}} \cdot E_{\theta_2^{i,j}}^* \cdot P_{\theta^{i,j}} + E_{\phi_1^{i,j}} \cdot E_{\phi_2^{i,j}}^* \cdot P_{\phi^{i,j}}) \cdot \sin \theta \cdot \Delta \theta \cdot \Delta \phi$$

$$\sigma_1 = \sum_{j=1}^{N\phi} \sum_{i=1}^{N\theta} (XPR \cdot E_{\theta_1^{i,j}} \cdot E_{\theta_1^{i,j}}^* \cdot P_{\theta^{i,j}} + E_{\phi_1^{i,j}} \cdot E_{\phi_1^{i,j}}^* \cdot P_{\phi^{i,j}}) \cdot \sin \theta \cdot \Delta \theta \cdot \Delta \phi$$

$$\sigma_2 = \sum_{j=1}^{N\phi} \sum_{i=1}^{N\theta} (XPR \cdot E_{\theta_2^{i,j}} \cdot E_{\theta_2^{i,j}}^* \cdot P_{\theta^{i,j}} + E_{\phi_2^{i,j}} \cdot E_{\phi_2^{i,j}}^* \cdot P_{\phi^{i,j}}) \cdot \sin \theta \cdot \Delta \theta \cdot \Delta \phi$$

Where:

- XPR = cross-polarization ratio (P_V/P_H)
- P_θ and P_ϕ are the incident field power densities from the assumed channel model
- $\Delta\theta$ and $\Delta\phi$ are the measurement angular increments
- $N\theta$ and $N\phi$ are the number of angular measurement points in θ and ϕ assuming the measurement is made over a sphere of angles.
- θ varies from 0 to π , and ϕ varies from 0 to 2π .

And the the antenna correlation coefficient is $\rho_e = \frac{|R_{12}|^2}{\sigma_1 \cdot \sigma_2}$

B.4.4 Test Procedure 4 (Two-stage throughput)

The following test procedure is used to measure OTA throughput and CQI given in Table B.2.1-1 using the two-stage method.

The FOM is measured by varying the average channel power. Here the power is not the output power from channel emulator, but is the total received power on the minimum sphere surface surrounding the DUT antenna, it does not include antenna gain's influence, which is same as that in multi-probe method and does not require averaging over angle rotation. The steps are shown below:

- 1) Measure the amplitude and phase patterns of each element of the DUT antenna array as defined in B.4.3 and store the results. The path loss calibration as described in section B.3.4 also should be done in this step.
- 2) Connect the equipment as shown in Figure B.2-3.
- 3) Load the measured antenna patterns into the channel emulator, and configure the desired MIMO channel model defined in section B.2.
- 4) Configure the eNodeB emulator and establish an LTE connection according to Vodafone, 'Detailed Test Plan of MIMO/multiple receiver antennas OTA measurement campaign for COST2100 and CTIA with the UE.
- 5) Perform the antenna pattern calibration described in section B.3.2 to compensate the pattern change introduced by the test platform, and make sure after this calibration the emulated pattern from this test platform is same as that measured in step 1)
- 6) Ensure and check that the eNodeB emulator behaviour is according to Table B.2.3.1-1.
- 7) Set eNodeB emulator parameters according to Table B.2.3.1-2 depending on the DUT type.
- 8) Set up number of frames to 5000, and repetition to 'Single Shot'.
- 9) Switch on the inner loop power control and ensure power continuously up.
- 10) Adjust the output power of the channel emulator to achieve roughly 50% of the maximum throughput and record this power level. The reference power, which is defined as the total received power on the minimum sphere surface surrounding the DUT antenna, can be deduced by using this power minus antenna gain and power loss between channel emulator output port and DUT temporary antenna connectors.

Throughput is calculated with the following formula:

$$\text{Throughput} = \frac{\text{Transmitted TBS} \times \text{No. of ACKs}}{\text{Measurement Time}}$$

Transmit Block Size (TBS): defines the transmitted bit number in each block. If there is a reference power available from a different test method, then perform the reference power calibration as described in B.3.2. In this case the throughput measured for the two-stage method can be meaningfully compared with the throughput for other methods.

- 11) Set the power to 8 dB below the power level used in step 10.
- 12) Measure throughput and the Channel Quality Indicator (CQI) for each DUT rotation angle in steps of 45 degrees. The DUT rotation is emulated from within the channel emulator by rotating measured antenna pattern.
- 13) Increase the average channel power by 2 dB and repeat step 12 until measurements have been completed at 8 dB above the power level in step 9.
- 14) Calculate the average value of the FOM for each power step over all rotation angles.

Table B.4.1-1: Throughput and CQI FOM result table

Device Model					
Average channel power [dBm]	P1	P2	P3	---	P _n
Rotation Angle	FOM Result				
0°					
45°					
90°					
135°					
180°					
225°					
270°					
315°					
Average					

B.4.5 Test Procedure 5 for two-channel method

The following test procedure is used to measure MIMO throughput and CQI given in Table B.2.1-1. The FOM is measured by varying the PDSCH resource element power controlled via setting the RS EPRE power. The steps are similar to the ones in section B.4.1 but with some changes.

- 1) Set up the paths to the antennas / polarizations to be used for this test, and select an antenna distance ($\theta_2 - \theta_1$).
- 2) Establish an LTE connection according to [12] with the turntable at $\varphi = 0$ degrees and with antenna 1 at $\theta_1 = 0$ degrees.
- 3) Set eNodeB emulator parameters according to Table B.2.4.1-2.
- 4) Set up number of subframes to 2000, and repetition to 'Single Shot'.
- 5) Adjust the power of PDSCH resource elements to a level approximately 1 dB higher than the point where throughput degradation starts to occur. Record this power level.

Throughput is calculated with the following formula:

$$\text{Throughput} = \frac{\text{Transmitted TBS} \times \text{No. of ACKs}}{\text{Measurement Time}}$$

- 6) Measure the FOM and record the FOM result.
- 7) Reduce the power level in steps of 0.5 dB and record the throughput / power levels accordingly, until the throughput value is less than 10 % of the maximum throughput of step 5.
- 8) Rotate the antennas by θ degrees and repeat steps 5 to 7 until all rotation angles have been measured
- 9) Calculate the average value of the FOM for each power step over all rotation angles.

Annex C (informative): Change history

Change history							
Date	TSG #	TSG Doc.	CR	Rev	Subject/Comment	Old	New
2009-03	R4#50bis	R4-091391			Skeleton report		0.0.1
2009-11	R4#53	R4-094953			Agreed Text Proposals in RAN4#51bis: R4-092515, 'Test Methodology for MIMO OTA', Spirent Communications R4-092438, 'Text Proposal for MIMO OTA report', Elektrobit Editorials: References to RAN4 tdocs are removed	0.0.1	0.0.2
2009-11	R4#53	R4-095027, R4-100926			Agreed Text Proposals in RAN4#52bis: R4-093944, 'TP for MIMO OTA TR on reverberation chambers methodology', Orange R4-093889, 'Text proposal to MIMO OTA TR for two-stage method', Agilent Technologies	0.0.2	0.1.0
2010-02	R4#54	R4-100997			R4-094266, 'MIMO OTA Text Proposal - 2 channel method', Rohde&Schwarz	0.1.0	0.2.0
2010-05	R4#55	R4-102194			Agreed Text Proposals in RAN4 AH#2 and RAN4#55: R4-101833, 'Revised skeleton of MIMO OTA TR 37.976', Vodafone. R4-101834, 'Revised TPs for MIMO OTA TR 37.976: Figure of Merits', Vodafone. R4-101835, 'Revised TPs for MIMO OTA TR 37.976: Operators Requirements', Vodafone. R4-101978, 'MIMO-OTA TR text update', Spirent Communications. R4-101437, 'Revised MIMO OTA work plan', Vodafone. R4-091405, 'MIMO OTA work plan', Vodafone.	0.2.0	0.3.0
2010-05	R4#55	R4-102246			Agreed text proposals: R4-100381, 'Text proposal to MIMO OTA TR for RF-controlled spatial fading emulator', Panasonic, Tokyo Institute of Technology R4-101979, 'MIMO OTA Channel Models', Spirent Communications, Elektrobit, Agilent Technologies, NTT-DoCoMo R4-102207, 'MIMO-OTA TP to TR 25-series MIMO OTA technical report (SNR definition)', Agilent Technologies R4-102237, 'Text proposal for 37.976: CE+RC Methodology', Azimuth Systems R4-102242, 'Text Proposal: MIMO OTA Methodology Comparison', Spirent Communications, Agilent Technologies, Qualcomm Incorporated, Elektrobit, Rohde&Schwarz, Azimuth Systems	0.3.0	1.0.0
2010-05	R4#55	R4-102357			Agreed text proposal (via email approval): R4-102241, 'TP: Test Plan for Anechoic Chamber based MIMO OTA methods', Elektrobit, Nokia, ETS-Lindgren, SATIMO, Spirent Communications, Agilent Technologies, Rohde&Schwarz, NTT DOCOMO, LG Electronics	1.0.0	1.1.0
2010-12	R4#57	R4-104803			Updates for MIMO OTA Study Item TR37.976 v1.1.0	1.1.0	1.2.0
2010-12	R4#57	R4-104883			Updates for MIMO OTA Study Item TR37.976 v1.1.0	1.1.0	1.2.0
2010-12	R4#57	R4-104950			Revised LTE MIMO-OTA test plan	1.1.0	1.2.0
2011-01	R4#57bis	R4-110525			TR 37.976 v1.2.1	1.2.0	1.2.1
2011-01	R4#58	R4-111529			TP Addition of test procedures for antenna-based metrics	1.2.1	1.3.0
2011-03	R4#58-AH	R4-11930			Incorporates the TPs approved in R4#58 R4-110645, 'TP to TR 37.976, detailing the two-channel method', Rohde & Schwarz R4-111616, 'TP to TR 37.976, changes to Annex B, eNodeB settings', Elektrobit, Rohde & Schwarz, NTT DoCoMo, Vodafone R4-111645, 'TP Addition to Antenna Pattern based Test Procedure', Qualcomm Incorporated, Agilent R4-111650, 'TP to TR 37.976, additions and corrections to Section 3.3 and Annex B', Rohde & Schwarz R4-111690, 'TP for 37.976: LTE MIMO OTA Test Plan for Reverberation Chamber Based Methodologies', Azimuth Systems, Bluetest, CTTC R4-111681, 'TP for TR37.976, corrections to Annex B', NTT DOCOMO R4-111682, 'TP: Text update for MIMO OTA candidate	1.3.0	1.4.0

				solution', Elektrobit		
2011-05	R4#59	R4-112505		Agreed Text Proposals: R4-112218, 'MIMO OTA work plan update ', Vodafone, NTT DoCoMo, Orange	1.4.0	1.5.0
2011-11	R4#61	R4-115903		Agreed Text Proposal: R4-114724, 'TP for defining the format of LTE MIMO OTA round robin data' Intel Corporation	1.5.0	1.6.0
2012-02	R4#62			Version 1.7.0 withdrawn		
2012-02	R4#62	R4-121108		Agreed text proposals from RAN4 #62: R4-120998 'TP for 3GPP TR 37.976 V1.6.0' The applicable Release is changed from 10 to 11.	1.6.0	1.8.0
2012-03	RP-55	RP-120271		Presentation to RAN for approval		1.8.0
2012-03	RP-55	RP-120271		Approved by RAN55	1.8.0	11.0.0
2014-09	SP-65	-	-	Update to Rel-12 version (MCC)	11.0.0	12.0.0
2016-01	SP-70	-	-	Update to Rel-13 version (MCC)	12.0.0	13.0.0

History

Document history		
V13.0.0	January 2016	Publication