

ETSI TR 136 922 V16.0.0 (2020-07)



**LTE;  
Evolved Universal Terrestrial Radio Access (E-UTRA);  
TDD Home eNode B (HeNB) Radio Frequency (RF)  
requirements analysis  
(3GPP TR 36.922 version 16.0.0 Release 16)**



---

Reference

RTR/TSGR-0436922vg00

---

Keywords

LTE

**ETSI**

650 Route des Lucioles  
F-06921 Sophia Antipolis Cedex - FRANCE

Tel.: +33 4 92 94 42 00 Fax: +33 4 93 65 47 16

Siret N° 348 623 562 00017 - NAF 742 C  
Association à but non lucratif enregistrée à la  
Sous-Préfecture de Grasse (06) N° 7803/88

---

**Important notice**

The present document can be downloaded from:

<http://www.etsi.org/standards-search>

The present document may be made available in electronic versions and/or in print. The content of any electronic and/or print versions of the present document shall not be modified without the prior written authorization of ETSI. In case of any existing or perceived difference in contents between such versions and/or in print, the prevailing version of an ETSI deliverable is the one made publicly available in PDF format at [www.etsi.org/deliver](http://www.etsi.org/deliver).

Users of the present document should be aware that the document may be subject to revision or change of status.

Information on the current status of this and other ETSI documents is available at

<https://portal.etsi.org/TB/ETSIDeliverableStatus.aspx>

If you find errors in the present document, please send your comment to one of the following services:

<https://portal.etsi.org/People/CommitteeSupportStaff.aspx>

---

**Copyright Notification**

No part may be reproduced or utilized in any form or by any means, electronic or mechanical, including photocopying and microfilm except as authorized by written permission of ETSI.

The content of the PDF version shall not be modified without the written authorization of ETSI.

The copyright and the foregoing restriction extend to reproduction in all media.

© ETSI 2020.

All rights reserved.

**DECT™**, **PLUGTESTS™**, **UMTS™** and the ETSI logo are trademarks of ETSI registered for the benefit of its Members.

**3GPP™** and **LTE™** are trademarks of ETSI registered for the benefit of its Members and of the 3GPP Organizational Partners.

**oneM2M™** logo is a trademark of ETSI registered for the benefit of its Members and of the oneM2M Partners.

**GSM®** and the GSM logo are trademarks registered and owned by the GSM Association.

---

# Intellectual Property Rights

## Essential patents

IPRs essential or potentially essential to normative deliverables may have been declared to ETSI. The information pertaining to these essential IPRs, if any, is publicly available for **ETSI members and non-members**, and can be found in ETSI SR 000 314: "*Intellectual Property Rights (IPRs); Essential, or potentially Essential, IPRs notified to ETSI in respect of ETSI standards*", which is available from the ETSI Secretariat. Latest updates are available on the ETSI Web server (<https://ipr.etsi.org/>).

Pursuant to the ETSI IPR Policy, no investigation, including IPR searches, has been carried out by ETSI. No guarantee can be given as to the existence of other IPRs not referenced in ETSI SR 000 314 (or the updates on the ETSI Web server) which are, or may be, or may become, essential to the present document.

## Trademarks

The present document may include trademarks and/or tradenames which are asserted and/or registered by their owners. ETSI claims no ownership of these except for any which are indicated as being the property of ETSI, and conveys no right to use or reproduce any trademark and/or tradename. Mention of those trademarks in the present document does not constitute an endorsement by ETSI of products, services or organizations associated with those trademarks.

---

# Legal Notice

This Technical Report (TR) has been produced by ETSI 3rd Generation Partnership Project (3GPP).

The present document may refer to technical specifications or reports using their 3GPP identities. These shall be interpreted as being references to the corresponding ETSI deliverables.

The cross reference between 3GPP and ETSI identities can be found under <http://webapp.etsi.org/key/queryform.asp>.

---

# Modal verbs terminology

In the present document "**should**", "**should not**", "**may**", "**need not**", "**will**", "**will not**", "**can**" and "**cannot**" are to be interpreted as described in clause 3.2 of the [ETSI Drafting Rules](#) (Verbal forms for the expression of provisions).

"**must**" and "**must not**" are **NOT** allowed in ETSI deliverables except when used in direct citation.

# Contents

Intellectual Property Rights .....	2
Legal Notice .....	2
Modal verbs terminology.....	2
Foreword.....	6
1 Scope .....	7
2 References .....	7
3 Definitions, symbols and abbreviations .....	7
3.1 Definitions .....	7
3.2 Symbols.....	7
3.3 Abbreviations .....	8
4 General .....	8
5 Radio scenarios .....	8
5.1 Deployment configurations .....	8
5.2 Interference scenarios.....	9
6 RF Aspects .....	10
6.1 Transmitter characteristics.....	10
6.1.1 HeNB output power .....	10
6.1.1.1 HeNB maximum output power .....	10
6.1.1.1.1 Analysis .....	10
6.1.1.1.2 Minimum requirement.....	11
6.1.1.2 HeNB output power for adjacent UTRA channel protection .....	11
6.1.1.3 HeNB output power for adjacent E-UTRA channel protection .....	12
6.1.2 Frequency error.....	13
6.1.2.1 Handover performance.....	13
6.1.2.2 Cell capacity.....	13
6.1.2.3 Timing.....	16
6.1.2.4 Minimum requirement .....	17
6.1.3 Adjacent Channel Leakage power Ratio (ACLR) .....	17
6.1.3.1 Minimum requirement .....	17
6.1.4 Operating band unwanted emissions .....	18
6.1.4.1 Minimum requirements.....	19
6.1.5 Spurious emissions .....	21
6.1.5.1 Mandatory requirements .....	21
6.1.5.2 Co-existence with HNB/HeNB operating in other bands.....	21
6.1.5.2.1 Minimum requirement.....	21
6.1.6 Transmitter intermodulation .....	22
6.1.6.1 Minimum requirement .....	23
6.2 Receiver characteristics .....	23
6.2.1 Reference sensitivity level .....	23
6.2.1.1 Uplink performance degradation of macrocell.....	23
6.2.1.1.1 Simulation setup .....	23
6.2.1.1.2 Simulation results .....	24
6.2.1.2 HeNB desensitization.....	25
6.2.1.3 Minimum requirement .....	27
6.2.2 Dynamic range.....	27
6.2.2.1 Deterministic analysis .....	27
6.2.2.2 System-level simulations .....	28
6.2.2.3 Minimum requirement .....	29
6.2.3 Adjacent channel selectivity (ACS) and narrow-band blocking .....	29
6.2.3.1 Simulation assumptions .....	29
6.2.3.2 Simulation results.....	30
6.2.3.3 Minimum requirements .....	31

6.2.4	Blocking characteristics .....	32
6.2.4.1	General blocking requirement .....	32
6.2.4.1.1	Minimum requirement .....	33
6.2.4.2	Co-location with other HNB/HeNB .....	34
6.2.5	Receiver Intermodulation .....	35
6.2.5.1	Analysis .....	35
6.2.5.2	Minimum requirement .....	35
6.2.6	In-channel selectivity .....	37
6.2.6.1	Analysis .....	37
6.2.6.2	Minimum requirement .....	37
6.3	Performance requirement .....	37
6.4	Synchronization requirement .....	38
6.4.1	Synchronization Accuracy .....	38
6.4.1.1	Synchronization error analysis .....	38
6.4.1.2	Synchronization requirement .....	39
6.4.2	Techniques for Synchronization .....	40
6.4.2.1	Synchronization using Network Listening .....	40
6.4.2.1.1	Interference Problems with Network Listening and Solutions .....	40
6.4.2.1.2	MBSFN Subframe based Network Listening .....	41
6.4.2.1.3	TDD Special Subframe based Network Listening .....	42
6.4.2.1.4	Indication of Stratum Level and Synchronization Status .....	45
6.4.2.1.5	Scheme Comparison .....	48
7	Interference control .....	48
7.1	HeNB measurements .....	48
7.1.1	Measurements from all cells .....	49
7.1.2	Measurements to identify surrounding cell layers .....	49
7.1.3	Measurements from macro cell layer .....	49
7.1.4	Measurements of other HeNB cells .....	50
7.2	HeNB self-configuration .....	51
7.2.1	Information Exchange between eNBs and HeNBs .....	51
7.3	Uplink interference control .....	53
7.3.1	Control Channel Protection .....	53
7.3.1.1	HeNB Uplink Control Channel Protection .....	53
7.3.1.2	Signalling offset over the backhaul .....	54
7.3.2	Smart Power Control based on Path Loss to Worst Victim Macro eNodeB .....	54
7.3.2.1	Power Cap Method .....	54
7.3.2.1.1	Simulation Assumptions .....	54
7.3.2.1.2	Simulation Results .....	55
7.3.2.1.3	Discussion of Results .....	58
7.3.2.2	Power Control based on PL from HUE to its serving HeNB and PL from HUE to its worst victim MeNB .....	58
7.3.2.2.1	Simulation Assumptions .....	58
7.3.2.2.2	Simulation Results .....	59
7.3.2.2.3	Discussion of Results .....	60
7.3.2.3	For Future Releases .....	60
7.4	Downlink interference control .....	60
7.4.1	Control Channel Protection .....	60
7.4.1.1	Control of HeNB downlink interference towards macro eNB control channels by frequency partitioning with per-subband interference estimation .....	61
7.4.1.2	Control of HeNB downlink interference among neighboring HeNBs control channels by frequency partitioning .....	62
7.4.2	Data Channel Protection .....	62
7.4.2.1	Control of HeNB Downlink Interference towards macro eNB data channels by frequency partition .....	62
7.4.2.2	Control of HeNB Downlink Interference among neighboring HeNBs .....	63
7.4.2.2.1	Centralized coordination .....	63
7.4.2.2.2	Distributed Dynamic Frequency Partitioning .....	64
7.4.2.3	Adaptive Frequency Selection .....	64
7.4.2.4	Downlink interference management based on mapping between PCIs and transmission patterns .....	65
7.4.2.5	Control of HeNB Downlink Interference by dynamically changing HeNB CSG ID .....	65
7.4.3	Power Control .....	66

7.4.3.1	HeNB power control based on HeNB-MUE path loss .....	66
7.4.3.2	Smart power control based on interference measurement from macro BS .....	67
7.5	Hybrid Cells .....	68
7.5.1	Hybrid Access Level of Service .....	68
7.5.2	DL Performance Evaluation .....	68
7.5.3	Hybrid Cell RB Resource Management.....	71
7.5.4	Hybrid Cell Power Management .....	72
<b>Annex A (informative):</b>	<b>Change History .....</b>	<b>73</b>
History .....		75

---

# Foreword

This Technical Report has been produced by the 3<sup>rd</sup> Generation Partnership Project (3GPP).

The contents of the present document are subject to continuing work within the TSG and may change following formal TSG approval. Should the TSG modify the contents of the present document, it will be re-released by the TSG with an identifying change of release date and an increase in version number as follows:

Version x.y.z

where:

- x the first digit:
  - 1 presented to TSG for information;
  - 2 presented to TSG for approval;
  - 3 or greater indicates TSG approved document under change control.
- Y the second digit is incremented for all changes of substance, i.e. technical enhancements, corrections, updates, etc.
- z the third digit is incremented when editorial only changes have been incorporated in the document.

---

# 1 Scope

The present document is the technical report for the work item on LTE TDD HeNB RF requirements, which was approved at TSG RAN#43. The objective of the WI is to first identify the relevant scenarios and then write an RF requirements specification that is applicable to LTE TDD HeNB.

---

# 2 References

The following documents contain provisions which, through reference in this text, constitute provisions of the present document.

- References are either specific (identified by date of publication, edition number, version number, etc.) or non-specific.
- For a specific reference, subsequent revisions do not apply.
- For a non-specific reference, the latest version applies. In the case of a reference to a 3GPP document (including a GSM document), a non-specific reference implicitly refers to the latest version of that document *in the same Release as the present document*.

- [1] 3GPP TR 21.905: "Vocabulary for 3GPP Specifications".
- [2] 3GPP TR 41.001: "GSM Release specifications".
- [3] 3GPP TR 21.912: "Example 2, using fixed text".
- [4] 3GPP TS36.211, "Physical Channels and Modulation".
- [5] 3GPP TS36.104, "Base Station radio transmission and reception".
- [6] 3GPP TS36.101, "User Equipment (UE) transmission and reception".
- [7] 3GPP TR 25 967 : "FDD Home Node B (HNB) RF Requirements".
- [8] 3GPP TR36.804, "Base Station (BS) radio transmission and reception".
- [9] 3GPP TR36.942, "Radio Frequency (RF) system scenarios".
- [10] 3GPP TR25.951, "FDD Base Station (BS) classification".
- [11] ITU-R Recommendation SM.329: "Unwanted emissions in the spurious domain".
- [12] ITU-R M.1225, Guidelines for evaluation of radio interface technologies for IMT-Advanced
- [13] 3GPP TS 36.213: "Physical layer procedures".

---

# 3 Definitions, symbols and abbreviations

## 3.1 Definitions

(Void)

## 3.2 Symbols

(Void)



## 3.3 Abbreviations

For the purposes of the present document, the abbreviations given in TR 21.905 [1] and the following apply. An abbreviation defined in the present document takes precedence over the definition of the same abbreviation, if any, in TR 21.905 [1].

HeNB	Home Enhanced Node B
HNB	Home NodeB
CSG	Closed Subscriber Group
GPS	Global Positioning System

---

## 4 General

This work item has the following objectives:

1. Specify the RF requirements for the E-UTRA TDD Home eNodeB in TS36.104 and the corresponding updates on the test specification in TS36.141. Some requirements could refer to the outcome of existing/ongoing related studies.
2. Investigate and find out effective interference control schemes to ensure good performance of both macro layer and HeNB. Although some of the studies could refer to UTRA HNB related work experience, e.g. deployment/interference scenarios, amount of studies are needed to find out the effective interference control schemes due to different physical techniques and system characters between E-UTRA and UTRA. The work should include but not be limited to the followings,
  - The operator has the means to obtain interference control related measurements reports from HeNB and/or HUE, e.g. the strength of signals and the identity from the macro cell layer and from other HeNBs.
  - The operator has the means to set the maximum output power and/or frequency of HeNB. This is expected to introduce changes to TS36.104.
  - The operator has the means to coordinate the HeNB and eNB timing and TDD configuration. This is expected to introduce changes to TS36.104.
  - The operator has guidance on how to control HeNB power and expected performance levels in the relevant scenarios.

The scope of this work item is limited to the LTE TDD mode.

---

## 5 Radio scenarios

### 5.1 Deployment configurations

In TR 25.967 [7], a number of different deployment configurations have been considered for FDD Home NodeB, including:

- Open access or CSG (Closed Subscriber Group)
- Dedicated channel or co-channel
- Fixed or adaptive (DL) maximum transmit power

For FDD or TDD Home eNodeB, the following deployment configuration should be considered in addition to the ones listed above:

- Fixed or adaptive resource partitioning

Specifically, the resource partitioning could be performed in frequency, time or spatial dimensions for interference coordination.

### Frequency partitioning

Most existing LTE ICIC mechanisms belong to this category, e.g., FFR and SFR. Frequency partitioning can be combined with power control to achieve better performance. Different from the partial co-channel configuration for HNB [7], frequency partitioning can be performed at the granularities of RBs within a carrier, as shown in Figure 5.1-1, which enables more flexible coordination not only between Macro and Home eNodeB, but also between the Home eNodeBs. For the frequency partitioning method, the Adjacent Channel Power Leakage (ACPL) problem should be taken into account in performance evaluation, similar to the dedicated channel configuration. If adaptive frequency partitioning is used, possible information exchanges between Home eNodeBs may need to be supported.

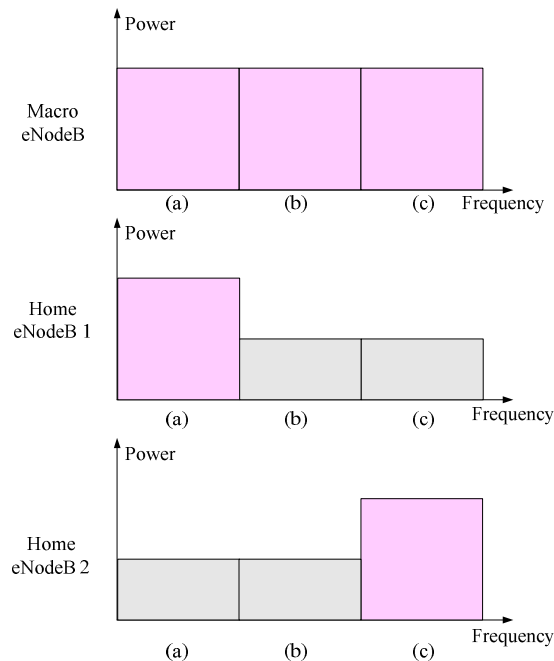

**Figure 5.1-1 Frequency Partitioning**

### Time partitioning

The resources used in Macro and Home eNodeBs can also be partitioned and coordinated in the time dimension. Different time zone or UL-DL configurations between HeNBs and macro eNBs or among HeNBs under specific conditions may provide some flexibility for interference coordination. However, it may also bring new interference risks. Further interference mitigation method based on the time partitioning is FFS.

### Spatial partitioning

Due to uplink-downlink channel reciprocity, TDD HeNBs can use beam coordination to improve interference conditions. For example, the HeNB can avoid beam collision with the Macro or other Home eNBs in a proactive or reactive way. These mechanisms may require a certain amount of information exchange between the HeNBs.

## 5.2 Interference scenarios

Table 5.2-1 and Figure 5.2-1 show the possible HeNB related interference scenarios. The listed interference scenarios are the same for both TDD and FDD. The main difference may exist in how to model the interference, especially for some control channels that are always present, e.g., BCH, SCH. For both TDD and FDD, we propose to evaluate the control interference based on the assumption that different base stations are synchronized to ensure the system performance even under the worst circumstance.

Table 5.2-1 Interference scenarios

Number	Aggressor	Victim	Priority
1	UE attached to Home eNode B	Macro eNode B Uplink	Yes
2	Home eNode B	Macro eNode B Downlink	Yes
3	UE attached to Macro eNode B	Home eNode B Uplink	Yes
4	Macro eNode B	Home eNode B Downlink	
5	UE attached to Home eNode B	Home eNode B Uplink	Yes
6	Home eNode B	Home eNode B Downlink	Yes
7	UE attached to Home eNode B and/or Home eNode B	Other System	
8	Other System	UE attached to Home eNode B and/or Home eNode B	

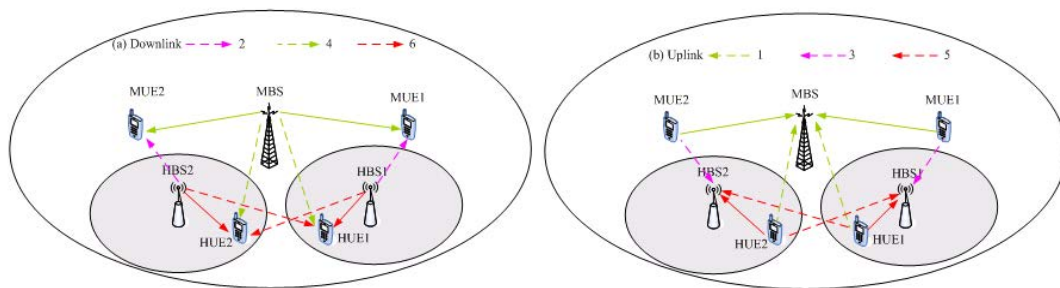

Figure 5.2-1 Interference Scenarios

## 6 RF Aspects

### 6.1 Transmitter characteristics

#### 6.1.1 HeNB output power

##### 6.1.1.1 HeNB maximum output power

###### 6.1.1.1.1 Analysis

From HeNB coverage and capacity point of view, it will be beneficial to define relatively larger output power. However, as already been demonstrated by numerous contributions, the maximum output power should be limited in order to control the HeNB->MeNB downlink interference. So, the maximum HeNB output power should be a trade-off between the HeNB performance and the interference towards close-by MeNB users, which do not have access to the HeNB. Based on some studies in RAN4, the simulation results show that in some cases the HeNB power can be set up to 20dBm. While in some other cases, e.g. in the case of shared carrier deployment, the HeNB power should be limited to a relatively low level.

Furthermore, the definition of the total HeNB output power should also consider supporting existing E-UTRAN UEs. The interfering power level for HeNB ACS requirement is defined -28dBm at 1% blocking probability, which means the MCL between HeNB and UE is 45dB based on the 23dBm UE maximum power. For UE, the current maximum tolerable interfering level for ACS is -25dBm. Assuming the total HeNB output power (i.e. the sum over all transmit antennas) equal to PheNB, the following formula should be true,

$$P_{heNB} + 25 < MCL = 45 \text{dB}$$

Seen from the above, HeNB total transmission power of ~20dBm is also applicable from link balance point of view.

So, it is proposed to set the HeNB total maximum output power requirement as 20dBm and the maximum power per antenna depending on different antenna configurations.

#### 6.1.1.1.2 Minimum requirement

Maximum output power,  $P_{max}$ , of the base station is the mean power level per carrier measured at the antenna connector in specified reference condition. The rated output power, PRAT, of the BS shall be as following,

$$\leq 20\text{dBm} - 10 \cdot \log_{10}(N)$$

Where,  $N$  is the number of transmitter antenna.  $N = 1, 2$  and  $4$ .

In normal conditions, the base station maximum output power shall remain within +2 dB and -2 dB of the rated output power declared by the manufacturer.

In extreme conditions, the base station maximum output power shall remain within +2.5 dB and -2.5 dB of the rated output power declared by the manufacturer.

#### 6.1.1.2 HeNB output power for adjacent UTRA channel protection

The Home BS shall be capable of adjusting the transmitter output power to minimize the interference level on the adjacent channels licensed to other operators in the same geographical area while optimize the Home BS coverage. These requirements are only applicable to Home BS. The requirements in this clause are applicable for AWGN radio propagation conditions.

The output power,  $P_{out}$ , of the Home BS shall be as specified in Table 6.1.1.2-1 under the following input conditions:

- $CPICH \hat{E}_c$ , measured in dBm, is the code power of the Primary CPICH on one of the adjacent channels present at the Home BS antenna connector for the CPICH received on the adjacent channels. If Tx diversity is applied on the Primary CPICH,  $CPICH \hat{E}_c$  shall be the sum in W of the code powers of the Primary CPICH transmitted from each antenna.
- $I_{oh}$ , measured in dBm, is the total received power density, including signals and interference but excluding the own Home BS signal, present at the Home BS antenna connector on the Home BS operating channel.

In case that both adjacent channels are licensed to other operators, the most stringent requirement shall apply for  $P_{out}$ . In the case when one of the adjacent channels is licensed to a E-UTRA operator while the other adjacent channel is licensed to a UTRA operator, the more stringent requirement of this subclause and subclause 6.1.1.3 shall apply for  $P_{out}$ . In case the Home BS's operating channel and both adjacent channels are licensed to the same operator, the requirements of this clause do not apply.

The input conditions defined for the requirements in this section are specified at the antenna connector of the Home BS. For Home BS receivers with diversity, the requirements apply to each antenna connector separately, with the other one(s) terminated or disabled. The requirements are otherwise unchanged. For Home BS(s) without measurement capability, a reference antenna with a gain of 0 dBi is assumed for converting these power levels into field strength requirements.

**Table 6.1.1.2-1: Home BS output power for adjacent operator UTRA channel protection**

Input Conditions	Output power, $P_{out}$
$I_{oh} > CPICH \hat{E}_c + 43 \text{ dB}$ And $CPICH \hat{E}_c \geq -105 \text{ dBm}$	$\leq 10 \text{ dBm}$
$I_{oh} \leq CPICH \hat{E}_c + 43 \text{ dB}$ and $CPICH \hat{E}_c \geq -105 \text{ dBm}$	$\leq \max(8 \text{ dBm}, \min(20 \text{ dBm}, CPICH \hat{E}_c + 100 \text{ dB}))$

Note 1: The Home BS transmitter output power specified in Table 6.1.1.2-1 assumes a Home BS reference antenna gain of 0 dBi, an target outage zone of 47dB around the Home BS for an UE on the adjacent channel, with an allowance of 2 dB for measurement errors, an ACIR of 33 dB, an adjacent channel UE CPICH  $\hat{E}_c$ /Io target of -18 dB and the same CPICH  $\hat{E}_c$  value at the adjacent channel UE as for the Home BS.

Note 2: For CPICH  $\hat{E}_c < -105$ dBm, the requirements in subclauses 6.1.1.1 apply.

Note 3: The output power  $P_{out}$  is the sum transmit power across all the antennas of the Home BS, with each transmit power measured at the respective antenna connectors.

### 6.1.1.3 HeNB output power for adjacent E-UTRA channel protection

The Home BS shall be capable of adjusting the transmitter output power to minimize the interference level on the adjacent channels licensed to other operators in the same geographical area while optimize the Home BS coverage. These requirements are only applicable to Home BS. The requirements in this clause are applicable for AWGN radio propagation conditions.

The output power,  $P_{out}$ , of the Home BS shall be as specified in Table 6.1.1.3-1 under the following input conditions:

- CRS  $\hat{E}_c$ , measured in dBm, is the Reference Signal Received Power per resource element on one of the adjacent channels present at the Home BS antenna connector for the Reference Signal received on the adjacent channels. For CRS  $\hat{E}_c$  determination, the cell-specific reference signal R0 according TS 36.211 [4] shall be used. If the Home BS can reliably detect that multiple TX antennas are used for transmission on the adjacent channel, it may use the average in  $W$  of the CRS  $\hat{E}_c$  on all detected antennas.
- $I_{oh}$ , measured in dBm, is the total received power density, including signals and interference but excluding the own Home BS signal, present at the Home BS antenna connector on the Home BS operating channel.

In case that both adjacent channels are licensed to other operators, the most stringent requirement shall apply for  $P_{out}$ . In the case when one of the adjacent channels is licensed to a E-UTRA operator while the other adjacent channel is licensed to a UTRA operator, the more stringent requirement of this subclause and subclause 6.1.1.3 shall apply for  $P_{out}$ . In case the Home BS's operating channel and both adjacent channels are licensed to the same operator, the requirements of this clause do not apply.

The input conditions defined for the requirements in this section are specified at the antenna connector of the Home BS. For Home BS receivers with diversity, the requirements apply to each antenna connector separately, with the other one(s) terminated or disabled. The requirements are otherwise unchanged. For Home BS(s) without measurement capability, a reference antenna with a gain of 0 dBi is assumed for converting these power levels into field strength requirements.

**Table 6.1.1.3-1: Home BS output power for adjacent operator E-UTRA channel protection**

Input Conditions	Output power, $P_{out}$
$I_{oh} > \text{CRS } \hat{E}_c +$ $10 \cdot \log_{10} (N_{RB}^{DL} \cdot N_{sc}^{RB})$ $+ 30 \text{ dB}$ and $\text{CRS } \hat{E}_c \geq -127 \text{ dBm}$	$\leq 10 \text{ dBm}$
$I_{oh} \leq \text{CRS } \hat{E}_c +$ $10 \cdot \log_{10} (N_{RB}^{DL} \cdot N_{sc}^{RB})$ $+ 30 \text{ dB}$ and $\text{CRS } \hat{E}_c \geq -127 \text{ dBm}$	$\leq \max(8 \text{ dBm}, \min(20 \text{ dBm}, \text{CRS } \hat{E}_c +$ $10 \cdot \log_{10} (N_{RB}^{DL} \cdot N_{sc}^{RB})$ $+ 85 \text{ dB}))$

Note 1: The Home BS transmitter output power specified in Table 6.1.1.3-1 assumes a Home BS reference antenna gain of 0 dBi, an target outage zone of 47dB around the Home BS for an UE on the adjacent channel, with an allowance of 2 dB for measurement errors, an ACIR of 30 dB, an adjacent channel UE  $\hat{E}_s/I_{ot}$  target of -6 dB and the same CRS  $\hat{E}_c$  value at the adjacent channel UE as for the Home BS.

Note 2: For CRS  $\hat{E}_c < -127$ dBm, the requirements in subclauses 6.1.1.1 apply.

Note 3: The output power  $P_{out}$  is the sum transmit power across all the antennas of the Home BS, with each transmit power measured at the respective antenna connectors.

Note 4:  $N_{RB}^{DL}$  is the number of downlink resource blocks in the own Home BS channel.

Note 5:  $N_{sc}^{RB}$  is the number of subcarriers in a resource block,  $N_{sc}^{RB} = 12$ .

## 6.1.2 Frequency error

Frequency error is the difference between the actual BS transmit frequency and the assigned frequency. The same source shall be used for RF frequency and data clock generation. Frequency accuracy is an important RF requirement for HeNB. A reasonable tradeoff between the cost and system performance should be made to derive the frequency error for HeNB. Frequency accuracy will affect the system performance in many areas, such as handover performance, cell throughput and timing etc.

### 6.1.2.1 Handover performance

Frequency accuracy requirement will affect the measurement precision, which may degrade the handover performance. For HeNB, there are three kinds of handover scenarios, (1) handover from eNB to HeNB, (2) handover from HeNB to eNB, (3) handover between HeNBs. Since eNB usually has a better frequency accuracy performance than HeNB, the handover between HeNBs is the worst scenario. Although the handover scenarios of HeNB have not been defined clearly in 3GPP, the frequency error should support all possible scenarios.

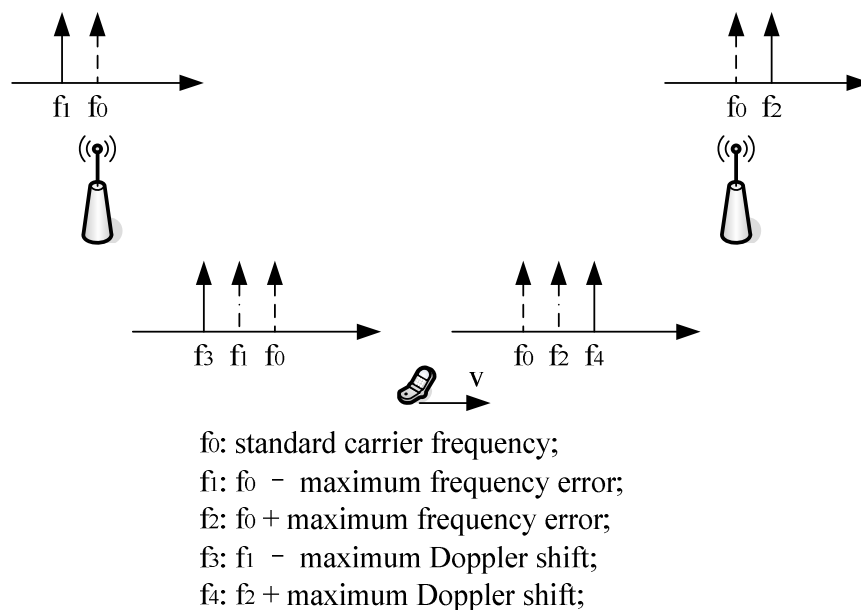

**Figure 6.1.2.1-1 Handover between HeNB**

For macro cells, eNB can support the handover at the speed of 350km/h. For home environment, the maximum speed of UE is only 30km/h. Since the frequency error of  $\pm 0.05$ ppm and speed of 350km/h can be supported by EUTRA, the frequency error of HeNB should be relaxed because of the limited maximum speed. The computation is same to the analysis for macro eNB. Assuming the operating frequency is 2.6GHz, the frequency accuracy of HeNB should be within  $\pm 0.34$ ppm.

### 6.1.2.2 Cell capacity

One of the main motivations to introduce HeNB is providing high data rate services for indoor environment. Therefore, the high order modulation and coding scheme such as 64QAM 5/6 must be supported by HeNB. However,

BS frequency error can result in UE demodulation frequency error, thus resulting in performance degradation for received signal as shown in the following formula.

$$R_k = S_k \cdot \frac{\sin(\pi N \Delta f_c T_s)}{N \sin(\pi \Delta f_c T_s)} e^{-j\pi(N-1)\Delta f_c T_s} + \sum_{\substack{m=0 \\ m \neq k}}^{N-1} S_m \cdot \frac{\sin(\pi(m-k-N\Delta f_c T_s))}{N \sin(\pi(m-k-N\Delta f_c T_s)/N)} e^{j\pi(1-1/N)(m-k-N\Delta f_c T_s)} + n$$

$$= \sum_{m=0}^{N-1} c_{m-k} S_m = c_0 S_k + \sum_{m \neq k} S_m c_m$$

Where,  $R_k, S_k, N, \Delta f_c, T_s$  are received signal, transmit signal, number of sub-carriers, frequency error and sampling time interval respectively. The first part in the right side is the expected signal on the observed subcarrier and the second part is the interferences from other sub-carriers other than the observed one. It is seen that frequency error results in amplitude fading and phase rotation for the expected signal on the observed sub-carriers and ICI between sub-carriers. Both these two factors will cause performance degradation for UE demodulation. Figure 6.1.2.2-1 shows the SNR degradation because of the frequency error in OFDM. For example, if the signal to noise ratio (SNR) is 20dB, the performance degradation can be ignored when the frequency error is less than 100Hz. If the frequency error is 400Hz, the performance degradation will be larger than 1dB, which implies the signal to inter-subcarrier interference and noise ratio (SINR) is less than 19dB.

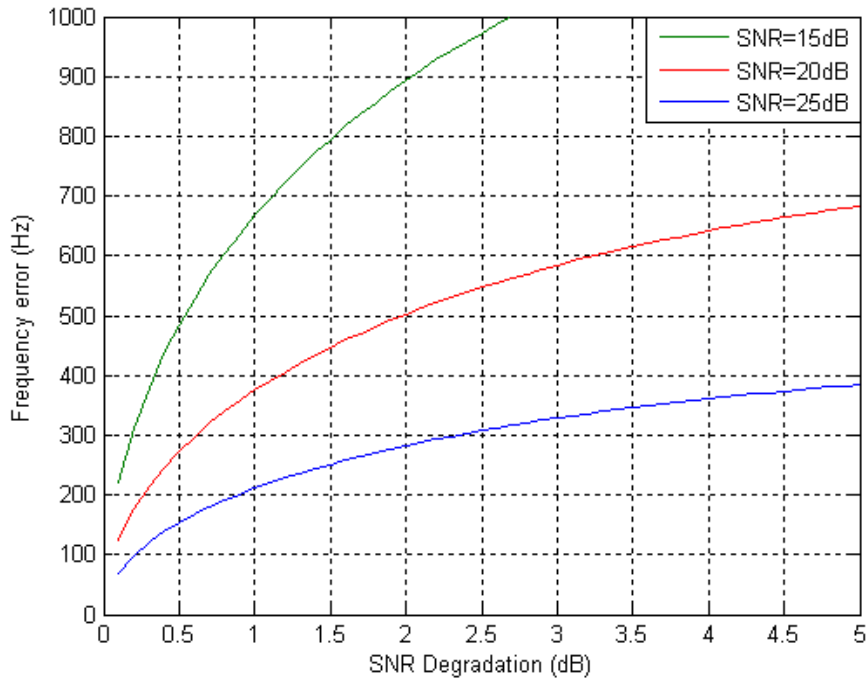

Figure 6.1.2.2-1 SNR degradation VS frequency error

In fact, the performance degradation is related to the Doppler shift and the relative error between HeNB and UE. Usually, UE has frequency offset estimation and compensation algorithm to follow frequency change due to mobility and BS transmit frequency error. Therefore, the link performance depends on the performance of the estimation and compensation algorithms. According to the OFDM performance analysis, as long as the residual frequency error after compensation is less than one percent of the subcarrier interval, the link performance degradation can be ignored.

In order to evaluate the impact of 0.25ppm BS frequency error on 64QAM, we compare UE performance for the cases listed in Table 6.1.2.2-1 using a commonly used UE algorithm. Since home eNode B is targeted at use in low delay spread environment, only relatively low speed environment related EVA and EPA channel type is considered.

**Table 6.1.2.2-1 Scenarios for evaluation of HeNB frequency error requirement**

Scenario #	Propagation condition	Doppler shift NOTE	Frequency error
Scenario 1	EVA	70Hz*	0.05ppm
Scenario 2	EVA	70Hz*	0.25ppm
Scenario 3	EPA	5Hz**	0.05ppm
Scenario 4	EPA	5Hz**	0.25ppm
Note *: corresponding to typical UE speed of ~38km/h in EVA condition.			
Note **: corresponding to typical UE speed of ~3km/h in EPA condition.			

Usually the short term frequency stability will affect the demodulation performance more. The short term frequency changing in time domain is in the order of few seconds and 10s may be an acceptable value to capture the frequency change period. So we use a sine wave to model the frequency change due to frequency stability in the simulations.

$$\Delta f_c = f_{max} * \sin(2\pi * t / T)$$

Where T =10s is the periodicity of the sine wave used to modulate the short term frequency stability characteristic in time domain.  $f_{max}$  is the frequency error (0.05ppm or 0.25ppm).

Figure 6.1.2.2-2 gives simulation results for scenario 1 and scenario 2 under EVA propagation channel. Figure 6.1.2.2-3 gives simulation results for scenario 3 and scenario 4.

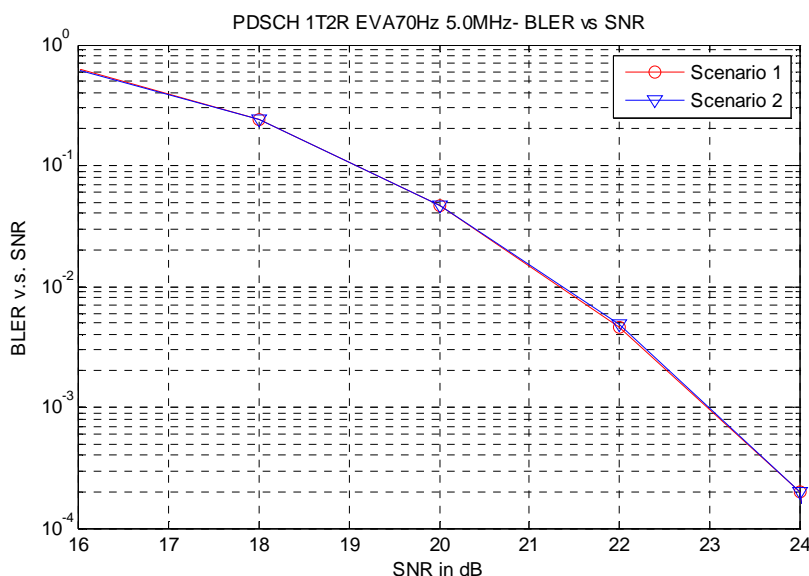

**Figure 6.1.2.2-2 Impact of frequency error on UE 64QAM demodulation performance, EVA70Hz**



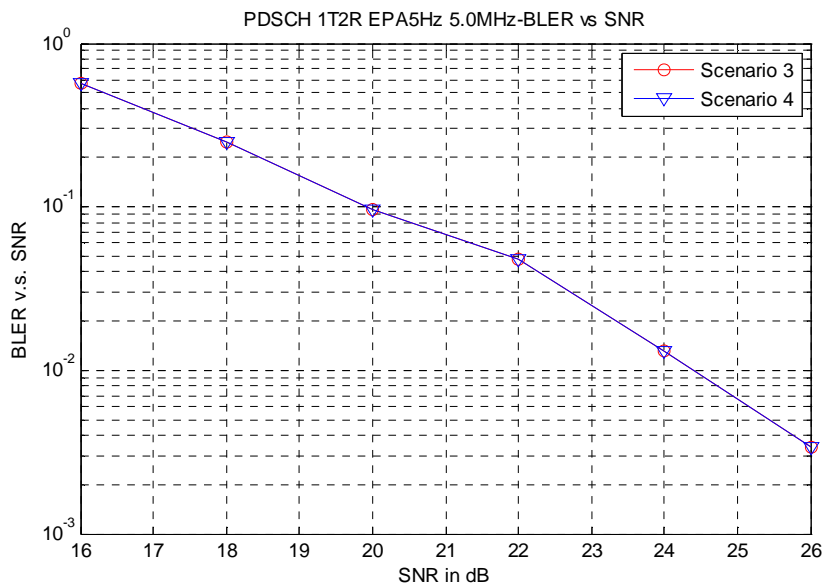

**Figure 6.1.2.2-3 Impact of frequency error on UE 64QAM demodulation performance, EPA5Hz**

It can be seen from the results, increasing frequency error requirement from current 0.05ppm to 0.25ppm results in almost no performance degradation for HeNB 64QAM.

### 6.1.2.3 Timing

As the carrier frequency source is also used to generate the data clock [5], the frequency error is also relative to the synchronization period when the network listening scheme is applied. As the HeNB cannot capture the GPS timing signal in most deployment scenarios, network listening scheme is a feasible synchronization solution for HeNB. HeNB may periodically utilize a synchronization signal such as the primary synchronization sequence (PSS), secondary synchronization sequence (SSS) and common reference signal (CRS) from eNB to drive its timing. According to the analysis in RAN4, the maximum synchronization period can be computed and listed in Table 6.1.2.3-1. Note that the frequency error is the relative frequency error between eNB and HeNB, or HeNB and HeNB. For example, if the frequency error of HeNB is 0.25ppm, the relative frequency error between eNB and HeNB is range from 0.2ppm to 0.3ppm, and the relative frequency error between HeNBs is range from 0 to 0.5ppm.

**Table 6.1.2.3-1 Synchronization maintenance periods with different frequency error values**

Frequency error	Maximum synchronization period
0.2ppm	7.5s
0.3ppm	5s
0.4ppm	3.75s
0.5ppm	3s

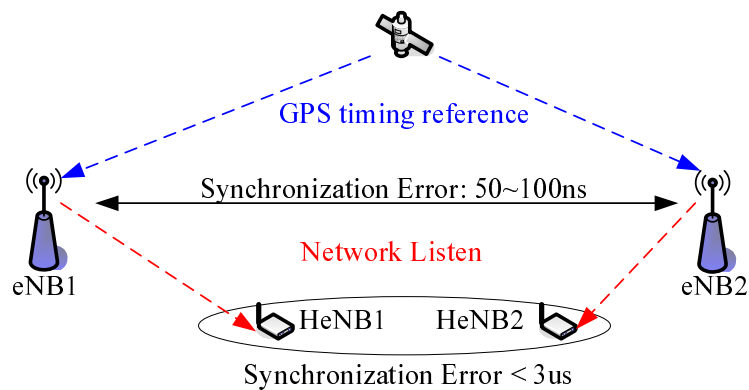

**Figure 6.1.2.3-1 Network listening synchronization scheme**

According to the above analysis, if the frequency error of HeNB is stricter than 0.3ppm, the synchronization maintenance period and related overhead seem to be acceptable.

#### 6.1.2.4 Minimum requirement

The modulated carrier frequency of the HeNB shall be accurate to within  $\pm 0.25$  ppm observed over a period of one subframe (1ms).

### 6.1.3 Adjacent Channel Leakage power Ratio (ACLR)

Adjacent Channel Leakage power Ratio (ACLR) is the ratio of the filtered mean power centred on the assigned channel frequency to the filtered mean power centred on an adjacent channel frequency.

The requirements shall apply whatever the type of transmitter considered (single carrier or multi-carrier). It applies for all transmission modes foreseen by the manufacturer's specification. For a multi-carrier BS, the requirement applies for the adjacent channel frequencies below the lowest carrier frequency transmitted by the BS and above the highest carrier frequency transmitted by the BS for each supported multi-carrier transmission configuration. The requirement applies during the transmitter ON period.

Reasonable ACLR requirements should be made to ensure the performance of macrocell operating in adjacent channel. The relative and absolute ACLR requirements had been studied in RAN4, the main focus is ensuring the downlink performance of the macrocell and both base station adjacent leakage power and UE blocking characteristics were considered.

#### 6.1.3.1 Minimum requirement

The ACLR is defined with a square filter of bandwidth equal to the transmission bandwidth configuration of the transmitted signal (BWConfig) centred on the assigned channel frequency and a filter centred on the adjacent channel frequency according to the tables below. Either the ACLR limits in the tables below or the absolute limit of -50dBm/MHz apply, whichever is less stringent.

Table 6.1.3.1-1: Home eNodeB ACLR in unpaired spectrum with synchronized operation

E-UTRA transmitted signal channel bandwidth $BW_{\text{Channel}}$ [MHz]	BS adjacent channel centre frequency offset below the first or above the last carrier centre frequency transmitted	Assumed adjacent channel carrier (informative)	Filter on the adjacent channel frequency and corresponding filter bandwidth	ACLR limit
1.4, 3	$BW_{\text{Channel}}$	E-UTRA of same BW	Square ( $BW_{\text{Config}}$ )	45 dB
	$2 \times BW_{\text{Channel}}$	E-UTRA of same BW	Square ( $BW_{\text{Config}}$ )	45 dB
5, 10, 15, 20	$BW_{\text{Channel}}$	E-UTRA of same BW	Square ( $BW_{\text{Config}}$ )	45 dB
	$2 \times BW_{\text{Channel}}$	E-UTRA of same BW	Square ( $BW_{\text{Config}}$ )	45 dB
NOTE 1: $BW_{\text{Channel}}$ and $BW_{\text{Config}}$ are the channel bandwidth and transmission bandwidth configuration of the E-UTRA transmitted signal on the assigned channel frequency.				

## 6.1.4 Operating band unwanted emissions

The operating band unwanted emission limits are defined from 10 MHz below the lowest frequency of the downlink operating band up to 10 MHz above the highest frequency of the downlink operating band.

The requirements shall apply whatever the type of transmitter considered (single carrier or multi-carrier) and for all transmission modes foreseen by the manufacturer's specification.

The unwanted emission limits in the part of the downlink operating band that falls in the spurious domain are consistent with ITU-R Recommendation SM.329 [11].

In E-UTRA, the SEM is specified in three regions [5].

- Region 1 (First adjacent channel): for 1.4, 3 and 5MHz, the offset between the channel edge frequency and the centre of the measuring filter -3dB point is defined as the first adjacent channel and for 10, 15 and 20 MHz, region 1 is defined as 0 to 5MHz. In this region, the emission limit usually has a slope and be relaxed compared to ACLR1 limit in the first adjacent channel.
- Region 2 (Second adjacent channel): for 1.4, 3 and 5MHz, region 2 is defined as second adjacent channel and for 10, 15 and 20MHz, region 2 is defined as 5 to 10MHz. In this region, the emission limit has tapered off and is usually defined with a fixed value which could be set to the same order of ACLR2 requirement.
- Region 3 (Spurious emission): in this region, the SEM is usually defined by the spurious emission limit.

The relative ACLR1 and ACLR2 requirements are proposed to 45dBc in RAN4. Assuming 20dBm maximum output power and 5MHz bandwidth for HeNB, the second adjacent channel leakage power at point B of figure 6.1.4-1 is about -42dBm/100kHz (20dBm – 45dBc = -25dBm/4.5MHz). We propose to make a 6dB maximum allowed relaxation for SEM in the first adjacent channel and then get an emission limit of -36dBm/100kHz at point A. Therefore, the emission

mask for first adjacent channel will be defined as  $-36dBm - \frac{6}{5} \left( \frac{f_{\text{offset}}}{MHz} - 0.05 \right) dB$ , where the  $f_{\text{offset}}$  is the

separation between the channel edge frequency and the centre of the measuring filter. The second adjacent channel emission mask could be defined as -42dBm/100kHz.

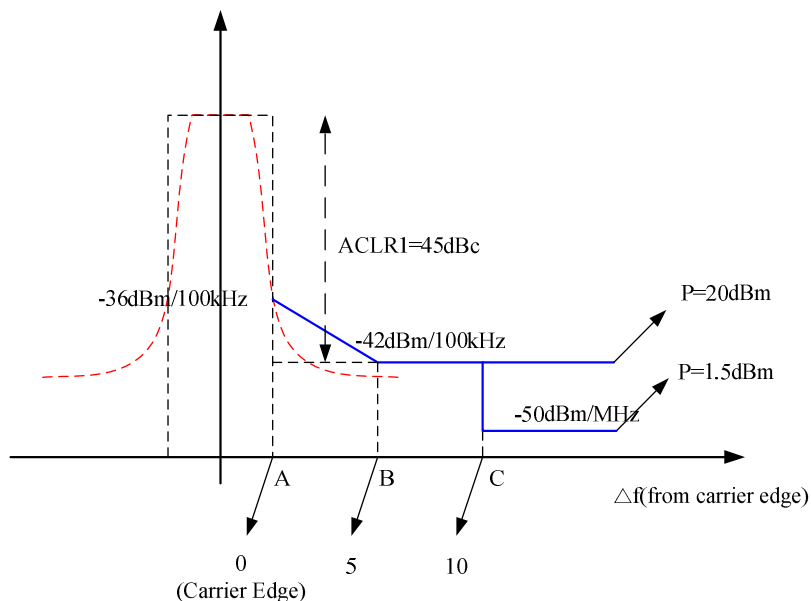

Figure 6.1.4-1 Spectrum emission mask (1<sup>st</sup> and 2<sup>nd</sup> adjacent channel)

In region 3, the emission limit is determined by the relative and absolute ACLR requirement whichever is less stringent, seen in figure 6.1.4-2. The absolute ACLR1&2 requirement is set to -50dBm/MHz. The emission limit in this domain is proposed to be defined as a function of the maximum output power of HeNB. The upper limit is about -32dBm/MHz (20dBm – 45dBc – 10log4.5) and the lower limit is -50dBm/MHz. Then the emission limit is specified by equation 2-1.

$$\begin{cases} P - 52dB, & \text{where } 2dBm \leq P \leq 20dBm \\ -50dBm, & \text{where } P < 2dBm \end{cases} \quad (6.2.5-1)$$

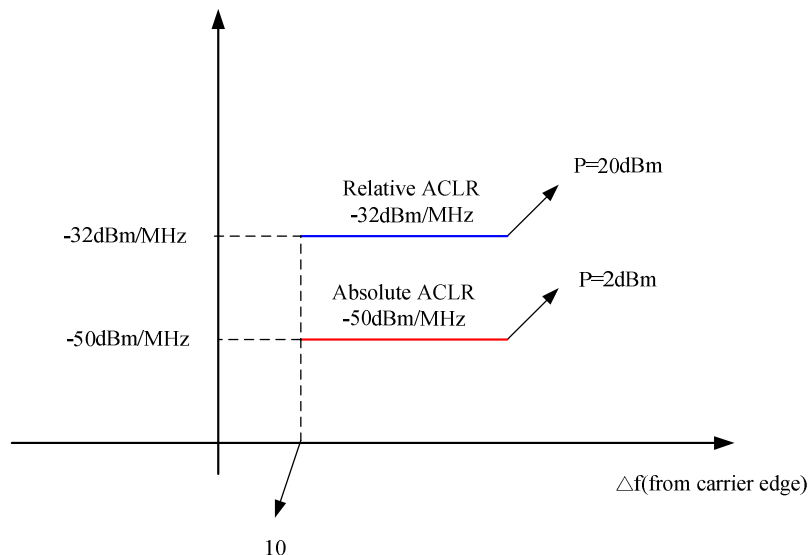

Figure 6.1.4-2 Spectrum emission mask layout (beyond 10MHz)

### 6.1.4.1 Minimum requirements

For E-UTRA Home eNodeB emissions shall not exceed the maximum levels specified in the Tables 6.1.4.1-1 to 6.2.5.1-3, where:

- $\Delta f$  is the separation between the channel edge frequency and the nominal -3dB point of the measuring filter closest to the carrier frequency.
- $f_{\text{offset}}$  is the separation between the channel edge frequency and the centre of the measuring filter.
- $f_{\text{offset}_{\text{max}}}$  is the offset to the frequency 10 MHz outside the downlink operating band.
- $\Delta f_{\text{max}}$  is equal to  $f_{\text{offset}_{\text{max}}}$  minus half of the bandwidth of the measuring filter.

For a multicarrier E-UTRA Home eNodeB the definitions above apply to the lower edge of the carrier transmitted at the lowest carrier frequency and the higher edge of the carrier transmitted at the highest carrier frequency.

**Table 6.1.4.1-1: General operating band unwanted emission limits for 1.4 MHz channel bandwidth**

Frequency offset of measurement filter -3dB point, $\Delta f$	Frequency offset of measurement filter centre frequency, $f_{\text{offset}}$	Minimum requirement	Measurement bandwidth (Note 1)
$0 \text{ MHz} \leq \Delta f < 1.4 \text{ MHz}$	$0.05 \text{ MHz} \leq f_{\text{offset}} < 1.45 \text{ MHz}$	$-30\text{dBm} - \frac{6}{1.4} \left( \frac{f_{\text{offset}}}{\text{MHz}} - 0.05 \right) \text{dB}$	100 kHz
$1.4 \text{ MHz} \leq \Delta f < 2.8 \text{ MHz}$	$1.45 \text{ MHz} \leq f_{\text{offset}} < 2.85 \text{ MHz}$	-36 dBm	100 kHz
$2.8 \text{ MHz} \leq \Delta f \leq \Delta f_{\text{max}}$	$3.3 \text{ MHz} \leq f_{\text{offset}} < f_{\text{offset}_{\text{max}}}$	$\begin{cases} P - 52\text{dB}, 2\text{dBm} \leq P \leq 20\text{dBm} \\ -50\text{dBm}, P < 2\text{dBm} \end{cases}$	1MHz

**Table 6.1.4.1-2: General operating band unwanted emission limits for 3 MHz channel bandwidth**

Frequency offset of measurement filter -3dB point, $\Delta f$	Frequency offset of measurement filter centre frequency, $f_{\text{offset}}$	Minimum requirement	Measurement bandwidth (Note 1)
$0 \text{ MHz} \leq \Delta f < 3 \text{ MHz}$	$0.05 \text{ MHz} \leq f_{\text{offset}} < 3.05 \text{ MHz}$	$-34\text{dBm} - 2 \left( \frac{f_{\text{offset}}}{\text{MHz}} - 0.05 \right) \text{dB}$	100 kHz
$3 \text{ MHz} \leq \Delta f < 6 \text{ MHz}$	$3.05 \text{ MHz} \leq f_{\text{offset}} < 6.05 \text{ MHz}$	-40 dBm	100 kHz
$6 \text{ MHz} \leq \Delta f \leq \Delta f_{\text{max}}$	$6.5 \text{ MHz} \leq f_{\text{offset}} < f_{\text{offset}_{\text{max}}}$	$\begin{cases} P - 52\text{dB}, 2\text{dBm} \leq P \leq 20\text{dBm} \\ -50\text{dBm}, P < 2\text{dBm} \end{cases}$	1MHz

**Table 6.1.4.1-3: General operating band unwanted emission limits for 5, 10, 15 and 20 MHz channel bandwidth**

Frequency offset of measurement filter -3dB point, $\Delta f$	Frequency offset of measurement filter centre frequency, $f_{\text{offset}}$	Minimum requirement	Measurement bandwidth (Note 1)
$0 \text{ MHz} \leq \Delta f < 5 \text{ MHz}$	$0.05 \text{ MHz} \leq f_{\text{offset}} < 5.05 \text{ MHz}$	$-36\text{dBm} - \frac{6}{5} \left( \frac{f_{\text{offset}}}{\text{MHz}} - 0.05 \right) \text{dB}$	100 kHz
$5 \text{ MHz} \leq \Delta f < 10 \text{ MHz}$	$5.05 \text{ MHz} \leq f_{\text{offset}} < 10.05 \text{ MHz}$	-42 dBm	100 kHz
$10 \text{ MHz} \leq \Delta f \leq \Delta f_{\text{max}}$	$10.5 \text{ MHz} \leq f_{\text{offset}} < f_{\text{offset}_{\text{max}}}$	$\begin{cases} P - 52\text{dB}, 2\text{dBm} \leq P \leq 20\text{dBm} \\ -50\text{dBm}, P < 2\text{dBm} \end{cases}$	1MHz

NOTE 1 As a general rule, the resolution bandwidth of the measuring equipment should be equal to the measurement bandwidth. However, to improve measurement accuracy, sensitivity and efficiency, the resolution bandwidth can be smaller than the measurement bandwidth. When the resolution bandwidth is smaller than the measurement bandwidth, the result should be integrated over the measurement bandwidth in order to obtain the equivalent noise bandwidth of the measurement bandwidth.

NOTE 2 The parameter P is defined as the aggregated maximum power of all transmit antenna ports of Home eNodeB.

## 6.1.5 Spurious emissions

### 6.1.5.1 Mandatory requirements

The requirements of either subclause 6.6.4.1.1 (Category A limits) or subclause 6.6.4.1.2 (Category B limits) of TS36.104 [5] shall also apply for HeNB.

### 6.1.5.2 Co-existence with HNB/HeNB operating in other bands

Taking into account the expected deployment scenarios of HeNB, coexistence with other types of base station are not meaningful. Therefore, only coexistence spurious emission requirements for protection other cross band HNB/HeNB operating in the same geographic area will be specified.

The assumed scenario for coexistence with other HNB/HeNB is described in Figure 6.1.5.2-1. Two HeNBs are placed in different rooms and opposite to a wall.

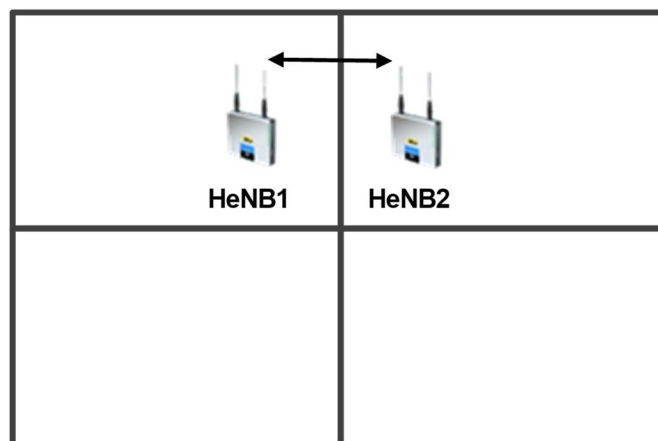

**Figure 6.1.5.2-1 Assumed interference scenario for coexistence with other HNB/HeNB**

$$PL(\text{dB}) = 127 + 30 \log_{10}(R/1000), R \text{ in m} \quad (6.2.6.2-1)$$

The path loss model listed above is used to calculate the path loss between two HeNBs, seen equation (6.2.6.2-1). The minimum separation distance between two HeNBs is assumed to be 1 meter. Assuming 10dB penetration loss and 0dBi antenna gain of HeNB, we can get a MCL of 47dB for co-location with other HNB/HeNB.

The maximum allowed interference power level is determined based on 0.8dB desensitization criterion. Assuming 13dB noise figure and 47dB MCL between two HeNBs, we can get a spurious emission limit of -71dBm/100kHz (-174dBm + 50dB + 13dB -7dB + 47dB) to protect other HeNB. However, there are 6dB difference in noise figure between HNB and HeNB which will bring also 6dB difference in the co-existence requirement. Since operators may deploy HNB and HeNB in the same operating band in real implementations, it's propose to use -71dBm/100kHz as the common requirement for protection of other HNB/HeNB operating in other frequency bands to simplify the specification.

#### 6.1.5.2.1 Minimum requirement

The power of any spurious emission shall not exceed the limits of Table 6.1.5.2.1-1 for a HeNB where requirements for coexistence with other HNB/HeNB in the same geographic area listed in the first column apply.

**Table 6.1.5.2.1-1: HeNB Spurious emissions limits for coexistence with other HNB/HeNB in the same geographic area**

Type of coexistence BS	Frequency range for co-location requirement	Maximum Level	Measurement Bandwidth	Note
UTRA FDD Band I or E-UTRA Band 1	1920 – 1980 MHz	-71 dBm	100 kHz	
UTRA FDD Band II or E-UTRA Band 2	1850 – 1910 MHz	-71 dBm	100 kHz	
UTRA FDD Band III or E-UTRA Band 3	1710 – 1785 MHz	-71 dBm	100 kHz	
UTRA FDD Band IV or E-UTRA Band 4	1710 – 1755 MHz	-71 dBm	100 kHz	
UTRA FDD Band V or E-UTRA Band 5	824 – 849 MHz	-71 dBm	100 kHz	
UTRA FDD Band VI or E-UTRA Band 6	815 – 850 MHz	-71 dBm	100 kHz	
UTRA FDD Band VII or E-UTRA Band 7	2500 – 2570 MHz	-71 dBm	100 KHz	
UTRA FDD Band VIII or E-UTRA Band 8	880 – 915 MHz	-71 dBm	100 KHz	
UTRA FDD Band IX or E-UTRA Band 9	1749.9 – 1784.9 MHz	-71 dBm	100 KHz	
UTRA FDD Band X or E-UTRA Band 10	1710 – 1770 MHz	-71 dBm	100 kHz	
UTRA FDD Band XI or E-UTRA Band 11	1427.9 – 1452.9 MHz	-71 dBm	100 kHz	
UTRA FDD Band XII or E-UTRA Band 12	698 – 716 MHz	-71 dBm	100 kHz	
UTRA FDD Band XIII or E-UTRA Band 13	777 – 787 MHz	-71 dBm	100 kHz	
UTRA FDD Band XIV or E-UTRA Band 14	788 – 798 MHz	-71 dBm	100 kHz	
E-UTRA Band 17	704 – 716 MHz	-71 dBm	100 kHz	
UTRA TDD in Band a) or E-UTRA Band 33	1900 – 1920 MHz	-71 dBm	100 kHz	
UTRA TDD in Band a) or E-UTRA Band 34	2010 – 2025 MHz	-71 dBm	100 kHz	
UTRA TDD in Band b) or E-UTRA Band 35	1850 – 1910 MHz	-71 dBm	100 kHz	
UTRA TDD in Band b) or E-UTRA Band 36	1930 – 1990 MHz	-71 dBm	100 kHz	
UTRA TDD in Band c) or E-UTRA Band 37	1910 – 1930 MHz	-71 dBm	100 kHz	
UTRA TDD in Band d) or E-UTRA Band 38	2570 – 2620 MHz	-71 dBm	100 kHz	
E-UTRA Band 39	1880 – 1920MHz	-71 dBm	100 kHz	
E-UTRA Band 40	2300 – 2400MHz	-71 dBm	100 kHz	

NOTE 1: As defined in the scope for spurious emissions in this clause, the coexistence requirements in Table 6.1.5.2.1-1 do not apply for the 10 MHz frequency range immediately outside the HeNB transmit frequency range of a downlink operating band. This is also the case when the transmit frequency range is adjacent to the Band for the co-location requirement in the table. The current state-of-the-art technology does not allow a single generic solution for co-location with other system on adjacent frequencies for 30dB BS-BS minimum coupling loss. However, there are certain site-engineering solutions that can be used. These techniques are addressed in TR 25.942 [9].

## 6.1.6 Transmitter intermodulation

The transmitter intermodulation requirement is a measure of the capability of the transmitter to inhibit the generation of signals in its non linear elements caused by presence of the own transmit signal and an interfering signal reaching the transmitter via the antenna. The requirement applies during the transmitter ON period and the transmitter transient period.

### 6.1.6.1 Minimum requirement

The transmitter intermodulation level is the power of the intermodulation products when an interfering signal is injected into the antenna connector. The wanted signal channel bandwidth  $BW_{\text{Channel}}$  shall be the maximum bandwidth supported by the base station. The offset of the interfering signal from the wanted signal shall be as in Table 6.1.6.1-1.

**Table 6.1.6.1-1 Interfering and wanted signals for the Transmitter intermodulation requirement**

Parameter	Value
Wanted signal	E-UTRA signal of maximum channel bandwidth $BW_{\text{Channel}}$
Interfering signal type	E-UTRA signal of channel bandwidth 5 MHz
Interfering signal level	Mean power level 30 dB below the mean power of the wanted signal
Interfering signal centre frequency offset from wanted signal carrier centre frequency	$-BW_{\text{Channel}}/2 - 12.5$ MHz $-BW_{\text{Channel}}/2 - 7.5$ MHz $-BW_{\text{Channel}}/2 - 2.5$ MHz $BW_{\text{Channel}}/2 + 2.5$ MHz $BW_{\text{Channel}}/2 + 7.5$ MHz $BW_{\text{Channel}}/2 + 12.5$ MHz
NOTE:	Interfering signal positions that are partially or completely outside of the downlink operating band of the base station are excluded from the requirement.

The transmitter intermodulation level shall not exceed the unwanted emission limits in subclause 6.1.3, 6.1.4 and 6.1.5 in the presence of an interfering signal according to Table 6.1.6.1-1. The measurement may be limited to frequencies on which third and fifth order intermodulation products appear, considering the width of these products.

## 6.2 Receiver characteristics

### 6.2.1 Reference sensitivity level

Reference sensitivity level is the minimum mean power received at the antenna connector at which a throughput requirement shall be met for a specified reference measurement channel. The main purpose to define the reference sensitivity requirement is to verify the receiver noise figure. Receiver noise figure will affect the uplink performance of macrocell and HeNB itself desensitization. These impacts could be studied by system level simulations.

#### 6.2.1.1 Uplink performance degradation of macrocell

##### 6.2.1.1.1 Simulation setup

The simulation parameters and assumptions are discussed and agreed on in RAN4 for HeNB (detailed information could be got in R4-092042). The hierarchical deployment scenario is illustrated in Figure 6.2.1.1.1-1. 100 HeNBs are deployed in a sector and each has one active HUE. Since the ACLR of UE is 30dB, the ACIR is assumed to be 30dB for adjacent interference calculation.



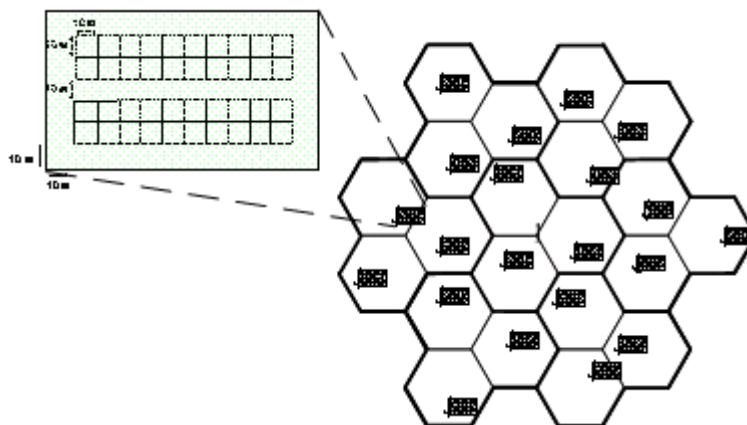

Figure 6.2.1.1.1-1 Hierarchical deployment scenario of macrocell and HeNB

In the simulations, the uplink power control scheme described in TS36.211 [4] is used. The noise figure will affect the uplink MCS selection and finally result in different output power setting. High output power of HUE may result in performance degradation of the macrocell. Therefore, the noise figure should be well planned to ensure the uplink performance of macrocell.

6.2.1.1.2 Simulation results

The noise floor of macro eNB with 10MHz bandwidth is about -100 dBm (-174 + 60 + 9.5 + 5 = -99.5 dBm). Therefore, the noise floor of HeNB in the simulation is assumed to be in the range from -99 dBm to -79 dBm. As a function of HeNB noise floor, the relative uplink throughput loss of macrocell is shown in Figure 6.2.1.1.2-1.

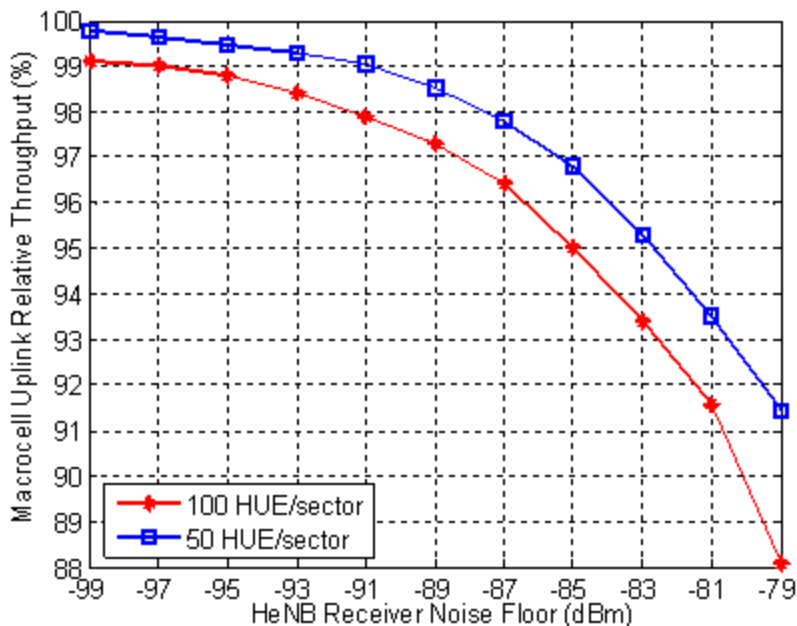

Figure 6.2.1.1.2-1 Relative uplink throughput loss versus noise floor

It is important to control the noise floor in a reasonable range to minimise the impact on uplink performance of macrocell operating in adjacent channel. Assuming the maximum allowed performance degradation is 3% [10], compared to macro eNB, it will desensitize the HeNB reference sensitivity by 10 to 13 dB, which corresponds to a noise floor of -89dBm and -86dBm.

### 6.2.1.2 HeNB desensitization

In this section, the impact on sensitivity degradation of HeNB due to interference from MUE is simulated. The simulation assumptions and deployment scenarios are the same as section 6.3.1.1. In the simulations, one MUE occupying the whole uplink bandwidth (10MHz) is randomly placed in the building block where HeNBs are deployed and no RoT control is considered for macrocell. In order to study the impact of different output power of MUE, the building block with HeNBs and MUE is placed in  $R/2$  and  $R$  respectively, where  $R$  is the radius of the macrocell.

Figure 6.2.1.2-1 gives the simulation results of uplink noise rise of HeNB versus different block locations. The blue curve represents noise rise due to uplink interference from other HUEs and the red together with green curve represent additional noise rise due to uplink interference from MUE. The additional noise rise is calculated based on 40% HeNBs suffering from the highest interference. Seen from the results, we can find that the additional noise rise is about 9 dB in the worst case (the MUE is located in cell edge with high output power,  $D = R$ ) and 5.5 dB in a normal case (the distance between building block and macro eNB is  $R/2$ ). Therefore, according to the simulation result shown in Figure 6.2.1.2-1, compared with macro eNB, 7 to 8 dB desensitization seems to be a good tradeoff for TD-LTE HeNB.

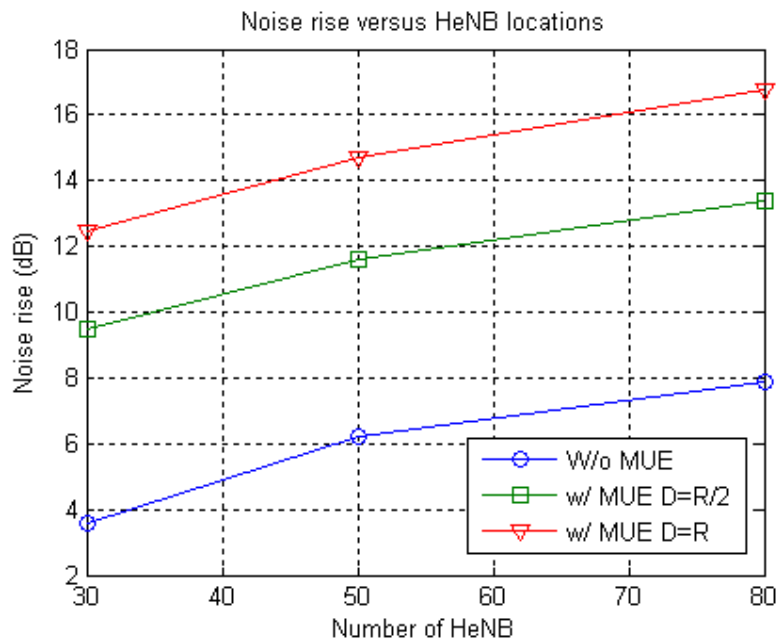

Figure 6.2.1.2-1 Noise rise versus different HeNB locations

For another approach in statistics, Figure 6.2.1.2-2 and Figure 6.2.1.2-3 demonstrates the CDF of HeNB noise rise with MUE being in  $R/2$  and  $R$  respectively. It is observed that the percentage of HeNBs with the highest interference from MUE have very big impact on the maximum tolerable noise rise. In Table 6.2.1.2-1 some noise rise values are summarize for different percentage of HeNB in statistics. If we decide HeNB noise rise based on 40% HeNBs suffering from the highest interference, the HeNB sensitivity can be degraded by 7~9dB.

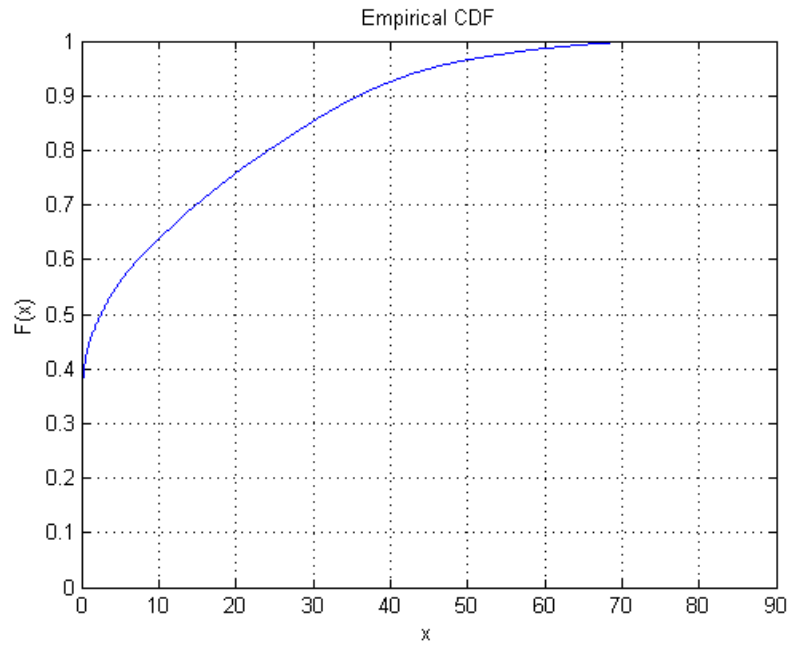

Figure 6.2.1.2-2 HeNB noise rise CDF, MUE distance from MeNB  $D=R/2$

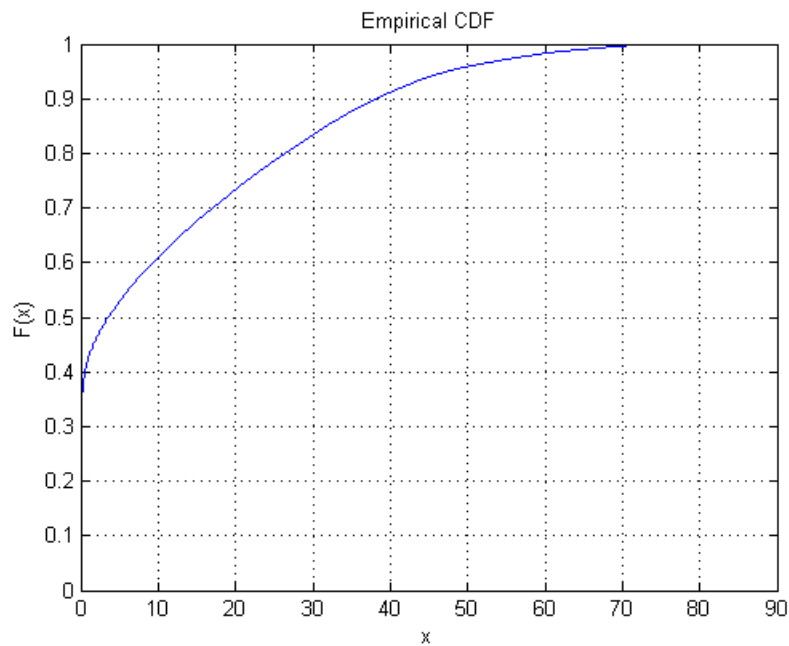

Figure 6.2.1.2-3 HeNB noise rise CDF, MUE distance from MeNB  $D=R$

Table 6.2.1.2-1 Summary of HeNB noise rise due to MUE interference

Probability of HeNB that observe highest interference	MUE distance from MeNB, $D=R/2$	MUE distance from MeNB, $D=R$ (worst case)
50%	2.5dB	3.59dB
40%	7.43dB	9.4dB
30%	14.9dB	17.14dB

### 6.2.1.3 Minimum requirement

The throughput shall be  $\geq 95\%$  of the maximum throughput of the reference measurement channel as specified in Annex A in TS36.104 with parameters specified in Table 6.2.1.3-1.

**Table 6.2.1.3-1: HeNB reference sensitivity levels**

E-UTRA channel bandwidth [MHz]	Reference measurement channel	Reference sensitivity power level, P <sub>REFSENS</sub> [dBm]
1.4	FRC A1-1 in Annex A.1	-98.8
3	FRC A1-2 in Annex A.1	-95.0
5	FRC A1-3 in Annex A.1	-93.5
10	FRC A1-3 in Annex A.1*	-93.5
15	FRC A1-3 in Annex A.1*	-93.5
20	FRC A1-3 in Annex A.1*	-93.5

Note\*: P<sub>REFSENS</sub> is the power level of a single instance of the reference measurement channel. This requirement shall be met for each consecutive application of a single instance of FRC A1-3 mapped to disjoint frequency ranges with a width of 25 resource blocks each

## 6.2.2 Dynamic range

The impact of co-channel uplink interference from an uncoordinated UE on the HeNB needs to be studied to derive a reasonable dynamic range requirement. The co-channel interference from an uncoordinated macro UE (MUE) and home UE (HUE) are studied based on deterministic analysis and system-level simulations respectively in the following sections.

### 6.2.2.1 Deterministic analysis

The assumed scenario for coexistence with uncoordinated MUE is described in Figure 6.2.2.1-1. The HeNB (CSG) is located on a table in an apartment. A MUE is placed in the same apartment and establishes a call with the macro BS.

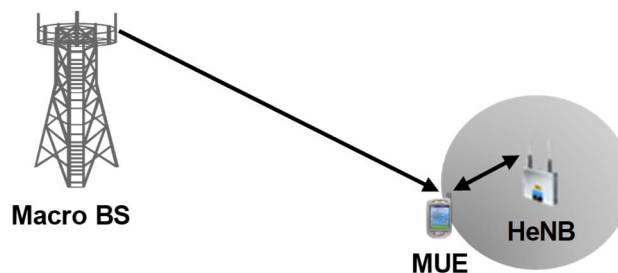

**Figure 6.2.2.1-1 Assumed interference scenario for coexistence with uncoordinated UE**

HeNB will cause a coverage hole (dead zone) to the co-channel deployed macrocell if received interference power at MUE exceeds the decoding threshold specified in TS36.101 [6]. The size of dead zone is determined by the output power of HeNB and the received wanted signal power of macro cell. The extension of the dead zone is restricted to be within several meters. The path loss model listed in equation (6.2.6.2-1) is used to determine the minimum distance that the MUE is able to go close to the HeNB. Figure 6.2.2.1-2 gives the relationship between the separation distance and received interference power level at HeNB antenna port. It's proposed to set the maximum received interference power level to -38dBm assuming 6 meters separation distance (dead zone) and 23dBm (PC 3 MUE) maximum output power.

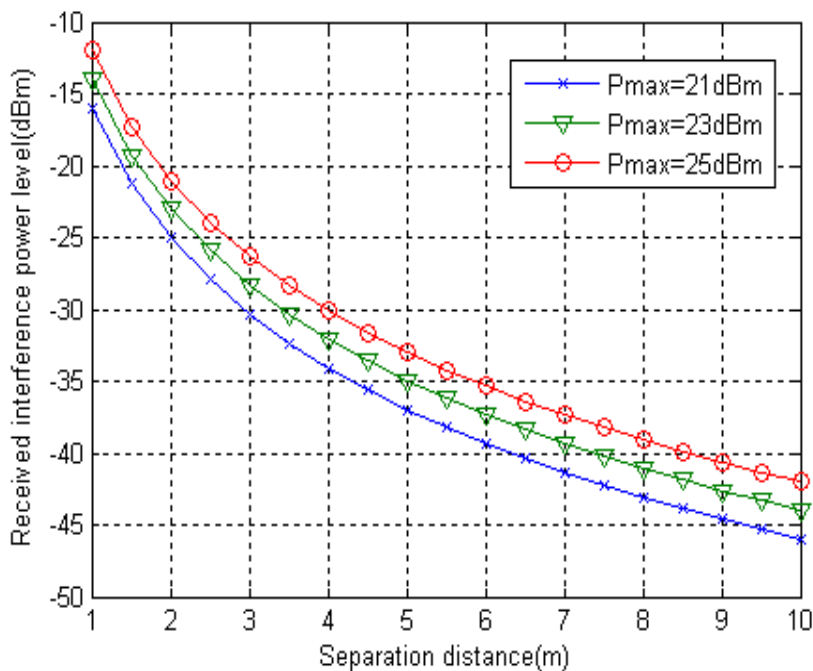

Figure 6.2.2.1-2 Minimum separation distance

6.2.2.2 System-level simulations

The assumed scenario and simulation assumptions are the same as section 6.2.1.1.1. The hierarchical deployment scenario of macrocell and HeNB is illustrated in Figure 6.2.2.2-1. One HeNB building block is randomly placed in a sector.

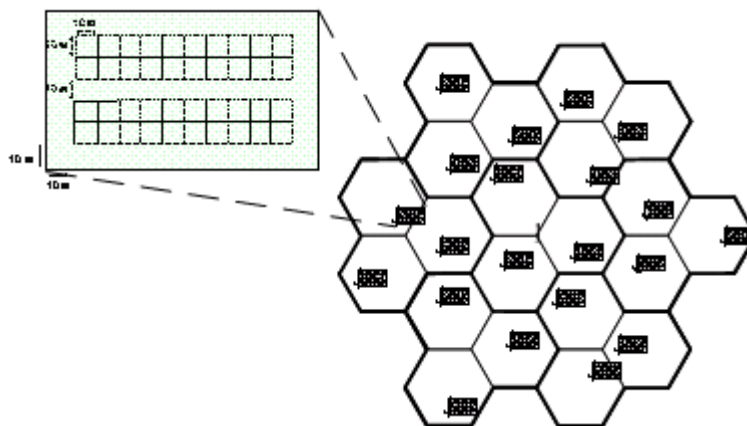

Figure 6.2.2.2-1 Hierarchical deployment scenario of macrocell and HeNB

Both co-channel interference from uncoordinated HUE and MUE are considered in our study. The MUE is located in the cell border and establishes a call with maximum output power. Fifty HUEs are randomly placed into the building block and each HeNB has an active user. The co-channel interference caused by MUE and HUE are defined as interference over thermal noise (IoT). In our simulations, uplink power control scheme described in TS36.211 [4] is used ( $\alpha = 1.0, P_0 = -106\text{dBm/RB}$ ). The simulation results are illustrated in Figure 6.2.2.2-2. The red line and blue line represent IoT level caused by other HUE and both other HUE and uncoordinated MUE respectively. Seen from the simulation results, we can get the following conclusions.

- Due to the limit coverage and deployment scenario, the HUE is very close to HeNB in most of cases and maintains the connection at low power level. Therefore, the main interference comes from the uncoordinated MUE.

- It's proposed to set the maximum IoT to 55dB to make sure the HeNB could suffer the interference from other HUE and uncoordinated MUE in most cases (99%).

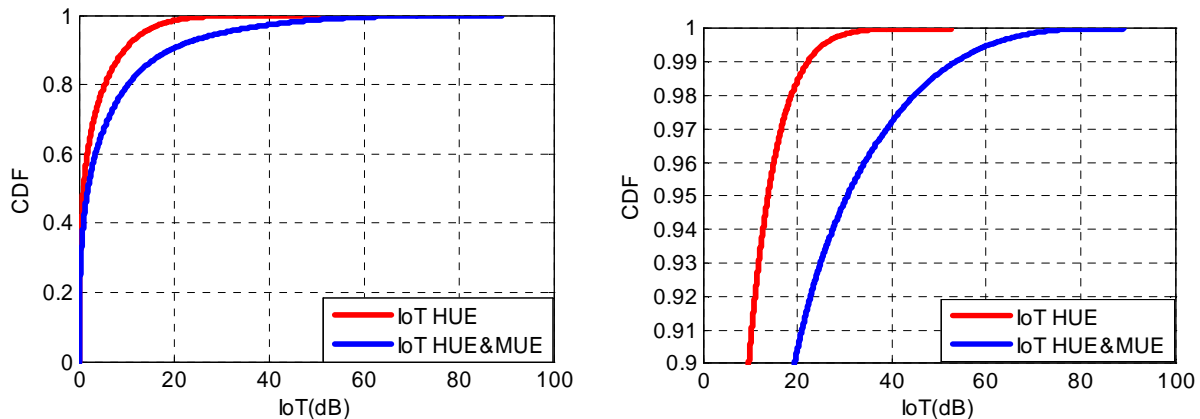

Figure 6.2.2.2-2 IoT level of HeNB

### 6.2.2.3 Minimum requirement

The throughput shall be  $\geq 95\%$  of the maximum throughput of the reference measurement channel as specified in Annex A with parameters specified in Table 6.2.2.3-1.

Table 6.2.2.3-1: Dynamic range

E-UTRA channel bandwidth [MHz]	Reference measurement channel	Wanted signal mean power [dBm]	Interfering signal mean power [dBm] / $BW_{Config}$	Type of interfering signal
1.4	FRC A2-1 in Annex A.2	-31.8	-44.2	AWGN
3	FRC A2-2 in Annex A.2	-27.9	-40.2	AWGN
5	FRC A2-3 in Annex A.2	-25.7	-38	AWGN
10	FRC A2-3 in Annex A.2*	-25.7	-35	AWGN
15	FRC A2-3 in Annex A.2*	-25.7	-33.2	AWGN
20	FRC A2-3 in Annex A.2*	-25.7	-31.9	AWGN

## 6.2.3 Adjacent channel selectivity (ACS) and narrow-band blocking

Adjacent channel selectivity (ACS) is a measure of the receiver ability to receive a wanted signal at its assigned channel in the presence of an adjacent channel signal with a specified centre frequency offset of the interfering signal to the band edge of a victim system. The HeNB receiver must have the ability to against the adjacent channel interference from the uncoordinated macrocell user. The following sections give the study results.

### 6.2.3.1 Simulation assumptions

The assumed coexistence scenario of macrocell and HeNB is illustrated in Figure 6.2.3.1-1. The HeNB and macro eNodeB (MeNB) are working in adjacent channel. The HeNB building block is located in the cell border and 10 MUEs are randomly placed in each sector. Detailed deployment parameters are listed in Table 6.2.3.1-1.

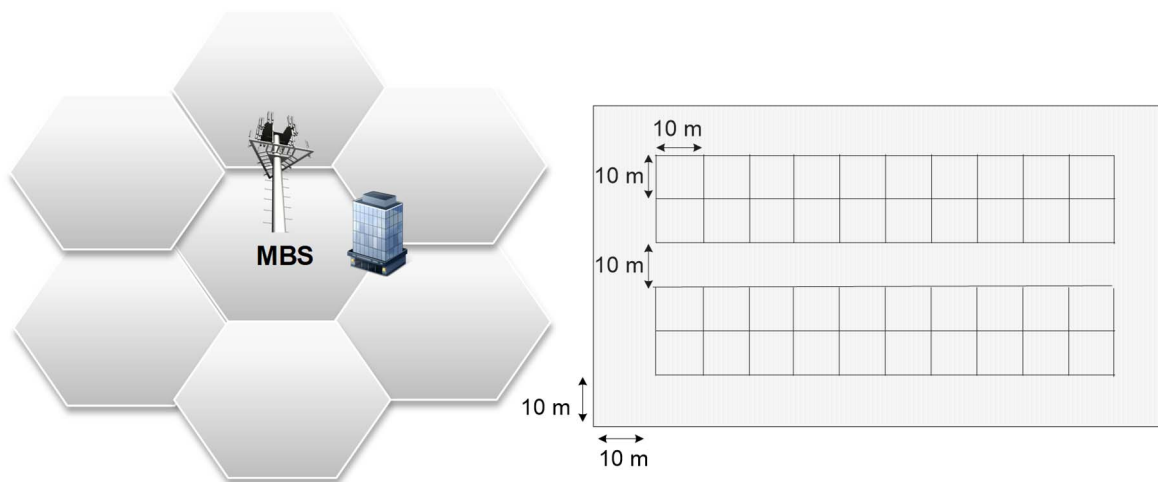

Figure 6.2.3.1-1 Assumed interference scenario for coexistence with uncoordinated UE(s)

Table 6.2.3.1-1 Simulation parameters

Macro cell parameters	Value
Cellular Layout	Hexagonal grid, 3 sectors per site, reuse 1.
Inter-site distance	500 m
UE power class	23 dBm (200 mW)
UE distribution	80% inside the building
HeNB parameters	Value
Number of HeNB per row	10
Number of blocks per sector	1
Number of floors per block	6
Number of HeNB	50
activation ratio	100%
Maximum output power	20dBm
Other parameters	Value
Propagation model	PL(dB) = 127+30log <sub>10</sub> (R/1000), R in m
Log-normal shadowing standard deviation	10 dB

### 6.2.3.2 Simulation results

The macro UE will be blocked when the adjacent channel interference power is larger than -20dBm (assuming 5dB margin based on minimum ACS requirement specified in TS36.101 [6]). Assuming the maximum output power of HeNB is 20dBm, we can get a minimum separation of 40dB between HeNB and MUE. UEs receiving higher interference than a blocking threshold of -20dBm will be removed from the UL interference statistics.

Figure 6.2.3.2-1 and 6.2.3.2-2 gives the uplink interference statistics caused by uncoordinated macro UE. Based on the simulation results, we proposed to define the adjacent channel interference level to -28dBm (24dB higher than EUTRA macro BS) which results in about 1% blocking probability of HeNB.

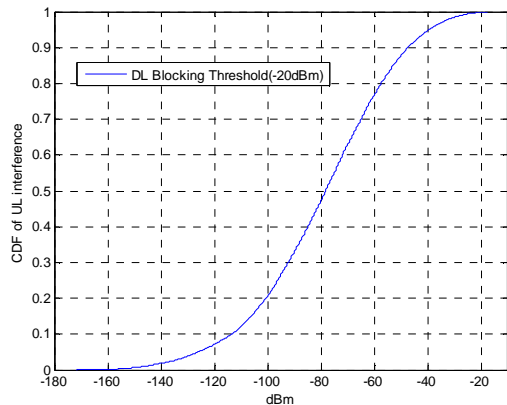

Figure 6.2.3.2-1 CDF of UL interference

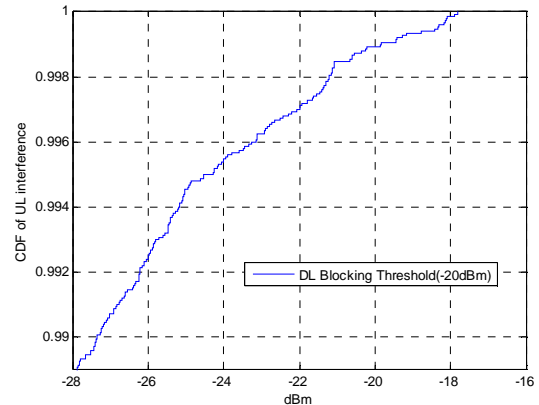

Figure 6.2.3.2-2 CDF of UL interference (Zoom in view)

### 6.2.3.3 Minimum requirements

The throughput shall be  $\geq 95\%$  of the maximum throughput of the reference measurement channel, with a wanted and an interfering signal coupled to the BS antenna input as specified in Tables 6.2.3.3-1 and 6.2.3.3-2 for narrowband blocking and in Table 6.2.3.3-3 for ACS. The reference measurement channel for the wanted signal is identified in Table 6.2.1.3-1 for each channel bandwidth and further specified in Annex A of TS36.104 [5].

Table 6.2.3.3-1: Narrowband blocking requirement

Wanted signal mean power [dBm]	Interfering signal mean power [dBm]	Type of interfering signal
$P_{\text{REFSENS}} + 14\text{dB}^*$	-33	See Table 6.2.3.3-2
Note*: $P_{\text{REFSENS}}$ depends on the channel bandwidth as specified in Table 6.2.1.3-1.		

Table 6.2.3.3-2: Interfering signal for Narrowband blocking requirement

E-UTRA Assigned BW [MHz]	Interfering RB centre frequency offset to the channel edge of the wanted signal [kHz]	Type of interfering signal
1.4	$252.5+m*180$ , $m=0, 1, 2, 3, 4, 5$	1.4 MHz E-UTRA signal, 1 RB*
3	$247.5+m*180$ , $m=0, 1, 2, 3, 4, 7, 10, 13$	3 MHz E-UTRA signal, 1 RB*
5	$342.5+m*180$ , $m=0, 1, 2, 3, 4, 9, 14, 19, 24$	5 MHz E-UTRA signal, 1 RB*
10	$347.5+m*180$ , $m=0, 1, 2, 3, 4, 9, 14, 19, 24$	5 MHz E-UTRA signal, 1 RB*
15	$352.5+m*180$ , $m=0, 1, 2, 3, 4, 9, 14, 19, 24$	5 MHz E-UTRA signal, 1 RB*
20	$342.5+m*180$ , $m=0, 1, 2, 3, 4, 9, 14, 19, 24$	5 MHz E-UTRA signal, 1 RB*
Note*: Interfering signal consisting of one resource block adjacent to the wanted signal		



**Table 6.2.3.3-3: Adjacent channel selectivity**

E-UTRA channel bandwidth [MHz]	Wanted signal mean power [dBm]	Interfering signal mean power [dBm]	Interfering signal centre frequency offset from the channel edge of the wanted signal [MHz]	Type of interfering signal
1.4	$P_{\text{REFSENS}} + 27\text{dB}^*$	-28	0.7025	1.4MHz E-UTRA signal
3	$P_{\text{REFSENS}} + 24\text{dB}^*$	-28	1.5075	3MHz E-UTRA signal
5	$P_{\text{REFSENS}} + 22\text{dB}^*$	-28	2.5025	5MHz E-UTRA signal
10	$P_{\text{REFSENS}} + 22\text{dB}^*$	-28	2.5075	5MHz E-UTRA signal
15	$P_{\text{REFSENS}} + 22\text{dB}^*$	-28	2.5125	5MHz E-UTRA signal
20	$P_{\text{REFSENS}} + 22\text{dB}^*$	-28	2.5025	5MHz E-UTRA signal

Note\*:  $P_{\text{REFSENS}}$  depends on the channel bandwidth as specified in Table 6.2.1.3-1.

## 6.2.4 Blocking characteristics

The blocking characteristic is a measure of the receiver ability to receive a wanted signal at its assigned channel in the presence of an unwanted interferer. The HeNB receiver must have the ability to against the interference from uncoordinated UE and other co-location HNB/HeNB. The following sections give the study results.

### 6.2.4.1 General blocking requirement

The general blocking requirement consists of in-band blocking and out-of-band blocking. The unwanted interferer is presented by E-UTRA signal for in-band blocking and a CW signal for out-of-band blocking.

In E-UTRA [8], the mean power of the E-UTRA interfering signal is equal to -43dBm which is a compromise between the 30dBm and 24dBm maximum output power assumption in TR36.942 [9] under worst case MCL condition.

The assumed coexistence scenario of macrocell and HeNB is illustrated in Figure 6.2.4.1-1. The HeNB and macro eNodeB (MeNB) are working in adjacent channel. The HeNB building block is located in the cell border and 10 MUEs are randomly placed in each sector. Detailed deployment parameters are listed in Table 6.2.4.1-1.

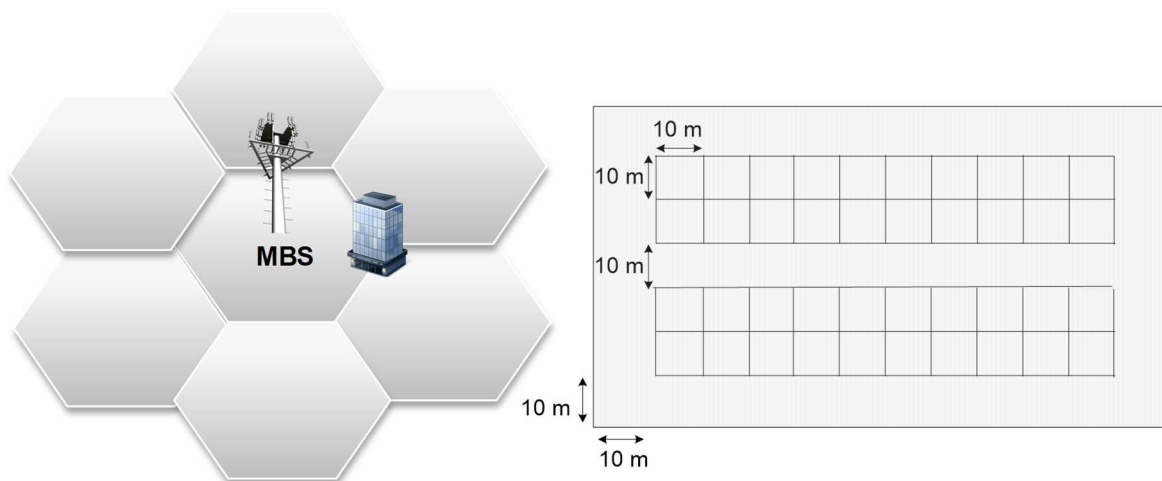

**Figure 6.2.4.1-1 Assumed interference scenario for coexistence with uncoordinated UE(s)**

Table 6.2.4.1-1 Simulation parameters

Macro cell parameters	Value
Cellular Layout	Hexagonal grid, 3 sectors per site, reuse 1.
Inter-site distance	500 m
UE power class	23 dBm (200 mW)
UE distribution	80% inside the building
HeNB parameters	Value
Number of HeNB per row	10
Number of blocks per sector	1
Number of floors per block	6
Number of HeNB	50
activation ratio	100%
Maximum output power	20dBm
Other parameters	Value
Propagation model	PL(dB) = 127+30log <sub>10</sub> (R/1000), R in m
Log-normal shadowing standard deviation	10 dB

The macro UE will be blocked when the interference power is larger than -25dBm (assuming 5dB margin based on minimum blocking requirement specified in TS36.101 [6]). Assuming the maximum output power of HeNB is 20dBm, we can get a minimum separation of 45dB between HeNB and MUE. UEs receiving higher interference than a blocking threshold of -25dBm will be removed from the UL interference statistics.

Figure 6.2.4.1-2 and 6.2.4.1-3 gives the uplink interference statistics caused by uncoordinated macro UE. Based on the simulation results, we proposed to define the channel interference level to -27dBm for blocking requirement which results in about 0.8% blocking probability of HeNB. In the meantime, we observe that -15dBm out-of-band blocking requirement seems to be also sufficient for HeNB.

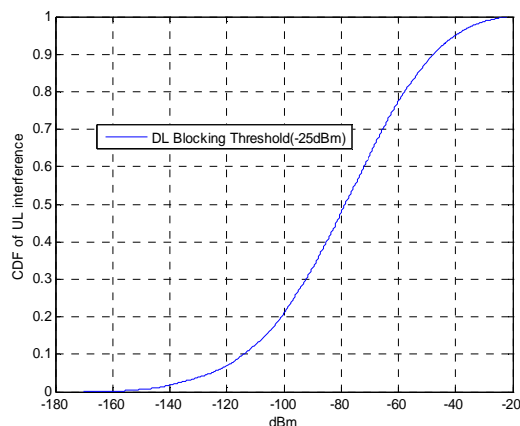

Figure 6.2.4.1-2 CDF of UL interference

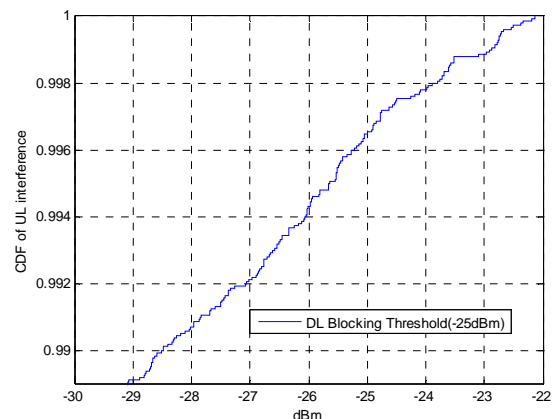

Figure 6.2.4.1-3 CDF of UL interference (Zoom in view)

#### 6.2.4.1.1 Minimum requirement

The throughput shall be  $\geq 95\%$  of the maximum throughput of the reference measurement channel, with a wanted and an interfering signal coupled to BS antenna input using the parameters in Table 6.2.4.1.1-1 and 6.2.4.1.1-2. The reference measurement channel for the wanted signal is identified in Table 6.2.1.3-1 for each channel bandwidth and further specified in Annex A of TS36.104.

Table 6.2.4.1.1-1: Blocking performance requirement for HeNB

Operating Band	Centre Frequency of Interfering Signal [MHz]	Interfering Signal mean power [dBm]	Wanted Signal mean power [dBm]	Interfering signal centre frequency minimum frequency offset from the channel edge of the wanted signal [MHz]	Type of Interfering Signal
1-7, 9-11, 13-14, 33-40	(F <sub>UL_low</sub> -20) to (F <sub>UL_high</sub> +20)	-27	P <sub>REFSENS</sub> +14dB*	See table 6.2.4.1.1.1-2	See table 6.2.4.1.1-2
	1 to (F <sub>UL_low</sub> -20) (F <sub>UL_high</sub> +20) to 12750	-15	P <sub>REFSENS</sub> +14dB*	—	CW carrier
8	(F <sub>UL_low</sub> -20) to (F <sub>UL_high</sub> +10)	-27	P <sub>REFSENS</sub> +14dB*	See table 6.2.4.1.1-2	See table 6.2.4.1.1-2
	1 to (F <sub>UL_low</sub> -20) (F <sub>UL_high</sub> +10) to 12750	-15	P <sub>REFSENS</sub> +14dB*	—	CW carrier
12	(F <sub>UL_low</sub> -20) to (F <sub>UL_high</sub> +12)	-27	P <sub>REFSENS</sub> +14dB*	See table 6.2.4.1.1-2	See table 6.2.4.1.1-2
	1 to (F <sub>UL_low</sub> -20) (F <sub>UL_high</sub> +12) to 12750	-15	P <sub>REFSENS</sub> +14dB*	—	CW carrier
17	(F <sub>UL_low</sub> -20) to (F <sub>UL_high</sub> +18)	-27	P <sub>REFSENS</sub> +14dB*	See table 6.2.4.1.1-2	See table 6.2.4.1.1-2
	1 to (F <sub>UL_low</sub> -20) (F <sub>UL_high</sub> +18) to 12750	-15	P <sub>REFSENS</sub> +14dB*	—	CW carrier

Note\*: P<sub>REFSENS</sub> depends on the channel bandwidth as specified in Table 6.2.1.3-1.

Table 6.2.4.1.1-2: Interfering signals for blocking performance requirement for HeNB

E-UTRA channel BW [MHz]	Interfering signal centre frequency minimum offset to the channel edge of the wanted signal [MHz]	Type of interfering signal
1.4	2.1	1.4MHz E-UTRA signal
3	4.5	3MHz E-UTRA signal
5	7.5	5MHz E-UTRA signal
10	7.5	5MHz E-UTRA signal
15	7.5	5MHz E-UTRA signal
20	7.5	5MHz E-UTRA signal

### 6.2.4.2 Co-location with other HNB/HeNB

The assumed scenario for co-location with other HNB/HeNB is described in Figure 6.2.4.2-1. Two HeNBs are placed in different rooms and opposite to a wall.

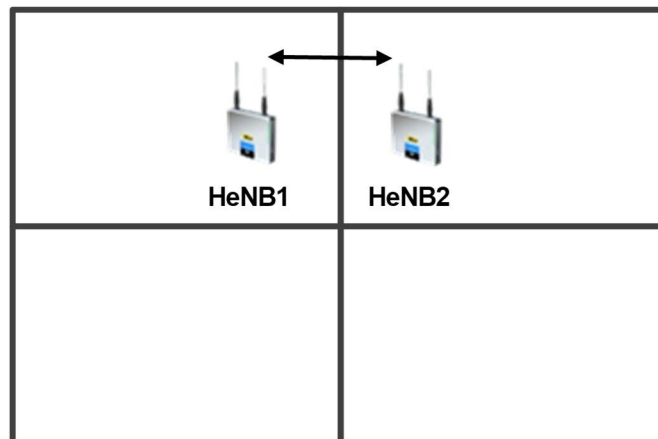

**Figure 6.2.4.2-1 Assumed interference scenario for co-location with other HNB/HeNB**

The minimum coupling loss between two co-located HeNBs is assumed to be 47dB. Assuming the maximum output power of HeNB is also 20dBm as HNB, the co-location blocking requirement to against other nearby cross-band HNB/HeNB will be -27dBm.

Based on above analysis, it's proposed to set the co-location blocking requirement to -27dBm to against other nearby cross-band HNB/HeNB. In addition, the power difference between wanted signal and interfering signal is proposed to be the same as EUTRA macro BS co-location blocking test. These requirements will be specified in section 7.6.2.1 of TS36.104 [5].

## 6.2.5 Receiver Intermodulation

### 6.2.5.1 Analysis

Receiver inter-modulation can occur when two interfering signals with a particular relationship are applied to a BS receiver. Two large interfering signals at the same time occur less frequently than a single interfering signal. Due to lower probability of two large interfering signals, the power level of the interfering signals for the inter-modulation requirement should be lower compared to Blocking requirement. For the Macro eNB, the level of IM interfering signals is -52dBm which is 9 dB lower compared to Blocking requirement of -43dBm. It is proposed to use the same relative values also for the home eNode B.

In the TR, the blocking interference level for Home eNode B is proposed to be -27dBm. Adopting the same relative values of 9dB also for Home eNode B inter-modulation requirement, the following interfering signals level for inter-modulation is proposed:

- Interfering signals: -36 dBm for both modulated and CW interferer.

As for the wanted signal level, it is proposed to keep the same relative value with interfering signal as that for MeNB in order not to put more stringent requirement for HeNB. So the following wanted signal level is proposed.

- Wanted signal:  $P_{\text{REFSENS}} + 14\text{dB}$

### 6.2.5.2 Minimum requirement

The throughput shall be  $\geq 95\%$  of the maximum throughput of the reference measurement channel, with a wanted signal at the assigned channel frequency and two interfering signals coupled to the BS antenna input, with the conditions specified in Tables 6.2.5.2-1 and 6.2.5.2-2 for intermodulation performance and in Table 6.2.5.2-3 for narrowband intermodulation performance. The reference measurement channel for the wanted signal is identified in section 6.3.1 for each channel bandwidth and further specified in Annex A of [5].

Table 6.2.5.2-1: Intermodulation performance requirement

Wanted signal mean power [dBm]	Interfering signal mean power [dBm]	Type of interfering signal
$P_{\text{REFSENS}} + 14\text{dB}^*$	-36	See Table 6.2.5.2-2
Note*: $P_{\text{REFSENS}}$ depends on the channel bandwidth as specified in section 6.3.1.		

Table 6.2.5.2-2: Interfering signal for Intermodulation performance requirement

E-UTRA channel bandwidth [MHz]	Interfering signal centre frequency offset from the channel edge of the wanted signal [MHz]	Type of interfering signal
1.4	2.1	CW
	4.9	1.4MHz E-UTRA signal
3	4.5	CW
	10.5	3MHz E-UTRA signal
5	7.5	CW
	17.5	5MHz E-UTRA signal
10	7.5	CW
	17.7	5MHz E-UTRA signal
15	7.5	CW
	18	5MHz E-UTRA signal
20	7.5	CW
	18.2	5MHz E-UTRA signal

Table 6.2.5.2-3: Narrowband intermodulation performance requirement

E-UTRA channel bandwidth [MHz]	Wanted signal mean power [dBm]	Interfering signal mean power [dBm]	Interfering RB centre frequency offset from the channel edge of the wanted signal [kHz]	Type of interfering signal
1.4	$P_{\text{REFSENS}} + 14\text{dB}^*$	-36	270	CW
		-36	790	1.4 MHz E-UTRA signal, 1 RB**
3	$P_{\text{REFSENS}} + 14\text{dB}^*$	-36	275	CW
		-36	790	3.0 MHz E-UTRA signal, 1 RB**
5	$P_{\text{REFSENS}} + 14\text{dB}^*$	-36	360	CW
		-36	1060	5 MHz E-UTRA signal, 1 RB**
10	$P_{\text{REFSENS}} + 14\text{dB}^*$ (***)	-36	415	CW
		-36	1420	5 MHz E-UTRA signal, 1 RB**
15	$P_{\text{REFSENS}} + 14\text{dB}^*$ (***)	-36	380	CW
		-36	1600	5MHz E-UTRA signal, 1 RB**
20	$P_{\text{REFSENS}} + 14\text{dB}^*$ (***)	-36	345	CW
		-36	1780	5MHz E-UTRA signal, 1 RB**
Note*: $P_{\text{REFSENS}}$ is related to the channel bandwidth as specified in section 6.3.1.				
Note**: Interfering signal consisting of one resource block positioned at the stated offset.				
Note***: This requirement shall apply only for a FRC A1-3 in [5] mapped to the frequency range at the channel edge adjacent to the interfering signals				

## 6.2.6 In-channel selectivity

Receiver in-channel selectivity requirement is a measure of the receiver ability to receive a wanted signal at its assigned resource block locations in the presence of an interfering signal received at a larger power spectral density.

### 6.2.6.1 Analysis

For Home eNode B, the same method as that for MeNB can be used for defining this requirement. The UL signals are just defined for 2 users, one being the "wanted" signal and the other one being the "interfering" signal at elevated power. Regarding the interferer level, a 16QAM "interfering" signal is proposed 25dB above its noise floor to mask the impact of receiver's own noise floor. The "wanted" signal was defined as a QPSK modulated FRC, for which  $\geq 95\%$  T-put should be achieved in the presence of the interfering signal. The only difference between MeNB and HeNB is the power level setting for wanted signal and interfering signal. Since the noise figure has been agreed as 13dB (8dB degradation compared to MeNB), the wanted signal and interfering signal levels for home eNode B is shown in Table 6.2.6.1-1.

**Table 6.2.6.1-1: RB allocations and power settings for wanted signal and interferer for HeNB**

E-UTRA channel BW [MHz]	RBs Wanted signal	RBs Interfering signal	Wanted signal level [dBm]	Interfering signal level [dBm]
1.4	3	3	-98.9	-79
3	9	6	-94.1	-76
5	15	10	-92.0	-73
10	25	25	-90.5	-69
15	25	25	-90.5	-69
20	25	25	-90.5	-69

### 6.2.6.2 Minimum requirement

The throughput shall be  $\geq 95\%$  of the maximum throughput of the reference measurement channel as specified in Annex A of [5] with parameters specified in Table 6.2.6.2-1 for HeNB.

**Table 6.2.6.2-1 E-UTRA Home BS in-channel selectivity**

E-UTRA channel bandwidth (MHz)	Reference measurement channel**	Wanted signal mean power [dBm]	Interfering signal mean power [dBm]	Type of interfering signal
1.4	A1-4 in Annex A.1	-98.9	-79	1.4 MHz E-UTRA signal, 3 RBs
3	A1-5 in Annex A.1	-94.1	-76	3 MHz E-UTRA signal, 6 RBs
5	A1-2 in Annex A.1	-92.0	-73	5 MHz E-UTRA signal, 10 RBs
10	A1-3 in Annex A.1	-90.5	-69	10 MHz E-UTRA signal, 25 RBs
15	A1-3 in Annex A.1*	-90.5	-69	15 MHz E-UTRA signal, 25 RBs*
20	A1-3 in Annex A.1*	-90.5	-69	20 MHz E-UTRA signal, 25 RBs*
Note*: Wanted and interfering signal are placed adjacently around DC				
Note**: the reference channel A1-x is defined in [5]				

## 6.3 Performance requirement

Compared with macro eNodeB, HeNB is usually deployed for indoor scenarios. The propagation conditions will contain more multi-paths with smaller multi-path delay due to the rich scattering characteristic of indoor environment. In LTE systems, which is based on multiple carrier frequencies with CP to combat the multi-path fading, the indoor demodulation performance can be expected at least as good as that under outdoor channel model. Moreover, from a

general point of view, HeNB can also be deployed for small-scale enterprise solutions. An outdoor hot spot model without very large multi-path delay, e.g. EVA, should also be considered for demodulation performance.

Furthermore, UE attached to HeNB is usually considered to move at a speed no faster than 30km/h, which corresponds to a maximum Doppler frequency of about 70Hz. Thus, it is feasible to define the HeNB performance requirements by utilizing some specific macro eNodeB test cases with low speeds.

For multi-path fading propagation conditions shown in B.2 of TS36.104 [5], EPA and EVA model with a maximum Doppler frequency no larger than 70Hz is considered for TD-LTE HeNB demodulation performance and the performance requirements remain the same as that in TS36.104 [5] accordingly.

## 6.4 Synchronization requirement

### 6.4.1 Synchronization Accuracy

#### 6.4.1.1 Synchronization error analysis

For LTE TDD, the inter-cell interferences of eNB (HeNB) to eNB (HeNB) and UE to UE are related to the cell synchronization. In order to overcome the above interferences, strict synchronization is required. For HeNB, the interference case of UE to UE at the uplink-to-downlink switch point is the crucial factor to the synchronization requirement because of the limited coverage. At the switch point, two kinds of interferences should be taken into account. One is MUE downlink disturbed by HUE uplink, the other is HUE downlink disturbed by MUE uplink.

If the HeNB coverage is up to tens meters, the synchronization error should be smaller than 1us. For the network listening scheme, such strict requirement will increase the implementation difficulty and synchronization overhead. However, as the minimum cyclic prefix of LTE is far larger than the sum of delay spread and propagation delay for indoor scenarios, a little interference caused by inaccurate synchronization will not result in performance degradation.

For LTE, there are two kinds of cyclic prefix (CP), i.e. the normal CP and extend CP, with their periods listed in Table.6.4.1.1-1.

**Table 6.4.1.1-1 the CP period of LTE**

	Normal	Extend
CP period	4.7/5.2us	16.7us

Since the most important application of HeNB focuses on the indoor scenarios such as home and office, ITU indoor channel models [12] are taken into account for reference, in which the maximum delay spreads of LOS (light-of-sight) and NLOS (non light-of-sight) scenarios are listed in Table.6.4.1.1-2.

**Table 6.4.1.1-2 the delay spread of indoor channel**

	ITU InH LOS	ITU InH NLOS
Maximum delay spread	0.13us	0.225us

In addition, the propagation delay is limited up to 1us because of the restricted transmission power and complex indoor scenarios. Thus, there is

$$\begin{aligned}
 [synchronization\ error]_{HeNB} &= [CP]_{\min} - [propagation\ delay]_{\max} - [delay\ spread]_{\max} \\
 &= 4.7us - 1us - 0.225us \\
 &= 3.475us
 \end{aligned}$$

Thus in many scenarios, a 3 us synchronization requirement can be adopted. The 3us requirement is also compatible with the macro cell. But it is also important that practical synchronization schemes (including GPS, IEEE 1588v2, open and closed loop network listening) are not excluded. Thus, if the HeNB derives its synchronization from a larger cell, then the propagation distance is larger and a different synchronization requirement is required compared with that in small cell. Therefore, it is important to have a synchronization requirement that is strict and practical.

Network listening is one essential practical scheme, as it works when GPS doesn't work (e.g. indoors) and IEEE 1588v2 is not available (e.g. with consumer-grade backhaul). Network listening can be performed in open loop or close loop fashion. Based on some studies in RAN4, the advantages of open loop vs. closed loop are explained and it is concluded that open loop network listening is essential for TD-LTE HeNBs. When synchronization is acquired using open loop network listening, the synchronizing HeNB is automatically offset by the propagation delay compared to the donor eNB or HeNB. Some requirements that take this fact into account are necessary. A 3us requirement for small cells is based on a propagation delay of 1.67 us and an implementation margin of 1.33 us. The same margin can be used in the large cell scenario as well. This will result in a synchronization requirement of 1.33 us + the propagation delay between the HeNB and the donor cell.

It should be noted that the guard period in the DwPTS subframe should be chosen so as to accommodate the propagation delay. The analysis in RAN4 shows that if the guard period is equal to twice the maximum propagation delay, an additional timing advance can be used to prevent UE-UE interference. The following figure demonstrates this. Note that un-accessed UEs can not know the additional timing advance, and therefore the UpPTS channel of un-accessed UEs must be disturbed by the additional timing advance, but with a small additional timing advance, this issue will be mitigated in some extent. The issue is specific to the open-loop scheme, FSS. For close-loop scheme, the additional timing advance is unnecessary.

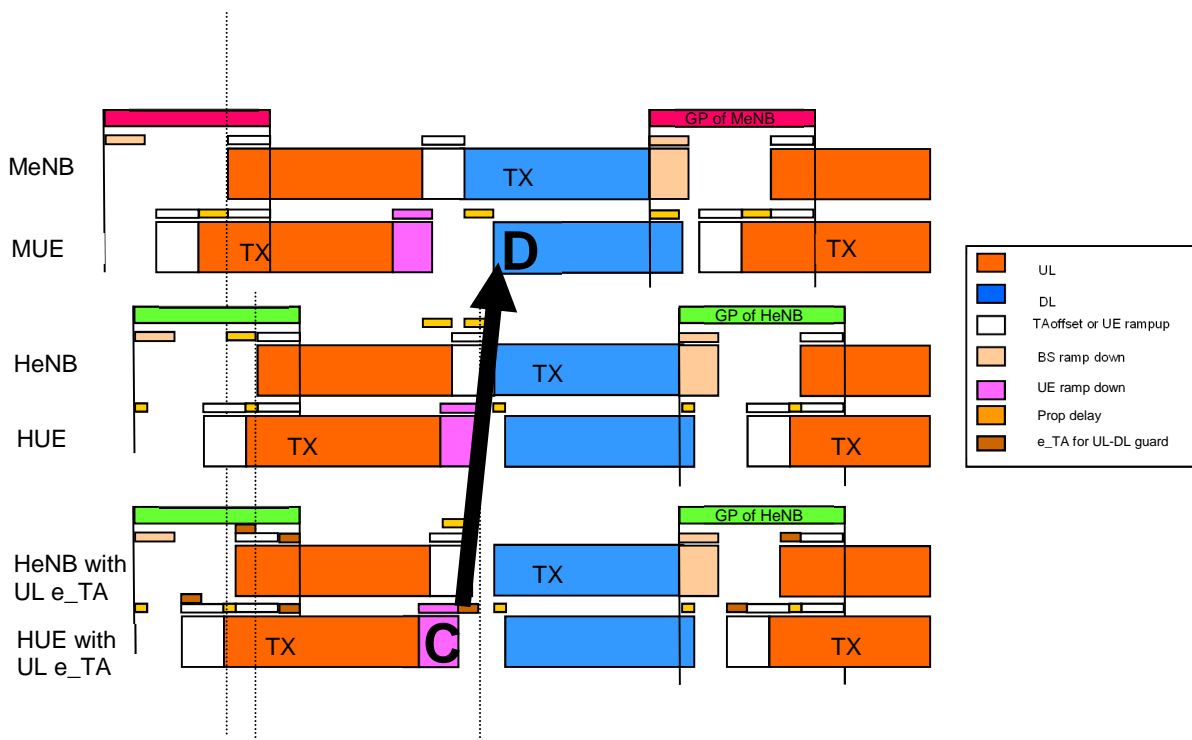

Figure 6.5-1 TDD HeNB Timing using Network Listening and Extra Timing Advance

### 6.4.1.2 Synchronization requirement

The synchronization requirement for a HeNB is defined as the difference in radio frame start timing, measured at the transmit antenna connectors, between the HeNB and any other HeNB or eNB which has overlapping coverage. The synchronization requirement shall be set to 3 us in all cases, except when the HeNB gets its synchronization when performing network listening off cells with propagation distance greater than 500m. This requirement shall apply independent of the synchronization technique used (GPS, IEEE 1588 v2, Network Listening). In scenarios where synchronization is obtained via network listening off cells with propagation distance greater than 500m, the synchronization requirement shall be 1.33 us plus the propagation delay between the HeNB and the cell selected as the network listening synchronization source (e.g. when the propagation distance is 2.6km, the synchronization requirement is 10 us). In terms of the network listening synchronization source selection, the best accurate synchronization source to GNSS should be selected.



## 6.4.2 Techniques for Synchronization

Three synchronization techniques have been identified for HeNB synchronization.

*GPS.* If a HeNB contains a GPS receiver and can acquire the GPS synchronization signals, then GPS provides the most accurate synchronization accuracy (on the order of 100ns). However, GPS receivers do not always work in some important scenarios (e.g. indoors.)

*IEEE 1588 v2.* Under good backhaul conditions (e.g. operator controlled fiber / Ethernet), IEEE 1588 v2 can provide sub-microsecond level accuracy. However, such good backhaul conditions may not always be possible. In particular backhauls over cable and DSL modems have significant jitter and delay variations. Note that the upstream packet delay  $\delta_1$  is often not equal to the downstream delay  $\delta_2$  creating an error of  $(\delta_1 - \delta_2)/2$ . This resulting error may be up to many milliseconds, rendering IEEE 1588v2 restricted for the application of TD-LTE synchronization.

*Network Listening.* Network listening can be used in scenarios where GPS and IEEE 1588 v2 do not work. For this reason, network listening is an essential synchronization scheme for TD-LTE HeNBs in those scenarios.

### 6.4.2.1 Synchronization using Network Listening

The technique in which a HeNB derives its timing from a synchronized eNB or HeNB (which in turn may be GNSS-synchronized) is referred to here as "synchronization using network listening." A HeNB that uses network listening (say HeNB1) may utilize a synchronization or reference signal from another eNB (say sync eNB) to derive its timing as in Fig. 6.4.2.1-1(a). Such single hop synchronization for HeNB is the most common case under good macro coverage based on analysis in RAN4. But when a HeNB can not acquire synchronization from a primary synchronization source (an eNB or HeNB with GNSS synchronization) then multiple hops could be supported. This concept is illustrated in Fig. 6.4.2.1-1(b) where HeNB2 acquires synchronization from HeNB1 which in turn acquires synchronization from eNB.

In the case of multihop synchronization, the concept of synchronization stratum can be introduced. The synchronization stratum of a particular HeNB is defined as the smallest number of hops between the HeNB and the GPS source. It should be noted that the synchronization stratum of a particular HeNB is one greater than its donor (H)eNB, i.e., the (H)eNB that it is tracking. In the figure below, sync eNB has stratum 0, HeNB1 has stratum 1 and HeNB2 has stratum 2.

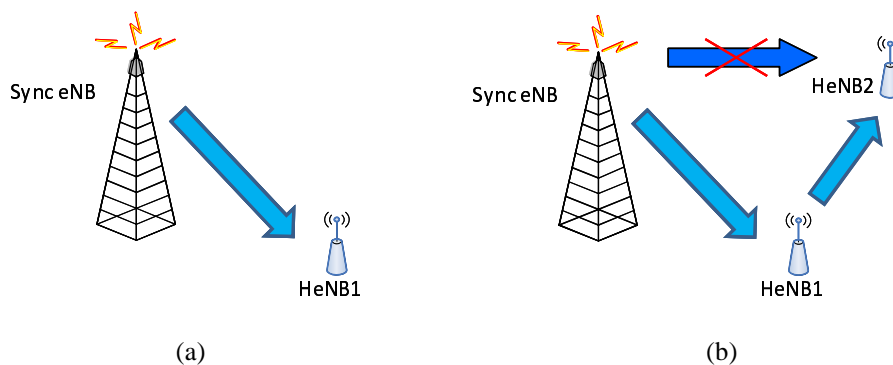

Fig. 6.4.2.1-1 Synchronization using Network listening

The HeNB may periodically track one or more signals from the donor cell (e.g. Primary and Secondary Synchronization Signals, Common Reference Signal, Positioning Reference Signal) to maintain its synchronization. Of course, tracking the PSS and SSS could come at the cost of some backward compatibility since a HeNB would need to shut down its PSS/SSS transmission to monitor the PSS/SSS of the donor (H)eNB. Two fully backward compatible schemes for tracking the Common Reference Signal (CRS) have been proposed, one that uses MBSFN subframes and one that uses the guard period between DL and UL transmission. A description of these schemes is given in the section 6.5.3.1.2 and 6.5.3.1.3.

#### 6.4.2.1.1 Interference Problems with Network Listening and Solutions

When a HeNB obtains synchronization through network listening, it has to stop transmitting and monitor the signals of its donor (H)eNB, this process is susceptible to interference. In particular, cells that are in the vicinity of others using

network listening may not be able to receive the synchronization signals from a farther off cell due to strong interference from these cells. This is shown in Fig. 6.4.2.1.1-1.

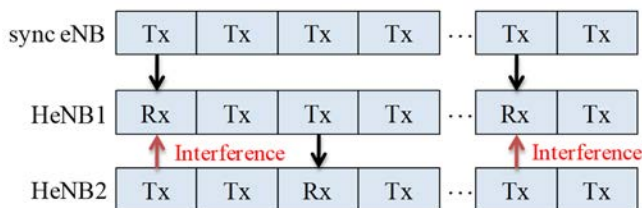

Fig. 6.4.2.1.1-1 Interference problem in network listening

One solution is to use appropriate DL Power Control to mitigate the interference from neighbour nodes when synchronization tracking. The interference from neighbour cell will be controlled in an acceptable level, which could ensure the network listening.

An alternate solution is to coordinate the tracking time between cells. Fig. 6.4.2.1.1-2 shows an example in which the tracking times are coordinated among different nodes. Here HeNB1 tracks sync eNB without interference from HeNB2. Additionally, HeNB2 tracks the synchronization signals from HeNB1. The results discussed in RAN4 show that virtually all HeNBs can obtain synchronization via coordinated silence.

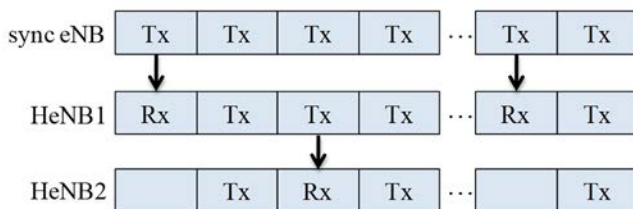

Fig. 6.4.2.1.1-2 Interference problem mitigation using Coordinated Silence

Note that synchronization maintenance can be done at very low periodicity as the clock drifts are 250ppb or less. In order to achieve satisfactory performance, the nodes must co-ordinate their silence periods, and utilize these opportunities to achieve and maintain synchronization. Coordinated information should be conveyed to the cells for synchronization tracking meanwhile these cells should have an initial common reference time, e.g. aligned SFN (system frame number), to ensure the execution. This initial reference time including SFN could be obtained at HeNB bootup by observing the time of the nearest cell, which may or may not be the same cell that the HeNB chooses to track later on.

6.4.2.1.2 MBSFN Subframe based Network Listening

The proposed scheme uses MBSFN subframes for tracking synchronization. An HeNB stops transmitting for a subframe to track synchronization. To minimize the impact on UEs, the HeNBs declare this subframe to be an MBSFN subframe. This method allows for multiple hops in the synchronization path. Also, all the nodes can track in a coordinated fashion (all declaring MBSFN subframes at the same time), thus minimizing interference.

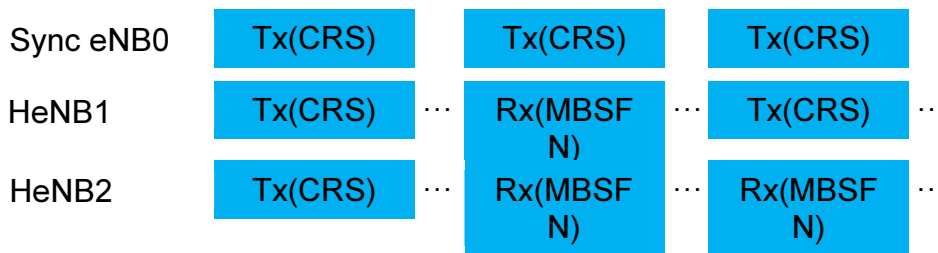

Fig. 6.4.2.1.2-1 Tracking using MBSFN Subframes

Furthermore, it ensures that the entire network uses the same synchronization source (e.g. GNSS) and that loops are not created. This is because each HeNB declares its stratum as one greater than that of its donor (H)eNB. It should be noted that the stratum number of a HeNB is self-configured, and that the HeNB tries to track the lowest available stratum node. This in turn allows the HeNB to be as close to GNSS time as possible. Furthermore, the stratum number is a dynamic quantity that could vary with changing RF conditions (if HeNB1 in the above example is turned off, then HeNB2 could obtain synchronization via a different route, say eNB0 → HeNB3 → HeNB4 → HeNB2, in which case it would have a stratum number of 3.) A HeNB should preferably synchronize to the lowest possible stratum. A flow chart to demonstrate deriving the stratum and using MBSFN subframes for tracking is given in the subsequent figure.

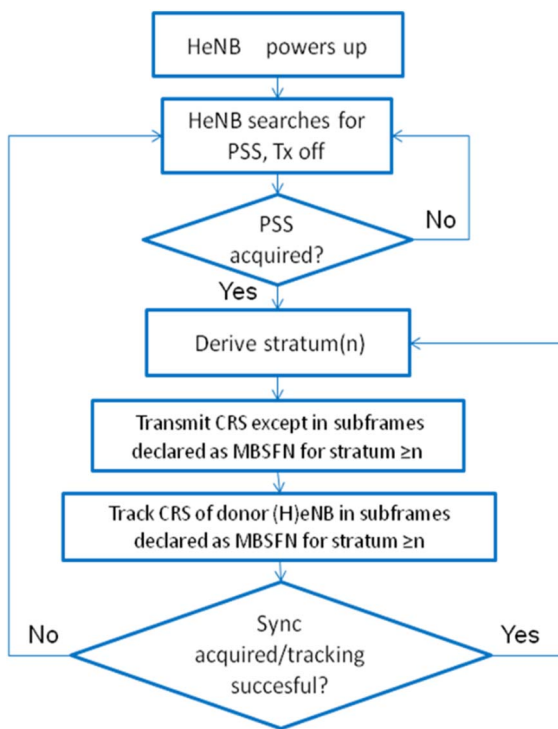

Fig. 6.4.2.1.2-2 HeNB Procedure for Synchronization using MBSFN Subframes

The overhead incurred by this scheme depends on the number of hops and would be equal to the number of hops times one subframe in every 320 subframes. (320ms corresponds to the highest configurable periodicity of MBSFN subframes). For a stratum-1 HeNB, the overhead is a little under 0.3%. It should also be noted that the MBSFN subframe based method can be used for FDD as well for deriving frequency synchronization (and potentially time synchronization if required in future releases).

6.4.2.1.3 TDD Special Subframe based Network Listening

To avoid asynchronous interference, another simple method is introduced for TDD system to achieve HeNB synchronizing to macro layer eNB, which there is no need HeNB install satellite receiver. In this solution, Home eNB

and macro layer eNBs utilize different special subframe configuration, macro layer configure with more OFDM symbols in DwPTS, and Home eNB with less OFDM symbols in DwPTS, so Home eNB can utilize the GP to track macro layer eNB common reference signal (CRS) in DwPTS without additionally impact on its normal transmission, and CRS tracing can be done every radio frame to generate a statistic tuning value, which ensure more robust synchronization. Meanwhile considered HeNB is mainly used for providing high data rate service, the DL resource is relative not stringent to provide such overhead for robust synchronization.

With this solution HeNB can only read CRS for synchronization, however this should be enough. When HeNB is power on, HeNB may follow the UE cell search process and get the accurate synchronization from the macro eNB while is assumed as accurate synchronization resource with satellite receiver. And then symbol timing, radio frame timing and eNB cell ID can be get by HeNB, which enable the HeNB conduct the aforementioned CRS based synchronization tracking procedure, which is mainly a process to track the synchronization on a finer time scale.

When HeNB is operating, its location is stable, so there is no need to always repeat the cell search process to get the timing. Only tracking the CRS periodically to maintain the synchronization with macro layer is enough for HeNB.

There are two CP lengths defined in TS 36.211, so the analysis is provided separately for the two cases.

**1. Normal CP case**

CRS on antenna port 0 and antenna port 1 are located in 1<sup>st</sup> and 5<sup>th</sup> OFDM symbol of each slot. Macro layer eNB can be configured unifiedly with more DwPTS symbols (i.e. config1, 2, 3, 4, 6, 7, 8, detailed configurations are shown in Table 6.4.2.1.3-1). HeNB use other different configuration to pair with macro layer configuration, such as config 0 or 5, in these configurations, HeNB only transmit 3 OFDM symbols. When HeNB track the timing, after its DwPTS transmission finish, HeNB transit to receiver state, normally the HeNB eNB DL->UL switching time is less than 15us, one symbol is enough for the switching, HeNB will receive the CRS from the 5<sup>th</sup> OFDM symbol. Also by configuring both macro eNB (config4) and HeNB (config2) with more symbols in DwPTS, the user data transmission is improved, such as HeNB can start to receive CRS from the 12<sup>th</sup> symbol of the special subframe.

Example of Macro eNB and HeNB configuration refer to Figure 6.4.2.1.3-1. Considering HeNB DL-> UL switching time, HeNB can receive macro eNB CRS in 5<sup>th</sup> OFDM symbol successfully.

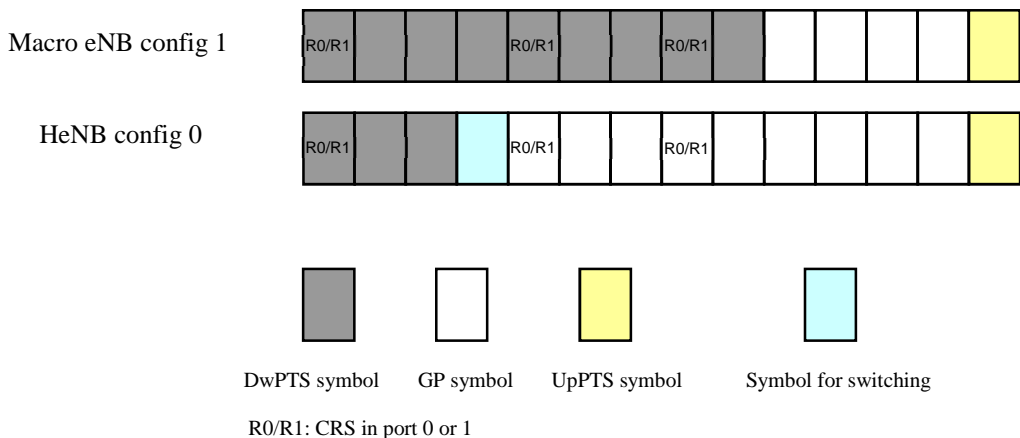

**Figure 6.4.2.1.3-1: Normal CP case, Macro eNB and HeNB DwPTS/GP/UpPTS configuration**

**Table 6.4.2.1.3-1: DwPTS/GP/UpPTS configuration**

Config	Normal CP			Extended CP		
	DwPTS	GP	UpPTS	DwPTS	GP	UpPTS
0	3	10	1	3	8	1
1	9	4	1	8	3	1
2	10	3	1	9	2	1
3	11	2	1	10	1	1
4	12	1	1	3	7	2
5	3	9	2	8	2	2
6	9	3	2	9	1	2
7	10	2	2			
8	11	1	2			

**2. Extended CP case**

CRS on antenna port 0 and antenna port1 are located in 1<sup>st</sup> and 4<sup>th</sup> OFDM symbol of each slot. Macro layer eNB can configure with more DwPTS symbols (i.e. config1, 2, 3, 5, 6). HeNB use different configuration, such as config 0 or 4, in these configurations, HeNB only transmit 3 OFDM symbols. When HeNB track the timing, after it's DwPTS transmission finish, HeNB transit to receiver state, normally the HeNB eNB DL->UL switching time is less than 15us, one symbol is for the switching, HeNB will receive the CRS from the 7<sup>th</sup> OFDM symbol. Also by configuring both macro eNB (config3) and HeNB (config1) with more symbols in DwPTS, the user data transmission is approved, such as HeNB can start to receive CRS 10<sup>th</sup> symbol of the special subframe.

Example of Macro eNB and HeNB configuration refer to Figure 6.4.2.1.3-2. Considering HeNB DL-> UL switching time, HeNB can receive macro eNB CRS in 7<sup>th</sup> OFDM symbol successfully.

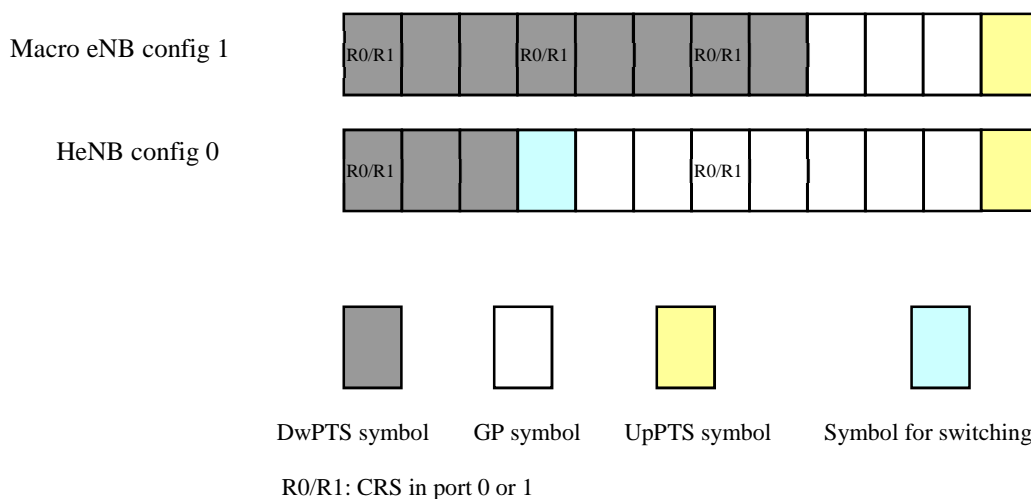

**Figure 6.4.2.1.3-2: Extend CP case, Macro eNB and HeNB DwPTS/GP/UpPTS configuration**

This solution based on macro cell layer and HeNB layer deployed different DwPTS/GP/UpPTS configurations. As for HeNB configuration, that can be fixed by operator before distribution. There is no impact on the air interface specifications. For two layers cell, only special subframe configuration is different, there is no interference issue between macro layer eNB and HeNB or related connected UE-UE. Also there is no backward compatibility issue for Rel8 eNB and UE, only requirement is to home eNB which need 440dell the cell search and track macro layer CRS function. Tracking period can be set by the HeNB, for the oscillator frequency stability is affected by the ambient temperature.

The feasibility of this scheme is relative to the macro cell configuration. If macro layer eNBs are configured with max GP, there is no way that a HeNB could use macro common reference signals for synchronization tracking.

For the scenario that HeNB are not able to synchronize directly to an eNB that is GNSS-synchronized, utilizing the special subframe configuration pairs, this solution also can fulfill 2 hops synchronization in some configurations. Take extended CP case for example, macro cell can be set with configuration 3, the first hop HeNB is set with configuration 1 or 5 and the second hop HeNB is set with configuration 0 or 4.

#### 6.4.2.1.4 Indication of Stratum Level and Synchronization Status

The HeNB should be aware of its neighbours synchronization hierarchy (stratum info), and then correspondingly decide its own stratum number. Also, the HeNB needs to let others know its own synchronization status and stratum info. Two solutions are proposed to fulfil this function as below.

Note that while the solutions are described in the context of the MBSFN-subframe based scheme, the use of these solutions for other schemes (including schemes not listed in the TR) is not precluded.

RAN4 endorses both backhaul signalling and blind detection schemes for indication of stratum level and synchronization status, and their adoption depends on the operator deployment choice.

It is up to the operator to choose either backhaul signalling or blind detection depending on the deployment.

##### 6.4.2.1.4.1 Stratum Indication Using Backhaul Signalling

The optional backhaul signalling of time synchronization status and stratum level are TDD HeNB specific. Optional only means that it is up to the operator to decide whether to use the signalling or not depending on the deployment.

An HeNB can get information of neighboring eNB's time synchronization status and stratum level over the backhaul by using the S1-AP eNB configuration transfer procedure and the S1-AP MME configuration transfer procedure.

The HeNB\_1 initiates S1-AP eNB configuration transfer procedure by sending the MME the eNB CONFIGURATION TRANSFER message containing the target eNB ID and Time Sync Info request. The MME forwards the request to the target eNB with the MME CONFIGURATION TRANSFER message.

When the (H)eNB\_2 receives the MME CONFIGURATION TRANSFER message with Time Sync Info request, it replies to the MME with eNB CONFIGURATION TRANSFER message containing its stratum level and sync status. The MME forwards the received information to the HeNB1.

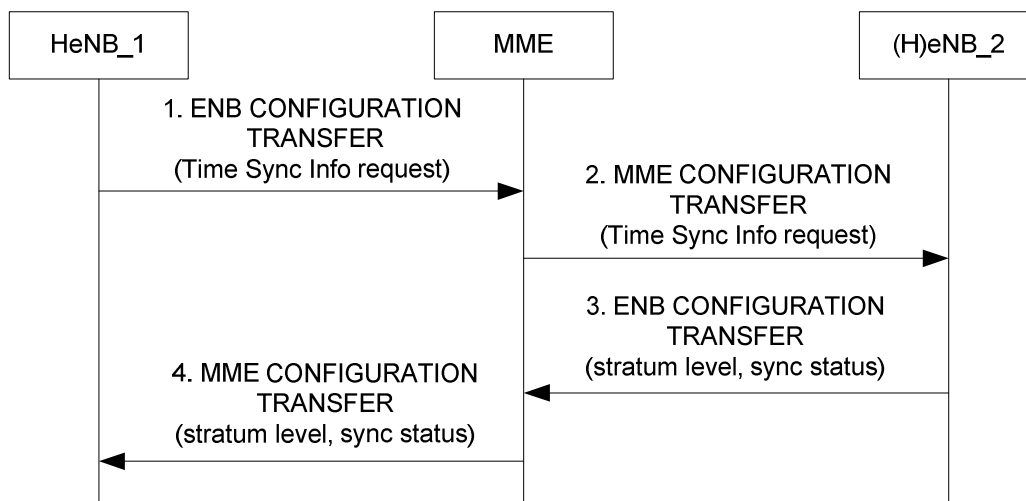

**Figure 6.4.2.1.4.1-1 Stratum Indication by Backhaul Signalling**

##### 6.4.2.1.4.2 Stratum Indication by Blind Detection

Blind detection, as an alternative mechanism, is also proposed in RAN4, which can fulfil the convey requirement for stratum info and synchronization status without signalling when the OAM configures or all HeNBs embedded pre-configure the same muting places (e.g. MBSFN subframes) for a given value of stratum and status, while configures different muting places for other values of stratum and status. Optional OAM signalling of MBSFN subframes as a function of stratum is available. If with all HeNBs embedded pre-configuration, then it is no need to send the OAM signalling. For blind detection, all HeNBs should well know the mapping relationship of each stratum and its muting place, here one instance of the muting place can be subframes declared as MBSFN for this stratum. One mapping example is illustrated on Fig 6.4.2.1.4.2-1, that HeNB stratum 1 will trace CRS in SF#2 of RF#1, HeNB stratum 2 will trace CRS of stratum 1 in SF#2 of RF#2, also mute to avoiding interference to HeNB of stratum 1 (this muting could be

omitted if power control is appropriately utilized then interference will be mitigated); similar ruling is taken to the following strata.

HeNB do blind detection for the existence of CRS on muting place for all possible stratum (normally on booting stage) and contrast the mapping table to recognize the strata of its surrounding base stations, and basing some strategy to decide its synchronization source, thus also decide its own stratum and muting place.

On normal working, HeNB execute network listening on its specific muting place according stratum, while that is also indicating its stratum and synchronization info for new booted neighbour who is doing blind detection.

Periodically, this HeNB may reserve all muting places for one or several rounds, and detect whether any change occurs which may impact its stratum, e.g. synchronization source node shutting down or new node booting up providing lower stratum than current source, and adapt its own stratum accordingly. Non-GNSS synchronized stratum and GNSS synchronized stratum can be differentiated if different muting places are used for the two which can ensure smooth stratum change between both types.

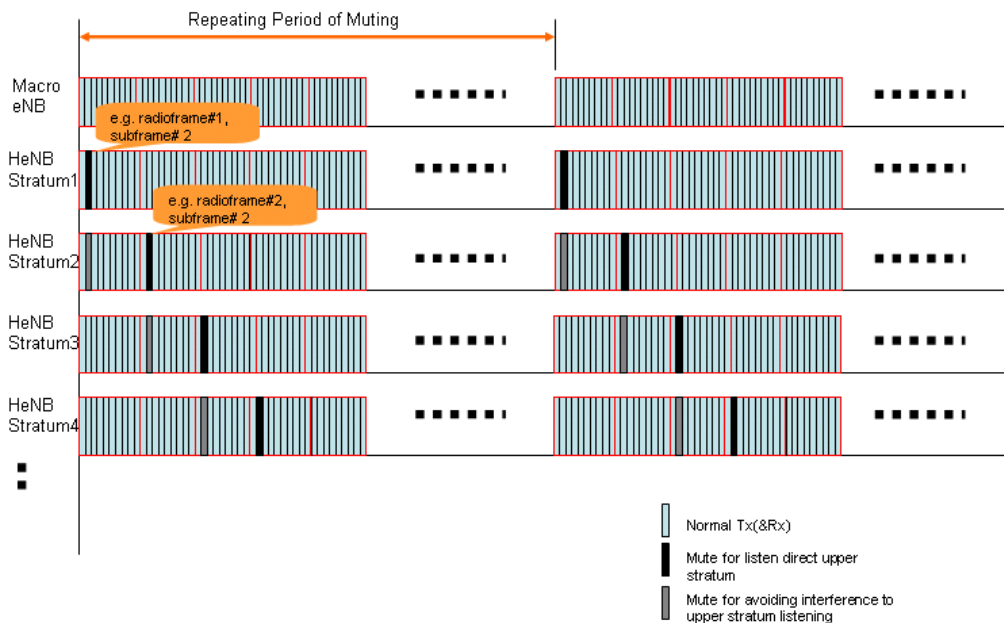

Fig. 6.4.2.1.4.2-1 Explanation for blind detection on stratum info and synchronization status

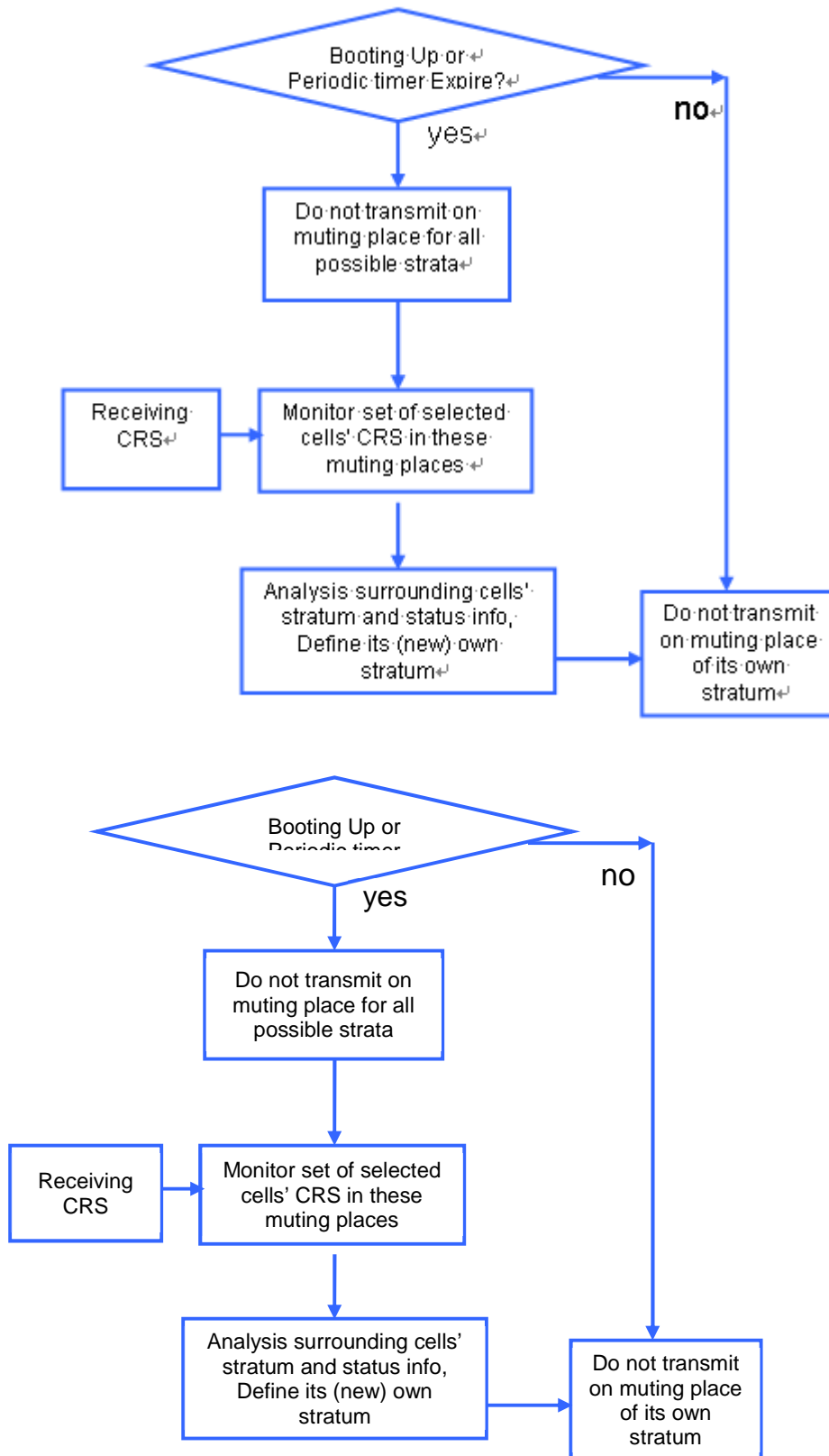

Fig. 6.4.2.1.4.2-2 HeNB procedure for blind detection on stratum info and synchronization status



### 6.4.2.1.5 Scheme Comparison

A brief comparison of the proposed schemes is shown in Table 6.4.2.1.5-1.

**Table 6.4.2.1.5-1: Comparisons for different network listening schemes**

Network Listening schemes	Scheme 1	Scheme 2
<b>Principle of the scheme</b>	Use MBSFN subframes for tracking CRS of donor (H)eNB	Use DwPTS for tracking CRS of donor (H)eNB
<b>Performance</b> (e.g. synchronization accuracy, speed, etc)	Meets requirements Provides flexible overhead-tracking periodicity tradeoff	Meets requirements CRS tracing can be done every Radio Frame, which ensure robust synchronization
<b>HeNB Overhead</b> (e.g. OFDM symbols per [320ms])	0.3% for stratum-1 nodes when using the lowest periodicity of only 1 MBSFN for tracking per 320ms	Maximum 12.86% with 2 switch point per RF Minimum 1.43% with 1 switch point per RF
<b>Number of multi-hops supported</b>	4	1, up to 2 with some cases of special SF configuration (e.g. Normal CP SSF Conf.4 → Conf. 2 → Conf. 5)
<b>Compatibility and impacts on current network</b>	Fully backward compatible	Fully backward compatible
<b>Impacts on specifications</b>	Optional backhaul signalling will be specified, and either backhaul signalling or blind detection scheme used depending on operator deployment.	No extra signalling is needed when supporting only single hop
<b>Others</b>	Could be used by a HeNB capable of either FDD or TDD mode	Could be used by a HeNB capable of TDD mode

RAN4 endorses both the GP based solution and the MBSFN subframe based solution.

## 7 Interference control

### 7.1 HeNB measurements

Several types of measurements that HeNB can perform are listed in the following subsections. The objectives of the HeNB measurements are

- to provide sufficient information to the HeNB for the purpose of interference mitigation
- to provide sufficient information to the HeNB such that the HeNB coverage can be maintained.

According to the measurement type, some of these measurements can be collected through Connected Mode UEs attached to the HeNB or via a DL Receiver function within the HeNB itself. Such DL receiver function is also called Network Listen Mode (NLM), Radio Environment Measurement (REM) or "HeNB Sniffer".

These measurements can also be used during the HeNB self-configuration process.

### 7.1.1 Measurements from all cells

This section identifies the potential measurements performed by HeNB during self-configuration and normal operation. Based on the measurements in Table 7.1.1-1, the HeNB can obtain useful information from its surrounding cells for purposes such as interference management.

**Table 7.1.1-1: HeNB measurements from surrounding cells**

Measurement Type	Purpose	Measurement Source(s)
Received Interference Power	Calculation of UL interference towards HeNB (from MUE)	HeNB UL Receiver

HeNB could use the Received Interference Power measurement to monitor the uplink interference. For example, a Received Interference Power measurement value larger than a pre-defined threshold would mean that at least an MUE which is interfered by a HeNB is close to the HeNB and that the MUE's Tx power would cause significant interference towards the HeNB. This measurement value may be used in calculating path loss between the HeNB and the MUE assuming that a single MUE dominates the interference. It is also preferable for the HeNB to distinguish between UL interference from the MUE and wanted signals from HUEs to improve the accuracy of interference measurement.

### 7.1.2 Measurements to identify surrounding cell layers

This section identifies the potential measurements performed by HeNB during self-configuration and normal operation. Based on the measurements in Table 7.1.2-1, the HeNB can obtain useful information to identify the layer of its surrounding cells and indirectly identifies other HeNBs nearby for purposes such as mobility handling.

**Table 7.1.2-1: HeNB measurements from surrounding cells**

Measurement Type	Purpose	Measurement Source(s)
Cell reselection priority information	Distinction between cell types based on frequency layer priority	HeNB DL Receiver
CSG status and ID	Distinction between cell layers based on CSG, and self-construction of neighbour list,	HeNB DL Receiver

### 7.1.3 Measurements from macro cell layer

This section identifies the potential measurements performed by HeNB during self-configuration and normal operation. Based on the measurements in Table 7.1.3-1, the HeNB can obtain useful information from its surrounding macro cells for purposes such as interference management.

**Table 7.1.3-1: HeNB measurements from surrounding macro cells**

Measurement Type	Purpose	Measurement Source(s)
RSRP	Calculation of co-channel DL interference towards macro UEs (from HeNB) Calculation of co-channel UL interference towards macro layer (from HUEs) Calculation of co-channel UL interference towards HeNB (from MUEs) based on estimated MUE Tx power Determine coverage of macro cell (for optimization of hybrid cell configuration)	HeNB DL Receiver HUE MUE (in case of hybrid cell)
Co-channel RSRQ	Determine quality of macro cell (for optimization of hybrid cell configuration)	HeNB DL Receiver HUE MUE (in case of hybrid cell)
Reference Signal Transmission Power	Estimation of path loss from HUE to MeNB	HeNB DL Receiver
Physical + Global Cell ID	Allow HeNB to instruct UEs to measure specific cells. Allow UE to report discovered cells to HeNB.	HeNB DL Receiver HUE

If a HeNB has receiver capability, then it is able to measure the received CRS  $\hat{E}_c$ , measured in dBm, which is the Reference Signal Received Power per resource element present at the Home BS antenna connector for the Reference Signal received on the co-channel. For CRS  $\hat{E}_c$  determination, the cell-specific reference signal R0 according to TS 36.211 shall be used. If the HeNB can reliably detect that multiple TX antennas are used for transmission on the co-channel, it may use the average in W of the CRS  $\hat{E}_c$  on all detected antennas. On start-up, the HeNB can measure the CRS  $\hat{E}_c$  power from the most dominant co-channel deployed macro cell.

**Table 7.1.3-2: HeNB measurements from surrounding macro cells**

Measurement Type	Purpose	Measurement Source(s)
Co-channel received CRS $\hat{E}_c$ (measured in dBm)	Measurement is used to determine whether HeNB is close to dominant Macro cell, or whether it is close to macro-cell-edge border.	HeNB DL Receiver

## 7.1.4 Measurements of other HeNB cells

This section identifies the potential measurements performed by HeNB during self-configuration and normal operation. Based on the measurements in Table 7.1.4-1, the HeNB can obtain useful information from its adjacent HeNBs for purposes such as interference management.

**Table 7.1.4-1: HeNB measurements from adjacent HeNBs**

Measurement Type	Purpose	Measurement Source(s)
Co-channel RSRP	Calculation of co-channel DL interference towards neighbour HUEs (from HeNB) Calculation of co-channel UL interference towards neighbour HeNBs (from HUEs)	HeNB DL Receiver HUE
Reference Signal Transmission Power	Estimation of path loss from HUE to HeNB	HeNB DL Receiver
Physical + Global Cell ID	Allow HeNB to instruct UEs to measure specific cells Allow UE to report discovered cells to HeNB.	HeNB DL Receiver HUE

## 7.2 HeNB self-configuration

### 7.2.1 Information Exchange between eNBs and HeNBs

The provision of information exchange between eNBs ↔ HeNBs and HeNBs ↔ HeNBs has potential benefits in allowing HeNBs to take account of uplink and downlink conditions at nearby eNBs and HeNBs when configuring power and/or resource blocks to use in uplink and downlink.

We consider several relevant metrics to compare these approaches:

- (1) **Latency:** It was recognized in several contributions that a reliable low latency scheme is desirable for interference management. In RAN4, it was discussed that the adaptation of HeNB parameters could be relatively slow, such that changes in interference/loading at eNB are not tracked on a sub-frame by sub-frame, or frame by frame, but rather more slowly as the traffic load varies on the eNB. Simulation results in RAN4 showed that with 50ms latency such relatively slow adaptation still offers significant performance benefits. Similarly simulation results also showed significant performance benefits at comparable latencies. Further benefits can be obtained by faster interference coordination, especially in the case of bursty traffic.
- (2) **Scalability and Complexity:** It is desirable to have the network complexity scale in a manageable manner with increasing number of HeNBs, UEs etc. Furthermore, different approaches are expected to have different implementation impacts at different network entities (eNB, MME etc.).
- (3) **Overhead:** The signalling overhead for exchanging interference management messages (for both the backhaul and Over-the-Air methods discussed subsequently) should be small.

Possible approaches for performing the information exchange are illustrated in Figure 7.2.1-1 and their potential benefits and drawbacks are described in the following. Flexible operations should be allowed to choose one or combination of information exchange approaches in HeNB deployment.

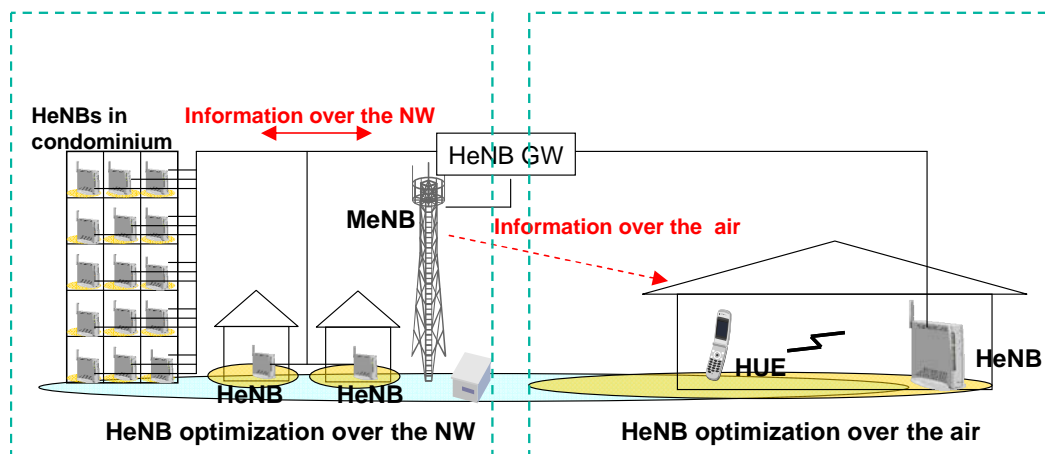

**Figure 7.2.1-1: Illustration of information exchange for Over-the-Air and Network based approaches**

#### *Option1. Over-the-air information, direct eNB to HeNB*

Potential benefits of this approach include:

- No impact to network load.
- Low latency for information signalled from eNB to HeNBs.
- Predictable timeline (independent of backhaul conditions), can be used for coordinated scheduling/transmission.

While this approach may offer low latency, there are several drawbacks:

- The eNB may not always be visible from the HeNB, even though there are victims requiring protection.

- For some advanced approaches for managing interference, it may be desirable to send different information to different groups of eNBs or HeNBs. An over the air broadcast would preclude such operation.
- The downlink would need to be interrupted whenever information is read over the air.
- Requires changes to eNB implementation

***Option2. Over-the-air information, (H)eNB to HeNB via UE***

For the DL, a victim UE forwards interference coordination related information from its serving (H)eNB to the aggressor HeNB.

For the UL: An aggressor UE forwards interference coordination related information from the victim (H)eNB to its serving (H)eNB.

Potential benefits of this approach:

- The downlink would not need to be interrupted to receive information over the air.
- Lower latency compared to backhaul solutions (i.e. Option3 and 4) (higher latency relative to Option 1).
- Predictable timeline (independent of backhaul conditions), can be used for coordinated scheduling/transmission.
- Different information can be sent to different HeNBs

Potential drawbacks to this approach:

- Rel8 UEs can't be used to relay the messages.
- Requires changes to (H)eNB implementation
- Can increase the number of UEs that need to be handled by the HeNB.

***Option3. X2 based interface between eNB and HeNB, and between HeNBs***

The potential benefits of this approach:

- Higher accuracy of information received at destination than the Over-the-Air approach
- Different information can be sent to different groups of eNBs or HeNBs

The potential drawbacks of this approach:

- The eNB may have large numbers of HeNBs within its coverage area which potentially means the macro would need to deal with many messages to/from HeNBs. Ways in which this could be mitigated could be considered by the relevant working groups for further study e.g. X2 could be between macro eNBs and HeNBs via HeNB gateways only, with the HeNB gateways performing a distribution/aggregation function towards the HeNBs. To reduce the complexity further the set of supported X2AP procedures could be limited, e.g. no handover over X2, and only sending Load Indication (OI, HII, RNTP) in the direction macro eNB to HeNB.
- Potentially large latency.

***Option4. S1 based interface between eNB and HeNB, and between HeNBs***

In some cases it is likely that direct physical links would not exist between (H)eNBs and HeNBs, and as such X2 would be a logical interface sharing a similar physical path to S1. With this in mind it could be argued that the information exchange could be made over S1 instead of X2. If compared to the X2 based approach there are some potential benefits to this approach:

- Higher accuracy of information received at destination than the Over-the-Air approach
- Different information can be sent to different groups of eNBs or HeNBs
- S1 signalling interface already exist in the current specifications

Potential drawbacks of this approach:

- Increased functionality and processing load at the MME.
- Increased latency
- Lack of alignment between eNB↔eNB, eNB↔HeNB and HeNB↔HeNB SON/interference management.
- Potential lack of alignment with likely future evolutions of interference management in Release 10 and beyond (assuming that these are less likely to be based on S1)

### 7.3 Uplink interference control

#### 7.3.1 Control Channel Protection

##### 7.3.1.1 HeNB Uplink Control Channel Protection

In the uplink, physical uplink control channel (PUCCH) interference from

- HUE (aggressor) to macro-eNB (victim),
- MUE (aggressor) to HeNB (victim), and
- HUE (aggressor) to HeNB (victim)

can be mitigated by enabling orthogonal transmissions. Uplink control signalling (PUCCH, CQI) reliability can be maintained for both HeNBs and macro-eNBs by making use of PUCCH offsets for enabling orthogonal PUCCH assignments between the HeNB and macro-eNB users. For PUCCH transmissions, over-provisioning can be made use of to ensure orthogonality of control channels between a HeNB UE and a macro-eNB UE as shown in Figure 7.3.1.1-1. It is possible to employ this method for Release-8 UEs without changing the physical layer design or RAN2 signalling.

macro-eNB control	macro-eNB control
HeNB control	HeNB control
HeNB control	HeNB control
macro-eNB control	macro-eNB control

Figure 7.3.1.1-1 UL control interference mitigation by PUCCH orthogonalization

### 7.3.1.2 Signalling offset over the backhaul

It would be desirable for the macro-eNB to signal an offset to all HeNBs within its coverage area in order that transmissions from UEs connected to HeNBs do not cause interference at the macro-eNB receiver (e.g., a HeNB deployed in close range of a macro-eNB). Conversely, a macro-eNB UE that is at the cell edge and therefore transmitting close to its maximum transmit power can interfere severely with a HeNB UE and the signalling offset can be made use of to mitigate interference. Alternately, a HeNB gateway can signal over S1, the offsets that each HeNB should use, thus providing the capability of configuring orthogonal PUCCH transmissions in neighboring HeNBs thereby avoiding HeNB (aggressor) to HeNB (victim) interference on the uplink.

One option for the HeNBs is to not allocate PUCCH resources on edge RBs as shown in Fig. 7.3.1.1-1 using over-provisioning. A typical macro-eNB deployment is likely to have PUCCH transmission on the band-edges to maximize the number of contiguous RBs that can be allocated to PUSCH. However, unlike macro-eNBs, utilizing the full uplink bandwidth may not be critical for HeNBs as they serve only a few users at a time. Therefore, the PUCCH resources in HeNBs can be "pulled" inward. The edge RBs not used by the HeNBs can be used by the macro-eNB for PUCCH for its UEs. Also, the macro-eNB, being aware of the RBs used by HeNBs in its coverage area, can schedule some users (e.g. UEs close to the macro and not near any HeNB) on RBs that overlap with HeNB UE PUCCH region. This results in reduced interference from macro-eNB UEs to HeNB UE PUCCH.

## 7.3.2 Smart Power Control based on Path Loss to Worst Victim Macro eNodeB

Interference from the Home UE (HUE) to the Macro eNodeB (MeNB) is particularly significant if the HUE is located close to the MeNB. On the other hand, an indoor HUE near its serving HeNB and far from the MeNB may be harmless. As discussed in RAN4, the HUE transmission power should be controlled based on path loss (PL) from the HUE to its worst victim MeNB (i.e. nearest neighbour MeNB).

The PL from HUE to MeNB can be estimated from HUE measurements of Reference Signal Received Power (RSRP) and MeNB Reference Signal (RS) Transmission (Tx) power. HeNB might know MeNB RS Tx power by means of decoding the variable "referenceSignalPower" in System Information Block Type2 (SIB2) message broadcasted from MeNB.

During this work item, such smart power control methods are proposed and their performance gain is investigated. The methods are as follows.

### 7.3.2.1 Power Cap Method

In this method, the maximum transmission power density (i.e. power cap) of HUE is restricted based on the interference rise at MeNB. The power cap is calculated as the function of PL from the HUE to its worst victim MeNB. The HUE is power-controlled based on PL to its serving HeNB, up to the level of the power cap.

Simulation results have been generated for an urban deployment model with varying HeNB density and for either full buffer or bursty traffic based on FDD. Similar performance trends also apply to TDD. The results are assume a fixed power cap of either 0.2 dB (labelled "tight") or 7 dB (labelled "loose", and it should be noted that this is a very loose cap, for which in practice the home UE power will likely be set considering coverage requirements of the HeNB alone rather than also considering interference to the macro layer).

#### 7.3.2.1.1 Simulation Assumptions

The simulation parameters largely follow the assumption in section 6.2.1.1.1 with the following specific parameters.

**Table 7.3.2.1.1-1: Simulation Parameters**

Parameter	Assumption
Deployment	Urban signalling Macro layer has 7 sites (21 sectors) with wrap-around, 500m ISD. 0% (urban) of home UEs are outdoors and 20% of macro UEs are outdoors.
Number of macro UEs per sector	20
Exterior wall loss	20dB
Shadowing correlation (one BS to multiple UEs)	Correlated shadowing
Macrocell power uplink control	Max power based on limiting noise rise to macro neighbours
Femtocell uplink power control	Max power based on limiting noise rise to macro neighbours (a similar approach to that described in [7] section 7.3.1 for WCDMA).
Link to system mapping	Per sub-carrier capacity approach
Scheduler	Frequency selective/Proportional fair
Traffic model	Full buffer or Bursty In the case of bursty traffic being modelled, 70% of UEs use the bursty traffic model, the remaining UEs are full-buffer.
Apartment block model	Dual stripe, 6 floors (=240 apartments), one "dual stripe" randomly dropped per macro sector. A variable probability of having active femto in each apartment.
Pathloss model	Full (rather than simplified) model

**7.3.2.1.2 Simulation Results**

Figure 7.3.2.1.2-1 below shows the average macrocell sector throughput as a function of the probability that there is an active HeNB in an apartment. Results are shown for two values of the target maximum "noise rise" that the home UE should generate at the macro eNB ("tight" and "loose"). It can be seen that with a low density of active HeNBs the "loose" approach provides adequate protection whereas at higher densities the "tight" cap is appropriate. This goes for both the full buffer and the bursty traffic models.

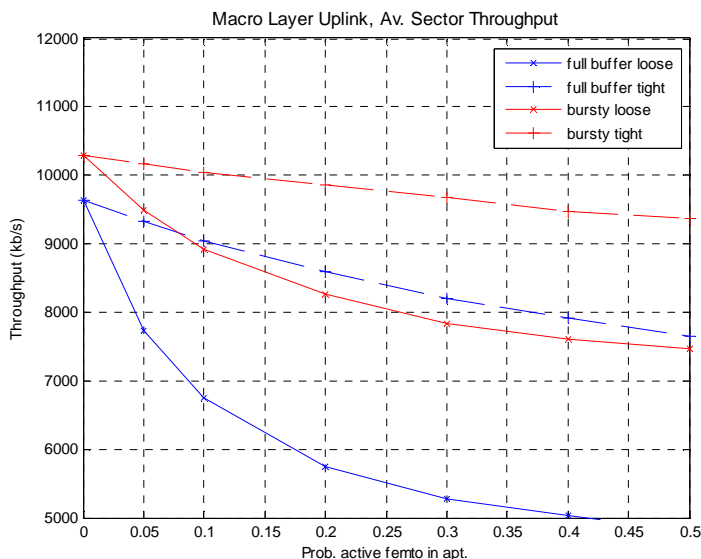

**Figure 7.3.2.1.2-1: Macrocell uplink average sector throughput**

Figure 7.3.2.1.2-2 below shows the cell edge (5 percentile) macro user throughput as a function of the probability that there is an active HeNB in an apartment. Again it can be seen that with a low density of active HeNBs the "loose"



approach provides adequate protection whereas at higher densities the "tight" cap is appropriate. This goes for both the full buffer and the bursty traffic models.

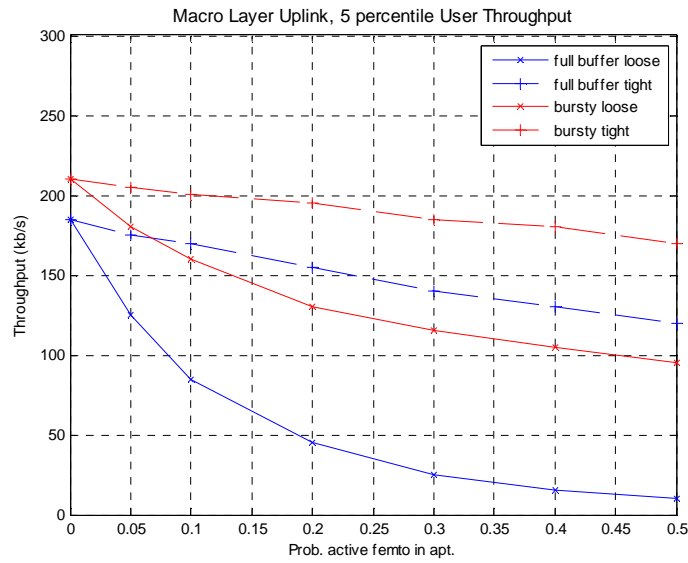

Figure 7.3.2.1.2-2: Macrocell uplink 5 percentile user throughput

Figure 7.3.2.1.2-3 below shows the mean Interference over Thermal (IoT) at the macro eNB. It can be seen that the IoT is controlled more with the "tight" cap particularly at high HeNB densities.

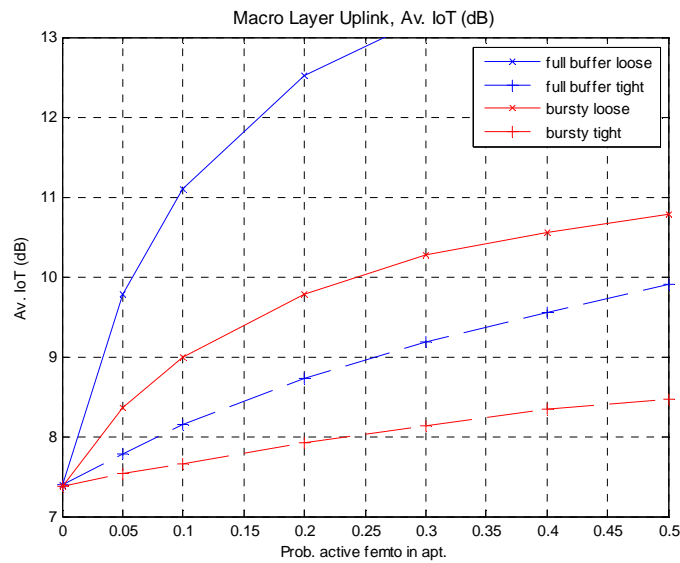

Figure 7.3.2.1.2-3: Macrocell Interference over Thermal

Figure 7.3.2.1.2-4 below shows the average HeNB sector throughput as a function of the probability that there is an active HeNB in an apartment. It can be seen that the "loose" cap results in a higher throughput. This goes for both the full buffer and the bursty traffic models.

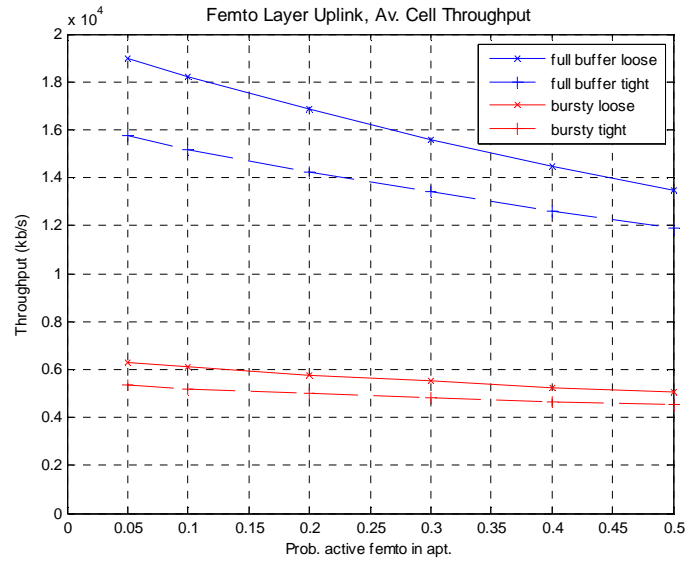

Figure 7.3.2.1.2-4: Femtocell uplink average sector throughput

Figure 7.3.2.1.2-5 below shows the cell edge (5 percentile) home user throughput as a function of the probability that there is an active HeNB in an apartment. Again it can be seen that the "loose" cap results in a higher throughput.

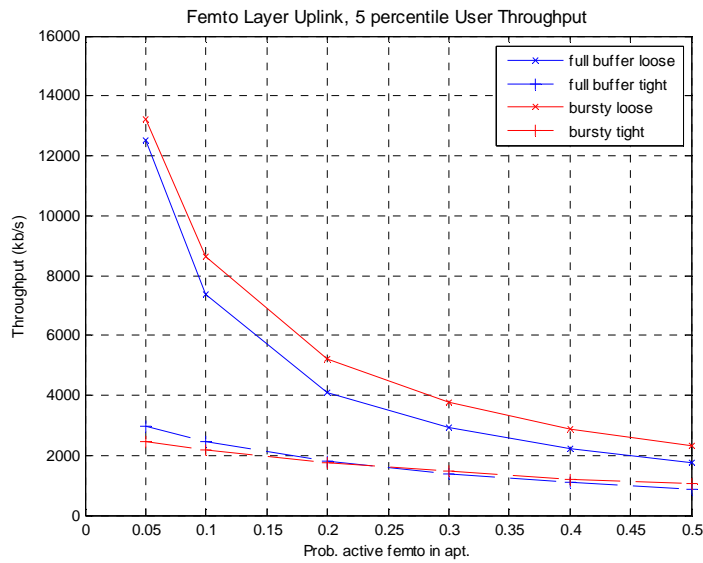

Figure 7.3.2.1.2-5: Femtocell uplink 5 percentile user throughput

Figure 7.3.2.1.2-6 shows the mean Interference over Thermal (IoT) at the HeNB.

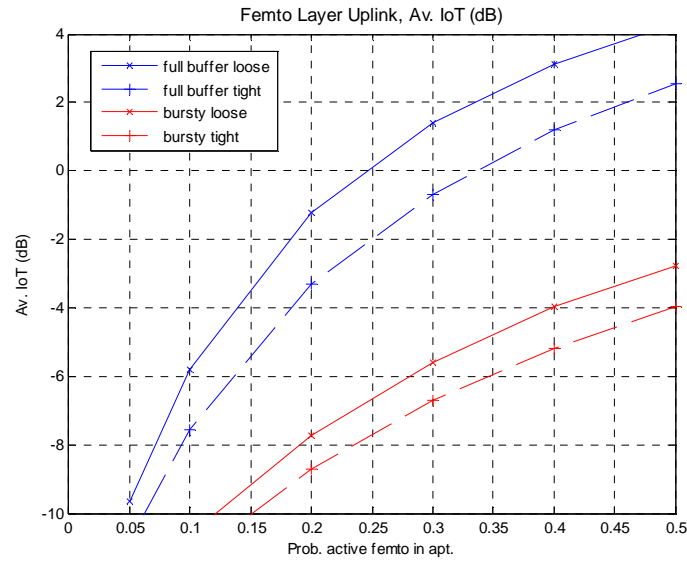

Figure 7.3.2.1.2-6: Femtocell Interference over Thermal

### 7.3.2.1.3 Discussion of Results

For low densities of HeNB a "loose" power cap is sufficient which allows higher HeNB throughputs than the "tight" power cap which is required for higher HeNB densities.

### 7.3.2.2 Power Control based on PL from HUE to its serving HeNB and PL from HUE to its worst victim MeNB

The UE specific term of the transmission power density  $P_{O\_PUSCH}$  should be defined as the function of PL from HUE to its serving HeNB ( $PL_{HUE-HeNB}$ ) and PL from HUE to its worst victim MeNB ( $PL_{HUE-MeNB}$ ) because the uplink transmission power is explicitly defined as the form using PL from UE to its serving eNodeB in the current specification [13]. For example, the power control where the UE specific term of  $P_{O\_PUSCH}$  is set to

$PL_{HUE-MeNB} - \alpha \times PL_{HUE-HeNB} + \text{interference\_rise\_at\_MeNB}$  (in dB) corresponds to the power cap method (The term  $-\alpha \times PL_{HUE-HeNB}$  is cancelled by path loss compensation term and the parameter  $\alpha$  is path loss compensation coefficient [13]). In general, the UE specific term of  $P_{O\_PUSCH}$  might be non-decreasing function of  $PL_{HUE-MeNB}$  and the dependency of  $PL_{HUE-HeNB}$  is implementation issue.

One realization of such power control is proposed during this work item; PL difference based power control. In this method, the UE specific term of  $P_{O\_PUSCH}$  is defined as the non-decreasing function of PL difference

$\Delta PL = PL_{HUE-MeNB} - PL_{HUE-HeNB}$  (in dB). The explicit form of the UE specific term of  $P_{O\_PUSCH}$  is also given in RAN4.

#### 7.3.2.2.1 Simulation Assumptions

The simulation parameters largely follow the suburban model with the following specific parameters. The following simulation is performed based on FDD. Similar performance trends also apply to TDD.

**Table 7.3.2.2.1-1: Simulation Parameters**

Parameter	Assumption
Deployment	Suburban model Macro layer has 7 sites (21 sectors) with wrap-around, 500m ISD. 10% of home UEs are outdoors and all macro UEs are indoors.
Number of macro UEs per sector	10
Exterior wall Loss	20dB
Shadowing correlation (one BS to multiple UEs)	Correlated shadowing
Macrocell power uplink control	Closed loop ICIC based on overload indicator, targeting the IoT value to 10 dB
Femtocell uplink power control	PL difference based TPC and FPC (for comparison)
Link to system mapping	EESM, same $\beta$ value for all MCS
Scheduler	Frequency selective / Proportional fair
Traffic model	Full buffer
Pathloss model	Full model

**7.3.2.2.2 Simulation Results**

Figure 7.3.2.2.2-1 and Figure 7.3.2.2.2-2 show the MUE and HUE throughputs for various HeNB densities, which is the number of HeNB per macro sector. The power control based on PL difference (PL-diff.) and conventional fractional power control (FPC) are compared.

Figure 7.3.2.2.2-1 indicates that the PL difference based power control mitigates the degradation of MUE throughput than FPC. Figure 7.3.2.2.2-2 (right) shows the PL difference based power control can keep the HUE average throughput at the same level of FPC. Its cost is the degradation of HUE 5 percentile throughput as shown in Fig. 7.3.2.2.2-2 (left). In the suburban model with 10 % outdoor HUE, the HUE that is correspond to HUE 5 percentile throughput is mainly located outdoors.

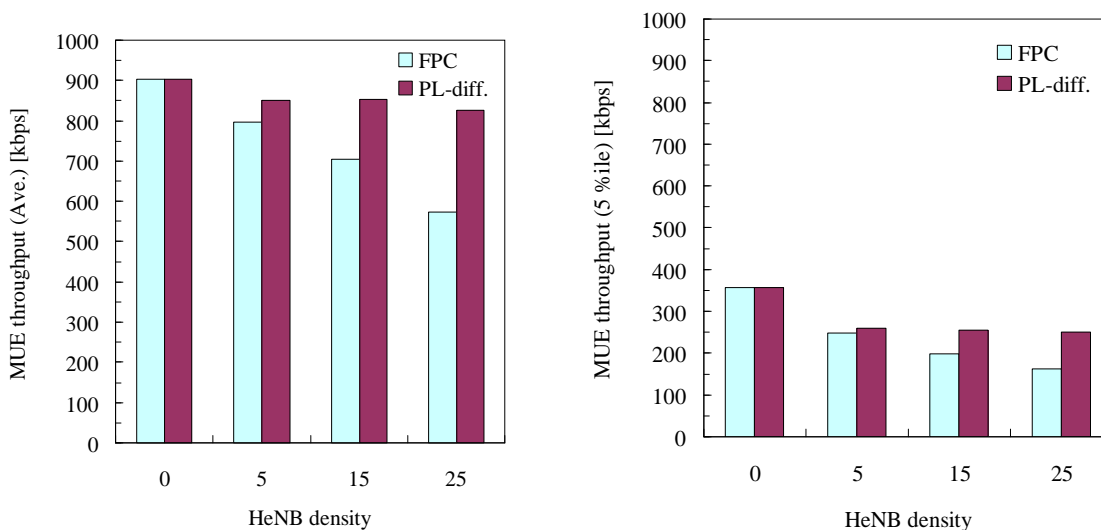

**Figure 7.3.2.2.2-1: MUE throughput (Left: Average, Right: 5 percentile)**

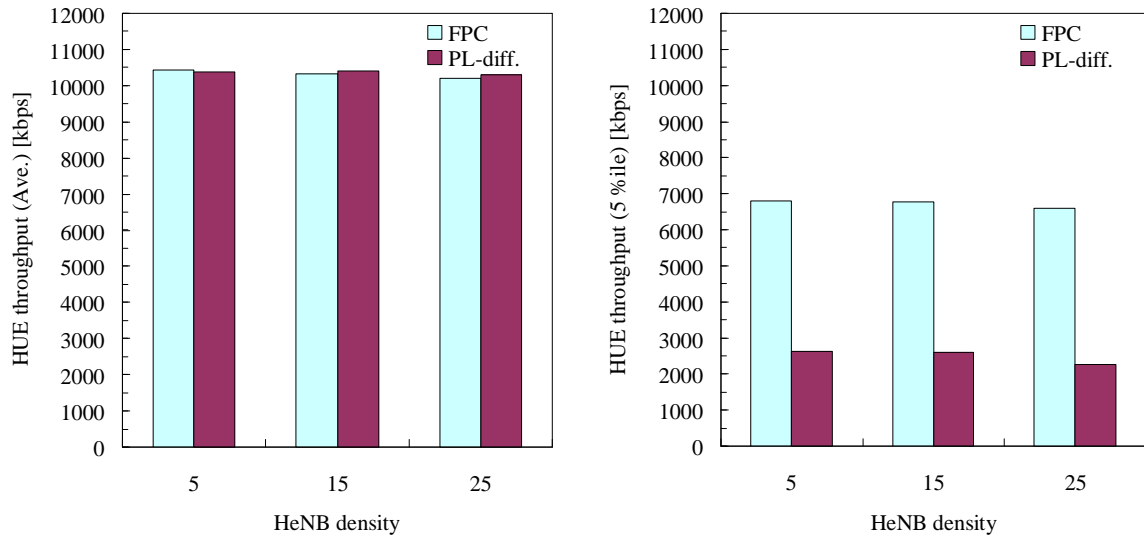

**Figure 7.3.2.2-2: HUE throughput (Left: Average, Right: 5 percentile)**

### 7.3.2.2.3 Discussion of Results

The power control based on PL difference can mitigate the degradation of MUE throughput. Its cost is the degradation of HUE 5 percentile throughput which is mainly correspond to outdoor HUE.

### 7.3.2.3 For Future Releases

The above smart power controls require no interference coordination between eNodeBs. As the result, it might be difficult to manage the interference from HUE as HeNB density increases. For future releases (LTE Release 10 or LTE-Advanced), the adaptive power control by means of X2 or S1 signalling between MeNB and HeNB or between HeNBs should be investigated (e.g. to take account of the density of active femtocells within a macrocell coverage area). Notice that during this work item, the adaptive power controls are proposed and their performance gain is investigated.

## 7.4 Downlink interference control

### 7.4.1 Control Channel Protection

Several techniques have been considered for data interference management. However control channel interference management is equally important since improved data SINR is not useful if the UEs cannot receive control channels. Thus, it is vital to have techniques that address control channel interference.

Downlink control channel (PDCCH) interference can occur in two directions in co-channel HeNB deployments.

- HeNB (aggressor) to macro-UE (victim), and
- macro-eNB (aggressor) to HUE (victim) if the UE is connected to a weaker HeNB cell (e.g. to access local information at the HeNB).

This can lead to problems both in connected mode and in idle mode such as:

1. UE being unable to reliably decode paging channel resulting in missed pages and therefore a user's inability to receive UE-terminated calls,
2. UE being unable to read common control channels, and
3. throughput degradation or degraded PDSCH performance.

The following are some of the techniques that could be used for control channel protection. It should be noted that some of these aspects may require UE implementation changes and should be considered for Rel 10 and beyond. It is possible that these methods offer gains for Rel 8/9 UEs; however, this needs to be studied further.

#### 7.4.1.1 Control of HeNB downlink interference towards macro eNB control channels by frequency partitioning with per-subband interference estimation

Frequency partitioning, or carrier offsetting, where HeNBs are confined to use only a part of the bandwidth can be used to mitigate interference problems. This scenario is shown in Fig. 7.4.1.1-1. By using scheduling techniques that would avoid data transmissions on those parts of the bandwidth, the levels of interference as seen at the receiver can be reduced. This could resolve the interference problem for the data transmissions, however, control channels such as PDCCH that span the entire bandwidth would still be affected.

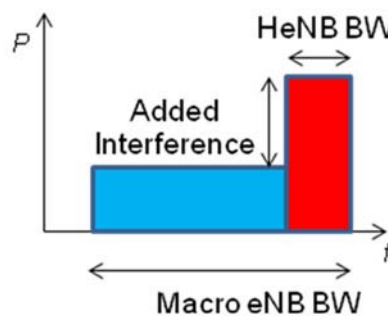

Fig. 7.4.1.1-1 Partial Bandwidth Coexistence

The effects of the high interference seen in one of the subbands can be mitigated if the interference estimation is done on a per-subband basis. This would confine the influence of the interference only to that subband and not allow it to affect the entire bandwidth. This in turn would mean that only some of the coded bits are affected. When wideband interference estimation is used, all the bits are affected and the probability of successfully decoding the message decreases. Assuming sufficient number of CCEs are used (i.e., enough code protection), the PDCCH BLER performance would be slightly degraded. But the transmission would likely be reliable enough not to significantly affect normal operation.

To illustrate the performance of this scheme, some simulation results are given. A simulation was performed to evaluate the impact on control channel performance of high interference on one of the subbands. Results for the cases of per-subband interference estimation and wideband interference estimation are presented.

The simulation considers a HeNB that uses one fourth of the bandwidth of the macro as shown in Fig. 7.4.1.1-1. A UE connected to a macro-eNB and receiving PDCCH transmission from it, sees high interference on one of the subbands. The level of interference is varied as a parameter relative to the noise level. The PDCCH error rate is compared for the cases when wideband interference estimation and per-subband interference estimation are used. The simulation parameters are given in Table 7.4.1.1-1. Only the results for 4 CCE PDCCH are given here but similar results were observed for other PDCCH sizes.

Table 7.4.1.1-1: Simulation parameters used

Parameter	Assumption
Information payload size	40 bits
Coding	1/3 rate TBCC with rate matching
Macro Bandwidth	5 MHz
HeNB bandwidth	1/4 of macro Bandwidth
Channel model	TU, 3km/h
Channel estimation	2-D MMSE channel estimation
Interference estimation	Ideal

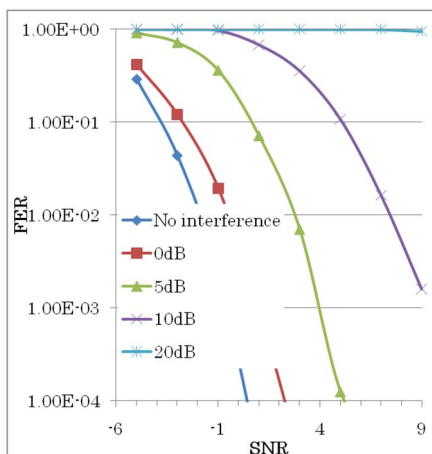

Fig. 7.4.1.1-2 CCE PDCCH BLER with wideband interference estimation

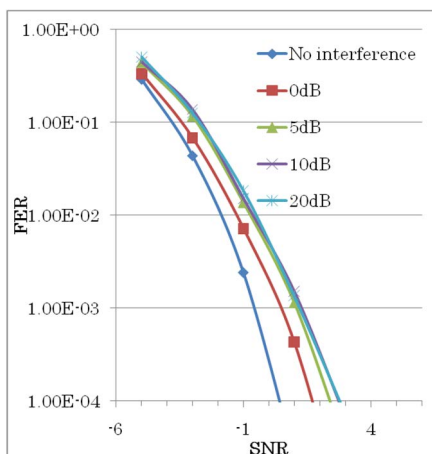

Fig.7.4.1.1-3 4CCE PDCCH BLER with subband interference estimation

### 7.4.1.2 Control of HeNB downlink interference among neighboring HeNBs control channels by frequency partitioning

Unlike data (PDSCH, PUSCH), there is no HARQ for control channel transmissions which must typically target fairly low BLER of 1% or less. HeNBs that are in close proximity of each other will not have reliable downlink control channels (e.g. PDCCH, PHICH, PCFICH, PBCH, P/S-SCH). One way to solve this is to segment the LTE carrier and allow the interfering HeNBs to transmit their control signalling in separate frequency domain resources. For example, if the LTE carrier is 20MHz then it would be segmented into two 10MHz carriers on the downlink with each of the two interfering HeNBs transmitting its control signalling (PDCCH, PHICH, PCFICH, P-SCH, S-SCH, PBCH) on one of the 10 MHz carriers.

Both Release-8 UEs and Release-9 UEs would access the HeNB as a 10 MHz carrier and receive control and broadcast signalling from HeNB within 10 MHz. However, Release-10 UEs can additionally be assigned PDSCH resource on the remaining 10 MHz frequency resources using carrier aggregation. Therefore, while Release-8/9 UEs are limited to allocations of 50 RBs, Release-10 UEs could be assigned any portion of the 100 RBs.

## 7.4.2 Data Channel Protection

### 7.4.2.1 Control of HeNB Downlink Interference towards macro eNB data channels by frequency partition

Frequency partition between Macro eNB and HeNB can be utilized to mitigate the interference from HeNB to Macro eNB. HeNB can get frequency partition information of its neighbour Macro eNB through air link measurement if

additional receiver is enabled on HeNB. Alternatively, a semi-static scheme can be adopted if a pre-configuration of the frequency partition can be determined by Macro eNB management server. For example, Macro eNB will schedule resource blocks to Macro UE based on its location. When HeNB gets its own location information, it will know which resource blocks will be assigned to a nearby macro UE.

With the knowledge of the frequency partition information, for example, HeNB knows which set of resource blocks will be used for Macro eNB cell center users (CCU), and which set of resource blocks will be used for Macrocell cell edge users (CEU), HeNB can coordinate its transmission to avoid its interference to nearby Macro UE by giving high scheduling priority to resource blocks not used by the nearby Macro UE. For example, if HeNB is located at the edge of the Macro eNB, HeNB will give higher priority to resource blocks used by macro center UEs for downlink transmission. If HeNB is located at the center of the Macro eNB, HeNB will give higher priority to resource blocks used by macro edge UEs for downlink transmission as shown in Figure 7.4.2.1-1.

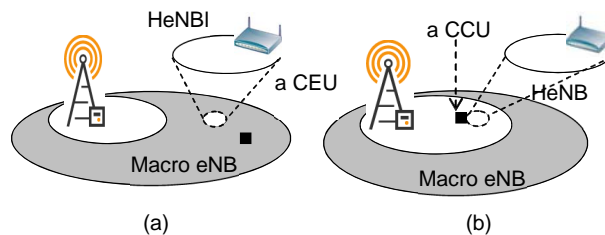

**Figure 7.4.2.1-1 Examples of HeNB and macro UE location**

## 7.4.2.2 Control of HeNB Downlink Interference among neighboring HeNBs

HeNBs listen to neighboring HeNBs' control channel and reference signal transmissions, determines the cell ID of each neighboring HeNB and measure the path loss from each of them. In addition, the HeNBs could also use reports from UEs.

Based on this information, HeNBs could use fractional frequency reuse (FFR) to orthogonalize the resources used and increase the overall performance of the network.

### 7.4.2.2.1 Centralized coordination

The centralized coordinator can form an adjacency graph of all HeNBs based on the reports from each HeNB.

Each HeNB estimates the fraction of time it needs to transmit according to the traffic load and channel conditions of its UEs, and reports this ratio to the centralized controller via S1 signalling.

- For mixed traffic with both delay sensitive traffic and delay tolerant traffic, two ratios which correspond to both traffic types will be reported.
- Each HeNB needs to update its report when at least one of the following event happens:
  - New traffic session initiation
  - UE channel condition variation over a pre-defined threshold

Given the adjacency graph and the reported ratios from each HeNB, the centralized coordinator determines

Option 1: the subframes that each HeNB is allowed to transmit, and notifies each HeNB of its transmission pattern via S1 signalling. A HeNB needs to properly configure DRX parameters of its UEs according to the transmission pattern notified by the centralized coordinator.

Option 2: the subbands or carrier frequency that each HeNB is allowed to transmit, and notifies each HeNB of its transmission pattern via S1 signalling.

Note that the S1 signalling load between HeNBs and the centralized coordinator could be large if the number of HeNB connections per coordinator is significant. To reduce S1 signalling, it is preferable to limit the number of HeNB reports to the centralized coordinator. For example, the centralized coordinator can assign a HeNB a lot more resources than it actually needs, and the HeNB will not send a report to the centralized controller unless it uses up all the assigned



resources. As HeNBs are generally lightly loaded, a HeNB may rarely send a report if it is assigned a large fraction of resources (i.e. subframes, subbands or carrier frequency).

#### 7.4.2.2.2 Distributed Dynamic Frequency Partitioning

Based on the information collected, the HeNBs can construct a "Jamming Graph" where each node denotes an active HeNB and an edge denotes jamming condition between two HeNBs. A jamming condition is declared when the channel gain difference between the interfering and serving links exceeds a certain threshold. The distributed fractional frequency reuse planning problem is now converted into a graph coloring problem, which could be solved in a distributed manner at low complexity.

Examples of such algorithms and brief performance analysis are given in several RAN4 contributions for both the FDD and TDD case.

This algorithm could be an adaptive algorithm in which resources are negotiated and adaptively allocated for different nodes, based on a utility function that enables nodes to quantify the benefit or loss due to each resource coordination action. These utility values can then be used at each node to select the right resource coordination requests to be sent to their neighbors, or to select the best requested coordination action from among multiple received requests, and hence to grant/reject the requests based on their quantified benefit to the network.

To support this adaptive algorithm, network nodes need to exchange information such as subbands reuse updates and utility information. The performance depends significantly on the latency of the messaging, especially in the case of non-full buffer traffic. This information should be taken into account while analyzing the different options for such information exchange (e.g. X2, S1, over-the-air, over-the-air via UE).

#### 7.4.2.3 Adaptive Frequency Selection

To minimize the mutual interference between HeNB and surrounding cells, RSRP measurements and cell re-selection priority information in SIBs or RRC message from neighbour cells could be utilized for HeNB to adaptively select its operating carrier frequency.

The original purpose of cell-reselection priority information is for UE to properly select its camping cell based on the frequency layer priority of each carrier. For interference avoidance, this information can be utilized by HeNB to appropriately select its operating frequency by decoding SIBs or RRC message from its neighbour cells during normal operation or in self-configuration mode. At the same time, HeNB should also measure co-channel or adjacent channel RSRP of the neighbour cells to make a proper selection. Furthermore, if the priority information of the neighbour cells is changed at a certain time after the HeNB has already started up, the HeNB should periodically update the priority information, measure the RSRP and adjust its operating frequency (if necessary).

Figure 7.4.2.3-1 below depicts a scenario where the HeNB is overlaid by both higher and lower priority frequency layers as shown for HeNB cell 1, and another scenario where the HeNB is overlaid by only one frequency layer as shown for HeNB cell 2.

For HeNB cell 1, when the measured RSRP of both higher and lower priority frequency layers exceed a predefined set of thresholds which implies that it is overlaid by more than one frequency layers, the HeNB should select its operating frequency that is being used by the cell that has the lower priority for interference mitigation. As illustrated in Figure 7.4.2.3-1, the HeNB cell 1 should select RF1 which is the lower priority carrier frequency. On the other hand, if the HeNB is overlaid by only one priority carrier frequency as shown for HeNB cell 2 in Figure 7.4.2.3-1, the HeNB should select a carrier frequency that corresponds to the smaller measured RSRP. For example, the HeNB cell 2 in Fig.7.4.2.3-1 should select RF2 which has smaller RSRP.

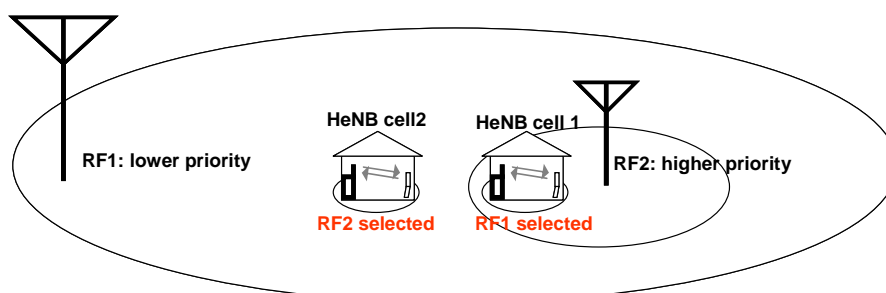

Figure 7.4.2.3-1 Examples of adaptive frequency selection scheme

The adaptive frequency selection scheme is applied most effectively to HeNBs in non-allowed CSG mode for avoiding the interference. In the case when the HeNB is operating in an open or hybrid access mode, it may also apply the scheme for interference avoidance.

#### 7.4.2.4 Downlink interference management based on mapping between PCIs and transmission patterns

Interference Management based on mapping between PCIs and transmission patterns requires a centralized coordinator. The centralized coordinator generates a number of transmission patterns and a function which maps transmission patterns to PCIs, and then sends to all cells the information of transmission patterns and the mapping function. The essentials of this scheme are as follows:

- When powered on, a HeNB will listen to neighboring cell transmissions, determine the Cell ID of these neighboring HeNBs, and report them to the centralized coordinator.
- The centralized coordinator can form an adjacency graph of all HeNBs based on the reports from each HeNB as well as its UEs.
- Given the adjacency graph, the centralized coordinator determines the followings semi-statically:
  - a set of transmission patterns; A pattern shows a profile of maximum Tx power for each PRB or group of PRBs
  - a function which maps transmission patterns to PCIs
- The centralized coordinator notifies to HeNBs and MeNBs of the followings via S1 signalling.
  - the set of transmission patterns
  - the function which maps transmission patterns to PCIs
- This notification makes it possible that all cells share the information of the transmission patterns and the mapping between the patterns and PCIs.
- HeNB should use PRBs according to the transmission pattern corresponding to its PCI.

Downlink interference management can be done as follows:

If a UE connected to a serving (H)eNB is close to a neighbouring HeNB, the downlink of the UE can be severely degraded due to high interference from the neighbouring HeNB. The serving (H)eNB can be macro eNB or HeNB. The UE detects the PCI and measures the RSRP of the neighbouring HeNB, and reports these to the serving (H)eNB. Because of the sharing of the information of the transmission patterns and the mapping between these patterns and PCI, the serving (H)eNB knows the transmission pattern of the neighbouring HeNB that the UE is close to. This makes it possible for the serving (H)eNB to allocate downlink resource such that the UE is not severely interfered by the neighbouring HeNB on its downlink.

#### 7.4.2.5 Control of HeNB Downlink Interference by dynamically changing HeNB CSG ID

To mitigate HeNB interference as well as to prevent free HeNB usage by neighbors, one option is to change the CSG ID of a closed access HeNB dynamically between

- Its default CSG ID which is assigned when it is deployed and
- A dedicated CSG ID which is configured by the operator.

This dedicated CSG ID is included in the Operator CSG list for every UE in the operator network. When the closed access HeNB changes its CSG ID to the dedicated CSG ID, it actually becomes accessible to each passing-by UE, thus alleviating its interference towards the macro cell. Note that this scheme would only be beneficial when a large fraction of UEs support CSG.

By dynamically changing the CSG IDs of closed access HeNBs in a coordinated manner, it might be possible to ensure that the number of closed access HeNBs using default CSG IDs under each macro cell does not go beyond a pre-defined upper bound at any time instant.

- A centralized controller (e.g. HeNB Gateway or HeNB management server) can set the upper bound, and configures, for each HeNB, the time intervals it supports the default CSG ID and the dedicated CSG ID, respectively. Then each HeNB dynamically varies its CSG ID based on the configuration parameters provided by the centralized controller.
  - Different macro cells may have different or common upper bounds.
  - Whenever a HeNB is deployed, the centralized controller can determine its adjacent macro cell based on its location and configure the time intervals it will employ the default CSG ID and the dedicated CSG ID, respectively.
  - The mechanisms of when and how to select a set of HeNBs is FFS. It may be possible to carefully arrange time intervals to employ default CSG IDs for different HeNBs to ensure that the number of closed access HeNBs using default CSG IDs under every macro cell can be upper limited at any time instant.
    - E.g. some HeNBs may use default CSG IDs the first 30 minutes of every hour, but others may not; alternatively, some HeNBs may use default CSG IDs 9AM-11PM everyday, but others may do.
  - The upper bound can be determined by
    - Simulation/numerical analysis
    - HeNB subscription profile
      - > E.g. make HeNBs "less open" if the subscription rate is high and the subscribers desire to do so.
    - Macro cell load
      - > E.g. make HeNBs "more open" when macro cell is heavily loaded, and "less open" when macro cell is lightly loaded.

Further study of this proposals and comparison to alternatives (e.g. hybrid cells) may be needed. In particular, the UE and core network impact of dynamically changing the CSG ID is for further study by the relevant working groups.

## 7.4.3 Power Control

### 7.4.3.1 HeNB power control based on HeNB-MUE path loss

HeNB should adjust the downlink transmit power by taking into account the path loss between the HeNB and an outdoor neighbour MUE including penetration loss in order to provide better interference mitigation for the MUE while maintaining good HeNB coverage for HUEs.

HeNB should set the transmit power of reference signal  $P_{tx}$  as follows:

$$P_{tx} \text{ (dBm)} = \text{MEDIAN}( P_m + P_{\text{offset}}, P_{tx\_upp}, P_{tx\_low} )$$

Where:

- $P_m$  (dBm) is RSRP from the nearest MeNB measured by the HeNB.  $P_m$  is dependent on path loss which includes the penetration loss between the nearest MeNB and the HeNB.
- $P_{\text{offset}}$  (dB) is the power offset described below in detail.
- $P_{tx\_upp}/P_{tx\_low}$  (dBm) is the upper/lower limit value for the transmit power of the reference signal. The maximum and the minimum total transmit power of HeNB should follow HNB in [7].

The HeNB can also set the maximum downlink transmit power in proportion to the transmit power of the reference signal. As the RSRP decreases, which means the HeNB is located close to the edge of the macro cell, the transmit power should be small in order to mitigate the downlink interference to the MUE.

$P_{\text{offset}}$  above should be defined based on path loss between the HeNB and the MUE. The path loss may consist of indoor path loss between the HeNB and cell edge of HeNB cell and the penetration loss. Therefore,  $P_{\text{offset}}$  should be formulated as follows:

$$P_{\text{offset}} = \text{MEDIAN}( P_{\text{offset}_o} + K \cdot \text{LE}, P_{\text{offset\_max}}, P_{\text{offset\_min}} )$$

Where:

- $P_{\text{offset}_o}$  (dB) is a predetermined power offset value corresponding to the indoor path loss. Typical value range between 50 and 100dB, and can be determined by the averaged measurement value.
- $K$  is an adjustable positive factor can be determined by the priority of HeNB operation. This value should be high to increase the total transmit power (MeNB is more acceptable to higher interference) and low to reduce the interference to MeNB operation.
- $\text{LE}$  (dB) is estimated penetration loss as below.
- $P_{\text{offset\_max}}/P_{\text{offset\_min}}$  (dB) is the maximum/minimum value of the  $P_{\text{offset}}$  by which the estimated and calculated  $P_{\text{offset}}$  can be prevented from being too large or too small. This value is dependent of the actual wall penetration loss plus  $P_{\text{offset}_o}$ . And the typical wall penetration loss ranges between 10 and 30dB.

If the path loss between the HeNB and the MUE can be estimated, then the transmit power of the HeNB should be set accordingly.

The path loss between the HeNB and the MUE should be estimated based on the difference between the estimated UL transmit power and the UL reception power (as the Received Interference Power) of the MUE. The estimated UL transmit power is based on the assumption that UL power control is applied for both MUE and HeNB as a UE. Then the UL transmit power can be calculated by the DL propagation loss from the surrounding MeNB to the HeNB utilizing the RSRP measurement.

#### 7.4.3.2 Smart power control based on interference measurement from macro BS

In the absence of alternative techniques such as resource partitioning, a fixed maximum power setting configured by the network is not sufficient to ensure minimum HeNB coverage range while protecting macro in all cases. Hence, a sensing of the HeNB environment can be used for setting the transmit power.

The HeNB adjust its maximum DL transmit power as a function of air interface measurements to avoid interfering with macro cell UEs. Examples of such measurements are total received interference, received CRS  $\hat{E}_c$  from the most dominant macro cell eNB, etc. The scheme is open loop, and does not involve the UEs and signalling between network nodes.

The HeNB shall adjust its maximum transmit power according to the following formula,

$$P_{tx} = \max(\min(\alpha \times (\text{CRS } \hat{E}_c + 10 \log(N_{RB}^{DL} \times N_{sc}^{RB})) + \beta, P_{\text{max}}), P_{\text{min}}) [\text{dBm}] \quad (1)$$

where parameters  $P_{\text{max}}$  and  $P_{\text{min}}$  is the maximum and minimum HeNB transmit power settings,  $\text{CRS } \hat{E}_c$  is measured in dBm, which is the Reference Signal Received Power per resource element present at the Home BS antenna connector received from the strongest co-channel macro cell.  $N_{RB}^{DL}$  is the number of downlink resource blocks in the HeNB channel.  $N_{sc}^{RB}$  is the number of subcarriers in a resource block ( $N_{sc}^{RB} = 12$ ). Parameter  $\alpha$  is a linear scalar that allows altering the slope of power control mapping curve,  $\beta$  is a parameter expressed in dB that can be used for altering the exact range of  $\text{CRS } \hat{E}_c$  covered by dynamic range of power control.

Parameters  $P_{\text{min}}$ ,  $\alpha$ , and  $\beta$  are considered to be HeNB configuration parameters, and  $P_{\text{max}}$  corresponds to the HeNBs maximum transmit power capability.

For the special case where the HeNB is unable to detect any co-channel deployed macro cells. The HeNB is free to use its maximum transmit power, or apply pre-set parameterized value based on the requirement of operator.

## 7.5 Hybrid Cells

Hybrid cells are being included in the 3GPP release 9 specifications. Hybrid HeNBs may provide different service levels to UEs that are members of the HeNB and non-member UEs. In RAN4, extensive deployment scenarios of hybrid cells have been discussed. The interference scenarios apply to most of the deployments under consideration.

For the scenario where HeNBs are on a shared carrier with eNBs, the interference management considerations are different between closed and hybrid access modes. For the closed access mode the used HeNB resources (e.g. power, RBs) are selected as a trade-off between performance at the HeNB/HUEs and interference caused to the macro eNB/MUEs. For the hybrid access mode the trade-off is between overall system performance (including both macro eNB and HeNB layers), and resources consumed at the HeNB by "visiting" (i.e. non-CSG member) UEs. These aspects are considered in more detail in the following sub-sections.

### 7.5.1 Hybrid Access Level of Service

Hybrid HeNB may provide different service levels to UEs that are members of the HeNB and non-member UEs. The lowest level of services is paging service, where a hybrid cell allows a non-member UE to access the cell to receive pages. A paging only hybrid cell is an interesting alternative to pure CSG cells. Since CSG cells have separate PCID space, switching between CSG and hybrid mode would have impact on both idle state and connected state home UEs. On the contrary, a hybrid cell could with paging-only service provides similar functionality as a CSG cell without incurring CSG-hybrid switching penalty.

If a hybrid cell only provides paging services to non-member UEs, data channel interference is similar to CSG HeNBs. The difference is that the hybrid cell has more information about the victim UE than a CSG cell. When the hybrid cell decides to handover (HO) the UE to a macro cell, interference coordination could be negotiated with the macro as part of the HO procedure. Some examples, are:

1. DL interference: The hybrid cell could reduce transmit power such that the UE handed over to the target cell has sufficient DL C/I to receive DL control channels from the target cell. The hybrid cell could also engage in fractional frequency reuse (FFR) with the target cell to enhance DL data rate of the victim UE.
2. UL interference: A hybrid cell and HO target cell could choose the power setting of this UE such that UL interference could be coordinated. UL control channels of the HO sUE could also be orthogonalized with the PUCCH of the source hybrid cell. UL data channel coordination through UL FFR could be configured on a semi-static basis.

Note that hybrid cells also have additional information on the channel quality of active UEs. Hence the adjustment made at the hybrid cell could fully take into account on the impact to ongoing traffic. In some extreme scenarios, hybrid cell could handover both the member UEs and non-member UEs to the macro cell.

If a hybrid cell provides data services to non-member UEs, the hybrid HeNB is similar to a pico cell with lower Tx power and different service level for members and non-members. In addition, a hybrid HeNB is different from a operator deployed pico cell in the following areas

1. A release 9 hybrid HeNB does not support X2 interface.
2. A hybrid HeNB could be customer deployed without proper RF planning
3. The density of hybrid HeNB could have much high density than operator deployed pico cells.

Given the challenges mentioned above, non-Rel-8 interference coordination schemes should be investigated for hybrid cells.

### 7.5.2 DL Performance Evaluation

Full buffer performance analysis is performed for CSG and hybrid HeNB deployments based on FDD. The dense-urban model corresponds to densely-populated areas where there are multi-floor apartment buildings with smaller size apartment units. Similar performance trends can be observed for TDD.

The set of simulation parameters are shown below:

- System bandwidth 5 MHz

- Macro Power = 43dBm
- HeNB power between [-10 dBm, 10 dBm].
  - Case 1, the HeNB power is fixed to 8 dBm
  - Case 2, the adaptive HeNB power setting is used to reduce the MUE outage
- ISD of 1km
- Noise power = -99dBm
- 57 cell wrap around model with 3 center cells simulated for traffic
- 10 macro UEs per cell
- HeNB penetration rate of 5%, and activity factor of 13%, this leads to 12 active home UEs per cell

The association algorithm in all cases is based on the best RSRQ among allowed cells. In the case of CSG cells, UEs are only allowed to associate with the macro cell or the HeNB in the same CSG group. In the case of hybrid cells, all cells are open.

The C/I and throughput distribution for CSG and hybrid cells are shown in Figures 7.5.2-1 to 7.5.2-4. As discussed in RAN4, adaptive power control could reduce outage for CSG cells. In the case of hybrid cells, there is no outage even without adaptive power control due to open association. Note that if different service levels are enforced for group member and non-group members, the fairness could be different from those shown in the figures.

Key mobile statistics (outage, 20% throughput and median throughput) are shown in Table 7.5.2-1. It is noted that hybrid cells improve the outage and edge user performance, while making little difference in high throughput region. This is consistent with the expectation that with hybrid cells, the network would be able to offload macro UEs in poor channel conditions to close by hybrid cells. It is also interesting to note that the improvements due to hybrid cell is much higher when adaptive HeNB power control is not available (800% gain versus 60% gain).

Note that backhaul limitation of CSG and hybrid cells are not modelled in the simulations. For practical deployments, users close by a hybrid cell is likely to be backhaul limited rather than air-interface limited.

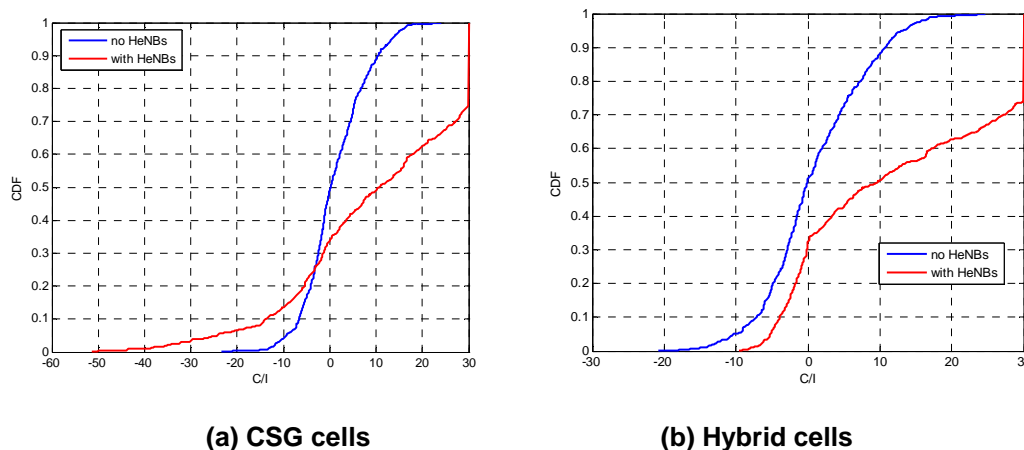

**Figure 7.5.2-1 C/I for CSG cells and hybrid cells deployments with 8 dBm HeNB Tx power**

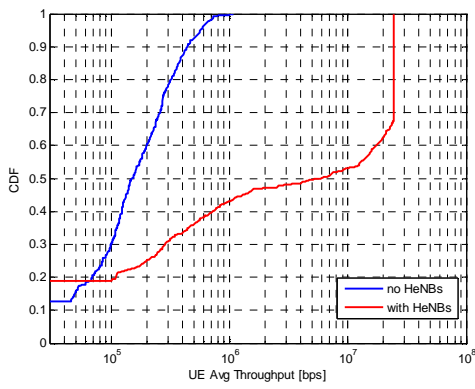

(a) CSG cells

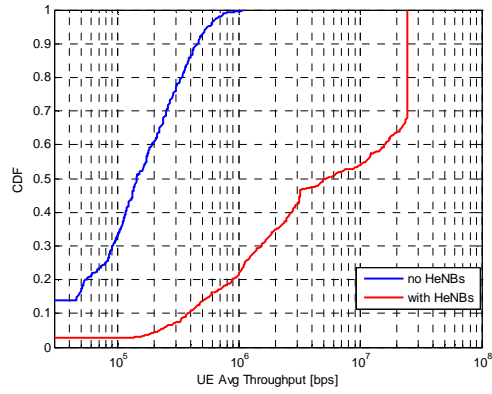

(b) Hybrid cells

Figure 7.5.2-2 Throughput for CSG cells and hybrid cells deployments with 8 dBm HeNB Tx power

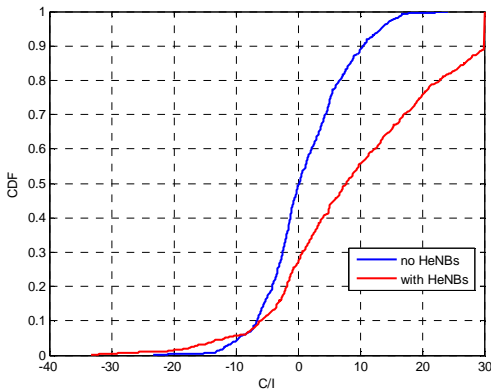

(a) CSG cells

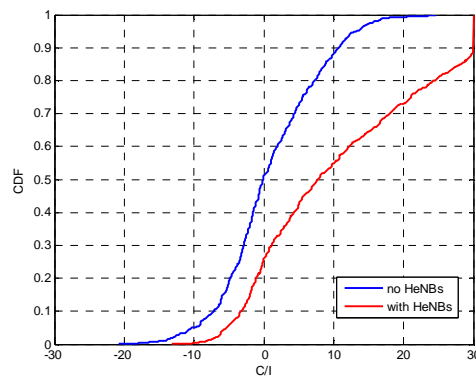

(b) Hybrid cells

Figure 7.5.2-3 C/I for CSG cells and hybrid cells deployments with adaptive HeNB Tx power

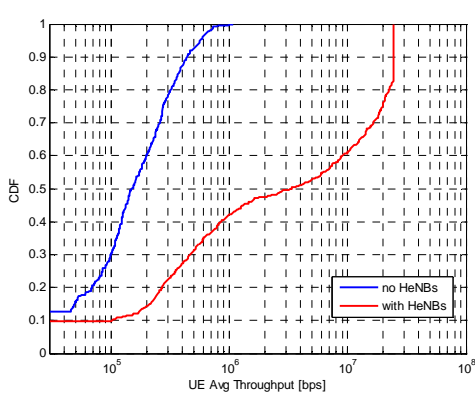

(a) CSG cells

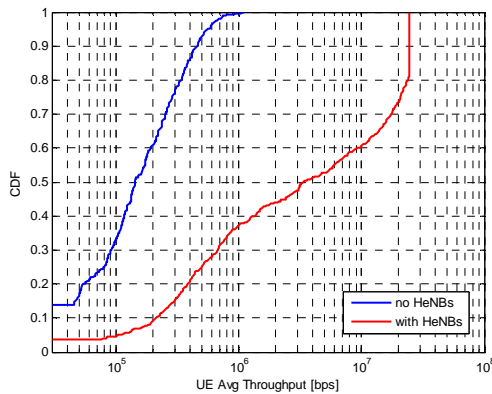

(b) Hybrid cells

Figure 7.5.2-4 Throughput for CSG cells and hybrid cells deployments with adaptive HeNB Tx power

Table 7.5.2-1 Summary of results

	Outage Probability (SNR < -6 dB)	Worst 20% mobile throughput (kbps)	Median throughput (kbps)
--	-------------------------------------	---------------------------------------	-----------------------------

No HeNB	12.7%	35	150
CSG HeNB with fixed Tx power of 8 dBm	18.9%	100	5600
CSG HeNB with adaptive Tx power	9.8 %	250	3300
Hybrid HeNB with fixed Tx power of 8 dBm	2%	900	5100
Hybrid HeNB with adaptive Tx power	3%	400	3400

### 7.5.3 Hybrid Cell RB Resource Management

For hybrid cells, non-CSG members consume RB resources at the HeNB, the amount of which will depend on the number of non-CSG UEs and the service level provided to the non-CSG UEs. One possible method of managing the RB resources used at a HeNB for non-CSG UEs is to reserve some RB resources for use by non-CSG UEs.

In hybrid access mode, if a HeNB accepts non-CSG members as temporary users, it would degrade CSG members' capacity similar to the open access HeNB. Moreover, when HeNB is under heavily loading, non-CSG UEs may be blocked first and diverted to macro eNBs. These diverted non-CSG UEs that are still within the coverage of the hybrid access HeNB may experience strong interferences from the HeNB.

In order to manage RB resource and mitigate the DL interference of the hybrid cells, a method called "Resource Priority Region (RPR)" may be used which guarantees a small percentage of HeNB resources for non-CSG members.

The RPR for the hybrid access HeNB divides radio resources of a HeNB into two regions for non-CSG members and CSG members respectively. The detailed definitions for each resource region are:

1. Non-CSG member priority region – non-CSG members have higher priority than CSG members.
2. CSG member priority region – CSG members have higher priority than non-CSG members.

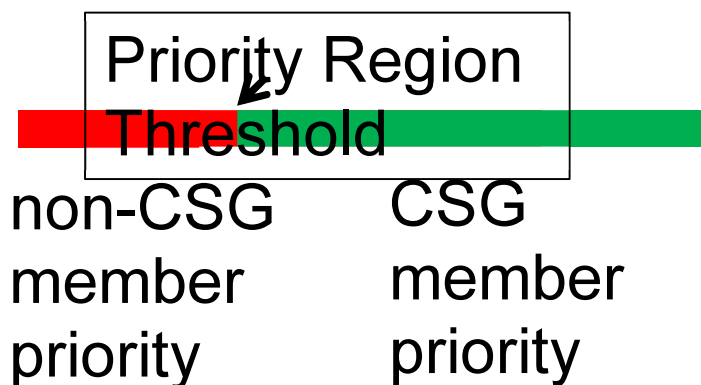

Fig.7.5.3-1 Resource Priority Region

A threshold – *Priority Region Threshold* (PRT) is set to separate resources between two priority regions. The PRT could be a time or physical resource block (PRB) in radio frames, and PRT could be statically or dynamically adjusted by exchanging ICIC messages between HeNB and macro eNB. The HeNB could autonomously define the threshold for release 9, and further enhancements allowing the threshold to be adapted e.g. based on S1 signalling could be considered for release 10.

The hybrid access HeNB with RPR efficiently decreases the blocking probability to non-CSG members when HeNB is exhausting its resource. Also, this method guarantees the CSG members throughput that HeNB are not affected by sharing the resource with non-CSG members.



## 7.5.4 Hybrid Cell Power Management

The optimum power setting for hybrid cells is likely to be different than for closed cells, in that for closed cells the power is set as a compromise between HeNB coverage and interference caused to neighbour "victim" cells, whereas for hybrid HeNB it is set as a compromise between overall system performance versus resources used at the HeNB by non-CSG UEs.

Measurements made by the HeNB of neighbour cells ("sniffing") can be used to set an appropriate downlink power. However the propagation conditions between a neighbouring (H)eNB and its associated UEs may differ significantly from the propagation conditions between a neighbouring (H)eNB and the HeNB as measured during "sniffing". Furthermore the propagation conditions between the HeNB and nearby non-served UEs will not be known. These differences will result in uncertainty when estimating the coverage of HeNB and neighbouring (H)eNBs to non-served UEs.

One potential way to allow a hybrid access mode HeNB to get a more accurate picture of its local environment is for the HeNB to request a UE to measure RSRP and/or RSRQ of both source and target cells immediately after a UE hands-in (active state) or registers with (idle state) the HeNB. This would apply particularly to non-CSG UEs but could also apply to CSG UEs. In this way the HeNB could, for example, determine if the hand-in or re-selection is a) due to poor signal level from the source (e.g. macro) cell or b) due to high interference from the HeNB. This would then allow the HeNB to determine its output power appropriately. For example if the signal is particularly poor on the source (e.g. macro) cell, the HeNB could use a relatively high power and/or provide relatively high access priorities for non CSG UEs, compared to the case where the signal level on the source cell is not so poor.

This basic approach would require no standards changes. Future standards releases could consider more sophisticated approaches aimed at improved performance e.g. based on UE storing measurement reports and/or events prior to a hand-in or reselection of a HeNB, with subsequent reporting to the HeNB.

## Annex A (informative): Change History

Change history							
Date	TSG #	TSG Doc.	CR	Rev	Subject/Comment	Old	New
2009-03	RAN4#50bis	R4-091231			TR skeleton		0.0.1
2009-06	RAN4#51bis	R4-092253			Agreed TPs in RAN4#51: R4-091787, "Text proposal for TDD HeNB related interference scenarios and deployment configurations", CMCC	0.0.1	0.1.0
2009-08	RAN4#52	R4-092863			Agreed TPs in RAN4#51bis: R4-092256, "Text proposal on ACLR requirements of TD-LTE HeNB", CMCC R4-092258, "Text proposal on frequency error of TD-LTE HeNB", CMCC R4-092259, "Text proposal on performance requirements of TD-LTE HeNB", CMCC	0.1.0	0.2.0
2009-08	RAN4#52	R4-093360			Agreed TPs in RAN4#52: R4-093333, "Text proposal on section 6.2.3 frequency error", CATT R4-093325, "Text proposal on TD-LTE HeNB receiver sensitivity", CMCC, CATT R4-093326, "Text proposal on TD-LTE HeNB spurious emission", CMCC R4-093327, "Text proposal on TD-LTE HeNB ACS requirement", CMCC R4-093328, "Text proposal on TD-LTE HeNB blocking requirements", CMCC R4-093329, "Text proposal on TD-LTE HeNB dynamic range", CMCC	0.2.0	0.3.0
2009-11	RAN4#53	R4-094562			Agreed TPs in RAN4#52bis: R4-093532, "Home eNode B receiver in channel selectivity requirement", CATT R4-093973, "Text proposal on HeNB receiver requirements", CMCC R4-093974, "Text proposal on HeNB spurious emission requirement", CMCC R4-094003, "Text proposal on TD-LTE HeNB operating band unwanted emissions", CMCC R4-094004, "Text proposal on HeNB transmitter intermodulation", CMCC R4-094005, "Text proposal on HeNB ACS and narrow band blocking requirements", CMCC R4-094007, "Home eNode B receiver intermodulation requirement", CATT R4-094074, "Home eNode B Maximum output power", CATT R4-094077, "Text proposal on TD-LTE HeNB synchronization requirements", CMCC, Qualcomm	0.3.0	0.4.0
2009-12	RAN#46	RP-091149			Submitted to RAN plenary for information	0.4.0	1.0.0
2010-01	RAN4 AdHoc#1	R4-100176			Agreed TPs in RAN4 #53: R4-094563, "Text proposal on TD-LTE HeNB performance requirement in TR36.922", CMCC, CATT R4-094985, "TDD HeNB synchronization requirement for large propagation distance case", Qualcomm Europe, CMCC, Nokia Siemens Networks, Nokia	1.0.0	1.1.0
2010-02	RAN4#54	R4-101074			Agreed TPs in RAN4 AdHoc#1: R4-100049, "Text Proposal for TR 36.922: TDD HeNB Synchronization using Network Listening", Nokia Siemens Networks, Nokia, Qualcomm Incorporated, CMCC R4-100177, "Text proposal on LTE TDD HeNB synchronization requirement", CMCC, Nokia Siemens Network, Nokia, Qualcomm Incorporated R4-100178, "Text proposal on LTE TDD HeNB interference control", CMCC R4-100234, "Text Proposal for TR 36.922: Interference control for LTE Rel-9 HeNB cells", Nokia Siemens Networks, Nokia, Panasonic Agreed TPs in RAN4 #54: R4-100328, "Text Proposal for TR 36.922: TDD HeNB Synchronization using Network Listening", Nokia Siemens Networks, Nokia, Qualcomm Incorporated, CMCC R4-100704, "Text proposal on LTE TDD HeNB interference control", CMCC R4-100705, "Text proposal on Home BS adjacent channel protection", CMCC	1.1.0	1.2.0

2010-03	RAN4#54	R4-101078			Indices update and editorial modifications	1.2.0	1.2.1
2010-03	RAN#47	RP-100192			Submitted to RAN plenary for approval	1.2.1	1.3.0
2010-03	RAN#47	RP-100192			Approved by RAN	1.3.0	9.0.0
2010-06	RP-48	RP-100627	001		Editorial modifications on TDD HeNB TR36.922	9.0.0	9.1.0
	SP-51				Upgraded unchanged from Rel-9	9.1.0	10.0.0
2012-09	SP-57	-	-	-	Update to Rel-11 version (MCC)	10.0.0	11.0.0
2014-09	SP-65	-	-	-	Update to Rel-12 version (MCC)	11.0.0	12.0.0
2016-01	SP-70	-	-	-	Update to Rel-13 version (MCC)	12.0.0	13.0.0
2017-03	RP-75	-	-	-	Update to Rel-14 version (MCC)	13.0.0	14.0.0

Change history							
Date	Meeting	TDoc	CR	Rev	Cat	Subject/Comment	New version
2018-06	SA#80	-	-	-	-	Update to Rel-15 version (MCC)	15.0.0
2020-06	SA#88					Update to Rel-16 version (MCC)	16.0.0

---

# History

<b>Document history</b>		
V16.0.0	July 2020	Publication