



**Digital cellular telecommunications system (Phase 2+) (GSM);
Universal Mobile Telecommunications System (UMTS);
LTE;
Performance characterization of the
Adaptive Multi-Rate (AMR) speech codec
(3GPP TR 26.975 version 15.0.0 Release 15)**



Reference

RTR/TSGS-0426975vf00

Keywords

GSM,LTE,UMTS

ETSI

650 Route des Lucioles
F-06921 Sophia Antipolis Cedex - FRANCE

Tel.: +33 4 92 94 42 00 Fax: +33 4 93 65 47 16

Siret N° 348 623 562 00017 - NAF 742 C
Association à but non lucratif enregistrée à la
Sous-Préfecture de Grasse (06) N° 7803/88

Important notice

The present document can be downloaded from:

<http://www.etsi.org/standards-search>

The present document may be made available in electronic versions and/or in print. The content of any electronic and/or print versions of the present document shall not be modified without the prior written authorization of ETSI. In case of any existing or perceived difference in contents between such versions and/or in print, the only prevailing document is the print of the Portable Document Format (PDF) version kept on a specific network drive within ETSI Secretariat.

Users of the present document should be aware that the document may be subject to revision or change of status.

Information on the current status of this and other ETSI documents is available at

<https://portal.etsi.org/TB/ETSIDeliverableStatus.aspx>

If you find errors in the present document, please send your comment to one of the following services:

<https://portal.etsi.org/People/CommiteeSupportStaff.aspx>

Copyright Notification

No part may be reproduced or utilized in any form or by any means, electronic or mechanical, including photocopying and microfilm except as authorized by written permission of ETSI.

The content of the PDF version shall not be modified without the written authorization of ETSI.

The copyright and the foregoing restriction extend to reproduction in all media.

© ETSI 2018.

All rights reserved.

DECT™, **PLUGTESTS™**, **UMTS™** and the ETSI logo are trademarks of ETSI registered for the benefit of its Members.

3GPP™ and **LTE™** are trademarks of ETSI registered for the benefit of its Members and of the 3GPP Organizational Partners.

oneM2M logo is protected for the benefit of its Members.

GSM® and the GSM logo are trademarks registered and owned by the GSM Association.

Intellectual Property Rights

Essential patents

IPRs essential or potentially essential to normative deliverables may have been declared to ETSI. The information pertaining to these essential IPRs, if any, is publicly available for **ETSI members and non-members**, and can be found in ETSI SR 000 314: *"Intellectual Property Rights (IPRs); Essential, or potentially Essential, IPRs notified to ETSI in respect of ETSI standards"*, which is available from the ETSI Secretariat. Latest updates are available on the ETSI Web server (<https://ipr.etsi.org/>).

Pursuant to the ETSI IPR Policy, no investigation, including IPR searches, has been carried out by ETSI. No guarantee can be given as to the existence of other IPRs not referenced in ETSI SR 000 314 (or the updates on the ETSI Web server) which are, or may be, or may become, essential to the present document.

Trademarks

The present document may include trademarks and/or tradenames which are asserted and/or registered by their owners. ETSI claims no ownership of these except for any which are indicated as being the property of ETSI, and conveys no right to use or reproduce any trademark and/or tradename. Mention of those trademarks in the present document does not constitute an endorsement by ETSI of products, services or organizations associated with those trademarks.

Foreword

This Technical Report (TR) has been produced by ETSI 3rd Generation Partnership Project (3GPP).

The present document may refer to technical specifications or reports using their 3GPP identities, UMTS identities or GSM identities. These should be interpreted as being references to the corresponding ETSI deliverables.

The cross reference between GSM, UMTS, 3GPP and ETSI identities can be found under <http://webapp.etsi.org/key/queryform.asp>.

Modal verbs terminology

In the present document "**should**", "**should not**", "**may**", "**need not**", "**will**", "**will not**", "**can**" and "**cannot**" are to be interpreted as described in clause 3.2 of the [ETSI Drafting Rules](#) (Verbal forms for the expression of provisions).

"**must**" and "**must not**" are **NOT** allowed in ETSI deliverables except when used in direct citation.

Contents

Intellectual Property Rights	2
Foreword.....	2
Modal verbs terminology.....	2
Foreword.....	5
1 Scope	6
2 References	6
3 Definitions and abbreviations.....	7
3.1 Definitions	7
3.2 Abbreviations	7
4 General	9
4.1 Project History.....	9
4.2 Overview of the AMR Concept.....	9
4.3 Functional Description in a GSM System	10
4.4 Presentation of the following sections.....	12
5 Quality in Clean Speech and Error Conditions	13
6 Quality under background noise and Errors Conditions	16
7 Performances in Tandeming and with variation of the input speech level.....	19
8 Performances with the Codec Adaptation turned on.....	21
9 VAD/DTX Performances	23
10 Performances with DTMF tones	24
11 Transparency to Signaling tones	26
12 Performances with special input signals	27
13 Language Dependency	28
14 Transmission Delay.....	28
15 Frequency Response.....	33
16 Complexity	34
Annex A: AMR GSM Characterization Phase Overview	37
Annex B: AMR Verification Phase Overview	40
Annex C: Additional Characterization Test Results.....	41
Annex D: AMR Performances as a function of FER and RBER.....	47
D.1 Results in Clean Speech in Δ MOS	48
D.2 Results in Car Noise.....	49
D.3 Results in Street Noise	51
D.4 Results in Office Noise:	52
References to Annex D:	53
Annex E: AMR Characterization in 3G Channels.....	54
E.1 Overview of the 3G Characterization Phase	54
E.2 Radio Simulator Parameters	55
E.2.1 General	55

E.2.2	Uplink.....	55
E.2.3	Downlink.....	56
E.3	AMR 3G Characterization Test Results in Clean Speech.....	56
E.4	AMR 3G Characterization Test Results in Car Noise.....	61
	References to Annex E:.....	62
Annex F:	Change history	63
	History	64

Foreword

This Technical Report has been produced by the 3rd Generation Partnership Project (3GPP).

The contents of the present document are subject to continuing work within the TSG and may change following formal TSG approval. Should the TSG modify the contents of the present document, it will be re-released by the TSG with an identifying change of release date and an increase in version number as follows:

Version x.y.z

where:

- x the first digit:
 - 1 presented to TSG for information;
 - 2 presented to TSG for approval;
 - 3 or greater indicates TSG approved document under change control.
- y the second digit is incremented for all changes of substance, i.e. technical enhancements, corrections, updates, etc.
- z the third digit is incremented when editorial only changes have been incorporated in the document.

1 Scope

The present document provides background information on the performances of the Adaptive Multi-Rate (AMR) speech codec. Experimental test results from the Verification and Characterization phases of testing are reported to illustrate the behavior of AMR in multiple operational conditions.

2 References

The following documents contain provisions which, through reference in this text, constitute provisions of the present document.

- References are either specific (identified by date of publication, edition number, version number, etc.) or non-specific.
 - For a specific reference, subsequent revisions do not apply.
 - For a non-specific reference, the latest version applies. In the case of a reference to a 3GPP document (including a GSM document), a non-specific reference implicitly refers to the latest version of that document *in the same Release as the present document*.
- [1] GSM 01.04: "Digital cellular telecommunications system (Phase 2+); Abbreviations and acronyms".
 - [2] 3GPP TR 21.905: "3rd Generation Partnership Project; Technical Specification Group Services and System Aspects; 3G Vocabulary".
 - [3] GSM 03.50: "Digital cellular telecommunications system (Phase 2+); Transmission planning aspects of the speech service in the GSM Public Land Mobile Network (PLMN) system".
 - [4] GSM 06.08: "3rd Generation Partnership Project; Half rate speech; Performance characterization of the GSM half rate speech codec".
 - [5] GSM 06.55: "3rd Generation Partnership Project; Performance Characterization of the GSM Enhanced Full Rate (EFR) speech codec".
 - [6] GSM 08.60: "3rd Generation Partnership Project; In-band control of remote transcoders and rate adaptors for Enhanced Full Rate (EFR) and full rate traffic channels".
 - [7] GSM 08.61: "3rd Generation Partnership Project; In-band control of remote transcoders and rate adaptors for half rate traffic channels".
 - [8] 3GPP TSG-RAN: UTRAN Typical Radio Interface Parameter Sets, Version 1.3, August 2000, from the GSM-A.
 - [9] 3GPP TS 25.211: "Transport channels and physical channels (FDD)".
 - [10] 3GPP TS 26.101: "Frame Structure".
 - [11] ITU-T Recommendation G.726: "40, 32, 24, 16 kbit/s Adaptive Differential Pulse Code Modulation (ADPCM)".
 - [12] ITU-T Recommendation G.728: "Coding of speech at 16 kbit/s using low-delay code excited linear prediction".
 - [13] ITU-T Recommendation G.729: "C source code and test vectors for implementation verification of the G.729 8 kbit/s CS-ACELP speech coder".
 - [14] ITU-T Recommendation E.180: "Technical characteristics of tones for the telephone service".
 - [15] ITU-T Recommendation G.723.1: "Dual rate speech coder for multimedia communications transmitting at 5.3 and 6.3 kbit/s".
 - [16] ITU-T Recommendation Q.23: "Technical features of push-button telephone sets".

3 Definitions and abbreviations

3.1 Definitions

For the purposes of the present document, the following terms and definitions apply:

Adaptive Multi-Rate (AMR) codec: speech and channel codec capable of operating in a GSM system at gross bit-rates of 11.4 kbit/s ("*half-rate*") and 22.8 kbit/s ("*full-rate*"). In addition, the codec may operate at various combinations of speech and channel coding (*codec mode*) bit-rates for each *channel mode*.

In UMTS, the AMR speech codec may operate at one of 8 possible *codec modes* bit rates

The following definitions apply to a GSM Radio Access Network only:

Bit-rate change: change of the *codec mode* bit-rates for a given (HR/FR) *channel mode*

Channel mode: GSM Half-rate or full-rate operation

Channel mode adaptation: control and selection of the (FR or HR) *channel mode*

Codec mode: for a given *channel mode*, the bit partitioning between the speech and channel codecs

Codec mode adaptation: control and selection of the *codec mode* bit-rates

Error Patterns: result of offline simulations stored on files. To be used by the "Error Insertion Device" to model the radio transmission from the output of the channel coder and interleaver to the input of the deinterleaver and channel decoder

Full-rate (FR): GSM Full-rate channel or GSM *channel mode*

Gross bit-rate: bit-rate of the *channel mode* selected (22,8 kbit/s or 11,4 kbit/s in GSM)

Half-rate (HR): GSM Half-rate channel or GSM *channel mode* (GSM Radio Access Network Only)

In-Band Signaling: signalling for codec mode indication and modification carried within the traffic channel.

Out-of-Band Signaling: signalling on the GSM control channels to support link control

General definitions:

Toll Quality: speech quality normally achieved on modern wireline telephones

Synonym with "ISDN quality" in most western countries.

Wireline quality: speech quality provided by modern wireline networks. Normally taken to imply quality at least as good as that of 32kbit/s ITU-T Recommendation G.726 [11] or ITU-T Recommendation G.728 [12] 16 kbit/s codecs

3.2 Abbreviations

For the purposes of the present document, the following abbreviations apply:

A/D	Analogue to Digital
ACR	Absolute Category Rating
ADPCM	Adaptive Differential Pulse Code Modulation
AMR	Adaptive Multi-Rate
BSC	Base Station Controller
BTS	Base Transceiver Station
C/I	Carrier-to-Interfere ratio
CI	Confidence Interval
CNI	Comfort Noise Insertion
CRC	Cyclic Redundancy Check
D/A	Digital to Analogue
DAT	Digital Audio Tape
DCR	Degradation Category Rating

DEC _i	Dynamic Error Condition # <i>i</i> simulating a GSM radio channel with a slowly varying C/I representative of slow fading conditions, under ideal Frequency Hopping in a TU3 multipath propagation profile unless otherwise stated. (9 different Dynamic Error Conditions were used in the AMR GSM Characterization Phase)
DSP	Digital Signal Processor
DTMF	Dual Tone Multi Frequency
DTX	Discontinuous Transmission for power consumption and interference reduction
EC _x	Error Conditions at <i>x</i> dB C/I simulating a GSM radio channel under static C/I using ideal Frequency Hopping in a TU3 multipath propagation profile
EFR	Enhanced Full Rate
ESP	Product of E (Efficiency), S (Speed) and P (Percentage of Power) of the DSP
FH	Frequency Hopping
FR	Full Rate (also GSM FR)
G.726	ITU 16/24/32kbit/s ADPCM codec
G.728	ITU 16kbit/s LD-CELP codec
G.729	ITU 8/6.4/11.8 kbit/s speech codec
GBER	Average gross bit error rate
GSM	Global System for Mobile communications
HR	Half Rate (also GSM HR)
IRS	Intermediate Reference System
ITU-T	International Telecommunication Union - Telecommunications Standardization Sector
MNRU	Modulated Noise Reference Unit
Mod. IRS	Modified IRS
MOPS	Million of Operation per Seconds
MOS	Mean Opinion Score
MS	Mobile Station
MSC	Mobile Switching Center

Multiple Error Patterns were used during the Characterization tests. They are identified by the propagation Error Conditions from which they are derived. The following conventions are used:

PCM	Pulse Code Modulation
PSTN	Public Switched Telecommunications Network
Q	Speech-to-speech correlated noise power ratio in dB
SD	Standard Deviation
SID	Silence Descriptor
SMG	Special Mobile Group
SNR	Signal To Noise Ratio
TCH-AFS	Traffic CHannel Adaptive Full rate Speech
TCH-AHS	Traffic CHannel Adaptive Half rate Speech
TDMA	Time Division Multiple Access
TFO	Tandem Free Operation
tMOPS	true Million of Operations per Seconds
TU _x	Typical Urban at multipath propagation profile at <i>x</i> km/s
VAD	Voice Activity Detector
wMOPS	weighted Million of Operations per Seconds

For abbreviations not given in this clause, see GSM 01.04 [1] and 3GPP TR 21.905 [2].

4 General

4.1 Project History

Following the standardization of the EFR speech codec, the SMG2 Speech Expert Group (SEG) and especially the SQSG (Speech Quality Strategy Group) were tasked by SMG to study possible strategies for the continuous improvement of the end to end performances of the speech service in GSM networks. SEG was specifically asked to evaluate the opportunity to design a robust Full Rate mode and/or an Enhanced Half Rate mode.

The SQSG report, presented to SMG in 1996, recommended to start a one-year feasibility study of a Multi-Rate speech codec capable to offer at the same time a Robust Full Rate mode and an Enhanced Half Rate mode providing wireline quality under low propagation error conditions¹.

The feasibility study was completed in 3Q97 and the results presented to SMG#23. Based on the feasibility report, SMG approved a new R98 Work Item for the development of the Adaptive Multi-Rate (AMR) Speech Codec.

A Qualification Phase was completed by the end of 2Q98 with the pre-selection of 5 candidates among the 11 proposals received by SMG11.

The selection tests took place in the summer of 1998 and the results analyzed in SMG11#7 in September 1998. SMG11 reached a consensus on one solution and recommended to SMG to select the ENS1 solution proposed by Ericsson, Nokia and Siemens as the basis of the AMR standard. This proposal was approved by SMG#27.

The completion of the AMR development included a short optimization phase restricted to the codec proponents followed by an exhaustive Verification and GSM Characterization Phase whose results are reported in the main part of the present document.

SMG later approved two additional Work Items for the selection of a Noise Suppressor and the development of a Wideband extension of the AMR speech codec. The outcome of these Work Items is not included in the present document.

In early 1999, 3GPP approved the selection of AMR as the mandatory speech codec. A simplified characterization in 3G Channels was completed in 2000 and the key results included in Annex E of the present document.

4.2 Overview of the AMR Concept

AMR is a Multi-Rate speech codec with the ability to operate at 8 distinct bit rates: 12,2; 10,2; 7,95; 7,4; 6,7; 5,9; 5,15 or 4,75 kbit/s. For compatibility with legacy systems, the 12,2 and 7,4 modes are compatible versions of the GSM EFR and IS-136 EFR speech codecs. In addition, the codec was designed to allow seamless switching on a frame by frame basis between the different modes.

The AMR speech codec provides a high quality speech service with the additional flexibility of the Multi-Rate approach allowing a gentle trade-off between quality and capacity as a function of the network load. This flexibility is equally applicable to 2G and 3G networks.

Application to a GSM Network:

Unlike previous GSM speech codecs (FR, EFR, and HR) which operate at a fixed rate and constant error protection level, the AMR speech codec offers the possibility to adapt the error protection level to the local radio channel and traffic conditions. A GSM system using the AMR speech codec may select the optimum channel (half or full rate) and codec mode (speech and channel bit rates) to deliver the best combination of speech quality and system capacity. This flexibility provides a number of important benefits:

- Improved speech quality in both half-rate and full-rate modes by means of codec mode adaptation i.e. by varying the balance between speech and channel coding for the same gross bit-rate;

¹ The SEG report also proposed to evaluate and standardize the Tandem Free Operation of the GSM codecs and proposed the creation of a new STC, later called SMG11, responsible for the end to end quality of the speech service in GSM Networks.

- The ability to trade speech quality and capacity smoothly and flexibly by a combination of channel and codec mode adaptation; this can be controlled by the network operator on a cell by cell basis;
- Improved robustness to channel errors under marginal radio signal conditions in full-rate mode. This increased robustness to errors and hence to interference may be used to increase capacity by operating a tighter frequency re-use pattern;
- Ability to tailor AMR operation to meet the different needs of operators;
- Potential for improved handover and power control resulting from additional signaling transmitted rapidly in-band.

The Multi-Rate concept is adaptable not only in terms of its ability to respond to changing radio and traffic conditions but also to be customized to the specific needs of network operators. This allows the codec to be operated in many ways of which three important GSM examples are:

- Full-rate only for maximum robustness to channel errors. This additional robustness may be used to extend the coverage in marginal signal conditions, or to improve the capacity by using a tighter frequency re-use, assuming high AMR MS penetration.
- Half-rate only for maximum capacity advantage; more than 100% capacity increase achievable relative to FR orEFR (i.e. same as existing HR). Significant quality improvements relative to the existing HR will be given for a large proportion of mobiles as a result of the codec mode adaptation to the channel conditions and excellent (wireline like) speech quality in half rate mode for low error conditions.
- Mixed half/full rate operation allowing a trade-off between quality and capacity enhancements according to the radio and traffic conditions and operator priorities.

4.3 Functional Description in a GSM System

The AMR speech codec includes a set of fixed rate speech codecs modes for half rate and full rate operation, providing the possibility to switch between the different modes as a function of the propagation error conditions. Each codec mode provides a different level of error protection through a dedicated distribution of the available gross bit rate (22,8 kbit/s in Full Rate and 11,4 kbit/s in Half rate) between source coding and channel coding.

The actual speech rate used for each speech frame depends on the existing radio channel conditions. A codec adaptation algorithm selects the optimized speech rate (or codec mode) as a function of the channel quality. The most robust codec mode is selected in bad propagation conditions. The codec mode providing the best quality is selected in good propagation conditions. The codec adaptation relies on channel quality measurements performed in the MS and the network and on in band information sent over the Air Interface together with the speech data.

The following diagram shows the main information flows over the key system interfaces:

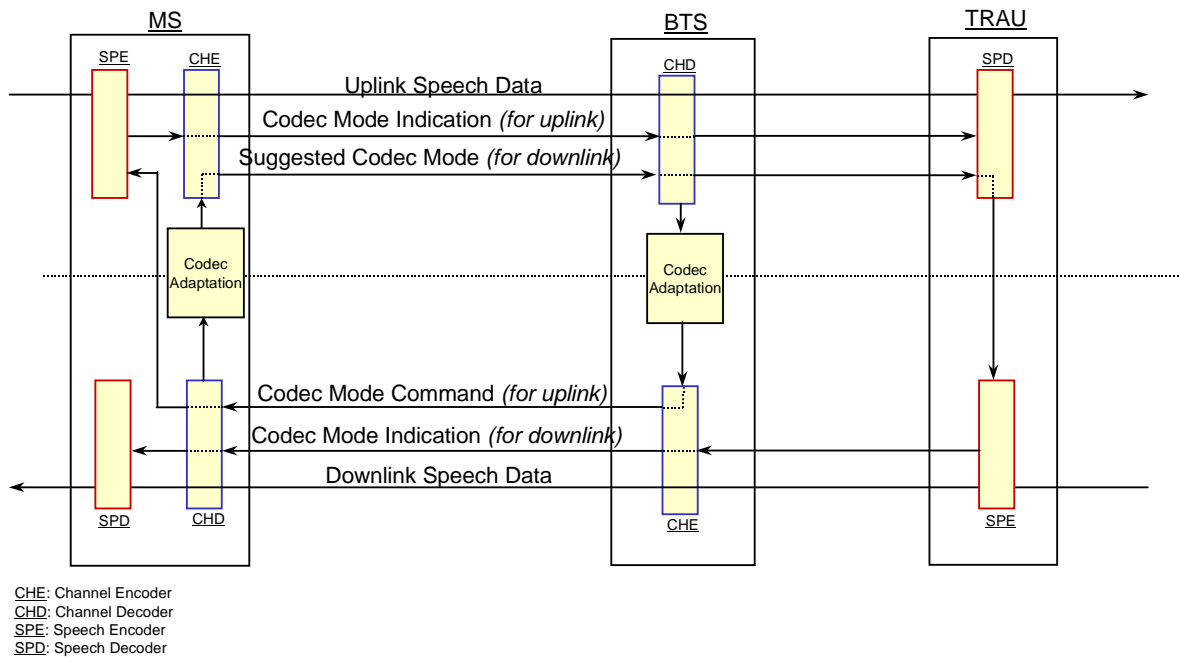

In both directions, the speech data frames are associated with a Codec Mode Indication used by the receiving end to select the correct channel and source decoders. In the network, the Codec Mode Indication must also be sent to the Transcoder Units so that the correct source decoding is selected.

For the adaptation of the uplink codec mode, the network must estimate the channel quality, identify the best codec for the existing propagation conditions and send this information to the MS over the Air Interface (Codec Mode Command Data field).

For the downlink codec adaptation, the MS must estimate the downlink channel quality and send to the network a quality information, which can be mapped in the network to a 'suggested' codec mode.

In theory, the codec mode can be changed every speech frame. In practice, because of the propagation delays and necessary filtering in the codec adaptation functions, the codec mode should be adapted at a lower rate.

Each link may use a different codec mode but it is mandatory for both links to use the same channel mode (either full rate or half rate).

The channel mode is selected by the Radio Resource management function in the network. It is done at call set up or after a handover. The channel type can further be changed during a call as a function of the channel conditions.

The key characteristics of the selected AMR solution are:

- 8 codec modes in Full Rate mode including the GSM EFR and IS136 EFR.
- 6 codec modes in Half Rate mode (also supported in Full Rate), including the IS136 EFR.
- Possibility to operate on a set of up to 4 codec modes selected at call set up or handover.
- Codec Mode Indications multiplexed with the Uplink Codec Mode Command and Suggested Downlink Codec Mode every other frame.
- In band signaling based on a 2 bits information field sent every other block coded over the Air Interface.

The full set of codec modes is listed in the following table:

Table 4.3.1: AMR Speech Codec Modes

Channel	Source codec bit-rate
TCH/FS/AMR (TCH/AFS)	12.2 kbit/s (GSM EFR)
	10.2 kbit/s
	7.95 kbit/s
	7.40 kbit/s (IS136 EFR)
	6.70 kbit/s
	5.90 kbit/s
	5.15 kbit/s
4.75 kbit/s	
TCH/HS/AMR (TCH/AHS)	7.95 kbit/s
	7.40 kbit/s (IS136 EFR)
	6.70 kbit/s
	5.90 kbit/s
	5.15 kbit/s
	4.75 kbit/s

4.4 Presentation of the following sections

The following sections provide a summary of the GSM Characterization Phase test results and background information on the codec performances analyzed during the Verification Phase.

Clauses 5 to 9 summarize the codec subjective quality performances under different representative environmental conditions as measured during the GSM Characterization Phase of the project. An overview of the GSM Characterization Phase is included in Annex A. Additional test results are also provided in Annex C and D.

Annex E contains an overview of the AMR 3G Characterization Phase and a summary of the corresponding subjective listening tests.

Clauses 10 to 16 provide information on the codec characteristics as reported during the Verification Phase including:

- The transparency to DTMF tones,
- The transparency to network signaling tones
- The performances special input signals
- The language and talker dependency
- The frequency response
- The transmission delay
- The complexity

Annex B lists the reference contributions used in these sections.

5 Quality in Clean Speech and Error Conditions

The codec performances in clean speech and error conditions were measured in Experiment 1a (Full Rate) and 1b (Half Rate) of the GSM Characterization phase of testing. The clean speech performance requirements were set for the best codec mode in each error condition as defined in the following table:

Table 5.1: Best Codec Performance Requirements in Clean Speech and Error Conditions

C/I	Full Rate Best Codec performance requirement	Half Rate Best Codec performance requirement
No Errors	EFR No Errors	G.728 [12] no errors
19 dB	EFR No Errors	G.728 [12] no errors
16 dB	EFR No Errors	G.728 [12] no errors
13 dB	EFR No Errors	FR at 13 dB
10 dB	G.728 [12] No Errors	FR at 10 dB
7 dB	G.728 [12] No Errors	FR at 7 dB
4 dB	EFR at 10 dB	FR at 4 dB

A summary of the essential test results is provided below. Additional results are included in Annex C.

The following figures provide a graphical representation (in Mean Opinion Scores) of the AMR performances in clean speech in Full Rate mode². Figure 5.1 compares the performance recorded for the best AMR full rate codec mode for each impairment condition, with the corresponding performance of EFR and the related AMR project performance requirement.

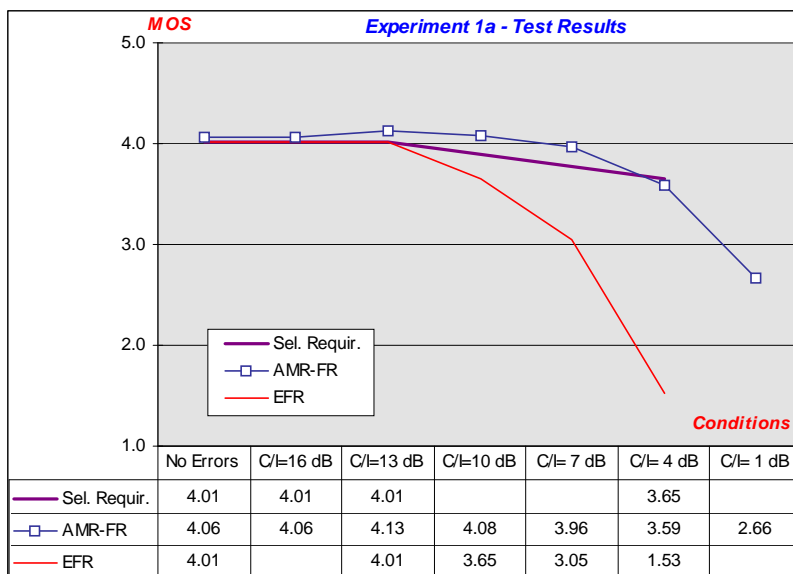

Figure 5.1: AMR full rate/clean speech performances curve (Best AMR Codec vs. EFR vs. Performance Requirements)

Figure 5.2 shows the performances recorded for all 8 AMR full rate codec modes in clean speech and error conditions.

Important Note: MOS values are provided in these figures **for information only**. Mean Opinion Scores can only be representative of the test conditions in which they were recorded (speech material, speech processing, listening

² In these figures, the performance of EFR at 13 dB was arbitrarily set to the performance of EFR in No Errors conditions.

conditions, language, and cultural background of the listening subjects...). Listening tests performed with other conditions than those used in the AMR Characterization phase of testing could lead to a different set of MOS results. On the other hand, the relative performances of different codec under tests is considered more reliable and less impacted by cultural difference between listening subjects. Finally, it should be noted that a difference of 0.2 MOS between two test results was usually found not statistically significant.

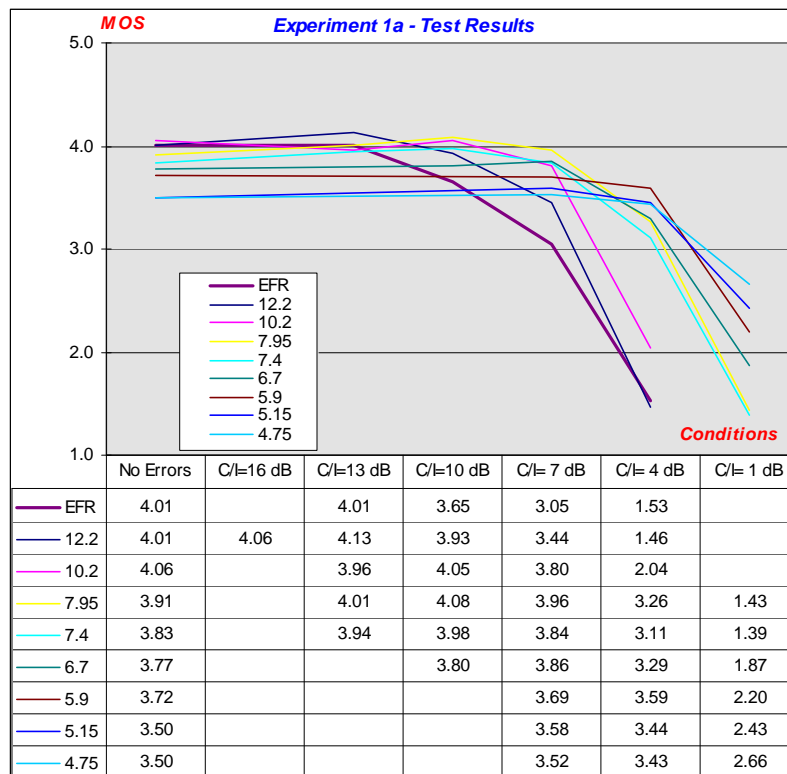

Figure 5.2: Family of curves for Experiment 1a (Clean speech in Full Rate)

The AMR Characterization test results showed that the selected solution satisfies the AMR requirements in clean speech in Full Rate Channel. The previous results demonstrate that the combination of all 8 speech codec modes provide a robust Full Rate speech codec down to 4 dB C/I.

The results also showed that the four highest codec modes (12.2, 10.2, 7.95 and 7.4) are equivalent to EFR in error free conditions and barely affected by propagation errors over a wide range Channel conditions (down to 10-7 C/I). The four lowest codec modes (6,7; 5,9; 5,15 and 4,75) are all judged in error free conditions to be equivalent to EFR at 10 dB C/I. The three lowest codec modes are statistically unaffected by propagation errors down to 4 dB C/I.

The following figures provide a graphical representation (in Mean Opinion Scores) of the AMR performances in clean speech in Half Rate mode³. Figure 5.3 compares the performance recorded for the best AMR half rate codec mode for each impairment condition, with the corresponding performance of the EFR, GSM FR and GSM HR speech codecs and the related AMR project performance requirement.

Figure 5.3 shows the performances recorded for all 6 AMR half rate codec modes in clean speech and error conditions.

Important Note: Once again, MOS values are provided in these figures **for information only**. Mean Opinion Scores can only be representative of the test conditions in which they were recorded (speech material, speech processing, listening conditions, language, and cultural background of the listening subjects...). Listening tests performed with other conditions than those used in the AMR Characterization phase of testing could lead to a different set of MOS results. On the other hand, the relative performances of different codec under tests is considered more reliable and less impacted by cultural difference between listening subjects. Finally, it should be noted that a difference of 0.2 MOS between two test results was usually found not statistically significant.

³ In these figures, the performances of EFR at 13 dB were arbitrarily set to the performances of EFR in No Errors conditions.

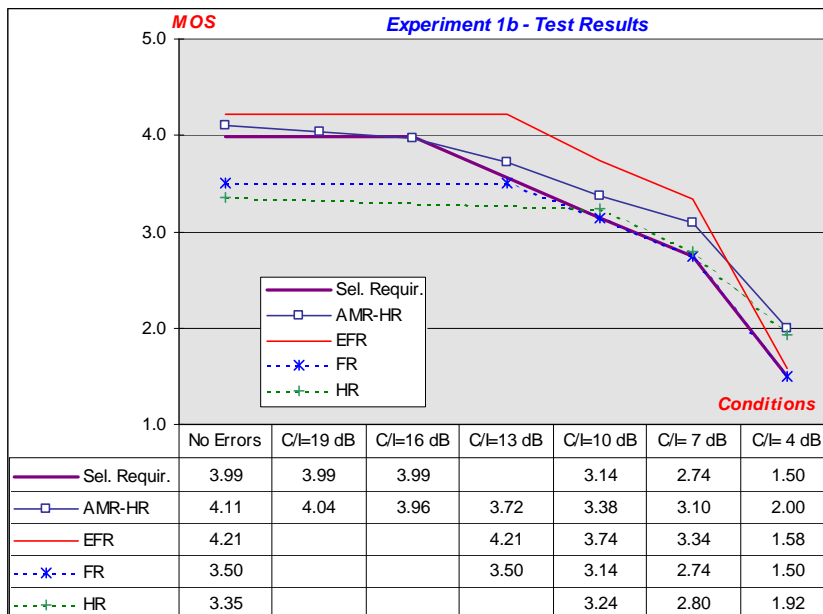

Figure 5.3: AMR half rate/clean speech performances curve (Best AMR Codec vs. EFR vs. GSM FR vs. GSM FR vs. Performance Requirements)

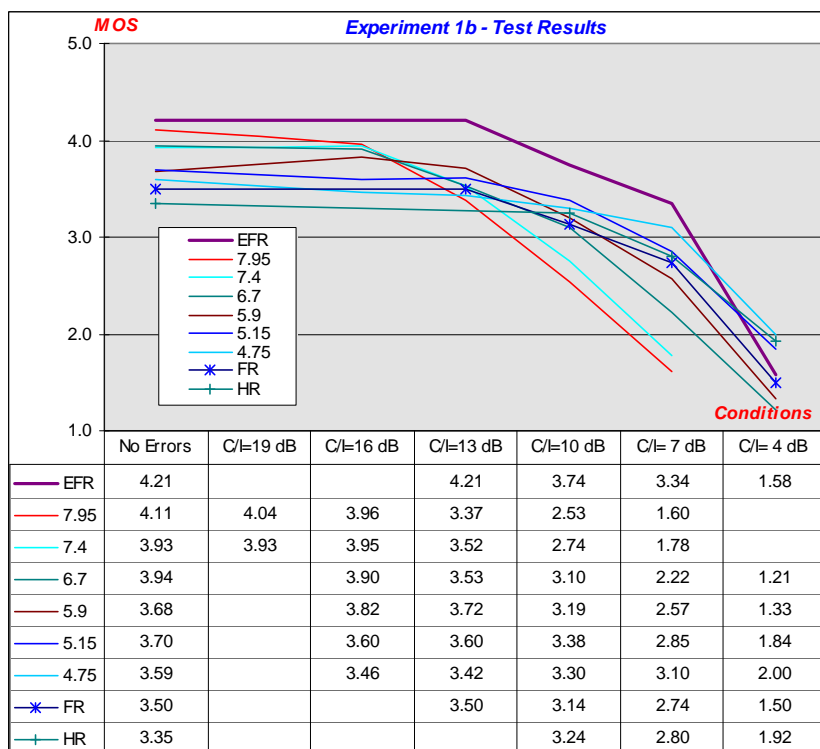

Figure 5.4: Family of curves for Experiment 1b (Clean Speech in Half Rate)

The AMR Characterization test results showed that the selected solution complies with the AMR requirements in clean speech in Half Rate Channel. The results demonstrate that the combination of all 6 speech codec modes provide a Half Rate speech codec equivalent to the ITU T Recommendation G.728 [12] (16 kbit/s) speech codec down to 16 dB C/I. Furthermore, the results show that AMR can provide significantly better performances than GSM FR in the full range of test conditions, and significantly better performances than the GSM HR codec down to 7 dB C/I.

The four highest codec modes (7,95; 7,4; 6,7 and 5,9) were found significantly better than the GSM FR in error free conditions down to 13 dB C/I and at least equivalent to the EFR at 10 dB C/I down to 16 dB C/I. The three highest modes (7,95; 7,4 and 6,7) are equivalent to the error free EFR in very low error conditions. The two lowest modes were found at least equivalent to the GSM FR over the full range of test conditions.

6 Quality under background noise and Errors Conditions

The codec performances under background noise and error conditions were measured in 6 different Experiments of the GSM Characterization phase of testing: Exp. 3a, 3b and 3c (Full Rate) and Exp. 3d, 3e and 3f (Half Rate). The following background noise types were included in the tests: Street Noise at 15 dB SNR (3a and 3d), Car noise at 15 dB SNR (3b and 3e) and Office noise at 20 dB SNR (3c and 3f). The corresponding performance requirements were set for the best codec mode in each error condition as defined in the following table:

Table 6.1: Best Codec Performance Requirements under background noise and Error Conditions

C/I	Full Rate Best Codec performance requirement	Half Rate Best Codec performance (requirement)
No Errors	EFR No Errors	EFR No Errors
19 dB	EFR No Errors	G.729 [13]/FR No Errors
16 dB	EFR No Errors	G.729 [13]/FR No Errors
13 dB	EFR No Errors	FR at 13 dB
10 dB	G.729 [13]/FR No Errors	FR at 10 dB
7 dB	G.729 [13]/FR No Errors	FR at 7 dB
4 dB	FR at 10 dB	FR at 4 dB

A summary of the essential test results is provided below. Additional results are included in Annex C.

The following figures provide a graphical representation (in Mean Opinion Scores) of the performances recorded in Full Rate in Experiments 3a, 3b and 3c⁴.

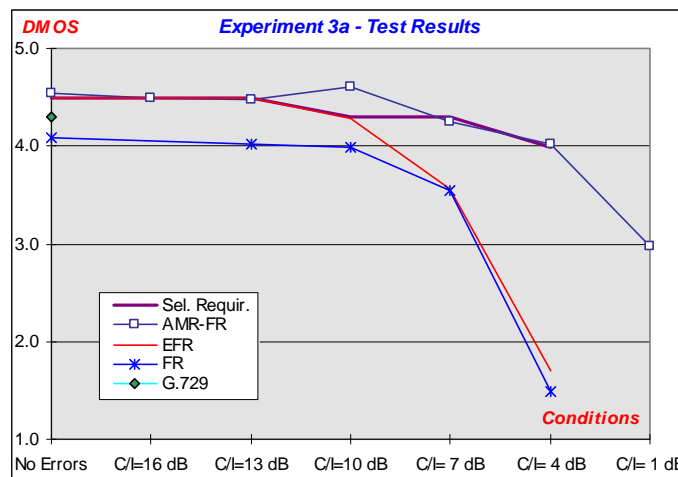

Figure 6.1: AMR performance curves for Experiment 3a (Full rate with Street Noise)

⁴ In these figures, the performances of EFR at 13 dB were arbitrarily set to the performances of EFR in No Errors conditions.

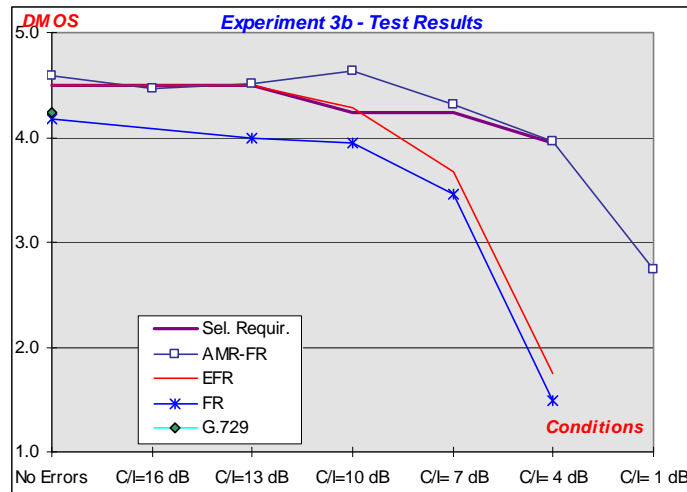

Figure 6.2: AMR performance curves for Experiment 3b (Full rate with Car Noise)

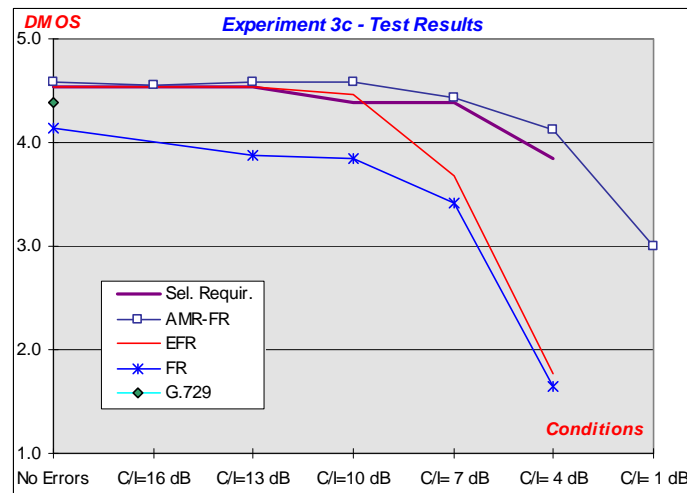

Figure 6.3: AMR performance curves for Experiment 3c (Full rate with Office Noise)

The AMR Characterization test results showed that the selected solution complies with the AMR requirements under background noise in Full Rate Channel. The results demonstrate that the combination of the 6 highest speech codec modes provide a robust Full Rate speech codec down to 4 dB C/I.

At high C/I (down to 13 dB) the three highest codec modes (12.2, 10.2 and 7.95) were found equivalent to EFR in error free condition. All codecs modes down to the AMR 5.9 performed better than the GSM FR across all test conditions. A couple of codecs (6.7, 5.9) still provide at 4 dB C/I a quality equivalent to the GSM FR at 10 dB C/I. The two lowest modes (5.15 and 4.75) were usually found worse than the GSM FR at 10 dB C/I across the range of test conditions⁵.

⁵ The support of the two lowest modes in Full Rate is required to allow Tandem Free Operation between a Half Rate MS and a Full Rate MS. They should not be the primary choice for operation in Full Rate mode only

The following figures provide a graphical representation (in Mean Opinion Scores) of the performances recorded in Half Rate in Experiments 3d, 3e and 3f⁶.

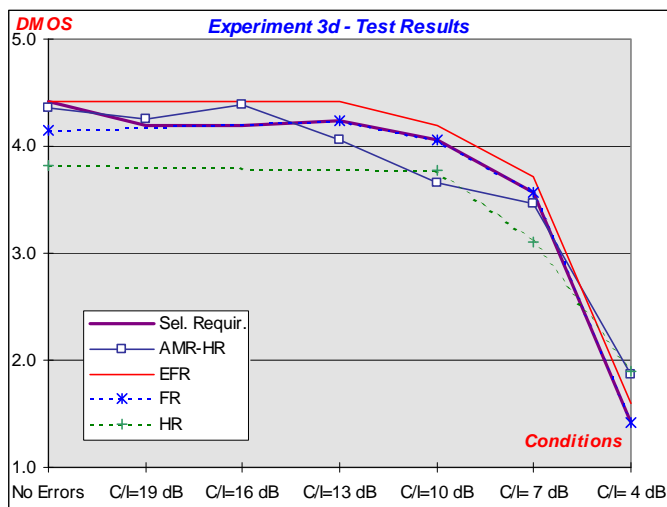

Figure 6.4: AMR performance curves for Experiment 3d (Half rate with Street Noise)

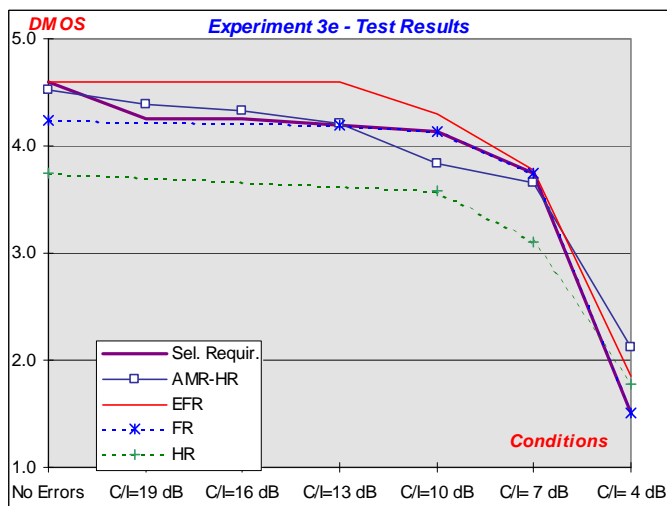

Figure 6.5: AMR performance curves for Experiment 3e (Half rate with Car Noise)

⁶ In these figures, the performance of EFR at 13 dB was arbitrarily set to the performances of EFR in No Errors conditions.

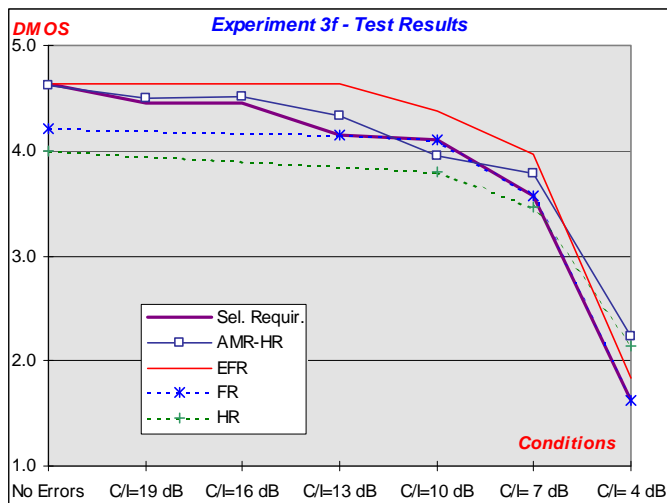

Figure 6.6: AMR performance curves for Experiment 3f (Half rate with Office Noise)

These results show that the highest AMR modes perform well under background noise conditions in half rate channel down to 16 dB C/I. In these conditions, the AMR performances are almost equivalent to EFR and significantly better than the GSM FR or GSM HR in the same test conditions.

None of the codec modes is able to meet the initial project requirement at 10 dB C/I. All codec modes are found worse than the target FR at 10 dB C/I in these conditions. This is the only critical failure recorded in the characterization phase.

At 7 dB C/I and below the two lowest codec modes match or exceed the performances of the GSM FR and GSM HR.

7 Performances in Tandeming and with variation of the input speech level

Experiment 2 and Experiment 6 of the GSM Characterization Test plan were intended to evaluate the performances of the AMR Codec modes in self-tandeming and cross-tandeming and with variation of the input speech level.

An overview of the corresponding results is provided in the following figures:

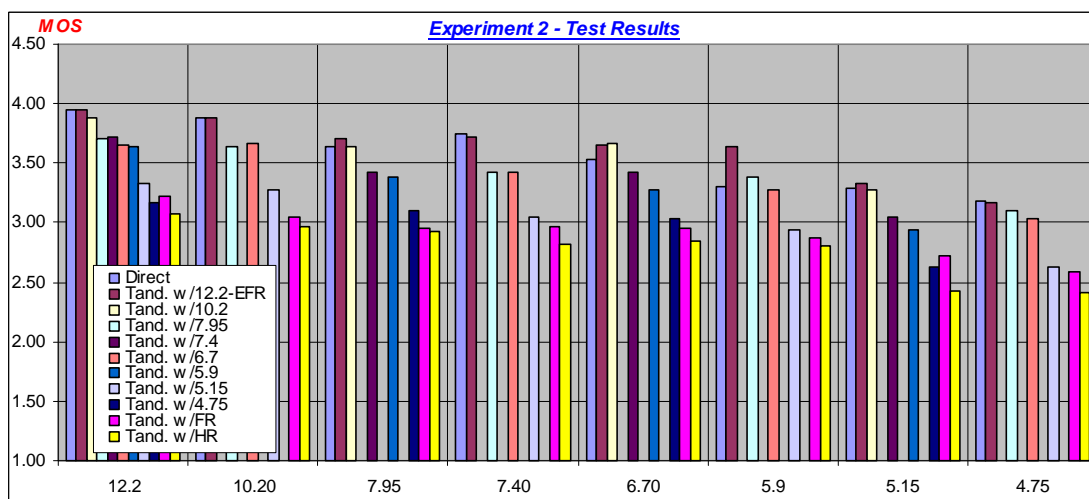

Figure 7.1: Experiment 2 Test Results (cross-codec tandeming)

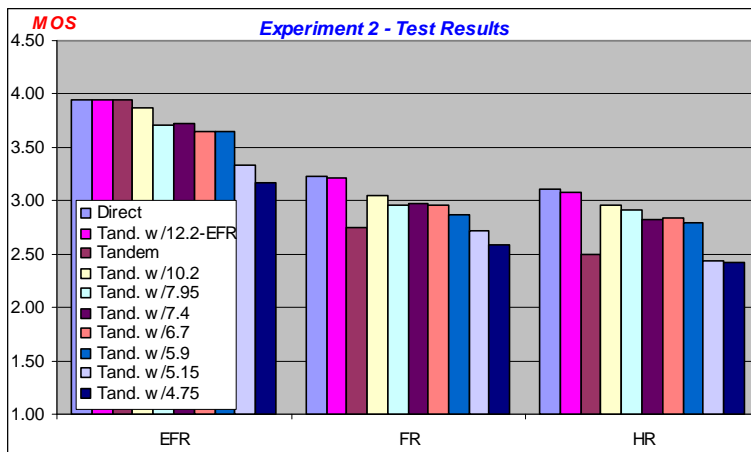

Figure 7.2: AMR Codec Tandeming performances with existing GSM Codecs

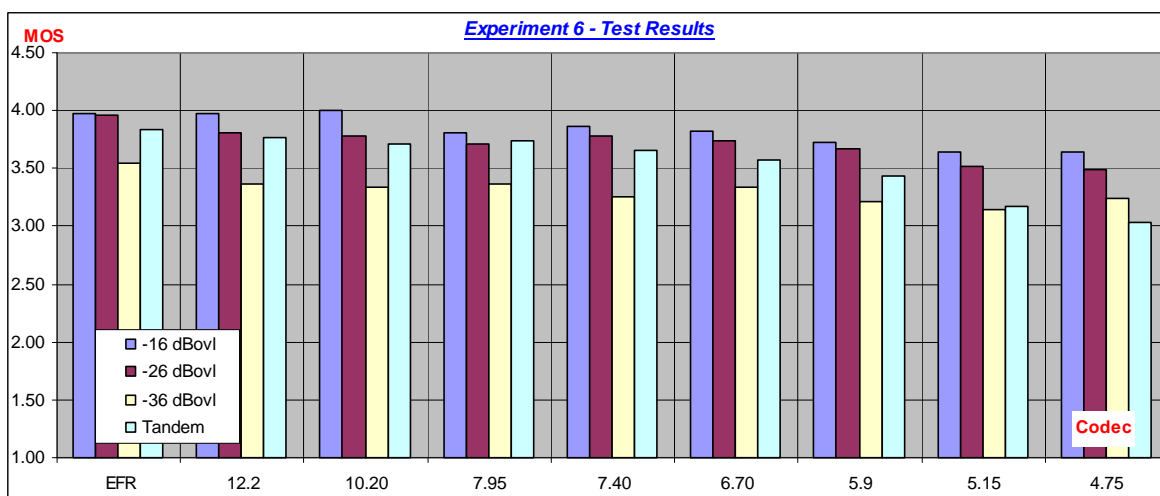

Figure 7.3: Combined results for Experiment 6 (Influence of input speech level and Tandeming)

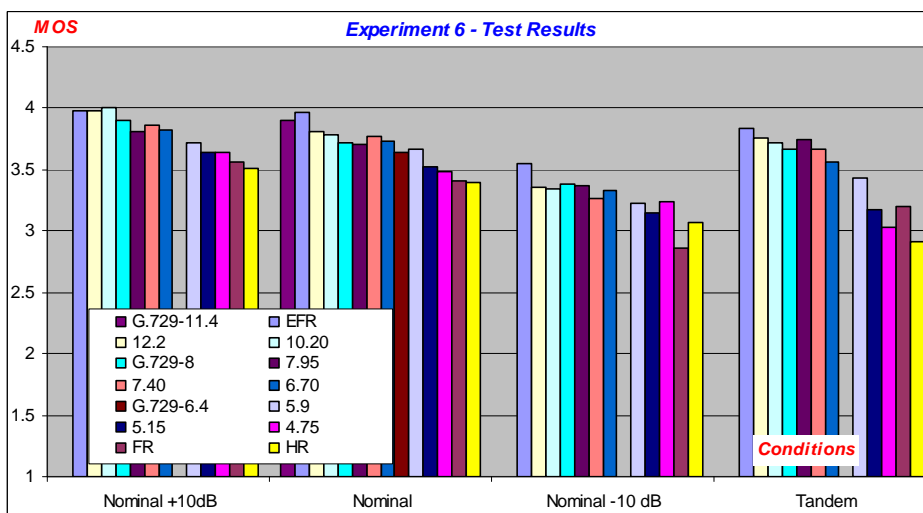

Figure 7.4: Combined results for Experiment 6 (Influence of input speech level and Tandeming) ordered by impairment type

The key performances demonstrated by Experiment 2 test results are:

- Tandeming with the clean speech error free 12.2 and 10.2 modes of AMR do not significantly degrade the single encoding performances of any of the AMR codec or existing GSM codecs.

- Any other tandeming configuration involving any two other AMR codecs introduce a significant degradation when compared to the single encoding performances of any of the two codecs involved in the tandem configuration. This degradation is however less significant than a tandem configuration involving either the GSM FR or the GSM HR.
- All tandeming configurations between two AMR speech codecs (except the worst configuration 5.15-4.75) are significantly better than the GSM FR or GSM HR in Tandem.

Experiment 6 test results show that the different AMR speech codec were not significantly more impacted by the input speech level than EFR. The highest codec modes (12.2 down to 7.4) were generally found equivalent for each impairment type (with variation of the input level or in tandem). The lowest codec modes were always found as least as good as the GSM FR.

In tandem conditions, the highest modes (down to 7.4 kbit/s) do not present a significant degradation compare to the single encoding condition. The lowest modes are at least as good as the GSM FR in tandeming and always better than the GSM HR.

8 Performances with the Codec Adaptation turned on

Experiments 4a (Full Rate) and 4b (Half Rate) of the GSM Characterization phase of testing were designed to evaluate the AMR performances with the adaptation turned on in long dynamic C/I profiles representative of operational propagation conditions. Multiple C/I profile were generated simulating different behavior of the radio channel and different slow fading effects. One profile was used to generate multiple Error Patterns representative of different Frequency Hopping operation mode: Ideal frequency hopping, non-ideal frequency hopping limited to 4 frequencies and no frequency hopping. Three different sets of codec modes were used in these Experiments. They are defined in the following table:

Table 8.1: Sets of codec modes for Experiment 4a and 4b

	Codec Modes for Experiment 4a	Codec Modes for Experiment 4b
Set #1	12.2, 7.95, 5.9	7.95, 6.7, 5.9, 5.15
Set #2	12.2, 7.95	6.7, 5.9, 4.75
Set #3	12.2, 7.40, 6.7, 5.15	7.40, 5.15

The thresholds and Hysteresis used for the codec adaptation in the different configurations are listed in the following table:

Table 8.2: Codec Mode Adaptation thresholds and Hysteresis used in Experiment 4a and 4b

Adaptation Thresholds and Hysteresis for Experiment 4a						
	Threshold 1	Hysteresis 1	Threshold 2	Hysteresis 2	Threshold 3	Hysteresis 3
Set #1	11,5 dB	2,0 dB	6,5 dB	2,0 dB		
Set #2	11,5 dB	2,0 dB				
Set #3	11,5 dB	2,0 dB	7,0 dB	2,0 dB	5,5 dB	2,0 dB

Adaptation Thresholds and Hysteresis for Experiment 4b

	Threshold 1	Hysteresis 1	Threshold 2	Hysteresis 2	Threshold 3	Hysteresis 3
Set #1	15,0 dB	2,0 dB	12,5 dB	2,5 dB	11,0 dB	2,0 dB
Set #2	12,5 dB	2,0 dB	11,0 dB	2,0 dB		
Set #3	13,5 dB	2,0 dB				

The results of Experiments 4a and 4b are presented in the following figures:

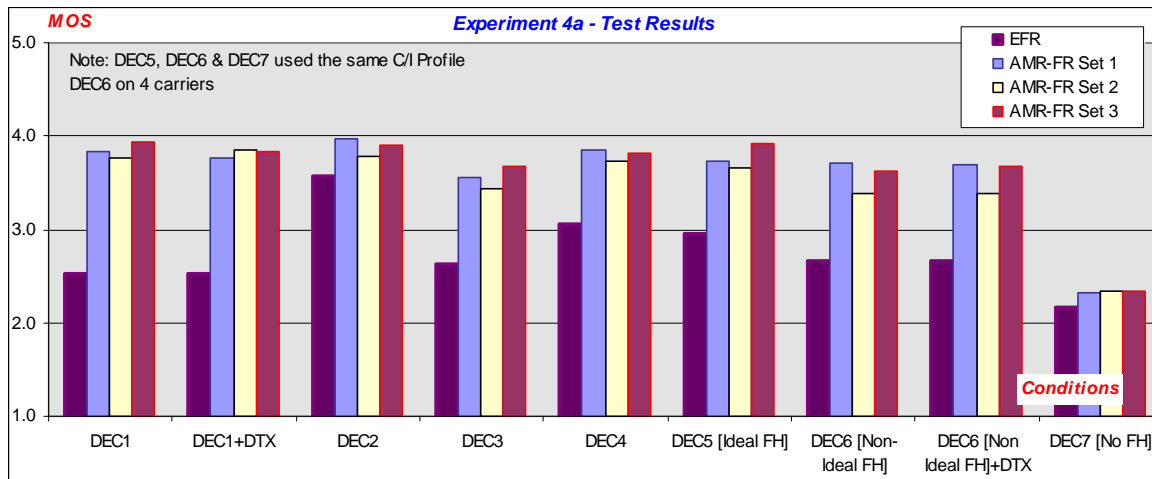

Figure 8.1: Experiment 4a Test Results (Dynamic Error conditions in Full Rate)

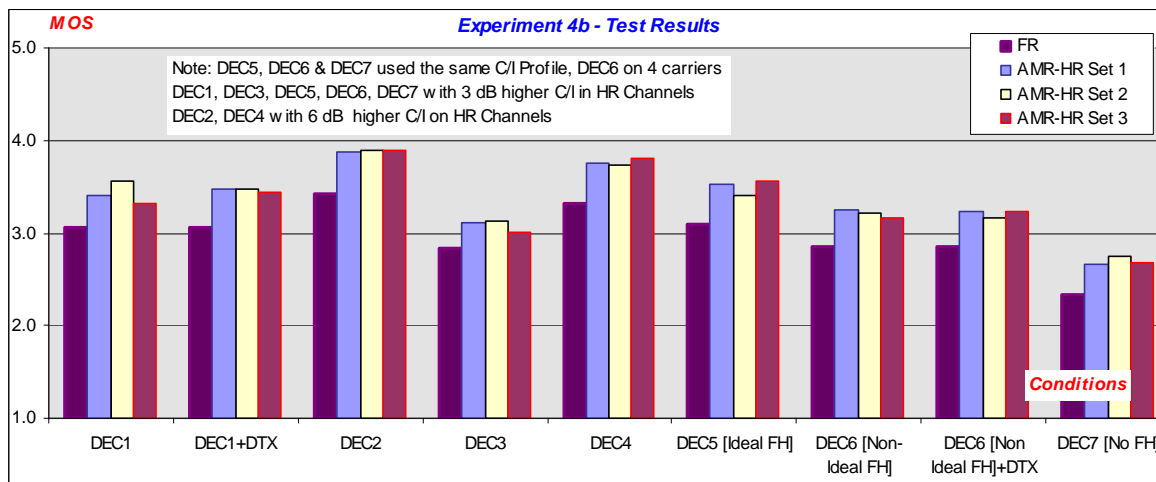

Figure 8.2: Experiment 4b Test Results (Dynamic Error conditions in Half Rate)

The results of Experiments 4a and 4b can be summarized as follows:

- In Full Rate, the three tested AMR codec sets were found significantly better than EFR in ideal or non-ideal frequency hopping cases. In some cases, the benefit was higher than 1 point MOS.
- In Half Rate, the three codec sets were found significantly better than the GSM FR codec (tested at 3 dB or 6 dB lower average C/I) in most cases with ideal or non-ideal frequency hopping activated.
- The performances with non-ideal frequency hopping were usually found equivalent to the performances with ideal frequency hopping for the AMR codec. The EFR codec seemed slightly more impacted in this case.
- No significant improvement compared to the references was identified in non-frequency hopping cases and low mobile speed in either full rate or half rate channels. The performances of all codecs without frequency hopping activated were always found significantly worse than their performances when ideal or non-ideal frequency hopping was used.

- No significant difference was found when DTX was activated in the return link in either full rate or half rate mode.
- There was no significant difference between the three codec sets used in full rate or half rate modes, even when the set was limited to two codec modes.

9 VAD/DTX Performances

The objective of Experiment 7 of the GSM characterization test plan was to evaluate the degradation induced by the activation of the voice activity detection and discontinuous transmission on the link under test⁷. The experiment was divided in 4 sub-experiments to separately test the effect on the Full Rate and Half Rate channel operation and then the performances of each VAD algorithm (ENS solution and Motorola solution). The tests used a 7-point Comparison Category Rating to amplify any possible degradation. They consisted in comparing a speech sample for which the VAD/DTX has been applied with the same speech sample without VAD/DTX but in the same channel error/impairment condition. The 7-point scale (CMOS=-3 to +3) corresponded to quality degradation defined as: 'Much worse', 'Worse', 'Slightly worse', 'About the same', 'Slightly better', 'Better' and 'Much better'.

The following impairment type were included in each experiment and tested for multiple error conditions (4, 10 and 16 dB C/I in Full Rate, 7, 13 and 19 dB in Half Rate):

- Single encoding in clean speech at nominal input level;
- Single encoding in clean speech 10 dB below the nominal input level;
- Single encoding in clean speech 10 dB above the nominal input;
- Single encoding in street noise at 15 dB SNR;
- Tandeming in street noise at 15 dB;
- Single encoding in car noise at 15 dB;
- Single encoding in office noise at 20.

The tests were performed with the adaptation turned on, using the sets of codec modes #1 of table 6.1. Nevertheless, a static C/I profile was used for all test conditions involving propagation errors.

The tests also included a set of references using the EFR codec with the original EFR VAD and the new AMR VAD algorithms in a subset of the impairment conditions, and the FR codec in clean speech with the original FR VAD. A null condition was also included in the test.

All test results with one exception showed that the activation of the AMR VAD/DTX do not introduce any significant degradation to the performances of AMR. The difference between the scores obtained by the different conditions were below their respective 95% confidence interval indicating that the degradation is not significantly different for either impairment type. The same results were found for both VAD solutions. A direct comparison between the two VAD options in paired experiments (Experiments 7a and 7c in Full Rate and Experiments 7b and 7d in Half Rate) did not allow to differentiate their respective performances.

The only condition showing a significantly higher degradation level in all tests performed was for the GSM FR codec with its own VAD algorithm. Even then, the score obtained by the FR/VAD codec association was not as bad as a being qualified as 'Slightly worse' (first degradation level in the 7-point CMOS scale). It was in the order of the degradation of a MNRU at 30 dB S/N compared with the original speech sample.

⁷ The influence of discontinuous transmission on the in band signaling (mode command and quality reporting) was tested in Experiment 4a and 4b.

10 Performances with DTMF tones

Twelve experiments were performed during the verification phase to evaluate the transparency of the AMR codec modes to DTMF tones. The corresponding test conditions are listed in Table 10.1. The experiments were limited to error free conditions only.

The frequency deviation was set for the duration of a digit, and was randomly chosen between -1.5 and +1.5%. The range of tone levels was chosen to avoid clipping in the digital domain and to exceed the minimum acceptable input level for the Linemaster™ unit used for the detection of DTMF tones.

A set of ten codecs was tested in each experiment, comprising the eight AMR modes, the full-rate GSM speech codec and the A-law codecs alone (direct condition).

Table 10.1: Experimental conditions for the evaluation of the AMR Codecs Transparency to DTMF Tones

Experiment	Low tone level (see note)	High tone level (see note)	Twist	Digit duration	Frequency deviation
1	-6 dBm	-6 dBm	0 dB	50 ms	none
2	-16 dBm	-16 dBm	0 dB	50 ms	none
3	-26 dBm	-26 dBm	0 dB	50 ms	none
4	-16 dBm	-16 dBm	0 dB	50 ms	+/- 1.5%
5	-19 dBm	-13 dBm	-6 dB	50 ms	none
6	-13 dBm	-19 dBm	6 dB	50 ms	none
7	-6 dBm	-6 dBm	0 dB	80 ms	none
8	-16 dBm	-16 dBm	0 dB	80 ms	none
9	-26 dBm	-26 dBm	0 dB	80 ms	none
10	-16 dBm	-16 dBm	0 dB	80 ms	+/- 1.5%
11	-19 dBm	-13 dBm	-6 dB	80 ms	none
12	-13 dBm	-19 dBm	6 dB	80 ms	none

NOTE: The levels are given as measured at the input to the DTMF detector, however, since the DAC is calibrated according to ITU-T Rec. G.711, 0dBm in the analogue section is equivalent to -6.15dBov in the digital section.

Test sequences:

For each experiment, 20 test sequences were processed per codec under test. Each test sequence was produced by the DTMF generator, and comprised a header of x ms followed by each of the 16 DTMF digits as defined in ITU-T Recommendation Q.23 [16]. The gap between adjacent DTMF digits was equal to the duration of the digits (see Table 1). The length of the header in sequence number n , was set to

$$x=200+n \text{ milliseconds; where } n=0..19.$$

This approach was taken to exercise the speech codecs over the complete range of possible phase relationships between the start of a DTMF digit and a speech codec frame (20ms in length). Thus each codec mode was subjected to 320 separate digits per experiment.

Test Procedure:

For each test sequence, the number of digits undetected by the DTMF detector was recorded. No attempt to identify misdetected digits was made, although there were no out of sequence digits observed.

Results:

The percentage of undetected digits measured for each codec mode is given in Table 10.2a for Experiments 1 to 6 (50ms digits), and in Table 10.2b for Experiments 7 to 12 (80ms digits).

Table 10.2a: Percentage of DTMF digits undetected when passed through different codecs with 50ms DTMF digits. The mean value is calculated over all six experiments.

Codec mode	Rate (kbit/s)	Exp. 1	Exp. 2	Exp. 3	Exp. 4	Exp. 5	Exp. 6	Mean
AMR mode 0	4.75	35.3%	40.9%	38.1%	41.3%	50.0%	43.8%	41.6%
AMR mode 1	5.15	32.8%	38.4%	34.7%	38.8%	52.5%	37.5%	39.1%
AMR mode 2	5.90	19.7%	20.3%	25.0%	25.3%	37.8%	19.1%	24.5%
AMR mode 3	6.70	7.8%	7.8%	10.6%	8.8%	23.4%	6.3%	10.8%
AMR mode 4	7.40	3.8%	5.0%	4.7%	4.1%	13.1%	2.2%	5.5%
AMR mode 5	7.95	0.3%	1.3%	1.3%	2.2%	9.7%	0.6%	2.6%
AMR mode 6	10.20	0.0%	0.0%	0.3%	0.0%	0.3%	0.0%	0.1%
AMR mode 7	12.20	0.0%	0.0%	0.0%	0.0%	0.0%	0.0%	0.0%
FR GSM	13.00	0.0%	0.0%	0.3%	0.0%	0.6%	0.0%	0.2%
Direct (A-law)	-	0.0%	0.0%	0.0%	0.0%	0.0%	0.0%	0.0%

Table 10.2b: Percentage of DTMF digits undetected when passed through different codecs with 80ms DTMF digits. The mean value is calculated over all six experiments.

Codec mode	Rate (kbit/s)	Exp. 7	Exp. 8	Exp. 9	Exp. 10	Exp. 11	Exp. 12	Mean
AMR mode 0	4.75	21.3%	24.7%	27.5%	26.9%	35.9%	26.6%	27.1%
AMR mode 1	5.15	18.1%	21.3%	25.9%	22.8%	33.4%	28.1%	24.9%
AMR mode 2	5.90	8.8%	11.6%	11.6%	7.8%	24.1%	9.4%	12.2%
AMR mode 3	6.70	1.6%	1.6%	2.5%	2.5%	5.9%	3.8%	3.0%
AMR mode 4	7.40	0.0%	0.0%	0.3%	0.6%	2.2%	0.3%	0.6%
AMR mode 5	7.95	0.0%	0.0%	0.0%	0.0%	1.9%	0.3%	0.4%
AMR mode 6	10.20	0.0%	0.0%	0.0%	0.0%	0.0%	0.0%	0.0%
AMR mode 7	12.20	0.0%	0.0%	0.0%	0.0%	0.0%	0.0%	0.0%
FR GSM	13.00	0.0%	0.0%	0.0%	0.0%	0.0%	0.0%	0.0%
Direct (A-law)	-	0.0%	0.0%	0.0%	0.0%	0.0%	0.0%	0.0%

Further observations:

Inspection of the results for the AMR speech codecs reveals notably worse performance for DTMF signals generated with negative twist. To eliminate the DTMF detector as the cause of this effect, subsets of Experiments 5 and 6 were repeated using a proprietary network based DTMF detection algorithm. These additional experiments also showed substantially worse performance in the presence of negative twist.

An analysis of the processed files revealed that for DTMF digits generated with negative or zero twist, the AMR speech codecs have a tendency to add additional negative twist to the signal. This effect is more pronounced for the lower rate speech codecs.

Conclusions:

The results for the full-rate GSM speech codec appear to be consistent with results from previous tests. No detection errors were measured for the reference A-law condition.

For 50ms DTMF digits, the 10,2 and 12,2 kbit/s AMR modes appear to be essentially transparent to DTMF signals under error free conditions, whereas the lower rate modes do not appear to be transparent.

For 80ms DTMF digits the 7,4, 7,95, 10,2 and 12,2 kbit/s modes appear to be essentially transparent to DTMF signals under error free conditions, whereas the lower rate modes do not appear to be transparent.

The AMR codecs seem to have a tendency to add negative twist to DTMF signals, and are therefore less transparent to digits with negative twist than positive twist. It is noted that DTMF signals are often generated by PSTN telephones with negative twist, e.g. -2dB, to account for the characteristics of the local loop.

11 Transparency to Signaling tones

The transparency to network signaling tones was tested for all 8 codec modes using typical French and German signaling tones.

French Signaling Tones

Five different types of French network signaling tones were tested: Two different dial tones, one ringing tone, a busy tone and a special information tone. The description of the different tones is given below:

- Continuous DIAL TONE number 1 at 440 Hz, 10s duration;
- Continuous DIAL TONE number 2 at 330+440 Hz, 10s duration;
- RINGING TONE at 440 Hz with 1.5–3.5s form factor and a total signal duration of 12.5s;
- BUSY TONE at 440Hz with 0.5–0.5s form factor and a total signal duration of 12.5s;
- SPECIAL INFORMATION TONE at 950/1400/1800 Hz and duration of $(3 \times 0.3 - 2 \times 0.03) - 1.0$ s and a total signal duration of 12.5 s.

The tone amplitude was set to -10 dBm0.

German Signaling Tones

Six different types of German network signaling tones were tested: Two dial tones, two ringing tones, a busy tone and a special information tone. The description of the different tones is given below.

- Continuous DIAL TONE number 1 at 425 Hz, 15s duration;
- Continuous DIAL TONE number 2 at 450 Hz, 15s duration;
- RINGING TONE number 1 at 425 Hz with 0.25–4.0–1.0–4.0–1.0–4.75s form factor, 15s total duration;
- RINGING TONE number 2 at 450 Hz with 0.25–4.0–1.0–4.0–1.0–4.75s form factor, 15s total duration;
- BUSY TONE at 425Hz with 0.48–0.48s form factor and a total duration of 10s;
- SPECIAL INFORMATION TONE at 950/1400/1800 Hz and $3 \times 0.33 - 1.0$ s form factor and a total duration of 10s.

The tone amplitude was set to -10 dBm0.

Additionally, a set of signaling tones was generated at -15 dBm0, which is the lowest level recommended in ITU-T Recommendation E.180 [14].

Test conditions

The signaling tones at a level of -10 dBm0 were tested under clean error conditions with no adaptation activated and fixing the codec mode to the 8 different possible modes. The signaling tones were also tested with adaptation on, under static errors with $C/I = 7$ dB.

This was tested for DTX off and DTX on.

The German signaling tones at a level of -15 dBm0 were only tested under clear channel conditions with DTX activated. This was done to ensure that the artifact identified for the FR speech codec with low level signaling tones and DTX did not appear in the case of AMR.

Test results

The testing has been performed by informal listening involving trained listeners, their main concern being to recognize the signaling tones.

The test results can be summarized as follows:

- 1) No significant difference was perceived between the tests performed with DTX ON and those performed with DTX OFF.
- 2) For the error free conditions: the decoded tones were always easily recognized. Yet the perceived quality was found to decrease when the codec rate decreases and for the two lowest bit rates (4.75 and 5.15) the quality was rather poor.
- 3) In presence of channel errors in Half Rate mode, the result was rather poor for the whole set of tones. In Full Rate mode, the quality was found acceptable with a slight degradation for the two dial tones. Note that the effect of errors was perceived for both channel modes, but more limited and clustered in some parts of the signal in Full Rate mode.

Conclusion

Although the quality of network signaling tones is audibly decreasing for lower bit rates and especially in presence of channel errors in Half Rate mode, the signaling tones were always easily recognized under all testing conditions. Additionally, DTX activation did not create any degradation of the transparency of the AMR codec towards signaling tones. This conclusion is still valid for low amplitude signaling tones.

12 Performances with special input signals

The behavior of the AMR speech codec in presence of multiple "special input signals" was tested during the Verification Phase. These tests included:

- Overload conditions;
- Additional background Noises and Talkers;
- Music signals;
- Idle channel behavior.

In informal expert listening tests, covering a wide range of overload levels and error conditions, there was no evidence to suggest that the AMR speech channel exhibits any significant problems, such as gross instability, in the presence of overload signals.

Similarly, tests in presence of multiple types of background noises or with a higher number of talkers did not exhibit any problem with any of the AMR speech codec modes.

The tests in presence of Music indicated that the AMR speech codec did not exhibit any problem when compared to the behavior of other well-known speech codecs (EFR, IS-641, G.729 [13]).

Finally, no significant problem was identified when testing the codec with signals at very low signal levels representative of an idle channel.

13 Language Dependency

The selection and characterization tests were performed by a large number of laboratories worldwide using different languages (see Annex A). Tests were performed in:

English (US and UK), French, German, Italian, Mandarin, Spanish

The results reported by the different laboratories were consistent. No significant quality difference was identified between the results reported by the different listening laboratories for the different AMR Codec Modes.

14 Transmission Delay

The transmission delay of a GSM communication using AMR has been evaluated using the same method as for the previous GSM speech codecs [2, 3 and 4]. The reference system delay distribution for the downlink and uplink directions are provided in figures 14.1 and 14.2 respectively. The speech transcoders are assumed to be remote located from the BTS (16 kbit/s or 8 kbit/s sub-multiplexing on the Abis and Ater Interfaces).

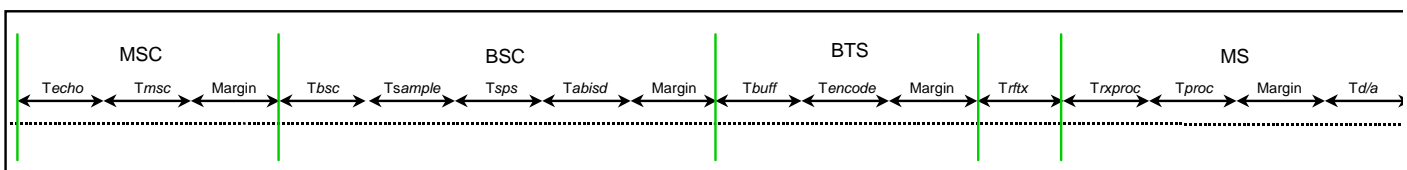

Figure 14.1: Reference Downlink delay distribution

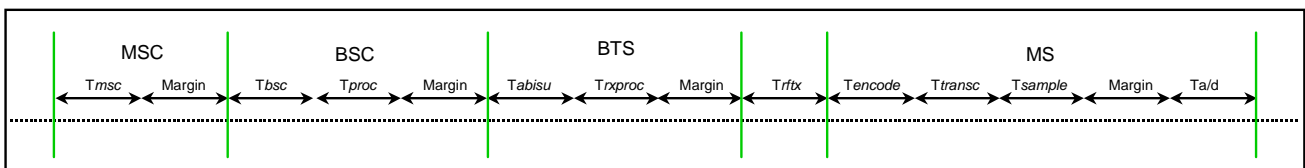

Figure 14.2: Reference Uplink delay distribution

The definition of the different delay parameters is given in the following table. The table also provides the value used for the parameter when not dependent of the type of speech codec or sub-multiplexing scheme over the Abis and Ater interfaces.

<i>Tabisd</i>	Time required to transmit the minimum number of speech data bits over the downlink Abis interface to start encoding a radio speech frame. Depends on the speech codec mode, the TRAU frame format and the Abis/Ater sub-multiplexing scheme. Note that most TRAU frame synchronization bits can ideally be transmitted by anticipation and are usually not included in this parameter.
<i>Tabisu</i>	Time required to transmit the minimum number of speech data bits over the uplink Abis interface to start decoding a speech frame. Depends on the speech codec mode, the TRAU frame format and the Abis/Ater sub-multiplexing scheme. Note that the TRAU frame synchronization bits can ideally be transmitted by anticipation and are usually not included in this parameter.
<i>Ta/d</i>	Delay in the analogue to digital converter in the uplink (implementation dependent). Set to 1ms [4].
<i>Tbsc</i>	Switching delay in the BSC (implementation dependent). Set to 0.5ms [2 and 4].
<i>Tbuff</i>	Buffering time required for the time alignment procedure for the in-band control of the remote transcoder. Set to 1.25 ms [2 and 4].
<i>Td/a</i>	Delay in the digital to analogue converter in the downlink (implementation dependent). Set to 1ms [2 and 4].
<i>Techo</i>	Delay induced by the echo canceller (implementation dependent). Set to 1ms [2 and 4].

<i>Tencode</i> :	Processing delay required to perform the channel encoding (implementation dependent). Depends on the channel coding complexity of each codec mode.
<i>Tmsc</i>	Switching delay in the MSC (implementation dependent). Set to 0.5ms [2 and 4].
<i>Tproc</i>	Processing delay required to perform the speech decoding (implementation dependent). Depends on the speech decoding complexity of each codec mode.
<i>Trftx</i>	Time required for the transmission of a speech frame over the air interface. Derived from the radio framing structure and the interleaving scheme. Worst case is 37.5 ms in Full Rate mode and 32.5 ms in Half Rate mode [2 and 4].
<i>Trxproc</i>	Processing delay required to perform the channel equalization, the channel decoding and SID-frame detection (implementation dependent). The channel decoding depends on the codec mode. The channel equalization part was set to 6.84 ms in Full Rate mode and 3.5 ms in Half Rate mode [4].
<i>Tsample</i>	Duration of the segment of PCM speech samples operated on by the speech transcoder: 25 ms in all cases corresponding to 20 ms for the processed speech frame and 5 ms of look ahead.
<i>Tsps</i>	Worst case processing delay required by the downlink speech encoder before an encoded bit can be sent over the Ater/Abis interface taking into account the speed on the Ater/Abis interface (implementation dependent). Depends on the speech coding complexity of each codec mode and on the sub-multiplexing rate on the Ater/Abis interface. Because of the priority given to the decoding, <i>Tproc</i> is also added to the overall downlink transmission delay.
<i>Ttransc</i>	MS speech encoder processing delay, from input of the last PCM sample to output of the final encoded bit (implementation dependent). For the evaluation of the transmission delay, it was assumed that the speech decoding has a higher priority than the speech encoding, i.e. this delay is artificially increased by the speech decoding delay.
Margin	Implementation dependent margins in the different system components. Set as follows: MSC Margin: 0.5 ms [2 and 4] BSC Margin: 0.5 ms [2 and 4] BTS Margin: 0.45 ms downlink, 0.3 ms uplink [2 and 4] MS Margin: 2 ms in Full Rate, 1.9 ms in Half Rate [2 and 4].

The processing delays were estimated using complexity figures for each codec mode. In addition, to take into account the dependence on the DSP implementation, the computation was based on the same methodology used for the previous GSM speech codecs [4].

The DSPs running the speech and channel codec are modeled with the 3 following parameters:

- **E** represents the DSP Efficiency. This corresponds to the ratio tMOPS/wMOPS of the codec implementation on the DSP.
- **S** represents for the speed of the DSP: Maximum Number of Operations that the DSP can run in 1 second. This number is expressed in MOPS.
- **P** represents the percentage of DSP processing power assigned to the codec.

The processing delay of a task of complexity X (in wMOPS) can then be computed using the equation:

$$D = \frac{20X}{ESP} \text{ ms}$$

For compatibility reasons, the same ESP parameter used for the EFR processing delays computation [4] was used: ESP=25⁸.

⁸ This ESP value was derived in 1996, during the EFR standardization. It is based on a 40 MHz DSP, with an efficiency of 1 and a 60% CPU availability. All processing delays would be improved assuming DSP performances corresponding to the state of the art of DSP technology.

The following tables provide the overall transmission delay parameters for each codec mode. The design objective for the Algorithmic Round Trip Transmission Delay ($ARTD = 2T_{sample} + 2T_{rftx} + Tabisu + Tabisd$) was set to the EFR ARTD increased by 10 ms in Full Rate mode, and the GSM HR ARTD increased by 10 ms in Half Rate mode.

Tables 14.1 and 14.2 define the parameters impacting the computation of the transmission delays over the Abis/Ater interfaces ($Tabisu$ and $Tabisd$) for the 16 kbit/s and 8kbit/s sub-multiplexing schemes respectively. The definition of different parameters is provided below. They are derived from the AMR TRAU frame format provided in [5 and 6].

Min # of bits: Minimum number of speech bits required to start the next operation (speech decoding in uplink or channel encoding in downlink).

Sync. bits: Additional synchronization bits in the TRAU frame (synchronization header not included) before reaching the last required bit.

Min # Data: Rank of the last required bit in the TRAU frame.

Anticip.: Number of bits that can be sent by anticipation.

Requir.: Resulting number of bits that must be received ($Min \#Data - \# Anticip.$).

Table 14.1: Tabisu (ms) and Tabisd (ms) computation tables for the 16 kbit/s sub-multiplexing scheme

	Mode	Min #	Sync.	Min #	# anticip.	# Requir.	Tabisu		Mode	Min #	Min #	# anticip.	# Requir.	Tabisd
		of bits	bits	Data						of bits	Data			
Full Rate 16k Upl	12.2	6		143	38	105	6.625	Full Rate 16k Dwnl	12.2	316	43	273	17.125	
	10.2	6		144	38	106	6.625		10.2	316	43	273	17.125	
	7.95	6		144	38	106	6.625		7.95	259	43	216	13.5	
	7.4	6		144	38	106	6.625		7.4	250	43	207	13	
	6.7	6		144	38	106	6.625		6.7	238	43	195	12.25	
	5.9	6		144	38	106	6.625		5.9	230	43	187	11.75	
	5.15	6		144	38	106	6.625	5.15	215	43	172	10.75		
	4.75	6		144	38	106	6.625	4.75	204	43	161	10.125		

Table 14.2: Tabisu (ms) and Tabisd (ms) computation tables for the 8 kbit/s sub-multiplexing scheme

	Mode	Min #	Sync.	Min #	# anticip.	# Requir.	Tabisu		Mode	Min #	Min #	# anticip.	# Requir.	Tabisd
		of bits	bits	Data						of bits	Data			
Half Rate 8k Upl	7.95	-	-	-	-	-	-	Half Rate 8k Dwnl	7.95	-	-	-	-	-
	7.4			70	3	67	8.375		7.4	160	3	157	19.625	
	6.7			76	9	67	8.375		6.7	160	9	151	18.875	
	5.9			77	17	60	7.5		5.9	158	17	141	17.625	
	5.15			77	22	55	6.875		5.15	157	22	135	16.875	
	4.75			77	20	57	7.125		4.75	147	20	127	15.875	

Tables 14.3 and 14.4 provide the overall Uplink and Downlink transmission delay for the different Full Rate codec modes using a 16 kbit/s sub-multiplexing scheme.

Tables 14.5 and 14.6 provide the overall Uplink and Downlink transmission delay for the different Half Rate codec modes using a 16 kbit/s sub-multiplexing scheme.

Tables 14.7 and 14.8 provide the overall Uplink and Downlink transmission delay for the different Half Rate codec modes using an 8 kbit/s sub-multiplexing scheme.

Table 14.3: Uplink Transmission Delay in Full Rate Mode (in ms and 16 kbit/s sub-multiplexing scheme)

UL FR 16k		12.2	10.2	7.95	7.4	6.7	5.9	5.15	4.75	FR	EFR
Delay Parameter											
MSC	Tmsc	0.5	0.5	0.5	0.5	0.5	0.5	0.5	0.5	0.5	0.5
	Margin	0.5	0.5	0.5	0.5	0.5	0.5	0.5	0.5	0.5	0.5
BSC	Tbsc	0.5	0.5	0.5	0.5	0.5	0.5	0.5	0.5	0.5	0.5
	Tproc	1.8160	1.8320	1.9920	1.7600	2.3600	2.024	2.0160	2.0160	1.5	1.27
	Margin	0.5	0.5	0.5	0.5	0.5	0.5	0.5	0.5	0.5	0.5
BTS	Tabisu	6.625	6.625	6.625	6.6	6.625	6.625	6.63	6.625	4	6.4375
	Trxproc eq	6.84	6.84	6.84	6.84	6.84	6.84	6.84	6.84	8.8	6.84
	Trxproc ch. dec.	1.9360	1.7440	3.880	1.3280	0.2560	0.2400	0.232	0.2320	0	1.96
	Margin	3	3	3	3	3	3	3	3	3	3
	Trftx	37.5	37.5	37.5	37.5	37.5	37.5	37.5	37.5	37.5	37.5
MS	Tencode	0.272	0.288	0.248	0.232	0.256	0.24	0.232	0.232	1.6	0.32
	Ttransc	12.976	12.680	13.256	12.104	13.50	11.0240	9.6560	11.240	8	12.17
	Tsample	25	25	25	25	25	25	25	25	20	20
	Tmargin	2	2	2	2	2	2	2	2	2	2
	Ta/d	1	1	1	1	1	1	1	1	1	1
Total Uplink		101.0	100.5	103.3	99.4	100.3	97.5	96.1	97.7	89.4	94.5

Table 14.4: Downlink Transmission Delay in Full Rate Mode (in ms and 16 kbit/s sub-multiplexing scheme)

DL FR 16k		12.2	10.2	7.95	7.4	6.7	5.9	5.15	4.75	FR	EFR
Delay Parameter											
MSC	Techo	1	1	1	1	1	1	1	1	1	1
	Tmsc	0.5	0.5	0.5	0.5	0.5	0.5	0.5	0.5	0.5	0.5
	Margin	0.5	0.5	0.5	0.5	0.5	0.5	0.5	0.5	0.5	0.5
BSC	Tbsc	0.5	0.5	0.5	0.5	0.5	0.5	0.5	0.5	0.5	0.5
	Tsample	25	25	25	25	25	25	25	25	20	20
	Tsps	2.28	2.28	2.28	2.28	2.28	2.28	2.28	2.28	1.6	2.3
	Tproc (Tsps)	1.8160	1.8320	1.9920	1.7600	2.3600	2.024	2.0160	2.0160		
	Tabisd	17.125	17.125	13.5	13	12.25	11.75	10.75	10.125	17.4	17.375
	Margin	0.5	0.5	0.5	0.5	0.5	0.5	0.5	0.5	0.5	0.5
BTS	Tbuff	1.25	1.25	1.25	1.25	1.25	1.25	1.25	1.25	1.25	1.25
	Tencode	0.272	0.288	0.248	0.232	0.256	0.24	0.232	0.232	1.6	1.6
	Margin	0.45	0.45	0.45	0.45	0.45	0.45	0.45	0.45	0.45	0.45
	Trftx	37.5	37.5	37.5	37.5	37.5	37.5	37.5	37.5	37.5	37.5
MS	Trxproc eq	6.84	6.84	6.84	6.84	6.84	6.84	6.84	6.84	8.8	6.84
	Trxproc ch. dec.	1.936	1.744	3.88	1.328	0.256	0.24	0.232	0.232	0	1.96
	Tproc	1.816	1.832	1.992	1.76	2.36	2.024	2.016	2.016	1.5	1.27
	Margin	2	2	2	2	2	2	2	2	2	2
	Td/a	1	1	1	1	1	1	1	1	1	1
Total Downlink		102.3	102.1	100.9	97.4	96.8	95.6	94.6	93.9	96.1	96.5

Table 14.5: Uplink Transmission Delay in Half Rate Mode (in ms and 16 kbit/s sub-multiplexing scheme)

UL HR16k		7.95	7.4	6.7	5.9	5.15	4.75	FR	EFR	HR
Delay Parameter										
MSC	Tmsc	0.5	0.5	0.5	0.5	0.5	0.5	0.5	0.5	0.5
	Margin	0.5	0.5	0.5	0.5	0.5	0.5	0.5	0.5	0.5
BSC	Tbsc	0.5	0.5	0.5	0.5	0.5	0.5	0.5	0.5	0.5
	Tproc	1.9920	1.7600	2.3600	2.0240	2.0160	2.0160	1.5	1.27	1.71
	Margin	0.5	0.5	0.5	0.5	0.5	0.5	0.5	0.5	0.5
BTS	Tabisu	6.625	6.6	6.625	6.625	6.63	6.625	4	6.4375	4.8125
	Trxproc eq	3.5	3.5	3.5	3.5	3.5	3.5	8.8	6.84	3.5
	Trxproc ch. dec.	1.1040	1.0800	1.0000	0.9440	0.9120	2.1280	0	1.96	2.3
	Margin	3	3	3	3	3	3	3	3	3
	Trftx	32.9	32.9	32.9	32.9	32.9	32.9	37.5	37.5	32.9
MS	Tencode	0.152	0.152	0.144	0.136	0.144	0.136	1.6	0.32	0.16
	Ttransc	13.256	12.104	13.50	11.0240	9.6560	11.240	8	12.17	15.6
	Tsample	25	25	25	25	25	25	20	20	24.4
	Tmargin	1.9	1.9	1.9	1.9	1.9	1.9	2	2	1.9
	Ta/d	1	1	1	1	1	1	1	1	1
	Total Uplink	92.4	91.0	92.9	90.1	88.7	91.4	89.4	94.5	93.3

Table 14.6: Downlink Transmission Delay in Half Rate Mode (in ms and 16 kbit/s sub-multiplexing scheme)

DL HR 16k		7.95	7.4	6.7	5.9	5.15	4.75	FR	EFR	HR
Delay Parameter										
MSC	Techo	1	1	1	1	1	1	1	1	1
	Tmsc	0.5	0.5	0.5	0.5	0.5	0.5	0.5	0.5	0.5
	Margin	0.5	0.5	0.5	0.5	0.5	0.5	0.5	0.5	0.5
BSC	Tbsc	0.5	0.5	0.5	0.5	0.5	0.5	0.5	0.5	0.5
	Tsample	25	25	25	25	25	25	20	20	24.4
	Tsps	1.74	1.74	1.74	1.74	1.74	1.74	1.6	2.3	7.8
	Tproc (Tsps)	1.992	1.76	2.36	2.024	2.016	2.016	0	0	0
	Tabisd	13.5	13	12.25	11.75	10.75	10.125	17.4	17.375	8.375
	Margin	0.5	0.5	0.5	0.5	0.5	0.5	0.5	0.5	0.5
BTS	Tbuff	1.25	1.25	1.25	1.25	1.25	1.25	1.25	1.25	1.25
	Tencode	0.152	0.152	0.144	0.136	0.144	0.136	1.6	1.6	0.16
	Margin	0.45	0.45	0.45	0.45	0.45	0.45	0.45	0.45	0.45
	Trftx	32.9	32.9	32.9	32.9	32.9	32.9	37.5	37.5	32.9
MS	Trxproc eq	3.5	3.5	3.5	3.5	3.5	3.5	8.8	6.84	3.5
	Trxproc ch. dec.	1.104	1.08	1	0.944	0.912	2.128	0	1.96	2.3
	Tproc	1.9920	1.7600	2.3600	2.0240	2.0160	2.0160	1.5	1.27	1.71
	Margin	1.9	1.9	1.9	1.9	1.9	1.9	2	2	1.9
	Td/a	1	1	1	1	1	1	1	1	1
Total Downlink	89.5	88.5	88.9	87.6	86.6	87.2	96.1	96.5	88.7	

Table 14.7: Uplink Transmission Delay in Half Rate Mode (in ms and 8 kbit/s sub-multiplexing scheme)

UL HR8k		7.95	7.4	6.7	5.9	5.15	4.75	FR/16k	EFR/16k	HR
Delay Parameter										
MSC	Tmsc	-	0.5	0.5	0.5	0.5	0.5	0.5	0.5	0.5
	Margin	-	0.5	0.5	0.5	0.5	0.5	0.5	0.5	0.5
BSC	Tbsc	-	0.5	0.5	0.5	0.5	0.5	0.5	0.5	0.5
	Tproc	-	1.7600	2.3600	2.0240	2.0160	2.0160	1.5	1.27	1.71
	Margin	-	0.5	0.5	0.5	0.5	0.5	0.5	0.5	0.5
BTS	Tabisu	-	8.38	8.375	7.500	7	7.13	4	6.4375	9.75
	Trxproc eq	-	3.5	3.5	3.5	3.5	3.5	8.8	6.84	3.5
	Trxproc ch. dec.	-	1.0800	1.0000	0.9440	0.9120	2.1280	0	1.96	2.3
	Margin	-	3	3	3	3	3	3	3	3
	Trftx	-	32.9	32.9	32.9	32.9	32.9	37.5	37.5	32.9
MS	Tencode	-	0.152	0.144	0.136	0.144	0.136	1.6	0.32	0.16
	Ttransc	-	12.104	13.50	11.0240	9.6560	11.240	8	12.17	15.6
	Tsample	-	25	25	25	25	25	20	20	24.4
	Tmargin	-	1.9	1.9	1.9	1.9	1.9	2	2	1.9
	Ta/d	-	1	1	1	1	1	1	1	1
	Total Uplink	N/A	92.8	94.7	90.9	88.9	91.9	89.4	94.5	98.2

**Table 14.8: Downlink Transmission Delay in Half Rate Mode
(in ms in 8 kbit/s sub-multiplexing scheme)**

DL HR 8k		7.95	7.4	6.7	5.9	5.15	4.75	FR/16k	EFR/16k	HR
Delay Parameter										
MSC	Techo	-	1	1	1	1	1	1	1	1
	Tmsc	-	0.5	0.5	0.5	0.5	0.5	0.5	0.5	0.5
	Margin	-	0.5	0.5	0.5	0.5	0.5	0.5	0.5	0.5
BSC	Tbsc	-	0.5	0.5	0.5	0.5	0.5	0.5	0.5	0.5
	Tsample	-	25	25	25	25	25	20	20	24.4
	Tsps	-	1.61	1.61	1.61	1.61	1.61	1.6	2.3	4.3
	Tproc (Tsps)	-								
	Tabisd	-	19.625	18.875	17.625	16.875	15.875	17.4	17.375	17.5
	Margin	-	0.5	0.5	0.5	0.5	0.5	0.5	0.5	0.5
BTS	Tbuff	-	1.25	1.25	1.25	1.25	1.25	1.25	1.25	1.25
	Tencode	-	0.152	0.144	0.136	0.144	0.136	1.6	1.6	0.16
	Margin	-	0.45	0.45	0.45	0.45	0.45	0.45	0.45	0.45
	Trftx	-	32.9	32.9	32.9	32.9	32.9	37.5	37.5	32.9
MS	Trxproc eq	-	3.5	3.5	3.5	3.5	3.5	6.84	8.8	3.5
	Trxproc ch. dec.	-	1.08	1	0.944	0.912	2.128	1.96	0	2.3
	Tproc	-	1.7600	2.3600	2.0240	2.0160	2.0160	1.5	1.27	1.71
	Margin	-	1.9	1.99	1.9	1.9	1.9	2	2	1.9
	Td/a	-	1	1	1	1	1	1	1	1
Total Downlink		N/A	93.2	93.1	91.3	90.6	90.8	96.1	96.5	94.4

15 Frequency Response

NOTE: The frequency response is essentially given as a piece of additional information. It should not be used to qualify the codec performances in terms of perceived quality or DTMF transparency.

The frequency response of the AMR codec was evaluated by computing the logarithmic gain of the frequency response of each codec mode, according to the following equation:

$$\text{Gain}_{\text{dB}} = 10 \log_{10} \left[\frac{\sum_{k=1}^M \text{out}(k)^2}{\sum_{k=1}^M \text{inp}(k)^2} \right]$$

where $\text{inp}(k)$ and $\text{out}(k)$ are the input (original) and output (processed) signals and M is the total number of processed samples.

The frequency response was computed for all 8 codec modes (12.2, 10.2, 7.95, 7.4, 6.7, 5.9, 5.15 and 4.75 kbit/s), in error-free condition, with DTX disabled. Tone signals were generated and processed in the range 50-3998 Hz with a frequency step of 21 Hz. Each tone lasted 8 seconds at a level of -26 dBovl. In order to discard potential transition effects of the codec, the first 512 samples (64 ms at $f_c=8$ kHz) of the input and output signals were not taken into account in the computation.

Figure 15.1 provides the frequency responses measured for the 8 AMR speech codecs. Table 15.1 lists the attenuation measured for each codec at the edges of the telephone bandwidth. The usual definition of 3-dB bandwidth can be applied to the 4 highest bit-rates leading to a bandwidth equal or wider than the telephone band. Some limitations appear for the 4 lower bit-rates.

Input Level dependency:

The same computation was repeated with different input levels: -16 dBovl and -36 dBovl to check the dependency of the frequency response to the input signal level. Similar curves were found in both curves.

Transition behavior:

In order to check if the potential transition behavior of the codec influences the shape of the curves, the computations were repeated without discarding the first 512 samples and using tones with a shorter length (500 ms). Once again, very similar curves were found in these conditions.

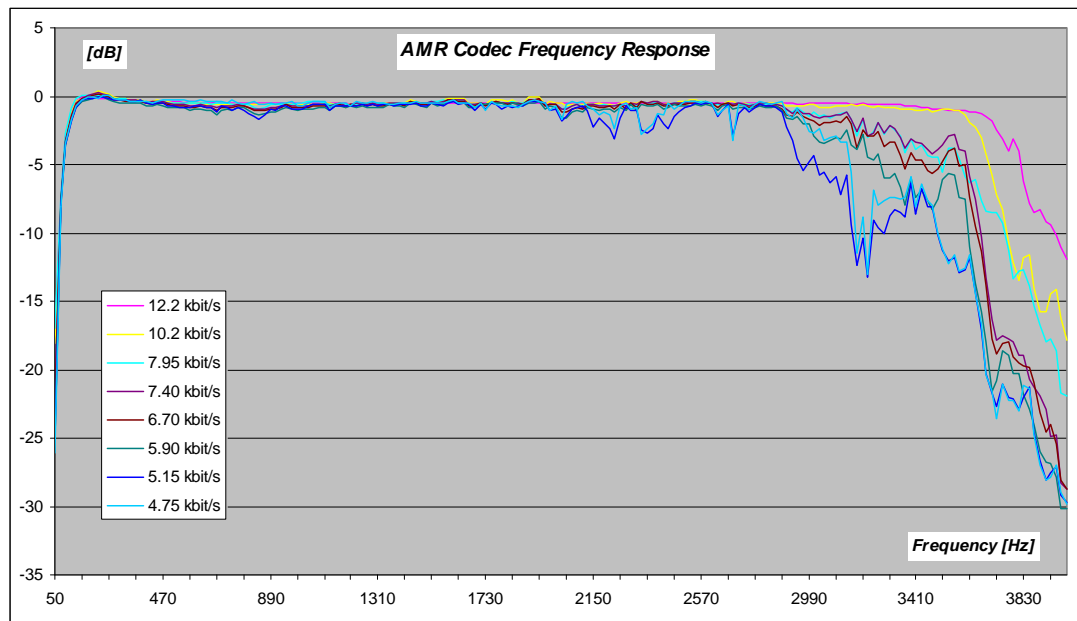

Figure 15.1: AMR Speech Codec Frequency Responses

Table 15.1: Attenuation at the telephone band limits

AMR Codec Modes [kbit/s]	Attenuation @ freq=302 Hz [dB]	Attenuation @ freq=3410 Hz [dB]
12.2	-0.28	-0.76
10.2	-0.18	-1.02
7.95	-0.11	-3.87
7.4	-0.23	-3.32
6.7	-0.32	-4.66
5.9	-0.45	-7.38
5.15	-0.30	-8.65
4.75	-0.24	-8.11

16 Complexity

The AMR speech codec modes complexity were evaluated using the methodology previously agreed for the standardization of the GSM HR and GSM EFR speech codec.

For each codec mode, the complexity is characterized by the following items:

- Number of cycles;
- Data memory size;
- Program memory size.

The actual values for these items will eventually depend on the final DSP implementation. The methodology adopted for the standardization of previous GSM speech codecs provides a way to overcome this difficulty.

In this methodology, the speech and channel coding functions are coded using a set of basic arithmetic operations. Each operation is allocated a weight representative of the number of instruction cycles required to perform that operation on a typical DSP device. The Theoretical Worst Case complexity (wMOPS) is then computed by a detailed counting of the worst case number of basic operations required to process a speech frame.

The wMOPS figure quoted is a weighted sum of all operations required to perform the speech and/or channel coding.

Note that in the course of the codec selection, the Worst Observed Frame complexity was also measured by recording the worst case complexity figure over the full set of speech samples used for the selection of the AMR codec.

In the case of AMR, the complexity was further divided in the following items:

- Speech coding complexity in terms of wMOPS, RAM, ROM Tables and Program ROM;
- Full Rate and Half Rate channel complexity in terms of wMOPS, RAM, ROM Tables and Program ROM.

The separation of the speech and channel complexity was motivated by the fact that these functions were generally handled by different system components in the network (speech transcoding functions in the TRAU and channel coding/decoding in the BTS).

Table 16.1 presents the Theoretical Worst Case (TWC) complexity (wMOPS) for the different AMR speech codecs in addition to the Worst Observed Frame (WOF) reported during the selection phase.

Tables 16.2 and 16.2 provide the same parameters for the Full Rate and Half Rate channel codecs.

Table 16.4, 16.5 and 16.6 provide the RAM, ROM Tables and Program ROM complexity figures for the different speech and channel codecs.

For reference, the corresponding AMR project objectives are also provided in these tables.

Table 16.1: AMR Speech Codec Theoretical Worst Case Complexity (in wMOPS)

Mode	12.2	10.2	7.95	7.4	6.7	5.9	5.15	4.75	TWC	WOF		
Speech encoder	14.05	13.66	14.18	13.03	14.03	11.35	9.65	11.63	14.18	13.14		
Speech decoder	2.31	2.33	2.53	2.24	2.49	2.57	2.57	2.57	2.57	2.19	EFR	Objective
Total Speech	16.36	15.99	16.71	15.27	16.52	13.92	12.22	14.20	16.75	15.33	15.21	24 ~ 1.6 EFR

Table 16.2: AMR Full Rate Channel Codec Theoretical Worst Case Complexity (in wMOPS)

Mode	12.2	10.2	7.95	7.4	6.7	5.9	5.15	4.75				
Constraint Length	5	5	7	5	5	7	5	7	TWC	WOF		
FR Channel Coder	0.34	0.36	0.31	0.29	0.32	0.3	0.29	0.29	0.36	0.33		
FR Channel Decoder	2.42	2.18	4.85	1.66	1.61	3.85	1.34	3.2	4.85	4.45	HR	Objective
Total Channel FR	2.76	2.54	5.16	1.95	1.93	4.15	1.63	3.49	5.21	4.78	2.69	5.7 ~ 2.1 HR

Table 16.3: AMR Half Rate Channel Codec Theoretical Worst Case Complexity (in wMOPS)

Mode	7.95	7.4	6.7	5.9	5.15	4.75						
Constraint Length	5	5	5	5	5	7	TWC	WOF				
HR Channel Coder	0.19	0.19	0.18	0.17	0.18	0.17	0.19	0.19				
HR Channel Decoder	1.38	1.35	1.25	1.18	1.14	2.66	2.66	2.64	HR	Objective		
Total Channel HR	1.57	1.54	1.43	1.35	1.32	2.83	2.85	2.83	2.69	3	~ 1.1 HR	

Table 16.4: AMR Codec RAM Requirements (in 16 bits words)

	Static	Dynamic	Total				
Speech encoder	1429	3039	4468				
Speech decoder	812	946	1758	EFR	Objective		
Total speech	2241	3039	5280	4711	10000	~ 2.1 EFR	
Channel encoder FR	271	1843	2114				
Channel decoder FR	280	1915	2195	HR	Objective		
Total channel FR	551	1915	2466	3154	6600	~ 2.1 HR	
Channel encoder HR	385	1317	1702				
Channel decoder HR	394	1420	1814	HR	Objective		
Total channel HR	779	1420	2199	3154	3500	~ 1.1 HR	
Channel Meas and Control	107	66	173				

Table 16.5: AMR Codec ROM Tables Requirements (in 16 bits words)

	ROM	EFR	Objective
Speech	14571	5267	17000 ~ 3.2 EFR
Channel	5049	900	5000 ~ 5.6 HR
Channel Meas and Control	187		
Total	19807		

Table 16.5: AMR Codec Program ROM (in number of operators)

	# of operators
Speech	4851
Channel	1279
Channel Meas and Control	63
Total	6193

Summary of the complexity results:

The AMR complexity parameters appear to be well within the initial constraints of the project.

The AMR speech codec complexity is slightly higher than the EFR complexity (in wMOPS and RAM), but the complete set of eight codecs requires 3 times more ROM than the EFR.

The channel codec complexity matches the initial project objectives (twice the HR channel codec complexity in Full Rate and once the HR channel codec complexity in Half Rate). The ROM required for the full set of codecs represents around 5 times the ROM required by the HR channel codec.

Annex A: AMR GSM Characterization Phase Overview

The AMR GSM Characterization Tests were performed on version [2.0] of the AMR speech codec source code⁹. Two host laboratories (Arcon and COMSAT, USA) shared the responsibility of processing the speech samples initially provided by the different listening laboratories. The host laboratories cross-checked the processing performed by the other laboratory and provided the results of this cross checking to the ETSI secretariat.

Eight listening laboratories performed the corresponding subjective listening tests in 6 different languages (Chinese, English, French, German, Italian and Spanish). All listening laboratories were requested to provide the results of the listening tests they performed on an Excel Workbook provided by the organization responsible for the Global analysis of the results.

The host laboratories and listening laboratories also provided their own report and analysis to fulfil their contractual commitment.

Seven different experiments and 17 sub-experiments were specified in the AMR Characterization Test Plan. The primary objectives of the different experiments are listed below:

- Experiment 1a and 1b: Performances in Clean Speech in a Full Rate (1a) and Half Rate (1b);
- Experiment 2: Interoperability Performances in Clean Speech (adaptation off);
- Experiment 3a, 3b and 3c: Performances under background noise conditions in a Full Rate;
- Experiment 3d, 3e and 3f: Performances under background noise conditions in a Half Rate;
- Experiment 4a and 4b: Performances in dynamic error conditions in a Full Rate (4a) and Full Rate (4b) (with adaptation on);
- Experiment 5: Performances in combined error conditions in Full Rate and Half Rate (with adaptation on);
- Experiment 6: Influence of the input speech level and Tandeming performances in Full Rate and Half Rate (adaptation off);
- Experiment 7a and 7b: Performance of the ENS VAD/DTX in Full Rate (7a) and Half Rate (7b);
- Experiment 7a and 7b: Performance of the Motorola VAD/DTX in Full Rate (7c) and Half Rate (7e).

⁹ This version also includes version [x.x] of the VAD Option 2.

The following table provides a summary of the impairment conditions included in each experiment.

Table A.1: Summary of the AMR Characterization Test conditions

Exp.	Full Rate	Half Rate	Clean Speech	Bckgrd Noise	Static Errors	Dynamic Errors	Adaptation On	Tandem
1a	X		X		X			
1b		X	X		X			
2	X	X	X					X
3a	X			X	X			
3b	X			X	X			
3c	X			X	X			
3d		X		X	X			
3e		X		X	X			
3f		X		X	X			
4a	X		X			X	X	
4b		X	X			X	X	
5	X	X		X		X	X	X
6	X	X	X					X
7a	X		X	X	X		X	X
7b		X	X	X	X		X	X
7c	X		X	X	X		X	X
7d		X	X	X	X		X	X

Each experiment was performed by two different laboratories in two different languages as shown in the following table.

Table A.2: Allocation of the Experiments to the Listening Laboratories

Laboratory : Languages Used:	Arcon	AT&T	France Telecom	Berkom	Nortel	Conexant	FUB	COMSAT	Number of Conditions Tested ¹⁰
	English	English Spanish	French	German	English	English	Italian	English Spanish Chinese	
1a FR		X (Eng)		X (Ger)					6x8
1b HR		X (Eng)		X (Ger)					7x6
2				X (Ger)	X (Eng)				7x8
3a FR			X (Fren)			X (Eng)			6x8
3b FR			X (Fren)			X (Eng)			6x8
3c FR			X (Fren)			X (Eng)			6x8
3d HR			X (Fren)			X (Eng)			7x6
3e HR			X (Fren)			X (Eng)			7x6
3f HR			X (Fren)			X (Eng)			7x6
4a FR		X (Span)			X (Eng)				9x3
4b FR		X (Span)			X (Eng)				9x3
5					X (Eng)		X (Ita)		7x2
6		X (Eng)						X (Chin)	7x3
7a (ENS)	X (Eng)							X (Span)	7x3
7b (ENS)	X (Eng)							X (Span)	7x3
7a (Motorola)	X (Eng)							X (Span)	7x3
7b (Motorola)	X (Eng)							X (Span)	7x3
Host lab:	Arcon	Arcon	COMSAT	COMSAT	Arcon COMSAT	ARCON	COMSAT	COMSAT	

¹⁰In this table, the first number represents the number of impairment conditions (propagation errors, tandeming, input level, dynamic profile...). The second number represents the number of codec modes or number of configurations under test. For Experiments 7, both numbers represent impairment types

The Characterization tests were performed in April-May 1999. The results were distributed over the AMR and SMG11 reflectors before May 21, 1999.

The global analysis was under the responsibility of the GSM North America Alliance.

The full set of results and report provided by the different laboratories were reviewed and approved in SMG11#11 (June 4-7, 1999) in Tampere, Finland. The final report was approved by SMG#29 (June 21-25, 1999) in Miami-FL, USA

Annex B: AMR Verification Phase Overview

The selected AMR speech codec was jointly proposed by Ericsson, Nokia and Siemens. It was identified during the selection phase by the acronym ENS1.

The proponents had the responsibility to complete the codec optimization after the approval by SMG of the selection phase results. The optimization phase essentially consisted in bug fixing and optimization of the channel coding.

To complete the standardization, a number of Third Parties volunteered to participate to the verification phase by submitting contributions which served as the basis for the present document. They are listed below with reference to the previous sections of this report.

Clauses	Description	Contributing Organizations
5-9	Characterization Tests	The Characterization Tests (Annex A) were funded by the GSM Association, with additional contributions from Ericsson, Motorola, Nokia, and Siemens
10	Performances with DTMF Tones	BT (Tdoc. SMG11 105/99)
11	Transparency to Announcement Tones	France Telecom and T-Mobil (Tdoc. SMG11 13/99)
12	Performances with Special Input Signals	France Telecom and Conexant (Tdocs SMG11 12/99 and 105/99)
	Overload Performances	BT (Tdoc SMG11 10/99)
	Idle Channel Behavior	Berkom and Lucent Technology (Tdocs SMG11 54/99 and 55/99)
	Channel Coding Performances during DTX	Nortel Networks (Tdoc SMG11 68/99)
	Muting Behavior	Nortel Networks and Philips (Tdocs SMG11 62/99 and 67/99)
13	Language Dependency	No direct contribution
14	Transmission Delay	Nortel Networks (Tdoc SMG11 158/99)
15	Frequency Response	CSELT (Tdoc SMG11 8/99)
16	Complexity	Alcatel, Philips, ST Microelectronics and Texas Instruments (Tdocs SMG11 75/99, 117/99, 194/99 and 398/99)

Annex C: Additional Characterization Test Results

This annex contains few additional results from the GSM Characterization Tests. Specifically, the following sections provide a summary of the speech quality measured for each codec mode under the different error conditions tested in Experiments 1 and 3. A number of actual test results are also provided to show the dispersion between tests performed by different laboratories.

C3.1 Performances in Clean Speech in Full Rate mode

The following table shows the typical test results dispersion (in Equivalent Q) by comparing the results obtained for the 2 tests performed for Experiment 1a:

Table C3.1-1: Example of test result dispersion for Experiment 1a (Full rate in clean speech)

C/I	Best Codec performance (requirement)	Test 1: ATandT (English)				Test 2: Berkom (German)			
		Qeq (Req.)	Best Mode	AMR Qeq.	Delta	Qeq (Req.)	Best Mode	AMR Qeq.	Delta
No Errors	EFR No Errors	30.29	10.20	31.85	1.56	27.82	12.20	28.81	0.99
16 dB	EFR No Errors	30.29	12.20	30.64	0.35	27.82	12.20	29.12	1.30
13 dB	EFR No Errors	30.29	12.20	31.42	1.13	27.82	12.20	31.18	3.36
10 dB	G.728 [12] No Errors	N/A	10.20	30.64	N/A	N/A	7.95	30.55	5.79
7 dB	G.728 [12] No Errors	N/A	6.70	28.28	N/A	N/A	7.95	28.09	3.34
4 dB	EFR at 10 dB	23.03	5.90	23.26	0.23	24.75	5.90	23.67	-1.08

The following tables summarize the performances of the different AMR codec modes under the tested error conditions with respect to well-known references in full rate mode and clean speech:

Table C3.1-2: AMR speech codec mode performances in clean speech in full rate

Codec Mode	Reference 1	Reference 2	Worse than Ref.2
	EFR No Errors	EFR @ 10dB C/I	
	Equivalent to Reference 1	Equivalent to Reference 2	
12.2	No Errors down to 10 dB C/I		7 dB C/I and below
10.2	No Errors down to 10 dB C/I	7 B C/I	4 dB C/I
7.95	No Errors down to 7 dB C/I		4 dB C/I
7.4	No Errors down to 7 dB C/I		4 dB C/I
6.7		No Errors down to 7 dB C/I	4 dB C/I
5.9		No Errors down to 4 dB C/I	
5.15		No Errors down to 4 dB C/I	
4.75		No Errors down to 4 dB C/I	

Table C3.1-3: Performances of the AMR speech codecs for different error conditions in clean speech in full rate

Error Condition	Reference 1	Reference 2	Worse than Ref.2
	EFR No Errors	EFR at 10 dB C/I	
	Equivalent to Reference 1	Equivalent to Reference 2	
No Errors	12.2, 10.2, 7.95, 7.4	6.7, 5.9, 5.15, 4.75	
13 dB C/I	12.2, 10.2, 7.95, 7.4	6.7, 5.9, 5.15, 4.75	
10 dB C/I	12.2, 10.2, 7.95, 7.4	6.7, 5.9, 5.15, 4.75	
7 dB C/I	7.95, 7.4	10.2, 6.7, 5.9, 5.15, 4.75	12.2
4 dB C/I		5.9, 5.15, 4.75	6.7, 7.95, 7.4 and higher modes

C3.2. Performances in Clean Speech in Half Rate mode

The following table shows the typical test results dispersion (in Equivalent Q) by comparing the results obtained for the 2 tests performed for Experiment 1b:

Table C3.2-1: Example of test result dispersion for Experiment 1b (Half rate in clean speech)

C/I	Best Codec performance (requirement)	Test 1: ATandT (English)				Test 2: Berkom			
		Qeq (Req.)	Best Mode	AMR Qeq.	Delta	Qeq (Req.)	Best Mode	AMR Qeq.	Delta
No Errors	G.728 [12] no errors	26.13	7.95	23.94	-2.19	25.22	7.95	28.73	3.52
19 dB	G.728 [12] no errors	26.13	7.95	22.94	-3.19	25.22	7.95	27.29	2.08
16 dB	G.728 [12] no errors	26.13	7.40	23.41	-2.72	25.22	7.95	27.04	1.83
13 dB	FR at 13 dB	N/A	5.90	19.63	N/A	N/A	5.90	23.51	N/A
10 dB	FR at 10 dB	16.36	5.90	16.30	-0.06	18.92	5.15	22.21	3.29
7 dB	FR at 7 dB	14.21	4.75	15.14	0.94	16.74	4.75	19.75	3.00
4 dB	FR at 4 dB	7.78	4.75	10.56	2.78	5.72	4.75	12.09	6.37

The following tables summarize the performances of the different AMR codec modes under the tested error conditions with respect to well-known references in half rate mode and clean speech:

Table C3.2-2: AMR speech codec mode performances in clean speech in half rate

Codec Mode	Reference 1	Worse than Ref.1 Better than Ref.2	Reference 2	Worse than Ref.2
	G.728 [12] No Errors		FR No Errors	
	Equivalent to Reference 1		Equivalent to Reference 2	
7.95	No Errors down to 16 dB C/I		13 dB C/I	10 dB C/I and below
7.4	No Errors down to 16 dB C/I		13 dB C/I	10 dB C/I and below
6.7	No Errors down to 16 dB C/I		13 dB C/I	10 dB C/I and below
5.9		No Errors down to 13 dB C/I		10 dB C/I and below
5.15			No Errors down to 13 dB C/I	10 dB C/I and below
4.75			No Errors down to 13 dB C/I	10 dB C/I and below

Table C3.2-3: Performances of the AMR speech codecs for different error conditions in clean speech in half rate

Error Condition	Reference 1	Reference 2	Worse than Ref.2 Better than Ref.3	Reference 3	Worse than Ref.3
	G.728 [12] No Errors	EFR at 10 dB C/I		FR at 10 dB C/I	
	Equivalent to Reference 1	Equivalent to Reference 2		Equivalent to Reference 2	
No Errors	7.95, 7.4, 6.7	5.9, 5.15, 4.75			
19 dB C/I	7.95, 7.4, 6.7	5.9, 5.15, 4.75			
16 dB C/I	7.95, 7.4, 6.7	5.9, 5.15,	4.75		
13 dB C/I		5.9, 5.15	6.7, 4.75, 7.4, 7.95		
10 dB C/I			5.15, 4.75	5.9, 6.7	7.4, 7.95
7 dB C/I				4.75	5.15, 5.9, 6.7, 7.4, 7.95
4 dB C/I					all

C3.3. Performances in Background Noise in Full Rate mode

The following tables show the typical test results dispersion (in Equivalent Q) by comparing the results obtained for the 2 tests performed for Experiment 3a, 3b and 3c.

Table C3.3-1: Example of test result dispersion for Experiment 3a (Full rate in Street Noise)

C/I	Best Codec performance (requirement)	Test 1: Conexant (English)				Test 2: France Telecom (French)			
		Qeq (Req.)	Best Mode	AMR Qeq.	Delta	Qeq (Req.)	Best Mode	AMR Qeq.	Delta
No Errors	EFR No Errors	28.05	10.20	27.56	-0.49	25.86	12.20	27.27	1.40
16 dB	EFR No Errors	28.05	12.20	27.56	-0.49	25.86	12.20	26.16	0.30
13 dB	EFR No Errors	28.05	12.20	26.83	-1.22	25.86	10.20	26.91	1.05
10 dB	G.729/FR [13] No Errors	23.75	10.20	28.23	4.48	25.86	10.20	28.32	2.46
7 dB	G.729/FR [13] No Errors	23.75	10.20	24.76	1.01	25.86	6.70	24.71	-1.16
4 dB	FR at 10 dB	20.90	6.70	23.66	2.77	24.15	5.90	22.57	-1.59

Table C3.3-2: Example of test result dispersion for Experiment 3b (Full rate in Car Noise)

C/I	Best Codec performance (requirement)	Test 1: Conexant (English)				Test 2: France Telecom (French)			
		Qeq (Req.)	Best Mode	AMR Qeq.	Delta	Qeq (Req.)	Best Mode	AMR Qeq.	Delta
No Errors	EFR No Errors	25.19	10.20	26.86	1.67	27.67	10.20	28.47	0.80
16 dB	EFR No Errors	25.19	12.20	25.40	0.21	27.67	12.20	26.85	-0.82
13 dB	EFR No Errors	25.19	12.20	25.62	0.43	27.67	12.20	27.79	0.13
10 dB	G.729/FR [13] No Errors	23.40	10.20	27.76	4.36	26.22	12.20	29.40	3.18
7 dB	G.729/FR [13] No Errors	23.40	10.20	24.32	0.92	26.22	10.20	25.04	-1.18
4 dB	FR at 10 dB	20.94	5.90	21.92	0.97	23.26	5.90	22.44	-0.83

Table C3.3-3: Example of test result dispersion for Experiment 3b (Full rate in Office Noise)

C/I	Best Codec performance (requirement)	Test 1: Conexant (English)				Test 2: France Telecom (French)			
		Qeq (Req.)	Best Mode	AMR Qeq.	Delta	Qeq (Req.)	Best Mode	AMR Qeq.	Delta
No Errors	EFR No Errors	31.24	10.20	33.09	1.85	29.37	12.20	30.90	1.53
16 dB	EFR No Errors	31.24	12.20	30.12	-1.12	29.37	12.20	30.90	1.53
13 dB	EFR No Errors	31.24	10.20	31.56	0.32	29.37	12.20	30.90	1.53
10 dB	G.729/FR [13] No Errors	26.67	10.20	31.56	4.89	28.62	10.20	30.90	2.28
7 dB	G.729/FR [13] No Errors	26.67	7.40	27.72	1.04	28.62	6.70	29.24	0.62
4 dB	FR at 10 dB	21.32	5.90	24.21	2.88	24.68	5.90	25.93	1.26

The following tables summarize the performances of the different AMR codec modes under the tested error conditions with respect to well-known references in full rate mode under background noise conditions:

Table C3.3-4: AMR speech codec mode performances under background noise conditions in full rate

Codec Mode	Reference 1	Worse than Ref.1 Better than Ref. 2	Reference 2	Worse than Ref.2
	EFR No Errors		FR No Errors	
	Equivalent to Reference 1		Equivalent to Reference 2	
12.2	No Errors down to 13 dB C/I	10 dB C/I		7 dB C/I and below
10.2	No Errors down to 10 dB C/I		7 B C/I	4 dB C/I
7.95	No Errors down to 16 dB C/I	13 dB C/I down to 10 dB C/I	7 B C/I	4 dB C/I
7.4		No Errors down to 16 dB C/I	13 dB C/I down to 7 dB C/I	4 dB C/I
6.7		No Errors down to 16 dB C/I	13 dB C/I down to 7 dB C/I	4 dB C/I
5.9			No Errors down to 7 dB C/I	Equivalent to FR at 10 dB at 4 dB C/I
5.15				Usually found below FR at 10 C/I
4.75				Usually found below FR at 10 C/I

Table C3.3-5: Performances of the AMR speech codecs for different error conditions under background noise conditions in full rate

Error Condition	Reference 1	Worse than Ref.1 Better than Ref.2	Reference 2	Worse than Ref.2
	EFR No Errors		FR No Errors	
	Equivalent to Reference 1		Equivalent to Reference 2	
No Errors		12.2, 10.2, 7.95	7.4, 6.7	5.9, 5.15, 4.75
13 dB C/I		12.2, 10.2	7.95	7.4, 6.7, 5.9, 5.15, 5.15, 4.75
10 dB C/I		10.2	7.95, 12.2	7.4, 6.7, 5.9, 5.15, 4.75
7 dB C/I				10.2, 7.95, 7.4, 6.7, 5.9, 5.15, 12.2, 4.75
4 dB C/I				All

C3.4. Performances in Background Noise in Half Rate mode

The following tables show the typical test results dispersion (in Equivalent Q) by comparing the results obtained for the 2 tests performed for Experiment 3d, 3e and 3f:

Table C3.4-1: Example of test result dispersion for Experiment 3a (Half rate in Street Noise)

C/I	Best Codec performance (requirement)	Test 1: Conexant (English)				Test 2: France Telecom (French)			
		Qeq (Req.)	Best Mode	AMR Qeq.	Delta	Qeq (Req.)	Best Mode	AMR Qeq.	Delta
No Errors	EFR No Errors	21.30	7.40	21.30	0.00	25.73	7.95	25.52	-0.22
19 dB	G.729/FR [13] No Errors	19.99	7.95	20.54	0.55	23.86	7.40	24.19	0.33
16 dB	G.729/FR [13] No Errors	19.99	7.95	20.20	0.21	23.86	7.95	25.85	1.99
13 dB	FR at 13 dB	18.21	5.90	17.56	-0.65	25.21	5.90	22.94	-2.26
10 dB	FR at 10 dB	17.56	5.15	15.69	-1.87	23.09	4.75	20.50	-2.59
7 dB	FR at 7 dB	14.92	4.75	15.17	0.25	19.92	4.75	18.64	-1.28
4 dB	FR at 4 dB	4.18	4.75	7.30	3.12	7.23	4.75	11.40	4.17

Table C3.4-2: Example of test result dispersion for Experiment 3b (Half rate in Car Noise)

C/I	Best Codec performance (requirement)	Test 1: Conexant (English)				Test 2: France Telecom (French)			
		Qeq (Req.)	Best Mode	AMR Qeq.	Delta	Qeq (Req.)	Best Mode	AMR Qeq.	Delta
No Errors	EFR No Errors	22.71	7.95	22.30	-0.41	27.26	7.95	25.66	-1.59
19 dB	G.729/FR [13] No Errors	20.28	7.40	21.55	1.28	23.17	7.95	24.72	1.55
16 dB	G.729/FR [13] No Errors	20.28	7.40	20.28	0.00	23.17	7.95	24.72	1.55
13 dB	FR at 13 dB	17.60	6.70	19.54	1.94	24.30	5.90	23.17	-1.13
10 dB	FR at 10 dB	17.60	5.15	16.61	-0.99	23.09	4.75	20.36	-2.73
7 dB	FR at 7 dB	14.51	4.75	15.01	0.50	21.26	4.75	19.53	-1.74
4 dB	FR at 4 dB	2.39	4.75	7.25	4.86	6.76	4.75	11.43	4.67

Table C3.4-3: Example of test result dispersion for Experiment 3b (Half rate in Office Noise)

C/I	Best Codec performance (requirement)	Test 1: Conexant (English)				Test 2: France Telecom (French)			
		Qeq (Req.)	Best Mode	AMR Qeq.	Delta	Qeq (Req.)	Best Mode	AMR Qeq.	Delta
No Errors	EFR No Errors	37.36	6.70	37.53	0.17	31.90	7.95	30.08	-1.82
19 dB	G.729/FR [13] No Errors	27.75	7.95	27.34	-0.41	28.29	7.95	29.29	1.00
16 dB	G.729/FR [13] No Errors	27.75	7.95	26.63	-1.12	28.29	7.95	29.80	1.51
13 dB	FR at 13 dB	19.20	5.90	22.81	3.61	27.99	5.90	27.90	-0.10
10 dB	FR at 10 dB	19.28	4.75	19.05	-0.23	27.09	5.90	25.24	-1.84
7 dB	FR at 7 dB	17.07	4.75	17.87	0.80	22.49	4.75	24.14	1.65
4 dB	FR at 4 dB	6.71	4.75	10.13	3.42	12.23	4.75	16.63	-1.82

The following tables summarize the performances of the different AMR codec modes under the tested error conditions with respect to well-known references in half rate mode under background noise conditions:

Table C3.4-4: AMR speech codec mode performances under background noise conditions in half rate

Codec Mode	Reference 1	Reference 2	(see Note below)	Reference 3	Worse than Ref.3
	EFR No Errors	FR No Errors		HR No Errors	
	Equivalent to Reference 1	Equivalent to Reference 2	Worse than Ref.2 Better than Ref.3	Equivalent to Reference 3	Worse than Ref.3
7.95	No Errors down to 16 dB C/I			13 dB C/I	10 dB C/I and below
7.4	No Errors	16 dB C/I		13 dB C/I	10 dB C/I and below
6.7	No Errors	16 to 13 dB C/I			10 dB C/I and below
5.9		No Errors down to 13 dB C/I		10 dB C/I	7 dB C/I and below
5.15			No Errors down to 13 dB C/I	10 dB C/I	7 dB C/I and below
4.75				No Errors down to 10 dB C/I	7 dB C/I and below

Table C3.4-5: Performances of the AMR speech codecs for different error conditions under background noise conditions in half rate

Codec Mode	Reference 1	Reference 2	(see Note above)	Reference 3	Worse than Ref.3
	EFR No Errors	FR No Errors		HR No Errors	
	Equivalent to Reference 1	Equivalent to Reference 2	Worse than Ref.2 Better than Ref.3	Equivalent to Reference 3	Worse than Ref.3
No Errors	7.95, 7.4, 6.7	5.9	5.15	4.75	
16 dB C/I	7.95	7.4, 6.7, 5.9	5.15	4.75	
13 dB C/I		5.9, 6.7	5.15	4.75, 7.95, 7.4	
10 dB C/I				5.9, 5.15, 4.75	7.95, 7.4, 6.7
7 dB C/I					4.75 Equivalent to FR at 7 dB C/I
4 dB C/I					5.15 and 4.75 better than FR at 4 dB C/I

Annex D: AMR Performances as a function of FER and RBER

In this annex, the GSM characterization test results are charted as a function of the Frame Erasure Rate (FER) or Residual Bit Error Rate (RBER) as measured for each Error Pattern used for the subjective listening tests. They are provided as an indication of the quality degradation to be expected for the implementation of the AMR speech codec in 3G networks.

In the following diagrams, the quality degradation is expressed in Δ MOS (or Δ DMOS) obtained by comparing the MOS (or DMOS) obtained by the different codecs for each impairment condition with the MOS (or DMOS) obtained by the EFR in Error Free in the same experiment.

The results were compiled as explained below:

- In all cases, the results represent the average scores obtained over all tests performed for each experiment as compiled in [D1];
- The reference is always EFR in Error Free as measured in the same experiment;
- The charts in clean speech (Figures D1a-D1d) were obtained from the Characterization test results for Experiments 1a and 1b (Test performed by ATandT and Berkom);
- The charts in Car Noise (Figures D.a-D2d) were obtained from the Characterization test results for Experiments 3b and 3e (Test performed by France Telecom and Conexant);
- The charts in Street Noise (Figures D3a-D3d) were obtained from the Characterization test results for Experiments 3a and 3d (Test performed by France Telecom and Conexant);
- The charts in Office Noise (Figures D4a-D4e) were obtained from the Characterization test results for Experiments 3c and 3f (Test performed by France Telecom and Conexant);
- In all cases, the actual results were manually altered to smoothen the shape of the curves;
- The reference FER and RBER were extracted from [2] (document prepared in 12/98 for the selection of the AMR Channel Coding scheme).

It should also be noted that the diagrams function of the FER are affected by the Residual Bit Error Rate for each test condition, while the diagrams function of the RBER are also function of the FER present for each test condition. The two sets of diagrams cannot be considered totally independent.

Finally, it should be pointed out that the FER and RBER estimates used to derive these diagrams are based on the limited number of error patterns used for the AMR characterization phase. These could be affected by some inaccuracies that could explain the difference in shapes between the different speech codec modes.

These results can also be compared to previous indications provided by S4 to R1 and S2 regarding the robustness of the AMR Speech Codec (Ref [3] and [4]). The following section is extracted from a Liaison Statement sent to R1 [3], the same reference is also used in [4] (Liaison to S2):

The frame error rate required for producing high speech quality with only small quality degradation compared to error free speech is typically FER < 0.5%. This requirement guarantees retaining the maximum quality of, e.g., the GSM EFR codec. The quality then degrades gracefully with increasing frame error rate. This FER limit should be considered as a conservative figure.

D.1 Results in Clean Speech in Δ MOS

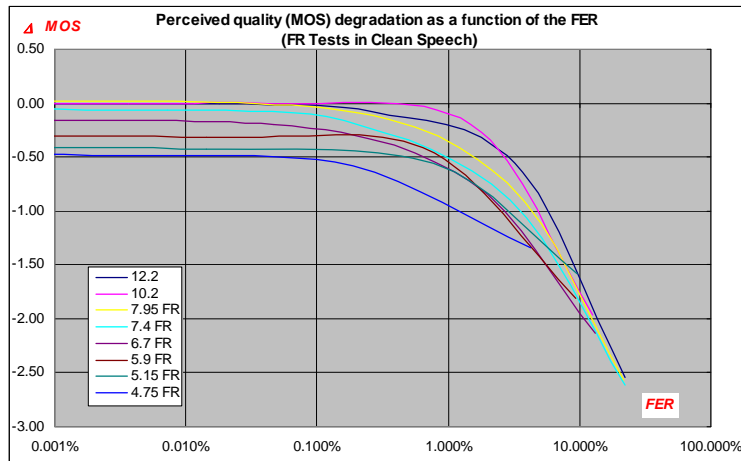

Figure D1a: Quality Degradation function of FER (FR Test Results)

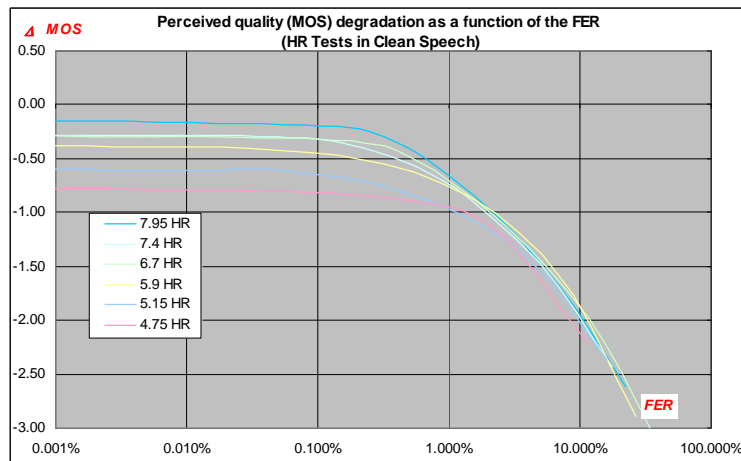

Figure D1b: Quality Degradation function of FER (HR Test Results)

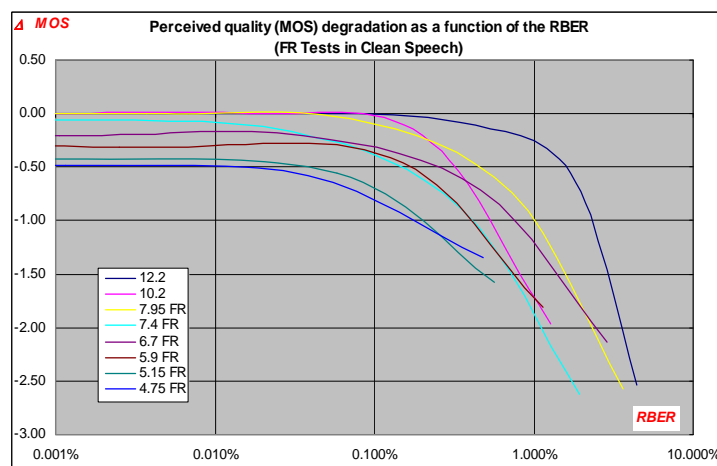

Figure D1c: Quality Degradation function of RBER (FR Test Results)

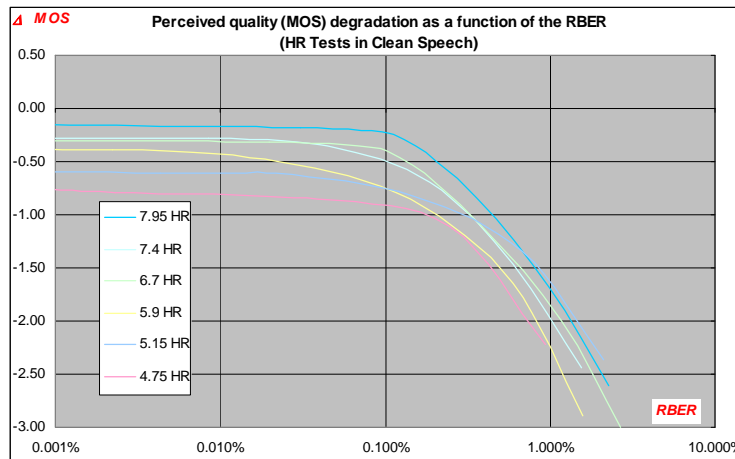

Figure D1d: Quality Degradation function of RBER (HR Test Results)

Comments on the previous results:

In clean speech, it appears that all codec modes do not show any significant quality degradation when the Frame Erasure Rate is lower than 0,5 %. In some instances, the range can even be extended to 1% FER without any quality degradation.

It is also interesting to note that at 1% FER degradation, the highest codec modes (12.2 and 10.2) are still equivalent to the second tier of codec modes (7.95 to 5.9) in error free. Similarly, the middle range codec modes (7.95 to 5.9) present the same quality at 1% FER than the lower rate codec modes (5.15 and 4.75) in error free conditions.

The experiments in Half Rate have slightly increased the differences between the codecs and with EFR as could have been expected, but the same trends can be observed.

The results as a function of the RBER are also very similar with a different range of acceptable RBER. The different codec modes do not present any significant quality degradation when the RBER is below 0.1%.

D.2 Results in Car Noise

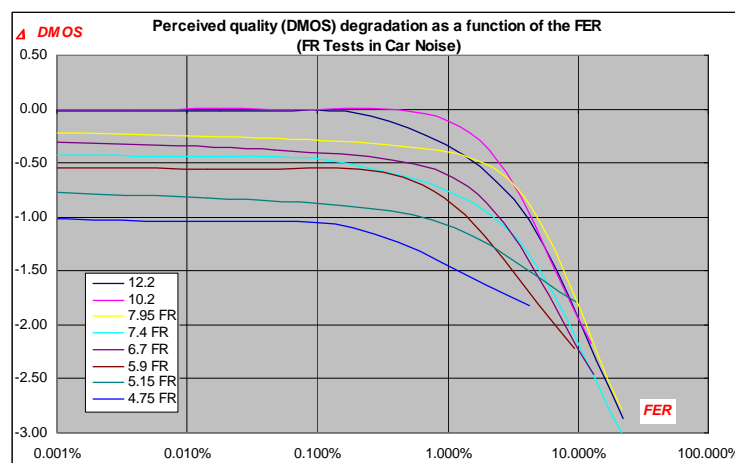

Figure D2a: Quality Degradation function of FER (FR Test Results)

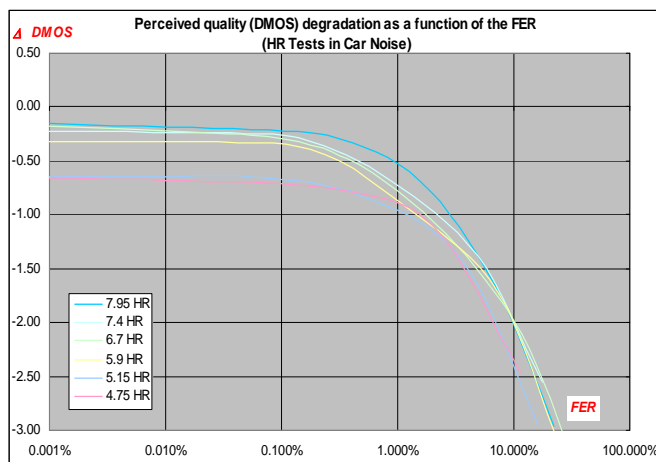

Figure D2b: Quality Degradation function of FER (HR Test Results)

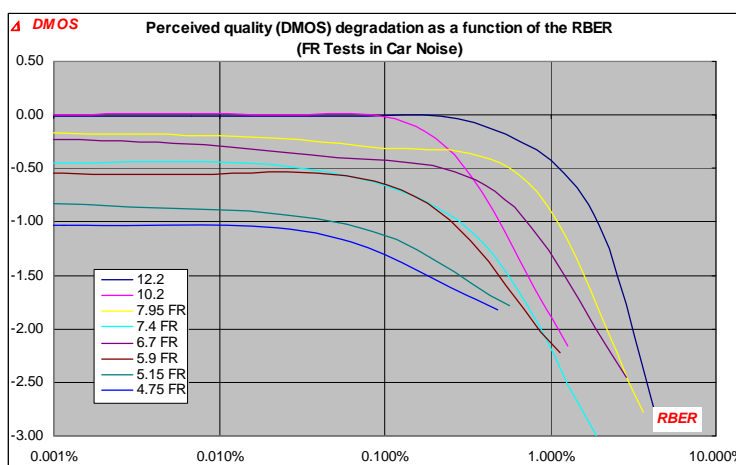

Figure D2c: Quality Degradation function of RBER (FR Test Results)

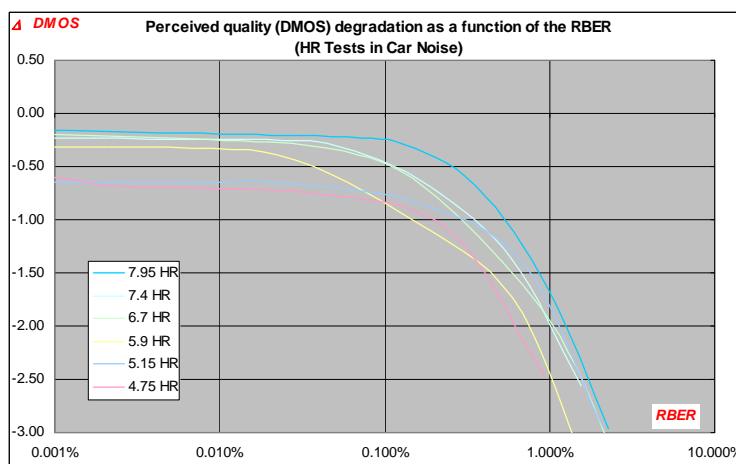

Figure D2d: Quality Degradation function of RBER (HR Test Results)

Comments on the previous results:

In car noise, no significant degradation is observed when the FER stays below 1% and the difference in quality between the different codecs is slightly amplified compared to the results clean speech.

D.3 Results in Street Noise

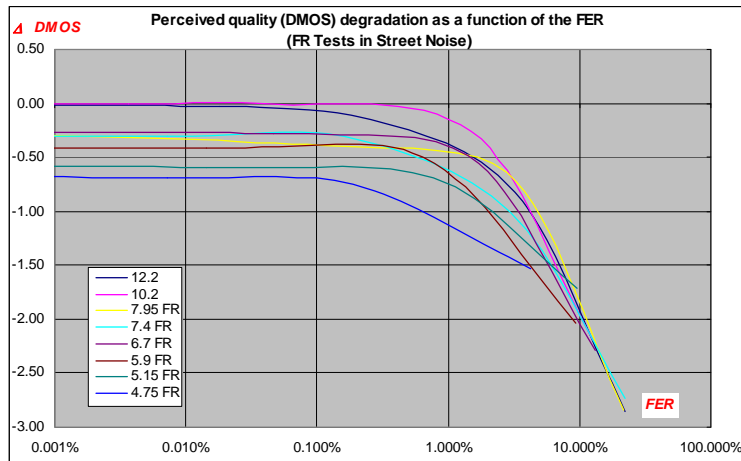

Figure D3a: Quality Degradation function of FER (FR Test Results)

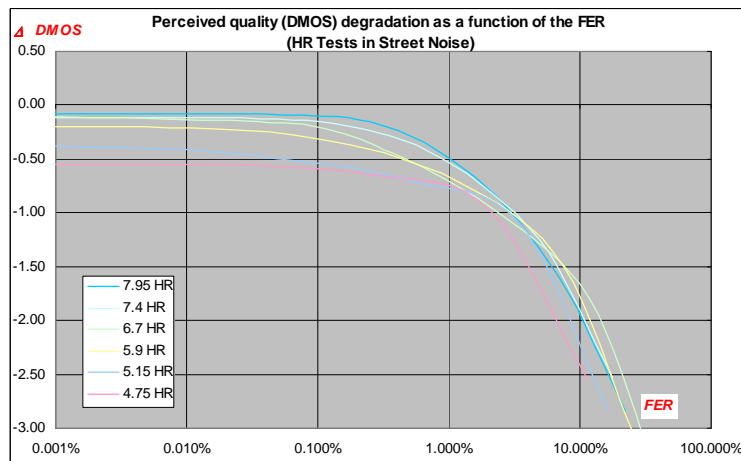

Figure D3b: Quality Degradation function of FER (HR Test Results)

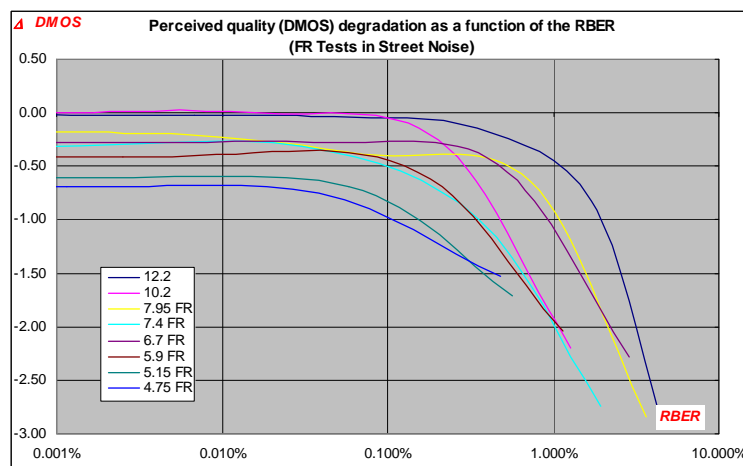

Figure D3c: Quality Degradation function of RBER (FR Test Results)

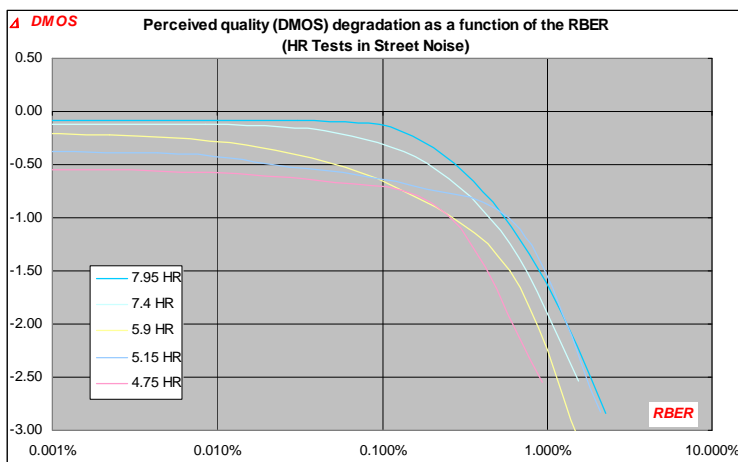

Figure D3d: Quality Degradation function of RBER (HR Test Results)

Comments on the previous results:

The results in street noise are in line with the previous results.

D.4 Results in Office Noise:

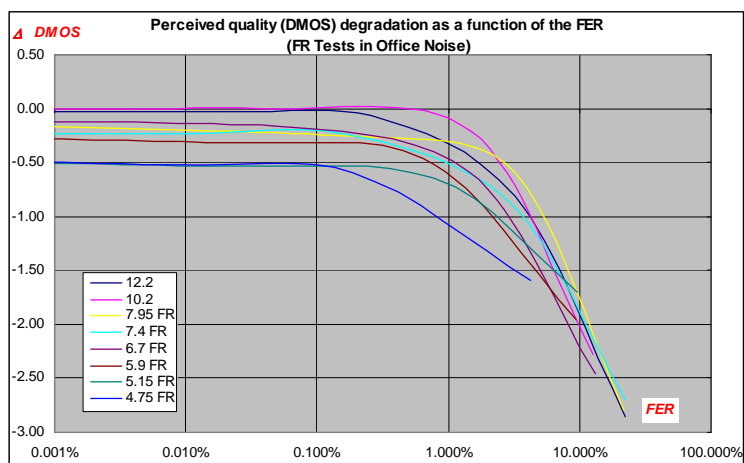

Figure D4a: Quality Degradation function of FER (FR Test Results)

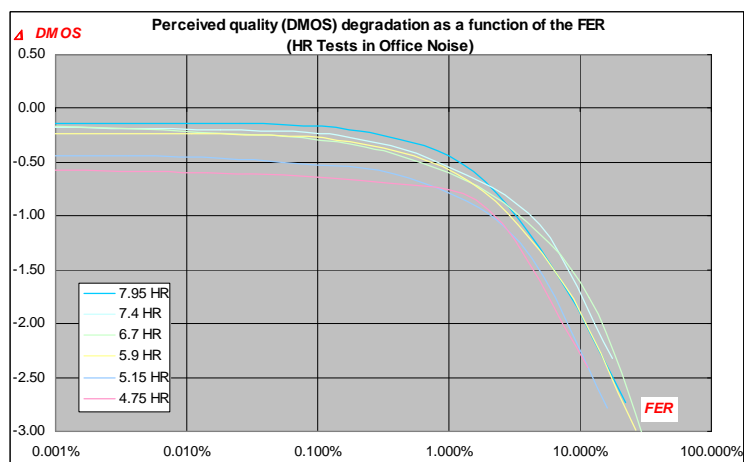

Figure D4b: Quality Degradation function of FER (HR Test Results)

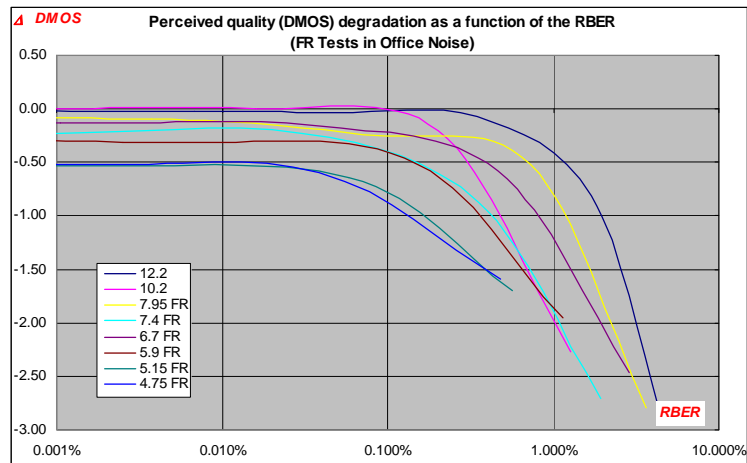

Figure D4c: Quality Degradation function of RBER (FR Test Results)

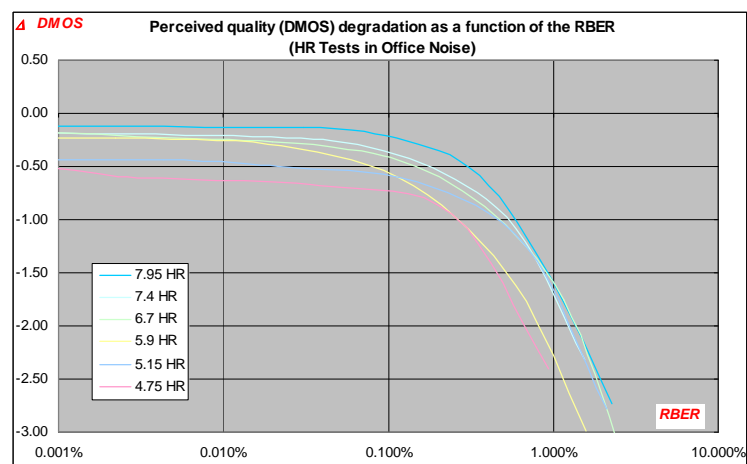

Figure D4d: Quality Degradation function of RBER (HR Test Results)

Comments on the previous results:

Same comment for the results in Office Noise

References to Annex D:

- [D1]: AMR Characterization Combined Test Results (spreadsheet): SMG11 Tdoc 243/99, SMG11#10, June 4-11, 1999, Tampere, Finland
- [D2]: Annex 3 to the LS to SMG2 WPB on alternative AMR channel coding schemes: "Objective test results for alternative AMR channel coding schemes" from Ericsson/Nokia/Siemens SMG11 Tdoc 329/98, SMG11#8Bis, December 17, 1998, London Heathrow, UK
- [D2]: S4 LS to TSG-R1 "Response to the TSG-R1 LS on Speech Services" Tdoc 185R/99, TSG-S4#3, March 24-26, 1999, Yokosuka, Japan
- [D4]: S4 LS to TSG-S2, S2 QoS and R3 "Error resilience in real-time packet multimedia payloads" Tdoc 179R/99, TSG-S4#5, June 14-16, 1999, Miami, FL-USA

Annex E: AMR Characterization in 3G Channels

E.1 Overview of the 3G Characterization Phase

Following the selection of AMR as the mandatory speech codec for the 3G system under the responsibility of 3GPP, it was decided to carry out a simplify 3G Characterization Phase to check the behavior of the speech codec in 3G radio channels. The corresponding tests, funded by the 3GPP PCG, were completed in 4Q00.

Because of the exhaustive tests already performed in the GSM environment, it was decided to restrict the scope of the 3G Characterization Phase to conditions directly impacted by the 3G Radio Interface. Consequently, most of the tests were performed in clean speech conditions, so that a maximum number of different propagation error conditions could be tested. The 3G Characterization Phase included 2 experiments and 3 sub-experiments, each performed by a different test laboratory. The scope of the different experiments is provided in the following table:

Table E.1: Summary of the AMR 3G Characterization Test conditions

Experiment	Test Laboratory	Language	Noise Condition
1a	<i>Dynastat</i>	English	Clean
1b	<i>Lookheed Martin GT</i>	Korean	Clean
1c	<i>NTT-AT</i>	Japanese	Clean
2	<i>Arcon</i>	English	Car Noise at 15dB SNR

The other tasks were under the responsibility of:

Lookheed Martin GT: Preparation of the Test Plan and Processing Procedures Specification

Nortel Networks and NTT DoCoMo: Preparation of the Error Patterns

Arcon:Host Laboratory and Global Analysis

The experiments were dimensioned to evaluate the performances of a subset of the AMR codec modes for 3 Path Profiles at 3 different target FER. All conditions involved single encoding only (No Tandem) without DTX activated. The actual error conditions tested are summarized in the following table. All AMR modes were also tested in No Error conditions in all experiments, in addition to the following references: ADPCM G.726 at 32kbit/s (Not in Exp.2), G.723.1 [15] at 6.3kbit/s, G.729 [13] at 8kbit/s (all 3 in No errors), GSM EFR at 10 and 7 dB C/I, GSM FR and IS-127 (both in No Errors and in Exp.1 only).

Table E.2: Overview of the tested conditions

Experiment.	Path Profile	Target FER	Modes Tested
1a	Uplink-Vehicular-B-50 km/h	0.5%, 1%, 3%	12.2, 7.95, 6.7, 5.15
	Downlink-Vehicular-B-120 km/h	0.5%, 1%, 3%	12.2, 7.95, 6.7, 5.15
	Uplink-Pedestrian-B-3 km/h	0.5%, 1%, 3%	10.2, 7.4, 5.90, 4.75
1b	Downlink-Vehicular-B-50 km/h	0.5%, 1%, 3%	12.2, 7.95, 6.7, 5.15
	Uplink-Indoor-A-3 km/h	0.5%, 1%, 3%	10.2, 7.4, 5.90, 4.75
	Downlink-Pedestrian-B-3 km/h	0.5%, 1%, 3%	10.2, 7.4, 5.90, 4.75
1c	Uplink-Vehicular-B-120 km/h	0.5%, 1%, 3%	12.2, 7.95, 6.7, 5.15
	Downlink- Indoor-A-3 km/h	0.5%, 1%, 3%	12.2, 7.95, 6.7, 5.15
	Uplink- Pedestrian-A-3 km/h	0.5%, 1%, 3%	10.2, 7.4, 5.90, 4.75
2	Downlink-Pedestrian-B-3 km/h	0.5%, 1%	10.2, 7.4, 5.90, 4.75
	Uplink-Vehicular-A-50 km/h	0.5%, 1%,	12.2, 7.95, 6.7, 5.15
	Uplink-Vehicular-B-120 km/h	0.5%, 1%,	10.2, 7.4, 5.90

E.2 Radio Simulator Parameters

The key parameters used for the simulation of the 3G Channels are summarized below. Note, however, that these parameters do not in any case ensure to meet appropriate QoS parameters for the different RAB subflows, for which a suitable example is to meet a residual BER for class B bits of 0.1% and a residual BER for class C bits of 0.5% at an SDU error ratio of 0.7% [E1]. Statistical analyses of the 3G error patterns used [E2], [E3] show that particularly for modes AMR12.2 and AMR10.2 the residual BER of class C bits partly is much higher than according to this example (up to 2.5% at a SDU error ratio of 0.5%). Moreover, the SDU error rate and residual BER figures obtained at a given radio simulator setting may exhibit considerable statistical variations, as, particularly for the case of 0.5% SDU error rate, the number of required frame erasures and residual bit errors is low compared to the length of the error pattern (1600 frames).

E.2.1 General

Maximum source bit rate of 12.2 kbit/s

12 bits CRC size on Class A Bits

Normal Frames (not compressed)

Channel Coding: Based on Convolutional Codes defined in [7]

Rate Matching: Median values of Rate Matching attributes defined in [7]

Power Control: The Power Control is made of two loops, the so-called inner and outer loops. The inner loop is used to decide on the PC command based on the estimation of the SIR and its comparison to the SIR target, the outer loop is made to adjust the SIR target according to metrics that are used to evaluate the quality of the link. The outer loop has been disabled, e.g. the SIR target has been fixed in comparison with waited FER values of 0.5%, 1%, and 3%. The algorithms used for the measurements as well as the adjustment of the SIR target are proprietary.

The Power Control Algorithm referenced as option #1 has been used for the inner loop, with 1 dB steps.

The Power Control implies a certain loop delay, due to the SIR estimation, the transmission of the command on the reverse link, the decision on the Power Control command and its application. A delay of 1 time slot is used. The assumed BER on TPC bits is 4 %.

Diversity: There exist transmit and receive diversity. It is assumed that Rx diversity will be very common in the future UMTS networks. Therefore, in Uplink, receiver diversity is used. The Transmit diversity can be used in Downlink, but there will be many Node B which won't offer this feature. Therefore, no Tx diversity is assumed in DL.

Propagation profiles and mobile speeds : The Working Groups of the TSG RAN use six different profiles: Indoor A and B, Outdoor to Indoor A and B, and Outdoor A and B.

These profiles in conjunction with the mobile speed are used to simulate different scenarios, e.g. Outdoor-to-Indoor with a mobile speed of 3 km/h is assumed to correspond to a pedestrian in a urban environment, at 50 km/h it can correspond to car in a suburban environment.

Regarding the 3G AMR characterization, some typical scenarios have been defined and from these scenarios the profile and the mobile speed to use have been derived: speed of 3km/h for profiles indoor A, Pedestrian A and Pedestrian B; speed of 50 km/h for Vehicular A and Vehicular B; speed of 120 km/h for Vehicular B.

E.2.2 Uplink

Spreading Factors: The spreading factor is 64 for the speech bitrates higher than 5.15 kbps, 128 otherwise.

Transport Format Combination Indicator: The TFCI informs the receiver about the instantaneous transport format combination of the transport channels mapped to the simultaneously transmitted uplink DPDCH radio frame. For this exercise, the TFCI is transmitted but not used because we suppose a perfect decoding (always the same transport format combination).

DCCH: A DCCH, of either 3.4 or 1.7 kbit/s depending on the spreading factor, shared the DPDCH with the TrCH carrying the voice.

Slot Format: The slot format for DPDCH and DPCCH is given in [8].

A spreading factor of 64 implies slot format #2 to be used for the DPDCH and a spreading factor of 128 implies slot format #1 to be used for the DPDCH. For DPCCH, non-compressed frame formats and no DL transmitter diversity imply to use slot format #0: the frame structure is 6 pilot bits + 2 TFCI + 2 TPC.

Gain Factors: The gain factor is the power offset between the DPCCH (which carries the control bits such as the Pilot bits, TFCI, TPC, etc.) and the DPDCH (which carries the user data and the UTRAN signalling). This difference of power comes from the difference between spreading factors.

The gain factor for DPCCH is 11 and the gain factor for DPDCH is 15.

Interferences: There was no MAI in Uplink, however an AWGN channel was used.

E.2.3 Downlink

Spreading Factors: The spreading factor is 128 for the speech bitrates higher than 5.15 kbps, 256 otherwise.

Transport Format Combination Indicator: For DL, BTFD is assumed. Therefore no TFCI is used for format detection.

For this exercise, there is no BTFD error because we suppose a perfect decoding (always the same transport format combination) and ratio of BTFD error is relatively low compared with FER of speech information.

DCCH: A DCCH, of either 3.4 or 1.7 kbit/s depending on the spreading factor, shared the DPDCH with the TrCH carrying the voice.

Slot Format: A spreading factor of 128 and 256, which depends on source bit-rate, and non-compressed frame format imply slot format #12 to be used for DPCH including both DPDCH and DPCCH. The frame structure for DPCCH is 4 pilot bits + 2 TPC.

Gain Factors: Equal gain factors are used both DPDCH and DPCCH for DL. This means there is no power offset between them.

Interferences: Channel setting defined in Table C.3 of [9] is used for DL.

E.3 AMR 3G Characterization Test Results in Clean Speech

The following diagrams present the raw test results of Experiments 1a, 1b and 1c, for the different path profiles and target FER tested in these experiments. The performances are presented as a function of the target FER. As in Annex D, the performances are usually showing no significant degradation of the speech quality down to 1% FER. It is to be noted that the shown performance degradation for modes AMR12.2 and AMR10.2 is worse than can be expected with more appropriate QoS attributes for class C bits.

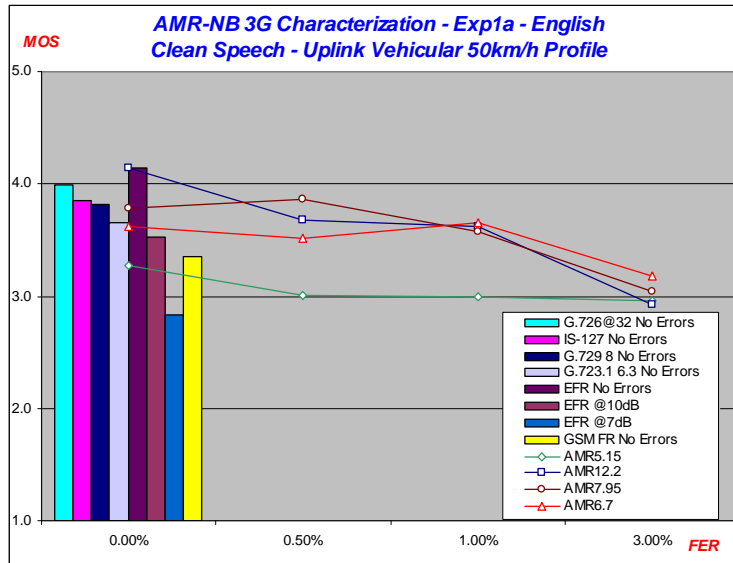

Figure E3-1: AMR 3G Characterization Exp. 1a Test Results – Clean Speech – Uplink Vehicular-B 50 km/h Profile

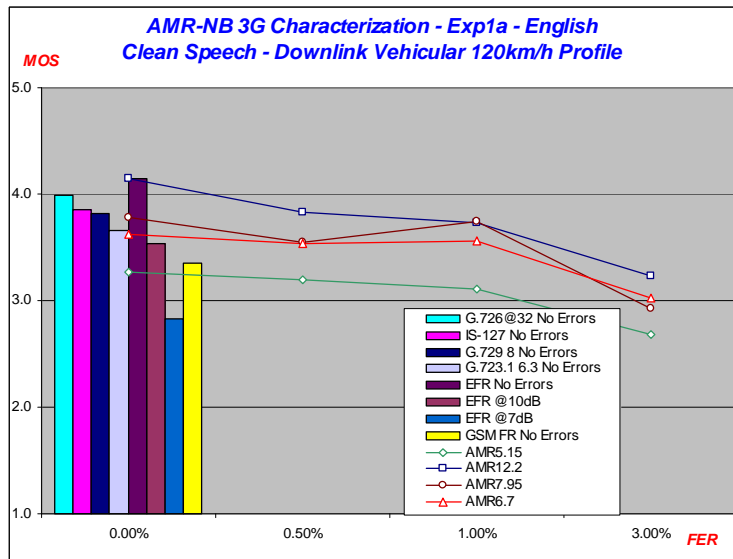

Figure E3-2: AMR 3G Characterization Exp. 1a Test Results – Clean Speech – Downlink Vehicular-B 120 km/h Profile

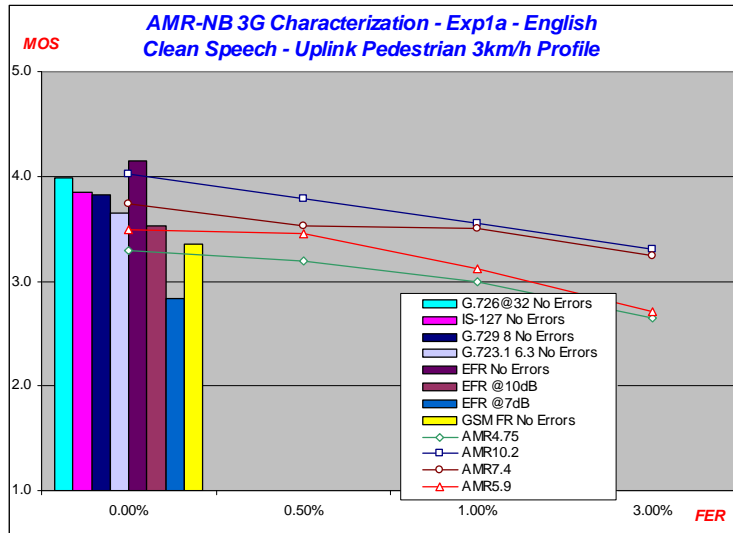

Figure E3-3: AMR 3G Characterization Exp. 1a Test Results – Clean Speech – Uplink Pedestrian-B 3 km/h Profile

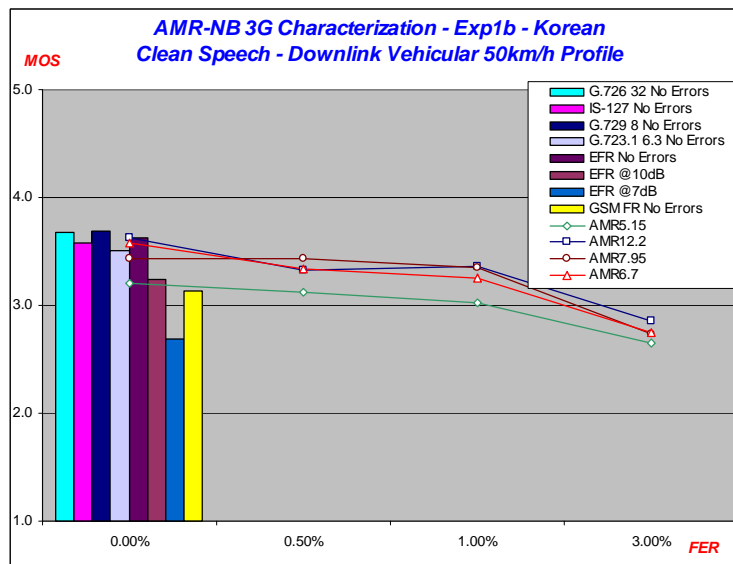

Figure E3-4: AMR 3G Characterization Exp. 1b Test Results – Clean Speech – Downlink Vehicular-B 50 km/h Profile

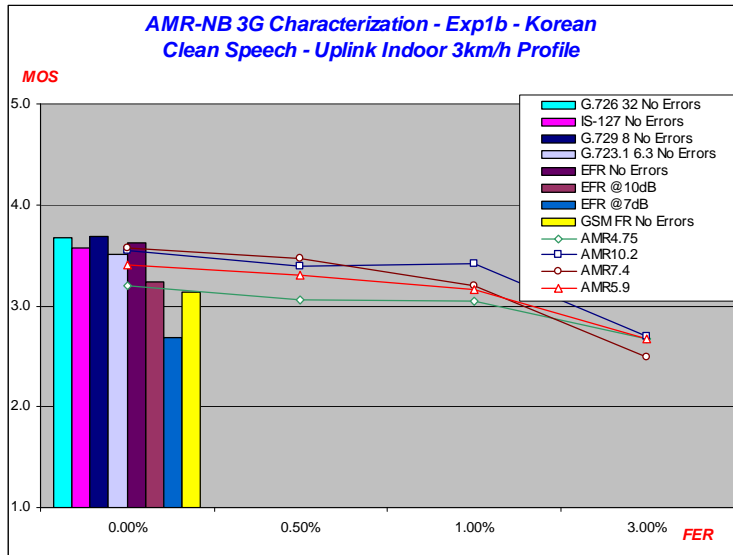

Figure E3-5: AMR 3G Characterization Exp. 1b Test Results – Clean Speech –Uplink Indoor-A 3 km/h Profile

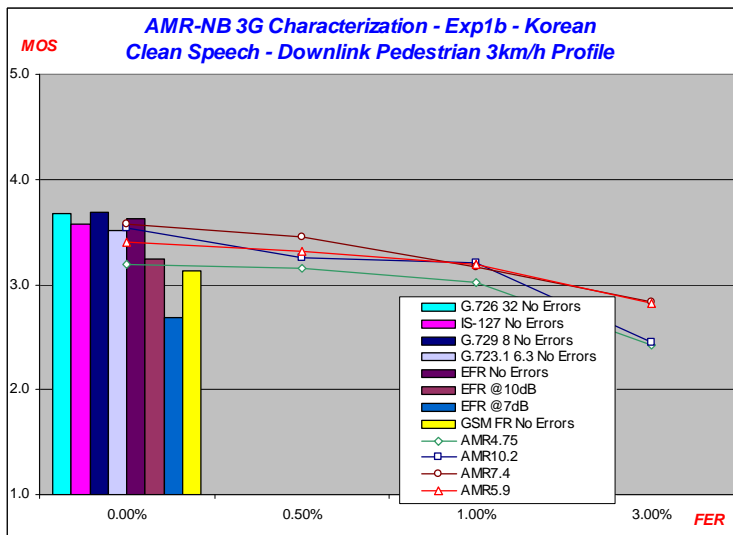

Figure E3-6: AMR 3G Characterization Exp. 1b Test Results – Clean Speech – Downlink Pedestrian-B 3 km/h Profile

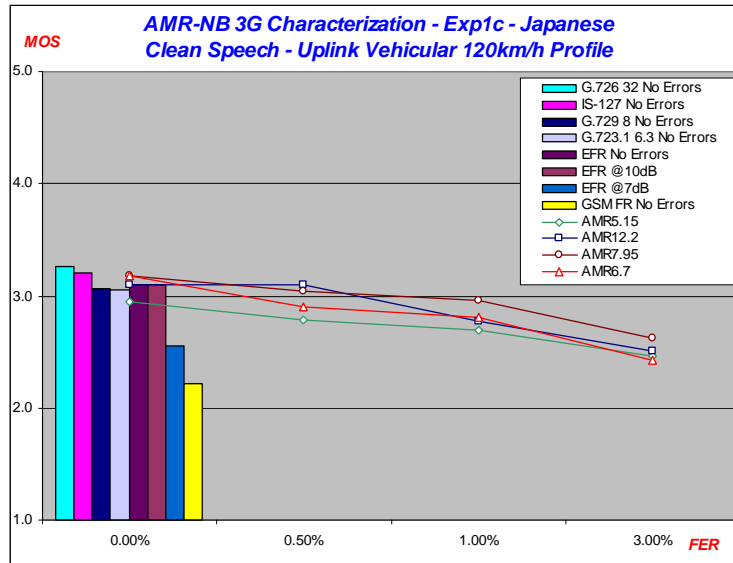

Figure E3-7: AMR 3G Characterization Exp. 1c Test Results – Clean Speech – Uplink Vehicular-B 120 km/h Profile

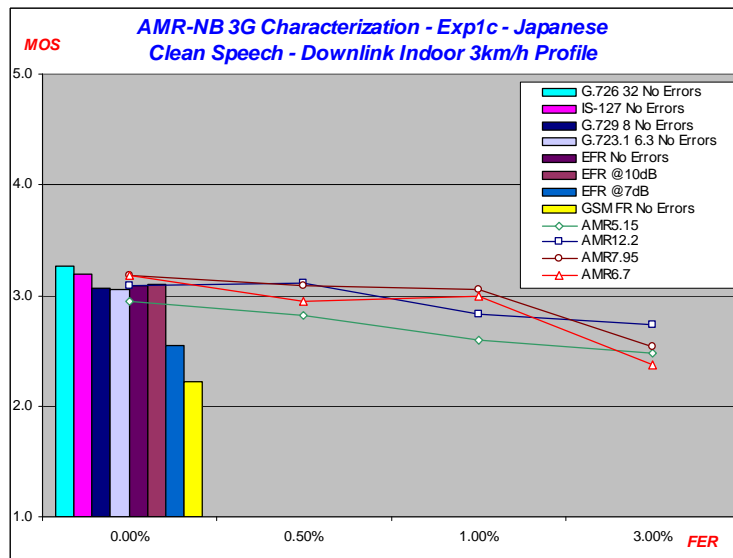

Figure E3-8: AMR 3G Characterization Exp. 1c Test Results – Clean Speech – Downlink Indoor-A 3 km/h Profile

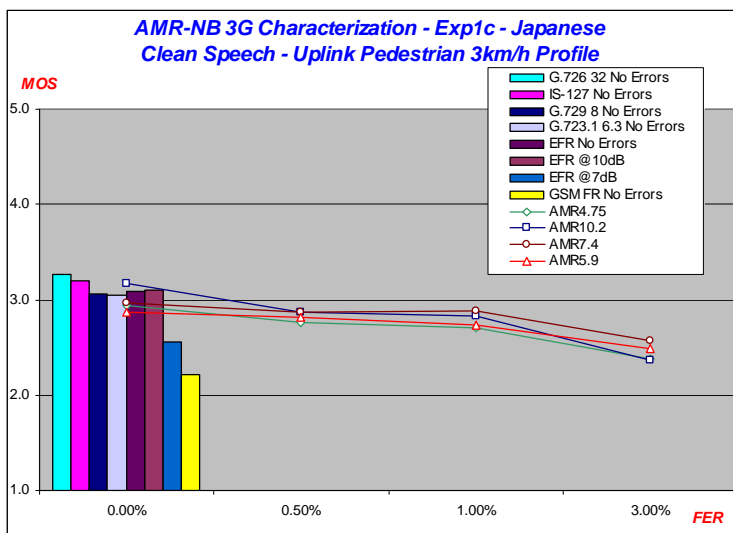

Figure E3-9: AMR 3G Characterization Exp. 1c Test Results – Clean Speech – Uplink Pedestrian-A 3 km/h Profile

E.4 AMR 3G Characterization Test Results in Car Noise

The following diagrams present the raw test results of Experiment 2 for the different path profiles and target FER tested in this experiment. The performances are presented as a function of the target FER. Again, and as in Annex D, the performances are usually showing no significant degradation of the speech quality down to 1% FER. It is to be noted that the shown performance degradation for modes AMR12.2 and AMR10.2 is worse than can be expected with more appropriate QoS attributes for class C bits.

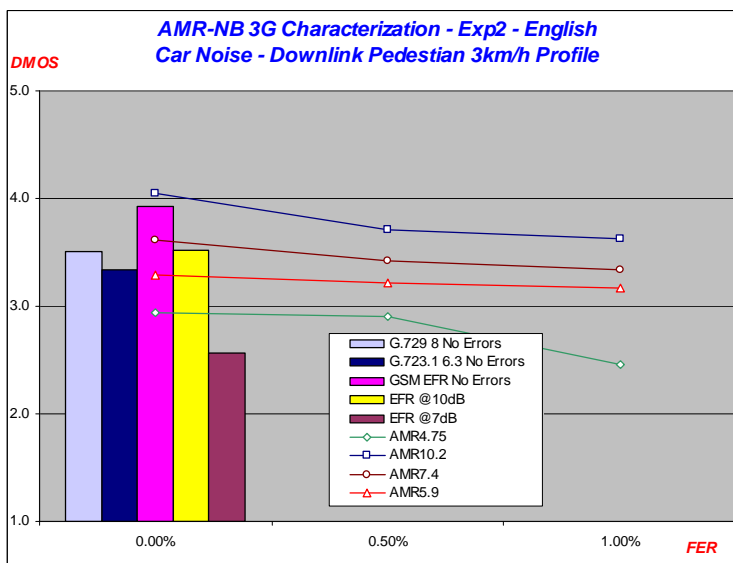

Figure E4-1: AMR 3G Characterization Exp. 2 Test Results – 15 dB SNR Car Noise – Downlink Pedestrian-B 3 km/h Profile

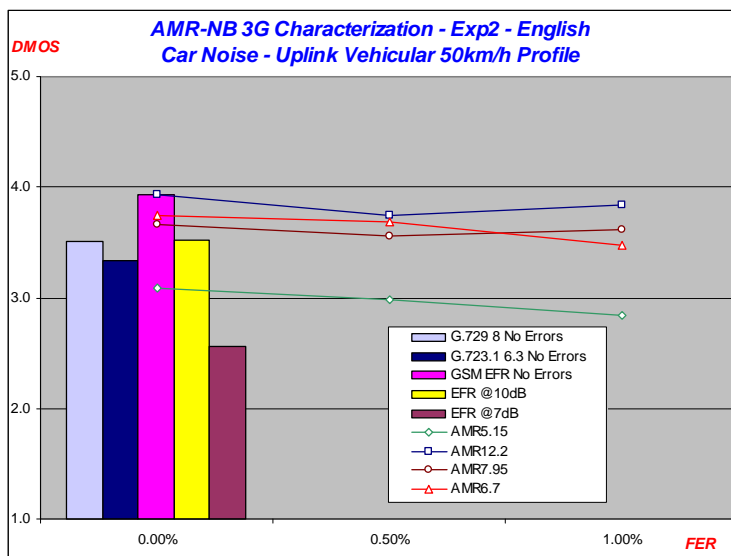

Figure E4-2: AMR 3G Characterization Exp. 2 Test Results – 15 dB SNR Car Noise – Uplink Vehicular-A 50 km/h Profile

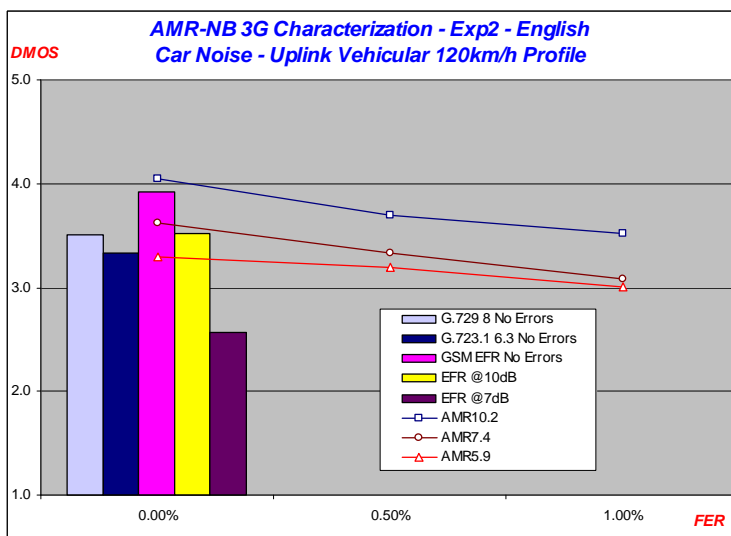

Figure E4-3: AMR 3G Characterization Exp. 2 Test Results – 15 dB SNR Car Noise – Uplink Vehicular-B 120 km/h Profile

References to Annex E:

- [E1] 3GPP TS 26.102: "AMR speech codec; Interface to Iu and Uu", Version 3.3.0
- [E2] 3GPP TSG-SA4 Tdoc S4-010053: "Statistics of 3G error patterns provided by NTT DoCoMo", January 2001, Munich, Germany
- [E3] 3GPP TSG-SA4 Tdoc S4-010490: "Statistics of 3G error patterns provided by Nortel Networks", September 2001, Erlangen, Germany

Annex F: Change history

Change history							
Date	TSG #	TSG Doc.	CR	Rev	Subject/Comment	Old	New
03-2001	11	SP-010097			Version for Release 4		4.0.0
09-2001	13	SP-010458	002		Clarification of 3G simulator settings used for AMR characterisation in 3G channels	4.0.0	4.1.0
06-2002	16				Version for Release 5	4.1.0	5.0.0
12-2004	26				Version for Release 6	5.0.0	6.0.0
06-2007	36				Version for Release 7	6.0.0	7.0.0
12-2008	42				Version for Release 8	7.0.0	8.0.0
12-2009	46				Version for Release 9	8.0.0	9.0.0
03-2011	51				Version for Release 10	9.0.0	10.0.0
09-2012	57				Version for Release 11	10.0.0	11.0.0
09-2014	65				Version for Release 12	11.0.0	12.0.0
12-2015	70				Version for Release 13	12.0.0	13.0.0

Change history							
Date	Meeting	TDoc	CR	Rev	Cat	Subject/Comment	New version
03-2017	75					Version for Release 14	14.0.0
06-2018	80					Version for Release 15	15.0.0

History

Document history		
V15.0.0	July 2018	Publication