

ETSI TR 126 944 V11.1.0 (2014-01)



**Universal Mobile Telecommunications System (UMTS);  
LTE;  
End-to-end multimedia services performance metrics  
(3GPP TR 26.944 version 11.1.0 Release 11)**



---

**Reference**

RTR/TSGS-0426944vb10

---

**Keywords**

LTE,UMTS

**ETSI**

650 Route des Lucioles  
F-06921 Sophia Antipolis Cedex - FRANCE

---

Tel.: +33 4 92 94 42 00 Fax: +33 4 93 65 47 16

Siret N° 348 623 562 00017 - NAF 742 C  
Association à but non lucratif enregistrée à la  
Sous-Préfecture de Grasse (06) N° 7803/88

---

**Important notice**

---

Individual copies of the present document can be downloaded from:

<http://www.etsi.org>

The present document may be made available in more than one electronic version or in print. In any case of existing or perceived difference in contents between such versions, the reference version is the Portable Document Format (PDF). In case of dispute, the reference shall be the printing on ETSI printers of the PDF version kept on a specific network drive within ETSI Secretariat.

Users of the present document should be aware that the document may be subject to revision or change of status. Information on the current status of this and other ETSI documents is available at

<http://portal.etsi.org/tb/status/status.asp>

If you find errors in the present document, please send your comment to one of the following services:

[http://portal.etsi.org/chaicor/ETSI\\_support.asp](http://portal.etsi.org/chaicor/ETSI_support.asp)

---

**Copyright Notification**

---

No part may be reproduced except as authorized by written permission.  
The copyright and the foregoing restriction extend to reproduction in all media.

© European Telecommunications Standards Institute 2014.  
All rights reserved.

**DECT™**, **PLUGTESTS™**, **UMTS™** and the ETSI logo are Trade Marks of ETSI registered for the benefit of its Members.  
**3GPP™** and **LTE™** are Trade Marks of ETSI registered for the benefit of its Members and of the 3GPP Organizational Partners.  
**GSM®** and the GSM logo are Trade Marks registered and owned by the GSM Association.

---

## Intellectual Property Rights

IPRs essential or potentially essential to the present document may have been declared to ETSI. The information pertaining to these essential IPRs, if any, is publicly available for **ETSI members and non-members**, and can be found in ETSI SR 000 314: *"Intellectual Property Rights (IPRs); Essential, or potentially Essential, IPRs notified to ETSI in respect of ETSI standards"*, which is available from the ETSI Secretariat. Latest updates are available on the ETSI Web server (<http://ipr.etsi.org>).

Pursuant to the ETSI IPR Policy, no investigation, including IPR searches, has been carried out by ETSI. No guarantee can be given as to the existence of other IPRs not referenced in ETSI SR 000 314 (or the updates on the ETSI Web server) which are, or may be, or may become, essential to the present document.

---

## Foreword

This Technical Report (TR) has been produced by ETSI 3rd Generation Partnership Project (3GPP).

The present document may refer to technical specifications or reports using their 3GPP identities, UMTS identities or GSM identities. These should be interpreted as being references to the corresponding ETSI deliverables.

The cross reference between GSM, UMTS, 3GPP and ETSI identities can be found under <http://webapp.etsi.org/key/queryform.asp>.

# Contents

Intellectual Property Rights .....	2
Foreword.....	2
Foreword.....	6
Introduction .....	6
1 Scope .....	8
2 References .....	8
3 Abbreviations .....	8
4 General description and approach .....	9
4.1 Definitions .....	9
4.2 QoE parameters .....	10
4.3 ESQoS parameters.....	11
4.4 SQoS parameters .....	11
5 QoE parameters .....	13
5.1 General .....	13
5.2 Service non-access .....	13
5.3 Service failure .....	13
5.4 Service setting-up time .....	13
5.5 Re-buffering .....	13
5.6 Image corruption .....	13
5.7 Edge noise .....	13
5.8 Blurriness .....	14
5.9 Colour reproduction accuracy .....	14
5.10 Blockiness .....	14
5.11 Incontinuous image with block .....	14
5.12 Freeze image .....	14
5.13 Audio quality.....	14
5.14 Audio/Video synchronization error .....	14
6 ESQoS parameters.....	14
6.1 General .....	14
6.2 Service non-availability.....	15
6.2.1 Abstract definition .....	15
6.2.2 Equation.....	15
6.2.3 Trigger point .....	15
6.3 Service failure ratio .....	15
6.3.1 Abstract definition .....	15
6.3.2 Equation.....	15
6.3.3 Trigger point .....	16
6.4 Initial connection time.....	16
6.4.1 Abstract definition .....	16
6.4.2 Equation.....	16
6.4.3 Trigger Point.....	16
6.5 Initial buffering time .....	16
6.5.1 Abstract definition .....	16
6.5.2 Equation.....	16
6.5.3 Trigger Point.....	17
6.6 Re-buffering frequency .....	17
6.6.1 Abstract definition .....	17
6.6.2 Equation.....	17
6.6.3 Trigger point .....	17
6.7 Re-buffering time .....	17
6.7.1 Abstract definition .....	17

6.7.2	Equation.....	17
6.7.3	Trigger point.....	17
6.8	Audio quality.....	18
6.8.1	Abstract definition.....	18
6.8.2	Equation.....	18
6.8.3	Trigger point.....	18
6.9	Intra-frame video quality.....	18
6.9.1	Abstract definition.....	18
6.9.2	Equation.....	18
6.9.3	Trigger point.....	18
6.10	Inter-frame video quality.....	19
6.10.1	Abstract definition.....	19
6.10.2	Equation.....	19
6.10.3	Trigger point.....	19
6.11	Audio/Video de-synchronization error.....	19
6.11.1	Abstract definition.....	19
6.11.2	Equation.....	19
6.11.3	Trigger point.....	19
7	SQoS parameters.....	20
7.1	SQoS parameters of each layer.....	20
7.1.1	Application.....	20
7.1.1.1	Frame rate.....	20
7.1.1.2	Frame loss ratio.....	20
7.1.1.3	Frame error ratio.....	20
7.1.1.4	Transaction rate.....	20
7.1.1.5	Transaction delay.....	20
7.1.2	Transport.....	20
7.1.2.1	Bandwidth.....	20
7.1.2.2	Transfer delay.....	20
7.1.2.3	Jitter.....	20
7.1.2.4	Packet loss ratio.....	20
7.1.2.5	Packet error ratio.....	21
7.1.3	Sub-transport.....	21
7.1.3.1	Frame loss ratio.....	21
7.1.3.2	Residual frame error ratio.....	21
7.1.3.3	Frame discard ratio.....	21
7.1.3.4	Residual bit ratio.....	21
7.1.3.5	Access delay.....	21
7.1.3.6	Block ratio.....	21
7.1.3.7	Soft handoff rate.....	21
7.2	SQoS parameters of each class.....	21
7.3	SQoS parameters of each service.....	22
8	Mapping between ESQoS and SQoS.....	23
8.1	General.....	23
8.2	PSS.....	25
8.3	MBMS.....	26
8.4	Video telephony.....	27
8.5	IMS.....	27
<b>Annex A:</b>	<b>PSS Performance Analysis with Theoretical Models.....</b>	<b>30</b>
A.1	Introduction.....	30
A.2	Scope.....	30
A.3	References.....	30
A.4	General models.....	31
A.4.1	Radio access network model.....	31
A.4.1.1	Model description.....	31
A.4.1.2	The block ratio of new calls and the failure ratio of handoff calls.....	32
A.4.2	Transport network model.....	33

A.4.2.1	Model description .....	33
A.4.2.2	The mean transfer delay and the transfer time .....	34
A.4.3	Node model .....	34
A.4.3.1	Simple node model .....	34
A.4.3.1.1	Model description .....	34
A.4.3.1.2	The transaction delay and the data loss ratio .....	35
A.4.3.2	Complex node model .....	35
A.4.3.2.1	Model description .....	35
A.4.3.2.2	The transaction delay .....	37
A.5	Modelling the relationship between ESQoS and SQoS .....	38
A.5.1	Service Non-Availability .....	38
A.5.1.1	Relative SQoS and other parameters .....	38
A.5.1.2	Model description .....	39
A.5.2	Service Failure Ratio .....	41
A.5.2.1	Relative SQoS and other parameters .....	41
A.5.2.2	Model description .....	42
A.5.3	Initial Connection Time .....	44
A.5.3.1	Relative SQoS and other parameters .....	44
A.5.3.2	Model description .....	45
A.5.4	Initial Buffering Time .....	47
A.5.4.1	Relative SQoS and other parameters .....	47
A.5.4.2	Model description .....	48
A.5.5	Re-Buffering Frequency .....	50
A.5.5.1	Relative SQoS and other parameters .....	50
A.5.5.2	Model description .....	50
A.5.6	Re-Buffering Time .....	51
A.5.6.1	Relative SQoS and other parameters .....	51
A.5.6.2	Model description .....	51
<b>Annex B:</b>	<b>Analysis of QoE .....</b>	<b>52</b>
B.1	Introduction .....	52
B.2	Process .....	52
B.2.1	Collection of QoE .....	52
B.2.2	Weightiness of Selected QoE .....	52
B.3	Results .....	52
B.3.1	Collection of QoE .....	52
B.3.2	Comparison of Weightiness among Selected QoE Parameters .....	54
<b>Annex C:</b>	<b>Comparison with TS 102 250 of ETSI STQ Mobile .....</b>	<b>55</b>
C.1	Introduction .....	55
C.2	References .....	55
C.3	Comparison with 3GPP E2EMSPM and ETSI STQ Mobile .....	56
C.3.1	Research Scope .....	56
C.3.1.1	Framework .....	56
C.3.1.2	Quality of experience .....	56
C.3.1.3	End-to-End Service Quality of Service .....	57
C.3.1.4	System Quality of Service .....	57
C.3.1.5	Mapping of End-to-End Service QoS and System QoS .....	58
C.3.2	Research Method .....	58
C.3.2.1	Statistics Model Analysis .....	58
C.3.2.2	Theory Model Analysis of Queue .....	59
C.3.2.3	Possible Further Work .....	59
C.4	Brief Introduction of the Work in ETSI STQ .....	59
<b>Annex D:</b>	<b>Change history .....</b>	<b>60</b>
History	.....	61

---

# Foreword

This Technical Report has been produced by the 3GPP.

The contents of the present document are subject to continuing work within the TSG and may change following formal TSG approval. Should the TSG modify the contents of the present document, it will be re-released by the TSG with an identifying change of release date and an increase in version number as follows:

Version 3.y.z

where:

- x the first digit:
  - 1 presented to TSG for information;
  - 2 presented to TSG for approval;
  - 3 Indicates TSG approved document under change control.
- y the second digit is incremented for all changes of substance, i.e. technical enhancements, corrections, updates, etc.
- z the third digit is incremented when editorial only changes have been incorporated in the specification;

---

# Introduction

The Quality of Experience (QoE), End-to-end Service Quality of Service (ESQoS) and System Quality of Service (SQoS) are important factors when introducing services to customers. When the next releases of 3G are launched to the mass market, several new mobile telecommunication multimedia services will be introduced to the general public. It is essential that a high quality of service is experienced by the user of these new 3G services in order to promote the idea of 3G as a global all-purpose communication tool for millions of people with widespread availability of terminal equipment.

The possibility of using multimedia services via 3G in a practical and reliable manner is extremely important in the near future. For these new services, it is certain that a much larger amount of traffic is generated between mobile terminals and services, i.e. traffic within 3G networks and between 3G networks and other networks will be higher than has been the case to date. This gives more importance to service quality requirements.

End-to-end multimedia service performance metrics are proposed to make it possible for operators, device provider and service providers to more conveniently evaluate their service quality as perceived by end-users. This includes:

- Definition of the performance characteristics that have most relevance to end users (the 'Quality of Experience' or QoE).
- Definition of the mapping between QoE and end-to-end service measured characteristics (the ESQoS), and mapping between ESQoS and service specific characteristics (the SQoS).

In the present document a top-down approach is used to illustrate the framework of all metrics.

The present document gives metrics of the end-to-end multimedia service performance on 3G networks that support PSS, PSC, video telephony, MBMS and IMS services, etc.

QoE parameters describe the end-to-end quality as experienced by the end users. These are difficult to measure and quantify.

SQoS parameters are metrics that are close related to the network status, and defined from the viewpoint of the service provider rather than the service user. SQoS parameters can be viewed as the inherent attributes of the networks, which are important in guaranteeing QoE requirements of the users.

ESQoS parameters describe the QoS of the end-to-end service. They are obtained directly from the QoE parameters by mapping them into parameters more relevant to operators, service providers and service providers.

In Annex A, PSS is taken as an example; several general models looking at different part of network are given. A mapping between QoE, ESQoS and SQoS is given using a mathematical approach, which defines a dimensioned relationship between user experiences and lower tiers of network performance.



---

# 1 Scope

The present document describes and defines performance metrics for popular multimedia services in 3G networks, including packed-switched streaming service (PSS), multimedia broadcast multicast service (MBMS), video telephony (VT), and IP multimedia subsystem service (IMS). The present document has a top-down approach, which starts with the Quality of Experience (QoE) parameters and metrics, and then provides End-to-end Service QoS (ESQoS) and System Quality of Service (SQoS) parameters and metrics and mapping between these different layers.

---

# 2 References

The following documents contain provisions which, through reference in this text, constitute provisions of the present document.

- References are either specific (identified by date of publication, edition number, version number, etc.) or non-specific.
- For a specific reference, subsequent revisions do not apply.
- For a non-specific reference, the latest version applies. In the case of a reference to a 3GPP document (including a GSM document), a non-specific reference implicitly refers to the latest version of that document *in the same Release as the present document*.

- [1] 3GPP TS 23.107: "Technical Specification Group Services and System Aspects; Quality of Service (QoS) concept and architecture".
- [2] 3GPP TS 23.207: "Technical Specification Group Services and System Aspects; End-to-end Quality of Service (QoS) concept and architecture".
- [3] ETSI TS 102 250-2 V1.4.1 (2006-03): "Speech Processing, Transmission and Quality Aspects (STQ); QoS aspects for popular services in GSM and 3G networks; Part 2: Definition of Quality of Service parameters and their computation".
- [4] IETF RFC 2679: "A One-way Delay Metric for IPPM".
- [5] IETF RFC 3133: "Terminology for Frame Relay Benchmarking".
- [6] ITU-R Recommendation BS.1387-1: "Method for objective measurements of perceived audio quality".
- [7] 3GPP TS 26.234: "Technical Specification Group Services and System Aspects; Transparent end-to-end Packet-switched Streaming Service (PSS); Protocols and codecs".
- [8] 3GPP TS 26.346: "Technical Specification Group Services and System Aspects; Multimedia Broadcast/Multicast Service (MBMS); Protocols and codecs".
- [9] ITU-T Recommendation P.10/G.100: "Vocabulary for performance and quality of service".

---

# 3 Abbreviations

For the purposes of the present document, the following abbreviations apply:

AS	Application Server
BGCF	Breakout Gateway Control Function
BM-SC	Broadcast-Multicast - Service Centre
CBC	Cell Broadcast Centre
CSCF	Call Session Control Function
DHCP	Dynamic Host Configuration Protocol
DNS	Domain Name System
ESQoS	End-to-end Service QoS

GGSN	Gateway GPRS Support Node
HSS	Home Subscriber Server
I-CSCF	Interrogating-CSCF
IMS	IP Multimedia Subsystem
IP-CAN	IP-Connectivity Access Network
LAV	Least Acceptable Value
MBMS	Multimedia Broadcast/Multicast Service
MGCF	Media Gateway Control Function
MGW	Media GateWay
P-CSCF	Proxy-CSCF
PSC	Packet-Switched Conversational service
PSS	Packed-Switched Streaming service
QoE	Quality of Experience
QoS	Quality of Service
SQoS	System Quality of Service
UE	User Equipment
VLR	Visitor Location Register
VT	Video Telephony

---

## 4 General description and approach

### 4.1 Definitions

#### Quality of Experience (QoE)

The overall acceptability of an application or service, as perceived subjectively by the end-user (see notes 1 and 2).

NOTE 1: Quality of Experience includes the complete end-to-end system effects (client, terminal, network, services infrastructure, etc).

NOTE 2: Overall acceptability may be influenced by user expectations and context.

For the purpose of the present document, QoE is limited to those parameters that are reasonably expected to be under the control of the Service Provider, i.e. it excludes aspects of specific terminal equipment implementation. In the document, the exact E2E measurement point will be defined for each service.

QoE indicates performance metrics as expressed from the end service user's point of view. They can be required or reported by the common users, and may be stated irrespective of their measurability.

SA4 has defined Quality of Experience (QoE) metrics and their transport for PSS and MBMS in [7] and [8], respectively. The PSS and MBMS QoE metrics features are optional for both PSS and MBMS streaming server and clients, and shall not disturb the PSS and MBMS service. A PSS or MBMS client supporting the feature shall perform the quality measurements in accordance to the measurement definitions, aggregate them into client QoE metrics and report the metrics to the PSS or MBMS server using described procedures in [7] and [8] for PSS and MBMS, respectively. The way the QoE metrics are processed and made available is out of the scope of the present document.

In general, a Service Provider will set service requirements in line with the end-user's expected QoE, which needs to be translated into parameters or metrics that the service provider can control or measure. Thus, it is necessary to map QoE metrics to measurable End-to-end Service QoS and System QoS parameters, which provide the means for the service providers to guarantee the service quality.

#### End-to-end Service QoS (ESQoS)

ESQoS is generally used to specify the performance of services from the perspective of operators and service providers. As the number of new services proliferates and becomes more complex, it is important for an operator to measure a network's ESQoS accurately and continuously improve it to achieve customer loyalty and maintain competitive edge.

ESQoS is measurable. It can be quantified exactly by several digital parameters, unlike QoE.

### System Quality of Service (SQoS)

The concept of SQoS is a subset of conventional QoS, which is defined in ITU-T Recommendation E.800 as the collective effect of service performances which together determines the satisfaction of a user of a service. It is characterized by the combined aspects of performance factors applicable to all services, such as:

- service support performance;
- service operability performance;
- service accessibility performance;
- service retainability performance;
- service integrity performance;
- service security performance;

Compared with ESQoS, SQoS denotes the point-to-point QoS, which is specifically related to the units and links of network systems, rather than the whole service or a network. SQoS can be viewed as the QoS consideration from the viewpoint of network operators.

## 4.2 QoE parameters

From the user perspective, the QoE cannot be defined only from technical measurements. It should be defined by user investigation using the following methods:

1. Users provide an opinion of QoE only with their feeling and experience. The QoE metric is subjective.
2. With some classic indicators of QoE, users can make a decision to choose some of them as the necessary indicators of QoE.

Service performance is characterized by the following:

Because QoE parameters and metrics directly relate to the definition of the service itself, it is possible to map the components of the service onto measurable ESQoS and SQoS parameters or metrics, as these relate directly to the performance of the components of the service.

This concept can be illustrated by considering the example of a video service, where QoE includes items such as:

- service setup delay;
- re-buffering duration;
- end to end delay;
- corruption duration;
- mean time between corruption;
- content quality(e.g. digital TV-like quality, analog TV-like quality, DSL-like video conference quality ISDN-like video conference quality, etc.);
- audio/video synchronization (or 'lip sync');
- service availability.

Common user requirements for different services are therefore collected and classified as our QoE, disregarding the measurability.

Users have different requirements for different services. So the QoE for service analysis varies with the types of services, methods of delivery and points of monitoring.

Figure 1 shows the model.

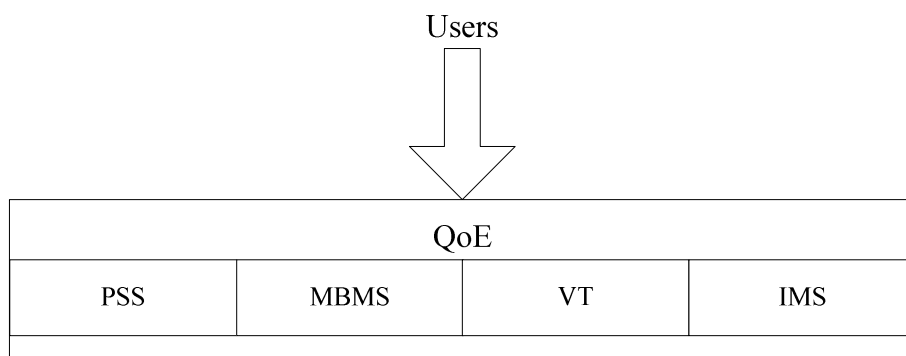

Figure 1: QoE

### 4.3 ESQoS parameters

As discussed, the user's definition of QoE does not consider measurability and so ESQoS parameters need to be introduced. These express QoS from the viewpoint of operators and service providers. ESQoS parameters are from end-to-end perspective, i.e. across the full set of components which together provide a service, and, most importantly can be measured and quantified.

ESQoS parameters depend on the type of service, and so there will be a set corresponding to each service.

Figure 2 shows the model including both the QoE and ESQoS aspects.

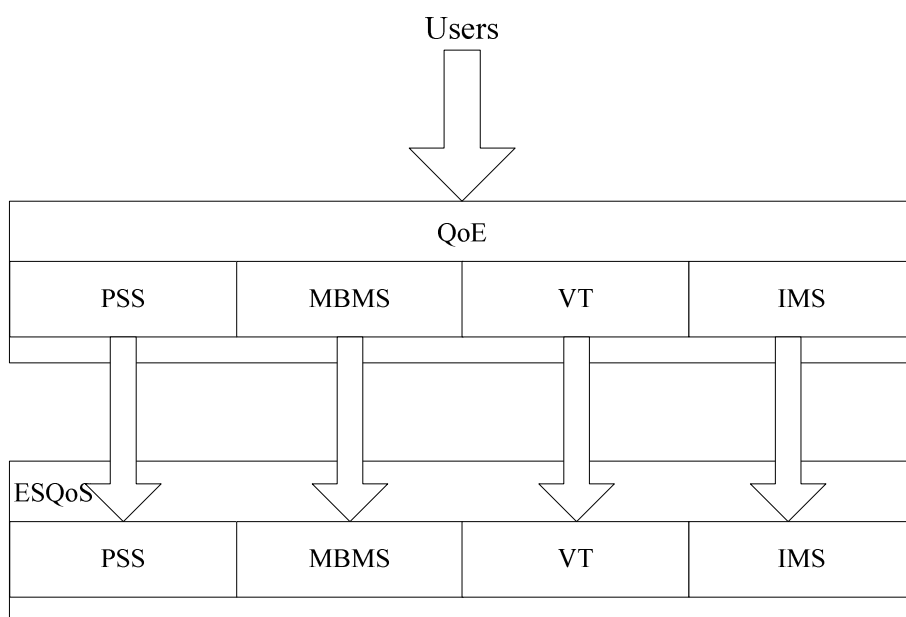

Figure 2: QoE and ESQoS parameters

### 4.4 SQoS parameters

The quality of a service perceived by the user is influenced by the network as well as by the terminal equipment. As the intelligence and complexity of an application used in 3G increases, application performance becomes an important factor in determining the quality perceived by the user. Within the present document, the influence of the terminal equipment and application have not been included.

Services are applications running on the common network components. SQoS parameters are specific metrics that provide measurements which reflect network component status, and are defined from the viewpoint of the service provider rather than the service user.

SQoS parameters can be classified to five classes as shown in figure 3.

NOTE: The network entities in the core network (CN) can be considered as servers.

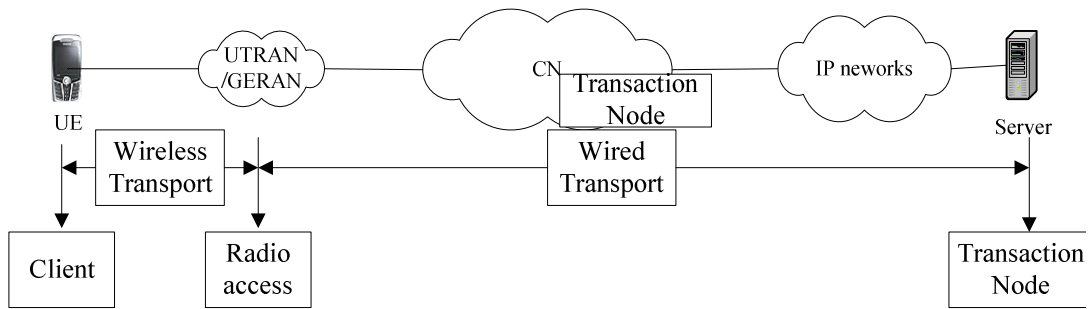

Figure 3: Five classes' scopes

Each class also has three layers which reflect the protocol layers in the network.

- The first is the Application layer.
- The second is the Transport layer.
- The third consists of Network, Data link and Physical layers.

Figure 4 presents the overall model.

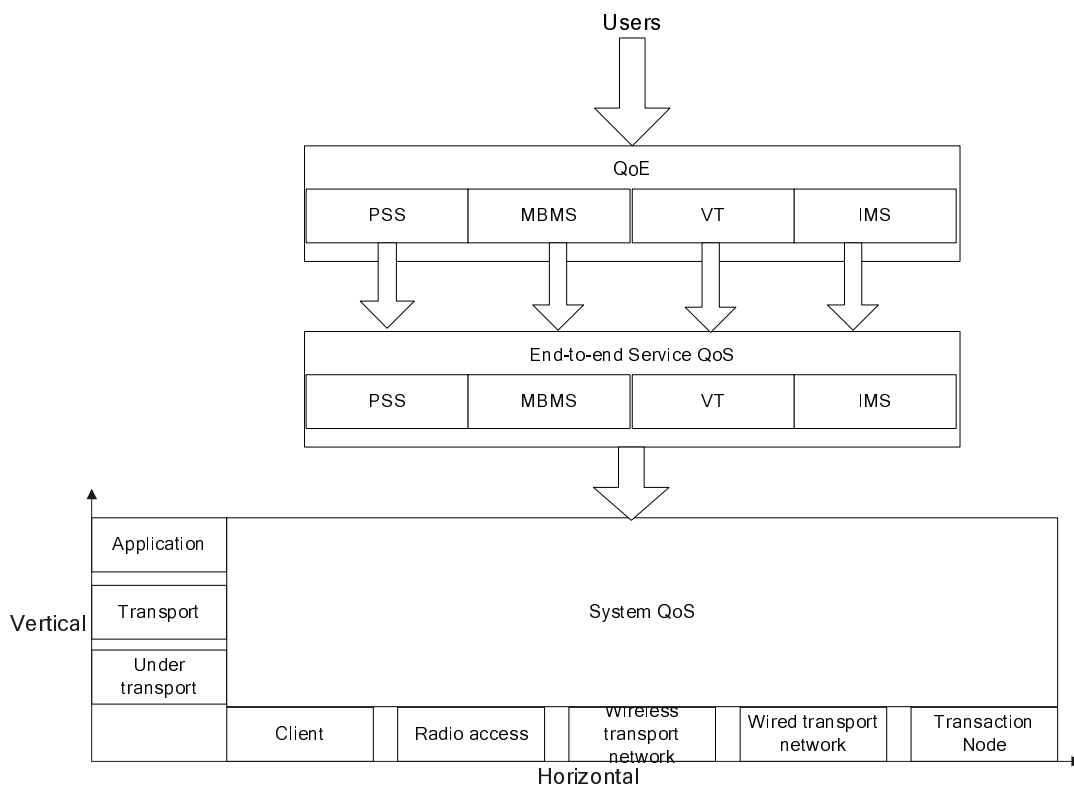

Figure 4: QoE, ESQoS and SQoS parameters

---

## 5 QoE parameters

### 5.1 General

The parameters and values in the following sections are necessary for the support of 3G services.

Firstly, for mobile communication systems, service performance depends on network availability factors expressed in terms of time availability (% of the time) and radio coverage availability (% of the radio coverage).

Service-specific QoE parameters may include, for the telephony service as an example, speech quality, level of background noise, level of echo, delay, etc. This section provides a parameter list for a Audio/Video service, each parameter would be calibrated on the following basis:

- 95 % probability;
- mean;
- target value;
- Least Acceptable Value (LAV).

This forms the basis of candidate material for standardization, and must be aligned with the work of the ITU-T.

### 5.2 Service non-access

The service cannot be accessed by the UE when requested by the user. The service non-access may be caused by the network unavailability or shutdown of service server, etc.

### 5.3 Service failure

The service can be accessed, but something occurs once the service is in use resulting in failure of service for the user. The service failure may be caused by overload of server, handoff of user or network congestion, etc.

### 5.4 Service setting-up time

The service setting-up time is the period from the time of service request to the time of service playing. The service setting-up time may vary from microsecond to seconds, and depends on the service requested by the user.

### 5.5 Re-buffering

Re-buffering denotes the time and the frequency of re-buffering during the usage of service. The main reason of re-buffering is the data network transmission rate cannot keep up with the real-time play requirements of the user's terminal.

### 5.6 Image corruption

Image corruption refers to the degree of corruption quality of a single image.

### 5.7 Edge noise

Edge Noise denotes the form of edge busyness that is characterized by spatially varying distortion that occurs in close proximity to the edges of objects in a video display.

## 5.8 Blurriness

Blurriness denotes the image/video quality as being indistinct.

## 5.9 Colour reproduction accuracy

Colour reproduction denotes the quality of accuracy in colour reproduction procedure.

## 5.10 Blockiness

Blockiness refers to the degree of image distortions that occurs in DCT-block edge compression due to compression error or packet loss.

## 5.11 Incontinuous image with block

Incontinuous image with block denotes the degree of data block consistency among continuous frames.

## 5.12 Freeze image

Freeze image refers to the degree of frozen image when video is playing, which is caused by inadequate received data or low frame transmission rate.

## 5.13 Audio quality

Audio quality describes the quality of audio as perceived by the user and mainly is decided by the codec algorithm, network transmission delay and capacity of terminal.

## 5.14 Audio/Video synchronization error

Audio/video synchronization error describes the time difference of the audio and video signal at the user side. Audio/video synchronization error is mainly caused by the network transmission delay and buffering delay.

---

# 6 ESQoS parameters

## 6.1 General

The ESQoS parameters can be obtained directly from the QoE. The process is shown in figure 5.

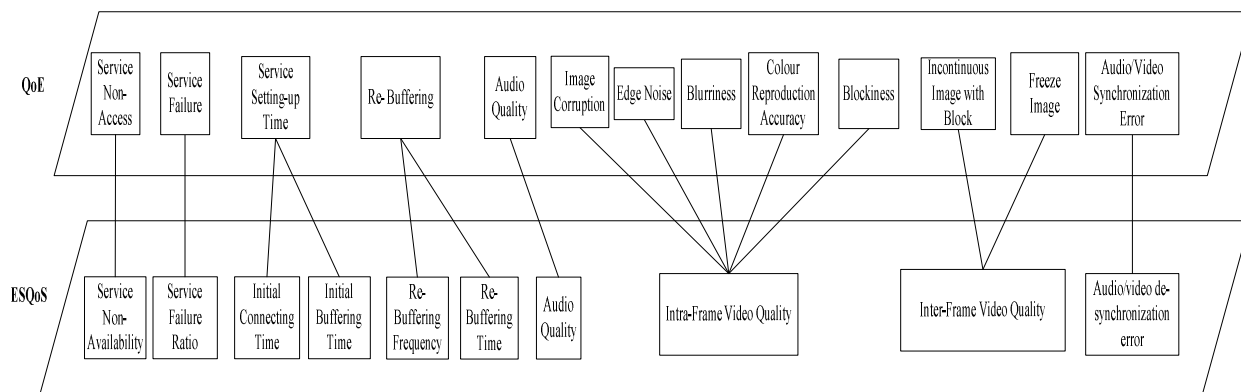

Figure 5: The ESQoS parameters from QoE

There are perfect and reasonable definitions of service QoS parameters in the TS 102 250-2 [3] of ETSI STQ Mobile. Parts of the outputs of TS 102 250-2 [3] are introduced to E2EMSPM's End-to-End Service QoS area for reference.

## 6.2 Service non-availability

### 6.2.1 Abstract definition

The Service Non-Availability describes the probability that the first data packet of the stream cannot be received by the UE when requested by the user. The "packet reception" is completed by appearance of the "buffering" message on the player at user side.

### 6.2.2 Equation

$$\text{Streaming Service Non - Availability [\%]} = \frac{\text{unsuccessful stream request attempts}}{\text{all stream request attempts}} \times 100 \%$$

### 6.2.3 Trigger point

Event from abstract equation	Trigger point from customer's point of view	Technical description / protocol part
Service access attempt	Start: Stream request	Start: RTSP: Setup
Successful attempt	Stop: "Buffering" message	Stop: Reception of first data packet
Unsuccessful attempt	Stop trigger point not reached.	

NOTE: The main causes of Service unavailable are:

- 1) Radio access is blocked or failed.
- 2) Transport network is busy or failed.
- 3) A server is busy or failed.

This parameter also depends on the connecting time limitation of the client.

## 6.3 Service failure ratio

### 6.3.1 Abstract definition

The Service Failure Ratio describes the probability that the service cannot be available for the UE of the user once the service is running. The typical case of "service failure" is by appearance of unexpected interruption of video or/and audio.

### 6.3.2 Equation

$$\text{Service Failure Ratio} = \frac{\text{times of incomplete service provision}}{\text{all successful service connections}} \times 100 \%$$



### 6.3.3 Trigger point

Event from abstract equation	Trigger point from customer's point of view	Technical description / protocol part
Service connection succeed	Start: "Buffering" message	Start: Reception of the first data packet
Complete service provisioning	Stop: service provisioning is over	Stop: Reception of the last data packet
incomplete service provisioning	Stop trigger point not reached.	

NOTE: The main causes of Service Failure are:

- 1) Network congestion.
- 2) Inadequate UE resources.
- 3) Some servers are failed.

## 6.4 Initial connection time

### 6.4.1 Abstract definition

The Initial Connection Time describes the time period needed to complete the establishment of service session.

### 6.4.2 Equation

$$\text{Initial Connection Time} = t_{\text{reception of first data packet}} - t_{\text{service request}}$$

### 6.4.3 Trigger Point

Event from abstract equation	Trigger point from customer's point of view	Technical description / protocol part
Time when service is requested	Start: Service request	Start: RTSP: Setup
Time when first data packet is received	Stop: "buffering" message	Stop: Reception of first data packet

## 6.5 Initial buffering time

### 6.5.1 Abstract definition

The Initial Buffering Time describes the interval from the time of reception of first data packet to the time of service playing.

### 6.5.2 Equation

$$\text{Initial Buffering Time} = t_{\text{service playing}} - t_{\text{reception of first data packet}}$$

### 6.5.3 Trigger Point

Event from abstract equation	Trigger point from customer's point of view	Technical description / protocol part
Time when first data packet is received	Start: "buffering" message	Start: Reception of first data packet
Time when service is playing	Stop: Video / Audio playing	Stop: The number of received packet reaches the threshold to play the service

## 6.6 Re-buffering frequency

### 6.6.1 Abstract definition

The Re-Buffering Frequency describes the times of occurrence of re-buffering during the service is provisioning.

### 6.6.2 Equation

$$\text{Re - Buffering Frequency} = \frac{\text{times of re - buffering}}{\text{total time of service provision}}$$

### 6.6.3 Trigger point

Event from abstract equation	Trigger point from customer's point of view	Technical description / protocol part
Times of occurrence of re-buffering	The number of "buffering" messages	The buffer for the service is empty
Total time of service provisioning	The total time of playing	The period of data transmission for service

## 6.7 Re-buffering time

### 6.7.1 Abstract definition

The Re-Buffering Time describes the average time of an event of re-buffering during the service is provisioning.

### 6.7.2 Equation

$$\text{Re - Buffering Time} = \frac{\text{total time of re - buffering}}{\text{total times of re - buffering}}$$

### 6.7.3 Trigger point

Event from abstract equation	Trigger point from customer's point of view	Technical description / protocol part
Total time of re-buffering	The total show time of "buffering" message	The time from buffer is empty to the packet of the buffer reaches the threshold of service provisioning
Times of occurrence of re-buffering	The number of "buffering" messages	The buffer for the service is empty

## 6.8 Audio quality

### 6.8.1 Abstract definition

The parameter Audio Quality describes the audio quality as perceived by the end-user.

ITU-R has defined an algorithm defined for audio information. It can be found in [6].

### 6.8.2 Equation

To be defined.

### 6.8.3 Trigger point

Event from abstract equation	Trigger point from customer's point of view	Technical description / protocol part
to be determined	Start: Begin of audio service reproduction	Start: Service players signal when the reproduction of the service starts
to be determined	Stop: End of audio service reproduction	Stop: RTSP: TEARDOWN

## 6.9 Intra-frame video quality

### 6.9.1 Abstract definition

The parameter Inter-Frame Video Quality measures the quality within a single video frame. It is noted that a standardized algorithm for the evaluation of intra-frame video quality does not exist, and further study is needed. In this document, PSNR is used to denote the intra-frame video quality.

### 6.9.2 Equation

$$Dist_n = \sum_i \sum_k MSE(x_{i,k}, y_{i,k})$$

$$PSNR = \frac{(\sum_n 10 \log_{10}(255 \times 255 / Dist_n))}{N}$$

where  $x_{i,k}$  and  $y_{i,k}$  are the pixel values of the  $n^{\text{th}}$  original and reconstructed frames, respectively,  $N$  is the total number of frames, and  $MSE(a,b)$  is the mean square error between value  $a$  and  $b$ , i.e.,  $MSE(a,b) = (a-b)^2$ .

### 6.9.3 Trigger point

Event from abstract equation	Trigger point from customer's point of view	Technical description / protocol part
to be determined	Start: Begin of video service reproduction	Start: Service players signal when the reproduction of the service starts
to be determined	Stop: End of video service reproduction	Stop: RTSP: TEARDOWN

## 6.10 Inter-frame video quality

### 6.10.1 Abstract definition

The parameter Inter-Frame Video Quality measures the quality of continuous video frames. It is noted that a standardized algorithm for the evaluation of inter-frame video quality does not exist, and further study is needed. In this document, standard deviation of PSNR (STD\_PSNR) is used to denote the inter-frame video quality.

### 6.10.2 Equation

$$STD\_PSNR = \sqrt{\frac{\sum_n (PSNR_n - PSNR)^2}{N}}$$

This metric captures the variability of PSNR over the entire video sequence.

### 6.10.3 Trigger point

Event from abstract equation	Trigger point from customer's point of view	Technical description / protocol part
to be determined	Start: Begin of video service reproduction	Start: Service players signal when the reproduction of the service starts
to be determined	Stop: End of video service reproduction	Stop: RTSP: TEARDOWN

## 6.11 Audio/Video de-synchronization error

### 6.11.1 Abstract definition

The parameter Audio/Video De-Synchronization Error describes the percentage of time difference of the audio and video signal at the user side exceeds a predefined threshold.

### 6.11.2 Equation

$$\text{Audio/Video De - Synchronizatin Error} = \frac{\text{total time of audio/video de - synchronization}}{\text{total time of service provision}}$$

### 6.11.3 Trigger point

Event from abstract equation	Trigger point from customer's point of view	Technical description / protocol part
Total time of audio/video de-synchronization	Accumulative time that audio/video is de- synchronous	Difference of the audio and video signal exceeds a predefined threshold
Total time of service provisioning	The total time of playing	The period of data transmission for service

---

## 7 SQoS parameters

### 7.1 SQoS parameters of each layer

SQoS parameters are defined according to one of three layers (Application, Transport and sub-Transport) as well as the network structure, SQoS parameters are first classified according to the layers.

Some parameters are selected according to protocol layers and give the definitions of each parameter. Most of the definitions are cited from documents of standards.

#### 7.1.1 Application

##### 7.1.1.1 Frame rate

Definition: The playing rate of frames, i.e. 30 frame/sec denotes a playing of 30 frames in one second.

##### 7.1.1.2 Frame loss ratio

Definition: Frame loss ratio indicates the extent of frame loss between the sender and receiver. Frame loss ratio=number of the unreceived frames / number of all sending frames.

##### 7.1.1.3 Frame error ratio

Definition: Frame error ratio=number of all error frame received/ number of all frames sent.

##### 7.1.1.4 Transaction rate

Definition: The average rate for servers to transact the data packet. Those servers may include: SGSN, GGSN, VLR, HLR, AuC, web server, media server, etc.

##### 7.1.1.5 Transaction delay

Definition: The sum of the time for a data packet to wait in queue and receive the service during the server transaction.

#### 7.1.2 Transport

##### 7.1.2.1 Bandwidth

Definition: The quantity of data transmitted per unit time in the network, usually expressed as bps.

##### 7.1.2.2 Transfer delay

Definition:  $dT$ , the transfer delay from Src to Dst at time  $T$  is defined by the statement: Src sent the first bit of a unit data to Dst at wire-time  $T$  and that Dst received the last bit of that packet at wire-time  $T+dT$ .

NOTE: If the transfer delay from Src to Dst at  $T$  is undefined (informally, infinite), this means that Src sent the first bit of a unit data to Dst at wire-time  $T$  and that Dst did not receive that unit data [4].

##### 7.1.2.3 Jitter

Definition: The differential time between the packet actual arrival time and its expected arrival time according to a standard clock.

##### 7.1.2.4 Packet loss ratio

Definition: Packet loss ratio=the number of unreceived packets/the number of packets sent.

### 7.1.2.5 Packet error ratio

Definition: Packet error ratio the number of received frames that contain an error in the frame payload divided by the total number of transmitted frames.

## 7.1.3 Sub-transport

### 7.1.3.1 Frame loss ratio

Definition: Frame loss ratio= the number of unreceived frames/the number of all sending frames.

### 7.1.3.2 Residual frame error ratio

Definition: The residual frame error ratio is the number of undetected error frames divided by the total number of transmitted frames in one direction of a single virtual connection.

### 7.1.3.3 Frame discard ratio

Definition: The number of received frames that are discarded because of a frame error divided by the total number of transmitted frames in one direction of a single virtual connection. Frame errors are defined as follows:

- 1) Frames those are too long or too short;
- 2) Frames that are not a multiple of 8 bits in length;
- 3) Frames with an invalid or unrecognized DLCI;
- 4) Frames with an abort sequence;
- 5) Frames with improper flag delimitation;
- 6) Frames that fail FCS [5].

### 7.1.3.4 Residual bit ratio

Definition: Indicates the undetected bit error ratio in the delivered SDUs. If no error detection is requested, Residual bit error ratio indicates the bit error ratio in the delivered SDUs [1].

### 7.1.3.5 Access delay

Definition: The delay time in queue of the station waiting for base station to assign a channel.

### 7.1.3.6 Block ratio

Definition: The frequency of channel arrangement request failure.

### 7.1.3.7 Soft handoff rate

Definition: The average rate for clients to handoff from one district to another.

## 7.2 SQoS parameters of each class

Some SQoS parameters are selected that is important enough for the five classes as table 1.

Table 1: SQoS parameters of each class

Class	SQoS parameters
Client	1) Frame rate 2) Frame loss ratio 3) Frame error ratio
Radio access network	1) Access delay 2) Soft handoff rate 3) Block ratio
Wireless transport network	1) Bandwidth 2) Transfer delay 3) Jitter 4) Packet loss ratio 5) Frame loss ratio 6) Frame error ratio 7) Frame discard ratio 8) Residual bit error ratio
Wired transport network	1) Bandwidth 2) Transfer delay 3) Jitter 4) Packet loss ratio 5) Frame loss ratio 6) Frame error ratio 7) Frame discard ratio 8) Residual bit error ratio
Transaction Node	1) Transaction rate 2) Transaction delay 3) Transaction capacity

### 7.3 SQoS parameters of each service

The general applicable SQoS parameters for each service (IMS, MBMS, PSS, and Video Telephone) are listed in table 2 according to both class and layers. A specific list of transaction node SQoS of each service is listed in table 3.

**Table 2: General applicable SQoS parameters for service**

Applicable SQoS parameters of IMS, MBMS,PSS, VT class		
Client	Application Layer	Frame rate Frame loss ratio, Frame error ratio
	Transport Layer Under transports	
Radio access network	Application Layer	
	Transport Layer Under transports	Block ratio
Wireless transport Network	Application Layer	Access delay
	Transport Layer	Soft handoff rate
Wired transport Network	Application Layer	Bandwidth Transfer Delay Jitter Packet loss ratio
	Transport Layer	Frame loss ratio, Frame error ratio, Frame discard ratio, Residual bit error ratio
Transaction Node	Application Layer	Bandwidth Transfer Delay
	Transport Layer	Jitter Packet loss ratio
Transaction Node	Application Layer	Frame loss ratio, Frame error ratio, Frame discard ratio, Residual bit error ratio
	Transport Layer	Transaction rate Transaction delay Transaction capacity
	Under transports	

The SQoS metrics of each service are different in the transaction node class.

**Table 3: Specific SQoS parameters for transaction node of each service**

Service and SQoS	PSS	IMS	MBMS	Video Telephony
Applicable Functional Entity	Base Station, SGSN, GGSN, VLR, HLR, AuC, web server, media server	Base Station, SGSN,GGSN, VLR, HLR, AuC,,IP-CAN,P-CSCF,I-CSCF,S-CSCF,HSS,DHC P,DNS,MGW,MGCF,BGCF,AS,MRFC,MRFP	Base Station, SGSN, GGSN, VLR, HLR, AuC, BM-SC, CBC, Data Sources and Content Provider	Base Station, SGSN,GGSN, VLR, HLR, AuC, MGW
SQoS Parameter	1)Transaction rate 2)Transaction delay 3) Transaction capacity			

## 8 Mapping between ESQoS and SQoS

### 8.1 General

Firstly, a general mapping between ESQoS and SQoS parameters for all the new services is presented, and then the specific characters of them are given.



Table 4: the ESQoS and SQoS parameters mapping

ESQoS			Service Non-Availability	Service failure ratio	Initial connection time	Initial buffering time	Rebuffering frequency	Rebuffering time	Audio quality	Intra-frame/inter-frame Video quality	Audio/video de-synchronization error
<b>SQoS</b>											
<b>Client</b>	Application	Frame rate Frame loss ratio, Frame error ratio				√	√ √ √	√ √ √	√ √ √	√ √ √	√ √ √
	Under transports										
<b>Radio access network</b>	Application										
	Under transports	Block ratio Access delay Soft handoff rate	√	√	√	√	√	√	√	√	√
<b>Wireless transport Network</b>	Application										
	Under transports	Bandwidth Transfer Delay Jitter Packet loss ratio	√	√	√ √	√ √	√ √ √ √	√ √ √ √	√ √ √ √	√ √ √ √	√ √ √ √
	Application										
	Under transports	Frame loss ratio, Frame error ratio, Frame discard ratio, Residual bit error ratio					√	√	√	√	√
<b>Wired transport Network</b>	Application										
	Under transports	Bandwidth Transfer Delay Jitter Packet loss ratio	√	√	√ √	√ √	√ √ √ √	√ √ √ √	√ √ √ √	√ √ √ √	√ √ √ √
	Under transports	Frame loss ratio, Frame error ratio, Frame discard ratio, Residual bit error ratio					√	√	√	√	√

ESQoS				Service Non-Availability	Service failure ratio	Initial connection time	Initial buffering time	Rebuffering frequency	Rebuffering time	Audio quality	Intra-frame/inter-frame Video quality	Audio/video de-synchronization error	
SQoS													
Transaction Node	Application	Base Station	Transaction rate	√	√	√	√	√	√	√	√	√	
			Transaction delay			√	√	√	√	√	√	√	√
			Transaction capacity	√	√								
	SGSN	Transaction rate	√	√	√	√	√	√	√	√	√	√	
		Transaction delay			√	√	√	√	√	√	√	√	
		Transaction capacity	√	√									
	GGSN	Transaction rate	√	√	√	√	√	√	√	√	√	√	
		Transaction delay			√	√	√	√	√	√	√	√	
		Transaction capacity	√	√									
	HLR	Transaction rate	√	√	√	√	√	√	√	√	√	√	
		Transaction delay			√	√	√	√	√	√	√	√	
		Transaction capacity	√	√									
	VLR	Transaction rate	√	√	√	√	√	√	√	√	√	√	
		Transaction delay			√	√	√	√	√	√	√	√	
		Transaction capacity	√	√									
AuC	Transaction rate	√	√	√	√	√	√	√	√	√	√		
	Transaction delay			√	√	√	√	√	√	√	√		
	Transaction capacity	√	√										

## 8.2 PSS

The specific transaction nodes that PSS involves are HLR, VLR, AuC, web servers and media servers, so these nodes are listed in table 5.

**Table 5: the ESQoS and SQoS parameters mapping of PSS**

ESQoS				Service Non-Availability	Service failure ratio	Initial connection time	Initial buffering time	Rebuffering frequency	Rebuffering time	Audio quality	Intra-frame/inter-frame Video quality	Audio/video de-synchronization error	
SQoS													
Transaction Node	Application	Web server	Transaction rate	√		√							
			Transaction delay			√							
			Transaction capacity	√									
	Media server	Transaction rate		√	√	√	√	√	√	√	√	√	
		Transaction delay			√	√	√	√	√	√	√	√	
		Transaction capacity		√									

### 8.3 MBMS

The specific transaction nodes that MBMS involves are BM-SC, CBC, Data Sources and Content Provider, so these nodes are listed in table 6.

**Table 6: the ESQoS and SQoS parameters mapping of MBMS**

ESQoS				Service Non-Availability	Service failure ratio	Initial connection time	Initial buffering time	Rebuffering frequency	Rebuffering time	Audio quality	Intra-frame/inter-frame Video quality	Audio/video de-synchronization error
SQoS	Application	Transaction Node	ESQoS									
		BM-SC	Transaction rate	√		√						
			Transaction delay			√						
		CBC	Transaction capacity	√								
			Transaction rate	√		√						
			Transaction delay			√						
			Transaction capacity	√								
		Data Sources	Transaction rate	√		√						
			Transaction delay			√						
			Transaction capacity	√								
		Content Provider	Transaction rate		√	√	√	√	√	√	√	√
			Transaction delay			√	√	√	√	√	√	√
			Transaction capacity		√							

## 8.4 Video telephony

The specific transaction nodes that Video Telephony involves are VLR and MGW, so these nodes are listed in table 7.

**Table 7: the ESQoS and SQoS parameters mapping of VT**

ESQoS				Service Non-Availability	Service failure ratio	Initial connection time	Initial buffering time	Rebuffering frequency	Rebuffering time	Audio quality	Intra-frame/inter-frame Video quality	Audio/video de-synchronization error
SQoS												
Transaction Node	Application	MGW	Transaction rate	√		√						
			Transaction delay			√						
			Transaction capacity	√								

## 8.5 IMS

The specific transaction nodes that IMS involves are HLR, VLR, AuC, IP-CAN, P-CSCF, I-CSCF, S-CSCF, HSS, DHCP, DNS, MGW, MGCF, BGCF, AS, MRFC and MRFP, so these nodes are listed in table 8.

Table 8: the ESQoS and SQoS parameters mapping of IMS

ESQoS				Service Non-Availability	Service failure ratio	Initial connection time	Initial buffering time	Rebuffering frequency	Rebuffering time	Audio quality	Intra-frame/inter-frame Video quality	Audio/video de-synchronization error	
SQoS													
Transaction Node	Application	IP-CAN	Transaction rate	√		√							
			Transaction delay			√							
		P-CSCF	Transaction capacity	√									
			Transaction rate	√		√							
			Transaction delay			√							
			Transaction capacity	√									
		I-CSCF	Transaction rate	√		√							
			Transaction delay			√							
			Transaction capacity	√									
			Transaction rate	√		√							
		S-CSCF	Transaction delay			√							
			Transaction capacity	√									
		HSS	Transaction rate	√		√							
			Transaction delay			√							
			Transaction capacity	√									
			Transaction rate	√		√							
		DHCP	Transaction delay			√							
			Transaction capacity	√									
		DNS	Transaction rate	√		√							
			Transaction delay			√							
	Transaction capacity	√											
	Transaction rate	√		√									
MGW	Transaction delay			√									
	Transaction capacity	√											
MGCF	Transaction rate	√		√									
	Transaction delay			√									
	Transaction capacity	√											
	Transaction rate	√		√									
BGCF		Transaction rate	√		√								

ESQoS				Service Non-Availability	Service failure ratio	Initial connection time	Initial buffering time	Rebuffering frequency	Rebuffering time	Audio quality	Intra-frame/inter-frame Video quality	Audio/video de-synchronization error
SQoS												
			Transaction delay			√						
		AS	Transaction capacity	√								
			Transaction rate	√		√						
			Transaction delay			√						
		MRFC	Transaction capacity	√								
			Transaction rate	√		√						
			Transaction delay			√						
		MRFP	Transaction capacity	√								
			Transaction rate	√		√						
			Transaction delay			√						
			Transaction capacity	√								

---

# Annex A: PSS Performance Analysis with Theoretical Models

## A.1 Introduction

The "End-to-end Multimedia Services Performance Metrics" work item is conducting a research on the performance metrics for popular multimedia services, including streaming, multimedia broadcast multicast service (MBMS), video telephony and IP Multimedia subsystem Service (IMS), etc. This annex will support and justify the results in the present document.

In this annex, the performance evaluation for end-to-end multimedia services based on System QoS (SQoS) and end-to-End Service QoS (ESQoS) parameters is conducted, to provide the possible operational methods for operators/service providers to guarantee the quality of the provided services. The quantitative study of ESQoS and SQoS parameters would benefit both operators/service providers and end users as well. It would offer models and metrics for operators/service providers to better manage network capacity and deploy services. It would also guide operators/service providers to provide the best service in limited bandwidth with little latency and packet loss.

In this annex, packet-switched streaming service is taken as an example.

---

## A.2 Scope

Theoretical models are introduced to study the ESQoS and SQoS parameters. The inherent relationship between the ESQoS and SQoS parameters of PSS is described, which provide the possible operational methods for the operators/service providers to guarantee of the service performance.

First, some general models are proposed to study the performance parameters of the multimedia services. Then, the accurate and concrete models are created to figure out the relationships of the ESQoS and SQoS parameters.

Further, these methods and models can be extended to other multimedia services.

---

## A.3 References

The following documents contain provisions which, through reference in this text, constitute provisions of the present document.

- References are either specific (identified by date of publication, edition number, version number, etc.) or non-specific.
- For a specific reference, subsequent revisions do not apply.
- For a non-specific reference, the latest version applies. In the case of a reference to a 3GPP document (including a GSM document), a non-specific reference implicitly refers to the latest version of that document *in the same Release as the present document*.

[1] CACC, Department of ECE, Duke University, Kishor S. Trivedi, Dharmaraja Selvamuthu, Xiaomin Ma: "Analytic Modeling of Handoffs in Wireless Cellular Networks", 2002.

[2] MISCHA SCHWARTZ, broadband integrated networks, Prentice Hall, 1996.

[3] Lin C. Performance evaluation of computer networks and computer systems, Tsinghua University Press, 2001.

## A.4 General models

Three classes of general models are presented including radio access network modelling, transport network modelling, node modelling. And there are two types of node models: simple node model and complex node model. These models can be used to study the performance metrics of various multimedia services and the network conditions. In this annex, queuing models are introduced to get the metrics, including the delay, failure ratio and loss ratio.

### A.4.1 Radio access network model

Some analytical models are introduced for the radio access network to evaluate some important parameters, such as the block ratio of new calls, the failure ratio of handoff calls.

#### A.4.1.1 Model description

As an example, a queuing model can be used for Streaming Service in the access cell [1].

The new calls and handoff calls share a fixed numbers of channels in the cell, and the left channels are reserved. A new call will be connected if an idle channel is available among the sharing channels, otherwise the call is blocked. A handoff call will be connected if an idle channel is available in the cell, otherwise the call is failed.

For simplicity, assume that the arrival stream of new calls, the stream of handoff arrivals, the channel holding time for new calls and handoff calls are all of exponential distributions. Besides, the model also considers the platform failure and the base repeater failure. All failures are assumed to be mutually independent. Times to platform and base repeater failures and repair are assumed to be exponentially distributed.

The parameters' definitions are as follows:

$\lambda_n$ :	the rate of arrival stream of new calls.
$\lambda_h$ :	the rate of stream of handoff arrivals.
$\mu_c$ :	the channel holding time for new calls.
$\mu_n$ :	the channel holding time for handoff calls.
$N_b$ :	the number of the base repeaters in the cell.
$M$ :	the channel number of each base repeater.
$g$ :	the reserved resources.
$\frac{1}{\lambda_s}$ :	mean time of platform failure.
$\frac{1}{\mu_s}$ :	mean time of platform repair.
$\frac{1}{\lambda_b}$ :	mean time of base repeater failure.
$\frac{1}{\mu_b}$ :	mean time of base repeater repair.

Now the system can be basically modelled as a queue, which can be presented by a Markov chain.

Solving the model, the block ratio of new calls and the failure ratio of handoff calls can be easily obtained.



### A.4.1.2 The block ratio of new calls and the failure ratio of handoff calls

Let:

$$\lambda = \lambda_n + \lambda_h$$

$$\mu = \mu_c + \mu_h$$

$$A = \frac{\lambda}{\mu}$$

$$A_1 = \frac{\lambda_h}{\mu_c + \mu_h}$$

Solving the Markov chain, it can be obtained:

$$P_d(N, g) = \frac{\frac{A^{N-g}}{N!} A_1^g}{\sum_{n=0}^{N-g-1} \frac{A^n}{n!} + \sum_{n=N-g}^N \frac{A^{N-g}}{n!} A_1^{n-(N-g)}}$$

$$P_b(N, g) = \frac{\sum_{n=N-g}^N \frac{A^{N-g}}{n!} A_1^{n-(N-g)}}{\sum_{n=0}^{N-g-1} \frac{A^n}{n!} + \sum_{n=N-g}^N \frac{A^{N-g}}{n!} A_1^{n-(N-g)}}$$

$$= A^{N-g} \frac{\sum_{k=0}^g \frac{A_1^k}{(k+N-g)!}}{\sum_{n=0}^{N-g-1} \frac{A^n}{n!} + \sum_{n=N-g}^N \frac{A^{N-g}}{n!} A_1^{n-(N-g)}}$$

$$P(s, k; N_b) = \begin{cases} \frac{\lambda_s}{\lambda_s + \mu_s} \frac{1}{k!} \left( \frac{\mu_b}{\lambda_b} \right)^k \left[ 1 + \sum_{j=1}^{N_b} \frac{1}{j!} \left( \frac{\mu_b}{\lambda_b} \right)^j \right]^{-1}, & \text{if } s=0, \\ \frac{\mu_s}{\lambda_s + \mu_s} \frac{1}{k!} \left( \frac{\mu_b}{\lambda_b} \right)^k \left[ 1 + \sum_{j=1}^{N_b} \frac{1}{j!} \left( \frac{\mu_b}{\lambda_b} \right)^j \right]^{-1}, & \text{if } s=1. \end{cases}$$

$$\bar{A}(N_b) =$$

$$\begin{cases} \sum_{k=0}^{N_b} P(0, k; N_b) + \sum_{k=0}^{N_b} P(1, k; N_b) \frac{N_b - k}{N_b}, & \text{w/o APS} \\ \sum_{k=0}^{N_b} P(0, k; N_b) + P(1, 0; N_b), & \text{w/ APS.} \end{cases}$$

$$\begin{aligned}
P_b^o(N_b, M, g) &= \bar{A}(N_b) \\
&+ \begin{cases} \mathbf{1}(G > 0) \sum_{k=1}^G P(1, k; N_b) \left(\frac{k}{N_b}\right) \\ + \sum_{k=G+1}^{N_b} P(1, k; N_b) P_b(kM - 1, g) \left(\frac{k}{N_b}\right), & \text{w/o APS} \\ \mathbf{1}(G > 0) \sum_{k=1}^G P(1, k; N_b) \\ + \sum_{k=G+1}^{N_b} P(1, k; N_b) P_b(kM - 1, g), & \text{w/ APS} \end{cases} \\
P_d^o(N_b, M, g) &= \bar{A}(N_b) \\
&+ \begin{cases} \sum_{k=1}^{N_b} P(1, k; N_b) P_d(kM - 1, g) \frac{k}{N_b}, & \text{w/o APS} \\ \sum_{k=1}^{N_b} P(1, k; N_b) P_d(kM - 1, g), & \text{w/ APS.} \end{cases}
\end{aligned}$$

Where  $\mathbf{I}(e)$  is the indicator function:  $\mathbf{I}(e) = 1$  if expression  $e$  is true; otherwise  $\mathbf{I}(e) = 0$ ;

$$G = \lfloor (g+1)/M \rfloor;$$

$P_b^o(N_b, M, g)$  is the block ratio of new calls and  $P_d^o(N_b, M, g)$  is the failure ratio of handoff calls.

## A.4.2 Transport network model

There are two types of network: wireless network and wired network. First the average transfer delay of a packet in the wired network is analyzed. In the transfer delay model, the transfer time is ignored. Then consider the transfer time of a amount of data in the whole transport network.

The transport network is very complex and to get the transfer delay of a packet is not so easy. For simplicity, the transport network with a Jackson network is modeled and the average transfer delay of a packet is analyzed [2].

### A.4.2.1 Model description

It is assumed that the packet switching network as a Jackson network to analysis the average transfer delay of a packet in the network.

- $\gamma$  : The total load of the network from outside.
- $\lambda_i$  : The load on link  $i$ .
- $L$  : The number of links in the network.
- $M$  : The average length of a packet.
- $R_i$  : The data transport rate of link  $i$ .

The analysis to the transfer time is very simple. The parameters used are as follows.

- $D$  : The size of the data to be transported.
- $d_{wireless}$  : The mean bandwidth in wireless network.

$d_{wired}$  The mean bandwidth in wired network.

### A.4.2.2 The mean transfer delay and the transfer time

Solving the transfer delay model, it can be obtained:

$$T_{tran\_delay} = \frac{1}{\gamma} \sum_{i=1}^L \frac{M}{R_i - M \lambda_i}$$

$T_{tran\_delay}$  is the mean transfer delay of a packet over the network.

It can be easily to get the transfer time:

$$T_{tran\_time} = \frac{D}{d_{wireless}} + \frac{D}{d_{wired}}$$

$T_{tran\_time}$  is the transfer time of data D over the wireless and wired transport network.

## A.4.3 Node model

The work "node" there means all the entities handling data in the network including the gateway, router, and server. There are four class of traffic in the network according to 3GPP. Among all the nodes, some just handle one class of traffic or some information requests and some need to handle all the four class of traffic. According to the class of data flow handled by each node, the nodes are classified into two kinds: simple nodes and complex nodes. A simple node only handles one class of traffic or some information requests and a complex node handles all the four class of traffic.

### A.4.3.1 Simple node model

In all the nodes related to the streaming service, the web server, media server, HLR, VLR and AuC are considered as the simple node.

Because these nodes just handle one class of traffic or some information requests, so a simple node is modelled as a queuing system. Solving the mode the transaction delay and the data loss ratio in the node can be get.

#### A.4.3.1.1 Model description

Assume that the data unit arrival into the node is Poisson distributed, and the transaction time of a data unit is exponentially distributed. These data units are scheduled using FIFO algorithm. And the buffer size is B (data unit). The parameters are defined as follows:

$\lambda$  : The arrival rate of data units.

$\frac{1}{\mu}$  : The mean transaction time to a data unit of the node.

$B$  : The buffer size in the node.

The model is as figure A.1.

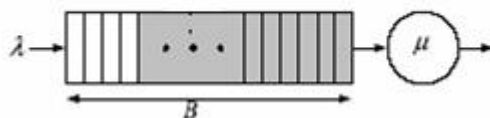

Figure A.1: A queuing model of a simple node

A.4.3.1.2 The transaction delay and the data loss ratio

Solving the model, it can be obtained.

$$T_w = \frac{\lambda}{\mu(\mu - \lambda)}$$

$$p_B = (1 - \rho)\rho^B = (1 - \frac{\lambda}{\mu})(\frac{\lambda}{\mu})^B$$

$T_w$  is the transaction delay and  $P_B$  is the data loss ratio.

A.4.3.2 Complex node model

In all the nodes related to the streaming service, the BS, SGSN and GGSN are considered as the complex node.

These nodes need to handle four class of data flow: conversational class, streaming class, interactive class and background class. Their delay requirements are getting stricter, and the transfer priority in a node is according to the delay requirements. So the complex node is modeled as a queuing system with four queues and a single server. Solving the mode, the transaction delay and the data loss ratio in the node can be get.

A.4.3.2.1 Model description

In the conversational class the voice traffic is analyzed and in the streaming class the video traffic is analyzed.

The voice traffic model

In the book Broadband Integrated Networks, Mischa Schwartz points out two models: fluid flow model and MMPP (Markov-modulated Poisson Process) model. Here the MMPP model is adopted. The MMPP model is as follows [3].

The model is a queuing system and the data source is combined by several voice sources as figure A.2. Each voice source has two states: on and off. When the source is in the state on, it generates voice data with Poisson arrival or rather it is silent. The model is as figure A.3.

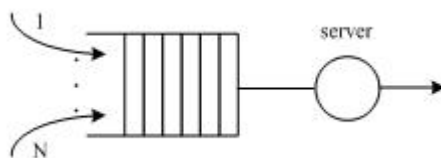

Figure A.2: A queuing model for voice traffic

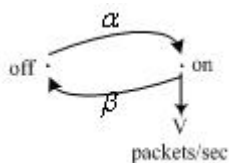

Figure A.3: Two-state model

The parameters are defined as follows:

- $N$  : The number of voice source in the voice model.
- $\alpha$  : The transfer rate from the off state to on state.
- $\beta$  : The transfer rate from the on state to off state.
- $V$  : The mean output data rate when the voice source is in the on state.

**The video traffic model**

Also adopting the way in the book "Broadband Integrated Networks", an equivalent process of the sum of M identical two state "minisources" for the video traffic of N video source is defined. The model is as figure A.4.

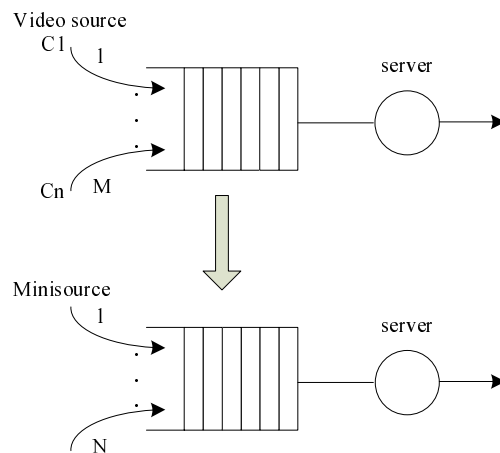

**Figure A.4: The model of video traffic**

The traffics of interactive class and background class are both assumed to be Poisson arrival.

And because the protocol of the data link layer is ATM, so it is assumed that the transaction time to each class data of the node is a constant.

All the buffers are infinite.

So the model of a complex node is as figure A.5.

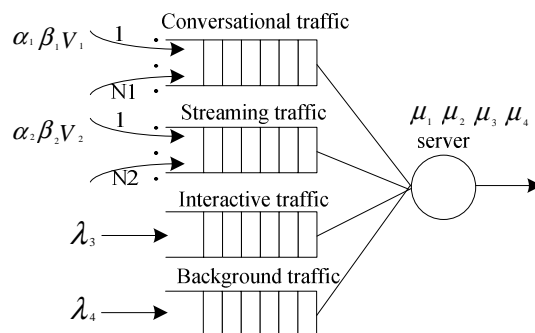

**Figure A.5: The model of a complex node**

- $\alpha_1$  : The transfer rate of the conversational traffic from the off state the on state.
- $\alpha_2$  : The transfer rate of the streaming traffic from the off state the on state.

$\beta_1$ :	The transfer rate of the conversational traffic from the on state to the off state.
$\beta_2$ :	The transfer rate of the streaming traffic from the on state to the off state.
$V_1$ :	The output data rate when the voice source is in the on state
$V_2$ :	The output data rate when the video source is in the on state
$\lambda_3$ :	The arrival rate of interactive traffic data units.
$\lambda_4$ :	The arrival rate of background traffic data units.
$\mu_1$ :	The transaction time of the node to the conversational traffic.
$\mu_2$ :	The transaction time of the node to the streaming traffic.
$\mu_3$ :	The transaction time of the node to the interactive traffic.
$\mu_4$ :	The transaction time of the node to the background traffic.

#### A.4.3.2.2 The transaction delay

$$T_w = \frac{1}{2} \sum_{i=1}^4 \rho_i * T_{si}$$

$$T_{w1} = \frac{T_w}{1 - \rho_1}$$

$$T_{w2} = \frac{T_w + \rho_1 * T_{w1}}{1 - \rho_2 - \rho_1}$$

$$T_{w3} = \frac{T_w + \rho_2 * T_{w2} + \rho_1 * T_{w1}}{1 - \rho_3 - \rho_2 - \rho_1}$$

$$T_{w4} = \frac{T_w + \rho_3 * T_{w3} + \rho_2 * T_{w2} + \rho_1 * T_{w1}}{1 - \rho_4 - \rho_3 - \rho_2 - \rho_1}$$

$T_{w1}$  is the transaction delay of the conversational traffic in the node.

$T_{w2}$  is the transaction delay of the streaming traffic in the node.

$T_{w3}$  is the transaction delay of the interactive traffic in the node.

$T_{w4}$  is the transaction delay of the background traffic in the node.

## A.5 Modelling the relationship between ESQoS and SQoS

The models of this section aim to describe the relationship of each ESQoS parameter and their relative SQoS parameters pointed out in the present document. Not all the SQoS parameters are analyzed with these models. It only gives some example to justify how to get the mapping between the ESQoS and SQoS in the present document.

### A.5.1 Service Non-Availability

#### A.5.1.1 Relative SQoS and other parameters

The parameters used for the service non-availability model are list in table A.1.

**Table A.1: the SQoS and other parameters in our model of service non-availability**

class	layer	SQoS	Other parameters	Model	Parameters to calculate
Radio access network	Under transports	Block ratio Soft handoff rate	The channel number The reserved channel number The rate of arrival stream of new calls The channel holding time for new calls The channel holding time for handoff calls The number of the base repeaters in the cell The channel number of each base repeater The reserved resources Mean time of platform failure Mean time of platform repair Mean time of base repeater failure Mean time of base repeater repair	Radio access network model	the block ratio of new calls $P_{\text{access\_failure}}$
Transaction node	Base station, SGSN, GGSN, HLR, VLR, AuC, Web server	Transaction rate Transaction capacity	Buffer size	Node model	Transaction failure ratio $P_{\text{web\_failure}}$

The first three columns are from the present document.

Other columns means the parameters affected the ESQoS also, but they are not SQoS parameters.

The general models used in our model are list in the column model. And the parameter to be analyzed are list behind the model column.

The radio access network and the web server for service non-availability without the wireless and wired network failure and the transaction nodes in the network are analyzed.

The parameters' locations used in our model are as figure A.6.

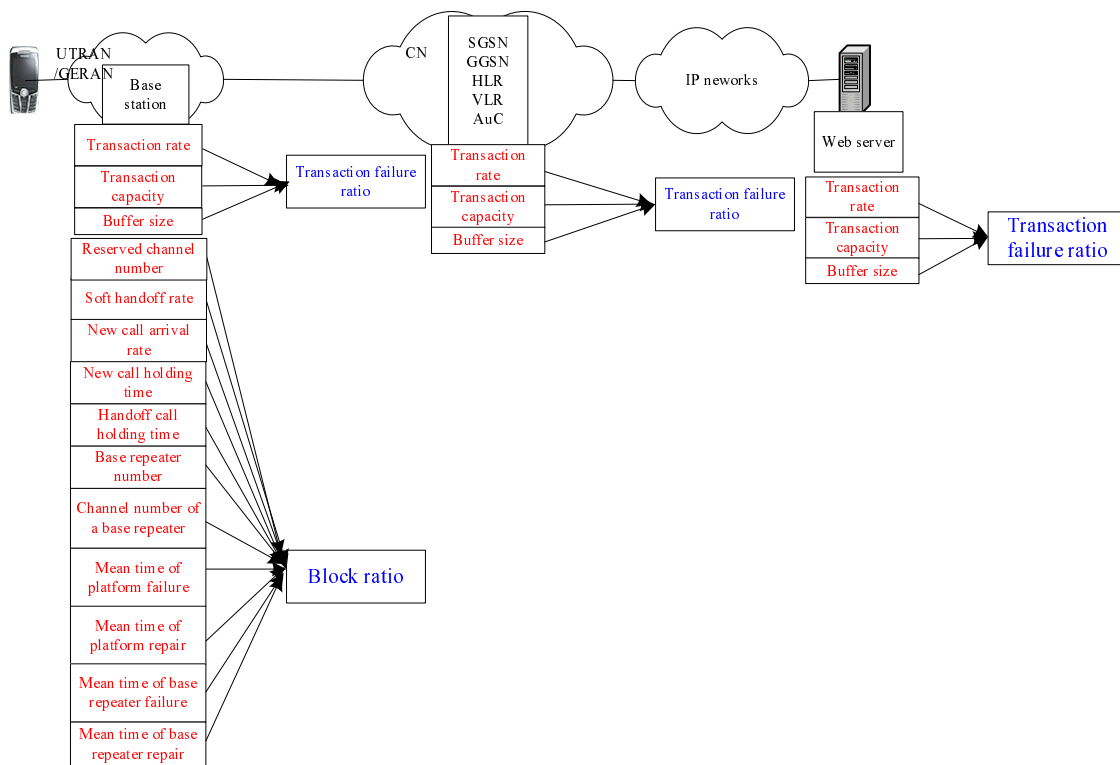

**Figure A.6: The locations of parameters used in service non-availability model**

NOTE: The parameter transaction rate and transaction capacity can be got by testing the transaction node. And the buffer size can also be easily got from the node.

The soft handoff rate, the new call arrival rate, new call holding time and handoff call holding time are statistical parameters. They can be got from the cell's statistical data of the cell.

The mean time of platform failure, mean time of platform repair, mean time of base repeater failure and the mean time of base repeater repair can be got by analysing the base station's performance. It is not included in our work. The base repeater's number and the channel number of base repeaters are the cell's setting parameters.

### A.5.1.2 Model description

Ignoring the wireless and wired network failure, the failure ratio of a data unit transferred in the network can be expressed as follows:

$$P_{\text{failure}} = P_{\text{access\_failure}} + P_{\text{Web\_failure}}$$

$$P_{\text{access\_failure}} = \bar{A}(N_b) + \begin{cases} 1(G > 0) \sum_{k=1}^G P(1, k; N_b) \left(\frac{k}{N_b}\right) + \sum_{k=G+1}^{N_b} P(1, k; N_b) P_b(kM - 1, g) \left(\frac{k}{N_b}\right), & \text{w/o APS} \\ 1(G > 0) \sum_{k=1}^G P(1, k; N_b) + \sum_{k=G+1}^{N_b} P(1, k; N_b) P_b(kM - 1, g), & \text{w/ APS} \end{cases}$$

$$P_{\text{web\_failure}} = (1 - \rho) \rho^B = \left(1 - \frac{\lambda}{\mu}\right) \left(\frac{\lambda}{\mu}\right)^B$$



All the parameters' definitions are from clause 4.

In the base station, the service non-availability can be changed by adjusting some parameters as table A.2.

**Table A.2: The simple relation between service non-availability and other parameters in the base station**

Parameters	Service non-availability
Transaction rate ↑	↓
Transaction capacity ↑	↓
Buffer size ↑	↓
Reserved channel number ↑	↑
Soft handoff rate ↑	↑
New call arrival rate ↑ ↑	↑
Handoff call holding time ↑	↓
New call holding time ↑	↓
Base repeater number ↑	↓
Channels number of a base repeater ↑	↓
Mean time of platform failure ↑	↑
Mean time of platform repair ↑	↓
Mean time of base repeater failure ↑	↑
Mean time of base repeater repair ↑	↓
↑ means value increases; ↓ means value decreases.	

In the transaction node (SGSN, GGSN, VLR, HLR, AuC, web server), the service non-availability can be changed by adjusting some parameters as table A.3.

**Table A.3: The simple relation between service non-availability and other parameters in the transaction nodes**

Parameters	Service non-availability
Transaction rate ↑	↓
Transaction capacity ↑	↓
Buffer size ↑	↓
↑ means value increases; ↓ means value decreases.	

## A.5.2 Service Failure Ratio

### A.5.2.1 Relative SQoS and other parameters

The parameters affect the service failure ratio are list in table A.4.

**Table A.4: the SQoS and other parameters in the model of service failure ratio**

class	layer	SQoS	Other parameters	Model	Parameters to calculate
Radio access network	Under transports	Block ratio Soft handoff rate	The rate of arrival stream of new calls The channel holding time for new calls The channel holding time for handoff calls The number of the base repeaters in the cell The channel number of each base repeater The reserved resources Mean time of platform failure Mean time of platform repair Mean time of base repeater failure Mean time of base repeater repair	Radio access network model	the failure ratio of handoff calls $P_{handoff\_failure}$
Transaction node	Base station, SGSN, GGSN, HLR, VLR, AuC, Media server	Transaction rate Transaction capacity	Buffer size	Node model	Transaction failure $P_{media\_failure}$

The radio access network and the media server for service failure ratio are analyzed, ignoring the wireless and wired network failure and the transaction nodes in the network.

The first three columns are from the present document.

Other columns means the parameters affected the QoE ESQoS also, but they are not SQoS parameters.

The general models used in our model are list in the column model. And the parameter to be analyzed are list behind the model column.

The radio access network and the media server for service failure ratio are analyzed without the wireless and wired network failure and the transaction nodes in the network.

The parameters' locations used in our model are as figure A.7.

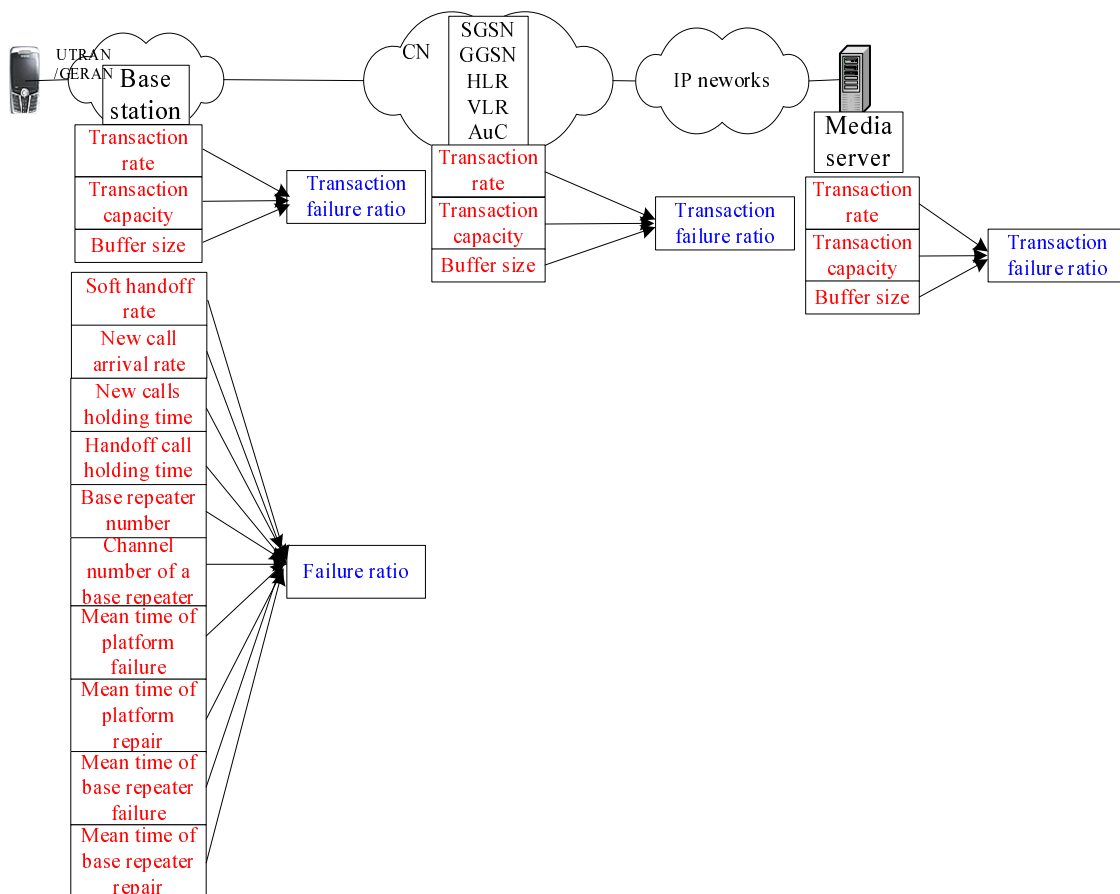

Figure A.7: The locations of parameters used in service failure ratio model

NOTE: The parameter transaction rate and transaction capacity can be got by testing the transaction node. And the buffer size can also be easily got from the node.

The soft handoff rate, the new call arrival rate, new call holding time and handoff call holding time are statistical parameters. They can be got from the cell's statistical data.

The mean time of platform failure, mean time of platform repair, mean time of base repeater failure and the mean time of base repeater repair can be got by analysing the base station's performance. It is not included in our work. The base repeater's number and the channel number of base repeaters are the cell's setting parameters.

### A.5.2.2 Model description

Ignoring the wireless and wired network failure, the failure ratio of a data unit transferred in the network can be expressed as follows:

$$P_{failure} = P_{handoff\_failure} + P_{media\_failure}$$

$$P_{handoff\_failure} = \bar{A}(N_b) + \begin{cases} \sum_{k=1}^{N_b} P(1, k; N_b) P_d(kM - 1, g) \frac{k}{N_b}, & \text{w/o APS} \\ \sum_{k=1}^{N_b} P(1, k; N_b) P_d(kM - 1, g), & \text{w/ APS.} \end{cases}$$

$$P_{media\_failure} = (1 - \rho) \rho^B = \left(1 - \frac{\lambda}{\mu}\right) \left(\frac{\lambda}{\mu}\right)^B$$

All the parameters' definitions are from clause 4.

In the base station, the service failure ratio can be changed by adjusting some parameters as table A.5.

**Table A.5: The simple relation between service failure ratio and other parameters in the base station**

Parameters	Service non-availability
Transaction rate ↑	↓
Transaction capacity ↑	↓
Buffer size ↑	↓
Soft handoff rate ↑	↑
New call arrival rate ↑	↑
Handoff call holding time ↑	↓
New call holding time ↑	↓
Base repeater number ↑	↓
Channels number of a base repeater ↑	↓
Mean time of platform failure ↑	↑
Mean time of platform repair ↑	↓
Mean time of base repeater failure ↑	↑
Mean time of base repeater repair ↑	↓
↑ means value increases; ↓ means value decreases.	

In the transaction node (SGSN, GGSN, VLR, HLR, AuC, media server), the service failure ratio can be changed by adjusting some parameters as table A.6.

**Table A.6: The simple relation between service failure ratio and other parameters in the transaction nodes**

Parameters	Service failure ratio
Transaction rate ↑	↓
Transaction capacity ↑	↓
Buffer size ↑	↓
↑ means value increases; ↓ means value decreases.	

An example is given to understand the further explain about the relationship.

In the radio access network, to decrease the service non-availability, both of the soft handoff rate and the new call arrival rate can be decreased. The two parameters are both related to the cell's radius.

Increase the total channel number or decrease the reserved channel number can also decrease the service non-availability. The total channel number can be computed from the base repeater number and the channels number of a repeater. The mean time of the repeater's failure and the mean time of repair also affect the total channel number.

To increase the mean time platform failure or decrease the mean time of repair also decreases the service non-availability.

In these transaction nodes, developing the performance (the transaction rate, transaction capacity and the buffer size) of them will decrease the service non-availability and the service failure ratio.

Adjusting the value of the soft hand rate, new call arriving rate, base repeater number, channels number of a base repeater, mean time of platform failure, mean time of platform repair, mean time of base repeater failure, mean time of base repeater repair, transaction rate, transaction capability and buffer size has the same effect on the service non-availability and the service failure ratio. But decreasing the reserved channel number will decrease the service non-availability and increase the service failure ratio.

## A.5.3 Initial Connection Time

### A.5.3.1 Relative SQoS and other parameters

The parameters affect the initial connection time are list in table A.7.

**Table A.7: the SQoS and other parameters in our model of initial connection time**

class	layer	SQoS	Other parameters	Model	Parameters to calculate
client	Application		Frame size		
Wireless transport network	Transports	Bandwidth Transport delay	The total transport data size during The connection procedure ( related to the protocols)	Transport network model	Transfer time $T_{tran\_time}$
Wired transport network	Transports	Bandwidth Transport delay	The total load from outside The load on one link The links number The average length of packet The link's data transport rate The total transport data size during The connection procedure ( related to the protocols)	Transport network model	Transfer time $T_{tran\_time}$ Transfer delay $T_{tran\_delay}$
Transaction node	Base station, SGSN, GGSN, HLR, VLR, AuC, Web server, Media server	Transaction delay Transaction rate	Buffer size	Node model	Transaction delay $T_{BS\_delay}$ $T_{SGSN\_delay}$ $T_{GGSN\_delay}$ $T_{VLR\_delay}$ $T_{HLR\_delay}$ $T_{AuC\_delay}$ $T_{web\_delay}$ $T_{media\_delay}$

The transfer delay and time of wireless /wired networks, the related transaction delay of transaction nodes for initial connection time are analyzed, disregarding radio access network's delay.

The parameters' locations used in our model are as figure A.8.

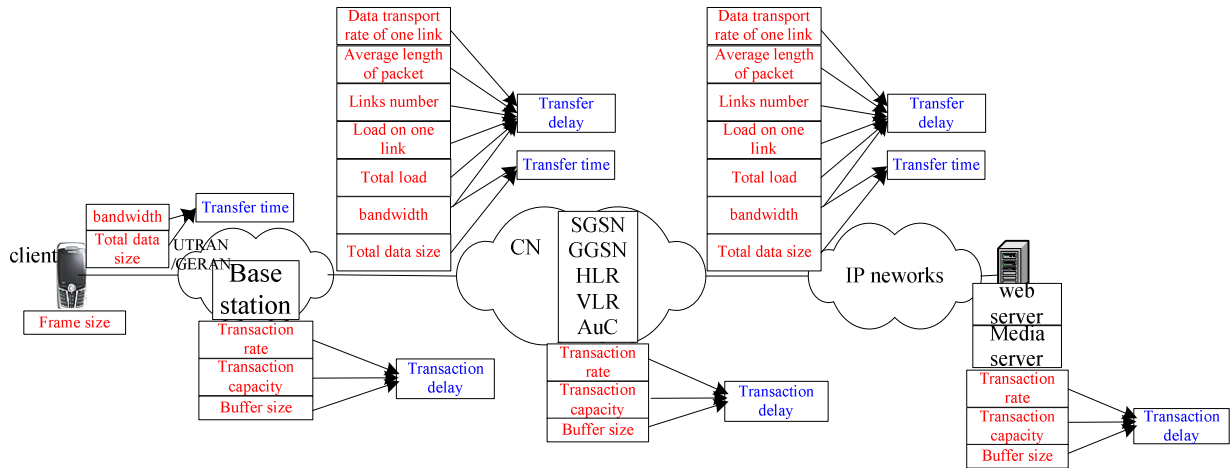

**Figure A.8: The locations of parameters used in service initial connection time model**

NOTE: The parameter transaction rate and transaction capacity can be got by testing the transaction node. And the buffer size in the transaction node can also be easily got from the node.

The total data size during the connection procedure depends on the frame size in the client and the protocols used. It includes the data for the initiation between client and the server and the first frame data.

The data transport rate of one link and links number are the network's framework parameters.

The load on one link, total load on the network and average length of packet can be got from the network's statistical data.

### A.5.3.2 Model description

The initial connection time ( $T_{connect}$ ) can be considered as a function of the transfer delay and the transfer time in network and the transaction delay in all the relative transaction nodes. The expression can be get as follows:

$$T_{connect} = F(T_{tran\_delay}, T_{tran\_time}, T_{BS\_delay}, T_{SGSN\_delay}, T_{GGSN\_delay}, T_{VLR\_delay}, T_{HLR\_delay}, T_{AuC\_delay}, T_{web\_delay}, T_{media\_delay})$$

And  $T_{connect}$  varies in the same manner as all the parameters.

$$T_{tran\_delay} = \frac{1}{\gamma} \sum_{i=1}^L \frac{M}{R_i - M \lambda_i}$$

$$T_{tran\_time} = \frac{D}{d_{wireless}} + \frac{D}{d_{wired}}$$

$T_{BS\_delay}$ ,  $T_{SGSN\_delay}$ ,  $T_{GGSN\_delay}$  can be got from formula  $T_{server\_delay1} = \frac{T_w + \rho_2 * T_{w2} + \rho_1 * T_{w1}}{1 - \rho_3 - \rho_2 - \rho_1}$

$T_{VLR\_delay}$ ,  $T_{HLR\_delay}$ ,  $T_{AuC\_delay}$ ,  $T_{web\_delay}$ ,  $T_{media\_delay}$  can be got from formula

$$T_{server\_delay2} = \frac{\lambda}{\mu(\mu - \lambda)}$$

All the parameters' definitions are from clause 4.

In the client, the initial connection time can be changed by adjusting some parameters as table A.8.

**Table A.8: The simple relation between initial connection time and other parameters in the client**

Parameters	Initial connection time
Buffer size ↑	↑
↑	means value increases;
↓	means value decreases.

In the wireless network, the initial connection time can be changed by adjusting some parameters as table A.9.

**Table A.9: The simple relation between initial connection time and other parameters in the wireless network**

Parameters	Initial connection time
Bandwidth ↑	↓
Total data size ↑	↑
↑	means value increases;
↓	means value decreases.

In the wired network, the initial connection time can be changed by adjusting some parameters as table A.10.

**Table A.10: The simple relation between initial connection time and other parameters in the wired network**

Parameters	Initial connection time
Bandwidth ↑	↓
Total data size ↑	↑
Total load ↑	↑
Load on one link ↑	↑
Links number ↑	↑
Average length of packet ↑	↑
Data transport rate of one link ↑	↓
↑	means value increases;
↓	means value decreases.

In the transaction nodes (base station, SGSN, GGSN, VLR, HLR, AuC, media server), the initial connection time can be changed by adjusting some parameters as table A.11.

**Table A.11: The simple relation between initial connection time and other parameters in the transactions nodes**

Parameters	Initial connection time
Transaction rate ↑	↓
Transaction capacity ↑	↓
Buffer size ↑	↓
↑	means value increases;
↓	means value decreases.

## A.5.4 Initial Buffering Time

### A.5.4.1 Relative SQoS and other parameters

The parameters affect the initial buffering time are list in table A.12.

**Table A.12: the SQoS and other parameters in our model of initial buffering time**

class	layer	SQoS	Other parameters	Model	Parameters to calculate
client	Application	Frame rate	Frame size Buffer size		
Wireless transport network	Transports	Bandwidth Transport delay	The total transport data size during The connection procedure ( related to the protocols)	Transport network model	Transfer time $T_{tran\_time}$
Wired transport network	Transports	Bandwidth Transport delay	The total load from outside The load on one link The links number The average length of packet The link's data transport rate The total transport data size during The connection procedure ( related to the protocols)	Transport network model	Transfer time $T_{tran\_time}$ Transfer delay $T_{tran\_delay}$
Transaction node	Base station, SGSN, GGSN, Media server	Transaction delay Transaction rate	Buffer size	Node model	Transaction delay $T_{BS\_delay}$ $T_{SGSN\_delay}$ $T_{GGSN\_delay}$ $T_{media\_delay}$

The transfer delay and time of wireless /wired networks, the related transaction delay of transaction node for initial buffering time are analyzed, ignoring delay of radio access network.

The parameters' locations used in our model are as figure A.9.

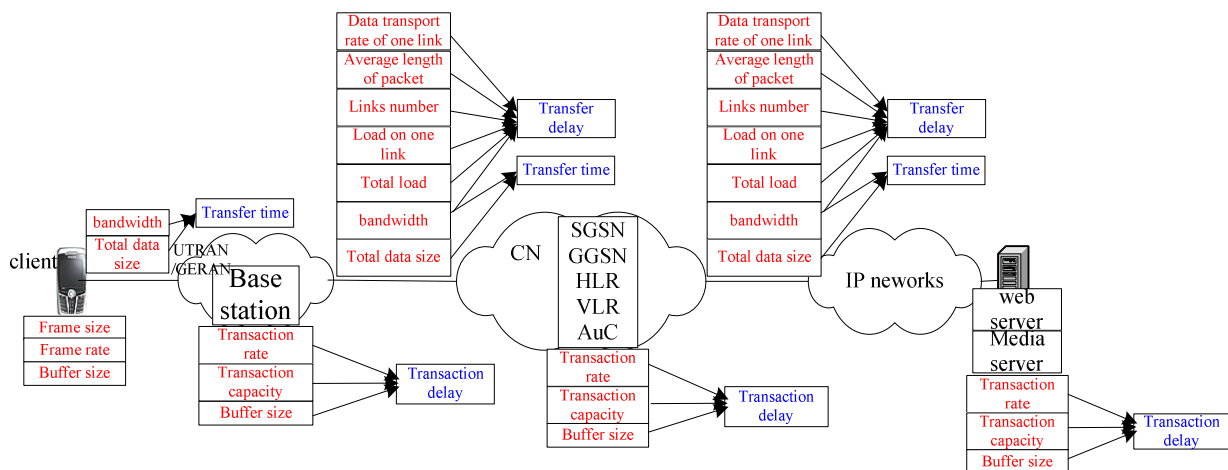

**Figure A.9: The locations of parameters used in service initial buffering time model**

**NOTE:** The parameter transaction rate and transaction capacity can be got by testing the transaction node. And the buffer size in the transaction node can also be easily got from the node.

The total data size during the connection procedure depends on the buffer size in the client and the protocols used. Why the frame size and frame rate are listed here? Because they affect the buffer size the system set.



The data transport rate of one link and links number are the network's framework parameters.

The load on one link, total load on the network and average length of packet can be got from the network's statistical data.

### A.5.4.2 Model description

The initial connection time ( $T_{buffering}$ ) can be considered as a function of the transfer delay and the transfer time in network and the transaction delay in all the relative transaction nodes. The expression can be get as follows:

$$T_{buffering} = F(T_{tran\_delay}, T_{tran\_time}, T_{BS\_delay}, T_{SGSN\_delay}, T_{GGSN\_delay}, T_{media\_delay})$$

And  $T_{buffering}$  varies in the same manner as all the parameters.

$$T_{tran\_delay} = \frac{1}{\gamma} \sum_{i=1}^L \frac{M}{R_i - M \lambda_i}$$

$$T_{tran\_time} = \frac{D}{d_{wireless}} + \frac{D}{d_{wired}}$$

$T_{BS\_delay}$ ,  $T_{SGSN\_delay}$ ,  $T_{GGSN\_delay}$  can be got from formula  $T_{server\_delay1} = \frac{T_w + \rho_2 * T_{w2} + \rho_1 * T_{w1}}{1 - \rho_3 - \rho_2 - \rho_1}$

$T_{media\_delay}$  can be got from formula  $T_{server\_delay2} = \frac{\lambda}{\mu(\mu - \lambda)}$ .

All the parameters' definitions are from section 4.

In the client, the initial buffering time can be changed by adjusting some parameters as table A.13.

**Table A.13: The simple relation between initial buffering time and other parameters in the client**

Parameters	Initial connection time
Buffer size ↑	↑
↑	means value increases;
↓	means value decreases.

In the wireless network, the initial buffering time can be changed by adjusting some parameters as table A.14.

**Table A.14: The simple relation between initial buffering time and other parameters in wireless network**

Parameters	Initial connection time
Bandwidth ↑	↓
Total data size ↑	↑
↑	means value increases;
↓	means value decreases.

In the wired network, the initial buffering time can be changed by adjusting some parameters as table A.15.

**Table A.15: The simple relation between initial buffering time and other parameters in wired network**

Parameters	Initial connection time
Bandwidth ↑	↓
Total data size ↑	↑
Total load ↑	↑
Load on one link ↑	↑
Links number ↑	↑
Average length of packet ↑	↑
Data transport rate of one link ↑	↓
↑ means value increases; ↓ means value decreases.	

In the transaction nodes (base station, SGSN, GGSN, VLR, HLR, AuC, media server), the initial buffering time can be changed by adjusting some parameters as table A.16.

**Table A.16: The simple relation between initial buffering time and other parameters in the transaction nodes**

Parameters	Initial connection time
Transaction rate ↑	↓
Transaction capacity ↑	↓
Buffer size ↑	↓
↑ means value increases; ↓ means value decreases.	

## A.5.5 Re-Buffering Frequency

### A.5.5.1 Relative SQoS and other parameters

The rebuffering is a important metric to reflect the network's condition. The majority of SQoS parameters affect it.

The model analyse the SQoS parameters' effect in the application and transports layers.

**Table A.17: the SQoS and other parameters in our model of service rebuffering frequency**

class	layer	SQoS	Other parameters	Model
client	Application	Frame rate Frame loss ratio Frame error ratio	Frame size Buffer size	Model the whole transport process
Radio access network	Under transports	Access delay	Channels	
Wireless transport network	Transports	Bandwidth Transport delay Jitter Packet loss ratio	Wireless transport condition	
	Under transports	Frame loss ratio, Frame error ratio, Frame discard ratio, Residual bit error ratio		
Wired transport network	Transports	Bandwidth Transport delay Jitter Packet loss ratio	network load, network framework	
	Under transports	Frame loss ratio, Frame error ratio, Frame discard ratio, Residual bit error ratio		
Transaction node	Base station, SGSN, GGSN, Media server	Transaction delay Transaction rate	Buffer size	

### A.5.5.2 Model description

Assumed the send data is initially distributed of  $F_0(t)$ . After the transportation, affected by the frame loss rate, the frame error rate, bandwidth and delay, the data is distributed of  $F(t)$  at the end. Here delay means transfer delay and transaction delay. The model is as figure A.10.

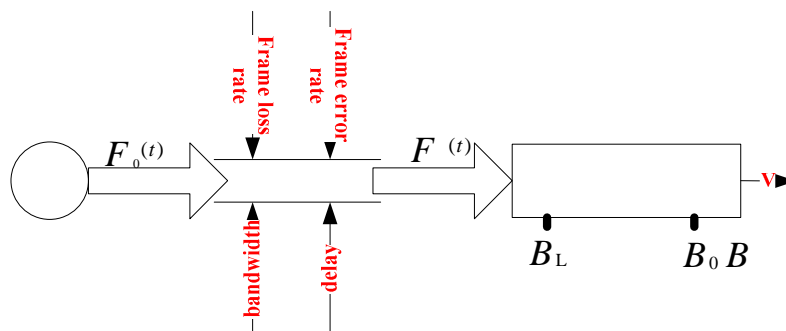

**Figure A.10: the model of transportation**

The effect of frame loss rate and frame error rate on the send data are the same. So it can be assume that the data become  $F_1(t)$  after affected by the frame loss rate and frame error rate. And it become  $F_2(t)$  after affected by the change of bandwidth, then become  $F(t)$  because of the delay at last. The functions  $F_1(t)$ ,  $F_2(t)$ ,  $F(t)$  can be analyzed after our simulation.

The initial data size in the buffer  $B$ . When the data in the buffer exceed  $B_0$ , the player starts to play, and when data is less than  $B_L$ , the rebuffering starts. The frame rate is  $V$  when it is playing.

$F(t)$  means the amount of arrival data, so  $F(t)$  is a monotonic increasing function. So its inverse function exists.

When  $B+(F(t)-v*t)<B_L$ , the system start rebuffering. And  $B_0-(B+(F(t)-v*t)) \leq F(t')-F(t)$ , where  $t'$  is the time when the rebuffering finishes.

$$F^{-1}(B_0-(B-v*t)) \leq t'$$

So the rebuffering frequency is:

$$\frac{\sum \mathbf{I}(B+(F(t)-v*t)<B_L)}{T_{\text{test}}}$$

$I(e)$  is the indicator function:  $I(e) = 1$  if expression  $e$  is true; otherwise  $I(e) = 0$ .

$T_{\text{test}}$  is the total time to test.

## A.5.6 Re-Buffering Time

### A.5.6.1 Relative SQoS and other parameters

The model is the same as clause 5.5.

### A.5.6.2 Model description

The rebuffering time of this time is:

$$t' - t = F^{-1}(B_0-(B-v*t)) - t$$

And the mean rebuffering time is:

$$\frac{\sum_{B+(F(t)-v*t)<B_L} F^{-1}(B_0-(B-v*t)) - t}{\sum \mathbf{I}(B+(F(t)-v*t)<B_L)}$$

---

## Annex B: Analysis of QoE

### B.1 Introduction

The SA4 "End-to-end Multimedia Services Performance Metrics" work item is conducting a research on the performance metrics for popular multimedia services, including streaming, multimedia broadcast multicast service (MBMS), video telephony and IP Multimedia subsystem Service (IMS), etc. This annex is an extension to the present document, which will support and justify the results in the present document.

In this annex, a subjective test is conducted to acquire the QoE. And the results of the test are listed in the following sections.

And also, in this annex, packet-switched streaming service is taken as an example.

---

### B.2 Process

From the user perspective, the service performance indicators cannot be defined only according to researcher's experience. It should be acquired by user investigation as well as experience.

#### B.2.1 Collection of QoE

The selected testers are kept unknown about any indicators. After watching given audio/video multimedia contents with different quality levels and experiencing those services, they take down the performance indicators only with their feeling and experience.

Then according to their record and description, the scope of QoE is determined.

The common user's requirements of service performance are collected and classified as our QoE, disregarding the measurability.

See clause 3.1.

#### B.2.2 Weightiness of Selected QoE

With DSCQS (see ITU-R Recommendation BT.500), testers are asked to mark each service and content in comparison with the reference. Those services and contents are provided with different quality levels of each selected indicator.

---

### B.3 Results

#### B.3.1 Collection of QoE

- Service Non-Access.
- Service Failure.
- Service Setting-up Time.
- Re-Buffering.
- Image corruption.

- Blurriness.
- Blockiness.
- Colour Reproduction Accuracy.
- Edge Noise.
- Freeze image.
- Incontinuous Image with block.
- Audio Quality.
- Audio/Video Synchronization Error.

### B.3.2 Comparison of Weightiness among Selected QoE Parameters

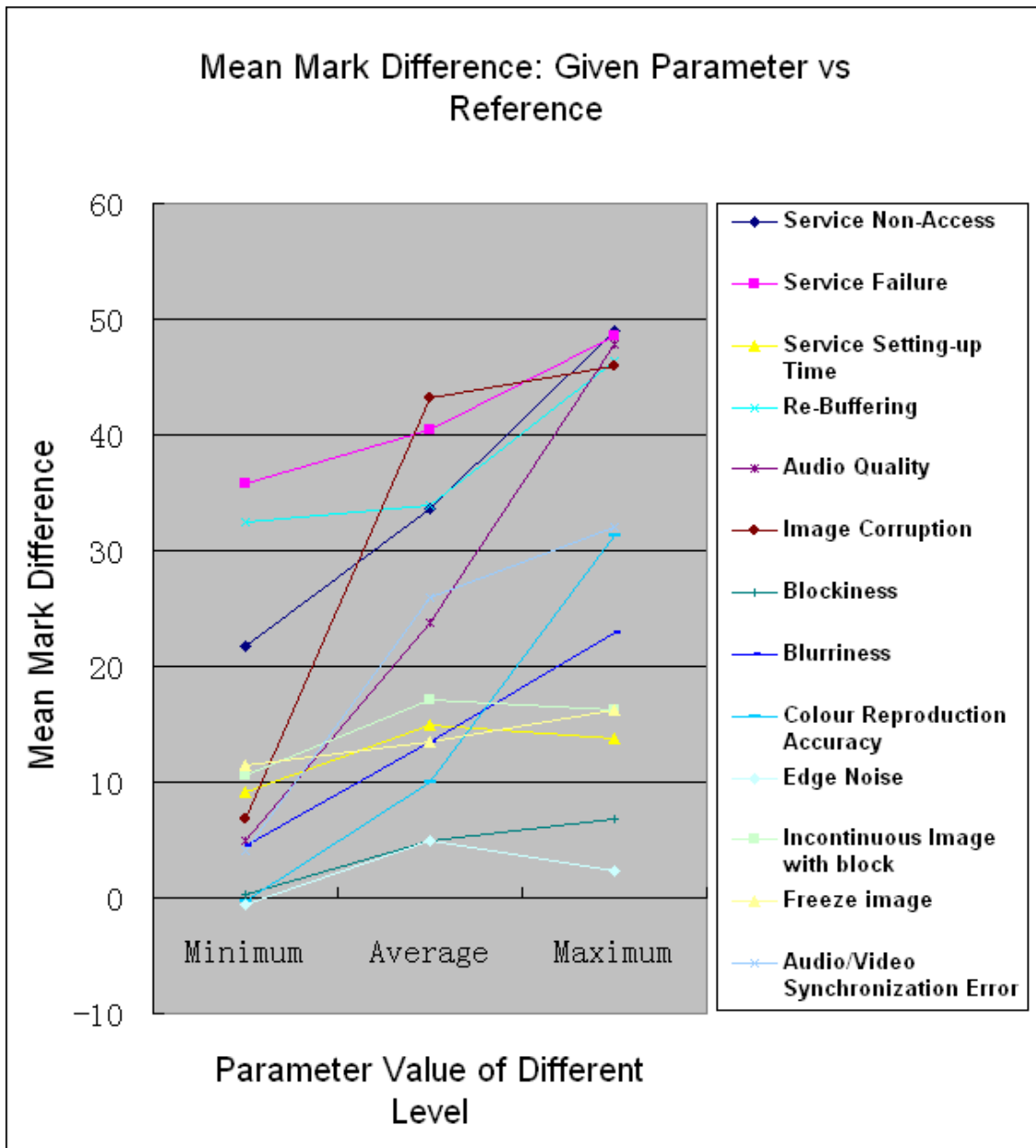

Figure B.1

---

# Annex C: Comparison with TS 102 250 of ETSI STQ Mobile

## C.1 Introduction

The SA4 "End-to-end Multimedia Services Performance Metrics" work item is conducting a research on the performance metrics for popular multimedia services, including streaming, multimedia broadcast multicast service (MBMS), video telephony and IP multimedia subsystem service (IMS), etc. This annex is an extension to the present document, which will support and justify the results in the present document.

In this annex, a comprehensive comparison of work between E2EMSPM and ETSI STQ Mobile is conducted to justify the work of E2EMSPM. And the results of the analysis are listed in the following sections.

---

## C.2 References

The following documents contain provisions which, through reference in this text, constitute provisions of the present document.

- References are either specific (identified by date of publication, edition number, version number, etc.) or non-specific.
- For a specific reference, subsequent revisions do not apply.
- For a non-specific reference, the latest version applies. In the case of a reference to a 3GPP document (including a GSM document), a non-specific reference implicitly refers to the latest version of that document *in the same Release as the present document*.

- [1] ETSI TS 102 250-1 (V1.1.1 - 10/2003): "Speech Processing, Transmission and Quality Aspects (STQ); QoS aspects of popular services in GSM and 3G networks; Part 1: Identification of Quality of Service aspects".
- [2] ETSI TS 102 250-2 (V1.4.1 - 03/2006): "Speech Processing, Transmission and Quality Aspects (STQ); QoS aspects of popular services in GSM and 3G networks; Part 2: Definition of Quality of Service parameters and their computation".
- [3] ETSI TS 102 250-3 (V1.3.2 - 09/2005): "Speech Processing, Transmission and Quality Aspects (STQ); QoS aspects of popular services in GSM and 3G networks; Part 3: Typical procedures for Quality of Service measurement equipment".
- [4] ETSI TS 102 250-4 (V1.1.1 - 10/2003): "Speech Processing, Transmission and Quality Aspects (STQ); QoS aspects of popular services in GSM and 3G networks; Part 4: Requirements for Quality of Service measurement equipment".
- [5] ETSI TS 102 250-5 (V1.3.1 - 11/2005): "Speech Processing, Transmission and Quality Aspects (STQ); QoS aspects of popular services in GSM and 3G networks; Part 5: Definition of typical measurement profiles".
- [6] ETSI TS 102 250-6 (V1.2.1 - 10/2004): "Speech Processing, Transmission and Quality Aspects (STQ); QoS aspects of popular services in GSM and 3G networks; Part 6: Post processing and statistical methods".
- [7] 3GPP TS 23 107 (V6.4.0 - 03/2006): "3rd Generation partnership Project; Technical Specification Group Services and System Aspects; Quality of Service (QoS) Concept and architecture (Release 6)".



## C.3 Comparison with 3GPP E2EMSPM and ETSI STQ Mobile

In this part, the difference is illuminated between 3GPP E2EMSPM and ETSI STQ Mobile on multimedia services from the following points of view.

### C.3.1 Research Scope

#### C.3.1.1 Framework

E2EMSPM has a systematic framework of End-to-end Multimedia Services Performance Metrics is as figure C.1.

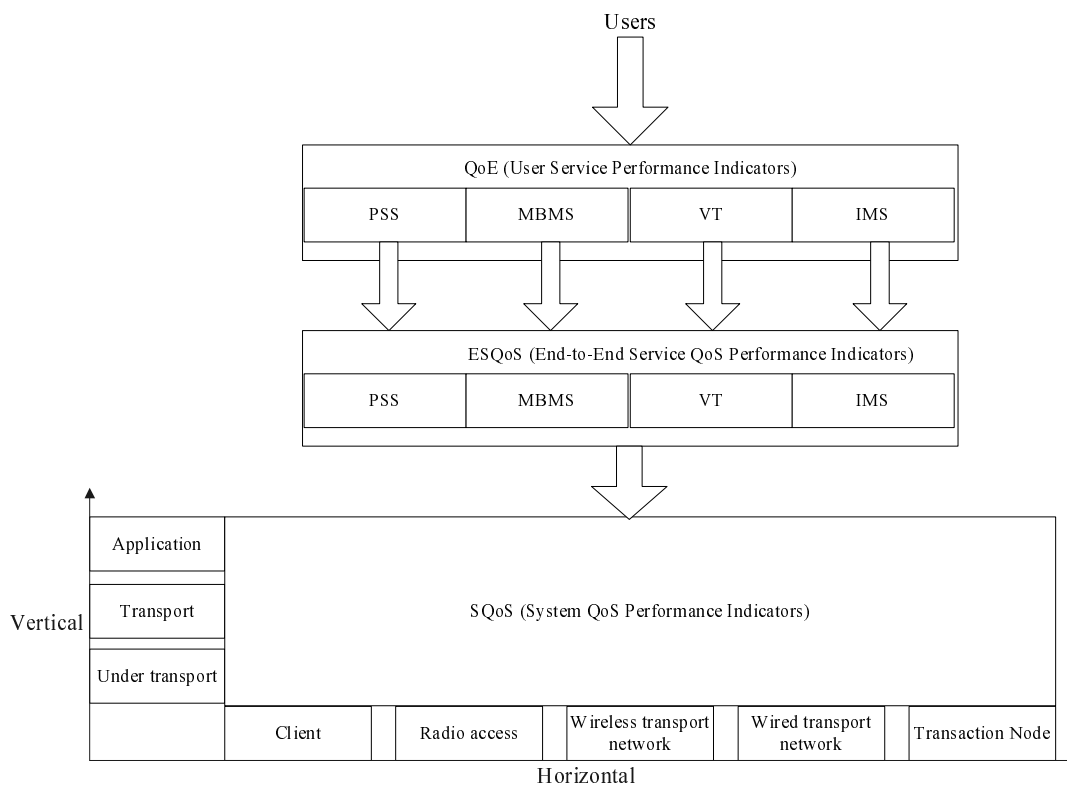

**Figure C.1: Systematic Framework of End-to-end Multimedia Services Performance Indicators**

ETSI STQ Mobile focuses on the similar area of End-to-End Service QoS.

#### C.3.1.2 Quality of experience

E2EMSPM brings up the concept of Quality of Experience (QoE). Yet ETSI STQ Mobile specifies the use of perceptual models for the evaluation of content quality, whenever applicable (e.g. TS 102 250-2 specifies the use of ITU-R Recommendation P.862.2 for speech quality evaluation).

The judgement of measurement results (e.g. target setting) and the correlation between measurement results and actual customer satisfaction are out of the scope of ETSI STQ Mobile.

QoE is how a user perceives the quality of service - how satisfied he or she is with the service. Although QoE is a subjective metric, it is important to quantify it. From the user's perspective, QoE cannot be defined only according to researcher's experience. It should be acquired by user investigation as well as experience.

The common user's requirements to different services are collected and classified as QoE, disregarding the measurability. Users have different requirements for different services. So the QoE for service analysis vary with the types of services.

### C.3.1.3 End-to-End Service Quality of Service

E2EMSPM considers service-related metrics of End-to-End Service Quality of Service (ESQoS). The measurements and provisioning of ESQoS are defined in terms of service capability and resource availability. ESQoS is generally used to specify services' quality considered by operators and service providers. The ability to measure ESQoS will give the operator some sense of the service's performance to the overall level of customer satisfaction.

ETSI STQ Mobile TS 102 250-2 [2] draws some steps in overall service QoS definition and analysis of mobile services. STQ takes the following QoS aspects from service perspective which are used for each service to define service QoS parameters.

- Network Availability.
- Network Accessibility.
- Service Accessibility.
- Service Integrity.
- Service Retainability.

Figure C.2 shows the model for quality of service parameters in ETSI STQ Part 2. The model has four layers.

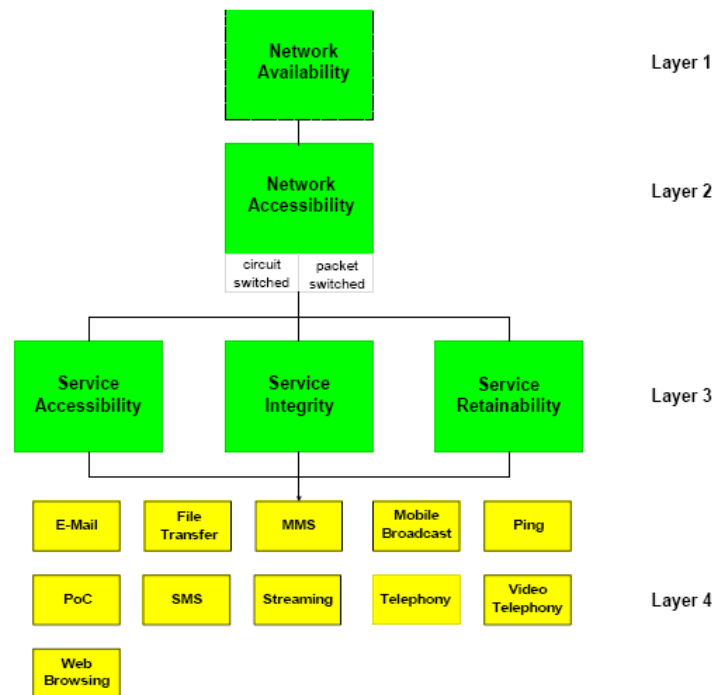

**Figure C.2: ETSI STQ Mobile QoS aspects and the corresponding QoS parameters**

So when end-to-end service QoS is concerned, both ETSI STQ Mobile and E2EMSPM have the similar study area on this topic. There are perfect and reasonable definitions of service QoS parameters in the TS of ETSI STQ. Part of the outputs of ETSI STQ Mobile should be introduced to E2EMSPM's End-to-End Service QoS area for reference.

### C.3.1.4 System Quality of Service

Generally, "UMTS Quality of Service (QoS) Concept and architecture" by 3GPP [8] is often referenced. It is a standard, describing UMTS bearers' structure, their management functions, and defines service quality classes and their attributes.

System Quality of Service (SQoS) defined in E2EMSPM is intrinsically a technical concept and is a subset of UMTS QoS. Compared with ESQoS, SQoS denotes the point-to-point QoS, which is specially related to the units and links of network systems. SQoS can be viewed as the QoS consideration from the viewpoint of network operators. It is measured and expressed in terms of network units and network links, which usually has little meaning to a user. Although a better network SQoS in many cases will result in better ESQoS, fulfilling all traffic SQoS parameters might not guarantee the satisfaction of the user or a high ESQoS.

In E2EMSPM the System QoS parameters are classified to five classes horizontally according to the different phases along with the whole network connection, including radio access network, wireless transport network, wired transport network, client transaction and network node transaction as shown in figure C.3. Some analytical models are introduced for every special section to evaluate some important parameters.

SQoS is out of the scope of ETSI STQ Mobile.

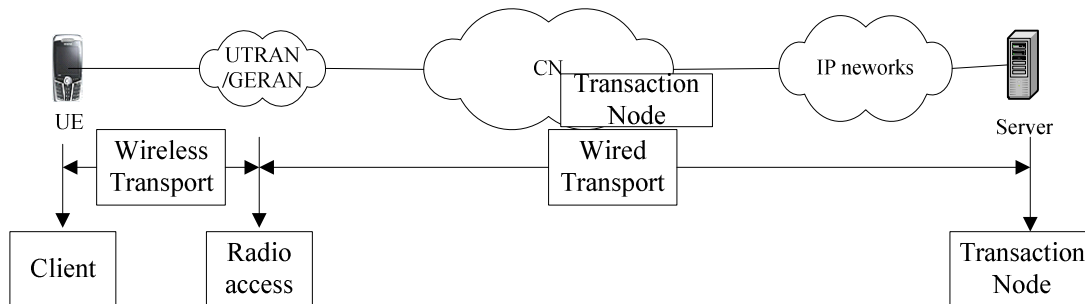

Figure C.3: Network phases to analyse System QoS

### C.3.1.5 Mapping of End-to-End Service QoS and System QoS

E2EMSPM introduces the theoretical models to study the relationship of End-to-End Service QoS and System QoS. The inherent relationship between the End-to-End Service QoS and System QoS parameters of PSS is described, which provide the possible operational methods for the operators/service providers to guarantee the service performance. E2EMSPM also gives some example to justify how we get the mapping between the End-to-End Service QoS and System QoS.

The relationship of End-to-End Service QoS and System QoS is beyond the scope of ETSI STQ Mobile.

## C.3.2 Research Method

### C.3.2.1 Statistics Model Analysis

Extensive studies involving high-speed network measurements indicate that the multimedia traffic in high-speed networks have self-similar and impulsive characteristics. The existence of self-similarity shows that Poisson process cannot accurately describe the real network traffic. In such high-speed mobile network the assumption of exponentiality does not apply any more.

ETSI STQ Mobile TS 102 250-6 [6] adopts the statistical model to calculate the QoS metrics of GSM and 3G networks. These models are more precise than traditional theoretical models. However, ETSI STQ Mobile focuses on the measurement of quality metrics for services that are already functional. The prediction of service performance (e.g. based on statistical models of traffic patterns and network characteristics) is out of the scope of ETSI STQ Mobile. It is very difficult to implement the calculation due to the lack of raw data, if the new multimedia services haven't become commercial deployment or they are just in the initial stage of deployment in GSM and 3G network.

Nowadays, there still have not authoritative statistical model to handle the coming multimedia services' raw data with self-similar and impulsive characteristics. Although the self-similar models can describe the statistical data more precisely, they will encounter difficulties with in-depth performance indicators analysis and calculation of the self-similar network traffic.

### C.3.2.2 Theory Model Analysis of Queue

Traditional telecom service traffic is adequately described by Markovian models (e.g. Poisson), which are amenable to accurate analysis. Generally, these models assume independence between events, and exponentially inter-event distributions.

Although queue theory fails to fit actual traffic of high-speed mobile networks, E2EMSPM still adopted these models to analyse the network traffic, mainly because Markovian models are mathematically tractable.

### C.3.2.3 Possible Further Work

The above two methods have its own advantages respectively for the fresh multimedia services, the optimal research method should combine statistics model with queue theory model to complement with each other.

The combined method might be adopted in future work beyond the scope of both ETSI STQ Mobile and E2EMSPM.

---

## C.4 Brief Introduction of the Work in ETSI STQ

The ETSI Speech Processing, Transmission and Quality Aspects (STQ) workgroup is actively working on QoS. STQ has published its Technical Specification, TS 102 250 "QoS aspects for popular services in GSM and 3G networks" [Part 1 to 6], which covers the following.

Part 1 [1] identifies QoS aspects for popular services in GSM and 3G networks. For each service the QoS indicators are listed. They are considered to be suitable for the quantitative characterization of the dominant technical QoS aspects as experienced from the end-user perspective.

Part 2 [2] defines QoS parameters and their computation for popular services in GSM and 3G networks. The technical QoS indicators, listed in part 1, are the basis for the parameter set chosen. The parameter definition is split into two parts: the abstract definition and the generic description of the measurement method with the respective trigger points. Only measurement methods not dependent on any infrastructure provided are described in the present document. The harmonized definitions given in the present document are considered as the prerequisites for comparison of QoS measurements and measurement results.

Part 3 [3] describes typical procedures used for QoS measurements over GSM, along with settings and parameters for such measurements.

Part 4 [4] defines the minimum requirements of QoS measurement equipment for GSM and 3G networks in the way that the values and trigger-points needed to compute the QoS parameter as defined in Part 2 can be measured following the procedures defined in Part 3. Test equipment fulfilling the specified minimum requirements will be allowed to perform the proposed measurements in a reliable and reproducible way.

Part 5 [5] specifies test profiles which are required to enable benchmarking of different GSM or 3G networks both within and outside national boundaries. It is necessary to have these profiles so that when a specific set of tests are carried out then customers are comparing "like for like" performance.

Part 6 [6] describes procedures to be used for statistical calculations in the field of QoS measurement of GSM and 3G networks using probing systems.

---

## Annex D: Change history

Change history							
Date	TSG #	TSG Doc.	CR	Rev	Subject/Comment	Old	New
2007-03	35	SP-070015			Approved at TSG SA#35	2.0.0	7.0.0
2008-12	42				Version for Release 8	7.0.0	8.0.0
2009-12	46				Version for Release 9	8.0.0	9.0.0
2011-03	51				Version for Release 10	9.0.0	10.0.0
2012-09	57				Version for Release 11	10.0.0	11.0.0
2013-12	62	SP-130568	0001		Correction to references	11.0.0	11.1.0

---

## History

<b>Document history</b>		
V11.0.0	October 2012	Publication
V11.1.0	January 2014	Publication