

ETSI TR 125 942 V4.1.0 (2001-12)

Technical Report

Universal Mobile Telecommunications System (UMTS); RF System scenarios (3GPP TR 25.942 version 4.1.0 Release 4)



Reference

RTR/TSGR-0425942Uv4R1

Keywords

UMTS

ETSI

650 Route des Lucioles
F-06921 Sophia Antipolis Cedex - FRANCE

Tel.: +33 4 92 94 42 00 Fax: +33 4 93 65 47 16

Siret N° 348 623 562 00017 - NAF 742 C
Association à but non lucratif enregistrée à la
Sous-Préfecture de Grasse (06) N° 7803/88

Important notice

Individual copies of the present document can be downloaded from:

<http://www.etsi.org>

The present document may be made available in more than one electronic version or in print. In any case of existing or perceived difference in contents between such versions, the reference version is the Portable Document Format (PDF). In case of dispute, the reference shall be the printing on ETSI printers of the PDF version kept on a specific network drive within ETSI Secretariat.

Users of the present document should be aware that the document may be subject to revision or change of status. Information on the current status of this and other ETSI documents is available at

<http://portal.etsi.org/tb/status/status.asp>

If you find errors in the present document, send your comment to:

editor@etsi.fr

Copyright Notification

No part may be reproduced except as authorized by written permission.
The copyright and the foregoing restriction extend to reproduction in all media.

© European Telecommunications Standards Institute 2001.
All rights reserved.

Intellectual Property Rights

IPRs essential or potentially essential to the present document may have been declared to ETSI. The information pertaining to these essential IPRs, if any, is publicly available for **ETSI members and non-members**, and can be found in ETSI SR 000 314: "*Intellectual Property Rights (IPRs); Essential, or potentially Essential, IPRs notified to ETSI in respect of ETSI standards*", which is available from the ETSI Secretariat. Latest updates are available on the ETSI Web server (<http://webapp.etsi.org/IPR/home.asp>).

Pursuant to the ETSI IPR Policy, no investigation, including IPR searches, has been carried out by ETSI. No guarantee can be given as to the existence of other IPRs not referenced in ETSI SR 000 314 (or the updates on the ETSI Web server) which are, or may be, or may become, essential to the present document.

Foreword

This Technical Report (TR) has been produced by ETSI 3rd Generation Partnership Project (3GPP).

The present document may refer to technical specifications or reports using their 3GPP identities, UMTS identities or GSM identities. These should be interpreted as being references to the corresponding ETSI deliverables.

The cross reference between GSM, UMTS, 3GPP and ETSI identities can be found under www.etsi.org/key.

Contents

Intellectual Property Rights	2
Foreword.....	2
Foreword.....	8
1 Scope	9
2 References	9
3 Definitions, symbols and abbreviations	10
3.1 Definitions	10
3.2 Symbols.....	10
3.3 Abbreviations	11
4 General	11
4.1 Single MS and BTS	12
4.1.1 Constraints	12
4.1.1.1 Frequency Bands and Channel Arrangement	12
4.1.1.2 Proximity.....	12
4.2 Mobile Station to Mobile Station	12
4.2.1 Near-far effect.....	12
4.2.2 Co-located MS and intermodulation	14
4.3 Mobile Station to Base Station	15
4.4 Base Station to Mobile Station	17
4.4.1 Near-far effect.....	17
4.4.2 Co-located Base Stations and intermodulation	19
4.5 Base Station to Base Station.....	19
5 Methodology for coexistence studies FDD/FDD	21
5.1 ACIR	21
5.1.1 Definitions	21
5.1.1.1 Outage	21
5.1.1.2 Satisfied user	21
5.1.1.3 ACIR.....	21
5.1.2 Introduction.....	21
5.1.2.1 Overview of the simulation principles	21
5.1.3 Simulated scenarios in the FDD - FDD coexistence scenario	22
5.1.3.1 Macro to macro multi-operator case	22
5.1.3.1.1 Single operator layout.....	22
5.1.3.1.2 Multi-operator layout.....	22
5.1.3.2 Macro to micro multi-operator case	22
5.1.3.2.1 Single operator layout, microcell layer.....	22
5.1.3.2.2 Multi-operator layout.....	23
5.1.3.3 Services simulated.....	24
5.1.4 Description of the propagation models	24
5.1.4.1 Received signal	24
5.1.4.2 Macro cell propagation model.....	25
5.1.4.3 Micro cell propagation model	25
5.1.5 Simulation description	26
5.1.5.1 Single step (snapshot) description.....	27
5.1.5.2 Multiple steps (snapshots) execution	27
5.1.6 Handover and Power Control modelling	27
5.1.6.1 Handover Modelling	27
5.1.6.1.1 Uplink Combining.....	27
5.1.6.1.2 Downlink Combining	28
5.1.6.2 Power Control modelling of traffic channels in Uplink	28
5.1.6.2.1 Simulation parameters	28
5.1.6.2.2 SIR calculation in Uplink	28
5.1.6.2.3 Admission Control Modelling in Uplink.....	28

5.1.6.3	Power Control modelling of traffic channels in Downlink	28
5.1.6.3.1	Simulation parameters	29
5.1.6.3.2	SIR calculation in Downlink	29
5.1.6.3.3	Admission Control Modelling in Downlink	29
5.1.6.3.4	Handling of Downlink maximum TX power.....	30
5.1.7	System Loading and simulation output.....	30
5.1.7.1	Uplink	30
5.1.7.1.1	Single operator loading.....	30
5.1.7.1.2	multi-operator case (macro to macro).....	30
5.1.7.1.3	multi-operator case (macro to micro)	31
5.1.7.2	Downlink.....	31
5.1.7.2.1	Single operator loading.....	31
5.1.7.2.2	multi-operator case (macro to macro).....	31
5.1.7.2.3	Multi-operator case (Macro to Micro).....	31
5.1.7.3	Simulation output.....	32
5.1.8	Annex: Summary of simulation parameters.....	33
5.1.9	Simulation Parameters for 24 dBm terminals	34
5.1.9.1	Uplink	34
5.2	BTS Receiver Blocking	35
5.2.1	Assumptions for simulation scenario for 1 Km cell radius	35
5.2.2	Assumptions for simulation scenario for 5 Km cell radius	36
6	Methodology for coexistence studies FDD/TDD.....	36
6.1	Evaluation of FDD/TDD interference	36
6.1.1	Simulation description	36
6.1.1.1	Simulated services.....	36
6.1.1.2	Spectrum mask	37
6.1.1.3	Maximum transmit power	37
6.1.1.4	Receiver filter.....	37
6.1.1.5	Power control	38
6.1.2	Macro Cell scenario	40
6.1.2.1	Evaluation method	40
6.1.2.2	Pathloss formula.....	40
6.1.2.3	User density.....	40
6.1.3	Micro cell scenario.....	41
6.1.3.1	Evaluation method	41
6.1.3.2	Pathloss formula.....	41
6.1.3.3	User density.....	41
6.1.4	Pico cell scenario	41
6.1.4.1	Evaluation method	41
6.1.4.2	Pathloss formula.....	41
6.1.4.3	User density.....	41
6.1.5	HCS scenario	42
6.2	Evaluation of FDD/TDD interference yielding relative capacity loss.....	42
6.2.1	Definition of system capacity	42
6.2.2	Calculation of capacity	42
6.2.2.1	Calculation of single operator capacity.....	43
6.2.2.2	Calculation of multi operator capacity	43
7	Methodology for coexistence studies TDD/TDD.....	44
7.1	Introduction	44
7.2	Evaluation of the TDD/TDD interference	44
7.3	Evaluation of TDD/TDD interference yielding relative capacity loss.....	44
7.4	ACIR	45
7.4.1	Macro to Macro multi-operator case.....	45
7.4.1.1	Synchronised operators	45
7.4.1.2	Non synchronised operators	45
7.4.1.2.1	Description of the Propagation Models	46
7.4.1.2.1.1	Minimum Coupling Loss (MCL).....	46
7.4.1.2.1.2	BS-to-MS and MS-to-BS propagation model.....	46
7.4.1.2.1.3	BS-to-BS propagation model	46
7.4.1.2.1.4	MS-to-MS propagation model	46

7.4.2	Simulation parameters	47
8	Results, implementation issues, and recommendations	49
8.1	FDD/FDD	49
8.1.1	ACIR for 21 dBm terminals	49
8.1.1.1	UL Speech (8 kbps): ACIR Intermediate macro to macro case	49
8.1.1.2	UL Speech (8 kbps): ACIR worst macro to macro case	50
8.1.1.3	DL Speech (8 kbps): ACIR intermediate macro to macro case	50
8.1.1.4	DL Speech (8 Kbps): ACIR worst macro to macro case	51
8.1.2	ACIR for 24 dBm terminals	52
8.1.2.1	UL Speech (8 kbps): macro to macro	52
8.1.2.2	UL Data (144 kbps): macro to macro	53
8.1.3	BTS Receiver Blocking	53
8.1.3.1	Simulation Results for 1 Km cell radius	53
8.1.3.2	Simulation Results for 5 Km cell radius	55
8.1.4	Transmit intermodulation for the UE	57
8.2	FDD/TDD	58
8.2.1	Evaluation of the FDD/TDD interference	58
8.2.1.1	Simulation results	58
8.2.1.2	Summary and Conclusions	62
8.2.2	Evaluation of FDD/TDD interference yielding relative capacity loss	62
8.2.2.1	Simulation results	62
8.3	TDD/TDD	62
8.3.1	Evaluation of the TDD/TDD interference	62
8.3.1.1	Simulation results	62
8.3.1.2	Summary and Conclusions	65
8.3.2	Evaluation of FDD/TDD interference yielding relative capacity loss	65
8.3.2.1	Simulation results	65
8.3.3	ACIR	65
8.3.3.1	Synchronised operators	65
8.3.3.1.1	Speech (8 kbps): UL and DL macro to macro case	65
8.3.3.1.2	Comparison with the FDD/FDD coexistence analysis results	67
8.3.3.2	Non synchronised operators	68
8.4	Site engineering solutions for co-location of UTRA-FDD with UTRA-TDD	69
8.4.1	General	69
8.4.2	Interference Mechanism	69
8.4.2.1	Unwanted UTRA-TDD emissions	69
8.4.2.2	Blocking of UTRA-FDD BS receiver	69
8.4.3	Site engineering solutions	70
8.4.3.1	Antenna installation	70
8.4.3.2	RF filters	70
8.4.3.2.1	UTRA-TDD base station transmitter filter	70
8.4.3.2.2	UTRA-FDD base station receiver filter	70
8.4.4	Scenario Examples	71
8.4.4.1	General	71
8.4.4.2	Scenario 1: Both TDD and FDD adjacent to 1920 MHz	71
8.4.3	Scenario 2a: TDD 1900-1915 MHz and FDD 1920-1940 MHz	71
8.4.4	Scenario 2b: TDD 1900-1920 MHz and FDD 1930-1980 MHz	72
9	Additional Coexistence studies	73
9.1	Simulation results on TDD local area BS and FDD wide area BS coexistence	73
9.1.1	Introduction	73
9.1.2	Simulator Description	74
9.1.2.1	Simulation procedure overview	74
9.1.2.2	System Scenario	74
9.1.2.3	Propagation Model	75
9.1.2.3.1	TDD BS to TDD UE	75
9.1.2.3.2	FDD UE to FDD BS	75
9.1.2.3.3	TDD UE to FDD BS	75
9.1.2.3.4	FDD UE to TDD UE	75
9.1.2.3.5	FDD UE to TDD BS	75
9.1.2.3.6	TDD BS to FDD BS	75

9.1.2.4	Power Control	76
9.1.2.5	Interference Modelling Methodology	76
9.1.3	Capacity Calculations	76
9.1.3.1	Calculation of Single Operator Capacity for TDD and FDD	76
9.1.3.2	Calculation of Multi Operator Capacity	77
9.1.3.3	Calculation of relative capacity loss	77
9.1.4	Simulation Parameters	78
9.1.5	Simulation results	78
9.1.6	Conclusions	79
10	Antenna-to-Antenna Isolation	79
10.1	Rationale for MCL value	79
11	Modulation accuracy	80
11.1	Downlink modulation accuracy	80
11.1.1	Simulation Condition and Definition	80
11.1.2	Simulation Results	80
11.1.3	Considerations	82
11.1.4	Conclusion	82
11.2	Uplink Modulation Accuracy	82
11.2.1	Value for Modulation Accuracy	82
11.2.2	References for minimum requirements	83
12	UE active set size	83
12.1	Introduction	83
12.2	Simulation assumptions	83
12.3	Simulation results	84
12.3.1	Case 1: Three sectored, 65° antenna	84
12.3.2	Case 2: Three sectored, 90° antenna	85
12.3.3	Case 3: Three sectored, 65° antenna, bad planning	86
12.3.4	Cases 4: Standard omni scenario	87
12.3.4.1	Case 4a: WINDOW_ADD = 5 dB	87
12.3.4.2	Case 4b: WINDOW_ADD = 3 dB	88
12.3.4.3	Case 4c: WINDOW_ADD = 7 dB	88
12.3.5	Case 5: Realistic map	89
12.4	Conclusions	90
13	Informative and general purpose material	90
13.1	CDMA definitions and equations	90
13.1.1	CDMA-related definitions	91
13.1.2	CDMA equations	92
13.1.2.1	BS Transmission Power	92
13.1.2.2	Rx Signal Strength for UE Not in Handoff (Static propagation conditions)	92
13.1.2.3	Rx Strength for UE Not in Handoff (Static propagation conditions)	93
13.1.2.4	Rx Signal Strength for UE in two-way Handover	94
14	Rationales for unwanted emission specifications	94
14.1	Out of band Emissions	94
14.1.1	Adjacent Channel Leakage Ratio	94
14.1.2	Spectrum mask	95
14.1.2.1	Spectrum mask for 43 dBm base station output power per carrier	95
14.1.2.2	Spectrum masks for other base station output powers	96
14.1.2.2.1	Output power > 43 dBm	96
14.1.2.2.2	39 dBm ≤ Output power ≤ 43 dBm	96
14.1.2.2.3	31 dBm ≤ Output power < 39 dBm	97
14.1.2.2.4	Output Power < 31 dBm	97
14.1.2.2.5	Frequency range	97
14.2	Spurious Emissions	98
14.2.1	Mandatory requirements	98
14.2.2	Regional requirements	98
14.2.2.1	Co-existence with adjacent services	98
14.2.2.2	Co-existence with other systems	98
15	Link Level performances	98

15.1	Propagation Models.....	98
15.1.1	Rationale for the choice of multipath fading Case 2.....	98
15.2	Simulation results for UE TDD performance test	99
15.2.1	Downlink Simulation assumptions	99
15.2.1.1	General	99
15.2.1.2	Additional downlink parameters	99
15.2	Downlink Simulation results and discussion	100
15.2.3	Uplink Simulation assumptions	102
15.2.3.1	General	102
15.2.3.2	Additional uplink parameters	102
15.2.4	Uplink Simulation results and discussion	102
15.3	Simulation results for UE FDD performance test.....	103
15.3.1	BTFD performance simulation	103
15.3.1.1	Introduction.....	103
15.3.1.2	Assumption	103
15.3.1.3	Simulation results.....	105
15.3.1.4	Conclusion	108
15.4	Simulation results for compressed mode.....	109
15.4.1	Simulation assumptions for compressed mode by spreading factor reduction	109
15.4.2	Simulation results for compressed mode by spreading factor reduction.....	110
15.4.2.1	Summary of performance results	110
15.4.2.2	Results.....	111
Annex A:	Change History	115
History		118

Foreword

This Technical Report has been produced by the 3rd Generation Partnership Project (3GPP).

The contents of the present document are subject to continuing work within the TSG and may change following formal TSG approval. Should the TSG modify the contents of the present document, it will be re-released by the TSG with an identifying change of release date and an increase in version number as follows:

Version x.y.z

where:

- x the first digit:
 - 1 presented to TSG for information;
 - 2 presented to TSG for approval;
 - 3 or greater indicates TSG approved document under change control.
- y the second digit is incremented for all changes of substance, i.e. technical enhancements, corrections, updates, etc.
- z the third digit is incremented when editorial only changes have been incorporated in the document.

1 Scope

During the UTRA standards development, the physical layer parameters will be decided using system scenarios, together with implementation issues, reflecting the environments that UTRA will be designed to operate in.

2 References

The following documents contain provisions which, through reference in this text, constitute provisions of the present document.

- References are either specific (identified by date of publication, edition number, version number, etc.) or non-specific.
- For a specific reference, subsequent revisions do not apply.
- For a non-specific reference, the latest version applies. In the case of a reference to a 3GPP document (including a GSM document), a non-specific reference implicitly refers to the latest version of that document *in the same Release as the present document*.

- [1] 3GPP TS 25.101: "Universal Mobile Telecommunications System (UMTS); UE Radio Transmission and Reception (FDD)".
- [2] 3GPP TS 25.102: "Universal Mobile Telecommunications System (UMTS); UTRA (UE) TDD; Radio Transmission and Reception".
- [3] 3GPP TS 25.104: "Universal Mobile Telecommunications System (UMTS); UTRA (BS) FDD; Radio transmission and Reception".
- [4] 3GPP TS 25.105: "Universal Mobile Telecommunications System (UMTS); UTRA (BS) TDD; Radio transmission and Reception".
- [5] Tdoc SMG2 UMTS L1 5/98: "UTRA system simulations for the multi-operator case", Oslo, Norway, 1-2 April 1998.
- [6] Tdoc SMG2 UMTS L1 100, 101/98 (1998): "Adjacent Channel Interference in UTRA system, revision 1".
- [7] Tdoc SMG2 UMTS L1 465/98: "Balanced approach to evaluating UTRA adjacent Channel protection requirements", Stockholm, 14-16 October 98.
- [8] Tdoc SMG2 UMTS L1 694/98: "The relationship between downlink ACS and uplink ACP in UTRA system", Espoo Finland, 14-18 December 1998.
- [9] ETSI TR 101 112 (V3.1.0): "Universal Mobile Telecommunications System (UMTS); Selection procedures for the choice of radio transmission technologies of the UMTS (UMTS 30.03 version 3.1.0)".
- [10] Pizarrosa, M., Jimenez, J. (eds.): "Common Basis for Evaluation of ATDMA and CODIT System Concepts", MPLA/TDE/SIG5/DS/P/001/b1, September 95.
- [11] Concept Group Alpha - Wideband Direct-Sequence CDMA, Evaluation document (Draft 1.0), Part 3: Detailed simulation results and parameters, ETSI SMG2#23, Bad Salzdetfurth, Germany, October 1-3, 1997.
- [12] TSG RAN WG4 TR 25.942 V 2.0.0 (1999) "RF System Scenarios"
- [13] TSG RAN WG4#3 Tdoc 96/99: "TDD/FDD co-existence - summary of results", Siemens
- [14] TSG RAN WG4#6 Tdoc 419/99: "Simulation results on FDD/TDD co-existence including real receive filter and C/I based power control", Siemens.
- [15] TSG RAN WG4#7 Tdoc 568/99: "Interference of FDD MS (macro) to TDD (micro)", Siemens.

- [16] ETSI TR 101 112 (V3.2.0): "Universal Mobile Telecommunications System (UMTS); Selection procedures for the choice of radio transmission technologies of the UMTS".
- [17] Evaluation Report for ETSI UMTS Terrestrial Radio Access (UTRA) ITU-R RTT Candidate (September 1998), Attachment 5.
- [18] J.E. Berg: "A Recursive Model For Street Microcell Path Loss Calculations", International Symposium on Personal Indoor and Mobile indoor Communications (PIMRC) '95, p 140 - 143, Toronto.
- [19] SMG2 UMTS L1 Tdoc 679/98: "Coupling Loss analysis for UTRA - additional results", Siemens.
- [20] TSG RAN WG4#8 Tdoc 653/99: "Summary of results on FDD/TDD and TDD/TDD co-existence", Siemens.
- [21] Siemens: "UTRA TDD Link Level and System Level Simulation Results for ITU Submission", SMG2 UMTS-ITU, Tdoc S298W61 (September 1998).
- [22] TSG R4#6(99) 364: "ACIR simulation results for TDD mode: speech in UpLink and in DownLink" (July 1999).
- [23] ETSI STC SMG2 UMTS L1#9, Tdoc 679/98:"Coupling Loss Analysis for UTRA - additional results".
- [24] ITU-R Recommendation P.452-8: "Prediction procedure for the evaluation of microwave interference between stations on the surface of the Earth at frequencies above about 0,7 GHz".
- [25] TSGR4#8(99)623: "Call admission criterion in UpLink for TDD mode".
- [26] SMG2 UMTS-ITU, Tdoc S298W61: "UTRA TDD Link Level and System Level Simulation Results for ITU Submission" (September 1998).
- [27] TS 25.942 V0.1.3 (1999-05), par.8.1: "RF System Scenarios", Alcatel, Ericsson, Nokia, NTT DoCoMo and Motorola: UL and DL ACIR simulations results.
- [28] 3GPP TAG RAN WG4 Tdoc 631/99: "Antenna-to-Antenna Isolation Measurements".
- [29] ETSI/STC SMG2 Tdoc 48/93: "Practical Measurement of Antenna Coupling Loss".
- [30] Tdoc R4-99677: "Comments on Modulation Accuracy and Code Domain Power," Motorola.
- [31] UMTS 30.03

3 Definitions, symbols and abbreviations

3.1 Definitions

(void)

3.2 Symbols

(void)

3.3 Abbreviations

For the purposes of the present document, the following abbreviations apply:

ACLR	Adjacent Channel Leakage power Ratio
ACS	Adjacent Channel Slectivity
MC	Monte-Carlo
PC	Power Control

4 General

The present document discusses system scenarios for UTRA operation primarily with respect to the radio transmission and reception. To develop the UTRA standard, all the relevant scenarios need to be considered for the various aspects of operation and the most critical cases identified. The process may then be iterated to arrive at final parameters that meet both service and implementation requirements.

Each scenario has four clauses:

- a) lists the system constraints such as the separation of the MS and BTS, coupling loss;
- b) lists those parameters that are affected by the constraints;
- c) describes the methodology to adopt in studying the scenario;
- d) lists the inputs required to examine the implications of the scenarios.

The following scenarios will be discussed for FDD and TDD modes (further scenarios will be added as and when identified):

- 1) Single MS, single BTS;
- 2) MS to MS;
- 3) MS to BS;
- 4) BS to MS;
- 5) BS to BS.

These scenarios will be considered for coordinated and uncoordinated operation. Parameters possibly influenced by the scenarios are listed in TS 25.101, TS 25.102, TS 25.104 and TS 25.105. These include, but are not limited to:

- out of band emissions;
- spurious emissions;
- intermodulation rejection;
- intermodulation between MS;
- reference interference level;
- blocking.

The scenarios defined below are to be studied in order to define RF parameters and to evaluate corresponding carrier spacing values for various configurations. The following methodology should be used to derive these results.

Define spectrum masks for UTRA MS and BS, with associated constraints on PA.

Evaluate the ACP as a function of carrier spacing for each proposed spectrum mask.

Evaluate system capacity loss as a function of ACP for various system scenarios (need to agree on power control algorithm).

Establish the overall trade-off between carrier spacing and capacity loss, including considerations on PA constraints if required. Conclude on the optimal spectrum masks or eventually come back to the definition of spectrum masks to achieve a better performance/cost trade-off.

NOTE: Existence of UEs of power class 1 with maximum output power defined in TS 25.101 for FDD and in TS 25.102 for TDD should be taken into account when worst case scenarios are studied.

4.1 Single MS and BTS

4.1.1 Constraints

The main constraint is the physical separation of the MS and BTS. The extreme conditions are when the MS is close to or remote from the BTS.

4.1.1.1 Frequency Bands and Channel Arrangement

Void.

4.1.1.2 Proximity

Table 1: Examples of close proximity scenarios in urban and rural environments

	Rural	Urban			
		Building	Street	pedestrian	indoor
BTS antenna height, H _b (m)	[20]	[30]	[15]	[6]	[2]
MS antenna height, H _m (m)	1,5	[15]	1,5	1,5	1,5
Horizontal separation (m)	[30]	[30]	[10]	[2]	[2]
BTS antenna gain, G _b (dB)	[17]	[17]	[9]	[5]	[0]
MS antenna gain, G _m (dB)	[0]	[0]	[0]	[0]	[0]
Path loss into building (dB)					
Cable/connector Loss (dB)	2	2	2	2	2
Body Loss (dB)	[1]	[1]	[1]	[1]	[1]
Path Loss - Antenna gain (dB)					

Path loss is assumed to be free space i.e. $38,25 + 20 \log d$ (m) dB, where d is the length of the sloping line connecting the transmit and receive antennas.

Editor's note: This will be used to determine MCL.

4.2 Mobile Station to Mobile Station

4.2.1 Near-far effect

a) System constraints

Dual mode operation of a terminal and hand-over between FDD and TDD are not considered here, since the hand-over protocols are assumed to avoid simultaneous transmission and reception in both modes.

The two mobile stations can potentially come very close to each other (less than 1m). However, the probability for this to occur is very limited and depends on deployment

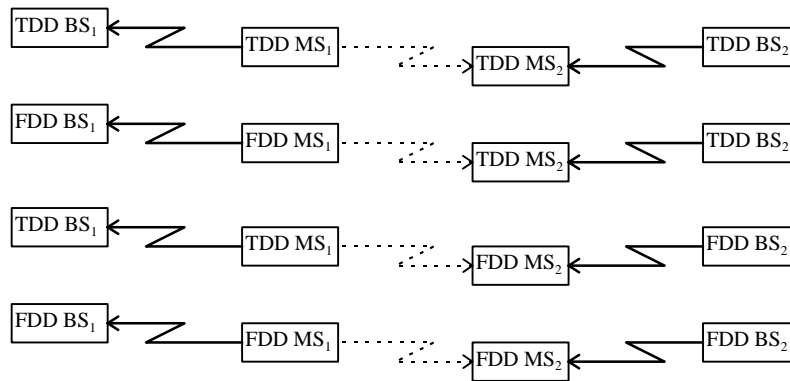

Figure 1: Possible MS to MS scenarios

NOTE: Both MS can operate in FDD or TDD mode.

b) Affected parameters

[FDD and TDD] MS Out-of-band emissions.

[FDD and TDD] MS Spurious emissions.

[FDD and TDD] MS Blocking.

[FDD and TDD] MS Reference interference level.

c) Methodology

The first approach is to calculate the minimum coupling loss between the two mobiles, taking into account a minimum separation distance. It requires to assume that the interfering mobile operates at maximum power and that the victim mobile operates 3 dB above sensitivity.

Another approach is to take into account the deployment of mobile stations in a dense environment, and to base the interference criterion on:

- the actual power received by the victim mobile station;
- the actual power transmitted by the interfering mobile station, depending on power control.

This approach gives as a result a probability of interference.

The second approach should be preferred, since the power control has a major impact in this scenario.

d) Inputs required

For the first approach, a minimum distance separation and the corresponding path loss is necessary. For the second approach, mobile and base station densities, power control algorithm, and maximum acceptable probability of interference are needed.

Minimum separation distance: 5 m [for outdoor, 1 m for indoor].

Mobile station density: [TBD in relation with service, cell radius and system capacity]

Base station density: [cell radius equal to 4 km for rural, 0,5 km for urban or 0,1 km for indoor].

Power control algorithm: [TBD].

Maximum acceptable probability of interference: 2 %.

e) scenarios for coexistence studies

The most critical case occurs at the edge of FDD and TDD bands. Other scenarios need to be considered for TDD operation in case different networks are not synchronised or are operating with different frame switching points.

FDD MS → TDD MS at 1 920 MHz (macro/micro, macro/pico).

TDD MS → FDD MS at 1 920 MHz (micro/micro, pico/pico).

TDD MS → TDD MS (micro/micro, pico/pico) for non synchronised networks.

These scenarios should be studied for the following services.

Table 1A

Environment	Services
Rural Macro	Speech, LCD 144
Urban Micro/Macro	Speech, LCD 384
Indoor Pico	Speech, LCD 384, LCD 2 048

4.2.2 Co-located MS and intermodulation

a) System constraints

Close mobile stations can produce intermodulation products, which can fall into mobile or base stations receiver bands. This can occur with MS operating in FDD and TDD modes, and the victim can be BS or MS operating in both modes.

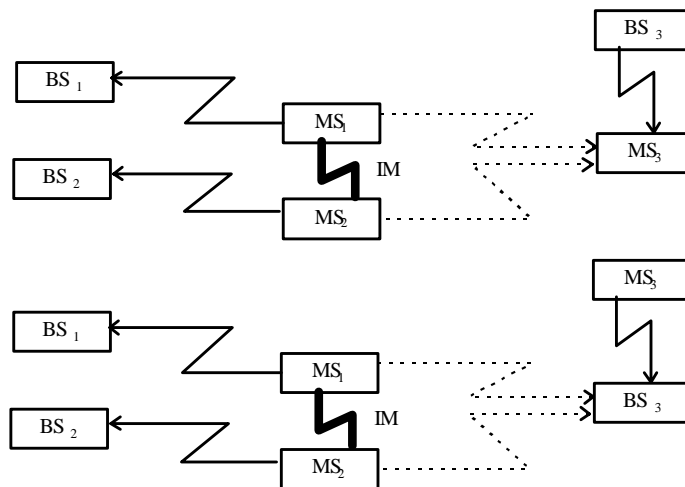

Figure 2: Possible collocated MS scenarios

b) Affected parameters

[FDD and TDD] intermodulation between MS.

[FDD and TDD] MS and BS blocking.

[FDD and TDD] MS and BS reference interference level.

c) Methodology

The first approach is to assume that the two mobile stations are collocated, and to derive the minimum coupling loss. It requires to assume that both mobiles are transmitting at maximum power.

Another approach can take into account the probability that the two mobiles come close to each other, in a dense environment, and to calculate the probability that the intermodulation products interfere with the receiver.

The second approach should be preferred.

d) Inputs required

Minimum separation distance: 5 m[for outdoor, 1 m for indoor]

Mobile station density: [TBD]

Base station density: [TBD in relation with MS density]

Power control algorithm: [TBD]

Maximum acceptable probability of interference: 2 %

4.3 Mobile Station to Base Station

a) System constraints

A mobile station, when far away from its base station, transmits at high power. If it comes close to a receiving base station, interference can occur.

The separation distance between the interfering mobile station and the victim base station can be small, but not as small as between two mobile stations.

Both the mobile and the base stations can operate in FDD and TDD modes, thus four scenarios are to be considered, as shown in figure 3.

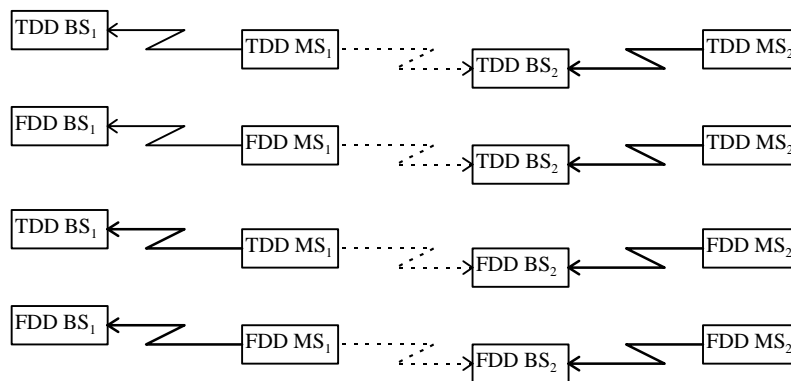

Figure 3: Possible MS to BS scenarios

b) Affected parameters

[FDD and TDD] MS Out-of-band emissions.

[FDD and TDD] MS Spurious emissions.

[FDD and TDD] BS Blocking.

[FDD and TDD] BS Reference interference level.

c) Methodology

The first approach is to assume that the mobile station transmits at maximum power, and to make calculations for a minimum distance separation. This approach is particularly well suited for the blocking phenomenon.

Another approach is to estimate the loss of uplink capacity at the level of the victim base station, due to the interfering power level coming from a distribution of interfering mobile stations. Those mobile stations are power controlled. A hexagonal cell lay-out is considered for the BS deployment with specified cell radius. Large cell radius are chosen since they correspond to worst case scenarios for coexistence studies.

The second approach should be preferred.

With both approaches two specific cases are to be considered.

Both base stations (BS₁ and BS₂) are co-located. This case occurs in particular when the same operator operates both stations (or one station with two carriers) on the same HCS layer.

The base stations are not co-located and uncoordinated. This case occurs between two operators, or between two layers.

d) Inputs required

Minimum separation distance: [30 m for rural, 15 m for urban, 3 m for indoor].

Base station density: [cell radius equal to 4 km for rural/macro, 1,5 km for urban/macro, 0,5 km for urban/micro or 0,1 km for indoor/pico].

Interfering mobile station density: [TBD in relation with service, cell radius and system capacity].

Power control algorithm: [TBD].

Maximum acceptable loss of capacity: [10 %].

e) scenarios for coexistence studies

Inter-operator guard band (uncoordinated deployment).

FDD macro/ FDD macro.

FDD macro/ FDD micro.

FDD macro/ FDD pico (indoor).

FDD micro/ FDD pico (indoor).

TDD macro/ TDD macro.

TDD macro/ TDD micro.

TDD macro/ TDD pico (indoor).

TDD micro/ TDD pico (indoor).

FDD macro/ TDD macro at 1 920 MHz.

FDD macro/ TDD micro at 1 920 MHz.

FDD macro/ TDD pico at 1 920 MHz.

FDD micro/ TDD micro at 1 920 MHz.

FDD micro/ TDD pico at 1 920 MHz.

Intra-operator guard bands.

FDD macro/ FDD macro (colocated).

FDD macro/ FDD micro.

- FDD macro/ FDD pico (indoor).
- FDD micro/ FDD pico (indoor).
- TDD macro/ TDD macro.
- TDD macro/ TDD micro.
- TDD macro/ TDD pico (indoor).
- TDD micro/ TDD pico (indoor).
- FDD macro/ TDD macro at 1 920 MHz.
- FDD macro/ TDD micro at 1 920 MHz.
- FDD macro/ TDD pico at 1 920 MHz.
- FDD micro/ TDD micro at 1 920 MHz.
- FDD micro/ TDD pico at 1 920 MHz.

These scenarios should be studied for the following services.

Table 1B

Environment	Services
Rural Macro	Speech, LCD 144
Urban Micro/Macro	Speech, LCD 384
Indoor Pico	Speech, LCD 384, LCD 2 048

4.4 Base Station to Mobile Station

4.4.1 Near-far effect

a) System constraints

A mobile station, when far away from its base station, receives at minimum power. If it comes close to a transmitting base station, interference can occur.

The separation distance between the interfering base station and the victim mobile station can be small, but not as small as between two mobile stations.

Both the mobile and the base stations can operate in FDD and TDD modes, thus four scenarios are to be considered, as shown in figure 4.

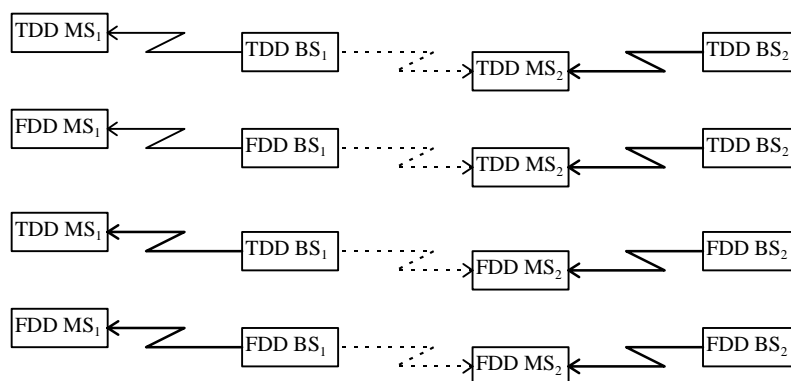

Figure 4: Possible BS to MS scenarios

b) Affected parameters

[FDD and TDD] BS Out-of-band emissions.

[FDD and TDD] BS Spurious emissions.

[FDD and TDD] MS Blocking.

[FDD and TDD] MS Reference interference level.

c) Methodology

The first approach is to calculate the minimum coupling loss between the base station and the mobile, taking into account a minimum separation distance. It requires to assume that the mobile is operating 3 dB above sensitivity.

The second approach is to take into account the deployment of mobile stations in a dense environment, and to base the interference criterion on the actual power received by the victim mobile station. This approach gives a probability of interference. An hexagonal cell lay-out is considered for the BS deployment with specified cell radius. Large cell radius are chosen since they correspond to worst case scenarios for coexistence studies.

The second approach should be preferred.

d) Inputs required

Minimum separation distance: [30 m for rural, 15 m for urban, 3 m for indoor].

Base station density: [cell radius equal to 4 km for rural/macro, 1,5 km for urban/macro, 0,5 km for urban/micro or 0,1 km for indoor/pico].

Victim mobile station density: [TBD in relation with service, cell radius and system capacity].

Downlink power control algorithm: [TBD].

Maximum acceptable probability of interference: 2 %.

e) scenarios for coexistence studies

Inter-operator guard band (uncoordinated deployment).

FDD macro/ FDD macro.

TDD macro/ TDD macro.

TDD macro/ FDD macro at 1 920 MHz.

Intra-operator guard bands.

FDD macro/ FDD micro.

TDD macro/ TDD micro.

TDD macro/ FDD macro at 1 920 MHz.

These scenarios should be studied for the following services.

Table 1C

Environment	Services
Rural Macro	Speech, LCD 144
Urban Micro/Macro	Speech, LCD 384
Indoor Pico	Speech, LCD 384, LCD 2 048

4.4.2 Co-located Base Stations and intermodulation

a) System constraints

Co-located base stations can produce intermodulation products, which can fall into mobile or base stations receiver bands. This can occur with BS operating in FDD and TDD modes, and the victim can be BS or MS operating in both modes.

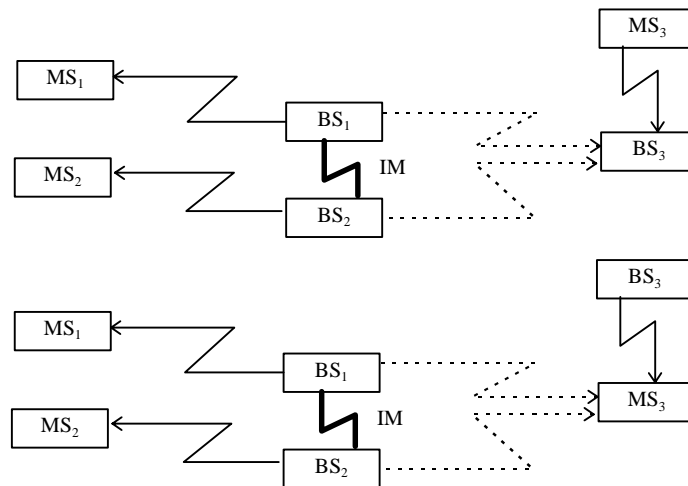

Figure 5: Possible collocated BS scenarios

b) Affected parameters

[FDD and TDD] intermodulation between BS.

[FDD and TDD] MS and BS blocking.

[FDD and TDD] MS and BS reference interference level.

c) Methodology

The first approach is to set a minimum separation distance between the two interfering base stations and the victim.

Another approach can take into account the probability that the intermodulation products interfere with the receiver, which does not necessarily receive at a fixed minimum level.

The second approach should be preferred.

d) Inputs required

Minimum separation distance between the two BS and the victim: [30 m for rural, 15 m for urban, 3m for indoor].

Mobile station density: [TBD].

Base station density: [TBD in relation with MS density].

Power control algorithm: [TBD].

Maximum acceptable probability of interference: 2 %.

4.5 Base Station to Base Station

a) System constraints

Interference from one base station to another can occur when both are co-sited, or when they are in close proximity with directional antenna. De-coupling between the BS can be achieved by correct site engineering on the same site, or by a large enough separation between two BS.

The base stations can operate either in FDD or TDD modes, as shown in Figure 6, but the scenarios also apply to co-existence with other systems.

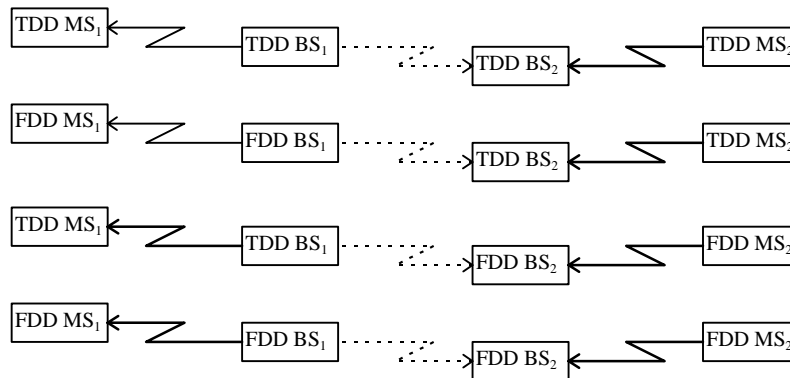

Figure 6: Possible BS to BS scenarios

b) Affected parameters

[FDD and TDD] BS Out-of-band emissions.

[FDD and TDD] BS Spurious emissions.

[FDD and TDD] BS Blocking.

[FDD and TDD] BS Reference interference level.

c) Methodology

This scenario appears to be fixed, and the minimum coupling loss could be here more appropriate than in other scenarios.

However, many factors are of statistical nature (number and position of mobile stations, power control behaviour, path losses, ...) and a probability of interference should here again be preferred.

d) Inputs required

Minimum coupling between two base stations, that are co-located or in close proximity to each other: see section Antenna to Antenna Isolation.

Mobile station density: [TBD in relation with service, cell radius and system capacity].

Base station density: [cell radius equal to 4 km for rural/macro, 1,5 km for urban/macro, 0,5 km for urban/micro or 0,1 km for indoor/pico].

Uplink and downlink power control algorithm: [TBD].

Maximum acceptable probability of interference: 2 %.

e) scenarios for coexistence studies

TDD BS → FDD BS at 1 920 MHz (macro/micro, macro/pico).

TDD BS → TDD BS (micro/micro, pico/pico) for non synchronised networks.

These scenarios should be studied for the following services.

Table 1D

Environment	Services
Rural Macro	Speech, LCD 144
Urban Micro/Macro	Speech, LCD 384
Indoor Pico	Speech, LCD 384, LCD 2 048

5 Methodology for coexistence studies FDD/FDD

5.1 ACIR

5.1.1 Definitions

5.1.1.1 Outage

For the purpose of the present document, an outage occurs when, due to a limitation on the maximum TX power, the measured E_b/N_0 of a connection is lower than the E_b/N_0 target.

5.1.1.2 Satisfied user

A user is satisfied when the measured E_b/N_0 of a connection at the end of a snapshot is higher than a value equal to E_b/N_0 target -0,5 dB.

5.1.1.3 ACIR

The Adjacent Channel Interference Power Ratio (ACIR) is defined as the ratio of the total power transmitted from a source (base station or UE) to the total interference power affecting a victim receiver, resulting from both transmitter and receiver imperfections.

5.1.2 Introduction

In the past, (see reference /1, 2, 3/) different simulators were presented with the purpose to provide capacity results to evaluate the ACIR requirements for UE and BS; in each of them similar approach to simulations are taken.

In the present document a common simulation approach agreed in WG4 is then presented, in order to evaluate ACIR requirements for FDD to FDD coexistence analysis.

5.1.2.1 Overview of the simulation principles

Simulations are based on snapshots where users are randomly placed in a predefined deployment scenario; in each snapshot a power control loop is simulated until E_b/N_0 target is reached; a simulation is made of several snapshots.

The measured E_b/N_0 is obtained by the measured C/I multiplied by the Processing gain

UE's not able to reach the E_b/N_0 target *at the end* of a PC loop are in outage; users able to reach at least (E_b/N_0 -0,5 dB) at the end of a PC loop are considered satisfied; statistical data related to outage (satisfied users) are collected at the end of each snapshot.

Soft handover is modeled allowing a maximum of 2 BTS in the active set; the window size of the candidate set is equal to 3 dB, and the cells in the active set are chosen randomly from the candidate set; selection combining is used in the Uplink and Maximum Ratio Combining in DL.

Uplink and Downlink are simulated independently.

5.1.3 Simulated scenarios in the FDD - FDD coexistence scenario

Different environments are considered: macro-cellular and micro-cellular environment.

Two coexistence cases are defined: macro to macro multi-operator case and macro to micro case.

5.1.3.1 Macro to macro multi-operator case

5.1.3.1.1 Single operator layout

Base stations are placed on a hexagonal grid with distance of 1 000 meters; the cell radius is then equal to 577 meters.

Base stations with Omni-directional antennas are placed in the middle of the cell.

The number of cells for each operator in the macro-cellular environment should be equal or higher than 19; 19 is considered a suitable number of cells when wrap around technique is used.

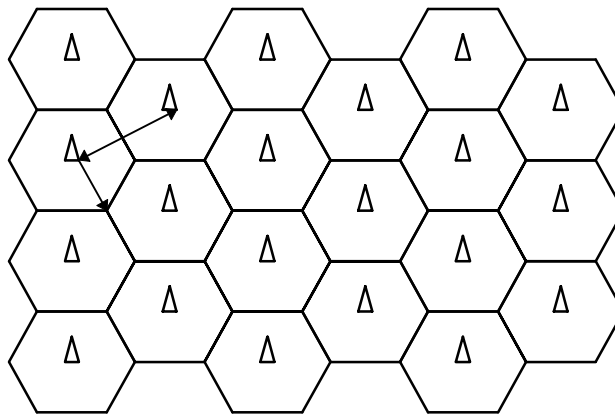

Figure 7: Macro-cellular deployment

5.1.3.1.2 Multi-operator layout

In the multi-operator case, two base stations shifting of two operators are considered:

- (worst case scenario): 577 m base station shift;
- (intermediate case): 577/2 m base station shift selected.

The best case scenario (0 m shifting = co-located sites) is NOT considered.

5.1.3.2 Macro to micro multi-operator case

5.1.3.2.1 Single operator layout, microcell layer

Microcell deployment is a Manhattan deployment scenario.

Micro cell base stations are placed to Manhattan grid, so that base stations are placed to street crossings as proposed in /6/. Base stations are placed every second junction, see Figure 8. This is not a very intelligent network planning, but then sufficient amount of inter cell interference is generated with reasonable low number of micro cell base stations.

The parameters of the micro cells are the following:

- block size = 75 m;
- road width = 15 m;
- intersite distance between line of sight = 180 m.

The number of micro cells in the micro-cellular scenario is 72.

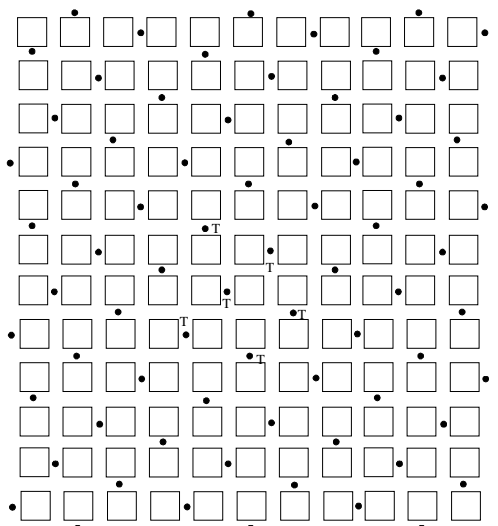

Figure 8 Microcell deployment

5.1.3.2.2 Multi-operator layout

The microcell layout is as it was proposed earlier (72 BSs in every second street junction, block size 75 meters, road width 15 meters); macro cell radius is 577 meters (distance between BSs is 1 000 meter).

Cellular layout for HCS simulations is as shown in figure 9. This layout is selected in order to have large enough macro cells and low amount number of microcells so that computation times remain reasonable. Further, macro cell base station positions are selected so that as many conditions as possible can be studied (i.e. border conditions etc.), and handovers can always be done.

When interference is measured at macro cell base stations in uplink, same channel interference is measured **only** from those users connected to the observed base station. The measured same channel interference is then multiplied by 1/F. F is the ratio of intra-cell interference to total interference i.e.:

$$F = I_{intra}(i) / (I_{intra}(i) + I_{inter}(i))$$

F is dependant on the assumed propagation model, however, several theoretical studies performed in the past have indicated that a typical value is around 0.6. An appropriate value for F can also be derived from specific macrocell-only simulations. Interference from micro cells to macro cell is measured by using wrap-around technique. Interference that a macro cell base station receives is then:

$$I = ACIR * I_{micro} + (1/F) * I_{macro},$$

where ACIR is the adjacent channel interference rejection ratio, and I_{macro} is same channel interference measured from users connected to the base station.

When interference is measured in downlink, same channel and adjacent channel interference is measured from all base stations. When interference from micro cells is measured wrap-around technique is used.

When interference is measured at micro cells in uplink and downlink, same channel and adjacent channel interference is measured from all base stations. When same channel interference is measured wrap-around is used.

When simulation results are measured all micro cell users and those macro cell users that are area covered by micro cells are considered. It is also needed to plot figures depicting position of bad quality calls, in order to see how they are distributed in the network. In addition, noise rise should be measured at every base station and from that data a probability density function should be generated.

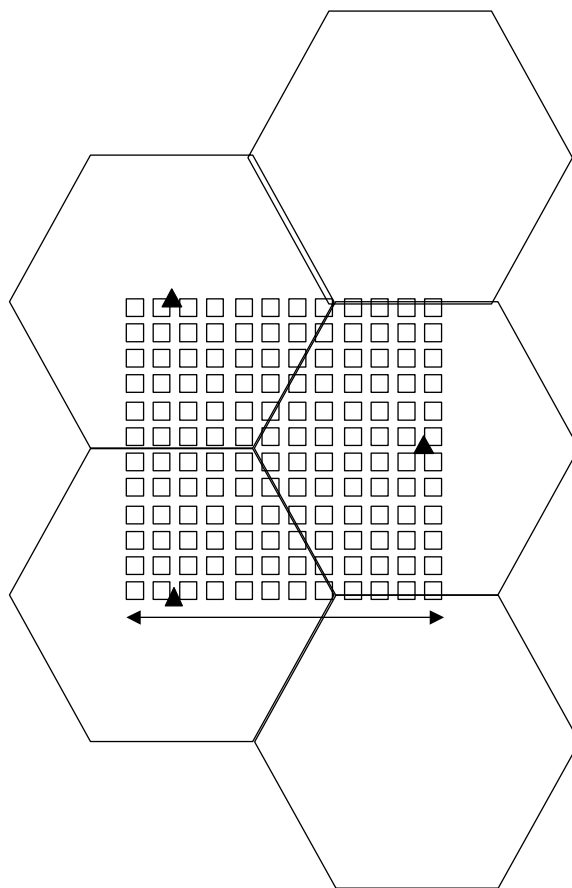

Figure 9 Macro-to micro deployment

5.1.3.3 Services simulated

The following services are considered:

- speech 8 kbps;
- data 144 kbps.

Speech and data services are simulated in separate simulations, i.e. no traffic mix is simulated.

5.1.4 Description of the propagation models

Two propagation environments are considered in the ACIR analysis: macro-cellular and micro-cellular.

For each environment a propagation model is used to evaluate the propagation path loss due to the distance; propagation models are adopted from /5/ and presented in the following clauses for macro and micro cell environments.

5.1.4.1 Received signal

An important parameter to be defined is minimum coupling loss (MCL), i.e.: what is the minimum loss in signal due to fact that the base stations are always placed much higher than the UE(s).

Minimum Coupling Loss (MCL) is defined as the minimum distance loss including antenna gain measured between antenna connectors; the following values are assumed for MCL:

- 70 dB for the Macro-cellular environment;
- 53 dB for the Microcell environment.

With the above definition, the received power in Down or Uplink can be expressed for the macro environment as:

$$RX_PWR = TX_PWR - \text{Max}(\text{pathloss_macro} - G_Tx - G_RX, \text{MCL})$$

and for the micro as:

$$RX_PWR = TX_PWR - \text{Max}(\text{pathloss_micro} - G_Tx - G_RX, \text{MCL})$$

where:

- RX_PWR is the received signal power;
- TX_PWR is the transmitted signal power;
- G_Tx is the Tx antenna gain;
- G_RX is the Rx antenna gain.

Within simulations it is assumed 11 dB antenna gain (including cable losses) in base station and 0 dB in UE.

5.1.4.2 Macro cell propagation model

Macro cell propagation model is applicable for the test scenarios in urban and suburban areas outside the high rise core where the buildings are of nearly uniform height /5/.

$$L = 40(1 - 4 \times 10^{-3} D_{hb}) \text{Log}_{10}(R) - 18 \text{Log}_{10}(D_{hb}) + 21 \text{Log}_{10}(f) + 80 \text{ dB}.$$

Where:

- R is the base station - UE separation in kilometers;
- f is the carrier frequency of 2 000 MHz;
- D_{hb} is the base station antenna height, in meters, measured from the average rooftop level.

The base station antenna height is fixed at 15 meters above the average rooftop (D_{hb} = 15 m). Considering a carrier frequency of 2000 MHz and a base station antenna height of 15 meters, the formula becomes:

$$L = 128.1 + 37.6 \text{Log}_{10}(R)$$

After L is calculated, log-normally distributed shadowing (LogF) with standard deviation of 10 dB should be added, so that the resulting pathloss is the following:

$$\text{Pathloss_macro} = L + \text{LogF}$$

NOTE 1: L shall in no circumstances be less than free space loss. This model is valid for NLOS case only and describes worse case propagation.

NOTE 2: The path loss model is valid for a range of D_{hb} from 0 to 50 meters.

NOTE 3: This model is designed mainly for distance from few hundred meters to kilometers, and there are not very accurate for short distances.

5.1.4.3 Micro cell propagation model

Also the micro cell propagation model is adopted from /5/. This model is to be used for spectrum efficiency evaluations in urban environments modelled through a Manhattan-like structure, in order to properly evaluate the performance in microcell situations that will be common in European cities at the time of UMTS deployment.

The proposed model is a recursive model that calculates the path loss as a sum of LOS and NLOS segments. The shortest path along streets between the BS and the UE has to be found within the Manhattan environment.

The path loss in dB is given by the well-known formula:

$$L = 20 \cdot \log_{10} \frac{4\pi d_n}{\lambda}$$

Where:

- d_n is the "illusory" distance;
- λ is the wavelength;
- n is the number of straight street segments between BS and UE (along the shortest path).

The illusory distance is the sum of these street segments and can be obtained by recursively using the expressions $k_n = k_{n-1} + d_{n-1} \cdot c$ and $d_n = k_n \cdot s_{n-1} + d_{n-1}$ where c is a function of the angle of the street crossing. For a 90° street crossing the value c should be set to 0,5. Further, s_{n-1} is the length in meters of the last segment. A segment is a straight path. The initial values are set according to: k_0 is set to 1 and d_0 is set to 0. The illusory distance is obtained as the final d_n when the last segment has been added.

The model is extended to cover the micro cell dual slope behavior, by modifying the expression to:

$$L = 20 \cdot \log_{10} \left(\frac{4\pi d_n}{\lambda} \cdot D \left(\sum_{j=1}^n s_{j-1} \right) \right).$$

Where:

$$D(x) = \begin{cases} x / x_{br}, & x > x_{br} \\ 1, & x \leq x_{br} \end{cases}.$$

Before the break point x_{br} the slope is 2, after the break point it increases to 4. The break point x_{br} is set to 300 m. x is the distance from the transmitter to the receiver.

To take into account effects of propagation going above rooftops it is also needed to calculate the pathloss according to the shortest geographical distance. This is done by using the commonly known COST Walfish-Ikegami Model and with antennas below rooftops:

$$L = 24 + 45 \log (d+20).$$

Where:

- d is the shortest physical geographical distance from the transmitter to the receiver in metros.

The final pathloss value is the minimum between the path loss value from the propagation through the streets and the path loss based on the shortest geographical distance, plus the log-normally distributed shadowing (LogF) with standard deviation of 10 dB should be added:

$$\text{Pathloss_micro} = \min (\text{Manhattan pathloss}, \text{macro path loss}) + \text{LogF}.$$

NOTE: This pathloss model is valid for microcell coverage only with antenna located below rooftop. In case the urban structure would be covered by macrocells, the former pathloss model should be used.

5.1.5 Simulation description

Uplink and Downlink are simulated independently, i.e. one link only is considered in a single simulation.

A simulation consists of several simulation steps (snapshot) with the purpose to cover a large amount of all the possible UE placement in the network; in each simulation step, a single placement (amongst all the possible configuration) of the UEs in the network is considered.

5.1.5.1 Single step (snapshot) description

A simulation step (snapshot) constitutes of mobile placement, pathloss calculations, handover, power control and statistics collecting.

In particular:

- at the beginning of each simulation step, the UE(s) are distributed randomly across the network, according to a uniform distribution;
- for each UE, the operator (**in case of macro to macro simulation**) is selected randomly, so that the number of users per base stations is the same for both operators;
- after the placement, the pathloss between each UE and base station is calculated, adding the lognormal fading, and stored to a so-called G-matrix (Gain matrix).

Distance attenuation and lognormal fading are kept constant during the execution of a snapshot.

- Based on the Gain Matrix, the active base stations (transmitting base stations) are selected for each UE based on the **handover algorithm**.
- Then a stabilization period (**power control loop**) is started; during stabilization power control is executed so long that the used powers reach the level required for the required quality.

During the power control loop, the Gain Matrix remain constant.

- A sufficient number of power control commands in each power control loop is supposed to be higher than 150.
- At the end of a power control loop, statistical data are collected; UEs whose quality is below the target are considered to be in outage; UEs whose quality is higher the target -0,5 dB are considered to be satisfied.

5.1.5.2 Multiple steps (snapshots) execution

When a single step (snapshot) is finished, UE(s) are re-located to the system and the above processes are executed again. During a simulation, as many simulation steps (snapshots) are executed as required in order to achieve sufficient amount of local-mean-SIR values.

For 8 kbps speech service, a sufficient amount of snapshots is supposed to be 10 000 values or more; for data service, a higher number of snapshot is required, and a sufficient amount of snapshots is supposed to be 10 times the value used of 8 kbps speech.

As many local-mean-SIR values are obtained during one simulation step (snapshot) as UE(s) in the simulation. Outputs from a simulation are SIR-distribution, outage probability, capacity figures etc.

5.1.6 Handover and Power Control modelling

5.1.6.1 Handover Modelling

The handover model is a non-ideal soft handover. Active set for the UE is selected from a pool of base stations that are candidates for handover. The candidate set is composed from base stations whose pathloss is within handover margin, i.e.: base stations whose received pilot is stronger than the received pilot of the strongest base station subtracted by the handover margin.

A soft hand-over margin of 3 dB is assumed.

The active set of base stations is selected randomly from the candidate base stations; a single UE may be connected to maximum of 2 base stations simultaneously.

5.1.6.1.1 Uplink Combining

In the uplink, selection combining among active base stations is performed so that the frame with highest average SIR is used for statistics collecting purposes, while the other frames are discarded.

5.1.6.1.2 Downlink Combining

In the downlink, macro diversity is modelled so that signal received from active base stations is summed together; maximal ratio combining is realized by summing measured SIR values together:

$$SIR = \frac{C_1}{I_1 + N} + \frac{C_2}{I_2 + N}.$$

5.1.6.2 Power Control modelling of traffic channels in Uplink

Power control is a simple SIR based fast inner loop power control.

Perfect power control is assumed, i.e.: during the power control loop each UE perfectly achieve the Eb/N0 target, assuming that the maximum TX power is not exceeded; with the assumption of perfect power control, PC error is assumed equal to 0 %, and PC delay is assumed to be 0 s.

UEs not able to achieve the Eb/N0 target at the end of a power control loop are considered in outage.

Initial TX power for the PC loop of UL Traffic Channel is based on path loss, thermal noise and 6 dB noise rise; however, the initial TX power should not affect the convergence process (PC loop) to the target Eb/N0.

5.1.6.2.1 Simulation parameters

UE Max TX power:

The maximum UE TX power is 21 dBm (both for speech and data), and UE power control range is 65 dBm; the minimum TX power is therefore -44 dBm.

Uplink Eb/N0 target (form RTT submission);

- macro-cellular environment: speech 6,1 dB, data 3,1 dB;
- micro-cellular environment: speech 3,3 dB, data 2,4 dB.

5.1.6.2.2 SIR calculation in Uplink

Local-mean SIR is calculated by dividing the received signal by the interference, and multiplying by the processing gain. Signals from the other users are summed together and seen as interference. Signal-to-interference-ratio will be:

$$SIR_{UL} = \frac{G_P \cdot S}{(1 - \beta) \cdot I_{OWN} + I_{OTHER} + N_0}$$

Where S is the received signal, Gp is processing gain, Iown is interference generated by those users that are connected to the same base station that the observed user, Iother is interference from other cells, No is thermal noise and β is an interference reduction factor due to the use of, for example, Multi User Detection (MUD) in UL.

MUD is NOT included in these simulations, therefore $\beta = 0$.

Thermal noise is calculated for 4.096 MHz band by assuming 5 dB system noise figure. Thermal noise power is then equal to -103 dBm.

In the multi-operator case, Iother also includes the interference coming from the adjacent operator; the interference coming from the operator operating on the adjacent is decreased by ACIR dB.

5.1.6.2.3 Admission Control Modelling in Uplink

Admission control is not included in this kind of simulation.

5.1.6.3 Power Control modelling of traffic channels in Downlink

Power control is a simple SIR based fast inner loop power control.

Perfect power control is assumed, i.e.: during the power control loop each DL traffic channel perfectly achieve the E_b/N_0 target, assuming that the maximum TX power is not exceeded; with the assumption of perfect power control, PC error is assumed equal to 0 %, and PC delay is assumed to be 0 s.

UEs whose DL traffic channel is not able to achieve the E_b/N_0 target at the end of a power control loop are considered in outage.

Initial TX power for the PC loop of DL Traffic Channel is chosen randomly in the TX power range; however, the initial TX power should not affect the convergence process (PC loop) to the target E_b/N_0 .

5.1.6.3.1 Simulation parameters

Traffic channel TX power:

Working assumption for DL traffic channel power control range is 25 dBm, and the maximum power for each DL traffic channel is (both for speech and data) the following:

- Macro-cellular environment: 30 dBm;
- Micro-cellular environment: 20 dBm.

Downlink E_b/N_0 target (from RTT submission):

- macro-cellular environment: speech 7,9 dB, data 2,5 dB with DL TX or RX diversity, 4,5 dB without diversity;
- micro-cellular environment: speech 6,1 dB, data 1,9 dB with DL TX or RX diversity.

5.1.6.3.2 SIR calculation in Downlink

Signal-to-interference-ratio in Downlink can be expressed as:

$$SIR_{DL} = \frac{G_P \cdot S}{\alpha \cdot I_{OWN} + I_{OTHER} + N_0}$$

Where S is the received signal, G_P is processing gain, I_{OWN} is interference generated by those users that are connected to the same base station that the observed user, I_{OTHER} is interference from other cells, α is the orthogonality factor and N_0 is thermal noise. Thermal noise is calculated for 4.096 MHz band by assuming 9 dB system noise figure. Thermal noise power is then equal to -99 dBm.

I_{OWN} includes also interference caused by perch channel and common channels.

Transmission powers for them are in total:

- macrocells: 30 dBm;
- microcells: 20 dBm.

The orthogonality factor takes into account the fact that the downlink is not perfectly orthogonal due to multipath propagation; an orthogonality factor of 0 corresponds to perfectly orthogonal intra-cell users while with the value of 1 the intra-cell interference has the same effect as inter-cell interference.

Assumed values for the orthogonality factor alpha are /1:

- macrocells: 0,4;
- microcells: 0,06.

In the multi-operator case I_{OTHER} also includes the interference coming from the adjacent operator; the interference coming from the operator operating on the adjacent is decreases by ACIR dB.

5.1.6.3.3 Admission Control Modelling in Downlink

Admission control is not included in this kind of simulation.

5.1.6.3.4 Handling of Downlink maximum TX power

During WG4#2 the issue of DL BS TX power limitation was addressed, i.e.: the case when the sum of all DL traffic channels in a cell exceeds the maximum base station TX power.

The maximum base station TX power are the following:

- macrocells: 43 dBm;
- microcells: 33 dBm.

If in the PC loop of each snapshot the overall TX power of each BS is higher than the Maximum Power allowed, at a minimum for each simulation statistical data related to this event have to be collected to validate the results; based on these results, in the future a different approach could be used for DL.

The mechanism used to maintain the output level of the base station equal or below the maximum is quite similar to an analogue mechanism to protect the power amplifier.

At each iteration, the mobiles request more or less power, depending on their C/I values. A given base station will be requested to transmit the common channels and the sum of the TCHs for all the mobiles it is in communication with.

If this total output power exceeds the maximum allowed for the PA, an attenuation is applied in order to set the output power of the base station equal to its maximum level. In a similar way that an RF variable attenuator would operate, this attenuation is applied on the output signal with the exception of common channels, i.e. all the TCHs are reduced by this amount of attenuation.

The power of the TCH for a given mobile will be:

$$\text{TCH}(n+1) = \text{TCH}(n) \text{ +/- Step} - \text{RF_Attenuation.}$$

5.1.7 System Loading and simulation output

5.1.7.1 Uplink

5.1.7.1.1 Single operator loading

The number of users in the uplink in the single operator case is defined as N_{UL_single} .

It is evaluated according to a 6 dB noise rise over the thermal noise in the UL (6 dB noise rise is equivalent to 75 % of the Pole capacity of a CDMA system):

- a simulation is run with a predefined number of users, and at the end the average noise rise (over the thermal noise) is measured; if lower than 6 dB, the number of users is increased until the 6 dB noise rise is reached;
- the number of users corresponding to a 6 dB noise rise is here defined as N_{UL_single} .

5.1.7.1.2 multi-operator case (macro to macro)

The number of users in the uplink in the multi-operator case is defined as N_{UL_multi} :

- it is evaluated, as in the single case, according to a 6 dB noise rise over the thermal noise in the UL; a simulation is run with a predefined number of users, and at the end the average noise rise (over the thermal noise) is measured; if lower than 6 dB, the number of users is increased until the 6 dB noise rise is reached;
- the number of users corresponding to a 6 dB noise rise is here defined as N_{UL_multi} .

For a given value of ACIR, the obtained N_{UL_multi} is compared to N_{UL_single} to evaluate the capacity loss due to the presence of a second operator.

5.1.7.1.3 multi-operator case (macro to micro)

It is very likely that noise rise does not change with the same amount for micro and macro cell layers if number of users is changed in the system. It is proposed that loading is selected with the following procedure.

Two different numbers of input users are included in the simulator:

- $N_{users_UL_macro}$;
- $N_{users_UL_micro}$:
 - 0) an ACIR value is selected;
 - 1) start a simulation (made of several snapshots) with an arbitrary number of $N_{users_UL_micro}$ and $N_{users_UL_macro}$;
 - 2) measure the system loading;
 - 3) run another simulation (made of several snapshots) by increasing the number of users (i.e.: $N_{users_UL_macro}$ or micro) in the cell layer having lower noise rise than the layer-specific threshold, and decreasing number of users (i.e. $N_{users_UL_micro}$ or macro) in the cell layer in which noise rise is higher than the layer-specific threshold etc. etc.;
 - 4) redo phases 1 and 2 until noise rise is equal to the specific threshold for both layers;
 - 5) when each layer reaches in average the noise rise threshold, the input values of $N_{UL_users_UL_macro}$ and micro are taken as an output and compared to the valuse obtained in the single operator case for the ACIR value chosen at step 0.

Two Options (Option A and Option B) are investigated in relation with the noise rise threshold:

Option A:

- the noise rise threshold for the macro layer is equal to 6 dB whilst the threshold for the microlayer is set to 20 dB. The noise rise is combination of interfrnce coming from the micro and the macro cell layers. Micro and macro cell layers are interacting, i.e. micro cell interference affects to macro cell layer and viceversa.

Option B:

- the noise rise threshold is set to 6dB for both the macro and the micro layer, but the microcells are de-sensitized of 14 dB.

5.1.7.2 Downlink

5.1.7.2.1 Single operator loading

The number of users in the downlink for the single operator case is defined as N_{DL_single} .

Downlink simulations are done so that single operator network is loaded so that 95 % of the users achieve an E_b/N_o of at least (target E_b/N_o -0,5 dB) (i.e.: 95 % of users are satisfied) and supported number of users N_{DL_single} is then measured."

5.1.7.2.2 multi-operator case (macro to macro)

In the multi operator case the networks is loaded so that 95 % of users are satisfied and the obtained number of user is defined as N_{DL_multi} .

For a given value of ACIR, the measured N_{DL_multi} is obtained and compared to the N_{DL_single} obtained in the single operator case.

5.1.7.2.3 Multi-operator case (Macro to Micro)

Similar reasoning to the UL case is applied.

5.1.7.3 Simulation output

The following output should be produced:

- capacity figures (N_UL and N_DL);
- DL and UL capacity vs ACIR in the multi-operator case (see Figure 10 for the macro to macro case);
- outage (non-satisfied users) distributions.

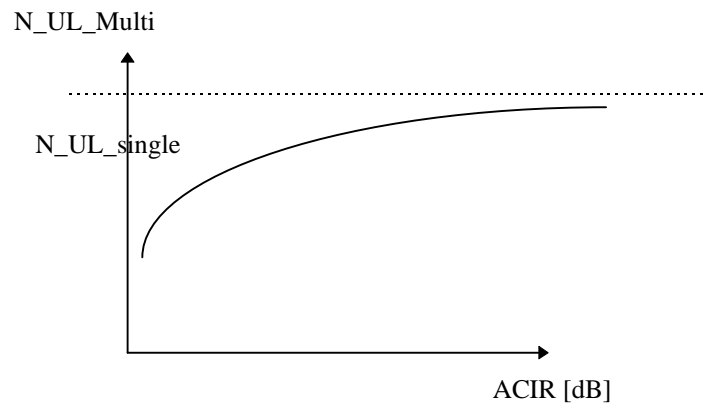

Figure 10 : Example of outage vs. ACIR (intermediate or worst case scenario layout)

5.1.8 Annex: Summary of simulation parameters

Table 2

Parameter	UL value	DL value
SIMULATION TYPE	snapshot	snapshot
PROPAGATION PARAMETERS		
MCL macro (including antenna again)	70 dB	70 dB
MCL micro (including antenna again)	53 dB	53 dB
Antenna gain (including losses)	11 dBi	0 dBi
	0 dBi	11 dBi
Log Normal fade margin	10 dB	10 dB
PC MODELLING		
# of snapshots	> 10 000 for speech > 10 * #of snapshot for speech for 144 kbps service	> 10 000 for speech > (10 * #_of_snapshot_for_speech in the 144 kbps case > 20 000 for data
#PC steps per snapshot	> 150	> 150
step size PC	perfect PC	perfect PC
PC error	0 %	0 %
margin in respect with target C/I	0 dB	0 dB
Initial TX power	path loss and noise, 6 dB noise rise	random initial
Outage condition	Eb/N0 target not reached due to lack of TX power	Eb/N0 target not reached due to lack of TX power
Satisfied user		measured Eb/N0 higher than Eb/N0 target -0,5 dB
HANDOVER MODELING		
Handover threshold for candidate set	3 dB	
active set	2	
Choice of cells in the active step	random	
Combining	selection	Maximum ratio combining
NOISE PARAMETERS		
noise figure	5 dB	9 dB
Receiving bandwidth	4.096 MHz proposed	4.096 MHz proposed
noise power	-103 dBm proposed	-99 dBm proposed
TX POWER		
Maximum BTS power		43 dBm macro 33 dBm micro
Common channel power		30 dBm macro 20 dBm micro
Maximum TX power speech	21 dBm	30 dBm macro 20 dBm micro
Maximum TX power data	21 dBm	30 dBm macro 20 dBm micro
Power control range	65 dB	25 dB
HANDLING of DOWNLINK maximum TX power		
		Problem identified, agreed to collect as a minimum statistical data A proposal from Nortel was made TBD
ADMISSION CONTROL	Not included	Not included
USER DISTRIBUTION		
		Random and uniform across the network
INTERFERENCE REDUCTION		
MUD	Off	N/A
non orthogonality factor macrocell	N/A	0,4
non orthogonality microcell	N/A	0,06
COMMON CHANNEL		
		Orthogonal

Parameter	UL value	DL value
ORTHOGONALITY		
DEPLOYMENT SCENARIO		
Macrocell		Hexagonal with BTS in the middle of the cell
microcell		Manhattan (from 30.03)
BTS type		omnidirectional
Cell radius macro		577 macro
Inter-site single operator		1 000 macro
Cell radius micro		block size = 75 m, road 15 m
Inter-site single micro		intersite between line of sight = 180 m
Intersite shifting macro		577 and 577/2 m
# of macro cells		> 19 with wrap around technique)
Intersite shifting macro-micro		see scenario
Number of cells per each operator		see scenario
Wrap around technique		Should be used
SIMULATED SERVICES		
bit-rate speech	8 kbps	8 kbps
Activity factor speech	100 %	100 %
Multipath environment macro	Vehicular macro	Vehicular macro
Eb/N0 target	6,1 dB	7,9 dB
Multipath environment macro	Outdoor micro	Outdoor micro
Eb/N0 target	3,3 dB	6,1 dB
Data rate	144 kbps	144 kbps
Activity factor speech	100 %	100 %
Multipath environment macro	Vehicular macro	Vehicular macro
Eb/N0 target	3,1 dB	2,5 dB with DL TX or RX diversity, 4,5 dB without diversity
Multipath environment macro	Outdoor micro	Outdoor micro
Eb/N0 target	2,4 dB	1,9 dB with DL TX or RX

5.1.9 Simulation Parameters for 24 dBm terminals

5.1.9.1 Uplink

The only difference in respect with the parameters listed in the previous clauses are:

- 3,84 Mcps chip rate considered;
- 24 dBm Max TX power for the UE (results provided for 21 dBm terminals as well);
- 68 dB dynamic range for the power control;
- # of snapshots per each simulation (3 000).

Therefore, the considered parameters are:

Table 2A

MCL	70 dB
BS antenna gain	11 dBi
MS antenna gain	0 dBi
Log normal shadowing	Standard Deviation of 10 dB
# of snapshot	3 000
Handover threshold	3 dB
Noise figure of BS receiver	5 dB
Thermal noise (NF included)	-103,16 dBm @ 3,84 MHz
Max TX power of MS	21 dBm/24 dBm
Power control dynamic range	65 dB/68 dB
Cell radius	577 m (for both systems)
Inter-site distance	1 000 m (for both systems)
BS offset between two systems (x, y)	Intermediate: (0,25 km, 0,14425 km) -> 0,289 km shift Worst: (0,5 km, 0,2885 km) -> 0,577 km shift
User bit rate	8 kbps and 144 kbps
Activity	100 %
Target Eb/IO	6,1 dB (8 kbps), 3,1 dB (144 kbps)
ACIR	25 - 40 dB

5.2 BTS Receiver Blocking

The simulations are static Monte Carlo using a methodology consistent with that described in the clause on ACIR.

The simulations are constructed using two uncoordinated networks that are on different frequencies. The frequencies are assumed to be separated by 10 MHz to 15 MHz or more so that the BS receiver selectivity will not limit the simulation, and so that the UE spurious and noise performance will dominate over its adjacent channel performance. These are factors that distinguish a blocking situation from an adjacent channel situation in which significant BS receiver degradation can be caused at very low levels due to the poor ACP from the UE.

During each trial of the simulations, uniform drops of the UE are made, power levels are adapted, and data is recorded. A thousand such trials are made. From these results, CDF of the total signal appearing at the receivers' inputs have been constructed and are shown in the graphs inserted in the result clause.

5.2.1 Assumptions for simulation scenario for 1 Km cell radius

The primary assumptions made during the simulations are:

- 1) both networks are operated with the average number of users (50) that provide a 6 dB noise rise;
- 2) the two networks have maximal geographic offset (a worst case condition);
- 3) cell radius is 1 km;
- 4) maximum UE power is 21 dBm;
- 5) UE spurious and noise in a 4,1 MHz bandwidth is 46 dB;
- 6) BS selectivity is 100 dB (to remove its effect);
- 7) C/I requirement is -21 dB;
- 8) BS antenna gain is 11 dB;
- 9) UE antenna gain is 0 dB; and
- 10) minimum path loss is 70 dB excluding antenna gains.

5.2.2 Assumptions for simulation scenario for 5 Km cell radius

The primary assumptions that are common to all simulations are:

- 1) the two networks have maximal geographic offset (a worst case condition);
- 2) cell radius is 5 km;
- 3) UE spurious and noise in a channel bandwidth is 46 dB;
- 4) BS selectivity is 100 dB (to remove its effect);
- 5) BS antenna gain is 11 dB;
- 6) UE antenna gain is 0 dB;
- 7) minimum path loss is 70 dB including antenna gains. In addition;
- 8) for the speech simulations, maximum UE power is 21 dBm and the C/I requirement is -21 dB;
- 9) for the data simulations, maximum UE power is 33 dBm and the C/I requirement is -11,4 dB.

NOTE: This is different from the basic assumption in the ACIR clause, since its data power level is 21 dBm, just like the speech level.

6 Methodology for coexistence studies FDD/TDD

6.1 Evaluation of FDD/TDD interference

[Editor's note: a better description of the parameters used to simulate the services is needed. Eb/N0 values for FDD and TDD to be specified in detail like in the FDD/FDD clause.]

6.1.1 Simulation description

The implementation method is not exactly the same as in [12].

Different main parameters, which are independent of the simulated environment, are as follows, and are assumed for both TDD and FDD mode.

- Application of a fixed carrier spacing of 5 MHz in all cases.
- Spectrum masks for BS and MS.
- Maximum transmit powers for BS and MS.
- Receiver filters for BS and MS.
- Power Control.

6.1.1.1 Simulated services

Concerning a service assumption all stations have used speech service.

6.1.1.2 Spectrum mask

WG4 agreed a definition to characterise the power leakage into adjacent channels caused mainly due to transmitter non-linearities. The agreed definition is:

- **Adjacent Channel Leakage power Ratio (ACLR):** The ratio of the transmitted power to the power measured after a receiver filter in the adjacent RF channel. Both the transmitted power and the received power are measured within a filter response that is nominally rectangular, with a noise power bandwidth equal to the chip rate.

Following the above definition, the ACLR for the spectrum masks for BS and MS are given in table 3.

Table 3: ACLR used in the simulations

Reference	Station	Macro		Micro		Pico		HCS	
		ACLR1	ACLR2	ACLR1	ACLR2	ACLR1	ACLR2	ACLR1	ACLR2
Tdoc [2]	MS	45,39 dB	-	40,38 dB	-	45,39 dB	-	-	-
	BS	60,39 dB	-	55,35 dB	-	60,39 dB	-	-	-
Tdoc [3], [4]	MS	32 dB	42 dB	-	-	-	-	32 dB	42 dB
	BS	45 dB	55 dB	-	-	-	-	45 dB	55 dB

6.1.1.3 Maximum transmit power

The maximum transmit powers for BS and MS are given in table 4.

The figures are defined according to the three environments assuming that a speech user occupies one slot and one code in TDD and one frame and one code in FDD.

Table 4: Maximum transmit power used in the simulations

Cell structure		Macro	Micro	Pico	HCS
TDD	MS	30 dBm	21 dBm	21 dBm	21 dBm
	BS	36 dBm	27 dBm	27 dBm	27 dBm
FDD	MS	21 dBm	14 dBm	14 dBm	21 dBm
	BS	27 dBm	20 dBm	20 dBm	27 dBm

6.1.1.4 Receiver filter

On the receiver side, in the first step an ideal RRC filter ($\alpha = 0,22$) has been implemented and in the second step a real filter has been implemented.

WG4 agreed on an Adjacent Channel Selectivity (ACS) definition as follows:

- **Adjacent Channel Selectivity (ACS):** Adjacent Channel Selectivity is a measure of a receiver's ability to receive a signal at its assigned channel frequency in the presence of a modulated signal in the adjacent channel. ACS is the ratio of the receiver filter attenuation on the assigned channel frequency to the receiver filter attenuation on the adjacent channel frequency. The attenuation of the filter on the assigned and adjacent channels is measured with a filter response that is nominally rectangular, with a noise power bandwidth equal to the chip rate.

Following the above definition, the ACS becomes infinity with the ideal RRC filter. The ACS with the real filter are given in table 5.

Table 5: ACS used in the simulations

	ACS with the real filter
MS	32 dB
BS	45 dB

6.1.1.5 Power control

Simulations with and without power control (PC) have been done.

In the first step a simple C based power control algorithm has been used. The PC algorithm controls the transmit power in the way to achieve sensitivity level at the receiver.

In the second step a C/I based power control algorithm has been used.

The model for power control uses the Carrier to Interferer (C/I) ratio at the receiver as well as the receiving information power level as shown in figure 11.

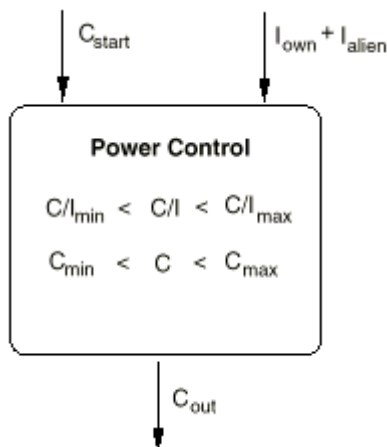

Figure 11: C/I based Power Control algorithm

The model considers the interference caused by alien systems as well as the intra-system interference. The control algorithm compares the C/I value at the receiver with the minimum required and the maximum allowed C/I value. In order to keep the received C/I in its fixed boundaries the transmission power is controlled (if possible). Consequently the most important value during power control is the C/I. If the C/I is in the required scope, the transmission power is varied to keep the received power in its fixed boundaries, too. Figure 12 shows an example of the power algorithm. The axis of ordinate contains the C/I threshold and the axis of abscissa contains the C-thresholds.

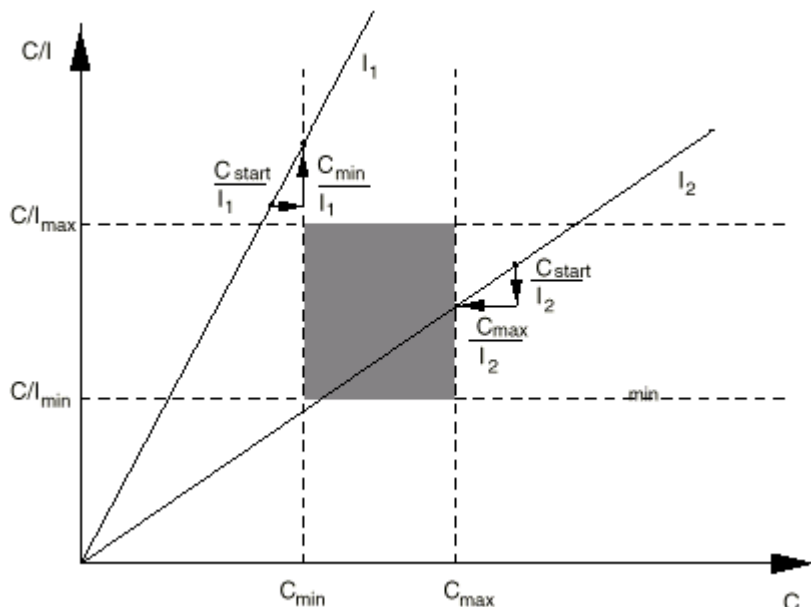

Figure 12: Example of power algorithm

The two straight lines include all possible values for $C/I(C)$ for a received interference power I_1 and I_2 . The area defined by the thresholds is marked with grey. The control of the corresponding station's transmission power should get the point on the straight line into the marked area. Regarding the interference I_1 , the transmission power must be pulled up until the minimum receiving power is reached. The upper C/I threshold demand cannot be fulfilled here. Concerning I_2 , the grey marked area can be reached.

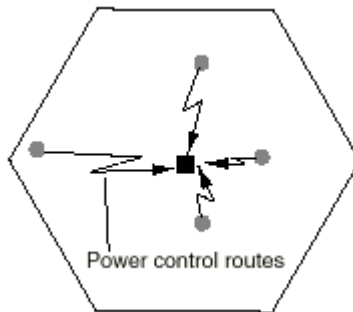

Figure 13: Power control in UL

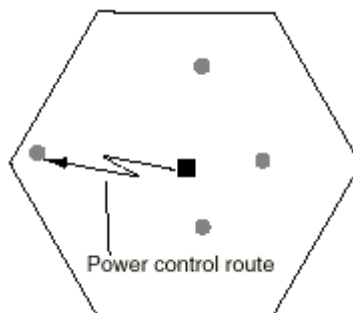

Figure 14: Power control in DL

It has to be remarked that the power control strategy in CDMA systems is different for uplink and downlink. In the uplink, each mobile has to be controlled in the way that the base station receives as low as possible power while keeping C/I requirements. Therefore the pathloss for each connection has to be considered. Concerning the downlink, the base station transmits every code with the same power regardless of the different coeval active connections. Consequently the power control must consider the mobile with the lowest receiving power level to ensure a working connection for each mobile.

The power control range is assumed as given in table 6.

The power control step size is 1 dB for both MS and BS.

Table 6: Power control range used in the simulations

Reference		Tdoc [2]	Tdoc [3], [4]
TDD	Uplink	80 dB	80 dB
	Downlink	30 dB	30 dB
FDD	Uplink	80 dB	65 dB

6.1.2 Macro Cell scenario

6.1.2.1 Evaluation method

Since for the macro scenario a hexagonal cell structure is assumed, a Monte-Carlo method has been chosen for evaluation. Each Monte-Carlo (MC) calculation cycle starts with the positioning of the receiver station (disturbed system) by means of an appropriate distribution function for the user path. The interfering (mobile) stations are assumed to be uniformly distributed. The density of interferers is taken as parameter. To start up we assume that only the closest user of the co-existing interfering system is substance of the main interference power. However to judge the impact of more than the one strongest interferer, some simulation cases are performed with the 5 strongest interferer stations. In simulations behind it was shown that taking into account more than 5 will not change the simulation results. In addition a transmitter station in the disturbed system and a receiver station in the interfering system are placed, i.e.: communication links in both systems are set up. At each MC cycle the pathloss between the disturbed receiver and the next interfering station as well as the pathloss for the communication links are determined according to the pathloss formula given in the next clause. Depending on the use of power control the received signal level C at the receiver station in the disturbed system is calculated. Finally the interference power I is computed taking into account the transmit spectrum mask and the receiver filter. C/I is then substance to the staistical evaluation giving the CDF.

6.1.2.2 Pathloss formula

The pathloss formula for the **Macro Vehicular Environment Deployment Model** is implemented to simulate the MS \leftrightarrow BS case (10 dB log-normal standard deviation, see annex B, clause B.1.6.4.3 in [9]). Both 2 000 m and 500 m cell-radii are considered. The simulation does not support sectorised antenna patterns so an omnidirectional pattern is used.

However [9] was generated before the evaluation phase of different concepts for UTRA, which were all FDD based systems. Therefore [9] does not name propagation models for all possible interference situations. E.g. considering TDD the mobile to mobile interference requires a model valid for transmitter and receiver antennas having the same height. In order to cover this case the outdoor macro model in [18] was used. The model is based on path loss formula from H. Xia considering that the height of the BS antenna is below the average building height. This is seen as reasonable approximation of the scenario. Furthermore it has to be considered that mobiles might be very close to each other, i.e. in LOS condition, which leads to considerably lower path loss. To take this effect into account LOS and NLOS is randomly chosen within a distance of 50 m (100 m) for MS - MS (BS - MS) interference whereas the probability for LOS increases with decreasing distance. Details can be found in [18].

6.1.2.3 User density

The user density of the TDD system is based on the assumption that 8 slots are allocated to DL and UL, respectively. Considering 8 or 12 codes per slot this yields 64 / 96 channels per carrier corresponding to 53,4 / 84,1 Erlang (2 % blocking). Taking into account that users are active within only one slot and that DTX is implemented we reach effective user densities of 5,14/km² / 8,10/km² for the 500 m cell radius (cell area = 0,649 km²) and 0,32/km² / 0,51/km² for the 2 000 m cell radius (cell area = 10,39 km²), respectively. Note that these figures "sound" rather small, since we concentrate on one slot on one carrier. However if an average traffic of 15 mE per user is assumed, these figures lead to 5 484 real users per km² / 8 636 real users per km². It should be emphasised that this investigations regards user on a single carrier at adjacent frequencies, since users on the second adjacent frequency will be protected by higher ACP figures. In addition one TDD carrier per operator is a very likely scenario at least in the first UMTS start-up phase.

The user density of the FDD system is based on the ITU simulation results given in [16]. For the macro environment 88 Erlang per carrier lead to an effective user density of 4,23/km² and 67,7/km² for the 200 m cell and 500 m cell respectively. Note that in FDD all users are active during the entire frame.

6.1.3 Micro cell scenario

6.1.3.1 Evaluation method

For the **Micro Pedestrian Deployment Model**, a Manhattan-grid like scenario has been generated. A 3x3 km² area with rectangular street layout is used. The streets are 30 m wide and each block is 200 m in length. This is in accordance to annex B, clause B.1.6.4.2 in [9].

In the microcellular environment evaluation a detailed event-driven simulation tool is used. A street-net is loaded into the simulator (according to [9]). A given number of mobiles is randomly distributed over the street-net with a randomly chosen direction. These mobiles move with a maximum speed of 5 km/h along the streets. If they come to a crossing there is a probability of 0,5 for going straight across the crossing and a probability of 0,25 for turning left and right respectively. If there is another mobile in the way, a mobile slows down to avoid a collision. This results in a distribution of the speed that comes close to the one described in [9]. Mobiles coming from the right may cross a crossing first. The model simulates the behaviour of cars and pedestrians in a typical Manhattan-grid layout. Based on the observed coupling loss the received signal C and the interference power I are determined in the same way as described for the macro scenario.

6.1.3.2 Pathloss formula

Using the propagation model presented in [17] by J.E.Berg, only one corner is considered, i.e. propagation along more than one corner results in an attenuation above 150 dB and is therefore negligible. The log normal standard deviation used is 10 dB.

6.1.3.3 User density

Starting again from 64 and 96 users per slot for TDD, we reach an effective user density of 129,36 per km² and 203,73 per km², respectively (e.g. 64 users → 53,4 Erlang → 6,675 Erlang per slot → 258,72 Erlang per km² (cell area = 0,0258 km², due to 72 BSs covering the streets) → 129,36 effective users (DTX)). Assuming on average 25 mE per user this will lead us to 82 791 and 130 388 users per km², which might be slightly too high in a real scenario. For that reason simulation cases for 10 000, 5 000 and 1 000 user per km² are added.

6.1.4 Pico cell scenario

6.1.4.1 Evaluation method

The third scenario studied is the **Indoor Office Test Environment Deployment Model**. This scenario is referenced as the **Pico**-scenario. It is implemented as described in annex B, clause B.1.6.4.1 of [9]. The office rooms give in principle a cell structure similar to the macro environment case, because only one floor without corridors is implemented. For that reason the evaluation method used is the same as in macro based on Monte-Carlo simulations.

6.1.4.2 Pathloss formula

The indoor path loss formula given in [9] was implemented (log-normal standard deviation 12 dB). However it is taken care that the coupling loss is not less than 38 dB, which corresponds to a 1m free-space loss distance.

6.1.4.3 User density

Some reasonable assumptions have been made on the user density in the pico cell scenario. If we take straight forward the ITU simulation results based on [9] e.g. for FDD, we reach 220 000 active users per km² (88 Erlang per BS, BS serves two rooms, i.e. 2 × 10 m × 10 m = 0,0002 km² with DTX = 0,5 → 220 000 active users per km²). Assuming further on average 300mE per user, there should be 29.333.333 users per km², which is not very realistic. For the simulations we added a 10 000 active users per km² case in FDD.

Starting from a realistic scenario we assumed that each user in a room occupies 10 m² yielding 10 user per room or 100 000 user/km². For TDD we get 100 000 / 8 × 0,5 (DTX) = 6 250 users per slot, which leads under the assumption of 100 mE per user to 625 active users per km². This is the lowest user density referred to in the simulation results clause. To judge the impact on the results the user density is increased up to almost 10 000 active users per km².

6.1.5 HCS scenario

The scenario is a multi-operator layout with a microcell TDD and a macrocell FDD system. The microcell layout has 20×20 Blocks of 75 m width separated by streets with 15m width. In an evaluation area of 12×12 blocks in the middle of the manhattan grid 72 BSs are placed in every second street junction. The FDD macrocells are placed with a distance of 1 000 m. Antenna heights are 10 m for TDD and 27 m for FDD BSs (see figure 15).

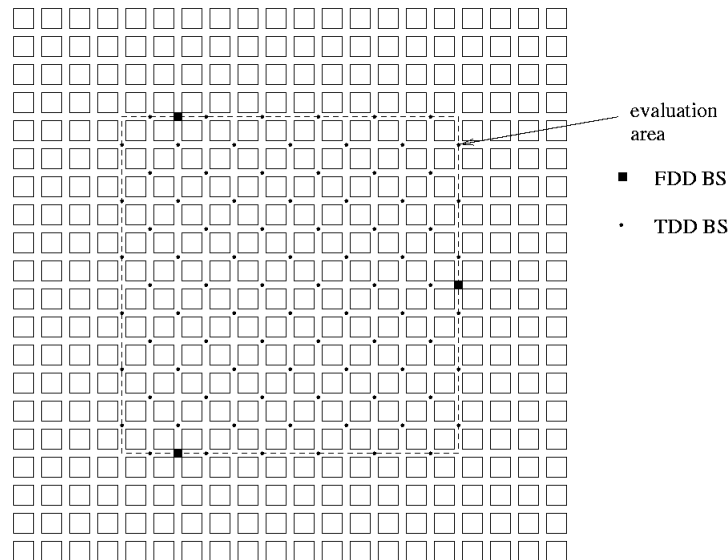

Figure 15: Multi-operator HCS scenario

The evaluation of interference has been done by Monte Carlo simulations where mobiles have been placed randomly on the streets and connected to their best serving BS. The user density in the FDD system has been 44 transmitting users per cell. All mobiles have been power controlled depending on the actual receive power and on the actual interference situation which in the case of a victim station consisted of a randomly chosen co-channel interference and the calculated adjacent channel, inter-system interference. In each snapshot, the adjacent channel interference power of the 30 strongest interferers has been summed up and evaluated.

6.2 Evaluation of FDD/TDD interference yielding relative capacity loss

6.2.1 Definition of system capacity

The capacity of the system is defined as the mean number of mobile stations per cell that can be active at a time while the probability that the C/I falls below a given threshold is below 5 %. All mobiles use the same service. This definition is different but strongly related to the so-called "satisfied user criterion", i.e. 98 % of all users have to be able to complete their call without being dropped due to interference. However the "satisfied user criterion" requires the mapping of C/I to BER/BLER values and time-continuous simulation techniques, while in [19] a Monte Carlo snap shot method is used. Please note that the definition incorporates the term "mean number of mobile stations". This mean that the load in different cells may be different while the mean load, i.e. the total number of users in the simulated scenario, remains constant during the simulation.

6.2.2 Calculation of capacity

A relative capacity loss is calculated as:

$$C = 1 - \frac{N_{multi}}{N_{single}}$$

where N_{single} is the maximum mean number of mobiles per cell that can be active at a time in the single operator case, i.e. without adjacent channel interference. N_{multi} is the maximum mean number of mobiles per cell that can be active at a time in the multi operator case, i.e. with adjacent channel interference originating in one interfering system in an adjacent transmit band.

6.2.2.1 Calculation of single operator capacity

Following the definition of capacity in 2.1, the percentage of users with a C/I below the given threshold has to be calculated. Since C/I is a random value, the simulation can lead to the cumulative distribution function:

$$F_{C/I, N_{\text{single}}} = P(\text{cir} < CIR, N_{\text{single}}).$$

The objective of the simulation is to find the number N_{single} that fulfils the relation:

$$P(\text{cir} < \text{threshold}, N_{\text{single}}) \leq 5\% .$$

N_{single} is determined as follows:

- 1) calibrate the co-channel interference;
- 2) place mobiles;
- 3) calculate best server;
- 4) control power;
- 5) calculate co-channel interference at perturbed station;
- 6) do power control for perturbed station;
- 7) Evaluate C/I;
- 8) remove all stations and continue with 2. Until a number of trials is reached;
- 9) calculate the CDF of C/I;
- 10) increase or decrease the number N_{single} and start again as long as the given outage probability is reached.

The co-channel interference power depends on a number of parameters, especially on the number of mobiles, their position and their power control behaviour. The co-channel interference power can be approximated by a normal distribution as long as the number of sources is large and as long as those sources are independent from each other. Although the sources are not totally independent, the co-channel interference coming from outside the simulated scenario is modelled by a normal distribution. For all cells having a complete set of co-channel cells in the simulated scenario, the co-channel interference is calculated exactly after power control in all co-channel cells.

The mean and the variance of the random co-channel interference is calculated with the following algorithm:

- calculate the statistic of co-channel interference in the victim cell;
- assume the same mean and variance to be valid for other cells;
- calculate the statistic again and repeat until the parameters of the co-channel interference distribution do not change any longer.

6.2.2.2 Calculation of multi operator capacity

Again following the definition of capacity in 2.1, the percentage of users with a C/I below the given threshold has to be calculated. Since C/I is a random value for each fixed N_{multi} the simulation can lead to a number of cumulative distribution functions:

$$F_{C/I, N_{\text{multi}}, N_{\text{other}}} = P(\text{cir} < CIR, N_{\text{multi}}, N_{\text{other}}).$$

N_{other} is the mean number of active mobiles per cell in the adjacent interfering system. The objective of the simulation is to find the number N_{multi} that fulfils the relation:

$$P(cir < threshold, N_{multi}, N_{other}) \leq 5\%$$

for a fixed number of N_{other} .

The procedure to determine N_{multi} is done similar as described in 2.2.1:

- 1) calibrate the co-channel interference in the victim system;
- 2) place mobiles in victim and interfering system;
- 3) calculate best server in victim and interfering system;
- 4) control power in both systems;
- 5) calculate co-channel interference at perturbed station;
- 6) calculate adjacent interference at perturbed station;
- 7) do power control for perturbed station;
- 8) evaluate C/I;
- 9) remove all stations and continue with 2. Until a number of trials is reached;
- 10) calculate the CDF of C/I;
- 11) increase or decrease the number N_{multi} and start again as long as the given outage probability is reached.

7 Methodology for coexistence studies TDD/TDD

7.1 Introduction

- Two different approaches to study the TDD/TDD coexistence are described in the following clauses: Evaluation of the interference, as done in the FDD/TDD case.
- ACIR approach, similar to the FDD/FDD case.

7.2 Evaluation of the TDD/TDD interference

The evaluation method is the same as used in the corresponding clause of the FDD/TDD coexistence study.

7.3 Evaluation of TDD/TDD interference yielding relative capacity loss

The evaluation method is the same as used in the corresponding clause of the FDD/TDD coexistence study yielding relative capacity loss (see clause 6.2).

7.4 ACIR

7.4.1 Macro to Macro multi-operator case

The relationship between ACIR and system capacity loss has been studied for speech service in a TDD system consisting of two operators with synchronised switching points (clause 7.3.1.1). This means that the two operators are, at the same time, both in uplink or in downlink. In that case uplink and downlink were studied separately.

A different set of simulations (clause 7.3.1.2) has been carried out supposing switching point synchronisation inside each operator and complete switching point asynchronisation between different operators. This means that all the cells controlled by the same operator have the same direction and that there is a complete overlapping between the uplink of the first operator and the downlink of the second one. Aim of this clause is to analyse capacity figures obtained by means of simulations performed for different ACIR values in this scenario.

7.4.1.1 Synchronised operators

The simulations have been performed in a macro-to-macro scenario, with 36 hexagonal cells wrapped around. Intermediate and worst case have been analysed for speech at 8 Kbps. The results showed in the third paragraph have been obtained using a sequential simulator that has been "adapted" in order to reproduce different snapshots of the network. No DCA technique is used. Radio resource assignment is random.

The simulator executes the following steps several times (snapshots):

- loading of the system with a fixed number of users and mobile distribution uniformly across the network;
- execution of different power control loops to achieve system stability;
- evaluation of the total interference amount both for uplink and downlink at the end of the power control loops.

The number of calls allowed for the multi-operator case is obtained applying the "6 dB noise rise" criterion in UL and the "satisfied user criterion" in DL, as illustrated in the FDD/FDD ACIR methodology description. The former involves the average noise rise in the network due to intracell interference, intercell interference and thermal noise, the latter is based on the signal to noise ratio at the user equipment and involves only intercell interference and thermal noise as perfect joint detection is assumed. System capacity loss is evaluated comparing, for different ACIR values, the number of calls allowed for the multi-operator case with the number of calls allowed for the single operator case.

7.4.1.2 Non synchronised operators

Simulations have been performed in a macro-to-macro scenario with 36 hexagonal cells wrapped around. The lack of synchronisation between the switching points of the two operators causes, with respect to the scenario described in [9], a new situation from an adjacent channel interference generation point of view. In the previous scenario, in fact, the two operators were both in uplink or in downlink and the adjacent channel interference was generated by the mobiles controlled by the other operator in the first case and by the base stations belonging to the other operator in the second one.

In this case the adjacent channel interference is generated in a different manner. Let's suppose the first operator in uplink and the second operator in downlink. The interference at each base station of the operator 1 (uplink) is due to the following contributions:

- co-channel interference generated by the mobiles controlled by the operator 1;
- adjacent channel interference due to the base stations belonging to the operator 2 (BS-to-BS interference).

The interference at each mobile of the operator 2 (downlink) is due to the following contributions:

- co-channel interference due to the base stations transmitting on the same frequency;
- adjacent channel interference due to the mobiles controlled by the operator 1 (MS-to-MS interference).

Therefore the adjacent channel interference due to the coexistence of not synchronised operators is of two kinds: MS-to-MS interference, suffered by the operator in downlink, and BS-to-BS interference, suffered by the operator in uplink. The second one is more destructive than the first one because of the involved powers and of the reduced path losses (the base stations are supposed to be in line-of-sight).

In [20] the different scenarios obtained varying the base station shifting of the two operators have been classified in best, intermediate and worst case on the base of the amount of adjacent channel interference with high probability suffered by the mobiles and by the base stations in the system (BS-to-MS interference and MS-to-BS interference).

In this case a new classification has to be introduced because the adjacent channel interference is generated in a different manner. The classification, based on the amount of BS-to-BS interference, the most destructive interference due to the presence of a not synchronised operator, is the following:

- worst case scenario: 0 m base station shifting (co-siting);
- intermediate case scenario: 577/2 m base station shifting;
- best case scenario: 577 m base station shifting.

Our simulations aim to estimate in the intermediate scenario the capacity loss suffered by the system because of the presence of a second operator for different ACIR values. It is important to stress that when we consider the uplink direction, the ACIR value applied to the adjacent channel interference is obtained considering the ACLR and the ACS of the base station and we will refer to this as ACIR BS-to-BS.

When we consider the downlink direction, the ACIR value applied to the adjacent channel interference is obtained considering the ACLR and the ACS of the mobile and we will refer to this as ACIR MS-to-MS.

7.4.1.2.1 Description of the Propagation Models

7.4.1.2.1.1 Minimum Coupling Loss (MCL)

The following values are assumed for the MCL (see [20]):

- 70 dB for the links MS-to-BS and BS-to-MS;
- 40 dB for the link MS-to-MS (this value has been obtained applying the free space loss formula and considering 1 m as minimum separation distance).

7.4.1.2.1.2 BS-to-MS and MS-to-BS propagation model

We have applied the propagation model described in [20].

7.4.1.2.1.3 BS-to-BS propagation model

The test scenario described in [20] implies that the base stations of the two operators are in line-of-sight with clearance of the first Fresnel zone. Therefore the propagation model applied is the free space loss model (see [17]).

The base station antenna gain used to calculate the power received in this case is 10 dB, instead of 13 dB, to consider the tilt of the antennas.

Thus, since the distance between BSs of different operators is 577/2 m, the path loss is 87 dB, and, including the antenna gains, 67 dB.

7.4.1.2.1.4 MS-to-MS propagation model

The propagation model employed in NLOS condition is the outdoor macro model based on the Xia formula described in [16]. The propagation model employed in LOS condition is the free space loss model. The standard deviation of the log-normal fading is, in both cases, $\sigma = 12$ dB.

7.4.2 Simulation parameters

[Editor's note: it has been clarified in the minutes of WG4 # 6 that the average TX power is 21 dBm and the peak power was assumed equal to 33 dBm; to be added to the list of parameters.]

Uplink and downlink Eb/N0 targets have been derived from [20], where link level simulation results for TDD mode are produced.

In table 7 a description of the parameters used in the simulations is given. Changes in respect with parameters used for the FDD/FDD analysis are reported in *italic*.

Table 7

Parameter	UL value	DL value
SIMULATION TYPE	Snapshot	Snapshot
PROPAGATION PARAMETERS		
MCL macro (including antenna gain)	70 dB	70 dB
MCL micro (including antenna gain)	53 dB	53 dB
Antenna gain (including losses)	11 dBi	0 dBi
	0 dBi	11 dBi
Log Normal fade margin	10 dB	10 dB
PC MODELLING		
# of snapshots	<i>800 for speech</i>	<i>800 for speech</i>
#PC steps per snapshot	> 150	> 150
Step size PC	perfect PC	perfect PC
PC error	0 %	0 %
Margin in respect with target C/I	0 dB	0 dB
<i>Initial TX power</i>	<i>Based on C/I target</i>	<i>Based on C/I target</i>
Outage condition	Eb/N0 target not reached due to lack of TX power	Eb/N0 target not reached due to lack of TX power
Satisfied user		measured Eb/N0 higher than Eb/N0 target - 0.5 dB
HANDOVER MODELING	<i>Not included</i>	<i>Not included</i>
NOISE PARAMETERS		
Noise figure	5 dB	9 dB
Receiving bandwidth	4.096 MHz proposed	4.096 MHz proposed
Noise power	-103 dBm proposed	-99 dBm proposed
TX POWER		
Maximum BTS power		43 dBm macro 33 dBm micro
Common channel power		30 dBm macro 20 dBm micro
Average TX power speech	21 dBm	30 dBm macro 20 dBm micro
Average TX power data	21 dBm	30 dBm macro 20 dBm micro
Power control range	65 dB	25 dB
HANDLING of DOWNLINK maximum TX power		
		Problem identified, agreed to collect as a minimum statistical data A proposal from Nortel was made TBD
ADMISSION CONTROL	Not included	Not included

Parameter	UL value	DL value
USER DISTRIBUTION		Random and uniform across the network
INTERFERENCE REDUCTION		
<i>MUD</i>	<i>On</i>	<i>On</i>
<i>Non orthogonality factor macrocells</i>	<i>0</i>	<i>0</i>
COMMON CHANNEL ORTHOGONALITY		Orthogonal
DEPLOYMENT SCENARIO		
Macrocell		Hexagonal with BTS in the middle of the cell
Microcell		Manhattan (from 30.03)
BTS type		Omnidirectional
Cell radius macro		577 macro
Inter-site single operator		1 000 macro
Cell radius micro		block size = 75 m, road 15 m
Inter-site single micro		intersite between line of sight = 180 m
Intersite shifting macro		577 and 577/2 m
# of macro cells		72 with wrap around technique
Intersite shifting macro-micro		see scenario
Number of cells per each operator		36
Wrap around technique		Used
SIMULATED SERVICES		
bit-rate speech	8 kbps	8 kbps
Activity factor speech	100 %	100 %
Multipath environment macro	Vehicular macro	Vehicular macro
Eb/N0 target	5,8 dB instead of 6,1 dB	8,3 dB instead of 7,9 dB
Multipath environment micro	Outdoor micro	Outdoor micro
Eb/N0 target	3,7 dB instead of 3,3 dB	6,1 dB
Data rate	144 kbps	144 kbps
Activity factor speech	100 %	100 %
Multipath environment macro	Vehicular macro	Vehicular macro
Eb/N0 target	4,1 dB instead of 3,1 dB	4,1 dB instead of 4 dB
Multipath environment micro	Outdoor micro	Outdoor micro
Eb/N0 target	2,2 dB	2,2 dB

8 Results, implementation issues, and recommendations

This clause is intended to collect results on carrier spacing evaluations and maybe some recommendation on deployment coordination, or on multi-layers deployment.

8.1 FDD/FDD

8.1.1 ACIR for 21 dBm terminals

[Editor's note: currently only results related to the macro-macro case and 8 kbps are included, for both UL and DL. Some results on the 144 kbps case available but NOT included yet.]

Results are presented for the following cases detailed below; UL and DL 8 Kbps speech service:

- intermediate case scenario where the second system are located at a half-cell radius shift;
- worst case scenario where the second system base stations are located at the cell border of the first system;
- average results for intermediate and worst case.

8.1.1.1 UL Speech (8 kbps): ACIR Intermediate macro to macro case

Table 8

ACIR (dB)	DoCoMo	Nokia	Ericsson	Motorola	Alcatel	Average
25	90,69 %	91,00 %	91,36 %	90,90 %	91,82 %	91,15 %
30	96,85 %	97,40 %	97,16 %	96,89 %	97,16 %	97,09 %
35	98,93 %	99,00 %	99,02 %	98,89 %	99,07 %	98,98 %
40	99,53 %	99,70 %	99,68 %	99,63 %	99,70 %	99,65 %

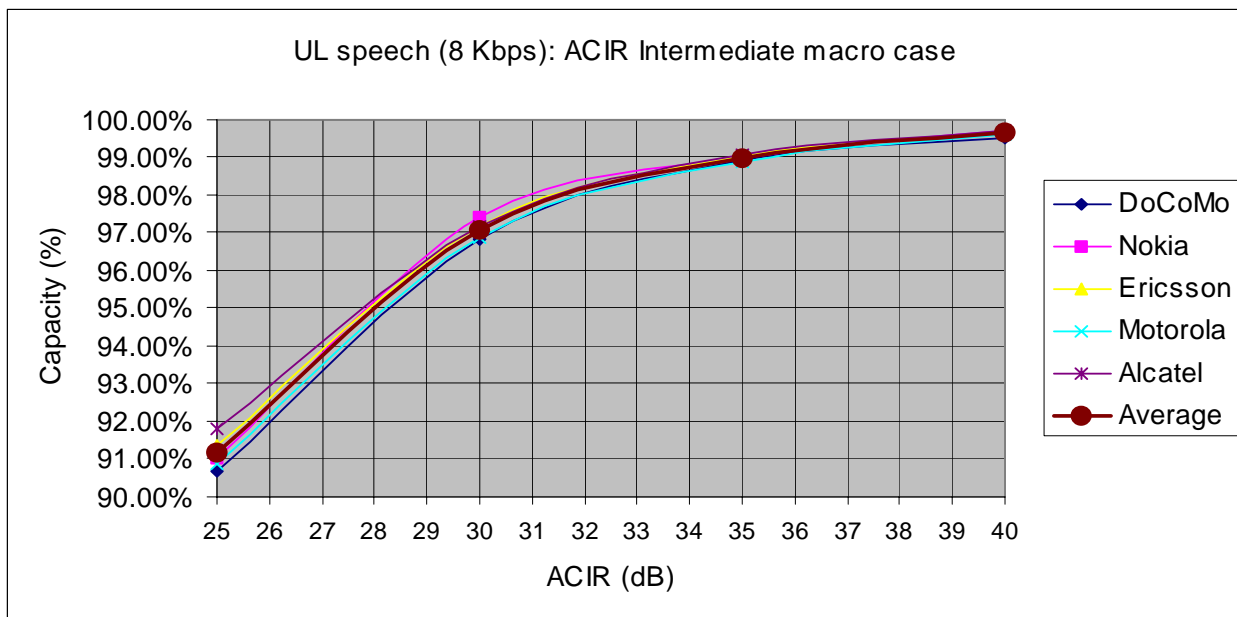

Figure 16

8.1.1.2 UL Speech (8 kbps): ACIR worst macro to macro case

Table 9

ACIR (dB)	DoCoMo	Nokia	Ericsson	Motorola	Alcatel	Average
25	87,50 %	87,00 %	87,70 %	88,08 %	88,45 %	87,75 %
30	95,42 %	96,20 %	95,82 %	95,71 %	95,90 %	95,81 %
35	98,57 %	98,90 %	98,57 %	98,59 %	98,68 %	98,66 %
40	99,50 %	99,70 %	99,53 %	99,56 %	99,57 %	99,57 %

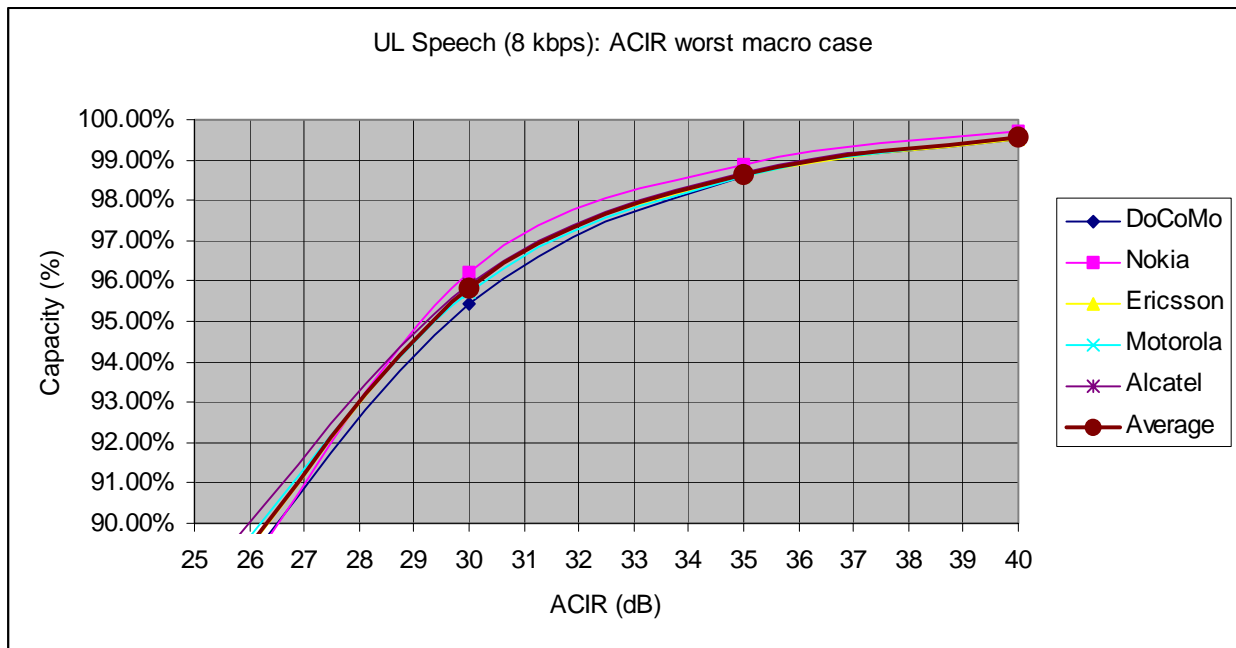

Figure 17

8.1.1.3 DL Speech (8 kbps): ACIR intermediate macro to macro case

Table 10

ACIR (dB)	DoCoMo	Nokia	Ericsson	Motorola	Average
25	86,54 %	93,50 %	89,41 %	87,01 %	89,12 %
30	94,16 %	97,40 %	95,35 %	94,28 %	95,30 %
35	97,73 %	99,00 %	98,21 %	97,91 %	98,21 %
40	99,09 %	99,90 %	99,29 %	99,34 %	99,41 %

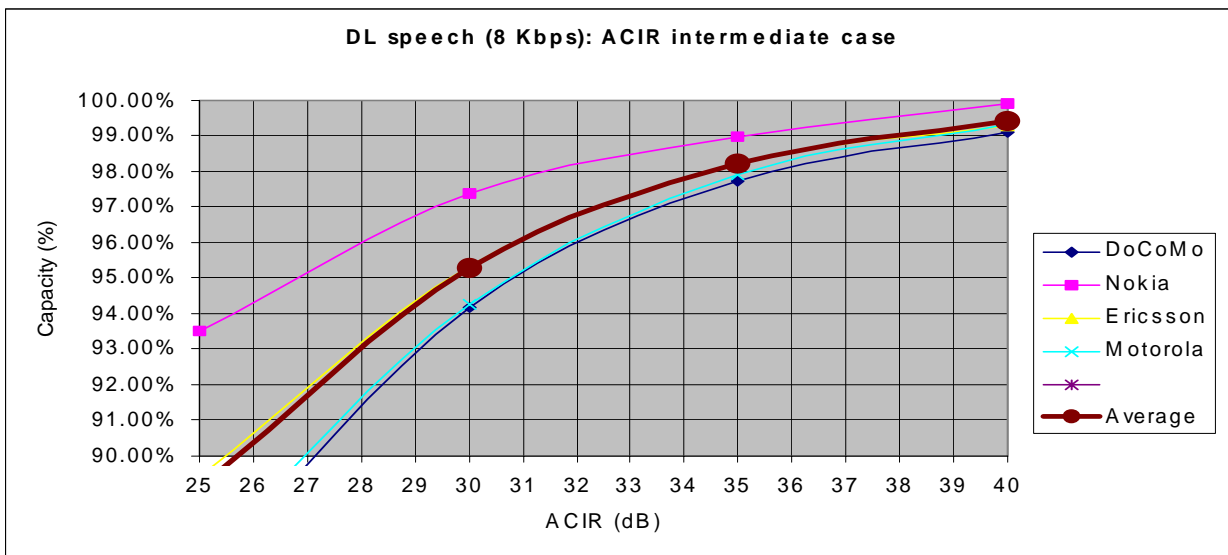

Figure 18

8.1.1.4 DL Speech (8 Kbps): ACIR worst macro to macro case

Table 11

ACIR (dB)	DoCoMo	Nokia	Ericsson	Motorola	Average
25	84,90 %	91,00 %	86,29 %	84,70 %	86,72 %
30	92,84 %	95,50 %	94,10 %	92,90 %	93,84 %
35	97,20 %	98,20 %	98,07 %	97,25 %	97,68 %
40	98,71 %	99,10 %	99,18 %	99,06 %	99,01 %

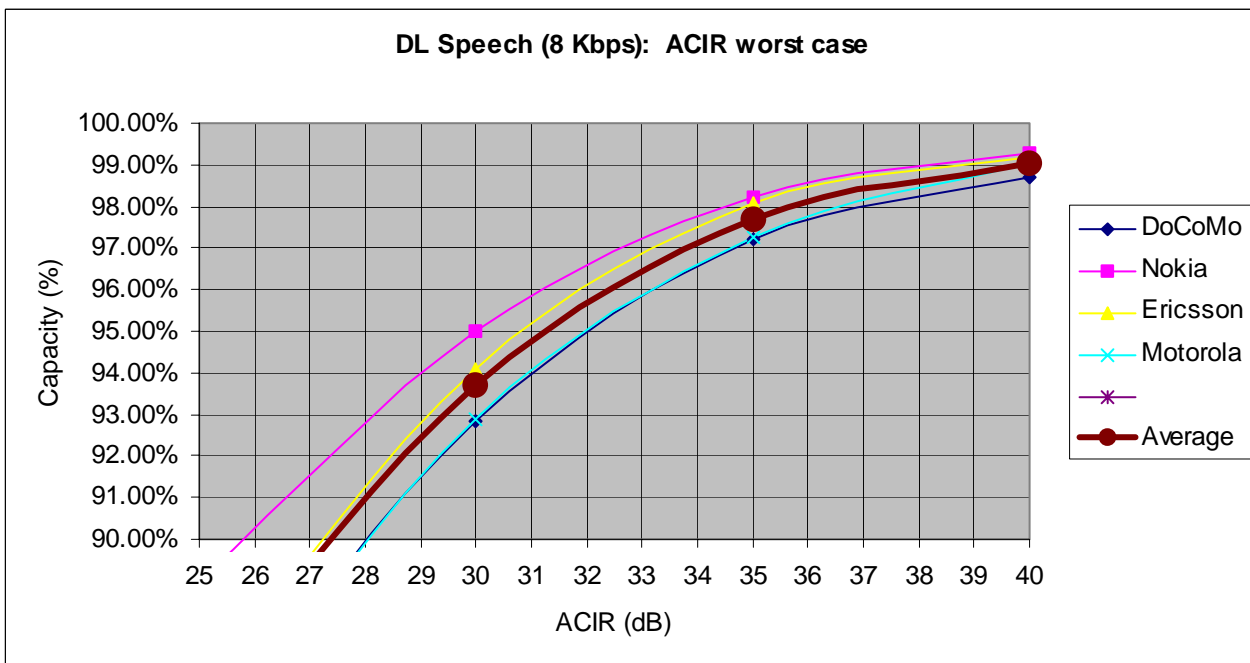

Figure 19

8.1.2 ACIR for 24 dBm terminals

In the following, results for UL ACIR with 24 dBm terminals are provided, for both speech (8 kbps) and data (144 kbps); the results are compared with those obtained with 21 dBm terminals.

8.1.2.1 UL Speech (8 kbps): macro to macro

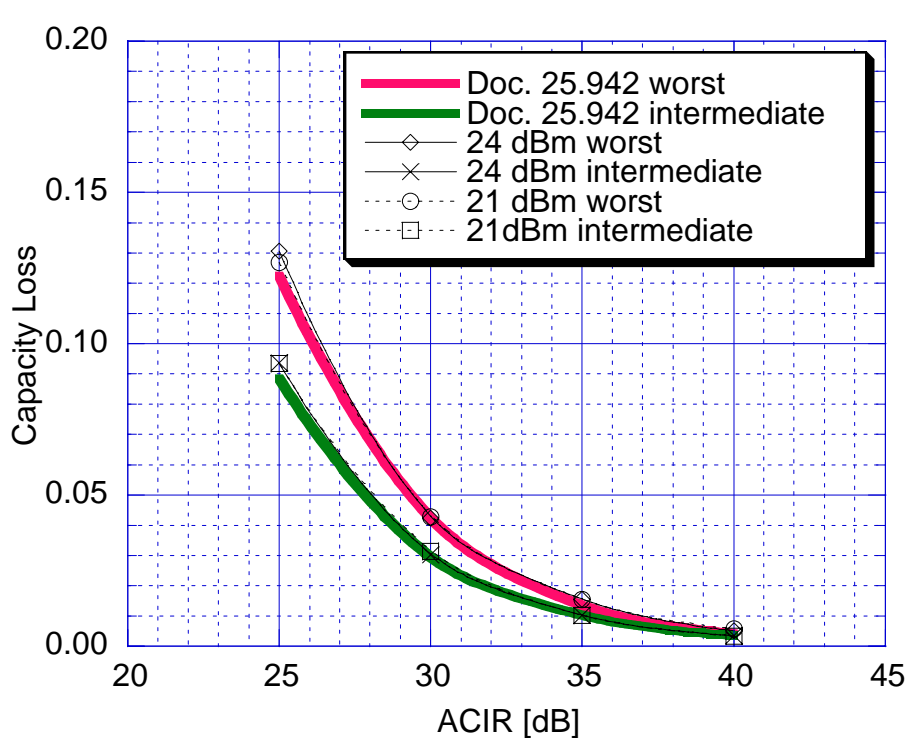

Figure 20

8.1.2.2 UL Data (144 kbps): macro to macro

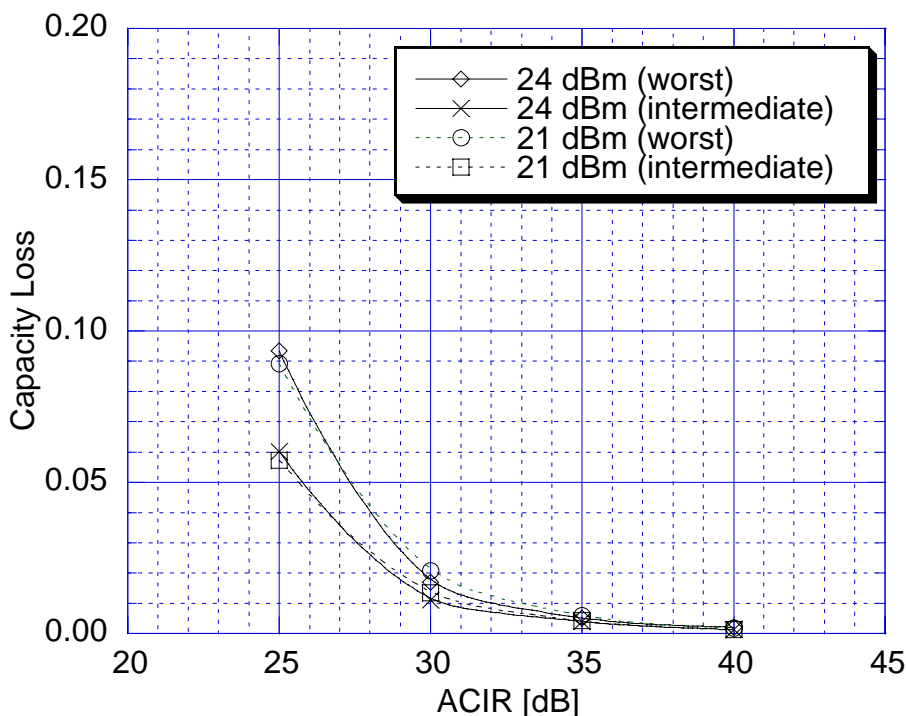

Figure 21

8.1.3 BTS Receiver Blocking

8.1.3.1 Simulation Results for 1 Km cell radius

[Editor's note: Please note that the results of the simulations are still within brackets.]

The first graph shows the overall CDF of the input signals to the receivers, and the second shows an expanded view of the occurrences having probability greater than .999. It can be seen that under the conditions of this simulation, the largest signal occurs at an amplitude of -54 dBm, and this occurs in less than 0,1 % of the cases. A minimum coupling loss scenario would have produced more pessimistic results.

Of course, the conditions just described are for a 21 dBm terminal. Simulations have not been done for a higher power terminal, but it is reasonable to assume that approximate scaling of the power levels by 12 dB (from 21 dBm to 33 dBm) should occur. Therefore, it may be proposed that $-54 + 12 = -42$ dBm should be considered a reasonable (if not slightly pessimistic) maximum value for the largest W-CDMA blocking signals.

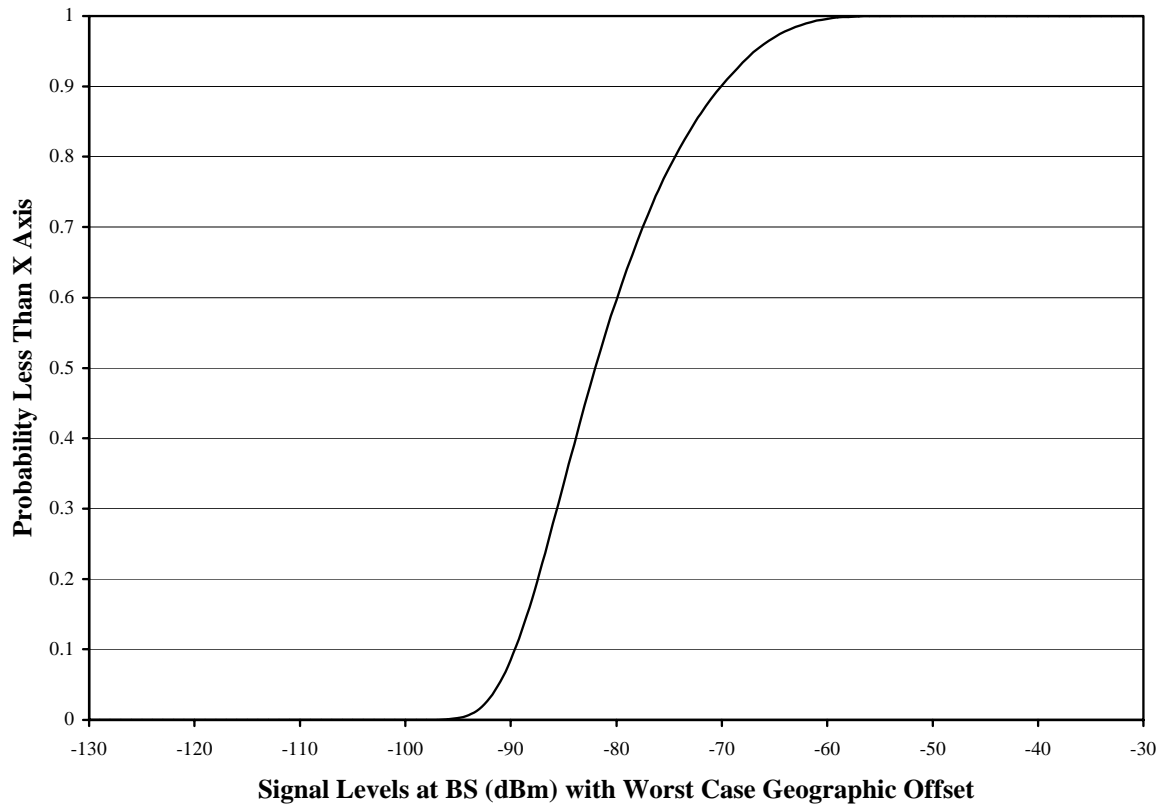

Figure 22

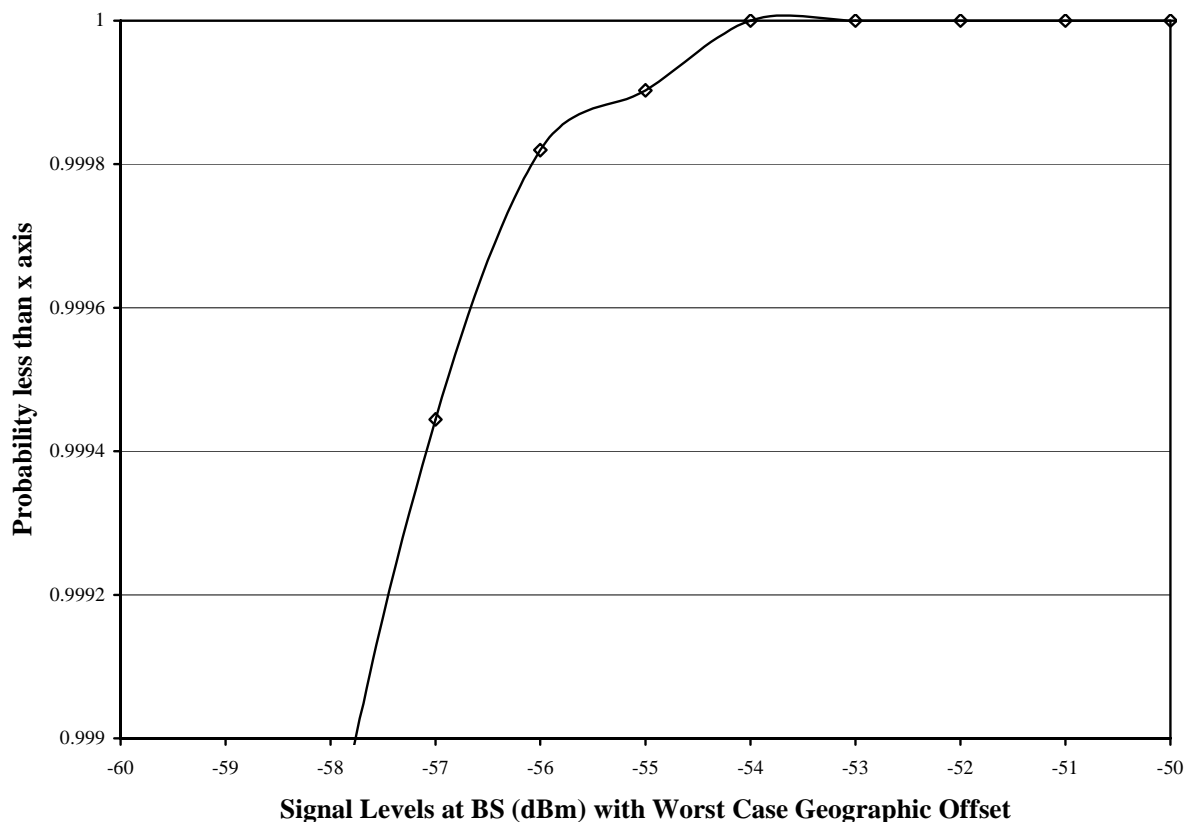

Figure 23

8.1.3.2 Simulation Results for 5 Km cell radius

Figure 24 shows the overall CDF of the input signals to the receivers using speech only, and figure 25 shows an expanded view of the occurrences having probability greater than .998. A sharp discontinuity can be seen at the -49 dBm input level in the expanded view. This occurs because in large cells there are a few occurrences of users operating at their maximum transmitted power level of 21 dBm while they are also close enough to another network's cell to produce a minimum coupling loss condition. Therefore, for this large of a cell, the received signal power level corresponding to 99,99 % of the occurrences is very close to the level dictated by MCL and is about -49 dBm (= 21 dBm – 70 dB).

The condition just described is for speech only systems with a maximum transmitted power level of 21 dBm. It is probably reasonable to assume that mixed speech and data systems would produce approximately the same result if the maximum power level for a data terminal were also 21 dBm. This is the case given in [12]. However, 33 dBm data terminals may exist, so it would be desirable to consider this higher power case also.

Figures 26 and 27 show the CDF of the input signals to the receivers in mixed speech and data systems. These indicate that 99,99 % of occurrences of the input signals to the receivers are about -40 dBm or less. Of course, with this large of a cell, the absolute maximum signal is dictated by MCL also and is only a few dB higher (33 dBm – 70 dB = -37 dBm).

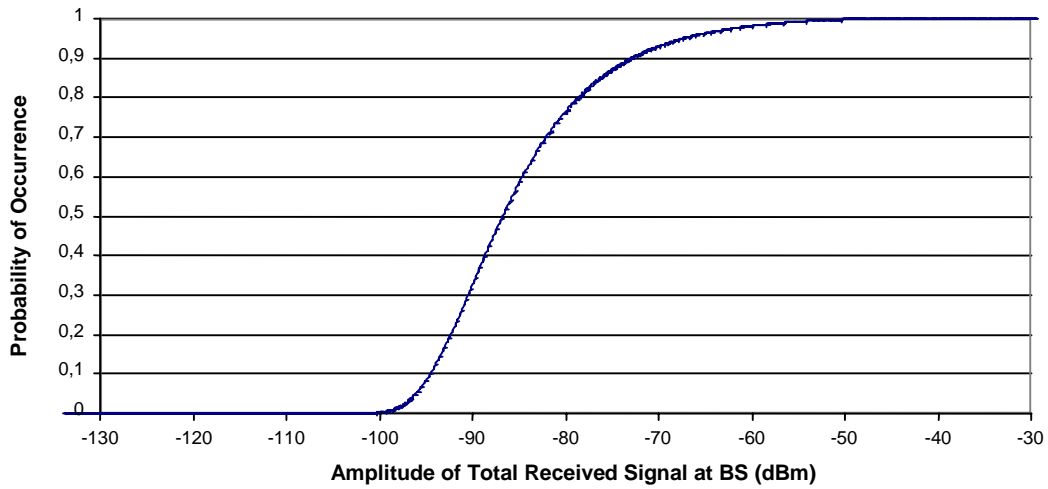

Figure 24: CDF of Total Signal for Speech Only System with 5 km Cells and Worst Case Geographic Offset

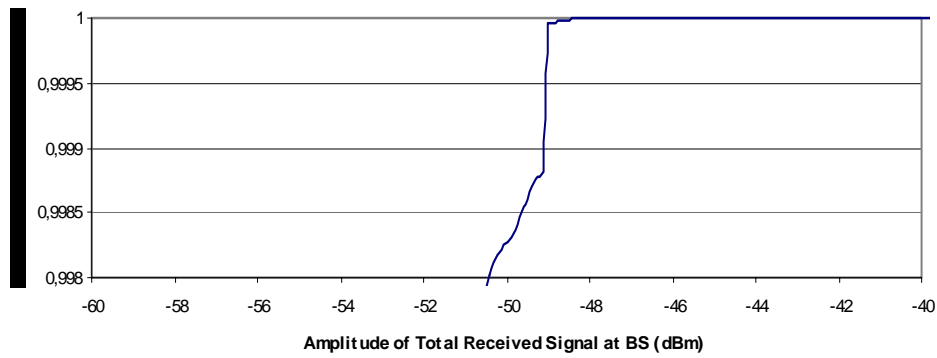

Figure 25: CDF of Total Signal for Speech Only System with 5 km Cells and Worst Case Geographic Offset

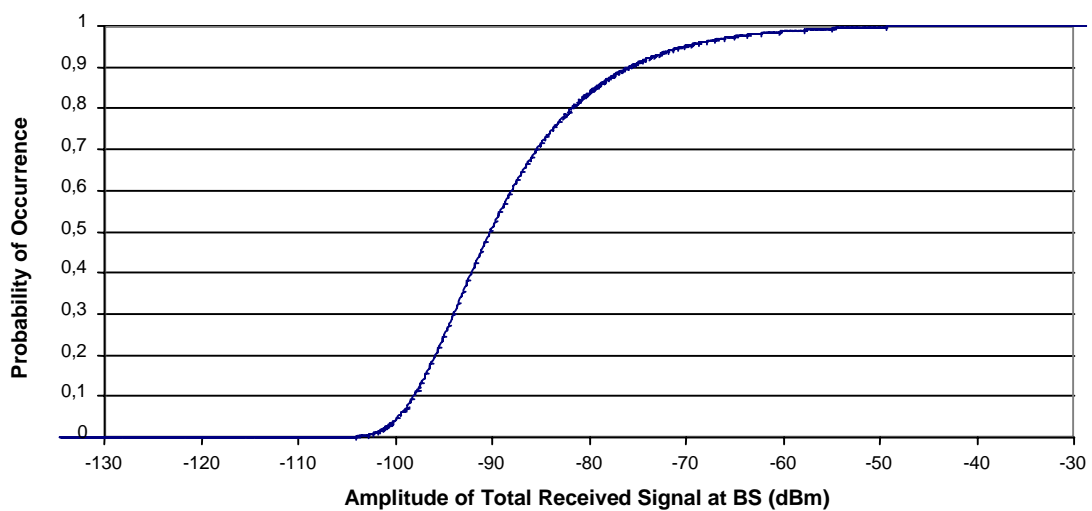

Figure 26: CDF of Total Signal for Mixed Speech and Data System with 5 km Cells and Worst Case Geographic Offset

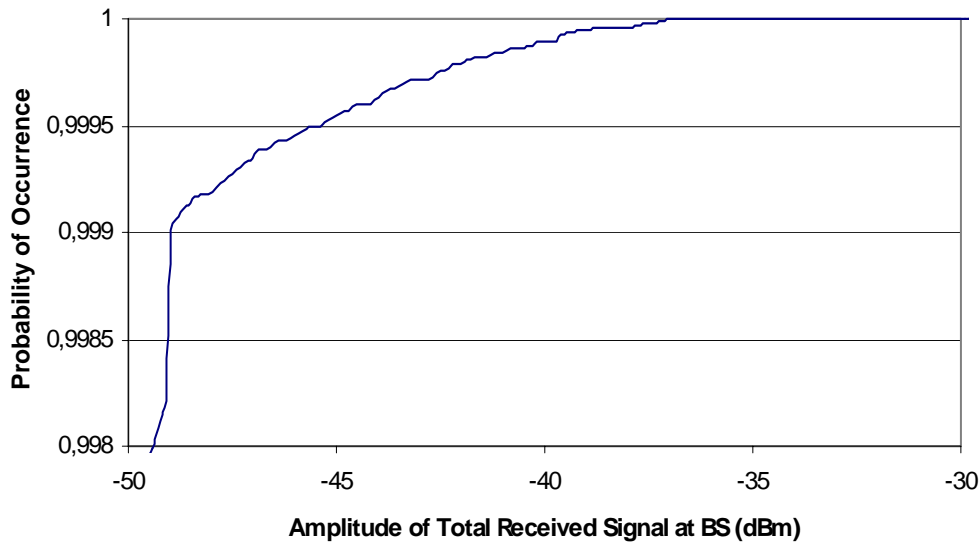

Figure 27: CDF of Total Signal for Mixed Speech and Data System with 5 km Cells and Worst Case Geographic Offset

Recent proposals from other companies have indicated that it may be desirable to allow more than the 3 dB degradation in sensitivity that is typically used in the measurement of a blocking spec. This is probably reasonable since:

- 1) the interfering UE's spurious and noise are going to dominate the noise in the victim cell in a real system; and
- 2) the measurement equipment is approaching the limit of its capability in the performance of this test.

The first comment is evident by observing that the interfering UE's noise two channels from its assigned frequency is probably typically in the range of -90 dBm (= -40 dBm - 50 dB), which is greatly larger than the typical noise floor of the receiver at -103 dBm. The second comment is evident by observing that the typical noise floor of most high quality signal generators is 65 dBc to 70 dBc with a W-CDMA signal. This results in test equipment generated noise of -105 to -110 dBm, which can produce a significant error in the blocking measurement.

In view of these concerns, it is probably reasonable to allow more than a 3 dB increase in the specified sensitivity level under the blocking condition. Other proposals recommend up to a 13 dB sensitivity degradation in the blocking spec and a 6 dB degradation in similar specs (like receiver spurious and IM). Motorola would consider 6 dB preferable.

In conclusion, the in-band blocking specification for UTRA should be -40 dBm (assuming that 33 dBm terminals will exist), and the interfering (blocking) test signal should be an HPSK carrier. A 6 dB degradation in sensitivity under the blocking condition should be allowed.

8.1.4 Transmit intermodulation for the UE

User Equipment(s) transmitting in close vicinity of each other can produce intermodulation products, which can fall into the UE, or BS receive band as an unwanted interfering signal. The transmit intermodulation performance is a measure of the capability of the transmitter to inhibit the generation of signals in its non linear elements caused by presence of the wanted signal and an interfering signal reaching the transmitter via the antenna.

The UE intermodulation attenuation is defined by the ratio of the output power of the wanted signal to the output power of the intermodulation product when an interfering CW signal is added at a level below the wanted signal. Both the wanted signal power and the IM product power are measured with a filter that has a Root-Raised Cosine (RRC) filter response with roll-off $\alpha = 0,22$ and a bandwidth equal to the chip rate. This test procedure is identical to the ALCR requirement with the exception of the interfering signal.

Therefore when performing this test, it is impossible to separate the contribution due to ACLR due to the wanted signal which would fall into the 1st and 2nd adjacent channel from the IMD product due to addition of interfering signal. Therefore the IMD cannot be specified to be the same value as the ALCR and has to be a lower value to account for the worst case ALCR contribution.

It is proposed the IMD value should be lower than the ACLR value by 2 dB. This value is to ensure the overall specification is consistent.

8.2 FDD/TDD

8.2.1 Evaluation of the FDD/TDD interference

8.2.1.1 Simulation results

The results corresponding to the individual parameters in the FDD/TDD co-existence simulations that are based on general assumptions described in clause 6 are shown in table 12.

Table 12: Description of results and the individual parameters used in the FDD/TDD co-existence simulations

No		individual parameters							Results		Required C/I
	Scenario	Cell structure	Cell radius	Receive filter	Power control type	User density in interfering system (/km ²)	# of the strongest interferer	Reference to Tdocs including figures	Probability of C/I less than requirement		
1	1	TDD MS perturbs FDD BS	Macro to Macro	500m	Ideal RRC ($\alpha = 0,02$)	None	5,14	1	[13]	1,5 %	-21 dB
	2						8,10			2 %	
	3						12,64			2,5 %	
	4					C based	5,14			0 %	
	5						8,10			0 %	
	6						12,64			0 %	
	7					None	5,14	5		2 %	
	8						8,10			3 %	
	9						12,64			4 %	
	10					C based	5,14			0 %	
	11						8,10			0 %	
	12						12,64			0 %	
	13				Real filter	None	5,14	30	[14]	8 %	
	14					C based				1,3 %	
	15					C/I based				2,2 %	
	16		2 000 m	Ideal RRC ($\alpha = 0,02$)	None	0,32	1	[13]		1,5 %	
	17						0,51			2 %	
	18						0,79			2,5 %	
	19					C based	0,32			1 %	
	20						0,51			1,5 %	
	21						0,79			2 %	
	22				Real filter	None	0,32	30	[14]	1,6 %	
	23					C based				1,6 %	
	24					C/I based				0,7 %	
	25		Micro to Micro	-	Ideal RRC ($\alpha = 0,02$)	None	1,563	1	[13]	0 %	
	26						7,813			0 %	
	27						15,625			0 %	
	28						129,36			0 %	
	29						203,73			0 %	
	30						224,08			0 %	
	31					C based	1,563			0 %	
	32						7,813			0 %	
	33						15,625			0 %	

No		individual parameters						Results		Required C/I	
		Scenario	Cell structure	Cell radius	Receive filter	Power control type	User density in interfering system (/km ²)	# of the strongest interferer	Reference to Tdocs including figures	Probability of C/I less than requirement	
	34						129,36			0 %	
	35						203,73			0 %	
	36						224,08			0 %	
	37		Pico to Pico	-	Ideal RRC ($\alpha = 0,02$)	None	1 E, 625	1	[13]	0 %	
	38						1,43 E, 2 187			0 %	
	39						2,36 E, 3 437,5			0 %	
	40						3,05 E, 5 937,5			0 %	
	41						3,39 E, 9 281,3			0 %	
	42						1 E, 13 475			0 %	
	43					C based	1 E, 625			0 %	
	44						1,43 E, 2 187			0 %	
	45						2,36 E, 3 437,5			0 %	
	46						3,05 E, 5 937,5			0 %	
	47						3,39 E, 9 281,3			0 %	
	48						1 E, 13 475			0 %	
2	1	FDD MS perturbs TDD MS	Macro to Macro	500 m	Ideal RRC ($\alpha = 0,02$)	None	67,7	1	[13]	0,3 %	-5,6 dB
	2					C based				0 %	
	3				Real filter	None		30	[14]	4,5 %	
	4					C based				0,22 %	
	5					C/I based				2,4 %	
	6			2 000 m	Ideal RRC ($\alpha = 0,02$)	None	4,23	1	[13]	0,5 %	
	7					C based				0,5 %	
	8				Real filter	None		30	[14]	0,8 %	
	9					C based				0,4 %	
	10					C/I based				0,5 %	
	11		Micro to Micro	-	Ideal RRC ($\alpha = 0,02$)	None	196	1	[13]	0 %	
	12						393			0 %	
	13						1 179			0 %	
	14						2 984			0 %	
	15					C based	196			0 %	
	16						393			0 %	
	17						1 179			0 %	
	18						2 984			0 %	

No		individual parameters						Results		Required C/I	
		Scenario	Cell structure	Cell radius	Receive filter	Power control type	User density in interfering system (/km ²)	# of the strongest interferer	Reference to Tdocs including figures	Probability of C/I less than requirement	
	19		Pico to Pico	-	Ideal RRC ($\alpha = 0,02$)	None	1 E, 220 000	1	[13]	0 %	
	20						3,54 E, 9 156			0 %	
	21					C based	1 E, 220 000			0 %	
	22						3,54 E, 9 156			0 %	
	23					None	1 E, 220 000	5		0 %	
	24						3,54 E, 9 156			0 %	
	25					C based	1 E, 220 000			0 %	
	26						3,54 E, 9 156			0 %	
	27		HCS	-	Real filter	C/I based	67,7	30	[15]	0 %	
3	1	FDD MS perturbs TDD BS	HCS	-	Real filter	C/I based	67,7	30	[15]	0 %	-8 dB

8.2.1.2 Summary and Conclusions

Many simulations for FDD/TDD co-existence on HCS and one layer environment considering either the ideal filter or the real filter and C/I based power control have been investigated.

The results in the realistic condition, which are chosen from the table in the previous clause (5) are shown in table 13.

Table 13: The simulation results for FDD/TDD co-existence in the realistic condition

No	Scenario	Cell structure	Results (Probability of C/I less than requirement)	Required C/I	Remarks
1	TDD MS perturbs FDD BS	Macro (Radius = 500 m)	2,2 %	-21 dB	- Real receive filter - C/I based power control - 30 strongest interferer
2		Macro (Radius = 2 000 m)	0,7 %		
3	FDD MS perturbs TDD MS	Macro (Radius = 500 m)	2,4 %	-5,6 dB	
4		Macro (Radius = 2 000 m)	0,5 %		
5		HCS	0 %		
6	FDD MS perturbs TDD BS	HCS	0 %	-8 dB	

It is obvious from the above results that the C/I requirements are met with high probability for all given scenarios in the most realistic conditions.

8.2.2 Evaluation of FDD/TDD interference yielding relative capacity loss

8.2.2.1 Simulation results

Based on the methodology described in clause 6.2 simulation results for various interference scenarios in different environments are summarised in table 14.

Table 14

Interferer / Victim	Macro vs. Macro	Micro vs. Micro	Pico vs. Pico	Macro vs. Micro
FDD MS / TDD BS	< 4 %	< 1 %	< 2 %	< 1 %
FDD MS / TDD MS	< 5 %	< 1 %	< 4 %	< 1 %
TDD MS / FDD BS	< 4 %	< 1 %	< 1 %	< 1 %

8.3 TDD/TDD

8.3.1 Evaluation of the TDD/TDD interference

8.3.1.1 Simulation results

The results corresponding to the individual parameters in the TDD/TDD co-existence simulations that are based on general assumptions described in clause 6 are shown in table 15.

Table 15: Description of results and the individual parameters used in the TDD/TDD co-existence simulations

No		individual parameters							Results		Required C/I
		Scenario	Cell structure	Cell radius	Receive filter	Power control type	User density in interfering system (/km ²)	# of the strongest interferer	Reference to Tdocs including figures	Probability of C/I less than requirement	
1	1	TDD MS perturbs TDD BS	Macro to Macro	500 m	Ideal RRC ($\alpha = 0,02$)	None	5,14	1	[13]	2 %	-8 dB
	2						8,10			3 %	
	3						12,64			4 %	
	4					C based	5,14			0,5 %	
	5						8,10			0,7 %	
	6						12,64			1,3 %	
	7				Real filter	None	5,14	30	[14]	10 %	
	8					C based				1,2 %	
	9					C/I based				3 %	
	10			2 000 m	Ideal RRC ($\alpha = 0,02$)	None	0,32	1	[13]	2 %	
	11						0,51			3 %	
	12						0,79			4 %	
	13					C based	0,32			1,3 %	
	14						0,51			1,5 %	
	15						0,79			2 %	
	16				Real filter	None	0,32	30	[14]	1,5 %	
	17					C based				1,5 %	
	18					C/I based				0,9 %	
	19		Micro to Micro	-	Ideal RRC ($\alpha = 0,02$)	None	1,563	1	[13]	0 %	
	20						7,813			0 %	
	21						15,625			0 %	
	22						129,36			0 %	
	23						203,73			0 %	
	24						224,08			0 %	
	25					C based	1,563			0 %	
	26						7,813			0 %	
	27						15,625			0 %	
	28						129,36			0 %	
	29						203,73			0 %	
	30						224,08			0 %	
	31		Pico to Pico	-	Ideal RRC ($\alpha = 0,02$)	None	1 E, 625	1	[13]	0 %	
	32						1,43 E, 2 187			0 %	

No		individual parameters						Results		Required C/I	
		Scenario	Cell structure	Cell radius	Receive filter	Power control type	User density in interfering system (/km ²)	# of the strongest interferer	Reference to Tdocs including figures	Probability of C/I less than requirement	
	33						2,36 E, 3 437,5			0 %	
	34						3,05 E, 5 937,5			0 %	
	35						3,39 E, 9 281,3			0 %	
	36						1 E, 13 475			0 %	
	37					C based	1 E, 625			0 %	
	38						1,43 E, 2 187			0 %	
	39						2,36 E, 3 437,5			0 %	
	40						3,05 E, 5 937,5			0 %	
	41						3,39 E, 9 281,3			0 %	
	42						1 E, 13 475			0 %	
2	1	TDD MS perturbs TDD MS	Macro to Macro	500 m	Real filter	None	5,14	30	[13]	0,1 %	-5,6 dB
	2					C based				0,06 %	
	3					C/I based				0,03 %	
	4			2 000 m		None	0,32			1 %	
	5					C based				0,2 %	
	6					C/I based				0,2 %	

8.3.1.2 Summary and Conclusions

Many simulations for TDD/TDD co-existence on HCS and one layer environment considering either the ideal filter or the real filter and C/I based power control have been investigated.

The results in the realistic condition, which are chosen from those in the table in clause 8.3.1.1 (table 15), are shown in table 16.

Table 16: The simulation results for TDD/TDD co-existence in the realistic condition

No	Scenario	Cell structure	Results (Probability of C/I less than requirement)	Required C/I	Remarks
1	TDD MS perturbs TDD BS	Macro (Radius = 500 m)	3 %	-8 dB	- Real receive filter - C/I based power control - 30 strongest interferer
2		Macro (Radius = 2 000 m)	0,9 %		
3	TDD MS perturbs TDD MS	Macro (Radius = 500 m)	0,03 %	-5,6 dB	
4		Macro (Radius = 2 000 m)	0,2 %		

It is obvious from the above results that the C/I requirements are met with high probability for all given scenarios in the most realistic conditions.

8.3.2 Evaluation of FDD/TDD interference yielding relative capacity loss

8.3.2.1 Simulation results

Based on the methodology described in clause 6.2 simulation results for various interference scenarios in different environments are summarised in table 17.

Table 17

Interferer / Victim	Macro vs. Macro	Micro vs. Micro	Pico vs. Pico	Macro vs. Micro
TDD MS / TDD BS	< 5 %	< 1 %	< 1 %	< 2 %
TDD BS / TDD MS	< 3 %	< 1 %	< 1 %	< 3 %
TDD MS / TDD MS	< 4 %	< 1 %	< 3 %	< 1 %

8.3.3 ACIR

8.3.3.1 Synchronised operators

8.3.3.1.1 Speech (8 kbps): UL and DL macro to macro case

In figures 28 and 29 the results of our simulations are shown for uplink and downlink in the intermediate and in the worst case.

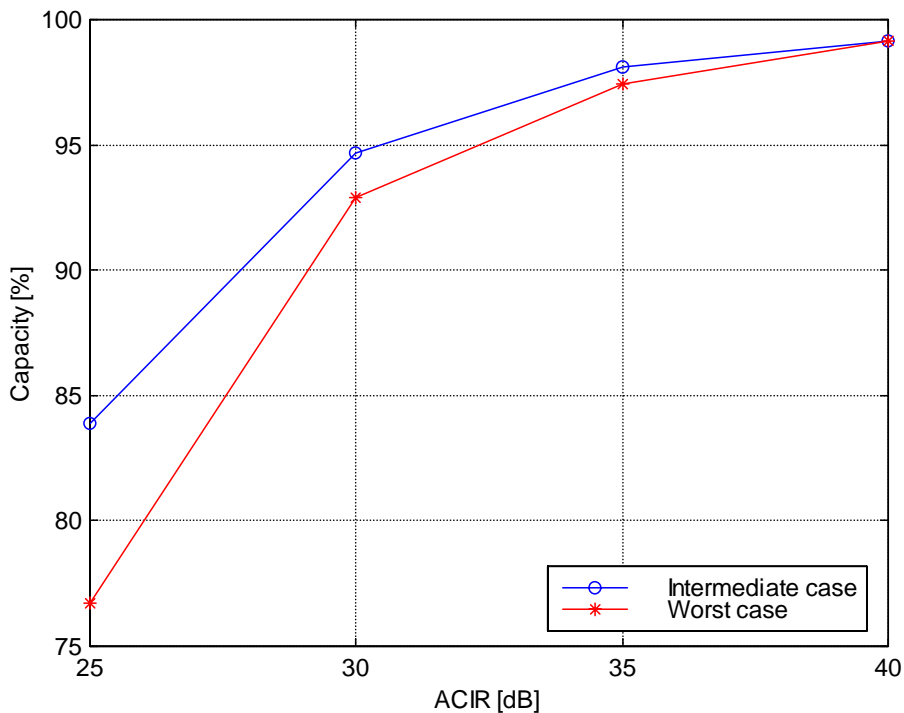

Figure 28: Relationship between ACIR and capacity loss for speech in UL in the intermediate and worst case

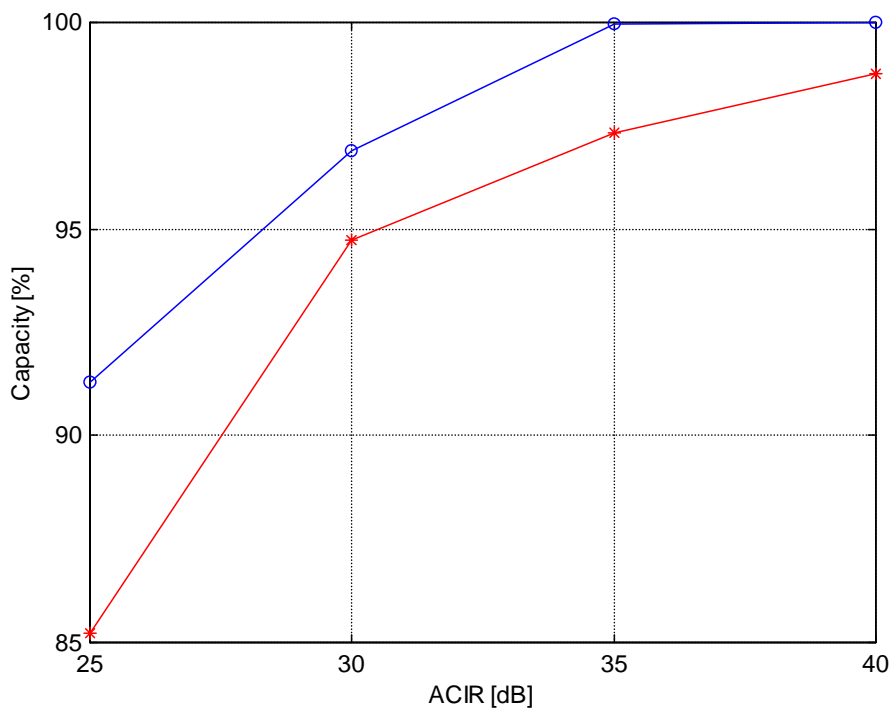

Figure 29: Relationship between ACIR and capacity loss for speech in DL in the intermediate and worst case

8.3.3.1.2 Comparison with the FDD/FDD coexistence analysis results

In tables 18 to 21 a comparison between our simulation results and those previously presented [27] for FDD mode has been made. Analysis of UL performances shows a different behavior of the TDD system when ACIR is equal to 25 dB to 30 dB in UL, both in the intermediate and in the worst case. On the contrary in DL system performances are similar and we can conclude that in this case an ACIR value close to 30 dB could be a good arrangement between system capacity and equipment realization.

Differences in UL performances are due to the noise rise criterion that we think inadequate for systems that use JD technique. In fact in FDD systems the high number of users and the absence of JD imply that the total received power is almost equal to the overall disturbance. On the contrary, in TDD systems the total received power is mainly composed by intracell interference that can be eliminated by JD. Thus an high average noise rise does not imply a high outage probability in the network. An admission criterion based on C/I in UL also could be more appropriate for the TDD case.

Table 18: System capacity comparison between FDD mode and TDD mode for different ACIR values: speech UL in intermediate macro-to-macro case

ACIR [dB]	FDD case			TDD case
	Min	Max	Average	
25	90,69 %	91,82 %	91,15 %	83,89 %
30	96,85 %	97,40 %	97,09 %	94,70 %
35	98,89 %	99,07 %	98,98 %	98,10 %
40	99,53 %	99,70 %	99,65 %	99,15 %

Table 19: System capacity comparison between FDD mode and TDD mode for different ACIR values: speech UL in worst macro-to-macro case

ACIR [dB]	FDD case			TDD case
	Min	Max	Average	
25	87,00 %	88,45 %	87,75 %	76,72 %
30	95,42 %	96,20 %	95,81 %	92,89 %
35	98,57 %	98,90 %	98,66 %	97,45 %
40	99,50 %	99,70 %	99,57 %	99,15 %

Table 20: System capacity comparison between FDD mode and TDD mode for different ACIR values: speech DL in intermediate macro-to-macro case

ACIR [dB]	FDD case			TDD case
	Min	Max	Average	
25	86,54 %	93,50 %	89,12 %	91,28 %
30	94,16 %	97,40 %	95,30 %	96,88 %
35	97,73 %	99,00 %	98,21 %	99,95 %
40	99,09 %	99,90 %	99,41 %	100 %

Table 21: System capacity comparison between FDD mode and TDD mode for different ACIR values: speech DL in worst macro-to-macro case

ACIR [dB]	FDD case			TDD case
	Min	Max	Average	
25	84,70 %	91,00 %	86,72 %	85,24 %
30	92,84 %	95,50 %	93,84 %	94,75 %
35	97,20 %	98,20 %	97,68 %	97,34 %
40	98,71 %	99,18 %	99,01 %	98,76 %

8.3.3.2 Non synchronised operators

In figures 30 and 31 simulation results in uplink and in downlink are produced. These results have been obtained performing 450 snapshots.

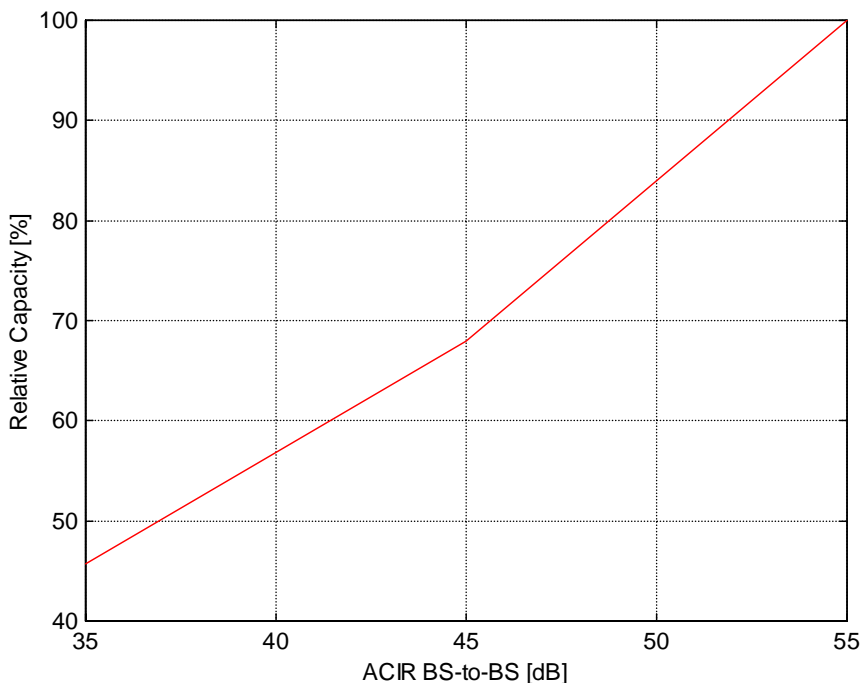

Figure 30: ACIR BS-to-BS and system capacity loss in UL

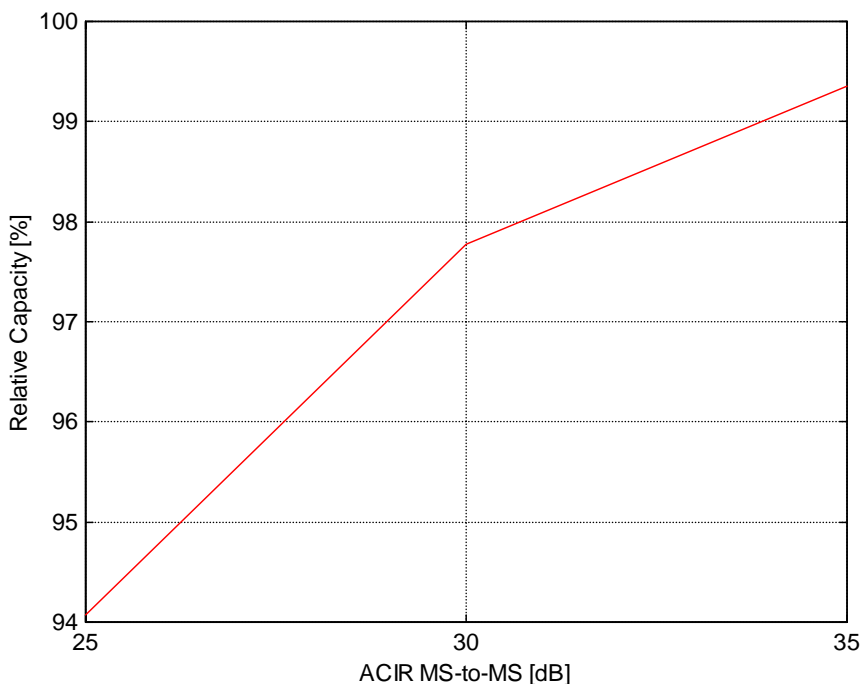

Figure 31: ACIR MS-to-MS and system capacity loss in DL

Figure 2 shows that downlink performances are not influenced very much by the presence of the second operator. This means that the MS-to-MS interference is not problematic for the system for an ACIR MS-to-MS value not lower than 30 dB.

In uplink the situation is different because of the presence of the BS-to-BS interference. In the single operator case the system is hard blocked. This means that the number of users per cell is determined only on the base of the resource availability and not on the base of the system interference. The introduction of a second operator not synchronised implies a loss in the system capacity that becomes acceptable for an ACIR BS-to-BS value between 50 dB and 55 dB.

8.4 Site engineering solutions for co-location of UTRA-FDD with UTRA-TDD

8.4.1 General

The minimum blocking requirements and minimum ACLR requirements as defined in [3] and [4] are not sufficient to enable the co-location of UTRA-FDD and UTRA-TDD base stations at a minimum coupling loss of 30 dB. A single generic solution cannot cover all combinations of TDD and FDD band allocation.

Instead site engineering solutions are required for this deployment scenario. Such site engineering solutions will be addressed in more detail in this section.

8.4.2 Interference Mechanism

For UTRA-FDD base station co-located with UTRA-TDD base stations, two interference mechanisms have to be considered.

8.4.2.1 Unwanted UTRA-TDD emissions

The unwanted emissions of the UTRA-TDD BS transmitter in the UTRA FDD uplink bands have to be sufficiently low not to desensitise the UTRA-FDD BS receiver. The following equation has to hold

$$I_{\text{acc}} \geq P_{\text{unwant,TDD}} - \text{CL}$$

where

I_{acc}	maximum acceptable interference level at the UTRA-FDD BS receiver
$P_{\text{unwant, TDD}}$	unwanted emission at the UTRA-TDD BS transmitter measured in the victim receive band
CL	coupling loss between UTRA-TDD BS transmitter and UTRA-FDD BS receiver

The maximum acceptable interference level I_{acc} depends on the cell size. For macro cells the allowed interference level is typically below the noise floor of the receiver.

The unwanted emission $P_{\text{unwant, TDD}}$ of the UTRA-TDD base station in the UTRA FDD uplink bands can be extracted from the spurious emission and ACLR requirements specified in [4]. The spurious emission level $P_{\text{unwant, TDD}}$ is explicit in [4]. For the minimum ACLR requirement the unwanted emission $P_{\text{unwant, TDD}}$ can be calculated by

$$P_{\text{unwant, TDD}} = P_{\text{TxD, TDD}} - \text{ACLR}$$

where $P_{\text{TxD, TDD}}$ is the transmit power of the UTRA-TDD base station.

For a UTRA TDD BS that already fulfils the TS 25.105 [4] unwanted emissions requirements for co-location with UTRA FDD, the ACLR and spurious emission levels $P_{\text{unwant, TDD}}$ are such that I_{acc} is below -110 dBm for $\text{MCL} = 30$ dB. Additional site engineering solutions at the aggressing UTRA TDD BS will then not be necessary for co-location.

8.4.2.2 Blocking of UTRA-FDD BS receiver

To avoid blocking of the UTRA-FDD BS receiver, the following equation has to hold

$$I_{\text{block}} \geq P_{\text{TDD}} - \text{CL}$$

where

I_{block}	maximum acceptable level of an unwanted interferer in the interferer transmit band
--------------------	--

P_{TDD}	transmit power of the UTRA-TDD BS
CL	coupling loss between UTRA-TDD transmitter and UTRA-FDD BS receiver

The maximum acceptable level of an unwanted interferer I_{block} for the UTRA-FDD base station can be extracted from the Adjacent Channel Selectivity and blocking characteristics specified in [3].

8.4.3 Site engineering solutions

To enable the co-location of UTRA-FDD and UTRA-TDD base stations site engineering has to limit the interference level at the UTRA-FDD BS receiver as well as the maximum acceptable level of an unwanted interferer in the interferer transmit band (blocking).

Different site engineering solutions are given in this section. These site engineering solutions may be used alone or in combination to meet the co-location requirements. The solutions apply either to the aggressor (UTRA TDD BS) or the victim (UTRA FDD BS) as summarised in Table 21.A.

Table 21A: Parameters for co-siting and corresponding possible [SITE ENGINEERING SOLUTION] UTRA TDD/FDD co-location.

UTRA TDD BS (Aggressor)	UTRA FDD BS (Victim)
$P_{Tx, TDD}$	I_{acc}, I_{block}
ACLR, Spurious emissions [UTRA TDD BS Tx filter]	ACS, Blocking req. [UTRA FDD BS Rx filter]
MCL [Antenna isolation]	

The operator of the victim BS are in control of the parameters on the right side in Table 21A, while the parameters on the left are controlled by the operator of the aggressing BS. The only site engineering solution that the operator of the victim BS is in full control of is additional UTRA FDD BS Receiver Filtering. The Scenario Examples in Subclause 8.4.4 therefore apply FDD BS Rx filtering as site engineering solution.

Depending on the deployment scenario for UTRA TDD BS, it is possible to reduce the output power of the UTRA-TDD base station. In the same way, in certain deployment scenarios the UTRA FDD BS may allow higher interference and blocker levels. Changing those parameters are not however generally applicable site engineering solutions.

8.4.3.1 Antenna installation

The coupling loss is determined by the installation of the UTRA-TDD BS transmit and UTRA-FDD BS receive antenna. As seen from [28], different antenna configurations give raise to a large variation in coupling loss values.

8.4.3.2 RF filters

8.4.3.2.1 UTRA-TDD base station transmitter filter

The unwanted emission of the UTRA-TDD base station transmitter in the victim receive band $P_{unwant, TDD}$ may be reduced by additional RF filters incorporated into the transmitter chain of the UTRA-TDD base station. To obtain an effective suppression of the unwanted emissions and a negligible suppression of the wanted signal, band-pass filters with high Q ceramic resonators can be used.

8.4.3.2.2 UTRA-FDD base station receiver filter

The level of unwanted interference in the interferer transmit band I_{block} may be decreased by additional RF filters incorporated into the receiver chain of the UTRA-FDD base station. To obtain an effective suppression of the unwanted interferer and only a small suppression of the wanted receive signal, band-pass or band-stop filters with high Q ceramic resonators can be used.

8.4.4 Scenario Examples

8.4.4.1 General

The site-engineering solutions shown in this chapter are describing co-location scenarios of a Wide Area BS UTRA-FDD with a Wide Area BS UTRA-TDD that fulfils the applicable co-location requirements in [4]. Co-location of other BS classes (Micro, Local Area) needs to be studied when the BS classification investigations are finalized and the Micro and Local Area base station requirements are included in the core specifications.

Scenario 1, 2a and 2b together, as described below, are allowing the use of the whole FDD spectrum.

Scenario 1 in chapter 8.4.4.2 is describing the situation when UTRA-FDD and UTRA-TDD are using adjacent frequencies at 1920 MHz. For those adjacent FDD and TDD frequency bands co-location with 30dB is not possible. However, those adjacent FDD and TDD frequencies can still be used in the network given the stated minimum BS-BS coupling loss is ensured.

Co-location site solutions for the non-adjacent FDD and TDD frequency bands are described in Scenario 2a and Scenario 2b.

The filter attenuation that is proposed in the following chapters 8.4.4.3 and 8.4.4.4 are examples based on the requirements of TS 25.104 regarding blocking and accepted performance degradation.

8.4.4.2 Scenario 1: Both TDD and FDD adjacent to 1920 MHz

- TDD range: ... – 1920 MHz; TDD BS output power: +43dBm
- FDD range: 1920 –... MHz

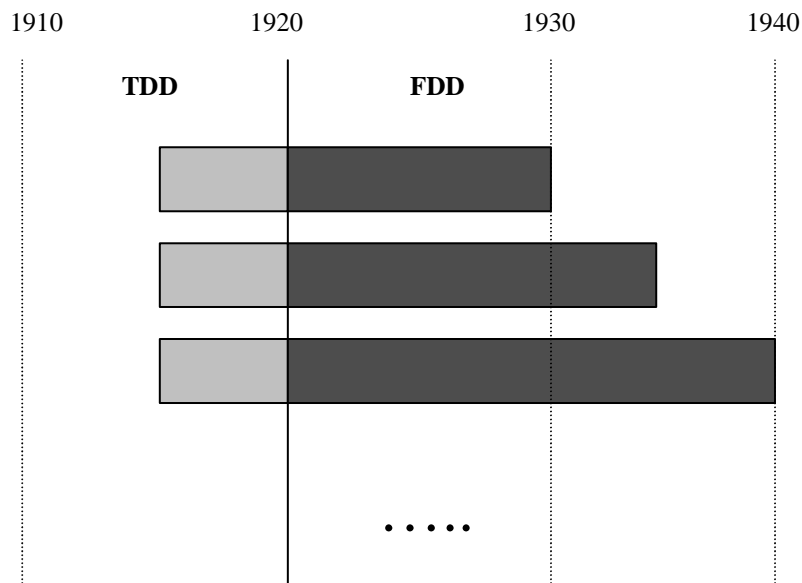

Figure 31A

Co-location of UTRA-FDD and UTRA-TDD with 30dB BS-BS coupling loss is even with cryogenic technology not possible due to the adjacent FDD and TDD channels without sufficient guard bands.

If only the site engineering solution “antenna installation” is used, the required BS – BS minimum coupling loss for this scenario is at least:

$$+43\text{dBm} - (-52\text{dBm [FDD ACS]}) = 95\text{dB}$$

8.4.3 Scenario 2a: TDD 1900-1915 MHz and FDD 1920-1940 MHz

- TDD range: 1900 – 1915 MHz; TDD BS output power: +43dBm

- FDD range: 1920 – 1940 MHz

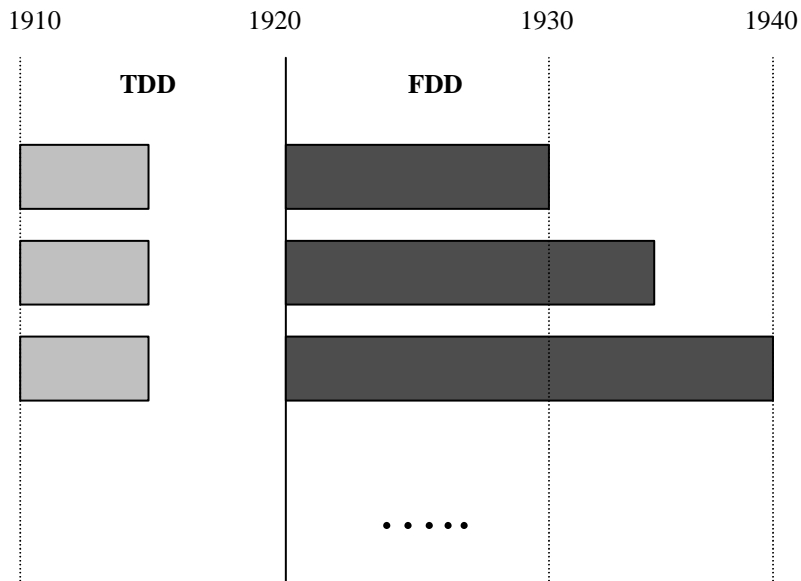

Figure 31B

Co-location of UTRA-FDD and UTRA-TDD with 30dB BS-BS coupling loss is possible by adding an external filter in the UTRA-FDD UL chains.

Filter parameters:

- Filter attenuation requirement in the range 1900 – 1915 MHz should be at least:

$$+43\text{dBm} + 3\text{dB [Multicarrier margin]} - 30\text{dB [BS-BS coupling loss]} - (-40\text{dBm [FDD inband blocking]}) = 56\text{dB}$$
- Inband losses of the filter in the range 1920 – 1940Mhz: $\leq 1\text{dB}$

8.4.4 Scenario 2b: TDD 1900-1920 MHz and FDD 1930-1980 MHz

- TDD range: 1900 – 1920 MHz; TDD BS output power: +43dBm
- FDD range: 1930 – 1980 MHz

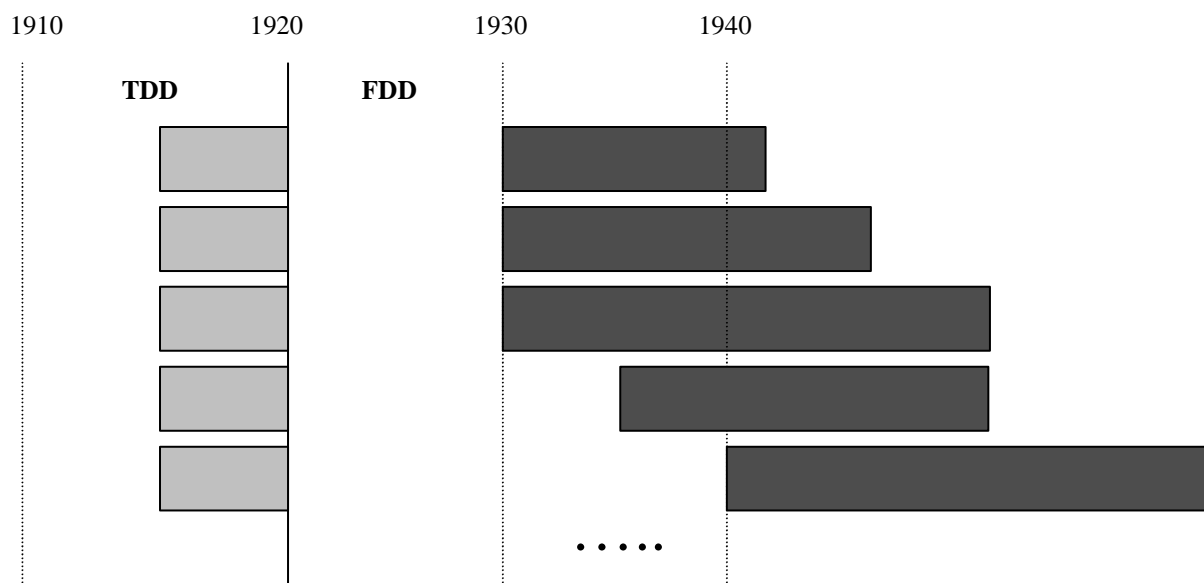

Figure 31C

Co-location of UTRA-FDD and UTRA-TDD with 30dB BS-BS coupling loss is possible by adding an external filter in the UTRA-FDD UL chains.

Filter parameters:

- Filter attenuation requirement in the range 1900 – 1920 MHz should be at least:

$$+43\text{dBm} + 3\text{dB [Multicarrier margin]} - 30\text{dB [BS-BS coupling loss]} \\ - (-40\text{dBm [FDD inband blocking]}) = 56\text{dB}$$
- Inband losses of the filter in the range 1930 – 1980 MHz: $\leq 1\text{dB}$

9 Additional Coexistence studies

9.1 Simulation results on TDD local area BS and FDD wide area BS coexistence

9.1.1 Introduction

The present document investigates the possibility of UTRA TDD-UTRA FDD coexistence. There are several possible configurations in which the likelihood of intersystem interference to occur is anticipated. This paper describes only one such situation. There might be other scenarios too which might require similar consideration however they are beyond the scope of the present document.

In the present document, the interaction between UTRA TDD indoor and UTRA FDD macro systems is studied. Here it has been considered that UTRA TDD and UTRA FDD systems belong to two different operators and are operating in adjacent bands. For UTRA FDD only UL is modelled. Owing to the frequency separation between UTRA TDD and UTRA FDD DL band the interference between UTRA TDD and UTRA FDD DL may not be very predominant. The results are presented in terms of capacity losses.

9.1.2 Simulator Description

The simulator used for evaluation of UTRA TDD and UTRA FDD co-existence is a static system level simulator. Simulations are based on snapshots where users are randomly placed in a predefined deployment scenario. In each snapshot a power control loop is simulated until E_b/N_0 target is reached. Simulation is made of several snapshots. The simulations are so conducted that the first set of simulation statistics is collected for independent environments (TDD Alone or FDD alone) and the second round of simulations constitutes of placing the two systems TDD and FDD in adjacent bands and the simulation statistics is recollected. The simulation statistics collected in a standalone environment and in adjacent channel operation environment determines the impact of the intersystem interference between TDD and FDD operating in adjacent bands. This is expressed in terms of capacity losses, power distribution behaviour and interference levels in each system.

9.1.2.1 Simulation procedure overview

A simulation step (snapshot) consists of mobile placement, pathloss calculations, handover, and power control and statistics collection. At the beginning of each simulation, UE's are randomly distributed. After the placement, the path loss between each UE and the BS is calculated, adding the lognormal fading, and stored to so called *G-matrix* (Gain matrix). Distance attenuation and lognormal fading are kept constant during the execution of a snapshot. Then power control loop is started. During this the power control is executed till the used power will reach the level required by the required quality. During the power control loop, the Gain Matrix remains constant. Sufficient number of power control commands in each power control loop should be greater than 150.

At the end of a power control loop, statistical data is collected. UE's whose quality is below the target $E_b/N_0 - 0,5$ dB are considered to be in outage state and UE's whose quality is higher than the target $E_b/N_0 - 0,5$ dB are considered to be satisfied.

When a single step (snapshot) is finished, UE's are re-located to the system and the above process is executed again. Multiple snapshots are executed to achieve sufficient amount for local mean SIR values.

9.1.2.2 System Scenario

In the present document, hierarchical system with FDD in macro and TDD in pico environment has been chosen. The systems have been deployed as indicated in figure 31D. The hexagonal cells represent the FDD macrocells and the TDD indoor system has been mapped on to the FDD middle cell. The TDD indoor layout has been adopted from [9].

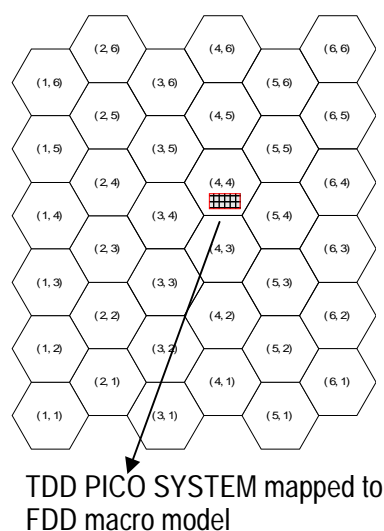

Figure 31D: TDD pico and FDD Macro evaluation layout; pico model chosen from [31]

Here, it is assumed that TDD is operating inside the building hence the signals entering and exiting the building are attenuated because of the wall losses. In order to model the attenuation, an additional loss of 10 dB is added to the path loss of all signals crossing the TDD cell edge.

Statistics from FDD is collected from the central cell only. And this cell is the COI (Cell of Interest). The multiple FDD cells have been deployed to generate adequate FDD interference for the TDD system. The FDD macro cell range has been set to 500 m.

9.1.2.3 Propagation Model

9.1.2.3.1 TDD BS to TDD UE

This model is obtained from [9]. The indoor path loss model expressed in dB is in the following simplified form, which is derived from the COST 231 indoor model. This low increase of path loss versus distance is a worst-case from the interference point of view:

$$L_1 = 37 + 30\log_{10}(r) + 18.3n^{((n+2)/(n+1)-0.46)}$$

Where:

- r is the transmitter-receiver separation given in metres;
- n is the number of floors in the path.

NOTE: The UE-UE and BS-BS propagation model for the indoor environment are the same as BS-UE propagation model except that the antenna gains are different.

9.1.2.3.2 FDD UE to FDD BS

The FDD UE-FDD BS propagation model, obtained originally from [9], is applicable for the test scenarios in urban and suburban areas outside the high rise core where buildings are of nearly uniform height. Assuming, that the base station antenna height is fixed at 15 m above the rooftop, and a carrier frequency of 2 GHz is used, the FDD UE-FDD BS path loss L_2 can be expressed as [2]:

$$L_2 = 15.3 + 37.6\log_{10}(r)$$

Where:

- r is the transmitter-receiver separation in meters.

9.1.2.3.3 TDD UE to FDD BS

This is determined from L_2 described above by adding wall loss attenuation to the calculated value.

9.1.2.3.4 FDD UE to TDD UE

For this path, it depends where the FDD terminals are located if the FDD terminals are within the indoor system then the pathloss L_1 is chosen otherwise if the FDD Terminals are outside the indoor system then L_2 is chosen, to L_2 wall loss attenuation is added.

9.1.2.3.5 FDD UE to TDD BS

For this path, it depends where the FDD terminals are located if the FDD terminals are within the indoor system then the pathloss L_1 is chosen otherwise if the FDD Terminals are outside the indoor system then L_2 is chosen, to L_2 wall loss attenuation is added.

9.1.2.3.6 TDD BS to FDD BS

The TDD BS-FDD BS path loss is calculated with the help of L_2 and the wall loss attenuation is added to L_2 .

In the system simulations, a log-normally distributed shadowing component with standard deviation of 10 dB (macro cell) or 12 dB (pico cell) is added to calculated propagation path loss.

9.1.2.4 Power Control

Power control is a simple SIR based power control. Perfect power control is assumed. With the assumption of perfect power control, PC error is assumed equal to 0 %, and PC delay is assumed to be 0 s.

- TDD UL Power Control Range: 65 dB.
- TDD DL Power Control Range: 30 dB.
- FDD UL Power Control Range: 65 dB.

9.1.2.5 Interference Modelling Methodology

The interference calculations are done such that in each links (UL or DL) the total interference is the sum of intra system interference and inter system interference's). In calculations for the intersystem interference, the RF characteristics of transmitter and receiver are taken into account by weighting adjacent system signal with a parameter ACIR. The definition for ACIR and other related radio parameters is explained below.

ACLR: is a measure of transmitter performance. It is defined as the ratio of the transmitted power to the power measured after a receiver filter in the adjacent RF channel. Both the transmitted power and the received power are measured with a filter response that is root-raised cosine, with a noise power bandwidth equal to the chip rate.

ACS: is measure of receiver performance. It is defined as the ratio of the receiver filter attenuation on the assigned channel frequency to the receiver filter attenuation on the adjacent frequency.

ACIR: is a measure of over all system performance. It is defined as the ratio of the total power transmitted from a source (base station or UE) to the total interference power affecting a victim receiver, resulting from both transmitter and receiver imperfections. They have following relationship:

$$ACIR = \frac{1}{\frac{1}{ACLR} + \frac{1}{ACS}}$$

For these simulations ACLR's and ACS's used are have been described in table 22.

Table 22:ACLR's and ACS's for TDD and FDD systems

	TDD				FDD	
	UE ACS	UE ACLR	BS ACS	BS ACLR	BS ACS	UE ACLR
dB	33	33	45	45	45	33

9.1.3 Capacity Calculations

9.1.3.1 Calculation of Single Operator Capacity for TDD and FDD

In order to study the impact of capacity due to adjacent channel interference between TDD and FDD the capacity evaluation of individual operators is done as follows. Single operator capacity designated by N_{Single} for each system is determined as follows:

- 1) generate BS's as per the selected environment (indoor case selected in these simulations);
- 2) reset the output data collection counters;
- 3) generate mobiles randomly;
- 4) calculate the path loss between each UE and the base station;
- 5) determine the best server;
- 6) calculate the co-channel interference;

- 7) control power till it stabilizes such that the used power will reach the level required by the required quality. This is the stabilization period;
- 8) execute sufficient number of power control commands in each power control loop;
- 9) collect the statistical data for outage and satisfied users .This is based on:
 - UE's whose SIR is lower than the target (in outage) and UEs whose SIR is higher than the target (satisfied);
- 10)increase or decrease the N_{Single} and start again till the satisfied user criterion is achieved.

The co-channel interference is modeled in the similar manner as described in [12]. Since in DL, the multiple transmitted signals are synchronously combined the intra operator interference is multiplied by orthogonality factor.

9.1.3.2 Calculation of Multi Operator Capacity

Mullet operator capacity designated by N_{Multi} is calculated as follows:

- 1) generate BS's as per the selected environment (option for pico,micro and macro.Pico considered here);
- 2) reset the output data collection counters;
- 3) generate mobiles randomly;
- 4) Calculate the path loss between each UE and the base station;
- 5) determine the best server;
- 6) calculate the co-channel interference and the adjacent channel interference at the victim station. (If the victim is TDD adjacent channel interference is from FDD system, if the victim is FDD adjacent channel interference is from TDD system);
- 7) control power till it stabilizes such that the used power will reach the level required by the required quality. This is the stabilization period;
- 8) a sufficient number of power control commands in each power control loop are executed;
- 9) collect the statistical data for outage and satisfied users for each operator .This is based on:
 - UE's whose SIR is lower than the target (in outage) and UEs whose SIR is higher than the target (satisfied);
- 10)increase or decrease the N_{Multi} and start again till the satisfied user criterion is achieved.

9.1.3.3 Calculation of relative capacity loss

N_{Single} and N_{Multi} were determined above. The relative capacity loss in each system is calculated as follows:

$$C = 1 - \frac{N_{Single}}{N_{Multi}},$$

where C is the relative capacity loss of the system.

The *capacity criterion* is such that the UE's whose SIR at the end of the simulation is lower than the target E_b/N_0 are in outage whereas UE's whose SIR is above the E_b/N_0 are satisfied. At each simulation round it is assumed that 95 % of the users fulfil the satisfied user criterion.

9.1.4 Simulation Parameters

Table 23 represents the system parameters chosen for these simulations. Radio parameters are chosen from [12].

Table 23: Simulation Parameters

Parameter	FDD UL	TDD UL	TDD DL
Service parameters			
Bit rate (speech)	8 kbps	8 kbps	8 kbps
Eb/No target [dB]	6,1	3,7	6,1
Processing gain [dB]	26,3	13,9	13,9
SIR target [dB]	-20,2	-10,2	-7,8
Radio parameters			
Max Tx power [dBm]	21 (UE)	21 (UE)	33 (BS)
Power cntrl range [dB]	65	65	30
Frequency [MHz]	1 925	1 920	1 920
Other parameters			
Radio environment	macro	pico	pico
BS MUD	off	off	-
Channel non-orthogonality	-	-	0.06
MCL [dB] (Minimum coupling loss)	70 FDD BS -> FDD UE, TDD BS, TDD UE	40 TDD BS -> TDD UE, FDD UE	40 TDD UE-> FDD UE

9.1.5 Simulation results

The impact of TDD interference to FDD system was studied by locating the TDD indoor system in different locations in the FDD COI. The FDD and TDD system capacity losses were observed as function of coupling loss between TDD system and FDD macro BS. The results are summarised in table 24.

Table 24: Impact of coupling loss between TDD and FDD systems

Impact of TDD-FDD system coupling loss	70.3	90.8	103.2	130.0
TDD UL Capacity Loss	< 1 %	< 1 %	< 1 %	< 1 %
TDD DL Capacity Loss	< 1 %	< 1 %	< 1 %	< 1 %
FDD UL Capacity Loss	< 11 %	< 4 %	< 2 %	< 1 %

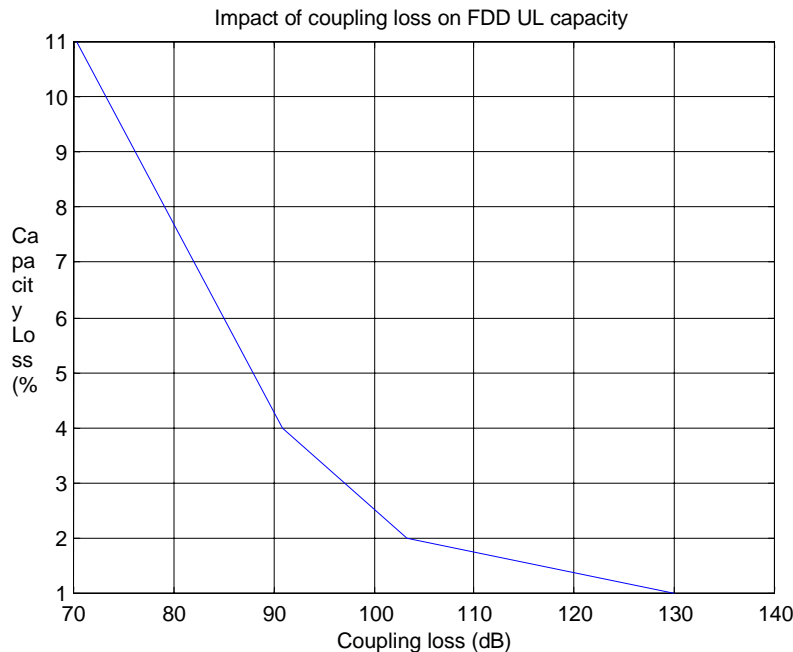

Figure 31A: FDD capacity loss along the coupling loss between FDD macro BS and TDD pico system

The results indicate that TDD indoor system capacity is not significantly affected by adjacent channel FDD interference. This is because there is adequate power available in TDD system to handle FDD interference.

9.1.6 Conclusions

Results indicate:

- no impact on TDD system capacity due to FDD operating in adjacent channel in this mode (FDD macro configuration);
- minor capacity losses are experienced by FDD UL if TDD system is too close to FDD BS (note however 10 m separation case is not valid from practical implementation point of view);
- adjacent channel operation of TDD and FDD system under stated conditions is possible;
- also, the TX powers of TDD entities in these simulations are very high. In practice, power levels in Local area TDD cells (in UL and DL) are obviously lower. Thus impact on FDD UL shall be reduced further.

10 Antenna-to-Antenna Isolation

10.1 Rationale for MCL value

The coupling losses between two co-sited base stations are depending on e.g. the deployment scenario and BS antenna gain values. As seen from e.g. [28], different deployment scenarios give raise to a large variation in coupling loss values. However, in order not to have different requirements for different deployment scenarios, it is fruitful to use one value of the minimum coupling loss (MCL) representing all deployment scenarios.

For the case of two operators co-siting their antenna installations on a roof-top, the antennas could be situated in each other's far-fields and the isolation that occur between the sites can be analysed using the ordinary Friis' transmission equation:

$$\text{Isolation [dB]} = 20 \log_{10} \left(\frac{2\pi R}{\lambda} \right) - \text{Gain [dBi]}$$

where R is the distance between the antennas, λ is the wavelength and Gain is the total effective gain of the two antennas.

When applying this equation to a deployment scenario with a separation distance of 10 meters between the two sites, both using 65° (14 dBi) sector antennas, an isolation of about 30 dB occur when the antennas are situated in a 35° angle compared to each other. This deployment scenario is regarded as typical to many co-sited antenna installations.

A coupling loss value of 30 dB also coincides with the minimum coupling loss value reported in [29] and one of the measured antenna configurations in [28]. It is also typical to many existing installations, as reported by several operators.

11 Modulation accuracy

11.1 Downlink modulation accuracy

11.1.1 Simulation Condition and Definition

For simplification, degradation was evaluated in terms of BER performance against modulation accuracy under the following assumptions that:

- propagation channel is static one, having a single path without Rayleigh fading;
- receiver has no RAKE receiver, diversity reception nor channel coding;
- ideal coherent demodulation is performed;
- measured channel is all data throughout a frame;
- each of information bit streams is generated by a pseudo random binary sequence of 15-stage having a different initial phase, spread by an independent orthogonal spreading code, and is multiplexed.

Modulation accuracy is supposed to be degraded by various factors like imperfection of roll-off filters, imbalance of quadrature modulators, phase jitters of local oscillators and etc. In the simulation, we have not given all possible degradation factors one by one, instead of which, we assumed that overall behaviour of error vectors caused by each degradation factor is Gaussian. As defined in clause 6.8.2 of TS 25.104 [3], a vector error was deliberately introduced and added to theoretically modulated waveform, and the square root of the ratio of the mean error vector power to the mean signal power was calculated in a %.

11.1.2 Simulation Results

Figure 1 shows degradation of E_b/N_0 at a BER of 10^{-3} against the modulation accuracy for three spreading factors (SF) of 4, 16 and 64 respectively, under condition of single code operation. In figure 32, performance degradation is shown for the case that number of channels multiplexed is 1, 4 and 16, keeping total information bit rate the same at a traffic level of a quarter of maximum system capacity. Figure 33 demonstrates similar degradation for different combination of SF and number of users, where traffic load is increased to half of maximum system capacity in comparison to the case of figure 34.

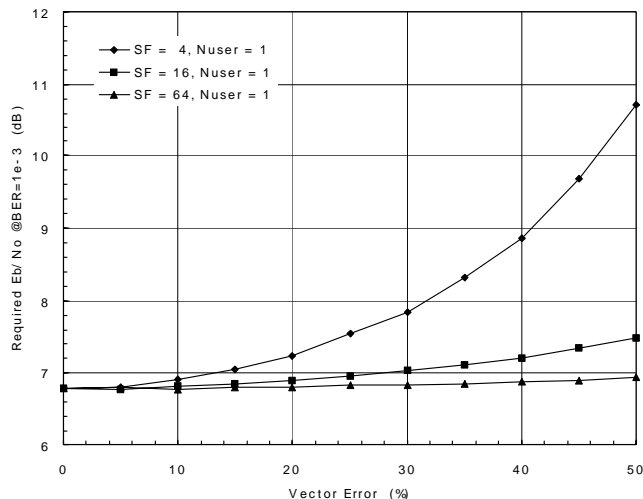

Figure 32: Degradation for the case of single code transmission

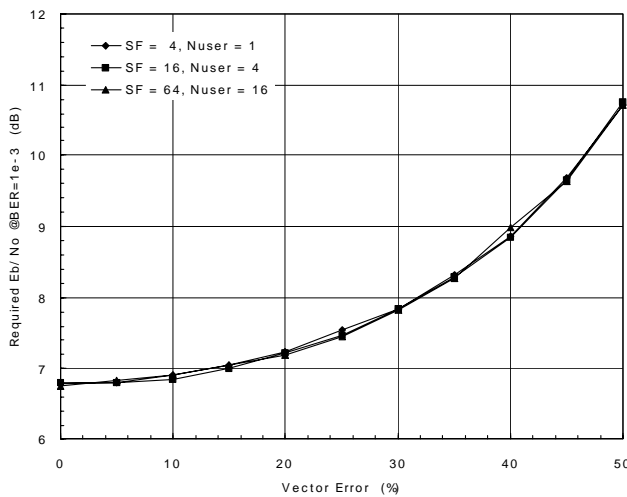

Figure 33: Degradation for the case of a quarter of the maximum traffic load

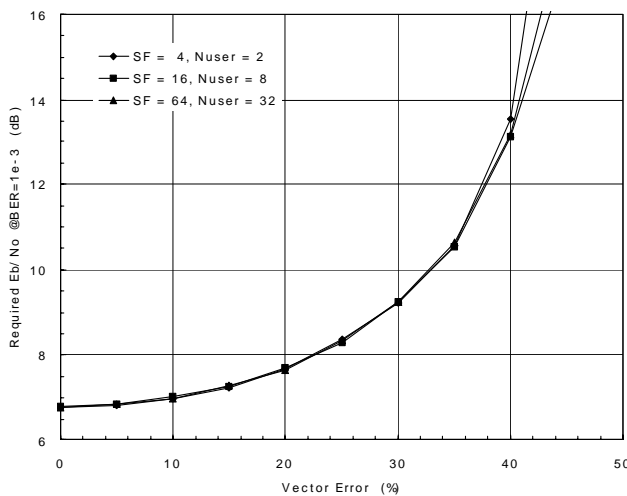

Figure 34: Degradation for the case of a half the maximum traffic load

11.1.3 Considerations

Firstly, as the number of users (or channels) to be multiplexed increases, degradation against modulation accuracy increases compared to the case of single code transmission. Secondly, degradation of BER performance against modulation accuracy does not depend on a spreading factor, SF, but on total information bit rate given to the system. For instance, for a given modulation accuracy, single code transmission for SF of 4 causes almost the same degradation for the multi code transmission of 16 channels for SF of 64. Finally, in case that total traffic load given to the system is half of full capacity, difference of degradation at modulation accuracy of 12,5 % and 23 % is about 0,8 dB.

Though the simulation was carried out for evaluation of modulation accuracy especially for base station, the results could also be used for another evaluation of that for UE by referring the case for single code operation shown in figure 28.

11.1.4 Conclusion

Though the simulation does not use measurement channel models consistent with those used in link level simulation work appearing in the pertinent specification documents, it gives prediction that mitigation of modulation accuracy of 12,5 % to 23 % may cause not negligible degradation to BER performance. Even in the case that total traffic load is half of maximum overall system capacity, the simulation results show degradation of 0,8 dB, and it is obvious that as number of channels comes close to maximum system capacity the degradation increases to a larger extent. Therefore, Fujitsu believes that the current modulation accuracy value of 12,5 % is quite reasonable and that the value should be kept in the document of TS 25.104 [3] as it is.

11.2 Uplink Modulation Accuracy

11.2.1 Value for Modulation Accuracy

The specification value for EVM_{chip} should be chosen to provide sufficient receiver performance and to limit the extra noise power that could be transmitted.

Receiver performance is determined by EVM_{symbol} . A typical minimum requirement for EVM in other cellular systems is 12,5 %. Assuming 12,5 % should be guaranteed for EVM_{symbol} even up to 2,048 kbps. Then corresponding minimum requirement for EVM_{chip} should be 25 %. Tougher requirements will provide unnecessary implementation constraints for terminals that do not support these high data rates.

With 25 % EVM_{chip} , the maximum amplitude of the noise error vector is 25 % of the amplitude of the signal vector. This means that the total UE power maybe increased by maximum 0,26 dB "noise power". Table below gives the relation between EVM_{chip} and worst-case additional power transmitted by UE.

Table 25

EVM_{chip} (%)	Max. Power increase (dB)
25	0,26
20	0,17
17,5	0,13
15	0,096
12,5	0,067

Considering the system performance, receiver performance and implementation perspective, a value of 17,5 % was considered a reasonable minimum requirement for WCDMA uplink modulation accuracy.

11.2.2 References for minimum requirements

PDC and TDMA have a similar modulation as WCDMA and have a minimum requirement of 12.5% for EVM_{symbol} .

PDC specification: Personal Digital Cellular Telecommunication System, clause 3.4.2.9, ARIB, RCR STD 27, Rev. G, 1998.

TDMA specification: Mobile Stations Minimum Performance, clause 3.3.2.1, TR45, TIA/EIA-136-270-A, 1998.

12 UE active set size

12.1 Introduction

The UE is connected to one or several cells in active mode. The cells to which the UE is connected to is called the active set (AS). The cells maybe sectors of the same (softer handover) BS or separate (soft handover) BS. The maximum required number of cells simultaneously in the AS (maximum size of the AS) is studied in this paper.

The study has been done with help of a static network planning tool where a very simple SHO criterion was applied.

12.2 Simulation assumptions

The used planning tool prototype can perform snapshot simulations and/or pixel by pixel calculations. For this study the pixel by pixel calculations were sufficient.

The SHO criterion was to include to the active set of a map pixel 1) the best cell, meaning the largest measured received CPICH E_c/N_0 , and 2) all the cells within WINDOW_ADD from the best cell. Furthermore the size of the active set in a pixel is the number of the cells in the active set of that pixel.

In most simulations the WINDOW_ADD parameter was 5 dB. The basis for this choice was to have approximately 40% soft handover probability which was considered as a worst, but still a realistic case.

The pixels from which the UE is not able to maintain a connection due to uplink power limitation are doomed to outage and at these pixels the size of the active set is set to zero. In all but the last simulation case the uplink outage was calculated for 144 kbit data. In the last case the uplink outage was calculated for 8 kbit/s speech. The radio network planning was targeted to better than 95 % coverage probability.

The simulations were done on the following cell layouts:

- Case 1: Three sectored, 65° antenna;
- Case 2: Three sectored, 90° antenna;
- Case 3: Three sectored, 65° antenna, bad radio network planning;
- Cases 4: Standard omni scenario used in the ACIR coexistence analysis:
 - Case 4a: WINDOW_ADD = 5 dB;
 - Case 4b: WINDOW_ADD = 3 dB;
 - Case 4c: WINDOW_ADD = 7 dB;
- Case 5: Realistic map.

In all but the last case the distance loss was calculated as $128,1 + 37,6 \times \lg(R)$, as used in the ACIR coexistence analysis, on top of which a log-normally distributed shadow fading term was added, with standard deviation of 10 dB. The log normal fading was generated so that the correlation between the fading terms from any pair of cells was 0,5. In the last case the distance loss was calculated by an extended Okumura-Hata model with area type correction factors fit to measured data.

12.3 Simulation results

In all simulation cases two figures are presented. First the network layout is depicted and then the distribution of the active set size is shown as a histogram.

12.3.1 Case 1: Three sectored, 65° antenna

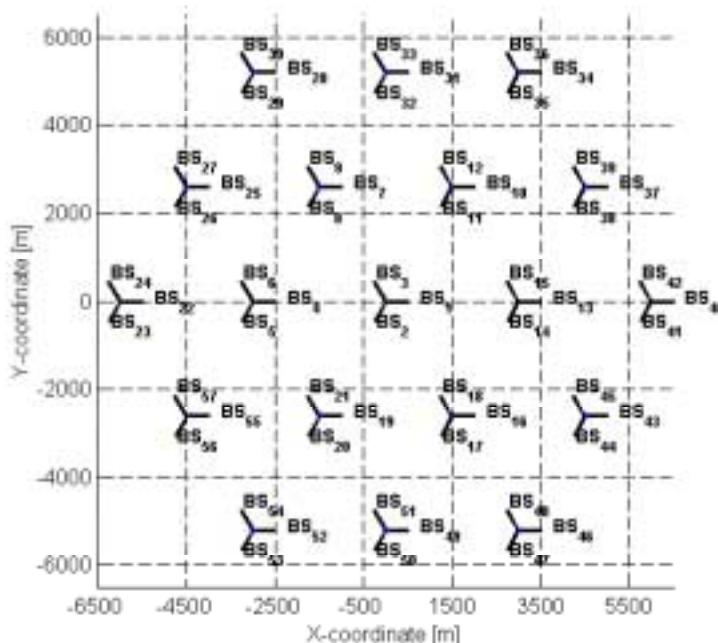

Figure 34A

SHO probability (area) WINDOW_ADD₁ = -5 dB (! different WINDOW_ADD possible !)

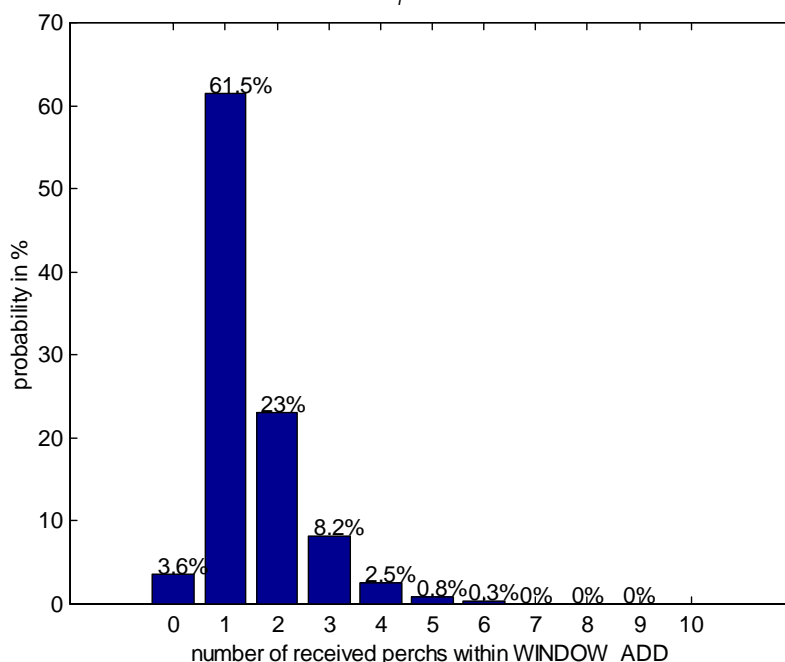

Figure 34B

12.3.2 Case 2: Three sectored, 90° antenna

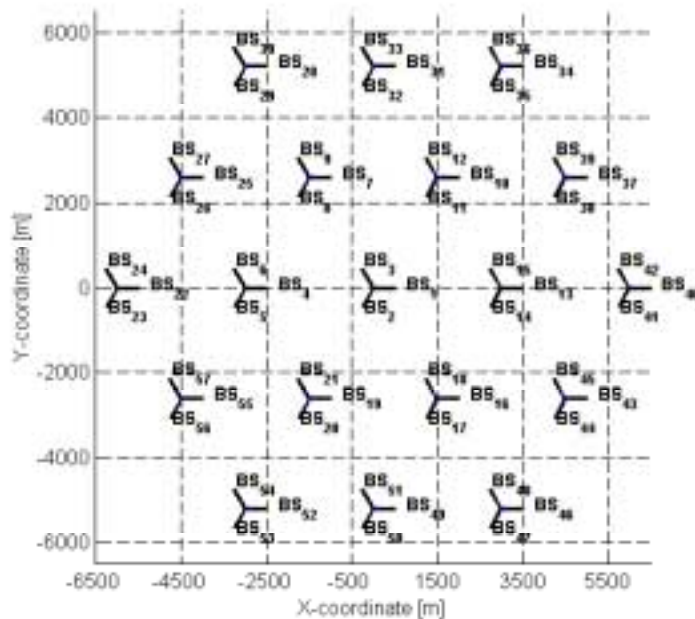

Figure 34C

SHO probability (area) WINDOW_ADD_i = -5 dB (! different WINDOW_ADD possible !)

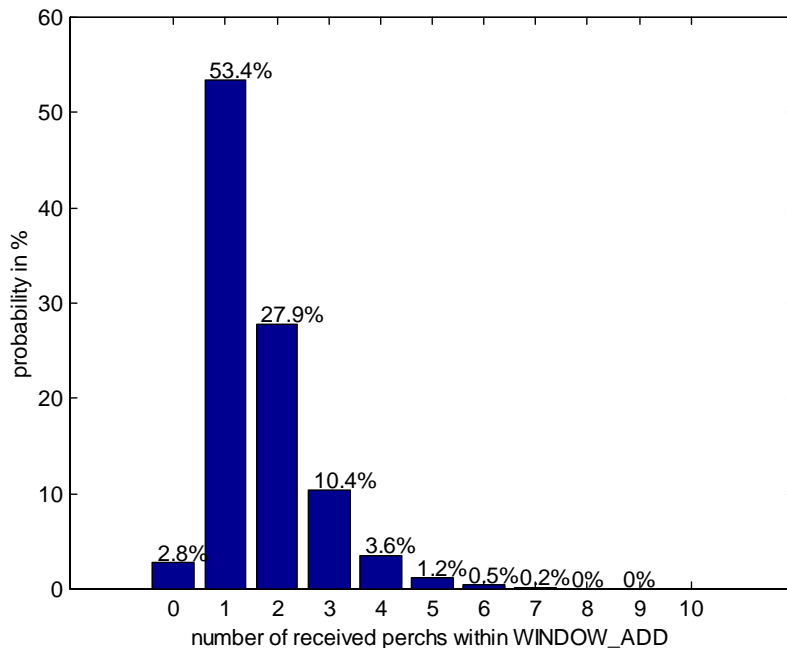

Figure 35

12.3.3 Case 3: Three sectored, 65° antenna, bad planning

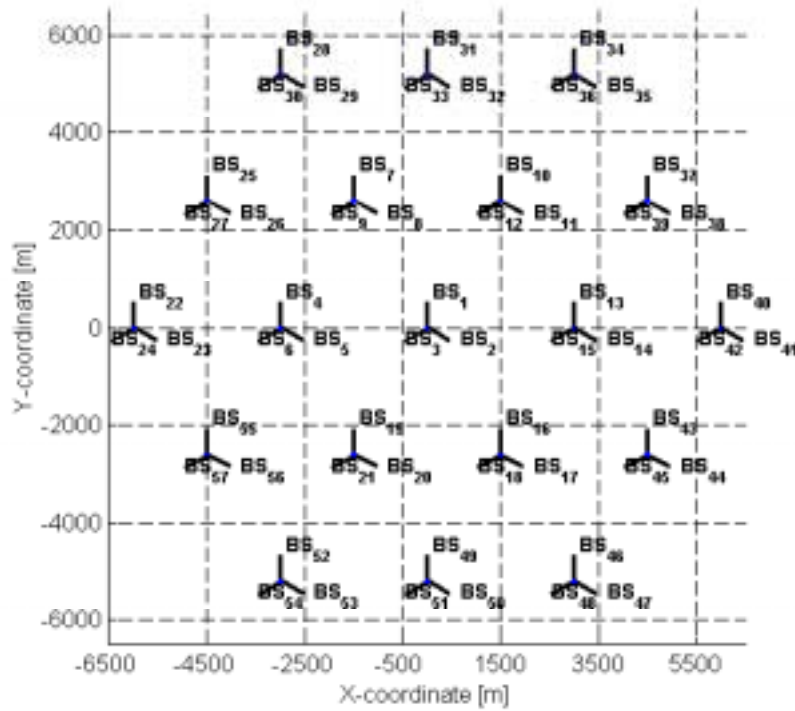

Figure 36

SHO probability (area) WINDOW_ADD₁ = -5 dB (! different WINDOW_ADD possible !)

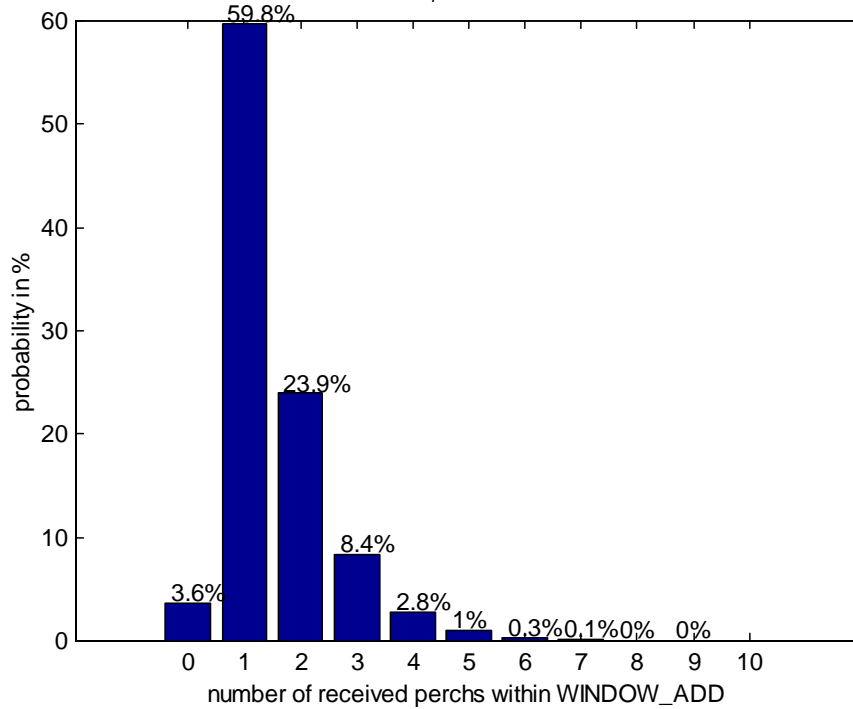

Figure 37

12.3.4 Cases 4: Standard omni scenario

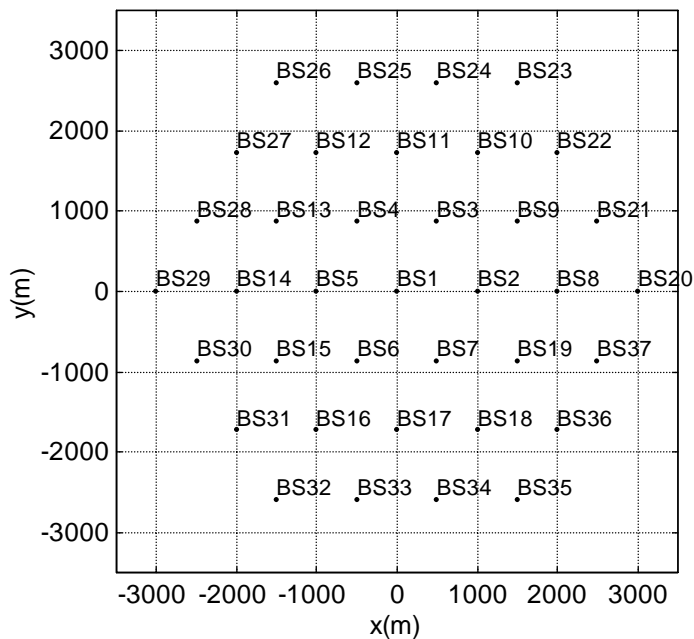

Figure 38

12.3.4.1 Case 4a: WINDOW_ADD = 5 dB

SHO probability (area) WINDOW_ADD₁ = -5 dB (! different WINDOW_ADD possible !)

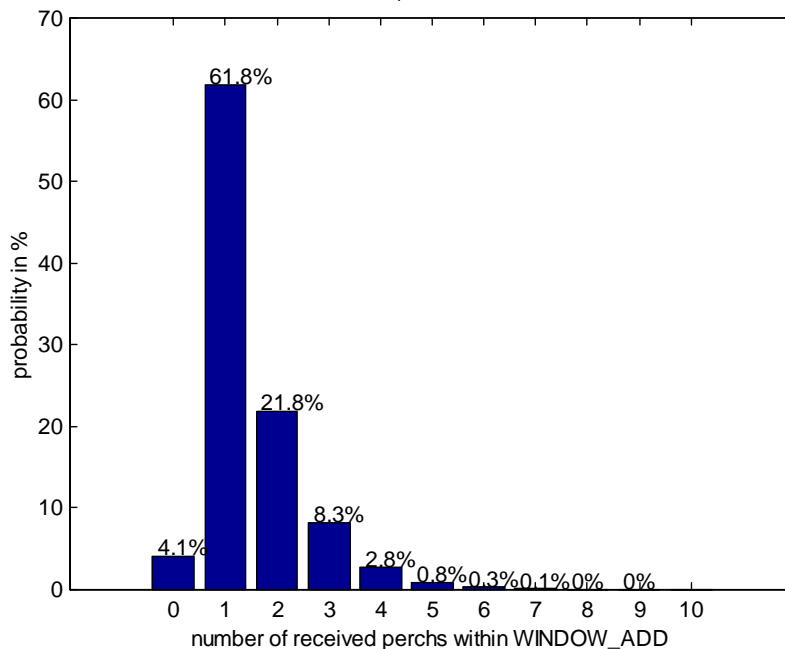

Figure 39

12.3.4.2 Case 4b: WINDOW_ADD = 3 dB

SHO probability (area) WINDOW_ADD₁ = -3 dB (! different WINDOW_ADD possible !)

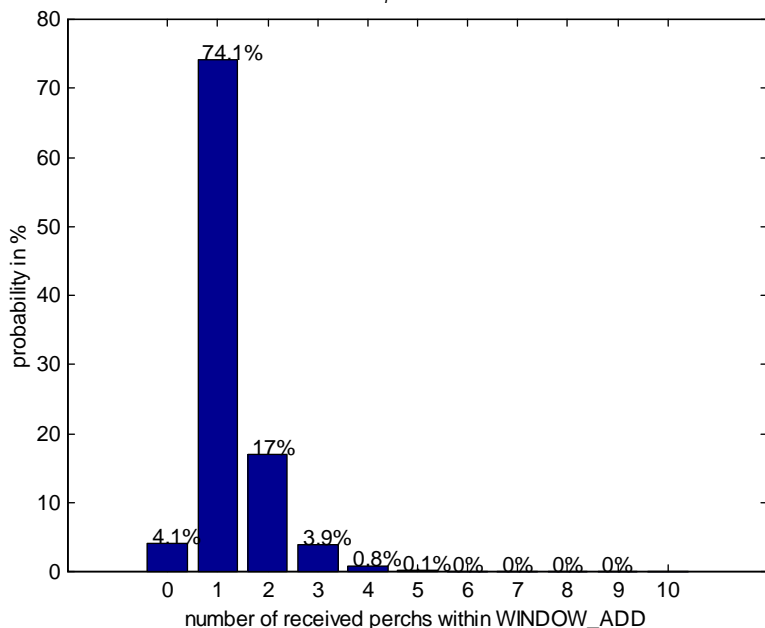

Figure 40

12.3.4.3 Case 4c: WINDOW_ADD = 7 dB

SHO probability (area) WINDOW_ADD₁ = -7 dB (! different WINDOW_ADD possible !)

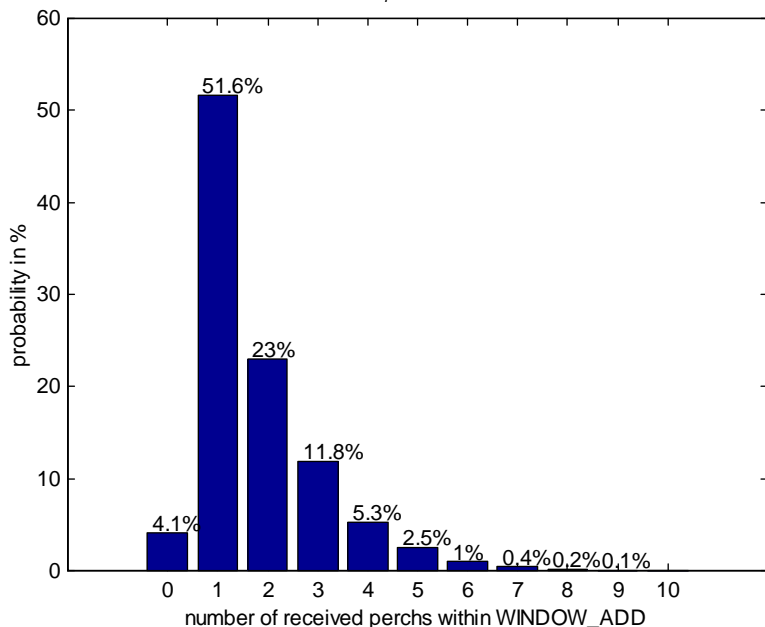

Figure 41

12.3.5 Case 5: Realistic map

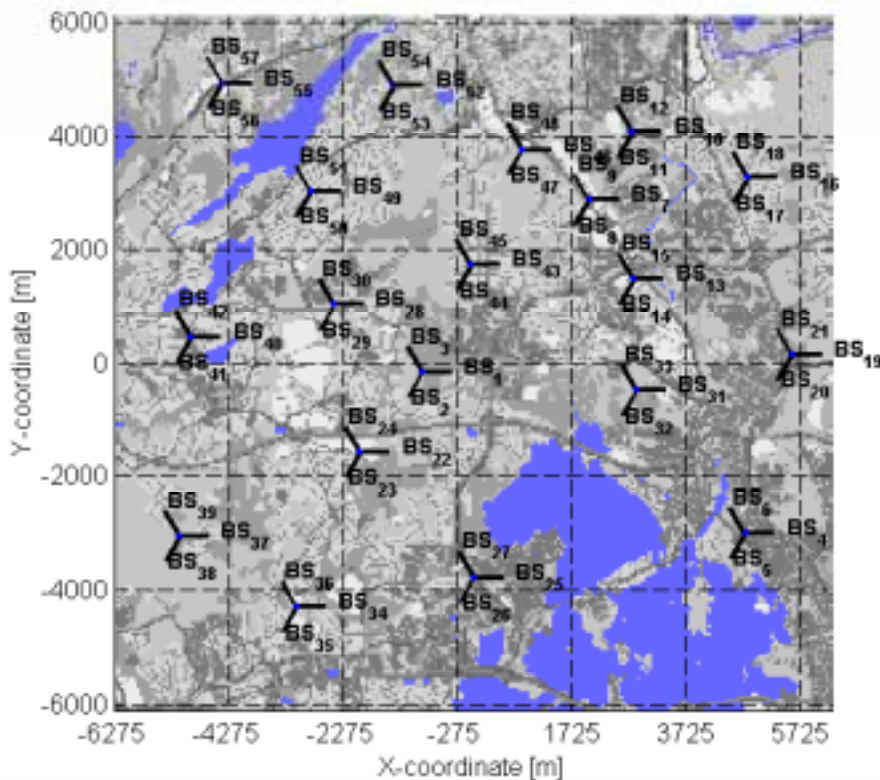

Figure 42

SHO probability (area) WINDOW_ADD₁ = -5 dB (! different WINDOW_ADD possible !)

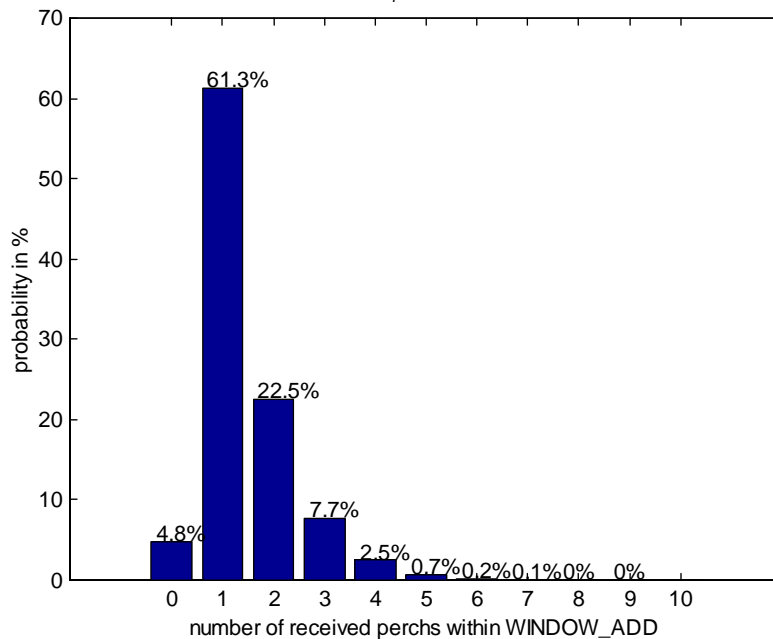

Figure 43

12.4 Conclusions

In all simulations there were less than 1% of the area in which there was equal number or more than 7 cells needed to the active set according to the SHO criteria. On the other hand assuming ideal HO measurements by UE and delay free HO procedure the gain of having more than 3 best cells in the active set is minimal. Thus, including extreme cases it can be concluded that UE does not have to support more than 4-6 as the maximum size of the active set.

13 Informative and general purpose material

13.1 CDMA definitions and equations

[Editor's note: These equations were moved from TS 25.101 V2.2.0, clause 3.4.]

[Editor's note: some of the equations need to be updated due to the change in terminology and in the Physical layer, e.g. due to the introduction of the CPICH in the 3GPP specs.]

13.1.1 CDMA-related definitions

The following CDMA-related abbreviations and definitions are used in various 3GPP WG4 documents.

Table 25A

Chip Rate	Chip rate of W-CDMA system, equals to 3,84 M chips per second.
SCCPCH	Secondary Common Control Physical Channel.
SCCPCH E_c	Average energy per PN chip for SCCPCH.
Data E_c	Average energy per PN chip for the DATA fields in the DPCH.
Data $\frac{E_c}{I_o}$	The ratio of the received energy per PN chip for the DATA fields of the DPCH to the total received power spectral density at the UE antenna connector.
$\frac{Data E_c}{I_{or}}$	The ratio of the average transmit energy per PN chip for the DATA fields of the DPCH to the total transmit power spectral density.
DPCH	Dedicated Physical Channel.
DPCH E_c	Average energy per PN chip for DPCH.
$\frac{DPCH E_c}{I_{or}}$	The ratio of the received energy per PN chip of the DPCH to the total received power spectral density at the UE antenna connector.
DCH	Dedicated Channel, which is mapped into Dedicated Physical Channel. DCH contains the data.
E_b	Average energy per information bit for the PCCPCH, SCCPCH and DPCH, at the UE antenna connector.
$\frac{E_b}{N_t}$	The ratio of combined received energy per information bit to the effective noise power spectral density for the PCCPCH, SCCPCH and DPCH at the UE antenna connector. Following items are calculated as overhead: pilot, TPC, TFCl, CRC, tail, repetition, convolution coding and Turbo coding.
E_c	Average energy per PN chip.
$\frac{E_c}{I_{or}}$	The ratio of the average transmit energy per PN chip for different fields or physical channels to the total transmit power spectral density.
FACH	Forward Access Channel.
F_{uw}	Frequency of unwanted signal.
Information Data Rate	Rate of the user information, which must be transmitted over the Air Interface. For example, output rate of the voice codec.
I_o	The total received power spectral density, including signal and interference, as measured at the UE antenna connector.
I_{oc}	The power spectral density of a band limited white noise source (simulating interference from other cells) as measured at the UE antenna connector.
I_{or}	The total transmit power spectral density of the Forward link at the base station antenna connector.
\hat{I}_{or}	The received power spectral density of the Forward link as measured at the UE antenna connector.
ISCP	Given only interference is received, the average power of the received signal after despreading to the code and combining. Equivalent to the RSCP value but now only interference is received instead of signal.
N_t	The effective noise power spectral density at the UE antenna connector.
OCNS	Orthogonal Channel Noise Simulator, a mechanism used to simulate the users or control signals on the other orthogonal channels of a Forward link.
OCNS E_c	Average energy per PN chip for the OCNS.
$\frac{OCNS E_c}{I_{or}}$	The ratio of the average transmit energy per PN chip for the OCNS to the total transmit power spectral density.
PCCPCH	Primary Common Control Physical Channel.
PCH	Paging Channel.
$PCCPCH \frac{E_c}{I_o}$	The ratio of the received PCCPCH energy per chip to the total received power spectral density at the UE antenna connector.
$\frac{PCCPCH E_c}{I_{or}}$	The ratio of the average transmit energy per PN chip for the PCCPCH to the total transmit power spectral density.

$Pilot_E_c$	Average energy per PN chip for the Pilot field in the DPCH.
$Pilot \frac{E_c}{I_o}$	The ratio of the received energy per PN chip for the Pilot field of the DPCH to the total received power spectral density at the UE antenna connector.
$\frac{Pilot_E_c}{I_{or}}$	The ratio of the average transmit energy per PN chip for the Pilot field of the DPCH to the total transmit power spectral density.
$TFCI_E_c$	Average energy per PN chip for the TFCI field in the DPCH.
$TFCI \frac{E_c}{I_o}$	The ratio of the received energy per PN chip for the TFCI field of the DPCH to the total received power spectral density at the UE antenna connector.
$\frac{TFCI_E_c}{I_{or}}$	The ratio of the average transmit energy per PN chip for the TFCI field of the DPCH to the total transmit power spectral density.
RSCP	Given only signal power is received, the average power of the received signal after despreading and combining.
TPC_E_c	Average energy per PN chip for the Transmission Power Control field in the DPCH.
$TPC \frac{E_c}{I_o}$	The ratio of the received energy per PN chip for the Transmission Power Control field of the DPCH to the total received power spectral density at the UE antenna connector.
$\frac{TPC_E_c}{I_{or}}$	The ratio of the average transmit energy per PN chip for the Transmission Power Control field of the DPCH to the total transmit power spectral density.

13.1.2 CDMA equations

The equations listed below describe the relationship between various parameters under different conditions.

13.1.2.1 BS Transmission Power

Transmit power of the Base Station is normalized to 1 and can be presented as:

$$\frac{PCCPCH_E_c}{I_{or}} + \frac{Pilot_E_c}{I_{or}} + \frac{TPC_E_c}{I_{or}} + \frac{TFCI_E_c}{I_{or}} + \frac{DATA_E_c}{I_{or}} + \frac{SCCPCH_E_c}{I_{or}} + \frac{OCNS_E_c}{I_{or}} = 1.$$

Dedicated Physical Channel consists of four different fields. Therefore, it can be shown that:

$$\frac{DPCH_E_c}{I_{or}} = \frac{Pilot_E_c}{I_{or}} + \frac{TPC_E_c}{I_{or}} + \frac{TFCI_E_c}{I_{or}} + \frac{DATA_E_c}{I_{or}}.$$

Hence, transmit power of Base Station can be presented also as:

$$\frac{PCCPCH_E_c}{I_{or}} + \frac{DPCH_E_c}{I_{or}} + \frac{SCCPCH_E_c}{I_{or}} + \frac{OCNS_E_c}{I_{or}} = 1.$$

13.1.2.2 Rx Signal Strength for UE Not in Handoff (Static propagation conditions)

For PCCPCH we get:

$$PCCPCH \frac{E_c}{I_o} = \frac{\frac{PCCPCH_E_c}{I_{or}}}{\frac{I_{oc}}{I_{or}} + 1},$$

and for a Dedicated Physical Channel:

$$DPCH \frac{E_c}{I_o} = \frac{\frac{DPCH_E_c}{I_{or}}}{\frac{I_{oc}}{I_{or}} + 1}.$$

For the Secondary Common Control Physical Channel we get:

$$SCCPCH \frac{E_c}{I_o} = \frac{\frac{SCCPCH - E_c}{I_{or}}}{\frac{I_{oc}}{\hat{I}_{or}} + 1} \cdot$$

E_b/N_t for the PCCPCH is given as:

$$PCCPCH \frac{E_b}{N_t} = \frac{\frac{PCCPCH - E_c}{I_{or}} \times \frac{\text{Chip Rate}}{\text{Information Data Rate}}}{\frac{I_{oc}}{\hat{I}_{or}}} \cdot$$

The same for Dedicated Channels is given as:

$$DCH \frac{E_b}{N_t} = \frac{\frac{DPCH - E_c}{I_{or}} \times \frac{\text{Chip Rate}}{\text{Information Data Rate}}}{\frac{I_{oc}}{\hat{I}_{or}}} \cdot$$

Similar equations can be derived for the Paging Channel and for the Forward Access Channel. For the Paging Channel we get:

$$PCH \frac{E_b}{N_t} = \frac{\frac{SCCPCH - E_c}{I_{or}} \times \frac{\text{Chip Rate}}{\text{Paging Data Rate}}}{\frac{I_{oc}}{\hat{I}_{or}}},$$

and the same for FACH is given as:

$$FACH \frac{E_b}{N_t} = \frac{\frac{SCCPCH - E_c}{I_{or}} \times \frac{\text{Chip Rate}}{\text{Control Data Rate}}}{\frac{I_{oc}}{\hat{I}_{or}}} \cdot$$

13.1.2.3 Rx Strength for UE Not in Handoff (Static propagation conditions)

Let us assume that the sum of the channel tap powers is equal to one in multi-path propagation conditions with L taps, i.e.:

$$\sum_{i=1}^L a_i^2 = 1,$$

where a_i represent the complex channel coefficient of the tap i . When assuming that a receiver combines all the multi-paths E_b/N_t for PCCPCH is given as:

$$PCCPCH \frac{E_b}{N_t} = \frac{PCCPCH - E_c}{I_{or}} \times \frac{\text{Chip Rate}}{\text{Information Data Rate}} \times \sum_{i=1}^L \frac{a_i^2}{\frac{I_{oc}}{\hat{I}_{or}} + (1 - a_i^2)} \cdot$$

As an example E_b/N_t for PCCPCH in Indoor channel is:

$$PCCPCH \frac{E_b}{N_t} = \frac{PCCPCH - E_c}{I_{or}} \times \frac{\text{Chip Rate}}{\text{Bearer Data Rate}} \times \left(\frac{0.900824}{\frac{I_{oc}}{\hat{I}_{or}} + 0.099176} + \frac{0.098773}{\frac{I_{oc}}{\hat{I}_{or}} + 0.901227} + \frac{0.000402}{\frac{I_{oc}}{\hat{I}_{or}} + 0.999598} \right) \cdot$$

Using the same assumptions, E_b/N_t for Dedicated Channels is given as:

$$DCH \frac{E_b}{N_t} = \frac{DPCH - E_c}{I_{or}} \times \frac{\text{Chip Rate}}{\text{Information Data Rate}} \times \sum_{i=1}^L \frac{a_i^2}{\frac{I_{oc}}{\hat{I}_{or}} + (1 - a_i^2)}.$$

13.1.2.4 Rx Signal Strength for UE in two-way Handover

When the received power from each cell is \hat{I}_{or} we get for each PCCPCH Channel:

$$PCCPCH \frac{E_c}{I_o} = \frac{\frac{PCCPCH - E_c}{I_{or}}}{\frac{I_{oc}}{\hat{I}_{or}} + 2}.$$

If the power received from cell 1 and cell 2 are \hat{I}_{or1} and \hat{I}_{or2} , respectively, then:

$$PCCPCH \frac{E_c}{I_o} (\text{Cell 1}) = \frac{\frac{PCCPCH - E_c}{I_{or1}}}{\frac{I_{oc}}{\hat{I}_{or1}} + \frac{\hat{I}_{or2}}{\hat{I}_{or1}} + 1},$$

and:

$$PCCPCH \frac{E_c}{I_o} (\text{Cell 2}) = \frac{\frac{PCCPCH - E_c}{I_{or2}}}{\frac{I_{oc}}{\hat{I}_{or2}} + \frac{\hat{I}_{or1}}{\hat{I}_{or2}} + 1}.$$

Similarly:

$$DCH \frac{E_b}{N_t} = \frac{DPCH - E_c}{I_{or}} \times \frac{\text{Chip Rate}}{\text{Information Data Rate}} \times \sum_{i=1}^L \frac{2a_i^2}{\frac{I_{oc}}{\hat{I}_{or}} + 1 + (1 - a_i^2)},$$

if the channel is non-static.

14 Rationales for unwanted emission specifications

ITU specification splits the unwanted emissions specification in two categories:

- out-of band emissions;
- spurious emissions.

The same approach was used in the TS 25.104 [3].

14.1 Out of band Emissions

14.1.1 Adjacent Channel Leakage Ratio

The system performances are linked to the ACIR values. ACIR in downlink depends on ACS of the UE and ACLR of the Base Station. Constraints on the UE PA design leads to UE ACLR value of 33 dB. It was then proposed to use the same value for UE ACS (a note was added in the UE specification to mention that requirement on the UE shall be reconsidered when the state of the art technology progresses).

The minimum requirement for the Base Station was derived from UE ACS in such a way that the BTS contribution on ACIR is low: a 45 dB requirement was adopted.

Due to the small impact of ACLR2 value on system performances, a 5dB margin was applied on ACLR1:
BS ACLR2 = 50 dB.

14.1.2 Spectrum mask

14.1.2.1 Spectrum mask for 43 dBm base station output power per carrier

The starting point for defining spectrum mask for UMTS was the FCC Part 24 recommendation, which is summarised in table 26.

Table 26

Frequency Offset from edge	Level	Measurement bandwidth
≤ 1 MHz	-13 dBm	> "-26 dB modulation bandwidth"/100
> 1 MHz	-13 dBm	1 MHz

The UMTS spectrum mask is derived from the one defined by the FCC specification. The rationales for differences are detailed below:

- **Frequency offset:** in FCC, frequency offset reference is the allocated band edge. Since spectrum definition has to be independent of operator allocation, the reference has been changed to the centre frequency of the measured carrier. Assuming that the nominal carrier spacing is 5MHz for UMTS, spectrum mask definition starts at 2,5 MHz offset.
- **Measurement bandwidth:** the "-26 dB modulation bandwidth" is approximately equal to 4,4 MHz. This leads to 44 kHz-measurement bandwidth. Since this value is not available in most measurement devices such as spectrum analysers, a standard value of 30 kHz was adopted. The level has been modified to reflect that change.
- **Mask shape:**
 - a flat region ① was defined for the first 200 kHz to take into account imperfections in baseband modulation. The rationales for 200 kHz are:
 - this gives sufficient margin to cope with the unwanted spectral response due to baseband modulation;
 - in case of narrow-band services (using 200 kHz channel raster) in the adjacent channel, it allows to provide additional protection for the second narrow-band channel;
 - the shape of the mask defined FCC Part 24 is a step. To reflect more accurately PA behaviour and to provide some further guarantee on levels in the adjacent bandwidth, the slope ② was introduced in replacement of the step;
 - the level of the slope ② at 3,5 MHz has been set in order to maintain a monotonic requirement around the 3,5 MHz offset where the measurement bandwidth changes from 30 kHz to 1 MHz;
 - spectrum mask at offset above 3,5 MHz ③ and ④ is equivalent to FCC part 24 requirement.

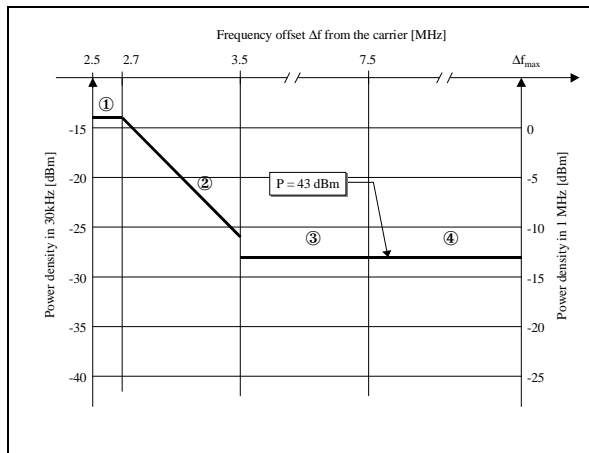

Figure 44

14.1.2.2 Spectrum masks for other base station output powers

The spectrum masks for other base station output powers were derived from the mask defined for 43 dBm output power.

14.1.2.2.1 Output power > 43 dBm

The FCC Part 24 requirement has to be met for any power. Hence, the spectrum mask defined for 43 dBm is applicable for power above 43 dBm.

14.1.2.2.2 39 dBm ≤ Output power ≤ 43 dBm

The spectrum mask for output power lower than 43 dBm was derived considering:

- ACLR1 requirement is 45 dBc;
- ACLR2 requirement is 50 dBc;
- overall spectrum specification (spectrum mask and spurious emission) must be monotonic.

The ACLR values can be estimated from the spectrum mask defined for 43 dBm base station:

- ACLR1 ≈ 49 dBc;
- ACLR2 = 50 dBc.

Since ACLR1 has a 4 dB margin, the clauses ①, ② and ③ are unchanged when the power decreases up to 39 dBm (= 43 dBm - 4 dB): at 39 dBm, ACLR1 is 45 dBc.

To comply with ACLR2 requirement, the clause ④ decreases dB per dB with the output power.

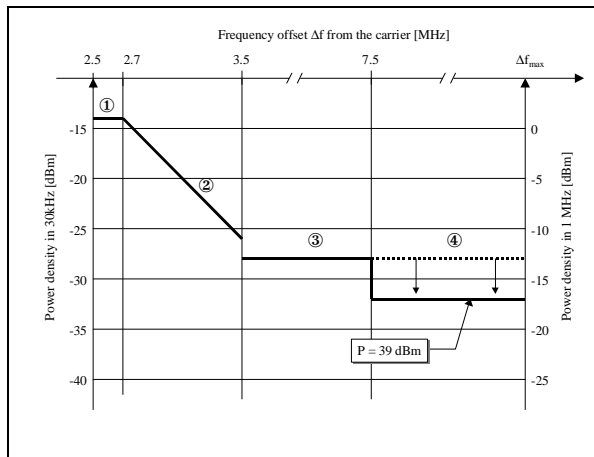

Figure 45

14.1.2.2.3 31 dBm ≤ Output power < 39 dBm

The spectrum mask defined above for 39 dBm output power complies with the ACLR1 and ACLR2 requirements. Hence, the overall mask defined for 39 dBm (clauses ①, ②, ③ and ④) decreases dB per dB with the power.

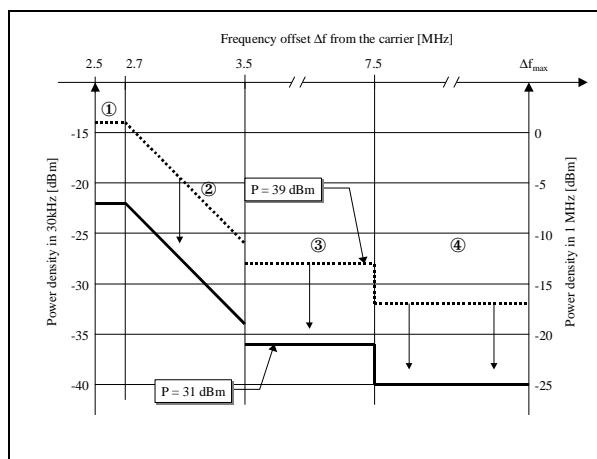

Figure 46

14.1.2.2.4 Output Power < 31 dBm

To take into account the existence of a noise floor in a transmitter, the mask definition has to reach a limit for low output power. Since the levels specified in spectrum mask for 31 dBm are low (compared to the spurious class A level), then this mask is applicable for any power below 31 dBm.

14.1.2.2.5 Frequency range

In ITU specification, the frequency limit between out of band emissions and spurious emissions is defined as 250 % of the necessary bandwidth. Applying this to UMTS with a 5 MHz necessary bandwidth lead to 12,5 MHz offset from the carrier frequency.

For low output power base station, the level at offset below 12,5 MHz (defined by the spectrum mask) are lower than the level of spurious emissions Category A as defined in ITU-R Recommendation SM.329-7.

To ensure that the transition between spectrum mask specification and spurious emissions specification keeps the requirements monotonous, it was decided to extend this 12,5 MHz offset up to the edge of the UMTS band.

As a result, the level of unwanted emissions at offset greater than 12,5 MHz from the carrier is always lower than or equal to the level of Category A spurious emissions (-13 dBm/1 MHz).

14.2 Spurious Emissions

14.2.1 Mandatory requirements

Two categories of spurious emissions are defined:

- Category A (clause 6.6.3.1.1) is directly transposed from ITU-R Recommendation SM.329-7;
- Category B (clause 6.6.3.1.2): the levels are derived from ITU-R Recommendation SM.329-7 but the transition bandwidth definitions were modified to allow more protection outside the UMTS band as explained below.

ITU-R Recommendation SM.329-7 Category B would allow a transition bandwidth from 12,5 MHz (250 % necessary bandwidth NB) to 60 MHz (12 x NB) where the Category A level is still applicable. This transition bandwidth was reduced in UMTS spurious emissions specification to ensure that the Category B value is reached at offset greater than 10MHz from the edges of the bandwidth allocated for UMTS services. This will ease co-existence between adjacent services.

14.2.2 Regional requirements

14.2.2.1 Co-existence with adjacent services

To further improve protection between services, a slope in the 10 MHz region on both sides of the UMTS bandwidth may be applicable (clause 6.6.3.6).

14.2.2.2 Co-existence with other systems

Specific spurious requirements are defined for co-existence with GSM 900 (clause 6.6.3.3), DCS1800 (clause 6.6.3.4) and PHS (clause 6.6.3.5). The values were derived from the requirements of the system under consideration.

15 Link Level performances

15.1 Propagation Models

15.1.1 Rationale for the choice of multipath fading Case 2

Propagation conditions are used to derive performance measurements in static conditions or multi-path fading environment.

In the following the rationale for the choice of multi-path fading called "Case 2" is described.

Propagation condition "Case 2" is aimed at testing the receiver under high delay spread conditions. It contains 3 taps that for FDD are spread over 20 μ s and for TDD over 12 μ s. The choice is a trade-off between the delay spread performance desired, the resulting receiver performance and the complexity imposed on the receiver.

From a practical point of view, this scenario will be very infrequently encountered in reality, since it is an extreme case. For FDD however, the 20 μ s tap does not give an unreasonable complexity or performance impact and is therefore included in the propagation conditions. Also, for FDD an extra "margin" in the propagation delay requirement may be needed to give efficient support of repeaters, since repeaters introduce additional delay.

Although TDD is also designed to work under such conditions, it has been concluded not to test all devices with a 20 μ s tap. In this extreme case TDD will work, but not without either degraded performance, reduced capacity, and/or increased receiver complexity. It is also not expected that TDD will support repeaters. For these reasons, a "Case 2" for TDD has been chosen with 12 μ s delay for the last tap.

15.2 Simulation results for UE TDD performance test

15.2.1 Downlink Simulation assumptions

15.2.1.1 General

Table 27

Parameter	Explanation/Assumption
Chip Rate	3,84 Mcps
Duration of TDMA frame	10 ms
Number of time slots per frame	15
Closed loop power control	OFF
AGC	OFF
Number of samples per chip	1 sample per chip
Propagation Conditions	As specified in annex B of TS 25.102 [2]. Hint: The delay taps has to be adopted to the nearest value in the chip raster for the simulations
Numerical precision	Floating point simulations
BLER target	10 E-1; 10 E-2; 10 E-3
BLER calculation	BLER will be calculated by comparing with transmitted and received bits
DCCH model	Random symbols transmitted, not evaluated in the receiver
TFCI model	Random symbols, not evaluated in the receiver but it is assumed that receiver gets error free reception of TFCI information
Turbo decoding	Max Log Map with 4 iterations
Measurement Channels	As specified in annex A of TS 25.102 [2] and TS 25.105 [4] (Refer to Tdoc TSGR4#7(99)554 as well)
Other L1 parameters	As Specified in latest L1 specifications

15.2.1.2 Additional downlink parameters

Table 28

\hat{I}_{or}/I_{oc}	Ratio to meet the required BLER target				
	Bit rate	Static	Case 1	Case 2	Case 3
$\Sigma DPCH_E_c/I_{or}$ [dB]	12,2 kbps	-6	-6	-3	-3
	64 kbps	-3	-3	0	0
	144 kbps	0	0	0	0
	384 kbps	0	0	0	0
Number of timeslots per frame per user	12,2 kbps: TS=1 64 kbps: TS=1 144 kbps: TS=1 384 kbps: TS=3				
Transmit diversity, "TxAA", "TSTD"	OFF				
Receiver antenna diversity	OFF				
Receiver	Architecture open to simulation, but should be stated together with simulation results.				
Parameters for RAKE receiver:					
Channel Estimation	Ideal on midamble				
Number of fingers	Equal to number of taps				
Parameters for Joint-Detector receiver:					
Joint-Detector	ZF-BLE				
Channel Estimation	Joint channel estimator according to article from Steiner and Baier in Freq., vol. 47, 1993, pp.292-298, based on correlation				

15.2 Downlink Simulation results and discussion

Simulations were performed for the 12,2 kbps, 64 kbps, 144 kbps and 384 kbps measurement channels. Propagation conditions were AWGN, Case 1, Case 2 and Case 3. Two different receiver architecture were used in the simulations, a conventional RAKE receiver and a Joint-Detector receiver with a zero forcing algorithm (ZF-BLE).

The results for the 12,2 kbps measurement channel with RAKE receiver structure were already presented at the last meeting. They are repeated here for convenience. The simulations for Case 2 were redone, because the propagation model was changed at the last meeting.

The results for the RAKE receiver in the static case (AWGN) were compared to the FDD-mode results for the 12,2 kbps channel in Tdoc R4-99739 and the results agreed very well. For the other measurement channels, the coding schemes differ. In this case no direct comparison from FDD-mode to TDD-mode can be drawn. Thus, no further benchmarking results are presented.

Because a margin due to real channel estimation is more difficult to determine for a joint detector than for a RAKE receiver, real channel estimation was used in the simulations of the joint detector receiver. Due to this, the Joint-Detector results are slightly worse compared to ideal channel estimation. This can be observed especially under static conditions (AWGN), where the same results are expected for RAKE and Joint-Detector.

The simulation results for \hat{I}_{or}/I_{oc} in dB are summarised in table 29.

In general, the values obtained by the RAKE receiver are proposed. However, for the high data rate services (144 kbps and 384 kbps) the RAKE receiver and Joint-Detector differ significantly in some cases (384 kbps Case 1 with BLER $10E-2$ and 384 kbps Case 3 with BLER $10E-3$) or the BLER target can not be reached with a RAKE receiver (144 kbps Case 3 with BLER $10E-2$ and BLER $10E-3$). If the results for the two receivers differ by more than 3 dB, the value obtained from the Joint-Detector plus additional 3 dB margin is proposed.

Table 29: Downlink \hat{I}_o/I_{oc} values in dB

Service	Environment	BLER	RAKE	JD	Proposed value
12.2 kbps	AWGN	10 E-2	-1,9	-1,6	-1,9
	Case 1	10 E-2	11,0	9,8	11,0
	Case 2	10E-2	3,0	2,7	3,0
	Case 3	10 E-2	1,7	0,4	1,7
64 kbps	AWGN	10 E-1	0,3	0,8	0,3
		10 E-2	0,6	1,0	0,6
	Case 1	10 E-1	10,8	9,2	10,8
		10 E-2	17,1	15,1	17,1
	Case 2	10 E-1	3,3	2,4	3,3
		10 E-2	7,2	6,4	7,2
	Case 3	10 E-1	2,2	1,9	2,2
		10 E-2	5,4	4,9	5,4
10 E-3		9,1	7,3	9,1	
144 kbps	AWGN	10 E-1	0,2	0,4	0,2
		10 E-2	0,4	0,7	0,4
	Case 1	10 E-1	10,8	9,0	10,8
		10 E-2	17,2	14,3	17,2
	Case 2	10 E-1	7,0	5,4	7,0
		10 E-2	10,7	9,3	10,7
	Case 3	10 E-1	8,7	5,4	8,7
		10 E-2	Error floor	9,2	12,2
10 E-3		Error floor	11,8	14,8	
384 kbps	AWGN	10 E-1	-0,4	-0,2	-0,4
		10 E-2	-0,2	0,0	-0,2
	Case 1	10 E-1	11,0	8,7	11,0
		10 E-2	17,7	13,9	16,9
	Case 2	10 E-1	6,0	4,5	6,0
		10 E-2	10,1	8,4	10,1
	Case 3	10 E-1	5,2	3,3	5,2
		10 E-2	8,3	5,3	8,3
10 E-3		14,7	7,0	10,0	

15.2.3 Uplink Simulation assumptions

15.2.3.1 General

Table 30

Parameter	Explanation/Assumption
Chip Rate	3,84 Mcps
Duration of TDMA frame	10 ms
Number of time slots per frame	15
Closed loop power control	OFF
AGC	OFF
Number of samples per chip	1 sample per chip
Propagation Conditions	As specified in annex B of TS 25.102 [2]. Hint: The delay taps has to be adopted to the nearest value in the chip raster for the simulations
Numerical precision	Floating point simulations
BLER target	10 E-1; 10 E-2; 10 E-3
BLER calculation	BLER will be calculated by comparing with transmitted and received bits
DCCH model	Random symbols transmitted, not evaluated in the receiver
TFCI model	Random symbols, not evaluated in the receiver but it is assumed that receiver gets error free reception of TFCI information
Turbo decoding	Max Log Map with 4 iterations
Measurement Channels	As specified in annex A of TS 25.102 [2] and TS 25.105 [4] (Refer to Tdoc TSGR4#7(99)554 as well)
Other L1 parameters	As Specified in latest L1 specifications

15.2.3.2 Additional uplink parameters

Table 31

Channel Estimation	Joint channel estimator according to article from Steiner and Baier in Freq., vol. 47, 1993, pp.292-298, based on correlation				
TPC model	Random symbols, not evaluated in receiver (power control is OFF)				
Receiver antenna diversity	ON				
\hat{I}_{or}/I_{oc} [dB]	Parameter to meet the required BLER				
# of DPCH _{oi}	Bit rate	Static	Case 1	Case 2	Case 3
	12,2 kbps	6	6	2	2
	64 kbps	4	4	0	0
	144 kbps	0	0	0	0
	384 kbps	0	0	0	0
Number of timeslots per frame per user	12,2 kbps: TS=1 64 kbps: TS=1 144 kbps: TS=1 384 kbps: TS=3				
Receiver	Joint Detector (ZF-BLE)				

15.2.4 Uplink Simulation results and discussion

Simulations were performed for the 12,2 kbps, 64 kbps, 144 kbps and 384 kbps measurement channels. Propagation conditions were AWGN, Case 1, Case 2 and Case 3. A joint-detector receiver with a zero forcing algorithm (ZF-BLE) and real channel estimation was used in the simulations.

No direct comparison from FDD-mode to TDD-mode can be drawn, because of the different modulation scheme and coding. Thus, no benchmarking results are presented.

The simulation results for \hat{I}_{or}/I_{oc} in dB are summarised in table 32.

Table 32: Uplink \hat{I}_o/I_{oc} values in dB

Service	Environment	BLER	JD
12,2 kbps	AWGN	10 E-2	-4,4
	Case 1	10 E-2	3,3
	Case 2	10 E-2	-2,9
	Case 3	10 E-2	-4,1
64 kbps	AWGN	10 E-1	-2,8
		10 E-2	-2,5
	Case 1	10 E-1	2,5
		10 E-2	6,4
	Case 2	10 E-1	-2,6
		10 E-2	-0,2
	Case 3	10 E-1	-2,8
		10 E-2	-1,1
10 E-3		0,3	
144 kbps	AWGN	10 E-1	-2,5
		10 E-2	-2,3
	Case 1	10 E-1	2,6
		10 E-2	6,4
	Case 2	10 E-1	0,6
		10 E-2	3,0
	Case 3	10 E-1	0,4
		10 E-2	2,4
10 E-3		3,8	
384 kbps	AWGN	10 E-1	-3,0
		10 E-2	-2,8
	Case 1	10 E-1	2,5
		10 E-2	5,7
	Case 2	10 E-1	0,0
		10 E-2	2,4
	Case 3	10 E-1	-0,7
		10 E-2	0,7
10 E-3		1,3	

15.3 Simulation results for UE FDD performance test

15.3.1 BTFD performance simulation

15.3.1.1 Introduction

Blind Transport format Detection (BTFD) is a technique that UE estimate the Transport Formats of Downlink channels without TFCI bits. The followings are simulation results for BTFD performance.

15.3.1.2 Assumption

Table 33 shows the simulation assumptions of this simulation. Another assumptions are defined as follows:

- 9 deferent Transport Format Combinations (table x.2) are informed during the call set up procedure, so that UE have to detect correct transport format from this 9 candidates;
- reference measurement channels defined in annex A.4 of TS 25.101 [1] are used in this simulation.

Moreover, it is pointed out that "Even if CRC check result is O.K., UE might detect false Transport Format", and proposed to regard this case as Block Error. It is obvious that the fault detection of transport format causes significant degradation to the service quality (e.g. AMR speech glitch). Therefore it should be evaluate the probability of these cases independently. In order to evaluate it, both BLER and FDR (False Transport Format Detection Ratio) are defined and evaluated in this simulation. The definitions of BLER and FDR are as follows:

- BLER: the probability of CRC check result is N.G;
- FDR: the probability that UE detect false transport format even CRC check is O.K.

Considering the FDR, the additional CRC parity bit length was specified to achieve, the better Transport Format detection performance in UE. (this study has shown in detail in Tdoc R1-99c54). Since 16bit CRC provides very good FDR performance (FDR \sim 1E-6), it has less necessity to evaluate such a good performance of rate detection. Besides the testing point of view, to test higher probability with higher confidence needs longer testing time. Therefore it is used CRC = 12bit in the reference measurement channels.

Table 33: Simulation assumptions

Parameter	Explanation/Assumption
Chip Rate	3,84 Mcps
Symbol rate (S.F.)	30 ksps (SF = 128)
Number of pilot symbols	2 symbols
Closed loop Power Control	OFF
AGC	OFF
Channel Estimation	Ideal
Number of samples per chip	1
Propagation Conditions	static, and multi-path fading case 3
Number of bits in AD converter	Floating point simulations
Number of Rake Fingers	Equals to number of taps in propagation condition models
Downlink Physical Channels and Power Levels	CPICH _{Ec/Ior} = -10 dB, PCCPCH _{Ec/Ior} = -12 dB, SCH _{Ec/Ior} = -12 dB (Combined energy of Primary and Secondary SCH) PICH _{Ec/Ior} = -15 dB OCNS _{Ec/Ior} = power needed to get total power spectral density (Ior) to 1. DPCH _{Ec/Ior} = power needed to get meet the required BLER target
BLER target	10 ⁻²
BLER calculation	BLER has been calculated by comparing with transmitted and received bits. So CRC is not used for BLER estimation
PCCPCH model	Random symbols transmitted, ignored in a receiver
PICH model	Random symbols transmitted, ignored in a receiver
DCCH model	Random symbols transmitted, ignored in a receiver
\hat{I}_{or} / I_{oc} values	-1 for static propagation condition -3 for multi-path fading condition (case 3)
SCH position	Offset between SCH and DPCH is zero chips meaning that SCH is overlapping with the first symbols in DPCH in the beginning of DPCH slot structure
Measurement Channels	Additional 3 types of measurement channel (figure 1, figure 2, figure 3)
Other L1 parameters	As Specified in latest L1 specifications
Parameter for BTFD simulation	Threshold D = infinity

Table 34: Transport format combinations informed during the call set up procedure in the test

	1	2	3	4	5	6	7	8	9
DTCH	12,2 k	10,2 k	7,95 k	7,4 k	6,7 k	5,9 k	5,15 k	4,75 k	1,95 k
DCCH	2,4 k								

15.3.1.3 Simulation results

Figure 47, figure 48 and figure 49 are simulation results for BTFD in case of static condition. Figure 50, figure 51 and figure 52 are results in case of multi-path fading condition case 3.

Every events are distinguish as in table 35.

Table 35: Events on the performance test of BTFD

		No error in Received Tr BLK		Some error in Received Tr BLK	
		CRC O.K.	CRC N.G.	CRC O.K.	CRC N.G.
Transport Format Detection	O.K.	(A)	N/A	(D)	(F)
	N.G.	(B)	(C)	(E)	(G)

Event (A) is a normal received case, and Event (D) can ignore because occurrence probability is below 1E-5. Simulation results are shown by three curves. Each curve is defined as follows:

- BLER(CUN) is BLock Error Ratio calculated on the simulation. It can be defined as following formula:

$$BLER(CUN) = \{(D)+(E)+(F)+(G)\} / total_frame;$$

- BLER(PRAC) is BLock Error Ratio measured in the test. Because, in the test, whether the Block Error is correct or not can be distinguished only from CRC check result. It can be defined as following formula:

$$BLER(PRAC) = \{(C)+(F)+(G)\} / total_frame;$$

- FDR is False transport format Detection Ratio. It can be defined as following formula:

$$FDR = \{(B)+(E)\} / total_frame.$$

Both BLER(CUN) and BLER(PRAC) can regard almost same from the following simulation result, therefore it is possible to evaluate BLER correctly in the test.

Simulation is performed to have 500 000 Blocks for all cases.

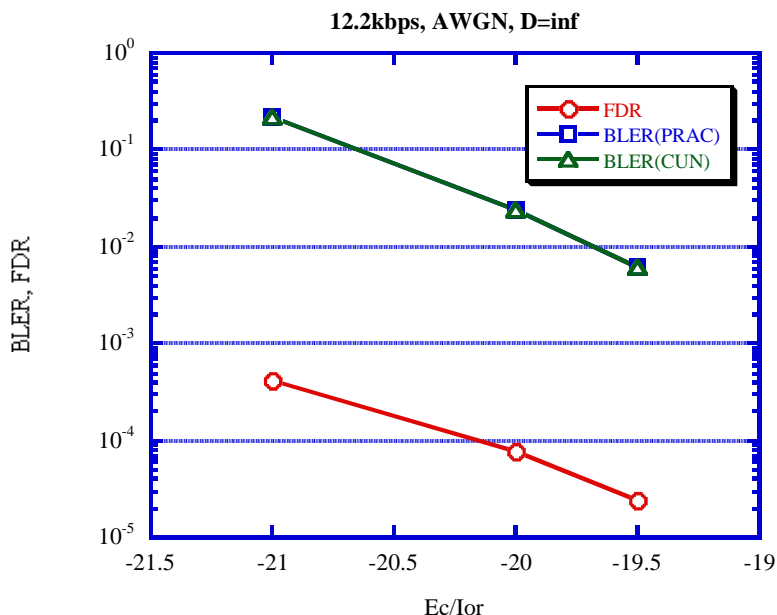

Figure 47: Ec/Ior vs. BLER (STATIC, 12,2 k)

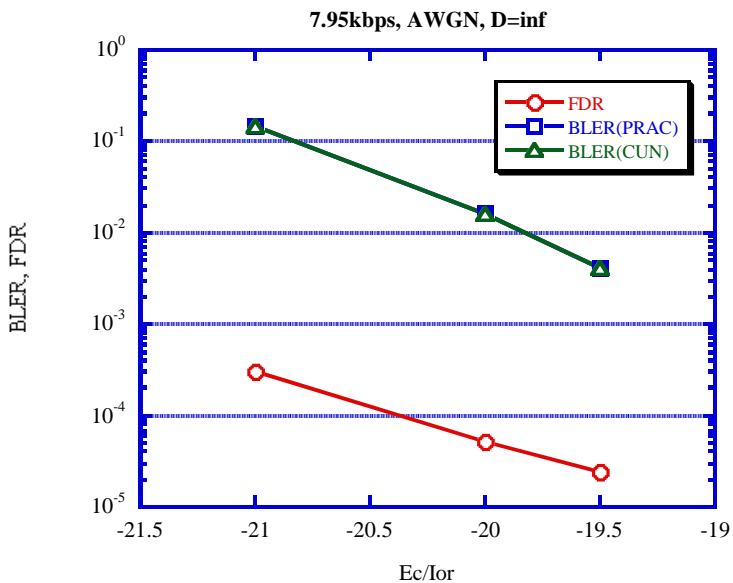

Figure 48: Ec/Ior vs. BLER (STATIC, 7,95 k)

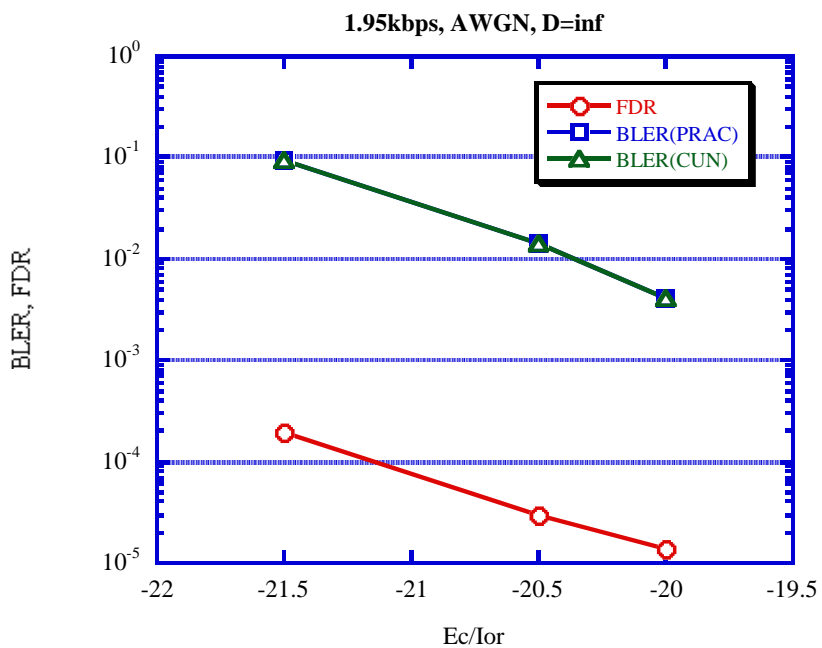

Figure 49: Ec/Ior vs. BLER (STATIC, 1,95 k)

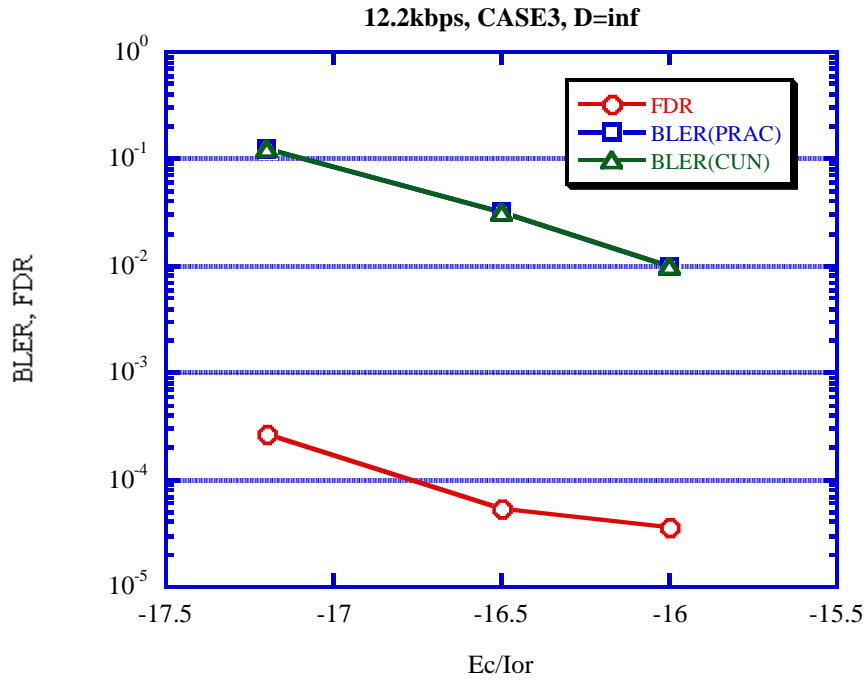

Figure 50: Ec/Ior vs. BLER (CASE3, 12,2 k)

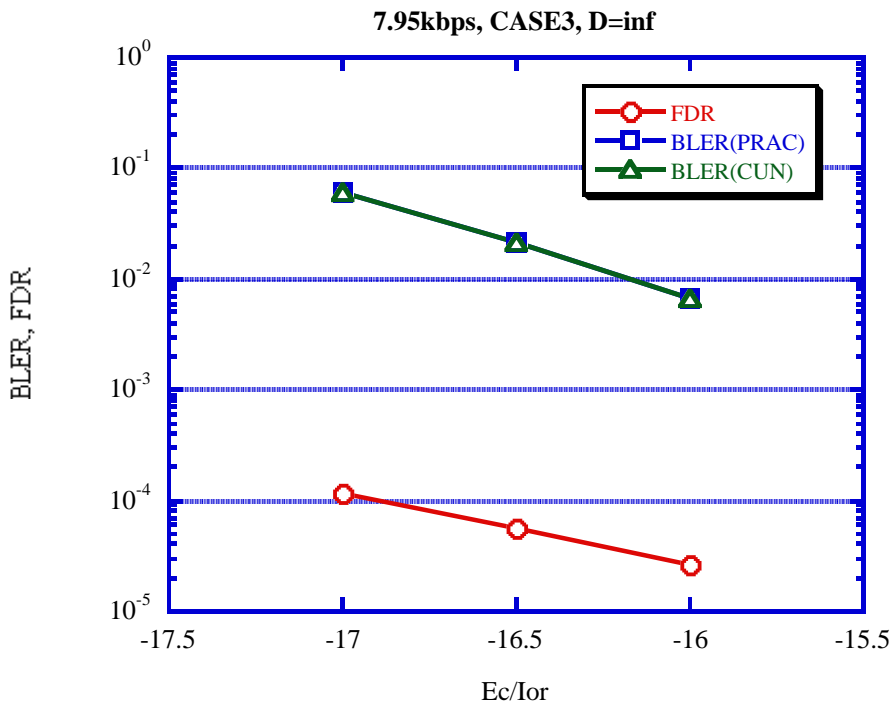

Figure 51: Ec/Ior vs. BLER (CASE3, 7,95 k)

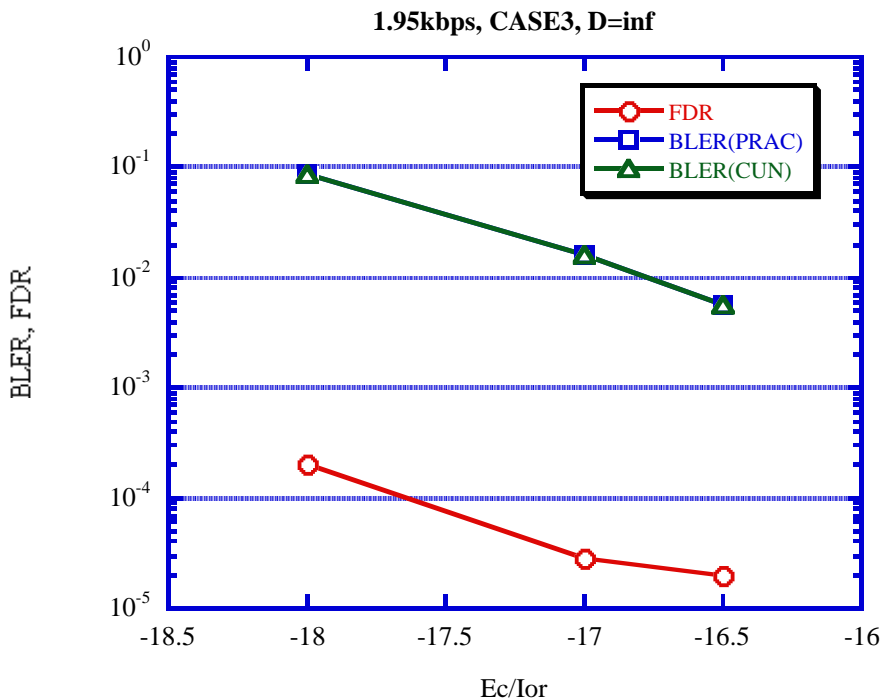

Figure 52: Ec/Ior vs. BLER (CASE3, 1,95 k)

15.3.1.4 Conclusion

From these simulation results, the value of DPCH_Ec/Ior on BLER = 1 % can be had. It can be decided specification values of DPCH_Ec/Ior with appropriate implementation margin. It is proposed the implementation margins 2 dB for static case, and 3dB for case 3 (same as the case using TFCI). It is because that there are no additional factor compare with the case using TFCI).

Additionally, from the results FDR can achieve below 10⁻⁴ on the point of BLER = 10⁻² in all cases. So it can be specified that FDR should not exceed 10⁻⁴ on this DPCH_Ec/Ior value.

Table 36: proposing specifications value for BTFD performance test

Propagation Condition	Rate	$\frac{DPCH_E_c}{I_{or}}$ (simulation)	Implementation Margin	$\frac{DPCH_E_c}{I_{or}}$ (specification)	BLER	FDR
Static	Rate 1 (12,2 kbps)	-19,7 dB	2,0 dB	-17,7 dB	10 ⁻²	10 ⁻⁴
	Rate 2 (7,95 kbps)	-19,8 dB		-17,8 dB	10 ⁻²	10 ⁻⁴
	Rate 3 (1,95 kbps)	-20,4 dB		-18,4 dB	10 ⁻²	10 ⁻⁴
Multi-path Fading Case 3	Rate 1 (12,2 kbps)	-16 dB	3,0 dB	-13 dB	10 ⁻²	10 ⁻⁴
	Rate 2 (7,95 kbps)	-16,2 dB		-13,2 dB	10 ⁻²	10 ⁻⁴
	Rate 3 (1,95 kbps)	-16,8 dB		-13,8 dB	10 ⁻²	10 ⁻⁴

15.4 Simulation results for compressed mode

15.4.1 Simulation assumptions for compressed mode by spreading factor reduction

The link performance of a physical channel in compressed mode is simulated. The compressed mode reference pattern is as defined in table 37 and the other link simulation parameters as defined in table 38 are used. The power control is on and the results give the probability distribution of the envelope when BLER target is set to 0,01. The compressed mode off shows the same results as the static performance of the downlink power control.

Measurements of $\frac{T_x DPCH - E_c}{I_{or}}$ and block error ratio (BLER) starts after 600 TTI's when the power controller is assumed to perform at the BLER-target. Sampling then continues for 10 000 TTI's before simulation stops.

Table 37: Compressed mode reference pattern 1 parameters

Parameter	Set 1	Comments
TGSN (Transmission Gap Starting Slot Number)	11	
TGL1 (Transmission Gap Length 1)	7	Also 4 and 14 are simulated
TGL2 (Transmission Gap Length 2)	-	
TGD (Transmission Gap Distance)	0	
TGPL1 (Transmission Gap Pattern Length)	2	
TGPL2 (Transmission Gap Pattern Length)	-	
TGPRC (Transmission Gap Pattern Repetition Count)	NA	
TGCFN (Transmission Gap Connection Frame Number):	NA	
UL/DL compressed mode selection	DL & UL	Only DL is simulated
UL compressed mode method	SF/2	
DL compressed mode method	SF/2	
Downlink frame type and Slot format	11B	
Scrambling code change	No	
RPP (Recovery period power control mode)	0	
ITP (Initial transmission power control mode)	0	

Table 38: Link layer parameters

Parameter	Explanation/Assumption
Inner Loop Power Control	On
Implementation margin	Not included
Number of Rake Fingers	Equals to number of taps in propagation condition models
Downlink Physical Channels and Power Levels	Annex C. Power relation of DPDCH and DPCCH during compressed mode shall be fixed.
Data rate	12,2 kbps
BLER target	BLER target is 10^{-2}
SCH position	Offset between SCH and DPCH is zero chips meaning that SCH is overlapping with the first symbols in DPCH in the beginning of DPCH slot structure
\hat{I}_{or} / I_{oc} values (dB)	9 dB
Propagation conditions	annex B, clause B.2.2. Case 2 (3 km/h)
Measurement channels	annex A, clause A.3, Downlink reference measurement channels
DeltaSIR1	0 dB
DeltaSIR after1	0 dB

15.4.2 Simulation results for compressed mode by spreading factor reduction

15.4.2.1 Summary of performance results

The simulation results presented in this clause show that average downlink power is not really affected by the compressed mode, which is related to the interference level in the system. However the variance of the transmitted power is increased, in this case the required additional downlink power is less than 1,5 dB to 1,6 dB for 90 % to 95 % of the samples (in time). This result is valid for all lengths of the time gaps. It seems the loss of power control due to the compressed gaps does not increase with a longer gap. The compressed mode pattern in this case is quite extreme, having 7 slot gaps every double frame.

Table 39

Parameter	Unit	Compressed mode off			TGL	Compressed mode on (TGL= 4, 7, 14)		
		95 %	90 %	50 %		95 %	90 %	50 %
Confidence level								
$\frac{TxDPCH_Ec}{I_{or}}$	dB	-17,3	-18,1	-20,6	4	-15,9	-16,5	-20,2
					7	-15,9	-16,6	-20,6
					14	-15,8	-16,6	-22,0
Average reported DTCH BLER value		0,0087 < BLER-target						

Table 40

	Unit	TGL	TGL = 4,7,14		
Confidence level			95 %	90 %	50 %
Difference in $\frac{TxDPCH_Ec}{I_{or}}$ from the case when compressed mode is off	dB	4	+1,4	+1,6	+0,4
		7	+1,4	+1,6	+0,0
		14	+1,5	+1,5	-1,4

15.4.2.2 Results

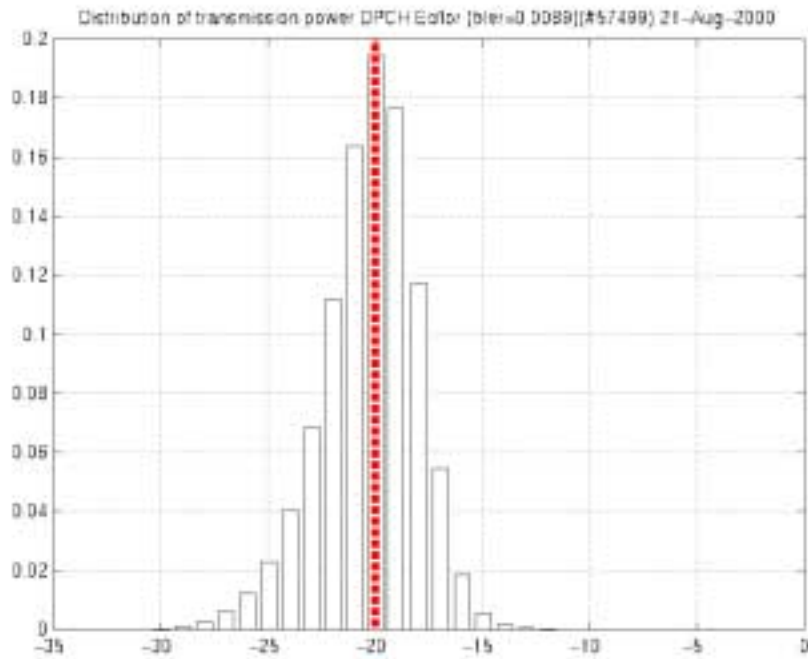

Figure 53: Distribution of transmission power DPCH_Ec/Ior for when compressed mode is off

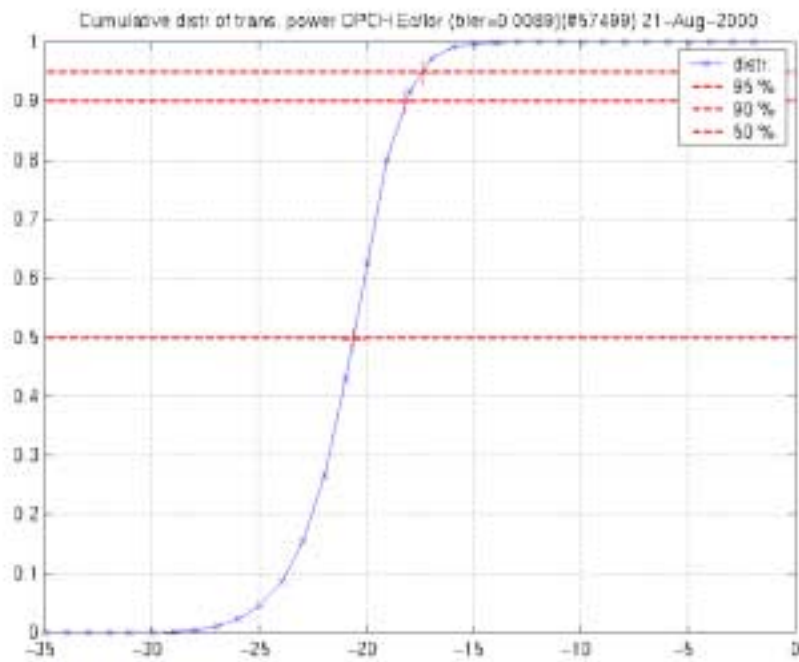

Figure 54: Cumulative distribution of transmission power DPCH_Ec/Ior when compressed mode is off

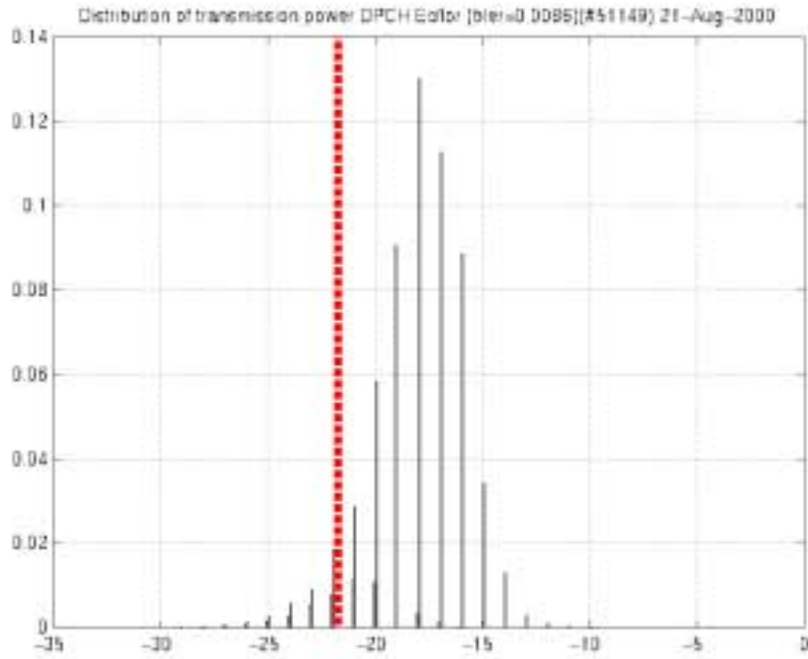

Figure 55: Distribution of transmission power DPCH_Ec/Ior when compressed mode is on. TGL = 4 slots. The gap in the PDF probably exists because of the bin widths



Figure 56: Cumulative distribution of transmission power DPCH_Ec/Ior when compressed mode is on. TGL = 4 slots

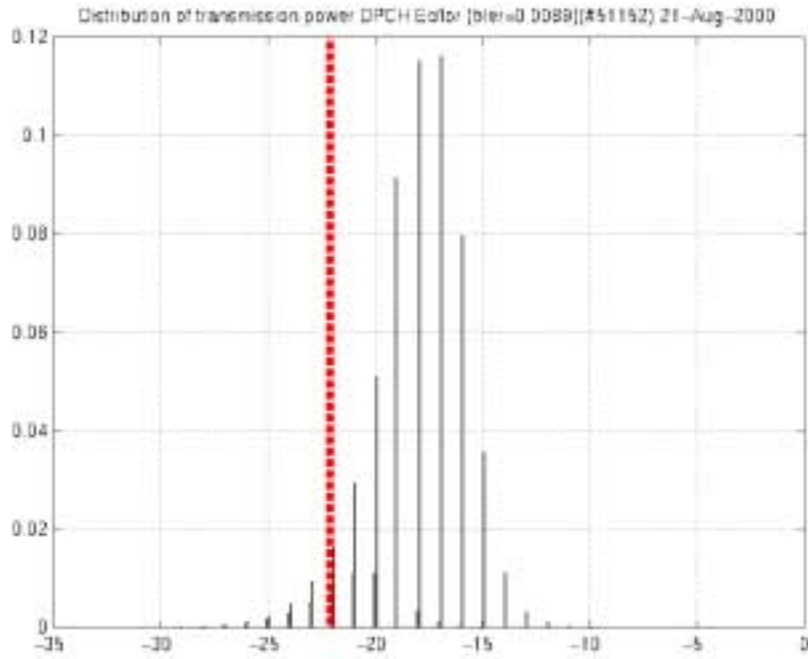

Figure 57: Distribution of transmission power DPCH_Ec/Ior when compressed mode is on. TGL = 7 slots. The gap in the PDF probably exists because of the bin widths



Figure 58: Cumulative distribution of transmission power DPCH_Ec/Ior when compressed mode is on. TGL = 7 slots

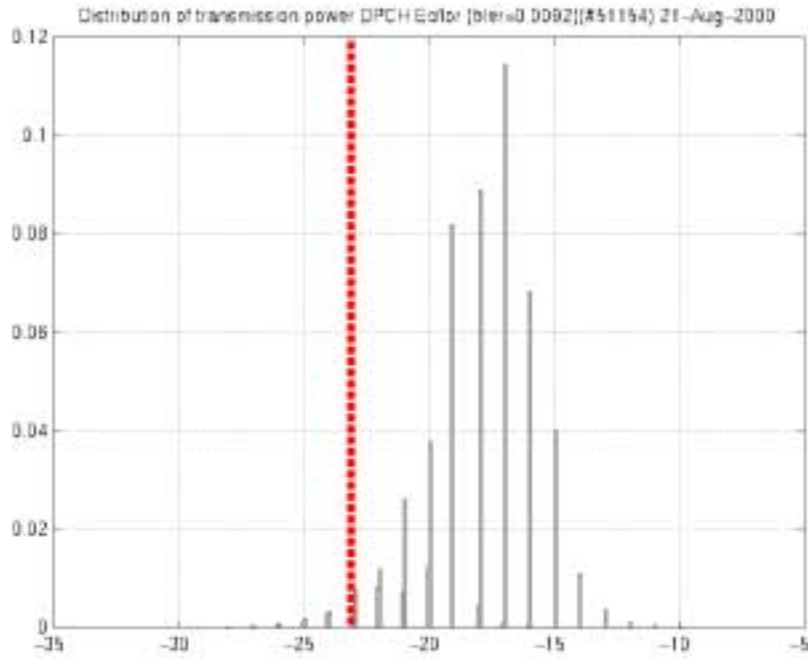

Figure 59: Distribution of transmission power DPCH_Ec/Ior when compressed mode is on. TGL = 14 slots. The gap in the PDF probably exists because of the bin widths



Figure 60: Cumulative distribution of transmission power DPCH_Ec/Ior when compressed mode is on. TGL = 14 slots

Annex A: Change History

Table A.1: Document history

Date	Version	Comment
February 1999	0.0.1	Based on XX.17 v 1.0.1 approved by ETSI at SMG # 29.
March 1999	0.0.2	Scope updated according to R4-99017. IPR clause modified.
April 1999	0.0.3	<ul style="list-style-type: none"> • Document restructured according to doc R4-99124. • Insertion of text from AH 02 (doc WG4-136) in clause 5.1: <ul style="list-style-type: none"> • clause 5.1 updated according on AH02 decisions during WG4#3 (see doc R4-99157): <ul style="list-style-type: none"> • DL power control • Minimum # of cells in the macrolayer (macro to macro) • New Macro to micro layer layout introduced as per Doc R4-99157 • Proposed insertion of text from document R4-99108 in the following clauses: <ul style="list-style-type: none"> • clause 5.2 (assumptions for simulation scenario); • clause 8.2 (Results - in square brackets -). • Proposal for a new clause on document status. • New document name introduced according to RAN #3 decisions.
May 1999	0.1.0	Version number raised to 0.1.0 at WG4#4.
May 1999	0.1.1	AH 02 agreements on UL microcell loading added in the macro-micro lading clause.
June 1999	0.1.2	<ul style="list-style-type: none"> • clause on Document Status (previous clause 10) moved to an annex. • annex A: Document Status updated. • New clause on Uplink Modulation Accuracy was introduced, based on R4-99220.
June 1999	0.1.3	<ul style="list-style-type: none"> • ACIR simulation results on the macro-to-macro FDD coexistence, UL and DL, 8 kbps added.
June 1999	1.0.0	<ul style="list-style-type: none"> • Insertion of text from document R4-99314 (BTS Receiver Blocking) in clauses: <ul style="list-style-type: none"> • clause 5.2 (assumptions for simulation scenario for 5 km cell radius); • clause 8.2 (results for 5 km cell radius).
July 1999	1.0.1	<ul style="list-style-type: none"> • Small editorial change correcting Figure numbering (Figure 17) in clause 8.2
September 1999	1.0.2	<ul style="list-style-type: none"> • Insertion of text (TDD/TDD coexistence analysis) from R4-99364 as agreed at WG4#6. Clauses: <ul style="list-style-type: none"> • clause 7.1 (TDD/TDD coexistence assumptions); • clause 8.3 (results on TDD/TDD coexistence analysis). • Editorial changes to replace "closed" loop power control with "inner" loop power control.

Date	Version	Comment
September 1999	2.0.0	<p>Document updated after WG4#7 for submission to RAN#5:</p> <ul style="list-style-type: none"> • New clause on "informative and general purpose material" introduced; • CDMA related equations and abbreviations introduced, taken from TS 25.101; • ACIR analysis with 24 dBm terminals from doc R4-99530 included; • New clause 5.1.10: parameters; • New clause 8.1.2: simulation results; • Contribution on UE active Set Size (R4-99491) included in new clause "UE Active Set Size", clause 10; • Text related to the specification for the FDD UE transmit IMD product (from R4-99427) included in new clause "Transmit intermodulation for the UE", clause 8.1.4.
December 1999	2.0.1	<ul style="list-style-type: none"> • Insertion of two new clauses moved from S25.103: "RF Parameters in Support of RRM" (R4-99671). • Clause 14: "RF Power Management Scenario" (Formally annex A). • Clause 15: "RF Handover Scenario" (Formally annex B). • Removal of annex A: " Document Status". • Insertion of Text from R4-99653 "Summary of results on FDD/TDD and TDD/TDD co-existence" in: <ul style="list-style-type: none"> • Clause 6.1 with clauses: "Evaluation of FDD/TDD interference" (assumptions); • Clauses 7.1 and 7.2 with clauses: Introduction + "Evaluation of TDD/TDD interference" (assumptions); • Clauses 8.2.1 and 8.2.1.1 with clauses: "Simulation Results" (for FDD/TDD); • Clause 8.3 and 8.3.1. with clauses: "Simulation Results" For TDD/TDD. • Insertion of a new clause 9 to include text from R4-99631 " Antenna-to Antenna Isolation Measurements. • Insertion of a new clause 13 to include text from R4-99715 " Rationales for unwanted emission specifications".
December 1999	2.1.1	<ul style="list-style-type: none"> • Insertion of a new clause 10.1 "Downlink modulation accuracy" under clause 10 from R4-99905. • Clause 9 "Antenna-to-Antenna Isolation Measurements" text was removed and replaced with text from Tdoc R4-99927 under a new clause 9 "Antenna-to-Antenna Isolation". • A note was added to clause 4, regarding the power class to consider (power class 1) when worst case scenarios are studied.
January 2000	2.1.2	<ul style="list-style-type: none"> • Editorial changes to clause 6 and clause 8 of the document to correct referenced document (R4-00xxxx from Siemens). • Insertion of text (TDD/TDD coexistence analysis) from R4-99870 as agreed at WG4#9: clauses 7.3.1.2 and 8.3.2.1.3.
March 2000	2.1.3	<ul style="list-style-type: none"> • New clause on link level performances added. • Doc R4000096 on propagation models included in clause 16.1 • TDD link level results on BS and UE included in clauses 16.2 and 16.3 according to tdocs R499890 and R499888. • Inclusion of proposal from doc R4-99869 on clause 4.4, with inclusion of a reference to clause 9 antenna to antenna isolation).

Date	Version	Comment
June 2000	2.2.0	<ul style="list-style-type: none"> Addition of text in clause 6.2, clause 7.3, clause 8.2.2 and clause 8.3.2 to include "Evaluation of FDD/TDD and TDD/TDD interference yielding relative capacity loss" as proposed in R4-000414, approved at RAN-WG4#12.
September 2000	2.3.0	<ul style="list-style-type: none"> No new changes added, only the document numbering is changed because it was presented as 2.3.0 at RAN#9.
January 2001	2.3.1	<ul style="list-style-type: none"> Insertion of a new clause "Additional Coexistence studies" between clause 8 "Results, implementation issues, and recommendations" and clause "Antenna-to-Antenna Isolation" previously clause , now clause 10. Renumbering of the subsequent clauses. Insertion of content of doc R4-000966 into clause 9.1. Insertion on clause 17 "Link Level performances" of the content of document R4-000951 and R4-000954.
February 2001	2.3.2	<ul style="list-style-type: none"> Removal of empty clauses.

Table A.2: CR approved at RAN#12

RAN doc	WG4 doc	Spec	CR	Phase	Title	Cat	V old	V new
RP-010357	R4-010635	25.942	1	R99	Clarification to TDD pico - FDD macro interference simulation results	F	3.0.0	3.1.0

Table A.3: CR approved at RAN#14

RAN doc	WG4 doc	Spec	CR	Phase	Title	Cat	V old	V new
RP-010785	R4-011622	25.942	3	Rel-4	Co-location UTRA-FDD with UTRA-TDD Site engineering solutions	A	4.0.0	4.1.0

History

Document history		
V4.0.0	September 2001	Publication
V4.1.0	December 2001	Publication