

ETSI TR 125 931 V15.0.1 (2019-05)



**Universal Mobile Telecommunications System (UMTS);
UTRAN functions, examples on signalling procedures
(3GPP TR 25.931 version 15.0.1 Release 15)**



Reference

RTR/TSGR-0325931vf01

Keywords

UMTS

ETSI

650 Route des Lucioles
F-06921 Sophia Antipolis Cedex - FRANCE

Tel.: +33 4 92 94 42 00 Fax: +33 4 93 65 47 16

Siret N° 348 623 562 00017 - NAF 742 C
Association à but non lucratif enregistrée à la
Sous-Préfecture de Grasse (06) N° 7803/88

Important notice

The present document can be downloaded from:

<http://www.etsi.org/standards-search>

The present document may be made available in electronic versions and/or in print. The content of any electronic and/or print versions of the present document shall not be modified without the prior written authorization of ETSI. In case of any existing or perceived difference in contents between such versions and/or in print, the prevailing version of an ETSI deliverable is the one made publicly available in PDF format at www.etsi.org/deliver.

Users of the present document should be aware that the document may be subject to revision or change of status.

Information on the current status of this and other ETSI documents is available at

<https://portal.etsi.org/TB/ETSIDeliverableStatus.aspx>

If you find errors in the present document, please send your comment to one of the following services:

<https://portal.etsi.org/People/CommiteeSupportStaff.aspx>

Copyright Notification

No part may be reproduced or utilized in any form or by any means, electronic or mechanical, including photocopying and microfilm except as authorized by written permission of ETSI.

The content of the PDF version shall not be modified without the written authorization of ETSI.

The copyright and the foregoing restriction extend to reproduction in all media.

© ETSI 2019.

All rights reserved.

DECT™, **PLUGTESTS™**, **UMTS™** and the ETSI logo are trademarks of ETSI registered for the benefit of its Members.

3GPP™ and **LTE™** are trademarks of ETSI registered for the benefit of its Members and of the 3GPP Organizational Partners.

oneM2M™ logo is a trademark of ETSI registered for the benefit of its Members and of the oneM2M Partners.

GSM® and the GSM logo are trademarks registered and owned by the GSM Association.

Intellectual Property Rights

Essential patents

IPRs essential or potentially essential to normative deliverables may have been declared to ETSI. The information pertaining to these essential IPRs, if any, is publicly available for **ETSI members and non-members**, and can be found in ETSI SR 000 314: *"Intellectual Property Rights (IPRs); Essential, or potentially Essential, IPRs notified to ETSI in respect of ETSI standards"*, which is available from the ETSI Secretariat. Latest updates are available on the ETSI Web server (<https://ipr.etsi.org/>).

Pursuant to the ETSI IPR Policy, no investigation, including IPR searches, has been carried out by ETSI. No guarantee can be given as to the existence of other IPRs not referenced in ETSI SR 000 314 (or the updates on the ETSI Web server) which are, or may be, or may become, essential to the present document.

Trademarks

The present document may include trademarks and/or tradenames which are asserted and/or registered by their owners. ETSI claims no ownership of these except for any which are indicated as being the property of ETSI, and conveys no right to use or reproduce any trademark and/or tradename. Mention of those trademarks in the present document does not constitute an endorsement by ETSI of products, services or organizations associated with those trademarks.

Foreword

This Technical Report (TR) has been produced by ETSI 3rd Generation Partnership Project (3GPP).

The present document may refer to technical specifications or reports using their 3GPP identities, UMTS identities or GSM identities. These should be interpreted as being references to the corresponding ETSI deliverables.

The cross reference between GSM, UMTS, 3GPP and ETSI identities can be found under <http://webapp.etsi.org/key/queryform.asp>.

Modal verbs terminology

In the present document "**should**", "**should not**", "**may**", "**need not**", "**will**", "**will not**", "**can**" and "**cannot**" are to be interpreted as described in clause 3.2 of the [ETSI Drafting Rules](#) (Verbal forms for the expression of provisions).

"**must**" and "**must not**" are **NOT** allowed in ETSI deliverables except when used in direct citation.

Contents

Intellectual Property Rights	2
Foreword.....	2
Modal verbs terminology.....	2
Foreword.....	6
1 Scope	7
2 References	7
3 Definitions, abbreviations and notation.....	8
3.1 Definitions	8
3.2 Abbreviations	8
3.3 Notation for the signalling procedures	10
3.4 Other Notations	11
4 UTRAN and UE protocol Architecture.....	12
4.1 Protocol Architecture	12
4.2 RANAP Procedures & Messages	12
4.3 SABP Procedures & Messages.....	15
4.4 RNSAP Procedures & Messages.....	15
4.5 NBAP Procedures & Messages	18
4.6 ALCAP.....	20
4.6.1 Q.2630.2 (Q.AAL2).....	20
4.7 RRC Procedures & Messages.....	20
4.8 BMC Procedures & Messages.....	22
4.9 DCH Frame Protocol Messages	22
4.10 DSCH Frame Protocol Messages	22
4.11 USCH Frame Protocol Messages	22
5 UTRAN Signalling Procedures.....	22
6 Procedures not related to a specific UE (global procedures).....	23
6.1 System Information Broadcasting	23
6.2 Service Area Broadcast	23
7 Procedures related to a specific UE.....	24
7.1 Paging.....	24
7.1.1 Paging for a UE in RRC Idle Mode and RRC connected mode (CELL_PCH and URA_PCH states).....	24
7.1.2 Paging for a UE in RRC Connected Mode (CELL_DCH and CELL_FACH states)	25
7.2 NAS Signalling Connection Establishment.....	26
7.3 RRC Connection Establishment	26
7.3.1 DCH Establishment	26
7.3.2 RACH/FACH Establishment	28
7.3.3 DCH Establishment with Pre-emption.....	28
7.4 RRC Connection Release	30
7.4.1 DCH Release	30
7.4.2 Common Transport Channel Release	31
7.5 RRC Connection Re-establishment.....	31
7.5.1 DCH Re-establishment	31
7.5.1.1 RRC connection Re-establishment (Anchor approach) – DCH Re-establishment.....	31
7.5.1.2 RRC Connection Re-establishment with SRNC Relocation - DCH Re-establishment.....	33
7.6 Radio Access Bearer Establishment	34
7.6.1 DCH - DCH Establishment - Synchronised.....	34
7.6.2 DCH - DCH Establishment - Unsynchronised	36
7.6.3 RACH/FACH - DCH Establishment	38
7.6.4 RACH/FACH - RACH/FACH Establishment	39
7.7 Radio Access Bearer Release	40
7.7.1 DCH - DCH Release - Synchronised.....	40
7.7.2 DCH - DCH Release - Unsynchronised.....	42

7.7.4	RACH/FACH - RACH/FACH Release	43
7.8	Radio Access Bearer Modification	44
7.8.1	DCCCH on DCH - Synchronised	44
7.8.1.1	Synchronised DCH modification, Bandwidth increase	45
7.8.1.2	Synchronised DCH modification, Bandwidth decrease	47
7.8.2	DCCCH on RACH/FACH	48
7.9	Physical Channel Reconfiguration	49
7.9.1	Physical Channel Reconfiguration (DCH)	49
7.9.2	Physical Channel Reconfiguration (CRNC Controlled)	51
7.10	Soft Handover [FDD]	51
7.10.1	Radio Link Addition (Branch Addition)	52
7.10.2	Radio link Deletion (Branch Deletion)	53
7.10.3	Radio link Addition & Deletion (Branch Addition & Deletion - simultaneously)	54
7.10.4	DSCH Mobility Procedure in Soft Handover (Moving DSCH within the Active Set)	55
7.10.5	HS-DSCH Mobility Procedures	56
7.10.5.1	Intra-Node B synchronised serving HS-DSCH cell change	56
7.10.5.2	Inter-Node B (intra DRNC) synchronised serving HS-DSCH cell change	57
7.11	Hard Handover	58
7.11.1	Backward Hard Handover	58
7.11.1.1	Hard Handover via Iur (DCH State)	58
7.11.1.2	Hard Handover with switching in the CN (UE connected to two CN nodes, DCH state)	62
7.11.1.2.1	Using SRNS Relocation scheme	62
7.11.1.2.2	Using Enhanced SRNS Relocation	65
7.11.1.3	Inter-Node B synchronised serving HS-DSCH cell change at hard handover	66
7.11.1.3.1	Inter-Node B (intra DRNC) synchronised serving HS-DSCH cell change at hard handover	67
7.11.1.3.2	Inter-Node B (inter DRNC) synchronised serving HS-DSCH cell change at hard handover	69
7.11.2	Forward Hard Handover	71
7.11.2.1	Cell Update	71
7.11.2.1.1	Using Cell Update with SRNS relocation	71
7.11.2.1.2	Using Enhanced SRNS Relocation	72
7.11.2.2	Cell Update via Iur without SRNS relocation	72
7.11.2.3	Cell Update via Iur without SRNS relocation (with C-RNTI reallocation)	74
7.11.2.4	Cell Update via Iur with USCH/DSCH, without SRNS relocation [TDD]	74
7.12	URA Update	76
7.12.1	Inter-RNS URA Update	76
7.12.1.1	Inter-RNS URA Update using SRNS Relocation	76
7.12.1.2	Using Enhanced SRNS Relocation	77
7.12.2	Inter-RNS URA Update via Iur without SRNS relocation	78
7.12.3	SRNS Relocation (UE connected to two CN nodes)	79
7.12.3.1	Using SRNS Relocation	79
7.12.3.2	Using Enhanced SRNS Relocation	81
7.13	HO & Cell Reselection between UTRAN and GSM/BSS	83
7.13.1	UTRAN ⇒ GSM/BSS	83
7.13.1.1	UTRAN ⇒ GSM/BSS	83
7.13.1.2	Service Based Intersystem Handover	85
7.13.1.3	Directed Retry	86
7.13.2	GSM/BSS ⇒ UTRAN	87
7.13.3	GPRS ⇒ UMTS Cell Reselection	88
7.13.4	UMTS ⇒ GPRS Cell Reselection, UE Initiated	88
7.13.5	UMTS ⇒ GPRS Cell Reselection, Network Initiated	89
7.14	Transport Channel Reconfiguration (DCH to DCH)	90
7.14.1	Synchronised Transport Channel Reconfiguration	90
7.14.1.1	Synchronised Reconfiguration, Q.2630.2 modification procedure not used	91
7.14.1.2	Synchronised Reconfiguration, Bandwidth Increase with Q.2630.2 modification procedure	92
7.14.1.3	Synchronised Reconfiguration, Bandwidth Decrease with Q.2630.2 modification procedure	94
7.14.2	Unsynchronised Transport Channel Reconfiguration	95
7.14.2.1	Unsynchronised Reconfiguration, Q.2630.2 modification procedure not used	95
7.14.2.2	Unsynchronised Reconfiguration, Bandwidth Increase with Q.2630.2 modification procedure	96
7.14.2.3	Unsynchronised Reconfiguration, Bandwidth Decrease with Q.2630.2 modification procedure	97
7.15	Direct Transfer	98
7.15.1	Uplink Direct Transfer	98

7.15.2	Downlink Direct Transfer	99
7.16	Downlink Power Control [FDD]	99
7.17	Shared Channels Configuration and Capacity Allocation	100
7.17.1	USCH/DSCH Configuration and Capacity Allocation [TDD]	100
7.17.2	HS-DSCH Configuration and Capacity Allocation	102
7.18	Channel and Mobile State Switching on Iur	103
7.18.1	General Description	103
7.18.2	Switching from Cell_FACH to Cell_DCH State	103
7.18.3	Switching from Cell_DCH to Cell_FACH State	105
7.19	MBMS Specific Procedures	107
7.19.1	MBMS Service Activation	107
7.19.2	MBMS Session Start	109
7.19.2a	MBMS Session Start for UE in Cell-DCH in DRNC	111
7.19.3	MBMS UE Mobility from a PTP to PTM cell	113
7.19.4	MBMS UE Mobility from PTM cell to PTP cell	115
7.19.5	MBMS Session Stop and Service termination	116
7.19.6	RAU during MBMS Session	119
7.20	E-DCH Specific Scenarios	120
7.20.1	E-DCH Establishment and EDCH TTI Reconfiguration	120
7.20.1.1	FDD	120
7.20.1.2	TDD	122
7.20.2	Soft Handover [FDD]	124
7.20.3	Intra-Node B synchronised serving E-DCH cell change [FDD]	125
7.20.4	Inter-Node B (intra DRNC) synchronised serving E-DCH cell change [FDD]	126
7.20.5	Hard Handover	128
Annex A (informative): Change History		132
History		133

Foreword

This Technical Report (TR) has been produced by the 3rd Generation Partnership Project (3GPP).

The contents of the present document are subject to continuing work within the TSG and may change following formal TSG approval. Should the TSG modify the contents of the present document, it will be re-released by the TSG with an identifying change of release date and an increase in version number as follows:

Version x.y.z

where:

- x the first digit:
 - 1 presented to TSG for information;
 - 2 presented to TSG for approval;
 - 3 or greater indicates TSG approved document under change control.
- y the second digit is incremented for all changes of substance, i.e. technical enhancements, corrections, updates, etc.
- z the third digit is incremented when editorial only changes have been incorporated in the document.

1 Scope

The present document describes the UTRAN functions by means of signalling procedure examples (Message Sequence Charts). The signalling procedure examples show the interaction between the UE, the different UTRAN nodes and the CN to perform system functions. This gives an overall understanding of how the UTRAN works in example scenarios.

2 References

The following documents contain provisions which, through reference in this text, constitute provisions of the present document.

- References are either specific (identified by date of publication, edition number, version number, etc.) or non-specific.
- For a specific reference, subsequent revisions do not apply.
- For a non-specific reference, the latest version applies. In the case of a reference to a 3GPP document (including a GSM document), a non-specific reference implicitly refers to the latest version of that document *in the same Release as the present document*.

- [1] 3GPP TR 25.990: "Vocabulary".
- [2] 3GPP TS 25.401: "UTRAN Overall Description".
- [3] 3GPP TS 25.413: "UTRAN Iu Interface RANAP Signalling".
- [4] 3GPP TS 25.423: "UTRAN Iur Interface RNSAP Signalling".
- [5] 3GPP TS 25.433: "UTRAN Iub Interface NBAP Signalling".
- [6] Void
- [7] 3GPP TS 25.301: "Radio Interface Protocol Architecture".
- [8] 3GPP TS 25.331: "RRC Protocol Specification".
- [9] 3GPP TS 25.419: "UTRAN Iu Interface: Service Area Broadcast Protocol SABP".
- [10] 3GPP TS 25.324: "Radio Interface for Broadcast/Multicast Services".
- [11] 3GPP TR 25.925: "Radio Interface for Broadcast/Multicast Services".
- [12] 3GPP TS 23.041: "Technical realisation of Cell Broadcast Service (CBS)".
- [13] 3GPP TS 25.425: "UTRAN Iur Interface User Plane Protocols for Common Transport Channel Data Streams".
- [14] 3GPP TS 25.435: "UTRAN Iub Interface User Plane Protocols for Common Transport Channel Data Streams".
- [15] 3GPP TS 25.427: "UTRAN Iub/Iur Interface User Plane Protocol for DCH Data Streams".
- [16] 3GPP TS 25.346: "Introduction of the Multimedia Broadcast Multicast Service".
- [17] ITU-T Recommendation Q.2630.2 (2000-12): "AAL type 2 Signalling Protocol (Capability Set 2)".
- [18] ITU-T Recommendation Q.2630.1 (1999-12): "AAL type 2 Signalling Protocol (Capability Set 1)".

3 Definitions, abbreviations and notation

3.1 Definitions

For the purposes of the present document, the terms and definitions given in TR 25.990 [1], TS 25.401 [2] and TS 25.423 [4] apply.

3.2 Abbreviations

For the purposes of the present document the following abbreviations apply:

NOTE: More extensive abbreviations on UMTS are provided in TR 25.990 [1].

AAL2	ATM Adaptation Layer type 2
ACK	Acknowledgement
AICH	Acquisition Indicator Channel
ALCAP	Access Link Control Application Part
AM	Acknowledged Mode
APN	Access Point Name
AS	Access Stratum
ATM	Asynchronous Transfer Mode
BCCH	Broadcast Control Channel
BCFE	Broadcast Control Functional Entity
BER	Bit Error Rate
BLER	Block Error Rate
BMC	Broadcast/Multicast Control
BSS	Base Station Sub-system
BSSMAP	Base Station System Management Application Part
CCCH	Common Control Channel
CCPCH	Common Control Physical Channel
CFN	Connection Frame Number
CM	Connection Management
CN	Core Network
CPICH	Common Pilot Channel
CRNC	Controlling RNC
C-RNTI	Cell RNTI
CS	Circuit Switched
DCA	Dynamic Channel Allocation
DCCH	Dedicated Control Channel
DCFE	Dedicated Control Functional Entity
DCH	Dedicated Channel
DC-SAP	Dedicated Control-SAP
DL	Downlink
DPCCH	Dedicated Physical Control Channel
DPCH	Dedicated Physical Channel
DRNC	Drift RNC
DRNS	Drift RNS
DRX	Discontinuous Reception
DSCH	Downlink Shared Channel
DTCH	Dedicated Traffic Channel
E-AGCH	EDCH – Absolute Grant Channel
E-DCH	Enhanced – Dedicated Channel
E-DPCH	EDCH – Dedicated Physical Channel
E-HICH	EDCH - HARQ Acknowledgement Indicator Channel
E-RGCH	EDCH – Relative Grant Channel
E-RNTI	E-DCH Radio Network Temporary Identifier
EP	Elementary Procedure
FACH	Forward Access Channel
FAUSCH	Fast Uplink Signalling Channel

FDD	Frequency Division Duplex
FFS	For Further Study
FN	Frame Number
FP	Frame Protocol
HS-DSCH	High Speed Downlink Shared Channel
HS-PDSCH	High Speed Physical Downlink Shared Channel
HS-SCCH	High Speed Shared Control Channel
ID	Identifier
IE	Information Element
IMEI	International Mobile Equipment Identity
IMSI	International Mobile Subscriber Identity
IP	Internet Protocol
ISCP	Interference on Signal Code Power
L1	Layer 1
L2	Layer 2
L3	Layer 3
LAI	Location Area Identity
MAC	Medium Access Control
MAC-hs	Medium Access Control for HS-DSCH
MBMS	Multimedia Broadcast Multicast Service
MCC	Mobile Country Code
MCCH	Multicast Control Channel
MM	Mobility Management
MNC	Mobile Network Code
MS	Mobile Station
MSC	Mobile services Switching Center
NAS	Non Access Stratum
NBAP	Node B Application Protocol
Nt-SAP	Notification SAP
NW	Network
O	Optional
ODMA	Opportunity Driven Multiple Access
PCCH	Paging Control Channel
PCH	Paging Channel
PDCP	Packet Data Convergence Protocol
PDSCH	Physical Downlink Shared Channel
PDU	Protocol Data Unit
PLMN	Public Land Mobile Network
PNFE	Paging and Notification control Functional Entity
PRACH	Physical Random Access CHannel
PS	Packet Switched
PSCH	Physical Synchronisation Channel
PTM	Point To Multipoint
P-TMSI	Packet Temporary Mobile Subscriber Identity
PTP	Point To Point
PUSCH	Physical Uplink Shared Channel
QoS	Quality of Service
RAB	Radio Access Bearer
RACH	Random Access CHannel
RAI	Routing Area Identity
RANAP	Radio Access Network Application Part
RB	Radio Bearer
RFE	Routing Functional Entity
RL	Radio Link
RLC	Radio Link Control
RNC	Radio Network Controller
RNS	Radio Network Subsystem
RNSAP	Radio Network Subsystem Application Part
RNTI	Radio Network Temporary Identifier
RRC	Radio Resource Control
RSCP	Received Signal Code Power
RSSI	Received Signal Strength Indicator

SAI	Service Area Identifier
SAP	Service Access Point
SCCP	Signalling Connection Control Part
SCFE	Shared Control Function Entity
SF	Spreading Factor
SFN	System Frame Number
SGSN	Serving GPRS Support Node
SHCCH	Shared Control Channel
SIR	Signal to Interference Ratio
SRNC	Serving RNC
SRNS	Serving RNS
S-RNTI	SRNC - RNTI
TDD	Time Division Duplex
TEID	Tunnel Endpoint Identifier
TF	Transport Format
TFCI	Transport Format Combination Indicator
TFCS	Transport Format Combination Set
TFS	Transport Format Set
TME	Transfer Mode Entity
TMGI	Temporary Multicast Group Identifier
TMSI	Temporary Mobile Subscriber Identity
Tr	Transparent
Tx	Transmission
UARFCN	UMTS Absolute Radio Frequency Channel Number
UE	User Equipment
UL	Uplink
UM	Unacknowledged Mode
UMTS	Universal Mobile Telecommunication System
UNACK	Unacknowledgement
URA	UTRAN Registration Area
U-RNTI	UTRAN-RNTI
USCH	Uplink Shared Channel
UTRAN	UMTS Terrestrial Radio Access Network

3.3 Notation for the signalling procedures

Complex signalling procedures may involve several protocols in different nodes.

In order to facilitate the understanding of these procedures, the following rules in the drawing of Message Sequence Chart (MSC) are applied:

- Messages are always exchanged between nodes, i.e. the sender and the receiver of a message are nodes and not single protocol entities;
- The protocol entity inside a node that is sending/receiving a message is represented by means of an ellipse, containing the protocol entity name;
- Each message is numbered, so that a numbered list with explanations can be added below the figure;
- Message parameters may be specified as shown in Figure 1 only when required for a clear understanding of the procedures;
- Explicit signalling is represented by means of continuous arrows;
- Inband signalling is represented by means of dotted arrows;
- A description of the relevant actions may be included as shown in Figure 1;
- The Setup and Release of Iub/Iur and Iu Data Transport Bearer with the ALCAP protocol is represented as shown in Figure 1;

- The transport channel used by the MAC protocol or the logical channel used by the RLC and RRC protocols may be indicated before the message name as shown in figure 1

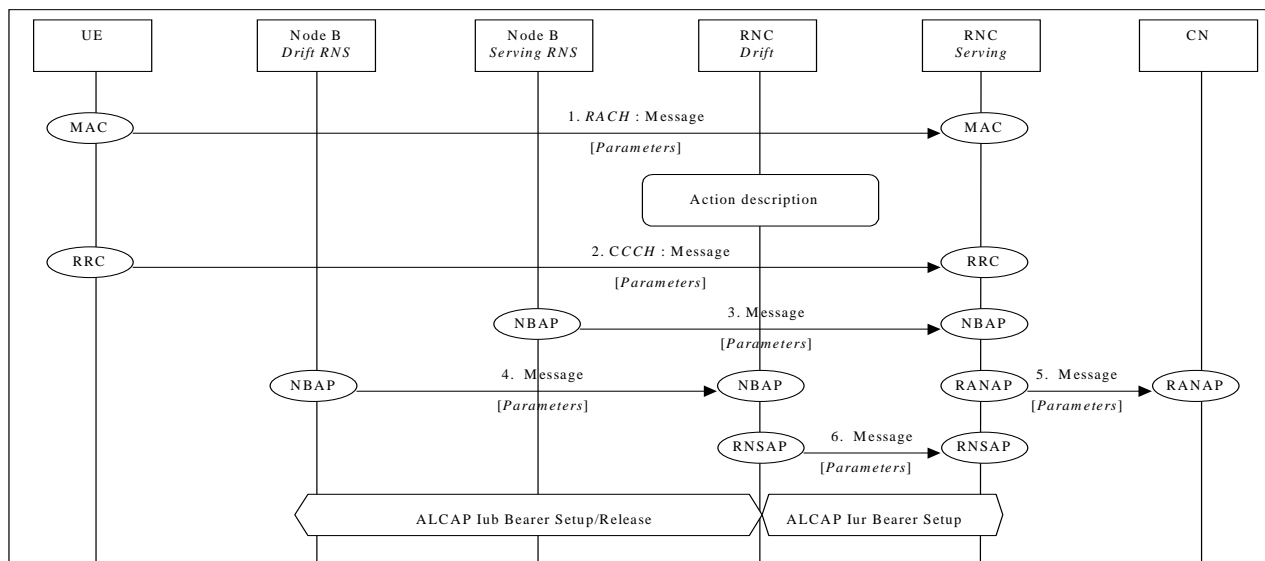

Figure 1: Example of signalling procedure notation

3.4 Other Notations

For the purposes of the present document, the following notations apply:

- [FDD] This tagging of a word indicates that the word preceding the tag "[FDD]" applies only to FDD. This tagging of a heading indicates that the heading preceding the tag "[FDD]" and the section following the heading applies only to FDD.
- [TDD] This tagging of a word indicates that the word preceding the tag "[TDD]" applies only to TDD, including 3.84Mcps TDD, 7.68Mcps TDD and 1.28Mcps TDD. This tagging of a heading indicates that the heading preceding the tag "[TDD]" and the section following the heading applies only to TDD, including 3.84Mcps TDD, 7.68Mcps TDD and 1.28Mcps TDD.
- [3.84Mcps TDD] This tagging of a word indicates that the word preceding the tag "[3.84Mcps TDD]" applies only to 3.84Mcps TDD. This tagging of a heading indicates that the heading preceding the tag "[3.84Mcps TDD]" and the section following the heading applies only to 3.84Mcps TDD.
- [1.28Mcps TDD] This tagging of a word indicates that the word preceding the tag "[1.28Mcps TDD]" applies only to 1.28Mcps TDD. This tagging of a heading indicates that the heading preceding the tag "[1.28Mcps TDD]" and the section following the heading applies only to 1.28Mcps TDD.
- [7.68Mcps TDD] This tagging of a word indicates that the word preceding the tag "[7.68Mcps TDD]" applies only to 7.68Mcps TDD. This tagging of a heading indicates that the heading preceding the tag "[7.68Mcps TDD]" and the section following the heading applies only to 7.68Mcps TDD.
- [FDD - ...] This tagging indicates that the enclosed text following the "[FDD -" applies only to FDD. Multiple sequential paragraphs applying only to FDD are enclosed separately to enable insertion of TDD specific (or common) paragraphs between the FDD specific paragraphs.
- [TDD - ...] This tagging indicates that the enclosed text following the "[TDD -" applies only to TDD including 3.84Mcps TDD, 7.68Mcps TDD and 1.28Mcps TDD. Multiple sequential paragraphs applying only to TDD are enclosed separately to enable insertion of FDD specific (or common) paragraphs between the TDD specific paragraphs.

[3.84Mcps TDD - ...] This tagging indicates that the enclosed text following the "[3.84Mcps TDD - " applies only to 3.84Mcps TDD. Multiple sequential paragraphs applying only to 3.84Mcps TDD are enclosed separately to enable insertion of FDD and TDD specific (or common) paragraphs between the 3.84Mcps TDD specific paragraphs.

[1.28Mcps TDD - ...] This tagging indicates that the enclosed text following the "[1.28Mcps TDD - " applies only to 1.28Mcps TDD. Multiple sequential paragraphs applying only to 1.28Mcps TDD are enclosed separately to enable insertion of FDD and TDD specific (or common) paragraphs between the 1.28Mcps TDD specific paragraphs.

[7.68Mcps TDD - ...] This tagging indicates that the enclosed text following the "[7.68Mcps TDD - " applies only to 7.68Mcps TDD. Multiple sequential paragraphs applying only to 7.68Mcps TDD are enclosed separately to enable insertion of FDD and TDD specific (or common) paragraphs between the 7.68Mcps TDD specific paragraphs.

Message When referring to a message in the specification, the MESSAGE NAME is written in bold, e.g. **Radio Link Setup Request**.

Frame When referring to a control or data frame in the specification, the CONTROL/DATA FRAME NAME is written in bold, e.g. **Downlink Synchronisation**.

4 UTRAN and UE protocol Architecture

4.1 Protocol Architecture

For a detailed description of the Protocol Architecture and the Radio Protocol Architecture for the UTRAN and the UE refer to TS 25.401 [2] and TS 25.301 [7] respectively.

4.2 RANAP Procedures & Messages

For a detailed description of RANAP procedures and messages refer to TS 25.413 [3]. Only Messages mentioned in the present document are shown. For each message is also given the list of example procedures where the message is used, as provided by this document.

Table 1

Message Name	UTRAN Procedure	Direction
Direct Transfer	Uplink Direct Transfer Downlink Direct Transfer	RNC ⇒ CN CN ⇒ RNC
Initial UE Message	NAS Signalling Connection Establishment	RNC ⇒ CN
Iu Release Command	RRC Connection Release Hard HO with switching in the CN SRNS Relocation UTRAN ⇒ GSM/BSS handover	CN ⇒ RNC CN ⇒ RNC CN ⇒ RNC CN ⇒ RNC
Iu Release Complete	RRC Connection Release Hard HO with switching in the CN SRNS Relocation UTRAN ⇒ GSM/BSS handover	RNC ⇒ CN RNC ⇒ CN RNC ⇒ CN RNC ⇒ CN
Paging	Paging for a UE in RRC Idle Mode Paging for a UE in RRC Connected Mode	CN ⇒ RNC CN ⇒ RNC
Radio Access Bearer Assignment Request	Radio Access Bearer Establishment Radio Access Bearer Release Radio Access Bearer Modification	CN ⇒ RNC CN ⇒ RNC CN ⇒ RNC
Radio Access Bearer Assignment Response	Radio Access Bearer Establishment Radio Access Bearer Release Radio Access Bearer Modification	RNC ⇒ CN RNC ⇒ CN RNC ⇒ CN
Relocation Command	Hard HO with switching in the CN SRNS Relocation UTRAN ⇒ GSM/BSS handover	CN ⇒ RNC CN ⇒ RNC CN ⇒ RNC
Relocation Complete	Hard HO with switching in the CN SRNS Relocation GSM/BSS handover ⇒ UTRAN	RNC ⇒ CN RNC ⇒ CN RNC ⇒ CN
Relocation Detect	Hard HO with switching in the CN SRNS Relocation GSM/BSS handover ⇒ UTRAN	RNC ⇒ CN RNC ⇒ CN RNC ⇒ CN
Relocation Failure	SRNS Relocation	RNC ⇒ CN
Relocation Request	Hard HO with switching in the CN SRNS Relocation GSM/BSS handover ⇒ UTRAN	CN ⇒ RNC CN ⇒ RNC CN ⇒ RNC
Relocation Request Acknowledge	Hard HO with switching in the CN SRNS Relocation GSM/BSS handover ⇒ UTRAN	RNC ⇒ CN RNC ⇒ CN RNC ⇒ CN
Relocation Required	Hard HO with switching in the CN SRNS Relocation UTRAN ⇒ GSM/BSS handover	RNC ⇒ CN RNC ⇒ CN RNC ⇒ CN
RAB Release Request	RRC Connection Establishment	RNC ⇒ CN
MBMS Session Start	MBMS Session Start and RAB Establishment MBMS Session Start and RAB Release	CN ⇒ RNC CN ⇒ RNC
MBMS Session Start Response	MBMS Session Start and RAB Establishment MBMS Session Start and RAB Release	RNC ⇒ CN RNC ⇒ CN
MBMS Session Update	MBMS Update RA list and RAB establishment	CN ⇒ RNC
MBMS Session Update Response	MBMS Update RA list and RAB establishment	RNC ⇒ CN
MBMS Session Stop	MBMS Session end MBMS service termination	CN ⇒ RNC CN ⇒ RNC
MBMS Session Stop Response	MBMS Session end MBMS service termination	RNC ⇒ CN RNC ⇒ CN
MBMS UE linking Request	MBMS UE linking MBMS UE De-linking	CN ⇒ RNC CN ⇒ RNC
MBMS UE linking Response	MBMS UE linking MBMS UE De-linking	RNC ⇒ CN RNC ⇒ CN
MBMS Registration Request	MBMS RAN Registration MBMS RAN De-registration	RNC ⇒ CN RNC ⇒ CN
MBMS Registration Response	MBMS RAN Registration MBMS RAN De-registration	CN ⇒ RNC CN ⇒ RNC
CN MBMS DeRegistration Request	MBMS Service termination	CN ⇒ RNC
CN MBMS Registration Response	MBMS Service termination	RNC ⇒ CN

Message Name	UTRAN Procedure	Direction
Uplink Information Exchange Request	Trace Information UE linking MBMS Multicast IP address and APN enquiry	RNC ⇒ CN RNC ⇒ CN
Uplink Information Exchange Response	Trace Information UE linking MBMS Multicast IP address and APN enquiry	CN ⇒ RNC CN ⇒ RNC
MBMS RAB establishment Indication	MBMS RAB establishment	RNC ⇒ CN
Enhanced Relocation Complete Request	Enhanced Relocation Complete	RNC ⇒ CN
Enhanced Relocation Complete Response	Enhanced Relocation Complete	CN ⇒ RNC
Enhanced Relocation Complete Confirm	Enhanced Relocation Complete Confirm	CN ⇒ RNC

4.3 SABP Procedures & Messages

For a detailed description of SABP procedures and messages refer to TS 25.419 [9]. Only Messages mentioned in the present document are shown. For each message is also given the list of example procedures where the message is used, as provided by this document.

Table 2

Message Name	UTRAN Procedure	Direction
Write-replace	Service Area Broadcast	CN ⇒ RNC
Write-replace Complete	Service Area Broadcast	RNC ⇒ CN
Write-Replace Failure	Service Area Broadcast	RNC ⇒ CN

4.4 RNSAP Procedures & Messages

For a detailed description of RNSAP procedures and messages refer to TS 25.423 [4]. Only Messages mentioned in the present document are shown. For each message is also given the list of example procedures where the message is used, as provided by this document.

Table 3

Message Name	UTRAN Procedure	Direction
Common Transport Channel Resources Release	Cell Update	SRNC ⇒ DRNC
Common Transport Channel Resources Initialisation Request	Cell Update MBMS UE linking/De-linking	SRNC ⇒ DRNC SRNC ⇒ DRNC
Common Transport Channel Resources Initialisation Response	Cell Update MBMS Channel Type Indication	DRNC ⇒ SRNC
DL Power Control Request	Downlink Power Control	SRNC ⇒ DRNC
Downlink Signalling Transfer Request	RRC Connection Re-establishment URA Update MBMS UE linking/De-linking MBMS URA linking/De-linking	SRNC ⇒ DRNC SRNC ⇒ DRNC SRNC ⇒ DRNC SRNC ⇒ DRNC
Radio Link Deletion Request	RRC Connection Re-establishment Soft Handover Hard Handover	SRNC ⇒ DRNC SRNC ⇒ DRNC SRNC ⇒ DRNC
Radio Link Deletion Response	RRC Connection Re-establishment Soft Handover Hard Handover	DRNC ⇒ SRNC DRNC ⇒ SRNC DRNC ⇒ SRNC
Radio Link Failure Indication	Hard Handover	DRNC ⇒ SRNC
Radio Link Reconfiguration Request	Radio Access Bearer Establishment Radio Access Bearer Release Physical Channel Reconfiguration Transport Channel Reconfiguration	SRNC ⇒ DRNC SRNC ⇒ DRNC SRNC ⇒ DRNC SRNC ⇒ DRNC
Radio Link Reconfiguration Commit	Radio Access Bearer Establishment Radio Access Bearer Release Physical Channel Reconfiguration Transport Channel Reconfiguration Radio Access Bearer Modification	SRNC ⇒ DRNC SRNC ⇒ DRNC SRNC ⇒ DRNC SRNC ⇒ DRNC SRNC ⇒ DRNC
Radio Link Reconfiguration Prepare	Radio Access Bearer Establishment Radio Access Bearer Release Physical Channel Reconfiguration Transport Channel Reconfiguration Radio Access Bearer Modification	SRNC ⇒ DRNC SRNC ⇒ DRNC SRNC ⇒ DRNC SRNC ⇒ DRNC SRNC ⇒ DRNC
Radio Link Reconfiguration Ready	Radio Access Bearer Establishment Radio Access Bearer Release Physical Channel Reconfiguration Transport Channel Reconfiguration Radio Access Bearer Modification	DRNC ⇒ SRNC DRNC ⇒ SRNC DRNC ⇒ SRNC DRNC ⇒ SRNC DRNC ⇒ SRNC
Radio Link Reconfiguration Response	Radio Access Bearer Establishment Radio Access Bearer Release Physical Channel Reconfiguration Transport Channel Reconfiguration	DRNC ⇒ SRNC DRNC ⇒ SRNC DRNC ⇒ SRNC DRNC ⇒ SRNC
Radio Link Restore Indication	Soft Handover Hard Handover Channel and Mobile State Switching on lur	DRNC ⇒ SRNC DRNC ⇒ SRNC DRNC ⇒ SRNC
Radio Link Setup Request	RRC Connection Re-establishment Hard Handover USCH/DSCH Configuration and Capacity Allocation [TDD] MBMS UE Linking/De-linking	SRNC ⇒ DRNC SRNC ⇒ DRNC SRNC ⇒ DRNC SRNC ⇒ DRNC
Radio Link Setup Response	RRC Connection Re-establishment Hard Handover USCH/DSCH Configuration and Capacity Allocation [TDD] MBMS Channel Type Indication	DRNC ⇒ SRNC DRNC ⇒ SRNC DRNC ⇒ SRNC
Relocation Commit	SRNS Relocation URA Update	Source RNC ⇒ Target RNC
Uplink Signalling Transfer Indication	RRC Connection Re-establishment URA Update MBMS Channel Type Indication	DRNC ⇒ SRNC DRNC ⇒ SRNC DRNC ⇒ SRNC
Information Exchange Initiation Request	MBMS IP Multicast address and APN enquiry	DRNC ⇒ SRNC
Information Exchange Initiation Response	MBMS IP Multicast address and APN enquiry	SRNC ⇒ DRNC

Message Name	UTRAN Procedure	Direction
MBMS Attach Command	MBMS UE linking MBMS URA linking	SRNC ⇒ DRNC SRNC ⇒ DRNC
MBMS Detach Command	MBMS UE De-linking MBMS URA De-linking	SRNC ⇒ DRNC SRNC ⇒ DRNC
MBMS Channel Type Reconfiguration Indication	MBMS Channel Type Indication	DRNC ⇒ SRNC
Enhanced Relocation Request	Enhanced Relocation	SRNC ⇒ DRNC
Enhanced Relocation Response	Enhanced Relocation	DRNC ⇒ SRNC

4.5 NBAP Procedures & Messages

For a detailed description of NBAP procedures and messages refer to TS 25.433 [5]. Only Messages mentioned in the present document are shown. For each message is also given the list of example procedures where the message is used, as provided by this document.

Table 4

Message Name	UTRAN Procedure	Direction
DL Power Control Request	Downlink Power Control	RNC ⇒ Node B
Physical Shared Channel Reconfiguration Request	USCH/DSCH Configuration and Capacity Allocation [TDD]	RNC ⇒ Node B
Physical Shared Channel Reconfiguration Response	USCH/DSCH Configuration and Capacity Allocation [TDD]	Node B ⇒ RNC
Radio Link Deletion	RRC Connection Release RRC Connection Re-establishment Hard Handover Soft Handover	RNC ⇒ Node B RNC ⇒ Node B RNC ⇒ Node B RNC ⇒ Node B
Radio Link Deletion Response	RRC Connection Release RRC Connection Re-establishment Hard Handover Soft Handover	Node B ⇒ RNC Node B ⇒ RNC Node B ⇒ RNC Node B ⇒ RNC
Radio Link Failure Indication	Hard Handover	Node B ⇒ RNC
Radio Link Reconfiguration Commit	Radio Access Bearer Establishment Radio Access Bearer Release Physical Channel Reconfiguration Transport Channel Reconfiguration Radio Access Bearer Modification	RNC ⇒ Node B RNC ⇒ Node B RNC ⇒ Node B RNC ⇒ Node B RNC ⇒ Node B
Radio Link Reconfiguration Prepare	Radio Access Bearer Establishment Radio Access Bearer Release Physical Channel Reconfiguration Transport Channel Reconfiguration Radio Access Bearer Modification	RNC ⇒ Node B RNC ⇒ Node B RNC ⇒ Node B RNC ⇒ Node B RNC ⇒ Node B
Radio Link Reconfiguration Ready	Radio Access Bearer Establishment Radio Access Bearer Release Physical Channel Reconfiguration Transport Channel Reconfiguration Radio Access Bearer Modification	Node B ⇒ RNC Node B ⇒ RNC Node B ⇒ RNC Node B ⇒ RNC Node B ⇒ RNC
Radio Link Reconfiguration Request	Radio Access Bearer Establishment Radio Access Bearer Release Physical Channel Reconfiguration Transport Channel Reconfiguration	RNC ⇒ Node B RNC ⇒ Node B RNC ⇒ Node B RNC ⇒ Node B
Radio Link Reconfiguration Response	Radio Access Bearer Establishment Radio Access Bearer Release Physical Channel Reconfiguration Transport Channel Reconfiguration	Node B ⇒ RNC Node B ⇒ RNC Node B ⇒ RNC Node B ⇒ RNC
Radio Link Restore Indication	RRC Connection Establishment RRC Connection Re-establishment Soft Handover Hard Handover Channel and Mobile State Switching on lur	Node B ⇒ RNC Node B ⇒ RNC Node B ⇒ RNC Node B ⇒ RNC Node B ⇒ RNC
Radio Link Setup Request	RRC Connection Establishment RRC Connection Re-establishment Hard Handover Soft Handover USCH/DSCH Configuration and Capacity Allocation [TDD]	RNC ⇒ Node B RNC ⇒ Node B RNC ⇒ Node B RNC ⇒ Node B RNC ⇒ Node B
Radio Link Setup Response	RRC Connection Establishment RRC Connection Re-establishment Hard Handover Soft Handover USCH/DSCH Configuration and Capacity Allocation [TDD]	Node B ⇒ RNC Node B ⇒ RNC Node B ⇒ RNC Node B ⇒ RNC Node B ⇒ RNC
System Information Update Request	System Information Broadcasting Service Area Broadcast	RNC ⇒ Node B RNC ⇒ Node B
System Information Update Response	System Information Broadcasting Service Area Broadcast	Node B ⇒ RNC Node B ⇒ RNC
Radio Link Preemption Required Indication	RRC Connection Establishment	Node B ⇒ RNC
MBMS Notification Update	MBMS Notification	RNC ⇒ Node B

4.6 ALCAP

ALCAP is a generic name to indicate the protocol(s) used to establish data transport bearers on the Iu, Iur and Iub interfaces. ITU-T Rec. Q.2630.2 (Q.AAL2) [17] is one of the selected protocols to be used as ALCAP. Q.2630.2 adds new optional capabilities to ITU-T Rec. Q.2630.1 [18].

The following should be noted:

- data transport bearers may be dynamically established using ALCAP or preconfigured;
- transport bearers may be established before or after allocation of radio resources.

4.6.1 Q.2630.2 (Q.AAL2)

The following figure is showing an example of use of Q.2630.2 in the UTRAN context, for the different interfaces.

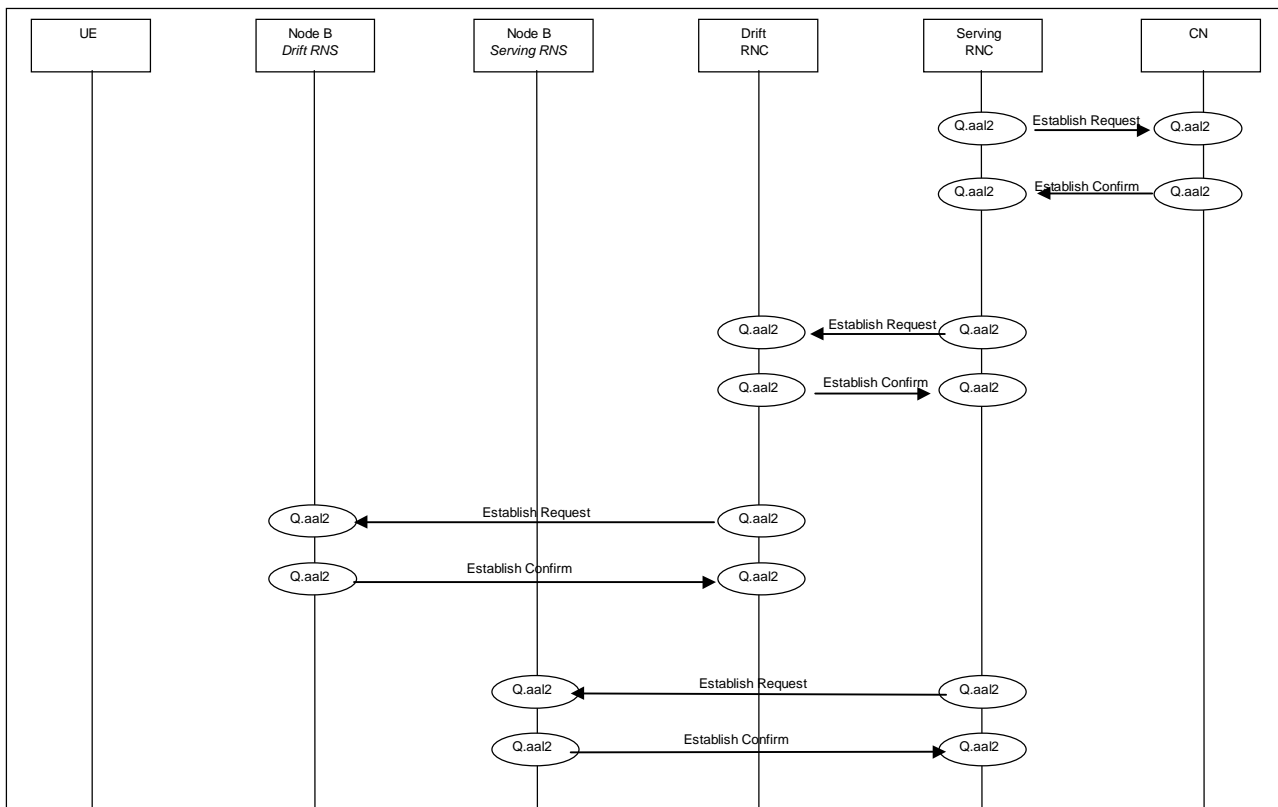

Figure 2: Example on Q.2630.2

4.7 RRC Procedures & Messages

For a detailed description of RRC procedures and messages refer to TS 25.331 [8]. Only Messages mentioned in the present document are shown. For each message is also given the list of example procedures where the message is used, as provided by this document.

Table 5

Message Name	UTRAN Procedure	Direction
Active Set Update	Soft Handover	RNC ⇒ UE
Active Set Update Complete	Soft Handover	UE ⇒ RNC
Cell Update	RRC Connection Re-establishment Cell Update	UE ⇒ RNC UE ⇒ RNC
Cell Update Confirm	RRC Connection Re-establishment Cell Update	RNC ⇒ UE RNC ⇒ UE
Direct Transfer	NAS Signalling Conn. Establishment	UE ⇔ RNC
Downlink Direct Transfer	Downlink Direct Transfer	RNC ⇒ UE
Initial Direct Transfer	NAS Signalling Connection Establishment	UE ⇒ RNC
Measurement Control	Downlink Power Control	RNC ⇒ UE
Measurement Report	Downlink Power Control	UE ⇒ RNC
Paging Type 1	Paging for a UE in RRC Idle Mode and RRC connected mode (CELL_PCH and URA_PCH states)Paging for a UE in RRC Connected Mode	RNC ⇒ UE
Paging Type 2	Paging for a UE in RRC Connected Mode (CELL_DCH and CELL_FACH states)	RNC ⇒ UE
Physical Channel Reconfiguration	Physical Channel Reconfiguration Hard Handover	RNC ⇒ UE RNC ⇒ UE
Physical Channel Reconfiguration Allocation	USCH/DSCH Configuration and Capacity Allocation [TDD]	RNC ⇒ UE
Physical Channel Reconfiguration Complete	Physical Channel Reconfiguration Hard Handover	UE ⇒ RNC UE ⇒ RNC
PUSCH Capacity Request	USCH/DSCH Configuration and Capacity Allocation [TDD]	UE ⇒ RNC
RB Reconfiguration	USCH/DSCH Configuration and Capacity Allocation [TDD]	RNC ⇒ UE
RB Reconfiguration Complete	USCH/DSCH Configuration and Capacity Allocation [TDD]	UE ⇒ RNC
RB Release	Radio Access Bearer Release	RNC ⇒ UE
RB Release Complete	Radio Access Bearer Release	UE ⇒ RNC
RB Setup	Radio Access Bearer Establishment	RNC ⇒ UE
RB Setup Complete	Radio Access Bearer Establishment	UE ⇒ RNC
RRC Connection Release	RRC Connection Release	RNC ⇒ UE
RRC Connection Release Complete	RRC Connection Release	UE ⇒ RNC
RRC Connection Request	RRC Connection Establishment.	UE ⇒ RNC
RRC Connection Setup	RRC Connection Establishment	RNC ⇒ UE
RRC Connection Setup Complete	RRC Connection Establishment	UE ⇒ RNC
System Information	System Information Broadcasting	Node B ⇒ UE
Transport Channel Reconfiguration	Physical Channel Reconfiguration	RNC ⇒ UE
Transport Channel Reconfiguration Complete	Physical Channel Reconfiguration	UE ⇒ RNC
UE Capability Information	NAS Signalling Conn. Establishment.	UE ⇒ RNC
Uplink Direct Transfer	Uplink Direct Transfer	UE ⇒ RNC
URA Update	Cell Update	UE ⇒ RNC
URA Update Confirm	Cell Update	RNC ⇒ UE
UTRAN Mobility Information Confirm	RRC Connection Re-establishment Cell Update URA Update	UE ⇒ RNC UE ⇒ RNC UE ⇒ RNC
Handover from UTRAN Command	UTRAN to GSM/BSS handover	RNC ⇒ UE
Handover to UTRAN Complete	GSM /BSS to UTRAN handover	UE ⇒ RNC
Cell Change Order from UTRAN	UMTS to GPRS Cell Reselection	RNC ⇒ UE
MBMS Modified Services Information	MBMS Notification (MCCH) MBMS Notification (DCCH)	RNC ⇒ UE
MBMS Unmodified Services Information	MBMS Notification	RNC ⇒ UE
MBMS Access Information	MBMS counting	RNC ⇒ UE
MBMS Common P-T-M RB information	MBMS P-T-M RB configuration	RNC ⇒ UE
MBMS Current Cell P-T-M RB Information	MBMS P-T-M RB configuration	RNC ⇒ UE
MBMS Neighbouring cell P-T-M RB Information	MBMS P-T-M RB configuration	RNC ⇒ UE
MBMS Modification Request	UE MBMS prioritisation	UE ⇒ RNC

4.8 BMC Procedures & Messages

For a detailed description of BMC procedures and messages refer to TR 25.925 [11] and TS 23.041 [12]. Only Messages mentioned in the present document are shown. For each message is also given the list of example procedures where the message is used, as provided by this document.

Table 6

Message Name	UTRAN Procedure	Direction
CBS Message	Service Area Broadcast	Node B ⇒ UE

4.9 DCH Frame Protocol Messages

For a detailed description of DCH Frame protocol messages refer to TS 25.427 [15]. Only Messages mentioned in the present document are shown. For each message is also given the list of example procedures where the message is used, as provided by this document.

Table 7

Message Name	UTRAN Procedure	Direction
Downlink Synchronisation	RRC Connection Establishment	SRNC ⇒ Node B
	Radio Access Bearer Establishment	SRNC ⇒ Node B
	Soft Handover	SRNC ⇒ Node B
Uplink Synchronisation	RRC Connection Establishment	Node B ⇒ SRNC
	Radio Access Bearer Establishment	Node B ⇒ SRNC
	Soft Handover	Node B ⇒ SRNC

4.10 DSCH Frame Protocol Messages

For a detailed description of DSCH Frame protocol messages refer to TS 25.425 [13]. Only Messages mentioned in the present document are shown. For each message is also given the list of example procedures where the message is used, as provided by this document.

Table 8

Message Name	UTRAN Procedure	Direction
DSCH Capacity Allocation	USCH/DSCH Configuration and Capacity Allocation [TDD]	DRNC ⇒ SRNC
DSCH Capacity Request	USCH/DSCH Configuration and Capacity Allocation [TDD]	SRNC ⇒ DRNC

4.11 USCH Frame Protocol Messages

For a detailed description of DSCH Frame protocol messages refer to TS 25.435 [14]. Only Messages mentioned in the present document are shown. For each message is also given the list of example procedures where the message is used, as provided by this document.

Table 9

Message Name	UTRAN Procedure	Direction
Dynamic PUSCH Assign	USCH/DSCH Configuration and Capacity Allocation [TDD]	RNC ⇒ Node B

5 UTRAN Signalling Procedures

The signalling procedures shown in the following sections do not represent the complete set of possibilities, nor do they mandate this kind of operation. The standard will specify a set of elementary procedures for each interface, which may

be combined in different ways in an implementation. Therefore these sequences are merely examples of a typical implementation.

The list of parameters is not be complete, but should only be seen as help for the understanding of the examples.

6 Procedures not related to a specific UE (global procedures)

This clause presents some signalling procedures not related to a specific UE.

6.1 System Information Broadcasting

This example shows an example of System Information broadcasting.

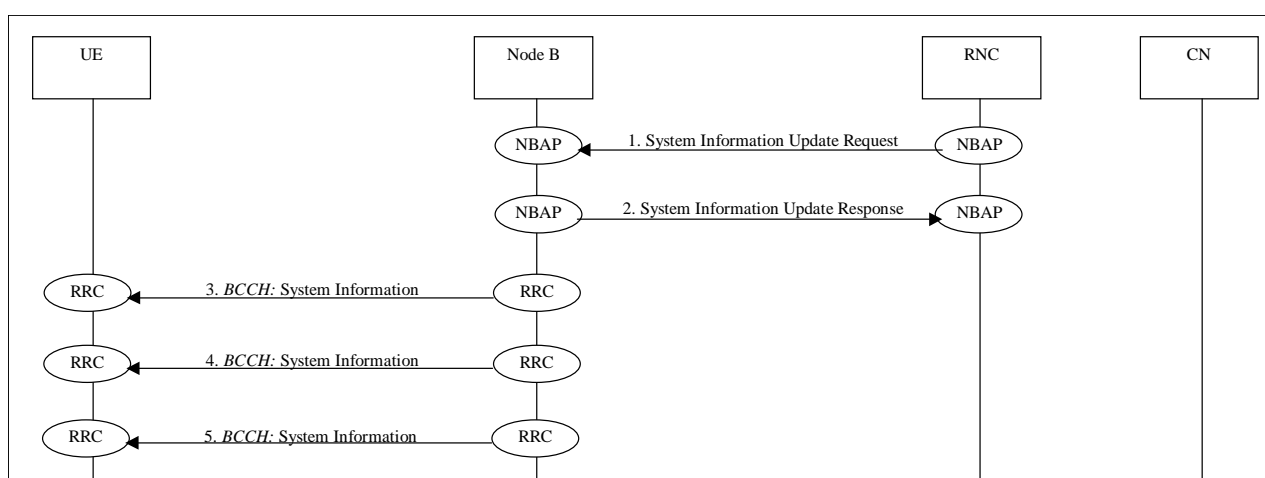

Figure 3: System Information Broadcasting

1. The RNC forwards the request to the pertinent node(s) B for via NBAP message **System Information Update Request**.
Parameters: Master/Segment Information Block(s) (System information to be broadcasted), BCCH modification time.
2. The Node B confirms the ability to broadcast the information sending **System Information Update Response** message to the RNC via NBAP. (If the Node B can not Broadcast the information as requested, System Information Update Failure is return to the RNC).
- 3./4./5. The information is broadcasted on the air interface by RRC message **System Information**.
Parameters: Master/Segment Information Block(s) (System information).

6.2 Service Area Broadcast

This example shows an example of broadcasting of Cell Information. UTRAN transports this broadcast information transparently.

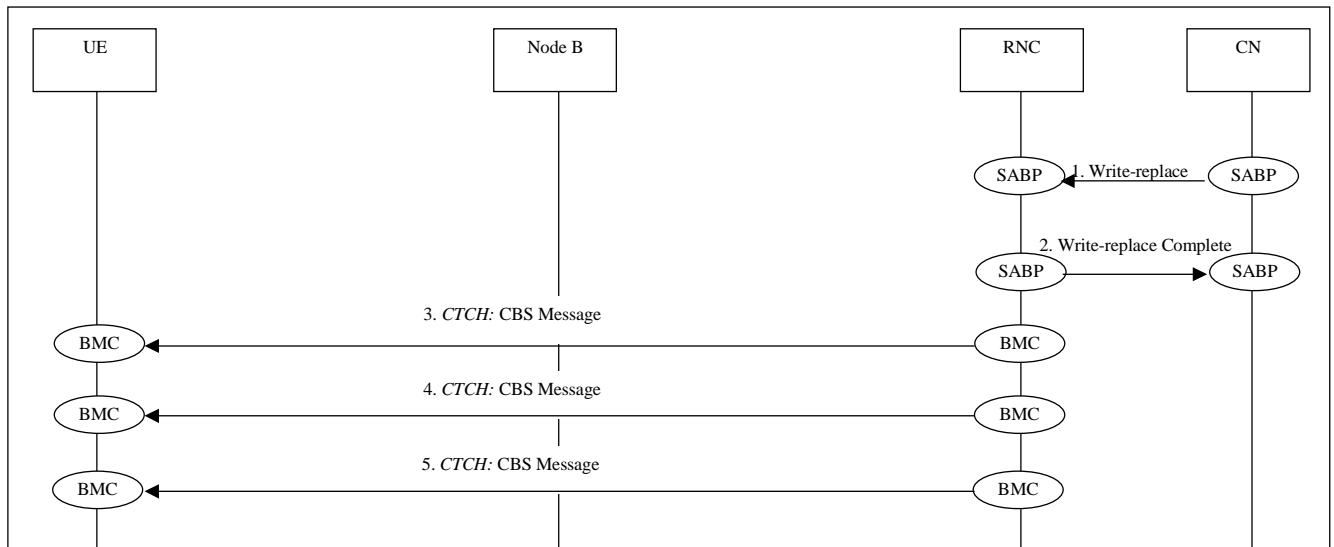

Figure 4: Service Area Broadcast

1. The CN asks the RNC for an information Broadcast via SABP message **Write-replace**.
Parameters: Broadcast-Message-Content, Service-Area-List.
2. The RNC confirm the ability to broadcast the information sending **Write-Replace Complete** message to the CN via SABP. (If the RNC can not Broadcast the information as requested, Write-replace Failure message is return to the CN).
- 3./4./5. The information is broadcasted on the air interface by BMC message **CBS Message**, carried over CTCH channel.
Parameters: Message ID, CB Data.

Note that the Node B is transparent to this messaging because (as mentioned in TS 25.324 [10], TR 25.925 [11] and TS 23.041 [12]) the BMC protocol is terminated in RNC (see also TS 25.301 [7]).

7 Procedures related to a specific UE

This clause presents a number of signalling procedures related to a specific UE.

7.1 Paging

This subclause presents two examples of Paging procedures for both the cases of a UE in RRC Idle Mode and RRC Connected Mode.

7.1.1 Paging for a UE in RRC Idle Mode and RRC connected mode (CELL_PCH and URA_PCH states)

This example shows how paging is performed for a UE in RRC Idle Mode. The UE may be paged for a CS or PS service. Since the UE is in RRC Idle Mode, the location is only known at CN level and therefore paging is distributed over a defined geographical area (e.g. LA).

NOTE: Example below illustrates scenario where LA spans across 2 RNCs.

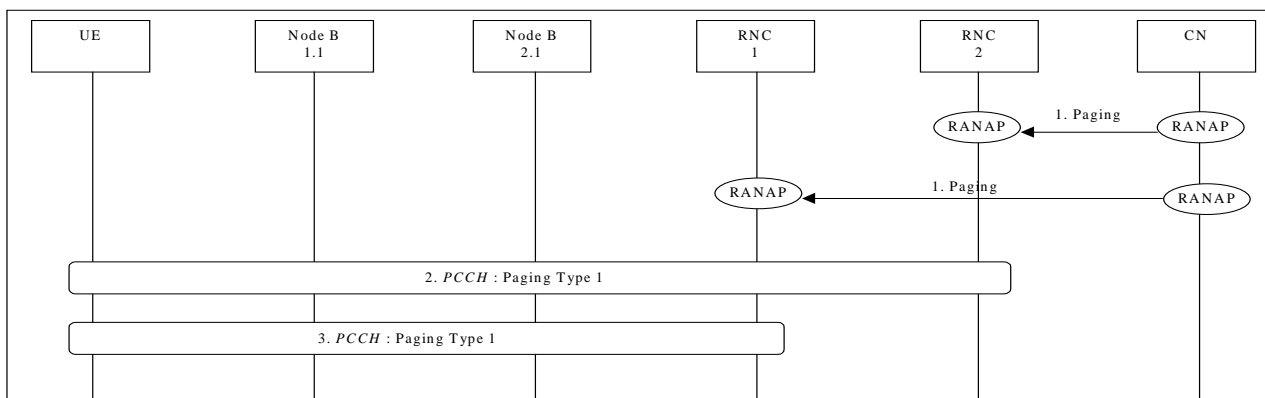

Figure 5: Paging for a UE in RRC Idle Mode

1. CN initiates the paging of a UE over a LA spanning two RNCs (i.e. RNC1 and RNC2) via RANAP message **Paging**.
Parameters: CN Domain Indicator, Permanent NAS UE Identity, Temporary UE Identity, Paging Cause.
2. Paging of UE performed by cell1 using **Paging Type 1** message.
3. Paging of UE performed by cell2 using **Paging Type 1** message.

The UE detects page message from RNC1 (as example) and the procedure for NAS signalling connection establishment follows. NAS message transfer can now be performed.

This procedure described for RRC idle mode, applies also to the RRC connected mode in the case of CELL_PCH and URA_PCH states.

7.1.2 Paging for a UE in RRC Connected Mode (CELL_DCH and CELL_FACH states)

This can occur in case of two core network domains, with the mobility management independent of each other. Two possible solutions exists:

- The UTRAN coordinates the paging request with the existing RRC connection.
- The UE coordinates the paging request with the existing RRC connection.

The following example shows how paging is performed for a UE in RRC Connected Mode (CELL_DCH and CELL_FACH states) when the UTRAN coordinates the paging request with the existing RRC connection using DCCH.

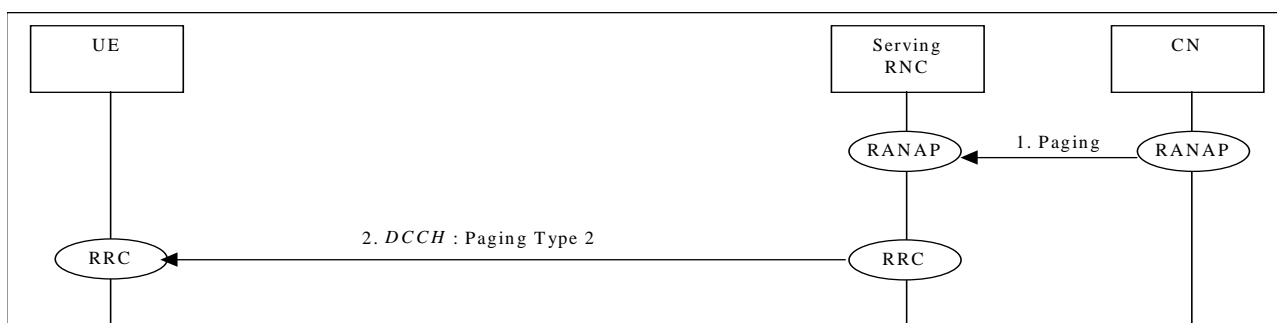

Figure 6: Paging for a UE in RRC Connected Mode (CELL_DCH and CELL_FACH states)

1. CN initiates the paging of a UE via RANAP message **Paging**.
Parameters: CN Domain Indicator, Permanent NAS UE Identity, Temporary UE Identity, Paging Cause.
2. SRNC sends RRC message **Paging Type 2**.

7.2 NAS Signalling Connection Establishment

This example shows establishment of a NAS Signalling Connection.

This establishment could be request by the terminal by itself (for example to initiate a service) or could be stimulated by a paging from the CN.

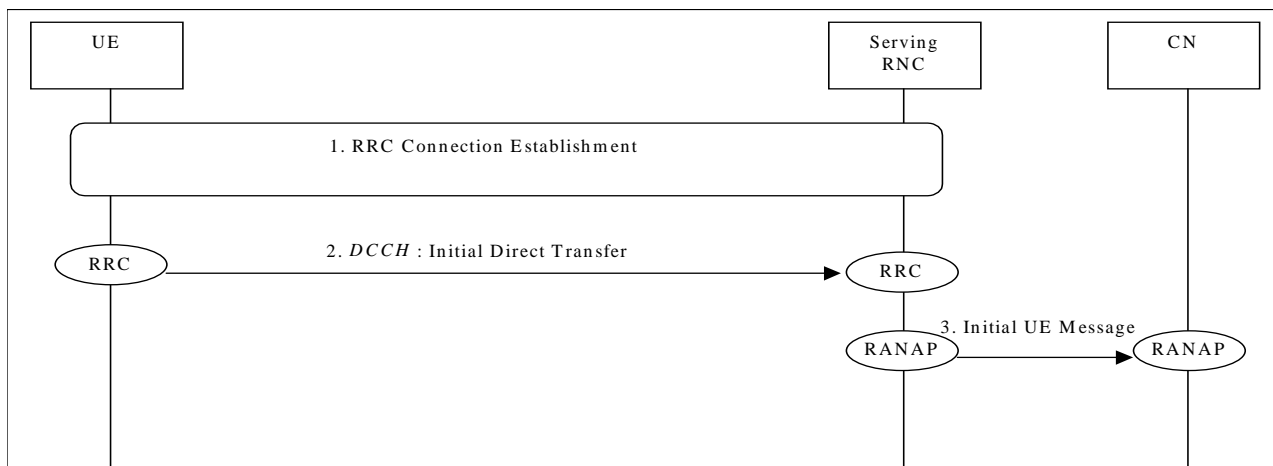

Figure 7: NAS Signalling Connection Establishment

1. RRC Connection is established (see 7.3.1 or 7.3.2).
2. UE sends RRC **Initial Direct Transfer** to SRNC.
Parameters: Initial NAS Message (could for a GSM based CN be e.g. CM Service Request, Location Update Request etc.) CN node indicator (it indicates the correct CN node into which the NAS message shall be forwarded).
3. SRNC initiates signalling connection to CN, and sends the RANAP message **Initial UE Message**.
Parameters: NAS PDU (could for a GSM based CN be e.g. CM Service Request, Location Update Request etc.), CN domain indicator (indicating the CN domain towards which this message is sent).

The NAS signalling connection between UE and CN can now be used for NAS message transfer.

7.3 RRC Connection Establishment

The following examples show establishment of a RRC connection either in dedicated transport channel (DCH) state or in common transport channel (RACH/FACH) state.

7.3.1 DCH Establishment

This example shows establishment of an RRC connection in dedicated transport channel (DCH) state.

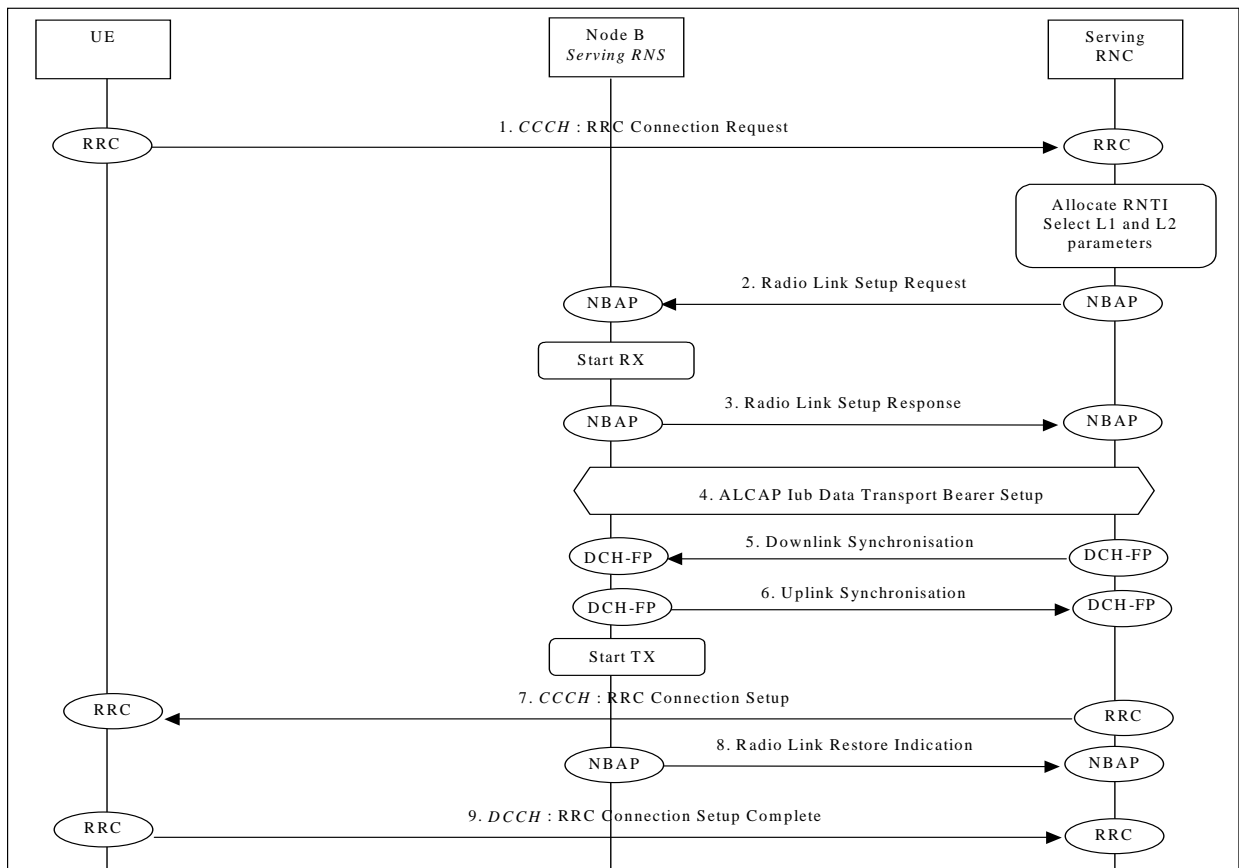

Figure 8: RRC Connection Establishment - DCH Establishment

1. The UE initiates set-up of an RRC connection by sending **RRC Connection Request** message on CCCH. Parameters: Initial UE Identity, Establishment cause.
2. The SRNC decides to use a DCH for this RRC connection, allocates U-RNTI and radio resources for the RRC connection. When a DCH is to be set-up, NBAP message **Radio Link Setup Request** is sent to Node B. Parameters: Cell id, Transport Format Set, Transport Format Combination Set, frequency, UL scrambling code [FDD], Time Slots [TDD], User Codes [TDD], Power control information.
3. Node B allocates resources, starts PHY reception, and responds with NBAP message **Radio Link Setup Response**. Parameters: Signalling link termination, Transport layer addressing information (AAL2 address, AAL2 Binding Identity) for the Iub Data Transport Bearer.
4. SRNC initiates set-up of Iub Data Transport bearer using ALCAP protocol. This request contains the AAL2 Binding Identity to bind the Iub Data Transport Bearer to the DCH. The request for set-up of Iub Data Transport bearer is acknowledged by Node B.
- 5./6. The Node B and SRNC establish synchronism for the Iub and Iur Data Transport Bearer by means of exchange of the appropriate DCH Frame Protocol frames **Downlink Synchronisation** and **Uplink Synchronisation**. Then Node B starts DL transmission.
7. Message **RRC Connection Setup** is sent on CCCH from SRNC to UE. Parameters: Initial UE Identity, U-RNTI, Capability update Requirement, Transport Format Set, Transport Format Combination Set, frequency, DL scrambling code [FDD], Time Slots [TDD], User Codes [TDD], Power control information.
8. Node B achieves uplink sync and notifies SRNC with NBAP message **Radio Link Restore Indication**.
9. Message **RRC Connection Setup Complete** is sent on DCCH from UE to SRNC. Parameters: Integrity information, ciphering information, UE radio access capability.

7.3.2 RACH/FACH Establishment

This example shows establishment of an RRC connection on the RACH/FACH common transport channel. A prerequisite for this example is that the necessary Iub Data Transport bearer for the RACH/FACH is established prior to this procedure.

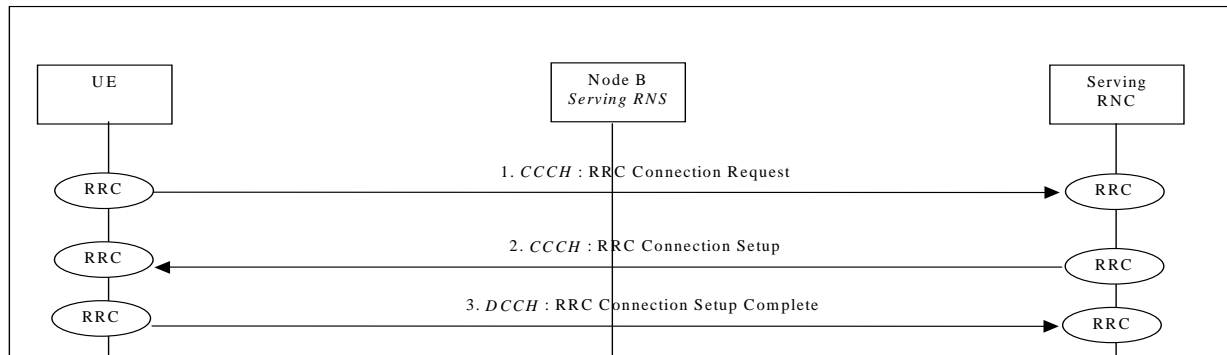

Figure 8b: RRC Connection Establishment – RACH/FACH Establishment

1. The UE initiates set-up of an RRC connection by sending **RRC Connection Request** message on CCCH.
Parameters: Initial UE Identity, Establishment cause.
2. The SRNC decides to use RACH/FACH for this RRC connection and allocates both U-RNTI and C-RNTI identifiers. Message **RRC Connection Setup** is sent on CCCH.
Parameters: Initial UE Identity, U-RNTI, C-RNTI, Capability update Requirement, frequency (optionally).
3. UE sends **RRC Connection Setup Complete** on a DCCH logical channel mapped on the RACH transport channel.
Parameters: Integrity information, ciphering information, UE radio access capability.

7.3.3 DCH Establishment with Pre-emption

This example shows the establishment of an RRC Connection in dedicated transport channel (DCH) state with pre-emption of resources as a result of Node B Admission Control. This assumes that the RL(s) pre-empted are the only RL(s) for a RAB that is released.

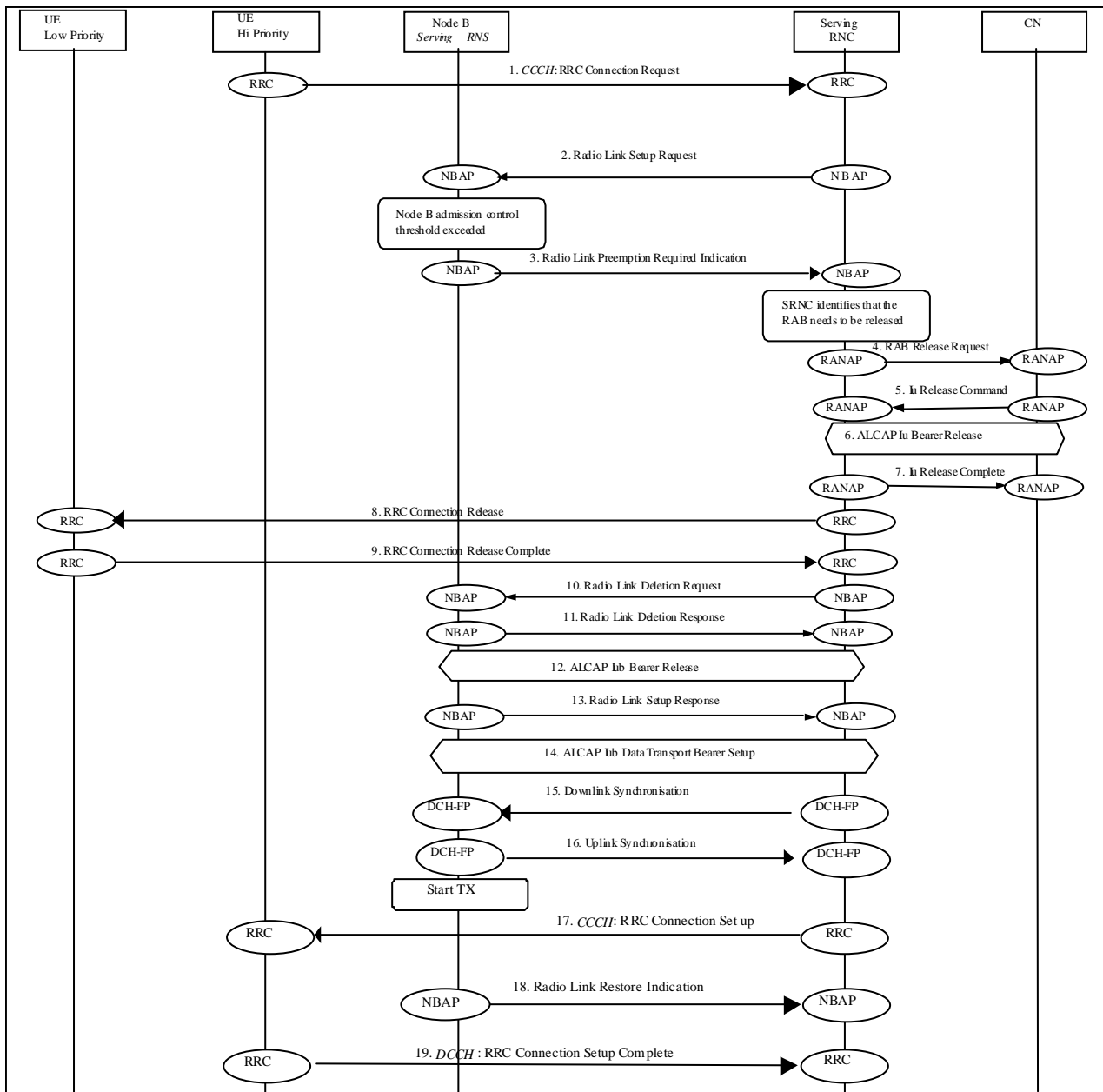

Figure 8c RRC Connection Establishment - DCH Establishment with pre-emption

1. See 7.3.1 Item 1.
2. When a DCH is to be set-up, NBAP message Radio Link Setup Request is sent to the Node B.
3. Node B attempts to allocate resources, but is unable to and responds with NBAP message **Radio Link Preemption Required Indication**, and starts the $T_{preempt}$ timer.
Parameters: RLInformation IE.
4. The SRNC pre-empts a RL and may send a RANAP message **RAB Release Request** to the CN.
Cause: RAB Pre-empted
5. If the CN agrees to the release of the dedicated Channel it sends the message **Iu Release Command** to the SRNC.
6. The SRNC initiates release of the Iu Data Transport bearer using ALCAP protocol.
7. The SRNC confirms the release by sending a **Iu Release Complete** message to the CN.
8. Message **RRC Connection Release** from SRNC to UE initiates the RRC connection release.
Parameters: Release Cause - Pre-emptive release
9. Message **RRC Connection Release Complete** from the UE to SRNC to confirm the RRC connection release.
10. The SRNC initiates the release of the link by sending **Radio Link Deletion** to the Node B. The Node B stops the $T_{preempt}$ timer.
11. The Node B confirms the release of the link by sending the **Radio Link Deletion Response** to the SRNC
12. The Node B initiates release of the Iub Data Transport Bearer using ALCAP protocol.

13. The Node B responds to Item 2 with NBAP message **Radio Link Setup Response**.
14-20 See 7.3.1 Items 4-9

7.4 RRC Connection Release

The following examples show RRC connection release either of a dedicated channel (DCH) or of a common transport channel (RACH/FACH).

7.4.1 DCH Release

This example shows RRC Connection release of a dedicated channel, in the case of macrodiversity on two nodes B, the first one connected to the Serving RNC, the second one to the Drift RNC.

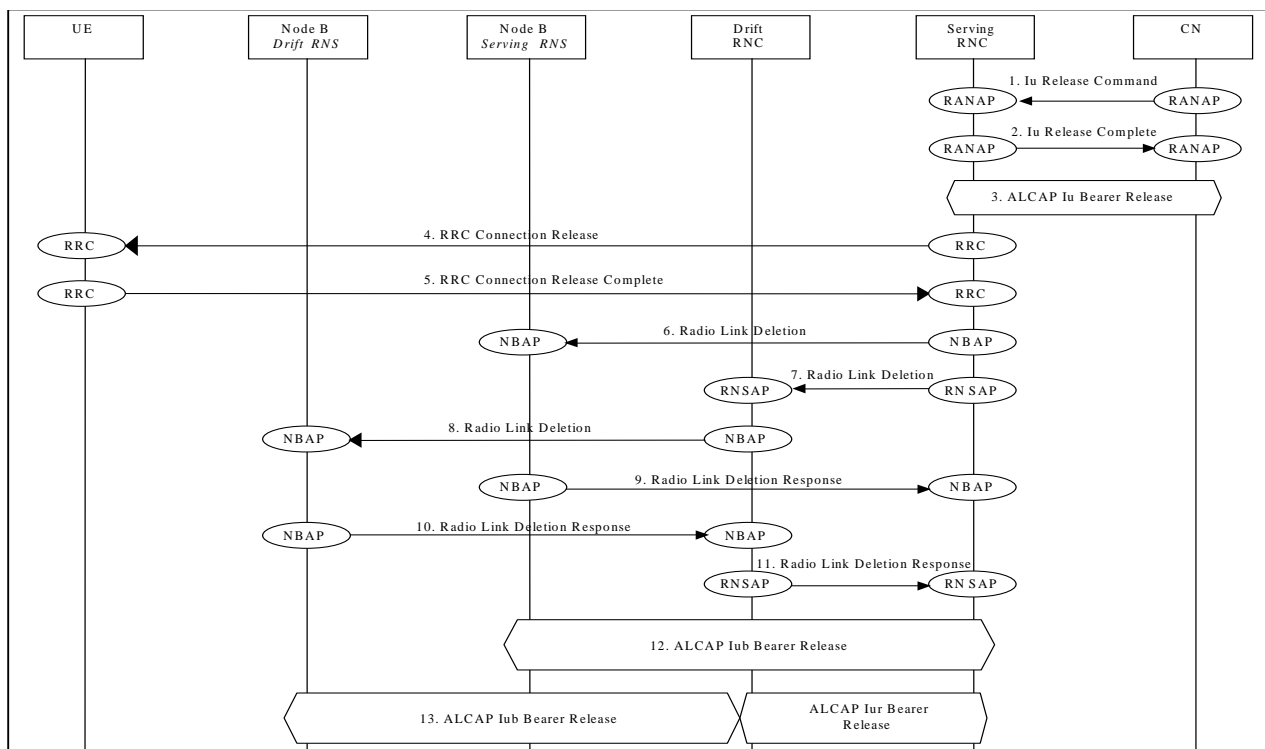

Figure 9: RRC Connection release of a dedicated channel

1. The CN initiates the release of a dedicated Channel by sending the message **Iu Release Command** to the SRNC.
Parameters: Cause.
2. The SRNC confirms the release by sending a **Iu Release Complete** message to the CN.
Parameters: Data volume Report (if data volume reporting to PS is required).
3. The SRNC initiates release of Iu Data Transport bearer using ALCAP protocol.
4. Message **RRC Connection Release** from SRNC to UE to initiate the RRC connection release.
Parameters: Cause.
5. Message **RRC Connection Release Complete** from UE to SRNC to confirm the RRC connection release.
6. The SRNC initiates the release of the link by sending the **Radio Link Deletion** to the Node B (SRNC).
7. The SRNC initiates the release of the link by sending the **Radio Link Deletion** to the Drift RNC.
8. The Drift RNC initiates the release of the link by sending the **Radio Link Deletion** to the Node B (Drift RNC).
9. The Node B (SRNC) confirms the release of the link by sending the **Radio Link Deletion Response** to the SRNC.

10. The Node B (Drift RNC) confirms the release of the link by sending the **Radio Link Deletion Response** to the Drift RNC.
11. The Drift RNC confirms the release of the link by sending the Radio Link Deletion Response to the SRNC.
12. The Node B (SRNC) initiates release of Iub Data Transport bearer using ALCAP protocol.
13. The Node B (Drift RNC) initiates release of Iub Data Transport bearer using ALCAP protocol.
14. The Drift RNC initiates release of Iur Data Transport bearer using ALCAP protocol.

7.4.2 Common Transport Channel Release

This example shows RRC Connection release of a common transport channel.

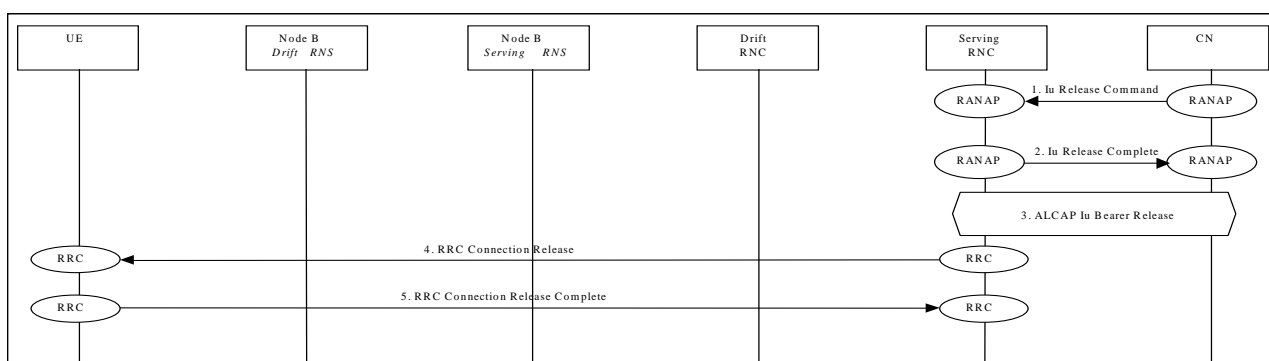

Figure 10: RRC Connection release of a common transport channel

1. The CN initiates the release of a dedicated Channel by sending the message **Iu Release Command** to the SRNC.
Parameters: Cause.
2. The SRNC confirms the release by sending a **Iu Release Complete** message to the CN.
Parameters: Data volume Report (if data volume reporting to PS is required).
3. The SRNC initiates release of Iu Data Transport bearer using ALCAP protocol.
4. Message **RRC Connection Release** from SRNC to UE to initiate the RRC connection release.
Parameters: Cause.
5. Message **RRC Connection Release Complete** from UE to SRNC to confirm the RRC connection release.

7.5 RRC Connection Re-establishment

The following examples show re-establishment of a RRC connection either on a dedicated channel (DCH) Examples of RRC Connection Re-establishment on a common channel (RACH/FACH) are found in the “Cell Update” section of this document.

7.5.1 DCH Re-establishment

7.5.1.1 RRC connection Re-establishment (Anchor approach) – DCH Re-establishment

This example shows re-establishment of a RRC connection in dedicated transport channel (DCH) state.

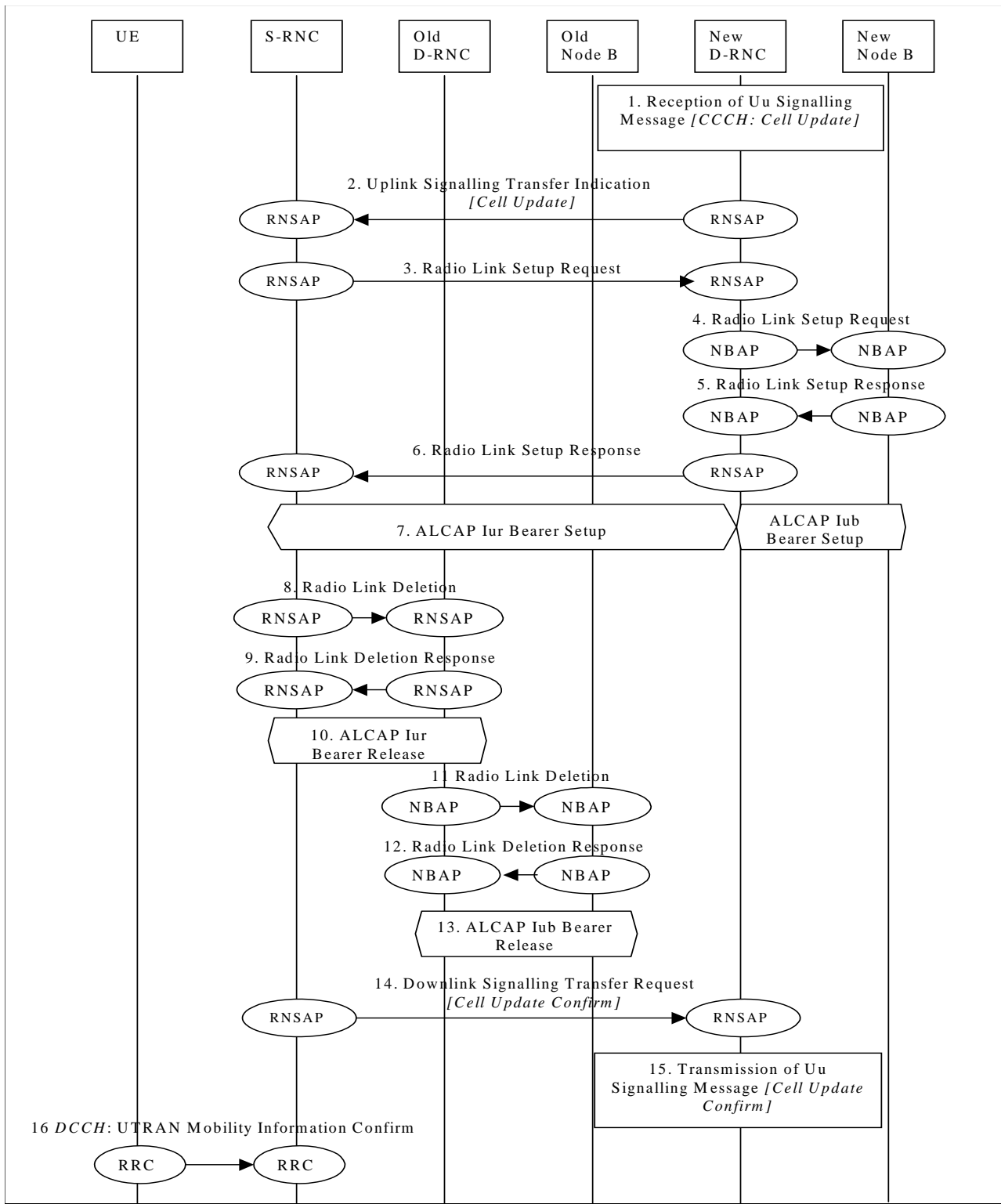

Figure 11: RRC connection Re-establishment (Anchor approach) – DCH Re-establishment

1. The UE initiates the re-establishment of the RRC connection with the new cell by sending Cell Update message on CCCH.
2. The new RNC delivers this message transparently as **Uplink Signalling Transfer Indication** message to the serving RNC, the RNSAP delivers it to the RRC.
3. The serving RNC allocates radio resources for the RRC connection on Iur, and sends the RNSAP message **Radio Link Setup Request** to the target RNC.

4. The target RNC sends the NBAP message **Radio Link Setup Request** to the target Node B.
5. Node B allocates resources, and responds with NBAP message **Radio Link Setup Response**.
6. Target RNC responds with RNSAP message **Radio Link Setup Response**.
7. Serving RNC initiates set-up of Iur / Iub Data Transport bearer using ALCAP protocol. This request contains the AAL2 Binding Identity to bind the Iur / Iub Data Transport Bearer to the DCH. The request for set-up of Iur / Iub Data Transport bearer is acknowledged by target RNC / Node B.
- 8./9./10./11./12./13. The SRNC initiates release of Iur/Iub Data Transport bearer using ALCAP protocol and also release of Iur/Iub Radio resource using RNSAP / NBAP protocols.
14. The RRC in the serving RNC prepare a RRC Connection Re-establishment message and the RNSAP sends it in the transparent message **Downlink Signalling Transfer Request** to the new CRNC.
15. The New CRNC delivers the **Cell Update Confirm** message on CCCH.
16. Message **UTRAN Mobility Information Confirm** is sent on the new DCCH from the UE to the serving RNC.

7.5.1.2 RRC Connection Re-establishment with SRNC Relocation - DCH Re-establishment

This subclause shows an example for the RRC Connection Re-establishment procedure, in dedicated transport channel (DCH) state.

It is assumed that a signalling link is available on the Iur, but no DCH is established on this interface.

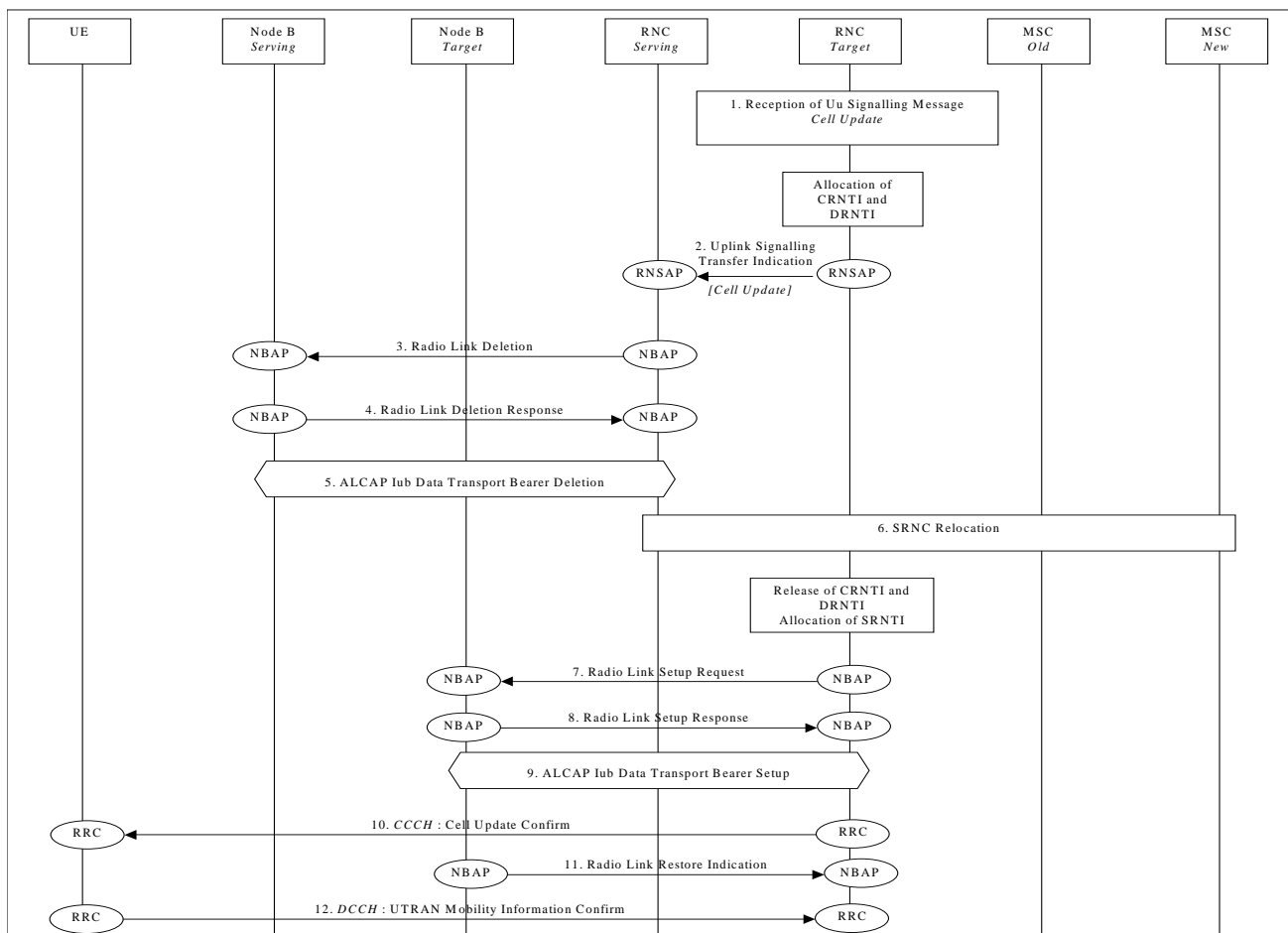

Figure 12: RRC Connection Re-establishment with SRNC Relocation - DCH Re-establishment

1. The UE initiates the re-establishment of the RRC connection with the new cell by sending **Cell Update** message on CCCH. The message is received by the Target RNC.
2. The target RNC delivers the received message transparently as **Uplink Signalling Transfer Indication** message to the serving RNC.
3. The Serving RNC sends NBAP message **Radio Link Deletion** to Node B.
Parameters: Cell id, Transport layer addressing information.
4. Node B deallocates radio resources. Successful outcome is reported in NBAP message **Radio Link Deletion Response**.
5. The SRNC initiates release of Iub Data Transport bearer using ALCAP protocol.
6. SRNC relocation procedure is triggered by the reception of the message **Cell Update** embedded in the RNSAP **Uplink Signalling Transfer Indication** message (relocation is performed in parallel with Radio Link release).
7. The target RNC (new SRNC) allocates RNTI and radio resources for the RRC connection, and sends the NBAP message **Radio Link Setup Request** to the target Node B.
Parameters: Cell id, Transport Format Set, Transport Format Combination Set, frequency, UL scrambling code [FDD], Time Slots [TDD], User Codes [TDD], Power control information.
8. Target Node B allocates resources, starts PHY reception, and responses with NBAP message **Radio Link Setup Response**.
Parameters: Signalling link termination, Transport layer addressing information for the Iub Data Transport Bearer.
9. Target RNC (new SRNC) initiates set-up of Iub Data Transport bearer using ALCAP protocol. This request contains the AAL2 Binding Identity to bind the Iub Data Transport Bearer to the DCH. The request for set-up of Iub Data Transport bearer is acknowledged by Node B.
10. Message **Cell Update Confirm** is sent on CCCH from target RNC (new SRNC) to UE.
Parameters: Old RNTI, New RNTI, Transport Format Set, Transport Format Combination Set, frequency, DL scrambling code [FDD], Time Slots [TDD], User Codes [TDD]
11. Target Node B achieves uplink sync on the Uu and notifies SRNC with NBAP message **Radio Link Restore Indication**.
12. Message **UTRAN Mobility Info Confirm** is sent on the new DCCH from the UE to the Target RNC (new SRNC).

NOTE 1: SRNC Relocation execution is performed asynchronously with respect to the RL deletion procedure (step 3/4).

NOTE 2: Whether SRNC Relocation involves two MSCs (as depicted in the figure) or a single one, has no impact on the UTRAN message flow shown in this example.

7.6 Radio Access Bearer Establishment

The following examples show establishment of a radio access bearer on a dedicated channel (DCH) or on a common transport channel (RACH/FACH) when the RRC connection already support a radio access bearer either on a dedicated channel (DCH) or on a common transport channel (RACH/FACH).

7.6.1 DCH - DCH Establishment - Synchronised

This example shows establishment of a radio access bearer (DCH) in dedicated transport channel (DCH) RRC state.

[FDD-The UE communicates via two Nodes B. One Node B is controlled by SRNC, one Node B is controlled by DRNC].

[TDD – The Nodes B shown in the figure are mutually exclusive in TDD mode.].

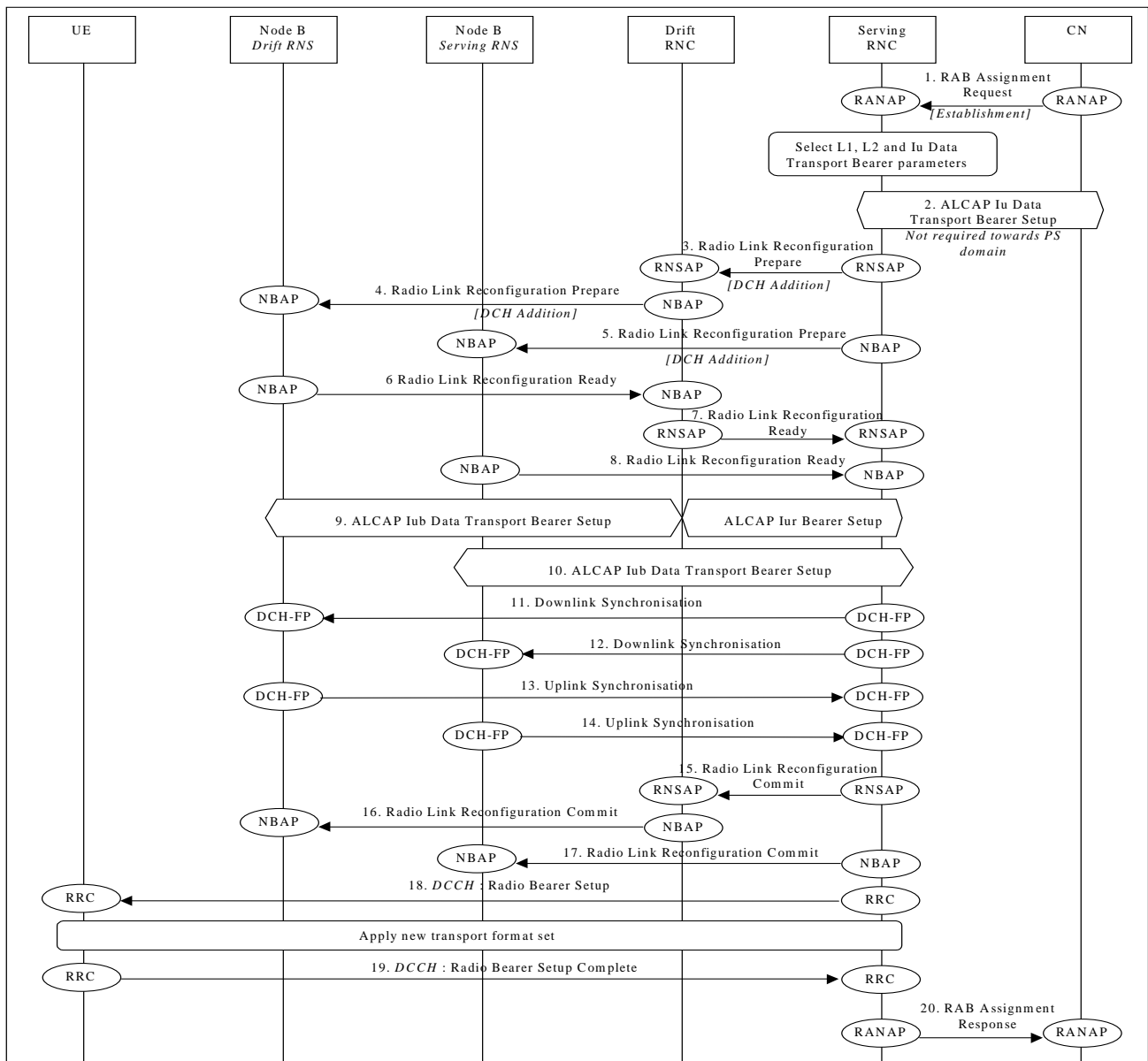

Figure 13: Radio Access Bearer Establishment - DCH - DCH Establishment - Synchronised

1. CN initiates establishment of the radio access bearer with RANAP message **Radio Access Bearer Assignment Request**.
Parameters: Radio Access Bearer parameters, User Plane Mode, Transport Address, Iu Transport Association.
2. SRNC initiates set-up of Iu Data Transport bearer using ALCAP protocol. This request contains the AAL2 Binding Identity to bind the Iu Data Transport Bearer to the Radio Access Bearer (this step is not required towards PS domain).
3. SRNC requests DRNC to prepare establishment of DCH to carry the radio access bearer (**Radio Link Reconfiguration Prepare**).
Parameters: Transport Format Set, Transport Format Combination Set, Power control information, instructions for DCH mapping on Iub Data Transport Bearers.
4. DRNC requests its Node B to prepare establishment of DCH to carry the radio access bearer (**Radio Link Reconfiguration Prepare**).
Parameters: Transport Format Set, Transport Format Combination Set, Power control information.
5. SRNC requests its Node B to prepare establishment of DCH to carry the radio access bearer (**Radio Link Reconfiguration Prepare**).
Parameters: Transport Format Set, Transport Format Combination Set, Power control information, Time Slots [TDD], User Codes [TDD].

6. Node B allocates resources and notifies DRNC that the preparation is ready (**Radio Link Reconfiguration Ready**).
Parameters: Transport layer addressing information (AAL2 address, AAL2 Binding Id) for Iub Data Transport Bearer.
7. DRNC notifies SRNC that the preparation is ready (**Radio Link Reconfiguration Ready**).
Parameters: Transport layer addressing information (AAL2 address, AAL2 Binding Id) for Iub Data Transport Bearer.
8. Node B allocates resources and notifies SRNC that the preparation is ready (**Radio Link Reconfiguration Ready**).
Parameters: Transport layer addressing information (AAL2 address, AAL2 Binding Id) for Iub Data Transport Bearer.
9. SRNC initiates setup of Iur/Iub Data Transport Bearer using ALCAP protocol. This request contains the AAL2 Binding Identity to bind the Iur/Iub Data Transport Bearer to DCH.
10. SRNC initiates setup of Iub Data Transport Bearer using ALCAP protocol. This request contains the AAL2 Binding Identity to bind the Iub Data Transport Bearer to DCH.
- 11./12./13./14. The Nodes B and SRNC establish synchronism for the Iub and Iur Data Transport Bearer by means of exchange of the appropriate DCH Frame Protocol frames **Downlink Synchronisation** and **Uplink Synchronisation**.
15. RNSAP message **Radio Link Reconfiguration Commit** is sent from SRNC to DRNC.
Parameters:
16. NBAP message **Radio Link Reconfiguration Commit** is sent from DRNC to Node B.
Parameters:
17. NBAP message **Radio Link Reconfiguration Commit** is sent from SRNC to Node B.
Parameters:
18. RRC message **Radio Access Bearer Setup** is sent by SRNC to UE.
Parameters: Transport Format Set, Transport Format Combination Set, Time Slots [TDD], User Codes [TDD].
19. UE sends RRC message **Radio Access Bearer Setup Complete** to SRNC.
20. SRNC sends RANAP message **Radio Access Bearer Assignment Response** to CN.

7.6.2 DCH - DCH Establishment - Unsynchronised

This example shows the establishment of a radio access bearer (DCH) in dedicated transport channel (DCH) RRC state. The UE communicates via two Nodes B. One Node B is controlled by SRNC, one Node B is controlled by DRNC. The reconfiguration time does not require to be synchronised among Node-Bs, SRNC and UE.

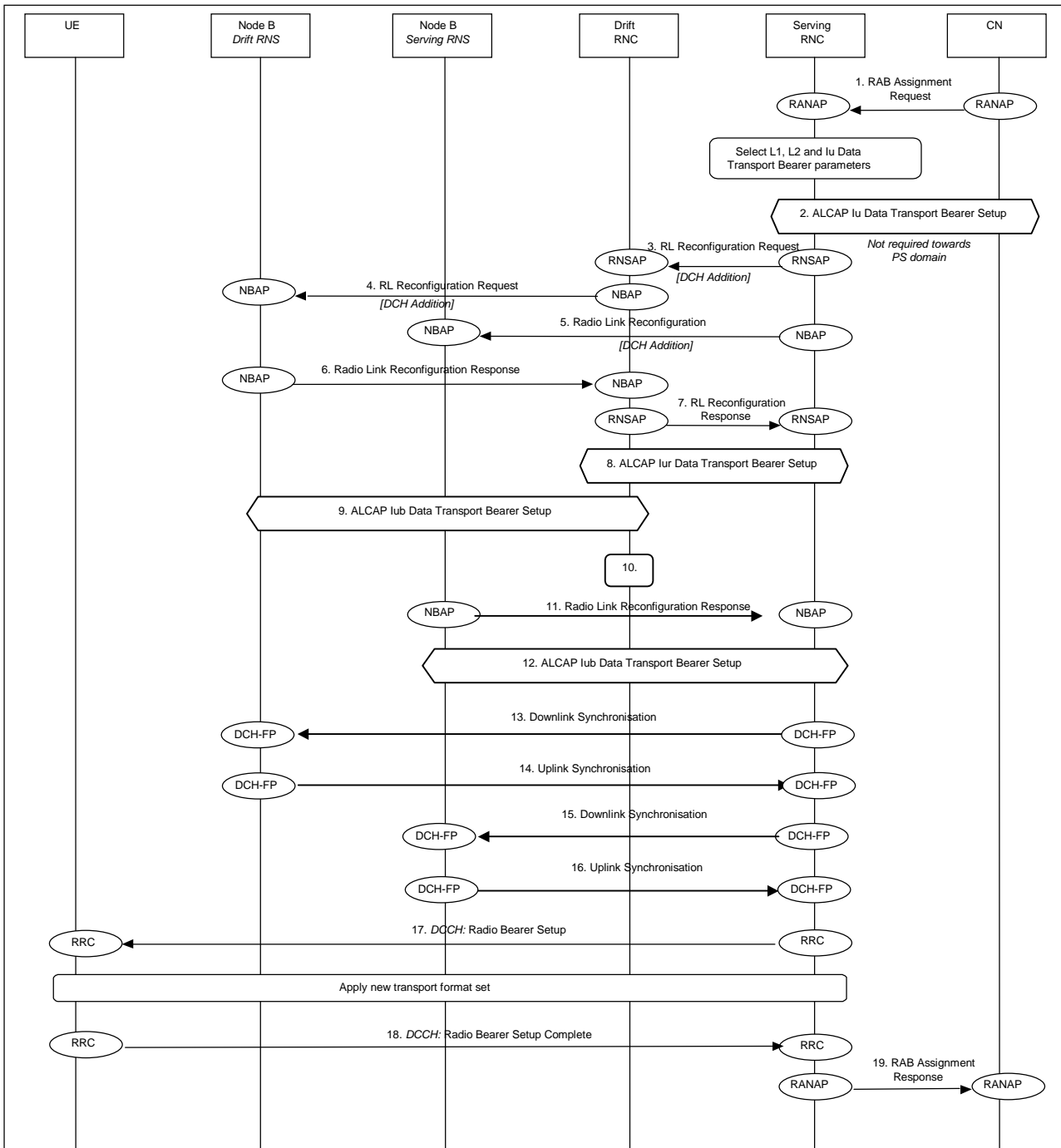

Figure 14: Radio Access Bearer Establishment - DCH - DCH Establishment – Unsynchronised

1. CN initiates establishment of the radio access bearer with RANAP **Radio Access Bearer Assignment Request** message.
Parameters: radio access bearer parameters, User Plane Mode, Transport Address, Iu Transport Association.
2. SRNC performs mapping of the radio access bearer QoS parameters to AAL2 link characteristics and initiates set-up of Iu Data Transport bearer using ALCAP protocol (this step is not required towards PS domain).
Parameters: Served User Generated Reference, AAL2 link characteristics ...
3. SRNC decided that there are no need for a synchronous RL reconfiguration, and requests DRNC to setup a new DCH sending the **RL Reconfiguration Request** message. The modification shall be done immediately without waiting for the command message.
Parameters: Bearer ID, Transport Format Set, Transport Format Combination Set, Power control information.

4. DRNC requests its Node B to establish of a new DCH in the existing Radio Link sending the **RL Reconfiguration Request** message.
Parameters: Bearer ID, Transport Format Set, Transport Format Combination Set, Power control information.
5. SRNC requests its Node B setup a new DCH in the existing Radio Link sending the **RL Reconfiguration Request** message.
Parameters: Bearer ID, Transport Format Set, Transport Format Combination Set, Power control information.
6. Node B allocates resources and notifies DRNC that the setup is done sending the **RL Reconfiguration Response** message.
Parameters: Transport layer addressing information (AAL2 address, AAL2 Binding Id) for Iub Data Transport Bearer.
7. DRNC notifies SRNC that the setup is done sending the **RL Reconfiguration Response** message.
Parameters: Transport layer addressing information (AAL2 address, AAL2 Binding Id) for Iub Data Transport Bearer.
8. SRNC initiates setup of Iur Data Transport Bearer using ALCAP protocol. This request contains the AAL2 Binding Identity to bind the Iur Data Transport Bearer to DCH.
9. SRNC initiates setup of Iub Data Transport Bearer using ALCAP protocol. This request contains the AAL2 Binding Identity to bind the Iub Data Transport Bearer to DCH.
10. DRNC performs bridging of Iub and Iur Data Transport bearers.
11. Node B allocates resources and notifies SRNC that the setup is sending the **RL Reconfiguration Response**.
Parameters: Transport layer addressing information (AAL2 address, AAL2 Binding Id) for Iub Data Transport Bearer.
12. SRNC initiates setup of Iub Data Transport Bearer using ALCAP protocol. This request contains the AAL2 Binding Identity to bind the Iub Data Transport Bearer to DCH.
- 13./14./15./16. The Nodes B and SRNC establish synchronism for the Iub and Iur Data Transport Bearer by means of exchange of the appropriate DCH Frame Protocol frames **Downlink Synchronisation** and **Uplink Synchronisation**.
17. RRC message **Radio Bearer Setup** is sent by SRNC to UE.
Parameters: Transport Format Set, Transport Format Combination Set.
18. UE sends RRC message **Radio Bearer Setup Complete** to SRNC.
19. SRNC sends RANAP message Radio Access Bearer Assignment Response to CN.
Parameters: Transport Address (Always for PS domain; for CS domain only if modified), Iu Transport Association (Always for PS domain; for CS domain only if modified).

7.6.3 RACH/FACH - DCH Establishment

This example shows the establishment of a radio access bearer (DCH) in common transport channel (RACH/FACH) RRC State.

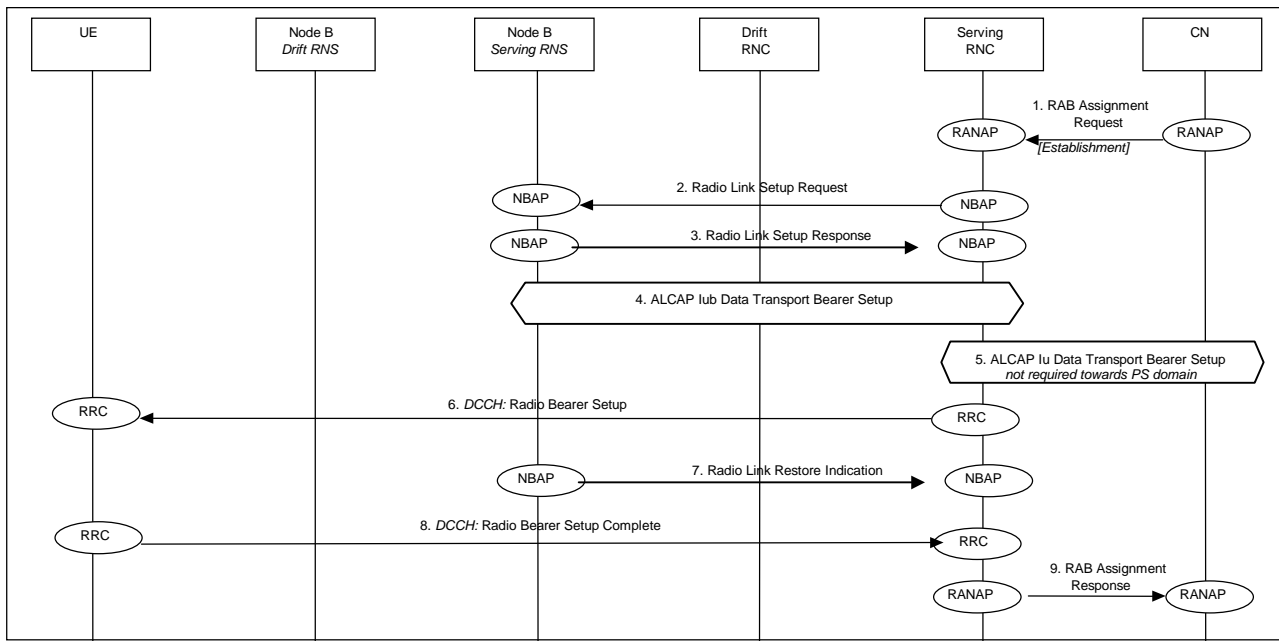

Figure 15: Radio Access Bearer Establishment – RACH/FACH - DCH Establishment – Unsynchronised

1. CN initiates establishment of the radio access bearer with RANAP **Radio Access Bearer Assignment Request** message.
Parameters: radio access bearer parameters, User Plane Mode, Transport Address, Iu Transport Association.
2. DRNC requests its Node B to establish of a new DCH in the existing Radio Link sending the **Radio Link Setup Request** message.
Parameters: Transport Format Set, Transport Format Combination Set, Power control information.
3. Node B allocates resources and notifies SRNC that the setup is sending the **Radio Link Setup Response**.
Parameters: Transport layer addressing information (AAL2 address, AAL2 Binding Id) for Iub Data Transport Bearer.
4. SRNC initiates setup of Iub Data Transport Bearer using ALCAP protocol. This request contains the AAL2 Binding Identity to bind the Iub Data Transport Bearer to DCH.
5. SRNC performs mapping of the radio access bearer QoS parameters to AAL2 link characteristics and initiates set-up of Iu Data Transport bearer using ALCAP protocol (this step is not required towards PS domain)
6. RRC message **Radio Bearer Setup** is sent by SRNC to UE.
Parameters: Transport Format Set, Transport Format Combination Set.
7. Node B achieves uplink sync and notifies SRNC with NBAP message **Radio Link Restore Indication**.
8. UE sends RRC message **Radio Bearer Setup Complete** to SRNC.
9. SRNC sends RANAP message **Radio Access Bearer Assignment Response** to CN.

7.6.4 RACH/FACH - RACH/FACH Establishment

This example shows the establishment of a radio access bearer (RACH/FACH) in common transport channel (RACH/FACH) RRC state.

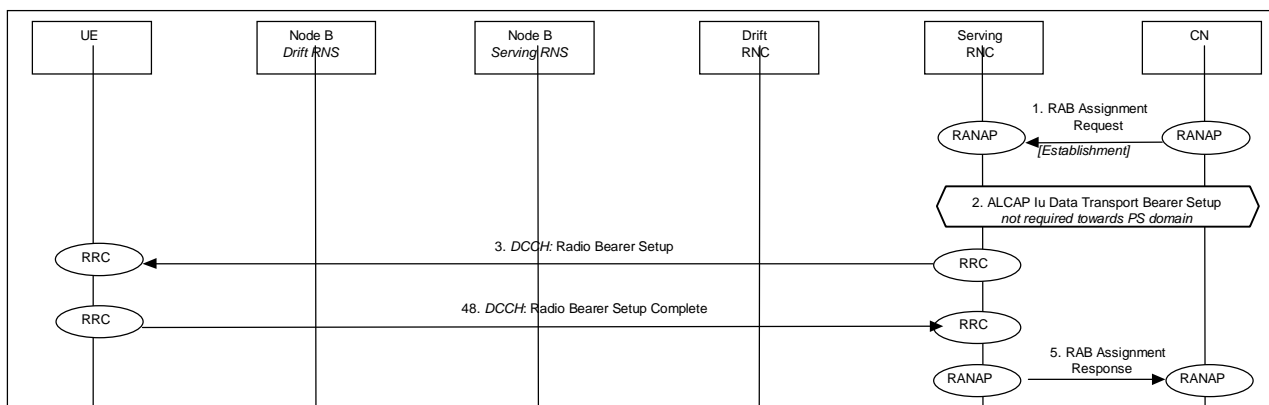

Figure 16: Radio Access Bearer Establishment – RACH/FACH – RACH/FACH Establishment – Unsynchronised

1. CN initiates establishment of the radio access bearer with RANAP **Radio Access Bearer Assignment Request** message.
Parameters: radio access bearer parameters, User Plane Mode, Transport Address, Iu Transport Association.
2. SRNC performs mapping of the radio access bearer QoS parameters to AAL2 link characteristics and initiates set-up of Iu Data Transport bearer using ALCAP protocol (this step is not required towards PS domain).
3. RRC message **Radio Bearer Setup** is sent by SRNC to UE.
Parameters: Transport Format Set, Transport Format Combination Set.
4. UE sends RRC message **Radio Bearer Setup Complete** to SRNC.
5. SRNC sends RANAP message **Radio Access Bearer Assignment Response** to CN.

7.7 Radio Access Bearer Release

The following examples show release of a radio access bearer either on a dedicated channel (DCH) or on a common transport channel (RACH/FACH) when the RRC connection already uses a dedicated channel (DCH) or a common transport channel (RACH/FACH).

7.7.1 DCH - DCH Release - Synchronised

This example shows release of a radio access bearer on a dedicated channel (DCH) when the RRC connection still uses a dedicated channel (DCH) after the release.

[FDD - The UE communicates via two Nodes B. One Node B is controlled by SRNC, one Node B is controlled by DRNC.]

[TDD – The Nodes B shown in the figure are mutually exclusive in TDD mode.]

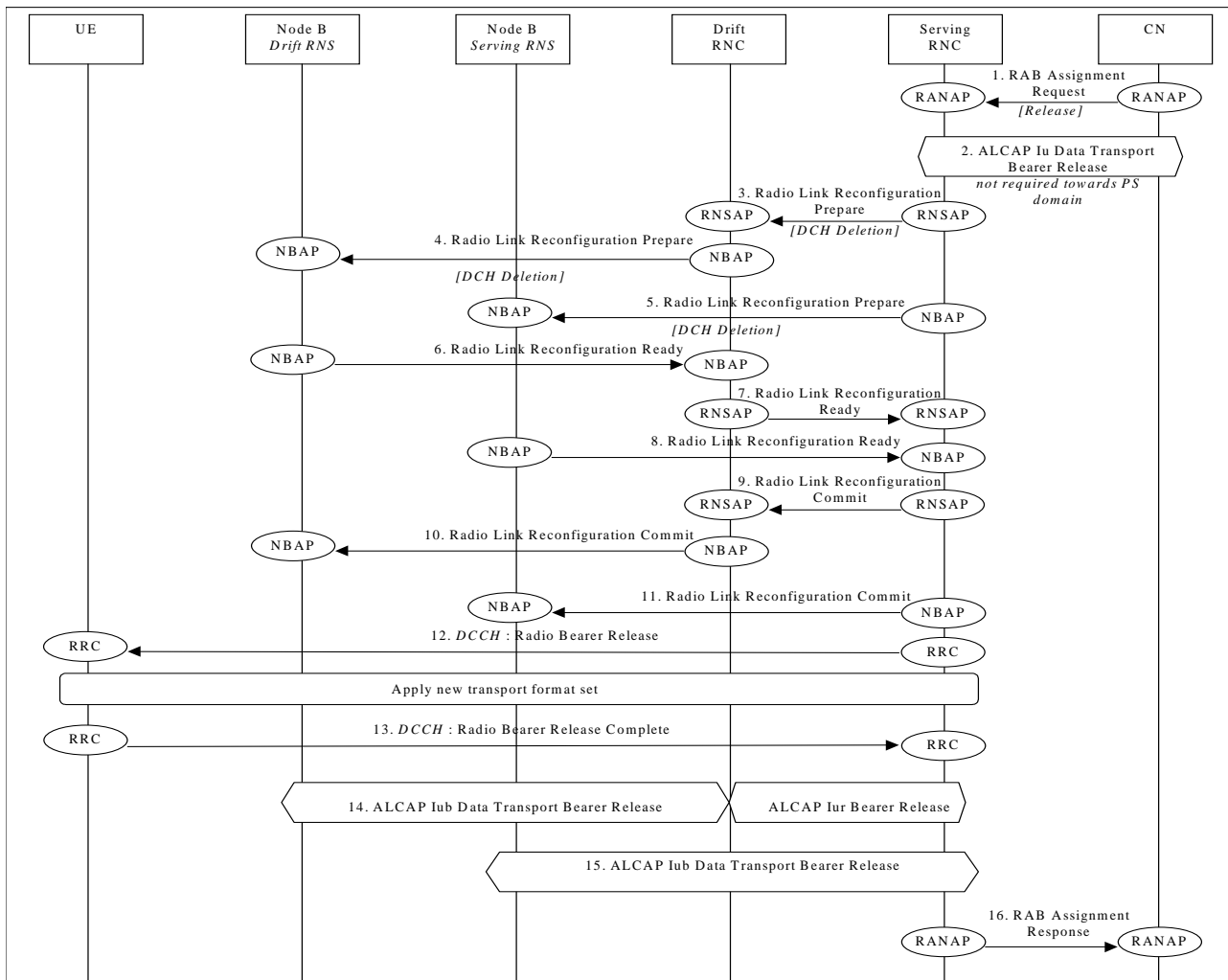

Figure 17: Radio Access Bearer Release - DCH - DCH Release - Synchronised

1. CN initiates release of the radio access bearer with RANAP message **Radio Access Bearer Assignment Request**.
2. SRNC initiates release of the Iu Data Transport bearer between the CN and the SRNC using the ALCAP protocol (this step is not required towards PS domain).
3. SRNC requests DRNC to prepare release of DCH carrying the radio access bearer (**Radio Link Reconfiguration Prepare**).
Parameters: Transport Format Combination Set, UL scrambling code.
4. DRNC requests its Node B to prepare release of DCH carrying the radio access bearer (**Radio Link Reconfiguration Prepare**).
Parameters: Transport Format Combination Set, UL scrambling code.
5. SRNC requests its Node B to prepare release of DCH carrying the radio access bearer (**Radio Link Reconfiguration Prepare**).
Parameters: Transport Format Combination Set, UL scrambling code [FDD], Time Slots [TDD], User Codes [TDD].
6. Node B notifies DRNC that release preparation is ready (**Radio Link Reconfiguration Ready**).
7. DRNC notifies SRNC that release preparation is ready (**Radio Link Reconfiguration ready**).
8. Node B notifies SRNC that release preparation is ready (**Radio Link Reconfiguration Ready**).
9. RNSAP message **Radio Link Reconfiguration Commit** is sent from SRNC to DRNC.
10. NBAP message **Radio Link Reconfiguration Commit** is sent from DRNC to Node B.

11. NBAP message **Radio Link Reconfiguration Commit** is sent from SRNC to Node B.
12. RRC message **Radio Bearer Release** is sent by SRNC to UE.
Parameters: Transport Format Set, Transport Format Combination Set, Time Slots [TDD], User Codes [TDD].
13. UE sends RRC message **Radio Bearer Release Complete** to SRNC.
14. Not used resources in-DRNC and Node B (Drift RNS) are released. DRNC initiates release of Iur and Iub (Drift RNS) Data Transport bearer using ALCAP protocol.
15. Not used resources in SRNC and Node B (Serving RNS, if any) are released. SRNC initiates release of Iub (Serving RNS) Data Transport bearer using ALCAP protocol.
16. SRNC acknowledges the release of radio access bearer (**Radio Access Bearer Assignment Response**). Note: This message may be sent any time after step 1 provided the RNC is prepared to receive new establishment request of a radio access bearer identified by the same radio access bearer identifier.

7.7.2 DCH - DCH Release - Unsynchronised

This example shows release of a radio access bearer on a dedicated channel (DCH) when the RRC connection still uses a dedicated channel (DCH) after the release. The UE communicates via two Nodes B. One Node B is controlled the SRNC, one Node B is controlled by DRNC. The reconfiguration does not require to be synchronised among Node-Bs, SRNC and UE.

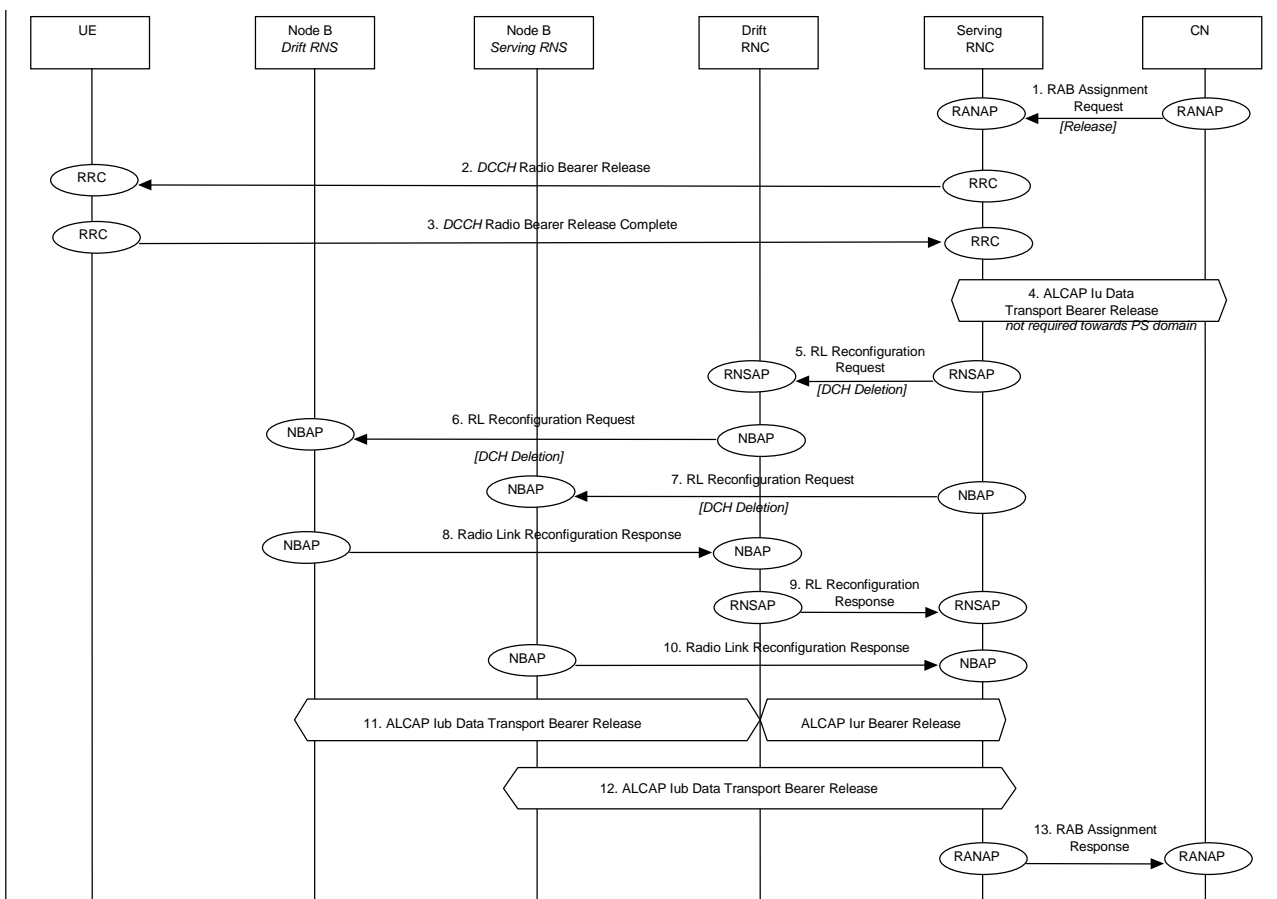

Figure 18: Radio Access Bearer Release - DCH - DCH Release - Unsynchronised

1. CN initiates release of the radio access bearer with RANAP Radio Access Bearer Assignment Request message.
2. RRC message Radio Bearer Release is sent by SRNC to UE.
3. UE sends RRC message Radio Bearer Release Complete to SRNC.

4. SRNC initiates release of the Iu Data Transport bearer between the CN and the SRNC using the ALCAP protocol (this step is not required towards PS domain).
5. SRNC requests DRNC to release of DCH carrying the radio access bearer.
Parameters: DCH ID, TFCS.
6. DRNC requests its Node B to release of DCH carrying the radio access bearer.
Parameters: DCH ID, TFCS.
7. SRNC requests its Node B to prepare release of DCH carrying the radio access bearer.
Parameters: DCH ID, TFCS.
8. Node B acknowledges DRNC.
9. DRNC acknowledges SRNC.
10. Node B acknowledges SRNC.
11. SRNC initiates release of Iur Data Transport bearer using ALCAP protocol. Note: the release of the Iur link may be done before step 9
12. SRNC initiates release of Iub Data Transport bearer using ALCAP protocol. Note: the release of the Iub link may be done before step 9.
13. SRNC acknowledges the release of radio access bearer to CN. Note: This message may be sent any time after step 3 provided the RNC is prepared to receive new establishment request of a radio access bearer identified by the same radio access bearer identifier.

7.7.4 RACH/FACH - RACH/FACH Release

This example shows release of a radio access bearer on a common transport channel (RACH/FACH) when the RRC connection still uses a common transport channel (RACH/FACH) after the release (RACH/FACH to RACH/FACH).

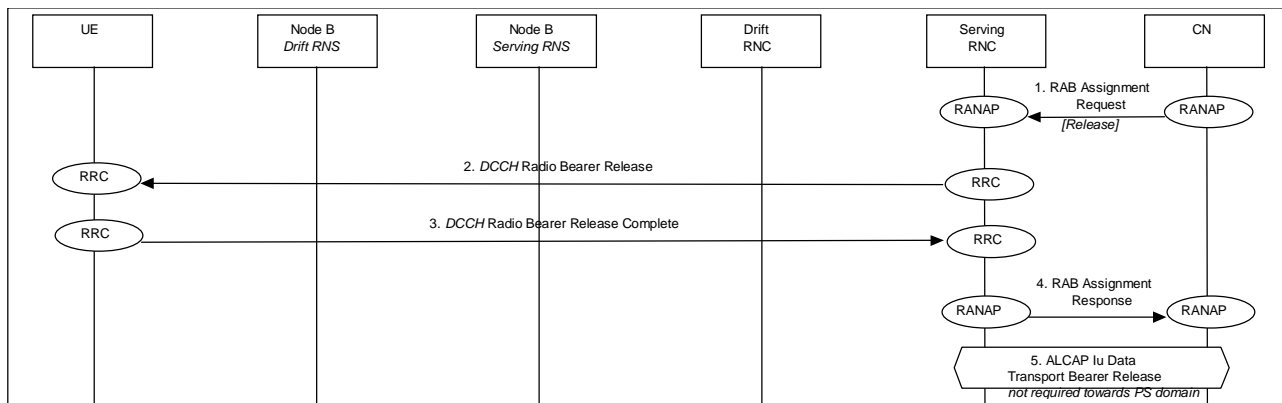

Figure 19: Radio Access Bearer Release - RACH/FACH - RACH/FACH Release

1. CN initiates release of the radio access bearer with RANAP **Radio Access Bearer Assignment Request** message.
2. RRC message **Radio Bearer Release** is sent by SRNC to UE.
3. UE sends RRC message **Radio Bearer Release Complete** to SRNC.
4. SRNC acknowledges the release of radio access bearer to CN.
5. SRNC initiates release of the Iu Data Transport bearer between the CN and the SRNC using the ALCAP protocol (this step is not required towards PS domain).

7.8 Radio Access Bearer Modification

The following examples show modification of a radio access bearer established either on a dedicated channel (DCH) or on a common transport channel (RACH/FACH). The procedure starts from a radio access bearer assignment because does not exist a special message to modify a radio access bearer, instead an “assignment” message is used.

7.8.1 DCCH on DCH - Synchronised

This example shows modification of a radio access bearer established on a dedicated channel (DCH) with UE in macrodiversity between two RNCs. A NSAP synchronised procedure is used and a successful case is shown. For an unsuccessful case it's important to note that a failure message can be sent in any point of the Message Sequence Chart (MSC); in particular could be in RRC reconfiguration response.

A radio access bearer modification procedure (via radio access bearer assignment message) is shown with mapping to Radio Bearer reconfiguration. Note that this is not possible if the used transport channel or logical channel is changed because the Radio Bearer reconfiguration does not permit a change in type of channel (see TS 25.331 [8]).

7.8.1.1 Synchronised DCH modification, Bandwidth increase

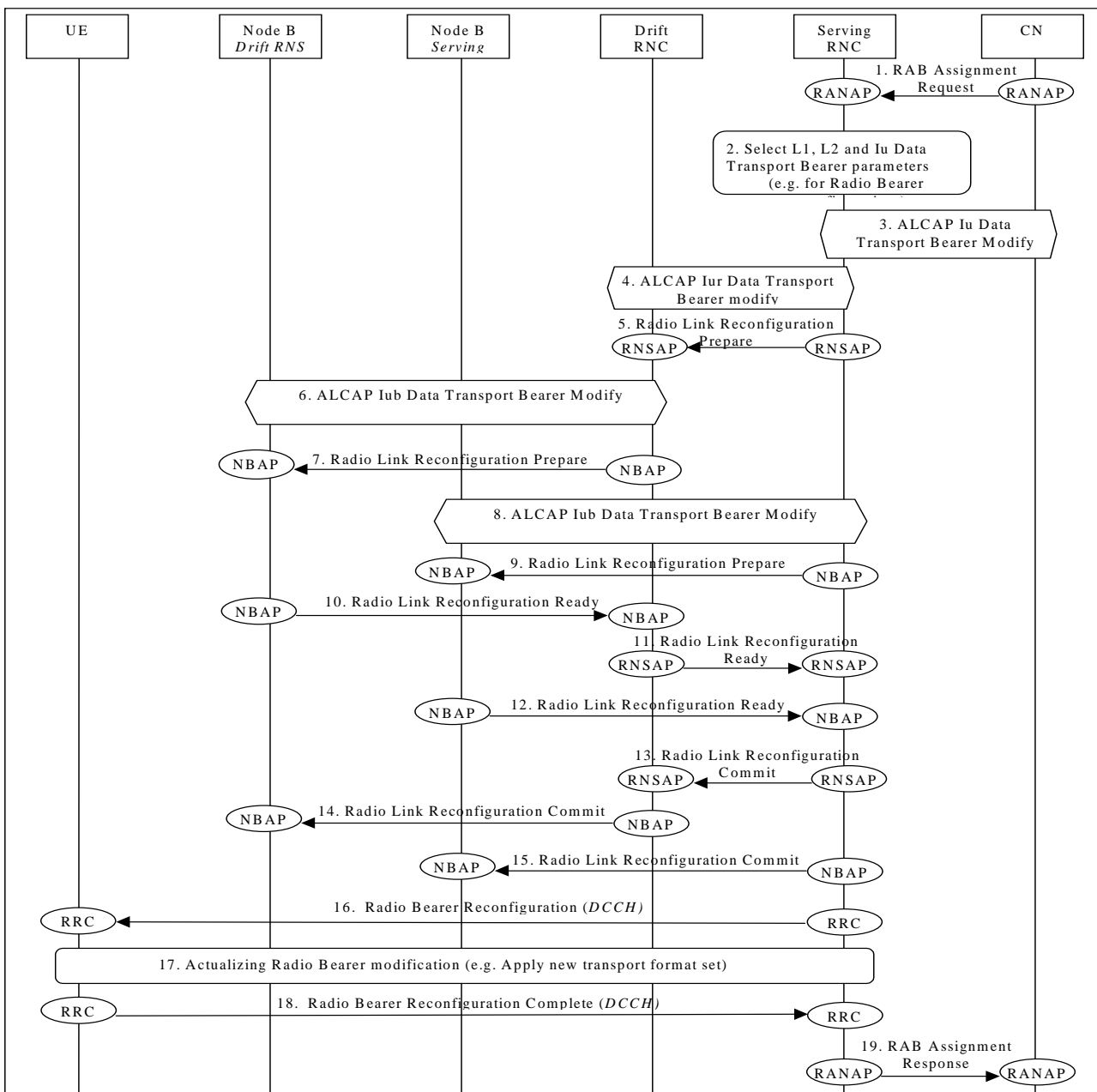

Figure 20: Radio Access Bearer Modification, Synchronised DCH modification, Bandwidth increase

1. CN initiates modification of the radio access bearer with RANAP message Radio Access Bearer Assignment Request.
Parameters: parameters to be modified at lower level e.g. Maximum Bit Rate.
2. Interworking functions. SRNC chooses which parameters (lower level) ought to be modified and what kind of procedure has to start up (i.e Radio Bearer Reconfiguration for RRC).
3. SRNC starts an Iu Data Transport Bearer Modification between the CN and the SRNC using the ALCAP protocol with AAL2 bindings carried by radio access bearer assignment message (this step is not required towards PS domain). This has to be done before Radio Reconfiguration itself because the transport channel must be ready when the radio channel will be ready.
4. SRNC initiates modify of Iur (Serving RNS) Data Transport bearer. In the case that ALCAP is implemented by Q.AAL2 (Q.2630.2 but without modification) it implies the release of the existing bearer and the establishment of a new one.

5. SRNC requests DRNC to prepare modification of DCH carrying the radio access bearer (**Radio Link Reconfiguration Prepare**).
Parameters: Transport Format Combination Set, UL scrambling code, Transport Bearer Request Indicator, etc.
6. DRNC initiates modify of Iub Data Transport bearer. In the case that ALCAP is implemented by Q.AAL2 (Q.2630.2 but without modification procedure) it implies the release of the existing bearer and the establishment of a new one.
7. DRNC requests its Node B to prepare modification of DCH related to the radio access bearer (**Radio Link Reconfiguration Prepare**).
8. SRNC initiates modify of Iub (Serving RNS) Data Transport bearer. In the case that ALCAP is implemented by Q.AAL2 (Q.2630.2 but without modification procedure) it implies the release of the existing bearer and the establishment of a new one.
9. SRNC requests its Node B to prepare modification of DCH carrying the radio access bearer (**Radio Link Reconfiguration Prepare**).
Parameters: Transport Format Combination Set, UL scrambling code [FDD], Time Slots [TDD], User Codes [TDD], Transport Bearer Request Indicator.
10. Node B (drift) notifies DRNC that modification preparation is ready (**Radio Link Reconfiguration Ready**).
11. DRNC notifies SRNC that modification preparation is ready (**Radio Link Reconfiguration ready**).
12. Node B (serving) notifies SRNC that modification preparation is ready (**Radio Link Reconfiguration Ready**).
Note: here a **Radio Link Reconfiguration Failure** could occur.
13. RNSAP message **Radio Link Reconfiguration Commit** is sent from SRNC to DRNC.
14. NBAP message **Radio Link Reconfiguration Commit** is sent from DRNC to Node B (drift).
15. NBAP message **Radio Link Reconfiguration Commit** is sent from SRNC to Node B (serving).
16. RRC message **Radio Bearer Reconfiguration** is sent by controlling RNC (here SRNC) to UE.
17. Both UE and Nodes B actualise modification of DCH (i.e. applying a new transport format).
18. UE sends RRC message **Radio Bearer Reconfiguration Complete** to SRNC.
19. SRNC acknowledges the modification of radio access bearer (**Radio Access Bearer Assignment Response**) towards CN.

7.8.1.2 Synchronised DCH modification, Bandwidth decrease

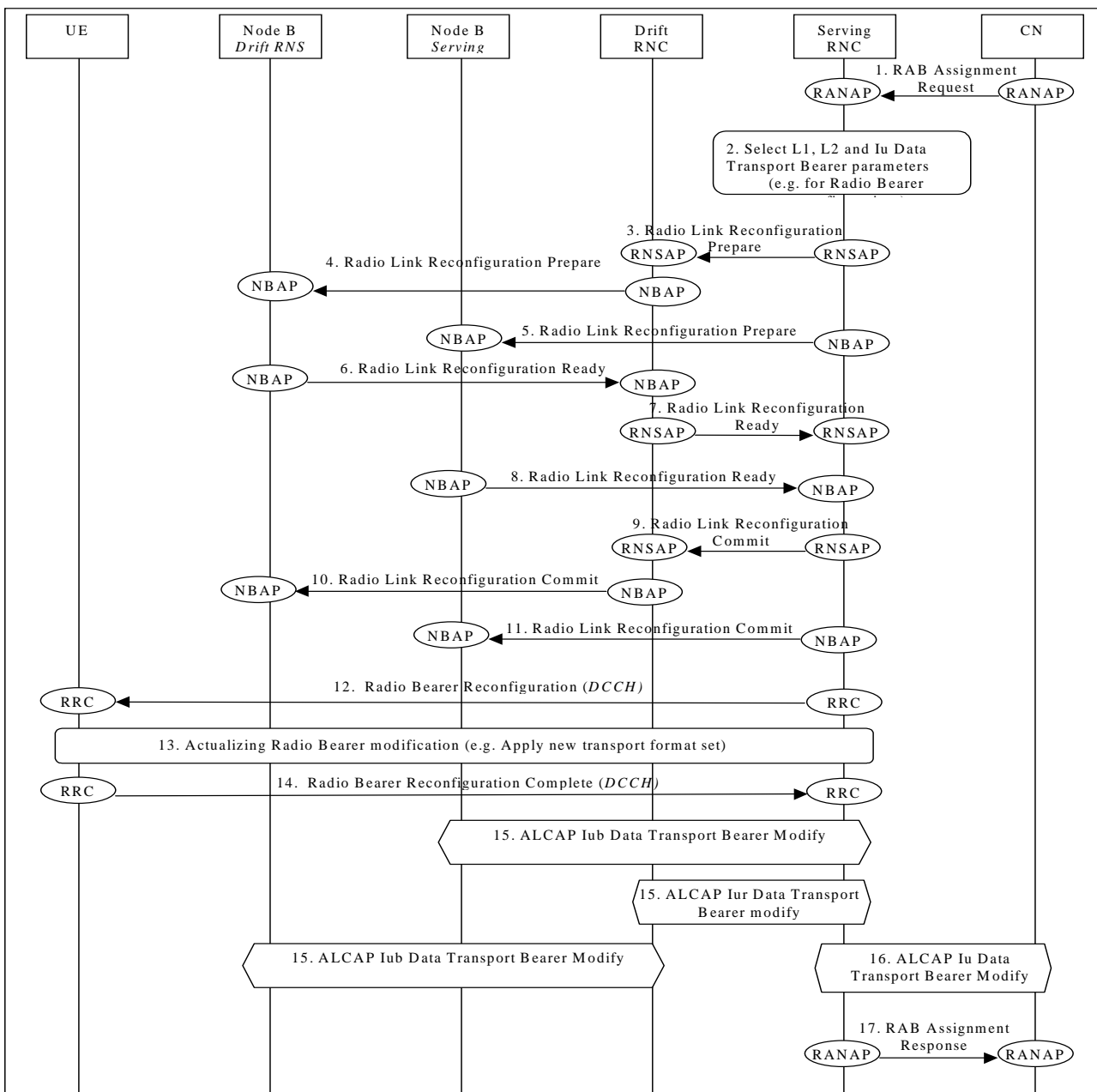

Figure 20a: Radio Access Bearer Modification, Synchronised DCH Modification, Bandwidth decrease

1. CN initiates modification of the radio access bearer with RANAP message Radio Access Bearer Assignment Request.
Parameters: parameters to be modified at lower level e.g. Maximum Bit Rate.
2. Interworking functions. SRNC chooses which parameters (lower level) ought to be modified and what kind of procedure has to start up (i.e Radio Bearer Reconfiguration for RRC).
3. SRNC requests DRNC to prepare modification of DCH carrying the radio access bearer (**Radio Link Reconfiguration Prepare**).
Parameters: Transport Format Combination Set, UL scrambling code, Transport Bearer Request Indicator, etc.
4. DRNC requests its Node B to prepare modification of DCH related to the radio access bearer (**Radio Link Reconfiguration Prepare**).
5. SRNC requests its Node B to prepare modification of DCH carrying the radio access bearer (**Radio Link Reconfiguration Prepare**).

Parameters: Transport Format Combination Set, UL scrambling code [FDD], Time Slots [TDD], User Codes [TDD], Transport Bearer Request Indicator.

6. Node B (drift) notifies DRNC that modification preparation is ready (**Radio Link Reconfiguration Ready**).
7. DRNC notifies SRNC that modification preparation is ready (**Radio Link Reconfiguration ready**).
8. Node B (serving) notifies SRNC that modification preparation is ready (**Radio Link Reconfiguration Ready**).
Note: here a **Radio Link Reconfiguration Failure** could occur.
9. RNSAP message **Radio Link Reconfiguration Commit** is sent from SRNC to DRNC.
10. NBAP message **Radio Link Reconfiguration Commit** is sent from DRNC to Node B (drift).
11. NBAP message **Radio Link Reconfiguration Commit** is sent from SRNC to Node B (serving).
12. RRC message **Radio Bearer Reconfiguration** is sent by controlling RNC (here SRNC) to UE.
13. Both UE and Nodes B actualise modification of DCH (i.e. applying a new transport format).
14. UE sends RRC message **Radio Bearer Reconfiguration Complete** to SRNC.
15. SRNC initiates modify of Iub (Serving RNS) Data Transport bearer. The same does DRNC with its own Iub. SRNC initiates modify of Iur (Serving RNS) Data Transport bearer. In the case that ALCAP is implemented by Q.AAL2 (Q.2630.2 but without modification procedure) it implies the release of the existing bearer and the establishment of a new one.
16. SRNC starts an Iu Data Transport Bearer Modification between the CN and the SRNC using the ALCAP protocol with AAL2 bindings carried by radio access bearer assignment message (this step is not required towards PS domain). This has to be done after the initialisation of the user plane mode.
17. SRNC acknowledges the modification of radio access bearer (**Radio Access Bearer Assignment Response**) towards CN.

7.8.2 DCCH on RACH/FACH

This example shows reconfiguration of a radio access bearer using a common transport channel (RACH/FACH). The difference with respect to the previous example is that here there is no macrodiversity because with a physical common channel (e.g. PRACH) it's impossible to be on macrodiversity

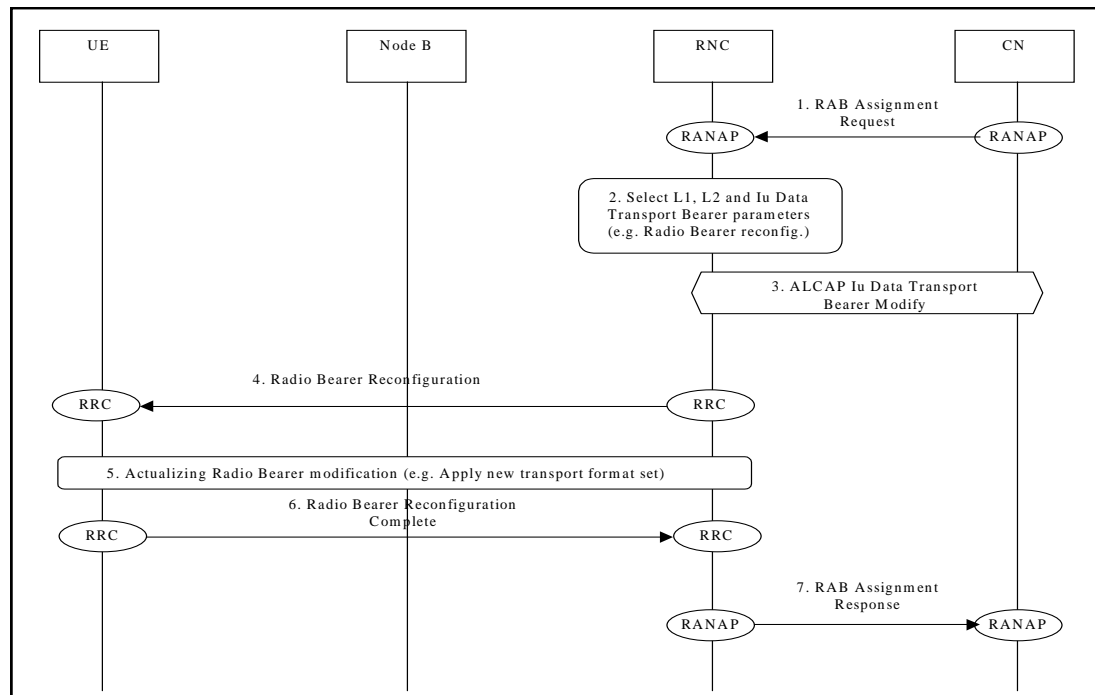

Figure 21: Radio Access Bearer Modification – RACH/FACH Modification

1. CN initiates modification of the radio access bearer with RANAP message Radio Access Bearer Assignment Request.
2. Interworking functions. SRNC chooses which parameters (lower level) ought to be modified and what kind of procedure has to start up (i.e Radio Bearer Reconfiguration for RRC).
3. RNC starts an Iu Data Transport Bearer Modification between the CN and the RNC using the ALCAP protocol with AAL2 bindings carried by radio access bearer assignment message (this step is not required towards PS domain). This has to be done before Radio Reconfiguration itself because the transport channel must be ready when the radio channel will be ready.
4. RRC message **Radio Bearer Reconfiguration** is sent by controlling RNC (here RNC) to UE. UE actualises modification of common transport channel (e.g. applying a new transport format).
5. Both UE and Nodes B actualise modification of DCH (i.e. applying a new transport format).
6. UE sends RRC message **Radio Bearer Reconfiguration Complete** to RNC.
7. RNC acknowledges the modification of radio access bearer (**Radio Access Bearer Assignment Response**) towards CN.

A radio access bearer modification procedure (via radio access bearer assignment message) is mapped with Radio Bearer reconfiguration. Note that this is not possible if we want to change what transport channel or logical channel you use, because Radio Bearer reconfiguration does not permit a change in type of channel (see TS 25.331 [8]).

7.9 Physical Channel Reconfiguration

7.9.1 Physical Channel Reconfiguration (DCH)

The following example shows an example for the Physical Channel Reconfiguration in dedicated channel (DCH) RRC state.

This procedure can be used, for example, to change the UL scrambling code of a UE.

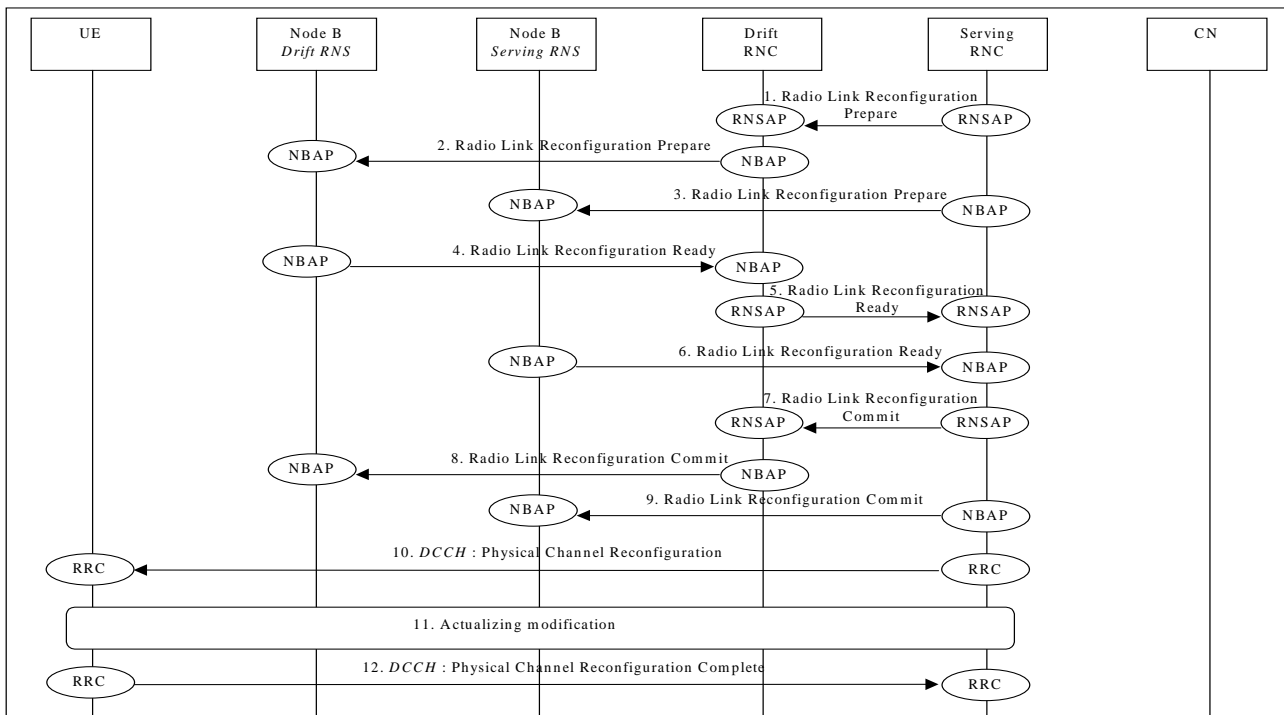

Figure 22: Physical Channel Reconfiguration (DCH)

1. SRNC decided that there is a need for a Physical Channel Reconfiguration and requests DRNC to prepare reconfiguration of DCH (Radio Link Reconfiguration Prepare).
Parameters: UL scrambling code [FDD], Power control information.
2. DRNC requests its Node B to prepare reconfiguration of physical channel (**Radio Link Reconfiguration Prepare**).
Parameters: Power control information, UL scrambling code [FDD], Time Slots [TDD], User Codes [TDD].
3. SRNC requests its Node B to prepare reconfiguration of physical channel (**Radio Link Reconfiguration Prepare**).
Parameters: Power control information, UL scrambling code [FDD], Time Slots [TDD], User Codes [TDD].
4. Node B allocates resources and notifies DRNC that the reconfiguration is ready (**Radio Link Reconfiguration Ready**).
Parameters: Transport layer addressing information (AAL2 address, AAL2 Binding Id) for Iub Data Transport Bearer.
5. DRNC notifies SRNC that the reconfiguration is ready (**Radio Link Reconfiguration Ready**).
Parameters: Transport layer addressing information (AAL2 address, AAL2 Binding Id) for Iur Data Transport Bearer.
6. Node B allocates resources and notifies SRNC that the reconfiguration is ready (**Radio Link Reconfiguration Ready**).
Parameters: Transport layer addressing information (AAL2 address, AAL2 Binding Id) for Iub Data Transport Bearer.
7. RNSAP message **Radio Link Reconfiguration Commit** is sent from SRNC to DRNC.
Parameters: CFN.
8. NBAP message **Radio Link Reconfiguration Commit** is sent from DRNC to Node B.
Parameters: CFN.
9. NBAP message **Radio Link Reconfiguration Commit** is sent from SRNC to Node B.
Parameters: CFN.
10. RRC message **Physical Channel Reconfiguration** is sent by SRNC to UE.
Parameters: UL scrambling code [FDD], Time Slots [TDD], User Codes [TDD], CFN.

11. Both UE and Nodes B actualise modification of the physical channel.

12. UE sends RRC message **Physical Channel Reconfiguration Complete** to SRNC.

7.9.2 Physical Channel Reconfiguration (CRNC Controlled)

This procedure shall be used to reconfigure the Physical Channel in the CRNC; in case of FDD it corresponds to the Down Link Code Reconfiguration Procedure, while in TDD it allows to change either TS or User Code.

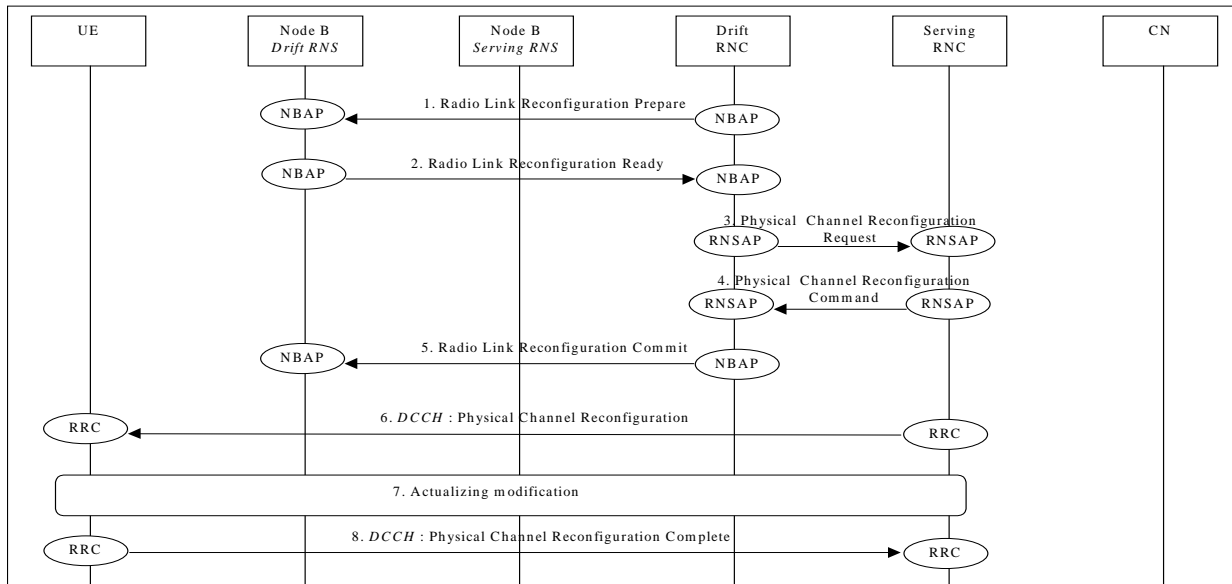

Figure 23: Physical Channel Reconfiguration (CRNC Controlled)

1. DRNC requests its Node B to reconfigure the physical channel (**Radio Link Reconfiguration Prepare**).
Parameters: Power control information, Time Slots [TDD], User Codes [TDD].
2. Node B allocates resources and notifies DRNC that the reconfiguration is ready (**Radio Link Reconfiguration Ready**).
Parameters: Transport layer addressing information (AAL2 address, AAL2 Binding Id) for Iub Data Transport Bearer.
3. DRNC decides that a Physical Channel Reconfiguration is needed and sends the RNSAP message **Physical Channel Reconfiguration Request** to the SRNC.
4. SRNC determines the CFN in which to perform the physical channel reconfiguration and sends the message **Physical Channel Reconfiguration Command**.
5. NBAP message **Radio Link Reconfiguration Commit** is sent from DRNC to Node B.
Parameters: CFN.
6. RRC message **Physical Channel Reconfiguration** is sent by SRNC to UE.
Parameters: Time Slots [TDD], User Codes [TDD], CFN.
7. Both UE and Nodes B actualise modification of the physical channel.
8. After the reconfiguration, the UE sends RRC message **Physical Channel Reconfiguration Complete** to SRNC.

7.10 Soft Handover [FDD]

This subclause presents some examples of soft handover procedures. The following cases are considered:

- Radio Link Addition (Branch Addition);
- Radio link Deletion (Branch Deletion);

- Radio link Addition & Deletion (Branch Addition & Deletion - simultaneously).

Soft Handover applies only to FDD mode.

7.10.1 Radio Link Addition (Branch Addition)

This example shows establishment of a radio link via a Node B controlled by another RNC than the serving RNC. This is the first radio link to be established via this RNS, thus macro-diversity combining/splitting with already existing radio links within DRNS is not possible.

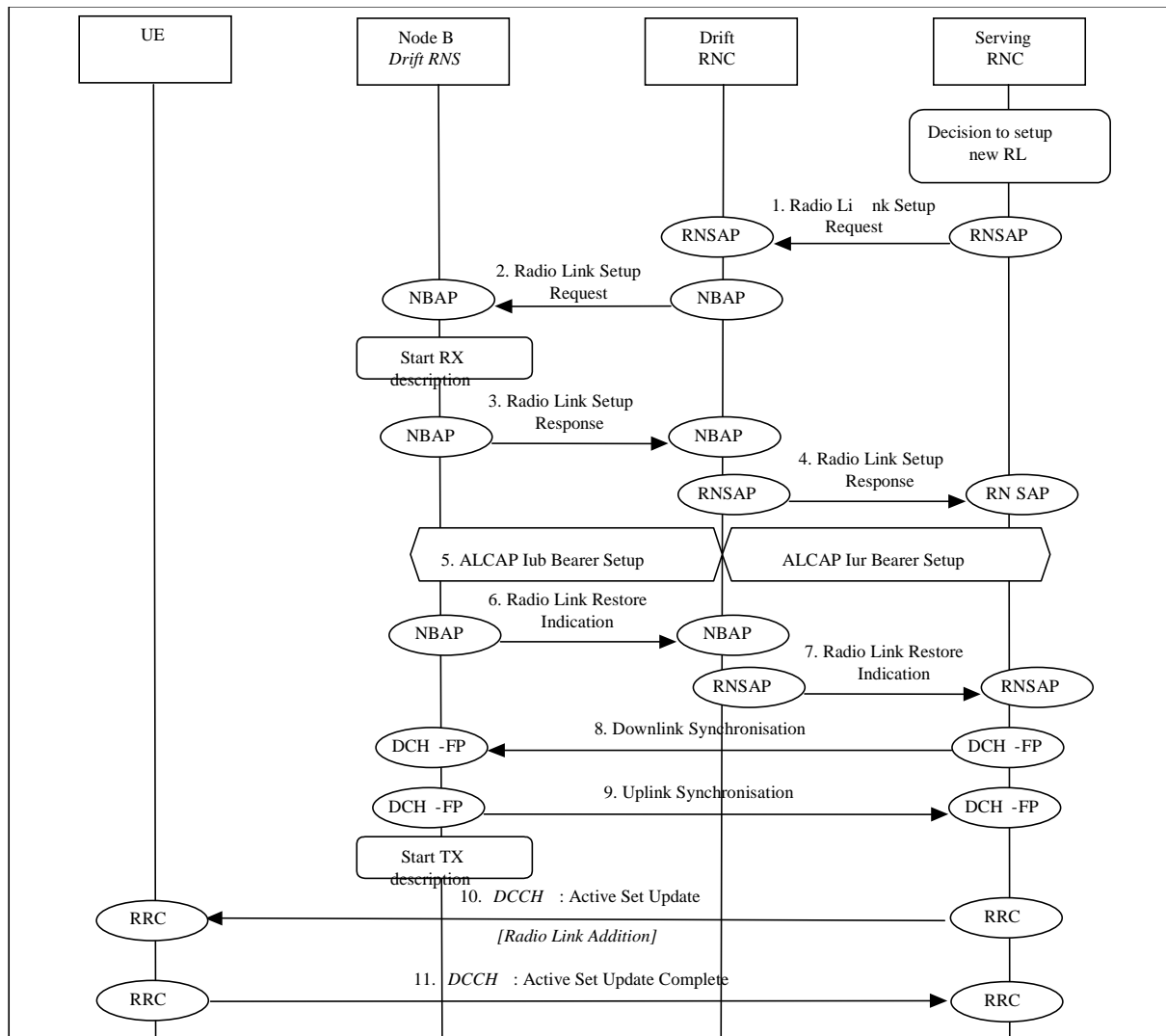

Figure 24: Soft Handover - Radio Link Addition (Branch Addition)

1. SRNC decides to setup a radio link via a new cell controlled by another RNC. SRNC requests DRNC for radio resources by sending RNSAP message **Radio Link Setup Request**. If this is the first radio link via the DRNC for this UE, a new Iur signalling connection is established. This Iur signalling connection will be used for all RNSAP signalling related to this UE.
Parameters: Cell id, Transport Format Set per DCH, Transport Format Combination Set, frequency, UL scrambling code.
2. If requested resources are available, DRNC sends NBAP message **Radio Link Setup Request** to Node B.
Parameters: Cell id, Transport Format Set per DCH, Transport Format Combination Set, frequency, UL scrambling code.
Then Node B starts the UL reception.
3. Node B allocates requested resources. Successful outcome is reported in NBAP message **Radio Link Setup Response**.

Parameters: Signalling link termination, Transport layer addressing information (AAL2 address, AAL2 Binding Identity(s)) for Data Transport Bearer(s).

4. DRNC sends RNSAP message **Radio Link Setup Response** to SRNC.
Parameters: Transport layer addressing information (AAL2 address, AAL2 Binding Identity) for Data Transport Bearer(s), Neighbouring cell information.
5. SRNC initiates setup of Iur/Iub Data Transport Bearer using ALCAP protocol. This request contains the AAL2 Binding Identity to bind the Iub Data Transport Bearer to DCH.
This may be repeated for each Iur/Iub Data Transport Bearer to be setup.
- 6./7. Node B achieves uplink sync on the Uu and notifies DRNC with NBAP message **Radio Link Restore Indication**. In its turn DRNC notifies SRNC with RNSAP message **Radio Link Restore Indication**.
- 8./9. Node B and SRNC establish synchronism for the Data Transport Bearer(s) by means of exchange of the appropriate DCH Frame Protocol frames **Downlink Synchronisation** and **Uplink Synchronisation**, relative already existing radio link(s). Then Node B starts DL transmission.
10. SRNC sends RRC message **Active Set Update** (Radio Link Addition) to UE on DCCH.
Parameters: Update type, Cell id, DL scrambling code, Power control information, Ncell information.
11. UE acknowledges with RRC message **Active Set Update Complete**.

NOTE: The order of transmission of **Radio Link Restore Indication** messages (steps 6 and 7) is not necessarily identical to that shown in the example. These messages could be sent before the ALCAP bearer setup (step 5) or after the transport bearer synchronisation (steps 8 and 9).

7.10.2 Radio link Deletion (Branch Deletion)

This example shows deletion of a radio link belonging to a Node B controlled by another RNC than the serving RNC.

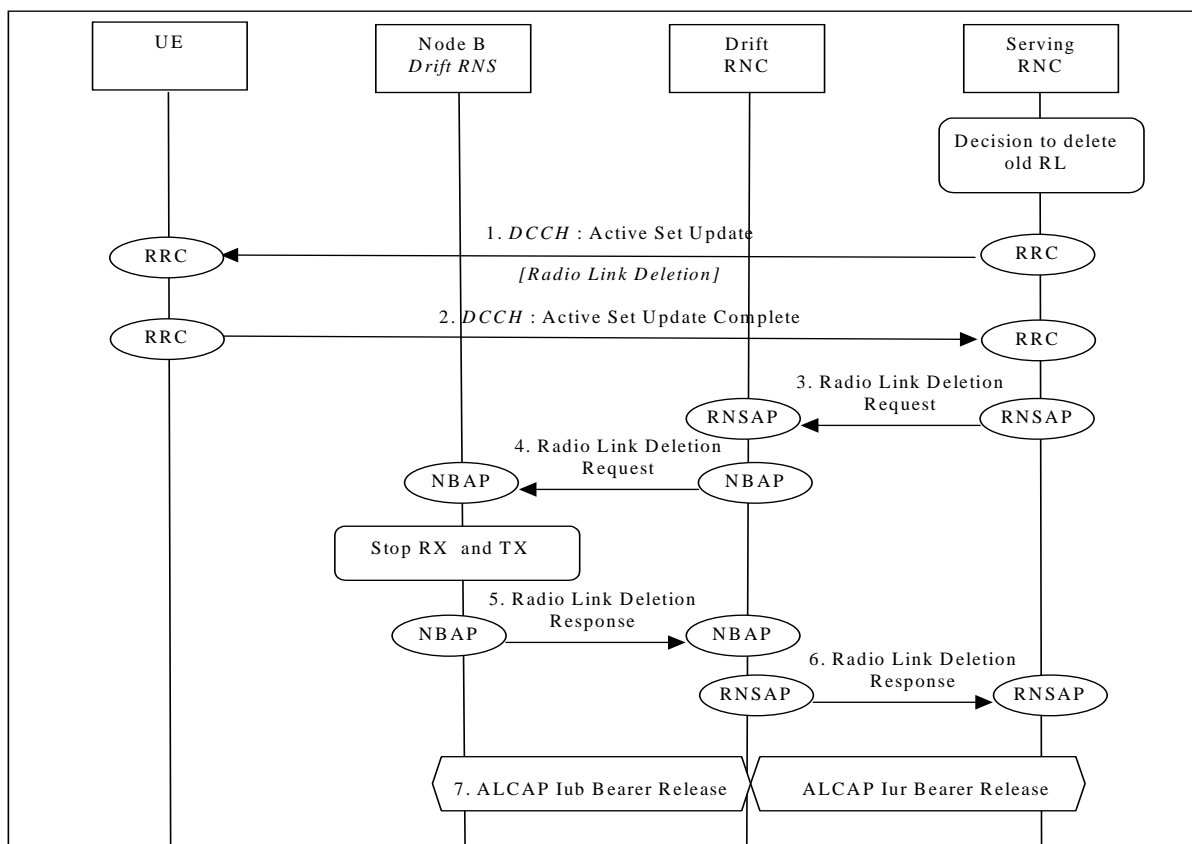

Figure 25: Soft Handover - Radio Link Deletion (Branch Deletion)

1. SRNC decides to remove a radio link via an old cell controlled by another RNC. SRNC sends RRC message **Active Set Update** (Radio Link Deletion) to UE on DCCH.
Parameters: Update type, Cell id.
2. UE deactivates DL reception via old branch, and acknowledges with RRC message **Active Set Update Complete**.
3. SRNC requests DRNC to deallocate radio resources by sending RNSAP message **Radio Link Deletion Request**.
Parameters: Cell id, Transport layer addressing information.
4. DRNC sends NBAP message **Radio Link Deletion Request** to Node B.
Parameters: Cell id, Transport layer addressing information.
5. Node B deallocates radio resources. Successful outcome is reported in NBAP message **Radio Link Deletion Response**.
6. DRNC sends RNSAP message **Radio Link Deletion Response** to SRNC.
7. SRNC initiates release of Iur/Iub Data Transport Bearer using ALCAP protocol.

7.10.3 Radio link Addition & Deletion (Branch Addition & Deletion - simultaneously)

This example shows simultaneous deletion of a radio link belonging to a Node B controlled by the serving RNC and the establishment of a radio link via a Node B controlled by another RNC than the serving RNC. This is the first radio link to be established via this RNS, thus macro-diversity combining/splitting with already existing radio links within DRNS is not possible.

This procedure is needed when the maximum number of branches allowed for the macrodiversity set has already been reached.

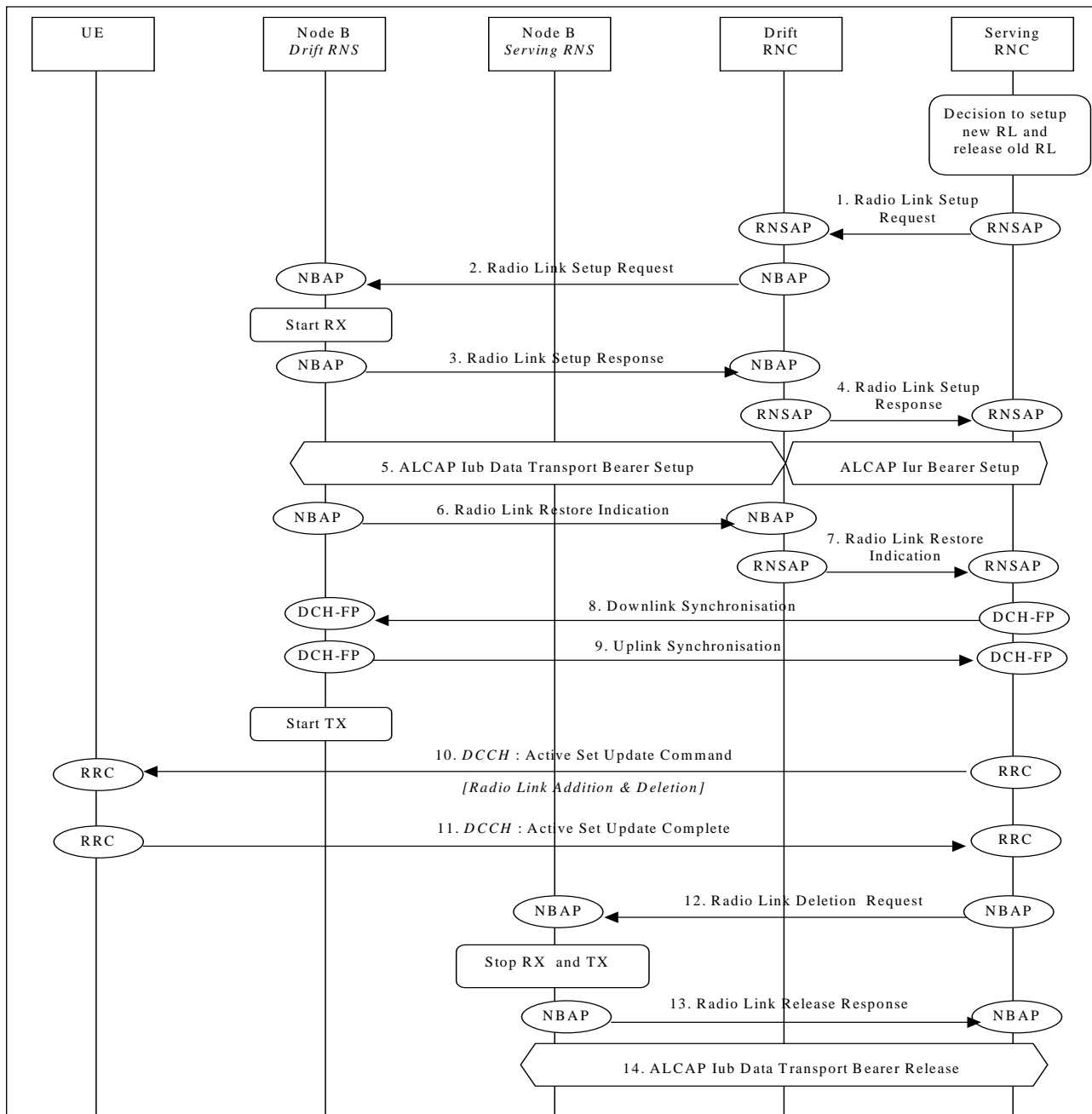

Figure 26: Soft Handover - Radio link Addition & Deletion (Branch Addition & Deletion - simultaneously)

- 1. ⇒ 9. See description 1. ⇒ 9. in subclause 7.10.1.
- 10. SRNC sends RRC message **Active Set Update** (Radio Link Addition & Deletion) to UE on DCCH.
Parameters: Update type, Cell id, DL scrambling code, Power control information, Ncell information.
- 11. UE deactivates DL reception via old branch, activates DL reception via new branch and acknowledges with RRC message **Active Set Update Complete**.
- 12. ⇒ 14. See description 3. ⇒ 7. in subclause 7.10.2.

7.10.4 DSCH Mobility Procedure in Soft Handover (Moving DSCH within the Active Set)

Void.

7.10.5 HS-DSCH Mobility Procedures

7.10.5.1 Intra-Node B synchronised serving HS-DSCH cell change

This subclause shows an example of an intra-Node B serving HS-DSCH cell change while keeping the dedicated physical channel configuration and the active set.

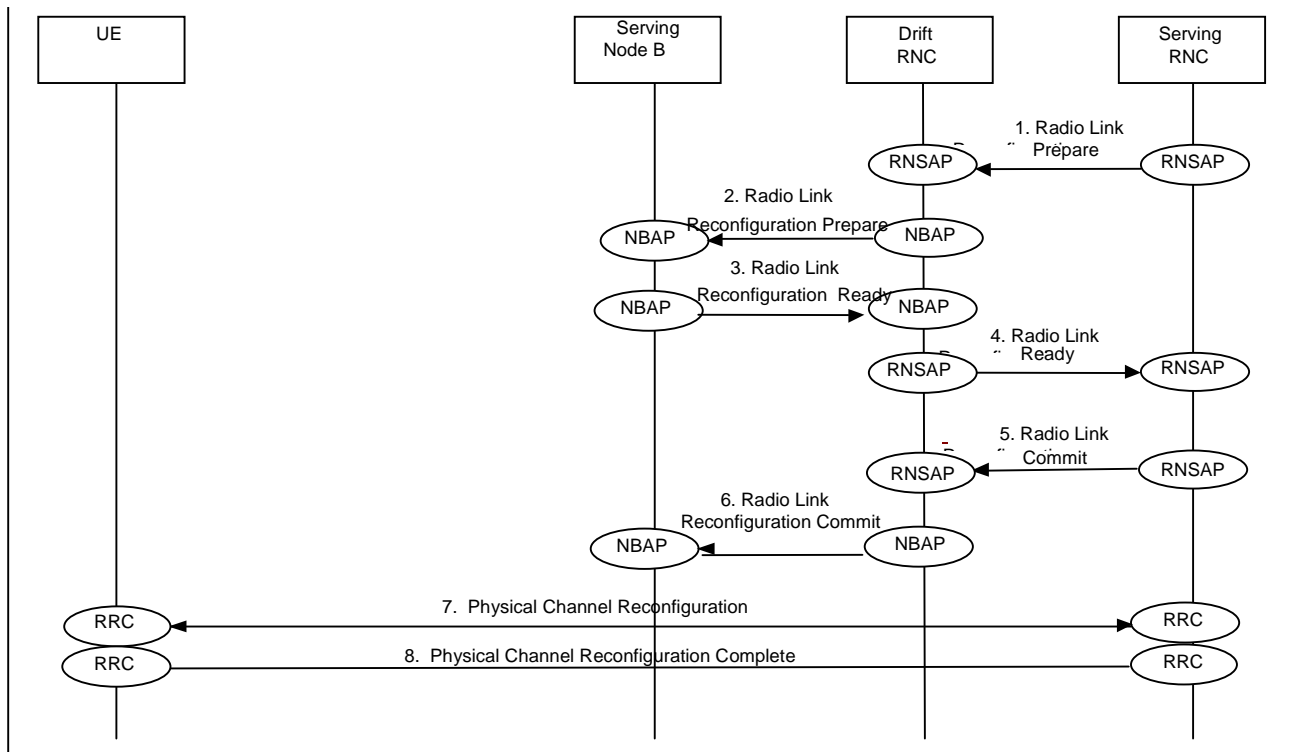

Figure 26b: Intra-Node B synchronised serving HS-DSCH cell change

1. The SRNC decides there is a need for a serving HS-DSCH cell change and prepares a RNSAP message **Radio Link Reconfiguration Prepare** which is transmitted to the DRNC.
Parameters: a SRNC selected HS-PDSCH RL ID.
2. In this case, both the source and target HS-DSCH cells are controlled by the same Node B. The DRNC requests the serving HS-DSCH Node B to perform a synchronised radio link reconfiguration using the NBAP message **Radio Link Reconfiguration Prepare**. The reconfiguration comprises a transfer of the HS-DSCH resources from the source HS-DSCH radio link to the target HS-DSCH radio link.
Parameters: a DRNC selected HS-DSCH RNTI and the HS-PDSCH RL ID.
3. The serving HS-DSCH Node B returns a NBAP message **Radio Link Reconfiguration Ready**.
Parameters: HS-DSCH Information Response.
4. The DRNC returns a RNSAP message **Radio Link Reconfiguration Ready** to the SRNC.
Parameters: HS-DSCH Information Response and the DRNC selected HS-DSCH-RNTI.
5. The SRNC now proceeds by transmitting RNSAP message **Radio Link Reconfiguration Commit** to the DRNC.
Parameters: SRNC selected activation time in the form of a CFN.
6. The DRNC transmits a NBAP message **Radio Link Reconfiguration Commit** to the serving HS-DSCH Node B. At the indicated activation time the serving HS-DSCH Node B stops HS-DSCH transmission to the UE in the source HS-DSCH cell and starts HS-DSCH transmission to the UE in the target HS-DSCH cell.
Parameters: SRNC selected activation time in the form of a CFN.
7. The SRNC transmits a RRC message **Physical Channel Reconfiguration** to the UE.
Parameters: activation time, MAC-hs reset indicator, serving HS-DSCH radio link indicator, HS-SCCH set info and H-RNTI.

- At the indicated activation time the UE, stops receiving HS-DSCH in the source HS-DSCH cell and starts HS-DSCH reception in the target HS-DSCH cell. The UE then returns a RRC message **Physical Channel Reconfiguration Complete** to the SRNC.

7.10.5.2 Inter-Node B (intra DRNC) synchronised serving HS-DSCH cell change

This subclause shows an ATM example of an inter-Node B serving HS-DSCH cell change while keeping the dedicated physical channel configuration and active set.

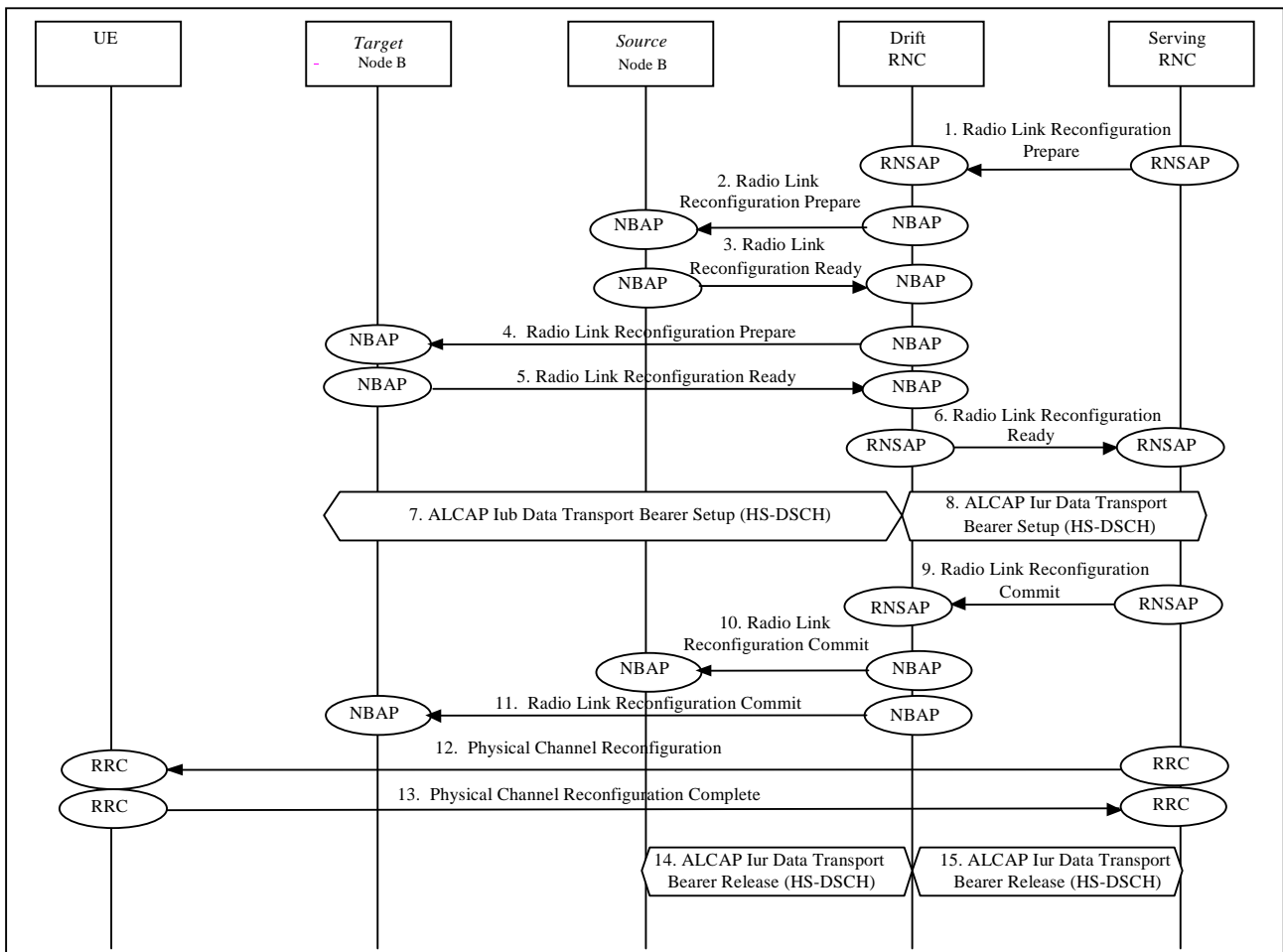

Figure 26c: Inter-Node B (intra-DRNC) synchronised serving HS-DSCH cell change

- The SRNC decides there is a need for a serving HS-DSCH cell change and prepares the RNSAP message **Radio Link Reconfiguration Prepare** which is transmitted to the DRNC. Parameters: a SRNC selected HS-PDSCH RL ID.
- In this case, the source and target HS-DSCH cells are controlled by different Node Bs. The DRNC requests the source HS-DSCH Node B to perform a synchronised radio link reconfiguration using the NBAP message **Radio Link Reconfiguration Prepare**, removing its HS-DSCH resources for the source HS-DSCH radio link. Parameters: HS-DSCH MAC-d Flows To Delete.
- The source HS-DSCH Node B returns a NBAP message **Radio Link Reconfiguration Ready**. Parameters: no HSDPA-specific parameters.
- The DRNC requests the target HS-DSCH Node B to perform a synchronised radio link reconfiguration using the NBAP message **Radio Link Reconfiguration Prepare**, adding HS-DSCH resources for the target HS-DSCH radio link. Parameters: HS-DSCH Information, a DRNC selected HS-DSCH RNTI and the HS-PDSCH RL ID.

5. The target HS-DSCH Node B returns the NBAP message **Radio Link Reconfiguration Ready**.
Parameters: HS-DSCH Information Response.
6. The DRNC returns the RNSAP message **Radio Link Reconfiguration Ready** to the SRNC.
Parameters: HS-DSCH Information Response and the DRNC selected HS-DSCH-RNTI.
7. The DRNC initiates set-up of a new Iub Data Transport Bearers using ALCAP protocol. This request contains the AAL2 Binding Identity to bind the Iub Data Transport Bearer to the HS-DSCH.
8. The SRNC may initiate set-up of a new Iur Data Transport bearer using ALCAP protocol. This request contains the AAL2 Binding Identity to bind the Iur Data Transport Bearer to the HS-DSCH.
9. The HS-DSCH transport bearer to the target HS-DSCH Node B is established. The SRNC proceeds by transmitting the RNSAP message **Radio Link Reconfiguration Commit** to the DRNC.
Parameters: SRNC selected activation time in the form of a CFN.
10. The DRNC transmits the NBAP message **Radio Link Reconfiguration Commit** to the source HS-DSCH Node B including the activation time. At the indicated activation time the source HS-DSCH Node B stops and the target HS-DSCH Node B starts transmitting on the HS-DSCH to the UE.
Parameters: SRNC selected activation time in the form of a CFN.
11. The DRNC transmits the NBAP message **Radio Link Reconfiguration Commit** to the target HS-DSCH Node B including the activation time. At the indicated activation time the source HS-DSCH Node B stops and the target HS-DSCH Node B starts transmitting on the HS-DSCH to the UE.
Parameters: SRNC selected activation time in form of a CFN.
12. The SRNC also transmits a RRC message **Physical Channel Reconfiguration** to the UE.
Parameters: activation time, MAC-hs reset indicator, serving HS-DSCH radio link indicator, HS-SCCH set info and H-RNTI.
13. At the indicated activation time the UE stops receiving HS-DSCH in the source HS-DSCH cell and starts HS-DSCH reception in the target HS-DSCH cell. The UE returns a RRC message **Physical Channel Reconfiguration Complete** to the SRNC.
14. The DRNC initiates release of the old Iub Data Transport bearer using ALCAP protocol.
15. If a new Iur Data Transport Bearer was set up in 8. then the SRNC initiates release of the old Iur Data Transport bearer using ALCAP protocol.

7.11 Hard Handover

This subclause presents some examples of hard handover procedures. These procedures are for both dedicated and common channels and may be applied in the following cases:

- intra-frequency Hard Handover (TDD mode);
- inter-frequency Hard Handover (FDD and TDD mode).

7.11.1 Backward Hard Handover

This subclause shows some examples of hard handover in the case of network initiated backward handovers.

7.11.1.1 Hard Handover via Iur (DCH State)

This subclause shows an example of Hard Handover via Iur, when the mobile is in DCH state, for both successful and unsuccessful cases. The text enclosed in brackets refers to the case when the UE has a DSCH [TDD].

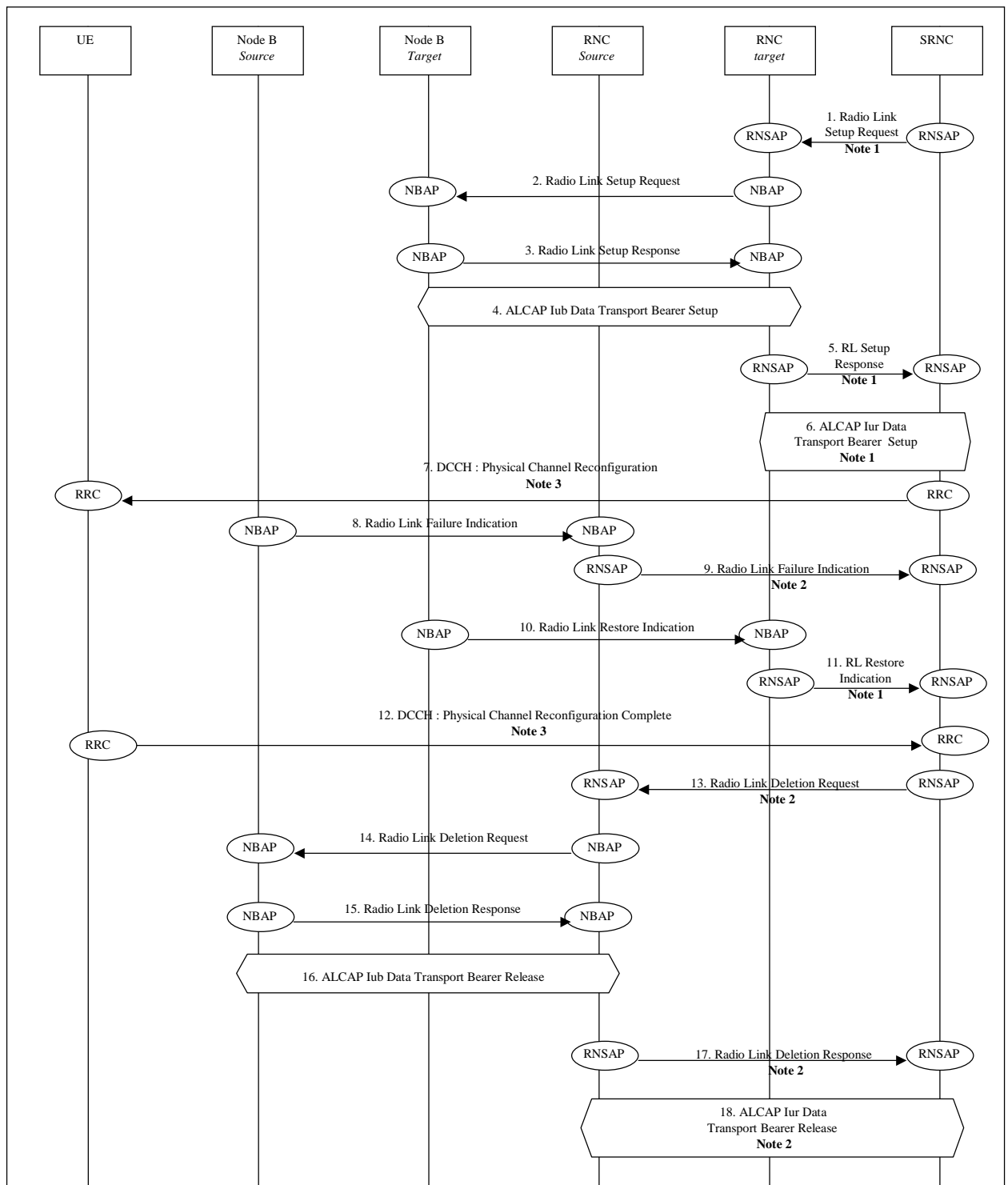

Figure 27: Hard Handover via Iur (DCH on Iur) – successful case

1. SRNC sends **Radio Link Setup Request** message to the target RNC.
Parameters: target RNC identifier, s-RNTI, Cell id, Transport Format Set, Transport Format Combination Set, [DSCH information [TDD]]. (see note 1).
2. The target RNC allocates RNTI and radio resources for the RRC connection and the Radio Link(s) (if possible), and sends the NBAP message **Radio Link Setup Request** to the target Node-B.
Parameters: Cell id, Transport Format Set, Transport Format Combination Set, frequency, UL scrambling code [FDD], Time Slots [TDD], User Codes [TDD], Power control information, [DSCH information [TDD]] etc.

3. Node B allocates resources, starts PHY reception, and responds with NBAP message **Radio Link Setup Response**.
Parameters: Signalling link termination, Transport layer addressing information for the Iub Data Transport Bearer, [DSCH information response[TDD].].
4. Target RNC initiates set-up of Iub Data Transport bearer using ALCAP protocol. This request contains the AAL2 Binding Identity to bind the Iub Data Transport Bearer to the DCH. The request for set-up of Iub Data Transport bearer is acknowledged by Node B. [A separate transport bearer is established for the DSCH.]
5. When the Target RNC has completed preparation phase, **Radio Link Setup Response** is sent to the SRNC (see note 1). [The message includes the DSCH information parameter [TDD].]
6. SRNC initiates set-up of Iur Data Transport bearer using ALCAP protocol. This request contains the AAL2 Binding Identity to bind the Iur Data Transport Bearer to the DCH. The request for set-up of Iur Data Transport bearer is acknowledged by Target RNC (see note 1). [A separate transport bearer is established for the DSCH [TDD].]
7. SRNC sends a RRC message **Physical Channel Reconfiguration** to the UE.
8. When the UE switches from the old RL to the new RL, the source Node B detects a failure on its RL and sends a NBAP message **Radio Link Failure Indication** to the source RNC.
9. The source RNC sends a RNSAP message **Radio Link Failure Indication** to the SRNC (see note 2).
10. Target Node B achieves uplink sync on the Uu and notifies target RNC with NBAP message **Radio Link Restore Indication**.
11. Target RNC sends RNSAP message **Radio Link Restore Indication** to notify SRNC (see note 2) that uplink sync has been achieved on the Uu.
12. When the RRC connection is established with the target RNC and necessary radio resources have been allocated, the UE sends RRC message **Physical Channel Reconfiguration Complete** to the SRNC.
13. The SRNC sends a RNSAP message **Radio Link Deletion Request** to the source RNC (see note 2).
14. The source RNC sends NBAP message **Radio Link Deletion Request** to the source Node B.
Parameters: Cell id, Transport layer addressing information.
15. The source Node B de-allocates radio resources. Successful outcome is reported in NBAP message **Radio Link Deletion Response**.
16. The source RNC initiates release of Iub Data Transport bearer using ALCAP protocol. [The DSCH transport bearer is released as well [TDD].]
17. When the source RNC has completed the release the RNSAP message Radio Link Deletion Response is sent to the SRNC (see note 2).
18. SRNC initiates release of Iur Data Transport bearer using ALCAP protocol. This request contains the AAL2 Binding Identity to bind the Iur Data Transport Bearer to the DCH. The request for release of Iur Data Transport bearer is acknowledged by the Source RNC (see note 2). [The DSCH transport bearer is also released [TDD].]

NOTE 1: This message is not necessary when the target RNC is the SRNC.

NOTE 2: This message is not necessary when the source RNC is the SRNC.

NOTE 3: The messages used are only one example of the various messages which can be used to trigger a handover, to confirm it or to indicate the handover failure. The different possibilities are specified in the RRC specification (25.331), subclause 8.3.5.2.

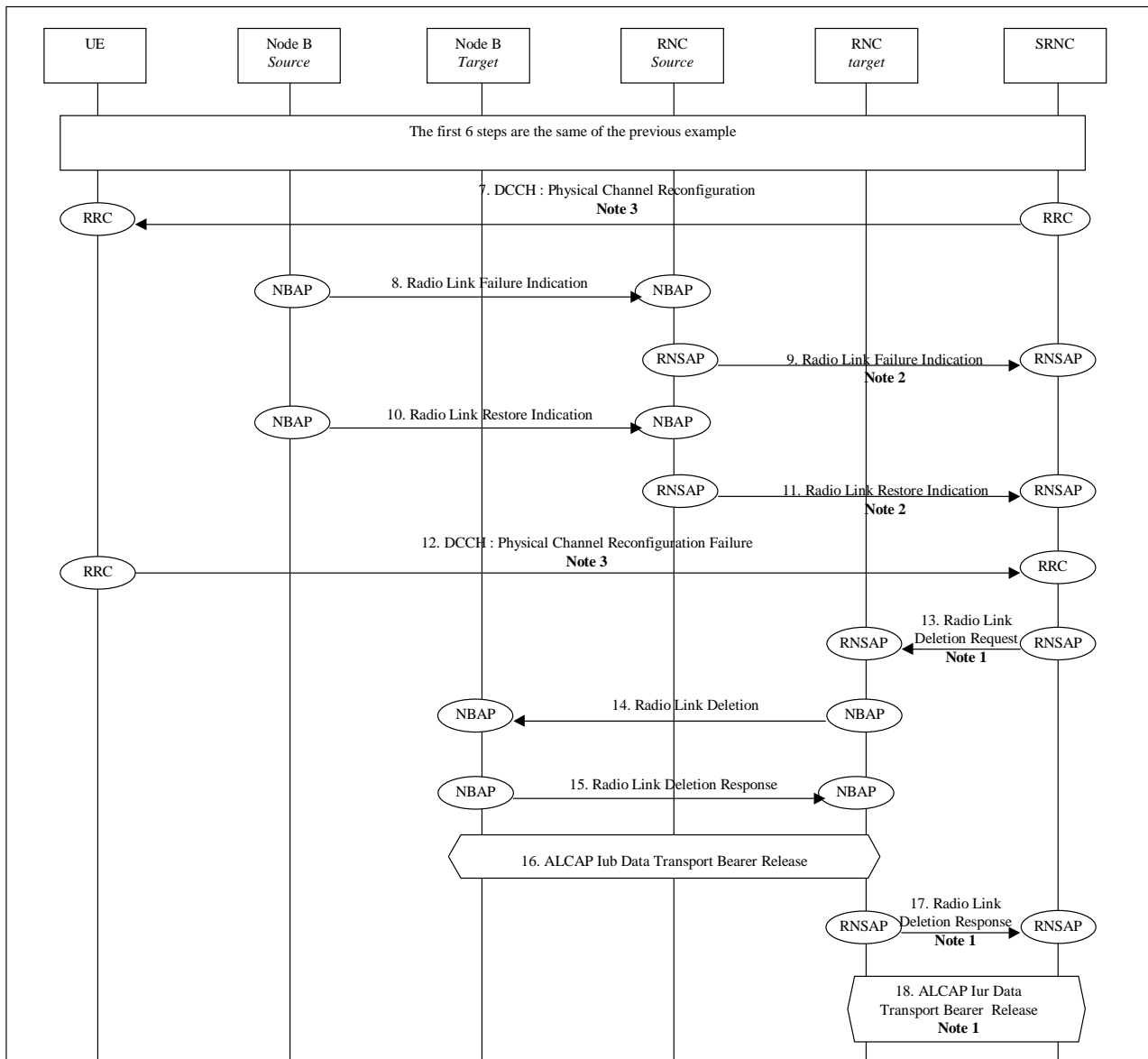

Figure 28: Hard Handover via lur (DCH on lur) – unsuccessful case.

The first 6 steps are the same of the previous example.

7. SRNC sends a RRC message **Physical Channel Reconfiguration** to the UE.
8. When the UE switch from the old RL to the new RL, the source Node B detect a failure on its RL and send a NBAP message **Radio Link Failure Indication** to the source RNC.
9. The SRNC sends a RNSAP message **Radio Link Failure Indication** to the source RNC (see note 2).
10. UE cannot access the target cell and switch back to the old one. The source Node B detects a RL restoration and send a NBAP message **Radio Link Restoration Indication** to the source RNC.
11. The SRNC sends a RNSAP message **Radio Link Restoration Indication** to the source RNC (see note 2).
12. When the RRC connection is re-established with the source RNC the UE sends RRC message **Physical Channel Reconfiguration Failure** to the SRNC.
13. The SRNC sends a RNSAP message **Radio Link Deletion Request** to the target RNC (see note 1).
14. The target RNC sends NBAP message **Radio Link Deletion Request** to the target Node B.
Parameters: Cell id, Transport layer addressing information.

15. The target Node B de-allocates radio resources. Successful outcome is reported in NBAP message **Radio Link Deletion Response**.
16. The target RNC initiates release of Iub Data Transport bearer using ALCAP protocol. [The DSCH transport bearer is released as well [TDD].]
17. When the target RNC has completed the release the RNSAP message **Radio Link Deletion Response** is sent to the SRNC (see note 1).
18. SRNC initiates release of Iur Data Transport bearer using ALCAP protocol. This request contains the AAL2 Binding Identity to bind the Iur Data Transport Bearer to the DCH. The Target RNC acknowledges the request for release of Iur Data Transport bearer (see note 1). [The DSCH transport bearer is also released [TDD].]

NOTE 1: This message is not necessary when the target RNC is the SRNC.

NOTE 2: This message is not necessary when the source RNC is the SRNC.

NOTE 3: The messages used are only one example of the various messages which can be used to trigger a handover, to confirm it or to indicate the handover failure. The different possibilities are specified in the RRC specification (25.331), clause 8.3.5.2.

7.11.1.2 Hard Handover with switching in the CN (UE connected to two CN nodes, DCH state)

7.11.1.2.1 Using SRNS Relocation scheme

This example shows Inter-RNS Hard Handover with switch in CN, in a situation in which the UE is connected to two CN nodes simultaneously and will be using one node B directly under the target RNC after the hard handover.

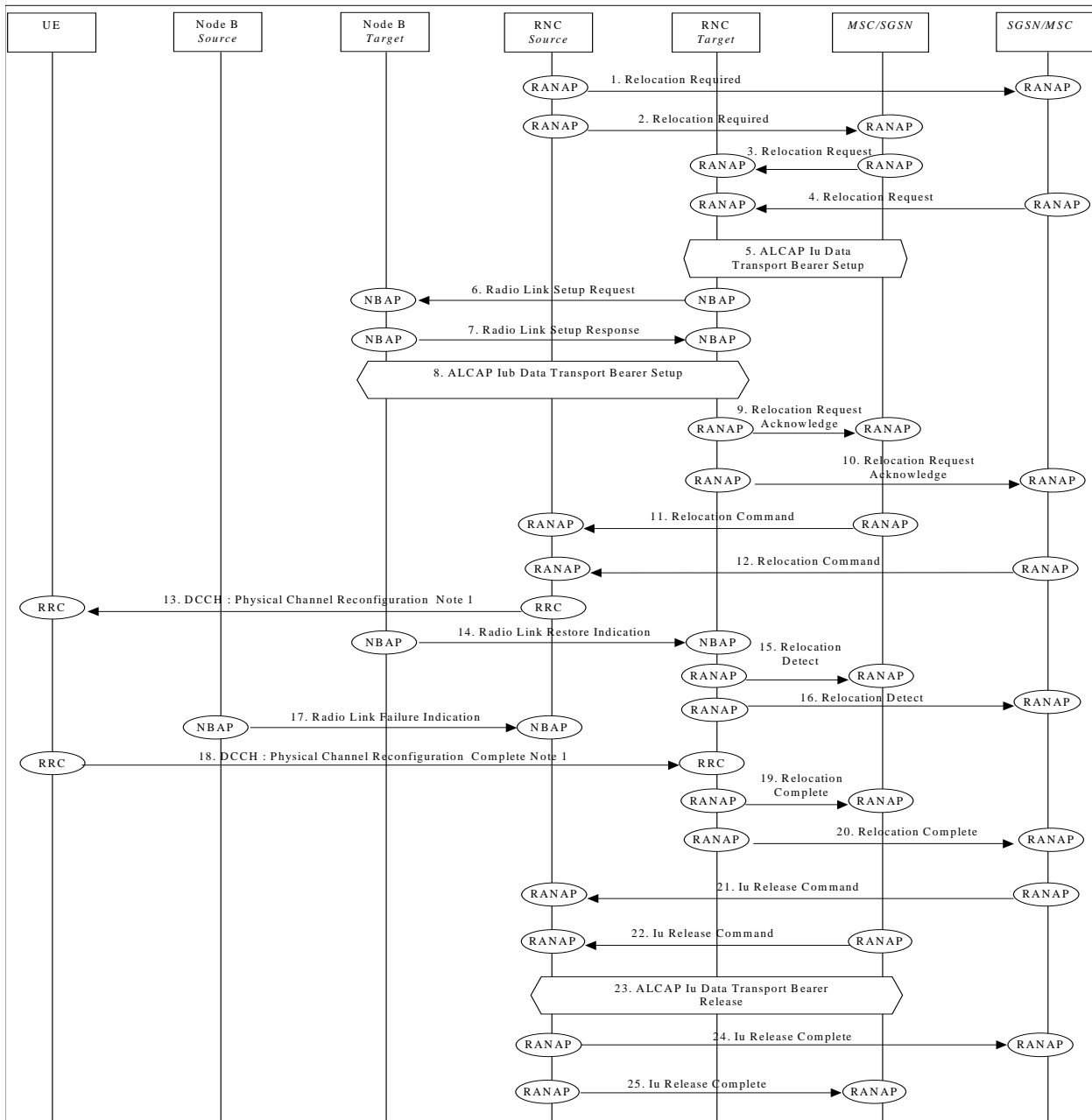

Figure 29: Hard Handover with switching in the CN using SRNS Relocation (UE connected to two CN nodes, DCH state)

Serving RNC makes the decision to perform the Hard Handover via CN. Serving RNC also decides into which RNC (Target RNC) the Serving RNC functionality is to be relocated.

1./2. SRNC sends **Relocation Required** messages to both CN nodes.

Parameters: target RNC identifier, Information field transparent to the CN node and to be transmitted to the target RNC.

Upon reception of **Relocation Required** message CN element prepares itself for the switch and may also suspend data traffic between UE and itself for some bearers.

3./4. When CN is aware of preparation, CN node conveys a **Relocation Request** message to the target RNC to allocate resources.

Parameters: bearer ID's requested to be rerouted towards the CN node, from which the **Relocation Request** originated.

CN indicates in the message whether it prefers point to multipoint type of connections within CN or hard switch in CN. In this example the latter is assumed.

Target RNC allocates necessary resources within the UTRAN to support the radio links to be used after completion of the Hard Handover procedure.

5. Target RNC and CN node establish the new Iu transport bearers for each Radio Access Bearer related to the CN node.

6./7./8. The target RNC allocates RNTI and radio resources for the RRC connection and the Radio Link, then sends the NBAP message **Radio Link Setup Request** to the target Node-B.

Parameters: Cell id, Transport Format Set, Transport Format Combination Set, frequency, UL scrambling code [FDD], Time Slots [TDD], User Codes [TDD], Power control information etc.

Node B allocates resources, starts PHY reception, and responds with NBAP message **Radio Link Setup Response**. Target RNC initiates set-up of Iub Data Transport bearer using ALCAP protocol. This request contains the AAL2 Binding Identity to bind the Iub Data Transport Bearer to the DCH.

9./10. When RNC has completed preparation phase, **Relocation Request Acknowledge** is sent to the CN elements.

Parameters: transparent field to the CN that is to be transmitted to the Source RNS.

11./12. When CN is ready for the change of SRNC, CN node sends a **Relocation Command** to the RNC. Message contains the transparent field provided by Target RNC.

Parameters: information provided in the Information field from the target RNC.

13. Source RNC sends a RRC message **Physical Channel Reconfiguration** to the UE.

14. Target Node B achieves uplink sync on the Uu and notifies target RNC with NBAP message **Radio Link Restore Indication**.

15./16. When target RNC has detected the UE, Relocation Detect message is sent to the CN nodes. Target RNC switches also the connection towards the new Iu, when UE is detected. After the switch UL traffic from node-B's is routed via the newly established MDC to the new MAC/RLC entities and finally to the correct Iu transport bearer. DL data arriving from the new Iu link is routed to newly established RLC entities, to the MAC and to the MD-splitter and Nodes B.

17. When the UE switches from the old RL to the new RL, the source Node B detects a failure on its RL and sends a NBAP message **Radio Link Failure Indication** to the source RNC.

18. When the RRC connection is established with the target RNC and necessary radio resources have been allocated the UE sends RRC message **Physical Channel Reconfiguration Complete** to the target RNC.

19./20. After a successful switch and resource allocation at target RNC, RNC sends **Relocation Complete** messages to the involved CN nodes.

At any phase, before the **Relocation Complete** message is sent, the old communication link between the CN and UE is all the time existing and working and the procedure execution can be stopped and original configuration easily restored. If any such unexceptional thing occurs a **Relocation Failure** message may be sent instead of any message numbered 3-10 and 13-15 described in this above.

21./22. The CN node initiates the release of the Iu connections to the source RNC by sending RANAP message **Iu Release Command**.

23. Upon reception of the release requests from the CN nodes the old SRNC executes all necessary procedures to release all visible UTRAN resources that were related to the RRC connection in question.

24./25. SRNC confirms the IU release to the CN nodes sending the message **Iu Release Complete**.

NOTE 1: The messages used are only one example of the various messages which can be used to trigger a handover, to confirm it or to indicate the handover failure. The different possibilities are specified in the RRC specification (25.331), subclause 8.3.5.2.

7.11.1.2.2 Using Enhanced SRNS Relocation

This example shows Inter-RNS Hard Handover with switch via Iur interface, in a situation in which the UE is connected to two CN nodes simultaneously and will be using one node B directly under the target RNC after the hard handover.

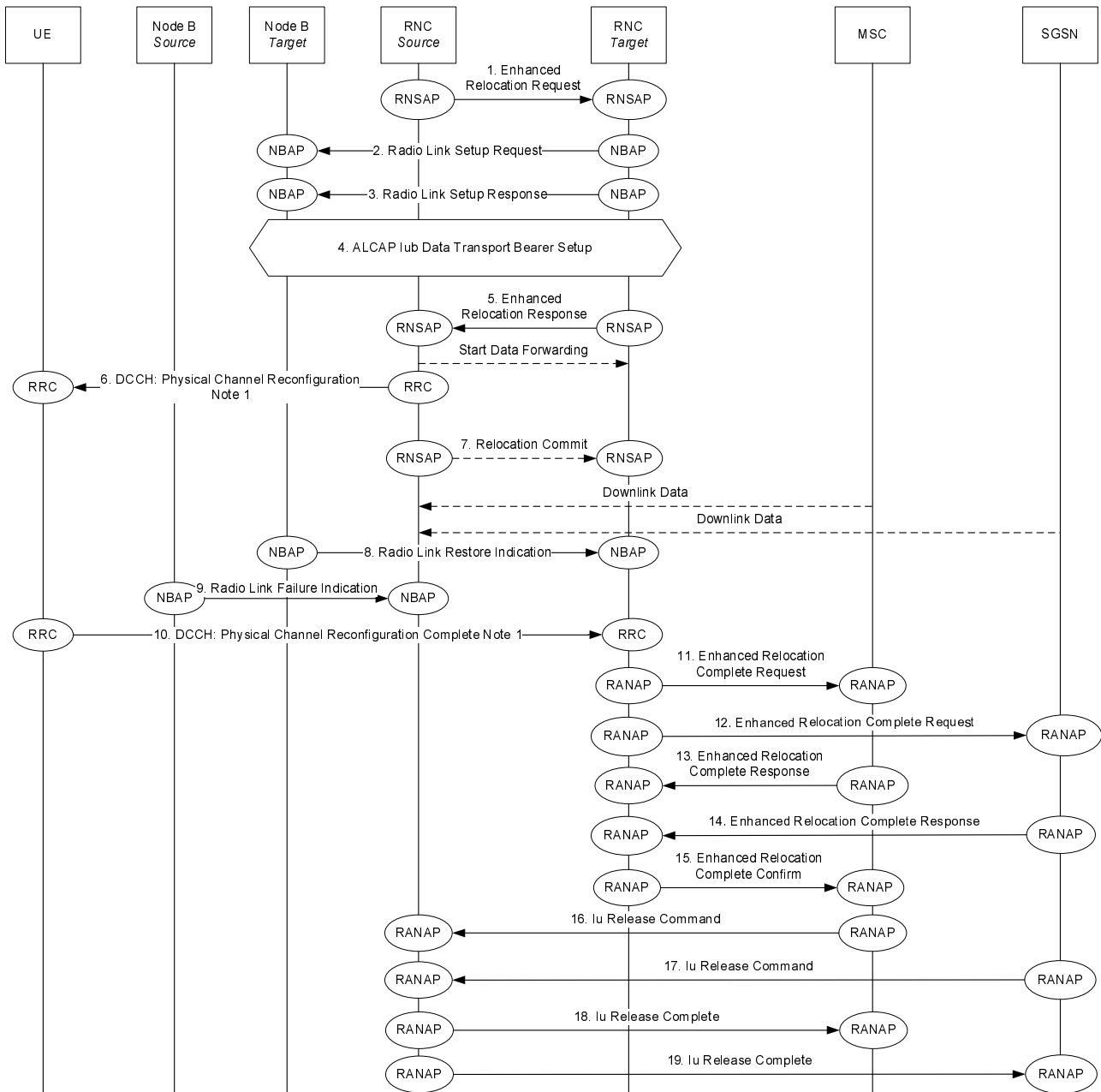

Figure 29A: Hard Handover with switching in the CN using Enhanced SRNS Relocation (UE connected to two CN nodes, DCH state)

Serving RNC makes the decision to perform the Hard Handover via Iur interface. Serving RNC also decides into which RNC (Target RNC) the Serving RNC functionality is to be relocated.

1. SRNC sends **Enhanced Relocation Request** messages to a neighboring RNC (Target RNC).

Parameters: Relocation Type, Cause, SRNC-ID, S-RNTI, Chosen Integrity Protection Algorithm, Integrity Protection Key, Target Cell ID, RRC Container and RANAP Container. The source RNC shall set Relocation Type to "UE Involved".

2./3./4. The target RNC allocates RNTI and radio resources for the RRC connection and the Radio Link, then sends the NBAP message **Radio Link Setup Request** to the target Node-B.

Parameters: Cell id, Transport Format Set, Transport Format Combination Set, frequency, UL scrambling code [FDD], Time Slots [TDD], User Codes [TDD], Power control information etc.

Node B allocates resources, starts PHY reception, and responds with NBAP message **Radio Link Setup Response**. Target RNC initiates set-up of Iub Data Transport bearer using ALCAP protocol. This request contains the AAL2 Binding Identity to bind the Iub Data Transport Bearer to the DCH.

5. Target RNC decides to accept the request and replies an RNSAP **Enhanced Relocation Response** containing RRC Reconfiguration message in RRC Container to be sent to UE to the Source RNC. After the reception of the Enhanced Relocation Response, the Source RNC may begin forwarding of DL data to the Target RNC after the establishment of transport bearer and UP initialization.
6. Source RNC sends a RRC message **Physical Channel Reconfiguration** to the UE
7. Source RNC may send RNSAP **Relocation Commit** to the Target RNC. The message contains SRNS Context including the sequence number of GTP-PDU next to be transmitted in UL/DL and the next PDCP sequence number that would have been used to send and received from UE in case delivery order is required or case of PDCP reservation.
8. Target Node B achieves uplink sync on the Uu and notifies target RNC with NBAP message **Radio Link Restore Indication**.
9. When the UE switch from the old RL to the new RL, the source Node B detect a failure on its RL and send a NBAP message **Radio Link Failure Indication** to the source RNC.
10. When the RRC connection is established with the target RNC and necessary radio resources have been allocated the UE sends RRC message **Physical Channel Reconfiguration Complete** to the target RNC.
11. Target RNC sends the **RANAP Enhanced Relocation Complete Request** message to the MSC, indicating that relocation is happened on the UE.
12. Target RNC sends the **RANAP Enhanced Relocation Complete Request** message to the SGSN, indicating that relocation is happened on the UE.
13. MSC configures the necessary Iu resources for the Target RNC and acknowledges with “**RANAP Enhanced Relocation Complete Response**” message to the Target RNC. In case ATM Transport option is deployed over Iu-CS UP, the MSC contains the Transport Layer Information in the message. After reception of the message in the Target RNC, the RNC initiates to establish AAL2 connection and executes Iu UP initialization.
14. SGSN configures the necessary Iu resources for the Target RNC and acknowledges with “**RANAP Enhanced Relocation Complete Response**” message to the Target RNC.
15. After completion of UP initialization, the Target RNC sends **RANAP Enhanced Relocation Complete Confirm** message to the MSC.
16. MSC initiates release of the resources in the source RNC by sending RANAP: **Iu Release Command**
17. SGSN initiates release of the resources in the source RNC by sending RANAP: **Iu Release Command**
- 18./19. SRNC confirm the IU release to the CN nodes sending the message **Iu Release Complete**.

NOTE 1: The messages used are only one example of the various messages which can be used to trigger a handover, to confirm it or to indicate the handover failure. The different possibilities are specified in the RRC specification (25.331), subclause 8.3.5.2.

7.11.1.3 Inter-Node B synchronised serving HS-DSCH cell change at hard handover

This subclause shows ATM examples of hard handover combined with an inter-Node B serving HS-DSCH cell change.

7.11.1.3.1 Inter-Node B (intra DRNC) synchronised serving HS-DSCH cell change at hard handover

In the following example the HS-DSCH mobility procedure is performed in two steps: the first step consists of establishing a new radio link without the HS-DSCH resources; the next step is a transfer of the HS-DSCH resources to this new radio link followed by a release of the old radio link. In the radio interface, a combined procedure is used.

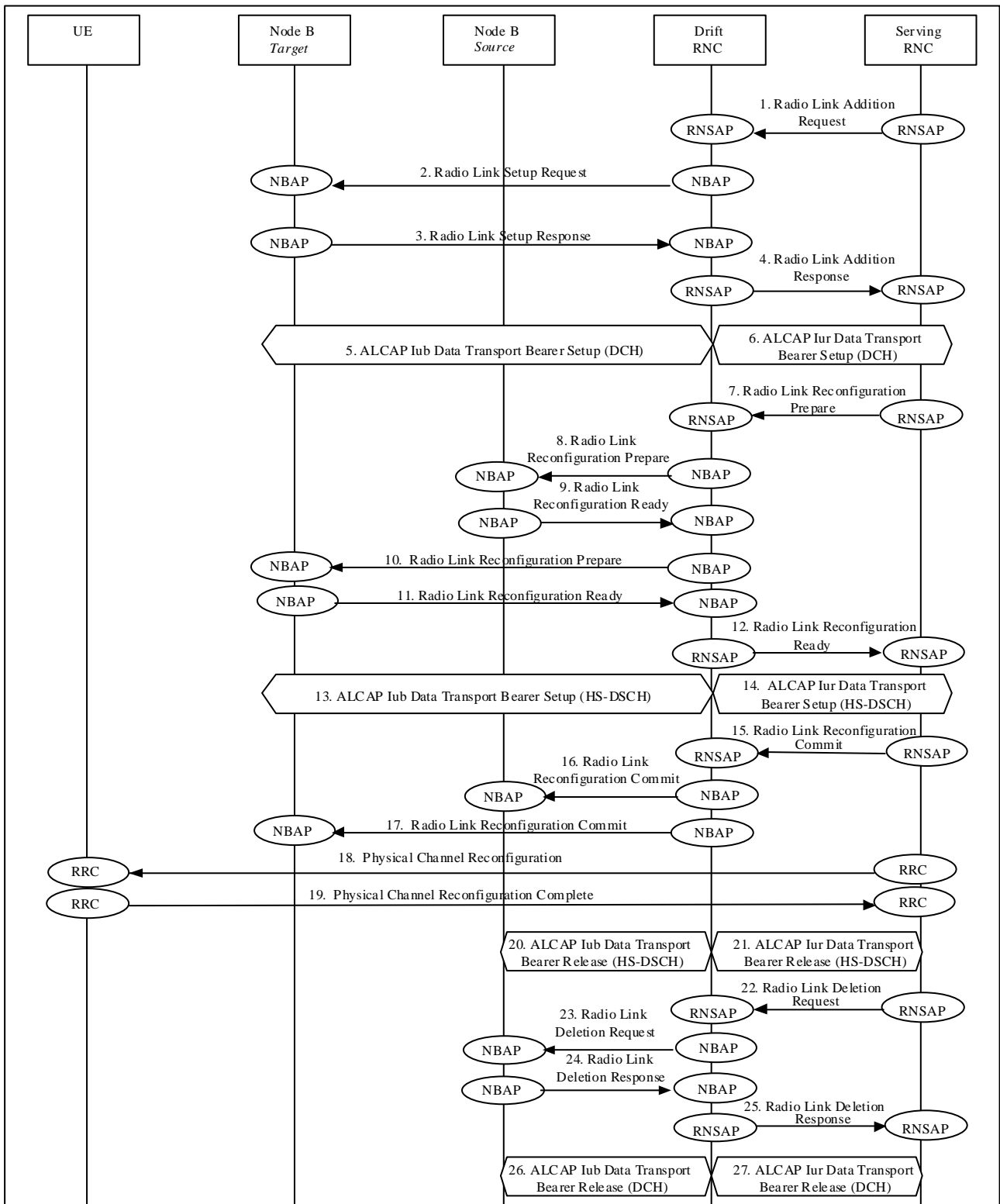

Figure 29a: Inter-Node B (intra DRNC) synchronised serving HS-DSCH cell change at hard handover

1. The SRNC decides that there is a need for a hard handover combined with a serving HS-DSCH cell change. It prepares a RNSAP message **Radio Link Addition Request**, which is transmitted to the DRNC.
Parameters: target cell ID.
2. The DRNC allocates radio resources for the new radio link and requests the target Node B to establish a new radio link by transmitting a NBAP message **Radio Link Setup Request**.
Parameters: no HSDPA-specific parameters.
3. The target Node B allocates resources, starts physical layer reception on the DPCH on the new radio link and responds with the NBAP message **Radio Link Setup Response**.
Parameters: no HSDPA-specific parameters.
4. The DRNC responds to the SRNC with the RNSAP message **Radio Link Addition Response** and the DCH transport bearer is established.
5. The DRNC initiates set-up of a new Iub Data Transport Bearers using ALCAP protocol. This request contains the AAL2 Binding Identity to bind the Iub Data Transport Bearer to the DCH.
6. In case of no combination in the DRNC, the SRNC initiates set-up of a new Iur Data Transport Bearer using ALCAP protocol. This request contains the AAL2 Binding Identity to bind the Iur Data Transport Bearer to the DCH.
7. As the next step, the SRNC prepares the RNSAP message **Radio Link Reconfiguration Prepare** which is transmitted to the DRNC.
Parameters: SRNC selected HS-PDSCH RL ID.
8. The DRNC requests the source HS-DSCH Node B to perform a synchronised radio link reconfiguration using the NBAP message **Radio Link Reconfiguration Prepare**, removing its HS-DSCH resources for the source HS-DSCH radio link.
Parameters: HS-DSCH MAC-d Flows To Delete.
9. The source HS-DSCH Node B returns the NBAP message **Radio Link Reconfiguration Ready**.
Parameters: no HSDPA-specific parameters.
10. The DRNC requests the target HS-DSCH Node B to perform a synchronised radio link reconfiguration using the NBAP message **Radio Link Reconfiguration Prepare**, adding HS-DSCH resources for the target HS-DSCH radio link.
Parameters: HS-DSCH information including an HS-PDSCH RL ID and a DRNC selected HS-DSCH RNTI.
11. The target HS-DSCH Node B returns the NBAP message **Radio Link Reconfiguration Ready**.
Parameters: HS-DSCH Information Response.
12. The DRNC returns the RNSAP message **Radio Link Reconfiguration Ready** to the SRNC.
Parameters: HS-DSCH information response and the DRNC selected HS-DSCH-RNTI.
13. The DRNC initiates set-up of a new Iub Data Transport Bearers using ALCAP protocol. This request contains the AAL2 Binding Identity to bind the Iub Data Transport Bearer to the HS-DSCH.
14. The SRNC may initiate set-up of a new Iur Data Transport Bearer using ALCAP protocol. This request contains the AAL2 Binding Identity to bind the Iur Data Transport Bearer to the HS-DSCH.
15. The HS-DSCH transport bearer to the target HS-DSCH Node B is established. The SRNC proceeds by transmitting the RNSAP message **Radio Link Reconfiguration Commit** to the DRNC including an SRNC selected activation time in the form of a CFN.
Parameters: SRNC selected activation time in the form of a CFN.
16. The DRNC transmits a NBAP message **Radio Link Reconfiguration Commit** to the source HS-DSCH Node B including the activation time. At the indicated activation time the source HS-DSCH Node B stops and the target HS-DSCH Node B starts transmitting on the HS-DSCH to the UE.
Parameters: SRNC selected activation time in the form of a CFN.
17. The DRNC transmits a NBAP message **Radio Link Reconfiguration Commit** to the target HS-DSCH Node B including the activation time. At the indicated activation time the source HS-DSCH Node B stops and the target HS-DSCH Node B starts transmitting on the HS-DSCH to the UE.
Parameters: SRNC selected activation time in the form of a CFN

18. The SRNC also transmits a RRC message **Physical Channel Reconfiguration** to the UE.
Parameters: activation time, DPCH information for the target cell, MAC-hs reset indicator, serving HS-DSCH radio link indicator, HS-SCCH set info and H-RNTI.
19. At the indicated activation time the UE abandons the current active set and initiates establishment of the DPCH in the target cell. When physical layer synchronisation is established in the target cell, it starts DPCH reception and transmission and HS-DSCH reception in the target cell. The UE returns the RRC message **Physical Channel Reconfiguration Complete** to the SRNC.
20. The DRNC initiates release of the old Iub Data Transport bearer to the source HS-DSCH Node B using ALCAP protocol.
21. If a new Iur Data Transport Bearer was set up in 14. then the SRNC initiates release of the old Iur Data Transport bearer using ALCAP protocol.
22. The SRNC then finalises the procedure by transmitting the RNSAP message **Radio Link Deletion Request** to the DRNC.
In the message the source cell to be deleted is identified.
Parameters: RL ID.
23. The DRNC transmits the NBAP message **Radio Link Deletion Request** to the source Node B.
Parameters: RL ID.
24. 24. The source Node B releases resources for the source radio link and returns the NBAP message **Radio Link Deletion Response** to the DRNC.
25. 25. The DRNC returns the RNSAP message **Radio Link Deletion Response** to the SRNC.
26. 26. The DRNC initiates release of the old Iub DCH Transport bearer to the source HS-DSCH Node B using ALCAP protocol.
27. 27. If a new Iur Data Transport Bearer was set up in 6. then the SRNC initiates release of the old Iur DCH Transport bearer using ALCAP protocol.

7.11.1.3.2 Inter-Node B (inter DRNC) synchronised serving HS-DSCH cell change at hard handover

In this second example the source Node B and the target Node B are controlled by two different DRNCs, referred to as source DRNC and target DRNC, respectively. In this case the HS-DSCH mobility procedure is performed in a single step.

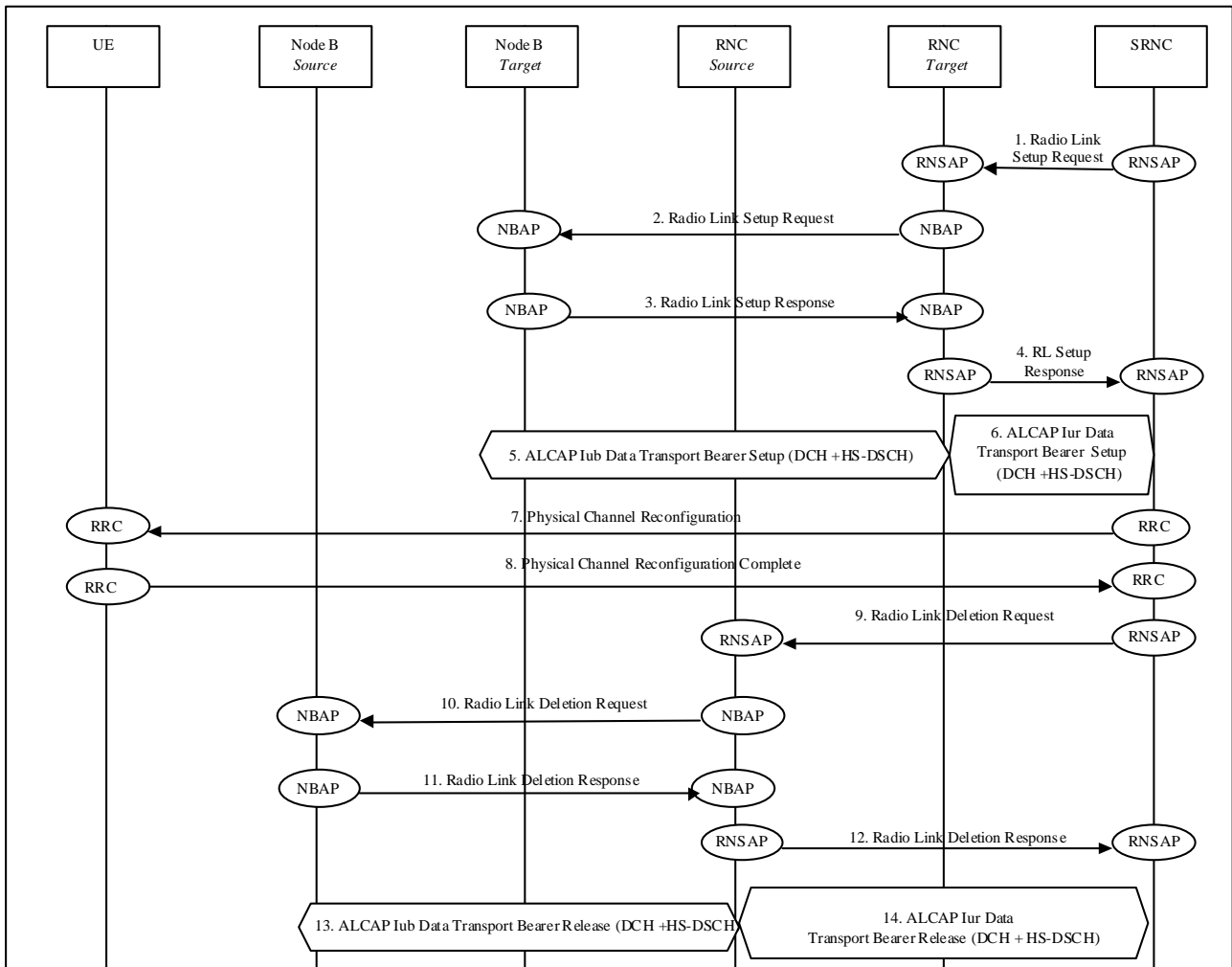

Figure 29b: Inter-Node B (inter DRNC) synchronised serving HS-DSCH cell change at hard handover

1. The SRNC decides that there is a need for hard handover combined with serving HS-DSCH cell change. It prepares the RNSAP message **Radio Link Setup Request**, which is transmitted to the target DRNC.
Parameters: HS-DSCH information and HS-PDSCH RL ID.
2. The target DRNC allocates radio resources for the new radio link and requests the target Node B to establish a new radio link by transmitting the NBAP message **Radio Link Setup Request**.
Parameters: HS-DSCH information, HS-DSCH-RNTI and HS-PDSCH RL ID.
3. The target Node B allocates resources, starts physical layer reception on the DPCH on the new radio link and responds with the NBAP message **Radio Link Setup Response**.
Parameters: HS-DSCH Information Response.
4. The target DRNC responds to the SRNC with the RNSAP message **Radio Link Setup Response**.
Parameters: HS-DSCH Information Response and HS-DSCH-RNTI.
5. The DRNC initiates the setup of Iub DCH and HS-DSCH Data Transport bearers to the target HS-DSCH Node B using ALCAP protocol.
6. The SRNC initiates the setup of Iur DCH and HS-DSCH Data Transport bearers.
7. The SRNC transmits the RRC message **Physical Channel Reconfiguration** to the UE.
Parameters: activation time, DPCH information for the target cell, MAC-hs reset indicator, serving HS-DSCH radio link indicator, HS-SCCH set info and H-RNTI.
8. At the indicated activation time the UE abandons the current active set and initiates establishment of the DPCH in the target cell. When physical layer synchronisation is established in the target cell, it starts DPCH reception

and transmission and HS-DSCH reception in the target cell. The UE returns the RRC message **Physical Channel Reconfiguration Complete** to the SRNC.

9. The SRNC then finalises the procedure by transmitting the RNSAP message **Radio Link Deletion Request** to the source DRNC.
In the message the source cell to be deleted is identified.
Parameters: RL ID.
10. The source DRNC transmits the NBAP message **Radio Link Deletion Request** to the source Node B.
Parameters: RL ID.
11. The source Node B releases resources for the source radio link and returns the NBAP message **Radio Link Deletion Response** to the source DRNC.
12. The source DRNC returns the RNSAP message **Radio Link Deletion Response** to the SRNC.
13. The DRNC initiates the release of the old Iub DCH and HS-DSCH Data Transport bearers to the target HS-DSCH Node B using ALCAP protocol.
14. The SRNC initiates the release of the old Iur DCH and HS-DSCH Data Transport bearers.

7.11.2 Forward Hard Handover

This subclause shows some examples of hard handover in the case of mobile initiated forward handovers.

Some examples of Cell Update procedures are shown, i.e. those procedures that update the position of the UE when a RRC connection exists and the position of the UE is known on cell level in the UTRAN. The UE is in CELL_PCH or CELL_FACH.

7.11.2.1 Cell Update

7.11.2.1.1 Using Cell Update with SRNS relocation

This example shows Inter-RNS Cell Update with switching in the CN (therefore with SRNS relocation) and RNTI reallocation.

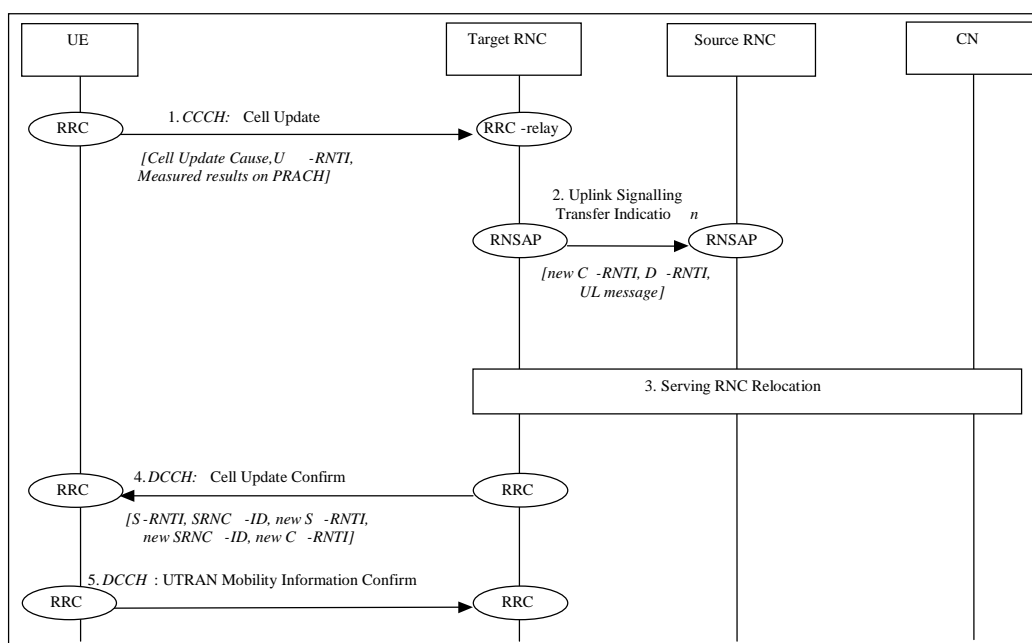

Figure 30: Cell Update with SRNS Relocation

1. UE sends a RRC message Cell Update to the UTRAN, after having made cell re-selection. Upon reception of a CCCH message from a UE, target RNC allocates a C-RNTI for the UE.
2. Controlling target RNC forward the received message (on CCCH) via **Uplink Signalling Transfer Indication** RNSAP message towards the SRNC. Message includes, besides target RNC-ID, also the allocated C-RNTI, which is to be used as UE identification within the C-RNC, and the D-RNTI. Upon reception of the RNSAP message SRNC decides to perform SRNS Relocation towards the target RNC.
3. Serving RNC relocation procedure is executed as defined in subclause 'SRNS Relocation Relocation (UE connected to a single CN node)'. After completing SRNS Relocation, target RNC allocates new S-RNTI for the UE, becoming the new serving RNC.
4. Target RNC responds to UE by RRC **Cell Update Confirm**, including old S-RNTI and SRNC ID as UE identifiers. Message contains also the new S-RNTI, SRNC-ID and C-RNTI.
5. UE acknowledges the RNTI reallocation by sending the RRC message **UTRAN Mobility Information Confirm**.

7.11.2.1.2 Using Enhanced SRNS Relocation

This example shows Inter-RNS Cell Update with switching in the CN (therefore with SRNS relocation) and RNTI reallocation.

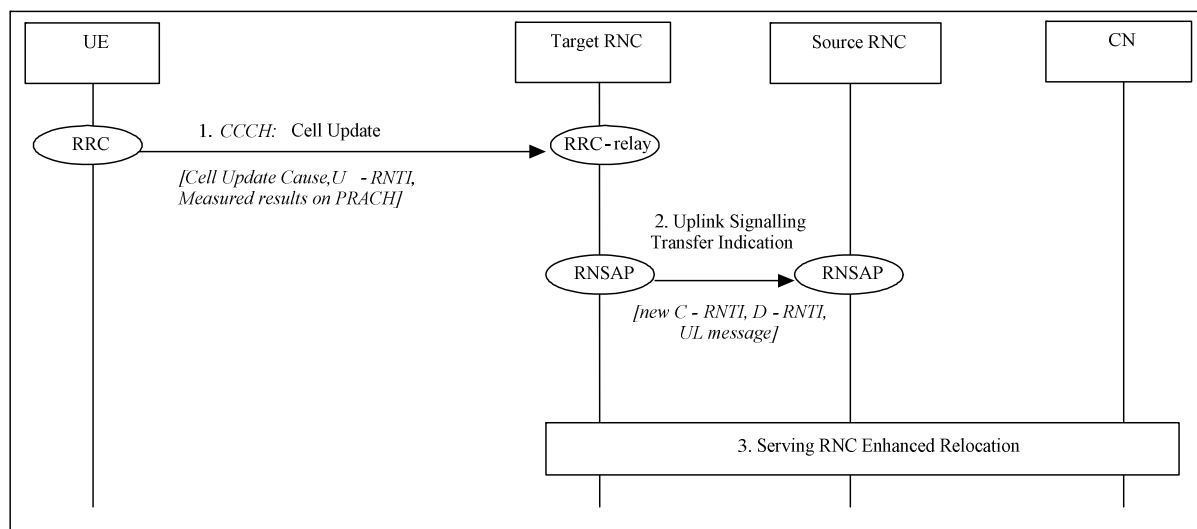

Figure xy: Cell Update with Enhanced SRNS Relocation

1. UE sends a RRC message Cell Update to the UTRAN, after having made cell re-selection. Upon reception of a CCCH message from a UE, target RNC allocates a C-RNTI for the UE.
2. Controlling target RNC forward the received message (on CCCH) via **Uplink Signalling Transfer Indication** RNSAP message towards the SRNC. Message includes, besides target RNC-ID, also the allocated C-RNTI, which is to be used as UE identification within the C-RNC, and the D-RNTI. Upon reception of the RNSAP message SRNC decides to perform Enhanced Relocation towards the target RNC.
3. Serving RNC Enhanced Relocation procedure is executed as defined in subclause 'SRNS Enhanced Relocation (UE connected to a single CN node)'. After completing SRNS Enhanced Relocation, target RNC allocates new S-RNTI for the UE, becoming the new serving RNC.

7.11.2.2 Cell Update via Iur without SRNS relocation

This example shows an Inter RNS cell update in DRNS without SRNS relocation when no Iur RACH/FACH transport bearer exists. In this example target DRNS, source DRNS and serving RNS are all located separately from each other. Other scenarios can be easily derived from this most comprehensive signalling procedure.

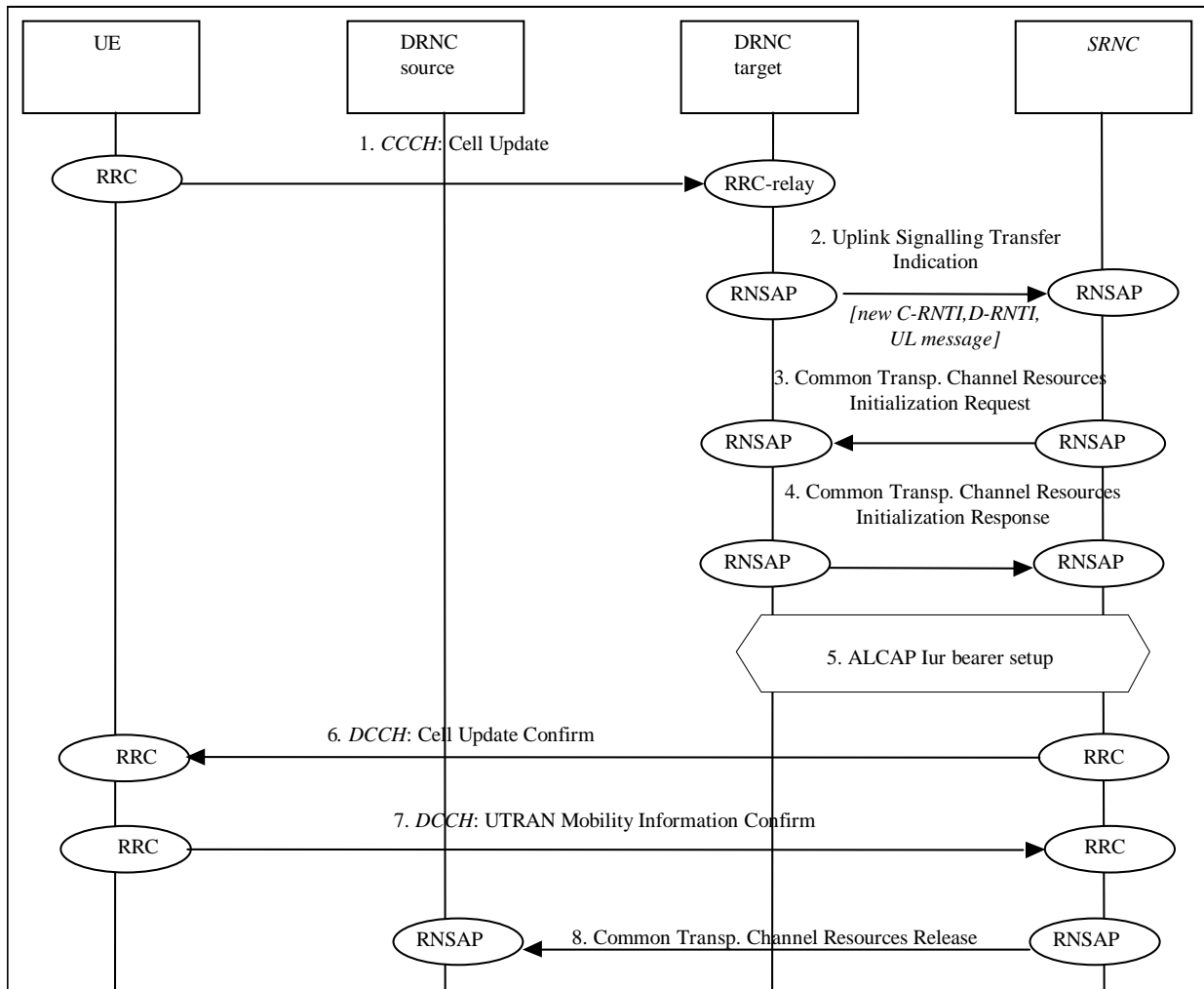

Figure 31: Cell Update via Iur without SRNS Relocation

1. UE sends an RRC message Cell Update to the UTRAN (Target DRNC), after having made cell re-selection.
2. Upon reception of a CCCH message from a UE, the target DRNC decodes the SRNC-ID and the S-RNTI. The UE is not registered in the target DRNC, thus the target DRNC allocates C-RNTI and D-RNTI for the UE. The target DRNC forwards the received uplink CCCH message towards the SRNC in the RNSAP **Uplink Signalling Transfer Indication** message. The Uplink Signalling Transfer message includes also the cell-ID of the cell from which the CCCH message was received, the D-RNC ID and the allocated C-RNTI and D-RNTI.
3. Upon reception of the Uplink Signalling Transfer message the SRNC decides not to perform an SRNS Relocation towards the target RNC. The SRNC initialises the UE context in the target RNC with the RNSAP **Common Transport Channel Resources Initialisation Request** message. The message includes the D-RNTI and the cell identity previously received in the Uplink Signalling Transfer indication message, as well as a request for transport layer address and binding identity if there exists no appropriate Iur transport bearer to be used for the UE.
4. The target DRNC sends the transport layer address, binding identity and optionally PHY parameters (FACH code,) to the SRNC with the RNSAP **Common Transport Channel Resources Initialisation Response** message
5. If there does not already exist an appropriate Iur transport bearer to be used for the UE, a transport bearer is established from the SRNC.
6. The SRNC sends RRC **Cell Update Confirm** to the UE. The message is sent in the Iur user plane. It will be sent by the target DRNC to the UE on the FACH coupled to the RACH. Subsequent FACH data may be sent on a different FACH if so decided by the target DRNC.

7. UE acknowledges the RNTI reallocation by sending the RRC message **UTRAN Mobility Information Confirm**.
8. The SRNC releases the UE context in the source DRNC by sending a **Common Transport Channel Resources Release** message. The source DRNC releases the D-RNTI.

7.11.2.3 Cell Update via Iur without SRNS relocation (with C-RNTI reallocation)

This example is similar to the previous one (7.11.2.2) with minor changes. It shows a cell update in DRNS without SRNS relocation when an Iur RACH/FACH transport bearer exists and the UE is already known in the DRNS. The DRNC decides to allocate a new C-RNTI for the UE but not a new D-RNTI because D-RNC does not change. Therefore the two columns DRNC of picture 31 merge themselves to represent this case.

7.11.2.4 Cell Update via Iur with USCH/DSCH, without SRNS relocation [TDD]

This example shows an inter-RNS cell update without SRNS relocation, when the UE is in Cell_FACH state and has been allocated DSCH and USCH before the Cell Update and when no Iur RACH/FACH transport bearer exists. In this example target RNS, source RNS and serving RNS are all located separately from each other. The procedure includes an implicit release of the USCH and DSCH, which includes release of the Radio Link in the old cell. A potential restoration of USCH and DSCH after the cell update, triggered by the SRNC, is not shown.

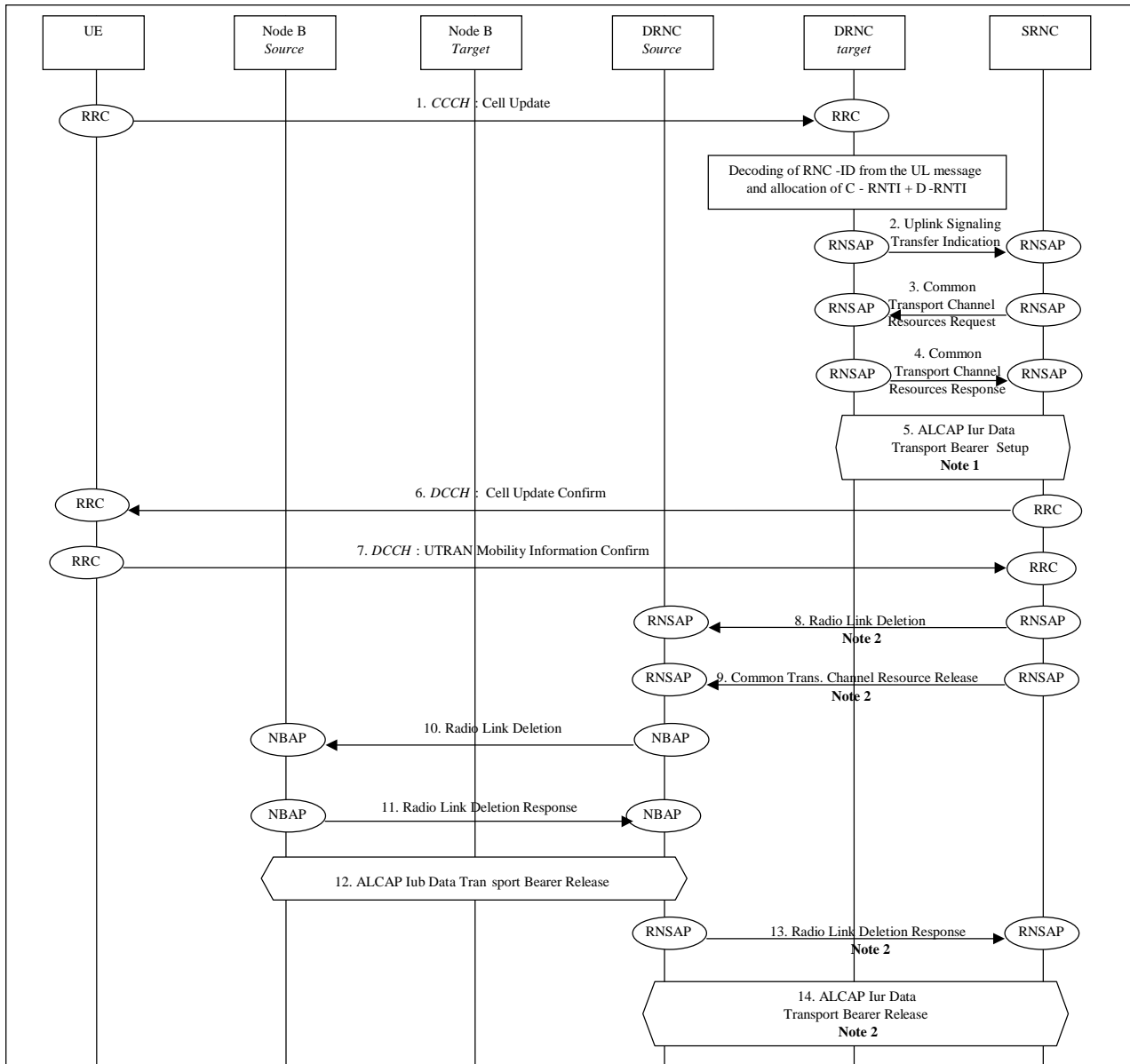

NOTE 1: These messages are not necessary if the Target RNC and the SRNC are identical.
 NOTE 2: These messages are not necessary if the Source RNC and the SRNC are identical.

Figure 32: Backward Cell Update via Iur (Cell_FACH State with USCH/DSCH) – successful case.

1. When the UE decides that a cell update is necessary, it sends an RRC message **Cell Update** to the Target RNC. This is a *CCCH* message carried on the *RACH* in the new cell. Upon reception of a *CCCH* message from a UE, the target DRNC decodes the SRNC ID and the S-RNTI. Supposing that the UE is not registered in the target DRNC (RNC ID and SRNTI unknown), the target DRNC allocates a C-RNTI and a D-RNTI for the UE.
2. The Target RNC forwards the **Cell Update** to the SRNC via an RNSAP **Uplink Signaling Transfer** message (see note 1). The Uplink Signaling Transfer message includes also the cell-ID of the cell from which the *CCCH* message was received, the D-RNTI and the allocated C-RNTI. Upon reception of the Uplink Signaling Transfer message the SRNC decides not to perform a SRNS Relocation towards the target RNC.
3. The SRNC initialises the UE context in the target RNC with the **RNSAP Common Transport Channel Resource Request** message. The message includes the D-RNTI and the cell identity previously received in the Uplink Signaling Transfer indication message, as well as a request for transport layer address and binding identity if there exists no appropriate Iur transport bearer to be used for the UE (see note 1)

4. The Target RNC responds with an RNSAP message **Common Transport Channel Resources Response** including the transport layer address, binding identity and optionally PHY parameters (FACH code, ..) (see note 1).
5. If there does not already exist an appropriate Iur transport bearer to be used for the UE, a transport bearer is established from the SRNC (see note 1).
6. The SRNC sends an RRC message **Cell Update Confirm** within the *DCCH* on *FACH* to the UE. The message is sent in the Iur user plane. It will be sent by the target DRNC to the UE on the FACH coupled to the RACH. Subsequent FACH data may be sent on a different FACH if so decided by the target DRNC.
7. UE acknowledges the RNTI reallocation by sending the RRC message **UTRAN Mobility Information Confirm**.
8. The SRNC releases the UE context in the source DRNC by sending a **Common Transport Channel Resource Release** message. The source DRNC releases the D-RNTI (see note 2).
9. The SRNC sends an RNSAP message **Radio Link Deletion** to the source RNC (see note 2).
10. The source RNC sends NBAP message **Radio Link Deletion** to the source Node B.
Parameters: Cell id, Transport layer addressing information.
11. The source Node B deletes the previous Radio link and the Communication Context. Successful outcome is reported in NBAP message **Radio Link Deletion Response**.
12. The source RNC initiates release of the corresponding Iub Data Transport bearers using ALCAP protocol.
13. When the source RNC has completed the release, the RNSAP message **Radio Link Deletion Response** is sent to the SRNC (see note 2).
14. SRNC initiates release of Iur Data Transport bearer using ALCAP protocol. The request for release of Iur Data Transport bearer is acknowledged by the Source RNC (see note 2).

7.12 URA Update

This subclause presents some examples of URA Update procedures, i.e. those procedures that update the UTRAN registration area of a UE when a RRC connection exists and the position of the UE is known on URA level in the UTRAN.

7.12.1 Inter-RNS URA Update

7.12.1.1 Inter-RNS URA Update using SRNS Relocation

This example shows Inter-RNS URA Update with switching in the CN (SRNS relocation).

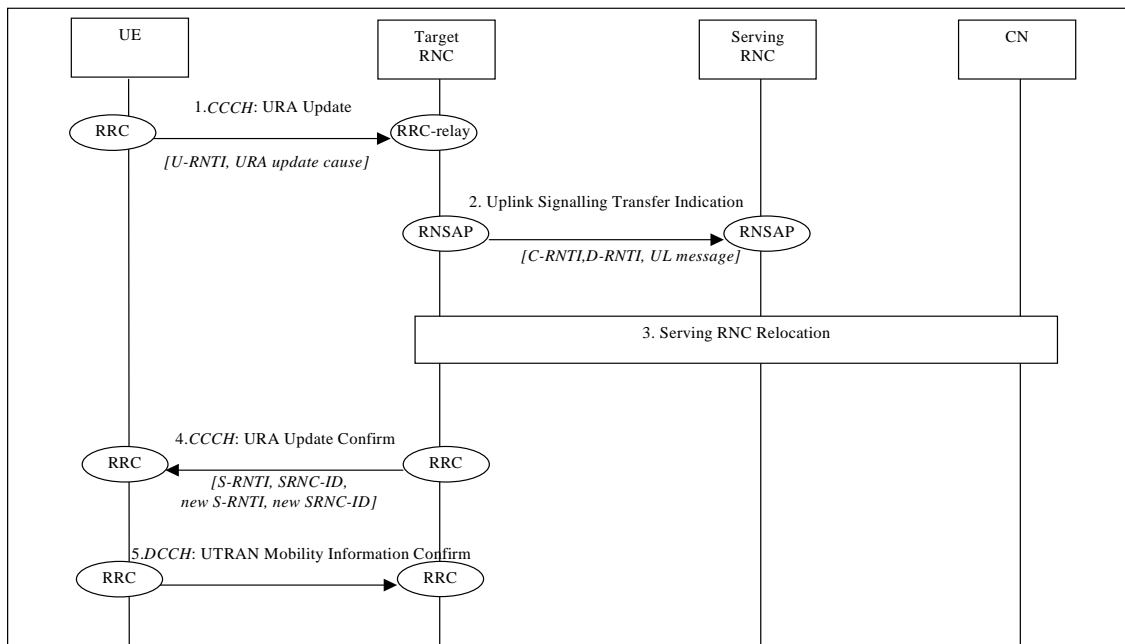

Figure 33: Inter RNS URA Update with switching in CN using SRNS Relocation.

1. UE sends a RRC message URA Update to the UTRAN, after having made cell re-selection. Upon reception of a CCCH message from an unknown UE, the target RNC becomes a controlling RNC and it allocates a new C-RNTI and a new D-RNTI for the UE.
2. The target RNC forwards the received uplink CCCH message towards the SRNC by RNSAP **Uplink Signalling Transfer Indication** message to the old Source/Controller RNC. Message includes, besides target RNC-ID, also the allocated C-RNTI, which is to be used as UE identification within the C-RNC, and the D-RNTI. Upon reception of the RNSAP message SRNC decides to perform SRNS Relocation towards the target RNC.
3. Serving RNC relocation procedure is executed as defined in subclause 'SRNS Relocation (UE connected to a single CN node)'. After having completed SRNS Relocation, target RNC allocates new S-RNTI for the UE becoming the new serving RNC. New SRNC also deletes the allocated C-RNTI, since it is not needed for an UE in URA_PCH state.
4. Serving RNC acknowledges the message by RRC **URA Update Confirm**, including old S-RNTI and SRNC ID as UE identifiers. Message contains also the new S-RNTI and RNC-ID.
5. UE acknowledges the RNTI reallocation by sending the RRC message **UTRAN Mobility Information Confirm** on DCCH.

7.12.1.2 Using Enhanced SRNS Relocation

This example shows Inter-RNS URA Update with switching in the CN (SRNS Enhanced Relocation).

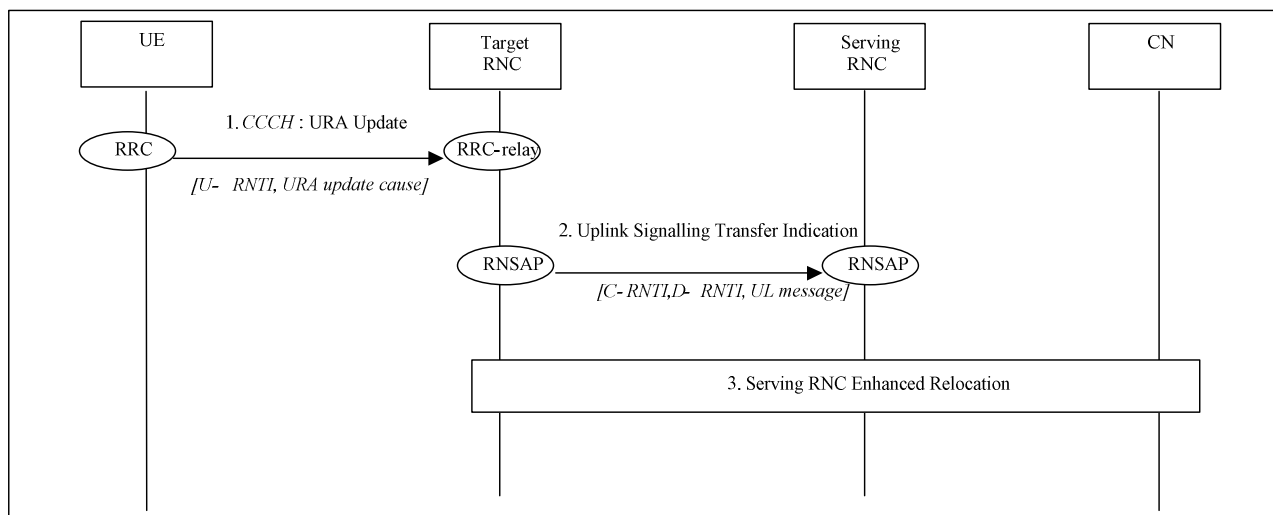

Figure 33A: Inter RNS URA Update with switching in CN using Enhanced SRNS Relocation.

1. UE sends a RRC message URA Update to the UTRAN, after having made cell re-selection. Upon reception of a CCCH message from an unknown UE, the target RNC becomes a controlling RNC and it allocates a new C-RNTI and a new D-RNTI for the UE.
2. The target RNC forwards the received uplink CCCH message towards the SRNC by RNSAP **Uplink Signalling Transfer Indication** message to the old Source/Controller RNC. Message includes, besides target RNC-ID, also the allocated C-RNTI, which is to be used as UE identification within the C-RNC, and the D-RNTI. Upon reception of the RNSAP message SRNC decides to perform SRNS Enhanced Relocation towards the target RNC.
3. Serving RNC Enhanced Relocation procedure is executed as defined in subclause 'SRNS Enhanced Relocation (UE connected to a single CN node)'. After having completed SRNS Enhanced Relocation, target RNC allocates new S-RNTI for the UE becoming the new serving RNC. New SRNC also deletes the allocated C-RNTI, since it is not needed for an UE in URA_PCH state.

7.12.2 Inter-RNS URA Update via Iur without SRNS relocation

This example shows an Inter RNS URA update in DRNS without SRNS relocation. In this example target RNS, source RNS and serving RNS are all located separately from each other. Other scenarios can be easily derived from this most comprehensive signalling procedure.

Please note that this example shows the case when no ciphering is required; for this case no channels on Iur are required and therefore the message flow 5 (Cell Update Confirm) is sent on CCCH. In the case that ciphering is required, that message must be sent on the DCCH (ciphering is performed at MAC-d level) and the flow becomes similar to the one shown for the Cell Update in section "Cell Update via Iur without RNS relocation".

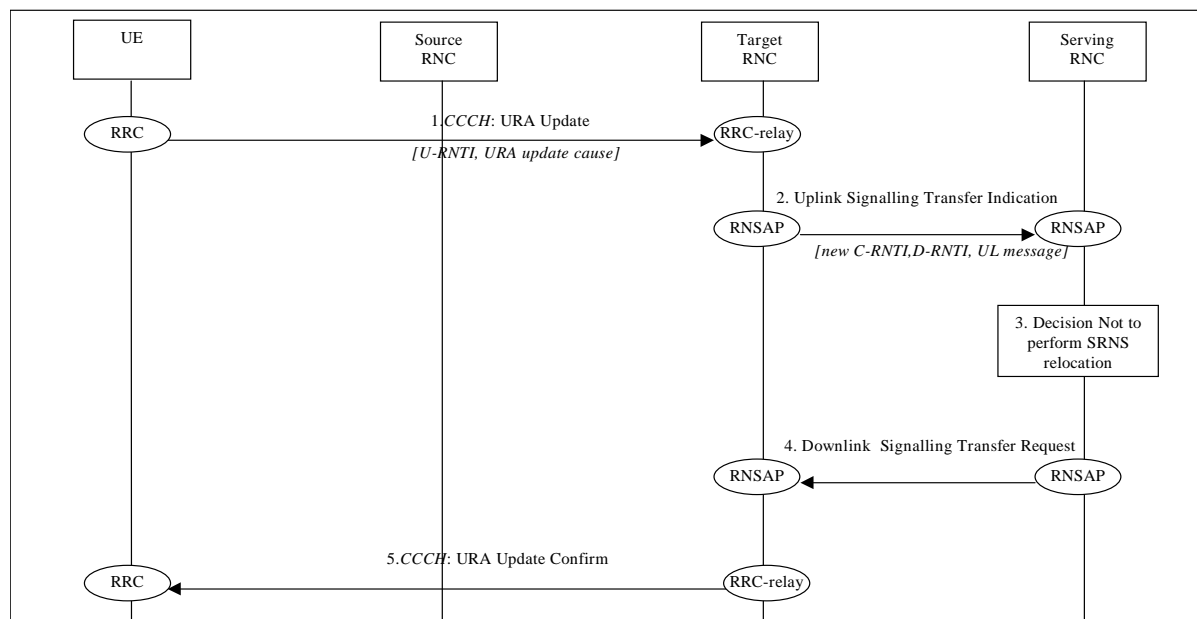

Figure 34: Inter-RNS URA Update via lur without SRNS relocation

1. UE sends a RRC message URA Update to the UTRAN, after having made cell re-selection and URA has changed.
2. Upon reception of the message from a UE, Target RNC decodes the RNC ID and the S-RNTI. The UE is not registered in the target RNC (RNC ID and SRNTI unknown), thus RNC allocates C-RNTI and D-RNTI for the UE. The Target RNC forward the received Uu signalling message towards the SRNC by RNSAP **Uplink Signalling Transfer Indication** message. The message includes also the cell-ID from which the message was received and the allocated C-RNTI and D-RNTI.
3. Upon reception of the RNSAP message SRNC decides not to perform an SRNS relocation towards the target RNC. The target RNC become C-RNC while SRNC remains unchanged.
4. SRNC delivers to Target RNC information upon, eventually new, RNTIs via a **Downlink Signalling Transfer Request**, transporting a URA Update Confirm.
5. The **URA Update Confirm** is forwarded to the UE (via CCCH with new RNTIs) from the target RNC.

7.12.3 SRNS Relocation (UE connected to two CN nodes)

7.12.3.1 Using SRNS Relocation

This example show SRNS Relocation, in situation in which the UE is connected to two CN nodes simultaneously (this means that RNC is connected to a SGSN and a MSC). It is assumed that:

- all cells in the active set are in one DRNC;
- the CN performs hard switching of the user traffic.

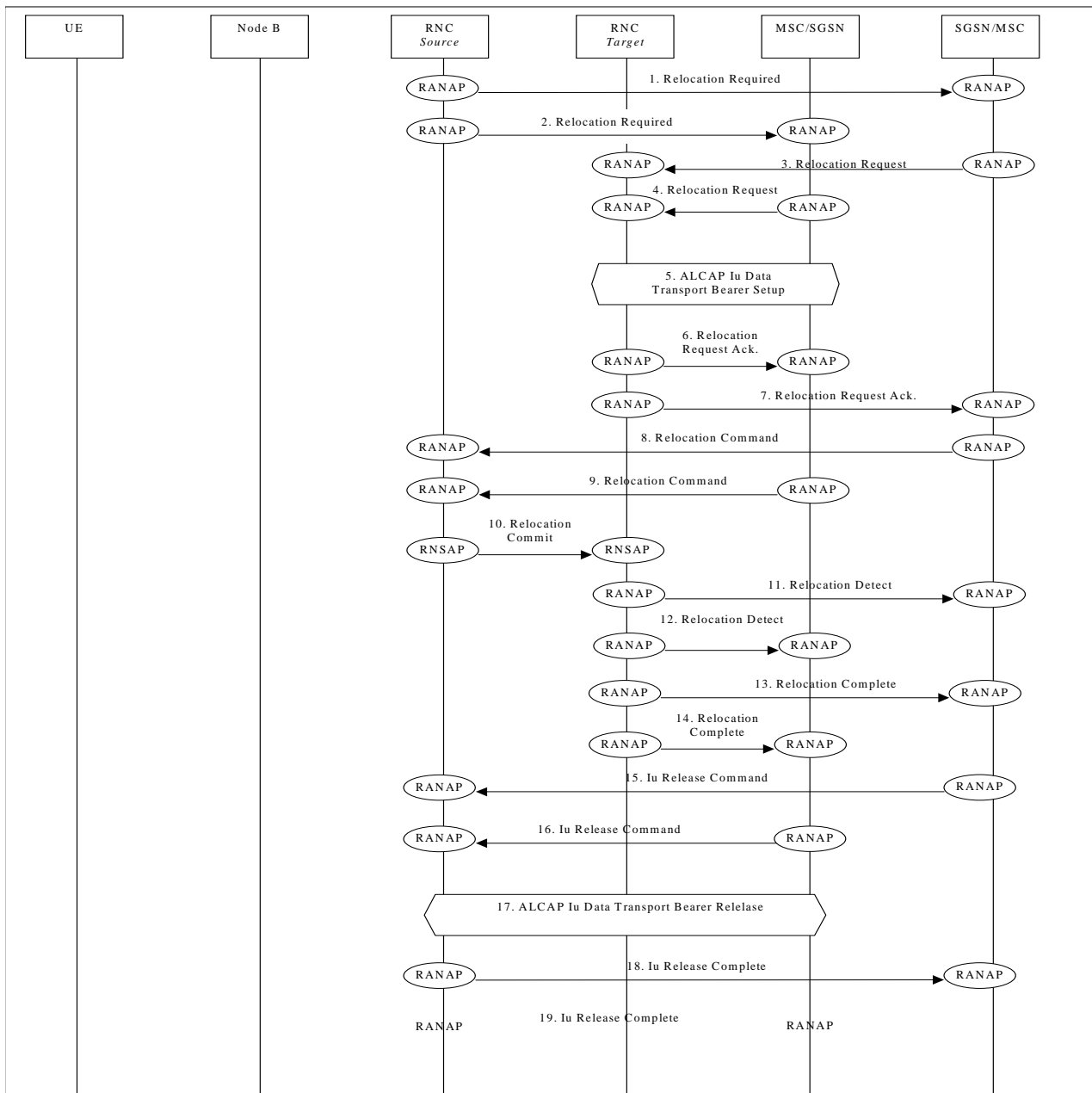

Figure 35: SRNS Relocation (UE connected to two CN nodes)

Note that the SRNC makes the decision to perform the Serving RNC relocation procedure. The Serving RNC also decides into which RNC (Target RNC) the Serving RNC functionality is to be relocated.

- 1./2. The source SRNC sends **Relocation Required** messages to both CN nodes.
Parameters: target RNC identifier, Information field that the CN node(s) shall pass transparently to the target RNC. This transparent field contains the UE identifier, number of CN nodes and other data.
Upon reception of **Relocation Required** message the CN element prepares itself for the switch and may also suspend user data traffic and/or signalling between UE and itself for some bearers.
- 3./4. When preparation is completed the CN node conveys a **Relocation Request** message to the target RNC.
Parameters: indication of which bearers should be routed towards this CN node, transparent information field sent by the source RNC, UE identifier.

The target RNC uses the UE identifier to link the requests from multiple CN nodes to each other and to the resources (e.g. Iub links) that the UE is currently using.

5. The targets RNC and CN node establish the new Iu transport bearers for each Radio Access Bearer related to that CN node.

- 6./7. When the source RNC and the target RNC have completed its preparation phase, **Relocation Request Acknowledge** message is sent to CN.
- 8./9. When the CN node is ready for the SRNC move, the CN node indicates the completion of preparation phase at the CN side for the SRNS Relocation by sending the **Relocation Command** message to the source RNC.
10. When the source RNC has received **Relocation Command** messages from all the CN nodes, the source RNC sends a **Relocation Commit** message to the target RNC to request the target RNC to proceed with the Relocation.
- 11./12. The target RNC sends the **Relocation Detect** message to the involved CN nodes and also executes both the DL and UL switch for all bearers at the earliest suitable time instance.
After the switch UL traffic from Node B's is routed via the newly established Macro Diversity Combiner to the new MAC/RLC entities and finally to the correct Iu transport bearer. UL data transmission to the old Iu transport bearer is ceased. Upon reception of Relocation Detect message, the CN may switch the user plane from the source RNC to the target RNC.
DL data arriving from the new Iu link is routed to newly established RLC entities, to the MAC and to the Macro Diversity Splitter and Nodes B. The DL data received from the old Iu is discarded.
- 13./14. Immediately after a successful switch at RNC, target RNC (=SRNC) sends **Relocation Complete** messages to the involved CN nodes.
If the User plane has not been switched at Relocation Detect, the CN switches from the old Iu transport bearers to the new ones.
- 15./16. After a successful switch at the CN node, the CN node initiates the release of the Iu connection to the source RNC by sending the RANAP message **Iu Release Command**.
17. Upon reception of the release requests from the CN nodes the old SRNC executes all necessary procedures to release all visible UTRAN resources that were related to the RRC connection in question.
- 18./19. SRNC confirm the Iu release to the CN nodes sending the message **Iu Release Complete**.

At any phase, before the **Relocation Complete** message is sent, the old communication link between the CN and UE is all the time existing and working and the procedure execution can be stopped and original configuration easily restored. If any such abnormal thing occurs a **Relocation Failure** may be sent instead of any message numbered 3-13 described.

7.12.3.2 Using Enhanced SRNS Relocation

This example shows SRNS Relocation, in a situation in which the UE is connected to two CN nodes simultaneously (this means that RNC is connected to a SGSN and a MSC). It is assumed that:

- all cells in the active set are in one DRNC;
- the CN performs hard switching of the user traffic.

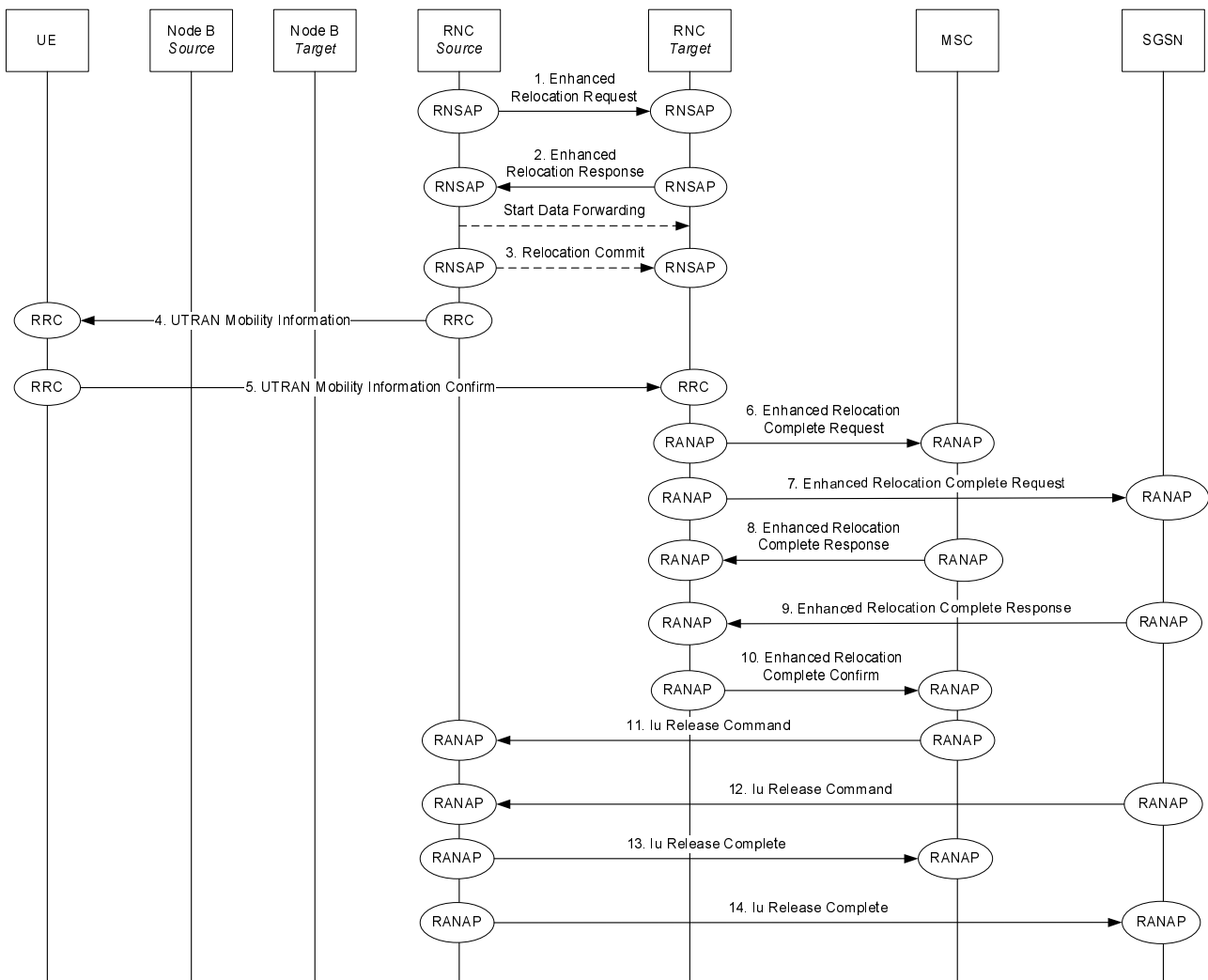

Figure 35A: Enhanced SRNS Relocation (UE connected to two CN nodes)

Note that the SRNC makes the decision to perform the Serving RNC Enhanced Relocation procedure. The Serving RNC also decides into which RNC (Target RNC) the Serving RNC functionality is to be relocated.

1. SRNC sends **Enhanced Relocation Request** messages to a neighboring RNC (Target RNC).

Parameters: Relocation Type, Cause, SRNC-ID, S-RNTI, Chosen Integrity Protection Algorithm, Integrity Protection Key, Target Cell ID, RRC Container and RANAP Container. The source RNC shall set Relocation Type to "UE Not Involved".

2. Target RNC decides to accept the request and replies an RNSAP **Enhanced Relocation Response** containing RRC Reconfiguration message in RRC Container to be sent to UE to the Source RNC. After the reception of the Enhanced Relocation Response, the Source RNC may begin forwarding of DL data to the Target RNC after the establishment of transport bearer and UP initialization.
3. Source RNC may send RNSAP **Relocation Commit** to the Target RNC. The message contains SRNS Context including the sequence number of GTP-PDU next to be transmitted in UL/DL and the next PDCP sequence number that would have been used to send and received from UE in case delivery order is required or case of PDCP reservation.
4. Target RNC sends UE e.g. RRC UTRAN Mobility Information to inform the new S-RNTI for the UE
5. Target RNC receives the UTRAN Mobility Information Confirm from the UE.

6. Target RNC sends the **RANAP Enhanced Relocation Complete Request** message to the MSC, indicating that relocation is happened on the UE. In MSS-MGW case, the MSS exchanges some messages with the MSS over Mc interface after reception of the **RANAP: Enhanced Relocation Complete Request** message.
7. Target RNC sends the **RANAP Enhanced Relocation Complete Request** message to the SGSN, indicating that relocation is happened on the UE.
8. MSC configures the necessary Iu resources for the Target RNC and acknowledges with “**RANAP Enhanced Relocation Complete Response**” message to the Target RNC. In case ATM Transport option is deployed over Iu-CS UP, the MSC contains the Transport Layer Information in the message. After reception of the message in the Target RNC, the RNC initiates to establish AAL2 connection and executes Iu UP initialization.
9. SGSN configures the necessary Iu resources for the Target RNC and acknowledges with “**RANAP Enhanced Relocation Complete Response**” message to the Target RNC.
10. After completion of UP initialization, the Target RNC sends **RANAP Enhanced Relocation Complete Confirm** message to the MSC.
11. MSC initiates release of the resources in the source RNC by sending RANAP: **Iu Release Command**
12. SGSN initiates release of the resources in the source RNC by sending RANAP: **Iu Release Command**
- 13./14. SRNC confirm the IU release to the CN nodes sending the message **Iu Release Complete**.

7.13 HO & Cell Reselection between UTRAN and GSM/BSS

This subclause presents some examples of handover procedure from UTRAN to GSM/BSS and vice versa.

The case of a UTRAN connected to UMTS CN connected to a 2G-MSC (i.e. via MAP/E interface) is shown. The case of an UTRAN connected a GSM CN through an IWF (where RANAP is interworked with BSSMAP) is not shown, because is equivalent from the point of view of the UTRAN.

The case of HO between UTRAN and GPRS and vice versa is also considered.

7.13.1 UTRAN ⇒ GSM/BSS

7.13.1.1 UTRAN ⇒ GSM/BSS

This example shows how handover (Hard Handover) is performed from UTRAN to GSM/BSS between a UMTS CN and a 2G-MSC.

NOTE: Procedures between CN and MSC, and between MSC and BSC are out of the scope of WG3, and are only included for clarity.

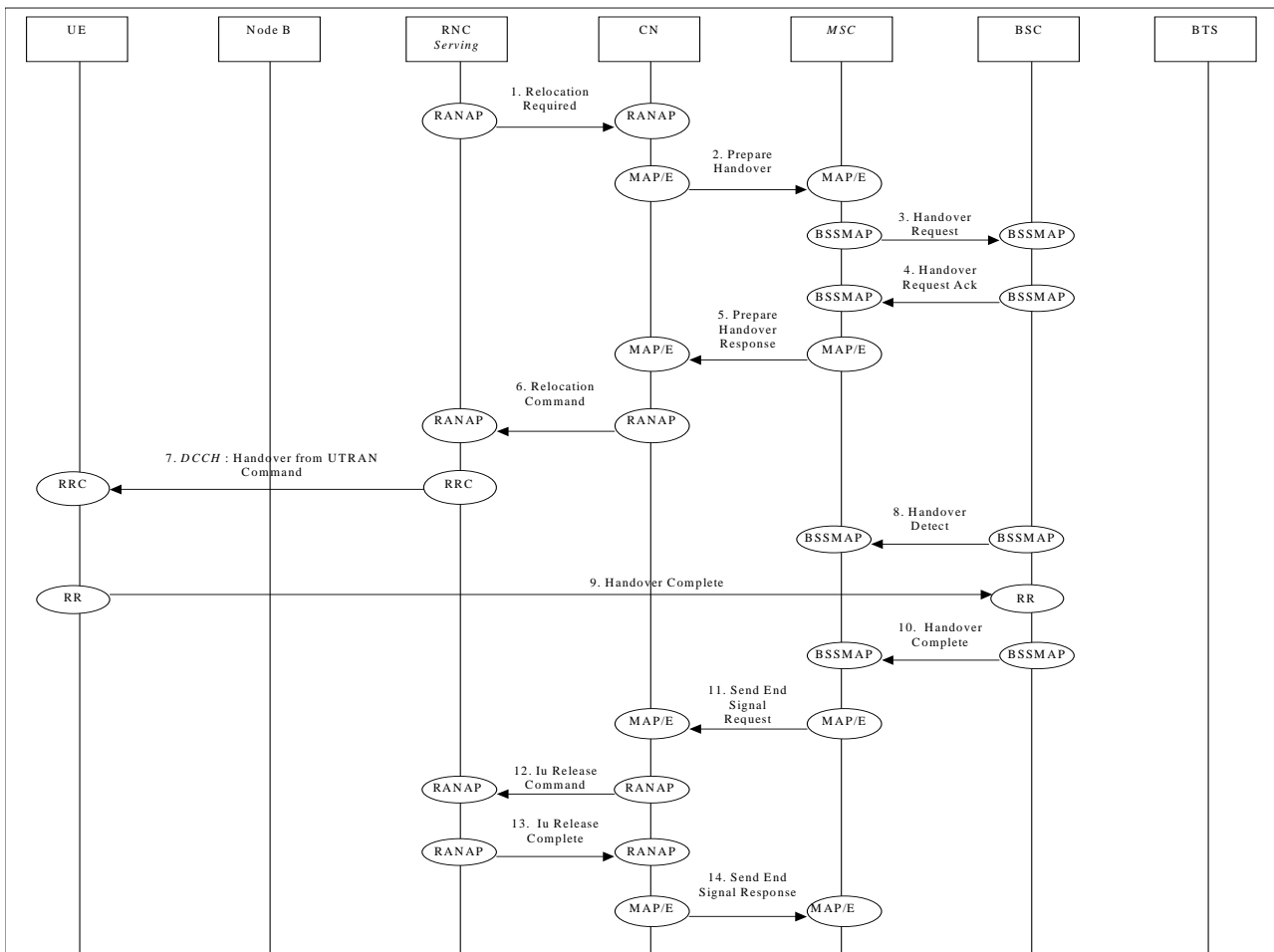

Figure 36: UTRAN ⇒ GSM/BSS handover

1. Upon detection of a trigger SRNC sends RANAP message **Relocation Required** to the CN.
 2. The UMTS CN will forward this request to the GSM MSC (indicated in the received message) over the MAP/E interface (MAP message **Prepare Handover**).
- Steps 3 & 4 follow the normal GSM procedures and are shown only for clarity.
5. Once initial procedures are complete in GSM MSC/BSS the MSC returns MAP/E message **Prepare Handover Response**.
 6. CN responds to the initial request from SRNC by sending RANAP message **Relocation Command** to the SRNC.
 7. Via existing RRC connection, SRNC sends RRC message Handover from UTRAN command to the UE One or several message from the other system can be included in this message.
- Procedures related to synchronisation etc. to GSM BSS are not shown.
- Steps 8 & 10 follow normal GSM procedures and are shown only for clarity.
11. Detection of the UE within the GSM coverage results in the MSC sending MAP/E message **Send End Signal Request** to the CN.
 12. CN initiates release of resources allocated by the former SRNC (**Iu Release Command**).
 13. Previously allocated bearer resources are released within UMTS (e.g. using RANAP and ALCAP protocols [ALCAP not shown]) (Iu Release Complete).

14. Procedure is concluded from UMTS point of view by CN sending MAP/E message Send End Signal Response (this message is not sent until the end of the call).

7.13.1.2 Service Based Intersystem Handover

If the *Service Handover* IE is included in the RAB ASSIGNMENT REQUEST message, the service based intersystem handover from UMTS to GSM can be performed. The following example shows the signalling flow.

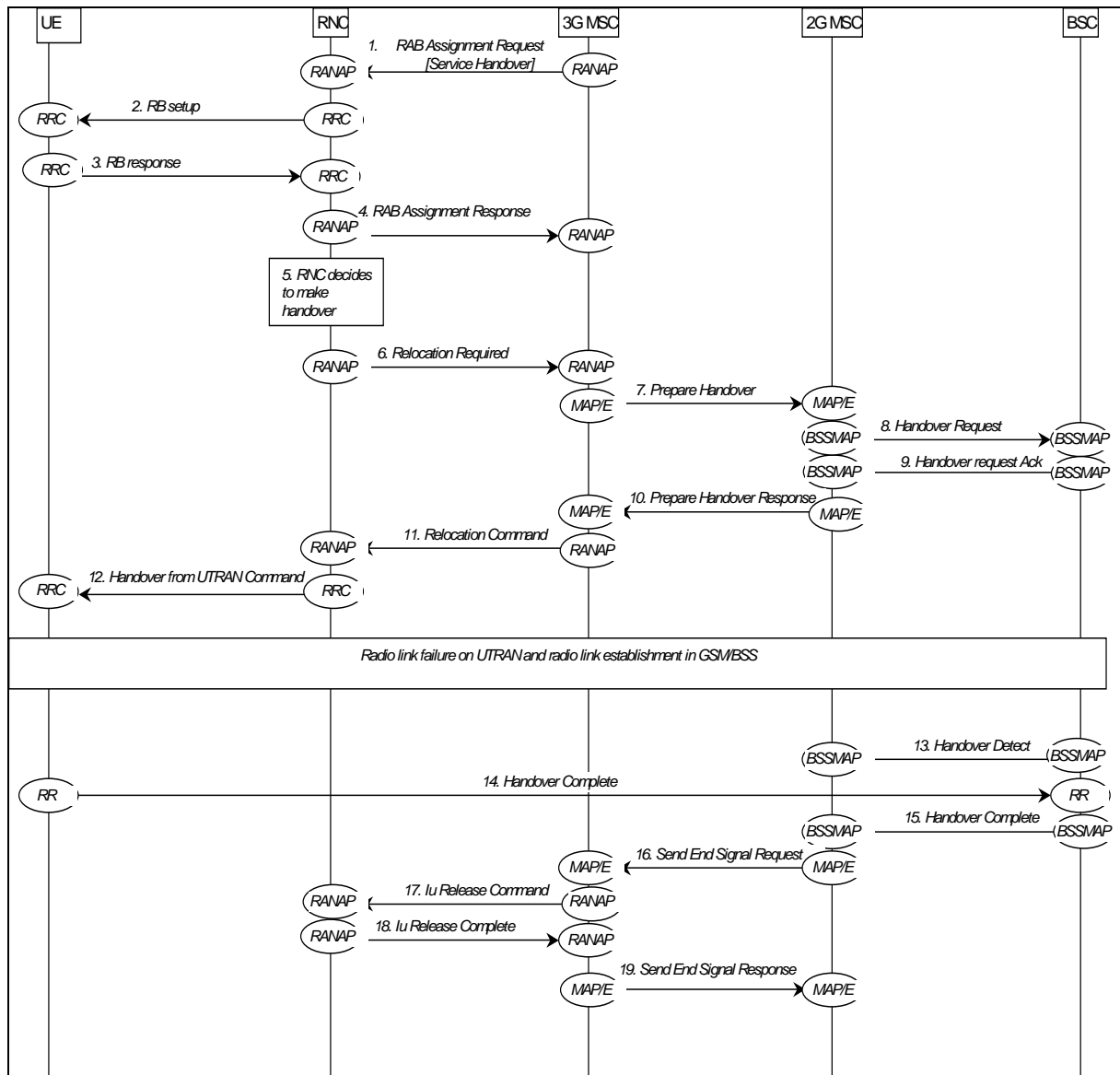

Figure 36a: Service based UTRAN to GSM/BSS Intersystem Handover

1. CN initiates establishment of the radio access bearer with RANAP message **Radio Access Bearer Assignment Request**.
Parameters: Service Handover.
2. RRC message **Radio Bearer Setup** is sent by RNC to UE.
3. UE sends RRC message **Radio Bearer Setup Complete** to RNC.
4. RNC sends RANAP message **Radio Access Bearer Assignment Response** to CN.

- 5 Being based on the value assumed from *Service Handover* IE, the RNC decides to perform handover towards GSM.
- 6 RNC sends RANAP message **Relocation Required** to the CN.

Steps 7 to 19 are the same as 2 to 14 in subclause 7.13.1.1.

7.13.1.3 Directed Retry

Directed retry could be used to avoid the assignment phase, allowing direct assignment of resources on GSM system by CN. The following figure shows the signalling flow.

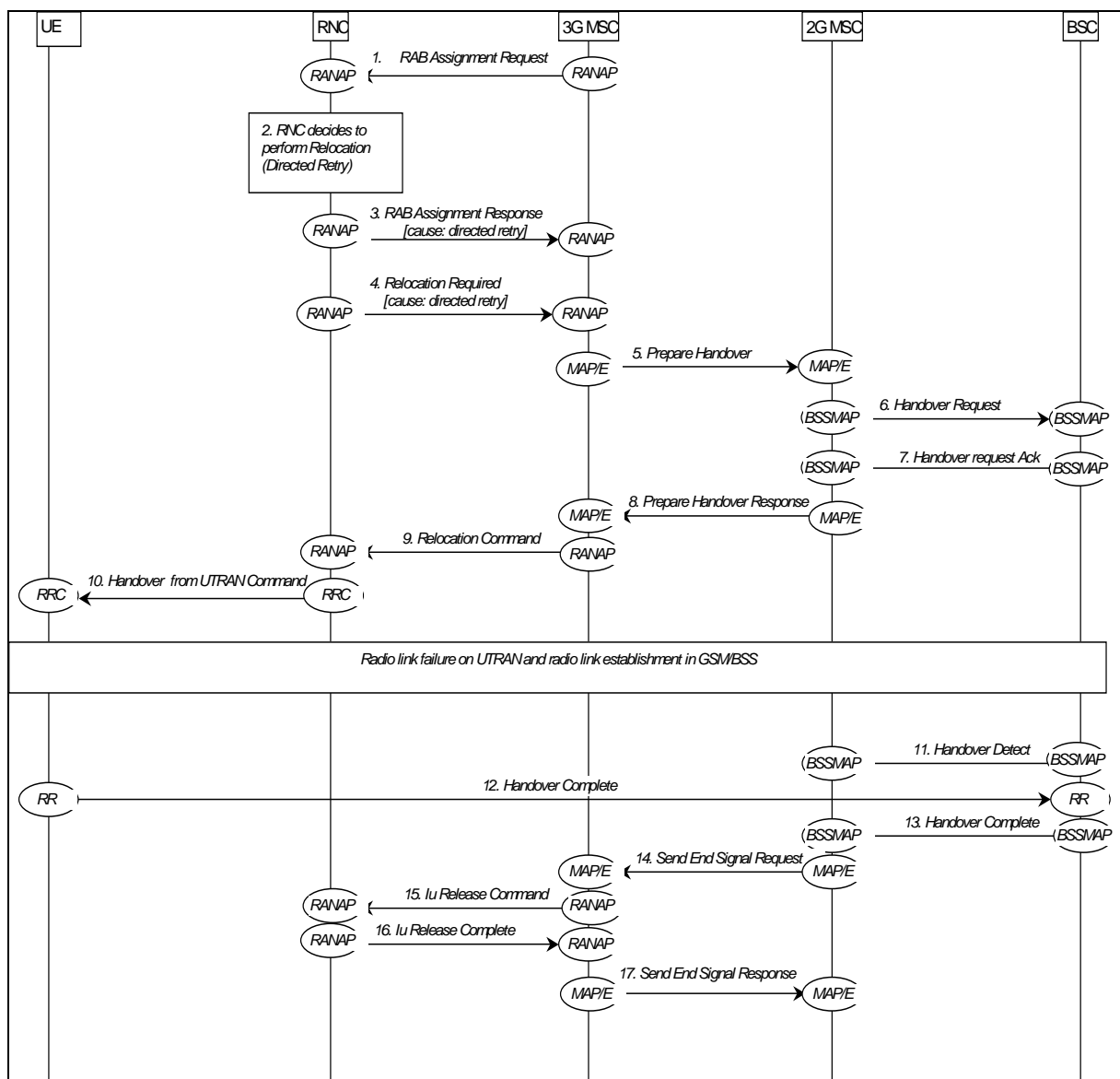

Figure 36b: Directed Retry

- 1. CN initiates establishment of the radio access bearer with RANAP message **Radio Access Bearer Assignment Request**.
- 2. RNC decides to perform relocated avoiding the Radio Bearer Setup phase.
- 3. RNC sends RANAP message **Radio Access Bearer Assignment Response** to CN with the RAB ID included in the list of RABs failed to setup and a cause value of "Directed Retry".

4. RNC sends RANAP message **Relocation Required** with cause value "Directed Retry".

Steps 5 to 17 are the same as 2 to 14 in subclause 7.13.1.1.

7.13.2 GSM/BSS ⇒ UTRAN

This example shows how handover (Hard Handover) is performed from GSM/BSS to UTRAN between a UMTS CN and a 2G-MSC.

NOTE: Procedures between CN and MSC, and between MSC and BSC are out of the scope of WG3, and are only included for clarity.

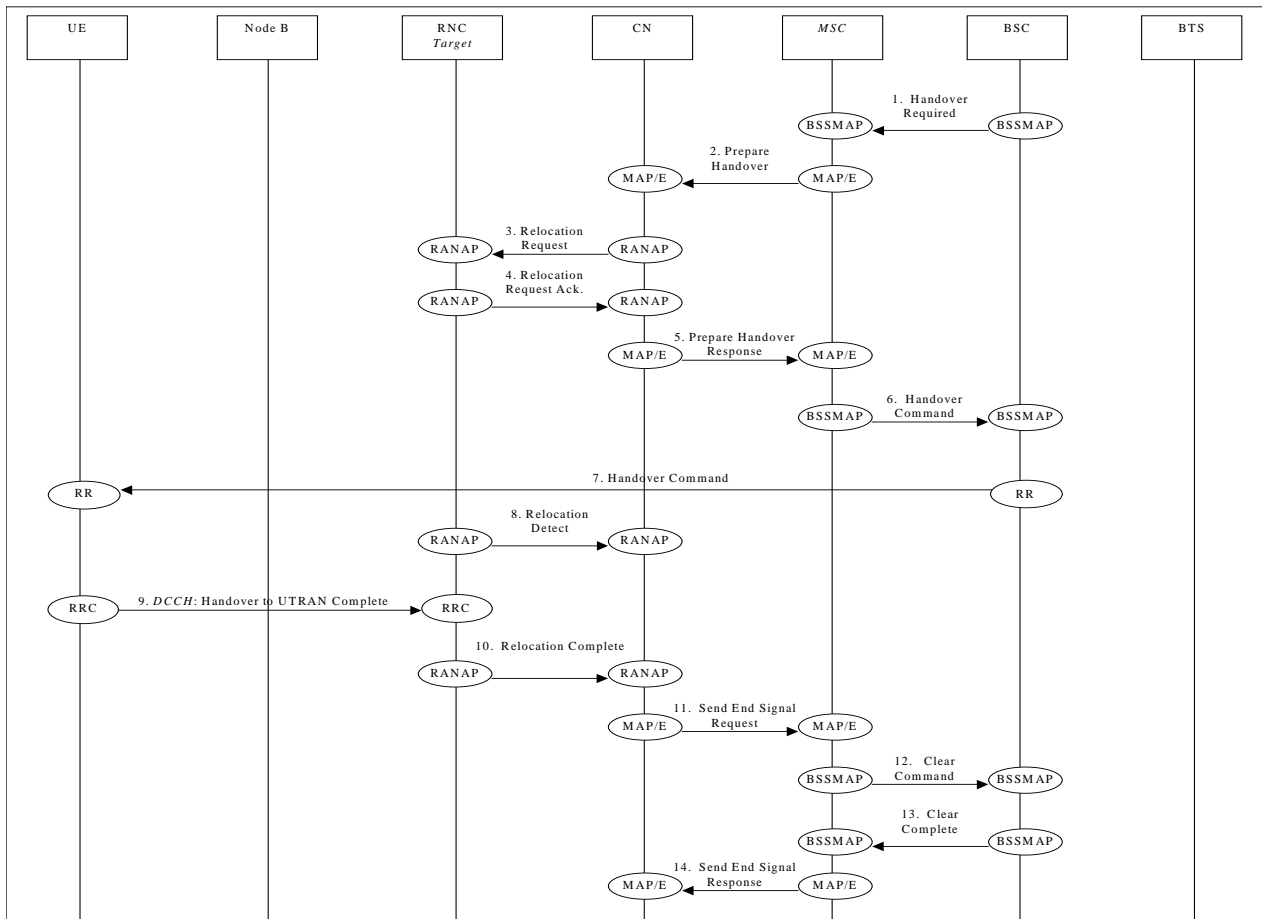

Figure 37: GSM/BSS ⇒ UTRAN handover

1. The BSC sends **Handover Required** message to the GSM MSC.
 2. The MSC sends MAP/E message **Prepare Handover** to the UMTS CN.
 3. The CN sends RANAP message **Relocation Request** to the Target RNC.
 4. Response **Relocation Request Acknowledge** is returned to the CN by the target RNC via RANAP.
 5. MAP/E message **Prepare Handover Response** is sent by the UMTS CN to the MSC.
- Steps 6 and 7 follow normal GSM procedures and are shown only for clarity.
8. When target RNC has detected the UE, **Relocation Detect** message is sent to the CN node.
 9. When the RRC connection is established with the target RNC and necessary radio resources have been allocated the UE sends RRC message **Handover to UTRAN Complete** to the target RNC.
 10. Once complete the target RNC sends RANAP message **Relocation Complete** to the CN.

11. CN sends MAP/E message **Send End Signal Request** to the MSC.
12. The MSC sends **Clear Command** message to the BSC.
13. The BSC responds with **Clear Complete** message to the GSM
15. The MSC sends MAP/E message **Send End Signal Response** to the UMTS CN to conclude the procedure (this message is not sent until the end of the call).

7.13.3 GPRS ⇒ UMTS Cell Reselection

This subclause shows UTRAN signalling procedures for GPRS to UTRAN Cell Reselection.

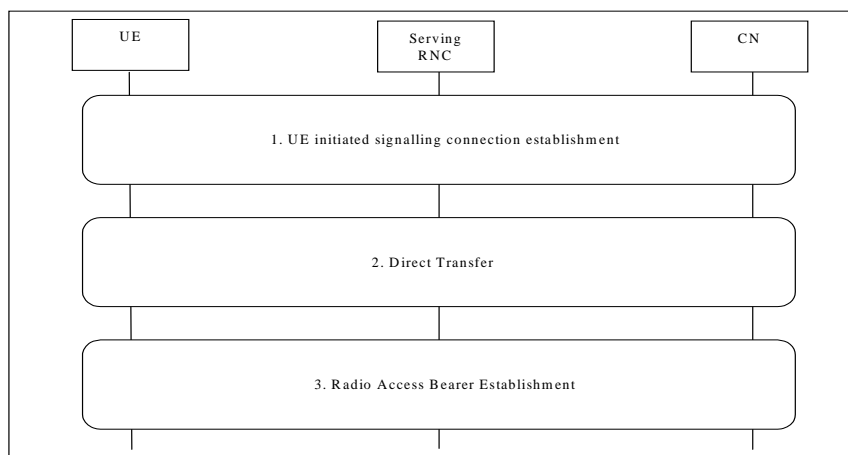

Figure 38

1. The UE selects a UTRAN cell, reads system information, and initiates establishment of a NAS signalling connection.
See section UE Initiated Signalling Connection Establishment.
2. The NAS signalling connection between UE and CN can now be used for NAS message transfer (e.g. execution of security functions).
See section Direct Transfer.
3. After necessary CN-GPRS preparations (e.g. UE context information retrieval), CN initiates establishment of radio access bearer(s).
See section Radio Access Bearer Establishment.

7.13.4 UMTS ⇒ GPRS Cell Reselection, UE Initiated

This subclause shows UTRAN signalling procedures for UTRAN to GPRS cell reselection initiated by UE..

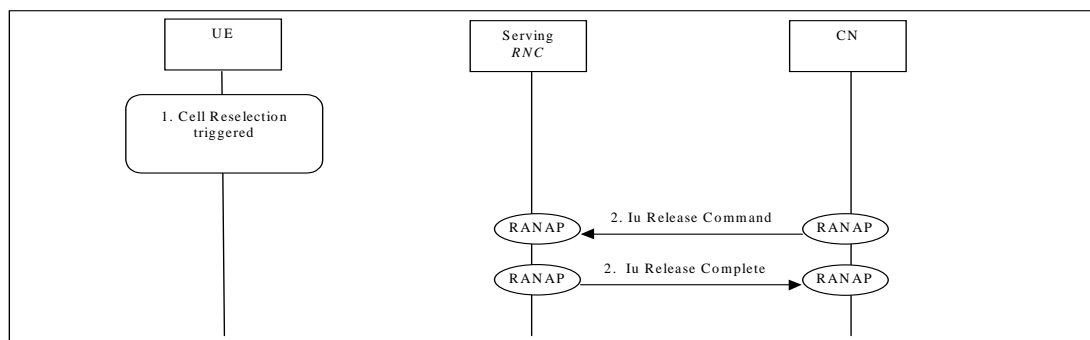

Figure: 39

1. The UE selects a GPRS cell, reads system information, and initiates establishment of UE-GPRS connection.

2. After necessary CN-GPRS preparations (e.g. UE context information retrieval), CN initiates release of Iu connection. SRNC releases the RRC connection.

7.13.5 UMTS ⇒ GPRS Cell Reselection, Network Initiated

This subclause shows UTRAN signalling procedures for UTRAN to GPRS Cell Reselection triggered by Serving RNC.

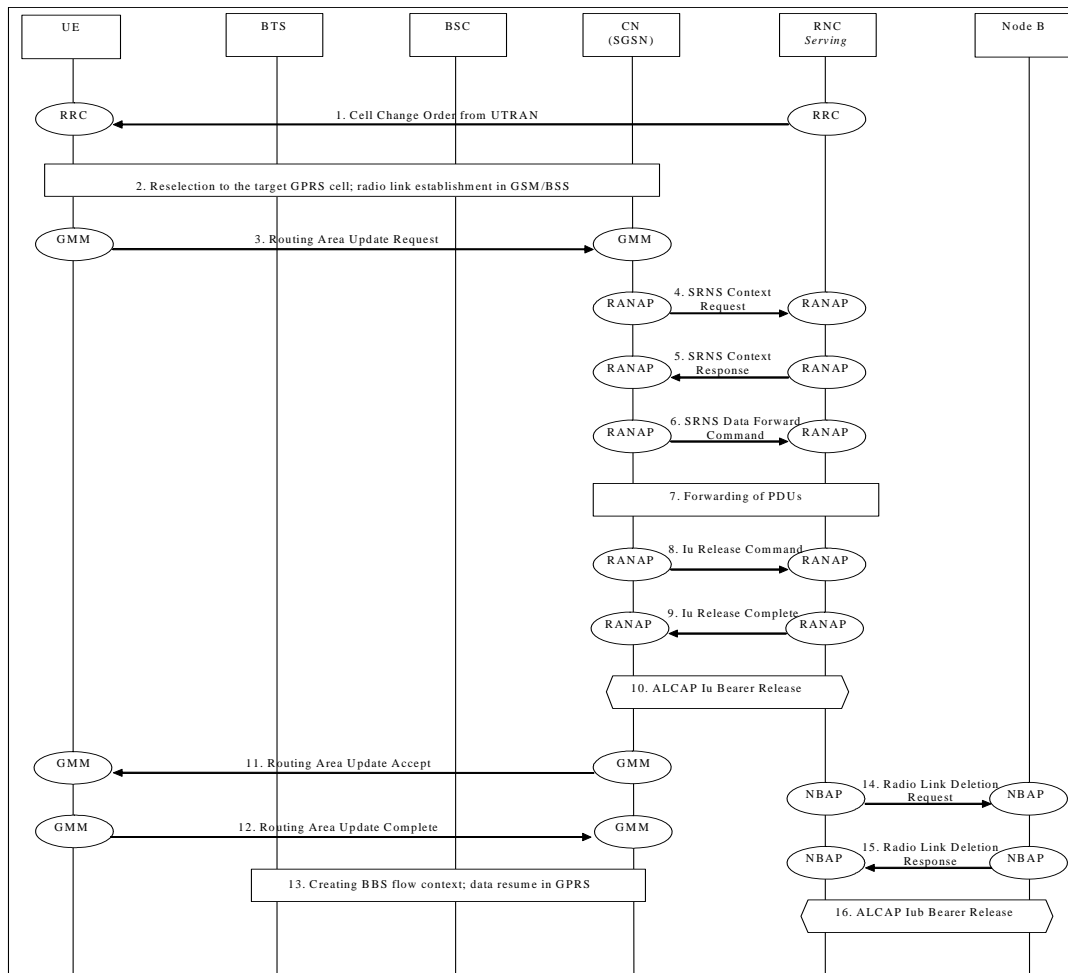

Figure 40: UTRAN to GPRS Cell Reselection

1. Upon detection of a trigger, SRNC initiates the handover to GSM/BSS by sending the RRC message **Cell Change Order from UTRAN** to the UE.
2. The UE reselecs to the target GPRS cell and establishes the radio connection to the GSM/BSS.
3. The UE initiates the GPRS Routing Area Update procedure by sending the GMM message **Routing Area Update Request** to the SGSN.
4. The SGSN sends the RANAP message **SRNS Context Request** to the SRNC listing the PS RABs for which context transfer shall be performed.
5. SRNC responds to the SGNS with the RANAP message **SRNS Context Response** containing the context information of all referenced PS RABs whose transfer is successful.
6. The SGSN asks the SRNC to forward its buffered data back to the SGSN by sending the RANAP message **SRNS Data Forward Command**. The message includes the list of PS RABs whose data should be forwarded, and necessary tunnelling information to be used for the data forwarding.
7. For each PS RAB indicated by the SRNS Data Forward Command, the SRNC starts duplicating and tunnelling the buffered data back to the SGSN.

8. The SGSN sends the RANAP message **Iu Release Command** to initiate the release of the Iu connection with UTRAN.
9. At the expiration of the RNC data forwarding timer (i.e. $T_{DATAfwd}$), the SRNC sends the RANP message **Iu Release Complete** message to the SGSN.
10. The SRNC initiates the release of Iu Data Transport bearer using ALCAP protocol.
11. The SGSN validates the UE's presence in the new RA by sending the GMM message **Routing Area Update Accept** to the UE. The message may contain a new P-TMSI that the network assigns to the UE.
12. The UE acknowledges the assignment of a new P-TMSI by sending the GMM message **Routing Area Update Complete** to the UE.
13. SGSN and BSS can execute the BSS Packet Flow Context procedure and data transmission can resume in the GPRS.
14. The SRNC initiates the release of the link by sending the NBAP message **Radio Link Deletion Request** to the Node B.
15. The Node B confirms the release of the link by sending the NBAP message **Radio Link Deletion Response** to the SRNC.
16. The Node B initiates the release of Iub Data Transport bearer using ALCAP protocol.

7.14 Transport Channel Reconfiguration (DCH to DCH)

7.14.1 Synchronised Transport Channel Reconfiguration

The procedure can be applied when the reconfiguration time requires being synchronised among Node-Bs, SRNC and UE.

7.14.1.1 Synchronised Reconfiguration, Q.2630.2 modification procedure not used



Figure 41: Synchronised Transport Channel Reconfiguration

1. SRNC decided that there is a need for a synchronous Transport Channel Reconfiguration and requests DRNC to prepare reconfiguration of DCH (**Radio Link Reconfiguration Prepare**).
Parameters: Transport Format Set, Transport Format Combination Set, Power control information, Time Slots [TDD], User Codes [TDD].
2. DRNC requests its Node B to prepare reconfiguration of DCH to carry the radio access bearer (**Radio Link Reconfiguration Prepare**).
Parameters: Transport Format Set, Transport Format Combination Set, Power control information Time Slots [TDD], User Codes [TDD].
3. SRNC requests its Node B to prepare reconfiguration of DCH (**Radio Link Reconfiguration Prepare**).
Parameters: Transport Format Set, Transport Format Combination Set, Power control information, Time Slots [TDD], User Codes [TDD].
4. Node B allocates resources and notifies DRNC that the reconfiguration is ready (**Radio Link Reconfiguration Ready**).
Parameters: Transport layer addressing information (AAL2 address, AAL2 Binding Id) for Iub Data Transport Bearer.
5. DRNC notifies SRNC that the reconfiguration is ready (**Radio Link Reconfiguration Ready**).
Parameters: Transport layer addressing information (AAL2 address, AAL2 Binding Id) for Iur Data Transport Bearer.
6. Node B allocates resources and notifies SRNC that the reconfiguration is ready (**Radio Link Reconfiguration Ready**).
Parameters: Transport layer addressing information (AAL2 address, AAL2 Binding Id) for Iub Data Transport Bearer.

7. SRNC initiates (if needed) establishment of new Iur/Iub Data Transport Bearers using ALCAP protocol. This request contains the AAL2 Binding Identity to bind the Iur/Iub Data Transport Bearer to DCH.
8. SRNC initiates (if needed) establishment of new Iub Data Transport Bearers using ALCAP protocol. This request contains the AAL2 Binding Identity to bind the Iub Data Transport Bearer to DCH.
9. RNSAP message **Radio Link Reconfiguration Commit** is sent from SRNC to DRNC.
Parameters: CFN.
10. NBAP message **Radio Link Reconfiguration Commit** is sent from DRNC to Node B.
Parameters: CFN.
11. NBAP message **Radio Link Reconfiguration Commit** is sent from SRNC to Node B.
Parameters: CFN.
12. RRC message **Transport Channel Reconfiguration** is sent by SRNC to UE.
13. UE sends RRC message **Transport Channel Reconfiguration Complete** to SRNC.
14. Not used resources in-DRNC and Node B (Drift RNS) are released. DRNC initiates release of Iur and Iub (Drift RNS) Data Transport bearer using ALCAP protocol.
15. Not used resources in SRNC and Node B (Serving RNS) are released. SRNC initiates release of Iub (Serving RNS) Data Transport bearer using ALCAP protocol.

7.14.1.2 Synchronised Reconfiguration, Bandwidth Increase with Q.2630.2 modification procedure

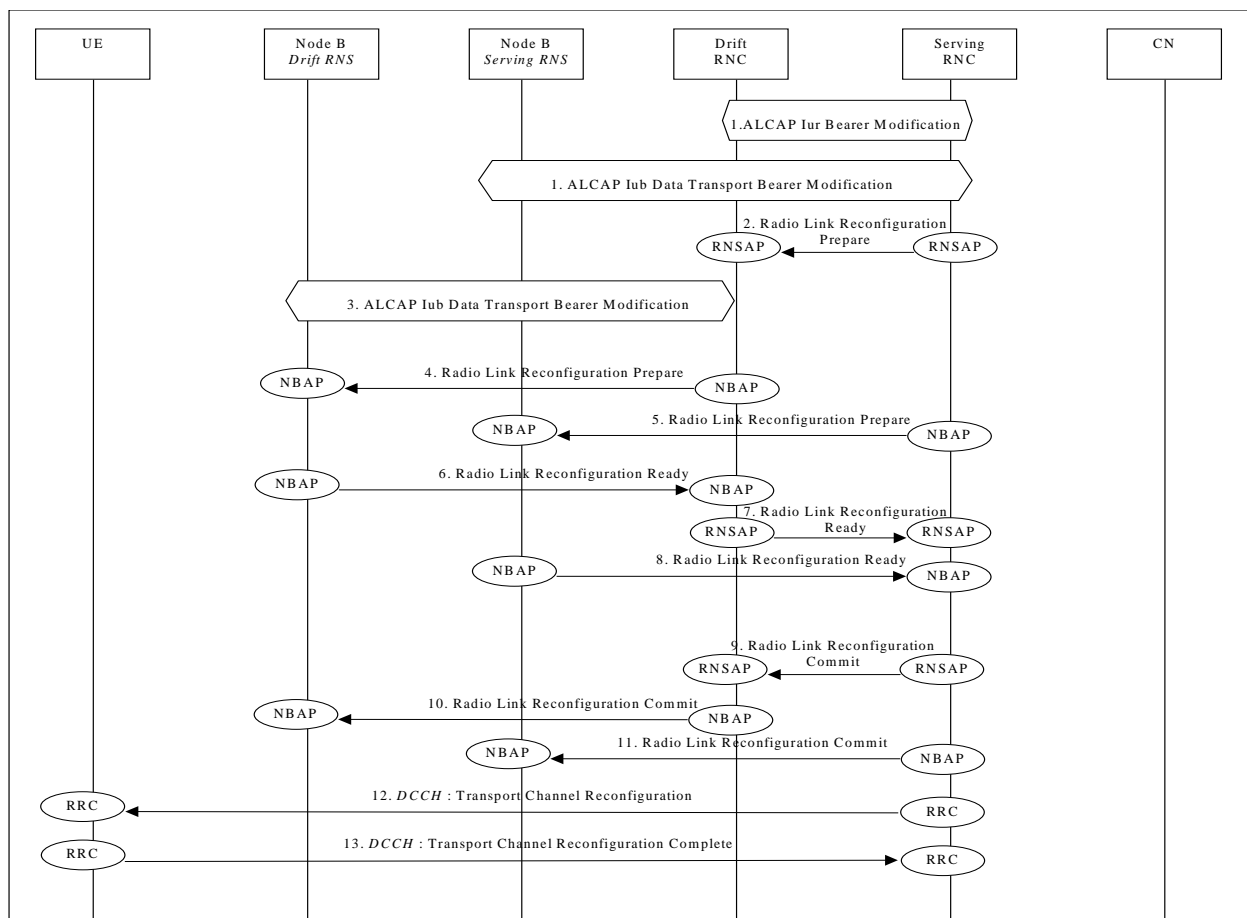

Figure 41a: Synchronised Transport Channel Reconfiguration, Bandwidth Increase

1. SRNC decides that there is a need for synchronous Transport Channel Reconfiguration and initiates transport bearer modification of the Transport Bearer(s), if LC modification is enabled over the connection(s).
2. SRNC requests DRNC to prepare reconfiguration of DCH (**Radio Link Reconfiguration Prepare**).
Parameters: Transport Format Set, Transport Format Combination Set, Power control information, Time Slots [TDD], User Codes [TDD], the flag "Transport Bearer Request Indicator" shall be set to BEARER NOT REQUESTED.
3. DRNC initiates transport bearer modification on Iub connection.
4. DRNC requests its Node B to prepare reconfiguration of DCH to carry the radio access bearer (**Radio Link Reconfiguration Prepare**).
Parameters: Transport Format Set, Transport Format Combination Set, Power control information Time Slots [TDD], User Codes [TDD], the flag "Transport Bearer Request Indicator" shall be set to BEARER NOT REQUESTED.
5. SRNC requests its Node B to prepare reconfiguration of DCH (**Radio Link Reconfiguration Prepare**).
Parameters: Transport Format Set, Transport Format Combination Set, Power control information, Time Slots [TDD], User Codes [TDD], the flag "Transport Bearer Request Indicator" shall be set to BEARER NOT REQUESTED.
6. Node B allocates resources and notifies DRNC that the reconfiguration is ready (**Radio Link Reconfiguration Ready**).
7. DRNC notifies SRNC that the reconfiguration is ready (**Radio Link Reconfiguration Ready**).
8. Node B allocates resources and notifies SRNC that the reconfiguration is ready (**Radio Link Reconfiguration Ready**).
9. RNSAP message **Radio Link Reconfiguration Commit** is sent from SRNC to DRNC.
Parameters: CFN
10. NBAP message **Radio Link Reconfiguration Commit** is sent from DRNC to Node B.
Parameters: CFN
11. NBAP message **Radio Link Reconfiguration Commit** is sent from SRNC to Node B.
Parameters: CFN
12. RRC message **Transport Channel Reconfiguration** is sent by SRNC to UE.
13. UE sends RRC message **Transport Channel Reconfiguration Complete** to SRNC.

7.14.1.3 Synchronised Reconfiguration, Bandwidth Decrease with Q.2630.2 modification procedure

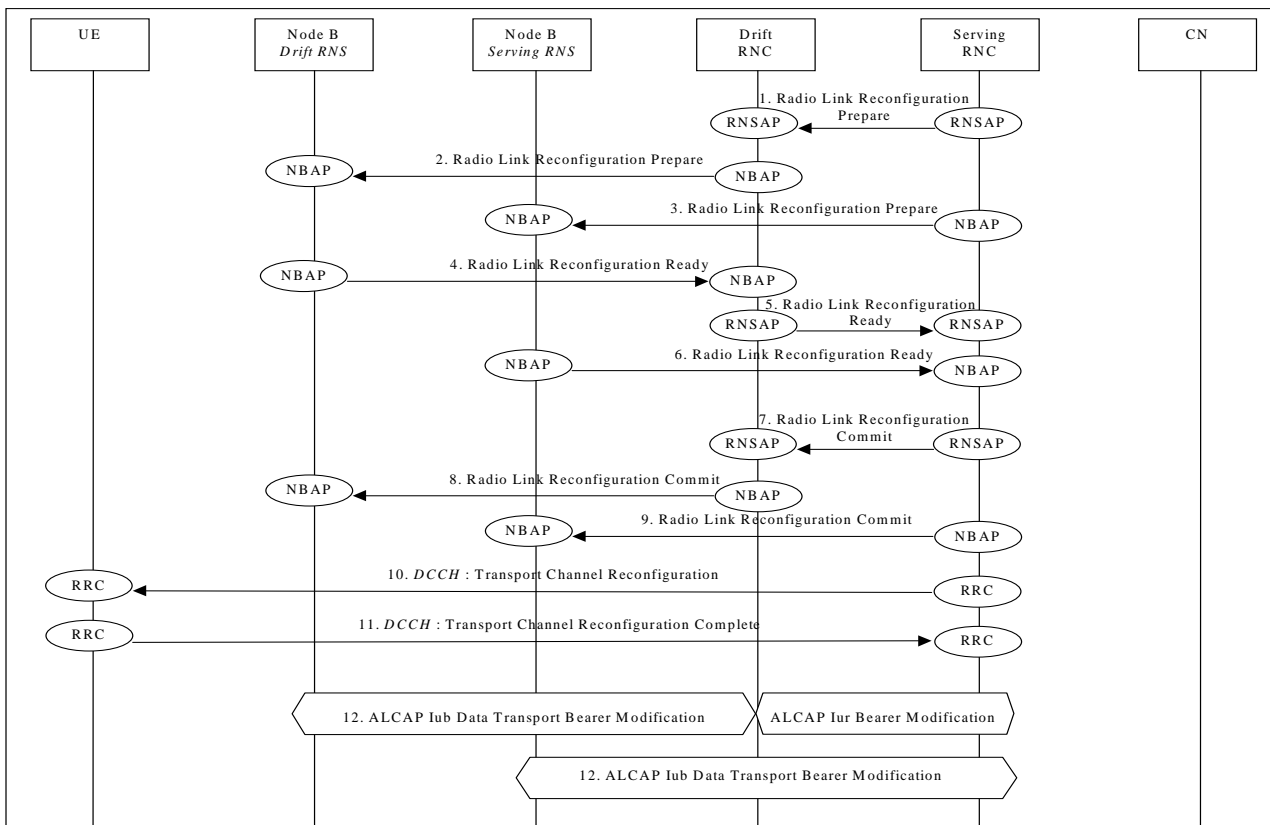

Figure 41b: Synchronised Transport Channel Reconfiguration, Bandwidth Decrease

1. SRNC decides that there is a need for a synchronous Transport Channel Reconfiguration and this procedure is initiated, if LC modification is enabled over the Transport Bearer(s). SRNC requests DRNC to prepare reconfiguration of DCH (Radio Link Reconfiguration Prepare).
Parameters: Transport Format Set, Transport Format Combination Set, Power control information, Time Slots [TDD], User Codes [TDD], the flag “Transport Bearer Request Indicator” shall be set to BEARER NOT REQUESTED.
2. DRNC requests the Node B to prepare reconfiguration of DCH to carry the radio access bearer (**Radio Link Reconfiguration Prepare**).
Parameters: Transport Format Set, Transport Format Combination Set, Power control information Time Slots [TDD], User Codes [TDD], the flag “Transport Bearer Request Indicator” shall be set to BEARER NOT REQUESTED.
3. SRNC requests its Node B to prepare reconfiguration of DCH (**Radio Link Reconfiguration Prepare**).
Parameters: Transport Format Set, Transport Format Combination Set, Power control information, Time Slots [TDD], User Codes [TDD], the flag “Transport Bearer Request Indicator” shall be set to BEARER NOT REQUESTED.
4. Node B allocates resources and notifies DRNC that the reconfiguration is ready (**Radio Link Reconfiguration Ready**).
5. DRNC notifies SRNC that the reconfiguration is ready (**Radio Link Reconfiguration Ready**).
6. Node B allocates resources and notifies SRNC that the reconfiguration is ready (**Radio Link Reconfiguration Ready**).
7. RNSAP message **Radio Link Reconfiguration Commit** is sent from SRNC to DRNC.
Parameters: CFN.

8. NBAP message **Radio Link Reconfiguration Commit** is sent from DRNC to Node B
Parameters: CFN.
9. NBAP message **Radio Link Reconfiguration Commit** is sent from SRNC to Node B.
Parameters: CFN.
10. RRC message **Transport Channel Reconfiguration** is sent by SRNC to UE.
11. UE sends RRC message **Transport Channel Reconfiguration Complete** to SRNC.
12. SRNC initiates a transport bearer modification for the Transport Bearer(s).

7.14.2 Unsynchronised Transport Channel Reconfiguration

The procedure can be applied when the reconfiguration time does not require being synchronised among Node-Bs, SRNC and UE.

7.14.2.1 Unsynchronised Reconfiguration, Q.2630.2 modification procedure not used

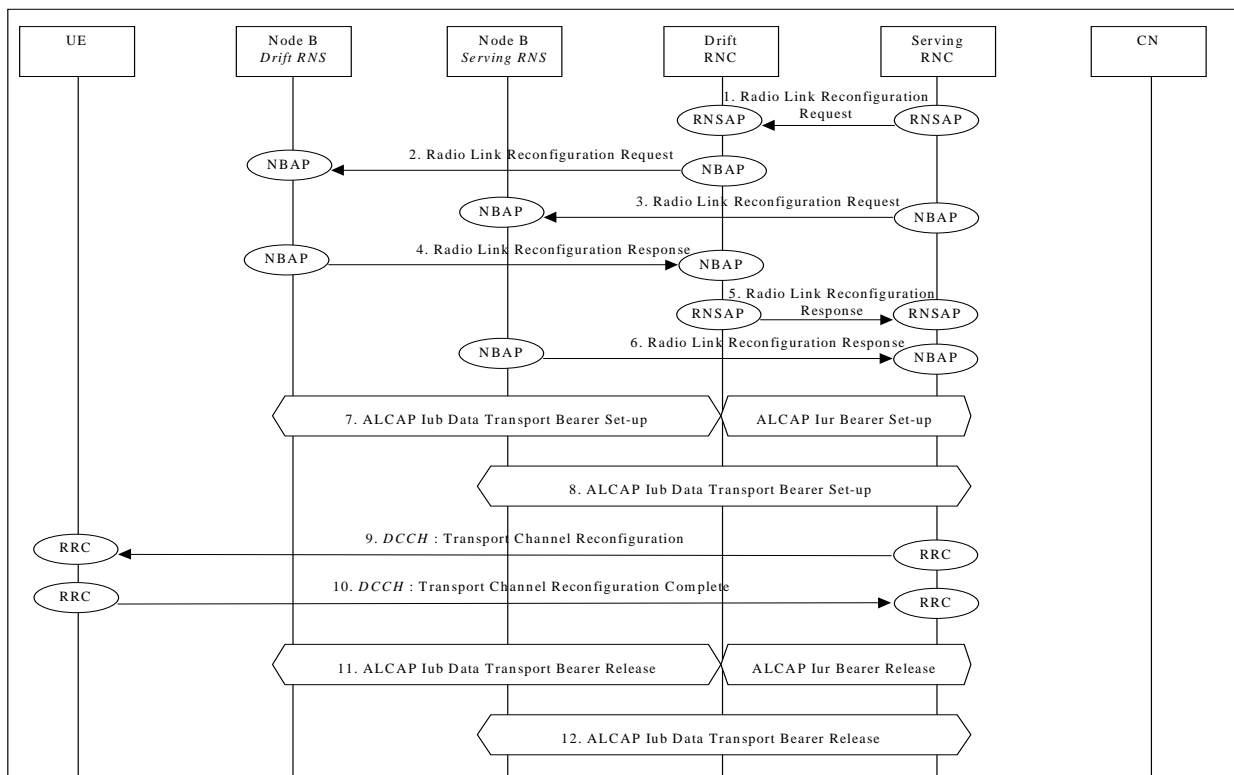

Figure 42: Unsynchronised Transport Channel Reconfiguration

1. SRNC decided that there are no need for a synchronised Transport Channel Reconfiguration, and requests DRNC to reconfigure the DCH. It includes in the message **Radio Link Reconfiguration Request** that the modification shall be done immediately without waiting for the commit message.
Parameters: Transport Format Set, Transport Format Combination Set, Power control information, Time Slots [TDD], User Codes [TDD].
2. DRNC requests its Node B to reconfigure the DCH in the existing Radio Link (**Radio Link Reconfiguration Request**).
Parameters: Transport Format Set, Transport Format Combination Set, Power control information, Time Slots [TDD], User Codes [TDD].
3. SRNC requests its Node B to reconfigure the DCH in the existing Radio Link (**Radio Link Reconfiguration Request**).
Parameters: Transport Format Set, Transport Format Combination Set, Power control information, Time Slots [TDD], User Codes [TDD].

4. Node B of the DRNC allocates resources and notifies DRNC that the reconfiguration is done (**Radio Link Reconfiguration Response**).
Parameters: Transport layer addressing information (AAL2 address, AAL2 Binding Id) for Iub Data Transport Bearer.
5. DRNC notifies SRNC that the reconfiguration is done (**Radio Link Reconfiguration Response**).
Parameters: Transport layer addressing information (AAL2 address, AAL2 Binding Id) for Iur Data Transport Bearer.
6. Node B of the SRNC allocates resources and notifies DRNC that the reconfiguration is done (**Radio Link Reconfiguration Response**).
Parameters: Transport layer addressing information (AAL2 address, AAL2 Binding Id) for Iub Data Transport Bearer.
7. SRNC initiates (if needed) establishment of new Iur/Iub Data Transport Bearers using ALCAP protocol. This request contains the AAL2 Binding Identity to bind the Iur/Iub Data Transport Bearer to DCH.
8. SRNC initiates (if needed) establishment of new Iub Data Transport Bearers using ALCAP protocol. This request contains the AAL2 Binding Identity to bind the Iub Data Transport Bearer to DCH.
9. RRC message **Transport Channel Reconfiguration** is sent by SRNC to UE.
10. UE sends RRC message **Transport Channel Reconfiguration Complete** to SRNC.
11. Not used resources in-DRNC and Node B (Drift RNS) are released. DRNC initiates release of Iur and Iub (Drift RNS) Data Transport bearer using ALCAP protocol
12. Not used resources in SRNC and Node B (Serving RNS) are released. SRNC initiates release of Iub (Serving RNS) Data Transport bearer using ALCAP protocol.

7.14.2.2 Unsynchronised Reconfiguration, Bandwidth Increase with Q.2630.2 modification procedure



Figure 42a: Unsynchronised Transport Channel Reconfiguration, Bandwidth Increase

1. SRNC decides that there is no need for a synchronised Transport Channel Reconfiguration and initiates the transport bearer modification of the Transport Bearer(s), if LC modification is supported over the Transport Bearer(s).
2. SRNC requests DRNC to reconfigure the DCH. It includes in the message **Radio Link Reconfiguration Request** that the modification shall be done immediately without waiting for the commit message.
Parameters: Transport Format Set, Transport Format Combination Set, Power control information, Time Slots [TDD], User Codes [TDD], the flag “Transport Bearer Request Indicator” shall be set to BEARER NOT REQUESTED.
3. DRNC initiates transport bearer modification, if LC modification is supported over the bearer.
4. DRNC requests its Node B to reconfigure the DCH in the existing Radio Link (**Radio Link Reconfiguration Request**).
Parameters: Transport Format Set, Transport Format Combination Set, Power control information, Time Slots [TDD], User Codes [TDD]. The flag “Transport Bearer Request Indicator” shall be set to BEARER NOT REQUESTED.
5. SRNC requests its Node B to reconfigure the DCH in the existing Radio Link (**Radio Link Reconfiguration Request**).
Parameters: Transport Format Set, Transport Format Combination Set, Power control information, Time Slots [TDD], User Codes [TDD], the flag “Transport Bearer Request Indicator” shall be set to BEARER NOT REQUESTED.
6. Node B of the DRNC allocates resources and notifies DRNC that the reconfiguration is done (**Radio Link Reconfiguration Response**).
7. DRNC notifies SRNC that the reconfiguration is done (**Radio Link Reconfiguration Response**).
8. Node B of the SRNC allocates resources and notifies DRNC that the reconfiguration is done (**Radio Link Reconfiguration Response**).
9. RRC message **Transport Channel Reconfiguration** is sent by SRNC to UE.
10. UE sends RRC message **Transport Channel Reconfiguration Complete** to SRNC.

7.14.2.3 Unsynchronised Reconfiguration, Bandwidth Decrease with Q.2630.2 modification procedure

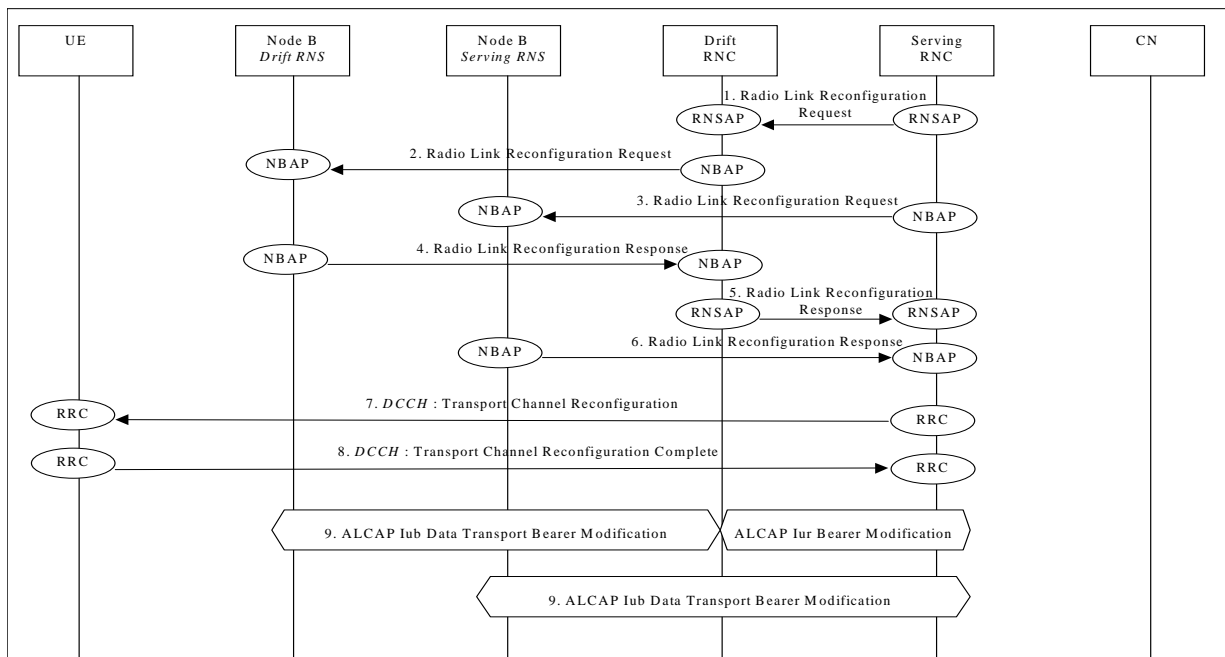

Figure 42b: Unsynchronised Transport Channel Reconfiguration, Bandwidth Decrease

1. SRNC decided that there are no need for a synchronised Transport Channel Reconfiguration, and requests DRNC to reconfigure the DCH. It includes in the message Radio Link Reconfiguration Request that the modification shall be done immediately without waiting for the commit message.
Parameters: Transport Format Set, Transport Format Combination Set, Power control information, Time Slots [TDD], User Codes [TDD], the flag "Transport Bearer Request Indicator" shall be set to BEARER NOT REQUESTED.
2. DRNC requests its Node B to reconfigure the DCH in the existing Radio Link (**Radio Link Reconfiguration Request**).
Parameters: Transport Format Set, Transport Format Combination Set, Power control information, Time Slots [TDD], User Codes [TDD], the flag "Transport Bearer Request Indicator" shall be set to BEARER NOT REQUESTED.
3. SRNC requests its Node B to reconfigure the DCH in the existing Radio Link (**Radio Link Reconfiguration Request**).
Parameters: Transport Format Set, Transport Format Combination Set, Power control information, Time Slots [TDD], User Codes [TDD], the flag "Transport Bearer Request Indicator" shall be set to BEARER NOT REQUESTED.
4. Node B of the DRNC allocates resources and notifies DRNC that the reconfiguration is done (**Radio Link Reconfiguration Response**).
5. DRNC notifies SRNC that the reconfiguration is done (**Radio Link Reconfiguration Response**).
6. Node B of the SRNC allocates resources and notifies DRNC that the reconfiguration is done (**Radio Link Reconfiguration Response**).
7. RRC message **Transport Channel Reconfiguration** is sent by SRNC to UE.
8. UE sends RRC message **Transport Channel Reconfiguration Complete** to SRNC.
9. SRNC initiates transport bearer modification of Iub/iur Data Transport Bearers using ALCAP protocol.

7.15 Direct Transfer

7.15.1 Uplink Direct Transfer

This example applies to the transportation of a NAS message through UTRAN. This flow applies when the terminal is in connected mode.

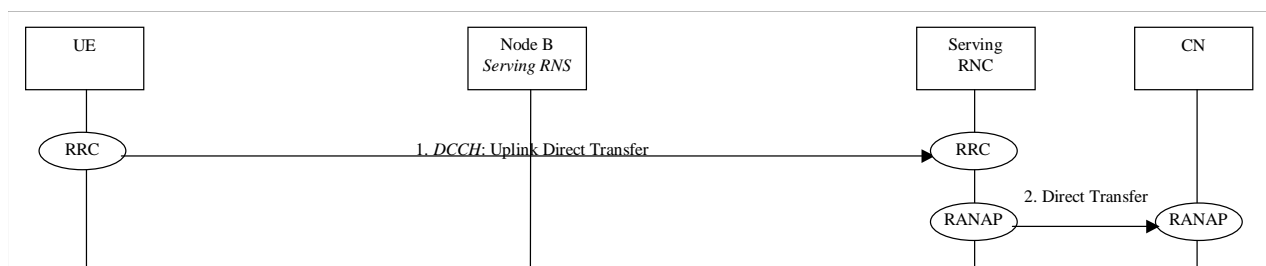

Figure 43: Uplink Direct Transfer

1. UE sends RRC **Uplink Direct Transfer Message** to SRNC.
Parameters: NAS Message.
2. SRNC sends the RANAP message **Direct Transfer** to the CN.
Parameters: NAS PDU.

The NAS message is transported transparently by the UTRAN.

7.15.2 Downlink Direct Transfer

This example applies to the transportation of a NAS message through UTRAN.

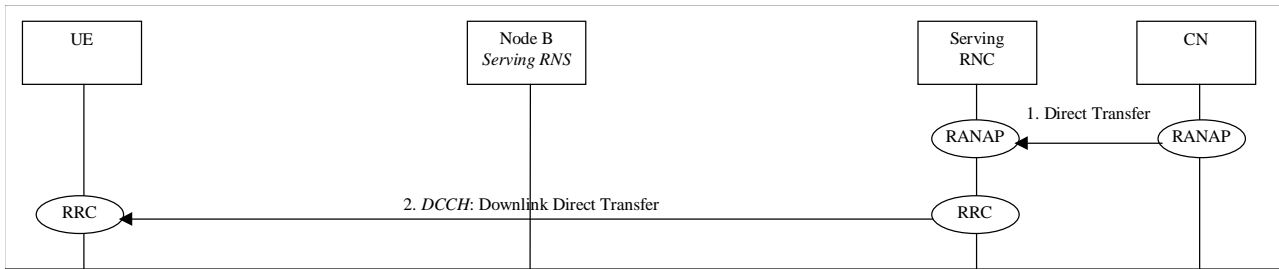

Figure 44: Downlink Direct Transfer

1. CN sends the RANAP message **Direct Transfer** to the SRNC.
Parameters: NAS PDU, CN domain Identity.
2. SRNC sends RRC **Downlink Direct Transfer Message** to UE.
Parameters: NAS Message.

The NAS message is transported transparently by the UTRAN.

7.16 Downlink Power Control [FDD]

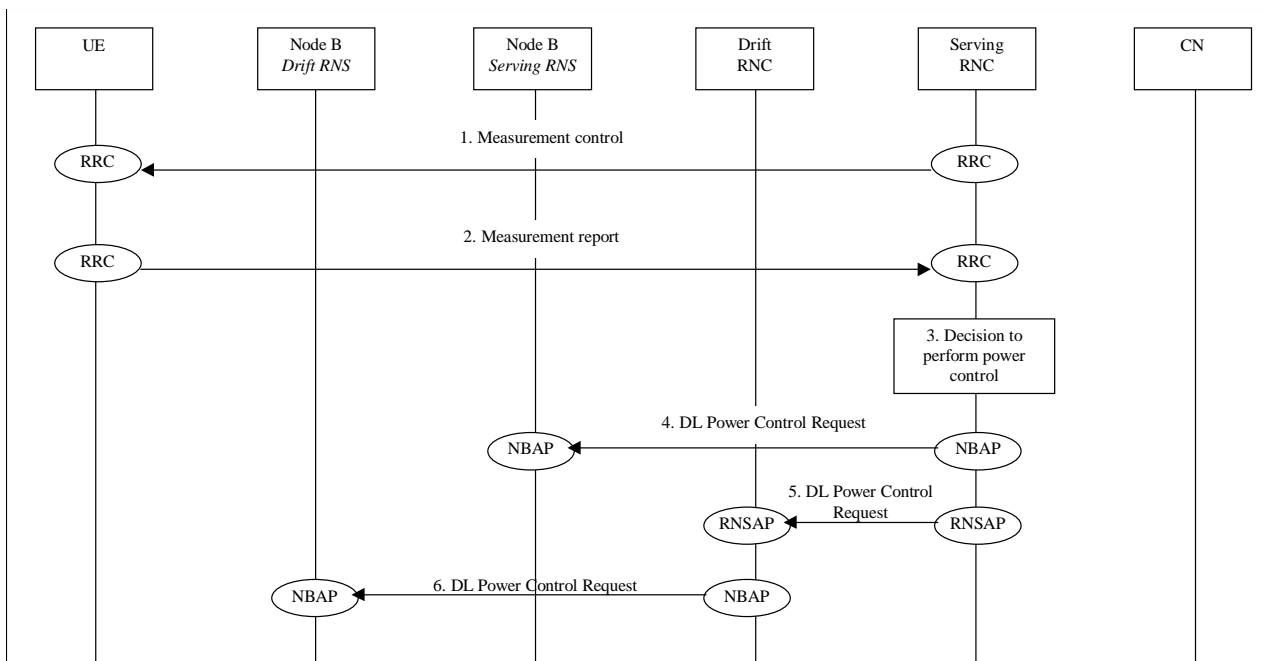

Figure 45: Downlink Power Control

1. SRNC send to UE a RRC Measurement Control message to setup a quality measure.
Parameters: Measurement ID number, Measurement type, Measurement command; This message is optional in the described flow.
2. UE after having performed the measure, send towards CRNC the report in Measurement Report.
3. CRNC decides to request NodeBs lower level (L1) to change power in DL.
4. SRNC sends the NBAP message **DL Power Control Request** to the controlled Node B
Parameters: RL ID, RL Reference power, Max Adjustment Step, Adjustment Period, Adjustment Ratio.

5. SRNC sends the RNSAP message **DL Power Control Request** to the DRNC
Parameters: RL ID, RL Reference power, Max Adjustment Step, Adjustment Period, Adjustment Ratio.
6. DRNC sends the NBAP message **DL Power Control Request** to the controlled Node B
Parameters: RL ID, RL Reference power, Max Adjustment Step, Adjustment Period, Adjustment Ratio.

7.17 Shared Channels Configuration and Capacity Allocation

7.17.1 USCH/DSCH Configuration and Capacity Allocation [TDD]

This subclause shows an example of USCH/DSCH configuration and capacity allocation.

It is assumed that no RL has been already established for the considered RRC connection on the serving cell (i.e. the UE is in cell_FACH state without USCH/DSCH) and that only standalone USCH/DSCH are going to be configured. In case the UE is in cell_DCH state or in cell_FACH state with USCH/DSCH, the Radio Link Reconfiguration procedure is used in steps 1-4-5-6 instead of the Radio Link Setup procedure.

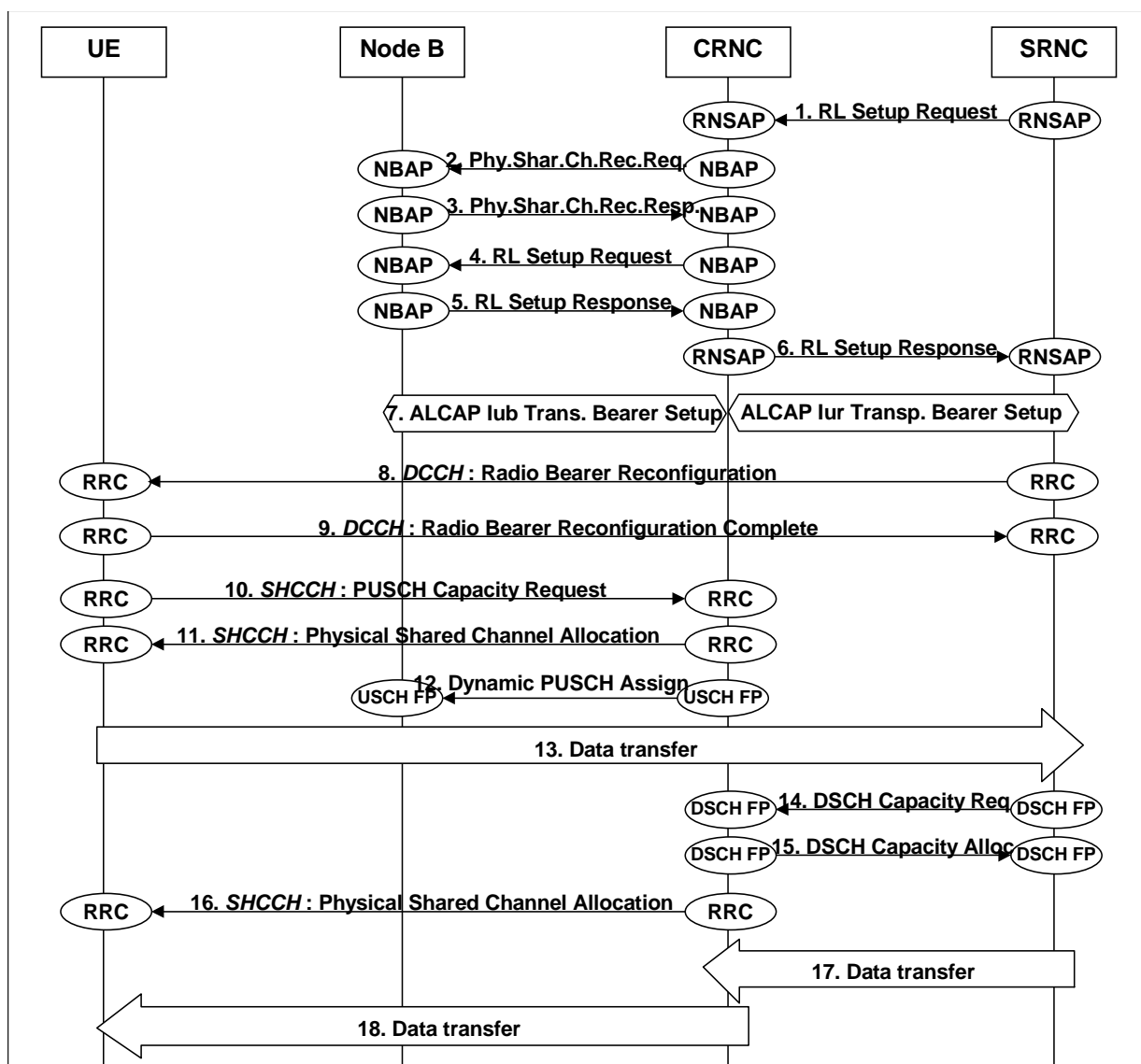

Figure 45a USCH/DSCH Configuration and Capacity Allocation

1. In case no RL has already been established on the RNC controlling the serving cell, the SRNC sends the RNSAP message **Radio Link Setup Request** to the target RNC.
Parameters: target RNC identifier, s-RNTI, Cell id, Transport Format Set (for DSCHs and USCHs), Transport Format Combination Set.

2. If necessary, the CRNC sends to the Node B the NBAP message **Physical Shared Channel Reconfiguration Request** in order to add, modify or delete any PDSCH Sets and PUSCH Sets in the Common Transport Channel data base.
Parameters: PDSCH Info (to add, modify or delete), PUSCH Info (to add, modify or delete).
3. The Node B updates the PDSCH and PUSCH Sets in the Common Transport Channel data base and makes them available to all the current and future DSCH and USCH transport channels. Then it responds with the NBAP message **Physical Shared Channel Reconfiguration Response**.
4. The RNC sends the NBAP message **Radio Link Setup Request** to the target Node-B.
Parameters: Cell id, Transport Format Set (for DSCHs and USCHs), Transport Format Combination Set, Power control information, etc.
5. Node B configures resources for USCHs and DSCHs and responds with NBAP message **Radio Link Setup Response**.
Parameters: Signalling link termination, Transport layer addressing information for the Iub Data Transport Bearer.
6. When the Target RNC has completed preparation phase, the RNSAP message **Radio Link Setup Response** is sent to the SRNC.
7. Target RNC initiates set-up of Iub Data Transport bearer using ALCAP protocol while the SRNC initiates set-up of Iur Data Transport bearer. These requests contain the AAL2 Binding Identity to bind the Iub/Iur Data Transport Bearers to the DSCHs/USCHs. The request for set-up of Iub Data Transport bearer is acknowledged by Node B, while the request for set-up of Iur Data Transport bearer is acknowledged by Target RNC.
8. The SRNC sends the RRC message **Radio Bearer Reconfiguration** to establish the requested USCHs and DSCHs.
Parameters: Radio Bearer information.
9. The UE replies with the RRC message **Radio Bearer Reconfiguration Complete**.
10. As soon as the RRC in the UE detects the necessity to send UL data on one USCH, it sends the RRC message **PUSCH Capacity Request** to obtain allocation of PUSCH resources from the CRNC.
Parameters: C-RNTI, Radio Bearer ID, RLC buffer info.
11. The CRNC determines which PUSCH Set to allocate to the USCH and sends a **Physical Shared Channel Allocation** message to the UE.
Parameters: C-RNTI, Allocation Period info (Activation CFN, Duration), PUSCH info.
12. The CRNC signals the allocation of PUSCH resources for a given UE to the Node B by means of a Dynamic PUSCH Assignment control frame.
Parameters: PUSCH Set Id, Activation CFN, and Duration.
13. At the scheduled CFN the UE may start transmitting UL data on the USCH for the assigned allocation period. UL data are forwarded by the CRNC to the SRNC.
14. As soon as the SRNC detects the necessity to send DL data on one DSCH, it sends a DSCH Capacity Request control frame to the CRNC.
Parameters: Common Transport Channel Priority Indicator, User buffer size.
15. The CRNC determines the amount of data (credits) that can be transmitted on the DSCH and reports this information back to the SRNC by means of DSCH Capacity Allocation control message.
Parameters: Common Transport Channel Priority Indicator, Max MACc-sh SDU Length, Credits, Interval, and Repetition Period.
16. The CRNC determines which PDSCH Set to allocate to the DSCH and sends a RRC message **Physical Shared Channel Allocation** to the UE.
Parameters: C-RNTI, Allocation Period info (Activation CFN, Duration), PDSCH info.
17. The SRNC starts sending DL data to the CRNC.
18. The CRNC schedules the DL transmission of DL data on DSCH according to the allocation of PDSCH resources.

7.17.2 HS-DSCH Configuration and Capacity Allocation

The following ATM example shows a sequence chart explaining the setup of HS-DSCH. It is assumed that the UE is in cell_DCH state. In case no RL has already been established, the Radio Link Setup procedure is used instead of the Radio Link Reconfiguration procedure.

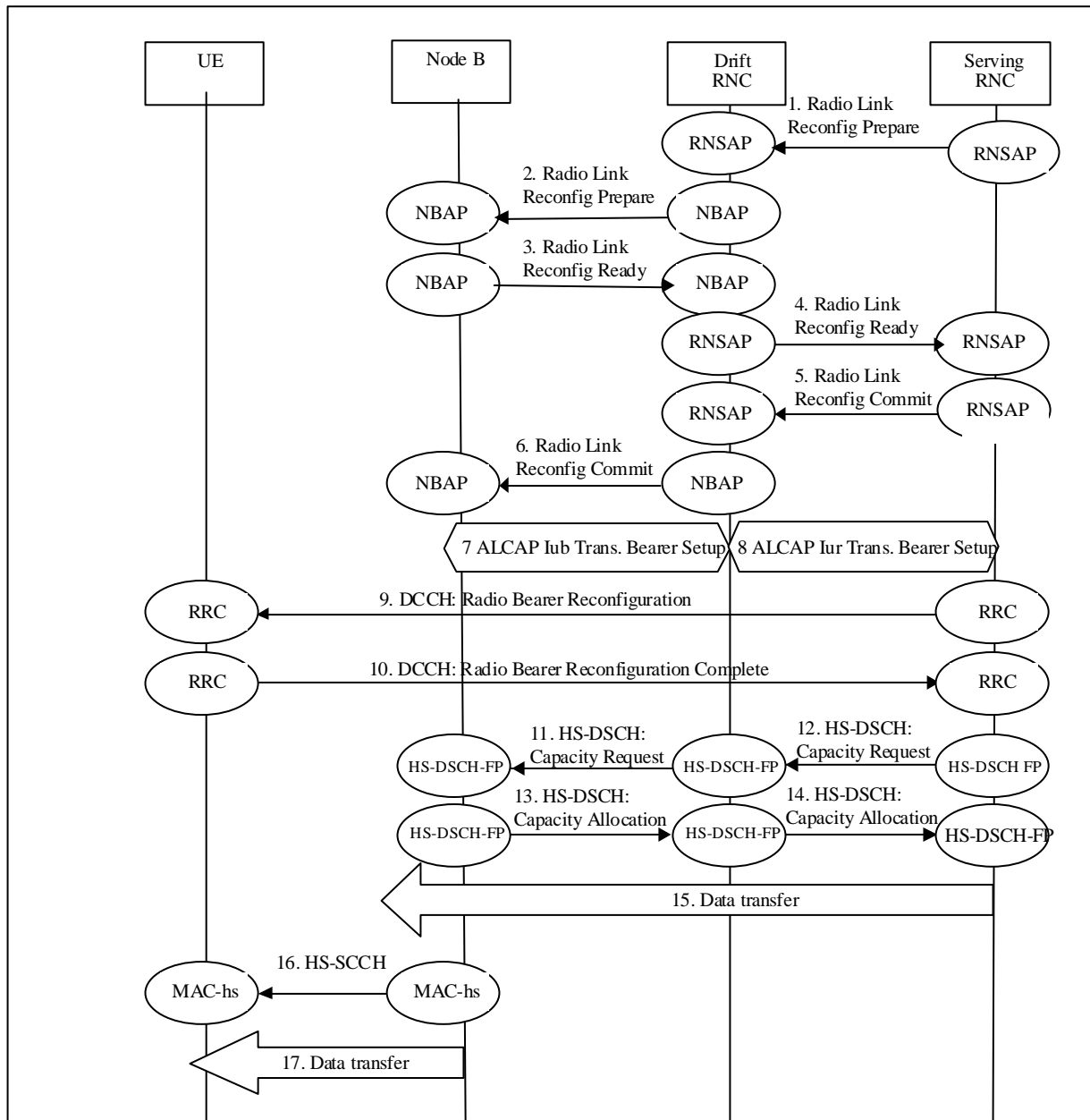

Figure 45b: HS-DSCH Configuration and Capacity Allocation

1. In order to channel-switch to the HS-DSCH, the radio link which shall carry the HS-DSCH has to be reconfigured. The SRNC initiates a Radio Link Reconfiguration by sending the RNSAP message **Radio Link Reconfiguration Prepare** to DRNC.
Parameters: HS-DSCH information and a SRNC selected HS-PDSCH RL ID.
2. The DRNC requests the respective Node B to prepare the synchronised RL reconfiguration by sending the NBAP message **Radio Link Reconfiguration Prepare**.
Parameters: HS-DSCH Information, a DRNC selected HS-DSCH RNTI and the HS-PDSCH RL ID.
3. Node B configures resources for the HS-DSCH and responds with the NBAP message **Radio Link Reconfiguration Ready**.
Parameters: HS-DSCH Information Response.

4. When the DRNC has completed the preparation phase, the RNSAP message **Radio Link Reconfiguration Ready** is sent to the SRNC.
Parameters: HS-DSCH Information Response and the DRNC selected HS-DSCH-RNTI.
5. The RNSAP message **Radio Link Reconfiguration Commit** is sent from SRNC to DRNC.
6. The NBAP message **Radio Link Reconfiguration Commit** is sent from DRNC to Node B.
7. The DRNC initiates set-up of Iub Data Transport Bearers using ALCAP protocol. This request contains the AAL2 Binding Identity to bind the Iub Data Transport Bearer to the HS-DSCH.
8. The SRNC initiates set-up of Iur Data Transport bearer using ALCAP protocol. This request contains the AAL2 Binding Identity to bind the Iur Data Transport Bearer to the HS-DSCH.
9. The SRNC sends the RRC message **Radio Bearer Reconfiguration** to the UE to establish the requested HS-DSCH.
10. The UE replies with the RRC message **Radio Bearer Reconfiguration Complete**. At this point in time, the HS-DSCH Transport Channel has been set up, and it is assumed that the MAC-hs in the Node B has already been configured earlier to have access to a pool of HS-PDSCH resources for HS-DSCH scheduling.
11. As soon as the SRNC detects the necessity to send HS-DL data on one HS-DSCH, it sends an HS-DSCH **Capacity Request** control frame within the HS-DSCH Frame Protocol to the CRNC.
Parameters: Common Transport Channel Priority Indicator and User Buffer Size.
12. The CRNC forwards this message (HS-DSCH **Capacity Request** control frame) to the Node B. So in this example sequence, the CRNC does not interfere with the HS-DSCH scheduling.
Parameters: Common Transport Channel Priority Indicator and User Buffer Size.
13. The Node B determines the amount of data (credits) that can be transmitted on the HS-DSCH and reports this information back to the DRNC in a HS-DSCH **Capacity Allocation** control frame in the HS-DSCH Frame Protocol.
Parameters: Common Transport Channel Priority Indicator, HS-DSCH Credits, HS-DSCH Interval, HS-DSCH Repetition period, Maximum MAC-d PDU length.
14. The DRNC sends the HS-DSCH **Capacity Allocation** control frame to SRNC. So again, the DRNC does not react itself to that message in this example.
Parameters: Common Transport Channel Priority Indicator, HS-DSCH Credits, HS-DSCH Interval, HS-DSCH Repetition period, Maximum MAC-d PDU length.
15. The SRNC starts sending DL data to the Node B. This is done via the two HS-DSCH Frame Protocol "hops" on Iur and Iub interface. The Node B schedules the DL transmission of DL data on HS-DSCH which includes allocation of PDSCH resources.
16. The Node B transmits the control information for the concerned UE using the HS-SCCH.
17. The Node B sends the HS-DSCH data to the UE on the HS-PDSCH(s).

7.18 Channel and Mobile State Switching on Iur

7.18.1 General Description

This subclause shows an example of switching of a mobile protocol state to another, which Iur is used, thus involving RNSAP procedure.

7.18.2 Switching from Cell_FACH to Cell_DCH State

The following examples show switching of protocol state from Cell_FACH to Cell_DCH providing UE with information on RACH/FACH flows and involving DRNC and Iur.

The resulting sequence is the following:

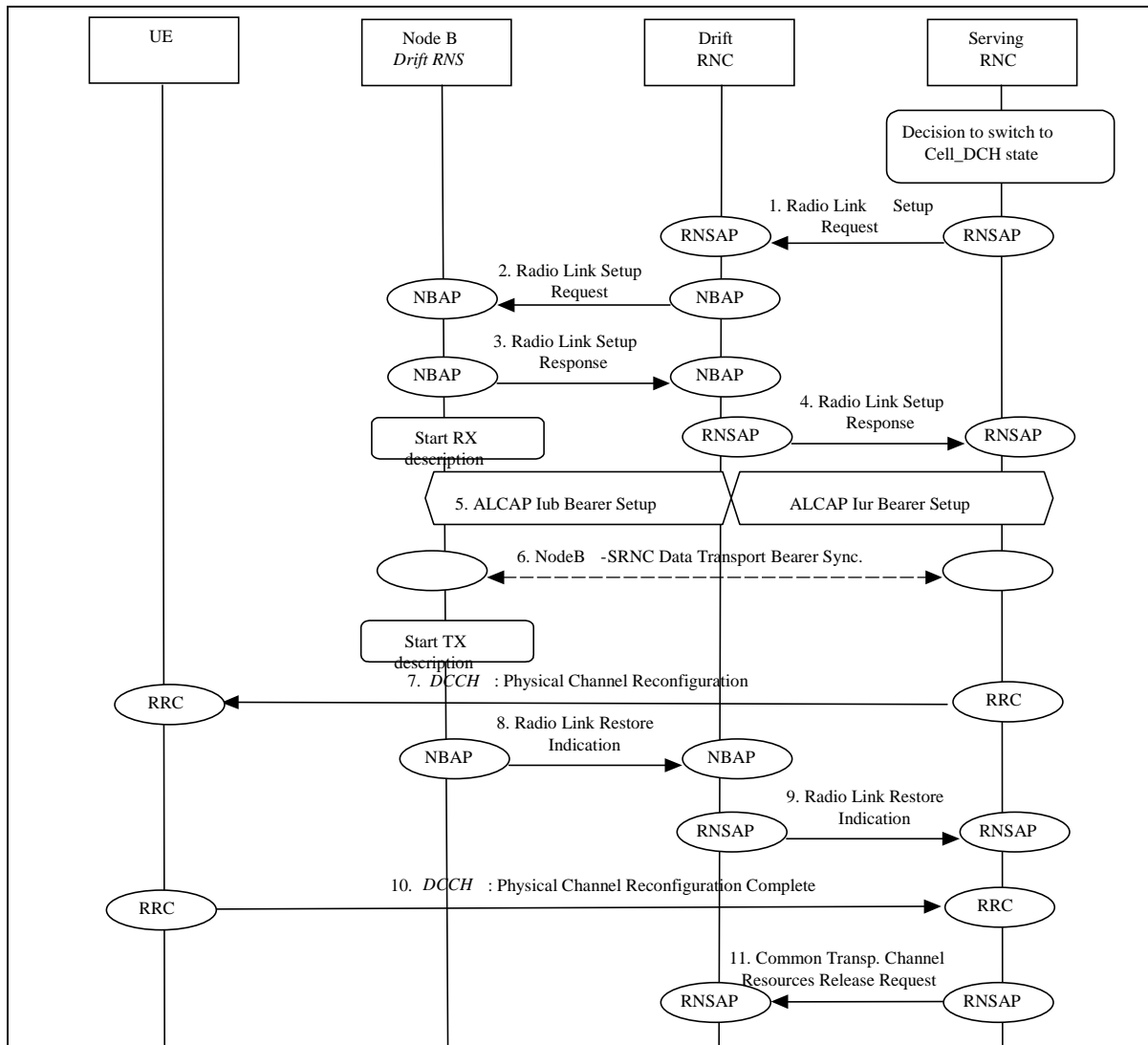

Figure 45b Switching from Cell_FACH to Cell_DCH State via Iur

1. SRNC decides to switch to CELL_DCH state, setting up a new radio link via a new cell controlled by DRNC. SRNC requests DRNC for radio resources by sending RNSAP message **Radio Link Setup Request**. If this is the first radio link via the DRNC for this UE, a new Iur signalling connection is established. This Iur signalling connection will be used for all RNSAP signalling related to this UE.
Parameters: Cell id, Transport Format Set per DCH, Transport Format Combination Set, frequency, UL scrambling code.
2. DRNC sends NBAP message **Radio Link Setup Request** to Node B.
Parameters: Cell id, Transport Format Set per DCH, Transport Format Combination Set, frequency, UL scrambling code.
3. Successful outcome is reported in NBAP message **Radio Link Setup Response**.
Parameters: Signalling link termination, Transport layer addressing information (AAL2 address, AAL2 Binding Identity(s)) for Data Transport Bearer(s).

Then Node B starts the UL reception.
4. DRNC sends RNSAP message **Radio Link Setup Response** to SRNC.
Parameters: Transport layer addressing information (AAL2 address, AAL2 Binding Identity) for Data Transport Bearer(s), Neighbouring cell information.
5. SRNC initiates setup of Iur, while DRNC is in charge to setup Iub, Data Transport Bearer using ALCAP protocol. This request contains the AAL2 Binding Identity to bind the Iub Data Transport Bearer to DCH.
Note: there is not a time relation between set up of Iur and Iub. Both must be carried out before next step.

6. Node B and SRNC establish synchronism for the Data Transport Bearer by means of exchange of the appropriate DCH Frame Protocol frames via **Downlink Synchronisation** and **Uplink Synchronisation**, relative to already existing radio link(s).
Then Node B starts DL transmission.
7. SRNC sends RRC message **Physical Channel Reconfiguration** to UE on DCCH.
Parameters: Update type, Cell id, DL scrambling code, Power control information, Ncell information.
8. Node B achieves uplink sync on the Uu and notifies DRNC with NBAP message **Radio Link Restore Indication**.
9. DRNC sends RNSAP message **Radio Link Restore Indication** to notify SRNC that uplink sync has been achieved on the Uu.
10. After the reconfiguration, the UE sends RRC message **Physical Channel Reconfiguration Complete** to SRNC.
11. The SRNC releases the UE context for CELL_FACH state in the source DRNC by sending a **Common Transport Channel Resources Release** message.

7.18.3 Switching from Cell_DCH to Cell_FACH State

In this scenario the SRNC needs to get the C-RNTI from DRNC to be able to indicate to the UE a new C-RNTI and which cell it is valid in (given by the Primary Scrambling Code).

The SRNC also needs to get either:

1. information in the RACH and/or FACH to be used (if the DRNC selects RACH and/or FACH in a different way than the UE would do based on broadcast information) including User Plane flow control information for the Iur FACH FP.
2. User Plane flow control information for the FACH (Secondary CCPCH) that the UE selects if no Secondary CCPCH information is provided to the UE in the RRC Physical Channel Reconfiguration message

If receiving the C-ID the DRNC shall allocate a C-RNTI and provide it together with the Primary CPICH information to the SRNC. Furthermore, if the DRNC would like to select another RACH and/or FACH than the UE would select based on the broadcast information the DRNC also provides information on the DRNC Selected RACH and/or FACH (alternative 1). If the DRNC does not select any FACH the DRNC shall provide the user plane flow control information (alternative 2).

The above solution would result in the following sequence:

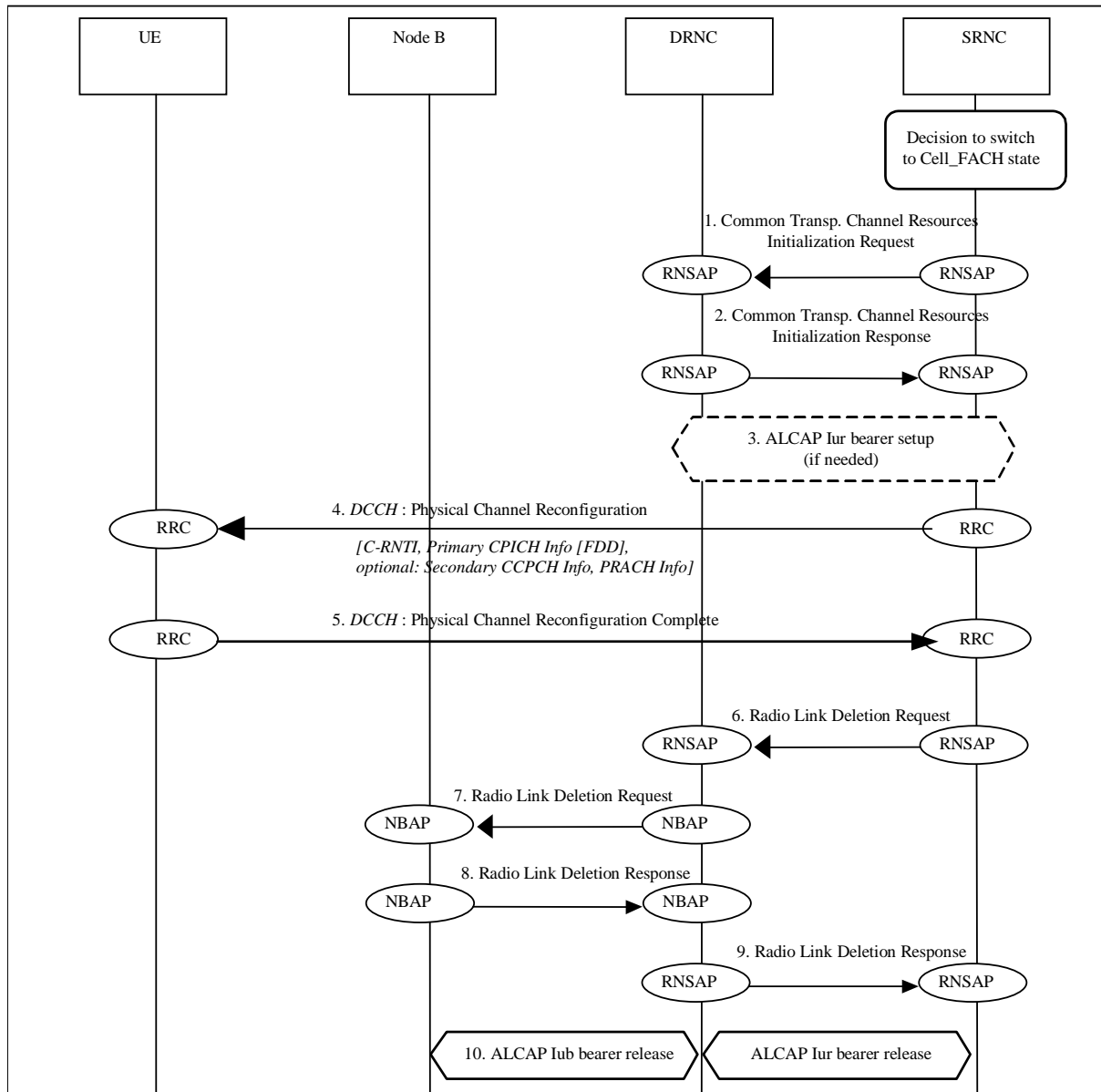

Figure 45c Switching from Cell_DCH to Cell_FACH State via Iur

1. SRNC decides to switch to CELL_FACH state, releasing its present radio link via a cell controlled by DRNC. The SRNC decides to setup a common channel for the UE via DRNC, informing DRNC with C-ID IE of the UE in order to obtain C-RNTI (allocated in the next step by DRNC) needed for RRC messages. This setup is done with the RNSAP **Common Transport Channel Resources Initialisation Request** message.
2. The target DRNC sends the transport layer address, binding identity and C-RNTI to the SRNC with the RNSAP **Common Transport Channel Resources Initialisation Response** message
3. SRNC initiates setup of Iur/Iub Data Transport Bearer (if needed) using ALCAP protocol. This request contains the AAL2 Binding Identity to bind the Iub Data Transport Bearer
4. SRNC sends RRC message **Physical Channel Reconfiguration** to UE on DCCH, with new C-RNTI and identification of the cell where it is valid.
5. After the reconfiguration, the UE sends RRC message **Physical Channel Reconfiguration Complete** to SRNC. Parameters: Update type, Cell id, DL scrambling code, Power control information, Ncell information.
6. SRNC releases DRNC for radio resources allocated for DCH by sending RNSAP message **Radio Link Deletion Request**
Parameters: Cell id, Transport Format Set per DCH, Transport Format Combination Set, frequency, UL scrambling code.

7. DRNC sends NBAP message **Radio Link Deletion Request** to Node B.
8. Successful outcome is reported in NBAP message **Radio Link Deletion Response**.
DRNC sends RNSAP message **Radio Link Deletion Response** to SRNC.
9. Not used resources in-DRNC and Node B (Drift RNS) are released. DRNC initiates release of Iub and SRNC of Iur Data Transport bearer using ALCAP protocol.

NOTE: there is not a time relation between set up of Iur and Iub. Both must be carried out before next step.

7.19 MBMS Specific Procedures

7.19.1 MBMS Service Activation

The following scenario gives an example message flow for UE joining an MBMS service. The example chosen is the one where the UE is in DRNC in state Cell-DCH receiving possible other services. This is the first UE joining the MBMS service in SRNC and DRNC.

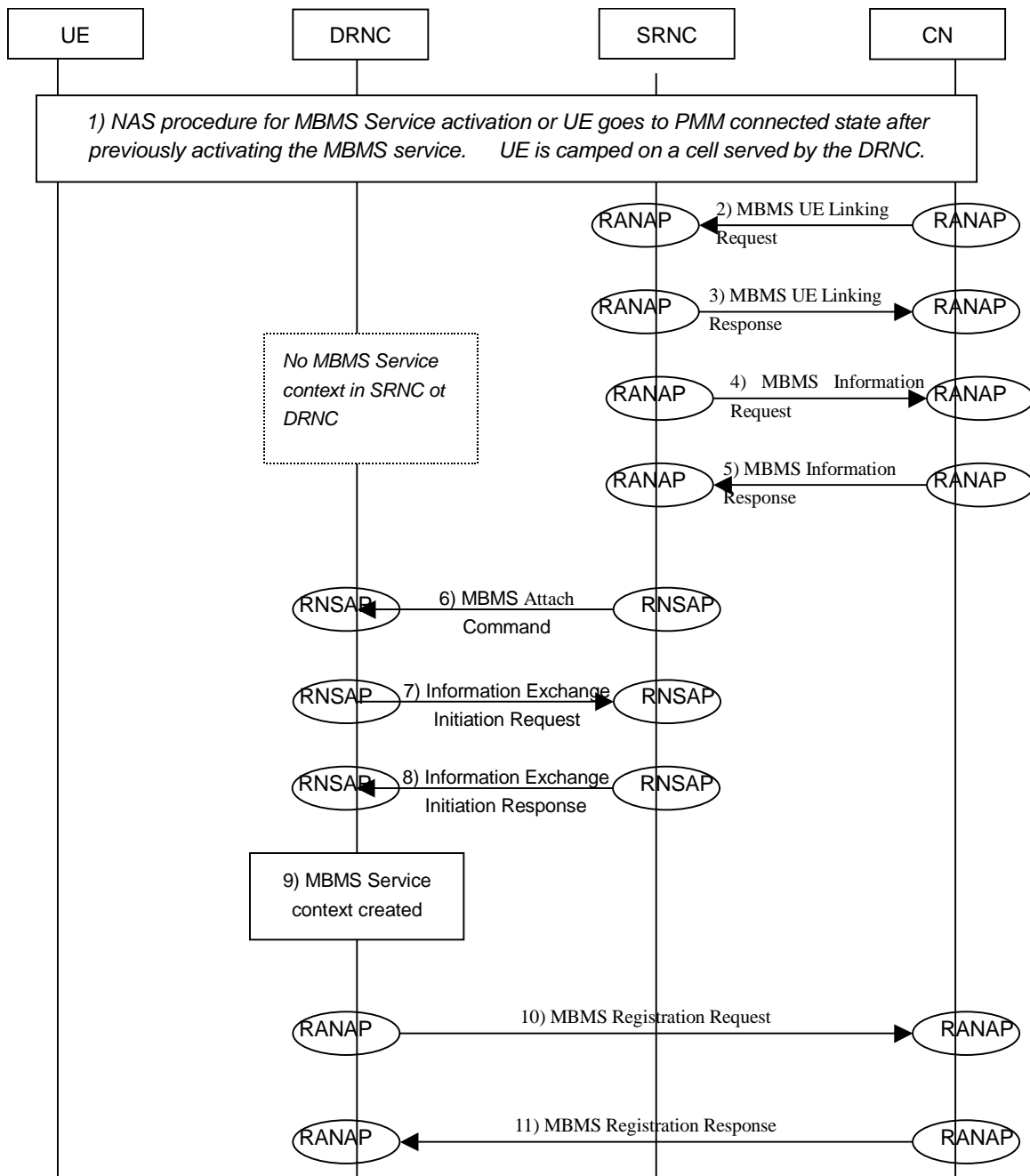

Figure 46: MBMS Service Activation

1. UE performs NAS procedure for MBMS Service Activation or having activated the service previously goes into PMM connected state. UE is in a cell in the DRNC. There is no MBMS context for this service in the DRNC.
2. The Core Network initiates the MBMS UE Linking procedure by sending RANAP **MBMS UE Linking Request** message to provide the SRNC with the list of MBMS Service Ids activated by this UE.
Parameters: TMGIs, PTP RB id
3. RNC sends an RANAP **MBMS UE Linking Response** message to Core Network after RNC updates the MBMS Service Context.
4. As the SRNC has no MBMS context for this service, it does not know the IP Multicast address or APN for this service. The SRNC request these from the SGSN using the connectionless RANAP **Uplink Information Exchange Request** message.
Parameters: TMGI.
5. SGSN responds with RANAP **Uplink Information Exchange Response** message.
Parameters: TMGI, IP Multicast Address and APN.

6. UE linking in the DRNC is performed using the RNSAP **MBMS Attach Command** message over the Iur interface.
Parameters: TMGIs
7. As the DRNC has no MBMS context for this service, it does not know the IP Multicast Address and APN for this service. The DRNC requests these from the SRNC using the connectionless RNSAP **Information Exchange Initiation Request** message.
Parameters: MBMS Bearer Service List
8. SRNC responds with RNSAP **Information Exchange Initiation Response** message
Parameters: TMGI, IP Multicast Address and APN
9. An MBMS Service Context for the service is created in the DRNC.
10. The DRNC informs the Core Network that it would like to receive MBMS Session Start Request messages by sending an RANAP **MBMS Registration Request** message.
Parameters: Registration Request type, TMGI, IP Multicast Address, APN, Global RNC id.
11. Core Network replies with an RANAP **MBMS Registration Response** message.

7.19.2 MBMS Session Start

The following is an example scenario for an MBMS Session Start. The RNC decides to perform counting and offer the service over PTM bearer. The UE is receiving a lower priority MBMS service over a PTP bearer. The UE capability does not allow reception of PTP and PTM bearers simultaneously.

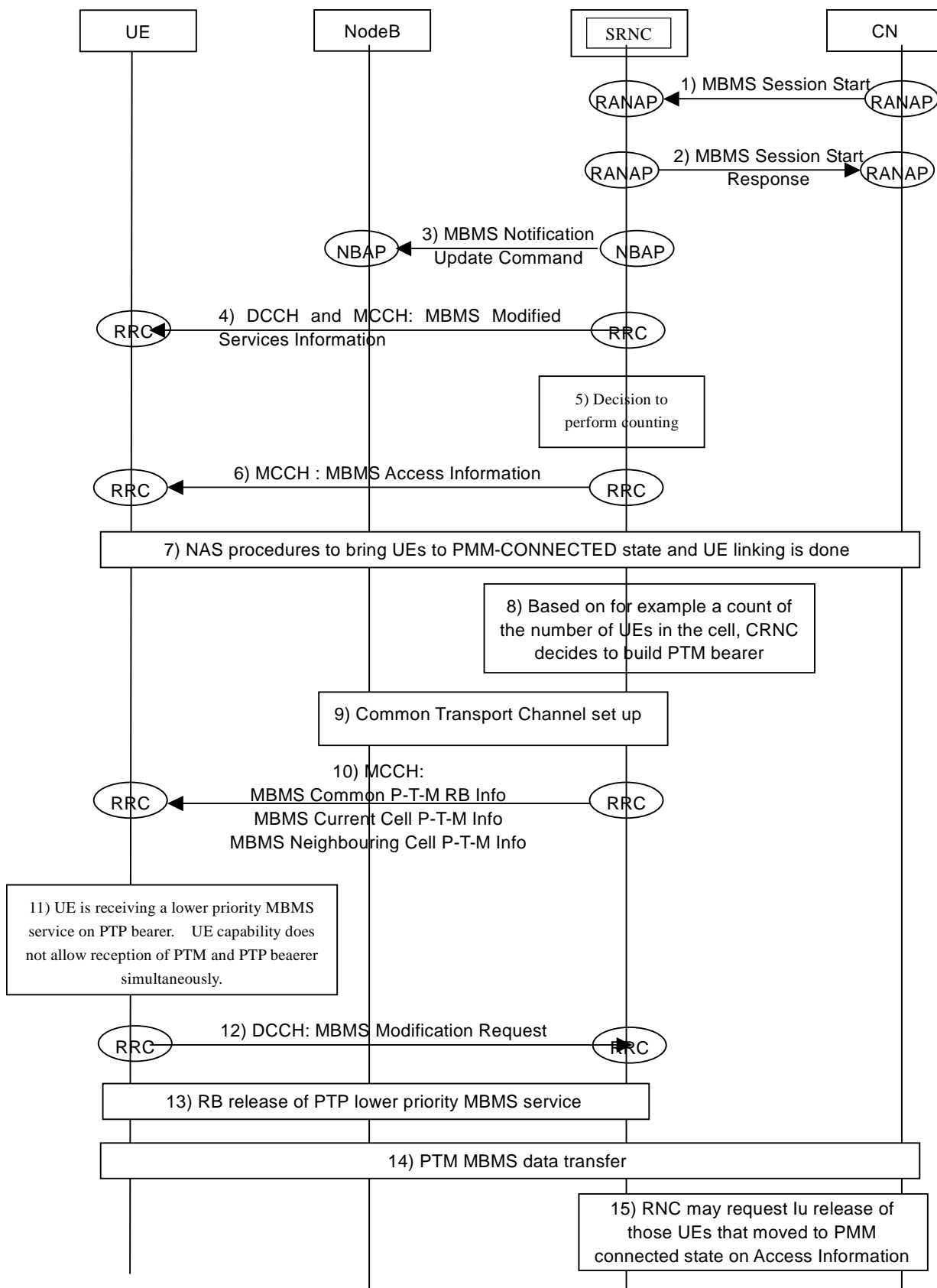

Figure 47: MBMS Session Start

1. When the MBMS session starts the SGSN informs all RNCs that is connected to this SGSN of the availability of data and requests the establishment of the User plane bearer using RANAP **MBMS Session Start** message . This also establishes the SCCP connection for the MBMS service.
Parameters: TMGI, Session id, Repetition number, Bearer Service type, Iu signaling connection id, RAB

parameters, PDP type, Session Duration, Service Area, Frequency layer convergence flag, RA list of idle mode UEs, Global CN-id

2. The RNC responds with an RANAP **MBMS Session Start Response** message. Since there are UEs in this RNC that have joined the service, it sets up the RAB for the MBMS service.
Parameters: Iu transport layer information
3. CRNC updates the MICH using NBAP **MBMS Notificaiton Update Command**. This message is updated for every change in MICH.
Parameters: C-ID, Common Physical Channel ID, Modification Period, MICH CFN, NI Information.
4. RNC is in the Service Area for the service. The RNC notifies the UE(s) about the start of the MBMS service by updating the RRC **MBMS Modified Services Info** message on the MCCH. This is sent on DCCH for UEs in Cell-DCH and on MCCH for other UEs.
Parameters: TMGI, Session id, UE action required, MBMS preferred frequency, Continued MCCH reading
5. RNC takes a decision to perform UE counting in order to evaluate what is the optimal method for MBMS delivery.
6. RNC requests UE to set up PMM connection using RRC **MBMS Access Info** message on MCCH.
Parameters: TMGI and probability factor.
7. A fraction of (or all) UEs who have joined the MBMS service establishes PMM connection towards CN. UE linking is done by the CN when Iu-ps connection is established for these UEs.
8. After counting, CRNC has enough information to make PTP/PTM decision. In this scenario there were enough UEs to exceed the threshold to justify ptm transmission.
9. The CRNC establishes the S-CCPCH and FACH which will carry the MTCH by using the Common Transport Channel Setup procedure.
10. CRNC informs UE of the MTCH channel used for the MBMS service in the cell and its neighbouring cells using the RRC **MBMS Common P-T-M RB Info, MBMS Current Cell P-T-M RB Info, MBMS Neighbouring Cell P-T-M RB Info** messages on MCCH.
Parameters: TMGI, MBMS UTRAN Cell Group Identifier, logical channel, transport channel, physical channel information, MSCHInformation per MBMS service.
11. UE is receiving a lower priority MBMS service on a PTP bearer. UE capability does not allow reception of a PTP and PTM bearer simultaneously.
12. UE requests the release of the PTP bearer for the other lower priority service using RRC **MBMS Modification Request** message.
Parameters: RB to be released.
13. RNC releases the PTP RB of the other lower priority MBMS service.
14. MBMS data transmission for this service on the PTM bearer.
15. RNC may request the release of the Iu connection for the UEs that were moved to PMM connected state during the counting process.

7.19.2a MBMS Session Start for UE in Cell-DCH in DRNC

The following is an example scenario for an MBMS Session Start for a UE in Cell-DCH in a DRNC. The DRNC decides to offer the service in PTM mode. The UE capability does not allow reception of PTP and PTM bearers simultaneously. The UE prioritises to receive MBMS service over the dedicated service.

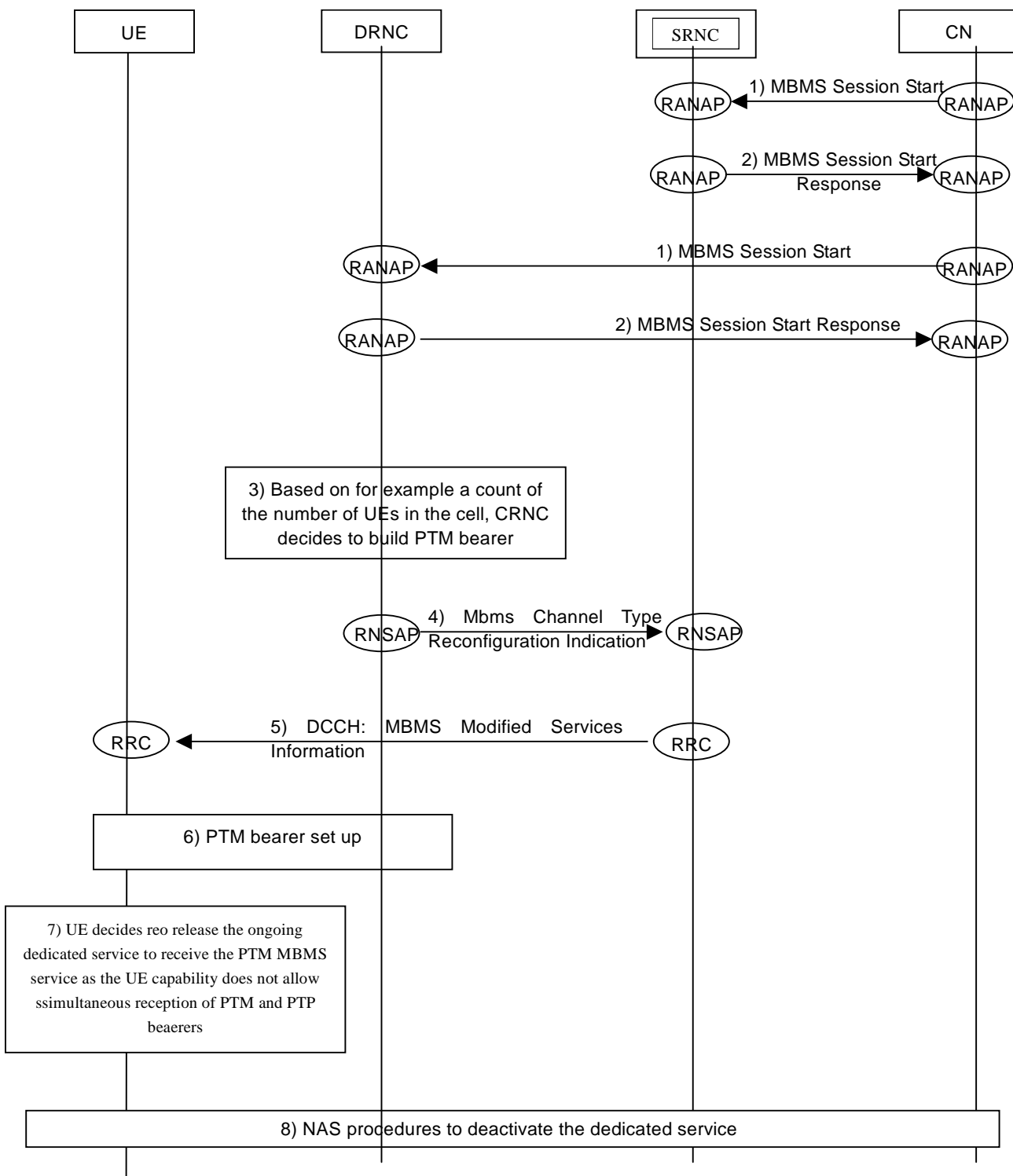

Figure 47a: MBMS Session Start for UE in Cell-DCH in DRNC

1. When the MBMS session starts the SGSN informs all registered RNCs of the availability of data and requests the establishment of the User plane bearer using RANAP **MBMS Session Start** message . This also establishes the SCCP connection for the MBMS service.
Parameters: TMGI, Session id, Repetition number, Bearer Service type, Iu signaling connection id, RAB parameters, PDP type, Session Duration, Service Area, Frequency layer convergence flag, RA list of idle mode UEs, Global CN-id

2. The RNCs responds with an RANAP **MBMS Session Start Response** message. Since there are UEs in this RNC that have joined the service, it sets up the RAB for the MBMS service.
Parameters: Iu transport layer information
3. CRNC makes PTP/PTM decision. In this scenario the CRNC makes a PTM decision.
4. The CRNC as DRNC sends MBMS Channel Type Reconfiguration Indication for all the cells for which it is the DRNC to the SRNCs.
Parameters: DRNC-ID, C-ID, TMGI, Transmission mode (PTM)
5. SRNC notifies users in Cell-DCH over DCCH using MBMS Modified Services information.
Parameters: TMGI, MBMS required UE action (acquire PTM RB Info), MBMS preferred frequency
6. PTM Radio beares are set up by CRNC.
7. UE decides that it wants to receive MBMS service. In this scenario, the UE is not capable of receiving both PTM and dedicated services.
8. UE invokes NAS procedures to request the release of the dedicated services.

7.19.3 MBMS UE Mobility from a PTP to PTM cell

This example shows a UE receiving MBMS service over a PTP bearer in the SRNC moving into DRNC area where the service is available over a PTM bearer.

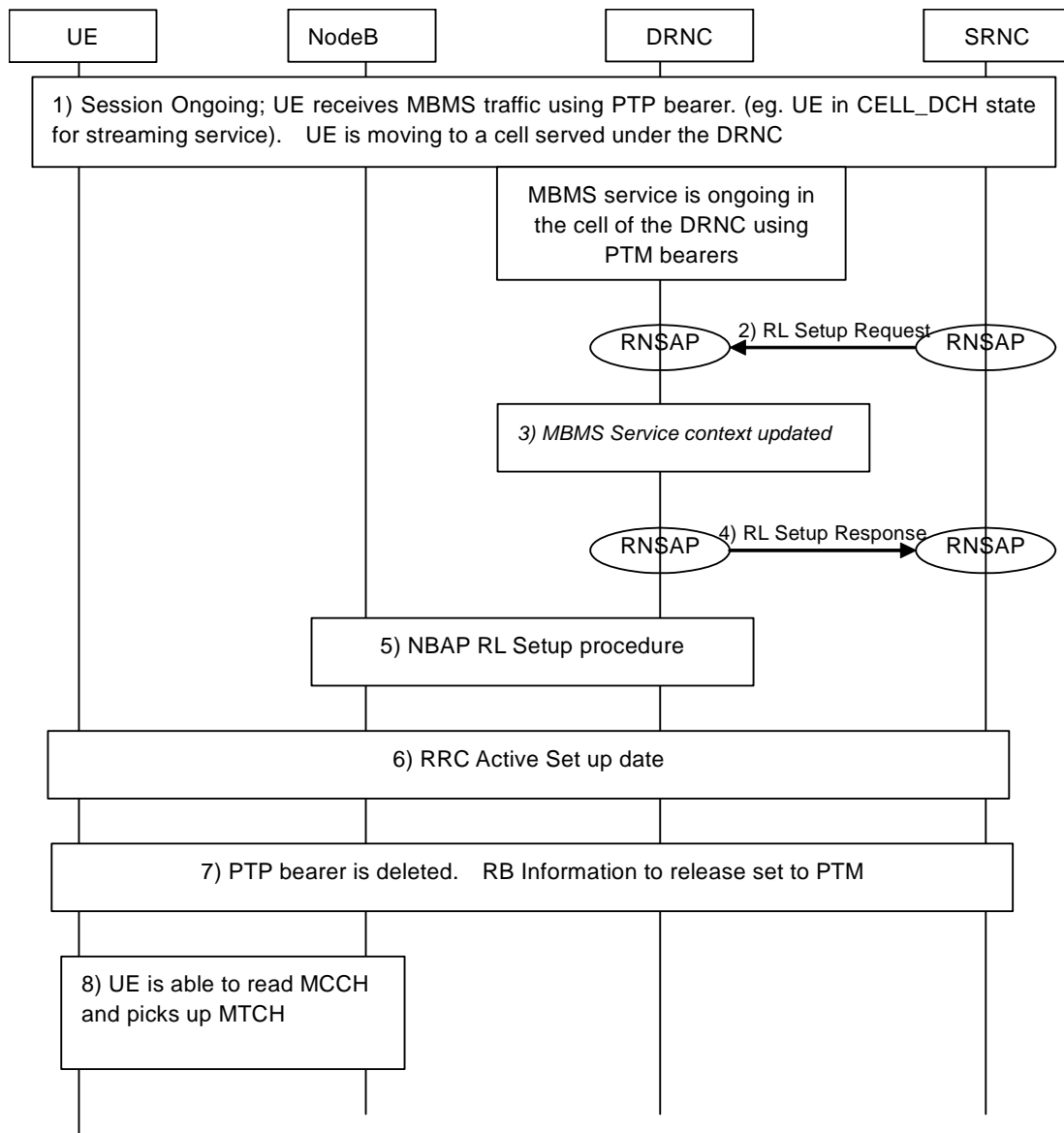

Figure 48: MBMS User mobility from PTP to PTM cell

1. MBMS Service has been activated and is currently ongoing. UE is receiving the MBMS traffic using a PTP bearer. SRNC makes the decision that to add a cell in the DRNC to the active set. The Cell already has PTM bearer for the MBMS service.
2. UE Linking is performed via using RNSAP **Radio Link Setup Request** message to add the radio link in the new cell.
Parameters: MBMS Bearer Service List,
3. MBMS service context in the DRNC is updated.
4. DRNC responds with RNSAP **RL set up response** message.
Parameters: Active MBMS Bearer Service List
5. NBAP RL Set up procedure to set up the RL on the NodeB
6. RRC Active Set Update to the UE to add the PTP radio link on the new cell to the active set.
7. When the cell in the DRNC is good enough to provide MBMS service to UE, the SRNC deletes the PTP radio bearer. The RRC **Radio Bearer Release** message includes the "MBMS RB list released to change transfer mode" IE to indicate that the release is due to transfer mode change, i.e. PTM availability.
Parameters (only MBMS specific ones listed): MBMS FLC capability, MBMS RB list released to change transfer mode

8. UE is able now to read information regarding the MBMS Service on the MCCH and picks up MTCH.

7.19.4 MBMS UE Mobility from PTM cell to PTP cell

This example shows an example scenario for the case when the UE moves from a cell in the SRNC with PTM bearer for the MBMS service to another cell in the DRNC. The DRNC chooses PTP transmission for the service.

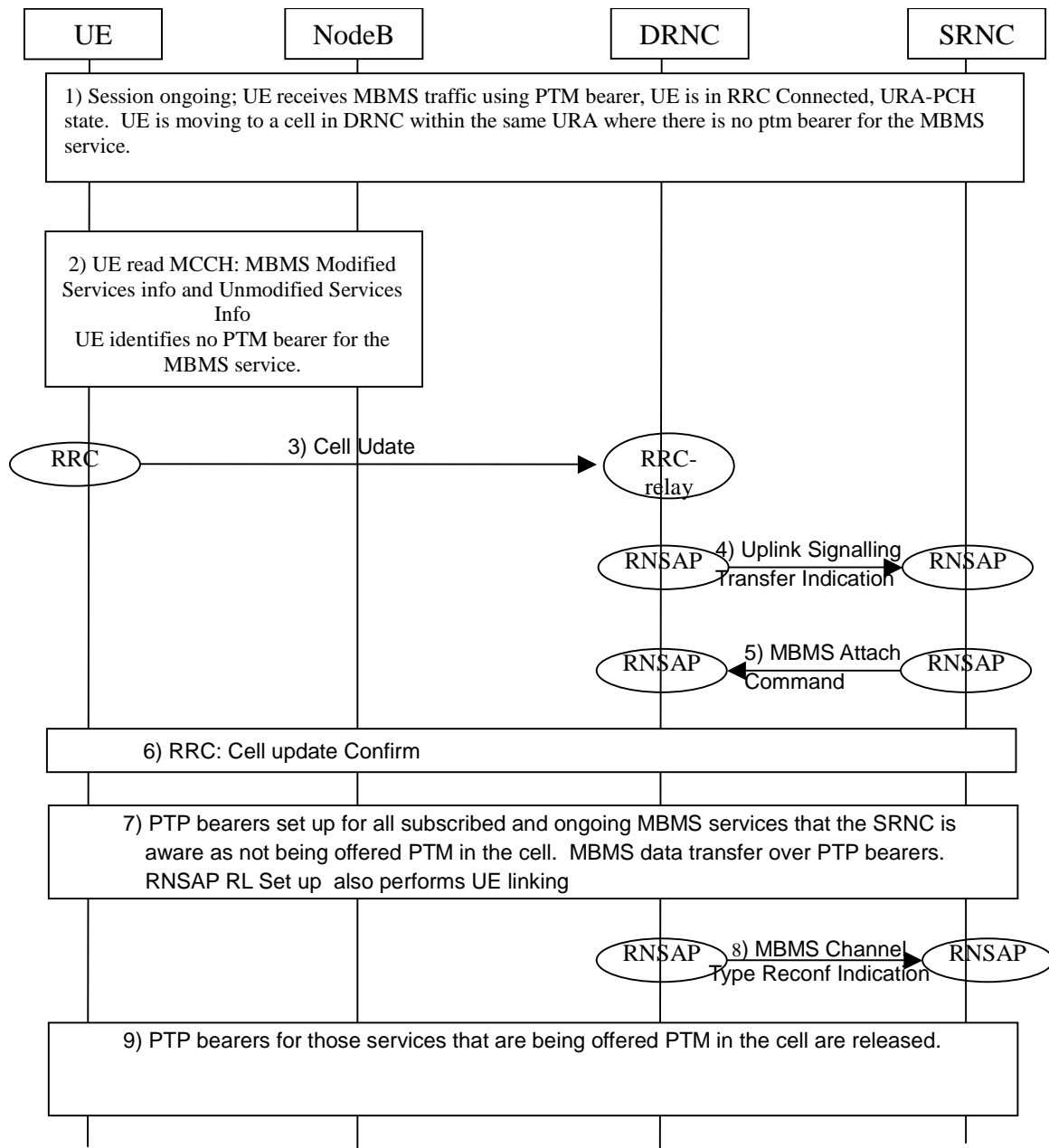

Figure 49: MBMS UE mobility from PTM to PTP cell

1. MBMS Service has been activated and is currently ongoing. UE is in URA-PCH state in the DRNC coverage area and is receiving the MBMS traffic using a PTM bearer. UE performs cell re-selection to a cell where there is no PTM bearer for the MBMS service within the same URA.
2. UE reads the RRC **Modified Services Info** and **Unmodified Services Info** messages on MCCH and identifies that there is no PTM bearer for the service in this cell.
3. UE sends a RRC **Cell Update** message.
Parameters: Cause Value set to MBMS reception.

4. DRNC relays the Cell update to the SRNC in RNSAP **Uplink Signalling Transfer Indication** message. Since this is the first access in the DRNC for this UE (UE linking information is not available in the DRNC), the DRNC cannot include the channel type indication to the SRNC.
5. SRNC sends MBMS ATTACH COMMAND to create a UE link in the DRNC, using the connection oriented service of the signalling bearer.
Parameters: MBMS Bearer Service List, D-RNTI if UE in Cell_FACH/Cell_PCH or SRNC-ID+URA-ID if UE in URA-PCH.
6. SRNC sends the RRC Cell Update Confirm message to the UE.
7. SRNC sets up PTP bearer for all the ongoing MBMS services that the user has subscribed to and that the SRNC is not aware as being offered PTM in the cell. The RNSAP **RL set up Request** message also performs UE linking. UE starts to receive MBMS service over PTP bearer.
8. DRNC is aware of activated MBMS service(s) for the UE and sends the connectionless RNSAP **MBMS Channel Type Reconfiguration Indication** message indicating PTP bearer type. This message includes the transmission mode for all the ongoing UE linked MBMS services.
Parameters: DRNC-id, C-ID, TMGI, Transmission mode, S-RNTI of affected UE.
9. SRNC releases the PTP bearers for those services that it is now aware as being offered PTM in the cell. UE starts to receive MBMS service over PTP bearer.

7.19.5 MBMS Session Stop and Service termination

The following example shows a scenario for MBMS session ends followed by a termination of the MBMS service.

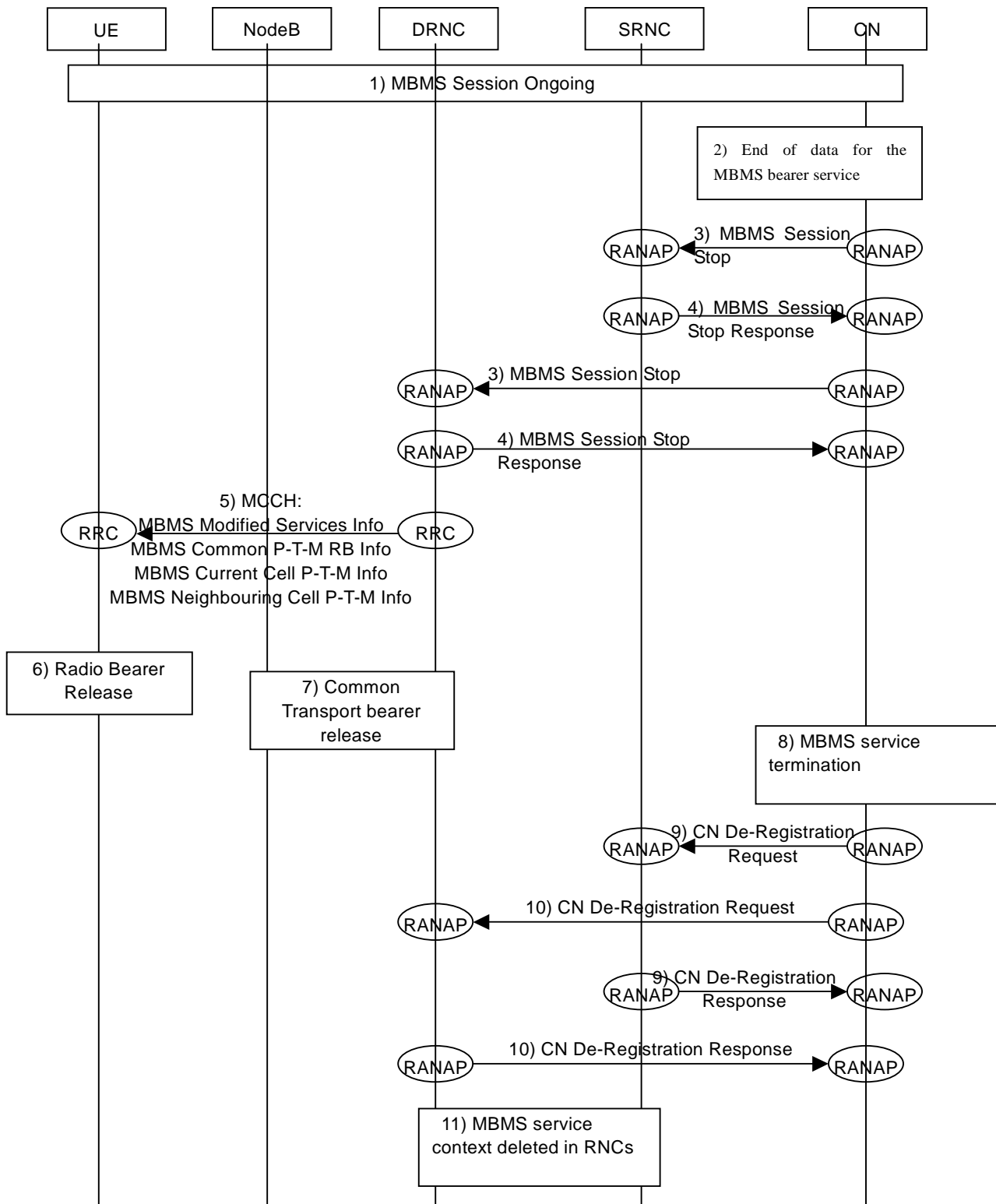

Figure 50: MBMS Session stop and Service termination

1. In this scenario it is assumed that an MBMS Session is ongoing with UE in DRNC receiving MBMS service over PTM bearers.
2. End of MBMS data session;
3. CN invokes RANAP **MBMS Session Stop** message towards all RNC that are explicitly or implicitly registered with the CN. RAB resources and Iu signaling connection are released.
Parameters: MBMS CN De-registration

4. RNCs send RANAP **MBMS Session Stop Response** message back to SGSN.
5. DRNC as CRNC also update and remove all relevant information related to the MBMS Service on the MCCH: **RRC Modified Services Info** message on MCCH. Parameters: TMGI, Release PTM RB; and all RB info on the PTM bearer for the service on RRC. **Common PTM RB Info, Current Cell PTM RB Info, Neighbouring Cell PTM RB Info**
6. UE releases the Radio Bearer for the MBMS service.
7. Iub bearer is released using NBAP Common Transport Bearer release procedure.
8. MBMS services terminates.
9. SGSN sends a RANAP **CN De-Registration Request** message to all RNCs registered with the CN in order to inform the RNC that a certain MBMS Service is no longer available.
Parameters: TMGI, Global CN-id.
10. RNCs replies with a RANAP **CN De-Registration Response** message back to the SGSN.
11. RNCs removes this MBMS service contexts and De-links all UEs from this service.

7.19.6 RAU during MBMS Session

The following scenario gives an example message flow for an Idle mode UE receiving MBMS service over PTM bearer crossing an RA boundary and performing a RAU update. The RA filtering option is used in the network.

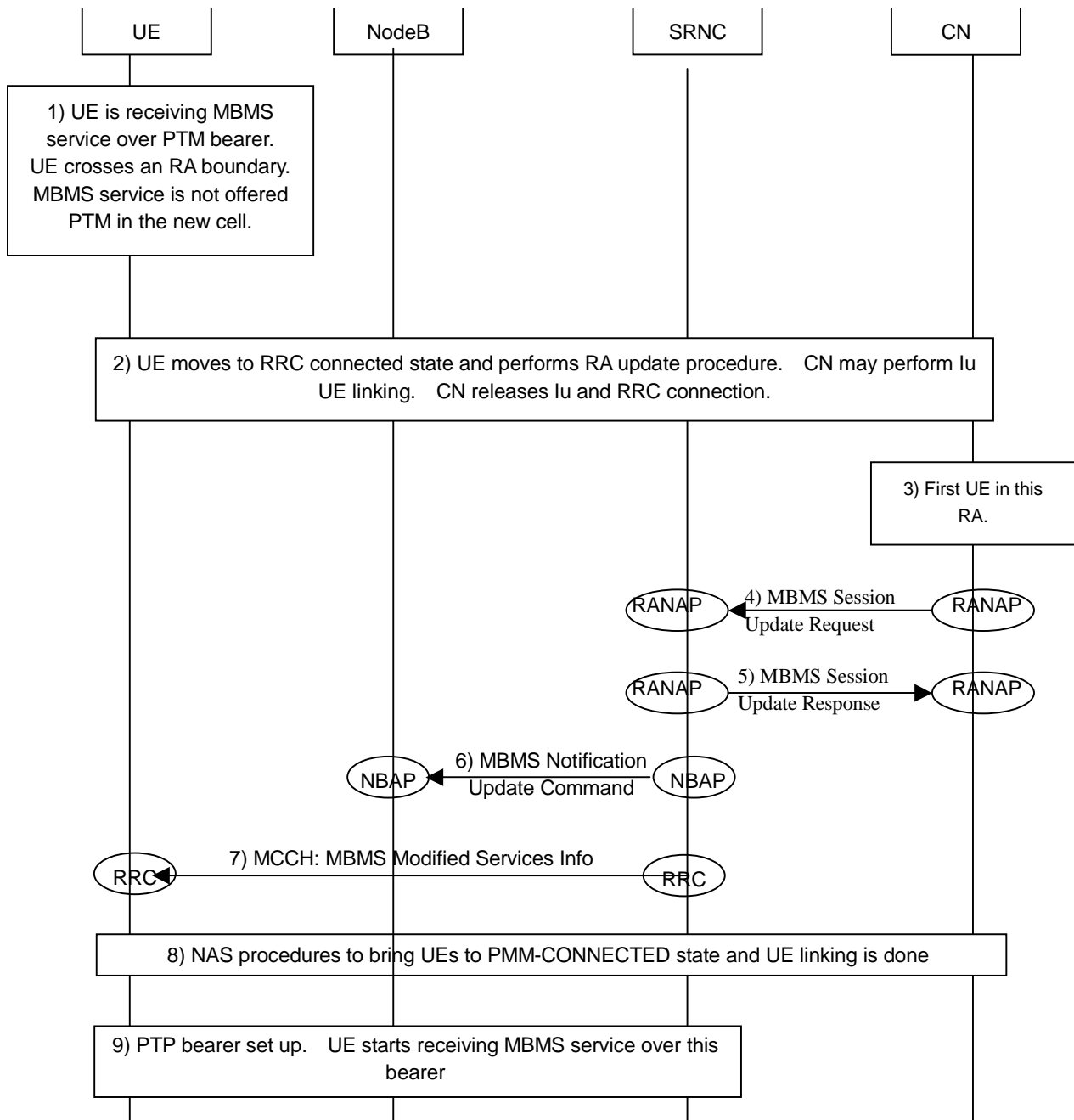

Figure 51: RA update procedure during a MBMS Session

1. UE in idle mode receiving MBMS service over PTM crosses RA boundry.
2. UE moves to connected mode and performs RA update. CN releases Iu connection on completion of RA udapte procedure. If the CN does not release Iu connection immediately, it must perform UE linking.
3. This is first UE in the RA.

4. Core Network sends an RANAP **MBMS Session Update** message to RNC after updating the RA list containing UEs.
Parameters: Session Update ID, Delta RA list of Idle mode UEs.
5. RNC responds with RANAP **MBMS Session Update Response** message. MBMS Iu bearer was already set up earlier.
Parameters: Session update Id.
6. RNC sends NBAP **MBMS Notification Update Command** to update the MICH in all the cells that is part of both the MBMS Service Area and one of the RNC's RAs indicated in the *RA to be added List* IE, if this IE is included in the *Delta RA List of Idle Mode UEs* IE group.
Parameters: C-ID, Common Physical Channel ID, Modification Period, MICH CFN, NI Information.
7. SRNC as CRNC updates the MCCH using RRC **MBMS Modified Services Info** message on MCCH in all the cells indicated in step 6 to request UE to establish PMM connection. As this is the first UE in the RA, the SRNC does not need to perform counting.
Parameters: MBMS Transmission id, MBMS Required UE action, Continue MCCH reading.
8. UE establishes PMM connection. CN performs UE linking.
9. SRNC sets up PTP radio bearer. UE starts to receive data over PTP radio bearer.

7.20 E-DCH Specific Scenarios

7.20.1 E-DCH Establishment and EDCH TTI Reconfiguration

7.20.1.1 FDD

This scenario shows an example of E-DCH configuration. Also TTI reconfiguration is shown in the same scenario. It is assumed that in this example DCH was established before.

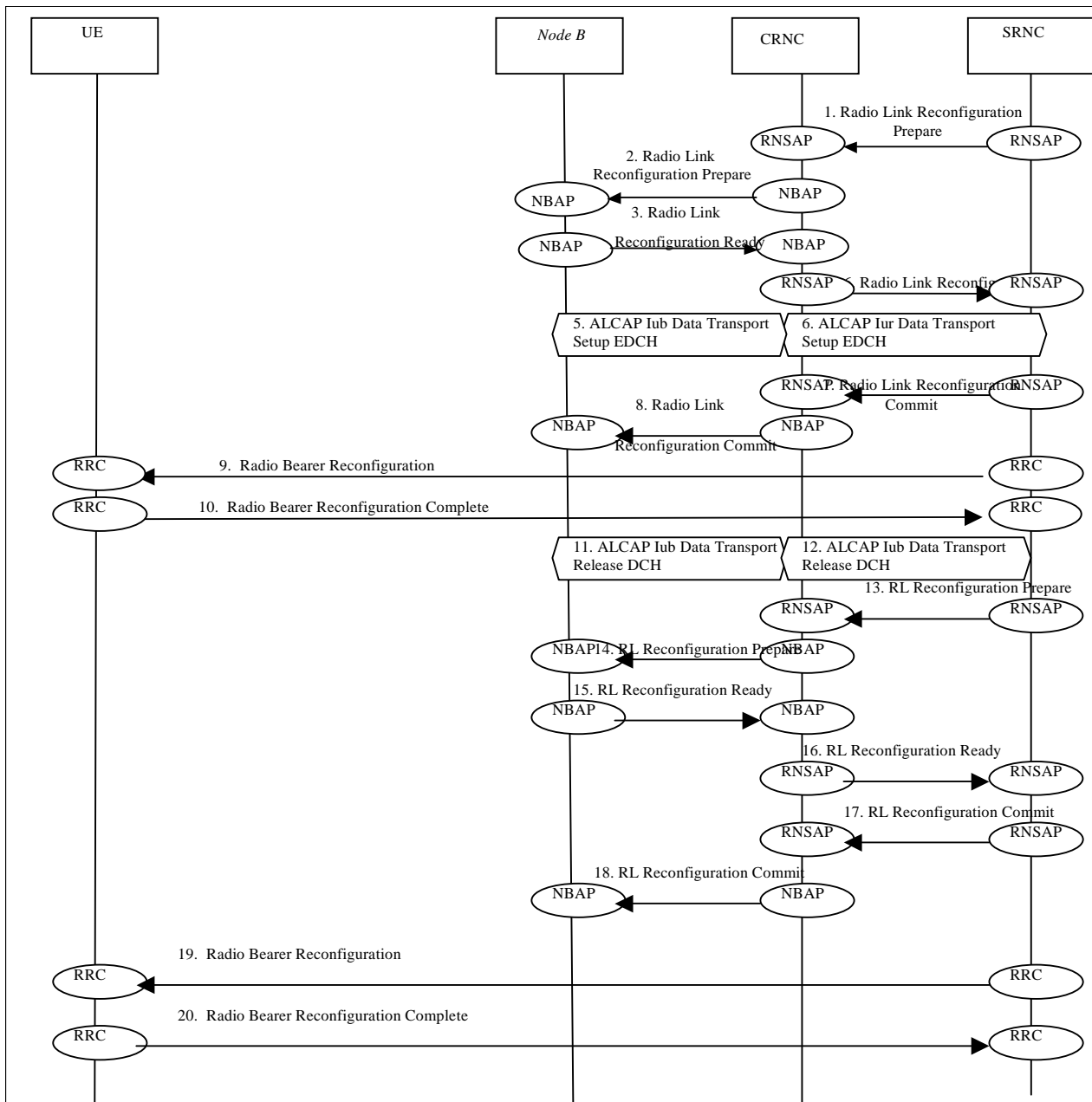

Figure 52: E-DCH Establishment and E-DCH TTI Reconfiguration

1. The SRNC decides there is a need for a establishing E-DCH for a UE and prepares the RNSAP message **Radio Link Reconfiguration Prepare** which is transmitted to the CRNC.
Parameters: DCHs to Delete IE, E-DPCH Information (TFCS, TTI), Serving E-DCH RL ID, E-DCH FDD Information.
2. The CRNC requests the E-DCH Node B to perform a synchronised radio link reconfiguration using the NBAP message **Radio Link Reconfiguration Prepare**, for the E-DCH radio link
Parameters: DCHs to Delete IE, Servine E-DCH RL ID, E-DCH FDD Information.
3. The E-DCH Node B returns a NBAP message **Radio Link Reconfiguration Ready**.
Parameters: DCH Information Response , E-DCH FDD Information Response.
4. The CRNC returns the RNSAP message **Radio Link Reconfiguration Ready** to the SRNC.
Parameters: DCH Information Response, E-DCH FDD Information Response.
5. The CRNC initiates set-up of a new Iub Data Transport Bearers using ALCAP protocol. This request contains the AAL2 Binding Identity to bind the Iub Data Transport Bearer to the E-DCH.

6. The SRNC initiates set-up of a new Iur Data Transport bearer using ALCAP protocol. This request contains the AAL2 Binding Identity to bind the Iur Data Transport Bearer to the E-DCH.
7. The SRNC proceeds by transmitting the RNSAP message **Radio Link Reconfiguration Commit** to the CRNC.
Parameters: SRNC selected activation time in the form of a CFN.
8. The CRNC transmits the NBAP message **Radio Link Reconfiguration Commit** to the E-DCH Node B including the activation time.
Parameters: CRNC selected activation time in the form of a CFN.
9. The SRNC also transmits a RRC message **Radio Bearer Reconfiguration** to the UE.
Parameters: activation time, E-DCH Info and E-RNTI.
10. The UE returns a RRC message **Radio Bearer Reconfiguration Complete** to the SRNC.
11. The CRNC initiates release of the old Iub Data Transport bearer (DCH) using ALCAP protocol.
12. The SRNC initiates release of the old Iur Data Transport bearer (DCH) using ALCAP protocol.
13. The SRNC decides there is a need for a TTI reconfiguration and prepares the RNSAP message **Radio Link Reconfiguration Prepare** which is transmitted to the CRNC.
Parameters: E-DPCH Information (TTI).
14. The CRNC requests the E-DCH Node B to perform a synchronised radio link reconfiguration using the NBAP message **Radio Link Reconfiguration Prepare**, for the E-DCH radio link
15. The E-DCH Node B returns a NBAP message **Radio Link Reconfiguration Ready**.
Parameters: E-DCH FDD Information Response.
16. The CRNC returns the RNSAP message **Radio Link Reconfiguration Ready** to the SRNC.
Parameters: E-DCH FDD Information Response.
17. The SRNC proceeds by transmitting the RNSAP message **Radio Link Reconfiguration Commit** to the CRNC.
Parameters: SRNC selected activation time in the form of a CFN.
18. The CRNC transmits the NBAP message **Radio Link Reconfiguration Commit** to the E-DCH Node B including the activation time.
Parameters: CRNC selected activation time in the form of a CFN.
19. The SRNC also transmits a RRC message **Radio Bearer Reconfiguration** to the UE.
Parameters: activation time, E-DCH Info and E-RNTI.
20. The UE returns a RRC message **Radio Bearer Reconfiguration Complete** to the SRNC.

7.20.1.2 TDD

This scenario shows an example of E-DCH configuration. It is assumed that in this example DCH was established before.

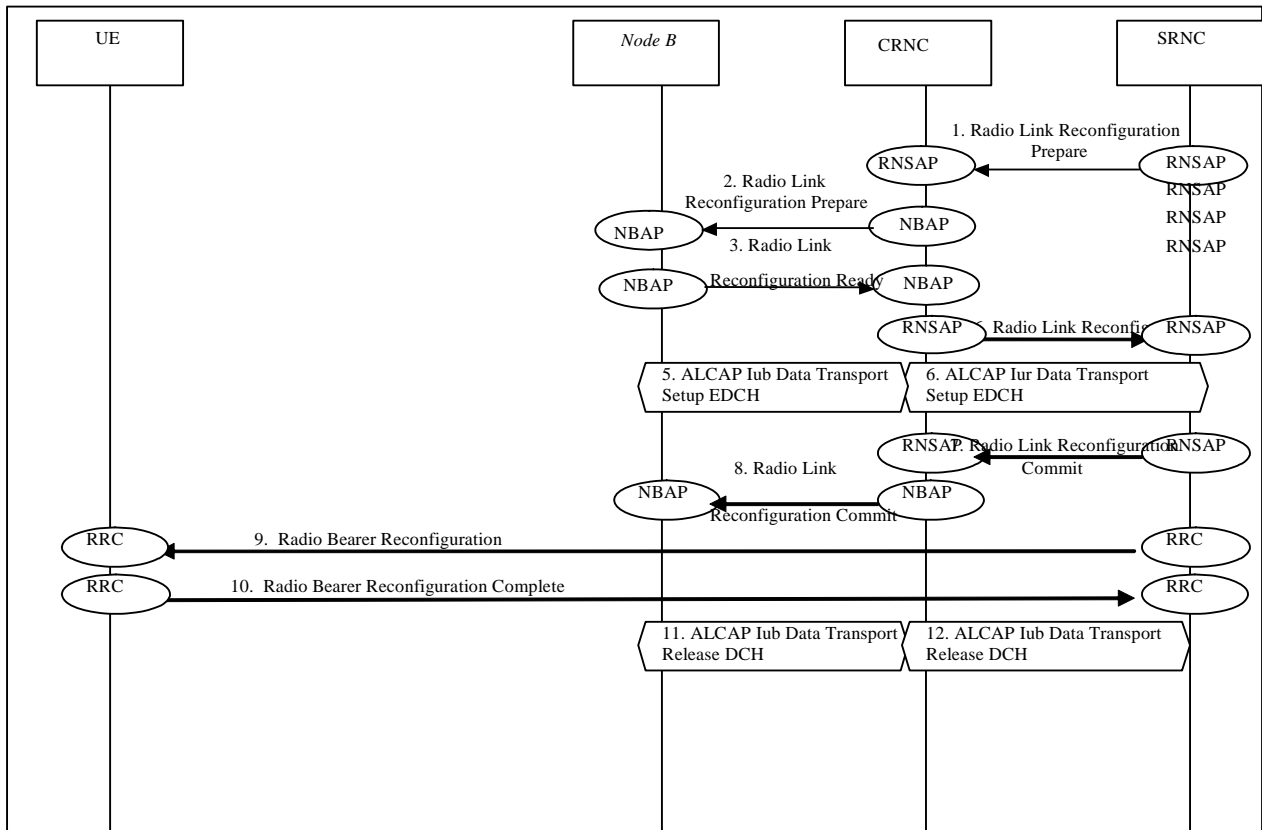

Figure 52a: TDD E-DCH Establishment

1. The SRNC decides there is a need for a establishing E-DCH for a UE and prepares the RNSAP message **Radio Link Reconfiguration Prepare** which is transmitted to the CRNC.
Parameters: DCHs to Delete IE, E-DCH Information (TFCS, TTI), Serving E-DCH RL ID.
2. The CRNC requests the E-DCH Node B to perform a synchronised radio link reconfiguration using the NBAP message **Radio Link Reconfiguration Prepare**, for the E-DCH radio link
Parameters: DCHs to Delete IE, Serving E-DCH RL ID, E-DCH Information.
3. The E-DCH Node B returns a NBAP message **Radio Link Reconfiguration Ready**.
Parameters: DCH Information Response, E-DCH TDD Information Response.
4. The CRNC returns the RNSAP message **Radio Link Reconfiguration Ready** to the SRNC.
Parameters: DCH Information Response, E-DCH TDD Information Response.
5. The CRNC initiates set-up of a new Iub Data Transport Bearers using ALCAP protocol. This request contains the AAL2 Binding Identity to bind the Iub Data Transport Bearer to the E-DCH.
6. The SRNC initiates set-up of a new Iur Data Transport bearer using ALCAP protocol. This request contains the AAL2 Binding Identity to bind the Iur Data Transport Bearer to the E-DCH.
7. The SRNC proceeds by transmitting the RNSAP message **Radio Link Reconfiguration Commit** to the CRNC.
Parameters: SRNC selected activation time in the form of a CFN.
8. The CRNC transmits the NBAP message **Radio Link Reconfiguration Commit** to the E-DCH Node B including the activation time.
Parameters: CRNC selected activation time in the form of a CFN.
9. The SRNC also transmits a RRC message **Radio Bearer Reconfiguration** to the UE.
Parameters: activation time, E-DCH Info and E-RNTI.
10. The UE returns a RRC message **Radio Bearer Reconfiguration Complete** to the SRNC.
11. The CRNC initiates release of the old Iub Data Transport bearer (DCH) using ALCAP protocol.

12. The SRNC initiates release of the old Iur Data Transport bearer (DCH) using ALCAP protocol.

7.20.2 Soft Handover [FDD]

Radio Link Addition (Branch Addition):

This example shows establishment of a radio link via a Node B controlled by another RNC than the serving RNC.

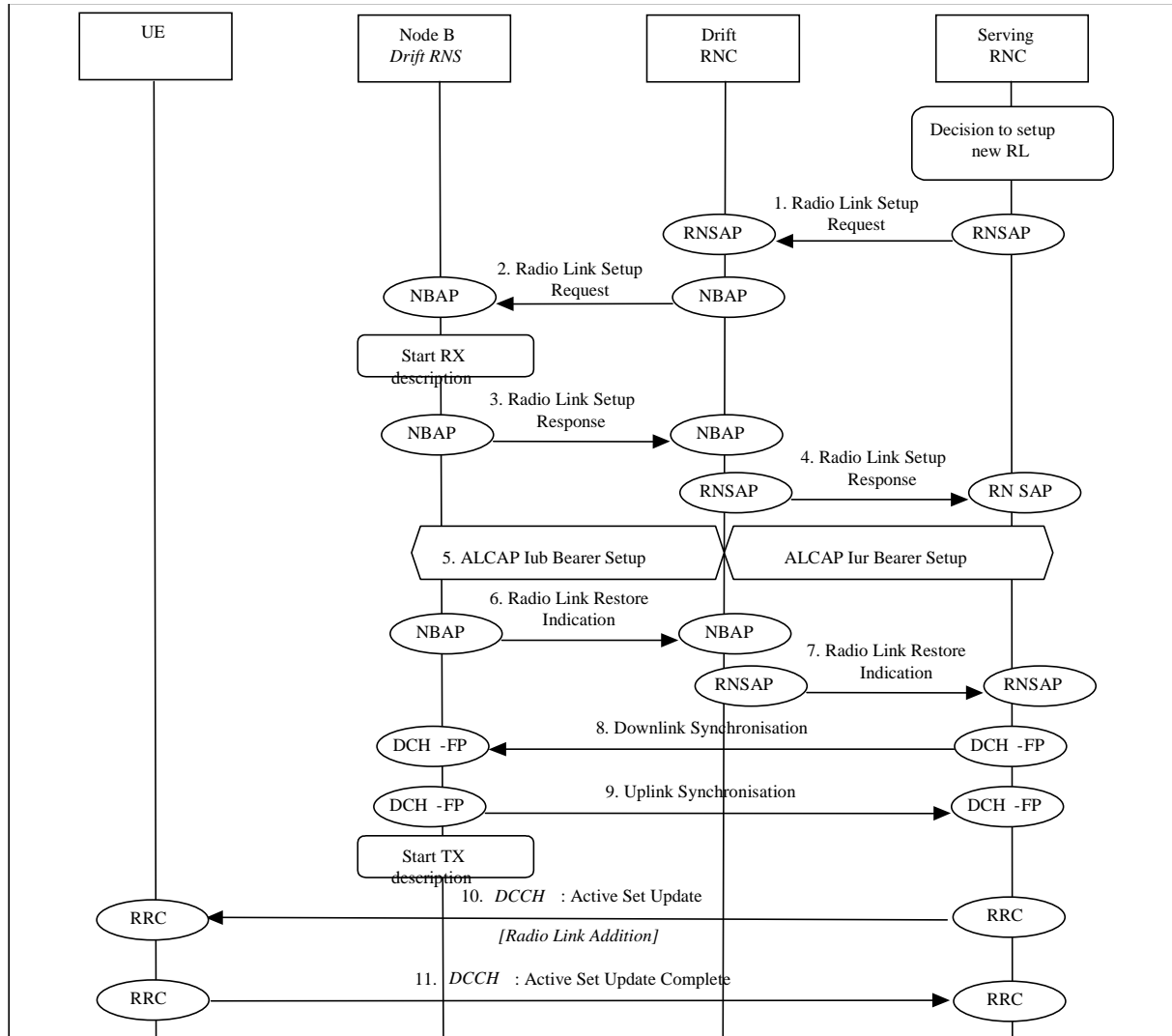

Figure 53: Soft Handover - Radio Link Addition (Branch Addition)

1. SRNC decides to setup a radio link with E-DCH via a new cell controlled by another RNC. The E-DCH serving RL is not in the new NodeB. So, this scenario is a soft HO branch addition without simultaneous serving E-DCH RL change. SRNC requests DRNC for radio resources by sending RNSAP message **Radio Link Setup Request**. If this is the first radio link via the DRNC for this UE, a new Iur signalling connection is established. This Iur signalling connection will be used for all RNSAP signalling related to this UE. Parameters: E-DPCH Information (TFCS, TTI), E-DCH FDD Information.
2. If requested resources are available, DRNC sends NBAP message **Radio Link Setup Request** to Node B. Parameters: Cell id, UL DPDCH Indicator for E-DCH operation, E-DPCH Information, E-DCH FDD Information. Then Node B starts the UL reception of DPCCH only. Reception of DPDCH, E-DPCCH and E-DPDCH will start only after Iub TBs are setup and UL sync is achieved.
3. Node B selects for each Radio Link of the specific UE, one of the E-RGCH/E-HICH codes, allocates an E-RGCH sequence number and an E-HICH sequence number, and sends this info to the RNC. Similarly, the Node B selects for the E-DCH serving Radio Link one of the E-AGCH codes, allocates an E-RNTI and sends this info

to the RNC with NBAP message **Radio Link Setup Response**.

Parameters: E-DCH RL Set ID, E-DCH FDD DL Control Channel Information, E-DCH FDD Information Response.

4. DRNC sends RNSAP message **Radio Link Setup Response** to SRNC.
Parameters: E-DCH FDD Information Response, E-DCH RL Set ID, E-DCH FDD DL Control Channel Information.
5. SRNC initiates setup of Iur/Iub Data Transport Bearer using ALCAP protocol. This request contains the AAL2 Binding Identity to bind the Iub Data Transport Bearer to E-DCH.
This may be repeated for each Iur/Iub Data Transport Bearer to be setup.
- 6./7. Node B achieves uplink sync on the Uu and notifies DRNC with NBAP message **Radio Link Restore Indication**. In its turn DRNC notifies SRNC with RNSAP message **Radio Link Restore Indication**.
- 8./9. Node B and SRNC establish synchronism for the Data Transport Bearer(s) by means of exchange of the appropriate DCH Frame Protocol frames **Downlink Synchronisation** and **Uplink Synchronisation**, relative already existing radio link(s). Then Node B starts DL transmission.
10. SRNC sends RRC message **Active Set Update** (Radio Link Addition) to UE on DCCH.
Parameters: Update type, Cell id, DL scrambling code, Power control information, Ncell information.
11. UE acknowledges with RRC message **Active Set Update Complete**.

7.20.3 Intra-Node B synchronised serving E-DCH cell change [FDD]

This subclause shows an example of an intra-Node B serving E-DCH cell change while keeping the dedicated physical channel configuration and the active set.

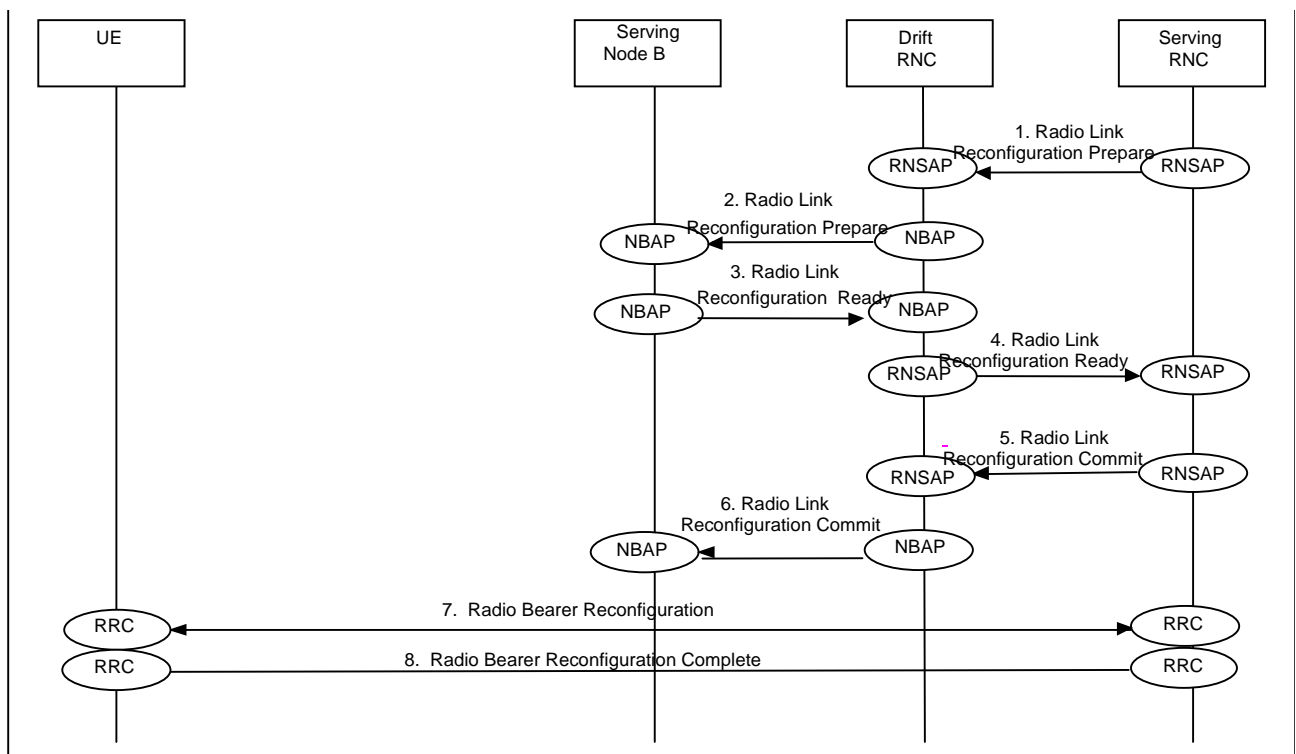

Figure 54: Intra-Node B synchronised serving E-DCH cell change

1. The SRNC decides there is a need for a serving E-DCH cell change and prepares a RNSAP message **Radio Link Reconfiguration Prepare** which is transmitted to the DRNC.
Parameters: Serving E-DCH RL ID.

2. In this case, both the source and target E-DCH cells are controlled by the same Node B. The DRNC requests the serving E-DCH Node B to perform a synchronised radio link reconfiguration using the NBAP message **Radio Link Reconfiguration Prepare**. The reconfiguration comprises a transfer of the E-DCH resources from the source E-DCH radio link to the target E-DCH radio link.
Parameters: Serving E-DCH RL ID.
3. The serving E-DCH Node B returns a NBAP message **Radio Link Reconfiguration Ready**.
Parameters: AGCH channelisation code (and scrambling code), E-RNTI.
4. The DRNC returns a RNSAP message **Radio Link Reconfiguration Ready** to the SRNC.
Parameters: AGCH channelisation code (and scrambling code), E-RNTI.
5. The SRNC now proceeds by transmitting RNSAP message **Radio Link Reconfiguration Commit** to the DRNC.
Parameters: SRNC selected activation time in the form of a CFN.
6. The DRNC transmits a NBAP message **Radio Link Reconfiguration Commit** to the serving E-DCH Node B. At the indicated activation time the serving E-DCH Node B stops sending E-DCH grants via the old E-AGCH and starts sending E-DCH grants to the UE via the E-AGCH in the target E-DCH cell.
Parameters: SRNC selected activation time in the form of a CFN.
7. The SRNC transmits a RRC message **Radio Bearer Reconfiguration** to the UE.
Parameters: activation time, E-DCH Info and E-RNTI.
8. At the indicated activation time the UE stops receiving E-DCH absolute grants from the source E-DCH cell and starts reception of E-DCH absolute grants in the target E-DCH cell. The UE then returns a RRC message **Radio Bearer Reconfiguration Complete** to the SRNC.

7.20.4 Inter-Node B (intra DRNC) synchronised serving E-DCH cell change [FDD]

This subclause shows an ATM example of an inter-Node B serving E-DCH cell change while keeping the dedicated physical channel configuration and active set.

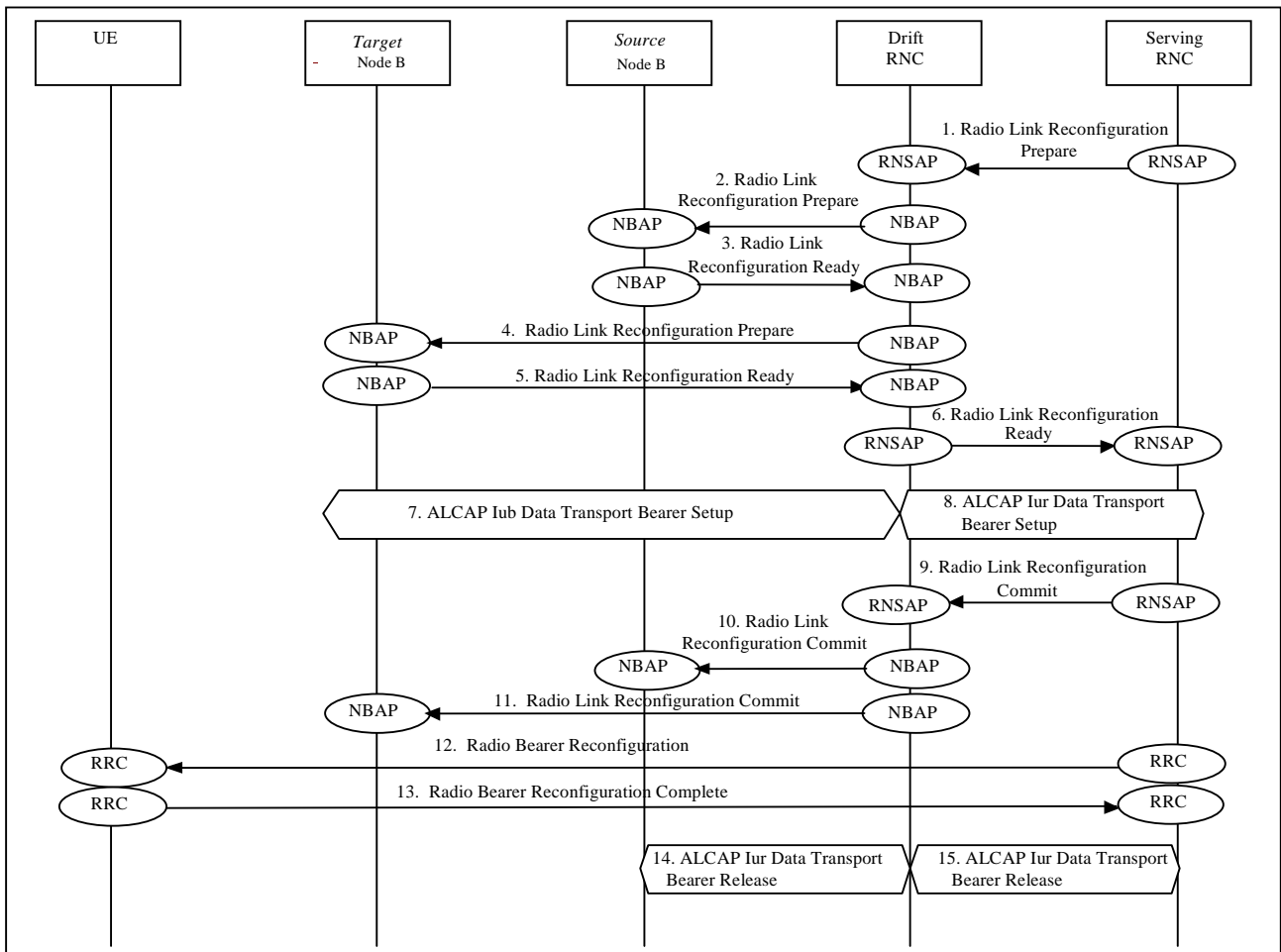

Figure 55: Inter-Node B (intra-DRNC) synchronised serving E-DCH cell change

1. The SRNC decides there is a need for a serving E-DCH cell change and prepares the RNSAP message a **Radio Link Reconfiguration Prepare** which is transmitted to the DRNC. Parameters: SRNC selected E-DCH RL ID.
2. In this case, the source and target E-DCH cells are controlled by different Node Bs. The DRNC requests the source E-DCH Node B to perform a synchronised radio link reconfiguration using the NBAP message **Radio Link Reconfiguration Prepare**, removing its E-DCH resources for the source E-DCH radio link Parameters: E-DCH MAC-d Flows To Delete.
3. The source E-DCH Node B returns a NBAP message **Radio Link Reconfiguration Ready**. Parameters: No E-DCH related parameters.
4. The DRNC requests the target E-DCH Node B to perform a synchronised radio link reconfiguration using the NBAP message **Radio Link Reconfiguration Prepare**, adding E-DCH resources for the target E-DCH radio link. Parameters: E-DCH FDD Information, a DRNC selected E-RNTI, E-DCH RL ID.
5. The target E-DCH Node B returns the NBAP message **Radio Link Reconfiguration Ready**. Parameters: E-DCH FDD Information Response.
6. The DRNC returns the RNSAP message **Radio Link Reconfiguration Ready** to the SRNC. Parameters: E-DCH FDD Information Response.
7. The DRNC initiates set-up of a new Iub Data Transport Bearers using ALCAP protocol. This request contains the AAL2 Binding Identity to bind the Iub Data Transport Bearer to the E-DCH.
8. The SRNC may initiate set-up of a new Iur Data Transport bearer using ALCAP protocol. This request contains the AAL2 Binding Identity to bind the Iur Data Transport Bearer to the E-DCH.

9. The E-DCH transport bearer to the target E-DCH Node B is established. The SRNC proceeds by transmitting the RNSAP message **Radio Link Reconfiguration Commit** to the DRNC.
Parameters: SRNC selected activation time in the form of a CFN.
10. The DRNC transmits the NBAP message **Radio Link Reconfiguration Commit** to the source E-DCH Node B including the activation time. At the indicated activation time the source E-DCH Node B stops and the target E-DCH Node B starts transmitting on the E-DCH to the UE.
Parameters: SRNC selected activation time in the form of a CFN.
11. The DRNC transmits the NBAP message **Radio Link Reconfiguration Commit** to the target E-DCH Node B including the activation time. At the indicated activation time the source E-DCH Node B stops and the target E-DCH Node B starts transmitting on the E-DCH to the UE.
Parameters: SRNC selected activation time in form of a CFN.
12. The SRNC also transmits a RRC message **Radio Bearer Reconfiguration** to the UE.
Parameters: activation time, E-DCH Info and E-RNTI.
13. At the indicated activation time the UE stops receiving E-DCH in the source E-DCH cell and starts E-DCH reception in the target E-DCH cell. The UE returns a RRC message **Radio Bearer Reconfiguration Complete** to the SRNC.
14. The DRNC initiates release of the old Iub Data Transport bearer using ALCAP protocol.
15. If the new Iur Data Transport Bearer was setup in 8, then the SRNC initiates release of the old Iur Data Transport bearer using ALCAP protocol.

7.20.5 Hard Handover

Inter-Node B (intra DRNC) synchronised serving E-DCH cell change at hard handover

In the following example the E-DCH mobility procedure is performed in two steps: the first step consists of establishing a new radio link without the E-DCH resources; the next step is a transfer of the E-DCH resources to this new radio link followed by a release of the old radio link. In the radio interface, a combined procedure is used.

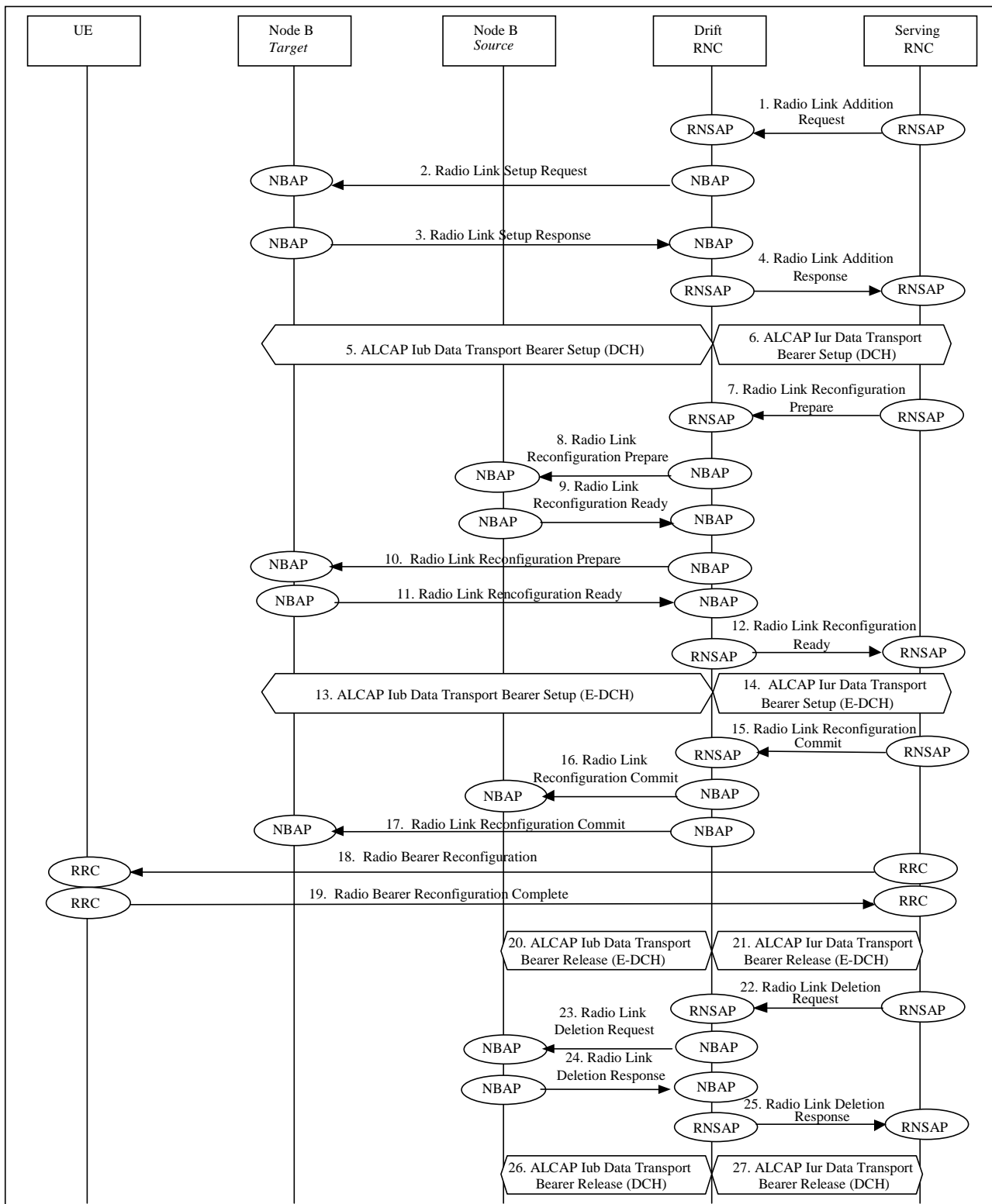

Figure 56: Inter-Node B (intra DRNC) synchronised serving E-DCH cell change at hard handover

1. The SRNC decides that there is a need for a hard handover combined with a serving E-DCH cell change. It prepares a RNSAP message **Radio Link Addition Request**, which is transmitted to the DRNC. Parameters: target cell ID.
2. The DRNC allocates radio resources for the new radio link and requests the target Node B to establish a new radio link by transmitting a NBAP message **Radio Link Setup Request**. Parameters: No E-DCH specific parameters.

3. The target Node B allocates resources, starts physical layer reception on the DPCH on the new radio link and responds with the NBAP message **Radio Link Setup Response**.
Parameters: No E-DCH specific parameters.
4. The DRNC responds to the SRNC with the RNSAP message **Radio Link Addition Response** and the DCH transport bearer is established.
5. The DRNC initiates set-up of a new Iub Data Transport Bearer using ALCAP protocol. This request contains the AAL2 Binding Identity to bind the Iur Data Transport Bearer to the DCH.
6. The SRNC initiates set-up of a new Iur Data Transport Bearers using ALCAP protocol. This request contains the AAL2 Binding Identity to bind the Iur Data Transport Bearer to the DCH.
7. As the next step, the SRNC prepares the RNSAP message **Radio Link Reconfiguration Prepare** which is transmitted to the DRNC.
Parameters: SRNC selected E-DCH RL ID.
8. The DRNC requests the source E-DCH Node B to perform a synchronised radio link reconfiguration using the NBAP message **Radio Link Reconfiguration Prepare**, removing its E-DCH resources for the source E-DCH radio link.
Parameters: E-DCH MAC-d Flows to Delete.
9. The source E-DCH Node B returns the NBAP message **Radio Link Reconfiguration Ready**.
Parameters: no E-DCH specific parameters.
10. The DRNC requests the target E-DCH Node B to perform a synchronised radio link reconfiguration using the NBAP message **Radio Link Reconfiguration Prepare**, adding E-DCH resources for the target E-DCH radio link.
Parameters: E-DCH RL ID, DRNC selected E-RNTI.
11. The target E-DCH Node B returns the NBAP message **Radio Link Reconfiguration Ready**.
Parameters: E-DCH Information Response.
12. The DRNC returns the RNSAP message **Radio Link Reconfiguration Ready** to the SRNC.
Parameters: E-DCH information response and the DRNC selected E-DCH-RNTI.
13. The DRNC initiates set-up of a new Iub Data Transport Bearers using ALCAP protocol. This request contains the AAL2 Binding Identity to bind the Iub Data Transport Bearer to the E-DCH.
14. The SRNC may initiate set-up of a new Iur Data Transport Bearers using ALCAP protocol. This request contains the AAL2 Binding Identity to bind the Iur Data Transport Bearer to the E-DCH.
15. The E-DCH transport bearer to the target E-DCH Node B is established. The SRNC proceeds by transmitting the RNSAP message **Radio Link Reconfiguration Commit** to the DRNC including an SRNC selected activation time in the form of a CFN.
Parameters: SRNC selected activation time in the form of a CFN.
16. The DRNC transmits a NBAP message **Radio Link Reconfiguration Commit** to the source E-DCH Node B including the activation time. At the indicated activation time the source E-DCH Node B stops and the target E-DCH Node B starts transmitting on the E-DCH to the UE.
Parameters: SRNC selected activation time in the form of a CFN.
17. The DRNC transmits a NBAP message **Radio Link Reconfiguration Commit** to the target E-DCH Node B including the activation time. At the indicated activation time the source E-DCH Node B stops and the target E-DCH Node B starts transmitting on the E-DCH to the UE.
Parameters: SRNC selected activation time in the form of a CFN
18. The SRNC also transmits a RRC message **Radio Bearer Reconfiguration** to the UE.
Parameters: activation time, E-DCH Info and E-RNTI.
19. At the indicated activation time the UE stops receiving E-DCH in the source E-DCH cell and starts E-DCH reception in the target E-DCH cell. The UE returns a RRC message **Radio Bearer Reconfiguration Complete** to the SRNC

20. The DRNC initiates release of the old Iub Data Transport bearer to the source E-DCH Node B using ALCAP protocol.
21. If a new Iur Data Transport Bearer was setup in 14, then the SRNC initiates release of the old Iur Data Transport bearer using ALCAP protocol.
22. The SRNC then finalises the procedure by transmitting the RNSAP message **Radio Link Deletion Request** to the DRNC.
In the message the source cell to be deleted is identified.
Parameters: RL ID.
23. The DRNC transmits the NBAP message **Radio Link Deletion Request** to the source Node B.
Parameters: RL ID.
24. The source Node B releases resources for the source radio link and returns the NBAP message **Radio Link Deletion Response** to the DRNC.
25. The DRNC returns the RNSAP message **Radio Link Deletion Response** to the SRNC.
26. The DRNC initiates release of the old Iub DCH Transport bearer to the source E-DCH Node B using ALCAP protocol.
27. The SRNC initiates release of the old Iur DCH Transport bearer using ALCAP protocol.

Annex A (informative): Change History

Change history					
TSG RAN#	Version	CR	Tdoc RAN	New Version	Subject/Comment
RAN_08	-	-	RP-000256	3.0.0	Approved at TSG RAN #8 and placed under Change Control
RAN_09	3.0.0	001 002 003		3.1.0	Approved at TSG RAN #9
RAN_10	3.1.0	004	RP-000633	3.2.0	Approved at TSG RAN #10
RAN_11	3.2.0	008	RP-010130	3.3.0	Approved at TSG RAN #11

Change history							
Date	TSG #	TSG Doc.	CR	Rev	Subject/Comment	Old	New
March 01	11	RP-010163	006		Approved at TSG RAN #11 and placed under Change Control	-	4.0.0
March 01	11	RP-010162	007		Approved at TSG RAN #11 and placed under Change Control	-	4.0.0
March 01	12	RP-010387	010		Approved at TSG RAN #12	4.0.0	4.1.0
12/2001	14	RP-010868	012	1	Obsolete or Missing Messages	4.1.0	4.2.0
03/2002	15	RP-020177	015		Corrections and updates	4.2.0	4.3.0
03/2002	15	RP-020177	017	1	DSCH-related additions to Handover scenarios	4.2.0	4.3.0
03/2002	15	-	-		Approved at TSG RAN #15 and placed under Change Control	4.3.0	5.0.0
06/2002	16	RP-020422	018	1	HSDPA Additions for Example Procedures	5.0.0	5.1.0
06/2002	16	RP-020415	021		Addition of pre-emption signalling sequences	5.0.0	5.1.0
12/2004	26	-	-	-	Introduction of Release 6 Technical Report	5.1.0	6.0.0
03/2005	27	RP-050057	025	1	Signalling flows for MBMS	6.0.0	6.1.0
06/2005	28	RP-050217	27	1	HS-DSCH Mobility procedures	6.1.0	6.2.0
06/2005	28	RP-050223	29		Feature Cleanup: Removal of DRAC	6.1.0	6.2.0
06/2005	28	RP-050230	30	1	Introduction of E-DCH scenarios	6.1.0	6.2.0
06/2005	28	RP-050227	31	1	Updates of MBMS scenarios	6.1.0	6.2.0
06/2005	28	RP-050219	33		Feature Clean-up: Removal of SSDT	6.1.0	6.2.0
06/2005	28	RP-050225	36		Feature Cleanup: Removal of CPCH	6.1.0	6.2.0
06/2005	28	RP-050222	38		Feature clean-up: Removal of DSCH (FDD mode)	6.1.0	6.2.0
03/2006	31	RP-060059	41		SRNS Relocation example correction	6.2.0	6.3.0
03/2006	31	-	-	-	Introduction of the Release 7 Technical Report	6.3.0	7.0.0
06/2006	32	RP-060275	45	1	Inter-RAT PS Continuity using CCO	7.0.0	7.1.0
09/2006	33	RP-060511	47		Introduction of 3.84 Mcps and 7.68Mcps TDD Enhanced Uplink	7.1.0	7.2.0
12/2006	34	RP-060837	48	1	Consistency of Specification Notations	7.2.0	7.3.0
03/2007	35	RP-070062	49		Introduction of 1.28 Mcps TDD Enhanced Uplink	7.3.0	7.4.0
12/2008	42	RP-080840	50		Introduction of Enhanced Relocation	7.4.0	8.0.0
12/2009					Created Rel-9 version based on v8.0.0	8.0.0	9.0.0
03/2011	SP-49	SP-100629			Clarification on the use of References (TS 21.801 CR#0030)	9.0.0	9.0.1
03/2011					Created Rel-10 version based on v9.0.1	9.0.1	10.0.0
06/2011	52	RP-110684	52		Correction of References	10.0.0	10.1.0
09/2012					Update to Rel-11 version (MCC)	10.1.0	11.0.0
09/2014					Update to Rel-12 version (MCC)	11.0.0	12.0.0
12/2015					Update to Rel-13 version (MCC)	12.0.0	13.0.0

Change history							
Date	Meeting	TDoc	CR	Rev	Cat	Subject/Comment	New version
2017-03	SA#75					Promotion to Release 14 without technical change	14.0.0
2018-07	SA#80	-	-	-	-	Promotion to Release 15 without technical change	15.0.0
2019-05	-	-	-	-	-	Correction of document type shown on cover	15.0.1

History

Document history		
V15.0.1	May 2019	Publication