



**Digital cellular telecommunications system (Phase 2+);
Universal Mobile Telecommunications System (UMTS);
LTE;
Signalling flows for the session setup
in the IP Multimedia core network Subsystem (IMS)
based on Session Initiation Protocol (SIP)
and Session Description Protocol (SDP);
Stage 3
(3GPP TR 24.930 version 12.0.0 Release 12)**



Reference

RTR/TSGC-0124930vc00

Keywords

GSM,LTE,UMTS

ETSI

650 Route des Lucioles
F-06921 Sophia Antipolis Cedex - FRANCE

Tel.: +33 4 92 94 42 00 Fax: +33 4 93 65 47 16

Siret N° 348 623 562 00017 - NAF 742 C
Association à but non lucratif enregistrée à la
Sous-Préfecture de Grasse (06) N° 7803/88

Important notice

The present document can be downloaded from:

<http://www.etsi.org>

The present document may be made available in electronic versions and/or in print. The content of any electronic and/or print versions of the present document shall not be modified without the prior written authorization of ETSI. In case of any existing or perceived difference in contents between such versions and/or in print, the only prevailing document is the print of the Portable Document Format (PDF) version kept on a specific network drive within ETSI Secretariat.

Users of the present document should be aware that the document may be subject to revision or change of status. Information on the current status of this and other ETSI documents is available at

<http://portal.etsi.org/tb/status/status.asp>

If you find errors in the present document, please send your comment to one of the following services:

http://portal.etsi.org/chaicor/ETSI_support.asp

Copyright Notification

No part may be reproduced or utilized in any form or by any means, electronic or mechanical, including photocopying and microfilm except as authorized by written permission of ETSI.

The content of the PDF version shall not be modified without the written authorization of ETSI.

The copyright and the foregoing restriction extend to reproduction in all media.

© European Telecommunications Standards Institute 2014.

All rights reserved.

DECT™, **PLUGTESTS™**, **UMTS™** and the ETSI logo are Trade Marks of ETSI registered for the benefit of its Members. **3GPP™** and **LTE™** are Trade Marks of ETSI registered for the benefit of its Members and of the 3GPP Organizational Partners.

GSM® and the GSM logo are Trade Marks registered and owned by the GSM Association.

Intellectual Property Rights

IPRs essential or potentially essential to the present document may have been declared to ETSI. The information pertaining to these essential IPRs, if any, is publicly available for **ETSI members and non-members**, and can be found in ETSI SR 000 314: *"Intellectual Property Rights (IPRs); Essential, or potentially Essential, IPRs notified to ETSI in respect of ETSI standards"*, which is available from the ETSI Secretariat. Latest updates are available on the ETSI Web server (<http://ipr.etsi.org>).

Pursuant to the ETSI IPR Policy, no investigation, including IPR searches, has been carried out by ETSI. No guarantee can be given as to the existence of other IPRs not referenced in ETSI SR 000 314 (or the updates on the ETSI Web server) which are, or may be, or may become, essential to the present document.

Foreword

This Technical Report (TR) has been produced by ETSI 3rd Generation Partnership Project (3GPP).

The present document may refer to technical specifications or reports using their 3GPP identities, UMTS identities or GSM identities. These should be interpreted as being references to the corresponding ETSI deliverables.

The cross reference between GSM, UMTS, 3GPP and ETSI identities can be found under <http://webapp.etsi.org/key/queryform.asp>.

Modal verbs terminology

In the present document "**shall**", "**shall not**", "**should**", "**should not**", "**may**", "**may not**", "**need**", "**need not**", "**will**", "**will not**", "**can**" and "**cannot**" are to be interpreted as described in clause 3.2 of the [ETSI Drafting Rules](#) (Verbal forms for the expression of provisions).

"**must**" and "**must not**" are **NOT** allowed in ETSI deliverables except when used in direct citation.

Contents

Intellectual Property Rights	2
Foreword.....	2
Modal verbs terminology.....	2
Foreword.....	4
1 Scope	5
2 References	5
3 Definitions, symbols and abbreviations	5
3.1 Definitions	5
3.2 Symbols.....	5
3.3 Abbreviations	6
4 Methodology	6
4.1 General	6
4.2 Key required to interpret signalling flows.....	6
5 Signalling flows for session initiation.....	7
5.1 Establishing a session when UE#1 and UE#2 do not have required resources available	7
5.1.1 Introduction.....	7
5.1.2 UE initiated IP-CAN bearer setup	7
5.1.2.1 Introduction.....	7
5.1.2.2 SDP capability negotiation not supported by UE#1.....	7
5.1.2.3 SDP capability negotiation supported by UE#1 and UE#2.....	21
5.1.2.4 SDP capability negotiation only supported by UE#1.....	35
5.1.3 Network initiated IP-CAN bearer setup.....	49
5.2 Establishing a session when UE#1 does not have required resources available while UE#2 has resources already available.....	63
5.2.1 Introduction.....	63
5.2.2 Signalling flow with UPDATE request	64
5.2.3 Signalling flow without UPDATE request	77
5.3 Establishing a session when UE#1 has resources available while UE#2 does not have required resources available	90
5.3.1 Introduction.....	90
5.3.2 Signalling Flow (with SDP answer in 200 (OK) response for INVITE request).....	90
5.3.3 Signalling Flow (with SDP answer in reliable 180 Ringing) response.....	97
5.3.4 Signalling Flow with SDP answer in reliable 183 Session Progress response for INVITE request when the IP-CAN performs resource reservation for UE#2	105
5.4 Establishing a session when UE#1 does not have required resources available and UE#2 is non-IMS.....	114
5.4.1 Introduction.....	114
5.4.2 Signalling Flow.....	114
5.4.3 Signalling flow (preconditions used, SDP capability negotiation not supported by UE#1, 2nd SDP offer offering AVP transport for video).....	122
5.4.4 Signalling Flow (preconditions not supported by SIP UA#2, SDP capability negotiation not supported by UE#1, 2nd SDP offer offering AVP transport for video).....	138
5.5 Establishing a session when UE#1 is non-IMS and UE#2 does not have required resources available.....	149
5.5.1 Introduction.....	149
5.5.2 Signalling Flow.....	149
5.6 Establishing a session when UE#1 and UE#2 have resources already available.....	154
5.6.1 Introduction.....	154
5.6.2 Signalling Flow (preconditions are not used)	154
5.6.3 Signalling Flow (preconditions are used)	158
Annex A (informative): Change history	167
History	169

Foreword

This Technical Report has been produced by the 3rd Generation Partnership Project (3GPP).

The contents of the present document are subject to continuing work within the TSG and may change following formal TSG approval. Should the TSG modify the contents of the present document, it will be re-released by the TSG with an identifying change of release date and an increase in version number as follows:

Version x.y.z

where:

- x the first digit:
 - 1 presented to TSG for information;
 - 2 presented to TSG for approval;
 - 3 or greater indicates TSG approved document under change control.
- y the second digit is incremented for all changes of substance, i.e. technical enhancements, corrections, updates, etc.
- z the third digit is incremented when editorial only changes have been incorporated in the document.

1 Scope

The present document gives examples of the session setup in the IM CN subsystem based on SIP and SDP.

These signalling flows provide detailed signalling flows, which expand on the overview information flows provided in 3GPP TS 23.228 [2]. The flows focus on a basic session setup, i.e. no flows will be provided for topology hiding, for sessions with IBCF involved or for sessions having certain features.

2 References

The following documents contain provisions which, through reference in this text, constitute provisions of the present document.

- References are either specific (identified by date of publication, edition number, version number, etc.) or non-specific.
- For a specific reference, subsequent revisions do not apply.
- For a non-specific reference, the latest version applies. In the case of a reference to a 3GPP document (including a GSM document), a non-specific reference implicitly refers to the latest version of that document *in the same Release as the present document*.

- [1] 3GPP TS 24.229: "IP Multimedia Call Control Protocol based on SIP and SDP; Stage 3".
- [2] 3GPP TS 24.228 Release 5: "Signalling flows for the IP multimedia call control based on Session Initiation Protocol (SIP) and Session Description Protocol (SDP) - Stage 3".
- [3] 3GPP TS 23.228: "IP Multimedia Subsystem (IMS); Stage 2".
- [4] IETF RFC 3261: "SIP: Session Initiation Protocol".
- [5] IETF RFC 3312: "Integration of Resource Management and Session Initiation Protocol (SIP)".
- [6] IETF RFC 3262: "Reliability of Provisional Responses in Session Initiation Protocol (SIP)".
- [7] IETF RFC 3311: "The Session Initiation Protocol (SIP) UPDATE Method".
- [8] IETF RFC 3264: "An Offer/Answer Model with Session Description Protocol (SDP)".
- [9] RFC 4032 (March 2005): "Update to the Session Initiation Protocol (SIP) Preconditions Framework".
- [10] draft-ietf-mmusic-sdp-capability-negotiation-08 (December 2007): "SDP Capability Negotiation".

Editor's note: The above document cannot be formally referenced until it is published as an RFC.

3 Definitions, symbols and abbreviations

3.1 Definitions

For the purposes of the present document, the [following] terms and definitions [given in ... and the following] apply.

3.2 Symbols

For the purposes of the present document, the following symbols apply:

3.3 Abbreviations

For the purposes of the present document, the following abbreviations apply:

AMR	Adaptive Multi-Rate
AS	Application Server
CN	Core Network
CSCF	Call Session Control Function
DSL	Digital Subscriber Line
FQDN	Fully Qualified Domain Name
HSS	Home Subscriber Server
HTTP	Hyper Text Transfer Protocol
I-CSCF	Interrogating CSCF
IM	IP Multimedia
IMS	IP Multimedia CN subsystem
IP	Internet Protocol
IP-CAN	IP-Connectivity Access Network
MGCF	Media Gateway Control Function
MRFC	Multimedia Resource Function Controller
MRFP	Multimedia Resource Function Processor
NGN	Next Generation Network
PCRF	Policy and Charging Rules Function
P-CSCF	Proxy CSCF
PSI	Public Service Identity
S-CSCF	Serving CSCF
SDP	Session Description Protocol
SIP	Session Initiation Protocol
UE	User Equipment

4 Methodology

4.1 General

The signalling flows provided in this document follow the methodology developed in 3GPP TS 24.228 [2]. The following additional considerations apply:

- a) 3GPP TS 24.228 [2] shows separate signalling flows with no configuration hiding between networks, and with configuration hiding between networks. Separate signalling flows are not shown in the present document;
- b) 3GPP TS 24.228 [2] breaks down the functionality of the various CSCFs. The functionality of the S-CSCF and I-CSCF is not relevant for the session setup procedure. Therefore S-CSCFs and I-CSCFs are collapsed into a single entity labelled "Intermediate IM CN subsystem entities".

4.2 Key required to interpret signalling flows

The key to interpret signalling flows specified in 3GPP TS 24.228 [2] subclauses 4.1 and 4.2 applies.

Each signalling flow table contains descriptions for headers where the content of the header is new to that signalling flow, as is already performed in 3GPP TS 24.228 [2].

However, 3GPP TS 24.228 [3] includes extensive descriptions for the contents of various headers following each of the tables representing the contents of the signalling flows. Where the operation of the header is identical to that shown in 3GPP TS 24.228 [2], then such text is not reproduced in the present document.

Additional text may also be found on the contents of headers within 3GPP TS 24.228 [2] in addition to the material shown in the present document.

In order to differentiate between messages for SIP and media, the notation in figure 4.1-1 is used.

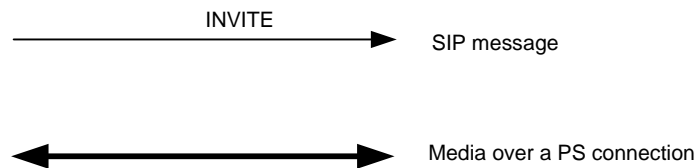

Figure 4.1-1: Signalling flow notation

5 Signalling flows for session initiation

5.1 Establishing a session when UE#1 and UE#2 do not have required resources available

5.1.1 Introduction

The following flows show the establishment of a session where UE#1 and UE#2 do not yet have the required local resources available and need to perform resource reservation. In subclause 5.1.2 both UEs will initiate the IP-CAN bearer setup. In subclause 5.1.3 the network will initiate the IP-CAN bearer setup for UE#1.

It is assumed that both the originating UE and terminating UE are using a dedicated IP-CAN bearer for SIP signalling and a dedicated IP-CAN bearer for media.

The box "Intermediate IM CN subsystem entities" stands for the combination of I-CSCF/S-CSCF on the originating and on the terminating side. Routing of messages between those nodes is not described in the flow below.

5.1.2 UE initiated IP-CAN bearer setup

5.1.2.1 Introduction

This subclause shows the establishment of a session where UE#1 and UE#2 need to reserve local resources. In subclause 5.1.2.3 the SDP capability negotiations [10] mechanism is used and supported by both UE#1 and UE#2. In subclause 5.1.2.4 only UE#1 supports the mechanism.

5.1.2.2 SDP capability negotiation not supported by UE#1

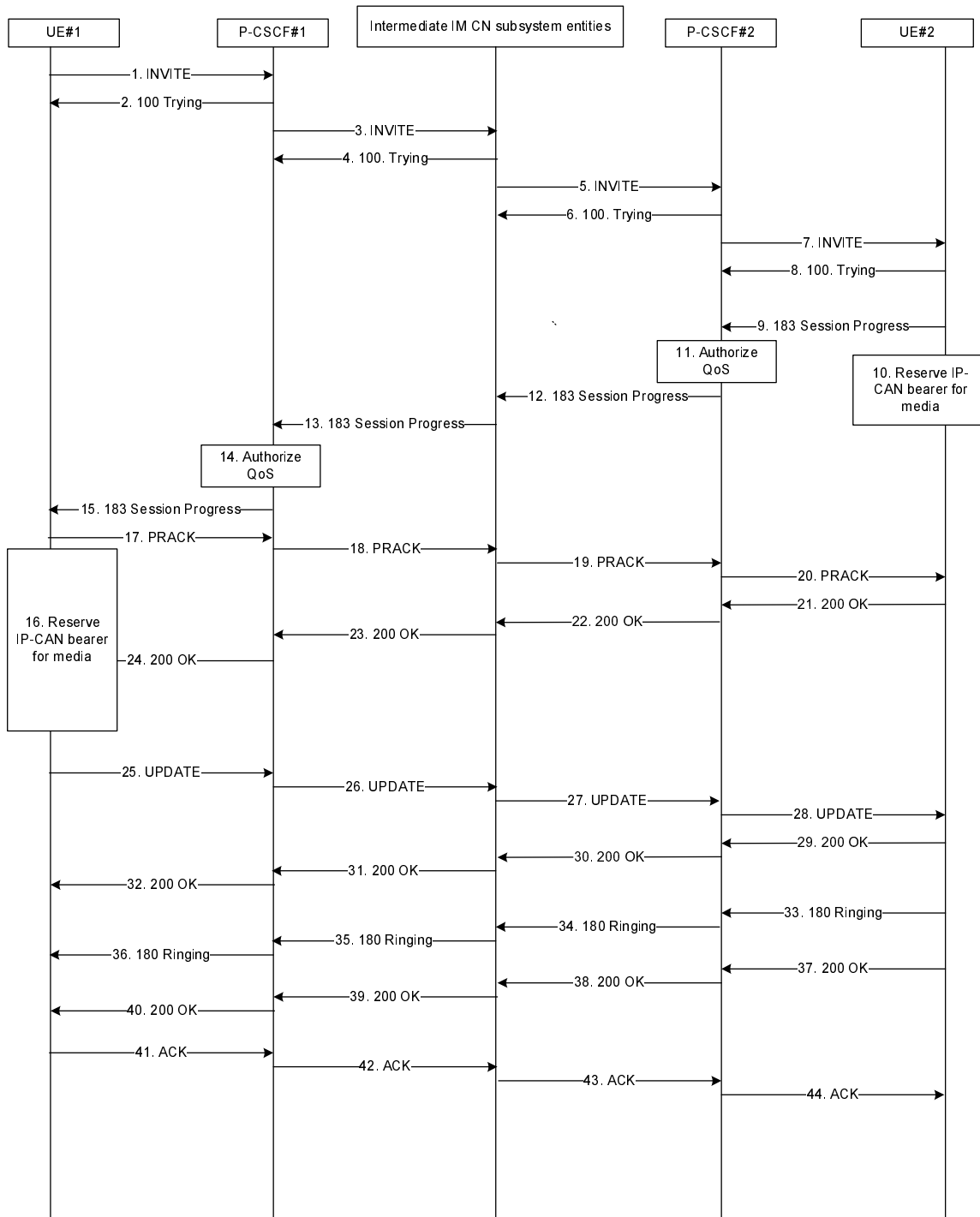

Figure 5.1.2.2-1: IMS session setup, resource reservation on both sides

NOTE: Support for SDP capability negotiation is only optional for 3GPP release 7 and release 8 UEs and non-IMS UEs.

The details of the signalling flows are as follows:

1. INVITE request (UE#1 to P-CSCF#1) see example in table 5.1.2.2-1

For this example, it is assumed that UE#1 is willing to establish a multimedia session comprising a video stream and an audio stream. The video stream supports two codecs, either H.263 or MPEG-4 Visual. The audio stream supports the AMR codec. For the video stream AVPF is offered and for the audio stream AVP is offered.

UE#1 indicates that it supports precondition and it indicates that it supports reliable provisional responses. However, it does not use the "Require" header for these capabilities.

UE#1 does not have available the resources that are necessary to transport the media.

UE#2 supports both AVP and AVPF and supports SDP capability negotiation and since only AVPF is being offered for video and only AVP is offered for audio UE#2 therefore accepts AVPF for video and AVP for audio.

For this example it is assumed, that signalling encryption was negotiated between UE and P-CSCF in the security mode set-up procedure during the last successful authentication. This option will only be shown in this example.

Table 5.1.2.2-1: INVITE request (UE#1 to P-CSCF)

```

INVITE tel:+1-212-555-2222 SIP/2.0
Via: SIP/2.0/UDP [5555::aaa:bbb:ccc:ddd]:1357;comp=sigcomp;branch=z9hG4bKnashds7
Max-Forwards: 70
Route: <sip:pcscf1.visited1.net:7531;lr;comp=sigcomp>, <sip:scscf1.home1.net;lr>
P-Preferred-Identity: "John Doe" <sip:user1_public1@home1.net>
P-Access-Network-Info: 3GPP-UTRAN-TDD; utran-cell-id-3gpp=234151D0FCE11
Privacy: none
From: <sip:user1_public1@home1.net>;tag=171828
To: <tel:+1-212-555-2222>
Call-ID: cb03a0s09a2sdfglkj490333
Cseq: 127 INVITE
Require: sec-agree
Supported: precondition, 100rel, gruu, 199
Accept: application/sdp,application/3gpp-ims+xml
Proxy-Require: sec-agree
Security-Verify: ipsec-3gpp; q=0.1; alg= hmac-sha-1-96; ealg=aes-cbc; spi-c=98765432; spi-
s=87654321; port-c=8642; port-s=7531
Contact: <sip:user1_public1@home1.net;gr=urn:uuid:f81d4fae-7dec-11d0-a765-
00a0c91e6bf6;comp=sigcomp>
Allow: INVITE, ACK, CANCEL, BYE, PRACK, UPDATE, REFER, MESSAGE
Content-Type: application/sdp
Content-Length: (...)

v=0
o=- 2987933615 2987933615 IN IP6 5555::aaa:bbb:ccc:ddd
s=-
c=IN IP6 5555::aaa:bbb:ccc:ddd
t=0 0
m=video 3400 RTP/AVPF 98 99
b=AS:75
a=curr:qos local none
a=curr:qos remote none
a=des:qos mandatory local sendrecv
a=des:qos none remote sendrecv
a=inactive
a=rtpmap:98 H263
a=fmtp:98 profile-level-id=0
a=rtpmap:99 MP4V-ES
m=audio 3456 RTP/AVP 97 96
b=AS:25.4
a=curr:qos local none
a=curr:qos remote none
a=des:qos mandatory local sendrecv
a=des:qos none remote sendrecv
a=inactive
a=rtpmap:97 AMR
a=fmtp:97 mode-set=0,2,5,7; maxframes=2
a=rtpmap:96 telephone-event

```

Supported: The UE indicates support for the 'precondition' mechanism, the support for reliable provisional responses and the support for the 199 (Early Dialog Terminated) response code.

SDP The SDP contains a set of codecs supported by UE#1 and desired by the user at UE#1 for this session. As the local preconditions are not fulfilled, both media are set to "inactive".

Security-Verify: The Security-Verify contains the content of the Security-Server header as received during last successful authentication. It indicates that integrity protection and encryption are in use for this session.

2. 100 (Trying) response (P-CSCF#1 to UE#1)

The P-CSCF responds to the INVITE request with a 100 (Trying) provisional response.

3. INVITE request (P-CSCF#1 to S-CSCF#1) - see example in table 5.1.2.2-2

Table 5.1.2.2-2: INVITE request (P-CSCF#1 to S-CSCF#1)

```
INVITE tel:+1-212-555-2222 SIP/2.0
Via: SIP/2.0/UDP pcscf1.visited1.net;branch=z9hG4bK240f34.1, SIP/2.0/UDP
    [5555::aaa:bbb:ccc:ddd]:1357;comp=sigcomp;branch=z9hG4bKnashds7
Max-Forwards: 69
Route: <sip:scscf1.home1.net;lr>
Record-Route: <sip:pcscf1.visited1.net;lr>
P-Asserted-Identity: "John Doe" <sip:user1_public1@home1.net>
P-Access-Network-Info:
P-Charging-Vector: icid-value="AyretyU0dm+602IrT5tAFrbHLso=023551024"
Privacy:
From:
To:
Call-ID:
Cseq:
Supported:
Accept:
Contact:
Allow:
Content-Type:
Content-Length: (...)

v=
o=
s=
c=
t=
m=
b=
a=
a=
a=
a=
a=
a=
```

4. 100 (Trying) response (S-CSCF#1 to P-CSCF#1)

The S-CSCF responds to the INVITE request with a 100 (Trying) provisional response.

5. INVITE request (S-CSCF#2 to P-CSCF#2) see example in table 5.1.2.2-3

Table 5.1.2.2-3: INVITE request (S-CSCF#2 to P-CSCF#2)

```
INVITE sip:[5555::eee:fff:aaa:bbb]:8805;comp=sigcomp SIP/2.0
Via: SIP/2.0/UDP scscf2.home2.net;branch=z9hG4bK764z87.1, SIP/2.0/UDP
    icscf2_s.home2.net;branch=z9hG4bK871y12.1, SIP/2.0/UDP
    scscf1.home1.net;branch=z9hG4bK332b23.1, SIP/2.0/UDP
    pcscf1.visited1.net;branch=z9hG4bK240f34.1, SIP/2.0/UDP
    [5555::aaa:bbb:ccc:ddd]:1357;comp=sigcomp;branch=z9hG4bKnashds7
Max-Forwards: 66
Route: <sip:pcscf2.visited2.net;lr>
Record-Route: <sip:scscf2.home2.net;lr>, <sip:scscf1.home1.net;lr>,
    <sip:pcscf1.visited1.net;lr>
P-Asserted-Identity:
P-Charging-Vector: icid-value="AyretyU0dm+602IrT5tAFrbHLso=023551024"
Privacy:
From:
To:
Call-ID:
Cseq:
Require:
```

```
Supported:
Accept:
Contact:
Allow:
P-Called-Party-ID: <sip:user2_public1@home2.net>
Content-Type:
Content-Length: (...)

v=
o=
s=
c=
t=
m=
b=
a=
a=
a=
a=
a=
a=
a=
```

6. 100 (Trying) response (P-CSCF#2 to S-CSCF#2)

The P-CSCF#2 responds to the INVITE request with a 100 (Trying) provisional response.

7. INVITE request (P-CSCF#2 to UE #2) - see example in table 5.1.2.2-4

P-CSCF#2 forwards the INVITE request to UE#2.

Table 5.1.2.2-4: INVITE request (P-CSCF#2 to UE#2)

```

INVITE sip:user2_public1@home2.net SIP/2.0
Via: SIP/2.0/UDP pcscf2.visited2.net:5088;comp=sigcomp;branch=z9hG4bK361k21.1, SIP/2.0/UDP
    scscf2.home2.net;branch=z9hG4bK764z87.1, SIP/2.0/UDP
    icscf2_s.home2.net;branch=z9hG4bK871y12.1, SIP/2.0/UDP
    scscf1.home1.net;branch=z9hG4bK332b23.1, SIP/2.0/UDP
    pcscf1.visited1.net;branch=z9hG4bK240f34.1, SIP/2.0/UDP
    [5555::aaa:bbb:ccc:ddd]:1357;comp=sigcomp;branch=z9hG4bKnashds7
Max-Forwards: 65
Route: <sip:scscf2.home2.net;lr>
Record-Route: <sip:pcscf2.visited2.net:5088;lr;comp=sigcomp>, <sip:scscf2.home2.net;lr>,
    <sip:scscf1.home1.net;lr>, <sip:pcscf1.visited1.net;lr>
P-Asserted-Identity:
Privacy:
From:
To:
Call-ID:
Cseq:
Require:
Supported:
Accept:
Contact:
Allow:
Content-Type:
Content-Length: (...)

v=
o=
s=
c=
t=
m=
b=
a=
a=
a=
a=
a=
a=
a=

```

8. 100 (Trying) response (UE#2 to P-CSCF)

The UE responds to the INVITE request with a 100 (Trying) provisional response.

9. 183 (Session Progress) response (UE#2 to P-CSCF) - - see example in table 5.1.2.2-5

UE#2 determines the complete set of codecs that it is capable of supporting for this session. It determines the intersection with those appearing in the SDP in the INVITE request. UE#2 makes the final codec selection and chooses H.263 and AMR.

UE#2 responds with a 183 (Session Progress) response containing SDP back to the originator. This response is sent to P-CSCF. UE#2 uses a conf line in the SDP to request a confirmation from UE#1 when the local resources are available at UE#1.

Table 5.1.2.2-5: 183 (Session Progress) response (UE#2 to P-CSCF#2)

```

SIP/2.0 183 Session Progress
Via: SIP/2.0/UDP pcscf2.visited2.net:5088;comp=sigcomp;branch=z9hG4bK361k21.1, SIP/2.0/UDP
    scscf2.home2.net;branch=z9hG4bK764z87.1, SIP/2.0/UDP
    icscf2_s.home2.net;branch=z9hG4bK871y12.1, SIP/2.0/UDP
    scscf1.home1.net;branch=z9hG4bK332b23.1, SIP/2.0/UDP
    pcscf1.visited1.net;branch=z9hG4bK240f34.1, SIP/2.0/UDP
    [5555::aaa:bbb:ccc:ddd]:1357;comp=sigcomp;branch=z9hG4bKnashds7
Record-Route: <sip:pcscf2.visited2.net:5088;lr;comp=sigcomp>, <sip:scscf2.home2.net;lr>,
    <sip:scscf1.home1.net;lr>, <sip:pcscf1.visited1.net;lr>
P-Access-Network-Info: 3GPP-UTRAN-TDD; utran-cell-id-3gpp=234151D0FCE11
Privacy: none
From:
To: <tel:+1-212-555-2222>;tag=314159
Call-ID:
CSeq:
Require: 100rel, precondition
Contact: <sip:user2_public1@home2.net;gr=urn:uuid:2ad8950e-48a5-4a74-8d99-
    ad76cc7fc74c;comp=sigcomp>
Allow: INVITE, ACK, CANCEL, BYE, PRACK, UPDATE, REFER, MESSAGE
RSeq: 9021
Content-Type: application/sdp
Content-Length: (...)

v=0
o=- 2987933623 2987933623 IN IP6 5555::eee:fff:aaa:bbb
s=-
c=IN IP6 5555::eee:fff:aaa:bbb
t=0 0
m=video 10001 RTP/AVPF 98
b=AS:75
a=crr:qos local none
a=crr:qos remote none
a=des:qos mandatory local sendrecv
a=des:qos mandatory remote sendrecv
a=inactive
a=conf:qos remote sendrecv
a=rtpmap:98 H263
a=fmtp:98 profile-level-id=0
m=audio 6544 RTP/AVP 97 96
b=AS:25.4
a=crr:qos local none
a=crr:qos remote none
a=des:qos mandatory local sendrecv
a=des:qos mandatory remote sendrecv
a=inactive
a=conf:qos remote sendrecv
a=rtpmap:97 AMR
a=fmtp:97 mode-set=0,2,5,7; maxframes=2
a=rtpmap:96 telephone-event

```

10. Reserve IP-CAN bearer for media

The terminating UA sets up the bearer in accordance with the media description received SDP.

11. Authorize QoS

P-CSCF authorizes the resources necessary for this session.

12 183 (session progress) response (P-CSCF#1 to S-CSCF#2) – see example in table 5.1.2.2-6**Table 5.1.2.2-6: 183 (Session Progress) response (P-CSCF#2 to S-CSCF#2)**

```

SIP/2.0 183 Session Progress
Via: SIP/2.0/UDP scscf2.home2.net;branch=z9hG4bK764z87.1, SIP/2.0/UDP
    icscf2_s.home2.net;branch=z9hG4bK871y12.1, SIP/2.0/UDP
    scscf1.home1.net;branch=z9hG4bK332b23.1, SIP/2.0/UDP
    pcscf1.visited1.net;branch=z9hG4bK240f34.1, SIP/2.0/UDP
    [5555::aaa:bbb:ccc:ddd]:1357;comp=sigcomp;branch=z9hG4bKnashds7
Record-Route:
P-Asserted-Identity: "John Smith" <sip:user2_public1@home2.net>
P-Access-Network-Info:
P-Charging-Vector: icid-value="AyretyU0dm+602IrT5tAFrbHLso=023551024"

```

```
Privacy:
From:
To:
Call-ID:
CSeq:
Require:
Contact:
Allow:
RSeq:
Content-Type:
Content-Length:
```

```
v=
o=
s=
c=
t=
m=
b=
a=
a=
a=
a=
a=
a=
a=
a=
m=
```

13. 183 (session progress) response (S-CSCF#1 to P-CSCF#1) – see example in table 5.1.2.2-7

Table 5.1.2.2-7: 183 (Session Progress) response (P-CSCF#2 to S-CSCF#2)

```
SIP/2.0 183 Session Progress
Via: SIP/2.0/UDP pcscf1.visited1.net;branch=z9hG4bK240f34.1, SIP/2.0/UDP
    [5555::aaa:bbb:ccc:ddd]:1357;comp=sigcomp;branch=z9hG4bKnashds7)
Record-Route:
P-Asserted-Identity:
P-Access-Network-Info:
P-Charging-Vector: icid-value="AyretyU0dm+602IrT5tAFrbHLso=023551024"
Privacy:
From:
To:
Call-ID:
CSeq:
Require:
Contact:
Allow:
RSeq:
Content-Type:
Content-Length:

v=
o=
s=
c=
t=
m=
b=
a=
a=
a=
a=
a=
a=
a=
a=
a=
a=
m=
```

14. Authorize QoS

P-CSCF authorizes the resources necessary for this session.

15. 183 (Session Progress) response (P-CSCF to UE) – see example in table 5.1.2.2-8

Table 5.1.2.2-8: 183 (Session Progress) response (P-CSCF#1 to UE#1)

```

SIP/2.0 183 Session Progress
Via: SIP/2.0/UDP [5555::aaa:bbb:ccc:ddd]:1357;comp=sigcomp;branch=z9hG4bKnashds7
Record-Route:
P-Asserted-Identity:
Privacy:
From:
To:
Call-ID:
CSeq:
Require:
Contact:
Allow:
RSeq:
Content-Type:
Content-Length:

v=
o=
s=
c=
t=
m=
b=
a=
a=
a=
a=
a=
a=
a=
a=

```

16. Reserve IP-CAN bearer for media

The originating UE sets up the bearer in accordance with the media description received SDP.

17 -24.PRACK request / 200(OK) response exchange

The PRACK request does not carry SDP as the final codec decision is already made as part of the initial offer/answer exchange.

25. UPDATE request (UE#1 to P-CSCF#1) - see example in table 5.1.2.2-9

UE#1 indicates that it can send and receive media as the necessary resources are available.

Table 5.1.2.2-9: UPDATE request (UE#1 to P-CSCF#1)

```

UPDATE <sip:[5555::eee:fff:aaa:bbb]:8805;comp=sigcomp
Via: SIP/2.0/UDP [5555::aaa:bbb:ccc:ddd]:1357;comp=sigcomp;branch=z9hG4bKnashds7
Max-Forwards: 70
Route: <sip:pcscf1.visited1.net:7531;lr;comp=sigcomp>, <sip:orig@scscf1.home1.net;lr>
From: <sip:user1_public1@home1.net>; tag=171828
To: <tel:+12125552222> tag=314159
Call-ID: cb03a0s09a2sdfg1kj490333
Cseq: 129 UPDATE
Require: sec-agree, precondition
Proxy-Require: sec-agree
Security-Verify: ipsec-3gpp; q=0.1; alg= hmac-sha-1-96; ealg=aes-cbc; spi-c=98765432; spi-
s=87654321; port-c=8642; port-s=7531
Contact: <sip:user1_public1@home1.net;gr=urn:uuid:f81d4fae-7dec-11d0-a765-
00a0c91e6bf6;comp=sigcomp>
Content-Type: application/sdp
Content-Length: (...)

v=0
o=- 2987933615 2987933615 IN IP6 5555::aaa:bbb:ccc:ddd
s=-
c=IN IP6 5555::aaa:bbb:ccc:ddd
t=0 0
m=video 3400 RTP/AVP 98

```

```

b=AS:75
a=curr:qos local sendrecv
a=curr:qos remote none
a=des:qos mandatory local sendrecv
a=des:qos mandatory remote sendrecv
a=sendrecv
a=rtpmap:98 H263
a=fmtp:98 profile-level-id=0
m=audio 3456 RTP/AVPF 97 96
b=AS:25.4
a=curr:qos local sendrecv
a=curr:qos remote none
a=des:qos mandatory local sendrecv
a=des:qos mandatory remote sendrecv
a=sendrecv
a=rtpmap:97 AMR
a=fmtp:97 mode-set=0,2,5,7; maxframes

```

26. UPDATE request (P-CSCF#1 to S-CSCF#1) - see example in table 5.1.2.2-10

Table 5.1.2.2-10: UPDATE request (P-CSCF#1 to S-CSCF#1)

```

UPDATE sip:[5555::eee:fff:aaa:bbb]:8805;comp=sigcomp SIP/2.0
Via: SIP/2.0/UDP pcscf1.visited1.net;branch=z9hG4bK240f34.1, SIP/2.0/UDP
    [5555::aaa:bbb:ccc:ddd]:1357;comp=sigcomp;branch=z9hG4bKnashds7
Max-Forwards: 69
P-Access-Network-Info:
P-Charging-Vector: icid-value="AyretyU0dm+602IrT5tAFrbHLso=023551024";
    ggsn=[5555::4b4:3c3:2d2:1e1]; pdp-sig=no; gcid=723084371; auth-token=43876559; flow-id=3
Route: <sip:scscf1.home1.net;lr>, <sip:scscf2.home2.net;lr>, <sip:pcscf2.visited2.net;lr>
From:
To:
Call-ID:
Cseq:
Require:
Contact:
Content-Type:
Content-Length:

v=
o=
s=
c=
t=
m=
b=
a=
a=
a=
a=
a=
a=
a=

```

27. UPDATE request (S-CSCF#2 to P-CSCF#2) - see example in table 5.1.2.2-11

Table 5.1.2.2-11: UPDATE request (S-CSCF#2 to P-CSCF#2)

```

UPDATE sip:[5555::eee:fff:aaa:bbb]:8805;comp=sigcomp SIP/2.0
Via: SIP/2.0/UDP scscf2.home2.net;branch=z9hG4bK764z87.1, SIP/2.0/UDP
    scscf1.home1.net;branch=z9hG4bK332b23.1, SIP/2.0/UDP
    pcscf1.visited1.net;branch=z9hG4bK240f34.1, SIP/2.0/UDP
    [5555::aaa:bbb:ccc:ddd]:1357;comp=sigcomp;branch=z9hG4bKnashds7
Max-Forwards: 67
Route: <sip:pcscf2.visited2.net;lr>
From:
To:
Call-ID:
Cseq:
Require:
Contact:
Content-Type:
Content-Length:

```

```
v=
o=
s=
c=
t=
m=
b=
a=
a=
a=
a=
a=
a=
```

28. UPDATE request (P-CSCF#2 to UE#2) - see example in table 5.1.2.2-12

Table 5.1.2.2-12: UPDATE request (S-CSCF#2 to P-CSCF#2)

```
UPDATE sip:[5555::eee:fff:aaa:bbb]:8805;comp=sigcomp SIP/2.0
Via: SIP/2.0/UDP pcscf2.visited2.net:5088;comp=sigcomp;branch=z9hG4bK361k21.1, SIP/2.0/UDP
    scscf2.home2.net;branch=z9hG4bK764z87.1, SIP/2.0/UDP
    scscf1.home1.net;branch=z9hG4bK332b23.1, SIP/2.0/UDP
    pcscf1.visited1.net;branch=z9hG4bK240f34.1, SIP/2.0/UDP
    [5555::aaa:bbb:ccc:ddd]:1357;comp=sigcomp;branch=z9hG4bKnashds7
Max-Forwards: 66
From:
To:
Call-ID:
Cseq:
Require:
Contact:
Content-Type:
Content-Length:

v=
o=
s=
c=
t=
m=
b=
a=
a=
a=
a=
a=
a=
```

29. 200 (OK) response (UE#2 to P-CSCF#1) - see example in table 5.1.2.2-13

UE acknowledges the UPDATE request with a 200 (OK) response.

UE indicates that the local resources are available

Table 5.1.2.2-13: 200(OK) response (UE to P-CSCF)

```

SIP/2.0 200 OK
Via: SIP/2.0/UDP pcscf2.visited2.net:5088;comp=sigcomp;branch=z9hG4bK361k21.1, SIP/2.0/UDP
scscf2.home2.net;branch=z9hG4bK764z87.1, SIP/2.0/UDP
icscf2_s.home2.net;branch=z9hG4bK871y12.1, SIP/2.0/UDP
scscf1.home1.net;branch=z9hG4bK332b23.1, SIP/2.0/UDP
pcscf1.visited1.net;branch=z9hG4bK240f34.1, SIP/2.0/UDP
[5555::aaa:bbb:ccc:ddd]:1357;comp=sigcomp;branch=z9hG4bKnashds7
P-Access-Network-Info: 3GPP-UTRAN-TDD; utran-cell-id-3gpp=234151D0FCE11
From: <sip:user1_public1@home1.net>;tag=171828
To: <tel:+12125552222>;tag=314159
Call-ID: cb03a0s09a2sdfgklj490333
Cseq: 129 UPDATE
Require: precondition
Content-Type: application/sdp
Content-Length: (...)

v=0
o=- 2987933615 2987933615 IN IP6 5555::eee:fff:aaa:bbb
s=-
c=IN IP6 5555::eee:fff:aaa:bbb
t=0 0
m=video 3400 RTP/AVPF 98
b=AS:75
a=curr:gqos local sendrecv
a=curr:gqos remote sendrecv
a=des:gqos mandatory local sendrecv
a=des:gqos mandatory remote sendrecv
a=rtptime:98 H263
a=fmtp:98 profile-level-id=0
m=audio 3456 RTP/AVP 97 96
b=AS:25.4
a=curr:gqos local sendrecv
a=curr:gqos remote sendrecv
a=des:gqos mandatory local sendrecv
a=des:gqos mandatory remote sendrecv
a=rtptime:97 AMR
a=fmtp:97 mode-set=0,2,5,7; maxframes

```

30. 200 (OK) response (P-CSCF#2 to S-CSCF#2) - see example in table 5.1.2.2-14**Table 5.1.2.2-14: 200(OK) response (P-CSCF#2 to S-CSCF#2)**

```

SIP/2.0 200 OK
Via: SIP/2.0/UDP scscf2.home2.net;branch=z9hG4bK764z87.1, SIP/2.0/UDP
scscf1.home1.net;branch=z9hG4bK332b23.1, SIP/2.0/UDP
pcscf1.visited1.net;branch=z9hG4bK240f34.1, SIP/2.0/UDP
[5555::aaa:bbb:ccc:ddd]:1357;comp=sigcomp;branch=z9hG4bKnashds7
P-Access-Network-Info:
From:
To:
Call-ID:
CSeq:
Require:
Content-Type:
Content-Length:

v=
o=
s=
c=
t=
m=
b=
a=
a=
a=
a=
a=
a=
a=
m=
b=

```

```

a=
a=
a=
a=
a=
a=
a=

```

31. **200 (OK) response (S-CSCF#1 to P-CSCF#21)** - see example in table 5.1.2.2-15

Table 5.1.2.2-15: 200(OK) response (S-CSCF#1 to P-CSCF#1)

```

SIP/2.0 200 OK
Via: SIP/2.0/UDP pcscf1.visited1.net;branch=z9hG4bK240f34.1, SIP/2.0/UDP
    [5555::aaa:bbb:ccc:ddd]:1357;comp=sigcomp;branch=z9hG4bKnashds7
From:
To:
Call-ID:
CSeq:
Require:
Content-Type:
Content-Length:

v=
o=
s=
c=
t=
m=
b=
a=
a=
a=
a=
a=
a=
m=
b=
a=
a=
a=
a=
a=
a=
a=
a=

```

32. **200 (OK) response (P-CSCF#1 to UE#1)** - see example in table 5.1.2.2-16

Table 5.1.2.2-16: 200(OK) response (P-CSCF#1 to UE#1)

```

SIP/2.0 200 OK
Via: SIP/2.0/UDP [5555::aaa:bbb:ccc:ddd]:1357;comp=sigcomp;branch=z9hG4bKnashds7
From:
To:
Call-ID:
CSeq:
Require:
Content-Type:
Content-Length:

v=
o=
s=
c=
t=
m=
b=
a=
a=
a=
a=
a=
a=
a=
a=
a=
a=

```

```
m=  
b=  
a=  
a=  
a=  
a=  
a=  
a=  
a=  
a=
```

33 -36 . **180 (Ringing) response**

UE#2 indicates that it is ringing. The UE#2 does not use Require '100rel' as the 180 (Ringing) does not have a SDP and therefore need not to be sent reliable.

37 -40 . **200 (OK) response**

When the called party answers the UE sends a 200 (OK) response final response to the INVITE request (6) to P-CSCF, and starts the media flow(s) for this session.

40-44 **ACK request**

The calling party responds to the 200 (OK) response with an ACK request.

5.1.2.3 SDP capability negotiation supported by UE#1 and UE#2

NOTE: Service specific information is not shown in the messages.

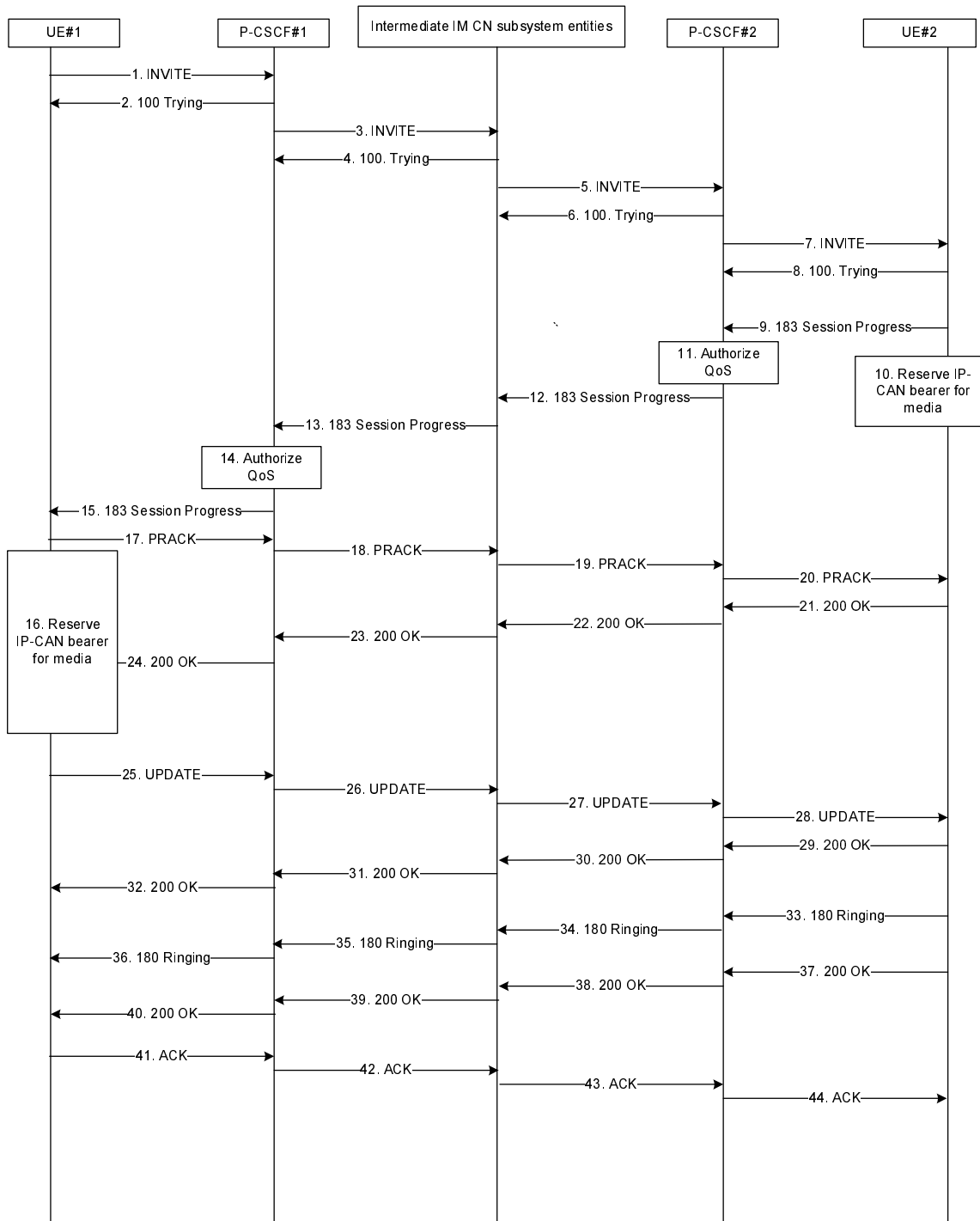

Figure 5.1.2.3-1: IMS session setup, resource reservation on both sides

The details of the signalling flows are as follows:

1. INVITE request (UE#1 to P-CSCF#1) see example in table 5.1.2.3-1

For this example, it is assumed that UE#1 is willing to establish a multimedia session comprising a video stream and an audio stream. The video stream supports two codecs, either H.263 or MPEG-4 Visual. The audio stream supports the AMR codec.

UE#1 indicates, using the SDP capability negotiation mechanism, that it supports and is willing to use AVPF transport for the video stream and the audio stream while offering AVP in the media line.

UE#1 indicates that it supports precondition and it indicates that it supports reliable provisional responses. However, it does not use the "Require" header for these capabilities.

UE#1 does not have available the resources that are necessary to transport the media.

UE#2 supports both AVP and AVPF and also supports SDP capability negotiation and since AVPF is being offered for both video and audio using the SDP capability negotiation mechanism UE#2 therefore accepts AVPF for both video and audio.

For this example it is assumed, that signalling encryption was negotiated between UE and P-CSCF in the security mode set-up procedure during the last successful authentication. This option will only be shown in this example.

Table 5.1.2.3-1: INVITE request (UE#1 to P-CSCF)

```

INVITE tel:+1-212-555-2222 SIP/2.0
Via: SIP/2.0/UDP [5555::aaa:bbb:ccc:ddd]:1357;comp=sigcomp;branch=z9hG4bKnashds7
Max-Forwards: 70
Route: <sip:pcscf1.visited1.net:7531;lr;comp=sigcomp>, <sip:scscf1.home1.net;lr>
P-Preferred-Identity: "John Doe" <sip:user1_public1@home1.net>
P-Access-Network-Info: 3GPP-UTRAN-TDD; utran-cell-id-3gpp=234151D0FCE11
Privacy: none
From: <sip:user1_public1@home1.net>;tag=171828
To: <tel:+1-212-555-2222>
Call-ID: cb03a0s09a2sdfg1kj490333
Cseq: 127 INVITE
Require: sec-agree
Supported: precondition, 100rel, gruu, 199
Accept: application/sdp,application/3gpp-ims+xml
Proxy-Require: sec-agree
Security-Verify: ipsec-3gpp; q=0.1; alg=hmac-sha-1-96; ealg=aes-cbc; spi-c=98765432; spi-
s=87654321; port-c=8642; port-s=7531
Contact: <sip:user1_public1@home1.net;gr=urn:uuid:f81d4fae-7dec-11d0-a765-
00a0c91e6bf6;comp=sigcomp>
Allow: INVITE, ACK, CANCEL, BYE, PRACK, UPDATE, REFER, MESSAGE
Content-Type: application/sdp
Content-Length: (...)

v=0
o=- 2987933615 2987933615 IN IP6 5555::aaa:bbb:ccc:ddd
s=-
c=IN IP6 5555::aaa:bbb:ccc:ddd
t=0 0
m=video 3400 RTP/AVP 98 99
a=tcap:1 RTP/AVPF
a=pcfg:1 t=1
b=AS:75
a=crr:qos local none
a=crr:qos remote none
a=des:qos mandatory local sendrecv
a=des:qos none remote sendrecv
a=inactive
a=rtpmap:98 H263
a=fmtp:98 profile-level-id=0
a=rtpmap:99 MP4V-ES
m=audio 3456 RTP/AVP 97 96
a=tcap:1 RTP/AVPF
a=pcfg:1 t=1
b=AS:25.4
a=crr:qos local none
a=crr:qos remote none
a=des:qos mandatory local sendrecv
a=des:qos none remote sendrecv
a=inactive
a=rtpmap:97 AMR
a=fmtp:97 mode-set=0,2,5,7; maxframes=2
a=rtpmap:96 telephone-event

```

Supported: The UE indicates support for the 'precondition' mechanism, the support for reliable provisional responses and the support for the 199 (Early Dialog Terminated) response code.

SDP The SDP contains a set of codecs supported by UE#1 and desired by the user at UE#1 for this session. As the local preconditions are not fulfilled, both media are set to "inactive".

Security-Verify: The Security-Verify contains the content of the Security-Server header as received during last successful authentication. It indicates that integrity protection and encryption are in use for this session.

2. 100 (Trying) response (P-CSCF#1 to UE#1)

The P-CSCF responds to the INVITE request with a 100 (Trying) provisional response.

3. INVITE request (P-CSCF#1 to S-CSCF#1) - see example in table 5.1.2.3-2

Table 5.1.2.3-2: INVITE request (P-CSCF#1 to S-CSCF#1)

```
INVITE tel:+1-212-555-2222 SIP/2.0
Via: SIP/2.0/UDP pcscf1.visited1.net;branch=z9hG4bK240f34.1, SIP/2.0/UDP
    [5555::aaa:bbb:ccc:ddd]:1357;comp=sigcomp;branch=z9hG4bKnashds7
Max-Forwards: 69
Route: <sip:scscf1.home1.net;lr>
Record-Route: <sip:pcscf1.visited1.net;lr>
P-Asserted-Identity: "John Doe" <sip:user1_public1@home1.net>
P-Access-Network-Info:
P-Charging-Vector: icid-value="AyretyU0dm+602IrT5tAFrbHLso=023551024"
Privacy:
From:
To:
Call-ID:
Cseq:
Supported:
Accept:
Contact:
Allow:
Content-Type:
Content-Length: (...)

v=
o=
s=
c=
t=
m=
b=
a=
a=
a=
a=
a=
a=
```

4. 100 (Trying) response (S-CSCF#1 to P-CSCF#1)

The S-CSCF responds to the INVITE request with a 100 (Trying) provisional response.

5. INVITE request (S-CSCF#2 to P-CSCF#2) see example in table 5.1.2.3-3

Table 5.1.2.3-3: INVITE request (S-CSCF#2 to P-CSCF#2)

```
INVITE sip:[5555::eee:fff:aaa:bbb]:8805;comp=sigcomp SIP/2.0
Via: SIP/2.0/UDP scscf2.home2.net;branch=z9hG4bK764z87.1, SIP/2.0/UDP
    icscf2_s.home2.net;branch=z9hG4bK871y12.1, SIP/2.0/UDP
    scscf1.home1.net;branch=z9hG4bK332b23.1, SIP/2.0/UDP
    pcscf1.visited1.net;branch=z9hG4bK240f34.1, SIP/2.0/UDP
    [5555::aaa:bbb:ccc:ddd]:1357;comp=sigcomp;branch=z9hG4bKnashds7
Max-Forwards: 66
Route: <sip:pcscf2.visited2.net;lr>
Record-Route: <sip:scscf2.home2.net;lr>, <sip:scscf1.home1.net;lr>,
    <sip:pcscf1.visited1.net;lr>
P-Asserted-Identity:
P-Charging-Vector: icid-value="AyretyU0dm+602IrT5tAFrbHLso=023551024"
Privacy:
From:
To:
Call-ID:
Cseq:
Supported:
```

```

Accept:
Contact:
Allow:
P-Called-Party-ID: <sip:user2_public1@home2.net>
Content-Type:
Content-Length: (...)

v=
o=
s=
c=
t=
m=
b=
a=
a=
a=
a=
a=
a=
a=

```

6. 100 (Trying) response (P-CSCF#2 to S-CSCF#2)

The P-CSCF#2 responds to the INVITE request with a 100 (Trying) provisional response.

7. INVITE request (P-CSCF#2 to UE #2) - see example in table 5.1.2.3-4

P-CSCF#2 forwards the INVITE request to UE#2.

Table 5.1.2.3-4: INVITE request (P-CSCF#2 to UE#2)

```

INVITE sip:user2_public1@home2.net SIP/2.0
Via: SIP/2.0/UDP pcscf2.visited2.net:5088;comp=sigcomp;branch=z9hG4bK361k21.1, SIP/2.0/UDP
scscf2.home2.net;branch=z9hG4bK764z87.1, SIP/2.0/UDP
icscf2_s.home2.net;branch=z9hG4bK871y12.1, SIP/2.0/UDP
scscf1.home1.net;branch=z9hG4bK332b23.1, SIP/2.0/UDP
pcscf1.visited1.net;branch=z9hG4bK240f34.1, SIP/2.0/UDP
[5555::aaa:bbb:ccc:ddd]:1357;comp=sigcomp;branch=z9hG4bKnashds7
Max-Forwards: 65
Route: <sip:scscf2.home2.net;lr>
Record-Route: <sip:pcscf2.visited2.net:5088;lr;comp=sigcomp>, <sip:scscf2.home2.net;lr>,
<sip:scscf1.home1.net;lr>, <sip:pcscf1.visited1.net;lr>
P-Asserted-Identity:
Privacy:
From:
To:
Call-ID:
Cseq:
Supported:
Accept:
Contact:
Allow:
Content-Type:
Content-Length: (...)

v=
o=
s=
c=
t=
m=
b=
a=
a=
a=
a=
a=
a=
a=

```

8. 100 (Trying) response (UE#2 to P-CSCF)

The UE responds to the INVITE request with a 100 (Trying) provisional response.

9. 183 (Session Progress) response (UE#2 to P-CSCF) - - see example in table 5.1.2.3-5

UE#2 determines the complete set of codecs that it is capable of supporting for this session. It determines the intersection with those appearing in the SDP in the INVITE request. UE#2 makes the final codec selection and chooses H.263 and AMR.

UE#2 supports the SDP capability negotiation mechanism, and is willing to use AVPF transport. It indicates the selection of AVPF in the SDP answer.

UE#2 responds with a 183 (Session Progress) response containing SDP back to the originator. This response is sent to P-CSCF. UE#2 uses a conf line in the SDP to request a confirmation from UE#1 when the local resources are available at UE#1.

Table 5.1.2.3-5: 183 (Session Progress) response (UE#2 to P-CSCF#2)

```

SIP/2.0 183 Session Progress
Via: SIP/2.0/UDP pcscf2.visited2.net:5088;comp=sigcomp;branch=z9hG4bK361k21.1, SIP/2.0/UDP
    scscf2.home2.net;branch=z9hG4bK764z87.1, SIP/2.0/UDP
    icscf2_s.home2.net;branch=z9hG4bK871y12.1, SIP/2.0/UDP
    scscf1.home1.net;branch=z9hG4bK332b23.1, SIP/2.0/UDP
    pcscf1.visited1.net;branch=z9hG4bK240f34.1, SIP/2.0/UDP
    [5555::aaa:bbb:ccc:ddd]:1357;comp=sigcomp;branch=z9hG4bKnashds7
Record-Route: <sip:pcscf2.visited2.net:5088;lr;comp=sigcomp>, <sip:scscf2.home2.net;lr>,
    <sip:scscf1.home1.net;lr>, <sip:pcscf1.visited1.net;lr>
P-Access-Network-Info: 3GPP-UTRAN-TDD; utran-cell-id-3gpp=234151D0FCE11
Privacy: none
From:
To: <tel:+1-212-555-2222>;tag=314159
Call-ID:
CSeq:
Require: 100rel, precondition
Contact: <sip:user2_public1@home2.net:gr=urn:uuid: 2ad8950e-48a5-4a74-8d99-
    ad76cc7fc74c;comp=sigcomp>
Allow: INVITE, ACK, CANCEL, BYE, PRACK, UPDATE, REFER, MESSAGE
RSeq: 9021
Content-Type: application/sdp
Content-Length: (...)

v=0
o=- 2987933623 2987933623 IN IP6 5555::eee:fff:aaa:bbb
s=-
c=IN IP6 5555::eee:fff:aaa:bbb
t=0 0
m=video 10001 RTP/AVPF 98
a=acfg:1 t=1
b=AS:75
a=curr:qos local none
a=curr:qos remote none
a=des:qos mandatory local sendrecv
a=des:qos mandatory remote sendrecv
a=inactive
a=conf:qos remote sendrecv
a=rtptime:98 H263
a=fmtp:98 profile-level-id=0
m=audio 6544 RTP/AVPF 97 96
a=acfg:1 t=1
b=AS:25.4
a=curr:qos local none
a=curr:qos remote none
a=des:qos mandatory local sendrecv
a=des:qos mandatory remote sendrecv
a=inactive
a=conf:qos remote sendrecv
a=rtptime:97 AMR
a=fmtp:97 mode-set=0,2,5,7; maxframes=2
a=rtptime:96 telephone-event

```

10. Reserve IP-CAN bearer for media

The terminating UA sets up the bearer in accordance with the media description received SDP.

11. Authorize QoS

P-CSCF authorizes the resources necessary for this session.

12 183 (session progress) response (P-CSCF#1 to S-CSCF#2) – see example in table 5.1.2.3-6**Table 5.1.2.3-6: 183 (Session Progress) response (P-CSCF#2 to S-CSCF#2)**

```

SIP/2.0 183 Session Progress
Via: SIP/2.0/UDP scscf2.home2.net;branch=z9hG4bK764z87.1, SIP/2.0/UDP
    icscf2_s.home2.net;branch=z9hG4bK871y12.1, SIP/2.0/UDP
    scscf1.home1.net;branch=z9hG4bK332b23.1, SIP/2.0/UDP
    pcscf1.visited1.net;branch=z9hG4bK240f34.1, SIP/2.0/UDP
    [5555::aaa:bbb:ccc:ddd]:1357;comp=sigcomp;branch=z9hG4bKnashds7
Record-Route:
P-Asserted-Identity: "John Smith" <sip:user2_public1@home2.net>

```

```
P-Access-Network-Info:
P-Charging-Vector: icid-value="AyretyU0dm+602IrT5tAFrbHLso=023551024"
Privacy:
From:
To:
Call-ID:
CSeq:
Require:
Contact:
Allow:
RSeq:
Content-Type:
Content-Length:

v=
o=
s=
c=
t=
m=
b=
a=
a=
a=
a=
a=
a=
a=
a=
a=
m=
```

13. 183 (session progress) response (S-CSCF#1 to P-CSCF#1) – see example in table 5.1.2.3-7

Table 5.1.2.3-7: 183 (Session Progress) response (P-CSCF#2 to S-CSCF#2)

```
SIP/2.0 183 Session Progress
Via: SIP/2.0/UDP pcscf1.visited1.net;branch=z9hG4bK240f34.1, SIP/2.0/UDP
    [5555::aaa:bbb:ccc:ddd]:1357;comp=sigcomp;branch=z9hG4bKnashds7
Record-Route:
P-Asserted-Identity:
P-Access-Network-Info:
P-Charging-Vector: icid-value="AyretyU0dm+602IrT5tAFrbHLso=023551024"
Privacy:
From:
To:
Call-ID:
CSeq:
Require:
Contact:
Allow:
RSeq:
Content-Type:
Content-Length:

v=
o=
s=
c=
t=
m=
b=
a=
a=
a=
a=
a=
a=
a=
a=
a=
a=
a=
m=
```

14. Authorize QoS

P-CSCF authorizes the resources necessary for this session.

15 183 (Session Progress) response (P-CSCF to UE) – see example in table 5.1.2.3-8

Table 5.1.2.3-8: 183 (Session Progress) response (P-CSCF#1 to UE#1)

```

SIP/2.0 183 Session Progress
Via: SIP/2.0/UDP [5555::aaa:bbb:ccc:ddd]:1357;comp=sigcomp;branch=z9hG4bKnashds7
Record-Route:
P-Asserted-Identity:
Privacy:
From:
To:
Call-ID:
CSeq:
Require:
Contact:
Allow:
RSeq:
Content-Type:
Content-Length:

v=
o=
s=
c=
t=
m=
b=
a=
a=
a=
a=
a=
a=
a=

```

16. Reserve IP-CAN bearer for media

The originating UE sets up the bearer in accordance with the media description received SDP.

17 -24.PRACK request / 200(OK) response exchange

The PRACK request does not carry SDP as the final codec decision is already made as part of the initial offer/answer exchange.

25. UPDATE request (UE#1 to P-CSCF#1) - see example in table 5.1.2.3-9

UE#1 indicates that it can send and receive media as the necessary resources are available.

UE#1 indicates that AVPF transport is used for the video stream and the audio stream.

Table 5.1.2.3-9: UPDATE request (UE#1 to P-CSCF#1)

```

UPDATE <sip:[5555::eee:fff:aaa:bbb]:8805;comp=sigcomp
Via: SIP/2.0/UDP [5555::aaa:bbb:ccc:ddd]:1357;comp=sigcomp;branch=z9hG4bKnashds7
Max-Forwards: 70
Route: <sip:pcscf1.visited1.net:7531;lr;comp=sigcomp>, <sip:orig@scscf1.home1.net;lr>
From: <sip:user1_public1@home1.net>; tag=171828
To: <tel:+12125552222> tag=314159
Call-ID: cb03a0s09a2sdfglkj490333
Cseq: 129 UPDATE
Require: sec-agree, precondition
Proxy-Require: sec-agree
Security-Verify: ipsec-3gpp; q=0.1; alg= hmac-sha-1-96; ealg=aes-cbc; spi-c=98765432; spi-
s=87654321; port-c=8642; port-s=7531
Contact: <sip:user1_public1@home1.net;gr=urn:uuid:f81d4fae-7dec-11d0-a765-
00a0c91e6bf6;comp=sigcomp>
Content-Type: application/sdp
Content-Length: (...)

v=0
o=- 2987933615 2987933615 IN IP6 5555::aaa:bbb:ccc:ddd
s=-
c=IN IP6 5555::aaa:bbb:ccc:ddd

```

```

t=0 0
m=video 3400 RTP/AVPF 98
b=AS:75
a=curr:goss local sendrecev
a=curr:goss remote none
a=des:goss mandatory local sendrecv
a=des:goss mandatory remote sendrecv
a=sendrecv
a=rtppmap:98 H263
a=fmtp:98 profile-level-id=0
m=audio 3456 RTP/AVPF 97 96
b=AS:25.4
a=curr:goss local sendrecev
a=curr:goss remote none
a=des:goss mandatory local sendrecv
a=des:goss mandatory remote sendrecv
a=sendrecv
a=rtppmap:97 AMR
a=fmtp:97 mode-set=0,2,5,7; maxframes

```

26 UPDATE request (P-CSCF#1 to S-CSCF#1) - see example in table 5.1.2.3-10

Table 5.1.2.3-10: UPDATE request (P-CSCF#1 to S-CSCF#1)

```

UPDATE sip:[5555::eee:fff:aaa:bbb]:8805;comp=sigcomp SIP/2.0
Via: SIP/2.0/UDP pcscf1.visited1.net;branch=z9hG4bK240f34.1, SIP/2.0/UDP
    [5555::aaa:bbb:ccc:ddd]:1357;comp=sigcomp;branch=z9hG4bKnashds7
Max-Forwards: 69
P-Access-Network-Info:
P-Charging-Vector: icid-value="AyretyU0dm+602IrT5tAFrbHLso=023551024";
    ggsn=[5555::4b4:3c3:2d2:1e1]; pdp-sig=no; gcid=723084371; auth-token=43876559; flow-id=3
Route: <sip:scscf1.home1.net;lr>, <sip:scscf2.home2.net;lr>, <sip:pcscf2.visited2.net;lr>
From:
To:
Call-ID:
Cseq:
Require:
Contact:
Content-Type:
Content-Length:

v=
o=
s=
c=
t=
m=
b=
a=
a=
a=
a=
a=
a=
a=

```

27. UPDATE request (S-CSCF#2 to P-CSCF#2) - see example in table 5.1.2.3-11

Table 5.1.2.3-11: UPDATE request (S-CSCF#2 to P-CSCF#2)

```

UPDATE sip:[5555::eee:fff:aaa:bbb]:8805;comp=sigcomp SIP/2.0
Via: SIP/2.0/UDP scscf2.home2.net;branch=z9hG4bK764z87.1, SIP/2.0/UDP
    scscf1.home1.net;branch=z9hG4bK332b23.1, SIP/2.0/UDP
    pcscf1.visited1.net;branch=z9hG4bK240f34.1, SIP/2.0/UDP
    [5555::aaa:bbb:ccc:ddd]:1357;comp=sigcomp;branch=z9hG4bKnashds7
Max-Forwards: 67
Route: <sip:pcscf2.visited2.net;lr>
From:
To:
Call-ID:
Cseq:
Require:
Contact:
Content-Type:

```



```
Content-Length:
```

```
v=
o=
s=
c=
t=
m=
b=
a=
a=
a=
a=
a=
a=
```

28. UPDATE request (P-CSCF#2 to UE#2) - see example in table 5.1.2.3-12

Table 5.1.2.3-12: UPDATE request (S-CSCF#2 to P-CSCF#2)

```
UPDATE sip:[5555::eee:fff:aaa:bbb]:8805;comp=sigcomp SIP/2.0
Via: SIP/2.0/UDP pcscf2.visited2.net:5088;comp=sigcomp;branch=z9hG4bK361k21.1, SIP/2.0/UDP
    scscf2.home2.net;branch=z9hG4bK764z87.1, SIP/2.0/UDP
    scscf1.home1.net;branch=z9hG4bK332b23.1, SIP/2.0/UDP
    pcscf1.visited1.net;branch=z9hG4bK240f34.1, SIP/2.0/UDP
    [5555::aaa:bbb:ccc:ddd]:1357;comp=sigcomp;branch=z9hG4bKnashds7
Max-Forwards: 66
From:
To:
Call-ID:
Cseq:
Require:
Contact:
Content-Type:
Content-Length:

v=
o=
s=
c=
t=
m=
b=
a=
a=
a=
a=
a=
a=
a=
```

29. 200 (OK) response (UE#2 to P-CSCF#1) - see example in table 5.1.2.3-13

UE#2 acknowledges the UPDATE request with a 200 (OK) response.

UE#2 indicates that the local resources are available.

UE#2 indicates that AVPF transport is used for the video stream and the audio stream.

Table 5.1.2.3-13: 200(OK) response (UE to P-CSCF)

```

SIP/2.0 200 OK
Via: SIP/2.0/UDP pcscf2.visited2.net:5088;comp=sigcomp;branch=z9hG4bK361k21.1, SIP/2.0/UDP
scscf2.home2.net;branch=z9hG4bK764z87.1, SIP/2.0/UDP
icscf2_s.home2.net;branch=z9hG4bK871y12.1, SIP/2.0/UDP
scscf1.home1.net;branch=z9hG4bK332b23.1, SIP/2.0/UDP
pcscf1.visited1.net;branch=z9hG4bK240f34.1, SIP/2.0/UDP
[5555::aaa:bbb:ccc:ddd]:1357;comp=sigcomp;branch=z9hG4bKnashds7
P-Access-Network-Info: 3GPP-UTRAN-TDD; utran-cell-id-3gpp=234151D0FCE11
From: <sip:user1_public1@home1.net>;tag=171828
To: <tel:+12125552222>;tag=314159
Call-ID: cb03a0s09a2sdfgklkj490333
Cseq: 129 UPDATE
Require: precondition
Content-Type: application/sdp
Content-Length: (...)

v=0
o=- 2987933615 2987933615 IN IP6 5555::eee:fff:aaa:bbb
s=-
c=IN IP6 5555::eee:fff:aaa:bbb
t=0 0
m=video 3400 RTP/AVPF 98
b=AS:75
a=curr:qos local sendrecv
a=curr:qos remote sendrecv
a=des:qos mandatory local sendrecv
a=des:qos mandatory remote sendrecv
a=rtpmap:98 H263
a=fmtp:98 profile-level-id=0
m=audio 3456 RTP/AVPF 97 96
b=AS:25.4
a=curr:qos local sendrecv
a=curr:qos remote sendrecv
a=des:qos mandatory local sendrecv
a=des:qos mandatory remote sendrecv
a=rtpmap:97 AMR
a=fmtp:97 mode-set=0,2,5,7; maxframes

```

30. 200 (OK) response (P-CSCF#2 to S-CSCF#2) - see example in table 5.1.2.3-14**Table 5.1.2.3-14: 200(OK) response (P-CSCF#2 to S-CSCF#2)**

```

SIP/2.0 200 OK
Via: SIP/2.0/UDP scscf2.home2.net;branch=z9hG4bK764z87.1, SIP/2.0/UDP
scscf1.home1.net;branch=z9hG4bK332b23.1, SIP/2.0/UDP
pcscf1.visited1.net;branch=z9hG4bK240f34.1, SIP/2.0/UDP
[5555::aaa:bbb:ccc:ddd]:1357;comp=sigcomp;branch=z9hG4bKnashds7
P-Access-Network-Info:
From:
To:
Call-ID:
CSeq:
Require:
Content-Type:
Content-Length:

v=
o=
s=
c=
t=
m=
b=
a=
a=
a=
a=
a=
a=
a=
m=
b=

```

```
a=
a=
a=
a=
a=
a=
a=
```

31. **200 (OK) response (S-CSCF#1 to P-CSCF#21)** - see example in table 5.1.2.3-15

Table 5.1.2.3-15: 200(OK) response (S-CSCF#1 to P-CSCF#1)

```
SIP/2.0 200 OK
Via: SIP/2.0/UDP pcscf1.visited1.net;branch=z9hG4bK240f34.1, SIP/2.0/UDP
    [5555::aaa:bbb:ccc:ddd]:1357;comp=sigcomp;branch=z9hG4bKnashds7
From:
To:
Call-ID:
CSeq:
Require:
Content-Type:
Content-Length:

v=
o=
s=
c=
t=
m=
b=
a=
a=
a=
a=
a=
a=
m=
b=
a=
a=
a=
a=
a=
a=
a=
a=
```

32. **200 (OK) response (P-CSCF#1 to UE#1)** - see example in table 5.1.2.3-16

Table 5.1.2.3-16: 200(OK) response (P-CSCF#1 to UE#1)

```
SIP/2.0 200 OK
Via: SIP/2.0/UDP [5555::aaa:bbb:ccc:ddd]:1357;comp=sigcomp;branch=z9hG4bKnashds7
From:
To:
Call-ID:
CSeq:
Require:
Content-Type:
Content-Length:

v=
o=
s=
c=
t=
m=
b=
a=
a=
a=
a=
a=
a=
a=
a=
a=
a=
```

```
m=  
b=  
a=  
a=  
a=  
a=  
a=  
a=  
a=  
a=
```

33 -36 . **180 (Ringing) response**

UE#2 indicates that it is ringing. The UE#2 does not use Require '100rel' as the 180 (Ringing) does not have a SDP and therefore need not to be sent reliable.

37 -40 . **200 (OK) response**

When the called party answers the UE sends a 200 (OK) response final response to the INVITE request (6) to P-CSCF, and starts the media flow(s) for this session.

40-44 **ACK request**

The calling party responds to the 200 (OK) response with an ACK request.

5.1.2.4 SDP capability negotiation only supported by UE#1

NOTE: Service specific information is not shown in the messages.

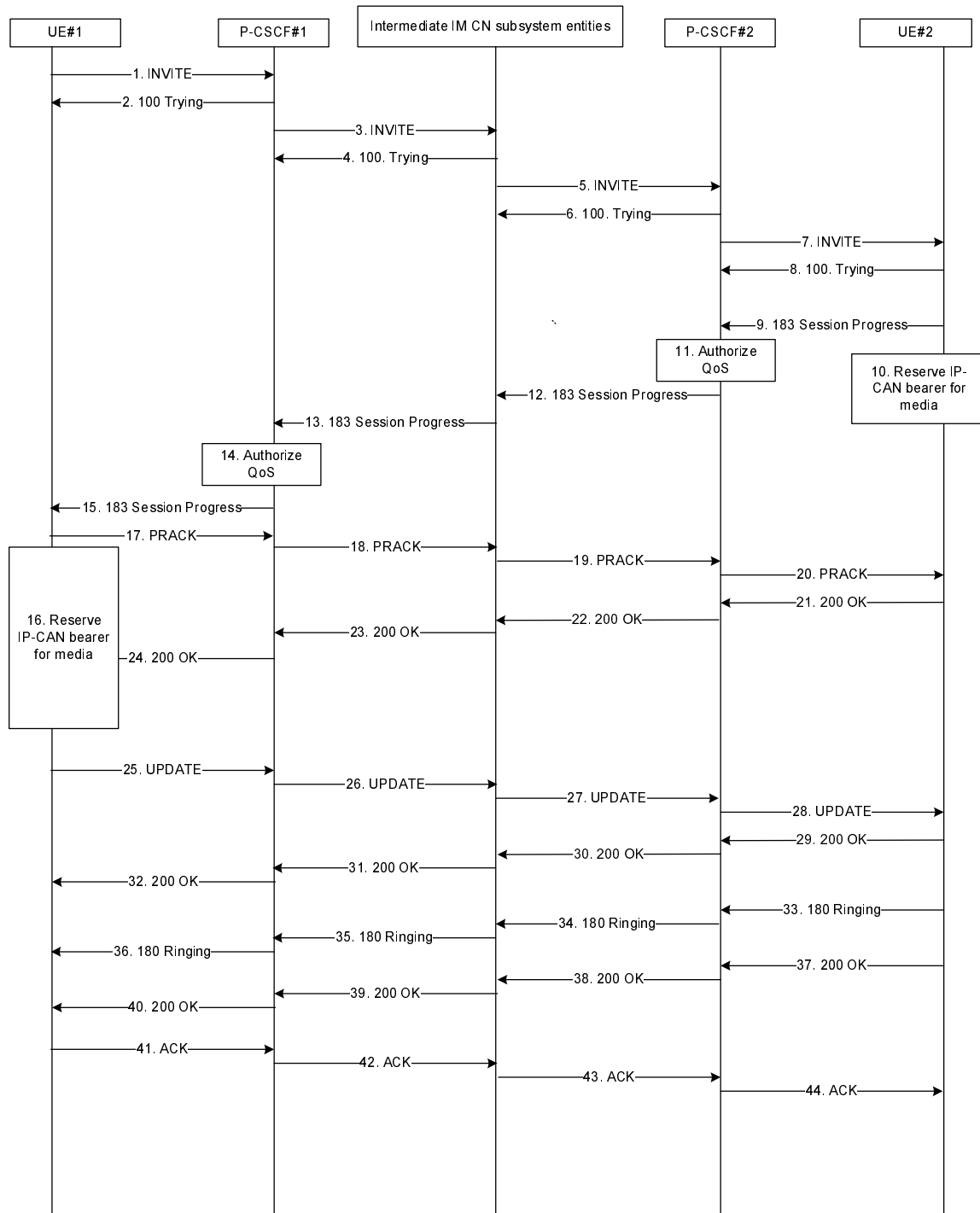

Figure 5.1.2.4-1: IMS session setup, resource reservation on both sides

NOTE: Support for SDP capability negotiation is only optional for 3GPP release 7 and release 8 UEs and non-IMS UEs.

The details of the signalling flows are as follows:

1. INVITE request (UE#1 to P-CSCF#1) see example in table 5.1.2.4-1

For this example, it is assumed that UE#1 is willing to establish a multimedia session comprising a video stream and an audio stream. The video stream supports two codecs, either H.263 or MPEG-4 Visual. The audio stream supports the AMR codec.

UE#1 indicates, using the SDP capability negotiation mechanism, that it supports and is willing to use AVPF transport for the video stream and the audio stream. while offering AVP in the media line

UE#1 indicates that it supports precondition and it indicates that it supports reliable provisional responses. However, it does not use the "Require" header for these capabilities.

UE#1 does not have available the resources that are necessary to transport the media.

UE#2 supports both AVP and AVPF but since it does not support SDP capability negotiation it cannot understand that AVPF is also being offered for video and therefore accepts AVP for video.

For this example it is assumed, that signalling encryption was negotiated between UE and P-CSCF in the security mode set-up procedure during the last successful authentication. This option will only be shown in this example.

Table 5.1.2.4-1: INVITE request (UE#1 to P-CSCF)

```

INVITE tel:+1-212-555-2222 SIP/2.0
Via: SIP/2.0/UDP [5555::aaa:bbb:ccc:ddd]:1357;comp=sigcomp;branch=z9hG4bKnashds7
Max-Forwards: 70
Route: <sip:pcscf1.visited1.net:7531;lr;comp=sigcomp>, <sip:scscf1.home1.net;lr>
P-Preferred-Identity: "John Doe" <sip:user1_public1@home1.net>
P-Access-Network-Info: 3GPP-UTRAN-TDD; utran-cell-id-3gpp=234151D0FCE11
Privacy: none
From: <sip:user1_public1@home1.net>;tag=171828
To: <tel:+1-212-555-2222>
Call-ID: cb03a0s09a2sdfglkj490333
Cseq: 127 INVITE
Require: sec-agree
Supported: precondition, 100rel, gruu, 199
Accept: application/sdp,application/3gpp-ims+xml
Proxy-Require: sec-agree
Security-Verify: ipsec-3gpp; q=0.1; alg= hmac-sha-1-96; ealg=aes-cbc; spi-c=98765432; spi-
s=87654321; port-c=8642; port-s=7531
Contact: <sip:user1_public1@home1.net;gr=urn:uuid:f81d4fae-7dec-11d0-a765-
00a0c91e6bf6;comp=sigcomp>
Allow: INVITE, ACK, CANCEL, BYE, PRACK, UPDATE, REFER, MESSAGE
Content-Type: application/sdp
Content-Length: (...)

v=0
o=- 2987933615 2987933615 IN IP6 5555::aaa:bbb:ccc:ddd
s=-
c=IN IP6 5555::aaa:bbb:ccc:ddd
t=0 0
m=video 3400 RTP/AVP 98 99
a=tcap:1 RTP/AVPF
a=pcfg:1 t=1
b=AS:75
a=curr:qos local none
a=curr:qos remote none
a=des:qos mandatory local sendrecv
a=des:qos none remote sendrecv
a=inactive
a=rtpmap:98 H263
a=fmtp:98 profile-level-id=0
a=rtpmap:99 MP4V-ES
m=audio 3456 RTP/AVP 97 96
a=tcap:1 RTP/AVPF
a=pcfg:1 t=1
b=AS:25.4
a=curr:qos local none
a=curr:qos remote none
a=des:qos mandatory local sendrecv
a=des:qos none remote sendrecv
a=inactive
a=rtpmap:97 AMR
a=fmtp:97 mode-set=0,2,5,7; maxframes=2
a=rtpmap:96 telephone-event

```

Supported: The UE indicates support for the 'precondition' mechanism, the support for reliable provisional responses and the support for the 199 (Early Dialog Terminated) response code.

SDP The SDP contains a set of codecs supported by UE#1 and desired by the user at UE#1 for this session. As the local preconditions are not fulfilled, both media are set to "inactive".

Security-Verify: The Security-Verify contains the content of the Security-Server header as received during last successful authentication. It indicates that integrity protection and encryption are in use for this session.

2. 100 (Trying) response (P-CSCF#1 to UE#1)

The P-CSCF responds to the INVITE request with a 100 (Trying) provisional response.

4. INVITE request (P-CSCF#1 to S-CSCF#1) - see example in table 5.1.2.4-2

Table 5.1.2.4-2: INVITE request (P-CSCF#1 to S-CSCF#1)

```
INVITE tel:+1-212-555-2222 SIP/2.0
Via: SIP/2.0/UDP pcscf1.visited1.net;branch=z9hG4bK240f34.1, SIP/2.0/UDP
    [5555::aaa:bbb:ccc:ddd]:1357;comp=sigcomp;branch=z9hG4bKnashds7
Max-Forwards: 69
Route: <sip:scscf1.home1.net;lr>
Record-Route: <sip:pcscf1.visited1.net;lr>
P-Asserted-Identity: "John Doe" <sip:user1_public1@home1.net>
P-Access-Network-Info:
P-Charging-Vector: icid-value="AyretyU0dm+602IrT5tAFrbHLso=023551024"
Privacy:
From:
To:
Call-ID:
Cseq:
Supported:
Accept:
Contact:
Allow:
Content-Type:
Content-Length: (...)

v=
o=
s=
c=
t=
m=
b=
a=
a=
a=
a=
a=
a=
```

4. 100 (Trying) response (S-CSCF#1 to P-CSCF#1)

The S-CSCF responds to the INVITE request with a 100 (Trying) provisional response.

5. INVITE request (S-CSCF#2 to P-CSCF#2) see example in table 5.1.2.4-3

Table 5.1.2.4-3: INVITE request (S-CSCF#2 to P-CSCF#2)

```
INVITE sip:[5555::eee:fff:aaa:bbb]:8805;comp=sigcomp SIP/2.0
Via: SIP/2.0/UDP scscf2.home2.net;branch=z9hG4bK764z87.1, SIP/2.0/UDP
    icscf2_s.home2.net;branch=z9hG4bK871y12.1, SIP/2.0/UDP
    scscf1.home1.net;branch=z9hG4bK332b23.1, SIP/2.0/UDP
    pcscf1.visited1.net;branch=z9hG4bK240f34.1, SIP/2.0/UDP
    [5555::aaa:bbb:ccc:ddd]:1357;comp=sigcomp;branch=z9hG4bKnashds7
Max-Forwards: 66
Route: <sip:pcscf2.visited2.net;lr>
Record-Route: <sip:scscf2.home2.net;lr>, <sip:scscf1.home1.net;lr>,
    <sip:pcscf1.visited1.net;lr>
P-Asserted-Identity:
P-Charging-Vector: icid-value="AyretyU0dm+602IrT5tAFrbHLso=023551024"
Privacy:
From:
```

```
To:
Call-ID:
Cseq:
Supported:
Accept:
Contact:
Allow:
P-Called-Party-ID: <sip:user2_public1@home2.net>
Content-Type:
Content-Length: (...)

v=
o=
s=
c=
t=
m=
b=
a=
a=
a=
a=
a=
a=
a=
```

6. **100 (Trying) response (P-CSCF#2 to S-CSCF#2)**

The P-CSCF#2 responds to the INVITE request with a 100 (Trying) provisional response.

7. **INVITE request (P-CSCF#2 to UE #2) - see example in table 5.1.2.4-4**

P-CSCF#2 forwards the INVITE request to UE#2.

Table 5.1.2.4-4: INVITE request (P-CSCF#2 to UE#2)

```

INVITE sip:user2_public1@home2.net SIP/2.0
Via: SIP/2.0/UDP pcscf2.visited2.net:5088;comp=sigcomp;branch=z9hG4bK361k21.1, SIP/2.0/UDP
    scscf2.home2.net;branch=z9hG4bK764z87.1, SIP/2.0/UDP
    icscf2_s.home2.net;branch=z9hG4bK871y12.1, SIP/2.0/UDP
    scscf1.home1.net;branch=z9hG4bK332b23.1, SIP/2.0/UDP
    pcscf1.visited1.net;branch=z9hG4bK240f34.1, SIP/2.0/UDP
    [5555::aaa:bbb:ccc:ddd]:1357;comp=sigcomp;branch=z9hG4bKnashds7
Max-Forwards: 65
Route: <sip:scscf2.home2.net;lr>
Record-Route: <sip:pcscf2.visited2.net:5088;lr;comp=sigcomp>, <sip:scscf2.home2.net;lr>,
    <sip:scscf1.home1.net;lr>, <sip:pcscf1.visited1.net;lr>
P-Asserted-Identity:
Privacy:
From:
To:
Call-ID:
Cseq:
Supported:
Accept:
Contact:
Allow:
Content-Type:
Content-Length: (...)

v=
o=
s=
c=
t=
m=
b=
a=
a=
a=
a=
a=
a=
a=

```

8. 100 (Trying) response (UE#2 to P-CSCF)

The UE responds to the INVITE request with a 100 (Trying) provisional response.

9. 183 (Session Progress) response (UE#2 to P-CSCF) - - see example in table 5.1.2.4-5

UE#2 determines the complete set of codecs that it is capable of supporting for this session. It determines the intersection with those appearing in the SDP in the INVITE request. UE#2 makes the final codec selection and chooses H.263 and AMR.

UE#2 does not support the SDP capability negotiation mechanism, and is not aware that UE#1 is willing to use AVPF transport. It indicates the selection of AVP in the SDP answer.

UE#2 responds with a 183 (Session Progress) response containing SDP back to the originator. This response is sent to P-CSCF. UE#2 uses a conf line in the SDP to request a confirmation from UE#1 when the local resources are available at UE#1.

Table 5.1.2.4-5: 183 (Session Progress) response (UE#2 to P-CSCF#2)

```

SIP/2.0 183 Session Progress
Via: SIP/2.0/UDP pcscf2.visited2.net:5088;comp=sigcomp;branch=z9hG4bK361k21.1, SIP/2.0/UDP
    scscf2.home2.net;branch=z9hG4bK764z87.1, SIP/2.0/UDP
    icscf2_s.home2.net;branch=z9hG4bK871y12.1, SIP/2.0/UDP
    scscf1.home1.net;branch=z9hG4bK332b23.1, SIP/2.0/UDP
    pcscf1.visited1.net;branch=z9hG4bK240f34.1, SIP/2.0/UDP
    [5555::aaa:bbb:ccc:ddd]:1357;comp=sigcomp;branch=z9hG4bKnashds7
Record-Route: <sip:pcscf2.visited2.net:5088;lr;comp=sigcomp>, <sip:scscf2.home2.net;lr>,
    <sip:scscf1.home1.net;lr>, <sip:pcscf1.visited1.net;lr>
P-Access-Network-Info: 3GPP-UTRAN-TDD; utran-cell-id-3gpp=234151D0FCE11
Privacy: none
From:
To: <tel:+1-212-555-2222>;tag=314159
Call-ID:
CSeq:
Require: 100rel, precondition
Contact: <sip:user2_public1@home2.net;gr=urn:uuid:2ad8950e-48a5-4a74-8d99-
    ad76cc7fc74;comp=sigcomp>
Allow: INVITE, ACK, CANCEL, BYE, PRACK, UPDATE, REFER, MESSAGE
RSeq: 9021
Content-Type: application/sdp
Content-Length: (...)

v=0
o=- 2987933623 2987933623 IN IP6 5555::eee:fff:aaa:bbb
s=-
c=IN IP6 5555::eee:fff:aaa:bbb
t=0 0
m=video 10001 RTP/AVP 98
b=AS:75
a=curr:qos local none
a=curr:qos remote none
a=des:qos mandatory local sendrecv
a=des:qos mandatory remote sendrecv
a=inactive
a=conf:qos remote sendrecv
a=rtpmap:98 H263
a=fmtp:98 profile-level-id=0
m=audio 6544 RTP/AVP 97 96
b=AS:25.4
a=curr:qos local none
a=curr:qos remote none
a=des:qos mandatory local sendrecv
a=des:qos mandatory remote sendrecv
a=inactive
a=conf:qos remote sendrecv
a=rtpmap:97 AMR
a=fmtp:97 mode-set=0,2,5,7; maxframes=2
a=rtpmap:96 telephone-event

```

10. Reserve IP-CAN bearer for media

The terminating UA sets up the bearer in accordance with the media description received SDP.

11. Authorize QoS

P-CSCF authorizes the resources necessary for this session.

12 183 (session progress) response (P-CSCF#1 to S-CSCF#2) – see example in table 5.1.2.4-6**Table 5.1.2.4-6: 183 (Session Progress) response (P-CSCF#2 to S-CSCF#2)**

```

SIP/2.0 183 Session Progress
Via: SIP/2.0/UDP scscf2.home2.net;branch=z9hG4bK764z87.1, SIP/2.0/UDP
    icscf2_s.home2.net;branch=z9hG4bK871y12.1, SIP/2.0/UDP
    scscf1.home1.net;branch=z9hG4bK332b23.1, SIP/2.0/UDP
    pcscf1.visited1.net;branch=z9hG4bK240f34.1, SIP/2.0/UDP
    [5555::aaa:bbb:ccc:ddd]:1357;comp=sigcomp;branch=z9hG4bKnashds7
Record-Route:
P-Asserted-Identity: "John Smith" <sip:user2_public1@home2.net>
P-Access-Network-Info:
P-Charging-Vector: icid-value="AyretyU0dm+602IrT5tAFrbHLso=023551024"

```

```
Privacy:  
From:  
To:  
Call-ID:  
CSeq:  
Require:  
Contact:  
Allow:  
RSeq:  
Content-Type:  
Content-Length:
```

```
v=  
o=  
s=  
c=  
t=  
m=  
b=  
a=  
a=  
a=  
a=  
a=  
a=  
a=  
a=  
m=
```

13. 183 (session progress) response (S-CSCF#1 to P-CSCF#1) – see example in table 5.1.2.4-7

Table 5.1.2.4-7: 183 (Session Progress) response (P-CSCF#2 to S-CSCF#2)

```
SIP/2.0 183 Session Progress
Via: SIP/2.0/UDP pcscf1.visited1.net;branch=z9hG4bK240f34.1, SIP/2.0/UDP
    [5555::aaa:bbb:ccc:ddd]:1357;comp=sigcomp;branch=z9hG4bKnashds7
Record-Route:
P-Asserted-Identity:
P-Access-Network-Info:
P-Charging-Vector: icid-value="AyretyU0dm+602IrT5tAFrbHLso=023551024"
Privacy:
From:
To:
Call-ID:
CSeq:
Require:
Contact:
Allow:
RSeq:
Content-Type:
Content-Length:

v=
o=
s=
c=
t=
m=
b=
a=
a=
a=
a=
a=
a=
a=
a=
a=
a=
m=
```

14. Authorize QoS

P-CSCF authorizes the resources necessary for this session.

15 183 (Session Progress) response (P-CSCF to UE) – see example in table 5.1.2.4-8

Table 5.1.2.4-8: 183 (Session Progress) response (P-CSCF#1 to UE#1)

```

SIP/2.0 183 Session Progress
Via: SIP/2.0/UDP [5555::aaa:bbb:ccc:ddd]:1357;comp=sigcomp;branch=z9hG4bKnashds7
Record-Route:
P-Asserted-Identity:
Privacy:
From:
To:
Call-ID:
CSeq:
Require:
Contact:
Allow:
RSeq:
Content-Type:
Content-Length:

v=
o=
s=
c=
t=
m=
b=
a=
a=
a=
a=
a=
a=
a=
a=

```

16. Reserve IP-CAN bearer for media

The originating UE sets up the bearer in accordance with the media description received SDP.

17 -24.PRACK request / 200(OK) response exchange

The PRACK request does not carry SDP as the final codec decision is already made as part of the initial offer/answer exchange.

25. UPDATE request (UE#1 to P-CSCF#1) - see example in table 5.1.2.4-9

UE#1 indicates that it can send and receive media as the necessary resources are available.

Table 5.1.2.4-9: UPDATE request (UE#1 to P-CSCF#1)

```

UPDATE <sip:[5555::eee:fff:aaa:bbb]:8805;comp=sigcomp
Via: SIP/2.0/UDP [5555::aaa:bbb:ccc:ddd]:1357;comp=sigcomp;branch=z9hG4bKnashds7
Max-Forwards: 70
Route: <sip:pcscf1.visited1.net:7531;lr;comp=sigcomp>, <sip:orig@scscf1.home1.net;lr>
From: <sip:user1_public1@home1.net>; tag=171828
To: <tel:+12125552222> tag=314159
Call-ID: cb03a0s09a2sdfglkj490333
Cseq: 129 UPDATE
Require: sec-agree, precondition
Proxy-Require: sec-agree
Security-Verify: ipsec-3gpp; q=0.1; alg= hmac-sha-1-96; ealg=aes-cbc; spi-c=98765432; spi-
s=87654321; port-c=8642; port-s=7531
Contact: <sip:user1_public1@home1.net;gr=urn:uuid:f81d4fae-7dec-11d0-a765-
00a0c91e6bf6;comp=sigcomp>
Content-Type: application/sdp
Content-Length: (...)

v=0
o=- 2987933615 2987933615 IN IP6 5555::aaa:bbb:ccc:ddd
s=-
c=IN IP6 5555::aaa:bbb:ccc:ddd
t=0 0
m=video 3400 RTP/AVP 98

```

```

b=AS:75
a=curr:qos local sendrecv
a=curr:qos remote none
a=des:qos mandatory local sendrecv
a=des:qos mandatory remote sendrecv
a=sendrecv
a=rtpmap:98 H263
a=fmtp:98 profile-level-id=0
m=audio 3456 RTP/AVP 97 96
b=AS:25.4
a=curr:qos local sendrecv
a=curr:qos remote none
a=des:qos mandatory local sendrecv
a=des:qos mandatory remote sendrecv
a=sendrecv
a=rtpmap:97 AMR
a=fmtp:97 mode-set=0,2,5,7; maxframes

```

26 UPDATE request (P-CSCF#1 to S-CSCF#1) - see example in table 5.1.2.4-10

Table 5.1.2.4-10: UPDATE request (P-CSCF#1 to S-CSCF#1)

```

UPDATE sip:[5555::eee:fff:aaa:bbb]:8805;comp=sigcomp SIP/2.0
Via: SIP/2.0/UDP pcscf1.visited1.net;branch=z9hG4bK240f34.1, SIP/2.0/UDP
    [5555::aaa:bbb:ccc:ddd]:1357;comp=sigcomp;branch=z9hG4bKnashds7
Max-Forwards: 69
P-Access-Network-Info:
P-Charging-Vector: icid-value="AyretyU0dm+6O2IrT5tAFrbHLso=023551024";
    ggsn=[5555::4b4:3c3:2d2:1e1]; pdp-sig=no; gcid=723084371; auth-token=43876559; flow-id=3
Route: <sip:scscf1.home1.net;lr>, <sip:scscf2.home2.net;lr>, <sip:pcscf2.visited2.net;lr>
From:
To:
Call-ID:
Cseq:
Require:
Content-Type:
Content-Length:

v=
o=
s=
c=
t=
m=
b=
a=
a=
a=
a=
a=
a=
a=

```

27. UPDATE request (S-CSCF#2 to P-CSCF#2) - see example in table 5.1.2.4-11

Table 5.1.2.4-11: UPDATE request (S-CSCF#2 to P-CSCF#2)

```

UPDATE sip:[5555::eee:fff:aaa:bbb]:8805;comp=sigcomp SIP/2.0
Via: SIP/2.0/UDP scscf2.home2.net;branch=z9hG4bK764z87.1, SIP/2.0/UDP
    scscf1.home1.net;branch=z9hG4bK332b23.1, SIP/2.0/UDP
    pcscf1.visited1.net;branch=z9hG4bK240f34.1, SIP/2.0/UDP
    [5555::aaa:bbb:ccc:ddd]:1357;comp=sigcomp;branch=z9hG4bKnashds7
Max-Forwards: 67
Route: <sip:pcscf2.visited2.net;lr>
From:
To:
Call-ID:
Cseq:
Require:
Contact:
Content-Type:
Content-Length:

v=

```

```

o=
s=
c=
t=
m=
b=
a=
a=
a=
a=
a=
a=

```

28. UPDATE request (P-CSCF#2 to UE#2) - see example in table 5.1.2.4-12

Table 5.1.2.4-12: UPDATE request (S-CSCF#2 to P-CSCF#2)

```

UPDATE sip:[5555::eee:fff:aaa:bbb]:8805;comp=sigcomp SIP/2.0
Via: SIP/2.0/UDP pcscf2.visited2.net:5088;comp=sigcomp;branch=z9hG4bK361k21.1, SIP/2.0/UDP
    scscf2.home2.net;branch=z9hG4bK764z87.1, SIP/2.0/UDP
    scscf1.home1.net;branch=z9hG4bK332b23.1, SIP/2.0/UDP
    pcscf1.visited1.net;branch=z9hG4bK240f34.1, SIP/2.0/UDP
    [5555::aaa:bbb:ccc:ddd]:1357;comp=sigcomp;branch=z9hG4bKnashds7
Max-Forwards: 66
From:
To:
Call-ID:
Cseq:
Require:
Content-Type:
Content-Length:

v=
o=
s=
c=
t=
m=
b=
a=
a=
a=
a=
a=
a=

```

29. 200 (OK) response (UE#2 to P-CSCF#1) - see example in table 5.1.2.4-13

UE#2 acknowledges the UPDATE request with a 200 (OK) response.

UE#2 indicates that the local resources are available.

Table 5.1.2.4-13: 200(OK) response (UE to P-CSCF)

```

SIP/2.0 200 OK
Via: SIP/2.0/UDP pcscf2.visited2.net:5088;comp=sigcomp;branch=z9hG4bK361k21.1, SIP/2.0/UDP
scscf2.home2.net;branch=z9hG4bK764z87.1, SIP/2.0/UDP
icscf2_s.home2.net;branch=z9hG4bK871y12.1, SIP/2.0/UDP
scscf1.home1.net;branch=z9hG4bK332b23.1, SIP/2.0/UDP
pcscf1.visited1.net;branch=z9hG4bK240f34.1, SIP/2.0/UDP
[5555::aaa:bbb:ccc:ddd]:1357;comp=sigcomp;branch=z9hG4bKnashds7
P-Access-Network-Info: 3GPP-UTRAN-TDD; utran-cell-id-3gpp=234151D0FCE11
From: <sip:user1_public1@home1.net>;tag=171828
To: <tel:+12125552222>;tag=314159
Call-ID: cb03a0s09a2sdfgklkj490333
Cseq: 129 UPDATE
Require: precondition
Content-Type: application/sdp
Content-Length: (...)

v=0
o=- 2987933615 2987933615 IN IP6 5555::eee:fff:aaa:bbb
s=-
c=IN IP6 5555::eee:fff:aaa:bbb
t=0 0
m=video 3400 RTP/AVP 98
b=AS:75
a=curr:gqos local sendrecv
a=curr:gqos remote sendrecv
a=des:gqos mandatory local sendrecv
a=des:gqos mandatory remote sendrecv
a=rtpmap:98 H263
a=fmtp:98 profile-level-id=0
m=audio 3456 RTP/AVP 97 96
b=AS:25.4
a=curr:gqos local sendrecv
a=curr:gqos remote sendrecv
a=des:gqos mandatory local sendrecv
a=des:gqos mandatory remote sendrecv
a=rtpmap:97 AMR
a=fmtp:97 mode-set=0,2,5,7; maxframes

```

30. 200 (OK) response (P-CSCF#2 to S-CSCF#2) - see example in table 5.1.2.4-14**Table 5.1.2.4-14: 200(OK) response (P-CSCF#2 to S-CSCF#2)**

```

SIP/2.0 200 OK
Via: SIP/2.0/UDP scscf2.home2.net;branch=z9hG4bK764z87.1, SIP/2.0/UDP
scscf1.home1.net;branch=z9hG4bK332b23.1, SIP/2.0/UDP
pcscf1.visited1.net;branch=z9hG4bK240f34.1, SIP/2.0/UDP
[5555::aaa:bbb:ccc:ddd]:1357;comp=sigcomp;branch=z9hG4bKnashds7
P-Access-Network-Info:
From:
To:
Call-ID:
CSeq:
Require:
Content-Type:
Content-Length:

v=
o=
s=
c=
t=
m=
b=
a=
a=
a=
a=
a=
a=
a=
m=
b=

```



```
a=
a=
a=
a=
a=
a=
a=
```

31. **200 (OK) response (S-CSCF#1 to P-CSCF#21)** - see example in table 5.1.2.4-15

Table 5.1.2.4-15: 200(OK) response (S-CSCF#1 to P-CSCF#1)

```
SIP/2.0 200 OK
Via: SIP/2.0/UDP pcscf1.visited1.net;branch=z9hG4bK240f34.1, SIP/2.0/UDP
    [5555::aaa:bbb:ccc:ddd]:1357;comp=sigcomp;branch=z9hG4bKnashds7
From:
To:
Call-ID:
CSeq:
Require:
Content-Type:
Content-Length:

v=
o=
s=
c=
t=
m=
b=
a=
a=
a=
a=
a=
a=
m=
b=
a=
a=
a=
a=
a=
a=
a=
a=
```

32. **200 (OK) response (P-CSCF#1 to UE#1)** - see example in table 5.1.2.4-16

Table 5.1.2.4-16: 200(OK) response (P-CSCF#1 to UE#1)

```
SIP/2.0 200 OK
Via: SIP/2.0/UDP [5555::aaa:bbb:ccc:ddd]:1357;comp=sigcomp;branch=z9hG4bKnashds7
From:
To:
Call-ID:
CSeq:
Require:
Content-Type:
Content-Length:

v=
o=
s=
c=
t=
m=
b=
a=
a=
a=
a=
a=
a=
a=
a=
a=
a=
```

```
m=  
b=  
a=  
a=  
a=  
a=  
a=  
a=  
a=  
a=
```

33 -36 . **180 (Ringing) response**

UE#2 indicates that it is ringing. The UE#2 does not use Require '100rel' as the 180 (Ringing) does not have a SDP and therefore need not to be sent reliable.

37 -40 . **200 (OK) response**

When the called party answers the UE sends a 200 (OK) response final response to the INVITE request (6) to P-CSCF, and starts the media flow(s) for this session.

40-44 **ACK request**

The calling party responds to the 200 (OK) response with an ACK request.

5.1.3 Network initiated IP-CAN bearer setup

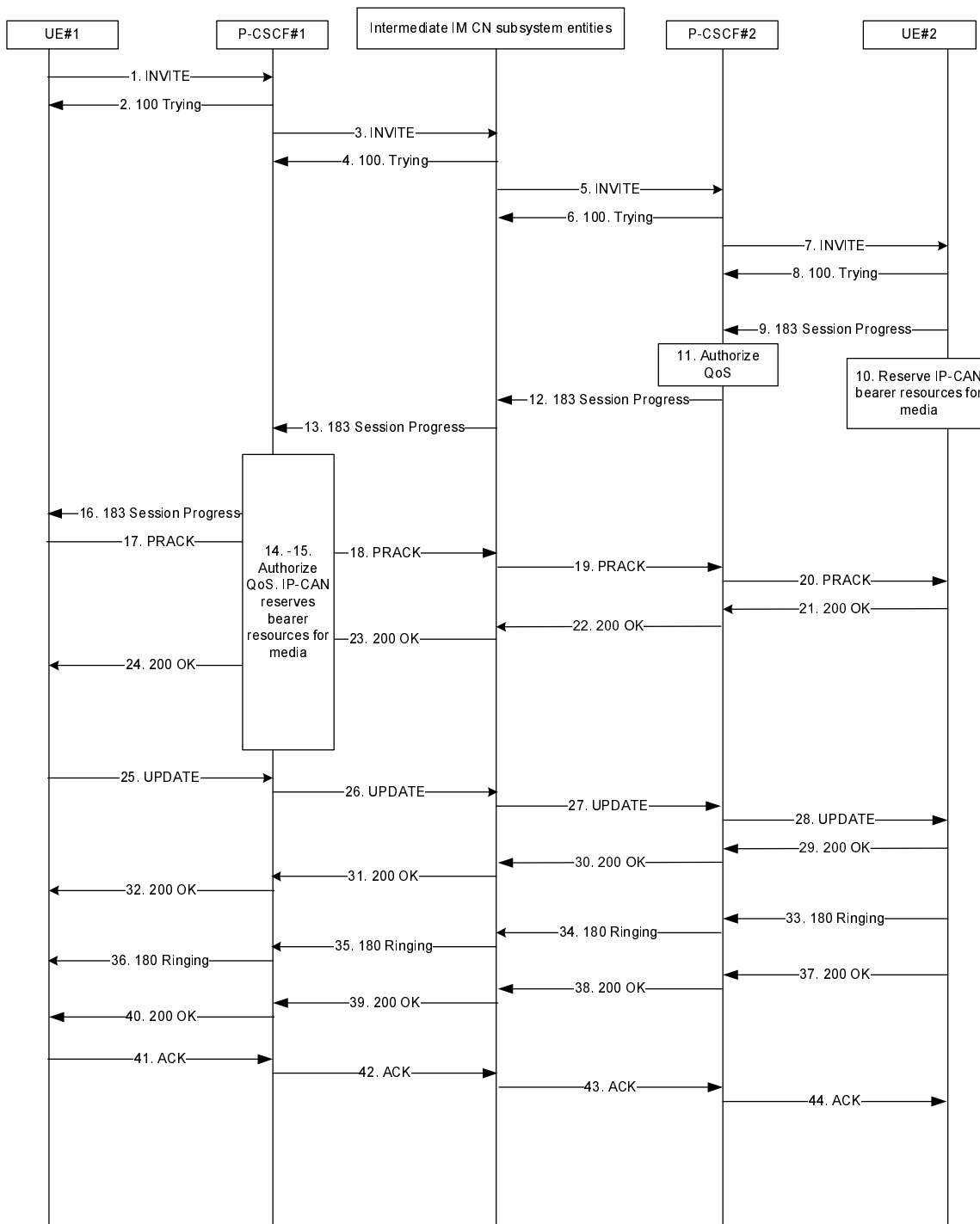

Figure 5.1.3-1: IMS session setup, resource reservation on both sides

The details of the signalling flows are as follows:

1. INVITE request (UE#1 to P-CSCF#1) see example in table 5.1.3-1

For this example, it is assumed that UE#1 is willing to establish a multimedia session comprising a video stream and an audio stream. The video stream supports two codecs, either H.263 or MPEG-4 Visual. The audio stream supports the AMR codec.

UE#1 indicates that it supports precondition and it indicates that it supports reliable provisional responses. However, it does not use the "Require" header for these capabilities.

UE#1 does not have available the resources that are necessary to transport the media.

For this example it is assumed, that signalling encryption was negotiated between UE and P-CSCF in the security mode set-up procedure during the last successful authentication. This option will only be shown in this example.

Table 5.1.3-1: INVITE request (UE#1 to P-CSCF)

```

INVITE tel:+1-212-555-2222 SIP/2.0
Via: SIP/2.0/UDP [5555::aaa:bbb:ccc:ddd]:1357;comp=sigcomp;branch=z9hG4bKnashds7
Max-Forwards: 70
Route: <sip:pcscf1.visited1.net:7531;lr;comp=sigcomp>, <sip:scscf1.home1.net;lr>
P-Preferred-Identity: "John Doe" <sip:user1_public1@home1.net>
P-Access-Network-Info: 3GPP-UTRAN-TDD; utran-cell-id-3gpp=234151D0FCE11
Privacy: none
From: <sip:user1_public1@home1.net>;tag=171828
To: <tel:+1-212-555-2222>
Call-ID: cb03a0s09a2sdfglkj490333
Cseq: 127 INVITE
Require: sec-agree
Supported: precondition, 100rel, gruu, 199
Accept: application/sdp,application/3gpp-ims+xml
Proxy-Require: sec-agree
Security-Verify: ipsec-3gpp; q=0.1; alg= hmac-sha-1-96; ealg=aes-cbc; spi-c=98765432; spi-
s=87654321; port-c=8642; port-s=7531
Contact: <sip:user1_public1@home1.net;gr=urn:uuid:f81d4fae-7dec-11d0-a765-
00a0c91e6bf6;comp=sigcomp>
Allow: INVITE, ACK, CANCEL, BYE, PRACK, UPDATE, REFER, MESSAGE
Content-Type: application/sdp
Content-Length: (...)

v=0
o=- 2987933615 2987933615 IN IP6 5555::aaa:bbb:ccc:ddd
s=-
c=IN IP6 5555::aaa:bbb:ccc:ddd
t=0 0
m=video 3400 RTP/AVP 98 99
b=AS:75
a=curr:qos local none
a=curr:qos remote none
a=des:qos mandatory local sendrecv
a=des:qos none remote sendrecv
a=inactive
a=rtpmap:98 H263
a=fmtp:98 profile-level-id=0
a=rtpmap:99 MP4V-ES
m=audio 3456 RTP/AVP 97 96
b=AS:25.4
a=curr:qos local none
a=curr:qos remote none
a=des:qos mandatory local sendrecv
a=des:qos none remote sendrecv
a=inactive
a=rtpmap:97 AMR
a=fmtp:97 mode-set=0,2,5,7; maxframes=2
a=rtpmap:96 telephone-event

```

Supported: The UE indicates support for the 'precondition' mechanism, the support for reliable provisional responses and the support for the 199 (Early Dialog Terminated) response code.

SDP The SDP contains a set of codecs supported by UE#1 and desired by the user at UE#1 for this session. As the local preconditions are not fulfilled, both media are set to "inactive".

Security-Verify: The Security-Verify contains the content of the Security-Server header as received during last successful authentication. It indicates that integrity protection and encryption are in use for this session.

2. 100 (Trying) response (P-CSCF#1 to UE#1)

The P-CSCF responds to the INVITE request with a 100 (Trying) provisional response.

5. INVITE request (P-CSCF#1 to S-CSCF#1) - see example in table 5.1.3-2

Table 5.1.3-2: INVITE request (P-CSCF#1 to S-CSCF#1)

```

INVITE tel:+1-212-555-2222 SIP/2.0
Via: SIP/2.0/UDP pcscf1.visited1.net;branch=z9hG4bK240f34.1, SIP/2.0/UDP
    [5555::aaa:bbb:ccc:ddd]:1357;comp=sigcomp;branch=z9hG4bKnashds7
Max-Forwards: 69
Route: <sip:scscf1.home1.net;lr>
Record-Route: <sip:pcscf1.visited1.net;lr>
P-Asserted-Identity: "John Doe" <sip:user1_public1@home1.net>
P-Access-Network-Info:
P-Charging-Vector: icid-value="AyretyU0dm+602IrT5tAFrbHLso=023551024"
Privacy:
From:
To:
Call-ID:
Cseq:
Supported:
Accept:
Contact:
Allow:
Content-Type:
Content-Length: (...)

v=
o=
s=
c=
t=
m=
b=
a=
a=
a=
a=
a=
a=

```

4. 100 (Trying) response (S-CSCF#1 to P-CSCF#1)

The S-CSCF responds to the INVITE request with a 100 (Trying) provisional response.

5. INVITE request (S-CSCF#2 to P-CSCF#2) see example in table 5.1.3-3

Table 5.1.3-3: INVITE request (S-CSCF#2 to P-CSCF#2)

```

INVITE sip:[5555::eee:fff:aaa:bbb]:8805;comp=sigcomp SIP/2.0
Via: SIP/2.0/UDP scscf2.home2.net;branch=z9hG4bK764z87.1, SIP/2.0/UDP
    icscf2_s.home2.net;branch=z9hG4bK871y12.1, SIP/2.0/UDP
    scscf1.home1.net;branch=z9hG4bK332b23.1, SIP/2.0/UDP
    pcscf1.visited1.net;branch=z9hG4bK240f34.1, SIP/2.0/UDP
    [5555::aaa:bbb:ccc:ddd]:1357;comp=sigcomp;branch=z9hG4bKnashds7
Max-Forwards: 66
Route: <sip:pcscf2.visited2.net;lr>
Record-Route: <sip:scscf2.home2.net;lr>, <sip:scscf1.home1.net;lr>,
    <sip:pcscf1.visited1.net;lr>
P-Asserted-Identity:
P-Charging-Vector: icid-value="AyretyU0dm+602IrT5tAFrbHLso=023551024"
Privacy:
From:
To:
Call-ID:
Cseq:
Require:
Supported:
Accept:
Contact:
Allow:
P-Called-Party-ID: <sip:user2_public1@home2.net>
Content-Type:
Content-Length: (...)

v=

```

```

o=
s=
c=
t=
m=
b=
a=
a=
a=
a=
a=
a=
a=
a=

```

6. 100 (Trying) response (P-CSCF#2 to S-CSCF#2)

The P-CSCF#2 responds to the INVITE request with a 100 (Trying) provisional response.

7. INVITE request (P-CSCF#2 to UE #2) - see example in table 5.1.3-4

P-CSCF#2 forwards the INVITE request to UE#2.

Table 5.1.3-4: INVITE request (P-CSCF#2 to UE#2)

```

INVITE sip:user2_public1@home2.net SIP/2.0
Via: SIP/2.0/UDP pcscf2.visited2.net:5088;comp=sigcomp;branch=z9hG4bK361k21.1, SIP/2.0/UDP
scscf2.home2.net;branch=z9hG4bK764z87.1, SIP/2.0/UDP
icscf2_s.home2.net;branch=z9hG4bK871y12.1, SIP/2.0/UDP
scscf1.home1.net;branch=z9hG4bK332b23.1, SIP/2.0/UDP
pcscf1.visited1.net;branch=z9hG4bK240f34.1, SIP/2.0/UDP
[5555::aaa:bbb:ccc:ddd]:1357;comp=sigcomp;branch=z9hG4bKnashds7
Max-Forwards: 65
Route: <sip:scscf2.home2.net;lr>
Record-Route: <sip:pcscf2.visited2.net:5088;lr;comp=sigcomp>, <sip:scscf2.home2.net;lr>,
<sip:scscf1.home1.net;lr>, <sip:pcscf1.visited1.net;lr>
P-Asserted-Identity:
Privacy:
From:
To:
Call-ID:
Cseq:
Require:
Supported:
Accept:
Contact:
Allow:
Content-Type:
Content-Length: (...)

v=
o=
s=
c=
t=
m=
b=
a=
a=
a=
a=
a=
a=
a=
a=

```

8. 100 (Trying) response (UE#2 to P-CSCF)

The UE responds to the INVITE request with a 100 (Trying) provisional response.

9. 183 (Session Progress) response (UE#2 to P-CSCF) - - see example in table 5.1.3-5

UE#2 determines the complete set of codecs that it is capable of supporting for this session. It determines the intersection with those appearing in the SDP in the INVITE request. UE#2 makes the final codec selection and chooses H.263 and AMR.

UE#2 responds with a 183 (Session Progress) response containing SDP back to the originator. This response is sent to P-CSCF. UE#2 uses a conf line in the SDP to request a confirmation from UE#1 when the local resources are available at UE#1.

Table 5.1.3-5: 183 (Session Progress) response (UE#2 to P-CSCF#2)

```

SIP/2.0 183 Session Progress
Via: SIP/2.0/UDP pcscf2.visited2.net:5088;comp=sigcomp;branch=z9hG4bK361k21.1, SIP/2.0/UDP
    scscf2.home2.net;branch=z9hG4bK764z87.1, SIP/2.0/UDP
    icscf2_s.home2.net;branch=z9hG4bK871y12.1, SIP/2.0/UDP
    scscf1.home1.net;branch=z9hG4bK332b23.1, SIP/2.0/UDP
    pcscf1.visited1.net;branch=z9hG4bK240f34.1, SIP/2.0/UDP
    [5555::aaa:bbb:ccc:ddd]:1357;comp=sigcomp;branch=z9hG4bKnashds7
Record-Route: <sip:pcscf2.visited2.net:5088;lr;comp=sigcomp>, <sip:scscf2.home2.net;lr>,
    <sip:scscf1.home1.net;lr>, <sip:pcscf1.visited1.net;lr>
P-Access-Network-Info: 3GPP-UTRAN-TDD; utran-cell-id-3gpp=234151D0FCE11
Privacy: none
From:
To: <tel:+1-212-555-2222>;tag=314159
Call-ID:
CSeq:
Require: 100rel, precondition
Contact: <sip:user2_public1@home2.net;gr=urn:uuid:2ad8950e-48a5-4a74-8d99-
    ad76cc7fc74;comp=sigcomp>
Allow: INVITE, ACK, CANCEL, BYE, PRACK, UPDATE, REFER, MESSAGE
RSeq: 9021
Content-Type: application/sdp
Content-Length: (...)

v=0
o=- 2987933623 2987933623 IN IP6 5555::eee:fff:aaa:bbb
s=-
c=IN IP6 5555::eee:fff:aaa:bbb
t=0 0
m=video 10001 RTP/AVP 98
b=AS:75
a=curr:qos local none
a=curr:qos remote none
a=des:qos mandatory local sendrecv
a=des:qos mandatory remote sendrecv
a=inactive
a=conf:qos remote sendrecv
a=rtpmap:98 H263
a=fmtp:98 profile-level-id=0
m=audio 6544 RTP/AVP 97 96
b=AS:25.4
a=curr:qos local none
a=curr:qos remote none
a=des:qos mandatory local sendrecv
a=des:qos mandatory remote sendrecv
a=inactive
a=conf:qos remote sendrecv
a=rtpmap:97 AMR
a=fmtp:97 mode-set=0,2,5,7; maxframes=2
a=rtpmap:96 telephone-event

```

10. Reserve IP-CAN bearer for media

The terminating UA sets up the bearer in accordance with the media description received SDP.

11. Authorize QoS

P-CSCF authorizes the resources necessary for this session.

12 (session progress) response (P-CSCF#1 to S-CSCF#2) – see example in table 5.1.3-6**Table 5.1.3-6: 183 (Session Progress) response (P-CSCF#2 to S-CSCF#2)**

```

SIP/2.0 183 Session Progress
Via: SIP/2.0/UDP scscf2.home2.net;branch=z9hG4bK764z87.1, SIP/2.0/UDP
    icscf2_s.home2.net;branch=z9hG4bK871y12.1, SIP/2.0/UDP
    scscf1.home1.net;branch=z9hG4bK332b23.1, SIP/2.0/UDP
    pcscf1.visited1.net;branch=z9hG4bK240f34.1, SIP/2.0/UDP
    [5555::aaa:bbb:ccc:ddd]:1357;comp=sigcomp;branch=z9hG4bKnashds7
Record-Route:
P-Asserted-Identity: "John Smith" <sip:user2_public1@home2.net>
P-Access-Network-Info:
P-Charging-Vector: icid-value="AyretyU0dm+602IrT5tAFrbHLso=023551024"

```



```
Privacy:  
From:  
To:  
Call-ID:  
CSeq:  
Require:  
Contact:  
Allow:  
RSeq:  
Content-Type:  
Content-Length:
```

```
v=  
o=  
s=  
c=  
t=  
m=  
b=  
a=  
a=  
a=  
a=  
a=  
a=  
a=  
a=  
m=
```

13. 183 (session progress) response (S-CSCF#1 to P-CSCF#1) – see example in table 5.1.3-7

Table 5.1.3-7: 183 (Session Progress) response (P-CSCF#2 to S-CSCF#2)

```

SIP/2.0 183 Session Progress
Via: SIP/2.0/UDP pcscf1.visited1.net;branch=z9hG4bK240f34.1, SIP/2.0/UDP
    [5555::aaa:bbb:ccc:ddd]:1357;comp=sigcomp;branch=z9hG4bKnashds7
Record-Route:
P-Asserted-Identity:
P-Access-Network-Info:
P-Charging-Vector: icid-value="AyretyU0dm+602IrT5tAFrbHLso=023551024"
Privacy:
From:
To:
Call-ID:
CSeq:
Require:
Contact:
Allow:
RSeq:
Content-Type:
Content-Length:

v=
o=
s=
c=
t=
m=
b=
a=
a=
a=
a=
a=
a=
a=
a=
a=
a=
m=

```

14-15. Authorize QoS and initiate IP-CAN bearer

P-CSCF authorises the respective IP flows and provides the QoS requirements for the resources necessary for this session.

In this case, this triggers the IP-CAN to initiate the reservation of required resources, including the initiation of an IP-CAN bearer setup or the modification of an existing one.

16. 183 (Session Progress) response (P-CSCF to UE) – see example in table 5.1.3-8

Table 5.1.3-8: 183 (Session Progress) response (P-CSCF#1 to UE#1)

```

SIP/2.0 183 Session Progress
Via: SIP/2.0/UDP [5555::aaa:bbb:ccc:ddd]:1357;comp=sigcomp;branch=z9hG4bKnashds7
Record-Route:
P-Asserted-Identity:
Privacy:
From:
To:
Call-ID:
CSeq:
Require:
Contact:
Allow:
RSeq:
Content-Type:
Content-Length:

v=
o=
s=
c=
t=
m=
b=
a=
a=
a=
a=
a=
a=
a=
a=

```

17 -24.PRACK request / 200(OK) response exchange

The PRACK request does not carry SDP as the final codec decision is already made as part of the initial offer/answer exchange.

25. UPDATE request (UE#1 to P-CSCF#1) - see example in table 5.1.3-9

UE#1 indicates, when it has received from the network an indication that an IP-CAN with necessary quality of service has been established, that it can send and receive media as the necessary resources are available.

Table 5.1.3-9: UPDATE request (UE#1 to P-CSCF#1)

```

UPDATE <sip:[5555::eee:fff:aaa:bbb]:8805;comp=sigcomp
Via: SIP/2.0/UDP [5555::aaa:bbb:ccc:ddd]:1357;comp=sigcomp;branch=z9hG4bKnashds7
Max-Forwards: 70
Route: <sip:pcscf1.visited1.net:7531;lr;comp=sigcomp>, <sip:orig@scscf1.home1.net;lr>
From: <sip:user1_public1@home1.net>; tag=171828
To: <tel:+12125552222> tag=314159
Call-ID: cb03a0s09a2sdfg1kj490333
Cseq: 129 UPDATE
Require: sec-agree, precondition
Proxy-Require: sec-agree
Security-Verify: ipsec-3gpp; q=0.1; alg= hmac-sha-1-96; ealg= aes-cbc; spi-c=98765432; spi-
s=87654321; port-c=8642; port-s=7531
Contact: <sip:user1_public1@home1.net;gr=urn:uuid:f81d4fae-7dec-11d0-a765-
00a0c91e6bf6;comp=sigcomp>
Content-Type: application/sdp
Content-Length: (...)

v=0
o=- 2987933615 2987933615 IN IP6 5555::aaa:bbb:ccc:ddd
s=-
c=IN IP6 5555::aaa:bbb:ccc:ddd
t=0 0
m=video 3400 RTP/AVP 98
b=AS:75
a=crr:qos local sendrecev
a=crr:qos remote none
a=des:qos mandatory local sendrecv

```

```

a=des:gqos mandatory remote sendrecv
a=sendrecv
a=rtpmap:98 H263
a=fmtp:98 profile-level-id=0
m=audio 3456 RTP/AVP 97 96
b=AS:25.4
a=curr:gqos local sendrecv
a=curr:gqos remote none
a=des:gqos mandatory local sendrecv
a=des:gqos mandatory remote sendrecv
a=sendrecv
a=rtpmap:97 AMR
a=fmtp:97 mode-set=0,2,5,7; maxframes

```

26 UPDATE request (P-CSCF#1 to S-CSCF#1) - see example in table 5.1.3-10

Table 5.1.3-10: UPDATE request (P-CSCF#1 to S-CSCF#1)

```

UPDATE sip:[5555::eee:fff:aaa:bbb]:8805;comp=sigcomp SIP/2.0
Via: SIP/2.0/UDP pcscf1.visited1.net;branch=z9hG4bK240f34.1, SIP/2.0/UDP
    [5555::aaa:bbb:ccc:ddd]:1357;comp=sigcomp;branch=z9hG4bKnashds7
Max-Forwards: 69
P-Access-Network-Info:
P-Charging-Vector: icid-value="AyretyU0dm+602IrT5tAFrbHLso=023551024";
    ggsn=[5555::4b4:3c3:2d2:1e1]; pdp-sig=no; gcid=723084371; auth-token=43876559; flow-id=3
Route: <sip:scscf1.home1.net;lr>, <sip:scscf2.home2.net;lr>, <sip:pcscf2.visited2.net;lr>
From:
To:
Call-ID:
Cseq:
Require:
Content-Type:
Content-Length:

v=
o=
s=
c=
t=
m=
b=
a=
a=
a=
a=
a=
a=

```

27. UPDATE request (S-CSCF#2 to P-CSCF#2) - see example in table 5.1.3-11

Table 5.1.3-11: UPDATE request (S-CSCF#2 to P-CSCF#2)

```

UPDATE sip:[5555::eee:fff:aaa:bbb]:8805;comp=sigcomp SIP/2.0
Via: SIP/2.0/UDP scscf2.home2.net;branch=z9hG4bK764z87.1, SIP/2.0/UDP
    scscf1.home1.net;branch=z9hG4bK332b23.1, SIP/2.0/UDP
    pcscf1.visited1.net;branch=z9hG4bK240f34.1, SIP/2.0/UDP
    [5555::aaa:bbb:ccc:ddd]:1357;comp=sigcomp;branch=z9hG4bKnashds7
Max-Forwards: 67
Route: <sip:pcscf2.visited2.net;lr>
From:
To:
Call-ID:
Cseq:
Require:
Contact:
Content-Type:
Content-Length:

v=
o=
s=
c=
t=

```

```

m=
b=
a=
a=
a=
a=
a=
a=

```

28. UPDATE request (P-CSCF#2 to UE#2) - see example in table 5.1.3-12

Table 5.1.3-12: UPDATE request (S-CSCF#2 to P-CSCF#2)

```

UPDATE sip:[5555::eee:fff:aaa:bbb]:8805;comp=sigcomp SIP/2.0
Via: SIP/2.0/UDP pcscf2.visited2.net:5088;comp=sigcomp;branch=z9hG4bK361k21.1, SIP/2.0/UDP
    scscf2.home2.net;branch=z9hG4bK764z87.1, SIP/2.0/UDP
    scscf1.home1.net;branch=z9hG4bK332b23.1, SIP/2.0/UDP
    pcscf1.visited1.net;branch=z9hG4bK240f34.1, SIP/2.0/UDP
    [5555::aaa:bbb:ccc:ddd]:1357;comp=sigcomp;branch=z9hG4bKnashds7
Max-Forwards: 66
From:
To:
Call-ID:
Cseq:
Require:
Content-Type:
Content-Length:

v=
o=
s=
c=
t=
m=
b=
a=
a=
a=
a=
a=
a=
a=

```

29. 200 (OK) response (UE#2 to P-CSCF#1) - see example in table 5.1.3-13

UE acknowledges the UPDATE request with a 200 (OK) response.

UE indicates that the local resources are available

Table 5.1.3-13: 200(OK) response (UE to P-CSCF)

```

SIP/2.0 200 OK
Via: SIP/2.0/UDP pcscf2.visited2.net:5088;comp=sigcomp;branch=z9hG4bK361k21.1, SIP/2.0/UDP
scscf2.home2.net;branch=z9hG4bK764z87.1, SIP/2.0/UDP
icscf2_s.home2.net;branch=z9hG4bK871y12.1, SIP/2.0/UDP
scscf1.home1.net;branch=z9hG4bK332b23.1, SIP/2.0/UDP
pcscf1.visited1.net;branch=z9hG4bK240f34.1, SIP/2.0/UDP
[5555::aaa:bbb:ccc:ddd]:1357;comp=sigcomp;branch=z9hG4bKnashds7
P-Access-Network-Info: 3GPP-UTRAN-TDD; utran-cell-id-3gpp=234151D0FCE11
From: <sip:user1_public1@home1.net>;tag=171828
To: <tel:+12125552222>;tag=314159
Call-ID: cb03a0s09a2sdfgk490333
Cseq: 129 UPDATE
Require: precondition
Content-Type: application/sdp
Content-Length: (...)

v=0
o=- 2987933615 2987933615 IN IP6 5555::eee:fff:aaa:bbb
s=-
c=IN IP6 5555::eee:fff:aaa:bbb
t=0 0
m=video 3400 RTP/AVP 98
b=AS:75
a=curr:qos local sendrecv
a=curr:qos remote sendrecv
a=des:qos mandatory local sendrecv
a=des:qos mandatory remote sendrecv
a=rtptime:98 H263
a=fmtp:98 profile-level-id=0
m=audio 3456 RTP/AVP 97 96
b=AS:25.4
a=curr:qos local sendrecv
a=curr:qos remote sendrecv
a=des:qos mandatory local sendrecv
a=des:qos mandatory remote sendrecv
a=rtptime:97 AMR
a=fmtp:97 mode-set=0,2,5,7; maxframes

```

30. 200 (OK) response (P-CSCF#2 to S-CSCF#2) - see example in table 5.1.3-14**Table 5.1.3-14: 200(OK) response (P-CSCF#2 to S-CSCF#2)**

```

SIP/2.0 200 OK
Via: SIP/2.0/UDP scscf2.home2.net;branch=z9hG4bK764z87.1, SIP/2.0/UDP
scscf1.home1.net;branch=z9hG4bK332b23.1, SIP/2.0/UDP
pcscf1.visited1.net;branch=z9hG4bK240f34.1, SIP/2.0/UDP
[5555::aaa:bbb:ccc:ddd]:1357;comp=sigcomp;branch=z9hG4bKnashds7
P-Access-Network-Info:
From:
To:
Call-ID:
CSeq:
Require:
Content-Type:
Content-Length:

v=
o=
s=
c=
t=
m=
b=
a=
a=
a=
a=
a=
a=
a=
m=
b=

```

m= b= a= a= a= a= a= a= a= a=
--

33 -36. **180 (Ringing) response**

UE#2 indicates that it is ringing. The UE#2 does not use Require '100rel' as the 180 (Ringing) response does not have a SDP and therefore need not to be sent reliable.

37 –40. **200 (OK) response**

When the called party answers the UE sends a 200 (OK) response final response to the INVITE request (6) to P-CSCF, and starts the media flow(s) for this session.

40-44. **ACK request**

The calling party responds to the 200 (OK) response with an ACK request.

5.2 Establishing a session when UE#1 does not have required resources available while UE#2 has resources already available

5.2.1 Introduction

The flow in subclause 5.2.2 shows the establishment of a session where UE#1 does not yet have the required local resources available and UE#1 needs perform to resource reservation (e.g. using a GRPS IP-CAN) while UE#2 already has the required local resources available and does not need to perform resource reservation (e.g. connected via IWLAN IP-CAN). This call flow assumes that UE#1 does not have resource ready before sending the PRACK request to the first reliable provisional response.

The flow in subclause 5.2.3 shows the establishment of a session where UE#1 needs to reserve local resources while UE#2 does not need to perform resource reservation (e.g. connected via IWLAN IP-CAN). This call flow assumes that the UE#1 has resources ready before sending the PRACK request to the first reliable provisional response.

The box "Intermediate IM CN subsystem entities" stands for the combination of I-CSCF/S-CSCF on the originating and on the terminating side. Routing of messages between those nodes is not described in the flow below.

5.2.2 Signalling flow with UPDATE request

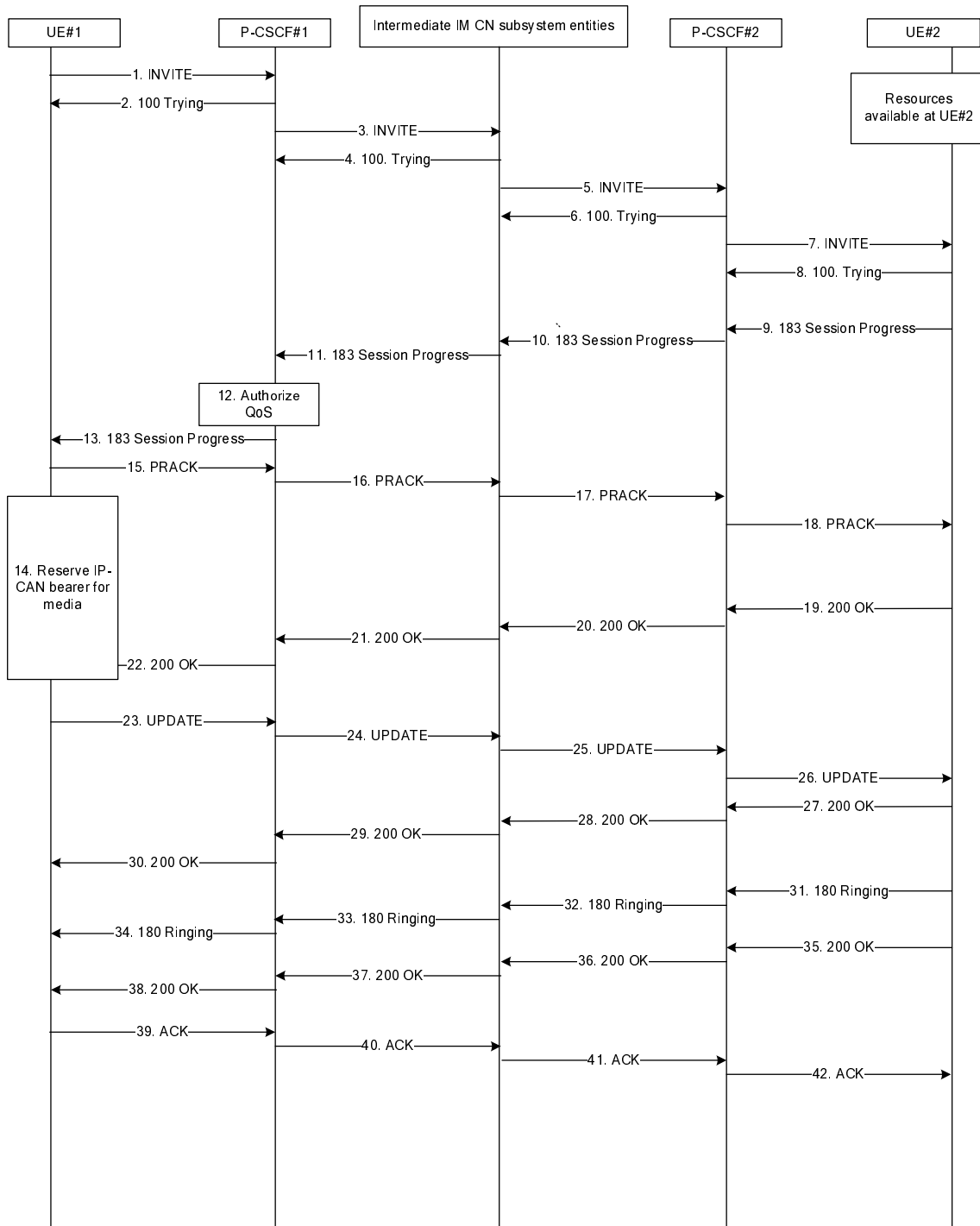

Figure 5.1-1: IMS session setup, resource reservation on originating side only

The details of the signalling flows are as follows:

1. INVITE request (UE#1 to P-CSCF#1) see example in table 5.2-1

For this example, it is assumed that UE#1 is willing to establish a multimedia session comprising a video stream and an audio stream. The video stream supports H.263 codec. The audio stream supports the AMR codec.

UE#1 indicates that it supports precondition and it indicates that it supports reliable provisional responses. However, it does not use the "Require" header for these capabilities.

UE#1 does not have available the resources that are necessary to transport the media.

Table 5.2-1: INVITE request (UE#1 to P-CSCF)

```

INVITE tel:+1-212-555-2222 SIP/2.0
Via: SIP/2.0/UDP [5555::aaa:bbb:ccc:ddd]:1357;comp=sigcomp;branch=z9hG4bKnashds7
Max-Forwards: 70
Route: <sip:pcscf1.visited1.net:7531;lr;comp=sigcomp>, <sip:scscf1.home1.net;lr>
P-Preferred-Identity: "John Doe" <sip:user1_public1@home1.net>
P-Access-Network-Info: 3GPP-UTRAN-TDD; utran-cell-id-3gpp=234151D0FCE11
Privacy: none
From: <sip:user1_public1@home1.net>;tag=171828
To: <tel:+1-212-555-2222>
Call-ID: cb03a0s09a2sdfglkj490333
Cseq: 127 INVITE
Require: sec-agree
Supported: precondition, 100rel, gruu, 199
Accept: application/sdp,application/3gpp-ims+xml
Proxy-Require: sec-agree
Security-Verify: ipsec-3gpp; q=0.1; alg=hmac-sha-1-96; spi-c=98765432; spi-s=87654321;
port-c=8642; port-s=7531
Contact: <sip:user1_public1@home1.net;gr=urn:uuid:f81d4fae-7dec-11d0-a765-
00a0c91e6bf6;comp=sigcomp>
Allow: INVITE, ACK, CANCEL, BYE, PRACK, UPDATE, REFER, MESSAGE
Content-Type: application/sdp
Content-Length: (...)

v=0
o=- 2987933615 2987933615 IN IP6 5555::aaa:bbb:ccc:ddd
s=-
c=IN IP6 5555::aaa:bbb:ccc:ddd
t=0 0
m=video 3400 RTP/AVP 98
b=AS:75
a=curr:qos local none
a=curr:qos remote none
a=des:qos mandatory local sendrecv
a=des:qos none remote sendrecv
a=inactive
a=rtpmap:98 H263
a=fmtp:98 profile-level-id=0
m=audio 3456 RTP/AVP 97 96
b=AS:25.4
a=curr:qos local none
a=curr:qos remote none
a=des:qos mandatory local sendrecv
a=des:qos none remote sendrecv
a=inactive
a=rtpmap:97 AMR
a=fmtp:97 mode-set=0,2,5,7; maxframes=2
a=rtpmap:96 telephone-event

```

Supported: The UE indicates support for the 'precondition' mechanism, the support for reliable provisional responses and the support for the 199 (Early Dialog Terminated) response code.

SDP The SDP contains a set of codecs supported by UE#1 and desired by the user at UE#1 for this session. As the local preconditions are not fulfilled, both media are set to "inactive".

2. 100 (Trying) response (P-CSCF#1 to UE#1)

The P-CSCF responds to the INVITE request with a 100 (Trying) provisional response.

3. INVITE request (P-CSCF#1 to S-CSCF#1) - see example in table 5.2-2

Table 5.2-2: INVITE request (P-CSCF#1 to S-CSCF#1)

```

INVITE tel:+1-212-555-2222 SIP/2.0
Via: SIP/2.0/UDP pcscf1.visited1.net;branch=z9hG4bK240f34.1, SIP/2.0/UDP
[5555::aaa:bbb:ccc:ddd]:1357;comp=sigcomp;branch=z9hG4bKnashds7
Max-Forwards: 69

```

```
Route: <sip:scscfl.homel.net;lr>
Record-Route: <sip:pcscfl.visited1.net;lr>
P-Asserted-Identity: "John Doe" <sip:user1_public1@homel.net>
P-Access-Network-Info:
P-Charging-Vector: icid-value="AyretyU0dm+602IrT5tAFrbHLso=023551024"
Privacy:
From:
To:
Call-ID:
Cseq:
Require:
Supported:
Accept:
Contact:
Allow:
Content-Type:
Content-Length: (...)

v=
o=
s=
c=
t=
m=
b=
a=
a=
a=
a=
a=
a=
```

4. 100 (Trying) response (S-CSCF#1 to P-CSCF#1)

The S-CSCF responds to the INVITE request with a 100 (Trying) provisional response.

5. INVITE request (S-CSCF#2 to P-CSCF#2) see example in table 5.2-3

Table 5.2-3: INVITE request (S-CSCF#2 to P-CSCF#2)

```

INVITE sip:[5555::eee:fff:aaa:bbb]:8805;comp=sigcomp SIP/2.0
Via: SIP/2.0/UDP scscf2.home2.net;branch=z9hG4bK764z87.1, SIP/2.0/UDP
    icscf2_s.home2.net;branch=z9hG4bK871y12.1, SIP/2.0/UDP
    scscf1.home1.net;branch=z9hG4bK332b23.1, SIP/2.0/UDP
    pcscf1.visited1.net;branch=z9hG4bK240f34.1, SIP/2.0/UDP
    [5555::aaa:bbb:ccc:ddd]:1357;comp=sigcomp;branch=z9hG4bKnashds7
Max-Forwards: 66
Route: <sip:pcscf2.visited2.net;lr>
Record-Route: <sip:scscf2.home2.net;lr>, <sip:scscf1.home1.net;lr>,
    <sip:pcscf1.visited1.net;lr>
P-Asserted-Identity:
P-Charging-Vector: icid-value="AyretyU0dm+602Irt5tAFrbHLso=023551024"
Privacy:
From:
To:
Call-ID:
Cseq:
Require:
Supported:
Accept:
Contact:
Allow:
P-Called-Party-ID: <sip:user2_public1@home2.net>
Content-Type:
Content-Length: (...)

v=
o=
s=
c=
t=
m=
b=
a=
a=
a=
a=
a=
a=
a=
a=

```

6. **100 (Trying) response (P-CSCF#2 to S-CSCF#2)**

The P-CSCF#2 responds to the INVITE request with a 100 (Trying) provisional response.

7. **INVITE request (P-CSCF#2 to UE #2) - see example in table 5.2-4**

P-CSCF#2 forwards the INVITE request to UE#2.

Table 5.2-4: INVITE request (P-CSCF#2 to UE#2)

```

INVITE sip:user2_public1@home2.net SIP/2.0
Via: SIP/2.0/UDP pcscf2.visited2.net:5088;comp=sigcomp;branch=z9hG4bK361k21.1, SIP/2.0/UDP
    scscf2.home2.net;branch=z9hG4bK764z87.1, SIP/2.0/UDP
    icscf2_s.home2.net;branch=z9hG4bK871y12.1, SIP/2.0/UDP
    scscf1.home1.net;branch=z9hG4bK332b23.1, SIP/2.0/UDP
    pcscf1.visited1.net;branch=z9hG4bK240f34.1, SIP/2.0/UDP
    [5555::aaa:bbb:ccc:ddd]:1357;comp=sigcomp;branch=z9hG4bKnashds7
Max-Forwards: 65
Route: <sip:scscf2.home2.net;lr>
Record-Route: <sip:pcscf2.visited2.net:5088;lr;comp=sigcomp>, <sip:scscf2.home2.net;lr>,
    <sip:scscf1.home1.net;lr>, <sip:pcscf1.visited1.net;lr>
P-Asserted-Identity:
Privacy:
From:
To:
Call-ID:
Cseq:
Require:
Supported:
Accept:
Contact:
Allow:
Content-Type:
Content-Length: (...)

v=
o=
s=
c=
t=
m=
b=
a=
a=
a=
a=
a=
a=
a=

```

8. 100 (Trying) response (UE#2 to P-CSCF)

The UE responds to the INVITE request with a 100 (Trying) provisional response.

9. 183 (Session Progress) response (UE#2 to P-CSCF) - - see example in table 5.2-5

UE#2 determines the complete set of codecs that it is capable of supporting for this session. It determines the intersection with those appearing in the SDP in the INVITE request. UE#2 supports both offered media streams

UE#2 responds with a 183 (Session Progress) response containing SDP back to the originator. This response is sent to P-CSCF. UE#2 uses a conf line in the SDP to request a confirmation from UE#1 when the local resources are available at UE#1.

UE#2 has all necessary resources available and indicates that in the SDP

Table 5.2-5: 183 (Session Progress) response (UE#2 to P-CSCF#2)

```

SIP/2.0 183 Session Progress
Via: SIP/2.0/UDP pcscf2.visited2.net:5088;comp=sigcomp;branch=z9hG4bK361k21.1, SIP/2.0/UDP
scscf2.home2.net;branch=z9hG4bK764z87.1, SIP/2.0/UDP
icscf2_s.home2.net;branch=z9hG4bK871y12.1, SIP/2.0/UDP
scscf1.home1.net;branch=z9hG4bK332b23.1, SIP/2.0/UDP
pcscf1.visited1.net;branch=z9hG4bK240f34.1, SIP/2.0/UDP
[5555::aaa:bbb:ccc:ddd]:1357;comp=sigcomp;branch=z9hG4bKnashds7
Record-Route: <sip:pcscf2.visited2.net:5088;lr;comp=sigcomp>, <sip:scscf2.home2.net;lr>,
<sip:scscf1.home1.net;lr>, <sip:pcscf1.visited1.net;lr>
P-Access-Network-Info: IEEE-802.11a
Privacy: none
From:
To: <tel:+1-212-555-2222>;tag=314159
Call-ID:
CSeq:
Require: 100rel, precondition
Contact: <sip:user2_public1@home2.net:gr=urn:uuid:2ad8950e-48a5-4a74-8d99-
ad76cc7fc74;comp=sigcomp>
Allow: INVITE, ACK, CANCEL, BYE, PRACK, UPDATE, REFER, MESSAGE
RSeq: 9021
Content-Type: application/sdp
Content-Length: (...)

v=0
o=- 2987933623 2987933623 IN IP6 5555::eee:fff:aaa:bbb
s=-
c=IN IP6 5555::eee:fff:aaa:bbb
t=0 0
m=video 10001 RTP/AVP 98
b=AS:75
a=curr:qos local sendrecv
a=curr:qos remote none
a=des:qos mandatory local sendrecv
a=des:qos mandatory remote sendrecv
a=inactive
a=conf:qos remote sendrecv
a=rtpmap:98 H263
a=fmtp:98 profile-level-id=0
m=audio 6544 RTP/AVP 97 96
b=AS:25.4
a=curr:qos local sendrecv
a=curr:qos remote none
a=des:qos mandatory local sendrecv
a=des:qos mandatory remote sendrecv
a=inactive
a=conf:qos remote sendrecv
a=rtpmap:97 AMR
a=fmtp:97 mode-set=0,2,5,7; maxframes=2
a=rtpmap:96 telephone-event

```

10. 183 (session progress) response (P-CSCF#2 to S-CSCF#2) – see example in table 5.2-6

Table 5.2-6: 183 (Session Progress) response (P-CSCF#2 to S-CSCF#2)

```

SIP/2.0 183 Session Progress
Via: SIP/2.0/UDP scscf2.home2.net;branch=z9hG4bK764z87.1, SIP/2.0/UDP
    icscf2_s.home2.net;branch=z9hG4bK871y12.1, SIP/2.0/UDP
    scscf1.home1.net;branch=z9hG4bK332b23.1, SIP/2.0/UDP
    pcscf1.visited1.net;branch=z9hG4bK240f34.1, SIP/2.0/UDP
    [5555::aaa:bbb:ccc:ddd]:1357;comp=sigcomp;branch=z9hG4bKnashds7
Record-Route:
P-Asserted-Identity: "John Smith" <sip:user2_public1@home2.net>
P-Access-Network-Info:
P-Charging-Vector: icid-value="AyretyU0dm+602IrT5tAFrbHLso=023551024"
Privacy:
From:
To:
Call-ID:
CSeq:
Require:
Contact:
Allow:
RSeq:
Content-Type:
Content-Length:

v=
o=
s=
c=
t=
m=
b=
a=
a=
a=
a=
a=
a=
a=
a=
a=

```

11. 183 (session progress) response (S-CSCF#1 to P-CSCF#1) – see example in table 5.2-7

Table 5.2-7: 183 (Session Progress) response (P-CSCF#2 to S-CSCF#2)

```
SIP/2.0 183 Session Progress
Via: SIP/2.0/UDP pcscf1.visited1.net;branch=z9hG4bK240f34.1, SIP/2.0/UDP
    [5555::aaa:bbb:ccc:ddd]:1357;comp=sigcomp;branch=z9hG4bKnashds7
Record-Route:
P-Asserted-Identity:
P-Access-Network-Info:
P-Charging-Vector: icid-value="AyretyU0dm+602IrT5tAFrbHLso=023551024"
Privacy:
From:
To:
Call-ID:
CSeq:
Require:
Contact:
Allow:
RSeq:
Content-Type:
Content-Length:

v=
o=
s=
c=
t=
m=
b=
a=
a=
a=
a=
a=
a=
a=
a=
a=
```

12. Authorize QoS

P-CSCF authorizes the resources necessary for this session.

13. 183 (Session Progress) response (P-CSCF to UE) – see example in table 5.2-8

Table 5.2-8: 183 (Session Progress) response (P-CSCF#1 to UE#1)

```

SIP/2.0 183 Session Progress
Via: SIP/2.0/UDP [5555::aaa:bbb:ccc:ddd]:1357;comp=sigcomp;branch=z9hG4bKnashds7
Record-Route:
P-Asserted-Identity:
Privacy:
From:
To:
Call-ID:
CSeq:
Require:
Contact:
Allow:
RSeq:
Content-Type:
Content-Length:

v=
o=
s=
c=
t=
m=
b=
a=
a=
a=
a=
a=
a=
a=
a=

```

14. Reserve IP-CAN bearer for media

The originating UE sets up the bearer in accordance with the media description received SDP.

15 -22.PRACK request / 200(OK) response exchange

The PRACK request does not carry SDP as the final codec decision is already made as part of the initial offer/answer exchange.

23. UPDATE request (UE#1 to P-CSCF#1) - see example in table 5.2-9

UE#1 indicates that it can send and receive media as the necessary resources are available.

Table 5.2-9: UPDATE request (UE#1 to P-CSCF#1)

```

UPDATE <sip:[5555::eee:fff:aaa:bbb]:8805;comp=sigcomp
Via: SIP/2.0/UDP [5555::aaa:bbb:ccc:ddd]:1357;comp=sigcomp;branch=z9hG4bKnashds7
Max-Forwards: 70
Route: <sip:pcscf1.visited1.net:7531;lr;comp=sigcomp>, <sip:orig@scscf1.home1.net;lr>
From: <sip:user1_public1@home1.net>; tag=171828
To: <tel:+12125552222> tag=314159
Call-ID: cb03a0s09a2sdfg1kj490333
Cseq: 129 UPDATE
Require: sec-agree,precondition
Proxy-Require: sec-agree
Security-Verify: ipsec-3gpp; q=0.1; alg=hmac-sha-1-96; spi=87654321; port1=7531
Contact: <sip:user1_public1@home1.net;gr=urn:uuid:f81d4fae-7dec-11d0-a765-
00a0c91e6bf6;comp=sigcomp>
Content-Type: application/sdp
Content-Length: (...)

v=0
o=- 2987933615 2987933615 IN IP6 5555::aaa:bbb:ccc:ddd
s=-
c=IN IP6 5555::aaa:bbb:ccc:ddd
t=0 0
m=video 3400 RTP/AVP 98
b=AS:75

```

```

a=curr:qos local sendrecv
a=curr:qos remote sendrecv
a=des:qos mandatory local sendrecv
a=des:qos mandatory remote sendrecv
a=sendrecv
a=rtpmap:98 H263
a=fmtp:98 profile-level-id=0
m=audio 3456 RTP/AVP 97 96
b=AS:25.4
a=curr:qos local sendrecv
a=curr:qos remote sendrecv
a=des:qos mandatory local sendrecv
a=des:qos mandatory remote sendrecv
a=sendrecv
a=rtpmap:97 AMR
a=fmtp:97 mode-set=0,2,5,7; maxframes

```

24. UPDATE request (P-CSCF#1 to S-CSCF#1) - see example in table 5.2-10

Table 5.2-10: UPDATE request (P-CSCF#1 to S-CSCF#1)

```

UPDATE sip:[5555::eee:fff:aaa:bbb]:8805;comp=sigcomp SIP/2.0
Via: SIP/2.0/UDP pcscf1.visited1.net;branch=z9hG4bK240f34.1, SIP/2.0/UDP
    [5555::aaa:bbb:ccc:ddd]:1357;comp=sigcomp;branch=z9hG4bKnashds7
Max-Forwards: 69
P-Access-Network-Info:
P-Charging-Vector: icid-value="AyretyU0dm+602IrT5tAFrbHLso=023551024";
    ggsn=[5555::4b4:3c3:2d2:1e1]; pdp-sig=no; gcid=723084371; auth-token=43876559; flow-id=3
Route: <sip:scscf1.home1.net;lr>, <sip:scscf2.home2.net;lr>, <sip:pcscf2.visited2.net;lr>
From:
To:
Call-ID:
Cseq:
Require:
Content-Type:
Content-Length:

v=
o=
s=
c=
t=
m=
b=
a=
a=
a=
a=
a=
a=
a=

```

25. UPDATE request (S-CSCF#2 to P-CSCF#2) - see example in table 5.2-11

Table 5.2-11: UPDATE request (S-CSCF#2 to P-CSCF#2)

```

UPDATE sip:[5555::eee:fff:aaa:bbb]:8805;comp=sigcomp SIP/2.0
Via: SIP/2.0/UDP scscf2.home2.net;branch=z9hG4bK764z87.1, SIP/2.0/UDP
    scscf1.home1.net;branch=z9hG4bK332b23.1, SIP/2.0/UDP
    pcscf1.visited1.net;branch=z9hG4bK240f34.1, SIP/2.0/UDP
    [5555::aaa:bbb:ccc:ddd]:1357;comp=sigcomp;branch=z9hG4bKnashds7
Max-Forwards: 67
Route: <sip:pcscf2.visited2.net;lr>
From:
To:
Call-ID:
Cseq:
Require:
Contact:
Content-Type:
Content-Length:

v=
o=

```

```
s=
c=
t=
m=
b=
a=
a=
a=
a=
a=
a=
```

26. UPDATE request (P-CSCF#2 to UE#2) - see example in table 5.2-12

Table 5.2-12: UPDATE request (S-CSCF#2 to P-CSCF#2)

```
UPDATE sip:[5555::eee:fff:aaa:bbb]:8805;comp=sigcomp SIP/2.0
Via: SIP/2.0/UDP pcscf2.visited2.net:5088;comp=sigcomp;branch=z9hG4bK361k21.1, SIP/2.0/UDP
    scscf2.home2.net;branch=z9hG4bK764z87.1, SIP/2.0/UDP
    scscf1.home1.net;branch=z9hG4bK332b23.1, SIP/2.0/UDP
    pcscf1.visited1.net;branch=z9hG4bK240f34.1, SIP/2.0/UDP
    [5555::aaa:bbb:ccc:ddd]:1357;comp=sigcomp;branch=z9hG4bKnashds7
Max-Forwards: 66
From:
To:
Call-ID:
Cseq:
Require:
Contact:
Content-Type:
Content-Length:

v=
o=
s=
c=
t=
m=
b=
a=
a=
a=
a=
a=
a=
a=
```

27. 200 (OK) response (UE#1 to P-CSCF#1) - see example in table 5.2-13

UE acknowledges the UPDATE request with a 200 (OK) response.

UE indicates that the local resources are available

Table 5.2-13: 200(OK) response (UE to P-CSCF)

```

SIP/2.0 200 OK
Via: SIP/2.0/UDP pcscf2.visited2.net:5088;comp=sigcomp;branch=z9hG4bK361k21.1, SIP/2.0/UDP
scscf2.home2.net;branch=z9hG4bK764z87.1, SIP/2.0/UDP
icscf2_s.home2.net;branch=z9hG4bK871y12.1, SIP/2.0/UDP
scscf1.home1.net;branch=z9hG4bK332b23.1, SIP/2.0/UDP
pcscf1.visited1.net;branch=z9hG4bK240f34.1, SIP/2.0/UDP
[5555::aaa:bbb:ccc:ddd]:1357;comp=sigcomp;branch=z9hG4bKnashds7
P-Access-Network-Info: 3GPP-UTRAN-TDD; utran-cell-id-3gpp=234151D0FCE11
From: <sip:user1_public1@home1.net>; tag=171828
To: <tel:+12125552222>;tag=314159
Call-ID: cb03a0s09a2sdfgklj490333
Cseq: 129 UPDATE
Require: precondition
Content-Type: application/sdp
Content-Length: (...)

v=0
o=- 2987933615 2987933615 IN IP6 5555::eee:fff:aaa:bbb
s=-
c=IN IP6 5555:: eee:fff:aaa:bbb
t=0 0
m=video 3400 RTP/AVP 98
b=AS:75
a=curr:qos local sendrecv
a=curr:qos remote sendrecv
a=des:qos mandatory local sendrecv
a=des:qos mandatory remote sendrecv
a=sendrecv
a=rtpmap:98 H263
a=fmtp:98 profile-level-id=0
m=audio 3456 RTP/AVP 97 96
b=AS:25.4
a=curr:qos local sendrecv
a=curr:qos remote sendrecv
a=des:qos mandatory local sendrecv
a=des:qos mandatory remote sendrecv
a=sendrecv
a=rtpmap:97 AMR
a=fmtp:97 mode-set=0,2,5,7; maxframes

```

28. **200 (OK) response (P-CSCF#2 to S-CSCF#2) - see example in table 5.2-14**

Table 5.2-14: 200(OK) response (P-CSCF#2 to S-CSCF#2)

```
SIP/2.0 200 OK
Via: SIP/2.0/UDP scscf2.home2.net;branch=z9hG4bK764z87.1, SIP/2.0/UDP
    scscf1.home1.net;branch=z9hG4bK332b23.1, SIP/2.0/UDP
    pcscf1.visited1.net;branch=z9hG4bK240f34.1, SIP/2.0/UDP
    [5555::aaa:bbb:ccc:ddd]:1357;comp=sigcomp;branch=z9hG4bKnashds7
P-Access-Network-Info:
From:
To:
Call-ID:
CSeq:
Require:
Content-Type:
Content-Length:

v=
o=
s=
c=
t=
m=
b=
a=
a=
a=
a=
a=
a=
```

29. **200 (OK) response (S-CSCF#1 to P-CSCF#21)** - see example in table 5.2-15

Table 5.2-15: 200(OK) response (S-CSCF#1 to P-CSCF#1)

```
SIP/2.0 200 OK
Via: SIP/2.0/UDP pcscf1.visited1.net;branch=z9hG4bK240f34.1, SIP/2.0/UDP
    [5555::aaa:bbb:ccc:ddd]:1357;comp=sigcomp;branch=z9hG4bKnashds7
From:
To:
Call-ID:
CSeq:
Require:
Content-Type:
Content-Length:

v=
o=
s=
c=
t=
m=
b=
a=
a=
a=
a=
a=
a=
a=
```

30. **200 (OK) response (P-CSCF#1 to UE#1)** - see example in table 5.2-16

Table 5.2-16: 200(OK) response (P-CSCF#1 to UE#1)

```
SIP/2.0 200 OK
Via: SIP/2.0/UDP [5555::aaa:bbb:ccc:ddd]:1357;comp=sigcomp;branch=z9hG4bKnashds7
From:
To:
Call-ID:
CSeq:
Require:
Content-Type:
Content-Length:

v=
o=
s=
c=
t=
m=
b=
a=
a=
a=
a=
a=
```

31 -34 . 180 (Ringing) response

UE#2 indicates that it is ringing. The UE#2 does not use Require '100rel' as the 180 (Ringing) response does not have a SDP and therefore need not to be sent reliable.

35 –38 .200 (OK) response

When the called party answers the UE sends a 200 (OK) response final response to the INVITE request (6) to P-CSCF, and starts the media flow(s) for this session.

39-42 ACK request

The calling party responds to the 200 (OK) response with an ACK request.

5.2.3 Signalling flow without UPDATE request

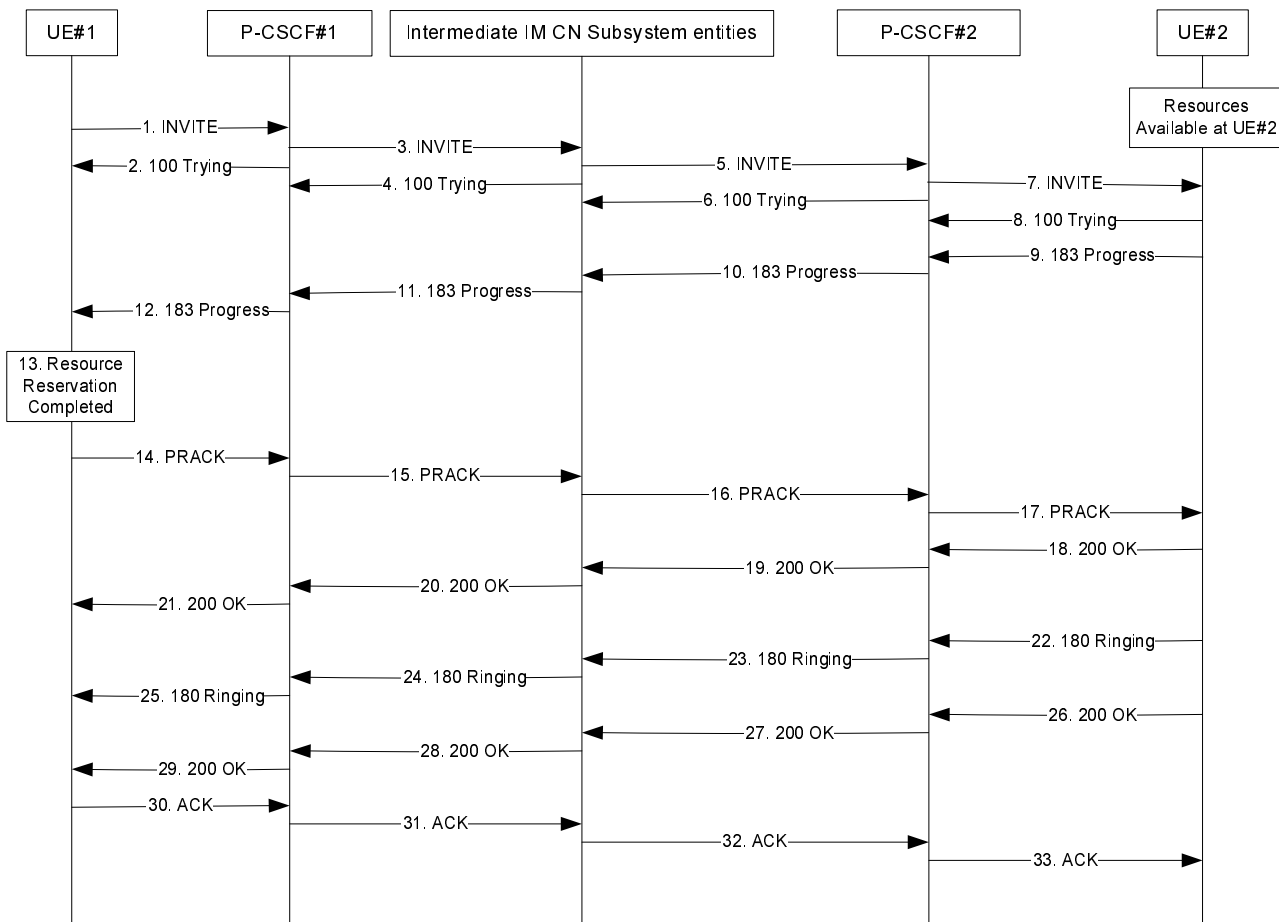

Figure 5.2.3-1: IMS session setup, resource reservation on originating side only

The details of the signalling flows are as follows:

1. INVITE request (UE#1 to P-CSCF#1) see example in table 5.2.3-1

For this example, it is assumed that UE#1 is willing to establish a multimedia session comprising a video stream and an audio stream. The video stream supports H.263 codec. The audio stream supports the EVRC codec.

UE#1 indicates that it supports precondition and it indicates that it supports reliable provisional responses. However, it does not use the "Require" header for these capabilities.

UE#1 does not have available the resources that are necessary to transport the media.

Table 5.2.3-1: INVITE request (UE#1 to P-CSCF)

```

INVITE tel:+1-212-555-2222 SIP/2.0
Via: SIP/2.0/UDP [5555::aaa:bbb:ccc:ddd]:1357;comp=sigcomp;branch=z9hG4bKnashds7
Max-Forwards: 70
Route: <sip:pcscf1.visited1.net:7531;lr;comp=sigcomp>, <sip:scscf1.home1.net;lr>
P-Preferred-Identity: "John Doe" <sip:user1_public1@home1.net>
P-Access-Network-Info: 3GPP2-1X-HRPD; ci-3gpp2=1234123412341234123412341234123411
Privacy: none
From: <sip:user1_public1@home1.net>;tag=171828
To: <tel:+1-212-555-2222>
Call-ID: cb03a0s09a2sdfg1kj490333
Cseq: 127 INVITE
    
```

```

Require: sec-agree
Supported: precondition, 100rel, gruu, 199
Proxy-Require: sec-agree
Accept: application/sdp,application/3gpp-ims+xml
Security-Verify: ipsec-3gpp; q=0.1; alg=hmac-sha-1-96; spi-c=98765432; spi-s=87654321;
port-c=8642; port-s=7531
Contact: <sip:user1_public1@home1.net;gr=urn:uuid:f81d4fae-7dec-11d0-a765-
00a0c91e6bf6;comp=sigcomp>
Allow: INVITE, ACK, CANCEL, BYE, PRACK, UPDATE, REFER, MESSAGE
Content-Type: application/sdp
Content-Length: (...)

v=0
o=- 2987933615 2987933615 IN IP6 5555::aaa:bbb:ccc:ddd
s=-
c=IN IP6 5555::aaa:bbb:ccc:ddd
t=0 0
m=video 3400 RTP/AVP 98
b=AS:75
a=curr:qos local none
a=curr:qos remote none
a=des:qos mandatory local sendrecv
a=des:qos none remote sendrecv
a=inactive
a=rtpmap:98 H263
a=fmtp:98 profile-level-id=0
m=audio 3456 RTP/AVP 97 96
b=AS:25.4
a=curr:qos local none
a=curr:qos remote none
a=des:qos mandatory local sendrecv
a=des:qos none remote sendrecv
a=inactive
a=rtpmap:97 EVRC/8000
a=ptime:20
a=rtpmap:96 telephone-event

```

Supported: The UE indicates support for the 'precondition' mechanism, the support for reliable provisional responses and the support for the 199 (Early Dialog Terminated) response code.

SDP The SDP contains a set of codecs supported by UE#1 and desired by the user at UE#1 for this session. As the local preconditions are not fulfilled, both media are set to "inactive".

2. 100 (Trying) response (P-CSCF#1 to UE#1)

The P-CSCF responds to the INVITE request with a 100 (Trying) provisional response.

3. INVITE request (P-CSCF#1 to S-CSCF#1) - see example in table 5.2.3-2

Table 5.2.3-2: INVITE request (P-CSCF#1 to S-CSCF#1)

```

INVITE tel:+1-212-555-2222 SIP/2.0
Via: SIP/2.0/UDP pcscf1.visited1.net;branch=z9hG4bK240f34.1, SIP/2.0/UDP
[5555::aaa:bbb:ccc:ddd]:1357;comp=sigcomp;branch=z9hG4bKnashds7
Max-Forwards: 69
Route: <sip:scscf1.home1.net;lr>
Record-Route: <sip:pcscf1.visited1.net;lr>
P-Asserted-Identity: "John Doe" <sip:user1_public1@home1.net>
P-Access-Network-Info:
P-Charging-Vector: icid-value="AyretyU0dm+602Irt5tAFrbHLso=023551024"
Privacy:
From:
To:
Call-ID:
Cseq:
Supported:
Accept:
Contact:
Allow:
Content-Type:
Content-Length: (...)

v=
o=

```



```
s=
c=
t=
m=
b=
a=
a=
a=
a=
a=
a=
```

4. 100 (Trying) response (S-CSCF#1 to P-CSCF#1)

The S-CSCF responds to the INVITE request with a 100 (Trying) provisional response.

5. INVITE request (S-CSCF#2 to P-CSCF#2) see example in table 5.2.3-3

Table 5.2.3-3: INVITE request (S-CSCF#2 to P-CSCF#2)

```
INVITE sip:[5555::eee:fff:aaa:bbb]:8805;comp=sigcomp SIP/2.0
Via: SIP/2.0/UDP scscf2.home2.net;branch=z9hG4bK764z87.1, SIP/2.0/UDP
    icscf2_s.home2.net;branch=z9hG4bK871y12.1, SIP/2.0/UDP
    scscf1.home1.net;branch=z9hG4bK332b23.1, SIP/2.0/UDP
    pcscf1.visited1.net;branch=z9hG4bK240f34.1, SIP/2.0/UDP
    [5555::aaa:bbb:ccc:ddd]:1357;comp=sigcomp;branch=z9hG4bKnashds7
Max-Forwards: 66
Route: <sip:pcscf2.visited2.net;lr>
Record-Route: <sip:scscf2.home2.net;lr>, <sip:scscf1.home1.net;lr>,
    <sip:pcscf1.visited1.net;lr>
P-Asserted-Identity:
P-Charging-Vector: icid-value="AyretyU0dm+602IrT5tAFrbHLso=023551024"
Privacy:
From:
To:
Call-ID:
Cseq:
Require:
Supported:
Accept:
Contact:
Allow:
P-Called-Party-ID: <sip:user2_public1@home2.net>
Content-Type:
Content-Length: (...)

v=
o=
s=
c=
t=
m=
b=
a=
a=
a=
a=
a=
a=
a=
a=
```

6. 100 (Trying) response (P-CSCF#2 to S-CSCF#2)

The P-CSCF#2 responds to the INVITE request with a 100 (Trying) provisional response.

7. INVITE request (P-CSCF#2 to UE #2) - see example in table 5.2.3-4

P-CSCF#2 forwards the INVITE request to UE#2.

Table 5.2.3-4: INVITE request (P-CSCF#2 to UE#2)

```

INVITE sip:user2_public1@home2.net SIP/2.0
Via: SIP/2.0/UDP pcscf2.visited2.net:5088;comp=sigcomp;branch=z9hG4bK361k21.1, SIP/2.0/UDP
    scscf2.home2.net;branch=z9hG4bK764z87.1, SIP/2.0/UDP
    icscf2_s.home2.net;branch=z9hG4bK871y12.1, SIP/2.0/UDP
    scscf1.home1.net;branch=z9hG4bK332b23.1, SIP/2.0/UDP
    pcscf1.visited1.net;branch=z9hG4bK240f34.1, SIP/2.0/UDP
    [5555::aaa:bbb:ccc:ddd]:1357;comp=sigcomp;branch=z9hG4bKnashds7
Max-Forwards: 65
Route: <sip:scscf2.home2.net;lr>
Record-Route: <sip:pcscf2.visited2.net:5088;lr;comp=sigcomp>, <sip:scscf2.home2.net;lr>,
    <sip:scscf1.home1.net;lr>, <sip:pcscf1.visited1.net;lr>
P-Asserted-Identity:
Privacy:
From:
To:
Call-ID:
Cseq:
Require:
Supported:
Accept:
Contact:
Allow:
Content-Type:
Content-Length: (...)

v=
o=
s=
c=
t=
m=
b=
a=
a=
a=
a=
a=
a=
a=

```

8. 100 (Trying) response (UE#2 to P-CSCF#2)

The UE responds to the INVITE request with a 100 (Trying) provisional response.

9. 183 (Session Progress) response (UE#2 to P-CSCF#2) - - see example in table 5.2.3-5

UE#2 determines the complete set of codecs that it is capable of supporting for this session. It determines the intersection with those appearing in the SDP in the INVITE request. UE#2 supports both offered media streams

UE#2 responds with a 183 (Session Progress) response containing SDP back to the originator. This response is sent to P-CSCF. UE#2 uses a conf line in the SDP to request a confirmation from UE#1 when the local resources are available at UE#1.

UE#2 has all necessary resources available and indicates that in the SDP

Table 5.2.3-5: 183 (Session Progress) response (UE#2 to P-CSCF#2)

```

SIP/2.0 183 Session Progress
Via: SIP/2.0/UDP pcscf2.visited2.net:5088;comp=sigcomp;branch=z9hG4bK361k21.1, SIP/2.0/UDP
scscf2.home2.net;branch=z9hG4bK764z87.1, SIP/2.0/UDP
icscf2_s.home2.net;branch=z9hG4bK871y12.1, SIP/2.0/UDP
scscf1.home1.net;branch=z9hG4bK332b23.1, SIP/2.0/UDP
pcscf1.visited1.net;branch=z9hG4bK240f34.1, SIP/2.0/UDP
[5555::aaa:bbb:ccc:ddd]:1357;comp=sigcomp;branch=z9hG4bKnashds7
Record-Route: <sip:pcscf2.visited2.net:5088;lr;comp=sigcomp>, <sip:scscf2.home2.net;lr>,
<sip:scscf1.home1.net;lr>, <sip:pcscf1.visited1.net;lr>
P-Access-Network-Info: IEEE-802.11a
Privacy: none
From:
To: <tel:+1-212-555-2222>;tag=314159
Call-ID:
CSeq:
Require: 100rel, precondition
Contact: <sip:user2_public1@home2.net:gr=urn:uuid:2ad8950e-48a5-4a74-8d99-
ad76cc7fc74;comp=sigcomp>
Allow: INVITE, ACK, CANCEL, BYE, PRACK, UPDATE, REFER, MESSAGE
RSeq: 9021
Content-Type: application/sdp
Content-Length: (...)

v=0
o=- 2987933623 2987933623 IN IP6 5555::eee:fff:aaa:bbb
s=-
c=IN IP6 5555::eee:fff:aaa:bbb
t=0 0
m=video 10001 RTP/AVP 98
b=AS:75
a=curr:qos local sendrecv
a=curr:qos remote none
a=des:qos mandatory local sendrecv
a=des:qos mandatory remote sendrecv
a=inactive
a=conf:qos remote sendrecv
a=rtpmap:98 H263
a=fmtp:98 profile-level-id=0
m=audio 6544 RTP/AVP 97 96
b=AS:25.4
a=curr:qos local sendrecv
a=curr:qos remote none
a=des:qos mandatory local sendrecv
a=des:qos mandatory remote sendrecv
a=inactive
a=conf:qos remote sendrecv
a=rtpmap:97 EVRC/8000
a=ptime:20
a=rtpmap:96 telephone-event

```

10. 183 (session progress) response (P-CSCF#2 to S-CSCF#2) – see example in table 5.2.3-6

Table 5.2.3-6: 183 (Session Progress) response (P-CSCF#2 to S-CSCF#2)

```

SIP/2.0 183 Session Progress
Via: SIP/2.0/UDP scscf2.home2.net;branch=z9hG4bK764z87.1, SIP/2.0/UDP
    icscf2_s.home2.net;branch=z9hG4bK871y12.1, SIP/2.0/UDP
    scscf1.home1.net;branch=z9hG4bK332b23.1, SIP/2.0/UDP
    pcscf1.visited1.net;branch=z9hG4bK240f34.1, SIP/2.0/UDP
    [5555::aaa:bbb:ccc:ddd]:1357;comp=sigcomp;branch=z9hG4bKnashds7
Record-Route:
P-Asserted-Identity: "John Smith" <sip:user2_public1@home2.net>
P-Access-Network-Info:
P-Charging-Vector: icid-value="AyretyU0dm+602IrT5tAFrbHLso=023551024"
Privacy:
From:
To:
Call-ID:
CSeq:
Require:
Contact:
Allow:
RSeq:
Content-Type:
Content-Length:

v=
o=
s=
c=
t=
m=
b=
a=
a=
a=
a=
a=
a=
a=
a=
a=

```

11. **183 (session progress) response (S-CSCF#1 to P-CSCF#1)** – see example in table 5.2.3-7

Table 5.2.3-7: 183 (Session Progress) response (P-CSCF#2 to S-CSCF#2)

```
SIP/2.0 183 Session Progress
Via: SIP/2.0/UDP pcscf1.visited1.net;branch=z9hG4bK240f34.1, SIP/2.0/UDP
    [5555::aaa:bbb:ccc:ddd]:1357;comp=sigcomp;branch=z9hG4bKnashds7
Record-Route:
P-Asserted-Identity:
P-Access-Network-Info:
P-Charging-Vector: icid-value="AyretyU0dm+602IrT5tAFrbHLso=023551024"
Privacy:
From:
To:
Call-ID:
CSeq:
Require:
Contact:
Allow:
RSeq:
Content-Type:
Content-Length:

v=
o=
s=
c=
t=
m=
b=
a=
a=
a=
a=
a=
a=
a=
a=
a=
```

12. 183 (Session Progress) response (P-CSCF#1 to UE#1) – see example in table 5.2.3-8

Table 5.2.3-8: 183 (Session Progress) response (P-CSCF#1 to UE#1)

```

SIP/2.0 183 Session Progress
Via: SIP/2.0/UDP [5555::aaa:bbb:ccc:ddd]:1357;comp=sigcomp;branch=z9hG4bKnashds7
Record-Route:
P-Asserted-Identity:
Privacy:
From:
To:
Call-ID:
CSeq:
Require:
Contact:
Allow:
RSeq:
Content-Type:
Content-Length:

v=
o=
s=
c=
t=
m=
b=
a=
a=
a=
a=
a=
a=
a=

```

13. Resource Reservation Completed

The originating UE has finished setting up resources in accordance with the media description required for the session.

14. PRACK request (UE#1 to P-CSCF#1) - see example in table 5.2.3-9

UE#1 indicates that it can send and receive media as the necessary resources are available.

Table 5.2.3-9: PRACK request (UE#1 to P-CSCF#1)

```

PRACK <sip:[5555::eee:fff:aaa:bbb]:8805;comp=sigcomp
Via: SIP/2.0/UDP [5555::aaa:bbb:ccc:ddd]:1357;comp=sigcomp;branch=z9hG4bKnashds7
Max-Forwards: 70
Route: <sip:pcscf1.visited1.net:7531;lr;comp=sigcomp>, <sip:orig@scscf1.home1.net;lr>
From: <sip:user1_public1@home1.net>; tag=171828
To: <tel:+12125552222> tag=314159
Call-ID: cb03a0s09a2sdfg1kj490333
Cseq: 128 PRACK
Require: sec-agree, precondition
Proxy-Require: sec-agree
Security-Verify: ipsec-3gpp; q=0.1; alg=hmac-sha-1-96; spi=87654321; port1=7531
Rack: 9021 127 INVITE
Contact: <sip:user1_public1@home1.net;gr=urn:uuid:f81d4fae-7dec-11d0-a765-
00a0c91e6bf6;comp=sigcomp>
Content-Type: application/sdp
Content-Length: (...)

v=0
o=- 2987933615 2987933615 IN IP6 5555::aaa:bbb:ccc:ddd
s=-
c=IN IP6 5555::aaa:bbb:ccc:ddd
t=0 0
m=video 3400 RTP/AVP 98
b=AS:75
a=curr:qos local sendrecev
a=curr:qos remote sendrecv
a=des:qos mandatory local sendrecv
a=des:qos mandatory remote sendrecv
a=sendrecv
a=rtptime:98 H263

```

```

a=fmtp:98 profile-level-id=0
m=audio 3456 RTP/AVP 97 96
b=AS:25.4
a=curr:qos local sendrecv
a=curr:qos remote sendrecv
a=des:qos mandatory local sendrecv
a=des:qos mandatory remote sendrecv
a=sendrecv
a=rtpmap:97 EVRC/8000
a=ptime:20

```

15. PRACK request (P-CSCF#1 to S-CSCF#1) - see example in table 5.2.3-10

Table 5.2.3-10: PRACK request (P-CSCF#1 to S-CSCF#1)

```

PRACK sip:[5555::eee:fff:aaa:bbb]:8805;comp=sigcomp SIP/2.0
Via: SIP/2.0/UDP pcscf1.visited1.net;branch=z9hG4bK240f34.1, SIP/2.0/UDP
    [5555::aaa:bbb:ccc:ddd]:1357;comp=sigcomp;branch=z9hG4bKnashds7
Max-Forwards: 69
P-Access-Network-Info:
P-Charging-Vector: icid-value="AyretyU0dm+602IrT5tAFrbHLso=023551024";
    ggsn=[5555::4b4:3c3:2d2:1e1]; pdp-sig=no; gcid=723084371; auth-token=43876559; flow-id=3
Route: <sip:scscf1.home1.net;lr>, <sip:scscf2.home2.net;lr>, <sip:pcscf2.visited2.net;lr>
From:
To:
Call-ID:
Cseq:
Require: Precondition
RAck:
Contact:
Content-Type:
Content-Length:

v=
o=
s=
c=
t=
m=
b=
a=
a=
a=
a=
a=
a=
a=

```

16. PRACK request (S-CSCF#2 to P-CSCF#2) - see example in table 5.2.3-11

Table 5.2.3-11: PRACK request (S-CSCF#2 to P-CSCF#2)

```

PRACK sip:[5555::eee:fff:aaa:bbb]:8805;comp=sigcomp SIP/2.0
Via: SIP/2.0/UDP scscf2.home2.net;branch=z9hG4bK764z87.1, SIP/2.0/UDP
    scscf1.home1.net;branch=z9hG4bK332b23.1, SIP/2.0/UDP
    pcscf1.visited1.net;branch=z9hG4bK240f34.1, SIP/2.0/UDP
    [5555::aaa:bbb:ccc:ddd]:1357;comp=sigcomp;branch=z9hG4bKnashds7
Max-Forwards: 67
Route: <sip:pcscf2.visited2.net;lr>
From:
To:
Call-ID:
Cseq:
Require:
RAck:
Contact:
Content-Type:
Content-Length:

v=
o=
s=
c=
t=

```

```
m=
b=
a=
a=
a=
a=
a=
a=
```

17. PRACK request (P-CSCF#2 to UE#2) - see example in table 5.2-12

Table 5.2.3-12: PRACK request (S-CSCF#2 to P-CSCF#2)

```
PRACK sip:[5555::eee:fff:aaa:bbb]:8805;comp=sigcomp SIP/2.0
Via: SIP/2.0/UDP pcscf2.visited2.net:5088;comp=sigcomp;branch=z9hG4bK361k21.1, SIP/2.0/UDP
scscf2.home2.net;branch=z9hG4bK764z87.1, SIP/2.0/UDP
scscf1.home1.net;branch=z9hG4bK332b23.1, SIP/2.0/UDP
pcscf1.visited1.net;branch=z9hG4bK240f34.1, SIP/2.0/UDP
[5555::aaa:bbb:ccc:ddd]:1357;comp=sigcomp;branch=z9hG4bKnashds7
Max-Forwards: 66
From:
To:
Call-ID:
Cseq:
Require:
RAck:
Contact:
Content-Type:
Content-Length:

v=
o=
s=
c=
t=
m=
b=
a=
a=
a=
a=
a=
a=
```

18. 200 (OK) response (UE#2 to P-CSCF#2) - see example in table 5.2.3-13

UE#2 acknowledges the PRACK request with a 200 (OK) response.

UE#2 indicates that the local resources are available.

Table 5.2.3-13: 200(OK) response (UE#2 to P-CSCF#2)

```

SIP/2.0 200 OK
Via: SIP/2.0/UDP pcscf2.visited2.net:5088;comp=sigcomp;branch=z9hG4bK361k21.1, SIP/2.0/UDP
    scscf2.home2.net;branch=z9hG4bK764z87.1, SIP/2.0/UDP
    icscf2_s.home2.net;branch=z9hG4bK871y12.1, SIP/2.0/UDP
    scscf1.home1.net;branch=z9hG4bK332b23.1, SIP/2.0/UDP
    pcscf1.visited1.net;branch=z9hG4bK240f34.1, SIP/2.0/UDP
    [5555::aaa:bbb:ccc:ddd]:1357;comp=sigcomp;branch=z9hG4bKnashds7
P-Access-Network-Info: IEEE-802.11a
From: <sip:user1_public1@home1.net>; tag=171828
To: <tel:+12125552222>;tag=314159
Call-ID: cb03a0s09a2sdfg1kj490333
Cseq: 128 PRACK
Require: precondition
Content-Type: application/sdp
Content-Length: (...)

v=0
o=- 2987933615 2987933615 IN IP6 5555::eee:fff:aaa:bbb
s=-
c=IN IP6 5555:: eee:fff:aaa:bbb
t=0 0
m=video 3400 RTP/AVP 98
b=AS:75
a=curr:qos local sendrecv
a=curr:qos remote sendrecv
a=des:qos mandatory local sendrecv
a=des:qos mandatory remote sendrecv
a=sendrecv
a=rtpmap:98 H263
a=fmtp:98 profile-level-id=0
m=audio 3456 RTP/AVP 97 96
b=AS:25.4
a=curr:qos local sendrecv
a=curr:qos remote sendrecv
a=des:qos mandatory local sendrecv
a=des:qos mandatory remote sendrecv
a=sendrecv
a=rtpmap:97 EVRC/8000
aptime:20

```

19. 200 (OK) response (P-CSCF#2 to S-CSCF#2) - see example in table 5.2.3-14

Table 5.2.3-14: 200(OK) response (P-CSCF#2 to S-CSCF#2)

```

SIP/2.0 200 OK
Via: SIP/2.0/UDP scscf2.home2.net;branch=z9hG4bK764z87.1, SIP/2.0/UDP
    scscf1.home1.net;branch=z9hG4bK332b23.1, SIP/2.0/UDP
    pcscf1.visited1.net;branch=z9hG4bK240f34.1, SIP/2.0/UDP
    [5555::aaa:bbb:ccc:ddd]:1357;comp=sigcomp;branch=z9hG4bKnashds7
P-Access-Network-Info:
From:
To:
Call-ID:
CSeq:
Require:
Content-Type:
Content-Length:

v=
o=
s=
c=
t=
m=
b=
a=
a=
a=
a=
a=
a=

```

20. **200 (OK) response (S-CSCF#1 to P-CSCF#1)** - see example in table 5.2.3-15

Table 5.2.3-15: 200(OK) response (S-CSCF#1 to P-CSCF#1)

```
SIP/2.0 200 OK
Via: SIP/2.0/UDP pcscf1.visited1.net;branch=z9hG4bK240f34.1, SIP/2.0/UDP
    [5555::aaa:bbb:ccc:ddd]:1357;comp=sigcomp;branch=z9hG4bKnashds7
From:
To:
Call-ID:
CSeq:
Require:
Content-Type:
Content-Length:

v=
o=
s=
c=
t=
m=
b=
a=
a=
a=
a=
a=
a=
a=
```

21. **200 (OK) response (P-CSCF#1 to UE#1)** - see example in table 5.2.3-16

Table 5.2.3-16: 200(OK) response (P-CSCF#1 to UE#1)

```
SIP/2.0 200 OK
Via: SIP/2.0/UDP [5555::aaa:bbb:ccc:ddd]:1357;comp=sigcomp;branch=z9hG4bKnashds7
From:
To:
Call-ID:
CSeq:
Require:
Content-Type:
Content-Length:

v=
o=
s=
c=
t=
m=
b=
a=
a=
a=
a=
a=
a=
a=
```

22 - 25 . **180 (Ringing) response**

UE#2 sends the 180 (Ringing) response.

26 - 29 . **200 (OK) response**

When the called party answers, the UE#2 sends a 200 (OK) response final response to the INVITE request and starts the media flow(s) for this session.

30 - 33 . **ACK request**

The calling party responds to the 200 (OK) response with an ACK request.

5.3 Establishing a session when UE#1 has resources available while UE#2 does not have required resources available

5.3.1 Introduction

The following flows show the establishment of a session where UE#1 already has all necessary local resources available (e.g. having an appropriate PDP context for the desired media available) and does not need to perform resource reservation while UE#2 does not yet have the required resources available and has to perform resource reservation.

Flow 5.3.2 shows the case where UE#2 performs resource reservation and uses a 200 (OK) response to the INVITE Request to send the SDP Answer. Flow 5.3.3 shows the case where UE#2 performs resource reservation and uses a 180 Ringing response to the INVITE Request to send the SDP Answer. Finally, Flow 5.3.4 shows the case where the IP-CAN performs the resource reservation for UE#2 and UE#2 uses a 183 Session Progress response to the INVITE Request to send the SDP Answer.

The box "Intermediate IM CN subsystem entities" stands for the combination of I-CSCF/S-CSCF on the originating and on the terminating side. Routing of messages between those nodes is not described in the flow below.

5.3.2 Signalling Flow (with SDP answer in 200 (OK) response for INVITE request)

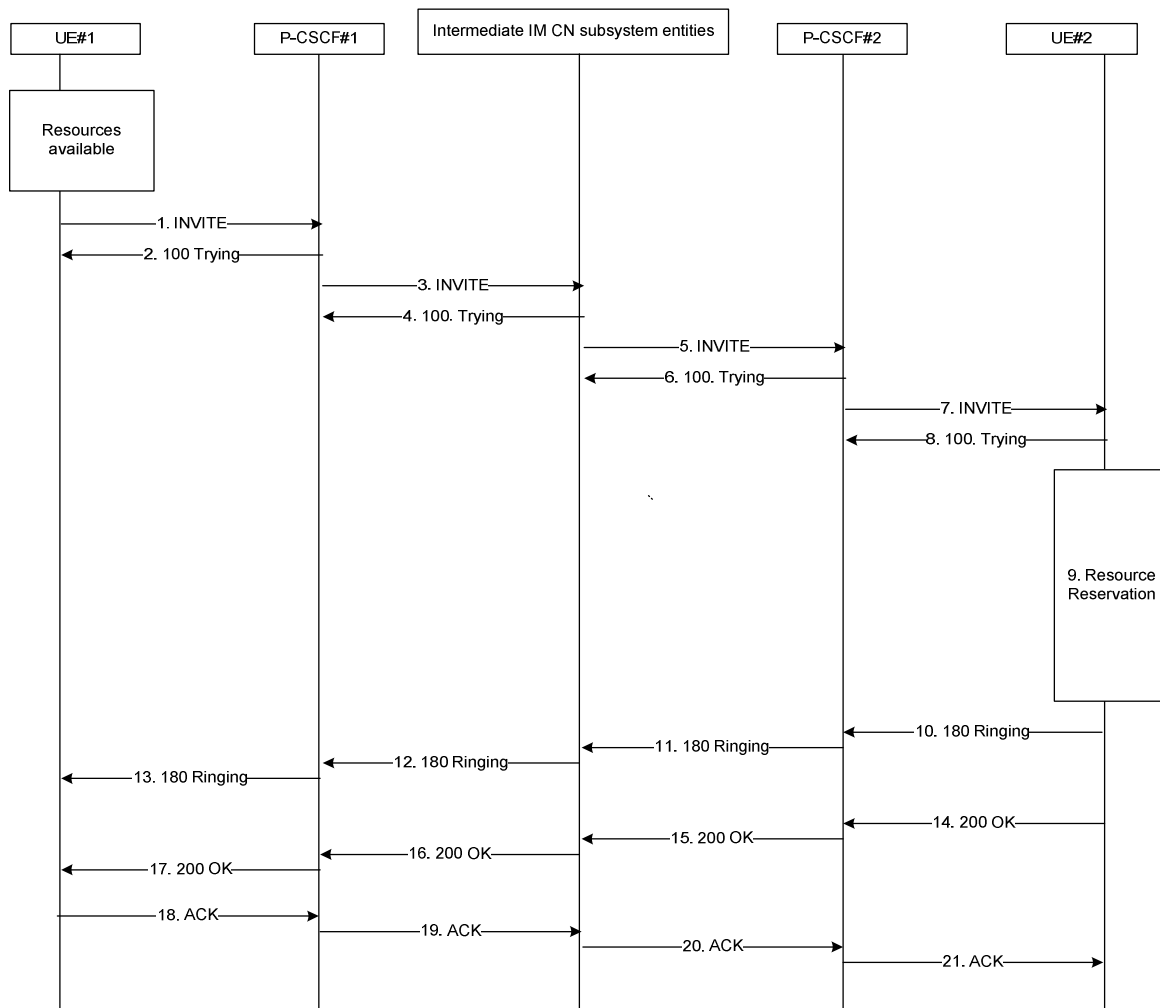

Figure 5.3-1: IMS session setup, resource reservation only on terminating side

The details of the signalling flows are as follows:

1. INVITE request (UE#1 to P-CSCF#1) see example in table 5.3-1

For this example, it is assumed that UE#1 is willing to establish a multimedia session comprising a video stream and an audio stream. The video stream supports H.263 codec. The audio stream supports the AMR codec.

UE#1 indicates that it supports precondition and it indicates that it supports reliable provisional responses. However, it does not use the "Require" header for these capabilities.

UE#1 does have available the resources that are necessary to transport the media.

Table 5.3-1: INVITE request (UE#1 to P-CSCF)

```

INVITE tel:+1-212-555-2222 SIP/2.0
Via: SIP/2.0/UDP [5555::aaa:bbb:ccc:ddd]:1357;comp=sigcomp;branch=z9hG4bKnashds7
Max-Forwards: 70
Route: <sip:pcscf1.visited1.net:7531;lr;comp=sigcomp>, <sip:scscf1.home1.net;lr>
P-Preferred-Identity: "John Doe" <sip:user1_public1@home1.net>
P-Access-Network-Info: 3GPP-UTRAN-TDD; utran-cell-id-3gpp=234151D0FCE11
Privacy: none
From: <sip:user1_public1@home1.net>;tag=171828
To: <tel:+1-212-555-2222>
Call-ID: cb03a0s09a2sdfgkjkj490333
Cseq: 127 INVITE
Require: sec-agree
Supported: precondition, 100rel,gruu, 199
Accept: application/sdp,application/3gpp-ims+xml
Proxy-Require: sec-agree
Security-Verify: ipsec-3gpp; q=0.1; alg= hmac-sha-1-96; spi-c=98765432; spi-s=87654321;
port-c=8642; port-s=7531
Contact: <sip:user1_public1@home1.net;gr=urn:uuid:f81d4fae-7dec-11d0-a765-
00a0c91e6bf6;comp=sigcomp>
Allow: INVITE, ACK, CANCEL, BYE, PRACK, UPDATE, REFER, MESSAGE
Content-Type: application/sdp
Content-Length: (...)

v=0
o=- 2987933615 2987933615 IN IP6 5555::aaa:bbb:ccc:ddd
s=-
c=IN IP6 5555::aaa:bbb:ccc:ddd
t=0 0
m=video 3400 RTP/AVP 98
b=AS:75
a=curr:gqos local sendrecv
a=curr:gqos remote none
a=des:gqos mandatory local sendrecv
a=des:gqos none remote sendrecv
a=rtpmap:98 H263
a=fmtp:98 profile-level-id=0
m=audio 3456 RTP/AVP 97 96
b=AS:25.4
a=curr:gqos local sendrecv
a=curr:gqos remote none
a=des:gqos mandatory local sendrecv
a=des:gqos none remote sendrecv
a=rtpmap:97 AMR
a=fmtp:97 mode-set=0,2,5,7; maxframes=2
a=rtpmap:96 telephone-event

```

Supported: The UE indicates support for the 'precondition' mechanism, the support for reliable provisional responses and the support for the 199 (Early Dialog Terminated) response code.

SDP The SDP contains a set of codecs supported by UE#1 and desired by the user at UE#1 for this session.

2. 100 (Trying) response (P-CSCF#1 to UE#1)

The P-CSCF responds to the INVITE request with a 100 (Trying) provisional response.

3. INVITE request (P-CSCF#1 to S-CSCF#1) - see example in table 5.3-2

Table 5.3-2: INVITE request (P-CSCF#1 to S-CSCF#1)

```
INVITE tel:+1-212-555-2222 SIP/2.0
Via: SIP/2.0/UDP pcscf1.visited1.net;branch=z9hG4bK240f34.1, SIP/2.0/UDP
    [5555::aaa:bbb:ccc:ddd]:1357;comp=sigcomp;branch=z9hG4bKnashds7
Max-Forwards: 69
Route: <sip:scscf1.homel.net;lr>
Record-Route: <sip:pcscf1.visited1.net;lr>
P-Asserted-Identity: "John Doe" <sip:user1_public1@homel.net>
P-Access-Network-Info:
P-Charging-Vector: icid-value="AyretyU0dm+602IrT5tAFrbHLso=023551024"
Privacy:
From:
To:
Call-ID:
Cseq:
Supported:
Accept:
Contact:
Allow:
Content-Type:
Content-Length: (...)

v=
o=
s=
c=
t=
m=
b=
a=
a=
a=
a=
a=
a=
```

4. 100 (Trying) response (S-CSCF#1 to P-CSCF#1)

The S-CSCF responds to the INVITE request with a 100 (Trying) provisional response.

5. INVITE request (S-CSCF#2 to P-CSCF#2) see example in table 5.3-3

Table 5.3-3: INVITE request (S-CSCF#2 to P-CSCF#2)

```

INVITE sip:[5555::eee:fff:aaa:bbb]:8805;comp=sigcomp SIP/2.0
Via: SIP/2.0/UDP scscf2.home2.net;branch=z9hG4bK764z87.1, SIP/2.0/UDP
    icscf2_s.home2.net;branch=z9hG4bK871y12.1, SIP/2.0/UDP
    scscf1.home1.net;branch=z9hG4bK332b23.1, SIP/2.0/UDP
    pcscf1.visited1.net;branch=z9hG4bK240f34.1, SIP/2.0/UDP
    [5555::aaa:bbb:ccc:ddd]:1357;comp=sigcomp;branch=z9hG4bKnashds7
Max-Forwards: 66
Route: <sip:pcscf2.visited2.net;lr>
Record-Route: <sip:scscf2.home2.net;lr>, <sip:scscf1.home1.net;lr>,
    <sip:pcscf1.visited1.net;lr>
P-Asserted-Identity:
P-Charging-Vector: icid-value="AyretyU0dm+602Irt5tAFrbHLso=023551024"
Privacy:
From:
To:
Call-ID:
Cseq:
Require:
Supported:
Accept:
Contact:
Allow:
P-Called-Party-ID: <sip:user2_public1@home2.net>
Content-Type:
Content-Length: (...)

v=
o=
s=
c=
t=
m=
b=
a=
a=
a=
a=
a=
a=
a=
a=
a=

```

6. 100 (Trying) response (P-CSCF#2 to S-CSCF#2)

The P-CSCF#2 responds to the INVITE request with a 100 (Trying) provisional response.

7. INVITE request (P-CSCF#2 to UE #2) - see example in table 5.3-4

P-CSCF#2 forwards the INVITE request to UE#2.

Table 5.3-4: INVITE request (P-CSCF#2 to UE#2)

```

INVITE sip:user2_public1@home2.net SIP/2.0
Via: SIP/2.0/UDP pcscf2.visited2.net:5088;comp=sigcomp;branch=z9hG4bK361k21.1, SIP/2.0/UDP
    scscf2.home2.net;branch=z9hG4bK764z87.1, SIP/2.0/UDP
    icscf2_s.home2.net;branch=z9hG4bK871y12.1, SIP/2.0/UDP
    scscf1.home1.net;branch=z9hG4bK332b23.1, SIP/2.0/UDP
    pcscf1.visited1.net;branch=z9hG4bK240f34.1, SIP/2.0/UDP
    [5555::aaa:bbb:ccc:ddd]:1357;comp=sigcomp;branch=z9hG4bKnashds7
Max-Forwards: 65
Route: <sip:scscf2.home2.net;lr>
Record-Route: <sip:pcscf2.visited2.net:5088;lr;comp=sigcomp>, <sip:scscf2.home2.net;lr>,
    <sip:scscf1.home1.net;lr>, <sip:pcscf1.visited1.net;lr>
P-Asserted-Identity:
Privacy:
From:
To:
Call-ID:
Cseq:
Require:
Supported:
Accept:
Contact:
Allow:
Content-Type:
Content-Length: (...)

v=
o=
s=
c=
t=
m=
b=
a=
a=
a=
a=
a=
a=
a=

```

8. 100 (Trying) response (UE#2 to P-CSCF)

The UE responds to the INVITE request with a 100 (Trying) provisional response.

9. Reserve IP-CAN bearer for media

The terminating UE sets up the bearer in accordance with the media description.

10. – 13. 180 (Ringing) response

UE#2 indicates that it is ringing. The UE#2 does not use Require '100rel' as the 180 (Ringing) response does not have a SDP and therefore need not to be sent reliable.

14 200 (OK) response (UE#2 to P-CSCF#2) - see example in table 5.3-5

UE indicates that the local resources are available

Table 5.3-5: 200(OK) response (UE to P-CSCF)

```

SIP/2.0 200 OK
Via: SIP/2.0/UDP pcscf2.visited2.net:5088;comp=sigcomp;branch=z9hG4bK361k21.1, SIP/2.0/UDP
    scscf2.home2.net;branch=z9hG4bK764z87.1, SIP/2.0/UDP
    icscf2_s.home2.net;branch=z9hG4bK871y12.1, SIP/2.0/UDP
    scscf1.home1.net;branch=z9hG4bK332b23.1, SIP/2.0/UDP
    pcscf1.visited1.net;branch=z9hG4bK240f34.1, SIP/2.0/UDP
    [5555::aaa:bbb:ccc:ddd]:1357;comp=sigcomp;branch=z9hG4bKnashds7
P-Access-Network-Info: 3GPP-UTRAN-TDD; utran-cell-id-3gpp=234151D0FCE11
From:
To:
Call-ID:
Cseq:
Require: precondition
Content-Type: application/sdp
Content-Length: (...)

v=0
o=- 2987933615 2987933615 IN IP6 5555::eee:fff:aaa:bbb
s=-
c=IN IP6 5555:: eee:fff:aaa:bbb
t=0 0
m=video 3400 RTP/AVP 98
b=AS:75
a=curr:gosp local sendrecv
a=curr:gosp remote sendrecv
a=des:gosp mandatory local sendrecv
a=des:gosp mandatory remote sendrecv
a=rtptime:98 H263
a=fmtp:98 profile-level-id=0
m=audio 3456 RTP/AVP 97 96
b=AS:25.4
a=curr:gosp local sendrecv
a=curr:gosp remote sendrecv
a=des:gosp mandatory local sendrecv
a=des:gosp mandatory remote sendrecv
a=rtptime:97 AMR
a=fmtp:97 mode-set=0,2,5,7; maxframes

```

15. 200 (OK) response (P-CSCF#2 to S-CSCF#2) - see example in table 5.3-6

Table 5.3-6: 200(OK) response (P-CSCF#2 to S-CSCF#2)

```

SIP/2.0 200 OK
Via: SIP/2.0/UDP scscf2.home2.net;branch=z9hG4bK764z87.1, SIP/2.0/UDP
    icscf2_s.home2.net;branch=z9hG4bK871y12.1, SIP/2.0/UDP
    scscf1.home1.net;branch=z9hG4bK332b23.1, SIP/2.0/UDP
    pcscf1.visited1.net;branch=z9hG4bK240f34.1, SIP/2.0/UDP
    [5555::aaa:bbb:ccc:ddd]:1357;comp=sigcomp;branch=z9hG4bKnashds7
P-Access-Network-Info: 3GPP-UTRAN-TDD; utran-cell-id-3gpp=234151D0FCE11
From:
To:
Call-ID:
Cseq:
Content-Type: application/sdp
Content-Length: (...)

v=
o=
s=
c=
t=
m=
b=
a=
a=
a=
a=
a=
a=
a=

```

16. 200 (OK) response (S-CSCF#1 to P-CSCF#1) - see example in table 5.3-7

Table 5.3-7: 200(OK) response (S-CSCF#1 to P-CSCF#1)

```

SIP/2.0 200 OK
Via: pcscf1.visited1.net;branch=z9hG4bK240f34.1, SIP/2.0/UDP
    [5555::aaa:bbb:ccc:ddd]:1357;comp=sigcomp;branch=z9hG4bKnashds7
P-Access-Network-Info: 3GPP-UTRAN-TDD; utran-cell-id-3gpp=234151D0FCE11
From:
To:
Call-ID:
Cseq:
Content-Type: application/sdp
Content-Length: (...)

v=
o=
s=
c=
t=
m=
b=
a=
a=
a=
a=
a=
a=
a=
a=
a=

```

17. 200 (OK) response (P-CSCF#1 to UE#1) - see example in table 5.3-8**Table 5.3-8: 200(OK) response (P-CSCF#1 to UE#1)**

```

SIP/2.0 200 OK
Via: [5555::aaa:bbb:ccc:ddd]:1357;comp=sigcomp;branch=z9hG4bKnashds7
P-Access-Network-Info: 3GPP-UTRAN-TDD; utran-cell-id-3gpp=234151D0FCE11
From:
To:
Call-ID:
Cseq:
Content-Type: application/sdp
Content-Length: (...)

v=
o=
s=
c=
t=
m=
b=
a=
a=
a=
a=
a=
a=
a=
a=
a=

```

18. -21.. ACK request

The calling party responds to the 200 (OK) response with an ACK request.

5.3.3 Signalling Flow (with SDP answer in reliable 180 Ringing) response

In the call flow shown in subclause 5.3.2, the SDP answer is returned to UE#1 in the final 200 (OK) response. An alternative call flow is shown in this section where SDP answer is returned to UE#1 in a reliable 180 (Ringing) response message.

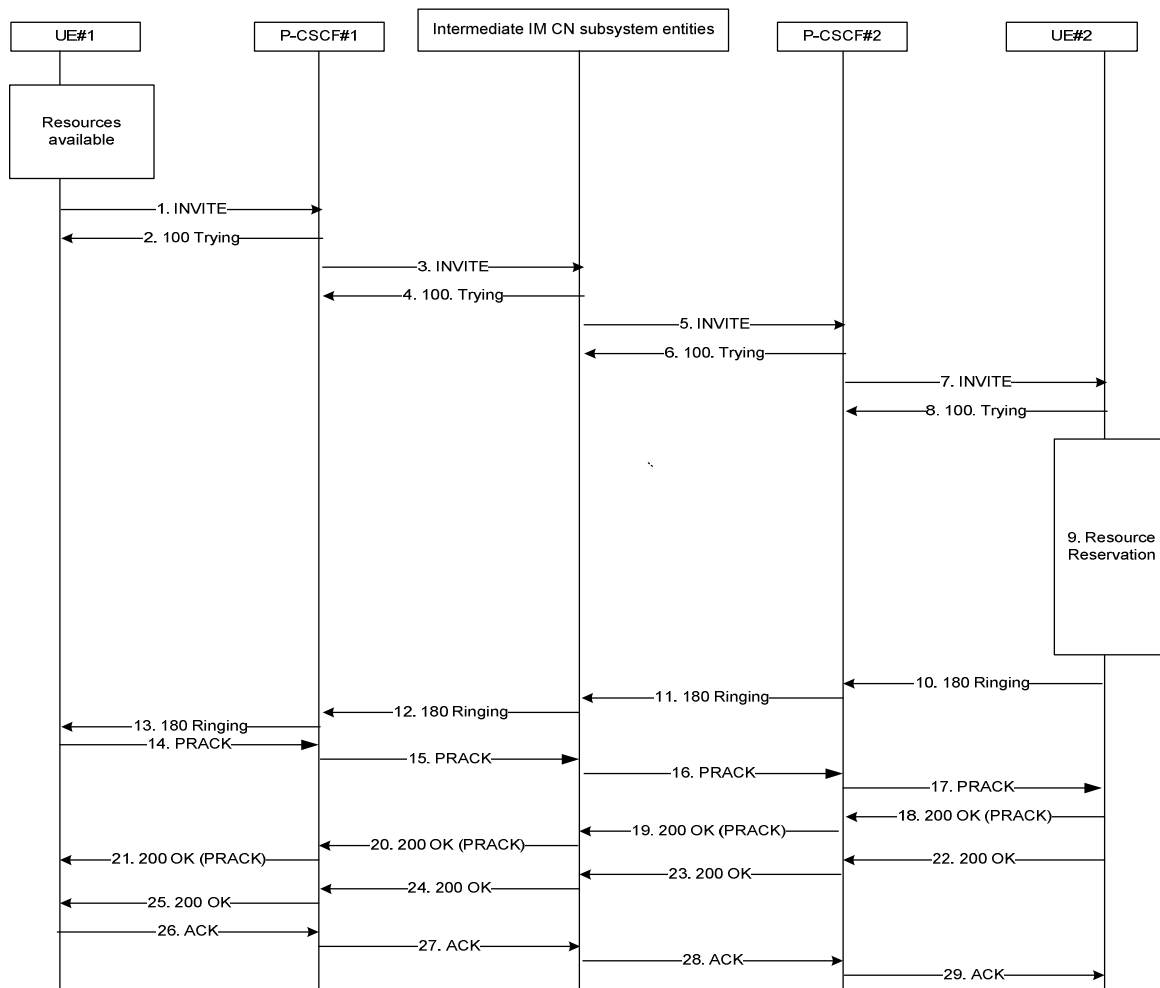

Figure 5.3-2: IMS session setup, resource reservation only on terminating side

The details of the signalling flows are as follows:

1. INVITE request (UE#1 to P-CSCF#1) see example in table 5.3-9

For this example, it is assumed that UE#1 is willing to establish a multimedia session comprising a video stream and an audio stream. The video stream supports H.263 codec. The audio stream supports the AMR codec.

UE#1 indicates that it supports precondition and it indicates that it supports reliable provisional responses. However, it does not use the "Require" header for these capabilities.

UE#1 does have available the resources that are necessary to transport the media.

Table 5.3-9: INVITE request (UE#1 to P-CSCF)

```

INVITE tel:+1-212-555-2222 SIP/2.0
Via: SIP/2.0/UDP [5555::aaa:bbb:ccc:ddd]:1357;comp=sigcomp;branch=z9hG4bKnashds7
Max-Forwards: 70
Route: <sip:pcscf1.visited1.net:7531;lr;comp=sigcomp>, <sip:scscf1.home1.net;lr>
P-Preferred-Identity: "John Doe" <sip:user1_public1@home1.net>
P-Access-Network-Info: 3GPP-UTRAN-TDD; utran-cell-id-3gpp=234151D0FCE11
Privacy: none
From: <sip:user1_public1@home1.net>;tag=171828
To: <tel:+1-212-555-2222>
Call-ID: cb03a0s09a2sdfglkj490333
Cseq: 127 INVITE
Require: sec-agree
Supported: precondition, 100rel, gruu, 199
Accept: application/sdp,application/3gpp-ims+xml
Proxy-Require: sec-agree
Security-Verify: ipsec-3gpp; q=0.1; alg= hmac-sha-1-96; spi-c=98765432; spi-s=87654321;
port-c=8642; port-s=7531
Contact: <sip:user1_public1@home1.net;gr=urn:uuid:f81d4fae-7dec-11d0-a765-
00a0c91e6bf6;comp=sigcomp>
Allow: INVITE, ACK, CANCEL, BYE, PRACK, UPDATE, REFER, MESSAGE
Content-Type: application/sdp
Content-Length: (...)

v=0
o=- 2987933615 2987933615 IN IP6 5555::aaa:bbb:ccc:ddd
s=-
c=IN IP6 5555::aaa:bbb:ccc:ddd
t=0 0
m=video 3400 RTP/AVP 98
b=AS:75
a=curr:qos local sendrecv
a=curr:qos remote none
a=des:qos mandatory local sendrecv
a=des:qos none remote sendrecv
a=rtpmap:98 H263
a=fmtp:98 profile-level-id=0
m=audio 3456 RTP/AVP 97 96
b=AS:25.4
a=curr:qos local sendrecv
a=curr:qos remote none
a=des:qos mandatory local sendrecv
a=des:qos none remote sendrecv
a=rtpmap:97 AMR
a=fmtp:97 mode-set=0,2,5,7; maxframes=2
a=rtpmap:96 telephone-event

```

Supported: The UE indicates support for the 'precondition' mechanism, the support for reliable provisional responses and the support for the 199 (Early Dialog Terminated) response code.

SDP The SDP contains a set of codecs supported by UE#1 and desired by the user at UE#1 for this session.

2. 100 (Trying) response (P-CSCF#1 to UE#1)

The P-CSCF responds to the INVITE request with a 100 (Trying) provisional response.

3. INVITE request (P-CSCF#1 to S-CSCF#1) - see example in table 5.3-10

Table 5.3-10: INVITE request (P-CSCF#1 to S-CSCF#1)

```
INVITE tel:+1-212-555-2222 SIP/2.0
Via: SIP/2.0/UDP pcscf1.visited1.net;branch=z9hG4bK240f34.1, SIP/2.0/UDP
    [5555::aaa:bbb:ccc:ddd]:1357;comp=sigcomp;branch=z9hG4bKnashds7
Max-Forwards: 69
Route: <sip:scscf1.homel.net;lr>
Record-Route: <sip:pcscf1.visited1.net;lr>
P-Asserted-Identity: "John Doe" <sip:user1_public1@homel.net>
P-Access-Network-Info:
P-Charging-Vector: icid-value="AyretyU0dm+602IrT5tAFrbHLso=023551024"
Privacy:
From:
To:
Call-ID:
Cseq:
Supported:
Accept:
Contact:
Allow:
Content-Type:
Content-Length: (...)

v=
o=
s=
c=
t=
m=
b=
a=
a=
a=
a=
a=
a=
```

4. 100 (Trying) response (S-CSCF#1 to P-CSCF#1)

The S-CSCF responds to the INVITE request with a 100 (Trying) provisional response.

5. INVITE request (S-CSCF#2 to P-CSCF#2) see example in table 5.3-11

Table 5.3-11: INVITE request (S-CSCF#2 to P-CSCF#2)

```

INVITE sip:[5555::eee:fff:aaa:bbb]:8805;comp=sigcomp SIP/2.0
Via: SIP/2.0/UDP scscf2.home2.net;branch=z9hG4bK764z87.1, SIP/2.0/UDP
    icscf2_s.home2.net;branch=z9hG4bK871y12.1, SIP/2.0/UDP
    scscf1.home1.net;branch=z9hG4bK332b23.1, SIP/2.0/UDP
    pcscf1.visited1.net;branch=z9hG4bK240f34.1, SIP/2.0/UDP
    [5555::aaa:bbb:ccc:ddd]:1357;comp=sigcomp;branch=z9hG4bKnashds7
Max-Forwards: 66
Route: <sip:pcscf2.visited2.net;lr>
Record-Route: <sip:scscf2.home2.net;lr>, <sip:scscf1.home1.net;lr>,
    <sip:pcscf1.visited1.net;lr>
P-Asserted-Identity:
P-Charging-Vector: icid-value="AyretyU0dm+602IrT5tAFrbHLso=023551024"
Privacy:
From:
To:
Call-ID:
Cseq:
Supported:
Accept:
Contact:
Allow:
P-Called-Party-ID: <sip:user2_public1@home2.net>
Content-Type:
Content-Length: (...)

v=
o=
s=
c=
t=
m=
b=
a=
a=
a=
a=
a=
a=
a=
a=
a=

```

6. 100 (Trying) response (P-CSCF#2 to S-CSCF#2)

The P-CSCF#2 responds to the INVITE request with a 100 (Trying) provisional response.

7. INVITE request (P-CSCF#2 to UE #2) - see example in table 5.3-12

P-CSCF#2 forwards the INVITE request to UE#2.

Table 5.3-12: INVITE request (P-CSCF#2 to UE#2)

```

INVITE sip:[5555::eee:fff:aaa:bbb]:8805;comp=sigcomp SIP/2.0
Via: SIP/2.0/UDP pcscf2.visited2.net:5088;comp=sigcomp;branch=z9hG4bK361k21.1, SIP/2.0/UDP
scscf2.home2.net;branch=z9hG4bK764z87.1, SIP/2.0/UDP
icscf2_s.home2.net;branch=z9hG4bK871y12.1, SIP/2.0/UDP
scscf1.home1.net;branch=z9hG4bK332b23.1, SIP/2.0/UDP
pcscf1.visited1.net;branch=z9hG4bK240f34.1, SIP/2.0/UDP
[5555::aaa:bbb:ccc:ddd]:1357;comp=sigcomp;branch=z9hG4bKnashds7
Max-Forwards: 65
Record-Route: <sip:pcscf2.visited2.net:5088;lr;comp=sigcomp>, <sip:scscf2.home2.net;lr>,
<sip:scscf1.home1.net;lr>, <sip:pcscf1.visited1.net;lr>
P-Asserted-Identity:
Privacy:
From:
To:
Call-ID:
Cseq:
Supported:
Accept:
Contact:
Allow:
Content-Type:
Content-Length: (...)

v=
o=
s=
c=
t=
m=
b=
a=
a=
a=
a=
a=
a=
a=

```

8. 100 (Trying) response (UE#2 to P-CSCF)

The UE responds to the INVITE request with a 100 (Trying) provisional response.

9. Reserve IP-CAN bearer for media

The terminating UE sets up the bearer in accordance with the media description.

10. – 13. 180 (Ringing) response - see example in table 5.3-13

After the resources have been reserved, UE#2 indicates that it is ringing. Since the message includes the SDP answer, this message is sent reliably.

Table 5.3-13: 180 (Ringing) response (UE2 to P-CSCF2)

```

SIP/2.0 180 Ringing
Via: SIP/2.0/UDP pcscf2.visited2.net:5088;comp=sigcomp;branch=z9hG4bK361k21.1, SIP/2.0/UDP
    scscf2.home2.net;branch=z9hG4bK764z87.1, SIP/2.0/UDP
    icscf2_s.home2.net;branch=z9hG4bK871y12.1, SIP/2.0/UDP
    scscf1.home1.net;branch=z9hG4bK332b23.1, SIP/2.0/UDP
    pcscf1.visited1.net;branch=z9hG4bK240f34.1, SIP/2.0/UDP
    [5555::aaa:bbb:ccc:ddd]:1357;comp=sigcomp;branch=z9hG4bKnashds7
Record-Route: <sip:pcscf2.visited2.net:5088;lr;comp=sigcomp>, <sip:scscf2.home2.net;lr>,
    <sip:scscf1.home1.net;lr>, <sip:pcscf1.visited1.net;lr>
From:
To: <tel:+1-212-555-2222>;tag=2236
Call-ID:
Cseq:
Require: 100rel, precondition
Allow: INVITE, ACK, CANCEL, BYE, PRACK, UPDATE, REFER, MESSAGE
RSeq: 9022
Content-Type: application/sdp
Content-Length: (...)

v=0
o=- 2987933615 2987933615 IN IP6 5555::eee:fff:aaa:bbb
s=-
c=IN IP6 5555:: eee:fff:aaa:bbb
t=0 0
m=video 3400 RTP/AVP 98
b=AS:75
a=curr:qos local sendrecv
a=curr:qos remote sendrecv
a=des:qos mandatory local sendrecv
a=des:qos mandatory remote sendrecv
a=rtpmap:98 H263
a=fmtp:98 profile-level-id=0
m=audio 3456 RTP/AVP 97 96
b=AS:25.4
a=curr:qos local sendrecv
a=curr:qos remote sendrecv
a=des:qos mandatory local sendrecv
a=des:qos mandatory remote sendrecv
a=rtpmap:97 AMR
a=fmtp:97 mode-set=0,2,5,7; maxframes

```

14. - 17. PRACK request - see example in table 5.3-14

UE#1 acknowledges the receipt of the 180 (Ringing). It does not contain SDP as the final codec decision is already made as part of the initial offer/answer exchange

Table 5.3-14: PRACK request (UE1 to P-CSCF1)

```

PRACK sip:[5555::eee:fff:aaa:bbb]:8805;comp=sigcomp SIP/2.0
Via: SIP/2.0/UDP [5555::aaa:bbb:ccc:ddd]:1357;comp=sigcomp;branch=z9hG4bKnashds7
Max-Forwards: 70
P-Access-Network-Info: 3GPP-UTRAN-TDD; utran-cell-id-3gpp=234151D0FCE11
Route: <sip:pcscf2.visited2.net:5088;lr;comp=sigcomp>, <sip:scscf2.home2.net;lr>,
    <sip:scscf1.home1.net;lr>, <sip:pcscf1.visited1.net;lr>
From: <sip:user1_public1@home1.net>;tag=171828
To: <tel:+1-212-555-2222>;tag=2236
Call-ID: cb03a0s09a2sdfglkj490333
Cseq: 128 PRACK
Require: sec-agree
Proxy-Require: sec-agree
Security-Verify: ipsec-3gpp; q=0.1; alg= hmac-sha-1-96; spi-c=98765432; spi-s=87654321;
    port-c=8642; port-s=7531
Rack: 9021 127 INVITE
Content-Length: 0

```

18 - 21. 200 (OK) response to (PRACK request)

UE#2 acknowledges the receipt of the PRACK request with the 200 (OK) response

22. 200 (OK) response (UE#2 to P-CSCF#2) - see example in table 5.3-15

User #2 answers the phone and this triggers UE #2 to send the 200 (OK) response.

Table 5.3-15: 200(OK) response (UE to P-CSCF)

```
SIP/2.0 200 OK
Via: SIP/2.0/UDP pcscf2.visited2.net:5088;comp=sigcomp;branch=z9hG4bK361k21.1, SIP/2.0/UDP
scscf2.home2.net;branch=z9hG4bK764z87.1, SIP/2.0/UDP
icscf2_s.home2.net;branch=z9hG4bK871y12.1, SIP/2.0/UDP
scscf1.home1.net;branch=z9hG4bK332b23.1, SIP/2.0/UDP
pcscf1.visited1.net;branch=z9hG4bK240f34.1, SIP/2.0/UDP
[5555::aaa:bbb:ccc:ddd]:1357;comp=sigcomp;branch=z9hG4bKnashds7
P-Access-Network-Info: 3GPP-UTRAN-TDD; utran-cell-id-3gpp=234151D0FCE11
From:
To:
Call-ID:
Cseq: 127 INVITE
Content-Length: 0
```

23. 200 (OK) response (P-CSCF#2 to S-CSCF#2) - see example in table 5.3-16

Table 5.3-16: 200(OK) response (P-CSCF#2 to S-CSCF#2)

```
SIP/2.0 200 OK
Via: SIP/2.0/UDP scscf2.home2.net;branch=z9hG4bK764z87.1, SIP/2.0/UDP
icscf2_s.home2.net;branch=z9hG4bK871y12.1, SIP/2.0/UDP
scscf1.home1.net;branch=z9hG4bK332b23.1, SIP/2.0/UDP
pcscf1.visited1.net;branch=z9hG4bK240f34.1, SIP/2.0/UDP
[5555::aaa:bbb:ccc:ddd]:1357;comp=sigcomp;branch=z9hG4bKnashds7
P-Access-Network-Info: 3GPP-UTRAN-TDD; utran-cell-id-3gpp=234151D0FCE11
From:
To:
Call-ID:
Cseq:
Content-Length: 0
```

24. 200 (OK) response (S-CSCF#1 to P-CSCF#1) - see example in table 5.3-17

Table 5.3-17: 200(OK) response (S-CSCF#1 to P-CSCF#1)

```
SIP/2.0 200 OK
Via: pcscf1.visited1.net;branch=z9hG4bK240f34.1, SIP/2.0/UDP
[5555::aaa:bbb:ccc:ddd]:1357;comp=sigcomp;branch=z9hG4bKnashds7
P-Access-Network-Info: 3GPP-UTRAN-TDD; utran-cell-id-3gpp=234151D0FCE11
From:
To:
Call-ID:
Cseq:
Content-Length: 0
```

25. 200 (OK) response (P-CSCF#1 to UE#1) - see example in table 5.3-18

Table 5.3-18: 200(OK) response (P-CSCF#1 to UE#1)

```
SIP/2.0 200 OK
Via: [5555::aaa:bbb:ccc:ddd]:1357;comp=sigcomp;branch=z9hG4bKnashds7
P-Access-Network-Info: 3GPP-UTRAN-TDD; utran-cell-id-3gpp=234151D0FCE11
From:
To:
Call-ID:
Cseq:
Content-Length: 0
```

26 - 29. ACK request

The calling party responds to the 200 (OK) response with an ACK request.

5.3.4 Signalling Flow with SDP answer in reliable 183 Session Progress response for INVITE request when the IP-CAN performs resource reservation for UE#2

When the IP-CAN performs the resource reservation for UE#2, UE#2 uses a 183 Session Progress response to the INVITE Request to send the SDP Answer.

NOTE 1: It will be possible for UE#2 to execute this signalling flow even if UE#2 is responsible to perform resource reservation.

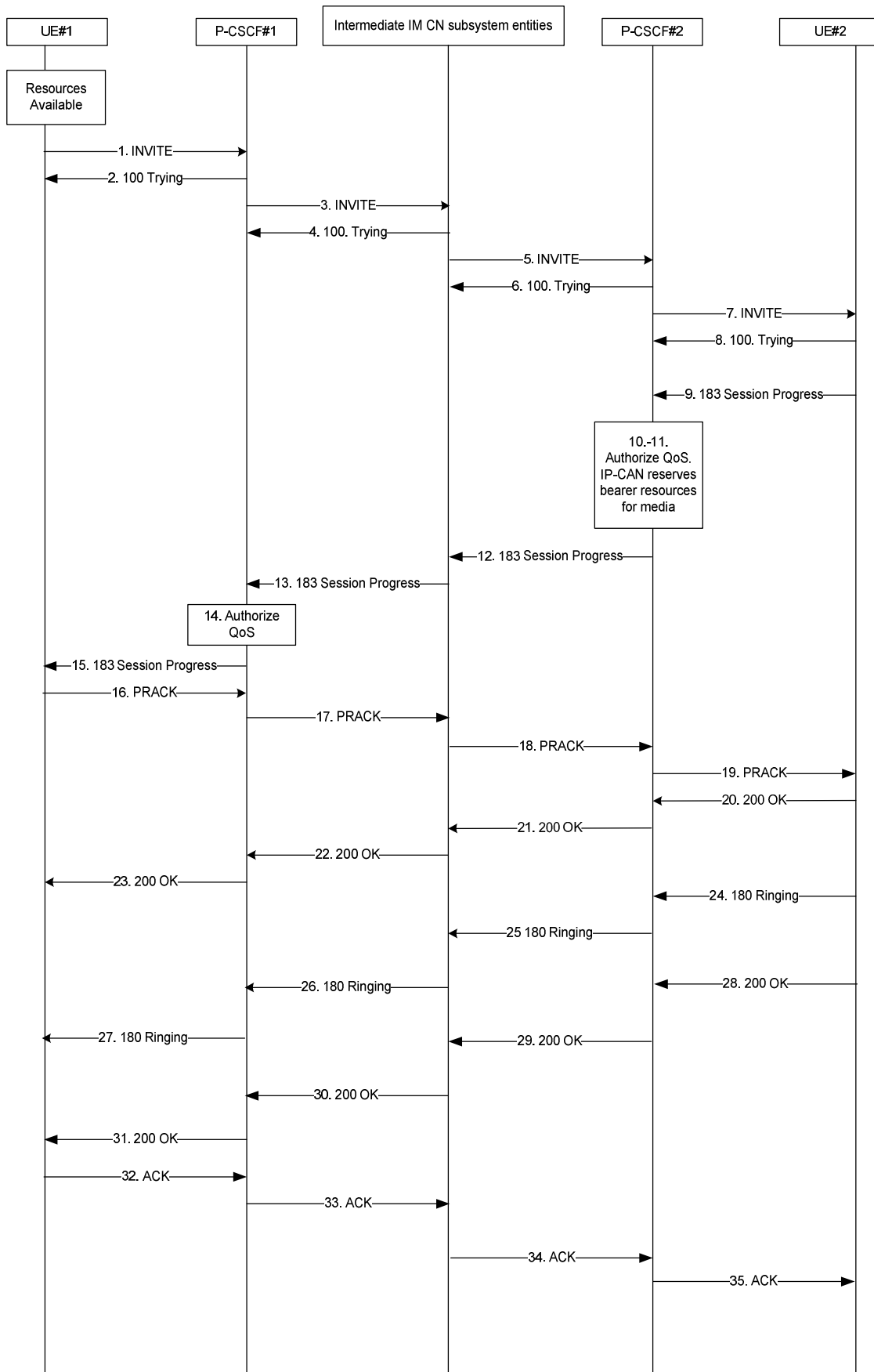

Figure 5.3-3: IMS session setup, resource reservation only on terminating side (NW-initiated)

The details of the signalling flows are as follows:

1. INVITE request (UE#1 to P-CSCF#1) see example in table 5.3-19

For this example, it is assumed that UE#1 is willing to establish a multimedia session comprising a video stream and an audio stream. The video stream supports H.263 codec. The audio stream supports the AMR codec.

UE#1 indicates that it supports precondition and it indicates that it supports reliable provisional responses. However, it does not use the "Require" header for these capabilities.

UE#1 does have available the resources that are necessary to transport the media.

Table 5.3-19: INVITE request (UE#1 to P-CSCF#1)

```

INVITE tel:+1-212-555-2222 SIP/2.0
Via: SIP/2.0/UDP [5555::aaa:bbb:ccc:ddd]:1357;comp=sigcomp;branch=z9hG4bKnashds7
Max-Forwards: 70
Route: <sip:pcscf1.visited1.net:7531;lr;comp=sigcomp>, <sip:scscf1.home1.net;lr>
P-Preferred-Identity: "John Doe" <sip:user1_public1@home1.net>
P-Access-Network-Info: 3GPP-UTRAN-TDD; utran-cell-id-3gpp=234151D0FCE11
Privacy: none
From: <sip:user1_public1@home1.net>;tag=171828
To: <tel:+1-212-555-2222>
Call-ID: cb03a0s09a2sdfg1kj490333
Cseq: 127 INVITE
Require: sec-agree
Supported: precondition, 100rel, gruu, 199
Accept: application/sdp,application/3gpp-ims+xml
Proxy-Require: sec-agree
Security-Verify: ipsec-3gpp; q=0.1; alg= hmac-sha-1-96; spi-c=98765432; spi-s=87654321;
port-c=8642; port-s=7531
Contact: <sip:user1_public1@home1.net;gr=urn:uuid:f81d4fae-7dec-11d0-a765-
00a0c91e6bf6;comp=sigcomp>
Allow: INVITE, ACK, CANCEL, BYE, PRACK, UPDATE, REFER, MESSAGE
Content-Type: application/sdp
Content-Length: (...)

v=0
o=- 2987933615 2987933615 IN IP6 5555::aaa:bbb:ccc:ddd
s=-
c=IN IP6 5555::aaa:bbb:ccc:ddd
t=0 0
m=video 3400 RTP/AVP 98
b=AS:75
a=curr:qos local sendrecv
a=curr:qos remote none
a=des:qos mandatory local sendrecv
a=des:qos none remote sendrecv
a=rtpmap:98 H263
a=fmtp:98 profile-level-id=0
m=audio 3456 RTP/AVP 97 96
b=AS:25.4
a=curr:qos local sendrecv
a=curr:qos remote none
a=des:qos mandatory local sendrecv
a=des:qos none remote sendrecv
a=rtpmap:97 AMR
a=fmtp:97 mode-set=0,2,5,7; maxframes=2
a=rtpmap:96 telephone-event

```

Supported: The UE indicates support for the 'precondition' mechanism, the support for reliable provisional responses and the support for the 199 (Early Dialog Terminated) response code.

SDP The SDP contains a set of codecs supported by UE#1 and desired by the user at UE#1 for this session.

2. 100 (Trying) response (P-CSCF#1 to UE#1)

The P-CSCF responds to the INVITE request with a 100 (Trying) provisional response.

3. INVITE request (P-CSCF#1 to S-CSCF#1) - see example in table 5.3-20

Table 5.3-20: INVITE request (P-CSCF#1 to S-CSCF#1)

```
INVITE tel:+1-212-555-2222 SIP/2.0
Via: SIP/2.0/UDP pcscf1.visited1.net;branch=z9hG4bK240f34.1, SIP/2.0/UDP
    [5555::aaa:bbb:ccc:ddd]:1357;comp=sigcomp;branch=z9hG4bKnashds7
Max-Forwards: 69
Route: <sip:scscf1.homel.net;lr>
Record-Route: <sip:pcscf1.visited1.net;lr>
P-Asserted-Identity: "John Doe" <sip:user1_public1@homel.net>
P-Access-Network-Info:
P-Charging-Vector: icid-value="AyretyU0dm+602IrT5tAFrbHLso=023551024"
Privacy:
From:
To:
Call-ID:
Cseq:
Supported:
Accept:
Contact:
Allow:
Content-Type:
Content-Length: (...)

v=
o=
s=
c=
t=
m=
b=
a=
a=
a=
a=
a=
a=
```

4. 100 (Trying) response (S-CSCF#1 to P-CSCF#1)

The S-CSCF responds to the INVITE request with a 100 (Trying) provisional response.

5. INVITE request (S-CSCF#2 to P-CSCF#2) see example in table 5.3-21

Table 5.3-21: INVITE request (S-CSCF#2 to P-CSCF#2)

```

INVITE sip:[5555::eee:fff:aaa:bbb]:8805;comp=sigcomp SIP/2.0
Via: SIP/2.0/UDP scscf2.home2.net;branch=z9hG4bK764z87.1, SIP/2.0/UDP
    icscf2_s.home2.net;branch=z9hG4bK871y12.1, SIP/2.0/UDP
    scscf1.home1.net;branch=z9hG4bK332b23.1, SIP/2.0/UDP
    pcscf1.visited1.net;branch=z9hG4bK240f34.1, SIP/2.0/UDP
    [5555::aaa:bbb:ccc:ddd]:1357;comp=sigcomp;branch=z9hG4bKnashds7
Max-Forwards: 66
Route: <sip:pcscf2.visited2.net;lr>
Record-Route: <sip:scscf2.home2.net;lr>, <sip:scscf1.home1.net;lr>,
    <sip:pcscf1.visited1.net;lr>
P-Asserted-Identity:
P-Charging-Vector: icid-value="AyretyU0dm+602IrT5tAFrbHLso=023551024"
Privacy:
From:
To:
Call-ID:
Cseq:
Require:
Supported:
Accept:
Contact:
Allow:
P-Called-Party-ID: <sip:user2_public1@home2.net>
Content-Type:
Content-Length: (...)

v=
o=
s=
c=
t=
m=
b=
a=
a=
a=
a=
a=
a=
a=
a=

```

6. 100 (Trying) response (P-CSCF#2 to S-CSCF#2)

The P-CSCF#2 responds to the INVITE request with a 100 (Trying) provisional response.

7. INVITE request (P-CSCF#2 to UE #2) - see example in table 5.3-22

Table 5.3-22: INVITE request (P-CSCF#2 to UE#2)

```

INVITE sip:user2_public1@home2.net SIP/2.0
Via: SIP/2.0/UDP pcscf2.visited2.net:5088;comp=sigcomp;branch=z9hG4bK361k21.1, SIP/2.0/UDP
scscf2.home2.net;branch=z9hG4bK764z87.1, SIP/2.0/UDP
icscf2_s.home2.net;branch=z9hG4bK871y12.1, SIP/2.0/UDP
scscf1.home1.net;branch=z9hG4bK332b23.1, SIP/2.0/UDP
pcscf1.visited1.net;branch=z9hG4bK240f34.1, SIP/2.0/UDP
[5555::aaa:bbb:ccc:ddd]:1357;comp=sigcomp;branch=z9hG4bKnashds7
Max-Forwards: 65
Route: <sip:scscf2.home2.net;lr>
Record-Route: <sip:pcscf2.visited2.net:5088;lr;comp=sigcomp>, <sip:scscf2.home2.net;lr>,
<sip:scscf1.home1.net;lr>, <sip:pcscf1.visited1.net;lr>
P-Asserted-Identity:
Privacy:
From:
To:
Call-ID:
Cseq:
Require:
Supported:
Accept:
Contact:
Allow:
Content-Type:
Content-Length: (...)

v=
o=
s=
c=
t=
m=
b=
a=
a=
a=
a=
a=
a=
a=

```

8. 100 (Trying) response (UE#2 to P-CSCF)

The UE responds to the INVITE request with a 100 (Trying) provisional response.

9. 183 (Session Progress) response (UE#2 to P-CSCF#2) - - see example in table 5.3-23

UE#2 determines the complete set of codecs that it is capable of supporting for this session. It determines the intersection with those appearing in the SDP in the INVITE request. UE#2 makes the final codec selection and chooses H.263 and AMR.

UE#2 responds with a 183 (Session Progress) response containing SDP back to the originator. This response is sent to P-CSCF.

Table 5.3-23: 183 (Session Progress) response (UE#2 to P-CSCF#2)

```

SIP/2.0 183 Session Progress
Via: SIP/2.0/UDP pcscf2.visited2.net:5088;comp=sigcomp;branch=z9hG4bK361k21.1, SIP/2.0/UDP
    scscf2.home2.net;branch=z9hG4bK764z87.1, SIP/2.0/UDP
    icscf2_s.home2.net;branch=z9hG4bK871y12.1, SIP/2.0/UDP
    scscf1.home1.net;branch=z9hG4bK332b23.1, SIP/2.0/UDP
    pcscf1.visited1.net;branch=z9hG4bK240f34.1, SIP/2.0/UDP
    [5555::aaa:bbb:ccc:ddd]:1357;comp=sigcomp;branch=z9hG4bKnashds7
Record-Route: <sip:pcscf2.visited2.net:5088;lr;comp=sigcomp>, <sip:scscf2.home2.net;lr>,
    <sip:scscf1.home1.net;lr>, <sip:pcscf1.visited1.net;lr>
P-Access-Network-Info: 3GPP-UTRAN-TDD; utran-cell-id-3gpp=234151D0FCE11
Privacy: none
From:
To: <tel:+1-212-555-2222>;tag=314159
Call-ID:
CSeq:
Require: 100rel, precondition
Contact: <sip:user2_public1@home2.net:gr=urn:uuid:2ad8950e-48a5-4a74-8d99-
    ad76cc7fc74;comp=sigcomp>
Allow: INVITE, ACK, CANCEL, BYE, PRACK, UPDATE, REFER, MESSAGE
RSeq: 9021
Content-Type: application/sdp
Content-Length: (...)

v=0
o=- 2987933623 2987933623 IN IP6 5555::eee:fff:aaa:bbb
s=-
c=IN IP6 5555::eee:fff:aaa:bbb
t=0 0
m=video 10001 RTP/AVP 98
b=AS:75
a=curr:qos local none
a=curr:qos remote sendrecv
a=des:qos mandatory local sendrecv
a=des:qos mandatory remote sendrecv
a=rtptime:98 H263
a=fmtp:98 profile-level-id=0
m=audio 6544 RTP/AVP 97 96
b=AS:25.4
a=curr:qos local none
a=curr:qos remote sendrecv
a=des:qos mandatory local sendrecv
a=des:qos mandatory remote sendrecv
a=rtptime:97 AMR
a=fmtp:97 mode-set=0,2,5,7; maxframes=2
a=rtptime:96 telephone-event

```

10.-11. Authorize QoS and reserve IP-CAN bearer for media

P-CSCF authorizes the resources necessary for this session.

NOTE 2: In the case where IP-CAN bearers are managed by the IP-CAN, this triggers the IP-CAN to initiate the reservation of required resources, including the initiation of an IP-CAN bearer setup or the modification of an existing one.

12-13. 183 (session progress) response

These steps progress in parallel with steps 10-11.

14. Authorize QoS

P-CSCF authorizes the resources necessary for this session.

15. 183 (Session Progress) response (P-CSCF#1 to UE#1) –**16.-23. PRACK request / 200(OK) response exchange**

The PRACK request does not carry SDP as the final codec decision is already made as part of the initial offer/answer exchange.

24. 180 (Ringing) response UE#2 to P-CSCF#2) - - see example in table 5.3-24-

The UE#2 indicates that it is ringing. The UE#2 does not use Require '100rel' as the 180 (Ringing) does not have a SDP and therefore need not to be sent reliable.

NOTE 3: According to RFC 4032 [9] there is no need to send a new offer from the terminating UE to indicate that resources are available since 180 (Ringing) will implicit indicate that resources are available.

Table 5.3-24: 180 (Ringing) response (UE#2 to P-CSCF#2)

```
SIP/2.0 180 Ringing
Via: SIP/2.0/UDP pcscf2.visited2.net:5088;comp=sigcomp;branch=z9hG4bK361k21.1, SIP/2.0/UDP
scscf2.home2.net;branch=z9hG4bK764z87.1, SIP/2.0/UDP
icscf2_s.home2.net;branch=z9hG4bK871y12.1, SIP/2.0/UDP
scscf1.home1.net;branch=z9hG4bK332b23.1, SIP/2.0/UDP
pcscf1.visited1.net;branch=z9hG4bK240f34.1, SIP/2.0/UDP
[5555::aaa:bbb:ccc:ddd]:1357;comp=sigcomp;branch=z9hG4bKnashds7
Record-Route: <sip:pcscf2.visited2.net:5088;lr;comp=sigcomp>, <sip:scscf2.home2.net;lr>,
<sip:scscf1.home1.net;lr>, <sip:pcscf1.visited1.net;lr>
P-Access-Network-Info: 3GPP-UTRAN-TDD; utran-cell-id-3gpp=234151D0FCE11
Privacy: none
From:
To: <tel:+1-212-555-2222>;tag=314159
Call-ID:
CSeq:
Require: 100rel
Contact: <sip:user2_public1@home2.net;gr=urn:uuid:2ad8950e-48a5-4a74-8d99-
ad76cc7fc74;comp=sigcomp>
Allow: INVITE, ACK, CANCEL, BYE, PRACK, UPDATE, REFER, MESSAGE
RSeq: 9021
Content-Length: 0
```

25-27. 180 (Ringing) response**28. 200 (OK) response UE#2 to P-CSCF#2 - - see example in table 5.3-25**

When the called party answers the UE#2 sends a 200 (OK) response final response to the INVITE request (7) to P-CSCF#2, and starts the media flow(s) for this session.

Table 5.3-25: 200 (OK) response (UE#2 to P-CSCF#2)

```

SIP/2.0 200 OK
Via: SIP/2.0/UDP pcscf2.visited2.net:5088;comp=sigcomp;branch=z9hG4bK361k21.1, SIP/2.0/UDP
    scscf2.home2.net;branch=z9hG4bK764z87.1, SIP/2.0/UDP
    icscf2_s.home2.net;branch=z9hG4bK871y12.1, SIP/2.0/UDP
    scscf1.home1.net;branch=z9hG4bK332b23.1, SIP/2.0/UDP
    pcscf1.visited1.net;branch=z9hG4bK240f34.1, SIP/2.0/UDP
    [5555::aaa:bbb:ccc:ddd]:1357;comp=sigcomp;branch=z9hG4bKnashds7
P-Access-Network-Info: 3GPP-UTRAN-TDD; utran-cell-id-3gpp=234151D0FCE11
Privacy: none
From:
To: <tel:+1-212-555-2222>;tag=314159
Call-ID:
CSeq:
Require: 100rel, precondition
Contact: <sip:user2_public1@home2.net:gr=urn:uuid:2ad8950e-48a5-4a74-8d99-
    ad76cc7fc74;comp=sigcomp>
Allow: INVITE, ACK, CANCEL, BYE, PRACK, UPDATE, REFER, MESSAGE
RSeq: 9021
Content-Length: 0

```

29.-31. 200 (OK) response**32.-35. ACK request**

The calling party responds to the 200 (OK) response with an ACK request.

5.4 Establishing a session when UE#1 does not have required resources available and UE#2 is non-IMS

5.4.1 Introduction

The following flows show the establishment of a session where UE#1, connected to the IM CN subsystem, does not yet have the required local resources available and needs to perform resource reservation while SIP UA#2 is a non-IMS UE.

It is assumed that the originating UE uses a dedicated IP-CAN bearer for SIP signalling and dedicated IP-CAN bearer for media.

The box "Intermediate IM CN subsystem entities" stands for the combination of I-CSCF/S-CSCF on the originating side. Routing of messages between those nodes is not described in the flow below.

As the topology on the non-IMS, terminating side is not known, only a UE is shown on the terminating side. However, this does not rule out the possibility that there are proxies in the terminating signalling path.

In subclause 5.4.2 the UE#1 establish a multimedia session comprising a video stream and an audio stream. The AVP transport is offered for the audio stream and the video stream in initial INVITE request. SIP UA#2 does not support the preconditions framework.

In subclause 5.4.3 the UE#1 establish a multimedia session comprising a video stream and an audio stream. The AVP transport is offered for the audio stream and the AVPF transport is offered for the video stream in initial INVITE request. SIP UA#2 supports the preconditions framework.

In subclause 5.4.4 the UE#1 establish a multimedia session comprising a video stream and an audio stream. The AVP transport is offered for the audio stream and the AVPF transport is offered for the video stream in initial INVITE request. SIP UA#2 does not support the preconditions framework.

5.4.2 Signalling Flow

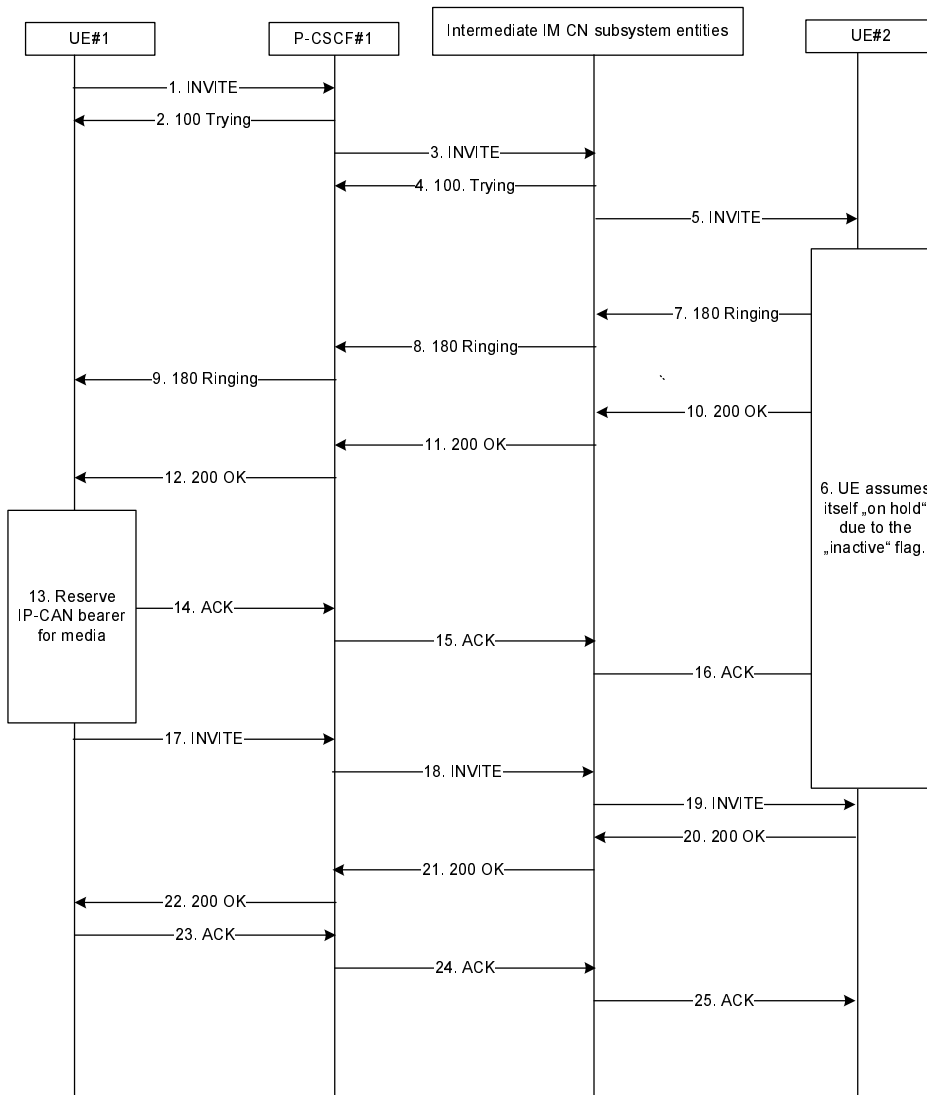

Figure 5.4-1: IMS session setup, resource reservation on both sides

The details of the signalling flows are as follows:

1. INVITE request (UE#1 to P-CSCF#1) see example in table 5.4-1

For this example, it is assumed that UE#1 is willing to establish a multimedia session comprising a video stream and an audio stream. The video stream supports the H.263 coded. The audio stream supports the AMR codec.

UE#1 indicates that it supports precondition and it indicates that it supports reliable provisional responses. However, it does not use the "Require" header for these capabilities.

UE#1 does not have available the resources that are necessary to transport the media.

Table 5.4-1: INVITE request (UE#1 to P-CSCF)

```

INVITE tel:+1-212-555-2222 SIP/2.0
Via: SIP/2.0/UDP [5555::aaa:bbb:ccc:ddd]:1357;comp=sigcomp;branch=z9hG4bKnashds7
Max-Forwards: 70
Route: <sip:pcscf1.visited1.net:7531;lr;comp=sigcomp>, <sip:scscf1.home1.net;lr>
P-Preferred-Identity: "John Doe" <sip:user1_public1@home1.net>
P-Access-Network-Info: 3GPP-UTRAN-TDD; utran-cell-id-3gpp=234151D0FCE11
Privacy: none
From: <sip:user1_public1@home1.net>;tag=171828
To: <tel:+1-212-555-2222>
Call-ID: cb03a0s09a2sdfg1kj490333
Cseq: 127 INVITE
    
```

```

Require: sec-agree
Supported: precondition, 100rel, gruu, 199
Accept: application/sdp,application/3gpp-ims+xml
Proxy-Require: sec-agree
Security-Verify: ipsec-3gpp; q=0.1; alg= hmac-sha-1-96; spi-c=98765432; spi-s=87654321;
port-c=8642; port-s=7531
Contact: <sip:user1_public1@home1.net;gr=urn:uuid:f81d4fae-7dec-11d0-a765-
00a0c91e6bf6;comp=sigcomp>
Allow: INVITE, ACK, CANCEL, BYE, PRACK, UPDATE, REFER, MESSAGE
Content-Type: application/sdp
Content-Length: (...)

v=0
o=- 2987933615 2987933615 IN IP6 5555::aaa:bbb:ccc:ddd
s=-
c=IN IP6 5555::aaa:bbb:ccc:ddd
t=0 0
m=video 3400 RTP/AVP 98
b=AS:75
a=curr:qos local none
a=curr:qos remote none
a=des:qos mandatory local sendrecv
a=des:qos none remote sendrecv
a=inactive
a=rtpmap:98 H263
m=audio 3456 RTP/AVP 97 96
b=AS:25.4
a=curr:qos local none
a=curr:qos remote none
a=des:qos mandatory local sendrecv
a=des:qos none remote sendrecv
a=inactive
a=rtpmap:97 AMR
a=fmtp:97 mode-set=0,2,5,7; maxframes=2
a=rtpmap:96 telephone-event

```

Supported: The UE indicates support for the "precondition" mechanism, the support for reliable provisional responses and the support for the 199 (Early Dialog Terminated) response code.

SDP The SDP contains a set of codecs supported by UE#1 and desired by the user at UE#1 for this session. As the local preconditions are not fulfilled, both media are set to "inactive".

2. 100 (Trying) response (P-CSCF#1 to UE#1)

The P-CSCF responds to the INVITE request with a 100 (Trying) provisional response.

3. INVITE request (P-CSCF#1 to S-CSCF#1) - see example in table 5.4-2

Table 5.4-2: INVITE request (P-CSCF#1 to S-CSCF#1)

```

INVITE tel:+1-212-555-2222 SIP/2.0
Via: SIP/2.0/UDP pcscf1.visited1.net;branch=z9hG4bK240f34.1, SIP/2.0/UDP
[5555::aaa:bbb:ccc:ddd]:1357;comp=sigcomp;branch=z9hG4bKnashds7
Max-Forwards: 69
Route: <sip:scscf1.home1.net;lr>
Record-Route: <sip:pcscf1.visited1.net;lr>
P-Asserted-Identity: "John Doe" <sip:user1_public1@home1.net>
P-Access-Network-Info:
P-Charging-Vector: icid-value="AyretyU0dm+602IrT5tAFrbHLso=023551024"
Privacy:
From:
To:
Call-ID:
Cseq:
Supported:
Accept:
Contact:
Allow:
Content-Type:
Content-Length: (...)

v=
o=
s=

```

```

c=
t=
m=
b=
a=
a=
a=
a=
a=
a=
a=

```

4. 100 (Trying) response (S-CSCF#1 to P-CSCF#1)

The S-CSCF responds to the INVITE request with a 100 (Trying) provisional response.

5. INVITE request (S-CSCF#1 to UE#2) see example in table 5.4-3

Table 5.4-3: INVITE request(S-CSCF#1 to UE#2)

```

INVITE sip:[5555::eee:fff:aaa:bbb]:8805;comp=sigcomp SIP/2.0
Via: SIP/2.0/UDP scscf1.home1.net;branch=z9hG4bK332b23.1, SIP/2.0/UDP
    pcscf1.visited1.net;branch=z9hG4bK240f34.1, SIP/2.0/UDP
    [5555::aaa:bbb:ccc:ddd]:1357;comp=sigcomp;branch=z9hG4bKnashds7
Max-Forwards: 66
Route: <sip:pcscf2.visited2.net;lr>
Record-Route: <sip:scscf1.home1.net;lr>, <sip:pcscf1.visited1.net;lr>
P-Asserted-Identity:
Privacy:
From:
To:
Call-ID:
Cseq:
Require:
Supported:
Accept:
Contact:
Allow:
P-Called-Party-ID: <sip:user2_public1@home2.net>
Content-Type:
Content-Length: (...)

v=
o=
s=
c=
t=
m=
b=
a=
a=
a=
a=
a=
a=
a=
a=
a=

```

6. UE#2 assumes itself on hold

UE#2 assumes itself on hold as media are set to inactive, i.e. UE#2 does not await or send media.

Resources are available.

7-9. 180 (Ringing) response

UE#2 indicates that it is ringing. It is assumed that UE#2 does not support the "100rel" extension and therefore the 180 (Ringing) response is not sent reliable, i.e. no SDP is sent in the 180 (Ringing) response.

10. 200 (OK) response (UE#2 to S-CSCF) - see example in table 5.4-5

User on the terminating side goes off hook. It is assumed that UE#2 plays some announcement to indicate to the user that the call is on hold.

UE#2 ignores the precondition that it received in the INVITE request as it does not support them. No preconditions are included in the SDP answer. Both media streams are set to "inactive".

Table 5.4-5: 200(OK) response (UE#2 to S-CSCF)

```
SIP/2.0 200 OK
Via: SIP/2.0/UDP scscf1.home1.net;branch=z9hG4bK332b23.1, SIP/2.0/UDP
    pcscf1.visited1.net;branch=z9hG4bK240f34.1, SIP/2.0/UDP
    [5555::aaa:bbb:ccc:ddd]:1357;comp=sigcomp;branch=z9hG4bKnashds7
Record-Route:
From:
To: <tel:+1-212-555-2222>;tag=314159
Call-ID:
Cseq:
Content-Type: application/sdp
Content-Length: (...)

v=0
o=- 2987933615 2987933615 IN IP6 5555::eee:fff:ggg:hhh
s=-
c=IN IP6 5555::eee:fff:ggg:hhh
t=0 0
m=video 3400 RTP/AVP 98
b=AS:75
a=inactive
a=rtpmap:98 H263
a=fmtp:98 profile-level-id=0
m=audio 3456 RTP/AVP 97 96
b=AS:25.4
a=inactive
a=rtpmap:97 AMR
a=fmtp:97 mode-set=0,2,5,7; maxframes
```

11. 200 (OK) response (S-CSCF#1 to P-CSCF#1) - see example in table 5.4-6

Table 5.4-6: 200(OK) response (S-CSCF#1 to P-CSCF#1)

```
SIP/2.0 200 OK
Via: SIP/2.0/UDP pcscf1.visited1.net;branch=z9hG4bK240f34.1, SIP/2.0/UDP
    [5555::aaa:bbb:ccc:ddd]:1357;comp=sigcomp;branch=z9hG4bKnashds7
Record-Route:
From:
To:
Call-ID:
Cseq:
Content-Type: application/sdp
Content-Length: (...)

v=
o=
s=
c=
t=
m=
b=
a=
a=
a=
m=
b=
a=
a=
a=
```

12. 200 (OK) response (P-CSCF#1 to UE#1) - see example in table 5.4-7

Table 5.4-7: 200(OK) response (P-CSCF to UE#1)

```

SIP/2.0 200 OK
Via: SIP/2.0/UDP [5555::aaa:bbb:ccc:ddd]:1357;comp=sigcomp;branch=z9hG4bKnashds7
Record-Route:
From:
To:
Call-ID:
Cseq:
Content-Type: application/sdp
Content-Length: (...)

v=
o=
s=
c=
t=
m=
b=
a=
a=
a=
m=
b=
a=
a=
a=

```

13 . Reserve IPCAN bearer for media

The originating UE sets up the bearer in accordance with the media description received SDP.

14.-16. .ACK request

The calling party responds to the 200 (OK) response with an ACK request.

17. INVITE request (UE#1 to P-CSCF#1) see example in table 5.4-8

UE#1 sets the media streams to active using a re-INVITE request

As UE#2 does not support preconditions, UE#1 does not include preconditions in the SDP.

Table 5.4-8: INVITE request (UE#1 to P-CSCF)

```

INVITE sip:[5555::eee:fff:aaa:bbb]:8805;comp=sigcomp
Via: SIP/2.0/UDP [5555::aaa:bbb:ccc:ddd]:1357;comp=sigcomp;branch=z9hG4bKnashds7
Max-Forwards: 70
Route: <sip:pcscf1.visited1.net:7531;lr;comp=sigcomp>, <sip:scscf1.home1.net;lr>
From: <sip:user1_public1@home1.net>;tag=171828
To: <tel:+1-212-555-2222>; tag=314159
Call-ID: cb03a0s09a2sdfg1kj490333
Cseq: 128 INVITE
Require: sec-agree
Supported: precondition, 100rel, gruu, 199
Accept: application/sdp,application/3gpp-ims+xml
Proxy-Require: sec-agree
Security-Verify: ipsec-3gpp; q=0.1; alg= hmac-sha-1-96; spi-c=98765432; spi-s=87654321;
port-c=8642; port-s=7531
Contact: <sip:user1_public1@home1.net;gr=urn:uuid:f81d4fae-7dec-11d0-a765-
00a0c91e6bf6;comp=sigcomp>
Allow: INVITE, ACK, CANCEL, BYE, PRACK, UPDATE, REFER, MESSAGE
Content-Type: application/sdp
Content-Length: (...)

v=0
o=- 2987933615 2987933615 IN IP6 5555::aaa:bbb:ccc:ddd
s=-
c=IN IP6 5555::aaa:bbb:ccc:ddd
t=0 0
m=video 3400 RTP/AVP 98
b=AS:75
a=rtpmap:98 H263
m=audio 3456 RTP/AVP 97 96
b=AS:25.4

```



```
a=rtpmap:97 AMR
a=fmtp:97 mode-set=0,2,5,7; maxframes=2
a=rtpmap:96 telephone-event
```

18. INVITE request (P-CSCF#1 to S-CSCF#1) see example in table 5.4-9

Table 5.4-9: INVITE request (P-CSCF#1 to S-CSCF)

```
INVITE sip:[5555::eee:fff:aaa:bbb]:8805;comp=sigcomp
Via: SIP/2.0/UDP pcscf1.visited1.net;branch=z9hG4bK240f34.1, SIP/2.0/UDP
    [5555::aaa:bbb:ccc:ddd]:1357;comp=sigcomp;branch=z9hG4bKnashds7
Max-Forwards: 69
Route: <sip:scscf1.home1.net;lr>
Record-Route: <sip:pcscf1.visited1.net;lr>
From:
To:
Call-ID:
Cseq:
Supported:
Accept:
Contact:
Allow:
Content-Type:
Content-Length:

v=
o=
s=
c=
t=
m=
b=
a=
m=
b=
a=
a=
a=
```

19. INVITE request (S-CSCF#1 to UE#2) see example in table 5.4-10

Table 5.4-10: INVITE request (S-CSCF#1 to UE#2)

```
INVITE sip:[5555::eee:fff:aaa:bbb]:8805;comp=sigcomp
Via: SIP/2.0/UDP pcscf1.visited1.net;branch=z9hG4bK240f34.1, SIP/2.0/UDP
    [5555::aaa:bbb:ccc:ddd]:1357;comp=sigcomp;branch=z9hG4bKnashds7
Max-Forwards:
Record-Route: < sip:scscf1.home1.net;lr>, <sip:pcscf1.visited1.net;lr>
From:
To:
Call-ID:
Cseq:
Supported:
Accept:
Contact:
Allow:
Content-Type:
Content-Length:

v=
o=
s=
c=
t=
m=
b=
a=
m=
b=
a=
a=
a=
```

20. 200 (OK) response (UE#2 to S-CSCF) - see example in table 5.4-11

UE#2 confirms the new SDP offer. Media is set to active

Table 5.4-11: 200(OK) response (UE#2 to S-CSCF)

```
SIP/2.0 200 OK
Via: SIP/2.0/UDP scscf1.home1.net;branch=z9hG4bK332b23.1, SIP/2.0/UDP
    pcscf1.visited1.net;branch=z9hG4bK240f34.1, SIP/2.0/UDP
    [5555::aaa:bbb:ccc:ddd]:1357;comp=sigcomp;branch=z9hG4bKnashds7
Record-Route:
From:
To: <
Call-ID:
Cseq:
Content-Type: application/sdp
Content-Length: (...)

v=0
o=- 2987933615 2987933615 IN IP6 5555::eee:fff:ggg:hhh
s=-
c=IN IP6 5555::eee:fff:ggg:hhh
t=0 0
m=video 3400 RTP/AVP 98
b=AS:75
a=rtpmap:98 H263
a=fmtp:98 profile-level-id=0
m=audio 3456 RTP/AVP 97 96
b=AS:25.4
a=rtpmap:97 AMR
a=fmtp:97 mode-set=0,2,5,7; maxframes
```

21. 200 (OK) response (S-CSCF#1 to P-CSCF#1) - see example in table 5.4-12**Table 5.4-12: 200(OK) response (S-CSCF#1 to P-CSCF#1)**

```
SIP/2.0 200 OK
Via: SIP/2.0/UDP pcscf1.visited1.net;branch=z9hG4bK240f34.1, SIP/2.0/UDP
    [5555::aaa:bbb:ccc:ddd]:1357;comp=sigcomp;branch=z9hG4bKnashds7
Record-Route:
From:
To:
Call-ID:
Cseq:
Content-Type:
Content-Length:(...)

v=
o=
s=
c=
t=
m=
b=
a=
a=
a=
m=
b=
a=
a=
a=
```

22. 200 (OK) response (P-CSCF#1 to UE#1) - see example in table 5.4-12

Table 5.4-7: 200(OK) response (P-CSCF to UE#1)

```
SIP/2.0 200 OK
Via: SIP/2.0/UDP [5555::aaa:bbb:ccc:ddd]:1357;comp=sigcomp;branch=z9hG4bKnashds7
Record-Route:
From:
To:
Call-ID:
Cseq:
Content-Type: application/sdp
Content-Length: (...)

v=
o=
s=
c=
t=
m=
b=
a=
a=
a=
m=
b=
a=
a=
a=
```

23.-25. .ACK request

The calling party responds to the 200 (OK) response with an ACK request.

5.4.3 Signalling flow (preconditions used, SDP capability negotiation not supported by UE#1, 2nd SDP offer offering AVP transport for video)

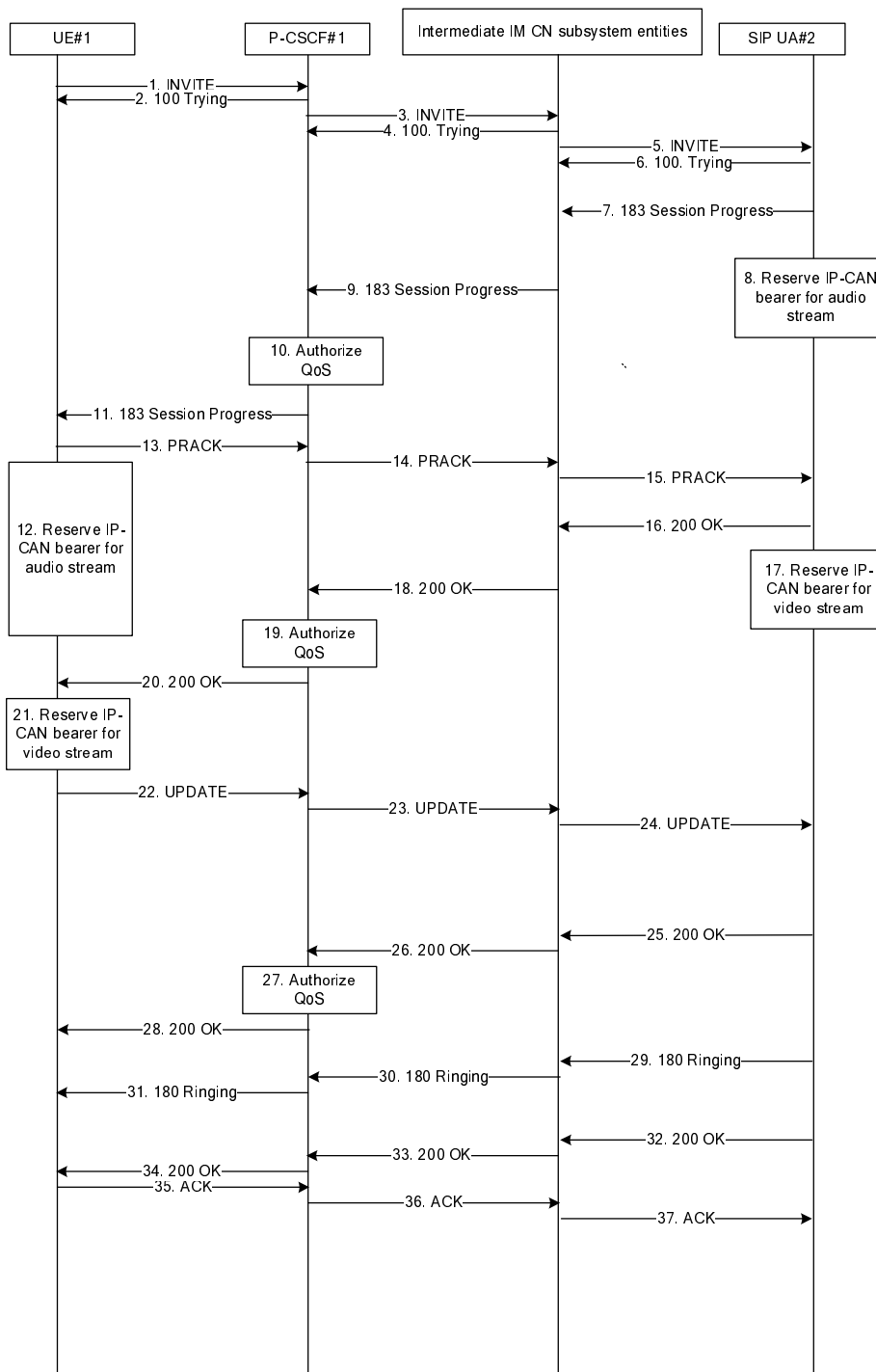

Figure 5.4.3-1: IMS session setup, resource reservation on both sides

The details of the signalling flows are as follows:

1. INVITE request (UE#1 to P-CSCF#1) see example in table 5.4.3-1

For this example, it is assumed that UE#1 is willing to establish a multimedia session comprising a video stream and an audio stream. The video stream supports two codecs, either H.263 or MPEG-4 Visual. The audio stream supports the AMR codec. The UE#1 is willing to establish the video stream using AVPF or AVP transport and the audio stream using AVP transport. The UE#1 does not support SDP capability negotiation.

UE#1 indicates that it supports and is willing to use AVPF transport for the video stream and AVP transport for the audio stream.

UE#1 indicates that it supports precondition and it indicates that it supports reliable provisional responses. However, it does not use the "Require" header for these capabilities.

UE#1 does not have available the resources that are necessary to transport the media.

For this example it is assumed, that signalling encryption was negotiated between UE and P-CSCF in the security mode set-up procedure during the last successful authentication. This option will only be shown in this example.

Table 5.4.3-1: INVITE request (UE#1 to P-CSCF#1)

```

INVITE tel:+1-212-555-2222 SIP/2.0
Via: SIP/2.0/UDP [5555::aaa:bbb:ccc:ddd]:1357;comp=sigcomp;branch=z9hG4bKnashds7
Max-Forwards: 70
Route: <sip:pcscf1.visited1.net:7531;lr;comp=sigcomp>, <sip:scscf1.home1.net;lr>
P-Preferred-Identity: "John Doe" <sip:user1_public1@home1.net>
P-Access-Network-Info: 3GPP-UTRAN-TDD; utran-cell-id-3gpp=234151D0FCE11
Privacy: none
From: <sip:user1_public1@home1.net>;tag=171828
To: <tel:+1-212-555-2222>
Call-ID: cb03a0s09a2sdfg1kj490333
Cseq: 127 INVITE
Require: sec-agree
Supported: precondition, 100rel, gruu, 199
Accept: application/sdp,application/3gpp-ims+xml
Proxy-Require: sec-agree
Security-Verify: ipsec-3gpp; q=0.1; alg= hmac-sha-1-96; ealg=aes-cbc; spi-c=98765432; spi-
s=87654321; port-c=8642; port-s=7531
Contact: <sip:user1_public1@home1.net;gr=urn:uuid:f81d4fae-7dec-11d0-a765-
00a0c91e6bf6;comp=sigcomp>
Allow: INVITE, ACK, CANCEL, BYE, PRACK, UPDATE, REFER, MESSAGE
Content-Type: application/sdp
Content-Length: (...)

v=0
o=- 2987933615 2987933615 IN IP6 5555::aaa:bbb:ccc:ddd
s=-
c=IN IP6 5555::aaa:bbb:ccc:ddd
t=0 0
m=video 3400 RTP/AVPF 98 99
b=AS:75
a=curr:qos local none
a=curr:qos remote none
a=des:qos mandatory local sendrecv
a=des:qos none remote sendrecv
a=inactive
a=rtpmap:98 H263
a=fmtp:98 profile-level-id=0
a=rtpmap:99 MP4V-ES
m=audio 3456 RTP/AVP 97 96
b=AS:25.4
a=curr:qos local none
a=curr:qos remote none
a=des:qos mandatory local sendrecv
a=des:qos none remote sendrecv
a=inactive
a=rtpmap:97 AMR
a=fmtp:97 mode-set=0,2,5,7; maxframes=2
a=rtpmap:96 telephone-event

```

Supported: The UE indicates support for the "precondition" mechanism, the support for reliable provisional responses and the support for the 199 (Early Dialog Terminated) response code.

SDP The SDP contains a set of codecs supported by UE#1 and desired by the user at UE#1 for this session. As the local preconditions are not fulfilled, both media are set to "inactive".

Security-Verify: The Security-Verify contains the content of the Security-Server header as received during last successful authentication. It indicates that integrity protection and encryption are in use for this session.

Table 5.4.3-7: 183 (Session Progress) response (SIP UA#2 to intermediate IM CN subsystem entities)

```

SIP/2.0 183 Session Progress
Via: SIP/2.0/UDP scscf1.home1.net;branch=z9hG4bK332b23.1, SIP/2.0/UDP
    pcscf1.visited1.net;branch=z9hG4bK240f34.1, SIP/2.0/UDP
    [5555::aaa:bbb:ccc:ddd]:1357;comp=sigcomp;branch=z9hG4bKnashds7
Record-Route: <sip:scscf1.home1.net;lr>, <sip:pcscf1.visited1.net;lr>
P-Access-Network-Info: 3GPP-UTRAN-TDD; utran-cell-id-3gpp=234151D0FCE11
Privacy: none
From:
To: <tel:+1-212-555-2222>;tag=314159
Call-ID:
CSeq:
Require: 100rel, precondition
Contact: <sip:user2_public1@home2.net;gr=urn:uuid:2ad8950e-48a5-4a74-8d99-
    ad76cc7fc74c;comp=sigcomp>
Allow: INVITE, ACK, CANCEL, BYE, PRACK, UPDATE, REFER, MESSAGE
RSeq: 9021
Content-Type: application/sdp
Content-Length: (...)

v=0
o=- 2987933623 2987933623 IN IP6 5555::eee:fff:aaa:bbb
s=-
c=IN IP6 5555::eee:fff:aaa:bbb
t=0 0
m=video 0 RTP/AVPF 98
m=audio 6544 RTP/AVP 97 96
b=AS:25.4
a=curr:qos local none
a=curr:qos remote none
a=des:qos mandatory local sendrecv
a=des:qos mandatory remote sendrecv
a=inactive
a=conf:qos remote sendrecv
a=rtpmap:97 AMR
a=fmtp:97 mode-set=0,2,5,7; maxframes=2
a=rtpmap:96 telephone-event

```

8. Reserve IP-CAN bearer for audio stream

The terminating UA sets up the bearer for the audio stream in accordance with the media description received SDP.

9. 183 (session progress) response (intermediate IM CN subsystem entities to P-CSCF#1) – see example in table 5.4.3-13

Table 5.4.3-9: 183 (Session Progress) response (intermediate IM CN subsystem entities to P-CSCF#1)

```
SIP/2.0 183 Session Progress
Via: SIP/2.0/UDP pcscf1.visited1.net;branch=z9hG4bK240f34.1, SIP/2.0/UDP
    [5555::aaa:bbb:ccc:ddd]:1357;comp=sigcomp;branch=z9hG4bKnashds7
Record-Route:
P-Asserted-Identity:
P-Access-Network-Info:
P-Charging-Vector: icid-value="AyretyU0dm+602IrT5tAFrbHLso=023551024"
Privacy:
From:
To:
Call-ID:
CSeq:
Require:
Contact:
Allow:
RSeq:
Content-Type:
Content-Length:

v=
o=
s=
c=
t=
m=
m=
b=
a=
a=
a=
a=
a=
a=
a=
a=
a=
a=
```

10. Authorize QoS

P-CSCF authorizes the resources necessary for this session.

11. 183 (Session Progress) response (P-CSCF#1 to UE#1) – see example in table 5.4.3-11

Table 5.4.3-11: 183 (Session Progress) response (P-CSCF#1 to UE#1)

```

SIP/2.0 183 Session Progress
Via: SIP/2.0/UDP [5555::aaa:bbb:ccc:ddd]:1357;comp=sigcomp;branch=z9hG4bKnashds7
Record-Route:
P-Asserted-Identity:
Privacy:
From:
To:
Call-ID:
CSeq:
Require:
Contact:
Allow:
RSeq:
Content-Type:
Content-Length:

v=
o=
s=
c=
t=
m=
m=
b=
a=
a=
a=
a=
a=
a=
a=
a=
a=
a=

```

12. Reserve IP-CAN bearer for audio stream

The originating UE sets up the bearer for audio stream in accordance with the media description received SDP.

13. PRACK request (UE#1 to P-CSCF#1) - see example in table 5.4.3-13

Since SIP UA#2 did not accept the video stream UE#1 includes a new SDP offer in the PRACK request.

UE#1 indicates that it supports and is willing to use AVP transport for the video stream and AVP transport for the audio stream. The video stream supports two codecs, either H.263 or MPEG-4 Visual. The audio stream supports the AMR codec.

UE#1 does not have available the resources that are necessary to transport the media.

Table 5.4.3-13: PRACK request (UE#1 to P-CSCF#1)

```

PRACK sip:[5555::eee:fff:aaa:bbb]:8805;comp=sigcomp SIP/2.0
Via: SIP/2.0/UDP [5555::aaa:bbb:ccc:ddd]:1357;comp=sigcomp;branch=z9hG4bKnashds7
Max-Forwards: 70
Route: <sip:pcscf1.visited1.net;lr>, <sip:scscf1.home1.net;lr>
From: <sip:user1_public1@home1.net>; tag=171828
To: <tel:+12125552222> tag=314159
Call-ID: cb03a0s09a2sdfglkj490333
Cseq: 128 PRACK
Rack: 9021 127 INVITE
Require: sec-agree, precondition
Proxy-Require: sec-agree
Security-Verify: ipsec-3gpp; q=0.1; alg=hmac-sha-1-96; ealg=aes-cbc; spi-c=98765432; spi-
s=87654321; port-c=8642; port-s=7531
Contact: <sip:user1_public1@home1.net;gr=urn:uuid:f81d4fae-7dec-11d0-a765-
00a0c91e6bf6;comp=sigcomp>
Content-Type: application/sdp
Content-Length: (...)

v=0
o=- 2987933615 2987933615 IN IP6 5555::aaa:bbb:ccc:ddd

```

Table 5.4.3-15: PRACK request (intermediate IM CN subsystem entities to SIP UA#2)

```

PRACK sip:[5555::eee:fff:aaa:bbb]:8805;comp=sigcomp SIP/2.0
Via: SIP/2.0/UDP scscf1.home1.net;branch=z9hG4bK332b23.1, SIP/2.0/UDP
    pcscf1.visited1.net;branch=z9hG4bK240f34.1, SIP/2.0/UDP
    [5555::aaa:bbb:ccc:ddd]:1357;comp=sigcomp;branch=z9hG4bKnashds7
Max-Forwards: 67
From:
To:
Call-ID:
Cseq:
Rack:
Require:
Proxy-Require:
Security-Verify:
Contact:
Content-Type:
Content-Length:

v=
o=
s=
c=
t=
m=
b=
a=
a=
a=
a=
a=
a=
a=
a=
m=
b=
a=
a=
a=
a=
a=
a=
a=
a=
a=
a=
a=

```

16. 200 (OK) response to PRACK request (SIP UA#2 to intermediate IM CN subsystem entities) - - see example in table 5.4.3-16

SIP UA#2 support AVP so it can accept the offered video stream.

The SIP UA#2 determines the complete set of codecs that it is capable of supporting for this session. It determines the intersection with those appearing in the SDP in the PRACK request. SIP UA#2 makes the codec selection and chooses AMR and H.263.

SIP UA#2 responds with a 200 (OK) response to PRACK containing SDP back to the originator. This response is sent to P-CSCF. SIP UA#2 uses a conf line in the SDP to request a confirmation from UE#1 when the local resources are available at UE#1.

Table 5.4.3-16: 200 (OK) response to PRACK request (SIP UA#2 to intermediate IM CN subsystem entities)

```

SIP/2.0 200 OK
Via: SIP/2.0/UDP scscf1.home1.net;branch=z9hG4bK332b23.1, SIP/2.0/UDP
    pcscf1.visited1.net;branch=z9hG4bK240f34.1, SIP/2.0/UDP
    [5555::aaa:bbb:ccc:ddd]:1357;comp=sigcomp;branch=z9hG4bKnashds7
P-Access-Network-Info: 3GPP-UTRAN-TDD; utran-cell-id-3gpp=234151D0FCE11
From:
To:
Call-ID:
CSeq:
Require: precondition
Contact: <sip:user2_public1@home2.net:gr=urn:uuid:2ad8950e-48a5-4a74-8d99-
    ad76cc7fc74c;comp=sigcomp>
Allow: INVITE, ACK, CANCEL, BYE, PRACK, UPDATE, REFER, MESSAGE
Content-Type: application/sdp
Content-Length: (...)

v=0
o=- 2987933623 2987933623 IN IP6 5555::eee:fff:aaa:bbb
s=-
c=IN IP6 5555::eee:fff:aaa:bbb
t=0 0
m=video 10001 RTP/AVP 98
b=AS:75
a=curr:qos local none
a=curr:qos remote none
a=des:qos mandatory local sendrecv
a=des:qos mandatory remote sendrecv
a=inactive
a=conf:qos remote sendrecv
a=rtpmap:98 H263
a=fmtp:98 profile-level-id=0
m=audio 6544 RTP/AVP 97 96
b=AS:25.4
a=curr:qos local sendrecv
a=curr:qos remote none
a=des:qos mandatory local sendrecv
a=des:qos mandatory remote sendrecv
a=inactive
a=conf:qos remote sendrecv
a=rtpmap:97 AMR
a=fmtp:97 mode-set=0,2,5,7; maxframes=2
a=rtpmap:96 telephone-event

```

17. Reserve IP-CAN bearer for video stream

The terminating UA sets up the bearer for video stream in accordance with the media description received SDP.

18. 200 (OK) response to PRACK request (intermediate IM CN subsystem entities to P-CSCF#1) - - see example in table 5.4.3-18

Table 5.4.3-18: 200 (OK) response to PRACK request (intermediate IM CN subsystem entities to P-CSCF#1)

```
SIP/2.0 200 OK
Via: SIP/2.0/UDP pcscf1.visited1.net;branch=z9hG4bK240f34.1, SIP/2.0/UDP
    [5555::aaa:bbb:ccc:ddd]:1357;comp=sigcomp;branch=z9hG4bKnashds7
P-Access-Network-Info:
From:
To:
Call-ID:
CSeq:
Require:
Contact:
Allow:
Content-Type:
Content-Length:

v=
o=
s=
c=
t=
m=
b=
a=
a=
a=
a=
a=
a=
a=
a=
m=
b=
a=
a=
a=
a=
a=
a=
a=
a=
a=
a=
a=
```

19. Authorize QoS

P-CSCF authorizes the resources necessary for this session.

20. 200 (OK) response to PRACK request (P-CSCF#1 to UE#1) - - see example in table 5.4.3-20

Table 5.4.3-20: 200 (OK) response to PRACK request (intermediate IM CN subsystem entities to P-CSCF#1)

```

SIP/2.0 200 OK
Via: SIP/2.0/UDP [5555::aaa:bbb:ccc:ddd]:1357;comp=sigcomp;branch=z9hG4bKnashds7
P-Access-Network-Info:
From:
To:
Call-ID:
CSeq:
Require:
Contact:
Allow:
Content-Type:
Content-Length:

v=
o=
s=
c=
t=
m=
b=
a=
a=
a=
a=
a=
a=
a=
a=
m=
b=
a=
a=
a=
a=
a=
a=
a=
a=
a=
a=
a=

```

21. Reserve IP-CAN bearer for video stream

The originating UE sets up the bearer for video stream in accordance with the media description received SDP.

22. UPDATE request (UE#1 to P-CSCF#1) - see example in table 5.4.3-22

UE#1 indicates that it can send and receive media once the necessary resources for both audio and video are available.

Table 5.4.3-22: UPDATE request (UE#1 to P-CSCF#1)

```

UPDATE sip:[5555::eee:fff:aaa:bbb]:8805;comp=sigcomp
Via: SIP/2.0/UDP [5555::aaa:bbb:ccc:ddd]:1357;comp=sigcomp;branch=z9hG4bKnashds7
Max-Forwards: 70
Route: <sip:pcscf1.visited1.net;lr>, <sip:scscf1.home1.net;lr>
From: <sip:user1_public1@home1.net>; tag=171828
To: <tel:+12125552222> tag=314159
Call-ID: cb03a0s09a2sdfg1kj490333
Cseq: 129 UPDATE
Require: sec-agree, precondition
Proxy-Require: sec-agree
Security-Verify: ipsec-3gpp; q=0.1; alg=hmac-sha-1-96; ealg=aes-cbc; spi-c=98765432; spi-
s=87654321; port-c=8642; port-s=7531
Contact: <sip:user1_public1@home1.net;gr=urn:uuid:f81d4fae-7dec-11d0-a765-
00a0c91e6bf6;comp=sigcomp>
Content-Type: application/sdp
Content-Length: (...)

v=0
o=- 2987933615 2987933615 IN IP6 5555::aaa:bbb:ccc:ddd

```

```

s=-
c=IN IP6 5555::aaa:bbb:ccc:ddd
t=0 0
m=video 3400 RTP/AVP 98
b=AS:75
a=curr:qos local sendrecv
a=curr:qos remote none
a=des:qos mandatory local sendrecv
a=des:qos mandatory remote sendrecv
a=sendrecv
a=rtpmap:98 H263
a=fmtp:98 profile-level-id=0
m=audio 3456 RTP/AVP 97 96
b=AS:25.4
a=curr:qos local sendrecv
a=curr:qos remote none
a=des:qos mandatory local sendrecv
a=des:qos mandatory remote sendrecv
a=sendrecv
a=rtpmap:97 AMR
a=fmtp:97 mode-set=0,2,5,7; maxframes

```

23. UPDATE request (P-CSCF#1 to intermediate IM CN subsystem entities) - see example in table 5.4.3-23

Table 5.4.3-23: UPDATE request (P-CSCF#1 to intermediate IM CN subsystem entities)

```

UPDATE sip:[5555::eee:fff:aaa:bbb]:8805;comp=sigcomp SIP/2.0
Via: SIP/2.0/UDP pcscf1.visited1.net;branch=z9hG4bK240f34.1, SIP/2.0/UDP
    [5555::aaa:bbb:ccc:ddd]:1357;comp=sigcomp;branch=z9hG4bKnashds7
Max-Forwards: 69
P-Access-Network-Info:
P-Charging-Vector: icid-value="AyretyU0dm+602IrT5tAFrbHLso=023551024";
    ggsn=[5555::4b4:3c3:2d2:1e1]; pdp-sig=no; gcid=723084371; auth-token=43876559; flow-id=3
Route: <sip:scscf1.homel.net;lr>
From:
To:
Call-ID:
Cseq:
Content-Type:
Content-Length:

v=
o=
s=
c=
t=
m=
b=
a=
a=
a=
a=
a=
a=
a=

```

24. UPDATE request (intermediate IM CN subsystem entities to SIP UA#2) - see example in table 5.4.3-24

Table 5.4.3-24: UPDATE request (intermediate IM CN subsystem entities to SIP UA#2)

```

UPDATE sip:[5555::eee:fff:aaa:bbb]:8805;comp=sigcomp SIP/2.0
Via: SIP/2.0/UDP scscf1.homel.net;branch=z9hG4bK332b23.1, SIP/2.0/UDP
    pcscf1.visited1.net;branch=z9hG4bK240f34.1, SIP/2.0/UDP
    [5555::aaa:bbb:ccc:ddd]:1357;comp=sigcomp;branch=z9hG4bKnashds7
Max-Forwards: 66
From:
To:
Call-ID:
Cseq:
Content-Type:
Content-Length:

v=
o=

```



```
s=
c=
t=
m=
b=
a=
a=
a=
a=
a=
a=
```

25. **200 (OK) response (SIP UA#2 to intermediate IM CN subsystem entities)** - see example in table 5.4.3-25

UE acknowledges the UPDATE request with a 200 (OK) response.

UE indicates that the local resources are available

Table 5.4.3-25: 200(OK) response (SIP UA#2 to intermediate IM CN subsystem entities)

```
SIP/2.0 200 OK
Via: SIP/2.0/UDP scscf1.home1.net;branch=z9hG4bK332b23.1, SIP/2.0/UDP
    pcscf1.visited1.net;branch=z9hG4bK240f34.1, SIP/2.0/UDP
    [5555::aaa:bbb:ccc:ddd]:1357;comp=sigcomp;branch=z9hG4bKnashds7
P-Access-Network-Info: 3GPP-UTRAN-TDD; utran-cell-id-3gpp=234151D0FCE11
From: <sip:user1_public1@home1.net>;tag=171828
To: <tel:+12125552222>;tag=314159
Call-ID: cb03a0s09a2sdfg1kj490333
Cseq: 129 UPDATE
Require: precondition
Content-Type: application/sdp
Content-Length: (...)

v=0
o=- 2987933615 2987933615 IN IP6 5555::eee:fff:aaa:bbb
s=-
c=IN IP6 5555::eee:fff:aaa:bbb
t=0 0
m=video 3400 RTP/AVP 98
b=AS:75
a=curr:qos local sendrecv
a=curr:qos remote sendrecv
a=des:qos mandatory local sendrecv
a=des:qos mandatory remote sendrecv
a=rtpmap:98 H263
a=fmtp:98 profile-level-id=0
m=audio 3456 RTP/AVP 97 96
b=AS:25.4
a=curr:qos local sendrecv
a=curr:qos remote sendrecv
a=des:qos mandatory local sendrecv
a=des:qos mandatory remote sendrecv
a=rtpmap:97 AMR
a=fmtp:97 mode-set=0,2,5,7; maxframes
```

26. **200 (OK) response (intermediate IM CN subsystem entities to S-CSCF#2)** - see example in table 5.4.3-26

Table 5.4.3-26: 200(OK) response (intermediate IM CN subsystem entities to P-CSCF#1)

```
SIP/2.0 200 OK
Via: SIP/2.0/UDP pcscf1.visited1.net;branch=z9hG4bK240f34.1, SIP/2.0/UDP
    [5555::aaa:bbb:ccc:ddd]:1357;comp=sigcomp;branch=z9hG4bKnashds7
From:
To:
Call-ID:
CSeq:
Require:
Content-Type:
Content-Length:

v=
o=
s=
```

```

c=
t=
m=
b=
a=
a=
a=
a=
a=
a=
m=
b=
a=
a=
a=
a=
a=
a=
a=
a=

```

27. Authorize QoS

P-CSCF authorizes the resources necessary for this session.

28. 200 (OK) response (P-CSCF#1 to UE#1) - see example in table 5.4.3-28

Table 5.4.3-28: 200(OK) response (P-CSCF#1 to UE#1)

```

SIP/2.0 200 OK
Via: SIP/2.0/UDP [5555::aaa:bbb:ccc:ddd]:1357;comp=sigcomp;branch=z9hG4bKnashds7
From:
To:
Call-ID:
CSeq:
Require:
Content-Type:
Content-Length:

v=
o=
s=
c=
t=
m=
b=
a=
a=
a=
a=
a=
a=
a=
m=
b=
a=
a=
a=
a=
a=
a=
a=
a=

```

29 -31. 180 (Ringing) response

SIP UA#2 indicates that it is ringing. The SIP UA#2 does not use Require "100rel" as the 180 (Ringing) does not have a SDP and therefore need not to be sent reliable.

32 -34. 200 (OK) response

When the called party answers the SIP UA#2 sends a 200 (OK) response to the INVITE request and starts the media flow(s) for this session.

35-37. ACK request

The calling party responds to the 200 (OK) response with an ACK request.

5.4.4 Signalling Flow (preconditions not supported by SIP UA#2, SDP capability negotiation not supported by UE#1, 2nd SDP offer offering AVP transport for video)

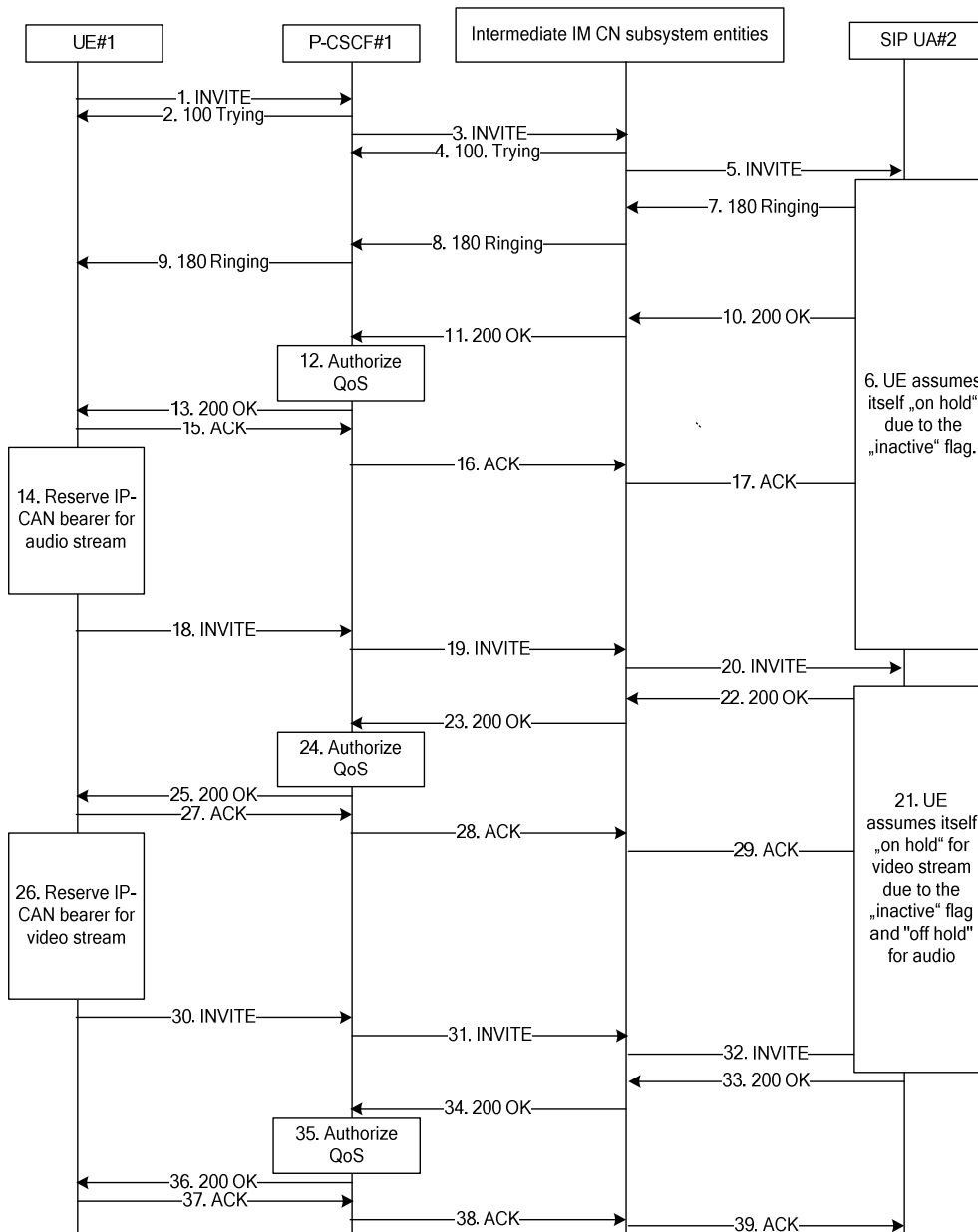

Figure 5.4.4-1: IMS session setup, resource reservation on both sides

The details of the signalling flows are as follows:

1. INVITE request (UE#1 to P-CSCF#1) see example in table 5.4.4-1

For this example, it is assumed that UE#1 is willing to establish a multimedia session comprising a video stream and an audio stream. The video stream supports the H.263 codec. The audio stream supports the AMR codec. The UE#1 is willing to establish the video stream using AVPF or AVP transport and the audio stream using AVP transport. In the initial SDP offer only AVPF is offered for the video stream since the UE#1 does not support SDP capability negotiation.

UE#1 indicates that it supports and is willing to use AVPF transport for the video stream and AVP transport for the audio stream.

UE#1 indicates that it supports precondition and it indicates that it supports reliable provisional responses. However, it does not use the "Require" header for these capabilities.

UE#1 does not have available the resources that are necessary to transport the media.

Table 5.4.4-1: INVITE request (UE#1 to P-CSCF)

```

INVITE tel:+1-212-555-2222 SIP/2.0
Via: SIP/2.0/UDP [5555::aaa:bbb:ccc:ddd]:1357;comp=sigcomp;branch=z9hG4bKnashds7
Max-Forwards: 70
Route: <sip:pcscf1.visited1.net:7531;lr;comp=sigcomp>, <sip:scscf1.home1.net;lr>
P-Preferred-Identity: "John Doe" <sip:user1_public1@home1.net>
P-Access-Network-Info: 3GPP-UTRAN-TDD; utran-cell-id-3gpp=234151D0FCE11
Privacy: none
From: <sip:user1_public1@home1.net>;tag=171828
To: <tel:+1-212-555-2222>
Call-ID: cb03a0s09a2sdfgk490333
Cseq: 127 INVITE
Require: sec-agree
Supported: precondition, 100rel
Proxy-Require: sec-agree
Security-Verify: ipsec-3gpp; q=0.1; alg=hmac-sha-1-96; spi-c=98765432; spi-s=87654321;
port-c=8642; port-s=7531
Contact: <sip:[5555::aaa:bbb:ccc:ddd]:1357;comp=sigcomp>
Allow: INVITE, ACK, CANCEL, BYE, PRACK, UPDATE, REFER, MESSAGE
Content-Type: application/sdp
Content-Length: (...)

v=0
o=- 2987933615 2987933616 IN IP6 5555::aaa:bbb:ccc:ddd
s=-
c=IN IP6 5555::aaa:bbb:ccc:ddd
t=0 0
m=video 3400 RTP/AVPF 98
b=AS:75
a=curr:qos local none
a=curr:qos remote none
a=des:qos mandatory local sendrecv
a=des:qos none remote sendrecv
a=inactive
a=rtpmap:98 H263
m=audio 3456 RTP/AVP 97 96
b=AS:25.4
a=curr:qos local none
a=curr:qos remote none
a=des:qos mandatory local sendrecv
a=des:qos none remote sendrecv
a=inactive
a=rtpmap:97 AMR
a=fmtp:97 mode-set=0,2,5,7; maxframes=2
a=rtpmap:96 telephone-event

```

Supported: The UE indicates support for the "precondition" mechanism and the support for reliable provisional responses

SDP The SDP contains a set of codecs supported by UE#1 and desired by the user at UE#1 for this session. As the local preconditions are not fulfilled, both media are set to "inactive".

2. 100 (Trying) response (P-CSCF#1 to UE#1)

The P-CSCF responds to the INVITE request with a 100 (Trying) provisional response.

3. INVITE request (P-CSCF#1 to intermediate IM CN subsystem entities) - see example in table 5.4.4-3

Table 5.4.4-3: INVITE request (P-CSCF#1 to intermediate IM CN subsystem entities)

```

INVITE tel:+1-212-555-2222 SIP/2.0
Via: SIP/2.0/UDP pcscf1.visited1.net;branch=z9hG4bK240f34.1, SIP/2.0/UDP
[5555::aaa:bbb:ccc:ddd]:1357;comp=sigcomp;branch=z9hG4bKnashds7

```

```

Max-Forwards: 69
Route: <sip:scscf1.home1.net;lr>
Record-Route: <sip:pcscf1.visited1.net;lr>
P-Asserted-Identity: "John Doe" <sip:user1_public1@home1.net>
P-Access-Network-Info:
P-Charging-Vector: icid-value="AyretyU0dm+602IrT5tAFrbHLso=023551024"
Privacy:
From:
To:
Call-ID:
Cseq:
Supported:
Contact:
Allow:
Content-Type:
Content-Length: (...)

```

```

v=
o=
s=
c=
t=
m=
b=
a=
a=
a=
a=
a=
a=
m=
b=
a=
a=
a=
a=
a=
a=
a=
a=

```

4. 100 (Trying) response (intermediate IM CN subsystem entities to P-CSCF#1)

The S-CSCF responds to the INVITE request with a 100 (Trying) provisional response.

5. INVITE request (intermediate IM CN subsystem entities to SIP UA#2) see example in table 5.4.4-5

Table 5.4.4-5: INVITE request (intermediate IM CN subsystem entities to SIP UA#2)

```

INVITE sip:[5555::eee:fff:aaa:bbb]:8805;comp=sigcomp SIP/2.0
Via: SIP/2.0/UDP scscf1.home1.net;branch=z9hG4bK332b23.1, SIP/2.0/UDP
    pcscf1.visited1.net;branch=z9hG4bK240f34.1, SIP/2.0/UDP
    [5555::aaa:bbb:ccc:ddd]:1357;comp=sigcomp;branch=z9hG4bKnashds7
Max-Forwards: 66
Record-Route: <sip:scscf1.home1.net;lr>, <sip:pcscf1.visited1.net;lr>
P-Asserted-Identity:
Privacy:
From:
To:
Call-ID:
Cseq:
Require:
Supported:
Contact:
Allow:
P-Called-Party-ID: <sip:user2_public1@home2.net>
Content-Type:
Content-Length: (...)

```

```

v=
o=
s=
c=
t=
m=

```

```

b=
a=
a=
a=
a=
a=
a=
m=
b=
a=
a=
a=
a=
a=
a=
a=
a=
a=

```

6. SIP UA#2 assumes itself on hold

SIP UA#2 assumes itself on hold as media are set to inactive, i.e. SIP UA#2 does not await or send media.

Resources are available.

7-9. 180 (Ringing) response

SIP UA#2 indicates that it is ringing. It is assumed that SIP UA#2 does not support the "100rel" extension and therefore the 180 (Ringing) response is not sent reliable, i.e. no SDP is sent in the 180 (Ringing) response.

10. 200 (OK) response (SIP UA#2 to S-CSCF) - see example in table 5.4.4-10

User on the terminating side accepts the call. It is assumed that SIP UA#2 plays some announcement to indicate to the user that the call is on hold.

As SIP UA#2 does not support AVPF transport, the SIP UA#2 does not accept the video stream.

SIP UA#2 ignores the precondition that it received in the INVITE request as it does not support them. No preconditions are included in the SDP answer. Both media streams are set to "inactive".

Table 5.4.4-10: 200(OK) response (SIP UA#2 to intermediate IM CN subsystem entities)

```

SIP/2.0 200 OK
Via: SIP/2.0/UDP scscf1.home1.net;branch=z9hG4bK332b23.1, SIP/2.0/UDP
    pcscf1.visited1.net;branch=z9hG4bK240f34.1, SIP/2.0/UDP
    [5555::aaa:bbb:ccc:ddd]:1357;comp=sigcomp;branch=z9hG4bKnashds7
Record-Route:
From:
To: <tel:+1-212-555-2222>;tag=314159
Call-ID:
Cseq:
Content-Type: application/sdp
Content-Length: (...)

v=0
o=- 2987933615 2987933615 IN IP6 5555::eee:fff:ggg:hhh
s=-
c=IN IP6 5555::eee:fff:ggg:hhh
t=0 0
m=video 0 RTP/AVPF 98
m=audio 3456 RTP/AVP 97 96
b=AS:25.4
a=inactive
a=rtpmap:97 AMR
a=fmtp:97 mode-set=0,2,5,7; maxframes

```

11. 200 (OK) response (intermediate IM CN subsystem entities to P-CSCF#1) - see example in table 5.4.4-11

Table 5.4.4-11: 200(OK) response (intermediate IM CN subsystem entities to P-CSCF#1)

```

SIP/2.0 200 OK
Via: SIP/2.0/UDP pcscf1.visited1.net;branch=z9hG4bK240f34.1, SIP/2.0/UDP
    [5555::aaa:bbb:ccc:ddd]:1357;comp=sigcomp;branch=z9hG4bKnashds7
Record-Route:
From:
To:
Call-ID:
Cseq:
Content-Type: application/sdp
Content-Length: (...)

v=
o=
s=
c=
t=
m=
m=
b=
a=
a=
a=

```

12. Authorize QoS

P-CSCF authorizes the resources necessary for this session.

13. 200 (OK) response (P-CSCF#1 to UE#1) - see example in table 5.4.4-13**Table 5.4.4-13: 200(OK) response (P-CSCF#1 to UE#1)**

```

SIP/2.0 200 OK
Via: SIP/2.0/UDP [5555::aaa:bbb:ccc:ddd]:1357;comp=sigcomp;branch=z9hG4bKnashds7
Record-Route:
From:
To:
Call-ID:
Cseq:
Content-Type: application/sdp
Content-Length: (...)

v=
o=
s=
c=
t=
m=
m=
b=
a=
a=
a=

```

14 . Reserve IPCAN bearer for audio stream

The originating UE sets up the bearer for audio stream in accordance with the media description received SDP.

15.-17. ACK request

The calling party responds to the 200 (OK) response with an ACK request.

18. INVITE request (UE#1 to P-CSCF#1) - see example in table 5.4.4-18

UE#1 sets the audio stream to active using a re-INVITE request and indicates that it supports and is willing to use AVP transport for the video stream and AVP transport for the audio stream.

As SIP UA#2 does not support preconditions, UE#1 does not include preconditions in the SDP.

As SIP UA#2 does not have resources for video stream, the video stream is indicated as "inactive".

Table 5.4.4-18: INVITE request (UE#1 to P-CSCF#1)

```

INVITE sip:[5555::eee:fff:aaa:bbb]:8805;comp=sigcomp
Via: SIP/2.0/UDP [5555::aaa:bbb:ccc:ddd]:1357;comp=sigcomp;branch=z9hG4bKnashds7
Max-Forwards: 70
Route: <sip:pcscf1.visited1.net:7531;lr;comp=sigcomp>, <sip:scscf1.home1.net;lr>
From: <sip:user1_public1@home1.net>;tag=171828
To: <tel:+1-212-555-2222>; tag=314159
Call-ID: cb03a0s09a2sdfglkj490333
Cseq: 128 INVITE
Require: sec-agree
Supported: precondition, 100rel, gruu, 199
Accept: application/sdp,application/3gpp-ims+xml
Proxy-Require: sec-agree
Security-Verify: ipsec-3gpp; q=0.1; alg= hmac-sha-1-96; spi-c=98765432; spi-s=87654321;
port-c=8642; port-s=7531
Contact: <sip:user1_public1@home1.net;gr=urn:uuid:f81d4fae-7dec-11d0-a765-
00a0c91e6bf6;comp=sigcomp>
Allow: INVITE, ACK, CANCEL, BYE, PRACK, UPDATE, REFER, MESSAGE
Content-Type: application/sdp
Content-Length: (...)

v=0
o=- 2987933615 2987933616 IN IP6 5555::aaa:bbb:ccc:ddd
s=-
c=IN IP6 5555::aaa:bbb:ccc:ddd
t=0 0
m=video 3400 RTP/AVP 98
b=AS:75
a=rtpmap:98 H263
a=inactive
m=audio 3456 RTP/AVP 97 96
b=AS:25.4
a=rtpmap:97 AMR
a=fmtp:97 mode-set=0,2,5,7; maxframes=2
a=rtpmap:96 telephone-event

```

19. INVITE request (P-CSCF#1 to intermediate IM CN subsystem entities) see example in table 5.4.4-19

Table 5.4.4-19: INVITE request (P-CSCF#1 to intermediate IM CN subsystem entities)

```

INVITE sip:[5555::eee:fff:aaa:bbb]:8805;comp=sigcomp
Via: SIP/2.0/UDP pcscf1.visited1.net;branch=z9hG4bK240f34.1, SIP/2.0/UDP
[5555::aaa:bbb:ccc:ddd]:1357;comp=sigcomp;branch=z9hG4bKnashds7
Max-Forwards: 69
Route: <sip:scscf1.home1.net;lr>
Record-Route: <sip:pcscf1.visited1.net;lr>
From:
To:
Call-ID:
Cseq:
Supported:
Contact:
Allow:
Content-Type:
Content-Length:

v=
o=
s=
c=
t=
m=
b=
a=
a=
m=
b=
a=
a=
a=

```

20. INVITE request (intermediate IM CN subsystem entities to SIP UA#2) see example in table 5.4.4-20**Table 5.4.4-20: INVITE request (S-CSCF#1 to SIP UA#2)**

```

INVITE sip:[5555::eee:fff:aaa:bbb]:8805;comp=sigcomp
Via: SIP/2.0/UDP scscf1.home1.net;branch=z9hG4bK332x23.1, SIP/2.0/UDP
    pcscf1.visited1.net;branch=z9hG4bK240f34.1, SIP/2.0/UDP
    [5555::aaa:bbb:ccc:ddd]:1357;comp=sigcomp;branch=z9hG4bKnashds7
Max-Forwards:
Record-Route: <sip:scscf1.home1.net;lr>, <sip:pcscf1.visited1.net;lr>
From:
To:
Call-ID:
Cseq:
Supported:
Contact:
Allow:
Content-Type:
Content-Length:

v=
o=
s=
c=
t=
m=
b=
a=
a=
m=
b=
a=
a=
a=

```

21. SIP UA#2 assumes itself on hold for video stream and off hold of audio stream

SIP UA#2 assumes itself on hold for video as media are set to inactive, i.e. SIP UA#2 does not await or send media for video stream. SIP UA#2 assumes itself off hold for audio and awaits and sends media for audio stream.

Resources are available.

22. 200 (OK) response (SIP UA#2 to intermediate IM CN subsystem entities) - see example in table 5.4.4-22

SIP UA#2 confirms the new SDP offer. Audio stream is set to active, video stream is set to inactive.

Table 5.4.4-22: 200(OK) response (SIP UA#2 to intermediate IM CN subsystem entities)

```

SIP/2.0 200 OK
Via: SIP/2.0/UDP scscf1.home1.net;branch=z9hG4bK332x23.1, SIP/2.0/UDP
    pcscf1.visited1.net;branch=z9hG4bK240f34.1, SIP/2.0/UDP
    [5555::aaa:bbb:ccc:ddd]:1357;comp=sigcomp;branch=z9hG4bKnashds7

```

```

Record-Route:
From:
To:
Call-ID:
Cseq:
Content-Type: application/sdp
Content-Length: (...)

v=0
o=- 2987933615 2987933615 IN IP6 5555::eee:fff:ggg:hhh
s=-
c=IN IP6 5555::eee:fff:ggg:hhh
t=0 0
m=video 3400 RTP/AVP 98
b=AS:75
a=rtpmap:98 H263
a=fmtp:98 profile-level-id=0
a=inactive
m=audio 3456 RTP/AVP 97 96
b=AS:25.4
a=rtpmap:97 AMR
a=fmtp:97 mode-set=0,2,5,7; maxframes

```

23. 200 (OK) response (intermediate IM CN subsystem entities to P-CSCF#1) - see example in table 5.4.4-23

Table 5.4.4-23: 200(OK) response (intermediate IM CN subsystem entities to P-CSCF#1)

```

SIP/2.0 200 OK
Via: SIP/2.0/UDP pcscf1.visited1.net;branch=z9hG4bK240f34.1, SIP/2.0/UDP
[5555::aaa:bbb:ccc:ddd]:1357;comp=sigcomp;branch=z9hG4bKnashds7
Record-Route:
From:
To:
Call-ID:
Cseq:
Content-Type:
Content-Length:(...)

v=
o=
s=
c=
t=
a=
m=
b=
a=
a=
a=
m=
b=
a=
a=
a=

```

24. Authorize QoS

P-CSCF authorizes the resources necessary for this session.

25. 200 (OK) response (P-CSCF#1 to UE#1) - see example in table 5.4.4-25

Table 5.4.4-25: 200(OK) response (P-CSCF#1 to UE#1)

```

SIP/2.0 200 OK
Via: SIP/2.0/UDP [5555::aaa:bbb:ccc:ddd]:1357;comp=sigcomp;branch=z9hG4bKnashds7
Record-Route:
From:
To:
Call-ID:
Cseq:
Content-Type: application/sdp
Content-Length: (...)

v=
o=
s=
c=
t=
a=
m=
b=
a=
a=
a=
m=
b=
a=
a=
a=

```

26 . Reserve IPCAN bearer for video stream

The originating UE sets up the bearer for video stream in accordance with the media description received SDP.

27.-29. ACK request

The calling party responds to the 200 (OK) response with an ACK request.

30. INVITE request (UE#1 to P-CSCF#1) see example in table 5.4.4-30

UE#1 sets the audio stream to active using a re-INVITE request and indicates that it supports and is willing to use AVP transport for the video stream and AVP transport for the audio stream.

As SIP UA#2 does not support preconditions, UE#1 does not include preconditions in the SDP.

As SIP UA#2 does not have resources for video stream, the video stream is indicated as "inactive".

Table 5.4.4-30: INVITE request (UE#1 to P-CSCF)

```

INVITE sip:[5555::eee:fff:aaa:bbb]:8805;comp=sigcomp
Via: SIP/2.0/UDP [5555::aaa:bbb:ccc:ddd]:1357;comp=sigcomp;branch=z9hG4bKnashds7
Max-Forwards: 70
Route: <sip:pcscf1.visited1.net:7531;lr;comp=sigcomp>, <sip:scscf1.home1.net;lr>
From: <sip:user1_public1@home1.net>;tag=171828
To: <tel:+1-212-555-2222>;tag=314159
Call-ID: cb03a0s09a2sdfg1kj490333
Cseq: 129 INVITE
Require: sec-agree
Supported: precondition, 100rel, gruu, 199
Accept: application/sdp,application/3gpp-ims+xml
Proxy-Require: sec-agree
Security-Verify: ipsec-3gpp; q=0.1; alg=hmac-sha-1-96; spi-c=98765432; spi-s=87654321;
port-c=8642; port-s=7531
Contact: <sip:user1_public1@home1.net;gr=urn:uuid:f81d4fae-7dec-11d0-a765-
00a0c91e6bf6;comp=sigcomp>
Allow: INVITE, ACK, CANCEL, BYE, PRACK, UPDATE, REFER, MESSAGE
Content-Type: application/sdp
Content-Length: (...)

v=0
o=- 2987933615 2987933617 IN IP6 5555::aaa:bbb:ccc:ddd
s=-
c=IN IP6 5555::aaa:bbb:ccc:ddd

```

```

t=0 0
m=video 3400 RTP/AVP 98
b=AS:75
a=rtpmap:98 H263
m=audio 3456 RTP/AVP 97 96
b=AS:25.4
a=rtpmap:97 AMR
a=fmtp:97 mode-set=0,2,5,7; maxframes=2
a=rtpmap:96 telephone-event

```

31. INVITE request (P-CSCF#1 to intermediate IM CN subsystem entities) see example in table 5.4.4-31

Table 5.4.4-31: INVITE request (P-CSCF#1 to intermediate IM CN subsystem entities)

```

INVITE sip:[5555::eee:fff:aaa:bbb]:8805;comp=sigcomp
Via: SIP/2.0/UDP pcscf1.visited1.net;branch=z9hG4bK240f34.1, SIP/2.0/UDP
    [5555::aaa:bbb:ccc:ddd]:1357;comp=sigcomp;branch=z9hG4bKnashds7
Max-Forwards: 69
Route: <sip:scscf1.home1.net;lr>
Record-Route: <sip:pcscf1.visited1.net;lr>
From:
To:
Call-ID:
Cseq:
Supported:
Contact:
Allow:
Content-Type:
Content-Length:

v=
o=
s=
c=
t=
m=
b=
a=
a=
m=
b=
a=
a=
a=

```

32. INVITE request (intermediate IM CN subsystem entities to SIP UA#2) see example in table 5.4.4-32

Table 5.4.4-32: INVITE request (intermediate IM CN subsystem entities to SIP UA#2)

```

INVITE sip:[5555::eee:fff:aaa:bbb]:8805;comp=sigcomp
Via: SIP/2.0/UDP pcscf1.visited1.net;branch=z9hG4bK240f34.1, SIP/2.0/UDP
    [5555::aaa:bbb:ccc:ddd]:1357;comp=sigcomp;branch=z9hG4bKnashds7
Max-Forwards:
Record-Route: < sip:scscf1.home1.net;lr>, <sip:pcscf1.visited1.net;lr>
From:
To:
Call-ID:
Cseq:
Supported:
Contact:
Allow:
Content-Type:
Content-Length:

v=
o=
s=
c=
t=
m=
b=
a=
a=

```

```
m=
b=
a=
a=
a=
```

33. 200 (OK) response (SIP UA#2 to intermediate IM CN subsystem entities) - see example in table 5.4.4-33

SIP UA#2 confirms the new SDP offer. Audio stream is set to active, video stream is set to active.

Table 5.4.4-33: 200(OK) response (SIP UA#2 to intermediate IM CN subsystem entities)

```
SIP/2.0 200 OK
Via: SIP/2.0/UDP scscf1.home1.net;branch=z9hG4bK332b23.1, SIP/2.0/UDP
    pcscf1.visited1.net;branch=z9hG4bK240f34.1, SIP/2.0/UDP
    [5555::aaa:bbb:ccc:ddd]:1357;comp=sigcomp;branch=z9hG4bKnashds7
Record-Route:
From:
To:
Call-ID:
Cseq:
Content-Type: application/sdp
Content-Length: (...)

v=0
o=- 2987933615 2987933617 IN IP6 5555::eee:fff:ggg:hhh
s=-
c=IN IP6 5555::eee:fff:ggg:hhh
t=0 0
m=video 3400 RTP/AVP 98
b=AS:75
a=rtpmap:98 H263
a=fmtp:98 profile-level-id=0
m=audio 3456 RTP/AVP 97 96
b=AS:25.4
a=rtpmap:97 AMR
a=fmtp:97 mode-set=0,2,5,7; maxframes
```

34. 200 (OK) response (intermediate IM CN subsystem entities to P-CSCF#1) - see example in table 5.4.4-34

Table 5.4.4-34: 200(OK) response (S-CSCF#1 to P-CSCF#1)

```
SIP/2.0 200 OK
Via: SIP/2.0/UDP pcscf1.visited1.net;branch=z9hG4bK240f34.1, SIP/2.0/UDP
    [5555::aaa:bbb:ccc:ddd]:1357;comp=sigcomp;branch=z9hG4bKnashds7
Record-Route:
From:
To:
Call-ID:
Cseq:
Content-Type:
Content-Length: (...)

v=
o=
s=
c=
t=
a=
m=
b=
a=
a=
a=
m=
b=
a=
a=
a=
```

35. Authorize QoS

P-CSCF authorizes the resources necessary for this session.

36. 200 (OK) response (P-CSCF#1 to UE#1) - see example in table 5.4.4-36

Table 5.4.4-36: 200(OK) response (P-CSCF to UE#1)

```
SIP/2.0 200 OK
Via: SIP/2.0/UDP [5555::aaa:bbb:ccc:ddd]:1357;comp=sigcomp;branch=z9hG4bKnashds7
Record-Route:
From:
To:
Call-ID:
Cseq:
Content-Type: application/sdp
Content-Length: (...)

v=
o=
s=
c=
t=
a=
m=
b=
a=
a=
a=
m=
b=
a=
a=
a=
```

37.-39. ACK request

The calling party responds to the 200 (OK) response with an ACK request.

5.5 Establishing a session when UE#1 is non-IMS and UE#2 does not have required resources available

5.5.1 Introduction

The following flow shows the establishment of a session where UE#1 is a non-IMS UE. i.e. is plain SIP while UE#2 is connected to the IM CN subsystem, does not yet have the required local resources available and needs to perform resource reservation.

It is assumed that the terminating UE uses a dedicated IP-CAN bearer for SIP signalling and dedicated IP-CAN bearer for media.

The box "Intermediate IM CN subsystem entities" stands for the combination of I-CSCF/S-CSCF on the terminating side. Routing of messages between those nodes is not described in the flow below.

As the topology on the non-IMS, originating side is not known, only a UE is shown on the terminating side. However, this does not rule out the possibility that there are proxies in the originating signalling path.

5.5.2 Signalling Flow

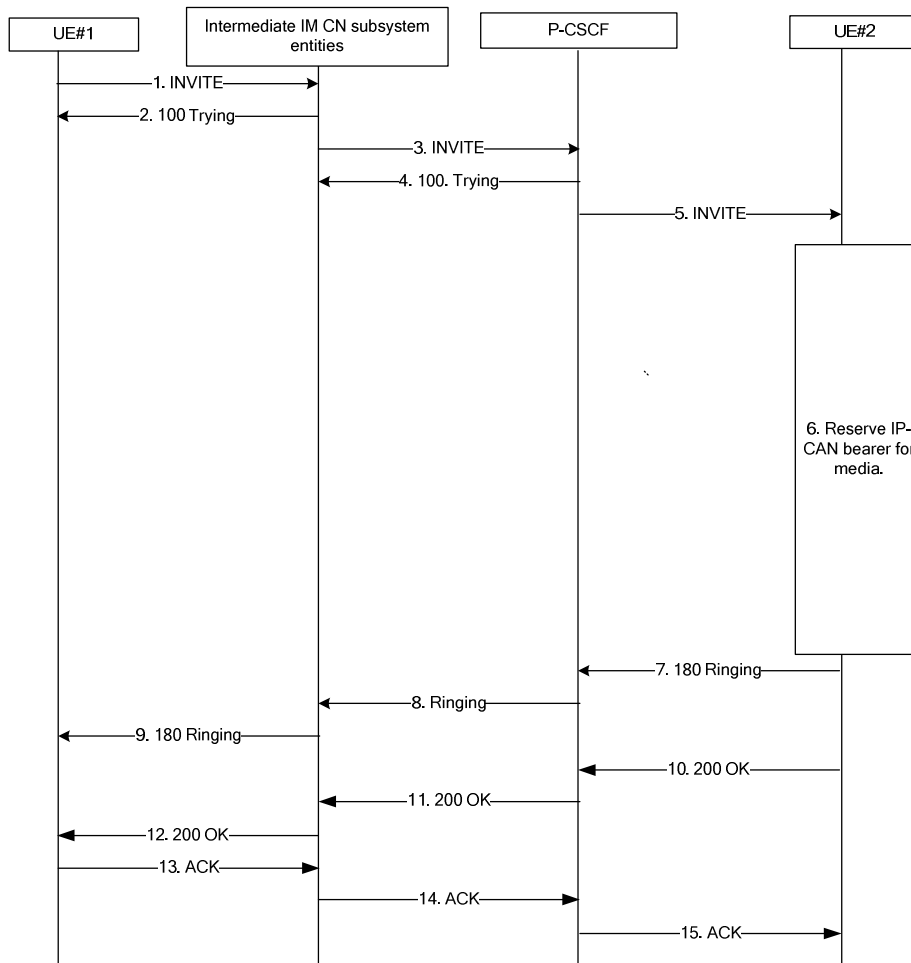

Figure 5.5-1: IMS session setup, resource reservation on terminating side

The details of the signalling flows are as follows:

1. INVITE request (UE#1 to P-CSCF#1) see example in table 5.5-1

For this example, it is assumed that UE#1 is willing to establish a multimedia session comprising a video stream and an audio stream. The video stream supports the H.263 coded. The audio stream supports the AMR codec.

UE# does not indicate that it supports precondition and does not indicate support for the 100rel extension.

Table 5.5-1: INVITE request (UE#1 to IM CN Subsystem entities)

```

INVITE tel:+1-212-555-2222 SIP/2.0
Via: SIP/2.0/UDP [5555::aaa:bbb:ccc:ddd]:1357;comp=sigcomp;branch=z9hG4bKnashds7
Max-Forwards: 70
Route: <sip:pcscf1.visited1.net:7531;lr;comp=sigcomp>, <sip:scscf1.home1.net;lr>
P-Preferred-Identity: "John Doe" <sip:user1_public1@home1.net>
P-Access-Network-Info: 3GPP-UTRAN-TDD; utran-cell-id-3gpp=234151D0FCE11
Privacy: none
From: <sip:user1_public1@home1.net>;tag=171828
To: <tel:+1-212-555-2222>
Call-ID: cb03a0s09a2sdfglkj490333
Cseq: 127 INVITE
Accept: application/sdp,application/3gpp-ims+xml
Contact: <sip:user1_public1@home1.net;gr=urn:uuid:f81d4fae-7dec-11d0-a765-00a0c91e6bf6;comp=sigcomp>
Allow: INVITE, ACK, CANCEL, BYE, REFER, MESSAGE
Content-Type: application/sdp
Content-Length: (...)

v=0
o=- 2987933615 2987933615 IN IP6 5555::aaa:bbb:ccc:ddd
s=-
    
```

```

c=IN IP6 5555::aaa:bbb:ccc:ddd
t=0 0
m=video 3400 RTP/AVP 98
b=AS:75
a=rtpmap:98 H263
m=audio 3456 RTP/AVP 97 96
b=AS:25.4
a=rtpmap:97 AMR
a=fmtp:97 mode-set=0,2,5,7; maxframes=2
a=rtpmap:96 telephone-event

```

SDP The SDP contains a set of codecs supported by UE#1 and desired by the user at UE#1 for this session.

2. 100 (Trying) response

The IM CN subsystem respond to the INVITE request with a 100 (Trying) provisional response.

3. INVITE request (S-CSCF to P-CSCF) - see example in table 5.5-2

Table 5.5-2: INVITE request (S-CSCF to P-CSCF)

```

INVITE sip:[5555::eee:fff:aaa:bbb]:8805;comp=sigcomp SIP/2.0
Via: SIP/2.0/UDP scscf2.home2.net;branch=z9hG4bK764z87.1, SIP/2.0/UDP
[5555::aaa:bbb:ccc:ddd]:1357;comp=sigcomp;branch=z9hG4bKnashds7
Max-Forwards: 66
Route: <sip:pcscf2.visited2.net;lr>
Record-Route: <sip:scscf2.home2.net;lr>
From:
To:
Call-ID:
Cseq:
Accept:
Contact:
Allow:
Content-Type:
Content-Length: (...)

v=
o=
s=
c=
t=
m=
b=
a=
a=
a=
a=
a=
a=

```

4. 100 (Trying) response (S-CSCF#1 to P-CSCF#1)

The S-CSCF responds to the INVITE request with a 100 (Trying) provisional response.

5. INVITE request (P-CSCF to UE) see example in table 5.5-3

Table 5.5-3: INVITE request (P-CSCF to UE)

```

INVITE sip:[5555::eee:fff:aaa:bbb]:8805;comp=sigcomp SIP/2.0
Via: SIP/2.0/UDP pcscf2.visited2.net:5088;comp=sigcomp;branch=z9hG4bK361k21.1, SIP/2.0/UDP
scscf2.home2.net;branch=z9hG4bK764z87.1, SIP/2.0/UDP
[5555::aaa:bbb:ccc:ddd]:1357;comp=sigcomp;branch=z9hG4bKnashds7
Max-Forwards: 65
Record-Route: <sip:pcscf2.visited2.net:5088;lr;comp=sigcomp>, <sip:scscf2.home2.net;lr>,
<sip:scscf1.home1.net;lr>
From:
To:
Call-ID:
Cseq:
Accept:

```



```

Require:
Contact:
Allow:
P-Called-Party-ID: <sip:user2_public1@home2.net>
Content-Type:
Content-Length: (...)

v=
o=
s=
c=
t=
m=
b=
a=
a=
a=
a=
a=
a=
a=
a=

```

6. . Reserve IPCAN bearer for media

The IMS UE sets up the bearer in accordance with the media description received SDP and if necessary its codec decision.

7-9 . 180 (Ringing) response

UE#2 indicates that it is ringing..

10. 200 (OK) response (UE#2 to P-CSCF) - see example in table 5.5-4

UE#2 does not use preconditions as they are not supported by the originating side.

Table 5.5-4: 200(OK) response (UE#2 to P-CSCF)

```

SIP/2.0 200 OK
Via: SIP/2.0/UDP pcscf2.visited2.net:5088;comp=sigcomp;branch=z9hG4bK361k21.1, SIP/2.0/UDP
    scscf2.home2.net;branch=z9hG4bK764z87.1, SIP/2.0/UDP
    [5555::aaa:bbb:ccc:ddd]:1357;comp=sigcomp;branch=z9hG4bKnashds7
Record-Route:
P-Access-Network-Info: 3GPP-UTRAN-TDD; utran-cell-id-3gpp=234151D0FCE11
Privacy: none
From:
To: <tel:+1-212-555-2222>;tag=314159
Call-ID:
Cseq:
Contact: <sip:user2_public1@home2.net;gr=urn:uuid:2ad8950e-48a5-4a74-8d99-
    ad76cc7fc74;comp=sigcomp>
Allow: INVITE, ACK, CANCEL, BYE, PRACK, UPDATE, REFER, MESSAGE
RSeq: 9021

Content-Type: application/sdp
Content-Length: (...)
v=0
o=- 2987933615 2987933615 IN IP6 5555::eee:fff:ggg:hhh
s=-
c=IN IP6 5555::eee:fff:ggg:hhh
t=0 0
m=video 3400 RTP/AVP 98
b=AS:75
a=rtpmap:98 H263
a=fmtp:98 profile-level-id=0
m=audio 3456 RTP/AVP 97 96
b=AS:25.4
a=rtpmap:97 AMR
a=fmtp:97 mode-set=0,2,5,7; maxframes

```

11. 200 (OK) response (P-CSCF to S-CSCF) - see example in table 5.5-5

Table 5.5-5: 200(OK) response (P-CSCF to S-CSCF)

```

SIP/2.0 200 OK
Via: SIP/2.0/UDP scscf2.home2.net;branch=z9hG4bK764z87.1, SIP/2.0/UDP
    [5555::aaa:bbb:ccc:ddd]:1357;comp=sigcomp;branch=z9hG4bKnashds7
Record-Route:
P-Access-Network-Info:
Privacy:
From:
To: <tel:+1-212-555-2222>;tag=314159
Call-ID:
Cseq:
Contact:
Allow:
RSeq:
Content-Type: application/sdp
Content-Length: (...)

v=
o=
s=
c=
t=
m=
b=
a=
a=
a=
m=
b=
a=
a=
a=

```

12. 200 (OK) response (P-CSCF#1 to UE#1) - see example in table 5.5-6**Table 5.5-6: 200(OK) response (S-CSCF to UE#1)**

```

SIP/2.0 200 OK
Via: SIP/2.0/UDP [5555::aaa:bbb:ccc:ddd]:1357;comp=sigcomp;branch=z9hG4bKnashds7
Record-Route:
Privacy:
From:
To: <tel:+1-212-555-2222>;tag=314159
Call-ID:
Cseq:
Contact:
Allow:
RSeq:
Content-Type: application/sdp
Content-Length: (...)

v=
o=
s=
c=
t=
m=
b=
a=
a=
a=
m=
b=
a=
a=
a=

```

13.-15. ACK request

The calling party responds to the 200 (OK) response with an ACK request.

5.6 Establishing a session when UE#1 and UE#2 have resources already available

5.6.1 Introduction

The following flows show the establishment of a session where both UE#1 and UE#2 are connected to the IM CN subsystem and already have the required local resources available so they do not need to perform resource reservation. The example that does not use preconditions is based on the Push to Talk over Cellular (PoC) on demand session establishment automatic answer scenario from OMA PoC 1.0 enabler but with a confirmed indication (no media buffering performed by the PoC Server). The example in subclause 5.6.3 shows the scenario where UE#1 has resources already reserved but supports the precondition mechanism and initiates session establishment following the procedures defined in 3GPP TS 24.229 [1] for when the originating UE supports preconditions. During session establishment the originating UE is unaware if the other endpoint requires the use of the preconditions mechanism or whether the other endpoint is required to reserve resources. In this example, the other endpoint, UE#2, also has its resources ready before answering the INVITE request with the first provisional response.

It is assumed that the both UEs uses a dedicated IP-CAN bearer for SIP signalling and dedicated IP-CAN bearer for media.

The box "Intermediate IM CN subsystem entities" stands for the combination of P-CSCF/I-CSCF/S-CSCF nodes in the network. Routing of messages between those nodes is not described in the flow below.

5.6.2 Signalling Flow (preconditions are not used)

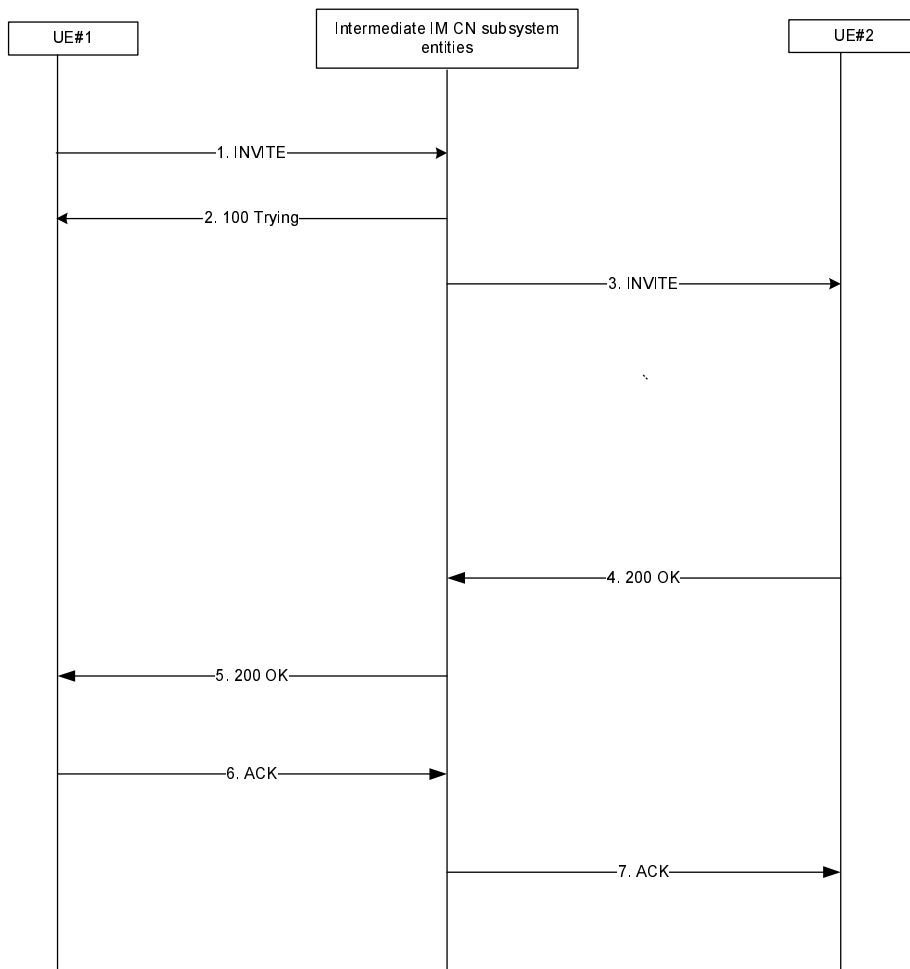

Figure 5.6-1: IMS session setup, no resource reservation, no preconditions

The details of the signalling flows are as follows:

1. INVITE request (UE#1 to P-CSCF#1) see example in table 5.6-1

For this example, it is assumed that UE#1 is willing to establish a multimedia session comprising an audio stream. The audio stream supports the AMR codec.

UE# does not indicate that it supports precondition and does not indicate support for the 100rel extension.

Within the Intermediate IM CN subsystem entities are two PoC Servers that acts as B2BUAs

Table 5.6-1: INVITE request (UE#1 to IM CN Subsystem entities)

```

INVITE sip:PoCConferenceFactoryURI.home1.net SIP/2.0
Via: SIP/2.0/UDP [5555::aaa:bbb:ccc:ddd]:1357;comp=sigcomp;branch=z9hG4bKnashds7
Max-Forwards: 70
Route: <sip:pcscf1.visited1.net:7531;lr;comp=sigcomp>, <sip:scscf1.home1.net;lr>
P-Preferred-Identity: "John Doe" <sip:user1_public1@home1.net>
P-Access-Network-Info: 3GPP-UTRAN-TDD; utran-cell-id-3gpp=234151D0FCE11
Privacy: none
From: <sip:user1_public1@home1.net>;tag=171828
To: <tel:+1-212-555-2222>
Call-ID: cb03a0s09a2sdfg1kj490333
Cseq: 127 INVITE
Accept: application/sdp,application/3gpp-ims+xml
Require: sec-agree,recipient-list-invite
Supported: timer, gruu, 199
Proxy-Require: sec-agree
Security-Verify: ipsec-3gpp; q=0.1; alg=hmac-sha-1-96; spi-c=98765432; spi-s=87654321;
port-c=8642; port-s=7531
Contact: <sip:user1_public1@home1.net;gr=urn:uuid:f81d4fae-7dec-11d0-a765-
00a0c91e6bf6;comp=sigcomp>;+g.poc.talkburst
Allow: INVITE, ACK, CANCEL, BYE, PRACK, UPDATE, REFER, MESSAGE, SUBSCRIBE, NOTIFY, PUBLISH
Accept-Contact: *;+g.poc.talkburst;require;explicit
User-Agent: PoC-client/OMA1.0 Acme-Talk5000/v1.01
Session-Expires: 1800;refresher=uac
Content-Type: multipart/mixed
Content-Length: (...)

--boundary1
Content-Type: application/sdp

v=0
o=- 2987933615 2987933615 IN IP6 5555::aaa:bbb:ccc:ddd
s=-
c=IN IP6 5555::aaa:bbb:ccc:ddd
t=0 0
m=audio 3456 RTP/AVP 97
b=AS:25.4
a=rtpmap:97 AMR
a=rtcp:5560
a=fmtp:97 mode-set=0,2,5,7; maxframes=2
m=application 2000 udp TBCP
a=fmtp:TBCP queuing=1; tb_priority=2; timestamp=1

--boundary1
Content-Type: application/resource-lists+xml
Content-Disposition: recipient-list

<?xml version="1.0" encoding="UTF-8"?>
<resource-lists xmlns="urn:ietf:params:xml:ns:resource-lists">
<list>
<entry uri="tel:+1-212-555-2222"/>
</list>
</resource-lists>
--boundary1--

```

SDP The SDP contains a set of codecs supported by UE#1 and desired by the user at UE#1 for this session.

Resource List The Resource List contains the URI of UE#2 being invited by the user at UE#1 for this session.

2. 100 (Trying) response

The IM CN subsystem respond to the INVITE request with a 100 (Trying) provisional response.

3. INVITE request (P-CSCF to UE) see example in table 5.6-2

Table 5.6-2: INVITE request (IM CN Subsystem entities to UE)

```

INVITE sip:[5555::eee:fff:aaa:bbb]:8805;comp=sigcomp SIP/2.0
Via: SIP/2.0/UDP pcscf2.visited2.net:5088;comp=sigcomp;branch=z9hG4bK361k21.1, SIP/2.0/UDP
scscf2.home2.net;branch=z9hG4bK764z87.1, SIP/2.0/UDP PoC-
SessionABCDEF@pocserver2.home2.net;session=1-1
Max-Forwards: 68
Record-Route: <sip:pcscf2.visited2.net:5088;lr;comp=sigcomp>, <sip:scscf2.home2.net;lr>
From: <sip:user1_public1@home1.net>;tag=487651
To:
Call-ID: 03a0sdcgklkj433s09a290bf3
Cseq: 10227 INVITE
Accept: application/sdp,application/3gpp-ims+xml
Supported: norefersub,timer, 199
Contact: <PoC-SessionABCDEF@pocserver2.home2.net;session=1-1>;+g.poc.talkburst
Allow:
P-Called-Party-ID: <sip:user2_public1@home2.net>
Accept-Contact: *;+g.poc.talkburst; require;explicit
User-Agent: PoC-serv/OMA1.0
Session-Expires: 1800;refresher=uas
Answer-Mode: Auto
Content-Type: application/sdp
Content-Length: (...)

v=
o=- 3361529879 3361529879 IN IP6 60333::ddd:ccc:aaa:bbb
s=
c=IN IP6 5555::ddd:ccc:aaa:bbb
t=
m=audio audio 63776 RTP/AVP 97
b=AS:25.4
a=rtpmap:97 AMR
a=rtcp:6390
a=fmtp:97 mode-set=0,2,5,7; maxframes=2
m=application 60000 udp TBCP
a=fmtp:TBCP queuing=1; tb_priority=2; timestamp=1

```

4. 200 (OK) response (UE#2 to IM CN Subsystem entities) - see example in table 5.6-3

UE#2 does not use preconditions as they are not supported by the originating side.

Table 5.6-3: 200(OK) response (UE#2 to IM CN Subsystem entities)

```

SIP/2.0 200 OK
Via: SIP/2.0/UDP pcscf2.visited2.net:5088;comp=sigcomp;branch=z9hG4bK361k21.1, SIP/2.0/UDP
scscf2.home2.net;branch=z9hG4bK764z87.1, SIP/2.0/UDP
SessionABCDEF@pocserver2.home2.net;session=1-1
Record-Route: <sip:pcscf2.visited2.net:5088;lr;comp=sigcomp>, <sip:scscf2.home2.net;lr>
P-Access-Network-Info: 3GPP-UTRAN-TDD; utran-cell-id-3gpp=234151D0FCE11
Privacy: none
From:
To: <tel:+1-212-555-2222>;tag=314159
Call-ID:
Cseq:
Require:timer
Contact: <sip:[5555::eee:fff:aaa:bbb]:8805;comp=sigcomp>;+g.poc.talkburst
Allow: INVITE, ACK, CANCEL, BYE, PRACK, UPDATE, REFER, MESSAGE
Server: PoC-client/OMA1.0 Acme-Talk5000/v1.01
Session-Expires: 1800;refresher=uas
Content-Type: application/sdp
Content-Length: (...)

v=0
o=- 2987933615 2987933615 IN IP6 5555::eee:fff:aaa:bbb
s=-
c=IN IP6 5555::eee:fff:aaa:bbb
t=0 0
m=audio 3456 RTP/AVP 97
b=AS:25.4
a=rtpmap:97 AMR
a=rtcp:75000
a=fmtp:97 mode-set=0,2,5,7; maxframes=2
m=application 75590 udp TBCP
a=fmtp:TBCP queuing=1; tb_priority=2; timestamp=1

```

5. 200 (OK) response (IM CN Subsystem entities to UE#1) - see example in table 5.6-4

Table 5.6-4: 200(OK) response (IM CN Subsystem entities to UE#1)

```
SIP/2.0 200 OK
Via: SIP/2.0/UDP [5555::aaa:bbb:ccc:ddd]:1357;comp=sigcomp;branch=z9hG4bKnashds7
Record-Route: <sip:scscf1.home1.net;lr>,<sip:pcscf1.visited1.net:7531;lr;comp=sigcomp>
Privacy:
From: <sip:user1_public1@home1.net>;tag=171828
To: <tel:+1-212-555-2222>;tag=257645
Call-ID: cb03a0s09a2sdfglkj490333
Cseq: 127 INVITE
Contact: <sip:PoC-SessionABCDEF@PoC-ServerA.home1.net;session=1-1>;+g.poc.talkburst
Allow:
Content-Type: application/sdp
Content-Length: (...)

v=0
o=- 3362987915 3362987915 IN IP6 57777::eee:fff:aaa:bbb
s=-
c=IN IP6 57777::eee:fff:aaa:bbb
t=0 0
m=audio 57787 RTP/AVP 97
b=AS:25.4
a=rtpmap:97 AMR
a=rtcp:57000
a=fmtp:97 mode-set=0,2,5,7; maxframes=2
m=application 57790 udp TBCP
a=fmtp:TBCP queuing=1; tb_priority=2; timestamp=1
```

6.-7. .ACK request

The calling party responds to the 200 (OK) response with an ACK request.

5.6.3 Signalling Flow (preconditions are used)

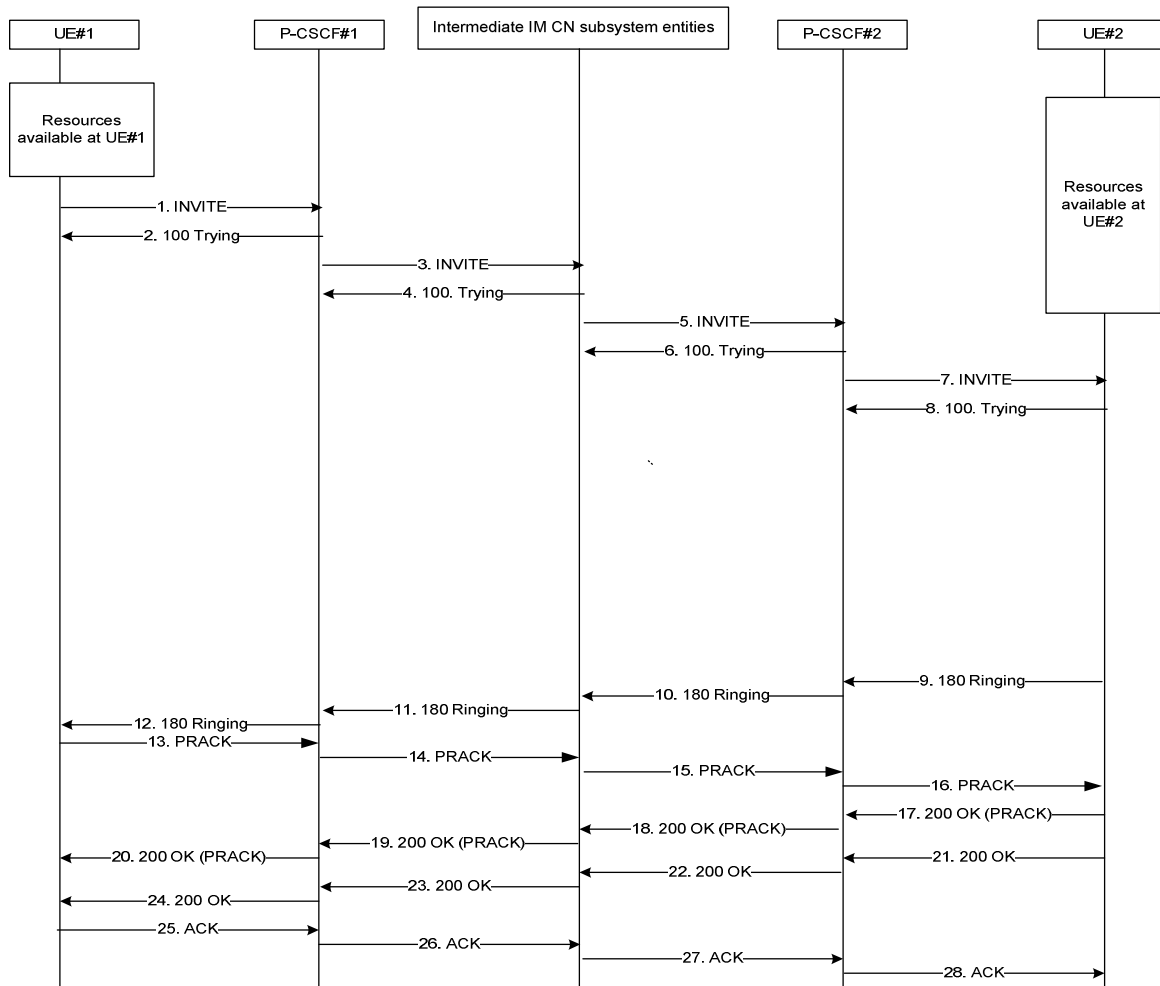

Figure 5.6-2: IMS session setup, no resource reservation, preconditions are used

The details of the signalling flows are as follows:

1. INVITE request (UE#1 to P-CSCF#1) see example in table 5.6-5

For this example, it is assumed that UE#1 is willing to establish a multimedia session comprising a video stream and an audio stream. The video stream supports H.263 codec. The audio stream supports the AMR codec.

UE#1 indicates that it supports precondition and it indicates that it supports reliable provisional responses. However, it does not use the "Require" header for these capabilities.

UE#1 does have available the resources that are necessary to transport the media.

Table 5.6-5: INVITE request (UE#1 to P-CSCF)

```

INVITE tel:+1-212-555-2222 SIP/2.0
Via: SIP/2.0/UDP [5555::aaa:bbb:ccc:ddd]:1357;comp=sigcomp;branch=z9hG4bKnashds7
Max-Forwards: 70
Route: <sip:pcscf1.visited1.net:7531;lr;comp=sigcomp>, <sip:scscf1.home1.net;lr>
P-Preferred-Identity: "John Doe" <sip:user1_public1@home1.net>
P-Access-Network-Info: 3GPP-UTRAN-TDD; utran-cell-id-3gpp=234151D0FCE11
Privacy: none
From: <sip:user1_public1@home1.net>;tag=171828
To: <tel:+1-212-555-2222>
Call-ID: cb03a0s09a2sdfgkjkj490333
Cseq: 127 INVITE
Require: sec-agree
Supported: precondition, 100rel, gruu, 199
Accept: application/sdp,application/3gpp-ims+xml
Proxy-Require: sec-agree
Security-Verify: ipsec-3gpp; q=0.1; alg= hmac-sha-1-96; spi-c=98765432; spi-s=87654321;
port-c=8642; port-s=7531
Contact: <sip:user1_public1@home1.net;gr=urn:uuid:f81d4fae-7dec-11d0-a765-
00a0c91e6bf6;comp=sigcomp>
Allow: INVITE, ACK, CANCEL, BYE, PRACK, UPDATE, REFER, MESSAGE
Content-Type: application/sdp
Content-Length: (...)

v=0
o=- 2987933615 2987933615 IN IP6 5555::aaa:bbb:ccc:ddd
s=-
c=IN IP6 5555::aaa:bbb:ccc:ddd
t=0 0
m=video 3400 RTP/AVP 98
b=AS:75
a=curr:qos local sendrecv
a=curr:qos remote none
a=des:qos mandatory local sendrecv
a=des:qos none remote sendrecv
a=rtpmap:98 H263
a=fmtp:98 profile-level-id=0
m=audio 3456 RTP/AVP 97 96
b=AS:25.4
a=curr:qos local sendrecv
a=curr:qos remote none
a=des:qos mandatory local sendrecv
a=des:qos none remote sendrecv
a=rtpmap:97 AMR
a=fmtp:97 mode-set=0,2,5,7; maxframes=2
a=rtpmap:96 telephone-event

```

Supported: The UE indicates support for the 'precondition' mechanism, the support for reliable provisional responses and the support for the 199 (Early Dialog Terminated) response code.

SDP The SDP contains a set of codecs supported by UE#1 and desired by the user at UE#1 for this session.

2. 100 (Trying) response (P-CSCF#1 to UE#1)

The P-CSCF responds to the INVITE request with a 100 (Trying) provisional response.

3. INVITE request (P-CSCF#1 to S-CSCF#1) - see example in table 5.6-7

Table 5.6-7: INVITE request (P-CSCF#1 to S-CSCF#1)

```
INVITE tel:+1-212-555-2222 SIP/2.0
Via: SIP/2.0/UDP pcscf1.visited1.net;branch=z9hG4bK240f34.1, SIP/2.0/UDP
    [5555::aaa:bbb:ccc:ddd]:1357;comp=sigcomp;branch=z9hG4bKnashds7
Max-Forwards: 69
Route: <sip:scscf1.homel.net;lr>
Record-Route: <sip:pcscf1.visited1.net;lr>
P-Asserted-Identity: "John Doe" <sip:user1_public1@homel.net>
P-Access-Network-Info:
P-Charging-Vector: icid-value="AyretyU0dm+602IrT5tAFrbHLso=023551024"
Privacy:
From:
To:
Call-ID:
Cseq:
Supported:
Accept:
Contact:
Allow:
Content-Type:
Content-Length: (...)

v=
o=
s=
c=
t=
m=
b=
a=
a=
a=
a=
a=
a=
```

4. 100 (Trying) response (S-CSCF#1 to P-CSCF#1)

The S-CSCF responds to the INVITE request with a 100 (Trying) provisional response.

5. INVITE request (S-CSCF#2 to P-CSCF#2) see example in table 5.6-8

Table 5.6-8: INVITE request (S-CSCF#2 to P-CSCF#2)

```

INVITE sip:[5555::eee:fff:aaa:bbb]:8805;comp=sigcomp SIP/2.0
Via: SIP/2.0/UDP scscf2.home2.net;branch=z9hG4bK764z87.1, SIP/2.0/UDP
    icscf2_s.home2.net;branch=z9hG4bK871y12.1, SIP/2.0/UDP
    scscf1.home1.net;branch=z9hG4bK332b23.1, SIP/2.0/UDP
    pcscf1.visited1.net;branch=z9hG4bK240f34.1, SIP/2.0/UDP
    [5555::aaa:bbb:ccc:ddd]:1357;comp=sigcomp;branch=z9hG4bKnashds7
Max-Forwards: 66
Route: <sip:pcscf2.visited2.net;lr>
Record-Route: <sip:scscf2.home2.net;lr>, <sip:scscf1.home1.net;lr>,
    <sip:pcscf1.visited1.net;lr>
P-Asserted-Identity:
P-Charging-Vector: icid-value="AyretyU0dm+602IrT5tAFrbHLso=023551024"
Privacy:
From:
To:
Call-ID:
Cseq:
Supported:
Accept:
Contact:
Allow:
P-Called-Party-ID: <sip:user2_public1@home2.net>
Content-Type:
Content-Length: (...)

v=
o=
s=
c=
t=
m=
b=
a=
a=
a=
a=
a=
a=
a=
a=
a=

```

6. 100 (Trying) response (P-CSCF#2 to S-CSCF#2)

The P-CSCF#2 responds to the INVITE request with a 100 (Trying) provisional response.

7. INVITE request (P-CSCF#2 to UE #2) - see example in table 5.6-9

P-CSCF#2 forwards the INVITE request to UE#2.

Table 5.6-9: INVITE request (P-CSCF#2 to UE#2)

```

INVITE sip:[5555::eee:fff:aaa:bbb]:8805;comp=sigcomp SIP/2.0
Via: SIP/2.0/UDP pcscf2.visited2.net:5088;comp=sigcomp;branch=z9hG4bK361k21.1, SIP/2.0/UDP
scscf2.home2.net;branch=z9hG4bK764z87.1, SIP/2.0/UDP
icscf2_s.home2.net;branch=z9hG4bK871y12.1, SIP/2.0/UDP
scscf1.home1.net;branch=z9hG4bK332b23.1, SIP/2.0/UDP
pcscf1.visited1.net;branch=z9hG4bK240f34.1, SIP/2.0/UDP
[5555::aaa:bbb:ccc:ddd]:1357;comp=sigcomp;branch=z9hG4bKnashds7
Max-Forwards: 65
Record-Route: <sip:pcscf2.visited2.net:5088;lr;comp=sigcomp>, <sip:scscf2.home2.net;lr>,
<sip:scscf1.home1.net;lr>, <sip:pcscf1.visited1.net;lr>
P-Asserted-Identity:
Privacy:
From:
To:
Call-ID:
Cseq:
Supported:
Accept:
Contact:
Allow:
Content-Type:
Content-Length: (...)

v=
o=
s=
c=
t=
m=
b=
a=
a=
a=
a=
a=
a=
a=

```

8. 100 (Trying) response (UE#2 to P-CSCF)

The UE responds to the INVITE request with a 100 (Trying) provisional response.

9. – 12. 180 (Ringing) response - see example in table 5.6-10

UE#2 determines the complete set of codecs that it is capable of supporting for this session. It determines the intersection with those appearing in the SDP in the INVITE request. UE#2 makes the final codec selection and chooses H.263 and AMR.

UE#2 responds with a 180 (Ringing) response containing SDP sent reliably back to the originator. This response is sent to P-CSCF. The SDP answer indicates that resources are reserved at both endpoints.

Table 5.6-10: 180 (Ringing) response (UE#2 to P-CSCF#2)

```

SIP/2.0 180 Ringing
Via: SIP/2.0/UDP pcscf2.visited2.net:5088;comp=sigcomp;branch=z9hG4bK361k21.1, SIP/2.0/UDP
scscf2.home2.net;branch=z9hG4bK764z87.1, SIP/2.0/UDP
icscf2_s.home2.net;branch=z9hG4bK871y12.1, SIP/2.0/UDP
scscf1.home1.net;branch=z9hG4bK332b23.1, SIP/2.0/UDP
pcscf1.visited1.net;branch=z9hG4bK240f34.1, SIP/2.0/UDP
[5555::aaa:bbb:ccc:ddd]:1357;comp=sigcomp;branch=z9hG4bKnashds7
Record-Route: <sip:pcscf2.visited2.net:5088;lr;comp=sigcomp>, <sip:scscf2.home2.net;lr>,
<sip:scscf1.home1.net;lr>, <sip:pcscf1.visited1.net;lr>
From:
To: <tel:+1-212-555-2222>;tag=2236
Call-ID:
Cseq:
Require: 100rel, preconditions
Allow: INVITE, ACK, CANCEL, BYE, PRACK, UPDATE, REFER, MESSAGE
RSeq: 9022
Content-Type: application/sdp
Content-Length: (...)

v=0
o=- 2987933615 2987933615 IN IP6 5555::eee:fff:aaa:bbb
s=-
c=IN IP6 5555:: eee:fff:aaa:bbb
t=0 0
m=video 3400 RTP/AVP 98
b=AS:75
a=curr:qos local sendrecv
a=curr:qos remote sendrecv
a=des:qos mandatory local sendrecv
a=des:qos mandatory remote sendrecv
a=rtpmap:98 H263
a=fmtp:98 profile-level-id=0
m=audio 3456 RTP/AVP 97 96
b=AS:25.4
a=curr:qos local sendrecv
a=curr:qos remote sendrecv
a=des:qos mandatory local sendrecv
a=des:qos mandatory remote sendrecv
a=rtpmap:97 AMR
a=fmtp:97 mode-set=0,2,5,7; maxframes

```

13. - 16. PRACK request - see example in table 5.6-11

UE#1 acknowledges the receipt of the 180 (Ringing) response with a PRACK request sent to UE#2. If UE#1 determines to make any further change in the media flows, it may include a new SDP answer in the PRACK request. In this example, the PRACK request does not contain SDP as the final codec decision is already made as part of the initial offer/answer exchange.

Table 5.6-11: PRACK request (UE#1 to P-CSCF#1)

```

PRACK sip:[5555::eee:fff:aaa:bbb]:8805;comp=sigcomp SIP/2.0
Via: SIP/2.0/UDP [5555::aaa:bbb:ccc:ddd]:1357;comp=sigcomp;branch=z9hG4bKnashds7
Max-Forwards: 70
P-Access-Network-Info: 3GPP-UTRAN-TDD; utran-cell-id-3gpp=234151D0FCE11
Route: <sip:pcscf2.visited2.net:5088;lr;comp=sigcomp>, <sip:scscf2.home2.net;lr>,
<sip:scscf1.home1.net;lr>, <sip:pcscf1.visited1.net;lr>
From: <sip:user1_public1@home1.net>;tag=171828
To: <tel:+1-212-555-2222>;tag=2236
Call-ID: cb03a0s09a2sdfglkj490333
Cseq: 128 PRACK
Require: precondition, sec-agree
Proxy-Require: sec-agree
Security-Verify: ipsec-3gpp; q=0.1; alg= hmac-sha-1-96; spi-c=98765432; spi-s=87654321;
port-c=8642; port-s=7531
Rack: 9021 127 INVITE
Content-Length: 0

```

17 - 20. 200 (OK) response (PRACK request)

UE#2 acknowledges the receipt of the PRACK request with the 200 (OK) response

21. **200 (OK) response (UE#2 to P-CSCF#2) - see example in table 5.6-12**

User #2 answers the phone and this triggers UE #2 to send the 200 (OK) response to answer the INVITE request.

Table 5.6-12: 200(OK) response (UE#2 to P-CSCF#2)

```
SIP/2.0 200 OK
Via: SIP/2.0/UDP pcscf2.visited2.net:5088;comp=sigcomp;branch=z9hG4bK361k21.1, SIP/2.0/UDP
scscf2.home2.net;branch=z9hG4bK764z87.1, SIP/2.0/UDP
icscf2_s.home2.net;branch=z9hG4bK871y12.1, SIP/2.0/UDP
scscf1.home1.net;branch=z9hG4bK332b23.1, SIP/2.0/UDP
pcscf1.visited1.net;branch=z9hG4bK240f34.1, SIP/2.0/UDP
[5555::aaa:bbb:ccc:ddd]:1357;comp=sigcomp;branch=z9hG4bKnashds7
P-Access-Network-Info: 3GPP-UTRAN-TDD; utran-cell-id-3gpp=234151D0FCE11
From:
To:
Call-ID:
Cseq: 127 INVITE
Content-Length: 0
```

22. **200 (OK) response (P-CSCF#2 to S-CSCF#2) - see example in table 5.6-13**

Table 5.6-13: 200 (OK) response (P-CSCF#2 to S-CSCF#2)

```
SIP/2.0 200 OK
Via: SIP/2.0/UDP scscf2.home2.net;branch=z9hG4bK764z87.1, SIP/2.0/UDP
icscf2_s.home2.net;branch=z9hG4bK871y12.1, SIP/2.0/UDP
scscf1.home1.net;branch=z9hG4bK332b23.1, SIP/2.0/UDP
pcscf1.visited1.net;branch=z9hG4bK240f34.1, SIP/2.0/UDP
[5555::aaa:bbb:ccc:ddd]:1357;comp=sigcomp;branch=z9hG4bKnashds7
P-Access-Network-Info: 3GPP-UTRAN-TDD; utran-cell-id-3gpp=234151D0FCE11
From:
To:
Call-ID:
Cseq:
Content-Length: 0
```

23. **200 (OK) response (S-CSCF#1 to P-CSCF#1) - see example in table 5.6-14**

Table 5.6-14: 200 (OK) response (S-CSCF#1 to P-CSCF#1)

```
SIP/2.0 200 OK
Via: pcscf1.visited1.net;branch=z9hG4bK240f34.1, SIP/2.0/UDP
[5555::aaa:bbb:ccc:ddd]:1357;comp=sigcomp;branch=z9hG4bKnashds7
P-Access-Network-Info: 3GPP-UTRAN-TDD; utran-cell-id-3gpp=234151D0FCE11
From:
To:
Call-ID:
Cseq:
Content-Length: 0
```

24. **200 (OK) response (P-CSCF#1 to UE#1) - see example in table 5.6-15**

Table 5.6-15: 200 (OK) response (P-CSCF#1 to UE#1)

```
SIP/2.0 200 OK
Via: [5555::aaa:bbb:ccc:ddd]:1357;comp=sigcomp;branch=z9hG4bKnashds7
P-Access-Network-Info: 3GPP-UTRAN-TDD; utran-cell-id-3gpp=234151D0FCE11
From:
To:
Call-ID:
Cseq:
Content-Length: 0
```

25 - 28. ACK request

The calling party responds to the 200 (OK) response with an ACK request.

Annex A (informative): Change history

Change history								
Date	TSG #	TSG Doc.	CR	Rev	Subject/Comment	Old	New	
2006-02					skeleton of the TR	0.0.0	0.0.0	
2006-02					Version 0.1.0 created as a result of CT1#41 The following CR's were incorporated and the editor adopted their content / structure to the revised TR structure: C1-060227 - only UE#1 needs to perform resource reservation C1-060537 - UE#1 and UE#2 need to perform resource reservation C1-060538 - only UE#2 needs to perform resource reservation	0.0.0	0.1.0	
2006-05					The following CR's were incorporated and the editor adopted their content / structure to the revised TR structure: C1-060701 - Establishing a session when UE#1 need to reserve resources and UE#2 is non-IMS C1-060703 - Miscellaneous Corrections against 24.930 C1-061066 - Establishing a session when UE#1 is non-IMS and UE#2 needs to reserve resources	0.1.0	0.2.0	
2006-09					The following CR's were incorporated and the editor adopted their content / structure to the revised TR structure: C1-061640 - PoC Session Establishment Flow C1-061757 - show encryption in Security-Verify C1-061878 - Call flow when originator has resources reserved and the called party needs to reserve resources	0.2.0	0.3.0	
2006-09	CT-33	CP-060451			Version 1.0.0 created for presentation to CT#33	0.3.0	1.0.0	
2006-11					Version 1.1.0 created as a result of CT1#44 The following CR"s were incorporated and the editor adopted their content / structure to the TR. C1-062323 - Editorial Tidy up of TR 24.930 C1-062330 - Editorial Changes	1.0.0	1.1.0	
2006-11	CT-34				V2.0.0 created by MCC to present TR for approval	1.1.0	2.0.0	
2006-12					V7.0.0 created by MCC as V2.0.0 was approved in CP-060651	2.0.0	7.0.0	
2007-03	CT-35	CP-070140	0001		REmoval of SDP in 200 (OK) INVITE	7.0.0	7.1.0	
2007-06	CT-36	CP-070374	0003	2	Network initiated IP-CAN bearer setup	7.1.0	7.2.0	
2007-06	CT-36	CP-070374	0002	3	Additional call flow for establishing a session when both endpoints do not need to reserve resources	7.1.0	7.2.0	
2007-06	CT-36	CP-070469	0004	2	Editorial Updates to Session Establishment Flows	7.1.0	7.2.0	
2007-12	CT-38	CP-070799	0006	3	Clarification on Network initiated IP-CAN bearer setup	7.2.0	7.3.0	
2008-03	CT-39	CP-080120	0009		No P-Media-Authorization header	7.3.0	7.4.0	
2008-03	CT-39	CP-080140	0011	2	Alternative call flow when originating UE needs to reserve resource	7.4.0	8.0.0	
2008-06	CT-40	CP-080341	0015	2	Addition of call flow using the SDP Capability Negotiation mechanism	8.0.0	8.1.0	
2008-06	CT-40	CP-080343	0013	4	Session Set-up when UE#1 has resources available and the IP-CAN initiates resource reservation for UE#2.	8.0.0	8.1.0	
2008-12	CT-42	CP-080846	0016		SIP message flow fix	8.1.0	8.2.0	
2008-12	CT-42	CP-080848	0017	1	Aligning initial INVITE request"s Accept header field with TS 24.229	8.1.0	8.2.0	

2008-12	CT-42	CP-080848	0018		SIP message modification for Max-Forwards header	8.1.0	8.2.0
2008-12	CT-42	CP-080848	0019		Indication of 199 (Early Dialog Terminated) support in call flows	8.1.0	8.2.0
2008-12	CT-42				Editorial cleanup by MCC	8.1.0	8.2.0
2009-12	CT-46				Upgrade to Rel-9	8.2.0	9.0.0
2011-03	CT-51				Upgrade to Rel-10	9.0.0	10.0.0
2011-12	CT-54	CP-110863	0025	1	Alignment of SDPCapNeg flows with modified video session procedures	10.0.0	10.1.0
2011-12	CT-54	CP-110863	0027		Session establishment flows to align with modified video session procedures	10.0.0	10.1.0
2012-09	CT-57				Upgrade to Rel-11	10.1.0	11.0.0
2014-06	CT-64	CP-140322	0028	1	SDP answer unnecessarily included both in reliable 183 response and in 200 response	11.0.0	12.0.0
2014-06	CT-64	CP-140322	0029	1	Relationship at P-CSCF between forwarding the 18x response and the initiation of resource reservation	11.0.0	12.0.0
2014-06	CT-64	CP-140330	0030	1	Corrections to headers in flows	11.0.0	12.0.0

History

Document history		
V12.0.0	October 2014	Publication