



**Digital cellular telecommunications system (Phase 2+);
Universal Mobile Telecommunications System (UMTS);
LTE;
Network composition feasibility study
(3GPP TR 22.980 version 13.0.0 Release 13)**



Reference

RTR/TSGS-0122980vd00

Keywords

GSM,LTE,UMTS

ETSI

650 Route des Lucioles
F-06921 Sophia Antipolis Cedex - FRANCE

Tel.: +33 4 92 94 42 00 Fax: +33 4 93 65 47 16

Siret N° 348 623 562 00017 - NAF 742 C
Association à but non lucratif enregistrée à la
Sous-Préfecture de Grasse (06) N° 7803/88

Important noticeThe present document can be downloaded from:
<http://www.etsi.org/standards-search>

The present document may be made available in electronic versions and/or in print. The content of any electronic and/or print versions of the present document shall not be modified without the prior written authorization of ETSI. In case of any existing or perceived difference in contents between such versions and/or in print, the only prevailing document is the print of the Portable Document Format (PDF) version kept on a specific network drive within ETSI Secretariat.

Users of the present document should be aware that the document may be subject to revision or change of status. Information on the current status of this and other ETSI documents is available at
<http://portal.etsi.org/tb/status/status.asp>

If you find errors in the present document, please send your comment to one of the following services:
<https://portal.etsi.org/People/CommitteeSupportStaff.aspx>

Copyright Notification

No part may be reproduced or utilized in any form or by any means, electronic or mechanical, including photocopying and microfilm except as authorized by written permission of ETSI.

The content of the PDF version shall not be modified without the written authorization of ETSI.
The copyright and the foregoing restriction extend to reproduction in all media.

© European Telecommunications Standards Institute 2016.
All rights reserved.

DECT™, **PLUGTESTS™**, **UMTS™** and the ETSI logo are Trade Marks of ETSI registered for the benefit of its Members.
3GPP™ and **LTE™** are Trade Marks of ETSI registered for the benefit of its Members and of the 3GPP Organizational Partners.
GSM® and the GSM logo are Trade Marks registered and owned by the GSM Association.

Intellectual Property Rights

IPRs essential or potentially essential to the present document may have been declared to ETSI. The information pertaining to these essential IPRs, if any, is publicly available for **ETSI members and non-members**, and can be found in ETSI SR 000 314: *"Intellectual Property Rights (IPRs); Essential, or potentially Essential, IPRs notified to ETSI in respect of ETSI standards"*, which is available from the ETSI Secretariat. Latest updates are available on the ETSI Web server (<https://ipr.etsi.org/>).

Pursuant to the ETSI IPR Policy, no investigation, including IPR searches, has been carried out by ETSI. No guarantee can be given as to the existence of other IPRs not referenced in ETSI SR 000 314 (or the updates on the ETSI Web server) which are, or may be, or may become, essential to the present document.

Foreword

This Technical Report (TR) has been produced by ETSI 3rd Generation Partnership Project (3GPP).

The present document may refer to technical specifications or reports using their 3GPP identities, UMTS identities or GSM identities. These should be interpreted as being references to the corresponding ETSI deliverables.

The cross reference between GSM, UMTS, 3GPP and ETSI identities can be found under <http://webapp.etsi.org/key/queryform.asp>.

Modal verbs terminology

In the present document "**shall**", "**shall not**", "**should**", "**should not**", "**may**", "**need not**", "**will**", "**will not**", "**can**" and "**cannot**" are to be interpreted as described in clause 3.2 of the [ETSI Drafting Rules](#) (Verbal forms for the expression of provisions).

"**must**" and "**must not**" are **NOT** allowed in ETSI deliverables except when used in direct citation.

Contents

Intellectual Property Rights	2
Foreword.....	2
Modal verbs terminology.....	2
Foreword.....	6
Introduction	6
1 Scope	7
2 References	7
3 Definitions, symbols and abbreviations	8
3.1 Definitions.....	8
3.2 Symbols.....	9
3.3 Abbreviations	9
4 Principles, Purpose and Benefits of Network Composition	10
4.1 Principles.....	10
4.1.1 General.....	10
4.1.2 Types of Network Composition.....	10
4.1.2 Other common styles.....	12
4.2 Purpose and Benefits.....	12
4.3 Management aspects.....	13
4.4 Resource control, resource usage and resource access provisioning.....	13
4.5 Multi-lateral Compositions.....	14
4.5.1 General.....	14
4.5.2 A set of bi-lateral Cas	15
4.5.3 A multi-lateral CA	16
4.5.4 Advantages and disadvantages of different approaches to support multi-lateral compositions	17
5 Composition Use Cases.....	18
5.1 Description	18
5.2 Network Composition between Core Networks	18
5.2.1 General.....	18
5.2.2 Inter-operator Network Composition (via GRX).....	18
5.2.2.1 Short Description	18
5.2.2.2 Actor Specific Issues and Benefits.....	19
5.2.2.3 Pre-Conditions	19
5.2.2.4 Normal Flow	20
5.2.2.5 Alternative Flow	20
5.2.2.6 Additional Information.....	20
5.2.3 On-demand inter-operator Network Composition	21
5.2.3.1 Short Description	21
5.2.3.2 Actor Specific Issues and Benefits.....	21
5.2.3.3 Pre-Conditions	22
5.2.3.4 Normal Flow	22
5.2.3.5 Alternative Flow	22
5.2.3.6 Additional Information.....	23
5.3 Network Composition between Core Network and Access Network.....	23
5.3.1 Composition of a nomadic I-WLAN with a 3GPP network	23
5.3.1.1 Short Description	23
5.3.1.2 Actor Specific Issues and Benefits.....	23
5.3.1.3 Pre-Conditions	24
5.3.1.4 Normal Flow	24
5.3.1.5 Alternative Flows	24
5.3.1.6 Additional Information.....	24
5.3.2 Scenario Extensions for I-WLAN / 3GPP network composition.....	25

5.3.2.1	Short Description	25
5.3.2.2	Actor Specific Issues and Benefits	25
5.3.2.3	Pre-Conditions	26
5.3.2.4	Normal Flow	26
5.3.2.5	Alternative Flow	26
5.3.2.6	Additional information	26
5.3.3	Network Composition of a moving network with 3GPP networks	26
5.3.3.1	Short Description	26
5.3.3.2	Actor Specific Issues and Benefits	27
5.3.3.3	Pre-Conditions	28
5.3.3.4	Normal Flow	28
5.3.3.5	Alternative Flow	28
5.3.3.6	Additional Information	28
5.3.4	Access Networks – Core/service/identity provider networks: Network Composition of different types of access networks with core networks providing different types of end user services	28
5.3.4.1	Scenario overview	28
5.3.4.2	Scenario technical description	29
5.3.4.3	Operator / user role	29
5.3.4.4	Composition Type	29
5.3.4.5	Framework Agreement and Composition Agreement	29
5.3.4.6	Scenario Benefits	29
5.4	Network Composition between Access Networks	30
5.5	Network Composition between Core Network and PAN/PN/UE	30
5.6	Network Composition between Access Network and PAN/PN/UE	31
5.6.1	Network Composition of individual users with access networks in public spaces	31
5.6.1.1	Short Description	31
5.6.1.2	Actor Specific Issues and Benefits	31
5.6.1.3	Pre-Conditions	32
5.6.1.4	Normal Flow	32
5.6.1.5	Alternative Flow	32
5.6.1.6	Additional Information	32
5.7	Network Composition between PNs	32
5.7.1	Short Description	32
5.7.2	Actor Specific Issues and Benefits	33
5.7.3	Pre-Conditions	33
5.7.4	Normal Flow	33
5.7.5	Alternative Flow	35
5.7.6	Additional Information	35
5.8	3GPP network operators forming a roaming consortium:	36
5.9	Decomposition between Core Network and Access Network	37
5.9.1	Decomposition between a nomadic I-WLAN and a 3GPP network	37
5.9.1.1	Short Description	37
5.9.1.2	Actor Specific Issues and Benefits	37
5.9.1.3	Pre-Conditions	38
5.9.1.4	Normal Flow	38
5.9.1.5	Alternative Flows	38
5.9.1.6	Additional Information	38
6	Description of Composition Process	38
6.1	Composition process	38
6.1.1	Media Sense	39
6.1.2	Discovery / Advertisement	39
6.1.3	Establishment of Security and Internetworking Connectivity	39
6.1.4	Composition Agreement Negotiation	40
6.1.5	Composition Agreement Realization	40
6.1.6	Maintaining a composed Composition Capable Network	40
6.2	Decomposition Process	41
6.2.1	Composition Agreement Unrealization	41
6.2.2	Composition Agreement Invalidation	41
6.2.3	Tear down of Security and Internetworking Connectivity	41
6.2.4	Media Channel Disabling	41
6.2.5	Decomposition Process Cooperation	42

6.3	Composition Update process	42
7	Potential Composition Requirements	42
7.1	High-level requirements	42
7.2	Security and Privacy	43
7.3	Functional requirements for Network Composition	43
8	Conclusions	45
9	Other concepts considered useful in the context of Network Composition	45
	Annex A: (informative) Additional information on Network Composition	46
A1	Illustration of composition procedure involving multiple Network Compositions	46
	Annex B (Informative): Change history	49
	History	50

Foreword

This Technical Report has been produced by the 3rd Generation Partnership Project (3GPP).

The contents of the present document are subject to continuing work within the TSG and may change following formal TSG approval. Should the TSG modify the contents of the present document, it will be re-released by the TSG with an identifying change of release date and an increase in version number as follows:

Version x.y.z

where:

- x the first digit:
 - 1 presented to TSG for information;
 - 2 presented to TSG for approval;
 - 3 or greater indicates TSG approved document under change control.
- y the second digit is incremented for all changes of substance, i.e. technical enhancements, corrections, updates, etc.
- z the third digit is incremented when editorial only changes have been incorporated in the document.

Introduction

In the last couple of years an increasing number of heterogeneous network types have come to the focus of attention, e.g. heterogeneous access systems (otherwise known as multi-access), Personal Area Networks (PANs), Personal Networks (PNs), moving networks etc. This trend is expected to continue. Different scenarios have been studied in the All-IP Network (AIPN) Feasibility Study in TR 22.978 [5], which lists "network extensibility/composition" as a key aspect of AIPN. The integration of PANs and Personal Networks will be specified within the scope of the Personal Network Management (PNM) work item. Related Technical Specification work is ongoing within the AIPN Stage 1 in TS 22.258 [6] and Personal Network Management Stage 1 in TS 22.259 [7]. It would be desirable for 3GPP networks to be able to integrate many of these heterogeneous network types, or to interwork with them, in an efficient manner that for operators is easy to manage and control.

This Technical Report is the result of a feasibility study on Network Composition, the concept of heterogeneous network/system integration and interworking. It builds on the work of AIPN and studies Network Composition in more detail. This includes integration of networks with different administrative domains, and the dynamic and flexible integration of ad-hoc networks, PANs, WLANs etc. Particularly, the possibility for a uniform Network Composition procedure is explored, independent of what kind of network is "composed" with the 3GPP system. Complementing the AIPN work, in this report a concrete dynamic 'plug&play' and flexible Network Composition procedure is described.

1 Scope

The present document explores the feasibility of a uniform procedure for the integration of, and the interworking with, a large variety of heterogeneous network types. This uniform procedure is called Network Composition. It focuses on ad-hoc networks, PANs, moving networks etc., but also includes access systems. The goal is to avoid the need for defining a new procedure for integration / interworking with each newly emerging network type and to explore the feasibility of making the Network Composition procedure dynamic and to minimize human intervention ("plug and play"). Of course, the high security (authentication, authorization) standards of 3GPP must thereby be maintained. Finally, it is desirable for the Network Composition procedure to be flexible regarding what functionality is assumed in the composing network.

It is conceivable that roaming within a pre-set commercial and technological environment could be established dynamically using the same procedure.

This Feasibility Study covers the following aspects:

- Description of purpose and benefits of composition
- Composition use cases highlighting uniformity, dynamicity, security, manageability, scalability, flexibility, as well as business aspects
- Study of potential composition requirements
- Description of the composition process
- Definition of traits and/or implications of introducing this functionality into the 3GPP system, covering subjects such as management, multi-link radio access, mobility, context & policy awareness, security, and media transcoding & adaptation capabilities.

2 References

The following documents contain provisions which, through reference in this text, constitute provisions of the present document.

- References are either specific (identified by date of publication, edition number, version number, etc.) or non-specific.
- For a specific reference, subsequent revisions do not apply.
- For a non-specific reference, the latest version applies. In the case of a reference to a 3GPP document (including a GSM document), a non-specific reference implicitly refers to the latest version of that document *in the same Release as the present document*.

- [1] 'D7-2 Ambient Networks Security Architecture', IST-2002-507134-AN/WP7/D02, F. Kohlmayer et al
http://www.ambient-networks.org/publications/D7-1_PU.pdf
- [2] 'Host Identity Protocol Architecture', R. Moskowitz, P. Nikander
<http://www.ietf.org/rfc/rfc4423.txt>
- [3] 'D3-2: Connecting Ambient Networks – Architecture and Protocol Design', IST-2002-507137-AN/WP3/D/3-2, J. Colás et al
http://www.ambient-networks.org/publications/AN_D3-2_for_publication.pdf
- [4] 3GPP TR 21.905: 'Vocabulary for 3GPP specifications'
- [5] 3GPP TR 22.978: 'All-IP Network (AIPN) feasibility study'
- [6] 3GPP TS 22.258: 'Service Requirements for the All-IP Network (AIPN); Stage 1'

- [7] 3GPP TS 22.259: 'Service Requirements for Personal Network Management; Stage 1'
- [8] 3GPP TS 22.278: 'Service requirements for evolution of the 3GPP system (Release 8)'3G
- [9] 'D8-A.3: Business Role Models', FP6-CALL4-027662-ANP2/D8-A.3', O. Rietkerk et al, January 2007
<http://www.ambient-networks.org/publications/>
- [10] 'D7-A.2: Draft System Description', FP6-CALL4-027662-ANP2/D7-A.2', M Johnsson, R Hancock, A Schieder et al, January 2007
<http://www.ambient-networks.org/publications/>
- [11] 3GPP TS 22.228: "Service requirements for the Internet Protocol (IP) multimedia core network subsystem".

3 Definitions, symbols and abbreviations

3.1 Definitions

For the purposes of the present document, the terms and definitions given in [4] and the following apply.

Editors note: need to add definition of Compensation

Composition Agreement (CA): A Composition Agreement is an electronic agreement between CCNs. It includes the policies to be followed by the composed CCNs, the identifier of the composed CCNs, how logical and physical resources are controlled and/or shared between the composing CCNs, compensation information, etc. Where the CA includes commercial and legal factors, the CA should be digitally signed by both CCNs (to support non-repudiation and legal enforcement).

Composition Capable Network (CCN): A network or user device capable of Network Composition. A network may be a 3GPP network or non-3GPP network.

Composition Process: A set of phases that all together describes the necessary procedures to perform a Network Composition between CCNs. The phases may not need to be strictly ordered, and one or more of the phases can be omitted depending on how the Network Composition is applied and its purpose.

Decomposition Process: A set of phases that all together describes the necessary procedures to cancel a Network Composition between CCNs. The phases may not need to be strictly ordered, and one or more of the phases can be omitted depending on how the Network Composition is cancelled.

Network Composition: A dynamically created cooperation between an evolved 3GPP network and another network or user device, or between networks/user devices in general. This cooperation is ruled by the Composition Agreement agreed during the Composition Process.

Resource, resource control, resource usage, and resource access provisioning: A resource is an entity provided by a CCN, e.g. bandwidth, AAA (Authentication, Authorisation, and Accounting) functionality and mobility functionality. It is characterized by the following: A resource is controlled – in the sense of configured and administered - by a CCN (e.g. a PLMN controls its AAA and mobility functionality) in order to show a certain specified behaviour. A resource can be used by a CCN (e.g. a User Equipment (UE) or PAN using the AAA and mobility functionality provided by a PLMN). The access to usage of the resource is provided (e.g. a Visited PLMN (VPLMN) provides access to the AAA functionality in the Home PLMN (HPLMN), or a mobile network provides access to the mobility functionality of a PLMN). Usage, control and access provisioning to a given resource can be performed by different CCNs. A resource may have inherent, resource type-specific properties that may be subject to CA negotiation.

Virtual Composition: Network Composition between CCNs that are not in direct physical contact but exchange information (e.g. through packets) via another transport network(s).

example: text used to clarify abstract rules by applying them literally.

3.2 Symbols

For the purposes of the present document, the following symbols apply:

Symbol format

<symbol> <Explanation>

3.3 Abbreviations

For the purposes of the present document, the abbreviations given in TR 21.905 [x] and the following apply. An abbreviation defined in the present document takes precedence over the definition of the same abbreviation, if any, in TR 21.905 [x].

For the purposes of the present document, the following abbreviations apply:

AAA	Authentication, Authorisation, and Accounting
AIPN	All-IP Network
AN	Access Network
CA	Composition Agreement
CCN	Composition Capable Network
CD	Control Delegation
CN	Core Network
CS	Control Sharing
DSL	Digital Subscriber Line
GANS	Generic Ambient Network Signalling
GRX	GPRS Roaming eXchange
GSMA	GSM Association
HIP	Host Identity Protocol
HLR	Home Location Register
HPLMN	Home PLMN
HSS	Home Subscriber Server
IKE	Internet Key Exchange
IMS	IP Multimedia Subsystem
IMSI	International Mobile Subscriber Identity
IP	Internet Protocol
IPSec	Internet Protocol Security
IPX	IP eXchange
ISIM	IM Services Identity Module
I-WLAN	Interworked WLAN
PAN	Personal Area Network
PDG	Packet Data Gateway
PLMN	Public Land Mobile Network
PN	Personal Network
PNM	Personal Network Management
QoS	Quality of Service
RAT	Radio Access Technology
RC	Roaming Consortium
RNC	Radio Network Controller
SGSN	Serving GPRS Support Node
SIM	Subscriber Identity Module
SLA	Service Level Agreement
UE	User Equipment
UICC	UMTS IC Card
USIM	UMTS Subscriber Identity Module
UTRAN	UMTS Terrestrial Radio Access Network
VPLMN	Visited PLMN
WLAN	Wireless Local Area Network

4 Principles, Purpose and Benefits of Network Composition

4.1 Principles

4.1.1 General

3GPP networks of today cooperate with other networks: For example, they exchange user traffic with other Public Land Mobile Networks (PLMNs), fixed network and the Internet, they cooperate with these networks on the basis of roaming agreements, and cooperate with non-3GPP Radio Access Technologies (RATs), e.g. Interworked WLAN (I-WLAN). 3GPP networks will also cooperate with user-owned networks, e.g. Personal Networks and PANs. The cooperation of 3GPP networks with other networks however is mostly of a static, preconfigured nature. For example, the cooperation with a I-WLAN Access Network is based on manual configuration, and the I-WLAN is expected to be immobile, i.e. the access point is statically installed and does not roam. Moreover, the process to (both technically and administratively) achieve cooperation with other networks is highly dependent on the nature of the network and the goal of the cooperation. Network Composition is about making this process both dynamic and uniform.

Network Composition is a uniform procedure that allows cooperation of two or more Composition Capable Networks. These other networks may be of a rather heterogeneous nature, ranging e.g. from PLMNs over fixed networks to Personal Area Networks and including 3rd party operated access networks. The cooperation enabled through Network Composition can be quite loose, as in the case of a dynamic roaming agreement between PLMNs. It can also be very tight, as in the case of the dynamic integration of a non-3GPP RAT into the evolved 3GPP network. The point is that, despite these differences, the basic procedure for achieving the cooperation in all scenarios is identical.

Network Composition furthermore is a procedure that allows a dynamic cooperation of the CCN with heterogeneous other networks. While an established framework agreement (e.g., a contract written on paper) between the composing parties that defines the context (e.g., legal or commercial) within which Network Composition is carried out may be required prior to composition, the actual composition is automated and 'on the fly'. This may include the dynamic, automated renegotiation and adaptation of certain parameters, e.g. bandwidth, within the limits pre-set in the framework agreement. However, also fully electronically negotiated agreements without prior framework agreement may be feasible.

The dynamically negotiated agreement between the composing CCNs is called Composition Agreement (CA). It contains the detailed parameters of the cooperation between composed networks. Together with a possible framework agreement, the CA reflects both business (contractual interaction points, payment method) and technical (management, QoS, technical capabilities) issues and also specifies the rights and duties for each party. Since potentially a large number of parameters would have to be negotiated, the (partial) re-use of CAs that have been used in previous compositions of the same parties, or that were pre-established offline, is anticipated in order to speed up the process.

4.1.2 Types of Network Composition

The cooperation of CCNs can happen on both the user plane and the control plane. Dynamic cooperation on the user plane is already possible today. It means user traffic originating from one network is forwarded in the other network. However, cooperation across network boundaries to achieve end-to-end control functions like QoS and security as well as mobility is currently very difficult to establish.

Cooperation on the control plane can take many forms. Individual control functionalities, e.g. mobility control, authentication and authorization, QoS control or charging, can be left unchanged by the composition process, or they can be delegated, or even integrated. Several types of composition can be distinguished based on how resources are contributed:

- **Network Interworking:** The composing CCNs stay separate networks also after composition. They maintain control of their own resources. An example for this composition type is interworking at the control plane to establish QoS. Here each of the composing networks accepts user traffic from the other network and provides a particular QoS. QoS control remains in each network. It is not delegated, integrated or shared. All resources that are contributed according to Networking Interworking have their control unchanged. Who has rights to provide the access to use the contributed resources is subject to the CA between composed CCNs and is not affected by

the composition type. For example, in this case, CCN 2 may provide access to use the contributed resources by CCN 1, and vice versa.

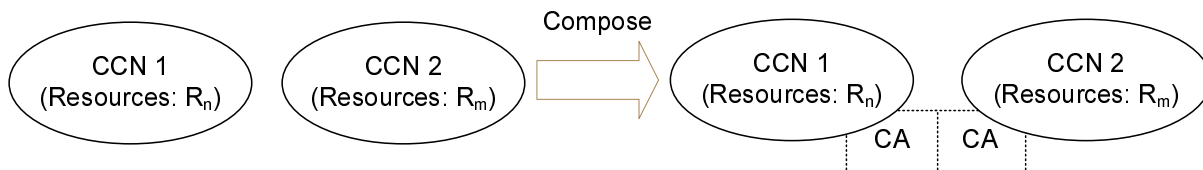

Figure 1: Network Interworking

- **Control Sharing:** Two CCNs stay separate, but share their resources. If a common control of any resources is involved, then a new common/virtual CCN (CCN 12) is created on top of the member CCNs. This new common/virtual CCN controls only the resources contributed to the new CCN. No member CCN has abilities to control the contributed resources, thus this is always done by the new common/virtual CCN. Also in this case, it is subject to the CA between CCN 1 and CCN 2 who is going to provide the access to use the contributed resources. Instead of exercising common control, control of certain resources can also be delegated to another CCN, which is defined below, so that after a composition has taken place, a CCN does not have control of the delegated resources anymore.

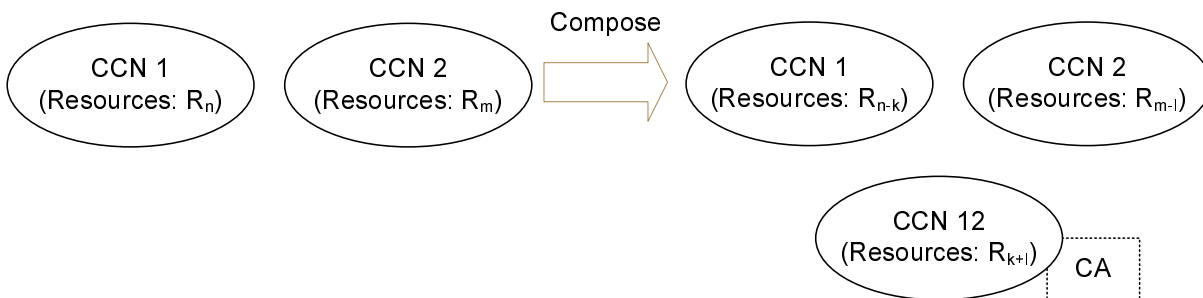

Figure 2: Control Sharing

- **Control Delegation (a special type of Control Sharing):** Here at least control of one resource is delegated from one CCN to the other CCN. The delegated resource control may also be located in a new (logical) CCN. Control delegation can be realized e.g. between a WLAN access network and the 3GPP network in a 3GPP-WLAN interworking scenario. Here, the AAA control for the WLAN access is delegated to the 3GPP network. Another example is the delegation of mobility control for mobile devices of a moving network to a mobile router. This allows network mobility in a way that is transparent to the mobile devices. All resources that are contributed according to Control Delegation follow the same set of rules defined for Network Interworking with the exception that right to control of the contributed resources are delegated to the other CCN who was not in control of the resource(s). Also in this case, it is separate issue on who has rights to do access provisioning and it is defined in the CA.

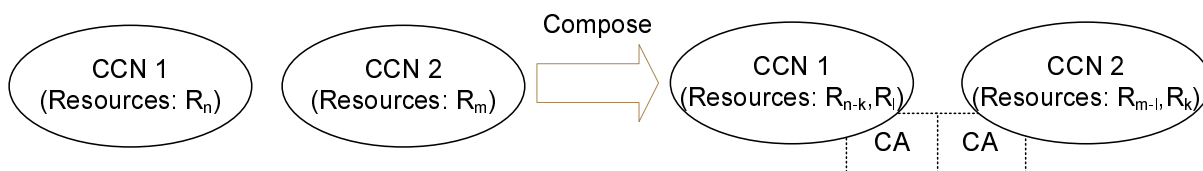

Figure 3: Control Delegation

- **Network Integration:** Two CCNs are merged to form one new CCN. All resources are inherited from the original CCNs, which are now controlled jointly. From the perspective a network or network element outside the new CCN, the original CCNs are no longer distinguishable. An example is the dynamic extension of the network of a single operator to include a new access network. All resources are controlled by a new common/virtual CCN, and access provisioning is done by this new CCN and/or another CCN.

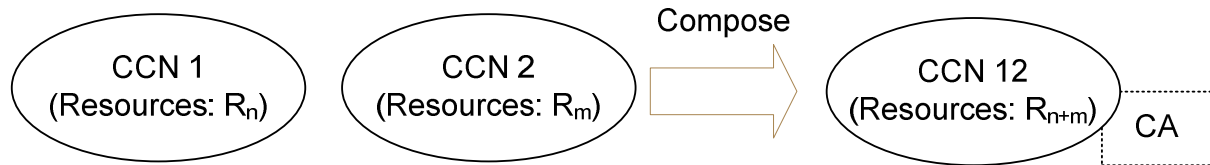

Figure 4: Network Integration

The composition types defined above can be also combined such that logical and physical resources are contributed in different ways. For example, if two resources A and B are contributed to a composition and A has its control delegated and B is under a common control, then the composition type is derived from the contributed resource requiring the highest level of co-operation. In this case, resource B represents the highest level of cooperation and therefore the composition type is control sharing with a new CCN.

The only exception is network integration where all resources are contributed in the same way; i.e. they are all under common control

The different composition types should be seen only as a rough classification to help understand a particular use case. They are not meant to be formal definitions and should not be used as such .

The Composition Process proceeds through a number of phases which are described in more detail in Sec. 6. They include a first advertisement and discovery phase in which composition is triggered, a phase in which the CA is negotiated, and a phase in which the CA is realized.

Network Composition does not prerequisite physical vicinity of the composing networks. Given adequate security, also a 'virtual composition' via a connecting bearer is conceivable.

However, in order to define the context (e.g., legal or commercial) within which Network Composition Network Composition is carried out, it is expected that the composing parties have already established a framework agreement before the actual Network Composition takes place. The substance of such a framework agreement and how it is set up is outside the scope of 3GPP. This can for example be done in a similar way as roaming agreements are negotiated today.

4.1.2 Other common styles

4.2 Purpose and Benefits

The purpose of Network Composition is a uniform, dynamic procedure for achieving dynamic network cooperation, particularly on the control plane. Such a procedure is expected to offer the following benefits:

- The Network Composition procedure enables new business opportunities as it facilitates flexible and more dynamic cooperation of heterogeneous networks on the control plane.
- As the network landscape becomes increasingly diverse, for example, due to the appearance of heterogeneous access network technologies (e.g., WLAN, WiMAX, etc.) and network types, the need for a uniform procedure that facilitates co-operation between the different networks arises. Network Composition defines precisely such a uniform procedure for co-operating between heterogeneous networks in a standardized way, which helps saving development time and cost..
- The uniformity of the Network Composition procedure furthermore saves infrastructure costs as the same infrastructure can be reused in all network cooperation scenarios.
- The dynamicity of the Network Composition procedure allows the network operator to quickly react to changing resource demands by extending network resources in an ad-hoc way.
- Electronic CAs based on pre-negotiated framework agreements are expected to save on transaction costs compared to completely manually prepared and negotiated agreements. They are especially suitable for dynamic business environments with many providers.

- Composition provides increased coverage, QoS and service availability to End-users as well as the promise of new value added services.
- In certain cases the real time nature of composition provides the opportunity for a seamless hand-over of the user's device from one CCN to another to ensure connectivity as well as QoS while being on the move.

4.3 Management aspects

In order to achieve a dynamic and automated operation of Network Composition, policies are considered a key aspect. Policies can provide the basis for the control of the behaviour and thus also the ability to manage a CCN. From the perspective of the needs of management of CCNs performing Network Composition, each CCN has a policy set which controls the behaviour of that CCN.

Policies may have default settings, but are generally explicitly configured to have appropriate values by the administrator of a CCN. Policies can be used to govern many different aspects of behaviour, but in the context of Network Composition, they shall at least be able to control the negotiation and the result of Network Composition. This should include the ability to (but is not restricted to):

- Decide with which other CCNs a CCN is willing to compose
- Negotiate right to use and control resources by the CCN with which a CCN is composing
- Arithmetically calculate a new set of policies for the new common CCN (if such a new CCN is created following the result of Network Composition), which will be the set of policies that controls the behaviour of that new CCN.

It shall be carefully noted that policies may explicitly or implicitly also be able to control the level of human interaction needed when for instance a decision shall be made whether a CCN shall compose with another CCN or not.

A policy has generally the nature of 'allowing' or 'disallowing' the usage and control of a resource (or set of resources) by a certain entity (e.g. a CCN), or entities. A policy can also be further qualified, e.g. as being applicable during a certain time period, or having meaning when at a certain location.

Assuming two CCNs, CCN_1 and CCN_2, each governed by a set of policies P1 and P2. The result of a Network Composition for each of the Composition Types will lead to the following:

Network Integration and Control Sharing:

A new CCN_12 is created, and which will be governed by a set of policies P12. This new set of policies should not allow more than the sum of allowing policies in P1 and P2, but may disallow more than the sum of disallowing policies in P1 and P2.

Control Delegation and Network Interworking:

No new CCN is created, and two, possibly updated policy sets P1 and P2 are maintained as from before Network Composition.

4.4 Resource control, resource usage and resource access provisioning

Network Composition is a dynamically created cooperation of CCNs. In this section we describe this cooperation in more detail.

The cooperation achieved by Network Composition is characterized by the trading of control and usage rights of resources. The composing CCNs contribute resources to the Network Composition; more precisely, they may contribute usage rights, control rights and access provisioning rights. The CA enumerates the contributed resources, and describes which rights the composing CCNs as well as the resulting CCN(s) have with respect to each resource as a result of Network Composition.

Control rights: Let us say there is a resource R, e.g. Mobility functionality. Let us also assume that this resource R is located in CCN "A"; in other words, the Mobility Anchor Point or the Radio Network Controller (RNC)/ Serving GPRS Support Node (SGSN) is located in CCN A. CCN A also fully controls the resource R. Control means the ability to configure, manipulate and manage the resource. Alternatively, CCN A may have acquired control of R via Network Composition. Then resource R may be located outside of A.

Usage rights: Also the usage of a resource can be subject to Network Composition. For example, CCNs can negotiate a Service Level Agreement (SLA) (a part of a CA) that allows one CCN to inject traffic into the other CCN. This corresponds to usage rights for the resource bandwidth.

Access provisioning rights: A resource is always used via an interface. Access to this interface is restricted, and a CCN may acquire the right for providing the access via Network Composition. Obviously, providing the access to a resource is different from the actual controlling of a resource.

When CCN A composes with another CCN, call it "B", then the resource R in A would be contributed in the following way:

- (Network Interworking), R is controlled by A and used by B through an interface.
- (Network Interworking) R is controlled by A and B provides an interface to use the resource R to other CCNs.
- (Control Delegation) R is controlled by B.
- (Control Sharing, Network Integration) R is controlled by a newly created CCN, call it "C", if A and B like to have shared control over the resource. Other CCNs may then compose with C, and depending on composition type, things as described here and above may then happen once again with the resource R.

Thus the Composition Type is determined based on which CCN controls the resource after Network Composition. It is not related to who provides access to the resource or to who uses it. Nonwithstanding, a CA would usually cover these aspects.

As a rather concrete example, if there is a WLAN hot spot who actually can do Authentication (but only of its own user base), and which then composes with a 3G network (who can do Authentication of its own user base), the resource is Authentication in this example, and please note that it is available in both networks but with potentially different contents, they may select to compose according to:

- Network Interworking, so that each of them can provide and control access to the authentication service provided by each CCN (the WLAN hot spot and the 3G network).
- Control Sharing, so that both can share and control the Authentication via a new CCN, which could be a valid option if e.g. their respective user bases overlap.
- Control Delegation, e.g. the WLAN hot spot can delegate the control of its Authentication resource to the 3G network, and then the 3G network can authenticate via either Authentication resource and manipulate the Authentication resource (e.g. the AAA server) in the WLAN network. If e.g. there is an overlap, it uses its own Authentication resource, but if another not known user for the 3G network shall be authenticated, then it could check with the WLAN hot spot's Authentication resource.
- Network Integration, not really applicable in this case, but would end up in a similar result as for Control Sharing.

4.5 Multi-lateral Compositions

4.5.1 General

Multi-lateral compositions involve more than two CCNs taking part in the same CA. A multi-lateral composition always starts with a bi-lateral composition where two CCNs compose bi-laterally and where they agree to support a multi-lateral CA. After this, a 3rd, 4th, etc CCN is able to join in and extend the multi-lateral composition.

There are two approaches that can be used to create a multi-lateral CA; 1) a set of bi-lateral CAs form a multi-lateral CA and 2) a multi-lateral CA formed through a composed CCN and it does not include any bi-lateral CAs. Both approaches result in the same multi-lateral composition consisting of contributed resources of member CCNs. In both cases, all member CCNs see each others and the contributed resources and a new CCN responsible of maintaining a multi-lateral CA is created on top of member CCNs. These approaches are further described in the following subsections.

4.5.2 A set of bi-lateral Cas

In the first approach, a composition is always performed by contacting one of member CCNs and therefore a composed CCN cannot be directly used. Resources could be contributed according to Network Interworking and Control Sharing including Control Delegation composition types and depending on the type of the bi-lateral composition; contributed resources are treated as follows:

- 1) Network Interworking: All contributed resources have their control unchanged meaning that resource owners (member CCNs) maintain their ability to control their resources. It is subject to a bi-lateral CA between member CCNs who has rights to do access provisioning.
- 2) Control Delegation: All contributed resources are treated according to the rules defined in previous case (Network Interworking) with the exception that right to control of the contributed resources is delegated to another member CCN. Also in this case, it is subject to a bi-lateral CA to define who has ability to provide access to the contributed resources.
- 3) Control Sharing: All resources having their control shared are controlled by a new common/virtual CCN on top of member CCNs. No member CCN has abilities to control of the contributed resources. Also in this case, any CCN including the new common/virtual CCN may provide access to use the contributed resources according to bi-lateral Cas between member CCNs.

Below, a simple example is provided to illustrate how 3 CCNs (X, Y and Z) form a new multi-lateral CA through a set of bi-lateral CAs.

Step 1: X contacts Y (or vice versa) and they decide to compose in order to establish a multi-lateral CA. It is important that the composing CCNs agree on whether they want to support multi-lateral Cas or not. Because if they decide to support multi-lateral Cas, then there are some requirements for the CA; i.e. all contributed resources must be equally available and visible to other member CCNs including also new CCNs that are not yet part of the composition. Through this composition, X contributes its resource x_1 according to Control Delegation (CD) and a new CCN W that is responsible of a multi-CA is created as illustrated below.

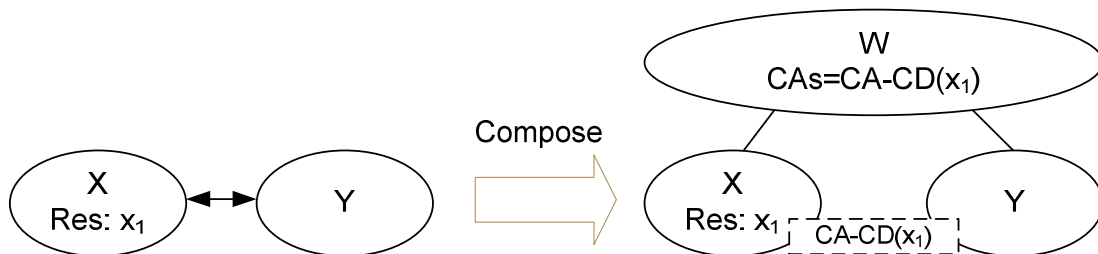

Figure 5: Multilateral Network Composition based on a set of bilateral CAs, step 1

After X and Y have composed, a new CCN W is created and it realizes their bi-lateral CA ($CA-CD(x_1)$) and rights to control the resource x_1 is delegated to Y. X, Y and W may do access provisioning of the resource x_1 according to the bi-lateral CA between X and Y.

Step 2: Z contacts Y and wants to compose with it. Y notifies Z that there is a multi-lateral CA available and that X is also a member of it. Z is willing to join in and extend this CA. Once X has approved Z as a new member, Y and Z compose and contribute their resources according to Control Sharing (CS); Y contributes its resources y_1 and y_2 and correspondingly Z contributes z_1 . Once Y and Z have composed, their bi-lateral CA extends the CCN W and after they have realized their bi-lateral CA, a multi-CA is extended by their bi-lateral CA as illustrated below.

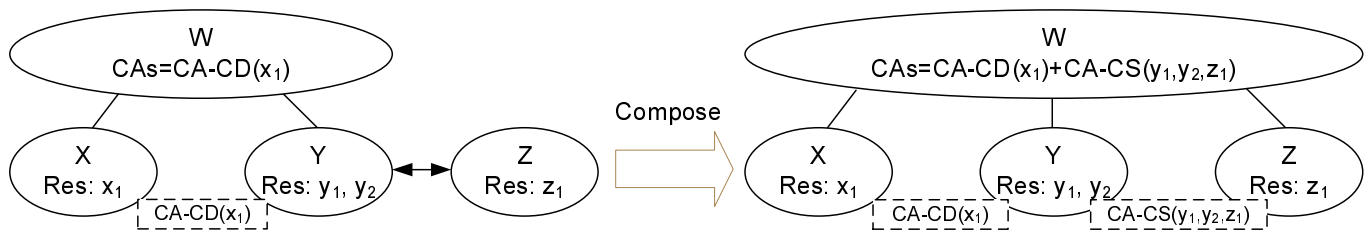

Figure 6: Multilateral Network Composition based on a set of bilateral CAs, step 2

After the composition, all contributed resources having their control shared (y_1 , y_2 and z_1) are controlled by the CCN W. No member CCN (X, Y and Z) has abilities to control these resources. Also in this case, CCNs are able to configure themselves to do access provisioning of these resources according to the bi-lateral Cas.

These two bi-lateral Cas ($CA-CD(x_1)$ and $CA-CS(y_1, y_2, z_1)$) forming a multi-lateral CA should be compatible with each other; i.e. there cannot be any resource conflicts between them.

4.5.3 A multi-lateral CA

In the second approach, a composition is always performed by contacting the CCN on top of member CCNs that is responsible of a multi-lateral CA and unlike in the former approach, the member CCNs cannot be used to extend a multi-lateral CA.

Resources could be contributed according to Network Interworking and Control Delegation and depending on how resources are contributed, they are treated as follows:

- 1) Network Interworking: The same way as described in the former approach (a set of bi-lateral CAs).
- 2) Control Delegation: All contributed resources are treated according to the rules defined in previous case (Network Interworking) with the exception that rights to control the contributed resources are delegated to the CCN on top of member CCNs. Also in this case, all CCNs may provide access to use the contributed resources according to related CAs.
- 3) Control Sharing: Not applicable or needed, since for example when X contributes its resource x_1 according to Control Delegation; i.e. the CCN on top of member CCNs has control of the resource, and when new CCNs join in they are able to control the resource x_1 via the top level CCN and this is in fact the same as Control Sharing from the resource control perspective.

Below, a simple example is provided to illustrate how 3 CCNs (X, Y and Z) form a new multi-lateral CA.

Step 1: X first likes to compose bi-laterally with Y, but where they discover they like to create a multi-lateral CA. For this purpose, a new CCN W is created with which both X and Y composes. When X composes with W it contributes its resource x_1 according to Control Delegation and correspondingly Y contributes y_1 and y_2 in the same way. This results a new multi-lateral CA consisting of both $CA-CD(x_1)$ and $CA-CD(y_1, y_2)$. The CCN W has rights to control the contributed resources; x_1 , y_1 and y_2 . At least one of CCNs (X, Y and W) should do access provisioning of these resources according to related CAs. There could be also multiple CCNs performing access provisioning of the same resource. This step is illustrated in figure below.

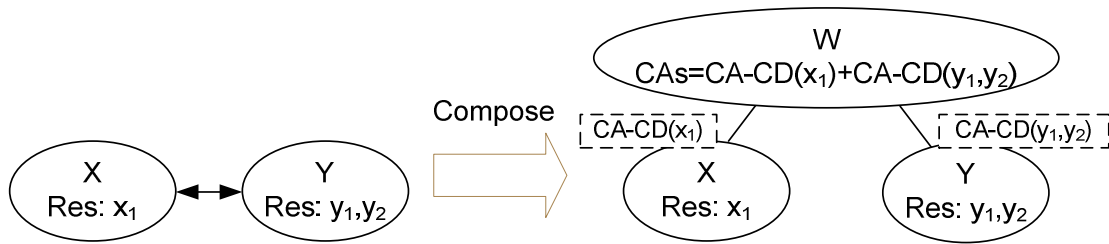

Figure 7: Multilateral Network Composition based on a multilateral CA, step 1

Step 2: Z then contacts W and composes with it and contributes its resource z_1 according to Control Delegation. By doing so, Z extends the multi-lateral CA, and which now includes CA-CD(z_1) and W has rights to control this resource. Again, at least one CCN should do access provisioning of this resource. This is illustrated below.

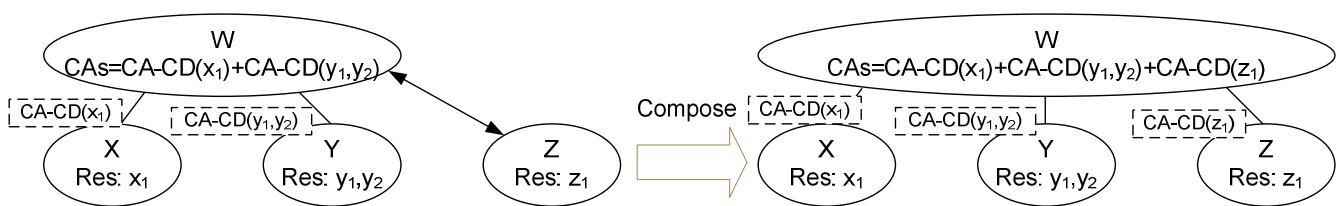

Figure 8: Multilateral Network Composition based on a multilateral CA, step 2

4.5.4 Advantages and disadvantages of different approaches to support multi-lateral compositions

As explained in previous subsections, there are two approaches of how to setup a multi-lateral composition. This subsection outlines the main differences between these approaches and lists their advantages and disadvantages.

The main differences between these two approaches relate to the method through which a multi-lateral CA is formed and extended.

In the first approach defined in section 4.5.1 – A set of bi-lateral CAs, joining in a multi-lateral CA is always done through one of member the CCNs, i.e. never by directly contacting the composed CCN that is responsible of a multi-lateral CA. In practice, this also means that the composed CCN does not need to reveal its identity to the outside.

In the second approach described in section 4.5.2 – A multi-lateral CA, joining in a multi-lateral CA is always done by directly contacting the composed CCN implying that it needs to reveal its identity to the outside.

There are also other minor differences like the second approach supports a smaller set of composition types than the first approach, but in practice both approaches are able to produce a multi-lateral composition with the same capabilities.

One advantage of the first approach is the possibility not to reveal the composed CCN's identity to the outside and therefore related issues like how to make other CCNs aware of the new identity and how to establish a secure communication based on the new identity can be omitted. For example, if we consider a number of 3GPP operators having 'only' bi-lateral business/technical agreements with each other, then a multi-lateral CA can be formed based on the existing bi-lateral CAs. In this case, there is no existing multi-lateral business/technical agreement over which a multi-lateral CA could be first created by two operators to later on allow more operators to join in. The de-centralized nature of this approach leads to some disadvantages; a CCN might need to maintain more than one (bi-lateral) CA for each multi-lateral CA it is part of. Another disadvantage is member CCNs' potential need to re-compose in order to maintain their membership in a multi-lateral CA and to maintain consistency of a multi-lateral CA when one or more member CCNs loose their connectivity.

In the second approach, a member CCN needs to maintain only a single CA for each multi-lateral CA and this can be seen as advantage compared to the first approach. Another advantage of this approach is its ability to use an existing multi-lateral business/technical agreement over which a multi-lateral CA could be then created. On the other hand, when there is no existing multi-lateral business/technical agreement, the composed CCN needs to have a visible and reachable identity and related interface(s) through which new members are able to contact it in order to join in. The table below summarizes the pros and cons of the two different approaches to create a multi-lateral CA.

	A set of bi-lateral CAs	A multi-lateral CA
Advantages	Well suited to form a multi-lateral CA based on existing bi-lateral CAs No need to have a composed CCN with the identity that is visible and reachable from the outside	A multi-lateral composition requires only one CA per member CCN Well suited to form a multi-lateral CA over an existing multi-lateral business/technical agreement.
Disadvantages	One multi-lateral composition may require more than one bi-lateral CA per member CCN Potential re-compositions of member CCNs in order to maintain consistency of the multi-lateral CA	A composed CCN needs to have visible and reachable identity to the outside

5 Composition Use Cases

5.1 Description

This section presents use cases illustrating the concept and advantages of Network Composition. The Composition is basically the same, independent of the heterogeneous nature of the CCNs. To illustrate this wide scope, a number of different use cases are discussed, each involving different network types. Presented are use cases on composition of Core Network (CN) with CN, Access Network (AN) with CN, AN or CN with Personal Network (PN) or Personal Area Network (PAN) as well as PN with PN and PAN with PAN.

Actors, business roles, and use cases, are further elaborated and discussed in [9], through which further understanding can be obtained on how business operations might develop in the future in light of Network Composition.

5.2 Network Composition between Core Networks

5.2.1 General

This class mainly involves core networks, which are either 3GPP Systems or non-3GPP Systems. Typically, at least one network is 3GPP System. Possible use cases are as follows:

5.2.2 Inter-operator Network Composition (via GRX)

5.2.2.1 Short Description

The principles of Network Composition Network Composition can be used to automate the establishment and/or update of roaming agreements or aspects thereof (e.g., service-level agreements, policies, charging information) between network operators. Guarded by an a-priori established framework agreement, inter-operator Network Composition allows dynamic (re-) negotiation of roaming agreements among 3GPP operators with no or minimum human intervention. For example, it allows network operators to dynamically extend, change, update, or withdraw roaming agreements or aspects thereof as need arises in the dynamic relation between operators (e.g., due to policy changes, or changes of resource and service availability/cost), without having to undergo a lengthy manual negotiation process.

Note: Inter-network communication among 3GPP operators is usually achieved via the GSM Association (GSMA) GPRS Roaming eXchange (GRX) network, which offers an IP backbone for 3GPP operators. Bi-lateral Network Composition between 3GPP operator networks can be carried out via the GRX (as illustrated in Figure 5-2.2).

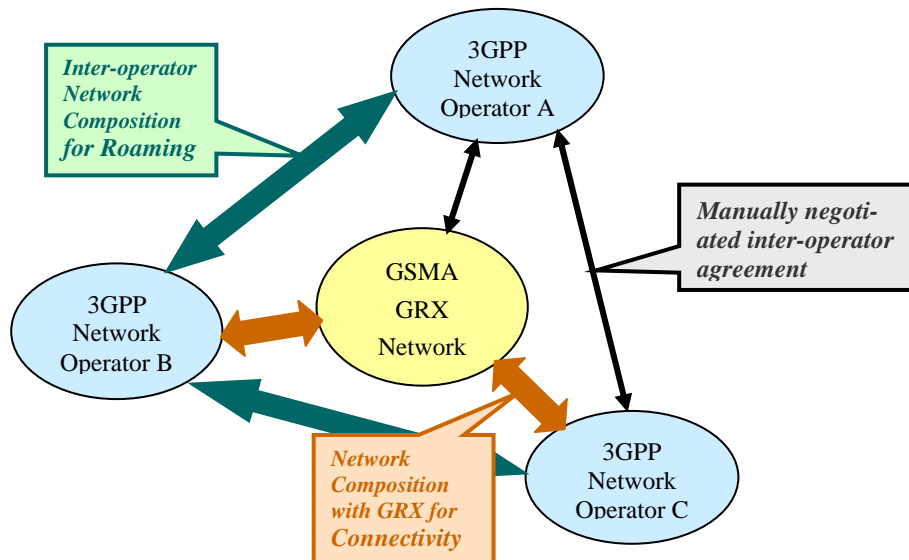

Figure 9 Inter-Operator Network Composition via GRX

In addition to inter-operator Network Composition for the purpose of establishing/ updating roaming agreements or aspects thereof, the example depicted in Figure 5-2.2.1 also shows the possibility for 3GPP operator networks to compose with the GRX network based on the dynamic Network Composition principle. Again, since the interworking agreement between 3GPP operators and the GRX is expected to become increasingly dynamic (e.g., resource usage and cost may be changed more frequently, additional service-specific QoS classes may be desired, new naming, address and routing configurations need to be exchanged, etc.), dynamic Network Composition allowing (re-)negotiation and realisation of interworking agreements "on the fly" (without having to undergo a lengthy manual process) is expected to become more important also between 3GPP operators and GRX provider(s).

5.2.2.2 Actor Specific Issues and Benefits

In the inter-operator Network Composition scenario, both actors are 3GPP operators. As this scenario shows, 3GPP operators can benefit from the concept of Network Composition as they can dynamically extend, modify or withdraw roaming agreements or aspects thereof, as need arises. This has the potential that current static inter-operator agreements, which are manually negotiated between human representatives of each operator, can be realised automatically and therefore be much more dynamic. For example, it allows for dynamic updates of roaming policies, service level agreements, etc.

In the operator-GRX Network Composition scenario, the actors are 3GPP operators on the one hand and the GSMA running the GRX network on the other hand. Again, both actors benefit from the fact that interworking agreements between 3GPP operators and the GRX (i.e., QoS classes, routing configurations, etc.) can be (re-)negotiated and realised more dynamically.

5.2.2.3 Pre-Conditions

An a-priori established framework agreement defines the configuration/operation of the dynamic composition process and guards the (re-)negotiation and update of inter-operator agreements in both composition scenarios. The framework agreement also defines the legal arrangement for the composition context.

Note: The framework agreement is expected to be established in a similar way as inter-operator roaming agreements or operator-GRX interworking agreements are established today. The main difference is that the framework agreement does not necessarily define all the details of the agreements, but rather allows some of the aspects to be (re-) negotiated dynamically through the Network Composition process.

5.2.2.4 Normal Flow

The flow is described as follows:

- 1) 3GPP operators compose their networks with the GRX network in order to establish connectivity between the networks.
- 2) 3GPP operators can then establish bi-lateral roaming agreements for policy control and charging through direct composition between their networks.

See , figure 10 for further details how inter-operator Network Composition via GRX can be accomplished

Note : The communication services needed for inter-operator Network Composition in the second step are provided by the GRX network, and are thus subject to the Composition Agreements established in the first step.

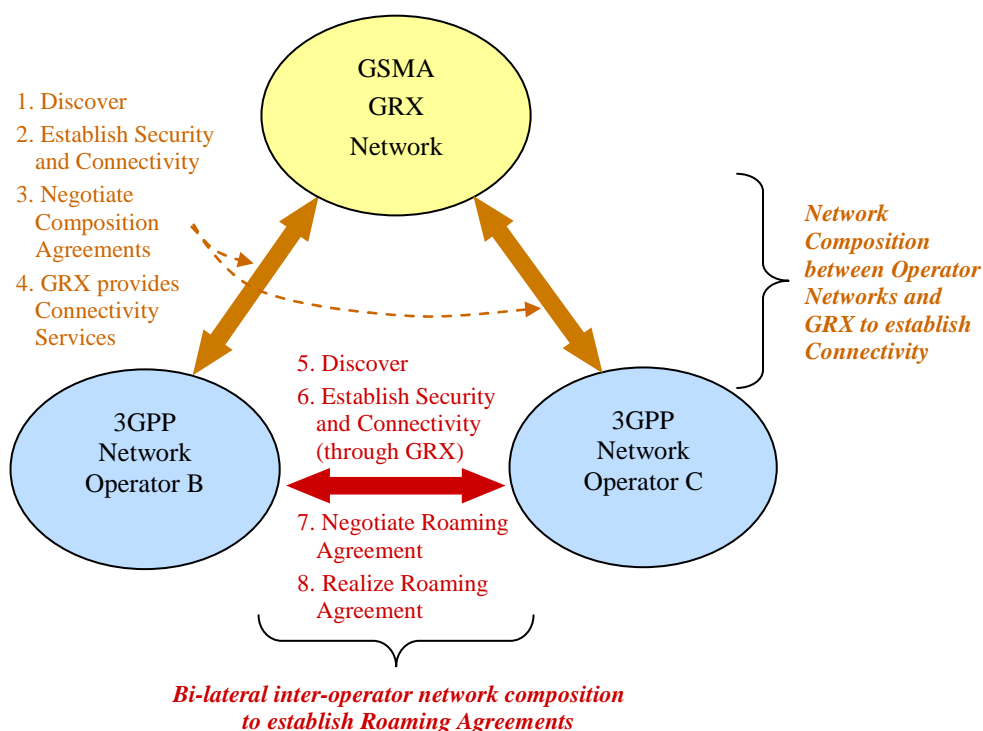

Figure 10 Network Composition between operator networks and GRX to establish inter-operator connectivity, and bi-lateral inter-operator Network Composition to negotiate roaming agreements.

5.2.2.5 Alternative Flow

Not applicable.

5.2.2.6 Additional Information

The use of the GRX in this use case does not restrict the concept to GSMA's GRX network; the GRX could be replaced by any inter-operator backbone network including the IP eXchange (IPX), which might complement the GRX network. In fact, discussions around the future inter-operator backbone seem to assume that there will be a multitude of IPX

providers that offer inter-operator connectivity to mobile operators. In such a multi-provider landscape, the benefits of Network Composition between the 3GPP operators and backbone providers, which allows dynamic (re-)negotiation and establishment of interworking agreements, are more significant.

Feasibility of this use case will depend on the 3GPP operator's network configuration and roaming policy.

Composition Type: The composition type is Network Interworking and 3GPP operators maintain their rights to control their contributed resources meaning that they do not gain any new resource controls through the composition. Both operators may do access provisioning of the contributed resources according to their bi-lateral CA.

5.2.3 On-demand inter-operator Network Composition

5.2.3.1 Short Description

This use case involves a user (Bob), who is currently on a business trip through South America. While driving through Country A, the user is attached to 3GPP VPLMN A, which has a roaming agreement with the user's HPLMN. As illustrated in Figure 5.3.2.1, this roaming agreement has been pre-established between the Bob's HPLMN and VPLMN A based on the 'normal' process of establishing roaming agreements.

When crossing the boarder to Country B, Bob's UE loses service from VPLMN A. The UE scans for other networks and detects the network of VPLMN B. However, Bob's HPLMN and VPLMN B have not yet established a complete roaming agreement, as the number of subscribers that require roaming support in this region (i.e., with VPLMN B) does not justify the human management cost to maintain and up-to-date roaming agreements between the operator networks.

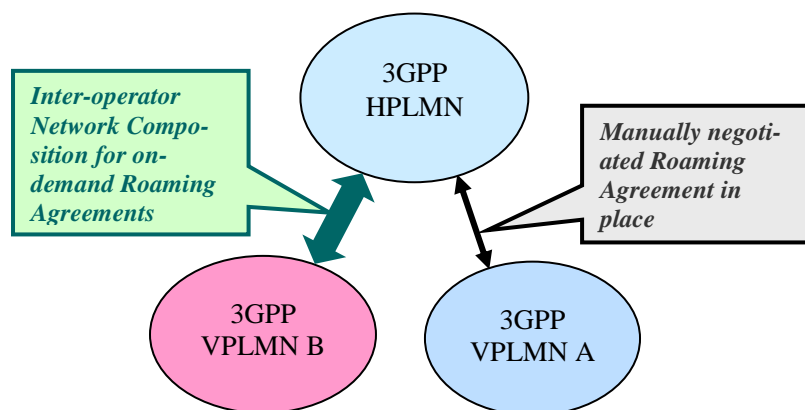

Figure 11 On-demand Inter-Operator Network Composition

The concept of Network Composition, on the contrary, allows operators to dynamically (re-)negotiate or update detailed roaming agreements in the event that a subscriber wants to gain access in a VPLMN with which the HPLMN has previously established a framework agreement (see Figure 11).

Unlike in today's roaming agreements, these framework agreements simply define the configuration and operation of the Composition Process and the boundaries and rules within which the dynamic (re-)negotiations are carried out.

As the operator-specific negotiations can be handled during the actual dynamic Composition Process, those framework agreements are therefore expected to be less complex and less specific to an operators, so that 'default' framework agreements can be used more easily.

5.2.3.2 Actor Specific Issues and Benefits

In this use case, the main actors are the two operators, namely the 3GPP HPLMN and 3GPP VPLMN B. Both operators benefit from the concept of Network Composition, as they can dynamically (re-)negotiated or update roaming agreements when need arises.

In particular, Network Composition allows flexibility and reduces operational costs by eliminating the necessity for operators to manually maintain and update roaming agreements between parties that only have little roaming subscribers. Instead, Network Composition allows (re-)negotiation and updates of roaming agreements on-demand, as need arises.

Note: Although this use case involves only 3GPP operators, the same principle can also be applied to inter-operator agreements between 3GPP and non-3GPP operators (e.g., WLAN providers).

5.2.3.3 Pre-Conditions

An a-priori established framework agreement, which only defines the static elements of an inter-operator agreement, defines the configuration and operation for the dynamic Composition Process and guards the (re-)negotiation and update of roaming agreements when need arises. The framework agreement also defines the legal arrangement for the composition context.

5.2.3.4 Normal Flow

When a user tries to access the network of a 3GPP operator that does currently not have a fully specified and/or up-to-date roaming agreement with the user's home operator, inter-operator Network Composition between the VPLMN and the 3GPP HPLMN could be triggered. After successful negotiation of the Composition Agreement, the VPLMN and the user's HPLMN have an up-to-date and complete roaming agreement that enables the user to leverage the VPLMN's access network and the HPLMN to generate some extra revenue. The Composition Agreement (or roaming agreement in this case) between the 3GPP operators provides the basis for policy control and charging while the user is roaming in the visited network.

Note that this composition scenario could also be applied between a 3GPP HPLMN and non-3GPP operators (e.g., WLAN providers), which provide Direct IP Access and/or 3GPP IP Access to HPLMN subscribers.

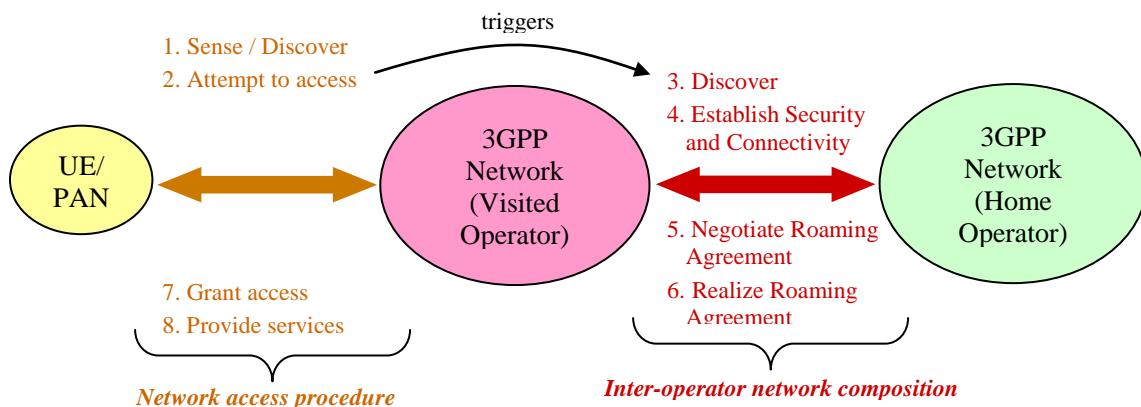

Figure 12 On-demand Inter-Operator Network Composition to establish Roaming Agreements.

5.2.3.5 Alternative Flow

In this particular use case, there is not necessarily a need for an explicit de-composition procedure, as the Composition Agreement between the operators could simply 'time out' if not refreshed prior to expiration. This means, the roaming agreement is (re-)negotiated and updated between the VPLMN and HPLMN, when the first user tries to attach.

The updated roaming agreement would then be valid for some or all subscribers of the HPLMN for the lifetime of the Composition Agreement (i.e., there is no need to execute the inter-operator Network Composition for each attaching UE).

5.2.3.6 Additional Information

The above use case provides the operators flexibility in the execution of the roaming agreements. Examples, could be flexibility on the roaming charges based on the number of roaming users between the two operators and also, on the services enabled between the networks.

Composition Type: See previous section - Inter-operator Network Composition (via GRX).

5.3 Network Composition between Core Network and Access Network

5.3.1 Composition of a nomadic I-WLAN with a 3GPP network

5.3.1.1 Short Description

Interworking of a I-WLAN with a 3GPP network is described in [5]. Usually this interworking is static in the sense that the I-WLAN is expected to be immobile. The scenario described here extends the interworking described in [5] and illustrates the case of a nomadic I-WLAN. A business case of the nomadic I-WLAN service provider could be the provisioning of 3GPP network access at mass events such as the world football championship, the Olympic games, rock concerts etc. On the site of the mass event, the I-WLAN is provided with a connecting bearer (e.g. Digital Subscriber Line - DSL) to the 3GPP operator's network. The I-WLAN thus typically performs a virtual Network Composition with the 3GPP network based on a pre-established Composition Agreement. Just as in [5], different scenarios are now possible: (i) UEs that have both UMTS IC Card (UICC) and a WLAN radio interface can now access the Internet via the WLAN Access Point based on their 3GPP subscription, or (ii) such UEs can even access 3GPP services, e.g. the IP Multimedia Subsystem (IMS)..

Compared to other use cases for Network Composition presented in this section, this use case has limited functionality and flexibility as the CA is already pre-established.

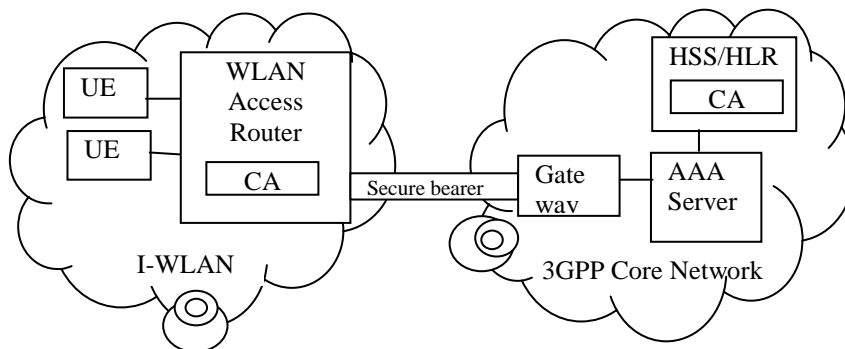

Figure 13: Network Composition of a nomadic I-WLAN with a 3GPP network

5.3.1.2 Actor Specific Issues and Benefits

Actors in this scenario are the 3GPP network, the I-WLAN and one or more UEs. The 3GPP network acts as an operator, the I-WLAN acts as a kind of user towards the 3GPP network and as a service provider towards the UE, and the UE acts as a user to both 3GPP and I-WLAN.

For both 3GPP operator and I-WLAN Service Provider, the scenario offers the benefits of extending the business case. The I-WLAN Service Provider may e.g. become a 'Hot-spot provider for mass events', moving its equipment to the corresponding site. The 3GPP operator can efficiently address such a market.

The dynamic establishment of 3GPP-WLAN interworking may however also save costs in the case of stationary WLANs (in airports etc): The I-WLAN Service Provider can install the WLAN on-the-fly, e.g. by buying and inserting

an extended UICC from the 3GPP operator which contains the Composition Agreement, and by connecting the Access Router e.g. to a DSL line; no additional configuration is necessary.

The 3GPP operator on the other hand can save costs by selling 'nomadic I-WLAN access packets' off-the-shelf to I-WLAN Service Providers. The contracts associated with this packet may be configured uniformly, i.e. they are not individually negotiated with each I-WLAN Service Provider. I-WLAN Service Providers could buy these packets (e.g. including the extended UICC with the CA) very much like users today buy USIM (UMTS Subscriber Identity Module) and SIM (Subscriber Identity Module) cards.

As a result the Network Composition procedure ultimately provides a capability to 'plug and play' the WLAN into the 3GPP network, thus enabling the WLAN to become – as I-WLAN – an additional radio access.

5.3.1.3 Pre-Conditions

Both 3GPP network and nomadic I-WLAN are CCNs. The I-WLAN has a pre-shared secret with the 3GPP operator, e.g. the I-WLAN Service Provider bought a special UICC, i.e. a UICC with a special contract (including a CA), that allows a CCN featuring the UICC to act as a I-WLAN. The CA contains the IP Address of the appropriate 3GPP gateway, e.g. a Packet Data Gateway (PDG). A storage in the 3GPP network, e.g. the HLR/HSS has stored the CA together with other contract-specific information (e.g. International Mobile Subscriber Identity (IMSI) etc).

5.3.1.4 Normal Flow

Technically, the composition between I-WLAN and 3GPP network could be performed as follows: When the I-WLAN senses the connecting bearer, it sends a message to the gateway to authenticate itself and request authorization. Subsequently the two networks set up a secure bearer (e.g. an IP Security (IPSec) tunnel, but confidentiality could also be handled on lower layers) to carry further messages. UEs can now access the I-WLAN as described in [5]. When the mass event is over, the operator triggers the I-WLAN to decompose, which implies tearing down the secure bearer

5.3.1.5 Alternative Flows

Not Applicable.

5.3.1.6 Additional Information

The 3GPP network (CCN_1) and the I-WLAN (CCN_2) compose, and the result is a (functionally slightly extended) CCN_1 and a (functionally slightly reduced) CCN_2. CCN_1 now contains a WLAN access network in addition to a UMTS Terrestrial Radio Access Network (UTRAN). CCN_2 continues to be a WLAN access network, still able to offer Internet Access to users without a 3GPP subscription, however it has partially delegated authentication, authorization and charging control functions to the 3GPP network.

Composition Type: The composition type is Network Interworking and the 3GPP network contributes its authentication, authorization and charging resources to provide access provisioning of these resources for its subscribers through the I-WLAN access network. The 3GPP network maintains control of the contributed resources. Both the 3GPP operator and the I-WLAN access network perform access provisioning of these contributed resources for UEs via WLAN and 3GPP accesses.

Framework Agreement and Composition Agreement: The I-WLAN Service Provider and the 3GPP operator offline negotiate a Framework Agreement (e.g. a contract in paper form) and, in the simple case described above, also already agree on the actual Composition Agreement (CA). The Framework Agreement contains the legal clauses and states that the I-WLAN may offer 3GPP access to UEs. It also states how the I-WLAN is reimbursed for its services. The Composition Agreement states that for users offering a 3GPP subscription, AAA functionality is delegated from the I-WLAN to the 3GPP network. It furthermore states that UEs may (or may not) access 3GPP services. It also contains the IP address of the 3GPP Gateway which the I-WLAN uses for composing. In the simplest case, the CA thus needs not to be negotiated on-line, but is simply confirmed as part of the Composition Process. I.e., the CA is pre-established and 'pulled from the shelf' when Network Composition is performed. In a slightly more sophisticated case, the Framework Agreement may allow the negotiation of a SLA between I-WLAN and 3GPP network within certain bandwidth limits. In this case, the pre-established CA would contain a proposed bandwidth, but also a note that this is negotiable.

5.3.2 Scenario Extensions for I-WLAN / 3GPP network composition

5.3.2.1 Short Description

The Network Composition use case presented in section 5.2.1 should be regarded as a rather specific and limited use case which can be gradually extended and generalized to reflect further more dynamic business environments and cooperation scenarios between the operator of WLAN access networks and 3GPP Core Network operators.

In general, a WLAN access network running his own business is interested to offer his service to the largest customer base possible. He would thus not restrict the composition opportunities to the support of subscribers of a number of well-known 3GPP core network operators, but seek to exploit any business opportunities arising. The potentially large number of different business partners would also restrict the feasibility of solutions requiring the off-line and manual negotiation of Composition Agreements (potentially excluding the exchange of special UICCs, as described in 5.2.1).

In this composition use case the WLAN access network intends to serve the customers of any 3GPP core network operator wishing to use the access facilities he provides. Serving the customers/subscribers of external 3GPP core networks requires the set-up of a Composition Agreement between the WLAN access network and the 3GPP core network operator to arrange for the agreement of supported services and their quality levels and the service costs and their compensation.

It is also assumed that the WLAN access network maintains a potentially large number of Composition Agreements with various different 3GPP core network operators in parallel. The WLAN access network thus needs to ensure that he provides access to all active UEs in accordance to the service quality requirements which might have been specified in the Composition Agreement between the 3GPP core network operator and the WLAN access network.

In this scenario no pre-established trust between the WLAN access network operator and the 3GPP core network operator is assumed due to the scalability limitations such an assumption would impose. Still, a particular WLAN access network can decide to build on pre-established trust to a limited number of 3GPP core network operators he frequently interacts with.

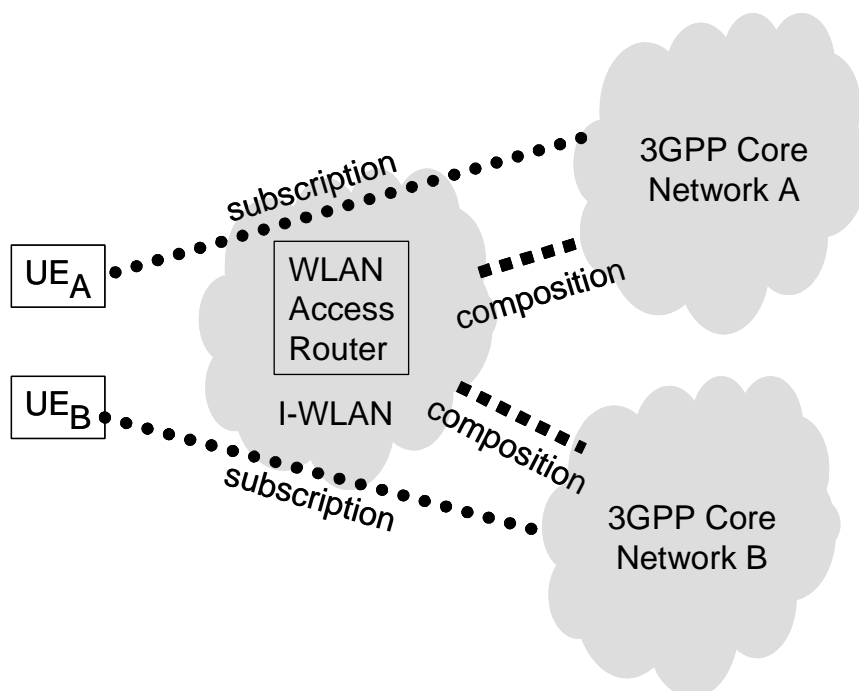

Figure 14: Network Composition of a WLAN access network with 3GPP core networks. Please note that the WLAN access network is able to act as an I-WLAN as depicted in the figure as a result of a Network Composition with one or more 3GPP core networks (but not prior to such compositions).

5.3.2.2 Actor Specific Issues and Benefits

Actors in this scenario are a WLAN access network, a number of 3GPP core network operators and the respective subscribers of these 3GPP core networks. The WLAN access network acts as an access provider (i.e. an I-WLAN

following a Network Composition) to the 3GPP subscribers and establishes Composition Agreements to the 3GPP core network operators to which the individual subscribers belong. The access service is provided to the subscribers, but the service compensation is arranged between the WLAN operator and the 3GPP core network operator by means of automated Composition Agreements. The establishment of the required trust between the WLAN access network and the 3GPP core network operator as well as the means to ensure service compensation are for further study. One possible solution could be to employ a trusted third party.

The actor specific benefits the 3GPP subscribers enjoy in this scenario include:

- Access to any composition capable WLAN access network is possible, and which could then act as an I-WLAN,
- No additional user credentials are necessary than the ones already stored on USIM and IM Services Identity Module (ISIM), and
- Service charges are taken care of by the 3GPP core network operator.

The WLAN access network gains access to a large customer base and is not required to implement an own subscriber handling including charging and billing functions.

The 3GPP core network operator benefits from coverage and capacity extensions through the additional usage of third party provided WLAN access services. He retains full control of his subscribers and the services provided to them.

5.3.2.3 Pre-Conditions

The WLAN and the 3GPP core network need to be CCNs. It is assumed that the 3GPP core (home) network operator of the 3GPP subscribers seeking to make use of the WLAN access service can be identified from the credentials presented by the 3GPP subscribers to the WLAN access network, i.e. the credentials already stored on USIM and ISIM.

5.3.2.4 Normal Flow

The WLAN access network may typically initiate a Network Composition with a 3GPP core network operator triggered from that a 3GPP subscriber tries to connect via the WLAN. But also an advertisement/discovery procedure (please refer to section 6.1.2) between the WLAN access network and 3GPP core network operators might lead to that CAs are established.

5.3.2.5 Alternative Flow

Not Applicable.

5.3.2.6 Additional information

Composition Type: Same as for the use case described in section 5.2.1.

5.3.3 Network Composition of a moving network with 3GPP networks

5.3.3.1 Short Description

The following use case illustrates that the operator of a moving network (defined in e.g. Sec 10.2 of TS22.258[6]) executes Network Composition with 3GPP network operators. By supporting the moving network capability, for example, a fast moving passenger train can offer Internet access and services provided by 3GPP networks to passengers while running on the railroad. The moving network automatically senses available 3GPP networks on the spot and maintains the connectivity by performing handover between network operators when possible and needed. To offer IP network access, the 3GPP network may assign and delegate a group of IP addresses that are used for the passengers on the train. The necessary bandwidth and necessary number of IP addresses are dependent on the number of passengers. The moving network dynamically negotiates QoS (e.g. bandwidth) and the range of IP addresses during the Composition Process.

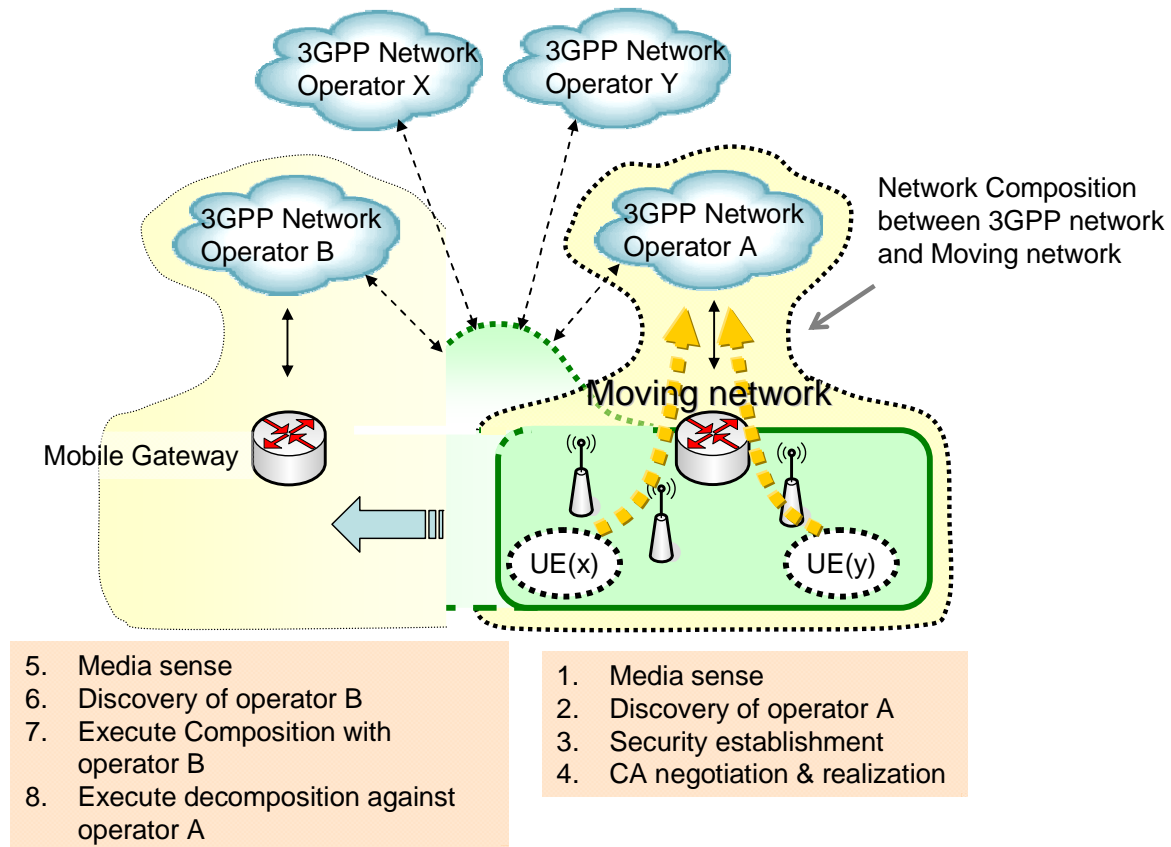

Figure 15: Network Composition of a moving network and 3GPP network

5.3.3.2 Actor Specific Issues and Benefits

Actor specific issues:

The CCN in a commercial vehicle (e.g. a train, a long-distance bus or a taxi) acts as a moving network operator and offers Internet access and 3G services to its passengers. The moving network operator has Composition Agreements with network operators A and B for connectivity and with X and Y for AAA of the passengers. To consolidate IP traffic to/from the passengers on the train, the moving network needs to negotiate a block of IP addresses for passengers and an appropriate level of QoS (e.g. bandwidth) is determined at the same time based on the number of passengers. When the train moves fast and crosses the boundary of the current 3GPP network, it needs to automatically and seamlessly re-execute Network Composition with the new 3GPP network and Network Decomposition with the old one. The moving network should also negotiate whether the previously agreed resources (e.g. the assigned QoS or IP addresses) can be continuously maintained after the change of 3GPP network operators. If some resources can not be maintained after the handover, the moving network handles this change e.g. by notifying it to the passengers or by prioritizing them to share the newly assigned resources.

On the other hand, 3GPP network operators A and B provide network access to the moving network operator. 3GPP network operators X and Y are the home operators of passengers x and y. Each passenger is authenticated by his or her home network operator via the moving network operator; therefore he or she does not have to have a direct access to its home operator. There is also a possibility that the moving network operator authenticates the passengers (e.g. based on vouchers / codes which are sold together with the tickets)

Benefits:

The moving network in the fast moving train can not only seamlessly offer network services, but also request only necessary QoS (e.g. bandwidth) and network resources (e.g. IP addresses) when it changes 3GPP network operators or when the number of passengers dynamically changes during its operation. For the passengers' home operators, radio resources are saved since user data traffic is consolidated and conveyed by the moving network and the control messages are minimized since the moving network handles the mobility. For the 3GPP network operator that is providing connectivity to the moving network, it becomes possible to dynamically allocate appropriate network resources, which leads to efficient network use.

5.3.3.3 Pre-Conditions

The CA between the moving network operator and the 3GPP network operators may not need full flexibility / dynamicity when the moving network runs the same route on a regular basis. In this case, the CA is mostly pre-established and only some parameters (such as bandwidth and the number of IP addresses) are negotiated during the Network Composition. Also, the users and the moving network should be composed in order to facilitate Internet access and services provided by 3GPP networks. The 3GPP operators providing connectivity for the moving network may have the CA according to their pre-established CAs with the moving network in order to support for example service continuity [11] of the moving network.

5.3.3.4 Normal Flow

The moving network senses and discovers the availability of the 3GPP network operator A (1)-(2). The moving network establishes security association with operator A (3) and executes CA negotiation and realization (4). For IP network access, operator A may delegate IP addresses to the moving network and allocate bandwidth in the core network for the moving network based on the CA.

When the moving network is about to move out of operator A's coverage area, it immediately executes media sense (5) and discovers operator B's network (6). The moving network executes Network Composition with operator B (7) and executes Decomposition against operator A (8). A series of the composition and Decomposition Processes are automatically executed in a timely manner for the sake of passengers on the fast moving train.

5.3.3.5 Alternative Flow

Not applicable.

5.3.3.6 Additional Information

The CA includes agreed-upon security level, QoS and composed network resources that are delegated to the other party. In this use case, the type of composition is 'Control Delegation' since a block of IP addresses and the mobility control function for the passengers are delegated to the moving network.

The CA between passenger x and the moving network can guarantee continuous availability and seamless use of services provided by operator X. The moving network needs to have a composition and connectivity with at least one 3GPP operator (e.g. operator A or B) at any time.

Operators A and B may have a CA to offer service continuity [11] to the moving network by performing service context or bearer traffic transfer between A and B. The currently attached operator (e.g. operator A) or a third party server may offer information on candidate CCNs (e.g. operator B) to the moving network before it starts to physically sense new CCNs, which will expedite the establishment of a CA and will contribute to service continuity. The CA between the currently attached operator and a candidate CCN may include agreement(s) based on which the currently attached operator is allowed to advertise the candidate CCN information to the outside.

Composition Type: Resources are contributed in two different ways in this use case; Network Interworking and Control Delegation, and the composition type is Control Delegation. A network operator (3GPP Network Operator A and B) contributes control of IP address management of selected subnet (Control Delegation) and provides usage of its mobility management and access resources (Network Interworking) for the moving network.

5.3.4 Access Networks – Core/service/identity provider networks: Network Composition of different types of access networks with core networks providing different types of end user services

5.3.4.1 Scenario overview

Interworking between Core Network (CN) and different types of Access Networks (AN) is described in [8]. The scenario depicted in figure 16 below shows how a number of ANs in different ways (e.g. by providing coverage, capacity, QoS) facilitate for the user the capability to connect to and use different services available via the CN. The relation between an AN and CN is not necessarily exclusive, i.e. an AN might provide its access services to multiple CNs in parallel. The CN as depicted may in future scenarios be further split up so that evolving and new actors on the

market provides different specialized services to users, and which should still be available via any type of access network for maximum flexibility and convenience for the user

5.3.4.2 Scenario technical description

A Network Composition between an AN and a CN may be triggered through the Advertisement and Discovery phase being an integral part of the Composition Process, or it may be triggered just by the fact that a user with his/her PN roams into a specific AN, which in turn would lead to a Network Composition between the AN and the CN. It may also be triggered by some other means, possibly as an offline operation, and may not even need to be performed through the Composition Process, but for example by using legacy modes of operation to 'compose' an AN with a CN. But generally, an AN makes a Network Composition by using the Composition Process described in section 6. Not further described in this contribution is how the user (of e.g. a PN) performs Network Compositions with ANs and CNs, but it is not unlikely that PN performs a 'simple' Network Composition with the AN merely to be able to reach the CN from which the user gets its services as well as its identity, which is then followed by a Network Composition with the CN to gain seamless and continuous access to various services, e.g. authentication, Internet access, and real-time collaboration services via the different ANs. CN, AN, and PN, are all examples of a CCN.

5.3.4.3 Operator / user role

In this scenario, a CN acts as an operator, an AN as a provider of access connectivity, and then there are users with their PNs/UEs which like to use the services available either via or possibly directly from the CN, by connecting to the CN via one or more of the ANs. It should then be noted that the CN can be able to provide transparent access services to the user via any of the ANs, and also be able to support mobility and handovers between ANs, as well as load balancing and other features for improved overall performance of the composed CCNs.

It shall then also be noted that an AN can generally provide its service(s) to multiple CNs, i.e. the usage of the Access Network is not exclusive to one CN (see figure 17). This allows for many-to-many relations between ANs and CNs, and enables an efficient sharing of the resources of the Access Network. Limitations might however apply, either resulting from an external agreement, e.g. following a clause of the Framework Agreement, or a local decision, e.g. following an admission control policy that prevents overloading an AN. In these cases, it might be that the AN is exclusively used by only one CN or a restricted group of CNs.

5.3.4.4 Composition Type

The Network Composition can be of various types, depending on the level of cooperation between an AN and a CN, and what level of functionality and performance that shall be made available to users. For any type of composition, there are no involved 3rd parties providing access provisioning of the contributed resources. Resource control and access provisioning schemes follow the rules defined in Section 4.4.

5.3.4.5 Framework Agreement and Composition Agreement

The Framework Agreement should include and provide the legal ruling of the business operation between a CN and an AN, and which may vary from market to market. The Framework Agreement may also contain a minimum level of cooperation, resource provisioning or service quality that must be supported by any AN and CN who likes to perform a Network Composition. The Composition Agreements will be specific from case to case, and can be matters of business, organisational, administrative and technical aspects.

5.3.4.6 Scenario Benefits

Network Composition can here be very beneficial to operators (being CNs in this context), AN providers, and users. The operator can 'follow' the user to any AN, and be able to offer services continuously via any AN. And further to this, it is an underlying tool for mitigating issues around network coverage and overall performance, costs for administration of business relationships to ANs, and having a future-proof framework in place that easily can extend service offerings also via new access network options as they emerge on the market. AN providers increase their ability vastly by being able to offer access to services to a much wider spectrum and volume of users, which is evident from the possibility of ANs having Composition Agreements with several CNs at a time.

And the users in turn can benefit from having far more options available when and where to use the services of an operator. Inherent to the scenario depicted is also to provide a general framework for how IMS-based services can be offered to users using any available access network option, and with service continuity [11] supported between the ANs.

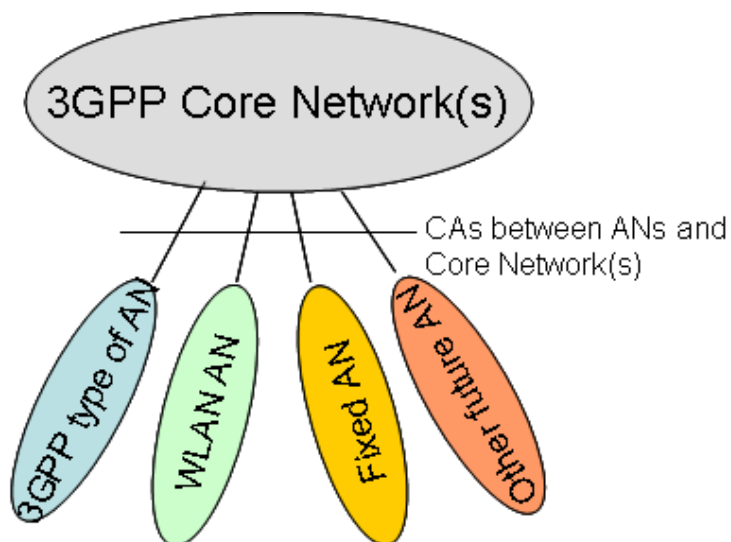

Figure 16: Network Composition of different types of access networks with a core network

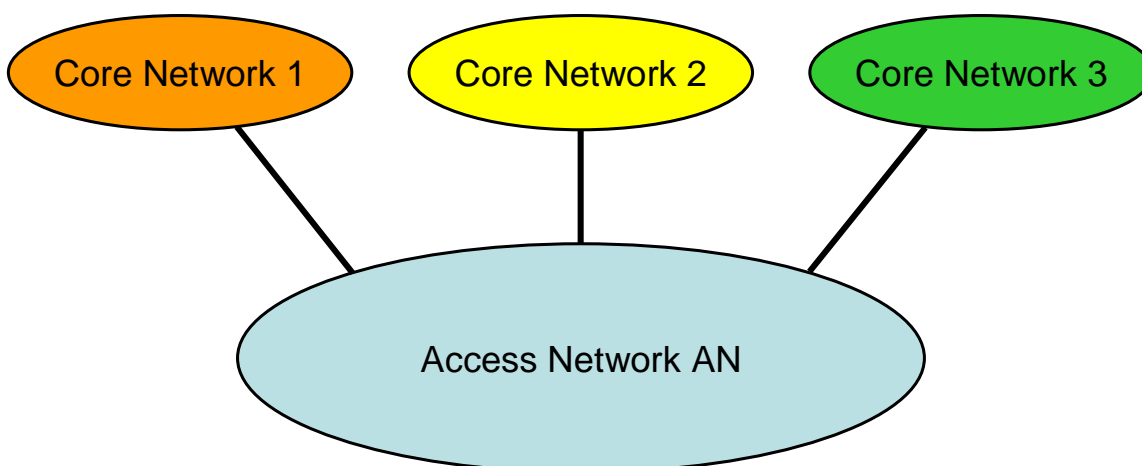

Figure 17: Network Composition of different access network with different core networks

5.4 Network Composition between Access Networks

TBD

5.5 Network Composition between Core Network and PAN/PN/UE

TBD

5.6 Network Composition between Access Network and PAN/PN/UE

In this class, access network and PAN/PN/UE are mainly involved. Core networks may be involved indirectly or temporarily. A possible use case is as follows:

5.6.1 Network Composition of individual users with access networks in public spaces

5.6.1.1 Short Description

A typical use case of this Network Composition is a PAN/PN/UE user connecting to WLAN networks in public facilities such as library, hospital and school. Figure 18 illustrates that Bob enters the WLAN network in the public library and executes network composition. The network capabilities of both networks are exchanged and available resources are negotiated with no or minimum user intervention. Not only can Bob communicate with or via the composed network, an appropriate level of security and QoS are also provided. The 3GPP network here plays a role of an authentication server to authenticate a PAN/PN/UE user. Once Bob is authorized to connect to the library WLAN network, he becomes able to communicate with other users (Alice in this case) that are already authorized and connected to that network.

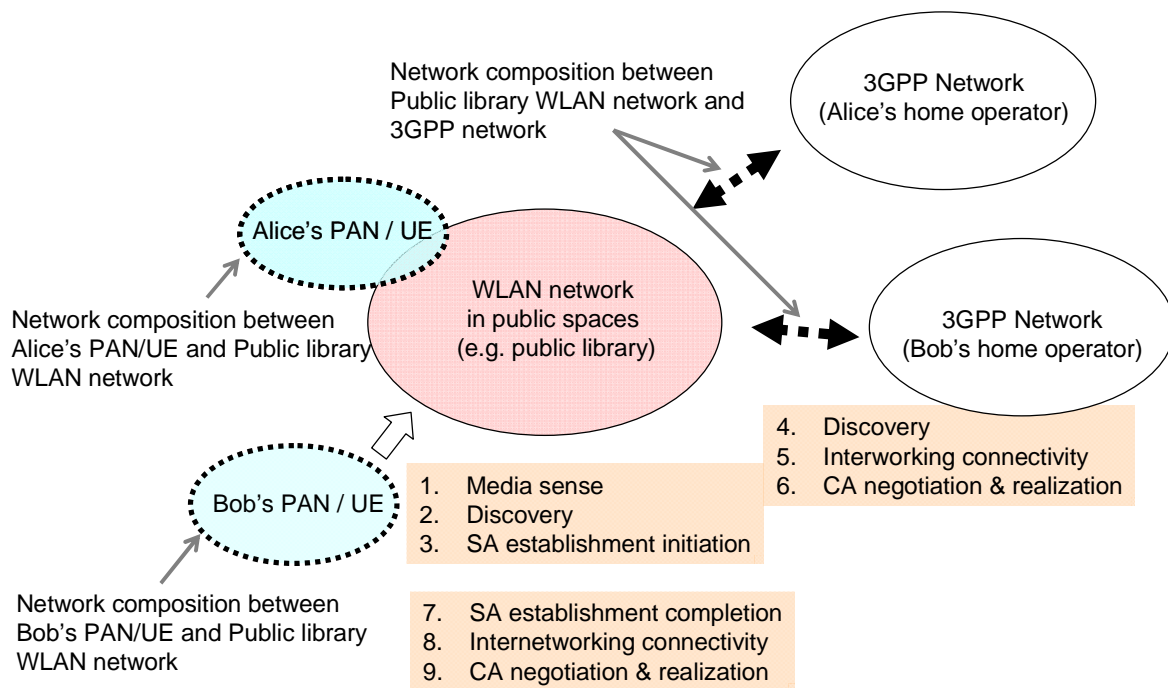

Figure 18: Network Composition between AN and PAN/PN/UE

5.6.1.2 Actor Specific Issues and Benefits

Actor specific issues:

- PAN/PN/UE users (Alice and Bob): When Bob wants to use the public library WLAN network, it may be necessary for him to be identified and authorized in a secure manner for the library's policy or in case he is charged to access the network facilities or services.
- Access network provider: In this use case, the public library WLAN network acts as the access network. The library WLAN network may need to authorize unspecified visitors who want to use the library facilities. Also, when the visitors in the library communicate with each other via the library WLAN network, appropriate level of security and privacy may need to be provided.

- 3GPP network operators: In this use case, Alice and Bob's home operators play a role of a trusted authentication server and/or certificate authority. Authentication information (e.g. security credentials) from the users may go through the access network to the home operators. Bob/Alice may also be charged to access some facilities/services in the library. The public library WLAN network and a 3GPP network may have an agreement that certain facilities/services could be charged through the 3GPP.

Benefits:

- Bob can automatically and securely access the library's facilities (e.g. the archive database or nearby printers). Also he can communicate with other users in the library with appropriate level of security and privacy. If necessary, Bob can get access to his home operator via the library WLAN network.
- The library WLAN network can authenticate Bob even if the library does not have the security information on Bob. In this case, his home operator acts as the authentication server or certificate authority.

5.6.1.3 Pre-Conditions

It is assumed that commercial agreements exist between PAN/PN/UE user and his or her home operator. The library WLAN network and users' home operators have agreed trust relationship.

5.6.1.4 Normal Flow

- Composition Process:
Bob's PAN senses and discovers the public library WLAN network (1) – (2) and initiates a security association (SA) establishment with it (3). To authorize Bob's access, the library WLAN network uses the 3GPP security framework by executing Network Composition with Bob's home operator (4) – (6). After successful authentication, a security association and connectivity are established between Bob's PAN and the library WLAN network (7) – (8). The Composition Process is finalized by negotiating and realizing the CA (9).
- Decomposition Process:
The composed network may be decomposed due to physical separation or policy control. Bob's PAN may execute de-composition when he is about to go outside the coverage of the library WLAN network. The library WLAN network may execute de-composition against Bob's home operator when the authentication process is completed. The Decomposition Process may be delayed when it is expected that Bob re-enters the library within a short period of time. The timing of Decomposition is agreed during the CA negotiation and the Decomposition is performed with no or minimum user intervention.

5.6.1.5 Alternative Flow

If authentication fails in (3) or (5), the Composition Process should be terminated.

5.6.1.6 Additional Information

The CA contains agreed-upon security level (with or without encryption, etc.), the level of resources or facilities that are granted to the user and the level of privacy that determines how much information of the user can be exposed to the others.

Composition Type: The composition type is Network Interworking and the library WLAN network provides usage of its access and other resources like the library facilities through the composition.

5.7 Network Composition between PNs

5.7.1 Short Description

In this use case, there are two users; Alice and Bob. Both users have a Personal Network (PN) based on Personal Network Management (PNM) according to TS 22.259 [7]. Bob is visiting Alice's home. Since Alice wants to provide Internet access and printing services for Bob, their PNs compose to enable Bob to use the provided services. The Network Composition is automatically performed by the PNM network entities with minimum user intervention. Through the composition of their PNs Alice and Bob can easily manage the provided resources and services and arrange access rights and settings of their personal devices.

5.7.2 Actor Specific Issues and Benefits

Main actors are the two users Alice and Bob. Further actors are the operators providing the PNM service for Alice and Bob. From PNM point of view, Bob can be seen as a Guest user.

Benefits - Users:

- Authorizations and settings for a PNM Guest access does not only apply to a particular Guest device but for all devices of the Guest PN (Bob's PN)
- The Composition Agreement specification provides the data description language and method for a uniform description of the access configuration
- The Composition negotiation specification provides a means for negotiating access rights and settings within PNM and may possibly be reused for interrogations
- A PLMN provides a security framework over which proximity connectivity between PNs is enabled in secure fashion
- A PLMN assisted resource control of PNs, i.e. an establishment of proximity connectivity, may be provided to the user for minimizing required human interactions

Benefits - AN/CN operator:

- Additional subscription and increased traffic over 3G air interface
- Enhanced satisfaction of their customers through Network Composition, PNM and the network capability to assist users in their personal devices' management

Specific Issues:

- Legal Frameworks between users is not an issue here, since Bob is Alice's visitor
- If a PNM service is provided for Alice and Bob by different operators/PLMNs, the Composition processing must be equally shared between the operators?

5.7.3 Pre-Conditions

Both users have configured their PNs in the PNM network entity and the PNM entities are ready to perform network compositions for the PN. Thus, the PNs are CCNs for the PN-PN network composition.

Composition Agreement negotiation and other Network Composition related signaling is enabled to take place between the entities of PNs located in network.

Alice has configured her PNM to accept new composition requests from Bob.

5.7.4 Normal Flow

Bob has arrived to Alice's home. Bob triggers his PN to compose with Alice's PN for being able to use resources and services of Alice. The composition trigger is sent by Bob's UE to his PNM network entity. Alice's PN contact data Bob gets from his UE's address/contact book. After this, Bob's PNM server contacts corresponding functionality of Alice's PN, which uses Alice's PNM configuration to verify if Bob is allowed to compose. Then the PNM network entities perform Network Composition based on guest-specific access settings and PAN- and PN-specific composition policies.

The composition results in a new CCN but the management of contributed resources and the handling of accesses by the other user is still performed by the PNM network entities similar to a PNM guest access according to TS 22.259 [7]. In contrast to the PNM guest access a Composition Agreement is now in place and regulates the guest access. An additional joint Composition Agreement may exist to define the rules for external interactions of the new CCN.

The type of composition is Control Sharing because each user gets particular control rights for the contributed resources of other PN as defined in the Composition Agreement. Both PNs have contributed PN resources to the composition but PNM control is not part of the composition. Instead, each user continues the management of the own PN and when PN modifications with significant composition impact are required, a re-negotiation is initiated. In this way, PNM configurations may change without requiring the Composition Agreement update.

In the particular use case scenario; Alice's PN contributes two resources; 1) printing service and 2) Internet access. The former is placed under a common control so that whenever Bob uses this service, he is able to control the printer according to his own needs; e.g. paper size and orientation. The latter involves the sharing of Alice's home broadband access, which is always on and Bob can use this service without being allowed to control it.

The new CCN and related resources are depicted in Figure 19 below. New policies for the new CCN are created and some policies could be also inherited from constituent CCNs. These policies define for example who can control resources that are visible through the new CCN and how these resources can be controlled. These policies govern the control and use of these resources. The new CCN and its coordination of controlling tasks are needed to avoid any contradicting and parallel control tasks.

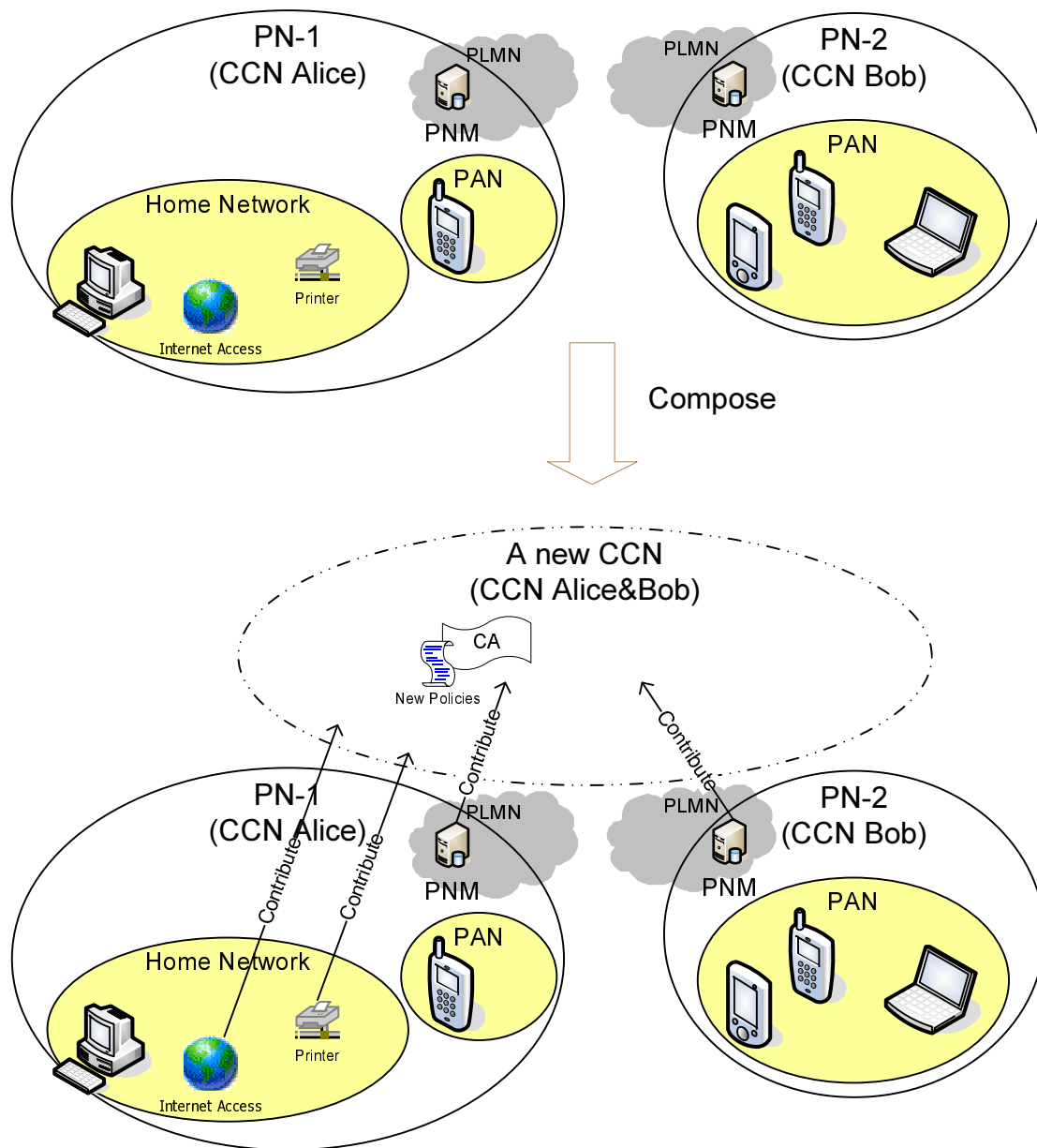

Figure 19: Network Composition between PNs

When Bob uses his UE to request printing service, he can change printer settings through the new CCN before starting a printing task. The controlling entity responsible of doing this in Bob's PN needs to coordinate its control actions with corresponding control entity in Alice's PN to avoid contradicting parallel control tasks and this coordination is carried

out through the new CCN. When the printer settings are changed, Bob's PN is notified about the result and Bob can start the printing task.

When Bob leaves, the created Network Composition should be removed and this can be done through the Decomposition Process. This process is initialized by Alice and this can be done in uncoordinated fashion in both Alice and Bob PNs.

5.7.5 Alternative Flow

Bob wants to use Alice's Internet access via a high-speed proximity connection. Otherwise he could not benefit from the broadband capabilities of the Internet access. The device, Bob is using to request the Internet access, determines Bob's communication preferences. Then the new CCN is used to contact Alice's PN in order to identify devices supporting suitable proximity connection technologies. The network may assist in the proximity connection establishment by controlling the local resources in both Alice's and Bob's devices and trying to establish the proximity connectivity without requiring manual configuration operations from users. This control may be carried out through the PNM and/or directly without the PNM. Once the new proximity connection has been established, both devices perform their network configuration, like IP address configuration, in coordinated fashion according to the information provided by the network. After this, Bob is able to directly connect to Alice's PN to access Internet.

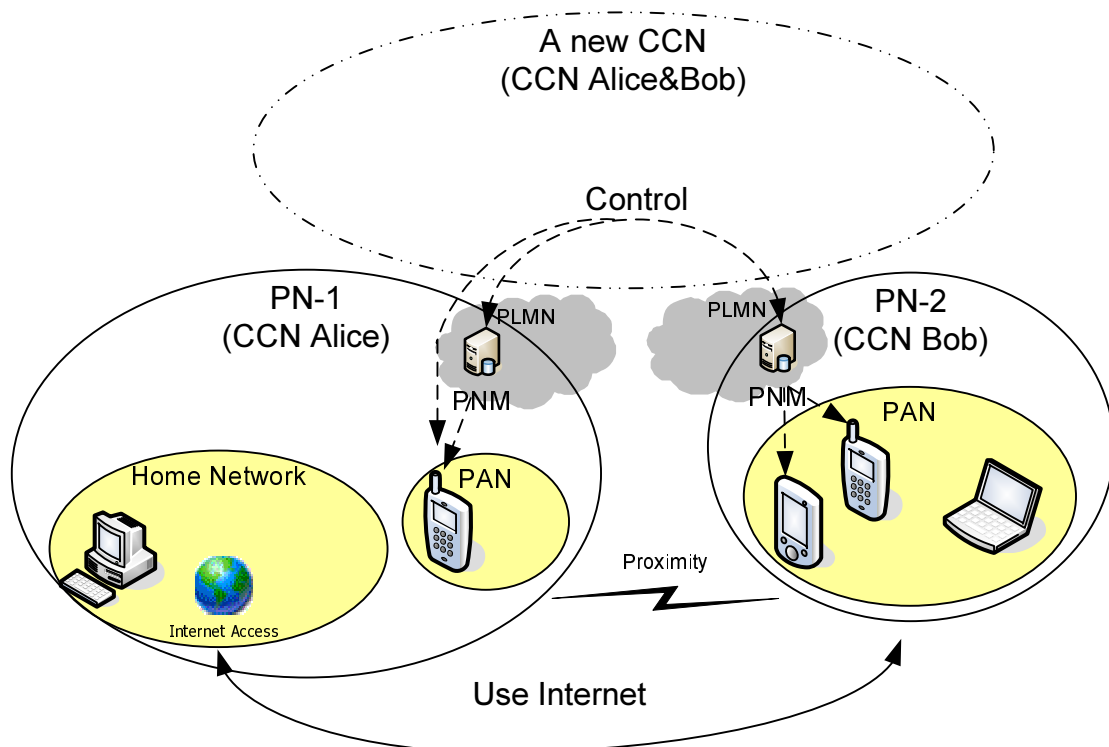

Figure 20: New CCN as a result as composition

5.7.6 Additional Information

The Composition Agreement may contain the contributed resources, the provided services, access rights, access settings, and configurations for the usage of resources and services in the new CCN. Usage configurations may include control schemes of all resources controllable through the new CCN. Beside of the Composition Agreement, the new CCN needs a list of constituent CCNs, related credentials and other security related information which could be also part of the CA.

Composition Type: The composition type is Control Sharing and Alice's PN contributes the printer and Internet access resources. The former is contributed according to Control Sharing and this resource becomes controllable through a new common/virtual CCN (CCN Alice&Bob), which also does access provisioning of this resource. The latter is contributed

according to Network Interworking and Alice's PN maintains control of this resource. Both Alice's and Bob's PNs perform access provisioning of Internet access resource.

5.8 3GPP network operators forming a roaming consortium:

Scenario overview: Assuming that there is a number of 3GPP network operators like to 'come together' for the purpose of creating a roaming consortium. It can also be safely assumed that at least two such operators would be needed from its inception, but later on more operators can join in, and that also some of them would like to leave the consortium. All this can be nicely supported through the creation of a multi-lateral Composition Agreement.

Scenario technical description: Referring to figure 21 below, 3GPP network operators A and B starts to compose to create a bi-lateral Composition Agreement. During the Composition Agreement Negotiation phase, they both understand that they would like to be the first operators forming a roaming consortium. This leads to the creation of a new common/virtual CCN (called Roaming Consortium (RC)), which sole purpose is to control and manage a multi-lateral CA, and from its inception in this use case, the only members of that multi-lateral CA are A and B. For each member in the multi-lateral CA, A and B to start with, a specification (an integral part of the CA) is provided that describes the roaming agreement towards any of the other members in the multi-lateral CA. This could basically say that 'for any user roaming into my operator network, and which has a subscription with any of the other members in the roaming consortium, the following terms apply.' The important aspect is that roaming is provided on equal terms towards all the other members in the roaming consortium. Please then note that the terms for let say operator A doesn't need to be the same as for operator B, but rather that it offers its terms on an equal basis to first B, and then later on C, D, etc.

When another 3GPP network operator, C, gets in touch with one of the operators in the roaming consortium, let say B, C and B can then compose bi-laterally once A has accepted C as a new member, and which results in that C becomes a member of the multi-lateral CA, so that the updated multi-lateral CA now consists of members A, B, and C. Finally, also D joins in via A, see figure below. All members in the multi-lateral CA has an updated copy of the multi-lateral CA, so each can monitor who the members are, and the terms for roaming. It shall then be noted that by using this option to create a multi-lateral CA, each new member is invited on the discretion of an individual member.

If now a member leaves the consortium, let say A, the member(s) whose membership in the multi-lateral CA depends on a bi-lateral CA with A, must now re-negotiate a bi-lateral CA with one of the other members in order to maintain membership. So if A leaves, D must re-join via either B or C (which might be executed (if possible) prior to the Decomposition between A and D).

Operator / user role: Each member CCN plays the equal role of being a 3GPP network operator, and which provides equal terms for roaming towards any other member CCN.

Composition Type: The Composition type for each bi-lateral Network Composition is probably of type Network Interworking. They offer (at least) mutually the usage of the resource authentication, together with the possibility to pass charging information between each other. The roaming consortium may exploit other possibilities for co-operation as well,. E.g. one operator may offer the usage of a video distribution resource to all the other members in the roaming consortium.

Framework Agreement and Composition Agreement: The Framework Agreement should include and provide the legal ruling of the business operation between any combinations of the member CCNs. For this particular use case, the Framework Agreement might even consist of a structured set of Framework Agreements, as the potentially global scope of a roaming consortium might lead to different ruling for different markets the roaming consortium span across. The Framework Agreement may also contain a minimum level of terms for roaming that must be supported by any of the member CCNs.

Scenario Benefits: Network Composition can here be extremely beneficial for the support and management of a roaming consortium. Any member CCN of the roaming consortium only needs to have one relation with another CCN, and it is very easy to dynamically increase or decrease the number of member CCNs in the roaming consortium. The overall costs for establishing and maintaining roaming agreements can thus be significantly decreased.

Further elaboration on the use case: As an example, nothing prohibits a specific 3GPP network operator to both be a member of a roaming consortium via a multi-lateral CA, while at the same time have bi-lateral (roaming agreement) Cas with any of the member CCNs in the roaming consortium. This can be used so the logic is that if a user roams in to a visited 3GPP network operator, and which might have both a bi-lateral roaming agreement and also a multi-lateral roaming agreement with the user's 3GPP home network operator, the bi-lateral roaming agreement takes precedence. If no such bi-lateral roaming agreement exists, one 'falls back' to the multi-lateral roaming agreement.

Another possibility that can be envisaged is to let the roaming consortium CCNs compose with other similar roaming consortium CCNs to establish bi-lateral roaming agreements between such roaming consortiums.

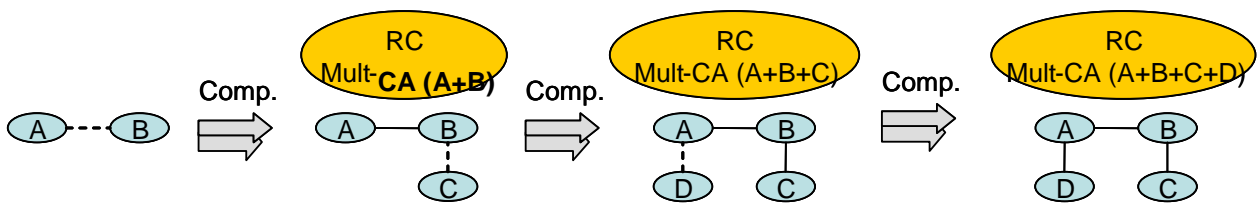

Figure 21: Creation of a multi-lateral CA by letting member CCNs compose with each other bi-laterally, and which results in updates of the multi-lateral CA.

Alternative scenario: The scenario above shows how the roaming consortium and the multi-lateral CA is created using the approach of using a number of bi-lateral CAs as described in section 4.5.1. Alternatively, the roaming consortium can be created as 'true' multi-lateral CA as described in section 4.5.2, and depicted in figure 22 below. Here A and B decides (after some first steps of communication not depicted in the figure) that they like to create a roaming consortium and for that purpose instantiates the new common/virtual CCN RC. A and B then composes with RC. Later on C and D might join in, and they will also compose with RC. RC maintains the multi-lateral CA. Other aspects of the multi-lateral composition are the same as for the first scenario depicted above, except for what is mentioned in pros and cons below.

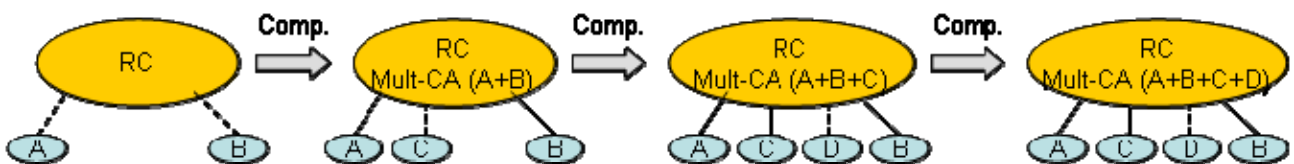

Figure 22: Alternative scenario for the creation of the roaming consortium.

Pros and cons: In the context of this use case the first scenario makes the management of the roaming consortium very easy as the consortium itself (at least from a composition point of view) doesn't need to be an (legal) entity/identity itself.

On the other hand, dynamicity in the first scenario might require the member CCNs to re-compose if they loose connectivity with a member CCN and which they rely on for the membership in the consortium. Please refer to section 4.5.3 which elaborates this in more detail.

5.9 Decomposition between Core Network and Access Network

5.9.1 Decomposition between a nomadic I-WLAN and a 3GPP network

5.9.1.1 Short Description

This use case describes on how Decomposition is carried out in the use case described in Section 5.2.1 'Composition of a nomadic I-WLAN with a 3GPP network'. The Decomposition is triggered by the IWLAN when the hot-spot coverage is not needed anymore and both networks (I-WLAN and 3GPP) proceed with the Decomposition.

5.9.1.2 Actor Specific Issues and Benefits

Actors in this scenario are the 3GPP network, the I-WLAN network and one or more UEs. The 3GPP network acts as an operator, the I-WLAN acts as a kind of user towards the 3GPP network and as a service provider towards the UE, and the UE acts as a user to both 3GPP and I-WLAN.

For both 3GPP operator and I-WLAN service provider, the original benefits described in the composition use case are still valid. The Decomposition capability is required to cancel dynamically established cooperation between the 3GPP network and the I-WLAN, since without this capability, the cooperation once established would be permanent; i.e. cannot be cancelled automatically once triggered,

5.9.1.3 Pre-Conditions

Both 3GPP network and nomadic I-WLAN are CCNs and they are composed according to the use case described in Section 5.2.1. Their CA defines how CCNs should decompose under different circumstances and who is triggering the Decomposition Process and how it is realized. In this example, we assume that through the CA the 3GPP operator has been assigned to trigger Decomposition.

5.9.1.4 Normal Flow

Once the operator decides that the extra access capability provided by the I-WLAN Service Provider is not needed anymore, the Decomposition process is triggered by the operator. Both CCNs initiate the decomposition according their CA. As a result, the I-WLAN stops serving new 3GPP users, but it continues to serve active 3GPP users until the operator notifies to stop doing so. The 3GPP users could for example be handed over to the 3GPP network, and then the Decomposition Process should be started. This notification could also be done when the operator discovers that there are no more active users connected through the I-WLAN or once the time limit defined in the CA expires..

The CCNs start the Decomposition Process with the Composition Agreement Unrealization phase. In the 3GPP network, resource re-configurations are done to stop providing AAA services for the I-WLAN and preparations to stop user data exchange between the 3GPP and the I-WLAN are also initiated. In the I-WLAN network, new users with a 3GPP subscription are not served anymore and therefore new AAA service requests to the 3GPP network are not generated.

After this phase, both CCNs proceed with the Decomposition Process and initiate the Composition Agreement Invalidation phase. During this phase, the CA is invalidated in both networks and remaining AAA information like accounting information is exchanged between networks. Both networks store the CA for further use. After this phase, both networks tear down the secure connection between them and all (secure) information exchange between them is stopped. Both networks disable the medium over which they were composed, because it is not needed for any other purposes.

5.9.1.5 Alternative Flows

Not applicable.

5.9.1.6 Additional Information

The 3GPP network and the I-WLAN restore their original state before they composed as a result of successful Decomposition Process. In practice, the I-WLAN restores its authentication, authorization and charging control.

The CA contains the details on how the Decomposition Process is carried out; i.e. the coordination between decomposing CCNs are required, since before the secure connection is teared down, charging information needs to be exchanged between networks.

The CA defines that once the Decomposition Process has been initiated, its execution should be delayed until one of the following conditions occurs; 1) the operator has sent the confirmation to start the Decomposition Process execution or 2) until the maximum defined delay has been reached. The maximum delay is defined in the CA and it could be tens of minutes for example.

6 Description of Composition Process

6.1 Composition process

The Composition Process includes a number of phases, denoted

- Media Sense,

- Discovery/Advertisement,
- Security and Internetworking Connectivity establishment,
- Composition Agreement Negotiation, and
- Composition Agreement Realization.

These phases are not necessarily passed in a one-way fashion. E.g. after establishing a security association, more services can be advertised which are only available to certain, trusted CCNs. In order to allow flexibility and efficiency, it is also possible to e.g. update the security association after determining the details of the *Composition Agreement* (CA). Also, an established Composition Agreement can later be renegotiated. Figure 1 below shows a principal flow diagram.

Further details and different aspects of the Composition Process can be found in [10].

6.1.1 Media Sense

The very starting point in the process of Network Composition for a CCN is to sense a medium that would enable communication with a neighbouring CCN. The activity in this phase is called 'Media Sense'.

Depending on the particular scenario, there may be different types of events, which may trigger Media Sense, for instance (note also a single user device may be a CCN):

- An operator connects a new access point to its network.
- Two operator-managed networks are connected for the first time.
- A user device is switched on and searches for networks in its vicinity.
- A PAN needs to cooperate with a remote CCN.

The 'sensing' also includes the case of discovering a remote CCN (no physical vicinity). The latter case is termed 'virtual composition'.

6.1.2 Discovery / Advertisement

Depending on the situation, Media sense is followed by either an advertisement or a discovery phase. The Advertisement/Discovery phase allows to identify a candidate CCN for network composition. It allows discovering other CCNs identifiers, resources, capabilities and (networks) services, as well as possibly pricing/tariff information.

Advertisement:

With active advertisements an CCN can offer (network) resources and services to other CCNs. The advertisement message includes an identifier, possibly based on cryptographic techniques, used by an CCN to bind the advertisement to a particular CCN, and may be authenticated and/or authorized at a later phase.

Discovery:

The CCN may alternatively listen to advertisements by other CCNs, or actively search for – and discover – its neighbours.

Note: Discovery/Advertisement may happen on layer 2 or layer 3. On layer 2, the messages are broadcasted as beacons. On layer 3 (e.g. for virtual compositions) they are sent as targeted composition queries.

6.1.3 Establishment of Security and Internetworking Connectivity

When the Advertisement/Discovery phase discovered a candidate CCN for composition, the two CCNs need to establish basic security and Internetworking connectivity. Cryptographic identifiers belonging to the CCNs involved in the Network Composition are used to bind the established shared key to the communicating CCNs and a cryptographic puzzle is used to protect against Denial of Service.

The identities of the CCNs might be authenticated and/or authorized using a Trusted Third Party. Alternatively the required trust relationship may be based on a pre-established shared secret or may even be opportunistic, e.g. the CCNs make a 'leap of faith', trusting the unauthenticated identities.

This message exchange may piggyback further information that allows the composing CCNs to establish type and purpose of the composition quickly.

At some point during this message exchange, or immediately afterwards, internetworking connectivity between the two CCNs is established.

6.1.4 Composition Agreement Negotiation

The next step of the Composition Process is the negotiation of the Composition Agreement (CA). The CA includes the policies to be followed in the composed CCN, the identifier of the composed CCN, how logical and physical resources are accessed, controlled and/or shared between the composing CCNs, compensation information, etc. Where the CA includes commercial factors, the CA should be digitally signed by both CCNs to provide non-repudiation.

Note: The negotiation can be carried out using the Generic Ambient Network Signalling (GANS) protocol framework [3], unless another protocol already exists for that particular purpose.

It is possible that the process of establishing a CA may involve increasing levels of authorization, e.g. negotiation of certain resources and services may only be authorized once the two CCNs have agreed the commercial aspects of the CA.

The outcome of the Composition Agreement Negotiation phase depends heavily on the use case, and what roles the composing CCNs have. The composition will then lead to a composition of types either network integration, control sharing or network interworking, as described above.

6.1.5 Composition Agreement Realization

The Composition Agreement Realization phase represents the completion of the composition. During this phase, network elements are configured to reflect the CA. Thereby, each of the composing CCNs must also carry out the configuration of its own resources by updating the policies and of their control functions.

6.1.6 Maintaining a composed Composition Capable Network

The result of the Network Composition process is either a new CCN, or an enlarged CCN (i.e. one CCN is absorbed into the other), or two interworking CCNs.

In any case, a fundamental issue after Network Composition is that some signalling must be exchanged between the CCNs involved in the composition, e.g. status and control information, to maintain the composition state. This could also include information that is normally exchanged during the Advertisement/Discovery phase, and which could lead to a re-iteration of the Network Composition process or even the request to de-compose.

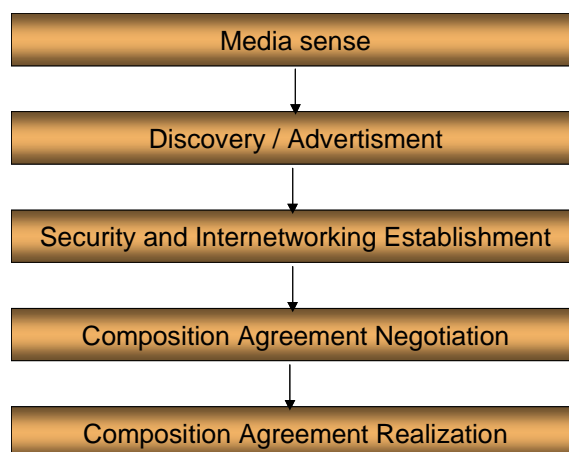

Figure 23: The principal Composition Process.

6.2 Decomposition Process

Decomposition is a process, which can be seen as 'inverse function' of the Composition Process. The Decomposition Process will restore the states of decomposing CCNs to their original state before CCNs composed. Additionally, all information produced during a Network Composition requiring further processing such as a charging info should be exchanged between decomposing CCNs. Unlike the Composition process, Decomposition does not always require or allow coordination between participating CCNs, because once a CCN has indicated its willingness to leave a Network Composition, if Decomposition fails due to some reason, decomposing CCNs should be able to recover from an interrupted Decomposition Process.

The interrupted Decomposition Process shall never leave the decomposing CCNs into an unstable state, thus a CCN can always restore control of the resources it had before the Decomposition started or before Network Composition according to the CA. For example, in case of "uncoordinated" Decomposition, the decomposing CCNs would restore control of the resources they had before they composed, since they are able to decompose unilaterally. Correspondingly, in case of "coordinated" Decomposition, the state would revert to the state before the Decomposition Process started, and may eventually, e.g. due to some timer has expired and/or that the Decomposition Process has been restarted a certain number of times but still failed to be completed, revert to the state before Network Composition, e.g. restoring control of the resources.

The Decomposition Process consists of following phases:

- Composition Agreement Unrealization,
- Composition Agreement Invalidation,
- Tear down of Security and Internetworking Connectivity, and
- Media Channel Disabling.

Two first phases are mandatory for all Decomposition Processes and the rest are optional. These phases are not necessarily passed in a one-way fashion. For example, before the whole Composition Agreement is unrealized and invalidated, a CCN might tear down related secure connection and additionally disable used media channel like radio interface if there are no further communication needs over this secure connection.

6.2.1 Composition Agreement Unrealization

This is a mandatory phase for all Decompositions and during this phase, a CCN releases all resources that were allocated/assigned for the Network Composition when the CA was realized and the policies are updated accordingly. For example, all involved network elements are re-configured; i.e. all dedicated functionalities are unassigned and other common functionalities are adjusted accordingly. When this phase is initiated, the Composition stops working and therefore any information such as accounting or charging information will not be generated anymore.

6.2.2 Composition Agreement Invalidation

This is a mandatory phase for all Decompositions and during this phase, a CCN releases all resources to maintain and manage the CA. The CA might be removed or it could be stored for further use and/or reference. All necessary information like accounting and charging information is exchanged between decomposing CCNs.

6.2.3 Tear down of Security and Internetworking Connectivity

This phase is optional and when executed, a CCN tear down a secure connection to the remote CCN(s), if the connectivity is not needed anymore, e.g. it might be in use by another Network Composition. The CCN might also delete used keying material and other security related information. Alternatively, the CCN might decide to store all security information for further use.

6.2.4 Media Channel Disabling

This phase is optional and when executed, a CCN disables a medium over which it was composed, if the medium is not needed anymore for example by another Network Composition, service and/or application.

6.2.5 Decomposition Process Cooperation

Coordination during the Decomposition Process may happen in different degrees. The CA should indicate which degree should be employed. One of the lowest degrees of coordination is a simple notification of the other (constituent) CCN before starting a (from then on) uncoordinated Decomposition Process and the tearing down of the secure connection. In a higher degree of cooperation the decomposing CCNs may need to exchange information (e.g. charging information) before they can decompose. This information exchange can be also (partially) done before the Decomposition Process is initiated, which would increase both robustness and resilience. For example, constituent CCNs may exchange information on a regular basis to maintain their status info and the granularity of this synchronization could be a subject to the common agreement and the CA. The highest degree of coordination requires to fully synchronizing the entire Decomposition Process. Here the CCNs perform all the Decomposition Process phases in a synchronized fashion, just like they performed the Composition process phases when they composed. As stated above, Decomposition may also happen in a completely uncoordinated fashion due to sudden loss of connectivity. The CCNs should be able to cope with this.

Considering that some information like charging info is collected/produced during a Network Composition and that this information needs further processing, it is essential to exchange such information between decomposing CCNs before they tear down their secure connection(s). Depending on the charging model, some sort of 'caching' is done and the cached charging information is transferred in 'bigger chunks' periodically and/or when requested. This also seems to be a subject to the Network Composition fault tolerance; e.g. how well the constituent CCNs are able to recover from the situation where a connection break triggers uncoordinated Decomposition.

In some scenarios, Decomposition may affect other compositions and even invalidate them. For example, if a PAN is composed with another PAN via a 3rd party access network and a 3GPP network. The 3rd party access network and the 3GPP network are also composed. When the 3rd party access network decomposes from the 3GPP network, the ongoing composition of the PANs cannot be maintained anymore due to connectivity loss and this might possibly occur without a prior notice. This scenario illustrates also that Decomposition may have to be performed without any further interaction or coordination between the formerly composed parties.

6.3 Composition Update process

A Composition Agreement can be changed without going through the whole Composition Process. In terms of the phases involved in Composition, this means that the Composition Agreement Negotiation & Realization phases are dynamic and that may need to be re-iterated resulting also in an updated Composition Agreement. Possible causes for triggering a Composition Update process may be various: service needs, mobility, link fading or failures, availability of new links or services, and so on.

7 Potential Composition Requirements

7.1 High-level requirements

3GPP shall provide functionality such that individual 3GPP PLMNs can act as CCNs. For this purpose, the following high-level functionalities must be supported:

- **Media Sensing:** A CCN must be able to sense a medium that would enable communication with another CCN.
- **Network Discovery and Advertisement:** A CCN should be able to detect available CCNs in its reach. A CCN willing to compose with another CCN should actively advertise its services/resources, policies, pricing/tariffs to a detected other CCN. Alternatively, the CCN should be able to listen to advertisements of other CCNs, and learn their resources and policies. It must be ensured that during network detection/advertisement the CCN cannot be attacked.
- **Security and Internetworking Establishment:** In order start a CA Negotiation, the two CCNs willing to compose must have security and internetworking connectivity.
- **Composition Agreement:** The composing CCNs shall lay down the technical details of their cooperation in a Composition Agreement.
- **Composition Agreement Negotiation:** CCNs shall be capable to dynamically negotiate a CA

- **Composition Agreement Realization:** CCNs shall be able to dynamically realize a CA, i.e. implement what has been agreed.
- **Composition Agreement Update and Reuse:** It shall be possible to dynamically update a CA. It shall also be possible to later re-use an already agreed CA.
- **Decomposition:** CCNs shall be able to dynamically decompose.
- **Timing Constraints:** Depending on the context in which Network Composition is used, it must be possible to perform both composition and Decomposition in a time frame that is acceptable to the humans affected.
- **Control function modularity:** Network Composition implies that the control of certain logical or physical resources (e.g. mobility, QoS) of CCNs may be delegated between the networks, switched on or off, integrated etc. Therefore it is necessary that the control functions of a CCN for these resources be modular. In other words, it should be possible to handle these control functions independently.
- **Regulatory support:** The negotiation and realization of a composition agreement must be able to address regulations from regulatory bodies and be able to enforce such regulations.

7.2 Security and Privacy

A flexible security mechanism should be performed in order that all the communications and negotiations take place in a secure manner with no or minimum human intervention. The privacy of each individual CCN (e.g. CCN identity-, CCN location- and other sensitive network information) should be protected, i.e. in a Network Composition one network can choose to allow or not to allow other networks to be aware of its sensitive information. Thus a trust relationship can be established and maintained between the various CCNs for composition.

7.3 Functional requirements for Network Composition

According to the high-level functionalities given initially in this chapter to enable a 3GPP network to act as a CCN, the following functional requirements for Network Composition have been identified in a more detailed view:

CCN:

- **Identity:** A CCN shall be identifiable in order to be able to refer to it uniquely, e.g. in a Composition Agreement. Examples of such an identifier could be a PLMN ID, or an identifier based on cryptographic properties
- **Creation of a CCN:** A CCN can be created by Network Composition of CCNs

Network Composition:

- **Disruption tolerance:** As a constituent CCN of a composed network may move or temporarily leave (radio) coverage, it should then be possible to maintain the composed network, i.e. there is no need to re-compose at re-attachment, in order to significantly improve performance and also the overall end user experience.
- **Multiple simultaneous Network Compositions:** A CCN should be able to compose with more than one another CCN simultaneously, as well as having multiple network compositions with one and the same CCN. Each Network Composition is based on an individual Composition Agreement.
- **Flexible resource admission control:** Once networks are composed, one network will permit devices in the other network to use its resources up to some appropriate level. Thus, Network Composition should be able to share or delegate authentication and authorization in the composed networks and to provide or limit resources based on its policy.
- **Support of multiple administrative domains:** The user or its network may roam beyond one administrative domain. Thus, Network Composition should support composition of networks that belong to different

administrative domains. Security and QoS between these domains should also be taken into consideration with no or minimum human interaction.

- **Resource Control:** Any resource that was controlled in a constituent CCN and which, after Network Composition, becomes part of a new CCN, must also be controlled in that new CCN. How it is controlled is described in the CA.
- **Service continuity:** When a CCN, due to mobility, needs to compose with a different CCN than the one it currently has a CA with, then, in order to continuously make use of services, the characteristics of the CA pertaining to services and that is currently agreed should be preserved when agreeing upon a new CA with the new CCN. Service interruptions should be minimized during the change (if those services can be offered). Whether to perform service continuity [11] between the composed CCNs and the degree of it depend on the negotiated CA(s) (potentially both the current and the new CA).
- **CCN discovery support:** If available, a CCN may be able to obtain information (e.g. type of network, supported QoS, and security level) on potential CCN candidates and advertise this information to another CCN in order to ease and possibly speed up the Composition Process between that other CCN and one or more of the potential CCN candidates.

Composition Agreements:

- **Pre-established Composition Agreements:** It needs to be possible to pre-establish CAs in an off-line, non-automated fashion.
- **Storage of Composition Agreements:** It needs to be possible for a CCN to store CAs and access them later. This way a CA can be reused, accelerating the Composition Process. Furthermore, this allows backtracking CAs for accountability purposes. The storage time could be stipulated by the CA.
- **Composition Agreement identification:** Each negotiated Composition Agreement shall be possible to refer to through some identifier, which must be unique at least in the scope of the parties (networks) that settled the agreement.
- **Scope of Composition Agreement:** The scope of a Composition Agreement is generally only bound to the parties (CCNs) that negotiated the agreement. If it also relies on any external parties (e.g. a home operator) for its execution, those external parties must be referred to in the Composition Agreement
- **Supervision of Composition Agreement:** It shall be possible in the Composition Agreement to allow for supervision of the correct execution of the Composition Agreement by all involved parties (CCNs). For example, access to a monitoring station that allows supervision of the execution/realisation or a log from the observation shall be granted. The information collected can be used in legal actions in case of disputes.

Composition Process:

- **Plug and Play:** The Composition Process should aim to minimize the need for human intervention.
- **Composition Process resilience:** If the Composition Process is disrupted or fails at any phase, the state in which each participating network was before the Composition Process started shall be recovered.

Composition Agreement Negotiation:

- **Accountability:** A Composition Agreement needs to provide capabilities to be legally binding. For example, it could be digitally signed by involved parties (CCNs). The CA needs to be verifiable for a time duration stipulated by the Framework Agreement.
- **Mutual authentication:** As part of negotiating a Composition Agreement between two parties (CCNs), the parties shall perform mutual authentication.
- **Policies:** The Composition Agreement Negotiation phase should be controlled by policies inherent to a CCN.

Decomposition Process:

- **Decomposition Process resilience:** If the Decomposition Process is disrupted or fails at any phase, control of the resources each participating CCN had before the Decomposition Process started or before Network Composition shall be restored according to the CA.
- **Autonomy:** A CCN should be able to perform the Decomposition Process autonomously without relying on other CCNs if allowed by the CA.
- **Coordination:** A CCN should be able to perform the Decomposition Process in coordination with other CCNs.
- **Plug and Play:** The Decomposition Process should aim to minimize the need for human intervention.
- **Authorization of Decomposition:** Only authorized CCNs (typically, the composed networks) shall be able to conduct or indicate Network Decomposition. The identifiers of the authorized CCNs should be part of the CA.

Editors Note: a 'may' requirement on the capability of a CCN to relay Advertisement information of other CCNs should be added (e.g. to support seamless handover).

8 Conclusions

In previous sections, this TR describes and defines the principles, characteristics and requirements of Network Composition. Key terms and concepts are introduced, which are then further on used in the TR when formulating use cases and requirements, as well as the Composition Process which is the core functionality of the novel idea of enabling so called composition-capable networks to connect and e.g. establish roaming agreements dynamically.

Network Composition provides new ways of networking and interworking, and opens up both for new business opportunities, as well as providing a baseline for solutions on problems that have been identified already today. The use cases aid in giving insights into areas of interest for Network Composition, and describes how values and benefits can be provided to both users and network operators as well as service providers, which are coming at different levels of cost & deployment increments.

It is recommended that 3GPP includes Network Composition in its scope in their future studies and work on evolved system. It is concluded that, depending on the scenario / use case, additional capabilities can range from rather minor to more sophisticated ones. The proper timing for creating requirements for Network Composition in 3GPP shall be a matter of the coordination and alignment with other activities within 3GPP, as well as the recognition of a (future) demand from the market on the need for solutions based on the Network Composition concept.

9 Other concepts considered useful in the context of Network Composition

- Note 1: As described in [1], for layer 2 connectivity, an efficient way of doing so is to use a generalization of the HIP-base exchange [2] that includes the generation of a shared session key using the Diffie-Hellmann algorithm.
- Note 2: Where the discovery phase occurs at level 3, it is assumed that existing protocols, e.g. HIP or IKEv2, could be used to establish the necessary security association between the two CCNs. However, these protocols may need to be extended to carry additional payloads, e.g. CCN specific credentials, purpose of composition etc.
- Note 3: When the security establishment is a layer 3 process, it is assumed the internetworking addresses associated with the cryptographic IDs of the CCNs can be discovered. When it is a layer 2 process, the internetworking address exchange or internetworking address configuration can also be handled as part of the layer 2 exchange. It should be possible to use the security association established at layer 2 to generate a layer 3 security association.

Annex A: (informative)

Additional information on Network Composition

A1 Illustration of composition procedure involving multiple Network Compositions

As an example of multiple dependent Network Compositions, let's consider the use case, in which our user Bob has an active connection provided by a 3GPP operator that has roaming agreement with Bob's home operator as represented in figure 24 below. It should be noted, that many multi-access, multi-radio and mobility aspects are either simplified or omitted here to better highlight issues of dynamic triggering of the Network Composition and network access.

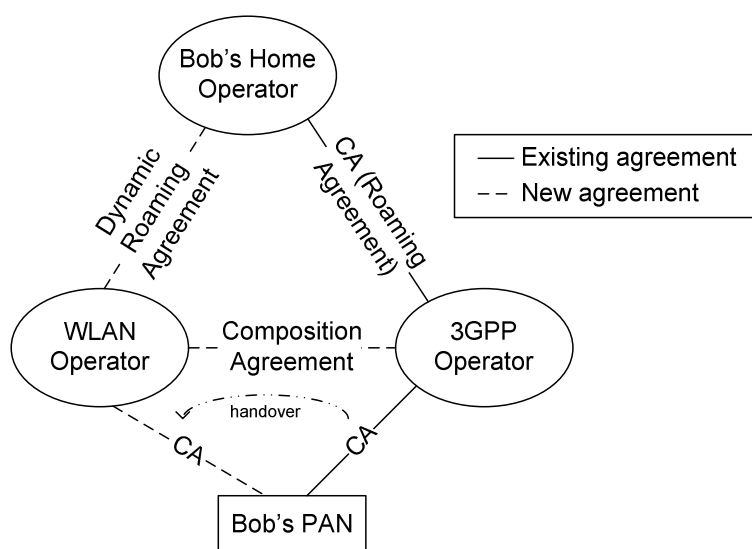

Figure 24: An example of Bob's PAN composing with visited networks.

When Bob's PAN detects a new WLAN access network, for which no roaming agreement with Bob's home operator exists, a new roaming agreement between the WLAN operator and Bob's home operator needs to be established; see section 5.1.2 – 'On-demand inter-operator network composition'.

In order to minimize service interruption between the 3GPP and WLAN access, the WLAN network should also interwork with Bob's current access network (i.e. the 3GPP network), and therefore a new Network Composition needs to be established between the WLAN and the 3GPP networks. This composition involves both handover and mobility functionalities in order to achieve mobility and fast handover support. Since Bob is performing a handover from wide area coverage (3GPP network) to short range coverage (WLAN network), he is able to maintain his 3GPP access until the WLAN network is ready; i.e., a new roaming agreement has been established and a new composition with the 3GPP network is ready.

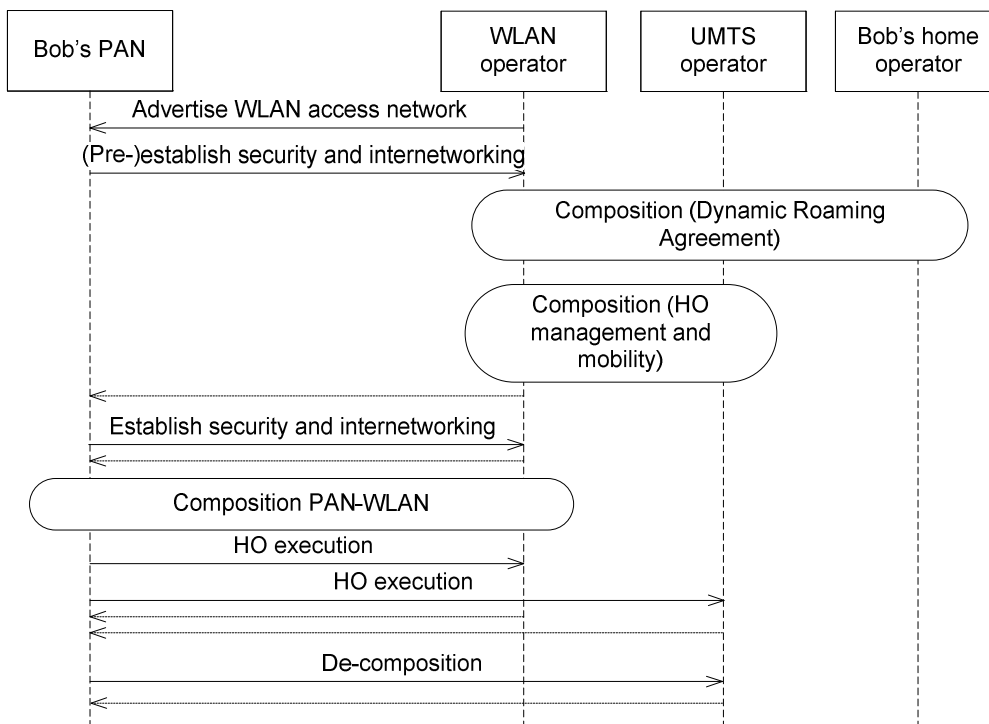

Figure 25: High level sequence chart.

In figure 25 above, a high level sequence diagram of the example described above is illustrated. Once Bob's PAN has detected a new WLAN access, it (pre-)establishes security and internetworking with the WLAN network in order to exchange security information (e.g. authentication/authorization info). This information is required to verify whether a network has capability to provide access for Bob. The WLAN network detects that it has no active roaming agreement with Bob's home operator and therefore a roaming agreement establishment is triggered. This roaming agreement is a bi-lateral in nature and it is established dynamically.

The WLAN network waits until a new roaming agreement with Bob's home operator has been successfully established and then it contacts the 3GPP network in order to compose with it bi-laterally. It is not feasible to start this Network Composition with the 3GPP operator until a roaming agreement has been established, because without it, the WLAN operator is not able to provide the access to Bob's PAN and therefore a handover is not needed.

After the WLAN network has successfully done user verification, Bob's PAN is informed about this and the access evaluation is then performed to evaluate handover needs and the composition decision is done. Once the composition establishment has been decided, both security and internetworking are 'upgraded' between Bob's PAN and the WLAN network to enable Composition Agreement Negotiation and a new composition is created over which handover and mobility are then executed.

Figure 26 below represents how the Composition Process is used during the detection of a new access (left side) and during the handover (right side). It also illustrates how Composition Process phases are not executed in one way fashion.

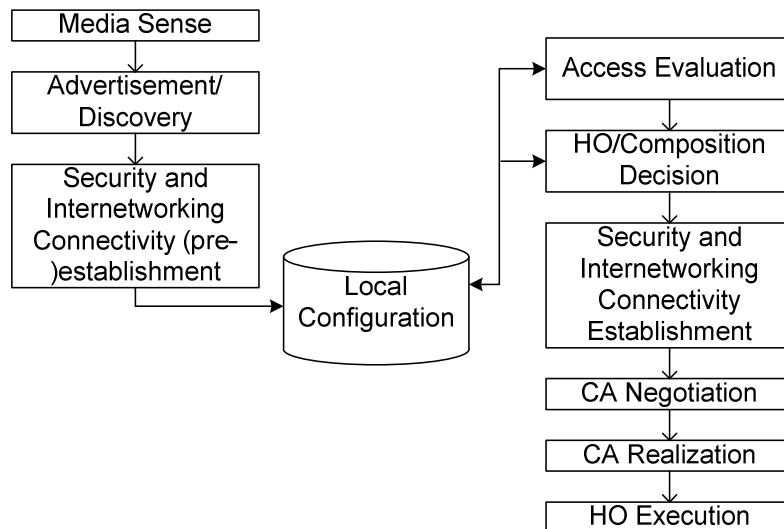

Figure 26: An example of Composition Process.

First, Media Sense, Advertisement/Discovery and Security and Internetworking Connectivity (pre-)establishment are performed and local configuration is updated accordingly. Once local configuration is up-to-date, it is used for access evaluation and based on the evaluation results both handover and composition decisions are carried out resulting in triggering a new composition establishment. Note that these three steps (Media Sense, Advertisement/Discovery, Security and Internetworking Connectivity Establishment) can be performed to update local configuration, without initializing the remaining steps of the Composition Process represented in right side.

After a new Network Composition has been successfully established, handover is executed over it and a Network Composition with the 3GPP network (that had been Bob's visited network) is removed by executing a Decomposition Process.

Annex B (Informative): Change history

Change history											
TSG SA#	SA Doc.	SA1 Doc	Spec	CR	Rev	Rel	Cat	Subject/Comment	Old	New	Work Item
2007-03	SA#35	SP-070137						Approved at SA#35 and placed under change control as version 8.0.0 (Rel-8)	2.0.0	8.0.0	
2007-06	SA#36	SP-070371	0001	2				Service Continuity Modifications - Use Cases and Requirements in Network Composition	8.0.0	8.1.0	
2009-12	SP-46							Updated to Rel-9 by MCC	8.1.0	9.0.0	
2011-03	-	-	-	-				Update to Rel-10 version (MCC)	9.0.0	10.0.0	
2012-09	-	-	-	-	-	-	-	Updated to Rel-11 by MCC	10.0.0	11.0.0	
2014-10								Updated to Rel-12 by MCC	11.0.0	12.0.0	
2015-12	-	-	-	-	-	-	-	Updated to Rel-13 by MCC	12.0.0	13.0.0	

History

Document history		
V13.0.0	January 2016	Publication