

ETSI TR 122 952 V14.0.0 (2017-03)



TECHNICAL REPORT

**Digital cellular telecommunications system (Phase 2+) (GSM);
Universal Mobile Telecommunications System (UMTS);
LTE;
Priority service guide
(3GPP TR 22.952 version 14.0.0 Release 14)**



Reference

RTR/TSGS-0122952ve00

Keywords

GSM,LTE,UMTS

ETSI

650 Route des Lucioles
F-06921 Sophia Antipolis Cedex - FRANCE

Tel.: +33 4 92 94 42 00 Fax: +33 4 93 65 47 16

Siret N° 348 623 562 00017 - NAF 742 C
Association à but non lucratif enregistrée à la
Sous-Préfecture de Grasse (06) N° 7803/88

Important notice

The present document can be downloaded from:
<http://www.etsi.org/standards-search>

The present document may be made available in electronic versions and/or in print. The content of any electronic and/or print versions of the present document shall not be modified without the prior written authorization of ETSI. In case of any existing or perceived difference in contents between such versions and/or in print, the only prevailing document is the print of the Portable Document Format (PDF) version kept on a specific network drive within ETSI Secretariat.

Users of the present document should be aware that the document may be subject to revision or change of status. Information on the current status of this and other ETSI documents is available at
<https://portal.etsi.org/TB/ETSIDeliverableStatus.aspx>

If you find errors in the present document, please send your comment to one of the following services:
<https://portal.etsi.org/People/CommiteeSupportStaff.aspx>

Copyright Notification

No part may be reproduced or utilized in any form or by any means, electronic or mechanical, including photocopying and microfilm except as authorized by written permission of ETSI.

The content of the PDF version shall not be modified without the written authorization of ETSI.
The copyright and the foregoing restriction extend to reproduction in all media.

© European Telecommunications Standards Institute 2017.
All rights reserved.

DECT™, **PLUGTESTS™**, **UMTS™** and the ETSI logo are Trade Marks of ETSI registered for the benefit of its Members.
3GPP™ and **LTE™** are Trade Marks of ETSI registered for the benefit of its Members and of the 3GPP Organizational Partners.
GSM® and the GSM logo are Trade Marks registered and owned by the GSM Association.

Intellectual Property Rights

IPRs essential or potentially essential to the present document may have been declared to ETSI. The information pertaining to these essential IPRs, if any, is publicly available for **ETSI members and non-members**, and can be found in ETSI SR 000 314: "*Intellectual Property Rights (IPRs); Essential, or potentially Essential, IPRs notified to ETSI in respect of ETSI standards*", which is available from the ETSI Secretariat. Latest updates are available on the ETSI Web server (<https://ipr.etsi.org>).

Pursuant to the ETSI IPR Policy, no investigation, including IPR searches, has been carried out by ETSI. No guarantee can be given as to the existence of other IPRs not referenced in ETSI SR 000 314 (or the updates on the ETSI Web server) which are, or may be, or may become, essential to the present document.

Foreword

The present document may refer to technical specifications or reports using their 3GPP identities, UMTS identities or GSM identities. These should be interpreted as being references to the corresponding ETSI deliverables.

The cross reference between GSM, UMTS, 3GPP and ETSI identities can be found under <http://webapp.etsi.org/key/queryform.asp>.

Modal verbs terminology

In the present document "**should**", "**should not**", "**may**", "**need not**", "**will**", "**will not**", "**can**" and "**cannot**" are to be interpreted as described in clause 3.2 of the [ETSI Drafting Rules](#) (Verbal forms for the expression of provisions).

"**must**" and "**must not**" are **NOT** allowed in ETSI deliverables except when used in direct citation.

Contents

Intellectual Property Rights	2
Foreword.....	2
Modal verbs terminology.....	2
Foreword.....	6
Introduction	6
1 Scope	7
2 References	7
3 Definitions and abbreviations.....	8
3.1 Definitions	8
3.2 Abbreviations	8
4 Service description	8
4.1 Assumptions and limitations	8
4.2 Registration / erasure.....	9
4.3 Interrogation.....	9
4.4 Call origination / invocation.....	9
4.4.1 Service accessibility.....	9
4.4.2 Priority radio resource queuing.....	9
4.4.3 Directed retry	10
4.5 Call progression.....	10
4.5.1 Progression in originating network	10
4.5.2 Progression in transit networks	11
4.5.3 Progression in terminating networks	11
4.5.4 Enhanced call-completion capabilities.....	11
4.5.4.1 Exemption from certain restrictive Network Management Controls (NMCs)	11
4.5.4.2 Trunk queuing	11
4.5.4.3 Treatment of glare conditions	12
4.5.4.4 Relationship of NMCs to trunk queuing	12
4.6 Call termination.....	12
4.7 Handover	13
4.8 Feature interactions	13
4.8.1 eMLPP	13
4.8.2 Call forwarding and call redirection / deflection	14
4.8.3 Call waiting.....	14
4.8.4 Emergency calls.....	15
4.8.5 Alternate Line Service (ALS).....	15
4.8.6 Asynchronous data.....	15
4.8.7 Customized Applications for Mobile Enhanced Logic (CAMEL) and Intelligent Network (IN).....	15
4.8.8 Call Origination restrictions.....	15
4.8.9 Call transfer	15
4.8.10 Multi-Party supplementary service (MPTY)	15
4.8.11 Prepaid service.....	15
4.8.12 Short Message Service (SMS)	15
4.8.13 Other supplementary services	15
4.9 Interworking considerations	16
4.9.1 ISDN Multiple Level Precedence and Pre-emption (MLPP).....	16
4.9.2 Roaming interactions	16
5 Call flows	16
5.1 Priority service call origination – radio resources available, call not queued.....	17
5.2 Priority service call termination – radio resources available, call not queued.....	19
5.3 Priority service call origination – radio resources unavailable, call queued.....	21
5.4 Priority service call termination – radio resources unavailable, call queued.....	22
5.5 Priority service call origination – radio resources unavailable and queue full	24

5.6	Priority service call termination – radio resources unavailable and queue full	25
5.7	Priority service call origination – radio resources unavailable and queue timeout.....	26
5.8	Priority service call termination – radio resources unavailable and queue timeout.....	27
5.9	Priority service call origination – radio resources unavailable and queue full, but higher priority	27
5.10	Priority service call termination – radio resources unavailable and queue full, but higher priority	28
5.11	Priority service call progression – MSC – outgoing trunk queuing.....	29
5.12	Priority service call progression – MSC – outgoing trunk queuing – timeout	30
5.13	Priority service call attempt by a non-service-user – Priority service denied.....	31
6	Operations, administration, maintenance, and provisioning	32
6.1	Priority level assignment	32
6.2	Subscription management	32
6.3	Accounting / charging	33
6.4	Service provider responsibility.....	33
6.5	Service user responsibility.....	33
Annex A:	Region specific aspects.....	34
A.1	U.S.A. specific aspects	34
A.1.1	Priority level assignment	34
A.1.2	Call origination / invocation	34
A.1.3	Mapping of priority indicators.....	34
A.1.4	Signalling of priority indicators.....	35
A.1.5	Feature interactions	37
A.1.5.1	eMLPP	37
A.1.6	Software access control	37
Annex B:	Use cases.....	38
B.1	Priority service call to Priority service subscriber in Priority service + eMLPP network.....	39
B.2	eMLPP call to eMLPP subscriber in Priority service + eMLPP network	40
B.3	Priority service call to eMLPP subscriber in Priority service only network	41
B.4	Normal call to eMLPP subscriber in Priority service only network.....	42
B.5	eMLPP call to Priority service subscriber in Priority service + eMLPP network.....	43
B.6	eMLPP call to eMLPP subscriber in Priority service + eMLPP network	44
B.7	Normal call to normal subscriber in Priority service + eMLPP network	45
B.8	An eMLPP subscriber roams to a Priority service + eMLPP network and initiates a call with the Priority service service code.....	46
B.9	Priority call to a subscriber in an eMLPP only network	47
Annex C:	Distinguishing Priority Service users and eMLPP users.....	48
Annex D (informative):	UTRAN to GERAN Redirection	51
D.1	MO UTRAN to MT UTRAN call	51
D.2	MO UTRAN to MT (UTRAN to GERAN reversion) call.....	51
D.3	MO UTRAN to Trunk call	51
D.4	MO (UTRAN to GERAN reversion) to MT UTRAN call.....	51
D.5	MO (UTRAN to GERAN reversion) to MT (UTRAN to GERAN reversion) call.....	51
D.6	MO (UTRAN to GERAN reversion) to Trunk call.....	51
D.7	Incoming NS/EP (trunk) to MT UTRAN call	52
D.8	Incoming NS/EP (trunk) to MT (UTRAN to GERAN reversion) call.....	52
D.9	MO UTRAN to MT (UTRAN to GERAN reversion) call, exception UE single mode.....	52

D.10 MO UTRAN to MT (UTRAN to GERAN reversion) call, exception only UTRAN Subscription52

Annex E: Change history53

History54

Foreword

This Technical Report (TR) has been produced by ETSI 3rd Generation Partnership Project (3GPP).

The contents of the present document are subject to continuing work within the TSG and may change following formal TSG approval. Should the TSG modify the contents of the present document, it will be re-released by the TSG with an identifying change of release date and an increase in version number as follows:

Version x.y.z

where:

- x the first digit:
 - 1 presented to TSG for information;
 - 2 presented to TSG for approval;
 - 3 or greater indicates TSG approved document under change control.
- y the second digit is incremented for all changes of substance, i.e. technical enhancements, corrections, updates, etc.
- z the third digit is incremented when editorial only changes have been incorporated in the document.

Introduction

This Technical Report (TR) provides a "Guide" for Priority Service. The intent of this "Guide" is to describe how existing 3GPP specifications support the high-level requirements identified for Priority Service in TR 22.950.

Priority Service allows qualified and authorized users to obtain priority access to available radio (voice or data traffic) resources on a priority basis before other PLMN users during situations when PLMN congestion is blocking call attempts. In addition, Priority Service supports priority call progression and call completion to support an "end-to-end" priority call.

Priority Service is intended to be used by qualified and authorized users, i.e., key emergency service personnel and those with leadership responsibilities, only during times of emergency situations and network congestion. Priority Service providers should adhere to uniform, nationwide operating access procedures.

Priority Service is to be available at all times in equipped markets in both the HPLMN and VPLMN within a country where a PLMN provider is offering the service. Priority Service is applicable to both GERAN and UTRAN and is activated on a per call basis using Priority Service dialling procedures.

Priority Service, supported by the 3GPP system set of services and features, is one element in the ability to deliver calls of a high priority nature from mobile to mobile networks, mobile to fixed networks, and fixed to mobile networks.

1 Scope

This present document addresses the Service Aspects (Service Description), Network Aspects (Call Flows), and Management Aspects (Operations, Administration, Maintenance, and Provisioning) of Priority Service, based on existing 3GPP specifications.

The Priority Service is intended to be used for both Voice and Data. However, this document only addresses Circuit Switched Voice Service. Data, multimedia and non-circuit switched aspects of Priority Service have not been addressed and are for further study.

The Priority Service is intended to interwork with external networks to provide an end-to-end service. Therefore, service interactions with external networks are considered within the scope of this document, although the specification of these interactions may be in another standard. If this occurs, a reference to that specification is made.

2 References

The following documents contain provisions which, through reference in this text, constitute provisions of the present document.

- References are either specific (identified by date of publication, edition number, version number, etc.) or non-specific.
- For a specific reference, subsequent revisions do not apply.
- For a non-specific reference, the latest version applies. In the case of a reference to a 3GPP document (including a GSM document), a non-specific reference implicitly refers to the latest version of that document *in the same Release as the present document*.

- [1] 3GPP TR 21.905: "Vocabulary for 3GPP Specifications".
- [2] 3GPP TR 22.950: "Priority service feasibility study".
- [3] 3GPP TS 22.011: "Service accessibility".
- [4] 3GPP TS 22.067: "enhanced Multi-Level Precedence and Pre-emption service (eMLPP); Stage 1".
- [5] 3GPP TS 23.067: "Enhanced Multi-Level Precedence and Pre-emption Service (eMLPP); Stage 2".
- [6] 3GPP TS 24.067: "Enhanced Multi-Level Precedence and Pre-emption service (eMLPP); Stage 3".
- [7] 3GPP TS 51.011: "Specification of the Subscriber Identity Module - Mobile Equipment (SIM-ME) interface".
- [8] 3GPP TS 31.102: "Characteristics of the USIM application".
- [9] 3GPP TS 48.008: "Mobile-services Switching Centre - Base Station system (MSC-BSS) Interface Layer 3 Specification".
- [10] Alliance for Telecommunications Industry Solutions (ATIS) T1.111-2001: Signaling System No.7, Message Transfer Part.
- [11] ATIS T1.631-1993 (R1999): High Probability of Completion HPC Network Capability.
- [12] ATIS T1.113-2000: Signalling System No. 7 (SS7) - Integrated Services Digital Network (ISDN) User Part (Revision of T1.113-1995; includes two Supplements: T1.113a-2000 & T1.113b-2001).
- [13] Federal Communications Commission (FCC) Second Report and Order (R&O) 00-242 (WT Docket No. 96-86).
- [14] ITU-T Recommendation Q.764, Signalling System No. 7 – ISDN user part signalling procedures.

3 Definitions and abbreviations

Refer to [1] for additional definitions and abbreviations used in this document that are not defined below.

3.1 Definitions

Service User: subscriber to Priority Service

Service Provider: provider of Priority Service

3.2 Abbreviations

ATIS	Alliance for Telecommunications Industry Solutions
IEPS	International Emergency Preference Scheme

4 Service description

4.1 Assumptions and limitations

Priority Service is a subscription service, based on eMLPP service, as described in the Priority Service feasibility study, 3GPP TR 22.950 [2]. There are no Stage 1, Stage 2, Stage 3 specifications for Priority Service. Only eMLPP Release 6 specifications have been updated to be compatible with Priority Service. The following primary 3GPP capabilities were identified in [2] to support Priority Service:

- Service Accessibility, as specified in 3GPP TS 22.011 [3],

- Enhanced Multi-Level Precedence and Pre-emption (eMLPP), as specified in 3GPP TS 22.067 [4], 3GPP TS 23.067 [5], and 3GPP TS 24.067 [6],
- Subscriber Identity Module (SIM), as specified in 3GPP TS 51.011 [7],
- Universal Subscriber Identity Module (USIM), as specified in 3GPP TS 31.102 [8],
- Priority Information Element, as specified in 3GPP TS 48.008 [9].

The following assumptions have been made to provide for Priority Service.

For the purposes of this document, the term "Service User" is a subscriber to Priority Service and a "Service Provider" is a provider of Priority Service.

No hardware or software modifications to existing Mobile Stations (MS) have been identified as required to support Priority Service. Priority Service subscribers may use MSs supporting the Adaptive Multi Rate (AMR), Enhanced Full Rate (EFR) and basic full rate voice codecs.

The ISDN User Part (ISUP) Precedence parameter used in the Multi-Level Precedence and Pre-emption (MLPP) service may be used to transmit the priority of the calling Service User through any transit networks to the terminating network.

4.2 Registration / erasure

The eMLPP registration and erasure procedures are not applicable for the Priority Service.

4.3 Interrogation

The eMLPP interrogation procedure is not applicable for the Priority Service.

4.4 Call origination / invocation

Service Users are the only subscribers that are allowed to invoke Priority Service. Priority Service is invoked on a per call basis.

4.4.1 Service accessibility

Service Accessibility, as specified in [3], supports an "Access Control" capability used by network operators to prevent overload of radio access channels under critical conditions. Access Class load shedding may be applied to a specified localized area and for a specified duration. Invoking access control does not pre-empt calls in progress.

For priority access to the network, a Service User receives treatment that is fully compliant with Service Accessibility capabilities with the following exceptions, extensions, or clarifications:

A call receives end-to-end priority treatment, including priority access to traffic channels on the originating side, when a Service User initiates a call using the Priority Service dialling procedure:

*Service Code (SC) + Destination Number.

A generic prefix may be used in place of "*SC".

A Service User is assigned Access Class(es) in the range of 11 – 15 to receive priority access to the network.

Support of Localized Service Area for Priority Service is not required.

4.4.2 Priority radio resource queuing

If a Service User invokes a Priority Service call and a radio traffic channel is available to serve the call, then call establishment proceeds.

If a Service User invokes a Priority Service call and a radio traffic channel is not available to serve the call, then the call is queued for the next available radio traffic channel according to the call's priority level and the arrival time.

If a Service User invokes a Priority Service call, a radio traffic channel is not available to serve the call, the queue for the cell is full, and the call's priority level is greater than the priority level of the lowest priority request in the queue, then the most recent Priority Service call request of the lowest priority is removed from the queue and the new Priority Service call is queued according to the call's priority level and arrival time.

If a Service User invokes a Priority Service call, a radio traffic channel is not available to serve the call, the queue for the cell is full, and the call's priority level is less than or equal to the priority level of the lowest priority request in the queue, then the new Priority Service call request is denied.

If a radio traffic channel becomes available to serve an originating Priority Service request and is assigned to the call, then the call is allowed to proceed.

If a Service User invokes a Priority Service call and the Priority Service call is queued for a radio traffic channel, but the maximum allowed time in queue expires before a radio traffic channel becomes available in the cell to serve the Priority Service call, then the Priority Service call is removed from the queue and the Priority Service call request is cleared.

The queue is a collection of all queued Priority Service calls in a cell. The queue is provisionable for a specified maximum number of Priority Service requests in queue.

The queue has a specified and provisionable maximum time that a Priority Service call may remain in queue for a radio traffic channel.

4.4.3 Directed retry

If no radio resources are available at a cell, the BSS may try to set up a call on a neighbouring cell if channels are free at that cell. If enabled, handover with cause "directed retry" is attempted if no radio traffic channel is available in the current cell.

Priority Service does not prevent handover with cause "directed retry", if enabled, from being attempted for non-Priority Service calls. If enabled, handover with cause "directed retry" should be attempted for Priority Service calls concurrently with radio resource queuing. If directed retry is not performed concurrently with queuing, handover with cause "directed retry", if enabled, should be attempted for Priority Service calls prior to radio resource queuing.

Directed retry handover may be attempted from a service provider's UMTS network to the service provider's GSM network when a priority call is invoked by a service user in the UMTS network that cannot assign a radio traffic channel due to resource congestion in UTRAN.

For a call originated/terminated on the UTRAN that is redirected to GERAN, the user's priority level is used for subsequent call processing (e.g., priority service processing on the GERAN).

4.5 Call progression

The Priority Service users receive priority call treatment/progression through the mobile network(s). A Priority Service call is given higher priority over normal calls in the originating mobile network, to interconnected networks (including the PSTN) and in the terminating network. Note: The ISDN MLPP feature may be used for signalling the priority level to other networks.

The term "call progression" is used to refer to procedures that are invoked to set up a call from the originating node, through any transit nodes, and on to the terminating node.

4.5.1 Progression in originating network

The originating Service Provider applies enhanced call-completion capabilities to increase the probability of successful call setup through the Service Provider's network and to any interconnecting (transit or terminating) network.

4.5.2 Progression in transit networks

Transit network providers apply enhanced call-completion capabilities to incoming Priority Service calls to increase the probability of successful call setup through the transit network. Transit network providers pass the Service User's priority level, if available, to any interconnecting (transit or terminating) network.

4.5.3 Progression in terminating networks

The terminating Service Provider passes the Service User's priority level through the Service Provider's network toward the destination node serving the called party.

4.5.4 Enhanced call-completion capabilities

To achieve end-to-end priority treatment, Priority Service introduces special call-progression capabilities in the Service Provider's network and also within transit networks. General (service-level) capabilities are highlighted in this section. Some of the call-progression procedures are intended to increase the probability of Priority Service call completion through network transit nodes. They are herein referred to as "enhanced call-completion capabilities".

4.5.4.1 Exemption from certain restrictive Network Management Controls (NMCs)

Priority Service calls may be exempted from certain restrictive NMCs (code controls, manual cancel-to controls, Automatic Congestion Control, Trunk Reservation control) to further increase the probability of completion of the call during severe congestion.

4.5.4.2 Trunk queuing

The MSC performs trunk queuing for Priority Service calls to increase the probability of completion of the call. The MSC allows Priority Service calls to be queued on an ISUP or MF trunk group that is marked for trunk queuing only if at least one trunk within the trunk group is in an in-service state. The trunk queuing feature provides the capability to place a Priority Service call that has experienced a No Circuit (NC) condition into a queue associated with a trunk group until a trunk becomes idle or a maximum queuing time has expired. After the first check of all trunk groups in a routing chain, if an idle trunk is not found in a trunk group on which trunk queuing has been provisioned, the call is entered into a queue. The MSC recognizes Priority Service calls and separates them from all other calls. All non-Priority Service calls that overflow to a busy trunk group on which Priority Service trunk queuing is active are sent to the next call treatment. A Priority Service call held in queue seizes the first trunk that becomes idle or, if the maximum queuing time interval expires, is sent to the next call treatment. Trunk queuing can be provided on network routable trunk types served by the MSC. For those trunk groups on which trunk queuing is provided, the following processes occur:

The MSC first searches in sequence all the trunk groups in a routing chain to determine if there is an idle trunk.

- If an idle trunk is found, the trunk is seized and used for call routing.
- Otherwise, if there was at least one trunk group in the routing chain marked for trunk queuing, then the MSC performs a second search of the routing chain.
- For the second search of the routing chain, the MSC returns to the first trunk group in the routing chain and will look for an idle trunk.
- If no idle trunk is found in the trunk group and the trunk group is marked for trunk queuing, then the MSC queues the call for trunk queuing; that is the MSC places the call in a first in first out (FIFO) queue for that trunk group and start the trunk queuing timer.
- If no trunk is seized from the first trunk group (i.e., the queuing timer times out or the trunk group is not marked for queuing), then the MSC proceeds to search the next trunk group in the routing chain.

During the second search of the routing chain, the MSC can skip all busy trunk groups that are not marked for trunk queuing and directly proceed to search the first trunk group in the chain marked for queuing.

Only Priority Service calls enter into Priority Service trunk queues. During the time that one or more Priority Service calls are held in a trunk queue for a particular trunk group, the MSC advances all non-Priority Service calls attempting

to use that trunk group to the next call treatment. That is, the trunk group with the trunk queuing feature, on which one or more Priority Service calls are held in a trunk queue, is considered busy for all non-Priority Service calls.

If any trunk becomes available in a trunk group with queued calls, then the first Priority Service call in queue is removed from the queue, routed on that trunk, and the trunk queuing timer is stopped for that call.

If a Priority Service call times out in a trunk queue and there are remaining trunk groups in the routing chain, then the MSC removes the call request from the queue and continues searching the remaining trunk groups in the routing chain to find an idle trunk. If a Priority Service call cannot be placed in a trunk queue because the trunk queue is full and there are remaining trunk groups in the routing chain, then the MSC continues searching the remaining trunk groups in the routing chain to find an idle trunk. The MSC provides the capability for trunk queuing to be enabled/disabled office wide and, if enabled office wide, to be disabled/re-enabled on any trunk group. The maximum number of Priority Service calls that may be simultaneously held in any trunk queue is provisionable. The maximum time that a Priority Service call may be held in a trunk queue is also provisionable.

If the calling party abandons the originating Priority Service call by pressing the END key or the system determines that radio contact with the calling party's MS is lost while a Priority Service call request is in a trunk queue, then the MSC/VLR takes the following actions:

- Stop the trunk queuing timer,
- Remove that Priority Service call request from the trunk queue,
- Clear the call according to normal call clearing procedures.

4.5.4.3 Treatment of glare conditions

Glare (dual seizure) occurs when switches at both ends of a two-way trunk try to seize the trunk for outgoing calls simultaneously.

With the activation of Trunk Queuing for Priority Service calls on a trunk group, the probability of glare occurring for Priority Service calls increases. This is particularly true when Trunk Queuing is activated on both ends of a trunk group. Normal glare procedures [12, 14] are applied for each trunk group during the first search of the routing chain, as well as during the second search of the routing chain for each trunk group that does not have Trunk Queuing activated.

During either the first or second search of the routing chain, if a Priority Service call encounters glare for the first time in a particular trunk group and yields, then the MSC/VLR attempts to seize an idle trunk on the same trunk group. If glare is encountered twice on the same trunk group during any single search of the routing chain, and

- this is the first search, then the MSC/VLR advances the call to the next call treatment,
- this is the second search and Trunk Queuing is not active on the trunk group, then the MSC/VLR advances the call to the next call treatment.
- this is the second search and Trunk Queuing is active on the trunk group, then the MSC/VLR attempts to seize an idle trunk on the same trunk group.

4.5.4.4 Relationship of NMCs to trunk queuing

Pre-hunt trunk group controls are processed before trunk queuing when they are active on the same trunk group. Trunk queuing is processed before post-hunt trunk group controls when they are active on the same trunk group.

4.6 Call termination

The terminating Service Provider applies enhanced call-completion capabilities to incoming Priority Service calls to increase the probability of successful call setup through the Service Provider's terminating network. Additionally, the terminating Service Provider passes the Service User's priority level through the Service Provider's network toward the destination node serving the called party.

A Priority Service call receives priority treatment (priority access traffic channels) on the terminating side, based on either the calling party priority level information received or default priority level. The default priority level is used only if the calling party priority level information is not received. If an MS provides specific radio channel preferences (e.g.,

dual rate, half rate, AMR) to the network during the call termination attempt and a radio traffic channel preferred by the MS is not available, the network attempts to allocate a radio traffic channel acceptable to the MS before queuing the Priority Service call request.

If an incoming Priority Service call terminates to a Service Provider network and a radio traffic channel is available to serve the call, then call establishment proceeds.

If an incoming Priority Service call terminates to a Service Provider network and a radio traffic channel is not available to serve the call, then the call is queued for the next available radio traffic channel according to the call's (received or default) priority level and the arrival time.

If an incoming Priority Service call terminates to a Service Provider network, a radio traffic channel is not available to serve the call, the queue for the cell is full, and the call's priority level is greater than the priority level of the lowest priority request in the queue, then the most recent Priority Service request of the lowest priority is removed from the queue and the new Priority Service call is queued according to the call's priority level and arrival time.

If an incoming Priority Service call terminates to a Service Provider network, a radio traffic channel is not available to serve the call, the queue for the cell is full, and the call's priority level is less than or equal to the priority level of the lowest priority request in the queue, then the new Priority Service call request is given the same treatment as appropriate for non-Priority Service calls that do not get a radio traffic channel.

If an incoming Priority Service call terminates to a Service Provider network and the Priority Service call is queued for a radio traffic channel, but the maximum allowed time in queue expires before a radio traffic channel becomes available in the cell to serve the Priority Service call, then the Priority Service call is removed from the queue and the Priority Service call request is given the same treatment as appropriate for non-Priority Service calls that do not get a radio traffic channel.

See subclause 4.4.2 for additional information on radio resource queuing.

4.7 Handover

Priority Service is supported during intra-BSC and intra-MS-C handover. Established Priority Service calls follow standard handover procedures as for normal calls. Queued Priority Service calls follow standard intra-MS-C Stand-alone Dedicated Control Channel (SDCCH) handover procedures.

If a system invokes intra-MS-C SDCCH handover procedures (e.g., when the Service User moves to a new cell served by the same BSC or another BSC on the same MS-C) while the Service User's originating Priority Service call request is queued for a radio traffic channel, the system re-queues the request based on call priority level and call arrival time in the new cell if no radio traffic channels are available in the new cell. The queue timer is restarted in the new cell. This allows queue management in the new cell to handle the call.

Inter-MS-C handover does not apply to Priority Service requests in queue. Inter-MS-C SDCCH handover for queued Priority Service calls is not supported. SDCCH handovers of queued Priority Service requests to new cells, when no radio traffic channels are available in the new cell should only take place when no other suitable radio traffic channels are available in the current cell. In such a situation, the priority level should be used to determine the place in the queue on the new cell.

4.8 Feature interactions

This clause is intended to describe Priority Service interactions with other features.

4.8.1 eMLPP

As a Service Provider option, it should be possible to offer Priority Service and eMLPP within the same network, but not to the same user. See Annex B for Use Cases.

Priority Service is a subscription-based service, based on eMLPP service. If eMLPP is provisioned in the network, the lowest eMLPP priority level (4) is the default for non-Priority Service users and does not involve any priority treatment. For priority treatment, a Service User receives treatment that is compliant with eMLPP service capabilities with the following exceptions, extensions, or clarifications:

- Support for an MS that is not eMLPP compatible is required.
- Support for the eMLPP Automatic Answering capability is not required.
- Support for Voice Broadcast Calls (VBS) and Voice Group Calls (VGCS) is not required.
- Priority Service applies to the Service Provider's entire permanent public GSM network.
- Support for Fast Call Set Up is not required.
- Support for Automatic invocation on call set up is not required.
- Service Users are able to invoke only their assigned priority level.

Priority Service call attempt overrides any eMLPP priority levels received from eMLPP capable mobile phones. That is Priority Service users are able to only invoke their assigned priority level, even if a Service User has indicated an eMLPP priority level when attempting a Priority Service call with an eMLPP capable phone.

The TS 48.008 priority levels of Priority Service users are higher than the priority levels of any other eMLPP users.

It should be noted that eMLPP also provides a priority level "A" that is intended for use internally by Service Provider technicians engaged in sustaining service availability. Priority level A is not intended for subscription and is not considered part of Priority Service. Such Service Provider technicians, when using eMLPP priority level "A", are viewed as part of Service Provider operations.

There is no impact on the functionality offered neither to eMLPP subscribers in an eMLPP only network nor to Priority Service subscribers in a Priority Service only network.

4.8.2 Call forwarding and call redirection / deflection

Service Users are not allowed to invoke Priority Service calls through call forwarding or re-direction (e.g., "*SC + termination address" as a forwarded-to number, or Priority Service invocation through other re-direction services, such as IN DP12 Redirection etc.).

If a Service User attempts to register "*SC + Destination Number" as a forwarded to number, the registration attempt fails.

An incoming Priority Service call is forwarded to the Call Forwarding Unconditional (CFU) number if CFU is active. The calling Service User's priority level is passed during the forwarding process.

An incoming Priority Service call is forwarded to the Call Forwarding Busy (CFB) number if CFB is active and if the called party's MS is busy. The calling Service User's priority level is passed during the forwarding process.

An incoming Priority Service call is forwarded to the Call Forwarding No Reply (CFNRy) number if CFNRy is active and if the incoming call is not answered. The calling Service User's priority level is passed during the forwarding process.

An incoming Priority Service call is forwarded to the Call Forwarding Not Reachable (CFNRc) number if CFNRc is active and if the called party's MS is not reachable. The calling Service User's priority level is passed during the forwarding process.

If the called party has invoked Call Deflection (CD), an incoming Priority Service call is deflected to the deflected-to number. The calling Service User's priority level is passed during the deflection process.

An incoming Priority Service call is forwarded to the Forward-to number if the call is forwarded by a CAMEL-based feature. The calling Service User's priority level is passed during the forwarding process.

4.8.3 Call waiting

Priority Service call users do not receive an incoming call indication while the call is being queued. Call Waiting applies only to active calls. No special interaction is applicable between Priority Service and Call Waiting; thus a Service User with an originating Priority Service call in queue is not informed of an incoming call while queued.

4.8.4 Emergency calls

There is no interaction between Priority Service and emergency calls.

If a service user dials *SC + [emergency call number], the call either receives radio traffic channel priority access treatment based on the service user's priority level or the call is denied. If a non-service user dials *SC + [emergency call number], the call is denied.

4.8.5 Alternate Line Service (ALS)

There is no interaction with ALS. This document assumes that Priority Service calls are made on the user's primary line, but they may also be made on the user's alternate line, subject to ALS restrictions, if the alternate line has the Priority Service subscription.

4.8.6 Asynchronous data

There is no interaction between Priority Service and asynchronous data calls.

4.8.7 Customized Applications for Mobile Enhanced Logic (CAMEL) and Intelligent Network (IN)

It is recognized that Priority Service call processing may be modified by interactions with CAMEL and IN-based features.

4.8.8 Call Origination restrictions

Barring of Outgoing Calls (BAOC), Barring of outgoing International Calls (BOIC) and Barring of Outgoing International Calls except to Home PLMN Country (BOIC-exHC) are subscription-based features and take precedence over Priority Service.

4.8.9 Call transfer

There is no interaction between Priority Service and Call Transfer.

4.8.10 Multi-Party supplementary service (MPTY)

For MPTY calling, the manner in which the initial call is processed is based on how the call was initiated (e.g., as a normal call or a Priority Service call). If a Service User, after establishing an initial (either normal or Priority Service) call, initiates a MPTY call by dialling (*SC + Destination Number), the call is treated as a Priority Service call and is routed to the Destination Number. The calling Service User's priority level is passed during the process.

4.8.11 Prepaid service

Priority Service applies only to post-paid calls. Users are not allowed to subscribe to Priority Service and Prepaid.

If a Priority Service call is placed to a terminating Prepaid subscriber, the call may be released if the called party's account balance is insufficient to accept the incoming call, or the call may be dropped during the conversation if the balance is exhausted.

4.8.12 Short Message Service (SMS)

Priority Service is not applicable to SMS transmissions.

4.8.13 Other supplementary services

No interactions with other supplementary services described in TS 22.004 have been identified.

4.9 Interworking considerations

4.9.1 ISDN Multiple Level Precedence and Pre-emption (MLPP)

The call set-up signalling between networks must be such that it can guarantee correct handling in transit networks and in the terminating network. This means that the signalling has to be able to distinguish between Priority Service and eMLPP service offerings, by indicating the type of priority service and the priority level, as well as indicate whether pre-emption is allowed in transit nodes (if not implicitly indicated by the priority service type and priority level.)

The only information that can be transferred between networks is as specified in the inter-network signalling systems. For this purpose, the 3GPP eMLPP specification states that interworking shall be done with the ISDN MLPP service.

The signalling for the ISDN MLPP service, as specified in ISDN User Part (ISUP) and in Bearer Independent Call Control (BICC), is not designed to differentiate between these two types of priority services, i.e. between the Priority Service and eMLPP, and this seems not possible to solve with the current ISUP and BICC specifications as the parameters for the MLPP service are not sufficient to cope with both services.

Examples of possible ways to solve this in ISUP and BICC would be to either expand the existing MLPP parameter to cope with both services, or to introduce a new parameter for the Priority Service, or reuse an existing parameter (e.g., ISUP Calling Party's Category, MLPP Service Domain). This work is outside the scope of 3GPP.

4.9.2 Roaming interactions

Support of Priority Service while roaming is primarily controlled through roaming agreements between Service Providers, but a Service Provider may also apply restrictions on the ability of incoming international roamers to invoke Priority Service.

The Service Provider may configure the network such that Priority Service call invocation by international roamers is prevented (e.g., based on the Mobile Country Code (MCC) in the International Mobile Subscriber Identity (IMSI)). The Service Provider sends the Service User's eMLPP subscription information as applicable to Priority Service unaltered when sending subscriber data to the visited network with which there is a mutual business agreement covering Priority Service. The Service Provider is not required to send the Service User eMLPP subscription information to a visited network to which there is no mutual business agreement.

Roaming is possible between an eMLPP only network and a Priority Service only network, i.e., between a) a network supporting eMLPP but not Priority Service and b) a network supporting Priority Service but not eMLPP. Service Users are not treated as being eMLPP subscribers when roaming into an eMLPP only network (i.e., treated like a non-eMLPP subscriber). eMLPP subscribers are not treated as being Service Users when roaming into a Priority Service only network (i.e., treated like a non-Priority Service subscriber). Roaming is intended to be backwards compatible with eMLPP specifications.

See Annex B for applicable Use Cases.

5 Call flows

This clause is intended to facilitate understanding of Priority Service and paraphrases information that is detailed in 3GPP specifications. This clause provides an illustration of a possible way the capabilities described in this document may be implemented to support Priority Service.

This clause describes various call flows that illustrate how Priority Service calls can be processed. Messages between the MSC and VLR are not shown in the figures nor described in the text following the figures since the MSC-VLR interface is not standardized. Required timers are not shown in the figures but are described in the text. The call flows assume that MS support of eMLPP is not required (i.e., eMLPP compatible handsets are not required). The call flows also assume that queuing due to the lack of radio resources or resources between the BSS and MSC is done at the BSS.

Standard 3GPP authentication and ciphering procedures are applicable to all call flows but are not depicted.

The following call flows are illustrated:

- 1 Priority Service Call Origination – Radio Resources Available, Call Not Queued,

- 2 Priority Service Call Termination – Radio Resources Available, Call Not Queued,
- 3 Priority Service Call Origination – Radio Resources Unavailable, Call Queued,
- 4 Priority Service Call Termination – Radio Resources Unavailable, Call Queued,
- 5 Priority Service Call Origination – Radio Resources Unavailable and Queue Full,
- 6 Priority Service Call Termination – Radio Resources Unavailable and Queue Full,
- 7 Priority Service Call Origination – Radio Resources Unavailable and Queue Timeout,
- 8 Priority Service Call Termination – Radio Resources Unavailable and Queue Timeout,
- 9 Priority Service Call Origination – Radio Resources Unavailable, Queue Full, but Higher Priority,
- 10 Priority Service Call Termination – Radio Resources Unavailable, Queue Full, but Higher Priority,
- 11 Priority Service Call Progression – MSC – Outgoing Trunk Queuing,
- 12 Priority Service Call Progression – MSC – Outgoing Trunk Queuing – Timeout,
- 13 Priority Service Call Attempt by a Non-Service User – Priority Service Denied.

5.1 Priority service call origination – radio resources available, call not queued

This clause illustrates a Mobile Originated (MO) Priority Service call establishment with early radio traffic channel assignment for a Service User. In this scenario, radio traffic channels are available when the Priority Service call is attempted. With the early assignment option, the PLMN allocates a traffic channel to the MS before the PLMN initiates call setup to the PSTN.

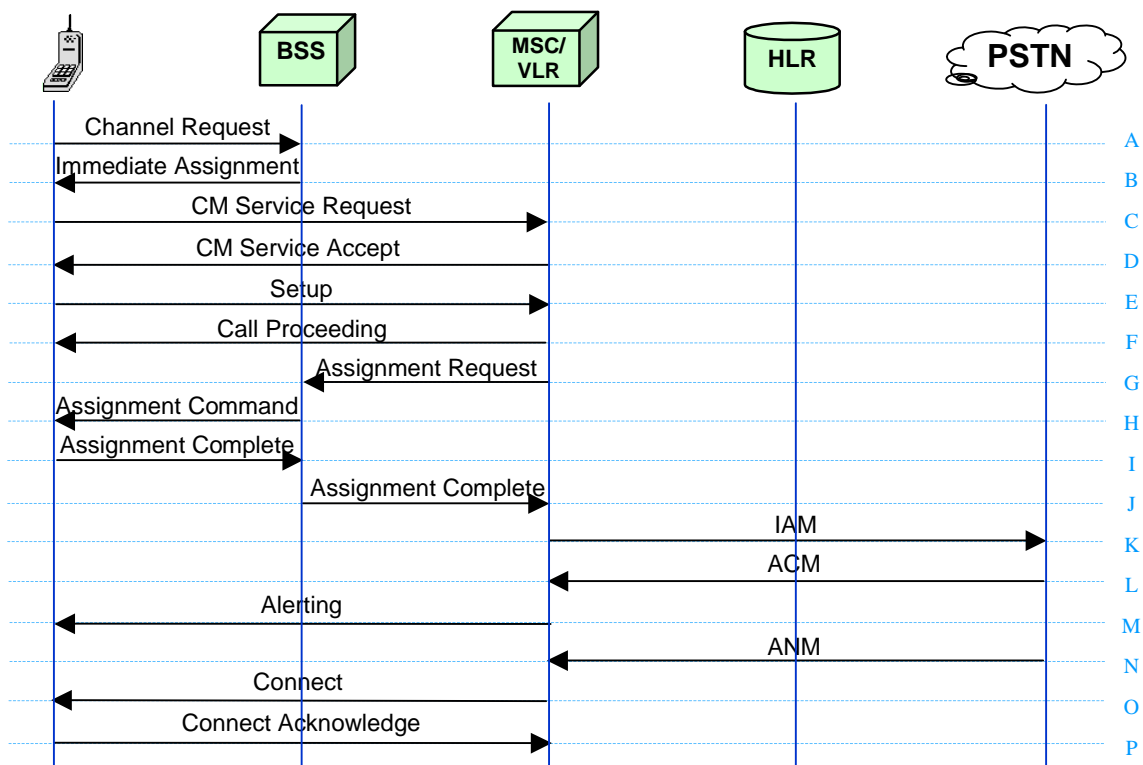

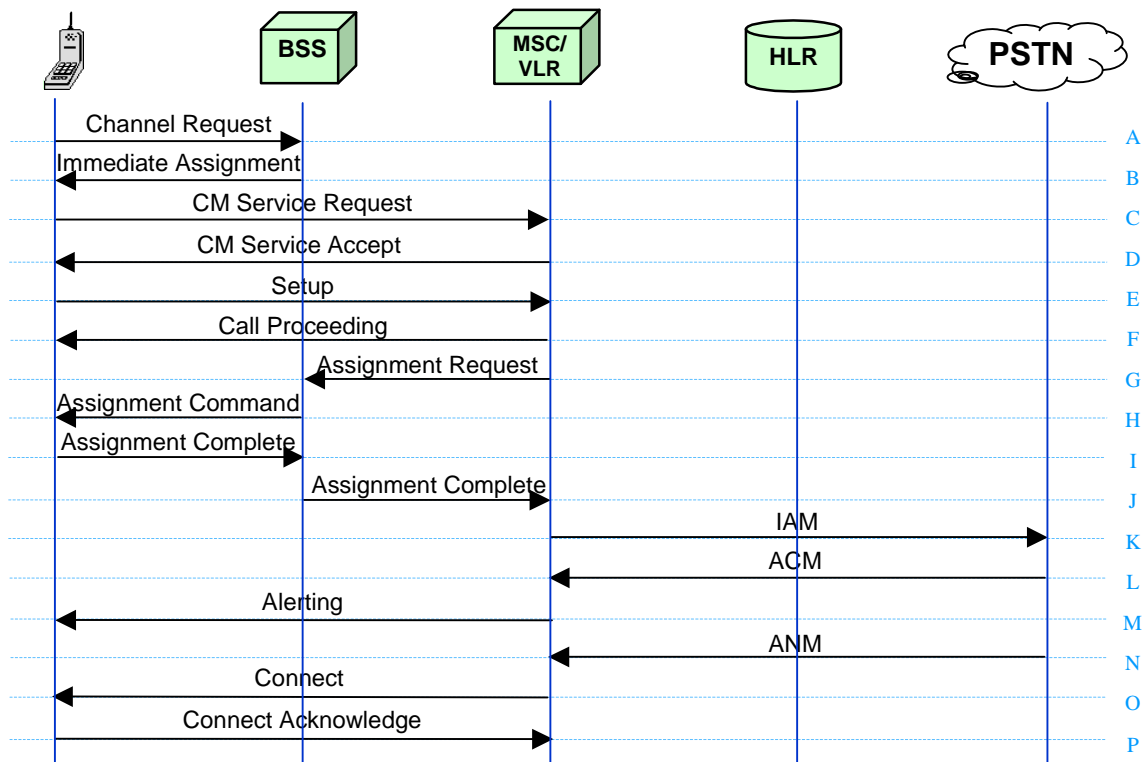

Figure 5.1: Priority Service Mobile Originated – Call Not Queued

Step 1: Immediate Assignment Procedure (Establish a Radio Resource (RR) connection between the MS and the BSS)

- A The Service user dials the Priority Service prefix (e.g., *272) + Destination Number. The MS sends a *Channel Request* message to the BSS on the Random Access Channel (RACH) channel. Having sent $M + 1$ *Channel Request* messages, the MS starts RR timer T3126. M is the value of the parameter "max retrans" broadcast on the Broadcast Control Channel (BCCH).
- B The BSS allocates a dedicated channel to the MS by sending an *Immediate Assignment* message on the same Common Control Channel (CCCH) timeslot on which it has received the *Channel Request*. The BSS starts RR timer T3101.

Step 2: Service Request and Contention Resolution Procedure (Establish the main signalling link between the MS and the BSS)

- C The MS stops RR timer T3126 on receipt of an *Immediate Assignment* message corresponding to one of its three last *Channel Request* messages. The MS stops sending *Channel Request* messages, sets the channel mode to signalling only, and activates the assigned channels. The MS sends a *CM Service Request* message to the MSC/VLR. The MS starts Mobility Management (MM) Timer T3230 and Call Control (CC) Timer T303.
- The initial service request *CM Service Request* message is sent by the MS to the BSS piggybacked in a Layer 2 (L2) Set Asynchronous Balance Mode (SABM) frame to establish the main signalling link. The BSS stops RR timer T3101 when the main signalling link is established. Contention resolution is achieved by the BSS by including the same *CM Service Request* message, received in the L2 SABM frame, in a L2 Unnumbered Acknowledgement (UA) frame.
 - The initial Layer 3 (L3) *CM Service Request* message is passed to the MSC/VLR by the BSS using a *Complete Layer 3 Information* message.
- D If the MSC/VLR omits authentication and ciphering, it sends a *CM Service Accept* message to the MS. Otherwise; the MSC/VLR starts the authentication procedure. (Authentication procedures are not illustrated in the call flow).

Step 3: Mobile Originating Call Establishment Procedure

- E The MS sends the *Setup* message after sending the *Ciphering Mode Complete* message to the BSS or after receiving the *CM Service Accept* message from the MSC/VLR. The *Setup* message includes the called address (e.g., *SC + Destination Number).
- F The MSC/VLR detects the dialled Priority Service prefix (e.g., *SC) in the dialled digit string and queries the user's profile to verify that the user is subscribed to Priority Service and to obtain the Service User's priority level. The MSC/VLR returns a *Call Proceeding* message towards the MS to indicate a positive outcome for the call setup procedure. On receipt of the *Call Proceeding* message, the MS stops CC timer T303 and starts CC timer T310.

Step 4: Traffic Channel Assignment (Early Assignment)

- G The MSC/VLR sends an *Assignment Request* message to the BSS, which includes the call priority level and the queuing allowed indicator.
- H As an idle radio traffic channel is available, the BSS initiates the channel assignment procedure by sending an *Assignment Command* message to the MS on the main signalling link and starts BSS Management Application Part (BSSMAP) timer T10 and RR timer T3107.
- I On receipt of the *Assignment Command* message, the MS initiates the activation of the channels, their connection, and the establishment of the main signalling links. After the main signalling link is successfully established, the MS returns an *Assignment Complete* message, specifying cause "normal event", to the network on the main Dedicated Control Channel (DCCH)
- J On receipt of the *Assignment Complete* message, the BSS releases the previously allocated resources, stops RR timer T3107, and stops BSSMAP timer T10. On successful assignment of the required channels, the BSS returns an *Assignment Complete* message to the MSC/VLR.

Step 5: Alerting Procedure

- K On receipt of the *Assignment Complete* message, the MSC/VLR sends an ISDN User Part (ISUP) *Initial Address Message (IAM)* to the succeeding switch and starts ISUP *IAM* timer T7. The ISUP *IAM* message includes the Calling Party's Category parameter set to the International Emergency Preference Scheme (IEPS) call marking for preferential call set up and the Precedence parameter set based on the Calling Party's priority level.
- L The destination returns an ISUP *Address Complete Message (ACM)*.
- M On receipt of the ISUP *ACM* message, the MSC/VLR stops ISUP timer T7 and sends an *Alerting* message to the calling MS. On receipt of the *Alerting* message, the MS stops timer CC T310.

Step 6: Call Connect Procedures

- N The destination returns an ISUP *ANswer Message (ANM)*.
- O On receipt of the ISUP *ANM* message, the MSC/VLR sends a *Connect* message to the calling MS, and starts CC timer T313.
- P On receipt of a *Connect* message, the MS attaches the user connection, returns a *Connect Acknowledge* message to the MSC/VLR, and stops any locally generated alerting indication (if applied). Upon receipt of a *Connect Acknowledge* message, the MSC/VLR stops all CC timers.

5.2 Priority service call termination – radio resources available, call not queued

This clause illustrates a Mobile Terminated (MT) Priority Service call establishment with early assignment when the incoming Priority Service call to a wireless called party is received at a terminating MSC. In this scenario, radio traffic channels are available when the incoming call is received. With the early assignment option, the PLMN initiates the assignment of a traffic channel upon receiving the *Call Confirmed* message from the MS.

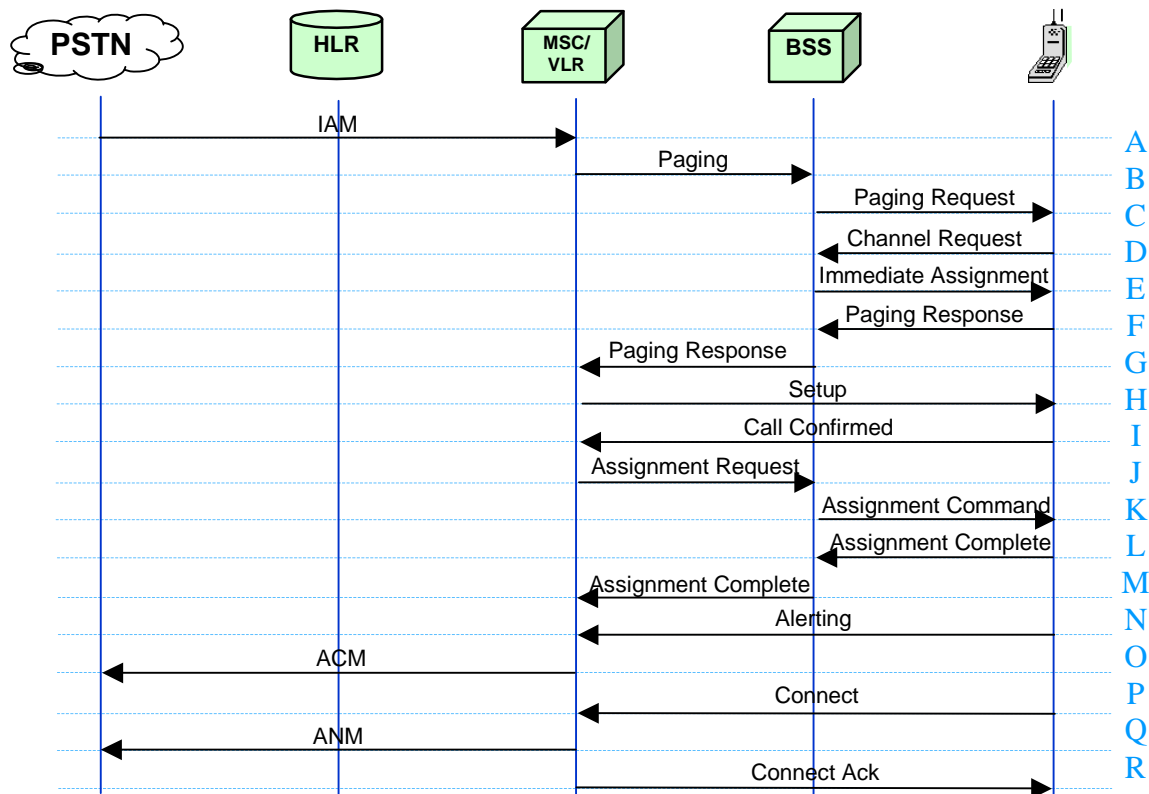

Figure 5.2: Priority Service Mobile Terminated – Call Not Queued

Step 1: Immediate Assignment Procedure (Establish a Radio Resource (RR) connection between the MS and the BSS)

A The MSC/VLR receives an ISUP *IAM* message from the PSTN which includes the Calling Party's Category parameter set to the IEPS call marking for preferential call set up and may include the Precedence parameter.

NOTE: In this call flow, the serving MSC/VLR is the Gateway MSC (GMSC). Furthermore, HLR query procedures are not illustrated.

B On receipt of the ISUP *IAM* message, the MSC/VLR sends a *Paging* message to the BSS.

C The BSS initiates the paging procedure to trigger RR connection establishment by broadcasting a *Paging Request* message on the appropriate paging subchannel on CCCH. The BSS starts RR timer T3113.

D On receipt of the *Paging Request* message from the BSS, the MS sends a *Channel Request* message, which includes the establishment cause "answer to paging", to the BSS on the RACH channel. Having sent M + 1 *Channel Request* messages, the MS starts RR timer T3126. M is the value of the parameter "max retrans" broadcast on the BCCH.

E The BSS allocates a dedicated channel to the MS by sending an *Immediate Assignment* message on the same CCCH timeslot on which it has received the *Channel Request* message. The BSS starts RR timer T3101.

Step 2: Service Request and Contention Resolution Procedure (Establish the main signalling link between the MS and the BSS)

F The MS stops RR timer T3126 on receipt of an *Immediate Assignment* message corresponding to one of its three last *Channel Request* messages. The MS stops sending *Channel Request* messages, sets the channel mode to signalling only, and activates the assigned channels.

- The *Paging Response* message is sent by the MS to the BSS piggybacked in a L2 SABM frame to establish the main signalling link. The BSS stops RR timer T3101 when the main signalling link is established. The BSS stops RR timer T3113 on receipt of the *Paging Response* message. Contention resolution is achieved by the BSS by including the same *Paging Response* message, received in the L2 SABM frame, in a L2 UA frame and sending it to the MS.

G On receipt of the *Paging Response* message, the BSS passes the L3 *Paging Response* message to the MSC/VLR using a *Complete Layer 3 Information* message.

Step 3: Mobile Terminating Call Establishment Procedure

H The MSC/VLR sends a *Setup* message to the MS after receiving the *Paging Response* message from the MS. The MSC/VLR starts CC timer T303.

I The MS acknowledges the receipt of the *Setup* message by returning a *Call Confirmed* message to the MSC/VLR. On receipt of the *Call Confirmed* message, the MSC/VLR stops CC timer T303 and starts CC timer T310.

Step 4: Traffic Channel Assignment (Early Assignment)

J The MSC/VLR sends an *Assignment Request* message to the BSS, which includes the call priority level and the queuing allowed indicator.

- When the Calling Party's Category parameter set to the IEPS call marking for preferential call set up and the Precedence parameter are received in the ISUP *IAM* message, the call priority level is based on the value received in the Precedence parameter.
- When the Calling Party's Category parameter set to the IEPS call marking for preferential call set up is received in the ISUP *IAM* message and the Precedence parameter is not received in the ISUP *IAM* message, the call priority level is based on a default value in the MSC/VLR.

K As an idle radio traffic channel is available, the BSS initiates the channel assignment procedure by sending an *Assignment Command* message to the MS on the main signalling link and starts BSS Management Application Part (BSSMAP) timer T10 and RR timer T3107.

L On receipt of the *Assignment Command* message, the MS initiates the activation of the channels, their connection, and the establishment of the main signalling links. After the main signalling link is successfully established, the MS returns an *Assignment Complete* message, specifying cause "normal event", to the network on the main DCCH.

M On receipt of the *Assignment Complete* message, the BSS releases the previously allocated resources, stops RR timer T3107, and stops BSSMAP timer T10. On successful assignment of the required channels, the BSS returns an *Assignment Complete* message to the MSC/VLR.

Step 5: Alerting Procedure

N The MS initiates user alerting by generating an appropriate tone or indication at the MS and by sending an *Alerting* message to the MSC/VLR.

O On receipt of the *Alerting* message, the MSC/VLR stops CC timer T310, starts CC timer T301, and sends an ISUP *ACM* message to the calling party.

Step 6: Call Connect Procedures

P The MS indicates acceptance of a mobile terminating call by sending a *Connect* message to the MSC/VLR. The MS starts CC timer T313.

Q On receipt of the *Connect* message, the MSC/VLR sends an ISUP *ANM* message to the calling party.

R On receipt of a *Connect* message, the MSC/VLR connects the traffic channel, stops CC timers T310, T303 or T301 (if running), and returns a *Connect Acknowledge* message to the MS. Upon receipt of a *Connect Acknowledge* message, the MS stops CC timer T313

5.3 Priority service call origination – radio resources unavailable, call queued

This clause illustrates a MO Priority Service call establishment with early assignment for a Service User. In this scenario, radio traffic channels *are not* available when the Priority Service call is attempted, the Priority Service request is queued, and call establishment proceeds when a radio traffic channel becomes available.

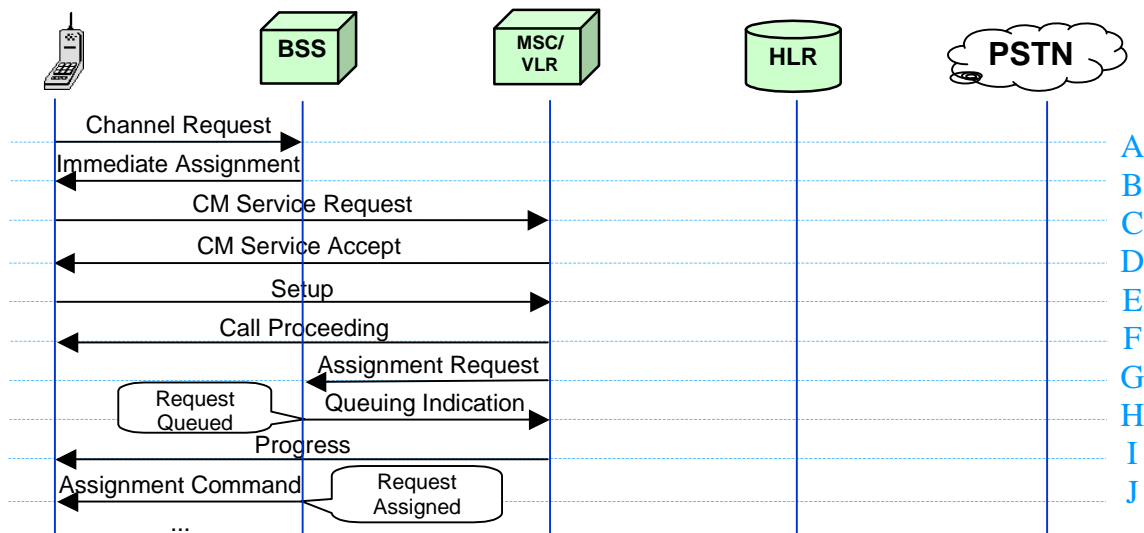

Figure 5.3: Priority Service Mobile Originated – Call Queued

A-G. Same as described in steps A-G of Clause 5.1.

H As no radio traffic channel is available on receipt of the *Assignment Request*, the BSS places the *Assignment Request* in a queue based on the Service User’s priority level and call initiation time at the cell. The BSS returns a *Queuing Indication* message to the MSC/VLR and starts BSSMAP timer T11. The BSSMAP timer T11 specifies the allowed queuing delay for the call and is determined by the Service Provider.

I On receipt of the *Queuing Indication* message, the MSC/VLR sends a *Progress* message to the MS. The *Progress* message includes the progress indicator information element with progress description set to #64 "Queuing". On receipt of the *Progress* message, the MS stops all CC timers related to the call, including CC timer T310.

J When an idle radio traffic channel becomes available before BSSMAP timer T11 expires, the BSS stops timer T11, sends an *Assignment Command* message to the MS on the main signalling link, and starts BSSMAP timer T10 and RR timer T3107.

K-R. Same as described in steps I-P of Clause 5.1.

5.4 Priority service call termination – radio resources unavailable, call queued

This clause illustrates a MT Priority Service call establishment with early assignment when an incoming Priority Service call to a wireless called party is received at a terminating MSC. In this scenario, radio traffic channels *are not* available when the Priority Service call is attempted, the Priority Service request is queued, and call establishment proceeds when a radio traffic channel becomes available.

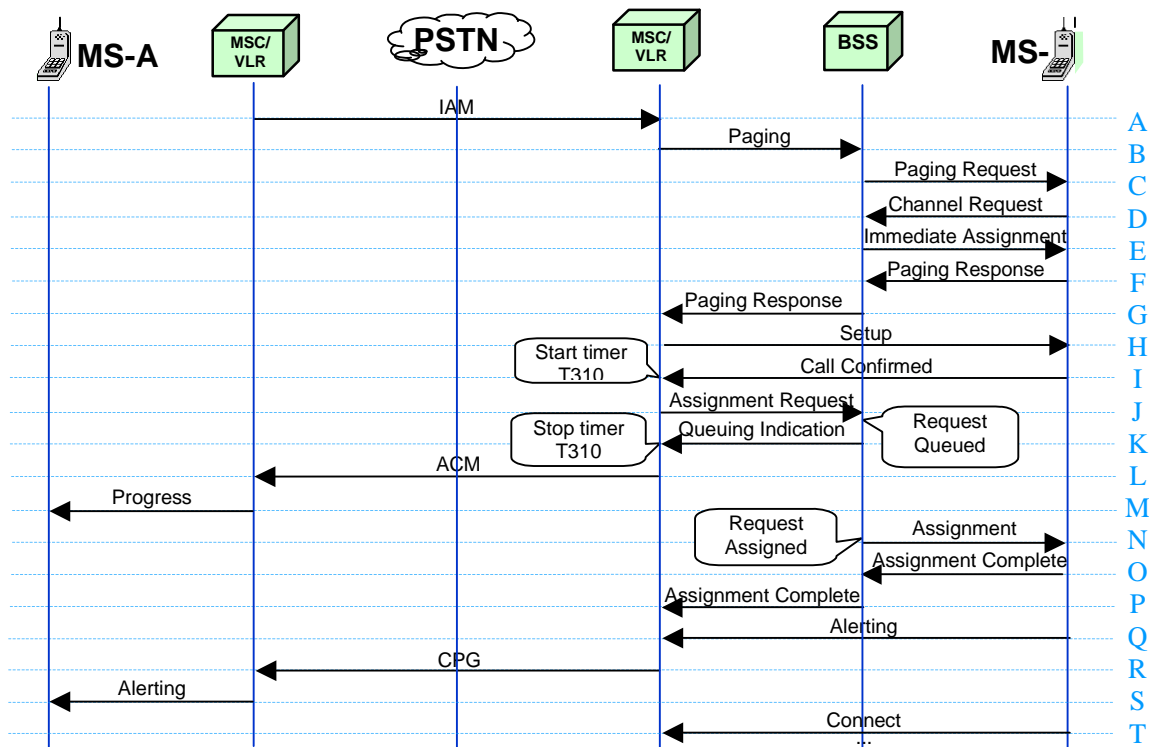

Figure 5.4: Priority Service Mobile Terminated – Call Queued

A-J. Same as described in steps A-J of Clause 5.2.

K As no radio traffic channel is available on receipt of the *Assignment Request* message, the BSS places the incoming call request in a queue based on the call priority and arrival time. The BSS returns a *Queuing Indication* message to the MSC/VLR and starts BSSMAP timer T11. The BSSMAP timer T11 specifies the allowed queuing delay for the call and is determined by the Service Provider.

L On receipt of the *Queuing Indication* message, the MSC/VLR stops CC timer T310 and sends an ISUP *ACM* message to the calling party with Called Party's Status Indicator set to "excessive delay".

M In the sub-case of mobile originated calls, on receipt of this ISUP *ACM* message with Called Party's Status Indicator set to "excessive delay", the originating MSC/VLR stops ISUP IAM timer (T7) and sends a *Progress* message to the calling MS (MS-A). The *Progress* message includes the progress indicator information element with progress description set to #64 "Queuing". On receipt of the *Progress* message, MS-A stops all CC timers related to the call, including CC timer T310.

N When an idle radio traffic channel becomes available before BSSMAP timer T11 expires, the BSS stops timer T11, sends an *Assignment Command* message to MS-B on the main signalling link, and starts BSSMAP timer T10 and RR timer T3107.

O On receipt of the *Assignment Command* message, MS-B initiates the activation of the channels, their connection, and the establishment of the main signalling links. After the main signalling link is successfully established, MS-B returns an *Assignment Complete* message, specifying cause "normal event", to the network on the main DCCH.

P On receipt of the *Assignment Complete* message, the BSS releases the previously allocated resources, stops RR timer T3107, and stops BSSMAP timer T10. On successful assignment of the required channels, the BSS returns an *Assignment Complete* message to the MSC/VLR.

Q The MS initiates user alerting by generating an appropriate tone or indication at the MS and by sending an *Alerting* message to the MSC/VLR.

R On receipt of the *Alerting* message, the MSC/VLR starts CC timer T301 and sends an ISUP *Call Progress (CPG)* message to the calling party with an event indicator set to "alerting" in the Event Information parameter.

- S In the sub-case of mobile originated calls, on receipt of the ISUP *CPG* message with an event indicator set to "alerting", the originating MSC/VLR sends an *Alerting* message to the calling MS (MS-A). The required steps that follow at the calling party are the same as described in steps N-P in Clause 5.1.
- T MS-B indicates acceptance of a mobile terminating call by sending a *Connect* message to the MSC/VLR. MS-B starts CC timer T313.
- U-V. Same as described in steps Q-R of Clause 5.2.

5.5 Priority service call origination – radio resources unavailable and queue full

This clause illustrates a MO Priority Service call establishment with early assignment for a Service User. In this scenario, radio traffic channels are not available when the Priority Service call is attempted, and the Priority Service request cannot be queued because the queue for the cell is full and the Service User's Priority Service priority is less than or equal to all the Priority Service requests already in the queue.

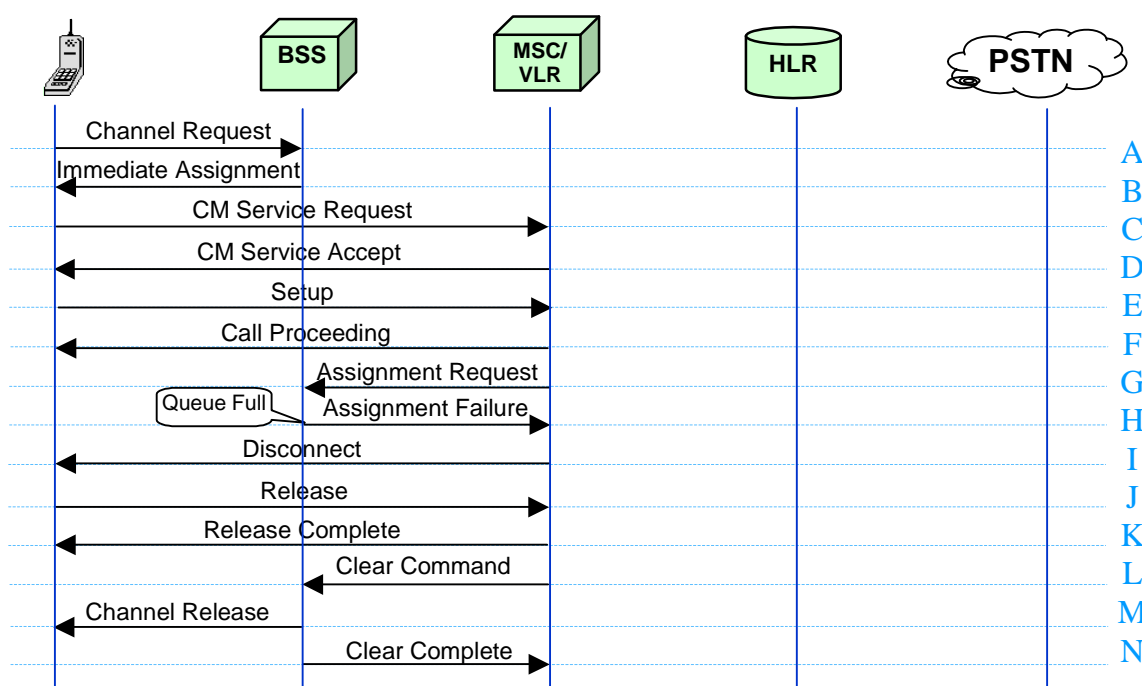

Figure 5.5: Priority Service Mobile Originated – Queue Full

- A-G. Same as described in steps A-G of Clause 5.1.
- H As no idle radio traffic channel is available on receipt of the *Assignment Request*, the queue for the cell is full, and the Service User's Priority Service priority is less than or equal to all the Priority Service requests already in the queue, the call origination request is denied. The BSS returns an *Assignment Failure* message to the MSC/VLR with cause "No Radio Resource Available".
- I The MSC/VLR initiates call clearing by stopping all running CC timers, sending a *Disconnect* message to the MS with cause #34 "no circuit/channel available", and starting CC timer T305.
- J On receipt of the *Disconnect* message, the MS stops all running CC timers, sends a *Release* message to the MSC/VLR, and starts CC timer T308.
- K On receipt of the *Release* message, the MSC/VLR stops all running CC timers, sends a *Release Complete* message to the MS, and releases the MM connection.
- L On receipt of the *Release Complete* message, the MS stops all running CC timers and releases the MM connection. The MSC/VLR indicates that the radio resource(s) should be released by sending a *Clear Command* message to the BSS with cause "No Radio Resource Available".

M On receipt of *Clear Command* message, the BSS sends a *Channel Release* message to the MS and starts RR timer T3109. When the main signalling link is disconnected, the BSS stops RR timer T3109 and starts RR timer T3111. When timer RR T3111 times out, the BSS deactivates the channels. On receipt of the *Channel Release* message, the MS disconnects the main signalling link and start RR timer T3110. When timer RR T3110 expires or the disconnection is confirmed, the MS deactivates all channels, considers the RR connection released, and returns to idle mode.

N Once the radio channel has been released, the BSS returns a *Clear Complete* message to the MSC/VLR.

5.6 Priority service call termination – radio resources unavailable and queue full

This clause illustrates a MT Priority Service call establishment with early assignment when the incoming Priority Service call to a wireless called party is received at a terminating MSC. In this scenario, radio traffic channels are not available when the incoming Priority Service call is attempted, and the Priority Service request cannot be queued because the queue for the cell is full and the Service User’s Priority Service priority is less than or equal to all the Priority Service requests already in the queue.

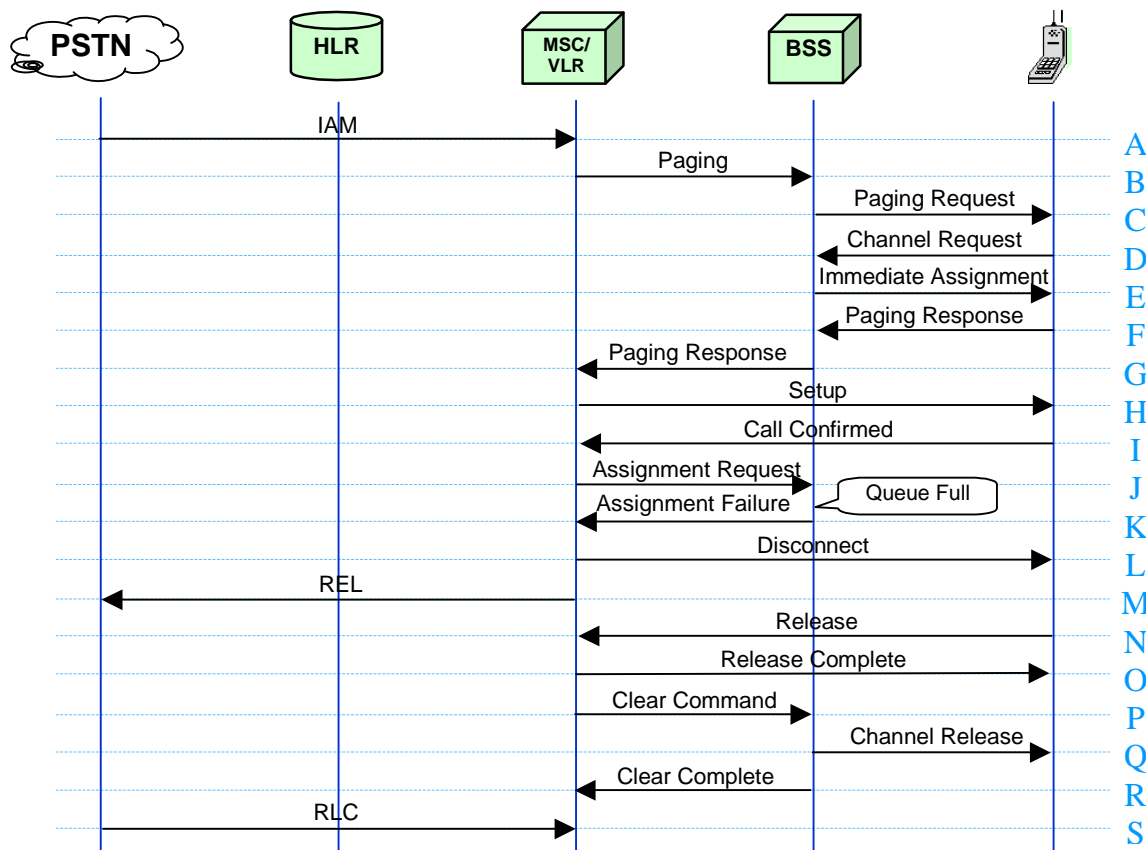

Figure 5.6: Priority Service Mobile Terminated – Queue Full

A-J. Same as described in steps A-J of Clause 5.2.

K As no idle radio traffic channel is available on receipt of the *Assignment Request* message, the queue for the cell is full, and the call priority is less than or equal to all the Priority Service requests already in the queue, the call termination request is denied. The BSS returns an *Assignment Failure* message to the MSC/VLR with cause "No Radio Resource Available".

L The MSC/VLR initiates call clearing by stopping all running CC timers, sending a *Disconnect* message to the MS with cause #34 "no circuit/channel available", and starting CC timer T305.

M The MSC/VLR returns an ISUP *Release (REL)* message to the calling party with cause "no circuit/channel available". Normal ISUP timers apply.

- N On receipt of the *Disconnect* message, the MS stops all running CC timers, sends a *Release* message to the MSC/VLR, and starts CC timer T308.
- O On receipt of the *Release* message, the MSC/VLR stops all running CC timers, sends a *Release Complete* message to the MS, and releases the MM connection. On receipt of the *Release Complete* message, the MS stops all running CC timers and releases the MM connection.
- P The MSC/VLR indicates that the radio resource(s) should be released by sending a *Clear Command* message to the BSS with cause "No Radio Resource Available".
- Q On receipt of *Clear Command* message, the BSS sends a *Channel Release* message to the MS and starts RR timer T3109. When the main signalling link is disconnected, the BSS stops RR timer T3109 and starts RR timer T3111. When timer RR T3111 times out, the BSS deactivates the channels. On receipt of the *Channel Release* message, the MS disconnects the main signalling link and start RR timer T3110. When timer RR T3110 expires or the disconnection is confirmed, the MS deactivates all channels, considers the RR connection released, and returns to idle mode.
- R Once the radio signalling channel has been released, the BSS returns a *Clear Complete* message to the MSC/VLR.
- S The MSC/VLR receives an ISUP *Release Complete (RLC)* message from the calling party.

5.7 Priority service call origination – radio resources unavailable and queue timeout

This clause illustrates a MO Priority Service call setup with early assignment for Service User. In this scenario, radio traffic channels are not available when the Priority Service call is attempted, and the Priority Service request has been queued but the queuing timer has timed-out.

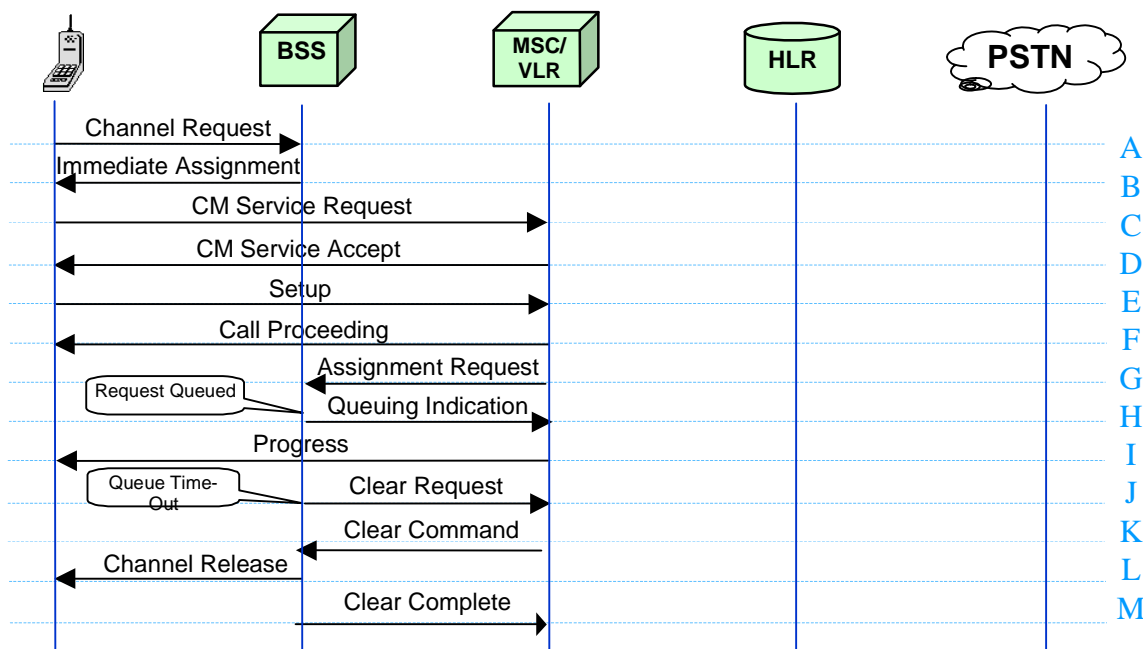

Figure 5.7: Priority Service Mobile Originated – Queue Time-Out

A-I. Same as described in steps A-I of Clause 5.3.

J If timer T11 expires before an idle radio traffic channel becomes available, the *Assignment Request* message is removed from the queue and a *Clear Request* message is sent to the MSC/VLR with cause "No Radio Resource Available".

K The MSC/VLR indicates that the radio resource(s) should be released by sending a *Clear Command* message to the BSS with cause "No Radio Resource Available".

L-M. Same as described in steps M-N of Clause 5.5.

5.8 Priority service call termination – radio resources unavailable and queue timeout

This clause illustrates a MT Priority Service call setup with early assignment when the incoming Priority Service call to a wireless called party is received at a terminating MSC. In this scenario, radio traffic channels are not available when the incoming Priority Service call is attempted, and the Priority Service request has been queued but the queuing timer has timed-out.

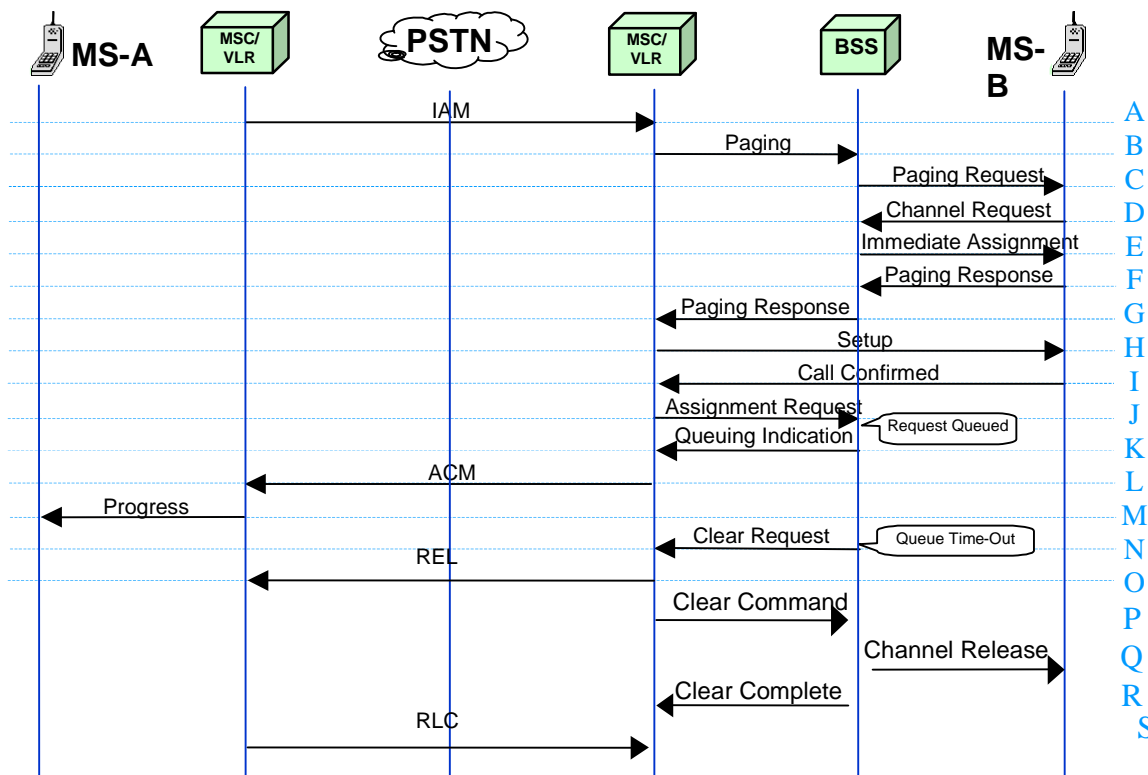

Figure 5.8: Priority Service Mobile Terminated – Queue Time-Out

A-M. Same as described in steps A-M of Clause 5.4.

N If timer T11 expires before an idle radio traffic channel becomes available, the *Assignment Request* message is removed from the queue and a *Clear Request* message is sent to the MSC/VLR with cause "No Radio Resource Available".

O Same as described in step M of Clause 5.6.

P-S Same as described in steps P-S of Clause 5.6

5.9 Priority service call origination – radio resources unavailable and queue full, but higher priority

This clause illustrates a MO Priority Service call establishment with early assignment for a Service User. In this scenario, radio traffic channels are not available when the Priority Service call is attempted, the queue for the cell is full, but the Service User’s Priority Service priority is greater than one or more Priority Service requests already in the queue.

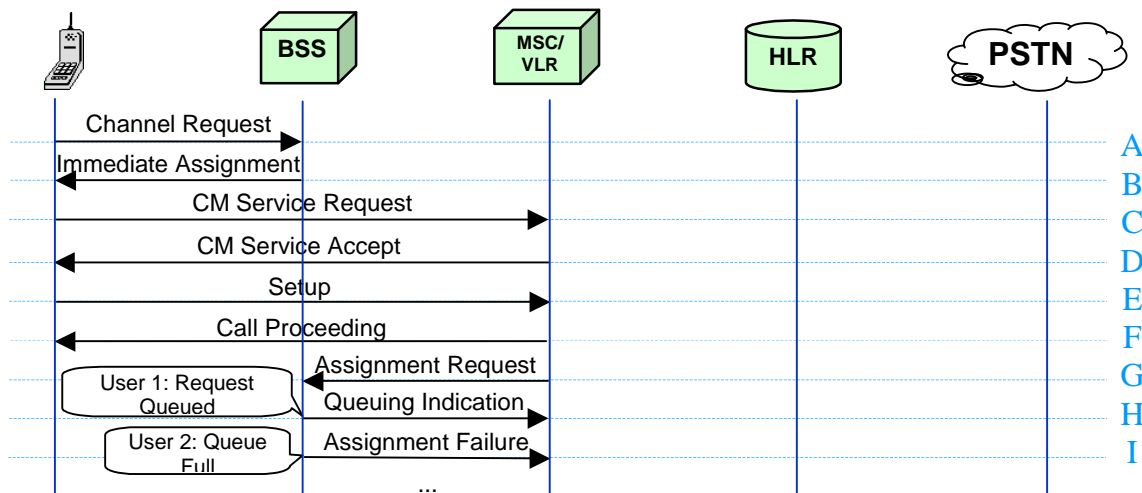

Figure 5.9: Priority Service Mobile Originated – Queue Full, but Higher Priority

A-G. Same as described in steps A-G of Clause 5.1.

H As no idle radio traffic channel is available on receipt of the *Assignment Request*, the queue for the cell is full, and the Service User's Priority Service priority is greater than one or more of the Priority Service requests already in the queue, then the lowest priority, most recent request in the queue is removed from the queue. The new *Assignment Request* message is placed in the queue in accordance with the Service User's priority and call request arrival time at the cell.

- The BSS returns a *Queuing Indication* message to the MSC/VLR for the request that was just queued (User 1 in Figure 5.9) and starts BSSMAP timer T11. The required steps that follow are the same as described in steps I-R of Clause 5.3 if an idle radio traffic channel is available before the BSSMAP timer T11 expires or in steps I-P of Clause 5.7 if the BSSMAP timer T11 expires before an idle radio traffic channel becomes available.

I The BSS initiates the clearing procedure, stops timer T11, and returns an *Assignment Failure* message to the MSC/VLR with cause "No Radio Resource Available" for the request that was removed from the queue (User 2 in Figure 5.9). The required steps that follow are the same as described in steps I-N of Clause 5.5.

5.10 Priority service call termination – radio resources unavailable and queue full, but higher priority

This clause illustrates a MT Priority Service call establishment with early assignment when the incoming Priority Service call to a wireless called party is received at a terminating MSC. In this scenario, radio traffic channels are not available when the incoming Priority Service call is received, the queue for the cell is full, but the call priority is greater than one or more Priority Service requests already in the queue.

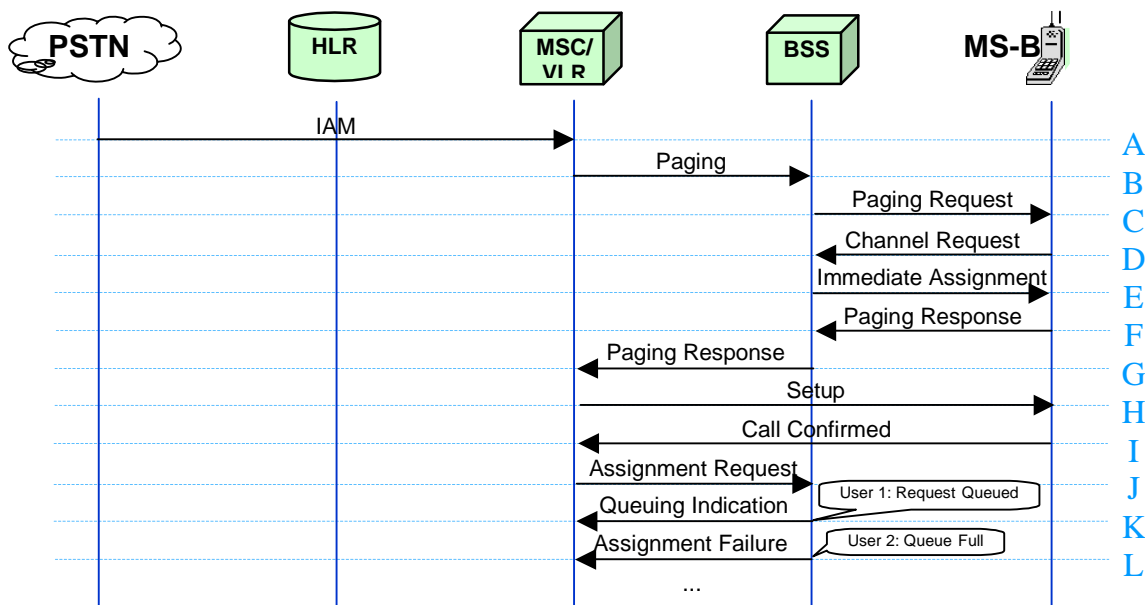

Figure 5.10: Priority Service Mobile Terminated – Queue Full, but Higher Priority

A-J. Same as described in steps A-J of Clause 5.2.

K As no idle radio traffic channel is available on receipt of the *Assignment Request* message, the queue for the cell is full, but the call's priority level is greater than one or more Priority Service requests already in the queue, then the call with the lowest priority, most recent request in the queue is removed from the queue. The new call is placed in the queue in accordance with the call priority and arrival time.

- The BSS returns a *Queuing Indication* message to the MSC/VLR for the request that was just queued (User 1 in Figure 5.10) and starts BSSMAP timer T11. The required steps that follow are the same as described in steps L-V of Clause 5.4 if an idle radio traffic channel is available before the BSSMAP timer T11 expires or in steps L-V of Clause 5.8 if the BSSMAP timer T11 expires before an idle radio traffic channel becomes available.

L The BSS initiates the clearing procedure, stops timer T11, and returns an *Assignment Failure* message to the MSC/VLR with cause "No Radio Resource Available" for the request that was removed from the queue (User 2 in Figure 5.10). The required steps that follow are the same as described in steps L-S of Clause 5.6.

5.11 Priority service call progression – MSC – outgoing trunk queuing

This clause illustrates the call flow for call progression for a Priority Service call with trunk queuing at the originating MSC.

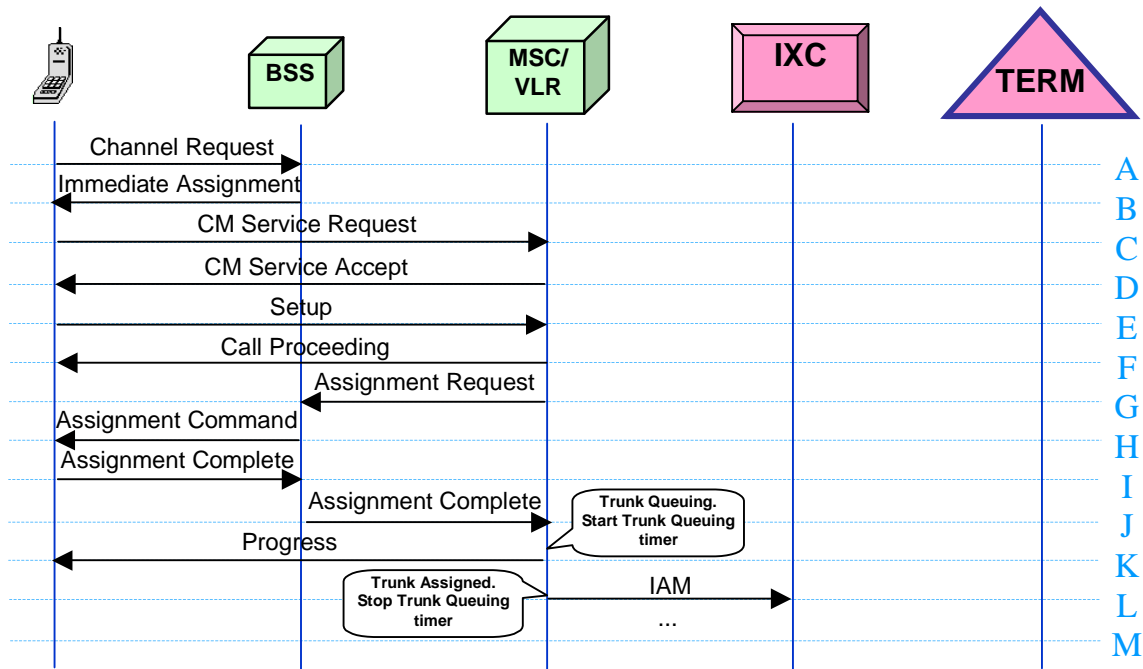

Figure 5.11: Call Progression – MSC – Outgoing Trunk Queuing

A-J. Same as described in steps A-J of Clause 5.1.

K On receipt of the *Assignment Complete* message, the MSC/VLR scans through all trunk groups in the route list for an idle trunk. As no idle outgoing trunk is available on receipt of the *Assignment Complete* message, the MSC/VLR places the call in an outgoing trunk queue based on a First-In, First-Out basis and starts the trunk queuing timer. The MSC/VLR then sends a *Progress* message to the MS. The *Progress* message includes the progress indicator information element with progress description set to #64 "Queuing". On receipt of the *Progress* message, the MS stops all CC timers related to the call, including CC timer T310.

L When an idle outgoing trunk becomes available before the trunk queuing timer expires, the MSC/VLR removes the call from the outgoing trunk queue, stops the trunk queuing timer, and sends an ISUP *IAM* message to the succeeding switch. The MSC/VLR starts ISUP *IAM* timer T7. The ISUP *IAM* message includes the Calling Party's Category parameter set to the IEPS call marking for preferential call set up and the Precedence parameter set based on the initiating Service User's priority level.

The required steps that follow are the same as described in steps L-P of Clause 5.1.

5.12 Priority service call progression – MSC – outgoing trunk queuing – timeout

This clause illustrates the call flow for call progression for a Priority Service call with trunk queuing at the originating MSC but the Priority Service request times out of the trunk queue before a trunk becomes available.

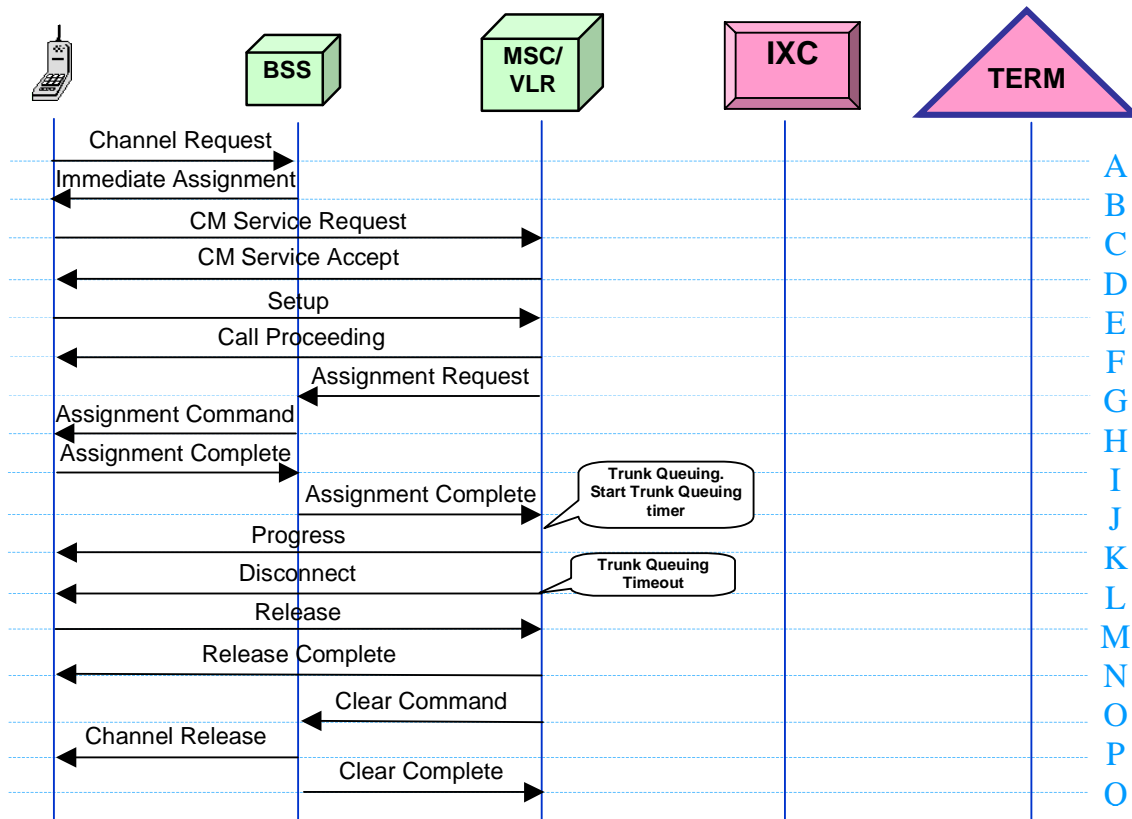

Figure 5.12: Call Progression – MSC – Outgoing Trunk Queuing – Timeout

A-K. Same as described in steps A-K of Clause 5.11.

L. If the trunk queuing timer expires before an idle trunk becomes available, the MSC/VLR removes the call from the outgoing trunk queue. The MSC/VLR then initiates call clearing by stopping all running CC timers, sending a *Disconnect* message to the MS with cause #34 "no circuit/channel available", and starting CC timer T305.

M-N. Same as described in steps J-K of Clause 5.5.

O. On receipt of the *Release Complete* message, the MS stops all running CC timers and releases the MM connection. The MSC/VLR indicates that the radio resource(s) should be released by sending a *Clear Command* message to the BSS with cause "Requested terrestrial resource unavailable".

P-Q. Same as described in steps M-N of Clause 5.5.

5.13 Priority service call attempt by a non-service-user – Priority service denied

This clause illustrates the call setup of a non-Priority Service user attempting a Priority Service call. In this scenario, the user is not subscribed to Priority Service and call setup is not allowed to proceed.

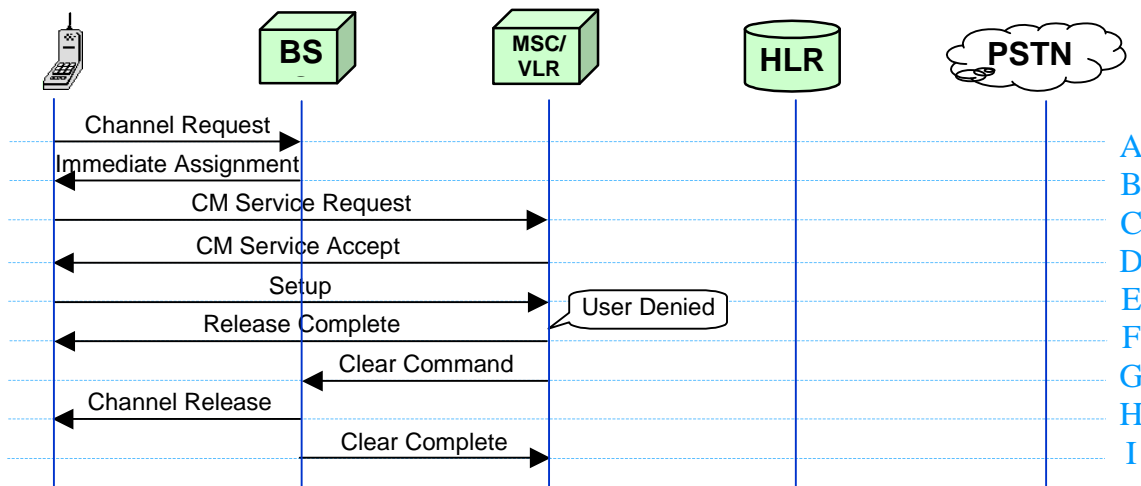

Figure 5.13: Non-Priority Service user – Denied

- A A non-Service User dials the Priority Service prefix (e.g., *272) + Destination Number. The MS sends a *Channel Request* message to the BSS on the RACH channel. Having sent $M + 1$ *Channel Request* messages, the MS starts RR timer T3126. M is the value of the parameter "max retrans" broadcast on the BCCH.
- B-E. Same as described in steps A-E of Clause 5.1.
- F The MSC/VLR detects the Priority Service prefix (e.g., *272) in the dialled digit string. The MSC/VLR determines from the caller's profile that the caller is not a Service User and rejects the request by stopping all running CC timers, responding with a Release Complete message to the MS with cause #63 "Service or option not available, unspecified", and releasing the MM connection.
- G On receipt of the Release Complete message, the MS stops all running CC timers and releases the MM connection. The MSC/VLR indicates that the radio resource(s) should be released by sending a Clear Command message to the BSS with cause "Response to MSC invocation".
- H-I. Same as described in steps M-N of Clause 5.5.

6 Operations, administration, maintenance, and provisioning

This clause specifies the network management and operational aspects of a Priority Service implementation.

6.1 Priority level assignment

A national or regional authority determines who is authorized for Priority Service and assigns Priority Service level(s), if applicable. There should be a uniform assignment of the following values within the national/regional networks.

- Service User Priority Level Assignment [1...n]
- TS 22.011 Access Class
- TS 22.067 eMLPP Priority Level
- TS 48.008 queuing allowed (qa) Value
- Precedence Level in the ISUP Precedence Parameter

6.2 Subscription management

Priority Service is a subscription-based service. Depending on the national/regional process for authorizing Priority Service, a clearly defined working relationship should exist between the subscriber (i.e., Service User), the authorizing

entity/entities, and the Service Provider(s) to ensure that as changes to the Priority Service subscriptions occur (for example, approval/assignment/changes to priority level, revocation of Priority Service authorization, etc.) the subscription information in the HLR is updated.

6.3 Accounting / charging

As Priority Service is a subscription-based service, the subscription information should be sent from a Service Provider's ordering/billing operations support system for provisioning in the HLR.

The Service Provider is responsible for collecting charging information and billing the Service User for Priority Service. Billing could be in the form of a flat fee and/or per call or per minute fees, however this is agreed between the Service Provider and the appropriate national authority.

The Service Provider should be capable of providing a summary account to the national authority, or designated representative, providing Priority Service information. This report might be the bill detailing all the non-recurring charges, if any, incurred for Priority Service for the reporting period, for example, a one-time charge for the establishment of a new Priority Service user.

The report may also contain the following type(s) of information:

- MSISDN
- Service System Identification Number/Billing Identification Number
- Home SID/BID
- Number Dialed
- Destination Location of Call (city, state, country)
- Date of Call
- Start Time
- End Time
- Minutes of Use
- Premium Charge per Minute
- Total Call Charge

The Call Detail Record (CDR) for the Service User should be able to differentiate between normal (non-Priority Service) and Priority Service calls.

6.4 Service provider responsibility

In addition to responsibilities outlined elsewhere in this document and in TR 22.950, Service Providers have the following responsibilities.

- Provide Priority Service in accordance with the national and regional instructions and laws, and adhere to uniform operating access procedures.
- As feasible, provide Priority Service to authorized roaming Service Users.

6.5 Service user responsibility

Priority Service subscribers (i.e., Service Users) are expected to invoke Priority Service during times of emergency and network congestion. If multiple levels are available, they are expected to be assigned and use the lowest level of priority applicable, and to identify their need for Priority Service in a planned method. This means that they try, to the best extent possible, to identify the need for subscription prior to an emergency occurring.

Annex A: Region specific aspects

This Annex describes region specific aspects of Priority Service.

A.1 U.S.A. specific aspects

This subclause describes U.S.A region specific aspects of Priority Service.

A.1.1 Priority level assignment

The sequence of events involved in receiving a Priority Service priority level assignment is as follows:

- A Service User submits a request to their Authorizing Agent for the lowest applicable priority level necessary.
- The Authorizing Agent forwards the request with a recommendation for approval or denial to the national designated authority.
- The National Designated Authority returns the final priority level assignment to the Authorizing Agent as well as provides the Service User information (including assigned priority level) to the Service Provider.
- The Authorizing Agent forwards the final priority assignment information to the Service User to complete the feedback loop.

See [13] for descriptions of Authorizing Agent and National Designated Authority.

A.1.2 Call origination / invocation

Within U.S. networks, a Priority Service call is invoked by dialling *SC + Destination Number, with a Service Code (SC) of "272".

Within U.S. networks, a Service User is assigned one or more Access Classes in the range of 12 – 14 to receive priority access to the network, in addition to an assigned Access Class in the range of 0-9.

A.1.3 Mapping of priority indicators

Within the U.S., there are five Priority Service priority levels. Table A-1 indicates the relationship among Service User Priority Assignment, TS 22.011 Access Classes, TS 22.067 eMLPP Priority Level, TS 48.008 Priority Level, TS 48.008 queuing allowed (qa) Value, and Precedence Level in the ISUP Precedence Parameter for Priority Service.

Table A.1: Mapping of Priority Indicators

Service User Priority Assignment	Access Class(es)	eMLPP Priority Level	48.008 Priority Level	48.008 qa Value	Precedence Level in ISUP Precedence Parameter
1 (highest)	14 and 13 and 12	B	2	1	0
2	14 and 13 and 12	0	3	1	1
3	13 and 12	1	4	1	2
4	13 and 12	2	5	1	3
5 (lowest)	12	3	6	1	4
	0-10	4	Implementation dependent, in the range of 7-14	Implementation Dependent	

Notes:

- a Access Classes 11 and 15 may be used for network internal use.
- b eMLPP Priority Level A may be used for network internal use.
- c TS 48.008 Priority Level 1 may be used for network internal use.

A.1.4 Signalling of priority indicators

Priority assignment for ISUP messages is specified in ANSI T1.111.5, Annex A [10]. For a Priority Service call, MTP message priority of 1 is used for ISUP IAM messages signalled to establish the call.

A Priority Service call invokes the High Probability of Completion (HPC) Network Capability as described in T1.631[11]. The HPC Network Capability sets Calling Party's Category parameter to "NS/EP call" in the ISUP IAM message to indicate that the call has been authorized to receive priority treatment. In the U.S., Service Providers use the "NS/EP call" value and not the IEPS value. For a Priority Service call, the Calling Party's Category parameter value of "NS/EP call" is propagated through the network and signalled to any interconnected network.

Service Provider transit nodes are expected to receive and pass the ISUP IAM message unaltered for all Priority Service calls. This explicitly includes the Calling Party's Category (CPC) parameter, the MTP Priority of the ISUP IAM message, and the ISDN MLPP Precedence Parameter.

For a Priority Service call, the ISUP Precedence parameter is encoded as indicated in Table A.2.

Table A.2: ISUP Precedence Parameter Encoding

Field	Description	Value
Look Ahead for Busy	Indicates whether look ahead for busy is allowed or whether the path has been reserved	Binary "10" (Look Ahead for Busy not allowed)
Precedence Level	Calling Party's Priority Level	Binary, 4 bits "0000" through "0100", based on Calling Party's Priority Level, as assigned to the Service User: Service User priority 1 = Precedence Level 0 (highest priority) Service User priority 2 = Precedence Level 1 Service User priority 3 = Precedence Level 2 Service User priority 4 = Precedence Level 3 Service User priority 5 = Precedence Level 4 (lowest priority)
Network Identity	Telephone Country Code of the originating network	Binary Coded Decimal, 4 digits, "0100" (indicating networks in the U.S.A.)
MLPP Service Domain	Priority Service Domain	Binary, 3 octets: NCS Wireless Priority Service-1 (Decimal 4194891) Binary: 0100 0000 0000 0010 0100 1011 NCS Wireless Priority Service-2 (Decimal 4194892) Binary: 0100 0000 0000 0010 0100 1100 NCS Wireless Priority Service-3 (Decimal 4194893) Binary: 0100 0000 0000 0010 0100 1101 NCS Wireless Priority Service-4 (Decimal 4194894) Binary: 0100 0000 0000 0010 0100 1110 NCS Wireless Priority Service-5 (Decimal 4194895) Binary: 0100 0000 0000 0010 0100 1111

The Precedence parameter includes the Look Ahead for Busy field to indicate whether a TCAP message may be sent prior to call setup to determine whether the called party's line is busy. Recognizing the call setup may be delayed, Priority Service does not support this functionality and the Precedence parameter is encoded accordingly.

The Network Identity (NI) field identifies the network or country which administers the service, not the country from which the call originates. Each digit is coded in binary coded decimal representation from 0 to 9. The first digit of this field is coded 0. The TCC (Telephone Country Code) follows in the second to fourth NI digits (the most significant TCC digit is in the 2nd NI digit). If the TCC is one or two digits long, the excess digit(s) is inserted with the code for the Recognized Operating Agency (ROA) or network identification, if necessary. If the 3rd and 4th NI digits are not required, they are coded all zeros.

The MLPP Service Domain is a 3-octet subfield that carries a code expressing in binary representation the number allocated to an MLPP Service Domain. These numbers are allocated in accordance with the procedures in Annex B, T1.113.3 [12]. The MLPP Service Domain values assigned to the National Communications System (NCS), the National Designated Authority as named in [13], correspond to Service User priority, i.e., NCS Wireless Priority

Service-1 is used for a Service User priority of 1, etc. Therefore, there is no MLPP service interaction among the various levels of Service User priority nor between Priority Service and other services using the Precedence parameter.

For a Priority Service call, it is desirable that all TCAP messages sent during initial call setup associated with the Priority Service call are sent with MTP message priority 2.

A.1.5 Feature interactions

A.1.5.1 eMLPP

For priority treatment, a Service User receives treatment that is compliant with eMLPP service capabilities with the following exceptions, extensions, or clarifications:

- Support for the eMLPP Pre-emption capability is not required and is not supported for Priority Service.

A.1.6 Software access control

Priority Service in the U.S. and U.S. territories is restricted to authorized individuals. Therefore, Service Providers do not implement Priority Service in their networks without an arrangement with the National Designated Authority. To support this restriction, the MSC/VLR should provide the capability to control access to, and activation of, the Priority Services software in the GSM BSS, MSC/VLR and HLR.

Annex B: Use cases

Regarding transfer of priority level information between networks, it is useful to highlight the case of networks having different degrees of service support and different phases of service implementation, such as "a new network supporting both Priority Service and eMLPP", "a new network supporting Priority Service only" and "an old network supporting eMLPP only" respectively. The following parameters are used in use cases.

Types of subscribers

- a) Priority Service subscribers (i.e., Service Users)
- b) eMLPP subscribers
- c) "Normal subscribers", having none of those services

Degrees of service support in networks

- a) Priority Service only networks
- b) eMLPP only networks
- c) Priority Service + eMLPP networks
- d) Networks supporting none of these services

Phases of network implementation

- a) "New" networks supporting the 3GPP standards release where Priority Service + eMLPP is specified
- b) "Old" networks not supporting the 3GPP standards release where Priority Service + eMLPP is specified

Networks involved

- a) Calls within one network
- b) Calls between neighbouring 3GPP networks
- c) Calls passing through intermediate 3GPP networks
- d) Calls passing through intermediate non-3GPP networks

Roaming

- a) Subscribers being in the home network
- b) Subscribers roaming in a visited network

In the following uses cases, to differentiate between Priority Service priority levels and eMLPP priority (precedence) levels respectively, these priority levels are called Priority Service1 – Priority Service5 and eMLPP1 – eMLPP7.

B.1 Priority service call to Priority service subscriber in Priority service + eMLPP network

This use case is intended to illustrate that the new Priority Service + eMLPP functionality fulfils the Priority Service requirements.

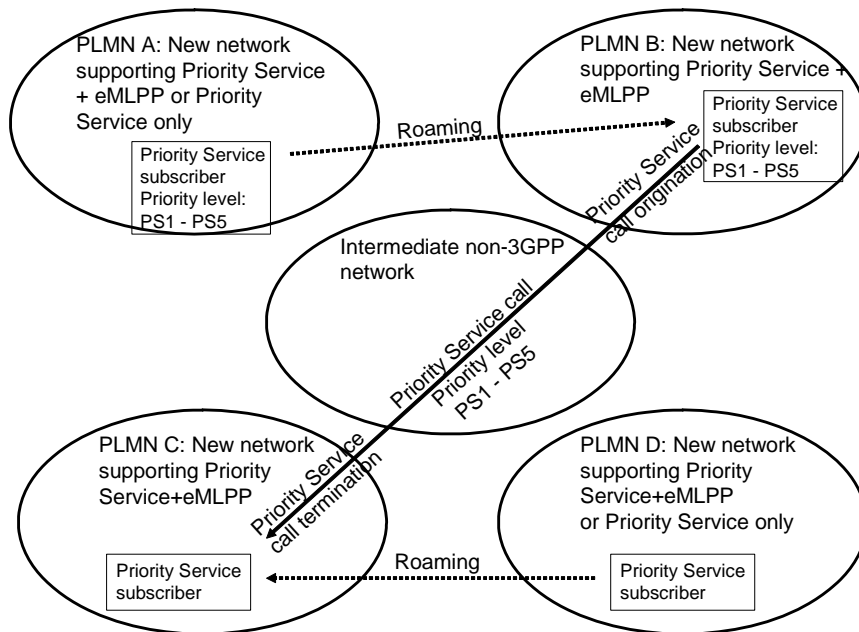

Figure B.1: Priority Service call to Priority Service subscriber in Priority Service + eMLPP network

Use case 1:

- Two Service Users (Priority Service subscribers), each with an assigned Priority Service priority level in the range of Priority Service1 – Priority Service5, belong to two different new networks (A and D) supporting both Priority Service and eMLPP or Priority Service only.
- The Service User roam to two different new networks (the Priority Service subscriber in network A roams to network B and the Priority Service subscriber in network D roams to network C) supporting both Priority Service and eMLPP.
- The Service User who roamed from network A to network B sets up a Priority Service priority call towards the Service User who roamed from network D to network C.
- The call is routed via an intermediate non-3GPP network.

In this use case, the call receives Priority Service treatment (priority access to traffic channels) on the terminating side in (C) according to the Priority Service level Priority Service1 – Priority Service5 as assigned to the Service User calling from (B). Since the end-to-end Priority Service is based on the Priority Service subscription of the calling party, this use case also applies to a called party without Priority Service subscription.

Priority Service calls should not be pre-empted by eMLPP calls.

B.2 eMLPP call to eMLPP subscriber in Priority service + eMLPP network

This use case is intended to illustrate the new Priority Service + eMLPP functionality fulfils the eMLPP requirements.

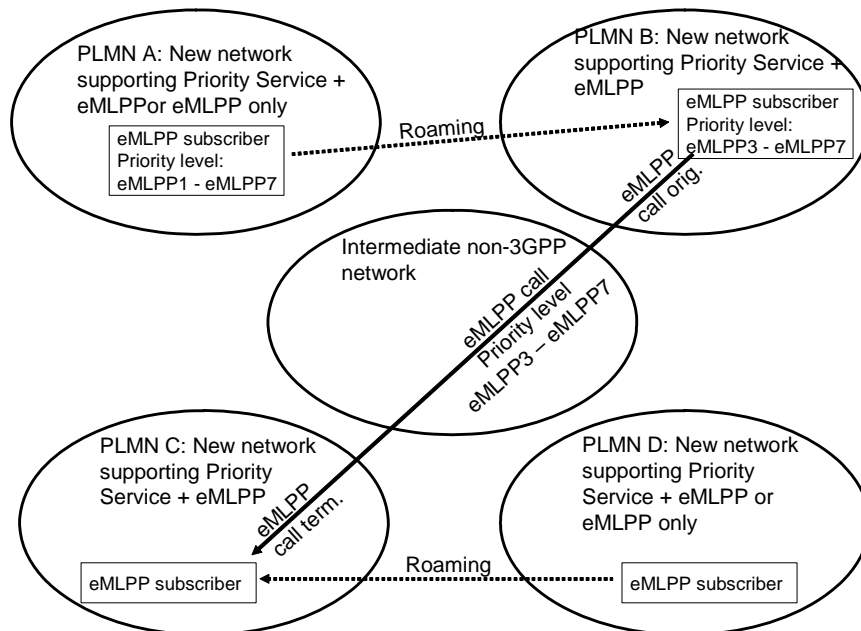

Figure B.2: eMLPP call to eMLPP subscriber in Priority Service + eMLPP network

Use case 2:

- Two eMLPP subscribers, each with assigned maximum and default priority (precedence) levels in the range of eMLPP1 – eMLPP7 belong to two different new networks (A and D) supporting both Priority Service and eMLPP or eMLPP only.
- The eMLPP subscribers roam to two different new networks (B and C) supporting both Priority Service and eMLPP where they will have priority (precedence) levels in the range of eMLPP3 – eMLPP7.
- The eMLPP subscriber in (B) sets up an eMLPP priority call towards the eMLPP subscriber in (C.)
- The call is routed via an intermediate non-3GPP network.

In this use case, the call terminating in (C) is treated as a terminating eMLPP call with the priority level either as requested by the calling subscriber at the call set-up in (B) or, if not requested at call set-up, according to the default priority level assigned to the calling eMLPP subscriber. Since eMLPP Service is based on the eMLPP subscription of the calling party, this use case also applies to a called party without eMLPP subscription.

Priority Service calls should not be pre-empted by eMLPP calls.

B.3 Priority service call to eMLPP subscriber in Priority service only network

This use case is intended to illustrate that Priority Service is not disturbed by eMLPP for terminating Priority Service calls.

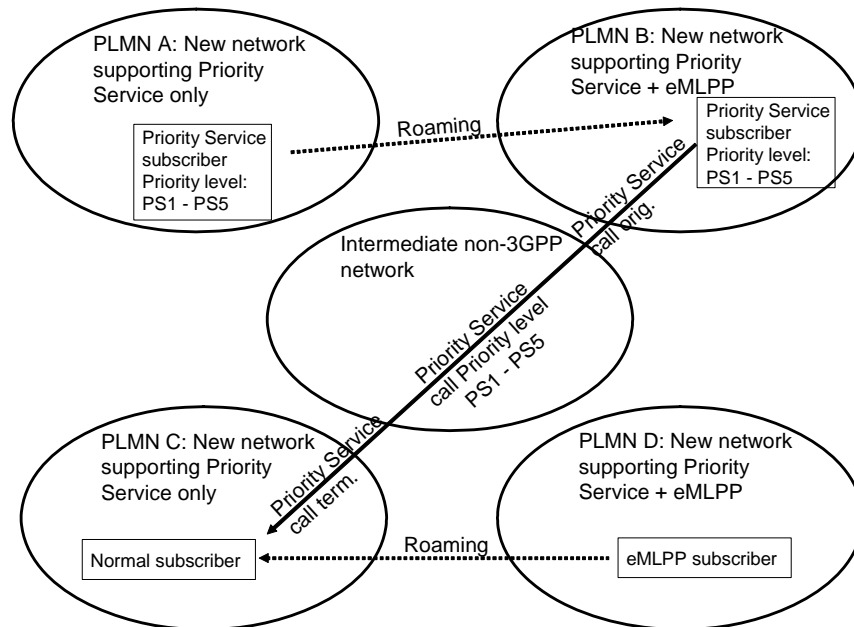

Figure B.3: Priority Service call to eMLPP subscriber in Priority Service only network

Use case 3:

- A Service User with an assigned Priority Service level in the range of Priority Service1 – Priority Service5 belongs to a new network (A) supporting Priority Service only,
- The Service User roams to a new network (B) supporting both Priority Service and eMLPP.
- An eMLPP subscriber with assigned maximum and default priority (precedence) levels in the range of eMLPP1 – eMLPP7 belongs to a new network (D) supporting both Priority Service and eMLPP.
- The eMLPP subscriber roams to a new network (C) supporting Priority Service only.
- The Service User in (B) sets up a Priority Service call towards the eMLPP subscriber in (C).
- The call is routed via an intermediate non-3GPP network.

In this use case, the call receives Priority Service treatment (priority access to traffic channels) on the terminating side in (C) according to the Priority Service level assigned to the calling Service User. The eMLPP subscriber roaming from (D) to (C) is treated as a normal subscriber in (C).

B.4 Normal call to eMLPP subscriber in Priority service only network

This use case is intended to illustrate that Priority Service is not disturbed by eMLPP for normal calls.

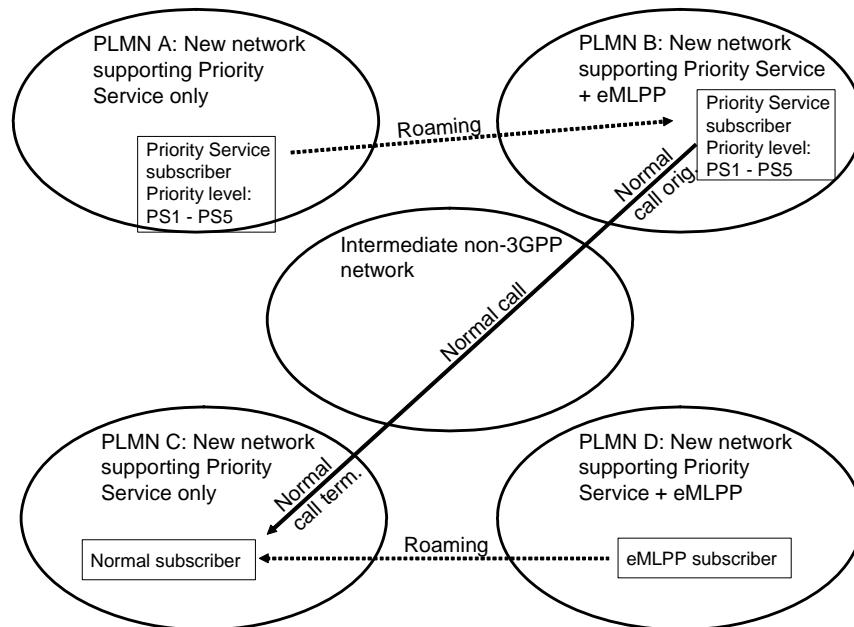

Figure B.4: Normal call to eMLPP subscriber in Priority Service only network

This use case is identical to use case 3, except that here the Priority Service subscriber in (B) initiates a normal call instead of a Priority Service call.

Use case 4:

- A Service User with an assigned Priority Service level in the range of Priority Service1 – Priority Service5 belongs to a new network (A) supporting Priority Service only,
- The Service User roams to a new network (B) supporting both Priority Service and eMLPP.
- An eMLPP subscriber with assigned maximum and default priority (precedence) levels in the range of eMLPP1 – eMLPP7 belongs to a new network (D) supporting both Priority Service and eMLPP.
- The eMLPP subscriber roams to a new network (C) supporting Priority Service only.
- The Service User in (B) sets up a normal call towards the eMLPP subscriber in (C).
- The call is routed via an intermediate non-3GPP network.

In this use case, the call does not receive any priority treatment, neither on the originating side in (B) nor on the terminating side in (C). The eMLPP subscriber roaming from (D) to (C) is treated as a normal subscriber in (C).

B.5 eMLPP call to Priority service subscriber in Priority service + eMLPP network

This use case is intended to illustrate that Priority Service is not disturbed by eMLPP for eMLPP calls.

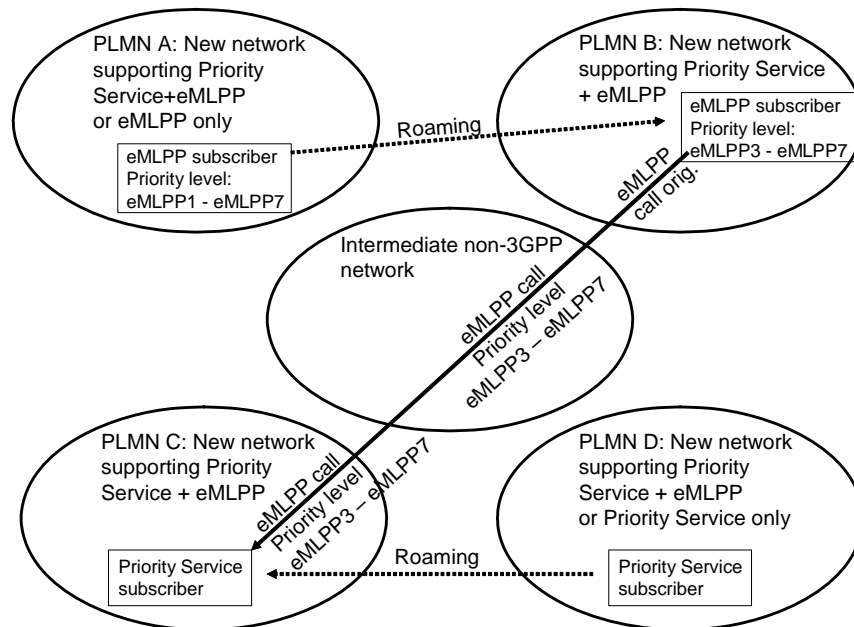

Figure B.5: eMLPP call to Priority Service subscriber in Priority Service + eMLPP network

Use case 5:

- An eMLPP subscriber with assigned maximum and default priority (precedence) levels in the range of eMLPP1 – eMLPP7 belongs to a new network (A) supporting both Priority Service and eMLPP or eMLPP only.
- The eMLPP subscriber roams to a new network (B) supporting both Priority Service and eMLPP where she will have priority (precedence) levels in the range of eMLPP3 – eMLPP7.
- A Service User with an assigned Priority Service level in the range of Priority Service1 – Priority Service5 belongs to a new network (D) supporting Priority Service + eMLPP or Priority Service only.
- The Service User roams to a new network (C) supporting both Priority Service and eMLPP.
- The eMLPP subscriber in (B) sets up an eMLPP call towards the Service User in (C).
- The call is routed via an intermediate non-3GPP network.

In this use case, the call terminating in (C) is treated as a terminating eMLPP call with the priority level either as requested by the calling subscriber at the call set-up in (B) or, if not requested at call set-up, according to the default priority level assigned to the calling eMLPP subscriber. Priority Service calls should not be pre-empted by eMLPP calls.

B.6 eMLPP call to eMLPP subscriber in Priority service + eMLPP network

This use case is intended to illustrate that today's existing eMLPP networks are not disturbed by the new Priority Service + eMLPP functionality.

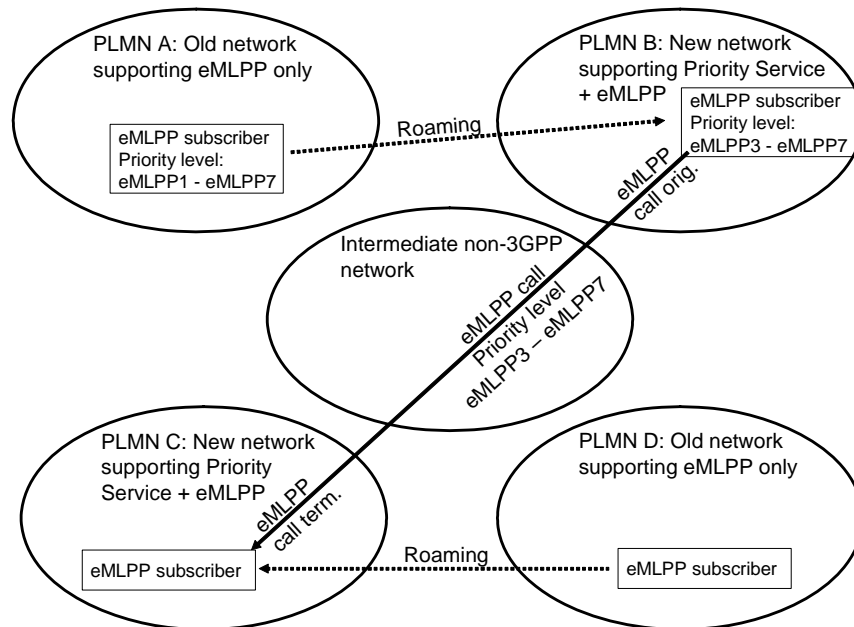

Figure B.6: eMLPP call to eMLPP subscriber in Priority Service + eMLPP network

Use case 6:

- Two eMLPP subscribers each with assigned maximum and default priority (precedence) levels in the range of eMLPP1 - eMLPP7 belong to two different old networks (A and D) supporting eMLPP only.
- The eMLPP subscribers roam to two different new networks supporting both Priority Service and eMLPP (B and C) where they will have priority (precedence) levels in the range of eMLPP3 – eMLPP7.
- The eMLPP subscriber in (B) sets up an eMLPP call towards the eMLPP subscriber in (C).
- The call is routed via an intermediate non-3GPP network.

In this use case, the call terminating in (C) is treated as a terminating eMLPP call with the priority level either as requested by the calling subscriber at the call set-up in (B) or, if not requested at call set-up, according to the default priority level assigned to the calling eMLPP subscriber. Priority Service calls should not be pre-empted by eMLPP calls.

B.7 Normal call to normal subscriber in Priority service + eMLPP network

This use case is intended to illustrate the normal case for a basic call as a reference and for completeness.

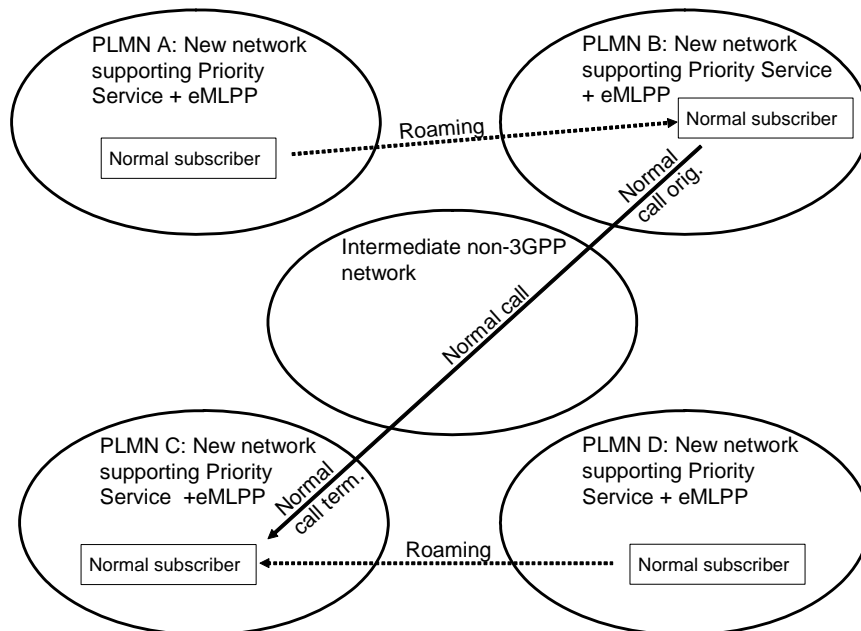

Figure B.7: Normal call to normal subscriber in Priority Service + eMLPP network

Use case 7:

- Two normal subscribers belong to two different new networks (A and D) supporting both Priority Service and eMLPP.
- The subscribers roam to two different new networks (B and C) supporting both Priority Service and eMLPP.
- The subscriber in (B) sets up a normal call towards the subscriber in (C).
- The call is routed via an intermediate non-3GPP network.

In this use case, the call is treated as a normal call in all networks.

B.8 An eMLPP subscriber roams to a Priority service + eMLPP network and initiates a call with the Priority service service code

This use case is intended to illustrate that eMLPP subscribers are not able to initiate Priority Service calls.

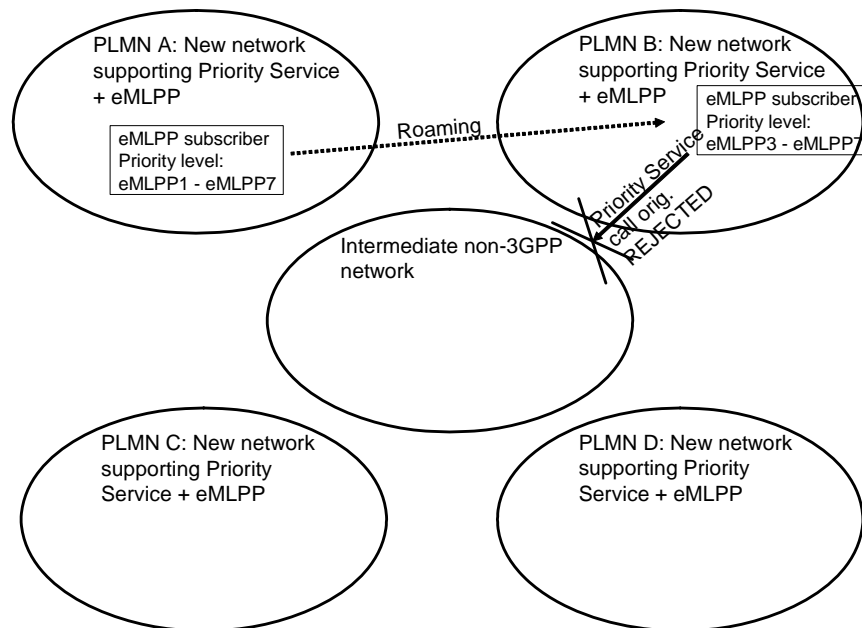

Figure B.8: An eMLPP subscriber roams to a Priority Service + eMLPP network and initiates a call with the Priority Service service code

Use case 8:

- An eMLPP subscriber belongs to a new network (A) supporting both Priority Service and eMLPP.
- The eMLPP subscriber roams to a new network (B) supporting both Priority Service and eMLPP.
- The eMLPP subscriber in (B) tries to initiate a Priority Service call using the Priority Service service code.
- The call set-up is rejected by network (B).

In this use case, the attempted call set-up attempt in (B) is denied as the eMLPP subscriber is not allowed to initiate Priority Service calls.

B.9 Priority call to a subscriber in an eMLPP only network

This use case intended to illustrate how Priority Service calls are treated in a terminating eMLPP network.

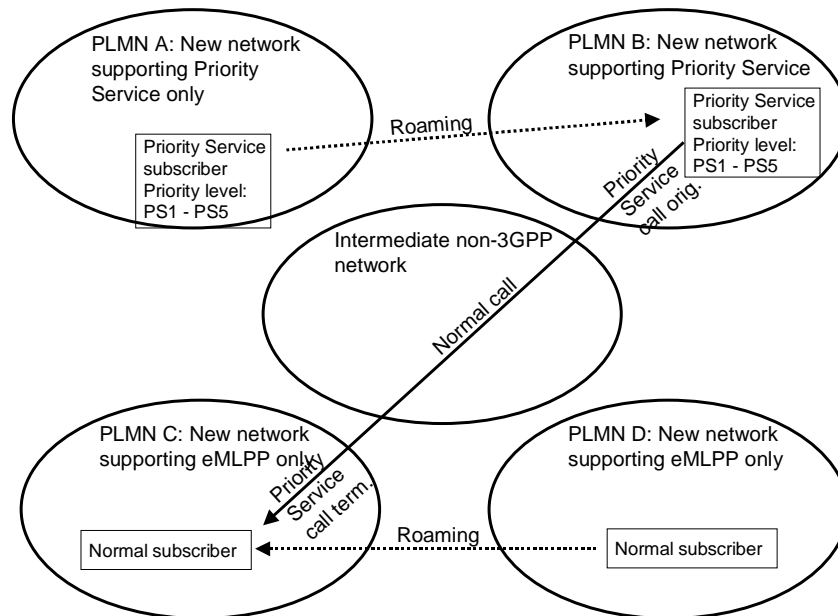

Figure B.9: Priority Service call terminating to an eMLPP network

The Service User in (B) initiates a Priority Service call to a subscriber in an eMLPP network (C).

Use case 9:

- A Service User with an assigned Priority Service level in the range of Priority Service1 to Priority Service5 belongs to network (A) supporting Priority Service only,
- The Service User roams to network (B) supporting Priority Service only.
- The subscriber belonging to network (D) roams to network (C) supporting eMLPP only.
- The Service User in (B) sets up a Priority Service call towards the called subscriber in (C).
- The call is routed via an intermediate non-3GPP network.

In this use case, the call receives Priority Service treatment in (B) and eMLPP treatment in (C). The call is treated based on the MLPP precedence parameter in (C), as specified in [4].

Note: In network (C) the priority service call may have higher priority level than some of the eMLPP calls. However, an incoming eMLPP call to a Priority Service network will not receive any priority treatment since the CPC value would not be set for Priority Service.

Annex C: Distinguishing Priority Service users and eMLPP users

As a Service Provider option, it is proposed that the following mechanism be used for distinguishing Priority Service users and eMLPP users.

Networks (HLR's/MSV's/VLR's) that support the hybrid service (eMLPP and Priority Service) are enhanced to support the prioritySubscription parameter in the EMLPP-Info parameter of the Insert Subscriber Data (ISD) message. The prioritySubscription parameter must be included for Priority Service data. For eMLPP data this parameter is not needed.

eMLPP or Priority Service only networks and/or networks that do not support eMLPP or Priority Service do not need to be changed to support the new prioritySubscription parameter in the ISD message. That is, network operators that do not want to offer the hybrid service (eMLPP and Priority Service) do not have to upgrade their networks.

For outbound roamers (roamers from hybrid networks), the hybrid HLR would make the determination on whether data should be sent to the MSC/VLR. For example, if an eMLPP subscriber defined in the hybrid HLR roams to a Priority Service MSC/VLR, the HLR would not send the EMLPP-Info parameter to the MSC/VLR.

For inbound roamers (roamers to hybrid networks), the hybrid MSC/VLR would make the determination of how to treat the EMLPP-Info parameter if received in the ISD message.

When the MSC/VLR is operating in hybrid mode (i.e., supporting both services), the MSC would need to map eMLPP priorities B – 4 to 48.008 priorities 8-13 respectively as shown in Table C-1.

Table C-1: eMLPP Priority Levels Mapping

eMLPP Priority Levels (in HLR)	48.008 Priority Levels
A	1 (used for Service Technicians)
B	8 (used for Service Technicians)
0	9
1	10
2	11
3	12
4	13

TS 29.002 (ASN.1):

```

EMLPP-Info ::= SEQUENCE {
    maxiumentitledPriority EMLPP-Priority,
    defaultPriority EMLPP-Priority,
    extensionContainer ExtensionContainer OPTIONAL,
    ... ,
    prioritySubscription [0] NULL OPTIONAL
}
    
```

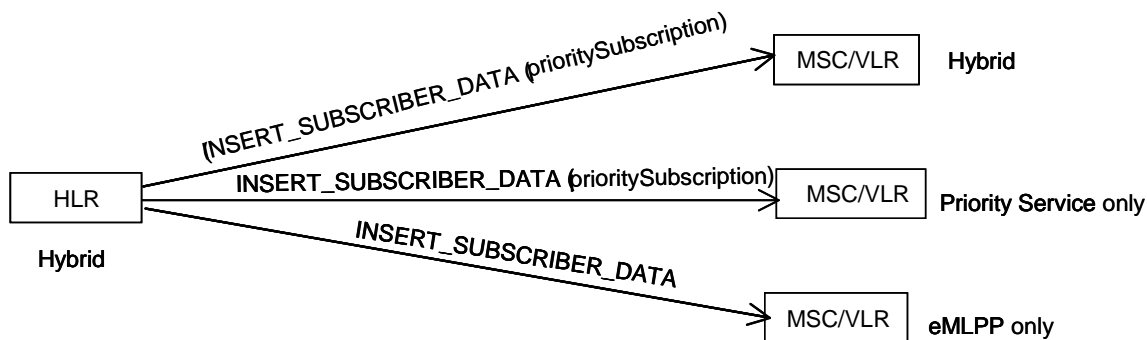

Figure C.2: Hybrid HLR

The following table summarizes the roaming scenarios of a Service User from a hybrid network.

Table C-2: Priority Service user Roaming from a Hybrid Network

MSC/VLR capability	ISD with PrioritySubscription parameter	Comments
Hybrid	Yes	When a Service User roams from one hybrid to another hybrid network, the HLR includes the PrioritySubscription parameter with the subscriber's priority service profile.
Priority Service only	Yes	When a Service User roams from a hybrid to a Priority Service only network, the HLR may include the PrioritySubscription parameter with the Service User's profile, but this parameter is ignored by the Priority Service only MSC/VLR as it does not recognize it. Alternatively the hybrid HLR may (through screening) block the inclusion of the PrioritySubscription parameter in the ISD message as it knows through datafill that it is communicating with a Priority Service only MSC/VLR.
eMLPP only	No	When a Service User roams from a hybrid to a eMLPP only network, the HLR does not send the Service User's profile as through datafill it knows that it is communicating with an eMLPP only MSC/VLR. The roamer will be treated as a normal (non-priority service) user.

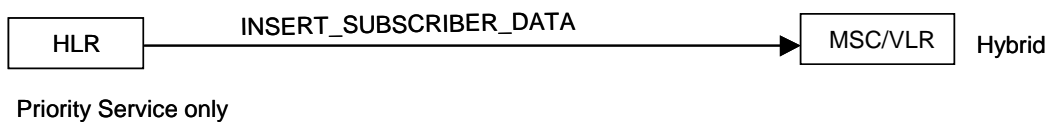

Figure C.3: Non-Hybrid HLR

The following table summarizes the roaming scenario of a Service User roaming to a Hybrid network.

Table C-3: Priority Service user Roaming to a Hybrid Network

MSC/VLR capability	ISD with PrioritySubscription parameter	Comments
Hybrid	Not Applicable	When a Service User roams from a Priority Service only network to a hybrid network, the Priority Service only HLR sends the Service User's profile without the PrioritySubscription parameter as it does not support it. The hybrid MSC/VLR knows through datafill that it is communicating with a Priority Service only HLR and treats the roamer as a Service User.

The following table summarizes the roaming scenarios of an eMLPP user from a hybrid network.

Table C-4: eMLPP User Roaming from a Hybrid Network

MSC/VLR capability	ISD with PrioritySubscription parameter	Comments
Hybrid	Not Applicable	When an eMLPP user roams from one hybrid to another hybrid network, the HLR sends the subscriber's eMLPP profile without the PrioritySubscription parameter as its not needed.
Priority Service only	Not Applicable	When an eMLPP user roams from a hybrid network to a Priority Service only network the HLR will not send the subscriber's eMLPP profile. The roamer will be treated as a normal (non-priority service) user.
eMLPP only	Not Applicable	When an eMLPP user roams from a hybrid network to an eMLPP only network the HLR sends the subscriber's eMLPP profile without the PrioritySubscription parameter as its not needed.

The following table summarizes the roaming scenarios of an eMLPP user to a hybrid network.

Table C-5: eMLPP User Roaming to a Hybrid Network

MSC/VLR capability	ISD with PrioritySubscription parameter	Comments
Hybrid	Not Applicable	When an eMLPP user roams from eMLPP only network to a Hybrid network, the eMLPP only HLR sends the subscriber's eMLPP profile. The hybrid MSC/VLR knows through datafill that it is communicating with an eMLPP only HLR and treats the roamer as an eMLPP roamer.

Annex D (informative): UTRAN to GERAN Redirection

The following Use Cases apply to circuit-switched voice priority call that is redirected from UTRAN to GERAN:

D.1 MO UTRAN to MT UTRAN call

A Service User originates a Priority Service call on UTRAN by dialling *SC + DN. The call completes (MT) to a UTRAN user served by the same 3G_MSC. Sufficient UTRAN resources are available for MO and MT. No handover/reversion occurs.

D.2 MO UTRAN to MT (UTRAN to GERAN reversion) call

A Service User originates a Priority Service call on UTRAN by dialling *SC + DN. Sufficient UTRAN resources are available for MO. Call completion is attempted to a UTRAN user served by the same 3G_MSC; however, UTRAN resource congestion occurs at MT, and the call reverts (handover with cause value "Directed Retry") to GERAN. For MT, the destination user has a dual-mode (UTRAN, GERAN) UE with subscription to both UTRAN and GERAN.

D.3 MO UTRAN to Trunk call

A Service User originates a Priority Service call on UTRAN by dialling *SC + DN. Sufficient UTRAN resources are available for MO. The call is routed on a trunk for a destination not served by the 3G_MSC. No handover/reversion occurs.

D.4 MO (UTRAN to GERAN reversion) to MT UTRAN call

A Service User originates a Priority Service call on UTRAN by dialling *SC + DN. UTRAN resource congestion occurs for MO, and the call reverts (handover with cause value "Directed Retry") to GERAN. Sufficient UTRAN resources are available for MT, and the call completes to a UTRAN user served by the same 3G_MSC.

D.5 MO (UTRAN to GERAN reversion) to MT (UTRAN to GERAN reversion) call

A Service User originates a Priority Service call on UTRAN by dialling *SC + DN. UTRAN resource congestion occurs for MO and the call reverts (handover with cause value "Directed Retry") to GERAN. Call completion is attempted to a UTRAN user served by the same 3G_MSC; however, UTRAN resource congestion occurs for MT, and the call reverts (handover with cause value "Directed Retry") to GERAN. For MT, the destination user has a dual-mode (UTRAN, GERAN) UE with subscription to both UTRAN and GERAN.

D.6 MO (UTRAN to GERAN reversion) to Trunk call

A Service User originates a Priority Service call on UTRAN by dialling *SC + DN. UTRAN resource congestion occurs for MO, and the call reverts (handover with cause value "Directed Retry") to GERAN. The call is routed on a trunk for a destination not served by the 3G_MSC.

D.7 Incoming NS/EP (trunk) to MT UTRAN call

The 3G MSC receives an incoming NS/EP call on a trunk with ISUP signalling. Sufficient UTRAN resources are available for MT, and the call completes to a UTRAN user served by the same 3G_MSC.

D.8 Incoming NS/EP (trunk) to MT (UTRAN to GERAN reversion) call

The 3G_MSC receives an incoming NS/EP call on a trunk with ISUP signalling. Call completion is attempted to a UTRAN user served by the same 3G_MSC; however, UTRAN resource congestion occurs for MT, and the call reverts (handover with cause value "Directed Retry") to GERAN. For MT, the destination user has a dual-mode (UTRAN, GERAN) UE with subscription to both UTRAN and GERAN.

D.9 MO UTRAN to MT (UTRAN to GERAN reversion) call, exception UE single mode

A Service User originates a Priority Service call on UTRAN by dialling *SC + DN. Sufficient UTRAN resources are available for MO. Call completion is attempted to a UTRAN user served by the same 3G_MSC; however, UTRAN resource congestion occurs for MT, and the call reverts (handover with cause value "Directed Retry") to GERAN. For MT, the destination user has a single-mode (UTRAN) UE, hence the handover fails.

D.10 MO UTRAN to MT (UTRAN to GERAN reversion) call, exception only UTRAN Subscription

A Service User originates a Priority Service call on UTRAN by dialling *SC + DN. Sufficient UTRAN resources are available for MO. Call completion is attempted to a UTRAN user served by the same 3G_MSC; however, UTRAN resource congestion occurs for MT, and the call reverts (handover with cause value "Directed Retry") to GERAN. For MT, the destination user has a dual-mode (UTRAN, GERAN) UE with subscription only to UTRAN, hence the handover fails.

Annex E: Change history

Change history											
TSG SA#	SA Doc.	SA1 Doc	Spec	CR	Rev	Rel	Cat	Subject/Comment	Old	New	WI
Jan. 2003		S1-030041	ab.cde					Initial draft presented at SA1#19	0.0.0	0.1.0	PRIOR
Mar. 2003		S1-030312						Incorporated results from SA1#19	0.1.0	0.2.0	PRIOR
April 2003		S1-030380						Incorporated results from 6-March-2003 conference call	0.3.0	0.4.0	PRIOR
May 2003		S1-030578						Incorporated results from SA1#20 (from S1-030486 and S1-030364)	0.4.0	0.5.0	PRIOR
July 2003 (input)		S1-030709	22.952			Rel6		Incorporated results from SA1#21-SWG meeting (from S1-030579, and S1-030580, S1-030581, S1-030584, S1-030639, as modified by meeting discussions)	0.5.0	0.6.0	PRIOR
July 2003 (output)		S1-030897	22.952			Rel6		Incorporated results from SA1#21 meeting (from S1-030710, S1-030711, S1-030757, S1-030821, and S1-030896, as modified by meeting discussions)	0.6.0		PRIOR
July 2003 (SA1 approved)		S1-030941	22.952			Rel6		Approved by SA1 to send to TSG-SA for information	1.0.0		PRIOR
October 2003 (SA1 approved)		S1-031249	22.952			Rel6		Approved by SA1 to send to TSG-SA #22 for approval	1.0.0	2.0.0	PRIOR
SP-22		S1-031249	22.952			Rel6		Approved by TSG-SA #22	2.0.0	6.0.0	PRIOR
SP-24	SP-040297	S1-040522	22.952	0001	-	Rel-6	F	TR 22.952 - Correction to Figure 5.7: Priority Service Mobile Originated – Queue Time-Out	6.0.0	6.1.0	PRIOR
SP-24	SP-040297	S1-040523	22.952	0002	-	Rel-6	F	TR 22.952 - Correction to Figure 5.8: Priority Service Call Termination – Radio Resources Unavailable and Queue Time-Out	6.0.0	6.1.0	PRIOR
SP-24	SP-040297	S1-040524	22.952	0003	-	Rel-6	F	Change of TS 08.08 reference to 48.008	6.0.0	6.1.0	PRIOR
SP-26	SP-040733	S1-040980	22.952	0004	-	Rel-6	F	Priority Service optional support for Emergency Service	6.1.0	6.2.0	PRIOR
SP-29	SP-050512	S1-050885	22.952	0005	-	Rel-6	F	Proposed addition to Directed Retry in TR22.952	6.2.0	6.3.0	PRIOR
SP-32	SP-060304	S1-060650	22.952	0006	-	Rel-6	F	Addition of UTRAN to GERAN Redirection related text to 22.952	6.3.0	6.4.0	PIOR-SR
SP-36			22.952			Rel-7		Updated from Rel-6 to Rel-7	6.4.0	7.0.0	
SP-42	-	-	22.952			Rel-8		Updated from Rel-7 to Rel-8	7.0.0	8.0.0	
SP-46	-	-	-	-	-	-	-	Updated to Rel-9 by MCC	8.0.0	9.0.0	
2011-03	-	-	-	-	-	-	-	Update to Rel-10 version (MCC)	9.0.0	10.0.0	
2012-09	-	-	-	-	-	-	-	Updated to Rel-11 by MCC	10.0.0	11.0.0	
2014-10								Updated to Rel-12 by MCC	11.0.0	12.0.0	
2015-12	-	-	-	-	-	-	-	Updated to Rel-13 by MCC	12.0.0	13.0.0	
2017-03	-	-	-	-	-	-	-	Updated to Rel-14 by MCC	13.0.0	14.0.0	

History

Document history		
V14.0.0	March 2017	Publication