



TECHNICAL REPORT

**Speech and multimedia Transmission Quality (STQ);
Guidance on objectives for Quality related Parameters
at VoIP Segment-Connection Points;
A support to NGN transmission planners**

Reference

RTR/STQ-239

Keywords

planning, quality, transmission, voice

ETSI

650 Route des Lucioles
F-06921 Sophia Antipolis Cedex - FRANCE

Tel.: +33 4 92 94 42 00 Fax: +33 4 93 65 47 16

Siret N° 348 623 562 00017 - NAF 742 C
Association à but non lucratif enregistrée à la
Sous-Préfecture de Grasse (06) N° 7803/88

Important notice

The present document can be downloaded from:

<http://www.etsi.org>

The present document may be made available in electronic versions and/or in print. The content of any electronic and/or print versions of the present document shall not be modified without the prior written authorization of ETSI. In case of any existing or perceived difference in contents between such versions and/or in print, the only prevailing document is the print of the Portable Document Format (PDF) version kept on a specific network drive within ETSI Secretariat.

Users of the present document should be aware that the document may be subject to revision or change of status. Information on the current status of this and other ETSI documents is available at

<http://portal.etsi.org/tb/status/status.asp>

If you find errors in the present document, please send your comment to one of the following services:

http://portal.etsi.org/chaicor/ETSI_support.asp

Copyright Notification

No part may be reproduced or utilized in any form or by any means, electronic or mechanical, including photocopying and microfilm except as authorized by written permission of ETSI.

The content of the PDF version shall not be modified without the written authorization of ETSI.

The copyright and the foregoing restriction extend to reproduction in all media.

© European Telecommunications Standards Institute 2014.

All rights reserved.

DECT™, **PLUGTESTS™**, **UMTS™** and the ETSI logo are Trade Marks of ETSI registered for the benefit of its Members. **3GPP™** and **LTE™** are Trade Marks of ETSI registered for the benefit of its Members and of the 3GPP Organizational Partners.

GSM® and the GSM logo are Trade Marks registered and owned by the GSM Association.

Contents

Intellectual Property Rights	6
Foreword.....	6
Modal verbs terminology.....	6
Introduction	6
1 Scope	7
2 References	7
2.1 Normative references	7
2.2 Informative references.....	7
3 Definitions and abbreviations.....	10
3.1 Definitions.....	10
3.2 Abbreviations	10
4 Reference Configuration	12
4.1 Generic Segment-connection Points.....	13
4.2 Transport Reference Parameters and Configurations	15
4.2.1 Reference Configurations	15
4.2.1.1 Backbone Configuration	15
4.2.1.2 PSTN/ISDN classic access Configuration	15
4.2.1.3 NGN PSTN/ISDN access Configuration	15
4.2.1.4 Access DSL/Ethernet Configuration	16
4.2.1.5 GSM Access configuration	16
4.2.1.6 Access configuration from UMTS Release 4.....	16
4.2.1.7 Access configuration from LTE.....	16
4.2.1.8 CPE reference configuration	17
4.3 Delay Values	17
4.3.1 Backbone Delay.....	17
4.4 Network parameters: End-to-End Delay, Talker Echo Loudness Rating, R Value	19
4.4.1 Delay with regional propagation delay (1 400 km / 7 ms).....	19
4.4.2 Categories of User Satisfaction.....	23
5 Guidance on Segment-connection Voice Quality Objectives	24
5.1 Guidance on Access Segment Objectives	24
5.2 Guidance on Total Transit Segment Objectives	25
5.2.1 Availability	25
5.3 Voice Terminals	25
5.4 End-to-End Aspects.....	25
6 Possible Implications due to other services.....	27
7 Synchronization of endpoints.....	27
8 Transmission of fax and modem	27
Annex A: Summary of Relevant Transmission Planning Data.....	28
A.1 Delay in VoIP Terminals.....	28
A.1.1 Send Delay	28
A.1.2 Receive delay	28
A.2 Network QoS Classes for Voice Applications	29
A.3 Comparison of Codecs, Link Speed and Capacity examples	30
A.4 Transport Reference Parameters	31
A.4.1 Backbone Parameters	31
A.4.2 Network and Access Parameters	32
A.4.3 Delay and Jitter Values.....	34

A.4.3.1	Configuration examples	39
A.4.4	GSM Access	48
A.4.5	UMTS Release 4 Access	48
A.4.6	LTE Access	49
Annex B:	Bandwidth calculations and prioritization in VoIP systems	51
Annex C:	Test templates for Voice applications based on the present document.....	54
C.1	Configuration: MSAN POTS - MSAN POTS.....	55
C.1.1	Configuration: MSAN POTS - MSAN POTS; Application: Voice	55
C.1.2	Configuration: MSAN POTS - MSAN POTS; Application: Fax, bit rate $\leq 14,4$ kbit/s	56
C.1.3	Configuration: MSAN POTS - MSAN POTS; Application: Fax, bit rate $> 14,4$ kbit/s.....	56
C.1.4	Configuration: MSAN POTS - MSAN POTS; Application: Modem V.32/V.32 bis - start procedure; handshake according V.25 without phase reversals	57
C.1.5	Configuration: MSAN POTS - MSAN POTS; Application: Modem, V.32/V.32 bis - start procedure; handshake according V.8 with phase reversals	58
C.2	Configuration: MSAN POTS - POTS	59
C.2.1	Configuration: MSAN POTS - POTS; Application: Voice.....	59
C.2.2	Configuration: MSAN POTS - POTS; Application: Fax, bit rate $\leq 14,4$ kbit/s	60
C.2.3	Configuration: MSAN POTS - POTS; Application: Fax, bit rate $> 14,4$ kbit/s	60
C.2.4	Configuration: MSAN POTS - POTS; Application: Modem, V.32/V.32 bis - start procedure; handshake according V.25 without phase reversals	61
C.2.5	Configuration: MSAN POTS - POTS; Application: Modem, V.32/V.32 bis - start procedure; handshake according V.8 with phase reversals	62
C.3	Configuration: POTS - MSAN POTS	63
C.3.1	Configuration: POTS - MSAN POTS; Application: Voice.....	63
C.3.2	Configuration: POTS - MSAN POTS; Application: Fax, bit rate $\leq 14,4$ kbit/s	64
C.3.3	Configuration: POTS - MSAN POTS; Application: Fax, bit rate $> 14,4$ kbit/s	64
C.3.4	Configuration: POTS - MSAN POTS; Application: Modem V.32/V.32 bis - start procedure; handshake according V.25 without phase reversals	65
C.3.5	Configuration: POTS - MSAN POTS; Application: Modem, V.32/V.32 bis - start procedure; handshake according V.8 with phase reversals	66
C.4	Configuration: DSL - DSL	67
C.4.1	Configuration: DSL - DSL; Application: POTS - POTS/Voice.....	67
C.4.2	Configuration: DSL - DSL; Application: POTS - POTS/Fax, bit rate $\leq 14,4$ kbit/s	67
C.4.3	Configuration: DSL - DSL; Application: POTS - POTS/Fax, bit rate $> 14,4$ kbit/s	68
C.4.4	Configuration: DSL - DSL; Application: POTS - POTS/Modem, V.32/V.32 bis - start procedure; handshake according V.25 without phase reversals	69
C.4.5	Configuration: DSL - DSL; Application: POTS - POTS/Modem, V.32/V.32 bis - start procedure; handshake according V.8 with phase reversals	70
C.5	Configuration: MSAN - DSL	71
C.5.1	Configuration: MSAN - DSL; Application: POTS - POTS/Voice.....	71
C.5.2	Configuration: MSAN - DSL; Application: POTS - POTS/Fax, bit rate $\leq 14,4$ kbit/s	72
C.5.3	Configuration: MSAN - DSL; Application: POTS - POTS/Fax, bit rate $> 14,4$ kbit/s	72
C.5.4	Configuration: MSAN - DSL; Application: POTS - POTS/Modem, V.32/V.32 bis - start procedure; handshake according V.25 without phase reversals	73
C.5.5	Configuration: MSAN - DSL; Application: POTS - POTS/Modem, V.32/V.32 bis - start procedure; handshake according V.8 with phase reversals	74
C.6	Configuration: DSL - MSAN	75
C.6.1	Configuration: MSAN - DSL; Application: POTS - POTS/Voice.....	75
C.6.2	Configuration: DSL - MSAN; Application: POTS - POTS/Fax, bit rate $\leq 14,4$ kbit/s	75
C.6.3	Configuration: DSL - MSAN; Application: POTS - POTS/Fax, bit rate $> 14,4$ kbit/s	76
C.6.4	Configuration: DSL - MSAN; Application: POTS - POTS/Modem, V.32/V.32 bis - start procedure; handshake according V.25 without phase reversals	77
C.6.5	Configuration: DSL - MSAN; Application: POTS - POTS/Modem, V.32/V.32 bis - start procedure; handshake according V.8 with phase reversals	78
C.7	Configuration: POTS - DSL.....	79
C.7.1	Configuration: POTS - DSL; Application: Voice	79

C.7.2	Configuration: POTS - DSL; Application: Fax, bit rate $\leq 14,4$ kbit/s	80
C.7.3	Configuration: POTS - DSL; Application: Fax, bit rate $> 14,4$ kbit/s	80
C.7.4	Configuration: POTS - DSL; Application: Modem, V.32/V.32 bis - start procedure; handshake according V.25 without phase reversals	81
C.7.5	Configuration: POTS - DSL; Application: Modem, V.32/V.32 bis - start procedure; handshake according V.8 with phase reversals	82
C.8	Configuration: DSL - POTS	83
C.8.1	Configuration: DSL - POTS; Application: Voice	83
C.8.2	Configuration: DSL - POTS; Application: Fax, bit rate $\leq 14,4$ kbit/s	84
C.8.3	Configuration: DSL - POTS; Application: Fax, bit rate $> 14,4$ kbit/s	84
C.8.4	Configuration: DSL - POTS; Application: Modem, V.32/V.32 bis - start procedure; handshake according V.25 without phase reversals	85
C.8.5	Configuration: DSL - POTS; Application: Modem, V.32/V.32 bis - start procedure; handshake according V.8 with phase reversals	86
C.9	Configuration: MSAN ISDN - MSAN ISDN	87
C.9.1	Configuration: MSAN ISDN - MSAN ISDN; Application: Voice	87
C.9.2	Configuration: MSAN ISDN - MSAN ISDN; Application: Fax, bit rate $\leq 14,4$ kbit/s	88
C.9.3	Configuration: MSAN ISDN - MSAN ISDN; Application: Fax, bit rate $> 14,4$ kbit/s	88
C.9.4	Configuration: MSAN ISDN - MSAN ISDN; Application: Modem, V.32/V.32 bis - start procedure; handshake according V.25 without phase reversals	89
C.9.5	Configuration: MSAN ISDN - MSAN ISDN; Application: Modem, V.32/V.32 bis - start procedure; handshake according V.8 with phase reversals	90
C.10	Configuration: ISDN - MSAN ISDN	91
C.10.1	Configuration: ISDN - MSAN ISDN; Application: Voice	91
C.10.2	Configuration: ISDN - MSAN ISDN; Application: Fax, bit rate $\leq 14,4$ kbit/s	92
C.10.3	Configuration: ISDN - MSAN ISDN; Application: Fax, bit rate $> 14,4$ kbit/s	92
C.10.4	Configuration: ISDN - MSAN ISDN; Application: Modem, V.32/V.32 bis - start procedure; handshake according V.25 without phase reversals	93
C.10.5	Configuration: ISDN - MSAN ISDN; Application: Modem, V.32/V.32 bis - start procedure; handshake according V.8 with phase reversals	94
C.11	Configuration: MSAN ISDN - ISDN	95
C.11.1	Configuration: MSAN ISDN - ISDN; Application: Voice	95
C.11.2	Configuration: MSAN ISDN - ISDN; Application: Fax, bit rate $\leq 14,4$ kbit/s	96
C.11.3	Configuration: MSAN ISDN - ISDN; Application: Fax, bit rate $> 14,4$ kbit/s	96
C.11.4	Configuration: MSAN ISDN - ISDN; Application: Modem, V.32/V.32 bis - start procedure; handshake according V.25 without phase reversals	97
C.11.5	Configuration: MSAN ISDN - ISDN; Application: Modem, V.32/V.32 bis - start procedure; handshake according V.8 with phase reversals	98
Annex D:	Bibliography	99
History		100

Intellectual Property Rights

IPRs essential or potentially essential to the present document may have been declared to ETSI. The information pertaining to these essential IPRs, if any, is publicly available for **ETSI members and non-members**, and can be found in ETSI SR 000 314: *"Intellectual Property Rights (IPRs); Essential, or potentially Essential, IPRs notified to ETSI in respect of ETSI standards"*, which is available from the ETSI Secretariat. Latest updates are available on the ETSI Web server (<http://ipr.etsi.org>).

Pursuant to the ETSI IPR Policy, no investigation, including IPR searches, has been carried out by ETSI. No guarantee can be given as to the existence of other IPRs not referenced in ETSI SR 000 314 (or the updates on the ETSI Web server) which are, or may be, or may become, essential to the present document.

Foreword

This Technical Report (TR) has been produced by ETSI Technical Committee Speech and multimedia Transmission Quality (STQ).

Modal verbs terminology

In the present document "**shall**", "**shall not**", "**should**", "**should not**", "**may**", "**may not**", "**need**", "**need not**", "**will**", "**will not**", "**can**" and "**cannot**" are to be interpreted as described in clause 3.2 of the [ETSI Drafting Rules](#) (Verbal forms for the expression of provisions).

"**must**" and "**must not**" are **NOT** allowed in ETSI deliverables except when used in direct citation.

Introduction

The present document is intended to fill a gap in a field where the industry has expressed an urgent need for standardized objectives. Based on the assumption that voice over IP services with the goal of users being satisfied or even very satisfied with the overall voice communication quality, the present document provides initial guidance on voice quality related parameters and respective objectives for interconnected networks.

The present document forms part of STQ's roadmap with respect to quality aspects of NGN.

1 Scope

The present document provides guidance on the quality parameters that need to be considered at the Segment-connection of Voice over IP (VoIP) services and provides guidance on objectives for these parameters.

Inside the TISPAN NGN overall architecture (see figure 1), the present document considers only the transport layer.

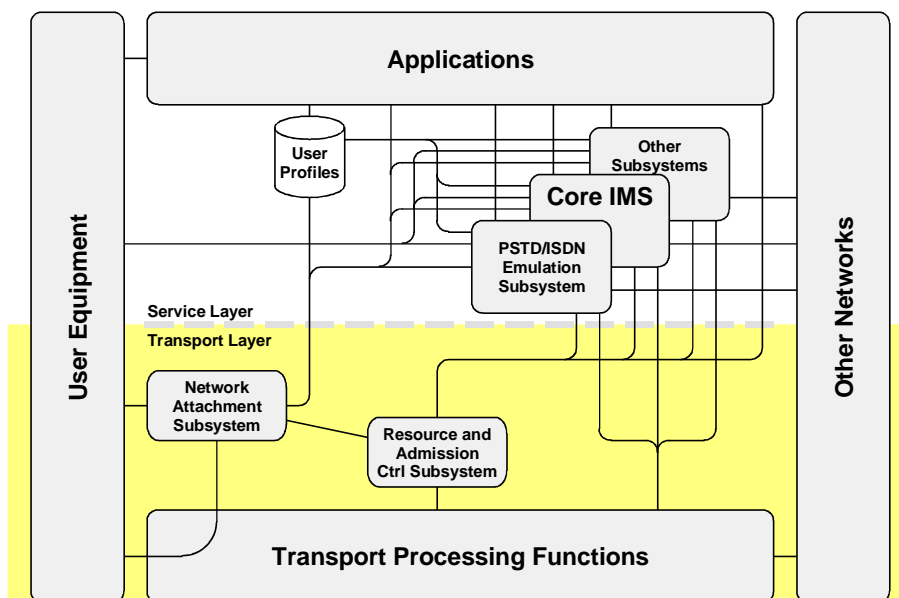

Figure 1: TISPAN NGN overall architecture (adapted from [i.14])

2 References

References are either specific (identified by date of publication and/or edition number or version number) or non-specific. For specific references, only the cited version applies. For non-specific references, the latest version of the reference document (including any amendments) applies.

Referenced documents which are not found to be publicly available in the expected location might be found at <http://docbox.etsi.org/Reference>.

NOTE: While any hyperlinks included in this clause were valid at the time of publication ETSI cannot guarantee their long term validity.

2.1 Normative references

The following referenced documents are necessary for the application of the present document.

Not applicable.

2.2 Informative references

The following referenced documents are not necessary for the application of the present document but they assist the user with regard to a particular subject area.

- [i.1] Recommendation ITU-T Y.1540 (2002): "Internet protocol data communication service - IP packet transfer and availability performance parameters".

- [i.2] Recommendation ITU-T Y.1541 (2006): "Network performance objectives for IP-based services".
- [i.3] Recommendation ITU-T Y.1542 (2006): "Framework for achieving end-to-end IP performance objectives".
- [i.4] Recommendation ITU-T G.107 (2008): "The E-model: a computational model for use in transmission planning".
- [i.5] Recommendation ITU-T G.108 (1999): "Application of the E-model: A planning guide".
- [i.6] Recommendation ITU-T G.109 (1999): "Definition of categories of speech transmission quality".
- [i.7] Void.
- [i.8] Void.
- [i.9] Recommendation ITU-T G.1020 (2006): "Performance parameter definitions for quality of speech and other voiceband applications utilizing IP networks".
- [i.10] ETSI ES 202 737: "Speech and multimedia Transmission Quality (STQ); Transmission requirements for narrowband VoIP terminals (handset and headset) from a QoS perspective as perceived by the user".
- [i.11] ETSI ES 202 738: "Speech and multimedia Transmission Quality (STQ); Transmission requirements for narrowband VoIP loudspeaking and handsfree terminals from a QoS perspective as perceived by the user".
- [i.12] ETSI ES 202 739: "Speech and multimedia Transmission Quality (STQ); Transmission requirements for wideband VoIP terminals (handset and headset) from a QoS perspective as perceived by the user".
- [i.13] ETSI ES 202 740: "Speech and multimedia Transmission Quality (STQ); Transmission requirements for wideband VoIP loudspeaking and handsfree terminals from a QoS perspective as perceived by the user".
- [i.14] ETSI ES 282 001: "Telecommunications and Internet converged Services and Protocols for Advanced Networking (TISPAN); NGN Functional Architecture".
- [i.15] GSMA Document IR.3445: "Inter-Service Provider IP Backbone Guidelines".
- [i.16] Recommendation ITU-T G.8261 (2008): "Timing and synchronization aspects in packet networks".
- [i.17] Recommendation ITU-T G.8262 (2007): "Timing characteristics of synchronous ethernet equipment slave clock (EEC)".
- [i.18] Recommendation ITU-T G.8264 (2008): "Timing distribution through packet networks".
- [i.19] IEEE 1588: "Standard for a Precision Clock Synchronization Protocol for Networked Measurement and Control System".
- [i.20] Recommendations ITU-T of the P.862-series: "Perceptual evaluation of speech quality (PESQ): An objective method for end-to-end speech quality assessment of narrow-band telephone networks and speech codecs".
- [i.21] Recommendation ITU-T P.834: "Methodology for the derivation of equipment impairment factors from instrumental models".
- [i.22] Recommendation ITU-T G.711: "Pulse code modulation (PCM) of voice frequencies".
- [i.23] Recommendation ITU-T G.726: "40, 32, 24, 16 kbit/s Adaptive Differential Pulse Code Modulation (ADPCM)".
- [i.24] Void.
- [i.25] Void.

- [i.26] Recommendation ITU-T G.729: "Coding of speech at 8 kbit/s using conjugate-structure algebraic-code-excited linear prediction (CS-ACELP)".
- [i.27] Recommendation ITU-T I.231.1: "Circuit-mode bearer service categories: Circuit-mode 64 kbit/s unrestricted, 8 kHz structured bearer service".
- [i.28] Recommendation ITU-T G.826: "End-to-end error performance parameters and objectives for international, constant bit-rate digital paths and connections".
- [i.29] Void.
- [i.30] Void.
- [i.31] IETF RFC 1483: "Multiprotocol Encapsulation over ATM Adaptation Layer".
- [i.32] CISCO: "LTE Design and Deployment Strategies".
- NOTE: Available at http://www.cisco.com/web/ME/expo2011/saudiarabia/pdfs/LTE_Design_and_Deployment_Strategies-Zeljko_Savic.pdf.
- [i.33] Siddharth Mohan, Rohit Kapoor, Bibhu Mohanty: "Latency in HSPA Data Networks".
- NOTE: Available at <https://www.qualcomm.com/media/documents/files/qualcomm-research-latency-in-hspa-data-networks.pdf>
- [i.34] "Validating voice over LTE end-to-end".
- NOTE: Available at http://www.ericsson.com/res/thecompany/docs/publications/ericsson_review/2012/er-volte-performance.pdf.
- [i.35] "LTE 'Real World' Performance Study, Broadband and Voice over LTE (VoLTE) Quality Analysis: TeliaSonera, Turku, Finland".
- NOTE: Available at <http://de.slideshare.net/wandalex/lte-real-world-performance-study>.
- [i.36] Ericsson white paper: "Latency Improvements in 3G Long Term Evolution".
- NOTE: Available at http://www.ericsson.com/hr/about/events/archieve/2007/mipro_2007/mipro_1137.pdf
- [i.37] ETSI TR 101 714 (V7.2.0): "Digital cellular telecommunications system (Phase 2+) (GSM); Performance Characterization of the GSM Adaptive Multi-Rate (AMR) speech codec (GSM 06.75 version 7.2.0 Release 1998)".
- [i.38] ETSI TR 126 976: "Digital cellular telecommunications system (Phase 2+); Universal Mobile Telecommunications System (UMTS); LTE; Performance characterization of the Adaptive Multi-Rate Wideband (AMR-WB) speech codec (3GPP TR 26.976)".
- [i.39] ETSI TR 126 935: "Digital cellular telecommunications system (Phase 2+); Universal Mobile Telecommunications System (UMTS); LTE; Packet Switched (PS) conversational multimedia applications; Performance characterisation of default codecs (3GPP TR 26.935)".
- [i.40] ETSI TR 125 912: "Universal Mobile Telecommunications System (UMTS); LTE; Feasibility study for evolved Universal Terrestrial Radio Access (UTRA) and Universal Terrestrial Radio Access Network (UTRAN) (3GPP TR 25.912)".
- [i.41] Recommendation ITU-T Q.3925: "Traffic flow types for testing quality of service parameters on model networks".

3 Definitions and abbreviations

3.1 Definitions

For the purposes of the present document, the following terms and definitions apply:

access segment: network segment from the customer interface (UNI) to the interface on the customer side of the first Gateway Router

segment-connection point: point between two segments

NOTE: The terms "interconnection" or "interconnection point" have been used in the NGN standards, e.g. in [i.14], the same terms are generally used for NNIs, not for the connection between access segment and transit segment, they might be misinterpreted. Therefore, throughout the present document, the terms "Segment-connection" or "Segment-connection point" are used.

total transit segment: segment between Gateway routers, including the gateway routers themselves

NOTE: The network segment may include interior routers with various roles.

3.2 Abbreviations

For the purposes of the present document, the following abbreviations apply:

ACELP	Algebraic Code-Excited Linear Prediction
ADM	Add-Drop-Multiplexer
ADPCM	Adaptive Differential Pulse Code Modulation
AGW	Access GateWay
AMR	Adaptive Multi-Rate
AMR/WB	Adaptive Multi-Rate/ Wide Band
ATM	Asynchronous Transfer Mode
BNG	Broadband Network Gateway
BRAS	Broadband Remote Access Server
BSC	Base Station Controller
BTS	Base Transceiver Station
CL	router Core Layer
CPE	Customer Premises Equipment
CPN	Customer Premises Network
CS-ACELP	Conjugate Structure Algebraic Code- Excited Linear Prediction
CSRC	Contributing Source Real-time Control protocol
DL	router Distribution Layer
DSL	Digital Subscriber Line
DSLAM	Digital Subscriber Line Access Multiplexer
ESP	Encapsulating Security Payload
ESR	Errored Seconds Ratio
ETH	Ethernet
FoIP	Fax over IP
GoB	Good or Better
GSM	Global System for Mobile communications
GSMA	Global System for Mobile communications Association
GW	GateWay
HARQ	Hybrid Automatic Repeat Request
HDLC	High-level Data Link Control
IAD	Integrated Access Device
Ie	equipment Impairment factor
IMS	IP Multimedia Subsystem
IP	Internet Protocol
IPDV	IP packet Delay Variation
IPER	IP packet Error Ratio
IPLR	IP packet Loss Ratio

IPTD	IP packet Transfer Delay
IPTV	Internet Protocol Television
ISDN	Integrated Services Digital Network
ITU	International Telecommunication Union
ITU-T	ITU Telecommunication Standardization Sector
JB	De-jitter Buffer
LAN	Local Area Network
MGW	Media Gateway
MoIP	Modem over IP
MOS	Mean Opinion Score
MSAN	Multi Service Access Node
MSC	Mobile Switching Centre
NGN	Next Generation Network
NNI	Network to Network Interface
NTP	Network Termination Point
PDH	Plesiochronous Digital Hierarchy
PLC	Packet Loss Concealment
POTS	Plain Old Telephone Service
PoW	Poor or Worse PLC
PPP	Point-to-Point Protocol
PSTN	Public Switched Telephone Network
PTP	Point To Point
QoS	Quality of Service
RACS	Resource Admission Control Subsystem
RGW	Residential Gateway
RHO	ρ
RNC	Radio Network Controller
RTP	real Time Protocol
SBC	Session Border Controller
SEC	SECurity
SIP	Session Initiation Protocol
SoIx	Service-oriented Interconnection
SPI	Security Parameters Index
STM 1	Synchronous Transport Module 1
SUM	Summary
SyncE	Synchronous Ethernet
TE	Terminal Equipment
TELR	Talker Echo Loudness Rating
TRAU	Transcoder and Rate Adaption Unit
TTI	Transmission Time Interval
UDP	User Datagram Protocol
UE	User
UL	Uplink
UMSC	UMTS Mobile Switching Centre
UMTS	Universal Mobile Telecommunications System
UNI	User Network Interface
VBD	Voice Band Data
VoIP	Voice over Internet Protocol
VPN	Virtual Private Network
WiMAX	Worldwide Interoperability for Microwave Access
xDSL	x Digital Subscriber Line

4 Reference Configuration

Compared to networks and systems that are circuit-based, those based on IP pose distinctly different challenges for planning and achieving the end-to-end performance levels necessary to adequately support the wide array of user applications (voice, data, fax, video, etc.). The fundamental quality objectives for these applications are well understood and have not changed as perceived by the user; what has changed is the technology (and associated impairments) in the layers below these applications. The very nature of IP-based routers and terminals, with their queuing methods and de-jitter buffers, respectively, makes realizing good end-to-end performance across multiple network operators a very major challenge for applications with stringent performance objectives. Fortunately Recommendations ITU-T Y.1540 [i.1] and Y.1541 [i.2] together provide the parameters needed to capture the performance of IP networks, and specify a set of "network QoS" classes with end-to-end objectives specified. It is widely accepted (i.e. beyond the ITU-T) that the network QoS classes of Recommendation ITU-T Y.1541 [i.2] should be supported by Next Generation Networks, and thus by networks evolving into NGNs. Recommendation ITU-T Y.1542 [i.3] considers various approaches toward achieving end-to-end (UNI-UNI) IP network performance objectives.

The general reference configuration for the present document follows the principles shown in figure 2; the number of concatenated transit providers may vary.

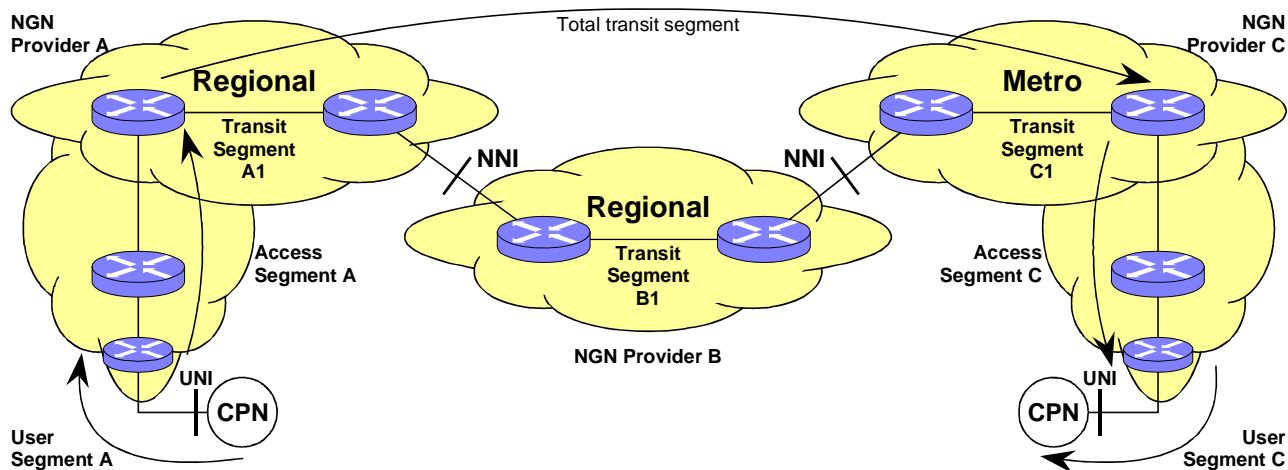

Figure 2: General Reference Configuration

- Thus the end-to-end connection can be decomposed into the User segment A.
- UNI A (sending side).
- Access segment A.
- Segment-connection Point Ain.
- Total transit segment.
- Segment-connection Point Cout.
- Access segment C.
- UNI C (receiving side).
- User segment C.

The total transit segment can be further decomposed into:

- Transit segment A1.
- Segment-connection point Aout.
- Transit segment A2 (NNI).
- Segment-connection point Bin.
- Transit segment B1.
- Segment-connection point Bout.
- Transit segment B2 (NNI).
- Segment-connection point Cin.
- Transit segment C1.

4.1 Generic Segment-connection Points

Due to real-world constraints the simplified **static divisor** approach according to Recommendation ITU-T Y.1542 [i.3] has been chosen for the impairment apportionment between access and transit networks.

This approach "divides" the UNI-to-UNI path into three segments and budgets the impairments such that the total objective is met in principle.

As outlined in [i.15] the delay values for the total transit segment are in a fixed relation to the distances between different geographical regions (see table 2). Thus, for the near future dynamic allocation of delay budgets is not expected to be implemented between user segments, access segments and transit segments.

In figure 3, the upper part displays the division of the connection as seen from a QoS point of view whereas the lower part shows this division in terms of the NGN Functional Architecture [i.14].

NOTE: The reference points Ic, Iw, and Iz are defined in [i.14] in clause 7.2.2.

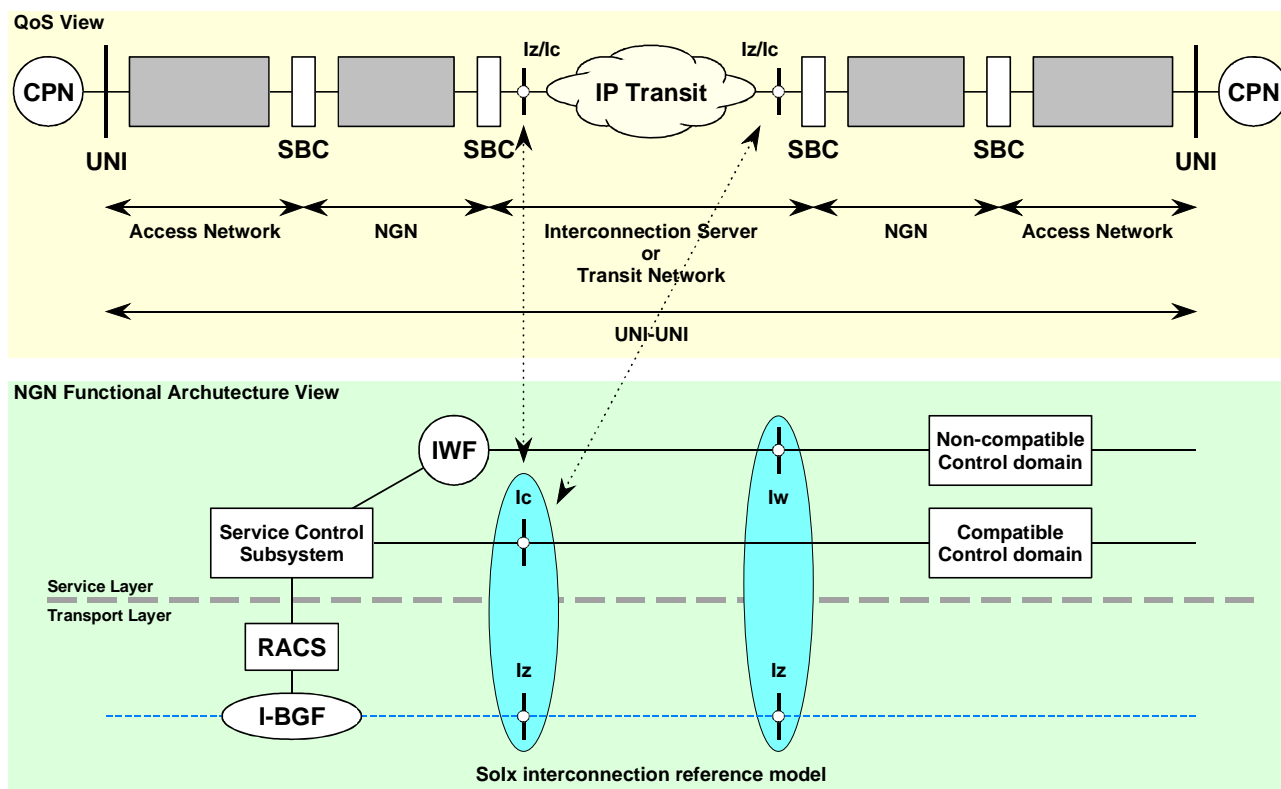

Figure 3: Division of the connection

Hence, there should be objectives for the following portions of the connection:

- UNI (send side) \leftrightarrow Segment-connection Point A.
- Segment-connection Point A \leftrightarrow Segment-connection Point C.
- Segment-connection Point C \leftrightarrow UNI (receive side).

The guidance on respective objectives is given in clause 5.

As illustrated in figure 3, SoIx interconnection is typically characterized by the presence of two types of information exchanged between the two interconnected domains:

- Service-related signalling information, that allows to identify the end-to-end service that has been requested. For example, in case of IMS-to-IMS SoIx interconnection, this is mapped to SIP signalling on the Ic reference point.
- Transport information that carries the bearer traffic.

The presence of the service-related signalling in SoIx interconnection enables the end-to-end service awareness.

An NGN interconnection could be a SoIx even if the transport information is not exchanged between the interconnected domains, as long as service-related signalling is exchanged.

An NGN transport layer interconnection is considered being part of an NGN SoIx interconnection if the transport layer is controlled from the service layer in both of the interconnected domains:

- **SoIx Interconnection interface** includes at least Ic and Iz reference points between two interconnected domains that have same or compatible service control sub systems/domains.
- **SoIx Interconnection interface with Interworking** includes at least the Iw and Iz reference points between two interconnected domains that have non- compatible service control sub systems/domains.

4.2 Transport Reference Parameters and Configurations

At the Segment-connection Points (figure 3) different access networks can be connected. Following access networks can be considered:

- PSTN/ISDN classic access Configuration.
- NGN PSTN/ISDN access Configuration.
- Access DSL Configuration.
- GSM.
- UMTS.
- LTE.

In the following clauses the end-to-end delay, and the Talker Echo Loudness Rating are defined. The detailed values of jitter and delay for the access are described in clause A.4.

4.2.1 Reference Configurations

The following clauses describe the Backbone and access reference configuration. In the calculation only one SBC is taken into account at the Segment-connection point.

4.2.1.1 Backbone Configuration

Figure 4 shows the backbone configuration. The number of elements used in the configuration and the delay values are described in clause A.4.



Figure 4: Backbone

4.2.1.2 PSTN/ISDN classic access Configuration

Figure 5 shows the PSTN/ISDN classic access configuration. The number of elements used in the configuration and the delay values are described in clause A.4.

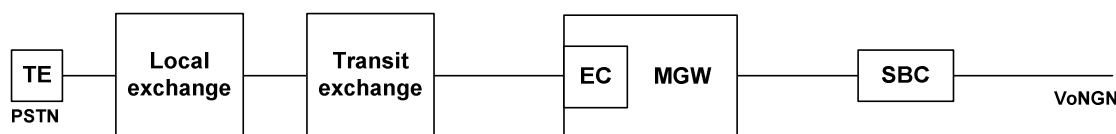

Figure 5: Reference configuration for PSTN/ISDN with classical access

4.2.1.3 NGN PSTN/ISDN access Configuration

Figure 6 shows the NGN PSTN/ISDN classic access configuration. The number of elements used in the configuration and the delay values are described in clause A.4.

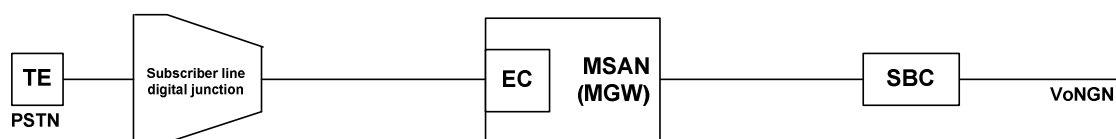

Figure 6: Reference configuration for NGN with PSTN/ISDN access

4.2.1.4 Access DSL/Ethernet Configuration

Figure 7 shows the xDSL access configuration. The number of elements used in the configuration and the delay values are described in clause A.4.

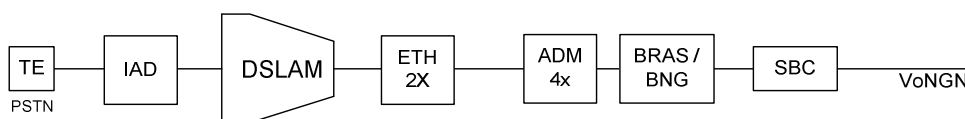

Figure 7: Reference configuration for DSL access

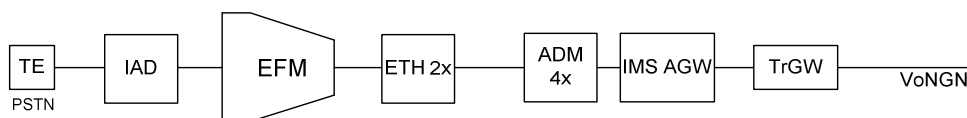

Figure 8: Reference configuration for Ethernet access

4.2.1.5 GSM Access configuration

Figure 9 shows the GSM access configuration. The number of elements used in the configuration and the delay values are described in clause A.4.

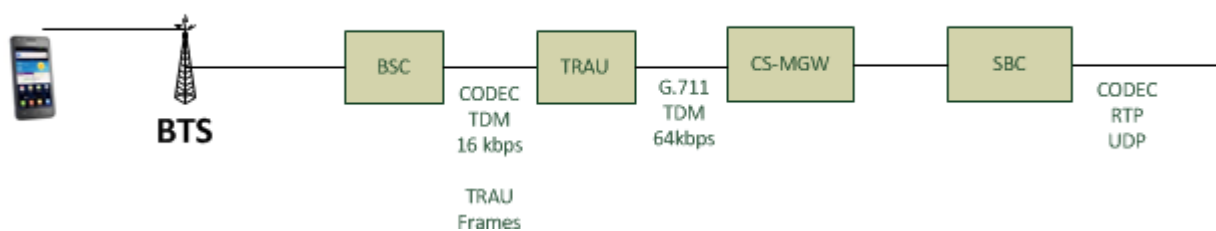

Figure 9: Reference configuration for GSM Access

4.2.1.6 Access configuration from UMTS Release 4

Figure 11 shows the UMTS Release 4 access configuration. The number of elements used in the configuration and the delay values are described in clause A.4.

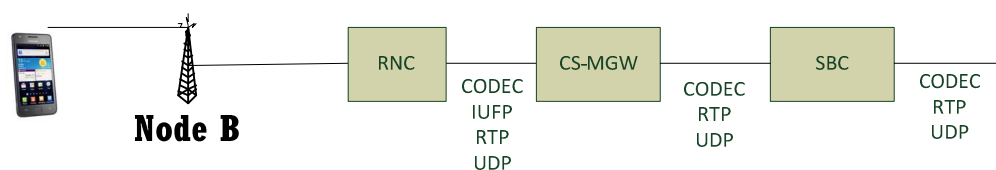

Figure 10: Reference configuration from UMTS Release 4

4.2.1.7 Access configuration from LTE

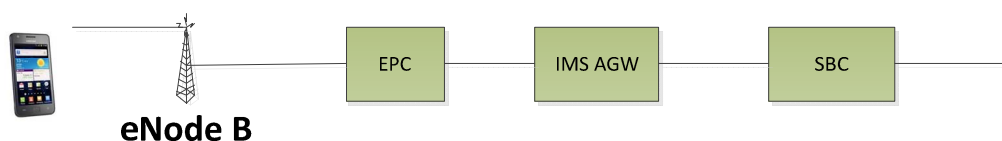

Figure 11: Shows the LTE access configuration

The number of elements used in the configuration and the delay values are described in clause A.4.

4.2.1.8 CPE reference configuration

The Jitter and Delay calculation is based on the fact that different terminals are connected at same time on the CPE.

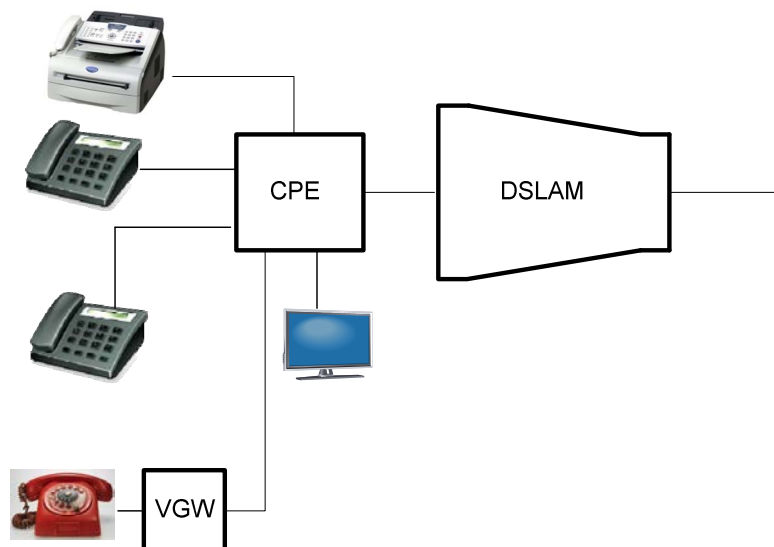

Figure 12: Terminal reference configuration for DSL access

4.3 Delay Values

4.3.1 Backbone Delay

Table 1 shows the long distance delay values for typical reference distances.

Table 1: Long Distance Delay

Distance	Propagation delay
1 400 km	7 ms
5 000 km (Intra Regional)	25 ms
10 000 km (Inter Regional)	50 ms
20 000 km (Inter Regional)	100 ms
27 500 km (Inter Regional)	137 ms

Table 2 shows E2E delay values between originating and terminating Service Provider premises. The values are based on Trace route measurements.

Table 2: End-to-End delay values between originating and terminating Service Provider premises

	West Europe	North Europe	East Europe	South Europe	East Asia	South Asia	Oceania	N. America East Cost	N. America West Cost	Central America	South America	Africa
	Vienna	RU - Vladimir RU - Moscow SE - Östersund	RO - Bucharest HU - Budapest	GR-Athens IT - Roma	(CN- Dongguan)	Malaysia - MY	Australia -AU Sydney	US Washington DC	US Vancouver	Panama - PA Mexico - MEX	Brasilia - BR	ZA - Cap town Burkina Fasso
West Europe Bern Paris Frankfurt	DE - AT (Frankfurt - Vienna) 7 ms CH - DE (Bern - Frankfurt) 8 ms CH - AT (Bern - Vienna) 10 ms FR- AT (Paris - Vienna) 15 ms	CH - RU (Bern - Vladimir) 23 ms CH - RU (Bern - Moscow) 22 ms DE - RU (Frankfurt- Moscow) 21 ms DE - SE (Frankfurt - Östersund) 12 ms	CH-RO (Bern - Bucharest) 25 ms DE-RO (Frankfurt - Bucharest) 18 ms DE-HU (Frankfurt - Budapest) 12 ms	CH-GR (Bern - Athens) 30 ms DE-GR (Frankfurt - Athens) 24 ms IT-CH (Roma - Cern) 22 ms Frankfurt - Roma 13 ms	CH - CN (Bern - Dongguan) 150 ms DE-CN (Frankfurt - Dongguan) 160 ms	CH- MY 110 ms DE - MY 115- 164 ms	CH-AU (Bern - Sydney) 170 ms DE-AU (Frankfurt - Melburne) 165 ms DE-AU (Frankfurt - Sydney) 146 ms	CH- US (Bern - Washington) 46 ms DE-US (Frankfurt - Washington) 55 ms	CH-US (Bern - Vancouver) 75 ms DE-US (Frankfurt - Vancouver) 75 ms	CH-PA (Bern - Panama) 103 ms DE-MEX (Frankfurt - Mexico City) 75 ms	CH-BR (Bern - Sao Paulo) 136 ms DE-BR (Frankfurt - Sao Paulo) 125 ms	CH-ZA (Bern - Cape Town) 108 ms DE-ZA (Frankfurt - Cape Town) 90 ms BE-BF 90 - 130 ms
North Europe (SE- Östersund)		SE - RU (Östersund - Moscow) 10 ms	SE-RO (Östersund - Bucharest) 30 ms	SE-GR (Östersund- Athens) 42 ms	SE-CN 150 ms	SE-MY 124 ms	SE-AU 171 ms	SE-US 62 ms	SE-US 83 ms	SE- PA 84 ms SE-MEX 78 ms	SE-BR 155 ms	SE-ZA 87 ms
East Europe (HU- Budapest)		HU- RU (Budapest - Moscow) 33 ms	HU - RO (Budapest- Bucharest) 14 ms	HU - GR (Budapest - Athens) 20 ms	HU-CN 166 ms	HU-MY 125 ms	HU-AU 170 ms	HU-US 60 ms	HU-US 100 ms	HU-PA 95 ms HU- MEX 96 ms	HU-BR 152 ms	HU-ZA 100 ms
South Europe (IT- Roma)		IT- RU (Roma - Moscow) 38 ms	IT-RO (Roma - Bucharest) 32 ms	(IT-GR) Roma - Athens 23 ms	IT-CN 160 ms	IT-MY 150 ms	IT-AU 160 ms	IT-US 55 ms	IT-US 95 ms	IT - PA 104 ms IT- MEX 113 ms	IR-BR 108 ms	IT-ZA 95 ms

4.4 Network parameters: End-to-End Delay, Talker Echo Loudness Rating, R Value

In this clause, end to end delay values (mouth to ear) for different access lines and the respective R-values (depending on the calculated delay) are shown.

The following clause describes the Network parameters: End-to-End Delay, Talker Echo Loudness Rating for a national network. The detailed values of End-to-End Delay, and Jitter values and the time values for the jitter buffers are described in clause A.4.

The delay calculation is based for the case when the access link is used for Voice and data application and the number of data packets in the playout Buffer are less than one.

If the same link is used for more voice channels, the number of channels which can be transmitted with a reasonable jitter over the link is between 70 % and 97 % of the channel capacity in dependency of the QoS policies.

For example: over a 2,048 Mbit/s link 9 voice channels (G.711, 20 ms packetization time) without QoS, 16 channels with diffserv and 21 channels with MPLS /VLAN can be transported.

Access links with a capacity of 128 kbit/s and 256 kbit/s should not be used for IP interconnections due to the high jitter caused on the access.

4.4.1 Delay with regional propagation delay (1 400 km / 7 ms)

The regional reference configuration is based on a distance of 1 400 km which is the average value for intra-European regional calls. The detailed time distribution is described in clause A.4.

For the calculation of the Voice Quality parameters used network parameters are contained in clause A.4. For the calculation is used the Packet size 20 ms, the codecs are G.729A and G.711.

In case VBD it's the goal to keep the audio end-to-end delay constant during the entire call. The jitter buffer has to be implemented in such a way that any jitter occurring during the entire call will not change the end to end delay.

In case of voice the strategy of jitter buffer implementation is to keep the end to end audio delay as low as possible under all jitter conditions. Any jitter buffer implementation should mostly not impair the listening speech quality as perceived by the user.

For voice calls between MSAN, IAD, MGW adaptive jitter buffers are required. The minimum jitter buffer size should be smaller or equal to one packet size.

For adaptive jitter buffers the maximum aberration from the real jitter in the network should be one packetization time interval. It is recommended that the jitter measurement period for Jitter should be 2-3 packet intervals, not only on one packet interval. The adaptation interval towards higher values should be done immediately after the jitter measurement period. The adaptation towards lower values should be after at least several seconds or during silence periods. Tables 3a, 3b, 3c and 3d show End-to-End delay in ms and R value between DSL lines and POTS. The R values are based on wired terminals with the Talker Echo Loudness Rating TELR = 65. In the case of DSL to DSL connections are calculated systems with the following upstream (e.g. 256, 384, 512, 768, 1 024 and 2 048) and downstream (e.g. 256, 384, 512, 768, 1 024, 1 152, 1 536, 2 048, 2 304, 3 072, 6 144).

The delay values of the used components are state of the art. The R values are based on wired terminals with the Talker Echo Loudness Rating TELR = 65.

For other national networks which have different propagation delay, the Access parameters from clause A.4.3 can be used.

To enable an easy comparison of the user satisfaction the tables are coloured in the same colours as table 4: Relation between R-value and user satisfaction.

**Table 3a: End-to-End delay between different access types
with wired terminals, G.711 packet size 10 ms and with 7 ms propagation delay**

G.711/10												
Uplink / Downlink	256 kbit/s	384 kbit/s	512 kbit/s	768 kbit/s	1 024 kbit/s	1 152 kbit/s	1 536 kbit/s	2 048 kbit/s	2 304 kbit/s	3 072 kbit/s	6 144 kbit/s	POTS
POTS	-	-	-	-	-	-	-	-	-	-	-	35 ms R=92
512 kbit/s	-	-	85 ms R=91	80 ms R=91	78 ms R=91	77 ms R=91	75 ms R=91	74 ms R=91	74 ms R=91	73 ms R=91	72 ms R=91	55 ms R=91
768 kbit/s	-	-	-	75 ms R=91	73 ms R=91	72 ms R=91	70 ms R=91	69 ms R=91	69 ms R=91	68 ms R=91	68 ms R=91	53 ms R=91

**Table 3b: End-to-End delay between different access types,
G.711, packet size 20 ms without TrFO and with 7 ms propagation delay**

G.711/20												
Uplink / Downlink	256 kbit/s	384 kbit/s	512 kbit/s	768 kbit/s	1 024 kbit/s	1 152 kbit/s	1 536 kbit/s	2 048 kbit/s	2 304 kbit/s	3 072 kbit/s	6 144 kbit/s	POTS
POTS	-	-	-	-	-	-	-	-	-	-	-	55 ms R=91
256 kbit/s	128 ms R=90	118 ms R=90	113 ms R=90	108 ms R=90	104 ms R=90	103 ms R=91	102 ms R=91	101 ms R=91	101 ms R=91	100 ms R=91	97 ms R=91	82 ms R=91
384 kbit/s	-	108 ms R=90	102 ms R=91	97 ms R=91	95 ms R=91	93 ms R=91	94 ms R=91	92 ms R=80	92 ms R=91	91 ms R=91	91 ms R=91	75 ms R=91

**Table 3c: End-to-End delay between different access types,
G.711, packet size 20 ms without TrFO and with 7 ms propagation delay (continued)**

G.711/20												
Uplink / Downlink	256 kbit/s	384 kbit/s	512 kbit/s	768 kbit/s	1 024 kbit/s	1 152 kbit/s	1 536 kbit/s	2 048 kbit/s	2 304 kbit/s	3 072 kbit/s	6 144 kbit/s	POTS
512 kbit/s	-	-	97 ms R=91	92 ms R=91	91 ms R=91	91 ms R=91	91 ms R=91	91 ms R=91	90 ms R=91	90 ms R=91	90 ms R=91	74 ms R=91
768 kbit/s	-	-	-	91 ms R=91	90 ms R=91	90 ms R=91	90 ms R=91	89 ms R=91	89 ms R=91	89 ms R=91	89 ms R=91	73 ms R=91
1 024 kbit/s	-	-	-	-	90 ms R=91	89 ms R=91	89 ms R=91	89 ms R=91	89 ms R=91	88 ms R=91	88 ms R=91	73 ms R=91
2 048 kbit/s	-	-	-	-	-	-	-	88 ms R=91	88 ms R=91	88 ms R=91	88 ms R=91	72 ms R=91
GSM	189 ms R=82	183 ms R=83	181 ms R=82	180 ms R=83	180 ms R=83	179 ms R=83	179 ms R=83	179 ms R=83	179 ms R=83	179 ms R=83	179 ms R=83	163 ms R=84
UMTS Rel.4	187 ms R=82	181 ms R=83	179 ms R=83	178 ms R=83	178 ms R=83	177 ms R=83	177 ms R=83	177 ms R=83	177 ms R=83	176 ms R=83	176 ms R=83	161 ms R=84
LTE	150 ms R=90	144 ms R=90	142 ms R=90	142 ms R=90	141 ms R=90	141 ms R=90	140 ms R=90	140 ms R=90	140 ms R=90	139 ms R=90	139 ms R=90	124 ms R=90

Table 3d: End-to-End delay between different access types,
G.729A, packet size 20 ms with 7 ms propagation delay

G.729/20												
Uplink / Downlink	256 kbit/s	384 kbit/s	512 kbit/s	768 kbit/s	1 024 kbit/s	1 152 kbit/s	1 536 kbit/s	2 048 kbit/s	2 304 kbit/s	3 072 kbit/s	6 144 kbit/s	POTS
POTS	-	-	-	-	-	-	-	-	-	-	-	-
256 kbit/s	125 ms R=80	117 ms R=80	112 ms R=80	108 ms R=81	105 ms R=81	105 ms R=81	102 ms R=81	102 ms R=81	102 ms R=81	101 ms R=81	100 ms R=81	83 ms R=81
384 kbit/s	-	108 ms R=81	103 ms R=81	99 ms R=81	97 ms R=81	96 ms R=81	94 ms R=81	94 ms R=81	94 ms R=81	94 ms R=81	94 ms R=81	79 ms R=81
512 kbit/s	-	-	94 ms R=81	94 ms R=81	94 ms R=81	94 ms R=81	94 ms R=81	94 ms R=81	94 ms R=81	94 ms R=81	94 ms R=81	78 ms R=81
768 kbit/s	-	-	-	94 ms R=81	94 ms R=81	94 ms R=81	93 ms R=81	93 ms R=81	93 ms R=81	93 ms R=81	93 ms R=81	78 ms R=81
1 024 kbit/s	-	-	-	-	93 ms R=81	93 ms R=81	93 ms R=81	93 ms R=81	93 ms R=81	93 ms R=81	93 ms R=81	77 ms R=81
2 048 kbit/s	-	-	-	-	-	-	-	93 ms R=81	93 ms R=81	93 ms R=81	93 ms R=81	77 ms R=81

4.4.2 Categories of User Satisfaction

The following information is an excerpt from Recommendation ITU-T G.109 [i.6].

While the single parameters describe the individual factors affecting speech transmission quality, it is the combined effect of all parameters together which leads to the overall level of speech transmission quality as perceived by the user. For transmission planning purposes, the E-model (Recommendation ITU-T G.107 [i.4]) is a useful tool for assessing the combined effect of all parameters and hence differentiating between categories of speech transmission quality.

The primary output of the E-model is the Transmission Rating Factor R. Table 4 gives the definitions of the categories of speech transmission quality in terms of ranges of Transmission Rating Factor R provided by Recommendation ITU-T G.107 [i.4]. Also provided are descriptions of "User satisfaction" for each category. Table 4 shows Relation between R-value and user satisfaction.

Table 4: Relation between R-value and user satisfaction

R Value	MOS CQEN Value	Categories of User Satisfaction
95	4,44	Very satisfied (Best)
94	4,42	
93	4,40	
92	4,38	
91	4,36	
90	4,34	
89	4,31	Satisfied (High)
88	4,29	
87	4,26	
85	4,20	
82	4,09	
81	4,06	
80	4,02	Some users dissatisfied (Medium)
77	3,90	
73	3,73	
70	3,59	
68	3,50	Many users dissatisfied (Low)
60	3,10	
50	2,58	Nearly all users dissatisfied (Poor)
$\text{MOS CQEN} = 1 + 0,035 \times R + 0,000007 \times R \times (R-60) \times (100-R)$		
NOTE 1: Connections with R-values below 50 are not recommended. NOTE 2: Although the trend in transmission planning is to use R-values, equations to convert R-values into other metrics e.g. MOS, % GoB, % PoW, C.		

5 Guidance on Segment-connection Voice Quality Objectives

The objectives proposed in the present document are based on transmission planning aspects as outlined in Recommendation ITU-T G.107 [i.4] (The E-model) and its companion documents Recommendations ITU-T G.108 [i.5] and G.109 [i.6]. For the purposes of verification of these objectives, Recommendations ITU-T of the P.862-series [i.20] and eventually Recommendation ITU-T P.834 [i.21] should be consulted. For the calculation according to G.107 all input parameters excluding the delay and I_e related values are set to default values according to Recommendation ITU-T G.107 [i.4]. This means, that the R-Values reached with different delay and I_e values are under optimal conditions, any deviation from default values for the other parameters will most probably decrease the quality.

The overall aim of the Segment-connection voice quality objectives is to enable network operators, service providers and indirectly also equipment manufacturers to provide end-to-end voice quality with which users are satisfied or even very satisfied. In order to achieve this goal the simplified approach here is, to limit end-to-end delay to 150 ms, except for cases where this is not feasible due to geographical constraints; also the accumulated sum across the entire connection should not exceed $I_e = 12$. With routers and gateways currently deployed the 150 ms margin can be reached with an inter-regional distance of 7 000 km (propagation delay of 60 ms) for xDSL Access. For PSTN Access an inter-regional distance of 15 000 km can be reached.

Clause A.4 provides detailed information on parameters used in the present document which can be useful in the context of the present document.

5.1 Guidance on Access Segment Objectives

The following IPDV limits can be applied for access networks (between TE to included SBC).

Table 5: Maximal IPDV values for xDSL and ETH Access Segment

Nature of Network	Jitter Value
Access Network (sending side)	< 35 ms
Access Network (receiving side)	< 10 ms (see note)
NOTE: 10 ms are recommended, the maximum IPDV value is 40 ms.	

Table 6: Maximal IPDV values for MSAN

Nature of Network	Jitter Value
Access Network (sending side)	< 5 ms
Access Network (receiving side)	< 5 ms

The target Jitter values are the maximum values occurring during one month. It is recommended to use dynamic Jitter Buffer with a minimum target delay in the Voice GW. Furthermore it is not recommended to use IP - IP GW (e.g. SBC) with Jitter Buffers.

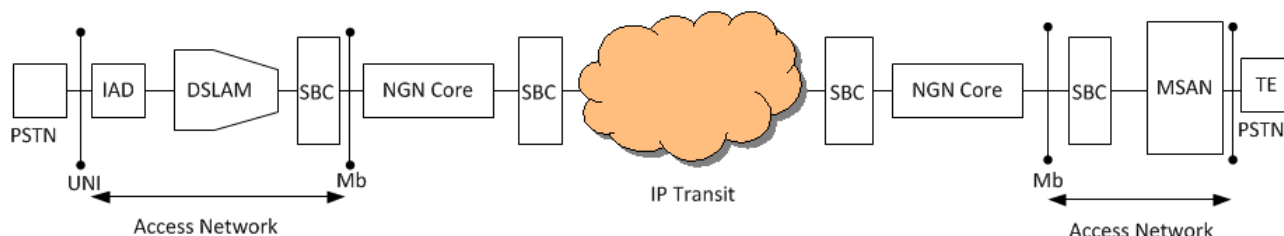

Figure 13: IAD-MSAN Jitter Budget

5.2 Guidance on Total Transit Segment Objectives

The following objectives can be applied between:

- Segment-connection point A \leftrightarrow Segment-connection point C.

See figure 2 for details. The objectives are based on the application of Class 0 of Recommendation ITU-T Y.1541 [i.2]. The determination of cases where Class 1 of Recommendation ITU-T Y.1541 [i.2] should be applied and the associated objectives are for further study.

Table 7: Guidance on Objectives for Total Transit Segments

Nature of Network	Jitter Value
IPDV Intra-continent Jitter Value -5 ms per Provider (maximum of 2 involved in the service delivery chain) (see note)	10 ms
IPDV Inter-continent Jitter Value -10 ms per Provider (maximum of 2 involved in the service delivery chain) (see note)	20 ms
IPLR	$3,0 \times 10^{-4}$
IPER	3×10^{-5}
le	0
NOTE: The Jitter Values are based on values contained in the GSMA document IR.3445 [i.15].	

5.2.1 Availability

Values for availability are following:

- Availability of the IP Backbone Service Provider Core: 99,995 %.
- Service Providers connection to IP Backbone Service Provider core with single connection: 99,7 %.
- Service Providers connection to IP Backbone Service Provider core with dual connection: 99,9 %.

5.3 Voice Terminals

In order to be able to achieve the goal of users being satisfied or even very satisfied with the overall voice communication quality it is assumed that the VoIP terminals used in this context comply with one or more of the following ETSI standards:

- ES 202 737 [i.10].
- ES 202 738 [i.11].
- ES 202 739 [i.12].
- ES 202 740 [i.13].

5.4 End-to-End Aspects

Figure 14 depicts a summary of the proposed delay objectives and the end-to-end delay targets that can be achieved between two xDSL or Ethernet lines. The figure presents the delay distribution between the calling and the called user. The delay of the calling user contains the packetization delay, the compression delay, the serialization time and the play out buffer size. The delay of the called user contains the decompression, the serialization time, the dejitter buffer delay and the PLC. The reference connection is based on an inter-regional distance of 74 000 km,(propagation delay and core equipment delay -60 ms), Inter-continent Jitter Value **20 ms**, minimal bandwidth 384 kbit/s (uplink and downlink).

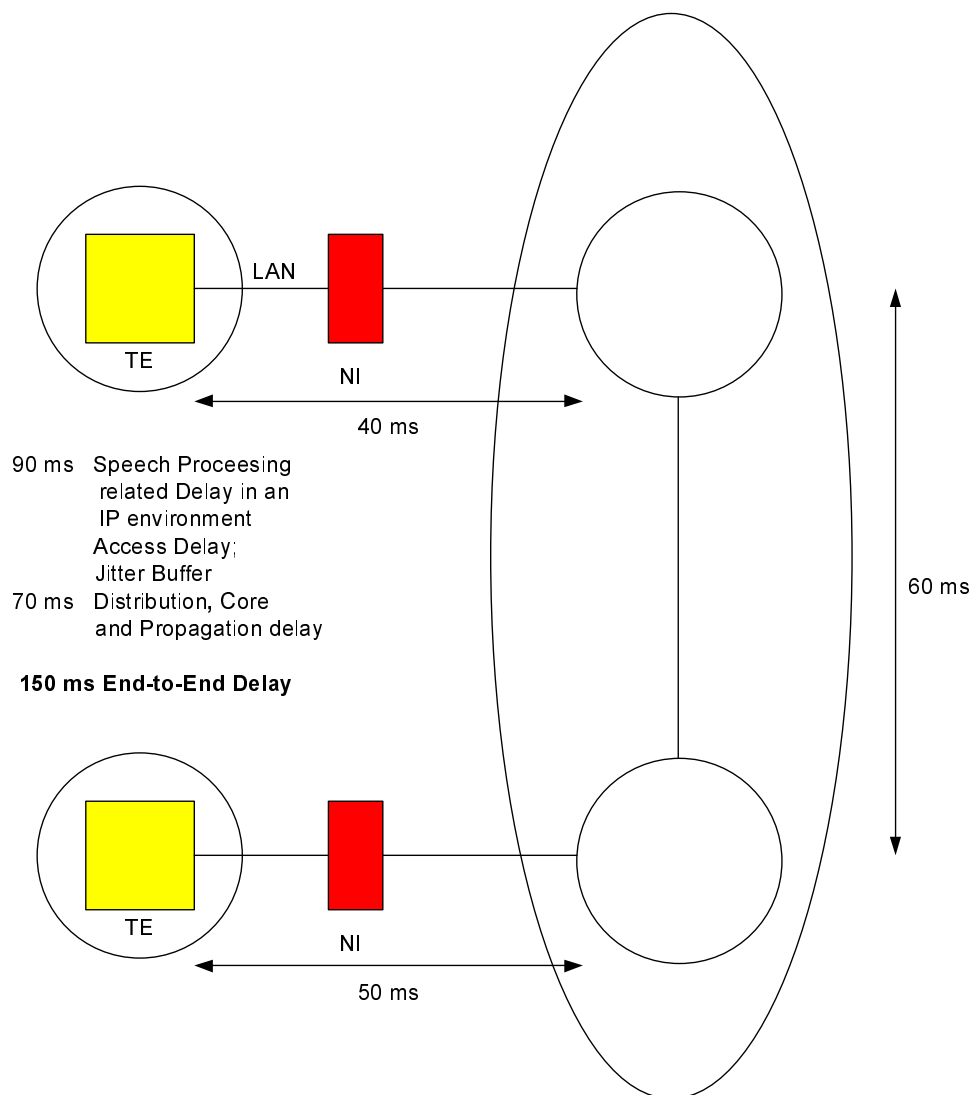

Figure 14: Maximal delay values for BEST (G.109) voice communication quality (R > 90) and Network Access Jitter < 35 ms

6 Possible Implications due to other services

Even though the present document is focussed on VoIP, it may be worthwhile to consider - at the time of deployment - implications that may arise due to other services which are likely to be carried over the same infrastructure. The following may serve as one example, with its provisional objectives being derived from past and current implementations in traditional networks.

EXAMPLE: The IP-based network should also be capable to carry the 64 kbit/s transparent data service described in Recommendation ITU-T I.231.1 [i.27], also known as "64 k clear-mode". The basis of the objective here is use of Recommendation ITU-T G.826 [i.28], a standard for synchronous digital networks. While the IP core is a packet network and not a synchronous network, it is being used to emulate a service currently transported over a synchronous network. Hence the performance of the emulation should be no worse than the performance of the synchronous network as specified by Recommendation ITU-T G.826 [i.28]. The standard requires an Errored Second Ratio (ESR) of $< 0,16$ for an STM-1 link which can carry about 1 200 "clear-mode" channels. From this, the end-to-end probability of loss per packet can be shown to be about $1,5 \times 10^{-6}$. In Recommendation ITU-T G.826 [i.28], budgets of 18,5 % of $1,5 \times 10^{-6}$ were allocated to each national network, so the packet loss for a national connection should be no more than $2,75 \times 10^{-7}$. Allocation of this ratio to individual operators' networks within the national network is yet to be agreed, but it is fairly unlikely that there will be more than three operators' switched networks between any customer and the international gateway, so an initial allocation could be $9,0 \times 10^{-8}$ to each operator's network.

Table 8: Summary of provisional objectives

Parameter	Provisional Objective
IP packet loss ratio for national connections	$2,75 \times 10^{-7}$
IP packet loss ratio for each operator's network	$9,0 \times 10^{-8}$
End-to-end probability IP packet loss ratio	$1,5 \times 10^{-6}$
IP packet error ratio for each operator's network	$1,0 \times 10^{-8}$

7 Synchronization of endpoints

To ensure the synchronization of the endpoints (e.g. MSAN, GW; AGW) the endpoints should be synchronized with Synchronous Ethernet (SyncE) based on the Recommendations ITU-T G.8261 [i.16], G.8262 [i.17] and G.8264 [i.18]. Additionally, PTP (IEEE 1588 v2 [i.19]) and NTPv4 may be used as mean for synchronization of endpoints. A distinction needs to be made between time and timing synchronization. Legacy networks tend only to be interested in timing synch whereas in IP based NGN, both time and timing can be important. Synchronous Ethernet provides timing synch whereas PTP and NTP provide both if correctly implemented.

8 Transmission of fax and modem

The present document describes the network parameters: End-to-End Delay, Talker Echo Loudness Rating, and R Value using adaptive jitter buffers. The disadvantage adaptive jitter buffer is that a part of the jitter budget is transferred to the user. While the human audio capacity is not very sensible to audio delay variation, modem and fax applications are extremely sensible to audio delay variation. For this reason adaptive jitter buffer are not appropriate for use with fax and modem transmission.

For fax and modem transmission a **fixed jitter** buffer is needed which maintains a constant size with constant end-to-end audio delay. The minimum size of jitter buffer for well-developed networks is 100 ms.

Annex A: Summary of Relevant Transmission Planning Data

This annex provides condensed information on transmission planning data that may be considered useful in the context of the present document.

A.1 Delay in VoIP Terminals

The following information is an excerpt from ES 202 737 [i.10], ES 202 738 [i.11], ES 202 739 [i.12] and ES 202 740 [i.13].

A.1.1 Send Delay

For a VoIP terminal, send delay is defined as the one-way delay from the acoustical input (mouthpiece) of this VoIP terminal to its interface to the packet based network. The total send delay is the upper bound on the mean delay and takes into account the delay contributions of all of the elements shown in figures 2 and A.1 in Recommendation ITU-T G.1020 [i.9], respectively.

The sending delay $T(s)$ is defined as follows:

$$T(s) = T(ps) + T(la) + T(aif) + T(asp) + T(s).$$

Where:

$$T(ps) = \text{packet size} = N \times T(fs).$$

N = number of frames (samples) per packet.

$T(fs)$ = frame size of encoder.

$T(la)$ = look-ahead of encoder.

$T(aif)$ = air interface framing.

$T(asp)$ = allowance for signal processing.

$T(s)$ = serialization time.

The additional delay required for IP packet assembly and presentation to the underlying link layer will depend on the link layer. When the link layer is a LAN (e.g. Ethernet), this additional time usually will be very small. For the purposes of the present document it is assumed that in the test setup this delay can be neglected.

NOTE: With the knowledge of the codec specific values for $T(fs)$ and $T(la)$ the requirements for send delay for any type of coder and any packet size $T(ps)$ can easily be calculated. Table A.1 provides examples for delay values calculated accordingly.

A.1.2 Receive delay

For a VoIP terminal, receive delay is defined as the one-way delay from the interface to the packet based network of this VoIP terminal to its acoustical output (earpiece). The total receive delay is the upper bound on the mean delay and takes into account the delay contributions of all of the elements shown in figures 3 and A.2 of Recommendation ITU-T G.1020 [i.9], respectively.

The receiving delay $T(r)$ is defined as follows:

$$T(r) = T(fs) + T(aif) + T(jb) + T(plc) + T(asp) + T(s).$$

Where:

T(fs) = frame size of encoder.

T(aif) = air interface framing.

T(jb) = de-jitter buffer size.

T(plc) = PLC buffer size.

T(asp) = allowance for signal processing.

T(s) = serialization time.

The additional delay required for IP packet disassembly and presentation from the underlying link layer will depend on the link layer. When the link layer is a LAN (e.g. Ethernet), this additional time usually will be very small. For the purposes of the present document it is assumed that in the test setup this delay can be neglected.

NOTE: With the knowledge of the codec specific values for T(fs) and T(la) the requirements for receive delay for any type of coder and any packet size T(ps) can easily be calculated. Table A.2 provides examples calculated accordingly.

A.2 Network QoS Classes for Voice Applications

The following information is an excerpt from Recommendation ITU-T Y.1541 [i.2].

Table A.1: Provisional IP network QoS class definitions and network performance objectives

Network Performance Parameter	Nature of Network Performance Objective	QoS Classes					
		Class 0	Class 1	Class 2	Class 3	Class 4	Class 5 Un-specified
IPTD	Upper bound on the mean IPTD	100 ms	400 ms	Not relevant for voice communication!			
IPDV	Upper bound on the 1 - 10 ⁻³ quantile of IPTD minus the minimum IPTD	50 ms	50 ms				
IPLR	Upper bound on the packet loss probability	1 × 10 ⁻³	1 × 10 ⁻³				
IPER	Upper bound	1 × 10 ⁻⁴					

A.3 Comparison of Codecs, Link Speed and Capacity examples

Table A.2a: Comparison of Codecs 20 ms packet frame duration

CODEC	G.711 (64 kb/s)	G.726 (32 kb/s)	G.726 (40 kb/s)	G.729A (8 kb/s)	G.722 (64 kb/s)	G.722.2 (23,85 kb/s)
le	0	7	2	11		
le, wb	36				13	8
Sample size	1	1	1	10	0,5	60
Number of samples per packet	160	160	160	2	320	1
RTP Payload [Bytes]	160	80	100	20	160	60
IP packet size [Bytes]	200	120	140	60	200	100
Ethernet packet size [Bytes]	226	146	164	86	226	126
IP SEC packet size [Bytes] (with ESP Frame)	264	184	202	120	264	160
IP Bandwith [kbit/s]	80,00	48	56	24,00	80,00	40,00
Ethernet bandwith [kbit/s]	90,40	58,4	65,6	34,40	90,40	50,40
IP SEC Bandwith [kbit/s]	105,60	73,6	80,8	48,00	105,60	64,00
ATM Bandwith [kbit/s] (RFC 1483 [i.31])	106,00	84	84,8	42,40	106,00	63,60

Table A.2b: Comparison of Codecs 10 ms packet frame duration

10 ms packet frame duration						
CODEC	G.711 (64 kb/s)	G.726 (32 kb/s)	G.726 (40 kb/s)	G.729A (8 kb/s)	G.722 (64 kb/s)	G.722.2 (23,85 kb/s)
Sample size	1	1	1	10	0,5	60
Number of samples per packet	80	80	80	1	160	1
RTP Payload [Bytes]	80	40	50	10	80	60
IP packet size [Bytes]	120	80	90	50	120	100
Ethernet packet size [Bytes]	146	106	116	76	146	126
IP SEC packet size [Bytes] (with ESP Frame)	184	144	154	112	184	160,4
IP Bandwith [kbit/s]	96,00	64	72	40,00	96,00	80,00
Ethernet bandwith [kbit/s]	116,80	84,8	92,8	60,80	116,80	100,80

Table A.3: IP and Ethernet Header Sizes calculation

IP Bandwidth	
Header	Encapsulation size [bytes]:
RTP header without CSRC	12
UDP header	8
Minimal IP header	20
MPLS Label	8
Ethernet bandwidth	
RTP header without CSRC	12
UDP header	8
Minimal IP header	20
Ethernet encapsulation without silence	26
MPLS Label	8

Table A.4: IP Sec Header Sizes calculation

IPSEC-ESP bandwidth [VPN tunnel] - 3DES - HMAC-SHA-1-96			
Header and/or encapsulation size [bytes]:			
Encrypted with RTP payload	RTP header without CSRC		12
	UDP header		8
	Minimal IP header		20
	ESP Trailer	Next Header	1
		Pad Length	1
	Padding	Variable	
ESP Header	Security Parameters Index (SPI)		4
	Sequence Number Field		4
	Initialization Vector (IV)		8
ESP Authentication			12
New IP Header			20
PPP encapsulation with HDLC frame (synchronous link)			8
MPLS Label			8

A.4 Transport Reference Parameters

A.4.1 Backbone Parameters

Table A.5 shows the number of elements used in the configuration and the delay values.

Table A.5: Transport Network parameters

SBC	ADM 4x	DL 2x	CL 4x	SBC 1	SBC 1	CL 4x	DL 2x	ADM 4x	SBC
0,1 ms	0,4 ms	1 ms	0,4 ms	0,1 ms	0,1 ms	0,4 ms	1 ms	0,4 ms	0,1 ms

A.4.2 Network and Access Parameters

Table A.6 shows backbone parameters.

Table A.6: Backbone parameters

Parameter	Value
IPDV Intra-continent jitter value -5 ms per provider (maximum of 2 involved in the service delivery chain)	10
IPDV Inter-continent jitter value -10 ms per provider (maximum of 2 involved in the service delivery chain)	20
IPLR	$3,0 \times 10^{-4}$
IPER	3×10^{-5}
le	0

Table A.7: Typical Network Values

DSLAM sending	0,1 ms - 0,3 ms		(Packet size 500 Byte - 1 500 Byte)
DSLAM Receiving	0,1 ms - 0,3 ms		(Packet size 500 Byte - 1 500 Byte)
Ethernet switch	0,1 ms - 0,3 ms		(Packet size 500 Byte - 1 500 Byte)
ATM switch STM 1	0,1 ms - 0,3 ms		(Packet size 500 Byte - 1 500 Byte)
ATM Access switch STM 1 (APEX)	0,3 ms - 1 ms		(Packet size 500 Byte - 1 500 Byte)
BRAS / BNG	1 ms - 3 ms		
WiMAX	25 ms		
Mobile Station GSM Uplink	72,1 ms		
Mobile Station GSM Downlink	14,3 ms		
BTS Uplink	15,8 ms		
BTS Downlink	40,8 ms		
PtP Microwave link	15,8 ms		
PDH Microwave link	1,4 ms		
BSC	1 ms		
TRAU Uplink	1,5 ms		
TRAU Downlink	39 ms		
MSC Uplink	0,5 ms		
MSC Downlink	1,5 ms		
UE, R.99	37 ms		
Node B, Uplink R.99	22 ms		
Node B, Downlink R.99	9 ms		
RNC Uplink R.99	12 ms		
RNC Downlink	12 ms		
TRAU R.99	11 ms		
UMSC	5 ms		
SBC	0,1 ms		
Router Distribution Layer	0,5 ms		
Router Core Layer	0,1 ms		
Digital transit exchange			
Digital-digital	0,45 ms		
Digital local exchange			
analogue-analogue	1,5 ms		
Digital local exchange, analogue subscriber line-digital junction	0,975 ms		
Digital local exchange, digital subscriber line-digital junction	0,825 ms		
Echo cancellers	0,5 ms		
PLC	3,25 ms		
Processing Time AGW	5 ms	Sending 1,5 ms - 2 ms Receiving 1,5 ms - 2 ms Internal 1 ms	

Processing Time RGW	10 ms		
----------------------------	-------	--	--

Table A.8 shows various coder parameters used in the mathematical model in clause A.4.3.

Table A.8: Coder and decoder parameters

CODER	
Packetization time	10 ms / 20 ms
Processing time	MGW (MSAN) = 3 ms; MGW (Mobile) = 10 ms IAD = 15 ms UMTS = 25 ms LTE = 51 ms
Coder related processing time G.729	25 ms
Serialization	Depends on the access
IP Sec Encoding	2 x 5 ms
DECODER	
Processing time receiving & air interface delay	MGW (MSAN) = 3 ms; MGW (Mobile) = 10 ms IAD = 15 ms UMTS = 20 ms LTE = 44 ms
Serialization time	Depends on the access
Jitter caused due queuing at the access segments downlink	Serialization time data packet
de-jitter buffer size	Depends of the codec
De-jitter buffer delay	0,5 time de-jitter buffer size
PLC	3,25 ms
Decompression Delay	G.711 - 1 ms G.729 - 2 ms
IP Sec Coding / Decoding	2 x 5 ms

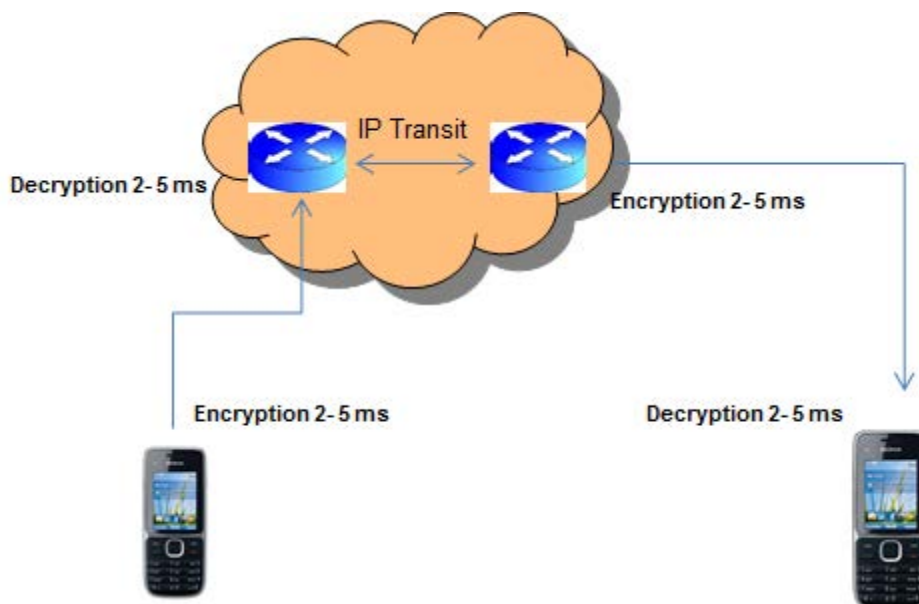

Figure A.1: IP Sec Encoding / decoding

A.4.3 Delay and Jitter Values

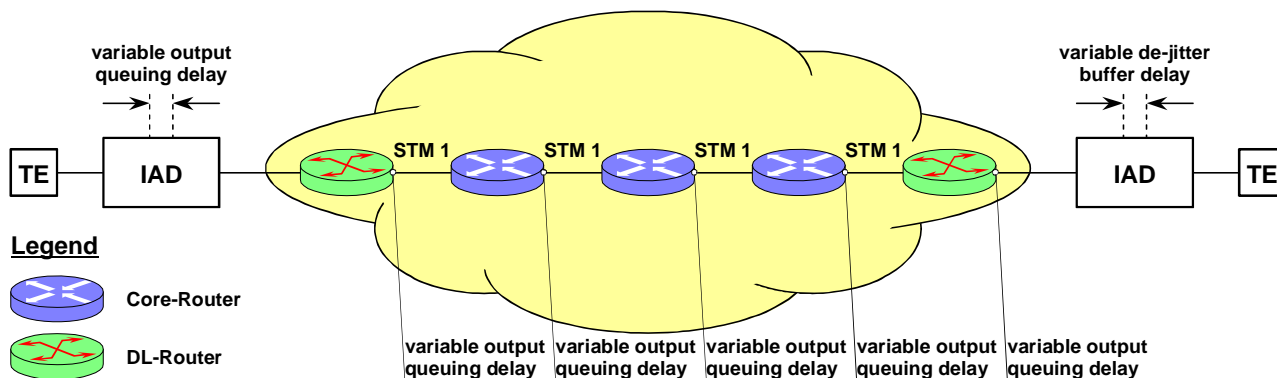

Figure A.2: Variable Delay and the De-Jitter Buffer Reference Diagram

From a de-jitter buffer point of view, it has to adapt to the maximum end-to-end delay variation (green curve in figure A.2 shows possible end-to-end audio delay variation, the steps are due to de-jitter buffer adoption to delay variation).

a) Playout buffer:

In the playout buffer are usually 1, 2 or more packets. In the playout buffer, no prioritization exists. A packet in the playout buffer has to be sent first, even if it is a low priority packet and a strict priority packet is waiting.

NOTE: The de-jitter buffer should compensate the time which is needed that the packets lives the playout buffer.

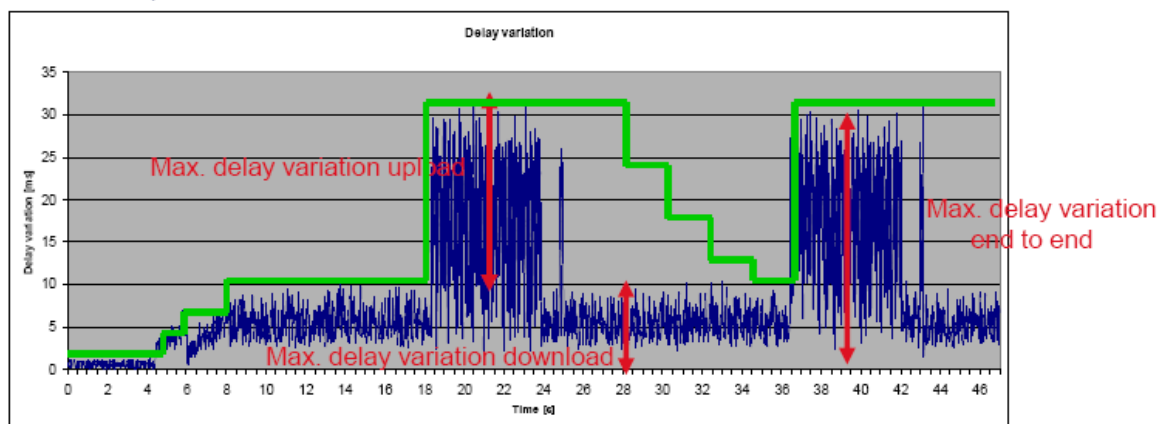

Figure A.3: Maximum Delay Variation

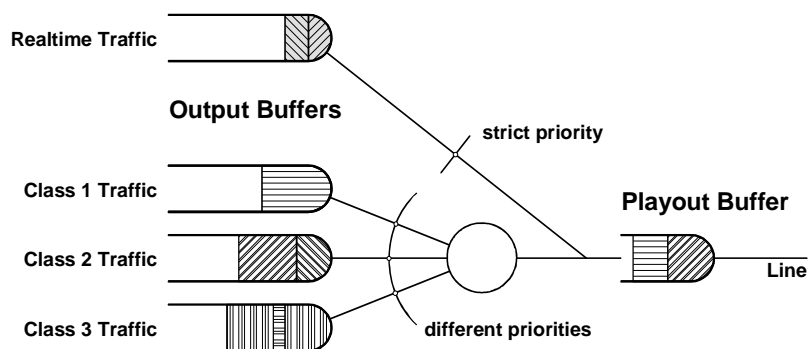

Figure A.4: Playout Buffer

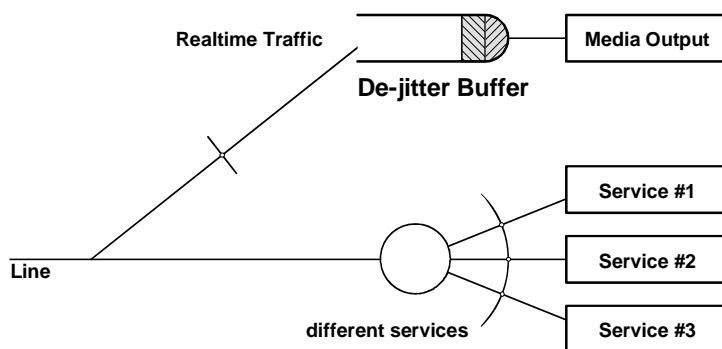

Figure A.5: De-jitter Buffer

b) De-jitter buffer:

The initial playout delay of the de-jitter buffer is configurable in most implementations. The maximum depth of the buffer before it overflows is normally set to 1,5 or 2,0 times this value.

For the calculation of the delay, the jitter caused by one data packet in the playout buffer was used.

The complete calculation of the delay and jitter values is contained in Excel file contained in archive tr_102775v010602p0.zip which accompanies the present document.

The Excel sheet is divided in four sheets for the Codecs G.711/20, G.729, G.711/10 and G.726/20/32 kb/s. the parameters which are needed for the calculation are marked in light blue, the results in yellow. The description of the parameters is listed in table A.9.

Table A.9: The description of parameters contained in figure A.6

No	Parameter	Description
1	BYTE User A & BYTE User B	Ethernet packet size [Bytes] of the used Codecs G.711/20 - 160 Bytes Payload + Header (e.g. 66 Bytes) (see note 1) G.711/10 - 80 Bytes Payload + Header G.729/20 - 20 Bytes Payload + Header G.726/20/32 - 80 Bytes Payload + Header In the simulation were used following settings: G.711/20 - 226 Bytes G.711/10 - 146 Bytes G.729/20 - 86 Bytes G.726/20/32 - 146 Bytes
2	Data Packet length Bytes	The maximal Ethernet packet size [Bytes] which can be transported, usually 1 536 bytes
3	Service Rate Sending Kbits/s Service Rate Receiving kbit/s	Ethernet service rate of the Uplink and Downlink
4	Packetization time Voice	Packetization time [s]
5	Processing time sending	Signal processing of the sending user [s]
6	Processing time sending mobile & & air interface delay	Coder related processing time sending, see TR 101 714 [i.37]; TR 126 976 [i.38]; TR 126 935 [i.39]; TR 125 912 [i.40]
7	PLC	Packet loss concealment 0 = No PLC 0,003 [s] with PLC
8	Processing time receiving	Signal processing time of the receiving side
9	Processing time receiving mobile & & air interface delay	Coder related processing time receiving, see TR 101 714 [i.37]; TR 126 976 [i.38]; TR 126 935 [i.39]; TR 125 912 [i.40]
10	Jitter Transit	Additional jitter caused due the transmission (e.g. SBC). (Additional to the sending jitter) [s]
11	The minimum value of the jitter buffer memory	If the jitter (see note 2) is higher than the minimum dejitter buffer size of the receiving side, this parameter should be set to 0. If the jitter (see note 2) is lower than the minimum dejitter buffer size of the receiving side, this value is set to the minimum dejitter buffer size [s]
12	Delay IP Bandwith Management	The processing time of the Bandwith Management [s]
13	Number of Packets in the Playout buffer	The default value is 1, the maximum is 1,5
14	Decompression delay/ Decoding delay	The decompression delay of the encoder [s]
15	Distance	The distance in km between the sending and receiving side
16	IP Sec delay	The processing delay caused due to IP Sec [s]
17	IAD Sending & IAD receiving	The delay values caused in the IAD or GW
18	JITTER Sending & Receiving	Summary of Sending & Receiving Jitter [s]

No	Parameter	Description
19	IAD send + IAD Rec GSM Sending + IAD IAD + GSM Receiving GSM - GSM U MTS Rel.4 GSM Sending + IAD IAD + UMTS Rel.4 Receiving U MTS-UMTS Rel4 L TE + IAD L TE - LTE	Delay values for different DSL and Mobile configurations in seconds [s]
NOTE 1: The header size is depending on the used stack, e.g. VLAN, MPLS etc. and should be calculated for the used link.		
NOTE 2: The estimated jitter is specified in point 17 (JITTER Sending & Receiving).		

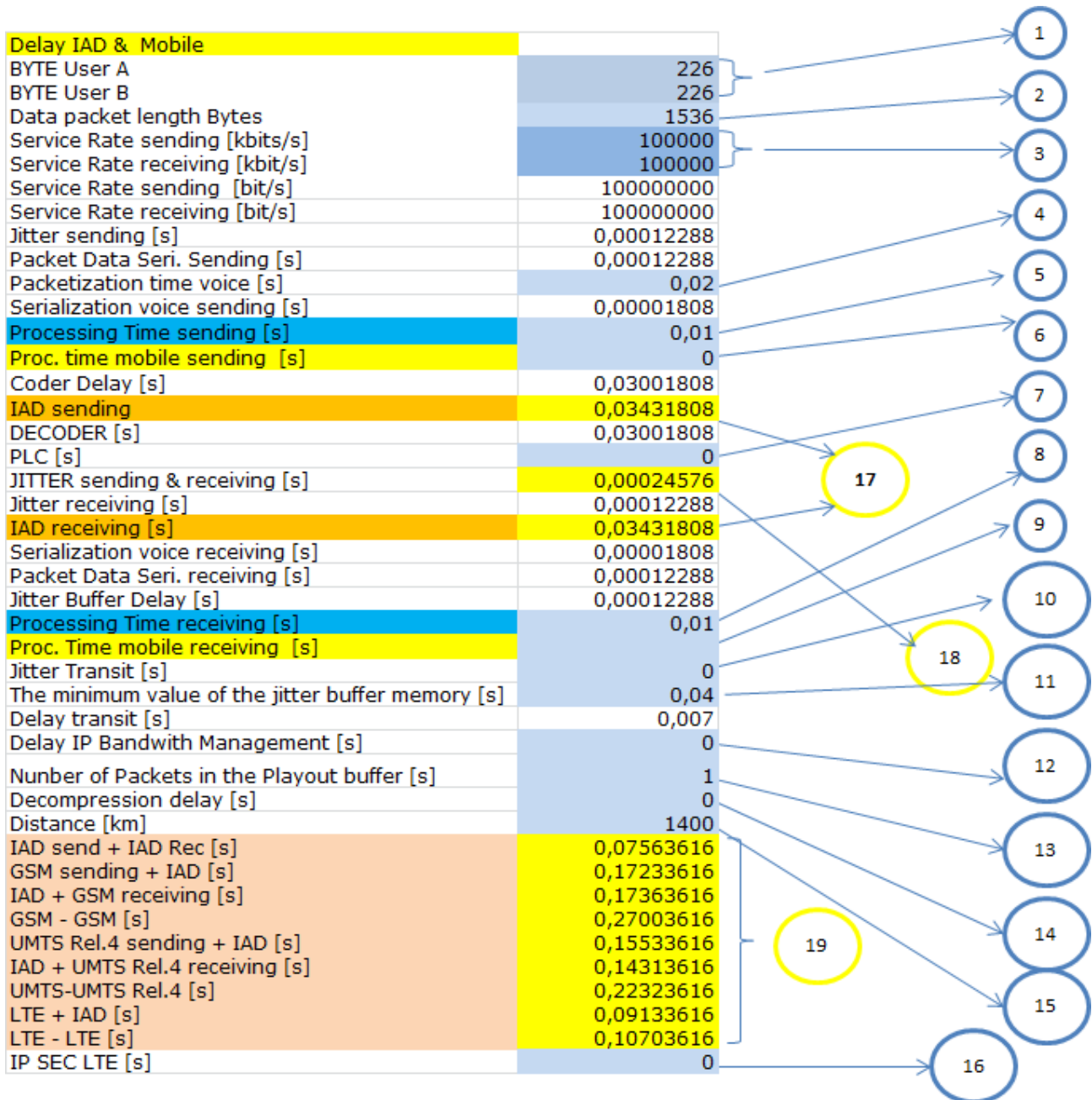

Figure A.6: Parameters used in the Excel sheet

A.4.3.1 Configuration examples

Delay IAD & Mobile	
BYTE User A	226
BYTE User B	226
Data packet length Bytes	1 536
Service Rate sending [kbits/s]	512
Service Rate receiving [kbit/s]	512
Service Rate sending [bit/s]	512 000
Service Rate receiving [bit/s]	512 000
Jitter sending [s]	0,024
Packet Data Seri. Sending [s]	0,024
Packetization time voice [s]	0,02
Serialization voice sending [s]	0,00353125
Processing Time sending [s]	0,015
Proc. time mobile sending [s]	0
Coder Delay [s]	0,03853125
IAD sending	0,04283125
DECODER [s]	0,04353125
PLC [s]	0
JITTER sending & receiving [s]	0,048
Jitter receiving [s]	0,024
IAD receiving [s]	0,04783125
Serialization voice receiving [s]	0,00353125
Packet Data Seri. receiving [s]	0,024
Jitter Buffer Delay [s]	0,024
Processing Time receiving [s]	0,015
Proc. Time mobile receiving [s]	0
Jitter Transit [s]	0
The minimum value of the jitter buffer memory [s]	0,04
Delay transit [s]	0,007
Delay IP Bandwidth Management [s]	0
Number of Packets in the Playout buffer [s]	1
Decompression delay [s]	0,001
Distance [km]	1 400
IAD send + IAD Rec [s]	0,0976625

Figure A.7: ETH - ETH Model

Delay IAD & Mobile	
BYTE User A	226
BYTE User B	226
Data packet length Bytes	1 536
Service Rate sending [kbits/s]	100 000
Service Rate receiving [kbit/s]	512
Service Rate sending [bit/s]	100 000 000
Service Rate receiving [bit/s]	512 000
Jitter sending [s]	0,00012288
Packet Data Seri. Sending [s]	0,00012288
Packetization time voice [s]	0,02
Serialization voice sending [s]	0,00001808
Processing Time sending [s]	0,01
Proc. time mobile sending [s]	
Coder Delay [s]	0,03001808
IAD sending	0,03431808
DECODER [s]	0,03953125
PLC [s]	0
JITTER sending & receiving [s]	0,02412288
Jitter receiving [s]	0,024
IAD receiving [s]	0,04383125
Serialization voice receiving [s]	0,00353125
Packet Data Seri. receiving [s]	0,024
Jitter Buffer Delay [s]	0,01206144
Processing Time receiving [s]	0,015
Proc. Time mobile receiving [s]	
Jitter Transit [s]	0
The minimum value of the jitter buffer memory [s]	0,04
Delay transit [s]	0,007
Delay IP Bandwith Management [s]	0
Number of Packets in the Playout buffer [s]	1
Decompression delay [s]	0,001
Distance [km]	1 400
IAD send + IAD Rec [s]	0,08514933
GSM sending + IAD [s]	0,18184933

Figure A.8: GSM - ETH Model

Delay IAD & Mobile	
BYTE User A	226
BYTE User B	226
Data packet length Bytes	1 536
Service Rate sending [kbits/s]	100 000
Service Rate receiving [kbit/s]	512
Service Rate sending [bit/s]	100 000 000
Service Rate receiving [bit/s]	512 000
Jitter sending [s]	0,00012288
Packet Data Seri. Sending [s]	0,00012288
Packetization time voice [s]	0,02
Serialization voice sending [s]	0,00001808
Processing Time sending [s]	0
Proc. time mobile sending [s]	0,025
Coder Delay [s]	0,04501808
IAD sending	0,04931808
DECODER [s]	0,03953125
PLC [s]	0
JITTER sending & receiving [s]	0,02412288
Jitter receiving [s]	0,024
IAD receiving [s]	0,04383125
Serialization voice receiving [s]	0,00353125
Packet Data Seri. receiving [s]	0,024
Jitter Buffer Delay [s]	0,01206144
Processing Time receiving [s]	0,015
Proc. Time mobile receiving [s]	0
Jitter Transit [s]	0
The minimum value of the jitter buffer memory [s]	0,04
Delay transit [s]	0,007
Delay IP Bandwith Management [s]	0
Number of Packets in the Playout buffer [s]	1
Decompression delay [s]	0,001
Distance [km]	1 400
IAD send + IAD Rec [s]	0,10014933
GSM sending + IAD [s]	0,19684933
IAD + GSM receiving [s]	0,19814933
GSM - GSM [s]	0,29454933
UMTS Rel.4 sending + IAD [s]	0,17984933

Figure A.9: UMTS - ETH Model

Delay POTS & Mobile	
Service Rate sending [kbits/s]	100 000
Service Rate receiving [kbit/s]	100 000
Service Rate sending [bit/s]	100000000
Service Rate receiving [bit/s]	100000000
Jitter sending [s]	0,00012288
Packet Data Seri. Sending [s]	0,00012288
Packetization time voice [s]	0,02
Serialization voice sending [s]	0,00001808
Processing Time sending [s]	0,003
Proc. time mobile sending [s]	0
Coder Delay [s]	0,02301808
IAD sending	0,02731808
DECODER [s]	0,02401808
PLC [s]	0
JITTER sending & receiving [s]	0,00024576
Jitter receiving [s]	0,00012288
IAD receiving [s]	0,02831808
Serialization voice receiving [s]	0,00001808
Packet Data Seri. receiving [s]	0,00012288
Jitter Buffer Delay [s]	0,00012288
Processing Time receiving [s]	0,003
Proc. Mobile receiving [s]	0
Jitter Transit [s]	0
The minimum value of the jitter buffer memory [s]	0,04
Delay transit [s]	0,007
Delay IP Bandwith Management [s]	0
Number of Packets in the Playout buffer [s]	1
Decompression delay [s]	0,001
Distance [km]	1 400
POTS sending [s]	0,02399308
POTS sending+ IAD receiving [s]	0,05931116
POTS receiving [s]	0,03199308
IAD sending + POTS receiving [s]	0,05931116
POTS receiving + sending [s]	0,05598616

Figure A.10: POTS - POTS Model

Delay POTS & Mobile	
Service Rate sending [kbits/s]	100 000
Service Rate receiving [kbit/s]	100 000
Service Rate sending [bit/s]	100 000 000
Service Rate receiving [bit/s]	100 000 000
Jitter sending [s]	0,00012288
Packet Data Seri. Sending [s]	0,00012288
Packetization time voice [s]	0,02
Serialization voice sending [s]	0,00001808
Processing Time sending [s]	0,01
Proc. time mobile sending [s]	0
Coder Delay [s]	0,03001808
IAD sending	0,03431808
DECODER [s]	0,02401808
PLC [s]	0
JITTER sending & receiving [s]	0,00024576
Jitter receiving [s]	0,00012288
IAD receiving [s]	0,02831808
Serialization voice receiving [s]	0,00001808
Packet Data Seri. receiving [s]	0,00012288
Jitter Buffer Delay [s]	0,00012288
Processing Time receiving [s]	0,003
Proc. Mobile receiving [s]	0
Jitter Transit [s]	0
The minimum value of the jitter buffer memory [s]	0,04
Delay transit [s]	0,007
Delay IP Bandwith Management [s]	0
Number of Packets in the Playout buffer [s]	1
Decompression delay [s]	0,001
Distance [km]	1 400
POTS sending [s]	0,03099308
POTS sending+ IAD receiving [s]	0,06631116
POTS receiving [s]	0,03199308
IAD sending + POTS receiving [s]	0,06631116
POTS receiving + sending [s]	0,06298616
GSM sending + POTS [s]	0,16301116

Figure A.11: GSM - POTS Model

Delay POTS & Mobile	
Service Rate sending [kbits/s]	100 000
Service Rate receiving [kbit/s]	100 000
Service Rate sending [bit/s]	100 000 000
Service Rate receiving [bit/s]	100 000 000
Jitter sending [s]	0,00012288
Packet Data Seri. Sending [s]	0,00012288
Packetization time voice [s]	0,02
Serialization voice sending [s]	0,00001808
Processing Time sending [s]	0
Proc. time mobile sending [s]	0,025
Coder Delay [s]	0,04501808
IAD sending	0,04931808
DECODER [s]	0,02401808
PLC [s]	0
JITTER sending & receiving [s]	0,00024576
Jitter receiving [s]	0,00012288
IAD receiving [s]	0,02831808
Serialization voice receiving [s]	0,00001808
Packet Data Seri. receiving [s]	0,00012288
Jitter Buffer Delay [s]	0,00012288
Processing Time receiving [s]	0,003
Proc. Mobile receiving [s]	0
Jitter Transit [s]	0
The minimum value of the jitter buffer memory [s]	0,04
Delay transit [s]	0,007
Delay IP Bandwith Management [s]	0
Number of Packets in the Playout buffer [s]	1
Decompression delay [s]	0,001
Distance [km]	1 400
POTS sending [s]	0,04599308
POTS sending+ IAD receiving [s]	0,08131116
POTS receiving [s]	0,03199308
IAD sending + POTS receiving [s]	0,08131116
POTS receiving + sending [s]	0,07798616
GSM sending + POTS [s]	0,17801116
POTS+ GSM receiving [s]	0,17801116
UMTS Rel.4 sending + POTS [s]	0,16101116

Figure A.12: UMTS - POTS

Delay POTS & Mobile	
Service Rate sending [kbits/s]	1000000
Service Rate receiving [kbit/s]	1000000
Service Rate sending [bit/s]	1000000000
Service Rate receiving [bit/s]	1000000000
Jitter sending [s]	0,000012288
Packet Data Seri. Sending [s]	0,000012288
Packetization time voice [s]	0,02
Serialization voice sending [s]	0,000001808
Processing Time sending [s]	0
Proc. time mobile sending [s]	0,051
Coder Delay [s]	0,071001808
IAD sending	0,075301808
DECODER [s]	0,023001808
PLC [s]	0
JITTER sending & receiving [s]	0,000024576
Jitter receiving [s]	0,000012288
IAD receiving [s]	0,027301808
Serialization voice receiving [s]	0,000001808
Packet Data Seri. receiving [s]	0,000012288
Jitter Buffer Delay [s]	0,000012288
Processing Time receiving [s]	0,003
Proc. Mobile receiving [s]	0
Jitter Transit [s]	0
The minimum value of the jitter buffer memory [s]	0,04
Delay transit [s]	0,007
Delay IP Bandwith Management [s]	0
Number of Packets in the Playout buffer [s]	1
Decompression delay [s]	0
Distance [km]	1400
POTS sending [s]	0,071976808
POTS sending+ IAD receiving [s]	0,106278616
POTS receiving [s]	0,030976808
IAD sending + POTS receiving [s]	0,106278616
POTS receiving + sending [s]	0,102953616
GSM sending + POTS [s]	0,202978616
POTS+ GSM receiving [s]	0,202978616
UMTS Rel.4 sending + POTS [s]	0,185978616
POTS + UMTS Rel.4 receiving [s]	0,173778616
LTE + POTS [s]	0,122978616

Figure A.13: LTE - POTS

Delay IAD & Mobile	
BYTE User A	226
BYTE User B	226
Data packet length Bytes	1 536
Service Rate sending [kbits/s]	100 000
Service Rate receiving [kbit/s]	100 000
Service Rate sending [bit/s]	100 000 000
Service Rate receiving [bit/s]	100 000 000
Jitter sending [s]	0,00012288
Packet Data Seri. Sending [s]	0,00012288
Packetization time voice [s]	0,02
Serialization voice sending [s]	0,00001808
Processing Time sending [s]	0,01
Proc. time mobile sending [s]	0
Coder Delay [s]	0,03001808
IAD sending	0,03431808
DECODER [s]	0,03101808
PLC [s]	0
JITTER sending & receiving [s]	0,00024576
Jitter receiving [s]	0,00012288
IAD receiving [s]	0,03531808
Serialization voice receiving [s]	0,00001808
Packet Data Seri. receiving [s]	0,00012288
Jitter Buffer Delay [s]	0,00012288
Processing Time receiving [s]	0,01
Proc. Time mobile receiving [s]	0
Jitter Transit [s]	0
The minimum value of the jitter buffer memory [s]	0,04
Delay transit [s]	0,007
Delay IP Bandwith Management [s]	0
Number of Packets in the Playout buffer [s]	1
Decompression delay [s]	0,001
Distance [km]	1 400
IAD send + IAD Rec [s]	0,07663616
GSM sending + IAD [s]	0,17333616
IAD + GSM receiving [s]	0,17463616
GSM - GSM [s]	0,27103616

Figure A.14: GSM - GSM

Delay IAD & Mobile	
BYTE User A	226
BYTE User B	226
Data packet length Bytes	1536
Service Rate sending [kbits/s]	1000000
Service Rate receiving [kbit/s]	6144
Service Rate sending [bit/s]	1000000000
Service Rate receiving [bit/s]	6144000
Jitter sending [s]	0,000012288
Packet Data Seri. Sending [s]	0,000012288
Packetization time voice [s]	0,02
Serialization voice sending [s]	0,000001808
Processing Time sending [s]	0
Proc. time mobile sending [s]	0,051
Coder Delay [s]	0,071001808
IAD sending	0,075301808
DECODER [s]	0,036294271
PLC [s]	0
JITTER sending & receiving [s]	0,002012288
Jitter receiving [s]	0,002
IAD receiving [s]	0,040594271
Serialization voice receiving [s]	0,000294271
Packet Data Seri. receiving [s]	0,002
Jitter Buffer Delay [s]	0,001006144
Processing Time receiving [s]	0,015
Proc. Time mobile receiving [s]	0
Jitter Transit [s]	0
The minimum value of the jitter buffer memory [s]	0,04
Delay transit [s]	0,007
Delay IP Bandwith Management [s]	0
Number of Packets in the Playout buffer [s]	1
Decompression delay [s]	0,001
Distance [km]	1400
IAD send + IAD Rec [s]	0,122896079
GSM sending + IAD [s]	0,219596079
IAD + GSM receiving [s]	0,220896079
GSM - GSM [s]	0,317296079
UMTS Rel.4 sending + IAD [s]	0,202596079
IAD + UMTS Rel.4 receiving [s]	0,190396079
UMTS-UMTS Rel.4 [s]	0,270496079
LTE + IAD [s]	0,139596079

Figure A.15: LTE - ETH

A.4.4 GSM Access

Table A.10 shows the number of elements and the delay values used for a GSM connection with AMR.

Table A.10: One way delay for GSM

	MS	BTS	ADM 2X	BSC	TRAU	MSC	MGW	SUM
Sending Packetization time 20 ms	101 ms (note 1) / 73,5 (note 2)						Coder 24	125
	41,248 ms (note 1)	59 ms (note 1)						
	40,6 ms (note 2)	32,9 ms (note 2) + 22,1 ms (BTS, MSC, BSC)						
Receiving De-jitter Buffer 40 ms Packetization time 20 ms	102,3 ms (note 1) / 46 (note 2)						Decoder 25	127
	Processing 13,6 ms	89,1 ms (note 1)						
	13,1 ms (note 2)	32,9 ms (note 2) + 50 ms (BTS, MSC, BSC)						
NOTE 1: According TR 101 714 [i.37] version 7.2.0 Release 1998, UE DL: Processing 16,24 ms, Tsample 25 ms; UE DL: Processing 13,2 ms.								
NOTE 2: TR 126 976 [i.38].								

A.4.5 UMTS Release 4 Access

Table A.10 shows the number of elements and the delay values used for an UMTS Release 4 connection for TrFO. The UMTS air interface receives IP/UDP/RTP/AMR packets.

Table A.11: One way delay for UMTS Release 4

UMTS Release 4	UE	NodeB	RiFu	RNC	ATM/IP	SUM
Sending	45 (note 2)				84,4	129
Receiving	40 (note 2)				71,8	112
NOTE 1: According to TR 126 935 [i.39]:						
<ul style="list-style-type: none"> • Encoder side: delay due to account framing, look-ahead, processing and packetization = 45 ms. • Uplink delay between UE and lu: 84,4 ms (see [i.11]). • Core network delay: a few ms. • Routing through IP: depending on the number of routers. • Downlink delay between lu and UE: 71,8 ms (see [i.11]). • Decoder side, taking into account jitter buffer, de-packetization and processing: 40 ms. 						
NOTE 2: UE UL: 20 ms + 5 ms + 20 ms. UE DL: 20 ms + 20 ms.						

SPEECH DELAY - DT

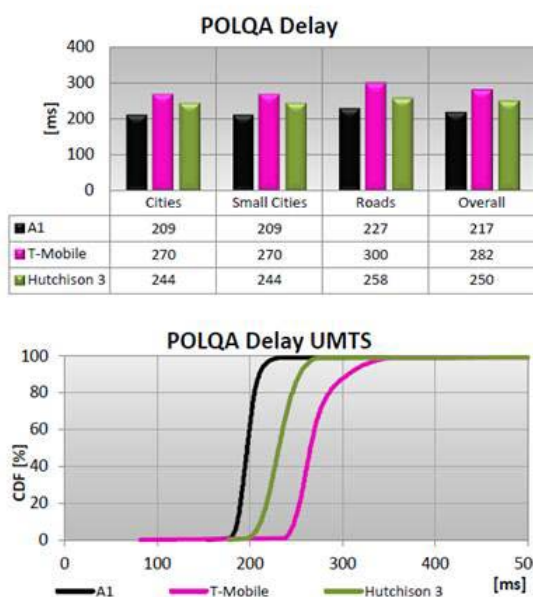

SPEECH DELAY CDF - DT OVERALL

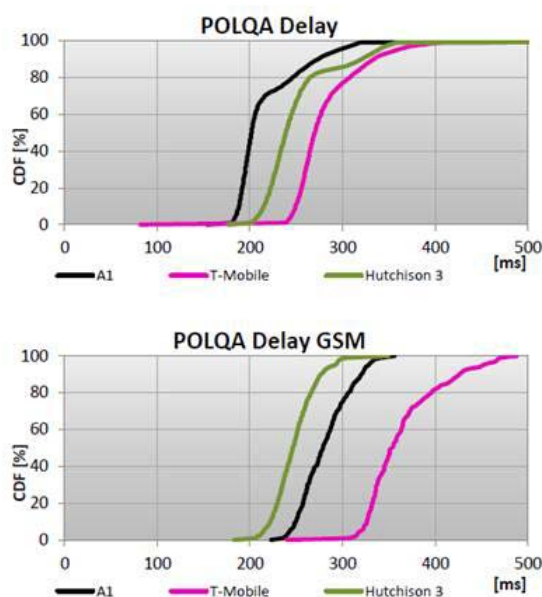

Figure A.16: Speech path delay of GSM and UMTS Networks in Austria

A.4.6 LTE Access

The LTE delay budget was measured in production environments Table A.12 shows the number of elements and the delay values used for an LTE connection with AMR WB. The end to end delay budget for LTE VoIP is considered here. The delay should be preferably below 170 ms.

Table A.12: One way delay for LTE

LTE	UE	Delay between P-GW and the eNB+ S1-U Transfer Delay	SUM
Sending Packetization time 20 ms	71 (note 1)	21 ms (notes 3 and 4)	92
Receiving de-jitter Buffer 40 ms Packetization time 20 ms	64 (note 1)	12 ms (notes 3 and 4)	76

According to TR 126 976 [i.38] for AMR and AMR/WB $T_{sample} = 25$ ms (duration of the 20 ms speech frame and 5 ms look ahead).

NOTE 1: UE UL: 20 ms (Codec)+5 ms (look ahead)+ 46,24 ms (16,24 ms - note 2 + 30 ms) = 71,24
 UE DL: 20 ms(JB)+43,6 ms (13,6 ms - note 2 + 30 ms) = 63,6
 The LTE scheduling is between 10 ms [i.32] and 30 ms depending of the scheduler implementation.

NOTE 2 According to TR 126 976 [i.38].

NOTE 3: Measured values at ETSI, CISCO, Ericsson and TeliaSonera premises [i.33] to [i.36].

NOTE 4: The delay budget was measured in production environments, The S1-U delay is bandwidth depended.

**Table A.13: U-plane latency analysis (estimated average in downlink)
according TR 125 912 [i.40] and S1-U Transfer Delay**

Step	Description	Value (30 % HARQ)
1	eNB Processing Delay (S1-U->Uu)	1 ms
2	Frame Alignment	1,022 ms
3	TTI for DL DATA PACKET	0,675 ms
4	HARQ Retransmission	0,3 x 5 ms
5	UE Processing Delay	1 ms
6	S1-U Transfer Delay and aGW	7 ms (note)
Total one way delay		12,2 ms

NOTE: The delay budget was measured in production environments, The S1-U delay is bandwidth depended.

**Table A.14: U-plane latency analysis (estimated average in uplink)
according TR 125 912 [i.40] and S1-U Transfer Delay**

Step	Description	Value (30 % HARQ)
0	UE wakeup time	Implementation dependent - Not included
1	UE Processing Delay	1 ms
2	Frame Alignment	1,423 ms
3	TTI for UL DATA PACKET (Piggy back scheduling information)	0,675 ms
4	HARQ Retransmission	0,3 x 5 ms
5	eNB Processing Delay (Uu -> S1-U)	1 ms
6	S1-U Transfer Delay and aGW	15 ms (note)
Total one way delay		20,6 ms

NOTE: The delay budget was measured in production environments, The S1-U delay is bandwidth depended.

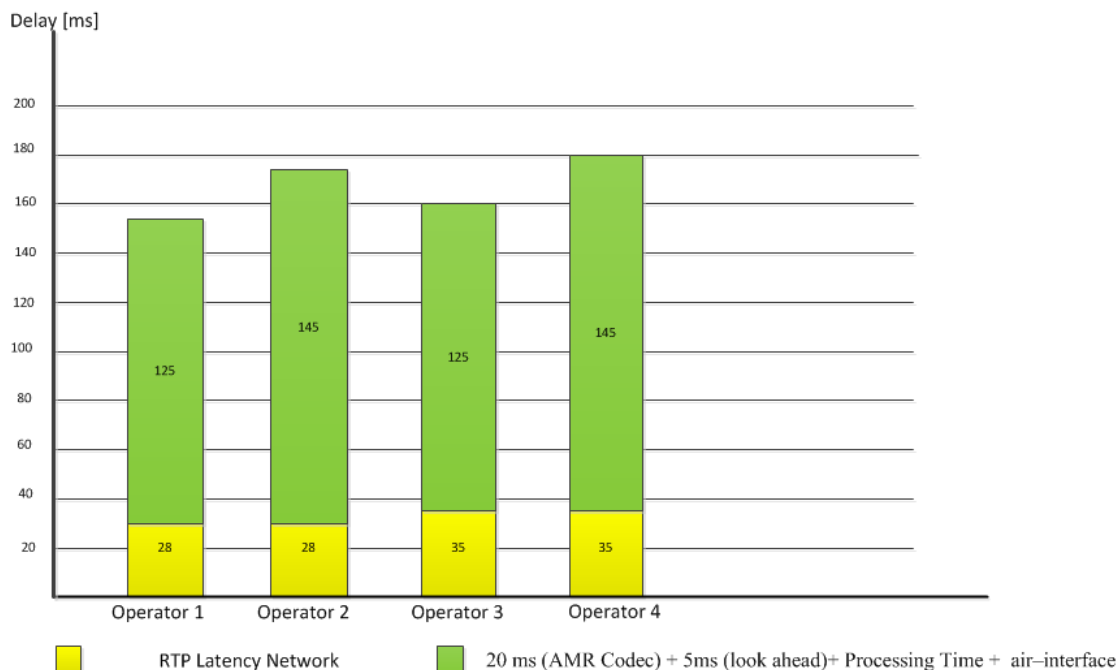

NOTE: Codec w/ look-ahead 25 ms

UE processing, average 100-120 ms (LTE scheduling & de-jitter 40-80 ms depending on scheduler implementation, load, packet bundling etc.)

Figure A.17: Speech path delay of VoLTE Networks [i.32] to [i.36]

Annex B: Bandwidth calculations and prioritization in VoIP systems

The IP delay of VoIP packets over a link transporting Voice and Data depends on following factors:

- the instantaneous system load (not the average system load);
- the size of the packets (both the size of the RTP packets and IP data packets on the same links);
- the manner in which QoS is implemented in the system (a system with priority, such as Diff-Serv, behaves differently than a system with best effort).

The average end-to-end propagation delay can be calculated numerically as a function of voice traffic (ρ_1 partial utilization) and data traffic (partial utilization ρ_2) with the so-called Khintchine Pollazcek-formula based on the $M / G / 1 / \infty$ calculation.

The numerical model for two classes of traffic with prioritization of Prof. Nocker (Rudolf Nocker: Verzögerungen in paketbasierten Kommunikationsnetzen) in the "worst case situation" fits best with real test results. The maximum capacity is bandwidth dependent. For example, the utilization for a 386 kbit/s link should not be higher than 85 %, a 4 Mbit/s link can be utilized with 96 %.

Table B.1

Utilization ($\rho_1 + \rho_2$)	Link capacity
RHO < 0,96	> 4 Mbit/s
RHO < 0,95	3 Mbit/s
RHO < 0,89	2 - 3 Mbit/s
RHO < 0,89	1 - 2 Mbit/s
RHO < 0,85	0,386 - 1 Mbit/s
Tests conditions: Data utilization $\rho_2 = 62$ %; Data Packet size = 1 500 bytes; Codec: G.711.	

The delay and jitter increase linearly up to a limit of parallel VoIP channels. Above this limit, the bandwidth utilization and the delay increase exponentially (see figure B.1) and the VoIP transmissions become unstable.

The lower figure B.1 applies to a bandwidth of 4 Mbit / s with G.729.

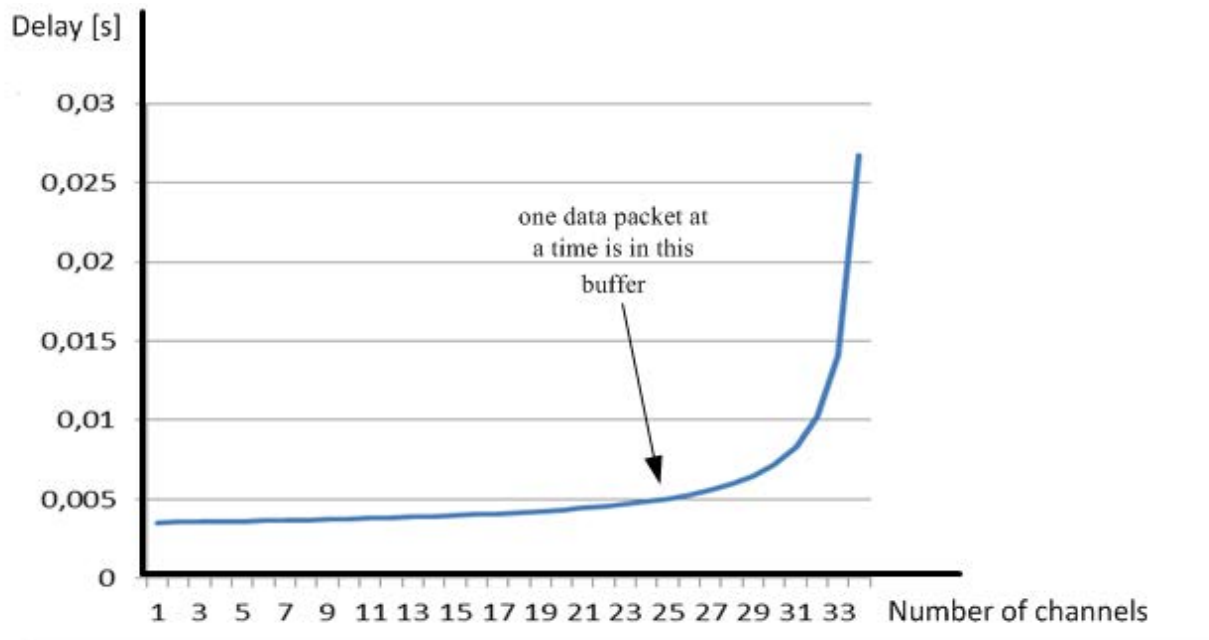
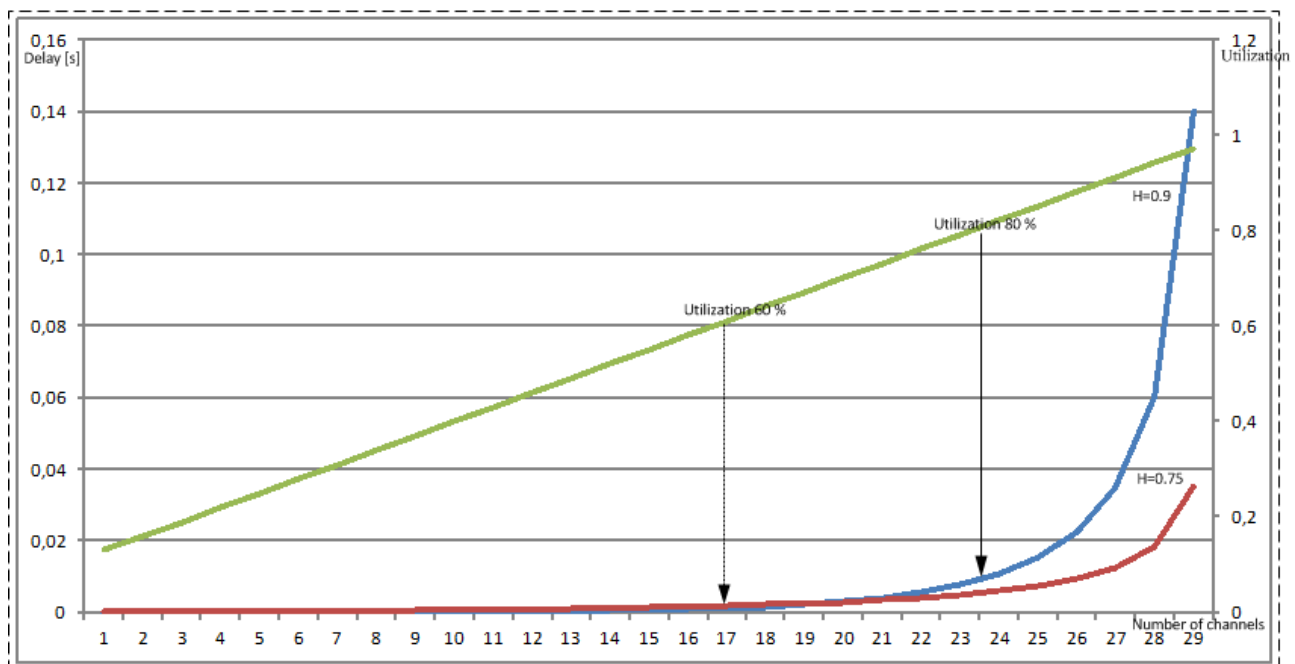

Figure B.1

Without prioritization only 40 % to 80 % of the bandwidth can be used depending on the flow characteristics, as can be seen in figure B.2.

Figure B.2: Traffic without prioritization with the flow characteristics $H = 0,9$ and $H = 0,75$

The figure B.2 applies to a bandwidth of 3 Mbit/s with the flow characteristics $H = 0,9$ and $H = 0,75$.

Table B.2

Characteristics of traffic flows (ITU-T Q.3925 [i.41])	
Data traffic flow characteristics	Hurst parameter
www ⁿ traffic is self-similar	$H = 0,7 - 0,9$
File transfer traffic	$H = 0,85 - 0,95$
E-mail traffic	$H = 0,75$
IPTV Multicast	$0,55 - 0,6$
IPTV Unicast	$0,75 - 0,8$
Signalling	$0,83$

Annex C: Test templates for Voice applications based on the present document

This annex contains test templates to test the quality parameters that need to be considered at the Segment-connections points of Voice over IP (VoIP) Modem over IP (MoIP) and Fax over IP (FoIP) services.

C.1 Configuration: MSAN POTS - MSAN POTS

C.1.1 Configuration: MSAN POTS - MSAN POTS; Application: Voice

Test num.	Testing time	Config / Test numbers	Codec	Packetization time	P.863	Delay Upstream	Delay Downstream	Active Level
1					Mean: Std-Dev: Range:	Mean: Std-Dev: Range:	Mean: Std-Dev: Range:	Mean: Std-Dev: Range:
2					Mean: Std-Dev: Range:	Mean: Std-Dev: Range:	Mean: Std-Dev: Range:	Mean: Std-Dev: Range:
3					Mean: Std-Dev: Range:	Mean: Std-Dev: Range:	Mean: Std-Dev: Range:	Mean: Std-Dev: Range:
4					Mean: Std-Dev: Range:	Mean: Std-Dev: Range:	Mean: Std-Dev: Range:	Mean: Std-Dev: Range:
5					Mean: Std-Dev: Range:	Mean: Std-Dev: Range:	Mean: Std-Dev: Range:	Mean: Std-Dev: Range:
6					Mean: Std-Dev: Range:	Mean: Std-Dev: Range:	Mean: Std-Dev: Range:	Mean: Std-Dev: Range:

C.1.2 Configuration: MSAN POTS - MSAN POTS; Application: Fax, bit rate $\leq 14,4$ kbit/s

Test num.	Testing time	Config / Test numbers	Codec	Packet. time	Delay Upstream	Delay Downstream	Active Level	Noise	Signal to Interval Noise
1					Mean: Std-Dev: Range:	Mean: Std-Dev: Range:	Mean: Std-Dev: Range:	Mean: Std-Dev: Range:	Mean: Std-Dev: Range:
2					Mean: Std-Dev: Range:	Mean: Std-Dev: Range:	Mean: Std-Dev: Range:	Mean: Std-Dev: Range:	Mean: Std-Dev: Range:
3					Mean: Std-Dev: Range:	Mean: Std-Dev: Range:	Mean: Std-Dev: Range:	Mean: Std-Dev: Range:	Mean: Std-Dev: Range:
4					Mean: Std-Dev: Range:	Mean: Std-Dev: Range:	Mean: Std-Dev: Range:	Mean: Std-Dev: Range:	Mean: Std-Dev: Range:
5					Mean: Std-Dev: Range:	Mean: Std-Dev: Range:	Mean: Std-Dev: Range:	Mean: Std-Dev: Range:	Mean: Std-Dev: Range:

C.1.3 Configuration: MSAN POTS - MSAN POTS; Application: Fax, bit rate $> 14,4$ kbit/s

Test num.	Testing time	Config / Test numbers	Codec	Packet. time	Delay Upstream	Delay Downstream	Active Level	Noise	Signal to Interval Noise
1					Mean: Std-Dev: Range:	Mean: Std-Dev: Range:	Mean: Std-Dev: Range:	Mean: Std-Dev: Range:	Mean: Std-Dev: Range:
2					Mean: Std-Dev: Range:	Mean: Std-Dev: Range:	Mean: Std-Dev: Range:	Mean: Std-Dev: Range:	Mean: Std-Dev: Range:
3					Mean: Std-Dev: Range:	Mean: Std-Dev: Range:	Mean: Std-Dev: Range:	Mean: Std-Dev: Range:	Mean: Std-Dev: Range:
4					Mean: Std-Dev: Range:	Mean: Std-Dev: Range:	Mean: Std-Dev: Range:	Mean: Std-Dev: Range:	Mean: Std-Dev: Range:
5					Mean: Std-Dev: Range:	Mean: Std-Dev: Range:	Mean: Std-Dev: Range:	Mean: Std-Dev: Range:	Mean: Std-Dev: Range:

C.1.4 Configuration: MSAN POTS - MSAN POTS; Application: Modem V.32/V.32 bis - start procedure; handshake according V.25 without phase reversals

Test num.	Testing time	Config / Test numbers	Codec	Packet. time	Delay Upstream	Delay Downstream	Active Level	Noise	Signal to Interval Noise
1					Mean: Std-Dev: Range:	Mean: Std-Dev: Range:	Mean: Std-Dev: Range:	Mean: Std-Dev: Range:	Mean: Std-Dev: Range:
2					Mean: Std-Dev: Range:	Mean: Std-Dev: Range:	Mean: Std-Dev: Range:	Mean: Std-Dev: Range:	Mean: Std-Dev: Range:
3					Mean: Std-Dev: Range:	Mean: Std-Dev: Range:	Mean: Std-Dev: Range:	Mean: Std-Dev: Range:	Mean: Std-Dev: Range:
4					Mean: Std-Dev: Range:	Mean: Std-Dev: Range:	Mean: Std-Dev: Range:	Mean: Std-Dev: Range:	Mean: Std-Dev: Range:
5					Mean: Std-Dev: Range:	Mean: Std-Dev: Range:	Mean: Std-Dev: Range:	Mean: Std-Dev: Range:	Mean: Std-Dev: Range:

C.1.5 Configuration: MSAN POTS - MSAN POTS; Application: Modem, V.32/V.32 bis - start procedure; handshake according V.8 with phase reversals

Test num.	Testing time	Config / Test numbers	Codec	Packet. time	Delay Upstream	Delay Downstream	Active Level	Noise	Signal to Interval Noise
1					Mean: Std-Dev: Range:	Mean: Std-Dev: Range:	Mean: Std-Dev: Range:	Mean: Std-Dev: Range:	Mean: Std-Dev: Range:
2					Mean: Std-Dev: Range:	Mean: Std-Dev: Range:	Mean: Std-Dev: Range:	Mean: Std-Dev: Range:	Mean: Std-Dev: Range:
3					Mean: Std-Dev: Range:	Mean: Std-Dev: Range:	Mean: Std-Dev: Range:	Mean: Std-Dev: Range:	Mean: Std-Dev: Range:
4					Mean: Std-Dev: Range:	Mean: Std-Dev: Range:	Mean: Std-Dev: Range:	Mean: Std-Dev: Range:	Mean: Std-Dev: Range:
5					Mean: Std-Dev: Range:	Mean: Std-Dev: Range:	Mean: Std-Dev: Range:	Mean: Std-Dev: Range:	Mean: Std-Dev: Range:

C.2 Configuration: MSAN POTS - POTS

C.2.1 Configuration: MSAN POTS - POTS; Application: Voice

Test Num.	Testing time	Config / Test numbers	Codec	Packet. time	P.863	Delay Upstream	Delay Downstream	Active Level
1					Mean: Std-Dev: Range:	Mean: Std-Dev: Range:	Mean: Std-Dev: Range:	Mean: Std-Dev: Range:
2					Mean: Std-Dev: Range:	Mean: Std-Dev: Range:	Mean: Std-Dev: Range:	Mean: Std-Dev: Range:
3					Mean: Std-Dev: Range:	Mean: Std-Dev: Range:	Mean: Std-Dev: Range:	Mean: Std-Dev: Range:
4					Mean: Std-Dev: Range:	Mean: Std-Dev: Range:	Mean: Std-Dev: Range:	Mean: Std-Dev: Range:
5					Mean: Std-Dev: Range:	Mean: Std-Dev: Range:	Mean: Std-Dev: Range:	Mean: Std-Dev: Range:

C.2.2 Configuration: MSAN POTS - POTS; Application: Fax, bit rate $\leq 14,4$ kbit/s

Test num.	Testing time	Config / Test numbers	Codec	Packet. time	Delay Upstream	Delay Downstream	Active Level	Noise	Signal to Interval Noise
1					Mean: Std-Dev: Range:	Mean: Std-Dev: Range:	Mean: Std-Dev: Range:	Mean: Std-Dev: Range:	Mean: Std-Dev: Range:
2					Mean: Std-Dev: Range:	Mean: Std-Dev: Range:	Mean: Std-Dev: Range:	Mean: Std-Dev: Range:	Mean: Std-Dev: Range:
3					Mean: Std-Dev: Range:	Mean: Std-Dev: Range:	Mean: Std-Dev: Range:	Mean: Std-Dev: Range:	Mean: Std-Dev: Range:
4					Mean: Std-Dev: Range:	Mean: Std-Dev: Range:	Mean: Std-Dev: Range:	Mean: Std-Dev: Range:	Mean: Std-Dev: Range:
5					Mean: Std-Dev: Range:	Mean: Std-Dev: Range:	Mean: Std-Dev: Range:	Mean: Std-Dev: Range:	Mean: Std-Dev: Range:

C.2.3 Configuration: MSAN POTS - POTS; Application: Fax, bit rate $> 14,4$ kbit/s

Test num.	Testing time	Config / Test numbers	Codec	Packet. time	Delay Upstream	Delay Downstream	Active Level	Noise	Signal to Interval Noise
1					Mean: Std-Dev: Range:	Mean: Std-Dev: Range:	Mean: Std-Dev: Range:	Mean: Std-Dev: Range:	Mean: Std-Dev: Range:
2					Mean: Std-Dev: Range:	Mean: Std-Dev: Range:	Mean: Std-Dev: Range:	Mean: Std-Dev: Range:	Mean: Std-Dev: Range:
3					Mean: Std-Dev: Range:	Mean: Std-Dev: Range:	Mean: Std-Dev: Range:	Mean: Std-Dev: Range:	Mean: Std-Dev: Range:
4					Mean: Std-Dev: Range:	Mean: Std-Dev: Range:	Mean: Std-Dev: Range:	Mean: Std-Dev: Range:	Mean: Std-Dev: Range:
5					Mean: Std-Dev: Range:	Mean: Std-Dev: Range:	Mean: Std-Dev: Range:	Mean: Std-Dev: Range:	Mean: Std-Dev: Range:

C.2.4 Configuration: MSAN POTS - POTS; Application: Modem, V.32/V.32 bis - start procedure; handshake according V.25 without phase reversals

Test num.	Testing time	Config / Test numbers	Codec	Packet. time	Delay Upstream	Delay Downstream	Active Level	Noise	Signal to Interval Noise
1					Mean: Std-Dev: Range:	Mean: Std-Dev: Range:	Mean: Std-Dev: Range:	Mean: Std-Dev: Range:	Mean: Std-Dev: Range:
2					Mean: Std-Dev: Range:	Mean: Std-Dev: Range:	Mean: Std-Dev: Range:	Mean: Std-Dev: Range:	Mean: Std-Dev: Range:
3					Mean: Std-Dev: Range:	Mean: Std-Dev: Range:	Mean: Std-Dev: Range:	Mean: Std-Dev: Range:	Mean: Std-Dev: Range:
4					Mean: Std-Dev: Range:	Mean: Std-Dev: Range:	Mean: Std-Dev: Range:	Mean: Std-Dev: Range:	Mean: Std-Dev: Range:
5					Mean: Std-Dev: Range:	Mean: Std-Dev: Range:	Mean: Std-Dev: Range:	Mean: Std-Dev: Range:	Mean: Std-Dev: Range:

C.2.5 Configuration: MSAN POTS - POTS; Application: Modem, V.32/V.32 bis - start procedure; handshake according V.8 with phase reversals

Test num.	Testing time	Config / Test numbers	Codec	Packet. time	Delay Upstream	Delay Downstream	Active Level	Noise	Signal to Interval Noise
1					Mean: Std-Dev: Range:	Mean: Std-Dev: Range:	Mean: Std-Dev: Range:	Mean: Std-Dev: Range:	Mean: Std-Dev: Range:
2					Mean: Std-Dev: Range:	Mean: Std-Dev: Range:	Mean: Std-Dev: Range:	Mean: Std-Dev: Range:	Mean: Std-Dev: Range:
3					Mean: Std-Dev: Range:	Mean: Std-Dev: Range:	Mean: Std-Dev: Range:	Mean: Std-Dev: Range:	Mean: Std-Dev: Range:
4					Mean: Std-Dev: Range:	Mean: Std-Dev: Range:	Mean: Std-Dev: Range:	Mean: Std-Dev: Range:	Mean: Std-Dev: Range:
5					Mean: Std-Dev: Range:	Mean: Std-Dev: Range:	Mean: Std-Dev: Range:	Mean: Std-Dev: Range:	Mean: Std-Dev: Range:

C.3 Configuration: POTS - MSAN POTS

C.3.1 Configuration: POTS - MSAN POTS; Application: Voice

Test num.	Testing time	Config / Test numbers	Codec	Packet. time	P.863	Delay Upstream	Delay Downstream	Active Level
1					Mean: Std-Dev: Range:	Mean: Std-Dev: Range:	Mean: Std-Dev: Range:	Mean: Std-Dev: Range:
2					Mean: Std-Dev: Range:	Mean: Std-Dev: Range:	Mean: Std-Dev: Range:	Mean: Std-Dev: Range:
3					Mean: Std-Dev: Range:	Mean: Std-Dev: Range:	Mean: Std-Dev: Range:	Mean: Std-Dev: Range:
4					Mean: Std-Dev: Range:	Mean: Std-Dev: Range:	Mean: Std-Dev: Range:	Mean: Std-Dev: Range:
5					Mean: Std-Dev: Range:	Mean: Std-Dev: Range:	Mean: Std-Dev: Range:	Mean: Std-Dev: Range:

C.3.2 Configuration: POTS - MSAN POTS; Application: Fax, bit rate $\leq 14,4$ kbit/s

Test num.	Testing time	Config / Test numbers	Codec	Packet. time	Delay Upstream	Delay Downstream	Active Level	Noise	Signal to Interval Noise
1					Mean: Std-Dev: Range:	Mean: Std-Dev: Range:	Mean: Std-Dev: Range:	Mean: Std-Dev: Range:	Mean: Std-Dev: Range:
2					Mean: Std-Dev: Range:	Mean: Std-Dev: Range:	Mean: Std-Dev: Range:	Mean: Std-Dev: Range:	Mean: Std-Dev: Range:
3					Mean: Std-Dev: Range:	Mean: Std-Dev: Range:	Mean: Std-Dev: Range:	Mean: Std-Dev: Range:	Mean: Std-Dev: Range:
4					Mean: Std-Dev: Range:	Mean: Std-Dev: Range:	Mean: Std-Dev: Range:	Mean: Std-Dev: Range:	Mean: Std-Dev: Range:
5					Mean: Std-Dev: Range:	Mean: Std-Dev: Range:	Mean: Std-Dev: Range:	Mean: Std-Dev: Range:	Mean: Std-Dev: Range:

C.3.3 Configuration: POTS - MSAN POTS; Application: Fax, bit rate $> 14,4$ kbit/s

Test num.	Testing time	Config / Test numbers	Codec	Packet. time	Delay Upstream	Delay Downstream	Active Level	Noise	Signal to Interval Noise
1					Mean: Std-Dev: Range:	Mean: Std-Dev: Range:	Mean: Std-Dev: Range:	Mean: Std-Dev: Range:	Mean: Std-Dev: Range:
2					Mean: Std-Dev: Range:	Mean: Std-Dev: Range:	Mean: Std-Dev: Range:	Mean: Std-Dev: Range:	Mean: Std-Dev: Range:
3					Mean: Std-Dev: Range:	Mean: Std-Dev: Range:	Mean: Std-Dev: Range:	Mean: Std-Dev: Range:	Mean: Std-Dev: Range:
4					Mean: Std-Dev: Range:	Mean: Std-Dev: Range:	Mean: Std-Dev: Range:	Mean: Std-Dev: Range:	Mean: Std-Dev: Range:
5					Mean: Std-Dev: Range:	Mean: Std-Dev: Range:	Mean: Std-Dev: Range:	Mean: Std-Dev: Range:	Mean: Std-Dev: Range:

C.3.4 Configuration: POTS - MSAN POTS; Application: Modem V.32/V.32 bis - start procedure; handshake according V.25 without phase reversals

Test num.	Testing time	Config / Test numbers	Codec	Packet. time	Delay Upstream	Delay Downstream	Active Level	Noise	Signal to Interval Noise
1					Mean: Std-Dev: Range:	Mean: Std-Dev: Range:	Mean: Std-Dev: Range:	Mean: Std-Dev: Range:	Mean: Std-Dev: Range:
2					Mean: Std-Dev: Range:	Mean: Std-Dev: Range:	Mean: Std-Dev: Range:	Mean: Std-Dev: Range:	Mean: Std-Dev: Range:
3					Mean: Std-Dev: Range:	Mean: Std-Dev: Range:	Mean: Std-Dev: Range:	Mean: Std-Dev: Range:	Mean: Std-Dev: Range:
4					Mean: Std-Dev: Range:	Mean: Std-Dev: Range:	Mean: Std-Dev: Range:	Mean: Std-Dev: Range:	Mean: Std-Dev: Range:
5					Mean: Std-Dev: Range:	Mean: Std-Dev: Range:	Mean: Std-Dev: Range:	Mean: Std-Dev: Range:	Mean: Std-Dev: Range:

C.3.5 Configuration: POTS - MSAN POTS; Application: Modem, V.32/V.32 bis - start procedure; handshake according V.8 with phase reversals

Test num.	Testing time	Config / Test numbers	Codec	Packet. time	Delay Upstream	Delay Downstream	Active Level	Noise	Signal to Interval Noise
1					Mean: Std-Dev: Range:	Mean: Std-Dev: Range:	Mean: Std-Dev: Range:	Mean: Std-Dev: Range:	Mean: Std-Dev: Range:
2					Mean: Std-Dev: Range:	Mean: Std-Dev: Range:	Mean: Std-Dev: Range:	Mean: Std-Dev: Range:	Mean: Std-Dev: Range:
3					Mean: Std-Dev: Range:	Mean: Std-Dev: Range:	Mean: Std-Dev: Range:	Mean: Std-Dev: Range:	Mean: Std-Dev: Range:
4					Mean: Std-Dev: Range:	Mean: Std-Dev: Range:	Mean: Std-Dev: Range:	Mean: Std-Dev: Range:	Mean: Std-Dev: Range:
5					Mean: Std-Dev: Range:	Mean: Std-Dev: Range:	Mean: Std-Dev: Range:	Mean: Std-Dev: Range:	Mean: Std-Dev: Range:

C.4 Configuration: DSL - DSL

C.4.1 Configuration: DSL - DSL; Application: POTS - POTS/Voice

Test num.	Testing time	Config / Test numbers	Bandwidth Upstream/ Downstream		Codec	Packet. time	Numb. of concurrent calls	P.863	Delay Upstream	Delay Downstream	Active Level
1								Mean: Std-Dev: Range:	Mean: Std-Dev: Range:	Mean: Std-Dev: Range:	Mean: Std-Dev: Range:
2								Mean: Std-Dev: Range:	Mean: Std-Dev: Range:	Mean: Std-Dev: Range:	Mean: Std-Dev: Range:
3								Mean: Std-Dev: Range:	Mean: Std-Dev: Range:	Mean: Std-Dev: Range:	Mean: Std-Dev: Range:
4								Mean: Std-Dev: Range:	Mean: Std-Dev: Range:	Mean: Std-Dev: Range:	Mean: Std-Dev: Range:

C.4.2 Configuration: DSL - DSL; Application: POTS - POTS/Fax, bit rate $\leq 14,4$ kbit/s

Test num.	Testing time	Config / Test numbers	Codec	Bandwidth Upstream/ Downstream		Packet. time	Numb. of concurrent calls	Delay Upstream	Delay Downstream	Active Level	Noise	Signal to Interval Noise
1								Mean: Std-Dev: Range:	Mean: Std-Dev: Range:	Mean: Std-Dev: Range:	Mean: Std-Dev: Range:	Mean: Std-Dev: Range:
2								Mean: Std-Dev: Range:	Mean: Std-Dev: Range:	Mean: Std-Dev: Range:	Mean: Std-Dev: Range:	Mean: Std-Dev: Range:
3								Mean: Std-Dev: Range:	Mean: Std-Dev: Range:	Mean: Std-Dev: Range:	Mean: Std-Dev: Range:	Mean: Std-Dev: Range:
4								Mean: Std-Dev: Range:	Mean: Std-Dev: Range:	Mean: Std-Dev: Range:	Mean: Std-Dev: Range:	Mean: Std-Dev: Range:
5								Mean: Std-Dev: Range:	Mean: Std-Dev: Range:	Mean: Std-Dev: Range:	Mean: Std-Dev: Range:	Mean: Std-Dev: Range:

C.4.3 Configuration: DSL - DSL; Application: POTS - POTS/Fax, bit rate > 14,4 kbit/s

Test num.	Testing time	Config / Test numbers	Codec	Bandwidth Upstream /Downstream		Packet. time	Numb. of concurrent calls	Delay Upstream	Delay Downstream	Active Level	Noise	Signal to Interval Noise
1								Mean: Std-Dev: Range:	Mean: Std-Dev: Range:	Mean: Std-Dev: Range:	Mean: Std-Dev: Range:	Mean: Std-Dev: Range:
2								Mean: Std-Dev: Range:	Mean: Std-Dev: Range:	Mean: Std-Dev: Range:	Mean: Std-Dev: Range:	Mean: Std-Dev: Range:
3								Mean: Std-Dev: Range:	Mean: Std-Dev: Range:	Mean: Std-Dev: Range:	Mean: Std-Dev: Range:	Mean: Std-Dev: Range:
4								Mean: Std-Dev: Range:	Mean: Std-Dev: Range:	Mean: Std-Dev: Range:	Mean: Std-Dev: Range:	Mean: Std-Dev: Range:
5								Mean: Std-Dev: Range:	Mean: Std-Dev: Range:	Mean: Std-Dev: Range:	Mean: Std-Dev: Range:	Mean: Std-Dev: Range:

C.4.4 Configuration: DSL - DSL; Application: POTS - POTS/Modem, V.32/V.32 bis - start procedure; handshake according V.25 without phase reversals

Test num.	Testing time	Config / Test numbers	Codec	Bandwidth Upstream/ Downstream		Packet. time	Numb. of concurrent calls	Delay Upstream	Delay Downstream	Active Level	Noise	Signal to Interval Noise
1								Mean: Std-Dev: Range:	Mean: Std-Dev: Range:	Mean: Std-Dev: Range:	Mean: Std-Dev: Range:	Mean: Std-Dev: Range:
2								Mean: Std-Dev: Range:	Mean: Std-Dev: Range:	Mean: Std-Dev: Range:	Mean: Std-Dev: Range:	Mean: Std-Dev: Range:
3								Mean: Std-Dev: Range:	Mean: Std-Dev: Range:	Mean: Std-Dev: Range:	Mean: Std-Dev: Range:	Mean: Std-Dev: Range:
4								Mean: Std-Dev: Range:	Mean: Std-Dev: Range:	Mean: Std-Dev: Range:	Mean: Std-Dev: Range:	Mean: Std-Dev: Range:
5								Mean: Std-Dev: Range:	Mean: Std-Dev: Range:	Mean: Std-Dev: Range:	Mean: Std-Dev: Range:	Mean: Std-Dev: Range:

C.4.5 Configuration: DSL - DSL; Application: POTS - POTS/Modem, V.32/V.32 bis - start procedure; handshake according V.8 with phase reversals

Test num.	Testing time	Config / Test numbers	Codec	Bandwidth Upstream/ Downstream		Packet. time	Numb. of concurrent calls	Delay Upstream	Delay Downstream	Active Level	Noise	Signal to Interval Noise
1								Mean: Std-Dev: Range:	Mean: Std-Dev: Range:	Mean: Std-Dev: Range:	Mean: Std-Dev: Range:	Mean: Std-Dev: Range:
2								Mean: Std-Dev: Range:	Mean: Std-Dev: Range:	Mean: Std-Dev: Range:	Mean: Std-Dev: Range:	Mean: Std-Dev: Range:
3								Mean: Std-Dev: Range:	Mean: Std-Dev: Range:	Mean: Std-Dev: Range:	Mean: Std-Dev: Range:	Mean: Std-Dev: Range:
4								Mean: Std-Dev: Range:	Mean: Std-Dev: Range:	Mean: Std-Dev: Range:	Mean: Std-Dev: Range:	Mean: Std-Dev: Range:
5								Mean: Std-Dev: Range:	Mean: Std-Dev: Range:	Mean: Std-Dev: Range:	Mean: Std-Dev: Range:	Mean: Std-Dev: Range:

C.5 Configuration: MSAN - DSL

C.5.1 Configuration: MSAN - DSL; Application: POTS - POTS/Voice

Test num.	Testing time	Config / Test numbers	Bandwidth Upstream/ Downstream		Codec	Packet. time	Numb. of concurrent calls	P.863	Delay Upstream	Delay Downstream	Active Level
1								Mean: Std-Dev: Range:	Mean: Std-Dev: Range:	Mean: Std-Dev: Range:	Mean: Std-Dev: Range:
2								Mean: Std-Dev: Range:	Mean: Std-Dev: Range:	Mean: Std-Dev: Range:	Mean: Std-Dev: Range:
3								Mean: Std-Dev: Range:	Mean: Std-Dev: Range:	Mean: Std-Dev: Range:	Mean: Std-Dev: Range:
4								Mean: Std-Dev: Range:	Mean: Std-Dev: Range:	Mean: Std-Dev: Range:	Mean: Std-Dev: Range:
5								Mean: Std-Dev: Range:	Mean: Std-Dev: Range:	Mean: Std-Dev: Range:	Mean: Std-Dev: Range:

C.5.2 Configuration: MSAN - DSL; Application: POTS - POTS/Fax, bit rate $\leq 14,4$ kbit/s

Test num.	Testing time	Config / Test numbers	Codec	Bandwidth Upstream/ Downstream		Packet. time	Numb. of concurrent calls	Delay Upstream	Delay Downstream	Active Level	Noise	Signal to Interval Noise
1								Mean: Std-Dev: Range:	Mean: Std-Dev: Range:	Mean: Std-Dev: Range:	Mean: Std-Dev: Range:	Mean: Std-Dev: Range:
2								Mean: Std-Dev: Range:	Mean: Std-Dev: Range:	Mean: Std-Dev: Range:	Mean: Std-Dev: Range:	Mean: Std-Dev: Range:
3								Mean: Std-Dev: Range:	Mean: Std-Dev: Range:	Mean: Std-Dev: Range:	Mean: Std-Dev: Range:	Mean: Std-Dev: Range:
4								Mean: Std-Dev: Range:	Mean: Std-Dev: Range:	Mean: Std-Dev: Range:	Mean: Std-Dev: Range:	Mean: Std-Dev: Range:
5								Mean: Std-Dev: Range:	Mean: Std-Dev: Range:	Mean: Std-Dev: Range:	Mean: Std-Dev: Range:	Mean: Std-Dev: Range:

C.5.3 Configuration: MSAN - DSL; Application: POTS - POTS/Fax, bit rate $> 14,4$ kbit/s

Test num.	Testing time	Config / Test numbers	Codec	Bandwidth Upstream/ Downstream		Packet. time	Numb. of concurrent calls	Delay Upstream	Delay Downstream	Active Level	Noise	Signal to Interval Noise
1								Mean: Std-Dev: Range:	Mean: Std-Dev: Range:	Mean: Std-Dev: Range:	Mean: Std-Dev: Range:	Mean: Std-Dev: Range:
2								Mean: Std-Dev: Range:	Mean: Std-Dev: Range:	Mean: Std-Dev: Range:	Mean: Std-Dev: Range:	Mean: Std-Dev: Range:
3								Mean: Std-Dev: Range:	Mean: Std-Dev: Range:	Mean: Std-Dev: Range:	Mean: Std-Dev: Range:	Mean: Std-Dev: Range:
4								Mean: Std-Dev: Range:	Mean: Std-Dev: Range:	Mean: Std-Dev: Range:	Mean: Std-Dev: Range:	Mean: Std-Dev: Range:
5								Mean: Std-Dev: Range:	Mean: Std-Dev: Range:	Mean: Std-Dev: Range:	Mean: Std-Dev: Range:	Mean: Std-Dev: Range:

C.5.4 Configuration: MSAN - DSL; Application: POTS - POTS/Modem, V.32/V.32 bis - start procedure; handshake according V.25 without phase reversals

Test num.	Testing time	Config / Test numbers	Codec	Bandwidth Upstream/ Downstream		Packet. time	Numb. of concurrent calls	Delay Upstream	Delay Downstream	Active Level	Noise	Signal to Interval Noise
1								Mean: Std-Dev: Range:	Mean: Std-Dev: Range:	Mean: Std-Dev: Range:	Mean: Std-Dev: Range:	Mean: Std-Dev: Range:
2								Mean: Std-Dev: Range:	Mean: Std-Dev: Range:	Mean: Std-Dev: Range:	Mean: Std-Dev: Range:	Mean: Std-Dev: Range:
3								Mean: Std-Dev: Range:	Mean: Std-Dev: Range:	Mean: Std-Dev: Range:	Mean: Std-Dev: Range:	Mean: Std-Dev: Range:
4								Mean: Std-Dev: Range:	Mean: Std-Dev: Range:	Mean: Std-Dev: Range:	Mean: Std-Dev: Range:	Mean: Std-Dev: Range:
5								Mean: Std-Dev: Range:	Mean: Std-Dev: Range:	Mean: Std-Dev: Range:	Mean: Std-Dev: Range:	Mean: Std-Dev: Range:

C.5.5 Configuration: MSAN - DSL; Application: POTS - POTS/Modem, V.32/V.32 bis - start procedure; handshake according V.8 with phase reversals

Test num.	Testing time	Config / Test numbers	Codec	Bandwidth Upstream/ Downstream		Packet. time	Numb. of concurrent calls	Delay Upstream	Delay Downstream	Active Level	Noise	Signal to Interval Noise
1								Mean: Std-Dev: Range:	Mean: Std-Dev: Range:	Mean: Std-Dev: Range:	Mean: Std-Dev: Range:	Mean: Std-Dev: Range:
2								Mean: Std-Dev: Range:	Mean: Std-Dev: Range:	Mean: Std-Dev: Range:	Mean: Std-Dev: Range:	Mean: Std-Dev: Range:
3								Mean: Std-Dev: Range:	Mean: Std-Dev: Range:	Mean: Std-Dev: Range:	Mean: Std-Dev: Range:	Mean: Std-Dev: Range:
4								Mean: Std-Dev: Range:	Mean: Std-Dev: Range:	Mean: Std-Dev: Range:	Mean: Std-Dev: Range:	Mean: Std-Dev: Range:
5								Mean: Std-Dev: Range:	Mean: Std-Dev: Range:	Mean: Std-Dev: Range:	Mean: Std-Dev: Range:	Mean: Std-Dev: Range:

C.6 Configuration: DSL - MSAN

C.6.1 Configuration: MSAN - DSL; Application: POTS - POTS/Voice

Test num.	Testing time	Config / Test numbers	Bandwidth Upstream/ Downstream		Codec	Packet. time	Numb. of concurrent calls	P.863	Delay Upstream	Delay Downstream	Active Level
1								Mean: Std-Dev: Range:	Mean: Std-Dev: Range:	Mean: Std-Dev: Range:	Mean: Std-Dev: Range:
2								Mean: Std-Dev: Range:	Mean: Std-Dev: Range:	Mean: Std-Dev: Range:	Mean: Std-Dev: Range:
3								Mean: Std-Dev: Range:	Mean: Std-Dev: Range:	Mean: Std-Dev: Range:	Mean: Std-Dev: Range:
4								Mean: Std-Dev: Range:	Mean: Std-Dev: Range:	Mean: Std-Dev: Range:	Mean: Std-Dev: Range:

C.6.2 Configuration: DSL - MSAN; Application: POTS - POTS/Fax, bit rate $\leq 14,4$ kbit/s

Test num.	Testing time	Config / Test numbers	Codec	Bandwidth Upstream/ Downstream		Packet. time	Numb. of concurrent calls	Delay Upstream	Delay Downstream	Active Level	Noise	Signal to Interval Noise
1								Mean: Std-Dev: Range:	Mean: Std-Dev: Range:	Mean: Std-Dev: Range:	Mean: Std-Dev: Range:	Mean: Std-Dev: Range:
2								Mean: Std-Dev: Range:	Mean: Std-Dev: Range:	Mean: Std-Dev: Range:	Mean: Std-Dev: Range:	Mean: Std-Dev: Range:
3								Mean: Std-Dev: Range:	Mean: Std-Dev: Range:	Mean: Std-Dev: Range:	Mean: Std-Dev: Range:	Mean: Std-Dev: Range:
4								Mean: Std-Dev: Range:	Mean: Std-Dev: Range:	Mean: Std-Dev: Range:	Mean: Std-Dev: Range:	Mean: Std-Dev: Range:
5								Mean: Std-Dev: Range:	Mean: Std-Dev: Range:	Mean: Std-Dev: Range:	Mean: Std-Dev: Range:	Mean: Std-Dev: Range:

C.6.3 Configuration: DSL - MSAN; Application: POTS - POTS/Fax, bit rate > 14,4 kbit/s

Test num.	Testing time	Config / Test numbers	Codec	Bandwidth Upstream /Downstream		Packet. time	Numb. of concurrent calls	Delay Upstream	Delay Downstream	Active Level	Noise	Signal to Interval Noise
1								Mean: Std-Dev: Range:	Mean: Std-Dev: Range:	Mean: Std-Dev: Range:	Mean: Std-Dev: Range:	Mean: Std-Dev: Range:
2								Mean: Std-Dev: Range:	Mean: Std-Dev: Range:	Mean: Std-Dev: Range:	Mean: Std-Dev: Range:	Mean: Std-Dev: Range:
3								Mean: Std-Dev: Range:	Mean: Std-Dev: Range:	Mean: Std-Dev: Range:	Mean: Std-Dev: Range:	Mean: Std-Dev: Range:
4								Mean: Std-Dev: Range:	Mean: Std-Dev: Range:	Mean: Std-Dev: Range:	Mean: Std-Dev: Range:	Mean: Std-Dev: Range:
5								Mean: Std-Dev: Range:	Mean: Std-Dev: Range:	Mean: Std-Dev: Range:	Mean: Std-Dev: Range:	Mean: Std-Dev: Range:

C.6.4 Configuration: DSL - MSAN; Application: POTS - POTS/Modem, V.32/V.32 bis - start procedure; handshake according V.25 without phase reversals

Test num.	Testing time	Config / Test numbers	Codec	Bandwidth Upstream/ Downstream		Packet. time	Numb. of concurrent calls	Delay Upstream	Delay Downstream	Active Level	Noise	Signal to Interval Noise
1								Mean: Std-Dev: Range:	Mean: Std-Dev: Range:	Mean: Std-Dev: Range:	Mean: Std-Dev: Range:	Mean: Std-Dev: Range:
2								Mean: Std-Dev: Range:	Mean: Std-Dev: Range:	Mean: Std-Dev: Range:	Mean: Std-Dev: Range:	Mean: Std-Dev: Range:
3								Mean: Std-Dev: Range:	Mean: Std-Dev: Range:	Mean: Std-Dev: Range:	Mean: Std-Dev: Range:	Mean: Std-Dev: Range:
4								Mean: Std-Dev: Range:	Mean: Std-Dev: Range:	Mean: Std-Dev: Range:	Mean: Std-Dev: Range:	Mean: Std-Dev: Range:
5								Mean: Std-Dev: Range:	Mean: Std-Dev: Range:	Mean: Std-Dev: Range:	Mean: Std-Dev: Range:	Mean: Std-Dev: Range:

C.6.5 Configuration: DSL - MSAN; Application: POTS - POTS/Modem, V.32/V.32 bis - start procedure; handshake according V.8 with phase reversals

Test num.	Testing time	Config / Test numbers	Codec	Bandwidth Upstream/ Downstream		Packet. time	Numb. of concurrent calls	Delay Upstream	Delay Downstream	Active Level	Noise	Signal to Interval Noise
1								Mean: Std-Dev: Range:	Mean: Std-Dev: Range:	Mean: Std-Dev: Range:	Mean: Std-Dev: Range:	Mean: Std-Dev: Range:
2								Mean: Std-Dev: Range:	Mean: Std-Dev: Range:	Mean: Std-Dev: Range:	Mean: Std-Dev: Range:	Mean: Std-Dev: Range:
3								Mean: Std-Dev: Range:	Mean: Std-Dev: Range:	Mean: Std-Dev: Range:	Mean: Std-Dev: Range:	Mean: Std-Dev: Range:
4								Mean: Std-Dev: Range:	Mean: Std-Dev: Range:	Mean: Std-Dev: Range:	Mean: Std-Dev: Range:	Mean: Std-Dev: Range:
5								Mean: Std-Dev: Range:	Mean: Std-Dev: Range:	Mean: Std-Dev: Range:	Mean: Std-Dev: Range:	Mean: Std-Dev: Range:

C.7 Configuration: POTS - DSL

C.7.1 Configuration: POTS - DSL; Application: Voice

Test num.	Testing time	Config / Test numbers	Codec	Packet. time	P.863	Delay Upstream	Delay Downstream	Active Level
1					Mean: Std-Dev: Range:	Mean: Std-Dev: Range:	Mean: Std-Dev: Range:	Mean: Std-Dev: Range:
2					Mean: Std-Dev: Range:	Mean: Std-Dev: Range:	Mean: Std-Dev: Range:	Mean: Std-Dev: Range:
3					Mean: Std-Dev: Range:	Mean: Std-Dev: Range:	Mean: Std-Dev: Range:	Mean: Std-Dev: Range:
4					Mean: Std-Dev: Range:	Mean: Std-Dev: Range:	Mean: Std-Dev: Range:	Mean: Std-Dev: Range:
5					Mean: Std-Dev: Range:	Mean: Std-Dev: Range:	Mean: Std-Dev: Range:	Mean: Std-Dev: Range:

C.7.2 Configuration: POTS - DSL; Application: Fax, bit rate $\leq 14,4$ kbit/s

Test num.	Testing time	Config / Test numbers	Codec	Packet. time	Delay Upstream	Delay Downstream	Active Level	Noise	Signal to Interval Noise
1					Mean: Std-Dev: Range:	Mean: Std-Dev: Range:	Mean: Std-Dev: Range:	Mean: Std-Dev: Range:	Mean: Std-Dev: Range:
2					Mean: Std-Dev: Range:	Mean: Std-Dev: Range:	Mean: Std-Dev: Range:	Mean: Std-Dev: Range:	Mean: Std-Dev: Range:
3					Mean: Std-Dev: Range:	Mean: Std-Dev: Range:	Mean: Std-Dev: Range:	Mean: Std-Dev: Range:	Mean: Std-Dev: Range:
4					Mean: Std-Dev: Range:	Mean: Std-Dev: Range:	Mean: Std-Dev: Range:	Mean: Std-Dev: Range:	Mean: Std-Dev: Range:
5					Mean: Std-Dev: Range:	Mean: Std-Dev: Range:	Mean: Std-Dev: Range:	Mean: Std-Dev: Range:	Mean: Std-Dev: Range:

C.7.3 Configuration: POTS - DSL; Application: Fax, bit rate $> 14,4$ kbit/s

Test num.	Testing time	Config / Test numbers	Codec	Packet. time	Delay Upstream	Delay Downstream	Active Level	Noise	Signal to Interval Noise
1					Mean: Std-Dev: Range:	Mean: Std-Dev: Range:	Mean: Std-Dev: Range:	Mean: Std-Dev: Range:	Mean: Std-Dev: Range:
2					Mean: Std-Dev: Range:	Mean: Std-Dev: Range:	Mean: Std-Dev: Range:	Mean: Std-Dev: Range:	Mean: Std-Dev: Range:
3					Mean: Std-Dev: Range:	Mean: Std-Dev: Range:	Mean: Std-Dev: Range:	Mean: Std-Dev: Range:	Mean: Std-Dev: Range:
4					Mean: Std-Dev: Range:	Mean: Std-Dev: Range:	Mean: Std-Dev: Range:	Mean: Std-Dev: Range:	Mean: Std-Dev: Range:
5					Mean: Std-Dev: Range:	Mean: Std-Dev: Range:	Mean: Std-Dev: Range:	Mean: Std-Dev: Range:	Mean: Std-Dev: Range:

C.7.4 Configuration: POTS - DSL; Application: Modem, V.32/V.32 bis - start procedure; handshake according V.25 without phase reversals

Test num.	Testing time	Config / Test numbers	Codec	Packet. time	Delay Upstream	Delay Downstream	Active Level	Noise	Signal to Interval Noise
1					Mean: Std-Dev: Range:	Mean: Std-Dev: Range:	Mean: Std-Dev: Range:	Mean: Std-Dev: Range:	Mean: Std-Dev: Range:
2					Mean: Std-Dev: Range:	Mean: Std-Dev: Range:	Mean: Std-Dev: Range:	Mean: Std-Dev: Range:	Mean: Std-Dev: Range:
3					Mean: Std-Dev: Range:	Mean: Std-Dev: Range:	Mean: Std-Dev: Range:	Mean: Std-Dev: Range:	Mean: Std-Dev: Range:
4					Mean: Std-Dev: Range:	Mean: Std-Dev: Range:	Mean: Std-Dev: Range:	Mean: Std-Dev: Range:	Mean: Std-Dev: Range:
5					Mean: Std-Dev: Range:	Mean: Std-Dev: Range:	Mean: Std-Dev: Range:	Mean: Std-Dev: Range:	Mean: Std-Dev: Range:

C.7.5 Configuration: POTS - DSL; Application: Modem, V.32/V.32 bis - start procedure; handshake according V.8 with phase reversals

Test num.	Testing time	Config / Test numbers	Codec	Packet. time	Delay Upstream	Delay Downstream	Active Level	Noise	Signal to Interval Noise
1					Mean: Std-Dev: Range:	Mean: Std-Dev: Range:	Mean: Std-Dev: Range:	Mean: Std-Dev: Range:	Mean: Std-Dev: Range:
2					Mean: Std-Dev: Range:	Mean: Std-Dev: Range:	Mean: Std-Dev: Range:	Mean: Std-Dev: Range:	Mean: Std-Dev: Range:
3					Mean: Std-Dev: Range:	Mean: Std-Dev: Range:	Mean: Std-Dev: Range:	Mean: Std-Dev: Range:	Mean: Std-Dev: Range:
4					Mean: Std-Dev: Range:	Mean: Std-Dev: Range:	Mean: Std-Dev: Range:	Mean: Std-Dev: Range:	Mean: Std-Dev: Range:
5					Mean: Std-Dev: Range:	Mean: Std-Dev: Range:	Mean: Std-Dev: Range:	Mean: Std-Dev: Range:	Mean: Std-Dev: Range:

C.8 Configuration: DSL - POTS

C.8.1 Configuration: DSL - POTS; Application: Voice

Test: num.	Testing time	Config / Test numbers	Codec	Packet. time	P.863	R Value	Delay Upstream	Delay Downstream	Active Level
1					Mean: Std-Dev: Range:	Mean: Std-Dev: Range:	Mean: Std-Dev: Range:	Mean: Std-Dev: Range:	Mean: Std-Dev: Range:
2					Mean: Std-Dev: Range:	Mean: Std-Dev: Range:	Mean: Std-Dev: Range:	Mean: Std-Dev: Range:	Mean: Std-Dev: Range:
3					Mean: Std-Dev: Range:	Mean: Std-Dev: Range:	Mean: Std-Dev: Range:	Mean: Std-Dev: Range:	Mean: Std-Dev: Range:
4					Mean: Std-Dev: Range:	Mean: Std-Dev: Range:	Mean: Std-Dev: Range:	Mean: Std-Dev: Range:	Mean: Std-Dev: Range:
5					Mean: Std-Dev: Range:	Mean: Std-Dev: Range:	Mean: Std-Dev: Range:	Mean: Std-Dev: Range:	Mean: Std-Dev: Range:

C.8.2 Configuration: DSL - POTS; Application: Fax, bit rate $\leq 14,4$ kbit/s

Test num.	Testing time	Config / Test numbers	Codec	Packet. time	Delay Upstream	Delay Downstream	Active Level	Noise	Signal to Interval Noise
1					Mean: Std-Dev: Range:	Mean: Std-Dev: Range:	Mean: Std-Dev: Range:	Mean: Std-Dev: Range:	Mean: Std-Dev: Range:
2					Mean: Std-Dev: Range:	Mean: Std-Dev: Range:	Mean: Std-Dev: Range:	Mean: Std-Dev: Range:	Mean: Std-Dev: Range:
3					Mean: Std-Dev: Range:	Mean: Std-Dev: Range:	Mean: Std-Dev: Range:	Mean: Std-Dev: Range:	Mean: Std-Dev: Range:
4					Mean: Std-Dev: Range:	Mean: Std-Dev: Range:	Mean: Std-Dev: Range:	Mean: Std-Dev: Range:	Mean: Std-Dev: Range:
5					Mean: Std-Dev: Range:	Mean: Std-Dev: Range:	Mean: Std-Dev: Range:	Mean: Std-Dev: Range:	Mean: Std-Dev: Range:

C.8.3 Configuration: DSL - POTS; Application: Fax, bit rate $> 14,4$ kbit/s

Test num.	Testing time	Config / Test numbers	Codec	Packet. time	Delay Upstream	Delay Downstream	Active Level	Noise	Signal to Interval Noise
1					Mean: Std-Dev: Range:	Mean: Std-Dev: Range:	Mean: Std-Dev: Range:	Mean: Std-Dev: Range:	Mean: Std-Dev: Range:
2					Mean: Std-Dev: Range:	Mean: Std-Dev: Range:	Mean: Std-Dev: Range:	Mean: Std-Dev: Range:	Mean: Std-Dev: Range:
3					Mean: Std-Dev: Range:	Mean: Std-Dev: Range:	Mean: Std-Dev: Range:	Mean: Std-Dev: Range:	Mean: Std-Dev: Range:
4					Mean: Std-Dev: Range:	Mean: Std-Dev: Range:	Mean: Std-Dev: Range:	Mean: Std-Dev: Range:	Mean: Std-Dev: Range:
5					Mean: Std-Dev: Range:	Mean: Std-Dev: Range:	Mean: Std-Dev: Range:	Mean: Std-Dev: Range:	Mean: Std-Dev: Range:

C.8.4 Configuration: DSL - POTS; Application: Modem, V.32/V.32 bis - start procedure; handshake according V.25 without phase reversals

Test num.	Testing time	Config / Test numbers	Codec	Packet. time	Delay Upstream	Delay Downstream	Active Level	Noise	Signal to Interval Noise
1					Mean: Std-Dev: Range:	Mean: Std-Dev: Range:	Mean: Std-Dev: Range:	Mean: Std-Dev: Range:	Mean: Std-Dev: Range:
2					Mean: Std-Dev: Range:	Mean: Std-Dev: Range:	Mean: Std-Dev: Range:	Mean: Std-Dev: Range:	Mean: Std-Dev: Range:
3					Mean: Std-Dev: Range:	Mean: Std-Dev: Range:	Mean: Std-Dev: Range:	Mean: Std-Dev: Range:	Mean: Std-Dev: Range:
4					Mean: Std-Dev: Range:	Mean: Std-Dev: Range:	Mean: Std-Dev: Range:	Mean: Std-Dev: Range:	Mean: Std-Dev: Range:
5					Mean: Std-Dev: Range:	Mean: Std-Dev: Range:	Mean: Std-Dev: Range:	Mean: Std-Dev: Range:	Mean: Std-Dev: Range:

C.8.5 Configuration: DSL - POTS; Application: Modem, V.32/V.32 bis - start procedure; handshake according V.8 with phase reversals

Test num.	Testing time	Config / Test numbers	Codec	Packet. time	Delay Upstream	Delay Downstream	Active Level	Noise	Signal to Interval Noise
1					Mean: Std-Dev: Range:	Mean: Std-Dev: Range:	Mean: Std-Dev: Range:	Mean: Std-Dev: Range:	Mean: Std-Dev: Range:
2					Mean: Std-Dev: Range:	Mean: Std-Dev: Range:	Mean: Std-Dev: Range:	Mean: Std-Dev: Range:	Mean: Std-Dev: Range:
3					Mean: Std-Dev: Range:	Mean: Std-Dev: Range:	Mean: Std-Dev: Range:	Mean: Std-Dev: Range:	Mean: Std-Dev: Range:
4					Mean: Std-Dev: Range:	Mean: Std-Dev: Range:	Mean: Std-Dev: Range:	Mean: Std-Dev: Range:	Mean: Std-Dev: Range:
5					Mean: Std-Dev: Range:	Mean: Std-Dev: Range:	Mean: Std-Dev: Range:	Mean: Std-Dev: Range:	Mean: Std-Dev: Range:

C.9 Configuration: MSAN ISDN - MSAN ISDN

C.9.1 Configuration: MSAN ISDN - MSAN ISDN; Application: Voice

Test num.	Testing time	Config / Test numbers	Codec	Packet. time	P.863	Delay Upstream	Delay Downstream	Active Level
1					Mean: Std-Dev: Range:	Mean: Std-Dev: Range:	Mean: Std-Dev: Range:	Mean: Std-Dev: Range:
2					Mean: Std-Dev: Range:	Mean: Std-Dev: Range:	Mean: Std-Dev: Range:	Mean: Std-Dev: Range:
3					Mean: Std-Dev: Range:	Mean: Std-Dev: Range:	Mean: Std-Dev: Range:	Mean: Std-Dev: Range:
4					Mean: Std-Dev: Range:	Mean: Std-Dev: Range:	Mean: Std-Dev: Range:	Mean: Std-Dev: Range:
5					Mean: Std-Dev: Range:	Mean: Std-Dev: Range:	Mean: Std-Dev: Range:	Mean: Std-Dev: Range:

C.9.2 Configuration: MSAN ISDN - MSAN ISDN; Application: Fax, bit rate $\leq 14,4$ kbit/s

Test num.	Testing time	Config / Test numbers	Codec	Packet. time	Delay Upstream	Delay Downstream	Active Level	Noise	Signal to Interval Noise
1					Mean: Std-Dev: Range:	Mean: Std-Dev: Range:	Mean: Std-Dev: Range:	Mean: Std-Dev: Range:	Mean: Std-Dev: Range:
2					Mean: Std-Dev: Range:	Mean: Std-Dev: Range:	Mean: Std-Dev: Range:	Mean: Std-Dev: Range:	Mean: Std-Dev: Range:
3					Mean: Std-Dev: Range:	Mean: Std-Dev: Range:	Mean: Std-Dev: Range:	Mean: Std-Dev: Range:	Mean: Std-Dev: Range:
4					Mean: Std-Dev: Range:	Mean: Std-Dev: Range:	Mean: Std-Dev: Range:	Mean: Std-Dev: Range:	Mean: Std-Dev: Range:
5					Mean: Std-Dev: Range:	Mean: Std-Dev: Range:	Mean: Std-Dev: Range:	Mean: Std-Dev: Range:	Mean: Std-Dev: Range:

C.9.3 Configuration: MSAN ISDN - MSAN ISDN; Application: Fax, bit rate $> 14,4$ kbit/s

Test num.	Testing time	Config / Test numbers	Codec	Packet. time	Delay Upstream	Delay Downstream	Active Level	Noise	Signal to Interval Noise
1					Mean: Std-Dev: Range:	Mean: Std-Dev: Range:	Mean: Std-Dev: Range:	Mean: Std-Dev: Range:	Mean: Std-Dev: Range:
2					Mean: Std-Dev: Range:	Mean: Std-Dev: Range:	Mean: Std-Dev: Range:	Mean: Std-Dev: Range:	Mean: Std-Dev: Range:
3					Mean: Std-Dev: Range:	Mean: Std-Dev: Range:	Mean: Std-Dev: Range:	Mean: Std-Dev: Range:	Mean: Std-Dev: Range:
4					Mean: Std-Dev: Range:	Mean: Std-Dev: Range:	Mean: Std-Dev: Range:	Mean: Std-Dev: Range:	Mean: Std-Dev: Range:
5					Mean: Std-Dev: Range:	Mean: Std-Dev: Range:	Mean: Std-Dev: Range:	Mean: Std-Dev: Range:	Mean: Std-Dev: Range:

C.9.4 Configuration: MSAN ISDN - MSAN ISDN; Application: Modem, V.32/V.32 bis - start procedure; handshake according V.25 without phase reversals

Test num.	Testing time	Config / Test numbers	Codec	Packet. time	Delay Upstream	Delay Downstream	Active Level	Noise	Signal to Interval Noise
1					Mean: Std-Dev: Range:	Mean: Std-Dev: Range:	Mean: Std-Dev: Range:	Mean: Std-Dev: Range:	Mean: Std-Dev: Range:
2					Mean: Std-Dev: Range:	Mean: Std-Dev: Range:	Mean: Std-Dev: Range:	Mean: Std-Dev: Range:	Mean: Std-Dev: Range:
3					Mean: Std-Dev: Range:	Mean: Std-Dev: Range:	Mean: Std-Dev: Range:	Mean: Std-Dev: Range:	Mean: Std-Dev: Range:
4					Mean: Std-Dev: Range:	Mean: Std-Dev: Range:	Mean: Std-Dev: Range:	Mean: Std-Dev: Range:	Mean: Std-Dev: Range:
5					Mean: Std-Dev: Range:	Mean: Std-Dev: Range:	Mean: Std-Dev: Range:	Mean: Std-Dev: Range:	Mean: Std-Dev: Range:

C.9.5 Configuration: MSAN ISDN - MSAN ISDN; Application: Modem, V.32/V.32 bis - start procedure; handshake according V.8 with phase reversals

Test num.	Testing time	Config / Test numbers	Codec	Packet. time	Delay Upstream	Delay Downstream	Active Level	Noise	Signal to Interval Noise
1					Mean: Std-Dev: Range:	Mean: Std-Dev: Range:	Mean: Std-Dev: Range:	Mean: Std-Dev: Range:	Mean: Std-Dev: Range:
2					Mean: Std-Dev: Range:	Mean: Std-Dev: Range:	Mean: Std-Dev: Range:	Mean: Std-Dev: Range:	Mean: Std-Dev: Range:
3					Mean: Std-Dev: Range:	Mean: Std-Dev: Range:	Mean: Std-Dev: Range:	Mean: Std-Dev: Range:	Mean: Std-Dev: Range:
4					Mean: Std-Dev: Range:	Mean: Std-Dev: Range:	Mean: Std-Dev: Range:	Mean: Std-Dev: Range:	Mean: Std-Dev: Range:
5					Mean: Std-Dev: Range:	Mean: Std-Dev: Range:	Mean: Std-Dev: Range:	Mean: Std-Dev: Range:	Mean: Std-Dev: Range:

C.10 Configuration: ISDN - MSAN ISDN

C.10.1 Configuration: ISDN - MSAN ISDN; Application: Voice

Test num.	Testing time	Codec	Packet. time	P.863	R Value	Delay Upstream	Delay Downstream	Active Level
1				Mean: Std-Dev: Range:	Mean: Std-Dev: Range:	Mean: Std-Dev: Range:	Mean: Std-Dev: Range:	Mean: Std-Dev: Range:
2				Mean: Std-Dev: Range:	Mean: Std-Dev: Range:	Mean: Std-Dev: Range:	Mean: Std-Dev: Range:	Mean: Std-Dev: Range:
3				Mean: Std-Dev: Range:	Mean: Std-Dev: Range:	Mean: Std-Dev: Range:	Mean: Std-Dev: Range:	Mean: Std-Dev: Range:
4				Mean: Std-Dev: Range:	Mean: Std-Dev: Range:	Mean: Std-Dev: Range:	Mean: Std-Dev: Range:	Mean: Std-Dev: Range:
5				Mean: Std-Dev: Range:	Mean: Std-Dev: Range:	Mean: Std-Dev: Range:	Mean: Std-Dev: Range:	Mean: Std-Dev: Range:

C.10.2 Configuration: ISDN - MSAN ISDN; Application: Fax, bit rate $\leq 14,4$ kbit/s

Test num.	Testing time	Config / Test numbers	Codec	Packet. time	Delay Upstream	Delay Downstream	Active Level	Noise	Signal to Interval Noise
1					Mean: Std-Dev: Range:	Mean: Std-Dev: Range:	Mean: Std-Dev: Range:	Mean: Std-Dev: Range:	Mean: Std-Dev: Range:
2					Mean: Std-Dev: Range:	Mean: Std-Dev: Range:	Mean: Std-Dev: Range:	Mean: Std-Dev: Range:	Mean: Std-Dev: Range:
3					Mean: Std-Dev: Range:	Mean: Std-Dev: Range:	Mean: Std-Dev: Range:	Mean: Std-Dev: Range:	Mean: Std-Dev: Range:
4					Mean: Std-Dev: Range:	Mean: Std-Dev: Range:	Mean: Std-Dev: Range:	Mean: Std-Dev: Range:	Mean: Std-Dev: Range:
5					Mean: Std-Dev: Range:	Mean: Std-Dev: Range:	Mean: Std-Dev: Range:	Mean: Std-Dev: Range:	Mean: Std-Dev: Range:

C.10.3 Configuration: ISDN - MSAN ISDN; Application: Fax, bit rate $> 14,4$ kbit/s

Test num.	Testing time	Config / Test numbers	Codec	Packet. time	Delay Upstream	Delay Downstream	Active Level	Noise	Signal to Interval Noise
1					Mean: Std-Dev: Range:	Mean: Std-Dev: Range:	Mean: Std-Dev: Range:	Mean: Std-Dev: Range:	Mean: Std-Dev: Range:
2					Mean: Std-Dev: Range:	Mean: Std-Dev: Range:	Mean: Std-Dev: Range:	Mean: Std-Dev: Range:	Mean: Std-Dev: Range:
3					Mean: Std-Dev: Range:	Mean: Std-Dev: Range:	Mean: Std-Dev: Range:	Mean: Std-Dev: Range:	Mean: Std-Dev: Range:
4					Mean: Std-Dev: Range:	Mean: Std-Dev: Range:	Mean: Std-Dev: Range:	Mean: Std-Dev: Range:	Mean: Std-Dev: Range:
5					Mean: Std-Dev: Range:	Mean: Std-Dev: Range:	Mean: Std-Dev: Range:	Mean: Std-Dev: Range:	Mean: Std-Dev: Range:

C.10.4 Configuration: ISDN - MSAN ISDN; Application: Modem, V.32/V.32 bis - start procedure; handshake according V.25 without phase reversals

Test num.	Testing time	Config / Test numbers	Codec	Packet. time	Delay Upstream	Delay Downstream	Active Level	Noise	Signal to Interval Noise
1					Mean: Std-Dev: Range:	Mean: Std-Dev: Range:	Mean: Std-Dev: Range:	Mean: Std-Dev: Range:	Mean: Std-Dev: Range:
2					Mean: Std-Dev: Range:	Mean: Std-Dev: Range:	Mean: Std-Dev: Range:	Mean: Std-Dev: Range:	Mean: Std-Dev: Range:
3					Mean: Std-Dev: Range:	Mean: Std-Dev: Range:	Mean: Std-Dev: Range:	Mean: Std-Dev: Range:	Mean: Std-Dev: Range:
4					Mean: Std-Dev: Range:	Mean: Std-Dev: Range:	Mean: Std-Dev: Range:	Mean: Std-Dev: Range:	Mean: Std-Dev: Range:
5					Mean: Std-Dev: Range:	Mean: Std-Dev: Range:	Mean: Std-Dev: Range:	Mean: Std-Dev: Range:	Mean: Std-Dev: Range:

C.10.5 Configuration: ISDN - MSAN ISDN; Application: Modem, V.32/V.32 bis - start procedure; handshake according V.8 with phase reversals

Test num.	Testing time	Config / Test numbers	Codec	Packet. time	Delay Upstream	Delay Downstream	Active Level	Noise	Signal to Interval Noise
1					Mean: Std-Dev: Range:	Mean: Std-Dev: Range:	Mean: Std-Dev: Range:	Mean: Std-Dev: Range:	Mean: Std-Dev: Range:
2					Mean: Std-Dev: Range:	Mean: Std-Dev: Range:	Mean: Std-Dev: Range:	Mean: Std-Dev: Range:	Mean: Std-Dev: Range:
3					Mean: Std-Dev: Range:	Mean: Std-Dev: Range:	Mean: Std-Dev: Range:	Mean: Std-Dev: Range:	Mean: Std-Dev: Range:
4					Mean: Std-Dev: Range:	Mean: Std-Dev: Range:	Mean: Std-Dev: Range:	Mean: Std-Dev: Range:	Mean: Std-Dev: Range:
5					Mean: Std-Dev: Range:	Mean: Std-Dev: Range:	Mean: Std-Dev: Range:	Mean: Std-Dev: Range:	Mean: Std-Dev: Range:

C.11 Configuration: MSAN ISDN - ISDN

C.11.1 Configuration: MSAN ISDN - ISDN; Application: Voice

Test num.	Testing time	Config / Test numbers	Codec	Packet. time	P.863	Delay Upstream	Delay Downstream	Active Level
1					Mean: Std-Dev: Range:	Mean: Std-Dev: Range:	Mean: Std-Dev: Range:	Mean: Std-Dev: Range:
2					Mean: Std-Dev: Range:	Mean: Std-Dev: Range:	Mean: Std-Dev: Range:	Mean: Std-Dev: Range:
3					Mean: Std-Dev: Range:	Mean: Std-Dev: Range:	Mean: Std-Dev: Range:	Mean: Std-Dev: Range:
4					Mean: Std-Dev: Range:	Mean: Std-Dev: Range:	Mean: Std-Dev: Range:	Mean: Std-Dev: Range:
5					Mean: Std-Dev: Range:	Mean: Std-Dev: Range:	Mean: Std-Dev: Range:	Mean: Std-Dev: Range:

C.11.2 Configuration: MSAN ISDN - ISDN; Application: Fax, bit rate $\leq 14,4$ kbit/s

Test num.	Testing time	Config / Test numbers	Codec	Packet. time	Delay Upstream	Delay Downstream	Active Level	Noise	Signal to Interval Noise
1					Mean: Std-Dev: Range:	Mean: Std-Dev: Range:	Mean: Std-Dev: Range:	Mean: Std-Dev: Range:	Mean: Std-Dev: Range:
2					Mean: Std-Dev: Range:	Mean: Std-Dev: Range:	Mean: Std-Dev: Range:	Mean: Std-Dev: Range:	Mean: Std-Dev: Range:
3					Mean: Std-Dev: Range:	Mean: Std-Dev: Range:	Mean: Std-Dev: Range:	Mean: Std-Dev: Range:	Mean: Std-Dev: Range:
4					Mean: Std-Dev: Range:	Mean: Std-Dev: Range:	Mean: Std-Dev: Range:	Mean: Std-Dev: Range:	Mean: Std-Dev: Range:
5					Mean: Std-Dev: Range:	Mean: Std-Dev: Range:	Mean: Std-Dev: Range:	Mean: Std-Dev: Range:	Mean: Std-Dev: Range:

C.11.3 Configuration: MSAN ISDN - ISDN; Application: Fax, bit rate $> 14,4$ kbit/s

Test num.	Testing time	Config / Test numbers	Codec	Packet. time	Delay Upstream	Delay Downstream	Active Level	Noise	Signal to Interval Noise
1					Mean: Std-Dev: Range:	Mean: Std-Dev: Range:	Mean: Std-Dev: Range:	Mean: Std-Dev: Range:	Mean: Std-Dev: Range:
2					Mean: Std-Dev: Range:	Mean: Std-Dev: Range:	Mean: Std-Dev: Range:	Mean: Std-Dev: Range:	Mean: Std-Dev: Range:
3					Mean: Std-Dev: Range:	Mean: Std-Dev: Range:	Mean: Std-Dev: Range:	Mean: Std-Dev: Range:	Mean: Std-Dev: Range:
4					Mean: Std-Dev: Range:	Mean: Std-Dev: Range:	Mean: Std-Dev: Range:	Mean: Std-Dev: Range:	Mean: Std-Dev: Range:
5					Mean: Std-Dev: Range:	Mean: Std-Dev: Range:	Mean: Std-Dev: Range:	Mean: Std-Dev: Range:	Mean: Std-Dev: Range:

C.11.4 Configuration: MSAN ISDN - ISDN; Application: Modem, V.32/V.32 bis - start procedure; handshake according V.25 without phase reversals

Test num.	Testing time	Config / Test numbers	Codec	Packet. time	Delay Upstream	Delay Downstream	Active Level	Noise	Signal to Interval Noise
1					Mean: Std-Dev: Range:	Mean: Std-Dev: Range:	Mean: Std-Dev: Range:	Mean: Std-Dev: Range:	Mean: Std-Dev: Range:
2					Mean: Std-Dev: Range:	Mean: Std-Dev: Range:	Mean: Std-Dev: Range:	Mean: Std-Dev: Range:	Mean: Std-Dev: Range:
3					Mean: Std-Dev: Range:	Mean: Std-Dev: Range:	Mean: Std-Dev: Range:	Mean: Std-Dev: Range:	Mean: Std-Dev: Range:
4					Mean: Std-Dev: Range:	Mean: Std-Dev: Range:	Mean: Std-Dev: Range:	Mean: Std-Dev: Range:	Mean: Std-Dev: Range:
5					Mean: Std-Dev: Range:	Mean: Std-Dev: Range:	Mean: Std-Dev: Range:	Mean: Std-Dev: Range:	Mean: Std-Dev: Range:

C.11.5 Configuration: MSAN ISDN - ISDN; Application: Modem, V.32/V.32 bis - start procedure; handshake according V.8 with phase reversals

Test num.	Testing time	Config / Test numbers	Codec	Packet. time	Delay Upstream	Delay Downstream	Active Level	Noise	Signal to Interval Noise
1					Mean: Std-Dev: Range:	Mean: Std-Dev: Range:	Mean: Std-Dev: Range:	Mean: Std-Dev: Range:	Mean: Std-Dev: Range:
2					Mean: Std-Dev: Range:	Mean: Std-Dev: Range:	Mean: Std-Dev: Range:	Mean: Std-Dev: Range:	Mean: Std-Dev: Range:
3					Mean: Std-Dev: Range:	Mean: Std-Dev: Range:	Mean: Std-Dev: Range:	Mean: Std-Dev: Range:	Mean: Std-Dev: Range:
4					Mean: Std-Dev: Range:	Mean: Std-Dev: Range:	Mean: Std-Dev: Range:	Mean: Std-Dev: Range:	Mean: Std-Dev: Range:
5					Mean: Std-Dev: Range:	Mean: Std-Dev: Range:	Mean: Std-Dev: Range:	Mean: Std-Dev: Range:	Mean: Std-Dev: Range:

Annex D: Bibliography

Recommendation ITU-T G.114 (2003): "One-way transmission time".

History

Document history		
V1.1.1	February 2009	Publication
V1.2.1	June 2009	Publication
V1.3.1	November 2009	Publication
V1.4.1	September 2010	Publication
V1.5.1	September 2011	Publication
V1.6.1	June 2014	Publication
V1.6.2	September 2014	Publication