



TECHNICAL REPORT

**Terrestrial Trunked Radio (TETRA);  
Voice plus Data (V+D): Designers' guide;  
Part 7: TETRA High-Speed Data (HSD);  
TETRA Enhanced Data Service (TEDS)**

---

**Reference**

RTR/TCCE-06229

---

**Keywords**

data, service, TETRA

**ETSI**

650 Route des Lucioles  
F-06921 Sophia Antipolis Cedex - FRANCE

Tel.: +33 4 92 94 42 00 Fax: +33 4 93 65 47 16

Siret N° 348 623 562 00017 - APE 7112B  
Association à but non lucratif enregistrée à la  
Sous-Préfecture de Grasse (06) N° w061004871

---

**Important notice**

The present document can be downloaded from the  
[ETSI Search & Browse Standards](#) application.

The present document may be made available in electronic versions and/or in print. The content of any electronic and/or print versions of the present document shall not be modified without the prior written authorization of ETSI. In case of any existing or perceived difference in contents between such versions and/or in print, the prevailing version of an ETSI deliverable is the one made publicly available in PDF format on [ETSI deliver](#) repository.

Users should be aware that the present document may be revised or have its status changed, this information is available in the [Milestones listing](#).

If you find errors in the present document, please send your comments to the relevant service listed under [Committee Support Staff](#).

If you find a security vulnerability in the present document, please report it through our [Coordinated Vulnerability Disclosure \(CVD\)](#) program.

---

**Notice of disclaimer & limitation of liability**

The information provided in the present deliverable is directed solely to professionals who have the appropriate degree of experience to understand and interpret its content in accordance with generally accepted engineering or other professional standard and applicable regulations.

No recommendation as to products and services or vendors is made or should be implied.

No representation or warranty is made that this deliverable is technically accurate or sufficient or conforms to any law and/or governmental rule and/or regulation and further, no representation or warranty is made of merchantability or fitness for any particular purpose or against infringement of intellectual property rights.

In no event shall ETSI be held liable for loss of profits or any other incidental or consequential damages.

Any software contained in this deliverable is provided "AS IS" with no warranties, express or implied, including but not limited to, the warranties of merchantability, fitness for a particular purpose and non-infringement of intellectual property rights and ETSI shall not be held liable in any event for any damages whatsoever (including, without limitation, damages for loss of profits, business interruption, loss of information, or any other pecuniary loss) arising out of or related to the use of or inability to use the software.

---

**Copyright Notification**

No part may be reproduced in any form or by any means except for the purpose of implementation of standards.

The content of the PDF version shall not be modified without the written authorization of ETSI.

The copyright and the foregoing restriction extend to reproduction in all media.

© ETSI 2026.

All rights reserved.

# Contents

Intellectual Property Rights .....	9
Foreword.....	9
Modal verbs terminology.....	9
1 Scope .....	10
2 References .....	10
2.1 Normative references .....	10
2.2 Informative references.....	10
3 Definition of terms, symbols and abbreviations.....	12
3.1 Terms.....	12
3.2 Symbols.....	19
3.3 Abbreviations .....	19
4 TETRA layered architecture .....	23
4.1 OSI reference model.....	23
4.2 TETRA protocol stack.....	24
4.2.1 Protocol architecture .....	24
4.2.2 Inter-layer communication.....	25
4.2.3 Testable boundaries .....	26
4.2.4 Service access points .....	26
5 Overview of TETRA High-Speed Data (HSD).....	26
5.1 Introduction .....	26
5.2 Physical layer and lower MAC layer enhancements .....	28
5.3 Higher protocol layer enhancements .....	29
5.4 Services and applications .....	29
6 Physical layer and lower MAC .....	30
6.1 Physical resources .....	30
6.2 TDMA frame structure .....	31
6.3 Slot structure .....	32
6.3.1 Slot structure for phase modulation .....	32
6.3.2 Slot structure for QAM.....	33
6.4 Radio transmission burst structure .....	34
6.4.1 Burst structure for phase modulation.....	34
6.4.2 Burst structure for QAM.....	36
6.4.3 Burst structure formats.....	37
6.4.3.1 Phase modulated burst formats .....	37
6.4.3.2 QAM modulated burst formats .....	38
6.5 Channel structure.....	39
6.5.0 General.....	39
6.5.1 Logical channels in phase modulation.....	39
6.5.1.0 Logical channel categories .....	39
6.5.1.1 Control CHannel (CCH) .....	40
6.5.1.2 Traffic CHannel (TCH).....	40
6.5.2 QAM channels.....	41
6.5.3 Mapping of logical channels into physical channels.....	42
6.5.3.1 Mapping in phase modulation.....	42
6.5.3.2 Mapping in QAM.....	42
6.6 Reference configuration .....	43
6.6.1 Reference configuration for phase modulation.....	43
6.6.2 Reference configuration for QAM.....	44
6.7 Modulation .....	44
6.7.1 Phase modulation.....	44
6.7.2 QAM.....	46
6.7.2.1 Modulation types.....	46
6.7.2.2 Bit to symbol mapping .....	46

6.7.2.3	Comparison of gross bit rates.....	50
6.8	Error control (lower MAC) .....	50
6.8.1	General.....	50
6.8.2	Error control schemes for phase modulation .....	52
6.8.3	Error control schemes for QAM channels .....	53
6.8.3.0	General .....	53
6.8.3.1	Slot Information CHannel - QAM/Uplink (SICH-Q/U).....	54
6.8.3.2	Slot Information CHannel - QAM/Downlink (SICH-Q/D).....	54
6.8.3.3	Access Assignment CHannel - QAM (AACH-Q).....	55
6.8.3.4	Signalling CHannel - QAM/Half slot Uplink (SCH-Q/HU) .....	55
6.8.3.5	Signalling CHannel - QAM/Uplink (SCH-Q/U).....	56
6.8.3.6	Signalling CHannel - QAM/Downlink (SCH-Q/D) and Broadcast Network CHannel - QAM (BNCH-Q).....	56
6.8.3.7	Signalling CHannel - QAM/Random Access (SCH-Q/RA).....	56
6.8.3.8	Broadcast Synchronization CHannel - QAM (BSCH-Q).....	57
6.8.3.9	Signalling CHannel data set B - QAM (SCH-Q/B).....	57
6.8.4	Coding for phase modulation.....	57
6.8.4.1	General .....	57
6.8.4.2	16-state Rate-Compatible Punctured Convolutional (RCPC) codes .....	57
6.8.4.3	Shortened (30,14) Reed-Muller block codes.....	59
6.8.4.4	Cyclic Redundancy Check (CRC) block code .....	59
6.8.5	Coding for QAM channels.....	60
6.8.5.0	General .....	60
6.8.5.1	8-state Parallel Concatenated Convolutional Code (PCCC) for QAM .....	61
6.8.5.1.0	PCCC encoding .....	61
6.8.5.1.1	Encoding by the upper 8-state RSC encoder of rate 1/2.....	61
6.8.5.1.2	Interleaving by the quadratic-congruence interleaver.....	62
6.8.5.1.3	Encoding the interleaved bits by the lower 8 state RSC encoder of rate 1/2 .....	63
6.8.5.1.4	Merging the systematic and parity bits for the PCCC encoder .....	63
6.8.5.1.5	Puncturing scheme for the PCCC encoder .....	63
6.8.5.1.6	Puncturing mask for the PCCC encoder with coding rate 2/3 .....	64
6.8.5.1.7	Puncturing mask for the PCCC encoder with coding rate 1/2 .....	64
6.8.5.2	(16,5) Reed-Muller (RM) code for QAM .....	64
6.8.6	Interleaving for phase modulation .....	64
6.8.7	Interleaving for QAM channels .....	65
6.8.8	Scrambling .....	66
6.8.8.1	General .....	66
6.8.8.2	Scrambling method .....	66
6.9	Synchronization and channel estimation .....	67
6.9.1	Frequency and time synchronization .....	67
6.9.1.1	Requirements .....	67
6.9.1.1.1	BS requirements .....	67
6.9.1.1.2	MS requirements .....	67
6.9.1.2	Synchronization on a CA cell.....	67
6.9.1.2.1	Initial synchronization via $\pi/4$ -DQPSK plus $\pi/8$ -D8PSK - CA .....	67
6.9.1.2.2	Fine synchronization in QAM channels - CA .....	68
6.9.1.3	Synchronization on a DA cell .....	70
6.9.2	Channel estimation in QAM channels .....	71
6.10	Power control .....	72
6.11	Link adaptation in TETRA high speed channels .....	72
7	Higher layer protocol.....	73
7.1	Protocol architecture.....	73
7.1.1	General packet data aspects .....	73
7.1.2	Architecture of the TETRA protocol stack .....	73
7.2	Multimedia Exchange layer.....	75
7.2.1	General MEX features .....	75
7.2.2	MEX routing services .....	75
7.2.3	MEX precedence .....	75
7.3	Subnetwork Dependent Convergence Protocol layer .....	76
7.3.1	Outline of SNDCP .....	76
7.3.2	Application-level QoS parameters .....	79

7.3.3	QoS negotiation .....	81
7.3.4	QoS filtering information for secondary PDP contexts .....	81
7.3.5	Assignment of PDP contexts to layer 2 communication links .....	82
7.3.6	Choice of layer 2 communication link parameters .....	82
7.3.7	Selection of channel .....	83
7.3.7.1	Initial PDCH access .....	83
7.3.7.2	Changing PDCH requirements .....	83
7.3.8	Header and data compression .....	84
7.3.9	Data priority in SMDCP .....	84
7.3.10	Reconnection following cell reselection .....	84
7.4	Operation of the data link layer (layer 2) protocol .....	85
7.4.1	Structure of the data link layer .....	85
7.4.2	Control channel usage .....	86
7.4.2.1	Common control channels and assigned channels .....	86
7.4.2.1.1	General .....	86
7.4.2.1.2	Common control channels .....	86
7.4.2.1.3	Assigned channels .....	87
7.4.2.1.4	Sharing channels between cells .....	88
7.4.2.2	$\pi/4$ -DQPSK channel .....	89
7.4.2.3	D8PSK channel .....	89
7.4.2.4	QAM channel .....	89
7.4.2.5	Slot and TDMA frame arrangement on uplink and downlink .....	90
7.4.2.6	Minimum mode for CA .....	91
7.4.2.7	Discontinuous downlink transmissions - time-sharing mode .....	91
7.4.2.8	Independent allocation of uplink and downlink .....	92
7.4.3	Communication links provided by the LLC .....	92
7.4.3.1	General .....	92
7.4.3.2	Basic link .....	93
7.4.3.3	Advanced link .....	94
7.4.3.4	Advanced link usage .....	95
7.4.3.4.1	Advanced link set-up .....	95
7.4.3.4.2	Segment size for advanced link .....	96
7.4.3.5	Layer 2 signalling .....	97
7.4.4	Some MAC processes .....	98
7.4.4.1	General .....	98
7.4.4.2	Addressing .....	99
7.4.4.2.1	General .....	99
7.4.4.2.2	Layer 2 addressing .....	100
7.4.4.3	Random access .....	100
7.4.4.3.1	General .....	100
7.4.4.3.2	Overview of random access channel on 25 kHz channel .....	102
7.4.4.3.3	Overview of random access channel on 50 kHz, 100 kHz or 150 kHz QAM channel .....	104
7.4.4.4	Reserved access .....	105
7.4.4.4.1	Use of reserved access .....	105
7.4.4.4.2	Basic slot granting .....	105
7.4.4.4.3	Multiple slot granting .....	105
7.4.4.5	Channel allocation .....	106
7.4.4.6	Power control .....	107
7.4.4.6.1	General .....	107
7.4.4.6.2	Open loop power control .....	107
7.4.4.6.3	Closed loop power control .....	108
7.5	Link adaptation on D8PSK or QAM channel .....	108
7.5.1	General .....	108
7.5.2	Algorithm using predefined choice of bit rates .....	109
7.5.3	Algorithm adapting with channel conditions .....	110
7.6	Energy economy and napping .....	111
7.6.0	Methods for reduced reception .....	111
7.6.1	Energy economy, dual watch and part-time reception on common control channel .....	112
7.6.1.1	Energy economy mode .....	112
7.6.1.2	Dual watch mode .....	113
7.6.1.3	Part-time reception on multi-slot MCCCH-Q .....	113
7.6.2	Napping on assigned channel .....	114

7.7	Data priority .....	115
7.8	Scheduled access .....	116
7.8.1	General.....	116
7.8.2	MS operation for sending scheduled messages.....	117
7.8.3	Schedule timing .....	118
7.9	Cell and channel selection .....	118
7.9.1	General.....	118
7.9.2	Cell selection/reselection .....	118
7.9.2.1	Cell selection.....	118
7.9.2.2	Cell reselection.....	119
7.9.3	Assigned channel types and channel classes.....	120
7.9.3.1	General .....	120
7.9.3.2	Examples.....	121
7.9.4	Network broadcast .....	125
7.9.4.1	Broadcast information.....	125
7.9.4.2	Acquiring cell synchronization and network information.....	126
7.9.4.2.1	Acquiring cell synchronization and network information on a CA cell .....	126
7.9.4.2.2	Acquiring cell synchronization and network information on a DA cell .....	126
7.9.5	Serving cell surveillance .....	127
7.9.6	PDCH channel assignment .....	127
7.9.7	Assigned channel replacement.....	127
7.9.8	MS MAC measurements and path loss calculation.....	128
7.10	Circuit mode calls.....	129
7.11	Short data and SDS-TL .....	130
7.12	Registration and group attachment.....	130
7.13	Classes of MS .....	131
7.13.1	General.....	131
7.13.2	MS fast switching or duplex capability.....	132
7.13.2.0	General .....	132
7.13.2.1	Frequency half duplex operation.....	132
7.13.2.1.1	Frequency half duplex capability.....	132
7.13.2.1.2	Fast switching capability .....	132
7.13.2.2	Frequency full duplex operation .....	133
8	System and RF aspects .....	133
8.1	Frequency bands and spectrum allocation issues .....	133
8.1.1	European spectrum allocations .....	133
8.1.2	Position outside Europe .....	134
8.2	Tx specifications .....	134
8.2.0	General.....	134
8.2.1	Transmitter nominal power and time mask.....	135
8.2.1.1	Transmitter power classes and nominal power .....	135
8.2.1.2	Transmitter output power time mask .....	136
8.2.2	Transmitter specifications for phase modulation .....	137
8.2.2.1	Vector error magnitude requirement at symbol time for phase modulation.....	137
8.2.2.2	Maximum adjacent power levels for phase modulation.....	138
8.2.2.3	Wide-band noise limits for phase modulation.....	138
8.2.3	Transmitter specifications for QAM .....	139
8.2.3.1	Vector error magnitude requirement at symbol time for QAM.....	139
8.2.3.2	Limits to emission on adjacent channels in QAM.....	140
8.2.3.3	Wideband noise limits in QAM .....	140
8.3	RX specifications .....	141
8.3.1	General.....	141
8.3.2	Receiver specifications for phase modulation.....	142
8.3.2.0	General .....	142
8.3.2.1	Receiver class.....	142
8.3.2.2	Dynamic reference sensitivity performance for phase modulation .....	143
8.3.2.3	Static reference sensitivity performance for phase modulation.....	145
8.3.2.4	Receiver performance at reference interference ratios for phase modulation .....	146
8.3.3	Receiver specifications for QAM .....	149
8.3.3.0	General .....	149
8.3.3.1	Dynamic reference sensitivity performance for QAM .....	149

8.3.3.2	Static reference sensitivity performance for QAM .....	151
8.3.3.3	Receiver performance at reference interference ratios for QAM .....	152
8.3.3.3.1	Adjacent channel interference .....	152
8.3.3.3.2	Co-channel interference.....	152
8.3.3.4	Relationship between $E_b/N_0$ and receiver sensitivity .....	153
8.4	Propagation models .....	154
8.4.1	Modified Hata model.....	154
8.4.2	Urban environment .....	154
8.4.3	Suburban environment.....	154
8.4.4	Open area environment .....	155
8.4.5	Reduced expression for $L_m$ versus distance .....	155
8.4.6	Slow varying log-normal component (Ls).....	155
8.4.6.1	Components of received signal strength .....	155
8.4.6.2	Coverage probability at a distance $r$ from transmitter .....	156
8.4.7	Tap delay model for performance simulations.....	156
8.4.8	High velocity (e.g. trainborne) TETRA HSD .....	157
9	Channel performance in QAM channels .....	160
9.0	General .....	160
9.1	Permissible modulation, coding rate and channel BW combinations.....	160
9.2	Coded channel performance .....	161
9.2.1	Noise performance .....	161
9.2.2	Interference performance .....	172
9.3	Uncoded channel performance .....	173
9.3.1	Noise performance .....	173
9.3.2	Interference performance .....	181
10	Typical link budget calculations.....	182
10.1	System parameters.....	182
10.2	Downlink model.....	183
10.3	Uplink model.....	183
10.4	Range versus throughput trade-offs.....	184
10.4.1	Range of TETRA HSD channels in urban environment .....	184
10.4.2	Range of TETRA HSD channels in suburban environment .....	186
10.4.3	Range consideration in open area and rural environments .....	187
10.4.4	Range evaluation for uncoded channels.....	187
10.4.5	TETRA HSD channel coverage comparison for Conventional Access .....	188
10.4.6	Throughput vs. range for TETRA HSD channels .....	189
10.5	Range extension methods .....	190
10.5.1	Non-antenna methods .....	190
10.5.2	Antenna methods .....	190
11	Location Information Protocol (LIP) signalling.....	191
12	Peripheral Equipment Interface (PEI) .....	192
13	Security.....	192
13.1	Introduction to TETRA security.....	192
13.2	TETRA air interface security .....	192
13.2.1	Air interface security components .....	192
13.2.2	Security classes .....	193
13.2.3	Encryption.....	194
13.2.3.1	Encryption algorithms .....	194
13.2.3.2	Encryption mechanism.....	194
13.2.3.3	Basic key stream allocation.....	194
13.2.3.4	PDU association on phase modulation channels.....	195
13.2.3.5	PDU association on QAM channels.....	195
13.2.3.5.0	Usage of PDU association on QAM channels .....	195
13.2.3.5.1	Fixed-mapping KSS allocation scheme .....	195
13.2.3.5.2	Offset-mapping KSS allocation scheme .....	196
13.2.4	Authentication.....	197
13.2.5	Air interface key management .....	197
13.2.6	Enable and disable .....	197
13.3	TETRA end-to-end security .....	198

14	Air to Ground Operation .....	198
<b>Annex A:</b>	<b>Simulation set-up .....</b>	<b>199</b>
<b>Annex B:</b>	<b>Channel estimation algorithms in QAM channels .....</b>	<b>200</b>
B.0	General .....	200
B.1	Interpolation-based CE.....	200
B.2	Bayesian CE.....	201
<b>Annex C:</b>	<b>Impact of channel estimation errors on MER.....</b>	<b>203</b>
History .....		205

---

# Intellectual Property Rights

## Essential patents

IPRs essential or potentially essential to normative deliverables may have been declared to ETSI. The declarations pertaining to these essential IPRs, if any, are publicly available for **ETSI members and non-members**, and can be found in ETSI SR 000 314: "*Intellectual Property Rights (IPRs); Essential, or potentially Essential, IPRs notified to ETSI in respect of ETSI standards*", which is available from the ETSI Secretariat. Latest updates are available on the [ETSI IPR online database](#).

Pursuant to the ETSI Directives including the ETSI IPR Policy, no investigation regarding the essentiality of IPRs, including IPR searches, has been carried out by ETSI. No guarantee can be given as to the existence of other IPRs not referenced in ETSI SR 000 314 (or the updates on the ETSI Web server) which are, or may be, or may become, essential to the present document.

## Trademarks

The present document may include trademarks and/or tradenames which are asserted and/or registered by their owners. ETSI claims no ownership of these except for any which are indicated as being the property of ETSI, and conveys no right to use or reproduce any trademark and/or tradename. Mention of those trademarks in the present document does not constitute an endorsement by ETSI of products, services or organizations associated with those trademarks.

**DECT™**, **PLUGTESTS™**, **UMTS™** and the ETSI logo are trademarks of ETSI registered for the benefit of its Members. **3GPP™**, **LTE™** and **5G™** logo are trademarks of ETSI registered for the benefit of its Members and of the 3GPP Organizational Partners. **oneM2M™** logo is a trademark of ETSI registered for the benefit of its Members and of the oneM2M Partners. **GSM®** and the GSM logo are trademarks registered and owned by the GSM Association.

**BLUETOOTH®** is a trademark registered and owned by Bluetooth SIG, Inc.

---

# Foreword

This Technical Report (TR) has been produced by ETSI Technical Committee TETRA and Critical Communications Evolution (TCCE).

The present document is part 7 of a multi-part deliverable covering Terrestrial Trunked Radio (TETRA); Voice plus Data (V+D): Designers' guide, as identified below:

ETSI ETR 300-1: "Overview, technical description and radio aspects";

ETSI TR 102 300-2: "Radio channels, network protocols and service performance";

ETSI TR 102 300-3: "Direct Mode Operation (DMO)";

ETSI ETR 300-4: "Network management";

ETSI TR 102 300-5: "Guidance on numbering and addressing";

ETSI TR 102 300-6: "Air-Ground-Air";

**ETSI TR 102 300-7: "TETRA High-Speed Data (HSD); TETRA Enhanced Data Service (TEDS)".**

---

# Modal verbs terminology

In the present document "**should**", "**should not**", "**may**", "**need not**", "**will**", "**will not**", "**can**" and "**cannot**" are to be interpreted as described in clause 3.2 of the [ETSI Drafting Rules](#) (Verbal forms for the expression of provisions).

"**must**" and "**must not**" are **NOT** allowed in ETSI deliverables except when used in direct citation.

---

# 1 Scope

The present document is aimed at a readership with a technical background wishing to have an overall understanding of the TEDS architecture, parameters and features for embarking on any of the following activities *before reading the standard*:

- 1) design and development of TETRA 2 network and equipment;
- 2) system and technical support activity in procurement phases of a TETRA 2 network;
- 3) upgrading of an existing TETRA network to a TEDS capable network;
- 4) applications development activity.

This list is not exhaustive. Although the emphasis is on a readership with a technical background a selective reading of the contents will also be of benefit to non-technical personnel engaged on other aspects of a TETRA 2 network. No market or user type information nor a competitive analysis with respect to other technologies or standards are included.

If any conflict is found between the present document and the clauses in the TETRA standard ETSI EN 300 392-2 [i.2] V3.7.1, or later versions, then ETSI EN 300 392-2 [i.2] takes precedence. In addition to describing TEDS architecture, parameters and features, the present document provides detailed system simulation results and typical link budget calculations to assist readers in their outline radio coverage planning. The effect of using TETRA 2 terminals in high velocity environments such as trainborne, not included in the standard, is also evaluated in the present document.

---

## 2 References

### 2.1 Normative references

Normative references are not applicable in the present document.

### 2.2 Informative references

References are either specific (identified by date of publication and/or edition number or version number) or non-specific. For specific references, only the cited version applies. For non-specific references, the latest version of the referenced document (including any amendments) applies.

NOTE: While any hyperlinks included in this clause were valid at the time of publication, ETSI cannot guarantee their long-term validity.

The following referenced documents may be useful in implementing an ETSI deliverable or add to the reader's understanding, but are not required for conformance to the present document.

- |       |  |
|-------|--|
| [i.1] | ISO/IEC 8348: "Information technology — Open Systems Interconnection — Network service definition".  |
| [i.2] | ETSI EN 300 392-2: "Terrestrial Trunked Radio (TETRA); Voice plus Data (V+D); Part 2: Air Interface (AI)".   |
| [i.3] | ETSI EN 300 394-1: "Terrestrial Trunked Radio (TETRA); Conformance testing specification; Part 1: Radio".  |
| [i.4] | ETSI EN 301 344: "Digital cellular telecommunications system (Phase 2+) (GSM); General Packet Radio Service (GPRS); Service description; Stage 2 (GSM 03.60)".   |
| [i.5] | ETSI TS 122 060: "Digital cellular telecommunications system (Phase 2+); Universal Mobile Telecommunications System (UMTS); General Packet Radio Service (GPRS); Service description; Stage 1 (3GPP TS 22.060)". |
| [i.6] | IETF RFC 1144: "Compressing TCP/IP headers for low-speed serial links".  |

- [i.7] IETF RFC 2507: "IP Header Compression".
- [i.8] IETF RFC 2508: "Compressing IP/UDP/RTP Headers for Low-Speed Serial Links".
- [i.9] IETF RFC 1977: "PPP BSD Compression Protocol".
- [i.10] IETF RFC 1978: "PPP Predictor Compression Protocol".
- [i.11] IETF RFC 3095: "RObust Header Compression (ROHC): Framework and four profiles: RTP, UDP, ESP and uncompressed".
- [i.12] ETSI EN 300 392-1: "Terrestrial Trunked Radio (TETRA); Voice plus Data (V+D); Part 1: General network design".
- [i.13] ETSI EN 300 396-3: "Terrestrial Trunked Radio (TETRA); Technical requirements for Direct Mode Operation (DMO); Part 3: Mobile Station to Mobile Station (MS-MS) Air Interface (AI) protocol".
- [i.14] ETSI ETR 300-1 (1997): "Terrestrial Trunked Radio (TETRA); Voice plus Data (V+D); Designers' guide; Part 1: Overview, technical description and radio aspects".
- [i.15] ETSI TR 102 491: "Electromagnetic compatibility and Radio spectrum Matters (ERM); TETRA Enhanced Data Service (TEDS); System reference document".
- [i.16] ETSI EN 300 113-1 (V1.6.1): "Electromagnetic compatibility and Radio spectrum Matters (ERM); Land mobile service; Radio equipment intended for the transmission of data (and/or speech) using constant or non-constant envelope modulation and having an antenna connector; Part 1: Technical characteristics and methods of measurement".
- [i.17] [CEPT ERC Report 68](#): "Monte-Carlo Simulation Methodology for the use in Sharing and Compatibility Studies between Different Radio Services or Systems", Naples, February 2000, revised in Regensburg, May 2001 and Baden, June 2002.
- [i.18] ERO: "SEAMCAT-3 User Manual", November 2005.
- [i.19] ETSI EN 300 392-7: "Terrestrial Trunked Radio (TETRA); Voice plus Data (V+D); Part 7: Security".
- [i.20] ETSI EN 302 109: "Terrestrial Trunked Radio (TETRA); Security; Synchronization mechanism for end-to-end encryption".
- [i.21] G. Cherubini, E. Eleftheriou, and S. Olcer: "Filtered Multitone Modulation for High-Speed Digital Subscriber Lines", IEEE™ J. Select. Areas Commun. vol. 20, no. 5.
- [i.22] T. S. Rappaport, Wireless Communications: "Principles & Practice", Prentice-Hall, 1996.
- [i.23] S. Le Goff, A. Glavieux and C. Berrou: "Turbo-Codes and High Spectral Efficiency Modulation", IEEE™ ICC 99, pp. 645-649, May 1994.
- [i.24] S. M. Kay, Fundamentals of Statistical Processing volume I: "Estimation Theory", Prentice-Hall, 1993.
- [i.25] D. O. Reudink: "Properties of Mobile Radio Propagation above 400 MHz", IEEE™ Transactions on Vehicular Technology, Vol. 2, VT-23, pp. 1-20, November 1974.
- [i.26] [CEPT ECC Decision \(08\)05](#): "The harmonisation of frequency bands for the implementation of digital Public Protection and Disaster Relief (PPDR) narrow band and wide band radio applications in bands within the 380-470 MHz range".
- [i.27] [CEPT ECC ERC Report 25](#): "The European table of frequency allocations and applications in the frequency range 8.3 KHz to 3000 GHz".
- [i.28] [CEPT ECC Decision \(04\)06](#): "The availability of frequency bands for the introduction of Wide Band Digital Land Mobile PMR/PAMR in the 400 MHz and 800/900 MHz bands".

[i.29] [CEPT ECC Decision \(16\)02](#): "Harmonised technical conditions and frequency bands for the implementation of Broadband Public Protection and Disaster Relief (BB-PPDR) systems".

## 3 Definition of terms, symbols and abbreviations

### 3.1 Terms

For the purposes of the present document, the following terms apply:

**access code:** subdivision of mobiles for random access opportunities

**acknowledged data transfer:** service provided by the layer below which gives an acknowledgement back over the air interface from the lower layer peer entity

NOTE: This service is used by the layer 3 entities to get a secure transmission including retransmissions.

**adjacent-channel interference:** interference caused by coupling from a signal in an adjacent channel

**advanced link:** bidirectional connection-oriented path between an MS and a BS using the acknowledged service - or unidirectional connection-oriented path between a BS and one or several MSs using the unacknowledged service - with provision of windowing, segmentation, extended error protection and choice among several throughputs

NOTE: The advanced link requires a set-up phase.

**air-interface:** wireless interface between a base station and a mobile station (trunked mode) or between two mobile stations (direct mode)

**announced cell reselection:** cell reselection where the MS MLE informs the SwMI both in the old cell (leaving cell) and in the new cell (arriving cell) that cell change is performed

**assessment:** act of estimating the path loss parameter of the serving cell main carrier or of a channel class (on the serving cell or an adjacent cell), based on measurements made on another channel or carrier radiated from the same site and applying conversion factors to those measurements

**assigned channel:** channel allocated by the infrastructure to certain MSs using channel allocation command(s) addressed to those MSs

NOTE: An assigned channel may be allocated for secondary control purposes or for a circuit mode call.

**Associated Control CHannel (ACCH):** dedicated signalling channel associated with a channel that has been assigned for circuit mode traffic

NOTE: It comprises the Fast Associated Control CHannel (FACCH) which uses frames 1 to 18 when there is no traffic in a given direction or the Slow Associated Control CHannel (SACCH) which is always available in frame 18 when there is traffic.

**background class data:** data that requires high delivery reliability but can tolerate delay

**background measurement:** measurements performed by the lower layers while maintaining the current service to the service users, i.e. the MS MLE

**basic link:** bidirectional connectionless path between one or several MSs and a BS, with provision of both unacknowledged and acknowledged services on a single message basis

**baud rate:** equivalent to signalling rate or symbol rate

**broadcast:** unidirectional point to multi-point mode of transmission

**burst header:** burst identifier (carrying a SICCH channel for all burst types, plus an AACH channel for the NDB)

**burst payload:** section of burst carrying traffic channel information

**C-plane:** plane for control and packet data signalling

**carrier specific signalling:** additional  $\pi/4$ -DQPSK common signalling channel allocated in conjunction with a traffic channel specific to the carrier

**cell reselection:** act of changing the serving cell from an old cell to a new cell

NOTE: Cell reselection is performed by procedures located in the MLE and in the MAC. When the reselection is made and possible registration is performed, the MS is said to be attached to the cell.

**channel class:** set of values indicating the general RF characteristics of a concentric channel or fully super-sectored channel

**channel estimation:** process of estimating the degradation of a digital radio channel by the propagation effect to apply correction

**cipher key:** value that is used to determine the transformation of plain text to cipher text in a cryptographic algorithm

**cipher text:** data produced through the use of encipherment

**co-channel interference:** interference between two different communication channels re-using the same frequency

**coherent detection:** conversion of the intermediate frequency (IF) signal to I and Q components so that the phase of the components is preserved

**Common Cipher Key (CCK):** cipher key that is generated by the infrastructure to protect group addressed signalling and traffic

NOTE: CCK is also used for protection of SSI identities (ESI) in layer 2.

**common control channels:** control channels transmitted by the infrastructure to control the MS population

NOTE: The common control channels comprise the  $\pi/4$ -DQPSK Main Control CHannel (MCCH) or QAM Main Control CHannel (MCCH-Q), and common Secondary Control CHannels (common SCCH).

**concentric channel:** channel that has essentially the same azimuthal radiation pattern as the main carrier and is radiated from the same site as the main carrier

**conforming channel:** channel that has essentially the same azimuthal radiation pattern as the main carrier, is radiated from the same site as the main carrier and has essentially the same range and coverage area as the main carrier

NOTE: A conforming channel is a special case of a concentric channel.

**Conventional Access (CA):** method of operation in which the main carrier uses phase modulation

**Conventional Access (CA) cell:** cell on which the main carrier uses phase modulation

**Conventional Access (CA) MS:** MS that is currently camped on a conventional access cell

**Cyclic Redundancy Check (CRC):** algorithm for detection and correction of accidental errors in a data stream

**D8PSK channel:** channel on which signalling and data messages are sent using either  $\pi/4$ -DQPSK bursts or  $\pi/8$ -D8PSK bursts

**delay spread:** measure of channel time dispersion due to multipath propagation

NOTE: The larger the delay spread (i.e. the relative propagation delays along the various paths), the more pronounced the channel frequency selectivity.

**Derived Cipher Key (DCK):** key generated during authentication for use in protection of individually addressed signalling and traffic

**Direct Access (DA):** method of operation in which the main carrier uses QAM

**Direct Access (DA) cell:** cell on which the main carrier uses QAM

**Direct Access (DA) MS:** MS that is currently camped on a direct access cell

**doppler bandwidth:** Same as doppler spread.

**doppler spread:** maximum doppler shift undergone by the received carrier, i.e. product of carrier frequency by the ratio of MS speed to light propagation speed

NOTE: The larger the doppler spread, the more pronounced the channel time selectivity.

**duplex frequency spacing:** fixed frequency spacing between uplink and downlink frequencies

**eccentric channel:** channel that is not radiated from the same site as the main carrier

NOTE: The TETRA standard ETSI EN 300 392-2 [i.2] supports up to a maximum separation of 4 km between the eccentric channel's transmitter site and the main carrier's transmitter site.

**Encryption Cipher Key (ECK):** cipher key that is used as input to the encryption algorithm where an air interface encryption algorithm from TEA set A is in use

NOTE: This key is derived from one of SCK, DCK, MGCK or CCK and modified using an algorithm by the broadcast data of the serving cell.

**Extended Cipher Key (CKX):** value that is used to determine the transformation of plain text to cipher text in a cryptographic algorithm where an air interface encryption algorithm from TEA set B is in use

**Extended Common Cipher Key (CCKX):** cipher key that is generated by the infrastructure to protect group addressed signalling and traffic where an air interface encryption algorithm from TEA set B is in use

NOTE: CCKX can also be used to protect SSI identities (ESI or MAE) in layer 2.

**Extended Derived Cipher Key (DCKX):** key generated during authentication for use in protection of individually addressed signalling and traffic where an air interface encryption algorithm from TEA set B is in use

**Extended Group Cipher Key (GCKX):** cipher key known by the infrastructure and MS to protect group addressed signalling and traffic where an air interface encryption algorithm from TEA set B is in use

**Extended Modified Group Cipher Key (MGCKX):** cipher key known by the infrastructure and MS to protect group addressed signalling and traffic that is composed algorithmically from CCKX and GCKX where an air interface encryption algorithm from TEA set B is in use

**Extended Static Cipher Key (SCKX):** predetermined cipher key that may be used to provide confidentiality in class 2 systems with a corresponding algorithm and may also be used in DMO or for fallback where an air interface encryption algorithm from TEA set B is in use

**end-to-end encryption:** encryption within or at the source end system, with the corresponding decryption occurring only within or at the destination end system

**fading bandwidth:** Same as doppler spread

**foreground measurement:** measurements performed by the lower layers while employing the whole capacity, e.g. no concurrent service is maintained

**frequency-selective fading:** distortion on channel frequency response due to multipath propagation, giving rise to variable attenuation (selectivity) and phase rotation with frequency

**fully super-sectored channel:** super-sectored channel that is radiated from the same site as the main carrier, and has an azimuthal extent that is greater than, and entirely contains, the azimuthal extent of the main carrier

**generator polynomial:** polynomial with binary coefficients used to define the relationship between a bit at the encoder output and the sequence of input bits

**gross bit rate:** number of modulation bits transmitted in a channel per second

**Group Cipher Key (GCK):** cipher key known by the infrastructure and MS to protect group addressed signalling and traffic

NOTE: Not used directly at the air interface but modified by CCK to give a modified group cipher key (MGCK).

**Group TETRA Subscriber Identity (GTSI):** identity used to set up and receive group calls and messages

NOTE: A TETRA user may have multiple GTSIs associated to its ITSI. Multiple users may have the same GTSI as a valid reception address.

**half duplex operation:** each MS asks for permission to transmit for each transaction

NOTE: In TETRA trunked mode operation half duplex means two-frequency simplex operation.

**Individual TETRA Subscriber Identity (ITSI):** identity used to specify an individual TETRA user

NOTE: An ITSI cannot be shared by multiple users.

**initial cell selection:** act of choosing a first serving cell to register in

NOTE: Initial cell selection is performed by procedures located in the MLE and in the MAC. When the cell selection is made and possible registration is performed, the MS is said to be attached to the cell.

**Initialization Value (IV):** sequence of symbols that randomize the KSG inside the encryption unit

**interleaving:** way to arrange data in a non-contiguous way in order to increase performance

**intermodulation products:** unwanted signals generated when two or more signals are present in a non-linear circuit

**interrupting measurement:** measurements performed by the lower layers interrupting current services

**inter-symbol interference:** distortion of the received signal caused by temporal spreading and consequent overlap of adjacent modulation symbols

**IP packet data:** packetized data according to the Internet Protocol

**irregular channel:** non-conforming channel that needs to be monitored by the MS in order for the MS to discover whether the channel would be usable as an assigned channel

NOTE: Sectorized channels and semi-super-sectorized channels are irregular channels. An eccentric channel is an irregular channel, if it does not fully cover the area of the cell. The SwMI may broadcast information about a fully super-sectorized channel as either a channel class or an irregular channel, if broadcast is needed (for example, if the channel does not fully cover the area of the cell).

**irregular channel monitoring:** monitoring of irregular channels on the serving cell or on adjacent cells

**key stream:** pseudo-random stream of symbols that is generated by a KSG for encipherment and decipherment

**Key Stream Generator (KSG):** cryptographic algorithm which produces a stream of symbols that can be used for encipherment and decipherment

NOTE: The initial state of the KSG is determined by the IV value.

**Key Stream Segment: (KSS):** key stream of arbitrary length

**link adaptation:** process of adaptively changing the modulation level on a D8PSK channel, or the modulation level and/or coding rate on a QAM channel

**logical channel:** generic term for any distinct data path

NOTE: Logical channels are considered to operate between logical endpoints.

**MAC block:** unit of information transferred between the upper MAC and lower MAC for a particular logical channel

NOTE: Logical channels are e.g. SCH/F, SCH/HD, SCH/HU, SCH-P8/F, SCH-P8/HD, SCH-P8/HU, SCH-Q/D, SCH-Q/U, SCH-Q/HU or SCH-Q/RA. The lower MAC performs channel coding for insertion into the appropriate physical slot, half slot or subslot.

**main carrier:** carrier containing the common control channel(s) transmitted by the infrastructure to control the MS population

NOTE: The frequency of the main carrier is broadcast by the infrastructure.

**Main Control CHannel (MCCH):** principal common control channel transmitted by the infrastructure to control the MSs in a conventional access cell

NOTE: The frequency of the main carrier for the conventional access cell is broadcast by the infrastructure, and the MCCH is located on timeslot 1 of the main carrier. The MCCH is a  $\pi/4$ -DQPSK channel.

**Main Control Channel - QAM (MCCH-Q):** principal common control channel transmitted by the infrastructure to control the MSs in a direct access cell

NOTE: The frequency of the main carrier for the direct access cell is broadcast by the infrastructure, and the MCCH-Q is located on timeslot 1 of the main carrier or timeslots 1 and 2 of the main carrier or timeslots 1, 2 and 3 of the main carrier or all four timeslots of the main carrier. The MCCH-Q is a QAM channel.

**message trunking:** traffic channel is permanently allocated for the complete duration of the circuit mode call

**minimum mode:** mode of operation in which the infrastructure allocates all four timeslots of a conventional access main carrier for traffic or assigned control purposes

NOTE 1: In this mode, only frame 18 can be used for common control without disturbing the established services.

NOTE 2: Minimum mode is not supported for direct access.

**Modified Group Cipher Key (MGCK):** cipher key known by the infrastructure and MS to protect group addressed signalling and traffic that is composed algorithmically from CCK and GCK

**monitoring:** act of measuring the power of a carrier and calculating the path loss parameter based upon information broadcast by the serving cell

NOTE: There are several types of monitoring:

- neighbour cell monitoring i.e. monitoring of the main carrier on adjacent cells;
- irregular channel monitoring i.e. monitoring of irregular carriers on the serving cell or on adjacent cells;
- main carrier monitoring i.e. monitoring of the main carrier on the serving cell.

**non-conforming channel:** channel that is not a conforming channel

NOTE: A non-conforming channel:

- has a different azimuthal radiation pattern from the main carrier; and/or
- has a different range and coverage area from the main carrier; and/or
- is not radiated from the same site as the main carrier.

**non-conforming concentric channel:** channel that has essentially the same azimuthal radiation pattern as the main carrier and is radiated from the same site as the main carrier, but has a different range and coverage area from the main carrier

**nonlinear distortion:** distortion caused by a deviation from a linear relationship between specified input and output parameters of a system or component

**normal mode:** mode of operation in which the MCCH is present in timeslot 1 of all frames 1 to 18 or in which the MCCH-Q is present in at least timeslot 1 of all frames 1 to 18

**omnidirectional antenna:** antenna system which radiates power uniformly in one plane with a directive pattern shape in a perpendicular plane

**Over-The-Air Rekeying (OTAR):** method by which the SwMI can transfer secret keys securely to terminals

**parity bits:** bits produced by the encoder in addition to the systematic bits

**phase modulation carrier:** carrier that is currently carrying  $\pi/4$ -DQPSK and/or D8PSK channel(s)

**physical channel:** timeslot plus its associated uplink and downlink frequency allocation

**pilot symbols:** pre-defined modulation symbols transmitted over the air interface for estimation of propagation channel behaviour

**polyphase filter bank:** complexity-saving approach to implement a filter bank

NOTE: This is discussed for instance in "Filtered Multitone Modulation for High-Speed Digital Subscriber Lines" [i.21].

**proprietary algorithm:** algorithm which is the intellectual property of a legal entity

**QAM carrier:** carrier that is currently carrying QAM channel(s)

**QAM channel:** channel on which signalling and data messages are sent using QAM bursts

**quasi-transmission trunking:** traffic channel is allocated for each call transaction (while the pressel is activated) and in addition the channel de-allocation is delayed for a short period at the end of the transaction (after the pressel release)

NOTE: During this "channel hang-time" the channel allocation may be re-used for a new call transaction that is part of the same call. A delayed channel de-allocation procedure applies at the end of each transaction.

**ramp-up/down:** transients at the power amplifier output at the leading and trailing edges of a burst transmission

**random access attempt:** period from the initiation of the random access procedure until the MS receives a response from the BS or abandons the procedure

NOTE: The random access is abandoned e.g. after sending the maximum permitted number of retries.

**ranking:** procedural method of listing cells in descending order from the most suitable for communication to the least suitable for communication

NOTE: Inputs to the ranking procedure are outputs from the monitoring and/or scanning process and network parameters received in the MLE broadcast.

**real-time class data:** data that cannot tolerate delay but can tolerate some packet loss

**roll-off factor:** parameter involved in the transmission filter design when SRRC shaping is used, with an impact on signal bandwidth occupancy

**scanning:** act of measuring the power of neighbour cells and calculating the path loss parameter based upon the information on the neighbour cells broadcast by the neighbour cells themselves

**scrambling:** process of randomizing the bit sequence to avoid eavesdropping and to distinguish base stations from each other

**SDU number:** number on the advanced link to keep TL-SDUs in order

**Secondary Control CHannel (SCCH):** control channel other than the MCCH or MCCH-Q

NOTE: There are two types of SCCH:

- a common SCCH, which has the same functionality as the MCCH (for Conventional Access) or MCCH-Q (for Direct Access) but is used only by a subset of the MS population; and
- an assigned SCCH, which may be allocated to certain MSs after an initial random access or paging message.

**sector antenna:** antenna system with a directive radiation in both azimuthal and vertical planes

**sectored channel:** channel that has an azimuthal extent that is smaller than, and contained entirely within, the azimuthal extent of the main carrier, and is radiated from the same site as the main carrier

**security class 1, 2 or 3:** classification of terminal and SwMI encryption and authentication support

**segment:** advanced link unit of transmission and re-transmission

NOTE: A segment is a numbered piece of a TL-SDU, normally fitting into one MAC layer PDU.

**semi-super-sectored channel:** super-sectored channel that is radiated from the same site as the main carrier, and has an azimuthal extent that exceeds the azimuthal extent of the main carrier in one azimuthal direction and is less than the azimuthal extent of the main carrier in the other azimuthal direction

**Service Access Point (SAP):** interface point through which the services of one layer are provided to the immediately higher layer

**serving cell:** cell that is currently providing service to the MS

**simplex:** half-duplex operation

NOTE: Mainly used in TETRA standardization to differentiate half-duplex from (full) duplex communication.

**Static Cipher Key (SCK):** predetermined cipher key that may be used to provide confidentiality in class 2 systems with a corresponding algorithm and may also be used in DMO or for fallback

**subscriber class:** subdivision of the subscriber population

NOTE: The operator may define the values and meaning of each class.

**super-sectored channel:** channel that has an azimuthal extent that exceeds the azimuthal extent of the main carrier in at least one azimuthal direction, and is radiated from the same site as the main carrier

NOTE: A super-sectored channel may be either a fully super-sectored channel or a semi-super-sectored channel.

**surveillance:** process of monitoring the quality of the radio link to the serving cell

**synchronization symbols:** pre-defined modulation symbols transmitted over the air interface for synchronization purposes

**systematic bits:** bits at the encoder output coinciding with the input bits

**telemetry class data:** data that can tolerate moderate delays and limited packet loss, and is intermittent or periodic in nature

**time-selective fading:** variation of channel attenuation in time due to MS motion

**TL-SDU:** SDU from the layer above the LLC (i.e. MLE)

**TM-SDU:** SDU from the layer above the MAC (i.e. LLC)

**transmission trunking:** traffic channel is individually allocated for each call transaction in a circuit mode call (for each activation of the pressel)

**U-plane:** plane for user traffic signalling

**umbrella channel:** assignable channel that fully covers the areas of multiple cells

**unacknowledged data transfer:** service provided by the layer below which does not give any acknowledgement back over the air interface from the lower layer peer entity

**unannounced cell reselection:** cell reselection where the MS MLE does not inform the old cell (leaving cell) that it intends to change to a new cell

NOTE: Only the new cell (arriving cell) is informed about the cell reselection.

**undeclared cell reselection:** cell reselection where the MS MLE does not inform the old cell (leaving cell) or the new cell (arriving cell) that cell change is performed

**$\pi/4$ -DQPSK channel:** channel on which signalling and data messages are sent using  $\pi/4$ -DQPSK bursts

## 3.2 Symbols

Void.

## 3.3 Abbreviations

For the purposes of the present document, the following abbreviations apply:

3GPP	3 <sup>rd</sup> Generation Partnership Project
AACH	Access Assignment CHannel
AACH-Q	Access Assignment CHannel, QAM
ACCH	Associated Control CHannel
AGA	Air - Ground - Air service
API	Application Programming Interface
ASSI	Alias Short Subscriber Identity
ATSI	Alias TETRA Subscriber Identity
AWGN	Additive White Gaussian Noise
BCCH	Broadcast Control CHannel
BCCH-Q	Broadcast Control CHannel, QAM
BCE	Bayesian Channel Estimator
BER	Bit Error Rate
BLCH	BS Linearization CHannel
BLCH-Q	BS Linearization CHannel, QAM
BNCH	Broadcast Network CHannel
BNCH-Q	Broadcast Network CHannel, QAM
BS	Base Station
BSCH	Broadcast Synchronization CHannel
BSCH-Q	Broadcast Synchronization CHannel, QAM
BU <sub>x</sub>	Bad Urban scenario in conjunction with an MS speed of $x$ km/h
BW	Bandwidth
CA	Conventional Access
CB	Control uplink Burst
CCH	Control CHannel
CCH-Q	Control CHannel, QAM
CCK	Common Cipher Key
CCKX	eXtended Common Cipher Key
CDMA	Code Division Multiple Access
CE	Channel Estimation/Estimator
CEPT	Conférence Européenne des administrations des Postes et Télécommunications
CKX	Cipher Key (TEA set B)
CLCH	Common Linearization CHannel
CLCH-Q	Common Linearization CHannel, QAM
CMCE	Circuit Mode Control Entity
CODEC	COder-DECoder
C-plane	Control-plane
CRC	Cyclic Redundancy Check
CSS	Carrier Specific Signalling
D8PSK	Differential 8 Phase Shift Keying
DA	Direct Access
DCK	Derived Cipher Key
DCKX	Extended Derived Cipher Key
DCOMP	Data COMpression Protocol
DQPSK	Differential Quaternary Phase Shift Keying
DSP	Digital Signal Processor
ECA	European Common Allocation
ECC	Electronics Communications Committee
ECK	Encryption Cipher Key (TEA set A)
EEC	European Economic Community
EIRP	Effective Isotropic Radiated Power
EQ <sub>x</sub>	EQualizer test with an MS speed of $x$ km/h
ERC	European Radiocommunications Committee

ERP	Effective Radiated Power
ETSI	European Telecommunications Standards Institute
EU	European Union
EVM	Error Vector Magnitude
FACCH	Fast Associated Control CHannel
FCB	Frequency Correction downlink Burst
FCS	Frame Check Sequence
FDD	Frequency Division Duplex
FER	Frame Erasure Rate
FIR	Finite Impulse Response
GCK	Group Cipher Key
GCKX	eXtended Group Cipher Key
GPRS	General Packet Radio Service
GSM	Global System for Mobile Communications
GSSI	Group Short Subscriber Identity
GTSI	Group TETRA Subscriber Identity
HH	HandHeld
HSD	High Speed Data
HT	Hilly Terrain
HT <sub>x</sub>	Hilly Terrain scenario in conjunction with an MS speed of <i>x</i> km/h
IBCE	Interpolation-Based Channel Estimator
IEC	International Electrotechnical Commission
IP	Internet Protocol
IPv4	IP version 4
IPv6	IP version 6
ISDN	Integrated Services Digital Network
ISO	International Organization for Standardization
ISSI	Individual Short Subscriber Identity
ITSI	Individual TETRA Subscriber Identity
IV	Initialization Value
KSG	Key Stream Generator
KSS	Key Stream Segment
LA	Location Area
LB	Linearization Burst
LCH	Linearization CHannel
LCH-Q	Linearization CHannel, QAM
LDB	Linearization Downlink Burst
LIP	Location Information Protocol
LLC	Logical Link Control
MAC	Medium Access Control
MAE	MAC Address Encryption
MC	MultiCarrier
MCC	Mobile Country Code
MCCH	Main Control CHannel
MCCH-Q	Main Control CHannel, QAM
MCL	Minimum Coupling Loss
MER	Message Error Rate
MEX	Multimedia EXchange layer
MGCK	Modified Group Cipher Key
MGCKX	eXtended Modified Group Cipher Key
MIMO	Multiple Input and Multiple Output
ML	Maximum Likelihood
MLE	Mobile Link Entity
MM	Mobility Management
MMSE	Minimum Mean Square Error
MNC	Mobile Network Code
MNI	Mobile Network Identity
MS	Mobile Station
MSEE	Mean Square Estimation Error
NDB	Normal Downlink Burst
NF	Noise Figure
NSAP	Network Service Access Point

NSAPI	Network Service Access Point Identifier
NUB	Normal Uplink Burst
OSI	Open Systems Interconnection
OTAR	Over-The-Air Rekeying
PAMR	Public Access Mobile Radio
PCCC	Parallel Concatenated Convolutional Code
PCOMP	Protocol COMpression Protocol
PDCH	Packet Data CHannel
PDF	Probability Density Function
PDN	Packet Data Network
PDP	Packet Data Protocol
PDS	Power Density Spectrum
PDU	Protocol Data Unit
PEI	Peripheral Equipment Interface
PHY	PHYSical layer
PL	Physical Layer
PMPR	Peak-to-Mean Power Ratio
PMR	Private Mobile Radio
PPDR	Public Protection and Disaster Relief
PSK	Phase Shift Keying
PSTN	Public Switched Telephone Network
QAM	Quadrature Amplitude Modulation
QoS	Quality of Service
RAB	Random Access uplink Burst
RA <sub>x</sub>	Rural Area scenario in conjunction with an MS speed of $x$ km/h
RCPC	Rate Compatible Punctured Convolutional code
RF	Radio Frequency
RFC	Request For Comments
RM	Reed-Muller
RMS	Root Mean Square
RMSVE	Root-Mean-Square Vector Error
RSC	Recursive Systematic Convolutional
RX	Receiver
SACCH	Slow Associated Control CHannel
SAP	Service Access Point
SB	Synchronization Burst
SCCH	Secondary Control CHannel
SCH	Signalling CHannel
SCH/F	Signalling CHannel, Full size
SCH/HD	Signalling CHannel, Half size Downlink
SCH/HU	Signalling CHannel, Half size Uplink
SCH-P8/F	Signalling CHannel, $\pi/8$ -D8PSK, Full size
SCH-P8/HD	Signalling CHannel, $\pi/8$ -D8PSK, Half size Downlink
SCH-P8/HU	Signalling CHannel, $\pi/8$ -D8PSK, Half size Uplink
SCH-Q	Signalling CHannel, QAM
SCH-Q/B	Signalling CHannel, QAM data set B Downlink
SCH-Q/D	Signalling CHannel, QAM full size Downlink
SCH-Q/HU	Signalling CHannel, QAM Half size Uplink
SCH-Q/RA	Signalling CHannel, QAM Random Access uplink
SCH-Q/U	Signalling CHannel, QAM full size Uplink
SCK	Static Cipher Key
SCKX	eXtended Static Cipher Key
SDS	Short Data Service
SDS-TL	Short Data Service Transport Layer
SDU	Service Data Unit
SICH	Slot Information CHannel
SICH-Q	Slot Information CHannel, QAM
SICH-Q/D	Slot Information CHannel, QAM Downlink
SICH-Q/U	Slot Information CHannel, QAM Uplink
SIR	Signal-to-Interference Ratio
SMI	Short Management Identity
SNAF	SubNetwork Access Function

SNDCP	SubNetwork Dependent Convergence Protocol
SNR	Signal-to-Noise Ratio
SRDoc	System Reference Document
SRRC	Square-Root Raised Cosine
SS	Supplementary Service
SSI	Short Subscriber Identity
SSVE	Sum Square Vector Error
STCH	STealing CHannel
SwMI	Switching and Management Infrastructure
TCH	Traffic CHannel
TCH/2,4	Traffic CHannel, net rate = 2,4 kbit/s
TCH/4,8	Traffic CHannel, net rate = 4,8 kbit/s
TCH/7,2	Traffic CHannel, net rate = 7,2 kbit/s
TCH-P8/10,8	Traffic CHannel for $\pi/8$ -D8PSK, net rate = 10,8 kbit/s
TCP	Transmission Control Protocol
TDMA	Time Division Multiple Access
TEA	TETRA Encryption Algorithm

NOTE: Used with specific numeric algorithm identity e.g. TEA1-7.

TEDS	TETRA Enhanced Data Service
TEI	Terminal Equipment Identity
TETRA	TErrestrial Trunked RAdio
TL	TETRA LLC
TLA-SAP	TETRA LLC Service Access Point A
TLB-SAP	TETRA LLC Service Access Point B
TLC-SAP	TETRA LLC Service Access Point C
TLE-SAP	TETRA LLC Service Access Point E
TM	TETRA MAC
TMA-SAP	TETRA MAC Service Access Point A
TMB-SAP	TETRA MAC Service Access Point B
TMC-SAP	TETRA MAC Service Access Point C
TMD-SAP	TETRA MAC Service Access Point D
TMI	TETRA Management Identity
TMV-SAP	TETRA MAC Virtual SAP
TP-SAP	TETRA Physical layer Service Access Point
TSI	TETRA Subscriber Identity
TU	Typical Urban
TU <sub>x</sub>	Typical Urban scenario in conjunction with an MS speed of <i>x</i> km/h
TX	Transmitter
UDP	User Datagram Protocol
U-plane	User-plane
USB	Universal Serial Bus
USSI	Unexchanged Short Subscriber Identity
V+D	Voice plus Data
WGFM	Working Group on Frequency Management
WGSE	Working Group on Spectrum Engineering
WT	Waiting Time
XOR	eXclusive OR
$\pi/4$ -DQPSK	$\pi/4$ -shifted Differential Quaternary Phase Shift Keying
$\pi/8$ -D8PSK	$\pi/8$ -shifted Differential 8 Phase Shift Keying

## 4 TETRA layered architecture

### 4.1 OSI reference model

Communication networks have to support the following aspects of protocol transfer to ensure correct functioning:

- 1) data has to arrive at the destination correctly and in a timely manner;
- 2) data delivered to the user at the destination has to be recognizable and in the proper form for its correct use.

This has led to defining network protocol operation in terms of lower level network services to provide the first capability and higher level protocols to satisfy the second requirement. The Open Systems Interconnection (OSI) reference model is shown in figure 4.1. It identifies seven functional layers and is generally accepted for description and specification of layered communication architectures.

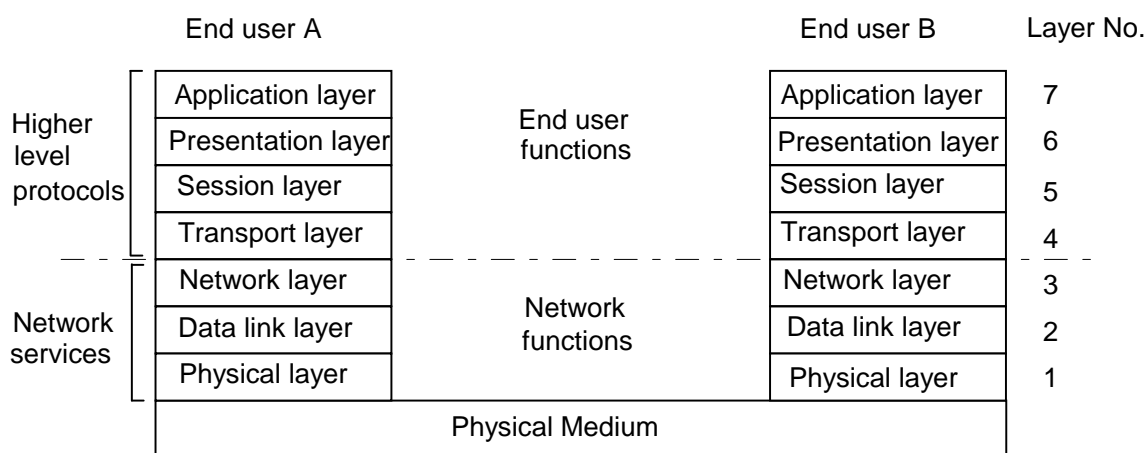

**Figure 4.1: OSI reference model for communication architectures**

The bottom three layers of the protocol stack are associated with the network services and are generally implemented in every node of the network (i.e. infrastructure and mobile stations). The upper four layers of the protocol stack provide services to the end users and are thus associated with the end users, not with the network.

The philosophy of layered architectures is based on each layer being independently specified in terms of the services it provides to its immediately higher layer and the services it relies on from its immediately lower layer. The layered architecture concept is based on "peer-to-peer" exchanges in which each layer exchanges information with its peer entity at the remote end.

**NOTE 1:** The layered architecture concept leads to equipment in which each layer can in theory be developed separately. The result of any changes to a layer is transparent to the layers above and below provided that the interface signals passed between layers remain unchanged.

Blocks of data passed through the service boundary for transmission by a layer are called Service Data Units (SDUs). Data is transferred between peer entities as Protocol Data Units (PDUs). Each PDU may contain both an SDU passed down from the layer above, and any necessary PDU header (i.e. protocol control information) added at the layer in question.

**EXAMPLE:** A layer N entity receives a layer N SDU from layer N+1 (the immediately higher layer) for transmission. The layer N entity then adds the appropriate layer N header to form a layer N PDU. It then sends the PDU to the peer layer N entity by issuing the PDU to the immediately lower layer for transmission. On passing through the service boundary, the PDU becomes the SDU of the immediately lower layer (i.e. the PDU becomes a layer N-1 SDU).

Similarly, for reception at the peer entity, the peer layer N entity removes the layer N header from the layer N PDU and processes and acts on it as appropriate, and delivers the layer N SDU to layer N+1 (where the SDU becomes a layer N+1 PDU).

The services of one layer to the immediately higher layer are provided at interface points called Service Access Points (SAPs). There may be multiple SAPs at one layer boundary.

Service primitives are used at each layer interface to provide the interaction between the service user at one layer and the service provider at the layer below. Four types of primitive (request/indication/response/confirm) are used in the protocol model as defined in ISO/IEC 8348 [i.1]. TETRA-specific additional information is shown in notes 2, 3 and 4.

- The request primitive type is used when a higher layer is requesting a service from the lower layer.
- The indication primitive type is used by a layer providing a service to notify the higher layer of any specific activity which is service related. The indication primitive may be the result of an activity of the lower layer related to the primitive type request at the peer entity.

NOTE 2: Some TETRA primitives used for layer management are not directly related to any data transfer service.

- The response primitive type is used by a layer to acknowledge receipt, from a lower layer, of the primitive type indication.

NOTE 3: In TETRA, at the LLC level, a response primitive may sometimes be used with upper layer data in order to force transportation of LLC acknowledgement and SDU in the same transmission. The SDU will then be placed in the LLC PDU containing the acknowledgement.

- The confirm primitive type is used by the layer providing the requested service to confirm that the activity has been completed.

NOTE 4: In TETRA, the confirm primitive may be the result of an activity of the lower layer related to the primitive type response at the peer entity and in that case it may contain service user data as an SDU.

The higher layers are not generally aware of detailed transport mechanisms, dealing only in terms of service primitives and PDUs. Conversely the lower layers are not aware of the content of SDUs.

The TETRA standard defines the protocols up to layer 3 of the OSI model.

## 4.2 TETRA protocol stack

### 4.2.1 Protocol architecture

The TETRA standard provides TETRA Mobile Stations (MSs) with the means to support circuit mode calls and short data via the Circuit Mode Control Entity (CMCE). It also provides the means to support Internet Protocol (IP) packet data via the Subnetwork Dependent Convergence Protocol layer (SNDCP) and the Multimedia Exchange layer (MEX). Packet data may be used by applications running directly within the MS and may be used by external data terminals that connect with the MS via the Peripheral Equipment Interface (PEI); in the latter case the PEI conveys packet data between the application and the MS. In either case, MEX performs routing and filtering, and may manage the relative precedence of packet data in cases where packet data flow is constrained by air-interface bandwidth limitations.

Figure 4.2 illustrates the architecture of the TETRA protocol stack for the MS. The Base Station (BS) has a similar protocol stack for layers 1, 2 and 3.

The Control plane (C-plane) corresponds to the signalling information, both control messages and packet data. The User plane (U-plane) corresponds to circuit mode voice and circuit mode data (plus end-to-end user signalling information).

The network layer (layer 3) is applicable only to the C-plane. It is divided into two sublayers containing the subnetwork access functions and the Mobile Link Entity. The subnetwork access functions provide the following services:

- The Mobility Management (MM) entity deals primarily with roaming, migration, registration, and attachment of group identities.
- The Circuit Mode Control Entity (CMCE) deals with call control, supplementary services and short data.
- The Subnetwork Dependent Convergence Protocol layer (SNDCP) provides the packet data services.

The Mobile Link Entity (MLE) manages the mobile connection (e.g. selecting a new serving cell when the present serving cell fails), and performs protocol discrimination (i.e. routing to the higher layer entities).

The data link layer (layer 2) comprises two sublayers:

- The Logical Link Control (LLC) entity is responsible for controlling the logical link between the MS and a BS over a single radio hop. It offers two types of link to the MLE: the basic link is available whenever the MS is receiving the BS; the advanced link is a more powerful link that may be set up on request.
- The Medium Access Control (MAC) entity is divided into two sublayers: the upper MAC and the lower MAC. The upper MAC handles the problem of sharing the medium between a number of users. It deals with channel allocation, random access and reserved access, and also with fragmentation, association, air interface encryption and link adaptation. The lower MAC performs the channel coding, interleaving and scrambling.

The physical layer (layer 1) deals with radio-oriented aspects such as modulation and demodulation, receiver and transmitter switching, frequency correction, symbol synchronization and channel estimation.

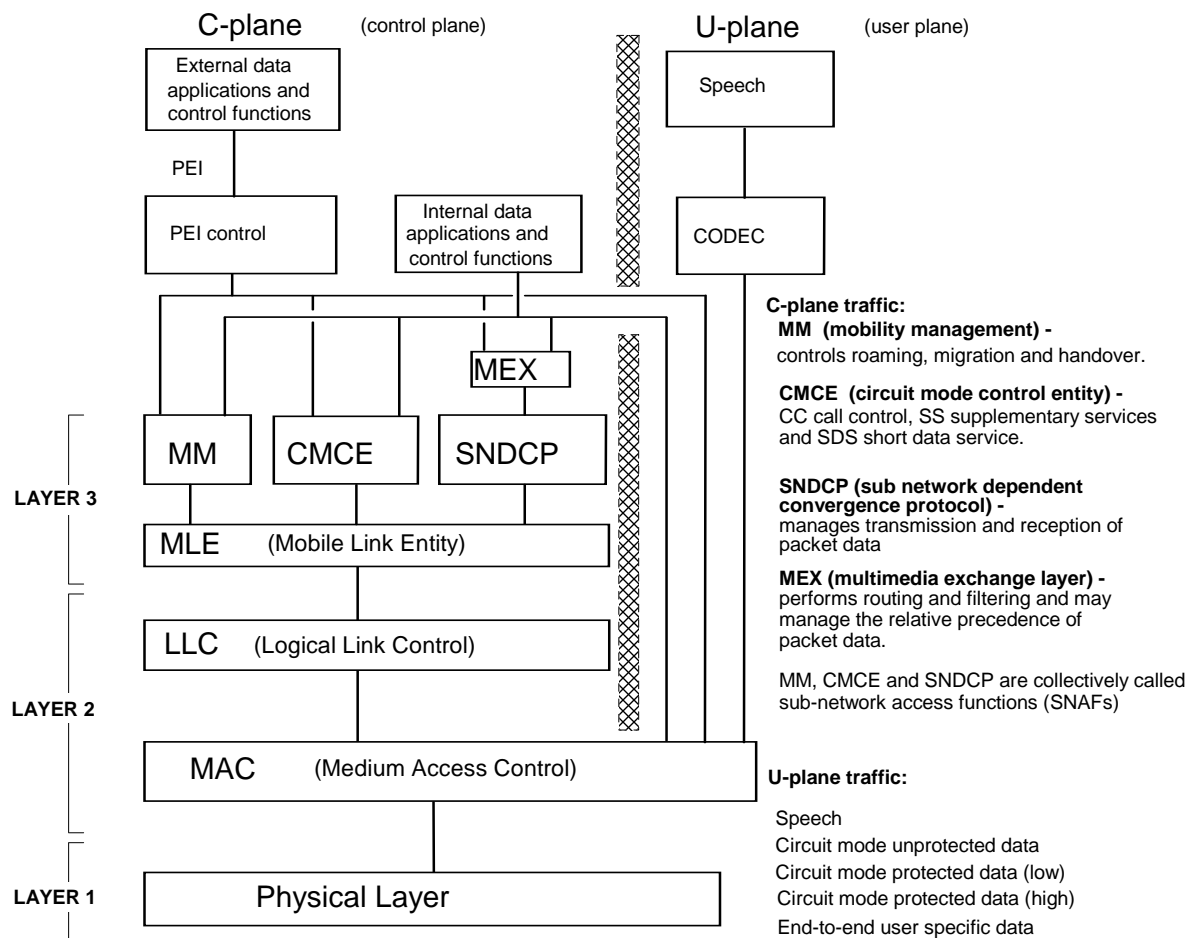

Figure 4.2: TETRA MS protocol stack

## 4.2.2 Inter-layer communication

In the TETRA protocol, the interaction between the layers and sublayers is described in terms of Service Access Points (SAPs), and service primitives and their parameters. (See clause 4.1 for the definition of SAPs and service primitives.)

In ETSI EN 300 392-2 [i.2], the word "shall" is used with SAPs, service primitives and parameters for clarity of protocol description and for traceability reasons in the protocol model. However the layered architecture represents only a conceptual model; the SAPs and primitives are not testable, and the primitive description is not intended to imply any specific implementation of the protocol.

### 4.2.3 Testable boundaries

As indicated in clause 4.2.2, the TETRA SAPs and primitives are not testable.

ETSI EN 300 394-1 [i.3] specifies the minimum technical characteristics of MSs and BSs, and the radio test methods used for type testing. The purpose of the conformance testing specification is to provide a sufficient quality of radio transmission and reception for equipment operating in a TETRA system and to minimize harmful interference to other equipment. It is intended primarily to test the physical layer and lower MAC. The conformance testing requires the equipment being tested to provide (among other things) an antenna connector as a test point.

Testing to verify that the equipment performs the full protocol correctly is outside the scope of ETSI EN 300 394-1 [i.3].

### 4.2.4 Service access points

The services of one layer to the immediately higher layer are provided at interface points called Service Access Points (SAPs).

At the top of the TETRA protocol model, MEX provides packet data services including high speed data services through two possible SAPs to APIs and applications embedded in the MS or connected to the MS via the TETRA PEI. Other services such as MM services, CMCE call control services, supplementary services and short data services have SAPs for access by APIs and applications.

The U-plane traffic (voice and circuit mode data) and end-to-end user signalling enter the MAC directly from the U-plane application (e.g. the speech CODEC), through a dedicated SAP.

---

## 5 Overview of TETRA High-Speed Data (HSD)

### 5.1 Introduction

The TETRA standard ETSI EN 300 392-2 [i.2] V3.2.1 was the first version which incorporated the High-Speed Data (HSD) enhancement, generally referred to as "TEDS" or TETRA Enhanced Data Service (figure 5.1). This incorporation resulted in an enhanced air interface known as the TETRA Release 2 or TETRA 2 air interface. This enhancement not only resulted in adding wider-band higher-speed channels to the TETRA physical layer but also required a substantial degree of change to the TETRA higher layer protocols. Most significant changes were introduced to the MAC and SNDCP layers. In addition, a Multimedia Exchange (MEX) layer was introduced on top of the SNDCP layer to facilitate an orderly transmission of simultaneous multimedia applications over the TETRA 2 air interface. These applications may originate either from a mobile station or a terminal equipment connected to a mobile station by the existing or the newly enhanced Peripheral Equipment Interface (PEI).

Since the publication of ETSI EN 300 392-2 [i.2] V3.2.1, further facilities and enhancements have been incorporated into the TETRA standard, for example:

- Direct Access (DA);
- more efficient acknowledgements for the extended advanced link;
- support of frequency range down to 138 MHz for  $\pi/4$ -DQPSK modulation; and
- new channel types (super-sectored channels and eccentric channels).

Some information has been included in the present document about these further facilities and enhancements.

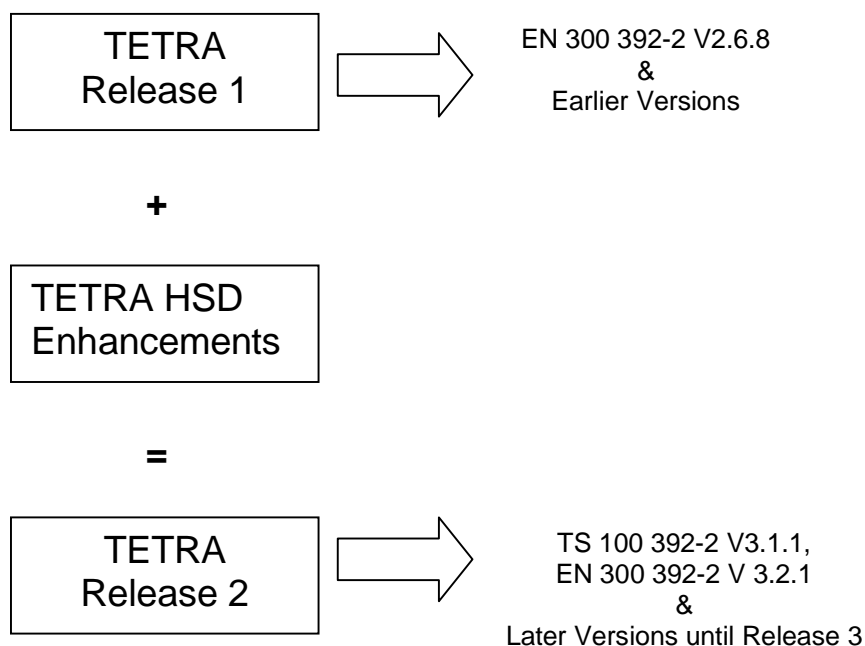

**Figure 5.1: Evolution of the TETRA standard**

In designing the physical layer and the higher layer protocols for the TETRA 2 standard, special care was taken to guarantee maximum backward-compatibility with the existing TETRA V+D Release 1 standard (TETRA 1). As a first measure of integration, the access to the HSD channels is allowed via the TETRA 1 control channel. Furthermore, the 4-slot TDMA access structure of the air interface plus its TDMA frames, slots and subslots have been preserved. Both 14,17 ms slots and 7,08 ms subslots are available as in TETRA 1, the former used for reserved access, and the latter for random access as well as reserved access.

In ETSI EN 300 392-2 [i.2] V3.2.1, access to the HSD channels was only allowed via a TETRA 1 ( $\pi/4$ -DQPSK) control channel; this method of operation is called Conventional Access. Then, in V3.5.1, an alternative option was added to allow cells to use a QAM HSD channel as the main control channel; this method of operation is called Direct Access.

The introduction of HSD channels required additional new modulations, channel coding and various coding rates. Three new channel bandwidths (50 kHz, 100 kHz and 150 kHz) were also introduced to the standard in addition to the existing 25 kHz channel bandwidth. For Conventional Access, the latter is utilized for transmission of control signalling (using the existing TETRA 1  $\pi/4$ -DQPSK modulation and coding) or for traffic purposes using the existing or new modulation and coding schemes.

Figure 5.2 shows an integrated TETRA network comprising a common TETRA 1 plus HSD enhanced infrastructure using Conventional Access. Common routers are depicted for TETRA 1 and HSD IP packet distribution within the network. Some or all base stations are enhanced to have one or more HSD transceivers in addition to traditional TETRA 1 transceivers. A TETRA 1 mobile station is able to communicate via an enhanced base station and the common infrastructure using all services and facilities offered by the TETRA 1 network whilst ignoring any HSD related signalling. On the other hand, an HSD enabled mobile station wishing to engage in HSD applications first registers in the traditional way via the TETRA 1 main control channel informing the infrastructure of its HSD capabilities. It could then request to be granted capacity on an HSD channel. Figure 5.2 also highlights the IP packet data nature of the TETRA HSD service and its external interconnection to another TETRA network, an external GPRS/3G network and a third unspecified external IP packet data network.

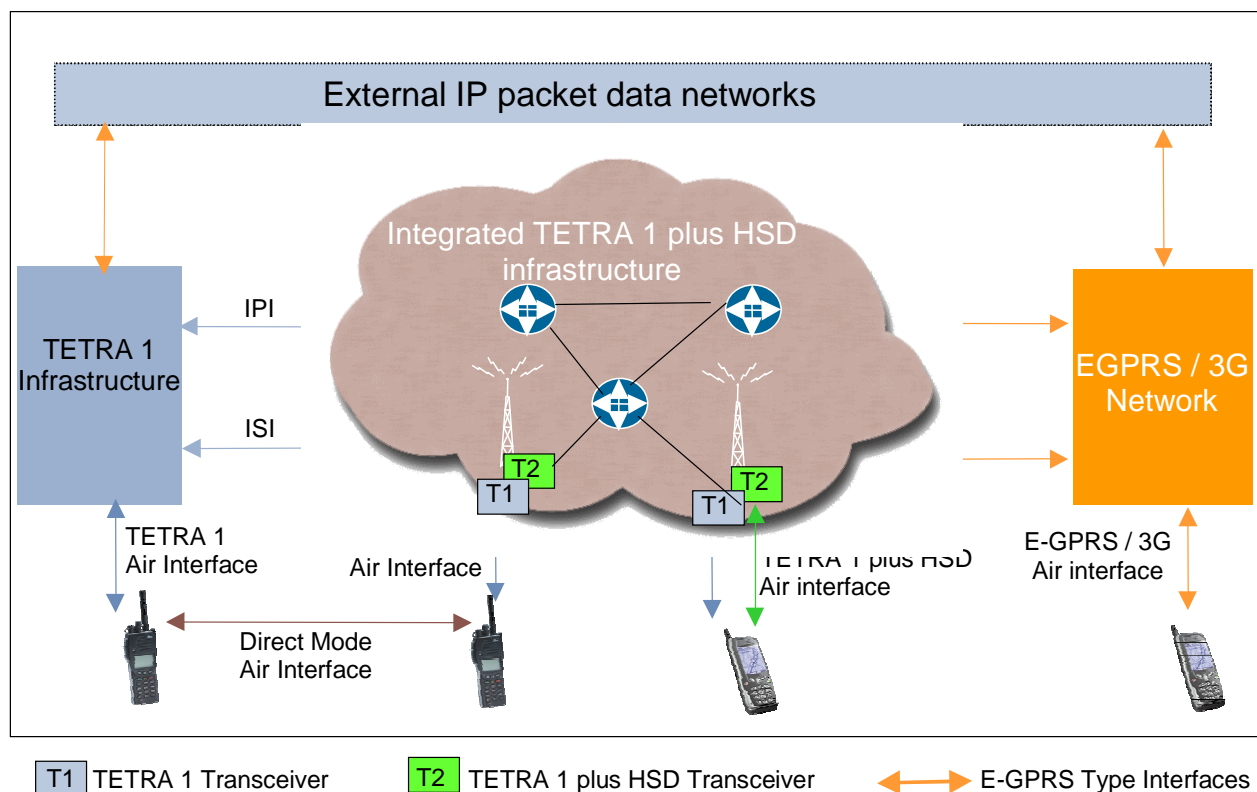

**Figure 5.2: Architecture of a TETRA 2 network using Conventional Access**

## 5.2 Physical layer and lower MAC layer enhancements

In order to ensure a reliable HSD link performance over TETRA mobile communication propagation environment which exhibits a heavily time-frequency selective fading, a number of up-to-date technological choices have been made for the physical and lower MAC layers of the HSD air interface:

- 1) Four spectral-efficient multilevel modulation schemes, i.e.  $\pi/8$ -D8PSK, 4-QAM, 16-QAM and 64-QAM have been introduced to boost the system data throughput and enable a real HSD capability. These modulation schemes add to the  $\pi/4$ -DQPSK modulation scheme used in the TETRA 1 standard.
- 2) The channels using the QAM scheme are provided with multiple sub-carriers, a technique known as "Multi-Carrier (MC) filterbank-based signalling", to achieve a robust performance even in frequency-selective fading channels. These sub-carriers are 2,7 kHz spaced with 8, 16, 32 and 48 number of sub-carriers used in channel bandwidths of 25 kHz, 50 kHz, 100 kHz and 150 kHz respectively.
- 3) A powerful turbo-coding scheme is adopted for payload channel encoding with rates 1/2 and 2/3 plus rate 1 (uncoded case).
- 4) A separate block channel encoding (Reed Muller) is adopted for short "header" blocks to exceed the payload performance and enable reliable slot decoding and network operations.
- 5) Link adaptation techniques are introduced to improve the system performance (e.g. overall message throughput), based on choosing adaptively the modulation level, the coding rate and possibly the RF channel bandwidth according to the varying channel propagation conditions.
- 6) Sectorized antennas have been introduced. For example, these could be used as a means of extending the HSD channel range to that of a TETRA 1 control channel without a need for additional base station sites. By using directional antennas such as panel antennas, a set of sectorized, high RF bandwidth channels can cover the full area of a TETRA 1 main control channel from a single base station site.

- 7) Super-sectored channels and eccentric channels were introduced in V3.7.1 of ETSI EN 300 392-2 [i.2]. An example of usage of a fully super-sectored channel could be as an umbrella channel with a circular coverage area that can be used by MSs from multiple co-sited sectored cells (i.e. cells whose service area is not circular).

The above enhancements provide a flexibility of selecting the required data throughput from a wide range extending to beyond 500 kbit/s.

### 5.3 Higher protocol layer enhancements

In addition to the above physical layer/lower MAC enhancements, key features have been added to the HSD channel higher layer protocols to support efficient IP packet data service over the air interface with point-to-point and point-to-multipoint capabilities. Three classes of data have been defined, i.e.:

- real-time class: for applications that cannot tolerate delivery delay;
- telemetry class: for applications with intermittent data which can tolerate moderate delivery delay and packet loss;
- background class: for applications that are intolerant of packet loss.

As an important addition to the TETRA standard, for each application, the enhanced protocols allow negotiation of Quality of Service (QoS) attributes between the protocol and the application. Furthermore, these attributes could be re-negotiated during the call. The attributes included in QoS negotiations are:

- data class;
- throughput;
- delay;
- reliability.

For instance, to facilitate transmission of some real-time data and telemetry applications, "scheduled access" has been introduced where capacity is provided to an application at regular time intervals without needing to engage in random access requests each time. An additional feature is a "data priority" mechanism which enables the Mobile Station (MS) to indicate a priority for obtaining from the Base Station (BS) reserved slots for packet data transmission. The cell reselection procedures have also been enhanced to allow channel and cell reselection within a more complex set of channel and cell types offered within the TETRA 2 standard.

Finally, the transmission of multimedia applications is managed by the MEX layer, which controls the time-varying data rate and precedence requirements of concurrently running multimedia applications.

### 5.4 Services and applications

The "TEDS" enabled TETRA MS may access all traditional TETRA services namely:

- bearer services (circuit mode data, short data and packet data);
- tele-services including the TETRA voice service;
- supplementary services.

In addition, such an MS may access the TETRA HSD channels using an IP packet data bearer service. The service access points provided by this bearer service allows handling concurrent multimedia applications through a Multimedia Exchange (MEX) layer. Each application whether single or multimedia could negotiate a set of Quality of Service (QoS) parameters. These depend on application (or data) class. The following list provides typical examples of applications under each data class which could be transmitted over the TETRA HSD channels:

- a) background class (best-effort type data); examples are:
- general file transfer;

- transfer of photographs and maps;
  - reliable delivery of despatch messages with attached maps, plans, photographs and documents, etc.;
  - secure delivery of patient and client records;
  - database enquiries e.g. police national computer.
- b) telemetry class; examples are:
- delivery of medical telemetry from patient to hospital;
  - location data;
  - vehicular telemetry.
- c) real-time class (data where timely delivery is essential and retransmissions are not permitted); examples are:
- video streaming;
  - video-conferencing.

It is to be noted that TETRA 2 standard is designed to the same level of security as TETRA 1 standard. This feature therefore provides an advantage for the TETRA HSD services compared to those provided e.g. in commercial 3G networks as far as the public safety and emergency relief users are concerned.

The TETRA standard continues to be developed and evolved by ETSI Technical Committee TETRA and Critical Communications Evolution TC-TCCE (formerly known as Technical Committee TETRA (TC-TETRA)).

## 6 Physical layer and lower MAC

### 6.1 Physical resources

The TETRA high-speed data HSD air interface follows closely the TETRA 1 air interface for backwards compatibility purposes. The physical resource available to the radio sub-system is an allocation of part of the radio spectrum. This resource is partitioned both in frequency and time. The TETRA BS operates in full Frequency Division Duplex (FDD) in which uplink and downlink frequencies are operational at the same time. MSs may operate in full FDD or half FDD (uplink and downlink are operational alternately) depending on the capability of the MS. In Europe, the CEPT allocated frequency bands are used by TETRA systems (see clause 8.1).

The TETRA high-speed air interface maintains the Time-Division Multiple Access (TDMA) structure using 4 timeslots per carrier. The timeslot is a basic unit of the TDMA structure. A pair of timeslots associated to a pair of FDD RF frequencies forms a physical channel. The latter conveys the traffic and signalling messages in the form of logical channels, the interface between the higher layer protocols and the HSD radio subsystem. In some operations up to 4 timeslots can be concatenated to increase the physical channel speed in which case a channel could occupy the whole carrier.

A TETRA system enhanced with high speed capability still uses one FDD carrier per cell, known as the main carrier, to carry the main control channel in a single timeslot as a minimum.

For Conventional Access, the radio characteristics of the main carrier are as follows:

- modulation:  $\pi/4$ -DQPSK;
- gross transmission rate: 36 kbit/s;
- duplex spacing: varies according to frequency allocation, see note below;
- RF carrier spacing: 25 kHz.

For Direct Access, the main carrier uses QAM, and the bandwidth of the main carrier is 25 kHz, 50 kHz, 100 kHz or 150 kHz. See also note below.

The TETRA HSD air interface introduces the following modulation types in addition to the  $\pi/4$ -DQPSK modulation used prior to this enhancement. These are used mainly for the IP packet data traffic used for high-speed data applications. (For Direct Access, the QAM modulation types are used also for control signalling on the main carrier.)

- $\pi/8$ -D8PSK;
- 4-QAM;
- 16-QAM;
- 64-QAM.

Furthermore, in addition to the existing 25 kHz channel, the following three new higher bandwidth channels have been introduced for QAM in order to boost the data throughput:

- 50 kHz;
- 100 kHz;
- 150 kHz.

The TETRA air interface (including HSD channels) was previously intended for use on frequencies from 300 MHz up to around 1 GHz. It has now also been tested for frequencies down to 138 MHz for  $\pi/4$ -DQPSK modulation.

NOTE: Certain values of duplex spacing are mandatory within harmonized frequency allocations. For example, within Europe a 10 MHz spacing is applied within the 410 MHz to 430 MHz frequency band. Within ITU Regions 2 and 3, a 45 MHz spacing is commonly used within the 806 MHz to 869 MHz band. In spectrum that is not internationally harmonized, the duplex spacing can vary on a national or regional basis.

## 6.2 TDMA frame structure

In the four-slot TDMA access method used each timeslot is a time interval of  $85/6 \text{ ms} \approx 14,167 \text{ ms}$ . For phase modulation the timeslot corresponds to 255 symbol durations, each one with a duration of  $500/9 \text{ } \mu\text{s} \approx 55,56 \text{ } \mu\text{s}$ . For QAM the timeslot is divided into 34 modulation symbol durations, each one with a duration of  $5/12 \text{ ms} \approx 416,7 \text{ } \mu\text{s}$ . The uplink timeslots may be subdivided into two equal subslots to increase efficiency, e.g. in random access by MSs.

The TDMA structure also includes multiframes (18 frames each) and hyperframes (60 multiframes each) as depicted in figure 6.1. The circuit mode user traffic (excluding air interface control signalling) from an 18-frame multiframe time period is compressed and conveyed within the first 17 frames, thus allowing the 18<sup>th</sup> frame to be used for control signalling without interrupting the flow of circuit mode traffic. This capability provides the background control channel signalling that is always present, even in minimum mode when all channels are allocated to traffic.

The start of the hyperframe, multiframe and TDMA frame received at the BS is delayed by the fixed period of 2 timeslots from the start of the hyperframe, multiframe and TDMA frame on the downlink. This is to enable the MS to respond to the downlink signalling within the associated uplink frame.

The physical content of a time slot is carried by a burst. The different types of bursts are defined in clause 6.4.

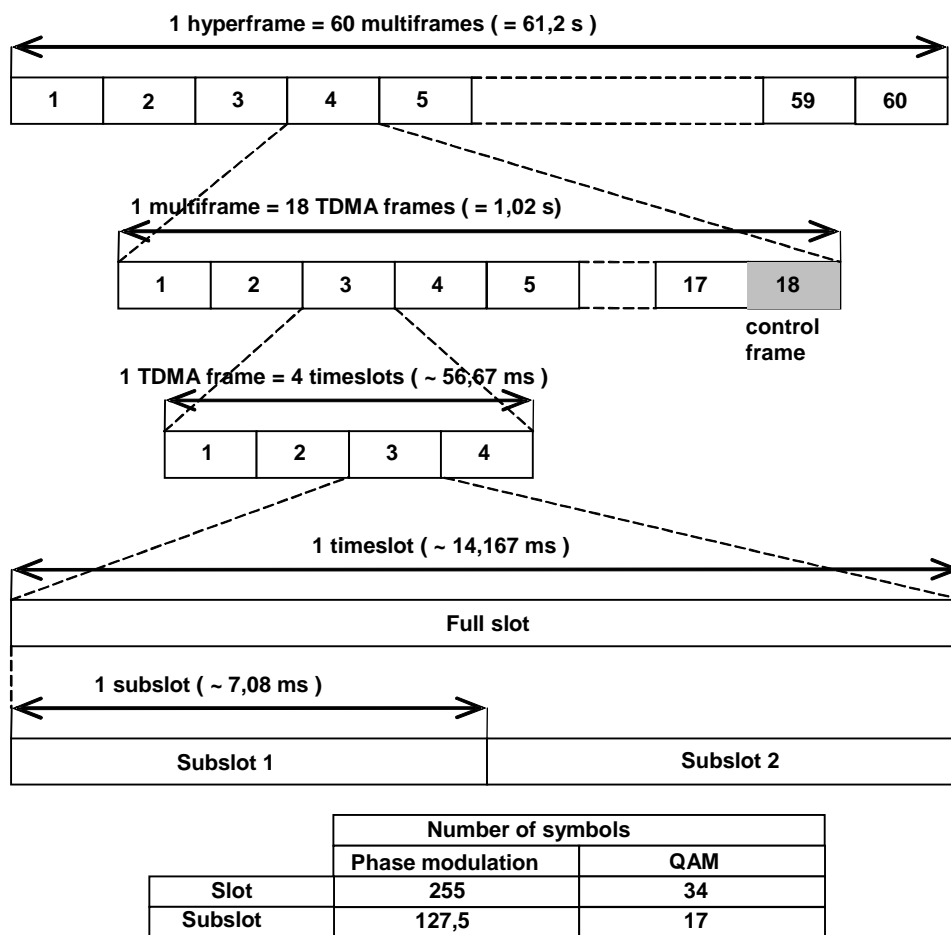

Figure 6.1: TETRA frame structure

## 6.3 Slot structure

### 6.3.1 Slot structure for phase modulation

There are powerful constraints on the slot structure due to the nature of the anticipated traffic (see figure 6.2). Because of the need to ramp up the MS transmitter power and linearize the MS power amplifier, the downlink transmission capacity is slightly greater than the uplink capacity. That is, the capacity is approximately 30 bits gross more in the  $\pi/4$ -DQPSK downlink slot even allowing for insertion of an extra intermediate training sequence in the downlink.

The extra downlink capacity has been used to transmit "low layer" MAC information. At the physical level the field has been designated the "broadcast block" since it is present on every downlink slot. At the MAC level the field is designated the Access Assignment CHannel (AACH). This field is not visible above the MAC level.

The AACH is primarily used for two purposes:

- On traffic channels it conveys the "usage marker", indicating the intended destination of the downlink slot, and the allowed user of the uplink slot. This feature makes the protocol more robust by reducing the occurrence of crossed calls caused by intermittent MS coverage ("under bridge or tunnel" phenomena) in which the MS emerges to find that the system has allocated the channel to another call. By noting the usage marker, the receiving and transmitting MSs can continuously verify that they have access rights to the channel.
- On signalling (control and user data) channels the physical broadcast block (AACH at the MAC level) is used to convey the access control elements (Access code and ALOHA frame length). Independent information on each access subslot can be conveyed in the AACH or a mix of traffic in one direction and signalling in the other.

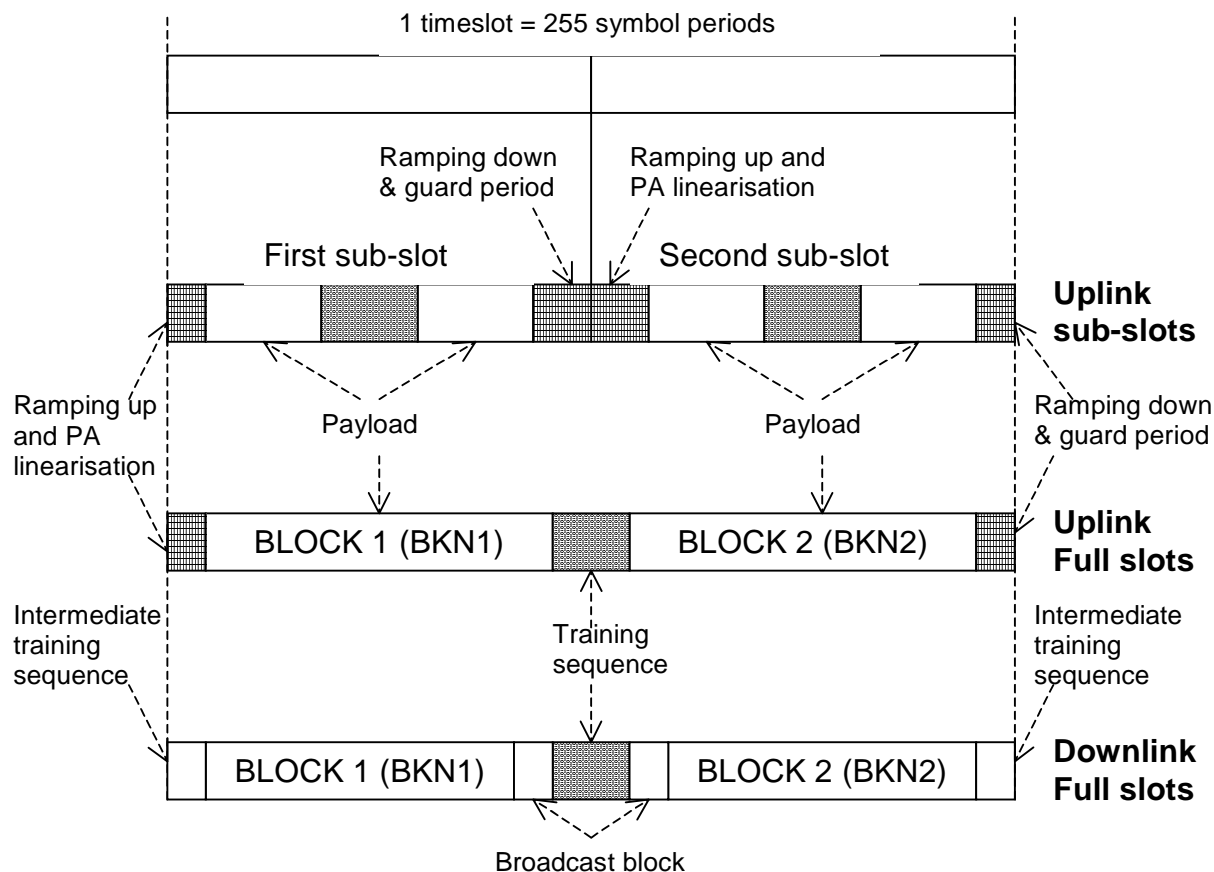

Figure 6.2: Physical layer basic slot structure for phase modulation

### 6.3.2 Slot structure for QAM

Similar to the phase modulation case, the QAM channels use subslots for some uplink control signalling and for random access purposes. The IP traffic is transmitted by timeslots (full slots) in uplink and downlink directions. Again, because of the need to ramp up and down of the MS transmitter power and allow for guard periods the downlink transmission capacity is slightly greater than the uplink capacity (34 symbols compared to 31 symbols as shown in figure 6.4).

As seen from figure 6.4 the QAM channels differ from the phase modulation channels in that the full or sub-slots carry single blocks of information rather than two separate blocks between which there is an insertion of training sequence blocks or broadcast blocks. Instead, the information "field" is a pattern of six types of symbol multiplexed as depicted in figure 6.5. The six symbol types are:

- 1) **frequency correction symbols** used in Frequency Correction Bursts (FCBs) for frequency correction of MSs on a DA cell;
- 2) **synchronization symbols** used to maintain synchronization of the MS after the initial synchronization carried via the main control channel; they are also used in FCBs for synchronization of MSs on a DA cell;
- 3) **secondary synchronization symbols** used in FCBs to help MSs, together with the surrounding pilot symbols, to time synchronize to the BS on a DA cell, following successful frequency correction;
- 4) **pilot symbols** of known value and pre-arranged positions used in the receiver for channel (propagation condition) estimation;
- 5) **header symbols** used to convey information related to data (payload) symbols;
- 6) **data symbols** which carry control signalling or IP user traffic.

The AACH-Q plays a similar role in QAM channels as AACH in phase modulation channels and is transmitted in the downlink only via some of the header symbols. Other header symbols are used, on both uplink and downlink, to indicate the modulation level and the coding rate of the payload.

## 6.4 Radio transmission burst structure

### 6.4.1 Burst structure for phase modulation

A burst is a period of RF carrier that is modulated by a data stream. A burst therefore represents the physical content of a timeslot or subslot.

There are six types of phase modulation burst in the system as listed below:

- 1) **Control uplink Burst (CB):**
  - The CB is used by the MS to transmit control messages to the BS.
- 2) **Linearization uplink Burst (LB):**
  - The LB may be used by the MS to linearize its transmitter. The LB contains no useful bits and its timing is only determined by the time mask (see clause 8.2).
- 3) **Linearization Downlink Burst (LDB):**
  - This burst may be used by the BS to linearize its transmitter. The linearization downlink burst contains non-useful bits and its timing is determined only by the time mask (see clause 8.2).
- 4) **Normal Uplink Burst (NUB):**
  - This burst is used by the MS to transmit control or traffic messages to the BS.
- 5) **Normal Downlink Burst (NDB):**
  - This burst is used by the BS in continuous transmission mode to transmit control or traffic messages to the MS. A discontinuous version is used by the BS in timesharing transmission mode.
- 6) **Synchronization Burst (SB):**
  - This burst is used by the BS in continuous transmission mode to broadcast synchronization messages and to transmit control messages to the MS. A discontinuous version is used by the BS in timesharing transmission mode.

Note that the burst type 6 uses  $\pi/4$ -DQPSK modulation only. The other five burst types may use either  $\pi/4$ -DQPSK or  $\pi/8$ -D8PSK modulation.

Figure 6.3 summarizes the description of the bursts and their timing with respect to the timeslot.

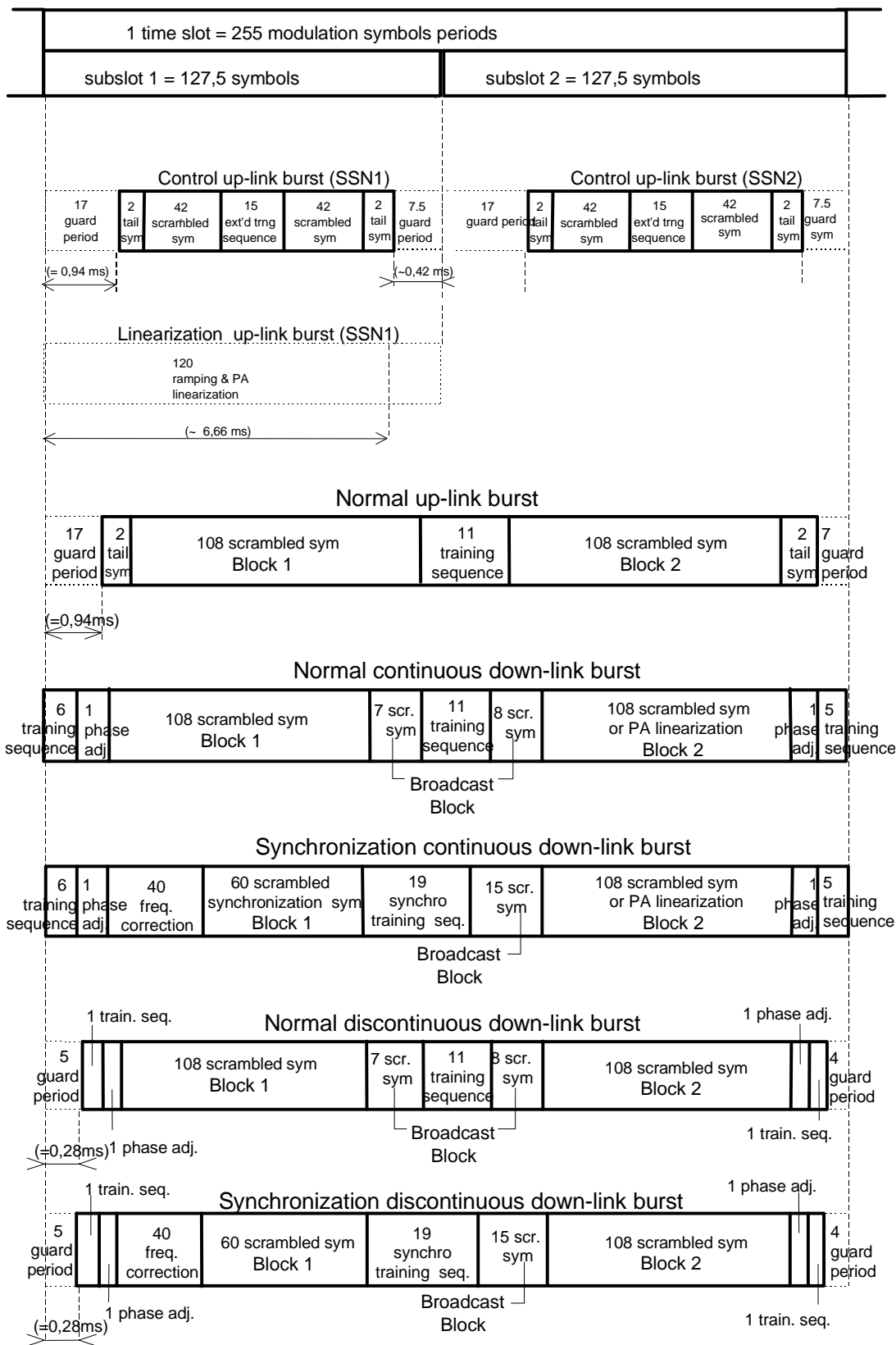

Figure 6.3: Burst types for phase modulation

## 6.4.2 Burst structure for QAM

There are seven types of QAM burst in the system as listed below:

- 1) **Control uplink Burst (CB):**
  - The CB is used by MS to transmit reserved access control messages to the BS.
- 2) **Random Access Burst (RAB):**
  - The RAB is transmitted in the uplink and uses 8 sub-carriers and 4-QAM for all QAM channel bandwidths. The RAB is used by MS to transmit random access control messages to the BS.
- 3) **Linearization uplink Burst (LB):**
  - The LB may be used by the MSs to linearize their transmitters. This burst contains no useful symbols and its timing is determined only by the time mask (see clause 8.2).
- 4) **Normal Uplink Burst (NUB):**
  - The NUB is used by MSs to transmit control messages and IP packet data traffic to the BS.
- 5) **Normal Downlink Burst (NDB):**
  - The NDB is used by the BS to transmit IP packet data traffic and control messages to the MS.
- 6) **Linearization Downlink Burst (LDB):**
  - The linearization downlink burst may be used by the BS to linearize its transmitter. Part of the linearization downlink burst contains non-useful symbols and its timing during the linearization portion is determined only by the time mask (see clause 8.2).
- 7) **Frequency Correction Burst (FCB):**
  - The FCB is used by the BS on a Direct Access cell to broadcast synchronization information and essential system information needed by an MS to synchronize with and use the facilities of a DA cell. On a 50 kHz, 100 kHz or 150 kHz channel, it may also contain other downlink signalling.

Figure 6.4 summarizes the description of the bursts and their timing with respect to the timeslot.



NOTE: In the case of QAM channels the partitioning of the bursts to contain different blocks for various control signalling information and user data is replaced with a "multiplexed symbol" format as described in clause 6.4.3.2.

### 6.4.3.2 QAM modulated burst formats

In QAM channels the physical content of a timeslot or subslot, referred to as the high-speed data burst, is arranged both in the frequency and time domain according to the symbol patterns depicted in figure 6.5.

The QAM bursts introduced in clause 6.4.2 namely CB, RAB, LB, NUB, NDB, LDB and FCB are built by multiplexing both in the time and frequency domain the coded payload and header symbols together with a sequence of known pilot and synchronization symbols. The latter symbols are transmitted only in 4-QAM, to allow more robust condition for channel estimation and synchronization recovery (see clause 6.9). The FCB also contains frequency correction symbols and secondary synchronization symbols, to help DA MSs to obtain frequency and time synchronization.

The possible numbers of sub-carriers are 8, 16, 32 and 48, corresponding to an overall bandwidth of 25 kHz, 50 kHz, 100 kHz and 150 kHz. The total number of symbols arranged within a burst is 34 for NDB, FCB and LDB, 31 for NUB, and 14 for CB and RAB.

As an example, the detailed structure of the NUB in a 25 kHz channel containing 8 sub-carriers illustrated in figure 6.5 (a). The 24 pilot symbols (P marks) are arranged within the time/frequency grid so as to allow a reasonable sampling of the channel frequency response without incurring a considerable efficiency loss. The pilot spacing in the time and frequency dimensions has been chosen so that an accurate estimation of the channel response can be achieved even in the worst-case (i.e. most selective) time and frequency dispersive propagation conditions. On the contrary, the 8 header symbols (H marks) are arranged within the burst as sparsely as possible so as to de-correlate the channel at their positions, but at the same time, as close as possible to the pilot symbols, to experience smaller channel estimation errors.

Further, the symbol sequence on each sub-carrier starts with two known synchronization symbols (for an overall number of 16 symbols) that are intended for frequency and clock synchronization recovery (S marks). Note that the synchronization symbols are also used as additional pilot symbols in channel estimation. Finally, the residual positions within the burst are used for 200 payload symbols (D marks).

Figure 6.5 also shows the burst structure for NDB, FCB, CB and RAB, which have quite similar patterns to NUB.

NOTE: For QAM, there are more payload symbols in the NDB than in the NUB.

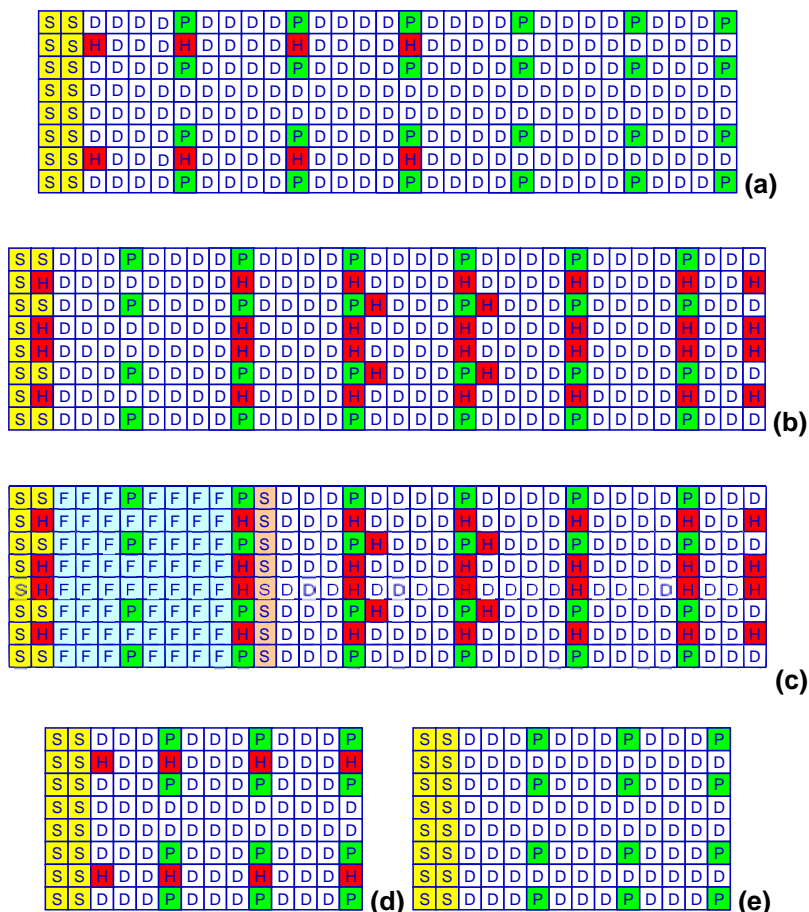

Figure 6.5: Structure of NUB (a), NDB (b), FCB (c), CB (d) and RAB (e), for a 25 kHz (8 sub-carrier) QAM channel

## 6.5 Channel structure

### 6.5.0 General

Each timeslot associated to a pair of RF frequencies (uplink and downlink) for frequency-division duplexing (FDD) forms a physical channel. The traffic, control and signalling information is packed by the MAC layer into logical channels. The latter are mapped onto the physical channels for transportation over the air interface. The channel structures for phase modulation and QAM are given in clauses 6.5.1 and 6.5.2. The mapping of logical channels onto physical channels is summarized in clause 6.5.3.

### 6.5.1 Logical channels in phase modulation

#### 6.5.1.0 Logical channel categories

The logical channels may be separated into two categories: the control channels carrying signalling messages and packet data and the traffic channels carrying speech or data information in circuit switched mode.

### 6.5.1.1 Control CHannel (CCH)

Five categories of control channel are defined for phase modulation. These channels carry signalling messages and packet data. All channel categories use  $\pi/4$ -DQPSK modulation except SCH (category 2), which uses either  $\pi/4$ -DQPSK or  $\pi/8$ -D8PSK modulation.

#### 1) Broadcast Control CHannel (BCCH):

- The BCCH is a unidirectional channel for common reception by all MSs. It broadcasts general information to all MSs. Two categories of BCCH are defined:
  - Broadcast Network CHannel (BNCH): for downlink use only to broadcast network information to MSs;
  - Broadcast Synchronization CHannel (BSCH): for downlink only to broadcast information used for frequency, time and scrambling synchronization of the MSs.

#### 2) Signalling CHannel (SCH):

- The SCH is shared by all MSs, but may carry messages specific to one MS or one group of MSs or all MSs. SCH may be divided into three categories:
  - Full size Signalling CHannel (SCH/F): used on both uplink and downlink, where messages are coded across an entire timeslot;
  - Half size Downlink Signalling CHannel (SCH/HD): downlink only, where messages are separately coded in each half of a timeslot;
  - Half size Uplink Signalling CHannel (SCH/HU): uplink only, where messages are coded across one subslot.
- These logical channels can use either  $\pi/4$ -DQPSK or  $\pi/8$ -D8PSK modulation. In the latter case the SCH notation changes to SCH-P8. For example, SCH/HD changes to SCH-P8/HD.

#### 3) Access Assignment CHannel (AACH):

- The AACH is present on all transmitted downlink slots. It is used to indicate on each physical channel the assignment of the uplink and downlink slots. The AACH is internal to the MAC.

#### 4) STealing CHannel (STCH):

- The STCH is a channel associated to a TCH that temporarily "steals" a part of the associated TCH capacity to transmit control messages. It may be used when fast signalling is required. In half duplex mode the STCH is unidirectional and has the same direction as the associated TCH.

#### 5) Linearization CHannel (LCH):

- The LCH is used by the BS and MS to linearize their transmitter. Two categories of LCH are defined:
  - Common Linearization CHannel (CLCH): used in the uplink and shared by all the MSs;
  - BS Linearization CHannel (BLCH): used in the downlink by the BS.

### 6.5.1.2 Traffic CHannel (TCH)

Two types of traffic channel are defined for speech or data applications and for different data message speeds using  $\pi/4$ -DQPSK:

- Speech Traffic CHannel (TCH/S).
- Circuit mode traffic channels TCH/7,2, TCH/4,8 and TCH/2,4 delivering net data rates of 7,2 kbit/s, 4,8 kbit/s and 2,4 kbit/s respectively. These channels use channel coding overhead of 0 kbit/s, 2,4 kbit/s and 4,8 kbit/s respectively.

Higher net rate up to 28,8 kbit/s, 19,2 kbit/s or 9,6 kbit/s may be achieved by allocating up to four physical channels to the same communication.

A single uncoded traffic channel is defined for  $\pi/8$ -D8PSK with a data rate of 10,8 kbit/s. This channel is designated TCH-P8/10,8.

## 6.5.2 QAM channels

The QAM part of MAC layer supports five Control CHannels (CCHs) used for both signalling and packet data messages. No TCH designation is defined for QAM since the user traffic is always in the form of packet data. These are also known as logical channels. The notation uses Q to identify QAM nature of the channel, U and D for full slot uplink and downlink messages. An H preceding a U denotes a subslot uplink message.

- 1) Broadcast Control CHannel (BCCH-Q):
  - The BCCH-Q is a unidirectional channel for common reception by all MSs. It broadcasts general information to all MSs. Two categories of BCCH-Q are defined:
    - the Broadcast Network CHannel (BNCH-Q): for downlink only, to broadcast network information from the BS to all MSs;
    - Broadcast Synchronization CHannel (BSCH-Q): for downlink only, to broadcast information used for frequency, time and scrambling synchronization of the Direct Access MSs and network information.
- 2) The Signalling CHannels SCH-Q/D, SCH-Q/U, SCH-Q/HU, SCH-Q/RA and SCH-Q/B:
  - The SCH-Q/D is used by the BS to send messages specific to one MS or a group of MSs or all MSs, whereas SCH-Q/U (and SCH-Q/HU) are used by an MS to send full slot (and subslot) messages to the BS. Each of these signalling channels are further subdivided according to modulation (4-QAM, 16-QAM and 64-QAM), coding rates (1/2, 2/3 and 1) and channel bandwidth (25 kHz, 50 kHz, 100 kHz and 150 kHz).
  - SCH-Q/RA contains random access uplink message, and is associated with only 25 kHz bandwidth, 4-QAM and 1/2 coding rate.
  - SCH-Q/B is used by the BS to send messages specific to one MS or a group of MSs or all MSs. SCH-Q/B is used only in the downlink direction and only on 50 kHz, 100 kHz and 150 kHz channels (in the FCB). The SCH-Q/B signalling channel uses 4-QAM modulation and 1/2 coding rate. (Only MSs that understand the FCB value in the SICH-Q/D will decode the SCH-Q/B.)
- 3) The Access Assignment CHannel (AACH-Q) is present on the transmitted downlink slots and contains the assignment of the uplink and downlink slots on each physical channel.
- 4) The Slot Information CHannel (SICH-Q) is used in both uplink (SICH-Q/U) and downlink (SICH-Q/D) to indicate the modulation and coding used in the remainder of the slot or subslot. The downlink SICH-Q also indicates whether the burst is an FCB.
- 5) The Linearization CHannel (LCH-Q) is used by the BS and MS to linearize their transmitters. The Common Linearization CHannel (CLCH-Q) is used in the uplink and is shared by all the MSs. The BS Linearization CHannel (BLCH-Q) is used in the downlink by the BS.

Logical channels AACH-Q and SICH-Q/D form the header in downlink bursts. SICH-Q/U forms the header in uplink bursts. These headers use 4-QAM and employ a different coding method (i.e. Reed Muller) to the payload. The coding rate employed for headers is 5/16. Furthermore, the header symbols are placed on sub-carriers occupying the central 25 kHz of QAM bursts (on the frequency axis) in any of the four channel bandwidths. These measures are to increase robustness in a multi-path environment.

## 6.5.3 Mapping of logical channels into physical channels

### 6.5.3.1 Mapping in phase modulation

The mapping of the phase modulated logical channels into physical channels is summarized in table 6.1.

**Table 6.1: Mapping of phase modulated logical channels into physical channels**

Logical channel	Direction	Burst type
BNCH	Downlink	NDB, SB
BSCH	Downlink	SB
SCH/F	Downlink/Uplink	NDB, NUB
SCH-P8/F*	Downlink/Uplink	NDB*
SCH/HD	Downlink	NDB, SB
SCH-P8/HD*	Downlink	NDB*
SCH/HU	Uplink	CB
SCH-P8/HU*	Uplink	CB*
AACH	Downlink	NDB, SB, NDB*
CLCH	Uplink	LB
BLCH	Downlink	NDB, SB, NDB*
STCH	Downlink/Uplink	NDB, NUB
TCH	Downlink/Uplink	NDB, NUB
TCH-P8/10,8*	Downlink/Uplink	NDB*, NUB*
NOTE: All logical channels and burst types use $\pi/4$ -DQPSK except those marked by an * which use $\pi/8$ -D8PSK. All physical channels are 25 kHz channels.		

For precise locations of the logical channels within bursts and other mapping details see clause 9.5 of ETSI EN 300 392-2 [i.2].

### 6.5.3.2 Mapping in QAM

The mapping of the QAM logical channels into physical channels is summarized in table 6.2.

**Table 6.2: Mapping of QAM logical channels into physical channels**

Logical channel	Direction	Burst type
BSCH-Q ‡	Downlink	FCB
BNCH-Q	Downlink	NDB, FCB
AACH-Q *	Downlink	NDB, FCB
SICH-Q/D *	Downlink	NDB, FCB
SICH-Q/U *	Uplink	NUB, CB
BLCH-Q	Downlink	LDB
CLCH-Q	Uplink	LB
SCH-Q/D	Downlink	NDB
SCH-Q/U	Uplink	NUB
SCH-Q/HU	Uplink	CB
SCH-Q/RA **	Uplink	RAB
SCH-Q/B ‡‡	Downlink	FCB

All logical channels and burst types in table 6.2 use any of the modulation types 4-QAM, 16-QAM and 64-QAM and any channel bandwidth of 25 kHz, 50 kHz, 100 kHz and 150 kHz except those marked as follows:

- AACH-Q, SICH-Q/D and SICH-Q/U (marked with \*) use sub-carriers within the central 25 kHz of the frequency axis, modulated with 4-QAM and 5/16 rate coding.
- SCH-Q/RA (marked with \*\*) uses any of the consecutive 25 kHz sections of QAM HSD channels with 4-QAM and 1/2 rate coding.
- BSCH-Q (marked with ‡) uses sub-carriers within the central 25 kHz of the frequency axis with 4-QAM and 1/2 rate coding.

- For 50 kHz, 100 kHz and 150 kHz channels, SCH-Q/B (marked with ‡‡) uses the outer sub-carriers of the frequency axis (i.e. the sub-carriers not within the central 25 kHz) with 4-QAM and 1/2 rate coding.

NOTE: On a 50 kHz, 100 kHz or 150 kHz QAM channel, the FCB contains both the BSCH-Q and SCH-Q/B logical channels whereas, on a 25 kHz QAM channel, the FCB contains only the BSCH-Q logical channel.

For precise locations of the logical channels within bursts and other mapping details see clause 9.5 of ETSI EN 300 392-2 [i.2].

## 6.6 Reference configuration

### 6.6.1 Reference configuration for phase modulation

The reference configuration illustrates the functional blocks of the radio-related functions. A reference configuration of the transmission chain for the phase modulation channels is shown in figure 6.6. As far as the TETRA standard is concerned only the transmission part is specified, the receiver being specified via overall performance requirements.

This reference configuration also defines the names of bits at different levels in the configuration.

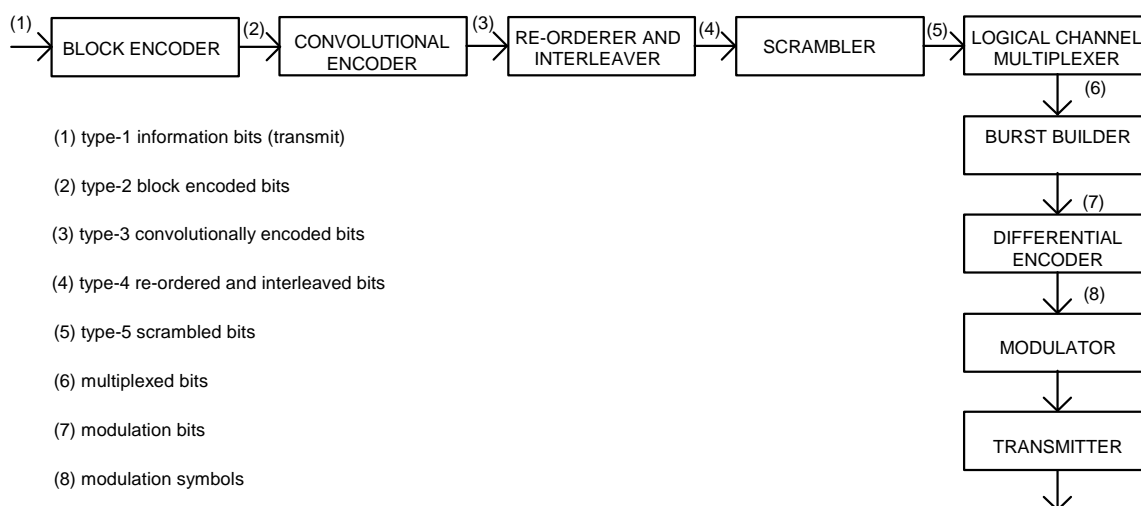

**Figure 6.6: Reference configuration for phase modulation**

## 6.6.2 Reference configuration for QAM

A reference configuration of the transmission chain for the QAM channels is shown in figure 6.7.

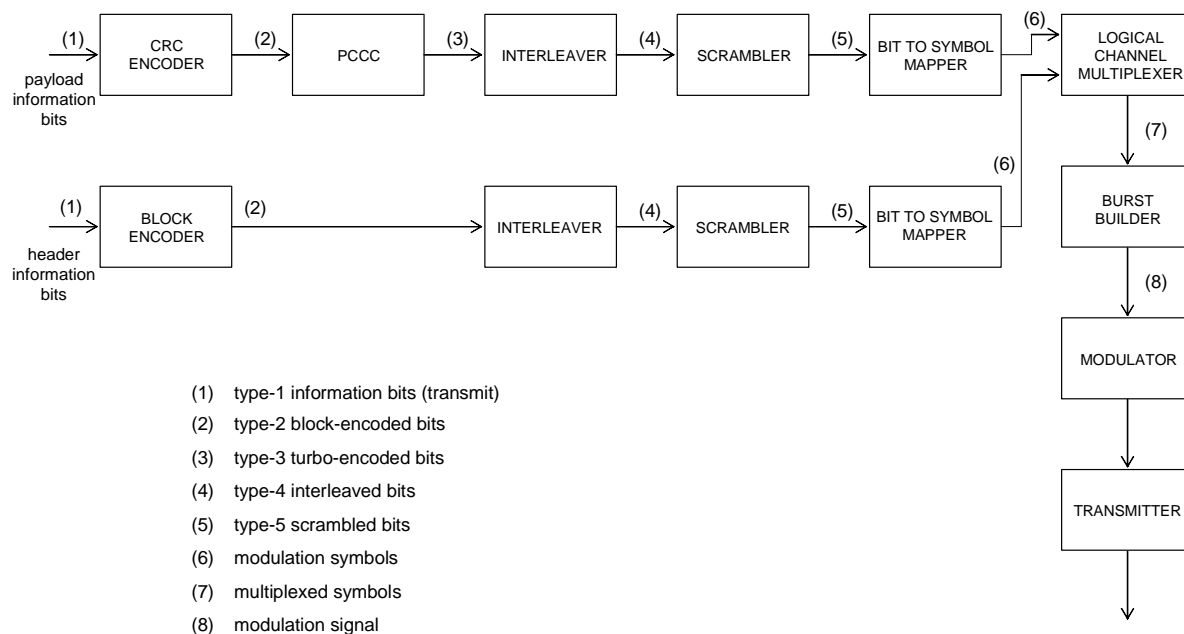

**Figure 6.7: Reference configuration for QAM**

## 6.7 Modulation

### 6.7.1 Phase modulation

The modulation used in the base-band part of phase modulation channels is  $\pi/4$ -shifted Differential Quaternary Phase Shift Keying ( $\pi/4$ -DQPSK) or  $\pi/8$ -shifted Differential 8 PSK ( $\pi/8$ -D8PSK). The modulation rate is 36 kbit/s for  $\pi/4$ -DQPSK and 54 kbit/s for  $\pi/8$ -D8PSK.

In the case of  $\pi/4$ -DQPSK modulation, the phase transition  $D\phi(k)$  is related to the modulation bits as shown in table 6.3 and figure 6.8.

**Table 6.3: Phase transitions for  $\pi/4$ -DQPSK modulation**

$B(2k-1)$	$B(2k)$	$D\phi(k)$
1	1	$-3\pi/4$
0	1	$+3\pi/4$
0	0	$+\pi/4$
1	0	$-\pi/4$

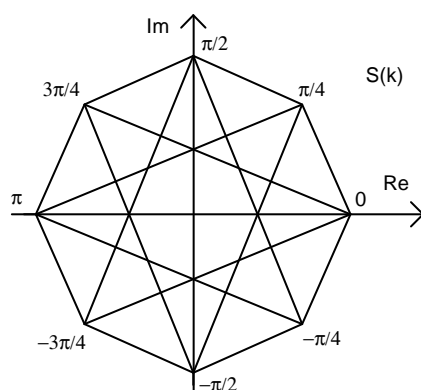

**Figure 6.8:  $\pi/4$ -DQPSK modulation symbol constellation and possible transitions**

The complex modulation symbol  $S(k)$  takes one of the eight values  $\exp(j n\pi/4)$ , where  $n = 2, 4, 6, 8$  for even  $k$  and  $n = 1, 3, 5, 7$  for odd  $k$ . The constellation of the modulation symbols and the possible transitions between them are as shown in figure 6.8.

In the case of  $\pi/8$ -D8PSK modulation, the phase transition  $D\phi(k)$  is related to the modulation bits as shown in table 6.4 and figure 6.9.

**Table 6.4: Phase transitions for  $\pi/8$ -D8PSK modulation**

$B(3k-2)$	$B(3k-1)$	$B(3k)$	$D\phi(k)$
0	0	0	$+\pi/8$
0	0	1	$+3\pi/8$
1	0	1	$+5\pi/8$
1	0	0	$+7\pi/8$
0	1	0	$-\pi/8$
0	1	1	$-3\pi/8$
1	1	1	$-5\pi/8$
1	1	0	$-7\pi/8$

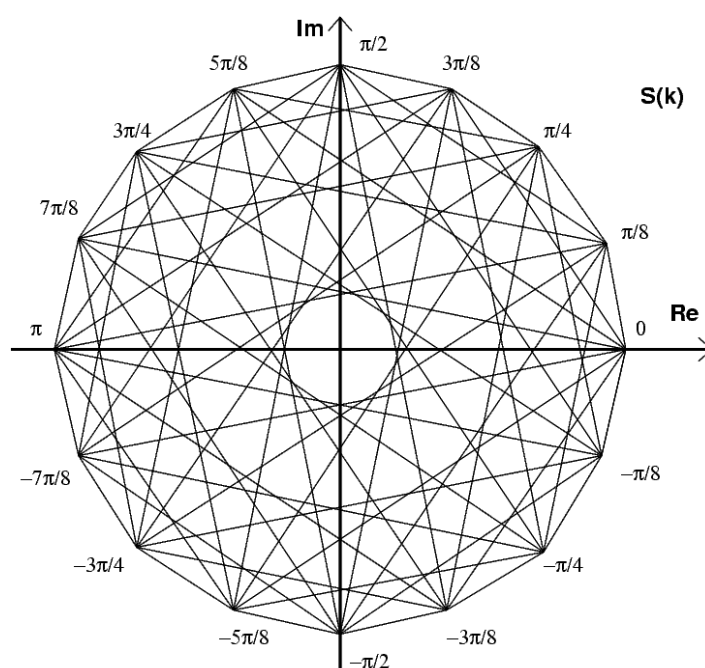

**Figure 6.9:  $\pi/8$ -D8PSK modulation symbol constellation and possible transitions**

The complex modulation symbol  $S(k)$  takes one of the sixteen values  $\exp(j n \pi / 8)$ , where  $n = 2, 4, 6, \dots, 16$  for even  $k$  and  $n = 1, 3, 5, \dots, 15$  for odd  $k$ . The constellation of the modulation symbols and the possible transitions between them are as shown in figure 6.9.

## 6.7.2 QAM

### 6.7.2.1 Modulation types

The Quadrature Amplitude Modulation is used in the base-band part of the QAM channels. Three types of QAM are used, namely, 4-QAM, 16-QAM or 64-QAM. Each modulation type may be used in any of the four channel bandwidths 25 kHz to 150 kHz to carry the payload.

Given the discrete channelization ranging from single 25 kHz channels up to 150 kHz, there is insufficient bandwidth to permit resolution of individual multi-path echoes in the transmission path. It is thus necessary to ensure that the channel time delay is a small fraction of the symbol period for negligible channel induced Inter Symbol Interference. For this reason, each QAM carrier is divided into a number of frequency-division multiplexed sub-carriers, each carrying a complex signal using one type of QAM modulation. The sub-carrier approach is used because the low symbol rate in each sub-carrier gives the modulation inherent resistance to time dispersion hence avoiding the need for a time-domain adaptive equalizer.

This multi sub-carrier approach uses 8 sub-carriers per 25 kHz in QAM channels, i.e. 8, 16, 32 and 48 sub-carriers in 25 kHz, 50 kHz, 100 kHz and 150 kHz channels respectively. The modulation symbol rate on each sub-carrier is 2 400 symbols/s. The overall carrier symbol rate is 19 200 symbols/s for 25 kHz carriers, 38 400 symbols/s for 50 kHz carriers, 76 800 symbols/s for 100 kHz carriers and 115 200 symbols/s for 150 kHz carriers. The modulation gross bit rates are given in table 6.8.

### 6.7.2.2 Bit to symbol mapping

Figures 6.10, 6.11 and 6.12 show the three different mappings of QAM symbols onto the complex plane. It can be seen from the three constellation diagrams that the pilot sub-carrier symbols and synchronization sub-carrier symbols are not constrained to lie on the constellation points, instead, they can take on any phase angle as long as the magnitude of these symbols corresponds to the synchronization/pilot locus. A circle of unity amplitude is selected, as this locus is independent of the modulation. Note that this circle is not the outer circle of 16-QAM and 64-QAM constellations. The header sub-carrier symbols also lie on this circle but use 4-QAM in all three cases.

Tables 6.5, 6.6 and 6.7 show the vector and bit definition for 4-QAM, 16-QAM and 64-QAM respectively.

The modulation symbol  $S_m(k)$  is related to the modulation bits defined in tables 6.5, 6.6 and 6.7, subject to the appropriate scaling factors:

- for 4-QAM the values in table 6.5 are multiplied by  $1/\sqrt{2}$ .
- for 16-QAM the values in table 6.6 are multiplied by  $1/\sqrt{10}$ .
- for 64-QAM the values in table 6.7 are multiplied by  $1/\sqrt{42}$ .

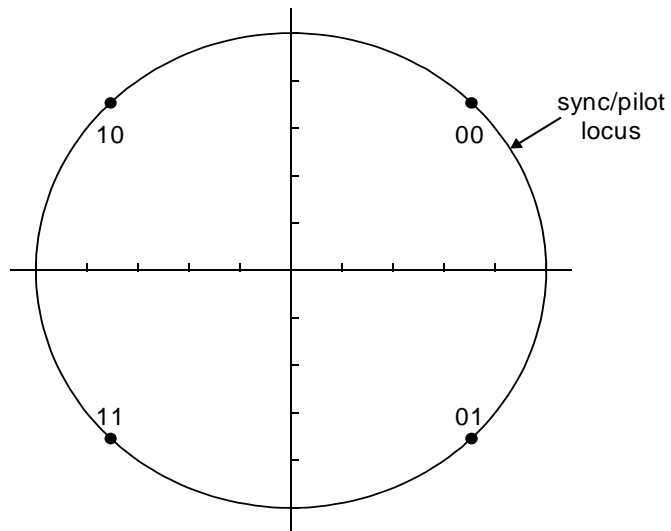

Figure 6.10: 4-QAM symbol constellation

Table 6.5: Vector and bit definition (4-QAM)

B(2k-1)	B(2k)	X+Yj
0	0	+1+1j
0	1	+1-1j
1	0	-1+1j
1	1	-1-1j

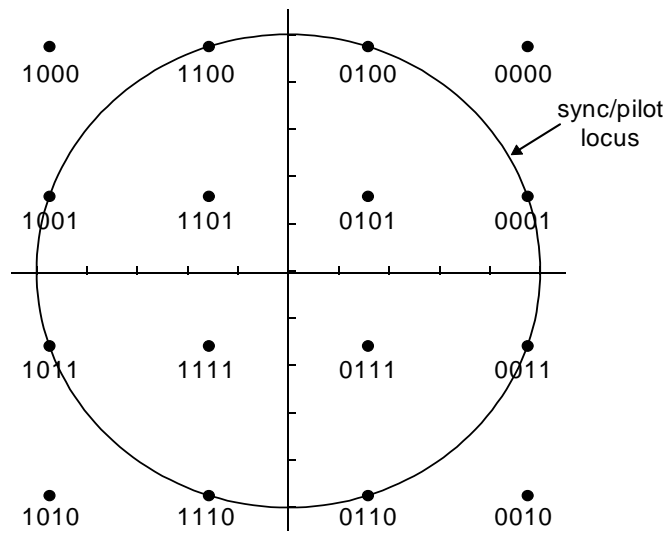

Figure 6.11: 16-QAM symbol constellation

Table 6.6: Vector and bit definition (16-QAM)

B(4k-3)	B(4k-2)	B(4k-1)	B(4k)	X+Yj
0	0	0	0	+3+3j
0	0	0	1	+3+1j
0	0	1	0	+3-3j
0	0	1	1	+3-1j
0	1	0	0	+1+3j
0	1	0	1	+1+1j
0	1	1	0	+1-3j
0	1	1	1	+1-1j
1	0	0	0	-3+3j
1	0	0	1	-3+1j
1	0	1	0	-3-3j
1	0	1	1	-3-1j
1	1	0	0	-1+3j
1	1	0	1	-1+1j
1	1	1	0	-1-3j
1	1	1	1	-1-1j

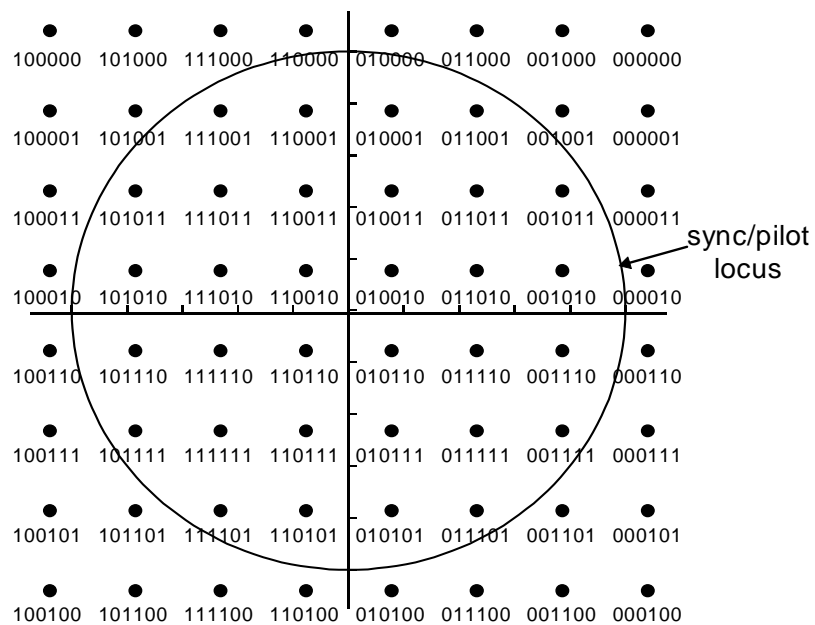

Figure 6.12: 64-QAM symbol constellation

Table 6.7: Vector and bit definition (64-QAM)

B(6k-5)	B(6k-4)	B(6k-3)	B(6k-2)	B(6k-1)	B(6k)	X+Yj
0	0	0	0	0	0	+7+7j
0	0	0	0	0	1	+7+5j
0	0	0	0	1	0	+7+1j
0	0	0	0	1	1	+7+3j
0	0	0	1	0	0	+7-7j
0	0	0	1	0	1	+7-5j
0	0	0	1	1	0	+7-1j
0	0	0	1	1	1	+7-3j
0	0	1	0	0	0	+5+7j
0	0	1	0	0	1	+5+5j
0	0	1	0	1	0	+5+1j
0	0	1	0	1	1	+5+3j
0	0	1	1	0	0	+5-7j
0	0	1	1	0	1	+5-5j
0	0	1	1	1	0	+5-1j
0	0	1	1	1	1	+5-3j
0	1	0	0	0	0	+1+7j
0	1	0	0	0	1	+1+5j
0	1	0	0	1	0	+1+1j
0	1	0	0	1	1	+1+3j
0	1	0	1	0	0	+1-7j
0	1	0	1	0	1	+1-5j
0	1	0	1	1	0	+1-1j
0	1	0	1	1	1	+1-3j
0	1	1	0	0	0	+3+7j
0	1	1	0	0	1	+3+5j
0	1	1	0	1	0	+3+1j
0	1	1	0	1	1	+3+3j
0	1	1	1	0	0	+3-7j
0	1	1	1	0	1	+3-5j
0	1	1	1	1	0	+3-1j
0	1	1	1	1	1	+3-3j
1	0	0	0	0	0	-7+7j
1	0	0	0	0	1	-7+5j
1	0	0	0	1	0	-7+1j
1	0	0	0	1	1	-7+3j
1	0	0	1	0	0	-7-7j
1	0	0	1	0	1	-7-5j
1	0	0	1	1	0	-7-1j
1	0	0	1	1	1	-7-3j
1	0	1	0	0	0	-5+7j
1	0	1	0	0	1	-5+5j
1	0	1	0	1	0	-5+1j
1	0	1	0	1	1	-5+3j
1	0	1	1	0	0	-5-7j
1	0	1	1	0	1	-5-5j
1	0	1	1	1	0	-5-1j
1	0	1	1	1	1	-5-3j
1	1	0	0	0	0	-1+7j
1	1	0	0	0	1	-1+5j
1	1	0	0	1	0	-1+1j
1	1	0	0	1	1	-1+3j
1	1	0	1	0	0	-1-7j
1	1	0	1	0	1	-1-5j
1	1	0	1	1	0	-1-1j
1	1	0	1	1	1	-1-3j
1	1	1	0	0	0	-3+7j
1	1	1	0	0	1	-3+5j
1	1	1	0	1	0	-3+1j
1	1	1	0	1	1	-3+3j
1	1	1	1	0	0	-3-7j
1	1	1	1	0	1	-3-5j
1	1	1	1	1	0	-3-1j
1	1	1	1	1	1	-3-3j

### 6.7.2.3 Comparison of gross bit rates

Table 6.8 shows the gross bit rate offered by TETRA high-speed modulation options in each of the four channel bandwidths available to high-speed data users. The single-slot and 4-slot  $\pi/4$ -DQPSK 25 kHz channel gross bit rates are included (*in italics*) for comparison purposes. It is seen that the  $\pi/8$ -D8PSK modulation provides 50 % higher gross bit rate than the  $\pi/4$ -DQPSK 25 kHz previously offered as the only modulation in TETRA networks. The  $\pi/8$ -D8PSK modulation is permitted only on 25 kHz channels.

The QAM modulations are permitted on all four channel bandwidths, hence providing a range of gross bit rates up to over 19 times the speed of  $\pi/4$ -DQPSK modulation. The wide range of gross bit rates available in high-speed channels in TETRA allows network operators and users to select a high-speed channel in accordance with their anticipated high-speed data applications. For a comparison of user throughput in TETRA high-speed channels refer to clause 10.4.6 and table 10.12.

**Table 6.8: Gross bit rates of TETRA high-speed channels (kbit/s)**

Modulation and channel type	Gross bit rate (kbit/s)			
	25 kHz	50 kHz	100 kHz	150 kHz
<i><math>\pi/4</math>-DQPSK 1-slot</i>	9	-	-	-
<i><math>\pi/4</math>-DQPSK 4-slot</i>	36	-	-	-
<i><math>\pi/8</math>-D8PSK 4-slot</i>	54	-	-	-
4-QAM 4-slot	38	77	154	230
16-QAM 4-slot	77	154	307	461
64-QAM 4-slot	115	230	461	691

## 6.8 Error control (lower MAC)

### 6.8.1 General

The information bits sent over the various TETRA HSD logical channels are protected by means of one or two coding schemes followed by interleaving and scrambling. These operations are carried out at the binary level, prior to mapping of bits onto (phase or QAM modulated) channel symbols.

Coding is used to reduce the occurrence of errors due to noise, interference, distortion and other channel impairments and also to detect errors in the decoded binary stream. Specifically, the logical channels carried by burst payloads are first passed through a Cyclic Redundancy Check (CRC) block encoder that appends to the information block 16 redundant bits. These bits are used at the receiver side to detect possible decision errors in the information block. The CRC code is concatenated with a more powerful code (a Rate Compatible Punctured Convolutional code for phase modulation or a Parallel Concatenated Convolutional code for QAM), with the task of reducing the occurrence of errors at the cost of a controlled loss in spectrum efficiency. In some cases, when propagation conditions are particularly favourable, the latter coding level may be omitted (this occurs for QAM channels). The other logical channels, i.e. those using the header section of the QAM burst (but also the AACH for phase modulation) do not employ CRC coding and rely on single-level powerful Reed-Muller block codes.

Interleaving consists of changing the order of bits in a binary sequence and represents a valid countermeasure against time-selective fading thanks to its capability to spread highly-deteriorated segments of signals over a larger number of signalling intervals. Finally, scrambling consists of "randomizing" the bits of a binary sequence through bit-by-bit multiplication by another (usually pseudo-random) binary sequence of equal length, and is used either to make the sequence more appropriate for transmission on a given channel, or to identify the transmit terminal (notably the BS) as the case is in TETRA.

A general conceptual scheme illustrating the concatenation of coding, interleaving and scrambling is depicted in figure 6.13, where the binary stream is seen to cross several interface levels, starting from the unprotected source information bits (denoted as type-1 bits and arranged in type-1 blocks) and ending up to the scrambled bits (denoted as type-5 bits and arranged in type-5 blocks), ready to be mapped either onto multiplexed blocks (for phase modulation, see figure 6.6) or onto channel symbols (for QAM, see figure 6.7) prior to burst building and transmission on the channel.

More specifically, the processing in the bit stream at the various interface levels is as follows:

- the type-1 bits are encoded by a block code, providing block-encoded bits. In some cases, tail bits are appended to these block-encoded bits. The block-encoded bits and the tail bits (if added) are referred to as type-2 bits and are packed in a type-2 block, which defines interface (2);
- the type-2 bits are encoded by a convolutional encoder (phase modulation) or by a parallel concatenated convolutional encoder (QAM), which provides the convolutionally encoded or PCCC encoded bits. In some cases, this encoding level may be missing (e.g. in QAM uncoded payload channels). These encoded bits are referred to as type-3 bits and are packed in a type-3 block, which defines interface (3);
- the type-3 bits are reordered and interleaved into interleaved bits. These bits are referred to as type-4 bits and are packed in a type-4 block, which defines interface (4);
- the type-4 bits are scrambled into type-5 bits, which compose a type-5 block; this defines interface (5).

All these operations are made on a per type-1 block basis. The block sizes at the various interface levels depend on the logical channel with which they are associated. The block size details between interfaces 1 and 5 are given in clause 6.8.2 for phase modulation and in clause 6.8.3 for QAM.

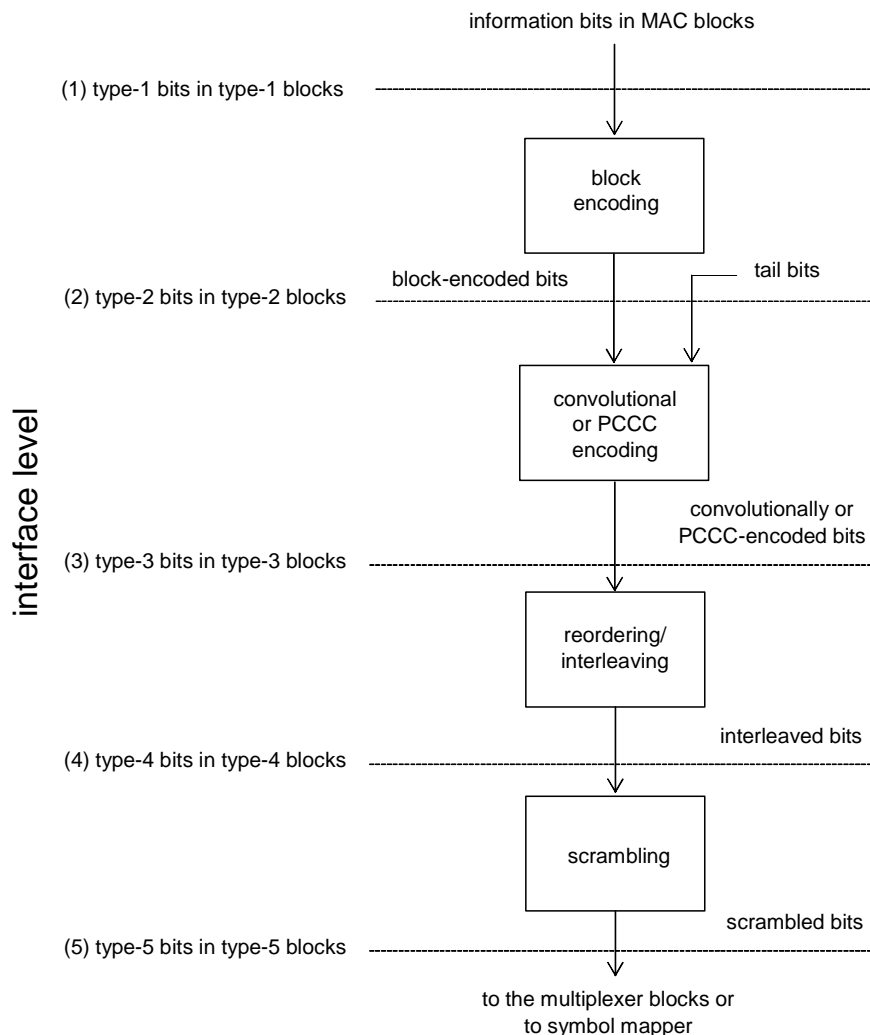

**Figure 6.13: Interfaces in the error control structure**

The error control schemes adopted for logical channels with phase modulation are described in detail in clause 6.8.2, while those relevant to QAM are treated in clause 6.8.3. Coding techniques are detailed in clauses 6.8.4 and 6.8.5 for channels using phase modulation and QAM, respectively. Interleaving for phase modulation is covered in clause 6.8.6, and in clause 6.8.7 for QAM. Finally, scrambling is discussed in clause 6.8.8.

## 6.8.2 Error control schemes for phase modulation

With reference to figure 6.13, the type-1 information bits (eventually including a MAC header) are packed in type-1 (or MAC) blocks. After encoding, interleaving and scrambling, the type-5 blocks are mapped into multiplexed blocks. A multiplexed block may be one of five different kinds: control block, broadcast block (BBK), synchronization block, block-1 block, or block-2 block.

As mentioned earlier, each logical channel has its own error control scheme, which for phase modulation will not be pursued in detail in view of the excessive number of channels to be treated. It is instructive however to provide a summary of error control differences between various phase modulation logical channels (both  $\pi/4$ -DQPSK and  $\pi/8$ -D8PSK types). These differences are highlighted below (see figure 6.13 for interface levels):

- 1) All control signalling logical channels (with the exception of AACH), i.e. BSCH, SCH/HD, SCH/HU, BNCH, STCH, SCH/F ( $\pi/4$ -DQPSK type) and SCH-P8/HD, SCH-P8/HU, SCH-P8/F ( $\pi/8$ -D8PSK type) use:
  - Stage 1 (between interfaces 1 and 2): Block code plus 4 tail bits.
  - Stage 2 (between interfaces 2 and 3): RCPC code, rate 2/3.
  - Stage 3 (between interfaces 3 and 4): Block interleaver.
  - Stage 4 (between interfaces 4 and 5): Scrambling.
- 2) AACH logical channel uses:
  - Stage 1: Reed Muller block code.
  - Stage 2: Not applied.
  - Stage 3: Not applied.
  - Stage 4: Scrambling.
- 3) TCH/4,8 and TCH/2,4 logical channels use:
  - Stage 1: 4 tail bits only.
  - Stage 2: RCPC code, rate 292/432 for TCH/4,8, rate 148/432 for TCH/2,4.
  - Stage 3: Interleaving over N blocks.
  - Stage 4: Scrambling.
- 4) TCH/7,2 and TCH-P8/10,8 logical channels use:
  - Scrambling in stage 4. Other stages are not applied.

For details of coding, interleaving and scrambling for phase modulation logical channels see clauses 6.8.4, 6.8.6 and 6.8.8 respectively.

Finally, table 6.10 shows the data block sizes  $K$  and  $K'$  for the type-2 blocks entering the RCPC encoder and the corresponding type-3 encoded blocks, respectively.

**Table 6.9: Values of  $K$  and  $K'$  (in bits) for phase modulation logical channels**

$\pi/4$ -DQPSK logical channels	$K$	$K'$
AACH	14	30
BSCH	60	120
SCH/HD	124	216
SCH/HU	92	168
BNCH	124	216
STCH	124	216
SCH/F	268	432
TCH/2,4	144	432
TCH/4,8	288	432
TCH/7,2 (uncoded)	432	432
$\pi/8$ -D8PSK logical channels	$K$	$K'$
SCH-P8/HD	196	324
SCH-P8/HU	148	252
SCH-P8/F	412	648
TCH-P8/10,8 (uncoded)	648	648

### 6.8.3 Error control schemes for QAM channels

#### 6.8.3.0 General

The error control schemes associated with logical channels employing QAM can be subdivided into two categories, namely those for channels using the header section of a burst (SICH-Q/U, SICH-Q/D and AACH-Q) and those for channels carrying on the payload section (SCH-Q/HU, SCH-Q/U, SCH-Q/D, BNCH-Q, SCH-Q/RA, BSCH-Q and SCH-Q/B). As already mentioned, the former channels are protected by means of a block Reed-Muller (RM) code followed by interleaving and scrambling, while the latter use a concatenation of CRC encoding, PCCC turbo encoding, interleaving and scrambling. In certain cases, the PCCC encoding stage may be omitted, this being referred to as uncoded case. The specific error control schemes utilized for the various logical channel are depicted in figure 6.14 and are described in clauses 6.8.3.1 to 6.8.3.9.

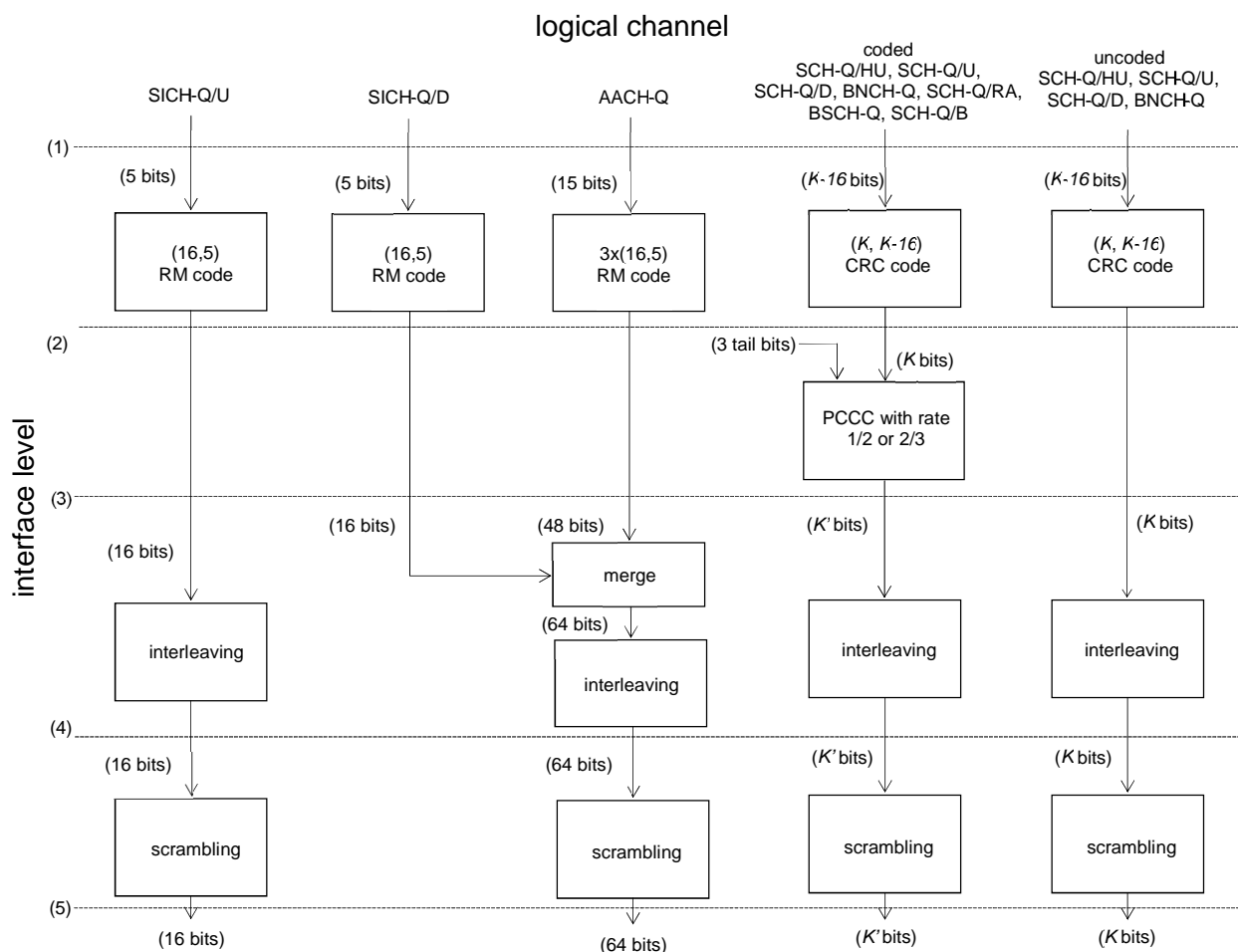

Figure 6.14: Error control structure for QAM logical channels

### 6.8.3.1 Slot Information CHannel - QAM/Uplink (SICH-Q/U)

The logical channel SICH-Q/U is borne by the header sections of the NUB and CB. The input is represented by a 5-bit binary sequence  $[b_i(1), b_i(2), \dots, b_i(5)]$  that is fed to a (16,5) RM block code (clause 6.8.5.2) producing a 16-bit coded sequence  $[b_o(1), b_o(2), \dots, b_o(16)]$ . This sequence is then fed to the interleaver (clause 6.8.7), which modifies the order of bits without changing the sequence length, and finally to the scrambling unit (clause 6.8.8).

### 6.8.3.2 Slot Information CHannel - QAM/Downlink (SICH-Q/D)

The logical channel SICH-Q/D uses part of the header section of the NDB and FCB. As with the uplink SICH, the input is represented by a 5-bit binary sequence, that is fed to the same (16,5) RM block code producing a 16-bit coded sequence  $[b_o(1), b_o(2), \dots, b_o(16)]$ . This sequence is then merged with the 48-bit sequence representing the AACH-Q channel, as discussed in clause 6.8.3.3, producing a 64-bit sequence that finally undergoes interleaving (clause 6.8.7) and scrambling (clause 6.8.8).

### 6.8.3.3 Access Assignment CHannel - QAM (AACH-Q)

The logical channel AACH-Q uses part of the header section of the NDB and FCB. Now the input sequence is 15 bit long  $[b_i(1), b_i(2), \dots, b_i(15)]$  and is subdivided into three 5-bit consecutive sub-sequences, as follows:  $[b_i(1), b_i(2), \dots, b_i(5)]$ ,  $[b_i(6), b_i(7), \dots, b_i(10)]$  and  $[b_i(11), b_i(12), \dots, b_i(15)]$ . Each sub-sequence is fed to a (16,5) RM block code (described in clause 6.8.5.2) and maps onto a 16-bit coded sub-sequence. Specifically, the sub-sequence  $[b_i(1), b_i(2), \dots, b_i(5)]$  generates the coded sub-sequence  $[b_o(1), b_o(2), \dots, b_o(16)]$ , the sub-sequence  $[b_i(6), b_i(7), \dots, b_i(10)]$  generates the coded sub-sequence  $[b_o(17), b_o(18), \dots, b_o(32)]$  and finally the sub-sequence  $[b_i(11), b_i(12), \dots, b_i(15)]$  generates the coded sub-sequence  $[b_o(33), b_o(34), \dots, b_o(48)]$ . The three coded sub-sequences are then merged together to form the 48-bit coded sequence  $[b_o(1), b_o(2), \dots, b_o(48)]$ .

As next step, this 48-bit sequence is appended to the 16-bit sequence representing the SICH-Q/D logical channel (whose generation is described in clause 6.8.3.2), leading to a 64-bit encoded sequence, that is subsequently fed to the interleaving and scrambling blocks (clauses 6.8.7 and 6.8.8).

### 6.8.3.4 Signalling Channel - QAM/Half slot Uplink (SCH-Q/HU)

The logical channel SCH-Q/HU is carried by the CB payload. The input sequence of  $K - 16$  information bits is first passed through a CRC encoder (clause 6.8.4.4), which appends 16 CRC bits so as to yield a sequence of  $K$  bits. The latter is then either applied to the input of a PCCC turbo encoder or left uncoded. In the former case, the sequence of  $K$  input bits is completed by appending three termination bits as described in clause 6.8.5.1.1. The PCCC encoder (clause 6.8.5.1) produces an encoded sequence of length  $K'$  bits, where  $K'$  depends on the coding rate and the payload capacity, i.e. the number of subcarriers and the modulation level. The  $K'$  PCCC encoded bits are then interleaved (clause 6.8.7) and scrambled (clause 6.8.8).

If the  $K$  bits after CRC block are to be left uncoded, then they are directly applied to the interleaver (clause 6.8.7) and the scrambler (clause 6.8.8).

The values of  $K$  and  $K'$  versus the coding rate (1/2, 2/3 and uncoded), the signal bandwidth and the number of constellation symbols are summarized in table 6.10 for the allowed cases.

**Table 6.10: Values of  $K$  and  $K'$  (in bits) for the SCH-Q/HU (CB payload)**

Bandwidth (kHz)	coding rate	4-QAM		16-QAM		64-QAM	
		$K$	$K'$	$K$	$K'$	$K$	$K'$
25	1/2	73	152	149	304	225	456
	2/3	-	-	-	-	301	456
	uncoded	-	-	304	-	456	-
50	1/2	157	320	317	640	477	960
	2/3	-	-	-	-	637	960
	uncoded	-	-	640	-	960	-
100	1/2	325	656	653	1 312	981	1 968
	2/3	-	-	-	-	1 309	1 968
	uncoded	-	-	1 312	-	1 968	-
150	1/2	493	992	989	1 984	1 485	2 976
	2/3	-	-	-	-	1 981	2 976
	uncoded	-	-	1 984	-	2 976	-

### 6.8.3.5 Signalling CHannel - QAM/Uplink (SCH-Q/U)

The logical channel SCH-Q/U is carried by the NUB payload. The encoding procedure is identical to that outlined for the SCH-Q/HU logical channel except for the values of  $K$  and  $K'$ , which are shown in table 6.11.

**Table 6.11: Values of  $K$  and  $K'$  (in bits) for the SCH-Q/U (NUB payload)**

Bandwidth (kHz)	coding rate	4-QAM		16-QAM		64-QAM	
		$K$	$K'$	$K$	$K'$	$K$	$K'$
25	1/2	197	400	397	800	597	1 200
	2/3	-	-	-	-	797	1 200
	uncoded	-	-	800	-	1 200	-
50	1/2	405	816	813	1 632	1 221	2 448
	2/3	-	-	-	-	1 629	2 448
	uncoded	-	-	1 632	-	2 448	-
100	1/2	821	1 648	1 645	3 296	2 469	4 944
	2/3	-	-	-	-	3 293	4 944
	uncoded	-	-	3 296	-	4 944	-
150	1/2	1 237	2 480	2 477	4 960	3 717	7 440
	2/3	-	-	-	-	4 957	7 440
	uncoded	-	-	4 960	-	7 440	-

### 6.8.3.6 Signalling CHannel - QAM/Downlink (SCH-Q/D) and Broadcast Network Channel - QAM (BNCH-Q)

The logical channels SCH-Q/D and BNCH-Q are carried by the NDB payload. The encoding procedure is identical to that outlined for the SCH-Q/HU and SCH-Q/U logical channel except for the values of  $K$  and  $K'$ , which are shown in table 6.12.

**Table 6.12: Values of  $K$  and  $K'$  (in bits) for the SCH-Q/D and BNCH-Q (NDB payload)**

Bandwidth (kHz)	coding rate	4-QAM		16-QAM		64-QAM	
		$K$	$K'$	$K$	$K'$	$K$	$K'$
25	1/2	201	408	405	816	609	1 224
	2/3	-	-	-	-	813	1 224
	uncoded	-	-	816	-	1 224	-
50	1/2	437	880	877	1 760	1 317	2 640
	2/3	-	-	-	-	1 757	2 640
	uncoded	-	-	1 760	-	2 640	-
100	1/2	909	1 824	1 821	3 648	2 733	5 472
	2/3	-	-	-	-	3 645	5 472
	uncoded	-	-	3 648	-	5 472	-
150	1/2	1 381	2 768	2 765	5 536	4 149	8 304
	2/3	-	-	-	-	5 533	8 304
	uncoded	-	-	5 536	-	8 304	-

### 6.8.3.7 Signalling CHannel - QAM/Random Access (SCH-Q/RA)

The logical channel SCH-Q/RA is carried by the RAB payload. The input sequence of 65 information bits is first passed through a CRC encoder (clause 6.8.4.4), which appends 16 CRC bits so as to yield a sequence of 81 bits. The latter is then applied to the input of a PCCC turbo encoder with rate  $r = 1/2$  (clause 6.8.5.1) and completed by appending three termination bits as described in clause 6.8.5.1.1. The PCCC encoder produces an encoded sequence of 168 bits. The encoded bits are then interleaved (clause 6.8.7) and scrambled (clause 6.8.8).

### 6.8.3.8 Broadcast Synchronization CHannel - QAM (BSCH-Q)

The logical channel BSCH-Q is carried by the data set A part of the FCB payload i.e. by the part of the FCB payload carried by the sub-carriers within the central 25 kHz of the frequency axis. The input sequence of 117 information bits is first passed through a CRC encoder (clause 6.8.4.4), which appends 16 CRC bits so as to yield a sequence of 133 bits. The latter is then applied to the input of a PCCC turbo encoder with rate  $r = 1/2$  (clause 6.8.5.1) and completed by appending three termination bits as described in clause 6.8.5.1.1. The PCCC encoder produces an encoded sequence of 272 bits. The encoded bits are then interleaved (clause 6.8.7) and scrambled with a predefined scrambling code (clause 6.8.8).

### 6.8.3.9 Signalling CHannel data set B - QAM (SCH-Q/B)

The logical channel SCH-Q/B is carried by the data set B part of the FCB payload i.e. by the part of the FCB payload carried by the outer sub-carriers of the frequency axis (i.e. by the sub-carriers not within the central 25 kHz of the frequency axis). The input sequence of  $K - 16$  information bits is first passed through a CRC encoder (clause 6.8.4.4), which appends 16 CRC bits so as to yield a sequence of  $K$  bits. The latter is then applied to the input of a PCCC turbo encoder with rate  $r = 1/2$  (clause 6.8.5.1) and completed by appending three termination bits as described in clause 6.8.5.1.1. The PCCC encoder produces an encoded sequence of length  $K'$  bits, where  $K'$  depends on the number of subcarriers. The  $K'$  PCCC encoded bits are then interleaved (clause 6.8.7) and scrambled (clause 6.8.8).

The values of  $K$  and  $K'$  are summarized in table 6.13 for the allowed cases.

**Table 6.13: Values of  $K$  and  $K'$  (in bits) for the SCH-Q/B (data set B payload)**

Bandwidth (kHz)	4-QAM, coding rate 1/2	
	$K$	$K'$
50	233	472
100	705	1416
150	1 177	2 360

## 6.8.4 Coding for phase modulation

### 6.8.4.1 General

Three different types of codes are used on phase modulation channels:

- 1) The burst payload data bits are first passed through a CRC encoder providing redundant bits for error detection capability.
- 2) The payload data bits equipped with CRC bits are then encoded by means of a Rate-Compatible Punctured Convolutional (RCPC) code, to provide robustness against noise, interference, non-linear distortion, etc.
- 3) An exception to 2) is the downlink broadcast block, which is encoded by means of a Reed-Muller block code prior to symbol mapping and insertion in the burst. This code provides more robustness for shorter blocks as in downlink broadcast block. No CRC protection or interleaving is employed in this case.

### 6.8.4.2 16-state Rate-Compatible Punctured Convolutional (RCPC) codes

The RCPC codes are used to encode the binary data block at the output of the CRC encoder. This encoding is performed in two steps:

- encoding by a 16-states mother code of rate  $1/4$ ;
- puncturing of the mother code so to obtain a 16-state RCPC code of rate  $K_2/K_3$ .

The input to the mother code of any type-2 bit implies the output, by the mother code, of 4 bits, which are calculated as follows.

Any of the 4 generator polynomials of the mother code,  $G_i(D)$ ,  $i = 1, 2, 3, 4$ , can be written as:

$$G_i(D) = \sum_{j=0}^4 g_{i,j} D^j \text{ for } i = 1, 2, 3, 4 \quad (6.1)$$

where  $g_{i,j} = 0$  or  $1$ ,  $j = 0, 1, 2, 3, 4$ .

This means that the encoded bits are defined by:

$$V[4(k-1) + i] = \sum_{j=0}^4 b_2(k-j) g_{i,j} \text{ for } i = 1, 2, 3, 4 \text{ and } k = 1, 2, \dots, K_2 \quad (6.2)$$

where the sum is meant modulo 2, and where  $b_2(k-j) = 0$  for  $k \leq j$ .

The generator polynomials of the mother code are:

$$\begin{aligned} G_1(D) &= 1 + D + D^4 \\ G_2(D) &= 1 + D^2 + D^3 + D^4 \\ G_3(D) &= 1 + D + D^2 + D^4 \\ G_4(D) &= 1 + D + D^3 + D^4 \end{aligned}$$

The coding rates envisaged for the 16-state RCPC codes are  $2/3$ ,  $1/3$ ,  $292/432$  and  $148/432$ . All of these are obtained by appropriate puncturing of the mother code output, i.e. deleting part of the parity bits produced by the above encoder, so as to reduce the coding rate and improve the overall system spectrum efficiency.

The puncturing formulas needed to obtain the above mentioned coding rates are provided in the standard. Here a different more intuitive description is followed, based on the use of a 8-bit *puncturing mask*, i.e. a sequence of 8 bits in which the number of bits set to zero determine the puncturing ratio, i.e. the fraction of bits to be punctured out from the sequence  $V(k)$ . The mask is iteratively applied to consecutive 8-bit segments of the sequence  $V(k)$ , and only the bits of the latter sequence coinciding with the ones in the puncturing mask are retained. The above approach relies on the assumption that the number of type-2 bits driving the RCPC encoder is even, so that the number of bits produced by the mother code is an integer multiple of 8. This is always true in view of the standardized block lengths.

**Coding rate 2/3:** The 8-bit puncturing mask providing the coding rate  $r = \frac{2}{3}$  is as follows:

(11001000)

This means that of every octet of bits (byte) produced by the mother code, only the first two and the fifth are retained and transmitted.

**Coding rate 1/3:** The 8-bit puncturing mask providing the coding rate  $r = \frac{1}{3}$  is as follows:

(11101110)

This means that of every octet of bits (byte) produced by the mother code, the fourth and the eighth are dropped, while the other six are retained and transmitted.

**Coding rate 292/432:** This coding rate is applied to a type-2 block of length 292 bits, producing at the mother encoder output a block of 1 168 bits (146 octets). Here the same 8-bit puncturing mask (11001000) defined for the coding rate  $r = \frac{2}{3}$  can be employed, with a slightly more complex procedure, as follows:

- a) the mask is applied to 22 consecutive octets, thus producing 66 bits, and the last (66-th) bit is further punctured out, so as to remain with 65 encoded bits;
- b) step a) is repeated 6 times, so as to produce 390 encoded bits from  $22 \times 6 = 132$  octets, i.e. 264 type-2 bits;
- c) finally, the mask is applied to the remaining 14 octets at the mother encoder output (corresponding to the last 28 type-2 bits), thus yielding 42 additional encoded bits, that are appended to the previous 390 bits so as to obtain the 432-bit type-3 block.

**Coding rate 148/432:** This coding rate is applied to a type-2 block of length 148 bits, producing at the mother encoder output a block of 592 bits (74 octets). Here the same 8-bit puncturing mask (11101110) defined for the coding rate  $r = 1/3$  can be employed, with a slightly more complex procedure, as follows:

- a) the mask is applied to 6 consecutive octets, thus producing 36 bits, and the last (36-th) bit is further punctured out, so as to remain with 35 encoded bits;
- b) step a) is repeated 12 times, so as to produce 420 encoded bits from  $6 \times 12 = 72$  octets, i.e. 144 type-2 bits;
- c) finally, the mask is applied to the remaining 2 octets at the mother encoder output (corresponding to the last 4 type-2 bits), thus yielding 12 additional encoded bits, that are appended to the previous 420 bits so as to obtain the 432-bit type-3 block.

### 6.8.4.3 Shortened (30,14) Reed-Muller block codes

The shortened (30,14) RM code is used to encode the downlink broadcast blocks (AACH channel) consisting of 14 type-1 bits into 30 type-2 bits. The vector of the 30 type-2 bits is derived by multiplying the input vector of 14 type-1 bit by a generator matrix  $\mathbf{G}$  given below.

$$\mathbf{G} = \mathbf{I}_{14} \begin{bmatrix} 1 & 0 & 0 & 1 & 1 & 0 & 1 & 1 & 0 & 1 & 1 & 0 & 0 & 0 & 0 & 0 \\ 0 & 0 & 1 & 0 & 1 & 1 & 0 & 1 & 1 & 1 & 1 & 0 & 0 & 0 & 0 & 0 \\ 1 & 1 & 1 & 1 & 1 & 1 & 0 & 0 & 0 & 0 & 1 & 0 & 0 & 0 & 0 & 0 \\ 1 & 1 & 1 & 0 & 0 & 0 & 0 & 0 & 0 & 0 & 1 & 1 & 1 & 1 & 0 & 0 \\ 1 & 0 & 0 & 1 & 1 & 0 & 0 & 0 & 0 & 0 & 1 & 1 & 1 & 0 & 1 & 0 \\ 0 & 1 & 0 & 1 & 0 & 1 & 0 & 0 & 0 & 0 & 1 & 1 & 0 & 1 & 1 & 0 \\ 0 & 0 & 1 & 0 & 1 & 1 & 0 & 0 & 0 & 0 & 1 & 0 & 1 & 1 & 1 & 0 \\ 1 & 1 & 1 & 1 & 1 & 1 & 1 & 1 & 1 & 1 & 0 & 1 & 1 & 1 & 1 & 1 \\ 1 & 0 & 0 & 0 & 0 & 0 & 1 & 1 & 0 & 0 & 1 & 1 & 1 & 0 & 0 & 1 \\ 0 & 1 & 0 & 0 & 0 & 0 & 1 & 0 & 1 & 0 & 1 & 1 & 0 & 1 & 0 & 1 \\ 0 & 0 & 1 & 0 & 0 & 0 & 0 & 1 & 1 & 0 & 1 & 0 & 1 & 1 & 0 & 1 \\ 0 & 0 & 0 & 1 & 0 & 0 & 1 & 0 & 0 & 1 & 1 & 1 & 0 & 0 & 1 & 1 \\ 0 & 0 & 0 & 0 & 1 & 0 & 0 & 1 & 0 & 1 & 1 & 0 & 1 & 0 & 1 & 1 \\ 0 & 0 & 0 & 0 & 0 & 1 & 0 & 0 & 1 & 1 & 1 & 0 & 0 & 1 & 1 & 1 \end{bmatrix} \quad (6.3)$$

where  $\mathbf{I}_{14}$  denotes the  $(14 \times 14)$  identity matrix.

### 6.8.4.4 Cyclic Redundancy Check (CRC) block code

The  $(K_1 + 16, K_1)$  code encodes  $K_1$  type-1 bits  $b_1(1), b_1(2), \dots, b_1(K_1)$  into  $(K_1 + 16)$  type-2 bits  $b_2(1), b_2(2), \dots, b_2(K_1 + 16)$ . The encoding rule is as follows:

The type-1 bits are treated as the coefficients of the polynomial:

$$M(X) = \sum_{k=1}^{K_1} b_1(k) X^{K_1-k} \quad (6.4)$$

Let  $F(X)$  be:

$$F(X) = \left[ (X^{16} M(X) + X^{K_1} \sum_{i=0}^{15} X^i) \bmod G(X) \right] + \sum_{i=0}^{15} X^i \quad (6.5)$$

where all operations are meant modulo 2, and  $G(X)$  is the generator polynomial of the code:

$$G(X) = X^{16} + X^{12} + X^5 + 1 \quad (6.6)$$

$F(X)$  is of degree 15, with co-efficients denoted by  $f(0), f(1), \dots, f(15)$ :

$$F(X) = \sum_{i=0}^{15} f(i) X^i \quad (6.7)$$

The  $K_2$  type-2 bits, with  $K_2 = K_1 + 16$ , are then given by:

$$b_2(k) = b_1(k) \quad \text{for } k = 1, 2, \dots, K_1, \text{ and}$$

$$b_2(k) = f(K_1 + 16 - k) \quad \text{for } k = K_1 + 1, K_1 + 2, \dots, K_1 + 16. \quad (6.8)$$

## 6.8.5 Coding for QAM channels

### 6.8.5.0 General

As is seen from figure 6.14, three different types of codes are used on QAM channels:

- 1) burst payload data bits are first passed through a CRC encoder providing redundant bits for error detection capability;
- 2) the payload data bits equipped with CRC bits may be encoded by means of a Parallel Concatenated Convolutional Code (PCCC) very similar to that used by 3GPP, to provide robustness against noise, interference, nonlinear distortion and other channel impairments; there are also cases in which the payload data bits after the CRC block are left uncoded (clauses 6.8.3.4 to 6.8.3.6);
- 3) the header section of the burst (when present) is encoded by means of a Reed-Muller block code prior to interleaving, with no CRC protection.

The above encoding procedures are summarized in figure 6.15. The sizes of the input and output data blocks depend on the logical channel they are associated with, on the modulation format and the PCCC coding rate employed (clause 6.8.3).

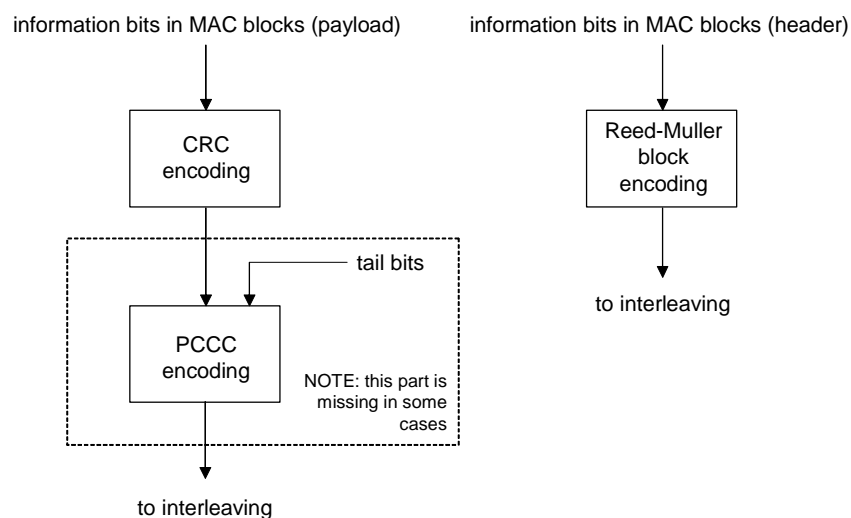

**Figure 6.15: Encoding levels for QAM channels**

The CRC code is the same for all types of burst payload and is identical to that discussed in clause 6.8.4.4 and will not be pursued here any further. The PCCC code for burst payloads and the block code for burst headers are described in detail in clauses 6.8.5.1 and 6.8.5.2.

## 6.8.5.1 8-state Parallel Concatenated Convolutional Code (PCCC) for QAM

### 6.8.5.1.0 PCCC encoding

With reference to figure 6.15, the PCCC block is used to encode the binary data block at the output of the CRC encoder. The PCCC encoder structure is shown in figure 6.16. The input binary data block is fed to two identical Recursive Systematic Convolutional (RSC) encoders, called constituent encoders, one processing the bits in their natural order of presentation, the other processing an interleaved version of the same block produced by the inner interleaver. Three tail bits are appended to each of the two blocks (original and interleaved) so as to force the final state of the respective RSCs to zero. The initial state of both constituent encoders is zero. More specifically, as sketched in figure 6.16, PCCC encoding is performed in five steps:

- encoding the input bits plus 3 tail bits by an 8-state RSC encoder of rate 1/2 (the upper RSC encoder in figure 6.16);
- interleaving the input bits by means of a quadratic-congruence inner interleaver;
- encoding the interleaved bits plus 3 tail bits by means of a second 8-state RSC encoder of rate 1/2 identical to the encoder in a) (the lower RSC encoder in figure 6.16), and retaining only the parity bits;
- merging together the systematic bits and the parity bits, so as to produce an encoded data block with coding rate 1/3;
- puncturing the bits in the above encoded data block so as to obtain an overall coding rate 1/2 or 2/3.

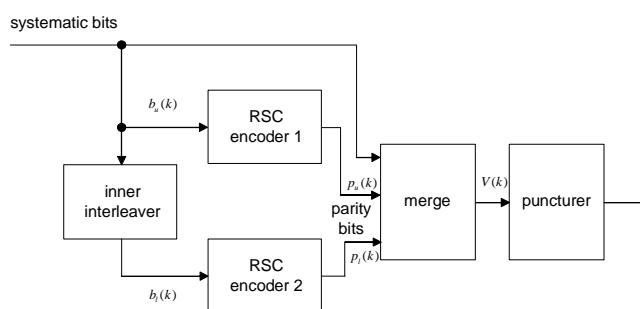

**Figure 6.16: PCCC encoder**

A more detailed description of the above five encoding steps is given in clauses 6.8.5.1.1 to 6.8.5.1.7.

#### 6.8.5.1.1 Encoding by the upper 8-state RSC encoder of rate 1/2

The RSC upper encoder structure is shown in figure 6.17. Here the summing blocks are binary modulo 2 adders. Let the input sequence of systematic bits be denoted as  $b_u(k)$ ,  $k = 1, 2, \dots, K$ . Initially the encoder state ( $s_2, s_1, s_0$ ) is zero, i.e. the bits stored in the shift register of figure 6.17 are all set to zero,  $s_2 = s_1 = s_0 = 0$ , and the switch is in the position 1. Then the input to the RSC encoder of the  $k$ -th bit implies the output of two bits, the first being the same bit applied at the input (systematic bit), the second (parity bit) produced by the encoder and denoted as  $p_u(k)$ ,  $k = 1, 2, \dots, K$ . After the last input bit is processed, there are  $K$  parity bits in addition to the  $K$  systematic bits. As final step, the RSC encoder is again forced to the zero state by applying to its input three additional bits, called termination bits and denoted as  $b_u(K+1)$ ,  $b_u(K+2)$ ,  $b_u(K+3)$ , that are chosen according to the particular state the encoder is left in after application of the last input bit. As is easily verified, the encoder is properly terminated by taking as termination bits the bits emerging from the shift register output, i.e. by setting the switch to position 2 and running the encoder for three additional steps. The additional three parity bits produced in response to the termination bits are denoted as  $p_u(K+1)$ ,  $p_u(K+2)$ ,  $p_u(K+3)$ .

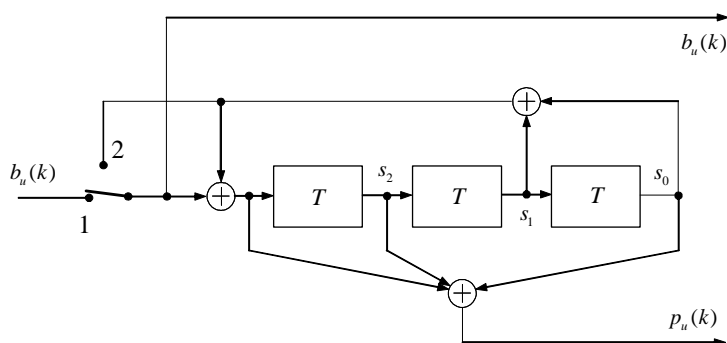

Figure 6.17: RSC encoder

It is easily seen that the tail bits have to be chosen according to table 6.14.

Table 6.14: Tail bits for the RSC encoder

Encoder state ( $s_2, s_1, s_0$ )	Tail bits $b_u(K+1), b_u(K+2), b_u(K+3)$
000	000
001	100
010	110
011	010
100	011
101	111
110	101
111	001

### 6.8.5.1.2 Interleaving by the quadratic-congruence interleaver

The task of the quadratic-congruence block interleaver is to re-order the sequence of bits  $b_u(k)$ ,  $k = 1, 2, \dots, K$  at the input of the PCCC encoder into permuted bits  $b_l(k)$ ,  $k = 1, 2, \dots, K$  by means of the following two-step algorithm:

- a) first, the sequence of indices  $c_m$ ,  $m = 0, 1, \dots, S-1$  is calculated, where  $S$  is the smallest power of 2 larger or equal than  $K$ , as follows:

$$c_0 = 0, \text{ and}$$

$$c_m = [c_{m-1} + m] \text{ mod } S, m = 1, 2, \dots, S-1 \quad (6.9)$$

- b) second, the  $K$  input bits  $b_u(1), b_u(2), \dots, b_u(K)$ , undergo the following procedure:

flag ← false

$i \leftarrow 0$

while  $i \leq \frac{(S-2)}{2}$

$x \leftarrow c_{i+1}$

$y \leftarrow [c_i + \frac{S}{2}] \text{ mod } S$

if ( $x < K$  and  $y < K$ )

swap bits  $b_u(x+1)$  and  $b_u(y+1)$

else if ( $x < K$  and  $y \geq K$ )

if (flag = true)

swap bits  $b_u(x+1)$  and  $b_u(t+1)$  (6.10)

```

    flag←false
else
    t ← x
    flag←true
else if (x ≥ K and y < K)
    if (flag = true)
        swap positions  $b_u(y + 1)$  and  $b_u(t + 1)$ 
        flag←false
    else
        t ← y
        flag←true
i ← i + 1

```

Upon completion of the above procedure, the input sequence of bits  $b_u(1), b_u(2), \dots, b_u(K)$  is turned into the sequence of interleaved bits  $b_l(1), b_l(2), \dots, b_l(K)$ .

As is easily recognized, the above interleaving technique permits on-the-fly operation, i.e. the interleaved bit positions are calculated in real time as the interleaving procedure goes on, with no need to pre-store them in memory. This permits to save on memory size.

#### 6.8.5.1.3 Encoding the interleaved bits by the lower 8 state RSC encoder of rate 1/2

The interleaved bits  $b_l(1), b_l(2), \dots, b_l(K)$  are fed to the lower RSC encoder, that is identical to the upper RSC encoder depicted in figure 6.17. After encoding of the above interleaved bits,  $K$  parity bits are generated, denoted as  $p_l(1), p_l(2), \dots, p_l(K)$ . As next step, three termination bits,  $b_l(K + 1), b_l(K + 2), b_l(K + 3)$ , are applied to the encoder input, whose function is to force the encoder to final zero state. These termination bits can be obtained from table 6.14 as for the upper RSC encoder or using a switch as indicated in figure 6.17. The termination bits generate three additional parity bits denoted as  $p_l(K + 1), p_l(K + 2), p_l(K + 3)$ .

Only the sequence of parity bits is taken into account for the lower RSC encoder, and is merged with the systematic and parity bits from the upper encoder prior to puncturing.

#### 6.8.5.1.4 Merging the systematic and parity bits for the PCCC encoder

The systematic and parity bits from the upper RSC encoder are merged together with the parity bits of the lower RSC encoder so as to generate a single sequence of  $3(K + 3)$  bits, denoted  $V(k), k = 1, 2, \dots, 3(K + 3)$ , as follows:

$$\{V(k)\}_{k=1}^{3(K+3)} \equiv \{b_u(1), p_u(1), p_l(1), b_u(2), p_u(2), p_l(2), \dots, b_u(K + 3), p_u(K + 3), p_l(K + 3)\} \quad (6.11)$$

In other words, the coded sequence  $V(k), k = 1, 2, \dots, 3(K + 3)$  is built as an orderly arrangement of  $K + 3$  groups of three-bit binary words, the  $i$ -th word comprising (in this exact order): the  $i$ -th systematic bit from the upper RSC encoder, the  $i$ -th parity bit from the upper RSC encoder and the  $i$ -th parity bit from the lower RSC encoder,  $i = 1, 2, \dots, K + 3$ .

#### 6.8.5.1.5 Puncturing scheme for the PCCC encoder

Code puncturing consists of deleting (and avoiding transmitting) part of the parity bits produced by an encoder, so as to reduce the coding rate and improve the overall system spectrum efficiency. In the case at hand, if no puncturing were carried out, the resulting coding rate would be 1/3, since  $K + 3$  input (systematic) bits have given rise to  $2(K + 3)$  parity bits, half of which produced by the upper RSC encoder, the other half by the lower RSC encoder. The above coding rate however is not permitted by the standard, the only available coding rates with PCCC being 1/2 and 2/3, both requiring puncturing of the sequence (6.11).

The fraction of bits to be punctured out from the sequence  $V(k)$ ,  $k = 1, 2, \dots, 3(K + 3)$  is called *puncturing ratio*, and is given by  $1 - (3r)^{-1}$ , where  $r \geq \frac{1}{3}$  is the desired coding rate after puncturing. To obtain  $r = \frac{1}{2}$ , the puncturing ratio is  $1/3$ , i.e. one bit out of three is punctured out from the sequence  $V(k)$ ,  $k = 1, 2, \dots, 3(K + 3)$ . Likewise, to have  $r = \frac{2}{3}$ , the puncturing ratio is  $1/2$ , i.e. half of the bits in the sequence  $V(k)$ ,  $k = 1, 2, \dots, 3(K + 3)$  are to be dropped.

Puncturing is carried out by means of a 12-bit puncturing mask, i.e. a sequence of 12 bits in which the number of bits set to zero determine the puncturing ratio. The mask is iteratively applied to consecutive 12-bit segments of the sequence  $V(k)$ ,  $k = 1, 2, \dots, 3(K + 3)$ , and only the bits of the latter sequence coinciding with the ones in the puncturing mask are retained. If the number of bits in the sequence  $V(k)$ ,  $k = 1, 2, \dots, 3(K + 3)$  is not a multiple of 12, the last segment of the sequence will contain less than 12 bits. In this case the puncturing mask is applied with the usual rule up to the last available bit.

#### 6.8.5.1.6 Puncturing mask for the PCCC encoder with coding rate 2/3

The 12-bit puncturing mask providing the coding rate  $r = \frac{2}{3}$  is as follows:

(110100101100)

#### 6.8.5.1.7 Puncturing mask for the PCCC encoder with coding rate 1/2

The 12-bit puncturing mask providing the coding rate  $r = \frac{1}{2}$  is as follows:

(110101110101)

It is observed that in this case the first and second half of the puncturing mask are identical, i.e. a 6-bit mask could be employed instead of a 12-bit mask. However, this is not done for uniformity with the  $r = \frac{2}{3}$  case.

### 6.8.5.2 (16,5) Reed-Muller (RM) code for QAM

The (16,5) Reed-Muller (RM) code is used to encode channels using the header section of the burst (clauses 6.8.3.1 to 6.8.3.3). Letting  $[b_i(1), b_i(2), \dots, b_i(5)]$  denote the vector of input bits to the encoder, they are encoded into a 16-bit output vector, as follows:

$$[b_o(1), b_o(2), \dots, b_o(16)] = [b_i(1), b_i(2), \dots, b_i(5)] \times \mathbf{G}, \quad (6.12)$$

where  $\mathbf{G}$  is the code generator matrix:

$$\mathbf{G} = \begin{bmatrix} 0 & 1 & 1 & 1 & 0 & 1 & 1 & 1 & 1 & 0 & 0 \\ 0 & 0 & 0 & 0 & 1 & 1 & 1 & 1 & 1 & 1 & 1 \\ \mathbf{I}_5 & 1 & 1 & 1 & 0 & 0 & 0 & 0 & 1 & 1 & 1 \\ 1 & 0 & 1 & 1 & 1 & 0 & 1 & 0 & 1 & 0 & 1 \\ 1 & 1 & 0 & 1 & 1 & 1 & 0 & 0 & 1 & 1 & 0 \end{bmatrix} \quad (6.13)$$

$\mathbf{I}_5$  denoting the  $(5 \times 5)$  identity matrix.

## 6.8.6 Interleaving for phase modulation

The interleaving methods used for high-speed  $\pi/8$ -D8PSK logical channels are unchanged from those used in the original TETRA  $\pi/4$ -DQPSK logical channels. Two methods are used, depending on the logical channel:

- Re-ordering  $K_3$  type-3 bits  $b_3(1), b_3(2), \dots, b_3(K_3)$  into  $K_4$  type-4 bits  $b_4(1), b_4(2), \dots, b_4(K_4)$ , with  $K=K_3=K_4$  at the output of the convolutional encoder (figure 6.6). The re-ordering is carried out in the following way:

$$b_4(k) = b_3(i), \quad i = 1, 2, \dots, K \quad (6.14)$$

with  $k = 1 + ((a \times i) \bmod K)$ .

- b) Interleaving over  $N$  blocks using two steps to interleave a sequence of  $M$  type-3 blocks  $B_3(1), B_3(2), \dots, B_3(M)$  of 432 bits each into a sequence of  $(M+N-1)$  type-4 blocks  $B_4(1), B_4(2), \dots, B_4(M+N-1)$  of 432 bits each, where  $M$  is an integer and  $N$  has values 1, 4, or 8. This interleaving is carried out as follows. Firstly, a diagonal interleaver interleaves the  $M$  blocks  $B_3(1), B_3(2), \dots, B_3(M)$  into  $(M+N-1)$  blocks  $B'_3(1), B'_3(2), \dots, B'_3(M+N-1)$ . Denoting by  $b'_3(m, k)$  the  $k$ -th bit of block  $B'_3(m)$ , with  $k = 1, 2, \dots, 432$  and  $m = 1, 2, \dots, M+N-1$ :

$$\begin{aligned} b'_3(m, k) &= b_3(m-j, j+1+(i \times N)) && \text{for } 1 \leq m-j \leq M \\ b'_3(m, k) &= 0 && \text{otherwise;} \end{aligned} \quad (6.15)$$

with  $j = (k-1) \text{ div } (432/N)$ , and  $i = (k-1) \text{ mod } (432/N)$ .

A block interleaver then interleaves each block  $B'_3(m)$  into type-4 block  $B_4(m)$ ,  $m = 1, 2, \dots, M+N-1$ :

$$b_4(m, i) = b'_3(m, k) \quad (6.16)$$

with  $k = 1, 2, \dots, 432$ , and  $i = 1 + ((103 \times k) \text{ mod } 432)$ .

## 6.8.7 Interleaving for QAM channels

Bit interleaving for QAM channels is based on a linear-congruence approach. Like the quadratic-congruence inner interleaver of the PCCC encoder (clause 6.8.5.1.2), this quality permits on-the-fly operation, i.e. the interleaved bit positions are calculated in real time as the interleaving procedure goes on, with no need to pre-store them in memory. This is useful for memory size saving.

The interleaver operates on a block of bits emerging from a CRC, PCCC or Reed-Muller encoder (see figure 6.15) and maps it on another binary block of the same length with permuted-order bits. A linear-congruence block interleaver is defined by two parameters, namely the block length  $K$  and a positive integer  $a$ . Specifically, a  $(K, a)$  block interleaver reorders  $K$  input bits  $q_i(1), q_i(2), \dots, q_i(K)$  into  $K$  bits  $q_o(1), q_o(2), \dots, q_o(K)$  according to the following rule:

$$q_o(k) = q_i(i), \quad i = 1, 2, \dots, K, \text{ with } k = 1 + (a \times i) \text{ mod } K \quad (6.17)$$

The values of  $K$  and  $a$  for the various logical channels, bandwidths and modulation formats are specified in table 6.15, relevant to logical channels mapping on burst headers, and table 6.16, relevant to logical channels mapping on burst payloads. Detailed error control schemes for logical channels for QAM can be found in clause 6.8.3. The last row of table 6.15 means that the block-encoded bits relevant to logical channels SICH-Q/D and AACH-Q are merged together (as indicated in clauses 6.8.3.2 and 6.8.3.3) and then interleaved.

**Table 6.15: Values of  $K$  and  $a$  for logical channels mapping on burst headers, for any bandwidth**

Logical channel	4/16/64-QAM
SICH-Q/U	$K=16, a=5$
SICH-Q/D + AACH-Q	$K=64, a=9$

Table 6.16: Values of  $K$  and  $a$  for logical channels mapping on burst payloads

Bandwidth	Logical channel	4-QAM	16-QAM	64-QAM
25 kHz	SCH-Q/HU	$K=152, a=13$	$K=304, a=17$	$K=456, a=23$
	SCH-Q/U	$K=400, a=21$	$K=800, a=29$	$K=1\ 200, a=37$
	SCH-Q/D, BNCH-Q	$K=408, a=23$	$K=816, a=29$	$K=1\ 224, a=35$
	SCH-Q/RA	$K=168, a=13$	-	-
	BSCH-Q	$K=272, a=19$	-	-
50 kHz	SCH-Q/HU	$K=320, a=17$	$K=640, a=27$	$K=960, a=31$
	SCH-Q/U	$K=816, a=29$	$K=1\ 632, a=41$	$K=2\ 448, a=49$
	SCH-Q/D, BNCH-Q	$K=880, a=29$	$K=1\ 760, a=41$	$K=2\ 640, a=53$
	BSCH-Q	$K=272, a=19$	-	-
	SCH-Q/B	$K=472, a=21$	-	-
100 kHz	SCH-Q/HU	$K=656, a=25$	$K=1\ 312, a=37$	$K=1\ 968, a=47$
	SCH-Q/U	$K=1\ 648, a=41$	$K=3\ 296, a=57$	$K=4\ 944, a=71$
	SCH-Q/D, BNCH-Q	$K=1\ 824, a=43$	$K=3\ 648, a=61$	$K=5\ 472, a=73$
	BSCH-Q	$K=272, a=19$	-	-
	SCH-Q/B	$K=1\ 416, a=37$	-	-
150 kHz	SCH-Q/HU	$K=992, a=33$	$K=1\ 984, a=45$	$K=2\ 976, a=55$
	SCH-Q/U	$K=2\ 480, a=49$	$K=4\ 960, a=71$	$K=7\ 440, a=89$
	SCH-Q/D, BNCH-Q	$K=2\ 768, a=53$	$K=5\ 536, a=75$	$K=8\ 304, a=91$
	BSCH-Q	$K=272, a=19$	-	-
	SCH-Q/B	$K=2\ 360, a=49$	-	-

## 6.8.8 Scrambling

### 6.8.8.1 General

Scrambling code is applied at the BS to coded and interleaved (type-4) bits of the transmit digital stream to distinguish that BS from other BSs. Following the initial frequency and slot synchronization by an MS on a CA cell, through the training sequence contained within the synchronization burst, the MS receives the BSCH (with a predefined scrambling code). Similarly, following the initial frequency and slot synchronization by an MS on a DA cell, through the QAM Frequency Correction Burst (FCB), the MS receives the BSCH-Q (with a predefined scrambling code). The BSCH and the BSCH-Q contain a scrambling code comprising "colour code" plus MNI (Mobile Network Identity). This scrambling code is used by the MS to descramble the contents of all other logical channels transmitted by that BS. Use of the correct scrambling code by the MS prevents the decoding of signalling information (other than the BSCH or BSCH-Q) transmitted by adjacent cells.

### 6.8.8.2 Scrambling method

Scrambling transforms  $K_4$  type-4 bits  $b_4(1), b_4(2), \dots, b_4(K_4)$  into  $K_5$  type-5 bits  $b_5(1), b_5(2), \dots, b_5(K_5)$ , with  $K_5 = K_4$ , as follows:

$$b_5(k) = b_4(k) + p(k) \quad \text{for } k = 1, 2, \dots, K_5 \quad (6.18)$$

where the addition is meant modulo 2, and  $p(k)$  is the  $k$ -th bit of the scrambling sequence.

The scrambling sequence is generated from the 30 bits of the extended colour code  $e(1), e(2), \dots, e(30)$  (see clause 23 of ETSI EN 300 392-2 [i.2]), by means of linear feedback registers. For the scrambling of BSCH and BSCH-Q, all bits  $e(1), e(2), \dots, e(30)$  are set equal to zero. For details of the scrambling sequence see clause 8.2.5 of ETSI EN 300 392-2 [i.2].

NOTE 1: The normal extended colour code is applied to the SCH/HD or BNCH contained in the second half of the synchronization burst, although it is sent in the same burst as BSCH. The normal extended colour code is also applied to AACH, even when it is sent in the same burst as BSCH.

NOTE 2: The normal extended colour code is applied to SCH-Q/B, although it is sent in the same burst as BSCH-Q. The normal extended colour code is also applied to AACH-Q and SICH-Q/D, even when they are sent in the same burst as BSCH-Q.

## 6.9 Synchronization and channel estimation

### 6.9.1 Frequency and time synchronization

#### 6.9.1.1 Requirements

##### 6.9.1.1.1 BS requirements

The frequency accuracy of the BS single frequency source is required to be better than  $\pm 0,2$  ppm ( $\pm 0,1$  ppm for frequencies above 520 MHz) for both RF frequency generation and clocking the timebase. A single source is to be used for all channels of the BS to ensure that different channels transmitted by the BS are frequency synchronized.

Furthermore, for time synchronization purposes, different channels transmitted by the BS have to be controlled by the same set of counters. The timing difference between the start of timeslots transmitted on different channels is required to be less than  $125/9$   $\mu$ s. This includes carriers that are carrying eccentric channels.

NOTE 1: When an MS moves to an eccentric channel within the cell, the timing difference seen by the MS depends additionally on the difference between its distance from the eccentric channel's transmitter site and its distance from the main carrier's transmitter site.

NOTE 2: The TETRA standard ETSI EN 300 392-2 [i.2] supports up to a maximum separation of 4 km between the eccentric channel's transmitter site and the main carrier's transmitter site.

In a TETRA network, it is not mandatory to synchronize the timebase counters of different BSs. However, in case of timesharing of the same channel by different BSs, the timing difference between the timebase references of any BS pair is required to be less than  $250/9$   $\mu$ s.

##### 6.9.1.1.2 MS requirements

The frequency accuracy of the MS is required to be within  $\pm 100$  Hz of the signals received from the BS. Note that the reference signal includes the BS frequency errors and the Doppler shift experienced in transmission to the MS. The received signals from the BS should be averaged over a sufficiently long time such that noise and interference errors are allowed for within the above  $\pm 100$  Hz.

The internal timebase of the MS is required to be adjusted to that of the signals received from the BS with a timing difference not exceeding  $125/9$   $\mu$ s. If the timing difference exceeds this figure, the MS should adjust its timebase in steps of not greater than  $125/9$   $\mu$ s at intervals of not less than 1 s and not greater than 3 s until the timing difference falls below  $125/9$   $\mu$ s. The error in assessment of the timing of the received BS signals should be less than  $125/18$   $\mu$ s.

The above frequency and timing accuracies are required to be met at 3 dB below the reference sensitivity level and 3 dB less carrier to interference ratio than the reference interference ratio. Both references are defined in clause 6 of ETSI EN 300 392-2 [i.2]. The static or dynamic reference sensitivity levels used depend on the applied propagation conditions.

When the MS obeys a channel allocation for an eccentric channel on the current cell, and when it moves from an eccentric channel, the timing difference perceived by the MS on the new channel relative to the old channel may be up to  $\pm 250/9$   $\mu$ s (caused by BS timing imperfections and geographical delay) in addition to any further propagation delay effects. See also clause 6.9.1.1.1.

#### 6.9.1.2 Synchronization on a CA cell

##### 6.9.1.2.1 Initial synchronization via $\pi/4$ -DQPSK plus $\pi/8$ -D8PSK - CA

At power-up, Conventional Access (CA) MSs whether intended to move to a high-speed channel or not obtain initial synchronization via the  $\pi/4$ -DQPSK synchronization burst (BSCH logical channel). The BSCH is transmitted regularly on frame 18 of phase modulated channels (or in any frame of an unallocated channel) in the downlink direction. The BSCH enables the MS to synchronize itself to the BS and if necessary correct its frequency standard to be in line with that of the BS. The MS synchronization requirements are given in clause 6.9.1.1.2. The signals sent by the BS for these purposes are frequency correction signals and synchronization signals.

The timings of timeslots, TDMA frames and multiframe are all related to a common set of counters which run continuously whether the MS and BS are transmitting or not. Thus, once the MS has determined the correct setting of these counters, all its processes are synchronized to the current serving BS. The MS has to time its transmissions to the BS in line with those received from the BS. This process is called "mobile timebase adjustment".

For timing counter details see clause 7.3 of ETSI EN 300 392-2 [i.2] (for phase modulation channels) and clause 7.5 of ETSI EN 300 392-2 [i.2] (for QAM channels).

The  $\pi/8$ -D8PSK modulated HSD channels continue to maintain synchronization in the same way as the  $\pi/4$ -DQPSK modulated channels using the frame 18. However, a different method for refinement of synchronization in QAM PDCHs is used, as described in clause 6.9.1.2.2.

#### 6.9.1.2.2 Fine synchronization in QAM channels - CA

Accurate carrier and symbol synchronization is a prerequisite for correct demodulation and decoding in the receiver. This means that the symbol timing offset  $\tau$  and the carrier frequency offset  $\nu$  of the incoming waveform have to be properly estimated. For CA, a first coarse estimate of the above parameters is carried out using  $\pi/4$ -DQPSK modulated synchronization burst (BSCH logical channel). This permits to restrict the uncertainty intervals to less than a symbol for  $\tau$  and less than around  $\pm 100$  Hz for  $\nu$ . As a further step, the above coarse estimates are refined resorting to a timing recovery algorithm followed by a frequency offset estimator. The synchronization accuracy of these algorithms is required to have minimal or no impact on the receiver MER/BER (message error rate/bit error rate).

With reference to the latter aspect, it may be useful to quantify the receiver performance degradation induced by synchronization errors with the aid of some curves of MER. The MER vs.  $\frac{E_b}{N_0}$  curves presented in figures 6.18 to 6.20 and in figures 6.21 to 6.23 are relevant to the logical channels SCH-Q/D and SCH-Q/HU, respectively. These results were obtained in the following conditions (see annex A for additional details):

- i) the signal bandwidth is  $B = 50$  kHz;
- ii) the modulation format and coding rate is 16-QAM -  $r = \frac{1}{2}$ ;
- iii) the propagation models are TU50-400 MHz, HT200-800 MHz and static;
- iv) timing and frequency synchronization errors are assumed zero-mean uncorrelated Gaussian random variables with various normalized standard deviations, denoted as  $\sigma_\tau/T$  and  $\sigma_\nu T$ , respectively;
- v) channel estimation is based on the Bayesian-in-time linear-interpolation-in-frequency approach outlined in clause B.2;
- vi) the receiver is affected by AWGN with two-sided power spectral density  $\frac{N_0}{2}$ .

It is pointed out that in view of the pure Gaussian model assumed for the synchronization errors, these may occasionally exceed the above mentioned uncertainty intervals (in particular, this is likely to occur often for the frequency error when  $\sigma_\nu T = 0,03$  since the 100 Hz limit is approximately 4 % of the subcarrier baud rate).

The results indicate that the MER performance degradation (compared to error-free synchronization identified by  $\sigma_\tau/T = 0$  and  $\sigma_\nu T = 0$ ) can be kept within fraction of a dB provided that  $\sigma_\nu T$  does not exceed 1 % and jointly  $\sigma_\tau/T$  does not exceed 2-4 %.

To ease synchronization, the TETRA HSD burst format includes the transmission of known training symbols (called synchronization and pilot symbols) at appropriate time-frequency positions in the slot (clause 6.4.3.2). The function of these symbols is to facilitate symbol/frequency synchronization and channel estimation (clause 6.9.2). More specifically, synchronization (S) symbols are transmitted on all subcarriers in the first signalling interval for all types of bursts (NUB, NDB, CB and RAB (and FCB)), whereas in the second interval all subcarriers are occupied by synchronization symbols for the NUB, CB, RAB, and only half subcarriers for the NDB (and FCB). The set of known symbols at the beginning of the burst is called burst *preamble*. In addition, pilot (P) symbols are uniformly arranged throughout the burst. The above nomenclature does not mean necessarily that synchronization has to strictly rely on S symbols, since pilot symbols can contribute to carrier and clock recovery as well.

NOTE: The FCB, which is needed for initial synchronization by DA MSs on a DA cell, includes the synchronization symbols and pilot symbols described above. It also includes frequency correction symbols and an additional set of synchronization symbols; see clause 6.9.1.3.

Comprising known symbols, the transmitted preamble has a predetermined shape and, accordingly, it can be detected by means of a correlator. This permits to jointly achieve burst identification and timing synchronization: at the receiver site, a local replica of the initial burst segment is correlated with the incoming waveform, and the instant when the correlator peaks gives an estimate of the burst time of arrival. The latter estimate can be employed to drive an interpolation circuit producing symbol-rate samples of the entire burst (payload, header and pilot sections) on each subcarrier after the demultiplexer, with small synchronization errors. A possible impairment to the above procedure is represented by the distortion introduced by multipath propagation on the preamble. However, this distortion is usually not so severe to hinder the correlator capability to recognize the preamble embedded in the received waveform, even when the receiver operates in fast fading conditions. Furthermore, the correlator performance is weakly affected by the presence of a residual frequency offset in the incoming waveform. This suggests that symbol timing recovery be the first synchronization task to carry out, followed by frequency synchronization.

Once the timing information has been acquired and the received signal samples are passed through the bank of matched filters, the carrier frequency offset has to be estimated and removed from the samples feeding the decoder. To this end, the same synchronization symbols in the burst preamble can be employed, resorting to the so-called delay and multiply approach. This consists first of removing the modulation from the samples of the burst preamble corresponding to synchronization symbols (this is done by multiplying the sample by the conjugate symbol) and second, averaging the available estimates of the differential phase between consecutive samples over the subcarriers.

As in the previous case, the fading channel may deteriorate the accuracy of the delay-and-multiply frequency recovery algorithm. Further options to improve the estimation performance are based on exploitation of the pilot symbols spread throughout the burst, or on joint channel-frequency estimation. However further details on these techniques are out of the scope of the present document.

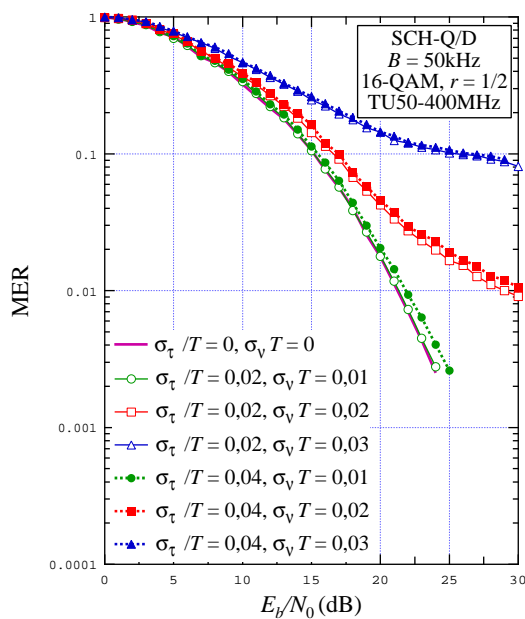

**Figure 6.18: MER vs.  $E_b/N_0$  for  $B = 50$  kHz, SCH-Q/D, 16-QAM  $r = 1/2$ , TU50-400 MHz channel, various combinations of timing and frequency synch. errors**

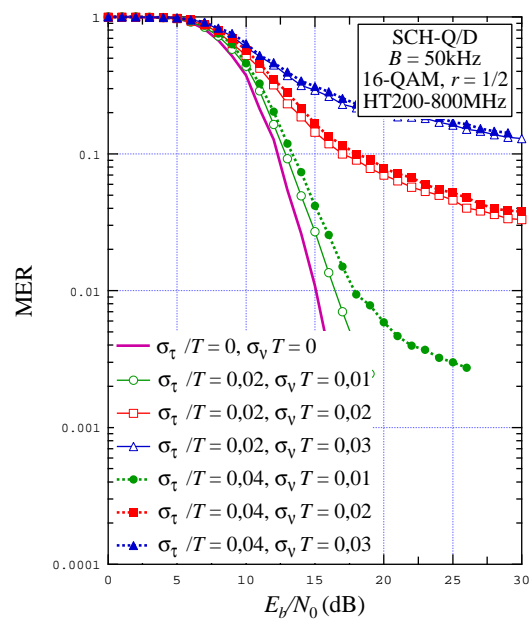

**Figure 6.19: MER vs.  $E_b/N_0$  for  $B = 50$  kHz, SCH-Q/D, 16-QAM  $r = 1/2$ , HT200-800 MHz channel, various combinations of timing and frequency synch. errors**

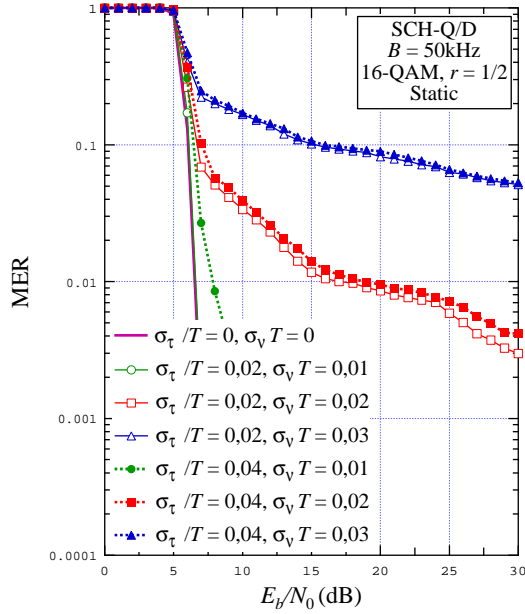

Figure 6.20: MER vs.  $E_b/N_0$  for  $B = 50$  kHz, SCH-Q/D, 16-QAM  $r = 1/2$ , static channel, various combinations of timing and frequency synch. errors

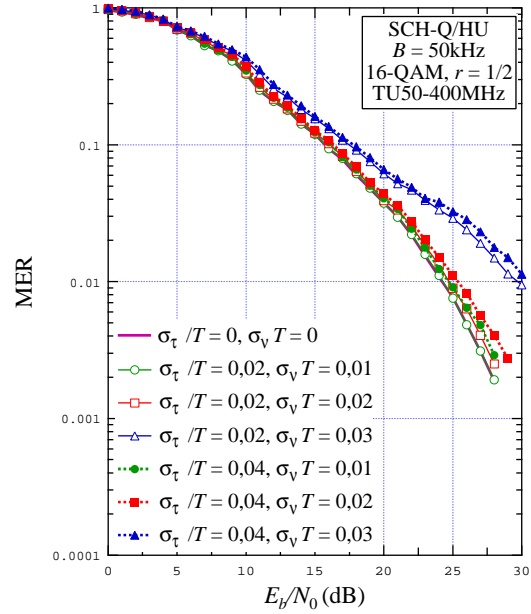

Figure 6.21: MER vs.  $E_b/N_0$  for  $B = 50$  kHz, SCH-Q/HU, 16-QAM  $r = 1/2$ , TU50-400 MHz channel, various combinations of timing and frequency synch. errors

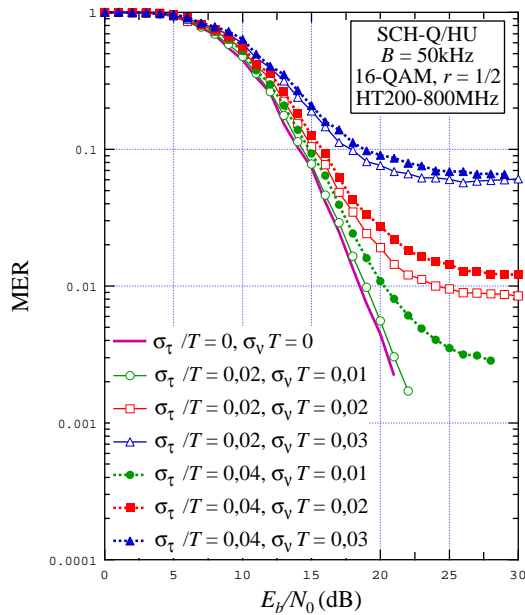

Figure 6.22: MER vs.  $E_b/N_0$  for  $B = 50$  kHz, SCH-Q/HU, 16-QAM  $r = 1/2$ , HT200-800 MHz channel, various combinations of timing and frequency synch. errors

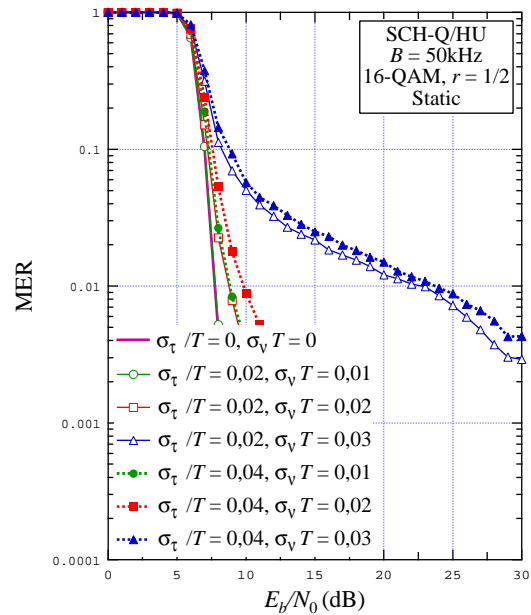

Figure 6.23: MER vs.  $E_b/N_0$  for  $B = 50$  kHz, SCH-Q/HU, 16-QAM  $r = 1/2$ , static channel, various combinations of timing and frequency synch. errors

### 6.9.1.3 Synchronization on a DA cell

At power-up, Direct Access (DA) MSs obtain initial synchronization via the QAM Frequency Correction Burst FCB (BSCH-Q logical channel). The FCB is transmitted regularly in the downlink direction on frame 18 of QAM channels on the DA main carrier; the FCB may also be transmitted during frames 1 to 18 of any QAM channel (on both the DA main carrier and QAM carriers other than the main carrier) and on unallocated QAM channels.

In addition to the synchronization symbols and pilot symbols included in the QAM Normal Downlink Burst (NDB), the FCB contains 60 frequency correction symbols and a set of 8 secondary synchronization symbols; see clause 6.4.3.2.

The FCB enables the MS to synchronize itself to the BS and if necessary correct its frequency standard to be in line with that of the BS. The MS synchronization requirements are given in clause 6.9.1.1.2. The frequency correction symbols enable the MS to obtain frequency synchronization. The synchronization symbols and secondary synchronization symbols, together with the pilot symbols, then enable the MS to obtain time synchronization.

The timings of timeslots, TDMA frames and multiframe are all related to a common set of counters which run continuously whether the MS and BS are transmitting or not. Thus, once the MS has determined the correct setting of these counters, all its processes are synchronized to the current serving BS. The MS has to time its transmissions to the BS in line with those received from the BS. This process is called "mobile timebase adjustment". For timing counter details for QAM channels, see clause 7.5 of ETSI EN 300 392-2 [i.2].

When the DA MS has obtained initial synchronization using the FCB, it may maintain its synchronization on QAM channels using the synchronization symbols and pilot symbols in QAM NDBs and further FCBs, using the same methods as described for CA MSs in clause 6.9.1.2.2.

## 6.9.2 Channel estimation in QAM channels

Thanks to its MultiCarrier (MC) structure, the TETRA HSD signal is known to be particularly resilient to propagation frequency-selective fading. Data transmission occurs simultaneously over a set of  $N$  equally-spaced subcarriers, each suffering only from a (complex-valued) random attenuation (apart from the inter-subcarrier interference due to the spectral overlap between adjacent subcarriers). Therefore, channel (or fading) estimation and equalization prior to the decoding stage reduce to the estimation of the cited attenuations throughout the burst, followed by their removal from the received samples.

This clause briefly overviews Channel Estimation (CE) issues for QAM channels. In annex B two CE schemes with different tradeoffs of complexity versus performance are presented and discussed in detail.

The following assumptions represent a reasonable baseline to develop a CE algorithm for the TETRA HSD context:

- 1) Timing and frequency synchronization has been already accomplished using, e.g. one of approaches outlined in clause 6.9.1.2 or clause 6.9.1.3.
- 2) The channel is selective both in the time and frequency domains. In particular, the relative motion between the BS and MS produces time-variance of the channel (time-selectivity), with a Doppler bandwidth normalized to the baud rate up to around 0,06 (this occurring with carrier frequency 800 MHz and mobile speed 200 km/h).
- 3) In any case the above Doppler bandwidth is such that, over the generic subcarrier, the fading process remains nearly constant (i.e. flat) within a symbol interval, and varies significantly only within a few to several symbol intervals.
- 4) The channel delay spread and the power distribution over the channel paths are such that the fading process remains nearly constant (i.e. flat) in the frequency domain across each subcarrier for a fixed signalling interval.
- 5) For simplicity, the frequency overlap between adjacent subcarriers will be ignored in the considerations below. Anyway, simulation results in clause 9 are obtained in realistic conditions, i.e. encompassing the impact of Inter-Carrier Interference (ICI) as well.

In view of the above assumptions, the generic sample out of the polyphase filter-bank can be written as:

$$x_{n,k} = \alpha_{n,k} c_{n,k} + w_{n,k}, \quad n = 0, 1, \dots, N - 1, \quad k = 0, 1, \dots, K - 1, \quad (6.19)$$

where  $N$  and  $K$  denote the number of subcarriers and the burst length (in symbols), respectively,  $\alpha_{n,k}$  is the complex-valued two-dimensional fading process to be estimated,  $c_{n,k}$  is the  $k$ -th symbol on the  $n$ -th subcarrier and  $w_{n,k}$  is AWGN.

Among all symbols  $c_{n,k}$  in (6.19), the synchronization (S) and pilot (P) symbols feature constant energy, i.e. all of these known symbols belong to a circle of constant radius, such that their energy equals the average energy of payload symbols. Depending on type (NUB, NDB, FCB, CB or RAB) and bandwidth (25 kHz, 50 kHz, 100 kHz or 150 kHz) of the burst, the arrangement of S and P symbols is similar to that shown in the examples of clause 6.4.3.2. Modulation from each sample  $x_{n,k}$  corresponding to a S or P location can be removed by dividing this sample by the corresponding symbol. This leads to a noisy estimate  $\hat{\alpha}_{n,k}$  of the two-dimensional fading process  $\alpha_{n,k}$  at the S and P locations, the estimation noise remaining stationary after the above division in view of the constant modulus of the S or P symbols. The above raw sequence of estimates  $\hat{\alpha}_{n,k}$  may then require some filtering to smooth out the effects of noise and interference. As a final step, the filtered estimates are used to evaluate the fading process at the data symbol locations throughout the burst, both in the time (symbol interval) and frequency (subcarrier) domains.

Several algorithms can be employed to achieve the above goal, with different performance-versus-complexity tradeoffs. The conceptually simplest yet reasonably accurate method is based on linear interpolation both in the time and frequency domains (as outlined in clause B.1). The approach is not computationally demanding but exhibits apparent performance limits when operating in fast fading conditions. A more accurate algorithm, albeit considerably more complex than the interpolation-based CE, is based on a Bayesian-in-time linear-interpolation-in-frequency approach (see clause B.2 for details).

## 6.10 Power control

Adaptive power control is only used by the MS. It is based on adjusting the RF transmit power, in order to ensure that the required quality of transmission is achieved with the least possible radiated power. Two types of power control are used:

- 1) Open loop: This is the default mechanism used by the MS to control its transmit power.
- 2) Closed loop: In this type, MS power changes are controlled via BS signalling.

Power control function results in the following advantages:

- reduction of power consumption (battery saving) in the MS;
- reduction of interference (co-channel and adjacent channel) in the TETRA network;
- reduction of interference to other nearby networks.

This function is managed by the MS during the initial access, and by the MS or BS during operational use. For more details on this function see clause 7.4.4.6.

## 6.11 Link adaptation in TETRA high speed channels

Link adaptation may be used by the BS and MS to improve usage of the channel. This is achieved by the BS and/or MS transmitters changing the modulation type and/or coding rate according to link conditions. Link adaptation is permitted on both D8PSK and QAM channels:

- 1) D8PSK channel: Link adaptation is achieved by choosing a  $\pi/4$ -DQPSK burst or a  $\pi/8$ -D8PSK burst on a slot-by-slot basis.
- 2) QAM channel: Link adaptation is carried out by selecting the modulation type (4-QAM, 16-QAM and 64-QAM) and/or coding rate (1/2, 2/3, 1) according to permissible combinations of modulation type and coding rate, given in clause 9.1. This is carried out on a slot-by-slot basis.

Link adaptation methods may include measurements of the radio link quality at the BS and the MS. It may also require the use of BS-MS link adaptation signalling to send radio link quality feedback between the two ends.

For further details on link adaptation refer to clause 7.5.

---

## 7 Higher layer protocol

### 7.1 Protocol architecture

#### 7.1.1 General packet data aspects

The TETRA standard provides TETRA Mobile Stations (MSs) with the means to support Internet Protocol (IP) packet data via the Subnetwork Dependent Convergence Protocol layer (SND CP) and the Multimedia Exchange layer (MEX). Packet data may be used by applications running directly within the MS and may be used by external data terminals that connect with the MS via the Peripheral Equipment Interface (PEI); in the latter case the PEI conveys packet data between the application and the MS. In either case, MEX may be used to control the relative volume of different packet data flows into SND CP in those cases where packet data flow is constrained by air-interface bandwidth limitations.

Access by packet data to the radio interface is controlled by SND CP. SND CP negotiates Quality of Service (QoS) requirements with the Switching and Management Infrastructure (SwMI) on behalf of each packet data application and obtains a suitable radio channel for the exchange of packet data between the MS and the Base Station (BS). Multiple MSs may share a Packet Data CHannel (PDCH). MSs contend for resource on the shared PDCH; the BS then allocates resource to individual MSs. MSs may request varying data priority levels for access to PDCH resource. In addition, the scheduled access service provides a method for MSs to transmit regularly-recurring intermittent data without repeated resource contention.

NOTE: The SwMI is the fixed part of the TETRA network, including BSs.

#### 7.1.2 Architecture of the TETRA protocol stack

Figure 7.1 illustrates the architecture of the TETRA protocol stack.

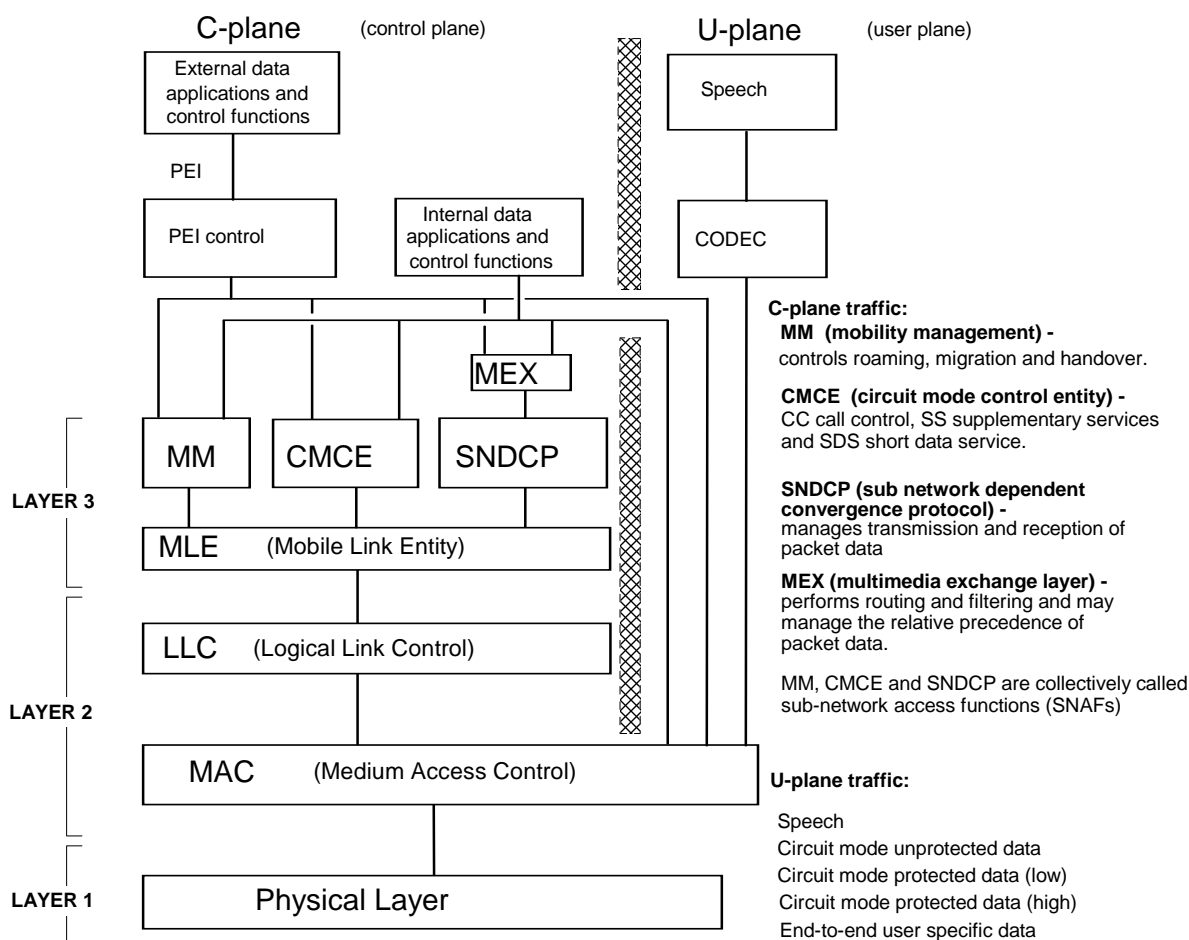

**Figure 7.1: Simplified TETRA MS protocol stack**

The Control plane (C-plane) corresponds to the signalling information, both control messages and packet data. The User plane (U-plane) corresponds to circuit mode voice and circuit mode data plus end-to-end user signalling information and encryption synchronization information. The separation of the C-plane and U-plane information takes place above the Medium Access Control layer; for example, incoming U-plane traffic is routed to the U-plane application (e.g. the speech CODEC) whilst C-plane information continues up the protocol stack.

The network layer (layer 3) is applicable only to the C-plane. It is divided into two sublayers containing the subnetwork access functions and the Mobile Link Entity. The subnetwork access functions provide the following services:

- a) The Mobility Management (MM) entity performs procedures for:
  - registration and de-registration of an MS;
  - attachment and detachment of group identities;
  - requesting energy saving mode or direct mode dual watch operation; and
  - moving to direct mode and returning to trunking mode operation.
- b) The Circuit Mode Control Entity (CMCE) performs procedures for transmission and reception of:
  - control information for circuit mode services;
  - control information for call-related and call-unrelated supplementary service messages; and
  - call-unrelated short data messages.
- c) The Subnetwork Dependent Convergence Protocol layer (SNDCP) provides the packet data services; it:
  - establishes the QoS requirements of individual packet data flows;

- buffers data packets from multiple applications; and
- controls the packet data transfer between MS and SwMI.

The Mobile Link Entity (MLE) has three main functions. It:

- multiplexes signalling messages from layer 2 into the MM, CMCE and SNDPCP entities;
- evaluates and replaces the radio resource i.e. it selects a new serving cell when the present serving cell fails or could be improved, and may request replacement of the current assigned channel if that channel fails or could be improved when the serving cell's main control channel still offers acceptable performance; and
- controls access to the radio resources by the SNDPCP and CMCE entities on instruction from the MM entity.

The data link layer (layer 2) comprises two sublayers: the Logical Link Control (LLC) entity and the Medium Access Control (MAC) entity. The MAC itself is divided into two sublayers: the upper MAC and the lower MAC.

The LLC offers two types of link to the MLE: the basic link is available whenever the MS is receiving the BS; the advanced link is a more powerful link (with numbered segmentation and windowing) that may be set up on request.

The functions of the upper MAC include channel allocation, random access control, granting and use of reserved slots, fragmentation of long messages, association of short messages, path loss calculation, and also link adaptation on a D8PSK or QAM channel. Also, air interface encryption is performed in the upper MAC when required (see clause 13).

The lower MAC performs the channel coding, interleaving and scrambling (see clause 6.8).

The physical layer deals with radio-oriented aspects such as modulation and demodulation, receiver and transmitter switching, frequency correction, symbol synchronization and channel estimation (see clause 6).

Clauses 7.2 to 7.13 describe the higher layer protocol (from MEX down to the upper MAC). In some of these clauses the protocol is described per entity; for example, MEX and SNDPCP are described in clauses 7.2 and 7.3. Clause 7.4 describes some aspects of operation of the data link layer protocol. Then further aspects of the protocol are described by function, particularly in cases where more than one layer is responsible for providing the function, for example, for link adaptation, energy economy, data priority, scheduled access, cell and channel selection and circuit mode calls.

## 7.2 Multimedia Exchange layer

### 7.2.1 General MEX features

The Multimedia Exchange (MEX) layer is located above the MS SNDPCP. MEX provides an interface between applications wishing to use packet data and the SNDPCP layer. If desired, applications may dispense with the services of MEX (though such applications communicate with SNDPCP through MEX). Otherwise, MEX prepares PDP contexts and QoS requirements in SNDPCP on behalf of the packet data applications, formats IP packets for transmission by SNDPCP and routes IP packets received from SNDPCP to the appropriate destination applications.

### 7.2.2 MEX routing services

Applications using MEX may either be internal to the MS or may be external, connected via the PEI. MEX provides a routing service for both internal and external applications.

Applications using MEX connect their TCP/UDP layers to MEX via a port number and IP address (i.e. a socket). These are then used by MEX for routing the application data to the correct PDP context in SNDPCP, and for routing IP packet data received from SNDPCP to the correct internal application or to the PEI control (see clause 12). The PEI control routes IP packet data to the correct external application.

### 7.2.3 MEX precedence

MEX may be used to manage the multiplexing of IP packets from multiple applications according to a relative MEX precedence so that, where delivery is limited by lack of channel resources, each application using MEX gets a prearranged share of the total resource (this is different from data priority). This may be used to control the relative flow rate of data packets serving different aspects of a multimedia application (e.g. audio and video).

The MEX layer provides internal data precedence management for multiple simultaneous applications. Each application may choose one of fourteen precedence levels. The MEX precedence mechanism consists of an application list, buffers and a precedence switch as shown in figure 7.2.

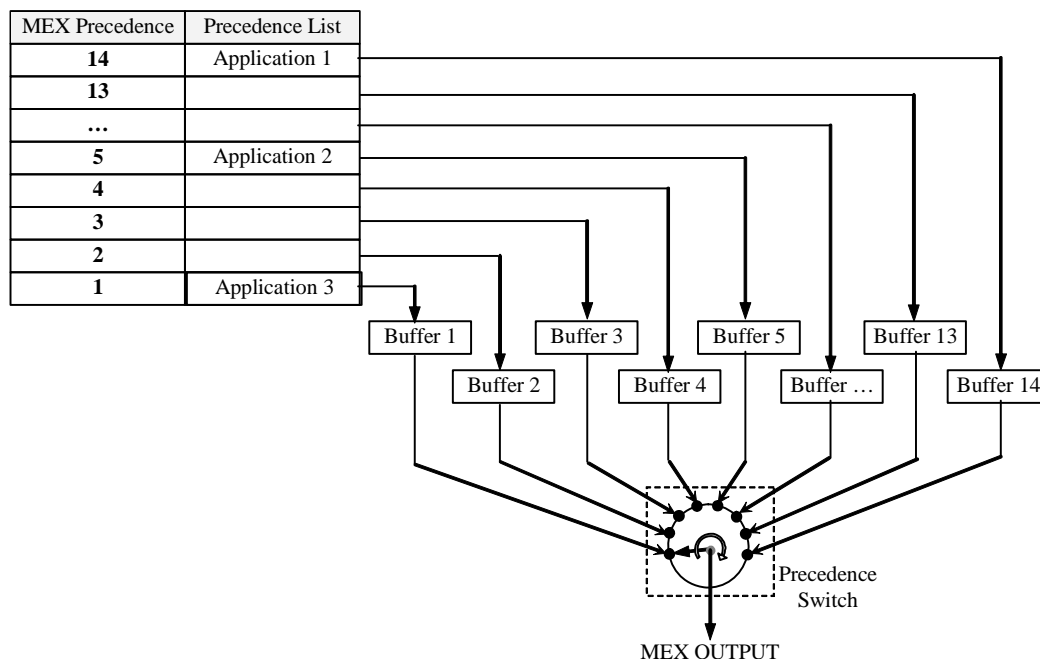

**Figure 7.2: MEX precedence**

Prior to PDP context activation, the application may choose a MEX precedence level. After an application chooses its MEX precedence, its payload is routed to a particular buffer. Each buffer output is connected to a precedence switch, which services high-precedence buffers more frequently than lower-precedence buffers.

MEX precedence may be modified during data transmission.

## 7.3 Subnetwork Dependent Convergence Protocol layer

### 7.3.1 Outline of SNDCP

The TETRA Subnetwork Dependent Convergence Protocol (SNDCP) layer manages the access of packet data to radio resources. SNDCP has two main functions:

- 1) SNDCP negotiates and maintains Packet Data Protocol (PDP) contexts between an MS and the SwMI. PDP contexts may be "primary" or "secondary" PDP contexts. A unique primary PDP context is established for each PDP address. The primary PDP context activation procedure involves the binding of a PDP address to an Individual TETRA Subscriber Identity (ITSI) and also the optional negotiation of compression algorithms and QoS parameters to be used during data transfer. Secondary PDP context activation involves binding the secondary PDP context to the PDP address of a primary PDP context and also the negotiation of compression algorithms and QoS parameters to be used during data transfer.
- 2) SNDCP buffers data packets from multiple applications and controls packet data transfer between MS and SwMI, transferring the data packets across the air interface using the services provided by layer 2. Data transfer is unacknowledged at the SNDCP level i.e. SNDCP does not perform retransmissions itself; however, SNDCP allows the application to select the acknowledged or unacknowledged layer 2 service for data transfer over the air interface. SNDCP provides mechanisms by which data may be compressed before being transmitted over the air interface.

The TETRA packet data service provides mechanisms to convey different higher layer protocols. Currently it supports the Internet Protocol (IP) versions 4 and 6, with IPv4 static and dynamic addressing, mobile IPv4 and IPv6 addressing. TETRA packet data extends TETRA to act as an IP subnet. This enables application programmers to build their applications in a well-standardized environment.

Figure 7.3 illustrates the protocol model for TETRA packet data when the application is located within the MS itself.

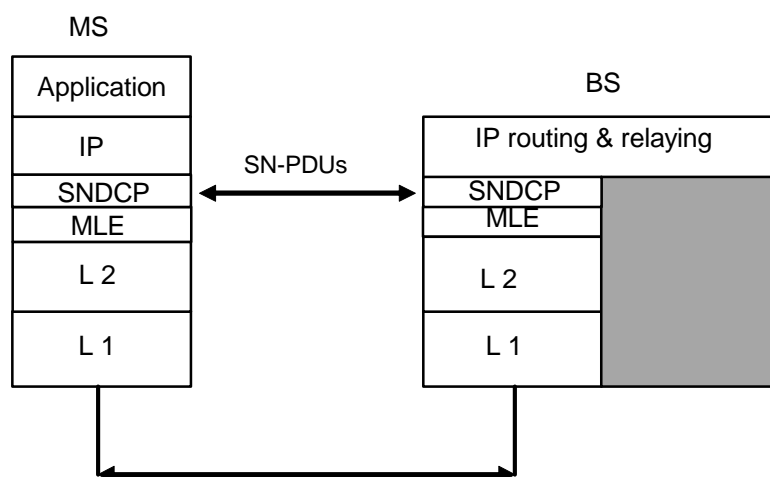

**Figure 7.3: Usage of TETRA packet data IP applications**

SNDCP is built around the concept of PDP contexts. A PDP context stores data relating to a particular packet data flow. The PDP context binds the local radio air interface address (i.e. TETRA ITSI) to the PDP address (i.e. IP address) of an application in that MS or in a data terminal connected to that MS. The PDP context maintains header and data compression state tables for that flow. The PDP context also stores and applies QoS information specific to the packet data flow using that PDP context. Up to fourteen separate PDP contexts may be in an activated state at the same time.

NOTE 1: An MS may have multiple IP addresses. Different data applications connected to the MS (or running within the MS) may use the same IP address (with different port numbers) or different IP addresses.

An application wishing to send or receive packet data first has to ask SNDCP to activate a PDP context. PDP context activation is initiated by the MS. The message exchange for PDP context activation normally takes place on the appropriate common control channel (either the main control channel (MCCH or MCCH-Q) or a common secondary control channel - see clause 7.4.2.1). The MS may activate primary PDP contexts and secondary PDP contexts.

Activation of a primary PDP context involves the negotiation of a PDP address (e.g. an IPv4 address) and other parameters to be used during data transfer. Each primary PDP context should have a different PDP address.

There are various types of address negotiation for primary PDP contexts:

- With IPv4 static addressing, an IP address is assigned permanently to the MS. The MS sends the IP address to the SwMI when the primary PDP context is activated.
- With IPv4 dynamic addressing, the SwMI assigns a dynamic IP address to the MS when the primary PDP context is activated.
- With mobile IPv4 addressing, an MS wishing to use Mobile IP services requests either "Mobile IPv4 Foreign Agent Care-of Address" or "Mobile IPv4 Co-located Care-of Address" when the primary PDP context is activated. The SwMI may then respond with a "Mobile IPv4 Care-of Address" plus additional information. For further information on mobile IPv4 addressing, see ETSI EN 300 392-2 [i.2], clause 28.
- With IPv6 addressing, the IP address is 128 bits (as compared to 32 bits in IPv4). Stateful address autoconfiguration will enable an IP address to be dynamically allocated, whereas stateless address autoconfiguration will enable an IP address to be generated through information broadcast on the network. In both methods, the node first generates a link local IPv6 address and uses this to obtain a global IPv6 address. For further information on IPv6 addressing, see ETSI EN 300 392-2 [i.2], clause 28.

When the MS has established one or more primary PDP contexts, it may request establishment of secondary PDP contexts. A secondary PDP context derives its PDP address from a primary PDP context but generally has different QoS requirements from the primary PDP context. Also, when the MS activates a secondary PDP context, it may include "QoS filter" information, indicating a port number or a range of port numbers appropriate to that PDP context.

Secondary PDP contexts are used by the SwMI to differentiate the QoS to be given to different data packets to be sent on the downlink to the same PDP address. If the MS has provided QoS filter information, the SwMI uses that information to determine whether a downlink data packet should use a secondary PDP context for that PDP address (by comparing the destination port number in the downlink data packet with the QoS filter information). If the destination port number in a downlink data packet does not match the QoS filter of any secondary PDP context for that PDP address, the SwMI should instead send the packet via the primary PDP context for that PDP address. If the MS does not specify a QoS filter during activation of a secondary PDP context, the SwMI should generate and use an automatic QoS filter (for example, recording the source port numbers of uplink data packets received via each secondary PDP context and using these to filter each downlink data packet on the basis of its destination IP address and destination port).

When activating a PDP context (either primary or secondary), the MS may specify QoS requirements for the flow of packets using that PDP context. The QoS information negotiated during PDP context activation includes the concept of three packet data classes: background class, telemetry class and real-time class. Background class data requires high delivery reliability but can tolerate delay; telemetry class data can tolerate moderate delays and limited packet loss and is intermittent or periodic in nature, so does not require the highest bit rate; real-time class data cannot tolerate delay but can tolerate some packet loss, so should be sent on an unacknowledged link. The QoS information also includes GPRS-compatible throughput and delay and reliability parameters and may include scheduled access requirements.

NOTE 2: SNDTCP may also modify the parameters of an activated PDP context and deactivate a PDP context.

The MS SNDTCP assigns each activated PDP context to an acknowledged advanced link or to the unacknowledged basic link. (A PDP context carrying real-time class data should be assigned to the unacknowledged basic link.)

When an MS has data to transfer but is currently using the common control channel, the SNDTCP sends a PDU to request permission to transmit its packet data. If the SwMI accepts the request, it sends a response PDU indicating acceptance and normally includes a channel allocation directing the MS to an assigned secondary control channel intended for use for packet data, termed a Packet Data CHannel (PDCH).

NOTE 3: The SwMI may allow the MS to use the common control channel for the exchange of packet data.

If QoS was negotiated during PDP context activation, the SwMI should choose whichever of its available PDCHs best suits the MS's QoS requirements (taking into account the QoS requirements of other MSs that are already using PDCHs in that cell); if QoS was not negotiated during PDP context activation, the SwMI should assume by default that this PDP context is required for background class data with unspecified throughput, delay and reliability. Alternatively, the MS may request a phase modulation channel or a specific number of phase modulation timeslots per TDMA frame when it requests access to a PDCH, in which case the SwMI should allocate the MS to a suitable phase modulation PDCH, if available.

Then, if the MS SNDTCP has assigned the PDP context to an acknowledged advanced link, and that advanced link is not already established, the SNDTCP requests layer 2 to set up an advanced link that suits the QoS requirements of the PDP context.

After the advanced link has been set up, or if the advanced link was already established, or if the MS SNDTCP has assigned the PDP context to the unacknowledged basic link, the SNDTCP may start to send data packets - issuing each data packet to layer 2 for transmission over the air interface.

NOTE 4: The SwMI is responsible for deciding which of the available links it will use to transmit packet data and is responsible for setting up any unacknowledged advanced links it may require for transmitting group-addressed packet data.

SNDTCP provides TCP/IP header compression and decompression, and compression and decompression of user data (performed independently for each PDP context).

The protocol for SNDTCP is described in terms of a state machine. There are three main states which are defined for both the MS and SwMI, namely READY, STANDBY and IDLE:

- READY state typically implies that the MS is located on a PDCH and is currently engaged in packet data transfer or has recently (defined by a timer) been engaged in packet data transfer;
- STANDBY state implies that the MS is no longer on a PDCH i.e. the MS has not recently been engaged in packet data transfer;
- IDLE state implies that the MS has no PDP contexts activated.

When the MS is located on a PDCH, it may continue to use the PDCH while in the READY state - normally until the inactivity timer (the READY timer) expires in the MS or the SwMI. The SwMI then directs the MS to leave the PDCH.

The MS may have a separate inactivity timer (the CONTEXT\_READY timer) for each PDP context. On expiry of the inactivity timer for a PDP context, the MS may be permitted to remain on the PDCH (e.g. if it is sending packet data for other PDP contexts). However, when the MS has further data to send for that PDP context, it needs to request permission to re-start transmitting packet data for the PDP context.

## 7.3.2 Application-level QoS parameters

This clause summarizes the QoS parameters available to applications using the MS SNDCP. Most of the QoS parameters apply to PDP contexts. However, some QoS parameters apply to specific data packets.

The following QoS parameters apply to PDP contexts. When used, they are provided by the application and are sent to the SwMI during PDP context activation unless otherwise indicated:

- PCOMP negotiation: this parameter may indicate several IP header compression methods. It allows the MS SNDCP to propose and negotiate a list of IP header compression methods with the SwMI (see clause 7.3.8).
- DCOMP negotiation: this parameter may indicate several data compression methods. It allows the MS SNDCP to propose and negotiate a list of data compression methods with the SwMI (see clause 7.3.8).
- CONTEXT\_READY time: a time up to 300 seconds may be proposed by the application. This is the value to be used for the inactivity timer for that PDP context (see clause 7.3.7). A long CONTEXT\_READY time, if agreed by the SwMI, may reduce packet delays perceived by an application transmitting intermittent data (e.g. telemetry class data) by allowing the MS to remain on the PDCH between transmissions.
- Data class (see note 1): this parameter indicates the class of data to be sent using that PDP context:
  - real-time class: QoS optimized for data that cannot tolerate delivery delay;
  - telemetry class: QoS optimized for intermittent or periodic data that can tolerate moderate delivery delay and packet loss; or
  - background class: QoS optimized for data that are intolerant of packet loss.

NOTE 1: One set of these six parameters (i.e. data class, minimum peak throughput, mean throughput, mean active throughput, delay class and reliability class) may be used, applying to both uplink and downlink. Alternatively, two sets of these six parameters may be used, one set associated with the uplink and the other set associated with the downlink. The latter method allows for asymmetrical data transfer.

- Minimum peak throughput (see note 1): values in the range  $< 1\ 000$  octets/second to  $\geq 64\ 000$  octets/second. This parameter indicates the minimum peak throughput of data packets requested or offered for a particular PDP context. This is the minimum throughput required when the PDP context is at its most active; if the peak rate available is lower than this, the application might not be usable (though the application may be capable of using a higher rate than this).
- Mean throughput (see note 1): values in the range 100 octets/hour to 50 000 000 octets/hour, or best effort. This parameter indicates the mean throughput of packet data expected by the application, averaged over the expected lifetime of the PDP context. These values correspond to those used by GPRS [i.4].
- Mean active throughput (see note 1): values in the range  $< 1\ 000$  octets/second to  $\geq 64\ 000$  octets/second. This parameter indicates the mean throughput of packet data expected by the application while the PDP context is actively transmitting or receiving data (i.e. while the PDP context's CONTEXT\_READY timer is active, if supported, or while the READY timer is active if CONTEXT\_READY timers are not supported).
- Delay class (see note 1): low, moderate, high, and unpredictable; see table 7.1. For packets sizes up to 1 024 octets, for moderate delay class and high delay class, the delays correspond to those used by GPRS [i.5].

The delay refers to the end-to-end delay for a data packet sent from an MS to another MS on the same network (i.e. the same SwMI), including random access. It does not include transfer delays in external networks.

NOTE 2: Low delay class values are not necessarily achievable in a busy network.

NOTE 3: Real-time class data requires the low delay class.

**Table 7.1: Packet delays for different delay classes**

Delay Class	Packet size ≤ 128 octets		128 octets < Packet size ≤ 1 024 octets		1 024 octets < Packet size ≤ 2 002 octets	
	Mean transfer delay (s)	95 <sup>th</sup> percentile delay (s)	Mean transfer delay (s)	95 <sup>th</sup> percentile delay (s)	Mean transfer delay (s)	95 <sup>th</sup> percentile delay (s)
Low	< 1	< 3	< 3	< 7	< 5	< 10
Moderate	< 5	< 25	< 15	< 75	< 30	< 150
High	< 50	< 250	< 75	< 375	< 110	< 560
Unpredictable	Undefined	Undefined	Undefined	Undefined	Undefined	Undefined

- Reliability class (see note 1): high, moderate or low. This parameter is used by the SNDCP (in the MS and SwMI) to decide which type of layer 2 communication link to use for packet data on that PDP context and to decide whether to request that layer 2 provides extended error control:
  - high (acknowledged link with Frame Check Sequence);
  - moderate (acknowledged link without Frame Check Sequence);
  - low (unacknowledged link, normally with no Frame Check Sequence and no retransmissions).

See table 7.2.

NOTE 4: For high and moderate reliability class, this parameter may also be used by the SNDCP to decide on the maximum number of retransmissions for the advanced link to be used for that PDP context.

NOTE 5: The lost packet probability requirements of the high reliability class may only be realizable if a high delay class or unpredictable delay class is permitted, and applies only while a usable PDCH is available.

NOTE 6: Real-time class data uses the low reliability class.

**Table 7.2: Definition of reliability classes**

Reliability class	Lost packet probability	Duplicate packet probability	Out of sequence Packet probability	Corrupt packet probability
High	< 10 <sup>-9</sup>	< 10 <sup>-9</sup>	< 10 <sup>-9</sup>	< 10 <sup>-9</sup>
Moderate	< 10 <sup>-4</sup>	< 10 <sup>-9</sup>	< 10 <sup>-5</sup>	< 10 <sup>-4</sup>
Low (see note 1)	Undefined	0 (see note 2)	0 (see note 2)	< 10 <sup>-4</sup>
NOTE 1: Uses an unacknowledged link.				
NOTE 2: Applies only if each packet is transmitted once.				

NOTE 7: The lost N-PDU probability for the low reliability class is shown in table 7.2 as "undefined". However, for example, some applications may need the lost N-PDU probability for real-time class data to be less than  $2,5 \times 10^{-2}$ .

- Schedule information i.e. schedule repetition period, maximum schedule timing error, scheduled number of data packets per grant and scheduled data packet size. This information allows the MS SNDCP to request and negotiate a schedule with the SwMI (see clause 7.8).
- NSAPI data priority: eight levels of priority. This parameter is a default data priority for data packets using that PDP context. It is not sent to the SwMI during PDP context activation: the MS SNDCP uses the NSAPI data priority for each of its PDP contexts that are actively transmitting or receiving data to decide on a suitable "MS default data priority" (see clauses 7.3.9 and 7.7).
- QoS requested/minimum/negotiated: a set of parameters indicating throughput on a  $\pi/4$ -DQPSK channel. This information is applicable only to phase modulation, and is retained in ETSI EN 300 392-2 [i.2] only for backwards compatibility with previous versions (see note 8). The information from the application is used by the MS SNDCP when it needs to set up an advanced link, not during PDP context activation.

NOTE 8: For D8PSK and QAM channels, and optionally for  $\pi/4$ -DQPSK channels, the other QoS parameters above (i.e. data class, minimum peak throughput, mean throughput, mean active throughput, delay class, reliability class, CONTEXT\_READY time and schedule information) negotiated during PDP context activation have more general applicability; alternatively, the default QoS (background class data with unspecified throughput, delay and reliability) may be used.

The following parameters may apply per data packet:

- Data importance: may be set to low, medium or high. This parameter is used locally by the MS in the event of potential buffer overflow or similar cases where the MS SNDCP may need to delete or cancel untransmitted or partially transmitted data. The MS SNDCP should preferentially delete or cancel lower importance data.
- Data priority: eight levels of priority, which allow the application to specify the priority for access to radio resources (see clauses 7.3.9 and 7.7).
- PDU priority: eight levels of priority, which allow the application to specify the PDU priority of a data packet. Data packets with high PDU priority may be queued for transmission ahead of data packets in the same MS with lower PDU priority. Also, the BS may restrict random access to the PDCH to the higher PDU priorities (most probably at times of heavy loading).

### 7.3.3 QoS negotiation

During PDP context activation, the MS SNDCP may ask the SwMI to agree the QoS parameters requested by the MS's packet data applications. If the SwMI is unable to provide the requested QoS, the SwMI may offer an alternative QoS which the MS may accept or reject. If the MS accepts the offered QoS, SNDCP reports the agreed QoS to the application that requested the PDP context activation.

Also, the MS and the SwMI may modify the QoS parameters of an activated PDP context when appropriate:

- The MS SNDCP is permitted to attempt to re-negotiate the QoS of an activated PDP context when the application's QoS requirements change.
- The SwMI may inform the MS when it alters the QoS of an activated PDP context; for example, the SwMI should inform the MS if it is no longer able to sustain a previously agreed schedule. When the SwMI informs the MS that it has altered the QoS of an activated PDP context, the MS SNDCP informs the applications that are using the affected PDP context.

### 7.3.4 QoS filtering information for secondary PDP contexts

When the MS requests activation of a secondary PDP context, it may include "QoS filter" information, indicating a port number or a range of port numbers appropriate to that PDP context, or specifically requesting that the SwMI generates and uses an automatic QoS filter for that PDP context. If the MS does not provide QoS filtering information, the SwMI either rejects the activation request or generates and uses an automatic QoS filter.

The MS may subsequently modify the QoS filter of an activated PDP context when appropriate, requesting that the SwMI adds the specified new QoS filter to the existing QoS filter, or requesting that the SwMI replaces the existing QoS filter with the new QoS filter, or requesting that the SwMI removes the specified items from the existing QoS filter. For example:

- If the MS has already provided a port number (or range), it may request that the SwMI adds further port numbers to the QoS filter; this may be useful if the MS wishes to add an application to the PDP context.
- If the SwMI is using an automatic QoS filter when it receives a request from the MS to add a QoS filter to that PDP context, the SwMI should combine the newly requested QoS filter with the automatic QoS filter and should use the new combined QoS filter with that PDP context.
- The MS may ask the SwMI to replace a port number (or range) with a new QoS filter for that PDP context.
- If the SwMI is using an automatic QoS filter when it receives a request from the MS to replace the QoS filter for that PDP context, the SwMI should stop using that automatic QoS filter and use the new QoS filter.

- The MS may ask the SwMI to remove a port number (or range) from the QoS filter for a PDP context; this could be useful if the MS now wishes the SwMI to use the related primary PDP context for those port number(s).

### 7.3.5 Assignment of PDP contexts to layer 2 communication links

Various types of layer 2 communication links are available for transmission of data packets i.e. acknowledged advanced link or unacknowledged basic link, or (for the downlink only) unacknowledged advanced link; see clause 7.4.3.

The MS SNDCP assigns a PDP context to a suitable layer 2 link when it first starts to use that PDP context. (SNDCP may assign more than one PDP context to the same layer 2 link.)

**NOTE:** When assigning particular acknowledged advanced links to PDP contexts, the SNDCP may choose to group PDP contexts requiring the same data class and reliability class on the same acknowledged advanced link.

The MS SNDCP requests the MS's layer 2 to set up acknowledged advanced links when required, but the SwMI sets up the unacknowledged advanced links. The unacknowledged basic link does not need setting up.

The MS's choice of layer 2 communication link type for a particular PDP context is based on the data class agreed for the PDP context, as indicated in table 7.3. (If QoS was not negotiated during PDP context activation, background class is assumed.)

**Table 7.3: MS assignment of layer 2 communication link type to PDP context**

Data class	Link type
Background	Acknowledged advanced link
Telemetry	Acknowledged advanced link
Real-time	Unacknowledged basic link (see note)
QoS not negotiated	Acknowledged advanced link
NOTE:	It is expected that a real-time class PDP context might be used only for unacknowledged streamed data. If any associated control signalling needs to be sent using an acknowledged service then a telemetry or background class PDP context using an acknowledged advanced link with small window size may be appropriate for the control signalling.

When the SwMI wishes to transmit unacknowledged packet data to one or more MSs, it may either use the unacknowledged basic link (e.g. for real-time class data) or may set up and use an unacknowledged advanced link.

### 7.3.6 Choice of layer 2 communication link parameters

When the MS SNDCP requires a new acknowledged advanced link, it asks layer 2 to set up the link and passes layer 2 QoS parameters for the link that suit the QoS requirements of the PDP contexts assigned to use that link.

An advanced link assigned to telemetry class data may be given a window size greater than one to help the transmitter to catch up with the schedule after a scheduled slot grant is missed or a transmission fails, but kept fairly small (e.g. 2 or 3) to limit the loss of partially delivered data packets if the link has to be reset. The maximum number of retransmissions may be set to a small number (e.g. 2 or 3), so that the transmitter can abandon an undelivered data packet, reset the advanced link and move on to the new data packet before too much delay is incurred.

An advanced link assigned to background class data may be given a large window size (e.g. fifteen) and a large maximum number of retransmissions (e.g. up to fifteen segment retransmissions and seven complete packet retransmissions) to maximize the chance of ultimately delivering the data packet. Use of a large window size may be useful to allow transmission of data packets to continue when segments of some data packets have not been received. It may also be useful on wide-bandwidth channels to ensure that there is enough data to send in uplink slots; this may apply particularly when the data packets may be small.

SNDCP should instruct layer 2 to use the extended error control Frame Check Sequence when transmitting a background class data packet or when transmitting a telemetry class data packet that requires high reliability. SNDCP normally instructs layer 2 not to use a Frame Check Sequence when transmitting real-time class data.

## 7.3.7 Selection of channel

### 7.3.7.1 Initial PDCH access

When an MS indicates to the SwMI that it wishes to transmit or receive packet data, the SwMI chooses a suitable channel as follows:

- if QoS was not negotiated for a PDP context, the SwMI assumes by default that this PDP context is required for background class data with unspecified throughput, delay and reliability;
- if the MS requests assignment to a single-slot or multi-slot  $\pi/4$ -DQPSK PDCH, the SwMI should allocate the MS to a suitable phase modulation channel, if available (see note 1);
- if the MS requests assignment to a phase modulation channel without specifying other information such as the number of slots, the SwMI should allocate the MS to a phase modulation channel, if available (see note 1);

NOTE 1: If a phase modulation channel is not available and the MS is QAM-capable, the SwMI may choose a QAM PDCH within the MS's declared capabilities.

- if the MS does not specifically request assignment to a phase modulation channel, and the MS has negotiated QoS for the PDP context, the SwMI should attempt to assign the MS to a channel within the MS's declared capabilities that provides adequate signal level and can satisfy the negotiated QoS requirements for the PDP context;
- if the MS does not specifically request assignment to a phase modulation channel, and the MS has not negotiated QoS for the PDP context, the SwMI should attempt to assign the MS to a channel within the MS's declared capabilities that provides adequate signal level, based on the default assumption that the MS requires a background class QoS with unspecified throughput, delay and reliability.

NOTE 2: CA cells that support  $\pi/8$ -D8PSK and/or QAM modulation, and DA cells, normally need to support QoS negotiation during PDP context activation. Support of QoS negotiation during PDP context activation is optional for a CA cell that only supports  $\pi/4$ -DQPSK modulation.

NOTE 3: In the TETRA standard ETSI EN 300 392-2 [i.2] V3.4.1 and earlier versions, an MS that did not negotiate QoS and did not specifically request a phase modulation channel was assigned to a single-slot  $\pi/4$ -DQPSK PDCH. In more recent versions of ETSI EN 300 392-2 [i.2], if the MS did not negotiate QoS during PDP context activation and does not specifically request a phase modulation channel when commencing use of the PDP context, the SwMI chooses a PDCH based on the MS's declared capabilities and the default assumption that the PDP context is required for background class data with unspecified throughput, delay and reliability. Thus, a recently designed MS that does not negotiate QoS will be unable to access D8PSK and QAM channels when using a SwMI that conforms to ETSI EN 300 392-2 [i.2] V3.4.1 (or earlier). An MS designed according to ETSI EN 300 392-2 [i.2] V3.4.1 (or earlier) that expects to be assigned to a single-slot  $\pi/4$ -DQPSK PDCH when it does not specifically request a phase modulation channel may be sent to some other type of PDCH when using a SwMI that conforms to a more recent version of ETSI EN 300 392-2 [i.2].

### 7.3.7.2 Changing PDCH requirements

An inactivity timer called the READY timer is used to control the time the MS stays on a PDCH. When the READY timer expires following inactivity, the MS is normally returned to the common control channel. Then, when the MS has packet data to send, it needs to request permission to transmit its packet data.

NOTE 1: The duration of the READY timer is provided by the SwMI.

MSs may also use CONTEXT\_READY timers, one per PDP context. The CONTEXT\_READY timer is an inactivity timer for that PDP context. Use of CONTEXT\_READY timers is required by an MS that supports the transmission or reception of data through more than one PDP context at the same time.

An MS supporting CONTEXT\_READY timers that is already on the PDCH is expected to request permission before transmitting data packets for a quiescent PDP context. (A quiescent PDP context is one which has not transmitted or received data packets since it was activated, or for a period of time greater than the duration of its CONTEXT\_READY timer.) This makes it possible for the SwMI to assess whether it should assign the MS to a different PDCH that would better suit the combined QoS requirements of all the MS's PDP contexts that are actively transmitting or receiving data and the QoS requirements of other users of the PDCH.

The duration of the CONTEXT\_READY timers are normally set to the duration of the READY timer but, if an application wishes, the duration of a CONTEXT\_READY timer may be negotiated with the SwMI during PDP context activation. A PDP context for intermittent data (such as telemetry class data) may benefit from using a longer CONTEXT\_READY timer than required by a PDP context for background class data.

NOTE 2: The normal procedure carried out when the READY time runs out is not performed while any CONTEXT\_READY timer is active.

### 7.3.8 Header and data compression

TETRA supports TCP/IP header compression (IETF RFC 1144 [i.6]), IP header compression (IETF RFC 2507 [i.7], IETF RFC 2508 [i.8]), BSD compression (IETF RFC 1977 [i.9]) and predictor compression (IETF RFC 1978 [i.10]). It is expected that a future edition of the TETRA standard will add support for robust header compression (IETF RFC 3095 [i.11]).

Negotiation of mutually-supported compression algorithms is carried out between MS and SwMI during PDP context activation. The MS sends the SwMI the list of algorithms that it can support. The SwMI responds by picking up those algorithms on the list which it accepts and returning a list of permitted algorithms to the MS. Any permitted compression algorithm may be switched on during data transfer. The selected compression type is identified within the header of the signalling message carrying each data packet.

### 7.3.9 Data priority in SNDCP

The data priority facility enables the MS to indicate a priority for obtaining access to radio resource, both for achieving access to a PDCH and for receiving slot grants on the PDCH. SNDCP works with layer 2 to provide support for data priority.

SNDCP chooses a suitable "MS default data priority" by inspection of the data priority requirements of PDP contexts that are actively transmitting or receiving data and negotiates this with the SwMI if it differs from the "network default data priority" indicated by the SwMI. SNDCP then informs layer 2 of the negotiated value of "MS default data priority" and advises layer 2 of any short-term variations in the data priority of individual data packets, so that layer 2 can indicate a priority for obtaining reserved slots. Also, when requesting access to a PDCH, the MS indicates the highest data priority of any pending data packets to the SwMI, so that the MS can be sent to the PDCH ahead of other MSs with lower data priority. The data priority mechanisms in layers 2 and 3 are described in more detail in clause 7.7.

### 7.3.10 Reconnection following cell reselection

When the MS temporarily loses access to the communication resources due to cell reselection, the MS MLE informs the SNDCP about the temporary break in access to the communication resources.

When the MS has switched to the appropriate common control channel on the new cell, and has performed registration and authentication if required, the MS MLE informs the SNDCP that access to the communication resources has resumed. Then, if the MS SNDCP was in the READY state prior to the cell reselection (i.e. was engaged in packet data transfer or had recently been engaged in packet data transfer), it normally sends a PDU to the SwMI SNDCP entity to perform reconnection of the currently activated PDP context(s) on the new cell, indicating whether it has any data to send. If the MS or the SwMI (or both) have data to send, the SwMI SNDCP entity sends a response PDU which may include a channel allocation directing the MS to a PDCH; then the MS SNDCP either:

- a) requests layer 2 to re-establish the relevant advanced link(s) on the new cell; or
- b) requests layer 2 to reconnect the relevant advanced link(s) on the new cell.

In the case of re-establishment of an advanced link, any partially transmitted data packets are lost (and any data packets for which an acknowledgement has not yet been received). Method b is called advanced link roaming. If supported by both MS and SwMI, advanced link roaming allows the MS to continue using the advanced link on the new cell with all parameters, variables and timers carried over from the previous cell and without loss of data - so that the MS may continue the transmission or reception of data segments from where it finished on the previous cell.

## 7.4 Operation of the data link layer (layer 2) protocol

### 7.4.1 Structure of the data link layer

The data link layer comprises two sublayers: the Logical Link Control (LLC) entity and the Medium Access Control (MAC) entity. The MAC itself is divided into two sublayers: the upper MAC and the lower MAC. The lower MAC performs the channel coding, interleaving and scrambling, as described in clause 6.8. Unless specified otherwise, references to "the MAC" throughout the remainder of clause 7 mean the upper MAC.

The LLC deals principally with the LLC link establishment and maintenance. The main functionalities of the MAC are channel access control, radio resource control and data transfer, and also link adaptation on a D8PSK or QAM channel. Also, air interface encryption is performed in the MAC when required.

Figure 7.4 shows the protocol model of the data link layer, its internal subdivision and its interaction with the upper layer (MLE) and lower layer (physical layer).

The control plane (C-plane) corresponds to the signalling information, both control messages and packet data, and broadcast messages. The user plane (U-plane) corresponds to circuit mode voice and circuit mode data plus end-to-end user signalling information and encryption synchronization information.

In the protocol model, the data link layer provides services to the MLE through Service Access Points (SAPs) supporting different functions:

- TLA-SAP for signalling messages;
- TLB-SAP for broadcasting system information from the Base Station to MSs; and
- TLC-SAP for internal layer management, status and configuration via data base access.

The U-plane traffic, end-to-end user signalling and encryption synchronization information enter the MAC directly from the U-plane application (e.g. the speech CODEC), through the TMD-SAP. No LLC functionality applies for U-plane information. (Though some traffic capacity may be stolen for C-plane signalling purposes in circuit mode.)

**NOTE:** Thus, separation of the C-plane and U-plane information takes place above the MAC layer. U-plane traffic is routed to the U-plane application whilst C-plane information continues up the protocol stack.

The TP-SAP is used for communication between the data link layer and Physical Layer (PL).

Internal communication between the LLC and MAC also uses SAPs, namely TMA-SAP, TMB-SAP and TMC-SAP, for services provided by the MAC to the LLC; they correspond to the separation between signalling, broadcast and layer management, as can be seen from the MLE. Internal communication between LLC and MAC may also use an additional SAP, namely the TLE-SAP, for the layer 2 signalling service that the LLC may provide to the MAC.

There is a (virtual) SAP TMV-SAP inside the MAC layer to allow a protocol description using primitives and logical channels. The selection of a specific logical channel triggers specific channel coding at the lower MAC, which performs the channel coding (see clause 6.8). The selection of a specific logical channel also triggers a specific modulation.

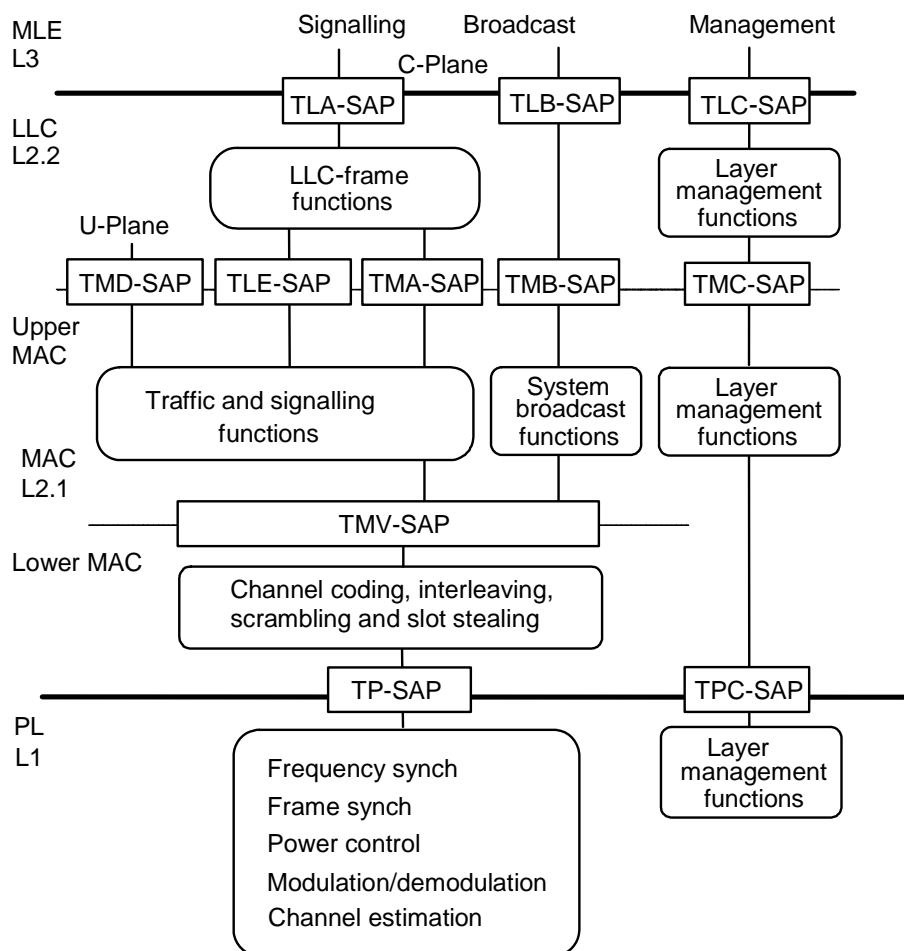

**Figure 7.4: Layer 2 reference architecture**

## 7.4.2 Control channel usage

### 7.4.2.1 Common control channels and assigned channels

#### 7.4.2.1.1 General

In TETRA, the BSs transmit on downlink frequencies and receive on uplink frequencies; the MSs transmit on uplink frequencies and receive on downlink frequencies. A downlink and uplink are paired together on two RF carriers. Each downlink RF carrier and its corresponding uplink RF carrier are separated by the duplex spacing.

#### 7.4.2.1.2 Common control channels

There are two types of cell: Conventional Access (CA) cells and Direct Access (DA) cells:

- a) In a CA cell, one 25 kHz phase modulation RF carrier is designated as the CA main carrier frequency. In the normal mode of operation, the Main Control CHannel (MCCH) occupies timeslot 1 of the CA main carrier, in all frames 1 to 18. This is a common control channel, used by CA MSs for common control signalling. It is a single-slot  $\pi/4$ -DQPSK channel.

If there are too many MSs in the CA cell for the MCCH to deal with all the common control signalling then, in addition to the MCCH, the BS controlling the cell may operate up to three single-slot  $\pi/4$ -DQPSK common secondary control channels ( $\pi/4$ -DQPSK common SCCHs) on the CA main carrier; these have the same functionality as the MCCH but are used only by a subset of the user population. The BS uses an information element in a broadcast message (the SYSINFO PDU) to indicate the number of common SCCHs currently in operation. The MS then calculates which common control channel to use from a parameter that it received on registration or at subscription.

On a CA cell, the MCCH and any common SCCHs each occupy only one slot capacity on the main carrier, and are always  $\pi/4$ -DQPSK channels. The first common SCCH (when in operation) occupies timeslot 2 of the main carrier; the second common SCCH (when in operation) occupies timeslot 3 of the main carrier; and the third common SCCH (when in operation) occupies timeslot 4 of the main carrier.

A CA MS is an MS that is currently camped on a CA cell, so it receives a  $\pi/4$ -DQPSK common control channel (i.e. the MCCH or a  $\pi/4$ -DQPSK common SCCH) unless it is directed by the BS to an assigned channel - assigned for a circuit mode call or for secondary control.

The BS may allocate all four timeslots of a CA main carrier for traffic or assigned control. Minimum mode operation then applies, in which the method of MCCH operation is changed (see clause 7.4.2.6).

- b) In a DA cell, one QAM RF carrier is designated as the DA main carrier frequency. The bandwidth of the DA main carrier is 25 kHz, 50 kHz, 100 kHz or 150 kHz. The DA Main Control CHannel (MCCH-Q) occupies one, two, three or four timeslots of the DA main carrier, in all frames 1 to 18. This is a common control channel, used by DA MSs for common control signalling. It is a QAM channel.

For DA, if the BS wishes to use more than one slot for common control signalling, it may use a multi-slot MCCH-Q; alternatively, it may use a single-slot MCCH-Q together with up to three single-slot QAM common SCCHs on the DA main carrier. The BS uses an information element in a broadcast message (the SYSINFO-DA PDU) to indicate the number of slots used for the MCCH-Q or the number of common SCCHs in operation. If common SCCHs are in operation, the MS calculates which common control channel to use from a parameter that it received on registration or at subscription.

On a DA cell, the MCCH-Q and any common SCCHs are always QAM channels.

A one-slot MCCH-Q occupies timeslot 1 of the DA main carrier; a two-slot MCCH-Q occupies timeslots 1 and 2 of the DA main carrier; a three-slot MCCH-Q occupies timeslots 1, 2 and 3 of the DA main carrier; and a four-slot MCCH-Q occupies timeslots 1, 2, 3 and 4 of the DA main carrier.

The first common SCCH (when in operation) occupies timeslot 2 of the DA main carrier; the second common SCCH (when in operation) occupies timeslot 3 of the DA main carrier; and the third common SCCH (when in operation) occupies timeslot 4 of the DA main carrier.

NOTE 1: The BS cannot use QAM common SCCH(s) if it is using a multi-slot MCCH-Q.

A DA MS is an MS that is currently camped on a DA cell, so it receives a QAM common control channel (i.e. the MCCH-Q or a QAM common SCCH) unless it is directed by the BS to an assigned channel - assigned for secondary control or for a circuit mode call.

From the perception of the MS, at any one time it is camped on either a CA cell or a DA cell, and it receives MLE broadcasts from the BS about channels available for allocation as assigned channels on that cell (see clause 7.9.4.1).

An MS may be both CA-capable and DA-capable. In that case it may sometimes be a CA MS and at other times a DA MS, depending on whether its current serving cell is a CA cell or a DA cell.

NOTE 2: A phase modulation carrier is a carrier that is currently carrying  $\pi/4$ -DQPSK and/or D8PSK channels. A QAM carrier is a carrier that is currently carrying QAM channels.

#### 7.4.2.1.3 Assigned channels

An MS receives either the MCCH or the MCCH-Q or the appropriate common SCCH unless the BS sends a channel allocation message addressed to that MS (addressed either individually or to one of the MS's group addresses), directing the MS to an assigned channel. An assigned channel occupies a timeslot or timeslots (in all frames 1 to 18), either on the main carrier or on another carrier as indicated in the channel allocation.

An assigned channel may be intended for use for a circuit mode call or alternatively may be an assigned Secondary Control Channel (assigned SCCH).

If the assigned channel is intended for use for a circuit mode call (see clause 7.10), the assigned channel may carry circuit mode traffic transmissions in frames 1 to 17. The transmitting MS may "steal" from the traffic capacity to send signalling messages. There is also a control channel, called Associated Control Channel (ACCH), associated with an assigned traffic channel. The ACCH may be available only in frame 18 (Slow Associated Control Channel (SACCH)), or it may be available in all frames 1 to 18 (Fast Associated Control Channel (FACCH)), depending on whether or not the assigned channel in that direction is carrying traffic.

NOTE: Also, if the allocated carrier is not the main carrier, and the assigned channel is a  $\pi/4$ -DQPSK or D8PSK channel, the BS may permit the MS to use timeslot 1 as an additional  $\pi/4$ -DQPSK channel (called a Carrier Specific Signalling (CSS) channel), to increase signalling capacity between the MS and BS.

An assigned SCCH may be allocated either:

- in order to continue control signalling after the initial random access or paging message; or
- for use as a packet data channel, for the exchange of packet data between the BS and MS(s).

In the case of a packet data channel, the BS may use the assigned channel for only one MS (i.e. similar to the usage of a channel for a circuit mode call), or it may use the assigned channel as a general packet data channel carrying packet data to and from many MSs sharing use of that channel. In either case the channel usage of both downlink and uplink is scheduled dynamically by the BS; and MSs transmit only under BS control (by random access or reserved access).

An assigned channel may be allocated as occupying up to four timeslots per TDMA frame, in order to provide a higher transfer rate. So, depending on the number of timeslots per TDMA frame used for assigned channels, up to four independent assigned channels may be supported on one carrier.

Circuit mode traffic transmission applies only on  $\pi/4$ -DQPSK channels, so an assigned channel intended for use for a circuit mode call is allocated as a  $\pi/4$ -DQPSK channel.

An assigned SCCH may be allocated as a  $\pi/4$ -DQPSK, D8PSK or QAM channel (as indicated in the channel allocation).

The RF bandwidth of a  $\pi/4$ -DQPSK or D8PSK channel is 25 kHz. The RF bandwidth of a QAM channel may be 25 kHz, 50 kHz, 100 kHz or 150 kHz (as indicated in the channel allocation).

The BS may allocate D8PSK channel(s) on the same RF carrier as  $\pi/4$ -DQPSK channel(s), in different timeslots - either on the main carrier or on other carriers.

EXAMPLE: On a phase modulation carrier, one timeslot could be assigned for a circuit mode voice call, one timeslot could be assigned for a one-slot circuit mode data call and two timeslots could be assigned for a two-slot D8PSK packet data channel. Alternatively, for example, all four timeslots could be assigned for a four-slot packet data channel.

The BS should not allocate a QAM channel on the same carrier as  $\pi/4$ -DQPSK or D8PSK channel(s).

For DA, the BS may allocate the MCCH-Q physical channel(s) as a QAM assigned channel for some MSs that are camped on the cell. Then the MSs in common mode and the MSs in assigned mode share the channel (though in some cases using slightly different procedures). Similarly, the BS may allocate a physical channel used as a QAM common SCCH also as a QAM assigned channel for some MSs, with the channel shared between the MSs in common mode and the MSs in assigned mode.

#### 7.4.2.1.4 Sharing channels between cells

As described in clause 7.4.2.1.2, a CA MS is an MS that is currently camped on a CA cell, so it receives a  $\pi/4$ -DQPSK common control channel (i.e. the MCCH or a  $\pi/4$ -DQPSK common SCCH) unless it is directed by the BS to an assigned channel. A DA MS is an MS that is currently camped on a DA cell, so it receives a QAM common control channel (i.e. the MCCH-Q or a QAM common SCCH) unless it is directed by the BS to an assigned channel. From the perception of the MS, at any one time it is camped on either a CA cell or a DA cell.

However, for cells that:

- are radiated from the same physical location or from locations sufficiently close together to permit sharing of eccentric channels; and

- share the same MCC, MNC, colour code and static cipher key or common cipher key (see ETSI EN 300 392-7 [i.19]),

the same channel may sometimes be used by more than one cell as an assigned channel, provided that the shared channel is radiated from the same physical location as the cells or within the permitted separation for eccentric channels (i.e. if the assigned channel's transmitter site is within 4 km of the main carrier's transmitter site for each of the sharing cells - see clause 6.9.1.1). Then:

- MSs camped on a CA cell might be assigned to a channel used also by DA MSs. For example:
  - A channel on a carrier other than either main carrier might be used as an assigned channel shared by both CA MSs and DA MSs. This may apply for both phase modulation carriers and QAM carriers.
  - If a channel on either main carrier is not being used for common control, it might be used as an assigned channel shared by both CA MSs and DA MSs.
  - The MCCH-Q or a QAM common SCCH might be used as an assigned SCCH for CA MSs. As described in clause 7.4.2.1.3, the MCCH-Q or a QAM common SCCH might also be used as an assigned SCCH for DA MSs camped on the DA cell. Thus, the channel could be shared between the DA MSs in common mode, DA MSs in assigned mode and CA MSs in assigned mode.
- In some cases, DA MSs might be assigned to a channel used also by DA MSs that are camped on a different DA cell as follows:
  - A channel on a carrier other than either DA main carrier might be used as an assigned channel shared by MSs from different DA cells. (The channel could also be shared by MSs from a CA cell.)

NOTE 1: The TETRA standard ETSI EN 300 392-2 [i.2] does not support use of any channel on a DA main carrier as an assigned channel for MSs that are camped on a different DA cell. This is because cell-specific broadcast information needs to be sent on the DA main carrier.

NOTE 2: The TETRA standard ETSI EN 300 392-2 [i.2] does not provide a general method for sharing of an assigned channel by MSs from different CA cells. However, annex R of ETSI EN 300 392-2 [i.2] notes a restricted method that SwMIs may be able to use without the MSs being aware of the usage.

#### 7.4.2.2 $\pi/4$ -DQPSK channel

On a  $\pi/4$ -DQPSK channel, all signalling and data messages and traffic are sent using  $\pi/4$ -DQPSK modulation.

The RF bandwidth of a  $\pi/4$ -DQPSK channel is 25 kHz.

#### 7.4.2.3 D8PSK channel

A "D8PSK channel" is the generic term for a channel on which signalling and data messages may be sent using either  $\pi/4$ -DQPSK bursts or  $\pi/8$ -D8PSK bursts. The transmitting BS or MS chooses whether to use a  $\pi/4$ -DQPSK burst or a  $\pi/8$ -D8PSK burst on a slot-by-slot basis; the process of adaptively changing the modulation level on a D8PSK channel is referred to as link adaptation, and is discussed in clause 7.5. The receiving MS or BS determines whether a slot or subslot (i.e. half slot) contains a  $\pi/4$ -DQPSK burst or a  $\pi/8$ -D8PSK burst by determining whether the training sequence uses the  $\pi/4$ -DQPSK form or the  $\pi/8$ -D8PSK form.

The RF bandwidth of a D8PSK channel is 25 kHz.

#### 7.4.2.4 QAM channel

All signalling and data messages on a QAM channel are sent using QAM modulation. The transmitting BS or MS chooses which modulation level and coding rate to use on a slot-by-slot basis (except in the case of random access by the MS); the process of adaptively changing the modulation level and coding rate on a QAM channel is referred to as link adaptation, and is discussed in clause 7.5. There are six valid combinations of modulation level and coding rate:

- 4-QAM, coding rate  $r = 1/2$ ;
- 16-QAM, coding rate  $r = 1/2$  or  $1$ ;

- 64-QAM, coding rate  $r = 1/2, 2/3$ , or 1.

The RF bandwidth of a QAM channel may be 25 kHz, 50 kHz, 100 kHz or 150 kHz.

Full slot signalling is used on the downlink of a QAM channel, using the full RF bandwidth of the QAM channel. The downlink slot information logical channel SICH-Q/D (and the Access Assignment Channel AACH-Q) within a QAM downlink burst always use 4-QAM with coding rate  $r = 1/2$ . The SICH-Q/D indicates the modulation level and coding rate used in the remainder of that downlink slot and indicates whether the burst is a Frequency Correction Burst (FCB). (The FCB always uses 4-QAM with coding rate  $r = 1/2$ .)

The random access burst on the uplink always uses 4-QAM, coding rate  $r = 1/2$  with a 25 kHz bandwidth - irrespective of the RF bandwidth of the QAM channel. For the purposes of the random access procedure, each subslot (i.e. half slot) that is available for random access is divided into 25 kHz frequency blocks. This provides two, four or six parallel "random access uplink RF channel subslots" within a single subslot on a 50 kHz, 100 kHz or 150 kHz channel respectively.

After the initial access, the MS may need to use full slots or subslots, reserved for that MS by the BS. These use the full RF bandwidth of the QAM channel. The slot information logical channel SICH-Q/U within the uplink burst always uses 4-QAM with coding rate  $r = 1/2$ . The SICH-Q/U indicates the modulation level and coding rate used in the remainder of that slot or subslot.

#### 7.4.2.5 Slot and TDMA frame arrangement on uplink and downlink

In TETRA, slots have a duration of approximately 14,167 ms. Then:

- four slots are grouped together to form a TDMA frame (of approximately 56,67 ms duration);
- 18 TDMA frames are grouped together to form a multiframe (of 1,02 seconds duration); and
- 60 multiframes are grouped together to form a hyperframe (of 61,2 seconds duration).

See also clause 6.2.

NOTE 1: Uplink slots may be subdivided into two subslots (see clause 6.3).

The structure is the same on both uplink and downlink, except that the same-numbered slots on the uplink lag behind the downlink by two slots as shown in figure 7.5. (In figure 7.5, time is shown running from left to right, so frame 6 is the first to appear (i.e. oldest) and frame 10 is the last to appear (i.e. newest).)

This slot arrangement allows a frequency half duplex MS on a single-slot channel to receive the downlink slot and also transmit in the corresponding (same-numbered) uplink slot. This is shown in figure 7.5 for a single-slot channel occupying timeslot 1. The BS transmission in frame 7 slot 1 on the downlink is received by the MS. The MS then has time to decide the relevant action to be performed in the similarly numbered frame 7 slot 1 on the uplink, which follows two slots later. For example, this shows how the Access Assignment Channel (AACH or AACH-Q) in each downlink slot can be used to convey access rights or usage information for the corresponding uplink slot.

NOTE 2: Figure 7.5 shows transmissions on timeslot 1. Similar principles apply to transmissions on timeslots 2, 3 and 4.

NOTE 3: The access assignment channel contains information about the downlink slot in which it appears and also the access rights or usage information for the corresponding uplink slot.

The slot arrangement enables time division duplex operation to be realized, allowing a frequency half duplex MS to support single-slot duplex call services; the MS can switch between its receive and transmit frequencies in time to be able to receive on its downlink slot and transmit in its uplink slot. (The switching between transmit and receive is transparent to the user of the MS, who will see continuous duplex operation.)

NOTE 4: If both of the parties in a duplex voice call are on the same site then a separate channel (uplink and downlink pair) is needed for each party.

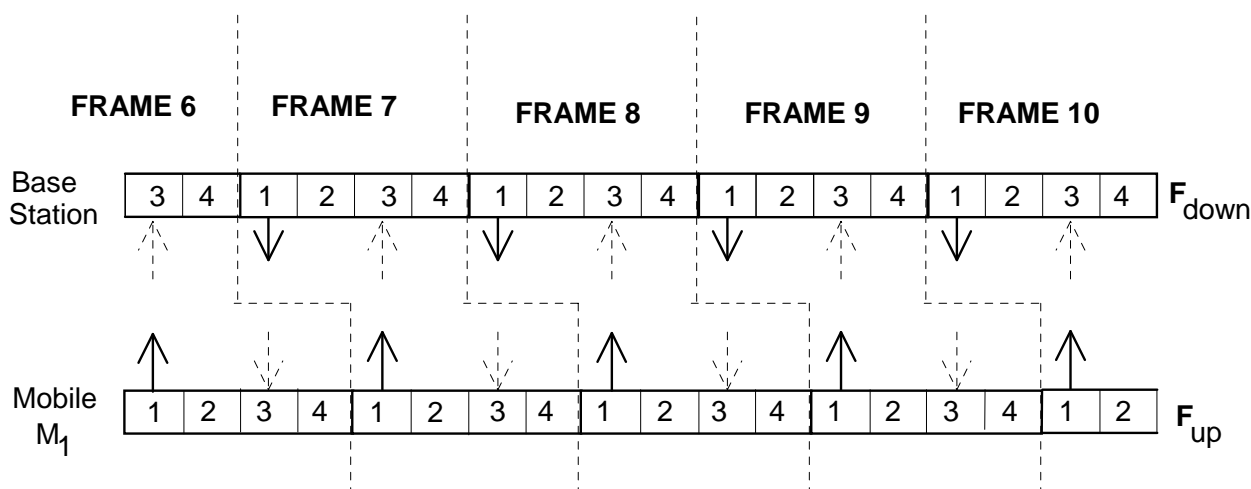

Figure 7.5: Uplink and downlink slot and TDMA frame arrangements

#### 7.4.2.6 Minimum mode for CA

In the normal mode of CA operation, the MCCH occupies timeslot 1 of the CA main carrier, in all frames 1 to 18. For CA, minimum mode allows a BS to allocate all four timeslots on the CA main carrier for either traffic or dedicated control purposes. A BS enters minimum mode when timeslot 1 on the CA main carrier is assigned so that there is no common control channel available in downlink timeslot 1. In this mode of operation, only frame 18 can be used for common control without disturbing the established services. (Though the BS may send common control signalling using the stealing channel or fast associated control channel or assigned SCCH of the established service.) MSs using the MCCH are required to be aware of when the system enters and leaves minimum mode.

The TETRA standard ETSI EN 300 392-2 [i.2] does not support minimum mode for DA.

#### 7.4.2.7 Discontinuous downlink transmissions - time-sharing mode

In the continuous mode of operation, the BS transmits continuously on the main carrier except when it is linearizing. (If there is no signalling information to send, the BS may send broadcast PDUs or null PDUs.)

The TETRA protocol supports BS discontinuous transmissions to allow phase modulation RF carriers (i.e. carriers currently carrying  $\pi/4$ -DQPSK and/or D8PSK channel(s)) to be shared among a number of base sites in a co-ordinated and synchronized manner. This mode of operation is only suitable for low density traffic areas or where the allocated radio spectrum is very limited. Three modes of time-sharing operation are available:

- a) Carrier sharing allows the four timeslots of a CA main carrier to be shared between up to four adjacent cells. For example, four CA cells may each use one timeslot on the main carrier, or two CA cells may each use two timeslots.
- b) In MCCH sharing mode, the MCCH may be shared by up to 36 CA cells. Each cell has a number of reserved frames during which only the BS for that cell may transmit on the downlink MCCH. The remaining frames (i.e. frames not reserved for any of the BSs) may be used as common frames during which any of the BSs may transmit on the downlink MCCH, scheduled by the infrastructure to avoid use of one slot by multiple BSs.

There will be a degraded access time to the system when using MCCH sharing; this may be acceptable in some systems for the sake of spectral efficiency.

- c) Traffic carrier sharing allows the four timeslots of phase modulation carriers other than the main carrier to be shared between up to four adjacent cells for  $\pi/4$ -DQPSK and D8PSK channels. This may apply for both CA cells and DA cells.

NOTE 1: For QAM carriers (i.e. carriers currently carrying QAM channel(s)), the BS transmits continuously except when it is linearizing.

NOTE 2: The equivalent of carrier sharing and MCCH sharing are not applicable for DA cells. Traffic carrier sharing of phase modulation carriers may apply for both CA cells and DA cells.

### 7.4.2.8 Independent allocation of uplink and downlink

A BS may allocate uplink and downlink channels for different purposes i.e. the same timeslot may be allocated for different purposes on the uplink and downlink of that carrier. This can apply to channels which are assigned for use as a traffic channel or control channel. For example, a traffic channel may be allocated in the downlink direction when the transmit MS is on another cell and there are only receiving MSs on the current cell; the corresponding uplink channel (timeslot or timeslots) may be allocated for a call which principally requires only an uplink channel.

The BS is not permitted to allocate different modulation modes (i.e.  $\pi/4$ -DQPSK, D8PSK, QAM) for the downlink channel and the corresponding uplink channel.

Some examples of permitted combinations of  $\pi/4$ -DQPSK uplink and downlink channels are listed below:

- a) circuit mode call X on downlink channel;  
circuit mode call Y on uplink channel.
- b) circuit mode call on downlink channel;  
assigned SCCH on uplink channel.
- c) assigned SCCH on downlink channel;  
circuit mode call on uplink channel.
- d) common control on downlink MCCH (slot 1);  
uplink slot 1 of main carrier allocated for a circuit mode call.
- e) downlink slot 1 of main carrier allocated for a circuit mode call;  
uplink slot 1 of main carrier available for common control.

NOTE: Control channel slots may be used in the other direction when appropriate. For instance, in case a), any ACCH in each direction is shared by the two unidirectional calls; in cases b) and c), the ACCH and SCCH are shared; in cases d) and e), the MSs in the circuit mode call share the common control channel.

## 7.4.3 Communication links provided by the LLC

### 7.4.3.1 General

Two types of communication link are provided by the LLC as a service to the MLE: the basic link and the advanced link. The basic link is available whenever the MS is synchronized to the BS, whereas the advanced link is a more powerful link that may be set up on request. When an advanced link is established, the basic link remains available.

In addition to the basic link and advanced link PDUs (and advanced link control PDUs), the LLC may send and receive layer 2 signalling PDUs. These PDUs carry various types of general signalling information relating to layer 2 functions - either LLC or MAC functions; see clause 7.4.3.5.

When the LLC wishes to send a PDU (either a basic link PDU or an advanced link PDU or a layer 2 signalling PDU), the LLC issues the PDU to the MAC as a MAC Service Data Unit (TM-SDU).

In the case of transmission by reserved access or stealing, the MAC provides only an unacknowledged signalling service to the LLC; the MAC receives the TM-SDU from the LLC, transmits the TM-SDU once and then informs the LLC when the message has been sent. Whereas, in the case of transmission by random access, the MAC in the MS is responsible for sending retries until it receives a MAC response from the BS indicating successful random access.

In either case, when the LLC is providing an acknowledged service to the higher layers, the LLC is responsible for sending retransmissions if it does not receive an acknowledgement. For unacknowledged message transmission, the LLC is responsible for sending multiple transmissions (except when the complete message is sent by random access).

There are two methods of sending a long message: fragmentation and segmentation. Fragmentation may be performed in the MAC for the basic link (or for layer 2 signalling), while segmentation may be performed in the LLC for an advanced link.

### 7.4.3.2 Basic link

The basic link offers the following services:

- acknowledged message transmission with a window size of 1;
- unacknowledged message transmission;
- un-numbered fragmentation of longer messages; and
- optional extended error control using a Frame Check Sequence, which is calculated over the entire TL-SDU (e.g. for longer messages that require fragmentation).

The basic link is used for general signalling messages (e.g. from the CMCE or MM). Also, the unacknowledged basic link may be used by the SNDCP for some packet data messages (e.g. for real-time class data).

The window size of 1 for the acknowledged basic link means that one Service Data Unit (TL-SDU) from the higher layers is sent and acknowledged at a time. This means that the LLC does not move on to the next TL-SDU until it has either received an acknowledgement for the current TL-SDU or the maximum number of retransmissions have been sent without an acknowledgement being received (or the higher layers cancel the transmission of the current TL-SDU).

The basic link protocol does not suppress received duplicates.

The unacknowledged basic link service does not guarantee in-order delivery at the receiving LLC if the PDU is sent more than once.

Scenarios showing acknowledged and unacknowledged basic link PDU exchange can be found in ETSI EN 300 392-2 [i.2], clause 22.2.1.

If a basic link message is too long to be sent in a single MAC transmission unit (MAC block), the MAC performs fragmentation of the message, subdividing the TM-SDU from the LLC - including the LLC header - into two or more fragments, where each fragment is sent in one MAC PDU within one MAC block. The whole TM-SDU contains only a single LLC header. The fragments are not numbered, so they need to be sent in sequence. If an error occurs during transmission of any of the fragments, the message cannot be reconstructed by the recipient and the MAC procedure fails, in which case the LLC has to re-send the whole message. (This is not the case for the advanced link illustrated in figure 7.8.)

Figure 7.6 illustrates the method when a message (MAC header and TM-SDU) fits within the MAC block size.

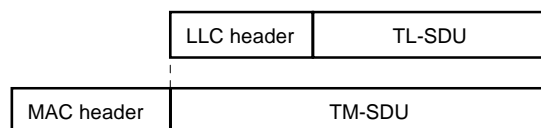

**Figure 7.6: Building of data link layer PDU (with no fragmentation)**

Figure 7.7 illustrates the MAC fragmentation procedure if the size of the TM-SDU exceeds the available capacity in a MAC block.

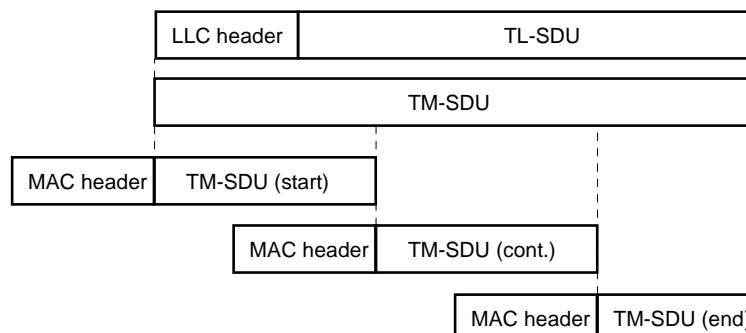

**Figure 7.7: MAC fragmentation of a long TM-SDU**

### 7.4.3.3 Advanced link

The advanced link provides a more reliable and efficient method for exchange of large quantities of acknowledged data, such as packet data transfer for background class data and telemetry class data. The advanced link needs a set-up phase.

The advanced link offers the following services:

- acknowledged message transmission on the uplink and downlink;
- unacknowledged message transmission for point-to-multipoint transfer on the downlink;
- a window mechanism, so that more than one TL-SDU can be sent before an acknowledgement is needed;
- numbered segmentation of longer messages, enabling selective retransmission of failed segments for point-to-point transfer or selective re-assembly for point-to-multipoint transfer; and
- extended error control using a Frame Check Sequence (FCS), which is calculated over the entire TL-SDU.

The advanced link protocol allows suppression of received duplicates.

For the unacknowledged advanced link, the LLC in the MS may deliver the received TL-SDUs out of sequence.

Scenarios showing advanced link set-up, reconnection and release, and data exchange and flow control can be found in ETSI EN 300 392-2 [i.2], clause 22.2.2.

The advanced link uses numbered segmentation in the LLC in cases when the message is too long to be sent in a single MAC block. So, the LLC divides the TL-SDU from the higher layers into two or more numbered segments, each with its own LLC header (which includes the TL-SDU number and the segment sequence number).

For point-to-point transfer, the selective retransmission is based on the LLC segments. The receiving LLC informs the transmitting LLC about which segments have been correctly received and about which segments have not yet been correctly received - usually using a bit map in advanced link acknowledgements, indicating the reception status of the segments. The transmitting LLC then re-sends the missing segments until all the segments have been received correctly (as recognized by the lower MAC layer's error detection). If an error is detected in a re-assembled TL-SDU by the LLC's Frame Check Sequence, the receiving LLC requests a complete retransmission of the TL-SDU.

For point-to-multipoint transfer, the receiving LLC combines segments from multiple transmissions of the same TL-SDU in order to re-assemble a complete TL-SDU.

Advanced link segmentation is illustrated in figure 7.8.

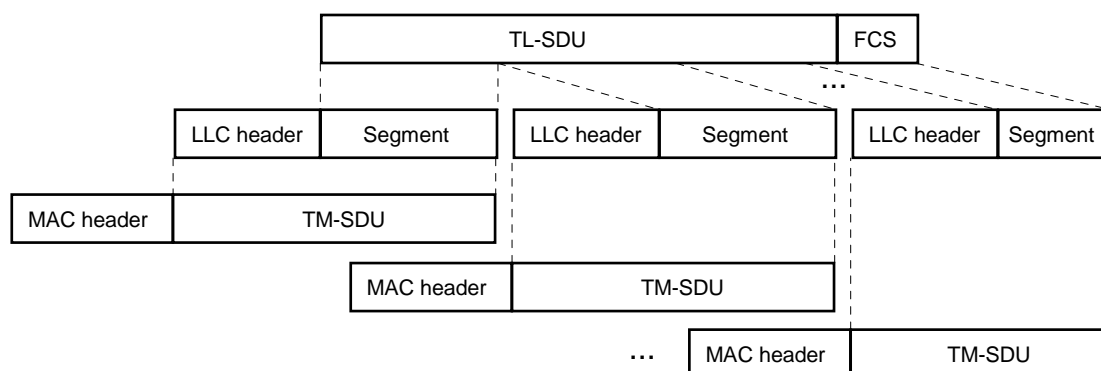

**Figure 7.8: Advanced link segmentation by the LLC**

There are two variants of advanced link: the original advanced link and the extended advanced link.

The original advanced link provides a window size of up to three and mandatory extended error control using a Frame Check Sequence (FCS). The extended advanced link provides a larger window size of up to 15, and the Frame Check Sequence is optional; the extended advanced link also has a more efficient acknowledgement system than the original advanced link. The number of simultaneous links in an MS depends on its capability. The MS may have up to four independent acknowledged advanced links, each dealing with a specific quality of service. The MS may use either:

- one original acknowledged advanced link plus up to three extended acknowledged advanced links; or

- up to four extended acknowledged advanced links.

In the current version of ETSI EN 300 392-2 [i.2], the MS may also have up to four independent unacknowledged advanced links per group address. However, it is expected that this may change in a future version of ETSI EN 300 392-2 [i.2].

If the MS has multiple simultaneous advanced links, some or all of the advanced links may share the same resource at the MAC layer, in which case there is only one basic link associated with those advanced links.

### 7.4.3.4 Advanced link usage

#### 7.4.3.4.1 Advanced link set-up

When the MS requests a new acknowledged advanced link, the set-up PDU contains parameters for negotiation such as the variant of advanced link (original/extended) and layer 2 QoS parameters such as the advanced link window size and the maximum numbers of segment retransmissions and complete packet retransmissions (see clause 7.3.6).

The protocol uses two elements "Connection width" and "Data transfer throughput" in the advanced link set-up PDU to indicate the type of resource information. The combinations are described below and are shown in table 7.4:

- The advanced link set-up PDU may request a phase modulation connection by including information related to  $\pi/4$ -DQPSK radio resources. For example, this may be used if an MS that supports QAM modulation would prefer to use a phase modulation channel; it may also be used if an MS that supports only phase modulation wishes to request a specific number of timeslots per TDMA frame. This facility in the advanced link set-up PDU provides radio resource information only in terms of  $\pi/4$ -DQPSK timeslots:
  - The MS may request a specific number of phase modulation timeslots per TDMA frame by setting the "Data transfer throughput" element to a value other than  $110_2$ . Then other elements indicate the requested radio resources in terms of  $\pi/4$ -DQPSK timeslots.
 

The "Data transfer throughput" element indicates how much of the total throughput of the requested radio resources should be available for the advanced link. Maximum throughput will be realized when there is only one MS using the whole capacity of the radio resource allocation. The lower values indicate that the same radio resources could be used for multiple advanced links for one or more MSs.
  - A request for a phase modulation channel without requesting a specific number of timeslots per TDMA frame is indicated by setting the "Connection width" element to "1" and the "Data transfer throughput" element to  $110_2$ .
- Alternatively (for example, if the MS wishes the BS to choose any appropriate channel (within the MS's capabilities and using any QoS information negotiated by the SNDCP during PDP context activation)), the advanced link set-up PDU may provide no information related to radio resources. This is indicated by setting the "Connection width" element to "0" and the "Data transfer throughput" element to  $110_2$ .

NOTE 1: These elements were used in this way to provide additional facilities within existing PDU elements.

NOTE 2: In the case of a request for a phase modulation connection, the BS should regard this as a request for either a  $\pi/4$ -DQPSK connection or a D8PSK connection (if the MS supports D8PSK channels).

**Table 7.4: Request for advanced link radio resource**

Connection width	Date transfer throughput	Meaning
0	$110_2$	No information about radio resources
0	not $110_2$	Single-slot phase modulation connection
1	$110_2$	Unspecified phase modulation connection (see note 1)
1	not $110_2$	Specified multislot phase modulation connection (see note 2)
NOTE 1: If an unspecified phase modulation connection is requested, the information about the number of $\pi/4$ -DQPSK timeslots per TDMA frame indicates the MS's maximum phase modulation capability. NOTE 2: If a specified multislot phase modulation connection is requested, the information about the number of $\pi/4$ -DQPSK timeslots per TDMA frame indicates the requested radio resource. The request may be for a symmetric or asymmetric phase modulation advanced link.		

If no advanced link exists when the MS has been sent to a PDCH, and the MS requested assignment to a phase modulation channel in the SDCP signalling for PDCH access, the information in the advanced link set-up PDU should correspond to the information in the SDCP signalling.

#### 7.4.3.4.2 Segment size for advanced link

For the advanced link, the LLC divides long data messages into numbered segments, where each segment is individually recognizable by its LLC header.

The segment size depends on the modulation mode of the channel:

- On a  $\pi/4$ -DQPSK or D8PSK channel, the segment size matches the available space in the MAC block. Therefore, on a D8PSK channel, segments may be of different sizes, depending on whether they are cut to be sent using  $\pi/4$ -DQPSK or  $\pi/8$ -D8PSK modulation for the first transmission of that segment.
- On a 25 kHz or 50 kHz QAM channel, the segment size is normally determined by the available space in a full-slot MAC block using 4-QAM with coding rate  $r = 1/2$  at the current RF bandwidth; on a 100 kHz or 150 kHz QAM channel, the segment size is normally determined by the available space in half of a full-slot MAC block using 4-QAM with coding rate  $r = 1/2$  at the current RF bandwidth. The first and last segment of a TL-SDU may be of different size.

Use of these segment sizes on a QAM channel means that, on a 25 kHz or 50 kHz QAM channel:

- a full slot using 4-QAM with coding rate  $r = 1/2$  can contain one advanced link segment;
- a full slot using 16-QAM with coding rate  $r = 1/2$  can contain two advanced link segments;
- a full slot using 16-QAM with coding rate  $r = 1$  can contain four advanced link segments;
- a full slot using 64-QAM with coding rate  $r = 1/2$  can contain three advanced link segments;
- a full slot using 64-QAM with coding rate  $r = 2/3$  can contain four advanced link segments;
- a full slot using 64-QAM with coding rate  $r = 1$  can contain six advanced link segments.

This is illustrated in figure 7.9.

The segment is defined as the unit of retransmission. Therefore, on a  $\pi/4$ -DQPSK channel, fragmentation is not needed for advanced link messages. On a D8PSK channel, fragmentation is needed when a segment cut for transmission using  $\pi/8$ -D8PSK modulation is retransmitted using  $\pi/4$ -DQPSK modulation (since the capacity of a  $\pi/8$ -D8PSK MAC block is greater than the capacity of a  $\pi/4$ -DQPSK MAC block).

On a 25 kHz or 50 kHz QAM channel, choice of the segment size corresponding to the smallest full-slot MAC block size (i.e. 4-QAM with coding rate  $r = 1/2$ ) enables segments to be retransmitted without fragmentation even if the modulation level and/or coding rate is changed. For example, if four segments are sent in a full slot using 64-QAM with coding rate  $r = 2/3$ , and the slot is not decoded by the recipient, then the four failed segments could be retransmitted in two slots using 16-QAM with coding rate  $r = 1/2$ , with two segments in each slot. If the recipient still fails to decode one (or both) of the 16-QAM slots, then the two (or four) failed segments could be retransmitted in two (or four) slots using 4-QAM with coding rate  $r = 1/2$ , with one segment in each slot.

NOTE: After a reduction of RF bandwidth (for example, if the RF bandwidth of the channel changes from 50 kHz to 25 kHz), fragmentation may be needed for retransmissions of segments cut for transmission on the old channel. Alternatively, the advanced link may be reset after a reduction of RF bandwidth.

The same principle applies on a 100 kHz or 150 kHz QAM channel except that the segment size corresponds to half the size of the smallest full-slot MAC block, so that segments do not become too large.

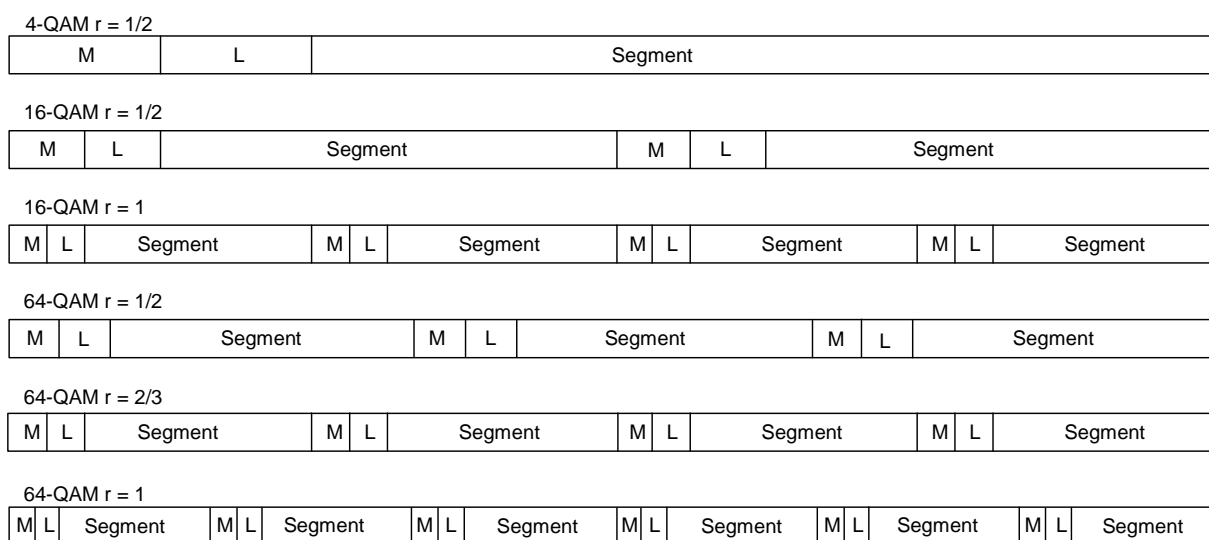

NOTE: In this figure, M represents MAC header and L represents LLC header

**Figure 7.9: Advanced link segments on a 25 kHz or 50 kHz QAM channel**

### 7.4.3.5 Layer 2 signalling

In addition to the basic and advanced links, the LLC may send and receive layer 2 signalling PDUs, which carry various types of general signalling information relating to layer 2 functions. These functions may be LLC or MAC functions. However, for the purposes of the data exchange mechanisms, the layer 2 signalling PDUs are treated as LLC PDUs.

The layer 2 signalling service provides unacknowledged message transmission, with un-numbered fragmentation of longer messages. The sending LLC may repeat a layer 2 signalling PDU to increase the probability of a correct reception. (The layer 2 signalling protocol does not suppress received duplicates.) The layer 2 signalling service does not guarantee in-order delivery at the receiving entity.

Currently, the uses of layer 2 signalling are for MAC functions:

- for the MAC in the MS to indicate short-term variations in the MS's required data priority, temporarily modifying the default data priority negotiated with the SwMI by the SNDPCP (see clause 7.7);
- for the BS to send schedule synchronization information (see clause 7.8); and
- for the BS to control link adaptation feedback by the MS and for the MAC in the MS and BS to send link adaptation feedback information on a D8PSK or QAM channel (see clause 7.5).

Where a layer 2 signalling PDU relates to a MAC function, the LLC provides the layer 2 signalling service to the MAC through a specific SAP, called the TLE-SAP. When the LLC sends or receives a layer 2 signalling PDU (relating to either an LLC or MAC function), it uses the data transfer service offered by the MAC at the TMA-SAP.

Thus, the process for the MAC to send a layer 2 signalling message using the layer 2 signalling service provided by the LLC is similar to the process when the MLE sends a message using the basic link or advanced link service provided by the LLC. The MAC issues a request primitive at the TLE-SAP containing the information to be sent in the layer 2 signalling PDU; then, when the MAC indicates that it is ready to send a message (for example, if it is ready to perform random access or has been granted a reserved slot), the LLC constructs the layer 2 signalling PDU and issues it to the MAC via the TMA-SAP. Similarly, for reception, the MAC delivers a received TM-SDU to the LLC via the TMA-SAP and, if the received LLC PDU is a layer 2 signalling PDU corresponding to a MAC function, the LLC delivers the information to the MAC via the TLE-SAP.

NOTE: The decision to use LLC PDUs to send information corresponding to some MAC functions was originally made because of shortage of available MAC PDU types. However, it has the advantage that layer 2 signalling PDUs may be used also for general LLC functions in the future. Also, the similarity to the method for the LLC (and hence the MAC) to provide service to the MLE means that the existing data transfer mechanisms in the MAC could be used also for the layer 2 signalling with little or no change.

## 7.4.4 Some MAC processes

### 7.4.4.1 General

Clause 7.4.4 looks at some of the MAC processes: layer 2 addressing, random access, reserved access, channel allocation and power control.

Then clauses 7.5 to 7.10 look at link adaptation on a D8PSK or QAM channel, energy economy and napping, data priority, scheduled access, cell and channel selection, and circuit mode calls. Those functions involve procedures performed by multiple layers, including the MAC. The involvement of all the relevant layers is outlined when the function is described.

The MS is required to receive the downlink of control channels as follows:

- When the MS is on a single-slot common control channel (the MCCH or a single-slot MCCH-Q or a common SCCH), it attempts to receive and decode the appropriate downlink slot on the main carrier, in all frames 1 to 18 - except that energy economy or dual watch mode and the cell reselection procedures may take precedence over reception on the common control channel.
- When the MS is on a multi-slot MCCH-Q, it attempts to receive and decode the appropriate downlink slots on the main carrier, in all frames 1 to 18 - except that energy economy or dual watch or part-time reception mode and the cell reselection procedures, and linearization and transmission requirements, may take precedence over reception on the multi-slot MCCH-Q.
- When the MS is on an assigned SCCH, it attempts to receive and decode the allocated downlink slot or slots, in all frames 1 to 18 - except that napping procedures and the cell reselection procedures, and linearization and transmission requirements on a multi-slot channel, may take precedence over reception on the assigned SCCH.

NOTE: The MS may operate with multi-slot channels without the need for the MS to support frequency full duplex operation (see clause 7.13).

- When an assigned channel is in use for traffic, there may be reduced reception requirements when the MS is transmitting in traffic mode and also reduced requirements for reception in frame 18 when the MS is receiving in traffic mode on a multi-slot channel; see clause 7.10.

The MAC in the MS looks for and processes any downlink messages addressed to that individual MS or to one of the MS's valid group addresses (and delivers the TM-SDU to the higher layers). The MS also looks for and processes broadcast signalling messages and the content of the access assignment channel (to check the current access rights).

The usage of channels is scheduled by the BS, and MSs transmit only under BS control. The random access protocol is generally needed when the MS sends a message to initiate a call or transaction. However, when an MS is required to send a solicited message or when the MS has further signalled to send after the initial access, the BS may reserve slots for that particular MS (reserved access). Reserved access enables a higher channel throughput to be achieved than for random access; this is because there are no collisions of messages from different MSs in reserved slots, so the only errors are those caused by propagation problems.

On a control channel, MSs may transmit messages only by random access or reserved access. (Also, during a circuit mode call, the transmitting MS may "steal" from the traffic channel capacity to send signalling messages; see clause 7.10.) MSs may transmit for linearization purposes in some predefined positions in frame 18, and also in subslots in other TDMA frames when the access assignment channel sent by the BS in downlink slots indicates a common linearization opportunity in the corresponding uplink slot.

In the case of non-contentious transmission (i.e. reserved access or stealing), the MAC provides an unacknowledged signalling service to the LLC. The MAC receives a TM-SDU from the LLC, transmits the TM-SDU once and then informs the LLC when the message has been sent. Acknowledgements and retransmissions are controlled by the LLC.

However, for random access, the MAC in the MS is responsible for sending retries until it receives a MAC response from the BS indicating successful random access.

If an SDU received from the LLC exceeds the available capacity in a MAC block, the MAC performs fragmentation, subdividing the SDU between two or more MAC blocks (as illustrated in figure 7.7). Conversely, if an SDU does not fill the available capacity in a MAC block, the MAC may perform PDU association, sending two or more independent PDUs within one MAC block; unused bits should be filled with a NULL PDU as illustrated in figure 7.10, or fill bits may be used (not shown).

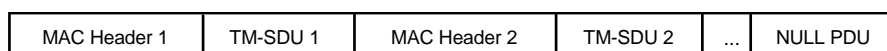

**Figure 7.10: Association of several MAC PDUs in one MAC block**

## 7.4.4.2 Addressing

### 7.4.4.2.1 General

The main TETRA identities are the subscriber identities, used to identify users of the system. These exist in two sizes:

- TETRA Subscriber Identity (TSI), 48 bits long, unique across the complete TETRA domain; and
- Short Subscriber Identity (SSI), 24 bits long, unique within one TETRA network.

The SSI is a truncation of the TSI, formed from a TSI by removing the Mobile Network Identity (MNI). The MNI comprises the 10-bit Mobile Country Code (MCC) and the 14-bit Mobile Network Code (MNC); see figure 7.11.

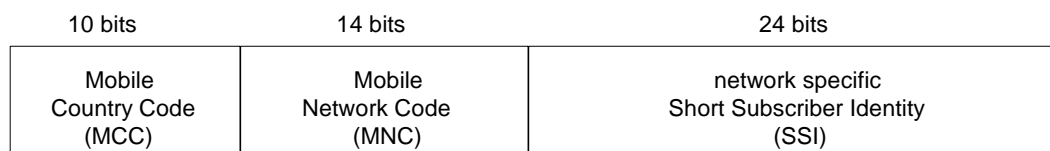

**Figure 7.11: Contents of TETRA Subscriber Identity (TSI)**

Each MS contains at least one family of TSIs. Each family contains one Individual TETRA Subscriber Identity (ITSI), and may have an Alias TETRA Subscriber Identity (ATSI) and some Group TETRA Subscriber Identities (GTSIs). An ITSI uniquely identifies a terminal user, whereas a GTSI usually refers to several terminal users. An ATSI is allocated by the SwMI when an MS visits a network other than its home network; an ATSI may also be allocated on the home network to support secure network operations. The shortened forms of ITSI, ATSI, and GTSI are Individual Short Subscriber Identity (ISSI), Alias Short Subscriber Identity (ASSI) and Group Short Subscriber Identity (GSSI). Also, an Un-exchanged Short Subscriber Identity (USSI) is used until a migrating MS has received an ASSI on this network.

The subscriber identities may be transferable from one equipment to another, whereas the TETRA Management Identity (TMI) is a non-transferable 48-bit network identity allocated to a particular piece of equipment independently from the TSI. The Short Management Identity (SMI) is a truncation of the TMI, formed from a TMI by removing the MNI.

The TETRA Equipment Identity (TEI) uniquely identifies one piece of TETRA equipment. It contains a Type Approval Code, Final Assembly Code, Electronic Serial Number and spare digit. It is allocated by the equipment manufacturer.

There are also Network Service Access Point (NSAP) addresses, which may be used to provide compatibility with external (non-TETRA) networks such as ISDN, PSTN and PDN.

The usage of TETRA addresses and identities is described in ETSI EN 300 392-1 [i.12], clause 7.

#### 7.4.4.2.2 Layer 2 addressing

MAC PDUs generally contain a layer 2 "address" element and an element specifying the type of address. The layer 2 address is the source address for an uplink PDU, or the destination address for a downlink PDU. The address in a MAC PDU is a Short Subscriber Identity (ISSI, ASSI or GSSI), an USSI, an SMI or a 10-bit event label (see below).

NOTE: Another address (when needed) may be contained within the layer 3 part of the message e.g. the called address for an uplink PDU, or the calling address for a downlink PDU. The SwMI makes the required address conversion between the uplink and downlink PDUs as appropriate.

When the MAC in the MS receives a PDU, it needs to check whether the PDU is addressed to itself e.g. whether the PDU contains one of its addresses or event labels. If addressed to itself, it processes the PDU and passes the TM-SDU to the LLC.

An event label is a temporary shortened form of address which replaces a specified SSI (ISSI, ASSI or GSSI) or SMI in the MAC PDUs. It is allocated by the BS at the MAC level, for one channel, and is visible only at the MAC layer. (The MAC translates the event label into the corresponding SSI or SMI before passing received information to the LLC.)

Event label assignment is intended primarily for when an advanced link or advanced links have been set up for the appropriate address (though it is permitted when there is only a basic link). Use of event labels on a packet data channel may be particularly useful, since reduction of the address size by 14 bits means that each LLC data segment can carry 14 bits more user data. Also, there are MAC PDUs (MAC-U-BLCK on the uplink, MAC-D-BLCK on the downlink) that can only be used with an event label. These PDUs are optimized for carrying advanced link data segments, and their use saves a further four bits per data segment on the uplink and 11 or 12 bits per data segment on the downlink.

#### 7.4.4.3 Random access

##### 7.4.4.3.1 General

The MAC in the MS uses a random access protocol when the MS sends a message to initiate information transfer to the BS. The random access protocol is generally used for unsolicited MS messages, whereas messages solicited by the BS are generally sent in a subslot or slot(s) reserved by the BS for that MS.

The random access protocol in TETRA is based on slotted Aloha procedures, with a superimposed framing structure controlled by the BS. By a suitable choice of access parameters, it is possible for the BS to:

- control the collision of access requests from different MSs;
- minimize access delay and traffic loss for a particular traffic loading;
- maintain peak throughput for a particular traffic loading;
- avoid protocol instability;
- dynamically restrict random access to different access priorities, and to selected groups and subscriber classes;
- provide simultaneously, independent access grades of service for different groups and subscriber classes.

NOTE 1: A subscriber class is a subdivision of the subscriber population, used at the MLE level for control of which MSs are allowed to use a cell, and at the MAC level for random access control. The operator may define the values and meaning of each class. An MS may belong to more than one of the 16 subscriber classes. The MS receives its subscriber class membership information on registration or at subscription.

Generally, the same random access procedures are suitable for use on all types of control channel (e.g. MCCH, MCCH-Q, SCCH, FACCH, SACCH), although the access parameters, waiting time and number of retries may be different.

Random access to the system is only permitted when invited by the BS. An MS wishing to access has to wait until an access opportunity is presented by the BS, as indicated in the downlink signalling.

The BS may offer random access opportunities to sets of MSs in turn by using different "access codes" in the access assignment channel. There is a maximum of four possible access codes (denoted A, B, C and D) active at any one time, and the BS marks each access opportunity with the appropriate access code. Alternatively, the BS may use a single access code.

The protocol supports use of these four different access codes, hence providing a range of grades of service to different subscribers. The way that the access codes are defined is a network operator option.

The binding of MSs to access codes is dynamic, broadcast periodically by the BS. The binding defines the minimum valid PDU priority for an access code. It may also restrict use of the access code to a set of subscriber classes, or to a group of MSs. An MS may use a subslot designated for a particular access code only if the PDU priority, and the subscriber class parameter or MS identity, conform to the current binding.

For a particular access code, requests from MSs are invited within "access frames" consisting of a number of access opportunities (uplink subslots). MSs generally randomize their transmissions within an access frame. This is to spread out the access requests within the access frame and so control collisions.

NOTE 2: Access frames are not the same as the TDMA frames described earlier.

The random access procedures are based on two types of PDU broadcast by the BS. The PDUs are:

i) The ACCESS-DEFINE PDU

This PDU is transmitted at intervals, how often being an operator option. It contains fairly slowly changing information about the random access parameters for an access code:

- the PDU priority and MS binding to the access code;
- a parameter defining when immediate access is permitted for the first transmission;
- the waiting time before deciding to re-try;
- the permitted number of random access retries;
- a frame-length multiplying factor;
- the uplink random access channel configuration (i.e. the uplink timeslots per frame that are potentially available for random access; this is not necessarily the same as the downlink channel configuration).

ii) The ACCESS-ASSIGN PDU

This PDU:

- is transmitted in every downlink slot of a  $\pi/4$ -DQPSK or D8PSK channel, on the AACH;
- is normally transmitted in downlink slots of a QAM channel (except slots containing BS linearization), on the AACH-Q.

The ACCESS-ASSIGN PDU conveys information about the usage of the downlink slot in which it appears, and also access rights for the corresponding (i.e. same-numbered) uplink timeslot, which is two slots later.

When the uplink is in use for control signalling, the ACCESS-ASSIGN PDU may contain two "access fields" which convey independent access rights for each of the two uplink subslots in the uplink slot.

The access field defines the allowed access code for the uplink subslot. It also may include a frame-length parameter indicating the number of following uplink subslots, for this access code, that constitute an access frame. Other values are used when the element does not mark the start of a new access frame, or when the uplink subslot is reserved for use by one MS and is therefore not available for random access, or when the uplink subslot is assigned for common linearization by MSs.

NOTE 3: The MS for which a subslot or slot(s) are reserved is informed separately using a downlink signalling message addressed to that MS. The identity of that MS does not appear in the ACCESS-ASSIGN PDU.

In other cases (for example, in frames 1 to 17 on an assigned SCCH), the ACCESS-ASSIGN PDU contains only one access field, which conveys access rights for both uplink subslots in the uplink slot.

When the uplink is in use for traffic, the ACCESS-ASSIGN PDU contains no access field, in which case the uplink slot is not available for random access or common linearization.

Also, the broadcast network channel BNCH (which contains the SYSINFO PDU) or BNCH-Q (which contains the SYSINFO-Q or SYSINFO-DA PDU) may include some default random access parameters to be assumed, for access code A, by MSs that have acquired the main carrier - until receipt of ACCESS-DEFINE PDUs. For BSs that do not need multiple access codes, the facilities provided by the SYSINFO, SYSINFO-Q and SYSINFO-DA PDUs may be adequate, so that the ACCESS-DEFINE PDU is not used.

The BS may optimize the system performance by varying the access code bindings, the frame-length and the other access parameters. The choice of parameters will depend on the type of system and the traffic mix.

#### 7.4.4.3.2 Overview of random access channel on 25 kHz channel

The basic format of the random access channel is illustrated in figures 7.12 to 7.15 inclusive.

NOTE 1: In these representations, the detailed TDMA frame structure (e.g. with a control timeslot and three traffic timeslots per TDMA frame) is not shown. The uplink control subslots (half timeslots) for this control channel are shown as if they were contiguous.

On a 25 kHz channel, an access request occupies one subslot on the uplink.

NOTE 2: In line with the slotted Aloha principle, access requests are made subslot synchronous i.e. in subslot 1 or subslot 2 - not partway through a subslot.

Figure 7.12 illustrates an example of designation of uplink subslots on a common control channel, showing multiple access codes and reserved subslots. The designation is performed using the ACCESS-ASSIGN PDU, with two access fields in the ACCESS-ASSIGN PDU sent in a downlink slot defining the use of the two corresponding uplink subslots. (For example, the two access fields in the ACCESS-ASSIGN PDU sent by the BS on the MCCH in downlink frame 1, slot 1 indicate the access rights for the two subslots in uplink frame 1, slot 1.)

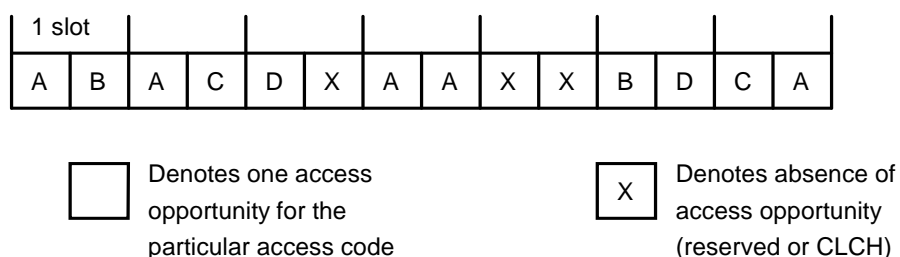

**Figure 7.12: Example of subslot structure on common control channel**

Figure 7.13 illustrates an example of designation of uplink subslots on an assigned SCCH, showing multiple access codes and reserved subslots. The designation is performed using the ACCESS-ASSIGN PDU, with a single access field in the ACCESS-ASSIGN PDU sent in a downlink slot defining the use of the two corresponding uplink subslots. (For example, the access field in the ACCESS-ASSIGN PDU sent by the BS on an assigned SCCH in downlink frame 1, slot 3 indicates the access rights for both subslots in uplink frame 1, slot 3.)

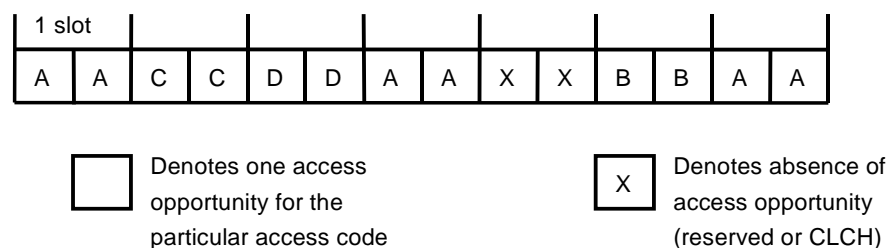

**Figure 7.13: Example of subslot structure on assigned SCCH**

Now consider only those subslots relevant to a particular access code. For these subslots, access requests are permitted only from MSs with a valid request for that access code. Those access requests are invited within "access frames". The access field in the ACCESS-ASSIGN PDU indicates the number of following uplink subslots, for this access code, that constitute an access frame. A special value ("ongoing frame") is used when the field does not mark the start of a new access frame.

When a user request is initiated, for example a valid request for access code A, the MS's MAC is permitted to send a first random access request in the next available access code A subslot (as indicated by an ACCESS-ASSIGN PDU received on the downlink), provided that this occurs within a designated time.

If an immediate first access request is not made, the MS's MAC has to wait for an ACCESS-ASSIGN PDU containing a frame marker for its access code, and then chooses a subslot randomly from that access frame for its first access request. An MS wishing to send a repeat transmission after an unsuccessful access request (no response) has to wait for an ACCESS-ASSIGN PDU containing a new frame marker for its access code and chooses another subslot randomly from that access frame.

This procedure is illustrated in figures 7.14 and 7.15, in which the subslots shown are only those control subslots marked for random access by access code A. WT is the retry time when the MS's MAC decides that its access request has failed (having received no response from the BS within that time).

In figure 7.14, the BS chooses to mark rolling access frames, with a new access frame marked for every subslot so that the resulting access frames overlap.

In figure 7.15, the BS chooses to mark discrete access frames, by using the "ongoing frame" value (here denoted by \*) to indicate ongoing frame continuation.

The choice between rolling access frames and discrete access frames is made by the BS. The MS does not need to know whether the BS intends to mark rolling access frames or discrete access frames; the MS access procedures are defined so that they are compatible with either method.

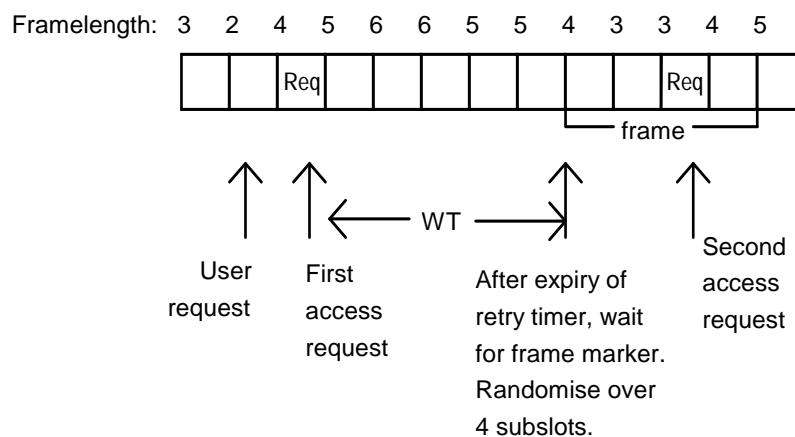

Figure 7.14: Example of random access procedure (BS using rolling access frames)

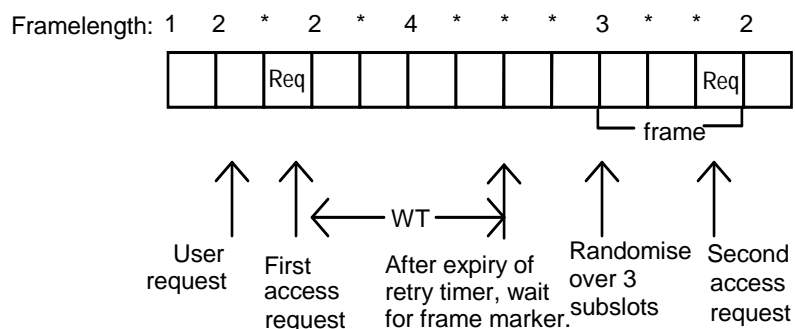

Figure 7.15: Example of random access procedure (BS using discrete access frames)

In either case, the BS may assess activity on the uplink channel in the subslots assigned to the access code, and may vary the frame-length to prevent excessive collision of access requests from different MSs and to minimize access delays. Under normal conditions, the frame-length can be short. Then, when collision is detected, the BS may increase the frame-length dynamically according to its estimate of the backlogged traffic. This allows rapid smoothing of traffic transients.

### 7.4.4.3.3 Overview of random access channel on 50 kHz, 100 kHz or 150 kHz QAM channel

There is an additional step in the procedure for random access on 50 kHz, 100 kHz and 150 kHz QAM channels as follows.

Access requests are sent within a 25 kHz bandwidth for all QAM channels. Therefore, for a 25 kHz QAM channel, an access request fully occupies one subslot on the uplink. However, for a 50 kHz, 100 kHz or 150 kHz channel, each subslot (i.e. half timeslot) that is available for random access is divided into 25 kHz frequency blocks - called random access uplink RF channel subslots - so that each subslot provides:

- two random access uplink RF channel subslots on a 50 kHz channel;
- four random access uplink RF channel subslots on a 100 kHz channel; or
- six random access uplink RF channel subslots on a 150 kHz channel.

This is illustrated in figure 7.16.

The MS uses the normal procedures for choosing a subslot randomly from an access frame and then counting the subslots to its chosen subslot. Thus, for the purposes of counting subslots in an access frame, the parallel random access uplink RF channel subslots are regarded as a single subslot. However, when the MS reaches its chosen subslot, there is then an additional procedure whereby the MS makes a random choice of one of the two, four or six random access uplink RF channel subslots corresponding to its chosen subslot; the MS then transmits its access request in the selected random access uplink RF channel subslot.

The provision of parallel random access uplink RF channel subslots enables a higher random access throughput than using the full RF bandwidth of the channel for one access request.

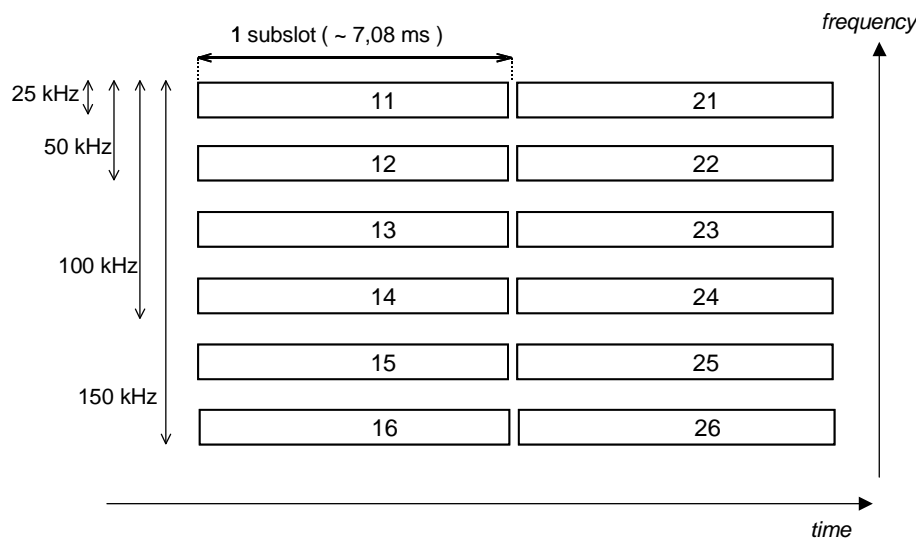

**Figure 7.16: Random access time / frequency structure for QAM channels**

#### 7.4.4.4 Reserved access

##### 7.4.4.4.1 Use of reserved access

The random access protocol is generally needed when an MS wishes to initiate a call or transaction. Once the random access to the system has been performed, subsequent transmissions from the MS can use reserved access i.e. the BS can schedule the MS transmissions into specified uplink slots. Thus, when the MS has further signalling to send after the initial access, it indicates its current requirement for reserved slots to the BS, and the BS may then reserve an uplink subslot or slot(s) for that MS. Similarly, when the BS sends the MS a message that requires a response, the BS may reserve an uplink subslot or slot(s) for that MS.

The ACCESS-ASSIGN PDU (on the access assignment channel) sent by the BS in downlink slots indicates which uplink slots and subslots are reserved and therefore not available for random access by other MSs. The MS for which a subslot or slot(s) are reserved is informed separately using a downlink signalling message addressed to that MS.

The basic slot granting facility enables the BS to grant a single subslot, or a single slot, or a number of slots occupying successive slots on the uplink of that common control channel or assigned channel. An additional facility for "multiple slot granting" is available on a QAM channel; this facility allows the BS to grant disjoint resources to an MS with one slot grant.

There is also a facility called scheduled access. The MS at SNDCP level negotiates that the BS will grant reserved capacity with a specified repetition period, in order to support applications that require regular transmissions of bursts of data. Then, when the schedule becomes active, the BS reserves slots for that MS without the MS needing to use random access; see clause 7.8.

##### 7.4.4.4.2 Basic slot granting

When using basic slot granting, the BS sends a PDU addressed to the MS with a "basic slot granting" element included in the PDU. The "basic slot granting" element indicates the amount of reserved capacity - a single subslot or one or more full slots - and the time delay until the start of the reservation. Where several slots are granted, these occupy successive slots on this uplink control channel (except jumping over slots corresponding to predefined opportunities for common linearization).

**EXAMPLE 1:** On the MCCH or a single-slot MCCH-Q, a three-slot granted allocation starting in slot 1 of frame 8 occupies also slot 1 of frames 9 and 10.

**EXAMPLE 2:** On an assigned SCCH using timeslots 3 and 4, a four-slot granted allocation starting in slot 4 of frame 10 occupies also slots 3 and 4 of frame 11 and slot 3 of frame 12.

##### 7.4.4.4.3 Multiple slot granting

Multiple slot granting is an alternative facility available for use on a QAM channel. It enables the BS to grant disjoint resources with one slot grant (i.e. within one PDU):

- by including up to seven explicit instances of the "basic slot granting" element in one slot grant; and/or
- by using an implicit repeat mechanism for each instance of the "basic slot granting" element, allowing the BS to specify that the MS should behave as if it had received the "basic slot granting" element a number of times (up to 11 times),

where each granting time delay after the first is counted from the end of the previous part of the multiple slot grant.

The implicit repeat mechanism allows a patterned repetition of resources to be granted with one "basic slot granting" element. For example, this may be useful for allocating resources to an MS that is using scheduled access with a fairly short schedule repetition period (i.e. within the range of the granting time delay), or for allocating resources to other MSs sharing the channel with an MS that is using scheduled access.

**EXAMPLE 1:** As a possible usage on a four-slot QAM channel, the BS could use the implicit repeat mechanism to make a slot grant consisting of one slot per TDMA frame for a number of TDMA frames. For example, if the BS sends a multiple slot grant in slot 1 of frame 3, comprising a single instance of the basic slot granting element granting a capacity allocation of one slot with a granting delay corresponding to three opportunities delay, and with an implicit repeat count of 9, the granted allocation comprises slot 4 of each of frames 3 to 12. (The implicit repeat count of 9 means that the one-slot grant applies 10 times. The granting delay of three, on a four-slot channel, means that each one-slot grant is separated by three uplink slots.)

Use of multiple explicit instances of the "basic slot granting" element may be useful for providing disjoint slot grants that are not based on a patterned repetition of resources.

**EXAMPLE 2:** On a QAM channel using timeslots 2, 3 and 4: for a multiple slot grant sent in slot 2 of frame 9 and comprising two explicit instances of the basic slot granting element (with no implicit repeating), where:

- the first basic slot granting element grants a capacity allocation of two slots with no granting delay; and
- the second basic slot granting element grants a capacity allocation of six slots with five opportunities delay.

The granted allocation comprises slots 2 and 3 of frame 9, slots 3 and 4 of frame 11, slots 2, 3 and 4 of frame 12 and slot 2 of frame 13.

Use of multiple explicit instances of the "basic slot granting" element in combination with the implicit repeat mechanism may be useful in some cases, for example, at the beginning of a patterned repetition of resources (or if the BS wishes to regain the exact synchronization of a patterned repetition of resources after a linearization opportunity).

**EXAMPLE 3:** On a four-slot QAM channel: for a multiple slot grant sent in slot 4 of frame 3 and comprising two instances of the basic slot granting element, where:

- the first basic slot granting element grants a capacity allocation of one slot with no granting delay, and there is no implicit repeating of the element; and
- the second basic slot granting element grants a capacity allocation of one slot with a granting delay corresponding to three opportunities delay, and there is an implicit repeat count of 8.

The granted allocation comprises slot 4 of each of frames 3 to 12 (i.e. as in example 1, but with the slot grant sent in a different downlink slot for BS scheduling flexibility).

Figure 7.17 shows an example of usage of the uplink. In this example, one MS is transmitting real-time class data, making regular transmissions using scheduled access. The BS can use multiple slot granting with the implicit repeat mechanism to grant slots to this MS. Another MS is transmitting background class data, for example for file transfer. The BS can use multiple slot granting to grant slots to this MS, fitting the granted slots in the gaps between the scheduled access transmissions but also leaving space for random access and/or reserved access for other MSs.

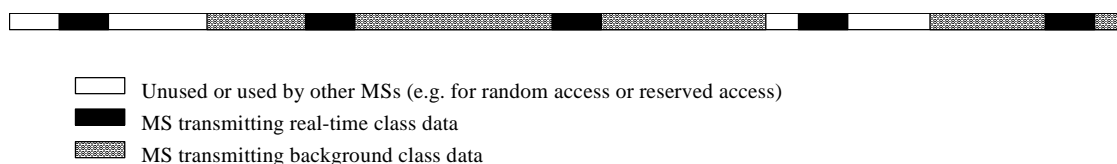

**Figure 7.17: Example of usage of the uplink channel**

#### 7.4.4.5 Channel allocation

The BS includes the "channel allocation" element in a downlink MAC PDU when it wishes to direct an MS or group of MSs to an assigned channel. The basic channel allocation for a  $\pi/4$ -DQPSK channel includes information about the type of allocation (e.g. replacement of the current channel or allocation of an additional independent channel for an independent service), the assigned timeslot or timeslots per TDMA frame and the allocated RF carrier.

When the BS wishes to allocate a D8PSK or QAM channel, or if it wishes to permit "napping" on the assigned channel, the BS uses an augmented channel allocation. This includes additional information such as:

- the RF bandwidth of the allocated channel;
- the modulation mode of the allocated channel ( $\pi/4$ -DQPSK, D8PSK or QAM);
- the conforming channel status (conforming, non-conforming concentric, sectored, super-sectored or eccentric);
- BS transmit power and BS link imbalance information; and
- napping information (optional).

A "concentric channel" is defined as a channel that has essentially the same azimuthal radiation pattern as the main carrier and is radiated from the same site as the main carrier. It may use a different modulation mode, RF bandwidth and/or RF power from the main carrier and may have a different range and coverage area from the main carrier.

A "conforming channel" is a concentric channel that has essentially the same range as the main carrier.

The following types of non-conforming assigned channel are supported:

- a "non-conforming concentric channel" is a concentric channel that has a larger or smaller range than the main carrier;
- a "sectored channel" has an azimuthal extent that is smaller than, and contained entirely within, the azimuthal extent of the main carrier, and is radiated from the same site as the main carrier;
- a "super-sectored channel" has an azimuthal extent that exceeds the azimuthal extent of the main carrier in at least one azimuthal direction, and is radiated from the same site as the main carrier; a super-sectored channel may be either a semi-super-sectored channel or a fully super-sectored channel (see clause 7.9.3);
- an "eccentric channel" is a channel that is not radiated from the same site as the main carrier; the TETRA standard ETSI EN 300 392-2 [i.2] supports up to a maximum separation of 4 km between the eccentric channel's transmitter site and the main carrier's transmitter site.

See also clause 7.9.3.

## 7.4.4.6 Power control

### 7.4.4.6.1 General

An MS is able to modify the RF power it transmits. Adaptive RF power control allows the system to minimize the transmit power used by the MS whilst maintaining the quality of the radio uplink. By transmitting at the lowest power needed, the MS minimizes any interference to co-channel and adjacent channel users. It also reduces its power consumption, and so may prolong its battery life.

There are two methods of adaptive power control for the MS. When using open loop power control, the MS adjusts its transmit power based on the strength of the signal received from the BS. In closed loop power control, the MS adjusts its transmit power as instructed by the BS. Closed loop power control applies only on  $\pi/4$ -DQPSK traffic channels.

The BS transmit power is static and not adaptively controlled (though it may be different on different RF carriers).

### 7.4.4.6.2 Open loop power control

Open loop power control is the default mechanism used by the MS to control its transmit power. The BS broadcasts the maximum power that MSs are allowed to use on that channel, and a value called "ACCESS\_PARAMETER" based on the BS power and configuration and on the mean power level that the BS would like to receive on that channel.

The MS subtracts its own measurements of the received BS signal strength from the ACCESS\_PARAMETER and, for reserved access or traffic transmissions, uses the result to set its own transmitter power (provided that the result is not greater than the maximum MS power for the channel and not greater than the maximum power that the MS supports).

Link adaptation applies on D8PSK and QAM channels, so the MS may increase its bit rate if it perceives that the link condition is good; see clause 7.5. On a D8PSK channel, it is expected that the BS will set the ACCESS\_PARAMETER so that the MS power is not reduced until the MS could use  $\pi/8$ -D8PSK modulation for some data categories. On a QAM channel, it is expected that the BS will set the ACCESS\_PARAMETER so that the MS power is not reduced until the MS could use the highest permitted uplink bit rate (except possibly coding rate = 1) for some data categories.

For random access transmissions on a 25 kHz channel, the MS may increase its transmit power up to the maximum MS power for the channel. On wider-bandwidth QAM channels, the maximum power is modified by a bandwidth factor.

#### 7.4.4.6.3 Closed loop power control

In closed loop power control, the BS controls the MS transmit power by sending the MS instructions to increase or decrease its transmit power by the specified number of steps. A step is equal to 5 dB, except that the first step is sometimes 2,5 dB (i.e. if an MS with a power class "L" is currently transmitting at its maximum power; see clause 8.2).

Closed loop power control applies only when the MS is transmitting circuit mode traffic, and applies only for the duration of that circuit mode traffic transmission (after which the MS reverts to open loop power control). Closed loop power control therefore applies only on  $\pi/4$ -DQPSK channels.

## 7.5 Link adaptation on D8PSK or QAM channel

### 7.5.1 General

On a D8PSK channel, signalling and data messages may generally be sent using either  $\pi/4$ -DQPSK or  $\pi/8$ -D8PSK bursts; the transmitting MS or BS chooses whether to use a  $\pi/4$ -DQPSK or  $\pi/8$ -D8PSK burst on a slot-by-slot basis. Similarly, on a QAM channel, the transmitting MS or BS chooses which modulation level and coding rate to use on a slot-by-slot basis (except in the case of random access by the MS and Frequency Correction Bursts sent by the BS).

Link adaptation is the process of adaptively changing the modulation level on a D8PSK channel, or the modulation level and/or coding rate on a QAM channel. Link adaptation may be employed in order to improve the link efficiency on a D8PSK or QAM channel.

In the link adaptation algorithm, the MAC may evaluate the current state of the link. Then, when sending a TM-SDU, the MAC of the transmitting MS or BS adaptively selects the appropriate bit rate to use (i.e. the modulation level, and the coding rate for QAM), based on:

- the current link conditions; and
- the "data category" parameter provided by the LLC with the data to be sent.

NOTE 1: It is not expected that the MS or BS would attempt to follow changes in the link conditions over a period shorter than about 0,5 seconds.

Alternatively, the MAC may use a predefined choice of bit rates for each of the data categories (or for some of the data categories). Then, when sending a TM-SDU, the MAC of the transmitting MS or BS selects the appropriate bit rate based solely on the "data category" parameter provided by the LLC with the data.

The "data category" parameter provides information about the type of data in the TM-SDU and the required reliability level for the transmission. For example, it may indicate whether the data to be sent is:

- background class data - reliability level 1 or 2 or 3; or
- telemetry class data - reliability level 1 or 2 or 3; or
- real-time class data; or
- non-classified data (i.e. TM-SDU does not contain packet data) - reliability level 1 or 2 or 3,

where reliability level 3 refers to better (i.e. higher) reliability than reliability levels 1 and 2, and reliability level 2 refers to better (i.e. higher) reliability than reliability level 1.

NOTE 2: In an implementation, fewer than three reliability levels could be used if preferred. For instance, if preferred, two reliability levels could be used for background class data and/or telemetry class data and/or non-classified data.

NOTE 3: The MAC uses both the data class and the reliability level when it selects the appropriate bit rate. For example, the appropriate bit rate for "telemetry class data - reliability level 1" may be different from that for "background class data - reliability level 1".

For non-classified data, the type of information may determine the reliability level for all transmissions of that PDU. For example, acknowledgements and data sent by acknowledged data transfer on the basic link should be sent using a high reliability for all transmissions.

However, for background class data or telemetry class data, the reliability level may vary for transmissions of one segment according to the number of times that segment has been transmitted, starting with low reliability and increasing to higher reliability if the first transmission(s) of that segment are not successful. For example, if using three reliability levels, the transmitting MS or BS could:

- use reliability level 1 for the first one or more transmissions of advanced link segments (enabling higher throughput when successful);
- then use reliability level 2 for the next one or more retransmissions of segments (if retransmissions are needed); and
- then revert to reliability level 3 for a segment either:
  - when the segment has been sent a specific number of times without success; and/or
  - when only a specific number of retransmissions remain before the maximum number of segment retransmissions of that segment is exceeded.

NOTE 4: At least the last two possible retransmissions of a segment before the maximum number of segment retransmissions of that segment is exceeded should be sent using a high reliability.

NOTE 5: The maximum number of segment transmissions using reliability level 1 (and/or reliability level 2) may depend on the maximum number of segment retransmissions for that advanced link. The maximum number of segment transmissions using reliability level 1 (and/or reliability level 2) may also vary according to the current channel conditions.

The choice of a low reliability for the first transmission(s) of segments allows use of a higher bit rate and therefore a higher throughput when segments are successfully received. However, if the first transmission(s) of a segment are not successfully received then the bit rate is reduced in order to improve the reliability of transfer of the segment.

## 7.5.2 Algorithm using predefined choice of bit rates

The MS or BS designer needs to choose suitable criteria for the MS or BS to decide on the current appropriate bit rate for each of the data categories. In a simple link adaptation algorithm, the MAC could make its choice of the bit rate to use for a transmission based solely on the "data category" parameter. Alternatively, the assessments of the appropriate bit rate for each of the data categories may be adaptive estimates, varying with the current channel conditions.

ETSI EN 300 392-2 [i.2] requires that an MS uses a link adaptation algorithm (either using predefined choices or adaptive estimates) to provide performance equal to or better than use of the following predefined choices of bit rate:

- when sending background class data or telemetry class data on a D8PSK channel:
  - one transmission of each segment at reliability level 1, using  $\pi/8$ -D8PSK modulation (see note 1);
  - if retransmission of a segment is needed: one transmission of that segment at reliability level 2, using  $\pi/8$ -D8PSK modulation (see note 1);
  - then, if retransmission of the segment is still needed: further transmission(s) of that segment at reliability level 3, using  $\pi/4$ -DQPSK modulation;

NOTE 1: On a D8PSK channel, fragmentation is generally needed when a segment first sent using  $\pi/8$ -D8PSK modulation is retransmitted using  $\pi/4$ -DQPSK modulation (because the segment is cut to match the size of a  $\pi/8$ -D8PSK MAC block). This impairs the performance of the  $\pi/4$ -DQPSK retransmission compared with the performance if the segment had been first sent using  $\pi/4$ -DQPSK modulation (in which case the segment would have been cut to match the size of a  $\pi/4$ -DQPSK MAC block). Therefore, the MS could decide adaptively not to attempt any segment transmissions using  $\pi/8$ -D8PSK modulation at times when the channel conditions are perceived as poor such that a  $\pi/8$ -D8PSK transmission would be unlikely to be successfully received.

- when sending background class data or telemetry class data on a QAM channel:
  - one transmission of each segment at reliability level 1:
    - using 64-QAM coding rate = 2/3 if the BS supports reception of 64-QAM; else
    - using 16-QAM coding rate = 1/2.
  - if retransmission of a segment is needed: one transmission of that segment at reliability level 2, using 16-QAM coding rate = 1/2;
  - then, if retransmission of the segment is still needed: further transmission(s) of that segment at reliability level 3, using 4-QAM coding rate = 1/2.

NOTE 2: Fragmentation is not generally needed when a segment first sent using 64-QAM is retransmitted using 16-QAM or 4-QAM (or when a segment first sent using 16-QAM is retransmitted using 4-QAM). This is because the segment size is chosen to correspond to the smallest full-slot MAC block size (i.e. 4-QAM with coding rate = 1/2) on a 25 kHz or 50 kHz QAM channel, or to half the size of the smallest full-slot MAC block size on a 100 kHz or 150 kHz channel; see clause 7.4.3.4.

It is expected that a simple link adaptation algorithm using a predefined choice of bit rates may be appropriate for telemetry class data because link performance information may be out-of-date. However, it is expected that, at least for background class data, MS (and BS) designers may prefer to use adaptive estimates of the appropriate bit rates in such a way as to provide better performance.

### 7.5.3 Algorithm adapting with channel conditions

In a more complex link adaptation algorithm, the MAC's choice of the appropriate bit rate to use for each of the data categories may vary adaptively according to the current channel conditions. This may enable better performance for some data classes. The criteria may be based on various types of information, such as the following:

- a) Link adaptation feedback information messages.

Two types of layer 2 signalling message may be used in the link adaptation process:

- the L2-LINK-FEEDBACK-CONTROL message may be used by the BS to request (or terminate) link adaptation feedback from the MS;
- the L2-LINK-FEEDBACK-INFO message may be used by the BS to send link adaptation feedback information to the MS, or by the MS to send link adaptation feedback information to the BS.

L2-LINK-FEEDBACK-INFO messages received from the BS may aid the MS in its choice of the appropriate bit rate for transmission. The feedback information may indicate the preferred modulation level, and coding rate for QAM, for a specified data class; alternatively it may provide the BS's estimate of the signal-to-noise ratio received on the uplink and (optionally) the BS's estimate of the channel model and speed.

Similarly, L2-LINK-FEEDBACK-INFO messages received from the MS may aid the BS in its choice of the appropriate bit rate for transmission to that MS.

- b) Link performance information.

The LLC may provide the MAC locally with link performance information relating to current advanced link performance, derived from recent segment success and failure information in received acknowledgements.

c) Measurements of reverse channel.

An MS may make measurements of the downlink channel, such as measurements of slot error rates on the downlink channel for different bit rates and/or measurements of the received signal-to-noise ratio. (When making measurements of the downlink channel, the MS may use information from any downlink slots on the channel, not only those slots containing information addressed to itself.) Use of this information, together with knowledge of the BS link imbalance and an MS correction factor, may enable the MS to make an approximate estimate of the uplink slot error rates.

Similarly, the BS may make measurements of the uplink slots used by the MS.

d) Choice of predefined bit rates for some of the data categories.

Predefined bit rates may be used temporarily as a default in the absence of preferred information, or may be used more generally for some of the data categories.

The information used may depend on the data category; for example, use of method b) is not appropriate when sending real-time class data. Also, use of method b) might not be appropriate for infrequent telemetry class data.

The information used by an MS may also depend on whether the MS is starting to send data (or a significant time has elapsed since the MS last transmitted data) or whether the MS has been transmitting data for some time. For example:

- use of method b) is not appropriate when the MS is starting to send advanced link data or if a significant time has elapsed since the MS last transmitted advanced link data;
- when the MS is starting to send advanced link data or if a significant time has elapsed since the MS last transmitted advanced link data, the MS could use method c) or use a predefined choice of bit rate;
- when the MS is starting to send real-time data, the MS could use method c) or use a predefined bit rate.

Similarly, the information used by the BS may depend on whether the BS is starting to send data to an MS (or a significant time has elapsed since the BS last transmitted data to that MS) or whether the BS has been transmitting data to that MS for some time.

NOTE: It is recommended that the BS requests link adaptation feedback during transmission of real-time class data to an individual MS if the BS wishes to use link adaptation for that data. Similarly, it is recommended that the BS sends link adaptation feedback when the MS is transmitting real-time class data if the BS wishes to enable the MS to use link adaptation for that data.

The MAC may use the chosen information in order to choose a bit rate such that the actual slot error rate for each data category is intended to lie within a target range. The target range would generally be different for the different data categories. The choice involves a trade-off between throughput and reliability of a single transmission: if the slot error rate exceeds the maximum acceptable then a lower bit rate may be appropriate in order to achieve more reliability; whereas, if the slot error rate is less than the minimum in the target range then a higher bit rate may be appropriate in order to achieve higher throughput.

For example, for background class data, the MAC might use an algorithm that allows relatively high slot error rates to be used for reliability level 1, thereby enabling choice of higher bit rates and therefore higher throughput, and relying on the advanced link retransmission protocol in the case of failed segments; then more moderate slot error rates may apply for reliability level 2; and lower slot error rates would apply for reliability level 3 (which is used when the maximum number of segment retransmissions may soon be exceeded).

It is expected that the MAC would use an algorithm with relatively low slot error rates for real-time class data.

## 7.6 Energy economy and napping

### 7.6.0 Methods for reduced reception

There are three methods for reduced reception by MSs. Energy economy mode (or dual watch mode with an energy economy group) is available for use on a common control channel - either the MCCH or MCCH-Q or a common SCCH. The part-time reception procedure is an alternative procedure that may apply on a multi-slot MCCH-Q. Also, a "napping" facility is available for use on an assigned channel.

## 7.6.1 Energy economy, dual watch and part-time reception on common control channel

### 7.6.1.1 Energy economy mode

There is an energy economy procedure in TETRA that may be used when the MS is on a common control channel (either MCCH or MCCH-Q or common SCCH). This is a method that MSs may use to conserve energy and hence extend battery life. It allows the MS to sleep for an agreed number of TDMA frames before waking up to receive a downlink slot (or slots).

The MS enters energy economy mode by negotiating with the BS. This negotiation is performed by a message exchange at the Mobility Management layer, either as part of the registration process or at any other time. The MS negotiates the level of energy economy with the BS, and the BS indicates the start point of the energy economy cycle. Then:

- If the MS is on a single-slot common control channel (i.e. the MCCH or a single-slot MCCH-Q or a common SCCH), and is not active in a message exchange, the MS's MAC follows a regular cycle of sleeping for the agreed number of TDMA frames and then receiving the appropriate downlink slot in one TDMA frame.
- If the MS is on a multi-slot MCCH-Q, there are two possible methods:
  - a) If the BS has broadcast that enhanced energy economy is available then, when the MS is not active in a message exchange, the MS's MAC follows a regular cycle of sleeping for the agreed number of TDMA frames and then receiving its required reception slot in one TDMA frame. The required reception slot is derived from the same parameter (received on registration or at subscription) that the MS uses to derive its reception slot when common SCCHs are in operation; see clause 7.4.2.1.2.
  - b) If the BS has broadcast that enhanced energy economy is not available then, when the MS is not active in a message exchange, the MS's MAC follows a regular cycle of sleeping for the agreed number of TDMA frames and then receiving all downlink slots comprising the multi-slot MCCH-Q in one TDMA frame.

NOTE 1: If the MS does not support enhanced energy economy (or does not wish to use enhanced energy economy) then, even if the BS indicates that enhanced energy economy is available, the MS when in the sleeping cycle receives all slots comprising the multi-slot MCCH-Q in the reception TDMA frames.

TETRA supports seven sleep ratios (called "energy economy groups"), ranging from 1:1 to 1:359. These are shown in table 7.5. For EG1 to EG4, the MS wakes up several times per multiframe. In EG5, it wakes up once per multiframe. In EG6, it wakes up once every four multiframe, and in EG7 only once every 20 multiframe. The choice of energy economy group depends on a compromise between extending battery life and the response time of the MS. For example, an MS in EG7 will drain its battery only very slowly; however, someone wanting to contact the user of the MS will have to wait for up to 20 seconds until the MS wakes up.

**Table 7.5: Definition of the energy economy groups and duration**

Energy economy group	TDMA frames to sleep	Period of cycle (TDMA frames)	Period of cycle (seconds)
EG1	1	2	0,113
EG2	2	3	0,17
EG3	5	6	0,34
EG4	8	9	0,51
EG5	17	18	1,02
EG6	71	72	4,08
EG7	359	360	20,4

Once the MS has started energy economy mode, it cannot be contacted except in the TDMA frames when it wakes up. The BS therefore needs to ensure that any messages for the MS are transmitted at the appropriate time. To do this, the BS needs to record which energy economy group each MS is in, and which start point was assigned to it.

NOTE 2: The BS needs a strategy for assigning start points to MSs. It should not assign the same awake slots to all MSs; otherwise there would be congestion in those slots. However, if the members of a user group are assigned widely differing awake slots, it may take a considerable time before they can all be contacted when a group call arrives for them.

Although a sleeping MS cannot be contacted by the BS during its sleep period, the MS wakes itself up immediately if it wishes to initiate a call or send a signalling message.

Energy economy mode is only applicable in idle mode. The MAC suspends energy economy mode temporarily when it moves to an assigned channel, or when the MS becomes active in a call or advanced link, or when it wishes to send a message, or when it receives a message from the BS (other than broadcast messages). The MAC returns to the sleeping cycle when it is on its common control channel and a timeout period has elapsed since the last activity.

Either the MS or the BS may initiate a message exchange to modify or stop energy economy mode at any time.

Energy economy mode is valid in all cells within a registered area. If an MS changes cell within the registered area, it may maintain the same energy economy mode and follow the same energy economy pattern after acquiring slot and frame synchronization on the new cell (but using the slot, frame and multiframe numbering of the new cell).

NOTE 3: All energy economy groups have a cyclic energy economy pattern within a hyperframe and so, given a start point and energy economy group, the MS may calculate the absolute frame and multiframe numbers in which it will receive the relevant downlink slot (or relevant downlink slots if appropriate for a multi-slot MCCH-Q).

The MS leaves energy economy mode if it leaves the registered area. If the MS wishes to re-enter energy economy mode, it has to make a new request to do so.

### 7.6.1.2 Dual watch mode

Dual watch may be performed by an MS that is capable of both V+D and TETRA Direct Mode operation (see ETSI EN 300 396-3 [i.13]). A dual watching MS may use either full dual watch or idle dual watch.

A full dual watch MS is capable of periodically receiving the V+D common control channel while it is in a Direct Mode call (when practicable). It is also capable of periodically receiving the Direct Mode RF carrier while it is in a V+D call and, when idle, it periodically receives both the Direct Mode RF carrier and the V+D common control channel. In order for the MS to periodically receive the V+D common control channel while in a Direct Mode call, the MS at the Mobility Management layer negotiates with the BS to use a periodic reception procedure similar to energy economy mode with an appropriate energy economy group when it requests to perform the full dual watching procedure.

An MS supporting idle dual watch is capable of periodically receiving both the Direct Mode RF carrier and the V+D common control channel when idle. The MS is not necessarily capable of receiving the V+D common control channel while it is in a Direct Mode call and is not necessarily capable of receiving the Direct Mode RF carrier while it is in a V+D call. When requesting idle dual watch mode, the MS at the Mobility Management layer may negotiate with the BS to use a periodic reception procedure similar to energy economy mode.

NOTE: It is optional for the MS to request to use an energy economy group when it is performing the idle dual watching procedure. It is also optional for the MS to inform the BS that it is performing idle dual watch.

The procedures on the V+D side for an MS when it is using dual watch mode with an energy economy group are similar to the procedures when using energy economy mode, except that the MS may transmit and/or receive on the Direct Mode side instead of sleeping and, in some cases, Direct Mode requirements may take precedence over V+D requirements to receive or transmit on the V+D common control channel. Therefore, the BS should be aware that a dual watching MS will not always be able to receive in the agreed slots. This may apply for all V+D common control channels. However, in particular, if the V+D common control channel is a multi-slot MCCH-Q and the BS does not support enhanced energy economy, there may be many cases when the MS is not able to receive all slots comprising the MCCH-Q.

### 7.6.1.3 Part-time reception on multi-slot MCCH-Q

As described in clause 7.6.1.1, the MS may use energy economy mode when on its common control channel if it has negotiated an energy economy group by a message exchange at the Mobility Management layer.

The part-time reception procedure is an alternative procedure that may apply when a DA MS is on a multi-slot MCCH-Q. If the BS has broadcast that part-time reception is permitted, this allows DA MSs in common mode on a multi-slot MCCH-Q to receive and decode just one downlink slot per TDMA frame when they have not sent or received a message recently (based on an inactivity timer). The required reception slot is derived from the same parameter (received on registration or at subscription) that the MS uses to derive its reception slot when common SCCHs are in operation.

When an MS is active on the multi-slot MCCH-Q, it reverts to multi-slot operation.

The part-time reception procedure may provide DA MSs in common mode on a multi-slot MCCH-Q with some opportunities for battery economy, neighbour cell monitoring, irregular channel monitoring and/or background scanning. However, it generally requires more reception than when the MS is using energy economy mode.

The part-time reception procedure applies only when the MS is in common mode on a multi-slot MCCH-Q. It does not apply when the MS is on an assigned channel.

## 7.6.2 Napping on assigned channel

The napping procedure is an independent procedure that may apply when the MS is on an assigned channel. It provides the MS with some opportunities for monitoring of neighbour cells, monitoring of irregular channels, main carrier monitoring and/or background scanning of neighbour cells, even when the MS is on a two-slot, three-slot or four-slot assigned channel; also, it may allow some battery economy in the MS. However, it generally requires more reception than when the MS is using energy economy mode. The napping procedure is performed by the MAC layer.

When the BS allocates an assigned channel, it may indicate that, when appropriate, MS "napping" is permitted on that assigned channel according to the specified napping information. The napping information comprises:

- the "napping reception frames" when in napping mode, specified as either:
  - all downlink TDMA frames; or
  - every two TDMA frames (so that the MS is only required to receive in either odd-numbered or even-numbered TDMA frames); or
  - every three TDMA frames (so that the MS is only required to receive in every third TDMA frame).
- the "napping reception timeslots" i.e. a timeslot bit map indicating the downlink slot or slots that the MS is required to receive in the napping reception frames when the MS is in napping mode (though limited to the slots appropriate to the downlink assigned channel);
- the value of the napping inactivity timer; and
- a flag indicating whether the MS may use reduced reception in frame 18 when not in napping mode.

The napping method allows the MS to use napping mode (i.e. perform reduced reception according to the napping reception frames and napping reception timeslots) when the MS has not sent or received a message recently, based on the napping inactivity timer. This allows napping during long gaps between transmissions on a packet data channel.

Also, the BS may instruct the MS dynamically that the MS may return to napping mode immediately (if not active on another address), by setting an element called the "immediate napping permission flag" to 1 in a MAC PDU addressed to the MS. This dynamic instruction may be used to allow the MS to use napping mode temporarily during short gaps in transmission. It may also be used to allow a fast return to napping mode at the end of the current data.

**NOTE:** Use of the immediate napping permission facility is restricted on  $\pi/4$ -DQPSK channels and when using  $\pi/4$ -DQPSK modulation on D8PSK channels.

The BS chooses whether to allow napping on an assigned channel, without a request from the MS, and also chooses the napping information. The choice may involve a compromise between allowing flexibility of scheduling of the downlink channel and giving opportunities for MS neighbour cell monitoring, irregular channel monitoring, main carrier monitoring, background scanning and/or battery economy. The choice may also involve a compromise between the preferred reception pattern during short gaps in transmission and during longer gaps between transmissions.

The BS also chooses when to use the immediate napping permission facility. The methods of use may depend on the type of data being sent by the BS or the MS. For example:

- When the BS is sending background class data to an MS, the BS may choose to set the "immediate napping permission flag" to 0 until the end of the data - except when there are intervals when the BS knows that it will be transmitting to other MSs for the next few slots or frames. Thus, the MS has to receive most of the downlink assigned slots during the data transfer. It returns to napping mode at the end of the data, either immediately or after the inactivity timer expires, depending on the setting of the "immediate napping permission flag".

- When the MS is sending background class data to the BS, the BS may choose whether to set the "immediate napping permission flag" to 0 or 1 - depending on whether it needs to have flexibility to send acknowledgements and slot grants in any slot of the downlink assigned channel.
- When the BS is sending data involving intermittent transmissions of short packets (such as real-time class data or telemetry class data), the BS may choose to set the "immediate napping permission flag" to 1 in most or all downlink MAC PDUs sent to the MS. (For packets that require more than one slot, the flag would be set to 1 only in the last of the slots sent to this MS.)
- When the MS is sending data involving intermittent transmissions of short packets, the BS may choose to set the "immediate napping permission flag" to 1 in most or all downlink MAC PDUs sent to the MS e.g. the downlink MAC PDUs containing the slot grants and/or link adaptation feedback messages.

## 7.7 Data priority

The data priority facility enables the MS to indicate a priority for obtaining reserved slots when it is sending packet data. For example, this permits a BS that supports data priority to grant slots to an MS with high data-priority PDUs to send ahead of other MSs with lower data-priority PDUs to send on the same channel. The BS indicates support of data priority using a bit in a broadcast message (SYSINFO, SYSINFO-Q or SYSINFO-DA PDU).

Also, when requesting access to a packet data channel, the MS indicates the highest data priority of any pending data packets to the BS, so that the MS can be sent to the packet data channel ahead of other waiting MSs with lower data priority.

There are eight defined values of data priority. (There is also an "undefined" value of data priority.)

- NOTE 1: Data priority is distinct from PDU priority. PDU priority affects the MS's queue re-ordering in the LLC and the MS's random access procedure. Data priority principally affects the speed of the MS's access to the packet data channel and the BS's criteria for slot granting on a shared packet data channel, but is also used for queue re-ordering in the LLC.

The SNDCP in an MS works with layer 2 to provide support for data priority.

The data priority of data packets may be defined by the SNDCP service user by two different methods. The first provides a data priority for each PDP context as a default data priority for data packets using that PDP context, and the second allows the SNDCP service user to set a data priority for individual data packets.

The BS signals a "network default data priority" to MSs at SNDCP level. The SNDCP in an MS that uses data priority chooses a preferred default data priority by inspection of the data priority requirements of PDP contexts that are actively transmitting or receiving data. If this differs from the network default data priority, the SNDCP in the MS negotiates a specific "MS default data priority" with the BS; otherwise it regards the MS default data priority as being the network default data priority. In either case, the MS default data priority is a data priority that the BS applies by default to all requirements for reserved slots indicated by that MS on a packet data channel unless temporarily overridden by a short-term data priority requested by the MS's MAC.

Also, when the SNDCP in the MS sends each packet data PDU, it includes the data priority for that PDU within the request primitive issued to the lower layers. This information enables the data link layer in the MS to perform queue re-ordering and to request short-term variations to the default data priority (allowing the BS to respond quickly to a data priority increase while minimizing the amount of signalling required to track rapidly changing data priorities):

- The LLC modifies the sending order of packet data SDUs to be sent on a channel as follows:
  - the LLC orders the packet data SDUs according to the PDU priority;
  - the LLC then orders the packet data SDUs within one PDU priority according to the data priority.
- The LLC may then modify the data priority of some SDUs such that, when a packet data SDU with a particular data priority is in the LLC queue, any data with lower data priority and preceding that SDU in the queue is promoted to the higher data priority; this is done in order to avoid delaying high data-priority SDUs.
- The LLC then informs the MAC of:
  - the maximum value of the data priority for the data in the LLC queue for that channel; and

- the subdivision of that data into data priorities (and data categories for a D8PSK or QAM channel).
- The MAC sends a layer 2 signalling message to the BS when it wishes to indicate a short-term variation in the MS's required data priority on that channel, temporarily modifying the default data priority negotiated by the SNDCP. The data priority layer 2 signalling message may contain either:
  - 1) a single short-term data priority (the maximum data priority for the data in the LLC queue for that channel); or
  - 2) up to seven data priority blocks each containing:
    - a data priority; and
    - the expected number of slots needed to send the currently queued data at that data priority,
 followed by the "residual data priority", which applies to slots following those included in the data priority block(s).

The MAC in the MS may send data priority layer 2 signalling messages to the BS intermittently, in order to update its data priority requirements. However, if using format 2 above, it should be noted that MS designers need to avoid excessive use of data priority layer 2 signalling messages, while at the same time avoiding delays in receiving high data-priority capacity when it is required (and avoiding receiving too much capacity with higher data priority than needed). So, for example, the precise details of the required number of slots at each data priority could be regarded as a "snapshot" of the current requirements, to be updated at intervals, without the MAC necessarily attempting to update its data priority requirements whenever the LLC has new data to send (unless there is an increase in the required data priority). Excessive use of data priority layer 2 signalling messages, in an attempt to track fluctuating data priority requirements too closely, may actually reduce the MS's overall data throughput.

NOTE 2: This is because, when the data priority layer 2 signalling message is sent by reserved access, it takes up space that could otherwise have been used for sending packet data (for example, an advanced link data segment). This contrasts with the method when the MS indicates its requirement for reserved slots in the reserved access procedure (see clause 7.4.4.4), for which the MAC PDU structure is defined such that the reservation requirement can be included in each uplink slot without affecting the amount of packet data that can be carried in the slot.

The data priority information sent by the MAC has a limited lifetime, so the MS default data priority applies after a timer has expired since the MS last sent a data priority layer 2 signalling message. The MS default data priority also applies when the MS initiates the random access procedure on this channel (unless the random access request is carrying a data priority layer 2 signalling message).

When the BS is controlling a shared channel used for packet data, it should use any information about the default data priority, and also any short-term data priority information received in data priority layer 2 signalling messages, in deciding when to grant reserved slots to the MSs that are sharing the channel. The BS may also use uplink fragmentation as a criterion in deciding when to grant slots to MSs.

The BS designer needs to choose methods for the BS to schedule the transmission of data packets to different MSs on the downlink channel.

## 7.8 Scheduled access

### 7.8.1 General

The scheduled access mechanism is provided to support MS applications that generate data packets at regular intervals, such as some types of real-time class data and telemetry class data. During PDP context activation, the MS at SNDCP level negotiates that the BS will grant reserved capacity with a specified repetition period and accuracy. Then, when the BS's SNDCP entity receives a data packet from the MS for that PDP context, the BS starts sending regular slot grants to the MS with the agreed repetition period and accuracy.

Use of the scheduled access mechanism usually avoids the need for the MS to make a random access attempt in order to request reserved slot(s) for each burst of data, and therefore increases channel efficiency.

NOTE 1: Scheduled access is available only when the SNDTCP supports QoS negotiation during PDP context activation.

In the schedule negotiation, the MS at SNDTCP level negotiates that the BS will grant uplink capacity (a number of reserved slots) with the specified repetition period and accuracy. The information negotiated is as follows:

- schedule repetition period: from 4 slot durations to 706 slot durations (approximately 10 s);
- schedule timing error: from  $\leq 1$  slot duration to  $\leq 128$  slot durations;
- scheduled number of data packets per grant: from 1 to 7; and
- scheduled data packet size for each data packet per grant: from 1 octet to 2 002 octets.

NOTE 2: The scheduled data packet size takes account of the packet size specified by the SNDTCP service user, the SNDTCP header and the effects of IP header compression and data compression, and, in the case of real-time class data, the number of transmission repetitions required for each data packet.

The number of reserved slots is the BS's estimate of the number of slots needed to send the specified quantity of data. (On a D8PSK or QAM channel, the BS's estimate will not always be correct because of the MS's use of link adaptation. The MS indicates its precise requirement when it transmits in the reserved slot(s).)

The BS may use multiple slot granting on a QAM channel. As described in clause 7.4.4.4.3, this allows the BS to grant disjoint resources with one slot grant by including multiple explicit instances of the "basic slot granting" element and/or by using an implicit repeat mechanism for each instance of the "basic slot granting" element. Multiple slot granting may be useful for allocating resources to an MS using scheduled access with a fairly short schedule repetition period, or for allocating resources to other MSs sharing the channel with an MS that is using scheduled access.

If the MS SNDTCP service user stops using a PDP context temporarily, it may inform the SNDTCP that it is pausing use of the schedule or of the entire PDP context. In either case, the SNDTCP sends a PDU to inform the SwMI.

If the MS indicates that it is pausing use of the schedule or PDP context, or if the BS perceives that the MS has not used the granted slots for a period of time, the BS may pause the schedule by ceasing to provide scheduled slot grants for that PDP context. The BS should re-start the slot grants if its SNDTCP entity receives a data packet from the MS for that PDP context.

The SwMI may inform the MS when it alters the QoS of an activated PDP context. For example, the SwMI should inform the MS if it is suspending a schedule because it can no longer provide sufficient resources to support the agreed schedule, or if it is able to support a suspended schedule again, or if it is cancelling a schedule because it wishes to permanently reallocate the scheduled resource. The BS should stop sending slot grants appropriate to the schedule if the PDP context containing the schedule is deactivated, or if the schedule is suspended or cancelled.

## 7.8.2 MS operation for sending scheduled messages

When the SNDTCP in the MS issues packet data to the lower layers, it includes a parameter in the request primitive to indicate whether the data should be treated as "not scheduled data", "initial scheduled data" or "scheduled data". When the SNDTCP starts sending data using a PDP context for which a schedule has been arranged (and after a substantial gap in the arrival of scheduled data from the service user), the SNDTCP instructs the lower layers to treat the first TL-SDU as "initial scheduled data"; further TL-SDUs are then labelled as "scheduled data".

NOTE 1: The data priority of a TL-SDU labelled as "scheduled data" is set to "undefined".

The LLC in the MS then indicates to the MAC whether the data in its sending buffer is "fully scheduled" or "unscheduled" or a mixture. For this purpose:

- initial scheduled data is treated as "unscheduled" so that, for example, the MAC may immediately use random access in order to send the data (if it does not currently have any reserved capacity and has not requested any);
- scheduled data is treated as "fully scheduled" (except for segment retransmissions), so that the MAC generally waits for a slot grant instead of attempting random access;
- all other types of data and signalling are treated as "unscheduled".

The LLC also indicates the lowest value of the "maximum schedule interval" for all fully scheduled data in the buffer.

NOTE 2: The maximum schedule interval is equal to the agreed schedule repetition period plus the schedule timing error. It therefore indicates the longest expected time between the granted slots for a particular schedule.

The MAC procedures for fully scheduled messages are similar to the procedures for unscheduled messages except that, if the LLC indicates that all the data in the LLC sending buffer is fully scheduled, the MAC does not attempt random access unless it considers that the schedule agreement has not been honoured - for example, if it does not currently have any reserved capacity granted on this control channel, and the elapsed time since its last transmission is greater than the lowest value of the maximum schedule interval (and is greater than a time-out value).

### 7.8.3 Schedule timing

The MAC in the MS is responsible for maintaining the MS schedule timing. When the SNDCP first sends a data packet for a PDP context with a schedule, it requests the lower layers to start issuing schedule timing prompts. The MAC then provides a schedule timing service to the higher layers, issuing schedule timing prompts at intervals corresponding to the schedule repetition period (continuing until the SNDCP indicates a change in the schedule repetition period or instructs the MAC to stop). When the SNDCP receives scheduled data from the service user (other than initial scheduled data), it buffers that data until it receives a schedule timing prompt; then, when the schedule timing prompt is received, the SNDCP sends the appropriate number of scheduled data packets.

The synchronization of the schedule timing prompts issued by the MAC is initially based on the timing of the request primitive from the SNDCP. However, the BS may send a layer 2 signalling message to define the schedule synchronization, in which case the MAC in the MS bases the timing of further schedule timing prompts on that synchronization. Thus, this message allows the BS to synchronize the times at which the SNDCP in the MS issues the scheduled data to the lower layers with the earliest times that the BS intends for the scheduled reserved slots.

NOTE: If the BS does not use the schedule synchronization message then, for some schedule repetition periods, if the MS also has other data to send while the schedule is running, there are cases when the MS may send its scheduled data with the other data before the reserved slots intended for the scheduled data. If this occurs, the MS may then have no data to send in the reserved slots intended for the scheduled data.

## 7.9 Cell and channel selection

### 7.9.1 General

The MLE in the MS is responsible for evaluating and replacing the radio resource i.e.:

- a) it selects a new serving cell when the current serving cell fails or could be improved; and
- b) it may request replacement of the current assigned channel if that channel fails or could be improved when the serving cell's main control channel still offers acceptable performance.

The MLE makes the decisions on cell and channel selection and reselection using threshold comparisons based on measurements made by the MS MAC. The MAC makes some of the measurements autonomously on the current channel(s) on the serving cell, passing the results to the MLE. The MAC makes other measurements on selected neighbouring cells or on selected channels on the serving cell on specific request of the MLE (see clause 7.9.8).

At cell selection or reselection, the MM layer performs the registration procedure when needed (see clause 7.12).

### 7.9.2 Cell selection/reselection

#### 7.9.2.1 Cell selection

The detailed implementation of the initial cell selection procedure and any associated algorithms is outside the scope of ETSI EN 300 392-2 [i.2]. The procedure needs to ensure that the MS selects a cell in which it can reliably decode downlink data on the main carrier, and in which it has a high probability of uplink communication.

When performing initial cell selection, the MS MLE initiates the MAC's foreground scanning procedure (see clause 7.9.2.2) so that the MAC makes signal level measurements on various cells. The MLE can use the results to produce a list of preferred cells, which it then ranks. The MS may then select the cell with the highest ranking, provided that the main carrier radio connection is of adequate quality, and then performs registration if needed. (If none of the cells is suitable, the MS continues the scanning of cells until a suitable cell is found or until the MS is powered down.)

### 7.9.2.2 Cell reselection

The MS MLE makes the decisions on cell reselection using threshold comparisons based on measurements made by the MAC and a comparison of the services provided by the serving cell and neighbour cell(s). It performs cell reselection if:

- the radio link on the serving cell has failed; or
- the quality of the serving cell's main carrier radio connection falls below a certain level (see note 1) and the quality of a neighbour cell exceeds that of the serving cell by a certain amount (see note 1).

NOTE 1: One set of thresholds applies if the service provided on the neighbour cell is the same as on the serving cell i.e. the MLE performs cell reselection if the serving cell is declared "radio improvable". Different thresholds apply if the service provided by the neighbour cell is lower than that provided by the serving cell i.e. the cell reselection may be postponed until the serving cell is declared "radio relinquishable".

Also, if the service provided by a neighbour cell is higher than that provided by the serving cell, the MLE may perform cell reselection, irrespective of the quality of the link on the serving cell, if the neighbour cell has a main carrier radio connection of sufficient quality (i.e. if the neighbour cell is "radio usable").

The MLE can perform cell reselection when the MS is attached to a cell in idle or traffic mode. The procedure can handle five categories: undeclared, unannounced, announced type 3, announced type 2 and announced type 1.

Undeclared cell reselection is used when the MS is not currently involved in any voice or circuit mode data calls. After the cell reselection, the MS may attempt to recover SMDCP and/or advanced link connections on the new cell.

Unannounced and the three types of announced cell reselection apply when the MS is engaged in a circuit mode call.

Unannounced cell reselection is used when the MS is unable to (or, in the case of listening to group calls, has no need to) inform the serving cell of its intention to find service on another cell prior to performing the cell reselection. The MS may attempt to recover the CMCE and SMDCP and/or advanced link connections on the new cell.

Announced cell reselection is used when the MS informs the serving cell prior to the cell change, and attempts to restore the call(s) upon arrival at the new serving cell. This maximizes the probability of restoring the CMCE and SMDCP connections on the new cell. Announced cell reselection is divided into three categories:

- Type 3 reselection is provided for MSs which are unable to perform background scanning of a selected neighbour cell (see note 4), and which therefore have to break the call(s) for a period and perform foreground scanning in order to acquire broadcast and synchronization information for the new cell. Upon selecting the new cell, call restoration signalling may be used to restore the call(s).
- Type 2 reselection requires that the MS has performed background scanning of a selected neighbour cell (and, in the case that the selected cell is a DA cell, has received a SYSINFO-DA PDU from the selected cell), so is therefore in a position to switch immediately to the new cell. In type 2 reselection, the SwMI does not direct the MS to a channel in the new cell. The MS selects the MCCH or MCCH-Q on the new cell and performs call restoration signalling and may then be allocated a traffic channel upon successful completion of this signalling.
- Type 1 reselection requires that the MS has performed background scanning (and, in the case that the selected cell is a DA cell, has received a SYSINFO-DA PDU from the selected cell), and that the SwMI is able to direct the MS from the traffic channel on the original cell to the MCCH or MCCH-Q on the new cell or directly to a traffic channel on the new cell. (The latter procedure amounts to seamless handover.) If the SwMI directs the MS to the MCCH or MCCH-Q, the SwMI may later allocate a traffic channel. No call restoration signalling is required from the MS.

NOTE 2: The MS does not explicitly attempt either type 1 or type 2 cell reselection. The MS includes the cell to which it intends to move in the cell reselection request. Also, if the MS is required to register on the new cell, and both the MS and the SwMI support forward registration (i.e. registration onto a cell other than the current serving cell), then the MS also includes a forward registration request with the cell reselection request. It is the SwMI, not the MS, that determines whether type 1 or type 2 cell reselection is to be applied.

NOTE 3: Scanning can be used when the MS is able to synchronize to the neighbour cell and decode:

- the BSCH (SYNC PDU) and BNCH (SYSINFO PDU) broadcast on the neighbour cell for a CA neighbour cell; or
- the BSCH-Q (SYNC-DA PDU) broadcast on the neighbour cell for a DA neighbour cell.

When scanning a DA neighbour cell, the SYNC-DA PDU contains all the essential information needed for the MS to decide whether it wishes to use the cell. However, the SYSINFO-DA PDU contains additional information needed before the MS can use the cell, so the MS may prefer to receive the SYSINFO-DA PDU on a likely DA cell before confirming its decision to use that cell.

NOTE 4: When performing scanning, the MS MAC measures the signal strength of the scanned carrier and calculates the path loss using the cell parameters broadcast on that neighbour cell (see clause 7.9.8). Three different methods of scanning are defined:

- foreground, where scanning is the only activity;
- background, where communications with the current serving cell are maintained in parallel with the scanning, and the scanning causes no interruption to that service; and
- interrupting, where communications with the current serving cell are maintained in parallel with the scanning, but the scanning causes some interruptions to that service.

It is optional for the MS to support type 1/2 cell reselection. However, if the SwMI provides broadcast of neighbour cell information, it has to support type 1 and/or type 2 cell reselection to those cells included in the neighbour cell information.

## 7.9.3 Assigned channel types and channel classes

### 7.9.3.1 General

A "concentric channel" is defined as a channel that has essentially the same azimuthal radiation pattern as the main carrier and is radiated from the same site as the main carrier. It may use a different modulation mode, RF bandwidth and/or RF power from the main carrier and may have a larger or smaller range and coverage area than the main carrier (i.e. it may be a non-conforming channel).

A "conforming channel" is a special case of a concentric channel. It has essentially the same azimuthal radiation pattern as the main carrier, is radiated from the same site as the main carrier and has essentially the same range and coverage area as the main carrier. A channel that is not a conforming channel is called a non-conforming channel.

NOTE 1: Common control channels (the MCCH or MCCH-Q, and any common SCCHs) are conforming channels by definition.  $\pi/4$ -DQPSK assigned channels on a CA cell are normally conforming channels.

In addition to conforming assigned channels, TETRA supports the following further types of assigned channel:

- A "non-conforming concentric channel" is a concentric channel that has a larger or smaller range and coverage area than the main carrier.
- A "sectorized channel" has an azimuthal extent that is smaller than, and contained entirely within, the azimuthal extent of the main carrier, and is radiated from the same site as the main carrier. Sectorized channels provide a method of extending the range of high RF-bandwidth channels.

- A "super-sector channel" has an azimuthal extent that exceeds the azimuthal extent of the main carrier in at least one azimuthal direction, and is radiated from the same site as the main carrier; a super-sector channel may be either a semi-super-sector channel or a fully super-sector channel:
  - a "semi-super-sector channel" is radiated from the same site as the main carrier, and has an azimuthal extent that exceeds the azimuthal extent of the main carrier in one azimuthal direction and is less than the azimuthal extent of the main carrier in the other azimuthal direction;
  - a "fully super-sector channel" is radiated from the same site as the main carrier, and has an azimuthal extent that is greater than, and entirely contains, the azimuthal extent of the main carrier.
- An "eccentric channel" is a channel that is not radiated from the same site as the main carrier (see note 2).

NOTE 2: The TETRA standard ETSI EN 300 392-2 [i.2] supports up to a maximum separation of 4 km between the eccentric channel's transmitter site and the main carrier's transmitter site. This value was chosen in the expectation that existing MSs would be able to tolerate this delay separation, given that they already need some tolerance in the channel timing that they can accept (for example, in order to cope with channels with long delay spreads). This then allows backwards compatibility with the capabilities of current MSs.

An "umbrella channel" is an assignable channel that fully covers the areas of multiple cells:

- A concentric channel that covers the radial extent of all its associated cells may be used as an umbrella channel.
- A fully super-sector channel that also covers the radial extent of all its associated cells may be used as an umbrella channel.
- An eccentric channel that fully covers the areas of all its associated cells may be used as an umbrella channel. (Conversely an eccentric channel could cover a smaller area than its associated cell, for example, with several short-range eccentric channels between them covering the area covered by the associated cell.)

A "channel class" is defined as a set of values indicating the general RF characteristics of a concentric channel or fully super-sector channel. The MS may predict the performance of channel(s) corresponding to a channel class from measurements made on another carrier on that cell, together with the characteristics of the channel class. A cell may offer more than one channel or carrier belonging to the same channel class.

An "irregular channel" is defined as a non-conforming channel that needs to be monitored by the MS in order for the MS to discover whether the channel would be usable as an assigned channel. The MS cannot predict the performance of irregular channels by measurements made on any other channel; it discovers which irregular channels would be usable as an assigned channel by monitoring each irregular carrier.

Sector channels and semi-super-sector channels are irregular channels. An eccentric channel is an irregular channel, if it does not fully cover the area of the cell. The SwMI may broadcast information about a fully super-sector channel as either a channel class or an irregular channel, if broadcast is needed (for example, if the channel does not fully cover the area of the cell i.e. if the radial range of the channel is less than the radial range of the main carrier).

NOTE 3: The SwMI does not need to broadcast information about channels that fully cover the area of the cell, since the MS does not normally need to monitor or assess these channels or inform the SwMI that these channels would be usable as an assigned channel. Nevertheless, the SwMI may choose to broadcast information about channels that fully cover the area of the cell; for example, in some cases, this may aid MSs that are sending or receiving real-time class data. (An MS that is sending or receiving real-time class data might prefer a channel that is more reliable than conforming when it is near the edge of the service area of the cell.)

### 7.9.3.2 Examples

Figure 7.18 shows an example of three adjacent cells each with non-conforming concentric channels. In general, concentric channels with higher RF bandwidths will have shorter ranges than concentric channels with lower RF bandwidths for the same RF power.

The MS predicts the performance of concentric channel(s) from measurements made on another carrier on that cell.

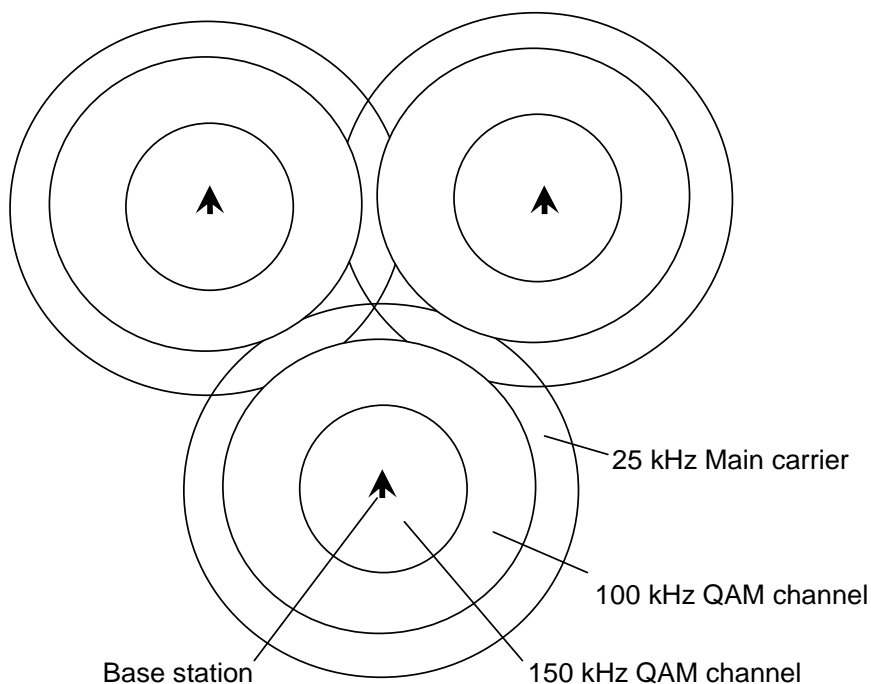

**Figure 7.18: Example of cells using non-conforming concentric channels**

Figure 7.19 shows an example of QAM sectored channels used with  $\pi/4$ -DQPSK conforming channels on a CA cell. For ease of illustration, the sectored channels are shown with less range than the  $\pi/4$ -DQPSK channels; in practice they would probably be designed to extend to the same range as the  $\pi/4$ -DQPSK channels.

The MS cannot predict the performance of a sectored channel by measurements made on any other channel; it discovers which sectored channels it can use by monitoring each sectored carrier.

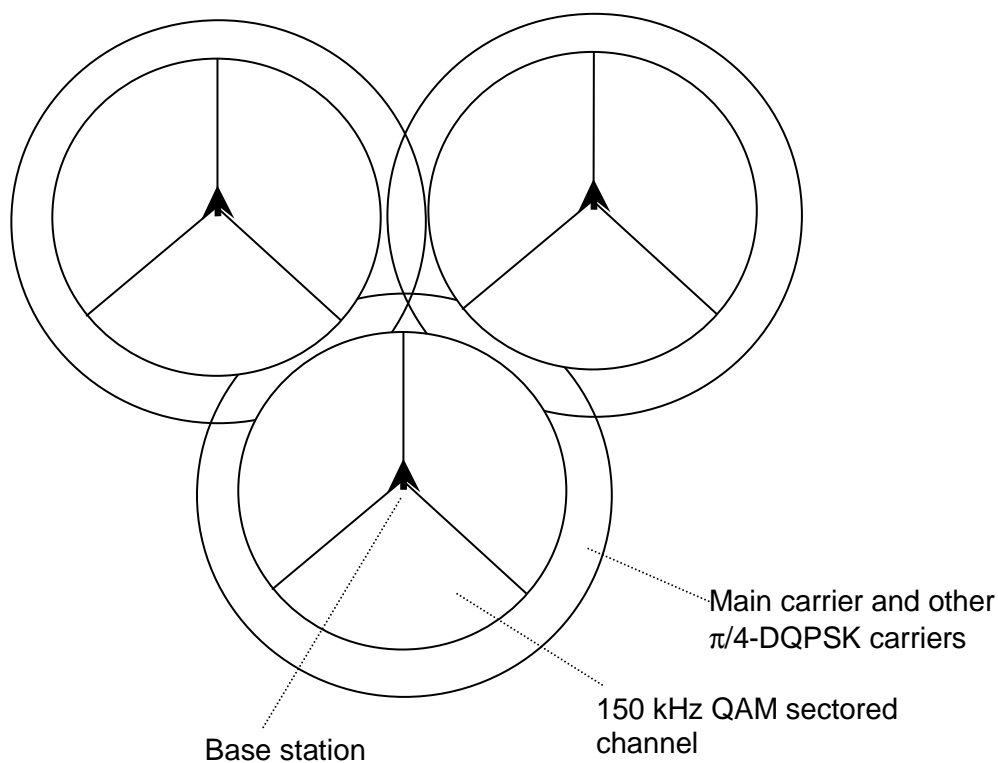

**Figure 7.19: Example of CA cells using sectored channels**

In the examples shown in figures 7.18 and 7.19, the service area covered by the main carrier is nominally circular.

Alternatively, it would be possible to have an implementation of the main carrier using sectored antennas, so that the service area covered by the main carrier is not circular. In this case the definitions of a "concentric channel", "conforming channel", "sectored channel", "super-sectored channel" and "eccentric channel" still apply. So, a "concentric channel" is still defined as a channel that is radiated from the same site as the main carrier and has essentially the same azimuthal radiation pattern as the main carrier, even though the coverage area of the concentric channel is not circular; a concentric channel may have a larger or smaller range and coverage area than the main carrier. A "conforming channel" is still defined as a concentric channel that has essentially the same range and coverage area as the main carrier. A "sectored channel" is radiated from the same site as the main carrier but has an azimuthal extent that is smaller than, and contained entirely within, the azimuthal extent of the main carrier. A "super-sectored channel" is radiated from the same site as the main carrier but has an azimuthal extent that exceeds the azimuthal extent of the main carrier in at least one azimuthal direction. And an "eccentric channel" is a channel that is not radiated from the same site as the main carrier.

Figure 7.20 shows an example of three adjacent CA "sectored cells", each with a main carrier implemented using a sectored antenna (with the three main carriers transmitted from the same physical location):

- Cell A is shown with only conforming channels (a main carrier and other  $\pi/4$ -DQPSK carriers).
- Cell B is shown with a main carrier and other  $\pi/4$ -DQPSK conforming channels, and also QAM non-conforming concentric channels with a smaller range than the main carrier.
- Cell C is shown with a main carrier and other  $\pi/4$ -DQPSK conforming channels, together with three QAM sectored channels - with the three sectored channels between them covering the azimuthal extent of the sectored cell. So, in this case, the sectored channels represent a further subdivision of the already sectored cell. (For ease of illustration, the sectored channels are shown with less range than the  $\pi/4$ -DQPSK channels; in practice they would probably be designed to extend to the same range as the  $\pi/4$ -DQPSK channels.)

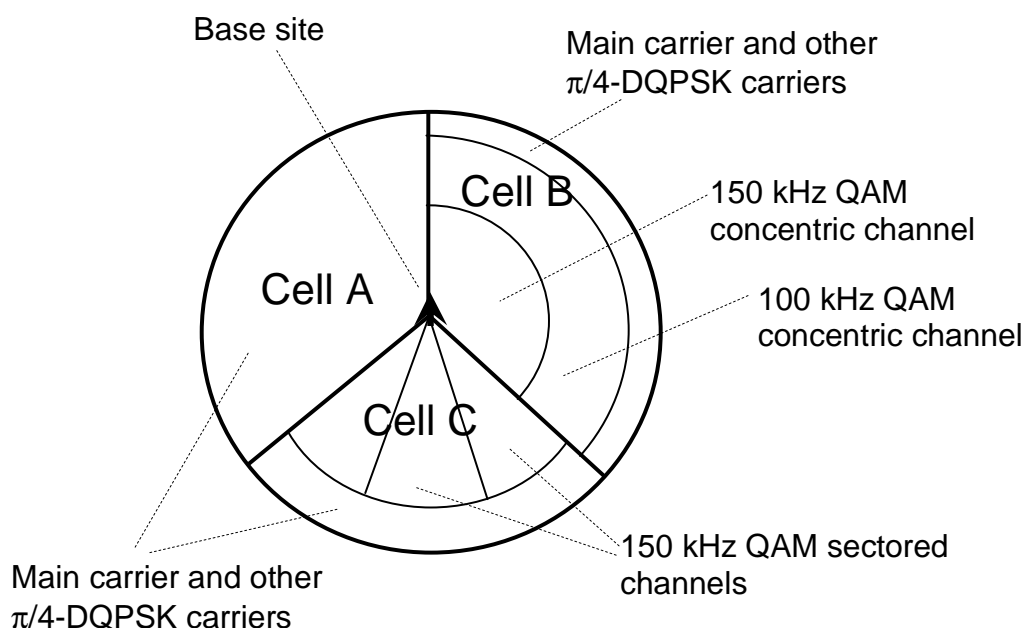
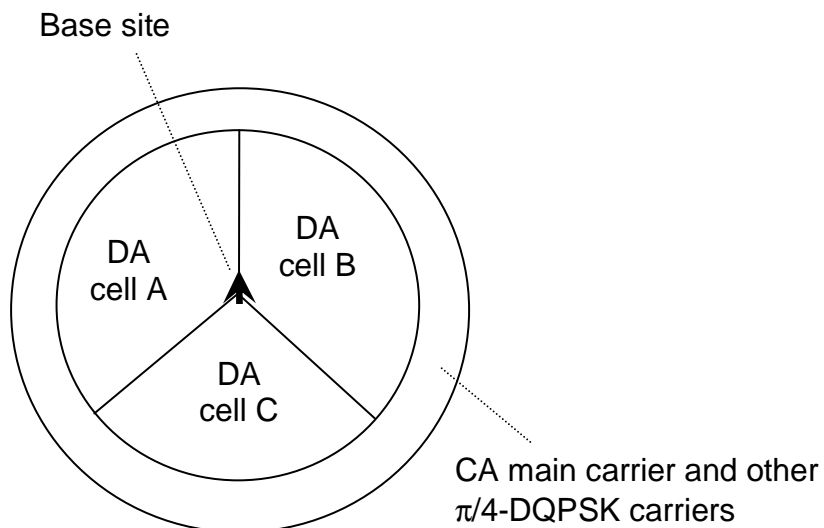

**Figure 7.20: Example of CA sectored cells**

A case of usage of a fully super-sectored channel might be for a channel that is radiated from the same site as the main carrier and exceeds the azimuthal extent of the main carrier in both azimuthal directions and also has at least the same range as the main carrier, so fully encompasses the coverage of the main carrier. This could allow an assigned channel to fully cover the areas of multiple cells, as an umbrella channel, allowing a multi-cell group call to use a single assigned channel throughout the cells covered by the channel. For example, figure 7.21 shows an example with:

- three adjacent DA "sectored cells", each with a main carrier implemented using a sectored antenna (with the three main carriers transmitted from the same physical location); and
- a CA cell that is nominally circular (with the main carrier transmitted from the same location as the DA cells).

Then a single nominally circular  $\pi/4$ -DQPSK assigned channel could be used for a group speech call involving MSs from all four cells. In this example, the  $\pi/4$ -DQPSK assigned channel is conforming relative to the CA main carrier, so the CA MSs joining the group call would receive a channel allocation indicating that the assigned channel is a conforming channel. The DA MSs joining the group call would receive a channel allocation indicating that the assigned channel is a super-sectored channel.



**Figure 7.21: Example of a fully super-sectored umbrella channel with DA sectored cells**

A case of usage of an eccentric channel might be to provide high-bandwidth QAM coverage to a packet data traffic "hotspot" in an area that is not at the centre of the cell. For example, figure 7.22 shows an example with:

- a 150 kHz QAM concentric channel available near the centre of the cell; and
- a 150 kHz QAM channel radiated from a different site within the cell (i.e. an eccentric channel), allowing 150 kHz QAM coverage within a specific area of the cell, for example, in an area of high population or where packet data traffic is expected to be higher than in other parts of the cell.

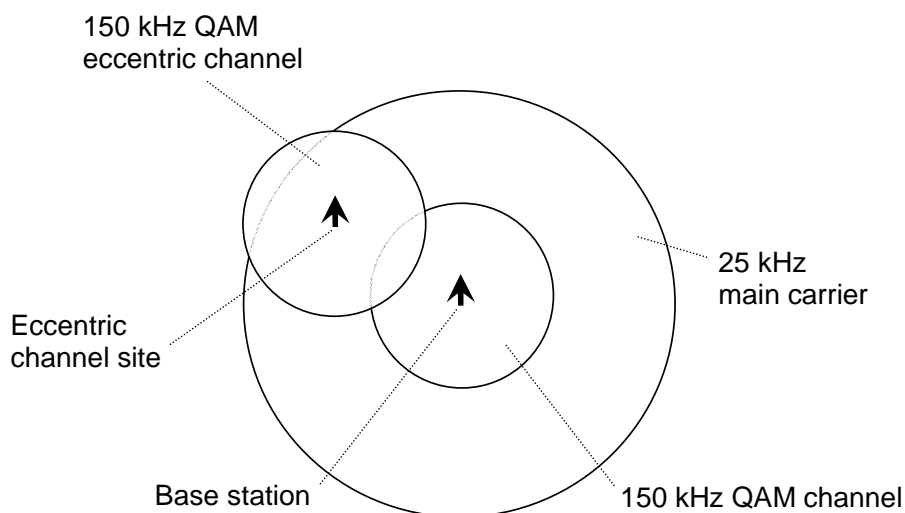

**Figure 7.22: Example of a cell using an eccentric channel**

## 7.9.4 Network broadcast

### 7.9.4.1 Broadcast information

The SwMI broadcasts various types of information for use by MSs during synchronization and when using the cell:

- a) The Broadcast Synchronization Channel (BSCH) contains the SYNC PDU at the MAC level and the D-MLE-SYNC PDU at the MLE level. The Broadcast Network Channel (BNCH) contains the SYSINFO PDU at the MAC level and the D-MLE-SYSINFO PDU at the MLE level. These PDUs are sent only on  $\pi/4$ -DQPSK and D8PSK channels. They are used by CA MSs - and also by DA MSs when they are on a  $\pi/4$ -DQPSK or D8PSK assigned channel.

The QAM Broadcast Synchronization Channel (BSCH-Q) contains the SYNC-DA PDU at the MAC level and the D-MLE-SYNC-DA PDU at the MLE level. This is sent only on QAM channels, and the information is used only by DA MSs. The QAM Broadcast Network Channel (BNCH-Q) may contain either:

- the SYSINFO-Q PDU at the MAC level and the D-MLE-SYSINFO-Q PDU at the MLE level; or
- the SYSINFO-DA PDU at the MAC level and the D-MLE-SYSINFO-DA PDU at the MLE level.

The SYSINFO-Q / D-MLE-SYSINFO-Q PDU is sent only on QAM channels and is used only by CA MSs, when they are on a QAM assigned channel. The SYSINFO-DA / D-MLE-SYSINFO-DA PDU is used only by DA MSs; it is sent principally on QAM channels (though it may be sent on  $\pi/4$ -DQPSK and D8PSK channels).

These broadcast PDUs contain parameters relating to the serving cell: essential information needed by the MS to synchronize with and use the facilities of the cell. The information includes the Mobile Network Identity (MNI), Location Area (LA), information about the services provided by this cell, system code, colour code, slot and frame synchronization information, information about the main carrier and some RF parameters.

NOTE 1: If an assigned channel is shared by MSs from different DA cells, the BS should not send the SYSINFO-DA or SYNC-DA PDU on that assigned channel.

- b) The SwMI may send general network broadcast PDUs at the MLE level to inform the MS MLE about further parameters for the serving cell, and to provide information about neighbour cells (in order to aid the MS in making choices about cell reselection). For example, the neighbour cell information may include information about the neighbour cell main carrier, MNI, LA, services provided and cell reselection parameters.
- c) A SwMI that supports non-conforming channels sends general network broadcast PDUs at the MLE level indicating the characteristics of available channel classes and irregular channels on the serving cell. The information includes the modulation modes and RF bandwidths of the available channel classes and irregular channels, the BS ERPs of the channel classes and the frequencies of the irregular channels. The MS MLE uses this information to assess the quality of the available channel classes and/or channels (via measurements and path loss calculations performed by the MAC) and provide channel selection advice to the SwMI.

The SwMI may also send information about channel classes and irregular channels on neighbour cells.

NOTE 2: More than one cell may send broadcast PDUs about available channel classes and irregular channels on the serving cell where those broadcasts relate to the same channels.

On a phase modulation common control channel or assigned channel, the SYNC PDU and SYSINFO PDU are transmitted in frame 18 using a fixed mapping. The BS transmits the SYNC PDU only in the defined positions, because the SYNC PDU is sent with a special training sequence; however, the SYSINFO PDU may also be transmitted during frames 1 to 17. (SYNC and SYSINFO PDUs may be sent in any slot on unallocated channels.)

On a DA main carrier, the SYNC-DA PDU and SYSINFO-DA PDU are transmitted in frame 18 using a fixed mapping. The SYNC-DA PDU and SYSINFO-DA PDU (and SYSINFO-Q PDU) may also be transmitted at any time on any QAM channel (though see note 1 above). This rule for the SYNC-DA PDU is different from the rule for the SYNC PDU on phase modulation channels because, on a QAM channel, the SICH-Q/D indicates whether each QAM downlink burst is an FCB (thus containing the SYNC-DA PDU).

## 7.9.4.2 Acquiring cell synchronization and network information

### 7.9.4.2.1 Acquiring cell synchronization and network information on a CA cell

An MS wishing to synchronize with a CA cell first attempts to synchronize with the synchronization training sequence contained in the synchronization burst (BSCH) of any phase modulation downlink carrier used on the cell. On acquiring synchronization, the MS then decodes the contents of the SYNC PDU (including the D-MLE-SYNC PDU) also contained in the synchronization burst. These contents include the MNI and colour code, which are used by the MS to de-scramble the contents of all other bursts transmitted by that BS. They also include the slot, frame and multiframe number for this downlink slot, thus giving the MS full frame synchronization with this BS.

**NOTE:** Having synchronized with a CA cell, the MS continues to decode subsequent SYNC PDUs transmitted by the BS but only uses those with the correct colour code to prevent the MS from using the BSCH transmitted by an adjacent cell.

Having acquired cell synchronization by receiving and decoding the SYNC PDU, the MS is now able to decode other  $\pi/4$ -DQPSK downlink bursts transmitted by the BS. The MS next searches for the BNCH in order to receive and decode the SYSINFO PDU, which contains system information for this cell - including information about the frequency of the main carrier, the number of common SCCHs in operation on the main carrier and various other parameters.

Having decoded the SYNC and SYSINFO PDUs, the MS may locate the MCCH on slot 1 of the main carrier or the appropriate common SCCH. The MS has all the information needed to communicate with the BS and may now receive other downlink PDUs and transmit uplink PDUs (when permitted by the usual reception and transmission procedures).

### 7.9.4.2.2 Acquiring cell synchronization and network information on a DA cell

An MS wishing to synchronize with a DA cell first attempts to synchronize with the QAM Frequency Correction Burst (FCB). On acquiring synchronization, the MS then decodes the contents of the SYNC-DA PDU (including the D-MLE-SYNC-DA PDU), which is contained within the FCB. These contents include the MNI and colour code, which are used by the MS to de-scramble the contents of all other bursts transmitted by that BS. They may also include:

- information about the bandwidth and frequency of downlink main carrier of this DA cell;
- the Location Area (LA) in which this DA cell is located;
- essential information about the security and services provided by this BS, and cell selection parameters;
- the slot, frame and multiframe number for this downlink slot, thus giving the MS full frame synchronization with this BS.

This information enables the MS to synchronize and locate the downlink main carrier of this DA cell and also decide whether it wishes to use the cell. The MS is also able to receive other bursts transmitted by the BS on the main carrier.

If the MS wishes to use the cell, it also needs to receive and decode the SYSINFO-DA PDU. This PDU duplicates some of the information from the SYNC-DA PDU and also contains further system information for this cell. The further information includes the duplex spacing of the DA main carrier, the number of slots comprising the MCCH-Q or the number of QAM common SCCHs in operation on the main carrier and various other parameters (e.g. random access parameters, further radio parameters and further information about the security and services provided by the BS).

Having decoded the SYNC-DA and SYSINFO-DA PDUs, the MS may locate the MCCH-Q or the appropriate QAM common SCCH. The MS has all of the information needed to communicate with the BS and may now receive other downlink PDUs and transmit uplink PDUs (when permitted by the usual reception and transmission procedures).

While camped on the cell, the MS has to continue to decode subsequent SYSINFO-DA PDUs transmitted by the BS. However, it is optional whether the MS continues to decode subsequent SYNC-DA PDUs.

**NOTE:** The SYNC-DA PDU contains all the essential information needed for the MS to decide whether it wishes to use the cell. However, the SYSINFO-DA PDU contains additional information needed before the MS can use the cell, so the MS may prefer to receive the SYSINFO-DA PDU on a likely DA cell before confirming its decision to use that cell.

## 7.9.5 Serving cell surveillance

While the MS is using a cell, the MAC in the MS makes signal level measurements on the current channel(s) on the serving cell and periodically reports a "path loss parameter" to the MLE (see clause 7.9.8).

The MS has to seek a new cell when the main carrier on the current serving cell fails to achieve certain defined signal level criteria. When the MS is receiving a conforming channel, it uses the signal level measurements on the current channel(s) as a direct substitute for measurements on the main carrier. When the MS is not currently receiving a conforming channel, and the current channel is a non-conforming concentric or sectored channel, it is possible for the MS to estimate the performance of the main carrier by applying BS Effective Radiated Power (ERP) and other conversion factors to measurements on the current channel (see clause 7.9.8); however, the calculation fails near the azimuthal edge of a sectored channel, so the MS has to make direct observations of the main carrier's signal level when using a failing sectored channel. If the MS is currently receiving only super-sectored and/or eccentric channels (and/or channels for which it does not understand the conforming channel status), the MS needs to make direct observations of the main carrier's signal level.

## 7.9.6 PDCH channel assignment

In a cell that only supports conforming channels, the SwMI assigns the MS to any PDCH it chooses in the current cell, knowing that the performance will be the same as the MS's current channel.

This cannot be assumed when the cell supports non-conforming channels.

Concentric channels and fully super-sectored channels may have lower radial ranges than the main carrier, in which case they do not fully cover the area covered by the main carrier. Sectored channels and semi-super-sectored channels are always irregular channels, and eccentric channels may be irregular channels.

The SwMI requires signal level advice from the MS before it can assign the MS to a channel that does not have the same coverage area as the MS's current channel and does not fully cover the area covered by the main carrier. Where an MS supports the use of non-conforming channels and the MS SMDCP requests permission to use a PDP context, the MS MLE attaches to the request a list of channel classes or individual irregular channels that appear to offer adequate signal level. In the case of non-conforming concentric channels and fully super-sectored channels, it is sufficient for the MS MLE to tell the SwMI which channel classes it can use (i.e. it does not identify individual channels). In the case of irregular channels, the MS MLE has to identify the individual irregular channels.

The MS can estimate the expected signal level for different channel classes by applying conversion factors to measurements made on the current channel if appropriate, or to measurements made on the main carrier, whereas it investigates the signal level on an irregular channel by making direct signal level measurements on that irregular channel.

NOTE 1: The SwMI may broadcast information about a fully super-sectored channel as either a channel class or an irregular channel, if broadcast is needed.

NOTE 2: The SwMI does not need to broadcast information about channels that fully cover the area of the cell, since the MS does not normally need to monitor or assess these channels or inform the SwMI that these channels would be usable as an assigned channel. Nevertheless, the SwMI may choose to broadcast information about channels that fully cover the area of the cell; for example, in some cases, this may aid MSs that are sending or receiving real-time class data.

## 7.9.7 Assigned channel replacement

When an MS is using a conforming assigned channel, the MS attempts to change to a new cell when its current channel fails - because it assumes that the main carrier has also failed. However, this is not necessarily appropriate when the MS is using a non-conforming PDCH that does not fully cover the area covered by the main carrier, for example, for a high RF-bandwidth concentric channel or for a sectored or semi-super-sectored channel.

The assigned channel replacement procedure may be used when the MS's current non-conforming channel begins to fail (for example, because the RF bandwidth is too high or because a sector change is needed in the case of a cell using sectored channels). It may be used also if the MS decides that it could obtain greater throughput by switching to a channel with a higher RF bandwidth.

The assigned channel replacement request procedure allows the MS MLE to send a PDU to the SwMI to request replacement of the current assigned channel with another channel on the same cell; the PDU indicates one or more acceptable channel classes and/or one or more acceptable irregular channels.

## 7.9.8 MS MAC measurements and path loss calculation

The MAC layer in the MS makes signal strength measurements both autonomously on the current channel(s) on the serving cell and, under the control of the MLE, on selected neighbouring cells and on selected other carriers on the serving cell. The signal strength measurements are passed to the MLE as an approximation of the radio path loss.

The MAC may also estimate the performance of the main carrier or of a channel class, based on measurements made on another channel and applying BS ERP and other conversion factors to those measurements. The process of estimating the radio path loss on the serving cell main carrier or for a channel class (on the serving cell or an adjacent cell), based on measurements made on another channel or carrier radiated from the same site, is referred to as "assessment".

The procedures performed autonomously by the MS MAC while the MS is using a cell are as follows:

- a) estimation of the radio path loss on the current channel(s) on the serving cell from signal strength measurements made on the current channel(s);
- b) measurements of the quality of the link on the current channel(s) on the serving cell; and
- c) if the MS is not currently receiving a conforming channel, and the current channel is a non-conforming concentric or sectored channel: assessment of the path loss on the main carrier of the serving cell, based on the measurements made on the current channel.

The MS MAC also performs the following procedures when requested by the MS MLE:

- i) The MLE may request assessment of the path loss for selected channel classes on the serving cell, based on the characteristics of those channel classes and the measurements made on the current channel.

**NOTE:** The relevant characteristics of the channel classes are the modulation mode, maximum permitted MS transmit power, minimum receive access level and BS transmit power relative to the main carrier. In the calculation, the MS also uses the BS transmit power relative to the main carrier for the current channel.

- ii) The MLE may request irregular channel monitoring i.e. monitoring of irregular carriers on the serving cell or on adjacent cells. When performing irregular channel monitoring, the MS measures the signal strength of the monitored carrier and calculates the path loss using the parameters broadcast on the serving cell.
- iii) The MLE may request neighbour cell monitoring i.e. monitoring of the main carrier on adjacent cells. Neighbour cell monitoring is used when the MS is not synchronized to the adjacent cell so has not decoded the adjacent cell's BSCH and BNCH (for a CA adjacent cell) or BSCH-Q (for a DA adjacent cell). When performing neighbour cell monitoring, the MS measures the signal strength of the monitored carrier and calculates the path loss. The parameters for the calculation may be broadcast on the serving cell.

When requesting neighbour cell monitoring, the MLE may also request assessment of the path loss for selected channel classes on the adjacent cell, based on the characteristics of those channel classes and the measurements made on the monitored main carrier on the adjacent cell.

- iv) The MLE may request scanning of the main carrier on adjacent cells. Scanning is used when the MS is able to synchronize to the adjacent cell and decode:
  - the adjacent cell's BSCH and BNCH for a CA adjacent cell; or
  - the adjacent cell's BSCH-Q for a DA adjacent cell.

When performing scanning, the MS measures the signal strength of the scanned carrier and calculates the path loss using the adjacent cell parameters broadcast on that adjacent cell.

When requesting scanning, the MLE may also request assessment of the path loss for selected channel classes on the adjacent cell, based on the characteristics of those channel classes and the measurements made on the scanned main carrier on the adjacent cell.

- v) The MLE may request main carrier monitoring i.e. monitoring of the main carrier on the serving cell and calculation of the path loss. This applies particularly if the MS is receiving only super-sectored and/or eccentric channels (and/or channels for which it does not understand the conforming channel status), but may apply also if the MS is receiving only sectored channel(s).

When requesting main carrier monitoring, the MLE may also request assessment of the path loss for selected channel classes on the serving cell, based on the characteristics of those channel classes and the measurements made on the main carrier.

## 7.10 Circuit mode calls

TETRA circuit mode calls may be voice calls or circuit mode data calls. Circuit mode traffic transmission applies only on  $\pi/4$ -DQPSK channels. However, the call set-up procedure for a circuit mode call may be performed on any channel.

EXAMPLE 1: A CA MS could be directed from the MCCH to a circuit mode call on a  $\pi/4$ -DQPSK channel.

EXAMPLE 2: A DA MS could be directed from the MCCH-Q to a circuit mode call on a  $\pi/4$ -DQPSK channel.

EXAMPLE 3: An MS could be directed from a 150 kHz QAM packet data channel to a circuit mode call on a  $\pi/4$ -DQPSK channel.

For voice calls, a single-slot channel is used. For circuit mode data, a one-slot, two-slot, three-slot or four-slot channel is used, and the data may be unprotected or may have low or high error protection added. The data rates offered for circuit mode data are as follows:

- unprotected: 7,2 kbit/s; 14,4 kbit/s; 21,6 kbit/s; 28,8 kbit/s;
- low protection: 4,8 kbit/s; 9,6 kbit/s; 14,4 kbit/s; 19,2 kbit/s;
- high protection: 2,4 kbit/s; 4,8 kbit/s; 7,2 kbit/s; 9,6 kbit/s.

For protected circuit mode data, interleaving is performed over 1, 4 or 8 blocks (the interleaving depth N).

A circuit mode call may be an individual call (point-to-point), group call (point-to-multipoint), acknowledged group call (point-to-multipoint, SwMI polls members of the group during the call) or broadcast call (point-to-point, one-way). Individual calls may use either simplex or duplex operation. Group calls and broadcast calls use simplex operation.

In message trunking, a traffic channel is allocated for the complete call. In transmission trunking, a traffic channel is allocated only for the duration of a traffic transmission (e.g. with MSs directed to the MCCH or MCCH-Q between transmissions); this can enable more efficient use of the traffic channels, but may result in delays during the call. In quasi-transmission trunking, the channel de-allocation is delayed for a short period at the end of each traffic transmission, so the traffic channel is retained if the next transmission in the call is requested quickly. The SwMI chooses which method to use.

Within the TETRA stack, most of the procedures for circuit mode calls are performed by the CMCE and the MAC. The CMCE performs the procedures for transmission and reception of control information for circuit mode services, for example, at call set-up and at the start and end of each circuit mode transmission. The CMCE also performs procedures for call-related supplementary service messages (which modify or supplement a teleservice or bearer service).

The actual U-plane traffic is generated by the U-plane application (e.g. the speech CODEC) for transmission, or is delivered to the U-plane application for reception. The U-plane traffic, end-to-end user signalling and encryption synchronization information enter the MAC directly from the U-plane application.

For further information on circuit mode calls, see ETSI ETR 300-1 [i.14] and ETSI EN 300 392-2 [i.2], clauses 14 and 23.

NOTE 1: The methods for circuit mode calls have not changed with the introduction of high speed data facilities.

NOTE 2: Future editions of the present document may include more details on circuit mode calls.

## 7.11 Short data and SDS-TL

The TETRA Short Data Service (SDS) is offered by the SDS entity within the CMCE:

- The pre-coded message service supports transmission and reception of 16-bit pre-coded status messages.
- The user-defined message service supports transmission and reception of:
  - user-defined data type 1: 16 bits of application-defined data;
  - user-defined data type 2: 32 bits of application-defined data;
  - user-defined data type 3: 64 bits of application-defined data;
  - user-defined data type 4: up to 2 047 bits of application-defined data (including 8-bit header, see note 1).

Short data messages (either pre-coded messages or user-defined messages) may be sent on any channel.

An additional protocol layer, called the Short Data Service Transport Layer (SDS-TL), enhances the service provided by the basic layer 3 SDS protocol for user-defined data type 4. The SDS-TL protocol uses an additional header within the user-defined data type 4.

NOTE 1: An 8-bit protocol header is also included in the basic SDS user-defined data type 4 service, so that the basic user-defined data type 4 service and the SDS-TL data transfer service do not disturb each other.

The SDS-TL protocol provides the following services:

- point-to-point, point-to-multipoint and broadcast message transfer;
- end-to-end acknowledgement of message receipt and consumption by application;
- store and forward; and
- support for multiple application protocols.

The SDS-TL supports both standard and non-standard applications.

For further information on short data and SDS-TL, see ETSI EN 300 392-2 [i.2], clauses 14 and 29.

NOTE 2: The methods for short data and SDS-TL have not changed with the introduction of high speed data facilities and Direct Access, except that the longest recommended length of the user-defined data type 4 when using the basic link depends on the modulation and RF bandwidth.

NOTE 3: Future editions of the present document may include more details on short data and SDS-TL.

## 7.12 Registration and group attachment

The Mobility Management (MM) entity performs procedures for:

- registration and de-registration of an MS; and
- attachment and detachment of group identities.

It also performs procedures for the MS to request energy saving mode or direct mode dual watch operation (see clause 7.6.1), and for the MS to inform the SwMI when it is moving to direct mode and returning to trunking mode.

The MM entity in the MS may send a registration message to the SwMI on the request of the user application, or when commanded by the SwMI, or when the MS decides that registration is required (for example, if the MS has performed cell reselection into a location area outside the current registered area and the new cell requires registration). The registration procedure includes an identity exchange when the MS migrates to a network other than the home network.

When the MS performs registration, it may include information about its capabilities using the "class of MS" information element. The MS may also include the "extended capabilities" information element, which provides information about additional capabilities. (The MS does not need to include the "extended capabilities" information element if it does not support any of the characteristics that are declared in that information element.)

NOTE 1: Support of QAM (and the QAM RF bandwidths) is declared using the "extended capabilities" information element, whereas support of D8PSK channels is indicated in the "class of MS" information element.

The MM entity may send a deregistration message to the SwMI on request of the user application e.g. at power down.

The group identity attachment/detachment procedure enables the MM entity in the MS and the SwMI to exchange information about the currently attached group identities in the MS i.e. the addresses that the MAC in the MS will regard as the valid group addresses when it is checking whether downlink PDUs are addressed to itself.

The MS may attach/detach group identities when it performs registration, or it may later attach/detach the groups using a specific attach/detach message. The MS may initiate the group attachment/detachment procedure, or the SwMI may initiate the group attachment/detachment procedure if it wishes to change the group identities in the MS. Also, the SwMI may request that the MS starts group attachment, or the MS may request that the SwMI starts group attachment.

For further information on the MM protocol, see ETSI EN 300 392-2 [i.2], clause 16.

NOTE 2: The methods for registration and group attachment/detachment have not changed with the introduction of high speed data facilities and Direct Access, except for the addition of some information in the "class of MS" information element and introduction of the "extended capabilities" information element.

NOTE 3: Future editions of the present document may include more details on registration and group attachment.

## 7.13 Classes of MS

### 7.13.1 General

Different MSs may have various levels of class and capability as follows:

- power class (see clause 8.2);
- A, B, D or E receiver class for phase modulation (see clause 8.3);
- optional capabilities that may be indicated by the MS to the SwMI during registration (in the "class of MS" and/or "extended capabilities" elements):
  - layer 3 capabilities such as the ability to support voice calls, circuit mode data calls, concurrent circuit mode services and/or TETRA packet data;
  - security capabilities such as the ability to support DCK air interface encryption, SCK air interface encryption, authentication and/or end-to-end encryption (see clause 13);
  - LLC capabilities such as the ability to support the original advanced link and/or extended advanced link(s);
  - upper MAC capabilities such as the ability to support common secondary control channels, minimum mode for CA, carrier specific signalling channels and/or MAC-D-BLCK PDU and augmented channel allocation (the MS is required to support the normal mode of operation on the MCCH and/or MCCH-Q);
  - for a CA MS: the ability to support operation on D8PSK channels and/or QAM channels, and the QAM RF bandwidths supported and the maximum QAM modulation level (the MS is required to support operation on  $\pi/4$ -DQPSK channels);
  - for a DA MS: the ability to support operation on  $\pi/4$ -DQPSK channels and/or D8PSK channels, and the QAM RF bandwidths supported and the maximum QAM modulation level (the MS is required to support operation on QAM channels);
  - fast switching capability or frequency full duplex capability - see clause 7.13.2 (the MS is required to support frequency half duplex operation);
  - for a CA MS: the MS's capability to support multi-slot channels and/or concurrent multi-carrier operation (the MS is required to support single-slot channels and single-carrier operation);

- for a DA MS: the MS's capability to support multi-slot phase modulation channels and/or concurrent multi-carrier operation (the MS is required to support single-slot and multislot QAM channels, and single-carrier operation);
- the MS's capability to operate on a new carrier without needing a linearization opportunity before transmission;
- capabilities that may be indicated by the MS to the SwMI when activating a PDP context:
  - the MS's capability to handle other services in addition to TETRA packet data (the packet data MS type).

## 7.13.2 MS fast switching or duplex capability

### 7.13.2.0 General

All MSs are required to provide frequency half duplex capability. An MS may optionally also provide fast switching capability or support frequency full duplex operation.

NOTE: TETRA BSs operate using frequency full duplex.

### 7.13.2.1 Frequency half duplex operation

#### 7.13.2.1.1 Frequency half duplex capability

A frequency half duplex MS has the ability either to transmit on an uplink frequency or receive on a downlink frequency at any time. It is not able to transmit and receive at the same time. This type of MS requires time to switch from its transmit to receive frequency and vice versa. In TETRA this has to be less than a timeslot duration.

Figure 7.23 shows the uplink and downlink slots of a single TDMA frame, with "x" marking an example of slots which can be used by a frequency half duplex MS; in this example only one downlink slot and the corresponding (same-numbered) uplink slot are used in a single TDMA frame. Using this arrangement, time division duplex operation can be realized allowing a frequency half duplex MS to support single-slot duplex call services.

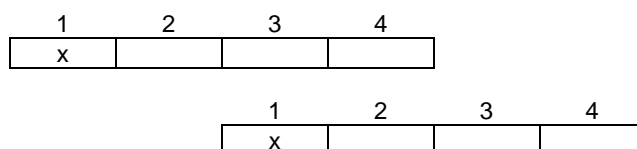

**Figure 7.23: Frequency half duplex operation**

In the example shown, the MS can receive the downlink slot and also transmit in the corresponding uplink slot. It is also possible for a frequency half duplex MS to operate with a multi-slot channel. However, in this case, the BS should not send signalling messages to that MS when the MS is transmitting traffic or transmitting in reserved slots (or switching from receive to transmit or from transmit to receive).

#### 7.13.2.1.2 Fast switching capability

A frequency half duplex MS may be capable of switching from transmit to receive, and from receive to transmit, between contiguous slots (e.g. capable of transmitting in uplink slot 2 and then receiving in the immediately following downlink slot 1). This type of MS is defined as a fast switching MS. A fast switching MS may fully support e.g.:

- two concurrent single-slot channels; or
- a two-slot duplex call service.

provided that the BS allocates the two slots with adjacent numbers (i.e. slots 1 and 2, or 2 and 3, or 3 and 4, or 4 and 1). Figure 7.24 shows the uplink and downlink slots of a single TDMA frame, with "x" marking an example of slots which can be used by a fast switching MS.

NOTE: Fast switching capability on a QAM channel is indicated to the SwMI independently from fast switching capability on a  $\pi/4$ -DQPSK or D8PSK channel.

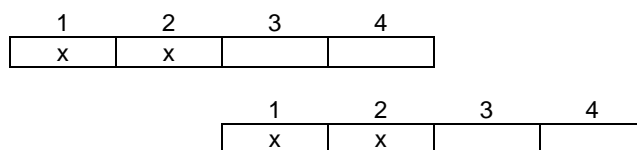

**Figure 7.24: Frequency half duplex operation with fast switching capability**

### 7.13.2.2 Frequency full duplex operation

A frequency full duplex MS has the ability to transmit on an uplink frequency and receive on a downlink frequency at the same time. Therefore, this type of MS can use all four uplink slots and all four downlink slots in a TDMA frame, as shown in figure 7.25. Any combination of these slots may be used for a single call (for example, a multi-slot packet data channel) or for multiple simultaneous calls (for example, up to four concurrent single-slot calls, or a single-slot voice call and a two-slot or three-slot packet data channel or circuit mode data call).

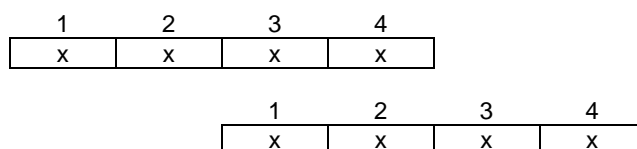

**Figure 7.25: Frequency full duplex operation**

## 8 System and RF aspects

### 8.1 Frequency bands and spectrum allocation issues

#### 8.1.1 European spectrum allocations

The operation of PMR/PAMR systems in Europe are based on allocation of licensed spectrum. The current practice is to share the designated spectrum for primary and secondary services based on compatibility studies and simulations carried out by WGSE of the ECC. The management of the spectrum allocation is performed by WGFM on a European basis. Individual European administrations could exercise some degree of freedom in their own countries subject to meeting the European compatibility criteria.

The ECC Decisions and Reports governing the PMR/PAMR frequency allocations in Europe are as follows:

- **CEPT ECC Decision (08)05 [i.26]:**
  - The harmonization of frequency bands for the implementation of digital Public Protection and Disaster Relief (PPDR) narrow band and wide band radio applications in bands within the 380 MHz to 470 MHz range.
- **CEPT ECC ERC Report 25 [i.27] (also known as ERC Recommendation T/R 25-08 or the ECA Table):**
  - The European Table of Frequency Allocations and Applications in the Frequency Range 8,3 kHz to 3 000 GHz.
  - This ECR Report maps the relevant ETSI EN standards with the appropriate spectrum bands.
- **CEPT ECC Decision (04)06 [i.28]:**
  - ECC Decision of 19 March 2004 on the availability of frequency bands for the introduction of Wide Band Digital Land Mobile PMR/PAMR in the 400 MHz and 800/900 MHz bands.

- **CEPT ECC Decision (16)02 [i.29]:**
  - Harmonized technical conditions and frequency bands for the implementation of Broadband Public Protection and Disaster Relief (BB-PPDR) systems.
  - This Decision covers inter alia the Least Restrictive Technical Conditions (LRTC) for the introduction of broadband systems (LTE) in the range 450 MHz to 470 MHz.

### **TETRA HSD frequency bands**

The HSD part of TETRA standard was designed to cover the same frequency bands as TETRA 1.

**NOTE:** Since that time, the TETRA standard has been tested for frequencies down to 138 MHz for  $\pi/4$ -DQPSK modulation. The performance below 300 MHz for  $\pi/8$ -D8PSK and QAM modulation is outside the scope of the TETRA standard.

Within the EEC, TETRA is primarily used in the following parts of the 380 MHz to 470 MHz band:

#### **380 MHz to 400 MHz band**

The portion 380 MHz to 385 MHz / 390 MHz to 395 MHz is used in Europe by Public Safety and associated government networks.

#### **410 MHz to 430 MHz band**

This band is widely used in Europe for non-public-safety PMR systems, and is also used by public safety systems in some countries.

#### **450 MHz to 470 MHz band**

There have been a small number of TETRA PMR (non-public-safety) deployments in this band. It is also assigned to CDMA 450 and 3GPP LTE technologies in some countries.

The compatibility simulations for TETRA HSD operation in these bands have been carried out by WGSE (Project Teams SE7 and SE27) using the TETRA TEDS SRDoc [i.15] and simulation techniques SEAMCAT and MCL [i.18].

## **8.1.2 Position outside Europe**

Countries outside the European Community do not have to adhere to the above bands. However many TETRA networks implemented outside the EEC do use these bands. TETRA is implemented outside the EEC in frequency bands between 300 MHz and 470 MHz, and also in the 700 MHz and 800 MHz bands.

## **8.2 Tx specifications**

### **8.2.0 General**

Clause 8.2 reviews the specifications related to practical implementation of the TETRA HSD transmitter, i.e. the extent to which, in practice, the parameters and the waveforms in a transmitter can depart from their ideal counterparts. The above discrepancy can be ascribed to finite arithmetic and finite length of digital filters, inaccuracies and drifts of analogue filters, non-linear distortion, quadrature modulation errors, inter-subcarrier interference in QAM channels due to spectral overlap, presence of noisy components, etc. The fidelity of the transmitter signal taking these effects into account is represented by transmitter "modulation accuracy".

The proper operation of a TETRA network also depends on meeting certain non-interference (compatibility) criteria with other networks. The other networks could be TETRA or non-TETRA networks operating in the vicinity of the intended TETRA network and using the same or adjacent frequency bands. To achieve this compatibility, the EU provides a minimum set of unwanted emission requirements (emissions at frequencies or time intervals outside the allocated channel ) that all transmitters should adhere to. However, individual network types (TETRA, GSM, etc.) are free to specify tighter specification if it leads to better running of their networks. There are many types of unwanted emission from a typical transmitter such as:

- 1) conducted unwanted emissions; consisting of:
  - close to carrier emissions, in useful parts or in transient (switching) parts of a burst;
  - far from carrier emissions, occurring at offsets of equal to, or greater than, 100 kHz from the carrier frequency; these emissions comprise discrete spurious emissions and wide-band noise;
  - emissions during linearization time periods or bursts or even during the non-transmit state of the transmitter;
- 2) radiated unwanted emissions, i.e. emissions radiated by the cabinet or the structure of the equipment;
- 3) inter-modulation products. Inter-modulation components are generated by the transmitter non-linearity when an interfering signal (reaching via the antenna) is present together with the wanted signal. Limits are introduced in the standard to inhibit generation of such components.

The details of the above emissions, their relationship with the time mask defined for a TETRA station transmission plus the permissible emission limits are given in clause 6 of ETSI EN 300 392-2 [i.2]. Measurement methods and conformance details are given in the TETRA RF conformance standard [i.3].

Clause 8.2.1 includes general transmitter specifications, i.e. transmitter power classes and nominal powers for BS and MS plus transmitter output power time masks. This is followed by clauses 8.2.2 and 8.2.3 providing in more detail the modulation vector error specification plus specifications for two of the most important emission types used in compatibility simulations, namely the adjacent power level and wide-band noise. Specifically, clause 8.2.2 gives these specifications for phase modulation channels, whilst clause 8.2.3 provides them for QAM channels.

## 8.2.1 Transmitter nominal power and time mask

### 8.2.1.1 Transmitter power classes and nominal power

Table 8.1 gives the power class and the nominal transmitter power for BS and MS for both phase modulation and QAM channels, the exception being the MS power classes 5 and 5L which apply only to QAM channels. These two MS power classes were added to allow for higher peak-to-mean power ratio in a QAM transmitter, which results in a lower mean powers in a QAM transmitter compared to the phase modulation transmitter of equal rated power.

**Table 8.1: Nominal power of TETRA transmitters**

Power class, MS	Nominal power, MS	Power class, BS	Nominal power, BS
1 (30 W)	45 dBm	1 (40 W)	46 dBm
1L ( 17,5 W)	42,5 dBm	2 (25 W)	44 dBm
2 (10 W)	40 dBm	3 (15 W)	42 dBm
2L (5,6 W)	37,5 dBm	4 (10 W)	40 dBm
3 (3 W)	35 dBm	5 (6,3 W)	38 dBm
3L (1,8 W)	32,5 dBm	6 (4 W)	36 dBm
4 (1 W)	30 dBm	7 (2,5 W)	34 dBm
4L (0,56 W)	27,5 dBm	8 (1,6 W)	32 dBm
5 (0,32 W) (see note)	25 dBm	9 (1 W)	30 dBm
5L (0,18 W) (see note)	22,5 dBm	10 (0,6 W)	28 dBm

NOTE: Power classes 5 and 5L apply only to QAM channels.

### 8.2.1.2 Transmitter output power time mask

The transmit level versus time mask for TETRA station transmission is shown in figure 8.1. For the time mask the power level of 0 dBc refers to the output power level of the TETRA station under consideration. The whole of the time mask applies to phase modulation. For QAM the mask is only specified up to 0 dBc level.

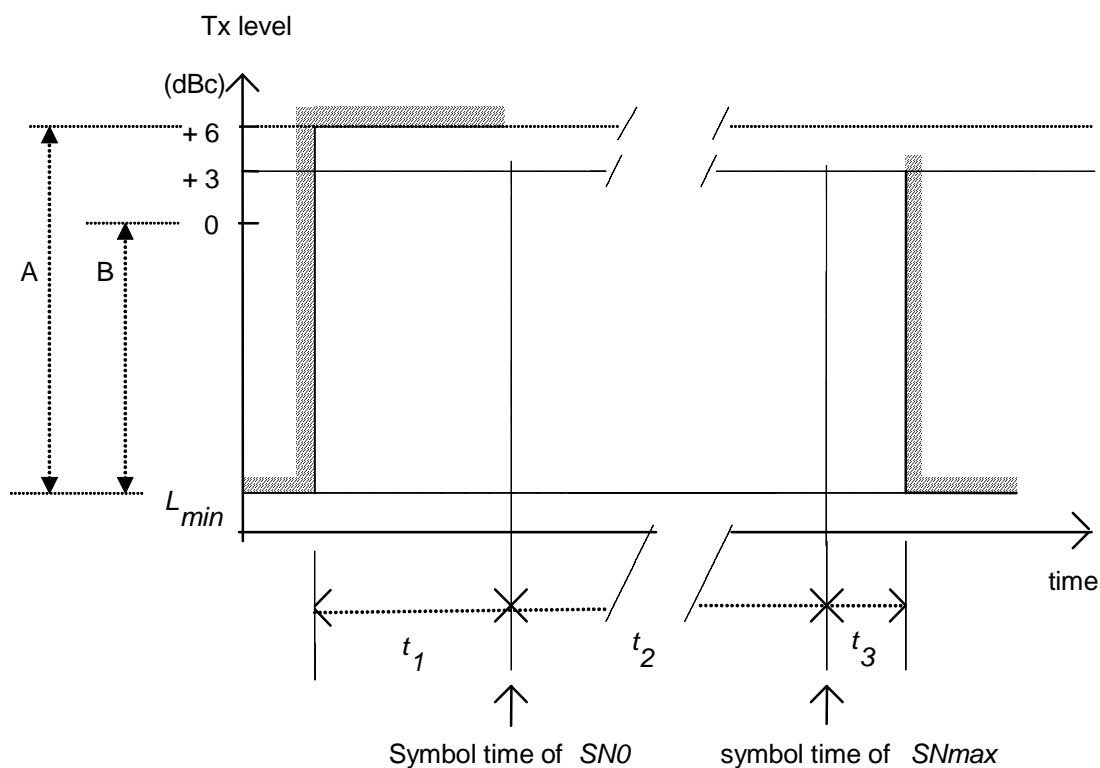

A: Mask height specified for phase modulation.  
 B: Mask for QAM. Note that this mask is not capped at 0 dB Tx level but is unspecified above this level.

NOTE:  $SN_0$  and  $SN_{max}$  are phase modulation symbol numbers. For QAM they should be replaced with  $SN-Q_1$  and  $SN-Q_{max}$ .

**Figure 8.1: Transmit power level versus time mask**

**Table 8.2: Transmit level versus time mask symbol durations (refer to figure 8.1)**

Modulation	Burst Type	$t_1$	$t_2$	$t_3$
Phase modulation	CB	16	103	15
	LB	119	0	15
	LDB	107	0	0
	NUB	16	231 (see note 1)	15
	NDB Discontinuous	7	246 (see note 1)	7
	NDB Continuous	Unspecified	Unspecified	Unspecified
QAM	CB, RAB	2,0	13,0	2,5
	LB	15,0	0,0	2,5
	NUB	2,0	30,0 (see note 1)	2,5

NOTE 1: In the case of single slot transmission.  
 NOTE 2: Values of  $t$  are for normal range operation. Values of  $t_1$  and  $t_3$  for phase modulation have been changed for long range operation. Values of  $t_3$  for QAM have been changed for long range operation.

Whenever bursts are consecutively transmitted by the same TETRA mobile station on the same frequency, the transmit level versus time mask applies at the beginning of the transmission of the first burst and at the end of the transmission of the last burst.

The symbol numbers are defined in clause 9 of ETSI EN 300 392-2 [i.2]. These are  $SN0$  to  $SNmax$  for phase modulation and  $SN-Q1$  to  $SN-Qmax$  for QAM. The timing of the transmitted bursts is specified in clause 7 of ETSI EN 300 392-2 [i.2]. The time periods  $t_1$ ,  $t_2$  and  $t_3$ , whose duration are stated in table 8.2, are defined in the following way:

- the time  $t_1$  starts at the beginning of the ramp-up of the first burst, and expires just before the symbol time of  $SN0$  for phase modulation (or  $SN-Q1$  for QAM);
- the time  $t_2$  starts at the symbol time of  $SN0$  ( $SN-Q1$  for QAM) of the first burst and finishes at the symbol time of  $SNmax$  ( $SN-Qmax$  for QAM) of the last burst;
- the time  $t_3$  starts just after the symbol time of  $SNmax$  ( $SN-Qmax$  for QAM) of the last burst and finishes at the end of the ramp-down.

For the time masks, the specification of transmit powers given in table 8.1 and the EVM specification of below 10 % apply during the time  $t_2$ .

## 8.2.2 Transmitter specifications for phase modulation

### 8.2.2.1 Vector error magnitude requirement at symbol time for phase modulation

Vector error magnitude requirement is to be fulfilled by the TETRA equipment with maximum and with minimum power levels (as defined in clause 8.2.1.1). To measure the vector error magnitude of data symbols it is required that the receiver is back-to-back connected to the transmitter, so as to avoid channel impairments such as distortion, noise and interference.

Let  $Z(k)$  be the output produced by observing the real transmitter through the ideal receive filter at symbol time  $t_k \times Z(k)$  is modelled as:

$$Z(k) = \{C_0 + [S(k) + E(k)]\}C_1W(k) \quad (8.1)$$

where:

- $E(k)$  is the vector error of modulation symbol  $S(k)$ ;
- $W(k) = \exp(jk\Theta)$  accounts for a frequency offset giving  $\Theta$  radians per symbol phase rotation due to transmitter frequency inaccuracy (see clause 7 of ETSI EN 300 392-2 [i.2]); the possible amplitude variations are integrated in the vector error;
- $C_0$  is a complex constant characterizing the residual carrier;
- $C_1$  is a complex constant representing the output amplitude and initial phase of the transmitter.

The magnitude of  $C_0$  has to be less than 5 % of the magnitude of  $S(k)$ . The task of the test receiver is then to estimate the symbol timing for processing the receive part followed by an estimation of the values of  $C_0$ ,  $C_1$  and  $\Theta$  (denoted by  $C_0'$ ,  $C_1'$  and  $\Theta'$  respectively). The test receiver then performs a normalization of the modulation symbol  $Z(k)$  accordingly. The modulation symbol that results from this normalization is denoted by  $Z'(k)$ :

$$Z'(k) = \left[ Z(k) \frac{\exp(-jk\Theta')}{C_1'} \right] - C_0' \quad (8.2)$$

The Sum Square Vector Error (SSVE) is then defined as:

$$SSVE = \sum_{k=1}^{SNmax} |Z'(k) - S(k)|^2 \quad (8.3)$$

where  $SNmax$  is the number of symbols in the burst.

The RMS vector error is then computed as the square root of the sum-square vector error divided by the number of symbols in the burst:

$$RMSVE = \sqrt{\frac{SSVE}{SNmax}} \quad (8.4)$$

The RMS vector error in any burst is specified at less than 0,1 and the peak vector error magnitude  $|Z(k)-S(k)|$  is specified at less than 0,3 for any symbol.

### 8.2.2.2 Maximum adjacent power levels for phase modulation

The TETRA specification for the maximum adjacent power level, emitted by a phase modulation channel is given in table 8.3.

**Table 8.3: Maximum adjacent power levels for phase modulation channels**

Frequency offset	Below 700 MHz		Above 700 MHz
	Maximum level for MS power classes 4 and 4L	Maximum level for other power classes	Maximum level for all power classes
25 kHz	-55 dBc	-60 dBc	-55 dBc
50 kHz	-70 dBc	-70 dBc	-65 dBc
75 kHz	-70 dBc	-70 dBc	-65 dBc (see note)
NOTE:	A level of -70 dBc applies for: BS power classes 1, 2 and 3 and for MS power classes 1 and 1L at frequencies above 700 MHz.		

The maximum adjacent power levels need not, in any case, fall below -36 dBm.

### 8.2.2.3 Wide-band noise limits for phase modulation

Tables 8.4 and 8.5 specify the wideband noise limits for phase modulation channels operating at frequencies below and above 700 MHz.

**Table 8.4: Wideband noise limits for frequencies below 700 MHz**

Frequency offset	Maximum wideband noise level		
	MS nominal power level $\leq 1$ W (class 4)	MS nominal power level = 1,8 W or 3 W (class 3L or 3)	MS nominal power level $\geq 5,6$ W (class 2L) BS all classes
100 kHz to 250 kHz	-75 dBc	-78 dBc	-80 dBc
250 kHz to 500 kHz	-80 dBc	-83 dBc	-85 dBc
500 kHz to $f_{rb}$	-80 dBc	-85 dBc	-90 dBc
$> f_{rb}$	-100 dBc	-100 dBc	-100 dBc
NOTE:	$f_{rb}$ denotes the frequency offset corresponding to the near edge of the receive band or 5 MHz (10 MHz for frequencies above 520 MHz) whichever is greater.		

**Table 8.5: Wideband noise limits for frequencies above 700 MHz**

Frequency offset	Maximum wideband noise level		
	MS nominal power level $\leq 1$ W (class 4)	MS nominal power levels from 1,8 W to 10 W and BS nominal power levels $\leq 10$ W	MS and BS nominal power levels from 15 W to 40 W
100 kHz to 250 kHz	-74 dBc	-74 dBc	-80 dBc
250 kHz to 500 kHz	-80 dBc	-80 dBc	-85 dBc
500 kHz to $f_{rb}$	-80 dBc	-85 dBc	-90 dBc
$> f_{rb}$	-100 dBc	-100 dBc	-100 dBc
NOTE:	$f_{rb}$ denotes the frequency offset corresponding to the near edge of the received band or 10 MHz whichever is greater.		

## 8.2.3 Transmitter specifications for QAM

### 8.2.3.1 Vector error magnitude requirement at symbol time for QAM

The assumed measure for modulation distortion is related to vector error magnitude of data symbols. This approach does not only take into account modulation filtering linear distortion (amplitude and phase) or the impact of inter-subcarrier spectral overlap or modulator impairments (quadrature offset, phase and linear amplitude errors in the modulation symbol constellation) but is a measure of the whole transmitter quality. It also takes into account local oscillator phase noise, filter distortion and non-linearity of amplifiers. Vector error magnitude is specified at symbol time as described below and the requirement set on vector error magnitude has to be fulfilled by the TETRA QAM equipment over all sub-carriers with maximum and with minimum power levels.

To measure the vector error magnitude of data symbols it is required that the receiver is back-to-back connected to the transmitter, so as to avoid channel impairments such as distortion, noise and interference. Assuming the receiver has ideal behaviour (this condition can be closely approximated in the lab), the  $k$ -th sample from the  $m$ -th subcarrier at the ideal (i.e. minimum intersymbol interference) sampling instant can be written in the form:

$$Z_m(k) = \{S_m(k) + E_m(k)\}F_m(k) \quad (8.5)$$

where the meaning of symbols is as follows:

- $S_m(k)$  is the  $k$ -th symbol on the  $m$ -th subcarrier, assumed belonging to an ideal QAM constellation of equally probable symbols, with mean square value normalized to unity;
- $E_m(k)$  is the complex-valued (vector) error associated to the symbol  $S_m(k)$ , due to the cited transmitter inaccuracies;
- $F_m(k)$  is the complex-valued (amplitude and phase) gain associated to the  $m$ -th subcarrier at the  $k$ -th symbol position, which can vary in time in view of possible transmitter oscillator inaccuracies (such as phase noise) and other impairments.

The measure for modulation distortion is the estimated Root-Mean-Square Vector Error (RMSVE), defined over all burst symbols as follows:

$$RMSVE = \sqrt{\frac{\sum_{m=1}^M \sum_{k=1}^L |E_m(k)|^2}{ML}} \quad (8.6)$$

where  $M$  and  $L$  denote the number of subcarriers and symbols over a subcarrier, respectively.

To evaluate the RMSVE in the laboratory, it is required that the two-dimensional (time-frequency) gain sequence  $F_m(k)$  is first estimated from the available observations  $Z_m(k)$  with the aid of synchronization and pilot symbols. This procedure is similar to that adopted when estimating the channel fading (clause 6.9.2) and leads to the estimated sequence of gains  $F'_m(k)$ , in which the estimation errors should be kept down to a negligible level. As next step, the observations are normalized to the estimated gains, yielding:

$$Z'_m(k) = \frac{Z_m(k)}{F'_m(k)} \approx S_m(k) + E_m(k) \quad (8.7)$$

Then the Sum Square Vector Error is calculated as follows:

$$SSVE = \sum_{m=1}^M \sum_{k=1}^L |Z'_m(k) - S_m(k)|^2 \quad (8.8)$$

It is noted that the difference at the right-hand side of (8.8) approximates the vector error  $E_m(k)$  on condition that the estimation errors on  $F'_m(k)$  are negligible. Therefore, from (8.6) and (8.8), an estimate for the RMSVE is as follows:

$$RMSVE = \sqrt{\frac{SSVE}{ML}} \quad (8.9)$$

The standard specifies that the RMSVE in any burst has to be less than 10 %. It is observed that due to the spectral overlap between adjacent sub-carriers, this parameter cannot be reduced to zero even when using ideal error-free transmitter components. The minimum value for RMSVE due to the above effect is found to be around 2 % to 3 %.

**NOTE:** It is recommended that the transmitter's RMS vector error in 64-QAM  $r = 1$  bursts should be significantly less than 10 % (e.g. 4 % to 6 %).

### 8.2.3.2 Limits to emission on adjacent channels in QAM

A crucial aspect in transmitter design is related to out-of-band spectral emission over the adjacent channels. This emission can be ascribed either to inaccuracies in transmitter implementation, such as the non-ideality of the transmit filter, following e.g. from truncation of its response, or the occurrence of nonlinear distortion in the final power amplifier and in quadrature frequency converters, etc. The above effects concur to create or increase unwanted out-of-band spectral emission. The TETRA HSD standard specifies constraints on the out-of-band emission in the adjacent channels in compliance with existing EU regulations [i.16], in the form of tables providing the maximum ratio (in dBc) between the power transmitted on the adjacent channels and the power transmitted in the useful signal bandwidth.

The above ratio is measured in the laboratory by means of the set-up specified in [i.3] clause 5.1, figure 5.1. Table 8.6 gives the maximum admissible values of the above power ratio (in dBc) for all signal bandwidths (25 kHz, 50 kHz, 100 kHz, 150 kHz) at three different offsets from the carrier frequency. In any case the power level at the output of the SRRC filter is measured during the transmission of the useful part of the burst, avoiding the ramp-up and ramp-down segments.

**Table 8.6: Maximum adjacent power levels for QAM channels**

Channel bandwidth	Frequency offset	Maximum level for MS and BS
25 kHz	25 kHz	-55 dBc
	50 kHz	-65 dBc
	75 kHz	-67 dBc
50 kHz	37,5 kHz	-55 dBc
	62,5 kHz	-63 dBc
	87,5 kHz	-65 dBc
100 kHz	62,5 kHz	-55 dBc
	87,5 kHz	-60 dBc
	112,5 kHz	-60 dBc
150 kHz	87,5 kHz	-55 dBc
	112,5 kHz	-60 dBc
	137,5 kHz	-60 dBc

### 8.2.3.3 Wideband noise limits in QAM

Another important issue in transmitter design is the control of wideband noise emission. Noise is generated in the final transmitter stages (e.g. frequency upconversion, power amplifier, etc.) and its spectrum normally extends several MHz far off the nominal transmission bandwidth. The standard poses limits to this type of radiation starting 100 kHz from the carrier frequency. The noise level is measured through a set-up similar to that employed for out-of-band spectral emission (clause 8.2.3.2), and the same references apply. The emission limits are given in the form of tables providing the maximum ratio (in dBc) between the noise power evaluated at different offsets from the carrier frequency and the power transmitted in the useful signal bandwidth.

Table 8.7 gives the relative noise level limits in dBc for all signal bandwidths (25 kHz, 50 kHz, 100 kHz, 150 kHz) at different offsets from the carrier frequency. The requirements apply symmetrically to both sides of the transmitter band.

Table 8.7: Wideband noise limits for QAM channels

Channel bandwidth	Frequency offset	Maximum wideband noise level for MS and BS	
		MS with nominal power level $\leq 3$ W	MS with nominal power level $\geq 5,6$ W BS all classes
25 kHz	100 kHz to 250 kHz	-70 dBc	-70 dBc
	250 kHz to 500 kHz	-74 dBc	-80 dBc
	500 kHz to 2 500 kHz	-80 dBc	-80 dBc
	2 500 kHz to $f_{rb}$	-80 dBc	-90 dBc
	$> f_{rb}$	-95 dBc	-95 dBc
50 kHz	112,5 kHz to 262,5 kHz	-68 dBc	-70 dBc
	262,5 kHz to 500 kHz	-72 dBc	-75 dBc
	500 kHz to $f_{rb}$	-78 dBc	-80 dBc
	$> f_{rb}$	-95 dBc	-95 dBc
100 kHz	137,5 kHz to 287,5 kHz	-60 dBc	-70 dBc
	287,5 kHz to 537,5 kHz	-65 dBc	-70 dBc
	537,5 kHz to 1 000 kHz	-73 dBc	-75 dBc
	1 000 kHz to $f_{rb}$	-73 dBc	-80 dBc
	$> f_{rb}$	-95 dBc	-95 dBc
150 kHz	162,5 kHz to 312,5 kHz	-60 dBc	-60 dBc
	312,5 kHz to 562,5 kHz	-63 dBc	-70 dBc
	562,5 kHz to 1 500 kHz	-70 dBc	-75 dBc
	1 500 kHz - $f_{rb}$	-70 dBc	-80 dBc
	$> f_{rb}$	-95 dBc	-95 dBc

NOTE:  $f_{rb}$  denotes the frequency offset corresponding to the near edge of the receive band or 5 MHz (10 MHz for frequencies above 520 MHz) whichever is greater.

## 8.3 RX specifications

### 8.3.1 General

A TETRA receiver is designed to operate satisfactorily under multipath conditions by incorporating techniques such as channel estimation, synchronization and error control techniques. However other sources of impairment may be present, mainly interfering signals from internal network and from external networks active in the vicinity of the receiver. To safeguard against such impairments additional specifications are introduced for the following effects by the TETRA standard in line with EU directives:

- 1) Receiver blocking performance: This is a measure of the receiver capability to block unwanted un-modulated signal on frequencies other than spurious responses or the adjacent channels.
- 2) Spurious response rejection: This is a measure of the receiver capability to reduce wanted signal degradation due to the presence of spurious un-modulated signals at any frequency for which blocking limit is not met.
- 3) Inter-modulation response rejection: This is a measure of the receiver capability to reduce the wanted signal degradation due to the presence of two or more inter-modulation products which have a specific frequency relationship to the wanted signal.
- 4) Unwanted equipment emission reduction: the TETRA standard ensures that the equipment (BS or MS) is designed to limit the conducted or radiated emissions from the cabinet or structure of the equipment at any frequency when in non-transmit state below an acceptable level.

The TETRA standard provides separate specification for phase modulation and QAM channels for effects 1 to 3. In the case of QAM channels these specifications cover separately channel bandwidths of 25 kHz, 50 kHz, 100 kHz and 150 kHz. In the case of effect 4 the specification is independent of transmit channels.

The details of the above specifications are not repeated in this guide for the sake of brevity. Instead, the focus of the remainder of this clause will be on receiver performance benchmarks which as a prerequisite requires that all specification related to the above impairments are met by the receiver. The receiver performance benchmarks are specified as the minimum performance provided by the receiver in the presence of noise and other interfering signals. The performance specifications are in terms of Message Erasure Rate (MER) or Bit Error Rate (BER).

The performance specification for phase modulation channels is outlined in clause 8.3.2, whilst the QAM channel performance specification is covered in clause 8.3.3.

## 8.3.2 Receiver specifications for phase modulation

### 8.3.2.0 General

Clause 8.3.2 defines receiver classes for phase modulation, in clause 8.3.2.1. It then provides reference performance benchmarks for the TETRA phase modulation receiver, i.e. the minimum performance (in terms of maximum admissible Message Error Rate (MER), or Bit Error Rate (BER)) the receiver has to be capable of in the presence of noise or interference, for a given reference input power level. Specifically, clause 8.3.2.2 defines the dynamic reference values of received signal power (receiver sensitivities) along with the corresponding limit MERs, for all phase modulation logical channels, to be met when the channel impairment is Additive Gaussian White Noise (AWGN). The assumed propagation conditions are TU50, HT200 and EQ200. In practice, a receiver driven by the reference input power in the presence of AWGN is required to exhibit a value of MER not exceeding the specified limit. The receiver noise figure is assumed to be 8 dB for the uplink (BS receiver) and 11 dB for the downlink (MS receiver).

Still assuming AWGN as the limiting factor, the reference values of received signal power over static (i.e. Gaussian) channel conditions are specified in clause 8.3.2.3 assuming a 3 % BER as performance target. Again, a receiver driven by the signal plus noise in the specified conditions is required to exhibit a BER not exceeding the indicated value.

Furthermore, clause 8.3.2.4 specifies the reference performance benchmarks to be met when the performance is limited by adjacent-channel or co-channel interference. The reference signal to interference ratios are first given. These are followed by the maximum permissible MS receiver MER or BER at reference interference levels under dynamic and static conditions. The assumed propagation conditions are TU50, HT200 and EQ200. A receiver driven by the signal plus interference in the above reference conditions is required to exhibit a BER or MER not exceeding the specified limits.

### 8.3.2.1 Receiver class

Four receiver classes have been defined by the TETRA standard according to their intended operating environments and test conditions:

- **Class B:** equipment is optimized for use in built-up and urban areas. The TETRA standard provides good performance at the reference sensitivity and interference level in static and TU50 conditions, but not in extreme propagation conditions (hilly terrain).
- **Class A:** equipment is optimized for use in urban areas and in areas with hilly or mountainous terrain. It is resilient to extreme propagation conditions (hilly terrain) and is specified in static, TU50 and HT200 conditions.
- **Class D:** equipment has the same performance requirements as class A for  $\pi/4$ -DQPSK modulation, and is further optimized to enhance the performance of  $\pi/8$ -D8PSK modulation in hilly or mountainous terrain using equalization or other techniques. It is resilient to extreme propagation conditions (hilly terrain) and is specified in static, TU50 and HT200 conditions.
- **Class E:** equipment comprises an equalizer and is specified in static, TU50, HT200 (PACQ only) and EQ200 conditions. It is not applicable to BS equipment. This class is only specified for  $\pi/4$ -DQPSK modulation.

### 8.3.2.2 Dynamic reference sensitivity performance for phase modulation

The minimum required dynamic reference sensitivity performance is specified according to the logical channel, the propagation condition and the receiver class at the dynamic reference sensitivity level. The dynamic reference sensitivity levels are:

- for MS  $\pi/4$ -DQPSK modulation: -103 dBm;
- for MS  $\pi/8$ -D8PSK modulation: -97 dBm;
- for BS  $\pi/4$ -DQPSK modulation: -106 dBm;
- for BS  $\pi/8$ -D8PSK modulation: -100 dBm.

The maximum permissible BS receiver MER or BER at dynamic receiver sensitivity performance with phase modulation is given in tables 8.8 and 8.8a. The equivalent data for MS is given in tables 8.9 and 8.9a. The performance with  $\pi/8$ -D8PSK modulation below 300 MHz is outside the scope of the TETRA standard.

**Table 8.8: Maximum permissible BS receiver MER or BER at dynamic reference sensitivity level with  $\pi/4$ -DQPSK modulation for frequencies below 300 MHz**

Logical channel	Error count type	Propagation condition		Propagation condition
		TU50 class A	HT200 class A	TU50 class B
<b><math>\pi/4</math>-DQPSK</b>				
SCH/HU	MER	10,5 %	11 %	10,5 %
SCH/F	MER	11 %	11 %	9,2 %
TCH/7,2	BER	2,5 %	4 %	2,2 %
TCH/4,8 N = 1	BER	4 %	4 %	2,2 %
TCH/4,8 N = 4	BER	1,2 %	4 %	1,2 %
TCH/4,8 N = 8	BER	0,4 %	4 %	0,06 %
TCH/2,4 N = 1	BER	1,2 %	1,3 %	0,55 %
TCH/2,4 N = 4	BER	0,08 %	0,3 %	0,08 %
TCH/2,4 N = 8	BER	0,015 %	0,15 %	0,015 %
STCH	MER	10,5 %	11 %	10,5 %

NOTE: N gives the number of interleaving blocks.

**Table 8.8a: Maximum permissible BS receiver MER or BER at dynamic reference sensitivity level with phase modulation for frequencies above 300 MHz**

Logical channel	Error count type	Propagation condition			Propagation condition
		TU50 class A	HT200 class A	TU50 class B	
<b><math>\pi/4</math>-DQPSK</b>					
SCH/HU	MER	8 %	9,5 %	8 %	
SCH/F	MER	11 %	11 %	8 %	
TCH/7,2	BER	2,5 %	4 %	2,2 %	
TCH/4,8 N = 1	BER	4 %	4 %	2 %	
TCH/4,8 N = 4	BER	1,2 %	4 %	0,4 %	
TCH/4,8 N = 8	BER	0,4 %	4 %	0,06 %	
TCH/2,4 N = 1	BER	1,2 %	1,3 %	0,35 %	
TCH/2,4 N = 4	BER	0,02 %	0,3 %	0,01 %	
TCH/2,4 N = 8	BER	0,01 %	0,15 %	0,01 %	
STCH	MER	9 %	11 %	8 %	
<b><math>\pi/8</math>-D8PSK</b>					
		<b>TU50 Class A, D</b>	<b>HT200 class A</b>	<b>HT200 class D</b>	<b>TU50 class B</b>
SCH-P8/HU	MER	7,4 %	19 %	14 %	6,3 %
SCH-P8/F	MER	10 %	29 %	18 %	8,9 %
TCH-P8/10,8	BER	1,6 %	4,5 %	3,6 %	1,4 %

NOTE: N gives the number of interleaving blocks.

**Table 8.9: Maximum permissible MS receiver MER or BER at dynamic reference sensitivity level with  $\pi/4$ -DQPSK modulation for frequencies below 300 MHz**

Logical channel	Error count type	Continuous downlink mode			Discontinuous downlink mode		Propagation condition
		Propagation condition			Propagation condition		
$\pi/4$ -DQPSK		TU50 Class A, E	HT200 Class A	EQ200 Class E	TU50 Class A	HT200 Class A	TU50 Class B
AACH	MER	10 %	17 %	16 %	10 %	17 %	11 %
BSCH	MER	8 %	13 %	22 %	8 %	11 %	8 %
SCH/HD	MER	10,5 %	11 %	21 %	11 %	11 %	11 %
BNCH	MER	10,5 %	11 %	21 %	11 %	11 %	11 %
SCH/F	MER	9,2 %	11 %	22 %	11 %	11 %	9,2 %
TCH/7,2	BER	2,5 %	4 %	4,5 %	2,5 %	4 %	2,2 %
TCH/4,8 N = 1	BER	2,2 %	4 %	6,4 %	4 %	4 %	2,2 %
TCH/4,8 N = 4	BER	1,1 %	3,3 %	2,7 %	1,2 %	4 %	1,1 %
TCH/4,8 N = 8	BER	0,4 %	3 %	1,5 %	0,4 %	4 %	0,4 %
TCH/2,4 N = 1	BER	0,55 %	1,1 %	0,82 %	1,2 %	1,3 %	0,55 %
TCH/2,4 N = 4	BER	0,08 %	0,4 %	0,017 %	0,08 %	0,4 %	0,08 %
TCH/2,4 N = 8	BER	0,015 %	0,13 %	0,01 %	0,015 %	0,2 %	0,015 %
STCH	MER	10,5 %	11 %	21 %	11 %	11 %	11 %

NOTE 1: N gives the number of interleaving blocks.  
NOTE 2: Class B receiver performance are for both continuous and discontinuous downlink mode.

**Table 8.9a: Maximum permissible MS receiver MER or BER at dynamic reference sensitivity level with phase modulation for frequencies above 300 MHz**

Logical channel	Error count type	Continuous downlink mode			Discontinuous downlink mode			Propagation condition
		Propagation condition			Propagation condition			
$\pi/4$ -DQPSK		TU50 Class A, E	HT200 Class A	EQ200 Class E	TU50 Class A	HT200 Class A	TU50 Class B	
AACH	MER	10 %	17 %	16 %	10 %	17 %	11 %	
BSCH	MER	8 %	11 %	22 %	8 %	11 %	8 %	
SCH/HD	MER	8 %	11 %	21 %	9 %	11 %	8 %	
BNCH	MER	8 %	11 %	21 %	9 %	11 %	8 %	
SCH/F	MER	8 %	11 %	22 %	11 %	11 %	8 %	
TCH/7,2	BER	2,5 %	4 %	4,5 %	2,5 %	4 %	2,2 %	
TCH/4,8 N = 1	BER	2 %	4 %	6,4 %	4 %	4 %	2 %	
TCH/4,8 N = 4	BER	0,4 %	3,3 %	2,7 %	1,2 %	4 %	0,4 %	
TCH/4,8 N = 8	BER	0,06 %	3 %	1,5 %	0,4 %	4 %	0,06 %	
TCH/2,4 N = 1	BER	0,35 %	1,1 %	0,82 %	1,2 %	1,3 %	0,35 %	
TCH/2,4 N = 4	BER	0,01 %	0,4 %	0,017 %	0,02 %	0,4 %	0,01 %	
TCH/2,4 N = 8	BER	0,01 %	0,13 %	0,01 %	0,01 %	0,2 %	0,01 %	
STCH	MER	8 %	11 %	21 %	9 %	11 %	8 %	
$\pi/8$ -D8PSK		TU50 Class A, D	HT200 Class A	HT200 Class D	TU50 Class A, D	HT200 Class A	HT200 Class D	TU50 Class B
SCH-P8/HD	MER	8,3 %	21 %	15 %	8,1 %	21 %	15 %	7,1 %
SCH-P8/F	MER	10 %	29 %	18 %	10 %	29 %	18 %	9,0 %
TCH-P8/10,8	BER	1,6 %	4,5 %	3,4 %	1,6 %	4,5 %	3,6 %	1,4 %

NOTE 1: N gives the number of interleaving blocks.  
NOTE 2: Class B receiver performance are for both continuous and discontinuous downlink mode.

### 8.3.2.3 Static reference sensitivity performance for phase modulation

The minimum required static reference sensitivity performance is specified according to the logical channel and the receiver class at the static reference sensitivity level. The static reference sensitivity levels are:

- for MS  $\pi/4$ -DQPSK modulation: -112 dBm;
- for MS  $\pi/8$ -D8PSK modulation: -107 dBm;
- for BS  $\pi/4$ -DQPSK modulation: -115 dBm;
- for BS  $\pi/8$ -D8PSK modulation: -110 dBm.

The maximum permissible BS receiver MER or BER at static receiver sensitivity performance with phase modulation is given in table 8.10. The equivalent data for MS is given in table 8.11.

**Table 8.10: Maximum permissible BS receiver MER or BER at static reference sensitivity level with phase modulation**

Logical channel	Error count type		
<b><math>\pi/4</math>-DQPSK</b>		<b>Class A</b>	<b>Class B</b>
SCH/HU	MER	3 %	3 %
SCH/F	MER	10 %	10 %
TCH/7,2	BER	3 %	4 %
TCH/4,8 N = 1	BER	3,3 %	0,3 %
TCH/4,8 N = 4	BER	1 %	0,2 %
TCH/4,8 N = 8	BER	0,4 %	0,2 %
TCH/2,4 N = 1	BER	0,2 %	0,01 %
TCH/2,4 N = 4	BER	0,01 %	0,01 %
TCH/2,4 N = 8	BER	0,01 %	0,01 %
STCH	MER	8 %	5 %
<b><math>\pi/8</math>-D8PSK</b>		<b>Class A, D</b>	<b>Class B</b>
SCH-P8/HU	MER	4,5 %	4,3 %
SCH-P8/F	MER	9,3 %	9,3 %
TCH-P8/10,8	BER	3,8 %	3,1 %
NOTE: N gives the number of interleaving blocks.			

**Table 8.11: Maximum permissible MS receiver MER or BER at static reference sensitivity level with phase modulation**

Logical channel	Error count type	Continuous downlink mode	Discontinuous downlink mode	
<b><math>\pi/4</math>-DQPSK</b>		<b>Class A, E</b>	<b>Class A</b>	<b>Class B</b>
AACH	MER	28 %	28 %	38 %
BSCH	MER	3 %	3 %	3 %
SCH/HD	MER	2,5 %	8 %	5 %
BNCH	MER	2,5 %	8 %	5 %
SCH/F	MER	4,5 %	9 %	9 %
TCH/7,2	BER	3,5 %	3,5 %	4 %
TCH/4,8 N = 1	BER	0,3 %	2 %	0,3 %
TCH/4,8 N = 4	BER	0,2 %	0,8 %	0,2 %
TCH/4,8 N = 8	BER	0,15 %	0,4 %	0,15 %
TCH/2,4 N = 1	BER	0,01 %	0,01 %	0,01 %
TCH/2,4 N = 4	BER	0,01 %	0,01 %	0,01 %
TCH/2,4 N = 8	BER	0,01 %	0,01 %	0,01 %
STCH	MER	2,5 %	8 %	5 %
<b><math>\pi/8</math>-D8PSK</b>		<b>Class A, D</b>	<b>Class A, D</b>	<b>Class B</b>
SCH-P8/HD	MER	5,6 %	5,6 %	1,6 %
SCH-P8/F	MER	10 %	10 %	9,3 %
TCH-P8/10,8	BER	3,9 %	3,9 %	3,2 %

NOTE 1: N gives the number of interleaving blocks.  
NOTE 2: Class B receiver performance are for both continuous and discontinuous downlink modes.

#### 8.3.2.4 Receiver performance at reference interference ratios for phase modulation

The minimum required reference interference performance (for co-channel,  $C/I_c$ , or adjacent channel,  $C/I_a$ ) is specified according to the logical channel, the propagation condition and the receiver class at the reference interference ratio. The reference interference ratio for phase modulation is given in table 8.12.

**Table 8.12: Reference interference ratio for phase modulation**

Modulation	Frequency (MHz)	C/I <sub>c</sub> (dB)	C/I <sub>a</sub> (dB)		
		MS and BS	MS	BS	MS and BS
$\pi/4$ -DQPSK	Below 700	19	-40	-45	
	Above 700	19			-40
$\pi/8$ -D8PSK	Below 700	25	-34	-39	
	Above 700	25			-34

The above specifications apply for:

- 1) co-channel interference with:
  - wanted input signal level of -85 dBm above the dynamic reference sensitivity level;
  - interference signal being a continuous TETRA random signal with the same modulation and the same propagation condition (but independently realized) as the wanted signal;
- 2) adjacent channel interference with:
  - wanted input signal level 3 dB above the dynamic reference sensitivity level;
  - interference signal being a continuous TETRA random signal with the same modulation as the wanted signal subjected to static propagation condition.

Tables 8.13 and 8.13a, and tables 8.14 and 8.14a, show the performance of phase modulation logical channels under TU50 and HT200 propagation conditions achieved at reference interference levels for BS and MS respectively. The performance with  $\pi/8$ -D8PSK modulation below 300 MHz is outside the scope of the TETRA standard.

**Table 8.13: Maximum permissible BS receiver MER or BER at reference interference level with  $\pi/4$ -DQPSK modulation for frequencies below 300 MHz**

Logical channel	Error count type	Propagation condition		Propagation condition
		TU50 class A	HT200 class A	TU50 class B
$\pi/4$ -DQPSK				
SCH/HU	MER	6,7 %	9,5 %	6,7 %
SCH/F	MER	6 %	9,2 %	6 %
TCH/7,2	BER	2 %	3,7 %	2 %
TCH/4,8 N= 1	BER	4 %	4 %	2 %
TCH/4,8 N= 4	BER	1,2 %	4 %	0,45 %
TCH/4,8 N= 8	BER	0,4 %	4 %	0,15 %
TCH/2,4 N= 1	BER	1,2 %	1,3 %	0,35 %
TCH/2,4 N= 4	BER	0,028 %	0,3 %	0,028 %
TCH/2,4 N= 8	BER	0,01 %	0,15 %	0,01 %
STCH	MER	7 %	9,2 %	7 %

NOTE: N gives the number of interleaving blocks.

**Table 8.13a: Maximum permissible BS receiver MER or BER at reference interference level with phase modulation for frequencies above 300 MHz**

Logical channel	Error count type	Propagation condition			Propagation condition
		TU50 class A	HT200 class A	TU50 class B	
$\pi/4$ -DQPSK					
SCH/HU	MER	6,5 %	9,5 %	6,5 %	
SCH/F	MER	6 %	9,2 %	6 %	
TCH/7,2	BER	2 %	3,7 %	2 %	
TCH/4,8 N = 1	BER	4 %	4 %	2 %	
TCH/4,8 N = 4	BER	1,2 %	4 %	0,4 %	
TCH/4,8 N = 8	BER	0,4 %	4 %	0,06 %	
TCH/2,4 N = 1	BER	1,2 %	1,3 %	0,35 %	
TCH/2,4 N = 4	BER	0,02 %	0,3 %	0,01 %	
TCH/2,4 N = 8	BER	0,01 %	0,15 %	0,01 %	
STCH	MER	7 %	9,2 %	7 %	
$\pi/8$ -D8PSK		TU50 Class A, D	HT200 class A	HT200 class D	TU50 class B
SCH-P8/HU	MER	7,3 %	19 %	13 %	6,6 %
SCH-P8/F	MER	10 %	29 %	18 %	9,1 %
TCH-P8/10,8	BER	1,6 %	4,5 %	3,7 %	1,4 %

NOTE: N gives the number of interleaving blocks.

**Table 8.14: Maximum permissible MS receiver MER or BER at reference interference level with  $\pi/4$ -DQPSK modulation for frequencies below 300 MHz**

Logical channel	Error count type	Continuous downlink mode			Discontinuous downlink mode		Propagation condition
		Propagation condition			Propagation condition		
$\pi/4$ -DQPSK		TU50 Class A, E	HT200 Class A	EQ200 Class E	TU50 Class A	HT200 Class A	TU50 Class B
AACH	MER	9 %	16 %	14 %	9 %	16 %	9 %
BSCH	MER	6 %	10 %	20 %	6 %	10 %	6 %
SCH/HD	MER	7 %	9,2 %	20 %	7 %	9,2 %	7 %
BNCH	MER	7 %	9,2 %	20 %	7 %	9,2 %	7 %
SCH/F	MER	6,5 %	9,2 %	20 %	6,5 %	7,5 %	6,5 %
TCH/7,2	BER	2 %	3,8 %	4,2 %	2 %	3,8 %	2 %
TCH/4,8 N = 1	BER	2 %	4 %	6,2 %	4 %	4 %	2 %
TCH/4,8 N = 4	BER	0,45 %	3,3 %	2,5 %	1,2 %	4 %	0,45 %
TCH/4,8 N = 8	BER	0,15 %	3 %	1,2 %	0,4 %	4 %	0,15 %
TCH/2,4 N = 1	BER	0,35 %	1,1 %	0,84 %	1,2 %	1,3 %	0,35 %
TCH/2,4 N = 4	BER	0,028 %	0,4 %	0,01 %	0,028 %	0,4 %	0,028 %
TCH/2,4 N = 8	BER	0,01 %	0,13 %	0,01 %	0,01 %	0,2 %	0,01 %
STCH	MER	7 %	9,2 %	20 %	7 %	9,2 %	7 %

NOTE 1: N gives the number of interleaving blocks.  
NOTE 2: Class B receiver performance are for both continuous and discontinuous downlink mode.

**Table 8.14a: Maximum permissible MS receiver MER or BER at reference interference level with phase modulation for frequencies above 300 MHz**

Logical channel	Error count type	Continuous downlink mode			Discontinuous downlink mode			Propagation condition
		Propagation condition			Propagation condition			
$\pi/4$ -DQPSK		TU50 Class A, E	HT200 Class A	EQ200 Class E	TU50 Class A	HT200 Class A	TU50 Class B	
AACH	MER	9 %	16 %	14 %	9 %	16 %	9 %	
BSCH	MER	6 %	10 %	20 %	6 %	10 %	6 %	
SCH/HD	MER	7 %	9,2 %	20 %	7 %	9,2 %	7 %	
BNCH	MER	7 %	9,2 %	20 %	7 %	9,2 %	7 %	
SCH/F	MER	6,5 %	9,2 %	20 %	6,5 %	7,5 %	6,5 %	
TCH/7,2	BER	2 %	3,8 %	4,2 %	2 %	3,8 %	2 %	
TCH/4,8 N = 1	BER	2 %	4 %	6,2 %	4 %	4 %	2 %	
TCH/4,8 N = 4	BER	0,4 %	3,3 %	2,5 %	1,2 %	4 %	0,4 %	
TCH/4,8 N = 8	BER	0,06 %	3 %	1,2 %	0,4 %	4 %	0,06 %	
TCH/2,4 N = 1	BER	0,35 %	1,1 %	0,84 %	1,2 %	1,3 %	0,35 %	
TCH/2,4 N = 4	BER	0,01 %	0,4 %	0,01 %	0,02 %	0,4 %	0,01 %	
TCH/2,4 N = 8	BER	0,01 %	0,13 %	0,01 %	0,01 %	0,2 %	0,01 %	
STCH	MER	7 %	9,2 %	20 %	7 %	9,2 %	7 %	
$\pi/8$ -D8PSK		TU50 Class A, D	HT200 Class A	HT200 Class D	TU50 Class A, D	HT200 Class A	HT200 Class D	TU50 Class B
SCH-P8/HD	MER	7,6 %	21 %	16 %	7,9 %	21 %	15 %	6,6 %
SCH-P8/F	MER	10 %	29 %	19 %	19 %	29 %	18 %	8,9 %
TCH-P8/10,8	BER	1,6 %	4,5 %	3,5 %	3,5 %	4,5 %	3,6 %	1,4 %

NOTE 1: N gives the number of interleaving blocks.  
NOTE 2: Class B receiver performance are for both continuous and discontinuous downlink mode.

### 8.3.3 Receiver specifications for QAM

#### 8.3.3.0 General

Clause 8.3.3 provides reference performance benchmarks for the TETRA HSD receiver, i.e. the minimum performance (in terms of maximum admissible Message Error Rate (MER), or Bit Error Rate (BER)) the receiver has to be capable of in the presence of noise or interference, for a given reference input power level. Specifically, clause 8.3.3.1 below defines the dynamic reference values of received signal power (receiver sensitivities) along with the corresponding limit MERs, for all QAM logical channels, to be met when the channel impairment is Additive Gaussian White Noise (AWGN). The assumed propagation conditions are TU50 and HT200, with carrier frequencies below or above 700 MHz. In practice, a receiver driven by the reference input power in the presence of AWGN is required to exhibit a value of MER not exceeding the specified limit. The receiver noise figure is assumed to be 8 dB for the uplink (BS receiver) and 11 dB for the downlink (MS receiver).

Still assuming AWGN as the limiting factor, the reference values of received signal power over static (i.e. Gaussian) channel conditions are specified in clause 8.3.3.2 assuming a 3 % BER as performance target. Again, a receiver driven by the signal plus noise in the specified conditions is required to exhibit a BER not exceeding the indicated value.

Furthermore, clause 8.3.3.3 specifies the reference performance benchmarks to be met when the performance is limited by adjacent-channel or co-channel interference. The rules on how to synthesize both the adjacent channel and co-channel interference and the performance thresholds to be met are also given. A receiver driven by the signal plus interference in the above reference conditions is required to exhibit a BER or MER not exceeding the specified limits.

Finally, the relationship between the receiver sensitivity and the received  $\frac{E_b}{N_0}$  is specified in clause 8.3.3.4. It can be used to associate an input power level to a value of MER using the MER vs.  $\frac{E_b}{N_0}$  diagrams, or vice versa, for noise-limited receiver operation.

The performance with QAM below 300 MHz is outside the scope of the TETRA standard.

NOTE: The multicarrier QAM is tolerant to most of the propagation effects down to 138 MHz, but deep slow fading may increase MER above the values defined for frequencies above 300 MHz.

#### 8.3.3.1 Dynamic reference sensitivity performance for QAM

The minimum required dynamic reference sensitivity performance is specified according to the logical channel, propagation condition, coding rate, modulation and channel bandwidth.

Table 8.15 specifies the dynamic reference sensitivity for frequencies below 700 MHz for 4-QAM, 16-QAM and 64-QAM.

Table 8.16 gives the maximum permissible receiver MER for frequencies below 700 MHz at the dynamic reference sensitivities specified in table 8.15.

Table 8.17 specifies the dynamic reference sensitivity for frequencies above 700 MHz for 4-QAM, 16-QAM and 64-QAM.

Table 8.18 gives the maximum permissible receiver MER for frequencies above 700 MHz at the dynamic reference sensitivities specified in table 8.17.

Table 8.15: BS and MS dynamic reference sensitivity for frequencies below 700 MHz

Modulation	Channel BW	BS, r = 1/2	BS, r = 2/3	MS, r = 1/2	MS, r = 2/3
4-QAM	25 kHz	-111 dBm		-108 dBm	
	50 kHz	-108 dBm		-105 dBm	
	100 kHz	-105 dBm		-102 dBm	
	150 kHz	-104 dBm		-101 dBm	
16-QAM	25 kHz	-106 dBm		-103 dBm	
	50 kHz	-102 dBm		-100 dBm	
	100 kHz	-100 dBm		-97 dBm	
	150 kHz	-99 dBm		-96 dBm	
64-QAM	25 kHz	-101 dBm	-98 dBm	-98 dBm	-95 dBm
	50 kHz	-98 dBm	-94 dBm	-95 dBm	-91 dBm
	100 kHz	-95 dBm	-92 dBm	-92 dBm	-88 dBm
	150 kHz	-94 dBm	-91 dBm	-91 dBm	-87 dBm

Table 8.16: Maximum permissible MS and BS receiver MER at dynamic reference sensitivity level for frequencies below 700 MHz

Type of channel	Payload modulation	BS/MS	Code rate	25 kHz		50 kHz		100 kHz		150 kHz	
				TU50	HT200	TU50	HT200	TU50	HT200	TU50	HT200
SCH-Q/RA	4-QAM	BS	1/2	11,1 %	7,4 %						
SICH-Q/U in CB	4-QAM	BS	1/2	5,5 %	1,8 %	3,6 %	1,6 %	3,8 %	1,2 %	5,3 %	2 %
SCH-Q/HU	4-QAM	BS	1/2	11 %	7,7 %	9,3 %	5,6 %	9 %	3,3 %	12,9 %	7,6 %
SICH-Q/U in NUB	4-QAM	BS	1/2	3,6 %	1,4 %	3,5 %	1,3 %	3,6 %	1,1 %	3,9 %	1,6 %
SCH-Q/U	4-QAM	BS	1/2	8,3 %	3,7 %	9,4 %	2 %	9 %	1,5 %	8,1 %	3,2 %
SICH-Q/D	4-QAM	MS	1/2	1,9 %	0,8 %	2,1 %	0,9 %	2,1 %	0,9 %	2,3 %	0,9 %
AACH-Q	4-QAM	MS	1/2	10 %	2,5 %	10 %	2,7 %	10 %	2,8 %	10 %	2,8 %
BNCH-Q, SCH-Q/D	4-QAM	MS	1/2	7,8 %	2,3 %	10 %	1,8 %	8,7 %	1,8 %	8,4 %	1,8 %
BSCH-Q	4-QAM	MS	1/2	13,3 %	3,6 %	11,5 %	3,0 %	10,8 %	2,9 %	13,3 %	3,4 %
SCH-Q/B	4-QAM	MS	1/2	-	-	7,6 %	1,1 %	8,1 %	0,9 %	10 %	1,2 %
SCH-Q/HU	16-QAM	BS	1/2	11,9 %	8,2 %	7,9 %	3,6 %	9,9 %	3,5 %	13,2 %	7,5 %
SCH-Q/U	16-QAM	BS	1/2	8,8 %	3,9 %	7 %	1,1 %	9,5 %	1,6 %	8,9 %	3,5 %
BNCH-Q, SCH-Q/D	16-QAM	MS	1/2	8,6 %	2,9 %	7,2 %	1 %	9 %	1,9 %	8,7 %	1,8 %
SCH-Q/HU	64-QAM	BS	1/2	11 %	7 %	8,9 %	4,8 %	8,7 %	3 %	12,1 %	6,2 %
SCH-Q/U	64-QAM	BS	1/2	7,8 %	3,7 %	9,9 %	3 %	7,7 %	1,6 %	6,9 %	2,7 %
BNCH-Q, SCH-Q/D	64-QAM	MS	1/2	7,4 %	2,6 %	9,3 %	1,9 %	7,3 %	1,8 %	7,4 %	1,6 %
SCH-Q/HU	64-QAM	BS	2/3	11,2 %	11,2 %	7,8 %	7,6 %	9,9 %	7,1 %	14,1 %	11,8 %
SCH-Q/U	64-QAM	BS	2/3	9,5 %	7,7 %	8,3 %	4,4 %	9,6 %	5,1 %	9,3 %	8,1 %
BNCH-Q, SCH-Q/D	64-QAM	MS	2/3	9,3 %	6,2 %	8,1 %	3 %	7,3 %	3,6 %	6,9 %	3,9 %

Table 8.17: BS and MS dynamic reference sensitivity for frequencies above 700 MHz

Modulation	Channel BW	BS, r = 1/2	BS, r = 2/3	MS, r = 1/2	MS, r = 2/3
4-QAM	25 kHz	-111 dBm		-108 dBm	
	50 kHz	-108 dBm		-105 dBm	
	100 kHz	-105 dBm		-102 dBm	
	150 kHz	-104 dBm		-101 dBm	
16-QAM	25 kHz	-107 dBm		-103 dBm	
	50 kHz	-103 dBm		-100 dBm	
	100 kHz	-100 dBm		-97 dBm	
	150 kHz	-99 dBm		-96 dBm	
64-QAM	25 kHz	-102 dBm	-98 dBm	-99 dBm	-95 dBm
	50 kHz	-98 dBm	-94 dBm	-95 dBm	-91 dBm
	100 kHz	-96 dBm	-92 dBm	-93 dBm	-89 dBm
	150 kHz	-94 dBm	-90 dBm	-92 dBm	-88 dBm

Table 8.18: Maximum permissible MS and BS receiver MER at dynamic reference sensitivity level for frequencies above 700 MHz

Type of channel	Payload modulation	BS/MS	Code rate	25 kHz		50 kHz		100 kHz		150 kHz	
				TU50	HT200	TU50	HT200	TU50	HT200	TU50	HT200
SCH-Q/RA	4-QAM	BS	1/2	14,2 %	5,9 %						
SICH-Q/U in CB	4-QAM	BS	1/2	4,6 %	1 %	5,3 %	1,1 %	3 %	1,2 %	4,2 %	1,4 %
SCH-Q/HU	4-QAM	BS	1/2	14,3 %	5,5 %	14,2 %	4,4 %	10,3 %	3,5 %	13,4 %	5,2 %
SICH-Q/U in NUB	4-QAM	BS	1/2	2,6 %	1 %	3,2 %	0,9 %	1,2 %	1 %	3,7 %	1,4 %
SCH-Q/U	4-QAM	BS	1/2	7 %	2 %	8,5 %	1,1 %	6,8 %	0,9 %	9,1 %	1,6 %
SICH-Q/D	4-QAM	MS	1/2	1,4 %	0,7 %	1,9 %	0,7 %	1,7 %	0,6 %	2,1 %	1 %
AACH-Q	4-QAM	MS	1/2	6 %	2,2 %	6 %	2 %	6 %	1,9 %	6,3 %	3,1 %
BNCH-Q, SCH-Q/D	4-QAM	MS	1/2	7,6 %	1,7 %	10 %	0,8 %	7,4 %	0,6 %	7,6 %	1,4 %
BSCH-Q	4-QAM	MS	1/2	10,6 %	2,3 %	9,1 %	2,2 %	10,4 %	2,3 %	12,4 %	4,3 %
SCH-Q/B	4-QAM	MS	1/2	-	-	6,4 %	0,3 %	5,7 %	0,7 %	7,6 %	1,3 %
SCH-Q/HU	16-QAM	BS	1/2	16,5 %	10,8 %	14,2 %	4,8 %	11,1 %	4,1 %	13,4 %	5,2 %
SCH-Q/U	16-QAM	BS	1/2	9 %	5,7 %	8,6 %	1,4 %	6,3 %	1,1 %	8,9 %	2,5 %
BNCH-Q, SCH-Q/D	16-QAM	MS	1/2	7,2 %	2,1 %	8,4 %	0,9 %	7,2 %	0,9 %	7,5 %	1,7 %
SCH-Q/HU	64-QAM	BS	1/2	16 %	11 %	13 %	5,7 %	12,2 %	8,4 %	11,3 %	5 %
SCH-Q/U	64-QAM	BS	1/2	7,5 %	6,7 %	10 %	4,8 %	8,3 %	4,4 %	6,5 %	2,9 %
BNCH-Q, SCH-Q/D	64-QAM	MS	1/2	9,4 %	5,6 %	7 %	1,8 %	8,1 %	2,7 %	8,9 %	6 %
SCH-Q/HU	64-QAM	BS	2/3	15,4 %	16,6 %	12,9 %	13,2 %	11,7 %	16 %	10,9 %	12,1 %
SCH-Q/U	64-QAM	BS	2/3	8 %	16,6 %	7,8 %	12,5 %	7,7 %	14 %	7,2 %	15,3 %
BNCH-Q, SCH-Q/D	64-QAM	MS	2/3	9,2 %	18,6 %	7,1 %	7,9 %	8,7 %	11,9 %	9,1 %	20,7 %

### 8.3.3.2 Static reference sensitivity performance for QAM

The minimum required static reference sensitivity performance for MS and BS is defined in tables 8.19 and 8.20, respectively. This means that when the receiver is driven by the input signal power specified in the tables, the receiver BER has to be less than or equal to 3 %.

**Table 8.19: QAM sensitivity levels for MS**

Channel BW	4-QAM 3 % BER Sensitivity	16-QAM 3 % BER Sensitivity	64-QAM 3 % BER Sensitivity
25 kHz	-113 dBm	-106 dBm	-101 dBm
50 kHz	-110 dBm	-103 dBm	-97 dBm
100 kHz	-107 dBm	-100 dBm	-95 dBm
150 kHz	-105 dBm	-99 dBm	-93 dBm

**Table 8.20: QAM sensitivity levels for BS**

Channel BW	4-QAM 3 % BER Sensitivity	16-QAM 3 % BER Sensitivity	64-QAM 3 % BER Sensitivity
25 kHz	-116 dBm	-109 dBm	-104 dBm
50 kHz	-113 dBm	-106 dBm	-100 dBm
100 kHz	-110 dBm	-103 dBm	-98 dBm
150 kHz	-108 dBm	-102 dBm	-96 dBm

### 8.3.3.3 Receiver performance at reference interference ratios for QAM

#### 8.3.3.3.1 Adjacent channel interference

As far as adjacent-channel interference is concerned, the receiver performance benchmarks are specified for a static channel (i.e. single-path distortionless) scenario. The minimum required reference adjacent channel interference power level is specified in table 8.21 as a function of the signal channel bandwidth. Here the interfering waveform is assumed to be a TETRA  $\pi/4$ -DQPSK transmission with a fixed frequency offset  $f_0$  from the QAM signal centre frequency, as specified in table 8.21.

**Table 8.21: Adjacent channel interferer frequency offsets and mean power levels for QAM**

QAM channel bandwidth	TETRA $\pi/4$ -DQPSK Interferer offset from $f_0$	TETRA $\pi/4$ -DQPSK Interferer level for MS	TETRA $\pi/4$ -DQPSK Interferer level for BS
25 kHz	25 kHz	-63 dBm	-62 dBm
50 kHz	37,5 kHz	-65 dBm	-65 dBm
100 kHz	62,5 kHz	-65 dBm	-65 dBm
150 kHz	87,5 kHz	-65 dBm	-65 dBm

It is required that the receiver BER does not exceed 3 % when the following signals are simultaneously input to the receiver:

- the wanted QAM signal, with level 3 dB above the static reference sensitivity level as specified in tables 8.19 and 8.20; and
- an interfering TETRA  $\pi/4$ -DQPSK random modulated continuous signal at a frequency offset  $f_0$  from the useful signal and level as defined in table 8.21.

#### 8.3.3.3.2 Co-channel interference

The minimum required reference co-channel interference performance is specified according to channel bandwidth, modulation, coding rate and propagation conditions. For the uplink (BS receiver), the co-channel interference ratio is defined for the SCH-Q/U logical channel only. For the downlink (MS receiver), the co-channel interference ratio is defined for SCH-Q/D logical channel only. Co-channel interference specifications apply for a wanted input signal level of 25 dB above the dynamic reference sensitivity (as specified in tables 8.15 and 8.17).

Table 8.22 defines co-channel interference ratios  $C/I_c$ , for frequencies below 700 MHz. Table 8.23 defines co-channel interference ratios  $C/I_c$ , for frequencies above 700 MHz. The maximum permissible MER for reference co-channel interference ratios is 10 %.

**Table 8.22: BS and MS minimum dynamic reference interference ratio ( $C/I_c$  for 10 % MER) for frequencies below 700 MHz**

Modulation	$r = 1/2$ TU50	$r = 1/2$ HT200	$r = 2/3$ TU50	$r = 2/3$ HT200
4-QAM	14 dB	12 dB	-	-
16-QAM	19 dB	17 dB	-	-
64-QAM	23 dB	22 dB	27 dB	26 dB

**Table 8.23: BS and MS minimum dynamic reference interference ratio ( $C/I_c$  for 10 % MER) for frequencies above 700 MHz**

Modulation	$r = 1/2$ TU50	$r = 1/2$ HT200	$r = 2/3$ TU50	$r = 2/3$ HT200
4-QAM	14 dB	12 dB	-	-
16-QAM	19 dB	17 dB	-	-
64-QAM	24 dB	23 dB	27 dB	29 dB

### 8.3.3.4 Relationship between $\frac{E_b}{N_0}$ and receiver sensitivity

The relationship between  $\frac{E_b}{N_0}$  and receiver sensitivity  $S$  is:

$$S(\text{dBm}) = \left(\frac{E_b}{N_0}\right)_s (\text{dB}) + k(\text{dBJ/K}) + \text{NF}(\text{dB}) + T_0(\text{dBK}) \\ + R_s(\text{dBHz}) - N_s(\text{dB}) + 10 \log \left( \lfloor N_d r \log_2 M \rfloor \right) + 30(\text{dB}) \quad (8.10)$$

where:

- $k = 1,38 \times 10^{-23}$  J/K ( $-228,6$  dBJ/K), Boltzmann's constant;
- $T_0 = 290$  K ( $24,62$  dBK), reference temperature for receiver noise figure;
- NF = receiver noise figure, assumed 8 dB for BS (uplink) and 11 dB for MS (downlink);
- $R_s = 2\,400$  baud ( $33,80$  dBHz), symbol rate;
- $N_s$  = number of symbols on each subcarrier; 34 for NDB and FCB, 31 for NUB, 14 for CB and RAB;
- $N_d$  = number of data (payload) symbols in the slot (see table 8.24);
- $r$  = payload coding rate (1/2, 2/3, 1);
- $M$  = alphabet size (4, 16, 64).

**Table 8.24: Number of data symbols in the slot**

Slot type	$N_d$			
	25 kHz	50 kHz	100 kHz	150 kHz
NDB	204	440	912	1 384
NUB	200	408	824	1 240
CB	76	160	328	496
RAB	84	-	-	-
FCB: BSCH-Q	136	136	136	136
SCH-Q/B	-	236	708	1 180

## 8.4 Propagation models

### 8.4.1 Modified Hata model

The modified Hata model [i.17] divides the total Path Loss (PL) into two main components; the median loss ( $L_m$ ) and loss due to slow fading ( $L_s$ ) as in (8.11):

$$PL = L_m + L_s \quad (8.11)$$

The  $L_s$  component is calculated using the shadowing model. In the rest of this clause, focus will be on the calculation of  $L_m$ .

The modified Hata model provides three sub-models to calculate  $L_m$  according to the value of the separation distance between transmitter and receiver ( $d$ ), i.e.  $d \leq 0,04 \text{ km}$ ,  $0,04 \text{ km} < d < 0,1 \text{ km}$  and  $d \geq 0,1 \text{ km}$ . Here for typical link budget calculations the focus is on the case  $d \geq 0,1 \text{ km}$ .

Note that  $L_m$  is in dB and  $d$  is in km.

#### *$L_m$ for $d \geq 0,1 \text{ km}$*

The model to calculate  $L_m$  varies for urban, suburban and open (rural) area environments. Three additional parameters need to be defined to specify path loss for each environment. These are  $a(f, H_m)$ ,  $b(f, H_b)$  and  $\alpha$  where:

$$a(f, H_m) = [1,1 \times \log_{10}(f) - 0,7] \times \min\{10, H_m\} - (1,56 \times \log_{10}(f) - 0,8) + \max\left\{0,20 \times \log_{10}\left(\frac{H_m}{10}\right)\right\} \quad (8.12)$$

$$b(f, H_b) = \min\left\{0,20 \times \log\left(\frac{H_b}{30}\right)\right\} \quad (8.13)$$

and 
$$\alpha = 1 \text{ for } d \leq 20 \text{ km} \quad (8.14)$$

$$\alpha = 1 + [0,14 + 0,000187 \times f + 0,00107 \times H_b] \times \left[\log_{10}\left(\frac{d}{20}\right)\right]^{0,8} \text{ for } 20 \text{ km} < d \leq 100 \text{ km} \quad (8.15)$$

where:

- $H_b$  is the transmitter antenna height in metres;
- $H_m$  is the receiver antenna height in metres;
- $f$  is the frequency in MHz.

Having introduced the required parameters,  $L_m$  can now be specified for the urban, suburban and open area environments. It should be noted that the path loss is accurate for the following conditions:

- $150 \text{ MHz} < f \leq 1\,500 \text{ MHz}$  frequency range;
- $H_b \leq 200 \text{ m}$ ;
- $H_m \geq 1,0 \text{ m}$ .

### 8.4.2 Urban environment

$$L_m\{\text{Urban}\} = 69,6 + 26,2 \times \log_{10}(f) - 13,82 \times \log_{10}(\max\{30, H_b\}) + [44,9 - 6,55 \times \log_{10}(\max\{30, H_b\})](\log_{10}(d))^\alpha - a(f, H_m) - b(f, H_b) \quad (8.16)$$

### 8.4.3 Suburban environment

$$L_m\{\text{Suburban}\} = L_m\{\text{Urban}\} - 2 \times \left\{ \log_{10} \left[ \frac{(\min\{\max\{150, f\}, 2000\})}{28} \right] \right\}^2 - 5,4 \quad (8.17)$$

## 8.4.4 Open area environment

$$L_m\{\text{Open Area}\} = L_m\{\text{Urban}\} - 4,78 \times \{\log_{10}[(\min\{\max\{150, f\}, 2000\})]\}^2 + 18,83 \times \log_{10}[\min\{\max\{150, f\}, 2000\}] - 40,94 \quad (8.18)$$

## 8.4.5 Reduced expression for Lm versus distance

Assuming frequency of operation (f) of 400 MHz or 800 MHz and a mobile antenna (Hm) the above path loss equations reduce to the following expression for a speedy calculation of the median path loss (Lm) for a given distance (d) or vice versa.

$$L_m = x + y \log(d) \quad (8.19)$$

where x and y are given in dB and d is in km. The values of x and y for an "urban" environment for frequencies 400 MHz and 800 MHz and a number of practical BS antenna heights (Hb) are given in table 8.25.

**Table 8.25: Values of parameters x and y in path loss equation**

Frequency (MHz)	Hb = 10 m		Hb = 20 m		Hb = 30 m		Hb = 50 m	
	x	y	X	y	x	y	x	y
400	126,8	35,2	120,7	35,2	117,2	35,2	114,2	33,8
800	134,6	35,2	128,6	35,2	125,1	35,2	122,0	33,8

The path loss in suburban and open area environments is lower than the urban area by values given in table 8.26. Note that these values, given in dBs, are dependent on frequency of operation but are independent of TX and RX antenna heights.

**Table 8.26: Reduction in path loss for suburban and open areas relative to urban area**

Frequency (MHz)	Suburban Lm (dB below urban Lm)	Open area Lm (dB below urban Lm)
400	8,1	25,6
800	9,6	28,0

## 8.4.6 Slow varying log-normal component (Ls)

### 8.4.6.1 Components of received signal strength

In an urban environment the signal strength at the receiver location usually does not contain a line-of-sight component from the BS transmitter. The received signal strength at such a location can be decomposed into a fast and a slow fluctuating component:

- The fast fluctuation occurs over a distance of a few wavelength and is caused by the multi-path effect in the vicinity of the receiver. This effect has a Rayleigh distribution. Lm represents the mean path-loss in which the Rayleigh fading is averaged out.
- The longer term fluctuation known as the shadowing effect. Observations have consistently shown that this is a log-normal effect for a given environment (urban, suburban or open area) and given set of transmitter to receiver link parameters. Table 8.27 shows the standard deviation of the signal strength slow fluctuation due to shadowing [i.22].

**Table 8.27: Standard deviation ( $\sigma$ ) of shadowing effect in urban and suburban environments**

Frequency (MHz)	Shadowing $\sigma$ , Urban Area (dB)	Shadowing $\sigma$ , Suburban Area (dB)
400	5,8	7,5
800	6,3	8,2

### 8.4.6.2 Coverage probability at a distance $r$ from transmitter

At a distance  $r$  from the BS the fraction of the locations at which the received signal strength is above a threshold ( $\tau$ ) determines the coverage probability at that distance. Normally the coverage is stated at the distance where the threshold corresponds to the receiver sensitivity. Often the fractional coverage is specified at 90 % of the locations at a distance  $r$ , which corresponds to over 98 % of the locations within the cell of the same radius [i.23].

The probability ( $P_o$ ) that the mean local signal strength ( $x$ ) exceeds the threshold ( $\tau$ ) is given by [i.22]:

$$P_o(r) = 1/2 + 1/2 \operatorname{erf}[(x - \tau) / \sigma \sqrt{2}] \quad (8.20)$$

where  $\sigma$  is the standard deviation of shadowing fluctuation and  $(x - \tau)$  determines the shadowing margin ( $L_s$ ) in dB for coverage probability  $P_o$ . Table 8.28 shows the computed  $L_s$  for a number of coverage probabilities.

**Table 8.28: Shadowing margin at different coverage probabilities**

Coverage probability at distance $r$ (%)	Shadowing margin $L_s$ (dB), Urban		Shadowing margin $L_s$ (dB), Suburban	
	400 MHz	800 MHz	400 MHz	800 MHz
90	7,4	8,1	9,6	10,5
80	4,9	5,3	6,3	6,9
70	3,0	3,3	3,9	4,3
60	1,5	1,6	1,9	2,1

### 8.4.7 Tap delay model for performance simulations

In simulation of the TETRA channel performance the link propagation model is represented by a stationary complex tap-gain process. This process is represented in terms of Probability Density Function (PDF) and a Power Density Spectrum (PDS) which models the Doppler spectrum (for more details see clause 6 of ETSI EN 300 392-2 [i.2]).

Table 8.29 shows a two-tap model originally used for TETRA  $\pi/4$ -DQPSK channels operating without equalization under different propagation environments, extended to a four-tap model for channels with equalizers. In the high-speed data QAM channel simulations represented in this guide the so-called GSM six-tap model (table 8.30) is used to improve accuracy, particularly under HT200 propagation environment.

In tables 8.29 and 8.30 CLASS is the tap-gain process  $a(t)$  having a PDS equal to the classical Doppler spectrum. The real and imaginary parts of  $a(t)$  exhibit an identical Gaussian PDF, an identical PDS and are mutually statistically independent. STATIC is a tap-gain process with a constant magnitude  $|a(t)|=1$ . RICE is a tap-gain process which is the sum process of the two processes CLASS and STATIC.

The equalizer class receiver has not been maintained for high-speed channels since the adoption of sub-carriers in these channels makes the use of equalizers unnecessary.

**Table 8.29: Tap delay/gain models in different propagation environments for phase modulation**

Propagation environment	Tap number	Relative delay ( $\mu$ s)	Average relative power (dB)	Tap-gain process
Static	1	0	0	STATIC(0)
Rural Area (RAX)	1	0	0	RICE
Typical Urban (TUX)	1	0	0	CLASS
	2	5	-22,3	CLASS
Bad Urban (BUX)	1	0	0	CLASS
	2	5	-3,0	CLASS
Hilly Terrain (HTX)	1	0	0	CLASS
	2	15	-8,6	CLASS
Equalizer Test (EQX)	1	0	0	CLASS
	2	11,6	0	CLASS
	3	73,2	-10,2	CLASS
	4	99,3	-16	CLASS

**Table 8.30: Tap delay/gain models in different propagation environments for QAM**

Propagation model	Tap number	Relative delay ( $\mu\text{s}$ )	Average relative power (dB)	Tap-gain process
Typical Urban (TUx)	1	0,0	-3,0	CLASS
	2	0,2	0,0	CLASS
	3	0,6	-2,0	CLASS
	4	1,6	-6,0	CLASS
	5	2,4	-8,0	CLASS
	6	5,0	-10,0	CLASS
Hilly Terrain (HTx)	1	0,0	0,0	CLASS
	2	0,2	-2,0	CLASS
	3	0,4	-4,0	CLASS
	4	0,6	-7,0	CLASS
	5	15,0	-6,0	CLASS
	6	17,2	-12,0	CLASS

### 8.4.8 High velocity (e.g. trainborne) TETRA HSD

When the MS speed exceeds 200 km/h, as occurs for instance in high-velocity trains or airborne terminals (e.g. public safety helicopters or aircraft), the receiver may incur a performance degradation with respect to the benchmarks established in clauses 9.2 and 9.3. This is definitely true if the GSM-like multipath Rayleigh channel models continue to be applicable. The reasons for this degradation are primarily:

- i) as the speed grows, the fading bandwidth gets larger and the pilot symbol spacing along the time axis becomes insufficient to ensure accurate sampling of the fading process;
- ii) the channel estimator is assumed to be matched to a fixed reference speed, namely 200 km/h (see annex A), and therefore its accuracy gets worse and worse as the actual speed continues to rise above the reference limit;
- iii) clock and frequency errors (most notably the latter) may grow considerably as a consequence of the channel time selectivity.

A selection of results illustrating the receiver MER performance versus  $\frac{E_b}{N_0}$  over high-velocity HT channels are presented in figures 8.2 to 8.4 for the SCH-Q/D and in figures 8.5 to 8.7 for the SCH-Q/HU. The simulation scenario is fully described in annex A. The main assumptions on signal and channel are as follows:

- i) the signal bandwidth is  $B = 50$  kHz;
- ii) the modulation and coding rate combinations are 4-QAM -  $r = \frac{1}{2}$ , 16-QAM -  $r = \frac{1}{2}$  and 64-QAM -  $r = \frac{1}{2}$ ;
- iii) the channel models are HT200, HT250 and HT300 at both 400 MHz and 800 MHz;
- iv) timing and frequency synchronization is assumed to be error-free;
- v) channel estimation is based on the Bayesian-in-time linear-interpolation-in-frequency approach;
- vi) the receiver is affected by AWGN with two-sided power spectral density  $\frac{N_0}{2}$ .

Inspection of results shows that:

- 1) At 400 MHz: for 4-QAM and 16-QAM, the performance loss with respect to HT200 is moderate up to HT300 for both the SCH-Q/D and SCH-Q/HU, with a maximum degradation of 2 dB to 3 dB at 10 % MER (figure 8.3). On the other hand, use of 64-QAM yields acceptable results up to HT300 for the SCH-Q/HU only, while for the SCH-Q/D the loss at 10 % MER is several dB larger (figure 8.4).
- 2) At 800 MHz: the loss of 4-QAM and 16-QAM is moderate with a maximum degradation of 2 dB to 3 dB up to HT300 for the SCH-Q/HU and up to HT250 for the SCH-Q/D. Also, the loss incurred by 64-QAM is acceptable up to HT250 for both the cited logical channels, with a more pronounced degradation (around 3 dB at 10 % MER) for the SCH-Q/D.

Additional results are provided in figures 8.8 and 8.9, obtained under the same assumptions of figures 8.3 and 8.6, respectively, except for the bandwidth that is now 150 kHz (48 subcarriers) instead of 50 kHz (16 subcarriers). It is noted that this bandwidth expansion entails a moderate performance improvement for all curves, to be ascribed to the beneficial impact of the larger data block size on the decoder operation.

Furthermore, some deeper insight on the impact of channel estimation errors on the receiver MER is provided in annex C, presenting a few additional curves of MER vs.  $\frac{E_b}{N_0}$  obtained under the assumption of either exact channel knowledge (error-free channel estimation) or exact knowledge of MS velocity for the Bayesian channel estimator (annex B.2). Although these results are obtained under unrealistic conditions, they may help shed light on the combined role of the various factors affecting the channel estimator performance (fading decorrelation properties, pilot symbol spacing, uncertainty on knowledge of the MS speed, etc.).

As a final remark, it is worth observing that the Rayleigh fading model used so far may often result too restrictive for a high-velocity scenario, since it entails the absence of the line-of-sight path. Instead, it seems more reasonable to assume that the line-of-sight path exists in links with airborne terminals and also in the typical environment surrounding high-velocity trains. In these cases, it would be more realistic to assume Ricean fading, including static (Gaussian) channel as limiting case, this entailing that the received waveform is less affected (or unaffected at all) by time and frequency selective fading as compared to the Rayleigh channel. If recognized, these favourable propagation conditions can be exploited to enhance channel estimation accuracy. For instance, in the limiting case of single-path Gaussian channel, the transmitted waveform does not incur any distortion except for the presence of a Doppler shift whose value may be as high as a few hundred Hz (e.g. for MS speed of 300 km/h and 800 MHz carrier frequency, the one-way shift is around 220 Hz and the roundtrip shift around 440 Hz), i.e. it may largely exceed the  $\pm 100$  Hz uncertainty interval established for low-speed terminals. However, if channel selectivity is negligible or absent, the receiver has a chance to recover the Doppler shift, using the pilot symbols, provided that the shift is not so large as to introduce ambiguity in the estimation process. For instance, if pilots are spaced 4 symbols apart, there is ambiguity for frequency shifts in excess of one fourth the baud rate, i.e. 600 Hz. A different approach avoiding the above ambiguity issue is resorting to a non-pilot-aided (blind) algorithm trying to shift the signal energy spectrum along the frequency axis so as to maximize the signal energy through the matched filter bank. In any case, it is noted that when the frequency shift is a non-negligible fraction of the baud rate, the receive filters are no longer matched to the incoming signal, and this adds further deterioration to the frequency estimation process whatever the algorithm employed.

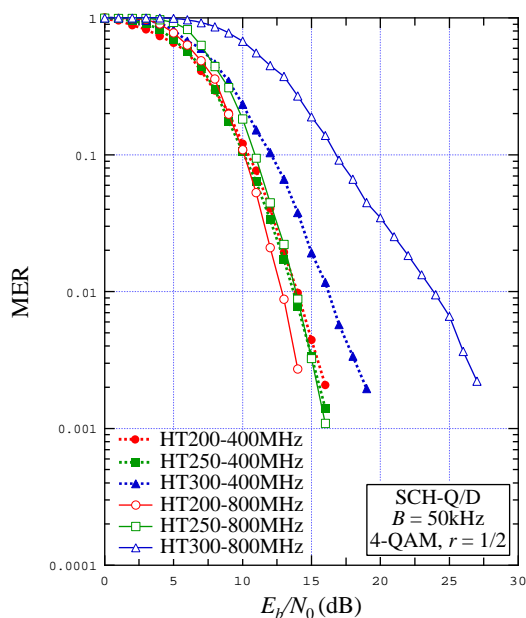

**Figure 8.2: MER vs.  $E_b/N_0$  for  $B = 50$  kHz, SCH-Q/D, 4-QAM  $r = 1/2$ , various HT channels**

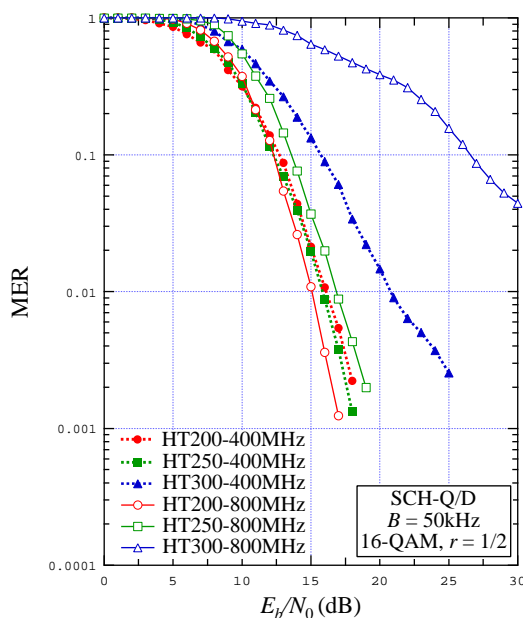

**Figure 8.3: MER vs.  $E_b/N_0$  for  $B = 50$  kHz, SCH-Q/D, 16-QAM  $r = 1/2$ , various HT channels**

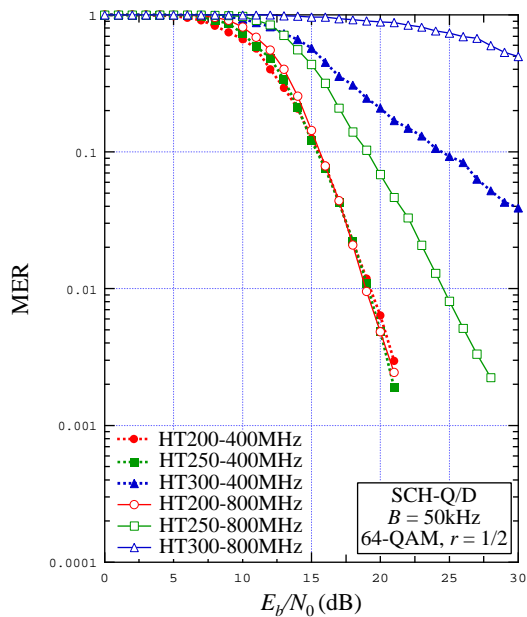

Figure 8.4: MER vs.  $E_b/N_0$  for  $B = 50$  kHz, SCH-Q/D, 64-QAM  $r = 1/2$ , various HT channels

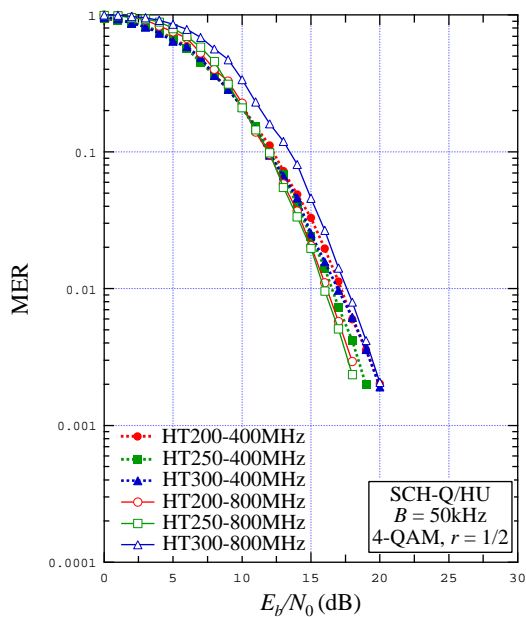

Figure 8.5: MER vs.  $E_b/N_0$  for  $B = 50$  kHz, SCH-Q/HU, 4-QAM  $r = 1/2$ , various HT channels

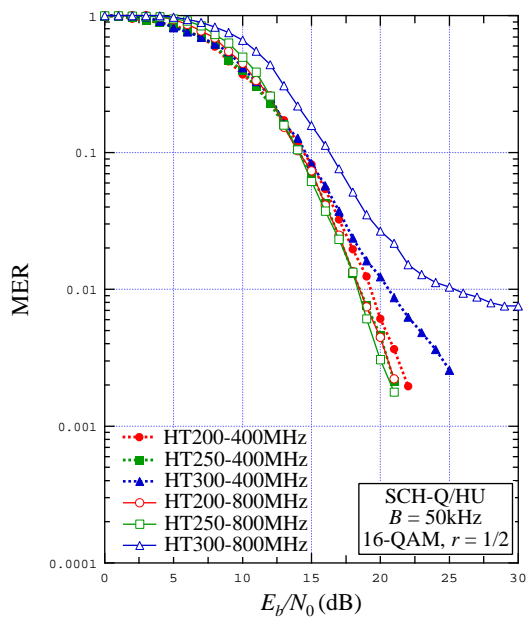

Figure 8.6: MER vs.  $E_b/N_0$  for  $B = 50$  kHz, SCH-Q/HU, 16-QAM  $r = 1/2$ , various HT channels

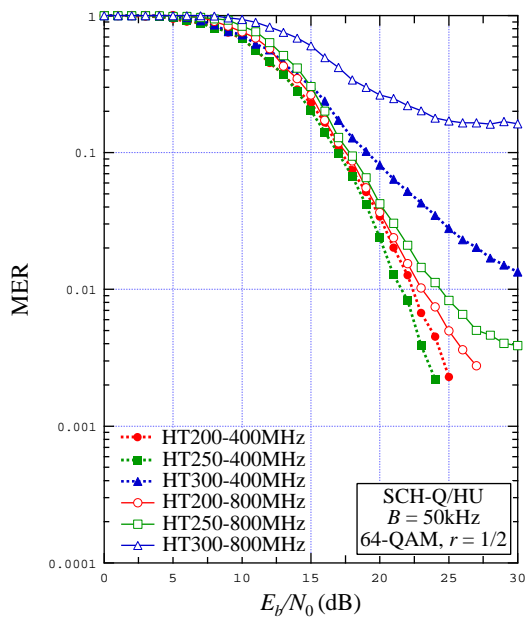

Figure 8.7: MER vs.  $E_b/N_0$  for  $B = 50$  kHz, SCH-Q/HU, 64-QAM  $r = 1/2$ , various HT channels

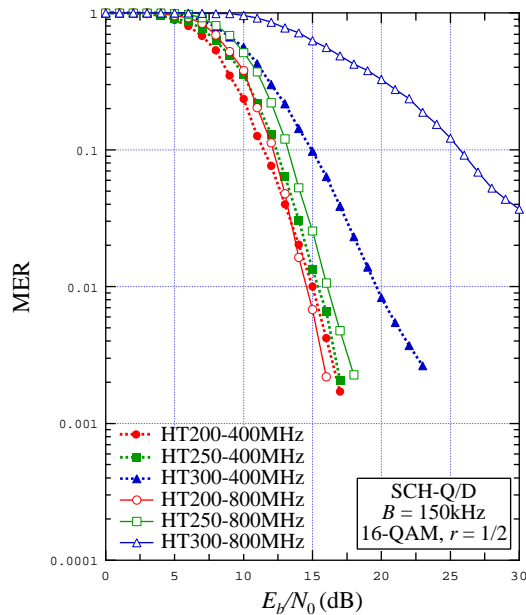

Figure 8.8: MER vs.  $E_b/N_0$  for  $B = 150$  kHz, SCH-Q/D, 16-QAM  $r = 1/2$ , various HT channels

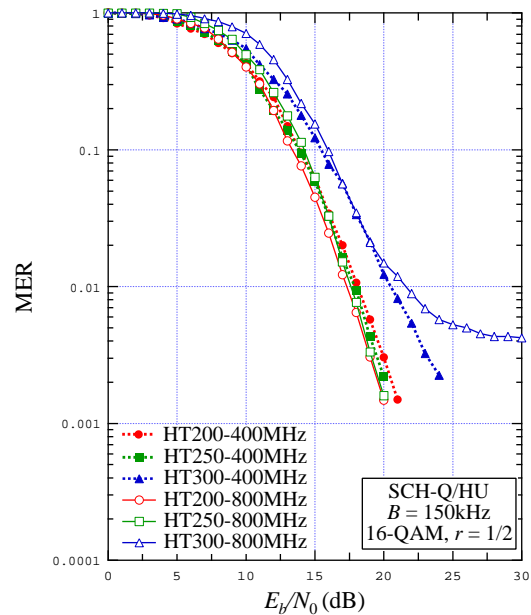

Figure 8.9: MER vs.  $E_b/N_0$  for  $B = 150$  kHz, SCH-Q/HU, 16-QAM  $r = 1/2$ , various HT channels

## 9 Channel performance in QAM channels

### 9.0 General

Clause 9 includes a set of simulation results illustrating the TETRA HSD receiver performance for a wide choice of combinations of the signal parameters, logical channels and propagation scenarios. The receiver performance is given in terms of curves of Message Error Rate (MER) as a function of the signal-to-noise ratio ( $\frac{E_b}{N_0}$ ) or Signal-to-Interference Ratio (SIR).

Clause 9.1 reviews the permissible combinations of modulation format, coding rate and channel bandwidth for all logical channels. Clause 9.2 presents simulation results relevant to the PCCC decoder performance for two sample logical channels carried by a burst payload (namely, the SCH-Q/HU and the SCH-Q/D) and also for a few header-borne logical channels (namely, SICH-Q/U in CB, SICH-Q/D and AACH-Q), assuming a variety of propagation conditions (TU50 and HT200 at 400 MHz and 800 MHz, static). Both noise and co-channel interference limited contexts are considered. Clause 9.3 parallels clause 9.2 for the uncoded SCH-Q/HU and SCH-Q/D channels, again under noise and interference limited conditions. Finally, some remarks are provided in clause 9.2 about the impact of modulation inaccuracies on TETRA HSD performance.

### 9.1 Permissible modulation, coding rate and channel BW combinations

The possible combinations of modulation and coding rate for payload channels (SCH-Q/RA, SCH-Q/HU, SCH-Q/U, BNCH-Q, SCH-Q/D, BSCH-Q and SCH-Q/B) are summarized in table 9.1. The dots indicate the availability of the combinations. The logical channels relying on burst headers (SICH-Q/U, SICH-Q/D and AACH-Q/D) utilize 4-QAM and a fixed coding rate ( $r = \frac{5}{16}$ ). Furthermore, the corresponding symbols are placed on subcarriers within the central 25 kHz (on the frequency axis) of the channel bandwidth.

**Table 9.1: Permissible modulation and coding rate combinations for payload channels**

Modulation	Coding rate	SCH-Q/RA	SCH-Q/HU, SCH-Q/U, BNCH-Q, SCH-Q/D	BSCH-Q, SCH-Q/B
4-QAM	$r=1/2$	•	•	•
	$r=2/3$			
	$r=1$			
16-QAM	$r=1/2$		•	
	$r=2/3$			
	$r=1$		•	
64-QAM	$r=1/2$		•	
	$r=2/3$		•	
	$r=1$		•	
NOTE: The modulation/coding rate combinations indicated in the table are available for all signal bandwidths (25 kHz, 50 kHz, 100 kHz and 150 kHz), with the exception of the SCH-Q/RA which uses the 25 kHz bandwidth only, BSCH-Q which uses the subcarriers within the central 25 kHz on the frequency axis, and SCH-Q/B which uses the outer subcarriers i.e. the subcarriers not within the central 25 kHz.				

## 9.2 Coded channel performance

### 9.2.1 Noise performance

The noise performance results, in the form of MER curves versus the  $\frac{E_b}{N_0}$  ratio, are presented in figures 9.1 to 9.20 for the SCH-Q/D, in figures 9.21 to 9.40 for the SCH-Q/HU, in figure 9.41 for the SICH-Q/D, in figure 9.42 for the AACH-Q and finally in figure 9.43 for the SICH-Q/U in CB. The simulation set-up is chosen as outlined in annex A, the main assumptions being:

- i) the signal bandwidth is  $B = 25$  kHz, 50 kHz, 100 kHz, 150 kHz;
- ii) the modulation and coding rate combinations are 4-QAM -  $r = \frac{1}{2}$ , 16-QAM -  $r = \frac{1}{2}$ , 64-QAM -  $r = \frac{1}{2}$  and 64-QAM -  $r = \frac{2}{3}$ ;
- iii) the scenarios are TU50-400 MHz, HT200-400 MHz, TU50-800 MHz, HT200-800 MHz and static;
- iv) header decoding is carried out through a Maximum Likelihood (ML) decoder employing soft metrics;
- v) timing and frequency synchronization is assumed to be error-free;
- vi) channel estimation is based on the Bayesian-in-time linear-interpolation-in-frequency approach;
- vii) the receiver is affected by AWGN with two-sided power spectral density  $\frac{N_0}{2}$ .

Observation of results suggests the following remarks:

- 1) For a given channel, the larger the bandwidth, the better the coded performance. This can be seen, for instance, from figures 9.1 and 9.4, both relevant to the TU50-400 MHz scenario. Increasing the bandwidth involves a larger coded block, and this has a beneficial impact on the turbo decoder.
- 2) Similar arguments can be used to explain why for a given bandwidth, modulation and coding rate the SCH-Q/D has an edge over the SCH-Q/HU. This is clearly related to the fact that the SCH-Q/D coded block is longer (approximately twice) than that of the SCH-Q/HU, and this entails a larger coding gain.
- 3) For fast-fading scenario (corresponding to the HT200-800 MHz channel), the choice of 64-QAM -  $r = \frac{2}{3}$  gives a MER floor around 1 % to 3 %, whereas the other choices of modulation and coding rate do not incur this problem, with MER curves easily reaching levels of 1 % or less.
- 4) As for the static channel, the MER curves are quite steeper compared to those related to slow or fast fading scenarios. For values of  $\frac{E_b}{N_0}$  in the range 5 dB to 12 dB, very low levels of MER can be attained irrespective of modulation, coding rate and signal bandwidth.

- 5) In spite of the limited number of header information bits included in the SICH-Q/D, AACH-Q and SICH-Q/U (in CB) logical channels, that clearly precludes the application of turbo-like codes, use of a powerful Reed-Muller block code enables better header decoding performance as compared to the payload decoder for all signal and burst formats and propagation scenarios.

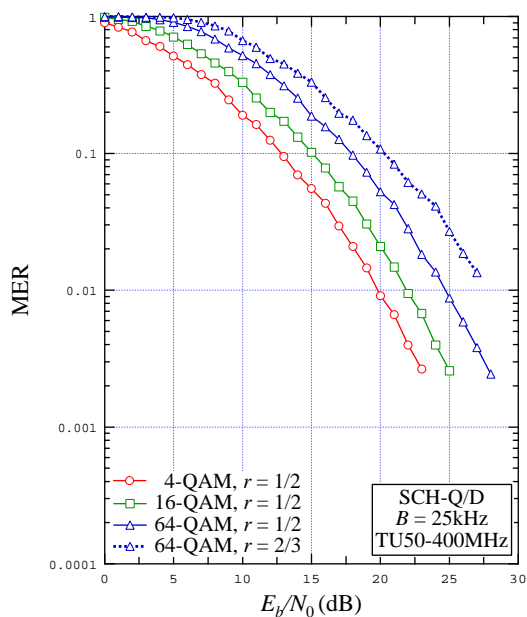

**Figure 9.1: MER vs.  $E_b/N_0$  for  $B = 25$  kHz, SCH-Q/D, TU50-400 MHz channel, various modulations/coding rate combinations**

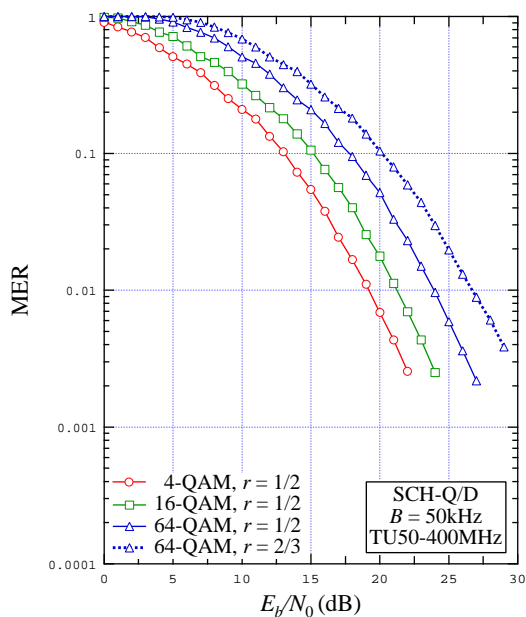

**Figure 9.2: MER vs.  $E_b/N_0$  for  $B = 50$  kHz, SCH-Q/D, TU50-400 MHz channel, various modulations/coding rate combinations**

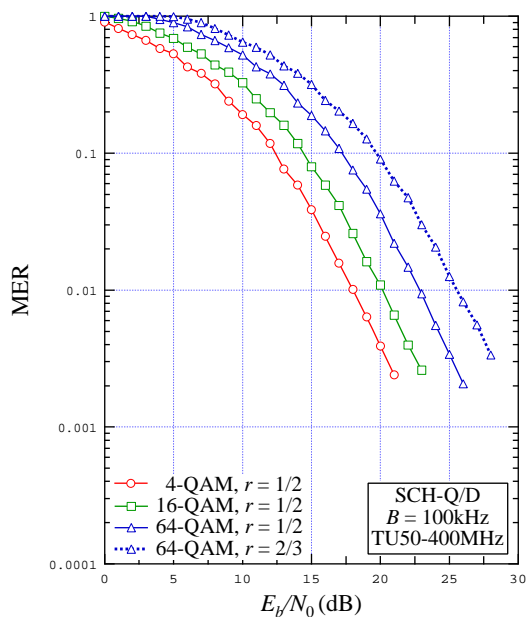

**Figure 9.3: MER vs.  $E_b/N_0$  for  $B = 100$  kHz, SCH-Q/D, TU50-400 MHz channel, various modulations/coding rate combinations**

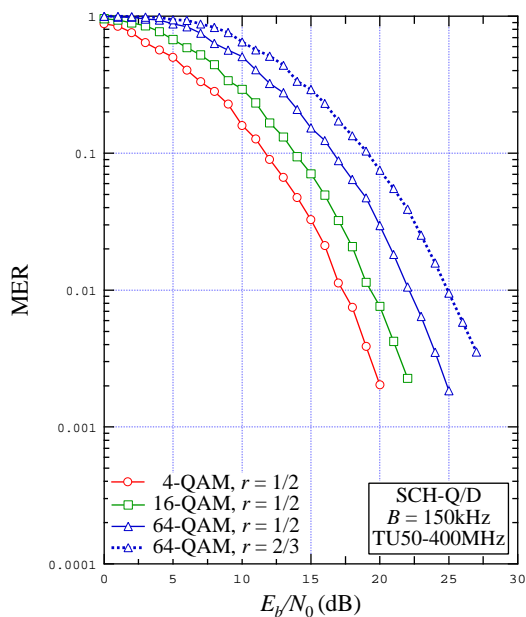

**Figure 9.4: MER vs.  $E_b/N_0$  for  $B = 150$  kHz, SCH-Q/D, TU50-400 MHz channel, various modulations/coding rate combinations**

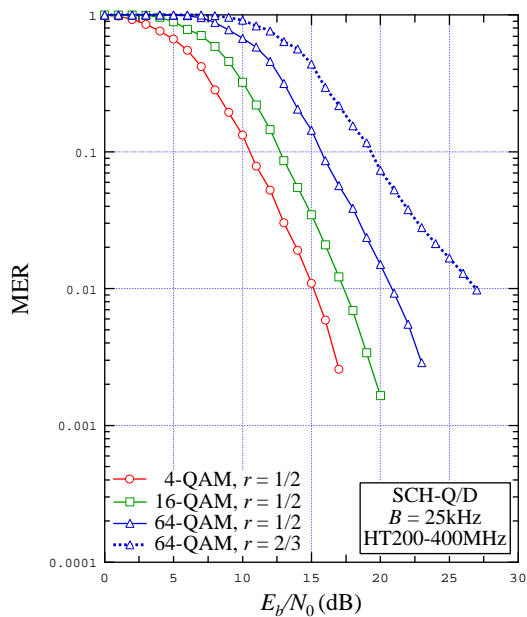

**Figure 9.5:** MER vs.  $E_b/N_0$  for  $B = 25$  kHz, SCH-Q/D, HT200-400 MHz channel, various modulations/coding rate combinations

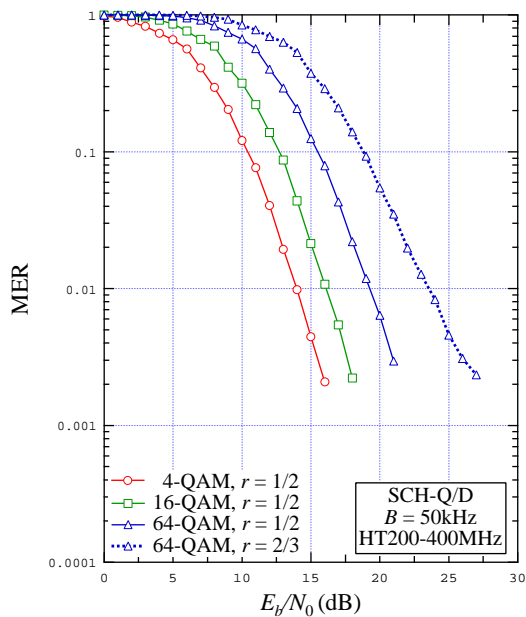

**Figure 9.6:** MER vs.  $E_b/N_0$  for  $B = 50$  kHz, SCH-Q/D, HT200-400 MHz channel, various modulations/coding rate combinations

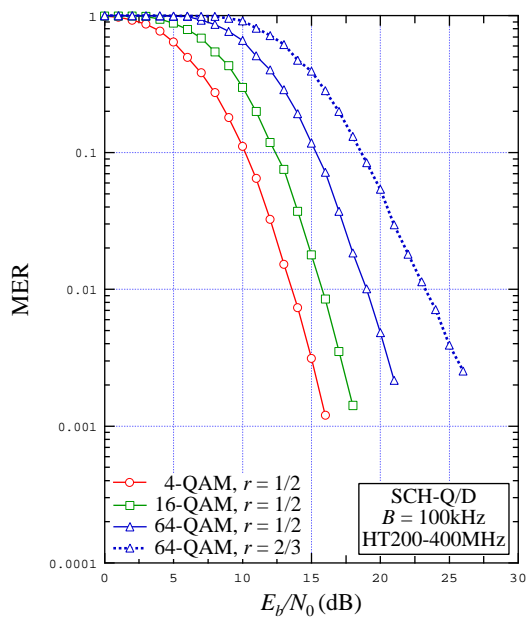

**Figure 9.7:** MER vs.  $E_b/N_0$  for  $B = 100$  kHz, SCH-Q/D, HT200-400 MHz channel, various modulations/coding rate combinations

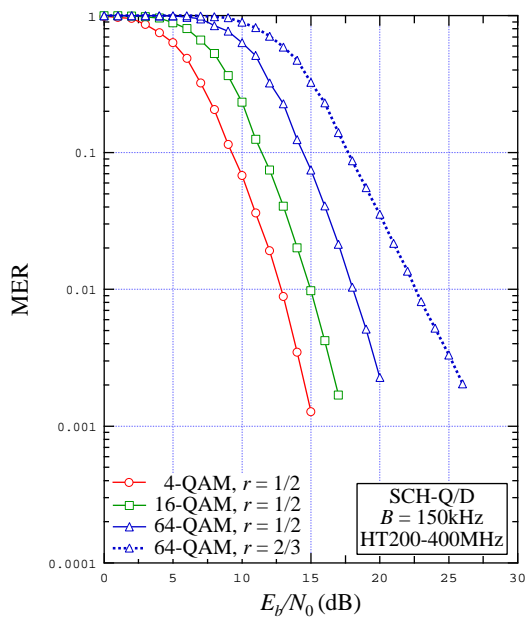

**Figure 9.8:** MER vs.  $E_b/N_0$  for  $B = 150$  kHz, SCH-Q/D, HT200-400 MHz channel, various modulations/coding rate combinations

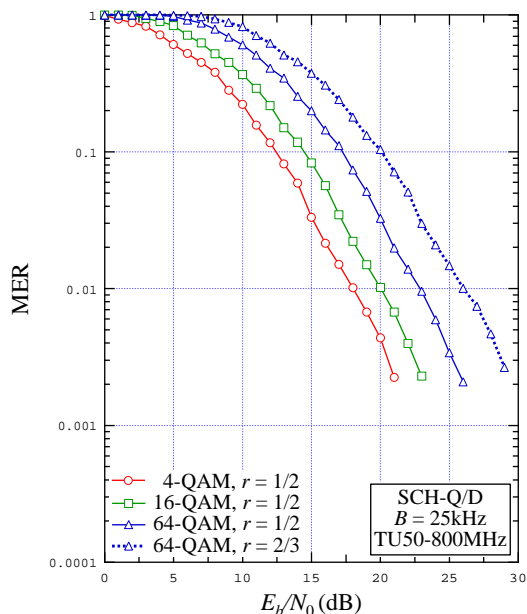

**Figure 9.9: MER vs.  $E_b/N_0$  for  $B = 25$  kHz, SCH-Q/D, TU50-800 MHz channel, various modulations/coding rate combinations**

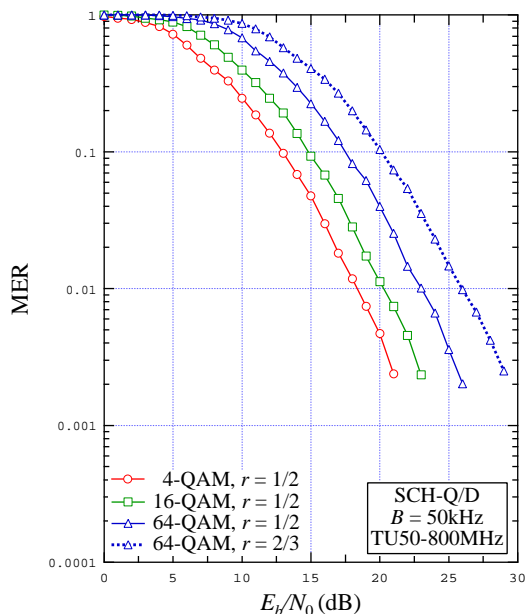

**Figure 9.10: MER vs.  $E_b/N_0$  for  $B = 50$  kHz, SCH-Q/D, TU50-800 MHz channel, various modulations/coding rate combinations**

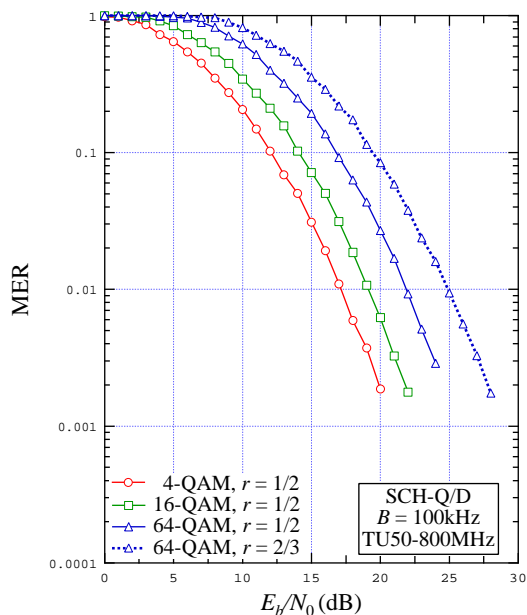

**Figure 9.11: MER vs.  $E_b/N_0$  for  $B = 100$  kHz, SCH-Q/D, TU50-800 MHz channel, various modulations/coding rate combinations**

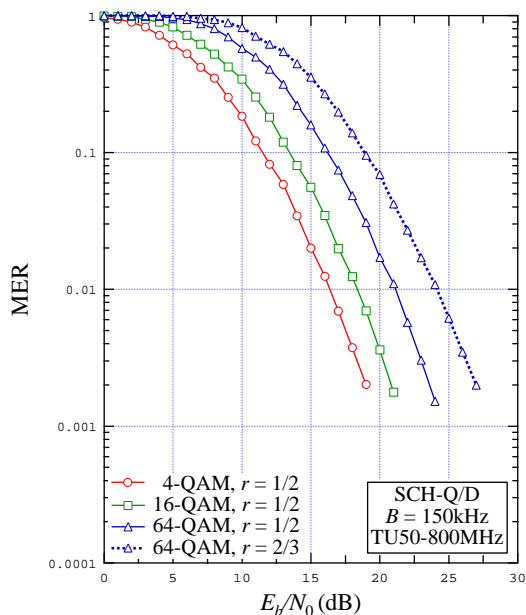

**Figure 9.12: MER vs.  $E_b/N_0$  for  $B = 150$  kHz, SCH-Q/D, TU50-800 MHz channel, various modulations/coding rate combinations**

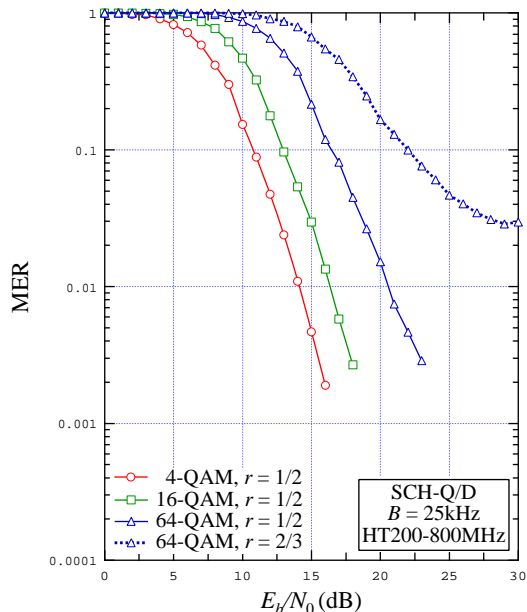

Figure 9.13: MER vs.  $E_b/N_0$  for  $B = 25$  kHz, SCH-Q/D, HT200-800 MHz channel, various modulations/coding rate combinations

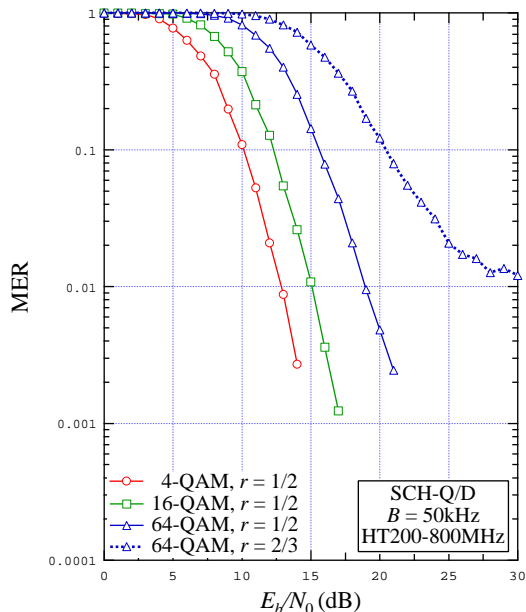

Figure 9.14: MER vs.  $E_b/N_0$  for  $B = 50$  kHz, SCH-Q/D, HT200-800 MHz channel, various modulations/coding rate combinations

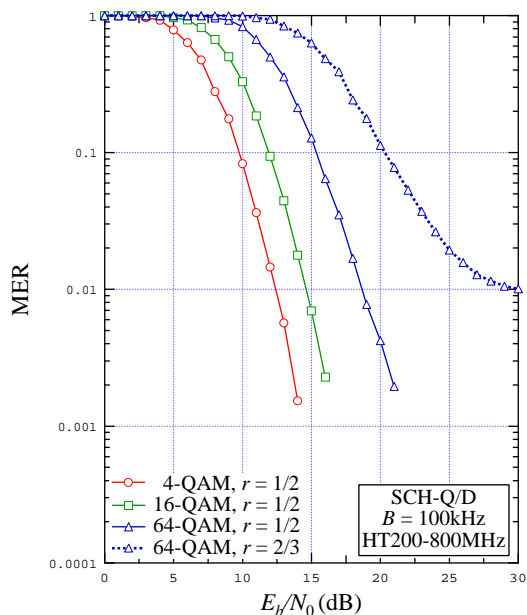

Figure 9.15: MER vs.  $E_b/N_0$  for  $B = 100$  kHz, SCH-Q/D, HT200-800 MHz channel, various modulations/coding rate combinations

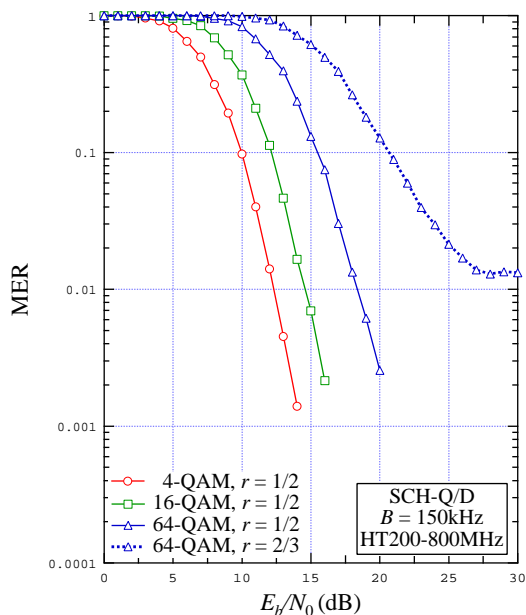

Figure 9.16: MER vs.  $E_b/N_0$  for  $B = 150$  kHz, SCH-Q/D, HT200-800 MHz channel, various modulations/coding rate combinations

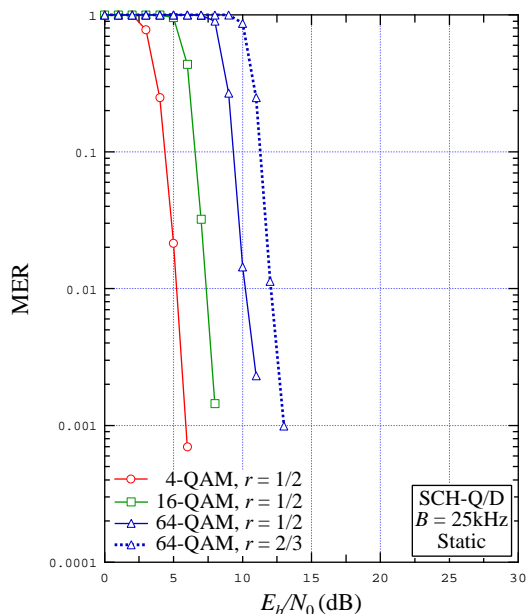

Figure 9.17: MER vs.  $E_b/N_0$  for  $B = 25$  kHz, SCH-Q/D, static channel, various modulations/coding rate combinations

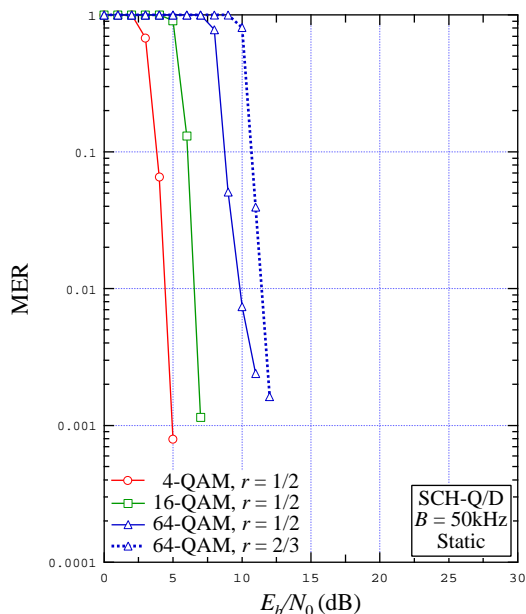

Figure 9.18: MER vs.  $E_b/N_0$  for  $B = 50$  kHz, SCH-Q/D, static channel, various modulations/coding rate combinations

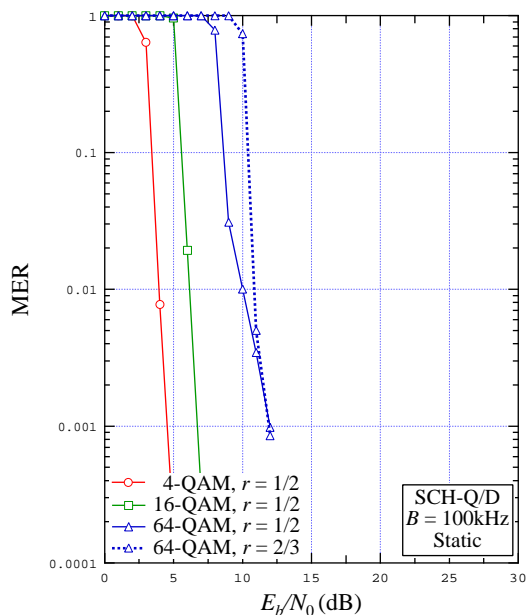

Figure 9.19: MER vs.  $E_b/N_0$  for  $B = 100$  kHz, SCH-Q/D, static channel, various modulations/coding rate combinations

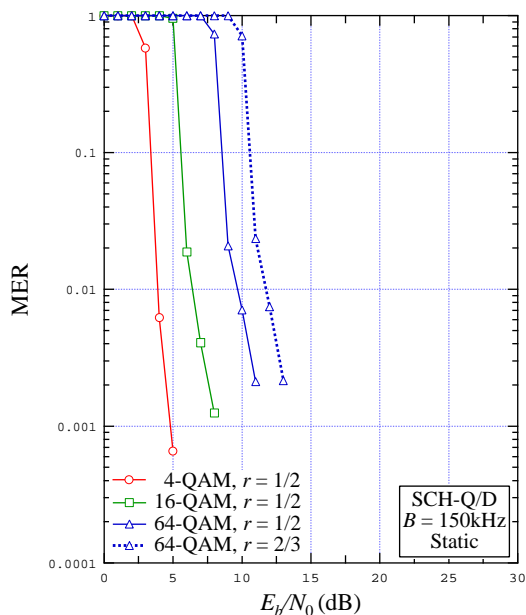

Figure 9.20: MER vs.  $E_b/N_0$  for  $B = 150$  kHz, SCH-Q/D, static channel, various modulations/coding rate combinations

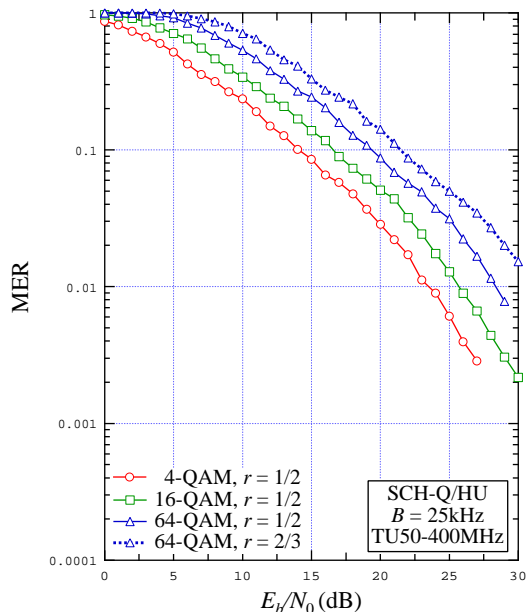

Figure 9.21: MER vs.  $E_b/N_0$  for  $B = 25$  kHz, SCH-Q/HU, TU50-400 MHz channel, various modulations/coding rate combinations

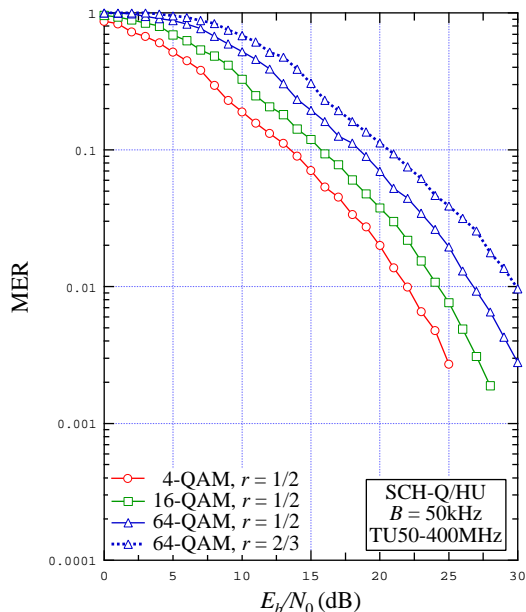

Figure 9.22: MER vs.  $E_b/N_0$  for  $B = 50$  kHz, SCH-Q/HU, TU50-400 MHz channel, various modulations/coding rate combinations

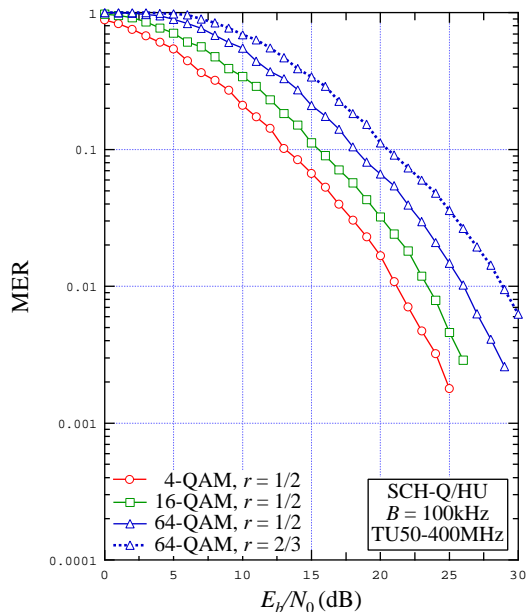

Figure 9.23: MER vs.  $E_b/N_0$  for  $B = 100$  kHz, SCH-Q/HU, TU50-400 MHz channel, various modulations/coding rate combinations

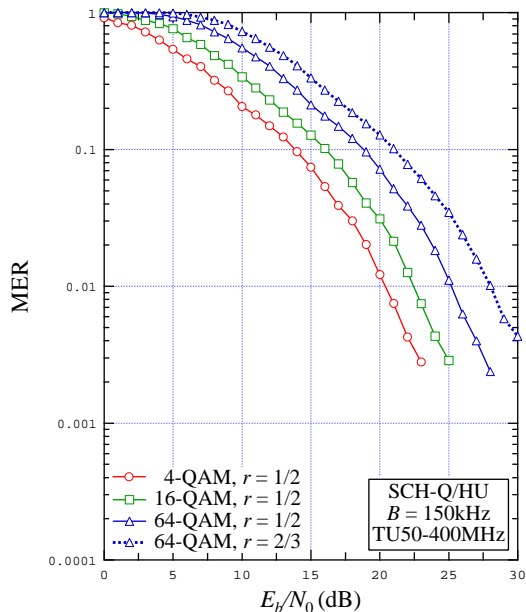

Figure 9.24: MER vs.  $E_b/N_0$  for  $B = 150$  kHz, SCH-Q/HU, TU50-400 MHz channel, various modulations/coding rate combinations

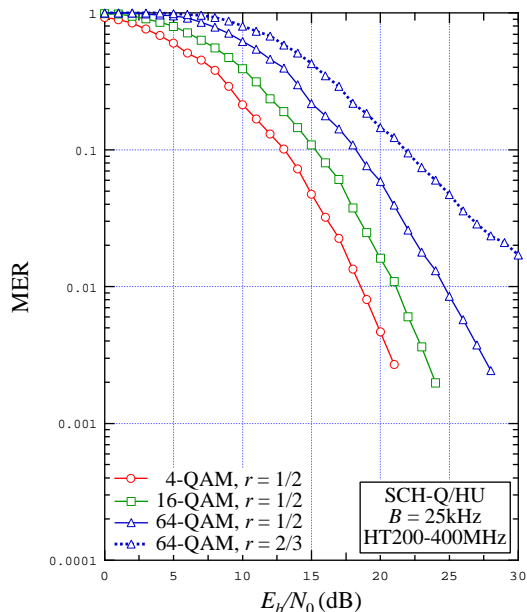

Figure 9.25: MER vs.  $E_b/N_0$  for  $B = 25$  kHz, SCH-Q/HU, HT200-400 MHz channel, various modulations/coding rate combinations

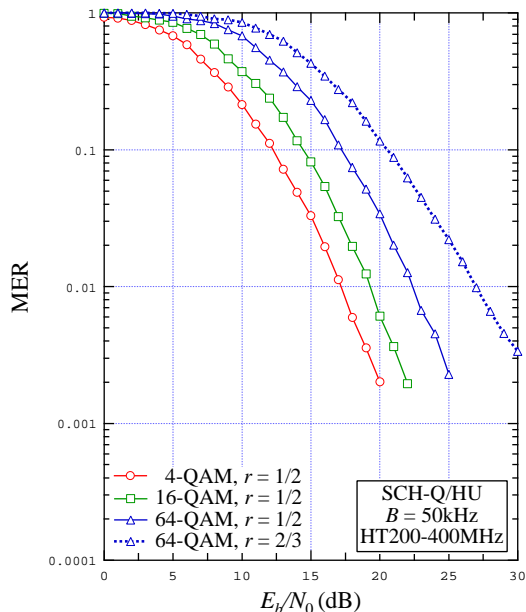

Figure 9.26: MER vs.  $E_b/N_0$  for  $B = 50$  kHz, SCH-Q/HU, HT200-400 MHz channel, various modulations/coding rate combinations

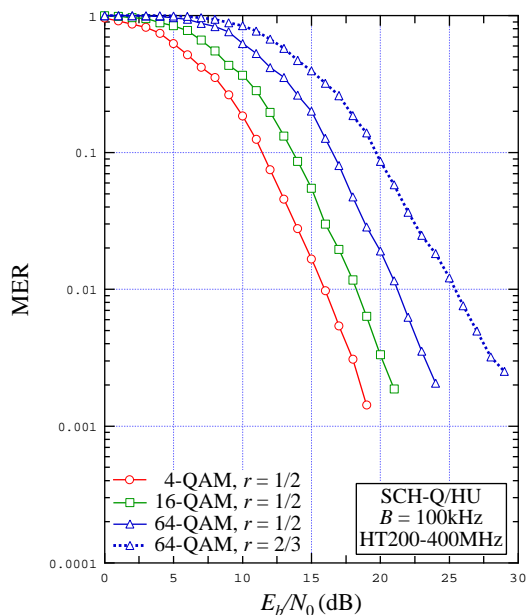

Figure 9.27: MER vs.  $E_b/N_0$  for  $B = 100$  kHz, SCH-Q/HU, HT200-400 MHz channel, various modulations/coding rate combinations

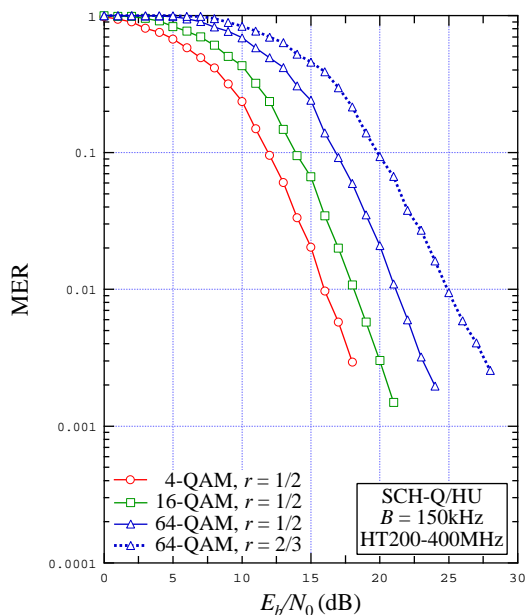

Figure 9.28: MER vs.  $E_b/N_0$  for  $B = 150$  kHz, SCH-Q/HU, HT200-400 MHz channel, various modulations/coding rate combinations

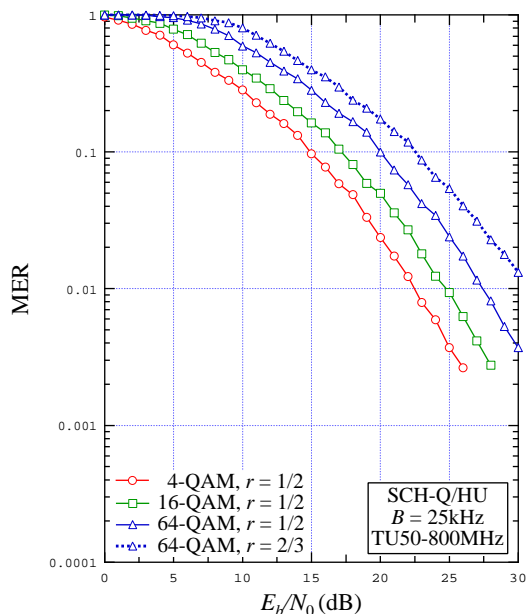

Figure 9.29: MER vs.  $E_b/N_0$  for  $B = 25$  kHz, SCH-Q/HU, TU50-800 MHz channel, various modulations/coding rate combinations

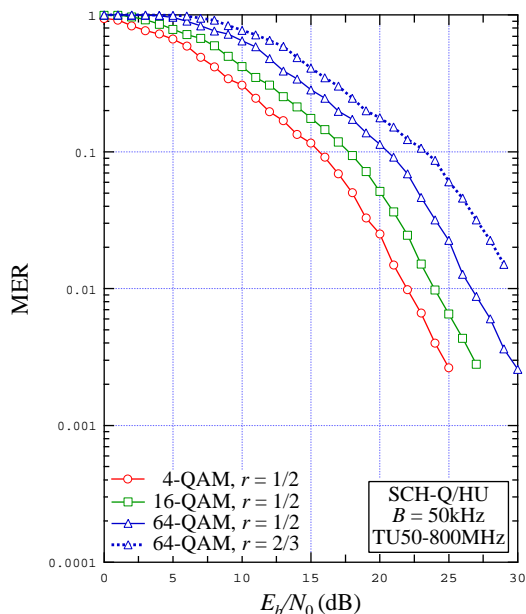

Figure 9.30: MER vs.  $E_b/N_0$  for  $B = 50$  kHz, SCH-Q/HU, TU50-800 MHz channel, various modulations/coding rate combinations

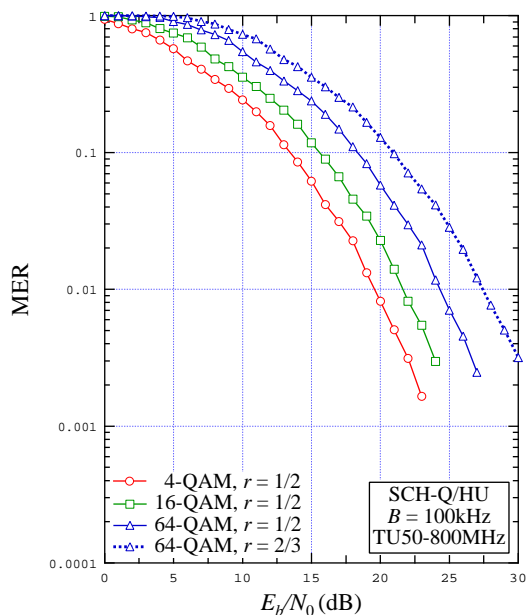

Figure 9.31: MER vs.  $E_b/N_0$  for  $B = 100$  kHz, SCH-Q/HU, TU50-800 MHz channel, various modulations/coding rate combinations

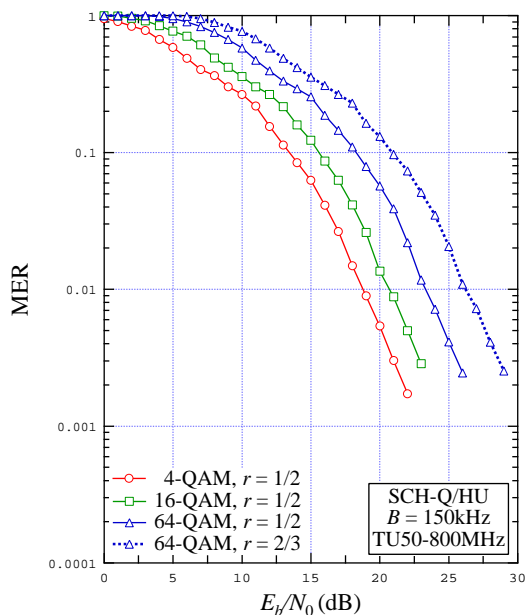

Figure 9.32: MER vs.  $E_b/N_0$  for  $B = 150$  kHz, SCH-Q/HU, TU50-800 MHz channel, various modulations/coding rate combinations

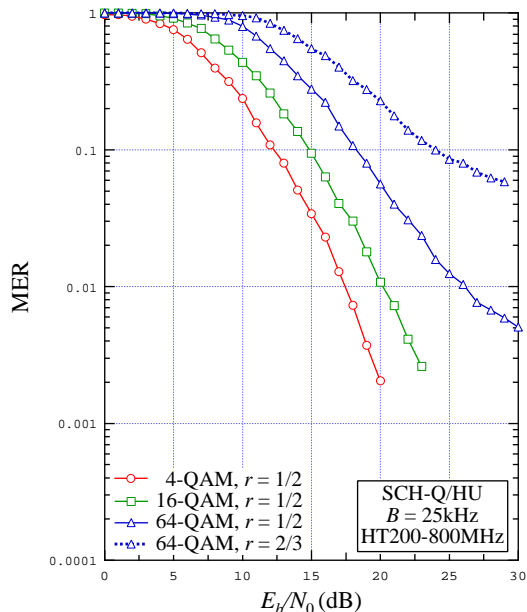

Figure 9.33: MER vs.  $E_b/N_0$  for  $B = 25$  kHz, SCH-Q/HU, HT200-800 MHz channel, various modulations/coding rate combinations

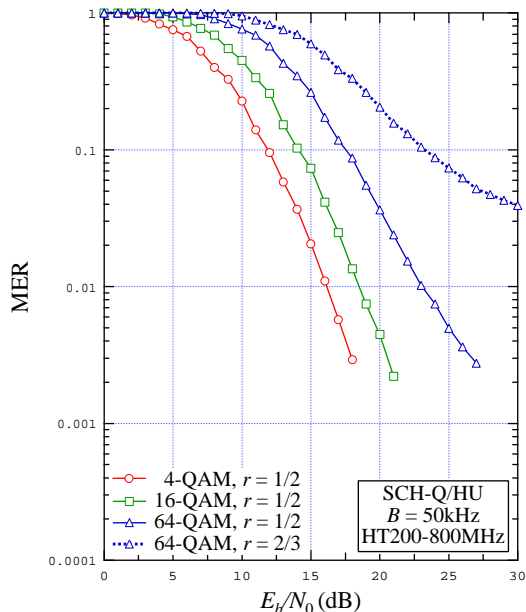

Figure 9.34: MER vs.  $E_b/N_0$  for  $B = 50$  kHz, SCH-Q/HU, HT200-800 MHz channel, various modulations/coding rate combinations

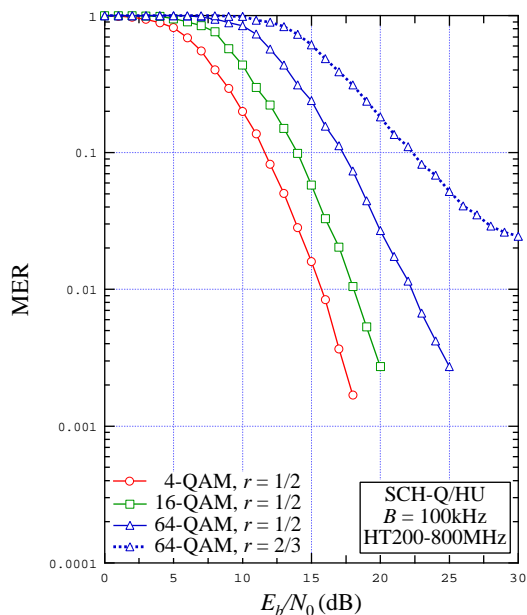

Figure 9.35: MER vs.  $E_b/N_0$  for  $B = 100$  kHz, SCH-Q/HU, HT200-800 MHz channel, various modulations/coding rate combinations

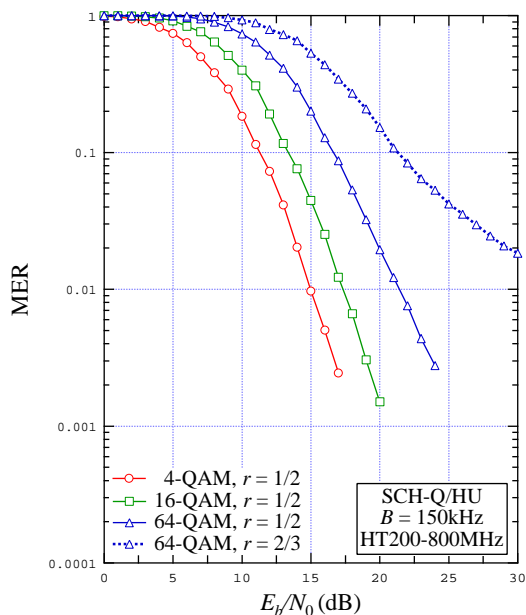

Figure 9.36: MER vs.  $E_b/N_0$  for  $B = 150$  kHz, SCH-Q/HU, HT200-800 MHz channel, various modulations/coding rate combinations

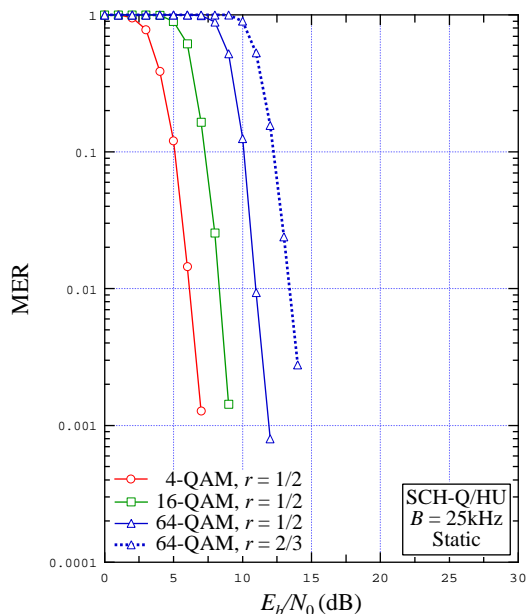

Figure 9.37: MER vs.  $E_b/N_0$  for  $B = 25$  kHz, SCH-Q/HU, static channel, various modulations/coding rate combinations

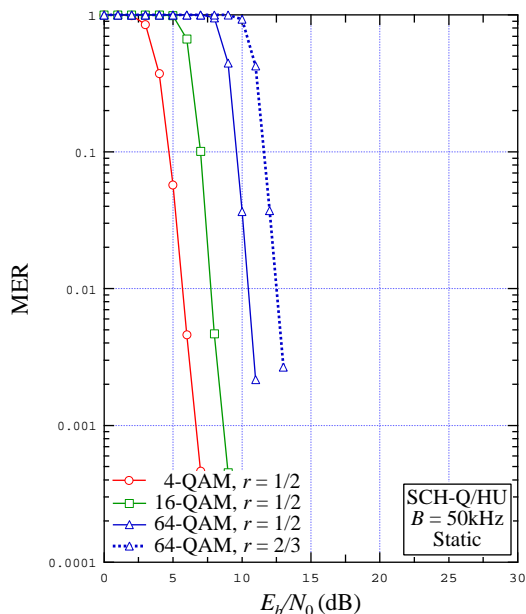

Figure 9.38: MER vs.  $E_b/N_0$  for  $B = 50$  kHz, SCH-Q/HU, static channel, various modulations/coding rate combinations

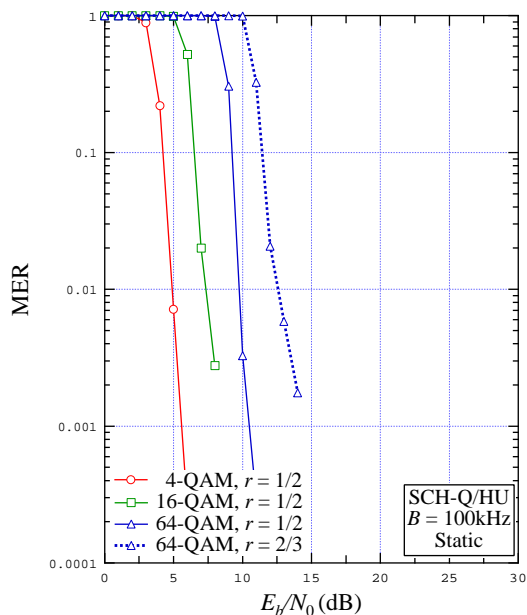

Figure 9.39: MER vs.  $E_b/N_0$  for  $B = 100$  kHz, SCH-Q/HU, static channel, various modulations/coding rate combinations

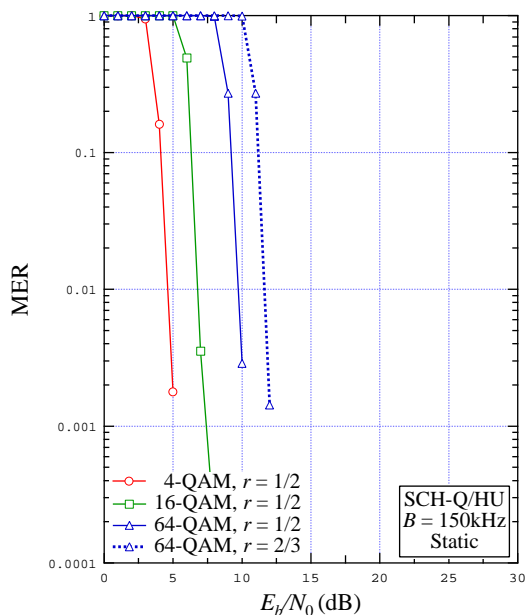

Figure 9.40: MER vs.  $E_b/N_0$  for  $B = 150$  kHz, SCH-Q/HU, static channel, various modulations/coding rate combinations

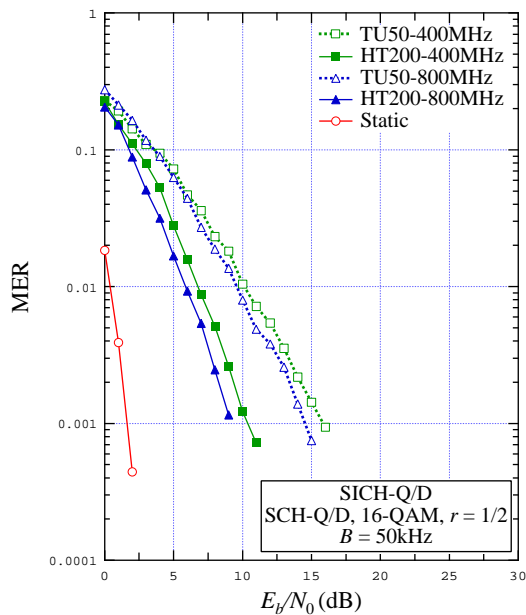

Figure 9.41: MER vs.  $E_b/N_0$  for  $B = 50$  kHz, SICH-Q/D, various propagation channels

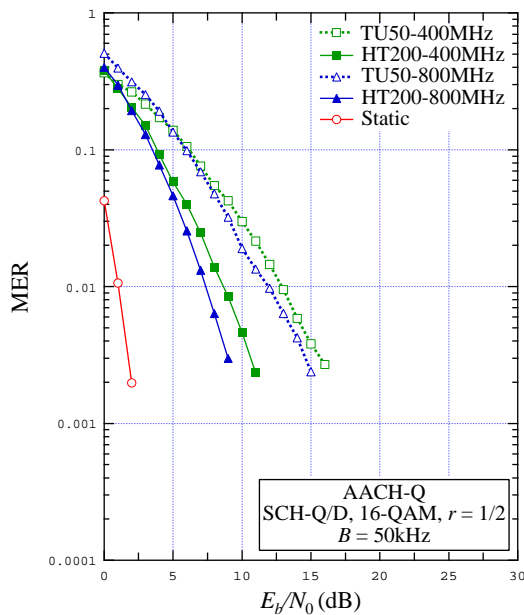

Figure 9.42: MER vs.  $E_b/N_0$  for  $B = 50$  kHz, AACH-Q, various propagation channels

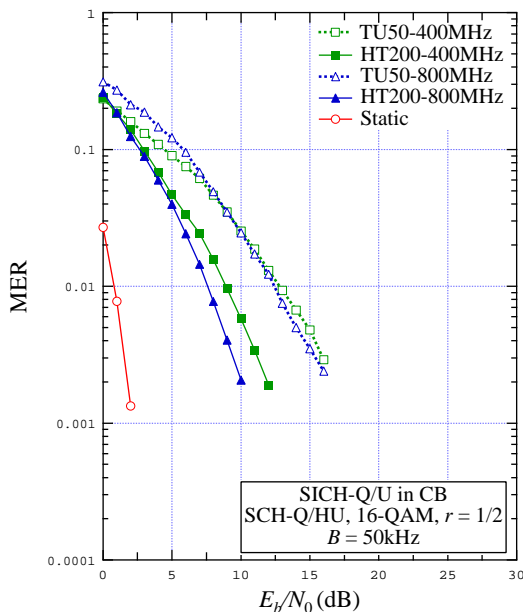

Figure 9.43: MER vs.  $E_b/N_0$  for  $B = 50$  kHz, SICH-Q/U in CB, various propagation channels

## 9.2.2 Interference performance

Figures 9.44 and 9.45 show a few sample curves of MER versus the Signal-to-Interference-Ratio (SIR) evaluated in the presence of a co-channel interfering signal, for the logical channels SCH-Q/D and SCH-Q/HU, respectively. The parameter values are identical to those adopted in clause 9.2.1 (additional details are specified in annex A), with the difference that now, for the sake of brevity, a single combination of parameters, namely  $B = 50$  kHz, 16-QAM,  $r = \frac{1}{2}$  is taken into account.

The propagation scenarios are TU50-400 MHz, HT200-800 MHz and static. Here, AWGN is no longer present and is replaced by co-channel interference with the same structure (as for bandwidth, burst type, modulation format, coding rate, etc.) of the wanted signal and also experiencing a frequency shift of 100 Hz (i.e. about 4 % of the signalling rate) and a timing shift of 1,5 symbol intervals with respect to the latter.

The results obtained demonstrate the receiver robustness to an in-band source of interference for both SCH-Q/D and SCH-Q/HU. Specifically, the performance improves when passing from the TU50-400 MHz to the HT200-800 MHz channel, and from the latter to the static channel, in full accordance with what obtained in the noise performance case.

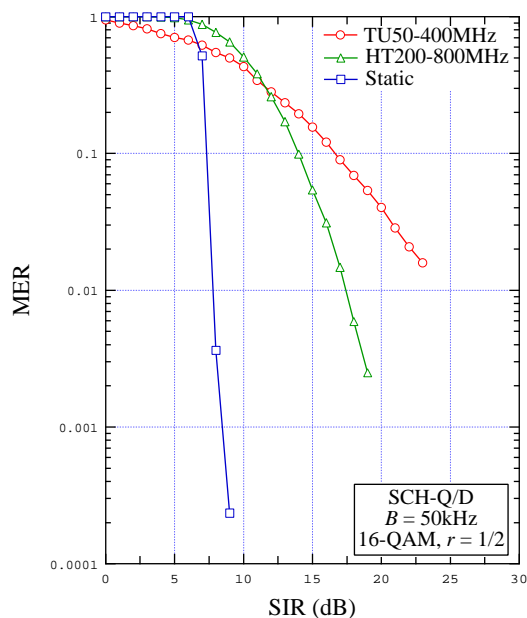

**Figure 9.44: MER vs. SIR for  $B = 50$  kHz, SCH-Q/D, 16-QAM  $r = 1/2$ , various channel combinations**

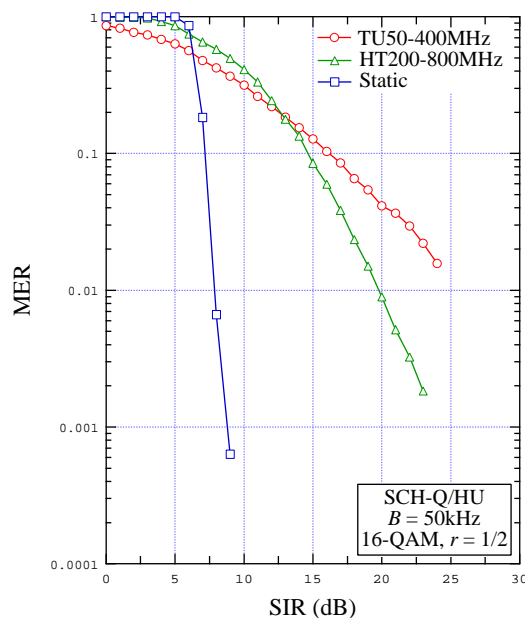

**Figure 9.45: MER vs. SIR for  $B = 50$  kHz, SCH-Q/HU, 16-QAM  $r = 1/2$ , various channel combinations**

## 9.3 Uncoded channel performance

### 9.3.1 Noise performance

The uncoded noise performance is presented by means of MER curves versus the  $\frac{E_b}{N_0}$  ratio in figures 9.46 to 9.57 for the SCH-Q/D and in figures 9.58 to 9.69 for the SCH-Q/HU. Additional sample results for uncoded SCH-Q/U are also included as figures 9.70 to 9.77. The simulation set-up is defined in annex A, the main assumptions being:

- i) the signal bandwidth is  $B = 25$  kHz, 50 kHz, 100 kHz, 150 kHz;
- ii) the modulation and coding rate combinations are 16-QAM  $r = 1$  and 64-QAM  $r = 1$ ;
- iii) the propagation scenarios are TU50-400 MHz, HT200-400 MHz, TU50-800 MHz, HT200-800 MHz and static;
- iv) timing and frequency synchronization is assumed to error-free;
- v) channel estimation is based on the Bayesian-in-time linear-interpolation-in-frequency approach;
- vi) the receiver is affected by AWGN with two-sided power spectral density  $\frac{N_0}{2}$ .

Observation of the figures suggests the following remarks:

- 1) The uncoded performance in terms of MER is definitely worse than that achievable in the coded cases and, unlike the latter, gets poorer as the number of subcarriers and/or the burst length grow. This is explained observing that the Bit Error Rate (BER) is now substantially independent of the data block size, and therefore it is easier to find a bit in error in a larger data block.

- 2) For slow fading (TU50-400 MHz) and small bandwidths (25 kHz and 50 kHz), a 10 % MER can often be attained provided that the  $\frac{E_b}{N_0}$  ratio is adequate. Conversely, over fast-fading channels (notably HT200-400 MHz and HT200-800 MHz) and/or for larger bandwidths, the uncoded performance is severely degraded and the MER curves tend to exhibit a floor higher than 10 %. This is especially true for high-order modulations.
- 3) As for the static channel, again uncoded transmission is poorer than the coded one, although the former permits to achieve very low values of MER as well. Note that because of absence of coding bits the uncoded channel has a higher throughput than the equivalent channel.

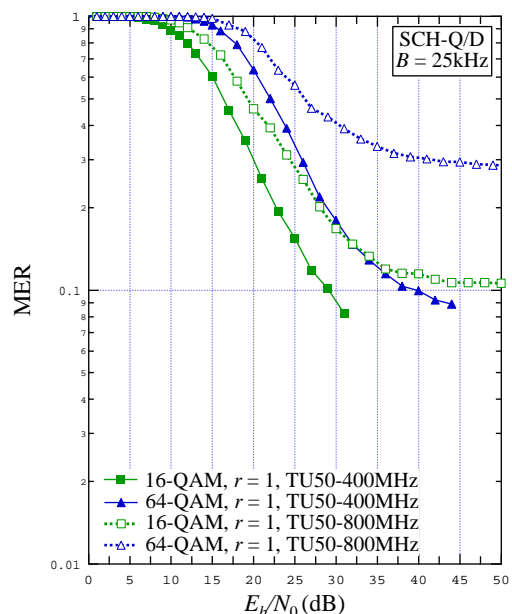

Figure 9.46: MER vs.  $E_b/N_0$  for  $B = 25$  kHz, SCH-Q/D, TU50-400 MHz and TU50-800 MHz channels, 16-QAM  $r = 1$  and 64-QAM  $r = 1$

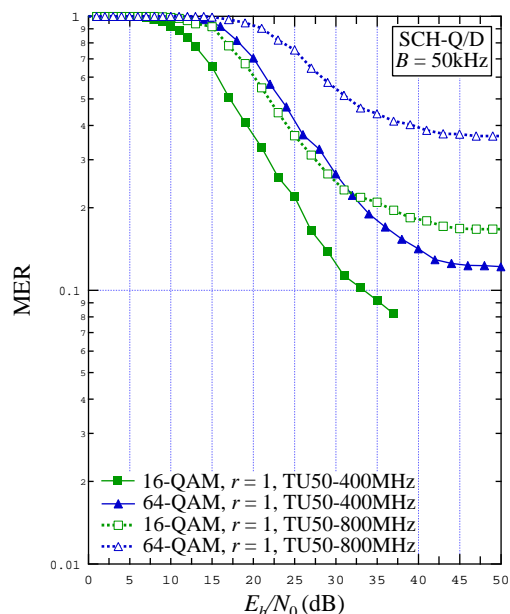

Figure 9.47: MER vs.  $E_b/N_0$  for  $B = 50$  kHz, SCH-Q/D, TU50-400 MHz and TU50-800 MHz channels, 16-QAM  $r = 1$  and 64-QAM  $r = 1$

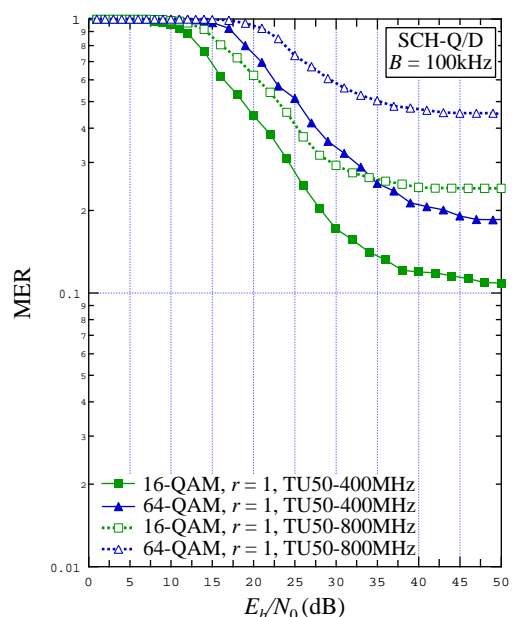

Figure 9.48: MER vs.  $E_b/N_0$  for  $B = 100$  kHz, SCH-Q/D, TU50-400 MHz and TU50-800 MHz channels, 16-QAM  $r = 1$  and 64-QAM  $r = 1$

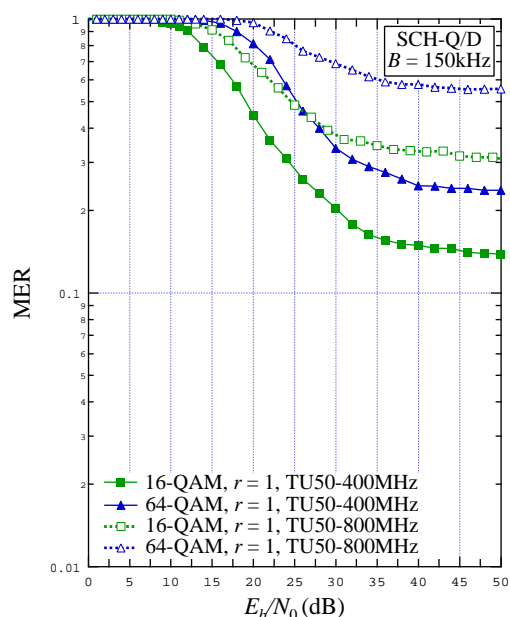
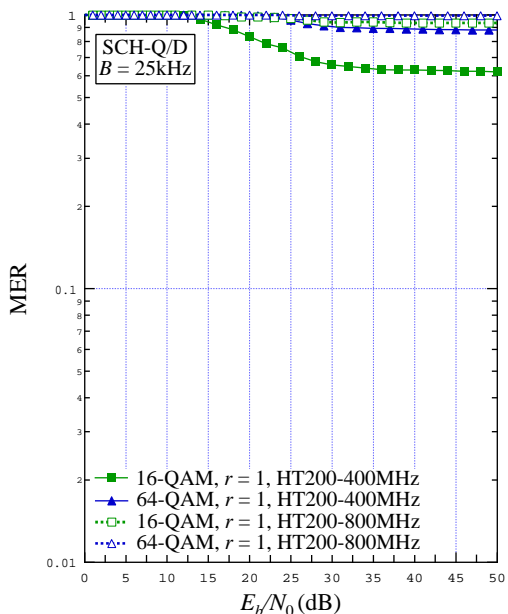
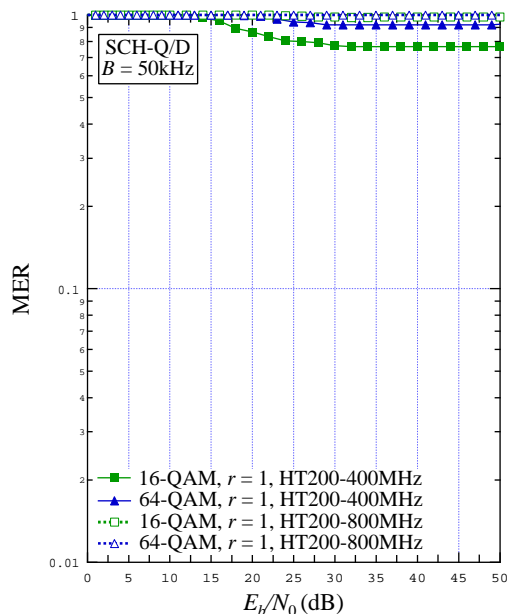

Figure 9.49: MER vs.  $E_b/N_0$  for  $B = 150$  kHz, SCH-Q/D, TU50-400 MHz and TU50-800 MHz channels, 16-QAM  $r = 1$  and 64-QAM  $r = 1$



**Figure 9.50: MER vs.  $E_b/N_0$  for  $B = 25$  kHz, SCH-Q/D, HT200-400 MHz and HT200-800 MHz channels, 16-QAM  $r = 1$  and 64-QAM  $r = 1$**



**Figure 9.51: MER vs.  $E_b/N_0$  for  $B = 50$  kHz, SCH-Q/D, HT200-400 MHz and HT200-800 MHz channels, 16-QAM  $r = 1$  and 64-QAM  $r = 1$**

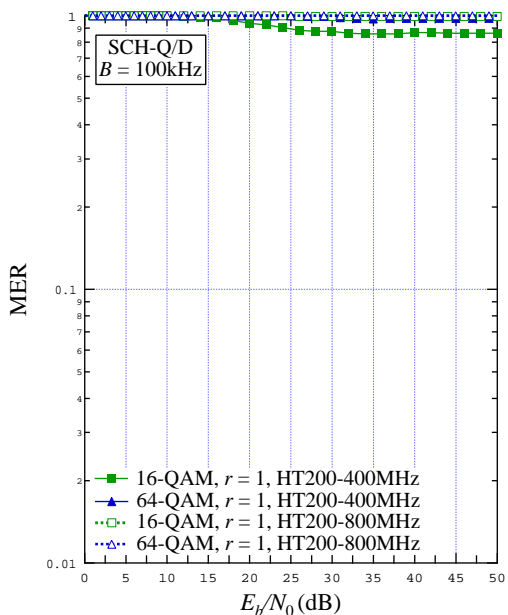

**Figure 9.52: MER vs.  $E_b/N_0$  for  $B = 100$  kHz, SCH-Q/D, HT200-400 MHz and HT200-800 MHz channels, 16-QAM  $r = 1$  and 64-QAM  $r = 1$**

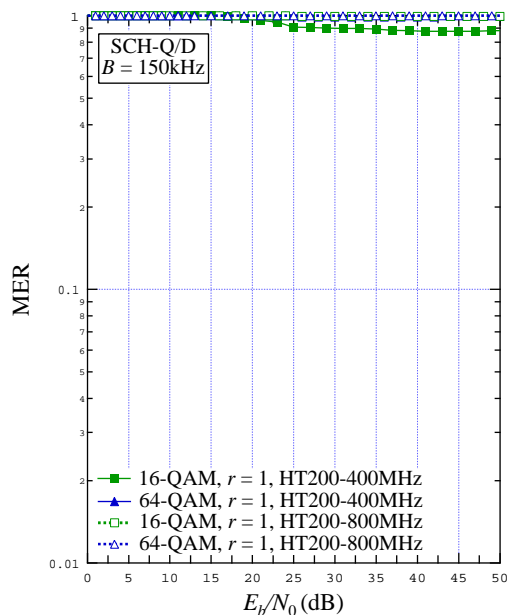

**Figure 9.53: MER vs.  $E_b/N_0$  for  $B = 150$  kHz, SCH-Q/D, HT200-400 MHz and HT200-800 MHz channels, 16-QAM  $r = 1$  and 64-QAM  $r = 1$**

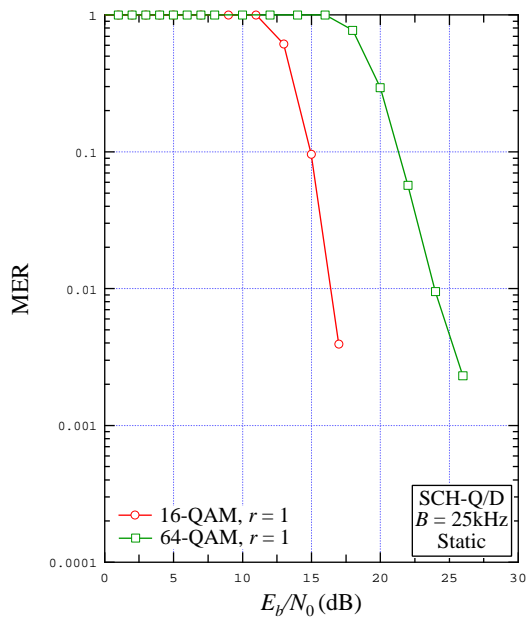

Figure 9.54: MER vs.  $E_b/N_0$  for  $B = 25$  kHz, SCH-Q/D, static channel, 16-QAM  $r = 1$  and 64-QAM  $r = 1$

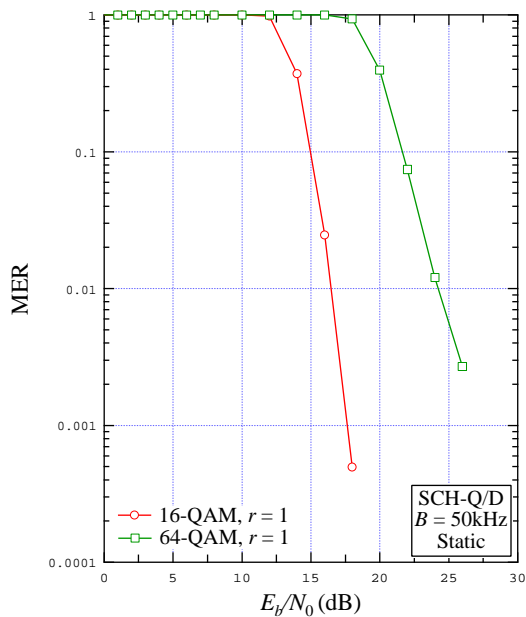

Figure 9.55: MER vs.  $E_b/N_0$  for  $B = 50$  kHz, SCH-Q/D, static channel, 16-QAM  $r = 1$  and 64-QAM  $r = 1$

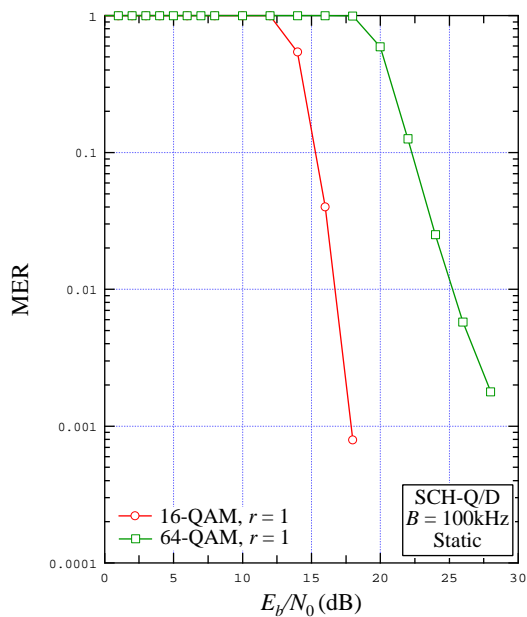

Figure 9.56: MER vs.  $E_b/N_0$  for  $B = 100$  kHz, SCH-Q/D, static channel, 16-QAM  $r = 1$  and 64-QAM  $r = 1$

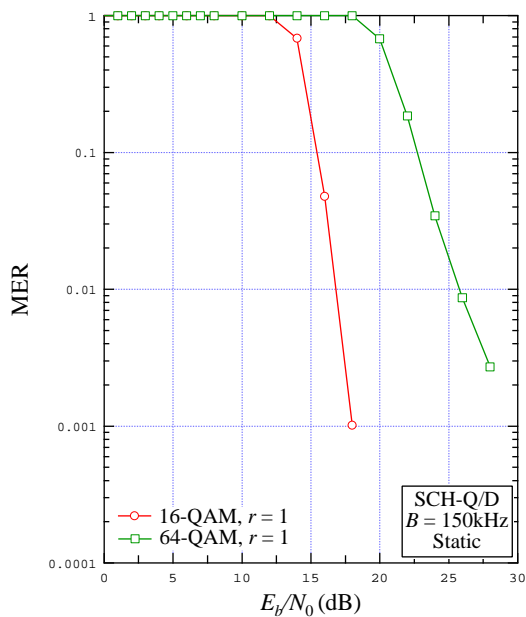
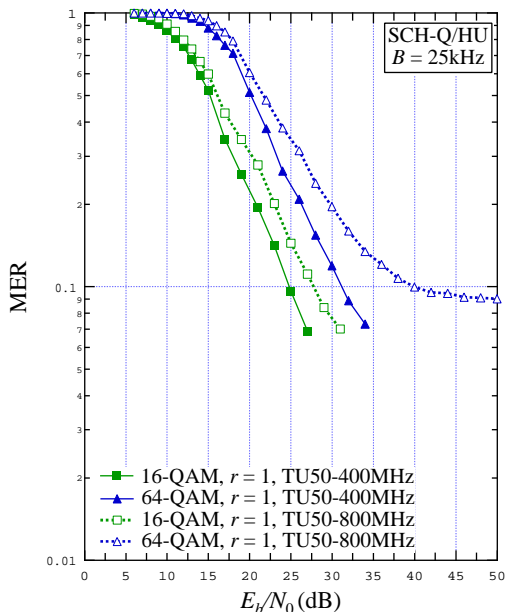
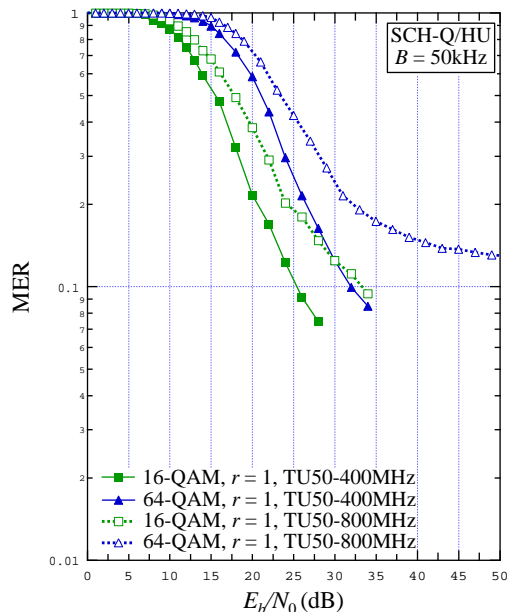

Figure 9.57: MER vs.  $E_b/N_0$  for  $B = 150$  kHz, SCH-Q/D, static channel, 16-QAM  $r = 1$  and 64-QAM  $r = 1$



**Figure 9.58: MER vs.  $E_b/N_0$  for  $B = 25$  kHz, SCH-Q/HU, TU50-400 MHz and TU50-800 MHz channels, 16-QAM  $r = 1$  and 64-QAM  $r = 1$**



**Figure 9.59: MER vs.  $E_b/N_0$  for  $B = 50$  kHz, SCH-Q/HU, TU50-400 MHz and TU50-800 MHz channels, 16-QAM  $r = 1$  and 64-QAM  $r = 1$**

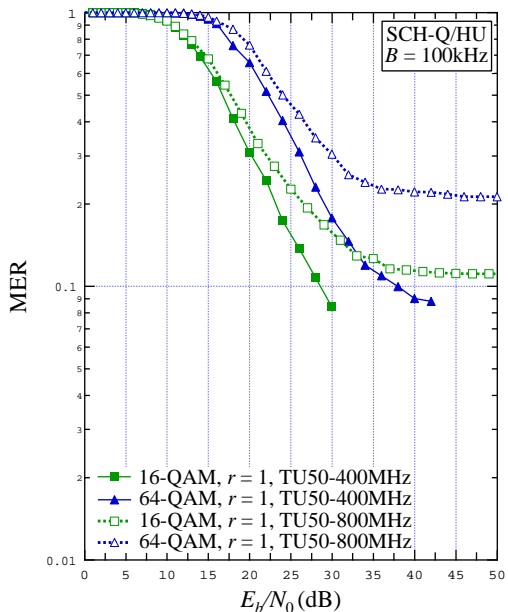

**Figure 9.60: MER vs.  $E_b/N_0$  for  $B = 100$  kHz, SCH-Q/HU, TU50-400 MHz and TU50-800 MHz channels, 16-QAM  $r = 1$  and 64-QAM  $r = 1$**

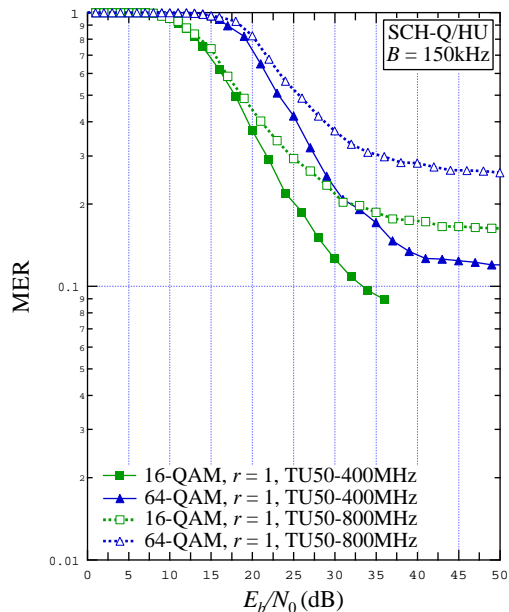

**Figure 9.61: MER vs.  $E_b/N_0$  for  $B = 150$  kHz, SCH-Q/HU, TU50-400 MHz and TU50-800 MHz channels, 16-QAM  $r = 1$  and 64-QAM  $r = 1$**

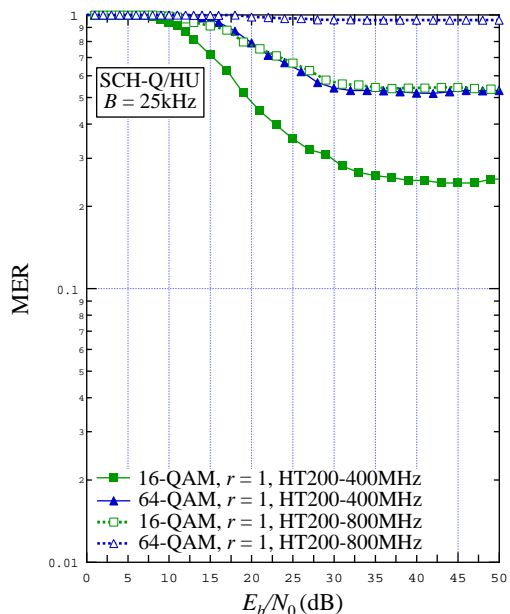

Figure 9.62: MER vs.  $E_b/N_0$  for  $B = 25$  kHz, SCH-Q/HU, HT200-400 MHz and HT200-800 MHz channels, 16-QAM  $r = 1$  and 64-QAM  $r = 1$

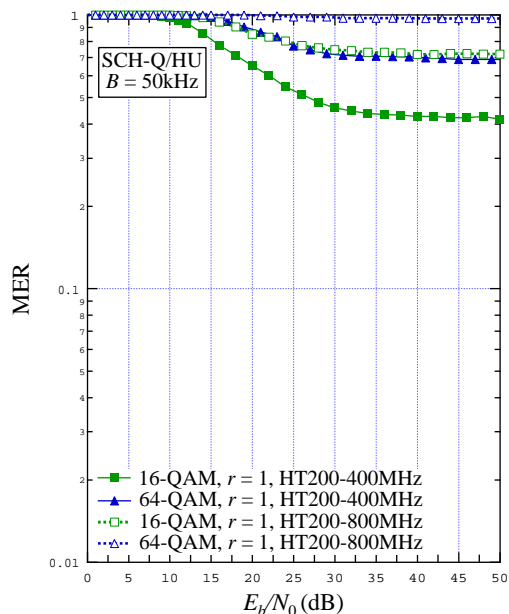

Figure 9.63: MER vs.  $E_b/N_0$  for  $B = 50$  kHz, SCH-Q/HU, HT200-400 MHz and HT200-800 MHz channels, 16-QAM  $r = 1$  and 64-QAM  $r = 1$

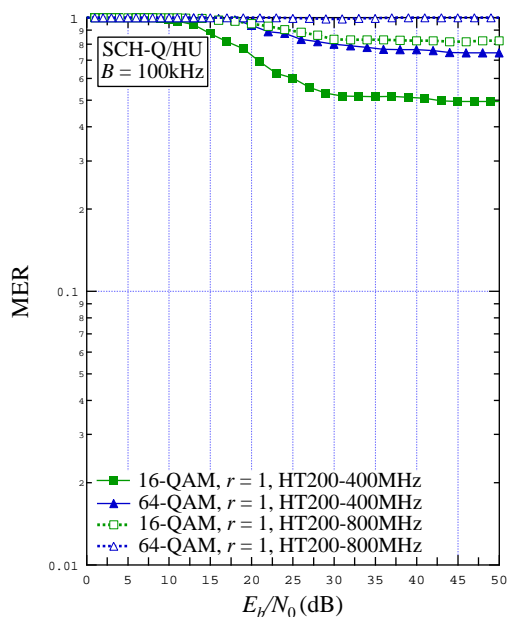

Figure 9.64: MER vs.  $E_b/N_0$  for  $B = 100$  kHz, SCH-Q/HU, HT200-400 MHz and HT200-800 MHz channels, 16-QAM  $r = 1$  and 64-QAM  $r = 1$

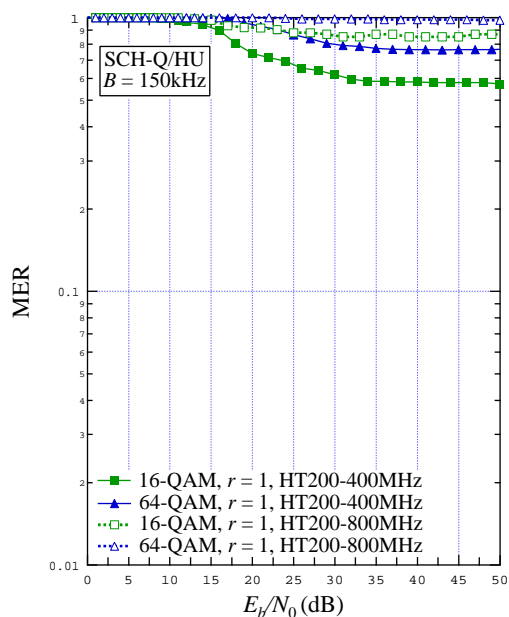
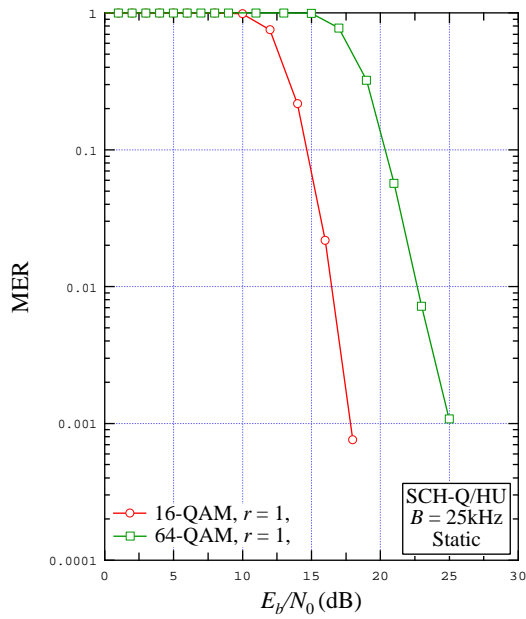
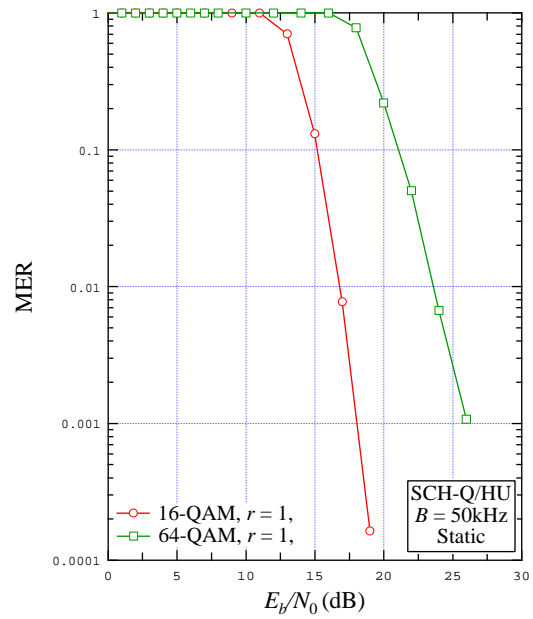

Figure 9.65: MER vs.  $E_b/N_0$  for  $B = 150$  kHz, SCH-Q/HU, HT200-400 MHz and HT200-800 MHz channels, 16-QAM  $r = 1$  and 64-QAM  $r = 1$



**Figure 9.66: MER vs.  $E_b/N_0$  for  $B = 25$  kHz, SCH-Q/HU, static channel, 16-QAM  $r = 1$  and 64-QAM  $r = 1$**



**Figure 9.67: MER vs.  $E_b/N_0$  for  $B = 50$  kHz, SCH-Q/HU, static channel, 16-QAM  $r = 1$  and 64-QAM  $r = 1$**

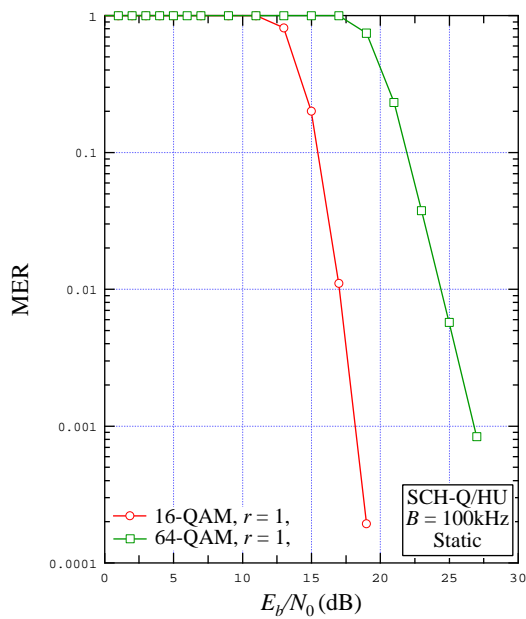

**Figure 9.68: MER vs.  $E_b/N_0$  for  $B = 100$  kHz, SCH-Q/HU, static channel, 16-QAM  $r = 1$  and 64-QAM  $r = 1$**

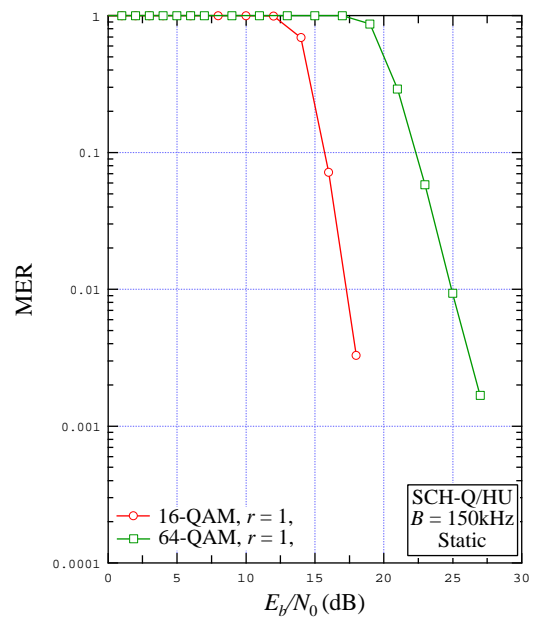

**Figure 9.69: MER vs.  $E_b/N_0$  for  $B = 150$  kHz, SCH-Q/HU, static channel, 16-QAM  $r = 1$  and 64-QAM  $r = 1$**

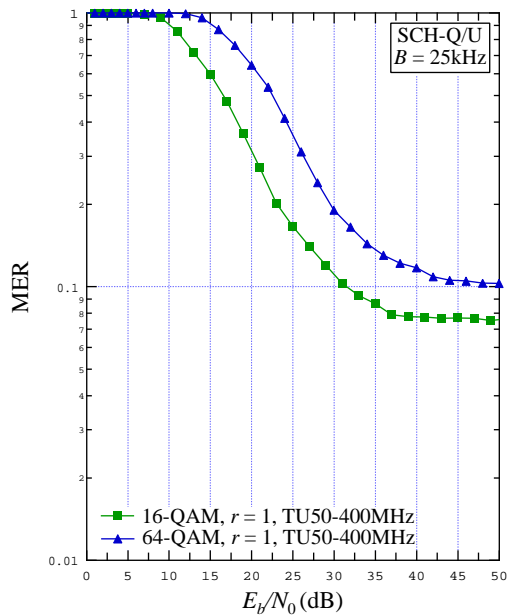

**Figure 9.70: MER vs.  $E_b/N_0$  for  $B = 25$  kHz, SCH-Q/U, TU50-400 MHz channel, 16-QAM  $r = 1$  and 64-QAM  $r = 1$**

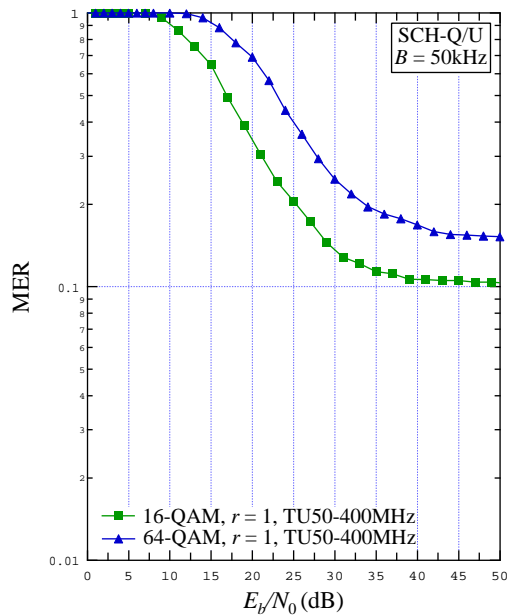

**Figure 9.71: MER vs.  $E_b/N_0$  for  $B = 50$  kHz, SCH-Q/U, TU50-400 MHz channel, 16-QAM  $r = 1$  and 64-QAM  $r = 1$**

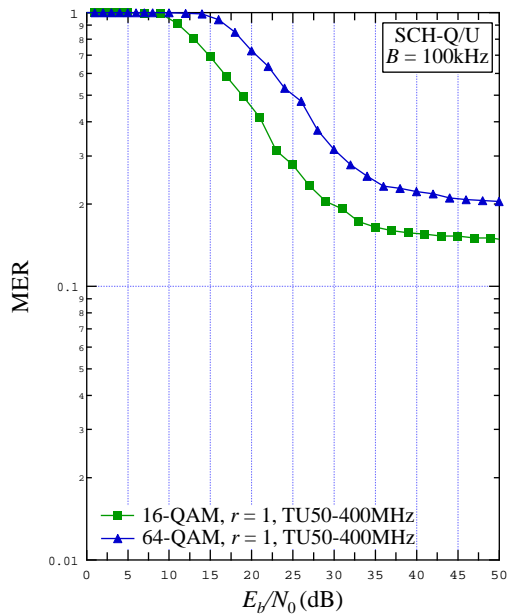

**Figure 9.72: MER vs.  $E_b/N_0$  for  $B = 100$  kHz, SCH-Q/U, TU50-400 MHz channel, 16-QAM  $r = 1$  and 64-QAM  $r = 1$**

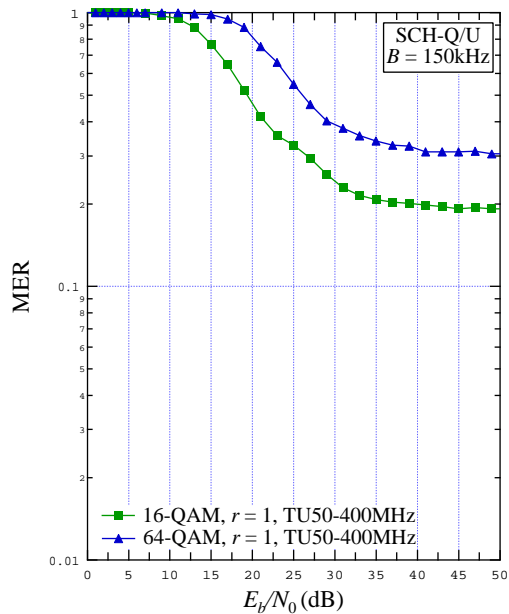

**Figure 9.73: MER vs.  $E_b/N_0$  for  $B = 150$  kHz, SCH-Q/U, TU50-400 MHz channel, 16-QAM  $r = 1$  and 64-QAM  $r = 1$**

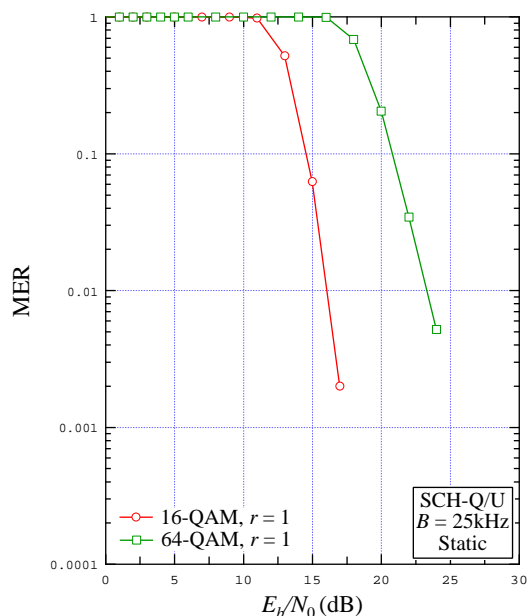

**Figure 9.74: MER vs.  $E_b/N_0$  for  $B = 25$  kHz, SCH-Q/U, static channel, 16-QAM  $r = 1$  and 64-QAM  $r = 1$**

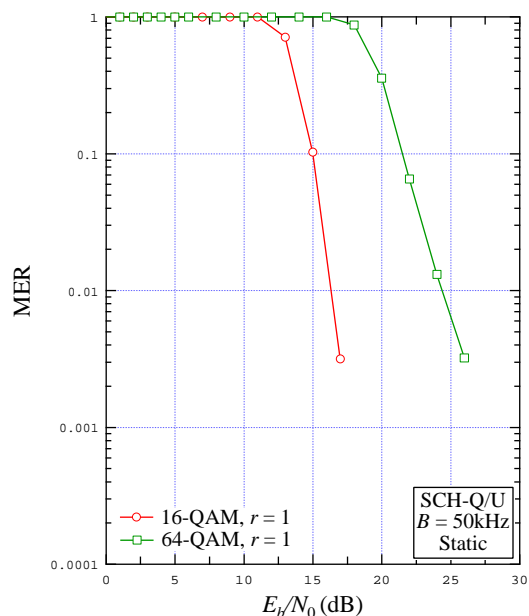

**Figure 9.75: MER vs.  $E_b/N_0$  for  $B = 50$  kHz, SCH-Q/U, static channel, 16-QAM  $r = 1$  and 64-QAM  $r = 1$**

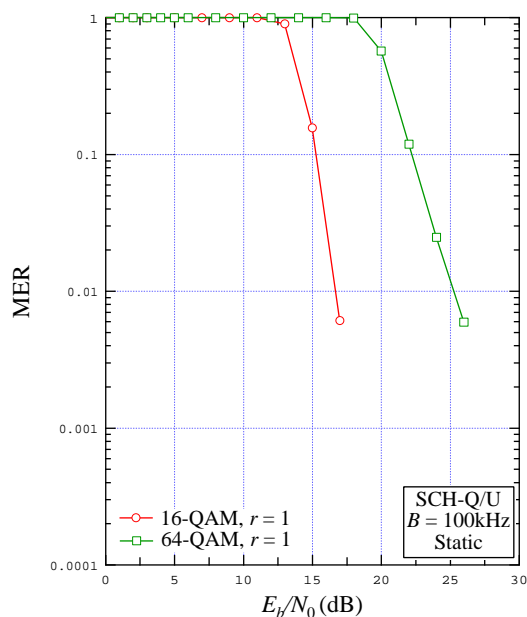

**Figure 9.76: MER vs.  $E_b/N_0$  for  $B = 100$  kHz, SCH-Q/U, static channel, 16-QAM  $r = 1$  and 64-QAM  $r = 1$**

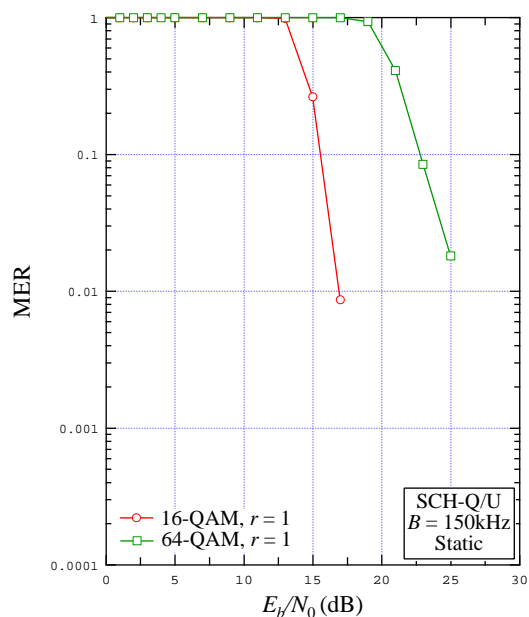

**Figure 9.77: MER vs.  $E_b/N_0$  for  $B = 150$  kHz, SCH-Q/U, static channel, 16-QAM  $r = 1$  and 64-QAM  $r = 1$**

### 9.3.2 Interference performance

Figures 9.78 and 9.79 show a few sample curves of MER versus SIR evaluated in the presence of a co-channel interfering signal, for the logical channels SCH-Q/D and SCH-Q/HU, respectively. The parameter values are identical to those adopted in clause 9.3.1 (additional details are provided in annex A) with the difference that now, for the sake of brevity, only a single combination of parameters, namely  $B = 50$  kHz, 16-QAM,  $r = \frac{1}{2}$  is taken into account.

The propagation scenarios are TU50-400 MHz, HT200-800 MHz and static. Here, AWGN is no longer present and is replaced by co-channel interference with the same structure (as for bandwidth, burst type, modulation format, coding rate, etc.) of the wanted signal and also experiencing a frequency shift of 100 Hz (i.e. about 4 % of the signalling rate) and a timing shift of 1,5 symbol intervals with respect to the latter.

Unlike the coded case, the 10 % MER level is only achieved over the TU50-400 MHz and static scenarios, whereas the performance over HT200-800 MHz is severely degraded.

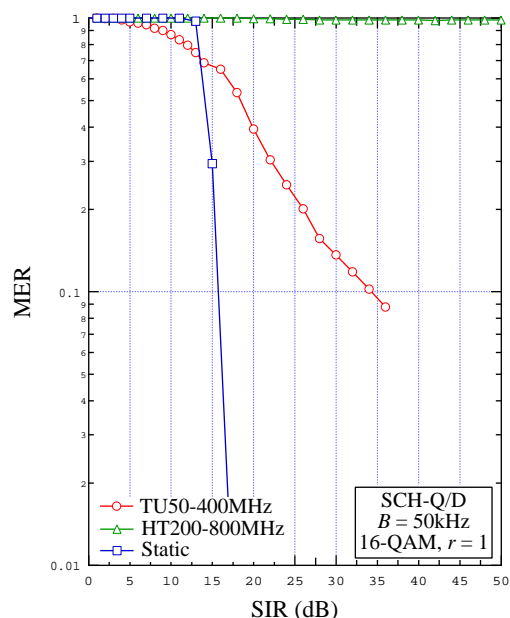

**Figure 9.78: MER vs. SIR for  $B = 50$  kHz, SCH-Q/D, 16-QAM  $r = 1$ , various channel combinations**

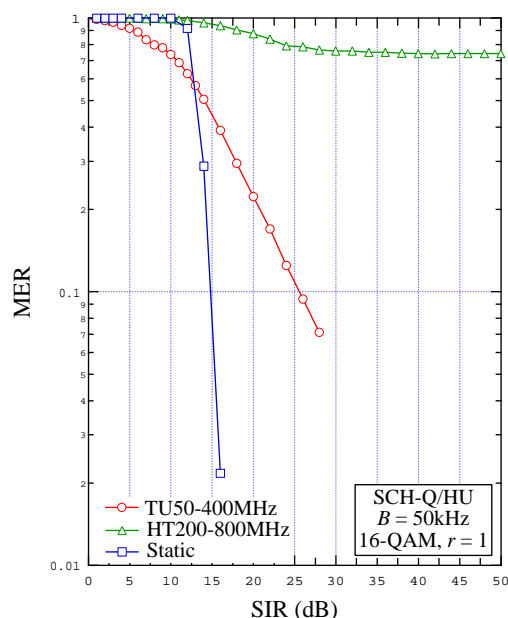

**Figure 9.79: MER vs. SIR for  $B = 50$  kHz, SCH-Q/HU, 16-QAM  $r = 1$ , various channel combinations**

## 10 Typical link budget calculations

### 10.1 System parameters

A number of link budget calculations are illustrated in this clause to assist the network designers to gain an early insight into the behaviour of typical links employing TETRA high-speed channels. They are based on system parameters in a commonly used scenario given in table 10.1. The actual link budgets presented are specific to downlink (BS to handheld terminal) and uplink (handheld to BS) for a 16-QAM channel having a bandwidth of 50 kHz. The aim is to calculate the range for a 90 % variability at the cell edge (99 % over the entire cell).

**Table 10.1: System parameters used in example link budgets**

System parameter	Value
Propagation model	Modified Hata
Topographic scenario	Urban
Frequency bands	400 MHz and 800 MHz
Shadowing (log-normal) standard deviation	5,8 dB @ 400 MHz 6,3 dB @ 800 MHz
Coverage probability at cell edge	90 %
Coverage probability over entire cell	99 %
Shadowing fade margin	7,4 dB @ 400 MHz 8,1 dB @ 800 MHz
Frequency re-use and interference margin	0 dB
In-building penetration	0 dB (outdoor scenario only)
BS TX antenna height	30 m
BS transmit mean power	44 dBm (power class 2)
BS TX antenna gain	10 dBi
BS transmitter to antenna loss	4 dB
BS receive diversity gain	3 dB (dual spatial diversity)
MS antenna height	1,5 m
MS RX antenna gain	-1 dB (handheld)

## 10.2 Downlink model

The link budget example below is for BS to a handheld terminal link specific to a 16-QAM, 1/2 rate coded 50 kHz channel. The handheld dynamic reference sensitivity is -100 dBm at 400 MHz and 800 MHz respectively. Table 10.2 shows a typical link budget used for the downlink range calculation.

**Table 10.2: Typical link budget for downlink**

	Parameter	400 MHz	800 MHz	Units
A	BS transmit mean power	44	44	dBm
B	BS TX antenna gain	10	10	dBi
C	BS transmitter to antenna loss	4	4	dB
D	BS EIRP (A+B-C)	50	50	dBm
E	Path loss	$117,2 + 35,2 \log(d)$	$125,18 + 35,2 \log(d)$	dB
F	Shadowing margin (90 % edge)	7,4	8,1	dB
G	MS receive antenna gain	0	0	dBi
H	MS cable loss	1	1	dB
I	MS dynamic sensitivity	-100	-100	dBm
J	D-E-F+G-H-I = J	$24,4 = 35,2 \log(d)$	$15,8 = 35,2 \log(d)$	-
K	Range	4,9	2,8	km

## 10.3 Uplink model

The link budget example below is for a handheld terminal to BS link specific to a 16-QAM, 1/2 rate coded 50 kHz channel. The BS dynamic reference sensitivity is -102 dBm at 400 MHz and -103 dBm at 800 MHz respectively. Table 10.3 shows a typical link budget used for the uplink range calculation.

**Table 10.3: Typical link budget for uplink range calculation**

	Parameter	400 MHz	800 MHz	Units
A	HH transmit mean power	30	30	dBm
B	HH TX antenna gain	0	0	dBi
C	HH transmitter to antenna loss	1	1	dB
D	HH EIRP (A+B-C)	29	29	dBm
E	Path loss	$117,2 + 35,22 \log(d)$	$125,1 + 35,2 \log(d)$	dB
F	Shadowing margin (90 % edge)	7,2	8,4	dB
G	BS receive antenna gain	10	10	dBi
H	BS receive diversity gain	3	3	dB
I	BS cable loss	4	4	dB
J	BS dynamic sensitivity	-102	-103	dBm
K	D-E-F+G+H-I-J = K	$15,6 = 35,2 \log(d)$	$7,5 = 35,2 \log(d)$	-
L	Range	2,8	1,6	km

A comparison of tables 10.2 and 10.3 indicates that a typical TETRA high-speed radio link between BS and a handheld MS is uplink limited. Under parameters assumed in table 10.1, a balanced link may be obtained by a reduction of the BS transmit power by 8,6 dB for 400 MHz or 800 MHz links. This reduction could be achieved by using a Class 6 BS transmitter (4 W) instead of the Class 2 (25 W) assumed in table 10.1.

Alternatively, a balanced link with a longer range (4,9 km for 400 MHz operation) may be obtained if the link design is based on a link between the BS and a vehicular mounted MS. In this case, the vehicular MS has to use a Class 2L or 2 (5,6 W or 10 W) transmitter instead of the 1 W used by the handheld MS in table 10.3.

Note that only a dual antenna space diversity is considered in table 10.3 for the uplink. Higher levels of BS receiver diversity and/or a combination of space and polarization diversity may result in further balancing of uplink and downlink with an increased range.

**NOTE:** In the uplink range calculations in this clause, it is assumed that the handheld terminal has the same transmit mean power (1 W) for  $\pi/4$ -DQPSK and high-speed channels. If the handheld MS design uses a common power amplifier for  $\pi/4$ -DQPSK and QAM channels, it might not be possible to achieve the same mean power because of the two channels exhibiting different Peak-to-Mean Power Ratios (PMPRs). In a QAM channel, a high PMPR is caused mainly by the usage of a number of sub-carriers (about 11 dB in total). As a comparison, this ratio is 3,2 dB for the  $\pi/4$ -DQPSK channel (which uses no sub-carriers). This results in the QAM transmitter mean power being approximately 8 dB lower than that of the  $\pi/4$ -DQPSK transmitter. The difference in PMPR could be reduced by peak clipping and DSP signal processing techniques to about 5 dB. Nonetheless, the lower mean power for the QAM channel results in a reduction of the uplink range in table 10.3 from 2,8 km (for  $\pi/4$ -DQPSK channel) to 2 km for the QAM channel with 5 dB PMPR difference. For 8 dB difference in PMPR, the QAM channel range will reduce further to 1,6 km.

## 10.4 Range versus throughput trade-offs

### 10.4.1 Range of TETRA HSD channels in urban environment

In this clause the typical range of high-speed channels using different permissible modulation type/coding rate pairs are calculated at 400 MHz and 800 MHz for use in initial network planning purposes. The phase modulated carriers are included partly for completion and partly to allow comparison of coverage to be made between TETRA high-speed channels and the legacy  $\pi/4$ -DQPSK channel. For Conventional Access, the latter is used as the main control channel for access to TETRA high-speed channels. All four channel bandwidth options for high-speed operation are considered. Note that all channels use the same transmit mean power of 44 dBm in the downlink and 30 dBm in the uplink.

The analysis here is carried out for cells that are nominally circular i.e. cells with an omnidirectional radiation pattern. The effect of sectorized cells are included separately in clause 10.5 under range extension methods. The basis for comparison of range in different channels is having identical link parameters except for receiver sensitivity which is dictated by individual channels; hence e.g. the channel EIRPs on the downlink or the uplink are identical for all high-speed channels and, in the case of Conventional Access, the benchmark  $\pi/4$ -DQPSK control channel.

Tables 10.4 and 10.5 show the results of range calculations in an urban environment for all channels (with exception of uncoded channels) based on dynamic and static reference receiver sensitivities respectively. Both BS to MS and MS to BS links are included. The receiver dynamic sensitivity is obtained under typical urban TU50 propagation conditions to comply with message Frame Error Rate (FER) of 10 %.

It can be observed from tables 10.4 and 10.5 that in general for a handheld terminal coverage the system is uplink-limited chiefly because of the BS EIRP advantage. A balanced coverage requires reducing the BS transmit power to achieve the same range as in the uplink. Alternatively, the uplink limitation is eliminated if vehicular mobile terminals are used as a basis for determining the uplink coverage.

**Table 10.4: Range of TETRA HSD channels for dynamic receiver sensitivity in urban environment**

Modulation type and coding rate	Channel bandwidth (kHz)	Downlink range (km)		Uplink range (km)	
		400 MHz	800 MHz	400 MHz	800 MHz
$\pi/4$ -DQPSK, $r = 2/3$	25	6,0	3,4	3,6	2,0
$\pi/8$ -D8PSK, $r = 2/3$	25	4,0	2,3	2,4	1,4
4-QAM, $r = 1/2$	25	8,3	4,7	5,0	2,8
	50	6,8	3,9	4,1	2,3
	100	5,6	3,2	3,4	1,9
	150	5,3	3,0	3,2	1,7
16-QAM, $r = 1/2$	25	6,0	3,4	3,6	2,1
	50	4,9	2,8	2,8	1,6
	100	4,0	2,3	2,4	1,3
	150	3,8	2,2	2,3	1,3
64-QAM, $r = 1/2$	25	4,3	2,6	2,6	1,5
	50	3,6	2,0	2,1	1,2
	100	2,9	1,8	1,8	1,0
	150	2,7	1,7	1,6	0,9
64-QAM, $r = 2/3$	25	3,6	2,0	2,1	1,2
	50	2,7	1,6	1,6	0,9
	100	2,2	1,4	1,4	0,8
	150	2,1	1,3	1,3	0,7

NOTE: It is assumed that the handheld terminal has the same transmit mean power (1 W) for  $\pi/4$ -DQPSK and high-speed channels.

**Table 10.5: Range of TETRA HSD channels for static receiver sensitivity in urban environment**

Modulation type	Channel bandwidth (kHz)	Downlink range (km)		Uplink range (km)	
		400 MHz	800 MHz	400 MHz	800 MHz
$\pi/4$ -DQPSK, $r = 2/3$	25	10,8	6,2	6,4	3,7
$\pi/8$ -D8PSK, $r = 2/3$	25	7,8	4,4	4,6	2,6
4-QAM, $r = 1/2$	25	11,5	6,6	6,9	3,8
	50	9,5	5,4	5,7	3,1
	100	7,8	4,4	4,7	2,6
	150	6,8	3,9	4,1	2,3
16-QAM, $r = 1/2$	25	7,3	4,2	4,4	2,4
	50	6,0	3,4	3,6	2,0
	100	4,9	2,8	3,0	1,6
	150	4,6	2,6	2,8	1,5
64-QAM, $r = 1/2$	25	5,3	3,0	3,2	1,7
	50	4,0	2,3	2,4	1,3
	100	3,6	2,0	2,1	1,2
	150	3,1	1,8	1,9	1,0

NOTE: It is assumed that the handheld terminal has the same transmit mean power (1 W) for  $\pi/4$ -DQPSK and high-speed channels.

## 10.4.2 Range of TETRA HSD channels in suburban environment

The range calculations are repeated for suburban environment. The results are given in tables 10.6 and 10.7 for dynamic and static receiver reference sensitivities respectively. A comparison of the ranges in urban and suburban environments show approximately an increase of 50 % in a suburban environment. Note that all channels use the same transmit mean power of 44 dBm in the downlink and 30 dBm in the uplink.

**Table 10.6: Range of TETRA HSD channels for dynamic receiver sensitivity in suburban environment**

Modulation type and coding rate	Channel bandwidth (kHz)	Downlink range (km)		Uplink range (km)	
		400 MHz	800 MHz	400 MHz	800 MHz
$\pi/4$ -DQPSK, $r = 2/3$	25	8,8	5,5	5,2	3,3
$\pi/8$ -D8PSK, $r = 2/3$	25	5,9	3,7	3,5	2,2
4-QAM, $r = 1/2$	25	12,2	7,6	7,2	4,5
	50	10,0	6,3	5,9	3,7
	100	8,2	5,1	4,9	3,1
	150	7,7	4,8	4,6	2,9
16-QAM, $r = 1/2$	25	8,8	5,5	5,2	3,5
	50	7,2	4,5	4,0	2,7
	100	5,9	3,7	3,5	2,2
	150	5,6	3,5	3,3	2,1
64-QAM, $r = 1/2$	25	6,3	4,2	3,8	2,5
	50	5,2	3,3	3,1	1,9
	100	4,3	2,9	2,5	1,7
	150	4,0	2,7	2,4	1,5
64-QAM, $r = 2/3$	25	5,2	3,3	3,1	1,9
	50	4,0	2,5	2,4	1,5
	100	3,3	2,2	2,1	1,3
	150	3,1	2,1	2,0	1,1

NOTE: It is assumed that the handheld terminal has the same transmit mean power (1 W) for  $\pi/4$ -DQPSK and high-speed channels.

**Table 10.7: Range of TETRA HSD channels for static receiver sensitivity in suburban environment**

Modulation type	Channel bandwidth (kHz)	Downlink range (km)		Uplink range (km)	
		400 MHz	800 MHz	400 MHz	800 MHz
$\pi/4$ -DQPSK, $r = 2/3$	25	15,8	9,9	9,4	5,9
$\pi/8$ -D8PSK, $r = 2/3$	25	11,4	7,1	6,8	4,2
4-QAM, $r = 1/2$	25	16,9	10,6	10,0	6,3
	50	13,9	8,7	8,2	5,1
	100	11,4	7,1	6,8	4,2
	150	10,0	6,3	5,9	3,7
16-QAM, $r = 1/2$	25	10,7	6,7	6,3	4,0
	50	8,8	5,5	5,2	3,3
	100	7,2	4,5	4,3	2,7
	150	6,8	4,2	4,0	2,5
64-QAM, $r = 1/2$	25	7,7	4,8	4,6	2,9
	50	5,9	3,7	3,5	2,2
	100	5,2	3,3	3,1	1,9
	150	4,6	2,9	2,7	1,7

NOTE: It is assumed that the handheld terminal has the same transmit mean power (1 W) for  $\pi/4$ -DQPSK and high-speed channels.

### 10.4.3 Range consideration in open area and rural environments

In practice, open areas void of scattered buildings and foliage occur rather infrequently. Instead, rural areas (or quasi-open areas) which experience some degree of clutter should be considered for evaluation. Therefore, rural area environment could have a wide range of propagation loss values, which lie between values related to suburban and open environments. For the purpose of illustration, a "typical" rural environment with a median propagation loss  $L_m$  approximately half way between suburban and open area environments (see table 8.26) is used in this clause. In addition, a reduced shadowing loss ( $L_s$ ) of half the suburban  $L_s$  (see table 8.27) is used for the sample range calculation. Table 10.8 compares the range for a downlink 16-QAM 50 kHz channel operating under urban, suburban and "typical" rural environments.

**Table 10.8: Range comparison of a "typical" rural with urban and suburban environments**

Propagation environment	Range (km) at 400 MHz	Range (km) at 800 MHz
Urban	4,9	2,8
Suburban	7,2	4,5
Typical rural	17,6	11,6
NOTE: Downlink 16-QAM, 50 kHz HSD channel is used.		

### 10.4.4 Range evaluation for uncoded channels

The results of simulation of sample uncoded channel performance (using SCH-Q/D and SCH-Q/U) were given in clause 9.3. The results indicate that the channel fails to achieve the performance criterion of  $MER = 0,1$  under heavy multipath (Rayleigh) conditions. For example, no QAM channel option performs adequately under HT200 condition and only a few 25 kHz and 50 kHz channels are useable under TU50 conditions. The ranges of these uncoded channels (carrying SCH-Q/D logical channel in the downlink) are compared to equivalent coded channels (with  $r = 1/2$ ) in table 10.9. The frequency of operation is 400 MHz. Table 10.9 indicates a large reduction in coverage area of the channel if coding is disabled. The resulting coverage area amounts only to 4,4 % to 11 % of the original values for the coded channel.

**Table 10.9: Range of uncoded TETRA HSD channels for dynamic receiver sensitivity in urban environment (downlink)**

Channel modulation and bandwidth	Propagation environment	Uncoded channel range (km)	Coded channel range (km)	% of uncoded to coded coverage area
16-QAM, 25 kHz	Urban	2,0	6,0	11,0
64-QAM, 25 kHz	Urban	0,9	4,3	4,4
16-QAM, 50 kHz	Urban	1,2	4,9	6,0
16-QAM, 25 kHz	Suburban	2,9	8,8	10,9
64-QAM, 25 kHz	Suburban	1,2	6,4	6,8
16-QAM, 50 kHz	Suburban	1,7	7,2	5,6

The above results indicate that the usage of uncoded channels under Rayleigh conditions is not advisable. Instead, these channels perform more satisfactorily when the link conditions change to Ricean (with a strong direct signal) or even better under line-of-sight (Gaussian) conditions.

Table 10.10 compares the range of TETRA high-speed 16-QAM and 64-QAM channels for coded ( $r = 1/2$ ) and uncoded cases over all four channel bandwidths under static (Gaussian) channel conditions. It can be seen that the range of the uncoded channel with 16-QAM modulation and 25 kHz channel bandwidth is about 2/3 of the equivalent coded channel. This falls to about 1/2 for 64-QAM modulation in a 150 kHz channel bandwidth. However, the throughput of the uncoded channel is twice the coded channel in all cases in table 10.10, because of the 1/2 rate coding employed in coded channels. It is therefore concluded that there is a viable throughput versus range trade-off for the use of uncoded channels under static or quasi-static conditions. An example being the use of link adaptation at distances close to BS antenna to switch to a 64-QAM,  $r=1$  channel in order to enhance the throughput.

It is to be noted that for proper operation of the uncoded link, the transmitter of the uncoded channel should operate with a significantly lower vector error (of modulation symbols in any burst) than the RMS value of 10 % specified in clause 6.7.1 of ETSI EN 300 392-2 [i.2].

Table 10.10: Comparison of uncoded and coded channel ranges under static conditions

Modulation type	Channel bandwidth (kHz)	Downlink range (km)				Uplink range (km)			
		400 MHz		800 MHz		400 MHz		800 MHz	
		Coded	Uncoded	Coded	Uncoded	Coded	Uncoded	Coded	Uncoded
16-QAM	25	7,3	4,9	4,2	2,8	4,4	2,9	2,4	1,7
	50	6,0	4,0	3,4	2,3	3,6	2,2	2,0	1,3
	100	4,9	3,1	2,8	1,8	3,0	1,8	1,6	1,1
	150	4,6	2,7	2,6	1,6	2,8	1,6	1,5	0,9
64-QAM	25	5,3	2,9	3,0	1,7	3,2	1,7	1,7	1,0
	50	4,0	2,2	2,3	1,3	2,4	1,3	1,3	0,8
	100	3,6	1,7	2,0	1,0	2,1	1,0	1,2	0,6
	150	3,1	1,5	1,8	0,9	1,9	0,9	1,0	0,5

NOTE: It is assumed that the handheld terminal has the same transmit mean power (1 W) for  $\pi/4$ -DQPSK and high-speed channels.

### 10.4.5 TETRA HSD channel coverage comparison for Conventional Access

Since the definition of coverage is statistical, it is instructive to determine for a Conventional Access cell what % of the reference cell (i.e.  $\pi/4$ -DQPSK, 25 kHz) would be covered by each high-speed channel. Based on 90 % cell edge coverage ( $\approx 99$  % cell coverage) for the reference channel, the cell coverage of other channels is shown in table 10.11. It can be observed that six of the newly introduced channels cover nearly 95 % or more of the reference channel, with two channel types exceeding the benchmark coverage by providing almost 100 % coverage. These channels could be added to existing TETRA 1 networks without a need for new base station sites or any special antennas (e.g. sector antennas) to improve the range. The highest throughput among this group of channels belongs to 16-QAM ( $r = 1/2$ ), 50 kHz and is 3,5 times the maximum throughput offered by the reference channel.

Six other channels provide about 70 % to 88 % coverage of the reference cell, which can be considered adequate for many applications, particularly for best effort QoS, again without a need for additional BS sites or sector antennas. However, the use of sector antennas (table 10.15) improves the coverage of the reference cell by these channels to around 99 %. The highest throughput among this group of channels belongs to 64-QAM ( $r = 1/2$ ), 50 kHz channel, which is 5 times that provided by the reference channel. It should be noted that this coverage is not uniform over the cell. As one moves radially from the BS to the cell edge, the first 70 % to 80 % of the radius is covered to a probability of 99 %. The deterioration starts gradually, increasing as one approaches the cell boundary, and is confined to the outer rims of the cell.

For the remaining five channels the reference cell coverage drops to 24 % to 47 %. It should be noted that this coverage is not uniform over the cell. The first 30 % to 50 % of the radius from the BS site are covered to a probability of 99 %. The deterioration starts gradually, increasing as one approaches the cell boundary. Again, as seen from table 10.15, using sectored antennas could provide the required 99 % coverage of the reference cell without the need for new BS sites.

**Table 10.11: Percentage of a CA cell covered by the TETRA HSD channels**

Modulation type and coding rate	Channel bandwidth (kHz)	Link budget gain advantage (dB)	Coverage as % of the reference cell
$\pi/4$ -DQPSK, $r = 2/3$	25	Reference channel	$\approx 99,0$
$\pi/8$ -D8PSK, $r = 2/3$	25	-6	82,5
4-QAM, $r = 1/2$	25	+5	$\approx 100,0$
	50	+2	$\approx 100,0$
	100	-1	98,0
	150	-2	97,0
16-QAM, $r = 1/2$	25	0	$\approx 99,0$
	50	-3	94,5
	100	-6	82,5
	150	-7	78,0
64-QAM, $r = 1/2$	25	-5	88,0
	50	-8	69,3
	100	-11	46,8
	150	-12	41,1
64-QAM, $r = 2/3$	25	-8	69,3
	50	-12	41,1
	100	-15	27,7
	150	-16	24,3

#### 10.4.6 Throughput vs. range for TETRA HSD channels

An estimate of the high-speed channel throughput (in kbit/s) for different high-speed channels using all four available time slots is given in table 10.12. The figures are obtained after allowance is made for the synchronization and pilot symbols, channel coding and lower layer protocol headers and functions. The throughput assessment is based on using MAC-U-BLCK PDU (see clause 7.4.4.2.2) for the uplink and MAC-D-BLCK PDU (see clause 7.4.4.2.2), without slot granting element, for the downlink in an original advanced link. The first row shows the throughput for a  $\pi/4$ -DQPSK channel for comparison purposes. Note that rates in kbit/s are based on transmitting data in all 4 slots and in 17 frames per multiframe. These rates are close to the true bit rates available to user IP packets in good channel conditions.

**Table 10.12: Estimated throughput (kbit/s) for different TETRA HSD channels**

Modulation type and coding rate	Channel bandwidth (kHz)							
	25		50		100		150	
	Uplink	Downlink	Uplink	Downlink	Uplink	Downlink	Uplink	Downlink
$\pi/4$ -DQPSK, $r = 2/3$	15	15						
$\pi/8$ -D8PSK, $r = 2/3$	24	24						
4-QAM, $r = 1/2$	10	10	24	26	49	55	77	86
16-QAM, $r = 1/2$	19	20	47	51	98	110	153	173
64-QAM, $r = 1/2$	29	30	71	77	146	164	230	259
64-QAM, $r = 2/3$	39	40	94	103	195	219	306	345
64-QAM, $r = 1$	58	60	141	154	293	329	459	518

It is instructive to compare high-speed channel spectrum efficiency in terms of IP traffic bits. Such a comparison is given in table 10.13, normalized to spectrum efficiency of the  $\pi/4$ -DQPSK channel. Only downlink efficiencies are given for this comparison (as observed from table 10.12, the efficiency figures for the uplink are slightly lower than the downlink).

It is seen that this efficiency is not independent of channel bandwidth but increases as higher bandwidths are used. The reason for this effect is the longer payload field for wider channels resulting in a lower ratio of protocol header to payload bits.

**Table 10.13: Comparison of spectrum efficiency (bit/s/Hz) for user IP traffic, normalized to  $\pi/4$ -DQPSK modulation case**

Modulation type and coding rate	Channel bandwidth (kHz)			
	25	50	100	150
$\pi/4$ -DQPSK, $r = 2/3$	1,00	-	-	-
$\pi/8$ -D8PSK, $r = 2/3$	1,52	-	-	-
4-QAM, $r = 1/2$	0,63	0,83	0,87	0,90
16-QAM, $r = 1/2$	1,27	1,62	1,75	1,83
64-QAM, $r = 1/2$	1,90	2,44	2,60	2,75
64-QAM, $r = 2/3$	2,54	3,27	3,48	3,65
64-QAM, $r = 1$	3,81	4,89	5,22	5,48

## 10.5 Range extension methods

### 10.5.1 Non-antenna methods

In QAM modulation with a given symbol energy (resulting from the same transmit power for different high-speed channels) the energy per delivered bit falls in proportion to the number of bits per symbol. Since  $E_b/N_0$  is used to determine the receiver sensitivity, using the link budget calculations (tables 10.2 and 10.3), the operating range would be reduced for higher modulation levels. This reasoning also applies to the two phase modulation channels.

In designing the TETRA high-speed QAM channels a number of techniques have been used to increase the range of these channels compared to the reference  $\pi/4$ -DQPSK channel:

- 1) introduction of multiple sub-carriers per channel (8 per 25 kHz);
- 2) coherent detection;
- 3) Parallel Concatenated Convolutional Coding (PCCC) i.e. a type of "turbo-coding".

These measures result in QAM receivers having a higher dynamic reference sensitivity than TETRA 1 receivers. The benefits are more significant in "HT200" (hilly terrain at 200 km/h) propagation environment.

In addition, the use of link adaptation, although not strictly extending the channel range, would allow continuity of service beyond the range of the original channel, albeit with a lower modulation level or coding rate, thus avoiding a break in communication. This is achieved by employing dynamic modulation level and coding-rate adaptation in response to channel performance.

### 10.5.2 Antenna methods

In general, in a cellular base station such as TETRA the antenna designer is faced with conflicting requirements of azimuthal coverage, high gain and low interference (to neighbouring cells). The main solution pursued in TETRA HSD part of the standard to remedy the range shortfall in HSD channels has been the sectored antenna. In this solution a cell is divided into a number of equal sectors each radiating with a directional antenna with a correct beam-width. This was due to availability of such antennas at the time of drafting the standard. This solution also leads to a side benefit of a smaller re-use distance in the cellular network planning and a decrease in overall spectrum requirement. Note that the sector radiation beams are static.

In order to employ sector antennas, the TETRA higher layer protocols have been modified in the current enhancements to allow channel re-selection for sectored channels in circular cells (see clause 7.9.3 and figure 7.19) and sectored channels within sectored cells (see clause 7.9.3 and figure 7.20). The sectored channels extend their range at the expense of azimuthal coverage. As a result, multiple antennas are needed in a BS site for equivalent of an omni-directional coverage. It should be noted that in the absence of sectored antennas a contiguous coverage of the TETRA service area by higher throughput HSD channels requires a significant number of additional BS sites, which implies a much higher level of complexity and cost.

Table 10.14 is a compilation of typical gains for current multi-element panel (sector) antennas of about 2 m high. This table also provides a comparison of the gain of sectored antennas with the gain of an omni-directional (co-linear) antenna of equivalent height. Four beam-width (3 dB) options are considered, namely 120 degrees, 90 degrees, 60 degrees and 30 degrees, requiring 3, 4, 6 and 12 antennas for a 360 degree coverage.

**Table 10.14: Typical gain of sector antennas compared to omni-directional antennas of the same height**

Frequency band (MHz)	Sector antenna beam-width (degree)				Omni-directional antenna gain (dBi)
	120	90	60	30	
400	11	13	15	18	7
800	13	15	17	20	9

NOTE: Based on current panel antennas of about 2 m high.

Table 10.15 provides the type of sectored antenna required for each high-speed channel to comply to within 1 dB or 2 dB with the typical coverage of the reference CA circular cell. Only in two cases more than a single 2 m-sector antenna is required to meet the shortfall. As seen, no new BS sites are necessary for the high-speed channels. However, the antenna plus installation cost and complexity increases for high throughput channels.

**Table 10.15: Typical sector-antenna beam-width required to match the reference CA channel coverage**

Modulation type and coding rate	Channel bandwidth (kHz)	Link budget gain advantage (dB)	Sector antenna 3 dB beam-width (degree)
$\pi/4$ -DQPSK, $r = 2/3$	25	Reference channel	Omni
$\pi/8$ -D8PSK, $r = 2/3$	25	-6	90
4-QAM, $r = 1/2$	25	+5	Omni
	50	+2	Omni
	100	-1	Omni
	150	-2	Omni
16-QAM, $r = 1/2$	25	0	Omni
	50	-3	Omni
	100	-6	90
	150	-7	90
64-QAM, $r = 1/2$	25	-5	120
	50	-8	60
	100	-11	30
	150	-12	30
64-QAM, $r = 2/3$	25	-8	60
	50	-12	30
	100	-15	30 (see note)
	150	-16	30 (see note)

NOTE: Two antennas are required to achieve the additional gain.

In conclusion, use of sectored channels results in:

- addition of high-speed channels to existing TETRA 1 networks without a need for additional BS sites;
- extending the range of higher speed channels to that of the reference circular cell.

The disadvantage is a more expensive base station due to duplication of hardware and the need for assigned channel replacement in moving from one sector to another within the cell.

Further enhancements to a TETRA base station in order to increase range and efficiency for HSD channels could be achieved by the use of smart antennas. In particular adaptive beam-forming and Multiple Input Multiple Output (MIMO) antenna techniques could result in further advantages. However, this area requires further work and standardization by TC-TETRA and is outside the scope of the present document.

## 11 Location Information Protocol (LIP) signalling

This topic was part of the TETRA Release 2 enhancements but not directly connected to the HSD enhancement. Hence it is outside the scope of the present document.

---

## 12 Peripheral Equipment Interface (PEI)

The PEI has been enhanced to handle HSD multimedia applications and Direct Access. Details of the PEI are outside the scope of the present document.

---

## 13 Security

### 13.1 Introduction to TETRA security

TETRA supports two types of security. Air interface security is applied independently over each separate air interface and may be used to secure signalling and voice traffic, including user data and user identities. It may also be used to protect the network from attack or misuse by unauthorized users. End-to-end security is applied between end users of a TETRA system and may be used to protect user speech and data.

Air interface security is intended to provide TETRA users with a radio interface that is as least as secure as a standard wire-connected telephone. Air interface security is specified in ETSI EN 300 392-7 [i.19]. Air interface security protects the user's identity, signalling, speech and data (circuit mode data, SDSs and packet data) on the air-interface link between the MS and the BS. It does not provide protection on internal links inside the SwMI or connections outside the SwMI (e.g. to the PSTN).

End-to-end encryption gives users an additional layer of security that does not rely on the security provided to the cables and links connecting internal SwMI components. It operates independently of air-interface security, but for maximum user protection, air interface security should be applied on top of end-to-end security to protect user identities and signalling messages. End-to-end encryption can be used to protect speech, circuit-mode data, SDS messages and packet data. ETSI does not specify the details of end-to-end security as the details tend to be user-specific. However, ETSI EN 302 109 [i.20] specifies the frame-stealing mechanism that may be used to support the use of end-to-end encryption.

Users may choose to apply end-to-end encryption in applications that take no account of ETSI EN 302 109 [i.20]. This may be used for encrypting packet data and circuit mode data, for example. However, that is outside the scope of TETRA.

TETRA does not provide any support for the security of short range wireless link technologies such as Wireless USB or Bluetooth®. Users of those technologies should take their own precautions to ensure that the wireless link does not undermine the security provided by TETRA air interface encryption and TETRA end-to-end encryption.

### 13.2 TETRA air interface security

#### 13.2.1 Air interface security components

TETRA air interface security comprises air-interface encryption, authentication, key management and enable/disable.

The air interface encryption may be used to protect MSs' addresses, signalling (including the user data contained in SDS messages and packet data) and circuit mode voice and data. This is described in clause 13.2.3. MSs' addresses may also be concealed by ASSIs (see clause 7.4.4.2.1).

Authentication provides a means for the SwMI to test the authenticity of the user and thus protect itself from misuse by unauthorized users. It also provides the MS with a means to test the validity of the present BS so that it can avoid using a fake BS that could be attempting to disrupt communication or intercept the user's voice and data communications. This is described in clause 13.2.4.

TETRA provides secure mechanisms for updating encryption keys by Over-The-Air Rekeying (OTAR). OTAR enhances the overall security of the system by making it easy for the SwMI's security manager to update the encryption keys in the MSs. This is described in clause 13.2.5.

The TETRA disable mechanism provides the SwMI's security manager with a secure means to disable a radio terminal using over-the-air signalling, thereby preventing unauthorized use of a lost or stolen MS. The related enable mechanism gives the SwMI's security manager a secure means to restore the operation of a previously disabled radio terminal using over-the-air signalling. This is described in clause 13.2.6.

Figure 13.1 gives a simplified illustration of the location of the TETRA air-interface security components within the TETRA protocol stack.

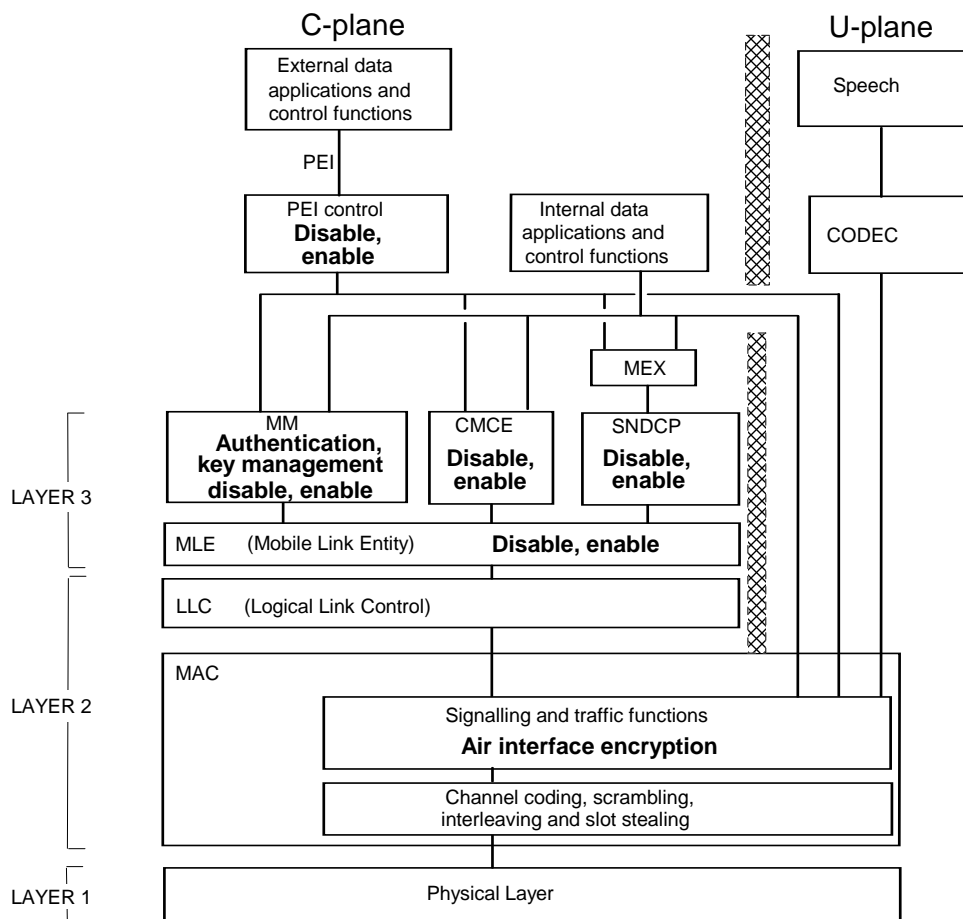

**Figure 13.1: Location of air-interface security functions in the MS's TETRA protocol stack**

### 13.2.2 Security classes

TETRA V+D defines three security classes for air-interface security, as follows:

- Class 1: Air-interface signalling is not encrypted. Authentication may be used.
- Class 2: Air-interface encryption is applied using a Static Cipher Key (SCK) common to all MSs using encryption on the same SwMI. Some broadcast signalling is not encrypted. Authentication may be used.
- Class 3: Air-interface encryption is applied using either individual Derived Cipher Keys (DCKs) or, in the case of group-addressed downlink signalling, a Common Cipher Key (CCK) that may be combined with a Group Cipher Key (GCK) to create a Modified Group Cipher Key (MGCK). Some broadcast signalling is not encrypted. Authentication is used.

## 13.2.3 Encryption

### 13.2.3.1 Encryption algorithms

TETRA presently supports seven standard encryption algorithms: TEA set A are the original algorithms which utilize 80 bit keys and comprises TEA1, TEA2, TEA3 and TEA4. Additional algorithms from TEA set B which utilize 192 bit keys and comprise TEA5, TEA6 and TEA7. The use of proprietary algorithms is also supported by the standard; however, requirements for interoperability should be taken into account when considering use of proprietary algorithms.

There are differences in the intended use and the exportability of equipment containing these algorithms. For example, TEA2 and TEA5 are intended for use by public safety users in Schengen and related European countries only; the others have wider applications ranging from general commercial use to public safety use in regions where TEA2/5 is not used.

Each of these seven algorithms can generate sufficient key stream per burst to be used in any of the TETRA logical channels (i.e. up to 8 288 bits). Copies of the algorithms may be obtained from the relevant custodian. Details of the algorithms and their custodians can be found at [www.etsi.org/security-algorithms-and-codes](http://www.etsi.org/security-algorithms-and-codes).

### 13.2.3.2 Encryption mechanism

TETRA encryption uses a stream cipher. Each bit of plain text to be encrypted is bit-wise exclusive ORed (XORed) with a pseudo-random key stream emitted by a Key Stream Generator (KSG). The KSG implements one of the encryption algorithms (TEA1, TEA2, TEA3, TEA4, TEA5, TEA6, TEA7 or proprietary). The KSG is initialized by an Encryption Cipher Key (ECK) and an Initialization Value (IV) at the start of each burst. The IV changes for each new burst. A new length of key stream, known as a Key Stream Segment (KSS), is thus generated for each burst where encryption or decryption is required. Where PDU association is used, more than one KSS may be required to encrypt a burst. The encrypted material (the cipher text) is deciphered in the receiver by XORing the cipher text with the same KSS. The same key stream bits have to be applied to the same message bits by both transmitter and receiver. To generate the same KSS, the receiver's KSG has to be initialized with the same ECK and IV as the transmitter.

If using an algorithm from TEA set A, the information required to calculate the IV is broadcast by the SwMI (see ETSI EN 300 392-7 [i.19], clause 6.3.2.1). The ECK is derived from an SCK, a CCK, an MGCK or a DCK combined with other items (see ETSI EN 300 392-7 [i.19], clause 6.3.2.2).

If using an algorithm from TEA set B, the information required to calculate the IV is broadcast by the SwMI (see ETSI EN 300 392-7 [i.19], clause 6.3.2.3). The Cipher Key (CKX) is an SCKX, a CCKX, an MGCKX or a DCKX (see ETSI EN 300 392-7 [i.19], clause 6.3.2.4).

One purpose of the continually changing IV is to ensure that, for a single ECK or CKX, the KSS continually changes. The IV repeat cycle in TETRA when using TEA set A is 23 days and 46 days when using TEA set B. It is desirable to change MSs' ECKs or CKXs before the IV repeats.

TETRA uses a stream cipher for air-interface security because a stream cipher using a simple XOR combining method does not create additional errors in the deciphered plaintext when errors occur in the received cipher text. This is important in the case of speech - use of encryption should not cause a noticeable degradation in the received speech quality.

TETRA addresses may also be encrypted over the air interface. For TEA set A, Encrypted Short Identity (ESI) is generated by the use of TA61 identity encryption (see ETSI EN 300 392-7 [i.19], clause 4.2.6).

Once TEA set B algorithms have totally replaced TEA set A algorithms in a network then MAC Addressed Encryption (MAE) provides a means to dynamically encrypt identities.

### 13.2.3.3 Basic key stream allocation

ETSI EN 300 392-7 [i.19], clause 6.4.1 specifies which KSS bits are required for each type of logical channel. The largest logical channel, the SCH-Q/D150, may require up to 8 288 bits of key stream (in the case of 64-QAM  $r = 1$  modulation). KSS bits are numbered starting with KSS(0), where KSS(0) is the first bit to be emitted by the KSG.

### 13.2.3.4 PDU association on phase modulation channels

On the control channel, the MAC may perform PDU association, where more than one PDU may be transmitted within one slot. On the downlink, these PDUs may be addressed to different identities and may use different cipher keys.

On phase modulation channels the KSS is restarted for each new SDU as illustrated in ETSI EN 300 392-7 [i.19], clause 6.4.2. To avoid KSS repeat on a phase modulation channel, the transmitter should avoid sending more than one SDU encrypted with the same encryption key within one slot (e.g. by delaying the transmission of SDUs using the same encryption key until later slots).

Where an algorithm from using TEA set A is used, a PDU association is employed to avoid KSS repeat. When using an algorithm from TEA set B, a PDU counter is included to avoid such a keystream repeat.

### 13.2.3.5 PDU association on QAM channels

#### 13.2.3.5.0 Usage of PDU association on QAM channels

PDU association is much more likely to be used on QAM channels than on phase modulation channels, by both the BS and the MS. One reason is that in QAM channels the LLC cuts advanced link segments to defined sizes that fit within fractions of the MAC logical channel capacity (see clause 7.4.3.4); the MAC then associates two or more segments into a single transmission burst (the number depending on the modulation and coding level that the MAC intends to apply for that particular burst). The other reason is that, since QAM logical channels may have much more capacity per slot than a phase modulation logical channel, the BS transmitter may wish to include many more basic link PDUs in a QAM burst than it could send in a phase modulation burst.

On QAM channels two different KSS allocation schemes are used to eliminate most occurrences of KSS repeat within the cycle time of the IV. (KSS repeat can still occur in the case of SCH-Q/RA bursts transmitted simultaneously by multiple MSs in different 25 kHz portions of a wider QAM channel using class 2 security and in the case of SCH-Q/HU bursts sent in both halves of the same slot.)

#### 13.2.3.5.1 Fixed-mapping KSS allocation scheme

Fixed mapping is used for KSSs derived from an SCK/SCKX, CCK/CCKX or MGCK/MGCKX for use in a QAM channel. Each fixed-mapped KSS is mapped so that a defined starting bit (e.g. KSS(0) or KSS(65)) is mapped to the location of the first bit of the first MAC header). Successive KSS bits are mapped to successive bits of the logical channel. This is independent of the location of the PDUs within the logical channel. Where a PDU bit does not require encryption, the corresponding KSS bit is discarded. Where a PDU bit does require encryption, the corresponding KSS bit is XORed with the PDU bit. Where associated PDUs are to be encrypted using different ECKs/CKXs, the KSS for each different ECK/CKX is mapped to the logical channel in the same way. This is illustrated in figures 13.2 and 13.3 (figure 13.3 shows three MAC PDUs being associated within a slot, but there may be more, depending on the sizes of the PDUs and the capacity of the slot). The starting bit numbers for the mapping to each type of QAM logical channel are defined in ETSI EN 300 392-7 [i.19], clause 6.4.1. The fixed mapping scheme avoids KSS repeats within a single slot even where multiple users groups share a common GCK/GCKX. However, where multiple different KSSs are required within a single slot, the transmitter may have to discard large portions of each KSS.

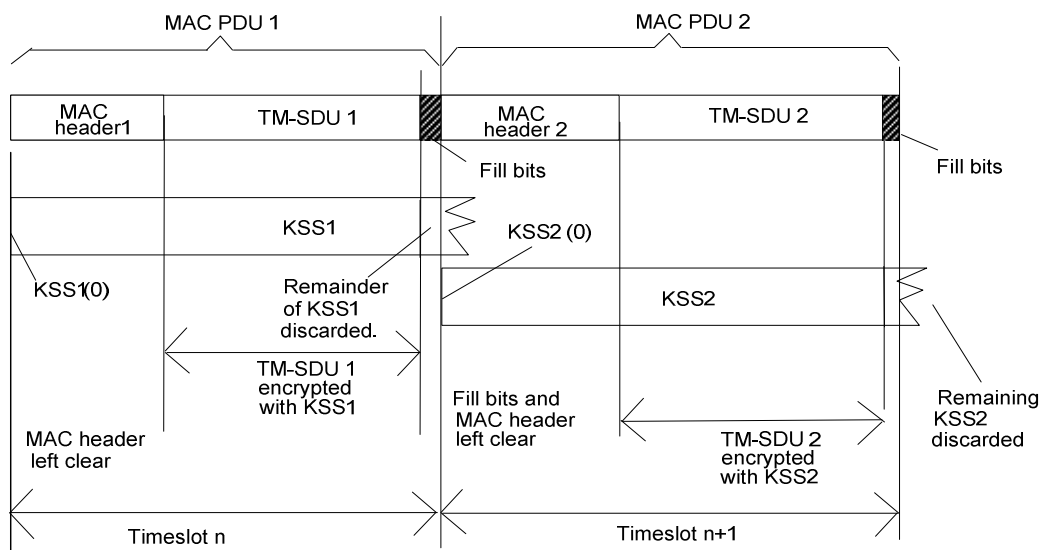

**Figure 13.2: Fixed-mapped allocation of KSS to encrypt QAM MAC PDUs**

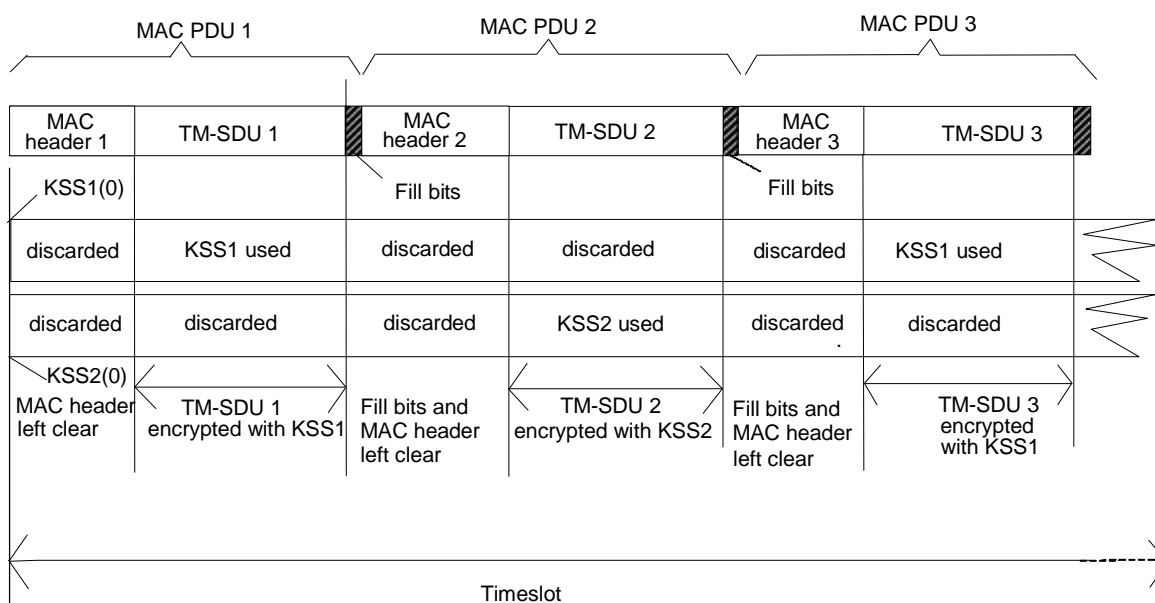

NOTE: In this example, TM-SDU 1 and TM-SDU 3 use the same cipher key but TM-SDU 2 uses a different cipher key.

**Figure 13.3: Fixed-mapped allocation of KSS to encrypt QAM MAC PDUs with PDU association for full slot logical channels**

### 13.2.3.5.2 Offset-mapping KSS allocation scheme

Offset mapping is used for KSSs derived from a DCK/DCKX for use in a QAM channel. Each offset-mapped KSS is mapped so that a defined starting bit (e.g. KSS(0) or KSS(65)) from the KSS corresponds to the first bit of the first MAC PDU to be encrypted with that KSS, and successive KSS bits are mapped to successive bits of PDUs encrypted using the same DCK/DCKX in the current slot or subslot.

Where a PDU bit does not require encryption, the corresponding KSS bit is discarded. Where a PDU bit does require encryption, the corresponding KSS bit is XORed with the PDU bit. The KSS mapping is continued to the last bit of the encrypted PDU (including any terminating fill bits) and then suspended until the first bit of the next (if any) PDU to be associated in that slot or subslot using the same DCK/DCKX (i.e. using the same uplink source address or downlink destination address). The KSS mapping is resumed on the first bit of any subsequent PDU using that DCK/DCKX in the present slot or subslot. Where associated PDUs are encrypted with different offset-mapped KSSs (i.e. using different DCKs/DCKXs), each different KSS is mapped to the logical channel in the same way, starting from the first bit of the first MAC header using that address. This is illustrated in figure 13.4 (figure 13.4 shows three MAC PDUs being associated within a slot, but there may be more, depending on the sizes of the PDUs and the capacity of the slot).

Fill bits are not encrypted.

The offset-mapping scheme minimizes the processing power used to generate KSSs. However, offset mapping can only be used without danger of KSS repeat where it can be guaranteed that PDUs sent to other addresses will not use the same key. This is only true for PDUs encrypted with DCKs/DCKXs.

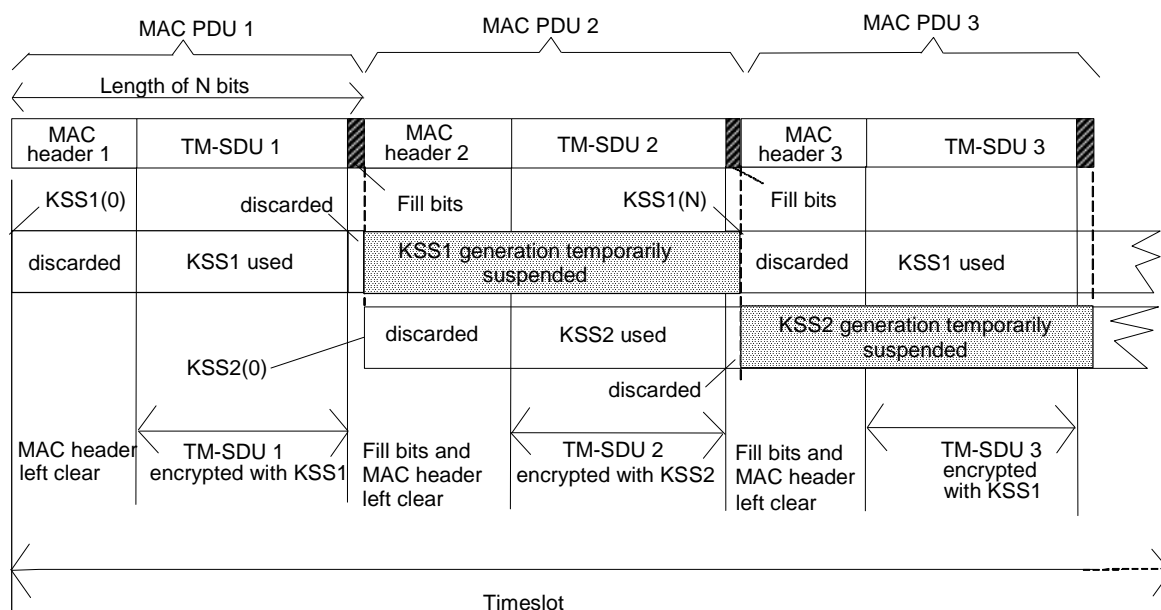

NOTE: In this example, TM-SDU 1 and TM-SDU 3 use the same KSS but TM-SDU 2 uses a KSS derived from a different DCK.

**Figure 13.4: Offset-mapped allocation of DCK/DCKX-derived KSSs to encrypt QAM MAC PDUs with PDU association for full slot logical channels**

## 13.2.4 Authentication

TETRA authentication is described in ETSI EN 300 392-7 [i.19], clauses 4.1 and 4.4. The authentication algorithm set TAA1 is used with encryption algorithm TEA set A. When TEA set B is in use either authentication algorithm set TAA1 or TAA2 may be used.

## 13.2.5 Air interface key management

TETRA air interface key management is described in ETSI EN 300 392-7 [i.19], clauses 4.2 and 4.5.

## 13.2.6 Enable and disable

TETRA air interface enable and disable is described in ETSI EN 300 392-7 [i.19], clause 5.

### 13.3 TETRA end-to-end security

The TETRA standards do not specify detailed methods of end-to-end encryption, since the algorithms and methods tend to be user-specific. However, ETSI EN 302 109 [i.20] indicates the basic mechanisms that may be used.

---

## 14 Air to Ground Operation

The Air - Ground - Air (AGA) service enables TETRA MSs to operate in special situations, where access to the base station is restricted and cell radius is controlled by round trip delay rather than by RF path loss; examples of large cells are air cells and sea cells. AGA operation may apply for both phase modulated channels and QAM channels.

Details of AGA operation are outside the scope of the present document.

## Annex A: Simulation set-up

This annex describes the simulation set-up that has been used to produce all simulation results presented in clause 9. The simulation tool includes all the features of the TETRA HSD Physical Layer (PHY) and is based on discrete-time processing. The main assumptions underlying simulation results are as follows:

- 1) The possible signal bandwidths are  $B = 25$  kHz, 50 kHz, 100 kHz and 150 kHz.
- 2) The permissible combinations of modulation and coding rate are 4-QAM -  $r = \frac{1}{2}$ , 16-QAM -  $r = \frac{1}{2}$ , 64-QAM -  $r = \frac{1}{2}$ , 64-QAM -  $r = \frac{2}{3}$ , 16-QAM -  $r = 1$  and 64-QAM -  $r = 1$ .
- 3) The burst types simulated are NDB, CB and NUB.
- 4) Payload coding is based on punctured PCCC turbo scheme with coding rates  $r = \frac{1}{2}$  and  $r = \frac{2}{3}$ .
- 5) Header coding consists of as constituent code a Reed Muller (16,5) block code.
- 6) The bank of transmit and receive matched filters are implemented through a polyphase filter-bank employing as prototype filter a root-raised-cosine law with roll-off 0,2, each truncated in time at 16 symbol intervals.
- 7) The possible scenarios include static channel conditions (i.e. no fading, single-path propagation) and the standard six-path propagation GSM profiles for the Typical Urban (TU) and Hilly Terrain (HT) environments, namely TU50-400 MHz, HT200-400 MHz, TU50-800 MHz, HT200-800 MHz.
- 8) The time-varying path gains are modelled as independent zero-mean Gaussian processes, whose power spectrum obeys the Jakes model [i.23] and whose mean square values follow the power-delay profile rule in accordance with the GSM model. The Jakes fading is simulated by filtering white Gaussian noise with a FIR filter whose impulse response is the inverse Fourier transform of the ideal Jakes law truncated to 51 symbol intervals.
- 9) Payload decoding employs initial equalized soft metrics (computed in accordance with the so-called "pragmatic approach" [i.24]) and includes 5 iterations.
- 10) Header decoding is performed through a ML decoder employing soft metrics.
- 11) Timing and frequency synchronization is assumed to be either error-free or with zero-mean Gaussian-distributed errors with standard deviation invariant with the SNR.
- 12) Channel estimation is based on the Bayesian-in-time linear-interpolation-in-frequency approach (clause B.2), in which the Bayesian component assumes a channel covariance matrix corresponding to the speed of 200 km/h irrespective of the actual mobile speed. This entails that the channel estimator is mismatched with respect to the actual channel statistics when the mobile speed is different from 200 km/h.
- 13) The receiver is affected by AWGN with two-sided power spectral density  $\frac{N_0}{2}$  (noise limited performance) or by co-channel interference with the same structure of the wanted signal (as far as bandwidth, burst type, modulation, coding rate, etc. are concerned), shifted in frequency by 100 Hz and in time by half symbol interval (interference limited performance).
- 14) The Message Error Rate (MER) metric, where a message, i.e. the entire data content of a time slot, is considered in error if a single bit is detected erroneously, has been adopted throughout as performance measure versus the mean-bit-energy-to-spectral-noise-density ratio  $\frac{E_b}{N_0}$  (noise limited performance) or versus signal-to-interference ratio SIR (interference limited performance).

## Annex B: Channel estimation algorithms in QAM channels

### B.0 General

In this annex, additional details concerning Channel Estimation (CE) schemes in clause 6.9.2 are provided. It is noted at the onset that pilot symbol spacing in the TETRA HSD burst is not uniform in the time nor in the frequency domain (clause 6.4.3). However, to ease focusing on the key ideas behind CE without delving into minor details, it is assumed in the following that pilot symbols are uniformly spaced in time and frequency. Such an approach is not very reductive and makes the presentation clearer. Accordingly, let  $c_{n_i k_j} = p_{i,j}$ ,  $1 \leq i \leq M_F, 1 \leq j \leq M_T$  denote the constant-energy sequence of known symbols, with  $|p_{i,j}| = \sqrt{E_p} = \text{const}$ ,  $1 \leq i \leq M_F, 1 \leq j \leq M_T$ ,  $M_T$  and  $M_F$  being the number of pilots along the time and frequency domains, respectively, and  $0 \leq n_i \leq N - 1$ ,  $0 \leq k_j \leq K - 1$ ,  $N$  and  $K$  denoting the number of subcarriers and signalling intervals in the burst, respectively.

### B.1 Interpolation-based CE

The approach based on interpolation, which will be referred to in the following as interpolation-based CE, or IBCE for short, is a low-complexity CE algorithm consisting of the following steps:

- 1) Data modulation from each received sample corresponding to a pilot symbol is wiped out by dividing the sample by the corresponding symbol, thus obtaining the sequence:

$$\hat{\alpha}_{n_i k_j} = \frac{x_{n_i k_j}}{p_{i,j}} = \alpha_{n_i k_j} + \frac{w_{n_i k_j}}{p_{i,j}}, \quad 1 \leq i \leq M_F, 1 \leq j \leq M_T, \quad (\text{B.1})$$

that can be viewed as a sequence of noisy observations of the two-dimensional fading process  $\alpha_{n,k}$ . In other terms, a set of noisy samples of the correlated two-dimensional low-pass fading process are made available.

- 2) Polynomial interpolation of the above noisy observations is used to estimate the fading samples over the positions of data symbols. The simplest technique is based on applying one-dimensional linear interpolation between adjacent samples along the time or frequency axis, followed by one-dimensional linear interpolation along the other axis. Focusing on a generic subcarrier of index  $\tilde{n}$ ,  $0 \leq \tilde{n} \leq N - 1$ , and letting  $\Delta_T$  denote pilot spacing in time (in signalling intervals), pilot symbols are located at the time indices  $k_1 = 0$ ,  $k_2 = \Delta_T, \dots$ ,  $k_{M_T} = M_T \Delta_T$ , with the constraint that the last position is a pilot, i.e.  $K = M_T \Delta_T + 1$ . The channel estimates on the  $\tilde{n}$ -th subcarrier using linear interpolation in time are given by:

$$\hat{\alpha}_{\tilde{n}, m \Delta_T + l} = \hat{\alpha}_{\tilde{n}, m \Delta_T} + \frac{\hat{\alpha}_{\tilde{n}, (m+1) \Delta_T} - \hat{\alpha}_{\tilde{n}, m \Delta_T}}{\Delta_T} l, \quad l = 1, \dots, \Delta_T - 1, m = 0, \dots, M_T - 1, \quad (\text{B.2})$$

where the sequence  $\hat{\alpha}_{\tilde{n}, m \Delta_T}$ ,  $m = 0, \dots, M_T - 1$ , has been obtained according to step 1). As next step, the same approach is replicated at each signalling interval  $\tilde{k}$ ,  $0 \leq \tilde{k} \leq K - 1$  along the frequency domain. Let  $\Delta_F$  denote the pilot spacing on the frequency axis (in subcarriers), i.e. the pilot symbols are located on the subcarriers of indices  $n_1 = 0$ ,  $n_2 = \Delta_F, \dots$ ,  $n_{M_F} = M_F \Delta_F$ , with  $N = M_F \Delta_F + 1$ . Then the intermediate fading samples are estimated as:

$$\hat{\alpha}_{m \Delta_F + l, \tilde{k}} = \hat{\alpha}_{m \Delta_F, \tilde{k}} + \frac{\hat{\alpha}_{(m+1) \Delta_F, \tilde{k}} - \hat{\alpha}_{m \Delta_F, \tilde{k}}}{\Delta_F} l, \quad l = 1, \dots, \Delta_F - 1, m = 0, \dots, M_F - 1, \quad (\text{B.3})$$

that concludes the IBCE.

Resorting to higher-order interpolation, based e.g. on second-order or spline polynomials, might improve the estimation accuracy but at the cost of an increased complexity. Further, the methods described above are also amenable to generalization to two-dimensional interpolation schemes. Regardless of the type of interpolation algorithm, however, the IBCE method does not require any a priori knowledge of the channel statistics and therefore it represents a viable minimum-complexity implementation.

## B.2 Bayesian CE

The idea behind the Bayesian CE, or BCE for short, is to exploit the a priori statistics of the parameters to be estimated (i.e. the fading samples) to obtain Minimum-Mean-Square-Error (MMSE) estimates. This problem is solved through the so-called Bayesian approach [i.25]. An intuitive explanation for this approach is as follows. If one has some prior statistical knowledge about the correlation existing among neighbouring fading samples along adjacent subcarriers and/or adjacent symbols (this amounts to saying that the fading covariance matrix is known), then this information can be properly incorporated into the CE algorithm to improve the CE accuracy. The resultant two-dimensional estimator is optimal on the average, i.e. it provides a Mean Square Estimation Error (MSEE) over the set of possible fading realizations. The optimal performance of the MSEE Bayesian CE, however, comes at the price of two-dimensional processing of the observations, leading to a high complexity estimator. A sub-optimal solution can however be devised, starting from the observation that even in the adverse HT200-800 MHz scenario, the fading variations in time (measured in symbol intervals) are faster than in frequency (measured in subcarriers). This suggests using a one-dimensional Bayesian approach in time over the subcarriers with pilot symbols, followed by simple linear interpolation in frequency. Adhering to this scheme, the sub-optimal BCE algorithm evolves according to the following steps:

- 1) Data modulation from each received sample corresponding to a pilot symbol is wiped out by dividing the sample by the corresponding symbol, thus obtaining the sequence of noisy observations of the two-dimensional fading process:

$$y_{n_i,k_j} = \frac{x_{n_i,k_j}}{p_{i,j}} = \alpha_{n_i,k_j} + \frac{w_{n_i,k_j}}{p_{i,j}}, \quad 1 \leq i \leq M_F, 1 \leq j \leq M_T, \quad (\text{B.4})$$

- 2) The accuracy of the "raw" channel estimates in the previous step can be improved using a time-domain smoothing Bayesian procedure on each subcarrier bearing pilot symbols. Focusing on one such subcarrier of index  $\bar{n}$ ,  $1 \leq \bar{n} \leq N$ , carrying equally-spaced pilot symbols with spacing  $\Delta_T$ , let  $\alpha_{\bar{n}}^T = [\alpha_{\bar{n},1}, \alpha_{\bar{n},2}, \dots, \alpha_{\bar{n},K}]^T$  denote the vector of fading samples in time along the  $\bar{n}$ -th subcarrier. Furthermore, let  $C_{\alpha_{\bar{n}}} = E\{\alpha_{\bar{n}}^T \alpha_{\bar{n}}\}$  represent the covariance matrix of  $\alpha_{\bar{n}}$ ,  $\mathbf{w}_{\bar{n}}^T = \frac{1}{\sqrt{E_p}} [w_{\bar{n},1}, w_{\bar{n},2}, \dots, w_{\bar{n},K}]^T$  the corresponding vector of the noise samples  $\frac{w_{n_i,k_j}}{p_{i,j}}$  in equation (B.4) with covariance matrix  $C_w = \sigma^2 I_{K \times K}$ ,  $\sigma^2$  being the variance of the samples  $\frac{w_{n_i,k_j}}{p_{i,j}}$  (assumed to be zero-mean and uncorrelated) and finally  $I_{K \times K}$  the  $K \times K$  identity matrix. Then, assuming  $\alpha_{\bar{n}}$  and  $\mathbf{w}_{\bar{n}}$  as independent complex-valued Gaussian random processes with autocovariance matrices  $C_{\alpha_{\bar{n}}}$  and  $C_w$ , respectively, it can be demonstrated that the optimal one-dimensional CE for the  $\bar{n}$ -th subcarrier is given by:

$$\hat{\alpha}_{\bar{n}} = C_{\alpha_{\bar{n}}} H^T [H C_{\alpha_{\bar{n}}} H^T + C_w]^{-1} \mathbf{y}_{\bar{n}}, \quad (\text{B.5})$$

where  $H$  is a  $M_T \times K$  (with  $M_T < K$ ) matrix whose entries are all zeros with the exception of  $[H]_{m,(m-1)\Delta_T+1} = 1$ ,  $1 \leq m \leq M_T$ .

- 3) Finally, polynomial interpolation along the frequency axis is used to estimate the fading samples at the symbol positions that do not carry pilot symbols, in accordance with the frequency-domain interpolation discussed at step 2) of the IBCE method.

An important aspect to be pointed out about the BCE concerns the required prior statistical knowledge of the fading covariance matrix  $C_{\alpha_n}$ . The optimal two-dimensional BCE would require the correlations in the time and frequency domains. However, in mobile wireless applications, the channel statistics are related to parameters such as the Doppler bandwidth (i.e. to the mobile speed) and the channel delay spread that both depend on the particular environment and are subject to changes with time and, consequently, they are typically unavailable at the receiver. A practical solution to this issue consists of "matching" the BCE to the fastest expected scenario as far as the Doppler bandwidth is concerned, i.e. that corresponding to the mobile speed of 200 km/h. This choice leads to a matched CE over the TU200-400 MHz and TU200-800 MHz channels, although a non-negligible mismatch occurs for the slower TU50-400 MHz and TU50-800 MHz scenarios (with normalized fading rate 0,03 instead of the true 0,0075, and 0,06 instead of 0,015, respectively). Despite the above mismatched operating conditions, however, simulation results have shown that the BCE exhibits a satisfactory behaviour both in slow and fast fading channels. As an additional remark about the algorithm complexity, it is noted that the BCE requires a matrix inversion of order  $K \times K$ , with  $K$  being the burst length, whose possible values are 30 (NUB), 34 (NDB and FCB) or 14 (CB and RAB). The result of this matrix inversion, however, can be pre-stored in memory for a reference value of signal-to-noise ratio, or carried out occasionally whenever the carrier frequency and/or the burst type is changed. It is noted that the matrix inversion is also amenable to some simplification in view of the low-density of the matrix  $H$ .

## Annex C: Impact of channel estimation errors on MER

This annex provides some further discussion on the impact of channel estimation errors on the MER receiver performance. Additional simulation results are shown in figures C.1 to C.4. Specifically, both figures C.1 and C.2 are relevant to the SCH-Q/D logical channel with the same selection of parameters as in figure 8.7. The difference with respect to the latter is that figure C.1 assumes the channel estimation procedure is error-free (ideal CE), i.e. the channel is known exactly at the receiver, while figure C.2 is obtained using the Bayesian-in-time linear-interpolation-in-frequency channel estimator described in clause B.2, with the assumption that the estimator is aware of the actual mobile speed (ideal BCE) instead of using a fixed 200 km/h as done in all other simulations (see discussion in clause B.2 and assumption 12 in annex A). Inspection of figure C.1 shows that if the channel were exactly known, then MER curves would progressively improve for growing fading bandwidth, i.e. as the product between the mobile speed and the carrier frequency gets larger. This is expected because the turbo decoder is known to behave better and better as the fading samples get uncorrelated. When the channel is estimated by means of the cited approach, the decoder performance is bound to improve as the speed grows (due the decorrelation effect on channel samples), until the fading bandwidth gets so large that the spacing of pilot symbols becomes inadequate for a correct sampling of the fading process. This explains why in figure C.2 the curves relevant to 250 km/h are similar or better than those for 200 km/h, whilst passing to 300 km/h results in a definite MER deterioration. Figures C.3 and C.4 are related to figure 8.8 as are figures C.1 and C.2 with respect to figure 8.7. Similar effects are also visible here, with some more uncertainty due to the shorter data block. It is noted in passing that the relative positions of the curves in figures 8.1 to 8.6 is the result of the combined effects of all the cited phenomena (i.e. beneficial impact of fading decorrelation and detrimental impact of fading undersampling and unknown mobile speed).

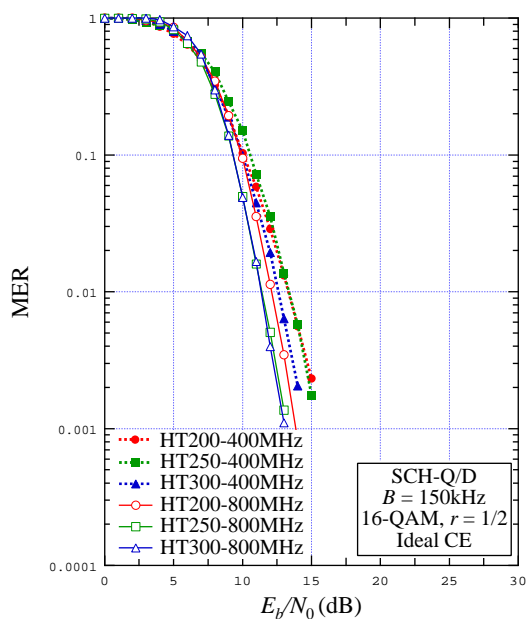

**Figure C.1: MER vs.  $E_b/N_0$  for  $B = 150$  kHz, SCH-Q/D, 16-QAM  $r = 1/2$ , various HT channels and ideal CE**

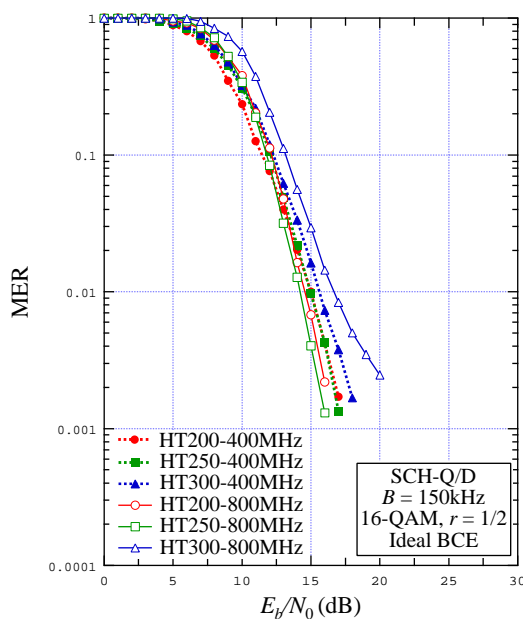

**Figure C.2: MER vs.  $E_b/N_0$  for  $B = 150$  kHz, SCH-Q/D, 16-QAM  $r = 1/2$ , various HT channels and ideal BCE**

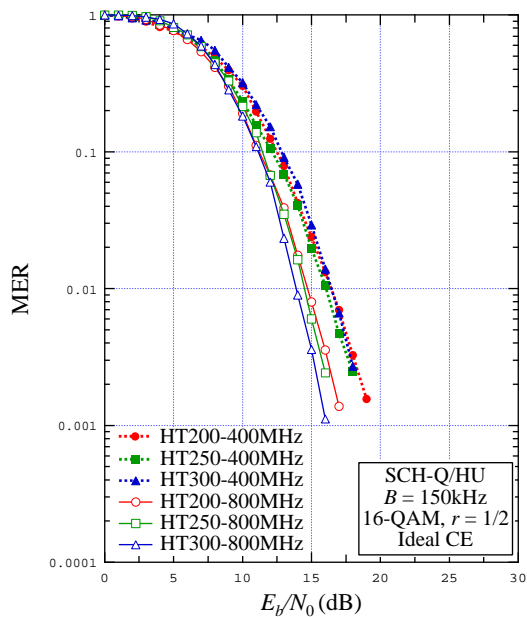

**Figure C.3: MER vs.  $E_b/N_0$  for  $B = 150$  kHz, SCH-Q/HU, 16-QAM  $r = 1/2$ , various HT channels and ideal CE**

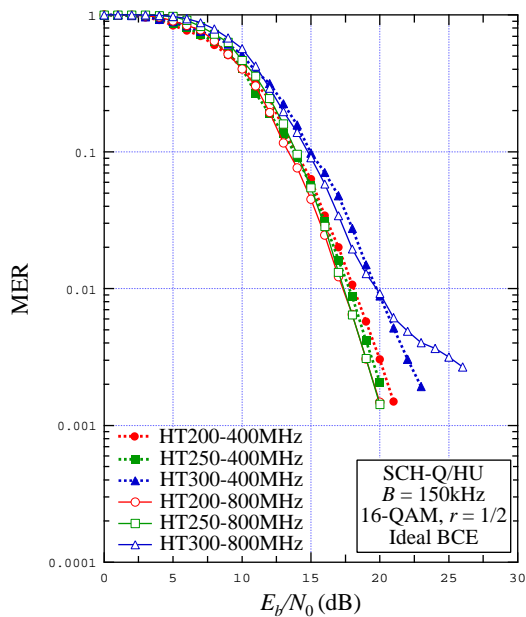

**Figure C.4: MER vs.  $E_b/N_0$  for  $B = 150$  kHz, SCH-Q/HU, 16-QAM  $r = 1/2$ , various HT channels and ideal BCE**

---

## History

<b>Version</b>	<b>Date</b>	<b>Status</b>
V1.1.1	October 2007	Publication as ETSI TR 102 580 (Historical)
V1.2.1	November 2016	Publication
V1.3.1	May 2026	Publication