

**Telecommunications security;  
Lawful Interception (LI);  
Notes on ISDN lawful interception functionality**

---



---

**Reference**

DTR/SEC-003016

---

**Keywords**

ISDN, lawful interception, security

**ETSI**

---

650 Route des Lucioles  
F-06921 Sophia Antipolis Cedex - FRANCE

Tel.: +33 4 92 94 42 00 Fax: +33 4 93 65 47 16

Siret N° 348 623 562 00017 - NAF 742 C  
Association à but non lucratif enregistrée à la  
Sous-Préfecture de Grasse (06) N° 7803/88

---

**Important notice**

Individual copies of the present document can be downloaded from:

<http://www.etsi.org>

The present document may be made available in more than one electronic version or in print. In any case of existing or perceived difference in contents between such versions, the reference version is the Portable Document Format (PDF). In case of dispute, the reference shall be the printing on ETSI printers of the PDF version kept on a specific network drive within ETSI Secretariat.

Users of the present document should be aware that the document may be subject to revision or change of status. Information on the current status of this and other ETSI documents is available at

<http://portal.etsi.org/tb/status/status.asp>

If you find errors in the present document, send your comment to:

[editor@etsi.fr](mailto:editor@etsi.fr)

---

**Copyright Notification**

No part may be reproduced except as authorized by written permission.  
The copyright and the foregoing restriction extend to reproduction in all media.

© European Telecommunications Standards Institute 2002.  
All rights reserved.

# Contents

Intellectual Property Rights .....	5
Foreword.....	5
1 Scope .....	6
2 References .....	6
3 Definitions and abbreviations.....	6
3.1 Definitions .....	6
3.2 Abbreviations .....	6
4 Introduction .....	6
5 Typical message sequence diagrams for IRI .....	7
5.1 General remarks .....	7
5.2 Remarks to tables .....	8
5.3 Remarks to scenarios.....	8
5.4 Originating target, basic call.....	9
5.4.1 Initial LI procedures.....	9
5.4.2 Set up of an additional call leg.....	11
5.4.3 IRI-CONTINUE records (general) .....	11
5.4.4 Answer by other party.....	11
5.4.5 Call release (originating or terminating target) .....	12
5.5 Terminating target, basic call .....	14
5.5.1 Initial LI procedure .....	14
5.5.2 Answer by target.....	16
5.5.3 Call release.....	16
5.6 Originating target call, invocation of LI relevant services .....	16
5.6.1 Call forwarded by called party.....	16
5.7 Terminating target call, invocation of LI relevant services .....	18
5.7.1 Terminating call at target is a forwarded call .....	18
5.7.2 Call forwarded by target .....	18
5.7.3 Target invokes Call Waiting (CW) .....	21
5.8 Target actions during a call in progress.....	21
5.8.1 Call HOLD by target.....	22
5.8.2 Call RETRIEVE by target .....	22
5.9 Three Party Service (3PTY).....	23
5.9.1 Target establishes Three Party Conference (3PTY).....	23
5.9.2 Target: Private communication with Active-Idle party.....	24
5.9.3 Target: Private communication with Active-Held party .....	24
5.9.4 Release of 3 PTY conference by Active-Held party .....	25
5.9.5 Release of 3 PTY conference by Active-Idle party .....	25
5.10 Add on conference (CONF) .....	25
5.10.1 Mapping of PartyId/ConferenceId to Communication Identifiers .....	26
5.10.2 Beginning a conference from the Idle call state.....	26
5.10.3 Beginning a conference from the Active call state .....	27
5.10.4 Adding a remote user.....	28
5.10.5 Splitting a remote user .....	29
5.10.6 Further actions during a conference.....	30
5.10.7 Target clears the conference .....	31
5.10.8 Option B (CC link only for active call).....	31
5.10.9 Add on conference using other protocols .....	31
5.11 Target exchange receives notification related to other party .....	32
5.12 Service activation (not call related).....	32
5.13 Service activation/invocation during a call .....	32
5.13.1 ISDN accesses .....	32
5.13.2 Analogue accesses .....	33
5.14 Unsuccessful calls from target (originating), IRI-BEGIN record sent .....	33

5.15	Unsuccessful calls from/to target, IRI-BEGIN record not sent .....	34
6	State model for an ISDN (overview description for CC link and IRI delivery).....	35
<b>Annex A:</b>	<b>Bibliography .....</b>	<b>38</b>
History .....		39

---

## Intellectual Property Rights

IPRs essential or potentially essential to the present document may have been declared to ETSI. The information pertaining to these essential IPRs, if any, is publicly available for **ETSI members and non-members**, and can be found in ETSI SR 000 314: "*Intellectual Property Rights (IPRs); Essential, or potentially Essential, IPRs notified to ETSI in respect of ETSI standards*", which is available from the ETSI Secretariat. Latest updates are available on the ETSI Web server (<http://webapp.etsi.org/IPR/home.asp>).

Pursuant to the ETSI IPR Policy, no investigation, including IPR searches, has been carried out by ETSI. No guarantee can be given as to the existence of other IPRs not referenced in ETSI SR 000 314 (or the updates on the ETSI Web server) which are, or may be, or may become, essential to the present document.

---

## Foreword

This Technical Report (TR) has been produced by ETSI Technical Committee Security (SEC).

---

# 1 Scope

The present document republishes information previously available in ES 201 671 [1] version 1.1.1, which is considered to be valuable, but which it was not appropriate to retain in future versions of ES 201 671 [1].

The present document gives detailed guidance on network functionality, beyond that provided in [1], on lawful interception as it applies to an ISDN. The handover interface remains as specified in [1].

The material is expected to be of particular use to:

- manufacturers;
- network operators;
- Law Enforcement Agencies;
- others who are concerned with the specification and implementation of lawful interception as it concerns an ISDN.

---

# 2 References

For the purposes of this Technical Report (TR) the following references apply:

- [1] ETSI ES 201 671 (V2.1.1): "Telecommunications security; Lawful Interception (LI); Handover interface for the lawful interception of telecommunications traffic".

---

# 3 Definitions and abbreviations

## 3.1 Definitions

For the purposes of the present document, the terms and definitions given in ES 201 671 [1] apply.

## 3.2 Abbreviations

For the purposes of the present document, the abbreviations defined in ES 201 671 [1] apply.

---

# 4 Introduction

The present document supplements ES 201 671 [1] in its application to an ISDN. ES 201 671 [1] describes HI2: IRI for circuit switching, HI3: CC for circuit switching, general procedures for circuit switched supplementary services and detailed procedures for circuit switched supplementary services in the annex "Circuit switched handover".

---

## 5 Typical message sequence diagrams for IRI

### 5.1 General remarks

The tables and message sequence diagrams (scenarios) of this clause are typical examples showing which parameters shall be included in the IRI records, and when the records shall be sent out to the LEA, for different call phases, call configurations and the invocation of supplementary services. The purpose of this clause is to supplement and clarify the procedures and the use of parameters which are specified in the main body and the normative annexes of ES 201 671 [1]. These normative parts have precedence in case of ambiguities.

A general principle for handling complex call configurations is to break down the scenarios for LI related tasks into several sub-scenarios, which are ideally identical for parts of basic calls or other "standard" call situations. This reduces significantly the complexity of specifying and realizing the LI related tasks. As a consequence, the scenarios below contain in many cases just a remark to another scenario with the applicable sequence, see example below.

**EXAMPLE:** Call Forwarding on No Reply (CFNR) is active for a target (party B).

- 1) An incoming call is, after a time-out, released at the target's access, but forwarded by the exchange. The sequence up to the release is handled similarly to a call released by B during ringing.
- 2) The following set up of the forwarded call to a party C is handled in the same way as for immediate forwarding, for example CFU.

Both transactions can be treated independently of each other. A new specific sequence for CFNR is not needed.

The tables and scenarios of this clause contain several typical cases. They do not cover all possible combinations, and are structured into clauses as follows:

#### **Basic calls**

5.4 Originating target, basic call

5.5 Terminating target, basic call

#### **Call with ISDN supplementary services being invoked**

5.6 Originating target call, invocation of LI relevant services

5.7 Terminating target call, invocation of LI relevant services

5.8 Target actions during a call in progress

5.9 Three Party Service (3PTY)

5.10 Add on conference (CONF)

5.11 Target exchange receives notification related to other party

#### **Subscriber Controlled Input (SCI)**

5.12 Service activation (not call related)

5.13 Service activation/invocation during a call

#### **Unsuccessful calls**

5.14 Unsuccessful calls from target (originating), IRI-BEGIN record sent

5.15 Unsuccessful calls from/to target, IRI-BEGIN record not sent

## 5.2 Remarks to tables

Within the tables, the parameters of an IRI record which are significant for the specific case are indicated. They depend, except for the mandatory parameters, of the type of a target call. The order of the IRI parameters is not fixed. The complete set of parameters, which may be part of an IRI record, is described in ES 201 671 [1] in annex A "Circuit switched network handover". The parameter notation uses the ASN.1 definitions of ES 201 671 [1].

Unless otherwise stated, the tables are applicable to all kinds of originating or terminating accesses, such as ISDN and analogue subscribers. Restrictions or differences may be mentioned in the column "remarks" or within additional text.

Mapping of parameters originated from signalling systems other than DSS1 or ISUP shall follow existing interworking specifications.

Only parameters and signals which are available from the standard signalling procedures shall be included. No additional procedures need be used for LI to obtain parameters which are not available by default. For example, no request for a missing CLI need be made, even if the signalling system would allow it.

Regarding the accuracy of the time stamp value of a record, it may be determined at any point in time during the period between the detection of an event and the sending of the related record.

## 5.3 Remarks to scenarios

The included scenarios are examples. They show successful LI invocations within a local exchange. Exceptional cases are not included. In case of ambiguities, the text of ES 201 671 [1] shall have priority.

The indicated call handling messages are, in general, not based on a specific protocol. However, in several cases protocol specific information needs to be mentioned. In these cases, the DSS1 functional access protocol is used, because it is a kind of superset standard of protocol features. Within the figures such cases are indicated by using DSS1 protocol message names in capital letters. Message sequences for other protocols, such as for analogue access, should be derived from the specified sequences.

The scenarios do not show all signalling protocol messages. The emphasis is on those messages which are significant for, or related to, IRI records and CC link events.

The IRI record parameters which are indicated as additional information in the scenarios are limited to significant ones for a given case. For example, parameters which are mandatory such as the LIID, data and time, etc. are not explicitly mentioned. The parameter names use logical names, as described in ES 201 671 [1] in annex A "Circuit switched network handover", instead of the exact ASN.1 notation.

It is not required that identical sequences result for the same actions of a target or another party. These sequences may depend on the actual access or network protocols, and the call configuration, for example purely local calls, or calls via other exchanges.

The master configuration chosen for decisions as to which parameters ought to be included in IRI records is transit call switching using ISDN user part signalling. This means, for example, that the information which can be provided by such calls shall also be available in case of purely local calls. As described above, the individual IRI records, which carry certain information, may vary.

As a general rule, intercept related information is transmitted to the LEMF within an IRI record when it first becomes available. In the scenarios, identical parameters are not repeated in succeeding records, unless their content or value has changed. However, an implementation may decide to repeat information which has already been sent, for example in order to avoid the need for a memory of previously sent parameters.

With respect to the CC links in case of multi party calls, the option "CC links for active and non-active calls" is generally shown (option A).

In general, the scenario figures contain one or more pictures depicting the actual configuration of the target and the other party, or parties, within a call and the target's call state.



Functional entities used within the scenarios:

- Target terminal: Equipment of the interception subject, which originates or terminates an intercepted call.
- Orig./term. SF\_T: Switching function of the target, containing the IIF; within these examples, the SF\_T is assumed to be a fixed ISDN network local exchange.
- Orig./term. SF\_P: Switching function of the other party; within these examples, the SF\_P is assumed to be a fixed ISDN network local exchange.
- Other party: Equipment of the other party(ies), which originates or terminates a call, in which the target is involved.
- LEMF HI2 (IRI): LEMF port, receiving IRI.
- LEMF HI3 (CC): LEMF port, receiving the content of communication (CC links).

NOTE: In general an incoming message to any functional entity causes one or more outgoing messages. In case of several outgoing messages, the order of sending them is purely implementation dependent. The figures do not intend to specify a fixed sequence.

## 5.4 Originating target, basic call

This clause concentrates on the description of basic calls, originated by the target. However, the IRI record tables partly depict parameters which can also be used in conjunction with the invocation of supplementary services.

### 5.4.1 Initial LI procedures

This clause includes the procedure until the point in time when the local exchange of the target (SF\_T) sends an IRI-BEGIN record, and sets up a CC link.

Corresponding transition in state model: *Begin, CC link set up* (the state model shows the special case of en-bloc signalling).

The IRI-BEGIN record constitutes the first record of an originating or terminating call.

NOTE: The exact point of sending the IRI-BEGIN record may depend on national regulations, and on the implementation of the IIF. For example, it may be sent immediately when connecting proceed indication (dial tone) or only when starting routing within the SF\_T. Irrespective of the point in time of sending the IRI-BEGIN record, it shall be possible to send an IRI-REPORT record if a call attempt is released at an earlier point in time.

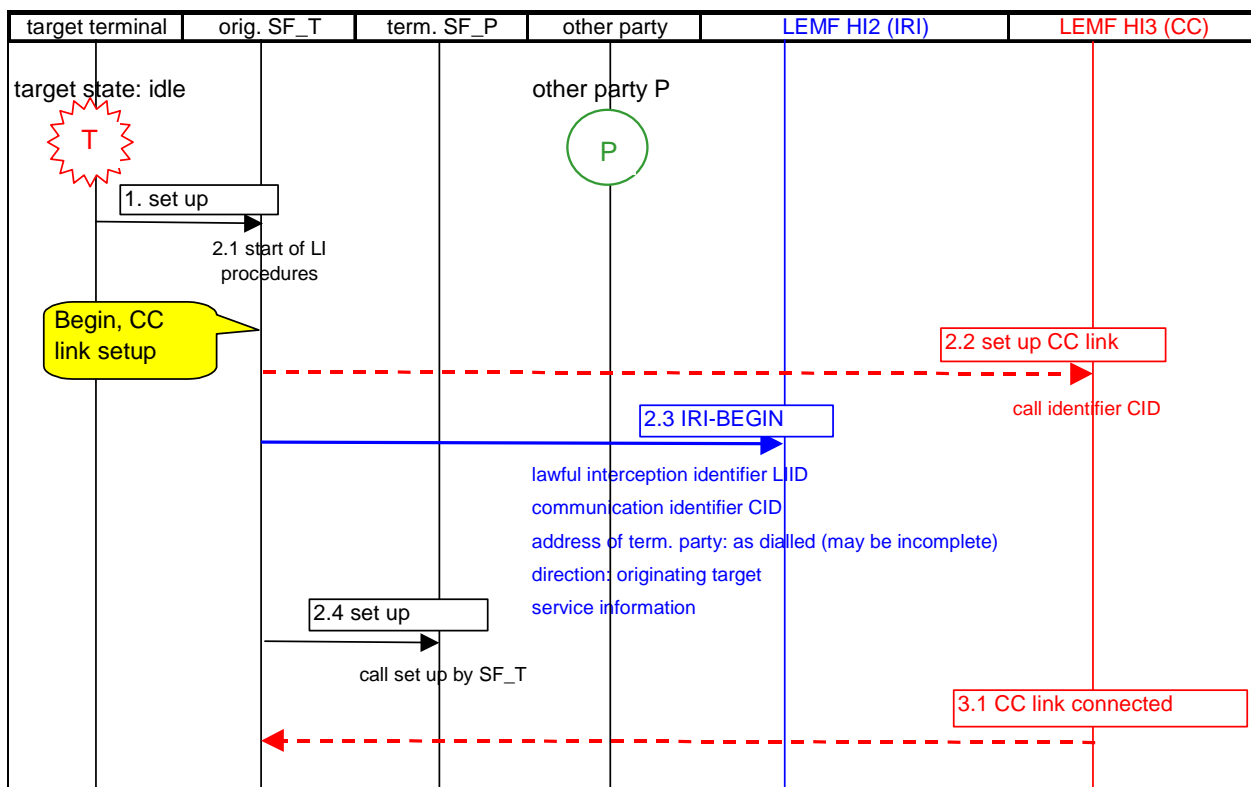

Figure 5.1: Start of call originating from target

Table 5.1: IRI-BEGIN record content for call originating from target

IRI - BEGIN record	
parameter name	remarks/parameter details
LawfullInterceptionIdentifier	identifying the LI activation (LIID)
communicationIdentifier	Communication Identifier of originating target call
timeStamp	at reception of set up request by target exchange
nature-Of-The-intercepted-call	gSM/ISDN/PSTN-circuit-call
intercepted-Call-Direct	originating-Target
intercepted-Call-State	setUpInProgress
partyInformation	party-Qualifier: originating-Party services-Information: BC/HLC/LLC (as available) supplementary-Services-Information (as available, e.g. CF related information, from previous forwardings, or forwarding by the target, subaddress, CUG, generic number)
partyInformation	party-Qualifier: terminating-Party calledPartyNumber (available digits, at this point in time)
callContentLinkInformation	setUpInProgress (CC link state)

After reception of the confirmation that the CC link has been answered, the CC link state changes to the value "callActive".

## 5.4.2 Set up of an additional call leg

In case of set up of a new call leg, for example when another call is in the *held state*, an IRI-BEGIN record as defined here is sent. I.e. a new, independent IRI transaction is set up. If the CC link option B is used ("*CC links only for actually active calls*"), no separate CC link is set up for this call leg and the existing CC link is used instead for transmission of the content of communication. The Communication Identifier shall contain the CCLID value of the CC link used.

## 5.4.3 IRI-CONTINUE records (general)

For a Basic Call, the first IRI-CONTINUE record is sent at reception of the Answer or Connect indication.

If supplementary services are invoked, such as:

- Call Waiting, or
- Call Forwarding.

IRI-CONTINUE records may be sent before answer or during the active phase of a call.

IRI-CONTINUE records are also used to report failures of the CC links or a CC link release by the LEMF.

When supplementary service parameters are available from the call handling procedures an IRI-CONTINUE record is sent.

The *Facility IE* shall be sent only if it contains components as defined in clause "Selection of parameters for IRI records" of reference ES 201 671 [1].

## 5.4.4 Answer by other party

For a Basic Call, the first IRI-CONTINUE record is sent at reception of the Answer or Connect indication (call is switched through), see figure 5.2. Alerting is not reported (for a basic call). The called party number needs only to be sent if the number in the IRI-BEGIN record was not complete (originating target, overlap sending/receiving). In this case, the IRI-CONTINUE record shall contain the complete number.

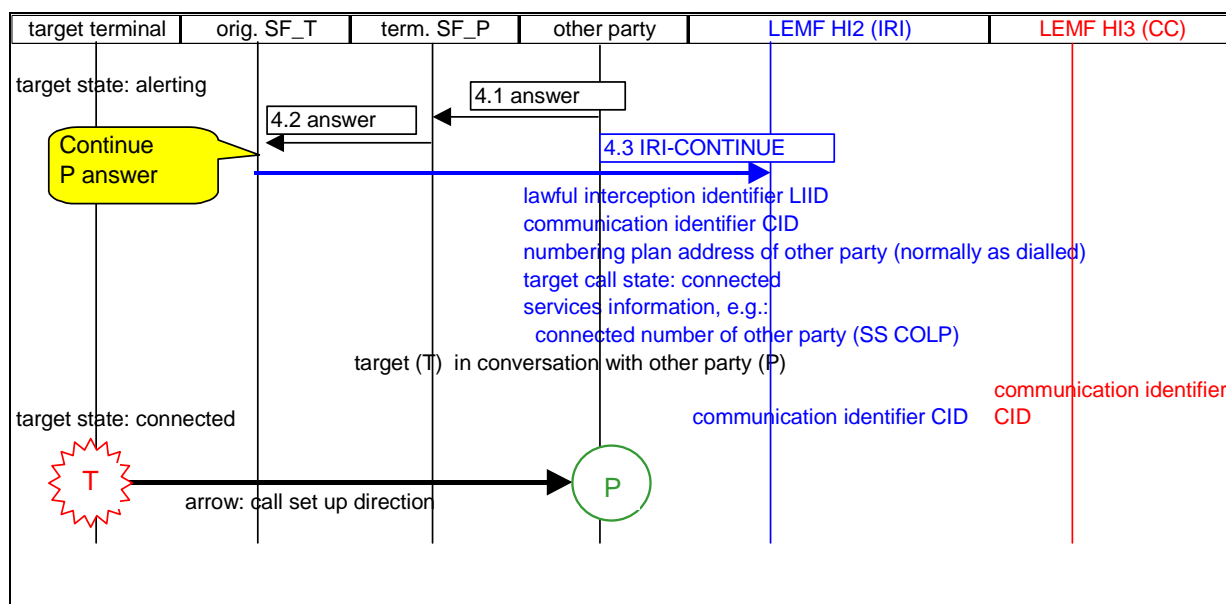

Figure 5.2: Answer by other party (terminating party P)

**Table 5.2: IRI-CONTINUE record content during call establishment, answer indication received**

<b>IRI - CONTINUE record</b>	
<b>parameter name</b>	<b>remarks/parameter details</b>
communicationIdentifier	Communication Identifier of originating target call
timeStamp	at reception of answer indication by target exchange
nature-Of-The-intercepted-call	gSM/ISDN/PSTN-circuit-call
intercepted-Call-State	connected
SimpleIndication	only for targets, e.g. call-Waiting-Indication (call is waiting at terminating target)
partyInformation	party-Qualifier: originating-Party services-Information: BC/HLC/LLC (if different from value in IRI-BEGIN record) supplementary-Services-Information (new information, as available)
partyInformation	party-Qualifier: terminating-Party calledPartyNumber (only if "other party": full number of other party) supplementary-Services-Information (new information, as available, e.g. connected number (see note 2), connected subaddress, generic notification indicator)
lawfulInterceptionIdentifier	identifying the LI activation (LIID)
callContentLinkInformation	callActive (normal case)
NOTE 1: This table relates to both cases, a target being originating or terminating party.	
NOTE 2: In case of a terminating target, the connected number is only included, if it is not equal to the target identity.	

### 5.4.5 Call release (originating or terminating target)

In case of an unsuccessful call, an IRI-END Record is sent if an IRI-BEGIN record has previously been sent. If a target call is released before sending an IRI-BEGIN record, an IRI-REPORT record is sent instead, see clause 5.15.

NOTE 1: Figure 5.3 does not show the detailed DSS1 or ISUP release sequences.

NOTE 2: The exact point of sending the IRI-END record may depend on national regulations, and on the implementation of the IIF. It may, for example in case of DSS1, be sent immediately when receiving or sending the RELEASE message, or when sending or receiving RELEASE COMPLETE.

The IRI-END Record is also applicable if the released call was a call, for example, forwarded or transferred by the target.

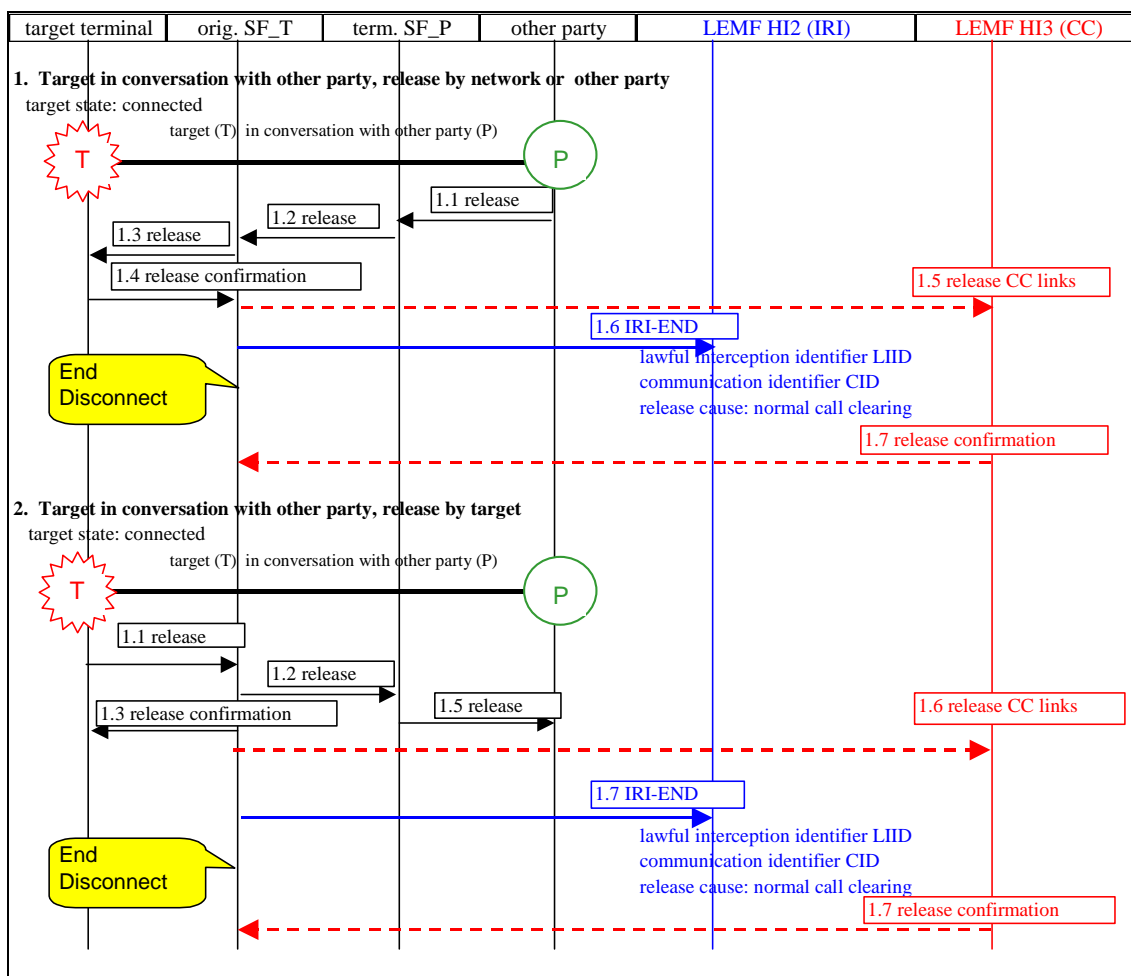

Figure 5.3: Call released, release started by target or other party/network

Table 5.3: IRI-END record for call released by target or by the network

IRI - END record	
parameter name	remarks/parameter details
LawfulInterceptionIdentifier	identifying the LI activation (LIID)
CommunicationIdentifier	Communication Identifier of originating target call
TimeStamp	at reception of release indication by target exchange
nature-Of-The-intercepted-call	gSM/ISDN/PSTN-circuit-call
Intercepted-Call-Direct	originating-Target/terminating-Target
intercepted-Call-State	idle
PartyInformation	party-Qualifier: originating-Party supplementary-Services-Information (new information, as available)
PartyInformation	party-Qualifier: terminating-Party supplementary-Services-Information (new information, as available)
release-Reason-Of-Intercepted-Call	cause value as received from signalling
CallContentLinkInformation	callReleased, release-Time, release-Reason
NOTE: This table relates to both cases, a target being originating or terminating party.	

## 5.5 Terminating target, basic call

### 5.5.1 Initial LI procedure

This is the procedure until the point in time when the local exchange of the target (target exchange) sends an IRI-BEGIN record, and sets up a CC link.

The IRI-BEGIN record constitutes the first record of an originating or terminating call.

NOTE: The exact point of sending the IRI-BEGIN record may depend on national regulations, and on the implementation of the IIF. It may for example be sent immediately when determining the target, as shown below, or only when the call set up has been confirmed. Irrespective of the point in time of sending the IRI-BEGIN record, it shall be possible to send an IRI-REPORT record if a call is released at an earlier point in time.

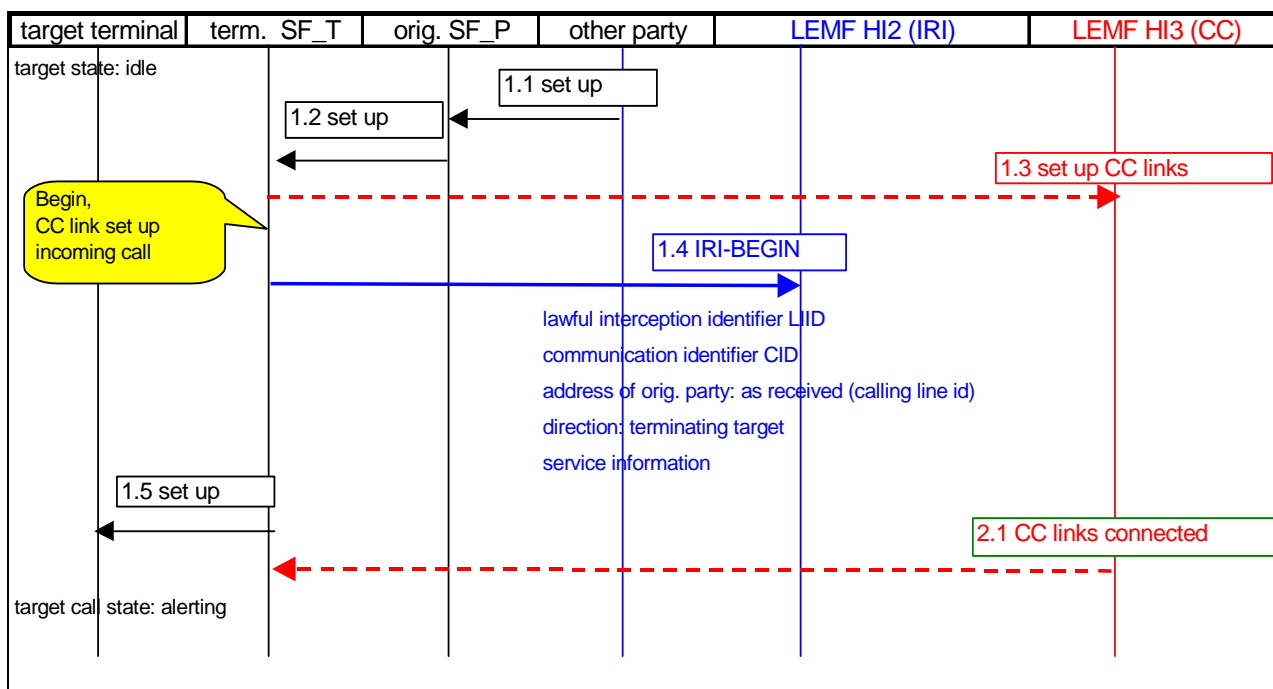

Figure 5.4: Start of call terminating at target

Table 5.4 includes possible parameters in the IRI-BEGIN record, including several parameters for supplementary services.

**Table 5.4: IRI-BEGIN record for call terminating at target**

IRI - BEGIN record	
parameter name	remarks/parameter details
lawfullInterceptionIdentifier	identifying the LI activation (LIID)
communicationIdentifier	Communication Identifier of originating target call
timeStamp	at reception of set up request at local exchange, term. side
nature-Of-The-intercepted-call	gSM/ISDN/PSTN-circuit-call
intercepted-Call-Direct	terminating-Target
intercepted-Call-State	setUpInProgress
partyInformation	party-Qualifier: originating-Party callingPartyNumber (as received, if available) services-Information: BC/HLC/LLC (as available) supplementary-Services-Information (as available/received, e.g. call forwarding related information), subaddress, CUG, generic number)
partyInformation	party-Qualifier: terminating-Party supplementary-Services-Information (as available, e.g. subaddress)
callContentLinkInformation	setUpInProgress

The record is sent at a set up request to the target, when it has been determined. In addition to the basic call parameters, several parameters for supplementary services are indicated in table 5.4. The record constitutes the first record of a terminating target call.

The BC, HLC and LLC parameters are in the case of an incoming ISUP call mapped from the USI parameter, if available. Otherwise, the TMR parameter is used. This corresponds to the normal procedure for mapping of ISUP to DSS1.

If the incoming call is a forwarded call, the parameters related to the previous forwarding(s) are included in the originating party information.

After reception of the confirmation that the CC link has been answered, the CC link state changes to the value "callActive".

Cases in which the target invokes call forwarding immediate (for example CFU) are part of clause 5.7.2, figure 5.7. If CF after determination of the target access (for example CFNR) is active, the record as defined here is sent. Before forwarding takes place, an IRI-END Record indicates the end of this first call section, and a new IRI transaction is started for the forwarded call, see clause 5.7.2, figure 5.8.

## 5.5.2 Answer by target

For a basic call, the first IRI-CONTINUE record is sent at reception of the Answer or Connect indication from the target.

Record content: See table 5.2.

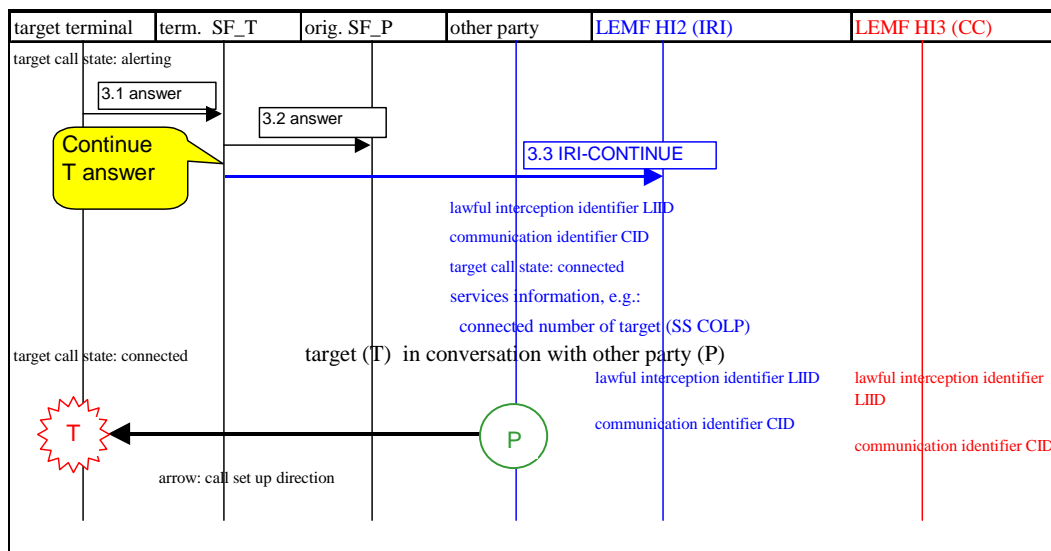

Figure 5.5: Terminating call to target, answer by target

## 5.5.3 Call release

See clause 5.4.5.

## 5.6 Originating target call, invocation of LI relevant services

Several services are mentioned in the clauses on basic originating target calls. In this clause specific services are considered which are of major significance for LI.

### 5.6.1 Call forwarded by called party

If the called party (P1) invokes call forwarding (CF) to a party P2, the related information (*redirection number* and *call diversion information*) is reported within an IRI-CONTINUE record, see figure 5.6. It is sent at reception of the backward information that call forwarding to P2 takes place at P1, for example in case of the ISUP after receiving ACM at the exchange of target T. The other records and the CC link set up are identically to a basic call.

If the call is forwarded further by party P2, for this forwarding hop additional IRI-CONTINUE records are generated, with the same forwarding-relevant parameters. In the case of ISUP signalling, the information is received by the target exchange within CPG messages.

The scenario in figure 5.6 starts from the state when the target exchange receives the information that P1 forwards the call.



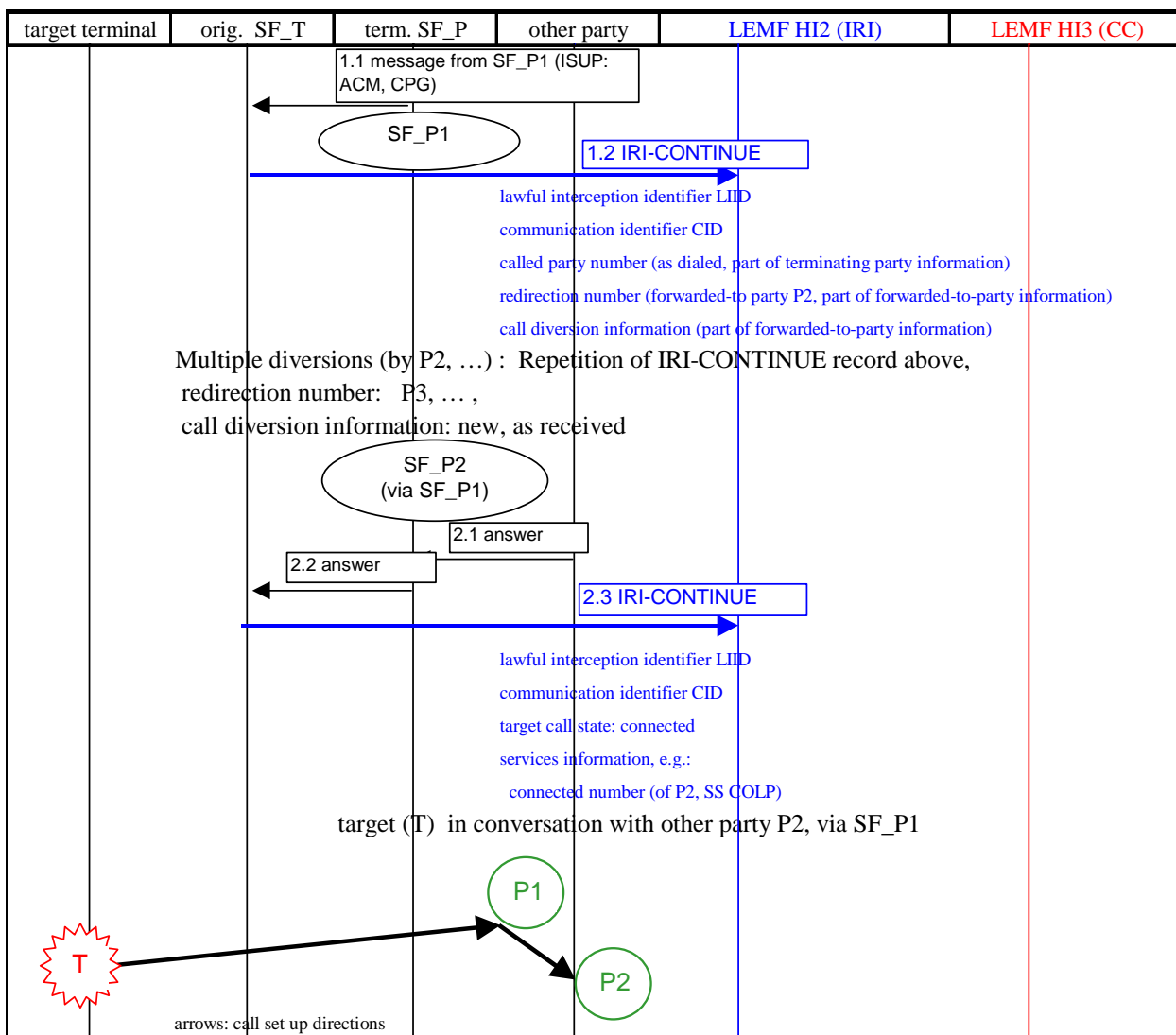

Figure 5.6: Originating call from target, forwarded by called party P1 to party P2

Table 5.5: IRI-CONTINUE record (1.2 in figure 5.6), call from target forwarded by called party P1

IRI - CONTINUE record	
parameter name	remarks/parameter details
lawfullInterceptionIdentifier	identifying the LI activation (LIID)
communicationIdentifier	Communication Identifier of originating target call
timeStamp	at reception of answer indication by target exchange
nature-Of-The-intercepted-call	gSM/ISDN/PSTN-circuit-call
intercepted-Call-State	setUpInProgress
partyInformation	party-Qualifier: originating-Party may be missing, if no new information is available.
PartyInformation	party-Qualifier: terminating-Party calledPartyNumber (full number of called party P1) supplementary-Services-Information (new information, as available)
PartyInformation	party-Qualifier: forwarded-to-Party supplementary-Services-Information: redirection number, call diversion information
callContentLinkInformation	callActive (normal case)

## 5.7 Terminating target call, invocation of LI relevant services

Several services are mentioned in the clauses on basic originating target calls. In this clause, specific services are considered which are of major significance for LI.

### 5.7.1 Terminating call at target is a forwarded call

See clause 5.5.1.

### 5.7.2 Call forwarded by target

Cases of immediate call forwarding, without accessing the target's terminal (for example CFU, CFB-NDUB):

- The first record related to the call is an IRI-BEGIN record. It contains within the PartyInformation of the forwarded-to-party the CF-relevant information (*redirection number, redirection information*), see figure 5.7.

Cases of call forwarding after accessing the target's terminal (for example CFNR, CD, Partial Rerouting, CFB-UDUB):

- A LI transaction (CC links, IRI records) has already been established. It is released, and simultaneously with the release of the call to the target, an IRI-END Record is sent, see figure 5.8.
- The call diversion procedure leads to a new LI transaction, with an IRI-BEGIN record as specified above, for immediate forwarding.

The connected line identity (COL-parameter) may be received in the standard way from the final destination of the call within the answer (or connect) message. It is included in the related IRI-CONTINUE record.

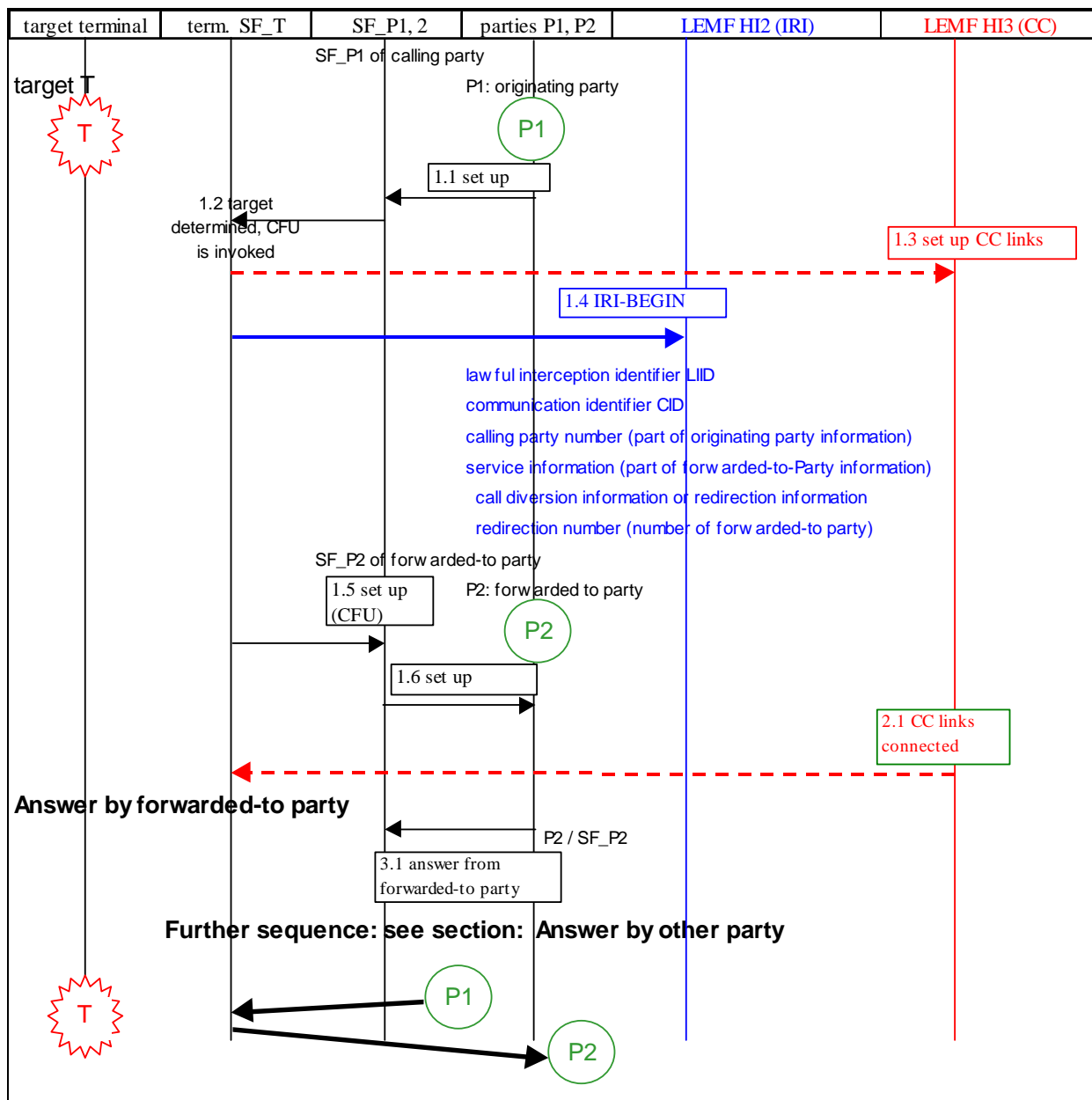
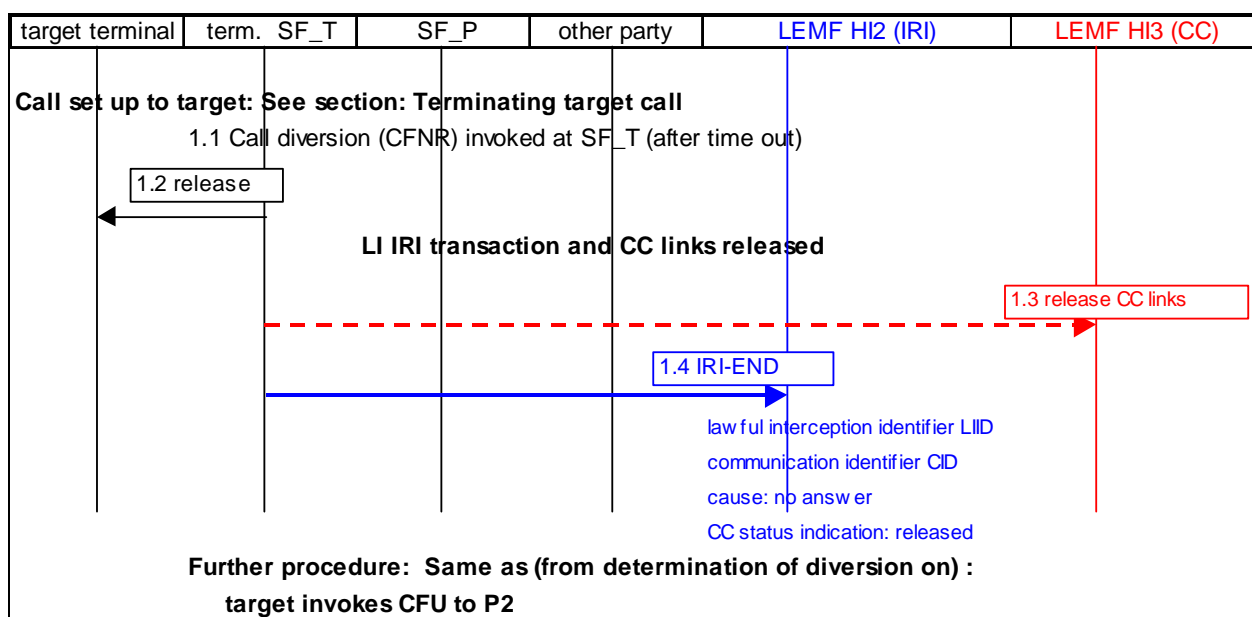

Figure 5.7: Target invokes call forwarding unconditional (CFU) to a party P2

Table 5.6 includes parameters in the IRI-BEGIN record. The call forwarding related information is part of the forwarded-to-Party information. The parameter "original called number" shall not be included if it is identical to the target identity.

**Table 5.6: IRI-BEGIN record (1.4 in figure 5.7) for call forwarded immediately by target**

IRI - BEGIN record	
parameter name	remarks/parameter details
lawfulInterceptionIdentifier	identifying the LI activation (LIID)
communicationIdentifier	Communication Identifier of originating target call
timeStamp	at reception of set up request at local exchange, term. side
nature-Of-The-intercepted-call	gSM/ISDN/PSTN-circuit-call
intercepted-Call-Direct	terminating-Target
intercepted-Call-State	setUpInProgress
partyInformation	party-Qualifier: originating-Party (Party P1) callingPartyNumber (as received, if available) services-Information: BC/HLC/LLC (as available) supplementary-Services-Information (as available/received, e.g. call forwarding related information), subaddress, CUG, generic number)
partyInformation	party-Qualifier: terminating-Party (target T) supplementary-Services-Information (as available, e.g. subaddress)
partyInformation	party-Qualifier: forwarded-to-Party (Party P2) supplementary-Services-Information: redirection number, call diversion information, ...
callContentLinkInformation	setUpInProgress



**Figure 5.8: Target invokes call forwarding on no reply (CFNR) to a party P2**

### 5.7.3 Target invokes Call Waiting (CW)

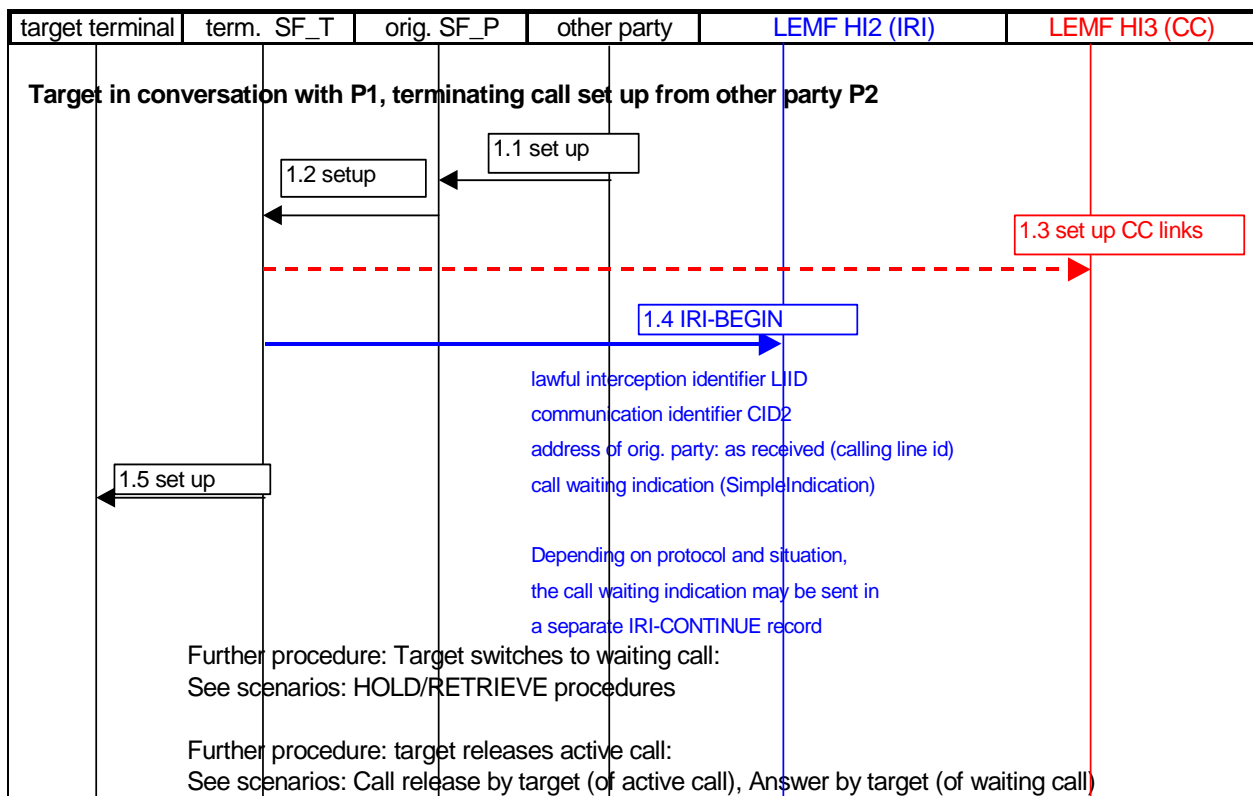

**Figure 5.9: Terminating target call, Call Waiting invoked by target**

## 5.8 Target actions during a call in progress

Several kinds of actions, which a target may perform during a call, are reported via the parameter *SimpleIndication*. In general, an IRI-CONTINUE record shall be generated when one of the reportable actions is detected. The scenarios below illustrate the actions HOLD and RETRIEVE.

### 5.8.1 Call HOLD by target

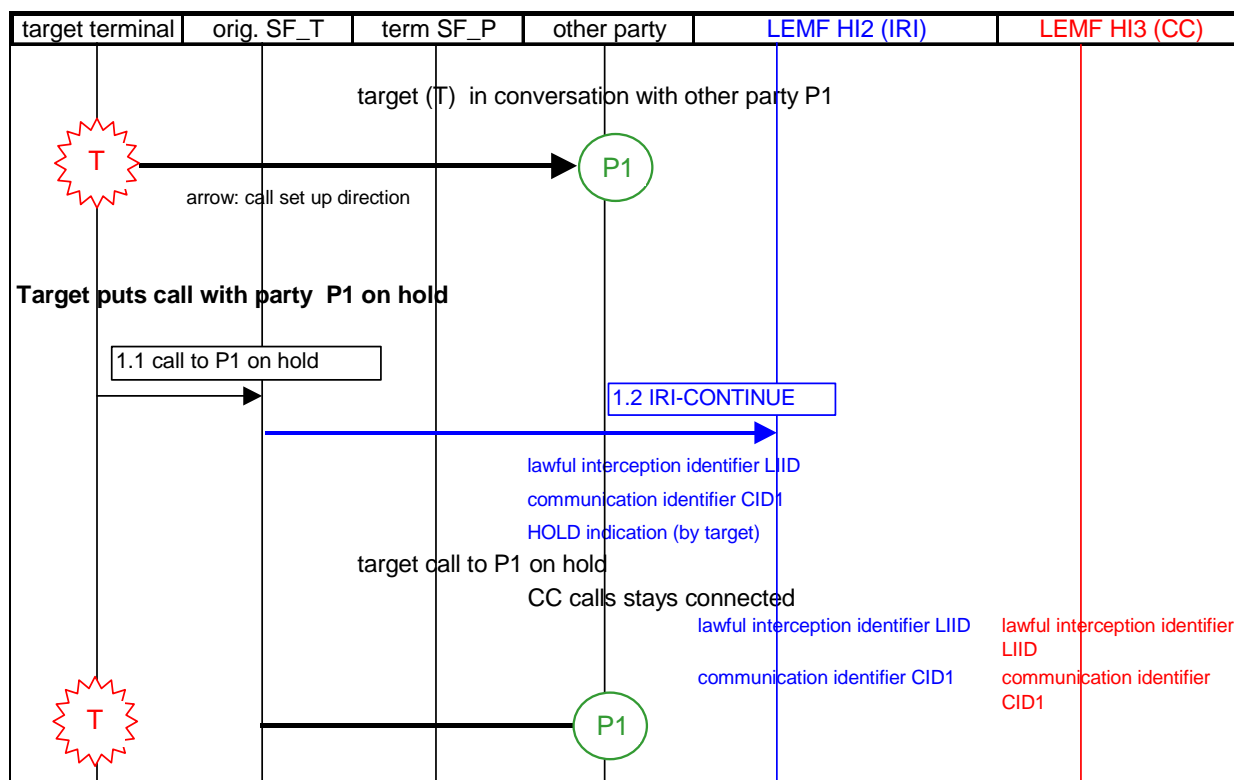

Figure 5.10: Target puts a call on hold

Further actions of the target within the held state are described in other clauses. For example, the set up of an additional call leg is treated similarly to the set up of a call from the idle state, see clause 5.4 and ES 201 671 [1] related to CC link options A/B (CC links for all calls/only for actually active calls).

### 5.8.2 Call RETRIEVE by target

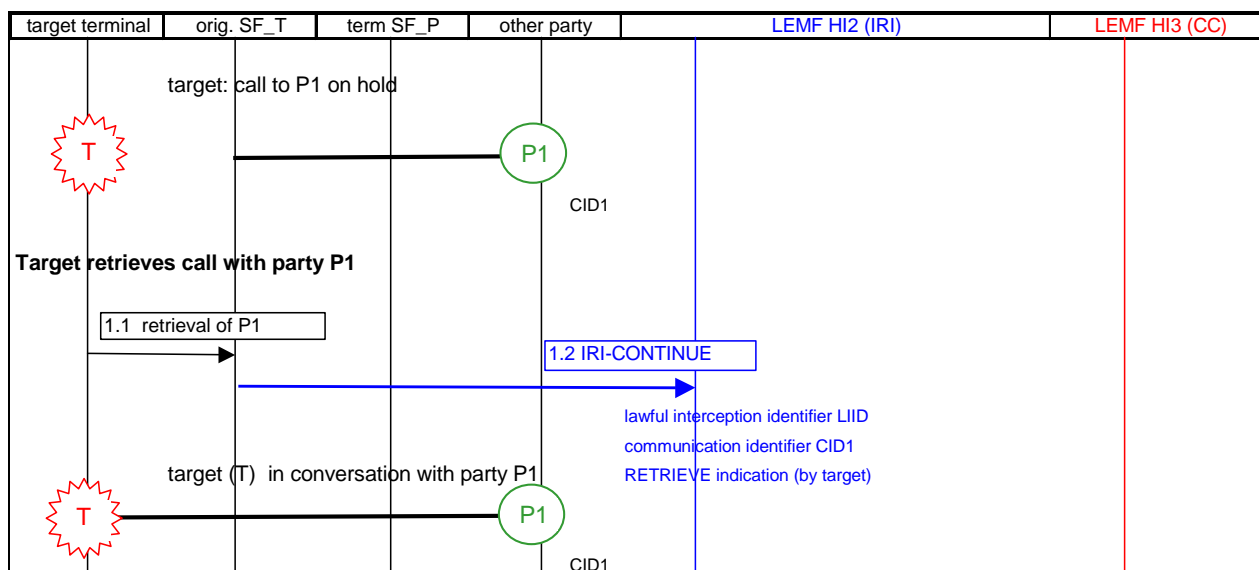

Figure 5.11: Target retrieves a held call

In case of CC link option B ("CC links only for actually active calls"), the CCLID value of the Communication Identifier shall point to the CC link which is used by the retrieved call leg.

## 5.9 Three Party Service (3PTY)

This clause describes procedures which may appear during the use of the 3PTY service. Emphasis is on those actions which are specific to the 3PTY service. With respect to proceeding of succeeding actions, which are identical to basic procedures (including HOLD and RETRIEVE), an according reference is given.

The 3PTY specific actions are in general reported within IRI-CONTINUE records. The parameter *partyInformation* related to the target (originating or terminating party) contains within its *supplementary-Services-Information* parts the relevant information.

The figures are based on the 3PTY service as defined for ISDN DSS1 users, including the operations of the functional protocol. The corresponding actions of other protocols, for example analogue or ISDN keypad users, shall be mapped to the DSS1 functional protocol operations, unless another ETSI standardized protocol is used which contains corresponding operation definitions (such as the GSM protocols). The Communication Identifiers CID1, 2 map to the DSS1 call references CR1, 2.

### 5.9.1 Target establishes Three Party Conference (3PTY)

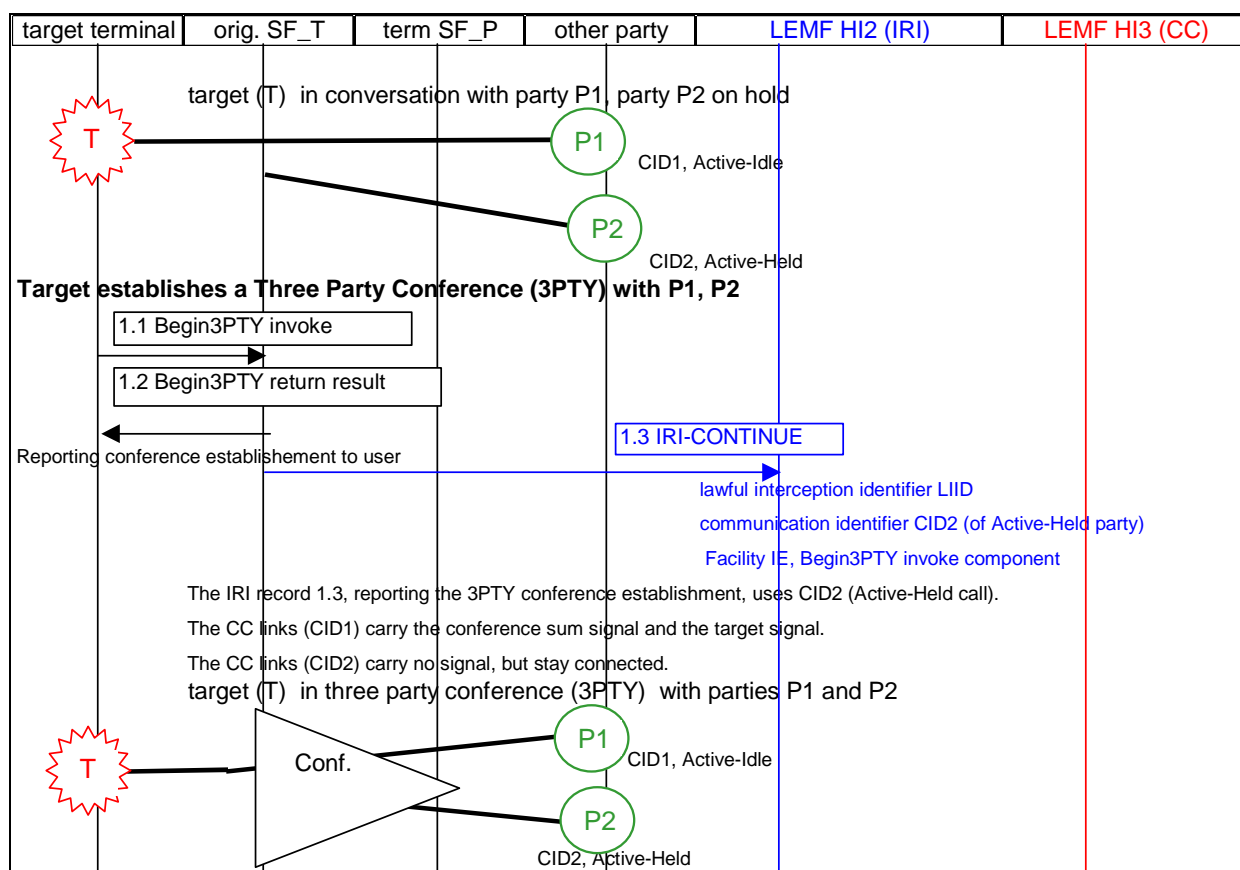

Figure 5.12: Target establishes a Three Party Conference with parties P1, P2

### 5.9.2 Target: Private communication with Active-Idle party

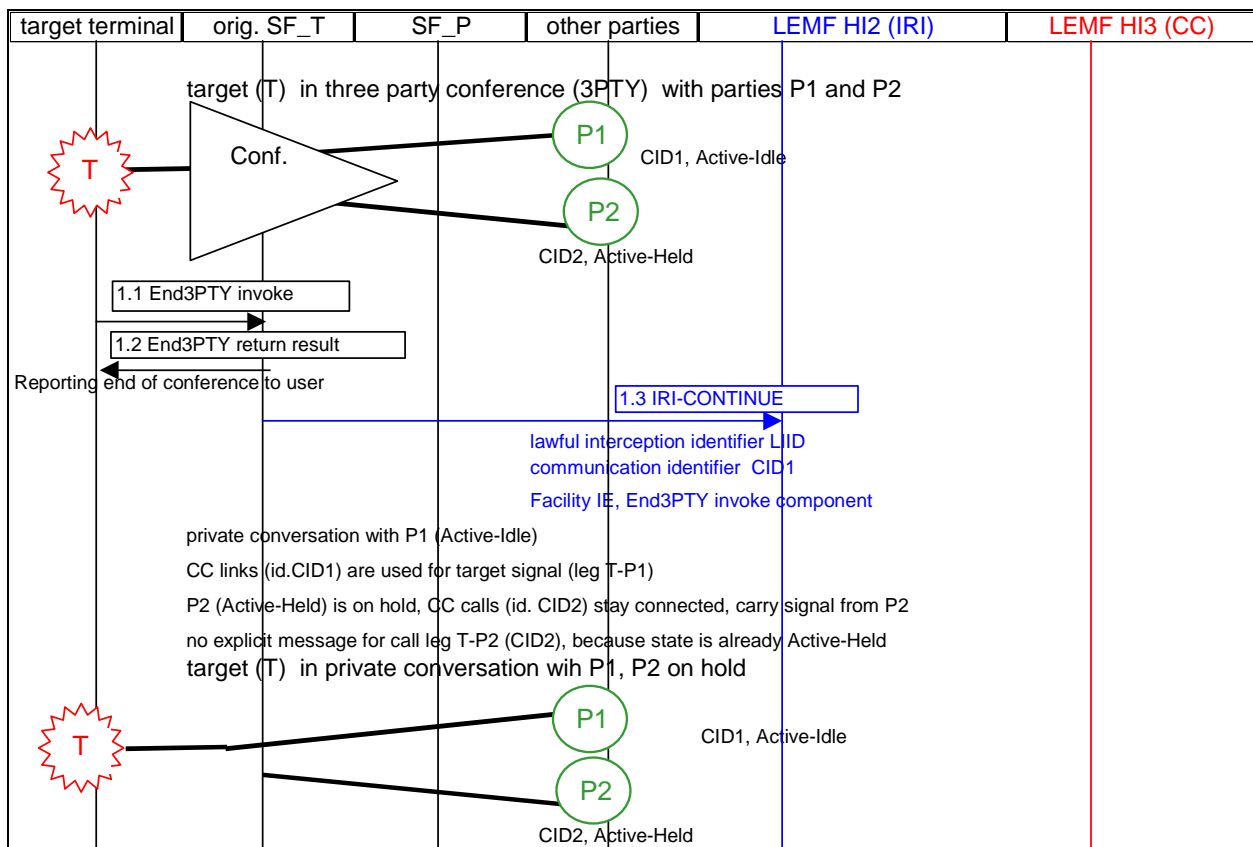

Figure 5.13: 3PTY service, target switches to a private conversion with the Active-Idle party (P1)

### 5.9.3 Target: Private communication with Active-Held party

In principle, the same scenario as above for a private communication with the Active-Idle party applies. The Communication Identifier for the appropriate call leg, CID2, is used. After this procedure, a state reversal takes place: P1 becomes the Active-Held party, P2 becomes the Active-Idle party. The related procedures are identical to the procedure "target puts call with P1 on hold", followed by the procedure "target retrieves call with party P2".



### 5.9.4 Release of 3 PTY conference by Active-Held party

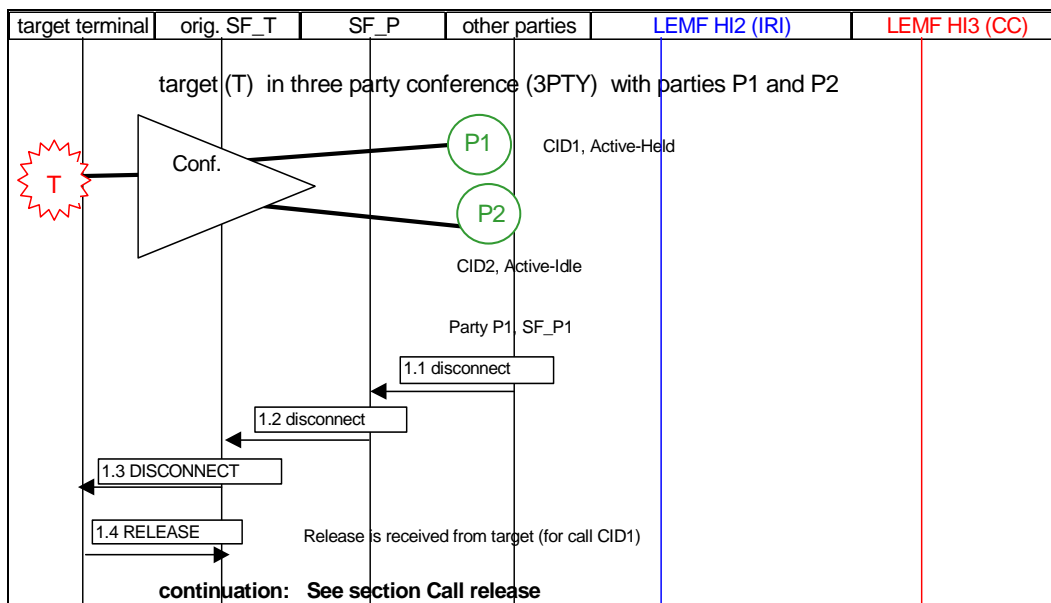

Figure 5.14: 3PTY service, Active-Held party (P1) releases

### 5.9.5 Release of 3 PTY conference by Active-Idle party

In principle, for release by the Active-Idle party (P2), the same scenario as above for release by the Active-Held party applies. After this procedure, a state change takes place: P1 becomes the Active-Idle party. The related procedure is identical to the procedure "target retrieves call with party P1".

## 5.10 Add on conference (CONF)

This clause describes procedures which may appear during the use of the add on conference service (CONF). Emphasis is on those actions which are specific to the CONF service. With respect to preceding or succeeding actions which are identical to basic procedures (including HOLD and RETRIEVE), an appropriate reference is given.

The CONF specific actions are in general reported within IRI-CONTINUE records. The parameter *partyInformation* related to the target contains within its *supplementary-Services-Information* parts the relevant information.

In the following clauses the term "remote user" is used below for the conferee, i.e. the passive conference participant.

The text and figures are based on the CONF service as defined for ISDN DSS1 users, including the operations of the functional protocol. The corresponding actions of other protocols, for example analogue or ISDN keypad users, shall be mapped to the DSS1 functional protocol operations, unless another ETSI standardized protocol is used which contains corresponding operation definitions (such as the GSM protocols). See also clause 5.10.9.

Clauses 5.10.1 to 5.10.7 describe the procedures using option A, i.e. for each call leg, and the connection to the conference device, separate CC links are set up. Clause 5.10.8 describes the differences when using option B.

## 5.10.1 Mapping of PartyId/ConferenceId to Communication Identifiers

The Communication Identifiers of the target call legs which participate in a conference have to be mapped to the PartyIds/ConferenceIds, because in several operations these identities are used by the conference procedures for identification of the remote users.

The mapping of ConferenceId/PartyId to a Communication Identifier is performed using the first message for a call, which acknowledges the request to connect the call to a conference. This is a FACILITY message to the served user (target), containing a facility IE with the *beginCONF return result component* (for the case of beginning a conference from an active call) or the *AddCONF return result component* (for adding a party to an existing conference device) respectively. The call references of these messages identify the call leg, and they can be used as a link to the Communication Identifier.

The call reference of a call leg is released after adding the leg to the conference, but its Communication Identifier (CID1, 2, etc.) shall be kept. The call reference of the first message setting up the conference (containing the *beginCONF invoke component*) is not released. It always maps to the Communication Identifier CID-CONF.

## 5.10.2 Beginning a conference from the Idle call state

For beginning a conference from the Idle call state, a SETUP message is sent by the target (call reference CR-CONF), with a *beginCONF invoke component*. After sending the acknowledgement to the served user (*beginCONF return result component* within a CONNECT message), the *beginCONF invoke component* shall be included in an IRI-BEGIN record. The component shall contain the ConferenceId parameter. A new Communication Identifier value is assigned (CID-CONF), identifying the connection target - conference device (used for the conference sum signal). The reception of the *beginCONF invoke component* by the LEMF indicates the successful CONF establishment. Unsuccessful attempts (resulting at the user access in *return error* or *reject* components) need not to be reported (general principle, see also ES 201 671 [1]).

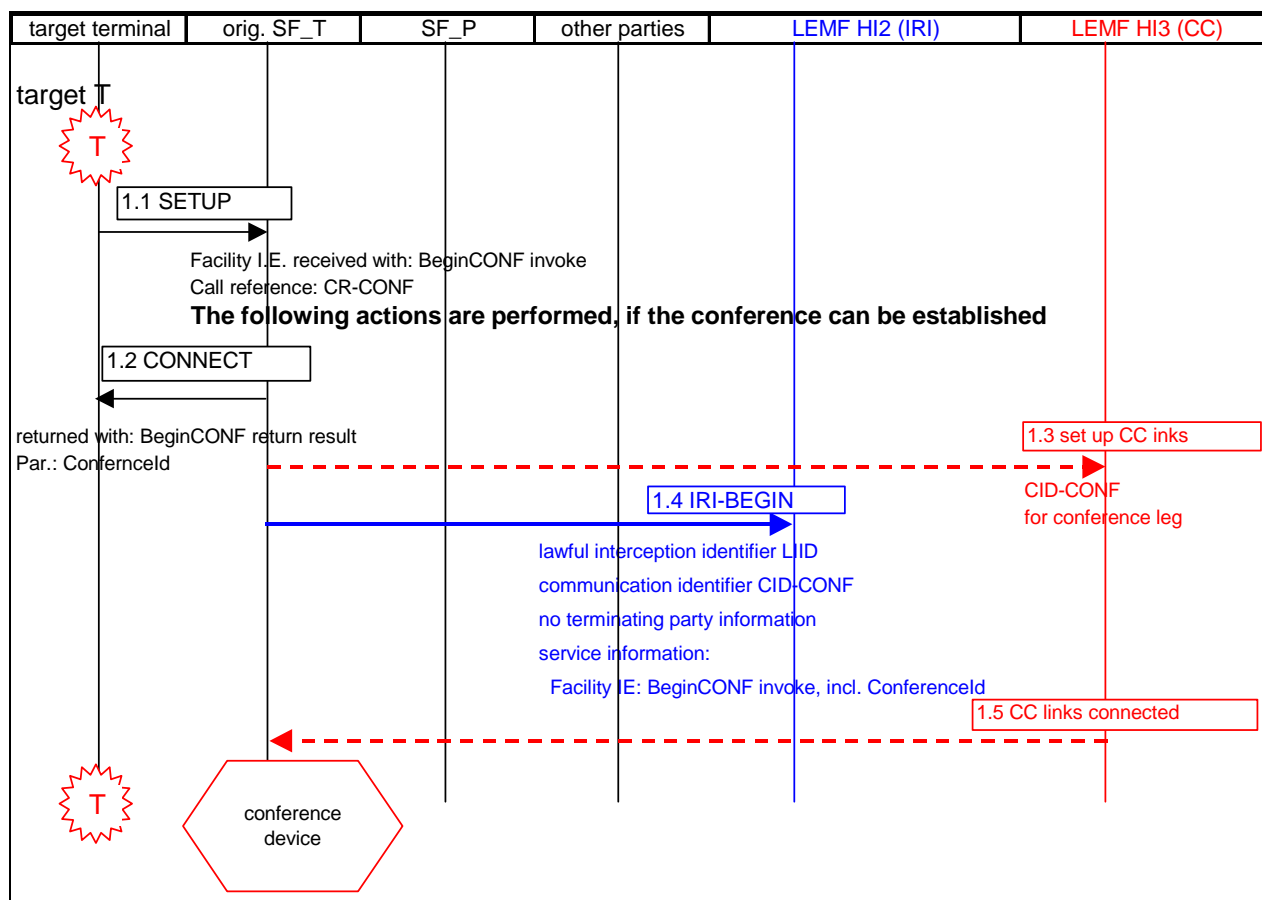

Figure 5.15: Add on conference, target starts conference from the idle call state

### 5.10.3 Beginning a conference from the Active call state

For beginning a conference from the *Active call state*, a FACILITY message with a *beginCONF invoke component* is sent by the target, using the call reference of the active call (CR1). After sending the acknowledgement to the served user, a *beginCONF return result component* within a FACILITY message, the *beginCONF invoke component* shall be included in an *IRI-BEGIN record*. The component shall contain the ConferenceId parameter and the PartyId (P1) of the call leg CID1. A new Communication Identifier value shall be assigned (CID-CONF), identifying the connection target - conference device (used for the conference sum signal).

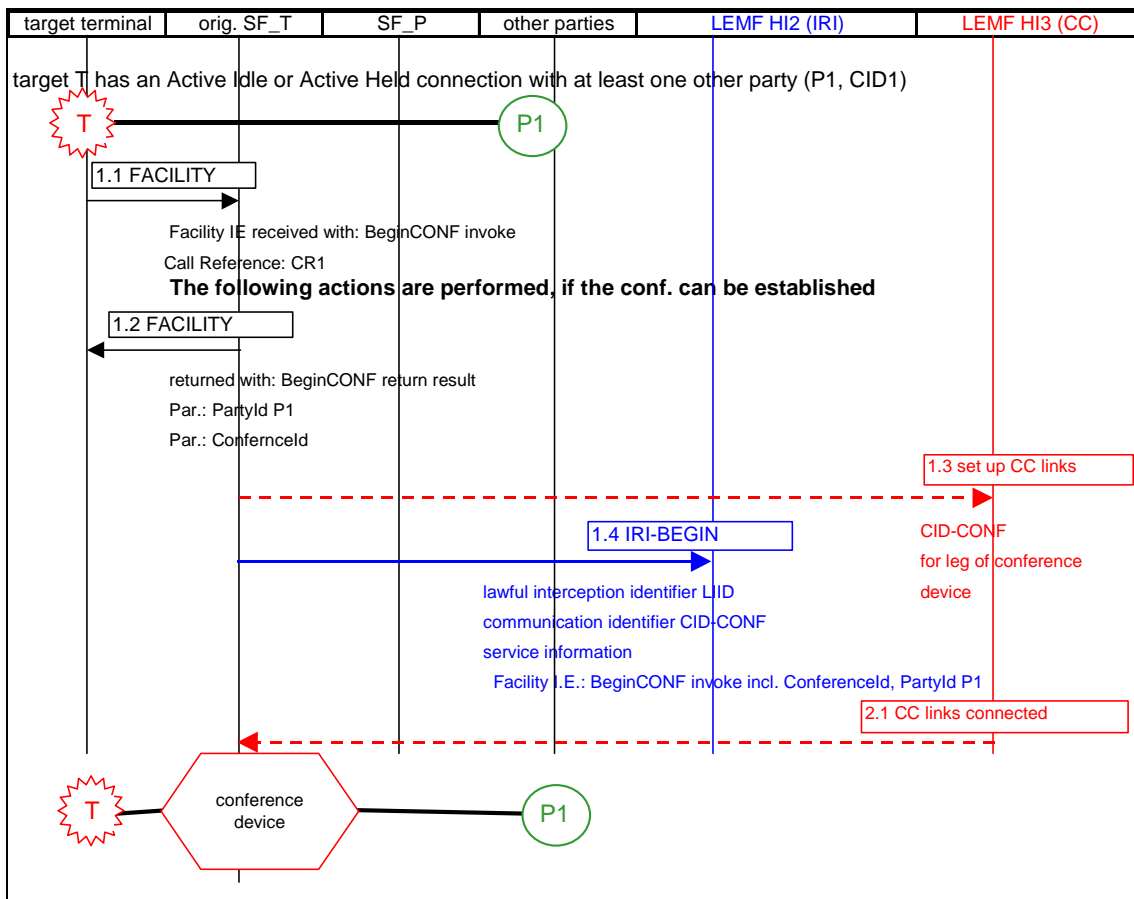

Figure 5.16: Add on conference, target starts conference from the active call state

## 5.10.4 Adding a remote user

For adding a remote user (party x) to an existing conference, a FACILITY message with a *AddCONF invoke component* is sent by the target, using the call reference of the call to be added (CR1). The message includes a *ConferenceId* parameter. The following acknowledgement (a FACILITY message) contains a *beginCONF return result component*, with a *PartyId* parameter. The Communication Identifier for the added call is CID1.

NOTE: After adding the call to the conference, its call reference CR1 is released, but its Communication Identifier CID1 is kept, for use in further records relating to this remote party connection, and to point to the CC links (they are not used while the party is in the conference).

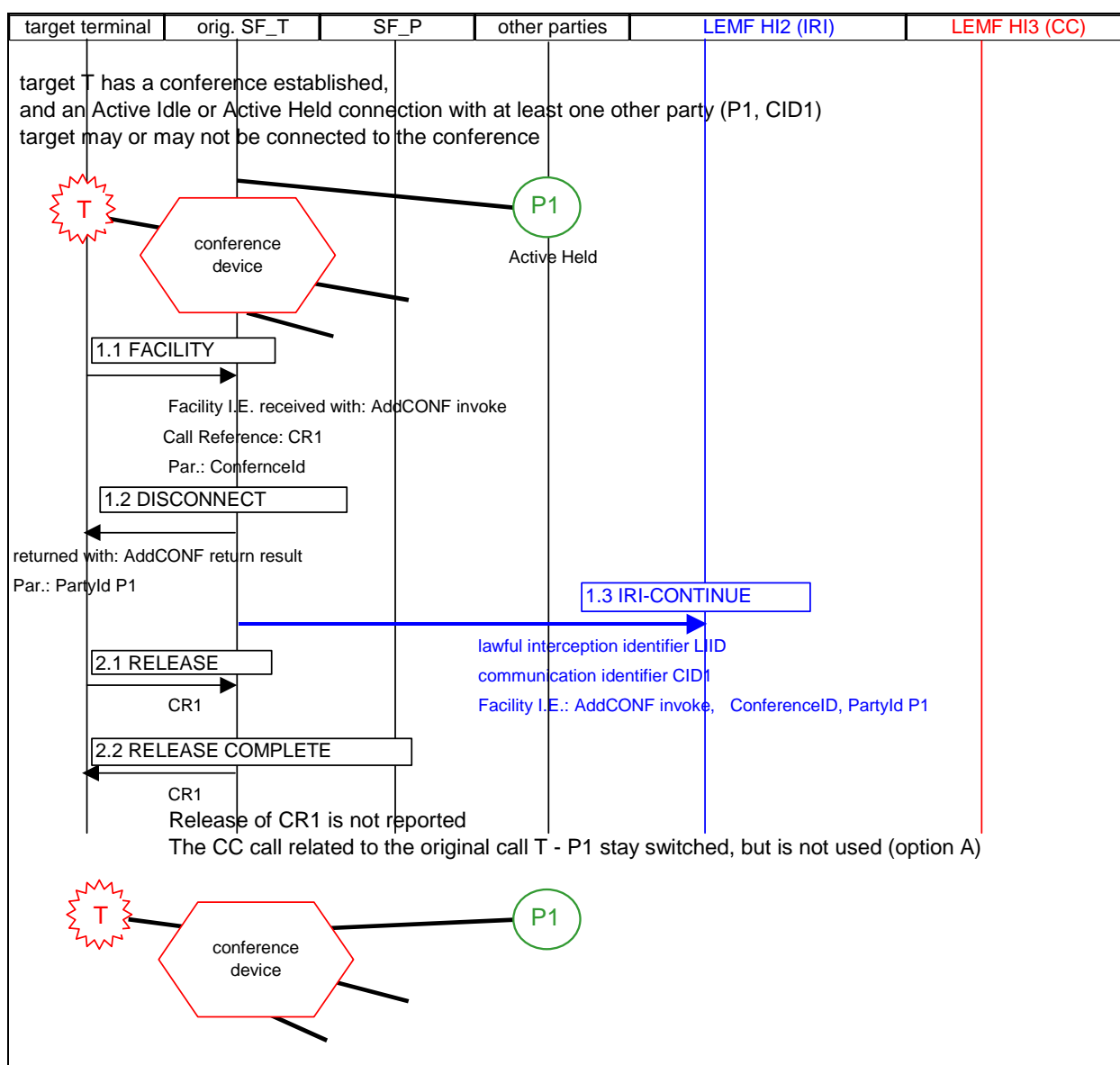

Figure 5.17: Add on conference, target adds a call (remote user) to the conference

### 5.10.5 Splitting a remote user

In case of splitting a remote user and (simultaneously) setting up a private conversation to it, a SETUP message is received from the target, using a new call reference. The message contains a facility IE with a *SplitCONF invoke component*. The remote party is identified by the ConferenceId and PartyId parameters of the invoke component.

A CONNECT message is sent to the target, to confirm the operation. The *SplitCONF invoke component* shall be sent within an IRI-CONTINUE record to the LEMF.

The Communication Identifier value used for the IRI record and the related CC links respectively is the value which has been assigned to this call leg, when the call to the remote party had originally been set up (CID1).

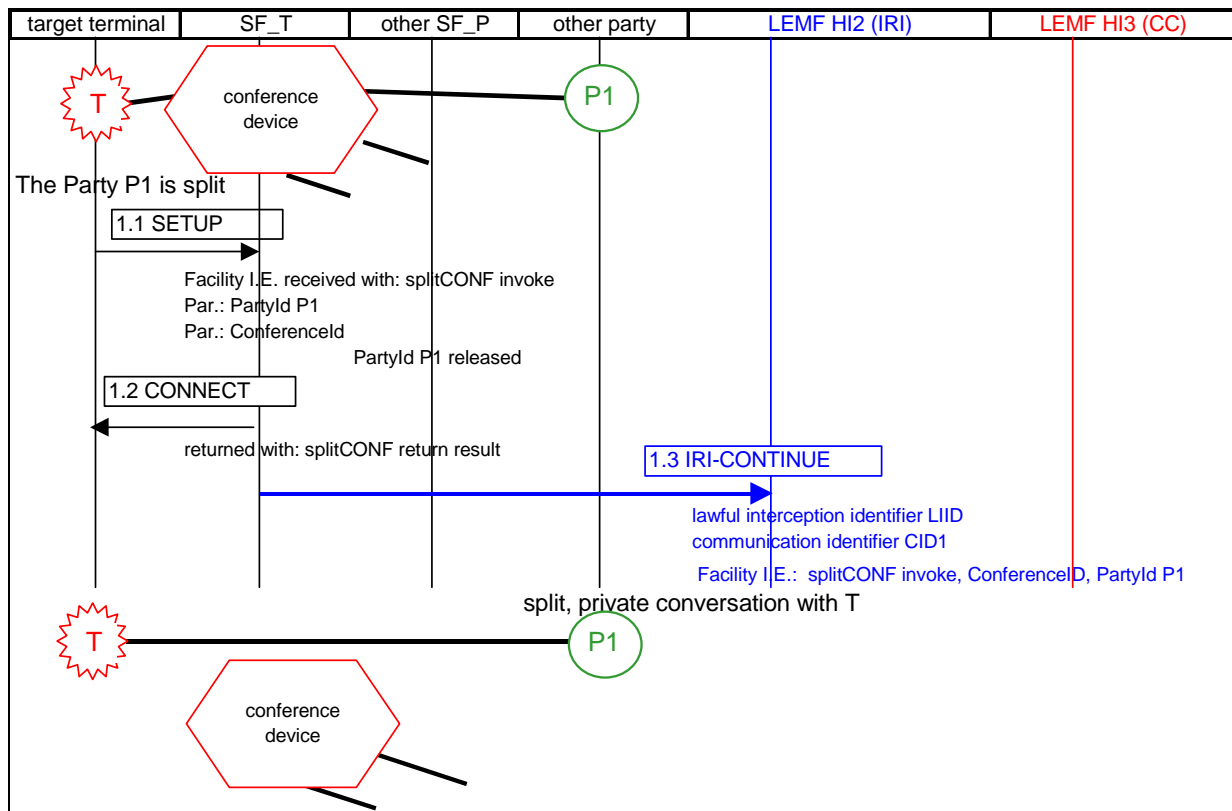

Figure 5.18: Add on conference, target splits a call (remote user) from the conference

### 5.10.6 Further actions during a conference

The actions *isolate*, *reattach*, *split*, *drop* and *remote party disconnected* are reported in IRI-CONTINUE records. The applicable Communication Identifier has to be determined via the PartyId. The figure below illustrates the procedure for isolating a party from the conference.

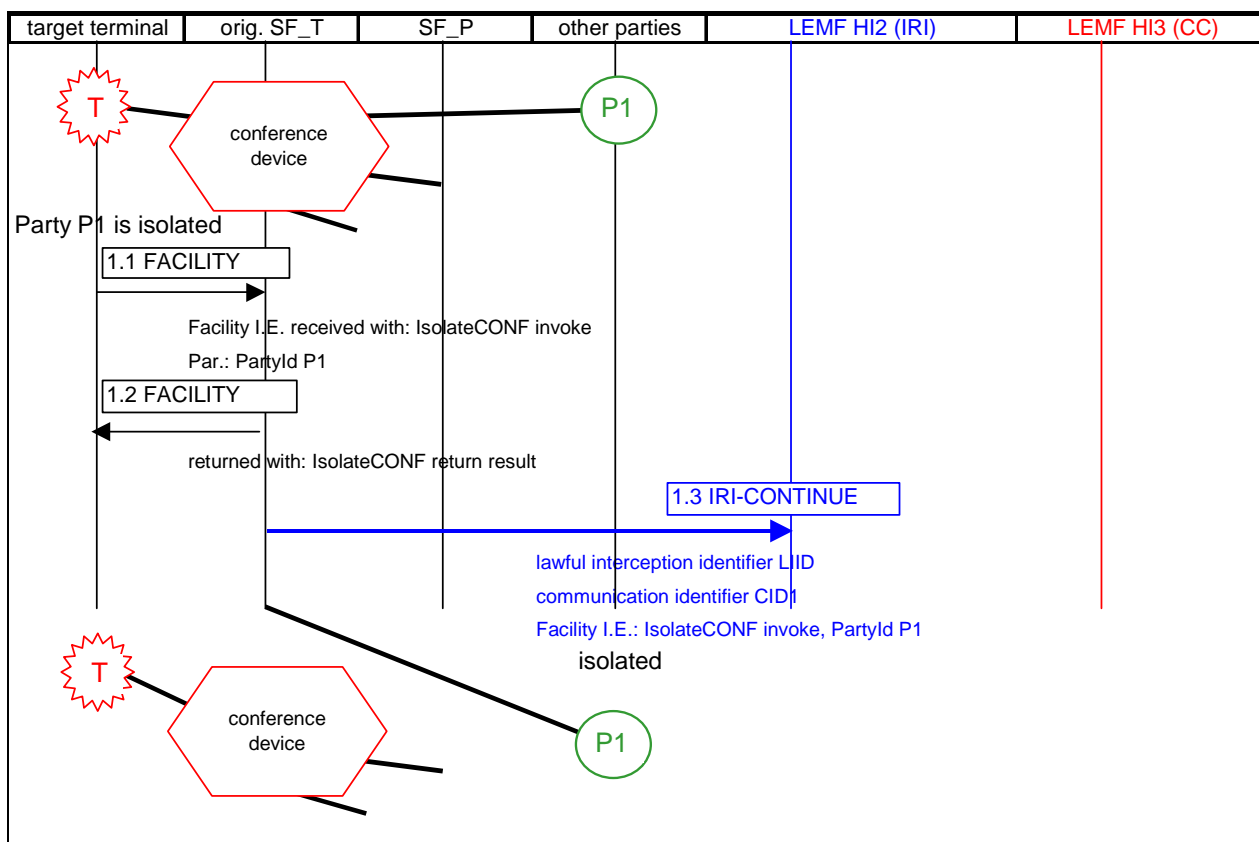

Figure 5.19: Add on Conference, target isolates a call (remote user) from the conference

### 5.10.7 Target clears the conference

The conference device and all call legs are released. Figure 5.20 shows the release of the conference device, the individual call legs are released in the standard way (release initiated by SF\_T).

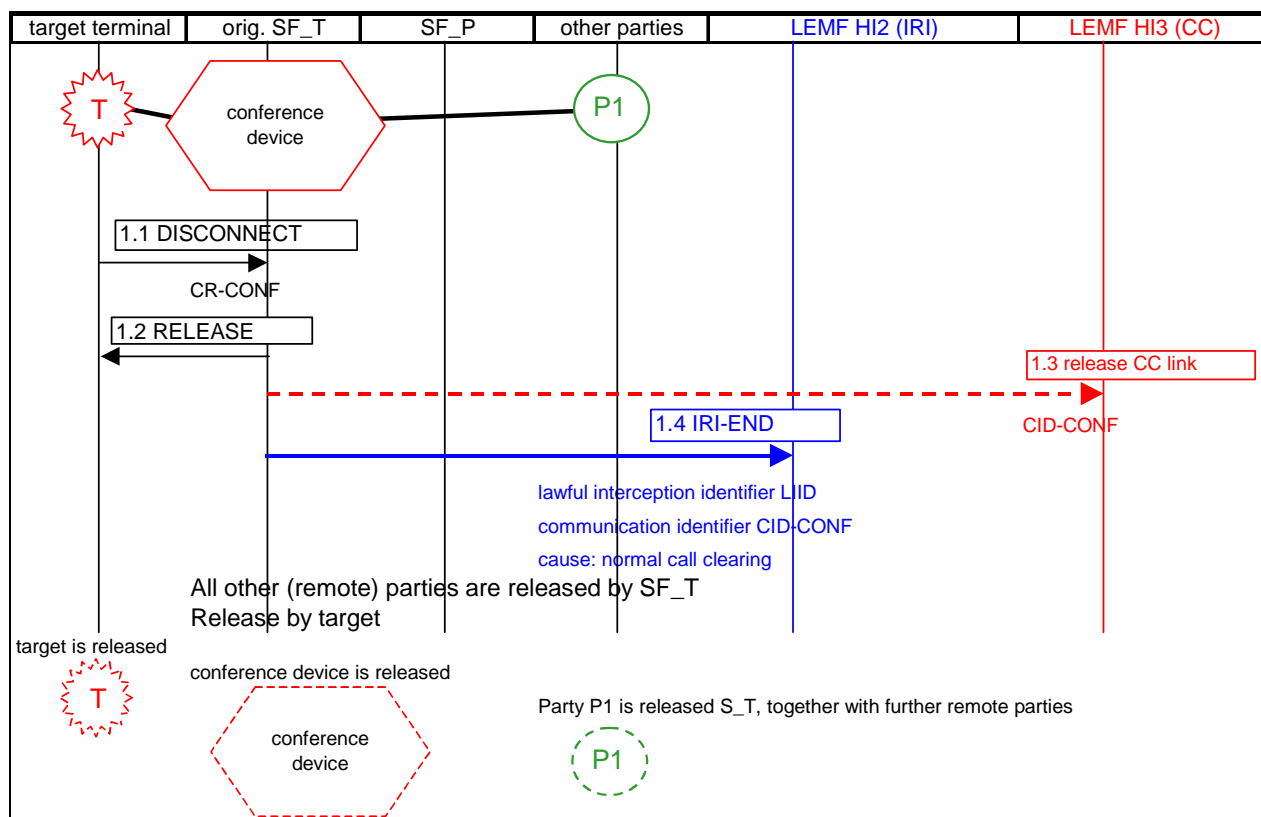

Figure 5.20: Add on conference, target clears the conference

### 5.10.8 Option B (CC link only for active call)

The above clauses assume option A. When using option B, only one CC link is needed. It is established during the beginning of the conference from idle, or reused from an existing active call (beginning from active). The CC links of calls which are added to the conference are released. In case of splitting a party, a new CC link needs to be set up.

In case of an ISDN BA, two CC links may exist, but the second set is only used if two target calls are simultaneously in the Active Idle state (in the conversation phase). This is in general not the case within a conference configuration, but is possible.

### 5.10.9 Add on conference using other protocols

The above clauses assumed the use of the DSS1 functional protocol. For other protocols at the user network interface which also support the add on conference supplementary services, the possible actions are in principle the same, or a subset of the DSS1 functions. The resulting information shall be mapped to the facility information elements of DSS1.

For the DSS1 keypad protocol, the same procedures are available as for the functional protocol.

For analogue users, in general, a conference may only begin from the idle state. The functions isolate, reattach and drop are not applicable.

## 5.11 Target exchange receives notification related to other party

In general, IRI records are applicable for notifications on events related to other parties, which are specified within the service standards to be sent via the ISUP Generic Notification indicator. This applies irrespective of whether or not ISUP is used, for example in purely local calls within the SF\_T.

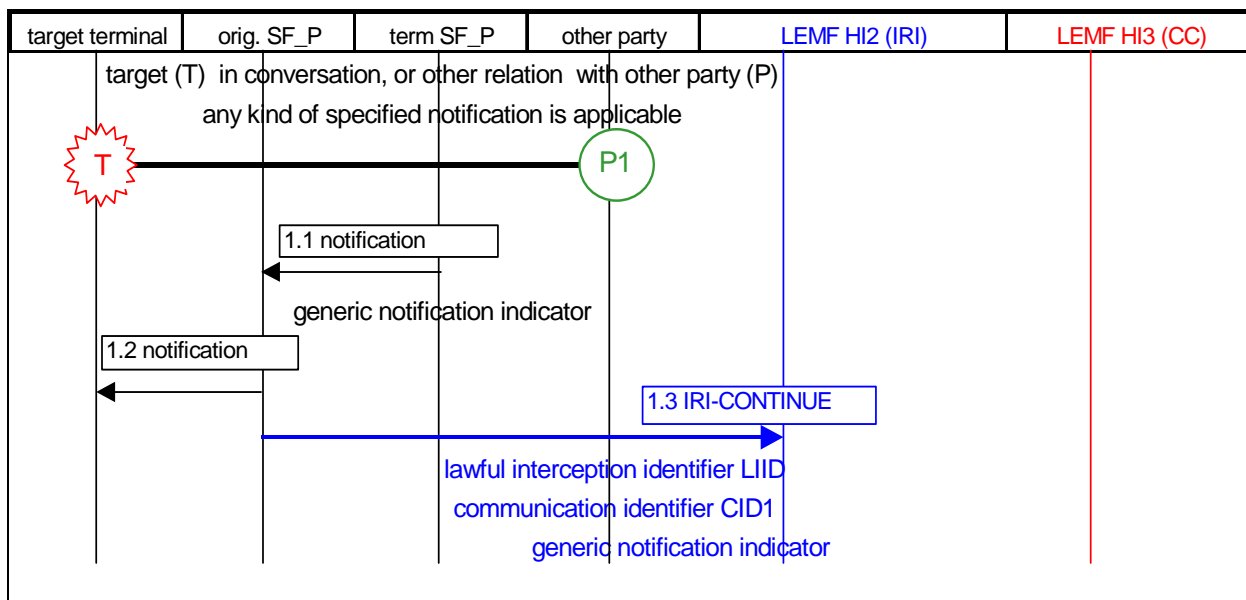

Figure 5.21: Notification received, related to other party

## 5.12 Service activation (not call related)

An IRI-REPORT record is sent after processing the subscriber request.

The IRI-REPORT record 2.2 contains the information which has been received from the target during the activation procedure.

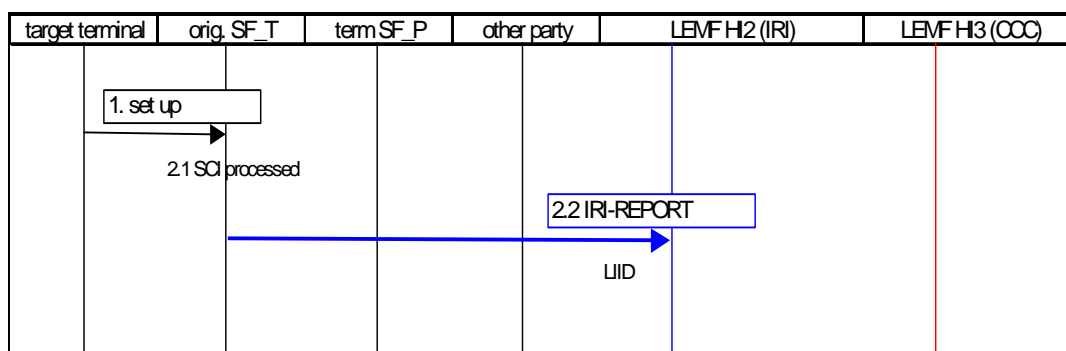

Figure 5.22: Service activation, not related to a call

## 5.13 Service activation/invocation during a call

### 5.13.1 ISDN accesses

Service activation during an existing call constitutes a separate transaction, treated as specified directly above.

Service invocations are actions related to a call. They are treated as parts of that call, i.e. reported, if required, via an IRI-CONTINUE record.



## 5.13.2 Analogue accesses

An attempt to perform a service activation or invocation, while a call is active, starts in general with a hook-flash (recall) signal and optionally a feature activation code. This may lead to putting the active call on hold and setting up a new call or call leg. This event may be reported by an IRI-BEGIN, (-CONTINUE), or -END record transaction.

If the following action is not a new call or call leg set up, but an invocation of a service related to the existing active call (for example invocation of a 3PTY conference), the invocation may be reported, using a new Communication Identifier value, within an IRI-REPORT record.

If an IRI-REPORT is not used, a CC link has already been set up. The CC link may or may not carry DTMF signals generated by the target for the service action. The resulting service action is reported in the specified way within an IRI record which uses, in case of a service invocation, the Communication Identifier of the related call.

## 5.14 Unsuccessful calls from target (originating), IRI-BEGIN record sent

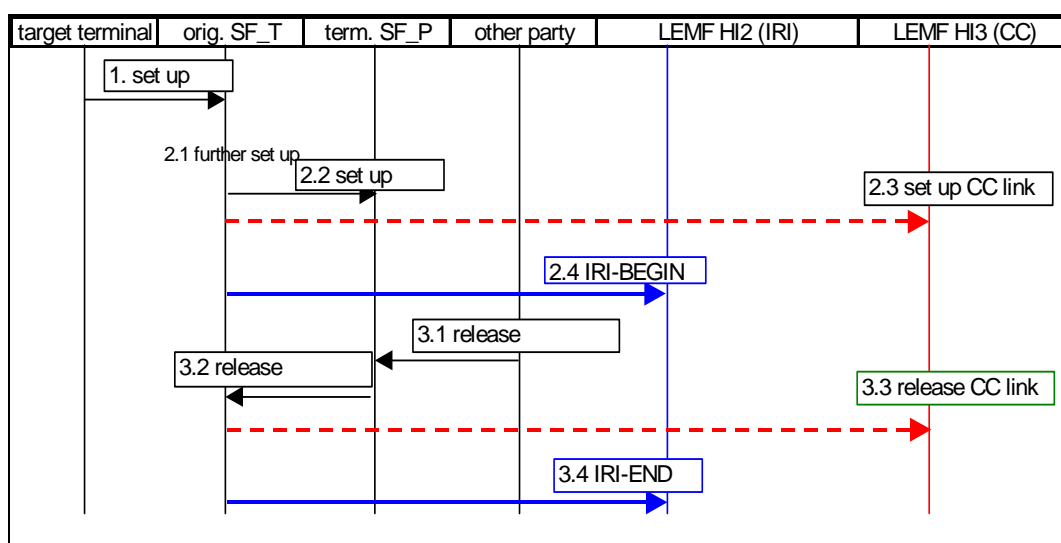

Figure 5.23: Unsuccessful target call, reported by IRI-BEGIN, -END record

## 5.15 Unsuccessful calls from/to target, IRI-BEGIN record not sent

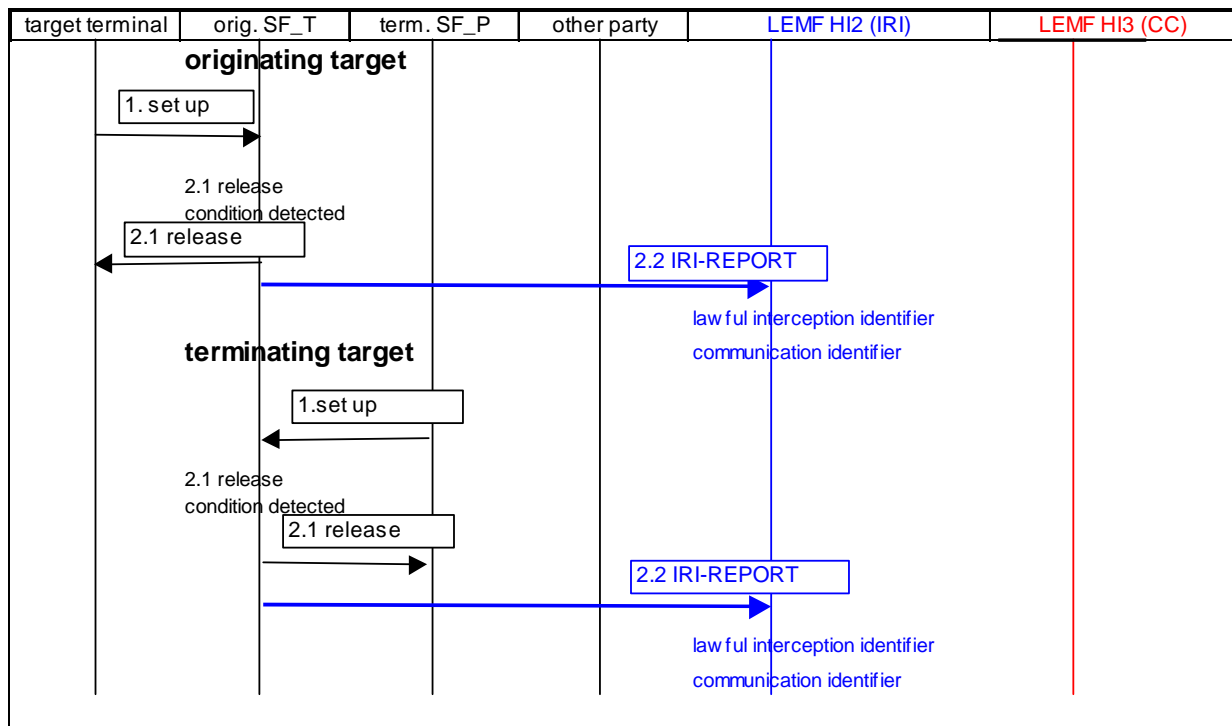
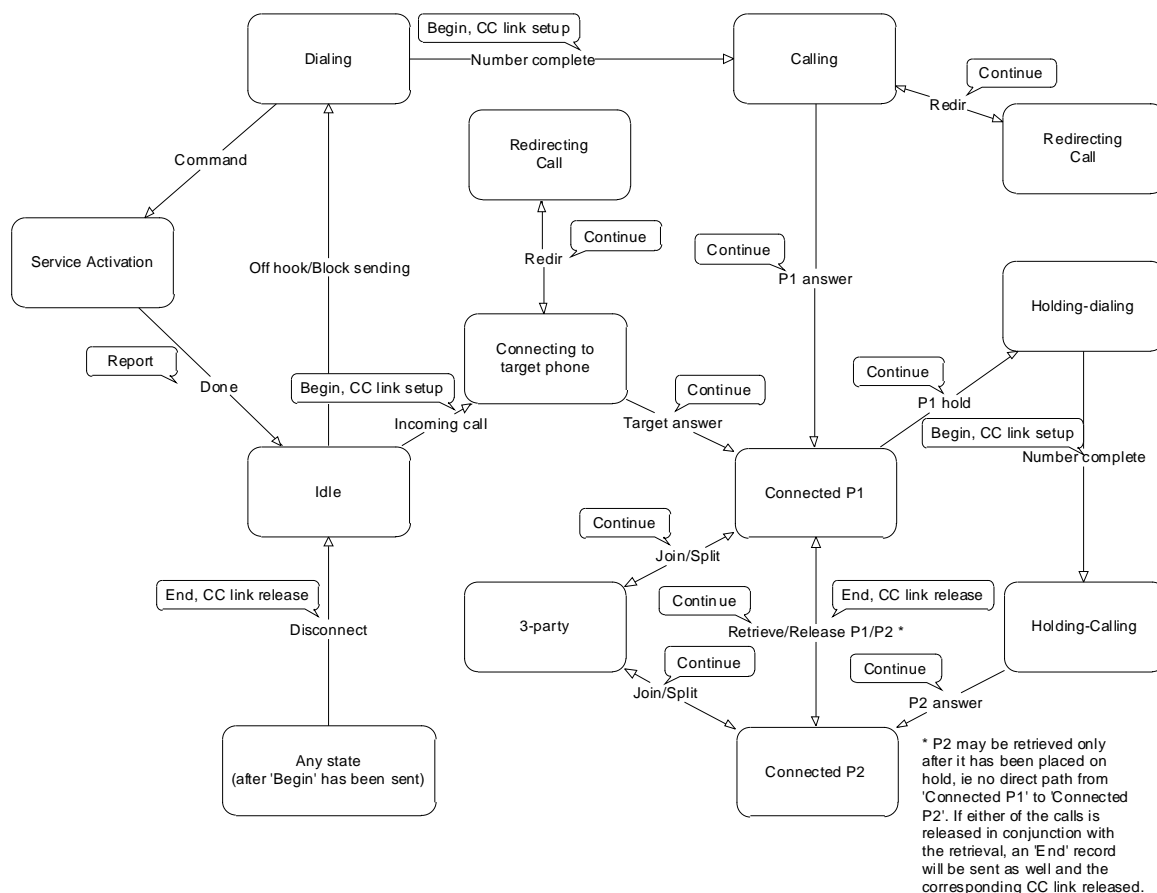

Figure 5.24: Unsuccessful target call, reported by IRI-REPORT record

# 6 State model for an ISDN (overview description for CC link and IRI delivery)

This clause describes under which conditions the different record types are sent. The general rule is to apply a best-effort approach. This means that events and data are handled according to standard protocols for telecommunications. It is not intended to define any additional or different requirements from ES 201 671 [1].

This clause describes an example approach which is not based on any specific implementation or national requirement. The reader should note that the state diagrams are not intended to be complete but are examples only.



State



Both-way state transition, meaning that the transition can occur repeatedly both ways

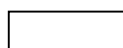

IRI message type sent at a related transition and any HI3 action

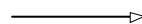

One-way state transition

**Figure 6.1: Overview state model for CC link operations and IRI delivery**

In order to further illustrate how state transitions and message sending interact, a few examples of specific traffic cases are given below.

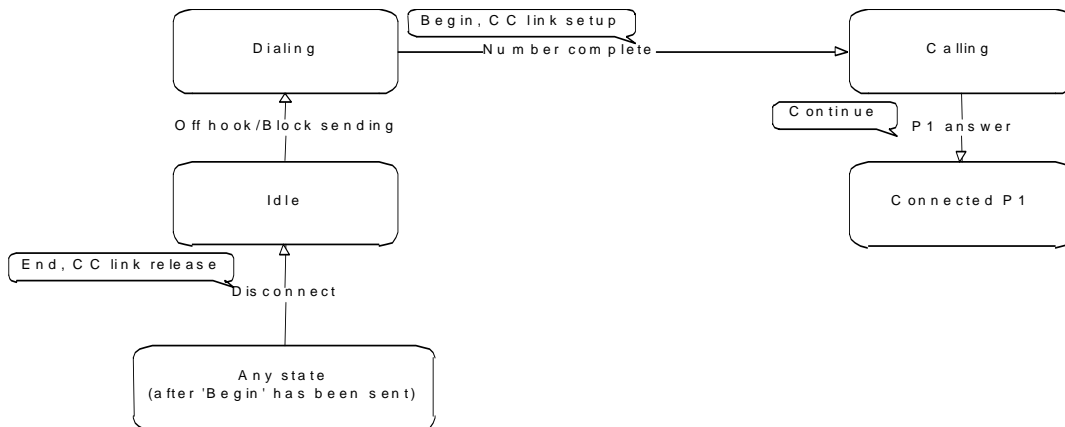

**Figure 6.2: A Simple originating call**

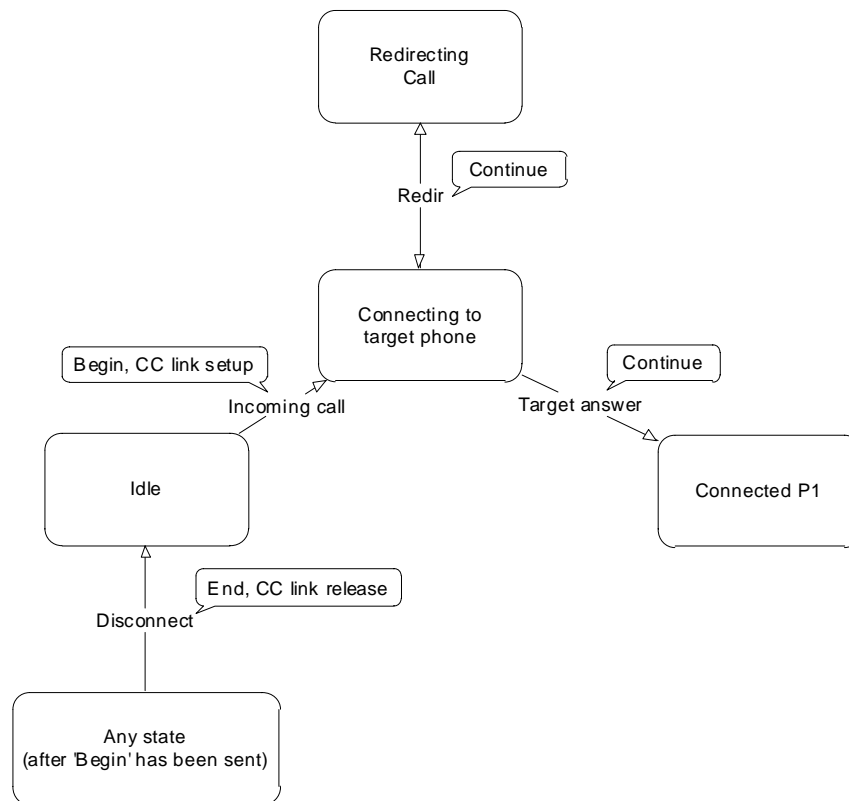

**Figure 6.3: Incoming call with redirection**

Figure 6.3 describes the case of interception continuing on call transfer.

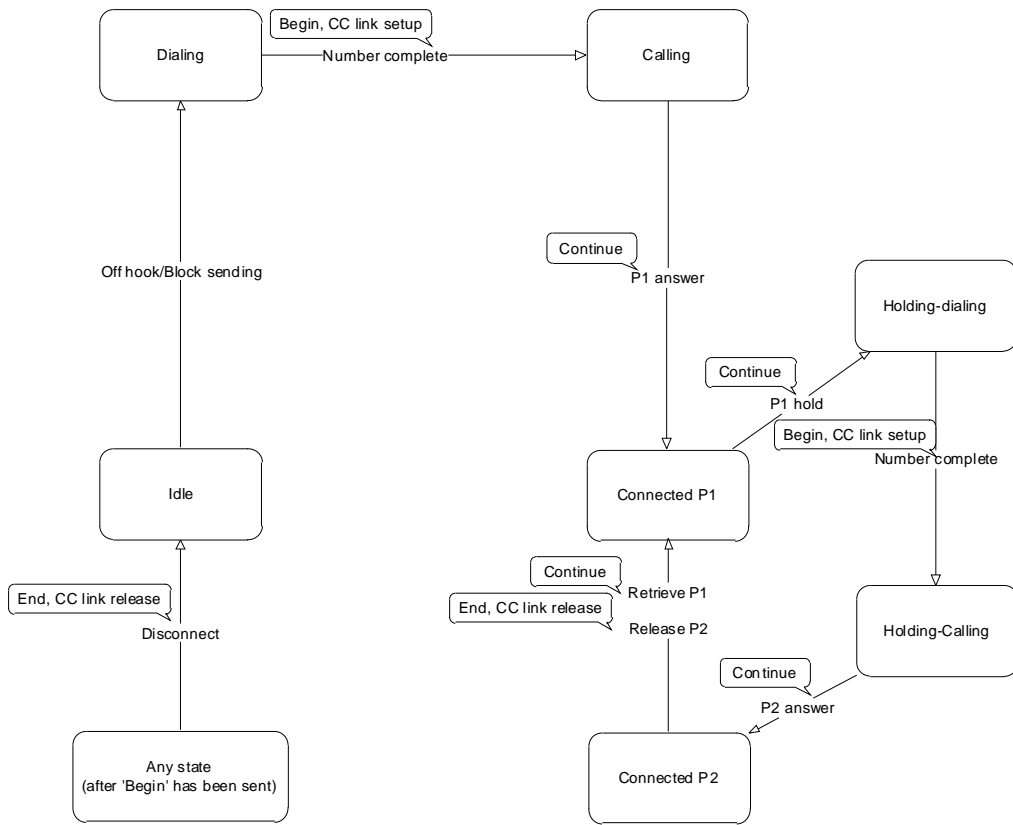

Figure 6.4: Originating call with enquiry

---

## Annex A: Bibliography

ETSI TS 101 331: "Telecommunications security; Lawful Interception (LI); Requirements of Law Enforcement Agencies".

ETSI ES 201 158: "Telecommunications security; Lawful Interception (LI); Requirements for network functions".

---

## History

<b>Document history</b>		
V1.1.1	March 2002	Publication