

**Transmission and Multiplexing (TM);
Access networks;
Spectral management on metallic access networks;
Part 1: Definitions and signal library**



Reference

RTR/ATTM-06004-1

Keywords

access, xDSL, VDSL, ADSL, SDSL, HDSL,
ISDN, POTS, local loop, modem, network,
spectral management, transmission, unbundling**ETSI**

650 Route des Lucioles
F-1 Sophia Antipolis Cedex - FRANCE

Tel.: +33 4 92 94 42 00 Fax: +33 4 93 65 47 16Siret N° 348 623 562 7 - NAF 742 C
Association à but non lucratif enregistrée à la
Sous-Préfecture de Grasse (06) N° /88

Important notice

Individual copies of the present document can be downloaded from:

<http://www.etsi.org>

The present document may be made available in more than one electronic version or in print. In any case of existing or perceived difference in contents between such versions, the reference version is the Portable Document Format (PDF). In case of dispute, the reference shall be the printing on ETSI printers of the PDF version kept on a specific network drive within ETSI Secretariat.

Users of the present document should be aware that the document may be subject to revision or change of status. Information on the current status of this and other ETSI documents is available at

<http://portal.etsi.org/tb/status/status.asp>

If you find errors in the present document, please send your comment to one of the following services:

http://portal.etsi.org/chaicor/ETSI_support.asp

Copyright Notification

No part may be reproduced except as authorized by written permission.
The copyright and the foregoing restriction extend to reproduction in all media.© European Telecommunications Standards Institute 2008.
All rights reserved.

DECTTM, **PLUGTESTS**TM, **UMTS**TM, **TIPHON**TM, the TIPHON logo and the ETSI logo are Trade Marks of ETSI registered for the benefit of its Members.

3GPPTM is a Trade Mark of ETSI registered for the benefit of its Members and of the 3GPP Organizational Partners.

Contents

Intellectual Property Rights	8
Foreword.....	8
1 Scope	9
2 References	9
2.1 Normative references	10
2.2 Informative references.....	10
3 Definitions and abbreviations.....	11
3.1 Definitions.....	11
3.2 Abbreviations	14
4 The technical purpose of Spectral Management	14
4.1 Bounding spectral pollution	15
4.2 The individual components of spectral pollution	15
5 Reference model of the local loop wiring	16
5.1 The concept of ports; interfaces to the Local Loop Wiring (LLW).....	17
5.2 Bounding spectral pollution by limiting signals at the ports	17
5.3 Reference model.....	18
6 Minimum set of characteristics for signal descriptions	19
7 Cluster 0 signals (DC power feeding)	19
7.1 "Class A" TNV power feeding (from LT-port)	20
7.2 "Class B" RFT power feeding (from the LT-port)	20
8 Cluster 1 signals (voice band)	21
8.1 "POTS" signals (voice band lines 300 Hz to 3 400 Hz)	21
8.1.1 Total signal voltage.....	21
8.1.2 Peak amplitude.....	21
8.1.3 Narrow-band signal voltage.....	21
8.1.4 Unbalance about earth	23
8.1.5 Feeding power (from the LT-port).....	24
8.1.6 Reference impedance Z_R	24
8.1.7 Ringing signal	24
8.1.8 Metering signals.....	25
9 Cluster 2 signals (semi broadband)	25
9.1 "ISDN.2B1Q" signals.....	25
9.1.1 Total signal power	25
9.1.2 Peak amplitude.....	25
9.1.3 Narrow-Band Signal Power (NBSP).....	26
9.1.4 Unbalance about earth	27
9.1.5 Feeding power (from the LT-port).....	28
9.2 "ISDN.MMS.43" signals	28
9.2.1 Total signal power	28
9.2.2 Peak amplitude.....	28
9.2.3 Narrow-band signal power.....	28
9.2.4 Unbalance about earth	29
9.2.5 Feeding power (from the LT-port).....	30
9.3 "Proprietary.SymDSL.CAP.QAM" signals.....	30
9.3.1 Total signal power	31
9.3.2 Peak amplitude.....	31
9.3.3 Narrow-Band Signal Power (NBSP).....	31
9.3.4 Unbalance about earth	32
10 Cluster 3 signals (symmetrical broadband)	33
10.1 "HDSL.2B1Q/3" signals (392 kbaud leased lines).....	33

10.1.1	Total signal power	33
10.1.2	Peak amplitude.....	34
10.1.3	Narrow-Band Signal Power (NBSP).....	34
10.1.4	Unbalance about earth	35
10.1.5	Feeding power (from the LT-port).....	36
10.2	"HDSL.2B1Q/2" signals (584 kbaud leased lines).....	36
10.2.1	Total signal power	36
10.2.2	Peak amplitude.....	36
10.2.3	Narrow-Band Signal Power (NBSP).....	36
10.2.4	Unbalance about earth	37
10.2.5	Feeding power (from the LT-port).....	38
10.3	"HDSL.2B1Q/1" signals (1 160 kbaud leased lines).....	38
10.3.1	Total signal power	38
10.3.2	Peak amplitude.....	39
10.3.3	Narrow-band signal power.....	39
10.3.4	Unbalance about earth	40
10.3.5	Feeding power (from the LT-port).....	41
10.4	"HDSL.CAP/2" signals	41
10.4.1	Total signal power	41
10.4.2	Peak amplitude.....	41
10.4.3	Narrow-Band Signal Power (NBSP).....	41
10.4.4	Unbalance about earth	42
10.4.5	Feeding power (from the LT-port).....	43
10.5	"SDSL::Fn" signals	43
10.5.1	Total signal power	44
10.5.2	Peak amplitude.....	44
10.5.3	Narrow-Band Signal Power (NBSP).....	45
10.5.4	Unbalance about earth	46
10.5.5	Feeding power (from the LT-port).....	47
10.6	"SDSL.asym::Fn" signals	47
10.6.1	Total signal power	48
10.6.2	Peak amplitude.....	48
10.6.3	Narrow-band signal power (upstream only)	49
10.6.4	Narrow-band signal power (downstream only).....	50
10.6.5	Unbalance about earth	52
10.6.6	Feeding power (from the LT-port).....	52
10.7	"e-SDSL::Fn" signals (enhanced SDSL).....	52
10.7.1	Total signal power	53
10.7.2	Peak amplitude.....	53
10.7.3	Narrow-Band Signal Power (NBSP).....	53
10.7.4	Unbalance about earth	53
10.7.5	Feeding Power (from the LT-port)	54
10.8	"Proprietary.SymDSL.CAP.A::Fn" signals.....	54
10.8.1	Total signal power	54
10.8.2	Peak amplitude.....	55
10.8.3	Narrow-Band Signal Power (NBSP).....	55
10.8.4	Unbalance about earth	56
10.9	"Proprietary.SymDSL.CAP.B::Fn" signals	57
10.9.1	Total signal power	58
10.9.2	Peak amplitude.....	58
10.9.3	Narrow-Band Signal Power (NBSP).....	58
10.9.4	Unbalance about earth	59
10.10	"Proprietary.SymDSL.CAP.C::Fn" signals	60
10.10.1	Total signal power	61
10.10.2	Peak amplitude.....	61
10.10.3	Narrow-Band Signal Power (NBSP).....	61
10.10.4	Unbalance about earth	62
10.11	"Proprietary.SymDSL.PAM::Fn" signals.....	64
10.11.1	Total signal power	64
10.11.2	Peak amplitude.....	65
10.11.3	Narrow-Band Signal Power (NBSP).....	65
10.11.4	Unbalance about earth	66

10.11.5	Feeding power (from the LT-port).....	67
10.12	"Proprietary.SymDSL.2B1Q::Fn" signals.....	67
10.12.1	Total signal power	68
10.12.2	Peak amplitude.....	68
10.12.3	Narrow-Band Signal Power (NBSP).....	68
10.12.4	Unbalance about earth	70
10.12.5	Feeding power (from the LT-port).....	71
10.13	"Proprietary.PCM.HDB3.2M.SR" signals.....	71
10.13.1	Total signal power	71
10.13.2	Peak amplitude.....	71
10.13.3	Narrow-Band Signal Power (NBSP).....	71
10.13.4	Unbalance about earth	72
10.13.5	Feeding power (from the LT-port).....	73
10.14	"Proprietary.PCM.HDB3.2M.SQ" signals	73
10.14.1	Total signal power	74
10.14.2	Peak amplitude.....	74
10.14.3	Narrow-Band Signal Power (NBSP).....	74
10.14.4	Unbalance about earth	75
11	Cluster 4 signals (asymmetrical broadband)	75
11.1	"ADSL/POTS (FO)" signals.....	75
11.1.1	Total signal power (downstream only)	75
11.1.2	Total signal power (upstream only)	76
11.1.3	Peak amplitude (upstream and downstream)	76
11.1.4	Narrow-band signal power (downstream only).....	76
11.1.5	Narrow-band signal power (upstream only)	77
11.1.6	Unbalance about earth (upstream and downstream)	79
11.2	"ADSL/POTS (FDD)" signals.....	80
11.2.1	Total signal power (downstream only)	80
11.2.2	Total signal power (upstream only)	80
11.2.3	Peak amplitude (upstream and downstream)	80
11.2.4	Narrow-band signal power (downstream only).....	80
11.2.5	Narrow-band signal power (upstream only)	82
11.2.6	Unbalance about earth (upstream and downstream)	82
11.3	"ADSL/ISDN (FO)" signals	82
11.3.1	Total signal power (downstream only)	82
11.3.2	Total signal power (upstream only)	82
11.3.3	Peak amplitude (upstream and downstream)	82
11.3.4	Narrow-band signal power (downstream only).....	82
11.3.5	Narrow-band signal power (upstream only)	84
11.3.6	Unbalance about earth (upstream and downstream)	85
11.4	"ADSL/ISDN (FDD)" signals	86
11.4.1	Total signal power (downstream only)	87
11.4.2	Total signal power (upstream only)	87
11.4.3	Peak amplitude (upstream and downstream)	87
11.4.4	Narrow-band signal power (downstream only).....	87
11.4.5	Narrow-band signal power (upstream only)	89
11.4.6	Unbalance about earth (upstream and downstream)	89
11.5	"ADSL2plus/A (FO)" signals (over POTS)	89
11.5.1	Total signal power (downstream only)	89
11.5.2	Total signal power (upstream only)	89
11.5.3	Peak amplitude (upstream and downstream)	89
11.5.4	Narrow-band signal power (downstream only).....	90
11.5.5	Narrow-band signal power (upstream only)	91
11.5.6	Unbalance about earth (upstream and downstream)	92
11.6	"ADSL2plus/A (FDD)" signals (over POTS).....	92
11.6.1	Total signal power (downstream only)	93
11.6.2	Total signal power (upstream only)	93
11.6.3	Peak amplitude (upstream and downstream)	93
11.6.4	Narrow-band signal power (downstream only).....	93
11.6.5	Narrow-band signal power (upstream only)	94
11.6.6	Unbalance about earth (upstream and downstream)	94

11.7	"ADSL2plus/B (FO)" signals (over ISDN)	94
11.7.1	Total signal power (downstream only)	94
11.7.2	Total signal power (upstream only)	95
11.7.3	Peak amplitude (upstream and downstream)	95
11.7.4	Narrow-band signal power (downstream only).....	95
11.7.5	Narrow-band signal power (upstream only)	96
11.7.6	Unbalance about earth (upstream and downstream)	97
11.8	"ADSL2plus/B (FDD)" signals (over ISDN)	98
11.8.1	Total signal power (downstream only)	98
11.8.2	Total signal power (upstream only)	98
11.8.3	Peak amplitude (upstream and downstream)	98
11.8.4	Narrow-band signal power (downstream only).....	99
11.8.5	Narrow-band signal power (upstream only)	100
11.8.6	Unbalance about earth (upstream and downstream)	100
11.9	"ADSL2plus/I (FO)" signals (all digital mode).....	100
11.9.1	Total signal power (downstream only)	100
11.9.2	Total signal power (upstream only)	100
11.9.3	Peak amplitude (upstream and downstream)	101
11.9.4	Narrow-band signal power (downstream only).....	101
11.9.5	Narrow-band signal power (upstream only)	102
11.9.6	Unbalance about earth (upstream and downstream)	103
11.10	"ADSL2plus/I (FDD)" signals (all digital mode).....	103
11.10.1	Total signal power (downstream only)	103
11.10.2	Total signal power (upstream only)	103
11.10.3	Peak amplitude (upstream and downstream)	103
11.10.4	Narrow-band signal power (downstream only).....	103
11.10.5	Narrow-band signal power (upstream only)	104
11.10.6	Unbalance about earth (upstream and downstream)	104
11.11	"ADSL2plus/J (FO)" signals (all digital, extended US).....	104
11.11.1	Total signal power (downstream only)	104
11.11.2	Total signal power (upstream only)	104
11.11.3	Peak amplitude (upstream and downstream)	104
11.11.4	Narrow-band signal power (downstream only).....	104
11.11.5	Narrow-band signal power (upstream only)	104
11.11.6	Unbalance about earth (upstream and downstream)	105
11.12	"ADSL2plus/J (FDD)" signals (all digital, extended US).....	106
11.12.1	Total signal power (downstream only)	106
11.12.2	Total signal power (upstream only)	106
11.12.3	Peak amplitude (upstream and downstream)	106
11.12.4	Narrow-band signal power (downstream only).....	106
11.12.5	Narrow-band signal power (upstream only)	106
11.12.6	Unbalance about earth (upstream and downstream)	106
11.13	"ADSL2plus/M (FO)" signals (over POTS, extended US)	106
11.13.1	Total signal power (downstream only)	106
11.13.2	Total signal power (upstream only)	107
11.13.3	Peak amplitude (upstream and downstream)	107
11.13.4	Narrow-band signal power (downstream only).....	107
11.13.5	Narrow-band signal power (upstream only)	107
11.13.6	Unbalance about earth (upstream and downstream)	108
11.14	"ADSL2plus/M (FDD)" signals (over POTS, extended US).....	108
11.14.1	Total signal power (downstream only)	108
11.14.2	Total signal power (upstream only)	108
11.14.3	Peak amplitude (upstream and downstream)	109
11.14.4	Narrow-band signal power (downstream only).....	109
11.14.5	Narrow-band signal power (upstream only)	109
11.14.6	Unbalance about earth (upstream and downstream)	109
12	Cluster 5 signals (broadband up to 30 MHz).....	109
12.1	"VDSL2-NL1" signals ("over POTS").....	109
12.1.1	Total signal power (downstream only)	109
12.1.2	Total signal power (upstream only)	111
12.1.3	Peak amplitude (upstream and downstream)	111

12.1.4	Narrow-band signal power (downstream only).....	111
12.1.5	Narrow-band signal power (upstream only)	115
12.1.6	Unbalance about earth (upstream and downstream)	119
12.2	"VDSL2-NL2" signals (over ISDN).....	120
12.2.1	Total signal power (downstream only)	121
12.2.2	Total signal power (upstream only)	122
12.2.3	Peak amplitude (upstream and downstream)	122
12.2.4	Narrow-band signal power (downstream only).....	122
12.2.5	Narrow-band signal power (upstream only)	127
12.2.6	Unbalance about earth (upstream and downstream)	129
12.3	"VDSL2-UK1" signals	129
12.3.1	Total signal power (downstream only)	130
12.3.2	Total signal power (upstream only)	130
12.3.3	Peak amplitude (upstream and downstream)	130
12.3.4	Narrow-band signal power (downstream only).....	130
12.3.5	Narrow-band signal power (upstream only)	133
12.3.6	Unbalance about earth (upstream and downstream)	135
13	Measurement methods of signal parameters	135
13.1	Peak amplitude	135
13.2	Narrow-band signal power (voltage).....	136
13.3	Unbalance about earth	136
13.3.1	Definition of earth.....	136
13.3.2	Transmitter Balance - LOV	136
13.3.3	Receiver balance - LCL	137
Annex A:	Bibliography	139
History		140

Intellectual Property Rights

IPRs essential or potentially essential to the present document may have been declared to ETSI. The information pertaining to these essential IPRs, if any, is publicly available for **ETSI members and non-members**, and can be found in ETSI SR 000 314: "*Intellectual Property Rights (IPRs); Essential, or potentially Essential, IPRs notified to ETSI in respect of ETSI standards*", which is available from the ETSI Secretariat. Latest updates are available on the ETSI Web server (<http://webapp.etsi.org/IPR/home.asp>).

Pursuant to the ETSI IPR Policy, no investigation, including IPR searches, has been carried out by ETSI. No guarantee can be given as to the existence of other IPRs not referenced in ETSI SR 000 314 (or the updates on the ETSI Web server) which are, or may be, or may become, essential to the present document.

Foreword

This Technical Report (TR) has been produced by ETSI Technical Committee Access, Terminals, Transmission and Multiplexing (ATTM).

The present document is part 1 of a multi-part deliverable covering Transmission and Multiplexing (TM); Access networks; Spectral management on metallic access networks, as identified below:

Part 1: "Definitions and signal library";

Part 2: "Technical methods for performance evaluations".

1 Scope

The present document gives guidance on a common language for Spectral Management specifications. It provides a set of definitions on Spectral Management quantities, including:

- a) a description of the technical purpose of Spectral Management;
- b) a common reference model to identify LT-ports, NT-ports, upstream, downstream, etc.;
- c) a minimum set of characteristics necessary to describe signals within the context of Spectral Management; and
- d) an informative library of electrical signals that may flow into the ports of a metallic access network.

The present document is applicable to simplify and harmonize the description of *network specific* Spectral Management documents. The objective is to be a clear reference for these documents, without making any specific choice on the technology mix that may use the access network. Network specific documents, that rule the cable fill and technology mix for Spectral Management purposes, can be kept compact by referring to the definitions in the present document.

The informative library of signal definitions is organized in clusters of signal categories. Each category defines, independent from other categories, a full set of signal limits between DC and 30 MHz. These categories are dominantly based on transmission equipment standards from ETSI and ITU (existing or in progress), and on the technical understanding of additional requirements to protect future technology. When these definitions are incomplete or not appropriate, *network specific* spectral management documents may use additional definitions.

The characteristics of each signal described in this signal library identify their absolute maximum (or minimum) values. They fully account for the spread in their actual value, unless this tolerance is explicitly specified. This means in practice that when a power limit of a signal category is specified by a single number (for instance 14 dBm), it refers to its nominal maximum power plus its tolerance (for instance $+13,5 \text{ dBm} \pm 0,5 \text{ dBm}$). This approach provides clear criteria to determine if a signal under test is compliant or not with a signal category from this library.

The intention of the present document is to present a set of signal descriptions from various sources collected into a single document. Some of the descriptions have their origin in xDSL related ETSI and ITU publications and some are completely new. Detailed references have been included where applicable.

Due to differences in the way these signals are described in the different sources, the description has been harmonized into a uniform format. This enables a unified signal specification method for spectral management purposes. It should be noted that, although this unification has been carried out with the best intentions, and with the best knowledge available, some content of the original source document may not have been correctly interpreted or copied into the present document.

In the case of discrepancies between a signal description in the present document and the original source document(s), the source(s) should be regarded as definitive. Therefore the content of the present document should be regarded as informative.

2 References

References are either specific (identified by date of publication and/or edition number or version number) or non-specific.

- For a specific reference, subsequent revisions do not apply.
- Non-specific reference may be made only to a complete document or a part thereof and only in the following cases:
 - if it is accepted that it will be possible to use all future changes of the referenced document for the purposes of the referring document;
 - for informative references.

Referenced documents which are not found to be publicly available in the expected location might be found at <http://docbox.etsi.org/Reference>.

For online referenced documents, information sufficient to identify and locate the source shall be provided. Preferably, the primary source of the referenced document should be cited, in order to ensure traceability. Furthermore, the reference should, as far as possible, remain valid for the expected life of the document. The reference shall include the method of access to the referenced document and the full network address, with the same punctuation and use of upper case and lower case letters.

NOTE: While any hyperlinks included in this clause were valid at the time of publication ETSI cannot guarantee their long term validity.

2.1 Normative references

The following referenced documents are indispensable for the application of the present document. For dated references, only the edition cited applies. For non-specific references, the latest edition of the referenced document (including any amendments) applies.

Not applicable.

2.2 Informative references

The following referenced documents are not essential to the use of the present document but they assist the user with regard to a particular subject area. For non-specific references, the latest version of the referenced document (including any amendments) applies.

POTS & ANALOGUE

- [i.1] ETSI TBR 021: "Terminal Equipment (TE); Attachment requirements for pan-European approval for connection to the analogue Public Switched Telephone Networks (PSTNs) of TE (excluding TE supporting the voice telephony service) in which network addressing, if provided, is by means of Dual Tone Multi Frequency (DTMF) signalling".
- [i.2] ETSI ES 201 970: "Access and Terminals (AT); Public Switched Telephone Network (PSTN); Harmonized specification of physical and electrical characteristics at a 2-wire analogue presented Network Termination Point (NTP)".
- [i.3] ETSI EN 300 001: "Attachments to the Public Switched Telephone Network (PSTN); General technical requirements for equipment connected to an analogue subscriber interface in the PSTN".
- [i.4] ETSI EN 300 450: "Access and Terminals (AT); Ordinary and Special quality voice bandwidth 2-wire analogue leased lines (A2O and A2S); Terminal equipment interface".
- [i.5] ETSI EN 300 453: "Access and Terminals (AT); Ordinary and Special quality voice bandwidth 4-wire analogue leased lines (A4O and A4S); Terminal equipment interface".

ISDN

- [i.6] ETSI TS 102 080: "Transmission and Multiplexing (TM); Integrated Services Digital Network (ISDN) basic rate access; Digital transmission system on metallic local lines".

HDSL

- [i.7] ETSI TS 101 135: "Transmission and Multiplexing (TM); High bit-rate Digital Subscriber Line (HDSL) transmission systems on metallic local lines; HDSL core specification and applications for combined ISDN-BA and 2 048 kbit/s transmission".

SDSL

- [i.8] ETSI TS 101 524: "Transmission and Multiplexing (TM); Access transmission system on metallic access cables; Symmetric single pair high bitrate Digital Subscriber Line (SDSL)".
- [i.9] ITU-T Recommendation G.991.2: "Single-Pair High-Speed Digital Subscriber Line (SHDSL) transceivers" (including all corrigenda and amendments).

ADSL

- [i.10] ETSI TS 101 388: "Access Terminals Transmission and Multiplexing (ATTM); Access transmission systems on metallic access cables; Asymmetric Digital Subscriber Line (ADSL) - European specific requirements [ITU-T Recommendation G.992.1 modified]".
- [i.11] ITU-T Recommendation G.992.1: "Asymmetric digital subscriber line (ADSL) transceivers" (including all corrigenda and amendments).
- [i.12] ITU-T Recommendation G.992.5: "Asymmetric Digital Subscriber Line (ADSL) transceivers - Extended bandwidth ADSL2 (ADSL2plus)".

VDSL

- [i.13] ETSI TS 101 270-1: "Transmission and Multiplexing (TM); Access transmission systems on metallic access cables; Very high speed Digital Subscriber Line (VDSL); Part 1: Functional requirements".
- [i.14] ITU-T Recommendation G993.2: "Very High Speed Digital Subscriber Line Transceivers 2 (VDSL2)" (including all corrigenda and amendments).

EMC & UNBALANCE

- [i.15] ITU-T Recommendation O.9: "Measuring arrangements to assess the degree of unbalance about earth".
- [i.16] ITU-T Recommendation G.117: "Transmission aspects of unbalance about earth".

VARIOUS

- [i.17] CENELEC EN 0-1: "Information technology equipment - Safety - Part 1: General Requirements".
- [i.18] CENELEC EN 0-21: "Information technology equipment - Safety - Part 21: Remote Power Feeding".
- [i.19] CENELEC CLC/prTR 2: "Electrical safety - Classification of interfaces for equipment to be connected to information and communications technology networks".
- [i.20] CENELEC CLC/prTS 7: "Safety aspects for xDSL signals on circuits connected to telecommunication networks (DSL: Digital Subscriber Line)".

3 Definitions and abbreviations

3.1 Definitions

For the purposes of the present document, the following terms and definitions apply:

access port: physical location, appointed by the loop provider, where signals (for transmission purposes) are injected into the local loop wiring

access rule: mandatory rule for achieving access to the local loop wiring, equal for all network operators who are making use of the same network cable that bounds the crosstalk in that network cable

cable fill (or degree of penetration): number and mixture of transmission techniques connected to the ports of a binder or cable bundle that are injecting signals into the access ports

Cable Management Plan (CMP): list of selected access rules dedicated to a specific network

NOTE: This list may include associated descriptions and explanations.

deployment rule: voluntary rule, irrelevant for achieving access to the local loop wiring and proprietary to each individual network operator

NOTE: A deployment rule reflects a network operator's own view about what the maximum length or maximum bitrate may be for offering a specific transmission service to ensure a chosen minimum quality of service.

disturber: source of interference in spectral management studies coupled to the wire pair connecting victim modems

NOTE: This term is intended solely as a technical term, defined within the context of these studies, and is not intended to imply any negative judgement.

downstream transmission: transmission direction from a port, labelled as LT-port, to another port, labelled as NT-port

NOTE: This direction is usually from the central office side via the local loop wiring, to the customer premises.

Echo Cancelled (EC): term used within the context of ADSL to designate ADSL (FO) systems with frequency overlap of downstream and upstream signals

NOTE: In this context, the usage of the abbreviation "EC" was only kept for historical reasons. The usage of the echo cancelling technology is not only limited to FO systems (frequency overlapped), but can also be used by FDD systems (frequency division duplexing).

local loop wiring: part of a metallic access network, terminated by well-defined ports, for transporting signals over a distance of interest

NOTE: This part includes mainly cables, but may also include a Main Distribution Frame (MDF), street cabinets, and other distribution elements. The local loop wiring is usually passive only, but may include active splitter-filters as well.

loop provider: organization facilitating access to the local loop wiring

NOTE: In several cases the loop provider is historically associated with the incumbent network operator, but other companies may serve as loop provider as well.

LT: Line Termination, at the place where the physical line to the customer starts

LT-access port (or LT-port for short): access port for injecting signals, designated as "LT-port"

NOTE: Such a port is commonly located at the central office side, and intended for injecting "downstream" signals.

max data rate: maximum data rate that can be recovered according to predefined quality criteria, when the received noise is increased with a chosen noise margin (or the received signal is decreased with a chosen signal margin)

network operator: organization that makes use of a local loop wiring for transporting telecommunication services

NOTE: This definition covers incumbent as well as competitive network operators.

noise margin: ratio (P_{n2}/P_{n1}) by which the received noise power P_{n1} may increase to power P_{n2} until the recovered signal no longer meets the predefined quality criteria

NOTE: This ratio is commonly expressed in dB.

NT: Network Termination, at the customer premise end of the line

NT-access port (or NT-port for short): access port for injecting signals, designated as "NT-port"

NOTE: Such a port is commonly located at the customer premises, and intended for injecting "upstream" signals.

performance: measure of how well a transmission system fulfils defined criteria under specified conditions

NOTE: Such criteria include reach, bitrate and noise margin.

power back-off: generic mechanism to reduce the transmitter's output power

NOTE: It has many purposes, including the reduction of power consumption, receiver dynamic range, crosstalk, etc.

power cut-back: specific variant of power back-off, used to reduce the dynamic range of the receiver, that is characterized by a frequency independent reduction of the in-band PSD

NOTE: It is used, for instance, in ADSL and SDSL.

PSD mask: absolute upper bound of a PSD, measured within a specified resolution band

NOTE: The purpose of PSD masks is usually to specify maximum PSD levels for stationary signals.

PSD template: expected average PSD of a stationary signal

NOTE: The purpose of PSD templates is usually to perform simulations. The levels are usually below or equal to the associated PSD masks.

signal category: class of signals meeting the minimum set of specifications identified in clause 6 of the present document

NOTE: Some signal categories may be distinct between different sub-classes, and may label them for instance as signals for "downstream" or for "upstream" purposes.

signal margin: ratio (P_{s1}/P_{s2}) by which the received signal power P_{s1} may decrease to power P_{s2} until the recovered signal no longer meets the predefined quality criteria

NOTE: This ratio is commonly expressed in dB.

spectral compatibility: generic term for the capability of transmission systems to operate in the same cable

NOTE: The precise definition is application dependent and has to be defined for each group of applications.

spectral management: art of making optimal use of limited capacity in (metallic) access networks

NOTE: This is for the purpose of achieving the highest reliable transmission performance and includes:

- Designing of deployment rules and their application.
- Designing of effective access rules.
- Optimized allocation of resources in the access network, e.g. access ports, diversity of systems between cable bundles, etc.
- Forecasting of noise levels for fine-tuning the deployment.
- Spectral policing to enforce compliance with access rules.
- Making a balance between conservative and aggressive deployment (low or high failure risk).

spectral management rule: generic term, incorporating (voluntary) deployment rules, (mandatory) access rules and all other (voluntary) measures to maximize the use of local loop wiring for transmission purposes

transmission equipment: equipment connected to the local loop wiring that uses a transmission technique to transport information

transmission system: set of transmission equipment that enables information to be transmitted over some distance between two or more points

transmission technique: electrical technique used for the transportation of information over electrical wiring

upstream transmission: transmission direction from a port, labelled as NT-port, to another port, labelled as LT-port

NOTE: This direction is usually from the customer premises, via the local loop wiring, to the central office side.

victim modem: modem, subjected to interference (such as crosstalk from all other modems connected to other wire pairs in the same cable) that is being studied in a spectral management analysis

NOTE: This term is intended solely as a technical term, defined within the context of these studies, and is not intended to imply any negative judgement.

3.2 Abbreviations

For the purposes of the present document, the following abbreviations apply:

AC/ac	Alternate Current
ADSL	Asymmetric Digital Subscriber Line
AIS	Alarm Indication Signal
CAP	Carrierless Amplitude/Phase modulation
CMP	Cable Management Plan
CSS	Customer-side Signal Source
DC/dc	Direct Current
DPBO	Downstream Power Back-Off
DTMF	Dual Tone Multi-Frequency
EC	Echo Cancelled
EMC	Electro-Magnetic Compatibility
ESS	Exchange-side Signal Source
FDD	Frequency Division Duplexing/Duplexed
FEXT	Far End CrossTalk
FO	Frequency Overlap, previously referred to as Echo Cancelled (EC)
HDSL	High bitrate Digital Subscriber Line
HPNA	Home Phonetone Networking Alliance
ISDN	Integrated Services Digital Network
ISDN-BA	ISDN Basic Access
LCL	Longitudinal Conversion Loss
LLW	Local Loop Wiring
LOV	Longitudinal Output Voltage
LT-port	Line Termination port
MDF	Main Distribution Frame
NBSP	Narrow-Band Signal Power
NBSV	Narrow-Band Signal Voltage
NEXT	Near End CrossTalk
NT-port	Network Termination port
PAM	Pulse Amplitude Modulation
PCM	Pulse Code Modulation
POTS	Plain Old Telephony Services
PSD	Power Spectral Density
PSTN	Public Switched Telephone Network
RFT	Remote Feeding Telecommunication
RSS	Remote Signal Sources
SDSL	Symmetrical (single pair high bitrate) Digital Subscriber Line
TBR	Technical Basis for Regulation
TC-PAM	Trellis Coded PAM
TNV	Telecommunications Network Voltage
UC-PAM	Ungerboeck Coded PAM
UPBO	Upstream Power Back-Off
VDSL	Very-high-speed Digital Subscriber Line
xDSL	(all systems) Digital Subscriber Line

4 The technical purpose of Spectral Management

Connecting a signal to a wire pair of a (metallic) access network cable causes parts of that signal couple to other wire pairs in the same cable bundle or binder group. Connecting more systems to the same cable will increase the total crosstalk noise level in each wire-pair, and disturbs systems that were already installed.

Existing access network cables are designed to facilitate a low crosstalk coupling at low frequencies (telephony band), but the frequency of signals in cables increases substantially due to the introduction of broadband transmission systems. The consequence will be a significant increase of the total crosstalk noise power in each wire pair.

Although existing transmission systems are designed to cope (to some extent) with this type of impairment, it places a limit on the capacity of what can be transported through that cable. Capacity, in this context, means the maximum bitrate that can be transported over a single wire-pair at given cable length, or the maximum length that can be reached at given bitrate. Above some impairment level, the reliability of installed systems becomes poor, and they will even fail when the impairment level is increased further.

Usually, systems are designed to function optimally when they are only impaired by identical systems (self-crosstalk) that use other wire-pairs in the same cable. In practice, it is quite common to mix different transmission technologies in one cable. This may cause some degradation of transmission capacity, compared to the above-mentioned idealized situation:

- if this degradation is minor, the technology mix is referred to as *compatible*;
- if this degradation is acceptable, the technology mix is referred to as *near-compatible*;
- if this degradation is not acceptable, the technology mix is referred to as *incompatible*.

To prevent this occurring and to ensure that only a few systems make an inefficient use of the access network, at the cost of all the others, measures have to be taken. This is referred to as "Spectral Management".

4.1 Bounding spectral pollution

The objective for *spectral management* is to control the maximum spectral pollution, thus enabling an efficient use of the access network for all connected systems. This can be achieved by focussing on the use of near-compatible systems in the *same cable* or cable bundle.

Spectral management is an issue for both the loop provider and the network operators (in some cases they are within the same organization).

- The best that a loop provider can do to help the network operator(s) on its network, is to bound the spectral pollution in its network. This can be achieved by putting limits on signals (levels, spectra), diversity (technology mix) and cable fill (number of systems). These limits may be dependent on the loop length. Defining relevant limits at the boundaries (or ports) of the access network is the most appropriate approach. This approach is not restricted to situations where more than one licence operator make use of the same binders or cable bundles; it is also essential when one operator mixes different broadband technologies into one binder or cable bundle.
- The best that *network operators* can do is making estimates of the maximum impairment level in a wire-pair, and define adequate deployment rules. Deployment rules define the maximum reach or bitrate for a given transmission technology, with "sufficient" noise margin (according to the network operator). Since the crosstalk coupling between the wire pairs in binders or cable bundles is only known by a very rough approximation, the maximum impairment level is also only known by a very rough estimate. In other words: the definition of adequate limits is an essential requirement for successful deployment rules, but it can never *guarantee* that deployment rules can be adequate under all conditions. It is an inconvenience, which each network operator has to face.

The present document provides an informative library of signal categories, to simplify spectral management specifications that bound the spectral pollution of a network. Guidelines for deployment rules are beyond the scope of the present document. A spectral management specification of a possible length dependency of the signal limits is also beyond the scope of the present document.

4.2 The individual components of spectral pollution

Defining adequate rules for controlling spectral pollution requires a technical understanding of how individual disturbers contribute to the total impairment. The crosstalk coupling functions and the attenuation characteristics of an existing access network are fixed and from an electrical point of view the network can be considered as a closed entity. Controlling the spectral pollution is therefore restricted to controlling what signals may, and may not, flow into the access network cables.

Figure 1 illustrates the impact of these cable characteristics on the transmission. Transceiver TR1.LT sends information to TR1.NT.

- Receiver TR1.NT receives the downstream signal from transmitter TR1.LT that has been attenuated by the insertion loss of the wire-pair.
- In addition, TR1.NT receives crosstalk noise through the NEXT coupling function (near end crosstalk), from the upstream signal transmitted by TR2.NT.
- In addition, TR1.NT receives crosstalk noise through the FEXT coupling function (far end crosstalk), from the downstream signal transmitted by TR2.LT.

This crosstalk noise deteriorates the signal to noise ratio of the received signal, and therefore the performance of the transmission between TR1.LT and TR1.NT.

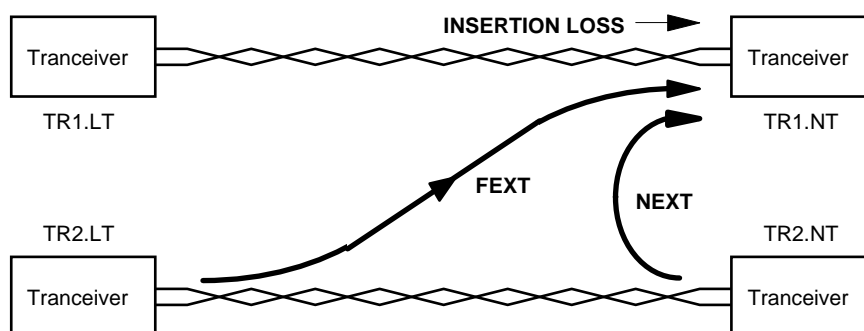

Figure 1: Various crosstalk paths

Crosstalk and attenuation characteristics are frequency dependent. Because of the differences in crosstalk coupling at the near and the far end, the relation between frequency allocation and sending direction is of major importance for the management of the crosstalk noise.

The crosstalk coupling to the far end of the transmitter (FEXT) is relatively low due to the attenuation. The crosstalk on the near end (NEXT) will be relatively high. So if the transmitter and the receiver at one end of the line would use the same frequency band, the transmitter outputs should be limited in order not to disturb the adjacent receivers. The result would be that the achievable wire-pair length would be limited because crosstalk limits the maximum allowed sending level. By using different frequency bands for transmitters and receivers at one end of the binder or cable bundle, this effect can be eliminated and the achievable length will increase.

NOTE 1: Some systems, such as FDD based ADSL, take advantage from allocating different frequency bands for transmitting signals in upstream and downstream direction. By using spectra that are only partly overlapped (EC systems), or not overlapped at all (FDD systems), the NEXT between these systems can be reduced significantly. Ideally, if there is no spectral overlap between up and downstream signals, and the binder or cable bundle is only filled with these systems, the transmission performance becomes FEXT-limited only since all NEXT has been eliminated.

NOTE 2: Consider the example of FEXT-limited ADSL: the NEXT at the NT due to neighbouring symmetric systems (such as HDSL and SDSL) can limit the ADSL downstream performance. By restricting the deployment distance of HDSL, the NEXT disturbance at the NT of longer ADSL lines will be attenuated by the extra cable length, increasing the ADSL capacity (or reach for a given capacity). It follows that the deployment range limit of HDSL systems has an impact on the deployment range limit of ADSL. This example shows that it may be desirable to make the specifications for the signal limits dependent on the loop length.

5 Reference model of the local loop wiring

This clause describes the reference model of the *local loop wiring* of an access network, from a spectral management point of view. It illustrates that local loop cable sections are asymmetrical in nature, because equipment near the local exchange side may differ from equipment near the customer side.

The Local Loop Wiring (LLW) of an access network includes mainly cables, but may also include a Main Distribution Frame (MDF), street cabinets, and other distribution elements.

From a Spectral Management point of view, signal sources are identified on their location:

- CSS: Customer-side Signal Sources.
- ESS: Exchange-side Signal Sources (such as local exchanges).
- RSS: Remote Signal Sources (such as repeaters and optical network units in street cabinets).

5.1 The concept of ports; interfaces to the Local Loop Wiring (LLW)

To give signal sources access to the Local Loop Wiring, their signals enter the LLW by flowing through so-called "ports". The ports are the interfaces to the Local Loop Wiring, and should therefore be well identified.

The following port-types are defined in this reference model:

- **LT-port**: the Line Termination port is generally used for connecting an ESS to the LLW.
- **NT-port**: the Network Termination port is generally used for connecting a CSS to the LLW.
- **LT.cab-port**: the LT-cabinet port is generally used for connecting an RSS to the LLW that links this port with an NT-port (or NT.cab-port) elsewhere in the LLW.
- **NT.cab-port**: the NT-cabinet port is generally used for connecting an RSS to the LLW that links this port with an LT-port (or LT.cab-port) elsewhere in the LLW.

At least two ports are required for communication. In special cases where access to the LLW at additional *well-identified* ports (such as in street cabinets) is provided for remote active devices (such as repeaters and optical network units), more ports may be involved.

5.2 Bounding spectral pollution by limiting signals at the ports

The signal limits that are summarized in the present document can be used to limit injected signals as they can be observed at the ports of the LLW.

The signals that many DSL systems generate are asymmetrical in nature. For instance ADSL systems generate different data signals in different transmission directions. ISDN and HDSL systems are symmetrical in their data signals, but their remote DC power feeding is asymmetrical. Therefore different port names are used in the Reference Model to simplify the description of signal limits that are transmission direction dependent.

NOTE 1: Reversing the transmission direction is generally not recommended, and may be implicitly forbidden by asymmetric signal limits at the ports. For example, ADSL systems are designed to maximize self-compatibility when all "downstream" signals in one cable flow into the same direction. Typically connection of one system the other way round would harm neighbouring systems unacceptably, and is excluded when it violates the limits.

In the case of symmetric signal limits, no further distinction on transmission direction is made. In the case of asymmetric signal limits, the following naming convention is used in the present document:

- **Downstream** signal limits are mandatory for signals that are injected into an LT-port (or LT.cab-port) of the Local Loop Wiring. LT-ports are usually located at the central office side of the local loop wiring.
- **Upstream** signal limits are mandatory for signals that are injected into an NT-port (or NT.cab-port) of the Local Loop Wiring. NT-ports are usually located at the customer side.

For each port, it must be well identified if this is an LT- or NT-port, and which signal limits are mandatory for these ports.

NOTE 2: An example of unintended reversal of transmission direction may occur when the Main Distribution Frame (MDF) of another licensed operator is not co-located with the MDF of the loop provider (at the local exchange). If some of the wire pairs of a distribution cable are used for connecting these two MDFs, then upstream and downstream signals in different wire pairs have to flow in the same cable direction. In such a case, a so-called tie-cable can solve the problem. Such a tie-cable should be fully dedicated to this purpose, and fully *separated* from the standard distribution cables.

NOTE 3: Signal limits need not be the same for all NT-ports or LT-ports. It is conceivable that the signal limits depend on e.g. the loop length. A specification of this possible length dependence is beyond the scope of the present document.

5.3 Reference model

Figure 2 shows a generic reference model of the Local Loop Wiring (LLW), from a Spectral Management point of view. The signals of various Signal Sources connected to the LLW flow into the LLW through *well-identified* ports. The following naming convention is used:

- The signals that flow through an *LT-port* into the Local Loop Wiring have their origin in an *Exchange-side Signal Source* (ESS), such as for instance a local exchange. When signal limits are direction dependent, the signals labelled in the present document as *downstream* are intended for injection into these LT-ports, unless explicitly stated otherwise.
- The signals that flow through an *NT-port* into the Local Loop Wiring have their origin in a *Customer-side Signal Source* (CSS). When signal limits are direction dependent, the signals labelled in the present document as *upstream* signals are intended for injection into these NT-ports, unless explicitly stated otherwise.
- The signals that flow through an optional *LT.cab-port* or *NT.cab-port* into the Local Loop Wiring have their origin in *Remote Signal Sources* (RSS). Their signal limits may be different from the limits that hold for LT-ports and NT-ports.

This model (see figure 2) enables the identification of upstream and downstream directions. Furthermore, a distinction between NT-ports may be made on the basis of the loop length, when specifying signal limits on the ports.

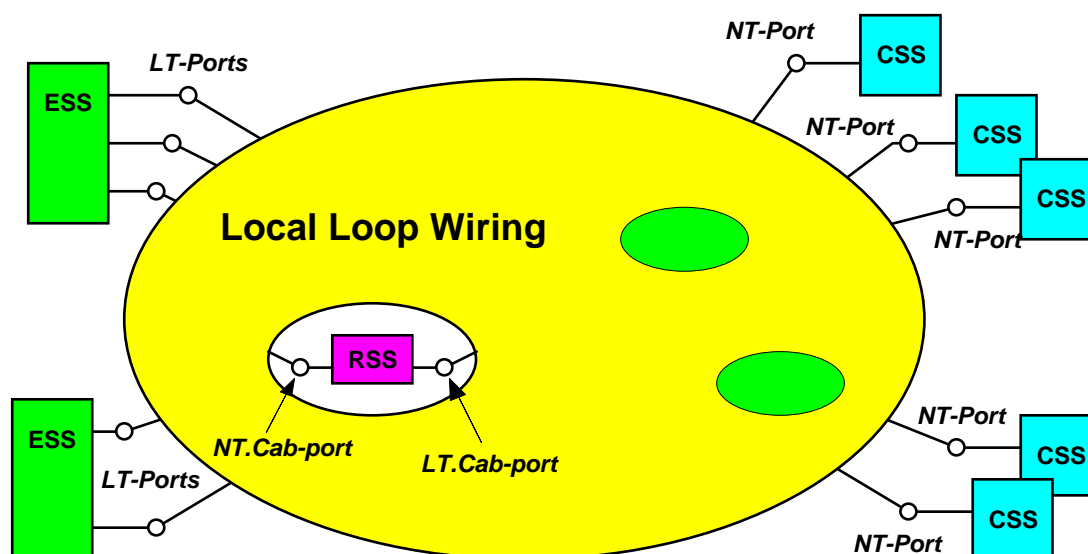

CSS: Customer-side Signal Source
 ESS: Exchange-side Signal Source
 RSS: Remote Signal Source
 LT-port: Line Termination Port, for injecting downstream signals from a ESS
 NT-port: Network Termination Port, for injecting upstream signals from a CSS
 LT.cab-port: LT-cabinet Port, for injecting downstream signals from a RSS
 NT.cab-port: NT-cabinet Port, for injecting upstream signals from a RSS

NOTE: "Connecting a Signal Source to a port of the Local Loop Wiring", does not necessary mean "intended for transmission through that local loop wiring". For instance, in-house transmission equipment (such as HPNA) may use existing in-house telephony wires, so they are also "connected to the local loop wiring". They will (unintentionally) inject signals into the Local Loop Wiring via the NT-ports. These signals are subject to the signal limits at the ports.

Figure 2: Reference model of the local loop wiring of an access network

6 Minimum set of characteristics for signal descriptions

To classify signals for spectral management purposes, the following parameters are relevant:

- Total signal voltage (or power).
- Peak amplitude.
- Narrow-band signal voltage (or power).
- Unbalance about earth (LOV and LCL).
- Feeding Power (if relevant).

In some cases, additional parameters are required, such as feeding requirements (in case of remote powering) and ringing signals.

7 Cluster 0 signals (DC power feeding)

This cluster summarizes maximum DC feeding voltages and currents, used for remote powering of transmission equipment (including POTS, ISDN, HDSL and SDSL). The DC power-feeding limits are supplementary to the AC signal descriptions in the succeeding clusters 1 to 5. By referring to both kinds of signal descriptions, the simultaneous use of AC signals and DC power feeding over the same wire pair can be enabled.

Feeding voltages and currents are to be limited for reasons like:

- General safety requirements, including any additional network related safety requirements and/or network protection requirements specified by the loop provider.
- Interoperability and/or prevention of damage to equipment and devices (system related reasons).

This cluster summarizes maximum DC feeding voltages and currents, used for remote powering of transmission equipment (including POTS, ISDN and xDSL). The DC power-feeding limits are supplementary to the AC signal descriptions in the succeeding clusters 1 to 5. By referring to both kinds of signal descriptions, the simultaneous use of AC signals and DC power feeding over the same wire pair can be enabled.

Feeding voltages and currents are to be limited for reasons like:

- General safety requirements, including any additional network related safety requirements and/or network protection requirements specified by the loop provider.
- Interoperability and/or prevention of damage to equipment and devices (system related reasons).

7.1 "Class A" TNV power feeding (from LT-port)

This category covers feeding voltages and currents that do not exceed the requirements relevant for safety, as can be found in Cenelec [i.19], [i.17] safety standards for TNV-3 circuits.

TNV-3 circuits have an operating voltage limit defined as a combination of the maximum DC-voltage and the peak AC-voltage, and may be subjected to overvoltages from the telecommunication network. TNV-3 circuits may be touched by users on a limited area of contact.

The present document provides information on how compliance with this signal class can be achieved and indicates the relevant specification(s):

To be compliant with this signal class, the combination of the DC power feeding and AC peak signal shall not exceed limits calculated from the formula: $(U_{DC}/120V + U_{AC,peak} / 70,7V \leq 1)$, and all requirements in [i.17] for TNV-3 circuits.

However in this context attention is drawn to CENELEC [i.20] for xDSL signals.

Reference: EN 0-1 [i.17].

Reference: TR 2 [i.19].

Reference: TS 7 [i.20].

7.2 "Class B" RFT power feeding (from the LT-port)

This category covers feeding voltages and currents that do not exceed the requirements relevant for safety as can be found in CENELEC [i.18] safety standards for RFT circuits (**R**emote **F**eeding **T**elecommunication). RFT circuits are subdivided into current limited circuits (RFT-C) and voltage limited circuits (RFT-V). The circuits may be subjected to overvoltages from the telecommunication network, and access to the conductors is restricted to service personnel. The present document provides information on how compliance with "class B" can be achieved and indicates the relevant specification(s):

To be compliant with "**class B.1" RFT-C Power Feeding**", the feeding current shall not exceed 60 mA DC for any feeding voltage value, and all other requirements in [i.18] for RFT-C circuits.

To be compliant with "**class B.2.1" RFT-V Power Feeding**", the steady state open circuit voltage from each conductor to earth shall not exceed 140 V dc, and all other requirements in [i.18] for RFT-V circuits.

To be compliant with "**class B.2.2" RFT-V Power Feeding**", the steady state open circuit voltage from each conductor to earth shall not exceed 200 V dc if the short circuit current is limited to 10 mA d.c, and all other requirements in [i.18] for RFT-V circuits.

Reference: EN 0-21 [i.18].

8 Cluster 1 signals (voice band)

This cluster summarizes signals that are generated by analogue transmission equipment (including POTS), voice band modems, analogue leased lines, telex signals encoded as voice band signals and music lines.

8.1 "POTS" signals (voice band lines 300 Hz to 3 400 Hz)

This category covers signals from telephony transmission equipment (e.g. telephones, voice band modems, Faxes, analogue leased lines, etc.) on a single wire pair. Unless other specified, the requirements on DTMF-signals (Dual Tone Multi-Frequency), as defined in [i.1], are equal to the voice signal.

A signal can be classified as a "POTS signal" if it is compliant with all the clauses below.

8.1.1 Total signal voltage

The present document provides information on how compliance with this signal category can be achieved and indicates where it is specified:

To be compliant with this signal category, the mean signal voltage over a reference impedance Z_R (see figure 5) shall not exceed a level of -9,7 dBV, measured within a frequency band from at least 200 Hz to 3,8 kHz, and over a one-minute period. This requirement does not apply to DTMF signals.

Reference: TBR 021 [i.1], clause 4.7.3.1 (tested according to clause A.4.7.3.1).

To be compliant with this signal category, the level of any tone in the DTMF high frequency group shall not be greater than -9,0 dBV + 2,0 dB = -7,0 dBV. The level of any tone in the low frequency group shall not be greater than -11,0 dBV + 2,5 dB = -8,5 dBV. This is to be measured when the TE interface is terminated with the specified reference impedance Z_R (see figure 5).

Reference: TBR 021 [i.1], clause 4.8.2.2 (tested according to clause A.4.8.2.2).

8.1.2 Peak amplitude

The present document provides information on how compliance with this signal category can be achieved and indicates the relevant specification(s):

To be compliant with this signal category, the peak-to-peak signal voltage over a reference impedance Z_R (see figure 5) shall not exceed a level of 5,0 V, measured within a frequency band from at least 200 Hz to 3,8 kHz.

The definition and measurement method of peak amplitude is specified in clause 13.1.

Reference: TBR 021 [i.1], clause 4.7.3.2 (tested according to clause A.4.7.3.2).

8.1.3 Narrow-band signal voltage

The present document provides information on how compliance with this signal category can be achieved and indicates the relevant specification(s):

To be compliant with this signal category, the narrow-band signal voltage (NBSV) shall not exceed the limits given in table 1, at any point in the frequency range 100 Hz to 30 MHz. This table specifies the break points of these limits, in which Z_R refers to the specified reference impedance Z_R (see figure 5). Limits for intermediate frequencies can be found by drawing a straight line between the break points on a logarithmic (Hz) - linear (dB) scale. Figure 3 illustrates the NBSV in a bandwidth-normalized way.

The NBSV is the average rms-voltage U of a sending signal into a (complex) load impedance Z , within a *power* bandwidth B . The measurement method of the NBSV is described in clause 13.2.

Reference: TBR 021 [i.1] (30 Hz to 4,3 kHz, clause 4.7.3.3), (4,3 kHz to 200 kHz, clause 4.7.3.4) the requirements above 200 kHz are extended from [i.1]. This extension is essential to guarantee compatibility with broadband xDSL systems.

Table 1: Break points of the narrow-band voltage limits

Frequency f	Impedance Z	Signal Level U	Power Bandwidth B	Spectral Voltage U/ \sqrt{B}
30 Hz	Z_R	-33,7 dBV	10 Hz	-43,7 dBV/ $\sqrt{\text{Hz}}$
100 Hz	Z_R	-10,7 dBV	10 Hz	-20,7 dBV/ $\sqrt{\text{Hz}}$
200 Hz	Z_R	-6,7 dBV	10 Hz	-16,7 dBV/ $\sqrt{\text{Hz}}$
3,8 kHz	Z_R	-6,7 dBV	10 Hz	-16,7 dBV/ $\sqrt{\text{Hz}}$
3,9 kHz	Z_R	-10,7 dBV	10 Hz	-20,7 dBV/ $\sqrt{\text{Hz}}$
4,0 kHz	Z_R	-16,7 dBV	10 Hz	-26,7 dBV/ $\sqrt{\text{Hz}}$
4,3 kHz	Z_R	-44,7 dBV	10 Hz	-54,7 dBV/ $\sqrt{\text{Hz}}$
4,3 kHz	Z_R	-40 dBV	300 Hz	-65 dBV/ $\sqrt{\text{Hz}}$
5,1 kHz	Z_R	-44 dBV	300 Hz	-69 dBV/ $\sqrt{\text{Hz}}$
8,9 kHz	Z_R	-44 dBV	300 Hz	-69 dBV/ $\sqrt{\text{Hz}}$
11,0 kHz	Z_R	-58,5 dBV	300 Hz	-83,5 dBV/ $\sqrt{\text{Hz}}$
11,0 kHz	Z_R	-58,5 dBV	1 kHz	-88,5 dBV/ $\sqrt{\text{Hz}}$
200 kHz	Z_R	-58,5 dBV	1 kHz	-88,5 dBV/ $\sqrt{\text{Hz}}$
200 kHz	135 Ω	-60 dBV	1 kHz	-90 dBV/ $\sqrt{\text{Hz}}$
500 kHz	135 Ω	-90 dBV	1 kHz	-120 dBV/ $\sqrt{\text{Hz}}$
500 kHz	135 Ω	-60 dBV	1 MHz	-120 dBV/ $\sqrt{\text{Hz}}$
30 MHz	135 Ω	-60 dBV	1 MHz	-120 dBV/ $\sqrt{\text{Hz}}$

NOTE: A voltage of 1 V, equals 0 dBV, and causes a power of +2,2 dBm in 600 Ω and +8,7 dBm in 135 Ω .

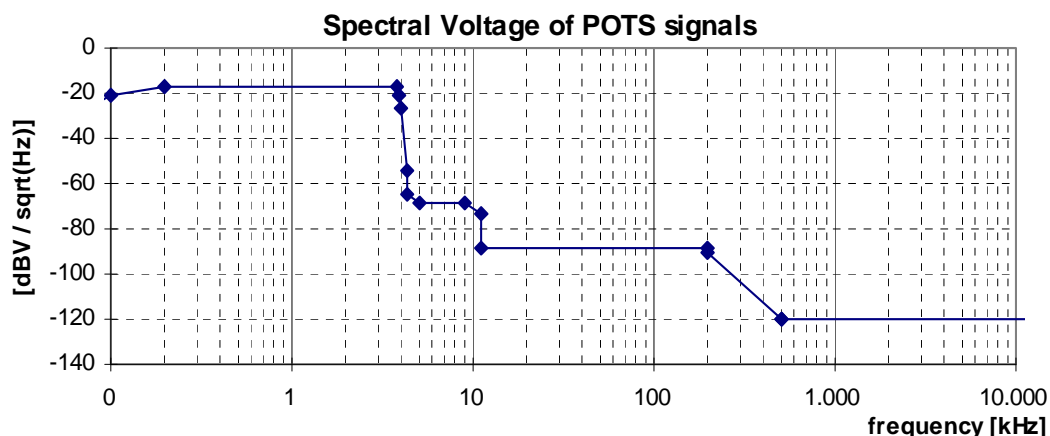

Figure 3: Spectral Voltage, for POTS signals, as specified in table 1

During tone signalling the limits given in table 1 do not apply to DTMF signals and are replaced by the following limits:

- In the range 4,3 kHz to 20 kHz, the individual level of any single frequency component shall not exceed -35,7 dBV, when terminated with Z_R .
- In the range 20 kHz to 200 kHz, the individual level of any single frequency component shall not exceed -40,7 dBV, when terminated with Z_R .
- In the range 200 kHz to 30 MHz, the individual level of any single frequency component is left for further study.

Reference: TBR 021 [i.1], clause 4.7.3.4.

8.1.4 Unbalance about earth

The present document provides information on how compliance with this signal category can be achieved and indicates the relevant specification(s):

To be compliant with this signal category, the balance of the signal that may flow through the LT-port or NT-port shall exceed minimum requirements, under the condition that the local loop wiring and its termination is well balanced. This can be verified by a Longitudinal Output Voltage (LOV) and a Longitudinal Conversion Loss (LCL) measurement at the source of that signal, as specified in clauses 13.3.2 and 13.3.3. The minimum LOV and LCL requirements hold for what can be observed at the ports of the Local Loop Wiring, when the Local Loop Wiring is replaced by an artificial impedance network described in clauses 13.3.2 and 13.3.3.

The differential termination impedance for LOV and LCL measurements shall be chosen equally to the impedance $R_T = R_1 + R_2$, as specified in table 2.

Table 2: Values for the components for the terminating impedance for measuring the LOV and LCL

	Value	Frequency range	Tolerance
Resistance R_T	300 Ω	50 Hz to 3 800 Hz	
Resistance R_T	135/2 Ω	3 800 Hz to 30 MHz	R1/R2 = 1 \pm 0,1 %
NOTE: TE powering by Feeding bridge according to TBR 021 [i.1], clause 4.4.3.			

The observed LOV shall have an rms voltage of below the value specified in table 3, measured in a *power* bandwidth B , centred over any frequency in the range from f_{\min} to f_{\max} , and averaged in any one second period. Compliance with this limitation is required with a longitudinal terminating impedance having value $Z_L(\omega) = R_L + 1 / (j\omega \times C_L)$ for all frequencies between f_{\min} to f_{\max} . Clause 13.3.2 defines an example measurement method for longitudinal output voltage.

The observed LCL shall be higher than the lower limits given in figure 4. The LCL values of the associated break frequencies of this figure are given in table 4. Clause 13.3.3 defines an example measurement method for longitudinal conversion loss.

Reference: TBR 021 [i.1], clauses 4.4.3 and 4.7.4.1.

Reference: EN 300 450 [i.4], clause 4.2.2.

Reference: EN 300 453 [i.5], clause 4.2.2.

Reference: TS 101 270-1 [i.13], clause 8.3.3.

Table 3: Values for the LOV limits

LOV	B	f_{\min}	f_{\max}	R_L	C_L
-46 dBV	1 kHz	510 Hz	10 kHz	100 Ω	150 nF

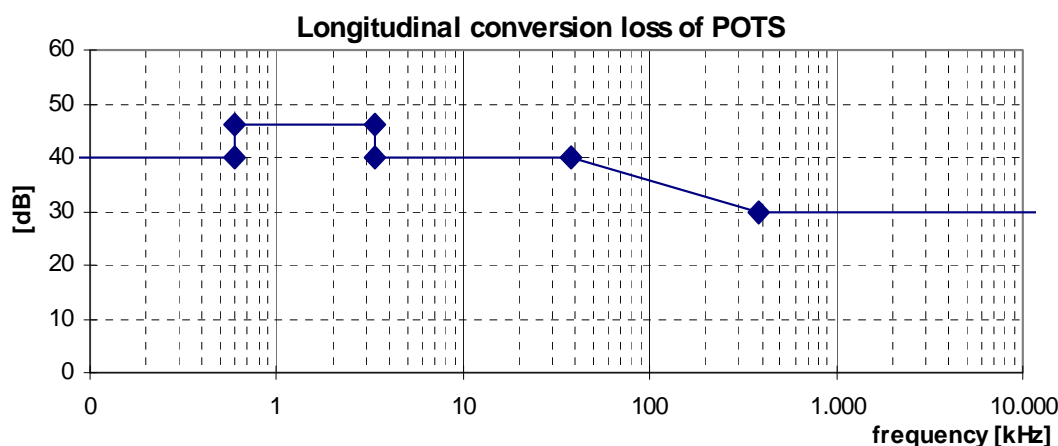

Figure 4: Minimum longitudinal conversion loss for a POTS-signal source

Table 4: Frequencies and LCL values of the breakpoints of the LCL mask in figure 4

Frequency range	Minimum value	Impedance
50 Hz to 600 Hz	40 dB	600 Ω
600 Hz to 3 400 Hz	46 dB	600 Ω
3 400 Hz to 3 800 Hz	40 dB	600 Ω
3 800 Hz to 38 kHz	40 dB	135 Ω
38 kHz to 380 kHz	40 dB to 30 dB	135 Ω
380 kHz to 30 MHz	30 dB	135 Ω

8.1.5 Feeding power (from the LT-port)

Power feeding is no integral part of this signal category, although it is not uncommon for POTS services. To enable power feeding in combination with this signal category, refer to Class A in clause 7. However, when ringing signals are present, the requirements in EN 0-1 [i.17], annex M has to be followed.

Reference: EN 0-1 [i.17].

Reference: EN 0-21 [i.18].

Reference: TR 2 [i.19].

Reference: TS 7 [i.20].

8.1.6 Reference impedance Z_R

The reference impedance Z_R , that is used to enable the specification of various signal levels, is the European harmonized complex impedance. This harmonized complex impedance (see figure 5) equals 270 Ω in series with a parallel combination of 750 Ω and 150 nF.

Reference: TBR 021 [i.1], clause A.2.1.

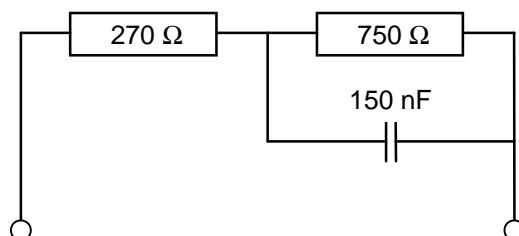
**Figure 5: Reference impedance Z_R**

8.1.7 Ringing signal

The present document provides information on how compliance with this signal category can be achieved and indicates the relevant specification(s):

To be compliant with this signal category, the AC ringing voltage shall not exceed the maximum values in table 5. The AC ringing signal may be or may be not superimposed on the DC feeding voltage.

Reference: ES 201 970 [i.2], clause 12.1.2.

Reference: EN 300 001 [i.3], clause 1.7.2.

Table 5: Maximum ringing signal (POTS service)

	Frequency	Maximum Voltage
ES 201 970 [i.2]	25 Hz \pm 2 Hz	100 V _{rms}
Country 1	50 Hz	100 V _{rms}
Country 2		

8.1.8 Metering signals

The present document provides information on how compliance with this signal category can be achieved and indicates the relevant specification(s):

To be compliant with this signal category, 50 Hz common mode metering pulses (if added to POTS lines), shall be within the limits of table 6.

NOTE: Most access networks are using a different type of metering signals.

Reference: EN 300 001 [i.3], clause 1.7.8.

Table 6: Maximum metering signal

Frequency	Voltage	Pulse width
48 Hz to 52 Hz	Maximum 100 V _{rms}	70 ms to 200 ms

9 Cluster 2 signals (semi broadband)

This cluster summarizes signals that are generated by digital transmission equipment up to 160 kbit/s, including ISDN-BA and 64 kbit/s and 128 kbit/s leased lines.

9.1 "ISDN.2B1Q" signals

This category covers signals generated by ISDN transmission equipment on a single wire-pair, based on 2B1Q line coding. This clause is based on the ETSI reports on ISDN equipment [i.6].

A signal can be classified as an "ISDN.2B1Q signal" if it is compliant with all the clauses below.

9.1.1 Total signal power

The present document provides information on how compliance with this signal category can be achieved and indicates the relevant specification(s):

To be compliant with this signal category, the mean signal power into a resistive load of 135 Ω shall not exceed a level of +13,5 dBm ($\pm 0,5$ dBm), measured within a frequency band from at least 100 Hz to 80 kHz.

Reference: TS 102 080 [i.6], clause A.12.3.

9.1.2 Peak amplitude

The present document provides information on how compliance with this signal category can be achieved and indicates the relevant specification(s):

To be compliant with this signal category, the nominal voltage peak of the largest signal pulse into a resistive load of 135 Ω shall not exceed a level of 2,5 V (± 5 %), measured within a frequency band from at least 100 Hz to 80 kHz.

The definition and measurement method of peak amplitude is specified in clause 13.1.

Reference: TS 102 080 [i.6], clause A.12.1.

9.1.3 Narrow-Band Signal Power (NBSP)

The present document provides information on how compliance with this signal category can be achieved and indicates the relevant specification(s):

To be compliant with this signal category, the Narrow-Band Signal Power (NBSP) into a resistive load impedance R , shall not exceed the limits given in table 7, at any point in the frequency range 100 Hz to 30 MHz. This table specifies the break points of these limits. Limits for intermediate frequencies can be found by drawing a straight line between the break points on a logarithmic (Hz) - linear (dB) scale. Figure 6 illustrates the NBSP in a bandwidth-normalized way.

The NBSP is the average power P of a sending signal into a load resistance R , within a *power* bandwidth B . The measurement method of the NBSP is described in clause 13.2.

NOTE: The NBSP specification in table 7 is reconstructed from the commonly used PSD specification in [i.6] (similar to figure 6), and used here since it is much wider applicable. This enables a unified specification method. PSD specifications are adequate when signals are purely random in nature, but cannot cover harmonic components in a signal (would cause infinite high "PSD" levels at these harmonic frequencies). NBSP specifications cover both signal types.

The nature of the original PSD specification in [i.6] is in fact a NBSP specification, since the use of a 10 kHz bandwidth (above 10 kHz) and a 1 MHz bandwidth (above 300 kHz) is mandatory in [i.6]. The additional use of a sliding window PSD specification in [i.6], in order to make sure that different systems do not fill the entire allowable bandwidth with noise up to the PSD limit, illustrates the NBSP nature of the PSD specification in [i.6] in more detail. Mark that in [i.6] the lower frequency (300 kHz) has been specified, while table 7 specifies centre frequencies (starting at 300 kHz + 500 kHz).

Reference: TS 102 080 [i.6], clause A.12.4.

Table 7: Break points of the narrow-band power limits

Centre Frequency f	Impedance R	Signal Level P	Power bandwidth B	Spectral Power P/B	
510 Hz	135 Ω	-0 dBm	1 kHz	-30 dBm/Hz	"X"
10 kHz	135 Ω	-0 dBm	1 kHz	-30 dBm/Hz	
10 kHz	135 Ω	10 dBm	10 kHz	-30 dBm/Hz	
50 kHz	135 Ω	10 dBm	10 kHz	-30 dBm/Hz	
500 kHz	135 Ω	-40 dBm	10 kHz	-80 dBm/Hz	
1,4 MHz	135 Ω	-40 dBm	10 kHz	-80 dBm/Hz	
5 MHz	135 Ω	-80 dBm	10 kHz	-120 dBm/Hz	
30 MHz	135 Ω	-80 dBm	10 kHz	-120 dBm/Hz	
800 kHz	135 Ω	-30 dBm	1 MHz	-90 dBm/Hz	"Y"
1,4 MHz	135 Ω	-30 dBm	1 MHz	-90 dBm/Hz	
3,637 MHz	135 Ω	-60 dBm	1 MHz	-120 dBm/Hz	
30 MHz	135 Ω	-60 dBm	1 MHz	-120 dBm/Hz	

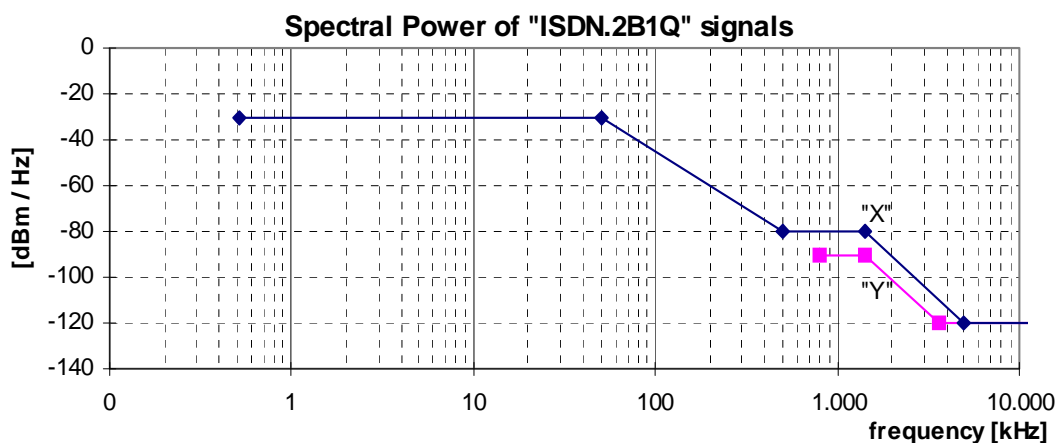

Figure 6: Spectral Power, for ISDN.2B1Q signals, as specified in table 7

9.1.4 Unbalance about earth

The present document provides information on how compliance with this signal category can be achieved and indicates the relevant specification(s):

To be compliant with this signal category, the balance of the signal that may flow through the LT-port or NT-port shall exceed minimum requirements, under the condition that the local loop wiring and its termination is well balanced. This can be verified by a Longitudinal Output Voltage (LOV) and a Longitudinal Conversion Loss (LCL) measurement at the source of that signal, as specified in clauses 13.3.2 and 13.3.3. The minimum LOV and LCL requirements hold for what can be observed at the ports of the Local Loop Wiring, when the Local Loop Wiring is replaced by an artificial impedance network described in clauses 13.3.2 and 13.3.3.

The differential termination impedance for LOV and LCL measurements shall be chosen equally to the design impedance $R_T = 135 \Omega$ of the Signal Source under test.

The observed LOV shall have an rms voltage of below the value specified in table 8, measured in a *power* bandwidth B , centred over any frequency in the range from f_{\min} to f_{\max} , and averaged in any one second period. Compliance with this limitation is required with a longitudinal terminating impedance having value $Z_L(\omega) = R_L + 1 / (j\omega \times C_L)$ for all frequencies between f_{\min} to f_{\max} . Clause 13.3.2 defines an example measurement method for longitudinal output voltage.

The observed LCL shall be higher than the lower limits given in figure 7. The LCL values of the associated break frequencies of this figure are given in table 9. Clause 13.3.3 defines an example measurement method for longitudinal conversion loss.

Reference: TS 102 080 [i.6], clause A.13.3.1, extended to 30 MHz according to [i.13].

Reference: TS 101 270-1 [i.13], clause 8.3.3.

Table 8: Values for the LOV limits

LOV	B	f_{\min}	f_{\max}	R_L	C_L
-46 dBV	10 kHz	5,1 kHz	225 kHz	100 Ω	150 nF

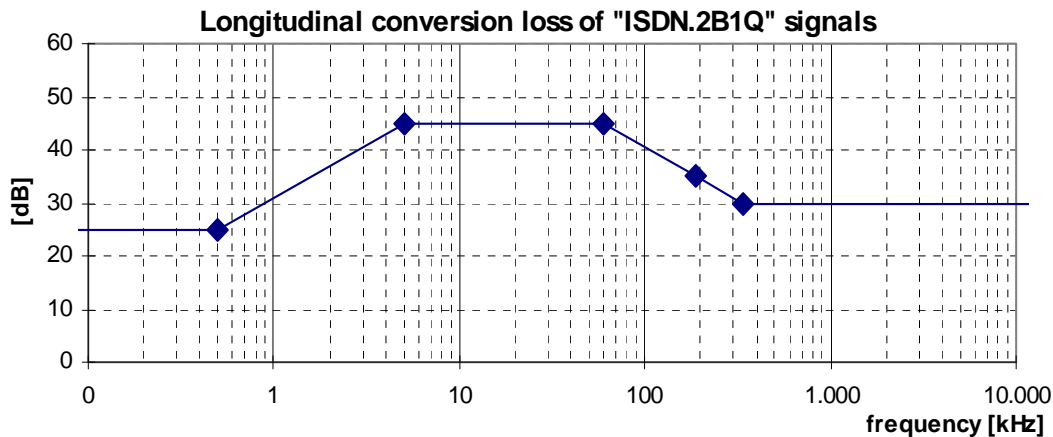

Figure 7: Minimum longitudinal conversion loss for a "ISDN.2B1Q" signal source

Table 9: Frequencies and LCL values of the breakpoints of the LCL mask in figure 7

Frequency range	LCL
< 0,5 kHz	25 dB
5 kHz	45 dB
60 kHz	45 dB
190 kHz	35 dB
337 kHz	30 dB
30 MHz	30 dB

9.1.5 Feeding power (from the LT-port)

Power feeding is no integral part of this signal category, although it is not uncommon for ISDN.2B1Q services. To enable power feeding in combination with this signal category, refer to one of the power feeding classes summarized in clause 7.

9.2 "ISDN.MMS.43" signals

This category covers signals generated by ISDN transmission equipment on a single wire-pair, based on MMS 43 (also known as 4B3T) line coding. This clause is based on the ETSI reports on ISDN equipment [i.6].

A signal can be classified as an "ISDN.MMS.43" signal if it is compliant with all clauses below.

9.2.1 Total signal power

The present document provides information on how compliance with this signal category can be achieved and indicates the relevant specification(s):

To be compliant with this signal category, the mean signal power into a resistive load of 150 Ω shall not exceed a level of +13,5 dBm ($\pm 0,5$ dBm), measured within a frequency band from at least 100 Hz to 100 kHz.

9.2.2 Peak amplitude

The present document provides information on how compliance with this signal category can be achieved and indicates the relevant specification(s):

To be compliant with this signal category, the nominal voltage peak of the largest signal pulse into a resistive load of 150 Ω shall not exceed a level of 2,0 V (± 10 %), measured within a frequency band from at least 100 Hz to 100 kHz.

The definition and measurement method of peak amplitude is specified in clause 13.1.

Reference: TS 102 080 [i.6], clause B.12.1.

9.2.3 Narrow-band signal power

The present document provides information on how compliance with this signal category can be achieved and indicates the relevant specification(s):

To be compliant with this signal category, the Narrow-Band Signal Power (NBSP) into a resistive load impedance R , shall not exceed the limits given in table 10, at any point in the frequency range 100 Hz to 30 MHz. This table specifies the break points of these limits. Limits for intermediate frequencies can be found by drawing a straight line between the break points on a logarithmic (Hz) - linear (dB) scale. Figure 8 illustrates the NBSP in a bandwidth-normalized way.

The NBSP is the average power P of a sending signal into a load resistance R , within a *power* bandwidth B . The measurement method of the NBSP is described in clause 13.2.

NOTE: The NBSP specification in table 10 is reconstructed from the commonly used PSD specification in [i.6] (similar to figure 8), and used here since it is much wider applicable. This enables a unified specification method. PSD specifications are adequate when signals are purely random in nature, but cannot cover harmonic components in a signal (would cause infinite high "PSD" levels at these harmonic frequencies). NBSP specifications cover both signal types.

The nature of the original PSD specification in [i.6] is in fact a NBSP specification, since the use of a 10 kHz bandwidth (above 10 kHz) and a 1 MHz bandwidth (above 300 kHz) is mandatory in [i.6]. The additional use of a sliding window PSD specification in [i.6], in order to make sure that different systems do not fill the entire allowable bandwidth with noise up to the PSD limit, illustrates the NBSP nature of the PSD specification in [i.6] in more detail.

Mark that in [i.6] the lower frequency (300 kHz) has been specified, while table 10 specifies centre frequencies (starting at 300 kHz + 500 kHz).

Reference: TS 102 080 [i.6], clause B.12.4.

Table 10: Break points of the narrow-band power limits

Centre Frequency f	Impedance R	Signal Level P	Power bandwidth B	Spectral Power P/B	
510 Hz	150 Ω	-0 dBm	1 kHz	-30 dBm/Hz	"X"
10 kHz	150 Ω	-0 dBm	1 kHz	-30 dBm/Hz	
10 kHz	150 Ω	10 dBm	10 kHz	-30 dBm/Hz	
50 kHz	150 Ω	10 dBm	10 kHz	-30 dBm/Hz	
300 kHz	150 Ω	-27 dBm	10 kHz	-67 dBm/Hz	
1 MHz	150 Ω	-27 dBm	10 kHz	-67 dBm/Hz	
5 MHz	150 Ω	-80 dBm	10 kHz	-120 dBm/Hz	"Y"
30 MHz	150 Ω	-80 dBm	10 kHz	-120 dBm/Hz	
800 kHz	150 Ω	-17 dBm	1 MHz	-77 dBm/Hz	
1 MHz	150 Ω	-17 dBm	1 MHz	-77 dBm/Hz	
3,69 MHz	150 Ω	-60 dBm	1 MHz	-120 dBm/Hz	
30 MHz	150 Ω	-60 dBm	1 MHz	-120 dBm/Hz	

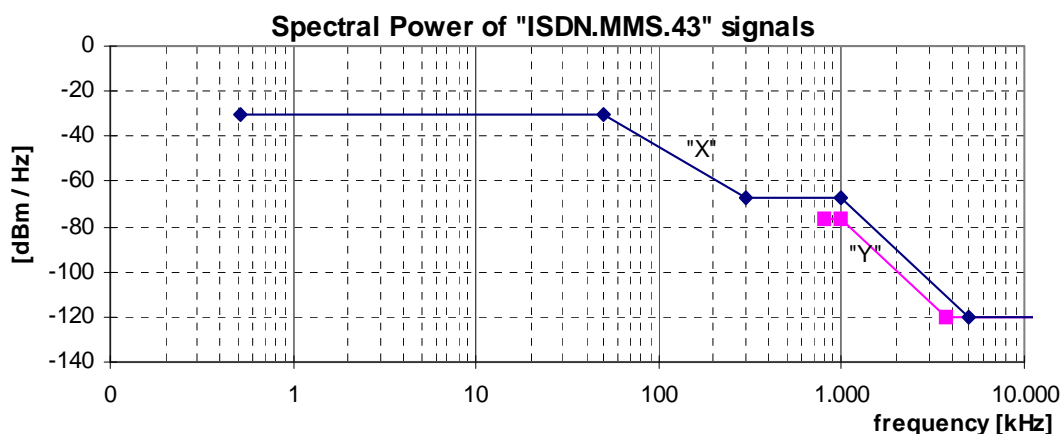

Figure 8: Spectral Power, for "ISDN.MMS.43" signals, as specified in table 10

9.2.4 Unbalance about earth

The present document provides information on how compliance with this signal category can be achieved and indicates the relevant specification(s):

To be compliant with this signal category, the balance of the signal that may flow through the LT-port or NT-port shall exceed minimum requirements, under the condition that the local loop wiring and its termination is well balanced. This can be verified by a Longitudinal Output Voltage (LOV) and a Longitudinal Conversion Loss (LCL) measurement at the source of that signal, as specified in clauses 13.3.2 and 13.3.3. The minimum LOV and LCL requirements hold for what can be observed at the ports of the Local Loop Wiring, when the Local Loop Wiring is replaced by an artificial impedance network described in clauses 13.3.2 and 13.3.3.

The differential termination impedance for LOV and LCL measurements shall be chosen equally to the design impedance $R_T = 150 \Omega$ of the Signal Source under test.

The observed LOV shall have an rms voltage of below the value specified in table 11, measured in a *power* bandwidth B , centred over any frequency in the range from f_{\min} to f_{\max} , and averaged in any one second period. Compliance with this limitation is required with a longitudinal terminating impedance having value $Z_L(\omega) = R_L + 1 / (j\omega \times C_L)$ for all frequencies between f_{\min} to f_{\max} . Clause 13.3.2 defines an example measurement method for longitudinal output voltage.

The observed LCL shall be higher than the lower limits given in figure 9. The LCL values of the associated break frequencies of this figure are given in table 12. Clause 13.3.3 defines an example measurement method for longitudinal conversion loss.

Reference: TS 102 080 [i.6], clause B.13.3 extended to 30 MHz according to [i.13].

Reference: TS 101 270-1 [i.13], clause 8.3.3.

Table 11: Values for the LOV limits

LOV	B	f_{\min}	f_{\max}	R_L	C_L
-46 dBV	10 kHz	5,1 kHz	245 kHz	100 Ω	150 nF

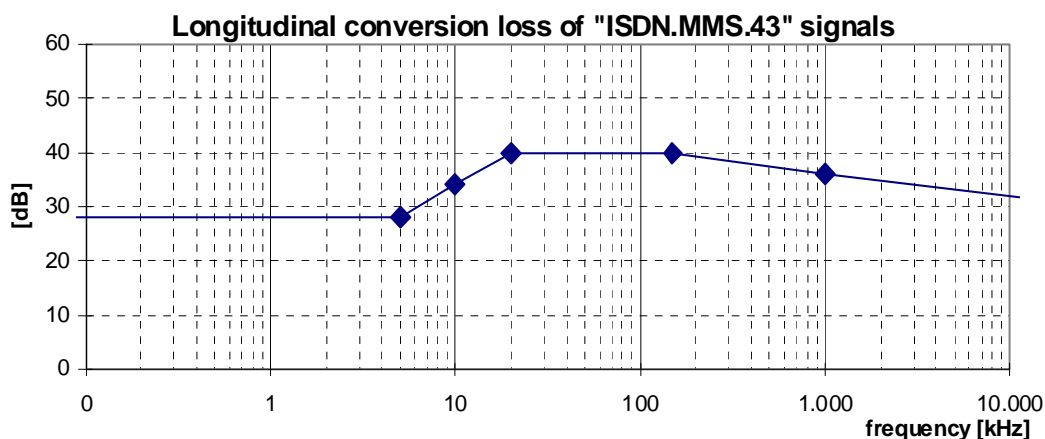

Figure 9: Minimum longitudinal conversion loss for a "ISDN.MMS43" signal source

Table 12: Frequencies and LCL values of the breakpoints of the LCL mask in figure 9

Frequency range	LCL
< 5 kHz	28 dB
10 kHz	34 dB
20 kHz	40 dB
150 kHz	40 dB
1 MHz	36 dB
30 MHz	30 dB

9.2.5 Feeding power (from the LT-port)

Power feeding is no integral part of this signal category, although it is not uncommon for ISDN.MMS.43 services. To enable power feeding in combination with this signal category, refer to one of the power feeding classes summarized in clause 7.

9.3 "Proprietary.SymDSL.CAP.QAM" signals

This category covers signals, generated by Proprietary multi-rate SymDSL transmission equipment on one wire-pair. This signal is labelled as Proprietary, since it is not covered by ETSI, ITU nor ANSI product standards. This signal definition is linecode independent, but dedicated to signals from transmission equipment for variable bit-rate leased lines that are using CAP or QAM modulation.

A signal can be classified as a "Proprietary.SymDSL.CAP.QAM" signal if it is compliant with all clauses below. Unless otherwise indicated, the following signal specifications apply with a resistive load impedance of 135 Ω .

9.3.1 Total signal power

The present document provides information on how compliance with this signal category can be achieved:

To be compliant with this signal category, the mean signal power into a resistive load of 135 Ω shall not exceed a level of +14 dBm, measured within a frequency band from at least 100 Hz to 1 MHz.

NOTE: No ETSI deliverable does specify this parameter.

9.3.2 Peak amplitude

The present document provides information on how compliance with this signal category can be achieved:

To be compliant with this signal category, the nominal voltage peak of the largest signal pulse into a resistive load of 135 Ω shall not exceed a level of 7,5 V (15 V peak-peak), measured within a frequency band from at least 100 Hz to 1 MHz.

The definition and measurement method of peak amplitude is specified in clause 13.1.

NOTE: No ETSI deliverable does specify this parameter.

9.3.3 Narrow-Band Signal Power (NBSP)

The present document provides information on how compliance with this signal category can be achieved:

To be compliant with this signal category, the Narrow-Band Signal Power (NBSP) into a resistive load impedance R , shall not exceed the limits given in table 13, at any point in the frequency range 100 Hz to 30 MHz. This table specifies the break points of these limits. Limits for intermediate frequencies can be found by drawing a straight line between the break points on a logarithmic (Hz) - linear (dB) scale. Figure 10 illustrates the NBSP in a bandwidth-normalized way.

The NBSP is the average power P of a sending signal into a load resistance R , within a *power* bandwidth B . The measurement method of the NBSP is described in clause 13.2.

NOTE: No ETSI deliverable does specify this parameter.

Table 13: Break points of the narrow-band signal power P

Centre frequency f	Impedance R	Signal Level P	Power bandwidth B	Spectral Power P/B	
510 Hz	135 Ω	-0 dBm	1 kHz	-30 dBm/Hz	"X"
10 kHz	135 Ω	-0 dBm	1 kHz	-30 dBm/Hz	
10 kHz	135 Ω	+10 dBm	10 kHz	-30 dBm/Hz	
50 kHz	135 Ω	+10 dBm	10 kHz	-30 dBm/Hz	
120 kHz	135 Ω	-9 dBm	10 kHz	-49 dBm/Hz	
300 kHz	135 Ω	-50 dBm	10 kHz	-90 dBm/Hz	
30 MHz	135 Ω	-50 dBm	10 kHz	-90 dBm/Hz	"Y"
300 kHz	135 Ω	-30 dBm	1 MHz	-90 dBm/Hz	
460 kHz	135 Ω	-50 dBm	1 MHz	-110 dBm/Hz	
30 MHz	135 Ω	-50 dBm	1 MHz	-110 dBm/Hz	

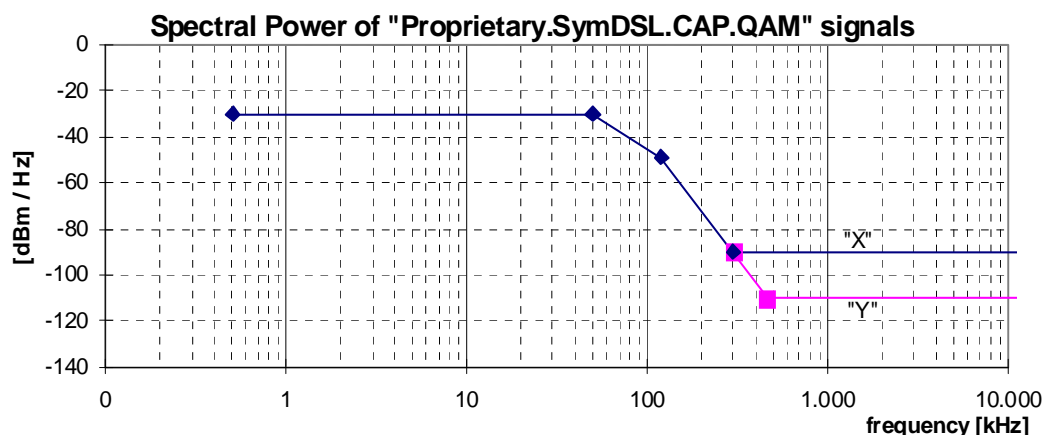

Figure 10: Spectral Power, for "Proprietary.SymDSL.CAP.QAM" signals, as specified in table 13

9.3.4 Unbalance about earth

The present document provides information on how compliance with this signal category can be achieved:

To be compliant with this signal category, the balance of the signal that may flow through the LT-port or NT-port shall exceed minimum requirements, under the condition that the local loop wiring and its termination is well balanced. This can be verified by a Longitudinal Output Voltage (LOV) and a Longitudinal Conversion Loss (LCL) measurement at the source of that signal, as specified in clauses 13.3.2 and 13.3.3. The minimum LOV and LCL requirements hold for what can be observed at the ports of the Local Loop Wiring, when the Local Loop Wiring is replaced by an artificial impedance network described in clauses 13.3.2 and 13.3.3.

The differential termination impedance for LOV and LCL measurements shall be chosen equally to the design impedance $R_T = 135 \Omega$ of the signal source under test.

The observed LOV shall have an rms voltage of below the value specified in table 14, measured in a *power* bandwidth B , centred over any frequency in the range from f_{\min} to f_{\max} , and averaged in any one second period. Compliance with this limitation is required with a longitudinal terminating impedance having value $Z_L(\omega) = R_L + 1 / (j\omega \times C_L)$ for all frequencies between f_{\min} to f_{\max} . Clause 13.3.2 defines an example measurement method for longitudinal output voltage.

The observed LCL shall be higher than the lower limits given in figure 11. The LCL values of the associated break frequencies of this figure are given in table 43. Clause 13.3.3 defines an example measurement method for longitudinal conversion loss.

NOTE: No ETSI deliverable does specify this parameter.

Table 14: Values for the LOV limits

LOV	B	f_{\min}	f_{\max}	R_L	C_L
-46 dBV	10 kHz	5,1 kHz	225 kHz	100 Ω	150 nF

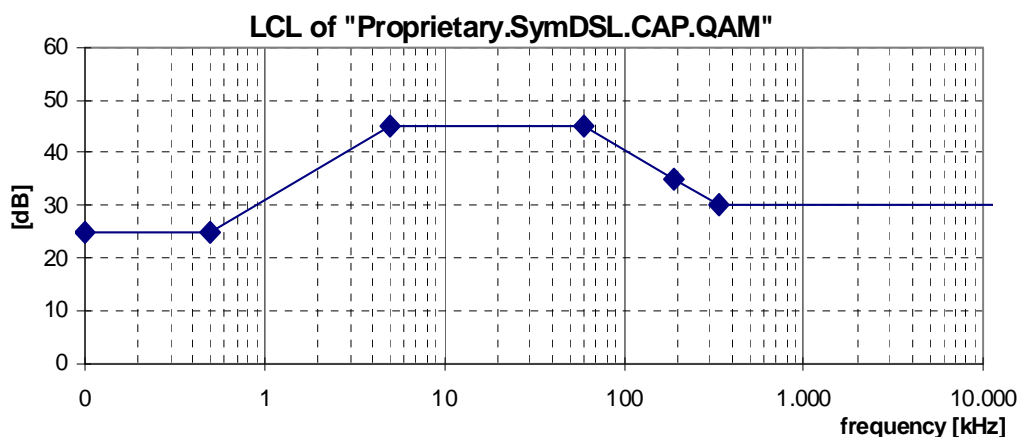

Figure 11: Minimum LCL for a "Proprietary.SymDSL.CAP.QAM" signal source

Table 15: Frequencies and LCL values of the breakpoints of the LCL mask in figure 11

Frequency	LCL
< 0,5 kHz	25 dB
5 kHz	45 dB
60 kHz	45 dB
190 kHz	35 dB
337 kHz	30 dB
30 MHz	30 dB

10 Cluster 3 signals (symmetrical broadband)

This cluster summarizes symmetrical signals that are generated by digital transmission equipment up to 2 Mbit/s, including HDSL and SDSL. If such a system requires more than one wire-pair for carrying that bitrate, the signal description holds for each individual wire-pair.

These signals are commonly used to carry services like high quality leased lines, with symmetrical bitrates (in up- and downstream directions).

10.1 "HDSL.2B1Q/3" signals (392 kbaud leased lines)

This category covers signals, generated by HDSL transmission equipment on three wire-pairs, based on 2B1Q line coding. This clause is based on the ETSI reports on HDSL equipment [i.7]. These are essentially 392 kbaud systems (per wire-pair).

A signal (per wire-pair) can be classified as an "HDSL.2B1Q/3 signal" if it is compliant with all clauses below. Unless otherwise indicated, the following signal specifications apply with a resistive load impedance of 135 Ω , and does not apply to the DC remote power feeding (if any).

10.1.1 Total signal power

The present document provides information on how compliance with this signal category can be achieved and indicates the relevant specification(s):

To be compliant with this signal category, the mean signal power into a resistive load of 135 Ω shall not exceed a level of +14 dBm, measured within a frequency band from at least 100 Hz to 784 kHz.

Reference: TS 101 135 [i.7], clause 5.8.4.4.

10.1.2 Peak amplitude

The present document provides information on how compliance with this signal category can be achieved and indicates the relevant specification(s):

To be compliant with this signal category, the nominal voltage peak of the largest signal pulse into a resistive load of 135Ω shall not exceed a level of 2,64 V ($\pm 7 \%$), measured within a frequency band from at least 100 Hz to 784 kHz. The definition and measurement method of peak amplitude is specified in clause 13.1.

Reference: TS 101 135 [i.7], clause 5.8.4.1.

10.1.3 Narrow-Band Signal Power (NBSP)

The present document provides information on how compliance with this signal category can be achieved and indicates the relevant specification(s):

To be compliant with this signal category, the Narrow-Band Signal Power (NBSP) into a resistive load impedance R , shall not exceed the limits given in table 16, at any point in the frequency range 100 Hz to 30 MHz. This table specifies the break points of these limits. Limits for intermediate frequencies can be found by drawing a straight line between the break points on a logarithmic (Hz) - linear (dB) scale. Figure 12 illustrates the NBSP in a bandwidth-normalized way.

The NBSP is the average power P of a sending signal into a load resistance R , within a power bandwidth B . The measurement method of the NBSP is described in clause 13.2.

Reference: TS 101 135 [i.7], clause 5.8.4.3. These numbers are reconstructed from PSD requirements in [i.7].

NOTE: The NBSP specification in table 16 is reconstructed from the commonly used PSD specification in [i.7] (similar to figure 12), and used here since it is much wider applicable. This enables a unified specification method. PSD specifications are adequate when signals are purely random in nature, but cannot cover harmonic components in a signal (would cause infinite high "PSD" levels at these harmonic frequencies). NBSP specifications cover both signal types.

Table 16: Break points of the narrow-band power limits

Centre Frequency f	Impedance R	Signal Level P	Power bandwidth B	Spectral Power P/B
0,51 kHz	135Ω	-7 dBm	1 kHz	-37 dBm/Hz
10 kHz	135Ω	-7 dBm	1 kHz	-37 dBm/Hz
10 kHz	135Ω	+3 dBm	10 kHz	-37 dBm/Hz
196 kHz	135Ω	+3 dBm	10 kHz	-37 dBm/Hz
1,96 MHz	135Ω	-77 dBm	10 kHz	-117 dBm/Hz
1,96 MHz	135Ω	-57 dBm	1 MHz	-117 dBm/Hz
30 MHz	135Ω	-57 dBm	1 MHz	-117 dBm/Hz

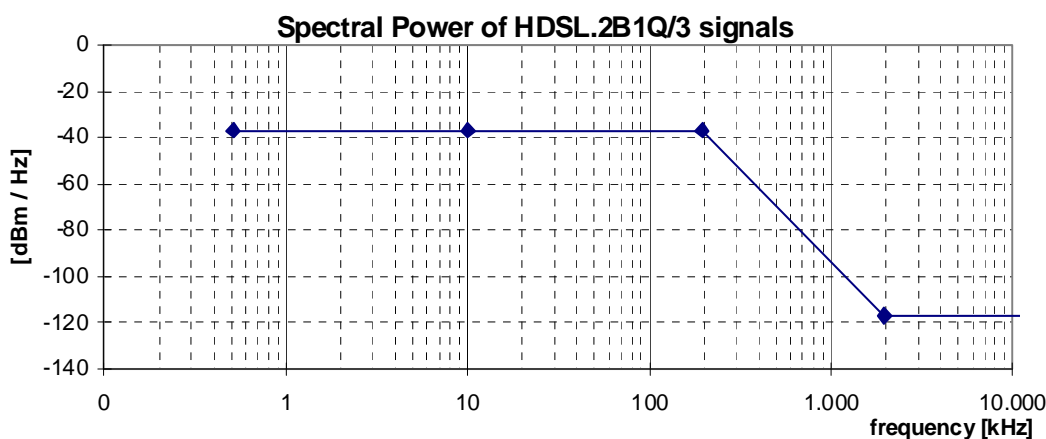

Figure 12: Spectral Power, for HDSL.2B1Q/3 signals, as specified in table 16

10.1.4 Unbalance about earth

The present document provides information on how compliance with this signal category can be achieved and indicates the relevant specification(s):

To be compliant with this signal category, the balance of the signal that may flow through the LT-port or NT-port shall exceed minimum requirements, under the condition that the local loop wiring and its termination is well balanced. This can be verified by a Longitudinal Output Voltage (LOV) and a Longitudinal Conversion Loss (LCL) measurement at the source of that signal, as specified in clauses 13.3.2 and 13.3.3. The minimum LOV and LCL requirements hold for what can be observed at the ports of the Local Loop Wiring, when the Local Loop Wiring is replaced by an artificial impedance network described in clauses 13.3.2 and 13.3.3.

The differential termination impedance for LOV and LCL measurements shall be chosen equally to the design impedance $R_T = 135 \Omega$ of the signal source under test.

The observed LOV shall have an rms voltage of below the value specified in table 17, measured in a *power* bandwidth **B**, centred over any frequency in the range from f_{\min} to f_{\max} , and averaged in any one second period. Compliance with this limitation is required with a longitudinal terminating impedance having value $Z_L(\omega) = R_L + 1 / (j\omega \times C_L)$ for all frequencies between f_{\min} to f_{\max} . Clause 13.3.2 defines an example measurement method for longitudinal output voltage.

The observed LCL shall be higher than the lower limits given in figure 13. The LCL values of the associated break frequencies of this figure are given in table 18. Clause 13.3.3 defines an example measurement method for longitudinal conversion loss.

Reference: TS 101 135 [i.7], clause 5.8.5.1 extended to 30 MHz according to [i.13].

Reference: TS 101 270-1 [i.13], clause 8.3.3.

Table 17: Values for the LOV limits

LOV	B	f_{\min}	f_{\max}	R_L	C_L
-46 dBV	10 kHz	5,1 kHz	410 kHz	100 Ω	150 nF

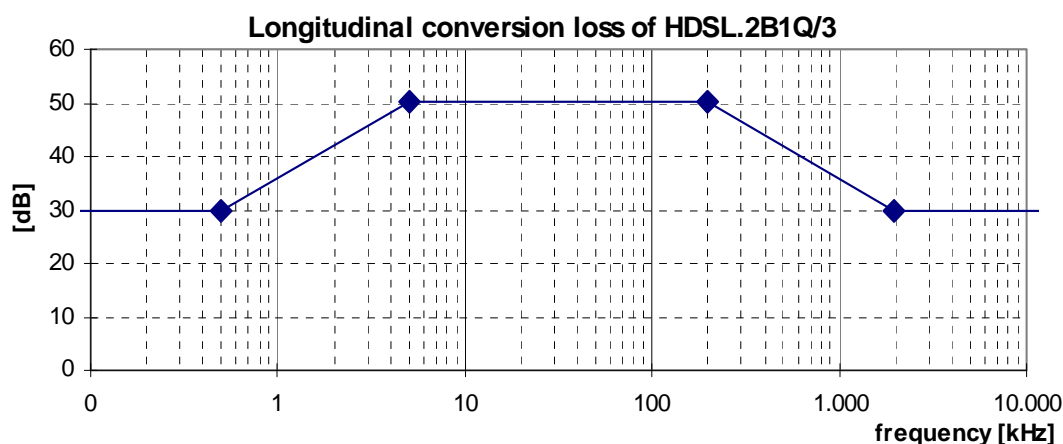

Figure 13: Minimum longitudinal conversion loss for a HDSL.2B1Q/3 signal source (392 kbaud/wirepair)

Table 18: Frequencies and LCL values of the breakpoints of the LCL mask in figure 13

Frequency	LCL
< 0,5 kHz	30 dB
5 kHz	50 dB
196 kHz	50 dB
1,96 MHz	30 dB
30 MHz	30 dB

10.1.5 Feeding power (from the LT-port)

Power feeding is no integral part of this signal category, although it is not uncommon for HDSL services. To enable power feeding in combination with this signal category, refer to one of the power feeding classes summarized in clause 7.

10.2 "HDSL.2B1Q/2" signals (584 kbaud leased lines)

This category covers signals, generated by HDSL transmission equipment on two wire-pairs, based on 2B1Q line coding. This clause is based on the ETSI reports on HDSL equipment [i.7]. These are essentially 584 kbaud systems (per wire-pair).

A signal (per wire-pair) can be classified as an "HDSL.2B1Q/2 signal" if it is compliant with all clauses below. Unless otherwise indicated, the following signal specifications apply with a resistive load impedance of 135 Ω , and does not apply to the DC remote power feeding (if any).

10.2.1 Total signal power

The present document provides information on how compliance with this signal category can be achieved and indicates the relevant specification(s):

To be compliant with this signal category, the mean signal power into a resistive load of 135 Ω shall not exceed a level of +14 dBm, measured within a frequency band from at least 100 Hz to 1 168 kHz.

Reference: TS 101 135 [i.7], clause 5.8.4.4.

10.2.2 Peak amplitude

The present document provides information on how compliance with this signal category can be achieved and indicates the relevant specification(s):

To be compliant with this signal category, the nominal voltage peak of the largest signal pulse into a resistive load of 135 Ω shall not exceed a level of 2,64 V ($\pm 7\%$), measured within a frequency band from at least 100 Hz to 1 168 kHz. The definition and measurement method of peak amplitude is specified in clause 13.1.

Reference: TS 101 135 [i.7], clause 5.8.4.1.

10.2.3 Narrow-Band Signal Power (NBSP)

The present document provides information on how compliance with this signal category can be achieved and indicates the relevant specification(s):

To be compliant with this signal category, the Narrow-Band Signal Power (NBSP) into a resistive load impedance R , shall not exceed the limits given in table 19, at any point in the frequency range 100 Hz to 30 MHz. This table specifies the break points of these limits. Limits for intermediate frequencies can be found by drawing a straight line between the break points on a logarithmic (Hz) - linear (dB) scale. Figure 14 illustrates the NBSP in a bandwidth-normalized way.

The NBSP is the average power P of a sending signal into a load resistance R , within a *power* bandwidth B . The measurement method of the NBSP is described in clause 13.2.

Reference: TS 101 135 [i.7], clause 5.8.4.3. These numbers are reconstructed from PSD requirements in [i.7].

NOTE: The NBSP specification in table 19 is reconstructed from the commonly used PSD specification in [i.7] (similar to figure 14), and used here since it is much wider applicable. This enables a unified specification method. PSD specifications are adequate when signals are purely random in nature, but cannot cover harmonic components in a signal (would cause infinite high "PSD" levels at these harmonic frequencies). NBSP specifications cover both signal types.

Table 19: Break points of the narrow-band power limits

Centre frequency f	Impedance R	Signal Level P	Power bandwidth B	Spectral Power P/B
0,51 kHz	135 Ω	-9 dBm	1 kHz	-39 dBm/Hz
10 kHz	135 Ω	-9 dBm	1 kHz	-39 dBm/Hz
10 kHz	135 Ω	+1 dBm	10 kHz	-39 dBm/Hz
292 kHz	135 Ω	+1 dBm	10 kHz	-39 dBm/Hz
2,92 MHz	135 Ω	-79 dBm	10 kHz	-119 dBm/Hz
2,92 MHz	135 Ω	-59 dBm	1 MHz	-119 dBm/Hz
30 MHz	135 Ω	-59 dBm	1 MHz	-119 dBm/Hz

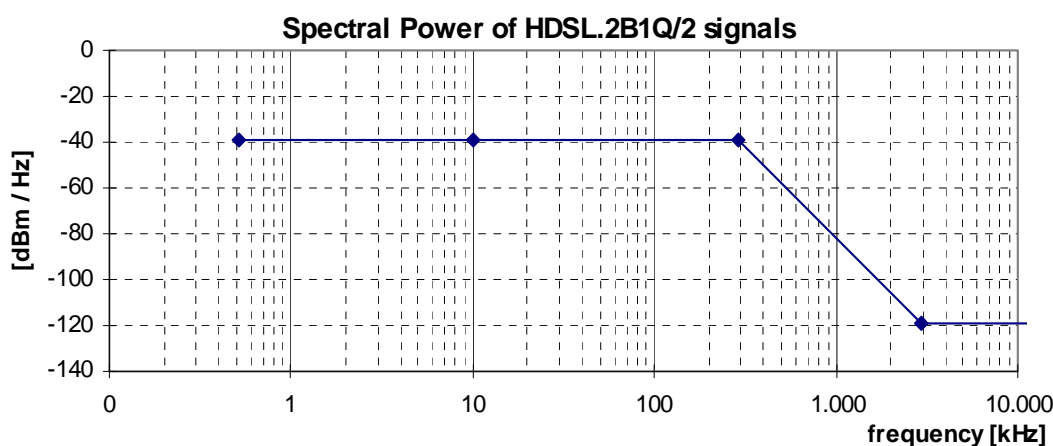

Figure 14: Spectral Power, for HDSL.2B1Q/2 signals, as specified in table 19

10.2.4 Unbalance about earth

The present document provides information on how compliance with this signal category can be achieved and indicates the relevant specification(s):

To be compliant with this signal category, the balance of the signal that may flow through the LT-port or NT-port shall exceed minimum requirements, under the condition that the local loop wiring and its termination is well balanced. This can be verified by a Longitudinal Output Voltage (LOV) and a Longitudinal Conversion Loss (LCL) measurement at the source of that signal, as specified in clauses 13.3.2 and 13.3.3. The minimum LOV and LCL requirements hold for what can be observed at the ports of the Local Loop Wiring, when the Local Loop Wiring is replaced by an artificial impedance network described in clauses 13.3.2 and 13.3.3.

The differential termination impedance for LOV and LCL measurements shall be chosen equally to the design impedance $R_T = 135 \Omega$ of the Signal Source under test.

The observed LOV shall have an rms voltage of below the value specified in table 20, measured in a *power* bandwidth B , centred over any frequency in the range from f_{\min} to f_{\max} , and averaged in any one second period. Compliance with this limitation is required with a longitudinal terminating impedance having value $Z_L(\omega) = R_L + 1 / (j\omega \times C_L)$ for all frequencies between f_{\min} to f_{\max} . Clause 13.3.2 defines an example measurement method for longitudinal output voltage.

The observed LCL shall be higher than the lower limits given in figure 15. The LCL values of the associated break frequencies of this figure are given in table 21. Clause 13.3.3 defines an example measurement method for longitudinal conversion loss.

Reference: TS 101 135 [i.7], clause 5.8.5.1 extended to 30 MHz according to [i.13].

Reference: TS 101 270-1 [i.13], clause 8.3.3.

Table 20: Values for the LOV limits

LOV	B	f_{\min}	f_{\max}	R_L	C_L
-46 dBV	10 kHz	5,1 kHz	575 kHz	100 Ω	150 nF

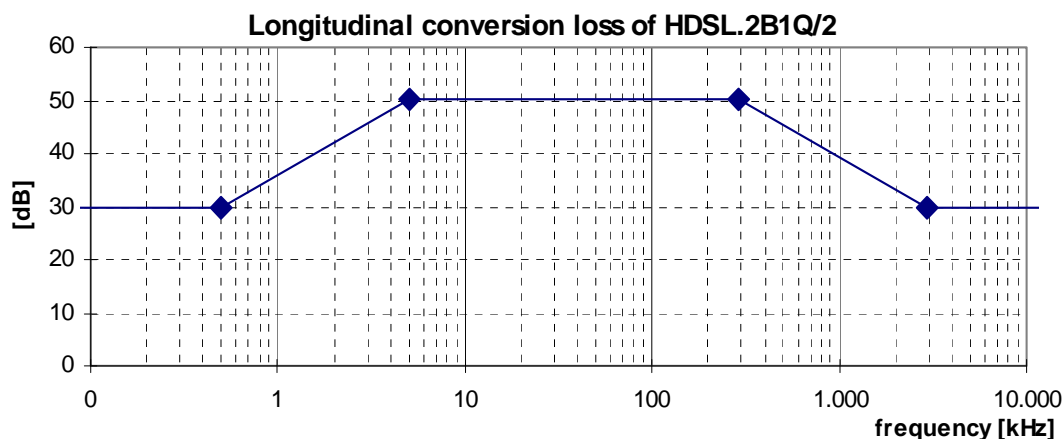

Figure 15: Minimum longitudinal conversion loss for a HDSL.2B1Q/2 signal source (584 kbaud/wirepair)

Table 21: Frequencies and LCL values of the breakpoints of the LCL mask in figure 15

Frequency	LCL
< 0,5 kHz	30 dB
5 kHz	50 dB
292 kHz	50 dB
2,92 MHz	30 dB
30 MHz	30 dB

10.2.5 Feeding power (from the LT-port)

Power feeding is no integral part of this signal category, although it is not uncommon for HDSL services. To enable power feeding in combination with this signal category, refer to one of the power feeding classes summarized in clause 7.

10.3 "HDSL.2B1Q/1" signals (1 160 kbaud leased lines)

This category covers signals, generated by HDSL transmission equipment on a single wire-pair, based on 2B1Q line coding. This clause is based on the ETSI reports on HDSL equipment [i.7].

A signal (per wire-pair) can be classified as an "HDSL.2B1Q/1 signal" if it is compliant with all clauses below. Unless otherwise indicated, the following signal specifications apply with a resistive load impedance of 135 Ω , and does not apply to the DC remote power feeding (if any).

10.3.1 Total signal power

The present document provides information on how compliance with this signal category can be achieved and indicates the relevant specification(s):

To be compliant with this signal category, the mean signal power into a resistive load of 135 Ω shall not exceed a level of +14 dBm, measured within a frequency band from at least 100 Hz to 2 320 kHz.

Reference: TS 101 135 [i.7], clause 5.8.4.4.

10.3.2 Peak amplitude

To be compliant with this signal category, the nominal voltage peak of the largest signal pulse into a resistive load of 135Ω shall not exceed a level of $2,50 \text{ V}$ ($\pm 7 \%$), measured within a frequency band from at least 100 Hz to $2\,320 \text{ kHz}$. The definition and measurement method of peak amplitude is specified in clause 13.1.

Reference: TS 101 135 [i.7], clause 5.8.4.1.

10.3.3 Narrow-band signal power

The present document provides information on how compliance with this signal category can be achieved and indicates the relevant specification(s):

To be compliant with this signal category, the Narrow-Band Signal Power (NBSP) into a resistive load impedance R , shall not exceed the limits given in table 22, at any point in the frequency range 100 Hz to 30 MHz . This table specifies the break points of these limits. Limits for intermediate frequencies can be found by drawing a straight line between the break points on a logarithmic (Hz) - linear (dB) scale. Figure 16 illustrates the NBSP in a bandwidth-normalized way.

The NBSP is the average power P of a sending signal into a load resistance R , within a *power* bandwidth B . The measurement method of the NBSP is described in clause 13.2.

NOTE: The NBSP specification in table 22 is reconstructed from the commonly used PSD specification in [i.7] (similar to figure 16), and used here since it is much wider applicable. This enables a unified specification method. PSD specifications are adequate when signals are purely random in nature, but cannot cover harmonic components in a signal (would cause infinite high "PSD" levels at these harmonic frequencies). NBSP specifications cover both signal types.

Reference: TS 101 135 [i.7], clause 5.8.4.3. These numbers are reconstructed from PSD requirements in [i.7].

Table 22: Break points of the narrow-band power limits

Centre frequency f	Impedance R	Signal Level P	Power bandwidth B	Spectral Power P/B
0,51 kHz	135Ω	-11,5 dBm	1 kHz	-41,5 dBm/Hz
10 kHz	135Ω	-11,5 dBm	1 kHz	-41,5 dBm/Hz
10 kHz	135Ω	-1,5 dBm	10 kHz	-41,5 dBm/Hz
485 kHz	135Ω	-1,5 dBm	10 kHz	-41,5 dBm/Hz
4,850 MHz	135Ω	-81,5 dBm	10 kHz	-121,5 dBm/Hz
4,850 MHz	135Ω	-61,5 dBm	1 MHz	-121,5 dBm/Hz
30 MHz	135Ω	-61,5 dBm	1 MHz	-121,5 dBm/Hz

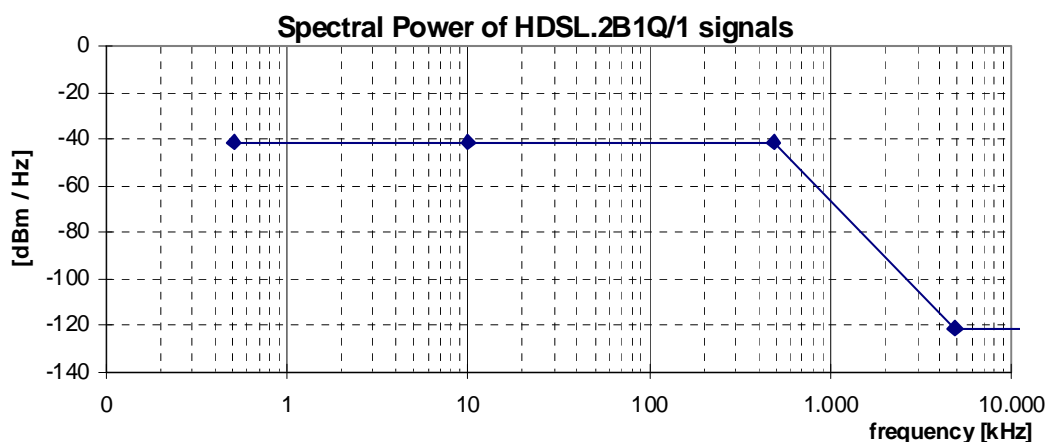

Figure 16: Spectral Power, for HDSL.2B1Q/1 signals, as specified in table 22

10.3.4 Unbalance about earth

The present document provides information on how compliance with this signal category can be achieved and indicates the relevant specification(s):

To be compliant with this signal category, the balance of the signal that may flow through the LT-port or NT-port shall exceed minimum requirements, under the condition that the local loop wiring and its termination is well balanced. This can be verified by a Longitudinal Output Voltage (LOV) and a Longitudinal Conversion Loss (LCL) measurement at the source of that signal, as specified in clauses 13.3.2 and 13.3.3. The minimum LOV and LCL requirements hold for what can be observed at the ports of the Local Loop Wiring, when the Local Loop Wiring is replaced by an artificial impedance network described in clauses 13.3.2 and 13.3.3.

The differential termination impedance for LOV and LCL measurements shall be chosen equally to the design impedance $R_T = 135 \Omega$ of the Signal Source under test.

The observed LOV shall have an rms voltage of below the value specified in table 23, measured in a *power* bandwidth **B**, centred over any frequency in the range from f_{\min} to f_{\max} , and averaged in any one second period. Compliance with this limitation is required with a longitudinal terminating impedance having value $Z_L(\omega) = R_L + 1 / (j\omega \times C_L)$ for all frequencies between f_{\min} to f_{\max} . Clause 13.3.2 defines an example measurement method for longitudinal output voltage.

The observed LCL shall be higher than the lower limits given in figure 17. The LCL values of the associated break frequencies of this figure are given in table 24. Clause 13.3.3 defines an example measurement method for longitudinal conversion loss.

Reference: TS 101 135 [i.7], clause 5.8.5.1, extended to 30 MHz according to [i.13].

Reference: TS 101 270-1 [i.13], clause 8.3.3.

Table 23: Values for the LOV limits

LOV	B	f_{\min}	f_{\max}	R_L	C_L
-46 dBV	10 kHz	5,1 kHz	890 kHz	100 Ω	150 nF

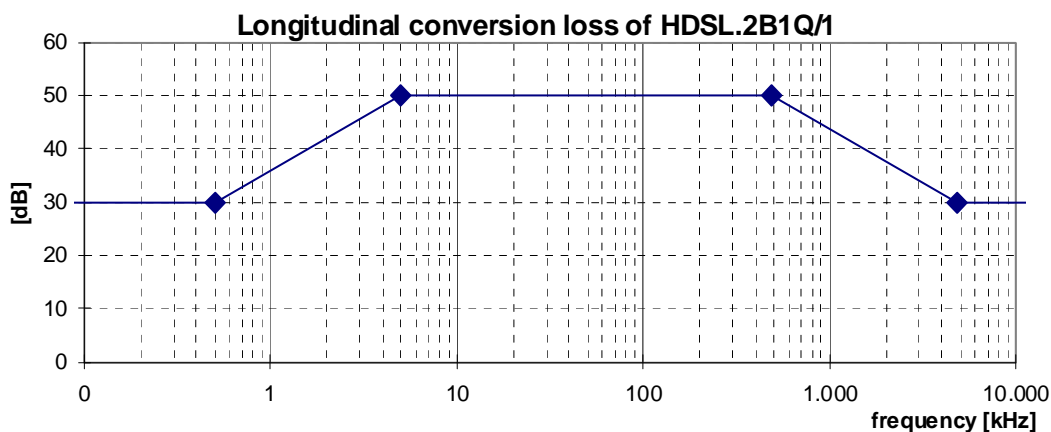

Figure 17: Minimum longitudinal conversion loss for a HDSL.2B1Q/1 signal source

Table 24: Frequencies and LCL values of the breakpoints of the LCL mask in figure 17

Frequency	LCL
< 0,5 kHz	30 dB
5 kHz	50 dB
485 kHz	50 dB
4,85 MHz	30 dB
30 MHz	30 dB

10.3.5 Feeding power (from the LT-port)

Power feeding is no integral part of this signal category, although it is not uncommon for HDSL services. To enable power feeding in combination with this signal category, refer to one of the power feeding classes summarized in clause 7.

10.4 "HDSL.CAP/2" signals

This category covers signals, generated by HDSL transmission equipment on two wire-pairs, based on CAP modulation. This clause is based on the ETSI reports on HDSL equipment [i.7].

A signal (per wire-pair) can be classified as an "HDSL.CAP/2 signal" if it is compliant with all clauses below. Unless otherwise indicated, the following signal specifications apply with a resistive load impedance of 135 Ω , and does not apply to the DC remote power feeding (if any).

10.4.1 Total signal power

The present document provides information on how compliance with this signal category can be achieved and indicates the relevant specification(s):

To be compliant with this signal category, the mean signal power into a resistive load of 135 Ω shall not exceed a level of +14 dBm, measured within a frequency band from at least 100 Hz to 1 MHz.

Reference: TS 101 135 [i.7], clause B.5.8.4.1.

10.4.2 Peak amplitude

The present document provides information on how compliance with this signal category can be achieved:

To be compliant with this signal category, the nominal voltage peak of the largest signal pulse into a resistive load of 135 Ω shall not exceed a level of 6,5 V (13 V peak-peak), measured within a frequency band from at least 100 Hz to 1 MHz. The definition and measurement method of peak amplitude is specified in clause 13.1.

NOTE: No ETSI deliverable does specify this parameter.

10.4.3 Narrow-Band Signal Power (NBSP)

The present document provides information on how compliance with this signal category can be achieved and indicates the relevant specification(s):

To be compliant with this signal category, the Narrow-Band Signal Power (NBSP) into a resistive load impedance R , shall not exceed the limits given in table 25, at any point in the frequency range 100 Hz to 30 MHz. This table specifies the break points of these limits. Limits for intermediate frequencies can be found by drawing a straight line between the break points on a logarithmic (Hz) - linear (dB) scale. Figure 18 illustrates the NBSP in a bandwidth-normalized way.

The NBSP is the average power P of a sending signal into a load resistance R , within a *power* bandwidth B . The measurement method of the NBSP is described in clause 13.2.

NOTE 1: The NBSP specification in table 25 is reconstructed from the commonly used PSD specification in [i.7] (similar to figure 18), and used here since it is much wider applicable. This enables a unified specification method. PSD specifications are adequate when signals are purely random in nature, but cannot cover harmonic components in a signal (would cause infinite high "PSD" levels at these harmonic frequencies). NBSP specifications cover both signal types.

NOTE 2: The NBSP specification of this signal category has been split into two overlapping limits: "X" and "Y". Both upper limits shall be met simultaneously. The 10 kHz bandwidth values represent the "maximum PSD values" from [i.7], while the 100 kHz bandwidth values represent the "nominal PSD values". The 100 kHz bandwidth specification has been added here to smooth spectral ripple (" $\pm 1,5$ dB") from the "maximum PSD" into the "nominal PSD".

Reference: TS 101 135 [i.7], clause B.5.8.4.2, reconstructed from the PSD requirements in [i.7].

Table 25: Break points of the narrow-band power limits

Centre frequency f	Impedance R	Signal Level P	Power bandwidth B	Spectral Power P/B	
0,51 kHz	135 Ω	-25,5 dBm	1 kHz	-55,5 dBm/Hz	"X"
3,98 kHz	135 Ω	-25,5 dBm	1 kHz	-55,5 dBm/Hz	
3,98 kHz	135 Ω	-15,5 dBm	10 kHz	-55,5 dBm/Hz	
21,50 kHz	135 Ω	-1,5 dBm	10 kHz	-41,5 dBm/Hz	
39,02 kHz	135 Ω	+1,5 dBm	10 kHz	-38,5 dBm/Hz	
237,58 kHz	135 Ω	+1,5 dBm	10 kHz	-38,5 dBm/Hz	
255,10 kHz	135 Ω	-1,5 dBm	10 kHz	-41,5 dBm/Hz	
272,62 kHz	135 Ω	-17 dBm	10 kHz	-57 dBm/Hz	
297,00 kHz	135 Ω	-30 dBm	10 kHz	-70 dBm/Hz	
1,188 MHz	135 Ω	-80 dBm	10 kHz	-120 dBm/Hz	
1,188 MHz	135 Ω	-60 dBm	1 MHz	-120 dBm/Hz	"Y"
30 MHz	135 Ω	-60 dBm	1 MHz	-120 dBm/Hz	
30 kHz	135 Ω	+10 dBm	100 kHz	-40 dBm/Hz	
250 kHz	135 Ω	+10 dBm	100 kHz	-40 dBm/Hz	

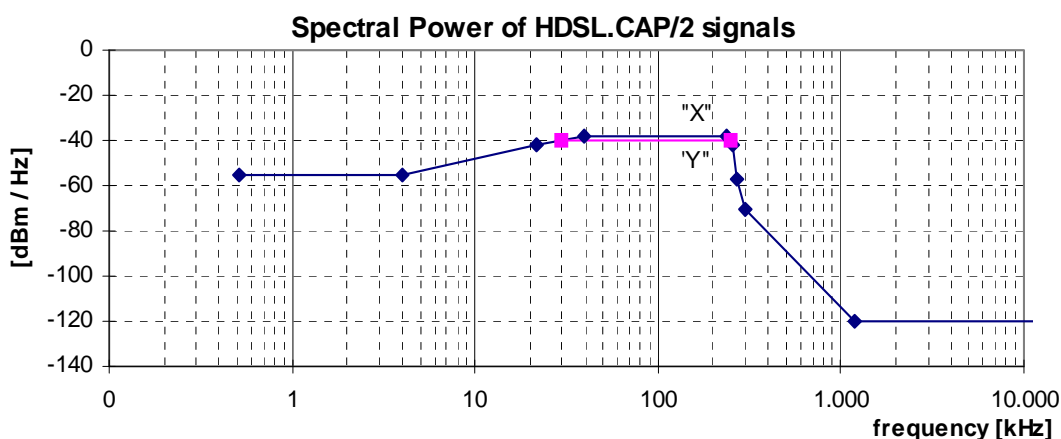

Figure 18: Spectral Power, for HDSL.CAP/2 signals, as specified in table 25

10.4.4 Unbalance about earth

The present document provides information on how compliance with this signal category can be achieved and indicates the relevant specification(s):

To be compliant with this signal category, the balance of the signal that may flow through the LT-port or NT-port shall exceed minimum requirements, under the condition that the local loop wiring and its termination is well balanced. This can be verified by a Longitudinal Output Voltage (LOV) and a Longitudinal Conversion Loss (LCL) measurement at the source of that signal, as specified in clauses 13.3.2 and 13.3.3. The minimum LOV and LCL requirements hold for what can be observed at the ports of the Local Loop Wiring, when the Local Loop Wiring is replaced by an artificial impedance network described in clauses 13.3.2 and 13.3.3.

The differential termination impedance for LOV and LCL measurements shall be chosen equally to the design impedance $R_T = 135 \Omega$ of the Signal Source under test.

The observed LOV shall have an rms voltage of below the value specified in table 26, measured in a *power* bandwidth B , centred over any frequency in the range from f_{\min} to f_{\max} , and averaged in any one second period. Compliance with this limitation is required with a longitudinal terminating impedance having value $Z_L(\omega) = R_L + 1 / (j\omega \times C_L)$ for all frequencies between f_{\min} to f_{\max} . Clause 13.3.2 defines an example measurement method for longitudinal output voltage.

The observed LCL shall be higher than the lower limits given in figure 19. The LCL values of the associated break frequencies of this figure are given in table 27. Clause 13.3.3 defines an example measurement method for longitudinal conversion loss.

Reference: TS 101 135 [i.7], clause B.5.8.5.1, extended to 30 MHz according to [i.13].

Reference: TS 101 270-1 [i.13], clause 8.3.3.

Table 26: Values for the LOV limits

LOV	B	f_{\min}	f_{\max}	R_L	C_L
-46 dBV	10 kHz	5,1 kHz	285 kHz	100 Ω	150 nF

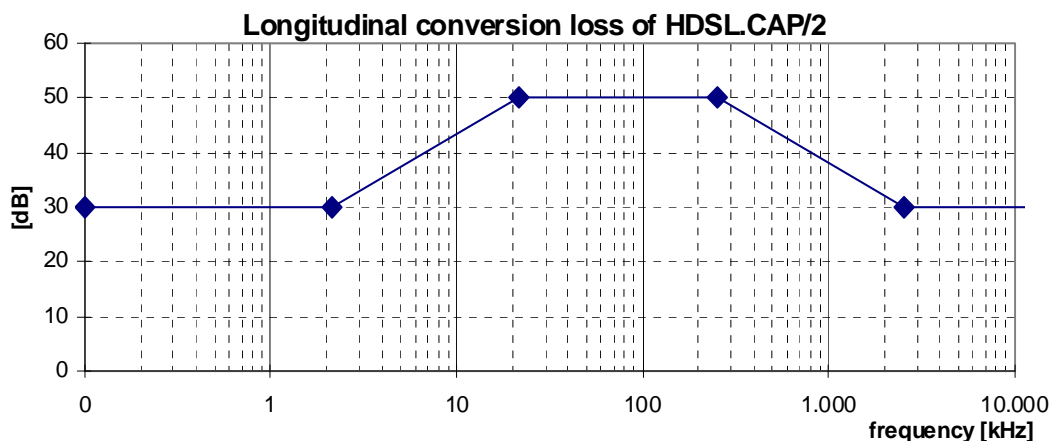

Figure 19: Minimum longitudinal conversion loss

Table 27: Frequencies and LCL values of the breakpoints of the LCL mask in figure 19

Frequency	LCL
< 2,15 kHz	30 dB
21,5 kHz	50 dB
255 kHz	50 dB
2,55 MHz	30 dB
30 MHz	30 dB

10.4.5 Feeding power (from the LT-port)

Power feeding is no integral part of this signal category, although it is not uncommon for HDSL services. To enable power feeding in combination with this signal category, refer to one of the power feeding classes summarized in clause 7.

10.5 "SDSL::Fn" signals

This category covers signals, generated by multi-rate SDSL transmission equipment on one or up to four wire pairs, up to 2 320 kb/s line rate per wire pair. This clause is based on ETSI SDSL standard [i.8] and on ITU Recommendation G.991.2 [i.9], but is not applicable to "enhanced" SDSL variants specified in annex E of [i.8]. The line code modulation used in these standards is Ungerboeck Coded Pulse Amplitude Modulation (UC-PAM), also known as Trellis Coded PAM (TC-PAM), and uses 16 levels per symbol (16 UC-PAM).

The SDSL standards specify both symmetric and asymmetric PSD masks. This signal description is dedicated to the symmetric variant. For the symmetric PSD masks the naming convention is "SDSL::Fn" where the phrase "Fn" is a placeholder for a number that is used as parameter F_N in the signal definition. Replacing "Fn" in the signal name by a value, changes the generic signal description into a specific description, since its value is required in the clauses below. It is referred to as the *Principal frequency* of the signal.

The Principal frequency F_N is indicative for the symbol rate (kbaud) that can be transported within these signal limits. A signal with a higher Principal Frequency occupies a wider spectrum. A signal with a lower Principal Frequency has a higher inband PSD. The principal frequency frequency F_N in this signal category does not exceed the value of 771 kHz.

Table 28 gives several examples on how to use the naming convention for specifying the actual parameter value F_n . It also illustrates some (informative) bitrates that can be transported within these signal limits, when using the associated (informative) modulation parameters. These are examples only, other system implementations may use the same signal limits in a different way.

Table 28: Example on how the naming convention relates to the actual parameter value F_N that is used in the clauses below to specify the signal limits of this signal category

Signal category	F_N (kHz)	Symbol Rate (kbaud)	Bit/symbol	Line Bitrate (kbit/s)
SDSL::67	66,67	66,67	3	200
SDSL::131	130,67	130,67	3	392
SDSL::174	173,33	173,33	3	520
SDSL::259	258,67	258,67	3	776
SDSL::344	344	344	3	1 032
SDSL::430	429,33	429,33	3	1 288
SDSL::515	514,67	514,67	3	1 544
SDSL::686	685,33	685,33	3	2 056
SDSL::771	770,67	770,67	3	2 312
NOTE: The actual bitrates and modulation parameters are implementation dependent, and informative only.				

10.5.1 Total signal power

The present document provides information on how compliance with this signal category can be achieved and indicates the relevant specification(s):

To be compliant with this signal category, the mean signal power into a resistive load of 135Ω shall not exceed a level of P_{\max} , measured within a frequency band from at least 100 Hz to $(2 \times F_N)$. P_{\max} has the following values for the different SDSL signals:

- $+13,5 \pm 0,5$ dBm for "SDSL::Fn" signals, when $F_N < 685$ kHz.
- $+14,5 \pm 0,5$ dBm for "SDSL::Fn" signals, when $F_N \geq 685$ kHz and $F_N < 771$ kHz.

Reference: TS 101 524 [i.8], clause 9.4.1.

Reference: ITU-T Recommendation G.991.2 [i.9], clauses B.4.1 and B.4.2.

10.5.2 Peak amplitude

The present document provides information on how compliance with this signal category can be achieved:

To be compliant with this signal category, the nominal voltage peak of the largest signal pulse into a resistive load of 135Ω shall not exceed a level of $V_{\text{peak}} (\pm 7 \%)$, measured within a frequency band from at least 100 Hz to $(2 \times F_N)$. V_{peak} has the following values for the different SDSL signals:

- 12 V for "SDSL::Fn" signals, when $F_N < 685$ kHz.
- 12 V for "SDSL::Fn" signals, when $F_N \geq 685$ kHz.

The definition and measurement method of peak amplitude is specified in clause 13.1.

NOTE: No ETSI deliverable does specify this parameter.

10.5.3 Narrow-Band Signal Power (NBSP)

The present document provides information on how compliance with this signal category can be achieved and indicates the relevant specification(s):

To be compliant with this signal category, the Narrow-Band Signal Power (NBSP) into a resistive load impedance R , shall not exceed the limits given in the tables in the following clauses, at any point in the frequency range 100 Hz to 30 MHz. Limits for intermediate frequencies can be found by drawing a straight line between the break points on a logarithmic (Hz) - linear (dB) scale. The NBSP is the average power P of a sending signal into a load resistance R , within a *power* bandwidth B . The measurement method of the NBSP is described in clause 13.2.

Table 29 describes the break points of these limits for the symmetric PSD masks for all Principal frequencies between 67 kHz and 771 kHz. Figure 20 illustrates the NBSP in a bandwidth-normalized way.

Reference: TS 101 524 [i.8], clause 9.4.1.

Reference: ITU-T Recommendation G.991.2 [i.9], clause B.4.1.

Table 29: Break points of the narrow-band signal power P , as a function of the Principal frequency F_N of the signal category

Frequency f	Impedance R	Signal Level P (dBm)	Noise Bandwidth B	Spectral Power P/B (dBm/Hz)
0,1 kHz	135 Ω	$P_0 + 1,4 + 20$	100 Hz	$P_0 + 1,4$
1 kHz	135 Ω	$P_0 + 1,4 + 20$	100 Hz	$P_0 + 1,4$
1 kHz	135 Ω	$P_0 + 1,4 + 30$	1 kHz	$P_0 + 1,4$
10 kHz	135 Ω	$P_0 + 1,4 + 30$	1 kHz	$P_0 + 1,4$
10 kHz	135 Ω	$P_0 + 1,4 + 40$	10 kHz	$P_0 + 1,4$
$0,1 \times F_N$	135 Ω	$P_0 + 1,4 + 40$	10 kHz	$P_0 + 1,4$
$0,275 \times F_N$	135 Ω	$P_0 + 40$	10 kHz	P_0
$0,4 \times F_N$	135 Ω	$P_0 - 2 + 40$	10 kHz	$P_0 - 2$
$0,475 \times F_N$	135 Ω	$P_0 - 4,5 + 40$	10 kHz	$P_0 - 4,5$
$0,6 \times F_N$	135 Ω	$P_0 - 14 + 40$	10 kHz	$P_0 - 14$
$0,9 \times F_N$	135 Ω	$P_0 - 45 + 40$	10 kHz	$P_0 - 45$
$0,96 \times F_N$	135 Ω	$P_1 + 40$	10 kHz	P_1
1,5 MHz	135 Ω	-65	10 kHz	-105
1,5 MHz	135 Ω	-50	1 MHz	-110
30 MHz	135 Ω	-50	1 MHz	-110

The reference power levels, P_0 and P_1 , in table 29 are given by the formulas below. Table 30 lists these values for few sample Principal frequencies.

$$P_0 = 10 \times \log_{10} \left(\frac{K_{SDSL}}{135} \right) - 10 \times \log_{10} \left(\frac{F_N}{F_0} \right)$$

$$P_1 = -57 - 15 \times \log_{10} \left(\frac{F_N}{F_0} \right)$$

$$K_{SDSL} = \begin{cases} 7,86 & F_N < 685 \text{ kHz} \\ 9,9 & F_N \geq 685 \text{ kHz} \end{cases}$$

$$F_0 = 1 \text{ kHz}$$

Table 30: Reference power levels, as a function of the Principle frequency

F_N	67	131	174	259	344	430	515	686	771	kHz
P_0	-30,6	-33,5	-34,8	-36,5	-37,7	-38,7	-39,5	-40,7	-41,2	dBm/Hz
P_1	-84,4	-88,8	-90,6	-93,2	-95,0	-96,5	-97,7	-99,5	-100,3	dBm/Hz

NOTE: The table summarizes some example values, calculated from their formulas.

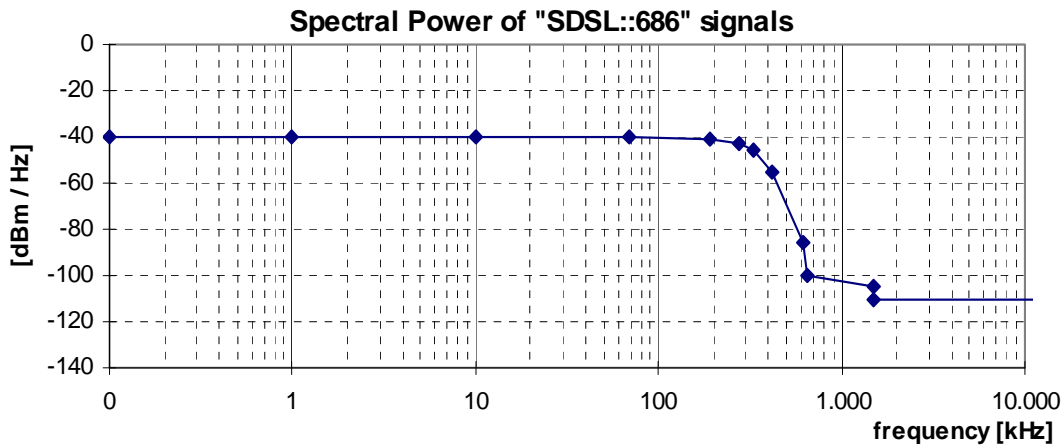

NOTE: These curves are dependent on the Principal frequency F_N , and this figure shows only an example.

Figure 20: Spectral Power, for "SDSL::686" signals (at $F_N = 686$ kHz), as specified in table 29

10.5.4 Unbalance about earth

The present document provides information on how compliance with this signal category can be achieved and indicates the relevant specification(s):

To be compliant with this signal category, the balance of the signal that may flow through the LT-port or NT-port shall exceed minimum requirements, under the condition that the local loop wiring and its termination is well balanced. This can be verified by a Longitudinal Output Voltage (LOV) and a Longitudinal Conversion Loss (LCL) measurement at the source of that signal, as specified in clauses 13.3.2 and 13.3.3. The minimum LOV and LCL requirements hold for what can be observed at the ports of the Local Loop Wiring, when the Local Loop Wiring is replaced by an artificial impedance network described in clauses 13.3.2 and 13.3.3.

The differential termination impedance for LOV and LCL measurements shall be chosen equally to the design impedance $R_T = 135 \Omega$ of the Signal Source under test.

The observed LOV shall have an rms voltage of below the value specified in table 31, measured in a *power* bandwidth B , centred over any frequency in the range from f_{\min} to f_{\max} , and averaged in any one second period. Compliance with this limitation is required with a longitudinal terminating impedance having value $Z_L(\omega) = R_L + 1 / (j\omega \times C_L)$ for all frequencies between f_{\min} to f_{\max} . Clause 13.3.2 defines an example measurement method for longitudinal output voltage.

The observed LCL shall be higher than the lower limits given in figure 21. The LCL values of the associated break frequencies of this figure are given in table 32. Clause 13.3.3 defines an example measurement method for longitudinal conversion loss.

Reference: TS 101 524 [i.8], clause 11.3.

Reference: ITU-T Recommendation G.991.2 [i.9], clause 11.1.

Table 31: Values for the LOV limits

LOV	B	f_{\min}	f_{\max}	R_L	C_L
-50 dBV	4 kHz	100 kHz	400 kHz	100 Ω	150 nF

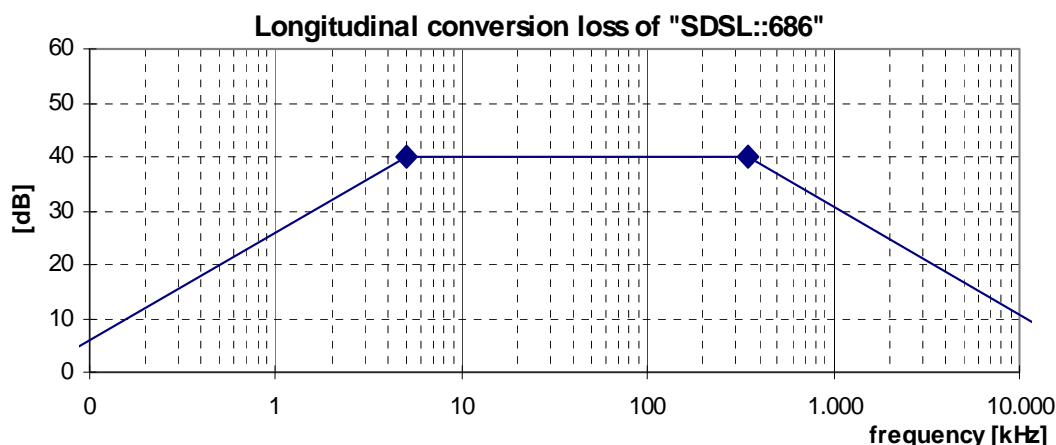

Figure 21: Minimum longitudinal conversion loss for a "SDSL::686" signal source

Table 32: Frequencies and LCL values of the breakpoints of the LCL mask in figure 21

Frequency	LCL
< 0,05 kHz	0 dB
0,05 kHz	0 dB
5 kHz	40 dB
$1/2 \times F_N$	40 dB
$50 \times F_N$	0 dB
30 MHz	0 dB

10.5.5 Feeding power (from the LT-port)

Power feeding is no integral part of this signal category, although it is not uncommon for SDSL services. To enable power feeding in combination with this signal category, refer to one of the power feeding classes summarized in clause 7.

10.6 "SDSL.asym::Fn" signals

This category covers signals, generated by multi-rate SDSL transmission equipment on one or up to four wire pairs, up to 2 320 kb/s line rate per wire pair. This clause is based on TS 101 524 [i.8] and on ITU-T Recommendation G.991.2 [i.9], but is not applicable to "enhanced" SDSL variants specified in annex E of [i.8]. The line code modulation used in these standards is Ungerboeck Coded Pulse Amplitude Modulation (UC-PAM), also known as Trellis Coded PAM (TC-PAM), and uses 16 levels per symbol (16 UC-PAM).

The SDSL standards specify both symmetric and asymmetric PSD masks. This signal description is dedicated to the symmetric variant. For the asymmetric PSD masks the naming convention is "SDSL.asym::Fn" where the phrase "Fn" is a placeholder for a number that is used as parameter F_N in the signal definition. Replacing "Fn" in the signal name by a value, changes the generic signal description into a specific description, since its value is required in the clauses below. It is referred to as the *Principal frequency* of the signal.

The Principal frequency F_N is indicative for the symbol rate (kbaud) that can be transported within these signal limits. A signal with a higher Principal Frequency occupies a wider spectrum. A signal with a lower Principal Frequency has a higher inband PSD. The principal frequency frequency F_N in this signal category does not exceed the value of 771 kHz.

The following four sub classes are defined:

- signal "SDSL.asym::686.NT", dedicated in [i.8] to 2 048 kbit/s upstream transmission;
- signal "SDSL.asym::686.LT", dedicated in [i.8] to 2 048 kbit/s downstream transmission;

- signal "SDSL.asym::771.NT", dedicated in [i.8] to 2 304 kbit/s upstream transmission;
- signal "SDSL.asym::771.LT", dedicated in [i.8] to 2 304 kbit/s downstream transmission.

Although this signal description is technology independent, several examples on how ETSI SDSL [i.8] make use of these signals are summarized in table 33. As a result, the bitrates in table 33, and their associated modulation parameters are informative only.

Table 33: Example on how the four subclasses of this signal category can be used for transporting data

Signal category	F_N (kHz)		Symbol Rate (kbaud)	Bit/symbol	Line Bitrate (kbit/s)
SDSL.asym::686.NT	686		685,33	3	2 056
SDSL.asym::686.LT	686		685,33	3	2 056
SDSL.asym::771.NT	771		770,67	3	2 312
SDSL.asym::771.LT	771		770,67	3	2 312
NOTE: The actual bitrates and modulation parameters are implementation dependent, and informative only.					

10.6.1 Total signal power

The present document provides information on how compliance with this signal category can be achieved and indicates the relevant specification(s):

To be compliant with this signal category, the mean signal power into a resistive load of 135 Ω shall not exceed a level of P_{max} , measured within a frequency band from at least 100 Hz to 3 MHz. P_{max} has the following values for the different SDSL signals:

- +16,25 \pm 0,5 dBm for "SDSL.asym::686.LT" signals;
- +16,50 \pm 0,5 dBm for "SDSL.asym::686.NT" signals;
- +14,75 \pm 0,5 dBm for "SDSL.asym::771.LT" signals;
- +15,25 \pm 0,5 dBm for "SDSL.asym::771.NT" signals.

Reference: TS 101 524 [i.8], clause 9.4.2.

Reference: ITU-T Recommendation G.991.2 [i.9], clauses B.4.1 and B.4.2.

10.6.2 Peak amplitude

The present document provides information on how compliance with this signal category can be achieved:

To be compliant with this signal category, the nominal voltage peak of the largest signal pulse into a resistive load of 135 Ω shall not exceed a level of V_{peak} (\pm 7 %), measured within a frequency band from at least 100 Hz to 3 MHz. V_{peak} has the following values for the different SDSL signals:

- 16V for "SDSL.asym::686.LT" signals;
- 16V for "SDSL.asym::686.NT" signals;
- 13V for "SDSL.asym::771.LT" signals;
- 13V for "SDSL.asym::771.NT" signals.

The definition and measurement method of peak amplitude is specified in clause 13.1.

NOTE: No ETSI deliverable does specify this parameter.

10.6.3 Narrow-band signal power (upstream only)

This clause is dedicated to "SDSL.asym::686.NT" and "SDSL.asym::771.NT" signals only.

The present document provides information on how compliance with this signal category can be achieved and indicates the relevant specification(s):

To be compliant with this signal category, the Narrow-Band Signal Power (NBSP) into a resistive load impedance R , shall not exceed the limits given in the tables in the following clauses, at any point in the frequency range 100 Hz to 30 MHz. Limits for intermediate frequencies can be found by drawing a straight line between the break points on a logarithmic (Hz) - linear (dB) scale. The NBSP is the average power P of a sending signal into a load resistance R , within a *power* bandwidth B . The measurement method of the NBSP is described in clause 13.2.

Table 34 gives the break points of the power limits for the upstream asymmetric NBSP limits for the signals "SDSL.asym::686.NT" and "SDSL.asym::771.NT". Figures 22 and 23 illustrate the NBSP in a bandwidth-normalized way.

Reference: TS 101 524 [i.8], clause 9.4.2.

Reference: ITU-T Recommendation G.991.2 [i.9], clause B.4.2.

Table 34: Break points of the narrow-band signal power P , as a function of the Principal frequency F_N of the signal category

frequency f	Impedance R	Signal Level P (dBm)	Noise Bandwidth B	Spectral Power P/B (dBm/Hz)
0,1 kHz	135 Ω	$P_0 + 1,4 + 20$	100 Hz	$P_0 + 1,4$
1 kHz	135 Ω	$P_0 + 1,4 + 20$	100 Hz	$P_0 + 1,4$
1 kHz	135 Ω	$P_0 + 1,4 + 30$	1 kHz	$P_0 + 1,4$
10 kHz	135 Ω	$P_0 + 1,4 + 30$	1 kHz	$P_0 + 1,4$
10 kHz	135 Ω	$P_0 + 1,4 + 40$	10 kHz	$P_0 + 1,4$
$0,1 \times F_N$	135 Ω	$P_0 + 1,4 + 40$	10 kHz	$P_0 + 1,4$
$0,275 \times F_N$	135 Ω	$P_0 + 40$	10 kHz	P_0
$0,4 \times F_N$	135 Ω	$P_0 - 2 + 40$	10 kHz	$P_0 - 2$
$0,475 \times F_N$	135 Ω	$P_0 - 4,5 + 40$	10 kHz	$P_0 - 4,5$
$0,6 \times F_N$	135 Ω	$P_0 - 15 + 40$	10 kHz	$P_0 - 15$
$0,85 \times F_N$	135 Ω	$P_0 - 45 + 40$	10 kHz	$P_0 - 45$
$0,96 \times F_N$	135 Ω	$P_1 + 40$	10 kHz	P_1
1,5 MHz	135 Ω	-65	10 kHz	-105
1,5 MHz	135 Ω	-50	1 MHz	-110
30 MHz	135 Ω	-50	1 MHz	-110

NOTE: The values for the parameters F_N , P_0 and P_1 are given in table 35.

Table 35: The power levels and principle frequency for defining NBSP limits in table 34 for upstream asymmetric SDSL signals

	SDSL.asym::686.NT	SDSL.asym::771.NT	
F_N	686	771	kHz
P_0	-37,7	-39,5	dBm/Hz
P_1	-99,5	-100,5	dBm/Hz

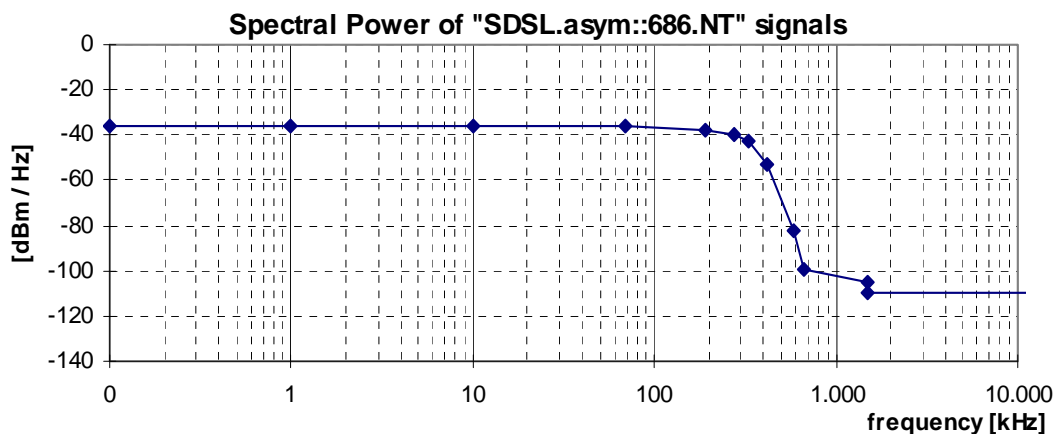

Figure 22: Spectral Power, for an "SDSL.asym::686.NT" signal, as specified in table 34

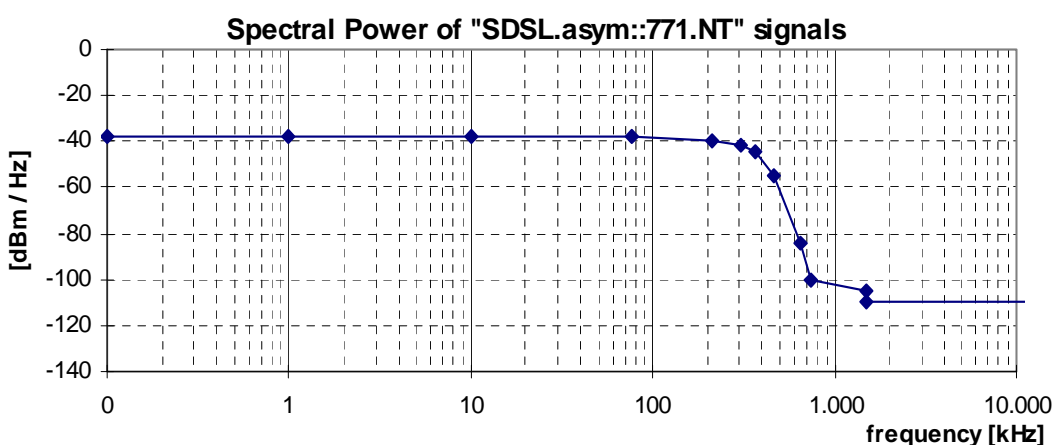

Figure 23: Spectral Power, for a "SDSL.asym::771.NT" signal, as specified in table 34

10.6.4 Narrow-band signal power (downstream only)

This clause is dedicated to "SDSL.asym::686.LT" and "SDSL.asym::771.LT" signals only.

The present document provides information on how compliance with this signal category can be achieved and indicates the relevant specification(s):

To be compliant with this signal category, the Narrow-Band Signal Power (NBSP) into a resistive load impedance R , shall not exceed the limits given in the tables in the following clauses, at any point in the frequency range 100 Hz to 30 MHz. Limits for intermediate frequencies can be found by drawing a straight line between the break points on a logarithmic (Hz) - linear (dB) scale. The NBSP is the average power P of a sending signal into a load resistance R , within a *power* bandwidth B . The measurement method of the NBSP is described in clause 13.2.

Table 36 gives the break points of the power limits for the upstream asymmetric NBSP limits for the signals "SDSL.asym::686.NT" and "SDSL.asym::771.NT". Figures 24 and 25 illustrate the NBSP in a bandwidth-normalized way.

Reference: TS 101 524 [i.8], clause 9.4.2.

Reference: ITU-T Recommendation G.991.2 [i.9], clause B.4.2.

Table 36: Break points of the narrow-band signal power P , as a function of the Principal frequency F_N of the signal category

Frequency f	Impedance R	Signal Level P (dBm)	Noise Bandwidth B	Spectral Power P/B (dBm/Hz)
0,1 kHz	135 Ω	$P_0 + 1,4 + 20$	100 Hz	$P_0 + 1,4$
1 kHz	135 Ω	$P_0 + 1,4 + 20$	100 Hz	$P_0 + 1,4$
1 kHz	135 Ω	$P_0 + 1,4 + 30$	1 kHz	$P_0 + 1,4$
10 kHz	135 Ω	$P_0 + 1,4 + 30$	1 kHz	$P_0 + 1,4$
10 kHz	135 Ω	$P_0 + 1,4 + 40$	10 kHz	$P_0 + 1,4$
$0,1 \times F_N \times w$	135 Ω	$P_0 + 1,4 + 40$	10 kHz	$P_0 + 1,4$
$0,3 \times F_N \times w$	135 Ω	$P_0 + 0,25 + 40$	10 kHz	$P_0 + 0,25$
$0,4 \times F_N \times w$	135 Ω	$P_0 - 1,1 + 40$	10 kHz	$P_0 - 1,1$
$0,45 \times F_N \times w$	135 Ω	$P_0 - 2,25 + 40$	10 kHz	$P_0 - 2,25$
$0,5 \times F_N \times w$	135 Ω	$P_0 - 4,5 + 40$	10 kHz	$P_0 - 4,5$
$0,6 \times F_N \times w$	135 Ω	$P_0 - 14 + 40$	10 kHz	$P_0 - 14$
$0,95 \times F_N \times w$	135 Ω	$P_0 - 45 + 40$	10 kHz	$P_0 - 45$
$1,1 \times F_N \times w$	135 Ω	$P_1 + 40$	10 kHz	P_1
1,5 MHz	135 Ω	-65	10 kHz	-105
1,5 MHz	135 Ω	-50	1 MHz	-110
30 MHz	135 Ω	-50	1 MHz	-110

NOTE 1: The values for the parameters F_N , P_0 and P_1 used in table 36 are given in table 37.

NOTE 2: w reflects how much "excess bandwidth" is used for the signals.

Table 37: The Principle frequency and power levels for upstream asymmetric SDSL signals

	SDSL.asym::686.LT	SDSL.asym::771.LT	
F_N	686	771	kHz
w	1,6	1,5	
P_0	-40,4	-42,2	dBm/Hz
P_1	-103,5	-104	dBm/Hz

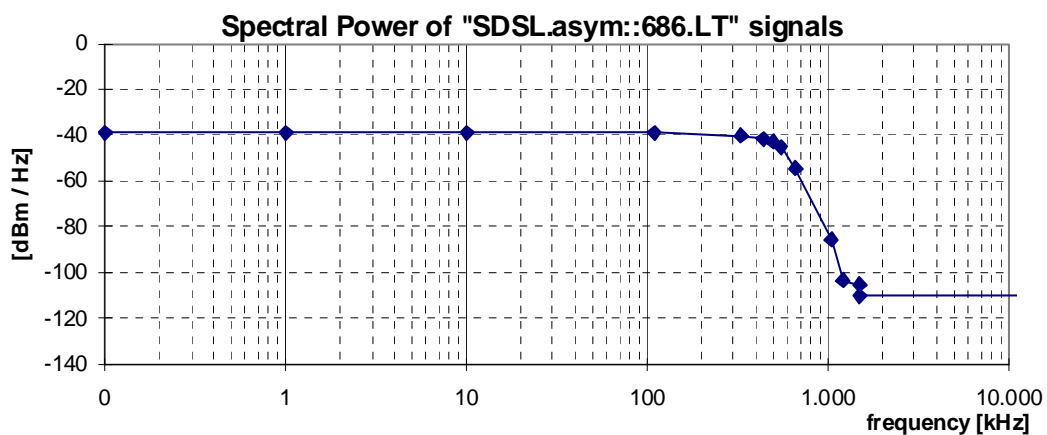

Figure 24: Spectral Power, for "SDSL.asym::686.LT" signal, as specified in table 36

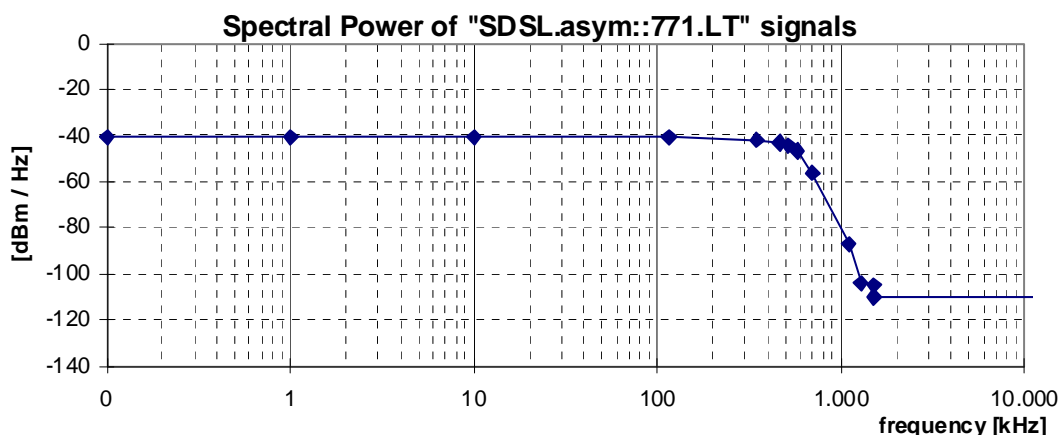

Figure 25: Spectral Power, for "SDSL.asym::771.LT" signal, as specified in table 36

10.6.5 Unbalance about earth

As for "SDSL::Fn" signal category.

10.6.6 Feeding power (from the LT-port)

Power feeding is no integral part of this signal category, although it is not uncommon for SDSL services. To enable power feeding in combination with this signal category, refer to one of the power feeding classes summarized in clause 7.

10.7 "e-SDSL::Fn" signals (enhanced SDSL)

This category covers signals, generated by multi-rate SDSL transmission equipment on one or up to four wire pairs, up to 5 696 kb/s per wire pair, as specified in annex E of ETSI SDSL standard [i.8]. This signal description is an extension to the "SDSL::Fn" signal description in a previous clause.

The phrase "Fn" is a placeholder for a number that is used as parameter F_N in the signal definition, representing the principal frequency. This is explained in the previous clause for "SDSL::Fn" signals. The principal frequency F_N does not exceed the value of 1 426 kHz for "e-SDSL::Fn" signals.

Enhanced SDSL addresses both the 16 UC-PAM and 32 UC-PAM variants specified in annex E of [i.8], The principal frequency of the PSD generated by 32 UC-PAM is lower than for 16 UC-PAM when used for transporting at the same bitrate.

Table 38 gives several examples on how to use the naming convention for specifying the actual parameter value F_N . It also illustrates some (informative) bitrates that can be transported within these signal limits, when using the associated (informative) modulation parameters. These are examples only, other system implementations may use the same signal limits in a different way.

Table 38: Example on how the naming convention relates to the actual parameter value F_N that is used in the clauses below to specify the signal limits of this signal category

Signal category	F_N (kHz)	Symbol Rate (kbaud)	Bit/symbol	Line Bitrate (kbit/s)
16 UC-PAM:				
e-SDSL::771	770,67	770,67	3	2 312
e-SDSL::	1 026,67	1 026,67	3	3 080
e-SDSL::	1 285,33	1 285,33	3	3 856
32 UC-PAM:				
e-SDSL::768	768,00	768,00	4	3 072
e-SDSL::964	964,00	964,00	4	3 856

Signal category	F_N (kHz)	Symbol Rate (kbaud)	Bit/symbol	Line Bitrate (kbit/s)
e-SDSL::	1 026,00	1 026,00	4	4 104
e-SDSL::	1 282,00	1 282,00	4	5 128
e-SDSL::	1 426,00	1 426,00	4	5 704
NOTE: The actual bitrates and modulation parameters are implementation dependent, and informative only.				

10.7.1 Total signal power

The present document provides information on how compliance with this signal category can be achieved and indicates the relevant specification(s):

To be compliant with this signal category, the mean signal power into a resistive load of 135Ω shall not exceed a level of P_{\max} , measured within a frequency band from at least 100 Hz to $(2 \times F_N)$.

The total signal power is dependent on the value of the principal frequency frequency F_N , and shall not exceed the values below:

- If $F_N < 674$ kHz, then $P_{\max} \leq 13,5 \text{ dBm} \pm 0,5 \text{ dBm}$.
- If $F_N \geq 674$ kHz and $F_N < 1 426$ kHz, then $P_{\max} \leq 14,5 \text{ dBm} \pm 0,5 \text{ dBm}$.
- If $F_N \geq 1 426$ kHz then $P_{\max} < -140 \text{ dBm}$.

Table 39 gives several examples how e-SDSL systems (according to TS 101 524 [i.8]) meet these power restrictions.

Table 39: Power limits specified in TS 101 524 [i.8] for e-SDSL

<p>For 16 UC-PAM modulation: +13,5 \pm 0,5 dBm for "e-SDSL::Fn" signals, when $F_N < 685$ kHz +14,5 \pm 0,5 dBm for "e-SDSL::Fn" signals, when ≥ 685 kHz $\leq F_N < 1 286$ kHz</p>
<p>For 32 UC-PAM modulation: +13,5 \pm 0,5 dBm for "e-SDSL::Fn" signals, when $F_N < 674$ kHz +14,5 \pm 0,5 dBm for "e-SDSL::Fn" signals, when 674 kHz $< F_N \leq 1 426$ kHz</p>

Reference: TS 101 524 [i.8], clauses 9.4.1 and E.4.

Reference: ITU-T Recommendation G.991.2 [i.9], clauses B.4.1 and B.4.2.

10.7.2 Peak amplitude

These definitions are identical as specified for "SDSL:Fn" signals.

10.7.3 Narrow-Band Signal Power (NBSP)

These definitions are identical as specified for "SDSL:Fn" signals, with the addition that F_N can have values up to 1 426 kHz.

10.7.4 Unbalance about earth

These definitions are identical as specified for "SDSL:Fn" signals.

10.7.5 Feeding Power (from the LT-port)

Power feeding is no integral part of this signal category, although it is not uncommon for e-SDSL services. To enable power feeding in combination with this signal category, refer to one of the power feeding classes summarized in clause 7.

10.8 "Proprietary.SymDSL.CAP.A::Fn" signals

This category covers signals, generated by Proprietary multi-rate SymDSL transmission equipment on one (or two) wire-pairs. This signal is labelled as *Proprietary*, since it is not covered by ETSI, ITU nor ANSI product standards.

This signal definition is linecode independent, but dedicated to signals from transmission equipment for variable bit-rate leased lines that are using CAP modulation. These definitions are partly based on the ETSI specifications on HDSL equipment [i.7].

In the naming convention "Proprietary.SymDSL.CAP.A::Fn", is the phrase "Fn" a placeholder for a number that is used as parameter F_N in the signal definition. Replacing "Fn" in the signal name by a value, changes the generic signal description into a specific description, since its value is required in the clauses below. It is referred to as the *Principal frequency* of the signal.

The Principal frequency F_N is indicative for the maximum symbol rate (kbaud) that can be transported within these signal limits. A signal with a higher Principal Frequency occupies a wider spectrum. Values between 72 kHz and 387 kHz are commonly used.

Table 40 gives several examples on how to use the naming convention for specifying the actual parameter value F_n . It also illustrates some (informative) bitrates that can be transported within these signal limits, when using the associated (informative) modulation parameters. These are examples only, other system implementations may use the same signal limits in a different way.

Table 40: Example on how the naming convention relates to the actual parameter value F_N that is used in the clauses below to specify the signal limits of this signal category

Signal category	F_N (kHz)	Baud Rate (kbaud)	Bitrate (kbit/s)	Bit/Symbol	Constellation size
Proprietary.SymDSL.CAP.A::72	72	72	144	2	8
Proprietary.SymDSL.CAP.A::91	91	91	272	3	16
Proprietary.SymDSL.CAP.A::133	133	133	400	3	16
Proprietary.SymDSL.CAP.A::176	176	176	528	3	16
Proprietary.SymDSL.CAP.A::261	261	261	784	3	16
Proprietary.SymDSL.CAP.A::261	261	261	1 040	4	32
Proprietary.SymDSL.CAP.A::311	311	311	1 552	5	64
Proprietary.SymDSL.CAP.A::344	344	344	2 064	6	128
Proprietary.SymDSL.CAP.A::387	387	387	2 320	6	128

NOTE: The bitrates and modulation parameters are informative only, and implementation dependent.

A signal (per wire-pair) can be classified as a "Proprietary.SymDSL.CAP.A::Fn" signal if it is compliant with all clauses below, *and* if parameter "Fn" is specified by a numerical value.

Unless otherwise indicated, the following signal specifications apply with a resistive load impedance of 135 Ω , and does not apply to the DC remote power feeding (if any).

10.8.1 Total signal power

The present document provides information on how compliance with this signal category can be achieved:

To be compliant with this signal category, the mean signal power into a resistive load of 135 Ω shall not exceed a level of +14 dBm, measured within a frequency band from at least 100 Hz to 1 MHz.

NOTE: No ETSI deliverable does specify this parameter.

10.8.2 Peak amplitude

The present document provides information on how compliance with this signal category can be achieved:

To be compliant with this signal category, the nominal voltage peak of the largest signal pulse into a resistive load of 135Ω shall not exceed a level of 6,5 V (13 V peak-peak), measured within a frequency band from at least 100 Hz to 1 MHz. The definition and measurement method of peak amplitude is specified in clause 13.1.

NOTE: No ETSI deliverable does specify this parameter.

10.8.3 Narrow-Band Signal Power (NBSP)

The present document provides information on how compliance with this signal category can be achieved:

To be compliant with this signal category, the Narrow-Band Signal Power (NBSP) into a resistive load impedance R , shall not exceed the limits given in table 41, at any point in the frequency range 100 Hz to 30 MHz. This table specifies the break points of these limits. Limits for intermediate frequencies can be found by drawing a straight line between the break points on a logarithmic (Hz) - linear (dB) scale. Figure 26 illustrates the NBSP in a bandwidth-normalized way.

The NBSP is the average power P of a sending signal into a load resistance R , within a *power* bandwidth B . The measurement method of the NBSP is described in clause 13.2.

NOTE: No ETSI deliverable does specify this parameter.

Table 41: Break points of the narrow-band signal power P , as a function of the Principal frequency F_N of the signal category (see table 40)

Centre frequency f	Impedance R	Signal Level P	Power bandwidth B	Spectral Power P/B
0,1 kHz	135Ω	-50 dBm	100 Hz	-70 dBm/Hz
4 kHz	135Ω	-39 dBm	100 Hz	-59 dBm/Hz
4 kHz	135Ω	-29 dBm	1 kHz	-59 dBm/Hz
10 kHz	135Ω	-12 dBm	1 kHz	-42 dBm/Hz
10 kHz	135Ω	-12 dBm	1 kHz	-42 dBm/Hz
40 kHz	135Ω	-9 dBm	1 kHz	-39 dBm/Hz
$F_L + F_N$	135Ω	-9 dBm	1 kHz	-39 dBm/Hz
$F_L + (1 + \alpha/2) \times F_N$	135Ω	-12 dBm	1 kHz	-42 dBm/Hz
$F_L + (1 + \alpha) \times F_N$	135Ω	-29 dBm	1 kHz	-59 dBm/Hz
500 kHz	135Ω	-46 dBm	1 kHz	-76 dBm/Hz
2 MHz	135Ω	-80 dBm	1 kHz	-110 dBm/Hz
2 MHz	135Ω	-50 dBm	1 MHz	-110 dBm/Hz
30 MHz	135Ω	-50 dBm	1 MHz	-110 dBm/Hz

NOTE: The parameter values for F_L , and α are defined as $F_L = 10$ kHz, and $\alpha = 0,15$.

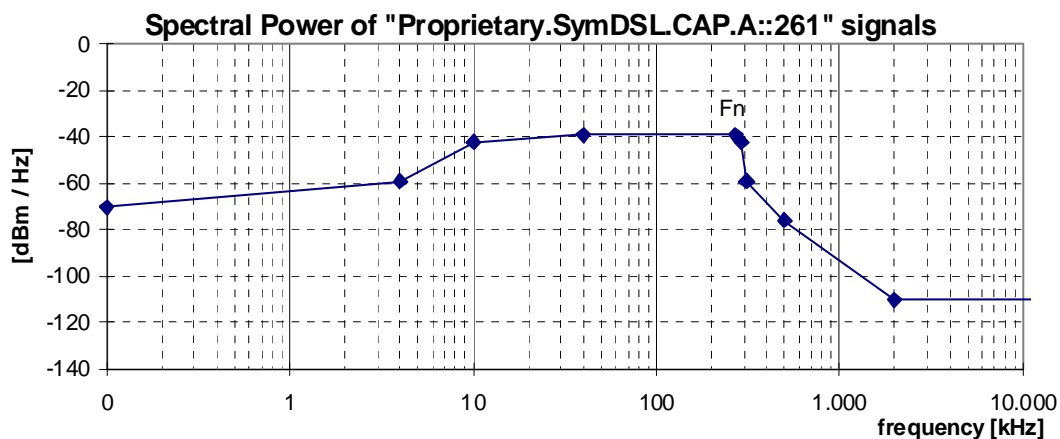

NOTE: These curves are dependent on the Principal frequency F_N , and that this figure shows an example only.

Figure 26: Spectral Power, for "Proprietary.SymDSL.CAP.A::261" signals (at $F_N = 261$ kHz), as specified in table 41

10.8.4 Unbalance about earth

The present document provides information on how compliance with this signal category can be achieved:

To be compliant with this signal category, the balance of the signal that may flow through the LT-port or NT-port shall exceed minimum requirements, under the condition that the local loop wiring and its termination is well balanced. This can be verified by a Longitudinal Output Voltage (LOV) and a Longitudinal Conversion Loss (LCL) measurement at the source of that signal, as specified in clauses 13.3.2 and 13.3.3. The minimum LOV and LCL requirements hold for what can be observed at the ports of the Local Loop Wiring, when the Local Loop Wiring is replaced by an artificial impedance network described in clauses 13.3.2 and 13.3.3.

The differential termination impedance for LOV and LCL measurements shall be chosen equally to the design impedance $R_T = 135 \Omega$ of the Signal Source under test.

The observed LOV shall have an rms voltage of below the value specified in table 42, measured in a *power* bandwidth B , centred over any frequency in the range from f_{\min} to f_{\max} , and averaged in any one second period. Compliance with this limitation is required with a longitudinal terminating impedance having value $Z_L(\omega) = R_L + 1 / (j\omega \times C_L)$ for all frequencies between f_{\min} to f_{\max} . Clause 13.3.2 defines an example measurement method for longitudinal output voltage.

The observed LCL shall be higher than the lower limits given in figure 27. The LCL values of the associated break frequencies of this figure are given in table 43. Clause 13.3.3 defines an example measurement method for longitudinal conversion loss.

NOTE: No ETSI deliverable does specify this parameter.

Table 42: Values for the LOV limits

LOV	B	f_{\min}	f_{\max}	R_L	C_L
-46 dBV	10 kHz	5,1 kHz	500 kHz	100 Ω	150 nF

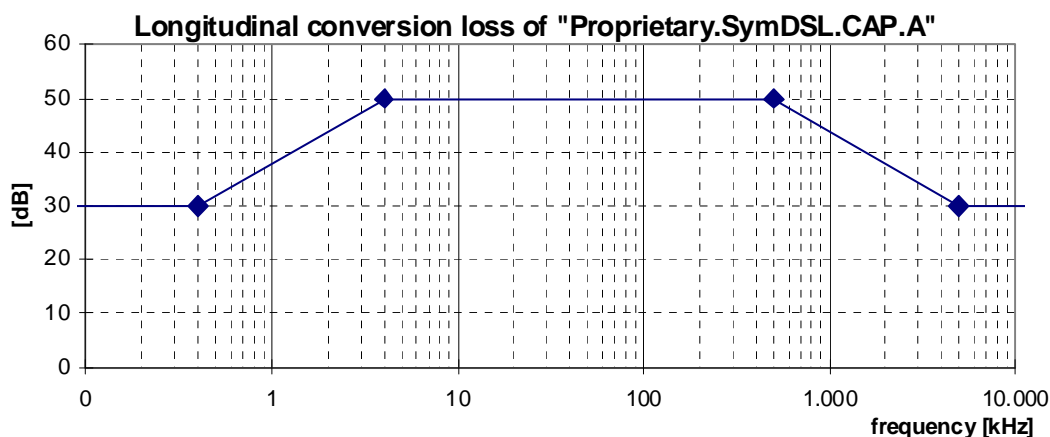

Figure 27: Minimum longitudinal conversion loss for a "Proprietary.SymDSL.CAP.A::261" signal source

Table 43: Frequencies and LCL values of the breakpoints of the LCL mask in figure 27

Frequency	LCL
< 0,4 kHz	30 dB
4 kHz	50 dB
500 kHz	50 dB
5 MHz	30 dB
30 MHz	30 dB

10.9 "Proprietary.SymDSL.CAP.B::Fn" signals

This category covers signals, generated by Proprietary multi-rate SymDSL transmission equipment. This signal is labelled as *proprietary*, since it is not covered by ETSI, ITU nor ANSI product standards.

The pass-band signal definition is linecode independent, but derived from CAP based HDSL signals defined in annex B of [i.7]. Their definition is driven by the deployment of proprietary multi-rate symmetric HDSL transmission equipment based on CAP modulation. This category covers other CAP implementation than covered by "Proprietary.SymDSL.CAP.A" signals, without significant advantages or disadvantages.

In the naming convention "Proprietary.SymDSL.CAP.B::Fn", is the phrase "Fn" a placeholder for a number that is used as parameter F_N in the signal definition. Replacing "Fn" in the signal name by a value, changes the generic signal description into a specific description, since its value is required in the clauses below. It is referred to as the *Principal frequency* of the signal.

The Principal frequency F_N is indicative for the maximum symbol rate (kbaud) that can be transported within these signal limits. A signal with a higher Principal Frequency occupies a wider spectrum. Values between 72 kHz and 387 kHz are commonly used.

Table 44 gives several examples on how to use the naming convention for specifying the actual parameter value F_n . It also illustrates some (informative) bitrates that can be transported within these signal limits, when using the associated (informative) modulation parameters. These are examples only, other system implementations may use the same signal limits in a different way.

Table 44: Example on how the naming convention relates to the actual parameter value F_N that is used in the clauses below to specify the signal limits of this signal category

Signal category	F_N (kHz)	Symbol Rate (kBaud)	Bits per Symbol	Bitrate (kbit/s)	Constellation size
Propriety.SymDSL.CAP.B::72	72	72	4	288	32
Propriety.SymDSL.CAP.B::100	100	100	4	400	32
Propriety.SymDSL.CAP.B::132	132	132	4	528	32
Propriety.SymDSL.CAP.B::196	196	196	4	784	32
Propriety.SymDSL.CAP.B::208	208	208	5	1 040	64
Propriety.SymDSL.CAP.B::310	311	310,4	5	1 552	64
Propriety.SymDSL.CAP.B::344	344	344	6	2 064	128
Propriety.SymDSL.CAP.B::387	387	386,7	6	2 320	128

NOTE: The bitrates and modulation parameters are informative only, and implementation dependent.

A signal (per wire-pair) can be classified as a "Proprietary.SymDSL.CAP.B::Fn" signal if it is compliant with all clauses below, *and* if parameter "Fn" is specified by a numerical value.

Unless otherwise indicated, the following signal specifications apply with a resistive load impedance of 135 Ω , and does not apply to the DC remote power feeding (if any).

10.9.1 Total signal power

The present document provides information on how compliance with this signal category can be achieved:

To be compliant with this signal category, the mean signal power into a resistive load of 135 Ω shall not exceed a level of +14 dBm, measured within a frequency band from at least 100 Hz to 1 MHz.

NOTE: No ETSI deliverable does specify this parameter.

10.9.2 Peak amplitude

The present document provides information on how compliance with this signal category can be achieved:

To be compliant with this signal category, the nominal voltage peak of the largest signal pulse into a resistive load of 135 Ω shall not exceed a level of 7,4 V measured within a frequency band from at least 100 Hz to 1 MHz. The definition and measurement method of peak amplitude is specified in clause 13.1.

NOTE: No ETSI deliverable does specify this parameter.

10.9.3 Narrow-Band Signal Power (NBSP)

The present document provides information on how compliance with this signal category can be achieved:

To be compliant with this signal category, the Narrow-Band Signal Power (NBSP) into a resistive load impedance R , shall not exceed the limits given in table 45, at any point in the frequency range 100 Hz to 30 MHz. This table specifies the break points of these limits. Limits for intermediate frequencies can be found by drawing a straight line between the break points on a logarithmic (Hz) - linear (dB) scale. Figure 28 illustrates the NBSP in a bandwidth-normalized way.

The NBSP is the average power P of a sending signal into a load resistance R , within a *power* bandwidth B . The measurement method of the NBSP is described in clause 13.2.

NOTE: No ETSI deliverable does specify this parameter.

Table 45: Break points of the narrow-band signal power P, as a function of the Principal frequency F_N of the signal category (see table 44)

Centre frequency f	Impedance R	Signal Level P	Power bandwidth B	Spectral Power P/B
0,1 kHz	135 Ω	A - 37 dBm	100 Hz	A - 17 dBm/Hz
4 kHz	135 Ω	A - 37 dBm	100 Hz	A - 17 dBm/Hz
4 kHz	135 Ω	A - 47 dBm	1 kHz	A - 17 dBm/Hz
9 kHz	135 Ω	A - 30 dBm	1 kHz	A dBm/Hz
$F_L + F_N$	135 Ω	A - 30 dBm	1 kHz	A dBm/Hz
$F_L + (1 + \alpha/2) \times F_N$	135 Ω	A - 33 dBm	1 kHz	A - 3 dBm/Hz
$F_L + (1 + \alpha) \times F_N$	135 Ω	A - 50 dBm	1 kHz	A - 20 dBm/Hz
500 kHz	135 Ω	-46 dBm	1 kHz	-76 dBm/Hz
2 MHz	135 Ω	-80 dBm	1 kHz	-110 dBm/Hz
2 MHz	135 Ω	-50 dBm	1 MHz	-110 dBm/Hz
30 MHz	135 Ω	-50 dBm	1 MHz	-110 dBm/Hz

NOTE: $F_L = 10$ kHz; $\alpha = 0,15$; $A = 13,5 - 10 \times \log_{10}(F_N/F_0) + 1$ dBm/Hz; $F_0 = 1$ Hz.

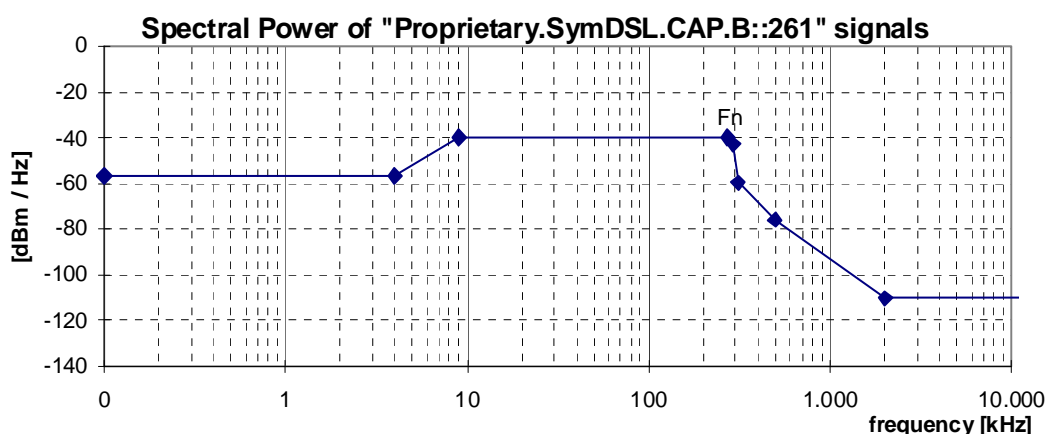

NOTE: These curves are dependent on the Principal frequency F_N , and that this figure shows an example only.

Figure 28: Spectral Power, for "Proprietary.SymDSL.CAP.B::261" signals (at $F_N = 261$ kHz), as specified in table 45

10.9.4 Unbalance about earth

The present document provides information on how compliance with this signal category can be achieved:

To be compliant with this signal category, the balance of the signal that may flow through the LT-port or NT-port shall exceed minimum requirements, under the condition that the local loop wiring and its termination is well balanced. This can be verified by a Longitudinal Output Voltage (LOV) and a Longitudinal Conversion Loss (LCL) measurement at the source of that signal, as specified in clauses 13.3.2 and 13.3.3. The minimum LOV and LCL requirements hold for what can be observed at the ports of the Local Loop Wiring, when the Local Loop Wiring is replaced by an artificial impedance network described in clauses 13.3.2 and 13.3.3.

The differential termination impedance for LOV and LCL measurements shall be chosen equally to the design impedance $R_T = 135 \Omega$ of the Signal Source under test.

The observed LOV shall have an rms voltage of below the value specified in table 46, measured in a *power* bandwidth B , centred over any frequency in the range from f_{\min} to f_{\max} , and averaged in any one second period. Compliance with this limitation is required with a longitudinal terminating impedance having value $Z_L(\omega) = R_L + 1 / (j\omega \times C_L)$ for all frequencies between f_{\min} to f_{\max} . Clause 13.3.2 defines an example measurement method for longitudinal output voltage.

The observed LCL shall be higher than the lower limits given in figure 29. The LCL values of the associated break frequencies of this figure are given in table 47. Clause 13.3.3 defines an example measurement method for longitudinal conversion loss.

NOTE: No ETSI deliverable does specify this parameter.

Table 46: Values for the LOV limits.

LOV	B	f_{\min}	f_{\max}	R_L	C_L
-46 BV	10 kHz	5,1 kHz	500 kHz	100 Ω	150 nF

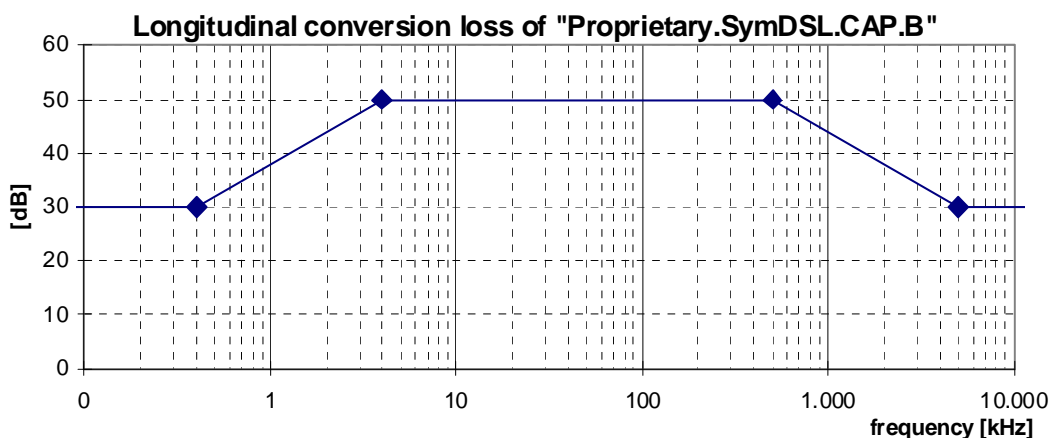

Figure 29: Minimum longitudinal conversion loss for a "Proprietary.SymDSL.CAP.B::261" signal source

Table 47: Frequencies and LCL values of the breakpoints of the LCL mask in figure 29

Frequency	LCL
< 0,4 kHz	30 dB
4 kHz	50 dB
500 kHz	50 dB
5 MHz	30 dB
30 MHz	30 dB

10.10 "Proprietary.SymDSL.CAP.C::Fn" signals

This category covers signals, generated by Proprietary multi-rate SymDSL transmission equipment on one wire-pair. This signal is labelled as *Proprietary*, since it is not covered by ETSI, ITU nor ANSI product standards.

This signal definition is linecode independent, but dedicated to signals from transmission equipment for variable bit-rate leased lines that are using CAP or QAM modulation.

In the naming convention "Proprietary.SymDSL.CAP.C::Fn", is the phrase "Fn" a placeholder for a number that is used as parameter F_N in the signal definition. Replacing "Fn" in the signal name by a value, changes the generic signal description into a specific description, since its value is required in the clauses below. It is referred to as the *Principal frequency* of the signal.

The Principal frequency F_N is indicative for the maximum symbol rate (kbaud) that can be transported within these signal limits. A signal with a higher Principal Frequency occupies a wider spectrum. Values between 72 kHz and 128 kHz are commonly used.

Table 48 gives several examples on how to use the naming convention for specifying the actual parameter value F_n . It also illustrates some (informative) bitrates that can be transported within these signal limits, when using the associated (informative) modulation parameters. These are examples only, other system implementations may use the same signal limits in a different way.

Table 48: Example on how the naming convention relates to the actual parameter value F_N that is used in the clauses below to specify the signal limits of this signal category

Signal category	F_N (kHz)	Baud Rate (kbaud)	Bitrate (kbit/s)	Bit/Symbol	Constellation size
Proprietary.SymDSL.CAP.C::72	72	72	144	2	8
Proprietary.SymDSL.CAP.C::88	88	88	264	3	16
Proprietary.SymDSL.CAP.C::96	96	96	288	3	16
Proprietary.SymDSL.CAP.C::112	112	112	336	3	16
Proprietary.SymDSL.CAP.C::128	128	128	384	3	16

NOTE: The bitrates and modulation parameters are informative only, and implementation dependent.

A signal can be classified as a "Proprietary.SymDSL.CAP.C::Fn" signal if it is compliant with all clauses below, *and* if parameter "Fn" is specified by a numerical value.

Unless otherwise indicated, the following signal specifications apply with a resistive load impedance of 135 Ω .

10.10.1 Total signal power

The present document provides information on how compliance with this signal category can be achieved:

To be compliant with this signal category, the mean signal power into a resistive load of 135 Ω shall not exceed a level of +14 dBm, measured within a frequency band from at least 100 Hz to 1 MHz.

NOTE: No ETSI deliverable does specify this parameter.

10.10.2 Peak amplitude

The present document provides information on how compliance with this signal category can be achieved:

To be compliant with this signal category, the nominal voltage peak of the largest signal pulse into a resistive load of 135 Ω shall not exceed a level of 7,5 V (15 V peak-peak), measured within a frequency band from at least 100 Hz to 1 MHz.

The definition and measurement method of peak amplitude is specified in clause 13.1.

NOTE: No ETSI deliverable does specify this parameter.

10.10.3 Narrow-Band Signal Power (NBSP)

The present document provides information on how compliance with this signal category can be achieved:

To be compliant with this signal category, the Narrow-Band Signal Power (NBSP) into a resistive load impedance R , shall not exceed the limits given in table 49, at any point in the frequency range 100 Hz to 30 MHz. This table specifies the break points of these limits. Limits for intermediate frequencies can be found by drawing a straight line between the break points on a logarithmic (Hz) - linear (dB) scale. Figure 30 illustrates the NBSP in a bandwidth-normalized way.

The NBSP is the average power P of a sending signal into a load resistance R , within a *power* bandwidth B . The measurement method of the NBSP is described in clause 13.2.

NOTE: No ETSI deliverable does specify this parameter.

Table 49: Break points of the narrow-band signal power P, as a function of the Principal frequency F_N of the signal category (see table 48)

Centre frequency f	Impedance R	Signal Level P (dBm)	Power bandwidth B	Spectral Power P/B (dBm/Hz)	
510 Hz	135 Ω	-56	1 kHz	-86	"X"
4 kHz	135 Ω	-56	1 kHz	-86	
10 kHz	135 Ω	-30	1 kHz	-60	
10 kHz	135 Ω	-20	10 kHz	-60	"Y"
$0,12 \times F_N + F_L$	135 Ω	$+7,6 - 0,380 \times f/f_0$	10 kHz	$-32,4 - 0,380 \times f/f_0$	
$0,23 \times F_N + F_L$	135 Ω	$+11,4 - 0,184 \times f/f_0$	10 kHz	$-28,6 - 0,184 \times f/f_0$	
$0,66 \times F_N + F_L$	135 Ω	$+11,2 - 0, \times f/f_0$	10 kHz	$-28,8 - 0, \times f/f_0$	
$1,06 \times F_N + F_L$	135 Ω	$+4,3 - 0, \times f/f_0$	10 kHz	$-35,7 - 0, \times f/f_0$	
$3,50 \times F_N$	135 Ω	$-38,2 - 0, \times f/f_0$	10 kHz	$-78,2 - 0, \times f/f_0$	
$3,90 \times F_N$	135 Ω	$-38,2 - 0, \times f/f_0$	10 kHz	$-78,2 - 0, \times f/f_0$	
F_Q	135 Ω	-50	10 kHz	-90	
30 MHz	135 Ω	-50	10 kHz	-90	
F_Q	135 Ω	-30	1 MHz	-90	
$7,00 \times F_N$	135 Ω	-50	1 MHz	-110	
30 MHz	135 Ω	-50	1 MHz	-110	
$F_L = 10 \text{ kHz}$		f = centre freq (Hz)		$f_0 = 1 \text{ kHz}$	
$F_Q = \left(\frac{-161 \times F_N + 0,295 \times F_N^2}{-31,8 + 0,0421 \times F_N} \right)$					

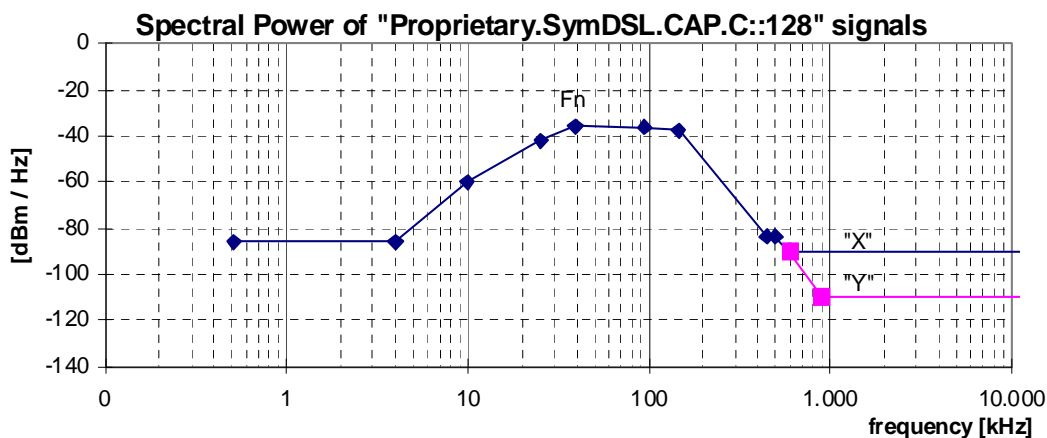

NOTE: These curves are dependent on the Principal frequency F_N , and that this figure shows an example only.

Figure 30: Spectral Power, for "Proprietary.SymDSL.CAP.C::128" signals (at $F_N = 128 \text{ kHz}$), as specified in table 49

10.10.4 Unbalance about earth

The present document provides information on how compliance with this signal category can be achieved:

To be compliant with this signal category, the balance of the signal that may flow through the LT-port or NT-port shall exceed minimum requirements, under the condition that the local loop wiring and its termination is well balanced. This can be verified by a Longitudinal Output Voltage (LOV) and a Longitudinal Conversion Loss (LCL) measurement at the source of that signal, as specified in clauses 13.3.2 and 13.3.3. The minimum LOV and LCL requirements hold for what can be observed at the ports of the Local Loop Wiring, when the Local Loop Wiring is replaced by an artificial impedance network described in clauses 13.3.2 and 13.3.3.

The differential termination impedance for LOV and LCL measurements shall be chosen equally to the design impedance $R_T = 135 \Omega$ of the Signal Source under test.

The observed LOV shall have an rms voltage of below the value specified in table 50, measured in a *power* bandwidth **B**, centred over any frequency in the range from f_{\min} to f_{\max} , and averaged in any one second period. Compliance with this limitation is required with a longitudinal terminating impedance having value $Z_L(\omega) = R_L + 1 / (j\omega \times C_L)$ for all frequencies between f_{\min} to f_{\max} . Clause 13.3.2 defines an example measurement method for longitudinal output voltage.

The observed LCL shall be higher than the lower limits given in figure 31. The LCL values of the associated break frequencies of this figure are given in table 51. Clause 13.3.3 defines an example measurement method for longitudinal conversion loss.

NOTE: No ETSI deliverable does specify this parameter.

Table 50: Values for the LOV limits

LOV	B	f_{\min}	f_{\max}	R_L	C_L
-46 BV	10 kHz	5,1 kHz	225 kHz	100 Ω	150 nF

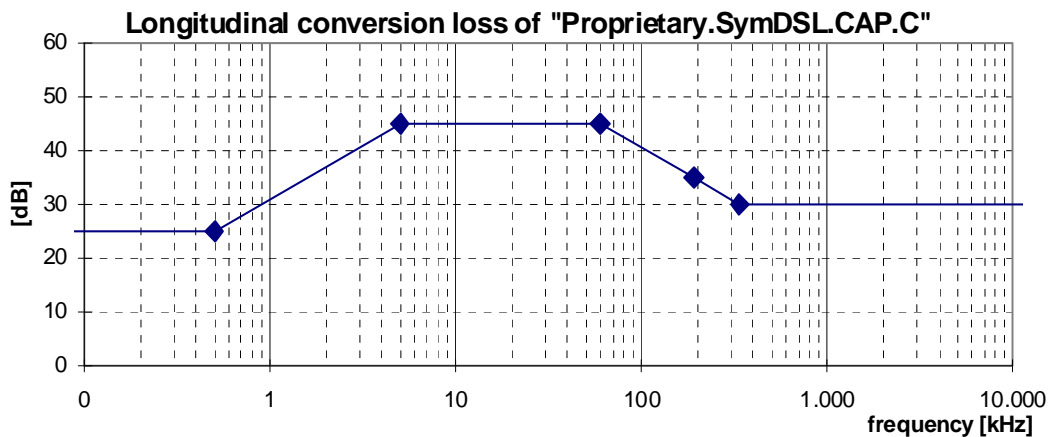

Figure 31: Minimum longitudinal conversion loss for a "Proprietary.SymDSL.CAP.C::Fn" signal source

Table 51: Frequencies and LCL values of the breakpoints of the LCL mask in figure 31

Frequency	LCL
< 0,5 kHz	25 dB
5 kHz	45 dB
60 kHz	45 dB
190 kHz	35 dB
337 kHz	30 dB
30 MHz	30 dB

10.11 "Proprietary.SymDSL.PAM::Fn" signals

This category covers signals, generated by Proprietary multi-rate SymDSL transmission equipment on a single wire pair. This signal is labelled as *Proprietary*, since it is not covered by ETSI, ITU nor ANSI product standards.

This signal definition is linecode independent, but dedicated to signals from transmission equipment that are using PAM modulation.

In the naming convention "Proprietary.SymDSL.PAM::Fn", is the phrase "Fn" a placeholder for a number that is used as parameter F_N in the signal definition. Replacing "Fn" in the signal name by a value, changes the generic signal description into a specific description, since its value is required in the clauses below. It is referred to as the *Principal frequency* of the signal.

The Principal frequency F_N is indicative for the maximum symbol rate (kbaud) that can be transported within these signal limits. A signal with a higher Principal Frequency occupies a wider spectrum. The clauses below are defined for all Principal frequencies between 80 kHz and 264 kHz.

Table 52 gives several examples on how to use the naming convention for specifying the actual parameter value F_n . It also illustrates some (informative) bitrates that can be transported within these signal limits, when using the associated (informative) modulation parameters. These are examples only, other system implementations may use the same signal limits in a different way.

Table 52: Naming convention for parameter F_N

Signal category	F_N (kHz)	Baud Rate (kbaud)	Bit/symbol	Bitrate (kbit/s)
Proprietary.SymDSL.PAM::80	80	80	2	160
Proprietary.SymDSL.PAM::258	258	258	4	1 032
Proprietary.SymDSL.PAM::264	264	264	3	792
NOTE: Example on how the naming convention relates to the actual parameter value F_N that is used in the clauses below to specify the signal limits of this signal category. The actual bitrates and modulation parameters are implementation dependent, and informative only. They are included here to illustrate that different bitrates can be carried by signals having the same Principal frequency.				

Two slightly different additional variants are identified for all signals with specified Principal Frequency:

- option A signals, are dedicated to Ungerboeck Coded PAM with 2, 3 or 4 bits per symbol (before encoding);
- option B signals, are dedicated to 2B1Q linecoded signals.

A signal can be classified as a "Proprietary.SymDSL.PAM::Fn" signal if it is compliant with all clauses below **and** if parameter "Fn" is specified by a numerical value.

NOTE: The Narrow-Band Signal Power (NBSP) of "Proprietary.SymDSL.PAM::Fn" signals, having a Principal frequency between 80 kHz to 141,3 kHz, also fit under the NBSP mask of ISDN.2B1Q signals. This does not hold for the Peak amplitude and Unbalance about earth, so these signal limits are not 100 % compliant with ISDN.2B1Q signals.

10.11.1 Total signal power

The present document provides information on how compliance with this signal category can be achieved:

To be compliant with this signal category, the mean signal power into a resistive load of 135 Ω shall not exceed a level of +14 dBm, measured within a frequency band from at least 100 Hz to $2 \times F_N$.

NOTE: No ETSI deliverable does specify this parameter.

10.11.2 Peak amplitude

The present document provides information on how compliance with this signal category can be achieved:

To be compliant with this signal category, the nominal voltage peak of the largest signal pulse into a resistive load of 135Ω shall not exceed a level of $V_{\text{peak}} (\pm 7 \%)$, measured within a frequency band from at least 100 Hz to $F_N \times 2$.

Two signal options have been defined, that are different only in their V_{peak} specification:

- for "option A" signals, V_{peak} shall not exceed 3,4 V (6,8 V peak-peak) (*dedicated to Ungerboeck Coded PAM*);
- for "option B" signals, V_{peak} shall not exceed 2,64 V (5,28 V peak-peak) (*dedicated to 2B1Q linecoded signals*).

The definition and measurement method of peak amplitude is specified in clause 13.1.

NOTE: No ETSI deliverable does specify this parameter.

10.11.3 Narrow-Band Signal Power (NBSP)

The present document provides information on how compliance with this signal category can be achieved:

To be compliant with this signal category, the Narrow-Band Signal Power (NBSP) into a resistive load impedance R , shall not exceed the limits given in tables 53 and 54, at any point in the frequency range 100 Hz to 30 MHz. Limits for intermediate frequencies can be found by drawing a straight line between the break points on a logarithmic (Hz) - linear (dB) scale. Table 53 describes the break points of these limits in a general way, table 54 specifies the associated parameters for all Principal frequencies between 80 kHz and 264 kHz. Figure 32 illustrates the NBSP in a bandwidth-normalized way.

The NBSP is the average power P of a sending signal into a load resistance R , within a power bandwidth B . The measurement method of the NBSP is described in clause 13.2.

NOTE: No ETSI deliverable does specify this parameter.

Table 53: Break points of the narrow-band signal power P , as a function of the Principal frequency F_N of the signal category (see table 52)

Centre frequency f	Impedance R	Signal Level P	Power bandwidth B	Spectral Power P/B
0,1 kHz	135 Ω		100 Hz	$SP_1(F_N)$
1 kHz	135 Ω		100 Hz	$SP_1(F_N)$
1 kHz	135 Ω	$P_{1,1k}(F_N)$	1 kHz	$SP_1(F_N)$
10 kHz	135 Ω	$P_{1,1k}(F_N)$	1 kHz	$SP_1(F_N)$
10 kHz	135 Ω	$P_{1,10k}(F_N)$	10 kHz	$SP_1(F_N)$
$F_1(F_N)$	135 Ω	$P_{1,10k}(F_N)$	10 kHz	$SP_1(F_N)$
$F_2(F_N)$	135 Ω	$P_{2,10k}(F_N)$	10 kHz	$SP_2(F_N)$
$F_3(F_N)$	135 Ω	-77 dBm	10 kHz	-117 dBm/Hz
$F_3(F_N)$	135 Ω	-57 dBm	1 MHz	-117 dBm/Hz
30 MHz	135 Ω	-57 dBm	1 MHz	-117 dBm/Hz
NOTE: The parameter values for $F_1, F_2, F_3, P_{1,1k}, P_{1,10k}, P_{2,10k}, SP_1, SP_2$, are defined for each F_N in table 54.				

Table 54: Definition of all Principal-frequency-dependent parameters that are used in table 53, for all Principal frequencies between 80 kHz and 264 kHz

F_N (kHz)	F1	F2	F3	SP1 (dBm/Hz)	P1,1k (dBm)	P1,10k (dBm)	SP2 (dBm/Hz)	P2,1k (dBm)	P2,10k (dBm)
$80 \leq F_N < 92$	$1/4 \times F_N$	$3/4 \times F_N$	$5,5 \times F_N$	-30,0	0,0	+10	-38,0	-8,0	+2,0
$92 \leq F_N < 104$	$1/4 \times F_N$	$3/4 \times F_N$	$5,5 \times F_N$	-30,5	-0,5	+9,5	-38,5	-8,5	+1,5
$104 \leq F_N < 116$	$1/4 \times F_N$	$3/4 \times F_N$	$5,5 \times F_N$	-31,0	-1,0	+9,0	-39,0	-9,0	+1,0
$116 \leq F_N < 129$	$1/4 \times F_N$	$3/4 \times F_N$	$5 \times F_N$	-31,5	-1,5	+8,5	-39,5	-9,5	+0,5
$129 \leq F_N < 146$	$1/4 \times F_N$	$3/4 \times F_N$	$5 \times F_N$	-32,0	-2,0	+8,0	-40,0	-10,0	0,0
$146 \leq F_N < 164$	$1/4 \times F_N$	$3/4 \times F_N$	$5 \times F_N$	-32,5	-2,5	+7,5	-40,5	-10,5	-0,5
$164 \leq F_N < 185$	$1/4 \times F_N$	$3/4 \times F_N$	$5 \times F_N$	-33,0	-3,0	+7,0	-41,0	-11,0	-1,0
$185 \leq F_N < 207$	$1/4 \times F_N$	$2/3 \times F_N$	$4,5 \times F_N$	-33,5	-3,5	+6,5	-41,5	-11,5	-1,5
$207 \leq F_N < 232$	$1/4 \times F_N$	$2/3 \times F_N$	$4 \times F_N$	-34,0	-4,0	+6,0	-42,0	-12,0	-2,0
$232 \leq F_N < 259$	$1/4 \times F_N$	$2/3 \times F_N$	$3,5 \times F_N$	-34,5	-4,5	+5,5	-42,5	-12,5	-2,5
$259 \leq F_N \leq 264$	$1/4 \times F_N$	$2/3 \times F_N$	$3,5 \times F_N$	-35,0	-5,0	+5,0	-43,0	-13,0	-3,0

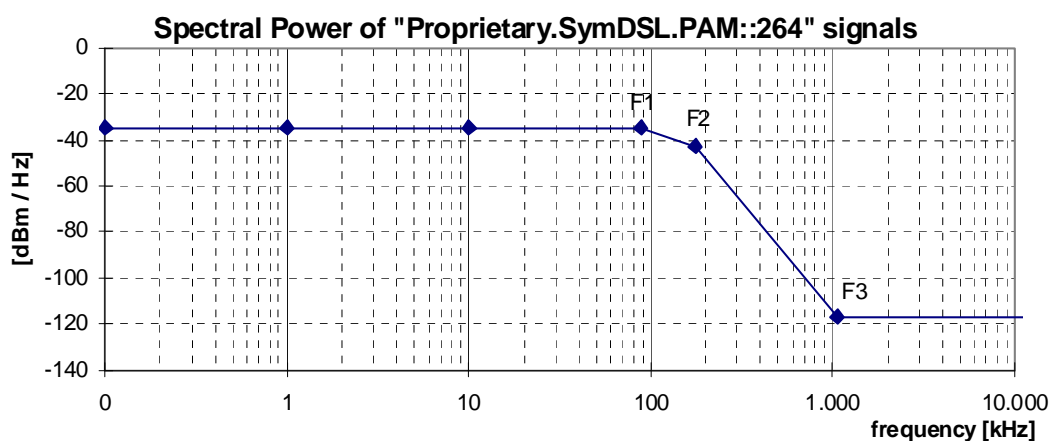

NOTE: These curves are dependent on the Principal frequency F_N , and this figure shows only an example.

Figure 32: Spectral Power, for "Proprietary.SymDSL.PAM::264" signals (at $F_N = 264$ kHz), as specified in tables 53 and 54

10.11.4 Unbalance about earth

The present document provides information on how compliance with this signal category can be achieved:

To be compliant with this signal category, the balance of the signal that may flow through the LT-port or NT-port shall exceed minimum requirements, under the condition that the local loop wiring and its termination is well balanced. This can be verified by a Longitudinal Output Voltage (LOV) and a Longitudinal Conversion Loss (LCL) measurement at the source of that signal, as specified in clause 13.3.2 and 13.3.3. The minimum LOV and LCL requirements hold for what can be observed at the ports of the Local Loop Wiring, when the Local Loop Wiring is replaced by an artificial impedance network described in clause 13.3.2 and 13.3.3.

The differential termination impedance for LOV and LCL measurements shall be chosen equally to the design impedance $R_T = 135 \Omega$ of the Signal Source under test.

The observed LOV shall have an rms voltage of below the value specified in table 55, measured in a *power* bandwidth B , centred over any frequency in the range from f_{\min} to f_{\max} , and averaged in any one second period. Compliance with this limitation is required with a longitudinal terminating impedance having value $Z_L(\omega) = R_L + 1 / (j\omega \times C_L)$ for all frequencies between f_{\min} to f_{\max} . Clause 13.3.2 defines an example measurement method for longitudinal output voltage.

The observed LCL shall be higher than the lower limits given in figure 33. The LCL values of the associated break frequencies of this figure are given in table 56. Clause 13.3.3 defines an example measurement method for longitudinal conversion loss.

NOTE: No ETSI deliverable does specify this parameter.

Table 55: Values for the LOV limits.

LOV	B	f_{\min}	f_{\max}	R_L	C_L
-46 dBV	10 kHz	5,1 kHz	500 kHz	100 Ω	150 nF

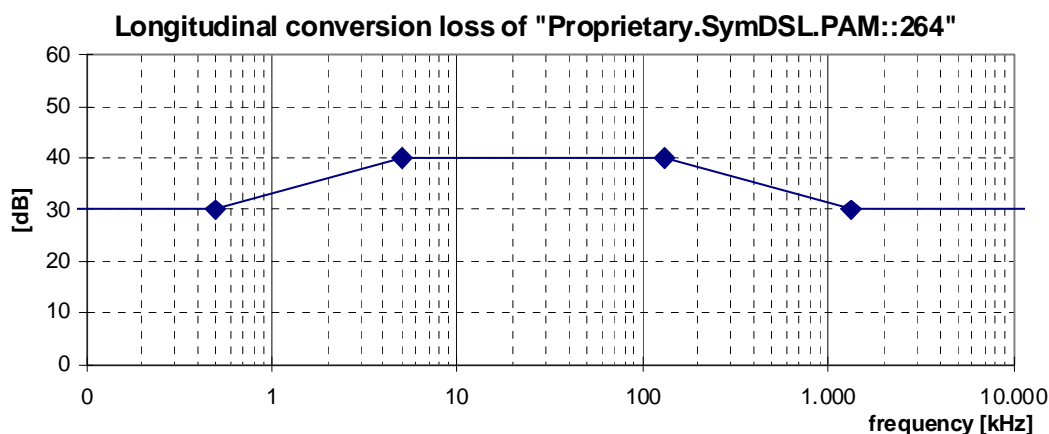

Figure 33: Minimum longitudinal conversion loss for a "Proprietary.SymDSL.PAM::264" signal source

Table 56: Frequencies and LCL values of the breakpoints of the LCL mask in figure 33

Frequency	LCL
< 0,5 kHz	slope: +20 dB/decade
5 kHz	40 dB
$1/2 \times F_N$	40 dB
$> 1/2 \times F_N$	slope: -20 dB/decade

10.11.5 Feeding power (from the LT-port)

Power feeding is no integral part of this signal category, although it is not uncommon for SymDSL based services. To enable power feeding in combination with this signal category, refer to one of the power feeding classes summarized in clause 7.

10.12 "Proprietary.SymDSL.2B1Q::Fn" signals

This category covers signals, generated by Proprietary multi-rate SymDSL transmission equipment on one, two, or three wire pairs. This signal is labelled as *Proprietary*, since it is not covered by ETSI, ITU nor ANSI product standards.

This signal definition is linecode independent, but dedicated to signals from transmission equipment that are using 2B1Q modulation (4-level PAM). The use of other line codes is not precluded.

In the naming convention "Proprietary.SymDSL.2B1Q::Fn", is the phrase "Fn" a placeholder for a number that is used as parameter F_N in the signal definition. Replacing "Fn" in the signal name by a value, changes the generic signal description into a specific description, since its value is required in the clauses below. It is referred to as the *Principal frequency* of the signal.

The Principal frequency F_N is indicative for the maximum symbol rate (kbaud) that can be transported within these signal limits. A signal with a higher Principal Frequency occupies a wider spectrum. The clause below are defined for all Principal frequencies between 32 kHz and 1 160 kHz.

Table 57 gives several examples on how to use the naming convention for specifying the actual parameter value F_n . It also illustrates some (informative) bitrates that can be transported within these signal limits, when using the associated (informative) modulation parameters. These are examples only, other system implementations may use the same signal limits in a different way.

Table 57: Naming convention for parameter F_N

Signal category	F_N (kHz)	Symbol Rate (kbaud)	Bit/symbol	Bitrate (kbit/s)
Proprietary.SymDSL.2B1Q::80	80	80	2	160
Proprietary.SymDSL.2B1Q::	1 160	1 160	2	2 320
NOTE: Example on how the naming convention relates to the actual parameter value F_N that is used in the clauses below to specify the signal limits of this signal category. The actual bitrates and modulation parameters are implementation dependent, and informative only.				

10.12.1 Total signal power

The present document provides information on how compliance with this signal category can be achieved:

To be compliant with this signal category, the mean signal power into a resistive load of 135 Ω shall not exceed a level of +14 dBm, measured within a frequency band from at least 100 Hz to $2 \times F_N$.

NOTE: No ETSI deliverable does specify this parameter.

10.12.2 Peak amplitude

The present document provides information on how compliance with this signal category can be achieved:

To be compliant with this signal category, the nominal voltage peak of the largest signal pulse into a resistive load of 135 Ω shall not exceed a level of $V_{\text{peak}} = 5 \text{ V} (\pm 7 \%)$, measured within a frequency band from at least 100 Hz to $F_N \times 2$. The definition and measurement method of peak amplitude is specified in clause 13.1.

NOTE: No ETSI deliverable does specify this parameter.

10.12.3 Narrow-Band Signal Power (NBSP)

The present document provides information on how compliance with this signal category can be achieved:

To be compliant with this signal category, the Narrow-Band Signal Power (NBSP) into a resistive load impedance R , shall not exceed the limits given in table 59, at any point in the frequency range 100 Hz to 30 MHz. Limits for intermediate frequencies can be found by drawing a straight line between the break points on a logarithmic (Hz) - linear (dB) scale. Table 53 describes the break points of these limits for all Principal frequencies between 32 kHz and 1 160 kHz. Figure 34 illustrates the NBSP in a bandwidth-normalized way.

The NBSP is the average power P of a sending signal into a load resistance R , within a *power* bandwidth B . The measurement method of the NBSP is described in clause 13.2.

NOTE: No ETSI deliverable does specify this parameter.

Table 58: Break points of the narrow-band signal power P, as a function of the Principal frequency F_N of the signal category

frequency f	Impedance R	Signal Level P (dBm)	Noise Bandwidth B	Spectral Power P/B (dBm/Hz)
0,1 kHz	135 Ω	$P_0 + 3,5 + 20$	100 Hz	$P_0 + 3,5$
1 kHz	135 Ω	$P_0 + 3,5 + 20$	100 Hz	$P_0 + 3,5$
1 kHz	135 Ω	$P_0 + 3,5 + 30$	1 kHz	$P_0 + 3,5$
10 kHz	135 Ω	$P_0 + 3,5 + 30$	1 kHz	$P_0 + 3,5$
10 kHz	135 Ω	$P_0 + 3,5 + 40$	10 kHz	$P_0 + 3,5$
$0,2 \times F_N$	135 Ω	$P_0 + 3,5 + 40$	10 kHz	$P_0 + 3,5$
$0,5 \times F_N$	135 Ω	$P_0 + 1,0 + 40$	10 kHz	$P_0 + 1,0$
$0,75 \times F_N$	135 Ω	$P_0 - 9,5 + 40$	10 kHz	$P_0 - 9,5$
$1 \times F_N$	135 Ω	$P_0 - 31,5 + 40$	10 kHz	$P_0 - 31,5$
$1,5 \times F_N$	135 Ω	$P_0 - 35 + 40$	10 kHz	$P_0 - 35$
$3,5 \times F_N$	135 Ω	$P_0 - 72,5 + 40$	10 kHz	$P_0 - 72,5$
$6 \times F_N$	135 Ω	-70	10 kHz	-110
$6 \times F_N$	135 Ω	-50	1 MHz	-110
30 MHz	135 Ω	-50	1 MHz	-110

The reference power level, P_0 , in table 58 is given by the formula below. Its value has been evaluated for a few sample Principal frequencies.

$$P_0 = 10 \log_{10} \left(\frac{2,65^2}{135} \times \frac{1 \text{ kHz}}{F_N} \right)$$

Table 59: Reference power levels, as a function of the Principle frequency

F_N	80	264	520	1 160	kHz
P_0	-31,87	-37,05	-40	-43,48	dBm/Hz
NOTE:	The table summarizes some sample values, calculated from this formula.				

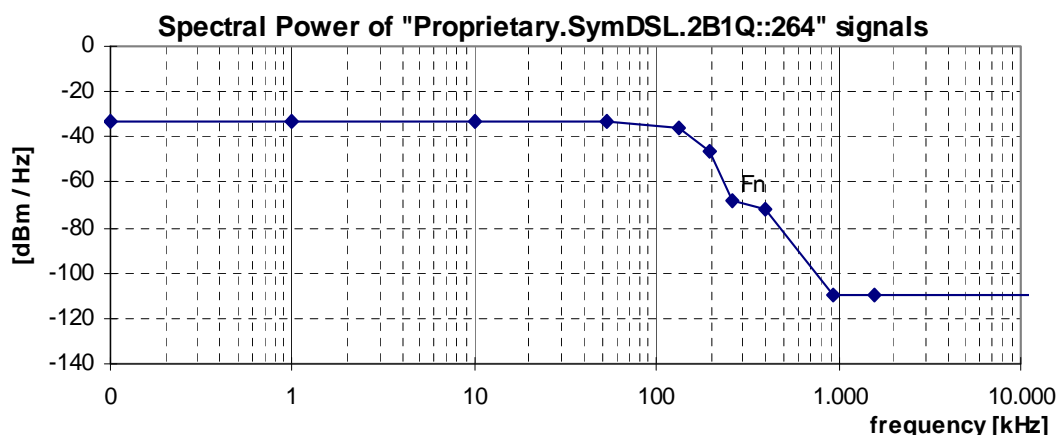

NOTE: These curves are dependent on the Principal frequency F_N , and this figure shows only an example.

Figure 34: Spectral Power, for "Proprietary.SymDSL.2B1Q::264" signals (at $F_N = 264$ kHz), as specified in table 53

10.12.4 Unbalance about earth

The present document provides information on how compliance with this signal category can be achieved:

To be compliant with this signal category, the balance of the signal that may flow through the LT-port or NT-port shall exceed minimum requirements, under the condition that the local loop wiring and its termination is well balanced. This can be verified by a Longitudinal Output Voltage (LOV) and a Longitudinal Conversion Loss (LCL) measurement at the source of that signal, as specified in clause 13.3.2 and 13.3.3. The minimum LOV and LCL requirements hold for what can be observed at the ports of the Local Loop Wiring, when the Local Loop Wiring is replaced by an artificial impedance network described in clause 13.3.2 and 13.3.3.

The differential termination impedance for LOV and LCL measurements shall be chosen equally to the design impedance $R_T = 135 \Omega$ of the Signal Source under test.

The observed LOV shall have an rms voltage of below the value specified in table 60, measured in a *power* bandwidth **B**, centred over any frequency in the range from f_{\min} to f_{\max} , and averaged in any one second period. Compliance with this limitation is required with a longitudinal terminating impedance having value $Z_L(\omega) = R_L + 1 / (j\omega \times C_L)$ for all frequencies between f_{\min} to f_{\max} . Clause 13.3.2 defines an example measurement method for longitudinal output voltage.

The observed LCL shall be higher than the lower limits given in figure 35. The LCL values of the associated break frequencies of this figure are given in table 61. Clause 13.3.3 defines an example measurement method for longitudinal conversion loss.

NOTE: No ETSI deliverable does specify this parameter.

Table 60: Values for the LOV limits

LOV	B	f_{\min}	f_{\max}	R_L	C_L
-50 dBV	4 kHz	100 kHz	400 kHz	100 Ω	150 nF

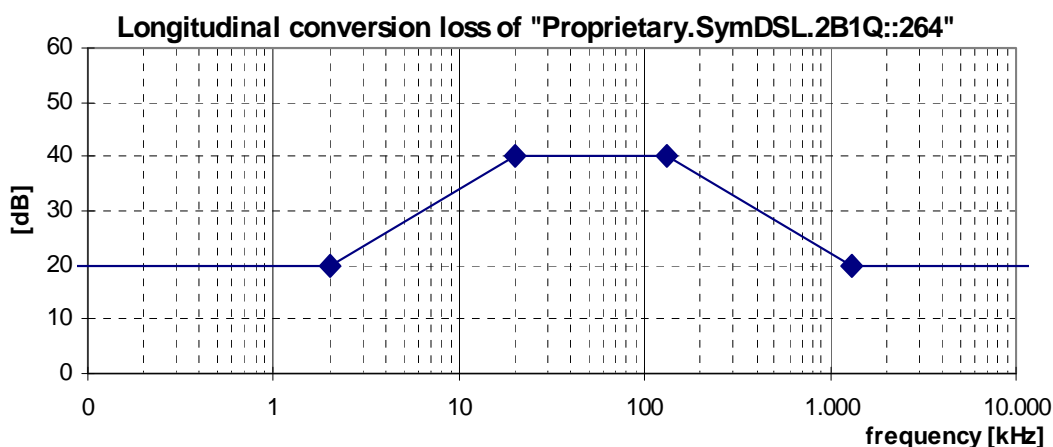

Figure 35: Minimum longitudinal conversion loss for a "Proprietary.SymDSL.2B1Q::264" signal source

Table 61: Frequencies and LCL values of the breakpoints of the LCL mask in figure 35

Frequency	LCL
< 2 kHz	20 dB
2 kHz	20 dB
20 kHz	40 dB
$1/2 \times F_N$	40 dB
$5 \times F_N$	20 dB
30 MHz	20 dB

10.12.5 Feeding power (from the LT-port)

Power feeding is no integral part of this signal category, although it is not uncommon for SymDSL services. To enable power feeding in combination with this signal category, refer to one of the power feeding classes summarized in clause 7.

10.13 "Proprietary.PCM.HDB3.2M.SR" signals

This category covers signals generated by 2 Mbit/s transmission equipment on two wire-pairs, usable for instance for ISDN-Primary Rate Access. This category includes HDB3 line coding and **sine** shaped transmit pulses in case of sending a randomized bit sequence. This signal is labelled as *proprietary*, since it is not covered by ETSI, ITU nor ANSI product standards.

A signal can be classified as a "Proprietary.PCM.HDB3.2M.SR" signal if it is compliant with all clauses below.

NOTE: The signals covered here are only applicable to systems which are using *sine shaped transmit pulses* and in case of *sending a randomized bit sequence*. Special bit sequences like AIS (Alarm Indication Signal) or others and other transmit pulse forms than described here can cause different signals. The way these characteristics are to be covered by specifications, are for further study.

10.13.1 Total signal power

The present document provides information on how compliance with this signal category can be achieved:

To be compliant with this signal category, the mean signal power into a resistive load of 130 Ω shall not exceed a level of +11 dBm ($\pm 0,5$ dBm), measured within a frequency band from at least 100 Hz to 20 MHz.

NOTE: No ETSI deliverable does specify this parameter.

10.13.2 Peak amplitude

The present document provides information on how compliance with this signal category can be achieved:

To be compliant with this signal category, the nominal voltage peak of the largest signal pulse into a resistive load of 130 Ω shall not exceed a level of 2,36 V (± 10 %), measured within a frequency band from at least 100 Hz to 20 MHz. The definition and measurement method of peak amplitude is specified in clause 13.1.

NOTE: No ETSI deliverable does specify this parameter.

10.13.3 Narrow-Band Signal Power (NBSP)

The present document provides information on how compliance with this signal category can be achieved:

To be compliant with this signal category, the Narrow-Band Signal Power (NBSP) into a resistive load impedance **R**, shall not exceed the limits given in table 62, at any point in the frequency range 100 Hz to 30 MHz. This table specifies the break points of these limits. Limits for intermediate frequencies can be found by drawing a straight line between the break points on a logarithmic (Hz) - linear (dB) scale. Figure 36 illustrates the NBSP in a bandwidth-normalized way.

The NBSP is the average power **P** of a sending signal into a load resistance **R**, within a *power* bandwidth **B**. The measurement method of the NBSP is described in clause 13.2.

NOTE: No ETSI deliverable does specify this parameter.

Table 62: Break points of the narrow-band power limits

Centre frequency f	Impedance R	Signal Level P	Power bandwidth B	Spectral Power P/B
0,51 kHz	130 Ω	-49,8 dBm	100 Hz	-69,8 dBm/Hz
10 kHz	130 Ω	-42 dBm	100 Hz	-62 dBm/Hz
10 kHz	130 Ω	-22 dBm	10 kHz	-62 dBm/Hz
1 MHz	130 Ω	-10 dBm	10 kHz	-50 dBm/Hz
20 MHz	130 Ω	-59 dBm	10 kHz	-99 dBm/Hz
20 MHz	130 Ω	-80 dBm	10 kHz	-120 dBm/Hz
30 MHz	130 Ω	-80 dBm	10 kHz	-120 dBm/Hz
20 MHz	130 Ω	-60 dBm	1 MHz	-120 dBm/Hz
30 MHz	130 Ω	-60 dBm	1 MHz	-120 dBm/Hz

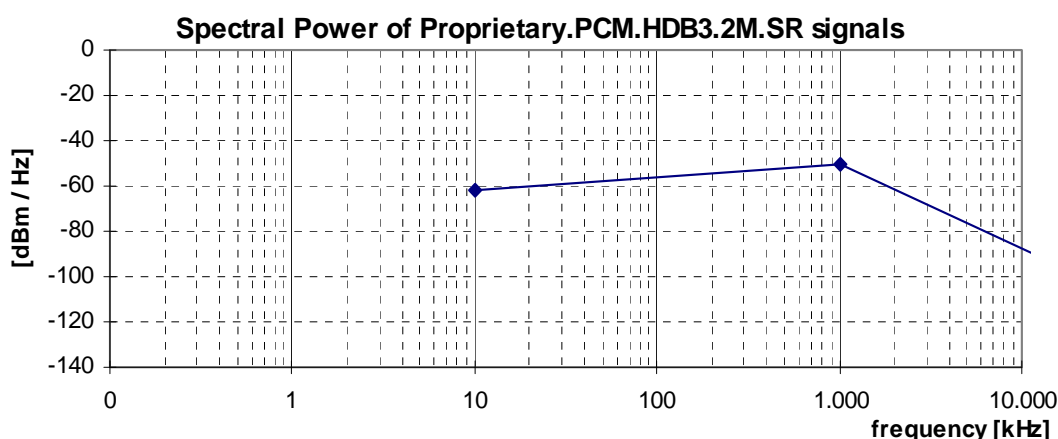

Figure 36: Spectral Power, for Proprietary.PCM.HDB3.2M.SR signals, as specified in table 62

10.13.4 Unbalance about earth

The present document provides information on how compliance with this signal category can be achieved:

To be compliant with this signal category, the balance of the signal that may flow through the LT-port or NT-port shall exceed minimum requirements, under the condition that the local loop wiring and its termination is well balanced. This can be verified by a Longitudinal Output Voltage (LOV) and a Longitudinal Conversion Loss (LCL) measurement at the source of that signal, as specified in clauses 13.3.2 and 13.3.3. The minimum LOV and LCL requirements hold for what can be observed at the ports of the Local Loop Wiring, when the Local Loop Wiring is replaced by an artificial impedance network described in clauses 13.3.2 and 13.3.3.

The differential termination impedance for LOV and LCL measurements shall be chosen equally to the design impedance $R_T = 135 \Omega$ of the Signal Source under test.

The observed LOV shall have an rms voltage of below the value specified in table 63, measured in a *power* bandwidth B , centred over any frequency in the range from f_{\min} to f_{\max} , and averaged in any one second period. Compliance with this limitation is required with a longitudinal terminating impedance having value $Z_L(\omega) = R_L + 1 / (j\omega \times C_L)$ for all frequencies between f_{\min} to f_{\max} . Clause 13.3.2 defines an example measurement method for longitudinal output voltage.

The observed LCL shall be higher than the lower limits given in figure 64. The LCL values of the associated break frequencies of this figure are given in table 64. Clause 13.3.3 defines an example measurement method for longitudinal conversion loss.

NOTE: No ETSI deliverable does specify this parameter.

Table 63: Values for the LOV limits

LOV	B	f_{\min}	f_{\max}	R_L	C_L
-46 dBV	10 kHz	5,1 kHz	2,15 MHz	100 Ω	150 nF

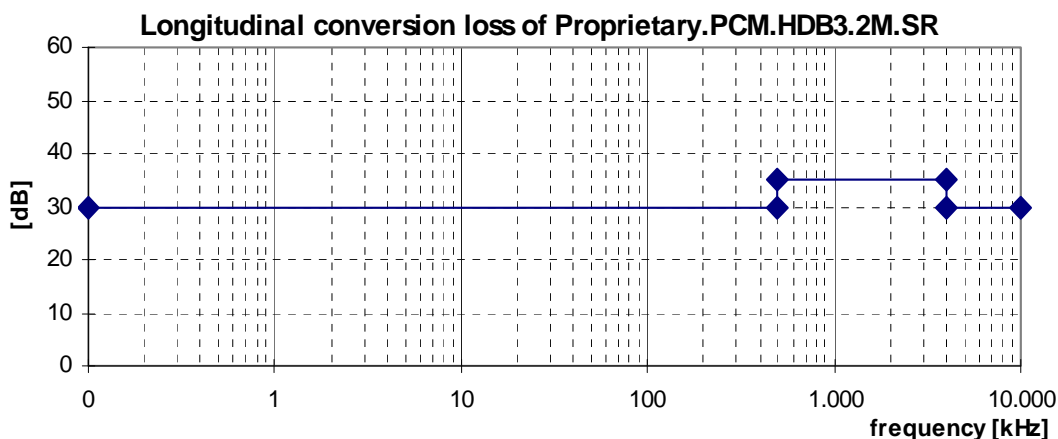

Figure 37: Minimum longitudinal conversion loss for a "Proprietary.PCM.HDB3.2M.SR" signal source

Table 64: Frequencies and LCL values of the breakpoints of the LCL mask in figure 37

Frequency range	LCL
< 500 kHz	30 dB
500 kHz	35 dB
1 MHz	35 dB
4 MHz	35 dB
30 MHz	30 dB

10.13.5 Feeding power (from the LT-port)

Power feeding is no integral part of this signal category, although it is not uncommon for PCM.HDB3 services. To enable power feeding in combination with this signal category, refer to one of the power feeding classes summarized in clause 7.

10.14 "Proprietary.PCM.HDB3.2M.SQ" signals

This category covers signals generated by 2 Mbit/s transmission equipment on two wire-pairs, usable for instance for ISDN-Primary Rate Access. This category include HDB3 line coding and square shaped transmit pulses in case of sending a randomized bit sequence. This signal is labelled as *proprietary*, since it is not covered by ETSI, ITU nor ANSI product standards.

A signal can be classified as a "Proprietary.PCM.HDB3.2M.SQ" signal if it is compliant with all clauses below.

NOTE: The signals covered here are only applicable to systems which are using *square shaped transmit pulses* and in case of *sending a randomized bit sequence*. Special bit sequences like AIS (Alarm Indication Signal) or others and other transmit pulse forms than described here can cause different signals. The way these characteristics are to be covered by specifications, are for further study.

10.14.1 Total signal power

The present document provides information on how compliance with this signal category can be achieved:

To be compliant with this signal category, the mean signal power into a resistive load of 120 Ω shall not exceed a level of +13 dBm, measured within a frequency band from 100 Hz to 30 MHz.

NOTE: No ETSI deliverable does specify this parameter.

10.14.2 Peak amplitude

The present document provides information on how compliance with this signal category can be achieved:

To be compliant with this signal category, the nominal peak amplitude of the largest signal into a resistive load of 120 Ω shall not exceed a level of 3,0 V \pm 5 %. The definition and measurement method of peak amplitude is specified in clause 13.1.

NOTE: No ETSI deliverable does specify this parameter.

10.14.3 Narrow-Band Signal Power (NBSP)

The present document provides information on how compliance with this signal category can be achieved:

To be compliant with this signal category, the Narrow-Band Signal Power (NBSP) into a resistive load impedance R , shall not exceed the limits given in table 65, at any point in the frequency range 100 Hz to 30 MHz. This table specifies the break points of these limits. Limits for intermediate frequencies can be found by drawing a straight line between the break points on a logarithmic (Hz) - linear (dB) scale. Figure 38 illustrates the NBSP in a bandwidth-normalized way.

The NBSP is the average power P of a sending signal into a load resistance R , within a *power* bandwidth B . The measurement method of the NBSP is described in clause 13.2.

NOTE: No ETSI deliverable does specify this parameter.

Table 65: Break points of the narrow-band power limits

Centre frequency f	Impedance R	Signal Level P	Power bandwidth B	Spectral Power P/B	
10 kHz	120 Ω	-40 dBm	100 Hz	-60 dBm/Hz	"X"
10 kHz	120 Ω	-20 dBm	10 kHz	-60 dBm/Hz	
100 kHz	120 Ω	-18 dBm	10 kHz	-58 dBm/Hz	
700 kHz	120 Ω	-7 dBm	10 kHz	-47 dBm/Hz	
1,2 MHz	120 Ω	-8 dBm	10 kHz	-48 dBm/Hz	
2 MHz	120 Ω	-14 dBm	10 kHz	-54 dBm/Hz	
20 MHz	120 Ω	-46 dBm	10 kHz	-86 dBm/Hz	
20 MHz	120 Ω	-55 dBm	10 kHz	-95 dBm/Hz	
30 MHz	120 Ω	-55 dBm	10 kHz	-95 dBm/Hz	
20 MHz	120 Ω	-26 dBm	1 MHz	-86 dBm/Hz	"Y"
30 MHz	120 Ω	-35 dBm	1 MHz	-95 dBm/Hz	

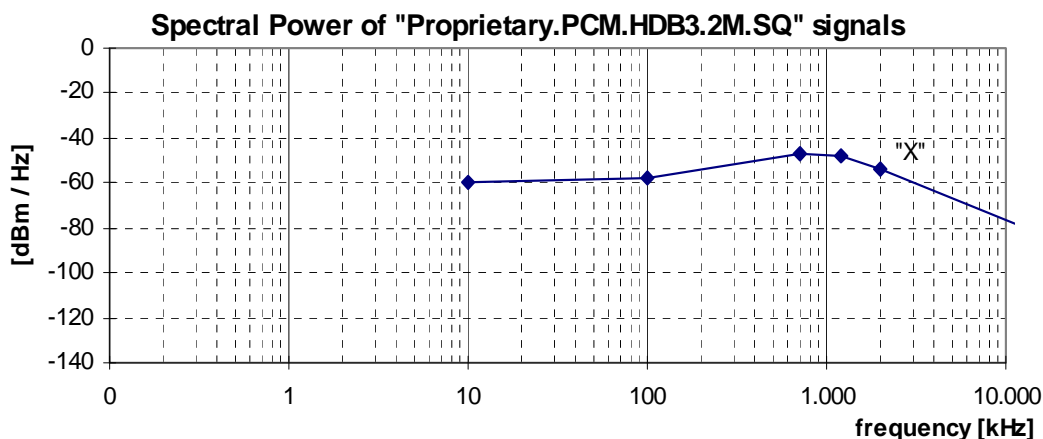

Figure 38: Spectral Power, for Proprietary.PCM.HDB3.2M.SQ signals, as specified in table 65

10.14.4 Unbalance about earth

The present document provides information on how compliance with this signal category can be achieved:

To be compliant with this signal category, the LCL shall be better than 35 dB at 1 024 kHz.

NOTE: No ETSI deliverable does specify this parameter.

11 Cluster 4 signals (asymmetrical broadband)

This cluster summarizes asymmetrical signals that are generated by digital transmission equipment up to 24 Mbit/s, including ADSL and ADSL2plus. Asymmetrically means a bitrate in the downstream direction and a significantly lower bitrate (e.g. 25 %) in the upstream direction.

NOTE: Asymmetrical DSL systems generate different signals in different transmission directions. Reversal of their transmission direction, which means the injection of upstream signals into LT-ports and downstream signals into the NT-ports, will cause a substantial reduction of the maximum reach. Such a reduction is even significant for all asymmetrical DSL systems when only one such system is reversed. Therefore the classification of asymmetrical DSL systems is consequently split into upstream and downstream specifications.

11.1 "ADSL/POTS (FO)" signals

This category covers signals, generated by ADSL transmission equipment, for which the downstream spectrum overlaps the upstream spectrum (Frequency Overlap). These signals may share the same wire pair with POTS signals.

This clause is based on ETSI and ITU reports on ADSL equipment [i.10] and [i.11]. A signal can be classified as an "ADSL/POTS (FO)" signal if it is compliant with all clauses below.

11.1.1 Total signal power (downstream only)

The present document provides information on how compliance with this signal category can be achieved and indicates the relevant specification(s):

To be compliant with this signal category, the mean downstream signal power into a resistive load of 100 Ω shall not exceed a level of +20,4 dBm, measured within a frequency band from at least 4 kHz to 3 MHz.

If measurements of the upstream power indicates that downstream power back-off is necessary, as described for the downstream PSD, then the maximum total transmit power shall be reduced accordingly.

Reference: TS 101 388 [i.10], clause 4.3.

Reference: ITU-T Recommendation G.992.1 [i.11], clause A.1.2.3.1.

11.1.2 Total signal power (upstream only)

The present document provides information on how compliance with this signal category can be achieved and indicates the relevant specification(s):

To be compliant with this signal category, the mean upstream signal power into a resistive load of 100 Ω shall not exceed a level of +12,5 dBm, measured within a frequency band from at least 4 kHz to 3 MHz.

Reference: TS 101 388 [i.10], clause 4.3.

Reference: ITU-T Recommendation G.992.1 [i.11], clause A.2.4.3.1.

11.1.3 Peak amplitude (upstream and downstream)

The present document provides information on how compliance with this signal category can be achieved:

To be compliant with this signal category, the nominal voltage peak of the largest signal pulse into a resistive load of 100 Ω shall not exceed a level of 19V (38 V peak-peak), measured within a frequency band from at least 100 Hz to 1 MHz. The definition and measurement method of peak amplitude is specified in clause 13.1.

NOTE: No ETSI deliverable does specify this parameter.

11.1.4 Narrow-band signal power (downstream only)

The present document provides information on how compliance with this signal category can be achieved and indicates the relevant specification(s):

To be compliant with this signal category, the Narrow-Band Signal Power (NBSP) into a resistive load impedance R , shall not exceed the limits given in table 66, at any point in the frequency range 100 Hz to 30 MHz. This table specifies the break points of these limits. Limits for intermediate frequencies can be found by drawing a straight line between the break points on a logarithmic (Hz) - linear (dB) scale. Figure 39 illustrates the NBSP in a bandwidth-normalized way.

The NBSP is the average power P of a sending signal into a load resistance R , within a power bandwidth B . The measurement method of the NBSP is described in clause 13.2.

NOTE 1: The NBSP specification in table 66 is reconstructed from the commonly used PSD specifications in [i.10] and [i.11] (similar to figure 39), and used here since it is much wider applicable. This enables a unified specification method. PSD specifications are adequate when signals are purely random in nature, but cannot cover harmonic components in a signal (would cause infinite high "PSD" levels at these harmonic frequencies). NBSP specifications cover both signal types.

NOTE 2: The NBSP specification of this signal category has been split into two overlapping limits: "X" and "Y". Both upper limits shall hold simultaneously. The 10 kHz bandwidth values represent the "maximum PSD values" from [i.10] and [i.11], and includes the pass band ripple. The 100 kHz bandwidth values represent the "average PSD values" in the passband to smooth out the spectral ripple of 3,5 dB. The 1 MHz bandwidth specification is equivalent to the "sliding window" specification in [i.10] and [i.11].

Reference: ITU-T Recommendation G.992.1 [i.11], clause A.1.2 reconstructed from PSD requirements.

Table 66: Break points of the narrow-band power limits

Centre frequency f	Impedance R	Signal Level P	Power bandwidth B	Spectral Power P/B	
0,1 kHz	600 Ω	-77,5 dBm	100 Hz	-97,5 dBm/Hz	"X"
1 kHz	600 Ω	-77,5 dBm	100 Hz	-97,5 dBm/Hz	
1 kHz	600 Ω	-67,5 dBm	1 kHz	-97,5 dBm/Hz	
4 kHz	600 Ω	-67,5 dBm	1 kHz	-97,5 dBm/Hz	
4 kHz	100 Ω	-52,5 dBm	10 kHz	-92,5 dBm/Hz	
25,875 kHz	100 Ω	+3,5 dBm	10 kHz	-36,5 dBm/Hz	
1 104 kHz	100 Ω	+3,5 dBm	10 kHz	-36,5 dBm/Hz	
3 093 kHz	100 Ω	-50 dBm	10 kHz	-90 dBm/Hz	
11 040 kHz	100 Ω	-50 dBm	10 kHz	-90 dBm/Hz	
30 000 kHz	100 Ω	-50 dBm	10 kHz	-90 dBm/Hz	

Centre frequency f	Impedance R	Signal Level P	Power bandwidth B	Spectral Power P/B	
60 kHz	100 Ω	$P_0 + 50$ dBm	100 kHz	P_0 dBm/Hz	"Y"
1 104 kHz	100 Ω	$P_0 + 50$ dBm	100 kHz	P_0 dBm/Hz	
3 093 kHz	100 Ω	-40 dBm	100 kHz	-90 dBm/Hz	
3 093 kHz	100 Ω	-30 dBm	1 MHz	-90 dBm/Hz	
4 545 kHz	100 Ω	-50 dBm	1 MHz	-110 dBm/Hz	
30 000 kHz	100 Ω	-50 dBm	1 MHz	-110 dBm/Hz	

NOTE: The values for parameter P_0 are defined in table 67, and are dependent from the received upstream power (Power back-off).

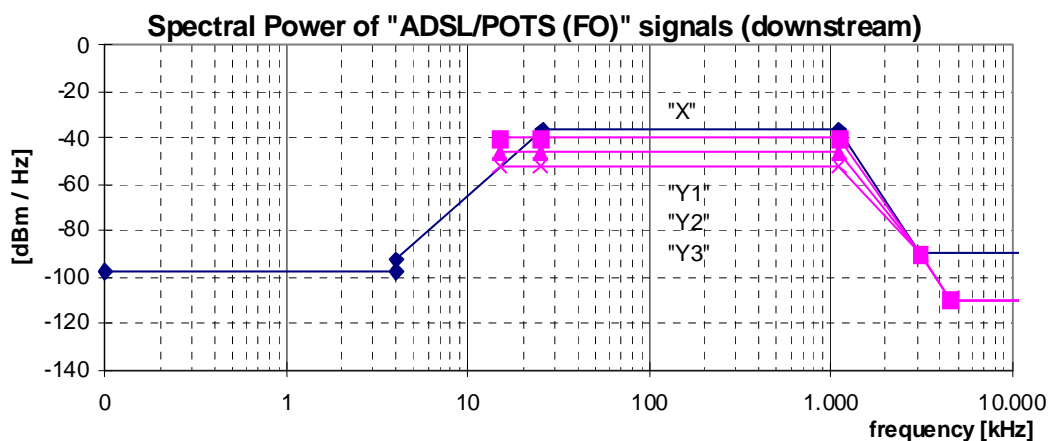

NOTE: The maximum spectral power varies with the value of parameter P_0 , as defined in table 67. Only the curves for the values $P_0 = -40$ dBm/Hz, $P_0 = -46$ dBm/Hz, and $P_0 = -52$ dBm/Hz are shown here.

Figure 39: Spectral Power, for "ADSL/POTS (FO)" signals, as specified in table 66

Power back-off. To be compliant with this signal category, the maximum downstream signal power shall be reduced when the received upstream power is above specified levels. If the total received upstream power from 28,031 kHz to 79,781 kHz (ADSL sub-carriers 7-18) is greater than +3 dBm into 100 Ω then parameter P_0 shall not exceed the values shown in table 67. (This specific variant of power back-off is also known as "power cut-back"). The received upstream power measurement shall be performed with an accuracy of ± 1 dB or better.

Reference: ITU-T Recommendation G.992.1 [i.11], clause A.3.1.

Table 67: Definition of parameter P_0 , as used in table 66

Upstream received power (dBm)	< 3	< 4	< 5	< 6	< 7	< 8	< 9
Parameter P_0 (dBm/Hz)	-40	-42	-44	-46	-48	-50	-52

11.1.5 Narrow-band signal power (upstream only)

The present document provides information on how compliance with this signal category can be achieved and indicates the relevant specification(s):

To be compliant with this signal category, the Narrow-Band Signal Power (NBSP) into a resistive load impedance R , shall not exceed the limits given in table 68, at any point in the frequency range 100 Hz to 30 MHz. This table specifies the break points of these limits. Limits for intermediate frequencies can be found by drawing a straight line between the break points on a logarithmic (Hz) - linear (dB) scale. Figure 40 illustrates the NBSP in a bandwidth-normalized way.

The NBSP is the average power P of a sending signal into a load resistance R , within a power bandwidth B . The measurement method of the NBSP is described in clause 13.2.

NOTE 1: The NBSP specification in table 66 is reconstructed from the commonly used PSD specifications in [i.10] and [i.11] (similar to figure 40), and used here since it is much wider applicable. This enables a unified specification method. PSD specifications are adequate when signals are purely random in nature, but cannot cover harmonic components in a signal (would cause infinite high "PSD" levels at these harmonic frequencies). NBSP specifications cover both signal types.

NOTE 2: The NBSP specification of this signal category has been split into two overlapping limits: "X" and "Y". Both upper limits shall hold simultaneously. The 10 kHz bandwidth values represent the "maximum PSD values" from [i.10] and [i.11], and includes the pass band ripple. The 100 kHz bandwidth values represent the "average PSD values" in the passband to smooth out the spectral ripple of 3,5 dB. The 1 MHz bandwidth specification is equivalent to the "sliding window" specification in [i.10] and [i.11].

Reference: ITU-T Recommendation G.992.1 [i.11], clause A.2.4 reconstructed from PSD requirements.

Table 68: Break points of the narrow-band power limits

Centre frequency f	Impedance R	Signal Level P	Power bandwidth B	Spectral Power P/B	
0,1 kHz	600 Ω	-77,5 dBm	100 Hz	-97,5 dBm/Hz	"X"
1 kHz	600 Ω	-77,5 dBm	100 Hz	-97,5 dBm/Hz	
1 kHz	600 Ω	-67,5 dBm	1 kHz	-97,5 dBm/Hz	
4 kHz	600 Ω	-67,5 dBm	1 kHz	-97,5 dBm/Hz	
4 kHz	100 Ω	-52,5 dBm	10 kHz	-92,5 dBm/Hz	
25,875 kHz	100 Ω	+5,5 dBm	10 kHz	-34,5 dBm/Hz	
138 kHz	100 Ω	+5,5 dBm	10 kHz	-34,5 dBm/Hz	"Y"
307 kHz	100 Ω	-50 dBm	10 kHz	-90 dBm/Hz	
11 040 kHz	100 Ω	-50 dBm	10 kHz	-90 dBm/Hz	
30 000 kHz	100 Ω	-50 dBm	10 kHz	-90 dBm/Hz	
60 kHz	100 Ω	+12 dBm	100 kHz	-38 dBm/Hz	
138 kHz	100 Ω	+12 dBm	100 kHz	-38 dBm/Hz	
307 kHz	100 Ω	-40 dBm	100 kHz	-90 dBm/Hz	
1 221 kHz	100 Ω	-40 dBm	100 kHz	-90 dBm/Hz	
1 221 kHz	100 Ω	-30 dBm	1 MHz	-90 dBm/Hz	
1 630 kHz	100 Ω	-50 dBm	1 MHz	-110 dBm/Hz	
11 040 kHz	100 Ω	-50 dBm	1 MHz	-110 dBm/Hz	
30 000 kHz	100 Ω	-50 dBm	1 MHz	-110 dBm/Hz	

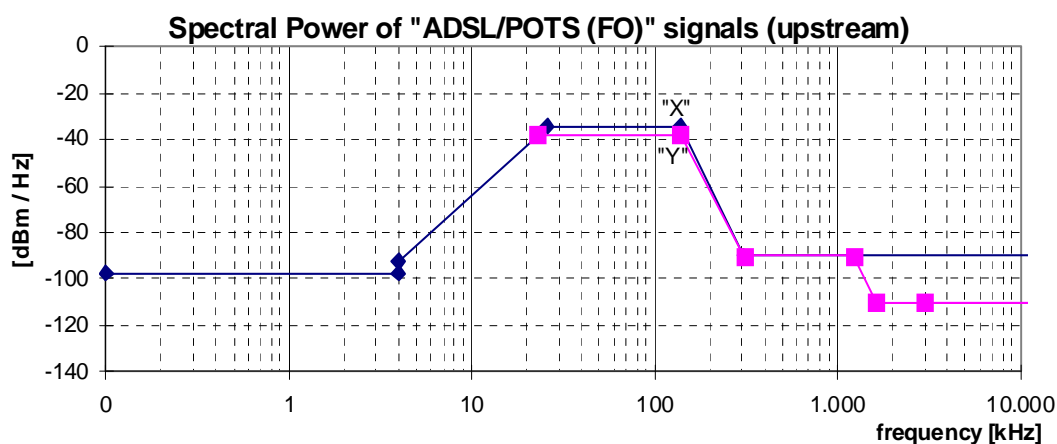

Figure 40: Spectral Power, for "ADSL/POTS (FO)" signals, as specified in table 68

11.1.6 Unbalance about earth (upstream and downstream)

The present document provides information on how compliance with this signal category can be achieved and indicates the relevant specification(s):

To be compliant with this signal category, the balance of the signal that may flow through the LT-port or NT-port shall exceed minimum requirements, under the condition that the local loop wiring and its termination is well balanced. This can be verified by a Longitudinal Output Voltage (LOV) and a Longitudinal Conversion Loss (LCL) measurement at the source of that signal, as specified in clauses 13.3.2 and 13.3.3. The minimum LOV and LCL requirements hold for what can be observed at the ports of the Local Loop Wiring, when the Local Loop Wiring is replaced by an artificial impedance network described in clauses 13.3.2 and 13.3.3.

The differential termination impedance for LOV and LCL measurements shall be chosen equally to the design impedance $R_T = 100 \Omega$ of the Signal Source under test.

The observed LOV shall have an rms voltage of below the value specified in table 69, measured in a *power* bandwidth **B**, centred over any frequency in the range from f_{\min} to f_{\max} , and averaged in any one second period. Compliance with this limitation is required with a longitudinal terminating impedance having value $Z_L(\omega) = R_L + 1 / (j\omega \times C_L)$ for all frequencies between f_{\min} to f_{\max} . Clause 13.3.2 defines an example measurement method for longitudinal output voltage.

The observed LCL shall be higher than the lower limits given in figure 41. The LCL values of the associated break frequencies of this figure are given in table 70. Clause 13.3.3 defines an example measurement method for longitudinal conversion loss. To be compliant with this signal category, this requirement shall be met for both the switched-on and switched-off mode of the signal source.

Reference: TS 101 270-1 [i.13], clauses 8.3.3 and E.3.2.

Table 69: Values for the LOV limits

	LOV	B	f_{\min}	f_{\max}	R_L	C_L
downstream	-46 dBV	10 kHz	5,1 kHz	1 825 kHz	100 Ω	150 nF
upstream	-46 dBV	10 kHz	5,1 kHz	210 kHz	100 Ω	150 nF

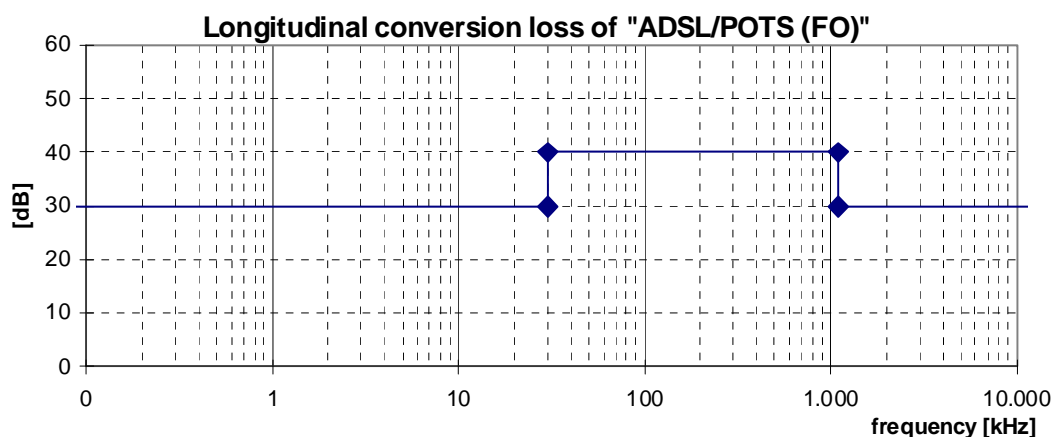

Figure 41: Minimum longitudinal conversion loss

Table 70: Frequencies and LCL values of the breakpoints of the LCL mask in figure 41

Frequency	LCL
< 30 kHz	30 dB
30 kHz	40 dB
1 104 kHz	40 dB
1 104 kHz	30 dB
30 MHz	30 dB

11.2 "ADSL/POTS (FDD)" signals

This category covers signals, generated by ADSL transmission equipment, which uses Frequency Division Duplexing (FDD) to separate upstream and downstream. In this mode, the usable frequency band of downstream signals is narrower and not overlapping the upstream, but adjacent to it, to minimize self-NEXT. Therefore this signal is called ADSL "with reduced NEXT" in the ITU. Therefore both downstream and upstream of "ADSL/POTS (FDD)" also fulfil the requirements of "ADSL/POTS (FO)" signals, as described in a previous clause of the present document.

These signals may share the same wire pair with POTS signals.

This clause is based on ETSI and ITU reports on ADSL equipment [i.10] and [i.11]. A signal can be classified as an "ADSL/POTS (FDD)" signal if it is compliant with all clauses below.

11.2.1 Total signal power (downstream only)

The present document provides information on how compliance with this signal category can be achieved and indicates the relevant specification(s):

To be compliant with this signal category, the mean downstream signal power into a resistive load of 100 Ω shall not exceed a level of +19,9 dBm, measured within a frequency band from at least 4 kHz to 3 MHz.

If measurements of the upstream power indicates that downstream power back-off is necessary, as described for the downstream PSD, then the maximum total transmit power shall be reduced accordingly.

Reference: TS 101 388 [i.10], clause 4.3.

Reference: ITU-T Recommendation G.992.1 [i.11], clause A.1.2.3.1.

11.2.2 Total signal power (upstream only)

The description of this signal characteristic equals that of "ADSL/POTS (FO)".

11.2.3 Peak amplitude (upstream and downstream)

The description of this signal characteristic equals that of "ADSL/POTS (FO)".

11.2.4 Narrow-band signal power (downstream only)

The present document provides information on how compliance with this signal category can be achieved and indicates the relevant specification(s):

To be compliant with this signal category, the Narrow-Band Signal Power (NBSP) into a resistive load impedance R , shall not exceed the limits given in table 71, at any point in the frequency range 100 Hz to 30 MHz. This table specifies the break points of these limits. Limits for intermediate frequencies can be found by drawing a straight line between the break points on a logarithmic (Hz) - linear (dB) scale. Figure 42 illustrates the NBSP in a bandwidth-normalized way.

The NBSP is the average power P of a sending signal into a load resistance R , within a *power* bandwidth B . The measurement method of the NBSP is described in clause 13.2.

NOTE 1: The NBSP specification in table 71 is reconstructed from the commonly used PSD specifications in [i.10] and [i.11] (similar to figure 42), and used here since it is much wider applicable. This enables a unified specification method. PSD specifications are adequate when signals are purely random in nature, but cannot cover harmonic components in a signal (would cause infinite high "PSD" levels at these harmonic frequencies). NBSP specifications cover both signal types.

NOTE 2: The NBSP specification of this signal category has been split into two overlapping limits: "X" and "Y". Both upper limits shall hold simultaneously. The 10 kHz bandwidth values represent the "maximum PSD values" from [i.10] and [i.11], and includes the pass band ripple. The 100 kHz bandwidth values represent the "average PSD values" in the passband to smooth out the spectral ripple of 3,5 dB. The 1 MHz bandwidth specification is equivalent to the "sliding window" specification in [i.10] and [i.11].

Reference: ITU-T Recommendation G.992.1 [i.11], clause A.1.2 reconstructed from PSD requirements.

Table 71: Break points of the narrow-band power limits

Centre frequency f	Impedance R	Signal Level P	Power bandwidth B	Spectral Power P/B		
0,1 kHz	600 Ω	-77,5 dBm	100 Hz	-97,5 dBm/Hz	"X"	
1 kHz	600 Ω	-77,5 dBm	100 Hz	-97,5 dBm/Hz		
1 kHz	600 Ω	-67,5 dBm	1 kHz	-97,5 dBm/Hz		
4 kHz	600 Ω	-67,5 dBm	1 kHz	-97,5 dBm/Hz		
4 kHz	100 Ω	-52,5 dBm	10 kHz	-92,5 dBm/Hz		
80 kHz	100 Ω	-32,5 dBm	10 kHz	-72,5 dBm/Hz		
137,9 kHz	100 Ω	-4,2 dBm	10 kHz	-44,2 dBm/Hz		
138 kHz	100 Ω	+3,5 dBm	10 kHz	-36,5 dBm/Hz		
1 104 kHz	100 Ω	+3,5 dBm	10 kHz	-36,5 dBm/Hz		
3 093 kHz	100 Ω	-50 dBm	10 kHz	-90 dBm/Hz		
11 040 kHz	100 Ω	-50 dBm	10 kHz	-90 dBm/Hz		
30 000 kHz	100 Ω	-50 dBm	10 kHz	-90 dBm/Hz		
170 kHz	100 Ω	$P_0 + 50$ dBm	100 kHz	P_0 dBm/Hz		"Y"
1 104 kHz	100 Ω	$P_0 + 50$ dBm	100 kHz	P_0 dBm/Hz		
3 093 kHz	100 Ω	-40 dBm	100 kHz	-90 dBm/Hz		
3 093 kHz	100 Ω	-30 dBm	1 MHz	-90 dBm/Hz		
4 545 kHz	100 Ω	-50 dBm	1 MHz	-110 dBm/Hz		
30 000 kHz	100 Ω	-50 dBm	1 MHz	-110 dBm/Hz		

NOTE: The values for parameter P_0 are defined in table 72, and are dependent from the received upstream power (Power back-off).

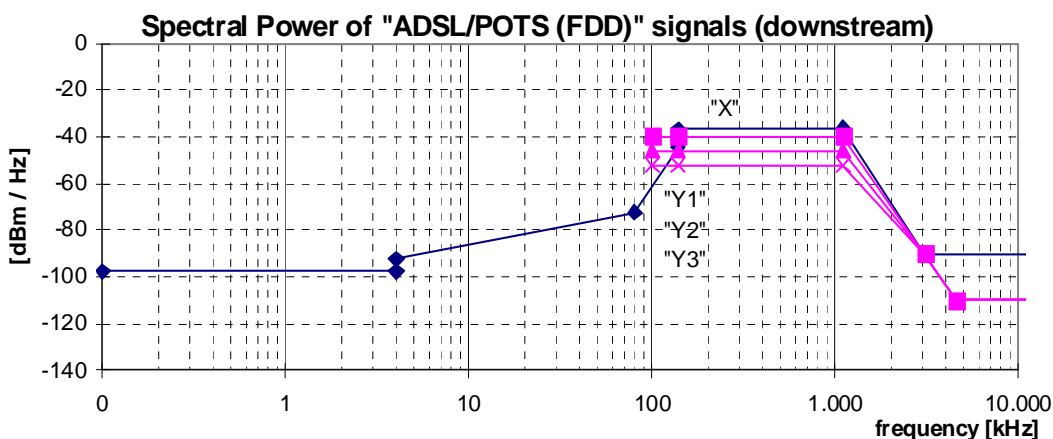

NOTE: The maximum spectral power varies with the value of parameter P_0 , as defined in table 72. Only the curves for the values $P_0 = -40$ dBm/Hz, $P_0 = -46$ dBm/Hz, and $P_0 = -52$ dBm/Hz are shown here.

Figure 42: Spectral Power, for "ADSL/POTS (FDD)" signals, as specified in table 71

Power back-off. To be compliant with this signal category, the maximum downstream signal power shall be reduced when the received upstream power is above specified levels. If the total received upstream power from 28,031 kHz to 79,781 kHz (ADSL sub-carriers 7-18) is greater than +3 dBm into 100 Ω then parameter P_{BO} shall not exceed the values shown in table 72. (This specific variant of power back-off is also known as "power cut-back"). The received upstream power measurement shall be performed with an accuracy of ± 1 dB or better.

Reference: ITU-T Recommendation G.992.1 [i.11], clause A.3.1.

Table 72: Definition of parameter P_0 , as used in table 71

Upstream received power (dBm)	< 3	< 4	< 5	< 6	< 7	< 8	< 9
Parameter P_0 (dBm/Hz)	-40	-42	-44	-46	-48	-50	-52

11.2.5 Narrow-band signal power (upstream only)

The description of this signal characteristic equals that of "ADSL/POTS (FO)".

11.2.6 Unbalance about earth (upstream and downstream)

The description of this signal characteristic equals that of "ADSL/POTS (FO)".

11.3 "ADSL/ISDN (FO)" signals

This category covers signals, generated by ADSL transmission equipment, for which the downstream spectrum overlaps the upstream spectrum (Frequency Overlap). These signals may share the same wire pair with ISDN signals.

This clause is based on ETSI and ITU reports on ADSL equipment [i.10] and [i.11]. A signal can be classified as an "ADSL/ISDN (FO)" signal if it is compliant with all clauses below.

11.3.1 Total signal power (downstream only)

The present document provides information on how compliance with this signal category can be achieved and indicates the relevant specification(s):

To be compliant with this signal category, the mean downstream signal power into a resistive load of 100 Ω shall not exceed a level of +19,9 dBm, measured within a frequency band from at least 4 kHz to 3 MHz.

If measurements of the upstream power indicates that downstream power back-off is necessary, as described for the downstream PSD, then the maximum total transmit power shall be reduced accordingly.

Reference: TS 101 388 [i.10], clauses 4.3 and C.2.2.

11.3.2 Total signal power (upstream only)

The present document provides information on how compliance with this signal category can be achieved and indicates the relevant specification(s):

To be compliant with this signal category, the mean upstream signal power into a resistive load of 100 Ω shall not exceed a level of +13,3 dBm, measured within a frequency band from at least 4 kHz to 3 MHz.

Reference: TS 101 388 [i.10], clauses 4.3 and C.3.3.

11.3.3 Peak amplitude (upstream and downstream)

The present document provides information on how compliance with this signal category can be achieved:

To be compliant with this signal category, the nominal voltage peak of the largest signal pulse into a resistive load of 100 Ω shall not exceed a level of 19 V (38 V peak-peak), measured within a frequency band from at least 100 Hz to 1 MHz. The definition and measurement method of peak amplitude is specified in clause 13.1.

NOTE: No ETSI deliverable does specify this parameter.

11.3.4 Narrow-band signal power (downstream only)

The present document provides information on how compliance with this signal category can be achieved and indicates the relevant specification(s):

To be compliant with this signal category, the Narrow-Band Signal Power (NBSP) into a resistive load impedance R , shall not exceed the limits given in table 73, at any point in the frequency range 100 Hz to 30 MHz. This table specifies the break points of these limits. Limits for intermediate frequencies can be found by drawing a straight line between the break points on a logarithmic (Hz) - linear (dB) scale. Figure 43 illustrates the NBSP in a bandwidth-normalized way.

The NBSP is the average power P of a sending signal into a load resistance R , within a power bandwidth B . The measurement method of the NBSP is described in clause 13.2.

Reference: TS 101 388 [i.10], clause 4.2.1.1, reconstructed from PSD requirements.

Reference: ITU-T Recommendation G.992.1 [i.11], clause B.1.3, reconstructed from PSD requirements

NOTE 1: The NBSP specification in table 73 is reconstructed from the commonly used PSD specifications in [i.10] and [i.11] (similar to figure 43), and used here since it is much wider applicable. This enables a unified specification method. PSD specifications are adequate when signals are purely random in nature, but cannot cover harmonic components in a signal (would cause infinite high "PSD" levels at these harmonic frequencies). NBSP specifications cover both signal types.

NOTE 2: The NBSP specification of this signal category has been split into two overlapping limits: "X" and "Y". Both upper limits shall hold simultaneously. The 10 kHz bandwidth values represent the "maximum PSD values" from [i.10] and [i.11], and includes the pass band ripple. The 100 kHz bandwidth values represent the "average PSD values" in the passband to smooth out the spectral ripple of 3,5 dB. The 1 MHz bandwidth specification is equivalent to the "sliding window" specification in [i.10] and [i.11].

Table 73: Break points of the narrow-band power limits

Centre Frequency f	Impedance R	Signal Level P	Power bandwidth B	Spectral Power P/B	
0,1 kHz	100 Ω	-70 dBm	100 Hz	-90 dBm/Hz	"X"
1 kHz	100 Ω	-70 dBm	100 Hz	-90 dBm/Hz	
1 kHz	100 Ω	-60 dBm	1 kHz	-90 dBm/Hz	
4 kHz	100 Ω	-60 dBm	1 kHz	-90 dBm/Hz	
4 kHz	100 Ω	-50 dBm	10 kHz	-90 dBm/Hz	
50 kHz	100 Ω	-50 dBm	10 kHz	-90 dBm/Hz	
80 kHz	100 Ω	-41,8 dBm	10 kHz	-81,8 dBm/Hz	
120 kHz	100 Ω	+3,5 dBm	10 kHz	-36,5 dBm/Hz	
1 104 kHz	100 Ω	+3,5 dBm	10 kHz	-36,5 dBm/Hz	
3 093 kHz	100 Ω	-50 dBm	10 kHz	-90 dBm/Hz	
11 040 kHz	100 Ω	-50 dBm	10 kHz	-90 dBm/Hz	
30 000 kHz	100 Ω	-50 dBm	10 kHz	-90 dBm/Hz	
100 kHz	100 Ω	$P_0 + 50$ dBm	100 kHz	P_0 dBm/Hz	"Y"
1 104 kHz	100 Ω	$P_0 + 50$ dBm	100 kHz	P_0 dBm/Hz	
3 093 kHz	100 Ω	-40 dBm	100 kHz	-90 dBm/Hz	
3 093 kHz	100 Ω	-30 dBm	1 MHz	-90 dBm/Hz	
4 545 kHz	100 Ω	-50 dBm	1 MHz	-110 dBm/Hz	
30 000 kHz	100 Ω	-50 dBm	1 MHz	-110 dBm/Hz	
NOTE: The values for parameter P_0 are defined in table 74, and are dependent from the received upstream power (Power back-off).					

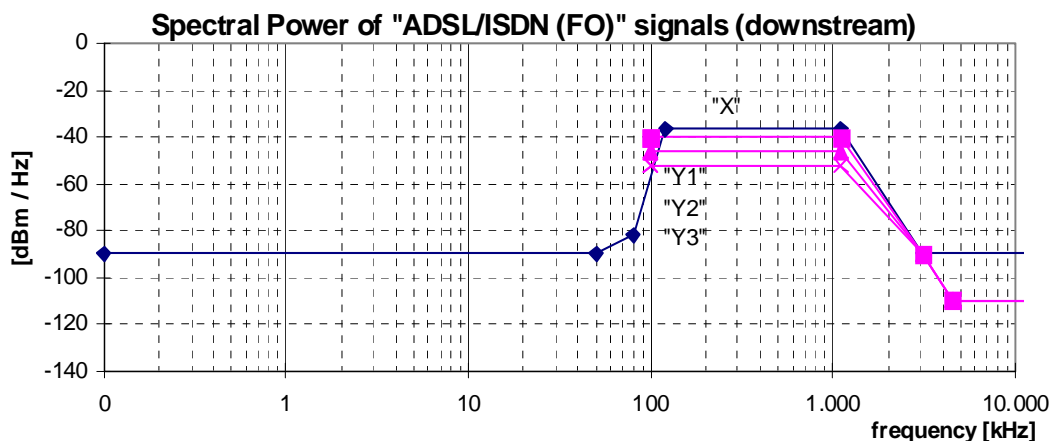

NOTE: The maximum spectral power varies with the value of parameter P_0 , as defined in table 74. Only the curves for the values $P_0 = -40$ dBm/Hz, $P_0 = -46$ dBm/Hz, and $P_0 = -52$ dBm/Hz are shown here.

Figure 43: Spectral Power, for "ADSL/ISDN (FO)" signals, as specified in table 73

Power back-off. To be compliant with this signal category, the maximum downstream signal power shall be reduced when the received upstream power is above specified levels. If the total received upstream power from 170,34 kHz to 222,09 kHz (ADSL sub-carriers 40-51) is greater than 0 dBm into 100 Ω then parameter P_{BO} shall not exceed the values shown in table 74. (This specific variant of power back-off is also known as "power cut-back"). The received upstream power measurement shall be performed with an accuracy of ± 1 dB or better.

Reference: TS 101 388 [i.10], clause C.4.17 (Uses subcarrier 40-51, values that have been adopted here).

Reference: ITU-T Recommendation G.992.1 [i.11], clause B.3.3 (Uses subcarrier 36-51, values that have been ignored here).

Table 74: Definition of parameter P_0 , as used in table 73

Upstream received power (dBm)	< 0	< 1,5	< 3	< 4,5	< 6	< 7,5	< 9
Parameter P_0	-40	-42	-44	-46	-48	-50	-52

11.3.5 Narrow-band signal power (upstream only)

The present document provides information on how compliance with this signal category can be achieved and indicates the relevant specification(s):

To be compliant with this signal category, the Narrow-Band Signal Power (NBSP) into a resistive load impedance R , shall not exceed the limits given in table 75, at any point in the frequency range 100 Hz to 30 MHz. This table specifies the break points of these limits. Limits for intermediate frequencies can be found by drawing a straight line between the break points on a logarithmic (Hz) - linear (dB) scale. Figure 44 illustrates the NBSP in a bandwidth-normalized way.

The NBSP is the average power P of a sending signal into a load resistance R , within a power bandwidth B . The measurement method of the NBSP is described in clause 13.2.

NOTE 1: The NBSP specification in table 75 is reconstructed from the commonly used PSD specifications in [i.10] and [i.11] (similar to figure 44), and used here since it is much wider applicable. This enables a unified specification method. PSD specifications are adequate when signals are purely random in nature, but cannot cover harmonic components in a signal (would cause infinite high "PSD" levels at these harmonic frequencies). NBSP specifications cover both signal types.

NOTE 2: The NBSP specification of this signal category has been split into two overlapping limits: "X" and "Y". Both upper limits shall hold simultaneously. The 10 kHz bandwidth values represent the "maximum PSD values" from [i.10] and [i.11], and includes the pass band ripple. The 100 kHz bandwidth values represent the "average PSD values" in the passband to smooth out the spectral ripple of 3,5 dB. The 1 MHz bandwidth specification is equivalent to the "sliding window" specification in [i.10] and [i.11].

Reference: TS 101 388 [i.10], clause 4.2.1.2, reconstructed from PSD requirements.

Reference: ITU-T Recommendation G.992.1 [i.11], clause B.2.2 reconstructed from PSD requirements.

Table 75: Break points of the narrow-band power limits

Centre frequency f	Impedance R	Signal Level P	Power bandwidth B	Spectral Power P/B		
0,1 kHz	100 Ω	-70 dBm	100 Hz	-90 dBm/Hz	"X"	
1 kHz	100 Ω	-70 dBm	100 Hz	-90 dBm/Hz		
1 kHz	100 Ω	-60 dBm	1 kHz	-90 dBm/Hz		
4 kHz	100 Ω	-60 dBm	1 kHz	-90 dBm/Hz		
4 kHz	100 Ω	-50 dBm	10 kHz	-90 dBm/Hz		
50 kHz	100 Ω	-50 dBm	10 kHz	-90 dBm/Hz		
80 kHz	100 Ω	-41,8 dBm	10 kHz	-81,8 dBm/Hz		
120 kHz	100 Ω	+5,5 dBm	10 kHz	-34,5 dBm/Hz		
276 kHz	100 Ω	+5,5 dBm	10 kHz	-34,5 dBm/Hz		
614 kHz	100 Ω	-50 dBm	10 kHz	-90 dBm/Hz		
11 040 kHz	100 Ω	-50 dBm	10 kHz	-90 dBm/Hz		
30 000 kHz	100 Ω	-50 dBm	10 kHz	-90 dBm/Hz		
120 kHz	100 Ω	+12 dBm	100 kHz	-38 dBm/Hz		"Y"
276 kHz	100 Ω	+12 dBm	100 kHz	-38 dBm/Hz		
614 kHz	100 Ω	-40 dBm	100 kHz	-90 dBm/Hz		
1 221 kHz	100 Ω	-40 dBm	100 kHz	-90 dBm/Hz		
1 221 kHz	100 Ω	-30 dBm	1 MHz	-90 dBm/Hz		
1 630 kHz	100 Ω	-50 dBm	1 MHz	-110 dBm/Hz		
11 040 kHz	100 Ω	-50 dBm	1 MHz	-110 dBm/Hz		
30 000 kHz	100 Ω	-50 dBm	1 MHz	-110 dBm/Hz		

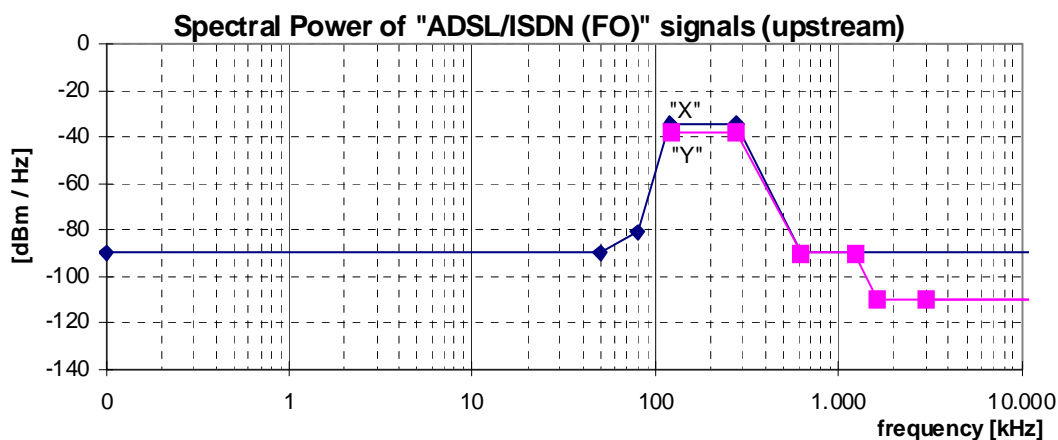

Figure 44: Spectral Power, for "ADSL/ISDN (FO)" signals, as specified in table 75

11.3.6 Unbalance about earth (upstream and downstream)

The present document provides information on how compliance with this signal category can be achieved and indicates the relevant specification(s):

To be compliant with this signal category, the balance of the signal that may flow through the LT-port or NT-port shall exceed minimum requirements, under the condition that the local loop wiring and its termination is well balanced. This can be verified by a Longitudinal Output Voltage (LOV) and a Longitudinal Conversion Loss (LCL) measurement at the source of that signal, as specified in clauses 13.3.2 and 13.3.3. The minimum LOV and LCL requirements hold for what can be observed at the ports of the Local Loop Wiring, when the Local Loop Wiring is replaced by an artificial impedance network described in clauses 13.3.2 and 13.3.3.

The differential termination impedance for LOV and LCL measurements shall be chosen equally to the design impedance $R_T = 100 \Omega$ of the Signal Source under test.

The observed LOV shall have an rms voltage of below the value specified in table 76, measured in a *power* bandwidth **B**, centred over any frequency in the range from f_{\min} to f_{\max} , and averaged in any one second period. Compliance with this limitation is required with a longitudinal terminating impedance having value $Z_L(\omega) = R_L + 1 / (j\omega \times C_L)$ for all frequencies between f_{\min} to f_{\max} . Clause 13.3.2 defines an example measurement method for longitudinal output voltage.

The observed LCL shall be higher than the lower limits given in figure 45. The LCL values of the associated break frequencies of this figure are given in table 77. Clause 13.3.3 defines an example measurement method for longitudinal conversion loss. To be compliant with this signal category, this requirement shall be met for both the switched-on and switched-off mode of the signal source.

Reference: TS 101 270-1 [i.13], clauses 8.3.3 and E.3.2.

Table 76: Values for the LOV limits

	LOV	B	f_{\min}	f_{\max}	R_L	C_L
downstream	-46 dBV	10 kHz	5,1 kHz	1 825 kHz	100 Ω	150 nF
upstream	-46 dBV	10 kHz	5,1 kHz	415 kHz	100 Ω	150 nF

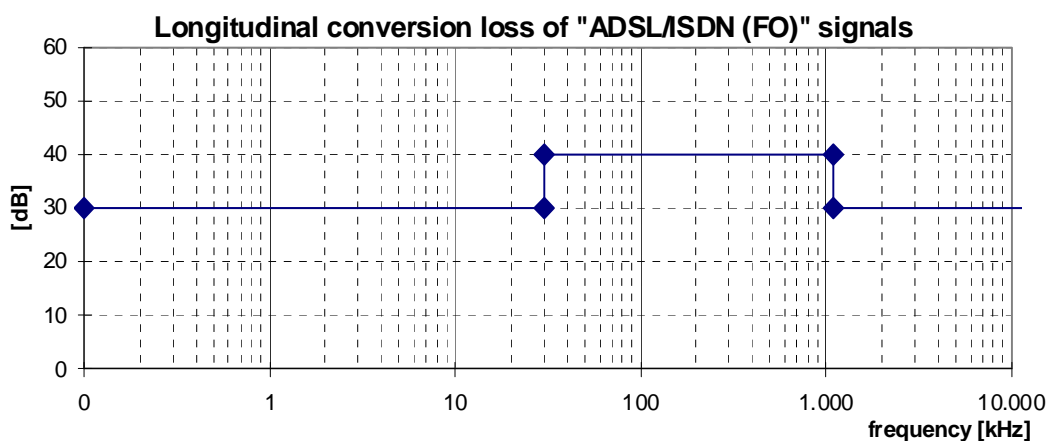

Figure 45: Minimum longitudinal conversion loss

Table 77: Frequencies and LCL values of the breakpoints of the LCL-mask in figure 45

Frequency	LCL
< 30 kHz	30 dB
30 kHz	40 dB
1 104 kHz	40 dB
1 104 kHz	30 dB
30 MHz	30 dB

11.4 "ADSL/ISDN (FDD)" signals

This category covers signals, generated by ADSL transmission equipment which uses Frequency Division Duplexing (FDD) to separate upstream and downstream. In this mode, the usable frequency band of downstream signals is narrower to limit the overlap with the upstream to four DMT tones. This is to minimize self-NEXT. Therefore this signal is called ADSL "with reduced NEXT" in the ITU. Therefore both downstream and upstream signals of "ADSL/ISDN (FDD)" also fulfil the requirements of "ADSL/ISDN (FO)" signals, as described in a previous clause of the present document.

These signals may share the same wire pair with ISDN signals.

This clause is based on ETSI and ITU reports on ADSL equipment [i.10] and [i.11]. A signal can be classified as an "ADSL/ISDN (FDD)" signal if it is compliant with all clauses below.

11.4.1 Total signal power (downstream only)

The present document provides information on how compliance with this signal category can be achieved and indicates the relevant specification(s):

To be compliant with this signal category, the mean downstream signal power into a resistive load of 100 Ω shall not exceed a level of +19,3 dBm, measured within a frequency band from at least 4 kHz to 3 MHz.

If measurements of the upstream power indicates that downstream power back-off is necessary, as described for the downstream PSD, then the maximum total transmit power shall be reduced accordingly.

Reference: TS 101 388 [i.10], clause 4.3.

11.4.2 Total signal power (upstream only)

The present document provides information on how compliance with this signal category can be achieved and indicates the relevant specification(s):

To be compliant with this signal category, the mean upstream signal power into a resistive load of 100 Ω shall not exceed a level of +13,3 dBm, measured within a frequency band from at least 4 kHz to 3 MHz.

Reference: TS 101 388 [i.10], clause 4.3.

11.4.3 Peak amplitude (upstream and downstream)

The description of this signal characteristic equals that of "ADSL/ISDN (FO)".

11.4.4 Narrow-band signal power (downstream only)

The present document provides information on how compliance with this signal category can be achieved and indicates the relevant specification(s):

To be compliant with this signal category, the Narrow-Band Signal Power (NBSP) into a resistive load impedance R , shall not exceed the limits given in table 73, at any point in the frequency range 100 Hz to 30 MHz. This table specifies the break points of these limits. Limits for intermediate frequencies can be found by drawing a straight line between the break points on a logarithmic (Hz) - linear (dB) scale. Figure 43 illustrates the NBSP in a bandwidth-normalized way.

The NBSP is the average power P of a sending signal into a load resistance R , within a *power* bandwidth B . The measurement method of the NBSP is described in clause 13.2.

Reference: TS 101 388 [i.10], clause 4.2.2.1, reconstructed from PSD requirements.

Reference: ITU-T Recommendation G.992.1 [i.11], clause B.1.3, reconstructed from PSD requirements.

NOTE 1: The NBSP specification in table 78 is reconstructed from the commonly used PSD specifications in [i.10] and [i.11] (similar to figure 46), and used here since it is much wider applicable. This enables a unified specification method. PSD specifications are adequate when signals are purely random in nature, but cannot cover harmonic components in a signal (would cause infinite high "PSD" levels at these harmonic frequencies). NBSP specifications cover both signal types.

NOTE 2: The NBSP specification of this signal category has been split into two overlapping limits: "X" and "Y". Both upper limits shall hold simultaneously. The 10 kHz bandwidth values represent the "maximum PSD values" from [i.10] and [i.11], and includes the pass band ripple. The 100 kHz bandwidth values represent the "average PSD values" in the passband to smooth out the spectral ripple of 3,5 dB. The 1 MHz bandwidth specification is equivalent to the "sliding window" specification in [i.10] and [i.11].

Table 78: Break points of the narrow-band power limits

Centre Frequency f	Impedance R	Signal Level P	Power bandwidth B	Spectral Power P/B	
0,1 kHz	100 Ω	-70 dBm	100 Hz	-90 dBm/Hz	"X"
1 kHz	100 Ω	-70 dBm	100 Hz	-90 dBm/Hz	
1 kHz	100 Ω	-60 dBm	1 kHz	-90 dBm/Hz	
4 kHz	100 Ω	-60 dBm	1 kHz	-90 dBm/Hz	
4 kHz	100 Ω	-50 dBm	10 kHz	-90 dBm/Hz	
93,1 kHz	100 Ω	-50 dBm	10 kHz	-90 dBm/Hz	
209 kHz	100 Ω	-22 dBm	10 kHz	-62 dBm/Hz	
253,9 kHz	100 Ω	-8,5 dBm	10 kHz	-48,5 dBm/Hz	
254 kHz	100 Ω	+3,5 dBm	10 kHz	-36,5 dBm/Hz	
1 104 kHz	100 Ω	+3,5 dBm	10 kHz	-36,5 dBm/Hz	
3 093 kHz	100 Ω	-50 dBm	10 kHz	-90 dBm/Hz	
11 040 kHz	100 Ω	-50 dBm	10 kHz	-90 dBm/Hz	
30 000 kHz	100 Ω	-50 dBm	10 kHz	-90 dBm/Hz	
276 kHz	100 Ω	$P_0 + 50$ dBm	100 kHz	P_0 dBm/Hz	
1 104 kHz	100 Ω	$P_0 + 50$ dBm	100 kHz	P_0 dBm/Hz	
3 093 kHz	100 Ω	-40 dBm	100 kHz	-90 dBm/Hz	
3 093 kHz	100 Ω	-30 dBm	1 MHz	-90 dBm/Hz	
4 545 kHz	100 Ω	-50 dBm	1 MHz	-110 dBm/Hz	
30 000 kHz	100 Ω	-50 dBm	1 MHz	-110 dBm/Hz	

NOTE: The values for parameter P_0 are defined in table 79, and are dependent from the received upstream power (Power back-off).

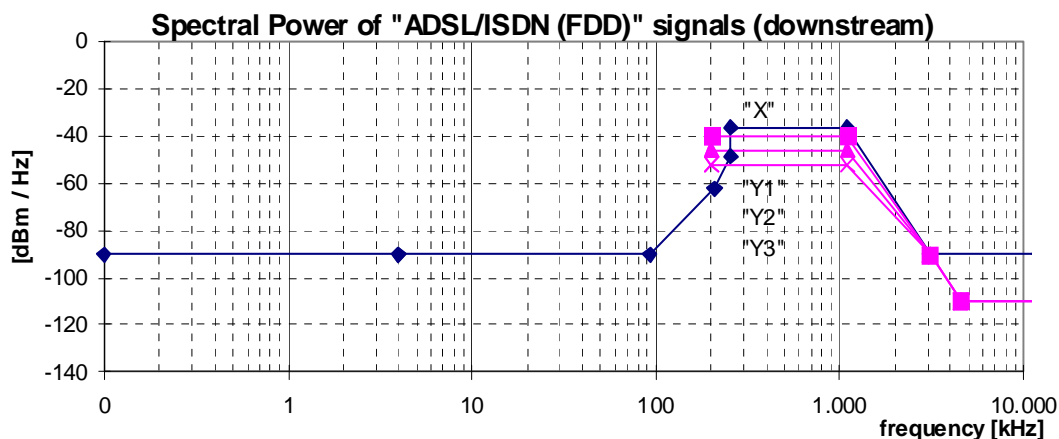

NOTE: The maximum spectral power varies with the value of parameter P_0 , as defined in table 79. Only the curves for the values $P_0 = -40$ dBm/Hz, $P_0 = -46$ dBm/Hz, and $P_0 = -52$ dBm/Hz are shown here.

Figure 46: Spectral Power, for "ADSL/ISDN (FDD)" signals, as specified in table 78

Power back-off. To be compliant with this signal category, the maximum downstream signal power shall be reduced when the received upstream power is above specified levels. If the total received upstream power from 170,34 kHz to 222,09 kHz (ADSL sub-carriers 40-51) is greater than 0 dBm into 100 Ω then parameter P_{BO} shall not exceed the values shown in table 79. (This specific variant of power back-off is also known as "power cut-back"). The received upstream power measurement shall be performed with an accuracy of ± 1 dB or better.

Reference: TS 101 388 [i.10], clause C.4.17 (Uses subcarrier 40-51, values that have been adopted here).

Reference: ITU-T Recommendation G.992.1 [i.11], clause B.3.3 (Uses subcarrier 36-51, values that have been ignored here).

Table 79: Definition of parameter P_0 , as used in table 78

Upstream received power (dBm)	< 0	< 1,5	< 3	< 4,5	< 6	< 7,5	< 9
Parameter P_0	-40	-42	-44	-46	-48	-50	-52

11.4.5 Narrow-band signal power (upstream only)

The description of this signal characteristic equals that of "ADSL/ISDN (FO)".

11.4.6 Unbalance about earth (upstream and downstream)

The description of this signal characteristic equals that of "ADSL/ISDN (FO)".

11.5 "ADSL2plus/A (FO)" signals (over POTS)

This category covers signals, generated by ADSL2plus transmission equipment, for which the downstream spectrum overlaps the upstream spectrum (Frequency Overlap). These signals may share the same wire pair with POTS signals.

This clause is based on ITU-T Recommendation G.992.5 [i.12]. A signal can be classified as an "ADSL2plus/A (FO)" signal if it is compliant with all clauses below.

11.5.1 Total signal power (downstream only)

The present document provides information on how compliance with this signal category can be achieved and indicates the relevant specification(s):

To be compliant with this signal category, the mean downstream signal power into a resistive load of 100 Ω shall not exceed a level of +20,4 dBm, measured within a frequency band from at least 4 kHz to 7 MHz.

Reference: ITU-T Recommendation G.992.5 [i.12], clause A.1.2.2.

11.5.2 Total signal power (upstream only)

The present document provides information on how compliance with this signal category can be achieved and indicates the relevant specification(s):

To be compliant with this signal category, the mean upstream signal power into a resistive load of 100 Ω shall not exceed a level of +12,5 dBm, measured within a frequency band from at least 4 kHz to 7 MHz.

Reference: ITU-T Recommendation G.992.5 [i.12], clause A.2.2.2.

11.5.3 Peak amplitude (upstream and downstream)

The present document provides information on how compliance with this signal category can be achieved:

To be compliant with this signal category, the nominal voltage peak of the largest signal pulse into a resistive load of 100 Ω shall not exceed a level of 19V (38 V peak-peak), measured within a frequency band from at least 100 Hz to 3 MHz. The definition and measurement method of peak amplitude is specified in clause 13.1.

NOTE: No ETSI deliverable specifies this parameter.

11.5.4 Narrow-band signal power (downstream only)

The present document provides information on how compliance with this signal category can be achieved and indicates the relevant specification(s):

To be compliant with this signal category, the Narrow-Band Signal Power (NBSP) into a resistive load impedance R , shall not exceed the limits given in table 80 at any point in the frequency range 100 Hz to 30 MHz. This table specifies the break points of these limits. Limits for intermediate frequencies can be found by drawing a straight line between the break points on a logarithmic (Hz) - linear (dB) scale. Figure 47 illustrates the NBSP in a bandwidth-normalized way.

The NBSP is the average power P of a sending signal into a load resistance R , within a power bandwidth B . The measurement method of the NBSP is described in clause 13.2.

NOTE: The NBSP specification of this signal category has been split into two overlapping limits: "X" and "Y". The reason for this split is the same as described in the NBSP descriptions for ADSL, e.g. clause 11.1.4.

Reference: ITU-T Recommendation G.992.5 [i.12], clause A.1.2 reconstructed from PSD requirements.

Table 80: Break points of the narrow-band power limits

Centre frequency f	Impedance R	Signal Level P	Power bandwidth B	Spectral Power P/B		
0,1 kHz	600 Ω	-77,5 dBm	100 Hz	-97,5 dBm/Hz	"X"	
4 kHz	600 Ω	-77,5 dBm	100 Hz	-97,5 dBm/Hz		
4 kHz	600 Ω	-72,5 dBm	100 Hz	-92,5 dBm/Hz		
25,875 kHz	100 Ω	+3,5 dBm	10 kHz	-36,5 dBm/Hz	"Y"	
1 104 kHz	100 Ω	+3,5 dBm	10 kHz	-36,5 dBm/Hz		
1 622 kHz	100 Ω	-6,5 dBm	10 kHz	-46,5 dBm/Hz		
2 208 kHz	100 Ω	-7,8 dBm	10 kHz	-47,8 dBm/Hz		
2 500 kHz	100 Ω	-19,4 dBm	10 kHz	-59,4 dBm/Hz		
3 001,5 kHz	100 Ω	-40 dBm	10 kHz	-80 dBm/Hz		
3 175 kHz	100 Ω	-60 dBm	10 kHz	-100 dBm/Hz		
30 000 kHz	100 Ω	-60 dBm	10 kHz	-100 dBm/Hz		
60 kHz	100 Ω	+10 dBm	100 kHz	-40 dBm/Hz		"Y"
1 104 kHz	100 Ω	+10 dBm	100 kHz	-40 dBm/Hz		
1 622 kHz	100 Ω	0 dBm	100 kHz	-50 dBm/Hz		
2 208 kHz	100 Ω	-1,3 dBm	100 kHz	-51,3 dBm/Hz		
2 500 kHz	100 Ω	-12,9 dBm	100 kHz	-62,9 dBm/Hz		
3 001,5 kHz	100 Ω	-33,5 dBm	100 kHz	-83,5 dBm/Hz		
3 175 kHz	100 Ω	-50 dBm	100 kHz	-100 dBm/Hz		
3 175 kHz	100 Ω	-40 dBm	1 MHz	-100 dBm/Hz		
4 545 kHz	100 Ω	-50 dBm	1 MHz	-110 dBm/Hz		
7 225 kHz	100 Ω	-52 dBm	1 MHz	-112 dBm/Hz		
30 000 kHz	100 Ω	-52 dBm	1 MHz	-112 dBm/Hz		

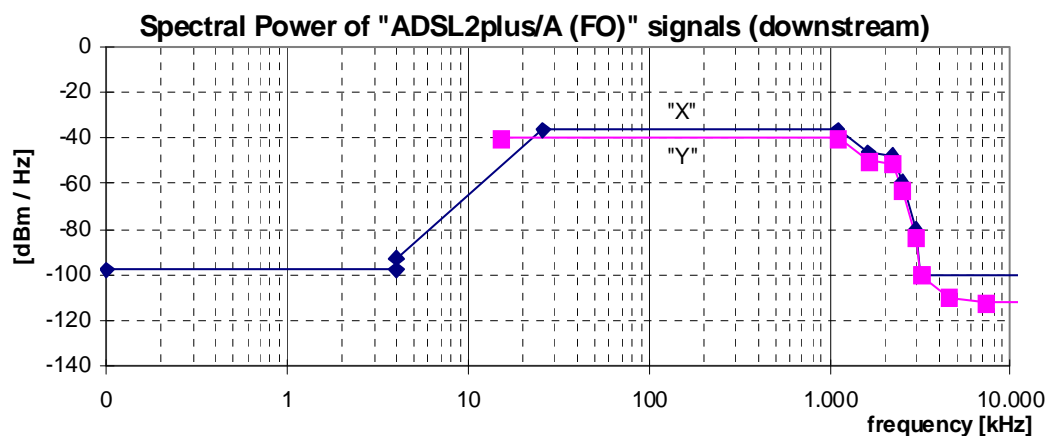

Figure 47: Spectral Power, for downstream "ADSL2plus/A (FO)", as specified in table 80

11.5.5 Narrow-band signal power (upstream only)

The present document provides information on how compliance with this signal category can be achieved and indicates the relevant specification(s):

To be compliant with this signal category, the Narrow-Band Signal Power (NBSP) into a resistive load impedance R , shall not exceed the limits given in table 81, at any point in a frequency range between 100 Hz to 30 MHz. This table specifies the break points of these limits. Limits for intermediate frequencies can be found by drawing a straight line between the break points on a logarithmic (Hz) - linear (dB) scale. Figure 48 illustrates the NBSP in a bandwidth-normalized way.

The NBSP is the average power P of a sending signal into a load resistance R , within a *power* bandwidth B . The measurement method of the NBSP is described in clause 13.2.

NOTE: The NBSP specification of this signal category has been split into two overlapping limits: "X" and "Y". The reason for this split is the same as described in the NBSP descriptions for ADSL, e.g. clause 11.1.5. The "ADSL2plus/A (FO)" limits for upstream are not the same as for "ADSL/POTS (FO)", due to a steeper slope near 138 kHz.

Reference: ITU-T Recommendation G.992.5 [i.12], clause A.2.2 reconstructed from PSD requirements.

Table 81: Break points of the narrow-band power limits

Centre frequency f	Impedance R	Signal Level P	Power bandwidth B	Spectral Power P/B	
0,1 kHz	600 Ω	-77,5 dBm	100 Hz	-97,5 dBm/Hz	"X"
4 kHz	600 Ω	-77,5 dBm	100 Hz	-97,5 dBm/Hz	
4 kHz	600 Ω	-72,5 dBm	100 Hz	-92,5 dBm/Hz	
25,875 kHz	100 Ω	+5,5 dBm	10 kHz	-34,5 dBm/Hz	
138 kHz	100 Ω	+5,5 dBm	10 kHz	-34,5 dBm/Hz	
243 kHz	100 Ω	-53,2 dBm	10 kHz	-93,2 dBm/Hz	
686 kHz	100 Ω	-60 dBm	10 kHz	-100 dBm/Hz	
5 275 kHz	100 Ω	-60 dBm	10 kHz	-100 dBm/Hz	
30 000 kHz	100 Ω	-60 dBm	10 kHz	-100 dBm/Hz	
60 kHz	100 Ω	+12 dBm	100 kHz	-38 dBm/Hz	"Y"
138 kHz	100 Ω	+12 dBm	100 kHz	-38 dBm/Hz	
243 kHz	100 Ω	-46,7 dBm	100 kHz	-96,7 dBm/Hz	
686 kHz	100 Ω	-50 dBm	100 kHz	-100 dBm/Hz	
1 411 kHz	100 Ω	-50 dBm	100 kHz	-100 dBm/Hz	
1 411 kHz	100 Ω	-40 dBm	1 MHz	-100 dBm/Hz	
1 630 kHz	100 Ω	-50 dBm	1 MHz	-110 dBm/Hz	
5 275 kHz	100 Ω	-52 dBm	1 MHz	-112 dBm/Hz	
30 000 kHz	100 Ω	-52 dBm	1 MHz	-112 dBm/Hz	

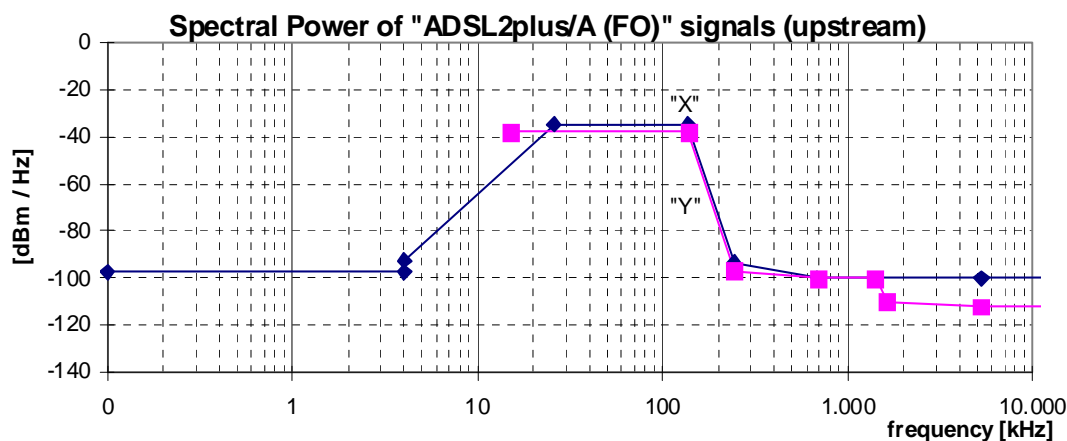

Figure 48: Spectral Power, for upstream "ADSL2plus/A (FO)" signals, as specified in table 81

11.5.6 Unbalance about earth (upstream and downstream)

The present document provides information on how compliance with this signal category can be achieved:

To be compliant with this signal category, the balance of the signal that may flow through the LT-port or NT-port shall exceed minimum requirements, under the condition that the local loop wiring and its termination is well balanced. This can be verified by a Longitudinal Output Voltage (LOV) and a Longitudinal Conversion Loss (LCL) measurement at the source of that signal. Clause 11.1.6 describes and refers to the concerning sections. Table 82 gives the values for the LOV limits in case of ADSL2plus while the LCL mask for ADSL2plus is given in figure 49. The LCL values of the associated break frequencies of this figure are given in table 83.

Table 82: Values for the LOV limits

	LOV	B	f_{min}	f_{max}	R_L	C_L
downstream	-46 dBV	10 kHz	5,1 kHz	3 650 kHz	100 Ω	150 nF
upstream	-46 dBV	10 kHz	5,1 kHz	210 kHz	100 Ω	150 nF

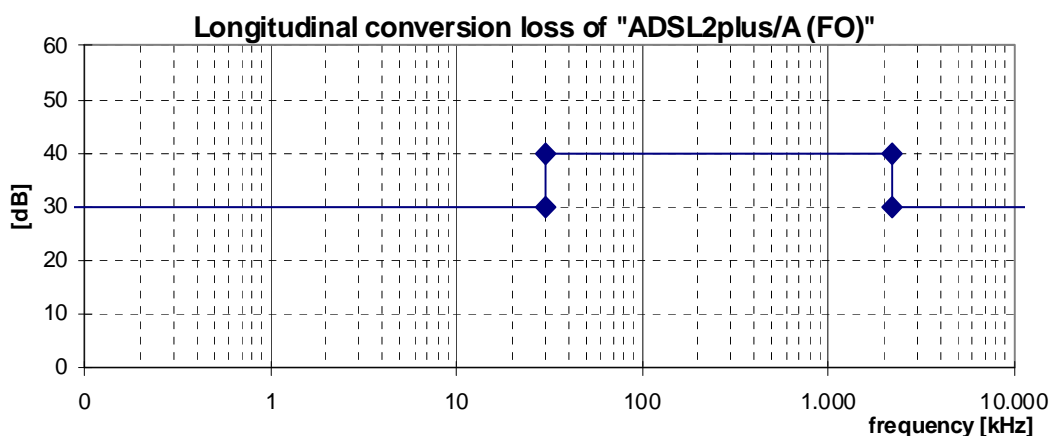

Figure 49: Minimum longitudinal conversion loss

Table 83: Frequencies and LCL values of the breakpoints of the LCL mask in figure 49

Frequency	LCL
< 30 kHz	30 dB
30 kHz	40 dB
2 208 kHz	40 dB
2 208 kHz	30 dB
30 MHz	30 dB

11.6 "ADSL2plus/A (FDD)" signals (over POTS)

This category covers signals, generated by ADSL2plus transmission equipment, which uses Frequency Division Duplexing (FDD) to separate upstream and downstream. In this mode, the usable frequency band of downstream signals is narrower and not overlapping the upstream, but adjacent to it, to minimize self-NEXT. Therefore both downstream and upstream signals of "ADSL2plus/A (FDD)" also fulfil the requirements of "ADSL2plus/A (FO)" signals, as described in a previous clause of the present document. These signals may share the same wire pair with POTS signals.

This clause is based on ITU-T Recommendation G.992.5 [i.12]. A signal can be classified as an "ADSL2plus/A (FDD)" signal if it is compliant with all clauses below.

11.6.1 Total signal power (downstream only)

The present document provides information on how compliance with this signal category can be achieved and indicates the relevant specification(s):

To be compliant with this signal category, the mean downstream signal power into a resistive load of 100 Ω shall not exceed a level of +19,9 dBm, measured within a frequency band from at least 4 kHz to 7 MHz.

Reference: ITU-T Recommendation G.992.5 [i.12], clause A.1.3.2.

11.6.2 Total signal power (upstream only)

The description of this signal characteristic equals that of "ADSL2plus/A (FO)".

11.6.3 Peak amplitude (upstream and downstream)

The description of this signal characteristic equals that of "ADSL2plus/A (FO)".

11.6.4 Narrow-band signal power (downstream only)

The present document provides information on how compliance with this signal category can be achieved and indicates the relevant specification(s):

To be compliant with this signal category, the Narrow-Band Signal Power (NBSP) into a resistive load impedance R , shall not exceed the limits given in table 84, at any point in the frequency range 100 Hz to 30 MHz. This table specifies the break points of these limits. Limits for intermediate frequencies can be found by drawing a straight line between the break points on a logarithmic (Hz) - linear (dB) scale. Figure 50 illustrates the NBSP in a bandwidth-normalized way.

The NBSP is the average power P of a sending signal into a load resistance R , within a power bandwidth B . The measurement method of the NBSP is described in clause 13.2.

NOTE: The NBSP specification of this signal category has been split into two overlapping limits: "X" and "Y". The reason for this split is the same as described in the NBSP descriptions for ADSL, e.g. clause 11.1.4.

Reference: ITU-T Recommendation G.992.5 [i.12], clause A.1.3 reconstructed from PSD requirements.

Table 84: Break points of the narrow-band power limits

Centre frequency f	Impedance R	Signal Level P	Power bandwidth B	Spectral Power P/B		
0,1 kHz	600 Ω	-77,5 dBm	100 Hz	-97,5 dBm/Hz	"X"	
1 kHz	600 Ω	-77,5 dBm	100 Hz	-97,5 dBm/Hz		
1 kHz	600 Ω	-67,5 dBm	1 kHz	-97,5 dBm/Hz		
4 kHz	600 Ω	-67,5 dBm	1 kHz	-97,5 dBm/Hz		
4 kHz	100 Ω	-52,5 dBm	10 kHz	-92,5 dBm/Hz		
80 kHz	100 Ω	-32,5 dBm	10 kHz	-72,5 dBm/Hz		
137,9 kHz	100 Ω	-4,2 dBm	10 kHz	-44,2 dBm/Hz		
138 kHz	100 Ω	+3,5 dBm	10 kHz	-36,5 dBm/Hz		
1 104 kHz	100 Ω	+3,5 dBm	10 kHz	-36,5 dBm/Hz		
1 622 kHz	100 Ω	-6,5 dBm	10 kHz	-46,5 dBm/Hz		
2 208 kHz	100 Ω	-7,8 dBm	10 kHz	-47,8 dBm/Hz		
2 500 kHz	100 Ω	-19,4 dBm	10 kHz	-59,4 dBm/Hz		
3 001,5 kHz	100 Ω	-40 dBm	10 kHz	-80 dBm/Hz		
3 175 kHz	100 Ω	-60 dBm	10 kHz	-100 dBm/Hz		
30 000 kHz	100 Ω	-60 dBm	10 kHz	-100 dBm/Hz		
170 kHz	100 Ω	+10 dBm	100 kHz	-40 dBm/Hz		"Y"
1 104 kHz	100 Ω	+10 dBm	100 kHz	-40 dBm/Hz		
1 622 kHz	100 Ω	0 dBm	100 kHz	-50 dBm/Hz		
2 208 kHz	100 Ω	-1,3 dBm	100 kHz	-51,3 dBm/Hz		
2 500 kHz	100 Ω	-12,9 dBm	100 kHz	-62,9 dBm/Hz		
3 001,5 kHz	100 Ω	-33,5 dBm	100 kHz	-83,5 dBm/Hz		

Centre frequency f	Impedance R	Signal Level P	Power bandwidth B	Spectral Power P/B	
3 175 kHz	100 Ω	-50 dBm	100 kHz	-100 dBm/Hz	
3 175 kHz	100 Ω	-40 dBm	1 MHz	-100 dBm/Hz	
4 545 kHz	100 Ω	-50 dBm	1 MHz	-110 dBm/Hz	
7 225 kHz	100 Ω	-52 dBm	1 MHz	-112 dBm/Hz	
30 000 kHz	100 Ω	-52 dBm	1 MHz	-112 dBm/Hz	

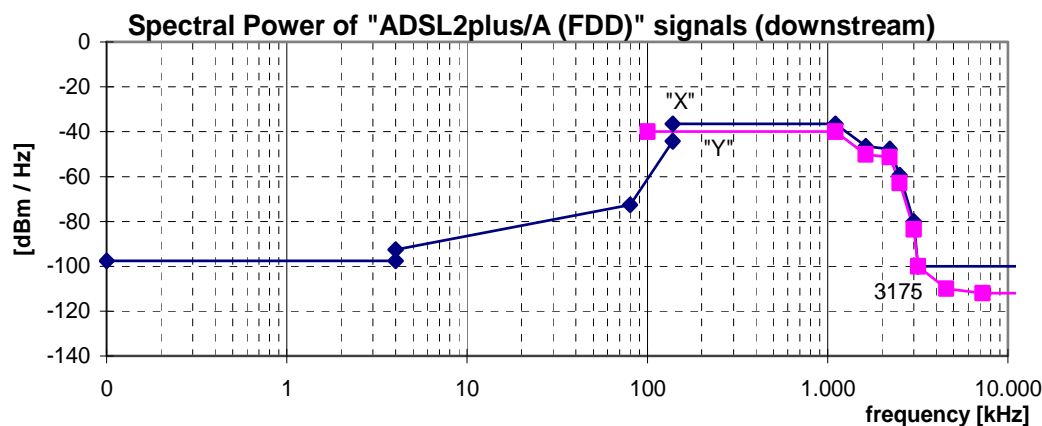

Figure 50: Spectral Power, for downstream "ADSL2plus/A (FDD)" signals, as specified in table 84

11.6.5 Narrow-band signal power (upstream only)

The description of this signal characteristic equals that of "ADSL2plus/A (FO)".

11.6.6 Unbalance about earth (upstream and downstream)

The description of this signal characteristic equals that of "ADSL2plus/A (FO)".

11.7 "ADSL2plus/B (FO)" signals (over ISDN)

This category covers signals, generated by ADSL2plus transmission equipment, for which the downstream spectrum overlaps the upstream spectrum (Frequency Overlap). These signals may share the same wire pair with ISDN signals.

This clause is based on ITU-T Recommendation G.992.5 [i.12]. A signal can be classified as an "ADSL2plus/B (FO)" signal if it is compliant with all clauses below.

11.7.1 Total signal power (downstream only)

The present document provides information on how compliance with this signal category can be achieved and indicates the relevant specification(s):

To be compliant with this signal category, the mean downstream signal power into a resistive load of 100 Ω shall not exceed a level of +19,9 dBm, measured within a frequency band from at least 4 kHz to 7 MHz.

Reference: ITU-T Recommendation G.992.5 [i.12], clause B.1.2.2.

11.7.2 Total signal power (upstream only)

The present document provides information on how compliance with this signal category can be achieved and indicates the relevant specification(s):

To be compliant with this signal category, the mean upstream signal power into a resistive load of 100 Ω shall not exceed a level of +13,3 dBm, measured within a frequency band from at least 4 kHz to 3 MHz.

Reference: ITU-T Recommendation G.992.5 [i.12], clause B.2.2.2.

11.7.3 Peak amplitude (upstream and downstream)

The description of this signal characteristic equals that of "ADSL2plus/A (FO)".

11.7.4 Narrow-band signal power (downstream only)

The present document provides information on how compliance with this signal category can be achieved and indicates the relevant specification(s):

To be compliant with this signal category, the Narrow-Band Signal Power (NBSP) into a resistive load impedance R , shall not exceed the limits given in table 85, at any point in the frequency range 100 Hz to 30 MHz. This table specifies the break points of these limits. Limits for intermediate frequencies can be found by drawing a straight line between the break points on a logarithmic (Hz) - linear (dB) scale. Figure 51 illustrates the NBSP in a bandwidth-normalized way.

The NBSP is the average power P of a sending signal into a load resistance R , within a *power* bandwidth B . The measurement method of the NBSP is described in clause 13.2.

NOTE: The NBSP specification of this signal category has been split into two overlapping limits: "X" and "Y". The reason for this split is the same as described in the NBSP descriptions for ADSL, e.g. clause 11.1.4.

Reference: ITU-T Recommendation G.992.5 [i.12], clause B.1.2, reconstructed from PSD requirements.

Table 85: Break points of the narrow-band power limits

Centre Frequency f	Impedance R	Signal Level P	Power bandwidth B	Spectral Power P/B	
0,1 kHz	100 Ω	-70 dBm	100 Hz	-90 dBm/Hz	"X"
1 kHz	100 Ω	-70 dBm	100 Hz	-90 dBm/Hz	
1 kHz	100 Ω	-60 dBm	1 kHz	-90 dBm/Hz	
4 kHz	100 Ω	-60 dBm	1 kHz	-90 dBm/Hz	
4 kHz	100 Ω	-50 dBm	10 kHz	-90 dBm/Hz	
50 kHz	100 Ω	-50 dBm	10 kHz	-90 dBm/Hz	
80 kHz	100 Ω	-41,8 dBm	10 kHz	-81,8 dBm/Hz	
120 kHz	100 Ω	+3,5 dBm	10 kHz	-36,5 dBm/Hz	
1 104 kHz	100 Ω	+3,5 dBm	10 kHz	-36,5 dBm/Hz	
1 622 kHz	100 Ω	-6,5 dBm	10 kHz	-46,5 dBm/Hz	
2 208 kHz	100 Ω	-7,8 dBm	10 kHz	-47,8 dBm/Hz	
2 500 kHz	100 Ω	-19,4 dBm	10 kHz	-59,4 dBm/Hz	
3 001,5 kHz	100 Ω	-40 dBm	10 kHz	-80 dBm/Hz	
3 175 kHz	100 Ω	-60 dBm	10 kHz	-100 dBm/Hz	
30 000 kHz	100 Ω	-60 dBm	10 kHz	-100 dBm/Hz	
100 kHz	100 Ω	+10 dBm	100 kHz	-40 dBm/Hz	"Y"
1 104 kHz	100 Ω	+10 dBm	100 kHz	-40 dBm/Hz	
1 622 kHz	100 Ω	0 dBm	100 kHz	-50 dBm/Hz	
2 208 kHz	100 Ω	-1,3 dBm	100 kHz	-51,3 dBm/Hz	
2 500 kHz	100 Ω	-12,9 dBm	100 kHz	-62,9 dBm/Hz	
3 001,5 kHz	100 Ω	-33,5 dBm	100 kHz	-83,5 dBm/Hz	
3 175 kHz	100 Ω	-50 dBm	100 kHz	-100 dBm/Hz	
3 175 kHz	100 Ω	-40 dBm	1 MHz	-100 dBm/Hz	
4 545 kHz	100 Ω	-50 dBm	1 MHz	-110 dBm/Hz	
7 225 kHz	100 Ω	-52 dBm	1 MHz	-112 dBm/Hz	
30 000 kHz	100 Ω	-52 dBm	1 MHz	-112 dBm/Hz	

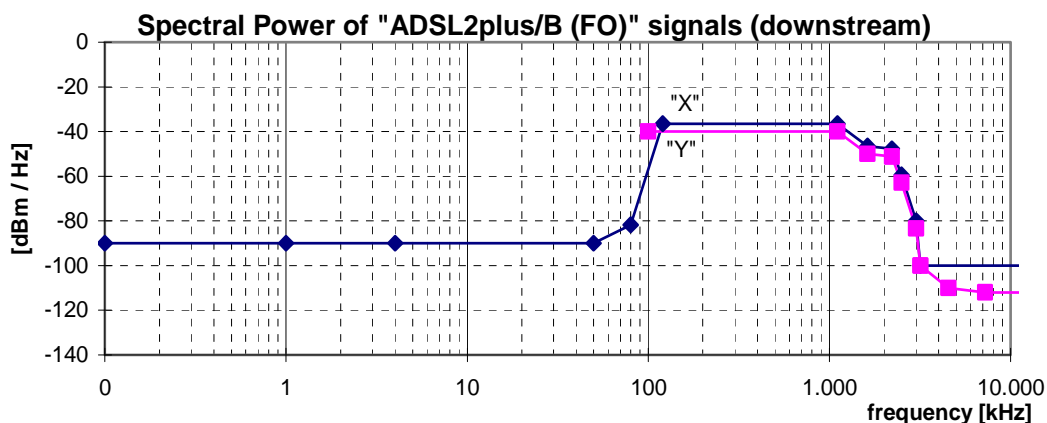

Figure 51: Spectral Power, for downstream "ADSL2plus/B (FO)" signals, as specified in table 85

11.7.5 Narrow-band signal power (upstream only)

The present document provides information on how compliance with this signal category can be achieved and indicates the relevant specification(s):

To be compliant with this signal category, the Narrow-Band Signal Power (NBSP) into a resistive load impedance R , shall not exceed the limits given in table 86, at any point in the frequency range 100 Hz to 30 MHz. This table specifies the break points of these limits. Limits for intermediate frequencies can be found by drawing a straight line between the break points on a logarithmic (Hz) - linear (dB) scale. Figure 52 illustrates the NBSP in a bandwidth-normalized way.

The NBSP is the average power P of a sending signal into a load resistance R , within a *power* bandwidth B . The measurement method of the NBSP is described in clause 13.2.

NOTE: The NBSP specification of this signal category has been split into two overlapping limits: "X" and "Y". The reason for this split is the same as described in the NBSP descriptions for ADSL, e.g. clause 11.1.5. The "ADSL2plus/B (FO)" limits for upstream are not the same as for "ADSL/ISDN (FO)", due to a steeper slope near 276 kHz.

Reference: ITU-T Recommendation G.992.5 [i.12], clause B.2.2 reconstructed from PSD requirements.

Table 86: Break points of the narrow-band power limits

Centre frequency f	Impedance R	Signal Level P	Power bandwidth B	Spectral Power P/B	
0,1 kHz	100 Ω	-70 dBm	100 Hz	-90 dBm/Hz	"X"
1 kHz	100 Ω	-70 dBm	100 Hz	-90 dBm/Hz	
1 kHz	100 Ω	-60 dBm	1 kHz	-90 dBm/Hz	
4 kHz	100 Ω	-60 dBm	1 kHz	-90 dBm/Hz	
4 kHz	100 Ω	-50 dBm	10 kHz	-90 dBm/Hz	
50 kHz	100 Ω	-50 dBm	10 kHz	-90 dBm/Hz	
80 kHz	100 Ω	-41,8 dBm	10 kHz	-81,8 dBm/Hz	
120 kHz	100 Ω	+5,5 dBm	10 kHz	-34,5 dBm/Hz	
276 kHz	100 Ω	+5,5 dBm	10 kHz	-34,5 dBm/Hz	
508,8 kHz	100 Ω	-58 dBm	10 kHz	-98 dBm/Hz	
686 kHz	100 Ω	-60 dBm	10 kHz	-100 dBm/Hz	"Y"
30 000 kHz	100 Ω	-60 dBm	10 kHz	-100 dBm/Hz	
120 kHz	100 Ω	+12 dBm	100 kHz	-38 dBm/Hz	
276 kHz	100 Ω	+12 dBm	100 kHz	-38 dBm/Hz	
508,8 kHz	100 Ω	-50 dBm	100 kHz	-100 dBm/Hz	
686 kHz	100 Ω	-50 dBm	100 kHz	-100 dBm/Hz	
1 411 kHz	100 Ω	-50 dBm	100 kHz	-100 dBm/Hz	

Centre frequency f	Impedance R	Signal Level P	Power bandwidth B	Spectral Power P/B	
1 411 kHz	100 Ω	-40 dBm	1 MHz	-100 dBm/Hz	
1 630 kHz	100 Ω	-50 dBm	1 MHz	-110 dBm/Hz	
5 275 kHz	100 Ω	-52 dBm	1 MHz	-112 dBm/Hz	
30 000 kHz	100 Ω	-52 dBm	1 MHz	-112 dBm/Hz	

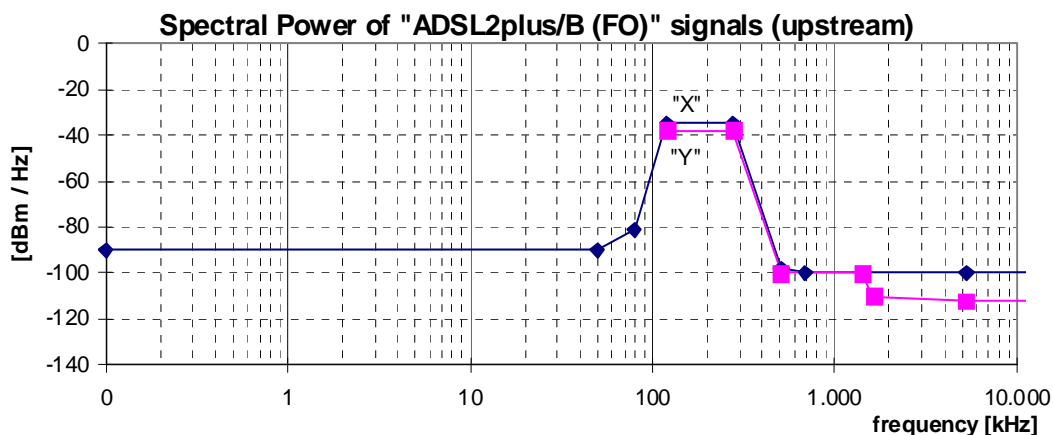

Figure 52: Spectral Power, for upstream "ADSL2plus/B (FO)" signals, as specified in table 86

11.7.6 Unbalance about earth (upstream and downstream)

The present document provides information on how compliance with this signal category can be achieved:

To be compliant with this signal category, the balance of the signal that may flow through the LT-port or NT-port shall exceed minimum requirements, under the condition that the local loop wiring and its termination is well balanced. This can be verified by a Longitudinal Output Voltage (LOV) and a Longitudinal Conversion Loss (LCL) measurement at the source of that signal, as specified in clause 13.3. The minimum LOV and LCL requirements hold for what can be observed at the ports of the Local Loop Wiring, when the Local Loop Wiring is replaced by an artificial impedance network described in clause 13.3. Table 87 gives the values for the LOV limits in case of ADSL2plus while the LCL mask for ADSL2plus is given in figure 53. The LCL values of the associated break frequencies of this figure are given in table 88.

Table 87: Values for the LOV limits

	LOV	B	f_{\min}	f_{\max}	R_L	C_L
downstream	-46 dBV	10 kHz	5,1 kHz	3 650 kHz	100 Ω	150 nF
upstream	-46 dBV	10 kHz	5,1 kHz	415 kHz	100 Ω	150 nF

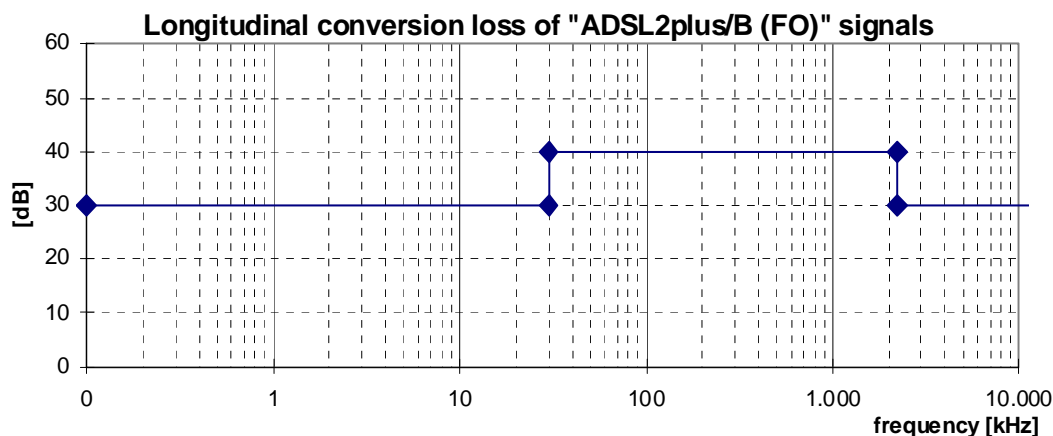

Figure 53: Minimum longitudinal conversion loss

Table 88: Frequencies and LCL values of the breakpoints of the LCL-mask in figure 53

Frequency	LCL
< 30 kHz	30 dB
30 kHz	40 dB
2 208 kHz	40 dB
2 208 kHz	30 dB
30 MHz	30 dB

11.8 "ADSL2plus/B (FDD)" signals (over ISDN)

This category covers signals, generated by ADSL2plus transmission equipment which uses Frequency Division Duplexing (FDD) to separate upstream and downstream. In this mode, the usable frequency band of downstream signals is narrower to limit the overlap with the upstream to four DMT tones. This is to minimize self-NEXT. Therefore both downstream and upstream signals of "ADSL2plus/B (FDD)" also fulfil the requirements of "ADSL2plus/B (FO)" signals, as described in a previous clause of the present document.

These signals may share the same wire pair with ISDN signals.

This clause is based on ITU-T Recommendation G.992.5 [i.12]. A signal can be classified as an "ADSL2plus/B (FDD)" signal if it is compliant with all clauses below.

11.8.1 Total signal power (downstream only)

The present document provides information on how compliance with this signal category can be achieved and indicates the relevant specification(s):

To be compliant with this signal category, the mean downstream signal power into a resistive load of 100 Ω shall not exceed a level of +19,3 dBm, measured within a frequency band from at least 4 kHz to 7 MHz.

If measurements of the upstream power indicates that downstream power back-off is necessary, as described for the downstream PSD, then the maximum total transmit power shall be reduced accordingly.

Reference: ITU-T Recommendation G.992.5 [i.12], clause B.1.3.2.

11.8.2 Total signal power (upstream only)

The description of this signal characteristic equals that of "ADSL2plus/B (FO)".

11.8.3 Peak amplitude (upstream and downstream)

The description of this signal characteristic equals that of "ADSL2plus/B (FO)".

11.8.4 Narrow-band signal power (downstream only)

The present document provides information on how compliance with this signal category can be achieved and indicates the relevant specification(s):

To be compliant with this signal category, the Narrow-Band Signal Power (NBSP) into a resistive load impedance R , shall not exceed the limits given in table 89, at any point in the frequency range 100 Hz to 30 MHz. This table specifies the break points of these limits. Limits for intermediate frequencies can be found by drawing a straight line between the break points on a logarithmic (Hz) - linear (dB) scale. Figure 54 illustrates the NBSP in a bandwidth-normalized way.

The NBSP is the average power P of a sending signal into a load resistance R , within a power bandwidth B . The measurement method of the NBSP is described in clause 13.2.

Reference: Recommendation G.992.5 [i.12], clause B.1.3, reconstructed from PSD requirements.

NOTE: The NBSP specification of this signal category has been split into two overlapping limits: "X" and "Y". The reason for this split is the same as described in the NBSP descriptions for ADSL, e.g. clause 11.1.4.

Table 89: Break points of the narrow-band power limits

Centre Frequency f	Impedance R	Signal Level P	Power bandwidth B	Spectral Power P/B	
0,1 kHz	100 Ω	-70 dBm	100 Hz	-90 dBm/Hz	"X"
1 kHz	100 Ω	-70 dBm	100 Hz	-90 dBm/Hz	
1 kHz	100 Ω	-60 dBm	1 kHz	-90 dBm/Hz	
4 kHz	100 Ω	-60 dBm	1 kHz	-90 dBm/Hz	
4 kHz	100 Ω	-50 dBm	10 kHz	-90 dBm/Hz	
93,1 kHz	100 Ω	-50 dBm	10 kHz	-90 dBm/Hz	
209 kHz	100 Ω	-22 dBm	10 kHz	-62 dBm/Hz	
253,9 kHz	100 Ω	-8,5 dBm	10 kHz	-48,5 dBm/Hz	
254 kHz	100 Ω	+3,5 dBm	10 kHz	-36,5 dBm/Hz	
1 104 kHz	100 Ω	+3,5 dBm	10 kHz	-36,5 dBm/Hz	
1 622 kHz	100 Ω	-6,5 dBm	10 kHz	-46,5 dBm/Hz	
2 208 kHz	100 Ω	-7,6 dBm	10 kHz	-47,8 dBm/Hz	
2 500 kHz	100 Ω	-19,4 dBm	10 kHz	-59,4 dBm/Hz	
3 001,5 kHz	100 Ω	-40 dBm	10 kHz	-80 dBm/Hz	
3 175 kHz	100 Ω	-60 dBm	10 kHz	-100 dBm/Hz	
30 000 kHz	100 Ω	-60 dBm	10 kHz	-100 dBm/Hz	"Y"
276 kHz	100 Ω	+10 dBm	100 kHz	-40 dBm/Hz	
1 104 kHz	100 Ω	+10 dBm	100 kHz	-40 dBm/Hz	
1 622 kHz	100 Ω	0 dBm	100 kHz	-50 dBm/Hz	
2 208 kHz	100 Ω	-1,3 dBm	100 kHz	-51,3 dBm/Hz	
2 500 kHz	100 Ω	-12,9 dBm	100 kHz	-62,9 dBm/Hz	
3 001,5 kHz	100 Ω	-33,5 dBm	100 kHz	-83,5 dBm/Hz	
3 175 kHz	100 Ω	-50 dBm	100 kHz	-100 dBm/Hz	
3 175 kHz	100 Ω	-40 dBm	1 MHz	-100 dBm/Hz	
3 750 kHz	100 Ω	-40 dBm	1 MHz	-100 dBm/Hz	
4 545 kHz	100 Ω	-50 dBm	1 MHz	-110 dBm/Hz	
7 225 kHz	100 Ω	-52 dBm	1 MHz	-112 dBm/Hz	
30 000 kHz	100 Ω	-52 dBm	1 MHz	-112 dBm/Hz	

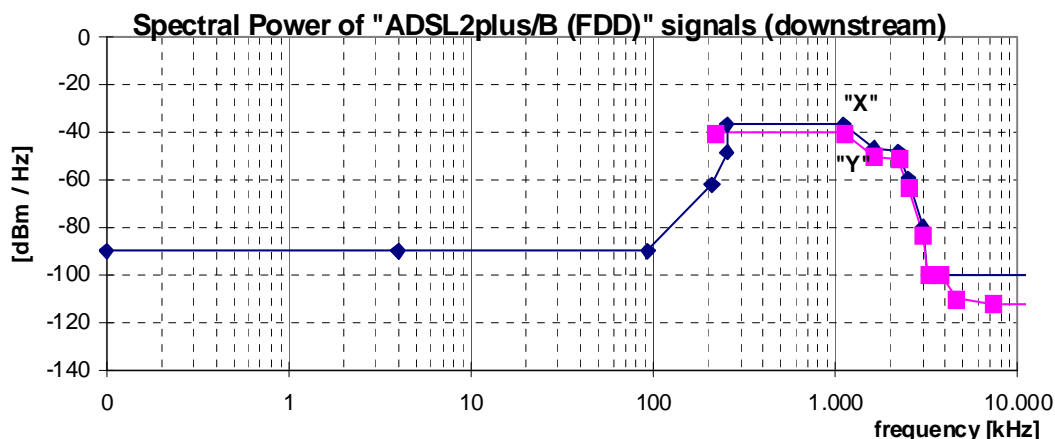

Figure 54: Spectral Power, for downstream "ADSL2plus/B (FDD)" signals, specified in table 89

11.8.5 Narrow-band signal power (upstream only)

The description of this signal characteristic equals that of "ADSL2plus/B (FO)".

11.8.6 Unbalance about earth (upstream and downstream)

The description of this signal characteristic equals that of "ADSL2plus/B (FO)".

11.9 "ADSL2plus/I (FO)" signals (all digital mode)

This category covers signals, generated by ADSL2plus transmission equipment, for which the downstream spectrum overlaps the upstream spectrum (Frequency Overlap). These signals do not share the same wire pair with POTS or ISDN signals.

This clause is based on ITU-T Recommendation G.992.5 [i.12]. A signal can be classified as an "ADSL2plus/I (FO)" signal if it is compliant with all clauses below.

11.9.1 Total signal power (downstream only)

The present document provides information on how compliance with this signal category can be achieved and indicates the relevant specification(s):

To be compliant with this signal category, the mean downstream signal power into a resistive load of 100 Ω shall not exceed a level of +20,4 dBm, measured within a frequency band from at least 4 kHz to 7 MHz.

Reference: ITU-T Recommendation G.992.5 [i.12], clause I.1.2.2.

11.9.2 Total signal power (upstream only)

The present document provides information on how compliance with this signal category can be achieved and indicates the relevant specification(s):

To be compliant with this signal category, the mean upstream signal power into a resistive load of 100 Ω shall not exceed a level of +13,3 dBm, measured within a frequency band from at least 4 kHz to 7 MHz.

Reference: ITU-T Recommendation G.992.5 [i.12], clause I.2.2.2.

11.9.3 Peak amplitude (upstream and downstream)

The present document provides information on how compliance with this signal category can be achieved:

To be compliant with this signal category, the nominal voltage peak of the largest signal pulse into a resistive load of 100 Ω shall not exceed a level of 19V (38 V peak-peak), measured within a frequency band from at least 100 Hz to 1 MHz. The definition and measurement method of peak amplitude is specified in clause 13.1.

NOTE: No ETSI deliverable does specify this parameter.

11.9.4 Narrow-band signal power (downstream only)

The present document provides information on how compliance with this signal category can be achieved and indicates the relevant specification(s):

To be compliant with this signal category, the Narrow-Band Signal Power (NBSP) into a resistive load impedance R , shall not exceed the limits given in table 90, at any point in the frequency range 100 Hz to 30 MHz. This table specifies the break points of these limits. Limits for intermediate frequencies can be found by drawing a straight line between the break points on a logarithmic (Hz) - linear (dB) scale. Figure 55 illustrates the NBSP in a bandwidth-normalized way.

The NBSP is the average power P of a sending signal into a load resistance R , within a *power* bandwidth B . The measurement method of the NBSP is described in clause 13.2.

NOTE: The NBSP specification of this signal category has been split into two overlapping limits: "X" and "Y". The reason for this split is the same as described in the NBSP descriptions for ADSL, e.g. clause 11.1.4.

Reference: ITU-T Recommendation G.992.5 [i.12], clause I.1.2 reconstructed from PSD requirements.

Table 90: Break points of the narrow-band power limits

Centre frequency f	Impedance R	Signal Level P	Power bandwidth B	Spectral Power P/B	
0,1 kHz	600 Ω	-28,5 dBm	100 Hz	-48,5 dBm/Hz	"X"
1,5 kHz	600 Ω	-28,5 dBm	100 Hz	-48,5 dBm/Hz	
3 kHz	600 Ω	-16,5 dBm	100 Hz	-36,5 dBm/Hz	
25,875 kHz	100 Ω	+3,5 dBm	10 kHz	-36,5 dBm/Hz	"Y"
1 104 kHz	100 Ω	+3,5 dBm	10 kHz	-36,5 dBm/Hz	
1 622 kHz	100 Ω	-6,5 dBm	10 kHz	-46,5 dBm/Hz	
2 208 kHz	100 Ω	-7,8 dBm	10 kHz	-47,8 dBm/Hz	
2 500 kHz	100 Ω	-19,4 dBm	10 kHz	-59,4 dBm/Hz	
3 001,5 kHz	100 Ω	-40 dBm	10 kHz	-80 dBm/Hz	
3 175 kHz	100 Ω	-60 dBm	10 kHz	-100 dBm/Hz	
30 000 kHz	100 Ω	-60 dBm	10 kHz	-100 dBm/Hz	
25 kHz	100 Ω	+10 dBm	100 kHz	-40 dBm/Hz	
1 104 kHz	100 Ω	+10 dBm	100 kHz	-40 dBm/Hz	
1 622 kHz	100 Ω	0 dBm	100 kHz	-50 dBm/Hz	
2 208 kHz	100 Ω	-1,3 dBm	100 kHz	-51,3 dBm/Hz	
2 500 kHz	100 Ω	-12,9 dBm	100 kHz	-62,9 dBm/Hz	
3 001,5 kHz	100 Ω	-33,5 dBm	100 kHz	-83,5 dBm/Hz	
3 175 kHz	100 Ω	-50 dBm	100 kHz	-100 dBm/Hz	
3 175 kHz	100 Ω	-40 dBm	1 MHz	-100 dBm/Hz	
3 750 kHz	100 Ω	-40 dBm	1 MHz	-100 dBm/Hz	
4 545 kHz	100 Ω	-50 dBm	1 MHz	-110 dBm/Hz	
7 225 kHz	100 Ω	-52 dBm	1 MHz	-112 dBm/Hz	
30 000 kHz	100 Ω	-52 dBm	1 MHz	-112 dBm/Hz	

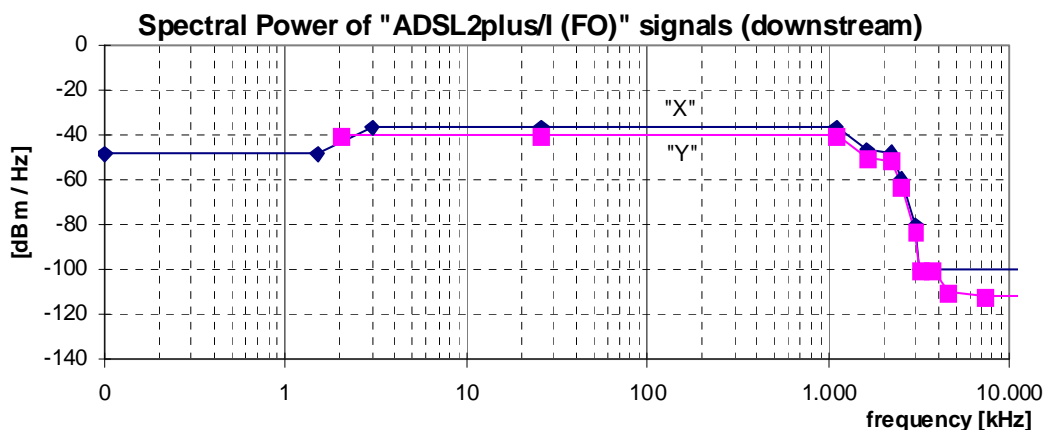

Figure 55: Spectral Power, for downstream "ADSL2plus/l (FO)" signals, as specified in table 90

11.9.5 Narrow-band signal power (upstream only)

The present document provides information on how compliance with this signal category can be achieved and indicates the relevant specification(s):

To be compliant with this signal category, the Narrow-Band Signal Power (NBSP) into a resistive load impedance R , shall not exceed the limits given in table 91, at any point in the frequency range 100 Hz to 30 MHz. This table specifies the break points of these limits. Limits for intermediate frequencies can be found by drawing a straight line between the break points on a logarithmic (Hz) - linear (dB) scale. Figure 56 illustrates the NBSP in a bandwidth-normalized way.

The NBSP is the average power P of a sending signal into a load resistance R , within a *power* bandwidth B . The measurement method of the NBSP is described in clause 13.2.

NOTE: The NBSP specification of this signal category has been split into two overlapping limits: "X" and "Y". The reason for this split is the same as described in the NBSP descriptions for ADSL, e.g. clause 11.1.5.

Reference: ITU-T Recommendation G.992.5 [i.12], clause I.2.2 reconstructed from PSD requirements.

Table 91: Break points of the narrow-band power limits

Centre frequency f	Impedance R	Signal Level P	Power bandwidth B	Spectral Power P/B	
0,1 kHz	600 Ω	-26,5 dBm	100 Hz	-46,5 dBm/Hz	"X"
1,5 kHz	600 Ω	-26,5 dBm	100 Hz	-46,5 dBm/Hz	
3 kHz	600 Ω	-14,5 dBm	100 Hz	-34,5 dBm/Hz	
10 kHz	100 Ω	+5,5 dBm	10 kHz	-34,5 dBm/Hz	
138 kHz	100 Ω	+5,5 dBm	10 kHz	-34,5 dBm/Hz	
243 kHz	100 Ω	-53,2 dBm	10 kHz	-93,2 dBm/Hz	
686 kHz	100 Ω	-60 dBm	10 kHz	-100 dBm/Hz	
5 275 kHz	100 Ω	-60 dBm	10 kHz	-100 dBm/Hz	
30 000 kHz	100 Ω	-60 dBm	10 kHz	-100 dBm/Hz	
25 kHz	100 Ω	+12 dBm	100 kHz	-38 dBm/Hz	
138 kHz	100 Ω	+12 dBm	100 kHz	-38 dBm/Hz	
243 kHz	100 Ω	-46,7 dBm	100 kHz	-96,7 dBm/Hz	
686 kHz	100 Ω	-50 dBm	100 kHz	-100 dBm/Hz	
1 411 kHz	100 Ω	-50 dBm	100 kHz	-100 dBm/Hz	
1 411 kHz	100 Ω	-40 dBm	1 MHz	-100 dBm/Hz	
1 630 kHz	100 Ω	-50 dBm	1 MHz	-110 dBm/Hz	
5 275 kHz	100 Ω	-52 dBm	1 MHz	-112 dBm/Hz	
30 000 kHz	100 Ω	-52 dBm	1 MHz	-112 dBm/Hz	

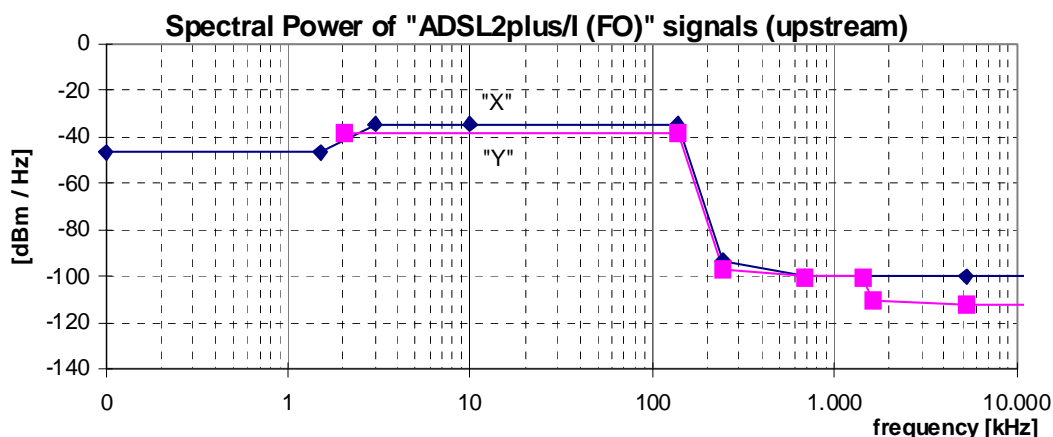

Figure 56: Spectral Power, for upstream "ADSL2plus/I (FO)" signals, as specified in table 91

11.9.6 Unbalance about earth (upstream and downstream)

The description of this signal characteristic equals that of "ADSL2plus/A (FO)".

11.10 "ADSL2plus/I (FDD)" signals (all digital mode)

This category covers signals, generated by ADSL2plus transmission equipment, which uses Frequency Division Duplexing (FDD) to separate upstream and downstream. In this mode, the usable frequency band of downstream signals is narrower and not overlapping the upstream, but adjacent to it, to minimize self-NEXT. Therefore both downstream and upstream of "ADSL2plus/I (FDD)" also fulfil the requirements of "ADSL2plus/I (FO)" signals, as described in a previous clause of the present document. These signals do not share the same wire pair with POTS or ISDN signals.

This clause is based on ITU-T Recommendation G992.5 [i.12]. A signal can be classified as an "ADSL2plus/I (FDD)" signal if it is compliant with all clauses below.

11.10.1 Total signal power (downstream only)

The description of this signal characteristic equals that of "ADSL2plus/A (FDD)".

Reference: ITU-T Recommendation G.992.5 [i.12], clause I.1.3.2.

11.10.2 Total signal power (upstream only)

The description of this signal characteristic equals that of "ADSL2plus/I (FO)".

11.10.3 Peak amplitude (upstream and downstream)

The description of this signal characteristic equals that of "ADSL2plus/I (FO)".

11.10.4 Narrow-band signal power (downstream only)

The present document provides information on how compliance with this signal category can be achieved and indicates the relevant specification(s):

The description of this signal characteristic equals that of "ADSL2plus/A (FDD)".

Reference: ITU-T Recommendation G.992.5 [i.12], clause I.1.3.

NOTE: There is one modification on the PSD mask, namely: For $0 < f < 4$ kHz, the PSD shall be below -97,5 kHz (no extra limitation of max power in 0 kHz to 4 kHz band).

11.10.5 Narrow-band signal power (upstream only)

The description of this signal characteristic equals that of "ADSL2plus/I (FO)".

11.10.6 Unbalance about earth (upstream and downstream)

The description of this signal characteristic equals that of "ADSL2plus/A (FO)".

11.11 "ADSL2plus/J (FO)" signals (all digital, extended US)

This category, "ADSL2plus/J (FO)", covers signals, generated by ADSL2plus transmission equipment, for which the downstream spectrum overlaps the (extended) upstream spectrum (Frequency Overlap). These signals do not share the same wire pair with POTS or ISDN signals.

This clause is based on ITU-T Recommendation G.992.5 [i.12]. A signal can be classified as an "ADSL2plus/J" signal if it is compliant with all clauses below.

11.11.1 Total signal power (downstream only)

The description of this signal characteristic equals that of "ADSL2plus/I (FO)".

Reference: ITU-T Recommendation G.992.5 [i.12], clause J.1.2.2.

11.11.2 Total signal power (upstream only)

The present document provides information on how compliance with this signal category can be achieved and indicates the relevant specification(s):

To be compliant with this signal category, the mean upstream signal power into a resistive load of 100 Ω shall not exceed a level of +13,4 dBm, measured within a frequency band from at least 4 kHz to 3 MHz.

Reference: ITU-T Recommendation G.992.5 [i.12], clause J.2.2.2.

11.11.3 Peak amplitude (upstream and downstream)

The description of this signal characteristic equals that of "ADSL2plus/I (FO)".

11.11.4 Narrow-band signal power (downstream only)

The description of this signal characteristic equals that of "ADSL2plus/I (FO)".

Reference: ITU-T Recommendation G.992.5 [i.12], clause J.1.2.

11.11.5 Narrow-band signal power (upstream only)

The present document provides information on how compliance with this signal category can be achieved and indicates the relevant specification(s):

To be compliant with this signal category, the Narrow-Band Signal Power (NBSP) into a resistive load impedance R , shall not exceed the limits given in table 93, at any point in the frequency range 100 Hz to 30 MHz. This table specifies the break points of these limits.

The ITU-T Recommendation G.992.5 [i.12], clause J.2.2 describes a family of 9 different upstream spectral mask called ADLU-32, ADLU-36 up to ADLU-64. The passband is defined as the band from 3 kHz tot an upperbound frequency f_1 which corresponds with the frequency spacing of the highest DMT symbol used in the passband. E.g. mask ADLU-32 defines an upstream mask with a its passband up to DMT symbol 32 corresponding with a upperbound frequency of 138 kHz. The NBSP specification in table 93 is based on the In-band Peak PSD (dBm/Hz) of ADLU-32 while the Frequency f_1 (kHz), Intercept Frequency f_{int} (kHz) and Intercept PSD Level PSD_{int} (dBm/Hz) are based on ADLU-64, ITU-T Recommendation G.992.5 [i.12], clause J.2.2, table J.3.

Limits for intermediate frequencies can be found by drawing a straight line between the break points on a logarithmic (Hz) - linear (dB) scale. Figure 57 illustrates the NBSP in a bandwidth-normalized way.

The NBSP is the average power P of a sending signal into a load resistance R , within a power bandwidth B . The measurement method of the NBSP is described in clause 13.2.

NOTE: The NBSP specification of this signal category has been split into two overlapping limits: "X" and "Y".
The reason for this split is the same as described in the NBSP descriptions for ADSL, e.g. clause 11.1.5.

Reference: ITU-T Recommendation G.992.5 [i.12], clause J.2.2 reconstructed from PSD requirements.

Table 92: Break points of the narrow-band power limits

Centre frequency f	Impedance R	Signal Level P	Power bandwidth B	Spectral Power P/B	
0,1 kHz	100 Ω	-26,5 dBm	100 Hz	-46,5 dBm/Hz	"X"
1,5 kHz	100 Ω	-26,5 dBm	100 Hz	-46,5 dBm/Hz	
3 kHz	100 Ω	-14,5 dBm	100 Hz	-34,5 dBm/Hz	
10 kHz	100 Ω	+5,5 dBm	10 kHz	-34,5 dBm/Hz	"X"
276 kHz	100 Ω	+5,5 dBm	10 kHz	-34,5 dBm/Hz	
493,41 kHz	100 Ω	-57,9 dBm	10 kHz	-97,9 dBm/Hz	
686 kHz	100 Ω	-60 dBm	10 kHz	-100 dBm/Hz	
5 275 kHz	100 Ω	-60 dBm	10 kHz	-100 dBm/Hz	
30 000 kHz	100 Ω	-60 dBm	10 kHz	-100 dBm/Hz	
25 kHz	100 Ω	+12 dBm	100 kHz	-38 dBm/Hz	"Y"
276 kHz	100 Ω	+12 dBm	100 kHz	-38 dBm/Hz	
493,41 kHz	100 Ω	-50 dBm	100 kHz	-100 dBm/Hz	
686 kHz	100 Ω	-50 dBm	100 kHz	-100 dBm/Hz	
1 411 kHz	100 Ω	-50 dBm	100 kHz	-100 dBm/Hz	
1 411 kHz	100 Ω	-40 dBm	1 MHz	-100 dBm/Hz	
1 630 kHz	100 Ω	-50 dBm	1 MHz	-110 dBm/Hz	
5 275 kHz	100 Ω	-52 dBm	1 MHz	-112 dBm/Hz	
30 000 kHz	100 Ω	-52 dBm	1 MHz	-112 dBm/Hz	

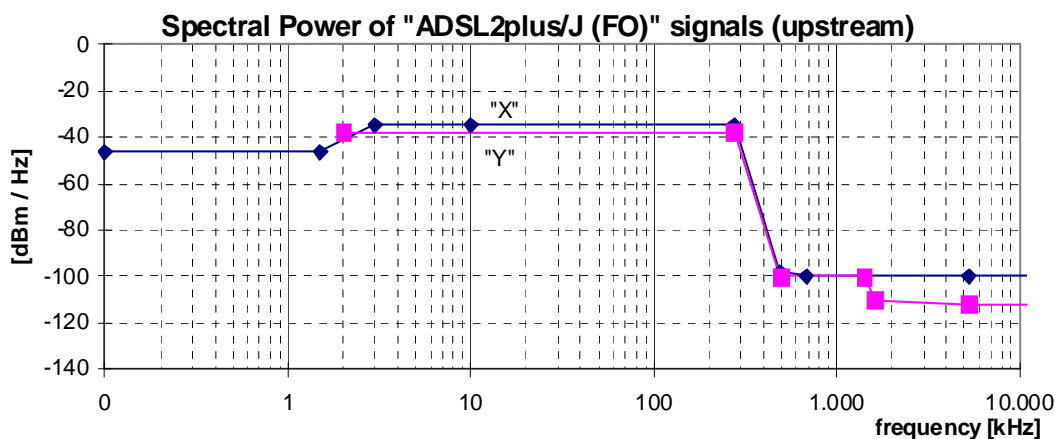

Figure 57: Spectral Power, for upstream "ADSL2plus/J (FO)" signals, as specified in table 92

11.11.6 Unbalance about earth (upstream and downstream)

The description of this signal characteristic equals that of "ADSL2plus/B (FO)".

11.12 "ADSL2plus/J (FDD)" signals (all digital, extended US)

This category covers signals, generated by ADSL2plus transmission equipment, which uses Frequency Division Duplexing (FDD) to separate upstream and downstream, and uses an extended upstream. In this mode, the usable frequency band of downstream signals is narrower and not overlapping the upstream, but adjacent to it, to minimize self-NEXT. Therefore both downstream and upstream of "FDD.ADSL2plus/J" also fulfil the requirements of "ADSL2plus/J (FO)" signals, as described in a previous clause of the present document.

These signals do not share the same wire pair with POTS or ISDN signals.

This clause is based on ITU-T Recommendation G992.5 [i.12]. A signal can be classified as an "ADSL2plus/J (FDD)" signal if it is compliant with all clauses below.

11.12.1 Total signal power (downstream only)

The description of this signal characteristic equals that of "ADSL2plus/B (FDD)".

Reference: ITU-T Recommendation G.992.5 [i.12], clause J.1.3.2.

11.12.2 Total signal power (upstream only)

The description of this signal characteristic equals that of "ADSL2plus/J (FO)".

11.12.3 Peak amplitude (upstream and downstream)

The description of this signal characteristic equals that of "ADSL2plus/J (FO)".

11.12.4 Narrow-band signal power (downstream only)

The description of this signal characteristic equals that of "ADSL2plus/B (FDD)".

Reference: ITU-T Recommendation G.992.5 [i.12], clause J.1.3.

11.12.5 Narrow-band signal power (upstream only)

The description of this signal characteristic equals that of "ADSL2plus/J (FO)".

Reference: ITU-T Recommendation G.992.5 [i.12], clause J.2.2.

11.12.6 Unbalance about earth (upstream and downstream)

The description of this signal characteristic equals that of "ADSL2plus/B (FO)".

11.13 "ADSL2plus/M (FO)" signals (over POTS, extended US)

This category covers signals, generated by ADSL2plus transmission equipment, for which the downstream spectrum overlaps the (extended) upstream spectrum (Frequency Overlap). These signals may share the same wire pair with POTS signals.

This clause is based on ITU-T Recommendation G.992.5 [i.12]. A signal can be classified as an "ADSL2plus/M (FO)" signal if it is compliant with all clauses below.

11.13.1 Total signal power (downstream only)

The description of this signal characteristic equals that of "ADSL2plus/A (FO)".

Reference: ITU-T Recommendation G.992.5 [i.12], clause M.1.2.2.

11.13.2 Total signal power (upstream only)

The present document provides information on how compliance with this signal category can be achieved and indicates the relevant specification(s):

To be compliant with this signal category, the mean upstream signal power into a resistive load of 100 Ω shall not exceed a level of +12,5 dBm, measured within a frequency band from at least 4 kHz to 3 MHz.

Reference: ITU-T Recommendation G.992.5 [i.12], clause M.2.2.2.

11.13.3 Peak amplitude (upstream and downstream)

The description of this signal characteristic equals that of "ADSL2plus/I (FO)".

11.13.4 Narrow-band signal power (downstream only)

The description of this signal characteristic equals that of "ADSL2plus/A (FO)".

Reference: ITU-T Recommendation G.992.5 [i.12], clause M.1.2.

11.13.5 Narrow-band signal power (upstream only)

The present document provides information on how compliance with this signal category can be achieved and indicates the relevant specification(s):

To be compliant with this signal category, the Narrow-Band Signal Power (NBSP) into a resistive load impedance R , shall not exceed the limits given in table 93, at any point in the frequency range 100 Hz to 30 MHz. This table specifies the break points of these limits.

The ITU-T Recommendation G.992.5 [i.12], clause M.2.2 describes a family of 9 different upstream spectral mask called EU-32, EU-36 up to EU-64. The passband is defined as the band from 3 kHz tot an upperbound frequency f_1 which corresponds with the frequency spacing of the highest DMT symbol used in the passband. E.g. mask EU-32 defines an upstream mask with a its passband up to DMT symbol 32 corresponding with a upperbound frequency of 138 kHz. The NBSP specification in table 15 is based on the In-band Peak PSD (dBm/Hz) of EU-32 while the Frequency f_1 (kHz), Intercept Frequency f_{int} (kHz) and Intercept PSD Level PSD_{int} (dBm/Hz) are based on EU-64, ITU-T Recommendation G.992.5 [i.12], clause M.2.2, table M.3.

Limits for intermediate frequencies can be found by drawing a straight line between the break points on a logarithmic (Hz) - linear (dB) scale. Figure 58 illustrates the NBSP in a bandwidth-normalized way.

The NBSP is the average power P of a sending signal into a load resistance R , within a *power* bandwidth B . The measurement method of the NBSP is described in clause 13.2.

NOTE: The NBSP specification of this signal category has been split into two overlapping limits: "X" and "Y". The reason for this split is the same as described in the NBSP descriptions for ADSL, e.g. clause 11.1.5.

Reference: ITU-T Recommendation G.992.5 [i.12], clause M.2.2 reconstructed from PSD requirements.

Table 93: Break points of the narrow-band power limits

Centre frequency f	Impedance R	Signal Level P	Power bandwidth B	Spectral Power P/B	
0,1 kHz	100 Ω	-77,5 dBm	100 Hz	-97,5 dBm/Hz	"X"
4 kHz	100 Ω	-77,5 dBm	100 Hz	-97,5 dBm/Hz	
4 kHz	100 Ω	-72,5 dBm	100 Hz	-92,5 dBm/Hz	
25,875 kHz	100 Ω	+5,5 dBm	10 kHz	-34,5 dBm/Hz	"Y"
276 kHz	100 Ω	+5,5 dBm	10 kHz	-34,5 dBm/Hz	
493,41 kHz	100 Ω	-57,9 dBm	10 kHz	-97,9 dBm/Hz	
686 kHz	100 Ω	-60 dBm	10 kHz	-100 dBm/Hz	
5 275 kHz	100 Ω	-60 dBm	10 kHz	-100 dBm/Hz	
30 000 kHz	100 Ω	-60 dBm	10 kHz	-100 dBm/Hz	

Centre frequency f	Impedance R	Signal Level P	Power bandwidth B	Spectral Power P/B	
60 kHz	100 Ω	+12 dBm	100 kHz	-38 dBm/Hz	"Y"
276 kHz	100 Ω	+12 dBm	100 kHz	-38 dBm/Hz	
493,41 kHz	100 Ω	-50 dBm	100 kHz	-100 dBm/Hz	
686 kHz	100 Ω	-50 dBm	100 kHz	-100 dBm/Hz	
1 411 kHz	100 Ω	-50 dBm	100 kHz	-100 dBm/Hz	
1 411 kHz	100 Ω	-40 dBm	1 MHz	-100 dBm/Hz	
1 630 kHz	100 Ω	-50 dBm	1 MHz	-110 dBm/Hz	
5 275 kHz	100 Ω	-52 dBm	1 MHz	-112 dBm/Hz	
30 000 kHz	100 Ω	-52 dBm	1 MHz	-112 dBm/Hz	

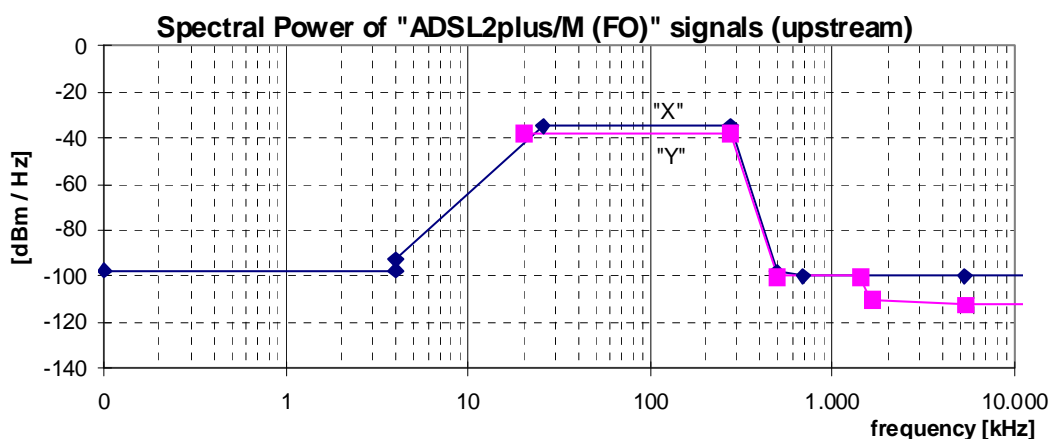

Figure 58: Spectral Power, for upstream ADSL2plus/M (FO) signals, as specified in table 93

11.13.6 Unbalance about earth (upstream and downstream)

The description of this signal characteristic equals that of "ADSL2plus/B (FO)".

11.14 "ADSL2plus/M (FDD)" signals (over POTS, extended US)

This category covers signals, generated by ADSL2plus transmission equipment, which uses Frequency Division Duplexing (FDD) to separate upstream and downstream. In this mode, the usable frequency band of downstream signals is narrower and not overlapping the upstream, but adjacent to it, to minimize self-NEXT. Therefore both downstream and upstream signals of "ADSL2plus/M (FDD)" also fulfil the requirements of "ADSL2plus/M (FO)" signals, as described in a previous clause of the present document.

These signals may share the same wire pair with POTS signals.

This clause is based on ITU-T Recommendation G.992.5 [i.12]. A signal can be classified as an "ADSL2plus/M (FDD)" signal if it is compliant with all clauses below.

11.14.1 Total signal power (downstream only)

The description of this signal characteristic equals that of "ADSL2plus/B (FDD)".

Reference: ITU-T Recommendation G.992.5 [i.12], clause M.1.3.2.

11.14.2 Total signal power (upstream only)

The description of this signal characteristic equals that of "ADSL2plus/M (FO)".

Reference: ITU-T Recommendation G.992.5 [i.12], clause M.2.2.2.

11.14.3 Peak amplitude (upstream and downstream)

The description of this signal characteristic equals that of "ADSL2plus/M (FO)".

11.14.4 Narrow-band signal power (downstream only)

The description of this signal characteristic equals that of "ADSL2plus/B (FDD)".

Reference: ITU-T Recommendation G.992.5 [i.12], clause M.1.3.

11.14.5 Narrow-band signal power (upstream only)

The description of this signal characteristic equals that of "ADSL2plus/M (FO)".

Reference: ITU-T Recommendation G.992.5 [i.12], clause M.2.2.

11.14.6 Unbalance about earth (upstream and downstream)

The description of this signal characteristic equals that of "ADSL2plus/B (FO)".

12 Cluster 5 signals (broadband up to 30 MHz)

12.1 "VDSL2-NL1" signals ("over POTS")

This category covers signals up to 12 MHz, generated by VDSL2 transmission equipment using band plan 998 (limit PSD mask B8-4). These signals may share the same wire pair with POTS signals. This signal description is derived from the ITU VDSL2 recommendation [i.14] and accounts for Power Back-Off in both downstream (DPBO, also known as PSD shaping) and upstream (UPBO) direction.

- The downstream signal limits are dependent on the *attenuation distance* between the local exchange and cabinet ("primary cable"), defined as the insertion loss (IL) of that loop measured at 300 kHz into a resistive load of 100 Ω . These limits are specified for a discrete number of (integer) attenuation distances. For all other attenuation distances, the downstream limits for the nearest specified IL-values apply, and not by means of interpolating the limits.
- The upstream signal limits are fixed, but defined in such a way that the actual transmit levels changes with the insertion loss between cabinet and customer premises.

A signal can be classified as a "VDSL2-NL1" signal if it is compliant with all clauses below.

12.1.1 Total signal power (downstream only)

The present document provides information on how compliance with this signal category can be achieved and indicates the relevant specification(s):

To be compliant with this signal category, the mean downstream signal power into a resistive load of 100 Ω shall not exceed the levels given in table 94, measured within a frequency band from at least 4 kHz to 30 MHz. In the special case of VDSL2 deployment from the local exchange, the limits associated with IL=0 apply.

Reference: ITU-T Recommendation G.993.2 [i.14], chapter 6.

Table 94: Total downstream transmit power as function of the measured insertion loss of the loop between local exchange and cabinet

IL (dB @ 300 kHz)	Downstream Total signal power (dBm)	L (m)
0	21,28	0
1	20,11	101
2	19,02	202
3	18,02	303
4	17,09	404
5	16,26	506
6	15,51	607
7	14,85	708
8	14,27	809
9	13,77	910
10	13,37	1 011
11	12,95	1 112
12	12,65	1 213
13	12,4	1 315
14	12,2	1 416
15	12,04	1 517
16	11,91	1 618
17	11,81	1 719
18	11,73	1 820
19	11,66	1 921
20	11,6	2 022
21	11,55	2 123
22	11,52	2 225
23	11,48	2 326
24	11,46	2 427
25	11,7	2 528
26	11,91	2 629
27	12,15	2 730
28	12,36	2 831
29	12,55	2 932
30	12,7	3 034
31	12,82	3 135
32	12,98	3 236
33	13,15	3 337
34	13,32	3 438
35	13,56	3 539
36	13,8	3 640
37	14,03	3 741
38	14,36	3 842
39	14,67	3 944
40	14,98	4 045
41	15,36	4 146
42	16,07	4 247
43	16,63	4 348
44	17,11	4 449
45	17,49	4 550
>45	17,5	>4 550

NOTE 1: The IL-values are normative. The L-values are informative and represent estimated loop lengths for a commonly used Dutch cable.

NOTE 2: These power levels can be different from those being defined or implied by ITU-T Recommendation G.993.2 [i.14]. Lower values are imposed at certain attenuation distances if the downstream power back-off (as defined in tables 95 and 96) requires this. Higher values are granted on other attenuation distances if the levels of modems in other wire pairs allow this. Current implementations of VDSL2 transmitters, compliant with [i.14], are not expected to be capable of generating output powers of more than 20,5 dBm.

NOTE 3: The power limit specified for IL > 45 dB may be too restrictive for VDSL2; refinement is for further study.

12.1.2 Total signal power (upstream only)

The present document provides information on how compliance with this signal category can be achieved and indicates the relevant specification(s):

To be compliant with this signal category, the mean upstream signal power into a resistive load of 100 Ω shall not exceed a level of +14,5 dBm, measured within a frequency band from at least 4 kHz to 30 MHz. Note that this limit is an upper limit only; the actual level may be significantly lower when the additional upstream receive limits (see table 98 and figure 62) require a strong power back-off in short loops.

Reference: ITU-T Recommendation G.993.2 [i.14], chapter 6.

12.1.3 Peak amplitude (upstream and downstream)

The present document provides information on how compliance with this signal category can be achieved:

To be compliant with this signal category, the nominal voltage peak of the largest signal pulse into a resistive load of 100 Ω shall not exceed a level of 19V (38 V peak-peak), measured within a frequency band from at least 100 Hz to 30 MHz. The definition and measurement method of peak amplitude is specified in clause 13.1.

12.1.4 Narrow-band signal power (downstream only)

The present document provides information on how compliance with this signal category can be achieved and indicates the relevant specification(s):

To be compliant with this signal category, the Narrow-Band Signal Power (NBSP) into a resistive load impedance R for a given attenuation distance, shall not exceed the limits given in tables 95 and 96, at any point in the frequency range 100 Hz to 30 MHz. These tables specify the break points of these limits. Limits for intermediate frequencies can be found by drawing a straight line between the break points on a logarithmic (Hz) - linear (dB) scale below 2 500 kHz and on a linear (Hz) - linear (dB) scale above 2 500 kHz. Figures 59 and 60 illustrate the NBSP in a bandwidth-normalized way.

The NBSP is the average power P of a sending signal into a load resistance R , within a *power* bandwidth B . The measurement method of the NBSP is described in clause 13.2.

NOTE 1: The NBSP specification in table 95 is reconstructed from the commonly used PSD specifications in [i.14] (similar to figure 59), and used here since the NBSP approach is much wider applicable. This enables a unified specification method. PSD specifications are adequate when signals are purely random in nature, but cannot cover harmonic components in a signal (would cause infinite high "PSD" levels at these harmonic frequencies). NBSP specifications cover both signal types.

NOTE 2: The NBSP specification of this signal category has been split into three overlapping limits: "X", "Y" and "Z". All these upper limits shall hold simultaneously. The 10 kHz bandwidth values represent the "peak PSD values" from [i.14], and include the pass band ripple. The 100 kHz bandwidth values represent the "nominal PSD values" in the passband to smooth out the spectral ripple of 3,5 dB. The 1 MHz bandwidth specification is equivalent to the sliding window specification, being common for ADSL (see [i.10] and [i.11]).

NOTE 3: The description of this signal characteristic is derived from "VDSL2 band plan 998" signals with PSD mask "B8-4". Downstream PSD Shaping has been applied between 80 KHz and 2 500 kHz.

Reference: ITU-T Recommendation G.993.2 [i.14], clause B.2.5.

Table 95: Break points of the NBSP limits, of the downstream transmit signal

Centre frequency f	Impedance R	Signal Level P	Power bandwidth B	Spectral Power P/B	
0,1 kHz	600 Ω	-77,5 dBm	100 Hz	-97,5 dBm/Hz	"X"
4 kHz	600 Ω	-77,5 dBm	100 Hz	-97,5 dBm/Hz	
4 kHz	100 Ω	-52,5 dBm	10 kHz	-92,5 dBm/Hz	"Y"
f ₁	100 Ω	P ₁ + 40 dB	10 kHz	P ₁	
f ₂	100 Ω	P ₂ + 40 dB	10 kHz	P ₂	
f ₃	100 Ω	P ₃ + 40 dB	10 kHz	P ₃	
f ₄	100 Ω	P ₄ + 40 dB	10 kHz	P ₄	
f ₅	100 Ω	P ₅ + 40 dB	10 kHz	P ₅	
f ₆	100 Ω	P ₆ + 40 dB	10 kHz	P ₆	
f ₇	100 Ω	P ₇ + 40 dB	10 kHz	P ₇	
f ₈	100 Ω	P ₈ + 40 dB	10 kHz	P ₈	
f ₉	100 Ω	P ₉ + 40 dB	10 kHz	P ₉	
f ₁₀	100 Ω	P ₁₀ + 40 dB	10 kHz	P ₁₀	
f ₁₁	100 Ω	P ₁₁ + 40 dB	10 kHz	P ₁₁	
f ₁₂	100 Ω	P ₁₂ + 40 dB	10 kHz	P ₁₂	
f ₁₃	100 Ω	P ₁₃ + 40 dB	10 kHz	P ₁₃	
f ₁₄	100 Ω	P ₁₄ + 40 dB	10 kHz	P ₁₄	
2 500 kHz	100 Ω	-8,8 dBm	10 kHz	-48,8 dBm/Hz	
3 749,999 kHz	100 Ω	-11,2 dBm	10 kHz	-51,2 dBm/Hz	
3 750 kHz	100 Ω	-40 dBm	10 kHz	-80 dBm/Hz	
3 925 kHz	100 Ω	-60 dBm	10 kHz	-100 dBm/Hz	
4 925 kHz	100 Ω	-60 dBm	10 kHz	-100 dBm/Hz	
5 025 kHz	100 Ω	-60 dBm	10 kHz	-100 dBm/Hz	
5 199,999 kHz	100 Ω	-40 dBm	10 kHz	-80 dBm/Hz	
5 200 kHz	100 Ω	-12,7 dBm	10 kHz	-52,7 dBm/Hz	
8 499,999 kHz	100 Ω	-14,8 dBm	10 kHz	-54,8 dBm/Hz	
8 500 kHz	100 Ω	-40 dBm	10 kHz	-80 dBm/Hz	
8 675 kHz	100 Ω	-60 dBm	10 kHz	-100 dBm/Hz	
30 000 kHz	100 Ω	-60 dBm	10 kHz	-100 dBm/Hz	
50 kHz	100 Ω	-46 dBm	100 kHz	-96 dBm/Hz	
f ₁	100 Ω	P ₁ + 46,5 dB	100 kHz	P ₁ -3,5 dB	
f ₂	100 Ω	P ₂ + 46,5 dB	100 kHz	P ₂ -3,5 dB	
f ₃	100 Ω	P ₃ + 46,5 dB	100 kHz	P ₃ -3,5 dB	
f ₄	100 Ω	P ₄ + 46,5 dB	100 kHz	P ₄ -3,5 dB	
f ₅	100 Ω	P ₅ + 46,5 dB	100 kHz	P ₅ -3,5 dB	
f ₆	100 Ω	P ₆ + 46,5 dB	100 kHz	P ₆ -3,5 dB	
f ₇	100 Ω	P ₇ + 46,5 dB	100 kHz	P ₇ -3,5 dB	
f ₈	100 Ω	P ₈ + 46,5 dB	100 kHz	P ₈ -3,5 dB	
f ₉	100 Ω	P ₉ + 46,5 dB	100 kHz	P ₉ -3,5 dB	
f ₁₀	100 Ω	P ₁₀ + 46,5 dB	100 kHz	P ₁₀ -3,5 dB	
f ₁₁	100 Ω	P ₁₁ + 46,5 dB	100 kHz	P ₁₁ -3,5 dB	
f ₁₂	100 Ω	P ₁₂ + 46,5 dB	100 kHz	P ₁₂ -3,5 dB	
f ₁₃	100 Ω	P ₁₃ + 46,5 dB	100 kHz	P ₁₃ -3,5 dB	
f ₁₄	100 Ω	P ₁₄ + 46,5 dB	100 kHz	P ₁₄ -3,5 dB	
2 500 kHz	100 Ω	-2,3 dBm	100 kHz	-52,3 dBm/Hz	
3 749,999 kHz	100 Ω	-4,5 dBm	100 kHz	-54,7 dBm/Hz	
3 750 kHz	100 Ω	-33,5 dBm	100 kHz	-83,5 dBm/Hz	
3 894 kHz	100 Ω	-50 dBm	100 kHz	-100 dBm/Hz	
3 999,999 kHz	100 Ω	-50 dBm	100 kHz	-100 dBm/Hz	
4 000 kHz	100 Ω	-60 dBm	100 kHz	-110 dBm/Hz	
5 055 kHz	100 Ω	-60 dBm	100 kHz	-110 dBm/Hz	
5 056 kHz	100 Ω	-62 dBm	100 kHz	-99,9 dBm/Hz	
5 199,999 kHz	100 Ω	-33,5 dBm	100 kHz	-83,5 dBm/Hz	

Centre frequency f	Impedance R	Signal Level P	Power bandwidth B	Spectral Power P/B	
5 200 kHz	100 Ω	-6,2 dBm	100 kHz	-56,2 dBm/Hz	
8 499,999 kHz	100 Ω	-8,3 dBm	100 kHz	-58,3 dBm/Hz	
8 500 kHz	100 Ω	-33,5 dBm	100 kHz	-83,5 dBm/Hz	
8 644 kHz	100 Ω	-50 dBm	100 kHz	-100 dBm/Hz	
8 645 kHz	100 Ω	-60 dBm	100 kHz	-110 dBm/Hz	
30 000 kHz	100 Ω	-60 dBm	100 kHz	-110 dBm/Hz	
9 145 kHz	100 Ω	-52 dBm	1 MHz	-112 dBm/Hz	"Z"
30 000 kHz	100 Ω	-52 dBm	1 MHz	-112 dBm/Hz	
NOTE 1: The limits between breakpoints shall be obtained by interpolation between adjacent breakpoints on a dB/ log(f) basis below 2 500 kHz and on a dB/f basis above 2 500 kHz.					
NOTE 2: The limits "Y" between 50 kHz and 2 500 kHz are 3,5 dB lower then the associated limits "X". This may be a bit too restrictive for VDSL2 when the PSD slope in this shaping region becomes steep. Refinements for the limits at these breakpoints require further study.					

Table 96: Definition of parameter f_k and P_k (with $k = 1$ to 14), of the downstream NBSP limits in table 95

IL		f_1 P_1	f_2 P_2	f_3 P_3	f_4 P_4	f_5 P_5	f_6 P_6	f_7 P_7	f_8 P_8	f_9 P_9	f_{10} P_{10}	f_{11} P_{11}	f_{12} P_{12}	f_{13} P_{13}	f_{14} P_{14}
0	f	80	137,999	138	1 104	1 622	2 208	N/A	N/A	N/A	N/A	N/A	N/A	N/A	N/A
	P	-72,5	-44,2	-36,5	-36,5	-46,5	-48	N/A	N/A	N/A	N/A	N/A	N/A	N/A	N/A
1	f	80	137,999	138	600	1 104	1 622	2 208	2 211	N/A	N/A	N/A	N/A	N/A	N/A
	P	-72,5	-44,2	-37,1	-37,7	-38,2	-48,6	-50,3	-48	N/A	N/A	N/A	N/A	N/A	N/A
2	f	80	137,999	138	250	600	1 104	1 622	2 208	2 214	N/A	N/A	N/A	N/A	N/A
	P	-72,5	-44,2	-37,6	-38	-38,9	-39,8	-50,6	-52,7	-48	N/A	N/A	N/A	N/A	N/A
3	f	80	137,999	138	250	400	600	850	1 104	1 622	2 208	2 217	N/A	N/A	N/A
	P	-72,5	-44,2	-38,2	-38,8	-39,5	-40,1	-40,9	-41,5	-52,7	-55,2	-48	N/A	N/A	N/A
4	f	80	137,999	138	250	400	600	850	1 104	1 622	2 208	2 220	N/A	N/A	N/A
	P	-72,5	-44,2	-38,7	-39,5	-40,4	-41,4	-42,3	-43,2	-54,8	-57,6	-48	N/A	N/A	N/A
5	f	80	137,999	138	250	400	600	850	1 104	1 350	1 622	2 208	2 223	N/A	N/A
	P	-72,5	-44,2	-39,3	-40,3	-41,4	-42,6	-43,8	-44,9	-51,1	-56,8	-60,1	-48,1	N/A	N/A
6	f	80	137,999	138	250	400	600	850	1 104	1 350	1 622	2 208	2 226	N/A	N/A
	P	-72,5	-44,2	-39,8	-41,1	-42,4	-43,8	-45,2	-46,5	-52,9	-58,9	-62,5	-48,1	N/A	N/A
7	f	80	137,999	138	250	400	600	850	1 104	1 350	1 622	2 208	2 229	N/A	N/A
	P	-72,5	-44,2	-40,4	-41,8	-43,4	-45	-46,7	-48,2	-54,8	-61	-65	-48,2	N/A	N/A
8	f	80	137,999	138	250	400	600	850	1 104	1 350	1 622	2 208	2 232	N/A	N/A
	P	-72,5	-44,2	-41	-42,6	-44,4	-46,2	-48,1	-49,9	-56,7	-63	-67,5	-48,3	N/A	N/A
9	f	80	137,999	138	250	400	600	850	1 104	1 350	1 622	2 208	2 235	N/A	N/A
	P	-72,5	-44,2	-41,5	-43,3	-45,4	-47,4	-49,6	-51,6	-58,5	-65,1	-69,9	-48,3	N/A	N/A
10	f	80	137,999	138	250	400	600	850	1 104	1 350	1 622	2 208	2 239	N/A	N/A
	P	-72,5	-44,2	-42,1	-44,1	-46,4	-48,7	-51,1	-53,3	-60,5	-67,3	-72,5	-48,1	N/A	N/A
11	f	80	137,999	138	250	400	600	850	1 104	1 350	1 622	2 208	2 242	N/A	N/A
	P	-72,5	-44,2	-42,7	-45	-47,5	-50,1	-52,8	-55,2	-62,6	-69,6	-75,3	-48,2	N/A	N/A
12	f	80	137,999	138	250	400	600	850	1 104	1 350	1 622	2 208	2 246	N/A	N/A
	P	-72,5	-44,2	-43,4	-45,8	-48,6	-51,5	-54,4	-57,1	-64,7	-71,9	-78,1	-48,1	N/A	N/A
13	f	80	137,999	138	250	400	600	850	1 104	1 350	1 622	2 198	2 208	2 248	N/A
	P	-72,5	-44,2	-44	-46,7	-49,7	-52,8	-56	-58,9	-66,8	-74,2	-80,6	-80	-48,1	N/A
14	f	80	137	250	400	600	850	1 104	1 350	1 622	2 162	2 208	2 248	N/A	N/A
	P	-72,5	-44,6	-47,5	-50,7	-54,1	-57,6	-60,7	-68,8	-76,4	-82,9	-80	-48,1	N/A	N/A
15	f	80	136	138	250	400	600	850	1 104	1 350	1 622	2 129	2 208	2 248	N/A
	P	-72,5	-45,1	-45,1	-48,3	-51,8	-55,4	-59,1	-62,5	-70,7	-78,6	-85,1	-80	-48,1	N/A
16	f	80	134	138	250	400	600	850	1 104	1 350	1 622	2 097	2 208	2 248	N/A
	P	-72,5	-45,7	-45,7	-49,1	-52,8	-56,6	-60,6	-64,2	-72,6	-80,7	-87,2	-80	-48,1	N/A
17	f	80	133	138	250	400	600	850	1 104	1 350	1 622	2 067	2 208	2 248	N/A
	P	-72,5	-46,3	-46,3	-49,8	-53,8	-57,8	-62	-65,9	-74,5	-82,8	-89,2	-80	-48,1	N/A
18	f	80	131	138	250	400	600	850	1 104	1 350	1 622	2 039	2 208	2 248	N/A
	P	-72,5	-46,9	-46,8	-50,6	-54,7	-59	-63,5	-67,5	-76,3	-84,8	-91,1	-80	-48,1	N/A
19	f	80	130	138	250	400	600	850	1 104	1 350	1 622	1 912	2 033	2 208	2 248
	P	-72,5	-47,3	-47,3	-51,3	-55,7	-60,2	-64,9	-69,1	-78,1	-86,7	-91,5	-91,5	-80	-48,1
20	f	80	129	138	250	400	600	850	1 104	1 350	1 622	1 782	2 033	2 208	2 248
	P	-72,5	-47,9	-47,9	-52	-56,6	-61,3	-66,2	-70,6	-79,8	-88,7	-91,5	-91,5	-80	-48,1

IL		f_1 P_1	f_2 P_2	f_3 P_3	f_4 P_4	f_5 P_5	f_6 P_6	f_7 P_7	f_8 P_8	f_9 P_9	f_{10} P_{10}	f_{11} P_{11}	f_{12} P_{12}	f_{13} P_{13}	f_{14} P_{14}
21	f	80	127	138	250	400	600	850	1 104	1 350	1 622	1 673	2 033	2 208	2 248
	P	-72,5	-48,5	-48,4	-52,7	-57,5	-62,4	-67,5	-72,2	-81,5	-90,5	-91,5	-91,5	-80	-48,1
22	f	80	126	138	250	400	600	850	1 104	1 350	1 594	2 033	2 208	2 248	N/A
	P	-72,5	-48,9	-48,9	-53,3	-58,3	-63,5	-68,8	-73,6	-83,2	-91,5	-91,5	-80	-48,1	N/A
23	f	80	125	138	250	400	600	850	1 104	1 350	1 540	2 033	2 208	2 248	N/A
	P	-72,5	-49,3	-49,3	-54	-59,2	-64,5	-70,1	-75,1	-84,8	-91,5	-91,5	-80	-48,1	N/A
24	f	80	124	138	250	400	600	850	1 104	1 350	1 491	2 031	2 206	2 246	N/A
	P	-72,5	-49,8	-49,8	-54,6	-60	-65,5	-71,3	-76,5	-86,3	-91,5	-91,5	-80	-48,1	N/A
25	f	80	123	138	250	400	600	850	1 104	1 350	1 447	1 911	2 086	2 126	2 208
	P	-72,5	-50,3	-50,3	-55,2	-60,8	-66,5	-72,5	-77,8	-87,8	-91,5	-91,5	-80	-47,8	-48
26	f	80	122	138	250	400	600	850	1 104	1 350	1 406	1 807	1 982	2 022	2 208
	P	-72,5	-50,7	-50,7	-55,8	-61,6	-67,5	-73,6	-79,2	-89,3	-91,5	-91,5	-80	-47,6	-48
27	f	80	121	138	250	400	600	850	1 104	1 369	1 693	1 868	1 908	2 208	N/A
	P	-72,5	-51,1	-51,1	-56,4	-62,3	-68,4	-74,7	-80,4	-91,5	-91,5	-80	-47,3	-48	N/A
28	f	80	120	138	250	400	600	850	1 104	1 334	1 593	1 768	1 808	2 208	N/A
	P	-72,5	-51,5	-51,5	-57	-63,1	-69,3	-75,8	-81,7	-91,5	-91,5	-80	-47	-48	N/A
29	f	80	119	138	250	400	600	850	1 104	1 301	1 505	1 680	1 720	2 208	N/A
	P	-72,5	-51,9	-51,9	-57,5	-63,8	-70,2	-76,8	-82,9	-91,5	-91,5	-80	-46,8	-48	N/A
30	f	80	118	138	250	400	600	850	1 104	1 270	1 433	1 608	1 648	2 208	N/A
	P	-72,5	-52,3	-52,3	-58,1	-64,5	-71	-77,9	-84	-91,5	-91,5	-80	-46,6	-48	N/A
31	f	80	117	138	250	400	600	850	1 104	1 240	1 380	1 555	1 595	1 622	
	P	-72,5	-52,8	-52,7	-58,6	-65,2	-71,9	-78,9	-85,2	-91,5	-91,5	-80	-46,1	-46,5	-48
32	f	80	116	138	250	400	600	850	1 104	1 205	1 322	1 497	1 538	1 622	2 208
	P	-72,5	-53,2	-53,2	-59,3	-66	-73	-80,2	-86,7	-91,5	-91,5	-80	-45,1	-46,5	-48
33	f	80	115	138	250	400	600	850	1 104	1 172	1 268	1 443	1 485	1 622	2 208
	P	-72,5	-53,7	-53,7	-59,9	-66,9	-74	-81,5	-88,2	-91,5	-91,5	-80	-44,2	-46,5	-48
34	f	80	114	138	250	400	600	850	1 104	1 141	1 217	1 392	1 434	1 622	2 208
	P	-72,5	-54,2	-54,2	-60,6	-67,8	-75,1	-82,7	-89,6	-91,5	-91,5	-80	-43,6	-46,5	-48
35	f	80	113	138	250	400	600	850	1 104	1 111	1 169	1 344	1 387	1 622	2 208
	P	-72,5	-54,7	-54,7	-61,3	-68,6	-76,2	-84	-91,1	-91,5	-91,5	-80	-42,4	-46,5	-48
36	f	80	112	138	250	400	600	850	1 061	1 122	1 297	1 341	1 622	2 208	N/A
	P	-72,5	-55,2	-55,2	-61,9	-69,5	-77,2	-85,3	-91,5	-91,5	-80	-41,6	-46,5	-48	N/A
37	f	80	111	138	250	400	600	850	1 009	1 077	1 252	1 296	1 622	2 208	N/A
	P	-72,5	-55,7	-55,7	-62,6	-70,4	-78,3	-86,6	-91,5	-91,5	-80	-41	-46,5	-48	N/A
38	f	80	110	138	250	400	600	850	962	1 036	1 211	1 256	1 622	2 208	N/A
	P	-72,5	-56,2	-56,2	-63,3	-71,2	-79,4	-87,9	-91,5	-91,5	-80	-39,9	-46,5	-48	N/A
39	f	80	109	138	250	400	600	850	919	996	1 171	1 217	1 622	2 208	N/A
	P	-72,5	-56,6	-56,6	-63,9	-72,1	-80,5	-89,2	-91,5	-91,5	-80	-39	-46,5	-48	N/A
40	f	80	108	138	250	400	600	850	880	959	1 134	1 180	1 622	2 208	N/A
	P	-72,5	-57,1	-57,1	-64,6	-73	-81,5	-90,4	-91,5	-91,5	-80	-38,3	-46,5	-48	N/A
41	f	80	107	138	250	400	600	843	921	1 096	1 143	1 622	2 208	N/A	N/A
	P	-72,5	-57,6	-57,6	-65,3	-73,8	-82,6	-91,5	-91,5	-80	-37,4	-46,5	-48	N/A	N/A
42	f	80	106	138	250	400	600	803	857	1 032	1 079	1 104	1 622	2 208	N/A
	P	-72,5	-58,1	-58,1	-66	-74,7	-83,7	-91,5	-91,5	-80	-36,5	-36,5	-46,5	-48	N/A
43	f	80	105	138	250	400	600	768	800	975	1 021	1 104	1 622	2 208	N/A
	P	-72,5	-58,6	-58,6	-66,6	-75,6	-84,8	-91,5	-91,5	-80	-36,7	-36,5	-46,5	-48	N/A
44	f	80	104	138	250	400	600	735	749	924	970	1 104	1 622	2 208	N/A
	P	-72,5	-59,1	-59,1	-67,3	-76,4	-85,8	-91,5	-91,5	-80	-36,5	-36,5	-46,5	-48	N/A
45	f	80	103	138	250	400	600	703	877	922	1 104	1 622	2 208	N/A	N/A
	P	-72,5	-59,6	-59,6	-68	-77,3	-86,9	-91,4	-80	-36,5	-36,5	-46,5	-48	N/A	N/A
>45	f	80	103	138	250	400	600	703	877	922	1 104	1 622	2 208	N/A	N/A
	P	-91,5	-91,5	-91,5	-91,5	-91,5	-91,5	-91,4	-80	-36,5	-36,5	-46,5	-48	N/A	N/A

NOTE 1: The label "N/A" denotes that a breakpoint is not used. The equivalent physical cable length L of the cable (last column of the table) is for information only, and estimated from a 0,5 mm GPLK cable model (model "KPN_L1", also known as "TP 150" in [i.13]).

NOTE 2: The breakpoints for IL > 45 dB may be too restrictive for VDSL2, refinements are for further study.

In the special case that VDSL2 is deployed from the local exchange, the attenuation length is zero (IL=0), and the associated rows from the table apply. Figure 59 illustrates the limits of the spectral powers (measured in 10 kHz and in 100 kHz) as function of the frequency, according to the specifications in tables 95 and 96.

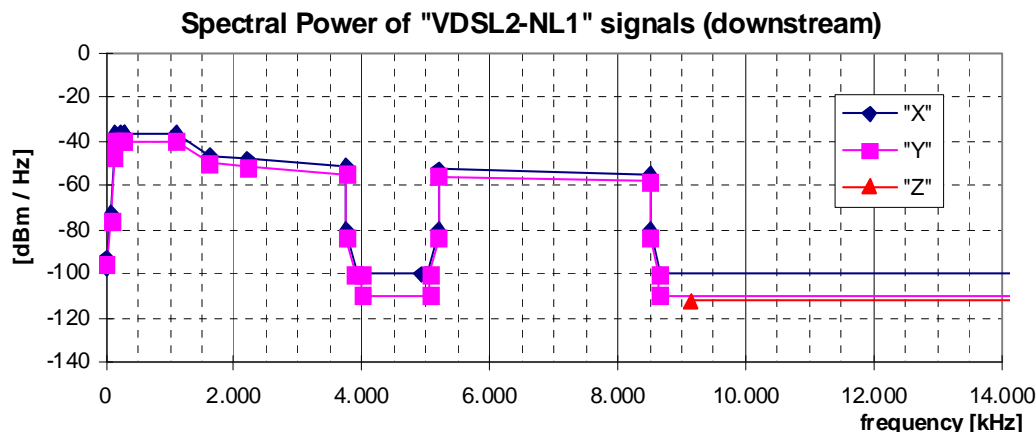

Figure 59: Spectral Power for "VDSL2-NL1" downstream signals, as specified in tables 95 and 96 for IL=0 dB

When VDSL2 is deployed from the cabinet, shaping of the above spectral powers can be significant between 134 kHz and 2 500 kHz. Figure 60 illustrates the limits of these spectral powers (measured in 10 kHz and in 100 kHz) for various attenuation distances (for IL=10 dB, IL=20 dB and IL=40 dB).

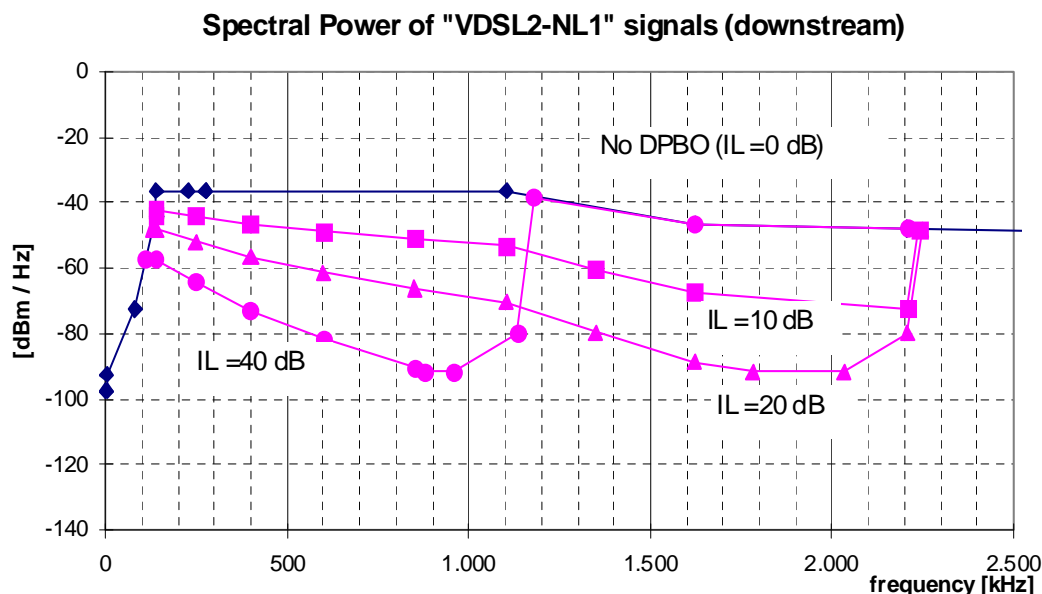

Figure 60: Spectral Power for "VDSL2-NL1" downstream signals, as specified in tables 95 and 96, for a frequency band where downstream PSD Shaping has been applied

12.1.5 Narrow-band signal power (upstream only)

The present document provides information on how compliance with this signal category can be achieved and indicates the relevant specification(s):

To be compliant with this signal category, the upstream signal shall comply *simultaneously* with *transmit limits*, dedicated to the upstream transmit signal observed at the NT-port of the sub loop wiring, and *receive limits*, dedicated to the upstream receive signal observed at the LT-port of the local loop wiring.

The transmit limits are maximum limits only, and the level of the transmitted in-band frequencies should often be reduced to comply simultaneously with the receive limits. The receive limits are concentrating on in-band frequencies mainly, and the insertion loss of the sub loop wiring determines how much the upstream transmitter should reduce its transmit level to comply with the receive limits as well. This mechanism is called Upstream Power Back-off, and this mechanism requires that the transmission system should have knowledge on the insertion loss between the LT and NT port of the sub loop wiring.

The way this information is to be acquired and handled is no part of the signal description. All methods enabling compliance with both transmit and receive limits are therefore considered as adequate. The ITU-T recommendation G993.2 [i.14], describes methods on how VDSL2 equipment could estimate this insertion loss, and how this information could be handled by the system to implement the associated upstream power back-off.

To be compliant with this signal category, the *Narrow-Band Signal Power* (NBSP) of the upstream signal *transmitted* into the NT-port of the sub loop wiring shall not exceed the limits given in table 97, at any point of the specified frequency range. Simultaneously, the NBSP *received* from the LT-port of the sub loop wiring shall not exceed the limits given in table 98.

The NBSP is the average power P of a signal, received into a resistive load R , within a *power* band width B . The measurement method of the NBSP is described in clause 13.2.

Tables 97 and 98 specify the break points of these limits. Limits for intermediate frequencies can be found by drawing a straight line between the break points on a logarithmic (Hz) - linear (dB) scale below 3 575 KHz and linear (Hz) - linear (dB) scale above 3 575 KHz. Figures 61 and 62 illustrate these NBSP limits in a bandwidth-normalized way.

NOTE 1: The NBSP specification in table 97 is reconstructed from the commonly used PSD specifications in [i.14] (similar to figure 62), and used here since the NBSP approach is much wider applicable. This enables a unified specification method. PSD specifications are adequate when signals are purely random in nature, but cannot cover harmonic components in a signal (would cause infinite high "PSD" levels at these harmonic frequencies). NBSP specifications cover both signal types.

NOTE 2: The NBSP specification of the upstream transmit signal (table 97) has been split into three overlapping limits: "X", "Y" and "Z". All three upper limits hold simultaneously. The 10 kHz bandwidth values represent the "maximum PSD values" from [i.14], and includes the pass band ripple. The 100 kHz bandwidth values represent the "average PSD values" in the pass band to smooth out the spectral ripple of 3,5 dB. The 1 MHz bandwidth specification is equivalent to the sliding window specification being common for ADSL.

NOTE 3: The NBSP specification of the upstream receive signal (table 98) has been split into four overlapping limits: "X1", "X2", "Y1" and "Y2". All these limits hold simultaneously, as explained in note 2.

Reference: ITU-T Recommendation G.993.2 [i.14], clause B2.4 reconstructed from PSD requirements.

Table 97: Break points of the NBSP limits of the upstream transmit signal

Centre frequency f	Impedance R	Signal Level P	Power bandwidth B	Spectral Power P/B	
0,1 kHz	600 Ω	-77,5 dBm	100 Hz	-97,5 dBm/Hz	"X"
4 kHz	600 Ω	-77,5 dBm	100 Hz	-97,5 dBm/Hz	
4 kHz	100 Ω	-52,5 dBm	10 kHz	-92,5 dBm/Hz	
25,875 kHz	100 Ω	+5,5 dBm	10 kHz	-34,5 dBm/Hz	
50 kHz	100 Ω	+5,5 dBm	10 kHz	-34,5 dBm/Hz	
80 kHz	100 Ω	+5,5 dBm	10 kHz	-34,5 dBm/Hz	
120 kHz	100 Ω	+5,5 dBm	10 kHz	-34,5 dBm/Hz	
138 kHz	100 Ω	+5,5 dBm	10 kHz	-34,5 dBm/Hz	
243 kHz	100 Ω	-53,2 dBm	10 kHz	-93,2 dBm/Hz	
686 kHz	100 Ω	-60 dBm	10 kHz	-100 dBm/Hz	
783 kHz	100 Ω	-60 dBm	10 kHz	-100 dBm/Hz	
2 825 kHz	100 Ω	-60 dBm	10 kHz	-100 dBm/Hz	
3 000 kHz	100 Ω	-60 dBm	10 kHz	-100 dBm/Hz	
3 000 kHz	100 Ω	-60 dBm	10 kHz	-100 dBm/Hz	
3 575 kHz	100 Ω	-60 dBm	10 kHz	-100 dBm/Hz	
3 750 kHz	100 Ω	-40 dBm	10 kHz	-80 dBm/Hz	
3 750 kHz	100 Ω	-11,2 dBm	10 kHz	-51,2 dBm/Hz	
5 200 kHz	100 Ω	-12,7 dBm	10 kHz	-52,7 dBm/Hz	
5 200 kHz	100 Ω	-40 dBm	10 kHz	-80 dBm/Hz	
5 375 kHz	100 Ω	-60 dBm	10 kHz	-100 dBm/Hz	
6 875 kHz	100 Ω	-60 dBm	10 kHz	-100 dBm/Hz	
7 050 kHz	100 Ω	-60 dBm	10 kHz	-100 dBm/Hz	
7 050 kHz	100 Ω	-60 dBm	10 kHz	-100 dBm/Hz	
8 325 kHz	100 Ω	-60 dBm	10 kHz	-100 dBm/Hz	
8 500 kHz	100 Ω	-40 dBm	10 kHz	-80 dBm/Hz	

Centre frequency f	Impedance R	Signal Level P	Power bandwidth B	Spectral Power P/B	
8 500 kHz	100 Ω	-14,8 dBm	10 kHz	-54,8 dBm/Hz	
10 000 kHz	100 Ω	-15,5 dBm	10 kHz	-55,5 dBm/Hz	
12 000 kHz	100 Ω	-15,5 dBm	10 kHz	-55,5 dBm/Hz	
12 000 kHz	100 Ω	-40 dBm	10 kHz	-80 dBm/Hz	
12 175 kHz	100 Ω	-60 dBm	10 kHz	-100 dBm/Hz	
14 350 kHz	100 Ω	-60 dBm	10 kHz	-100 dBm/Hz	
14 351 kHz	100 Ω	-60 dBm	10 kHz	-100 dBm/Hz	
14 526 kHz	100 Ω	-60 dBm	10 kHz	-100 dBm/Hz	
30 000 kHz	100 Ω	-60 dBm	10 kHz	-100 dBm/Hz	
50 kHz	100 Ω	+12 dBm	100 kHz	-38 dBm/Hz	"Y"
80 kHz	100 Ω	+12 dBm	100 kHz	-38 dBm/Hz	
120 kHz	100 Ω	+12 dBm	100 kHz	-38 dBm/Hz	
138 kHz	100 Ω	+12 dBm	100 kHz	-38 dBm/Hz	
243 kHz	100 Ω	-46,7 dBm	100 kHz	-96,7 dBm/Hz	
686 kHz	100 Ω	-50 dBm	100 kHz	-100 dBm/Hz	
783 kHz	100 Ω	-50 dBm	100 kHz	-100 dBm/Hz	
2 825 kHz	100 Ω	-50 dBm	100 kHz	-100 dBm/Hz	
2 999,999 kHz	100 Ω	-50 dBm	100 kHz	-100 dBm/Hz	
3 000 kHz	100 Ω	-50 dBm	100 kHz	-100 dBm/Hz	
3 575 kHz	100 Ω	-50 dBm	100 kHz	-100 dBm/Hz	
3 749,999 kHz	100 Ω	-33,5 dBm	100 kHz	-83,5 dBm/Hz	
3 750 kHz	100 Ω	-5,7 dBm	100 kHz	-54,7 dBm/Hz	
5 199,999 kHz	100 Ω	-6,2 dBm	100 kHz	-56,2 dBm/Hz	
5 200 kHz	100 Ω	-33,5 dBm	100 kHz	-83,5 dBm/Hz	
5 375 kHz	100 Ω	-60 dBm	100 kHz	-110 dBm/Hz	
6 875 kHz	100 Ω	-60 dBm	100 kHz	-110 dBm/Hz	
7 049,999 kHz	100 Ω	-60 dBm	100 kHz	-110 dBm/Hz	
7 050 kHz	100 Ω	-60 dBm	100 kHz	-110 dBm/Hz	
8 325 kHz	100 Ω	-60 dBm	100 kHz	-110 dBm/Hz	
8 499,999 kHz	100 Ω	-33,5 dBm	100 kHz	-83,5 dBm/Hz	
8 500 kHz	100 Ω	-8,3 dBm	100 kHz	-58,3 dBm/Hz	
10 000 kHz	100 Ω	-9 dBm	100 kHz	-59 dBm/Hz	
11 999,999 kHz	100 Ω	-9 dBm	100 kHz	-59 dBm/Hz	
12 000 kHz	100 Ω	-33,5 dBm	100 kHz	-83,5 dBm/Hz	
12 175 kHz	100 Ω	-60 dBm	100 kHz	-110 dBm/Hz	
14 350 kHz	100 Ω	-60 dBm	100 kHz	-110 dBm/Hz	
14 351 kHz	100 Ω	-60 dBm	100 kHz	-110 dBm/Hz	
14 526 kHz	100 Ω	-60 dBm	100 kHz	-110 dBm/Hz	
30 000 kHz	100 Ω	-60 dBm	100 kHz	-110 dBm/Hz	
12 675 kHz	100 Ω	-52 dBm	1 MHz	-112 dBm/Hz	"Z"
14 350 kHz	100 Ω	-52 dBm	1 MHz	-112 dBm/Hz	
14 351 kHz	100 Ω	-52 dBm	1 MHz	-112 dBm/Hz	
14 526 kHz	100 Ω	-52 dBm	1 MHz	-112 dBm/Hz	
30 000 kHz	100 Ω	-52 dBm	1 MHz	-112 dBm/Hz	
NOTE: The PSD values between breakpoints shall be obtained by interpolation between adjacent breakpoints as follows: - below 3 575 kHz: on a dB / $\log_{10}(f)$ basis; and - above 3 575 kHz: on a dB / f basis.					

Table 98: Break points of the NBSP limits of the upstream receive signal

Frequency f	Impedance R	Signal Level P	Power bandwidth B	Spectral Power P/B	
3 575 kHz	100 Ω	-43,45 dBm	10 kHz	-83,45 dBm/Hz	"X1"
...	100 Ω	interp	10 kHz	interp	
5 375 kHz	100 Ω	- 52,65 dBm	10 kHz	-92,65 dBm/Hz	
8 325 kHz	100 Ω	-53,41 dBm	10 kHz	-93,41 dBm/Hz	"X2"
...	100 Ω	interp	10 kHz	interp	
12 175 kHz	100 Ω	-63,37 dBm	10 kHz	-103,37 dBm/Hz	
3 575 kHz	100 Ω	-36,95 dBm	100 kHz	-86,95 dBm/Hz	"Y1"
...	100 Ω	interp	100 kHz	interp	
5 375 kHz	100 Ω	-46,15 dBm	100 kHz	-96,15 dBm/Hz	
8 325 kHz	100 Ω	-46,91 dBm	100 kHz	-96,91dBm/Hz	"Y2"
...	100 Ω	interp	100 kHz	interp	
12 175 kHz	100 Ω	-56,87 dBm	100 kHz	-106,87dBm/Hz	

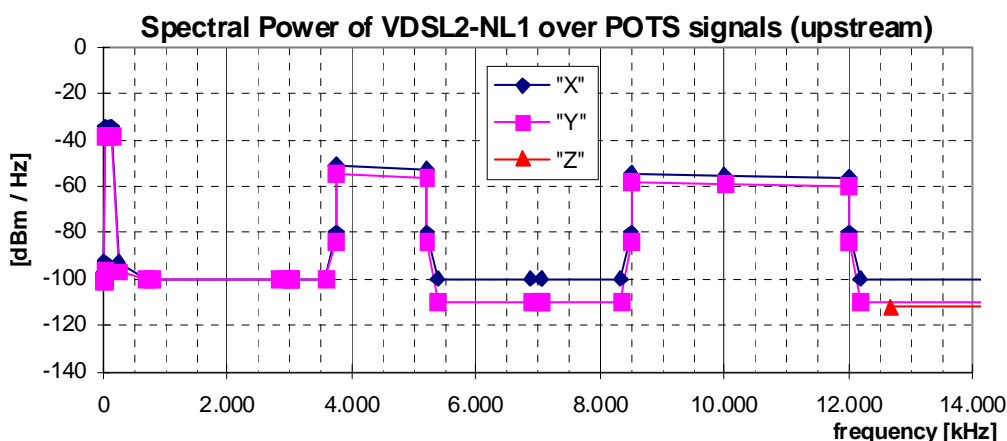

Figure 61: Spectral Power for "VDSL2-NL1" upstream *transmit* signals, as specified in table 97

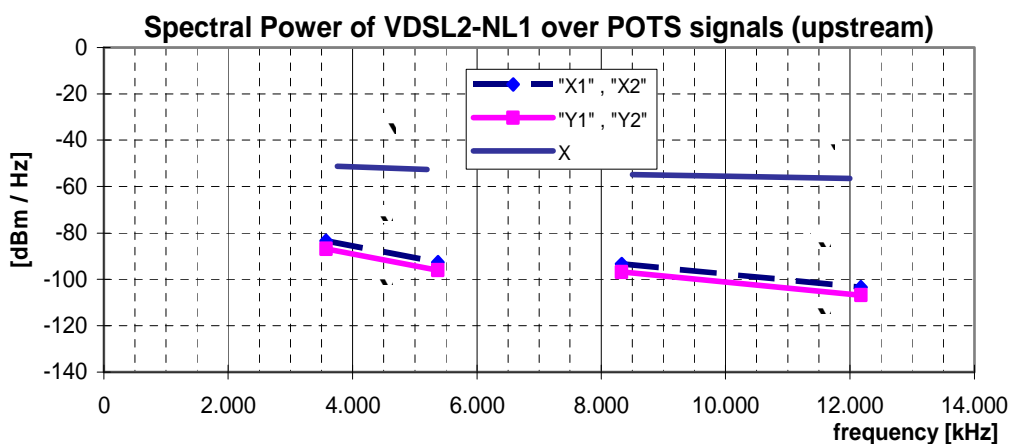

Figure 62: Spectral Power for "VDSL2-NL1" upstream *receive* signals, as specified in table 98

12.1.6 Unbalance about earth (upstream and downstream)

The present document provides information on how compliance with this signal category can be achieved and indicates the relevant specification(s):

To be compliant with this signal category, the balance of the signal that may flow through the LT-port or NT-port shall exceed minimum requirements, under the condition that the local loop wiring and its termination is well balanced. This can be verified by a Longitudinal Output Voltage (LOV) and a Longitudinal Conversion Loss (LCL) measurement at the source of that signal, as specified in clauses 13.3.2 and 13.3.3. The minimum LOV and LCL requirements hold for what can be observed at the ports of the Local Loop Wiring, when the Local Loop Wiring is replaced by an artificial impedance network described in clauses 13.3.2 and 13.3.3.

The differential termination impedance for LOV and LCL measurements shall be chosen equally to the design impedance $R_T = 100 \Omega$ of the Signal Source under test.

The observed LOV shall have an rms voltage of below the value specified in table 99, measured in a *power* bandwidth B, centred over any frequency in the range from f_{\min} to f_{\max} , and averaged in any one second period. Compliance with this limitation is required with a longitudinal terminating impedance having value $Z_L(\omega) = R_L + 1 / (j\omega \times C_L)$ for all frequencies between f_{\min} to f_{\max} . Clause 13.3.2 defines an example measurement method for longitudinal output voltage.

The observed LCL shall be higher than the lower limits given in figure 63. The LCL values of the associated break frequencies of this figure are given in table 100. Clause 13.3.3 defines an example measurement method for longitudinal conversion loss. To be compliant with this signal category, this requirement shall be met for both the switched-on and switched-off mode of the signal source.

Reference: TS 101 270-1 [i.13], clauses 8.3.3 and E.3.2.

Table 99: Values for the LOV limits

	LOV	B	f_{\min}	f_{\max}	R_L	C_L
downstream	-46 dBV	10 kHz	5,1 kHz	1 825 kHz	100 Ω	150 nF
upstream	-46 dBV	10 kHz	5,1 kHz	210 kHz	100 Ω	150 nF

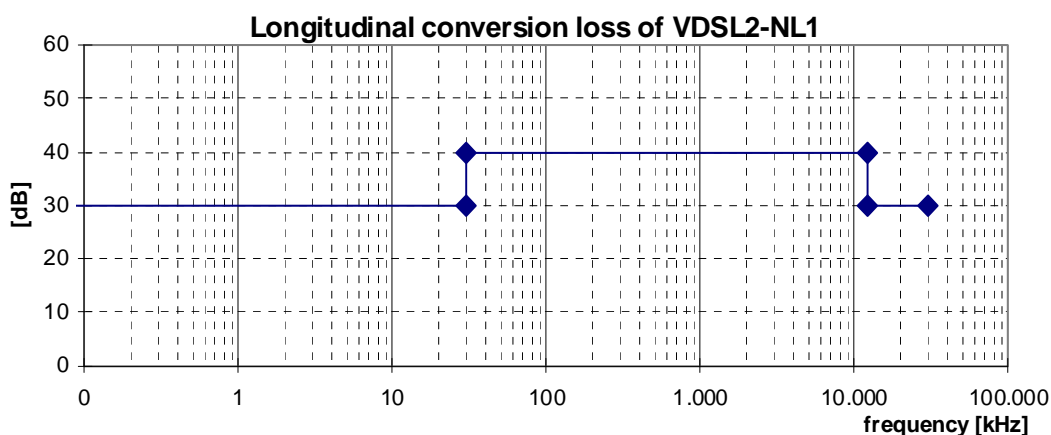

Figure 63: Minimum longitudinal conversion loss

Table 100: Frequencies and LCL values of the breakpoints of the LCL mask in figure 63

Frequency	LCL
< 30 kHz	30 dB
30 kHz	40 dB
12 MHz	40 dB
12 MHz	30 dB
30 MHz	30 dB

NOTE These LCL values are currently under study within ETSI and ITU, and may change in future.

12.2 "VDSL2-NL2" signals (over ISDN)

This category covers signals up to 12 MHz, generated by VDSL2 transmission equipment using band plan 998 (limit PSD mask B8-6). These signals may share the same wire pair with ISDN signals.

This signal description is derived from the ITU VDSL2 recommendation [i.14] and accounts for Power Back-Off in both downstream (DPBO, also known as PSD shaping) and upstream (UPBO) direction.

- The downstream signal limits are dependent on the *attenuation distance* between the local exchange and cabinet ("primary cable"), defined as the insertion loss (IL) of that loop measured at 300 kHz into a resistive load of 100 Ω . These limits are specified for a discrete number of (integer) attenuation distances. For all other attenuation distances, the downstream limits for the nearest specified IL-values apply, and not by means of interpolating the limits.
- The upstream signal limits are fixed, but defined in such a way that the actual transmit levels changes with the insertion loss between cabinet and customer premises.

A signal can be classified as a "VDSL2-NL2" signal if it is compliant with all clauses below.

12.2.1 Total signal power (downstream only)

The present document provides information on how compliance with this signal category can be achieved:

To be compliant with this signal category, the mean downstream signal power into a resistive load of 100 Ω shall not exceed the levels given in table 101, measured within a frequency band from at least 4 kHz to 30 MHz. In the special case of VDSL2 deployment from the local exchange, the limits associated with IL=0 apply.

Table 101: Total downstream transmit power as function of the measured insertion loss of the loop between local exchange and cabinet

IL (dB @ 300 kHz)	Downstream Total signal power(dBm)	L (m)
0	20,8	0
1	19,5	101
2	18,4	202
3	17,4	303
4	16,4	404
5	15,5	506
6	14,8	607
7	14,1	708
8	13,6	809
9	13,1	910
10	12,7	1 011
11	12,4	1 112
12	12,1	1 213
13	11,9	1 315
14	11,8	1 416
15	11,7	1 517
16	11,6	1 618
17	11,5	1 719
18	11,5	1 820
19	11,4	1 921
20	11,4	2 022
21	11,4	2 123
22	11,4	2 225
23	11,3	2 326
24	11,3	2 427
25	11,6	2 528
26	11,8	2 629
27	12,1	2 730
28	12,3	2 831
29	12,5	2 932
30	12,6	3 034
31	12,8	3 135
32	12,9	3 236
33	13,1	3 337
34	13,3	3 438
35	13,5	3 539
36	13,8	3 640
37	14,0	3 741
38	14,3	3 842
39	14,7	3 944
40	15,0	4 045
41	15,4	4 146
42	16,1	4 247
43	16,6	4 348
44	17,1	4 449
45	17,5	4 550
>45	17,5	>4 550

	IL (dB @ 300 kHz)	Downstream Total signal power(dBm)		L (m)	
NOTE 1:	The IL-values are normative. The L-values are informative and represent estimated loop lengths for a commonly used Dutch cable.				
NOTE 2:	These power levels can be different from those being defined or implied by ITU-T Recommendation G.993.2 [i.14]. Lower values are imposed at certain attenuation distances if the downstream power back-off (as defined in tables 102 and 103) requires this. Higher values are granted on other attenuation distances if the levels of modems in other wire pairs allow this. Current implementations of VDSL2 transmitters, compliant with ITU-T Recommendation G993.2 [i.14], are not expected to be capable of generating output powers of more than 20,5 dBm.				
NOTE 3:	The power limit specified for IL>45 dB may be too restrictive for VDSL2; refinement is for further study.				

12.2.2 Total signal power (upstream only)

The present document provides information on how compliance with this signal category can be achieved and indicates the relevant specification(s):

To be compliant with this signal category, the mean upstream signal power into a resistive load of 100 Ω shall not exceed a level of +14,5 dBm, measured within a frequency band from at least 4 kHz to 30 MHz. Note that this limit is an upper limit only; the actual level may be significantly lower when the additional spectral receive limits to upstream signals require a strong power back-off in short loops.

Reference: ITU-T Recommendation G.993.2 [i.14], chapter 6.

12.2.3 Peak amplitude (upstream and downstream)

The present document provides information on how compliance with this signal category can be achieved:

To be compliant with this signal category, the nominal voltage peak of the largest signal pulse into a resistive load of 100 Ω shall not exceed a level of 19V (38 V peak-peak), measured within a frequency band from at least 100 Hz to 30 MHz. The definition and measurement method of peak amplitude is specified in clause 13.1.

12.2.4 Narrow-band signal power (downstream only)

The present document provides information on how compliance with this signal category can be achieved and indicates the relevant specification(s):

To be compliant with this signal category, the Narrow-Band Signal Power (NBSP) into a resistive load impedance R for a given IL-value, shall not exceed the limits given in tables 102 and table 103, at any point in the frequency range 100 Hz to 30 MHz. These tables specify the break points of these limits. Limits for intermediate frequencies can be found by drawing a straight line between the break points on a logarithmic (Hz) - linear (dB) scale below 2 500 kHz and on a linear (Hz) - linear (dB) scale above 2 500 kHz. Figures 64 and 65 illustrate the NBSP in a bandwidth-normalized way.

The NBSP is the average power P of a sending signal into a load resistance R , within a *power* bandwidth B . The measurement method of the NBSP is described in clause 13.2.

NOTE 1: The NBSP specification in table 102 is reconstructed from the commonly used PSD specifications in [i.14] (similar to figure 64), and used here since it is much wider applicable. This enables a unified specification method. PSD specifications are adequate when signals are purely random in nature, but cannot cover harmonic components in a signal (would cause infinite high "PSD" levels at these harmonic frequencies). NBSP specifications cover both signal types.

NOTE 2: The NBSP specification of this signal category has been split into three overlapping limits: "X", "Y" and "Z". All these upper limits shall hold simultaneously. The 10 kHz bandwidth values represent the "maximum PSD values" [i.14], and includes the pass band ripple. The 100 kHz bandwidth values represent the "average PSD values" in the passband to smooth out the spectral ripple of 3,5 dB. The 1 MHz bandwidth specification is equivalent to the sliding window specification being common for ADSL (see [i.10] and [i.11]).

Reference: ITU-T Recommendation G.993.2 [i.14], clause B.2.5.

The description of this signal characteristic is derived from VDSL2 "band plan 998" signals with PSD mask "B8-6". Downstream PSD Shaping has been applied between 101,2 KHz and 2 500 kHz.

Table 102: Break points of the NBSP limits of the downstream transmit signal

Centre frequency f	Impedance R	Signal Level P	Power bandwidth B	Spectral Power P/B		
0,1 kHz	600 Ω	-77,5 dBm	100 Hz	-97,5 dBm/Hz	"X"	
4 kHz	600 Ω	-77,5 dBm	100 Hz	-97,5 dBm/Hz		
4 kHz	100 Ω	-52,5 dBm	10 kHz	-92,5 dBm/Hz	"X"	
80 kHz	100 Ω	-52,5 dBm	10 kHz	-92,5 dBm/Hz		
f ₁	100 Ω	P ₁ + 40 dB	10 kHz	P ₁		
f ₂	100 Ω	P ₂ + 40 dB	10 kHz	P ₂		
f ₃	100 Ω	P ₃ + 40 dB	10 kHz	P ₃		
f ₄	100 Ω	P ₄ + 40 dB	10 kHz	P ₄		
f ₅	100 Ω	P ₅ + 40 dB	10 kHz	P ₅		
f ₆	100 Ω	P ₆ + 40 dB	10 kHz	P ₆		
f ₇	100 Ω	P ₇ + 40 dB	10 kHz	P ₇		
f ₈	100 Ω	P ₈ + 40 dB	10 kHz	P ₈		
f ₉	100 Ω	P ₉ + 40 dB	10 kHz	P ₉		
f ₁₀	100 Ω	P ₁₀ + 40 dB	10 kHz	P ₁₀		
f ₁₁	100 Ω	P ₁₁ + 40 dB	10 kHz	P ₁₁		
f ₁₂	100 Ω	P ₁₂ + 40 dB	10 kHz	P ₁₂		
f ₁₃	100 Ω	P ₁₃ + 40 dB	10 kHz	P ₁₃		
f ₁₄	100 Ω	P ₁₄ + 40 dB	10 kHz	P ₁₄		
2 500 kHz	100 Ω	-8,8 dBm	10 kHz	-48,8 dBm/Hz	"X"	
3 749,999 kHz	100 Ω	-11,2 dBm	10 kHz	-51,2 dBm/Hz		
3 750 kHz	100 Ω	-40 dBm	10 kHz	-80 dBm/Hz		
3 925 kHz	100 Ω	-60 dBm	10 kHz	-100 dBm/Hz		
4 925 kHz	100 Ω	-60 dBm	10 kHz	-100 dBm/Hz		
5 025 kHz	100 Ω	-60 dBm	10 kHz	-100 dBm/Hz		
5 199,999 kHz	100 Ω	-40 dBm	10 kHz	-80 dBm/Hz		
5 200 kHz	100 Ω	-12,7 dBm	10 kHz	-52,7 dBm/Hz		
8 499,999 kHz	100 Ω	-14,8 dBm	10 kHz	-54,8 dBm/Hz		
8 500 kHz	100 Ω	-40 dBm	10 kHz	-80 dBm/Hz		
8 675 kHz	100 Ω	-60 dBm	10 kHz	-100 dBm/Hz		
30 000 kHz	100 Ω	-60 dBm	10 kHz	-100 dBm/Hz		
50 kHz	100 Ω	-46 dBm	100 kHz	-96 dBm/Hz		"Y"
80 kHz	100 Ω	-46 dBm	100 kHz	-96 dBm/Hz		
f ₁	100 Ω	P ₁ + 46,5 dB	100 kHz	P ₁ -3,5 dB		
f ₂	100 Ω	P ₂ + 46,5 dB	100 kHz	P ₂ -3,5 dB		
f ₃	100 Ω	P ₃ + 46,5 dB	100 kHz	P ₃ -3,5 dB		
f ₄	100 Ω	P ₄ + 46,5 dB	100 kHz	P ₄ -3,5 dB		
f ₅	100 Ω	P ₅ + 46,5 dB	100 kHz	P ₅ -3,5 dB		
f ₆	100 Ω	P ₆ + 46,5 dB	100 kHz	P ₆ -3,5 dB		
f ₇	100 Ω	P ₇ + 46,5 dB	100 kHz	P ₇ -3,5 dB		
f ₈	100 Ω	P ₈ + 46,5 dB	100 kHz	P ₈ -3,5 dB		
f ₉	100 Ω	P ₉ + 46,5 dB	100 kHz	P ₉ -3,5 dB		
f ₁₀	100 Ω	P ₁₀ + 46,5 dB	100 kHz	P ₁₀ -3,5 dB		

Centre frequency f	Impedance R	Signal Level P	Power bandwidth B	Spectral Power P/B	
f ₁₁	100 Ω	P ₁₁ + 46,5 dB	100 kHz	P ₁₁ -3,5 dB	
f ₁₂	100 Ω	P ₁₂ + 46,5 dB	100 kHz	P ₁₂ -3,5 dB	
f ₁₃	100 Ω	P ₁₃ + 46,5 dB	100 kHz	P ₁₃ -3,5 dB	
f ₁₄	100 Ω	P ₁₄ + 46,5 dB	100 kHz	P ₁₄ -3,5 dB	
2 500 kHz	100 Ω	-2,3 dBm	100 kHz	-52,3 dBm/Hz	
3 749,999 kHz	100 Ω	-4,5 dBm	100 kHz	-54,7 dBm/Hz	
3 750 kHz	100 Ω	-33,5 dBm	100 kHz	-83,5 dBm/Hz	
3 894 kHz	100 Ω	-50 dBm	100 kHz	-100 dBm/Hz	
3 999,999 kHz	100 Ω	-50 dBm	100 kHz	-100 dBm/Hz	
4 000 kHz	100 Ω	-60 dBm	100 kHz	-110 dBm/Hz	
5 055 kHz	100 Ω	-60 dBm	100 kHz	-110 dBm/Hz	
5 056 kHz	100 Ω	-62 dBm	100 kHz	-99,9 dBm/Hz	
5 199,999 kHz	100 Ω	-33,5 dBm	100 kHz	-83,5 dBm/Hz	
5 200 kHz	100 Ω	-6,2 dBm	100 kHz	-56,2 dBm/Hz	
8 499,999 kHz	100 Ω	-8,3 dBm	100 kHz	-58,3 dBm/Hz	
8 500 kHz	100 Ω	-33,5 dBm	100 kHz	-83,5 dBm/Hz	
8 644 kHz	100 Ω	-50 dBm	100 kHz	-100 dBm/Hz	
8 645 kHz	100 Ω	-60 dBm	100 kHz	-110 dBm/Hz	
30 000 kHz	100 Ω	-60 dBm	100 kHz	-110 dBm/Hz	
9 145 kHz	100 Ω	-52 dBm	1 MHz	-112 dBm/Hz	"Z"
30 000 kHz	100 Ω	-52 dBm	1 MHz	-112 dBm/Hz	
NOTE 1: The limits between breakpoints shall be obtained by interpolation between adjacent breakpoints on a dB / log(f) basis below 2 500 kHz and on a dB/f basis above 2 500 kHz.					
NOTE 2: The limits "Y" between 50 kHz and 2 500 kHz are 3,5 dB lower than the associated limits "X". This may be a bit too restrictive for VDSL2 when the PSD slope in this shaping region becomes steep. Refinements for the limits at these breakpoints require further study.					

**Table 103: Definition of parameter f_k and P_k , (with $k = 1$ to 14),
of the downstream NBSP limits in table 102**

IL		f_1 P_1	f_2 P_2	f_3 P_3	f_4 P_4	f_5 P_5	f_6 P_6	f_7 P_7	f_8 P_8	f_9 P_9	f_{10} P_{10}	f_{11} P_{11}	f_{12} P_{12}	f_{13} P_{13}	f_{14} P_{14}
0	f	101,2	227,11	275,999	276				N/A	N/A	N/A	N/A	N/A	N/A	N/A
	P	-92,5	-62	-48,5	-36,5	-36,5	-46,5	-48	N/A	N/A	N/A	N/A	N/A	N/A	N/A
1	f	101,2	227,11	275,999	276	850					N/A	N/A	N/A	N/A	N/A
	P	-92,5	-62	-48,5	-37,3	-38	-38,2	-48,6	-50,3	-48	N/A	N/A	N/A	N/A	N/A
2	f	101,2	227,11	275,999	276	600					N/A	N/A	N/A	N/A	N/A
	P	-92,5	-62	-48,5	-38,1	-38,9	-39,8	-50,6	-52,7	-48	N/A	N/A	N/A	N/A	N/A
3	f	101,2	227,11	275,999	276	600	850					N/A	N/A	N/A	N/A
	P	-92,5	-62	-48,5	-38,9	-40,1	-40,9	-41,5	-52,7	-55,2	-48	N/A	N/A	N/A	N/A
4	f	101,2	227,11	275,999	276	400	600	850					N/A	N/A	N/A
	P	-92,5	-62	-48,5	-39,7	-40,4	-41,4	-42,3	-43,2	-54,8	-57,6	-48	N/A	N/A	N/A
5	f	101,2	227,11	275,999	276	400	600	850						N/A	N/A
	P	-92,5	-62	-48,5	-40,5	-41,4	-42,6	-43,8	-44,9	-51,1	-56,8	-60,1	-48,1	N/A	N/A
6	f	101,2	227,11	275,999	276	400	600	850							N/A
	P	-92,5	-62	-48,5	-41,3	-42,4	-43,8	-45,2	-46,5	-52,9	-58,9	-62,5	-48,1	-48,8	N/A
7	f	101,2	227,11	275,999	276	400	600	850							N/A
	P	-92,5	-62	-48,5	-42,1	-43,4	-45	-46,7	-48,2	-54,8	-61	-65	-48,2	-48,8	N/A
8	f	101,2	227,11	275,999	276	400	600	850							N/A
	P	-92,5	-62	-48,5	-42,9	-44,4	-46,2	-48,1	-49,9	-56,7	-63	-67,5	-48,3	-48,8	N/A
9	f	101,2	227,11	275,999	276	400	600	850							N/A
	P	-92,5	-62	-48,5	-43,7	-45,4	-47,4	-49,6	-51,6	-58,5	-65,1	-69,9	-48,3	-48,8	N/A
10	f	101,2	227,11	275,999	276	400	600	850						N/A	N/A
	P	-92,5	-62	-48,5	-44,6	-46,4	-48,7	-51,1	-53,3	-60,5	-67,3	-72,5	-48,1	N/A	N/A
11	f	101,2	227,11	275,999	276	400	600	850							N/A
	P	-92,5	-62	-48,5	-45,5	-47,5	-50,1	-52,8	-55,2	-62,6	-69,6	-75,3	-48,2	-48,8	N/A
12	f	101,2	227,11	275,999	276	400	600	850						N/A	N/A
	P	-92,5	-62	-48,5	-46,4	-48,6	-51,5	-54,4	-57,1	-64,7	-71,9	-78,1	-48,1	N/A	N/A
13	f	101,2	227,11	275,999	276	400	600	850							N/A
	P	-92,5	-62	-48,5	-47,3	-49,7	-52,8	-56	-58,9	-66,8	-74,2	-80,6	-80	-48,1	N/A
14	f	101,2	227,11	275,999	276	400	600	850							N/A
	P	-92,5	-62	-48,5	-48,1	-50,7	-54,1	-57,6	-60,7	-68,8	-76,4	-82,9	-80	-48,1	N/A
15	f	101,2	227,11	274	276	400	600	850							N/A
	P	-92,5	-62	-49	-49	-51,8	-55,4	-59,1	-62,5	-70,7	-78,6	-85,1	-80	-48,1	N/A
16	f	101,2	227,11	271	276	400	600	850							N/A
	P	-92,5	-62	-49,8	-49,8	-52,8	-56,6	-60,6	-64,2	-72,6	-80,7	-87,2	-80	-48,1	N/A
17	f	101,2	227,11	268	276	400	600	850							N/A
	P	-92,5	-62	-50,6	-50,6	-53,8	-57,8	-62	-65,9	-74,5	-82,8	-89,2	-80	-48,1	N/A
18	f	101,2	227,11	265	276	400	600	850							N/A
	P	-92,5	-62	-51,4	-51,4	-54,7	-59	-63,5	-67,5	-76,3	-84,8	-91,1	-80	-48,1	N/A
19	f	101,2	227,11	262	276	400	600	850							N/A
	P	-92,5	-62	-52,1	-52,1	-55,7	-60,2	-64,9	-69,1	-78,1	-86,7	-91,5	-91,5	-80	-48,1
20	f	101,2	227,11	259	276	400	600	850							N/A
	P	-92,5	-62	-52,9	-52,9	-56,6	-61,3	-66,2	-70,6	-79,8	-88,7	-91,5	-91,5	-80	-48,1
21	f	101,2	227,11	256	276	400	600	850							N/A
	P	-92,5	-62	-53,7	-53,6	-57,5	-62,4	-67,5	-72,2	-81,5	-90,5	-91,5	-91,5	-80	-48,1
22	f	101,2	227,11	253,999	276	400	600	850							N/A
	P	-92,5	-62	-54,3	-54,3	-58,3	-63,5	-68,8	-73,6	-83,2	-91,5	-91,5	-80	-48,1	N/A
23	f	101,2	227,11	251	276	400	600	850							N/A
	P	-92,5	-62	-55,1	-55	-59,2	-64,5	-70,1	-75,1	-84,8	-91,5	-91,5	-80	-48,1	N/A
24	f	101,2	227,11	249	276	400	600	850							N/A
	P	-92,5	-62	-55,7	-55,7	-60	-65,5	-71,3	-76,5	-86,3	-91,5	-91,5	-80	-48,1	N/A
25	f	101,2	227,11	247	276	400	600	850							N/A
	P	-92,5	-62	-56,3	-56,3	-60,8	-66,5	-72,5	-77,8	-87,8	-91,5	-91,5	-80	-47,8	N/A
26	f	101,2	227,11	244	276	400	600	850							N/A
	P	-92,5	-62	-57	-57	-61,6	-67,5	-73,6	-79,2	-89,3	-91,5	-91,5	-80	-47,6	-48
27	f	101,2	227,11	242	276	400	600	850							N/A
	P	-92,5	-62	-57,6	-57,6	-62,3	-68,4	-74,7	-80,4	-91,5	-91,5	-80	-47,3	-48	N/A
28	f	101,2	227,11	240	276	400	600	850							N/A
	P	-92,5	-62	-58,2	-58,2	-63,1	-69,3	-75,8	-81,7	-91,5	-91,5	-80	-47	-48	N/A
29	f	101,2	227,11	238	276	400	600	850							N/A
	P	-92,5	-62	-58,8	-58,7	-63,8	-70,2	-76,8	-82,9	-91,5	-91,5	-80	-46,8	-48	N/A
30	f	101,2	227,11	236	276	400	600	850							N/A
	P	-92,5	-62	-59,3	-59,3	-64,5	-71	-77,9	-84	-91,5	-91,5	-80	-46,6	-48	N/A
31	f	101,2	227,11	234	276	400	600	850							N/A
	P	-92,5	-62	-59,9	-59,9	-65,2	-71,9	-78,9	-85,2	-91,5	-91,5	-80	-46,1	-46,5	-48
32	f	101,2	227,11	232	276	400	600	850							N/A
	P	-92,5	-62	-60,6	-60,6	-66	-73	-80,2	-86,7	-91,5	-91,5	-80	-45,1	-46,5	-48

IL		f_1 P_1	f_2 P_2	f_3 P_3	f_4 P_4	f_5 P_5	f_6 P_6	f_7 P_7	f_8 P_8	f_9 P_9	f_{10} P_{10}	f_{11} P_{11}	f_{12} P_{12}	f_{13} P_{13}	f_{14} P_{14}	
33	f	101,2	227,11	230	276	400	600	850								
	P	-92,5	-62	-61,3	-61,3	-66,9	-74	-81,5	-88,2	-91,5	-91,5	-80	-44,2	-46,5	-48	
34	f	101,2	227,11	276	400	600	850									N/A
	P	-92,5	-62	-62	-67,8	-75,1	-82,7	-89,6	-91,5	-91,5	-80	-43,6	-46,5	-48		N/A
35	f	101,2	223	276	400	600	850									N/A
	P	-92,5	-62,7	-62,7	-68,6	-76,2	-84	-91,1	-91,5	-91,5	-80	-42,4	-46,5	-48		N/A
36	f	101,2	219	276	400	600	850								N/A	N/A
	P	-92,5	-63,4	-63,4	-69,5	-77,2	-85,3	-91,5	-91,5	-80	-41,6	-46,5	-48		N/A	N/A
37	f	101,2	215	276	400	600	850								N/A	N/A
	P	-92,5	-64,1	-64,1	-70,4	-78,3	-86,6	-91,5	-91,5	-80	-41	-46,5	-48		N/A	N/A
38	f	101,2	211	276	400	600	850	962							N/A	N/A
	P	-92,5	-64,8	-64,8	-71,2	-79,4	-87,9	-91,5	-91,5	-80	-39,9	-46,5	-48		N/A	N/A
39	f	101,2	207	276	400	600	850	919	996						N/A	N/A
	P	-92,5	-65,5	-65,5	-72,1	-80,5	-89,2	-91,5	-91,5	-80	-39	-46,5	-48		N/A	N/A
40	f	101,2	203	276	400	600	850	880	959						N/A	N/A
	P	-92,5	-66,2	-66,2	-73	-81,5	-90,4	-91,5	-91,5	-80	-38,3	-46,5	-48		N/A	N/A
41	f	101,2	199	276	400	600	843	921							N/A	N/A
	P	-92,5	-67	-66,9	-73,8	-82,6	-91,5	-91,5	-80	-37,4	-46,5	-48		N/A	N/A	N/A
42	f	101,2	196	276	400	600	803	857							N/A	N/A
	P	-92,5	-67,6	-67,6	-74,7	-83,7	-91,5	-91,5	-80	-36,5	-36,5	-46,5	-48		N/A	N/A
43	f	101,2	192	276	400	600	768	800	975						N/A	N/A
	P	-92,5	-68,4	-68,4	-75,6	-84,8	-91,5	-91,5	-80	-36,7	-36,5	-46,5	-48		N/A	N/A
44	f	101,2	188	276	400	600	735	749	924	970					N/A	N/A
	P	-92,5	-69,1	-69,1	-76,4	-85,8	-91,5	-91,5	-80	-36,5	-36,5	-46,5	-48		N/A	N/A
45	f	101,2	185	276	400	600	703	877	922						N/A	N/A
	P	-92,5	-69,8	-69,8	-77,3	-86,9	-91,4	-80	-36,5	-36,5	-46,5	-48		N/A	N/A	N/A
>	f	101,2	185	276	400	600	703	877	922						N/A	N/A
45	P	-92,5	-91,5	-91,5	-91,5	-91,5	-91,4	-80	-36,5	-36,5	-46,5	-48		N/A	N/A	N/A

NOTE 1: The label "N/A" denotes that a breakpoint is not used.
 NOTE 2: The breakpoints for IL>45 dB may be too restrictive for VDSL2, refinements are for further study.

In the special case that VDSL2 is deployed from the local exchange, the IL-value is zero. Figure 64 illustrates the limits of the spectral powers (measured in 10 kHz and in 100 kHz) as function of the frequency, according to the specifications in tables 102 and 103.

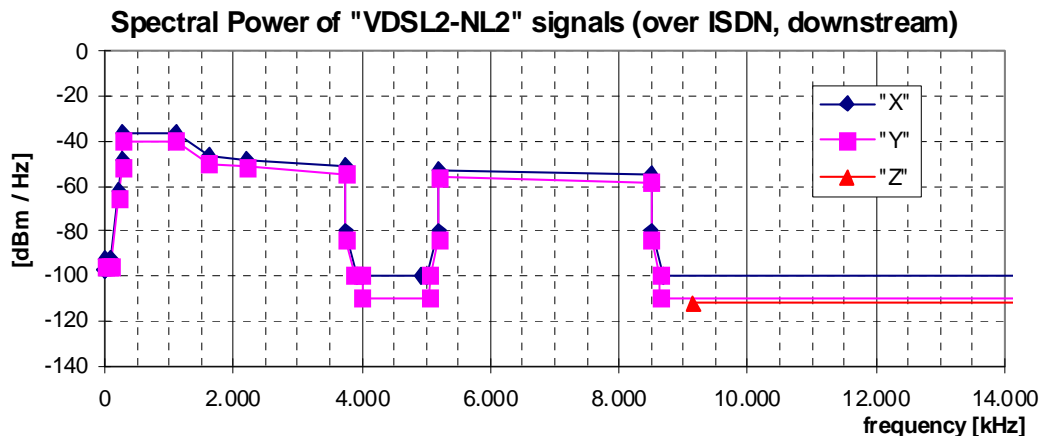

Figure 64: Spectral Power for "VDSL2-NL2" downstream signals (over ISDN), as specified in tables 102 and 103 for IL=0 dB

When VDSL2 is deployed from the cabinet, shaping of the above spectral powers can be significant between 276 kHz and 2 500 kHz. Figure 65 illustrates the limits of these spectral powers (measured in 10 kHz and in 100 kHz) for various IL-values (for IL =10 dB, IL=20 dB and IL=40 dB).

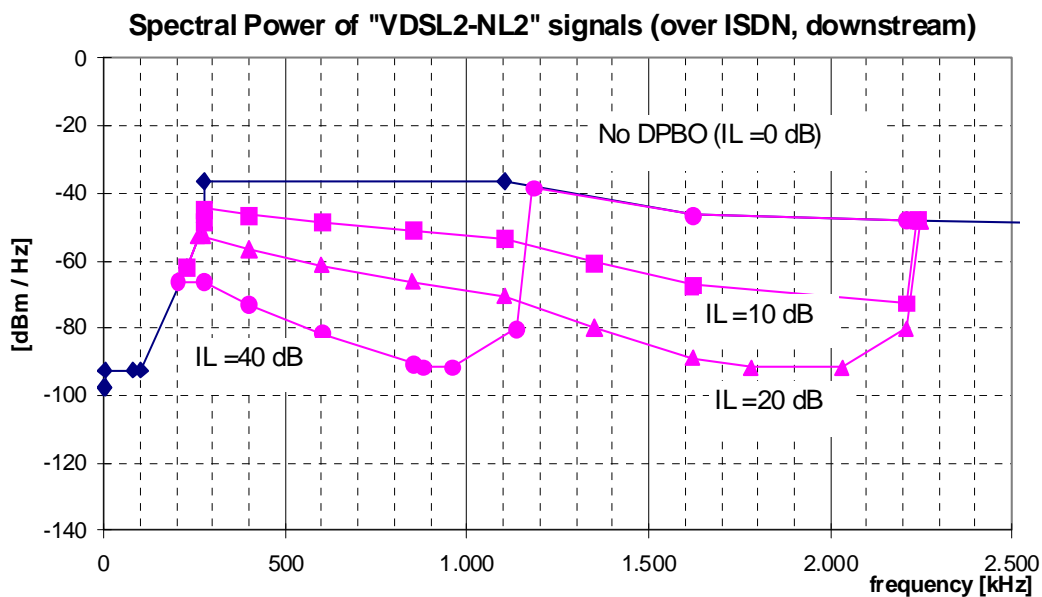

Figure 65: Spectral Power for "VDSL2-NL2" downstream signals (over ISDN), as specified in tables 102 and 103 in the frequency region where downstream PSD Shaping has been applied

12.2.5 Narrow-band signal power (upstream only)

The present document provides information on how compliance with this signal category can be achieved and indicates the relevant specification(s):

To be compliant with this signal category, the upstream signal shall comply *simultaneously* with *transmit limits*, dedicated to the upstream transmit signal observed at the NT-port of the sub loop wiring, and *receive limits*, dedicated to the upstream receive signal observed at the LT-port of the local loop wiring.

The upstream limits for "VDSL2-NL2" signals are equal to the limits specified before for "VDSL2-NL1" signals, with the only difference that the transmit limits are different. The transmit limits for "VDSL2-NL2" signals are specified in table 104 and illustrated in figure 66.

Reference: ITU-T Recommendation G.993.2 [i.14], clause B2.4 reconstructed from PSD requirements.

Table 104: Break points of the NBSP limits of the upstream transmit signal

Centre frequency f	Impedance R	Signal Level P	Power bandwidth B	Spectral Power P/B	
0,1 kHz	600 Ω	-77,5 dBm	100 Hz	-97,5 dBm/Hz	"X"
4 kHz	600 Ω	-77,5 dBm	100 Hz	-97,5 dBm/Hz	
4 kHz	100 Ω	-52,5 dBm	10 kHz	-92,5 dBm/Hz	
50 kHz	100 Ω	-50 dBm	10 kHz	-90 dBm/Hz	
80 kHz	100 Ω	-41,8 dBm	10 kHz	-81,8 dBm/Hz	
120 kHz	100 Ω	5,5 dBm	10 kHz	-34,5 dBm/Hz	
276 kHz	100 Ω	5,5 dBm	10 kHz	-34,5 dBm/Hz	
508,8 kHz	100 Ω	-58 dBm	10 kHz	-98 dBm/Hz	
686 kHz	100 Ω	-60 dBm	10 kHz	-100 dBm/Hz	
783 kHz	100 Ω	-60 dBm	10 kHz	-100 dBm/Hz	
2 825 kHz	100 Ω	-60 dBm	10 kHz	-100 dBm/Hz	
3 000 kHz	100 Ω	-60 dBm	10 kHz	-100 dBm/Hz	
3 000 kHz	100 Ω	-60 dBm	10 kHz	-100 dBm/Hz	
3 575 kHz	100 Ω	-60 dBm	10 kHz	-100 dBm/Hz	
3 750 kHz	100 Ω	-40 dBm	10 kHz	-80 dBm/Hz	
3 750 kHz	100 Ω	-11,2 dBm	10 kHz	-51,2 dBm/Hz	
5 200 kHz	100 Ω	-12,7 dBm	10 kHz	-52,7 dBm/Hz	
5 200 kHz	100 Ω	-40 dBm	10 kHz	-80 dBm/Hz	
5 375 kHz	100 Ω	-60 dBm	10 kHz	-100 dBm/Hz	
6 875 kHz	100 Ω	-60 dBm	10 kHz	-100 dBm/Hz	
7 050 kHz	100 Ω	-60 dBm	10 kHz	-100 dBm/Hz	
7 050 kHz	100 Ω	-60 dBm	10 kHz	-100 dBm/Hz	
8 325 kHz	100 Ω	-60 dBm	10 kHz	-100 dBm/Hz	
8 500 kHz	100 Ω	-40 dBm	10 kHz	-80 dBm/Hz	
8 500 kHz	100 Ω	-14,8 dBm	10 kHz	-54,8 dBm/Hz	
10 000 kHz	100 Ω	-15,5 dBm	10 kHz	-55,5 dBm/Hz	
12 000 kHz	100 Ω	-16,5 dBm	10 kHz	-56,5 dBm/Hz	
12 000 kHz	100 Ω	-40 dBm	10 kHz	-80 dBm/Hz	
12 175 kHz	100 Ω	-60 dBm	10 kHz	-100 dBm/Hz	
14 350 kHz	100 Ω	-60 dBm	10 kHz	-100 dBm/Hz	
14 351 kHz	100 Ω	-60 dBm	10 kHz	-100 dBm/Hz	
14 526 kHz	100 Ω	-60 dBm	10 kHz	-100 dBm/Hz	
30 000 kHz	100 Ω	-60 dBm	10 kHz	-100 dBm/Hz	
50 kHz	100 Ω	-43,5 dBm	100 kHz	-93,5 dBm/Hz	"Y"
80 kHz	100 Ω	-35,3 dBm	100 kHz	-85,3 dBm/Hz	
120 kHz	100 Ω	+12 dBm	100 kHz	-38 dBm/Hz	
276 kHz	100 Ω	+12 dBm	100 kHz	-38 dBm/Hz	
508,8 kHz	100 Ω	-50 dBm	100 kHz	-100 dBm/Hz	
686 kHz	100 Ω	-50 dBm	100 kHz	-100 dBm/Hz	
783 kHz	100 Ω	-50 dBm	100 kHz	-100 dBm/Hz	
2 825 kHz	100 Ω	-50 dBm	100 kHz	-100 dBm/Hz	
2 999,999 kHz	100 Ω	-50 dBm	100 kHz	-100 dBm/Hz	
3 000 kHz	100 Ω	-50 dBm	100 kHz	-100 dBm/Hz	
3 575 kHz	100 Ω	-50 dBm	100 kHz	-100 dBm/Hz	
3 749,999 kHz	100 Ω	-33,5 dBm	100 kHz	-83,5 dBm/Hz	
3 750 kHz	100 Ω	-5,7 dBm	100 kHz	-54,7 dBm/Hz	
5 199,999 kHz	100 Ω	-6,2 dBm	100 kHz	-56,2 dBm/Hz	
5 200 kHz	100 Ω	-33,5 dBm	100 kHz	-83,5 dBm/Hz	
5 375 kHz	100 Ω	-60 dBm	100 kHz	-110 dBm/Hz	
6 875 kHz	100 Ω	-60 dBm	100 kHz	-110 dBm/Hz	
7 049,999 kHz	100 Ω	-60 dBm	100 kHz	-110 dBm/Hz	
7 050 kHz	100 Ω	-60 dBm	100 kHz	-110 dBm/Hz	
8 325 kHz	100 Ω	-60 dBm	100 kHz	-110 dBm/Hz	
8 499,999 kHz	100 Ω	-33,5 dBm	100 kHz	-83,5 dBm/Hz	
8 500 kHz	100 Ω	-8,3 dBm	100 kHz	-58,3 dBm/Hz	
10 000 kHz	100 Ω	-9 dBm	100 kHz	-59 dBm/Hz	
11 999,999 kHz	100 Ω	-10 dBm	100 kHz	-60 dBm/Hz	
12 000 kHz	100 Ω	-33,5 dBm	100 kHz	-83,5 dBm/Hz	

Centre frequency f	Impedance R	Signal Level P	Power bandwidth B	Spectral Power P/B	
12 175 kHz	100 Ω	-60 dBm	100 kHz	-110 dBm/Hz	
14 350 kHz	100 Ω	-60 dBm	100 kHz	-110 dBm/Hz	
14 351 kHz	100 Ω	-60 dBm	100 kHz	-110 dBm/Hz	
14 5266 kHz	100 Ω	-60 dBm	100 kHz	-110 dBm/Hz	
30 000 kHz	100 Ω	-60 dBm	100 kHz	-110 dBm/Hz	
12 675 kHz	100 Ω	-52 dBm	1 MHz	-112 dBm/Hz	"Z"
14 350 kHz	100 Ω	-52 dBm	1 MHz	-112 dBm/Hz	"Z"
14 351 kHz	100 Ω	-52 dBm	1 MHz	-112 dBm/Hz	"Z"
14 526 kHz	100 Ω	-52 dBm	1 MHz	-112 dBm/Hz	"Z"
30 000 kHz	100 Ω	-52 dBm	1 MHz	-112 dBm/Hz	"Z"

NOTE: The PSD values between breakpoints shall be obtained by interpolation between adjacent breakpoints as follows:
- below 3 575 kHz: on a dB / $\log_{10}(f)$ basis; and
- above 3 575 kHz: on a dB / f basis.

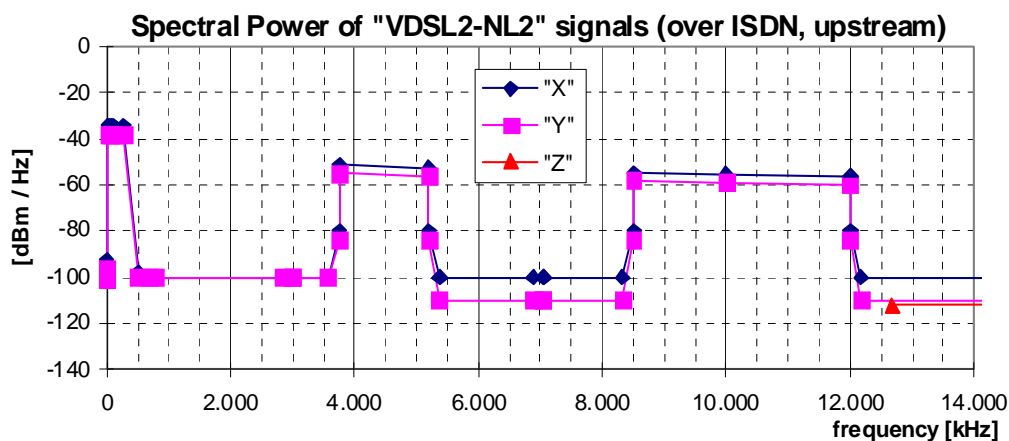

Figure 66: Spectral Power, for "VDSL2-NL2" upstream signals (over ISDN), as specified in table 104

12.2.6 Unbalance about earth (upstream and downstream)

The present document provides information on how compliance with this signal category can be achieved:

To be compliant with this signal category, the balance of the signal that may flow through the LT-port or NT-port shall exceed minimum requirements, under the condition that the local loop wiring and its termination is well balanced.

The unbalance limits for "VDSL2-NL2" signals are equal to the limits specified before for "VDSL2-NL1" signals.

12.3 "VDSL2-UK1" signals

This category covers signals up to 7,05 MHz, generated by VDSL2 transmission equipment using band plan 997 (limit PSD mask B7-1). These signals may share the same wire pair with POTS signals. This signal description is derived from the ITU VDSL2 recommendation G.993.2 [i.14]. The downstream signal is enhanced by loop dependent PSD shaping, also known as downstream Power Back-off (DPBO).

- The downstream signal limits are dependent on the *attenuation distance* between the local exchange and cabinet ("primary cable"), defined as Downstream Power Backoff Exchange Side Electrical Loss (DPBOESEL) of that loop measured at 300 kHz into a resistive load of 100 Ω .
- The upstream signal limits are dependent on the electrical length of the cable (UPBO, also referred to as k_{10}) between the cabinet and the customer measured in dB at 1MHz into a resistive load of 100 Ω .

A signal can be classified as a "VDSL2-UK1" signal if it is compliant with all clauses below.

12.3.1 Total signal power (downstream only)

The present document provides information on how compliance with this signal category can be achieved and indicates the relevant specification(s):

To be compliant with this signal category, the mean downstream signal power into a resistive load of 100 Ω shall not exceed +11,5 dBm.

Reference: ITU-T Recommendation G.993.2 [i.14], chapter 6, table 6-1/G.993.2. Profile 8c.

12.3.2 Total signal power (upstream only)

The present document provides information on how compliance with this signal category can be achieved and indicates the relevant specification(s):

To be compliant with this signal category, the mean upstream signal power into a resistive load of 100 Ω shall not exceed a level of +14,5 dBm, measured within the frequency bands from 25 kHz to 138 kHz and 2,999 MHz to 5,101 MHz.

Reference: ITU-T Recommendation G.993.2 [i.14], chapter 6, table 6-1/G.993.2. Profile 8c.

12.3.3 Peak amplitude (upstream and downstream)

No limit is specified.

NOTE: Peak amplitude is constrained by safety and DC power dissipation considerations.

12.3.4 Narrow-band signal power (downstream only)

The present document provides information on how compliance with this signal category can be achieved:

To be compliant with this signal category, the Narrow-Band Signal Power (NBSP) into a resistive load impedance R for a given DBBOESEL-value, shall not exceed the limits given in tables 105 and 106, at any point in the frequency range 100 Hz to 30 MHz.

**Table 105: Break points of the NBSP limits,
of the downstream transmit signal (cabinet PSD mask)**

Centre Frequency f (MHz)	Impedance R (Ω)	Signal Level P (dBm)	Power Bandwidth B	Spectral Power P/B (dBm/Hz)
0,	600	-77,5	100 Hz	-97,5
0,004	600	-77,5	100 Hz	-97,5
0,004	100	-72,5	100 Hz	-92,5
0,08	100	-32,5	10 kHz	-72,5
0,138	100	-9,5	10 kHz	-49,5
0,166	100	-9,5	10 kHz	-49,5
f_1	100	$P_1 + 40$ dB	10 kHz	P_1
f_2	100	$P_2 + 40$ dB	10 kHz	P_2
f_3	100	$P_3 + 40$ dB	10 kHz	P_3
f_4	100	$P_4 + 40$ dB	10 kHz	P_4
f_5	100	$P_5 + 40$ dB	10 kHz	P_5
f_6	100	$P_6 + 40$ dB	10 kHz	P_6
f_7	100	$P_7 + 40$ dB	10 kHz	P_7
f_8	100	$P_8 + 40$ dB	10 kHz	P_8
f_9	100	$P_9 + 40$ dB	10 kHz	P_9
f_{10}	100	$P_{10} + 40$ dB	10 kHz	P_{10}
f_{11}	100	$P_{11} + 40$ dB	10 kHz	P_{11}
f_{12}	100	$P_{12} + 40$ dB	10 kHz	P_{12}
2,208	100	-9,5	10 kHz	-49,5
2,249	100	-9,5	10 kHz	-49,5
2,423	100	-16,5	10 kHz	-56,5
2,999	100	-16,5	10 kHz	-56,5
3	100	-40	10 kHz	-80
3,175	100	-40	1 MHz	-100
4	100	-40	1 MHz	-100
4,001	100	-50	1 MHz	-110
4,924	100	-50	1 MHz	-110
4,925	100	-40	1 MHz	-100
5,099	100	-40	10 kHz	-80
5,1	100	-16,5	10 kHz	-56,5
7,05	100	-16,5	10 kHz	-56,5
7,051	100	-40	10 kHz	-80
7,225	100	-40	1 MHz	-100
7,226	100	-50	1 MHz	-110
30	100	-50	1 MHz	-110

NOTE: The limits between breakpoints shall be obtained by interpolation between adjacent breakpoints on a dB/log(f) basis below 3,01 MHz and on a dB/f basis above 3,01 MHz.

**Table 106: Definition of parameter f_k and P_k , (with $k = 1$ to 12),
of the downstream NBSP limits in table 105, for DPBOESEL 0 dB to 52 dB**

DPBOESEL		f_1 P_1	f_2 P_2	f_3 P_3	f_4 P_4	f_5 P_5	f_6 P_6	f_7 P_7	f_8 P_8	f_9 P_9	f_{10} P_{10}	f_{11} P_{11}	f_{12} P_{12}
0	f	0,168	2,207	N/A	N/A	N/A	N/A	N/A	N/A	N/A	N/A	N/A	N/A
	P	-49,5	-49,5	N/A	N/A	N/A	N/A	N/A	N/A	N/A	N/A	N/A	N/A
2	f	0,168	1,546	1,622	2,207	N/A	N/A	N/A	N/A	N/A	N/A	N/A	N/A
	P	-49,5	-49,5	-50,8	-53,0	N/A	N/A	N/A	N/A	N/A	N/A	N/A	N/A
4	f	0,168	1,346	1,468	1,622	2,207	N/A	N/A	N/A	N/A	N/A	N/A	N/A
	P	-49,5	-49,5	-52,1	-55,2	-58,2	N/A	N/A	N/A	N/A	N/A	N/A	N/A
6	f	0,168	1,191	1,25	1,4	1,622	2,207	N/A	N/A	N/A	N/A	N/A	N/A
	P	-49,5	-49,5	-51,0	-54,7	-59,5	-63,4	N/A	N/A	N/A	N/A	N/A	N/A
8	f	0,168	0,939	1,104	1,25	1,468	1,622	2,207	N/A	N/A	N/A	N/A	N/A
	P	-49,5	-49,5	-50,6	-54,8	-60,4	-63,9	-68,6	N/A	N/A	N/A	N/A	N/A
10	f	0,168	0,582	0,7	0,9	1,104	1,25	1,4	1,622	2,207	N/A	N/A	N/A
	P	-49,5	-49,5	-50,6	-52,4	-54,1	-58,6	-62,7	-68,2	-73,9	N/A	N/A	N/A
12	f	0,168	0,372	0,5	0,7	0,9	1,104	1,25	1,4	1,622	1,9	2,207	N/A
	P	-49,5	-49,5	-51,1	-53,4	-55,6	-57,7	-62,3	-66,7	-72,6	-75,8	-79,1	N/A
14	f	0,168	0,241	0,3	0,5	0,7	0,9	1,104	1,4	1,622	1,9	2,162	2,207
	P	-49,5	-49,5	-50,5	-53,6	-56,3	-58,8	-61,2	-70,7	-76,9	-80,5	-83,7	-80
16	f	0,169	0,199	0,3	0,5	0,7	0,9	1,104	1,25	1,468	1,622	2,1	2,207
	P	-49,8	-50,5	-52,5	-56,0	-59,1	-62,0	-64,7	-69,9	-76,8	-81,3	-88,2	-80
18	f	0,173	0,3	0,5	0,7	0,9	1,104	1,4	1,622	1,9	1,994	2,072	2,207
	P	-51,3	-54,5	-58,4	-61,9	-65,1	-68,3	-78,7	-85,6	-90,1	-91,5	-91,5	-80
20	f	0,179	0,3	0,5	0,7	1,104	1,4	1,622	1,707	2,072	2,207	N/A	N/A
	P	-53,4	-56,5	-60,9	-64,7	-71,8	-82,7	-90	-91,5	-91,5	-80	N/A	N/A
22	f	0,179	0,184	0,3	0,5	0,7	1,104	1,25	1,536	1,869	2,004	2,005	N/A
	P	-53,4	-55,2	-58,5	-63,3	-67,6	-75,3	-81,2	-91,5	-91,5	-80	-49,5	N/A
24	f	0,179	0,189	0,3	0,5	0,7	1,104	1,38	1,4	1,468	1,622	1,758	1,759
	P	-53,4	-57,0	-60,5	-65,7	-70,4	-78,8	-90	-90	-91,5	-91,5	-80	-49,5
26	f	0,179	0,196	0,3	0,5	0,7	1,104	1,281	1,404	1,448	1,578	1,579	N/A
	P	-53,4	-59,1	-62,5	-68,2	-73,2	-82,4	-90	-90,1	-91,1	-80	-49,5	N/A
28	f	0,179	0,199	0,211	0,301	0,5	0,7	0,9	1,104	1,193	1,349	1,468	1,469
	P	-53,4	-60,0	-61,4	-64,5	-70,6	-76,0	-81,1	-85,9	-90	-90	-80	-49,5
30	f	0,179	0,199	0,242	0,3	0,5	0,7	0,9	1,115	1,25	1,369	1,370	N/A
	P	-53,4	-60,0	-64,3	-66,5	-73,0	-78,9	-84,2	-90	-90	-80	-49,5	N/A
32	f	0,179	0,193	0,199	0,286	0,301	0,5	0,7	0,993	1,162	1,281	1,282	N/A
	P	-53,4	-58,4	-60,0	-68,0	-68,5	-75,5	-81,7	-90	-90	-80	-49,5	N/A
34	f	0,179	0,193	0,199	0,264	0,3	0,301	0,5	0,7	0,879	1,083	1,202	1,203
	P	-53,4	-58,4	-60,0	-66,2	-69	-70,5	-77,9	-84,5	-90	-90	-80	-49,5
36	f	0,179	0,193	0,199	0,243	0,3	0,301	0,5	0,7	0,781	1,011	1,13	1,132
	P	-53,4	-58,4	-60,0	-64,4	-69	-72,5	-80,3	-87,3	-90	-90	-80	-49,5
38	f	0,179	0,193	0,199	0,3	0,301	0,5	0,695	0,7	0,919	1,039	1,04	N/A
	P	-53,4	-58,4	-60,0	-69	-74,5	-82,8	-90	-90	-90	-80	-49,5	N/A
40	f	0,179	0,193	0,199	0,3	0,301	0,5	0,621	0,818	0,938	0,939	N/A	N/A
	P	-53,4	-58,4	-60,0	-69	-76,5	-85,2	-90	-90	-80	-49,5	N/A	N/A
42	f	0,179	0,193	0,199	0,3	0,301	0,5	0,555	0,728	0,849	0,850	N/A	N/A
	P	-53,4	-58,4	-60,0	-69	-78,5	-87,7	-90	-90	-80	-49,5	N/A	N/A
44	f	0,179	0,193	0,199	0,3	0,301	0,5	0,649	0,7	0,771	0,772	N/A	N/A
	P	-53,4	-58,4	-60,0	-69	-79	-90	-90	-85,6	-80	-49,5	N/A	N/A
46	f	0,179	0,193	0,199	0,3	0,301	0,5	0,579	0,7	0,701	N/A	N/A	N/A
	P	-53,4	-58,4	-60,0	-69	-79	-90	-90	-80	-49,5	N/A	N/A	N/A
48	f	0,179	0,193	0,199	0,3	0,301	0,464	0,5	0,515	0,638	0,639	N/A	N/A
	P	-53,4	-58,4	-60,0	-69	-79	-88,4	-90	-90	-80	-49,5	N/A	N/A
50	f	0,179	0,193	0,199	0,3	0,301	0,472	0,5	0,581	0,582	N/A	N/A	N/A
	P	-53,4	-58,4	-60,0	-69	-79	-88,8	-86,4	-80	-49,5	N/A	N/A	N/A
52	f	0,179	0,193	0,199	0,3	0,301	0,452	0,551	0,552	N/A	N/A	N/A	N/A
	P	-53,4	-58,4	-60,0	-69	-79	-87,8	-80	-49,5	N/A	N/A	N/A	N/A

NOTE 1: The label "N/A" denotes that a breakpoint is not used.

NOTE 2: If the parameter DPBOESEL is greater than 52 dB, the values associated with 52 apply for this signal description.

The PSD of the downstream signal description changes with the downstream power back-off exchange side electrical loss (DPBOESEL). Examples are shown in figure 67 for different values for DPBOESEL.

In practice, where multiple paths with different loss values exist between exchange and cabinet, a compromise DPBOESEL value is commonly selected to cause similar fractional harm to exchange based and cabinet based services.

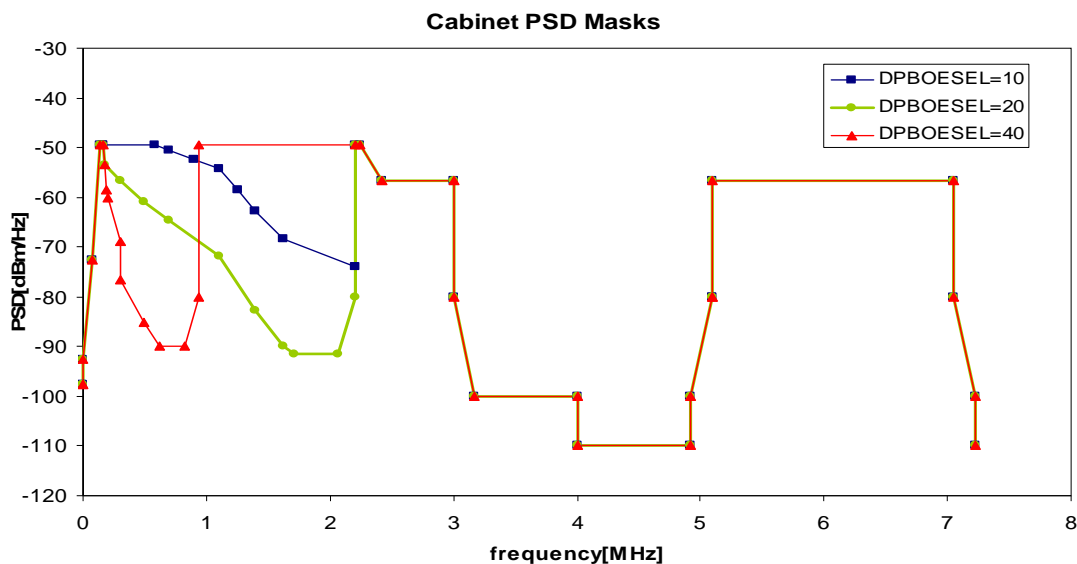

Figure 67: Spectral power for "VDSL2-UK1" downstream signals, as specified in tables 105 and 106, for different values of DPBOESEL

12.3.5 Narrow-band signal power (upstream only)

The present document provides information on how compliance with this signal category can be achieved:

To be compliant with this signal category, the Narrow-Band Signal Power (NBSP) into a resistive load impedance R for a given UPBO-value, shall not exceed the limits given in tables 107 and 108, at any point in the frequency range 100 Hz to 30 MHz.

The PSD of the upstream signal description changes with the upstream values for UPBO. Examples are shown in figure 68, for different values for UPBO, ranging from 0 dB to 17 dB.

**Table 107: Break points of the NBSP limits,
of the upstream transmit signal (customer PSD mask)**

Centre Frequency f (MHz)	Impedance R (Ω)	Signal Level P (dBm)	Power Bandwidth B	Spectral Power P/B (dBm/Hz)
0,	600	-77,5	100 Hz	-97,5
0,004	600	-77,5	100 Hz	-97,5
0,004	100	-72,5	100 Hz	-92,5
0,026	100	5,5	10 kHz	-34,5
0,138	100	5,5	10 kHz	-34,5
0,243	100	-53,2	10 kHz	-93,2
0,686	100	-60	10 kHz	-100
2,825	100	-60	10 kHz	-100
2,999	100	$P_1 + 40$ dB	10 kHz	P_1
3	100	$P_2 + 40$ dB	10 kHz	P_2
4	100	$P_3 + 40$ dB	10 kHz	P_3
5,1	100	$P_4 + 40$ dB	10 kHz	P_4
5,101	100	$P_5 + 40$ dB	10 kHz	P_5
5,275	100	-60	10 kHz	-100
5,276	100	-70	10 kHz	-110
5,776	100	-50	1 MHz	-110
30	100	-50	1 MHz	-110

NOTE: The limits between breakpoints shall be obtained by interpolation between adjacent breakpoints on a dB/log(f) basis below 2,825 MHz and on a dB/ f basis above 2,825 MHz. The values above and including 2,825 MHz are according to ITU-T Recommendation G.993.2 [i.14].

**Table 108: Definition of parameter P_k , (with $k = 1$ to 6),
of the upstream NBSP limits in table 107, for UPBO 0 dB to 17 dB**

UPBO	P_1	P_2	P_3	P_4	P_5
0	-85,9	N/A	-90,5	N/A	-94,9
1	-84,2	N/A	-88,5	N/A	-92,6
2	-82,5	N/A	-86,5	N/A	-90,4
3	-80,7	N/A	-84,5	N/A	-88,1
4	-80	-79	-82,5	N/A	-85,9
5	-80	-77,3	-80,5	N/A	-83,6
6	-80	-75,6	-78,5	N/A	-81,3
7	-80	-73,8	-76,5	-79,1	-80
8	-80	-72,1	-74,5	-76,8	-80
9	-80	-70,4	-72,5	-74,6	-80
10	-80	-68,6	-70,5	-72,3	-80
11	-80	-66,9	-68,5	-70	-80
12	-80	-65,2	-66,5	-67,8	-80
13	-80	-63,4	-64,5	-65,5	-80
14	-80	-61,7	-62,5	-63,3	-80
15	-80	-60	-60,5	-61	-80
16	-80	-58,2	-58,5	-58,8	-80
17	-80	-56,5	-56,5	-56,5	-80

NOTE: The effective range of UPBO is limited to 0 dB to 17 dB. Values of UPBO in excess of 17 dB do not result in an increased mask. Within these bounds any value of UPBO may be used.

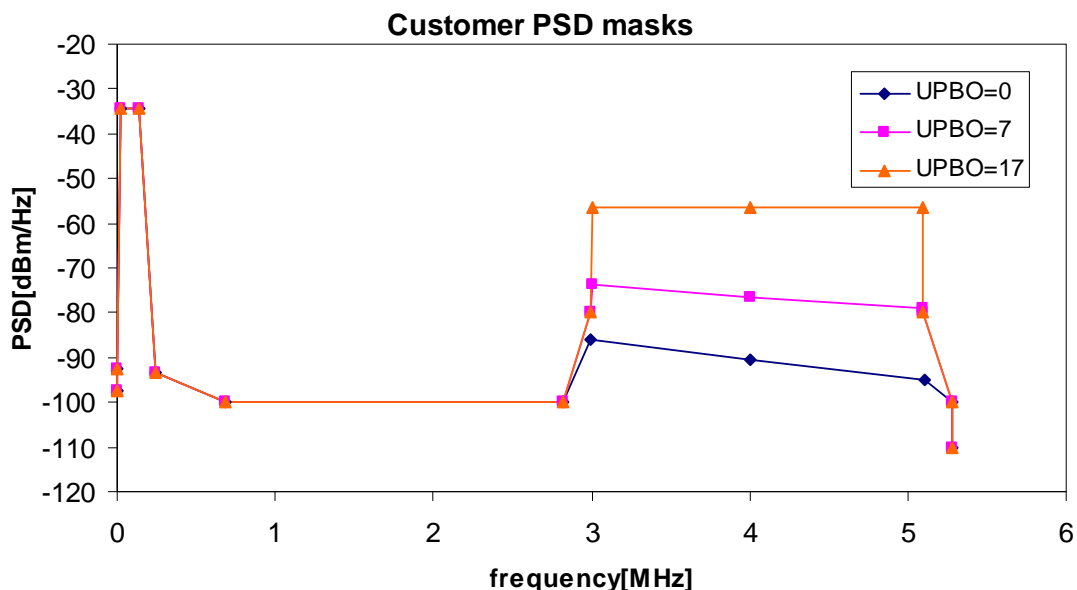

Figure 68: Spectral power for "VDSL2-UK1" upstream signals, as specified in tables 107 and 108, for different values of UPBO

12.3.6 Unbalance about earth (upstream and downstream)

The present document provides information on how compliance with this signal category can be achieved:

To be compliant with this signal category, the unbalance about earth shall not exceed the associated limits specified for "VDSL2-NL1" signals.

13 Measurement methods of signal parameters

13.1 Peak amplitude

The present document provides information on the peak amplitude:

The peak amplitude is defined as the peak voltage amplitude measured in a continuous sending signal such that the probability of exceeding that amplitude is less than 10^{-7} . It shall be measured into a resistive load R , and over a period of not less than 120 s. The bandwidth B of the measuring instrument depends on the characteristics of the signal under test, and should be sufficiently wide. Each clause in the present document, specifying maximum values for the peak amplitude, specifies minimum values for this bandwidth B as well.

The measurement period of at least 120 s is required to generate a peak amplitude to better than 10^{-7} probability for all known DSL types except DMT ADSL. DMT's combination of near-Gaussian distribution and low symbol rate would force a measurement period on the order of 42 minutes to generate 10^7 symbols - however, 120 s will generate a peak measurement on the order of 90 % of the 10^{-7} peak.

13.2 Narrow-band signal power (voltage)

The narrow band signal power is defined as the average power P of a sending signal into a resistive load R , within a *power* bandwidth B centred at a specified frequency. The power bandwidth is different from the commonly used -3 dB bandwidth, since it fully accounts for the shape of the transfer function $H(f)$ of frequency selective filters while measuring narrow band power (or rms-voltage). The power bandwidth of a frequency selective filter is defined as shown below.

$$B_{power} = \frac{1}{|H_{max}|^2} \int |H(f)|^2 \times df$$

13.3 Unbalance about earth

The present document provides information on dealing with unbalance about earth and indicates relevant specification(s):

Poor balance of a signal source, connected to a local loop wiring, leads to conditions in the network where systems using the same cable could be harmed. If the combination of system and wire pair shows a poor balance about earth, this will result in unwanted radiated emissions (egress) which will be visible in the environment of the wire pair and which also will be received by adjacent wire pairs (crosstalk).

13.3.1 Definition of earth

Measurements of both LOV and LCL must be considered as 3 terminal measurements. These terminals are the conductors of a port to the Local Loop Wiring or to a signal source (ESS, CSS or RSS). Two terminals are those of the differential mode and the third terminal is that of the earth used of the common mode.

- In the case of a signal source that is connected to a local earth point, then the measurement equipment should be connected to the same earth point. The earth point of the measurement equipment should be taken from a point close to the measurement port of the equipment. The connection to the earth point of the signal source should be of low impedance.
- In the case of a signal source that has no reference to earth, then that source must be placed centrally on an earthed copper or similar high conductivity metal plate of dimension greater than twice the area of the minimum rectangle bounding the perimeter of the signal source. The earth point of the measurement equipment should be taken from a point close to the measurement port of the equipment. The connection to the metal plane should be of low impedance.

13.3.2 Transmitter Balance - LOV

The balance of transmitters is normally expressed in the "Longitudinal Output Voltage" (LOV). This is the common mode portion of the generated signal, and specified for many transmission systems defined by ETSI TM6 (e.g. see [i.6] and [i.7]).

The longitudinal output voltage is the longitudinal component of the output signal that occurs on the line interface (ports of the local loop wiring). The definition of the LOV can be found in the ITU-T Recommendation G.117 [i.16].

Figure 69 gives an example measurement method for longitudinal output voltage. Further examples can be derived from [i.15] and [i.16]. For direct use of this test configuration, the IUT should be able to generate a signal in the absence of a signal from the far end. The ground reference for these measurements shall be the building ground.

NOTE: During regenerator test (where required) each wire on the side which is not under test has to be connected to ground by a terminating impedance having the value of $R_T/2$ in series with a capacitance of at least 330 nF.

Reference: ITU-T Recommendation O.9 [i.15].

Reference: ITU-T Recommendation G.117 [i.16].

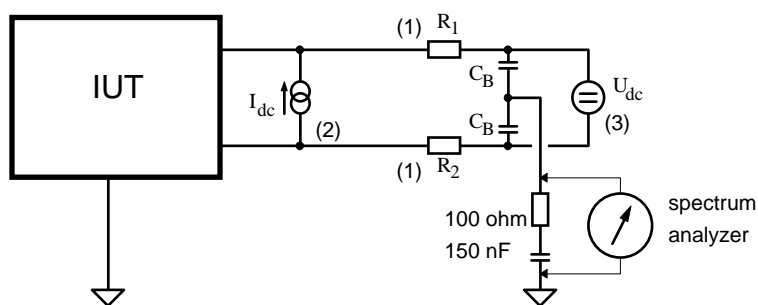

NOTE 1: The remarks below apply to figure 69:

(1) These resistors have to be matched: $R_1 = R_2 = R_T/2$ and $R_1/R_2 = 1 \pm 0,1 \%$.

(2) For LTU test only if remote power feeding is supplied.

(3) For NTU test only if remote power feeding is required DC blocking capacitors = C_B .

NOTE 2: The value of the components C_B is to be considered carefully for the frequency range and design impedance the measuring adapter is used for. At low frequencies other measurement methods could be more appropriate.

Figure 69: Measurement method for longitudinal output voltage (LOV)

13.3.3 Receiver balance - LCL

The balance of receivers is normally expressed in the "Longitudinal Conversion Loss" (LCL). The definition of the LCL can be found in [i.15]. Additionally, LCL is specified for all transmission systems defined by ETSI TM6 (e.g. see [i.6] and [i.7]).

The Longitudinal Conversion Loss (LCL) is given by: $LCL = 20 \log (e_l/e_m)$ (dB) where e_l is the applied longitudinal voltage referenced to the building ground and e_m is the resultant metallic voltage appearing across a termination with the impedance as given in the relevant clause (see figure 70).

Figure 70 defines an example of the measurement method for the Longitudinal Conversion Loss (LCL). Measurement should be performed with the IUT powered up but inactive (no transmit signal).

Reference: ITU-T Recommendation O.9 [i.15].

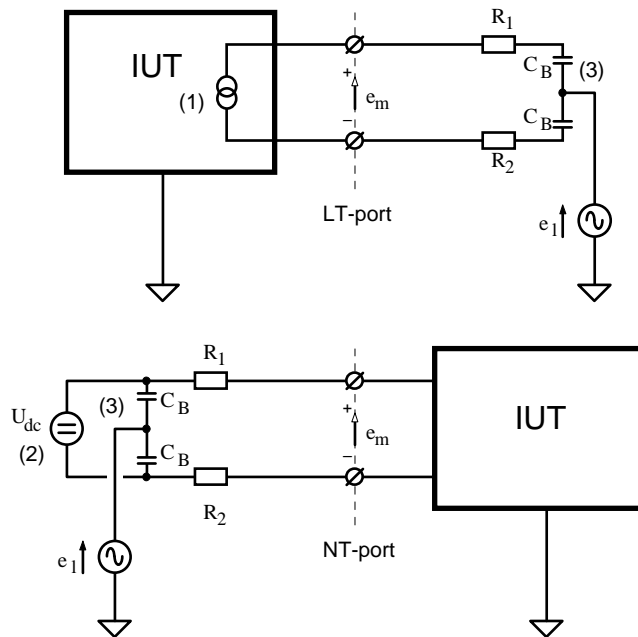

NOTE 1: The remarks below apply to figure 70:

- (1) For LT test only if remote powering is supplied.
- (2) For NT test only if remote powering is required. The power supply shall have at least an impedance of $10 \times (R_1 + R_2)$ for the test frequencies of the LCL.
- (3) DC blocking capacitors = C_B .

NOTE 2: The value of the components C_B is to be considered carefully for the frequency range and design impedance the measuring adapter is used for. At low frequencies other measurement methods could be more appropriate.

Figure 70: Measurement method for longitudinal conversion loss

Annex A: Bibliography

ACCESS CABLES

- ETSI/STC TM6(97)02: "Cable reference models for simulating metallic access networks", R.F.M. van den Brink, ETSI-TM6, Permanent document TM6(97)02, revision 3, Luleå, Sweden, June (970p02r3).

ADSL

- ITU-T Recommendation G.992.2: "Splitterless asymmetric digital subscriber line (ADSL) transceivers".

EMC & UNBALANCE

- ETSI EN 300 386-2 (V1.1.3): "Electromagnetic compatibility and Radio spectrum Matters (ERM); Telecommunication network equipment; ElectroMagnetic Compatibility (EMC) requirements; Part 2: Product family standard".

History

Document history		
V1.1.1	September 2000	Publication
V1.2.1	August 2001	Publication
V1.3.1	December 2002	Publication
V1.4.1	March 2006	Publication
V1.5.1	September 2008	Publication