

# TR 101 632 V6.0.0 (1999-04)

---

*Technical Report*

**Digital cellular telecommunications system (Phase 2+);  
Interface protocols for the connection of Short Message  
Service Centres (SMSCs) to Short Message Entities (SMEs)  
(GSM 03.39 version 6.0.0 Release 1997)**

---



**GSM**®  
GLOBAL SYSTEM FOR  
MOBILE COMMUNICATIONS

**ETSI** 

---

Reference

---

DTR/SMG-040339Q6 (f4003004.PDF)

Keywords

---

Digital cellular telecommunications system,  
Global System for Mobile communications (GSM)

**ETSI**

Postal address

---

F-06921 Sophia Antipolis Cedex - FRANCE

Office address

---

650 Route des Lucioles - Sophia Antipolis  
Valbonne - FRANCE  
Tel.: +33 4 92 94 42 00 Fax: +33 4 93 65 47 16  
Siret N° 348 623 562 00017 - NAF 742 C  
Association à but non lucratif enregistrée à la  
Sous-Préfecture de Grasse (06) N° 7803/88

Internet

---

secretariat@etsi.fr  
Individual copies of this ETSI deliverable  
can be downloaded from  
<http://www.etsi.org>  
If you find errors in the present document, send your  
comment to: editor@etsi.fr

---

**Copyright Notification**

---

No part may be reproduced except as authorized by written permission.  
The copyright and the foregoing restriction extend to reproduction in all media.

© European Telecommunications Standards Institute 1999.  
All rights reserved.

# Contents

Intellectual Property Rights.....	9
Foreword .....	9
1 Scope.....	10
2 References.....	10
3 Abbreviations and definitions.....	11
3.1 Abbreviations.....	11
3.2 Definitions .....	12
4 General.....	12
<b>Annex A: Short Message Peer to Peer (SMPP) Interface Specification.....</b>	<b>13</b>
A.1 Introduction.....	13
A.1.1 Purpose .....	13
A.1.2 Scope .....	13
A.2 Functional overview.....	13
A.2.1 ESMEs to SMSC .....	14
A.2.2 SMSC to ESME.....	14
A.2.3 Backward compatibility .....	14
A.3 Interface Specification .....	15
A.4 Protocol Messages.....	15
A.5 Use of Primitives.....	16
A.5.1 Initiation of Communication with SMSC.....	16
A.5.2 Steady-State Communication with the SMSC.....	17
A.5.3 Terminating Communication with the SMSC .....	17
A.5.4 Error Handling and Retransmission .....	17
A.5.5 Protocol Message Types .....	18
A.5.5.1 ESME to SMSC .....	18
A.5.5.2 SMSC to ESME .....	18
A.6 Message Layouts.....	19
A.6.1 Definitions .....	19
A.6.2 Message Header Format .....	20
A.6.2.1 “Generic_Nak” Command.....	20
A.6.2.1.1 “Generic_Nak” Syntax .....	20
A.6.3 Message Body Formats.....	21
A.6.3.1 “BIND” Operation .....	21
A.6.3.1.1 “BIND_RECEIVER” Syntax .....	21
A.6.3.1.2 “BIND_RECEIVER_RESP” Syntax .....	22
A.6.3.1.3 “BIND_TRANSMITTER” Syntax .....	22
A.6.3.1.4 “BIND_TRANSMITTER_RESP” Syntax.....	22
A.6.3.2 “UNBIND” Operation.....	22
A.6.3.2.1 “UNBIND” Syntax .....	22
A.6.3.2.2 “UNBIND_RESP” Syntax.....	23
A.6.3.3 “SUBMIT_SM” Operation .....	23
A.6.3.3.1 “SUBMIT_SM” Syntax.....	23
A.6.3.3.2 SUBMIT_SM_RESP” Syntax .....	25
A.6.3.4 “DELIVER_SM” Operation.....	25
A.6.3.4.1 “DELIVER_SM” Syntax .....	25
A.6.3.4.2 “DELIVER_SM_RESP” Syntax .....	25
A.6.3.5 “QUERY_SM” Operation.....	25
A.6.3.5.1 “QUERY_SM” Syntax .....	25
A.6.3.5.2 “QUERY_SM_RESP” Syntax.....	26

A.6.3.6	“CANCEL_SM” Operation.....	26
A.6.3.6.1	“CANCEL_SM” Syntax .....	27
A.6.3.6.2	“CANCEL_SM_RESP” Syntax.....	28
A.6.3.7	“REPLACE_SM” Operation.....	28
A.6.3.7.1	“REPLACE_SM” Syntax .....	28
A.6.3.7.2	“REPLACE_SM_RESP” Syntax.....	29
A.6.3.8	“ENQUIRE_LINK” Operation .....	29
A.6.3.8.1	“ENQUIRE_LINK” Syntax.....	29
A.6.3.8.2	“ENQUIRE_LINK_RESP” Syntax .....	29
A.7	System Definitions .....	29
A.7.1	Error Codes.....	30
A.7.2	Command I.D. Values.....	30
A.7.3	GSM Error Codes .....	31
A.7.4	Message States.....	31
A.7.5	Time Format .....	31
<b>Annex B: Short Message Service Centre External Machine Interface.....</b>		<b>32</b>
B.1	Introduction.....	32
B.1.1	Position of interface.....	33
B.1.2	Interface history .....	33
B.2	Structure of EMI Messages.....	34
B.2.1	Examples.....	34
B.3	EMI COMMANDS .....	35
B.3.1	Application initiated commands .....	35
B.3.2	SMSC initiated commands.....	36
B.4	EMI Commands Syntax .....	36
B.4.1	Address syntax.....	36
B.4.2	Call input operation - 01 .....	36
B.4.2.1	Call input operation (positive result).....	37
B.4.2.2	Call input operation (negative result) .....	37
B.4.3	Multiple address call input operation - 02 .....	38
B.4.3.1	Multiple address call input operation (positive result) .....	39
B.4.3.2	Multiple address call input operation (negative result) .....	39
B.4.4	Call input with supplementary services operation - 03 .....	40
B.4.4.1	Call input with supplementary services operation (positive result) .....	41
B.4.4.2	Call input with supplementary services operation (negative result) .....	41
B.4.5	SMS message transfer operation - 30.....	42
B.4.5.1	SMS message transfer operation (positive result) .....	42
B.4.5.2	SMS message transfer operation (negative result) .....	43
B.4.6	SMT alert operation - 31.....	43
B.4.6.1	SMT alert operation (positive result) .....	43
B.4.6.2	SMT alert operation (negative result) .....	44
B.5	50-Series of EMI Messages .....	44
B.5.1	Abstract Data Types.....	45
B.5.2	Standard string.....	47
B.5.3	Submit Short Message operation -51 .....	48
B.5.3.1	Submit Short Message operation (positive result).....	48
B.5.3.2	Submit Short Message operation (negative result).....	49
B.5.4	Delivery Short Message operation -52.....	49
B.5.4.1	Delivery Short Message operation (positive result) .....	50
B.5.4.2	Delivery Short Message operation (negative result).....	50
B.5.5	Delivery notification operation -53.....	51
B.5.5.1	Delivery Notification operation (positive result).....	51
B.5.5.2	Delivery Notification operation (negative result).....	52
B.5.6	Inquiry message operation -55 .....	52
B.5.6.1	Inquiry message operation (positive result).....	53
B.5.6.2	Inquiry message operation (negative result).....	53

B.5.7	Delete message operation -56 .....	54
B.5.7.1	Delete message operation (positive result) .....	54
B.5.7.2	Delete message operation (negative result) .....	55
B.5.8	Response Inquiry message operation -57 .....	55
B.5.8.1	Response inquiry message operation (positive result) .....	56
B.5.8.2	Response inquiry message operation (negative result) .....	56
B.5.9	Response delete message operation -58 .....	57
B.5.9.1	Response delete message operation (positive result) .....	57
B.5.9.2	Response delete message operation (negative result) .....	58
B.6	Error codes overview .....	58
B.6.1	Error codes .....	58
<b>Annex C: SMSC to SME interface specification .....</b>		<b>60</b>
C.1	Introduction .....	60
C.1.1	System architecture .....	60
C.1.2	What to communicate .....	60
C.1.3	How to communicate .....	60
C.1.4	What to do with the information .....	60
C.1.5	Interface profile .....	61
C.2	Operations .....	61
C.2.1	Introduction .....	61
C.2.2	Operations from the SME to the SMSC .....	61
C.2.3	Operations from the SMSC to the SME .....	62
C.2.4	Common operations .....	62
C.3	Operation details .....	63
C.3.1	Submit .....	63
C.3.2	Cancel .....	64
C.3.3	Delivery request .....	65
C.3.4	Status report request .....	65
C.3.5	Disable status report request .....	66
C.3.6	Enable status report request .....	66
C.3.7	Login .....	67
C.3.8	Logout .....	67
C.3.9	Change password .....	67
C.3.10	Change profile parameter .....	68
C.3.11	Delivery .....	68
C.3.12	Status report .....	69
C.3.13	Reachability notification .....	69
C.3.14	Delivery data indication .....	70
C.3.15	Alive .....	70
C.3.16	Ack .....	71
C.3.17	Nack .....	71
C.4	Interface parameters .....	71
C.4.1	Parameter types .....	72
C.4.2	Parameter definitions .....	72
C.5	SME link .....	80
C.5.1	Introduction .....	80
C.5.2	Binary coded SME link .....	80
C.5.2.1	SME parameter format .....	80
C.5.2.2	SME operation format .....	81
C.5.3	Text based SME link .....	81
C.5.3.1	SME operation format .....	82
C.5.3.2	Example session .....	82
C.6	Waiting indication service .....	83
C.6.1	Purpose of the service .....	83
C.6.2	Interface profile .....	84

C.6.2.1	Operations needed.....	84
C.6.2.2	Parameters needed.....	84
C.6.2.3	SME link .....	85
<b>Annex D:</b>	<b>SMSC Open Interface Specification .....</b>	<b>86</b>
D.1	Introduction .....	86
D.1.1	Scope .....	86
D.1.2	Annex Structure .....	86
D.2	Overview .....	86
D.2.1	SMSC and SMEs .....	86
D.2.2	Services Available .....	86
D.2.3	General procedures in the SMSC to SME protocol .....	87
D.2.3.1	Summary .....	87
D.2.3.2	Procedures for Handling Operation Failure .....	87
D.2.3.3	SME Recovery Strategy .....	87
D.2.3.3.1	SMSC Recovery Strategy .....	87
D.3	SMSC Access Procedures .....	88
D.3.1	Procedure for Submission of an SM .....	88
D.3.2	Procedure for Deletion of an SM .....	89
D.3.3	Procedure for Replacement of an SM .....	90
D.3.4	Procedure for Deletion of All SMs .....	92
D.3.5	Procedure for Enquiring on an SM .....	93
D.3.6	Procedure for Cancelling Status Report Requests on an SM .....	93
D.3.7	Procedure for Requesting an Alert SME.....	94
D.3.8	Procedure for Receiving an Incoming SM.....	94
D.3.9	Procedure for Retrieving Incoming SMs, SRs and Alert SMEs.....	95
D.3.10	Procedure for Getting the Open Interface Version Number.....	96
D.4	Message Format .....	96
D.4.1	Header Details .....	96
D.4.1.1	Invoke Message Header .....	96
D.4.1.2	Result Message Header .....	97
D.4.2	Operation Data.....	97
D.4.2.1	Submit SM Invoke .....	98
D.4.2.2	Submit SM Result .....	98
D.4.2.3	Delete SM Invoke .....	99
D.4.2.4	Delete SM Result .....	99
D.4.2.5	Replace SM Invoke .....	99
D.4.2.6	Replace SM Result .....	100
D.4.2.7	Delete All SMs Invoke .....	101
D.4.2.8	Delete All SMs Result .....	101
D.4.2.9	Status Report Invoke .....	101
D.4.2.10	Status Report Result.....	101
D.4.2.11	Enquire SM Invoke .....	102
D.4.2.12	Enquire SM Result .....	102
D.4.2.13	Cancel Status Report Invoke .....	103
D.4.2.14	Cancel Status Report Result .....	103
D.4.2.15	Alert SME Request Invoke.....	103
D.4.2.16	Alert SME Request Result .....	103
D.4.2.17	Alert SME Invoke .....	104
D.4.2.18	Alert SME Result .....	104
D.4.2.19	Deliver SM Invoke .....	105
D.4.2.20	Deliver SM Result.....	105
D.4.2.21	Retrieve Request Invoke .....	105
D.4.2.22	Retrieve Request Result .....	105
D.4.2.23	Get Version Invoke .....	105
D.4.2.24	Get Version Result .....	106
D.4.3	Field Definitions .....	106
D.4.3.1	Accept Time - 14 character string .....	106

D.4.3.2	ASR Reference Number - 4 byte integer .....	106
D.4.3.3	Available Flag - 1 byte integer .....	106
D.4.3.4	Completion Time - 14 character string .....	106
D.4.3.5	Data Coding Scheme - 1 byte integer .....	106
D.4.3.6	Delivery Failure Reason - 1 byte integer .....	107
D.4.3.7	Destination Address - variable length string - length held in "Destination Address Length" .....	107
D.4.3.8	Destination Address Length - 1 byte integer .....	107
D.4.3.9	Enquiry Type - 1 byte integer .....	108
D.4.3.10	Expiry Time - 14 character string .....	108
D.4.3.11	Intermediate Time .....	108
D.4.3.12	Invoke Time - 14 character string .....	108
D.4.3.13	MSISDN - variable length string - length held in "MSISDN Length" .....	108
D.4.3.14	MSISDN Length - 1 byte integer .....	108
D.4.3.15	OI Version Number - 1 byte integer .....	108
D.4.3.16	Originating Address - variable length string - length held in "Originating Address Length" .....	109
D.4.3.17	Originating Address Length - 1 byte integer .....	109
D.4.3.18	Priority - 1 byte integer .....	109
D.4.3.19	Protocol Id - 1 byte integer .....	109
D.4.3.20	Receive Ready Flag - 1 byte integer .....	109
D.4.3.21	Reply Path - 1 byte integer .....	110
D.4.3.22	Result - 1 byte integer .....	110
D.4.3.23	Retrieve Order - 1 byte integer .....	110
D.4.3.24	Retrieval Type - 1 byte integer .....	110
D.4.3.25	SM Reference Type - 1 byte integer .....	110
D.4.3.26	SM Status - 1 byte integer .....	111
D.4.3.27	SM Text - variable length string - length held in "SM Text Size (Bytes)" .....	111
D.4.3.28	SM Text Size (Bytes) - 1 byte integer .....	111
D.4.3.29	SM Text Size (Characters) - 1 byte integer .....	111
D.4.3.30	SME Reference Number - 4 byte integer .....	111
D.4.3.31	SME Result - 1 byte integer .....	111
D.4.3.32	SME Reference Number Type - 1 byte integer .....	113
D.4.3.33	SMSC Reference Number - 4 byte integer .....	113
D.4.3.34	Status Report Override - 1 byte integer .....	113
D.4.3.35	Status Report Request - 1 byte integer .....	113
D.4.3.36	Sub-Logical SME Number - 1 byte integer .....	114
D.4.3.37	Validity Period (Absolute) - 14 character string .....	114
D.4.3.38	Validity Period (Relative) - 1 byte integer .....	114
D.4.3.39	Validity Period Type - 1 byte integer .....	114

**Annex E: SMSC Computer Access Service and Protocol Manual .....115**

E.1	Introduction .....	115
E.2	Overview .....	115
E.2.1	The Short Message Service .....	115
E.2.1.1	Submission and delivery .....	116
E.2.1.2	Message buffering .....	116
E.2.1.3	Notifications .....	117
E.2.2	Software structure .....	117
E.2.2.1	Computer Access Unit .....	118
E.3	Computer Access Protocol .....	118
E.3.1	Connect and disconnect .....	119
E.3.1.1	Connect Initiated from SMS-C .....	119
E.3.1.2	Connect Initiated from the user system .....	119
E.3.1.3	Disconnect .....	119
E.3.2	Open procedure .....	119
E.3.3	Submit Short Message .....	120
E.3.4	Retrieve Short Message or Message Notification .....	120
E.3.5	Delete Short Message .....	121
E.3.6	Close procedure .....	121

E.4 Connect and Disconnect Procedures..... 121

E.4.1 X.25 ..... 121

E.4.1.1 Multipoint support ..... 122

E.4.1.2 Connect from the user system..... 122

E.4.1.3 Connect from SMS-C..... 122

E.4.1.4 Disconnect..... 122

E.5 Scenarios ..... 123

E.5.1 Submit Short Message from the User System..... 123

E.5.2 Delivery of Message from SMS-C..... 123

E.6 Design considerations ..... 124

E.6.1 SMS-C Configuration ..... 124

E.6.2 Designing for High Throughput..... 124

E.6.2.1 Notifications ..... 124

E.6.2.2 X.25 Multipoint support..... 125

E.7 Protocol Data Unit Definitions ..... 125

**Annex F (informative): Change Request History .....130**

History ..... 131



---

## Intellectual Property Rights

IPRs essential or potentially essential to the present document may have been declared to ETSI. The information pertaining to these essential IPRs, if any, is publicly available for **ETSI members and non-members**, and can be found in SR 000 314: "*Intellectual Property Rights (IPRs); Essential, or potentially Essential, IPRs notified to ETSI in respect of ETSI standards*", which is available **free of charge** from the ETSI Secretariat. Latest updates are available on the ETSI Web server (<http://www.etsi.org/ipr>).

Pursuant to the ETSI IPR Policy, no investigation, including IPR searches, has been carried out by ETSI. No guarantee can be given as to the existence of other IPRs not referenced in SR 000 314 (or the updates on the ETSI Web server) which are, or may be, or may become, essential to the present document.

---

## Foreword

This Technical Report (TR) has been produced by the Special Mobile Group (SMG).

The present document provides a single document within which proprietary Short Message Service Centre (SMSC) to Short Message Entity (SME) interface standards are accommodated as optional implementations. Publication in the present document of the de facto protocols, should limit the proliferation of proprietary standards and will benefit new SC/SME developers who may then adopt one or more of the existing protocols outlined. The present document describes a range of alternative interfaces which may be utilised by SMSC and SME, developers for the connection of SMEs to SMSCs within the digital cellular telecommunications system.

The contents of the present document is subject to continuing work within SMG and may change following formal SMG approval. Should SMG modify the contents of the present document it will be re-released with an identifying change of release date and an increase in version number as follows:

Version 6.x.y

where:

- 6 indicates Release 1997 of GSM Phase 2+
- x the second digit is incremented for all changes of substance, i.e. technical enhancements, corrections, updates, etc.
- y the third digit is incremented when editorial only changes have been incorporated in the specification.

---

# 1 Scope

The present document describes a range of alternative interfaces which may be utilised by Short Message Service Centre (SMSC), and Short Message Entity (SME), developers for the connection of SMEs to SMSCs.

The purpose of the present document is to provide a single document within which the various proprietary SMSC to SME interface standards may be accommodated as optional implementations.

As stated in GSM 03.40 [1], the functionality of the SMSC is outside of the scope of the GSM Technical Specifications. As a result, no standardised interfaces have been specified for the connection of SMEs to the SMSC. In the absence of a prevailing standard, SC (Service Centre), developers have devised their own protocols which have not necessarily been based on any existing standards and are therefore largely incompatible with one another. It has been recognised by TC-SMG, that the development of a single European Telecommunication Standard (ETS) at this stage, would be of little value as these proprietary standards are now in extensive use in many networks.

TC-SMG has concluded that the publication by ETSI of the various de facto protocols, will limit the further proliferation of proprietary standards and will benefit new SC/SME developers who may then adopt one or more of the existing protocols outlined in the present document.

---

# 2 References

The following documents contain provisions which, through reference in this text, constitute provisions of the present document.

- References are either specific (identified by date of publication, edition number, version number, etc.) or non-specific.
- For a specific reference, subsequent revisions do not apply.
- For a non-specific reference, the latest version applies.
- A non-specific reference to an ETS shall also be taken to refer to later versions published as an EN with the same number.
- For this Release 1997 document, references to GSM documents are for Release 1997 versions (version 6.x.y).

- [1] GSM 03.40: "Digital cellular telecommunications system (Phase 2+); Technical realization of the Short Message Service (SMS) Point-to-Point (PP)".
- [2] GSM 01.04: "Digital cellular telecommunication system (Phase 2+); Abbreviations and acronyms".
- [3] ETS 300 133-3: "Paging Systems (PS); European Radio Messaging System (ERMES) Part 3: Network aspects".
- [4] GSM 09.02: "Digital cellular telecommunications system (Phase 2+); Mobile Application Part (MAP) specification".
- [5] CCITT Recommendation X.208, Specification of Abstract Syntax Notation One (ASN.1). Blue book, Melbourne 1988.
- [6] CCITT Recommendation X.209, Specification of Basic Encoding Rules (BER) for Abstract Syntax Notation One. Blue book, Melbourne 1988.
- [7] CCITT Recommendation X.25 of 1984.
- [8] SMS-C Technical Description. EN/LZT 123 718.
- [9] SMPP Applications Guide: Version 2.0 Aldiscon Limited.

## 3 Abbreviations and definitions

### 3.1 Abbreviations

For the purposes of the the present document, the following abbreviations apply:

SC	Service Centre
SME	Short Message Entity
SMPP	Short Message Peer to Peer
SMSC	Short Message Service Centre

#### Abbreviations used in annex A

ACK	Acknowledgement
AIM	Application Interface Module
API	Application Programming Interface
CDR	Call Detail Record
ESME	External Short Message Entity. Refer to note[1]
MB	Message Bureau - This is typically an operator message bureau.
MSC	Mobile Switching Centre
MSISDN	Mobile Station ISDN Number, i.e. a telephone number
MS	Mobile Station
NAK	Negative Acknowledgement
SME	Short Message Entity
SMSC	Short Message Service Centre
SMPP	Short Message Peer to Peer
VC	Virtual Connection. Refer to note [1]
VMA	VoiceMail Alert or Message Waiting Indication (MWI)
VPS	Voice Processing System

#### Abbreviations used in annex B

CMG	Computer Management Group
EMI	External Machine Interface
ERMES	European Radio MESSaging System
ETS	European Technical Standard
FAX	Facsimile
GSM	Global System for Mobile communication
IVR	Interactive Voice Response
MSISDN	Mobile Station ISDN number
MS	Mobile Station
O&M	Operations and Maintenance
PC	Personal Computer
PLMN	Public Land Mobile Network
PSTN	Public Switched Telephone Network
SM	Short Message
SME	Short Message Entity
SMH	Short Message Handler
SMS	Short Message Service
SMSC	Short Message Service Centre
SMT	Short Message Terminal
UCP	Universal Computer Protocol
VMS	Voice Mail System

Additional abbreviations used within the present document may be found in GSM 01.04 [2].

## 3.2 Definitions

For the purposes of annex D of the present document the following definitions apply.

**High Availability SME:** An SME directly connected to the SMSC which is available most of the time - for example a voice mail system.

**Low Availability SME:** An SME which is only occasionally available - for example a MS.

**SMSC Reference number:** Reference number for an SM allocated by the SMSC. Not the same as an SME reference number.

**SME Reference number:** Reference number for an SM allocated by the SME. Not the same as an SMSC reference number.

For the purposes of annex A of this ETS the following definitions apply.

**External Short Message Entity:** This refers to such external sources and sinks of short messages as Voice Processing or Message Handling computers. It specifically excludes SMEs which are part of the interface to the PLMN.

**Virtual Connection:** This refers to a virtual circuit in the X.25 implementation.

---

## 4 General

The individual specifications contained in the annexes to the present document outline the details of the various optional SC to SME interface standards. The present document does not provide recommendations, as to the preferred implementation as all are regarded as being of equal merit. SC/SME implementors should therefore adopt the protocol most suited to their particular implementation, application or market.

The proprietary SC to SME interface protocols contained in the annexes are as follows:

- Annex A: Short Message Peer to Peer (SMPP) Interface Specification (Aldiscon Information Systems)
- Annex B: Short Message Service Centre external machine interface (Computer Management Group)
- Annex C: SMSC to SME Interface Specification (Nokia Cellular Systems)
- Annex D: SMSC Open Interface Specification (SEMA Group)
- Annex E: SMSC Computer Access Service And Protocol Manual (Ericsson)

Control (through TC-SMG), over the contents of the annexes remains with owners of the proprietary standards.

**NOTE:** ETSI take no responsibility for the viability of any of the optional SC to SME interface protocols contained in the annexes. Enquires relating to their technical content should be made directly to the editing authority for each specification.

---

# Annex A: Short Message Peer to Peer (SMPP) Interface Specification

## A.1 Introduction

### A.1.1 Purpose

This annex specifies a generalized interface between an SMSC and non-PLMN SMEs. Typically it specifies the interface used between the SMSC and Paging or VoiceMail systems. The command format defines a Short Message Peer to Peer Protocol (hereafter referred to as SMPP). This protocol may be implemented over a variety of underlying interfaces/communications protocols, namely X.25, or TCP/IP.

Using this interface, an external Short Message Entity such as a Paging or VoiceMail system may bind/ unbind to the SMSC, submit, cancel, replace and query short messages. The SMSC forwards responses and short messages (e.g delivery receipts, pager messages) to the external Short Message Entity.

### A.1.2 Scope

This annex is intended for designers and implementers of the interface between an SMSC and SMEs (Short Message Entities).

---

## A.2 Functional overview

Interworking between the SMSC and ESMEs are categorised as:

- (protocol) messages from ESMEs to the SMSC, and
- (protocol) messages from SMSC to ESMEs.

Figure A.1 illustrates these categories which are detailed in the following clauses.

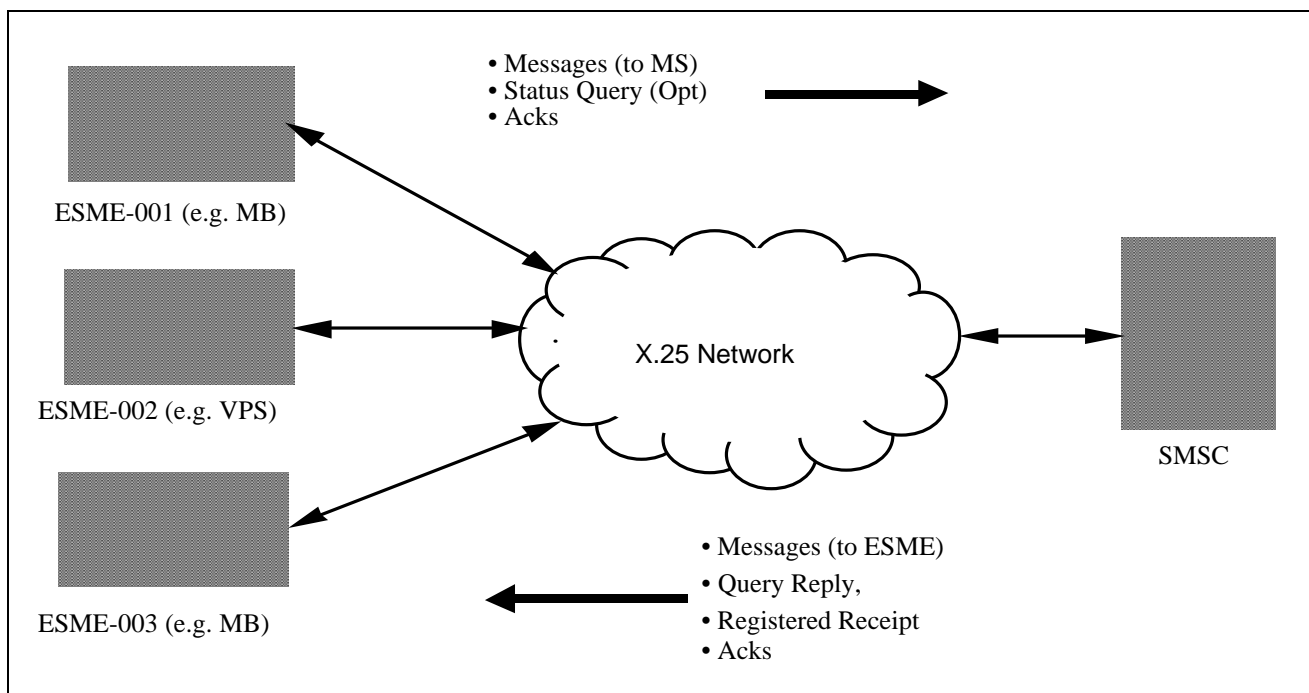

Figure A.1: SMSC & ESME Interworking using X.25

### A.2.1 ESMEs to SMSC

Subscribers to a GSM Network may receive short messages from ESMEs. The means whereby these messages are originally generated within or are submitted to the ESME is beyond the scope of this annex, but the following are possible examples:

- Calls directly dialled or diverted to a Message Bureau operator and forwarded to the SMSC.
- Messages originated from terminals at a corporate customer’s site.
- Voice-Mail Alerts originating for a VPS indicating voice messages at a customer’s mailbox.

Messages that are submitted to the SMSC by an ESME are immediately acknowledged. This acknowledgement informs the ESME that the message submitted is a valid message (i.e. fields are set to valid values).

In addition to “Message Submission”, an ESME may “Query” the SMSC for the status of previously submitted messages, or cancel delivery of previously submitted messages using the Message ID returned by the SMSC when the particular message was originally submitted.

### A.2.2 SMSC to ESME

The SMSC can deliver short messages to the ESME. A typical example would be the SMSC sending short messages to an MB for onward delivery as pager messages.

In addition the SMSC may use the “deliver short message” mechanism to generate a “Delivery Receipt”. (See SMPP Applications guide [9] for details).

### A.2.3 Backward compatibility

Where changes have occurred in the Interface Specification between versions, the “interface\_version” provided in the “Bind” primitive is used to discriminate between version numbers for backward compatibility.

### A.3 Interface Specification

The interface between the SMSC and ESME may be based on X.25, or TCP/IP. For details of a particular implementation refer to the SMPP Applications Guide [9].

The interface between the SMSC and the ESMEs regardless of the underlying network type will be a client-server model, in which, the SMSC has the server role and the ESME the client role. In the remainder of the present document, "client" is referred to the system that initiates a connection and "server" is referred to the system that services a connection.

NOTE: This annex specifies the interface at the network layer. However, this interface may be implemented over the transport layer. Figure A.2 provides a perspective on the scope of this annex:

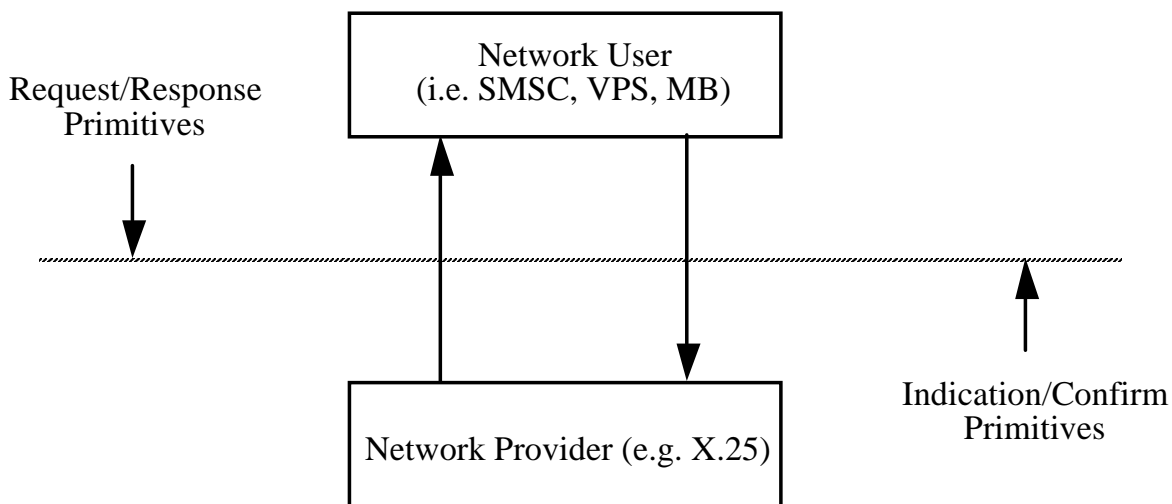

Figure A.2: Model of SMSC-ESME Interface

### A.4 Protocol Messages

All messages sent, either ESME to SMSC, or SMSC to ESME, will generate an immediate response.

As previously mentioned, a message submitted from an ESME to SMSC can generate up to two responses. These are:

- an application level "resp", and
- Where the message was submitted to the SMSC with the registered delivery flag set, a status report generated after the submitted short message reaches its final state.

Figure A.3 depicts a possible sequence of these messages (e.g for an X.25 or TCP/IP based implementation).

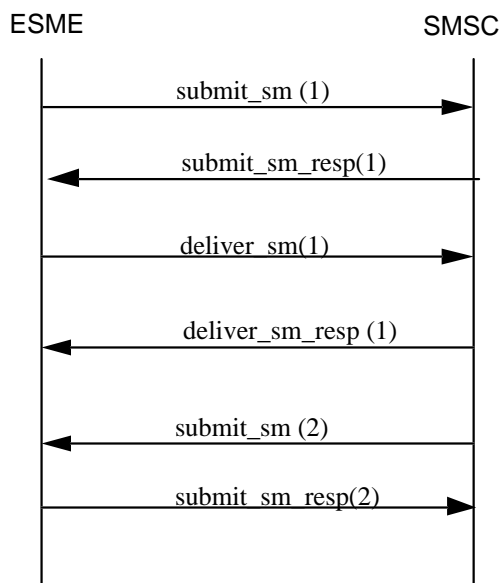

Figure A.3: Sample Message Sequence

For details of ESME/SMSC protocol message sequences refer to the SMPP Applications Guide [9].

---

## A.5 Use of Primitives

This clause describes an overview of the mechanism for exchange of primitives between the ESME and SMSC. For details for a particular network implementation, such as X.25 or TCP/IP, see the SMPP Applications guide [9].

### A.5.1 Initiation of Communication with SMSC

The ESME establishes communication with the SMSC, by an implementation specific mechanism (see SMPP Applications guide [9]).

Two ‘virtual connections’ are required. One will be used for messages originating in the ESME system, and the response messages for them. (e.g. submit\_sm, query\_sm, cancel\_sm etc.), while the other will be used for messages originating in the SMSC and their responses (e.g. deliver\_sm).

Once a ‘virtual connection’ has been established, each of the two processes on the ESME should send either a Bind-Transmitter request or a Bind-Receiver request. If a Bind Transmitter request is sent, the process on the SMSC that receives it will receive messages originating in the ESME system. If a Bind Receiver request is sent, the process on the SMSC that receives it will forward messages to the ESME. Responses will invariably be returned on the same ‘virtual connection’ as the corresponding request messages.

Figure A.4 illustrates this :



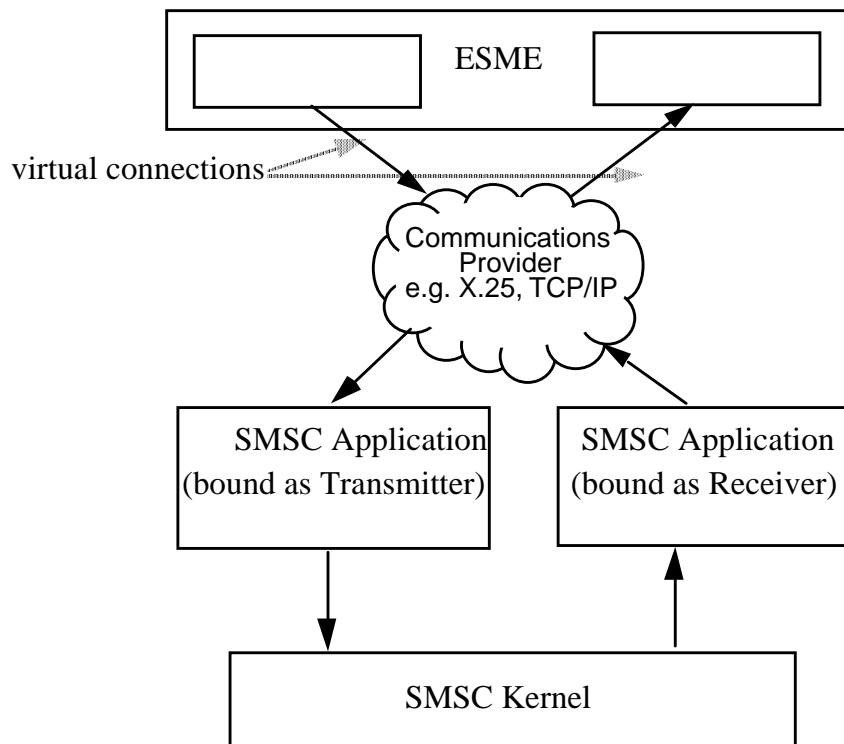

Figure A.4: ESME/SMSC Communication

## A.5.2 Steady-State Communication with the SMSC

Once a connection has been established and an authenticated 'bind' request has been acknowledged, further requests/responses can be exchanged. A response will be issued for each request.

## A.5.3 Terminating Communication with the SMSC

If, at any time, either the ESME or the SMSC needs to terminate communications with the other, it should issue an "unbind" request over the appropriate 'virtual connection'. This enables the receiving system to break communications in an orderly fashion. For both 'virtual connections', the unbind request should be acknowledged by the receiving system before the 'virtual connection' is closed.

## A.5.4 Error Handling and Retransmission

On receipt of a message the receiving system will ensure that the message type is valid, and then check, where appropriate, the validity of the fields of the message body. If the message type or the values of the fields are incorrect an error code indicating this will be returned in the response message to the originator. A table of error and status codes can be found in Section A.7.1

Should an error be generated by the underlying communication network or the application being used on the host machine it is the responsibility of the sender of the message to retransmit to the destination. The originator should maintain a retry count and when this limit has been reached on a single message attempt the circuit should be closed. The ESME should attempt to re-connect. The re-connect method will be the same as the start-up protocol.

The Sequence number in the message header should be generated by the EM. This number should be incremented monotonically with each new transaction. This field will be preserved by the receiving system and returned in the acknowledgement message. This allows for transaction mapping and the detection of duplicate messages.

## A.5.5 Protocol Message Types

The following message types are supported by the SMPP. The “command id” field of the protocol message. is set to specify the particular message.

The detailed formats of these messages are defined in Section A.6.

### A.5.5.1 ESME to SMSC

The following messages are sent from the ESME to the SMSC

**Table A.1: Message Types from ESME to SMSC.**

Command ID	Description
bind_receiver	This command is issued by the ESME to inform the SMSC that this ESME wishes to act as a Server
bind_transmitter	This command is issued by the ESME to inform the SMSC that this ESME wishes to act as a Client
unbind	This command is issued by the ESME to Inform the SMSC that this ESME wishes to terminate its activities.
submit_sm	This command is issued by the ESME to submit a short message to the SMSC for transmission to a specified subscriber.
deliver_sm_resp	This command is issued by the ESME to acknowledge the receipt of a deliver_sm.
query_sm	This command is issued by the ESME to query the status of a previously submitted Short Message.
cancel_sm	This command is issued by the ESME to cancel one or more outstanding short messages for a subscriber. The command may specify a particular message or all messages for a particular source and destination.
replace_sm	This command is issued by the ESME to replace an outstanding short message for a subscriber.
enquire_link	Enquires whether the ESME-SMSC session is functioning, and thereby provides a link confidence-check.
generic_nak	Generic response to a command for which the message header is invalid.

### A.5.5.2 SMSC to ESME

The following messages are sent from the SMSC to the ESME.

Table A.2: Message Types from SMSC to ESME

Command ID	Description
bind_transmitter_resp	Response to "bind_transmitter". Messages submitted with this command id will contain a status indicating success or failure of the corresponding "bind_transmitter".
bind_receiver_resp	Response to "bind_receiver". Messages submitted with this command id will include a status indicating success or failure of the corresponding "bind_receiver".
unbind_resp	Response to "unbind". Messages submitted with this command id will include a status indicating success or failure of the corresponding "unbind".
submit_sm_resp	Response indicating that a short message has been accepted successfully or not. Messages submitted with this command id will include the status indicating success or failure of the corresponding "submit_sm".
deliver_sm	This command is issued by the SMSC to submit a short message to the ESME for delivery. It may also be used to return a delivery receipt for a message which had been submitted with the delivery receipt flag set.
query_sm_resp	Response to "query_sm". Messages submitted with this command id will include the status indicating success or failure of the corresponding "query_sm" in addition to data relating to the queried message.
cancel_sm_resp	Response to "replace_sm". Messages submitted with this command id will include the status indicating success or failure of the corresponding "replace_sm".
replace_sm_resp	Response to "replace_sm". Messages submitted with this command id will include the status indicating success or failure of the corresponding "replace_sm".
enquire_link_resp	Response to "enquire_link". Messages submitted with this command id will include the status indicating success or failure of the corresponding "enquire_link".
generic_nak	Generic response to a command for which the message header is invalid.

## A.6 Message Layouts

The general format of all protocol messages exchanged between the ESME and the SMSC will consist of a message header followed by a message body.

### A.6.1 Definitions

In the following descriptions the following definitions will be used:

**Integer:** a signed value with the defined number of bytes

NOTE: The bytes will always be transmitted MSB first.

**C-Octet String:** a series of ASCII characters terminated with the NUL character.

**C-Octet String (Decimal):** a series of ASCII characters terminated with the NUL character.

NOTE: The octet string should represent a sequence of decimal digits

**C-Octet String (Hex):** a series of ASCII characters terminated with the NUL character.

NOTE: The octet string should represent a sequence of hexadecimal digits

Where reference is made below to NULL settings of Octet-String fields this implies that the field consists of a single NUL character, i.e. an Octet encoded with value zero.

Where reference is made to NULL settings of Integer fields this implies that the field is unused and can be set to 0.

## A.6.2 Message Header Format

**Table A.3: Message Header Format**

Element	Size bytes	Type	Description
Command Length	4	Integer	This field defines the total length of the packet including the length field.
Command ID	4	Integer	The field indicates the type of request to be invoked by this protocol message, e.g. 'submit_sm', 'query_sm' etc..  A request command identifier will be allocated to each request primitive. The following range is reserved for these purposes: 0h to FFh. A response command identifier will be allocated to each response primitive. The following range is reserved for these purposes: 08000000h to 0800000FF (In general a response command identifier will be identical to the corresponding request command identifier, but with bit 31 set.) For details of the actual IDs see clause A.7.2.
Command Status	4	Integer	This field will indicate the success or failure of a request. This field is only relevant in the response message, so in the request message it should contain NULL. A list of exception codes is given in clause A.7.1.
Sequence No.	4	Integer	A sequence number allowing requests and responses to be associated. Allocation of this reference number is the responsibility of the originator, who should ensure that the number is monotonically increasing for each submitted request. The associated response packet must preserve this field. The range is 01h to 07FFFFFFh
Optional Message Body	var.	mixed	A list of parameters corresponding to the Command type. These fields are detailed in clause A.6.3

### A.6.2.1 "Generic\_Nak" Command

This is a generic response to a command for which the message header is invalid.

#### A.6.2.1.1 "Generic\_Nak" Syntax

Apart from setting the header fields, no other parameters are required in the data body.

## A.6.3 Message Body Formats

### A.6.3.1 “BIND” Operation

There are two variations of the Bind Command namely “bind\_transmitter” and “bind\_receiver”. The Command ID setting specifies whether the Bind is the “bind\_transmitter” or “bind\_receiver” primitive.

The purpose of the Bind operation is to register an instance of an ESME with the SMSC system, and inform the SMSC that the sending SME wishes to use this virtual circuit for commands initiated by the SMSC. To this end the Bind must provide key information within the “message” field of the protocol message.

- The **password** must match the SMSC administration password for the instance of the ESME.
- The **system\_id** and **system\_type** provide a unique identification of the interface.

Associated with the interface is a unique default “callback address” which is configured via SMSC administration. The “callback address” is employed as the default source address, in cases where the actual ESME address is not supplied.

The interface may act as either an ESME in it’s own right or as an agent for the transport of messages to or from other ESME’s. (See figure 6-1).

In it’s role as agent, the range of ESME addresses served by the interface is specified via a “regular expression” (See Note 2). This may be defined explicitly in the bind request or configured by SMSC administration.

NOTE 1: For the bind\_transmitter the addr\_ton, addr\_npi and range of SME addresses (address\_range) is not relevant and should be set to NULL.

NOTE 2: The “regular expression” in this context is a text pattern representing a range of addresses or a specific address. For further detail refer to the SMPP Application Guide[9].

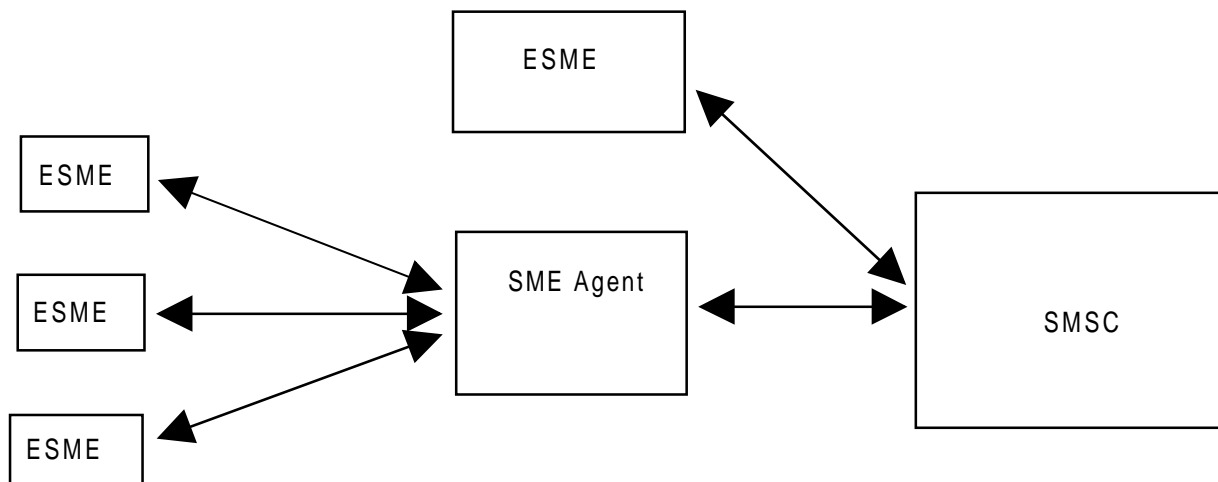

Figure A.5: ESME/SME address routing to/from SMSC

#### A.6.3.1.1 “BIND\_RECEIVER” Syntax

These parameters are included in the “message” field of the protocol message when the “command id” field is “bind\_receiver”.

Table A.4: Bind\_Receiver Message Parameters

Field Name	Size (bytes)	Type	Description
system_id	Var. Max 16	C-Octet String	Identifies the system requesting a bind to the SMSC. This variable length field may have leading spaces.
password	Var. Max 9	C-Octet String	The password is used for security purposes. This is a configurable attribute within the SMSC.
system_type	Var. Max 13	C-Octet String	Identifies the type of system requesting the bind. This may enable SMSC responses which are particular to a given type of ESME This variable length field may have leading spaces.
interface_version	1	Integer	Identifies the version number (major) of the interface to be implemented.
addr_ton	1	Integer	Type of Number for use in routing Delivery Receipts. (See GSM 03.40 [1] clause 9.1.2.5) Where not required this should be NULL.
addr_npi	1	Integer	Numbering Plan Identity for use in routing Delivery Receipts. (See GSM 03.40 [1] clause 9.1.2.5) Where not required this should be NULL.
address_range	Var. Max 41	C-Octet String	Address range for use in routing short messages and Delivery Receipts to an ESME. This variable length field may have leading spaces. Where not required this should be a single NULL byte.

#### A.6.3.1.2 “BIND\_RECEIVER\_RESP” Syntax

Apart from setting the header fields, the acknowledge message to a ‘bind\_receiver’ requires only a single parameter.

Table A.5: Bind\_Receiver\_Resp Message Parameters

Field Name	Size (bytes)	Type	Description
system_id	Var. Max 16	C-Octet String	Identifies the SMSC to the ESME requesting the bind.

#### A.6.3.1.3 “BIND\_TRANSMITTER” Syntax

These parameters are included in the “message” field of the protocol message when the “command id” field is “bind\_transmitter”.

The Message layout is identical to the “bind\_receiver” Message Layout except that the **addr\_ton**, **addr\_npi** and the **range of SME addresses**(address\_range) are not relevant and should be set to NULL

#### A.6.3.1.4 “BIND\_TRANSMITTER\_RESP” Syntax

The Message layout is identical to the “bind\_receiver\_resp” Message Layout except that the “command id” field setting specifies “bind\_transmitter\_resp”.

### A.6.3.2 “UNBIND” Operation.

The purpose of the Unbind operation is to deregister an instance of an ESME from the SMSC system.

#### A.6.3.2.1 “UNBIND” Syntax

Apart from setting the header fields, no other parameters are required in the data body.

### A.6.3.2.2 “UNBIND\_RESP” Syntax

Apart from setting the header fields, no other parameters are required in the data body.

### A.6.3.3 “SUBMIT\_SM” Operation

This command is issued by the ESME to submit a short message to the SMSC for transmission to a specified subscriber.

When a real source address is provided in a registered submit\_sm request, the source address can be used as the destination address for a delivery receipt. It can also be used in identifying the message source in a CDR. This source address must fall in the range of addresses associated with the bind command.

Where the originator of messages from the ESME is the ESME itself, or where the ESME does not have a real source address, the source address fields may be defaulted to NULL, and the source address will be taken from the SMSC administration “callback address” for the particular ESME instance.

The submit\_sm operation can also be used to replace a short message which has previously been submitted. This is achieved by setting the replace\_if\_present\_flag to 0x01 in the Interface. The first message found in the SMSC whose source and destination match those given in the submit\_sm will have its text replaced by the text in the short\_message field of the submit\_sm.

#### A.6.3.3.1 “SUBMIT\_SM” Syntax

These parameters are included in the “message” field of the protocol message when the “command id” field is “submit\_sm”.

**Table A.6: Submit\_Sm Message Parameters**

Field Name	Size (bytes)	Type	Description
service_type	Var. Max 6	C-Octet String	Reserved for future use. This should be set to a single NULL byte.
source_addr_ton	1	Integer	Type of number for source. Where not required this should be NULL. (See GSM 03.40 [1] clause 9.1.2.5)
source_addr_npi	1	Integer	Numbering Plan Indicator for source Where not required this should be NULL. (See GSM 03.40 [1] clause 9.1.2.5)
source_addr	Var. Max 21	C-Octet String (Decimal)	Address of SME which originated this message. This is the source address of the short message submitted. This variable length field may have leading spaces Where not required this should be a single NULL byte
dest_addr_ton	1	Integer	Type of number for destination. Where not required this should be NULL (See GSM 03.40 [1] clause 9.1.2.5)
dest_addr_npi	1	Integer	for destination Where not required this should be NULL. (See GSM 03.40 [1] clause 9.1.2.5)

**Table A.7: Submit\_Sm Message Parameters**

Field Name	Size (bytes)	Type	Description
destination_addr	Var. Max 21	C-Octet String decimal	Destination address of this short message. For mobile terminated messages, this is the MSISDN address of the target subscriber. This variable length field may have leading spaces. Where not required this should be a single NULL byte.
esm_class	1	Integer	Indication of message type. For the submit_sm command this field is unused, and should be set to NULL. For the deliver_sm command however, this field may identify the message as a delivery receipt
protocol ID	1	Integer	GSM Protocol ID (See GSM 03.40 [1] clause 9.2.3.9)
priority_flag	1	Integer	Designates the message as priority. Setting priority on a message moves it to the top of the SMSC message queue for that subscriber. 0 = non-priority (default) 1 = priority >1=Reserved
schedule_delivery_time	17	C-Octet String	The absolute date and time at which delivery of this message must be attempted. The format is defined in clause A.7.5 Where not required this should be a single NULL byte.
validity_period	17	C-Octet String	The expiration time of this message. This is specified as an absolute date and time of expiry. The format is defined in clause A.7.5 Where not required this should be a single NULL byte.
registered_delivery_flag	1	Integer	Flag indicating if the message is a registered short message and thus if a Delivery Receipt is required upon the message attaining a final state. 0=No receipt required (non-registered delivery). 1=Receipt required (registered delivery) >1=Reserved
replace_if_present_flag	1	Integer	Flag indicating if submitted message should replace an existing message between the specified source and destination. 0=Don't Replace (default) 1=Replace >1=Reserved
data_coding	1	Integer	GSM Data-Coding-Scheme ( See GSM 03.40 [1] clause 9.2.3.10)

**Table A.8: Submit\_Sm Message Parameters**

Field Name	Size (bytes)	Type	Description
sm_default_msg_id	1	Integer	Indicates the default short message to send, by providing an index into the table of Predefined Messages set up by the SMSC administrator. This should be set to NULL if a text message is being sent. Range is 0x01 to 0x64. (See SMPP Applications Guide [9] - Default Short Message).
sm_length	1	Integer	Length of the text of the message in bytes.
short_message	Var. Max 161	C-Octet String	Up to 160 bytes of data. This is the text that is transmitted to the mobile station. Note that only 'sm_length' bytes will be used.



### A.6.3.3.2 SUBMIT\_SM\_RESP” Syntax

These parameters are included within the “message” field of the protocol message when the “message type” field is “submit\_sm\_resp”.

**Table A.9: Submit\_Sm\_Resp Message Parameters**

Field Name	Size (bytes)	Type	Description
Message_id	Var. Max 9	C-Octet String (Hex)	This field contains the message ID internal to the SMSC. It may be used at a later stage to query the status of a message, to replace a message, or match the original message to a corresponding delivery receipt (deliver_sm) message. If absent this field must contain a single NULL byte. The SMSC will return a value for this field.

### A.6.3.4 “DELIVER\_SM” Operation

This is issued by the SMSC. Using this command, the SMSC may submit a short message to the ESME for delivery. It is also used to return a delivery receipt for a message which had been submitted with the delivery receipt flag set.

The values for destination address will depend on whether the ESME is the final destination of the short message, or merely routes the message to its final recipient (e.g. paging messages).

One should note that delivery receipts are returned to the originating SME using this command. In this instance of a deliver\_sm command, the esm\_class field will identify the message as a delivery receipt, and the required data relating to the original short message will be given in the message text field. (See SMPP Applications Guide [9] - Delivery Receipts).

#### A.6.3.4.1 “DELIVER\_SM” Syntax

The parameters included within the “message” field of the protocol message when the “command id” field is “deliver\_sm”, are the same as for “submit\_sm”.

#### A.6.3.4.2 “DELIVER\_SM\_RESP” Syntax

The parameters included within the “message” field of the protocol message when the “command id” field is “deliver\_sm\_resp”, are the same as for “submit\_sm\_resp”.

### A.6.3.5 “QUERY\_SM” Operation

This Command is issued by the ESME to query the status of a previously submitted short message.

Where a message to be replaced was originally submitted with an individually identified SME source address, the originator address in the query\_sm command must match. Where the original source address was defaulted to NULL, (i.e. the originator of messages from the ESME is the ESME itself, or the ESME does not have a real source address) then the originator address in the query\_sm command should also be NULL, and the source address will be taken from the SMSC administration “callback address” for the particular ESME instance.

#### A.6.3.5.1 “QUERY\_SM” Syntax

These parameters are included within the “message” field of the protocol message when the message type is “query\_sm”.

**Table A.10: Query\_Sm Message Parameters**

Field Name	Size (bytes)	Type	Description
original_message_id	Var. Max 9	C-Octet String (Hex)	Message ID of the message whose state is to be queried. This must be the Message ID allocated to the original short message when submitted to the SMSC by the submit_sm command, and returned in the submit_sm_resp message by the SMSC. This variable length field may have leading spaces..
originating_ton	1	Integer	Type of Number of originator This is used for verification purposes, and must match that supplied in the corresponding 'submit_sm' request (See GSM 03.40 [1] clause 9.1.2.5)
originating_npi	1	Integer	Numbering Plan Identity of originator This is used for verification purposes, and must match that supplied in the corresponding 'submit_sm' request (See GSM 03.40 [1] clause 9.1.2.5)
originating_addr	Var. Max 21	C-Octet String (Decimal)	Address of originator This is used for verification purposes, and must match that supplied in the corresponding 'submit_sm' request

#### A.6.3.5.2 "QUERY\_SM\_RESP" Syntax

These parameters are included within the "message" field of the protocol message when the message type is "query\_sm\_response".

**Table A.11: Query\_Sm\_Resp**

Field Name	Size (bytes)	Type	Description
original_message_id	Var. Max 9	C-Octet String (Hex)	Message ID of the message whose state is being queried. This must be the Message ID allocated to the original short message when submitted to the SMSC by the submit_sm command, and returned in the submit_sm_resp message by the SMSC. This variable length field may have leading spaces.
final_date	Var. Max 17	C-Octet String	Date and time when the submitted message reached the final state. For messages which have not yet reached a final state this field will contain a single NULL byte The date format is detailed in clause A.7.5.
message_status	1	Integer	Specifies the status of the SM. See clause A.7.4
GSM_code	1	Integer	Where appropriate this holds a GSM error code defining the reason for failure of message delivery. (See GSM 03.40 [1] clause 3.3) (Refer also to clause A.7.3)

#### A.6.3.6 "CANCEL\_SM" Operation

This command is issued by the ESME to cancel one or more outstanding short messages. The command may specify a particular message, or all messages for a particular source and destination.

- If the message ID is set to the ID of a previously submitted message, then provided the source and destination addresses supplied in the interface match, that message will be cancelled.

- If the message ID is null all outstanding undelivered messages with the source and destination addresses given in the interface will be cancelled for the particular interface of the AIM. If the source address is set to NULL in the interface the source address will be taken from the SMSC administration “callback address” for the particular ESME instance.
- A typical use of the command is to cancel outstanding undelivered VoiceMail Alert messages for a subscriber whose mailbox has just been directly accessed by the subscriber. The response (cancel\_sm\_resp) will indicate whether the message(s) had already been sent

A.6.3.6.1 “CANCEL\_SM” Syntax

These parameters are included within the “message” field of the protocol message when the message type is “cancel\_sm”.

**Table A.12: Cancel\_Sm Message Parameters**

Field Name	Size (bytes)	Type	Description
service type	Var. Max 6	C-Octet String	Reserved for future use. This should be set to a single NULL byte.
original_message_id	Var. Max 9	C-Octet String (Hex)	Message ID of the message to be cancelled. This must be the Message ID allocated to the original short message when submitted to the SMSC by the submit_sm command, and returned in the submit_sm_resp message by the SMSC. This variable length field may have leading spaces.
source_addr_ton	1	Integer	Type of Number of originator. This is used for verification purposes, and must match that supplied in the corresponding ‘submit_sm’ request. Where not required this should be NULL. (See GSM 03.40 [1] clause 9.1.2.5)
source_addr_npi	1	Integer	Numbering Plan Identity of originator. This is used for verification purposes, and must match that supplied in the corresponding ‘submit_sm’ request. Where not required this should be NULL. (See GSM 03.40 [1] clause 9.1.2.5)

**Table A.13: Cancel\_Sm Message Parameters**

Field Name	Size (bytes)	Type	Description
source_addr	Var. Max 21	C-Octet String (Decimal)	Source address of message(s) to be cancelled. This is used for verification purposes, and must match that supplied in the corresponding ‘submit_sm’ request. This variable length field may have leading spaces.
dest_addr_ton	1	Integer	Type of number for destination. (See GSM 03.40 [1] clause 9.1.2.5)
dest_addr_npi	1	Integer	Numbering Plan Indicator for destination (See GSM 03.40 [1] clause 9.1.2.5)
destination_addr	Var. Max 21	C-Octet String (Decimal)	Destination address of message(s) to be cancelled. This is used for verification purposes, and must match that supplied in the corresponding ‘submit_sm’ request. This variable length field may have leading spaces. Where not required this should be a single NULL byte.

### A.6.3.6.2 “CANCEL\_SM\_RESP” Syntax

Apart from setting the header fields, no other parameters are required in the data body.

### A.6.3.7 “REPLACE\_SM” Operation

This command is issued by the ESME to replace an outstanding short message for a subscriber.

The message\_id is set to the ID of a previously submitted message. Where a message to be replaced was originally submitted with an individually identified SME source address, the originator address in the replace\_sm command must match. Where the original source address was defaulted to NULL, (i.e. the originator of messages from the ESME is the ESME itself, or the ESME does not have a real source address) then the originator address in the replace\_sm command should also be NULL, and the source address will be taken from the SMSC administration “callback address” for the particular ESME instance.

#### A.6.3.7.1 “REPLACE\_SM” Syntax

These parameters are included within the “message” field of the protocol message when the “command id” field is “replace\_sm”.

**Table A.14: Replace\_Sm Message Parameters**

Field Name	Size (bytes)	Type	Description
original_message_id	Var. Max 9	C-Octet String (Hex)	Message ID of the message to be replaced. This must be the Message ID allocated to the original short message when submitted to the SMSC by the submit_sm command, and returned in the submit_sm_resp message by the SMSC. This variable length field may have leading spaces
orig_addr_ton	1	Integer	Type of Number of originator. This is used for verification purposes, and must match that supplied in the corresponding 'submit_sm' request. Where not required this should be NULL
dest_addr_ton	1	Integer	Numbering Plan Identity of originator. This is used for verification purposes, and must match that supplied in the corresponding 'submit_sm' request Where not required this should be NULL
originating_addr	Var Max 21	ASCII	Originating address of the short message to be replaced. This is used for verification purposes, and must match that supplied in the corresponding 'submit_sm' request. This variable length field may have leading spaces.
schedule_delivery_time	17	C-Octet String	The absolute date and time at which delivery of this message must be attempted. Where not specified the original scheduled delivery time, if specified, will apply. The format is defined in clause A.7.5 Where not required this should be a single NULL byte.

**Table A.15: Replace\_Sm Message Parameters**

Field Name	Size (bytes)	Type	Description
validity_period	17	C-Octet String	The expiration time of this message. This is specified as an absolute date and time of expiry. Where not specified the original expiration time, if specified, will apply. The format is defined in clause A.7.5 Where not required this should be a single NULL byte.
registered_delivery_flag	1	Integer	Flag indicating if the message is a registered short message and thus if a Delivery Receipt is required upon the message attaining a final state. (See SMPP Applications Guide [9] - Delivery Receipts) 0=No receipt required (non-registered delivery). 1=Receipt required (registered delivery) >1=Reserved
sm_default_msg_id	1	Integer	Indicates the default short message to send, by providing an index into the table of predefined messages set up by the SMSC administrator. This should be set to NULL if a text message is being sent. Range is 0x01 to 0x64 (See SMPP Applications Guide [9] - Default Short Message).
sm_length	1	Integer	Length of the text of the message in bytes
short_message	Var. Max 161	C-Octet String	Up to 160 bytes of data. This is the text that is transmitted to the mobile station. This text, if specified will be used to replace the existing text for the originally submitted SM. (See SMPP Applications Guide [9] - Default Short Message).

### A.6.3.7.2 “REPLACE\_SM\_RESP” Syntax

Apart from setting the header fields, no other parameters are required in the data body.

### A.6.3.8 “ENQUIRE\_LINK” Operation

This message is used to provide a confidence-check of the communication path between ESME and the SMSC. On receipt of this request the SMSC will simply respond with an `enquire_link_resp`, thus verifying that the application level connection between ESME and SMSC is functioning.

#### A.6.3.8.1 “ENQUIRE\_LINK” Syntax

Apart from setting the header fields, no other parameters are required in the data body.

#### A.6.3.8.2 “ENQUIRE\_LINK\_RESP” Syntax

Apart from setting the header fields, no other parameters are required in the data body.

---

## A.7 System Definitions

The following sections define the various system codes for Command-ID’s and Error Codes.

NOTE: For ease of maintenance a ‘C’ include file is available which defines the actual values for these definitions.

## A.7.1 Error Codes

The following are a list of error codes that can be returned in the status field of a message.

**Table A.16: Error Codes**

Error Code	Description
ESME_ROK	Ok - Message Acceptable
ESME_RINVMSGLEN	Invalid Message Length
ESME_RINVCMDLEN	Invalid Command Length
ESME_RINVCMDID	Invalid Command ID
ESME_RINVBNDSTS	Invalid bind status
ESME_RALYBND	Bind attempted when already bound
ESME_RINVPRTF LG	Invalid priority flag
ESME_RINVREGDLVFLG	Invalid registered-delivery flag
ESME_RSYSERR	SMSC system error
ESME_RINVPAR	Invalid parameter
ESME_RINVSRCADR	Invalid source address
ESME_RINVDSTADR	Invalid destination address
ESME_RINVMSGID	Invalid message-id
ESME_RINVPASWD	Invalid password
ESME_RINVPASWDLEN	Invalid password length
ESME_RINVSYSIDSRV	Invalid System-ID
ESME_RCNTCANMSG	Cannot cancel a message
ESME_RINVDATFMT	Invalid date format
ESME_RCNTREPMMSG	Cannot replace a message
ESME_RMSGQFUL	Too many messages in queue, at present
ESME_RSERNOTSUP	Service not supported
ESME_RINVREPADDR	Address Mismatch in Replacement attempt
ESME_RUNKNOWNERR	Unknown Error

## A.7.2 Command I.D. Values

The following is a list of the command ids and their associated values.

**Table A.17: Command ID Values**

Command ID Code	Command ID	Description
ESME_BNDRCV	bind_receiver	Bind to SMSC Kernel as a receiver
ESME_BNDRCV_RESP	bind_receiver_resp	Response to bind_receiver
ESME_BNDTRN	bind_transmitter	Bind to SMSC Kernel as transmitter
ESME_BNDTRN_RESP	bind_transmitter_resp	Response to bind_transmitter
ESME_UBD	unbind	Unbind from SMSC Kernel
ESME_UBD_RESP	unbind_resp	Response to unbind
ESME_SUB_SM	submit_sm	Submit a short-message
ESME_SUB_SM_RESP	submit_sm_resp	Response to submit_sm
SMSC_DELIVER_SM	deliver_sm	Submit a short-message to ESME
SMSC_DELIVER_SM_RESP	deliver_sm_resp	Response to deliver_sm
ESME_QUERY_SM	query_sm	Query status of a short-message
ESME_QUERY_SM_RESP	query_sm_resp	Response to query_sm
ESME_CANCEL_SM	cancel_sm	Cancel a short message(s)
ESME_CANCEL_SM_RESP	cancel_sm_resp	Response to cancel_sm
ESME_REPLACE_SM	replace_sm	Replace a short message
ESME_REPLACE_SM_RESP	replace_sm_resp	Response to replace_sm
ESME_QRYLINK	enquire_link	Link confidence check
ESME_QRYLINK_RESP	enquire_link_resp	Response to enquire_link
ESME_NACK	nack	Negative Acknowledgement

### A.7.3 GSM Error Codes

Where the message is submitted to the SMSC with the registered delivery flag set, a status report is generated after the submitted short message reaches its final state. The following is a list of the GSM error codes (See GSM 03.40 [1] clause 3.3) and their associated descriptions returned in the delivery receipt:

**Table A.18: GSM Error Codes**

Error Code	Description
ERROR_NONE	No error code given
P_UNKNOWN	unknown subscriber
P_PROVISION	Not Provisioned
T_BARRED	Call barred
T_SUPPORT	Facility not supported
T_ABSENT	Absent Subscriber
T_MSSUPPORT	SMS not supported by MS
T_MSERROR	Error in MS receiving message
P_ILLEGAL_SUB	Illegal Subscriber
P_ILLEGAL_EQUIP	Illegal Equipment
T_SYSTEM	System Failure
T_MEMCAP	Memory capacity exceeded

### A.7.4 Message States

The following is a list of the states that a short message may achieve.

**Table 19: Message States**

Message State	Description
EN_ROUTE	Message is enroute
DELIVERED	Message in delivered state
EXPIRED	Message validity period has expired
DELETED	Message has been deleted
UNDELIVERABLE	Message is undeliverable
ACCEPTED	Message is in accepted state
INVALID	Message is in invalid state

### A.7.5 Time Format

Time and Date fields are represented in a format similar to that specified in GSM 03.40 [1] clause 9.2.3.11. In this interface all time/date related fields will be in ASCII with the following format:

“YYMMDDhhmssstnp” where

- ‘YY’ last two digits of the year (00-99)
- ‘MM’ month (01-12)
- ‘DD’ day (01-31)
- ‘hh’ hour (00-23)
- ‘mm’ minute (00-59)
- ‘ss’ second (00-59)
- ‘t’ tenths of second (0-9)
- ‘nn’ Time difference in quarter hours between local time (as expressed in the first 13 bytes) and UTC (Universal Time Constant) time (00-48).
- ‘p’ - “+” Local time is nn quarter hours advanced in relation to UTC time.
- “\_” Local time is nn quarter hours retarded in relation to UTC time.

NOTE: Where responses are reported by the SMSC the local time of the SMSC will be given, and the format will be “YYMMDDhhmss”, with the same definitions as above.

---

## Annex B: Short Message Service Centre External Machine Interface

This annex describes the interface used between the SMSC System and other computer systems and applications. The interface is based on the ERMES UCP (Universal Computer Protocol) with some SMSC-specific extensions.

Throughout this annex the interface is called 'EMI': External Machine Interface.

Annex structure

This annex is structured as follows:

- Clause B.1 contains the introduction to the EMI. It describes the position of the EMI between the SMSC components and the external machines.
- Clause B.2 shows the structure of EMI messages and provides examples of valid exchanges of commands between the SMSC and the applications.
- Clause B.3 defines the EMI operations, and describes briefly the actions that are expected from the SMSC and the Application upon reception of the commands (these are further detailed in the respective design documents).
- Clause B.4 shows the syntax of EMI command messages.
- Clause B.5 shows the syntax of the 50-series of EMI command messages.
- Clause B.6 summarizes the error codes for the EMI operations.

---

### B.1 Introduction

For submission and reception of Short Messages the Short Message Service Centre can interface with (among others):

- GSM Mobile Telephones (PLMN),
- Interactive Voice Response systems,
- Voice Messaging systems,
- a MENU application accessed from PC's through terminal emulation,
- dedicated PC applications.

**NOTE:** Throughout this annex the External Machine will be referred to as 'SME' or 'PC'. For the latter, it can of course be any application system.

In order to allow any service provider to develop dedicated applications, an interface was developed to access SMSC functions. This manual describes that interface.



## B.1.1 Position of interface

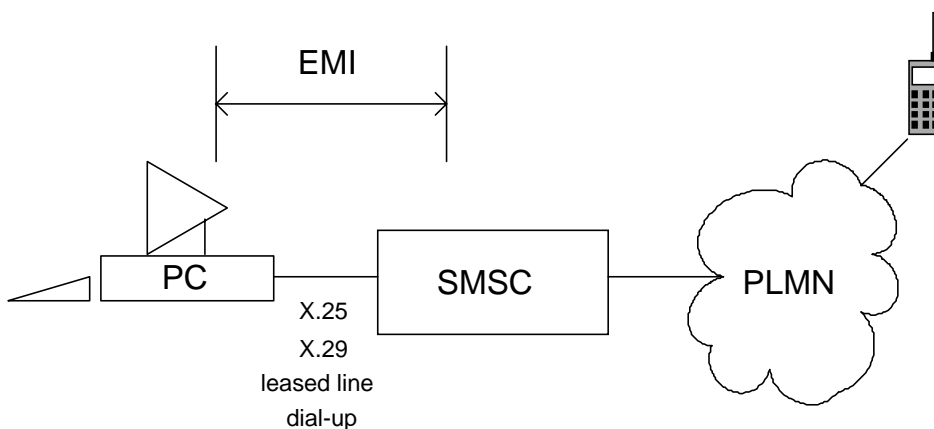

**Figure B.1: EMI: External view**

When viewed from the PC side, the EMI provides access to the SMSC functions:

- Submission of Short Messages
- Reception of Short Messages
- Reception of Notifications

The SMSC can be viewed as a Black Box: Short Messages are directed to the GSM mobile telephone of the recipient. The SMSC and the PLMN only function as relay mechanisms for those Messages. The only visible action of the SMSC apart from this, is the provision of Notifications: upon request the SMSC will notify the originator of the SM regarding the status of the SM.

EMI can use the following lower level protocols as a carrier:

- X.25
- X.29
- PSTNa (analog modem lines)
- ISDN
- tcp/ip
- other on request

The set-up of the connection between the SMSC Platform and the PC depends on the carrier used. Once the connection is established, the EMI operations can be used.

## B.1.2 Interface history

The SMSC External Machine Interface (EMI) is based on an extended subset of the UCP protocol defined for the ERMES paging system in ETS 300 133-3 [3]. When referring to 'UCP' in the context of the SMSC, almost always the EMI, the extended subset of the ERMES UCP, is meant.

In the SMSC the UCP protocol was chosen as the basis for the EMI because

- 1) the first operators that used the SMSC required to use the UCP protocol to interact with external machines.
- 2) it allows service providers to use a single mechanism to interface to both ERMES based paging systems and the SMSC.
- 3) no re-invention of 'yet another' protocol had to take place.

In order to provide access to the more extensive set of SMS commands, it was necessary to extend the UCP definition with some additional, SMSC specific commands, such as 'SMS message transfer operation' and 'SMT alert operation'

## B.2 Structure of EMI Messages

In the ERMES/UCP-based EMI protocol, the message structure is as follows:

stx <header> / <data> / <checksum> etx

- stx = 02(hex)
- etx = 03(hex)

NOTE that in the examples 'stx', 'etx' and '/' each represent only one character.

As separator between header and data, between data and checksum, as well as between parameters, a '/' (2F(hex)) is used.

In parameters that contain a list, the items are separated by a ',' (2C(hex)). Numeric characters (0..F) are encoded as in IA5. Alphanumeric characters are encoded as two numeric IA5 characters, the higher 3 bits (0..7) first, the lower 4 bits (0..F) thereafter.

The <header> consists of the following 4 mandatory fields:

**Table B.1: <header> mandatory fields**

Parameter	Type	Description
TRN	2 num. char.	Transaction reference number, right justified with leading zero
LEN	5 num. char.	Total number of IA5 characters contained between stx and etx, right justified with leading zeros.
O/R	Char 'O' or 'R'	'O' indicates operation, 'R' indicates result
OT	2 num. char.	Operation Type (see list in Clause B.3).

The <data> fields depend on the Operation Type. For each Operation Type they are listed in the next chapters.

The <checksum> is derived by the addition of all bytes of the header, data field separators and data fields (i.e. all characters after the stx-character, up to and including the last '/' before the checksum field). The 8 Least Significant Bits (LSB) of the result is then represented as two printable characters. The character containing 4 Most Significant Bits (MSB) (of those 8 LSB) shall be transmitted first. For example, if the checksum is 3A(hex) the representation shall be the characters '3' (33(hex)) and 'A' (41(hex)).

### B.2.1 Examples

Below you will find examples of the SMS message transfer operation and responses. The message sent is "hello":

stx01/00045/O/30/66677789///1/////68656C6C6F/CEetx

stx01/00041/R/30/A//66677789:180594141236/F3etx

stx01/00052/O/30/66677789///1/558/0138/////68656C6C6F/3Aetx

stx01/00041/R/30/A//66677789:180594141430/EFetx

In the acknowledgement, the 'system message' parameter is used to indicate the recipient address and timestamp. Note that the 'Authentication Code' parameter is not used. The Notification requested in the first example will be sent to the originator of the short message, only as long as this session exists.

---

## B.3 EMI COMMANDS

EMI commands can be initiated either from the PC, or from the SMSC. Each command will lead to an action on the other side. The other side will respond with a positive or negative acknowledgement. During the handling of commands, no other commands shall be sent; i.e. the SMSC does not support 'windowing'. Any command received in such time will be discarded.

### B.3.1 Application initiated commands

The following PC initiated operations are available:

**Table B.2: PC initiated operations**

Command id	Command Name
01	Call input operation
02	Multiple address call input operation
03	Call input with supplementary services operation
30	SMS message transfer operation
31	SMT alert operation
32	(reserved)
33	(reserved)
40	(reserved)
41	(reserved)
5x	50-series, see Clause B.5

The definitions of operations '01', '02' and '03' are identical to the corresponding operations defined in GSM 03.40 [1].

The 'Call input operation' is the normal means of submitting a Short Message. The SMSC must, when it receives this command, send the message to the recipient address that is specified in the command.

The 'Multiple address call input operation' is used to address a number of recipients in one operation. The command contains a list of recipient addresses. The SMSC will send the same message to all addresses in this list.

The 'Call input with supplementary services operation' is used when a message is to be scheduled for deferred delivery.

The 'SMS message transfer operation' is used to submit a message when SMSC specific services are required, such as notification request, deferred delivery, or validity period.

The 'SMT alert operation' can be used by the application to alert the SMSC to send messages and notifications to the application. It can only be used when the application uses a connection that supports Calling Line Identification, such as X.25.

## B.3.2 SMSC initiated commands

SMSC initiated operations (used to deliver Notifications or Mobile Originated Short Messages) are:

**Table B.3: SMSC initiated operations**

Command id	Command Name
01	Call input operation
34	(reserved)
36	(reserved)
38	(reserved)
42	(reserved)
43	(reserved)
5x	50-series, see Clause B.5

The SMSC uses the 'Call input operation' to transfer Notifications and Mobile Originated Short Messages to the PC (Short Message Terminal). The initiative to do so lies either with the SMSC (Notifications on messages submitted in the current session) or with the PC (the SMT has to issue an SMT alert command).

## B.4 EMI Commands Syntax

This clause shows the syntax of the data fields of the EMI commands. For the syntax of the complete messages, please refer to Clause B.2, Structure of EMI messages. For each command also the format of the positive and negative responses is given, including the possible error codes. For convenience, all error codes are summarized in Clause B.6, Error Codes Overview. The order in which the commands are listed is:

- 1) general commands, used for normal SM transfer.
- 2) SMSC specific extensions, used to address SMS functions not foreseen in the UCP definition.

In the column marked 'Presence', 'M' indicates that the field is Mandatory, and 'O' indicates that it is Optional.

### B.4.1 Address syntax

For all addresses used in the EMI-messages the following syntax rules are valid:

In the case the national prefix is used in the network the following syntax is seen as valid addresses:

<trunk-prefix><trunk-code><telephone-nr>

<int-prefix><country-code><trunk-code><telephone-nr>

<+><country-code><trunk-code><telephone-nr> (This format may only be used on Mobile Stations.)

In case the national prefix is not used in the network, the following syntax is seen as valid addresses (in these situations, a valid telephone number will be recognized by its length):

<int-prefix><country-code><telephone-nr>

<telephone-nr>

<+><country-code><telephone-nr> (This format may only be used on Mobile Stations.)

### B.4.2 Call input operation - 01

This operation can be used by the PC to submit a message to the SMSC. This operation is also used by the SMSC to deliver Short Messages and Notifications to a PC user. The following list shows the parameters in the operation data field:

**Table B.4: Parameters in the operation data field**

Parameter	Type	Presence	Description
AdC	String of num. char.	M	Address code recipient, maximum length is 16 digits.
OAdC	String of num. char.	O	Address code originator, maximum length is 16 digits.
AC	String of char.	O	Authentication code originator.
MT	1 numeric character	M	Message type. Associated parameters depend on the value of the message type.
MT=1:			Tone only: No additional parameters used.
MT=2: NMsg	String of char.	O	Numeric message.
MT=3: AMsg	String of char.	O	Alphanumeric message.
MT=4: NB	String of num. char.	M	No. of bits in Transparent Data (TD) message.
TMsg	String of char.	O	TD message encoded into IA5 characters.

- The AC parameter is ignored if present.

### B.4.2.1 Call input operation (positive result)

The following list shows the parameters in the positive result data field:

**Table B.5:**

Parameter	Type	Presence	Description
ACK	Char "A"	M	Positive acknowledgement
SM	String of char.	O	System message

The SM parameter contains the following three fields:

**Table B.6:**

SM Parameter	Type	Description
AdC	String of num. char.	Address code recipient, maximum length is 16 digits.
SEP	char ':'	Separator
SCTS	String of 12 num char.	Service Centre time-stamp DDMMYYhhmmss

When the SMSC initiates this operation, the contents of the SM parameter will be discarded.

### B.4.2.2 Call input operation (negative result)

The following list shows the parameters in the negative result data field:

**Table B.7:**

Parameter	Type	Presence	Description
NACK	Char "N"	M	Negative acknowledgement
EC	2 num. char.	M	Error code
SM	String of char.	O	System message

The following error codes can be returned in the operation negative result:

- 01 Checksum error
- 02 Syntax error
- 04 Operation not allowed (at this point in time)

- 05 Call barring active
- 06 AdC invalid
- 07 Authentication failure
- 08 Legitimation code for all calls, failure
- 24 Message too long
- 26 Message type not valid for the pager type

## B.4.3 Multiple address call input operation - 02

This message can be used by the PC to submit a message to the SMSC. With this operation a list of recipients of the message may be specified thus reducing the traffic between the SMSC and the PC. The following list shows the parameters in the operation data field:

**Table B.8:**

Parameter	Type	Presence	Description
NPL	String of num. char.	M	Number of parameters in the following RAd:s list.
RAd:s	String of num. char.	M	List of parameters: Each parameter consists of AdC Address code recipient, maximum length is 16 digits with optional legitimisation code for all calls.
OAdC	String of num. char.	O	Address code originator, maximum length is 16 digits.
AC	String of char.	O	Authentication code originator.
MT	1 numeric char.	M	Message type. Associated parameters depend on the value of the message type.
MT=1:			Tone only: No additional parameters used.
MT=2: NMsg	String of char.	O	Numeric message.
MT=3: AMsg	String of char.	O	Alphanumeric message.
MT=4: NB TMsg	String of num. char. String of char.	M O	No. of bits in Transparen Data (TD) message. TD message encoded into IA5 characters.
MT=5: PNC	Char 'H' or char 'I'	O	Definition of the PNC from which the standard text shall be chosen. Char 'H' represents PNC-H; char 'I' represents PNC-I.
LNo	String of num. char.	O	Standard text list number requested by the calling party.
LST	String of num. char.	O	Legitimation code for standard text.
TNo	String of num. char.	O	Standard text number requested by the calling party.

- The NPL parameter must range from 1 to 20 thus limiting the length of the RAd:s list to 20. An IW also contains the DEST\_MAX parameter. The NPL must also have a value less than or equal to this parameter.
- The RAd:s is a list of NPL RAd fields. A RAd field contains an address and optionally a legitimisation code. If the legitimisation code is present it is separated from the address by a comma ",". If the legitimisation code is not present the comma may be omitted. If present the legitimisation code is discarded by the IW.
- The AC parameter is ignored if present.
- Currently the PC interworking needs to support MT=2 and MT=3. The parameters for MT=5 are essential if the Message Type (MT) defined is standard text.

### B.4.3.1 Multiple address call input operation (positive result)

The following list shows the parameters in the positive result data field:

**Table B.9:**

Parameter	Type	Presence	Description
ACK	Char "A"	M	Positive acknowledgement
SM	String of char.	O	System message

The SM field contains the following three fields:

**Table B.10:**

SM Parameter	Type	Description
AdC	String of num. char.	Address code recipient, maximum length is 16 digits.
SEP	char ':'	Separator
SCTS		String of 12 num. char. Service Centre time-stamp DDMMYYhhmmss

Since the operation allows for a maximum of 20 addresses to be provided the positive result may also contain a maximum of 20 address:time-stamp combinations.

If some of the addresses are invalid, and some are valid, the invalid addresses can be recognized by the absence of the timestamp field. If all addresses are invalid, a negative result is returned.

### B.4.3.2 Multiple address call input operation (negative result)

The following list shows the parameters in the negative result data field:

**Table B.11:**

Parameter	Type	Presence	Description
NACK	Char "N"	M	Negative acknowledgement
EC	2 numeric char.	M	Error code
SM	String of char.	O	System message

The following error codes can be returned in the operation negative result:

- 01 Checksum error
- 02 Syntax error
- 04 Operation not allowed (at this point in time)
- 05 Call barring active
- 06 AdC invalid
- 07 Authentication failure
- 08 Legitimation code for all calls, failure
- 23 Message type not supported by system
- 24 Message too long
- 26 Message type not valid for the pager type

## B.4.4 Call input with supplementary services operation - 03

This operation can be used by the PC to submit a Short message to the SMSC. The following list shows the parameters in the operation data field:

**Table B.12:**

Parameter	Type	Presence	Description
RAd	String of num. char.	M	AdC Address code recipient, maximum length is 16 digits, combined with optional legitimisation code for all calls.
OAdC	String of num. char.	O	Address code originator, maximum length is 16 digits.
AC	String of char.	O	Authentication code originator.
NPL	String of num. char.	M	Number of parameters in the following GA:s list.
GA:s	String of char.	O	List of additional GA:s requested by the calling party.
RP	Char '1'	O	Repetition requested.
PR	Char '1' or char '3'	O	Priority request 1 or 3.
LPR	String of num. char.	O	Legitimation code for priority requested.
UR	Char '1'	O	Urgent message indicator request.
LUR	String of num. char.	O	Legitimation code for urgent message.
RC	Char '1'	O	Reverse charging request.
LRC	String of num. char.	O	Legitimation code for reverse charging
DD	Char '1'	O	Deferred delivery request.
DDT	10 num. char.	O	Deferred delivery time DDMMYYHHmm
MT	1 numeric char.	M	Message type. Associated parameters depend on the value of the message type.
MT=1:			Tone only: No additional parameters used.
MT=2: NMsg	String of char.	O	Numeric message.
MT=3: AMsg	String of char.	O	Alphanumeric message.
MT=4: NB TMsg	String of num. char. String of char.	M O	No. of bits in Transparent Data (TD) message. TD message encoded into IA5 characters.
MT=5: PNC	Char 'H' or 'I'	O	Definition of the PNC from which the standard text shall be chosen. Char 'H' represents PNC-H; char 'I' represents PNC-I.
LNo	String of num. char.	O	Standard text list number requested by the calling party.
LST	String of num. char.	O	Legitimation code for standard text.
TNo	String of num. char.	O	Standard text number requested by the calling party.

- The RAD field contains an address and optionally a legitimisation code. If the legitimisation code is present it is separated from the address by a comma ",". If the legitimisation code is not present the comma may be omitted. If present the legitimisation code is discarded by the IW.
- The AC parameter is ignored if present.
- The NPL must be equal to zero. If the NPL contains anything else than zero a negative response with "GA not valid" (09) must be sent to the message sender. Since NPL must be equal to zero the GA:s list must also be empty.
- The RP parameter may not be set. If the RP parameter is set a negative response with "Repetition not allowed" (10) must be sent to the message sender.
- The PR parameter may not be set. If the PR parameter is set a negative response with "Priority call not allowed" (12) must be sent to the message sender.
- The LPR parameter may not be set. If the LPR parameter is set a negative response with "Priority call not allowed" (12) must be sent to the message sender.
- The UR parameter may not be set. If the UR parameter is set a negative response with "Urgent message not allowed" (14) must be sent to the message sender.
- The LUR parameter may not be set. If the LUR parameter is set a negative response with "Urgent message not allowed" (14) must be sent to the message sender.



- The RC parameter may not be set. If the RC parameter is set a negative response with "Reverse charging not allowed" (16) must be sent to the message sender.
- The LRC parameter may not be set. If the LRC parameter is set a negative response with "Reverse charging not allowed" (16) must be sent to the message sender.
- The parameter NB is essential when MT=4.
- The parameters for MT=5 are essential if the Message Type (MT) defined is standard text.

### B.4.4.1 Call input with supplementary services operation (positive result)

The following list shows the parameters in the positive result data field:

**Table B.13:**

Parameter	Type	Presence	Description
ACK	Char "A"	M	Positive acknowledgement
SM	String of char.	O	System message

The SM parameter contains the following three fields:

**Table B.14:**

SM Parameter	Type	Description
AdC	String of num. char.	Address code recipient, maximum length is 16 digits.
SEP	char ':'	Separator
SCTS	String of 12 num. char.	Service Centre time-stamp

### B.4.4.2 Call input with supplementary services operation (negative result)

The following list shows the parameters in the negative result data field:

**Table B.15:**

Parameter	Type	Presence	Description
NACK	Char "N"	M	Negative acknowledgement
EC	2 numeric char.	M	Error code
SM	String of char.	O	System message

The following error codes can be returned in the operation negative result:

- 01 Checksum error
- 02 Syntax error
- 03 Operation not supported by system
- 04 Operation not allowed (at this point in time)
- 05 Call barring active
- 06 AdC invalid
- 07 Authentication failure
- 08 Legitimation code for all calls, failure
- 10 Repetition not allowed
- 11 Legitimation code for repetition, failure

- 12 Priority call not allowed
- 13 Legitimation code for priority call, failure
- 14 Urgent message not allowed
- 15 Legitimation code for urgent message, failure
- 16 Reverse charging not allowed
- 17 Legitimation code for reverse charging, failure
- 18 Deferred delivery not allowed
- 21 Standard text not valid
- 23 Message type not supported by system
- 24 Message too long
- 26 Message type not valid for the pager type

## B.4.5 SMS message transfer operation - 30

This operation can be used by the PC to submit a message to the SMSC. With this operation Short Message specific services can be requested. The following list shows the parameters in the operation data field:

**Table B.16:**

Parameter	Type	Presence	Description
AdC	String of num. char.	M	Address code recipient, maximum length is 16 digits.
OAdC	String of num. char.	O	Address code originator, maximum length is 16 digits.
AC	String of char.	O	Authentication code originator.
NRq	Char '1'	O	Notification requested.
NAd	String of num. char.	O	Notification address.
NPID	4 num. char.	O	Notification PID value: 0100 Mobile Station 0122 Fax Group 3 0131 X.400 0138 Menu 0139 PC appl. over PSTNa 0339 PC appl. over X.25
DD	Char '1'	O	Deferred delivery request.
DDT	10 num. char.	O	Deferred delivery time DDMMYYHHmm
VP	10 num. char.	O	Validity period DDMMYYHHmm.
AMsg	String of char.	O	Alphanumeric message, maximum length 160 characters.

### B.4.5.1 SMS message transfer operation (positive result)

The following list shows the parameters in the positive result data field:

**Table B.17:**

Parameter	Type	Presence	Description
ACK	Char "A"	M	Positive acknowledgement
MVP	10 num. char.	O	Modified validity period
SM	String of char.	O	System message

The SM parameter contains the following three fields:

**Table B.18:**

SM Parameter	Type	Description
AdC	String of num. char.	Address code recipient, maximum length is 16 digits.
SEP	char ':'	Separator
SCTS	String of 12 num. char.	Service Centre time-stamp DDMMHHhmmss

### B.4.5.2 SMS message transfer operation (negative result)

The following list shows the parameters in the negative result data field:

**Table B.19:**

Parameter	Type	Presence	Description
NACK	Char "N"	M	Negative acknowledgement
EC	2 numeric char.	M	Error code
SM	String of char.	O	System message

The following error codes can be returned in the operation negative result:

- 01 Checksum error
- 02 Syntax error
- 04 Operation not allowed (at this point in time)
- 05 Call barring active
- 06 AdC invalid
- 07 Authentication failure
- 08 Legitimation code for all calls, failure
- 24 Message too long
- 26 Message type not valid for the pager type

### B.4.6 SMT alert operation - 31

This operation can be used by a PC (SMT) to alert the SC. The following list shows the parameters in the operation data field:

**Table B.20:**

Parameter	Type	Presence	Description
AdC	String of num. char.	M	Address code for the SMT, maximum length is 16 digits.
PID	String of num. char.	M	PID value for the SMT.

#### B.4.6.1 SMT alert operation (positive result)

The following list shows the parameters in the positive result data field:

**Table B.21:**

Parameter	Type	Presence	Description
ACK	Char "A"	M	Positive acknowledgement
SM	String of char.	O	System message

The positive SMT alert operation result text SM parameter must contain the number of messages waiting in the SC destined for the subscriber the alert was generated for. The number consists of four digits and contains leading zero's.

### B.4.6.2 SMT alert operation (negative result)

The following list shows the parameters in the negative result data field:

**Table B.22:**

Parameter	Type	Presence	Description
NACK	Char "N"	M	Negative acknowledgement
EC	2 numeric char.	M	Error code
SM	String of char.	O	System message

The following error codes can be returned in the operation negative result:

- 01 Checksum error
- 02 Syntax error
- 04 Operation not allowed (at this point in time)
- 05 Call barring active
- 06 AdC invalid
- 07 Authentication failure
- 08 Legitimation code for all calls, failure
- 24 Message too long
- 26 Message type not valid for the pager type

---

## B.5 50-Series of EMI Messages

This clause introduces the newly defined 50-series of operations. The following defines these operations:

**Table B.23:**

EMI operation	Name	initiated by
51	Submit_short_message	External Machine
52	Deliver_short_message	SMSC
53	Deliver_notification	SMSC
55	Inquiry_message	External Machine
56	Delete_message	External Machine
57	Response_inquiry_message	SMSC
58	Response_delete_message	SMSC

These new messages have been introduced in order to provide more facilities to the SMSC users. If a user has used one of these new operations during a session, it is assumed that the other (output) operations are supported as well. Otherwise, the operations defined in the previous chapters will be used, on order to maintain compatibility with earlier implementations of EMI.

## B.5.1 Abstract Data Types

For a higher maintainability a new generic Abstract Data Type (ADT) is introduced for all operations described in this chapter. This means that all 50-series of EMI strings, including responses, shall contain all fields listed, fields not appropriate shall be left empty.

The following is a description of this generic ADT (where 'Num string' indicates 'string of numeric char.')

**Table B.24:**

Member	Length	Type	Meaning
AdC	20	Num string	Address code recipient for the SM
OAdC	20	Num string	Address code originator
AC	16	Num string	Authentication code originator
NRq	1	Num char.	Notification Request
NAdC	20	Num string	Notification Address
NT	1	Num char.	Notification Type: Buffered message notification (BN), Delivery Notification (DN), Non-delivery notification (ND), 0 default value, 1 = BN, 2 = DN, 3 = ND, 4 = BN+DN, 5 = BN+ND, 6 = DN+ND, 7 = all.
NPID	4	4 num char.	Notification PID value 0100 Mobile Station 0122 Fax Group 3 0131 X.400 0138 Menu 0139 PC appl. over PSTNa 0339 PC appl. over X.25 0539 PC appl. over TCP/IP
LRq	1	1 num char.	Last Resort Address request: 0 = not used, 1 = LRAd used
LRAd	20	Num string	Last Resort Address
LPID	4	4 num char.	LRAD PID value 0100 Mobile Station 0122 Fax Group 3 0131 X.400 0138 Menu 0139 PC appl. over PSTNa 0339 PC appl. over X.25 0539 PC appl. over TCP/IP
DD	1	1 num char.	Deferred Delivery requested
DDT	10	10 num char.	Deferred delivery time in DDMMYYHHmm
VP	10	10 num char.	Validity period in DDMMYYHHmm
RPID	4	Num string	Replace PID value (reserved for future use)
SCTS	12	Num string	Service Centre Time Stamp in DDMMYYHHmmss. For a Short Message this is the time stamp of the Short Message itself. For a Notification this is the time stamp of the corresponding Short Message.
Dst	1	1 num char.	Delivery status: 0 = delivered 1 = buffered (see Rsn) 2 = not delivered (see Rsn)

(continued)

Table B.24 (concluded):

Member	Length	Type	Meaning
Rsn	3	3 num char.	Reason code, value '000'...'255'
DSCTS	12	Num string	Delivery time stamp in DDMMYYHHmmss. Indicates the actual time of delivery of the Short Message.
MT	1	1 num char.	Message Type. Associated parameters depend on the value of MT.
MT=2: NMsg	640	Char. string	Numeric message.
MT=3: AMsg	640	Char. string	Alphanumeric message.
MT=4: NB	4	Num string	No. of bits in Transparent Data (TD) message.
TMsg	140	Char. string	TD message encoded into IA5 characters.
MMS	1	1 num char.	More Messages to Send (to the same SME)
PR	1	1 char.	(reserved for Priority Requested)
DCs	2	2 hex char.	Data Coding scheme: 0 = default alphabet 1 = user defined data
MCLs	1	1 num char.	Message class: 0 = message class 0 1 = message class 1 2 = message class 2 3 = message class 3
RPI	1	Num string	(reserved for Reply Path)
CPg	1	Num string	(reserved for Code Page)
RPLy	1	1 num char.	(reserved for Reply type)
RES1	x	Num string	(reserved for future use)
RES2	x	Num string	(reserved for future use)
RES3	x	Num string	(reserved for future use)
RES4	x	Num string	(reserved for future use)
RES5	x	Num string	(reserved for future use)

x = not specified yet

A generic ADT for the EMI response is defined as follows:

- For a positive response:

Member	Type
AcK	Positive acknowledgement
MVP	Modified Validity Period
SM	System Message

- For a negative response:

Member	Type
AcK	Positive acknowledgement
MVP	Modified Validity Period
SM	System Message

## B.5.2 Standard string

The advantage of using the generic ADT for all new EMI operations is, that one standard string can be used for all operations. The string is build complying to the [REF 1] specifications as follows:

stx <header> / <data> / <checksum> etx

- stx = 02(hex)
- etx = 03(hex)

The string header is build up in the same way as is done in UCP.

The data field shall always contain **ALL fields** listed in the 5x series generic ADT. These fields are separated by '/'. If a member of the ADT is not used in a specific message type, its place in the data string is empty, but the field separators will be present ('/').

For example the data block for INQM (OAdC and AdC fields only) will look like:

../55/O/012345/0324/////////.....

This format provides a high degree of flexibility as well as upwards compatibility to future EMI specifications.

This does also apply for the responses. For example, the positive response message contains the MVP field. This field is only used for the SUBS message positive response; in all other cases this field is left empty.

In the columns marked 'Presence' of the sections to follow, 'M' indicates that the field is Mandatory, 'O' indicates that the parameter is Optional and '-' indicates that the parameter shall not be present.

## B.5.3 Submit Short Message operation -51

This operation is used to submit a Short Message to the SMSC. The operation can be used for Short Messages with an alphanumeric or a binary message text field. In the latter case the MT parameter shall be set to '4'.

**Table B.25:**

Member	Presence	Meaning
AdC	M	Address code recipient for the SM
OAdC	M	Address code originator
AC	O	Authentication code originator
NRq	O	Notification Request
NAdC	O	Notification Address
NT	O	Notification Type
NPID	O	Notification PID value
LRq	O	Last Resort Address request
LRAd	O	Last Resort Address
LPID	O	LRAD PID value
DD	O	Deferred Delivery requested
DDT	O	Deferred delivery time in DDMMYYHHmm
VP	O	Validity period in DDMMYYHHmm
RPID	O	Replace PID value (reserved for future use)
SCTS	-	Service Centre Time Stamp in DDMMYYHHmmss.
Dst	-	Delivery status
Rsn	-	Reason code
DSCTS	-	Delivery time stamp in DDMMYYHHmmss.
MT	M	Message Type.
MT=2: NMsg	O	Numeric message.
MT=3: AMsg	O	Alphanumeric message.
MT=4: NB	M	No. of bits in Transparent Data (TD) message.
TMsg	O	TD message encoded into IA5 characters.
MMS	-	More Messages to Send (to the same SME)
PR	-	(reserved for Priority Requested)
DCs	O	Data Coding scheme
MCLs	O	Message class. See GSM 03.38. Shall be supplied when MT=4, discarded otherwise.
RPI	-	(reserved for Reply Path)
CPg	-	(reserved for Code Page)
RPLy	-	(reserved for Reply type)

### B.5.3.1 Submit Short Message operation (positive result)

The following list shows the parameters in the positive result data field:

**Table B.26:**

Parameter	Type	Presence	Description
ACK	Char "A"	M	Positive acknowledgement
MVP	String of char	O	Modified validity period
SM	String of char.	O	System message



The SM parameter contains the following three fields:

**Table B.27:**

SM Parameter	Type	Description
AdC	String of num. char.	Address code recipient, maximum length is 16 digits.
SEP	char ':'	Separator
SCTS	String of 12 num char	Service Centre time-stamp DDMMYYhhmmss.

### B.5.3.2 Submit Short Message operation (negative result)

The following list shows the parameters in the negative result data field:

**Table B.28:**

Parameter	Type	Presence	Description
NACK	Char "N"	M	Negative acknowledgement
EC	2 num. char.	M	Error code
SM	String of char.	O	System message

### B.5.4 Delivery Short Message operation -52

This operation (DELS) is used to deliver a Short Message. The operation is initiated by the SMSC and answered by the SME.

**Table B.29:**

Member	Presence	Meaning
AdC	M	Address code recipient for the SM
OAdC	M	Address code originator
AC	-	Authentication code originator
NRq	-	Notification Request
NAdC	-	Notification Address
NT	-	Notification Type
NPID	-	Notification PID value
LRq	-	Last Resort Address request
LRAAd	-	Last Resort Address
LPID	-	LRAD PID value
DD	-	Deferred Delivery requested
DDT	-	Deferred delivery time in DDMMYYHHmm
VP	O	Validity period in DDMMYYHHmm
RPID	-	Replace PID value (reserved for future use)
SCTS	M	Service Centre Time Stamp in DDMMYYHHmss.
Dst	-	Delivery status
Rsn	-	Reason code
DSCTS	-	Delivery time stamp in DDMMYYHHmss.
MT	M	Message Type.
MT=2: NMsg	O	Numeric message.
MT=3: AMsg	O	Alphanumeric message.
MT=4: NB	M	No. of bits in Transparent Data (TD) message.
TMsg	O	TD message encoded into IA5 characters.
MMS	O	More Messages to Send (to the same SME)
PR	-	(reserved for Priority Requested)
DCs	O	Data Coding scheme
MCLs	O	Message class. See GSM 03.38. Shall be supplied when MT=4, discarded otherwise.
RPI	-	(reserved for Reply Path)
CPg	-	(reserved for Code Page)
RPLy	-	(reserved for Reply type)

#### B.5.4.1 Delivery Short Message operation (positive result)

The following list shows the parameters in the positive result data field:

**Table B.30:**

Parameter	Type	Presence	Description
ACK	Char "A"	M	Positive acknowledgement
MVP	String of char	-	Modified validity period
SM	String of char.	O	System message

#### B.5.4.2 Delivery Short Message operation (negative result)

The following list shows the parameters in the negative result data field:

**Table B.31:**

Parameter	Type	Presence	Description
NACK	Char "N"	M	Negative acknowledgement
EC	2 num. char.	M	Error code
SM	String of char.	O	System message

## B.5.5 Delivery notification operation -53

This operation (DELN) is used to indicate the (changed) status of a previously submitted Short Message to the SMSC. The operation is initiated by the SMSC.

**Table B.32:**

Member	Presence	Meaning
AdC	M	Address code recipient for the SM
OAdC	M	Address code originator
AC	-	Authentication code originator
NRq	-	Notification Request
NAdC	-	Notification Address
NT	-	Notification Type
NPID	-	Notification PID value
LRq	-	Last Resort Address request
LRAd	-	Last Resort Address
LPID	-	LRAD PID value
DD	-	Deferred Delivery requested
DDT	-	Deferred delivery time in DDMMYYHHmm
VP	-	Validity period in DDMMYYHHmm
RPID	-	Replace PID value (reserved for future use)
SCTS	M	Service Centre Time Stamp in DDMMYYHHmmss. This is the time stamp of the corresponding Short Message.
Dst	M	Delivery status
Rsn	M	Reason code
DSCTS	M	Delivery time stamp in DDMMYYHHmmss. Indicates the time of (non)delivery of the corresponding Short Message, or the time of creation of this notification.
MT	M	Message Type.
MT=2: NMsg	-	Numeric message.
MT=3: AMsg	O	Alphanumeric message.
MT=4: NB	-	No. of bits in Transparent Data (TD) message.
TMsg	-	TD message encoded into IA5 characters.
MMS	O	More Messages to Send (to the same SME)
PR	-	(reserved for Priority Requested)
DCs	-	Data Coding scheme
MCLs	-	Message class. See GSM 03.38. Shall be supplied when MT=4, discarded otherwise.
RPI	-	(reserved for Reply Path)
CPg	-	(reserved for Code Page)
RPLy	-	(reserved for Reply type)

### B.5.5.1 Delivery Notification operation (positive result)

The following list shows the parameters in the positive result data field:

**Table B.33:**

Parameter	Type	Presence	Description
ACK	Char "A"	M	Positive acknowledgement
MVP	String of char	-	Modified validity period
SM	String of char.	O	System message

### B.5.5.2 Delivery Notification operation (negative result)

The following list shows the parameters in the negative result data field:

**Table B.34:**

Parameter	Type	Presence	Description
NACK	Char "N"	M	Negative acknowledgement
EC	2 num. char.	M	Error code
SM	String of char.	O	System message

### B.5.6 Inquiry message operation -55

This operation is initiated by the SME towards the SMSC to inquire about the status of a buffered message. As a result the SMSC can initiate a Response Inquiry message operation.

**Table B.35:**

Member	Presence	Meaning
AdC	M	Address code recipient for the SM
OAdC	M	Address code originator
AC	O	Authentication code originator
NRq	-	Notification Request
NAdC	-	Notification Address
NT	-	Notification Type
NPID	-	Notification PID value
LRq	-	Last Resort Address request
LRAd	-	Last Resort Address
LPID	-	LRAD PID value
DD	-	Deferred Delivery requested
DDT	-	Deferred delivery time in DDMMYYHHmm
VP	-	Validity period in DDMMYYHHmm
RPID	-	Replace PID value (reserved for future use)
SCTS	-	Service Centre Time Stamp in DDMMYYHHmss.
Dst	-	Delivery status
Rsn	-	Reason code
DSCTS	-	Delivery time stamp in DDMMYYHHmss.
MT	-	Message Type.
MT=2: NMsg	-	Numeric message.
MT=3: AMsg	-	Alphanumeric message.
MT=4: NB	-	No. of bits in Transparent Data (TD) message. TD message encoded into IA5 characters.
TMsg	-	
MMS	-	More Messages to Send (to the same SME)
PR	-	(reserved for Priority Requested)
DCs	-	Data Coding scheme
MCLs	-	Message class. See GSM 03.38. Shall be supplied when MT=4, discarded otherwise.
RPI	-	(reserved for Reply Path)
CPg	-	(reserved for Code Page)
RPLy	-	(reserved for Reply type)

### B.5.6.1 Inquiry message operation (positive result)

The following list shows the parameters in the positive result data field:

**Table B.36:**

Parameter	Type	Presence	Description
ACK	Char "A"	M	Positive acknowledgement
MVP	String of char	-	Modified validity period
SM	String of char.	O	System message

### B.5.6.2 Inquiry message operation (negative result)

The following list shows the parameters in the negative result data field:

**Table B.37:**

Parameter	Type	Presence	Description
NACK	Char "N"	M	Negative acknowledgement
EC	2 num. char.	M	Error code
SM	String of char.	O	System message

## B.5.7 Delete message operation -56

This operation is initiated by the SME to delete one or more buffered Short Messages.

**Table B.38:**

Member	Presence	Meaning
AdC	M	Address code recipient for the SM
OAdC	M	Address code originator
AC	O	Authentication code originator
NRq	-	Notification Request
NAdC	-	Notification Address
NT	-	Notification Type
NPID	-	Notification PID value
LRq	-	Last Resort Address request
LRAd	-	Last Resort Address
LPID	-	LRAD PID value
DD	-	Deferred Delivery requested
DDT	-	Deferred delivery time in DDMMYYHHmm
VP	-	Validity period in DDMMYYHHmm
RPID	-	Replace PID value (reserved for future use)
SCTS	-	Service Centre Time Stamp in DDMMYYHHmms.
Dst	-	Delivery status
Rsn	-	Reason code
DSCTS	-	Delivery time stamp in DDMMYYHHmms.
MT	M	Message Type.
MT=2: NMsg	-	Numeric message.
MT=3: AMsg	O	Alphanumeric message. Contains the time stamps (format YYMMDDhhmms) of the buffered Short Message(s), separated by spaces. Format: <code>TIMESTAMP {TIMESTAMP}</code>
MT=4: NB	-	No. of bits in Transparent Data (TD) message.
TMsg	-	TD message encoded into IA5 characters.
MMS	O	More Messages to Send (to the same SME)
PR	-	(reserved for Priority Requested)
DCs	-	Data Coding scheme
MCLs	-	Message class. See GSM 03.38. Shall be supplied when MT=4, discarded otherwise.
RPI	-	(reserved for Reply Path)
CPg	-	(reserved for Code Page)
RPLy	-	(reserved for Reply type)

### B.5.7.1 Delete message operation (positive result)

The following list shows the parameters in the positive result data field:

**Table B.39:**

Parameter	Type	Presence	Description
ACK	Char "A"	M	Positive acknowledgement
MVP	String of char	-	Modified validity period
SM	String of char.	O	System message

### B.5.7.2 Delete message operation (negative result)

The following list shows the parameters in the negative result data field:

**Table B.40:**

Parameter	Type	Presence	Description
NACK	Char "N"	M	Negative acknowledgement
EC	2 num. char.	M	Error code
SM	String of char.	O	System message

### B.5.8 Response Inquiry message operation -57

This operation is initiated by the SMSC in response to an Inquiry message operation. If necessary, the SMSC will start a dial-back session.

**Table B.41:**

Member	Presence	Meaning
AdC	M	Address code recipient for the SM
OAdC	-	Address code originator
AC	-	Authentication code originator
NRq	-	Notification Request
NAdC	-	Notification Address
NT	-	Notification Type
NPID	-	Notification PID value
LRq	-	Last Resort Address request
LRAd	-	Last Resort Address
LPID	-	LRAD PID value
DD	-	Deferred Delivery requested
DDT	-	Deferred delivery time in DDMMYYHHmm
VP	-	Validity period in DDMMYYHHmm
RPID	-	Replace PID value (reserved for future use)
SCTS	-	Service Centre Time Stamp in DDMMYYHHmss.
Dst	-	Delivery status
Rsn	-	Reason code
DSCTS	-	Delivery time stamp in DDMMYYHHmss.
MT	M	Message Type.
MT=2: NMsg	-	Numeric message.
MT=3: AMsg	O	Alphanumeric message. Contains the recipient address and the time stamps (format YYMMDDhhmmss) of the buffered Short Message(s), separated by spaces. Format: [TEXT1] <AdC> [TEXT2] {TIMESTAMP}
MT=4: NB	-	No. of bits in Transparent Data (TD) message.
TMsg	-	TD message encoded into IA5 characters.
MMS	O	More Messages to Send (to the same SME)
PR	-	(reserved for Priority Requested)
DCs	-	Data Coding scheme
MCLs	-	Message class. See GSM 03.38. Shall be supplied when MT=4, discarded otherwise.
RPI	-	(reserved for Reply Path)
CPg	-	(reserved for Code Page)
RPLy	-	(reserved for Reply type)

### B.5.8.1 Response inquiry message operation (positive result)

The following list shows the parameters in the positive result data field:

**Table B.42:**

Parameter	Type	Presence	Description
ACK	Char "A"	M	Positive acknowledgement
MVP	String of char	-	Modified validity period
SM	String of char.	O	System message

### B.5.8.2 Response inquiry message operation (negative result)

The following list shows the parameters in the negative result data field:

**Table B.43:**

Parameter	Type	Presence	Description
NACK	Char "N"	M	Negative acknowledgement
EC	2 num. char.	M	Error code
SM	String of char.	O	System message



## B.5.9 Response delete message operation -58

This operation is initiated by the SMSC to indicate which Short Messages have been deleted successfully.

**Table B.44:**

Member	Presence	Meaning
AdC	M	Address code recipient for the SM
OAdC	-	Address code originator
AC	-	Authentication code originator
NRq	-	Notification Request
NAdC	-	Notification Address
NT	-	Notification Type
NPID	-	Notification PID value
LRq	-	Last Resort Address request
LRAd	-	Last Resort Address
LPID	-	LRAD PID value
DD	-	Deferred Delivery requested
DDT	-	Deferred delivery time in DDMMYYHHmm
VP	-	Validity period in DDMMYYHHmm
RPID	-	Replace PID value (reserved for future use)
SCTS	-	Service Centre Time Stamp in DDMMYYHHmss.
Dst	-	Delivery status
Rsn	-	Reason code
DSCTS	-	Delivery time stamp in DDMMYYHHmss.
MT	M	Message Type.
MT=2: NMsg	-	Numeric message.
MT=3: AMsg	O	Alphanumeric message. Contains the recipient address and the time stamps (format YYMMDDhhmss) of the deleted Short Message(s), separated by spaces. Format: [TEXT3] <AdC> [TEXT4] {TIMESTAMP} [TEXT5]
MT=4: NB	-	No. of bits in Transparent Data (TD) message.
TMsg	-	TD message encoded into IA5 characters.
MMS	O	More Messages to Send (to the same SME)
PR	-	(reserved for Priority Requested)
DCs	-	Data Coding scheme
MCLs	-	Message class. See GSM 03.38. Shall be supplied when MT=4, discarded otherwise.
RPI	-	(reserved for Reply Path)
CPg	-	(reserved for Code Page)
RPLy	-	(reserved for Reply type)

### B.5.9.1 Response delete message operation (positive result)

The following list shows the parameters in the positive result data field:

**Table B.45:**

Parameter	Type	Presence	Description
ACK	Char "A"	M	Positive acknowledgement
MVP	String of char	-	Modified validity period
SM	String of char.	O	System message

## B.5.9.2 Response delete message operation (negative result)

The following list shows the parameters in the negative result data field:

**Table B.46:**

Parameter	Type	Presence	Description
NACK	Char "N"	M	Negative acknowledgement
EC	2 num. char.	M	Error code
SM	String of char.	O	System message

---

## B.6 Error codes overview

Error codes which can be returned in the operations negative result are listed in [1] paragraph 9.2.6. All operations defined in the ERMES recommendation which are not implemented

in the SMSC, EMI returns with error code 03 ("Operation not supported by system").

### B.6.1 Error codes

Error Code    Message

- 01 Checksum error
- 02 Syntax error
- 03 Operation not supported by system
- 04 Operation not allowed
- 05 Call barring active
- 06 AdC invalid
- 07 Authentication failure
- 08 Legitimation code for all calls, failure
- 09 GA not valid
- 10 Repetition not allowed
- 11 Legitimation code for repetition, failure
- 12 Priority call not allowed
- 13 Legitimation code for priority call, failure
- 14 Urgent message not allowed
- 15 Legitimation code for urgent message, failure
- 16 Reverse charging not allowed
- 17 Legitimation code for rev. charging, failure
- 18 Deferred delivery not allowed
- 19 New AC not valid
- 20 New legitimation code not valid

- 21 Standard text not valid
- 22 Time period not valid
- 23 Message type not supported by system
- 24 Message too long
- 25 Requested standard text not valid
- 26 Message type not valid for the pager type
- 27 Message not found in SMSC
- 30 Subscriber hang-up
- 31 Fax group not supported
- 32 Fax message type not supported

The following table summarizes some special occurrences of error codes:

**Table B.47:**

<b>Error Code</b>	<b>Meaning</b>
02	Error in the NPID parameter (SMS Message transfer) or in the PID parameter (SMT Alert).
04	Any internal error (e.g. no resources), often of temporary nature. If the RAd:s (number of addresses) parameter contained more addresses than the specified maximum, the System Message parameter will contain "too many addresses".
05	One of the addresses is on the blacklist.

---

## Annex C: SMSC to SME interface specification

### C.1 Introduction

This clause introduces the Short Message Entity (SME) and the Short Message Service Centre (SMSC) architecturally, and explains how the interface between these two systems will be specified in the rest of this annex.

#### C.1.1 System architecture

A Short Message Entity (SME) is interconnected through a Short Message Entity Interface (SME-IF) with a Short Message Service Centre (SMSC). The main purpose of this interconnection is to send short messages from the SMEs to the Mobile Stations (MS) and from the MSs to the SMEs. Also other kind of information maybe conveyed over the interconnection, e.g. status reports and alerts from the GSM network to the SMEs. The system architecture discussed in this annex thus consists of the SME and the SMSC, and the purpose of this annex is to specify the SME-IF between the two.

#### C.1.2 What to communicate

The information communicated across the SME-IF is specified as SME operations sent as an entity from one system to the other. Typical operation is submitting a short message from the SME to the SMSC

The SME operations are specified in sections C.2 and C.3 of this annex.

Each SME operation carries a number of SME parameters with it, i.e. data items specifying the subscriber, some facts about the operation itself, etc.

The SME parameters are specified in clause C.4 of this annex.

#### C.1.3 How to communicate

Clauses C.2, C.3 and C.4 thus specify *what* is to be sent between the SME and the SMSC. The realization of that communication is the topic of section C.5.

Clause C.5 introduces the question of *how* to communicate between the SME and the SMSC, i.e. the coding of information related to operations and the SME link between the two systems, carrying the SME operations.

#### C.1.4 What to do with the information

The specifications in clauses C.2 through C.5 thus enable communication between the SME and the SMSC.

Clause C.6 introduces the service concept: assuming some SME operations (with the proper SME parameters) from the SME and the SMSC, what kind of short messages the subscriber is going to receive?

## C.1.5 Interface profile

In this annex the operations and the parameters specified for each operation represent a maximum amount of information the SME or the SMSC may provide. It is very important to notice that in most cases it is not reasonable for the SME to send all the possible parameters, if the SMSC can provide that information or the information is static. Note also that in some cases the operator may want to restrict the use of some parameters. An example of this is the originating address, showing the sender of the short message. A value stored in the SMSC for each SME could be used instead of letting the SME set the address.

Because of what is said above it must be possible to state the information and the link between the two systems; such a statement is called the interface profile of the SME-IF.

Profiling example is given in clause C.6 for the service specified there.

## C.2 Operations

### C.2.1 Introduction

This clause defines the operations between the SME and the SMSC; please refer to subclause C.1.2 for an introduction to their role in this annex and the SME-SMSC architecture. Parameters related to each operation are specified in clause C.3.

The operations are divided to operations originated by the SME, operations originated by the SMSC and operations that can be originated by both the SME and the SMSC.

When defining the operations the different SMEs might use, two basic types of SMEs were considered:

- querying SMEs;
- listening SMEs.

Querying SMEs do not receive anything from the SMSC automatically, but they want to query if there is something to be retrieved. The SME is typically connected to the SMSC every now and then to submit a message and may at the same time also check if there is something to be received. An example of this kind of an SME is a PC-application with a modem connection to the SMSC.

Listening SME type is always ready to receive if the SMSC has something to send to it. This type of SMEs are usually always connected and perhaps the best example is a voice mail system sending notifications about new voice messages to the MSs.

The type of the SME must be specified before the SME may start to operate. The type is stored in the SMSC as well as some other information about the SME.

### C.2.2 Operations from the SME to the SMSC

<b>operation</b>	<b>definition</b>
submit	This operation is used by the SME for sending short messages from to an MS.
cancel	This operation is used by the SME for cancelling short messages it has sent.
delivery request	This operation is used by the SME for retrieving mobile originated short messages.
status report request	This operation is used by the SME for requesting status reports of previously submitted short messages.
disable status report req.	This operation is used by the SME for disabling the status report request for a previously submitted short message.

enable status report req.	This operation is used by the SME for enabling the status report request for a previously submitted short message.
login	This operation is used by the session based SMEs (SME is connected until its operations are performed) before any other operations.
logout	This operations is used by the session based SMEs (SME is connected until its operations are performed) for indicate the end of the session.
change password	This operation is used by the SME for changing password used in login operation.
change profile parameter	This operation is used by the SME for changing values of those interface profile parameters that it is allowed to change.

### C.2.3 Operations from the SMSC to the SME

<b>operation</b>	<b>definition</b>
delivery	This operation is used by the SMSC for delivering mobile originated short messages to the SME.
status report	This operation is used by the SMSC for sending a status reports describing the current status of a short message sent by the SME.
reachability notification	This operation is used by the SMSC for indicating to the SME that an MS to which the SME has tried to sent a short message is now reachable.
delivery data notification	This operation is used by the SMSC for indicating that there is new short message or a status report waiting for retrieval.

### C.2.4 Common operations

<b>operation</b>	<b>definition</b>
alive	This operation may be used by both the SME and the SMSC for checking whether the link between the SME and the SMSC is still alive.
ack	This operation is used by both the SME and the SMSC for indicating back the positive result to the initiator of the operation.
nack	This operation is used by both the SME and the SMSC for indicating the negative result to the initiator of the operation.

---

## C.3 Operation details

### C.3.1 Submit

Submit in its simplest mode just passes the short message text to the SMSC which takes care of the delivery. There are, however, also some special features that may be requested with the submit operation like reachability notification, first delivery time, message to many recipients etc.

There are two ways for the SME to produce short messages:

- The SME builds the message text and places it into the parameter **user data** in submit operation. The text is sent with other necessary parameters to the SMSC. The SMSC then sends the message as such to the MS.
- The SME does not build the message text, but places a code indicating some predefined message in the SMSC into parameter **standard message identifier** in submit operation. The code is sent with other necessary parameters to the SMSC. The SMSC then sends the predefined message corresponding to the value of standard message identifier to the MS. Note that the predefined message may have places for parameter values coming from the SME. An example of this is given in clause C.6.1.

The submitted short message can be identified afterwards in two ways: by using time stamp generated by the SMSC (returned in acknowledgement) and the destination address or with short message identifier given by the SME in submit. Note that if the identifier is used, it is up to the SME to guarantee that the identifier is unique.

#### Operation parameters:

- short message identifier
- number of destinations
- destination address type
- destination address
- originating address type
- originating address
- protocol identifier
- data coding scheme
- validity period relative (see note 1)
- validity period absolute (see note 1)
- first delivery time integer (see note 2)
- first delivery time absolute (see note 2)
- reply path
- replace
- user data length (see note 3)
- user data (see note 3)
- standard message identifier (see note 3)
- language (see note 3)
- status report request
- reachability notification

- cancel enabled

NOTE 1: either relative or absolute validity period

NOTE 2: either integer or absolute first delivery time

NOTE 3: either user data or standard message identifier, user data length may be used together with user data and language together with standard message identifier

**Acknowledgement** contains additional parameter service centre time stamp.

**Flow of operations:**

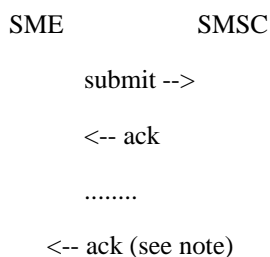

NOTE: More than one ack in case more than one destination address was given

### C.3.2 Cancel

NOTE: It is possible to cancel more than one message with one operation. If the short message is already sent to GSM network, it cannot be cancelled anymore.

Cancelling may be disabled in submit operation. Disabling is useful e.g. in cases where there are such messages to a certain MS that should not be cancelled, but the cancellation is done according to destination address.

**Operation parameters:**

- short message identifier
- service centre time stamp
- destination address type
- destination address
- originating address type
- originating address
- filter

**Acknowledgement** does not contain any additional parameters.

**Flow of operations:**

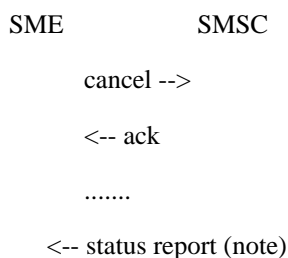

NOTE: Status report(s) may follow in case status report was requested for the cancelled message(s) and SME is of type listening.



### C.3.3 Delivery request

This operation is used by the querying SME to retrieve a mobile originated short message.

**Operation parameters:**

The operation does not require any parameters.

**Acknowledgement** contains parameter message count telling how many deliveries will follow.

**Flow of operations:**

SME	SMSC
	delivery request -->
<-- ack	
<-- delivery (note)	
ack -->	

NOTE: Deliveries will follow in case there are messages to be retrieved. The SME controls the delivery sequence with a parameter get next in ack operation.

### C.3.4 Status report request

This operation is used by the querying SME to request a status report of a previously submitted short messages.

NOTE: It is possible to request a status report to more than one message with one operation.

To be able to get status reports, the status report request must be set in submit operation.

**Operation parameters:**

- short message identifier
- service centre time stamp
- destination address type
- destination address
- originating address type
- originating address
- filter

**Acknowledgement** contains parameter message count telling how many status reports will follow.

**Flow of operations:**

SME	SMSC
	status report request -->
<-- ack	
<-- status report (note)	
ack -->	

NOTE: Status reports will follow in case there are status reports to be retrieved. The SME controls the status report sequence with a parameter get next in ack operation.

### C.3.5 Disable status report request

This operation is used by the SME to disable the status report request for a previously submitted short message.

NOTE: It is possible to affect to more than one message with one operation.

#### Operation parameters:

- short message identifier
- service centre time stamp
- destination address type
- destination address
- originating address type
- originating address
- filter

**Acknowledgement** does not contain any additional parameters.

#### Flow of operations:

SME	SMSC	
		disable status report req -->
		<-- ack

### C.3.6 Enable status report request

This operation is used by the SME to enable the status report request for a previously submitted short message.

NOTE: It is possible to affect to more than one message with one operation.

#### Operation parameters:

- short message identifier
- service centre time stamp
- destination address type
- destination address
- originating address type
- originating address
- filter

**Acknowledgement** does not contain any additional parameters.

#### Flow of operations:

SME	SMSC	
		enable status report req -->
		<-- ack

## C.3.7 Login

If an SME is session based, i.e. SME is connected until its operations are performed, a login must be done first.

With the login, it is possible to define the version of interface software. The SMSC selects the interface profile to be used based on user identity given in the login operation.

**NOTE:** That the information given in login may also be included in operations like submit in case the SME just wants to perform one operation but does not want do anything else (no session needed).

### Operation parameters:

- user identity
- password
- interface version

**Acknowledgement** contains parameter message count telling the number of new message waiting for retrieval in case the SME is capable to receive mobile originated messages.

### Flow of operations:

<u>SME</u>	<u>SMSC</u>
	login -->
	<-- ack

## C.3.8 Logout

If an SME is session based, i.e. it has done a login to perform some operations, it must do a logout when the session should be closed.

### Operation parameters:

Logout operation does not need any parameters.

**Acknowledgement** does not contain any additional parameters.

### Flow of operations:

SME	SMSC
	logout -->
	<-- ack

## C.3.9 Change password

This operation is used by the SME to change the password used in login operation.

### Operation parameters:

- user identity
- old password
- new password

**Acknowledgement** does not contain any additional parameters.

**Flow of operations:**

SME	SMSC
	change password -->
<-- ack	

### C.3.10 Change profile parameter

This operation is used by the SME to change those parameters of the interface profile that it is allowed to change, e.g. default validity period and interface version.

**Operation parameters:**

- parameter identification
- new parameter value

**Acknowledgement** does not contain any additional parameters.

**Flow of operations:**

SME	SMSC
	change profile parameter -->
<-- ack	

### C.3.11 Delivery

This operation is used by the SMSC deliver mobile originated short messages to the SME.

After a successful delivery the message will be removed from the SMSC.

**Operation parameters:**

- service centre time stamp
- destination address type
- destination address
- originating address type
- originating address
- protocol identifier
- data coding scheme
- reply path
- user data length
- user data

**Acknowledgement** may contain parameter get next in case the delivery was requested by the SME with delivery request operation.

**Flow of operations:**

SME	SMSC
	<-- delivery
	ack -->

### C.3.12 Status report

This operation is used by the SMSC for sending a status report describing current status of a previously submitted short message.

After a successful delivery the status report will be removed from the SMSC if it describes the final status of the message, i.e. no further delivery attempts will follow.

**Operation parameters:**

- short message identifier
- service centre time stamp
- destination address type
- destination address
- originating address type
- originating address
- discharge time
- status
- delivery error code

**Acknowledgement** may contain parameter get next in case the delivery was requested by the SME with status report request operation.

**Flow of operations:**

SME	SMSC
	<-- status report
	ack -->

### C.3.13 Reachability notification

This operation is used by the SMSC to indicate to the SME that a specific MS is now reachable. The reachability notification may be sent because of an alert received from the GSM network or because of a temporary error other than absent subscriber to a delivery attempt. Reachability notification must be requested in a submit operation.

If the SME does not cancel the short message after receiving the reachability notification, the message will be delivered after a while.

**Operation parameters:**

- short message identifier
- service centre time stamp
- destination address type
- destination address
- originating address type
- originating address
- reachability type

**Acknowledgement** does not contain any additional parameters.

**Flow of operations:**

SME	SMSC	
		<-- reachability notification
		ack -->

## C.3.14 Delivery data indication

This operation is used by the SMSC to indicate that there is a new short message or a status report waiting for retrieval.

**Operation parameters:**

- destination address type
- destination address
- originating address type
- originating address
- data type

**Acknowledgement** does not contain any additional parameters.

**Flow of operations:**

SME	SMSC	
		<-- delivery data indication
		ack -->

## C.3.15 Alive

This operation can be used by both the SMSC and the SME to check whether the link between the SME and the SMSC is still alive. The recipient of the operation must send an acknowledgement back to the originator if the alive operation is received correctly.

**Operation parameters:**

Operation does not need any parameters.

**Acknowledgement** does not contain any additional parameters.

**Flow of operations:**

SME	SMSC
	<-- alive
ack -->	
.....	
alive -->	
<-- ack	

### C.3.16 Ack

This operation is used by both the SMSC and the SME to send back the positive result of the operation to its originator.

**Operation parameters:**

- initial operation sequence number
- initial operation
- (additional parameters)

Sequence number of the operation to which this is an acknowledgement is present only on binary coded SME link.

The additional parameters depend on the initial operation.

### C.3.17 Nack

This operation is used by both the SMSC and the SME to send back the negative result of the operation to its originator.

**Operation parameters:**

- initial operation sequence number
- initial operation
- error code
- error text

Sequence number of the operation to which this is an acknowledgement is present only on binary coded SME link.

---

## C.4 Interface parameters

This clause specifies the parameters that the operations communicated between the SME and the SMSC may carry; please refer to subclause C.1.2 for an introduction to their role in this annex and the SME-SMSC architecture.

## C.4.1 Parameter types

Allowed types for the parameter values are:

<b>integer</b>	single integer of one, two or four bytes.
<b>int. vector</b>	vector of single integers.
<b>IA5</b>	character vector (non-terminated string) of IA5 characters.
<b>BCD</b>	vector of BCD digits and two additional characters '+' and '-', each being represented with 4 bits (0000 = '0', 0001 = '1', ... , 1001 = '9', 1010 = '+', 1011 = '-', 1100 - 1110 reserved, 1111 = last 4 bits of the vector, if they are not used), one byte of the vector may thus contain two digits or '+' or '-' characters.
<b>GSM7</b>	character vector of GSM 03.38 characters (i.e. in the default 7-bit coded alphabet of the SMS), 7 bits per character, packed into octets according to GSM 03.38.
<b>GSM8</b>	character vector of GSM 03.38 characters (i.e. in the default 7-bit coded alphabet of the SMS), 8 bits per character with a zero bit as the most significant bit of each byte.
<b>8BIT</b>	vector of 8 bit bytes which will be sent transparently through the SMSC.

Integer values are presented in two's complement notation, with the most significant byte in the former byte of parameter value.

BCD digits are presented so that in each byte, the **higher** order digit is coded in **lowest** order bits 3, 2, 1 and 0. If the number of BCD digits is odd, then bits 7, 6, 5 and 4 within the last byte should always be set to one.

Types GSM7 and 8BIT may be used only in cases where *the entire short message text is supplied as one parameter value*.

Type GSM8 may be used *only in character vectors to be copied into a short message without any other processing than conversion to type GSM7 by the services*.

## C.4.2 Parameter definitions

Each parameter has a unique identifier. Identifier values from 0 to 80 are reserved for parameters defined in this annex. Values from 81 to 99 may be used for building short message texts. The use is agreed between the SME and the SMSC operator.

### Sequence Number

Id:	1
Type:	integer
Explanation:	Sequence number of this operation, numbers incremented cyclically from 0 through 9999 (modulo 10000).



**Operation**

Id: 2

Type: integer

Explanation: Value as follows:

- 1 submit
- 2 cancel
- 3 delivery request
- 4 status report request
- 5 disable status report request
- 6 enable status report request
- 7 login
- 8 logout
- 9 change password
- 10 change profile parameter
- 11 delivery
- 12 status report
- 13 reachability notification
- 14 delivery data notification
- 15 alive
- 16 ack
- 17 nack

**Short Message Identifier**

Id: 3

Type: Integer

Explanation: Identifier given by the SME for the short message.

**Number Of Destinations**

Id: 4

Type: integer

Explanation: Number of destination addresses to follow. May be used for sending the same short message to many recipients. Maximum value is 20.

**Destination Address Type**

Id: 5

Type: integer

Explanation: As defined in GSM 03.40 [1]. (145 for an international address using ISDN/telephone numbering plan.)

**Usually not needed.**

**Destination Address**

Id: 6

Type: IA5/BCD

Explanation: destination address in GSM network, values in range '0'...'9' or '-' or '+'. '-' and '+' may be used in case there is no destination address type specified. '+' indicates destination address type 145. '-' is ignored.

**Originating Address Type**

Id: 7

Type: integer

Explanation: As defined in GSM 03.40 [1]. (145 for an international address using ISDN/telephone numbering plan.)

**Usually not needed.**

**Originating Address**

Id: 8

Type: IA5/BCD

Explanation: Originating address, values in range '0'...'9' or '-' or '+'. '-' and '+' may be used in case there is no originating address type specified. '+' indicates originating address type 145. '-' is ignored.

**Protocol Identifier**

Id: 9

Type: integer

Explanation: As defined in GSM 03.40 [1].

**Usually not needed.**

**Data Coding Scheme**

Id: 10

Type: integer

Explanation: As defined in GSM 03.38.

**Usually not needed.**

**Validity Period Relative**

Id: 11

Type: integer

Explanation: the length of the validity period of the short message counted from the time the message is received by the SMSC, integer representation as defined in GSM 03.40 [1]. If this parameter and validity period absolute are left out, SME specific default validity period is used.

**Validity Period Absolute**

Id: 12

Type: IA5/BCD

Explanation: The absolute time of the validity period termination of the short message, value consists of year, month, day, hour, minute, second and time zone as defined in GSM 03.40 [1]. If this parameter and validity period relative are left out, installation specific default validity period is used.

**First Delivery Time Integer**

Id: 13  
Type: integer  
Explanation: Time in seconds waited before the first delivery attempt of the short message will be made.  
**Usually not needed.**

**First Delivery Time Absolute**

Id: 14  
Type: IA5/BCD  
Explanation: Time for the first delivery attempt of the short message. Absolute representation as defined in GSM 03.40 [1] for the absolute validity period.  
**Usually not needed.**

**Reply Path**

Id: 15  
Type: integer  
Explanation: Value as follows:  
0 no reply path provided  
1 reply path provided

**Replace**

Id: 16  
Type: integer  
Explanation: If there is already a short message from the same originating address to the same destination address it may be replaced.

NOTE: The replace message type of protocol identifier parameter.

Value as follows:  
0 don't replace  
1 replace

**User Data Length**

Id: 17  
Type: integer  
Explanation: The length of the user data.  
**Usually not needed.**

**User Data**

Id: 18  
Type: IA5/GSM7/GSM8/8BIT  
Explanation: The entire short message text which is sent as such to MS.

**Standard Message Identifier**

Id: 19  
Type: integer  
Explanation: An alternative to user data: a code identifying the short message text stored in the SMSC.

**Language**

Id: 20  
Type: integer  
Explanation: Identifies the language of a standard message that should be sent. Used together with standard message identifier.

**Status Report Request**

Id: 21  
Type: integer  
Explanation: Defines in what cases the status report should be returned. Bit map representation. If bit set to 1, a status report will be produced if such a situation occurs.

Meaning of bits in status report request:

- 0 temporary error
- 1 validity period expired
- 2 delivery failed
- 3 delivery successful
- 4 message cancelled
- 5 message deleted by the operator

Other bits are reserved for future use.

NOTE: The status report may be returned automatically or it may have to be requested by the SME with a status report request operation.

**Reachability Notification**

Id: 22  
Type: integer  
Explanation: Value as follows:  
0 no reachability notification requested  
1 reachability notification requested

NOTE: That the reachability notification may be requested only if the SME is of type listening.

**Cancel Enabled**

Id: 23  
Type: integer  
Explanation: Defines the possibility to cancel the message later.  
Value as follows:  
0 cancelling is disabled  
1 cancelling is enabled

**Service Centre Time Stamp**

Id: 24  
Type: IA5  
Explanation: As defined in GSM 03.40 [1]

**Filter**

Id: 25  
Type: integer  
Explanation: Defines how the messages should be identified in operations cancel, status report request, enable status report request and disable status report request. Bit map representation. Note that all combinations are not reasonable.  
  
Meaning of bits:  
0 service centre time stamp  
1 destination address  
2 short message identifier  
3 originating address  
4 time before service centre time stamp  
5 time after service centre time stamp

**User Identity**

Id: 26  
Type: IA5  
Explanation: Identity used in login. Max. 8 characters.

**Password (Old/New)**

Id: 27  
Type: IA5  
Explanation: Password used in login. Max. 8 characters.

**Interface Version**

Id: 28  
Type: IA5  
Explanation: Version of the interface software to be used.

**Parameter Identifier**

Id: 29  
Type: integer  
Explanation: Id number of parameter the default value of which should be changed.

**New Parameter Value**

Id: 30  
Type: integer/IA5/BCD  
Explanation: New default value for a parameter.  
Explanation: As defined in GSM 03.40 [1].

**Status**

Id: 32  
Type: integer  
Explanation: Status of the short message:  
Value as follows:  
0 in process  
1 validity period expired  
2 delivery failed  
3 delivery successful  
4 message cancelled  
5 message deleted by the operator

**Delivery Error Code**

Id: 33  
Type: integer  
Explanation: Value returned from the GSM network to a delivery attempt.  
Value as follows:  
0 no error code  
1 unknown subscriber  
11 no SMS teleservice  
13 call barred  
19 MS does not support SMS  
20 error in MS  
21 facility not supported  
29 absent subscriber  
36 system failure

**Reachability Notification Type**

Id: 34  
Type: integer  
Explanation: Value as follows:  
0 reachability notification caused by a temporary error to delivery attempt  
1 reachability notification caused by an alert from the network.

**Data Type**

Id: 35  
Type: integer  
Explanation: Type of data to be retrieved.  
Value as follows:  
0 short message to be retrieved  
1 status report to be retrieved

**Initial Operation Sequence Number**

Id: 36  
Type: integer  
Explanation: Sequence number of the operation to which this an response, values from 0 to 9999.

**Initial Operation**

Id: 37  
Type: integer  
Explanation: Value of the operation to which this a response. Value as specified for operation.

**Get Next**

Id: 38  
Type: integer  
Explanation: Parameter used in acknowledgement operation to delivery and status report operations indicating whether the next short message or status report should delivered or not.  
  
Value as follows:  
0 don't deliver next message  
1 deliver next message

**Message Count**

Id: 39  
Type: integer  
Explanation: Tells how many new mobile originated messages there are waiting for retrieval or how many status reports or deliveries will follow after status report or delivery request.

**Error Code**

Id: 40  
Type: integer  
Explanation: Error code of an operation.  
  
Value as follows:  
0 unspecified error  
1 protocol error  
2 operation not allowed  
3 checksum error  
4 no SMSC response  
5 system error  
6 unexpected operation  
7 message error  
8 login failure  
9 invalid address  
10 invalid parameter value  
11 invalid character  
12 message too long

**Error Text**

Id: 41  
Type: IA5  
Explanation: Text describing the error.

## C.5 SME link

### C.5.1 Introduction

As specified in previous clauses, operations are basically nothing but a sequence of parameters.

Each parameter may be characterized by the following attributes:

- identifier
- type
- length of value
- value.

The SME link specification problem thus becomes the following: how to communicate a sequence of parameters between the SME and the SMSC so that both ends would know what parameters are present, of what type they are, how long they are and what is the actual value.

In this clause two different SME links are specified:

- binary coded SME link
- text based SME link

### C.5.2 Binary coded SME link

On binary coded SME link all four attributes of each parameter are always communicated over the SME link. This makes the link very flexible. There can be parameters to be included to the short message text and adding new parameters does not require synchronised updates to both to the SME and the SMSC. The link is also flexible in a sense that it is possible to start with a very basic service and then add the functionality later. The binary coded link is meant to be used with X.25 or TCP/IP connections. The binary coded SME link is mainly targeted to SMEs like voice mail systems and paging systems.

#### C.5.2.1 SME parameter format

Each (identifier, type, length, value) -quadruplet is coded according to figure C.1.

The identifier (id) field value for a parameter is taken from the parameter lists specified in clause C.3.2.

The type field values in binary coding and a guidance for counting the value of the corresponding length field are as follows (types specified in clause C.3.1):

<b>0000</b>	reserved for the end mark (length must be = 0,)
<b>0001</b>	single integer (length must be = 1, 2 or 4)
<b>0010</b>	int. vector (length = 2 x number of integers)
<b>0011</b>	IA5 (length = number of characters)
<b>0100</b>	BCD (length = number of bytes)
<b>0101</b>	GSM7 (length = number of packed bytes)
<b>0110</b>	GSM8 (length = number of characters)
<b>0111</b>	8BIT (length = number of bytes)

**1000 through 1111** are reserved and *must not be produced* by SMEs.



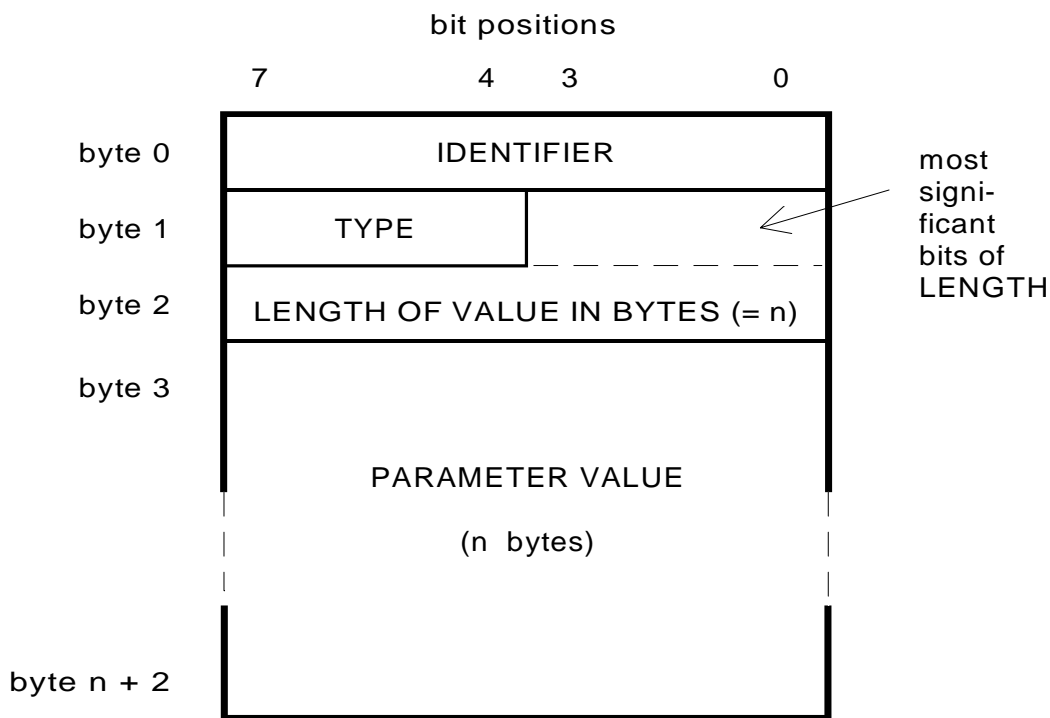

Total length of parameter = n + 3 bytes.

Figure C.1: Coding of a parameter on the binary coded SME link

### C.5.2.2 SME operation format

The format of operations on binary coded SME link is:

#### HEADER DATA STOP

The **HEADER** contains parameters sequence number and operation identifier. Both are represented with identifier, type, length and value just like any other parameter.

The **DATA** consists of parameters needed for the operation in question.

The **STOP** is three bytes of all zero bits, i.e. a parameter where identifier, type and length are all zeroes.

There is no separators between the parameters because the length of each parameter is known.

Since X.25 or TCP/IP is used, the error correction mechanisms provided by the network layer are considered adequate: no error checking is included.

### C.5.3 Text based SME link

On text based SME link only the parameter values are communicated. This actually means that the number and order of parameters related to each operation must be fixed. Of course the profiling method enables that the parameters per operation can depend on user identification but the flexibility is not as good as on binary coded link. The clear advantage of text based SME link is that it meant for serial line connections, e.g. modems, X.25 PAD connections, that are easy to use and also the implementation is quite simple. The text based SME link is very well suitable e.g. for PC applications.

### C.5.3.1 SME operation format

The format of operations on text based SME link is:

#### **START HEADER DATA CHECKSUM STOP**

The **START** is character "STX" (02h, i.e. 02 in hexadecimal).

The **HEADER** consists of an operation identifier, and is ended with a TAB (09h) as any other parameter.

The **DATA** consists of parameters needed for the operation in question. On a text based link only the value of the parameter is present, no type is defined. The parameter values are of type IA5; printing characters from 20h to 7Eh, CR (0Dh) and LF (0Ah). Also those parameters that are of type integer in the list specified in clause C.3.2. are represented as text. Parameters are ended with TAB characters.

The **CHECKSUM** is calculated as follows (programming language C):

```
while (b_ptr != b_ptr_max) {
    sum += *b_ptr++;
    sum &= 0x00FF;
}
```

All characters from very first start character to the last character before the CHECKSUM character are included into the sum.

The CHECKSUM is represented as two printable characters. The character containing the 4 most significant bits shall be transmitted first. For example, if the CHECKSUM is 3Ah the representation shall be the characters '3' (33h) and 'A' (41h).

The **STOP** is characters "ETX LF" (03h 0Ah).

General operation thus looks like this:

```
<STX>operation<TAB>parameter<TAB>[parameter<TAB>]checksum<ETX><LF>
```

### C.5.3.2 Example session

Example session given here contains operations login, submit and logout. Note that in submit operation example only parameters destination address, validity period and user data are given by the SME.

SME <--> SMSC

Login -->

```
<STX>01<TAB>UserIdentity<TAB>Password<TAB>InterfaceVersion<TAB>Checksum<ETX><LF>
```

Ack <--

```
<STX>16<TAB>01<TAB>MessageCount<TAB>Checksum<ETX><LF>
```

Submit -->

```
<STX>03<TAB>DestinationAddress<TAB>ValidityPeriodRelative<TAB>UserData<TAB>Checksum<ETX><LF>
```

Ack <--

```
<STX>16<TAB>03<TAB>ServiceCentreTimeStamp<TAB>Checksum<ETX><LF>
```

Example of Nack <--

```
<STX>17<TAB>03<TAB>ErrorCode<TAB>ErrorText<TAB>Checksum<ETX><LF>
```

Logout -->

<STX>08<TAB>Checksum<ETX><LF>

Ack <--

<STX>16<TAB>08<TAB>Checksum<ETX><LF>

---

## C.6 Waiting indication service

The specifications in the preceding clauses have outlined the SME-IF in terms of information and link. This clause provides *auxiliary information* by specifying a *sample* service as a "consumer" of information - thus making the preceding clauses more understandable.

This clause outlines one service called Waiting indication service.

The services will be specified in terms of

- purpose of the service (from the subscribers' point of view)
- interface profile for the service including
  - minimum list of operations needed for the service,
  - minimum list of parameters needed for the operations,
  - SME link to be used.

### C.6.1 Purpose of the service

The purpose of the Waiting indication service is to provide a short message to the voice mail subscriber whenever his/her voice mailbox becomes non-empty, i.e. the first voice message is placed there after emptying (being in connection with) the mailbox.

The service includes the cancellation of undelivered short message, if the subscriber empties the mailbox before the short message has been delivered to his/her MS.

The service also uses reachability notification so that the voice mail system may make a delivery call when it knows that the MS is reachable and that there are voice messages to be listened. If the delivery call fails the voice mail system may replace the short message stored in the SMSC with a new message telling the current status of the mailbox. If the delivery call is successful the short message will be cancelled.

The short message texts are produced in the SMSC according to information received from the voice mail system.

Two different standard messages are defined for this service. One for the initial short message and another for the update message.

The content of the first short message could be the following, with places for parameter values indicated with ^ ^:

"New ^type^ message from ^caller^ received."

The actual short message, the content of which is shown above, would, for example, look like this:

"New voice message from 112233 received."

The content of the update short message could be following.

"You have ^totnew^ new and ^toturg^ urgent messages in your mailbox."

The actual short message in this case could look like this:

"You have 4 new and 2 urgent messages in your mailbox."

By defining more texts it is possible to extent the service to cover also standard message service offering possibility to send messages like "Call home", "Call secretary", etc.

## C.6.2 Interface profile

### C.6.2.1 Operations needed

Operations from the SME:

login

submit

cancel

logout

Operations from the SMSC:

reachability notification

Common operations:

ack

nack

### C.6.2.2 Parameters needed

login:

user identity

password

interface version

submit:

destination address

originating address

validity period relative

replace

standard message identifier

language

reachability notification

cancel enabled

type (note)

totnew (note)

toturg (note)

caller (note)

NOTE: These parameters are additional parameters submit operation and they are used when building short message texts.

cancel:

destination address

logout:

(no parameters)

reachability notification:

destination address

reachability type

### C.6.2.3 SME link

The SME link to be used would be a binary coded link over X.25 connection.

The SME is of type listening.

---

# Annex D: SMSC Open Interface Specification

## D.1 Introduction

The objective of this annex is to provide a sufficiently detailed description of the protocol to be used for exchanging messages between an SMSC and an SME to allow a reader to implement that protocol.

### D.1.1 Scope

The content of this annex is relevant to the implementers of any system which implements the functionality of an SME by communicating with an SMSC.

### D.1.2 Annex Structure

Clause D. 2 provides an overview of the SMSC to SME message protocol.

Clause D.3 describes the procedures involved in the message protocol.

Clause D.4 gives details of the message formats.

---

## D.2 Overview

This clause explains the purpose of the SMSC to SME protocol.

### D.2.1 SMSC and SMEs

The exact functionality of SMEs, and the interfaces between SMEs and the SMSC, is specifically stated in GSM 03.40 [1] to be beyond the scope of the GSM recommendations. This annex describes a protocol which SMEs can use to communicate with an SMSC over any suitable transport service (such as that provided with X.25, DECnet or SS7).

The SMEs which communicate directly with the SMSC are assumed to be trusted systems. Control of access to usage of this protocol is outside the scope of this annex. Systems belonging to third parties should be connected via an SME which controls who may access the SMSC and what facilities are available to them.

### D.2.2 Services Available

SMEs may invoke the following operations using the SMSC to SME protocol:

- |                       |   |
|-----------------------|---|
| <b>Submit SM</b>      | Request to deliver an SM to an MS.  |
| <b>Delete SM</b>      | Delete a previously submitted SM. This SM must have not yet been delivered.   |
| <b>Replace SM</b>     | Replace a previous SM with a new SM to the same destination MSISDN. A new SMSC reference number is allocated to the replacement SM. |
| <b>Delete All SMs</b> | Delete all undelivered SMs previously submitted by the SME to a destination MSISDN.   |
| <b>Enquire SM</b>     | Obtain information on a previously submitted SM.  |
| <b>Cancel SRR</b>     | Cancel all Status Report requests made on a previously submitted SM. The SM must have not yet been delivered.                       |

<b>Alert SME Request</b>	Request an 'Alert SME' message when the specified MSISDN becomes registered.
<b>Retrieve Request</b>	Request transmission by the SMSC of any queued Incoming SM, Status Report or Alert SME messages, or request that none are transmitted.
<b>Get Version</b>	Request the Open Interface version number supported by the SMSC.

SMEs may receive the following operations using the SMSC to SME protocol:

<b>Alert SME</b>	An indication that an MSISDN has registered with the GSM network.
<b>Status Report</b>	A report of the status of a previously submitted SM. This will indicate delivery or a reason for failure to deliver the SM.
<b>Incoming SM</b>	An SM from an MSISDN has been sent destined for the SME.

## D.2.3 General procedures in the SMSC to SME protocol

### D.2.3.1 Summary

The SME invokes an operation of the SMSC by sending a request. On completion of the request by the SMSC, the SMSC sends a result to the SME reporting the completion status of the request.

The SME may receive a request from the SMSC if it has previously submitted a request asking for a Status Report, if it has requested an Alert SME or if it receives a mobile-originated SM. It sends a result to the SMSC for each request.

### D.2.3.2 Procedures for Handling Operation Failure

#### D.2.3.3 SME Recovery Strategy

SME-invoked operations either complete with the SME receiving confirmation of the SMSC's attempt to perform them, or with no reply from the SMSC. If no reply is received from the SMSC this should be interpreted as a rejection of the message by the SMSC. The SME should implement a time-out on the result.

This annex imposes no defined recovery algorithm on the SME, it may repeat failed operations or abandon them.

Repetition of a failed invocation by the SME may lead to duplicated invocations. This is because the SMSC does not detect the SME's non-receipt of an SMSC response, so it behaves as though its responses were always received by the SME. The SMSC makes no provision for roll-back of any operation it has performed.

The effect of the SME duplicating an operation is as follows:

- Re-submission of an SM to which the SME has given an SME reference number of the KEY type (see clause D.4.3.32 for a full explanation of SME reference number types). The re-submission of an already accepted SM will fail with an "already in store" error.
- Re-submission of an SM to which the SME has not given an SME reference number of the KEY type (see clause D.4.3.32 for a full explanation of SME reference number types). The SM will be accepted again on the re-submission, which will result in it being delivered twice and, if a Status Report has been requested, in two Status Reports being returned to the SME.
- Deletion of an already deleted SM. The second deletion will fail with a "no such SM" error.

#### D.2.3.3.1 SMSC Recovery Strategy

The SMSC ensures that the SME receives SMs, Status Report messages and Alert SME messages (collectively referred to as SMSC\_Invoke messages in the following text). It follows a timed retry recovery strategy if it cannot send an SMSC\_Invoke message to the SME or if the SME does not acknowledge an SMSC\_Invoke message. The precise nature of this timed recovery strategy is outside the scope of this annex. If an SMSC\_Invoke message waiting to be sent passes its expiry time before reaching the SME, the SMSC stops attempting to send it and discards it.

SMSC recovery only applies to SMSC-invoked operations. The SMSC does not retry its responses to SME-invoked operations but behaves as though the responses were always received by the SME.

The SMSC cannot distinguish between:

- Failure to send an SMSC\_Invoke message to the SME.
- Successfully sending an SMSC\_Invoke message but failing to receive the acknowledgement.

The SMSC makes a timed retry in both cases. Therefore the SME may receive a particular SMSC\_Invoke message twice if an error has occurred.

---

## D.3 SMSC Access Procedures

This clause defines the procedures for the exchange of information between the SME and the SMSC.

### D.3.1 Procedure for Submission of an SM

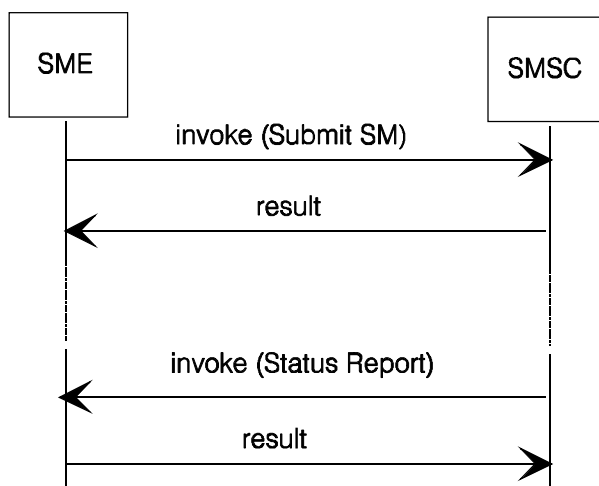

**Figure D.1: Submission of an SM**

The procedure is shown in figure D.1. It is initiated by the SME to request the SMSC to deliver an SM to an MS. The procedure consists of the following actions:

- An invoke is sent by the SME containing a submit SM operation.
- A result is sent by the SMSC indicating that it has completed the submit SM operation and the SM has been secured in the SMSC database.
- An invoke is sent by the SMSC passing a Status Report for the SM (if a Status Report has been requested).
- A result is sent by the SME indicating that it has accepted the Status Report.

An SM submission may request a Status Report for a particular set of circumstances. After a delivery attempt is made, the SMSC checks whether one of the selected circumstances has occurred. If one has occurred, the SMSC sends a Status Report to the SME. The Status Report identifies the SM to which it relates and describes the status of that SM. It also carries the SME internal reference supplied by the SME when submitting the SM.

The SMSC does not monitor SM expiry dates in real-time so a Status Report informing the SME that an SM has expired will be sent some time after the actual expiry time. If an SME needs to know whether or not an SM has expired it should send an Enquire SM rather than rely on the receipt of a Status Report.

If a Status Report is not accepted by the SME, the SMSC timed retry algorithm is applied until the SMSC receives a Status Report acceptance or the Status Report expires.



It is possible, depending on the circumstances for which a Status Report is requested, that more than one Status Report will follow the SM submission request; e.g. if Status Reports are requested for "Unable to deliver SM - retrying delivery" a Status Report will be generated for each delivery attempt. However it is important to remember that the SMSC queues messages for a destination internally. When it tries to deliver to a destination it attempts to deliver the message at the head of the queue, if this delivery attempt results in "Unable to deliver SM - retrying delivery" a status report will be generated for this first message (if requested) and the delivery attempt ends. No attempt was made to deliver the other messages for this destination so no status reports will be generated for them.

### D.3.2 Procedure for Deletion of an SM

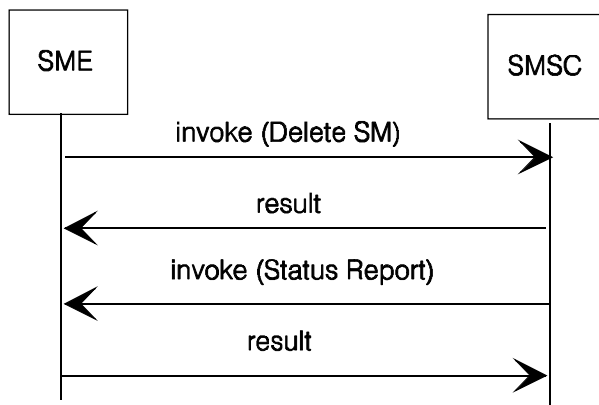

Figure D.2: Deletion of an SM

The procedure is shown in figure D.2. It is initiated by the SME to request the SMSC to delete an SM previously submitted for delivery to an MS. The procedure consists of the following actions:

- An invoke is sent by the SME containing a delete SM operation.
- A result is sent by the SMSC indicating that it has completed the delete SM operation.
- An invoke is sent by the SMSC passing a Status Report for the SM (if a Status Report was requested when the SM was submitted).
- A result is sent by the SME indicating that it has accepted the Status Report.

If a Status Report on "deletion by SME" was requested when the SM was originally submitted, the SMSC sends a Status Report to the SME. The procedure is the same as for SM submission.

Note that because the generation of status reports and their subsequent delivery is an entirely separate process from the return of the delete result it is possible (and quite likely) that the status report invoke will be sent by SMS2000 before the result of the delete SM operation is returned.

The SMSC will only delete the SM if the originating address of the SM to be deleted matches the originating address contained in the request. If there is no match the request will be rejected and a result returned indicating "SM not in SMSC database" (as there is no SM with the specified reference belonging to the requester).

### D.3.3 Procedure for Replacement of an SM

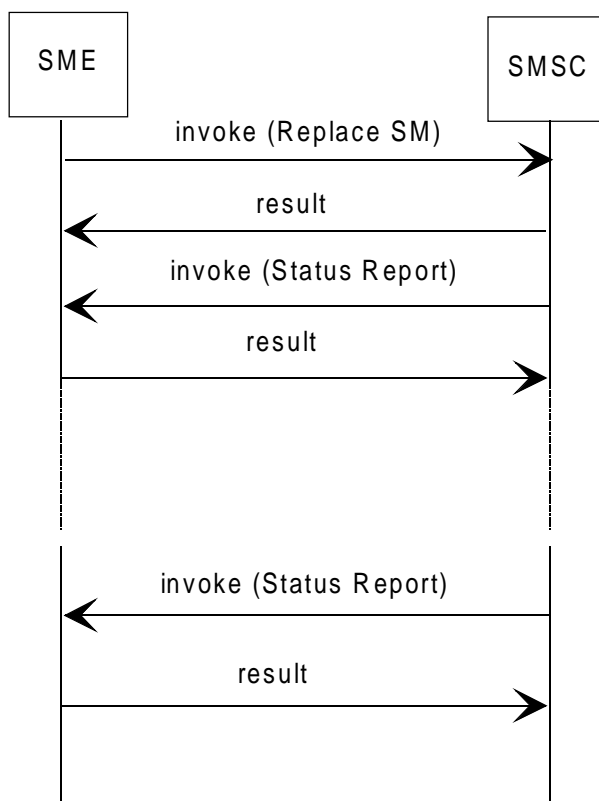

**Figure D.3: Replacement of an SM**

The procedure is shown in figure D.3. It is initiated by the SME to request the SMSC to replace an SM previously submitted for delivery to an MS with another SM to the same MS. This procedure provides a shorthand way to combine the effects of the delete SM and submit SM procedures. The procedure consists of the following actions:

- An invoke is sent by the SME containing a replace SM operation.
- A result is sent by the SMSC indicating that it has completed the replace SM operation.
- An invoke is sent by the SMSC passing a Status Report for the SM (if a Status Report was requested when the SM was submitted).
- A result is sent by the SME indicating that it has accepted the Status Report.
- An invoke is sent by the SMSC passing a Status Report for the SM (if a Status Report has been requested).
- A result is sent by the SME indicating that it has accepted the Status Report.

Since this procedure combines the effects of the submit SM and delete SM procedures, two sets of Status Reports may be generated: for the deletion of the original SM and for the status of the replacement SM. It is possible, depending on the circumstances for which a Status Report is requested, that more than one Status Report will follow the submission of the SM replacement; e.g. if Status Reports are requested for "Unable to deliver SM - retrying delivery" a Status Report will be generated for each delivery attempt. The SMSC sends the Status Reports to the SME using the same procedure as for SM submission.

The SMSC carries out the deletion of the SM to be replaced and the submission of the replacement SM as two operations. It is therefore possible that the submission may succeed and the deletion fail (for example because the old SM has already been delivered).

Because status reports are routed and delivered by a separate mechanism to the replace result message it is not possible to predict with certainty what order they will occur in. It is quite likely that the status report generated on deletion of the original message will be sent to the SME by the SMSC before the replace result message is received. It is also possible (but less likely) that the status report generated as a result of attempting to deliver the new short message will be received before the replace result message is received. Finally it is possible (but very unlikely) that the status report generated by the first delivery attempt for the new message will be sent by the SMSC before the status report generated by deletion of the old message. So the following sequences are all possible (as are other variations) in addition to the one shown above :

#### Sequence 1

- The SME sends a replace invoke;
- The SMSC sends a status report invoke (for the delete);
- The SME sends a result acknowledging the status report;
- The SMSC sends a result acknowledging the replace request;
- The SMSC sends a status report invoke (for the first delivery attempt of the new message);
- The SME sends a result acknowledging the status report.

#### Sequence 2

- The SME sends a replace invoke;
- The SMSC sends a status report invoke (for the delete);
- The SME sends a result acknowledging the status report;
- The SMSC sends a status report invoke (for the first delivery attempt of the new message);
- The SME sends a result acknowledging the status report.
- The SMSC sends a result acknowledging the replace request;

#### Sequence 3

- The SME sends a replace invoke;
- The SMSC sends a status report invoke (for another action totally unrelated to the replace. e.g. delivery of a previously submitted SM);
- The SME sends a result acknowledging the status report;
- The SMSC sends a status report invoke (for the first delivery attempt of the new message);
- The SME sends a result acknowledging the status report.
- The SMSC sends a result acknowledging the replace request;
- The SMSC sends a status report invoke (for the delete);
- The SME sends a result acknowledging the status report;

The SMSC carries out the deletion of the SM to be replaced and the submission of the replacement SM as two operations. It is therefore possible that the submission may succeed and the deletion fail (for example because the old SM has already been delivered).

The SMSC will only delete the SM if the originating address of the SM to be deleted matches the originating address contained in the request. If there is no match the delete request will be rejected and a result returned indicating "SM not in SMSC database" (as there is no SM with the specified reference belonging to the requester). The submission of the new SM will be carried out as usual.

### D.3.4 Procedure for Deletion of All SMs

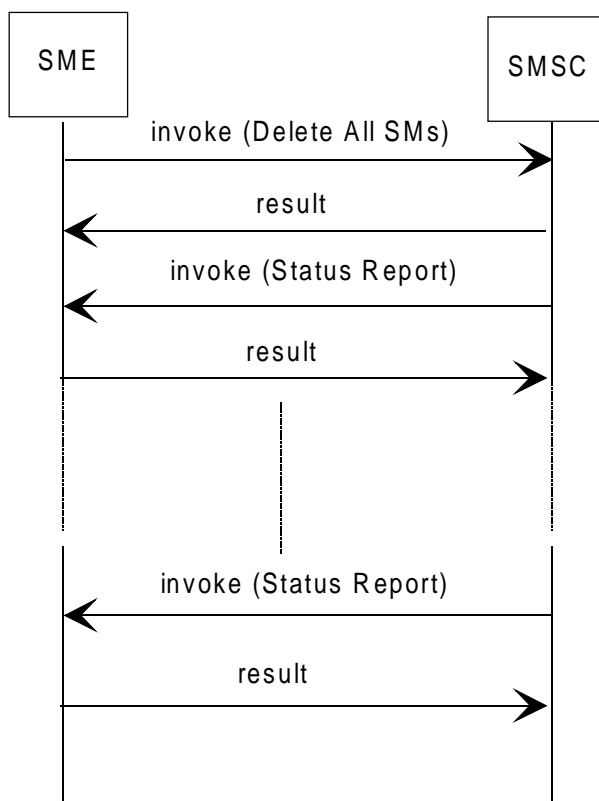

**Figure D.4: Deletion of All SMs**

The procedure is shown in figure D.4. It is initiated by the SME to request the SMSC to delete all SMs remaining undelivered which were previously submitted for delivery to an MS by the SME. The procedure consists of the following actions:

- An invoke is sent by the SME containing a delete all SMs operation.
- A result is sent by the SMSC indicating that it has completed the delete all SMs operation.
- A number of invokes may be sent by the SMSC each passing a Status Report for a deleted SM (if a Status Report was requested when the SM was submitted).
- A result is sent by the SME in response to each Status Report indicating that the report has been accepted.

Since this procedure may delete many SMs, many Status Reports may be generated, one for each deleted SM. The SMSC sends the Status Reports to the SME using the same procedure as for SM submission.

The SMSC will only delete those SMs where the originating address of the SM to be deleted matches the originating address contained in the request.

### D.3.5 Procedure for Enquiring on an SM

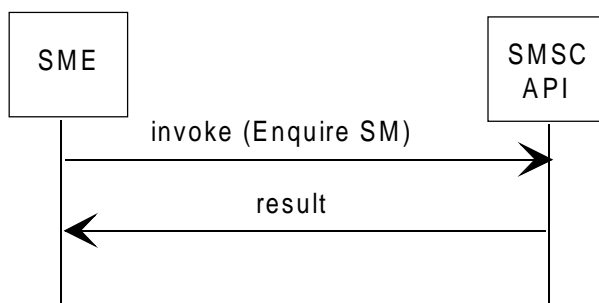

Figure D.5: Enquiry on an SM

The procedure is shown in figure D.5. It is initiated by the SME to request the SMSC to return information on an SM previously submitted for delivery to an MS. The procedure consists of the following actions:

- An invoke is sent by the SME containing an enquire SM operation.
- A result is sent by the SMSC, indicating that the SMSC has completed the enquire SM operation.

The result gives the delivery status of the SM.

An SM is only retained within the SMSC message store for a limited period after the SM has been delivered or delivery attempts have been abandoned, or after its validity period has expired. Once the SM has been archived from the SMSC message store any Enquire SM will get the result 'SM is not in SMSC database'. The SMSC retention period for SMs is outside the scope of this annex.

Because the SMSC stores all SM messages internally in GSM format, the returned message information will be encoded in GSM format, even if the message was originally submitted using IA5 encoding.

The SMSC will only return information about the SM if the originating address of the stored SM matches the originating address contained in the request. If there is no match the request will be rejected and a result returned indicating "SM not in SMSC database" (as there is no SM with the specified reference belonging to the requester).

### D.3.6 Procedure for Cancelling Status Report Requests on an SM

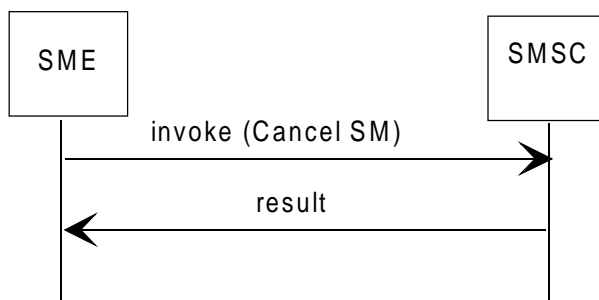

Figure D.6: Cancel of SRR on an SM

The procedure is shown in figure D.6. It is initiated by the SME to cancel any Status Report requests on an SM previously submitted for delivery to an MS. The procedure consists of the following actions:

- An invoke is sent to the SMSC containing the Cancel SRR operation
- A result is sent by the SMSC indicating that the SMSC has completed the cancel SRR operation.

The cancel will stop any Status Reports being generated after the cancel has been received. Any Status Reports that have already been generated will still be passed to the SME.

The SMSC will only cancel SR for the SM if the originating address of the stored SM matches the originating address contained in the request. If there is no match the request will be rejected and a result returned indicating "SM not in SMSC database" (as there is no SM with the specified reference belonging to the requester).

### D.3.7 Procedure for Requesting an Alert SME

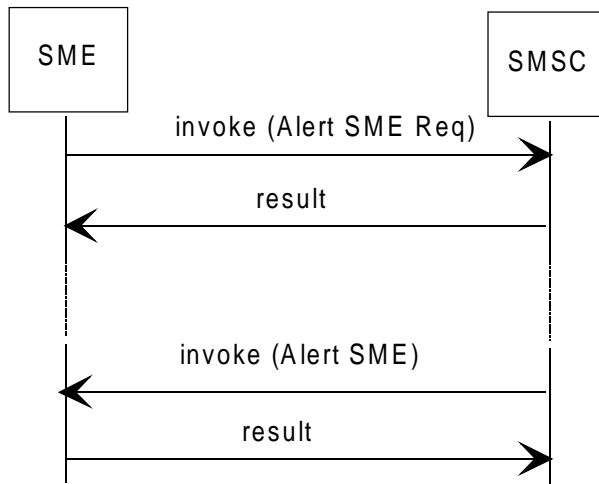

Figure D.7: Request an Alert SME

The procedure is shown in figure D.7. It is initiated by the SME to request the SMSC to notify the SME when an MSISDN is registered. The procedure consists of the following actions:

- An invoke is sent to the SMSC containing an alert SME request operation.
- A result is sent by the SMSC indicating that the SMSC has completed the alert SME request operation and the requirement to send an alert SME has been noted in the SMSC database.
- An invoke is sent by the SMSC containing an Alert SME for the requested MSISDN.
- A result is sent by the SME indicating that it has accepted the Alert SME.

The Alert SME Request will result in an Alert SME being generated when the requested MSISDN registers with the GSM network.

It does not matter how many times a single SME requests an Alert SME on a single destination - it will only be notified (by invoke Alert SME) once.

### D.3.8 Procedure for Receiving an Incoming SM

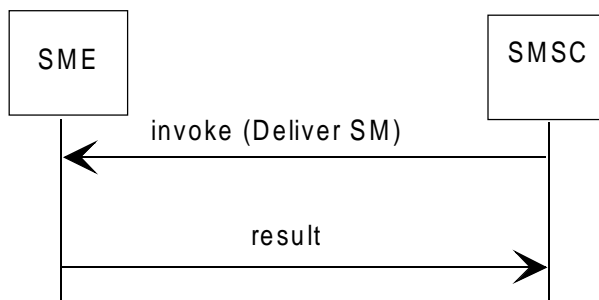

Figure D.8: Delivery of an SM

The procedure is shown in figure D.8. It is initiated by the SMSC to deliver an SM to the SME. The procedure consists of the following actions:

- An invoke is sent by the SMSC containing an Incoming SM to the SME.
- A result is sent by the SME, indicating that it has accepted the Incoming SM.

This procedure is only used for SME's that can receive SM's from MSISDNs.

### D.3.9 Procedure for Retrieving Incoming SMs, SRs and Alert SMEs

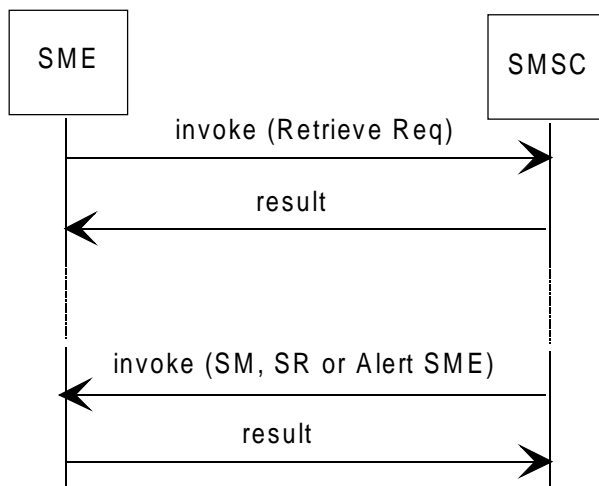

Figure D.9: Retrieval Request

The procedure is shown in figure D.9. It is initiated by the SME to request the SMSC to switch on or off the sending of queued messages (Incoming SMs, Status Reports or Alert SMEs). The procedure consists of the following actions:

- An invoke is sent by the SME containing a retrieval request to initiate or inactivate the message transmissions.
- A result is sent by the SMSC indicating that the SMSC has noted the request.
- If there are queued messages and retrieval has been initiated then a number of invokes are sent by the SMSC passing Incoming SM, Status Report or Alert SME.
- For each invoke received by the SME a result is sent by the SME indicating that it has accepted a message.

This procedure has a number of uses. It gives SMEs control over when they receive messages. It enables SMEs whose communications link to the SMSC has been unavailable to request queued messages when it is ready for them. It gives the SME the ability to apply flow control with the SMSC by switching on and off the flow of messages to the SME.

The SME has two choices on the retrieve order of the messages. These are a) high priority SMs, then normal priority SMs and status reports interleaved, then alert SMEs, b) high priority SMs, then normal priority SMs, then status reports, then alert SMEs.

The SMSC will only retrieve messages (SMs, SRs, and alerts) which have the supplied originating address as their destination.

### D.3.10 Procedure for Getting the Open Interface Version Number

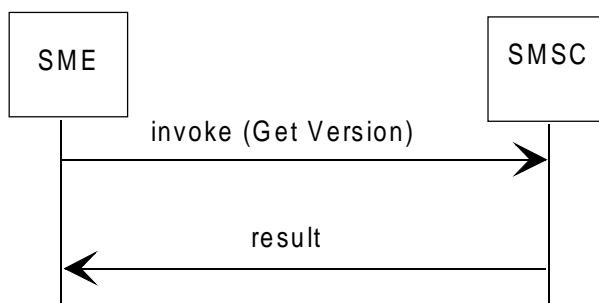

Figure D.10: Get Version

The procedure is shown in figure D.10. It is initiated by the SME to request the version number of the Open Interface supported by the SMSC. The procedure consists of the following actions:

- An invoke is sent by the SME containing a get version request
- A result is sent by the SMSC indicating the version number.

## D.4 Message Format

Messages are made up of a *header* and *data* part. Each invoke and result message is made up of a *header* and a *data* part in that order. The *header* part indicates the type of message and the *data* is the type-specific data. The *data* part must not exceed 215 bytes in length.

The encoding scheme and transmission mechanism used to transfer the messages defined by this protocol are outside the scope of this annex.

### D.4.1 Header Details

#### D.4.1.1 Invoke Message Header

Table D.1: Header Part for Invoke

Opref (4 octets)
Message type (1 octet)
Operation (1 octet)
2 octets - unused
Data size (2 octets)

Opref provides a unique reference for an operation.

Message Type is 0, indicating invoke.

Operation identifies the type of operation and takes one of the following values:

- 0 = Submit SM
- 1 = Delete SM
- 2 = Replace SM
- 3 = Delete All SMs
- 4 = Status Report



- 5 = Enquire
- 6 = Cancel Status Report
- 7 = Alert Request
- 8 = Alert SME
- 9 = Deliver

Data size gives the length of the *data* part of the message in octets.

### D.4.1.2 Result Message Header

**Table D.2: Header Part for Result**

Opref (4 octets)
Message type (1 octet)
Operation (1 octet)
2 octets - unused
Data size (2 octets)

Opref is the value from the corresponding invoke.

Message Type is 1, indicating result.

Operation is the value from the corresponding invoke.

Data size gives the length of the *data* part of the message in octets.

## D.4.2 Operation Data

This subclause lists the contents of the *data* part of the message for each of the different types of operation. The invoke and the result of each operation each have an associated *data* parameter format.

For transmission purposes, the *data* parameter is defined to be a contiguous block of bytes. Each field within the block follows the previous without filler bytes, and the first field is defined to start in the least significant byte of the block (i.e. the first field occurs at the lowest address in memory). The transmission of the whole *data* parameter is performed to preserve this order, therefore for byte-oriented transmission mediums, the bytes are transmitted from low memory addresses first. Clause D.4.3 describes how data is stored within fields.

### D.4.2.1 Submit SM Invoke

**Table D.3: Data Part for Submit SM Invoke**

MSISDN length
MSISDN
SME reference type
SME reference number
priority
originating address length
originating address
validity period type
[validity period (absolute)]
[validity period (relative)]
data coding scheme
status report request
protocol id
reply path
SM text size (characters)
SM text size (bytes)
SM text
[Sub-Logical SME number]

Arguments in square brackets are omitted under certain circumstances:

"Validity period (relative)" is omitted unless "validity period type" is RELATIVE.

"Validity period (absolute)" is omitted unless "validity period type" is ABSOLUTE.

"Sub-Logical SME number" is omitted by SMEs using the general X.25 access method.

When submitting a SM which you may subsequently wish to enquire on, replace or delete (other than by use of 'delete all') you must either provide an SME Reference of type KEY or you must record the SMSC Reference returned in the Submit SM Result. Using the SMSC Reference is more efficient. SME references of type NOT KEY may not be used to access a SM in the SMSC.

### D.4.2.2 Submit SM Result

**Table D.4: Data Part for Submit SM Result**

result
[SMSC reference number]
[accept time]

Arguments in square brackets are omitted under certain circumstances:

"SMSC reference number" is omitted unless "result" indicates success.

"accept time" is omitted unless "result" indicates success.

If you need to access the SM to which this result applies on the SMSC you must either record the returned SMSC reference number, or have supplied a SME reference of type KEY in the Submit SM Invoke.

### D.4.2.3 Delete SM Invoke

**Table D.5: Data Part for Delete SM Invoke**

SM reference type
[SME reference number]
[SMSC reference number]
MSISDN length
MSISDN
originating address length
originating address
[Sub-Logical SME number]

Arguments in square brackets are omitted under certain circumstances:

"SME reference number" is omitted unless "SM reference type" is SME REFERENCE.

"SMSC reference number" is omitted unless "SM reference type" is SMSC REFERENCE.

"Sub-Logical SME number" is omitted by SMEs using the general X.25 access method.

To access an SM you must either supply a SMSC reference number or an SME Reference number. You may only use the SME reference number if when you submitted the SM you provided an SME reference number of type KEY. If you attempt to access a SM on a NOT KEY SME reference number the SMSC will fail to find the SM.

### D.4.2.4 Delete SM Result

**Table D.6: Data Part for Delete SM Result**

result
--------

### D.4.2.5 Replace SM Invoke

**Table D.7: Data Part for Replace SM Invoke**

<b>SM reference type</b>	Of the SM to be deleted
[SME reference number]	
[SMSC reference number]	
MSISDN length	Of both the SM to be deleted and the replacement SM
MSISDN	
SME reference number type	Of the replacement SM
SME reference number	
priority	
originating address length	
originating address	
validity period type	
[validity period (absolute)]	
[validity period (relative)]	
data coding scheme	
status report request	
protocol id	
reply path	
SM text size (characters)	
SM text size (bytes)	
SM text	
[Sub-Logical SME number]	

Arguments in square brackets are omitted under certain circumstances:

"SME reference number" for the SM to be replaced is omitted unless "SM reference type" is SME REFERENCE.

"SMSC reference number" for the SM to be replaced is omitted unless "SM reference type" is SMSC REFERENCE.

"Validity period (relative)" for the replacement SM is omitted unless "validity period type" is RELATIVE.

"Validity period (absolute)" for the replacement SM is omitted unless "validity period type" is ABSOLUTE.

"Sub-Logical SME number" is omitted by SMEs using the general X.25 access method.

### D.4.2.6 Replace SM Result

**Table D.8: Data Part for Replace SM Result**

result	Applies to the deletion
result	Applies to the addition
[SMSC reference number]	of the replacement SM
[accept time]	

Arguments in square brackets are omitted under certain circumstances:

"SMSC reference number" is omitted unless "result" of the submission indicates success.

"accept time" is omitted unless "result" of the submission indicates success.

The following matrix shows how the different combinations of the two result fields should be interpreted.

Deletion Result	Addition Result	Meaning
0	0	Replace successful
0	2	The delete succeeded, but it was not possible to insert the new message because the SMSC database is full.
0	3	The delete succeeded, but it was not possible to insert the new message because the SMSC database was busy.
0	5	The delete succeeded, but the new message has not been added to the SMSC database because a message with the specified key type SME reference number already exists for this destination.
1	1	Operation rejected because argument value(s) were missing or invalid
3	3	The entire replace failed because the SMSC database was busy.
4	0	The short message which was specified to be replaced did not exist (or has been delivered), the new message has been added to the SMSC database.
4	2	The short message which was specified to be replaced did not exist, the new message has not been added to the SMSC database because the database is full.
4	3	The short message which was specified to be replaced did not exist, the new message has not been added to the SMSC database because the database was busy.
4	5	The short message which was specified to be replaced did not exist, the new message has not been added to the SMSC database because a message with the specified key type SME reference number already exists for this destination.

Any other combination of result codes indicates a logic error in the SMSC.

### D.4.2.7 Delete All SMs Invoke

**Table D.9: Data Part for Delete All SMs Invoke**

MSISDN length
MSISDN
originating address length
originating address
status report override
[Sub-Logical SME number]

Arguments in square brackets are omitted under certain circumstances:

"Sub-Logical SME number" is omitted by SMEs using the general X.25 access method.

### D.4.2.8 Delete All SMs Result

**Table D.10: Data Part for Delete All SMs Result**

result
--------

### D.4.2.9 Status Report Invoke

**Table D.11: Data Parameter for Status Report Invoke**

MSISDN length
MSISDN
SME reference number type
SME reference number
SMSC reference number
accept time
SM status
[completion time]
[intermediate time]
[delivery failure reason]
originating address length
originating address
Invoke time

Arguments in square brackets are omitted under certain circumstances:

"Delivery failure reason" is omitted unless "SM status" is "Unable to deliver SM - delivery abandoned", or "Unable to deliver SM - retrying delivery"

"Completion time" is omitted when "SM status" is "Unable to deliver SM - retrying delivery"

"intermediate time" is omitted when "SM status" is not "Unable to deliver SM - retrying delivery"

Status Report Invoke supplies the SMSC reference number originally returned in the SM Submit Result, and the SME reference number sent in the original SM Submit Invoke. These numbers allow the SME to identify the SM to which the status report relates. In addition the SME reference number type is returned. If this field indicates the SME reference is of type KEY then this reference can be used to access the SM. If it indicates the SME reference is of type NOT KEY then attempts to locate the SM on this reference will fail.

### D.4.2.10 Status Report Result

**Table D.12: Data Part for Status Report Result**

SME result
------------

### D.4.2.11 Enquire SM Invoke

**Table D.13: Data Parameter for Enquire SM Invoke**

SM reference type
[SME reference number]
[SMSC reference number]
MSISDN length
MSISDN
originating address length
originating address
enquiry type
[Sub-Logical SME number]

Arguments in square brackets are omitted under certain circumstances:

"SME reference number" is omitted unless "SM reference type" is SME REFERENCE.

"SMSC reference number" is omitted unless "SM reference type" is SMSC REFERENCE.

"Sub-Logical SME number" is omitted by SMEs using the general X.25 access method.

To access a SM you must either supply a SMSC reference number or an SME Reference number. You may only use the SME reference number if when you submitted the SM you provided an SME reference number of type KEY. If you attempt to access a SM on a NOT KEY SME reference number the SMSC will fail to find the SM.

### D.4.2.12 Enquire SM Result

**Table D.14: Data Parameter for Enquire SM Result**

result	
enquiry type	
SM status	None of the fields after "result" are present unless "result" indicates success
[completion time]	
[delivery failure reason]	
priority	
originating address length	
originating address	
accept time	
expiry time	
data coding scheme	Present only if "result" indicates success and Enquire SM Invoke requested SM attributes
status report request	
protocol id	
reply path	
SM text size (characters)	
SM text size (bytes)	
SM text	

Arguments in square brackets are omitted under certain circumstances:

"Delivery failure reason" is omitted unless "SM status" is "Unable to deliver SM - delivery abandoned", or "Unable to deliver SM - retrying delivery"

"Completion time" is omitted when "SM status" is "Unable to deliver SM - retrying delivery"

When result indicates failure no other fields are returned.

### D.4.2.13 Cancel Status Report Invoke

**Table D.15: Data Parameter for Cancel Status Report Invoke**

SM reference type
SME reference number
[SMSC reference number
MSISDN length
MSISDN
originating address length
originating address
[Sub-Logical SME number]

Arguments in square brackets are omitted under certain circumstances:

"SME reference number" is omitted unless "SM reference type" is SME REFERENCE.

"SMSC reference number" is omitted unless "SM reference type" is SMSC REFERENCE.

"Sub-Logical SME number" is omitted by SMEs using the general X.25 access method.

To cancel status reports for a SM you must either supply a SMSC reference number or an SME Reference number. You may only use the SME reference number if when you submitted the SM you provided an SME reference number of type KEY. If you attempt to access a SM on a NOT KEY SME reference number the SMSC will fail to find the SM.

### D.4.2.14 Cancel Status Report Result

**Table D.16: Data Parameter for Cancel Status Report Result**

result
--------

### D.4.2.15 Alert SME Request Invoke

**Table D.17: Data Parameter for Alert SME Request Invoke**

MSISDN length
MSISDN
ASR reference number
originating address length
originating address
[Sub-Logical SME number]

Arguments in square brackets are omitted under certain circumstances:

"Sub-Logical SME number" is omitted by SMEs using the general X.25 access method.

It is not possible to delete, enquire on, or replace Alert requests. Therefore it is not necessary to distinguish between KEY and NOT KEY ASR reference numbers. All ASR reference numbers are of type NOT KEY.

### D.4.2.16 Alert SME Request Result

**Table D.18: Data Parameter for Alert SME Request Result**

result
[SMSC reference number]
[accept time]

Arguments in square brackets are omitted under certain circumstances:

"SMSC reference number" is omitted unless "result" indicates success.

"accept time" is omitted unless "result" indicates success.

It is not possible to delete, enquire on or replace Alert requests. The SMSC reference number returned is only supplied to provide a reference which may be compared with the one in the following Alert SME Invoke.

If an SME submits multiple Alert SME requests for the same destination (MSISDN) the reference returned for all such Alert SME requests will be the same. Also only a single Alert SME invoke will be sent to that SME when the destination becomes available.

### D.4.2.17 Alert SME Invoke

**Table D.19: Data Parameter for Alert SME Invoke**

MSISDN length
MSISDN
ASR reference number
SMSC reference number
originating address length
originating address
available flag
[delivery failure reason]
invoke time

Arguments in square brackets are omitted under certain circumstances:

"delivery failure reason" is omitted unless "available flag" indicates unavailable.

The SMSC reference number supplied will be the same as that received in the Alert SME Request Result which was sent when this alert was requested. The ASR reference number supplied will be the one which was contained in the Alert SME Request which requested this Alert.

Irrespective of how many Alert SME requests an SME makes relating to a single destination (providing it makes at least 1) that SME will only receive a single Alert SME invoke when the destination becomes available. All the request attempts will have returned the same SMSC reference number.

### D.4.2.18 Alert SME Result

**Table D.20: Data Parameter for Alert SME Result**

SME result
------------



### D.4.2.19 Deliver SM Invoke

**Table D.21: Data Parameter for Deliver SM Invoke**

destination address length
destination address
SMSC reference number
originating address length
originating address
data coding scheme
protocol id
reply path
SM text size (characters)
SM text size (bytes)
SM text
accept time
invoke time

It is theoretically possible (but unlikely in practice) for the data for a deliver SM invoke request to exceed the maximum *data* part size of 215 bytes. In the unlikely event of this occurring the SMSC will truncate the SM text to reduce the *data* part to 215 bytes, and change the SM text size (characters) and SM text size (bytes) accordingly.

### D.4.2.20 Deliver SM Result

**Table D.22: Data Parameter for Deliver SM Result**

SME result
------------

### D.4.2.21 Retrieve Request Invoke

**Table D.23: Data Parameter for Retrieve Request Invoke**

originating address length
originating address
receive ready flag
[retrieve order]

Arguments in square brackets are omitted under certain circumstances:

"retrieve order" is omitted unless "receive ready flag" is 1 (ON).

### D.4.2.22 Retrieve Request Result

**Table D.24: Data Parameter for Retrieve Request Result**

result
--------

### D.4.2.23 Get Version Invoke

**Table D.25: Data Parameter for Get Version Invoke**

originating address length
originating address

## D.4.2.24 Get Version Result

Table D.26: Data Parameter for Get Version Result

result
oi version number

## D.4.3 Field Definitions

This subclause provides detailed descriptions of the fields that may appear in *header* and *data* parts. The fields are of two data types:

- String. Array of char. The characters that may appear in the array depend on the field. Strings are not NULL terminated. Strings are in ASCII unless otherwise stated.
- Integer. 1 byte, 2 byte or 4 byte. Integers larger than 1 byte are stored with the least significant byte first and the most significant byte last. Integers are not aligned on word or longword boundaries. All integers are unsigned.

### D.4.3.1 Accept Time - 14 character string

Time that the SM was accepted into the SMSC message store. The format is YYMMDDHHMMSSZZ, with ZZ being the time zone, ((ZZ-48)/4) being the difference from GMT in hours. For example 92122113000048 represents 1 pm on December 21st 1992 GMT.

### D.4.3.2 ASR Reference Number - 4 byte integer

Value of the SME's reference number for an Alert SME Request. This field is not used by the SMSC, it is stored, and returned in the Alert SME Invoke.

### D.4.3.3 Available Flag - 1 byte integer

Boolean flag indicating if the MSISDN is available. 0 is false (ie. unavailable), and 1 is true (available).

### D.4.3.4 Completion Time - 14 character string

The time that the SMSC completed delivery of an SM to a mobile or the time at which it abandoned its delivery attempts, which may be because of permanent delivery failure, message expiry or deletion. The format is as for Accept Time.

### D.4.3.5 Data Coding Scheme - 1 byte integer

Specifies how the text of the SM is encoded. The full range of valid values of Data Coding Scheme is defined in GSM 03.38 version 4.0.0. The PLMN with which you are interworking may not support the full range of options defined in GSM 03.38. Please obtain a list of the values which you are permitted to use (and may expect to receive) from your network operator.

Your network operator will have configured the SMSC to recognise one value in the range 1 - 7 which is not already used by GSM 03.38. This value will have the following meaning - coding is IA5. The short message text is coded by the SME using the IA5 subset of ASCII characters. The text is automatically converted into GSM encoded format by the SMSC before the SM is delivered to the MSISDN. the SMSC will change the value of Data Coding Scheme supplied to 0 (default GSM alphabet) before delivering the message.

The SMSC does not perform any validation or manipulation of Data Coding Scheme other than that described above.

### D.4.3.6 Delivery Failure Reason - 1 byte integer

Specifies the reason why the SMSC was unable to deliver an SM. The possible values are:

Value	Reason
3	Unknown Subscriber
4	Teleservice Not Provisioned
6	Call Barred
7	Facility Not Supported
8	Absent Subscriber
9	SMS Not Provisioned
10	Error in MS
11	System Failure
12	CUG Reject
13	Memory Capacity Exceeded
99	No Delivery attempt yet completed for this SM

Values 1, 2 and 5 are not currently used.

Refer to GSM 03.40 [1] for a full explanation of the above reasons.

The SMSC is usually configured to treat many of these reasons listed above as temporary. The failure of a delivery for a temporary reason will not cause the SMSC to abandon attempts to deliver an SM. How the SMSC is configured will determine which of these reasons it is possible to receive when a Status Report Invoke with an SM Status of "unable to deliver SM - retrying delivery" (i.e. a temporary error) is received, and which it is possible to receive when a Status Report Invoke with an SM Status of "Unable to deliver - delivery abandoned" (i.e. a permanent error) is received.

Note that when enquiring the delivery failure reasons for all undelivered messages for a single MSISDN will all be the same at any given point in time. This is because delivery failure reason is the reason why the last delivery attempt to that MSISDN failed. The SMSC queues messages for a destination and when it tries to deliver to a destination it starts at the head of the queue and keeps delivering until an attempt fails or all messages for the destination have been delivered. The SMSC does not generate delivery failure status reports for those messages it did not actually attempt to deliver. Therefore the presence of a delivery failure reason in an enquire result does NOT necessarily mean that an attempt has been made to deliver that particular message, merely that an attempt has been made to deliver a message to that destination and the attempt failed with the returned delivery failure reason. Message delivery attempts are made in the order in which the messages are secured by the SMSC (except for high priority messages for which an immediate delivery attempt is made). Messages which have been abandoned will have an individual delivery failure reason recorded against them.

### D.4.3.7 Destination Address - variable length string - length held in "Destination Address Length"

Address where the SM is to be delivered. Formatted as in GSM 09.02 [4] - see clause D.4.3.16 for more details.

### D.4.3.8 Destination Address Length - 1 byte integer

The number of digits in the following destination address. Will be in the range 3 to 20.

### D.4.3.9 Enquiry Type - 1 byte integer

Flag used by SME to indicate whether or not SMSC should return SM attributes with the Enquire SM Result. A value of 0 indicates no attributes required; any other value will cause the SMSC to return the SM attributes.

### D.4.3.10 Expiry Time - 14 character string

Time that the SM will expire. The format is as for Accept Time.

### D.4.3.11 Intermediate Time

This field is only present in a Status Report Invoke. This field and Completion time are mutually exclusive, only one or the other will be present. If this field is present it indicates the time at which the delivery attempt to which the Status report relates was made.

### D.4.3.12 Invoke Time - 14 character string

The time at which the invoke was sent by the SMSC to the SME. The format is as for Accept Time. When a Status report is successfully delivered at the first attempt Invoke time will correspond very closely with the time at which the event reported occurred. However if there is any delay in delivery there could be a significant difference between the time at which the event which gave rise to the Status Report occurred and the Invoke time returned in the Status report.

### D.4.3.13 MSISDN - variable length string - length held in "MSISDN Length"

The ISDN number of the destination MS of the SM in ASCII, with the digits given in descending order of significance. The number must be an international number, and must be formatted using the E.164/E.163 numbering plan. The number does not include type of number or numbering plan fields - these are assumed.

### D.4.3.14 MSISDN Length - 1 byte integer

The number of digits of the following MSISDN. Must be in the range 9 to 16.

### D.4.3.15 OI Version Number - 1 byte integer

The version number of the Open Interface supported by this SMSC installation. The SME must be compatible with the specified Open Interface Version.

### D.4.3.16 Originating Address - variable length string - length held in "Originating Address Length"

This field contains the address of the originator of the SM and is used by the SMSC to determine who owns a SM. The owner of a SM is deemed to be the device at the SMs originating address. The address supplied in this field is displayed on the receiving handset (in the SMS-DELIVER basic element TP-Originating-Address). Its format based on GSM 09.02 [4]:

Character	Format	Meaning
1	Hexadecimal	Extension indicator (top bit) and type of number (remaining 3 bits) - Bits 5 - 8 in GSM 09.02 [4]
2	Hexadecimal	Numbering plan - Bits 1 - 4 in GSM 09.02 [4]
3 and up	Decimal	The number

The hexadecimal fields contain ASCII characters in the ranges "0" to "9" and "A" to "F". The decimal fields contain ASCII characters in the range "0" to "9".

### D.4.3.17 Originating Address Length - 1 byte integer

The number of digits in the following originating address. Must be in the range 3 to 20.

### D.4.3.18 Priority - 1 byte integer

Priority of the SM. One of:

Value	Description
0	High priority.
1	Normal priority.

### D.4.3.19 Protocol Id - 1 byte integer

The full list of possible values of Protocol Id is defined in GSM 03.40 [1]. Protocol Id is passed through the SMSC transparently. Not all PLMNs will support all of the facilities which can be selected by setting the Protocol Id field. The SMSC will be configured by the operator of the service centre to which you connect to reject all short messages requesting facilities which the PLMN does not support. Your service centre operator will be able to supply you with the list of Protocol Id values which you are allowed to specify in short messages which you submit. They will also be able to supply you with a list of the values of Protocol Id which you may receive in Deliver SM Invokes - this list may be different from the list of values you are allowed to submit.

### D.4.3.20 Receive Ready Flag - 1 byte integer

Used by an SME on a retrieve request to indicate whether it is ready to receive messages (invokes) from the SMSC. The possible values are:

Value	Description
0	Off - Not ready to receive invokes from the SMSC - the SMSC is instructed not to send them.
1	On - Ready to receive invokes from the SMSC - the SMSC is instructed to send them

### D.4.3.21 Reply Path - 1 byte integer

As defined in GSM 03.40 [1]. Must be either 0 (FALSE) or 1 (TRUE). Passed through the SMSC transparently.

### D.4.3.22 Result - 1 byte integer

The result of the operation or part of the operation. The possible values are:

Value	Description
0	Success
1	Operation rejected because argument value(s) were missing or invalid
2	Failed because SMSC database is full
3	Failed because SMSC is busy
4	Failed because specified SM is not in the SMSC database (in the case of the Delete SM, Enquire SM and Replace SM operations) or because the SMSC database holds no SMs from the SME for the specified destination MSISDN (in the case of the Delete All SMs operation)
5	Failed because SM was already in the SMSC database

### D.4.3.23 Retrieve Order - 1 byte integer

The order in which messages are to be received by the SME after issuing a retrieve request. The possible values are:

Value	Order
0	High Priority SMs first then, Normal Priority SMs and Status Reports interleaved, then Alert SMEs
1	High Priority SMs first, then Normal Priority SMs, then Status Reports, then Alert SMEs

### D.4.3.24 Retrieval Type - 1 byte integer

Used by an SME to indicate what message types it is ready to receive from the SMSC. The possible values are:

Value	Description
0	No messages (request being used to check API version number)
1	All messages
2	SMs only

If a value of 2 is supplied all queued status reports and alert SME notifications for the retrieving destination will be discarded.

### D.4.3.25 SM Reference Type - 1 byte integer

Method of specifying an SM to be deleted or replaced. The possible values are:

Value	Description
0	SME REFERENCE. The SME reference number of the SM is quoted. This method can only be used if the SME reference number type of the SM is KEY. See clause D.4.3.32 for more details of SME reference number types. In "Delete SM Invoke" and "Replace SM Invoke", if the SME reference type argument is SME REFERENCE then the following SME reference number argument is assumed by the SMSC to be of type KEY.
1	SMSC REFERENCE. The MSISDN and SMSC reference number of the SM is quoted. This method can be used for all SMs. Note: the SMSC reference for an SM is only unique when combined with its MSISDN.

### D.4.3.26 SM Status - 1 byte integer

Status of an SM as reported in a Status Report or Enquire SM Result. The possible values are:

Value	Status
1	Unable to deliver SM - delivery abandoned
2	SM expired
3	SM delivered
4	SM deleted by SME
5	SM deleted by the SMSC operators
6	Unable to deliver SM - retrying delivery

### D.4.3.27 SM Text - variable length string - length held in "SM Text Size (Bytes)"

Text of the SM. Least significant byte first. Format of the text depends on the data coding scheme.

### D.4.3.28 SM Text Size (Bytes) - 1 byte integer

Size of the SM text in bytes. If the text is in the compressed GSM encoded format (see the data coding scheme argument) this will differ from the SM text size in characters, otherwise they will be the same. Must be in the range 1 - 160 if the text is in IA5 format, or 1 - 140 if the text is in the GSM format.

### D.4.3.29 SM Text Size (Characters) - 1 byte integer

Size of the SM text in characters. Must be in the range 1 - 160.

### D.4.3.30 SME Reference Number - 4 byte integer

Value of the SME's reference for an SM. See clause D.4.3.32 for more information on SME reference numbers.

### D.4.3.31 SME Result - 1 byte integer

SME Result is used to convey the result of an SMSC originated invoke. SME Result is sent from the SME to the SMSC. In table D.27 'message' means short message, status report or alert SME notification.

**Value** is the integer value which the SME returns in the Result field of Status report result, Deliver SM result or Alert SME result.

**Description** is a short description of the meaning this value is intended to convey to the SMSC.

**Meaning** is a description of the circumstances in which it is intended that the *value* should be sent to the SMSC.

**Meaning** also describes the way in which the SMSC will respond on receipt of this value.

Table D.27: SME Result

Value	Description	Meaning
0	Success	The SME has accepted the message. The SMSC may report the message as delivered, and mark it for deletion.
1	Invalid Data	The SME has rejected the message because the message does not contain the arguments expected, or the arguments received contain invalid or unexpected values. OR The SME returning this result has attempted to forward a message to a remote system, but the SM has been rejected and the remote system has indicated it cannot process the Invoke type sent to it. OR The SME returning this error is the final destination of the message and is not able to deal with the invoke type it has been sent. The SMSC will make timed retries to deliver this message.
2	Database Full	The SME (or ultimate destination) contains a message data store. The SME has rejected the message because this store is full. The SMSC will make timed retries to deliver this message.
3	SME Busy	The SME has rejected the message because it is too busy to process it at this time. The SMSC should make timed retries to deliver this message.
5	Duplicate SM	The SME has rejected the message because it believes it to be a duplicate of one it has already received. The SMSC may report the message as delivered, and mark it for deletion.
6	Destination Unavailable	The SME returning this result has attempted to deliver the SM to a remote system and has failed. The reason for this failure is that the remote system is not available. The SME or the final destination will issue a Retrieve SM Invoke for this destination when it becomes available. The SMSC is not required to perform timed retries. Note that when a destination is not available the choice between returning this value and Call barred should be made entirely on the basis of which behaviour is required from the SMSC.
20	Call Barred by User	Either the SME returning this result has attempted to deliver the SM to a remote system and has failed because the remote system is not available. OR The destination is not prepared to accept messages at this time. The SME returning this result has determined that the destination of the message to which this result applies has invoked a call barring function (implemented either in the SME or in the remote network). The SMSC is to continue attempting to deliver this message according to a timed retry schedule.
21	Transmission Error	Temporary transmission error. The SME returning this result has attempted to deliver the message to which this result applies to a remote destination. The remote destination has rejected the message indicating that there was a problem in reception, the message was unreadable, etc. AND there is some chance of the third party system being able to read the message if re-transmitted. OR the SME returning this error is the final destination of the SM, but has encountered a problem in interpreting the message which may be a result of garbled transmission. The SMSC is to continue attempting to deliver this message according to a timed retry schedule.
22	Facility not Supported	The SME has tried to use a network facility in delivering this message but has been refused use of the facility. The SMSC will continue attempting to deliver this message according to a timed retry schedule.
23	Error in SME	The SME returning this result has encountered an internal processing error dealing with this message. This error should be used as a catch all for any situation not explicitly covered where The SMSC is required to make timed retry attempts.
24	Unknown Subscriber	Destination not known to SME database/ Network. The SME returning this error has attempted to deliver this message to a remote destination and has determined that the destination does not exist, or is not a registered user of the service offered by the SME. The SMSC is to abandon all delivery attempts for the message to which this result relates and all others for the same destination.
25	Call Barred by Network Operator	The SME has determined that the network operator has barred access to the final destination of the message. The SMSC is to abandon all delivery attempts for the message to which this result relates and all other messages for the same destination.
120	Network Failure	The SME has detected failure of the communications network it is using. The SMSC will continue to make timed retries to deliver the message. The SMSC will raise an operational event to report receipt of this result code. This event may be configured to sound the contact closure alarm (if installed).

The values of SME result are partitioned as follows :

- 0 - 19. Errors relating to the SME application;
- 20 - 119. Errors relating to the communications protocol used either to communicate with the SME, or by the SME to communicate with the ultimate destination of the message.
- 120+. Errors relating to major communications failures which SMS2000 is required to report.



### D.4.3.32 SME Reference Number Type - 1 byte integer

Type of the SME's reference number for an SM. The following are supported.

Value	Description
1	KEY
2	NOT KEY

The differences between the types are as follows:

- a) When deleting, replacing or enquiring on an SM with a SME reference number of the KEY type, the SME reference number can be used to identify the SM. If the SME reference number is of type 'NOT KEY' then the SMSC reference number must be used.
- b) The SMSC will not accept two SMs from a single originating address with the same SME reference number destined for the same destination if the SME reference of both messages is of type KEY. SME references should be unique for a given originating address. This can be useful in recovery situations where it is uncertain whether an SM has been accepted by the SMSC.

If SME reference numbers are not required by the SME, then type NOT KEY should be used. All SMs can then be given the same SME reference number.

### D.4.3.33 SMSC Reference Number - 4 byte integer

The SMSC reference number for an SM. When combined with the MSISDN or the destination address (for an Incoming SM), this uniquely identifies the SM.

### D.4.3.34 Status Report Override - 1 byte integer

This flag can be used to suppress the delivery of Status Reports generated as a consequence of a Delete All SMs Invoke. A value of 1 causes Status Report generation to be suppressed. The possible values are:

Value	Description
0	No override - status reports will be generated according to the current setting of the Status Report Request field for each short message deleted.
1	Override - No status reports will be generated as a result of the deletion of the short messages affected by this command.

### D.4.3.35 Status Report Request - 1 byte integer

Set of circumstances for which the SME requests the SMSC to produce a Status Report. Each possible status of a SM corresponds to a bit in the status report request. If the bit is set then a Status Report will be generated if the SM takes the corresponding status.

#### Bit Status

- 0 Unable to deliver SM - delivery abandoned
- 1 SM expired
- 2 SM delivered
- 3 SM deleted by SME
- 4 SM deleted by SMSC operators
- 5 Unable to deliver SM - retrying delivery
- 6-7 Not used

(bit 0 is the least significant bit, bit 7 the most significant)

Any number and combination of bits may be set to request Status Reports for a variety of status.

A status of "Unable to deliver SM - delivery abandoned" means that a SM delivery attempt has failed and no further delivery attempts will be made.

A Status Report indicating that an SM has expired will be generated some time after the SM expiry date, not necessarily at the exact expiry time.

A status of "Unable to deliver SM - retrying delivery" means that a SM delivery attempt has failed but a further delivery attempt will be made. Therefore, another Status Report may be generated. This may be on the next delivery attempt, or depending on which other status bits have been set, on one of the other circumstances arising. Once a Status Report indicating one of the other status has been received, no further delivery attempts will be made and no other Status Report will be generated.

#### D.4.3.36 Sub-Logical SME Number - 1 byte integer

This field is basically an account number. It is a value to be used in the least significant part of the logical SME identifier in call data (billing) records generated as a result of the SME request.

#### D.4.3.37 Validity Period (Absolute) - 14 character string

Validity period of the SM expressed as an absolute time (validity periods earlier than the current time cause the SMSC to expire an SM immediately without making any attempt to deliver it). It uses the same format as the SM status time argument.

The validity period cannot be more than 16 weeks later than the time of submission to the SMSC.

#### D.4.3.38 Validity Period (Relative) - 1 byte integer

Validity period of the SM expressed as a delta time relative to the time of the SM's acceptance by the SMSC. The following values are supported.

Value (V)	Delta Time	
0 to 143	$(V + 1) * 5$ mins	(5 mins to 720 mins, in 5 minute intervals)
144 to 167	$((V - 143) * 0.5) + 12$ hours	(12.5 hours to 24 hours, in 0.5 hour intervals)
168 to 196	$(V - 166)$ days	(2 days to 30 days, in 1 day intervals)
197 to 208	$(V - 192)$ weeks	(5 weeks to 16 weeks, in 1 week intervals)
209 to 255	Not used	

#### D.4.3.39 Validity Period Type - 1 byte integer

This type identifies the period for which the SMSC will retain an SM whilst attempting to deliver it. The following types of validity period are supported:

Value	Description
0	NONE. No validity period specified. A default SMSC value is used.
1	ABSOLUTE. The validity period is expressed as an absolute time.
2	RELATIVE. The validity period is expressed as a delta time relative to the time of the SM's acceptance by the SMSC.

---

# Annex E: SMSC Computer Access Service and Protocol Manual

## E.1 Introduction

This annex describes the SMS-C Computer Access Protocol used between SMS-C and external computers.

This annex is intended for programmers responsible for the development of applications for communicating with SMS-C, using the SMS-C Computer Access Protocol.

### Overview of contents

The clauses in this annex are organised as follows:

Overview:

- gives an introduction to the Short Message Service and a description of the SMS-C software structure.
- Computer Access Protocol
- describes the protocol between the external computer and SMS-C.
- Connect and Disconnect Procedures
- describes the connect and disconnect procedures for the different types of lower protocol layers.
- Scenarios illustrates the communication between an external computer and SMS-C.
- Design Considerations
- provides some useful hints for the application programmer.
- Protocol Data Unit Definitions
- defines the Computer Access Protocol Data Units using ASN.1 syntax.

---

## E.2 Overview

### E.2.1 The Short Message Service

The purpose of the Short Message Service is to provide the means for transferring of short messages, up to 160 characters, between Short Message Terminals (SMT) and GSM Mobile Stations (MS) via a Short Message Service Center (SMS-C). There are different types of SMT interfaces – one being the Computer Access Interface which provides services for external computers communicating with SMS-C through the Computer Access Protocol.

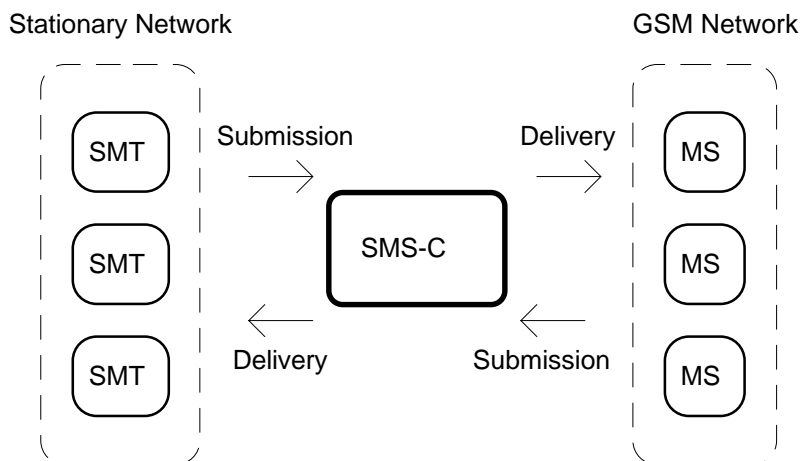

The Short Message Service provides the means for transferring of short messages between Short Message Terminals and Mobile Stations via a Short Message Service Center.

**Figure E.1: The Short Message Service Center.**

SMS-C is an interworking unit between stationary networks and the GSM Network. It acts as a store and forward center for short messages. Two different point-to-point services have been defined: Mobile Originated (MO) and Mobile Terminated (MT).

### E.2.1.1 Submission and delivery

Short messages are submitted to SMS-C by Mobile Stations and Short Message Terminals. A short message always originates or terminates in the GSM network. This means that short messages can never be sent between two users both located in stationary networks.

Through notifications, the message originator may be informed about successful or unsuccessful delivery of the short message.

When submitting a message, the message originator must specify the:

- message priority – non urgent, normal or urgent;
- notification level, see subclause E.2.1.3 Notifications;
- destination address – the GSM telephone number of the Mobile Station.

Optional parameters which can be set by the message originator are:

- validity time, which specifies the latest time at which the message delivery should be attempted. If not specified by the message originator, the default value specified through configuration parameters will be used;
- deferred delivery time which specifies at what time the message should be delivered;
- alternative notification address. This parameter can be used to change the address to where the notifications should be sent. The default value is the message originator's address.

### E.2.1.2 Message buffering

All messages and notifications are safely stored in a database on an external media within SMS-C. Hence, the existence of the short message is guaranteed once it has been successfully submitted. This concept is called message buffering.

A short message is deleted when the delivery succeeds or when the validity time expires. During buffering SMS-C is responsible for the short message.

### E.2.1.3 Notifications

A notification is a short message created by SMS-C containing information about the delivery of a short message. The following types of notifications exist:

- Delivery notification, generated when a short message is successfully delivered.
- Buffered message notification, generated when the first attempt to deliver a short message was unsuccessful, due to the recipient being temporarily inaccessible.
- Non-delivery notification, generated due to a permanent failure or when the validity time of the short message expires.

The message originator can specify all notification types when submitting a short message. Any combination of the three notification types above is valid.

## E.2.2 Software structure

The SMS-C software consists of a number of components, each responsible for a dedicated set of services. The Message Kernel is the central message store and forward component, responsible for safe storing of messages, routing and retry attempts.

The Message Kernel maintains a uniform interface to a set of Access Units (AU). There is one AU for each type of connection:

- Computer AU for connections to external computers.
- Interactive Terminal AU for connections to asynchronous terminals.
- Public Land Mobile Network AU for connections to the GSM network.

The software structure overview is given in figure E.2.

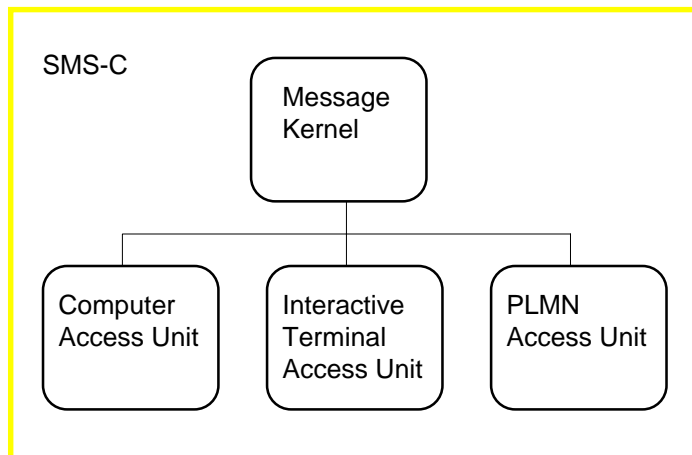

The Message Kernel maintains a uniform interface to the different types of Access Units.

**Figure E.2: Software Structure Overview.**

### E.2.2.1 Computer Access Unit

The Computer Access Unit provides services for computers communicating with SMS-C using the Computer Access Protocol .

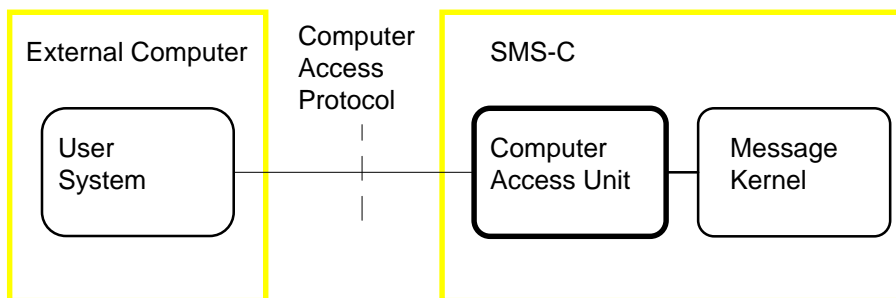

The Computer Access Unit provides services for the External Computer.

**Figure E.3: Computer Access Unit.**

The functions available to the external computer are:

- submit short messages destined to mobile stations;
- retrieve short messages originating from mobile stations;
- retrieve notifications containing information about the delivery of short messages;
- delete short messages that have been submitted but not yet delivered.

The external computer is identified to SMS-C by its network address.

The implementation is a Client/Server approach, where the user system in the external computer makes the decisions to submit, retrieve or delete messages and to disconnect. A connection can, however, be initiated from either side.

## E.3 Computer Access Protocol

The interface towards the external computer is through the Computer Access Protocol. This protocol is placed on top of the network/transport layer, which is X.25 in the first release of the SMS-C software.

The Computer Access Protocol defines the following Protocol Data Units:

**Table E.1: Protocol Data Units.**

<b>OpenReqPDU</b>	Open request from SMS-C
<b>OpenRspPDU</b>	Open response from the user system
<b>CloseReqPDU</b>	Close request from the user system
<b>SubmitReqPDU</b>	Submit request from the user system
<b>SubmitRspPDU</b>	Submit response from SMS-C
<b>RetrieveReqPDU</b>	Retrieve request from the user system
<b>RetrieveRspPDU</b>	Retrieve response from SMS-C
<b>DeleteReqPDU</b>	Delete request from the user system
<b>DeleteRspPDU</b>	Delete response from SMS-C

The protocol data units are defined in clause E.7.

### E.3.1 Connect and disconnect

The connect and disconnect procedures are different depending on the lower protocol layers used. See clause E.4 for further information.

The connect can be initiated from either side.

#### E.3.1.1 Connect Initiated from SMS-C

If a message or message notification is available for a user system that is not currently connected, SMS-C will establish a connection. SMS-C will only establish **one** connection, regardless of the number of messages to be transmitted to the same user address. Nothing is transmitted until the user system makes a retrieve request.

If the user system tries to establish a connection when one already exists, the attempt will be rejected by SMS-C.

#### E.3.1.2 Connect Initiated from the user system

The user system establishes a connection with SMS-C when it has a message to submit. Normally the user system sends its message/messages immediately after the connect.

Before disconnecting, the user system should request messages from SMS-C. When the queue is empty the user system is expected to disconnect.

#### E.3.1.3 Disconnect

The user system is expected to initiate the disconnect by sending a close request. SMS-C will disconnect when this request is received.

SMS-C will also disconnect if the user system goes idle for more than a specified period of time.

### E.3.2 Open procedure

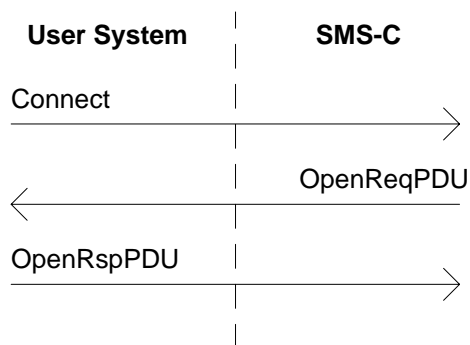

The OpenReqPDU specifies the supported release levels of the Computer Access Protocol. The OpenRspPDU specifies the release level to be used.

**Figure E.4: Open Procedure.**

After the connect, SMS-C transmits an OpenReqPDU specifying the supported release levels of the Computer Access Protocol.

The user system returns an OpenRspPDU that specifies the release level to be used.

### E.3.3 Submit Short Message

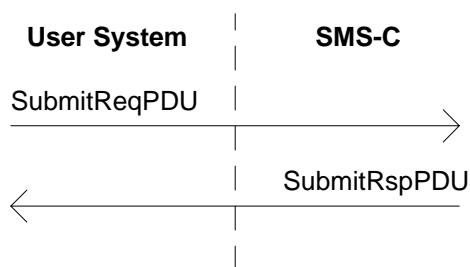

To submit a message the user system transmits a SubmitReqPDU. SMS-C responds with a SubmitRspPDU containing a return code and a unique message identification.

**Figure E.5: Submit Short Message.**

To submit a short message the user system transmits a SubmitReqPDU to SMS-C. The PDU contains the message priority, notification level, destination address and the short message text. Optional information is validity time, alternative notification address and deferred delivery time.

SMS-C responds with a SubmitRspPDU which contains a return code and a unique message identification. A positive return code indicates that the Message Kernel has taken over the responsibility of the message.

The actual delivery of the short message to the recipient is reported later by means of message notifications.

NOTE: The user system specifies, when submitting the short message, the type of notifications to be generated.

### E.3.4 Retrieve Short Message or Message Notification

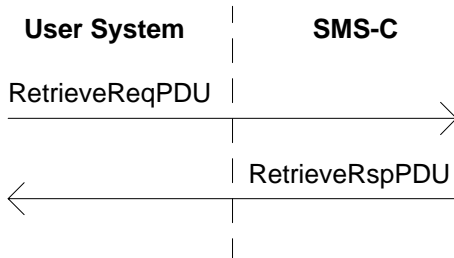

The user system transmits a RetrieveReqPDU to retrieve a message. SMS-C responds with a RetrieveRspPDU containing a short message, a message notification or a “no message” indicator.

**Figure E.6: Retrieve Message.**

To retrieve a short message or message notification the user system transmits a RetrieveReqPDU. SMS-C responds with a RetrieveRspPDU which contains either a short message, a message notification or a “no message” indicator.

When the user system has retrieved one message it must send another RetrieveReqPDU to find out whether there are more messages waiting.

To make sure that all messages are retrieved, the user system must continue to transmit RetrieveReqPDU until a RetrieveRspPDU with a “no message” indicator is received.

#### When is the Message deleted from the database

A short message or message notification, retrieved by the user system, is deleted from the database in SMS-C when a subsequent RetrieveReqPDU, SubmitReqPDU, DeleteReqPDU or CloseReqPDU is received.



### E.3.5 Delete Short Message

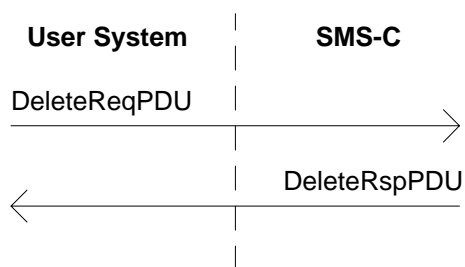

The user system transmits a DeleteReqPDU to request deletion of a short message. SMS-C responds with a DeleteRspPDU containing a return code.

**Figure E.7: Delete Short Message.**

A previously submitted short message that is not yet delivered can be deleted by the user system. Deletion of a short message can be done either by specifying the message identification or the recipient. In the latter case, all short messages from the user system to that recipient are deleted.

The user system transmits a DeleteReqPDU and SMS-C responds with a DeleteRspPDU which contains a return code. A positive return code indicates that the specified short message/messages have been deleted.

### E.3.6 Close procedure

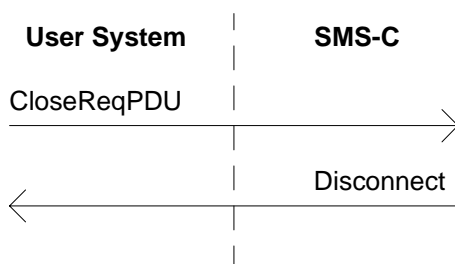

When finished, the user system sends a CloseReqPDU. SMS-C disconnects when this PDU is received.

**Figure E.8: Close procedure.**

When the user system is finished a CloseReqPDU should be sent. SMS-C disconnects when this PDU is received.

---

## E.4 Connect and Disconnect Procedures

### E.4.1 X.25

The Computer Access Interface handles multiple X.25 lines. Only SVCs, Switched Virtual Circuits are supported.

The D- and Q-bits are not used.

Reversed charging must be accepted by the user system if requested by SMS-C.

### E.4.1.1 Multiport support

The user system is identified to SMS-C by its DTE address. To allow a user system to have more than one SVC connected in parallel, i.e. to be identified as several users, SMS-C can be configured to support the following features:

- At connect from the user system, a specified number of digits can be given in the Call User Data field to form a subaddress. This subaddress is appended to the DTE address to form the originator address, by which the external computer is known to SMS-C.
- When SMS-C connects to the user system, in order to deliver a short message or a message notification, the subaddress is removed from the originator address and inserted in the Call User Data field.

The number of digits used for the subaddress are specified through configuration parameters in SMS-C. If the user system does not provide any subaddress or if the number of digits are less than specified in the configuration, zeroes are appended. At connect from SMS-C, the appended zeroes are inserted in the Call User Data field.

NOTE: This feature is dependent on configuration parameters in SMS-C. Contact your SMS-C representative to discuss the issue.

### E.4.1.2 Connect from the user system

When the user system connects to SMS-C, the following information must be present in the Call Request Packet:

Calling DTE address This address is used as the sender address when submitting messages, and as receiver address when receiving messages

Call user data Hex: 'C0434150xxxxxx' The first byte has the two leading bits set, indicating DTE-to-DTE use. Then follows "CAP". After "CAP", one or more subaddress digits might follow. "CAP" and the subaddress are coded in the IA5 character set.

### E.4.1.3 Connect from SMS-C

When SMS-C connects to the user system the following information is present in the call request packet:

Call user data Hex: 'C0434150xxxxxx' The first byte has the two leading bits set, indicating DTE-to-DTE use. Then follows "CAP". After "CAP", one or more subaddress digits might follow. "CAP" and the subaddress are coded in the IA5 character set.

Calling DTE address The DTE address of SMS-C. This address is not provided by SMS-C. It will be present only if provided by the network.

Reversed charging might be requested.

### E.4.1.4 Disconnect

The following diagnostic codes are given at disconnect:

- 0 Normal disconnect.
- 1 The SMS-C process has been forced to terminate.
- 2 Timeout towards the user system.
- 3 SMS-C is temporary blocked.
- 4 Not expected PDU is received.
- 5 Failure on lower levels.
- 6 Unexpected data is received.
- 7 Illegal release level is given in OpenRspPDU.

8 Invalid calling address

SMS-C will disconnect if an interrupt or reset is received.

---

## E.5 Scenarios

### E.5.1 Submit Short Message from the User System

The scenario below illustrates the case when the user system wants to submit a message to SMS-C. The user system establishes a connection and submits a message. Before terminating the session, the user system checks if SMS-C has something to deliver.

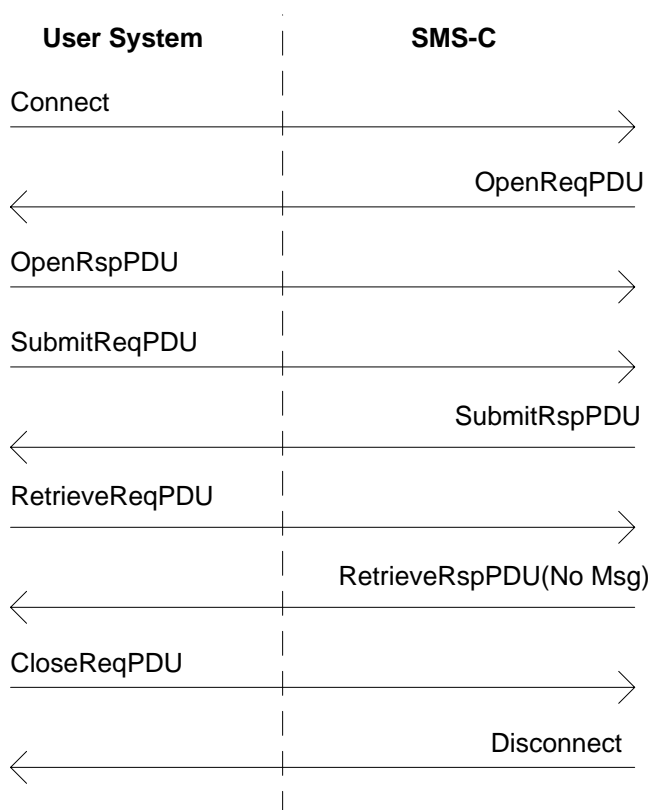

Figure E.9: Submit Short Message from the User System.

### E.5.2 Delivery of Message from SMS-C

The scenario illustrates the case when SMS-C has a short message or message notification to deliver to the user system.

Since the user system is not currently connected, SMS-C connects. In order to retrieve any message or message notification the user system sends a RetrieveReqPDU. SMS-C responds with a RetrieveRspPDU which contains either a short message or message notification.

Before terminating the session, the user system checks if there are any more messages waiting by sending another RetrieveReqPDU.

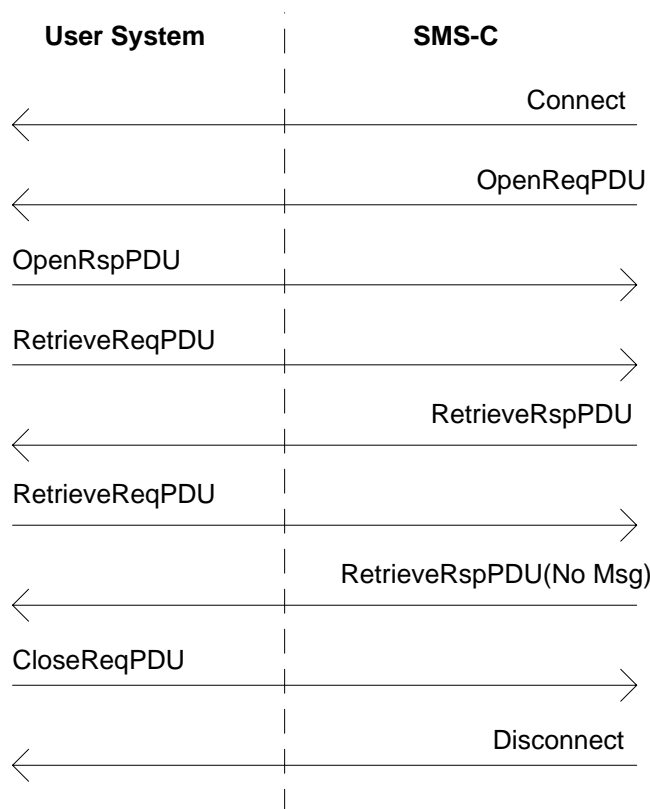

Figure E.10: Delivery of Message from SMS-C.

---

## E.6 Design considerations

### E.6.1 SMS-C Configuration

In SMS-C there are a number of configuration parameters which determine the characteristics of the system. An application designer should consider the following parameters:

- X.25 multiport support – determines whether SMS-C supports this feature or not.
- user system idle time – if the user system is idle for more than this period of time, SMS-C will disconnect.
- default validity time – if the user system does not specify a validity time, in the SubmitReqPDU, this value will be used.
- maximum validity time – determines the maximum validity time the user system can specify in the SubmitReqPDU.
- maximum deferred delivery time – determines the maximum deferred delivery time the user system can specify in the SubmitReqPDU.

### E.6.2 Designing for High Throughput

When designing an application demanding high throughput consider the following:

#### E.6.2.1 Notifications

Use of notifications should be avoided. From SMS-C’s point of view the handling of a notification is equal to a short message. This means that the capacity of SMS-C is decreased if notifications are used.

## E.6.2.2 X.25 Multiport support

X.25 multiport support may be used to increase the message throughput:

- Connect several SVCs in parallel and use them to submit and retrieve messages.
- In a high volume environment, allocating one port to input only (for notifications) and several ports to output might increase the throughput. Use the alternative notification address option to specify the address of the input port.

---

## E.7 Protocol Data Unit Definitions

This clause defines the Computer Access Protocol Data Units using Abstract Notation One (ASN.1), see CCITT Recommendation X.208 [5].

Each PDU is serialised using the Basic Encoding Rules (BER), see CCITT Recommendation X.209 [6].

```

CAP DEFINITIONS ::= BEGIN
CAP-PDUs ::=
CHOICE
{
  [0]openReq           -- Open request from SMS-C (server)
    OpenReqPDU,

  [1]openRsp          -- Open response from User System (client)
    OpenRspPDU,

  [2]closeReq         -- Close request from User System (client)
    CloseReqPDU,

  [3]submitReq        -- Submit request from User System (client)
    SubmitReqPDU,

  [4]submitRsp        -- Submit response from SMS-C (server)
    SubmitRspPDU,

  [5]retrieveReq      -- Retrieve request from User System (client)
    RetrieveReqPDU,

  [6]retrieveRsp      -- Retrieve response from SMS-C (server)
    RetrieveRspPDU,

  [7]deleteReq        -- Delete request from User System (client)
    DeleteReqPDU,

  [8]deleteRsp        -- Delete response from SMS-C (server)
    DeleteRspPDU
}

```

```

-- OpenReqPDU.      Sent from SMS-C to the user system. Contains a list
--                  of supported release levels of the protocol.

OpenReqPDU ::=
SEQUENCE OF
  RelLevel          -- List of supported release levels
                   -- Each entry consists of at least 1 digit.

-   OpenRspPDU.     Sent from the user system to SMS-C in response
--                  to the OpenReqPDU. Contains the release level of the
--                  protocol to be used.

OpenRspPDU ::= IMPLICIT RelLevel          -- Release level to be used.

-   CloseReqPDU.    Sent from the user system to SMS-C.
--                  Indicates that the user system finishes the session.

CloseReqPDU ::= IMPLICIT NULL            -- No parameters
-   SubmitReqPDU.   Sent from the user system to SMS-C.
--                  Contains short message.

SubmitReqPDU ::= SEQUENCE {
notificationLevel  priority                -- Message priority Priority,
-- Notification level NotificationLevel, destAddress
-- Destination address Address, messageText      -- Message text MessageText, [0]
validity IMPLICIT -- Optional validity time UTCTime OPTIONAL, [1] alternNotAddress
-- Optional alternative -- notification address Address OPTIONAL, [2] defDelivery IMPLICIT --
Optional deferred delivery time UTCTime OPTIONAL }

-   SubmitRspPDU.   Sent from SMS-C to the user system in response
--                  to a SubmitReqPDU. Contains return code and a
--                  unique message identification.

SubmitRspPDU ::= SEQUENCE {
  returnCode ReturnCode, messageId MessageId }

```

```
-- RetrieveReqPDU. Sent from the user system to SMS-C.
--           Indicates that the user system is ready to receive.

RetrieveReqPDU ::= IMPLICIT NULL                -- No parameters

- RetrieveRspPDU. Sent from SMS-C to the user system in response to
-- a RetrieveReqPDU.
--           Contains a short message, a notification or a
--           "no message" indicator.

RetrieveRspPDU ::= CHOICE {
  [0] SEQUENCE { messageText MessageText, origAddress Address of originator Address },
  [1] notification -- Message notification Notification, NULL
  -- No more messages }

- DeleteReqPDU . Sent from the user system to SMS-C.
--           Specifies the deletion of one or several messages.

DeleteReqPDU ::= CHOICE {
  messageId -- Specific message MessageId, destAddress
  -- All messages to a specific destination Address }

- DeleteRspPDU. Sent from SMS-C to the user system in response to
-- a DeleteReqPDU.
--           Contains return code.

DeleteRspPDU ::= IMPLICIT returnCode ReturnCode
```

```

Priority ::= ENUMERATED { normal(0), nonUrgent(1),          -- Lowest priority urgent(2) }

NotificationLevel ::=
  BITSTRING          -- True when bit is set
  {
    DeliveredNotification(0),
    NonDeliveredNotification(1),
    BufferedNotification(2)
  }

MessageText ::=
  SEQUENCE
  {
    msgTxtCoding      -- Alphabet used
    MsgTxtCoding,
    text              -- coded according to msgTxtCoding
    Text
  }

MsgTxtCoding ::=
  ENUMERATED
  {
    osi8859_1(0)      -- OSI 8859-1
  }

Text ::=
  OCTET STRING (SIZE 1..160)

Address ::=
  SEQUENCE
  {
    Pid               -- Type of address
    Pid,
    addr              -- Address
    PackedBCDString
  }

Pid ::=
  ENUMERATED
  {
    gsm(0),           -- GSM telephone number
    it(56),           -- Interactive terminal PSTN number (hex 38)
    ca(57)            -- Computer Access X.25 DTE number (hex 39)
  }

Notification ::=
  SEQUENCE
  {
    MessageId,
    ENUMERATED
    {
      messageDelivered(0),
      messageBuffered(1),
      messageNotDelivered(2)
    },
    msgCreationTime
    UTCTime,
    destAddress
    Address,
    ReasonCode OPTIONAL -- used with messageNotDelivered
  }

ReasonCode
  ENUMERATED
  {
    unknownRecipient(1),
    messageTimedOut(2),
    functionNotSupported(3),
    otherError(4)
  }

RelLevel ::=          -- Release Level
  PackedBCDString

MessageId ::=
  OCTET STRING

PackedBCDString ::=
  OCTET STRING
  -- The digits 0 through 9, two digits
  -- per octet.
  -- each digit encoded as 0000 to 1001.
  -- 1111 used for padding at the end, if
  -- needed.
  -- The leftmost digit is the most
  -- significant.

ReturnCode ::=
  SEQUENCE
  {
    ENUMERATED
  }

```



```

    {   ok (0),                               -- The request is forwarded into
                                              -- the kernel of SMS-C,
                                              -- and the kernel has taken over
                                              -- responsibility.
        notAvailable(1),                      -- The kernel of SMS-C is not available
        protocolError(2)                     -- Protocol error
        noMessageDeleted(3)                  -- There is no message to delete;
                                              -- might be returned in DeleteRspPDU.
    }
    errorCode
        ErrorCode OPTIONAL                    -- If protocolError
}

ErrorCode
ENUMERATED
{
    illegalPriority(2),                       -- Illegal priority
    illegalPid(3),                           -- Illegal recipient Pid
    illegalAddr(4),                          -- Illegal recipient address
    illegalTxtCoding(5),                     -- Illegal message text coding
    illegalValTime(6),                       -- Illegal validity time
    illegalNotAddr(7),                      -- Illegal notification address
    illegalDelTime(8),                      -- Illegal deferred delivery time
    messageTooLong(9),                      -- Message size is too long
    unexpectedTag(11),                      -- Unexpected tag encountered
    expectedSequence(12),                   -- "Sequence" tag was expected
    expectedInteger(13),                   -- "Integer" tag was expected
    expectedBitstring(14),                 -- "Bit string" tag was expected
    expectedOctstring(15),                 -- "Octet string" tag was expected
    expectedEnumerated(16)                 -- "Enumerated" tag was expected
}

END -- End of module describing the CAP protocol
```

---

## Annex F (informative): Change Request History

<b>Change history</b>					
<b>SMG No.</b>	<b>TDoc. No.</b>	<b>CR. No.</b>	<b>Section affected</b>	<b>New version</b>	<b>Subject/Comments</b>
SMG#16				4.0.0	ETSI Publication
SMG#20				5.0.0	Release 1996 version
SMG#27				6.0.0	Release 1997 version

---

# History

<b>Document history</b>		
V6.0.0	April 1999	Publication