

TR 101 362 V6.0.1 (1998-07)

Technical Report

**Digital cellular telecommunications system (Phase 2+);
Radio network planning aspects
(GSM 03.30 version 6.0.1 Release 1997)**

The GSM logo is positioned in the upper right quadrant. It features the letters 'GSM' in a bold, blue, sans-serif font. Below the letters, the text 'GLOBAL SYSTEM FOR MOBILE COMMUNICATIONS' is written in a smaller, blue, sans-serif font. A small registered trademark symbol (®) is located to the right of the text. The background of the logo area consists of several large, overlapping, light blue curved shapes that resemble signal waves or a stylized 'G'.

GSM®
GLOBAL SYSTEM FOR
MOBILE COMMUNICATIONS

The ETSI logo is located in the lower center of the page. It consists of the word 'ETSI' in a bold, black, sans-serif font. To the right of the text is a stylized graphic element consisting of several concentric, curved lines that form a shape resembling a stylized 'S' or a signal wave.

ETSI

Reference

DTR/SMG-020330Q6 (cm00300s.PDF)

Keywords

Digital cellular telecommunications system,
Global System for Mobile communications (GSM)

ETSI

Postal address

F-06921 Sophia Antipolis Cedex - FRANCE

Office address

650 Route des Lucioles - Sophia Antipolis
Valbonne - FRANCE
Tel.: +33 4 92 94 42 00 Fax: +33 4 93 65 47 16
Siret N° 348 623 562 00017 - NAF 742 C
Association à but non lucratif enregistrée à la
Sous-Préfecture de Grasse (06) N° 7803/88

Internet

secretariat@etsi.fr
<http://www.etsi.fr>
<http://www.etsi.org>

Copyright Notification

No part may be reproduced except as authorized by written permission.
The copyright and the foregoing restriction extend to reproduction in all media.

© European Telecommunications Standards Institute 1998.
All rights reserved.

Contents

Intellectual Property Rights.....	5
Foreword	5
1 Scope.....	6
1.1 References.....	6
1.2 Abbreviations.....	6
2 Traffic distributions	6
2.1 Uniform.....	6
2.2 Non-uniform	7
3 Cell coverage.....	7
3.1 Location probability.....	7
3.2 Ec/No threshold	7
3.3 RF-budgets.....	7
3.4 Cell ranges	8
3.4.1 Large cells	8
3.4.2 Small cells	9
3.4.3 Microcells.....	9
4 Channel re-use.....	10
4.1 C/Ic threshold.....	10
4.2 Trade-off between Ec/No and C/Ic	10
4.3 Adjacent channel suppressions	11
4.4 Antenna patterns	11
4.5 Antenna heights	11
4.6 Path loss balance.....	11
4.7 Cell dimensioning	11
4.8 Channel allocation	12
4.9 Frequency hopping.....	12
4.10 Cells with extra long propagation delay.....	12
5 Propagation models	12
5.1 Terrain obstacles	12
5.2 Environment factors.....	13
5.3 Field strength measurements.....	13
5.4 Cell adjustments.....	13
6 Glossary	13
7 Bibliography.....	14
Annex A.1: (class 4) Example of RF-budget for GSM MS handheld RF-output peak power 2 W	15
Annex A.2: (class 2) Example of RF-budget for GSM MS RF-output peak power 8 W	17
Annex A.3: (DCS1800 classes 1&2): Example of RF-budget for DCS 1800 MS RF-output peak power 1 W & 250 mW	18
Annex A.4: Example of RF-budget for GSM 900 Class4 (peak power 2 W) in a small cell.....	19
Annex B: Propagation loss formulas for mobile radiocommunications	20
B.1 Hata Model [4], [8]	20
B.1.1 Urban	20
B.1.2 Suburban	20
B.1.3 Rural (Quasi-open)	20
B.1.4 Rural (Open Area)	20

B.2	COST 231-Hata Model [7]	20
B.3	COST 231 Walfish-Ikegami Model [7]	21
B.3.1	Without free line-of-sight between base and mobile (small cells)	21
B.3.1.1	Lo free-space loss.....	21
B.3.1.2	Lrts roof-top-to-street diffraction and scatter loss	21
B.3.1.3	Lmsd multiscreen diffraction loss	21
B.3.2	With a free line-of-sight between base and mobile (Street Canyon).....	22
Annex C:	Path Loss vs Cell Radius	23
Annex D:	Planning Guidelines for Repeaters	27
D.1	Introduction.....	27
D.2	Definition of Terms.....	27
D.3	Gain Requirements.....	28
D.4	Spurious/Intermodulation Products.....	28
D.5	Output Power/Automatic Level Control (ALC)	29
D.6	Local oscillator sideband noise attenuation	29
D.7	Delay Requirements	29
D.8	Wideband Noise	30
D.9	Outdoor Rural Repeater Example	30
D.9.1	Rural repeater example for GSM 900	30
D.9.1.1	Intermodulation products/ALC setting	30
D.9.1.2	Wideband noise.....	31
D.10	Indoor Low Power Repeater Example	31
D.10.1	Indoor repeater example for DCS 1800	31
D.10.1.1	Intermodulation products/ALC setting	32
D.10.1.2	Wideband noise.....	32
D.11	Example for a Repeater System using Frequency Shift.....	32
D.11.1	Example for GSM 900	32
D.11.1.1	Intermodulation products/ALC setting and levelling criteria	33
D.11.1.2	Wideband noise.....	34
D.11.1.3	Multipath environment	34
Annex E:	Document change history.....	35
History		36

Intellectual Property Rights

IPRs essential or potentially essential to the present document may have been declared to ETSI. The information pertaining to these essential IPRs, if any, is publicly available for **ETSI members and non-members**, and can be found in SR 000 314: *"Intellectual Property Rights (IPRs); Essential, or potentially Essential, IPRs notified to ETSI in respect of ETSI standards"*, which is available **free of charge** from the ETSI Secretariat. Latest updates are available on the ETSI Web server (<http://www.etsi.fr/ipr> or <http://www.etsi.org/ipr>).

Pursuant to the ETSI IPR Policy, no investigation, including IPR searches, has been carried out by ETSI. No guarantee can be given as to the existence of other IPRs not referenced in SR 000 314 (or the updates on the ETSI Web server) which are, or may be, or may become, essential to the present document.

Foreword

This Technical Report (TR) has been produced by the Special Mobile Group (SMG) of the European Telecommunications Standards Institute (ETSI).

This TR describes the radio network planning aspects within the digital cellular telecommunications system.

The contents of this TR is subject to continuing work within SMG and may change following formal SMG approval. Should SMG modify the contents of this TR, it will be re-released by SMG with an identifying change of release date and an increase in version number as follows:

Version 6.x.y

where:

- 6 indicates GSM Phase 2+ Release 1997;
- x the second digit is incremented for all other types of changes, i.e. technical enhancements, corrections, updates, etc.;
- y the third digit is incremented when editorial only changes have been incorporated in the specification.

1 Scope

This ETSI Technical Report (TR) is a descriptive recommendation to be helpful in cell planning.

1.1 References

References may be made to:

- a) specific versions of publications (identified by date of publication, edition number, version number, etc.), in which case, subsequent revisions to the referenced document do not apply; or
- b) all versions up to and including the identified version (identified by "up to and including" before the version identity); or
- c) all versions subsequent to and including the identified version (identified by "onwards" following the version identity); or
- d) publications without mention of a specific version, in which case the latest version applies.

A non-specific reference to an ETS shall also be taken to refer to later versions published as an EN with the same [1]

GSM 01.04: "Digital cellular telecommunications system (Phase 2+); Abbreviations and acronyms".

- [2] GSM 05.02: "Digital cellular telecommunications system (Phase 2+); Multiplexing and multiple access on the radio path".
- [3] GSM 05.05: "Digital cellular telecommunications system (Phase 2+); Radio transmission and reception".
- [4] GSM 05.08: "Digital cellular telecommunications system (Phase 2+); Radio subsystem link control".
- [5] CCIR Recommendation 370-5: "VHF and UHF propagation curves for the frequency range from 30 MHz to 1000 MHz".
- [6] CCIR Report 567-3: "Methods and statistics for estimating field strength values in the land mobile services using the frequency range 30 MHz to 1 GHz".
- [7] CCIR Report 842: "Spectrum-conserving terrestrial frequency assignments for given frequency-distance separations".
- [8] CCIR Report 740: "General aspects of cellular systems".

1.2 Abbreviations

Abbreviations used in this TR are given clause 6 (Glossary) and in GSM 01.04 [1].

2 Traffic distributions

2.1 Uniform

A uniform traffic distribution can be considered to start with in large cells as an average over the cell area, especially in the country side.

2.2 Non-uniform

A non-uniform traffic distribution is the usual case, especially for urban areas. The traffic peak is usually in the city centre with local peaks in the suburban centres and motorway junctions.

A bell-shaped area traffic distribution is a good traffic density macro model for cities like London and Stockholm. The exponential decay constant is on average 15 km and 7,5 km respectively. However, the exponent varies in different directions depending on how the city is built up. Increasing handheld traffic will sharpen the peak.

Line coverage along communication routes as motorways and streets is a good micro model for car mobile traffic. For a maturing system an efficient way to increase capacity and quality is to build cells especially for covering these line concentrations with the old area covering cells working as umbrella cells.

Point coverage of shopping centres and traffic terminals is a good micro model for personal handheld traffic. For a maturing system an efficient way to increase capacity and quality is to build cells on these points as a complement to the old umbrella cells and the new line covering cells for car mobile traffic.

3 Cell coverage

3.1 Location probability

Location probability is a quality criterion for cell coverage. Due to shadowing and fading a cell edge is defined by adding margins so that the minimum service quality is fulfilled with a certain probability.

For car mobile traffic a usual measure is 90 % area coverage per cell, taking into account the minimum signal-to-noise ratio E_c/N_0 under multipath fading conditions. For lognormal shadowing an area coverage can be translated into a location probability on cell edge (Jakes, 1974).

For the normal case of urban propagation with a standard deviation of 7 dB and a distance exponential of 3.5, 90 % area coverage corresponds to about 75 % location probability at the cell edge. Furthermore, the lognormal shadow margin in this case will be 5 dB, as described in CEPT Recommendation T/R 25-03 and CCIR Report 740.

3.2 E_c/N_0 threshold

The mobile radio channel is characterized by wideband multipath propagation effects such as delay spread and Doppler shift as defined in GSM 05.05 annex C. The reference signal-to-noise ratio in the modulating bit rate bandwidth (271 kHz) is $E_c/N_0 = 8$ dB including 2 dB implementation margin for the GSM system at the minimum service quality without interference. The E_c/N_0 quality threshold is different for various logical channels and propagation conditions as described in GSM 05.05.

3.3 RF-budgets

The RF-link between a Base Transceiver Station (BTS) and a Mobile Station (MS) including handheld is best described by an RF-budget as in annex A which consists of 4 such budgets; A.1 for GSM 900 MS class 4; A.2 for GSM 900 MS class 2, A.3 for DCS 1800 MS classes 1 and 2, and A.4 for GSM 900 class 4 in small cells.

The antenna gain for the hand portable unit can be set to 0 dBi due to loss in the human body as described in CCIR Report 567. An explicit body loss factor is incorporated in annex A.3

At 900 MHz, the indoor loss is the field strength decrease when moving into a house on the bottom floor on 1.5 m height from the street. The indoor loss near windows (< 1 m) is typically 12 dB. However, the building loss has been measured by the Finnish PTT to vary between 37 dB and -8 dB with an average of 18 dB taken over all floors and buildings (Kajamaa, 1985). See also CCIR Report 567.

At 1800 MHz, the indoor loss for large concrete buildings was reported in COST 231 TD(90)117 and values in the range 12 - 17 dB were measured. Since these buildings are typical of urban areas a value of 15 dB is assumed in annex A.3. In rural areas the buildings tend to be smaller and a 10 dB indoor loss is assumed.

The isotropic power is defined as the RMS value at the terminal of an antenna with 0 dBi gain. A quarter-wave monopole mounted on a suitable earth-plane (car roof) without losses has antenna gain 2 dBi. An isotropic power of -113 dBm corresponds to a field strength of 23.5 dBuV/m for 925 MHz and 29.3 dBuV/m at 1795 MHz, see CEPT Recommendation T/R 25-03 and GSM 05.05 section 5 for formulas. GSM900 BTS can be connected to the same feeders and antennas as analog 900 MHz BTS by diplexers with less than 0.5 dB loss.

3.4 Cell ranges

3.4.1 Large cells

In large cells the base station antenna is installed above the maximum height of the surrounding roof tops; the path loss is determined mainly by diffraction and scattering at roof tops in the vicinity of the mobile i.e. the main rays propagate above the roof tops; the cell radius is minimally 1 km and normally exceeds 3 km. Hata's model and its extension up to 2000 MHz (COST 231-Hata model) can be used to calculate the path loss in such cells (see COST 231 TD (90) 119 Rev 2 and annex B).

The field strength on 1.5 m reference height outdoor for MS including handheld is a value which inserted in the curves of CCIR Report 567-3 Figure 2 (Okumura) together with the BTS antenna height and effective radiated power (ERP) yields the range and re-use distance for urban areas (section 5.2).

The cell range can also be calculated by putting the maximum allowed path loss between isotropic antennas into the Figures 1 to 3 of annex C. The same path loss can be found in the RF-budgets in annex A. The figures 1 and 2 (GSM 900) in annex C are based on Hata's propagation model which fits Okumura's experimental curves up to 1500 MHz and figure 3 (DCS 1800) is based on COST 231-Hata model according to COST 231 TD (90) 119 Rev 2.

The example RF-budget shown in annex A.1 for a GSM900 MS handheld output power 2 W yields about double the range outdoors compared with indoors. This means that if the cells are dimensioned for handhelds with indoor loss 10 dB, the outdoor coverage for MS will be interference limited, see section 4.2. Still more extreme coverage can be found over open flat land of 12 km as compared with 3 km in urban areas outdoor to the same cell site.

For GSM 900 the Max EIRP of 50 W matches MS class 2 of max peak output power 8 W, see annex A.2.

An example RF budget for DCS 1800 is shown in annex A.3. Range predictions are given for 1 W and 250 mW DCS 1800 MS with BTS powers which balance the up- and down- links.

The propagation assumptions used in annex A1, A2, A3 are shown in the tables below :

For GSM 900 :

	Rural (Open Area)	Rural (Quasi-open)	Urban
Base station height (m)	100	100	50
Mobile height (m)	1.5	1.5	1.5
Hata's loss formula (d in km)	$90.7+31.8\log(d)$	$95.7+31.8\log(d)$	$123.3+33.7\log(d)$
Indoor Loss (dB)	10	10	15

For DCS 1800 :

	Rural (Open Area)	Rural (Quasi-Open)	Urban (*)
Base station	60	60	50

height (m)			
Mobile height (m)	1.5	1.5	1.5
COST 231	$100.1+33.3\log(d)$	$105.1+33.3\log(d)$	$133.2+33.8\log(d)$
Hata's loss formula (d in km)			
Indoor Loss (dB)	10	10	15

(*) medium sized city and suburban centres (see COST 231 TD (90) 119 Rev2). For metropolitan centres add 3 dB to the path loss.

NOTE 1: The rural (Open Area) model is useful for desert areas and the rural (Quasi-Open) for countryside.

NOTE 2: The correction factors for Quasi-open and Open areas are applicable in the frequency range 100-2000 MHz (Okumura,1968).

3.4.2 Small cells

For small cell coverage the antenna is sited above the median but below the maximum height of the surrounding roof tops and so therefore the path loss is determined by the same mechanisms as stated in section 3.4.1. However large and small cells differ in terms of maximum range and for small cells the maximum range is typically less than 1-3 km. In the case of small cells with a radius of less than 1 km the Hata model cannot be used.

The COST 231-Walfish-Ikegami model (see annex B) gives the best approximation to the path loss experienced when small cells with a radius of less than 5 km are implemented in urban environments. It can therefore be used to estimate the BTS ERP required in order to provide a particular cell radius (typically in the range 200 m - 3 km).

The cell radius can be calculated by putting the maximum allowed path loss between the isotropic antennas into figure 4 of annex C.

The following parameters have been used to derive figure 4 :

Width of the road, $w = 20$ m
 Height of building roof tops, $H_{roof} = 15$ m
 Height of base station antenna, $H_b = 17$ m
 Height of mobile station antenna, $H_m = 1.5$ m
 Road orientation to direct radio path, $\Phi = 90^\circ$
 Building separation, $b = 40$ m

For GSM 900 the corresponding propagation loss is given by :

$$\text{Loss (dB)} = 132.8 + 38\log(d/\text{km})$$

For DCS 1800 the corresponding propagation loss is given by :

$$\begin{aligned} \text{Loss (dB)} &= 142.9 + 38\log(d/\text{km}) \text{ for medium sized cities and suburban centres} \\ \text{Loss (dB)} &= 145.3 + 38\log(d/\text{km}) \text{ for metropolitan centres} \end{aligned}$$

An example of RF budget for a GSM 900 Class 4 MS in a small cell is shown in annex A.4.

3.4.3 Microcells

COST 231 defines a microcell as being a cell in which the base station antenna is mounted generally below roof top level. Wave propagation is determined by diffraction and scattering around buildings i.e. the main rays propagate in street canyons. COST 231 proposes the following experimental model for microcell propagation when a free line of sight exists in a street canyon :

$$\begin{aligned} \text{Path loss in dB (GSM 900)} &= 101,7 + 26\log(d/\text{km}) \quad d > 20 \text{ m} \\ \text{Path loss in dB (DCS 1800)} &= 107,7 + 26\log(d/\text{km}) \quad d > 20 \text{ m} \end{aligned}$$

The propagation loss in microcells increases sharply as the receiver moves out of line of sight, for example, around a street corner. This can be taken into account by adding 20 dB to the propagation loss per corner, up to two or three corners (the propagation being more of a guided type in this case). Beyond, the complete COST231-Walfish-Ikegami model as presented in annex B should be used.

Microcells have a radius in the region of 200 to 300 metres and therefore exhibit different usage patterns from large and small cells. They can be supported by generally smaller and cheaper BTS's. Since there will be many different microcell environments, a number of microcell BTS classes are defined in GSM 05.05. This allows the most appropriate microcell BTS to be chosen based upon the Minimum Coupling Loss expected between MS and the microcell BTS. The MCL dictates the close proximity working in a microcell environment and depends on the relative BTS/MS antenna heights, gains and the positioning of the BTS antenna.

In order to aid cell planning, the micro-BTS class for a particular installation should be chosen by matching the measured or predicted MCL at the chosen site with the following table.

The microcell specifications have been based on a frequency spacing of 6 MHz between the microcell channels and the channels used by any other cell in the vicinity. However, for smaller frequency spacings (down to 1.8 MHz) a larger MCL must be maintained in order to guarantee successful close proximity operation. This is due to an increase in wideband noise and a decrease in the MS blocking requirement from mobiles closer to the carrier.

Micro-BTS class	Recommended MCL (GSM 900)		Recommended MCL (DCS 1800)	
	Normal	Small freq. spacing	Normal	Small freq. spacing
M1	60	64	60	68
M2	55	59	55	63
M3	50	54	50	58

Operators should note that when using the smaller frequency spacing and hence larger MCL the blocking and wideband noise performance of the micro-BTS will be better than necessary.

Operators should exercise caution in choosing the microcell BTS class and transmit power. If they depart from the recommended parameters in 05.05 they risk compromising the performance of the networks operating in the same frequency band and same geographical area.

4 Channel re-use

4.1 C/Ic threshold

The C/Ic threshold is the minimum co-channel carrier-to-interference ratio in the active part of the timeslot at the minimum service quality when interference limited. The reference threshold $C/I_c = 9$ dB includes 2 dB implementation margin on the simulated residual BER threshold. The threshold quality varies with logical channels and propagation conditions, see GSM 05.05.

4.2 Trade-off between E_c/N_0 and C/Ic

For planning large cells the service range can be noise limited as defined by E_c/N_0 plus a degradation margin of 3 dB protected by 3 dB increase of C/Ic, see annex A.

For planning small cells it can be more feasible to increase E_c/N_0 by 6 dB corresponding to an increase of C/Ic by 1 dB to cover shadowed areas better. $C/(I+N) = 9$ dB represents the GSM limit performance.

To permit handheld coverage with 10 dB indoor loss, the E_c/N_0 has to be increased by 10 dB outdoors corresponding to a negligible increase of C/Ic outdoors permitting about the same interference limited coverage for MS including handhelds. The range outdoors can also be noise limited like the range indoors as shown in section 3.4 and annex A.1.

4.3 Adjacent channel suppressions

Adjacent channel suppression (ACS) is the gain (I_a/I_c) in C/I when wanted and unwanted GSM RF-signals co-exist on adjacent RF channels whilst maintaining the same quality as in the co-channel case, i.e. $ACS = C/I_c - C/I_a$. Taking into account frequency errors and fading conditions in the product of spectrum and filter of wanted and unwanted GSM RF-signals, ACS = 18 dB is typical as can be found in GSM 05.05.

1st ACS ≥ 18 dB, i.e. $C/I_{a1} \leq -9$ dB for $C/I_c = 9$ dB in GSM 05.05, imposes constraints of excluding the 1st adjacent channel in the same cell. However, the 1st adjacent channel can be used in the 1st adjacent cell, as $C/I_c \leq 12$ dB and ACS ≥ 18 dB gives an acceptable handover- margin of ≥ 6 dB for signalling back to the old BTS as shown in GSM 05.08. An exception might be adjacent cells using the same site due to uplink interference risks.

2nd ACS ≥ 50 dB, i.e. $C/I_{a2} \leq -41$ dB for $C/I_c = 9$ dB in GSM 05.05, implies that due to MS power control in the uplink, as well as intra-cell handover, it is possible that the 2nd adjacent channel can be used in the same cell. Switching transients are not interfering due to synchronized transmission and reception of bursts at co-located BTS.

4.4 Antenna patterns

Antenna patterns including surrounding masts, buildings, and terrain measured on ca 1 km distance will always look directional, even if the original antenna was non-directional. In order to achieve a front-to-back ratio F/B of greater than 20 dB from an antenna with an ideal F/B > 25 dB, backscattering from the main lobe must be suppressed by using an antenna height of at least 10 m above forward obstacles in ca 0.5 km. In order to achieve an omni-directional pattern with as few nulls as possible, the ideal non-directional antenna must be isolated from the mast by a suitable reflector. The nulls from mast scattering are usually in different angles for the duplex frequencies and should be avoided because of creating path loss imbalance.

The main lobe antenna gains are typically 12-18 dBi for BTS, and 2-5 dBi for MS. Note that a dipole has the gain 0 dBd = 2 dBi.

4.5 Antenna heights

The height gain under Rayleigh fading conditions is approximately 6 dB by doubling the BTS antenna height. The same height gain for MS and handheld from reference height 1.5 m to 10 m is about 9 dB, which is the correction needed for using CCIR Recommendation 370.

4.6 Path loss balance

Path loss balance on uplink and downlink is important for two-way communication near the cell edge. Speech as well as data transmission is dimensioned for equal quality in both directions. Balance is only achieved for a certain power class (section 3.4).

Path loss imbalance is taken care of in cell selection in idle mode and in the handover decision algorithms as found in GSM 05.08. However, a cell dimensioned for 8 W MS (GSM 900 class 2) can more or less gain balance for 2 W MS handheld (GSM 900 class 4) by implementing antenna diversity reception on the BTS.

4.7 Cell dimensioning

Cell dimensioning for uniform traffic distribution is optimized by at any time using the same number of channels and the same coverage area per cell.

Cell dimensioning for non-uniform traffic distribution is optimized by at any time using the same number of channels but changing the cell coverage area so that the traffic carried per cell is kept constant with the traffic density. Keeping the path loss balance by directional antennas pointing outwards from the traffic peaks the effective radiated power (ERP) per BTS can be increased rapidly out-wards. In order to make the inner cells really small the height gain can be decreased and the antenna gain can be made smaller or even negative in dB by increasing the feeder loss but keeping the antenna front-to-back ratio constant (section 4.4).

4.8 Channel allocation

Channel allocation is normally made on an FDMA basis. However, in synchronized networks channel allocation can be made on a TDMA basis. Note that a BCCH RF channel must always be fully allocated to one cell.

Channel allocation for uniform traffic distribution preferably follows one of the well known re-use clusters depending on C/I-distribution, e.g. a 9-cell cluster (3-cell 3-site repeat pattern) using 9 RF channel groups or cell allocations (CAs), (Stjernvall, 1985).

Channel allocation for non-uniform traffic distribution preferably follows a vortex from a BTS concentration on the traffic centre, if a bell-shaped area traffic model holds. In real life the traffic distribution is more complicated with also line and point traffic. In this case the cell areas will be rather different for various BTS locations from city centre. The channel allocation can be optimized by using graph colouring heuristics as described in CCIR Report 842.

Base transceiver station identity code (BSIC) allocation is done so that maximum re-use distance per carrier is achieved in order to exclude co-channel ambiguity.

Frequency co-ordination between countries is a matter of negotiations between countries as described in CEPT Recommendation T/R 25-04. Co-channel and 200 kHz adjacent channels need to be considered between PLMNs and other services as stated in GSM 05.05.

Frequency sharing between GSM countries is regulated in CEPT Recommendation T/R 20-08 concerning frequency planning and frequency co-ordination for the GSM service.

4.9 Frequency hopping

Frequency hopping (FH) can easily be implemented if the re-use is based on RF channel groups (CAs). It is also possible to change allocation by demand as described in GSM 05.02.

In synchronized networks the synchronization bursts (SB) on the BCCH will occur at the same time on different BTS. This will increase the time to decode the BSIC of adjacent BTS, see GSM 05.08. The SACCH on the TCH or SDCCH will also occur at the same time on different BTS. This will decrease the advantage of discontinuous transmission (DTX). In order to avoid this an offset in the time base (FN) between BTS may be used.

If channel allocation is made on a TDMA basis and frequency hopping is used, the same hop sequence must be used on all BTS. Therefore the same time base and the same hopping sequence number (HSN) shall be used.

4.10 Cells with extra long propagation delay

Cells with anticipated traffic with ranges more than 35 km corresponding to maximum MS timing advance can work properly if the timeslot after the CCCH and the timeslot after the allocated timeslot are not used by the BTS corresponding to a maximum total range of 120 km.

5 Propagation models

5.1 Terrain obstacles

Terrain obstacles introduce diffraction loss, which can be estimated from the path profile between transmitter and receiver antennas. The profile can preferably be derived from a digital topographic data bank delivered from the national map survey or from a land resource satellite system, e.g. Spot. The resolution is usually 500*500 m² down to 50*50 m² in side and 20 m down to 5 m in height. This resolution is not sufficient to describe the situation in cities for microcells, where streets and buildings must be recognized.

5.2 Environment factors

Environment factors for the nearest 200 m radius from the mobile play an important role in both the 900 MHz and 1800 MHz bands. For the Nordic cellular planning for NMT there is taken into account 10 categories for land, urban and wood. Further studies are done within COST 231.

Coarse estimations of cell coverage can be done on pocket computers with programs adding these environment factors to propagation curves of CCIR Recommendation 370-5 figure 9 and CCIR Report 567-3 figure 2 (Okumura, 1968).

5.3 Field strength measurements

Field strength measurements of the local mean of the lognormal distribution are preferably done by digital averaging over the typical Rayleigh fading. It can be shown that the local average power can be estimated over 20 to 40 wavelengths with at least 36 uncorrelated samples within 1 dB error for 90 % confidence (Lee, 1985).

5.4 Cell adjustments

Cell adjustments from field strength measurements of coverage and re-use are recommended after coarse predictions have been done. Field strength measurements of rms values can be performed with an uncertainty of 3.5 dB due to sampling and different propagation between Rayleigh fading and line-of-sight. Predictions can reasonably be done with an uncertainty of about 10 dB. Therefore cell adjustments are preferably done from field strength measurements by changing BTS output power, ERP, and antenna pattern in direction and shape.

6 Glossary

ACS	Adjacent Channel Suppression (section 4.3)
BCCH	Broadcast Control Channel (section 4.8)
BTS	Base Transceiver Station (section 3.3)
BSIC	Base Transceiver Station Identity Code (section 4.8)
CA	Cell Allocation of radio frequency channels (section 4.8)
CCCH	Common Control Channel (section 4.10)
COST	European Co-operation in the field of Scientific and Technical Research
DTX	Discontinuous Transmission (section 4.9)
Ec/No	Signal-to-Noise ratio in modulating bit rate bandwidth (section 3.2)
FH	Frequency Hopping (section 4.9)
FN	TDMA Frame Number (section 4.9)
F/B	Front-to-Back ratio (section 4.4)
HSN	Hopping Sequence Number (section 4.9)
MS	Mobile Station (section 3.3)
PLMN	Public Land Mobile Network
Ps	Location (site) Probability (section 3.1)
SACCH	Slow Associated Control Channel (section 4.9)
SB	Synchronization Burst (section 4.9)

SDCCH Stand-alone Dedicated Control Channel (section 4.9)

TCH Traffic Channel (section 4.9)

7 Bibliography

CEPT Recommendation T/R 20-08 Frequency planning and frequency co-ordination for the GSM service;

CEPT Recommendation T/R 25-03 Co-ordination of frequencies for the land mobile service in the 80, 160 and 460 MHz bands and the methods to be used for assessing interference;

CEPT Recommendation T/R 25-04 Co-ordination in frontier regions of frequencies for the land mobile service in the bands between 862 and 960 MHz;

CEPT Liaison office, P.O. Box 1283, CH-3001 Berne.

- 1 Jakes, W.C., Jr.(Ed.) (1974) Microwave mobile communications. John Wiley, New York, NY, USA.
- 2 Kajamaa, Timo (1985) 900 MHz propagation measurements in Finland in 1983-85 (PTT Report 27.8.1985.) Proc NRS 86, Nordic Radio Symposium, ISBN 91-7056-072-2.
- 3 Lee, W.C.Y. (Feb., 1985) Estimate of local average power of a mobile radio signal. IEEE Trans. Vehic. Tech., Vol. VT-34, 1.
- 4 Okumura, Y. et al (Sep.-Oct., 1968) Field strength and its variability in VHF and UHF land-mobile radio service. Rev. Elec. Comm. Lab., NTT, Vol. 16, 9-10.
- 5 Stjernvall, J-E (Feb. 1985) Calculation of capacity and co-channel interference in a cellular system. Nordic Seminar on Digital Land Mobile Radio Communication (DMR I), Espoo, Finland.
- 6 A.M.D. Turkmani, J.D. Parsons and A.F. de Toledo "Radio Propagation into Buildings at 1.8 GHz". COST 231 TD (90) 117
- 7 COST 231 "Urban transmission loss models for mobile radio in the 900- and 1800- MHz bands (Revision 2)" COST 231 TD (90) 119 Rev 2.
- 8 Hata, M. (1980) Empirical Formula for Propagation Loss in Land Mobile Radio Services, IEEE Trans. on Vehicular Technology VT-29.

Annex A.1: (class 4) Example of RF-budget for GSM MS handheld RF-output peak power 2 W

Propagation over land in urban and rural areas						
Receiving end:		BTS	MS	Eq.		
TX:		MS	BTS	(dB)		
Noise figure (multicoupl.input)	dB	8	10	A		
Multipath profile	1)	TU50	TU50	(no FH)		
Ec/No min. fading	1)	dB	8	8	B	
RX RF-input sensitivity		dBm	-104	-102	C=A+B+W-174	
Interference degrad. margin		dB	3	3	D	
RX-antenna cable type		1-5/8"	0			
Specific cable loss		dB/100m	2	0		
Antenna cable length		m	120	0		
Cable loss + connector		dB	4	0	E	
RX-antenna gain		dB	12	0	F	
Isotropic power, 50 % Ps		dBm	-109	-99	G=C+D+E-F	
Lognormal margin 50 % -> 75 % Ps		dB	5	5	H	
Isotropic power, 75 % Ps		dBm	-104	-94	I=G+H	
Field strength, 75 % Ps		dBuV/m	33	43	J=I+137	
C/Ic min.fading, 50 % Ps	1)	dB	9	9		
C/Ic prot. at 3 dB degrad.		dB	12	12		
C/Ic protection, 75 % Ps		2)	dB	19	19	
Transmitting end:		MS	BTS	Eq.		
RX:		BTS	MS	(dB)		
TX RF-output peak power		W	2	6		
(mean power over burst)		dBm	33	38	K	
Isolator + combiner + filter		dB	0	3	L	
RF peak power, combiner output		dBm	33	35	M=K-L	
TX-antenna cable type			0	1-5/8"		
Specific cable loss		dB/100m	0	2		
Antenna cable length		m	0	120		
Cable loss + connector		dB	0	4	N	
TX-antenna gain		dB	0	12	O	
Peak EIRP		W	2	20		
(EIRP = ERP + 2 dB)		dBm	33	43	P=M-N+O	
Isotropic path loss, 50 % Ps		3)	dB	139	139	Q=P-G-3

Isotropic path loss, 75 % Ps		dB	134	134	R=P-I-3
Range, outdoor, 75 % Ps	4)	km	2.0	2.0	
Range, indoor, 75 % Ps	4)	km	0.7	0.7	

- 1) E_c/N_0 and C/I_c for residual BER = 0.4 %, TCH/FS (class Ib) and multi-path profiles as defined in GSM 05.05 annex 3. Bandwidth $W = 54$ dBHz.
- 2) Uncorrelated C and I with 75 % location probability (P_s). lognormal distribution of shadowing with standard deviation 7 dB. $P_s = 75$ % corresponds to ca 90 % area coverage, see Jakes, pp.126-127.
- 3) 3 dB of path loss is assumed to be due to the antenna/body loss
- 4) Max. range based on Hata. Antenna heights for BTS = 50 m and MS = 1.5 m. Indoor loss = 15 dB.

Annex A.2: (class 2) Example of RF-budget for GSM MS RF-output peak power 8 W

Propagation over land in urban and rural areas				
Receiving end:		BTS	MS	Eq.
TX:		MS	BTS	(dB)
Noise figure (multicoupl.input)	dB	8	8	A
Multipath profile	1)	RA250	RA250	(no FH)
Ec/No min. fading	1)	dB	8	B
RX RF-input sensitivity		dBm	-104	C=A+B+W-174
Interference degrad. margin		dB	3	D
RX-antenna cable type		1-5/8"	RG-58	
Specific cable loss	dB/100m	2	50	
Antenna cable length	m	120	4	
Cable loss + connector	dB	4	2	E
RX-antenna gain	dB	12	2	F
Isotropic power, 50 % Ps	dBm	-109	-101	G=C+D+E-F
Lognormal margin 50 % -> 75 % Ps	dB	5	5	H
Isotropic power, 75 % Ps	dBm	-104	-96	I=G+H
Field strength, 75 % Ps	dBuV/m	33	41	J=I+137
C/Ic min.fading, 50 % Ps	1)	dB	9	
C/Ic prot. at 3 dB degrad.		dB	12	
C/Ic protection, 75 % Ps	2)	dB	19	
Transmitting end:		MS	BTS	Eq.
RX:		BTS	MS	(dB)
TX RF-output peak power	W	8	16	
(mean power over burst)	dBm	39	42	K
Isolator + combiner + filter	dB	0	3	L
RF peak power, combiner output	dBm	39	39	M=K-L
TX-antenna cable type		RG-58	1-5/8"	
Specific cable loss	dB/100m	50	2	
Antenna cable length	m	4	120	
Cable loss + connector	dB	2	4	N
TX-antenna gain	dB	2	12	O
Peak EIRP	W	20	50	
(EIRP = ERP + 2 dB)	dBm	39	47	P=M-N+O
Isotropic path loss, 50 % Ps	dB	148	148	Q=P-G
Isotropic path loss, 75 % Ps	dB	143	143	R=P-I
Range, outdoor, 75 % Ps	3)	km	30.7	30.7

1) Ec/No and C/Ic for residual BER = 0.2 %, TCH/FS (class Ib) and multi-path profiles as defined in GSM 05.05 annex 3. Bandwidth W = 54 dBHz.

2) Uncorrelated C and I with 75 % location probability (Ps). Lognormal distribution of shadowing with standard deviation 7 dB. Ps = 75 % corresponds to ca 90 % area coverage, see Jakes, pp.126-127.

3) Max. range in quasi-open areas based on Hata. Antenna heights for BTS = 100 m and MS = 1.5 m.

Annex A.3: (DCS1800 classes 1&2): Example of RF-budget for DCS 1800 MS RF-output peak power 1 W & 250 mW

Propagation over land in urban and rural areas				
Receiving end:		BTS	MS	Eq.
TX:		MS	BTS	(dB)
Noise figure(multicoupl.input)	dB	8	12	A
Multipath profile		TU50 or	RA130	
Ec/No min. fading	dB	8	8	B
RX RF-input sensitivity	dBm	-104	-100	C=A+B+W-174
Interference degrad. margin	dB	3	3	D (W=54.3 dBHz)
Cable loss + connector	dB	2	0	E
RX-antenna gain	dBi	18	0	F
Diversity gain	dB	5	0	F1
Isotropic power, 50 % Ps	dBm	-122	-97	G=C+D+E-F-F1
Lognormal margin 50 % ->75 % Ps	dB	6	6	H
Isotropic power, 75 % Ps	dBm	-116	-91	I=G+H
Field Strength 75 % Ps		27	51	J=I+142.4 at 1.8 GHz
Transmitting end:		MS	BTS	Eq.
RX:		BTS	MS	(dB)
TX PA output peak power	W	-	15.8/3.98	
(mean power over burst)	dBm	-	42/36	K
Isolator + combiner + filter	dB	-	3	L
RF Peak power,(ant.connector)	dBm	30/24	39/33	M=K-L
1)	W	1.0/0.25	7.9/2.0	
Cable loss + connector	dB	0	2	N
TX-antenna gain	dBi	0	18	O
Peak EIRP	W	1.0/0.25	316/79.4	
	dBm	30/24	55/49	P=M-N+O
Isotropic path loss,50 % Ps	2)	dB	149/143	149/143 Q=P-G-3
Isotropic path loss, 75 % Ps	dB	143/137	143/137	R=P-I-3
Range km - 75 % Ps				
Urban, out of doors			1.91/1.27	
Urban, indoors			0.69/0.46	
Rural (Open area), out of doors			19.0/12.6	
Rural (Open area), indoors			9.52/6.28	

1) The MS peak power is defined as:

- a) If the radio has an antenna connector, it shall be measured into a 50 Ohm resistive load.
- b) If the radio has an integral antenna, a reference antenna with 0 dBi gain shall be assumed.

2) 3 dB of the path loss is assumed to be due to antenna/body loss.

Annex A.4: Example of RF-budget for GSM 900 Class4 (peak power 2 W) in a small cell

Propagation over land in urban and rural areas				
Receiving end:		BTS	MS	Eq.
TX :		MS	BTS	(dB)
Noise figure(multicoupl.input)	dB	8	10	A
Multipath profile		TU50	TU50	
Ec/No min. fading	dB	8	8	B
RX RF-input sensitivity	dBm	-104	-102	C=A+B+W-174
Interference degrad. margin	dB	3	3	D (W=54.3 dBHz)
Cable loss + connector	dB	2	0	E
RX-antenna gain	dBi	16	0	F
Diversity gain	dB	3	0	F1
Isotropic power, 50 % Ps	dBm	-118	-99	G=C+D+E-F-F1
Lognormal margin 50 % ->75 % Ps	dB	5	5	H
Isotropic power, 75 % Ps	dBm	-113	-94	I=G+H
Field Strength 75 % Ps		24	43	J=I+137 at 900 MHz
Transmitting end:		MS	BTS	Eq.
RX:		BTS	MS	(dB)
TX PA output peak power	W	-	12.6	
(mean power over burst)	dBm	-	41	K
Isolator + combiner + filter	dB	-	3	L
RF Peak power,(ant.connector)	dBm	33	38	M=K-L
1)	W	2	6.3	
Cable loss + connector	dB	0	2	N
TX-antenna gain	dBi	0	16	O
Peak EIRP	W	2	158	
	dBm	33	52	P=M-N+O
Isotropic path loss,50 % Ps 2)	dB	148	148	Q=P-G-3
Isotropic path loss, 75 % Ps	dB	143	143	R=P-I-3
Range km - 75 % Ps				
Urban, out of doors		1.86		
Urban, indoors		0.75		

1) The MS peak power is defined as:

- a) If the radio has an antenna connector, it shall be measured into a 50 Ohm resistive load.
- b) If the radio has an integral antenna, a reference antenna with 0 dBi gain shall be assumed.

2) 3 dB of the path loss is assumed to be due to antenna/body loss.

Annex B: Propagation loss formulas for mobile radiocommunications

B.1 Hata Model [4], [8]

Frequency f: 150 - 1000 MHz

Base station height H_b: 30 - 200 m

Mobile height H_m: 1 - 10 m

Distance d: 1 - 20 km

Large and small cells (i.e. base station antenna heights above roof-top levels of buildings adjacent to the base station)

B.1.1 Urban

$$L_u \text{ (dB)} = 69.55 + 26.16 \cdot \log(f) - 13.82 \cdot \log(H_b) - a(H_m) + [44.9 - 6.55 \cdot \log(H_b)] \cdot \log(d)$$

a(H_m) correction factor for vehicular station antenna height.

For a medium-small city :

$$a(H_m) = [1.1 \cdot \log(f) - 0.7] \cdot H_m - [1.56 \cdot \log(f) - 0.8]$$

For a large city :

$$a(H_m) = 8.29 \cdot [\log(1.54 \cdot H_m)]^2 - 1.1 \quad \text{for } f \leq 200 \text{ MHz}$$

$$a(H_m) = 3.2 \cdot [\log(11.75 \cdot H_m)]^2 - 4.97 \quad \text{for } f \geq 400 \text{ MHz}$$

B.1.2 Suburban

$$L_{su} \text{ (dB)} = L_u - 2 \cdot [\log(f/28)]^2 - 5.4$$

B.1.3 Rural (Quasi-open)

$$L_{rqo} \text{ (dB)} = L_u - 4.78 \cdot [\log(f)]^2 + 18.33 \cdot \log(f) - 35.94$$

B.1.4 Rural (Open Area)

$$L_{ro} \text{ (dB)} = L_u - 4.78 \cdot [\log(f)]^2 + 18.33 \cdot \log(f) - 40.94$$

B.2 COST 231-Hata Model [7]

Frequency f: 1500 - 2000 MHz

Base station height H_b: 30 - 200 m

Mobile height H_m: 1 - 10 m

Distance d: 1 - 20 km

Large and small cells (i.e. base station antenna heights above roof-top levels of buildings adjacent to the base station).

Urban areas (for rural areas the correction factors given in subparagraph 1.3 and 1.4 can be used up to 2000 MHz).

$$L_u \text{ (dB)} = 46.3 + 33.9 \cdot \log(f) - 13.82 \cdot \log(H_b) - a(H_m) + [44.9 - 6.55 \cdot \log(H_b)] \cdot \log(d) + C_m$$

with :

$$a(H_m) = [1.1 \cdot \log(f) - 0.7] \cdot H_m - [1.56 \cdot \log(f) - 0.8]$$

$C_m = 0$ dB for medium sized city and suburban centres with moderate tree density

$C_m = 3$ dB for metropolitan centres

B.3 COST 231 Walfish-Ikegami Model [7]

Frequency f : 800 - 2000 MHz

Base station height H_b : 4 - 50 m

Mobile height H_m : 1 - 3 m

Distance d : 0.02 - 5 km

Height of buildings H_{roof} (m)

Width of road w (m)

Building separation b (m)

Road orientation with respect to the direct radio path Φ ($^\circ$)

Urban areas

B.3.1 Without free line-of-sight between base and mobile (small cells)

$$L_b = L_o + L_{rts} + L_{msd} \text{ (or } L_b = L_o \text{ for } L_{rts} + L_{msd} \leq 0)$$

with :

B.3.1.1 L_o free-space loss

$$L_o = 32.4 + 20 \cdot \log(d) + 20 \cdot \log(f)$$

B.3.1.2 L_{rts} roof-top-to-street diffraction and scatter loss

$$L_{rts} = -16.9 - 10 \cdot \log(w) + 10 \log(f) + 20 \cdot \log(H_r - H_m) + L_{cri}$$

$$\text{with } L_{cri} = -10 + 0.354 \cdot \Phi \text{ for } 0 \leq \Phi < 35^\circ$$

$$L_{cri} = 2.5 + 0.075 \cdot (\Phi - 35) \text{ for } 35 \leq \Phi < 55^\circ$$

$$L_{cri} = 4.0 - 0.114 \cdot (\Phi - 55) \text{ for } 55 \leq \Phi < 90^\circ$$

B.3.1.3 L_{msd} multiscreen diffraction loss

$$L_{msd} = L_{bsh} + k_a + k_d \cdot \log(d) + k_f \cdot \log(f) - 9 \cdot \log(b)$$

$$\text{with } L_{bsh} = -18 \cdot \log(1 + H_b - H_{roof}) \quad \text{for } H_b > H_{roof}$$

$$= 0 \quad \text{for } H_b \leq H_{roof}$$

$$\begin{aligned}
 k_a &= 54 && \text{for } H_b > H_{\text{roof}} \\
 &= 54 - 0.8 \cdot (H_b - H_{\text{roof}}) && \text{for } d \geq 0.5 \text{ and } H_b \leq H_{\text{roof}} \\
 &= 54 - 0.8 \cdot (H_b - H_{\text{roof}}) \cdot (d/0.5) && \text{for } d < 0.5 \text{ and } H_b \leq H_{\text{roof}}
 \end{aligned}$$

$$\begin{aligned}
 k_d &= 18 && \text{for } H_b > H_{\text{roof}} \\
 &= 18 - 15 \cdot (H_b - H_{\text{roof}}) / H_{\text{roof}} && \text{for } H_b \leq H_{\text{roof}}
 \end{aligned}$$

$$\begin{aligned}
 k_f &= -4 + 0.7 \cdot (f/925 - 1) && \text{for medium sized cities and} \\
 &&& \text{suburban centres with moderate} \\
 &&& \text{tree density} \\
 &= -4 + 1.5 \cdot (f/925 - 1) && \text{for metropolitan centres}
 \end{aligned}$$

B.3.2 With a free line-of-sight between base and mobile (Street Canyon)

Microcells (Base station antennas below roof top level)

$$L_b = 42.6 + 26 \cdot \log(d) + 20 \cdot \log(f) \text{ for } d \geq 0.020 \text{ km}$$

Annex C: Path Loss vs Cell Radius

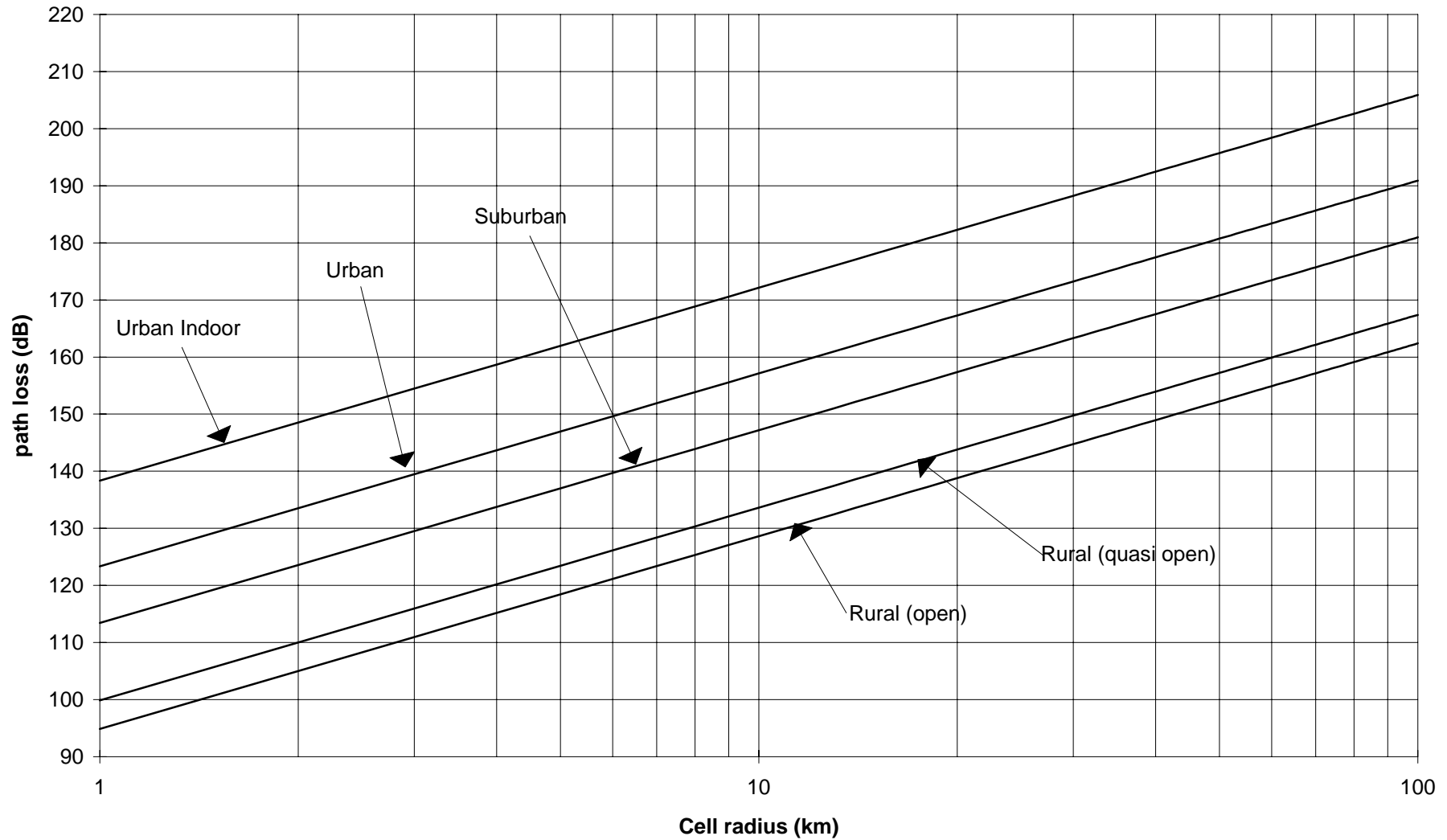

Figure1: Path loss vs Cell Radius, BS height = 50 m, MS height = 1.5 m (GSM 900)

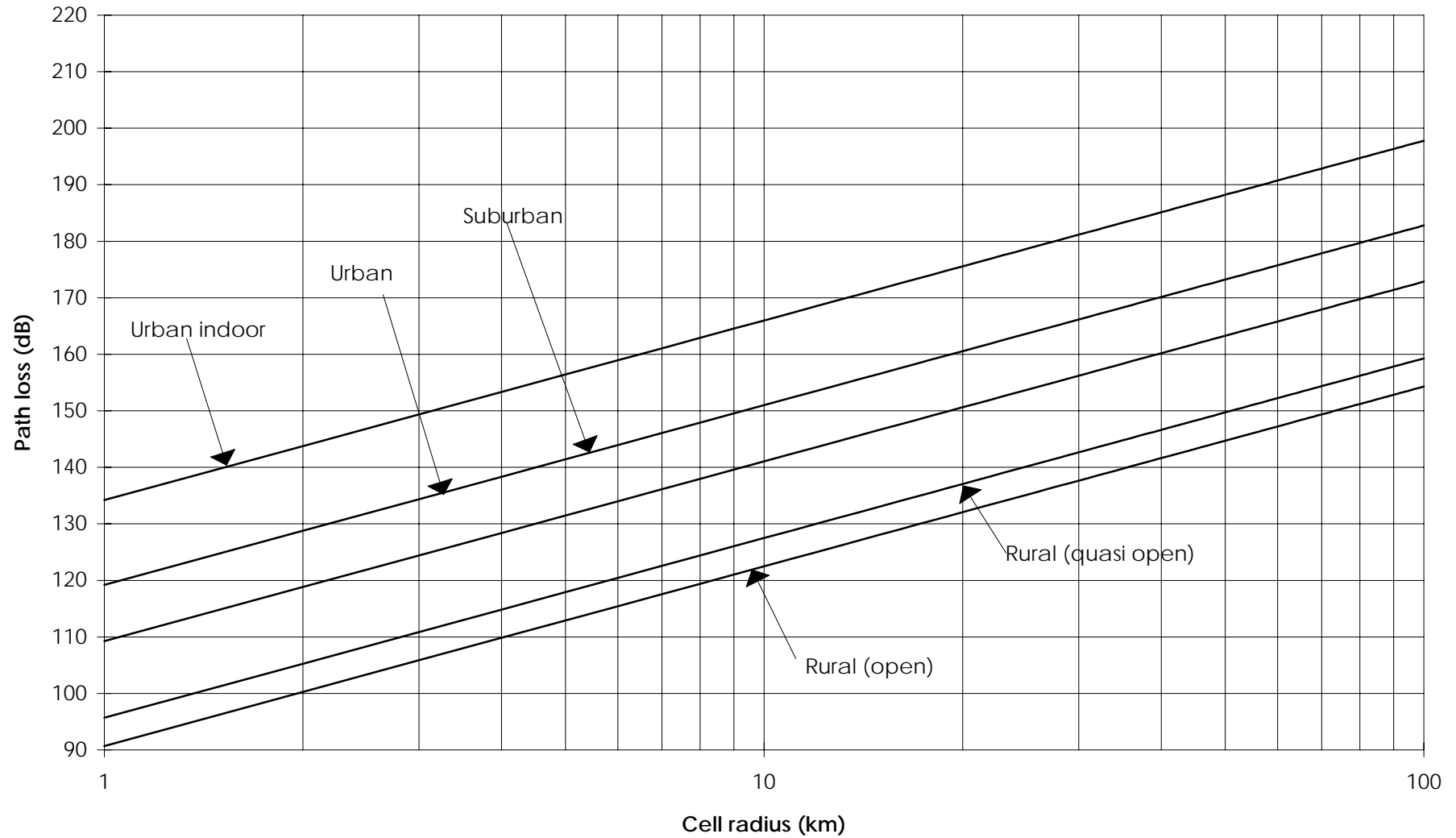

Figure 2: Path loss vs Cell Radius, BS height = 100 m, MS height = 1.5 m (GSM 900)

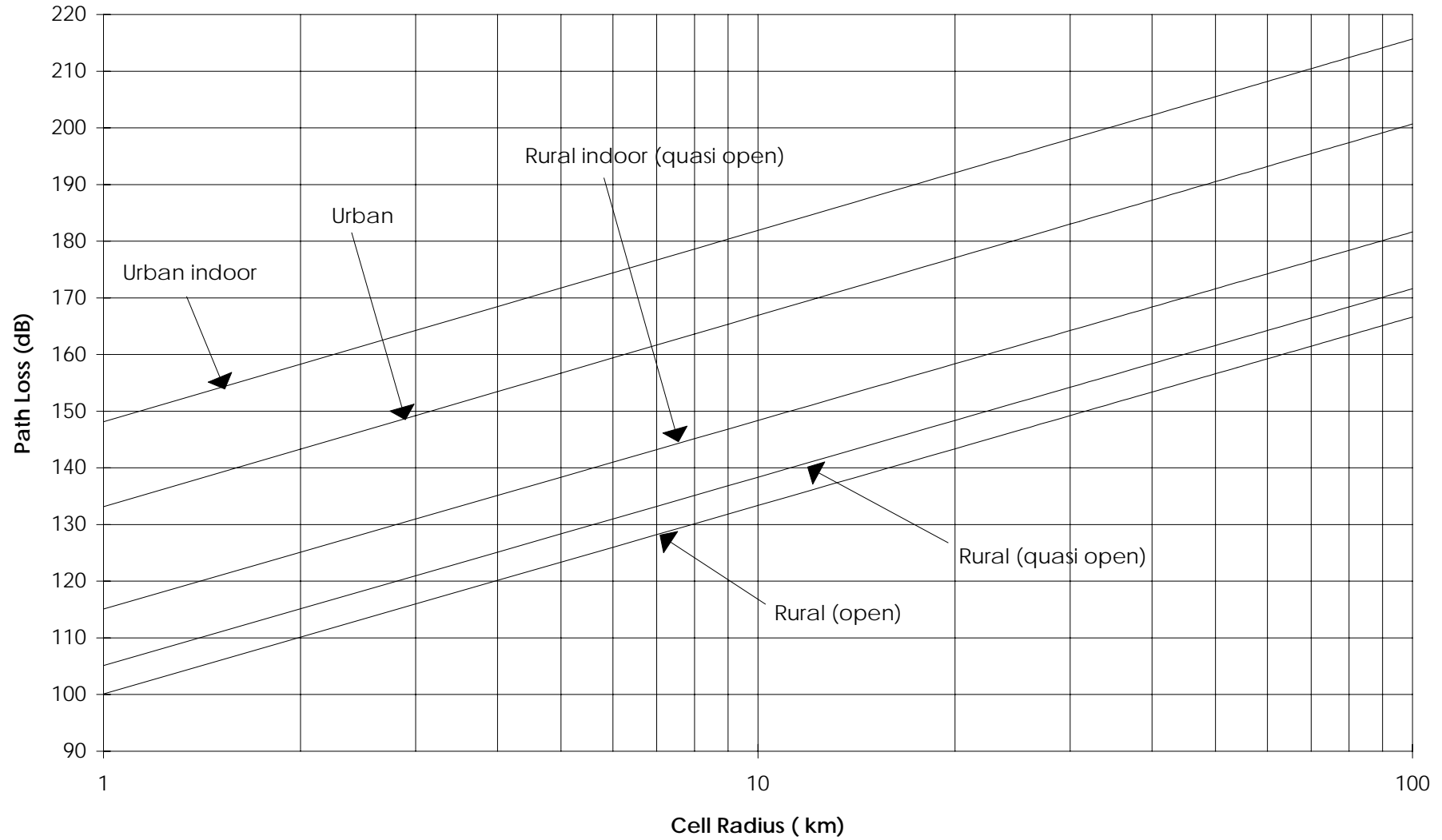

Figure 3: Path loss vs Cell Radius, Urban BS height = 50 m, Rural BS height = 60 m, MS height = 1.5 m (DCS 1800)

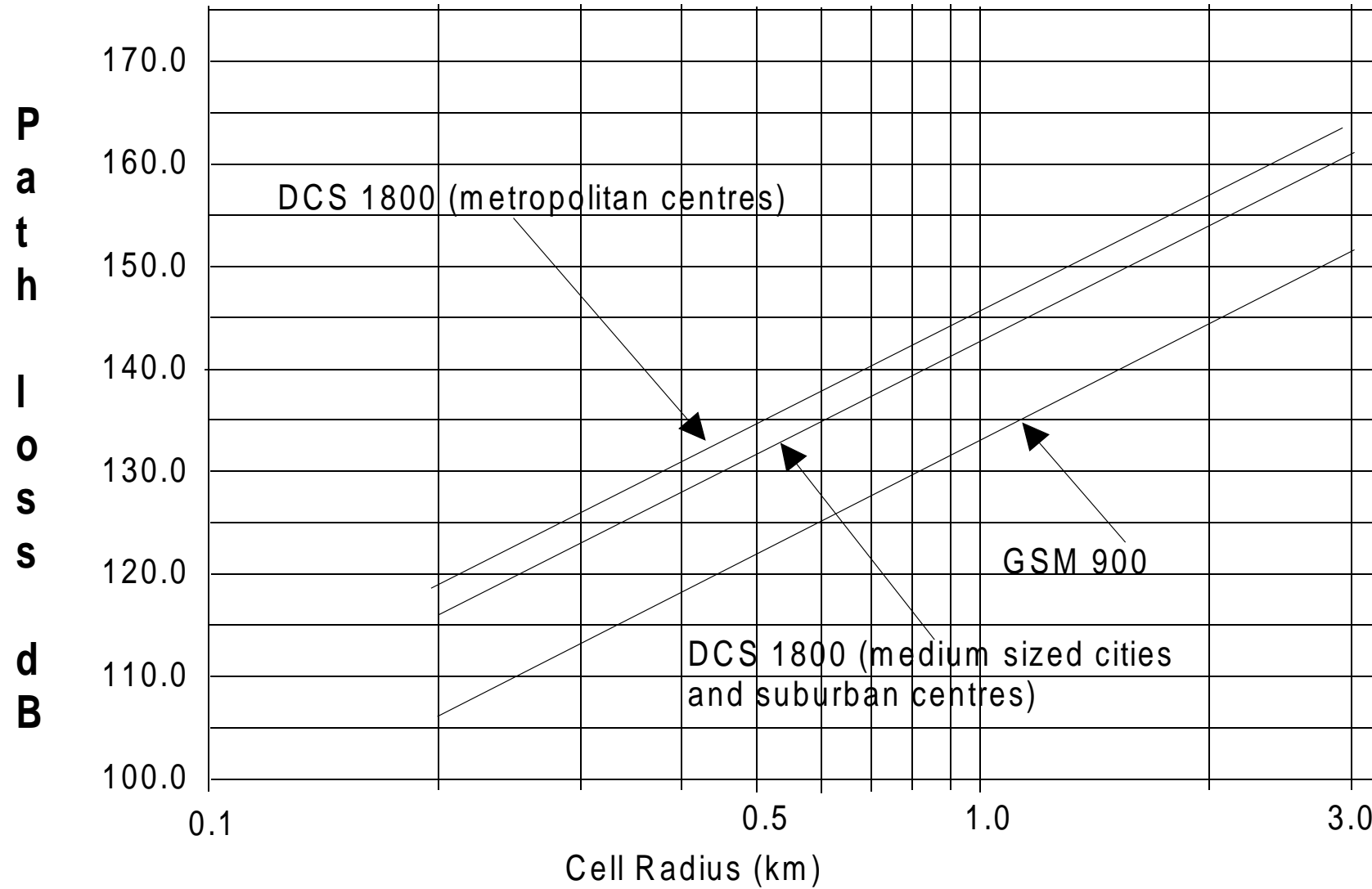

Figure 4: Path loss vs Cell Radius for small cells (see section 3.4.2)

Annex D: Planning Guidelines for Repeaters

D.1 Introduction

Repeaters can be used to enhance network coverage in certain locations. This annex provides guidelines for the design and installation of repeaters as network infrastructure elements. It covers both in building and outdoor applications. The principles within it may also form a basis for the design of repeaters for other applications within the system.

D.2 Definition of Terms

The situation where two BTSs and two MSs are in the vicinity of a repeater is shown in figure 5 below. BTS_A and MS_A belong to operator A and BTS_B and MS_B belong to a different operator, operator B.

When planning repeaters, operators should consider the effects of the installation on both co-ordinated and uncoordinated operators. In the following sections, it is assumed that in the uncoordinated scenario, the repeater is planned and installed only for the benefit of operator A. Operator A is therefore, co-ordinated and operator B uncoordinated.

In certain situations, operators may agree to share repeaters. Under these conditions, the repeater is planned and installed to provide benefit to all co-ordinated operators. If all operators within the GSM or DCS bands share a repeater, only the co-ordinated scenario exists.

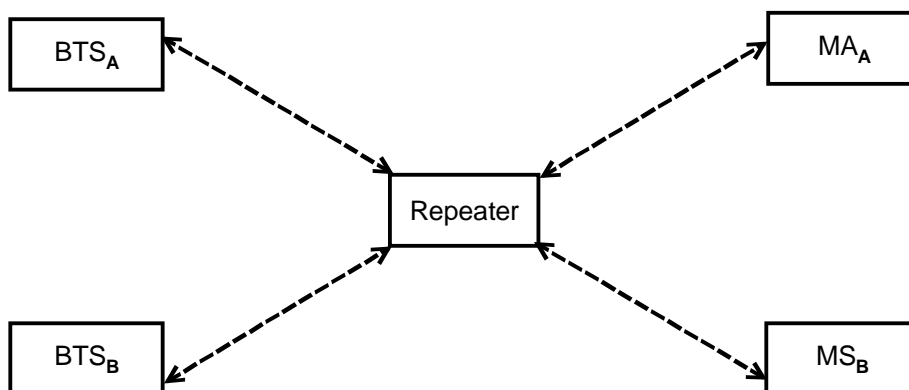

Figure 5: Repeater Scenario for two BTSs and two MSs

The following abbreviations are used in this annex:

G	Repeater Gain
PBTS	BTS Output Power (in dBm)
PMS	MS Output Power (in dBm)
PmaxDL	Maximum Repeater Downlink Output Power (in dBm)
PmaxUL	Maximum Repeater Uplink Output Power (in dBm)
NDL	Repeater Downlink Noise Output in RX bandwidth (in dBm)
NUL	Repeater Uplink Noise Output in RX bandwidth (in dBm)
SMS	MS Reference Sensitivity (in dBm)
SBTS	BTS Reference Sensitivity (in dBm)
C/Ic	Carrier to Interference ratio for cochannel interference
CL1	BTS to Repeater Coupling Loss (terminal to terminal)
CL2	Repeater to MS Coupling Loss (terminal to terminal)
CL3	The measured or estimated out of band coupling loss between a close coupled communication system and the repeater (terminal to terminal)
M	Number of carriers amplified by repeater

Gsys	The out of band repeater gain plus the gain of the external repeater antenna less the cable loss to that antenna.
Gcom_3	The antenna gain of a close coupled communications system.
Ms	A safety margin for equipment used inside public buildings which should include the height gain of the external repeater antenna plus, if appropriate, the out of band building penetration loss.

D.3 Gain Requirements

The uplink and downlink gains should be such as to maintain a balanced link. The loss of diversity gain in the uplink direction may need to be considered.

The gain of the repeater within its operating band should be as flat as possible to ensure that calls set up on a BCCH at one frequency can be maintained when the TCH is on a different frequency.

The gain should be at least 15 dB smaller than the isolation between the antenna directed towards the BTS and the antenna directed towards the MSs, in order to prevent self oscillation. It is recommended to measure the isolation before installation of the repeater.

Within the GSM/DCS1800 bands, but outside of the repeater operating range of frequencies, the installation of the repeater should not significantly alter the cellular design of uncoordinated operators. In the uncoordinated scenario, the repeater should not:

- i) amplify downlink signals from another operator such that MSs of that operator within a reasonable distance of the repeater select a remote cell amplified by the repeater as opposed to the local cell of that operator.
- ii) amplify uplink signals from other operators' MSs within a reasonable distance of that repeater and transmit them in such a direction as to cause more interference to other BTSs of that operator than other MSs in the area.

For equipment used in public buildings where other communications systems could operate in very close vicinity (less than [5]m) of the repeater antennas, special care must be taken such that out of band signals are not re-radiated from within the building to the outside via the repeater system and vice versa. When using repeaters with an antenna mounted on the outside of the building, the effect of any additional height should be considered. If the close coupled communication system is usually constrained within the building, it may be necessary to consider the negation of building penetration loss when planning the installation. It is the operators responsibility to ensure that the out of band gain of the repeater does not cause disruption to other existing and future co-located radio communication equipment. This can be done by careful choice of the repeater antennas and siting or if necessary, the inclusion of in-line filters to attenuate the out of band signals from other systems operating in the close vicinity of the repeater.

The following equation can be used to ensure an adequate safety margin in these cases:

$$G_{sys} < G_{com_3} + CL_3 - M_s \quad (D.3.1)$$

Where G_{com_3} is not known, a value of 2 dBi should be used.

Where M_s is not known a value of 15 dB should be used.

D.4 Spurious/Intermodulation Products

When planning repeaters, operators should ensure that during operation, the spurious and intermodulation products generated by the repeater at uncoordinated frequencies are less than the limits specified in GSM 05.05.

At co-ordinated frequencies, the intermodulation attenuation of the repeater in the GSM/DCS bands should be greater than the following limits:

$$IM3 \text{ attenuation}_{DL} \geq C/I_c + \text{BTS power control range} \quad (D.4.1)$$

$$IM3 \text{ attenuation}_{UL} \geq P_{maxUL} - SB_{TS} + C/I_c - CL_1 \quad (D.4.2)$$

These limits apply in all cases except for initial random access bursts amplified by a repeater.

D.5 Output Power/Automatic Level Control (ALC)

The maximum repeater output power per carrier will be limited by the number of carriers to be enhanced and the third order intermodulation performance of the repeater. Operators should ensure that the requirements of section D.4 are met for the planned number of active carriers, the output power per carrier, and the repeater implementation.

The number of simultaneously active carriers to be enhanced may be different in the uplink and downlink directions.

When designing ALC systems, the following should be considered:

- i) When the ALC is active because of the close proximity of a particular MS, the gain is reduced for all MSs being served by the repeater, thereby leading to a possible loss of service for some of them. The operating region of the ALC needs to be minimized to reduce the probability of this occurrence.
- ii) The response of the ALC loop needs careful design. The ALC should not result in a significant distortion of the power/time profile of multiple bursts.
- iii) The ALC design should handle the TDMA nature of GSM signal so that it shall be effective for SDCCH and TCH transmissions with and without DTX.
- iv) The ALC may not operate quickly enough to cover the initial random access bursts sent by MSs. The intermodulation product requirement listed in section D.4 need not apply for these transient bursts.
- v) The ALC must have sufficient dynamic range to ensure that it maintains an undistorted output at the specified maximum power level when a fully powered-up MS is at the CL2min coupling loss.
- vi) In a non-channelized repeater the ALC will limit the total output power (i.e. peak of the sum of powers in each carrier). In most cases, the maximum ALC limit should be 3 dB above the power per carrier for two carriers whose third order intermodulation products just meet the requirements of section 4. When more than two carriers are simultaneously amplified, a higher limit may be employed provided the operator ensures that worst case intermodulation products meet the requirements of section D.4.

D.6 Local oscillator sideband noise attenuation

A local oscillator of a heterodyne type repeater with high sideband noise can cause a problem in uncoordinated scenarios. If the receive level from an uncoordinated MS is significantly higher than the receive level from the co-ordinated MS, both signals can be mixed with approximately the same level into the same IF, degrading the performance of the wanted signal.

To avoid this, an IF type repeater equipped with a local oscillator should have a sideband noise attenuation at an offset of 600 kHz from the local oscillator frequency given by the equation:

$$\text{Sideband noise attenuation} = \text{CL2max} - \text{CL2min} + C/Ic \quad (\text{D.6.1})$$

D.7 Delay Requirements

The ability of the MS to handle step changes in the time of arrival of the wanted signal is specified in GSM 05.05. When planning repeaters for contiguous coverage with other infrastructure elements, it is recommended that the additional delay through the repeater does not exceed the performance of the MS.

The additional delay through the repeater should not cause a problem except in extreme multipath propagation conditions.

The delay of the repeater will reduce the range of the cell in the area enhanced by the repeater. A delay of 8 microseconds is equivalent to a range reduction of 2.4 km.

D.8 Wideband Noise

Wideband noise is a problem for uncoordinated scenarios. The noise level at the uncoordinated operators' frequencies needs to be such that an uncoordinated MS or BTS in the vicinity of the repeater is not desensitized as a result. The following equations provide the maximum noise output by the repeater in the receiver bandwidth for the downlink and uplink:

$$NDL \leq SMS - C/Ic + CL2Bmin \quad (D.8.1)$$

$$NUL \leq SBTS - C/Ic + CL1Bmin \quad (D.8.2)$$

In co-ordinated scenarios, the maximum noise output by the repeater in the receiver bandwidth for the downlink direction is:

$$NDL \leq PmaxDL - BTS \text{ power control range} - C/Ic \quad (D.8.3)$$

D.9 Outdoor Rural Repeater Example

D.9.1 Rural repeater example for GSM 900

Rural repeaters are used to enhance areas of poor coverage due to terrain limitations. The repeater is located where a suitable signal strength can be received from the donor BTS. Typical signal levels received from the BTS at the input port to the repeater are in the range -50 to -70 dBm. This figure includes the height advantage and the gain of the antenna directed towards the BTS. The received signal is amplified and retransmitted towards the area of poor coverage.

Figure 6 shows typical signal levels in the uplink and downlink directions. Two limiting cases for the MS to repeater coupling loss are shown. A diversity gain of 3 dB is assumed at the BTS making the effective reference sensitivity level -107 dBm.

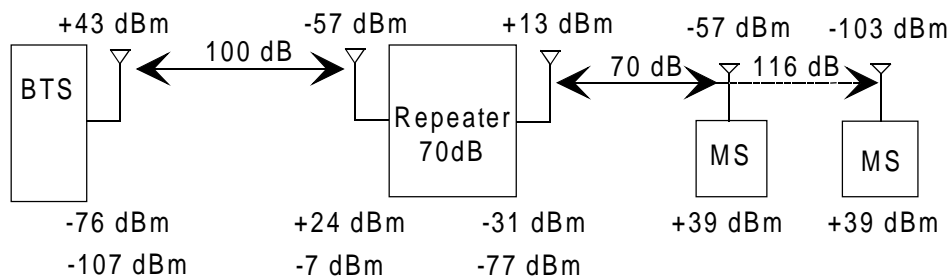

Figure 6: Uplink and downlink signal levels for a rural repeater

The minimum coupling loss between the MS and the repeater is assumed to be 70 dB.

D.9.1.1 Intermodulation products/ALC setting

In this example an amplifier with a third order intercept (P_{TOI}) of +50 dBm is assumed.

The setting of the ALC for the two tone case is governed by the following equation (in dB):

$$P_{ALC} = (2 P_{TOI} + IM_3)/3 + 3 \quad (D.9.1.1)$$

where IM_3 is the limit specified in GSM 05.05. The inclusion of factor of 3 dB is described in section D.5.

$$P_{ALC} = 24.3 \text{ dBm.}$$

Dependent on manufacturer guide-lines, the ALC setting may need to be reduced if many carriers are passing through the repeater.

In this example, the ALC is unlikely to be activated on the downlink. It could do so in applications with smaller BTS to repeater coupling loss.

On the uplink, the ALC is activated when the MS is transmitting at full power, at the minimum coupling loss. The repeater gain is reduced so that the output power is limited to 24 dBm. This gain reduction may degrade the service given to other MSs served by the repeater until the BTS power control algorithm has reduced the MS output power.

D.9.1.2 Wideband noise

Wideband noise needs to be considered for both the uplink and the downlink for uncoordinated scenarios.

A 70 dB coupling loss is assumed between the repeater and the uncoordinated MS and the repeater and the uncoordinated BTS. Then, using equations D.8.1 and D.8.2, the maximum noise power output is given by:

$$N_{DL} = N_{UL} = -104 - 9 + 70 = -43 \text{ dBm}$$

The maximum noise figure required to achieve this noise level in both the uplink and down link directions is given by the following equation:

$$F \leq N - G - kT - B$$

$$\leq -43 - 70 - (-174) - 53$$

$$\leq 8 \text{ dB}$$

where F is the noise figure, N is the maximum noise level, G is the gain, kT is equal -174 dBm/Hz and B is the bandwidth conversion factor equal to 53 dB.

D.10 Indoor Low Power Repeater Example

D.10.1 Indoor repeater example for DCS 1800

Indoor repeaters are used to compensate for the losses associated with building attenuation.

The signal level received from the BTS at the input port to the repeater is typically in the range -60 to -80 dBm. This figure includes the height advantage of placing an antenna on the roof of the building and the gain of the antenna directed towards the BTS.

Figure 7 shows typical signal levels in the uplink and downlink directions. Two limiting cases for the MS to repeater coupling losses are shown.

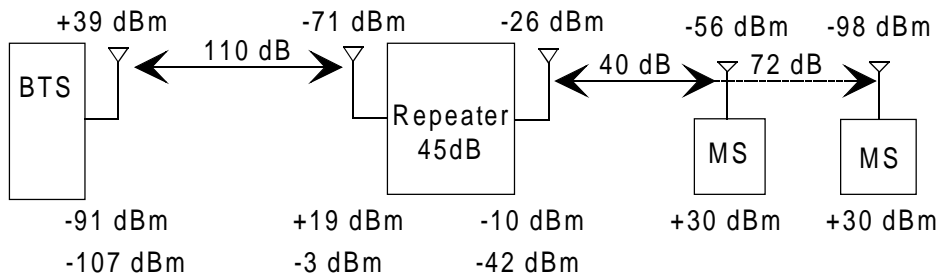

Figure 7: Uplink and downlink signal levels for indoor repeater

The minimum coupling loss between the MS and the repeater is assumed to be 40 dB.

D.10.1.1 Intermodulation products/ALC setting.

Indoor repeaters are likely to be small low cost devices. Consequently, for indoor repeaters, the intermodulation performance is not as good as a rural repeater. In this example, an amplifier with a third order intercept (P_{TOI}) of +40 dBm is assumed.

For P_{TOI} equal to 40 dBm and IM_3 equal to -30 dBm, then using equation D.9.1.1:

$$P_{ALC} = 19.7 \text{ dBm.}$$

On the uplink, the ALC is activated when the MS is transmitting at full power, at the minimum coupling loss. The repeater gain is reduced so that the output power is limited to 19 dBm. The received signal level at the BTS of -91 dBm is likely to be below the desired level which the MS power control algorithm seeks to maintain. Therefore, the MS is likely to remain powered up and the ALC will remain in operation continuously. Since, there is likely to be only one simultaneous user of this type of repeater, this is normally acceptable.

D.10.1.2 Wideband noise

Assuming a minimum coupling loss between the repeater and an unco-ordinated BTS of 65 dB, and between the repeater and an uncoordinated MS of 40 dBm, the following maximum noise levels are obtained using equations D.8.1 and D.8.2.

$$N_{DL} = -100 - 9 + 40 = -69 \text{ dBm}$$

$$N_{UL} = -104 - 9 + 65 = -48 \text{ dBm}$$

The uplink noise level is easy to achieve in view of the low gain. The maximum noise figure required to achieve this noise level in down link directions is given by the following equation:

$$F \leq N - G - kT - B$$

$$\leq -69 - 40 - (-174) - 53$$

$$\leq 12 \text{ dB}$$

where F is the noise figure, N is the maximum noise level, G is the gain, kT is equal -174 dBm/Hz and B is the bandwidth conversion factor equal to 53 dB.

D.11 Example for a Repeater System using Frequency Shift

D.11.1 Example for GSM 900

Repeaters are used to enhance areas of poor coverage due to terrain limitations. The useable gain in an installation with a normal repeater is in generally limited in order to keep the repeater gain with a margin of 15 dB below the coupling of donor antenna and coverage antenna. Repeater systems using frequency shift relax the limitation in the usable gain of a normal repeater, due to different frequencies of the output signal and input signal.

The repeater system consist of a master unit close to the BTS and at least one remote unit close to the area to be covered. The master unit amplifies the signals from the BTS and shifts them to other GSM channels called link channels in the allocated band of the operator. In the remote unit the link channels will be transferred to the original channels and amplified. A mobile station in the coverage area of the remote unit will detect the signals having passed the repeater system without any difference to a signal directly received from a BTS but the additional delay. The uplink channel settings of the repeater system follow exactly the settings of the downlink channels for the link path. Thus an uplink signal from a mobile in the coverage area of the repeater system will be received on its expected frequency by the BTS. Through application of sideband inversion technique on the downlink signals the BCCH cannot be decoded by a MS located between the master unit and the remote unit.

The master unit of the repeater system is located in the vicinity of a donor BTS with a relatively low coupling path loss of typically 30 dB to 60 dB. The downlink amplification is adjusted to the lowest necessary value in order to reduce the transmitted signal strength on the link channels of the master unit output.

As a consequence of the high gain of the remote unit of the repeater system the distance to the master unit can be relatively high while the desired output power level is still maintained. The link path loss may vary up to 90 dB depending on the maximum gain of the remote unit. Oscillation of the repeater units is suppressed due to the shift between input and output frequencies and the decoupling between coverage antenna and link antenna can be lower than the actual gain set in the remote unit. Therefore the effort for the installation at the remote unit location does not exceed the normal level.

Figure 8 shows typical signal levels in the uplink and downlink directions. Two cases with maximum coupling loss of 135 dB and an assumed minimum coupling loss of 70 dB for the MS to repeater path are shown.

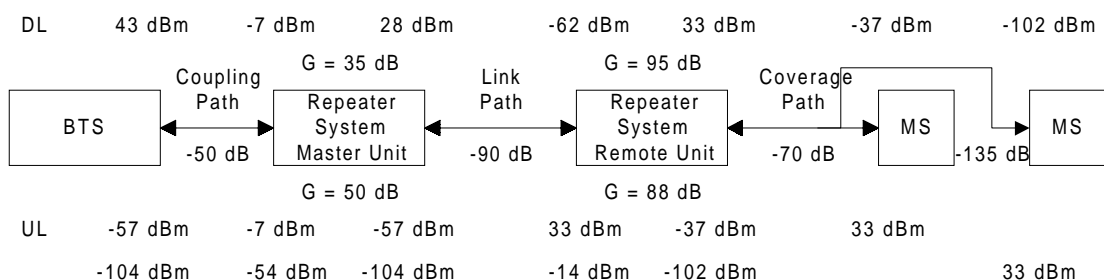

Figure 8: Uplink and downlink signal levels for a repeater system using frequency shift

D.11.1.1 Intermodulation products/ALC setting and levelling criteria

In this example a repeater system with separate amplifier chain for each GSM channel is used. Thus a multiple carrier operation does not have an impact on the ALC settings in order to keep intermodulation products low as described in subchapter D.9.1.1.

On the uplink, the ALC will be activated when the MS is transmitting at full power, at the minimum coupling loss of 70 dB. The repeater gain is reduced in this example by the ALC setting which is assumed to an output power of 33 dBm. This gain reduction may degrade the service given to other MSs served by the repeater until the BTS power control algorithm has reduced the MS output power.

In addition to the definitions in subchapter D.2 the following term are used:

- GMU(DL,UL) Gain of master unit of repeater system in the downlink or uplink path
- GRU(DL,UL) Gain of remote unit of repeater system in the downlink or uplink path
- GTOT(DL,UL) Gain of the complete repeater system in one path calculated from BTS to remote unit repeater in the downlink or uplink path
- FTOT(UL) Noise figure of the complete repeater system including link path in the uplink path
- FMU(UL) Noise figure of the master unit of the repeater system in the uplink path
- FRU(UL) Noise figure of the remote unit of the repeater system in the uplink path
- CL2max Maximum Coupling loss between MS and repeater system
- CL(MU<->RU) Coupling loss between master unit and remote unit
- PRUmax(DL) Maximum output power of the remote unit in the downlink
- Mn Margin between repeater system output noise level at the BTS and equivalent input noise level of the BTS. This is a positive value if the repeater noise is lower.
- NTOT Noise level of repeater system at BTS input.

As an example for the leveling of a repeater system using frequency shift see figure 8.

Downlink levelling:

In the downlink path it is intended to have a certain signal level retransmitted from the remote unit for coverage purposes. Thus the leveling of the repeater system is determined by the formula:

$$GRU(DL) = PRU_{max}(DL) + CL(MU \leftrightarrow RU) + CL1 - PBTS - GMU(DL)$$

In an installation the values for the coupling losses have to be measured. The remaining variable GMU(DL) has to be adjusted such, that the output power of the downlink signals of the master unit is as low as possible without danger of being interfered at the remote unit location.

Uplink levelling:

The adjustment of the uplink path gain is determined by the two demands: first the downlink and uplink path have to be balanced. Second, the receiver input shall not be desensitised by the repeater noise. The uplink gain between remote unit input and BTS input is

$$GTOT(UL) = SBTS - PMS + CL2_{max} = GRU(UL) + GMU(UL) - CL(MU \leftrightarrow RU) - CL1,$$

which can be transformed to

$$GRU(UL) = SBTS + CL1 + CL(MU \leftrightarrow RU) + CL2_{max} - PMS - GMU(UL).$$

This gives a relation for the gain setting of the remote unit with respect to the gain setting of the master unit when all coupling losses are determined. A further criteria for the leveling of the uplink is the total noise figure of the repeater system. In order to obtain a value close to the remote unit noise figure, the gain setting of the single repeater unit shall not be much lower than the path loss its output signal has to bridge.

A desensitisation of the BTS will be prevented by keeping the uplink gain of the single repeater units close to the value of the path loss to be bridged. The noise at the BTS receiver input can be calculated from the total noise figure of the repeater system:

$$FTOT(\text{lin}) = FRU(UL, \text{lin}) + (FMU(UL, \text{lin}) - 1) / (GRU(UL, \text{lin}) * CL(MU \leftrightarrow RU, \text{lin})).$$

The variables marked by lin are linear and thus not logarithmic values. The noise at the BTS receiver input at room temperature for a given bandwidth of a GSM channel results in:

$$NTOT = FTOT + GTOT(UL) + kT + B = FTOT + GTOT(UL) + (-174) + 53$$

This noise level has to be smaller than the equivalent noise at the receiver input:

$$NTOT \leq SBTS - C/I_c - M_n = SBTS - 9\text{dB} - 3\text{dB}$$

A noise margin M_n equal to 3 dB is assumed. With a sensitivity of $SBTS = -104$ dBm the noise level of $NTOT = -116$ dBm should not be exceeded.

D.11.1.2 Wideband noise

The repeater system using frequency shift is supposed to operate with dedicated channelised amplifiers. Therefore the uncoordinated scenario does not apply.

D.11.1.3 Multipath environment

Regions with strong multipath signals of direct signals from the BTS and delayed signals from the repeater system of nearly equal level should be avoided. One method to achieve this can be a coupling of the master unit of the repeater system to the BTS sector directed to the counterside of the area to be covered by the repeater system. Furthermore the geographic situation may prevent as well the occurrence of such strong multipath areas, so that as well omnidirectional cells as donor cells can be possible.

Annex E: Document change history

SPEC	SMG#	CR	PHASE	VERS	NEW_VERS	SUBJECT
03.30	s25	A003	R97	5.0.0		Repeater Systems using Frequency Shift
03.30	s26	A003	R97	5.0.0	6.0.0	Repeater systems using Frequency Shift

History

Document history		
V6.0.1	July 1998	Publication