



TECHNICAL
BASIS for
REGULATION

DRAFT
pr **TBR 25**

August 1995

Source: ETSI TC-BTC

Reference: DTBR/BTC-02060

ICS: 30.040.40

Key words: leased line, terminal equipment, interface

**Business TeleCommunications (BTC);
140 Mbit/s digital unstructured and structured leased lines
(D140U and D140S);
Attachment requirements for terminal equipment interface**

ETSI

European Telecommunications Standards Institute

ETSI Secretariat

Postal address: F-06921 Sophia Antipolis CEDEX - FRANCE

Office address: 650 Route des Lucioles - Sophia Antipolis - Valbonne - FRANCE

X.400: c=fr, a=atlas, p=etsi, s=secretariat - **Internet:** secretariat@etsi.fr

Tel.: +33 92 94 42 00 - Fax: +33 93 65 47 16

Copyright Notification: No part may be reproduced except as authorized by written permission. The copyright and the foregoing restriction extend to reproduction in all media.

© European Telecommunications Standards Institute 1995. All rights reserved.

Contents

Foreword	5
Introduction	5
1 Scope	7
2 Normative references	7
3 Definitions, symbols and abbreviations	8
3.1 Definitions	8
3.2 Symbols	8
3.3 Abbreviations	8
4 Requirements	9
4.1 Mechanical characteristics	9
4.2 Electrical characteristics	10
4.2.1 Output port	10
4.2.1.1 Signal coding	10
4.2.1.2 Waveform shape	10
4.2.1.3 Output timing	12
4.2.1.4 Output jitter	12
4.2.1.5 Output frame structure	13
4.2.2 Input port	13
4.3 Safety	14
4.4 Overvoltage protection	14
4.5 ElectroMagnetic Compatibility (EMC)	14
Annex A (normative): Test methods	15
A.1 General	15
A.1.1 Equipment connection	15
A.1.2 Test environment	15
A.2 Test methods	16
A.2.1 Signal coding at the output port	16
A.2.2 Waveform shape at the output port	16
A.2.3 Output timing	17
A.2.4 Output jitter	18
A.2.5 Frame structure	19
Annex B (normative): Definition of CMI code	20
B.1 General	20
B.2 Definition	20
Annex C (normative): Definition of frame structure	21
C.1 Frame structure at 139 264 kbit/s	21
Annex D (normative): TBR Requirements Table (TBR-RT)	22
Annex E (informative): Bibliography	23
History	24

Blank page

Foreword

This draft Technical Basis for Regulation (TBR) has been produced by the Business Telecommunications (BTC) Technical Committee, in conjunction with the Terminal Equipment (TE) and Transmission and Multiplexing (TM) Technical Committees, of the European Telecommunications Standards Institute (ETSI), and is now submitted for the Public Enquiry phase of the ETSI standards approval procedure.

This TBR resulted from a mandate from the Commission of the European Community (CEC) to provide harmonised standards for the support of the Second Phase Directive (91/263/EEC).

This TBR is based on information from ITU-T Recommendations and ETSI publications and the relevant documents are quoted where appropriate.

Introduction

The Council Directive on the application of Open Network Provision (ONP) to leased lines (92/44/EEC) concerns the harmonisation of conditions for open and efficient access to, and use of, the leased lines provided over public telecommunications networks, and the availability throughout the European Community (EC) of a minimum set of leased lines with harmonised technical characteristics.

At the date of publication of this TBR, the 140 Mbit/s unstructured and structured leased lines are not part of the minimum set of leased lines under the Leased Line Directive and it is not planned that they will be added to the minimum set.

Two classes of standard will be used for the interfaces of terminal equipment designed for connection to the ONP leased lines. European Telecommunications Standards (ETSS), which are voluntary, give the full technical specifications for these interfaces, whereas TBRs give the essential requirements under the Second Phase Directive (91/263/EEC) for attachment to the leased lines. This TBR is a subset of the corresponding prETS 300 690.

ETS 300 166 and CCITT Recommendations G.703 are used as the basis for the terminal equipment interface.

Blank page

1 Scope

This TBR specifies the attachment requirements and the corresponding conformance tests for a terminal equipment interface for:

- connection to the Network Termination Points (NTPs) of 139 264 kbit/s Digital Unstructured leased lines (D140U); and
- connection to the NTPs of 139 264 kbit/s Digital Structured leased lines (D140S) with an information transfer rate of 138 240 kbit/s without restriction on binary content.

These leased lines are defined in prETS 300 686 and prETS 300 688.

The term "attachment requirements" in the context of this TBR refers to the essential requirements for access that apply under articles 4d and 4f of the Second Phase Directive (91/263/EEC). Conformance to these requirements does not guarantee end-to-end interoperability. Essential requirements under articles 4c and 4e are not applicable to this TBR.

This TBR is applicable to all interfaces intended for connection to the D140U or D140S leased line. It covers the essential requirements for the mechanical and electrical characteristics of the terminal equipment interface. Interfaces intended only for connection to the D140U leased lines which do not comply with the specified requirements on output structure, do not satisfy the attachment requirements for connection to the D140S structured leased line.

Customer premises wiring and installation between the terminal equipment and the NTP are outside the scope of this TBR.

2 Normative references

This TBR incorporates by dated or undated reference, provisions from other publications. These references are cited at the appropriate places in the text and the publications are listed hereafter. For dated references, subsequent amendments to, or revisions of any of these publications apply to this TBR only when incorporated into it by amendment or revision. For undated references the latest edition of the publication referred to applies.

- [1] CCITT Recommendation G.703 (1991): "Physical/electrical characteristics of hierarchical digital interfaces".
- [2] CCITT Recommendation O.151 (1992): "Error performance measuring equipment for digital systems at the primary rate and above".
- [3] CCITT Recommendation O.171 (1992): "Timing jitter measuring equipment for digital systems".

NOTE: This TBR also contains a number of informative references which have been included to indicate the sources from which various material has been derived, hence they do not have an associated normative reference number. Details of these publications are given in annex E. In some cases the same publication may have been referenced in both a normative and an informative manner.

3 Definitions, symbols and abbreviations

3.1 Definitions

For the purposes of this TBR, the following definitions apply:

frame: A repetitive set of consecutive bits in which the position of each bit can be identified by reference to a frame alignment signal.

frame alignment signal: The distinctive signal inserted in every frame always occupying the same relative position within the frame and used to establish and maintain frame alignment.

leased lines: The telecommunications facilities provided by a public telecommunications network that provide defined transmission characteristics between network termination points and that do not include switching functions that the user can control (e.g. on-demand switching).

Network Termination Point (NTP): All physical connections and their technical access specifications which form part of the public telecommunications network and are necessary for access to and efficient communication through that public network.

Safety Extra-Low Voltage (SELV) circuit: A secondary circuit which is so designed and protected that under normal and single fault conditions, the voltage between any two accessible parts and, for class 1 equipment, between any accessible part and the equipment protective earthing terminal does not exceed a safe value (subclause 1.2.8.5 of EN 60950).

terminal equipment: Equipment intended to be connected to the public telecommunications network, i.e.:

- to be connected directly to the termination of a public telecommunication network; or
- to interwork with a public telecommunications network being connected directly or indirectly to the termination of a public telecommunications network,

in order to send, process, or receive information.

3.2 Symbols

None

3.3 Abbreviations

For the purposes of this TBR, the following abbreviations apply:

ac	alternating current
BNC	Bayonet Nut Connector
CMI	Coded Mark Inversion
D140S	140 Mbit/s Digital Structured leased line
D140U	140 Mbit/s Digital Unstructured leased line
dc	direct current
EMC	ElectroMagnetic Compatibility
FA1	Frame Alignment byte 1
FA2	Frame Alignment byte 2
LSB	Least Significant Bit
MSB	Most Significant Bit
NTP	Network Termination Point
ONP	Open Network Provision
ppm	parts per million
PRBS(2 ²³ -1)	Pseudo Random Bit Sequence as defined in subclause 2.2 of CCITT Recommendation O.151 [2]
RX	RX is a signal input (at either the terminal equipment or the test equipment, see figure 1)
SELV	Safety Extra-Low Voltage
TBR-RT	TBR-Requirements Table

TX TX is a signal output (at either the terminal equipment or the test equipment, see figure 1)
 UI Unit Interval

4 Requirements

The terminal equipment is for use with D140U or D140S leased lines.

The D140U 139 264 kbit/s unstructured leased line provides a bidirectional point-to-point digital connection with an information transfer rate of 139 264 kbit/s without restriction on binary content. Any structuring of the data is the responsibility of the user.

The D140S 139 264 kbit/s structured leased line provides a bidirectional point-to-point digital connection with an information transfer rate of 138 240 kbit/s without restriction on binary content. Any structuring of the data within the transparent 138 240 kbit/s part of the frame is the responsibility of the user.

For both D140U and D140S the provision of timing is the responsibility of the user; however, in certain installations the leased line provider may be able to offer a leased line that is synchronised to the network.

4.1 Mechanical characteristics

Justification: Without a means of connection, it is impossible for the terminal equipment to connect to the network, therefore this is included in order for the terminal equipment to interwork with the network (article 4f).

Requirement: The terminal equipment interface shall provide two coaxial 75 Ω connectors, one each for transmit and receive. The outer conductor of the output connector shall be connected to signal ground.

There is no requirement under this TBR for a particular plug or socket to be provided on the terminal equipment.

NOTE 1: prETS 300 690 specifies that the terminal equipment shall provide either:

- two coaxial sockets, one each for transmit and receive; these sockets being either 75 Ω Bayonet Nut Connector (BNC) sockets or 75 Ω sockets of the type specified in IEC 169-13; or
- two coaxial plugs at the end of a cord (or cords), one each for transmit and receive; these plugs being either 75 Ω BNC plugs or 75 Ω plugs of the type specified in IEC 169-13.

NOTE 2: The transmit pair is the output from the terminal equipment interface. The receive pair is the input to the terminal equipment interface, as shown in figure 1. Where the terms "output" and "input" are used without qualification in this TBR, they refer to the terminal equipment interface.

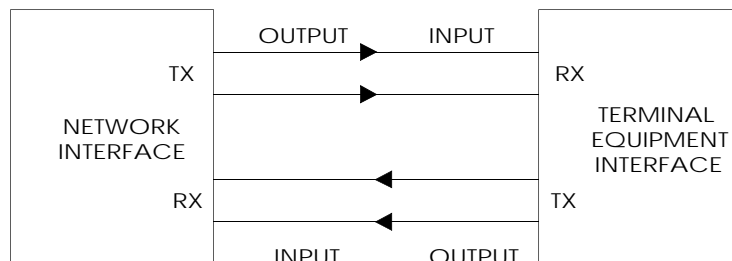

Figure 1

Test: There shall be a visual inspection that two 75 Ω connectors are provided.

4.2 Electrical characteristics

4.2.1 Output port

4.2.1.1 Signal coding

Justification: The correct signal coding is necessary for the output signals from the terminal equipment to be recognised correctly at the input to the NTP. Failure to provide the correct coding may cause error reports within the network. A requirement on signal coding is therefore included in order to prevent harm to the network (article 4d).

Requirement: The signal transmitted at the output port shall comply with the Coded Mark Inversion (CMI) encoding rules (see annex B).

Test: The test shall be conducted according to subclause A.2.1.

4.2.1.2 Waveform shape

Justification: The correct waveform shape both limits the voltages to line and ensures correct recognition of the pulses. Incorrect recognition of pulses may cause error reports within the network. A requirement on waveform shape is therefore included in order to prevent harm to the network (article 4d).

Requirement: The pulse at the output port shall comply with the requirements given in figures 2 and 3 and table 1; based on CCITT Recommendation G.703.

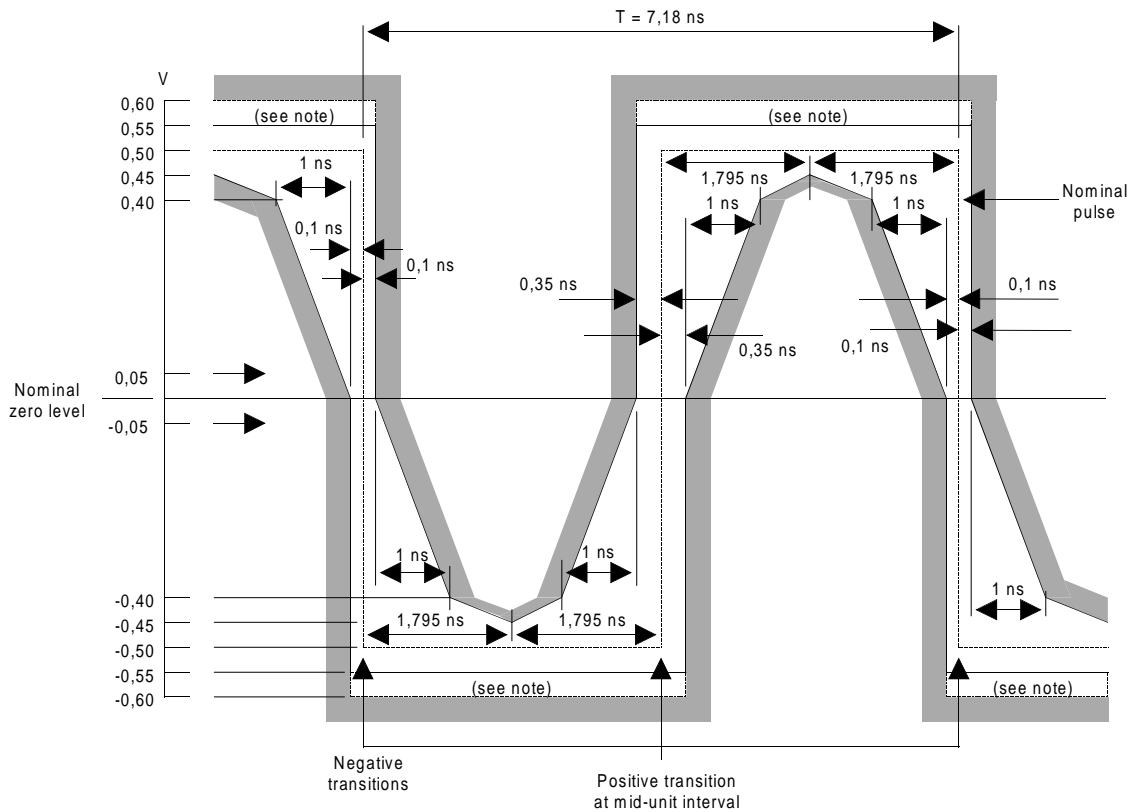

NOTE: The maximum "steady state" amplitude shall not exceed the 0,55 V limit. Overshoots and other transients are permitted to fall into the dotted area, bounded by the amplitude levels 0,55 V and 0,60 V, provided they do not exceed the steady state level by more than 0,05 V.

Figure 2: Mask of a pulse corresponding to a binary 0

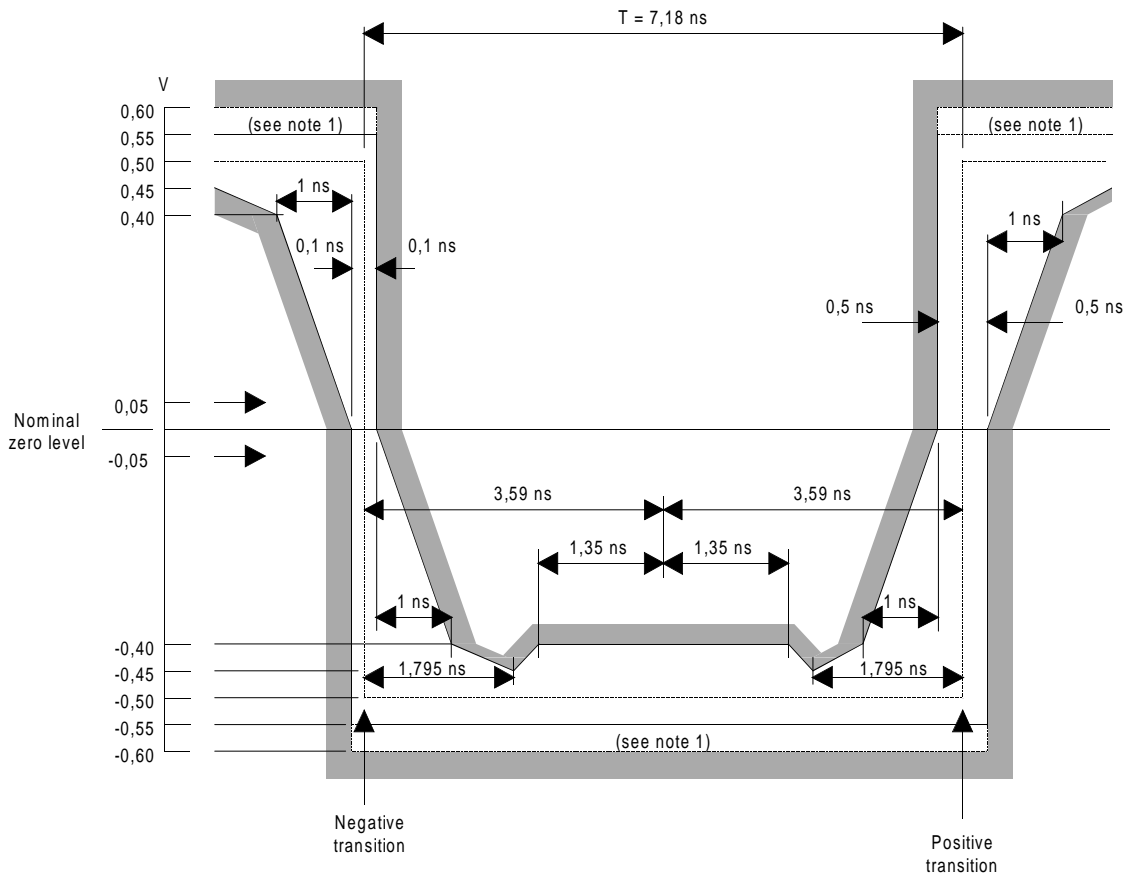

NOTE 1: The maximum "steady state" amplitude shall not exceed the 0,55 V limit. Overshoots and other transients are permitted to fall into the dotted area, bounded by the amplitude levels 0,55 V and 0,60 V, provided they do not exceed the steady state level by more than 0,05 V.

NOTE 2: The inverse pulse shall have the same characteristics, noting that the timing tolerance at the level of the negative and positive transitions are $\pm 0,1$ ns and $\pm 0,5$ ns respectively.

Figure 3: Mask of a pulse corresponding to a binary 1

Table 1: Waveform shape at output port

Pulse shape	Nominally rectangular and conforming with the masks shown in figures 2 and 3.
Test load impedance	75 Ω non-reactive
Peak to peak voltage	1,0 \pm 0,1 V
Rise time between 10 % and 90 % amplitudes of the measured steady state amplitude	≤ 2 ns
Transition timing tolerance (referred to the mean value of the 50 % amplitude points of the negative transition)	Negative transitions: $\pm 0,1$ ns Positive transitions at unit interval boundaries: $\pm 0,5$ ns Positive transitions at mid-interval: $\pm 0,35$ ns

Test: The test shall be conducted according to subclause A.2.2.

4.2.1.3 Output timing

Justification: Pulses at the wrong bit rate may not be properly recognised and may cause error reports within the network. A requirement on output timing is therefore included in order to prevent harm to the network (article 4d).

The terminal equipment may derive its timing from:

- a) an internal source (e.g. an internal clock);
- b) an external reference signal input;
- c) the received signal at the input port.

Requirement: For each of the timing arrangements intended for use, the bit rate at the output port shall be within the limits of 139 264 kbit/s \pm 15 parts per million (ppm), when any relevant external reference signal, including the received signal at the input port, is within its stated tolerance.

Test: The test shall be conducted according to subclause A.2.3.

4.2.1.4 Output jitter

Justification: A high level of jitter causes error reports within some networks, therefore this requirement is included to prevent harm to the network (article 4d).

Requirement: The peak-to-peak output jitter shall not exceed the limits of table 2 when measured with a band pass filter with the defined cut-off frequencies. At frequencies below the lower 3 dB point, the attenuation of the high pass filter shall rise with a value greater than, or equal to, 20 dB per decade. At frequencies above the upper 3 dB point, the attenuation of the low pass filtration shall rise with a value greater than, or equal to, 60 dB per decade.

For the purpose of testing, any signal input from which the output timing is derived shall be provided with the maximum tolerable input jitter, and with the maximum tolerable input frequency deviation, as specified by the manufacturer.

Where the output timing of the terminal equipment is taken from the leased line, the input to the terminal equipment shall be provided with components of sinusoidal jitter at points on the curve of figure 4 and table 3.

Table 2: Maximum output jitter

Measurement filter bandwidth		Output jitter
Lower cut-off (high pass)	Upper cut-off (low pass)	Unit Interval (UI) peak- to-peak (maximum)
200 Hz	3 500 kHz	0,05

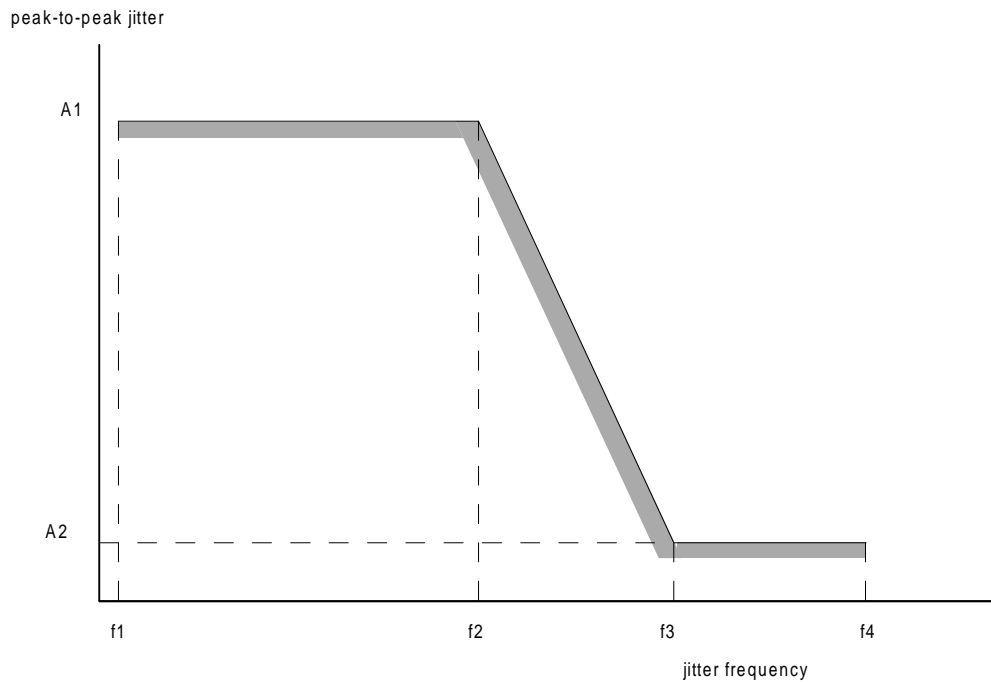

Figure 4: Input jitter tolerance

Table 3: Input jitter tolerance

Peak-to-peak amplitude (UI)		Frequency			
A1	A2	f1	f2	f3	f4
1,5	0,075	200 Hz	500 Hz	10 kHz	3 500 kHz

Test: The test shall be conducted according to subclause A.2.6.

4.2.1.5 Output frame structure

Justification: If the input bit stream to the structured leased line does not have the correct Frame Alignment bytes 1 (FA1) and Frame Alignment bytes 2 (FA2), the leased line will not be able to achieve frame alignment for the purposes of monitoring the line and may cause error reports. Therefore a requirement on the frame alignment signals is included to prevent harm to the network (article 4d).

Requirement: For terminal equipments intended for connection to the D140S structured leased line, the bit stream transmitted at the output of the terminal equipment shall be structured as defined in annex C.

Test: The test shall be conducted according to subclause A.2.5.

4.2.2 Input port

There are no requirements on the input port under this TBR.

Justification: The requirements imposed on the terminal equipment output port do not require the correct receipt of data at the terminal equipment input port. The network output port should be protected against both short circuit and open circuit. Therefore there are no requirements within the base standard prETS 300 690 that can be considered as essential requirements.

4.3 Safety

There are no safety requirements under this TBR.

NOTE: Safety requirements are imposed under the Low Voltage Directive (73/23/EEC) and articles 4a and 4b of the Second Phase Directive (91/263/EEC). prETS 300 690 subclause 4.3 defines the terminal equipment interface as an Safety Extra-Low Voltage (SELV) circuit. Detailed requirements for SELV circuits are given in EN 60950.

4.4 Overvoltage protection

There are no overvoltage protection requirements under this TBR.

NOTE: Requirements for overvoltage protection requirements on a 75 Ω interface are under study. Requirements may be added to this TBR when appropriate specifications become available.

4.5 ElectroMagnetic Compatibility (EMC)

There are no EMC requirements under this TBR.

NOTE: General EMC requirements are imposed under the EMC Directive (89/336/EEC). Requirements for conducted emissions will be added to this TBR when appropriate specifications become available if these requirements are not imposed under the EMC Directive.

Annex A (normative): Test methods

A.1 General

This annex describes the test principles to determine the compliance of a terminal equipment against the requirements of this TBR.

It is outside the scope of this TBR to identify the specific details of the implementation of the tests.

A terminal equipment may be designed for through-connecting and may fulfil the electrical requirements only if through-connected. In these cases the requirements of this TBR are valid and the tests are carried out with the through-connection terminated as specified by the equipment supplier.

Details of test equipment accuracy and the specification tolerance of the test devices are not included in all cases. Where such details are provided they shall be complied with, but the way they are expressed shall not constrain the method of implementing the test.

NOTE: Attention is drawn to the issue of measurement uncertainty which may be addressed in future documents. Not all the required test results make allowance for spurious events during testing (e.g. errors due to EMC effects), which may make it necessary to repeat a test.

The given test configurations do not imply a specific realisation of the test equipment or test arrangement, or the use of specific test devices. However any test configuration used shall provide those test conditions specified under "interface state", "stimulus" and "monitor" for each individual test.

The test equipment shall be a device, or a group of devices, generating a stimulus signal conforming to this annex and capable of monitoring the signal received from the interface.

The terminal equipment interface under test shall have the ability to transmit a bit pattern for test purposes, e.g. a Pseudo Random Bit Sequence (PRBS(2²³-1)) as defined in subclause 2.2 of CCITT Recommendation O.151 [2]). Where this cannot be provided, an alternative method of conducting the test shall be provided.

A.1.1 Equipment connection

The tests shall be applied at the sockets or plugs supplied with the terminal equipment for connection to the leased line interface. Connecting cable between the sockets and test equipment shall be kept to a minimum, except where cable is specified as part of the test.

Where plugs are provided at the end of a cord, the tests specified in subclause A.2.2 may be performed at the point of connection of the cord to the terminal equipment, since the requirements are based on CCITT Recommendation G.703 which makes no allowance for any plug and cord.

A.1.2 Test environment

All tests shall be performed at:

- an ambient temperature in the range +19 °C to +25 °C;
- a relative humidity in the range 5 % to 75 %.

For terminal equipment which is not designed to operate within the environmental range specified above, all tests shall be performed in an environmental condition as specified by the supplier.

For terminal equipment which is directly powered (either wholly or partly) from the mains supply, all tests shall be carried out with ± 5 % of the rated voltage of that supply. If the equipment is powered by other means and those means are not supplied as part of the apparatus (e.g. batteries, stabilised alternative current (ac) supplies, direct current (dc) all tests shall be carried out within the power supply limit declared by the supplier. If the power supply is ac, the test shall be conducted within ± 4 % of the rated frequency.

A.2 Test methods

One test may cover more than one requirement. The scope of each test is defined under the heading "purpose".

A.2.1 Signal coding at the output port

Purpose: To verify that the signal coding at the terminal equipment output port complies with the CMI coding rules as required by subclause 4.2.1.1.

Test configuration: Figure A.1.

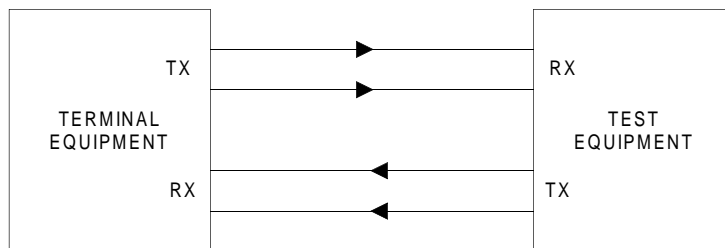

Figure A.1: Signal coding at output port

Interface state: Powered.

Stimulus: The terminal equipment shall transmit a pseudo random bit stream, e.g. PRBS($2^{23}-1$). For terminal equipment which can generate a structured signal in accordance with annex C the PRBS may be transmitted in the payload section of the frame. For terminal equipment which cannot generate such a structured signal, the PRBS should be transmitted in the whole bit stream.

Monitor: The output bit stream for a test period of sufficient time to allow transmission of 100 occurrences of the above patterns plus the latency period of the error detection mechanism.

Results: There shall be no errors in the CMI encoding.

A.2.2 Waveform shape at the output port

Purpose: To verify conformance of the output waveform shape with the requirements of subclause 4.2.1.2.

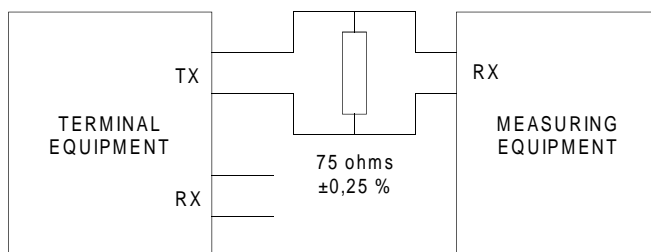

Figure A.2: Waveform shape at output port

Test configuration: Figure A.2.

Interface state: Powered.

Stimulus: Undefined.

Monitor: Marks and spaces transmitted from the NTP, measuring the amplitude and pulse shapes corresponding to binary 0 and binary 1. A bandwidth of 1 GHz or greater shall be used to ensure the capture of over or undershoot of the pulse.

The overall measurement accuracy shall be better than 30 mV. For all measurements using these masks, the signal shall be ac coupled, using a capacitor of not less than 0,01 μF , to the input of the oscilloscope (or other equipment) used for the measurement. The nominal zero for both masks shall be aligned with the oscilloscope trace with no input signal. With the signal then applied, the vertical position of the trace can then be adjusted with the objective of meeting the limits of the masks. Any such adjustment shall be the same for both masks and shall not exceed $\pm 0,05 \text{ V}$. This shall be checked by removing the input signal again and ensuring that the trace lies within $\pm 0,05 \text{ V}$ of the nominal zero level of the masks.

The masks allow for high frequency jitter caused by intersymbol interference in the output stage, but not for jitter present in the timing signal associated with the source of the interface signal.

When using an oscilloscope technique to determine pulse compliance with the mask, it is important that successive traces of the pulses overlay in order to suppress the effects of low frequency jitter. This can be accomplished by several techniques, e.g.:

- triggering the oscilloscope on the measured waveform; or
- providing both the oscilloscope and the pulse output circuits with the same clock signal.

Results: Each pulse in a coded pulse sequence shall meet the limits of the relevant mask given in figures 4 and 5, irrespective of the state of the preceding or succeeding pulses, with both pulse masks fixed in the same relation to a common timing reference, i.e. with their normal start and finish edges coincident.

The rise and decay time shall be measured between - 0,4 V and 0,4 V and shall not exceed 2 ns.

A.2.3 Output timing

Purpose: To measure the output timing as defined in subclause 4.2.1.3.

Test Configuration: Figure A.3.

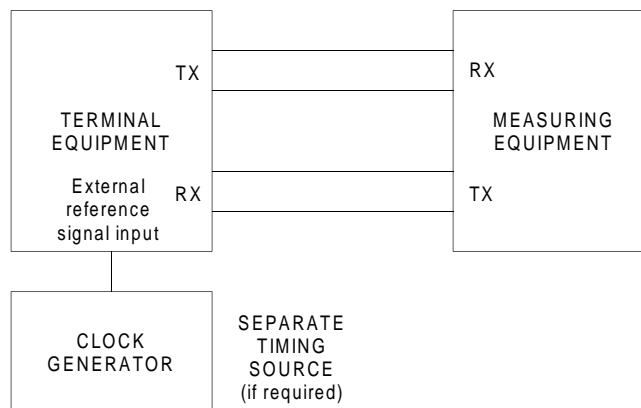

Figure A.3: Output timing

Interface state: Powered.

Stimulus: The terminal equipment shall be configured to provide output timing from each of its intended timing arrangements. Any external reference signal input, including the input port, from which timing can be derived, shall be provided with timing at the bit rate limits as specified by the terminal equipment manufacturer.

Monitor: The bit rate of the signal decoded from output port of the terminal equipment.

Results: The bit rate shall be within the limits given in subclause 4.2.1.3.

A.2.4 Output jitter

Purpose: To measure the maximum output jitter as defined in subclause 4.2.1.4.

NOTE: Further information on the measurement of jitter can be found in CCITT Supplement number 3.8, Fascicle IV.4 (1988).

Test Configuration: Figure A.4.

The terminal equipment shall be tested in each of the following configurations (where these modes of operation are supported):

- output timing referenced to the internal clock; and
- output timing referenced to any external clock source from which timing can be derived (including derivation from the input signal).

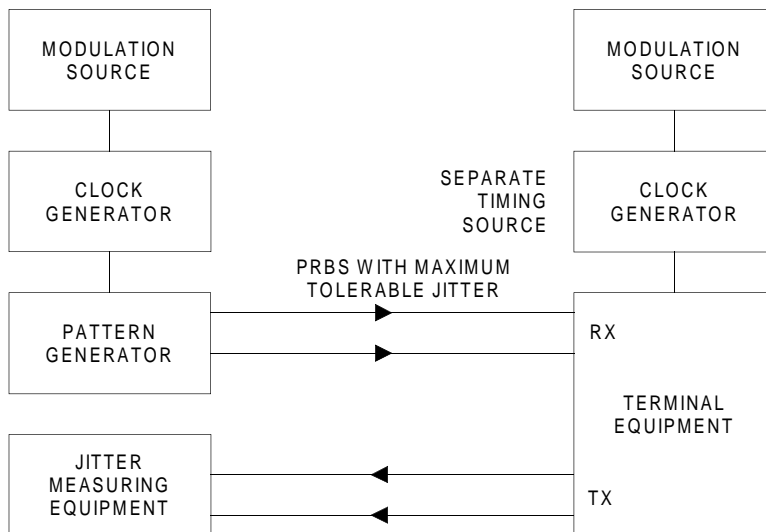

NOTE: The modulation source may be included in the clock generator and/or the pattern generator, or it may be provided separately.

Figure A.4: Jitter measurement

Interface state: Powered.

Stimulus: The output signal of the test equipment shall be CMI encoded and conform to a pulse shape as defined in figures 19 and 20 of CCITT Recommendation G.703 [1], which are reproduced in figures 2 and 3 of this TBR. For terminal equipment which can accept a structured signal in accordance with annex C, the bit stream shall be structured into frames according to annex C. The binary content of the data contained in the payload of the frame shall be a PRBS(2²³-1). For terminal equipment which cannot accept such a structured signal, the PRBS should be transmitted in the whole bit stream.

Measurements shall be made with both the input signals at the digital rate limits of 139 264 kbit/s \pm 15 ppm and between these limits, sufficient to verify jitter compliance over the specified frequency range. As a minimum the test shall be performed at the upper and lower limits and at the nominal rate.

The modulation source for the terminal equipment input bit stream shall generate individual components of sinusoidal jitter at points on the curve of figure 4 and table 3 of this TBR.

The modulation source for the external timing (if needed) shall be independent from that for the input signal and shall generate the maximum tolerable jitter, and maximum frequency deviation, as specified by the manufacturer of the terminal equipment.

It may be necessary to synchronise the two clock generators to avoid a high occurrence of slips.

Monitor: The jitter at the output port using equipment complying with CCITT Recommendation O.171 [3].

Results: The peak-to-peak jitter shall comply with table 2 of subclause 4.2.1.4.

A.2.5 Frame structure

Purpose: To verify compliance with the requirements for terminal equipment output structure defined in subclause 4.2.1.5. The test verifies the presence of the FA1 and FA2 within a frame of 2 176 octets.

Test configuration: Figure A.5.

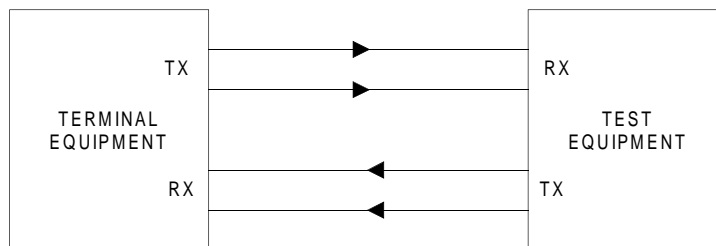

Figure A.5: Structure

Interface state: Powered.

Stimulus: The terminal equipment shall transmit a pseudo random bit stream, e.g. PRBS($2^{23}-1$) within the payload section of the frame.

If necessary, a CMI encoded stimuli shall be applied to the input of the terminal equipment at a bit rate within the limits of 139 264 kbit/s \pm 15 ppm.

Monitor: The bit stream at the output of the terminal equipment.

Results: The output bit stream shall comprise consecutive frames of 2 176 octets commencing with the two octets FA1 and FA2 as defined in annex C.

Annex B (normative): Definition of CMI code

B.1 General

This annex specifies the CMI code. The contents of this annex are based on subclause 9.1 of CCITT Recommendation G.703.

B.2 Definition

CMI is a 2-level non-return-to-zero code in which binary 0 is coded so that both amplitude levels, A_1 and A_2 , are attained consecutively, each for half a unit time interval $T/2$.

Binary 1 is coded by either of the amplitude levels A_1 or A_2 , for one full unit time interval (T), in such a way that the level alternates for successive binary 1s.

An example is given in figure B.1.

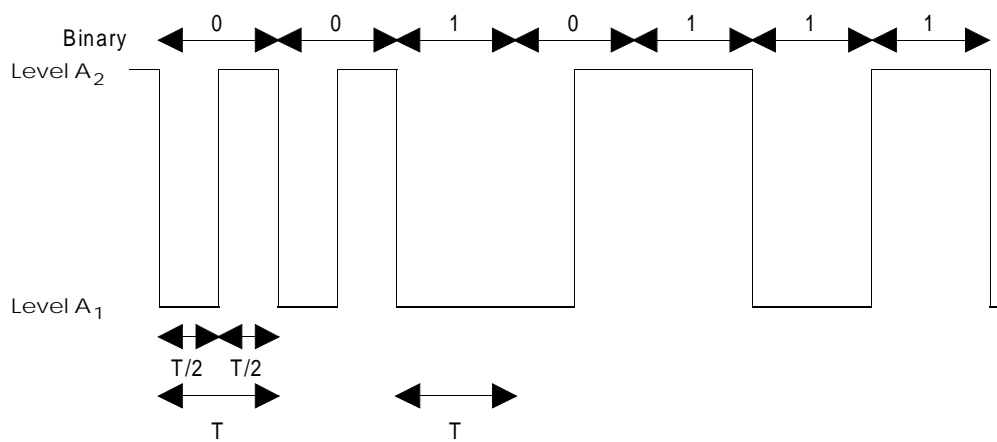

Figure B.1: Example of CMI coded binary signal

Annex C (normative): Definition of frame structure

C.1 Frame structure at 139 264 kbit/s

The basic frame structure at 139 264 kbit/s for attachment to the D140S leased line shall comprise 2 716 octets, the first two bytes of which comprise the frame alignment bytes; this is defined in figures C.1 and C.2. The order of transmission of information in figure C.1 is first from left to right and then top to bottom. Within each byte the Most Significant Bit (MSB) is transmitted first. The MSB (bit 1) is illustrated at the left of figure C.2.

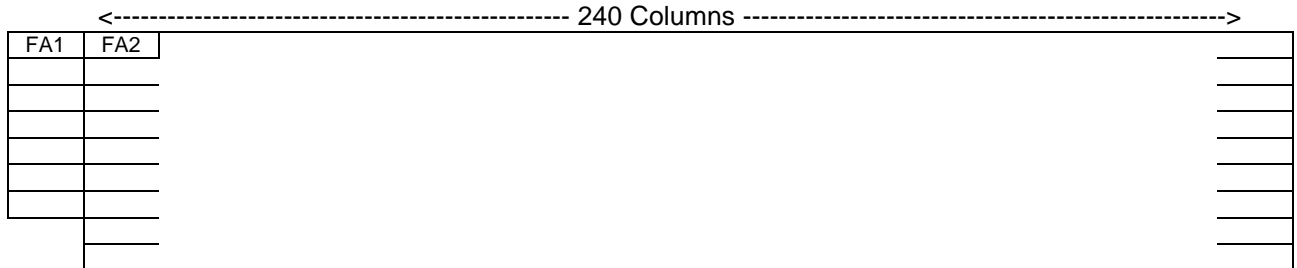
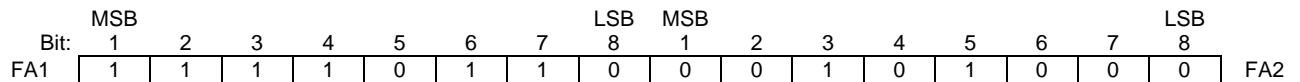

Figure C.1: Frame structure at 139 264 kbit/s



LSB: Least Significant Bit

Figure C.2: Frame alignment signal at 139 264 kbit/s

NOTE: The 2 176 octet frame will normally comprise 16 octets of path overhead and 2 160 octets of payload. Further details are given in prETS 300 690.

Annex D (normative): TBR Requirements Table (TBR-RT)

Notwithstanding the provisions of the copyright clause related to the text of this TBR, ETSI grants that users of this TBR may freely reproduce the TBR-RT proforma in this annex so that it can be used for its intended purposes and may further publish the completed TBR-RT.

Table D.1: TBR conditions table for attachment requirements for terminal equipment to digital 140 Mbit/s leased lines (D140U and D140S) as given in prTBR 25

Reference	Condition	Status	Support (Y/N)
C1	Is the terminal equipment intended for connection to the D140S structured leased line?	If YES then M else N	

Table D.2: TBR requirements table for attachment requirements for terminal equipment to digital 140 Mbit/s leased lines (D140U and D140S) as given in prTBR 25

TBR Reference		prTBR 25		
Item	Reference	Requirement	Status note 1	Support note 2
1	4.1	Mechanical characteristics	M	
2	4.2.1.1	Signal coding	M	
3	4.2.1.2	Waveform shape	M	
4	4.2.1.3	Output timing	M	
5	4.2.1.3 (a)	- internal source of timing	O	
6	4.2.1.3 (b)	- external timing reference (note 3)	O	
7	4.2.1.3 (c)	- timing derived from input port	O	
8	4.2.1.4	Output jitter	M	
9	4.2.1.5	Output frame structure	C1	
10	4.2.2	Input port	N	
11	4.3	Safety	N	
12	4.4	Overvoltage protection	N	
13	4.5	Electromagnetic compatibility	N	
NOTE 1: Status is "Mandatory (M)", "Not a requirement (N)", "Optional (O)" or "Conditional (Cx)". For Conditional see table D.1.				
NOTE 2: The support column has been added to the requirements table so that the table may be used as an implementation conformance statement proforma. Support is Y (equipment claims to fully implement the requirement of the TBR) or N (equipment does not claim to conform to the requirement of the TBR).				
NOTE 3: Where the timing may be derived from an external reference signal, the terminal equipment supplier shall declare the maximum input jitter and maximum timing deviation of this signal for the purpose of testing the output timing accuracy of subclause 4.2.1.3 and the output jitter limits of subclause 4.2.1.4.				

Annex E (informative): Bibliography

- 89/336/EEC: "Council Directive of 3 May 1989 on the approximation of the laws of Member States relating to electromagnetic compatibility".
- 91/263/EEC: "Council Directive of 29 April 1991 on the approximation of the laws of Member States concerning telecommunications terminal equipment, including the mutual recognition of their conformity".
- 92/44/EEC: "Council Directive of 5 June 1992 on the application of Open Network Provision to leased lines".
- CCITT Recommendation G.703 (1991): "Physical/electrical characteristics of hierarchical digital interfaces".
- CCITT Supplement number 3.8, Fascicle IV.4 (1988): "Guidelines concerning the measurement of jitter".
- prETS 300 686: "Business TeleCommunications (BTC); 34 Mbit/s and 140 Mbit/s digital leased lines (D34U, D34S, D140U and D140S), Network interface presentation".
- prETS 300 688: "Business TeleCommunications (BTC); 140 Mbit/s digital leased lines (D140U and D140S), Connection characteristics".
- prETS 300 690: "Business TeleCommunications (BTC); 140 Mbit/s digital leased lines (D140U and D140S), Terminal equipment interface".
- EN 60950 (1992): "Safety of information technology equipment including electrical business equipment".
- ETS 300 166 (1993): "Transmission and Multiplexing (TM); Physical and electrical characteristics of hierarchical digital interfaces for equipment using the 2 048 kbit/s-based plesiochronous or synchronous digital hierarchies".
- IEC 169-13 (1976): Part 13: R.F. coaxial connectors with inner diameter of outer conductor 5,6 mm (0,22 in) - Characteristic impedance 75 Ω (Type 1,6/5,6) - Characteristic impedance 50 Ω (Type 1,8/5,6) with similar mating dimensions.

History

Document history	
August 1995	Public Enquiry PE 89: 1995-08-07 to 1995-12-01
May 1996	Converted into Adobe Acrobat Portable Document Format (PDF)