



TECHNICAL
BASIS for
REGULATION

FINAL DRAFT
pr **TBR 21**

June 1996

Source: ETSI TC-TE

Reference: DTBR/TE-05055

ICS: 33.040

Key words: PSTN, TE, non-voice

**Terminal Equipment (TE);
Attachment requirements for pan-European approval for
connection to the analogue Public Switched Telephone Networks
(PSTNs) of TE (excluding TE supporting
the voice telephony service) in which network
addressing, if provided, is by means of Dual Tone
Multi Frequency (DTMF) signalling**

ETSI

European Telecommunications Standards Institute

ETSI Secretariat

Postal address: F-06921 Sophia Antipolis CEDEX - FRANCE

Office address: 650 Route des Lucioles - Sophia Antipolis - Valbonne - FRANCE

X.400: c=fr, a=atlas, p=etsi, s=secretariat - **Internet:** secretariat@etsi.fr

Tel.: +33 92 94 42 00 - Fax: +33 93 65 47 16

*

Copyright Notification: No part may be reproduced except as authorized by written permission. The copyright and the foregoing restriction extend to reproduction in all media.

© European Telecommunications Standards Institute 1996. All rights reserved.

Contents

Foreword	7
Introduction	7
1 Scope	9
2 Normative references	9
3 Definitions and abbreviations	10
3.1 Definitions	10
3.1.1 General terms	10
3.1.2 States	11
3.2 Abbreviations	11
4 Requirements	12
4.1 General requirement	12
4.2 Physical characteristics of the connection to the PSTN	12
4.3 Requirements under all conditions	13
4.3.1 Polarity	13
4.4 General requirements in quiescent state	13
4.4.1 DC resistance	13
4.4.2 Characteristics of TE for ringing signals	13
4.4.2.1 Impedance	13
4.4.2.2 Transient response	13
4.4.2.3 DC current	14
4.4.3 Impedance unbalance about earth	14
4.4.4 Resistance to earth	14
4.5 Ringing signal detector sensitivity	15
4.6 Transition from quiescent to loop state	15
4.6.1 Acceptance of breaks in the loop in a call attempt	15
4.6.2 Loop current characteristics	16
4.7 General loop steady state requirements	17
4.7.1 DC characteristics	17
4.7.2 Impedance	18
4.7.3 Sending level limitations	19
4.7.3.1 Mean sending level	19
4.7.3.2 Instantaneous voltage	19
4.7.3.3 Voltage level in a 10 Hz bandwidth	19
4.7.3.4 Sending level above 4,3 kHz	20
4.7.4 Impedance unbalance about earth	21
4.7.4.1 Longitudinal Conversion Loss	21
4.7.4.2 Output Signal Balance	21
4.7.5 Resistance to earth	22
4.8 Call attempt	22
4.8.1 Automatic dialling	22
4.8.1.1 Dialling without dial tone detection	22
4.8.1.2 Dialling with dial tone detection	23
4.8.2 DTMF signalling	23
4.8.2.1 Frequency combinations	23
4.8.2.2 Signalling levels	23
4.8.2.2.1 Absolute levels	23
4.8.2.2.2 Level difference	24
4.8.2.3 Unwanted frequency components	24
4.8.2.4 Tone duration	24
4.8.2.5 Pause duration	24
4.8.3 Automatically repeated call attempts	24
4.9 Transition from loop to quiescent state	25

4.10	Safety	25
4.11	EMC	25
Annex A (normative): Test methods		26
A.1	General	26
A.1.1	Equipment connection.....	26
A.1.2	Test environment	26
A.1.3	Powered state	27
A.1.4	Measurements to earth	27
A.1.5	Equivalent test methods.....	27
A.1.6	Additional information to support the test.....	27
A.2	Test impedances	28
A.2.1	Reference impedance.....	28
A.2.2	Non-reactive line termination.....	28
A.3	Feeding bridge.....	28
A.4	Test methods.....	28
A.4.1	General requirement	28
A.4.2	Physical characteristics of connection to the PSTN.....	29
A.4.3	Requirements in all conditions	29
A.4.3.1	Polarity	29
A.4.4	General requirements in quiescent state	29
A.4.4.1	DC Resistance.....	29
A.4.4.2	Characteristics of TE for ringing signals	30
A.4.4.2.1	Impedance	30
A.4.4.2.2	Transient response	31
A.4.4.2.3	DC current.....	31
A.4.4.3	Impedance unbalance about earth	32
A.4.4.4	Resistance to earth.....	33
A.4.5	Ringing signal detector sensitivity	34
A.4.6	Transition from quiescent to loop state	35
A.4.6.1	Acceptance of breaks in the loop in a call attempt	35
A.4.6.2	Loop current characteristics	35
A.4.7	General loop state requirements.....	36
A.4.7.1	DC characteristics.....	36
A.4.7.2	Impedance	37
A.4.7.3	Sending level limitations	38
A.4.7.3.1	Mean sending level	38
A.4.7.3.2	Instantaneous voltage.....	39
A.4.7.3.3	Voltage level in a 10 Hz bandwidth	40
A.4.7.3.4	Sending level above 4,3 kHz.....	41
A.4.7.3.4.1	Sending level above 4,3 kHz during DTMF dialling	41
A.4.7.3.4.2	Sending level above 4,3 kHz during communication	42
A.4.7.4	Impedance unbalance about earth	43
A.4.7.4.1	Longitudinal Conversion Loss.....	43
A.4.7.4.2	Output Signal Balance	44
A.4.7.5	Resistance to earth.....	45
A.4.8	Call attempt.....	46
A.4.8.1	Automatic dialling.....	46
A.4.8.1.1	Dialling without dial tone detection	46
A.4.8.1.2	Dialling with dial tone detection	46
A.4.8.2	DTMF signalling.....	47
A.4.8.2.1	Frequency combinations.....	47
A.4.8.2.2	Signalling levels	48
A.4.8.2.3	Unwanted frequency components	49
A.4.8.2.4	Tone duration	50
A.4.8.2.5	Pause duration	52
A.4.8.3	Automatically repeated call attempts.....	53

A.4.9	Transition from loop to quiescent state.....	54
Annex B (normative):	TBR Requirements Table (TBR-RT).....	55
B.1	Guidance for completion of the TBR-RT.....	55
B.1.1	Condition table.....	55
B.1.2	Requirements table.....	55
Annex C (informative):	Bibliography.....	58
History.....		59

Blank page

Foreword

This final draft Technical Basis for Regulation (TBR) has been produced by the Terminal Equipment (TE) Technical Committee of the European Telecommunications Standards Institute (ETSI) and is now submitted for the voting phase of the ETSI standards approval procedure.

Introduction

The existing analogue presentation of Public Switched Telephone Networks (PSTNs) in European countries are technically somewhat different, due to historical reasons. The services being offered to the end users also differ to a certain extent.

The increasing use of analogue terminals in the European networks, and especially terminals offering non-voice services, such as modems and facsimile, is a measure of the need for such equipment seen by European business companies. This type of equipment is undergoing constant and rapid development, and it is therefore imperative that the delay in, and cost of, market introduction caused by the approval procedures is the minimum possible. Otherwise, new innovative products may be available to Europe at later dates than to other regions in the world. Also, countries in Europe where the market is comparatively small may never benefit from these products, if the cost of market introduction is too high.

According to directive 91/263/EEC, Terminal Equipment (TE) is required, among other things, to:

- not cause harm to the network - Article 4(d);
- be able to interwork with the network in order to set up, hold, modify, charge for and clear down a connection - Article 4(f);
- interwork via the public telecommunications network, in justified cases - Article 4(g).

Although different, the networks have some basic commonalities. By restricting the requirements to cover only the interworking that is essential for the establishment of a call to/from a terminal, the signalling aspects can be simplified and harmonized.

This TBR specifies a harmonised set of requirements which will allow terminals, excluding voice telephony terminals subject to Article 4(g) requirements, to be analogue connected to the existing European PSTNs. It covers all relevant essential requirements in directive 91/263/EEC. All safety requirements are covered by the Low Voltage Directive (LVD) and therefore there are no requirements for Articles 4(a) and 4(b). All Electro Magnetic Compatibility (EMC) requirements are covered by the EMC directive and therefore no requirements for Articles 4(c) are included in this TBR. Article 4(e) is not applicable for a non-radio system. Article 4(g) is not applicable for non-voice terminals.

This TBR specifies the connection arrangements (plug or socket, of the supplier's choice) to be provided by the terminal equipment. An adapter may be required between the terminal and the existing national network termination point in individual countries. Such an adapter is outside the scope of this TBR.

The pan-European approval requirements for TE access to an analogue presented PSTN are related to the network's capabilities. A single terminal may consume all of this (given) capability, or it can be shared by a number of terminals all being connected to the Network Termination Point (NTP) in an arbitrary combination of parallel and/or series connections. In this case the performance of each individual terminal will need to be better than required by this TBR to ensure satisfactory interworking with the network. Connection of terminal equipment in series and/or parallel is a national matter. An ETR offering guidance on this subject is currently under preparation.

Blank page

1 Scope

This Technical Basis for Regulation (TBR) specifies the technical characteristics (electrical and mechanical interface requirements and access control protocol) under Articles 4(d) and 4(f) of Directive 91/263/EEC to be provided by a single Terminal Equipment (TE) which is:

- intended for pan-European approval; and
- capable of 2-wire access to an analogue Public Switched Telephone Network (PSTN) line at the Network Termination Point (NTP); but
- excluding TE which is capable of supporting the voice telephony justified case service as specified in Article 4(g) of Directive 91/263/EEC.

The objective of this TBR is to ensure that no harm occurs to the public network, and to ensure interworking between network and terminal so that calls can be routed successfully through the network, but without any guarantee of terminal to terminal interoperability. There are no requirements in this TBR under Article 4(g) of Directive 91/263/EEC.

This TBR covers TE which is capable of originating a circuit-switched call using Dual Tone Multi Frequency (DTMF) signalling and/or receiving an incoming circuit-switched call. Other signalling methods (e.g. loop disconnect signalling), if provided in the terminal and intended to be used in certain European countries, are subject to appropriate national regulations in addition to this TBR, in respect of that feature. Also, signalling for supplementary features (e.g. register recall, reception of metering pulses from the network) if provided in the terminal, and intended to be used in certain European countries, are subject to the appropriate national regulations.

For each requirement in this TBR a test is given, including measurement methods. Requirements apply at that interface of the TE which connects directly (by galvanic means) to the PSTN via a network termination point. The TE may be stimulated to perform the test by additional equipment if necessary.

This TBR specifies the connection arrangements (plug or socket, of the supplier's choice) to be provided by the TE. An adapter may be required between the terminal and the existing national network termination point in individual countries. Such an adapter is outside the scope of this TBR.

Where the origination or reception of calls by the TE is invoked, or otherwise controlled, by other equipment external to the TE, the TE still needs to be capable of fulfilling the essential requirements under Articles 4d) and 4f) at the interface to the public network. This TBR requires the manufacturer or supplier of the TE to declare the conditions met by such external devices so that their use does not cause the TE to fail to meet the essential requirements.

2 Normative references

This TBR incorporates by dated and undated reference, provisions from other publications. These normative references are cited at the appropriate places in the text and the publications are listed hereafter. For dated references, subsequent amendments to or revisions of any of these publications apply to this TBR only when incorporated in it by amendment or revision. For undated references the latest edition of the publication referred to applies.

- [1] Miniature 6-position plug as described in FCC 47, CFR 68.500: "Code of Federal Regulations (USA); Title 47 Telecommunication; Chapter 1 Federal Communications Commission, Part 68 Connection of Terminal Equipment to the Telephone Network; Subpart F Connectors; Section 68.500 Specification".

NOTE: The above document can be obtained from:

Superintendent of Documents
Washington DC 20402
United States
Tel: + 1 202 512 18003

[2] CCITT Recommendation G.117 (1990): "Transmission aspects of unbalance about earth (definitions and methods)".

[3] ITU-T Recommendation G.100 (1993): "Definitions used in Recommendations on general characteristics of international telephone connections and circuits".

3 Definitions and abbreviations

3.1 Definitions

For the purposes of this TBR, the following definitions apply:

3.1.1 General terms

automatic repeat call attempts: An automatic repeat call attempt made by the TE to the same network address as the result of the failure of the previous call attempt and not as a result of an external stimulus to the TE.

call attempt: The process by which the TE seizes the PSTN line and sends signalling characters of the network address with which the TE wishes to communicate.

connection to earth: Connection to earth means that all the following points, as applicable are connected to the earth point during measurement:

- a point in the TE which is intended to be connected to mains earth (in practice this might be carried out by connecting to the earth of the mains source which is supplying the TE);
- connector points which are intended to be connected to earth during the normal operation of the apparatus.

dBV: Absolute voltage level expressed in decibels with respect to 1 volt.

Longitudinal Conversation Loss: As described in CCITT Recommendation G.117 [2] subclause 4.1.3.

Network Termination Point (NTP): The physical point at the boundary of the PSTN intended to accept the connection of a TE. See figure 1.

Output Signal Balance (OSB): As described in CCITT Recommendation G.117 [2] subclause 4.3.1.

peak to peak voltage (V_{pp}): Peak to peak voltage in this TBR is the difference between the maximum and minimum voltage during any 10 ms window.

Public Switched Telephone Network (PSTN): The term is used to describe the ordinary telephone system including subscriber lines, local exchanges and the complete system of trunks and the exchange hierarchy which makes up the network.

reference impedance Z_R: A complex impedance made up of 270 ohms in series with a parallel combination of 750 ohms and 150 nF. This is shown in annex A, figure A.1.

repeat call attempt: A further call attempt to the same network address resulting from a failure to establish connection during the previous call attempt.

repeat call attempt sequence: A series of internally generated automatic repeat call attempts made in response to an initial call attempt.

NOTE: Additional, but separate, call requests are permitted to initiate separate repeat call attempt sequences.

return loss: As described in ITU-T Recommendation G.100 [3] subclause 1.5.

Terminal Connection Point (TCP): The point of the TE intended to be connected to the PSTN. An adapter may be required between the terminal and the existing national network termination point in individual countries. Such an adapter is outside the scope of this TBR (see figure 1).

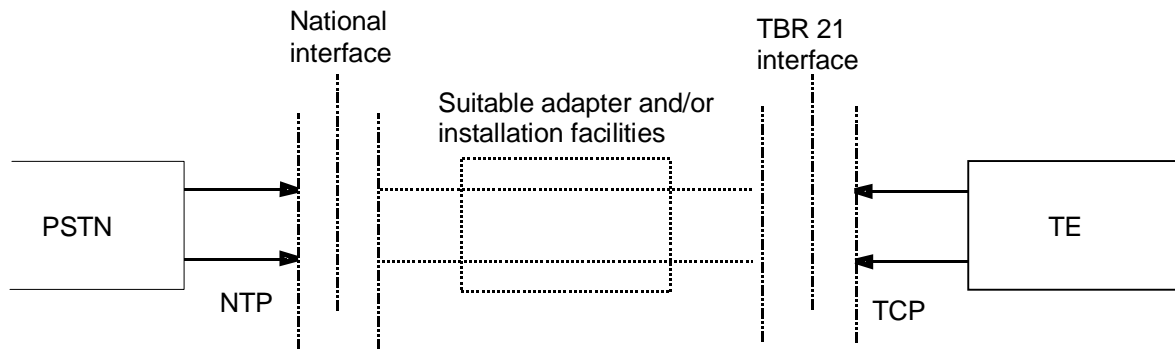

Figure 1: Terminal connection point and Network Termination Point

Terminal Equipment (TE): Equipment intended to be connected to the public telecommunication network; i.e.:

- to be connected directly to the termination of a public telecommunication network; or
- to interwork with a public telecommunication network being connected directly or indirectly to the termination of a public telecommunication network,

in order to send, process or receive information. The system of connection may be wire, radio, optical or other electromagnetic system.

NOTE: This definition is copied from the Directive 91/263/EEC.

3.1.2 States

loop state: The state where the TE draws sufficient DC current to activate the exchange.

loop steady state: A loop state excluding the transitions from and to quiescent state.

quiescent state: The state where the TE draws insufficient DC current to activate the exchange.

3.2 Abbreviations

For the purposes of this TBR, the following abbreviations apply:

AC	Alternating Current
ADSI	Analogue Display Services Interface
DC	Direct Current
DTMF	Dual Tone Multi-Frequency
EMC	ElectroMagnetic Compatibility
LCL	Longitudinal Conversion Loss
LVD	Low Voltage Directive
NTP	Network Termination Point
OSB	Output Signal Balance
PSTN	Public Switched Telephone Network
rms	root mean square
SCWID	Spontaneous Call Waiting Identification
TCP	Terminal Connection Point
TBR-RT	TBR Requirements Table
TE	Terminal Equipment
V _{pp}	peak to peak Voltage

4 Requirements

The TE shall comply with the provisions of this TBR when tested via contact pins 3 and 4 as shown in table 1.

NOTE 1: The pan-European approval requirements for TE access to an analogue presented PSTN are related to the network's capabilities. A single terminal may consume all of this (given) capability, or it can be shared by a number of terminals all being connected to the NTP in an arbitrary combination of parallel and/or series connections. In this case the performance of each individual terminal will need to be better than required by this TBR to ensure satisfactory interworking with the network. Connection of terminal equipment in series and/or parallel is a national matter. An ETR offering guidance on this subject is currently under preparation.

NOTE 2: The feeding voltage value of 50 VDC in the requirement and test parts is only a harmonised test value. It does not necessarily reflect the real PSTN supply voltages.

4.1 General requirement

Justification: Where the origination or reception of calls by the TE is invoked, or otherwise controlled by other equipment external to the TE, the TE shall still be capable of fulfilling the essential requirements under Articles 4(d) and 4(f) of directive 91/263/EEC at the interface to the public network.

Requirement: Where the origination or reception of calls by the TE is invoked, or otherwise controlled by other equipment external to the TE, the manufacturer or supplier of the TE shall declare the conditions that need to be met by such external devices so as to enable the user to ensure that their use does not cause the TE to fail to meet the essential requirements.

Test: By confirming the presence of such declaration.

4.2 Physical characteristics of the connection to the PSTN

Justification: 91/263/EEC, Article 4(f); Interworking with the PSTN is assured by requiring the TE to interwork with different European networks, where different features may be offered, but where all networks can perform the basic interworking on two wires. To facilitate the use of adapters, the TE requires a known type of connection arrangement.

Requirement: The TE shall provide a connector either as a plug or as a socket. The connector, if a plug, shall be capable of connecting with a miniature 6-position socket as specified in FCC 47, CFR 68.500 [1] clause (b) and if a socket, shall be capable of connecting with a miniature 6-position plug as specified in FCC 47, CFR 68.500 [1] clause (a).

NOTE 1: The TE may include a means (e.g. a lead) which adapts an interface of the TE to the connector described in this clause upon which the TCP is presented. The requirements of this TBR apply at the TCP and this means is considered to be an integral part of the TE.

NOTE 2: This connector is often referred to as RJ 11/12.

Table 1: Contact assignments

Contact number	Contact function
1	Unspecified
2	Unspecified
3/4	TCP
5	Unspecified
6	Unspecified

Test: By visual inspection. The interworking capability shall be verified through the tests in annex A.

4.3 Requirements under all conditions

4.3.1 Polarity

Justification: 91/263/EEC, Article 4(f); Interworking with the PSTN is assured by requiring the TE to operate with both polarities, since a fixed polarity is not guaranteed.

Requirement: The TE shall conform to the requirements of this TBR for both polarities of line feeding voltage.

Test: Where tests with both polarities are needed this is indicated in relevant clauses in annex A.

4.4 General requirements in quiescent state

4.4.1 DC resistance

Justification: 91/263/EEC, Article 4(f); Interworking with the PSTN is assured by requiring the TE to present a sufficiently high DC resistance in quiescent state so as not to disturb the basic call control and to prevent the malfunction of network call control equipment.

Requirement: The current drawn by the TE when connected to a source of:

- 100 VDC;
- 50 VDC;
- 25 VDC,

shall not exceed that which would be drawn by a 1 M Ω resistor replacing the TE. This requirement applies 30 seconds after the voltage has been applied.

Test: The test shall be conducted according to annex A, subclause A.4.4.1.

4.4.2 Characteristics of TE for ringing signals

4.4.2.1 Impedance

Justification: 91/263/EEC, Article 4(f); Interworking with the PSTN is assured by requiring the TE to present an impedance to ringing signals that is sufficiently high.

Requirement: The impedance of the TE at frequencies of 25 Hz and 50 Hz shall not be less than 4 k Ω when tested at 30 V rms.

Test: The test shall be conducted according to annex A, subclause A.4.4.2.1.

4.4.2.2 Transient response

Justification: 91/263/EEC, Article 4(f); Interworking with the PSTN is assured by limiting the current transient at the beginning of a ringing signal.

Requirement: When ringing signals are applied to the terminal equipment in the quiescent state, the resulting current shall not cause the public exchange to detect a loop state. This shall be verified by DC excitation of the TE in quiescent state. The current shall be equal to or less than 25 mA, 1 ms after commencement of the excitation, and equal to or less than 10 mA, 6 ms after commencement.

Test: The test shall be conducted according to annex A, subclause A.4.4.2.2.

4.4.2.3 DC current

Justification: 91/263/EEC, Article 4(f); Interworking with the PSTN is assured by requiring the TE to avoid creating DC current due to asymmetric load of the ringing signal (e.g. caused by the use of overvoltage arrestors). This requirement avoids false seizure of the PSTN.

Requirement: The resulting DC current during the ringing signal, tested with a 25 Hz and 50 Hz AC signal at a voltage of 90 V rms superimposed on a DC voltage of 60 V, shall be less than 0,6 mA.

Test: The test shall be conducted according to annex A, subclause A.4.4.2.3.

4.4.3 Impedance unbalance about earth

Justification: 91/263/EEC, Article 4(d); Protection of the PSTN from harm. Unbalance may cause crosstalk.

The impedance unbalance about earth is expressed as the Longitudinal Conversion Loss (LCL).

Requirement: Where the supplier's instructions state that a connection to earth is intended, the Longitudinal Conversion Loss when the AC termination of the TE is 600 Ω shall be at least the values given in table 2 and figure 2.

Table 2: Longitudinal Conversion Loss, minimum values

Frequency range	Minimum value
50 Hz to 600 Hz	40 dB
600 Hz to 3 400 Hz	46 dB

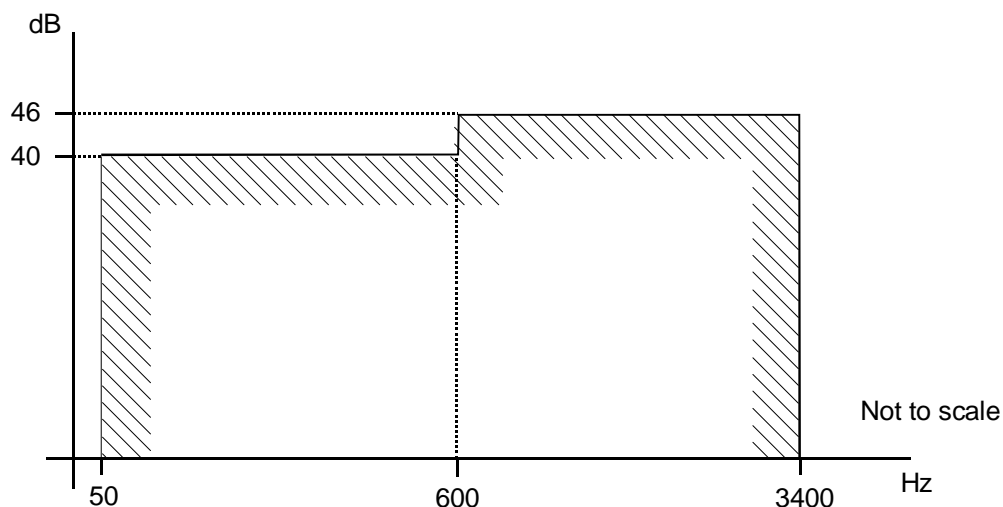

Figure 2: Longitudinal Conversion Loss, minimum values

Test: The test shall be conducted according to annex A, subclause A.4.4.3.

4.4.4 Resistance to earth

Justification: 91/263/EEC, Article 4(f); Interworking with the PSTN is assured by requiring the TE to present a sufficiently high DC resistance to earth in the quiescent state to prevent the malfunction of network call control equipment.

Requirement: Where the supplier's instructions state that a connection to earth is intended, the DC resistance between each line terminal of the TE and earth in the quiescent state when tested at 100 V DC, shall be not less than 10 MΩ.

Test: The test shall be conducted according to annex A, subclause A.4.4.4

4.5 Ringing signal detector sensitivity

Justification: 91/263/EEC, Article 4(f); Interworking with the PSTN is assured by requiring the TE to detect valid ringing signals.

Requirement: If a ring detect function is provided and enabled, the TE shall be able to respond to ringing signals of 30 Vrms at 25 Hz and 50 Hz with a cadence of 1 s ON and 5 s OFF, superimposed on a 50 VDC feeding voltage.

The response shall be as stated by the supplier.

Test: The test shall be conducted according to annex A, subclause A.4.5.

NOTE 1: For example, a TE might:

- generate a signal denoting an incoming call in accordance with the supplier's instructions; or
- be configured to seize the line according to subclause 4.6.

NOTE 2: A TE designer should be aware that a number of different ringer voltages, frequencies and cadences are in use, and more are likely to be brought into use within the countries of Europe. Also, non-polarised ringing signals exist. To ensure operation within the countries in which the TE is intended to be used, the designer must choose the appropriate combination of parameters. An incorrect choice of parameters could lead to unsatisfactory operation.

A TE with a ringing detector facility should be capable of responding to all the ringing voltages, frequencies and cadences in Europe. This could be achieved by either, the TE having a single universal mode of operation, or by the TE having a number of selective modes of operation, which together embrace the range of ringing conditions.

NOTE 3: In some countries the PSTN generates signals as low as 24 Vrms - particularly for electro-acoustic ringers without local power supply. It is recognised that this voltage may be insufficient to produce an acoustic output expected from some users or suitable for applications in noisy surroundings.

NOTE 4: PSTN test signals and unintended induction from power lines may cause significant signal levels to appear on the line. Such conditions may cause incorrect interworking, if the TE does not provide sufficient immunity.

4.6 Transition from quiescent to loop state

4.6.1 Acceptance of breaks in the loop in a call attempt

Justification: 91/263/EEC, Article 4(f); Interworking with the PSTN is assured by requiring the TE to accept breaks in the loop current during establishment of loop state.

Requirement: If, during the transition from quiescent to the loop state for the purpose of making a call, the line feeding current has first reached and remained at a value greater than 12,8 mA for a duration of between 30 ms and 500 ms, the current is interrupted for a period of 400 ms. When the source of the feeding current is reconnected:

- the line current shall have reached a value of greater than 12,8 mA within 20 ms of the reconnection of the feeding source;
- during the period between 20 ms and 100 ms following the reconnection of the feeding source, the current shall not drop below 12,8 mA for more than 7 ms. For the purpose of this requirement, any periods during which the current is less than 12,8 mA are aggregated and the total shall not exceed the limit stated.

This requirement applies when the line feeding current is provided by a source of 50 V DC in series with a resistance of 850 Ω .

Test: The test shall be conducted according to annex A, subclause A.4.6.1.

4.6.2 Loop current characteristics

Justification: 91/263/EEC, Article 4(f); Interworking with the PSTN is assured by requiring the TE to seize the line.

Requirement: The loop current determined by the TE shall:

- a) exceed the value of I_{f1} before t_1 after the seizure; and
- b) remain above I_{f1} for at least a further $(t_2 - t_{01})$ time; and
- c) remain above I_{f2} between t_2 and t_3 , for conditions of the table 4 and figure 4.

The limit values $(t_1 - t_0)$, $(t_2 - t_{01})$, $(t_3 - t_{01})$, I_{f1} and I_{f2} are given in tables 3 and 4 and shown in figures 3 and 4 and:

- « t_0 » is the reference moment of seizure, when the loop current exceeds 0,1 mA for the first time with a feeding voltage of 50 VDC and stays above this value for more than 5 ms;
- « t_{01} » is the reference moment, when the loop current exceeds the current I_{f1} for the first time with a feeding voltage of 50 VDC and stays above this value for more than 5 ms; and
- transient periods are permitted during which the loop current drops below the limits stated in this clause, as long as when aggregated, they do not exceed 7 ms.

Table 3:

TE current characteristics with feeding resistors which are not used during the loop steady state

Condition		Requirements		
Feeding voltage	Feeding resistance	Time (ms)		Current (mA)
V_f	R_f	$t_1 - t_0$	$t_2 - t_{01}$	I_{f1}
50VDC	150 kΩ.	400	400	0,30
50VDC	36 kΩ.	400	400	1,25
50VDC	24 kΩ.	400	400	1,86
50VDC	8 kΩ.	400	400	5,00

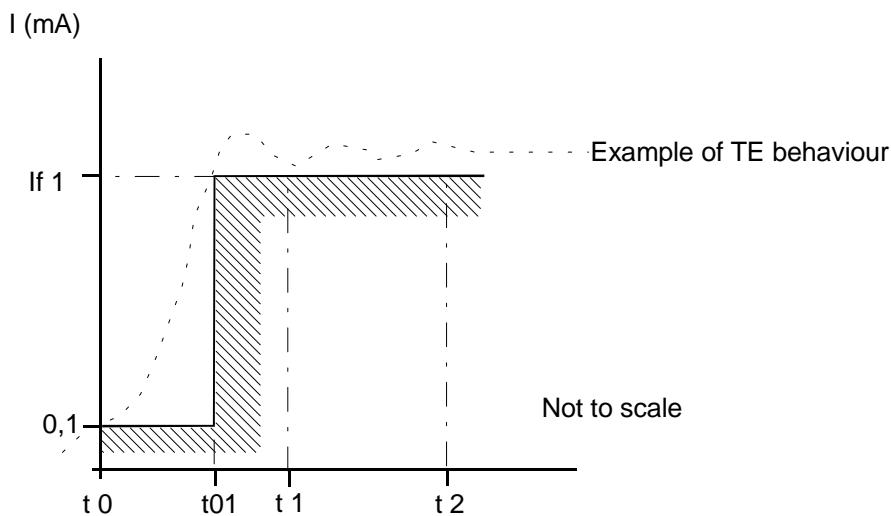

Figure 3:

TE current characteristics with feeding resistors which are not used during the loop steady state

Table 4:
TE current characteristics with feeding resistors which are used during the loop steady state

Condition		Requirements				
Feeding voltage	Feeding resistance	Time (ms)			Current (mA)	
Vf	Rf	t1-t0	t2-t01	t3-t01	If1	If2
50VDC	3,2 kΩ	30	500	1 200	13,1	12,8
50VDC	230 Ω	20	500	1 200	49,6	49,6

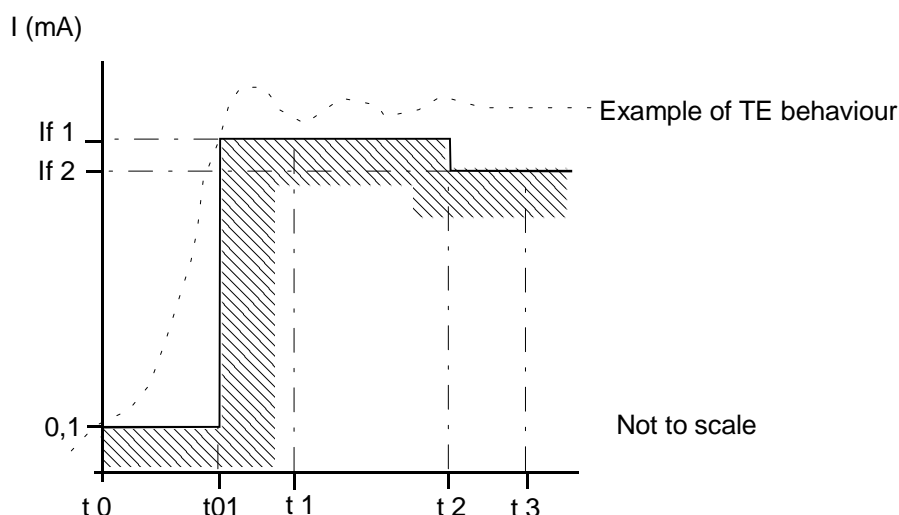

Figure 4:
TE current characteristics with feeding resistors which are used during the loop steady state

Test: The test shall be conducted according to annex A, subclause A.4.6.2.

4.7 General loop steady state requirements

The requirements during the loop steady state apply when the TE has been in the loop state for a minimum of 1,2 s with a line feeding current which can be obtained when the TE is connected to a source of 50 VDC in series with a resistor within the range of 3 200 Ω to 230 Ω.

4.7.1 DC characteristics

Justification: 91/263/EEC, Article 4(f); Interworking with the European PSTN, some of which having different DC characteristics, is assured by requiring the TE to present a sufficiently low DC resistance in loop state.

Requirement: The DC voltage/current characteristics of the TE within the operating range as stated in subclause 4.7 shall not exceed the limits given in table 5 and shown in figure 5.

Table 5: TE voltage/current characteristics

Point	Voltage (V)	Current (mA)
A	9,0	0
B	9,0	20,0
C	14,5	42,0
D	40,0	50,0
E	40,0	60,0
F	0	60,0
G	0	0

NOTE: Limits for intermediate currents can be found by drawing a straight line between the break points on a linear voltage/current scale.

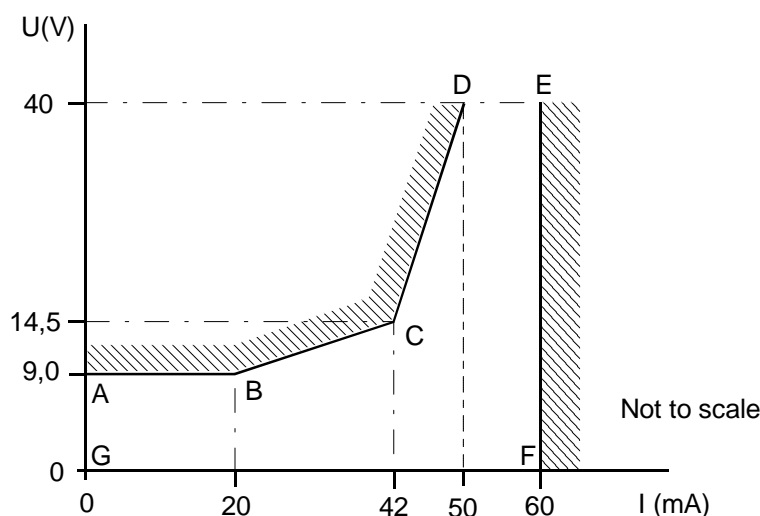

Figure 5: TE voltage/current characteristics

Test: The test shall be conducted according to annex A, subclause A.4.7.1.

4.7.2 Impedance

Justification: 91/263/EEC, Article 4(f); Interworking with the PSTN is assured by requiring the TE to present an impedance which allows proper functioning of call control and to maintain stability in the PSTN.

Requirement: The TE shall meet the following requirements:

- at frequencies greater than 300 Hz, but less than or equal to 4 000 Hz, the return loss calculated with respect to the reference impedance Z_R (at the same frequency) shall not be less than 8 dB; and
- at frequencies that are greater than or equal to 200 Hz and less than or equal to 300 Hz:
 - a) the return loss calculated with respect to the reference impedance Z_R (at the same frequency) shall not be less than 6 dB; and
 - b) the reactive component of the impedance shall not be greater than 500 Ω inductive (+j 500).

Test: The test shall be conducted according to annex A, subclause A.4.7.2.

4.7.3 Sending level limitations

4.7.3.1 Mean sending level

Justification: 91/263/EEC, Article 4(d); Protection of the PSTN from harm is assured by limiting the signal sent into the PSTN by the TE so that the interfering effects of the signal can be predicted and avoided.

Requirement: The mean sending level in the frequency range 200 Hz to 3 800 Hz over a one-minute period shall not be greater than - 9,7 dBV when the TE interface is terminated with the reference impedance Z_R . This requirement does not apply to DTMF signals.

Test: The test shall be conducted according to annex A, subclause A.4.7.3.1.

4.7.3.2 Instantaneous voltage

Justification: 91/263/EEC, Article 4(d); Protection of the PSTN from harm is assured by limiting the signal sent into the PSTN by the TE so that the interfering effects of the signal can be predicted and avoided.

Requirement: The peak to peak voltage in the frequency range 200 Hz to 3 800 Hz shall not exceed 5,0 volts when the TE interface is terminated with the reference impedance Z_R .

Test: The test shall be conducted according to annex A, subclause A.4.7.3.2.

4.7.3.3 Voltage level in a 10 Hz bandwidth

Justification: 91/263/EEC, Article 4(d); Protection of the PSTN from harm is assured by limiting the signal sent into the PSTN by the TE so that the interfering effects of the signal can be predicted and avoided.

Requirement: The voltage within a 10 Hz bandwidth centred at any point in the frequency range 30 Hz to 4 300 Hz, and wholly contained within that frequency band, shall not exceed the limits given in table 6 and figure 6 when the TE interface is terminated with the reference impedance Z_R . This requirement does not apply to DTMF signals.

Table 6: Voltage in a 10 Hz bandwidth

Points	Frequency kHz	Sending level dBV
A	0,03	- 33,7
B	0,1	- 10,7
C	0,2	- 6,7
D	3,8	- 6,7
E	3,9	- 10,7
F	4,0	- 16,7
G	4,3	- 44,7
NOTE: Limits for intermediate frequencies can be found by drawing a straight line between the break points on a logarithmic (Hz) - linear (dB) scale.		

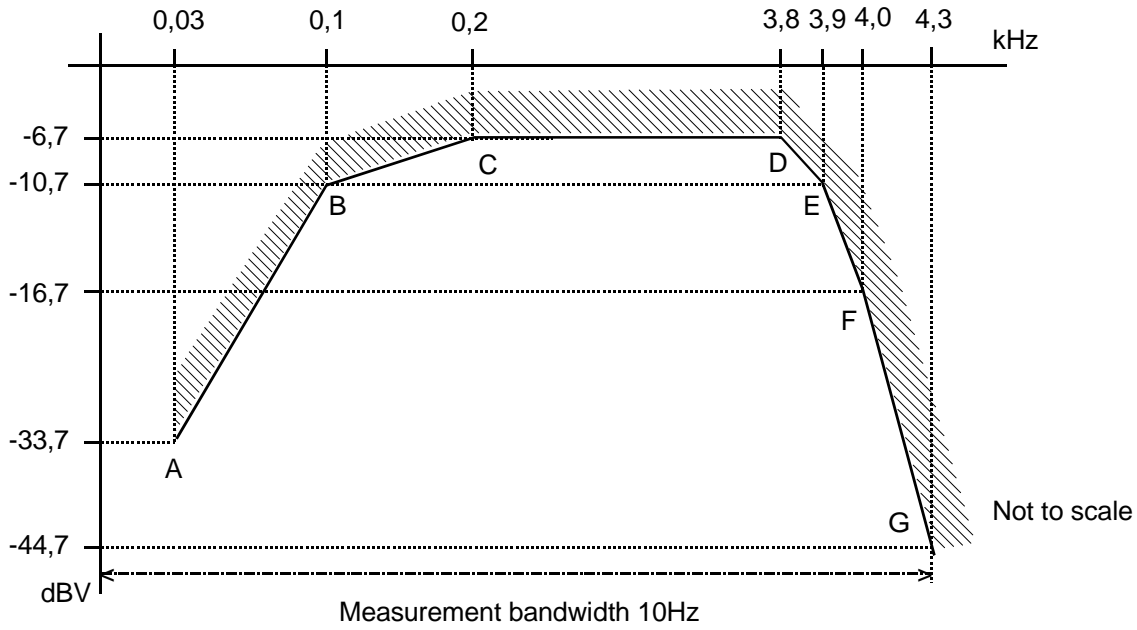

Figure 6: Voltage level in a 10 Hz bandwidth

Test: The test shall be conducted according to annex A, subclause A.4.7.3.3.

4.7.3.4 Sending level above 4,3 kHz

Justification: 91/263/EEC, Article 4(d); Protection of the PSTN from harm is assured by limiting the signal sent into the PSTN by the TE so that the interfering effects of the signal can be predicted and avoided.

Requirement: The total voltage level in a bandwidth, defined in table 7, wholly contained within the frequency range 4,3 kHz to 200 kHz, arising from normal operation of the TE when in an on-line, non-dialling state, and when terminated with Z_R , shall not exceed the limits shown in table 7 and figure 7.

During tone signalling the limits given in table 7 and figure 7 do not apply and are replaced by the following:

In the range 4,3 kHz to 20 kHz, the individual level of any single frequency component shall not exceed 35,7 dBV.

In the range 20 kHz to 200 kHz, the individual level of any single frequency component shall not exceed 40,7 dBV.

NOTE: "Normal operation of the TE" is defined in the test, see annex A, subclause A.1.3.

Table 7: Sending level above 4,3 kHz

Points	Frequency range kHz	Sending level in a specified bandwidth dBV	Measurement bandwidth
G to H	4,3 to 5,1	- 40 decreasing to - 44	300 Hz
H to I	5,1 to 8,9	- 44	300 Hz
I to J	8,9 to 11	- 44 decreasing to - 58,5	300 Hz
J to K	11 to 200	- 58,5	1 kHz
NOTE:	Limits for intermediate frequencies can be found by drawing a straight line between the break points on a logarithmic (Hz) - linear (dB) scale.		

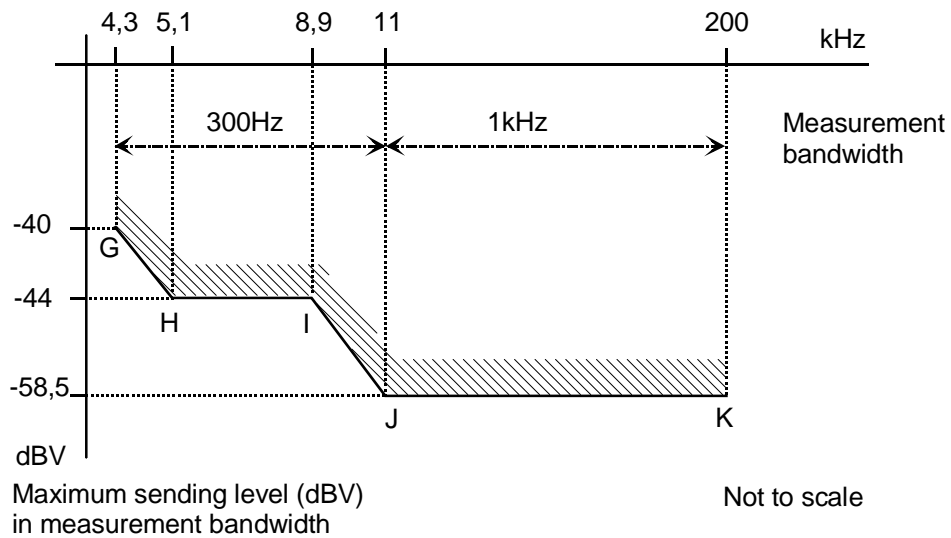

Figure 7: Sending level above 4,3 kHz

Test: The test shall be conducted according to annex A, subclauses A.4.7.3.4.1 and A.4.7.3.4.2.

4.7.4 Impedance unbalance about earth

Justification: 91/263/EEC, Article 4(d); Protection of the PSTN from harm. Unbalance may cause crosstalk.

The impedance unbalance about earth is expressed as the LCL when in the receiving mode and Output Signal Balance (OSB) when in the transmitting mode.

4.7.4.1 Longitudinal Conversion Loss

Requirement: Where the supplier's instructions state that a connection to earth is intended, the LCL when the AC termination of the TE is 600 Ω shall be at least the values given in table 8 and figure 8.

Test: The test shall be conducted according to annex A, subclause A.4.7.4.1.

4.7.4.2 Output Signal Balance

Requirement: Where the supplier's instructions state that a connection to earth is intended, the OSB when the AC termination of the TE is 600 Ω shall be at least the values given in table 8 and figure 8. This requirement only applies at frequencies where the unbalance level exceeds - 70 dBV with the test method shown in subclause A.4.7.4.2.

Table 8: Output Signal Balance and Longitudinal Conversion Loss, minimum values

Frequency range	Minimum value
50 Hz to 600 Hz	40 dB
600 Hz to 3 400 Hz	46 dB
3 400 Hz to 3 800 Hz	40 dB

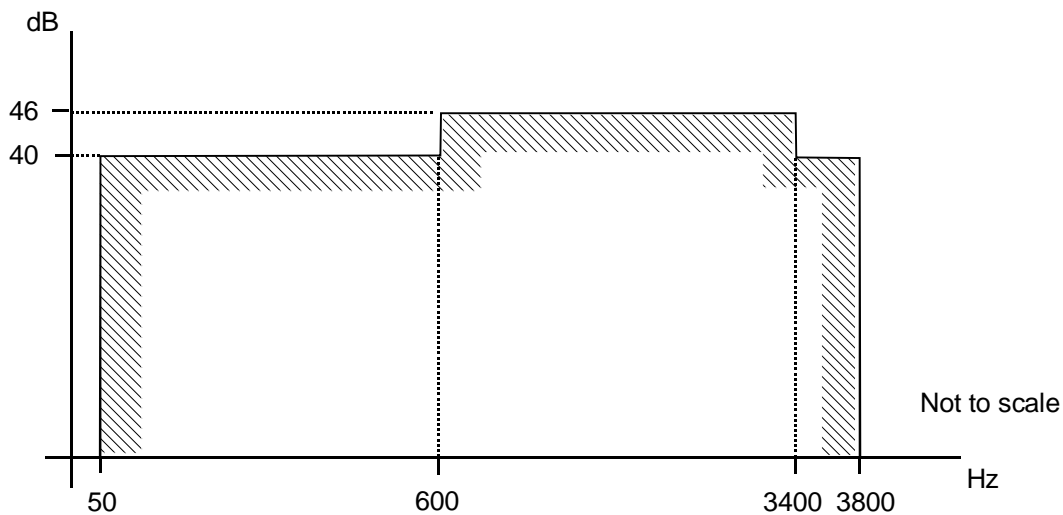

Figure 8: Output Signal Balance and Longitudinal Conversion Loss, minimum values

Test: The test shall be conducted according to annex A, subclause A.4.7.4.2.

4.7.5 Resistance to earth

Justification: 91/263/EEC, Article 4(f); Interworking with the PSTN is assured by requiring the TE to present a sufficiently high DC resistance to earth in loop state so as not to disturb the basic call control function.

Requirement: Where the supplier's instructions state that a connection to earth is intended, the DC resistance between each line terminal of the TE and earth in loop state when tested at 100 V DC shall be not less than 1 M Ω .

Test: The test shall be conducted according to annex A, subclause A.4.7.5.

4.8 Call attempt

All requirements in subclause 4.7 will also apply during a call attempt.

This clause only applies for terminals intended for outgoing calls.

4.8.1 Automatic dialling

This requirement applies only to a TE with an automatic seizing and dialling function. It applies when the TE is in automatic dialling mode.

4.8.1.1 Dialling without dial tone detection

Justification: 91/263/EEC, Article 4(f); Interworking with the PSTN is assured by requiring a TE with automatic dialling to start sending its digits during the time period when the network is ready to receive digits under normal conditions.

Requirement: The TE shall start dialling not earlier than 2,7 s and before 8 s has elapsed after the loop state is established. Where adjustments are available to the user, resulting in a lower value, this is acceptable as long as the 2,7 s limit remains within the available range.

NOTE: It is recognised that, in some rare cases, the network may not be able to receive dialling signals within 3 s. Also, some networks will not accept addressing information after 5 s has elapsed.

Test: The test shall be conducted according to annex A, subclause A.4.8.1.1.

4.8.1.2 Dialling with dial tone detection

Justification: 91/263/EEC, Article 4(f); Interworking with the PSTN is assured by requiring a TE with automatic dialling to start sending its digits during the time period when the network is ready to receive digits.

Requirement: If the TE is intended for automatic dialling with an automatic dial tone detection, and this facility is enabled in accordance with the supplier's instruction, it shall start dialling within 8 s of the start of the application of:

- a continuous dial tone; and
- a cadenced dial tone whose cadence comprises a repeated sequence of: 200 ms ON, followed by 200 ms OFF, followed by 600 ms ON, followed by 1000 ms OFF.

For the purposes of this requirement, the dial tone is defined as a single tone signal, delivered from a generator with a source impedance equal to Z_R , in the frequency range 300 Hz to 500 Hz, whose level is between - 35,7 dBV and - 0,7 dBV when measured across the reference impedance Z_R which substitutes the TE.

Test: The test shall be conducted according to annex A, subclause A.4.8.1.2.

4.8.2 DTMF signalling

4.8.2.1 Frequency combinations

Justification: 91/263/EEC, Article 4(f); Interworking with the PSTN is assured by requiring the TE to send digits that the network accepts.

Requirement: The TE shall use DTMF signalling characters according to table 9. However, the number of characters supported by the TE can be restricted, in which case only those frequencies assigned to the supported characters shall be used. The tolerances on the frequencies for the characters supported shall be $\pm 1,5 \%$.

Table 9: DTMF signalling frequency combinations

Low group Hz	High group Hz			
	1 209	1 336	1 477	1 633
697	1	2	3	A
770	4	5	6	B
852	7	8	9	C
941	*	0	#	D

Test: The test shall be conducted according to annex A, subclause A.4.8.2.1.

4.8.2.2 Signalling levels

4.8.2.2.1 Absolute levels

Justification: 91/263/EEC, Article 4(f); Interworking with the PSTN is assured by requiring the TE to send digits that the network accepts.

Requirement: The level of any tone in the DTMF high frequency group shall be - 9,0 dBV +2,0/-2,5 dB and the level of any tone in the low frequency group shall be - 11,0 dBV +2,5/-2,0 dB when the TE interface is terminated with the reference impedance Z_R .

Test: The test shall be conducted according to annex A, subclause A.4.8.2.2.

4.8.2.2 Level difference

Justification: 91/263/EEC, Article 4(f); Interworking with the PSTN is assured by requiring the TE to send digits that the network accepts.

Requirement: During sending of any DTMF frequency combination, the level of the tone in the high frequency group shall be 1 dB to 4 dB higher than the level of the tone in the low frequency group.

Test: The test shall be conducted according to annex A, subclause A.4.8.2.2.

4.8.2.3 Unwanted frequency components

Justification: 91/263/EEC, Article 4(f); Interworking with the PSTN is assured by requiring the TE to send digits that the network accepts.

Requirement: When transmitting any DTMF tone combination during a call attempt, the total sending level of all unwanted frequency components in the frequency range 250 Hz to 4 300 Hz shall be at least 20 dB below the low frequency group component.

Test: The test shall be conducted according to annex A, subclause A.4.8.2.3.

4.8.2.4 Tone duration

This requirement applies where the DTMF signalling tone duration is controlled automatically by the TE.

Justification: 91/263/EEC, Article 4(f); Interworking with the PSTN is assured by requiring the TE to send DTMF tones for a minimum period of time in order that the receivers in the exchange can recognise the digit being sent.

Requirement: The TE shall provide a setting whereby the duration for which any individual DTMF tone combination sent is not less than 65 ms. The time shall be measured from the time when the tone reaches 90 % of its steady-state value, until it has dropped to 90 % of its steady-state value.

NOTE: For correct operation of supplementary services such as SCWID (Spontaneous Call Waiting Identification) and ADSI (Analogue Display Services Interface), DTMF tone bursts will need to be no longer than 90 ms.

Test: The test shall be conducted according to annex A, subclause A.4.8.2.4.

4.8.2.5 Pause duration

This requirement applies where the DTMF signalling pause duration is controlled automatically by the TE.

Justification: 91/263/EEC, Article 4(f); Interworking with the PSTN is assured by requiring the TE to provide a minimum period of "Tone Off" between DTMF digits in order that the receivers in the exchange can determine the end of any digit from the start of the next.

Requirement: The TE shall provide a setting whereby the duration of the pause between any individual DTMF tone combination is not less than 65 ms. The time shall be measured from the time when the tone has dropped to 10 % of its steady-state value, until it has risen to 10 % of its steady-state value.

NOTE: In order to ensure correct reception of all the digits in a network address sequence, some networks may require a sufficient pause after the last DTMF digit signalled and before normal transmission starts.

Test: The test shall be conducted according to annex A, subclause A.4.8.2.5.

4.8.3 Automatically repeated call attempts

Justification: 91/263/EEC, Article 4(d); Protection of the PSTN from harm is achieved by restricting automatically repeated call attempts from the TE.

Requirement: The TE shall not automatically initiate an internally generated repeat call attempt less than 5 s after the termination of the previous call attempt in the same repeat attempt sequence. The previous call attempt is considered to be terminated when the TE returns to the quiescent state. There shall be no more than 15 repeated call attempts in a repeated call attempt sequence.

NOTE: Although this TBR permits repeat call attempts to be made after an interval of 5 seconds, the interval between repeat call attempts, in most practical applications, will usually be set to a value considerably greater than this so as to provide an appropriate compromise between the rate of redialling and the likelihood of the repeat call attempt being successful. Where this interval is user adjustable, TE suppliers are recommended to provide guidance to users on how to select a setting that would best suit the types of applications for which the TE is intended (e.g. taking into account the typical holding times for calls).

Test: The test shall be conducted according to annex A, subclause A.4.8.3.

4.9 Transition from loop to quiescent state

Justification: 91/263/EEC, article 4(f); Interworking with the PSTN is assured by requiring the TE to correctly release the line.

Requirement : When the TE is connected to a source of 50 VDC in series with a resistor of 2 050 Ω and initiates the transition from the loop to the quiescent state in order to release a call, the current drawn by the TE shall:

- drop to a value below 0,5 mA not later than 200 ms after the reference moment of the release; and
- in the case of automatic release and subsequent automatic reseizure for the purposes of making a new call, remain below a value of 0,5 mA for a minimum of a further 1,5 s. In this case, it is permitted for there to be transient periods during which the current exceeds 0,5 mA, as long as, when aggregated, they do not exceed 20 ms.

The reference moment of the release is defined as the moment when, for the first time, the current has dropped to a value below 10 mA and has remained at a value below 10 mA for a period or periods which, when aggregated, exceed 20 ms.

NOTE: Subclause 4.4 states the requirements for the quiescent state, including the D.C. resistance (subclause 4.4.1).

Test: The test shall be conducted according to annex A, subclause A.4.9.

4.10 Safety

There are no safety requirements under this TBR.

NOTE: Safety requirements are imposed under directive 73/23/EEC, and Articles 4(a) and 4(b) of directive 91/263/EEC.

4.11 EMC

There are no EMC requirements under this TBR.

NOTE: There are no specific EMC requirements arising from Article 4(c) in directive 91/263/EEC and consequently, all EMC aspects are covered by directive 89/336/EEC.

Annex A (normative): Test methods

A.1 General

This annex describes the test principles to determine the compliance of a TE against the requirements of this TBR.

TE may require the provision of external termination or stimuli in order to assess its conformity with this TBR. In this case, such termination or stimuli shall need to be provided in order for the tests to be carried out but shall not influence the results of measurements which shall be obtained under the normal operating condition of the TE. In order to do this, it may be necessary for the supplier to provide additional equipment or information for the purpose of test.

The test configurations given do not imply a specific realisation of test equipment or arrangement or use of specific test devices for conformance testing. The test parameters defined in this annex are "ideal" parameters. Equipment accuracies or component tolerances are not prescribed for test implementations, with the exception of guidance and information notes. Any deviations from the ideal which are present when using real test implementations shall be taken into account in calculating measurement uncertainty. Correction of systematic effects may be used to reduce measurement uncertainty.

The test equipment shall be a device, or group of devices, generating a stimulus signal and providing the test conditions (e.g. feeding conditions) conforming to this annex and capable of monitoring the received signal from the interface.

If inconsistencies are discovered between the test annex and the requirements, then the requirements shall take precedence in problem resolution.

A.1.1 Equipment connection

The tests shall be applied at the Terminal Connection Point (see figure 1).

Contact number	Test socket connected to
1	Unconnected, see note
2	Unconnected, see note
3/4	TCP
5	Unconnected, see note
6	Unconnected, see note
NOTE:	For a special application, pins (other than 3 and 4) may be intended to be additionally in contact with the NTP. In this case the supplier shall indicate the function of such pins and during the test they will be connected as would be intended during normal operation.

NOTE 1: See subclause A.1.4 for additional connections for performing measurements to earth.

NOTE 2: A special test adapter may be needed to connect the TE with the test instruments, however this adapter should not modify the characteristics of the TE.

A.1.2 Test environment

All tests shall be performed under non-condensing conditions at:

- an ambient temperature in the range from + 15 °C to + 35 °C;
- a relative humidity in the range from 5 % to 85 %;
- an air pressure in the range 86 kPa to 106 kPa.

For TE which is not designed to operate over the entire specified environmental range, all tests shall be performed at any point within the operational range specified by the supplier.

For TE which is directly powered (either wholly or partly) from the mains supply, all tests shall be carried out within $\pm 5\%$ of the rated voltage of the TE. If the equipment is powered by other means and those means are not supplied as part of the apparatus (e.g., batteries, stabilised AC supplies, DC) all tests shall be carried out within the power supply limit declared by the supplier. If the power supply is AC, the test shall be conducted within $\pm 4\%$ of the rated frequency.

A.1.3 Powered state

Tests shall be carried out with the TE powered on, under normal operating conditions defined by the supplier.

A.1.4 Measurements to earth

Where a measurement to earth is defined and the supplier's instructions state that a connection to earth is intended, then all the following points, as applicable, shall be connected to the earth point:

- a point in the TE which is intended to be connected to mains earth (in practice this might be carried out by connecting to the earth of the mains source which is supplying the TE);
- connector points which are intended to be connected to earth during the normal operation of the apparatus.

Where the TE has no facility for connection to earth, for example by one of the above points, then the test does not apply.

A.1.5 Equivalent test methods

Laboratories may use other test methods provided they are electrically equivalent to those specified.

Where test methods other than those specified are used the test report shall include statements that uniquely identify the selected test methods. However full technical details of the test methods need not be included in the test report.

NOTE: This is intended to allow traceability where alternative test methods are used

A.1.6 Additional information to support the test

It is necessary for the supplier to provide facilities to allow all tests to be carried out. Examples of these facilities could be the following:

- a) a facility to remain in the loop state without transmitting signals; and
- b) a facility to transmit all types of signal (e.g. all data rates) that the TE transmits while not receiving any signal.

NOTE: The special test facilities such as those in a) and b) above need not to be provided in the product finally marketed, but provided by the supplier when needed.

However if alternative methods are feasible these are also acceptable.

A.2 Test impedances

A.2.1 Reference impedance

Where the test defines the use of the reference impedance then this shall be as follows:

Reference impedance Z_R : This is a complex impedance made up of 270 Ω in series with a parallel combination of 750 Ω and 150 nF as shown in figure A.1.

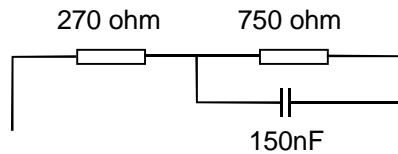

NOTE: Specific realisations of the reference impedance required for the performance of the tests should have a return loss against Z_R exceeding 40 dB within the frequency range 200 Hz to 4 300 Hz.

Figure A.1: Reference impedance

A.2.2 Non-reactive line termination

NOTE: All resistors specified in this annex for testing should be nominally non-reactive, such that any resistor or group of resistors should have a reactive impedance at any frequency in the range to be measured, not exceeding 0,5 % of the nominal impedance.

A.3 Feeding bridge

The feeding bridge specified in this annex is a configuration of test equipment used to:

- apply to the TE terminals electrical conditions consistent with those defined in the test;
- suitably couple measurement equipment to the TE terminals.

The feeding bridge is assumed to be ideal, so that:

- DC feeding and AC termination of the TE are as defined in the test;
- all measurements are referenced to the TE terminals (e.g. the feeding bridge does not cause an attenuation or delay, in the parameter to be measured, between the TE terminals and the measuring equipment).

If requested by the supplier (e.g. for TE with an adaptive filter) the TE shall be reset before repeating a test with a different feeding condition.

Within individual test cases, "AC termination of TE" defines the total AC impedance to be seen by the TE including all test equipment (feeding bridge, measuring equipment, reference impedance fixtures, etc.).

A.4 Test methods

One test may cover more than one requirement. The scope of each test is defined under the heading "purpose".

A.4.1 General requirement

Test by visual inspection.

A.4.2 Physical characteristics of connection to the PSTN

Test by visual inspection.

A.4.3 Requirements in all conditions

A.4.3.1 Polarity

Where tests with both polarities are needed this is indicated in relevant clauses in this annex.

A.4.4 General requirements in quiescent state

A.4.4.1 DC Resistance

Requirement: Subclause 4.4.1.

Purpose: To check whether the TE presents a resistance of at least 1 M Ω when tested at 25 VDC, 50 VDC and 100 VDC in the quiescent state.

Measurement principle:

Preamble: Set the TE in quiescent state.

Test state: Quiescent state.

Test configuration:

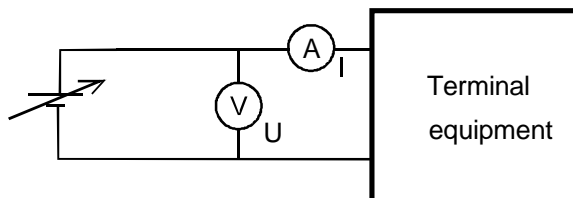

Figure A.2

Measurement points: U = 25 VDC, 50 VDC and 100 VDC.

Measurement execution:

Apply the test voltage U between the line terminals of the TE for at least 30 s before measuring DC current I. The test shall be carried out for both polarities of the applied voltage.

Formal processing: None.

Verdict: When tested at U the current I shall be less than or equal to the values of I_{max} in table A.1:

Table A.1

U (VDC)	I_{max} (μ A)
25	25
50	50
100	100

if yes then Pass; else Fail.

Guidance: None.

A.4.4.2 Characteristics of TE for ringing signals

A.4.4.2.1 Impedance

Requirement: Subclause 4.4.2.1.

Purpose: To determine whether the TE presents an impedance in the quiescent state during ringing within the specified range.

Measurement principle:

Preamble: Set the TE in quiescent state with any auto answering facility disabled.

Test state: Quiescent state.

Test configuration:

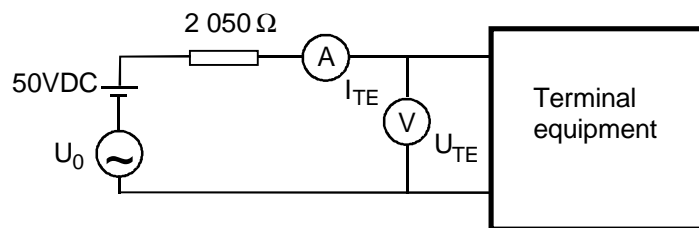

Figure A.3

DC feeding arrangement: Feed Voltage = 50 V DC.

AC feeding arrangement: Sinusoidal source U₀ 25 Hz and 50 Hz, 30 V rms U_{TE} measured across the TE.

Measurement points: Voltage U_{TE} and current I_{TE} measured for the frequencies of 25 Hz and 50 Hz.

Safety Warning: This test presents the potential for a shock hazard. Ensure satisfactory safety precautions are implemented to reduce the risk of electric shock.

Measurement execution:

Using the test configuration shown, apply the ringing signal continuously to the TE. Adjust the source voltage (U₀) to set the voltage across the TE (U_{TE}) to 30 V rms. However, if U_{TE} is less than 30 V rms for a source voltage of 90 V rms then the source voltage is not increased further and the test is deemed completed. Otherwise, measure the current (I_{TE}) flowing in the circuit.

Formal processing: The impedance of the TE during ringing can be calculated using the following formula:

$$|Z_{Ri}| = \frac{U_{TE}}{I_{TE}}$$

Verdict: If it is possible to apply 30 V rms at the TE terminals with a source voltage of less than or equal to 90 V rms and if |Z_{Ri}| is equal to or greater than 4 kΩ then Pass; else Fail.

Guidance: True rms reading instruments should be used because voltages and currents across the TE may not be sinusoidal.

A.4.4.2.2 Transient response

Requirement: Subclause 4.4.2.2.

Purpose: To check that the transient DC characteristics of the TE in quiescent state comply with subclause 4.4.2.2.

Measurement principle:

Preamble: Set the TE in quiescent state with the line terminals shorted together.

Test state: Quiescent state. The TE shall have been in the quiescent state for not less than 1 minute.

Test configuration:

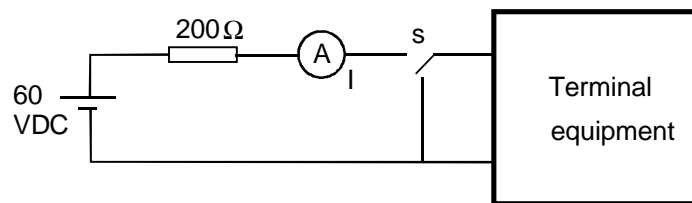

Figure A.4

DC feeding arrangement: Feed Voltage = 60 V DC.

Measurement points: Measure current 1 ms and 6 ms after the connection of the voltage source.

Measurement execution:

Connect the voltage source to the TE with the switch S and monitor the line current.

Verdict: If the line current is less than or equal to 25 mA 1 ms after the connection and less than or equal to 10 mA 6 ms after the connection then Pass; else Fail.

Guidance: None.

A.4.4.2.3 DC current

Requirement: Subclause 4.4.2.3.

Purpose: To determine whether the DC component of the ringing current exceeds 0,6 mA.

Measurement principle:

Preamble: Set the TE in quiescent state with any auto answer facility disabled.

Test state: Quiescent state.

Test configuration:

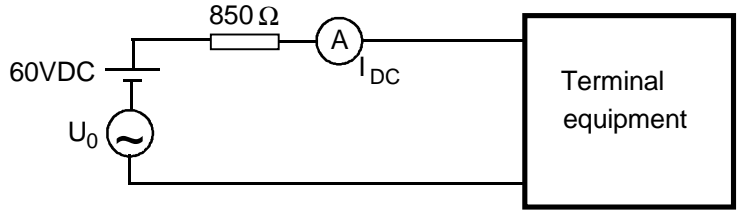

Figure A.5

DC feeding arrangement: Feed Voltage = 60V DC.

AC feeding arrangement: Sinusoidal source $U_0 = 90 \text{ V rms}$, 25 Hz and 50 Hz .

Safety Warning: This test presents the potential for a shock hazard. Ensure satisfactory safety precautions are implemented to reduce the risk of electric shock.

Measurement execution:

Using the test configuration shown, apply the ringing signal. After 400 ms measure the current I_{DC} for one or more complete cycles of the DC voltage. The test shall be carried out for both polarities of the feeding voltage.

Formal processing: Calculate the average value (I_{DC}).

Verdict: If the magnitude of I_{DC} is less than or equal to 0,6 mA then Pass; else Fail.

Guidance: The sampling rate should be chosen to give an even integer of samples in one cycle.

A.4.4.3 Impedance unbalance about earth

Requirement: Subclause 4.4.3.

Purpose: To ensure that the impedance unbalance about earth expressed as Longitudinal Conversion Loss meets the requirements.

Measurement principle:

Preamble: Set the TE in quiescent state.

Test state: Quiescent state.

Test configuration:

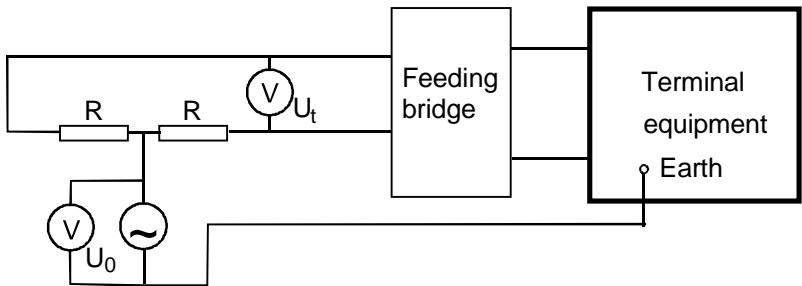

Figure A.6

DC feeding arrangement: Feed voltage: 50 V. Feed resistance: 230 Ω . The test shall be made with both polarities.

Measurement points: The resistors R shall be 300 Ω.

U_o shall be a sinusoidal signal with a constant voltage of 0,775 V rms throughout the specified frequency range (50 Hz to 3 400 Hz in 1/3th octave steps). Measurement of the transverse voltage U_t shall be performed with a suitable frequency selective voltmeter.

Measurement execution:

Measure the voltage U_t across the specified frequency range. The test shall be carried out for both polarities of feeding.

Formal processing: The measured value of U_t is used to calculate the Longitudinal Conversion Loss by using the following equation at all the measurement points:

$$\text{Longitudinal Conversion Loss} = 20\log_{10} \left| \frac{U_o}{U_t} \right| \text{ dB}$$

Verdict: If the Longitudinal Conversion Loss is greater than or equal to the specified limits in table 2 and figure 2 then Pass; else Fail.

Guidance: The test sender output impedance should be less than 500 Ω.
The voltmeter input impedance should be greater than 100 kΩ.

A.4.4.4 Resistance to earth

Requirement: Subclause 4.4.4.

Purpose: To check whether the TE complies with subclause 4.4.4 in the quiescent state.

Measurement principle:

Preamble: Set the TE in quiescent state.

Test state: Quiescent state.

Test configuration:

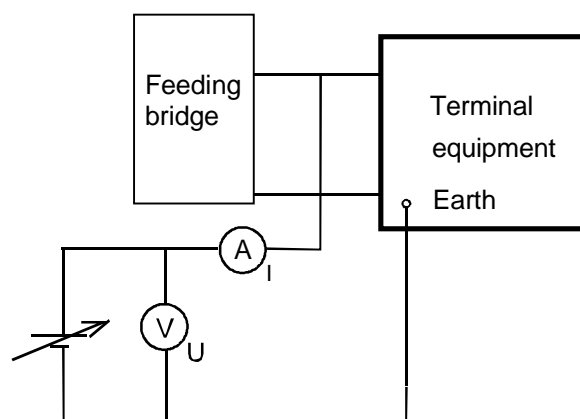

Figure A.7

DC feeding arrangement: Feed voltage: 50 V. Feed resistance: 230 Ω.

Measurement points: U = 100 volts DC.

Measurement execution:

Apply test voltage U between one of the line terminals and the earth connection point or points specified by the supplier's instructions for at least 30 s before measuring current I . The test shall be carried out for both line terminals and for both polarities of the applied test voltage and applied feeding voltage.

Formal processing: Resistance to earth (R) = U/I .

Verdict: If R is greater than or equal to 10 M Ω then Pass; else Fail.

Guidance: None.

A.4.5 Ringing signal detector sensitivity

Requirement: Subclause 4.5.

Purpose: To determine the ability of the TE to respond as stated to ringing signals as specified by the supplier.

Measurement principle:

Preamble: Set the TE in quiescent state with answering facility enabled.

Test state: Quiescent state.

Test configuration:

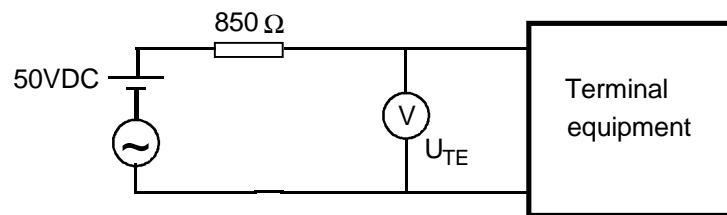

Figure A.8

DC feeding arrangement: Feed Voltage = 50 V DC.

Measurement points: The ringing signal shall have a sinusoidal source of 25 Hz and 50 Hz and a cadence of 1 s ON and 5 s OFF.

$$U_{TE} = 30 \text{ Vrms}$$

Safety Warning: This test presents the potential for a shock hazard. Ensure satisfactory safety precautions are implemented to reduce the risk of electric shock.

Measurement execution:

Using the test configuration shown in figure A.8, apply, one at a time, each one of the ringing signals described in "Measurement points" to the circuit to determine whether they are detected by the TE as stated by the supplier.

Formal processing: None.

Verdict: If TE detects all the ringing signals above described in "Measurement points" then Pass; else Fail.

Guidance: For automatic answering TE, after the stimulation to cause the seizure, the requirement stated in subclause 4.6.2 and its associated test case apply.

A.4.6 Transition from quiescent to loop state

A.4.6.1 Acceptance of breaks in the loop in a call attempt

Requirement: Subclause 4.6.1.

Purpose: To check that the DC characteristics of the TE during the transition from quiescent to loop state comply with subclause 4.6.1.

Measurement principle:

Preamble: Set the TE in quiescent state.

Test state: In transition from quiescent to loop state.

Test configuration:

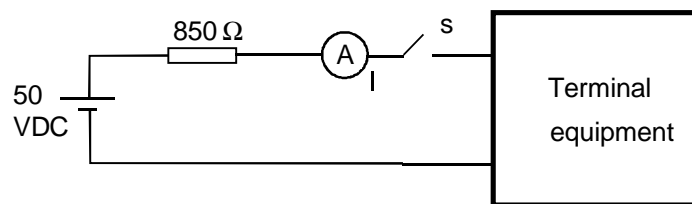

Figure A.9

DC feeding arrangement: Feed voltage: 50 VDC.

Measurement points: as in test configuration.

Measurement execution:

Monitor the current across the TE line termination. Cause the TE to make a transition from the quiescent to the loop state. When the line feeding current has first reached and remained at a value greater than 12,8 mA for:

test 1: 30 ms;

test 2: 500 ms.

interrupt the current for a period of 400 ms. Continue to monitor the current for a period of 100 ms after restoration.

Formal processing: If the current drops below 12,8 mA for more than one period of time, then sum all the periods to obtain the total time for comparison with the limit.

Verdict: If the line current has reached a value greater than 12,8 mA within 20 ms of the restoration AND if, during the period between 20 ms and 100 ms after the restoration, the current does not drop below 12,8 mA for more than 7 ms, then Pass; else Fail.

Guidance: None.

A.4.6.2 Loop current characteristics

Requirement: Subclause 4.6.2.

Purpose: To check that the current/time characteristics of the TE during the transition from quiescent to loop state comply with subclause 4.6.2.

Measurement principle:

Preamble: Set the TE in quiescent state for a time greater than 1 minute.

Test state: Cause the TE to make a transition to loop state.

Test configuration:

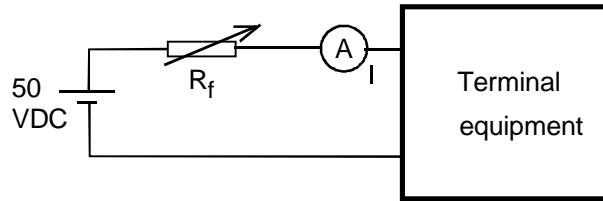

Figure A.10

DC feeding arrangement: Feed voltage: 50 VDC. Feed resistance R_f , each of the following: 150 k Ω , 36 k Ω , 24 k Ω , 8 k Ω , 3,2 k Ω , 230 Ω .

Measurement points: Feed resistances listed above in the DC feeding arrangement.

Measurement execution:

Before measuring for each resistance value, keep the TE in quiescent state for 1 minute. In sequence, select a R_f resistance value according to the selected feeding resistance and then cause the TE to make a transition from the quiescent to the loop state.

Test 1: For R_f : 150 k Ω , 36 k Ω , 24 k Ω and 8 k Ω , monitor I for the period from t_0 to t_2 as indicated in table 3 and figure 3.

Test 2: For R_f : 3,2 k Ω and 230 Ω , monitor I for the period from t_0 to t_3 as indicated in table 4 and figure 4.

Formal processing: For each feeding resistance, calculate the sum of the transient periods where the current I falls under the limit of figure 3 or figure 4 as relevant.

Verdict: If for test 1 the TE complies with the limits stated in table 3 and in figure 3 apart from transients whose aggregated period is less than 7 ms and if for test 2 the TE complies with the limits stated in table 4 and in figure 4 apart from transients whose aggregated period is less than 7 ms then Pass; else Fail.

Guidance: None.

A.4.7 General loop state requirements

A.4.7.1 DC characteristics

Requirement: Subclause 4.7.1.

Purpose: To verify that the steady-state DC loop characteristics are within the limits given in table 5, and shown in figure 5. The test only applies to TE which are capable of reaching the loop state.

Measurement principle:

Preamble: Set the TE in quiescent state.

Test state: Loop state.

Test configuration:

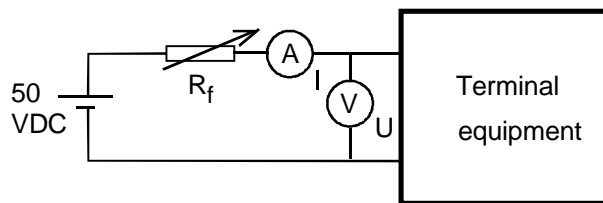

Figure A.11

DC feeding arrangement: Feed voltage: 50 V. Feed resistance: each of the following: 230 Ω , 850 Ω , 2 050 Ω , and 3 200 Ω . Polarity shall be switched between each feed resistance.

Measurement execution:

In sequence, select a feed resistance value according to the DC feeding arrangement and then cause the TE to enter the loop state after making sure that the TE has been held at least 1 minute in quiescent state. When the terminal has been in the loop state for at least 1,2 s, measure the DC current drawn by the TE and the DC voltage across the TE for each of the feed conditions. Allow sufficient settling time, to a maximum of 3 s, to ensure that the measured value is stable to within $\pm 0,5\%$ for at least 0,2 s. Then repeat the sequence for other measurement points, repeating each time a transition from quiescent state to loop state.

Formal processing: None.

Verdict: If the DC voltage/current characteristics are within the limits given in table 5, and shown in figure 5 then Pass; else Fail.

Guidance: Allowing "sufficient settling time" is useful to ensure test repeatability and reproducibility. Nevertheless if the stated stability cannot be found, the settling time shall be limited to 3 s. In this latter case a measurement accuracy improvement may be obtained by averaging several measurement readings made during the settling time.

A.4.7.2 Impedance

Requirement: Subclause 4.7.2.

Purpose: To verify that the return loss of the input impedance (Z_i) of the TE in relation to the reference impedance Z_R is within the limits specified below.

Measurement principle:

Preamble: Set the TE in loop state.

Test state: Loop state.

Test configuration:

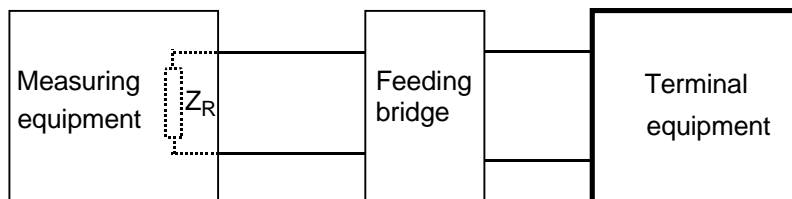

Figure A.12

DC feeding arrangement: Feed voltage: 50 V. Feed resistance: each of the following: 230 Ω , 850 Ω , 2 050 Ω , and 3 200 Ω . Polarity shall be switched between each feed resistance.

AC termination of TE: Z_R

Measurement points:

The test signal shall be sinusoidal with a constant voltage, whose level shall be pre-set to that required to achieve a level of - 10 dBV at the TE line terminals.

$f_{\min} = 200$ Hz, $f_{\max} = 4\,000$ Hz with step intervals of not more than 1/3 of an octave.

Measurement execution:

When the TE has been in the loop state for at least 1,2 s, measure the modulus and phase of the voltage and current flowing at the measurement frequency. Calculate the complex impedance (Z_i) of the TE.

Formal processing: Return loss $\alpha = 20\log_{10} \left| \frac{Z_R + Z_i}{Z_R - Z_i} \right|$ where Z_R is the reference impedance and Z_i is the impedance of the TE.

Verdict: If for frequencies that are above 300 Hz and not greater than 4 000 Hz, the return loss is greater than or equal to 8 dB;

and for frequencies that are not less than 200 Hz but are not greater than 300 Hz the return loss is greater than or equal to 6 dB;

and for frequencies that are not less than 200 Hz but are not greater than 300 Hz the inductive (reactive) component of impedance is less than 500 Ω (+j 500 Ω), then Pass; else Fail.

Guidance: None.

A.4.7.3 Sending level limitations

A.4.7.3.1 Mean sending level

Requirement: Subclause 4.7.3.1.

Purpose: To check that the mean sending level in the frequency range 200 Hz to 3 800 Hz over a one-minute period shall not be greater than - 9,7 dBV when the TE interface is terminated with the reference impedance Z_R .

Measurement principle:

Preamble: Set the TE in loop state.

Test state: The TE shall be in loop state and sending representative signals continuously.

Test configuration:

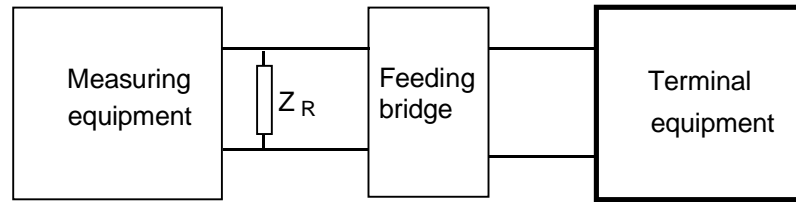

Figure A.13

DC feeding arrangement: Feed voltage: 50 V. Feed resistance: each of the following: 230 Ω , and 3 200 Ω . Polarity shall be switched between each feed resistance.

AC termination of TE: Z_R

Measurement points: The TE is exercised to send to line representative combinations of its declared output capabilities.

Measurement execution:

The TE shall be set in loop state, transmitting representative signals continuously. The mean sending level in the frequency range 200 Hz to 3 800 Hz transmitted across the termination points of the TE shall be determined over a one-minute period.

Formal processing: None.

Verdict: If the mean level over a one-minute period is less than or equal to - 9,7 dBV then Pass; else Fail.

Guidance: TE with adjustable output level is set up in accordance with the supplier's instructions for intended use, or in the absence of instructions, is set to send at its maximum level. The TE is then operated in accordance with its intended use. For data equipment (e.g. modems), any output signal may be a test message consisting of a representative bit pattern or a scrambled signal. For answering machines or similar equipment where the output is derived from recorded speech, any recorded signal shall have been prepared in accordance with the supplier's instruction for intended use.

A.4.7.3.2 Instantaneous voltage

Requirement: Subclause 4.7.3.2.

Purpose: To check that the peak to peak voltage of the TE complies with subclause 4.7.3.2.

Measurement principle:

Preamble: Set the TE in loop state.

Test state: The TE shall be in loop state and sending representative signals.

Test configuration:

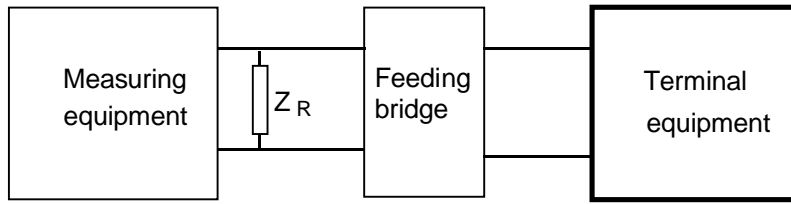

Figure A.14

DC feeding arrangement: Feed voltage: 50 V. Feed resistance: each of the following: 230 Ω , and 3 200 Ω . Polarity shall be switched between each feed resistance.

AC termination of TE: Z_R

Measurement points: The TE is exercised to send to the line:

- representative combinations of its declared output capabilities;
- DTMF signals.

Measurement execution:

The TE shall be set in the loop state, transmitting representative signals. The peak to peak voltage transmitted across the termination points of the TE, shall be measured.

Formal processing: None.

Verdict: If the peak to peak voltage is not higher than 5,0 V then Pass; else Fail.

Guidance: TE with adjustable output level is set up in accordance with supplier's instructions to send at its maximum intended level.

A.4.7.3.3 Voltage level in a 10 Hz bandwidth

Requirement: Subclause 4.7.3.3.

Purpose: To check that the TE complies with subclause 4.7.3.3.

Measurement principle:

Preamble: Set the TE in loop state.

Test state: The TE shall be in loop state and sending representative signals continuously.

Test configuration:

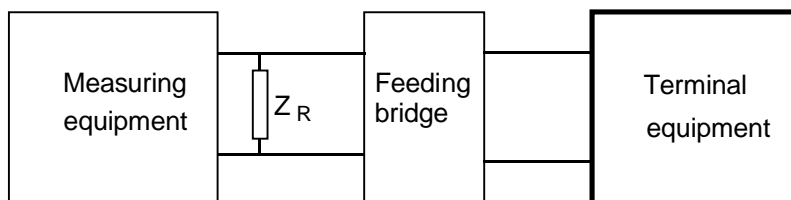

Figure A.15

DC feeding arrangement: Feed voltage: 50 V. Feed resistance: each of the following: 230 Ω , and 3 200 Ω . Polarity shall be switched between each feed resistance.

AC termination of TE: Z_R

Measurement points: The TE is exercised to send to line representative combinations of its declared output capabilities.

Measurement execution:

The TE shall be set in loop state, transmitting representative signals continuously. The voltage level transmitted across the TCP shall be measured. It shall be determined whether the level within every 10 Hz bandwidth wholly contained in the frequency range 30 Hz to 4 300 Hz is less than or equal to the limits given in table 6 and figure 6. In the case of data equipment (e.g. modems) the level shall only be measured during the data transfer phase.

Formal processing: None.

Verdict: If the levels are according to table 6 and figure 6 then Pass; else Fail.

Guidance: TE with adjustable output level is set up in accordance with the supplier's instructions to send at its maximum intended level.

A.4.7.3.4 Sending level above 4,3 kHz

A.4.7.3.4.1 Sending level above 4,3 kHz during DTMF dialling

Requirement: Subclause 4.7.3.4.

Purpose: To check that the TE complies with subclause 4.7.3.4 when transmitting any DTMF tone combination during a call attempt.

Measurement principle:

Preamble: Set the TE in loop state.

Test state: DTMF dialling.

Test configuration:

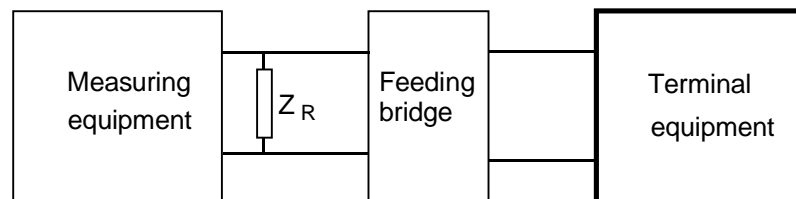

Figure A.16

DC feeding arrangement: Feed voltage: 50 V. Feed resistance: each of the following: 230 Ω , and 3 200 Ω . Polarity shall be switched between each feed resistance.

AC termination of TE: Z_R

Measurement points: Where all characters of table 9 are available, select digits A, 6, 8 and *. Else if all numerals are available, select digits 3, 5, 7 and 0, else select all available digits.

Measurement execution:

The TE shall be set in the loop state, transmitting DTMF characters to line.

Measurement shall be made during the tone duration as defined in subclause 4.8.2.4 (minimum duration 65 ms).

It shall be determined whether all single frequency components individually have a sending level less than or equal to - 35,7 dBV in the range 4,3 kHz to 20 kHz and -40,7 dBV in the range 20 kHz to 200 kHz.

Formal processing: None.

Verdict: If the voltage level of each single frequency component is less than or equal to - 35,7 dBV in the range 4,3 kHz to 20 kHz and - 40,7 dBV in the range 20 kHz to 200 kHz then Pass; else Fail.

Guidance: All characteristics of the TE are captured for practical purposes when the diagonal in table 9 is used, going from the digit with the largest frequency difference in its combination (highest/lowest frequency) up to the digit with the smallest frequency difference.

A.4.7.3.4.2 Sending level above 4,3 kHz during communication

Requirement: Subclause 4.7.3.4.

Purpose: To check that the TE complies with subclause 4.7.3.4 in loop state.

Measurement principle:

Preamble: Set the TE in loop state.

Test state: The TE shall be in loop state and sending representative signals continuously.

Test configuration:

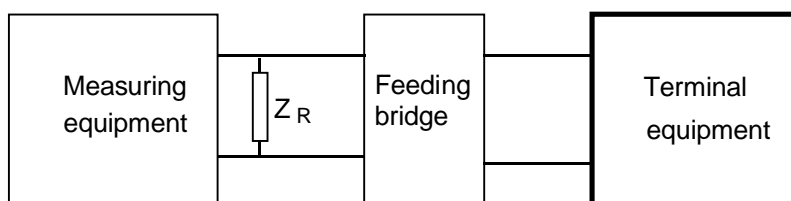

Figure A.17

DC feeding arrangement: Feed voltage: 50 V. Feed resistance: each of the following: 230 Ω, and 3 200 Ω. Polarity shall be switched between each feed resistance.

AC termination of TE: Z_R

Measurement points: The TE is exercised to send to line representative combinations of its declared output capabilities.

Measurement execution:

The TE is set in loop state, transmitting representative signals continuously. The sending level across the termination points of the TE shall be measured. It is determined whether the level in a bandwidth defined in table 7, wholly contained in the frequency range 4,3 kHz to 200 kHz, is less than or equal to the limits of table 7 and figure 7. Where these limits are exceeded it is determined whether exceeding the limits is caused by tone signals having one or more single frequency component whose individual voltage level is less than or equal to - 35,7 dBV in the range 4,3 kHz to 20 kHz and - 40,7 dBV in the range 20 kHz to 200 kHz.

Formal processing: None.

Verdict: If the sending level complies with table 7 and figure 7 then Pass.

If the only non-compliance with table 7 and figure 7 is due to a tone signal with one or more single frequency components whose individual levels are less than or equal to - 35,7 dBV in the range 4,3 kHz to 20 kHz and - 40,7 dBV in the range 20 kHz to 200 kHz then Pass; else, Fail.

Guidance: TE with adjustable output level is set up in accordance with supplier's instructions to send at its maximum level.

A.4.7.4 Impedance unbalance about earth

A.4.7.4.1 Longitudinal Conversion Loss

Requirement: Subclause 4.7.4.1.

Purpose: To ensure that the impedance unbalance about earth, expressed as Longitudinal Conversion Loss, meets the requirements.

Measurement principle:

Preamble: Set the TE in loop state.

Test state: Loop state.

Test configuration:

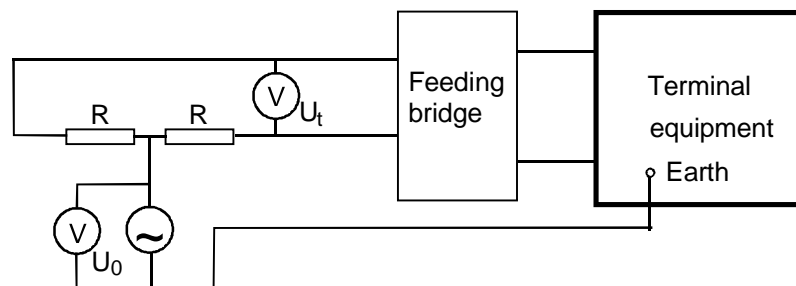

Figure A.18

DC feeding arrangement: Feed voltage: 50 V. Feed resistance: each of the following: 230 Ω , 850 Ω , 2 050 Ω , and 3 200 Ω . Polarity shall be switched between each feed resistance.

Measurement points: The resistors R shall be 300 Ω.

U_0 shall be a sinusoidal signal with a constant voltage of 0,775 V throughout the specified frequency range (50 Hz to 3 800 Hz in 1/3th octave steps). Measurement of the transverse voltage U_t shall be performed with a suitable frequency selective voltmeter.

Measurement execution:

Measure the longitudinal voltage U_t across the specified frequency range for each of the feed conditions. Allow sufficient settling time at each feed condition to ensure that the measured value is stable to within ± 0,5 % for at least 0,2 s.

Formal processing: The measured value of U_t is used to calculate the Longitudinal Conversion Loss by using the following equation:

$$\text{Longitudinal Conversion Loss} = 20\log_{10}\left|\frac{U_0}{U_t}\right| \text{ dB} .$$

Verdict: If the Longitudinal Conversion Loss is greater than the specified limit in table 8 and figure 8 then Pass; else Fail.

Guidance: The test sender output impedance should be less than 500 Ω. The voltmeter input impedance should be greater than 100 kΩ.

A.4.7.4.2 Output Signal Balance

Requirement: Subclause 4.7.4.2.

Purpose: To ensure that the impedance unbalance about earth, expressed as output signal balance, meets the requirements.

Measurement principle:

Preamble: Set the TE in loop state.

Test state: Loop state.

Test configuration:

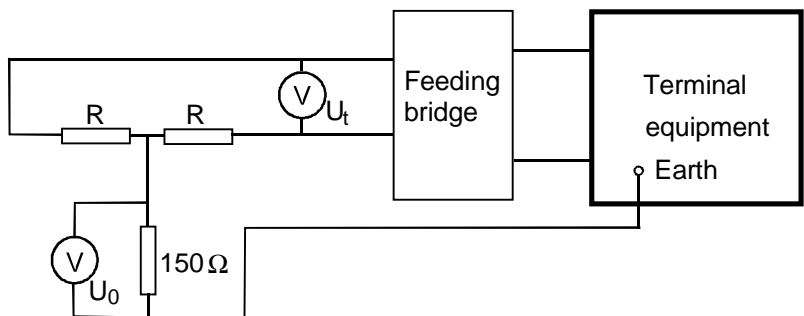

Figure A.19

DC feeding arrangement: Feed voltage: 50 V. Feed resistance: each of the following: 230 Ω, 850 Ω, 2 050 Ω, and 3 200 Ω. Polarity shall be switched between each feed resistance.

Measurement points: The resistors R shall be 300 Ω. Measurement of the voltages U_0 and U_t shall be performed with a suitable frequency selective voltmeter.

Measurement execution:

The TE is set in the loop state transmitting representative signals to line.

Formal processing: The measured values of U_o and U_t are used to calculate the OSB by using the following equation:

$$\text{Output Signal Balance} = 20 \log_{10} \left| \frac{U_t}{U_o} \right| \text{dB.}$$

For frequencies at which U_o is less than -70 dBV the OSB is not calculated.

Verdict: If the OSB is greater than the specified limit in table 8 and figure 8 then Pass; else Fail. For frequencies at which U_o is less than -70 dBV there is no OSB requirement.

Guidance: The voltmeter input impedance should be greater than 100 k Ω .

A.4.7.5 Resistance to earth

Requirement: Subclause 4.7.5.

Purpose: To check whether the TE complies with subclause 4.7.5 in the loop state.

Measurement principle:

Preamble: Set the TE in loop state.

Test state: Loop state.

Test configuration:

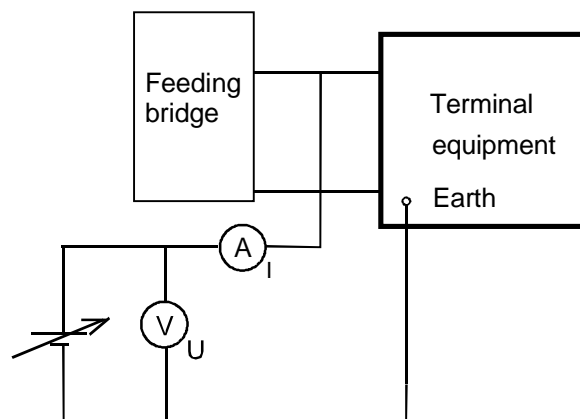

Figure A.20

DC feeding arrangement: Feed voltage: 50 V. Feed resistance: 230 Ω .

Measurement points: $U = 100$ VDC.

Measurement execution:

Apply test voltage U between one of the line terminals and the earth connection point or points specified by the supplier's instructions for at least 30 s before measuring current I . The test shall be carried out for both polarities of the applied test voltage and applied feeding voltage.

Formal processing: Resistance to earth (R) = U/I .

Verdict: If R is greater than or equal to 1 MΩ then Pass; else Fail.

Guidance: None.

A.4.8 Call attempt

A.4.8.1 Automatic dialling

A.4.8.1.1 Dialling without dial tone detection

Requirement: Subclause 4.8.1.1.

Purpose: To check that the TE starts dialling within the allowed period after seizure.

Measurement principle:

Preamble: Set the TE in quiescent state, tone-detector if any, disabled. If the pause before dialling is adjustable by the user, set it in accordance with the supplier's instructions to the closest available value to the midpoint between 3 and 8 s. If two values are equally close to the mid point, then use the lower value.

Test state: Automatic DTMF dialling.

Test configuration:

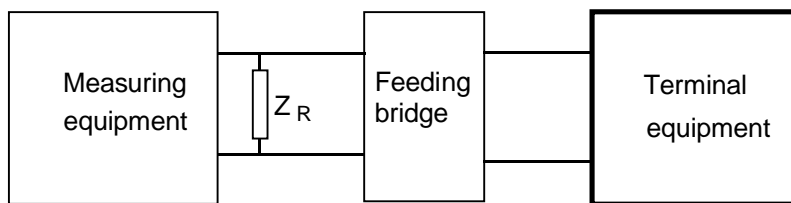

Figure A.21

DC feeding arrangement: Feed voltage: 50 V. Feed resistance: 850 Ω.

AC termination of TE: Z_R .

Measurement execution:

The TE is set in the loop state, transmitting signalling characters to line. The time shall be measured from seizure up to the start of the first digit.

Formal processing: None.

Verdict: If the time delay is equal to or greater than 2,7 s and dialling has started within 8 s then Pass; else Fail.

Guidance: None.

A.4.8.1.2 Dialling with dial tone detection

Requirement: Subclause 4.8.1.2.

Purposes: To check whether, after seizure, the TE starts dialling within the allowed period after the start of the dial tone.

Measurement principle:

Preamble: Set the TE in quiescent state with dial tone detector enabled.

Test state: Automatic DTMF dialling.

Test configuration:

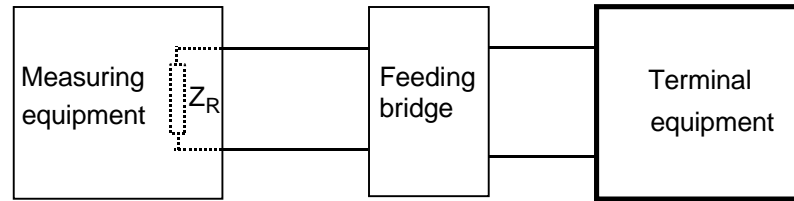

Figure A.22

DC feeding arrangement: Feed voltage: 50 V. Feed resistance: 850 Ω.

AC termination of TE: Z_R .

Measurement points: The detection range that shall be tested is limited by the frequencies and voltage levels given in the table below. The levels are defined across the reference impedance Z_R .

Detection range, frequencies:

Frequency (Hz)	Level (dBV)
300	- 0,7
300	- 35,7
500	- 35,7
500	- 0,7

Measurement execution:

The TE is set in the loop state, ready for transmitting signalling tones to the line.

Two tests shall be performed. In both tests the dial tone is activated 3 s after having established the loop state.

- Test 1 Send continuous dial tone. Time is measured from the start of the dial tone;
- Test 2 Send a repeated sequence of cadenced dial tone whose cadence consists of a period of 200 ms ON followed by 200 ms OFF, 600 ms ON and 1000 ms OFF. Time is measured from the start of the sequence.

Formal processing: None.

Verdict: If the TE has started dialling before 8 s in both tests 1 and 2, measured from the start of the dial tone, then Pass; else Fail.

Guidance: The level is supplied from a generator such that the total impedance of the generating and feeding circuitry is Z_R . The TE is replaced by a matching impedance Z_R for the purpose of level measurement. The TE is in-circuit for the purpose of timing measurement.

A.4.8.2 DTMF signalling

Guidance: Dial tone may be necessary to activate dialling.

A.4.8.2.1 Frequency combinations

Requirement: Subclause 4.8.2.1.

Purpose: To check whether the TE sends appropriate DTMF signal frequency combinations. The allowed combinations are listed in the table 9.

Measurement principle:

Preamble: Set the TE in loop state

Test state: Dialling.

Test configuration:

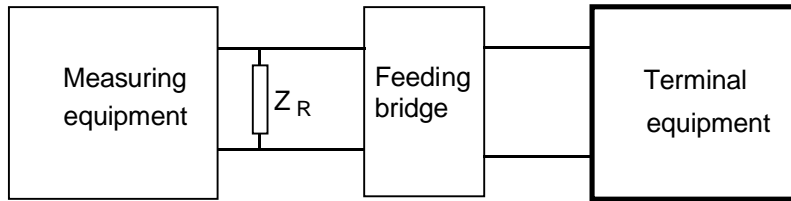

Figure A.23

DC feeding arrangement: Feed voltage: 50 V. Feed resistance: 850 Ω .

AC termination of TE: Z_R .

Measurement points: All supported characters shall be verified. The tolerances on the available frequencies shall be not more than $\pm 1,5\%$.

Measurement execution:

The TE is set in the loop state, transmitting DTMF signals to line.

Measurement shall be made during the tone duration as defined in subclause 4.8.2.4 (minimum duration 65 ms).

Formal processing: None.

Verdict: If all available frequencies are according to table 9, with a tolerance of $\pm 1,5\%$, then Pass; else Fail.

Guidance: None.

A.4.8.2.2 Signalling levels

Requirement: Subclause 4.8.2.2.1

Purpose: To check whether the TE sends appropriate DTMF signals. The level of any tone in the DTMF high frequency group shall be - 9,0 dBV +2,0/-2,5 dB and the level of any tone in the low frequency group shall be - 11,0 dBV +2,5/-2,0 dB when the TE interface is terminated with the reference impedance Z_R . The level of the tone in the high frequency group shall be 1 to 4 dB higher than the level of the tone in the low frequency group.

Measurement principle:

Preamble Set the TE in loop state. Maximum duration of tone burst setting.

Test state: Dialling.

Test configuration:

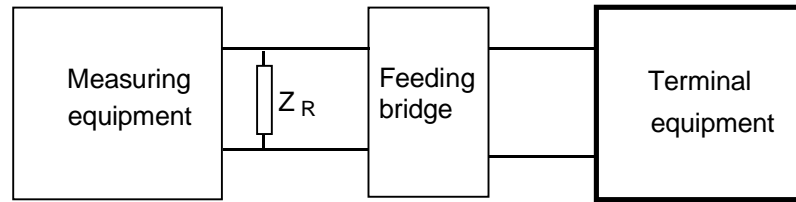

Figure A.24

DC feeding arrangement: Feed voltage: 50 V. Feed resistance: each of the following: 230 Ω , and 3 200 Ω .
Polarity shall be switched between each feed resistance.

AC termination of TE: Z_R .

Measurement points: All supported characters shall be verified.

Measurement execution:

The TE is set in the loop state, transmitting DTMF signals to line.

Measurement shall be made during the tone duration as defined in subclause 4.8.2.4 (minimum duration 65 ms).

Formal processing: None.

Verdict: If the tone in the high frequency group has a level between -7,0 dBV and -11,5 dBV and if the tone in the low frequency group has a level between -8,5 dBV and -13,0 dBV and if the difference between the levels is between 1 and 4 dB then Pass: else Fail.

Guidance: None.

A.4.8.2.3 Unwanted frequency components

Requirement: Subclause 4.8.2.3.

Purpose: To check the total sending level of all unwanted frequencies in the frequency range 250 Hz to 4 300 Hz. The level shall be at least 20 dB below the low frequency group component, when transmitting any DTMF tone combination during a call attempt.

Measurement principle:

Preamble: Set the TE in loop state.

Test state: Dialling.

Test configuration:

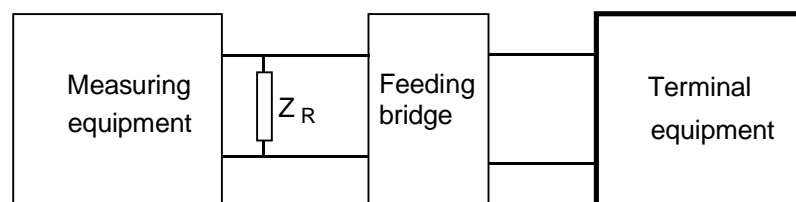

Figure A.25

DC feeding arrangement: Feed voltage: 50 V. Feed resistance: each of the following: 230 Ω , and 3 200 Ω .
Polarity shall be switched between each feed resistance.

AC termination of TE: Z_R .

Measurement points: Where all characters of table 9 are available, select digits A, 6, 8 and *. Else if all numerals are available, select digits 3, 5, 7 and 0, else select all available digits.

Measurement execution:

The TE is set in the loop state, transmitting DTMF characters to the line.

Measurement shall be made during the sending period as defined in subclause 4.8.2.4 (minimum duration 65 ms).

Formal processing: Integration of all signal levels is divided in 3 parts:

- from 250 Hz up to the lower DTMF component;
- from the lower DTMF component up to the higher DTMF component;
- from the higher DTMF component up to 4 300 Hz.

Summation of all three parts gives the total unwanted sending level result. Frequencies up to 50 Hz on either side of the DTMF components shall be excluded from the summation. This result is compared with the level of the lower DTMF component.

Verdict: If the total unwanted signal level is at least 20 dB below the level of the lower DTMF component for all available digits then Pass; else Fail.

Guidance The total unwanted sending level is calculated from the following formula:

$$\Sigma = \sqrt{a^2 + b^2 + c^2}$$

A.4.8.2.4 Tone duration

Requirement: Subclause 4.8.2.4.

Purpose: To check whether the TE sends DTMF signals of the appropriate duration. This requirement applies only to a TE with an automatic dialling function. It applies when the TE is in automatic dialling mode.

The TE shall provide a setting whereby the duration of any individual DTMF tone combination shall be at least 65 ms measured from the time when the tone level has reached 90 % of its steady-state value (without interruption), until it has dropped to 90 % of its steady-state value.

Measurement principle:

Preamble: Set the TE in loop state.

Test state: Automatic dialling. Tone signal duration according to supplier's instructions.

Test configuration:

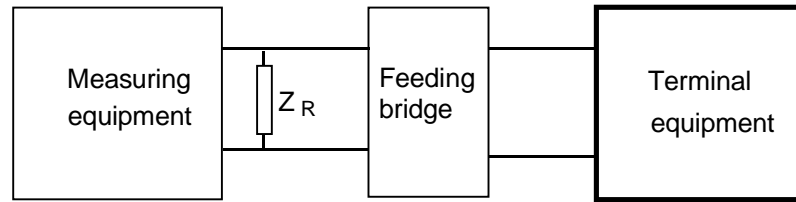

Figure A.26

DC feeding arrangement: Feed voltage: 50 V. Feed resistance: 850 Ω .

AC termination of TE: Z_R .

Measurement points: Where all characters of table 9 are available, select digits A, 6, 8 and *. Else if all numerals are available, select digits 3, 5, 7 and 0, else select all available digits.

Measurement execution:

Set tone signalling duration according to supplier's instructions.

The TE is set in the loop state, transmitting DTMF signals to the line. Capture the waveform of the DTMF signal.

Formal processing:

In this formal processing, three waveforms derived from the measured waveform are used. These are referred to as waveforms A, B and C.

Determine waveform A such that at any time the instantaneous value of waveform A is equal to the absolute value of difference between the value of the measured waveform at that time and the mean value of the measured waveform over a period of 10 ms centred on that time.

Determine waveform B such that at any time its value is the greater of the linear interpolation of the maxima of waveform A, and waveform A.

Determine waveform C such that at any time its value is the greater of the linear interpolation of the maxima of waveform B, and waveform B.

Determine the reference level such that it is 90% of the highest level which waveform C exceeds for 20 ms during the burst.

The duration of the burst is the duration of the greatest period of time for which waveform C exceeds the reference level.

Verdict:

If all bursts have a duration greater than or equal to 70 ms then Pass. If any burst has a duration of less than 60 ms then Fail;

The test shall be repeated ten times for any burst for which the duration is between 60 and 70 ms and the mean duration calculated. If the mean duration for all such bursts is greater than or equal to 65 ms then Pass; else Fail.

Guidance:

The repeatability of this test is intrinsically poor because the measured duration of the burst depends on the phase relationship of the tones. Therefore averaging is needed for borderline cases.

The relationship between the measured waveform and waveforms A, B and C is shown in figure A.27.

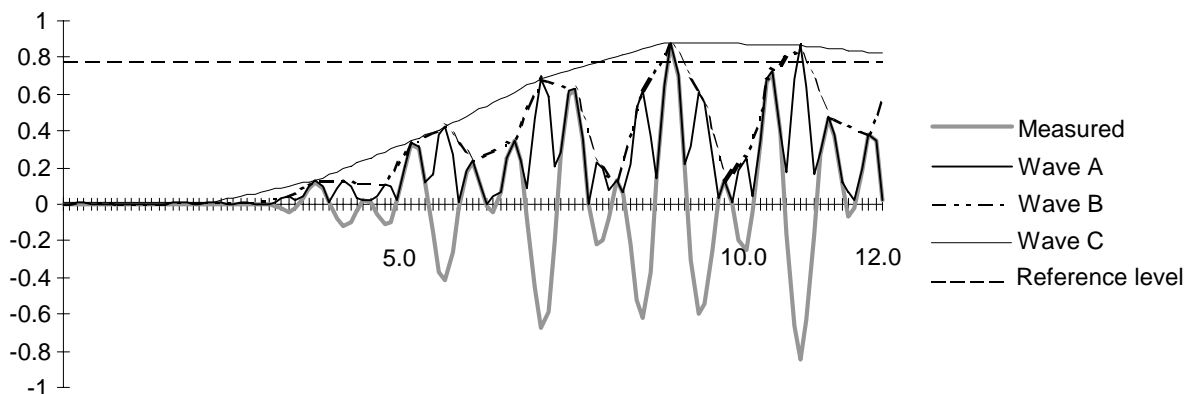

Figure A.27

A.4.8.2.5 Pause duration

Requirement: Subclause 4.8.2.5.

Purpose: To check whether the TE sends DTMF signals with the appropriate pauses. This requirement applies only to a TE with an automatic dialling function.

The TE shall provide a setting whereby the duration of the pause between the DTMF tone combinations shall be at least 65 ms. Time is measured from the moment when the tone has dropped to 10 % of its steady-state value, until it has risen to 10 % of its steady-state value.

Measurement principle:

Preamble: Set the TE in loop state.

Test state: Automatic dialling.

Test configuration:

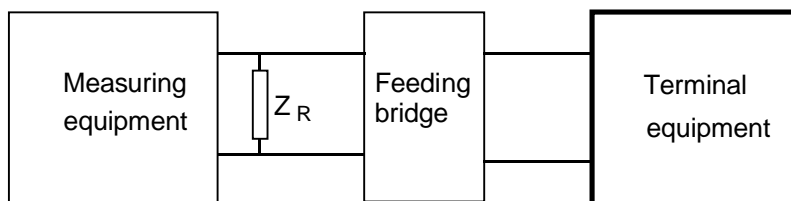

Figure A.28

DC feeding arrangement: Feed voltage: 50 V. Feed resistance: 850 Ω.

AC termination of TE: Z_R .

Measurement points: Where all characters of table 9 are available, select digits A, 6, 8 and *. Else if all numerals are available, select digits 3, 5, 7 and 0, else select all available digits.

Measurement execution:

The TE is set in the loop condition, transmitting DTMF signals to line. Set pause duration in accordance with the supplier's instructions. Capture the waveform of the sequence of bursts.

Formal processing: In this formal processing, a number of waveforms derived from the measured waveform are used. These shall be calculated independently for each burst. These are referred to as waveforms A, B, C etc.

Determine waveform A such that at any time the instantaneous value of waveform A is equal to the absolute value of difference between the value of the measured waveform at that time and the mean value of the measured waveform over a period of 10 ms centred on that time.

Determine waveform B such that at any time its value is the greater of the linear interpolation of the maxima of waveform A, and waveform A.

Determine waveform C such that at any time its value is the greater of the linear interpolation of the maxima of waveform B, and waveform B.

Determine the reference level such that it is 10% of the highest level which waveform C exceeds for 20 ms during the burst.

The pause between two bursts is the time between the last instant that waveform C is greater than the reference level for the first burst and the first instant that waveform C is greater than the reference level for the second burst.

Verdict: If all pauses have a duration greater than or equal to 70 ms then Pass;

If any pause has a duration of less than 60 ms then Fail;

If any pause has a duration of between 60 ms and 70 ms then the test shall be repeated 10 times, and the mean duration of the pause between each of the pairs on characters calculated. If each mean duration is greater than 65 ms then Pass; otherwise Fail.

Guidance: The repeatability of this test is intrinsically poor because the measured duration of the burst depends on the phase relationship of the tones. Therefore averaging is needed for borderline cases.

A.4.8.3 Automatically repeated call attempts

Requirement: Subclause 4.8.3.

Purpose: To check that the TE complies with subclause 4.8.3.

Measurement principle:

Preamble: Set TE for automatic repeat call attempts to the same number. Set number of repeat call attempts to the maximum. Put TE in quiescent state.

Test state: Alternates between DTMF dialling, loop state and quiescent state.

Test configuration:

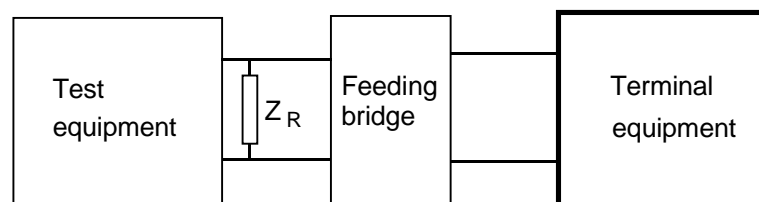

Figure A.29

DC feeding arrangement: Feed voltage: 50 V. Feed resistance: 850 Ω .

AC termination of TE: Z_R .

Measurement execution:

Cause TE to dial out without subsequent successful connection. Monitor TE line terminals. Measure the duration of the shortest interval (t) between transition to the quiescent state and the loop state for the next automatically initiated, internally generated call attempt. Record the number of repeated call attempts.

Formal processing: None.

Verdict: If the interval (t) is greater than or equal to 5 s and if there is no more than 15 repeated call attempts in a call attempt sequence or if the TE does not make any repeated call attempt in the duration of the test then Pass; else Fail.

Guidance: If the interval between call attempts is user adjustable then it shall be set to the minimum interval in accordance with supplier's instructions.

A.4.9 Transition from loop to quiescent state

Requirement: Subclause 4.9.

Purpose: To determine, whether the TE changes correctly from the loop to the quiescent state.

Measurement principle:

Preamble: Set the TE to loop state and in the case of automatic procedures set the period which the TE will subsequently be in the quiescent state to its minimum value and activate the automatic procedure.

Test state: Cause the TE to make a transition to quiescent state.

Test configuration:

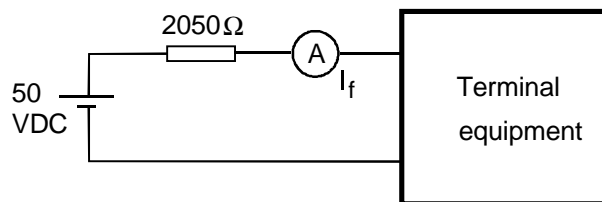

Figure A.30

DC feeding arrangement: Feed voltage 50 VDC.

Measurement points: Monitor the current I_f after it falls under 10 mA.

Measurement execution:

Cause the TE to make a transition from loop to quiescent state. Monitor the current drawn by the TE.

Formal Processing: None.

Verdict: If the TE complies with the limits of subclause 4.9 then Pass, else Fail.

Guidance: None.

Annex B (normative): TBR Requirements Table (TBR-RT)

Copyright release for TBR-RT proformas

Users of this TBR may freely reproduce annex B which contains this TBR-RT proforma so that it may be used for its intended purpose. Users may further publish the completed TBR-RT.

B.1 Guidance for completion of the TBR-RT

B.1.1 Condition table

For the requirements, there is a table of condition questions.

The Reference column contains references in the form C.x where:

- C: means Condition;
- x: uniquely identifies the element of the table.

The Condition column contains a question, the answer to which determines whether the corresponding requirement(s) in the Requirements Table shall be mandatory.

The Status column identifies whether a "Yes" or "No" answer causes relevant requirements to be mandatory for the TE. The following codes are used:

- M: means that the relevant requirements are mandatory;
- N: means that the relevant requirements are not applicable.

The Support column is blank for the user to complete.

B.1.2 Requirements table

The Number column provides an unique identifier to each requirement.

The Reference column lists the subclause reference in the TBR where the requirement may be found.

The TBR Requirement column gives the clause title of the relevant clause, supplemented by any additional information necessary to identify the requirement.

The Status column contains one of the following items:

- M: means that the requirement is mandatory;
- C.x: means that the requirement is mandatory if the relevant condition is met.

In some cases, two or more Conditions are included in the status column. The requirement shall be mandatory if the boolean combination of them is true.

The Support column is blank for the user to complete.

Table B.1: Condition table

Reference	Condition	Status	Support (Y/N)	Comment
C.1.	Is the TE controlled by an external device for the origination and/or the reception of a call?	If YES then M else N		
C.2.	Is the TE intended to have a connection to earth?	If YES then M else N		
C.3.	Is the TE intended to be in loop state?	If YES then M else N		
C.4.	Is the TE intended for call answer?	If YES then M else N		
C.5.	Is the TE intended for call set-up?	If YES then M else N		
C.6.	Is the TE intended for dialling with DTMF?	If YES then M else N		
C.7.	Is the TE intended for automatic dialling without dial tone detection?	If YES then M else N		
C.8.	Is the TE intended for automatic dialling with a dial tone detection?	If YES then M else N		
C.9.	Is the TE intended for use in receiving mode?	If YES then M else N		
C.10.	Is the TE intended for use in transmitting mode?	If YES then M else N		
C.11.	Is the TE intended for making internally generated automatically repeated call attempts?	If YES then M else N		
C.12.	Is the TE intended for automatically controlled signalling tone duration?	If YES then M else N		
C.13.	Is the TE intended for automatically controlled signalling pause duration?	If YES then M else N		

Table B.2: Requirements table

No.	Reference	TBR Requirement	Status	Support (Y/N)
R.1.	4.1	General requirement	C.1	
R.2.	4.2	Physical characteristics of connection to the PSTN	M	
R.3.	4.3.1	Polarity	M	
R.4.	4.4.1	DC resistance	M	
R.5.	4.4.2.1	Impedance	M	
R.6.	4.4.2.2	Transient response	M	
R.7.	4.4.2.3	DC-current	M	
R.8.	4.4.3	Impedance unbalance about earth	C.2	
R.9.	4.4.4	Resistance to earth	C.2	
R.10.	4.5	Ringin signal detector sensitivity	C.4	
R.11.	4.6.1	Acceptance of breaks in the loop in a call attempt	C.5	
R.12.	4.6.2	Loop current characteristics	C.3	
R.13.	4.7.1	DC characteristics	C.3	
R.14.	4.7.2	Impedance	C.3	
R.15.	4.7.3.1	Mean sending level	C.3	
R.16.	4.7.3.2	Instantaneous voltage	C.3	
R.17.	4.7.3.3	Voltage levels in a 10 Hz bandwidth	C.3	
R.18.	4.7.3.4	Sending level above 4,3 kHz	C.3	
R.19.	4.7.4.1	Longitudinal Conversion Loss	C.2 and C.3 and C.9	
R.20.	4.7.4.2	Output Signal Balance	C.2 and C.3 and C.10	
R.21.	4.7.5	Resistance to earth	C.2 and (C.4 or C.5)	
R.22.	4.8.1.1	Dialling without dial tone detection	C.7	
R.23.	4.8.1.2	Dialling with dial tone detection	C.8	
R.24.	4.8.2.1	Frequency combinations	C.6	
R.25.	4.8.2.2.1	Absolute levels	C.6	
R.26.	4.8.2.2.2	Level difference	C.6	
R.27.	4.8.2.3	Unwanted frequency components	C.6	
R.28.	4.8.2.4	Tone duration	C.6 and C.12	
R.29.	4.8.2.5	Pause duration	C.6 and C.13	
R.30.	4.8.3	Automatically repeated call attempts	C.11	
R.31.	4.9	Transition from loop to quiescent state	C.3	

Annex C (informative): Bibliography

- 73/23/EEC: "Council Directive of 19 February 1973 on the harmonisation of the laws of the Member States relating to electrical equipment designed for use within certain voltage limits". The Low Voltage Directive (LVD). (OJ L77 26.03.73).
- 89/336/EEC: "Council Directive of 3 May 1989 on the approximation of the laws of the Member States relating to electromagnetic compatibility". The EMC Directive. (OJ L139 23.05.89).
- 91/263/EEC: "Council Directive of 29 April 1991 on the approximation of the laws of the Member States concerning telecommunications terminal equipment, including the mutual recognition of their conformity". The TTE Directive. (OJ L128 23.05.91).

History

Document history		
July 1995	Public Enquiry	PE 87: 1995-07-10 to 1995-11-03
June 1996	Vote	V 105: 1996-06-10 to 1996-08-16