



EUROPEAN
TELECOMMUNICATION
STANDARD

ETS 300 913

March 1998

Fourth Edition

Source: SMG

Reference: RE/SMG-040701QR6

ICS: 33.020

Key words: Digital cellular telecommunications system, Global System for Mobile communications (GSM)



**Digital cellular telecommunications system (Phase 2+);
General on Terminal Adaptation Functions (TAF)
for Mobile Stations (MS)
(GSM 07.01 version 5.6.1)**

ETSI

European Telecommunications Standards Institute

ETSI Secretariat

Postal address: F-06921 Sophia Antipolis CEDEX - FRANCE

Office address: 650 Route des Lucioles - Sophia Antipolis - Valbonne - FRANCE

Internet: secretariat@etsi.fr - <http://www.etsi.fr> - <http://www.etsi.org>

Tel.: +33 4 92 94 42 00 - Fax: +33 4 93 65 47 16

Copyright Notification: No part may be reproduced except as authorized by written permission. The copyright and the foregoing restriction extend to reproduction in all media.

© European Telecommunications Standards Institute 1998. All rights reserved.

Contents

Foreword	5
1 Scope.....	7
2 Normative references.....	7
3 Abbreviations	9
4 Access reference configuration.....	10
5 Functions to support data services.....	10
6 Support of non transparent Bearer Services	11
6.1 Functions of the Layer 2 Relay	11
6.2 Radio Link Services Used.....	12
6.3 Flow Control - General Description	12
6.3.1 End to End Flow Control	12
6.3.2 Back Pressure.....	12
6.3.3 Receive not Ready	13
7 Structure of the GSM 07-series of Specifications	13
8 Functions common to all interfaces.....	13
8.1 Synchronization of the Traffic Channel.....	13
8.2 Filtering of Channel Control Information	15
8.2.1 General	15
8.2.2 Filtering process to be applied.....	15
8.3 Terminal Compatibility Decision	16
8.3.1 Compatibility Check	16
8.3.2 Selection of Appropriate Terminal Function	17
8.3.3 Indication of Compatibility Requirements to the PLMN	17
8.3.3.1 Indication in case of Mobile terminating calls	17
8.3.3.2 Indication in case of Mobile originating calls	19
8.4 Test Loops	20
8.5 Alternate speech/data and speech/facsimile group 3	20
8.6 Multislot configuration spit/combine function.....	20
8.6.1 Non-transparent data	20
8.6.2 Transparent data.....	20
Annex A (Informative): List of Bearer Capability Elements.....	21
Annex B (Normative): Setting of Bearer Capability, Low Layer Compatibility and High Layer Compatibility Information Element for GSM Bearer Services and GSM TeleServices.....	28
B.0 Scope.....	28
B.1 Bearer Capability Information Element.....	28
B.1.1 Introduction.....	28
B.1.1.1 General Consideration	28
B.1.1.2 Interpretation of the Diagrams	29
B.1.2 Bearer Service 20 ... 26, Data Circuit Duplex Asynchronous	40
B.1.2.1 Unrestricted / restricted digital information transfer capability	40
B.1.2.2 3.1 kHz audio ex-PLMN information transfer capability.....	42
B.1.3 Bearer Service 30 ... 34, Data Circuit Duplex Synchronous	44
B.1.3.1 Unrestricted digital information transfer capability.....	44
B.1.3.1.1 Non-X.32 Cases	44

	B.1.3.1.2	X.32 Case (Packet Service).....	46
	B.1.3.1.4	48kbit/s and 56 kbit/s transparent Case.....	48
	B.1.3.1.5	64kbit/s bit transparent Case	50
	B.1.3.2	3.1 kHz audio ex-PLMN information transfer capability.....	51
	B.1.3.2.1	Non-X.32 Cases.....	51
	B.1.3.2.2	X.32 Case (Packet Service).....	52
B.1.4		Bearer Service 40 ... 46, PAD Access Asynchronous	53
B.1.5		Bearer Service 50 ... 53 ,Data Packet Duplex Synchronous, Unrestricted digital information transfer capability	55
B.1.6		Bearer Service 61, Alternate Speech/Data	56
	B.1.6.1	Bearer Service 61, Speech.....	56
	B.1.6.2	Bearer Service 61, 3.1 kHz audio ex-PLMN information transfer capability ..	57
	B.1.6.2.1	Asynchronous	57
	B.1.6.2.2	Synchronous.....	59
B.1.7		Bearer Service 81, Speech followed by Data.....	60
	B.1.7.1	Bearer Service 81, Speech.....	60
	B.1.7.2	Bearer Service 81, 3.1 kHz audio ex-PLMN information transfer capability ..	60
	B.1.7.2.1	Asynchronous	60
	B.1.7.2.2	Synchronous.....	60
B.1.8		Teleservice 11 ... 12, Speech	60
B.1.9		Teleservice 21 ... 23, Short Message.....	60
B.1.10		Teleservice 61, Alternate Speech and Facsimile group 3	60
	B.1.10.1	Teleservice 61, Speech.....	60
	B.1.10.2	Teleservice 61, Facsimile group 3.....	61
B.1.11		Teleservice 62, Automatic Facsimile group 3	62
	B.1.12	Valid combinations of FNUR, AIUR, ACC and MaxNumTCH.....	62
	B.1.12.1	Transparent services.....	62
	B.1.12.2	Non-transparent services.....	62
B.2		Low Layer/High Layer Compatibility Information Element	63
	B.2.1	Introduction	63
	B.2.1.1	General Consideration.....	63
	B.2.1.2	Interpretation of the Tables.....	63
	B.2.2	LLC Bearer Service 21 ... 26.....	64
	B.2.2.1	Unrestricted / restricted digital information transfer capability	64
	B.2.2.2	3.1 kHz audio ex-PLMN information transfer capability.....	64
	B.2.3	LLC Bearer Service 31 ... 34.....	65
	B.2.3.1	Unrestricted / restricted digital information transfer capability	65
	B.2.3.2	3.1kHz audio ex-PLMN information transfer capability.....	65
	B.2.4	LLC Bearer Services 41 ... 46	66
	B.2.5	LLC Bearer Services 51 ... 53	66
	B.2.5.1	Unrestricted digital information transfer capability	66
	B.2.6	LLC Bearer Service 61.....	66
	B.2.6.1	3,1 kHz audio ex-PLMN information transfer capability, Asynchronous.....	66
	B.2.6.2	3,1 kHz audio ex-PLMN information transfer capability, Synchronous	66
	B.2.7	LLC Bearer Service 81.....	66
	B.2.7.1	3,1 kHz audio ex-PLMN information transfer capability, Asynchronous.....	66
	B.2.7.2	3,1 kHz audio ex-PLMN information transfer capability, Synchronous	66
	B.2.8	HLC Teleservices 11 ... 12	67
	B.2.9	HLC Teleservices 21 ... 23	67
	B.2.10	HLC Teleservice 61	67
	B.2.11	HLC Teleservice 62	67
	History.....		68

Foreword

This fourth Edition European Telecommunications Standard (ETS) has been produced by the Special Mobile Group (SMG) of the European Telecommunications Standards Institute (ETSI).

This ETS outlines the functions needed for terminal adaptation within the digital cellular telecommunications system (Phase 2+).

The contents of this ETS is subject to continuing work within SMG and may change following formal SMG approval. Should SMG modify the contents of this ETS, it will be resubmitted for OAP by ETSI with an identifying change of release date and an increase in version number as follows:

Version 5.x.y

where:

- y the third digit is incremented when editorial only changes have been incorporated in the specification;
- x the second digit is incremented for all other types of changes, i.e. technical enhancements, corrections, updates, etc.

Transposition dates	
Date of adoption of this ETS:	3 April 1998
Date of latest announcement of this ETS (doa):	30 June 1998
Date of latest publication of new National Standard or endorsement of this ETS (dop/e):	31 December 1998
Date of withdrawal of any conflicting National Standard (dow):	31 December 1998

1 Scope

This European Telecommunications Standard (ETS) is based on the principles of terminal adaptor functions presented in the CCITT I-series of recommendations (I.460 - I.463).

The GSM PLMN supports a wide range of voice and non-voice services in the same network. In order to enable non-voice traffic in the GSM PLMN there is a need to connect various kinds of terminal equipments to the Mobile Termination (MT). The target of this ETS is to outline the functions needed for the terminal adaptation.

In the GSM 02.02 (ETS 300 904) the bearer services are described. The general network configuration is described in GSM 03.02 and the GSM PLMN access reference configuration is defined in GSM 04.02. The various connection types used in the GSM PLMN are presented in GSM 03.10. Terminology used in this ETS is presented in GSM 01.04 (ETR 350). For support of data services between GSM PLMN and other networks see GSM 09-series of Specifications.

2 Normative references

This ETS incorporates by dated and undated reference, provisions from other publications. These normative references are cited at the appropriate places in the text and the publications are listed hereafter. For dated references, subsequent amendments to or revisions of any of these publications apply to this ETS only when incorporated in it by amendment or revision. For undated references, the latest edition of the publication referred to applies.

- [1] GSM 01.04 (ETR 350): "Digital cellular telecommunication system (Phase 2); Abbreviations and acronyms".
- [2] GSM 02.02 (ETS 300 904): "Digital cellular telecommunication system (Phase 2+); Bearer Services (BS) supported by a GSM Public Land Mobile Network (PLMN)".
- [3] GSM 02.03 (ETS 300 905): "Digital cellular telecommunication system (Phase 2+); Teleservices supported by a GSM Public Land Mobile Network (PLMN)".
- [4] GSM 03.02: "Digital cellular telecommunication system (Phase 2+); Network architecture".
- [5] GSM 03.10: "Digital cellular telecommunication system (Phase 2+); GSM Public Land Mobile Network (PLMN) connection types".
- [6] GSM 04.02: "Digital cellular telecommunication system (Phase 2+); GSM Public Land Mobile Network (PLMN) access reference configuration".
- [7] GSM 04.08 (ETS 300 940): "Digital cellular telecommunication system (Phase 2+); Mobile radio interface layer 3 specification".
- [8] GSM 04.21 (ETS 300 945): "Digital cellular telecommunication system; Rate adaption on the Mobile Station - Base Station System (MS - BSS) interface".
- [9] GSM 04.22 (ETS 300 946): "Digital cellular telecommunication system (Phase 2+); Radio Link Protocol (RLP) for data and telematic services on the Mobile Station - Base Station System (MS - BSS) interface and the Base Station System - Mobile-services Switching Centre (BSS - MSC) interface".
- [10] GSM 05.05 (ETS 300 910): "Digital cellular telecommunication system (Phase 2+); Radio transmission and reception".
- [11] GSM 07.02 (ETS 300 914): "Digital cellular telecommunication system (Phase 2+); Terminal Adaptation Functions (TAF) for services using asynchronous bearer capabilities".

- [12] GSM 07.03 (ETS 300 915): "Digital cellular telecommunication system (Phase 2+); Terminal Adaptation Functions (TAF) for services using synchronous bearer capabilities".
- [13] GSM 07.05: "Digital cellular telecommunication system (Phase 2+); Use of Data Terminal Equipment - Data Circuit terminating Equipment (DTE - DCE) interface for Short Message Service (SMS) and Cell Broadcast Service (CBS)".
- [14] GSM 07.07 (ETS 300 916): "Digital cellular telecommunication system (Phase 2+); AT command set for GSM Mobile Equipment (ME)".
- [15] GSM 09.01 (ETR 359): "Digital cellular telecommunication system (Phase 2); General network interworking scenarios".
- [16] GSM 09.02 (ETS 300 974): "Digital cellular telecommunication system (Phase 2+); Mobile Application Part (MAP) specification".
- [17] GSM 09.03: "Digital cellular telecommunication system; Signalling requirements on interworking between the Integrated Services Digital Network (ISDN) or Public Switched Telephone Network (PSTN) and the Public Land Mobile Network (PLMN)".
- [18] GSM 09.04: "Digital cellular telecommunication system; Interworking between the Public Land Mobile Network (PLMN) and the Circuit Switched Public Data Network (CSPDN)".
- [19] GSM 09.05: "Digital cellular telecommunication system; Interworking between the Public Land Mobile Network (PLMN) and the Packet Switched Public Data Network (PSPDN) for Packet Assembly/Disassembly (PAD) facility access".
- [20] GSM 09.06 (ETS 300 975): "Digital cellular telecommunication system (Phase 2+); Interworking between a Public Land Mobile Network (PLMN) and a Packet Switched Public Data Network/Integrated Services Digital Network (PSPDN/ISDN) for the support of packet switched data transmission services".
- [21] GSM 09.07 (ETS 300 976): "Digital cellular telecommunication system (Phase 2+); General requirements on interworking between the Public Land Mobile Network (PLMN) and the Integrated Services Digital Network (ISDN) or Public Switched Telephone Network (PSTN)".
- [22] GSM 09.08: "Digital cellular telecommunication system; Application of the Base Station System management Application Part (BSSMAP) on the E-interface".
- [23] GSM 09.10: "Digital cellular telecommunication system (Phase 2+); Information element mapping between Mobile Station - Base Station System and BSS - Mobile-services Switching Centre (MS - BSS - MSC) Signalling procedures and the Mobile Application Part (MAP)".
- [24] GSM 09.11: "Digital cellular telecommunication system (Phase 2+); Signalling interworking for supplementary services".
- [25] GSM 09.90: "Digital cellular telecommunication system (Phase 2+); Interworking between Phase 1 infrastructure and Phase 2+ Mobile Stations (MS)".
- [26] CCITT Series V Recommendations: "Data communication over the Telephone network".
- [27] CCITT Series V.42bis: "Data Compression for Data Circuit Terminating Equipment (DCE) using Error Correction Procedures".
- [28] CCITT Series X Recommendations: "Data Communication networks".

- [29] CCITT Recommendation X.25 "Interface between data terminal equipment (DTE) and data circuit - terminating equipment (DCE) for terminals operating in the packet mode and connected to public data networks by dedicated circuit".
- [30] CCITT Recommendation X.150: "Data Communication Networks: Transmission, Signalling and Switching, Network Aspects, Maintenance and Administrative Arrangements".
- [31] CCITT Recommendation V.25bis: "Automatic Calling and/or Answering Equipment on the General Switched Telephone Network (GSTN) using the 100-Series Interchange Circuits".
- [32] ITU-T Recommendation V.25ter: "Serial asynchronous automatic dialing and control".
- [33] CCITT Recommendation V.54: "Loop Test Devices for Modems".
- [34] CCITT Recommendation V.110: "Support of data terminal equipments (DTEs) with V-Series interfaces by an integrated services digital network".
- [35] CCITT Recommendation I.460-I.464: "ISDN Overall Network Aspects and Functions, User Network Interfaces".
- [36] ETS 300 102-1: "Integrated Services Digital Network (ISDN); User-network interface layer 3 specifications for basic call control".
- [37] ETR 018: "Integrated Services Digital Network (ISDN), Application of the BC-, HLC-, LLC-Information elements by terminals supporting ISDN services".
- [38] ISO/IEC 6429: "Information technology - Control functions for coded character sets".
- [39] Personal Computer Memory Card Association: "PCMCIA 2.1 or PC-Card 3.0 electrical specification or later revisions".
- [40] IrDA "IrPHY Physical signalling standard".
- [41] TIA-617: "Data Transmission Systems and Equipment - In-Band DCE Control".
- [42] CCITT Recommendation V.120: "Support by an ISDN of data terminal equipment with V-Series type interfaces with provision for statistical multiplexing".
- [43] GSM 03.34 (TS 101 038): "Digital cellular telecommunication system (Phase 2+); High Speed Circuit Switched Data (HSCSD); Stage 2 Service description".

3 Abbreviations

In addition to those below, abbreviations used in this ETS are listed in GSM 01.04.

CALL PROC	CALL PROCEEDING
CALL CONF	CALL CONFIRMED
CONNACK	CONNECT ACKNOWLEDGEMENT

4 Access reference configuration

Figure 1 presents the reference configuration for access to a GSM PLMN (see GSM 04.02).

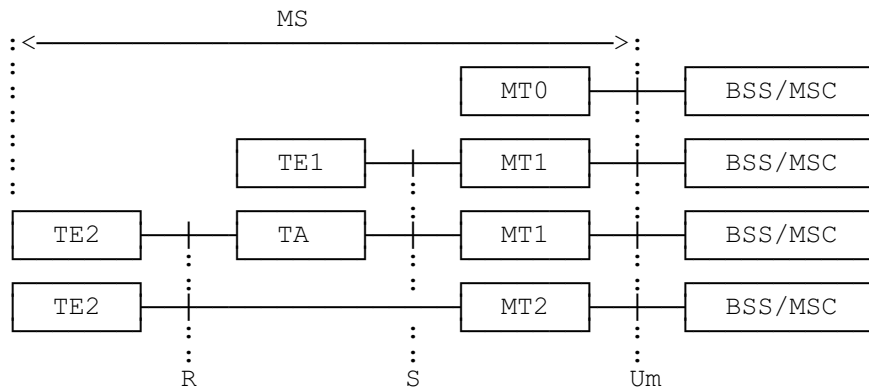

—+— = reference point

TE1 = ISDN terminal

TE2 = V- or X-type terminal

TA = Terminal Adaptor

BSS = Base Station System

MSC = Mobile Switching Centre

Figure 1: GSM PLMN Access Reference Configuration

Within the scope of this ETS the Mobile Termination MT0 means a fully integrated MS including data terminal and its adaptation functions. MT1 includes ISDN terminal adaptation functions and MT2 includes CCITT V- or X-series terminal adaptation functions among other MT functions.

5 Functions to support data services

The main functions of the MT to support data services are:

- functions to ensure conformity of terminal service requests to network capability;
- physical connection of the reference points R and S;
- flow control of signalling and mapping of user signalling to/from GSM PLMN access signalling;
- rate adaptation of user data (see GSM 04.21);
- flow control of non-transparent user data and mapping of flow control for asynchronous data services;
- support of data integrity between the MS and the interworking function in the GSM PLMN;
- end-to-end synchronization between terminals;
- filtering of status information;
- functions to support non-transparent bearer services e.g. termination of the Radio Link Protocol (RLP) and the Layer 2 Relay function (L2R) including optional data compression function (where applicable);
- terminal compatibility checking;
- optional support of local test loops.

In addition, functions to support autocalling and autoanswering are optionally specified in accordance with CCITT Rec. V.25 bis or with ITU-T Rec. V.25 ter (although the use of other autocalling/auto-answering

procedures are not prohibited provided that mapping in a functionally equivalent way to GSM 04.08 call control is also provided).

Other functional entities can be envisaged apart from the TAF. One of the physical interface to all these functions is the DTE/DCE interface to the MT. Normally, this DTE/DCE interface is associated with the TAF, if available. Therefore the access to any of these other functional entities, if implemented, via the DCE/DTE interface must be triggered by appropriate command sequences which are described in the applicable specifications (although the use of other procedures is not prohibited provided that mapping in a functionally equivalent way is also provided). These command sequences can be issued by the DTE only when the MT is in the appropriate command status and there is no data connection pending. They are interpreted by an MT internal control function and result in an association of the DTE/DCE interface with the addressed function, if available.

6 Support of non transparent Bearer Services

In order to support non transparent bearer services a Layer 2 Relay (L2R) function is included in the mobile termination. The details of the particular L2R function for the different non transparent bearer services are contained in the appropriate GSM 07-series Specification. This section describes the general aspects of the L2R function.

The Layer 2 Relay (L2R) function provides for the reliable transportation of known, i.e. non transparent, user protocols across the radio interface of a GSM PLMN. The L2R functions are located in the Mobile Termination (MT) and the Interworking Function (IWF) associated with a Mobile Switching Centre (MSC). The L2R uses the services provided by the Radio Link Protocol (RLP) to transport the non transparent protocol information between the MS and the IWF.

6.1 Functions of the Layer 2 Relay

The complete protocol reference models for data and telematic services are described in GSM 03.10. The subset of those protocol reference models relating to the L2R function is reproduced in figure 2.

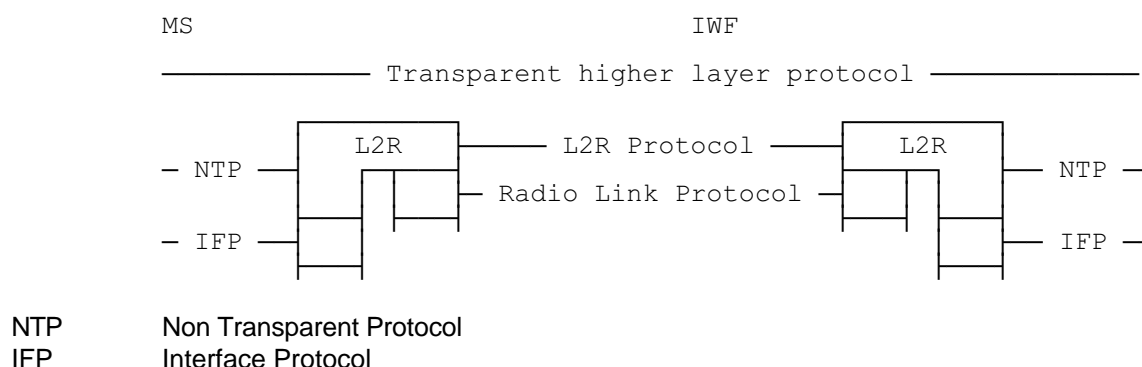

Figure 2

The Non Transparent Protocol (NTP) will normally be a layer 2 protocol for OSI conformant protocols or an equivalent in the case of non OSI protocols. The Interface Protocol (IFP) will normally be a layer 1 protocol for OSI conformant systems or equivalent for non OSI systems.

The L2R can be considered to consist of 3 sub-functions, see figure 3.

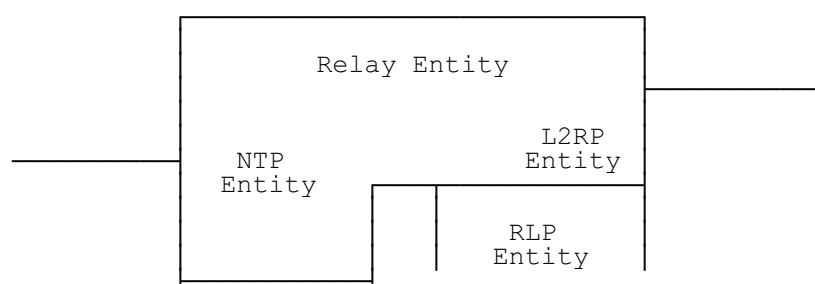

Figure 3

The 3 sub-functions are:

- A Non Transparent Protocol Entity
- A L2R Protocol Entity
- A Relay Entity

The NTP-entity interfaces the L2R to the IFP-entity and provides an interface to the particular NTP.

The L2RP-entity interfaces the L2R to the RLP-entity and provides an interface to the appropriate L2R protocol.

The Relay-entity provides the mapping between the NTP-entity and the L2R-entity. If applicable, it contains the data compression function. The negotiable parameters are exchanged with the remote Relay-entity by means of the RLP XID frame.

It should be noted that the inter-layer interfaces within the MS and the IWF and within the L2R will not be specified by GSM, any description given is for explanatory purposes only and is not intended to indicate a method of implementation. Therefore, the specification of the L2R is in terms of the peer-peer protocols. Generally, the non transparent and interface protocols will be specified elsewhere, e.g. CCITT Recommendation X.25 Layer 2 and 1. Thus the main specification for the L2R will consist of the L2R peer-peer protocols.

6.2 Radio Link Services Used

The L2R function uses services defined in GSM Specification 04.22 (Radio Link Protocol).

6.3 Flow Control - General Description

A flow control active condition can take place under a number of circumstances:

- End to end flow control (DTE to DTE matter);
- Backpressure (buffers filling);
- Receive not ready (RLP condition).

It is possible that there will be an interaction between flow control active and inactive conditions in each circumstance.

6.3.1 End to End Flow Control

A DTE may wish to send a flow control active condition to another DTE.

Provisions exists in the L2R entity to transfer a flow control active condition (sent by its associated DTE) to the other L2R entity as soon as possible. This mechanism in the L2R entities allows such a flow control condition to be put ahead of any queuing which exists in the L2R entities.

Such a mechanism avoids build up of data in buffers which can be undesirable.

The L2R entity, receiving a flow control active condition from its associated DTE, stops sending data to that associated DTE immediately.

6.3.2 Back Pressure

The L2R and RLP entities have buffers which may become full to a predetermined threshold for a number of reasons, e.g. severe radio fading, failure or slowness of DTE to react to end to end flow control, certain RNR conditions. When this predetermined threshold is reached, a flow control active condition is sent to the associated DTE which is then prevented from sending any data, subsequently, the flow control inactive condition is sent to the associated DTE when the L2R or RLP entities have indicated that there is sufficient free capacity in their buffers for data flow from the associated DTE to proceed.

The corresponding peer-layer procedure to assess the respective buffer conditions are a layer management matter and are not dealt with here. It is also considered an implementation matter to ensure that such procedure do not result in loss of data or considerable reduction in throughput.

6.3.3 Receive not Ready

When the RNR condition arises, an RLP indication is sent to the other RLP entity which in turn shall send a flow control active condition to its associated L2R entity. That L2R entity shall then send a flow control active condition to its associated DTE.

An RNR condition may result in the Execution of "back pressure" as mentioned under 6.3.2.

7 Structure of the GSM 07-series of Specifications

The structure of the Specifications is as follows:

- | | |
|-------|---|
| 07.01 | General on Terminal Adaptation Functions for Mobile Stations |
| 07.02 | Terminal Adaptation Functions for Services using Asynchronous Bearer Capabilities |
| | This Specification defines the interfaces and terminal adaptation functions integral to a MT which enable the attachment of Asynchronous Terminals to a MT. |
| 07.03 | Terminal Adaptation Functions for Services using Synchronous Bearer Capabilities |
| | This Specification defines the interfaces and terminal adaptation functions integral to a MT which enable the attachment of Synchronous Terminals to a MT. |

8 Functions common to all interfaces

8.1 Synchronization of the Traffic Channel

As long as there is no connection between the traffic channel and the interface to the TE this interface must be terminated in the appropriate way.

Prior to exposing the traffic channel of a GSM PLMN connection to transmission of user data, the controlling entities of the connection have to assure of the availability of the traffic channel(s). This is done by the so called synchronization process:

- starting on the indication of "physical connection established" resulting from the PLMN inherent outband signalling procedure. This indication is given on reception of the message CONNECT in case of MOC, on reception of the message CONNACK in case of MTC and on reception of the message MODIFY COMPLETE in case of in-call modification.
- ending by indicating the successful execution of this process to the controlling entity, which then takes care of the further use of the inband information (data, status).

With respect to the TAF for the transparent bearer capability support the synchronization procedure with the channel codings 2.4, 4.8 and 9.6 kbit/s is as follows:

- sending of synchronization pattern 1/OFF (all data bits "1" / all status bits "OFF", all E-bits "1") to the IWF. In multislot transparent operation, the synchronisation pattern sent is 1/OFF with the exception of the bit positions S1, first X, S3, and S4 which contain the substream number and multiframe alignment pattern (Ref. GSM TS 04.21);
- searching for detection of the synchronization pattern received from the IWF, and in multislot operation, also searching for the multiframe alignment pattern "0000 1001 0110 0111 1100 0110 1110 101" (Ref. to GSM 04.21) in bit position S4 and substream numbers in bit positions S1, first X, and S3. The value of the bits E4-E7 shall not be checked;
- holding CT106, 107 and 109 in the OFF condition;

With respect to the TAF for the transparent bearer capability support the procedure with the TCH/F14.4 is as follows:

ETS 300 913 (GSM 07.01 version 5.6.1): March 1998

- sending of synchronization pattern 1/OFF (all data bits "1" / status bits in M2 "OFF") to the network in the multiframe structure with the multiframe alignment pattern "0000 1001 0110 0111 1100 0110 1110 101" in the M1 (Ref. to GSM TS 4.21) and, in a multislot case, sending substream numbers in the bit M2
- searching for the detection of the multiframe alignment pattern "0000 1001 0110 0111 1100 0110 1110 101" (Ref. to GSM 04.21) in the bit M1 originating from the network, and, in a multislot case, searching for substream numbers in the bit M2. (Any 5 bit sequence in the multiframe alignment pattern is unique, i.e. the multiframe alignment can take place by the recognition of five successive S1 bits.)
- holding CT106, 107 and 109 in the OFF condition;

When the synchronisation pattern and, in case of multislot operation or TCH/F14,4, the multiframe alignment pattern from the IWF have been recognized as a steady state (see note 1) the TAF continues sending the synchronization patterns to the IWF unless a timer T (=500ms) expires.

- NOTE 1:
- An idle frame sent by the BSS and received by the MS has the same pattern as the synchronization pattern 1/OFF.
 - At the moment when the message CONNECT (MOC) or CONNACK (MTC) is received at the MS, it is guaranteed that this pattern is received from the MSC/IWF with the exception of a loss of frame synchronization on the Abis interface.
 - The handling of frame stealing in case of 2400 bit/s full rate data channels is implementation dependent.

From this time, after the expiration of the timer T of each allocated traffic channel for the call, the filtering process according to section 8.2 applies and the information on the receiving lines CT106 and CT109 (M2 bit in the TCH/F14.4 case, ref to GSM 04.21) from the IWF are directly mapped to the respective sending lines. The condition on CT107 will be changed from "OFF" to "ON", the data bits received from the IWF are mapped to CT104, and CT103 is mapped to the data bits sent towards the IWF.

During the synchronization process described above i.e. while the synchronization pattern is being sent by the MT, the MT will not send the V.110 frame structure to the ISDN terminal. Once the timer T of each traffic channel(s) allocated for the call expires the synchronization pattern will continue to be transmitted from the MT to the IWF, however, the MT will start sending the V.110 frames received from the IWF to the ISDN terminal. The MT will start looking for the ISDN frame alignment to be received from the ISDN terminal. On recognizing frame alignment the MT will cease sending its synchronization pattern to the IWF and connect the ISDN terminal through to the IWF. In case of multislot operation or TCH/14.4 the MT shall adapt the data stream as defined in GSM TS 04.21.

With respect to the TAF for non-transparent bearer capability support the synchronization procedure is as follows:

- receiving V.110 frames on all allocated traffic channels for the call
- initiating the RLP link establishment by sending a RLP-SABM across the radio interface.
- holding CT106, 107, 109 in the OFF condition.

When the RLP link has been established, CT107 will be changed from "OFF" to "ON". From this time the information from/to the RLP, including status changes, will be mapped by the L2R entity applicable to the particular bearer capability. The MT will not send V.110 frame structure to the ISDN terminal and will not start looking for ISDN frame alignment to be received from the ISDN terminal unless the RLP link has been established. On recognizing frame alignment the information from/to the RLP will be mapped by the L2R entity.

It should be noted that in a GSM PLMN V.-series and X.-series interfaces are only supported in full duplex mode. Thus the call control phase can be mapped almost completely to the signalling procedure (the S-bits during the call control phase are irrelevant). However, the "ready for data" condition (i.e. CT 106/109, in the case of V.-series interface, and I-circuit, in the case of X.-series interface) is derived directly from the traffic channel (see also filtering of channel information).

8.2 Filtering of Channel Control Information

8.2.1 General

The DTEs taken into account for the PLMN at the MS side conform to CCITT's DTE/DCE interface specifications, which assume basically an error-free environment, i.e.

- limited distance, point-to-point local interconnection of the interface circuits for data and status;
- steady state signalling.

The envisaged use of these DTEs in the PLMN environment leads to the exposure of these "interconnections" to the PLMN radio channel. To assure proper operation even under these conditions appropriate measures have to be taken. In the non transparent case the RLP satisfies the requirement for both data and status lines.

In the transparent case the

- data line aspects have to be dealt with end-to-end between the users, while
- status line aspects are of concern to the network, which are dealt with in the following.

8.2.2 Filtering process to be applied

Filtering of channel control information is only relevant at the MS side in the transparent mode of operation. By applying filtering measures the condition of a DTE/DCE control interchange circuit, for which the DTE constitutes the information sink, will be preserved until another condition is signalled for an "integration time" period by the channel control information (status bits) of the rate adaptation scheme.

The filtering mechanism is understood to reside between the rate adaptation function (information source) and the DTE (information sink). It receives the unfiltered condition of the respective control interchange circuit set according to the actual sequential appearance of the individual associated status bit and forwards the filtered condition to the DTE.

The filtering process starts when the traffic channel synchronization ends with the expiry of timer T.

V.-series interface

CT 106

In the transparent mode the remote inband control of this circuit is needed to support a modem retrain procedure.

OFF-ON transition at the MS will authorize the DTE to send data; if wrongly set, loss of data may occur.

ON-OFF transition at the MS will cause the DTE to cease transmitting data; set wrongly may impair the performance in connection usage.

CT 109

In the transparent mode the remote inband control of this circuit is needed to:

- trigger the interpretation of received data;
- indicate to the DTE the state of the connection.

OFF-ON transition at the MS will authorize the DTE to rely on the condition of the received data interchange circuit, set wrongly may cause receipt of wrong data, while setting late may cause loss of data.

ON-OFF transition at the MS:

- will cause the DTE to cease receiving data;

- may initiate release of the connection during a data phase by the DTE giving an ON-OFF transition on circuit 108/2.

Setting this condition wrongly may cause loss of data and potentially release the connection.

X.-series interface

I-circuit

The OFF-ON transition of this circuit in connection with the appropriate conditions of the other interchange circuit will indicate the "ready for data" status of the connection. As received data may commence immediately following this status change, the delay in conveying this condition shall be kept as short as possible.

As a clear request/indication will be directly mapped to the PLMN outband signalling the ON-OFF integration time should be rather long.

Filtering mechanism

A filtering mechanism shall be provided by an integration process on those SB and X bits carrying status information in the V.110 frame or in the multiframe structure. The integration periods applied are:

V-series	Transition	Integration period	Status stream
CT 106	Off-On	1 s	X
CT 106	On-Off	1 s	X
CT 109	Off-On	200 ms	SB
CT 109	On-Off	5 s	SB
X-series	Transition	Integration period	Status stream
I-circuit	Off-On	40 ms	SB
I-circuit	On-Off	5 s	SB

The integration process shall ensure that the interchange circuits do not change state in response to spurious transitions of the status bits during the integration period.

The integration process shall operate reliably with error characteristics as specified in GSM 05.05.

8.3 Terminal Compatibility Decision

The establishment of a mobile terminated connection depends on a positive decision on the terminal compatibility. The Mobile Station (MS) contributes to this process by performing (depending on the individual call set-up condition):

- a compatibility check;
- the selection of the appropriate terminal function; and
- the indication of compatibility requirements to the PLMN;

initiated by a call set-up request from the PLMN. The aforementioned functions shall be carried out as follows.

8.3.1 Compatibility Check

Annex B of GSM 04.08 applies, particularly paragraphs B.3, B.3.1 and B.3.2. As regards the therein mentioned user-to-user compatibility checking the following applies:

When the calling user requests a service with user-to-user compatibility significance indicated by the presence of HLC and LLC information element in the call set-up request, the MS shall check that the service supported by the called user matches concerning the contents of the HLC/LLC information element.

If a mismatch is detected, then the MS shall reject the offered call using the cause No.88 "Incompatible Destination".

8.3.2 Selection of Appropriate Terminal Function

The MS shall select the appropriate terminal functions following a positive result of the compatibility check and/or forwarding the indication of compatibility requirements to the PLMN.

8.3.3 Indication of Compatibility Requirements to the PLMN

8.3.3.1 Indication in case of Mobile terminating calls

In support of:

- PSTN originated calls, and
- ISDN originated calls using 3.1 kHz audio Bearer Capability (BC), as well as
- ISDN originated calls using unrestricted digital Bearer Capability but not specifying all parameters for deducing a Bearer Service.

Mobile specific requirements to be dealt with in the Bearer Capability information element the call confirmed message has been introduced in the call control protocol (GSM 04.08). This also allows for renegotiation of specific parameters at the beginning of the connection set-up process. The specific parameters are:

- a) mobile specific requirements:
- Connection element (transparent/non transparent);
 - Structure (note 1);
 - User information layer 2 protocol (note 1);
 - Intermediate rate (note 2), (note 3);
 - Modem Type (note 1), (note 3);
 - User Rate (note 3);
 - Compression ,
 - Fixed network user rate, (note 3) (note 4)
 - Other modem type, (note 3) (note 4)
 - User initiated modification *indication* (note 4)

The following parameters are indicated by the MS to the network, only:

- Acceptable channel codings (note 5)
- Maximum number of traffic channels, (note 5)
- Wanted air interface user rate (note 6)

NOTE 1: This parameter is correlated with the value of the parameter connection element.

NOTE 2: For non-transparent services this parameter is correlated with the value of the parameter negotiation of intermediate rate requested.

NOTE 3: Modification of these parameters may be proposed by the MS. The Network may accept it or not.

NOTE 4: This parameter shall be included by the MS only in case it was received from the network.

NOTE 5: This parameter shall be included only in case the parameter 'fixed network user rate' is included.

NOTE 6: This parameter shall be included only for non-transparent services and in case the parameter 'fixed network user rate' is included.

- b) requirements with effects at the partner terminal:

- Number of data bits;

- Number of stop bits;
- Parity.

The MS indicates the radio channel requirement in the call confirmed message. If the MS indicates the support of "dual" (HR and FR channels) the final decision, which radio channel is chosen, is done by the network in an RR message.

If the network proposes optional support of both transparent and non transparent connection elements but does not indicate a user information layer 2 protocol, the MS shall set the appropriate value, if choosing non transparent in the call confirmed message and out-band flow control is not requested.

Additionally the values of the parameters structure, modem type and intermediate rate have to be set in conformance with the values of the parameters radio channel requirements, negotiation of intermediate rate requested and connection element.

Section B.1.1.2 and table B.1 in the annex B describe the negotiation procedure. Annex B table B.4 describes the selection of the modem type and the dependence on the value of the parameter connection element. Annex B table B.4 describes the selection of the intermediate rate and user rate and their dependence upon the value of the NIRR parameter and the equipments capabilities.

The following MTC cases can be deduced from the individual call set-up request conditions

- a) If the set-up does not contain a BC information element, the MS in the call confirmed message shall include any BC information (single or multiple BC-IE). In case of multiple BC-IEs one BC-IE must indicate the information transfer capability "speech".
- b) If the set-up message contains a single BC-IE, the MS in the call confirm message shall use either a single BC-IE, if it wants to negotiate mobile specific parameter values, or, unless otherwise specified in annex B, no BC-IE, if it agrees with the requested ones.
- c) If the set-up contains a multiple BC-IE, the MS in the call confirmed message shall use either a multiple BC-IE, if it wants to negotiate mobile specific parameter values, or, unless otherwise specified in annex B, no BC-IE, if it agrees with the requested ones. Alternatively a single BC-IE containing fax group 3 only shall be used if a multiple BC-IE requesting speech alternate fax group 3 is received and the MS is not able to support the speech capability. Annex B, table B.7, describes the negotiation rules.

If the BC-IE contains 3.1 kHz ex PLMN, the MS is allowed to negotiate all mobile specific parameter values listed above. If the BC-IE contains facsimile group 3, the MS is allowed to negotiate the connection element (transparent/non transparent) only. In any case, if the set-up message requests a "single service", the MS must not answer in the call confirmed message requesting a "dual service" and vice versa.

However, for dual services with repeat indicator set to circular (alternate) the MS may change the sequence of dual BC-IEs within the call confirmed message (preceded by the same value of the repeat indicator), if it wants to start with a different Bearer Capability than proposed by the network as the initial one.

In addition, the MS may propose to the network to modify User Rate, Modem Type and Intermediate Rate in the CALL CONFIRMED message. The network may accept or release the call.

If the BC-IE received from the network contains the parameters 'fixed network user rate', 'other modem type' and possibly the 'user initiated modification', the MS can either:

- a) discard these parameters, or
- b) include the possibly modified values for the 'fixed network user rate' and 'other modem type' in the BC-IE of the call confirmed message. The network might accept or reject the modified values. In this case the MS shall also include the parameters 'maximum number of traffic channels' and 'acceptable channel codings'. Additionally for non-transparent services, the MS shall also include the parameters 'wanted air interface user rate' and the 'user initiated modification indication'.

In case a), The MS shall use the fall-back bearer service indicated by the remaining parameters of the BC-IE on a singleslot configuration (ref GSM 04.21).

In case b), a singleslot configuration shall be used by the MS, in case the 'maximum number of traffic channels' is set to "1 TCH" and the 'user initiated modification indication' is set either to "user initiated modification not required" or to "user initiated modification upto 1TCH may be requested"; otherwise the MS shall use a multislot configuration (ref GSM 04.21).

In case the 'acceptable channel codings' is indicated by the MS, the decision which channel coding is used is done by the network and indicated to the mobile station with an RR message. The 'acceptable channel codings' parameter takes precedence over the 'negotiation of intermediate rate requested' parameter for non-transparent services. Also the intermediate rate and user rate per traffic channel in a multislot configuration are not indicated by the 'intermediate rate' and 'user rate' parameters of the BC-IE, but depend on the chosen channel coding only.

If the parameters 'fixed network user rate', 'other modem type' were not included in the BC-IE received, or no BC-IE was received, the MS shall not include these parameters in the CALL CONFIRMED message (i.e. octets 6d, 6e and 6f, ref. to GSM 04.08).

8.3.3.2 Indication in case of Mobile originating calls

In support of mobile originating calls the values of BC-IE parameters are requested in the set-up message from the MS. If the MS indicates the support of both transparent and non transparent connection elements the network shall return its choice in the call proceeding message. The MS is not allowed to indicate support of both transparent and non transparent, if the MS also requests out-band flow control, i.e. it does not indicate a layer 2 protocol.

Additionally the value of the parameter modem type has to be set depending on the value of the parameter connection element as described in annex B, table B.4a.

The set-up message contains a single or multiple BC-IE. In case of multiple BC-IEs one BC-IE must indicate the information transfer capability "speech".

If the set-up message requests a "single service", the network must not answer in the call proceeding message requesting a "dual service" and vice versa. Alternatively the network shall answer with a single BC-IE containing fax group 3 if a multiple BC-IE requesting speech alternate fax group 3 is received but the network does not allow the use of this alternate service. Annex B, table B.7, describes the negotiation rules. If the MS requests a "dual service" the network is not allowed to change the sequence of the service.

If the set-up message indicates that negotiation of intermediate rate is requested then the network shall behave as described in annex B, table B.4b.

Unless otherwise specified in annex B, if no BC-IE parameter needs negotiation it is up to the network if it sends a CALL PROC message (with or without a BC-IE) towards the MS or not.

For multislot and TCH/F14.4 operations the MS shall include an appropriate set of the parameters 'fixed network user rate', 'other modem type', 'maximum number of TCH' and 'acceptable channel codings' in the BC-IE of the SETUP message. In a non-transparent multislot operation, the MS shall also include the parameters 'wanted air interface user rate' and 'user initiated modification indication' in the BC-IE of the SETUP message. In a non-transparent TCH/F14.4 operation the MS shall also include the parameter 'wanted air interface user rate' It shall also set the other parameters of the BC-IE (i.e. 'user rate') to values identifying a fall-back bearer service. The fall-back bearer service shall be within the same bearer service group as the general bearer service. Depending on the network two situations can be distinguished:

- a) The network supports the requested operation:

In this case the network must include the parameter 'fixed network user rate', 'other modem type' and possibly 'user initiated modification' in the BC-IE(s) of the CALL PROCEEDING message, irrespective whether or not they contain modified values or just a copy of the received ones.

The 'acceptable channel codings' indicated by the MS in the SETUP message takes precedence over the 'negotiation of intermediate rate requested' parameter for non-transparent services. The intermediate rate per traffic channel and the user rate per traffic channel is dependent on the chosen channel coding only. The chosen channel coding is indicated to the mobile station by the network with an RR message.

- b) The network does not support the requested operation:

In this case the BC-IE of the CALL PROCEEDING message will not contain the parameters 'fixed network user rate' and 'other modem type' or no BC-IE will be included in the CALL PROCEEDING message at all. The mobile station shall then discard the parameters 'fixed network user rate', 'other modem type', 'maximum number of TCH', 'acceptable channel codings', 'wanted air interface user rate' and 'user initiated modification indication' sent with the SETUP message and apply the fall-back bearer service.

In case a), a singleslot configuration shall be used by the MS, in case the 'maximum number of traffic channels' is set to "1 TCH" and the 'user initiated modification indication' is set either to "user initiated modification not requested" or to "user initiated modification upto 1TCH may be requested".

In case b), The MS shall use the fall-back bearer service indicated by the remaining parameters of the BC-IE on a singleslot configuration (ref GSM 04.21).

8.4 Test Loops

In principle, both V.-series and X.-series interfaces allow for an activation of local or remote test loops by the terminal (ref. CCITT V.54/X.150). A comprehensive solution of such test loops in a GSM system has to consider the special conditions of the interface between the terminal (part of the MS) and the transmission equipment (part of the modem pool of a particular IWF within the MSC). In addition, the impact of the radiolink is to be taken into account with respect to the test objectives. Due to those special conditions a GSM system is not capable to support remote test loops. It is an implementation choice to what extent the activation of local test loops by the terminal is supported in the MT.

8.5 Alternate speech/data and speech/facsimile group 3

These alternate services may be initiated by either V.25 bis or manual procedures. In the former case, standard call establishment procedures will apply. In the latter case, CT106, CT107, CT108.2 and CT109 are in the OFF condition.

Selection of the data phase (from the speech phase) will be by manual intervention via the MS causing ICM by means of CT108.2 going to ON condition. In case of dual data services (alternate speech/data or speech followed by data) the "Reverse call setup direction" information element of the modify message (determined by MMI) together with information about the initial call setup direction may be used to control the IWF modem (working as calling or answering modem). In case of alternate speech/facsimile refer to GSM 03.45. The ensuing data phase shall follow all the operational procedures as described in 07-series.

Selection of the speech phase (from the data phase) will be by manual intervention via the MS causing ICM (phone off-hook condition at the MT and data call end condition at the TE).

During the ensuing speech phases, CT107, CT106 and CT109 will be maintained in the OFF condition.

Subsequent re-selection of the data phase will be by manual intervention via the MS causing CT108.2 going to ON condition initiating ICM. At this point, re-synchronization will take place as described in section 8.1 above.

8.6 Multislot configuration spit/combine function

In multislot configurations using multiple parallel channels the data flow is split into substreams between the Spit/Combine-function in the TAF and the network.

8.6.1 Non-transparent data

In non-transparent data operations the N(S)-numbering in the RLP-header is used for controlling the order of the data in the substreams (ref GSM 04.22).

8.6.2 Transparent data

In transparent multislot configurations status bits S1, S3 and the X-bit between the D12 and D13 are used for transferring substream numbering information. The S4-bit is used for frame synchronization between the parallel substreams (ref GSM 04.21).

Annex A (Informative): List of Bearer Capability Elements

This annex lists the GSM Bearer Capability Elements which need to be provided on the Dm channel to support Terminal adaptation function to Interworking control procedures.

Elements and their Values:

Information Transfer Capability:

This element is relevant between the IWF and the fixed network

Values: - Speech
 - Unrestricted Digital
 - Group 3 Facsimile (note 1)
 - 3.1 kHz Ex PLMN (note 2)
 - Restricted Digital (note 3)

NOTE 1: Used for facsimile transmission, unrestricted digital between MT and IWF and 3.1 kHz audio from IWF towards the fixed network.

NOTE 2: unrestricted digital between MT and IWF and 3.1 kHz audio from IWF towards the fixed network.

NOTE 3: unrestricted digital between MT and IWF and restricted digital information from IWF towards the fixed network; this value is signalled in the "Other ITC" element, due to a lack of further code points in the "ITC" element.

Transfer Mode:

This element is relevant between MT and IWF

Values: - Circuit
 - Packet

Structure:

This element is relevant between MT and IWF.

Values: - Service Data Unit Integrity (note 4)
 - Unstructured (note 5)

NOTE 4: applicable for connection element "non transparent".

NOTE 5: applicable for connection element "transparent".

Configuration:

This element is relevant for a PLMN connection.

Values: - Point to point

Establishment:

This element is relevant for a PLMN connection.

Values: - Demand

Sync/Async:

This element is relevant between TE/TA and MT and between IWF and the fixed network.

Values: - Synchronous

Negotiation:

This element is relevant between MT and IWF.

Values: - In band negotiation not possible

User Rate:

This element is relevant between TE/TA and MT and between IWF and the fixed network, except in case the parameter FNUR is present..

Values: - 0.3 kbit/s
- 1.2 kbit/s
- 1200/75 bit/s
- 2.4 kbit/s
- 4.8 kbit/s
- 9.6 kbit/s
- 19.2 kbit/s (see note 6)

NOTE 6: This value cannot be signalled between MT and IWF, but it can be used according to the rules in GSM 09.07 (Table 6A, 6B) for such connections.

Intermediate Rate:

This element is relevant between MT and BSS and BSS and IWF

Values: - 8 kbit/s
- 16 kbit/s

Network Independent Clock on Tx:

This element is relevant between TE/TA and MT in the transmit direction.

Values: - Not required
- Required

Network Independent Clock on Rx:

This element is relevant between TE/TA and MT in the receive direction.

Values: - Not accepted
- accepted

Number of Stop Bits:

This element is relevant between the TE/TA and MT and between IWF and fixed network in case of asynchronous transmission.

Values: - 1 bit
- 2 bit

Number of Data Bits Excluding Parity If Present:

This element is relevant between TE/TA and MT and between IWF and the fixed network in case of a character oriented mode of transmission.

Values: - 7 bit
- 8 bit

Parity Information:

This element is relevant between TE/TA and MT and between IWF and the fixed network for a character oriented mode of transmission.

Values:

- Odd
- Even
- None
- Forced to 0
- Forced to 1

Duplex Mode:

This element is relevant between MT and IWF.

Values:

- Full Duplex

Modem Type:

This element is relevant between the IWF and the fixed network in case of 3.1 kHz audio ex-PLMN information transfer capability.

Values:

- V.21
- V.22
- V.22 bis
- V.23
- V.26 ter
- V.32
- autobauding type 1
- none

Radio Channel Requirement:

This element is relevant between MT and BSS

Values:

- Full Rate support only Mobile Station
- Dual Rate support Mobile Station/Half Rate preferred
- Dual Rate support Mobile Station/Full Rate preferred

Connection Element:

This element is relevant between MT and IWF

Values:

- Transparent
- Non Transparent
- both, Transparent preferred
- both, Non transparent preferred

User Information Layer 2 Protocol:

This element is relevant between TE/TA and MT and between IWF and the fixed network.

Values:

- ISO 6429
- X.25
- X.75 layer 2 modified (CAPI)
- Character oriented Protocol with no Flow Control mechanism

Signalling Access Protocol:

This element is relevant between TE/TA and MT.

Values:

- I.440/450
- X.21
- X.28, dedicated PAD, individual NUI
- X.28, dedicated PAD, universal NUI

- X.28, non dedicated PAD
- X.32

Rate Adaptation:

This element is relevant between IWF and the fixed network.

- Values:
- V.110/X.30
 - X.31 flagstuffing
 - no rate adaptation
 - V.120 (note 7)

NOTE 7: - this value is signalled in the "Other Rate Adaption" element, due to a lack of further code points in the "Rate Adaption" element.

Coding Standard:

This element refers to the structure of the BC-IE defined in GSM 04.08.

- Values:
- GSM

User Information Layer 1 Protocol:

This element characterize the layer 1 protocol to be used between MT and BSS (Um interface) according to GSM 05.01.

- Values:
- default

Negotiation of Intermediate Rate requested:

This element is relevant between MT and BSS and BSS and IWF.

- Values:
- no meaning associated
 - 6 kbit/s radio interface is requested for a full rate channel with a user rate up to and including 4.8 kbit/s, non transparent service

Compression:

This element is relevant between MT and IWF.

- Values:
- compression possible/allowed
 - compression not possible/allowed

Rate adaption header / no header:

This element is relevant between IWF and the fixed network. It is only applicable for V.120 rate adaptation.

- Values:
- Rate adaption header not included
 - Rate adaption header included

Multiple frame establishment support in data link:

This element is relevant between IWF and the fixed network. It is only applicable for V.120 rate adaptation.

- Values:
- Multiple frame establishment not supported. Only UI frames allowed.
 - Multiple frame establishment supported.

Mode of operation:

This element is relevant between IWF and the fixed network. It is only applicable for V.120 rate adaptation.

Values: - Bit transparent mode of operation
 - Protocol sensitive mode of operation

Logical link identifier negotiation:

This element is relevant between IWF and the fixed network. It is only applicable for V.120 rate adaptation.

Values: - Default, LLI=256 only
 - Full protocol negotiation (note 8)

NOTE 8: A connection over which protocol negotiation will be executed is indicated in the „In-band / out-band negotiation“ parameter.

Assignor / assignee:

This element is relevant between IWF and the fixed network. It is only applicable for V.120 rate adaptation.

Values: - Message originator is „default assignee“
 - Message originator is „assignor only“

In-band / out-band negotiation:

This element is relevant between IWF and the fixed network. It is only applicable for V.120 rate adaptation.

Values: - Negotiation is done with USER INFORMATION messages on a temporary signalling connection
 - Negotiation is done in-band using logical link zero.

Fixed network user rate, FNUR (Note 12)

This element is relevant between the IWF and the fixed network.

Values Fixed network user rate not applicable (note 9)

 9.6 kbit/s
 14.4 kbit/s
 19.2 kbit/s
 28.8 kbit/s
 38.4 kbit/s
 48.0 kbit/s
 56.0 kbit/s
 64.0 kbit/s

NOTE 9: not used by currently specified services

Wanted air interface user rate, WAIUR (Note 12)

This element is relevant between the MT and the IWF

Values Air interface user rate not applicable (note 10)

 9.6 kbit/s
 14.4 kbit/s
 19.2 kbit/s
 28.8 kbit/s
 38.4 kbit/s

43.2 kbit/s

57.6 kbit/s

interpreted by the network as 38.4 kbit/s (note 1)

NOTE 10: not used by currently specified services

Acceptable channel codings, ACC (Note 12)

This element is relevant between the MT and the IWF.

Value: TCH/F4.8 acceptable
TCH/F9.6 acceptable
TCH/F14.4 acceptable

Maximum number of traffic channels, MaxNumTCH (Note 12)

This element is relevant between the MT and the IWF.

Value: 1 TCH
2 TCH
3 TCH
4 TCH
5 TCH
6 TCH
7 TCH (note11)
8 TCH (note11)

NOTE11: not used by currently specified services

Other modem type, OMT (Note 12)

This element is relevant between the IWF and the fixed network in case of 3.1 kHz audio ex-PLMN

Values: - no other modem type specified in this field
- V.34

User initiated modification indication, UIMI (Note 12)

This element is relevant between the MT and the IWF.

Values: - user initiated modification not requested
- user initiated modification upto 1 TCH requested
- user initiated modification upto 2 TCH requested
- user initiated modification upto 3 TCH requested
- user initiated modification upto 4 TCH requested

NOTE 12: These GBS-related parameters are optional.

For a multislot configuration, the following applies to the parameters contained in the BC-IE:

- Half rate channels are not supported. The MS shall code the radio channel requirement as "Full rate support only MS" or "Dual rate support MS, full rate preferred". In the second case, the network shall assign full rate channel(s) only.
- The 'fixed network user rate' and 'other modem type' (ref. table B.4a) takes precedence over the 'user rate' and 'modem type'.
- The ACC indicates which channel coding is acceptable and supported by the MS. In case of CE:NT the TCH/F4.8 and TCH/F9.6 acceptable is equivalent to the support of NIRR. If TCH/F4.8 acceptable only or TCH/F9.6 acceptable only or TCH/F14.4 acceptable only is indicated, the

assigned channel type which can be chosen by the network is TCH/F4.8 or TCH/F9.6 or TCH/F14.4, respectively.

- The 'intermediate rate' parameter is overridden. The intermediate rate used per each TCH/F is derived from the chosen channel type:

channel type	IR per TCH/F
TCH/F4.8	8 kbit/s
TCH/F9.6	16 kbit/s
TCH/F14.4	intermediate rate is to be defined

- The user rate per TCH is derived from the chosen channel type:

channel type	user rate per TCH
TCH/F4.8	4.8 kbit/s
TCH/F9.6	9.6 kbit/s

For CE:T, the padding procedure described in GSM 04.21 can be applied.

Annex B (Normative): Setting of Bearer Capability, Low Layer Compatibility and High Layer Compatibility Information Element for GSM Bearer Services and GSM TeleServices

B.0 Scope

This annex describes the relationship between the various parameters of the GSM Bearer Capability Information Element (BC-IE), their validity and the possible settings with reference to each GSM Bearer service/Teleservice defined in GSM 02.02 and GSM 02.03 as well as the various occurrences during the connection control (section B.1). Furthermore, the contents of the Low Layer (LLC) and the High Layer (HLC) Compatibility Information Elements are described (section B.2).

B.1 Bearer Capability Information Element

B.1.1 Introduction

B.1.1.1 General Consideration

In general, the purpose of the bearer capability information element (BC-IE) is to request a particular bearer service to be provided by the network. This indication is carried by certain connection control messages which for the subject matter of this document may be categorized into those messages:

- related to the call set-up phase and those
- used during the established connection.

During the call set-up phase the GSM BC-IE (single or multiple) is included in:

- the SETUP message generated by the requesting entity (either MS or MSC) to establish a mobile-originated or mobile-terminated call, respectively, and in
- the CALL CONFIRMED or CALL PROCEEDING messages, respectively, generated by the responding entity (either MS or MSC) in order to negotiate certain parameter values. If no BC-IE is contained in the SETUP message (PSTN-originated call with single-numbering scheme) the CALL CONFIRMED message indicates the complete applicable BC-IE. In this case neither the value "unrestricted digital" for the information transfer capability nor the multislot for TCH/14 related parameters shall be used.

During the established connection the GSM BC-IE is included in the MODIFY, MODIFY COMPLETE, and MODIFY REJECT messages in order to change the service (bearer capability) or to change the maximum number of traffic channels and/or wanted air interface user rate when a non-transparent multislot data service is in use.

If the maximum number of traffic channels and/or wanted air interface user rate is to be changed, the BC-IE included in the MODIFY message shall not indicate a different bearer service than the one used at this stage of the connection - the values of the parameters 'maximum number of traffic channels' and/or 'wanted air interface user rate' may be changed, only.

The subsequent tables and subsections of section B.1 deal with the representation of the individual contents of the GSM BC-IE during the call set-up phase. For the use during the established connection refer to GSM 04.08.

With respect to the individual parameter settings at the MS the following cases may be distinguished (ref. GSM 07.02 and GSM 07.03):

- Mobile-originated call set up by a MS consisting of a MT with R interface:
The setting results from respective MMI actions and/or MT internal settings.
- Mobile-originated call set up by a MS consisting of a MT with S interface:
The setting of the GSM BC is derived from the ISDN BC and LLC/HLC elements contained in the ISDN SETUP message received from the terminal. It is complemented by information resulting from respective MMI actions and/or MT internal settings.

- Mobile-terminated call set up to a MS consisting of a MT with R interface:
The BC related part of the compatibility check is carried out according to the knowledge of the MT concerning its implemented functions (i.e. answering the call). The requested field values of the non-negotiable parameters and the selected field values of the negotiable parameters determine the selection of the terminal function to be used for the intended connection.
- Mobile-terminated call set up to a MS consisting of a MT with S interface:
The GSM BC received from the MSC is mapped by the MT onto an applicable ISDN BC. In some cases a HLC may be generated, if it is not otherwise available (e.g. for group 3 facsimile). The BC related part of the compatibility check is up to the terminal connected to the S interface of the MT, as is the selection of the terminal function (i.e. answering the call) to be used for the intended connection.

B.1.1.2 Interpretation of the Diagrams

The purpose of the subsequent diagrams is to achieve unambiguous representation of the individual contents of the GSM BC-IE for the various occurrences during the call set-up phase, covering all bearer services and teleservices according to GSM 02.02 and GSM 02.03.

The basic principle adopted is a graphic scheme, or mask, wherein the ordinate designates the individual parameters of the GSM BC-IE and the abscissa gives the possible field values of these parameters. The abbreviations used in these sections are defined in table B.5. The allowed content of any GSM BC-IE is represented by a number of graphs connecting parameter values (abscissa points) of all parameters (ordinate points). Each graphic scheme is subdivided into two independent parts:

- "Layer/Protocol related" part and
- "Radio Channel related" part.

The generation of all GSM BC-IEs in all call set-up messages shall be in accordance with these graphs. Sections B.1.2 through B.1.11 show individual sets of graphs for each service group (BS/TS) and for each type of applicable Information Transfer Capability.

In addition, the following rules apply:

- Those parameters which have only one possible field value for all recognized services are shown in table B.5, where they are marked accordingly in the column "common setting of field values". They are not represented in the graphic scheme.
- Not all parameters of the GSM BC-IE are relevant for each service (BS/TS). This is represented by specific abscissa points with a value of "NA" (Not Applicable) allocated to these parameters. The graphs pass through these points for each such parameter. The actual field value to be used in the GSM BC-IE is marked in the column "default setting of field values (NA)" of table B.5. An abscissa point with a value of "NAV" (Not AVailable) indicates that the entire octet carrying this parameter (ref. table B.2 "General Structure of the GSM BC-Information Element") shall be omitted.
- There is a particular dependency of the parameters "User Information Layer 2 Protocol (UIL2P)" and "Connection Element (CE)":
 - If the MS sends a GSM BC-IE with a CE value other than "Transparent (T)", the parameter UIL2P is essential. Its field value must be set as indicated in the applicable graph.
 - If the MSC sends a GSM BC-IE in the SETUP message, the parameter UIL2P may also be absent in the case of the CE parameter value being other than "Transparent (T)".
- Certain parameters of the GSM BC-IE may be negotiated during the connection establishment phase. Table B.1 shows these parameters and the relations of their values in the SETUP message and in the CALL CONFIRMED/CALL PROCEEDING message, respectively, both for the mobile-originated and mobile-terminated case. A parameter may indicate a field value of one of the following types:
 - "requested value" indicating a request which cannot be changed by the responding entity;
 - "offered value" indicating a proposal which may be changed by the responding entity;

- a particular choice value leaving it up to the responding entity which value ultimately applies;
- "as requested" indicating that the requested value applies and is confirmed (by returning it);
- "selected value" indicating that a particular value applies either out of the offered set or as a free choice out of the defined set of values.
- "supported value" indicating a value supported by the responding entity.

Table B.1: BC-Parameters subject to negotiation procedure

Mobile Originated Call:

BC-parameter	Message	
	SETUP	CALL PROC
NDB	requested value	as requested
NPB	requested value	as requested
NSB	requested value	as requested
CE	requested value (T/NT)	as requested
	"both" with the preferred value indicated (e.g. both NT)	selected value (T/NT)
UIL2P	requested value ²⁾ or NAV ¹⁾	as requested or NAV ⁴⁾
User Rate	requested value	as requested
DC	requested value ²⁾	as requested or "NO" ⁷⁾
FNUR	requested value	supported value
Other MT	requested value	supported value

Mobile Terminated Call:

BC-parameter	Message	
	SETUP	CALL CONF
NDB	offered value	selected value (free choice)
NPB	offered value	selected value (free choice)
NSB	offered value	selected value (free choice)
CE	requested value (T/NT)	as requested or selected value (T/NT) (free choice) ³⁾
	"both" with the preferred value indicated (e.g. both NT)	selected value (T/NT)
UIL2P	offered value ²⁾ or NAV ⁴⁾	selected or NAV ¹⁾
User Rate	offered value	selected value ⁵⁾
DC	requested value ²⁾	as requested or "NO" ⁷⁾
FNUR	offered value	selected value ⁶⁾
Other MT	offered value	selected value ⁶⁾

- 1) for CE:T only or out-band flow control requested by the MS
- 2) not for CE:T
- 3) when the SETUP message contains no BC-IE (single numbering scheme)
- 4) "NAV" shall not be interpreted as an out-band flow control request by the MS
- 5) The modification of User Rate must be in conjunction with Modem Type and Intermediate Rate
- 6) The modification of the Fixed Network User Rate shall be in conjunction with the Modem Type and/or Other Modem Type.

- 7) In case of a Mobile Terminated Call, if the SETUP message does not contain a BC-IE, the MS shall behave as if the DC is set to "data compression not possible".
In case of a MOC or a MTC where no BC-IE is included in the CALL PROCEEDING or CALL CONFIRMED message, respectively, the MS or the network shall behave as if the DC was set to "data compression not possible" or "data compression not allowed", respectively.

Table B.2: General Structure of the BC-Information Element

OCTET	INFORMATION ELEMENT FIELD
3	Radio channel requirements Coding standard Transfer mode Information Transfer Capability
4	Structure 2) Duplex mode Configuration Establishment Negotiation of Intermediate Rate Requested Compression
5	Rate adaption 2) Signalling access protocol
5a	Other ITC 2) 3) Other rate adaption
5b	Rate adaption header / no header 2) 3) Multiple frame establishment support in data link Mode of operation Logical link identifier negotiation Assignor / assignee In-band / out-band negotiation
6	User information layer 1 protocol 2) Synchronous / asynchronous
6a	Number of stop bits 2) Negotiation Number of data bits User rate
6b	Intermediate rate 2) NIC on transmission NIC on reception Parity information
6c	Connection element 2) Modem type
6d	Fixed network user rate 4) Other modem type
6e	Maximum number of traffic channels 4) Acceptable channel codings
6f	Wanted air interface user rate 4) User initiated modification indication
7	User information layer 2 protocol 1) 2)

- 1) octets optional.
- 2) octets only available if the parameter "Information Transfer Capability" does not indicate "Speech".
- 3) for V.120 rate adaption only
- 4) optional octets available only if the parameter "Information Transfer Capability" does not indicate "Speech".

Table B.3a: Selection of flow control method (for CE:NT with SA:A only)

	flow control method		
information element	in-band	out-band ³⁾	none
number of data bits	7 or 8	7 or 8	7 or 8
user information layer 2 protocol	ISO 6429 ¹⁾	NAV	COPnoFICt ²⁾

- 1) ISO6429 stands for "ISO 6429, codeset 0, DC1/DC3" and is applicable for 7 and 8 bit codes.
- 2) COPnoFICt stands for a character oriented protocol with no flow control mechanism (no reserved characters for flow control).
- 3) "out-band" flow control requires V.42 in case of PSTN or V.110 in case of ISDN. If the V.110 flow control mechanism is not supported, where required, the call pending shall be terminated.
If the V.42 functionality is not supported by the modem in the IWF or in the fixed network, the call will be supported with a fallback to the non-V.42 mode. In this case the IWF will release the call if due to temporary throughput problems on the radio interface or initiation of flow control by the MS and the inability to flow control the fixed network modem an overflow of the L2R buffers occurs.
Note that a phase 1 network may release the call, if the V.42 functionality is not provided by the IWF or the fixed network modem. As V.42 does not apply to V.21 and V.23 modems, outband flow control can not be supported for these modem types.

Table B.3b: Selection of GSM Profile (for CE:NT with SA:S only)

Mobile Terminated Call:

BC-parameter	Message SETUP	Message CALL CONF
UIL2P	X.25	X.25 or X.75

Table B.4a: Modem Type subject to negotiation procedure

Mobile Originated Call:

	BC-parameter MT and OMT ⁶⁾	
BC-parameter CE	Message SETUP	Message CALL PROC
T	V-series	V-series
NT	V-series	V-series
	autobauding type 1	autobauding type 1 or V-series ¹⁾
bothT or bothNT	V-series	V-series
	autobauding type 1	autobauding type 1 or V-series ¹⁾²⁾

Mobile Terminated Call:

BC-parameter MT and OMT ⁶⁾		
BC-parameter CE	Message SETUP	Message CALL CONF
T	V-series	V-series
NT	V-series	V-series or autobauding type 1 ³⁾
	autobauding type 1	autobauding type 1 or V-series ⁴⁾
bothT or bothNT	V-series	V-series
	autobauding type 1	autobauding type 1 or V-series ⁴⁾⁵⁾

- 1) No autobauding capability in the IWF:MSC
- 2) CE:T selected by IWF/MS
- 3) Free choice if the SETUP contains no BC-IE (single numbering scheme)
If the IWF/MS has no autobauding capability, a V-series modem type is used
- 4) When the MS does not allow the use of autobauding capability
- 5) CE:T selected by the MS
- 6) When the MT indicates "autobauding", "modem for undefined interface" or "none", the OMT shall be set to "no other modem type". Any other values of the MT is overridden by the OMT value.

Table B.4b: Intermediate Rate negotiation procedure

If the user rate is 9.6 kbit/s the intermediate rate negotiation procedure is not applicable and NIRR shall be set to "No meaning".

Recipient of SETUP supports full rate, non transparent, 6 kbit/s radio interface rate and the user rate is up to/equal 4.8 kbit/s:

BC-parameter	Message SETUP	Message CALL CONF or CALL PROC
NIRR	6 kbit/s	6 kbit/s
IR	16 kbit/s	8 kbit/s
User Rate	up to/equal 4.8 kbit/s	as requested

NOTE 2: In case of a Mobile Terminated Call, if the SETUP message does not contain a BC-IE, the MS shall behave as if NIRR set to "No meaning".

In case of a MOC or a MTC where no BC-IE is included in the CALL PROCEEDING or CALL CONFIRMED message, respectively, the MS or the network shall behave as if the NIRR was set to "No meaning".

Recipient of SETUP does support full rate, non transparent, but not in connection with 6 kbit/s radio interface rate:

BC-parameter	Message SETUP	Message CALL CONF or CALL PROC
NIRR	6 kbit/s	No meaning
IR	16 kbit/s	16 kbit/s
User Rate	up to/equal 4.8 kbit/s	as requested

NOTE 3: If no other parameter needs negotiation, the CALL CONF/PROC message need not contain any BC-IE.

In case of a MOC or a MTC where no BC-IE is included in the CALL PROCEEDING or CALL CONFIRMED message, respectively, the MS or the network shall behave as if the NIRR was set to "No meaning".

NOTE 4: In case a GBS-operation is requested and acknowledged, the MS indicates the acceptable channel codings. The indicated acceptance of TCH/F4.8 is equivalent to the support of 6 kbit/s radio interface rate per TCH/F and therefor overrides the NIRR parameter.

Table B.4c Negotiation of fixed network user rate

BC-parameter	Message SETUP	Message CALL PROC/CONFIRMED
FNUR	requested value	equal or lower than the requested value

The network might accept the modified value or reject the call. The FNUR negotiation is applicable in case of a HSCSD-operation, only.

Table B.4d Negotiation of user initiated modification indication

BC-parameter	Message SETUP	Message CALL PROC/CONFIRMED
UIMI	offered value	equal to or a value indicating a request for modification to a lower number of traffic channels than offered

Table B.5: BC parameter setting (part 1)

Abbreviations for Parameters and Values:		common setting of field values		
		default setting of field values (NA)	v	v
ITC...Information Transfer Capability:	- Speech - UDI..Unrestricted Digital - FAX3..Group 3 Facsimile - 3.1 kHz..3.1 kHz Ex PLMN - RDI..Restricted Digital			
TM....Transfer Mode:	- ci..Circuit	X	X	
S.....Structure:	- SDU..Service Data Unit Integrity - Unstructured	X		
C.....Configuration:	- pp..Point to point	X	X	
E.....Establishment:	- de..Demand	X	X	
SA....Sync/Async:	- S..Synchronous - A..Asynchronous			
N....Negotiation	- ibn..in band negotiation not possible	X	X	
UR....User Rate:	- 0.3..0.3 kbit/s - 1.2..1.2 kbit/s - 1.2/0.075..1200/75 bit/s - 2.4..2.4 kbit/s - 4.8..4.8 kbit/s - 9.6..9.6 kbit/s			
IR....Intermediate Rate:	- 4.. 4 kbit/s - 8.. 8 kbit/s - 16.. 16 kbit/s - not_used..not used	X		
NICT..Network Independent Clock on Tx:	- not_required.. Not required - required	X	X	
NICR..Network Independent Clock on Rx:	- not_accepted..not accepted - accepted	X	X	
NSB...Number of Stop Bits:	- 1..1 bit - 2..2 bit	X		
NDB...Number of Data Bits Excluding Parity If Present:	- 7.. 7 bit - 8.. 8 bit	X		
NPB...Parity Information:	- Odd - Even - None - 0.. Forced to 0 - 1.. Forced to 1	X		
UIL1P>User Information Layer 1 Protocol	- def..default layer 1 protocol	X	X	

Table B.5: BC parameter setting (part 2)

Abbreviations for Parameters and Values		common setting of field values	
		default setting of field values (NA)	
		V	V
DM....Duplex Mode:	- - fd.. Full Duplex	X	X
MT....Modem Type:	- V.21 - V.22 - V.22 bis - V.23 - V.26 ter - V.32 - autol.. autobauding type 1 - none	X	
RCR...Radio Channel Requirement:	- FR Full Rate support only Mobile Station - dual HR Dual Rate support Mobile Station/ Half Rate preferred - dual FR Dual Rate support Mobile Station/ Full Rate preferred		
CE....Connection Element:	- T.. Transparent - NT.. Non Transparent - bothT both transparent preferred - bothNT both non Transparent preferred		
UIL2P.User Information Layer 2 Protocol:	- ISO6429..ISO6429, codeset 0, DC1/DC3 - X.25 - X.75..X.75 layer 2 modified (CAPI) - COPnoFlCt..Character oriented protocol with no flow control mechanism		
SAP...Signalling Access Protocol:	- I.440.. I.440/450 - X.21 - X.28deIN.. X.28, dedicated PAD, individual NUI - X.28deUN.. X.28, dedicated PAD, universal NUI - X.28nond.. X.28, non dedicated PAD - X.32	X	
RA....Rate Adaptation:	- V.110.. V.110/X.30 - X.31Flag.. X.31 flagstuffing - NO.. no rate adaptation - V.120	X	
CS....Coding Standard:	- GSM	X	X
NIRR..Negotiation of Intermediate Rate Requested:	NM..No Meaning associated with this value 6kbit/s..6kbit/s radio interface rate requested	X	
DC....Data Compression	- DC.. compression possible/allowed - NO.. compression not possible/allowed		

Table B.5: BC parameter setting (part 3)

Abbreviations for Parameters and Values		common setting of field values	
		v	v
		default setting of field values (NA)	
FNUR...Fixed Network User Rate	- FNUR not applicable		
	- 9.6.. 9.6 kbit/s		
	- 14.4.. 14.4 kbit/s		
	- 19.2.. 19.2 kbit/s		
	- 28.8.. 28.8 kbit/s		
	- 38.4.. 38.4 kbit/s		
	- 48.0.. 48.0 kbit/s		
	- 56.0.. 56.0 kbit/s		
	- 64.0.. 64.0 kbit/s		
WAIUR...Wanted Air Interface User Rate	- WAIUR not applicable		
	- 9.6.. 9.6 kbit/s		
	- 14.4.. 14.4 kbit/s		
	- 19.2.. 19.2 kbit/s		
	- 28.8.. 28.8 kbit/s		
	- 38.4.. 38.4 kbit/s		
	- 43.2.. 43.2 kbit/s		
	- 57.6.. 57.6 kbit/s		
	- int 38.4.. interpreted by the network as 38.4 kbit/s		
ACC.....Acceptable channel codings	- 4.8.. TCH/F4.8 acceptable		
	- 9.6.. TCH/F9.6 acceptable		
	- 14.4..TCH/F14.4 acceptable		
MaxNumTCH...Maximum Number of Traffic Channels	- 1.. 1 TCH		
	- 2.. 2 TCH		
	- 3.. 3 TCH		
	- 4.. 4 TCH		
	- 5.. 5 TCH		
	- 6.. 6 TCH		
	- 7.. 7 TCH		
	- 8.. 8 TCH		
OMT...Other modem type	- no OMT.. no other modem type		
	- V.34.. V.34		
User initiated modification indication	- not req.. user initiated modification not required		
	- upto 1 TCH.. user initiated modification upto 1 TCH may be requested		
	- upto 2 TCH.. user initiated modification upto 2 TCH may be requested		
	- upto 3 TCH.. user initiated modification upto 3 TCH may be requested		
	- upto 4 TCH.. user initiated modification upto 4 TCH may be requested		

Table B.6: Channel combinations

Single Bearer and Teleservices

MS indication BC	Network selection CT
FR	FR
dual FR	FR or HR
dual HR	HR or FR

Alternate services

MS indication BC(1)	BC(2)	Network selection CT(1)	CT(2)	or	CT(1)	CT(2)
FR	FR	FR	FR			
FR	dual Rate	FR	FR			
dual Rate	dual Rate	FR	FR	or	HR	HR
dual Rate	FR	FR	FR			

Followed-by services

MS indication BC(1)	BC(2)	Network selection CT(1)	CT(2)	or	CT(1)	CT(2)	or	CT(1)	CT(2)
FR	FR	FR	FR						
FR	dual Rate	FR	FR						
dual Rate	dual Rate	FR	FR	or	HR	HR	or	FR	HR
dual Rate	FR	FR	FR						

BC Bearer Capability
CT Channel Type
dual Rate {dual FR | dual HR}

Table B.7: TS61/TS62 Negotiation rules

Mobile Originating Call

Subscription	SETUP	CALL PROCEED
TS61	TS61 s/f	TS61 s/f or TS62
	TS61 f/s	TS61 f/s or TS62
	TS62	TS62
TS62	TS61 s/f	TS62
	TS61 f/s	TS62
	TS62	TS62

Mobile Terminating Call

Subscription	SETUP	CALL CONFIRMED
TS61	TS61 s/f	TS61 s/f or TS61 f/s or TS62
	TS61 f/s	TS61 s/f or TS61 f/s or TS62
	TS62	TS62
	no BC	TS61 s/f or TS61 f/s or TS62
TS62	TS62	TS62
	no BC	TS62 (Note1)

s/f = speech then fax
f/s = fax then speech

NOTE 1: TS61 is also accepted if the VMSC supports TS61 and does not perform subscription checking on a CALL CONFIRMED message (see GSM 02.01 and GSM 09.07).

B.1.2 Bearer Service 20 ... 26, Data Circuit Duplex Asynchronous

B.1.2.1 Unrestricted / restricted digital information transfer capability

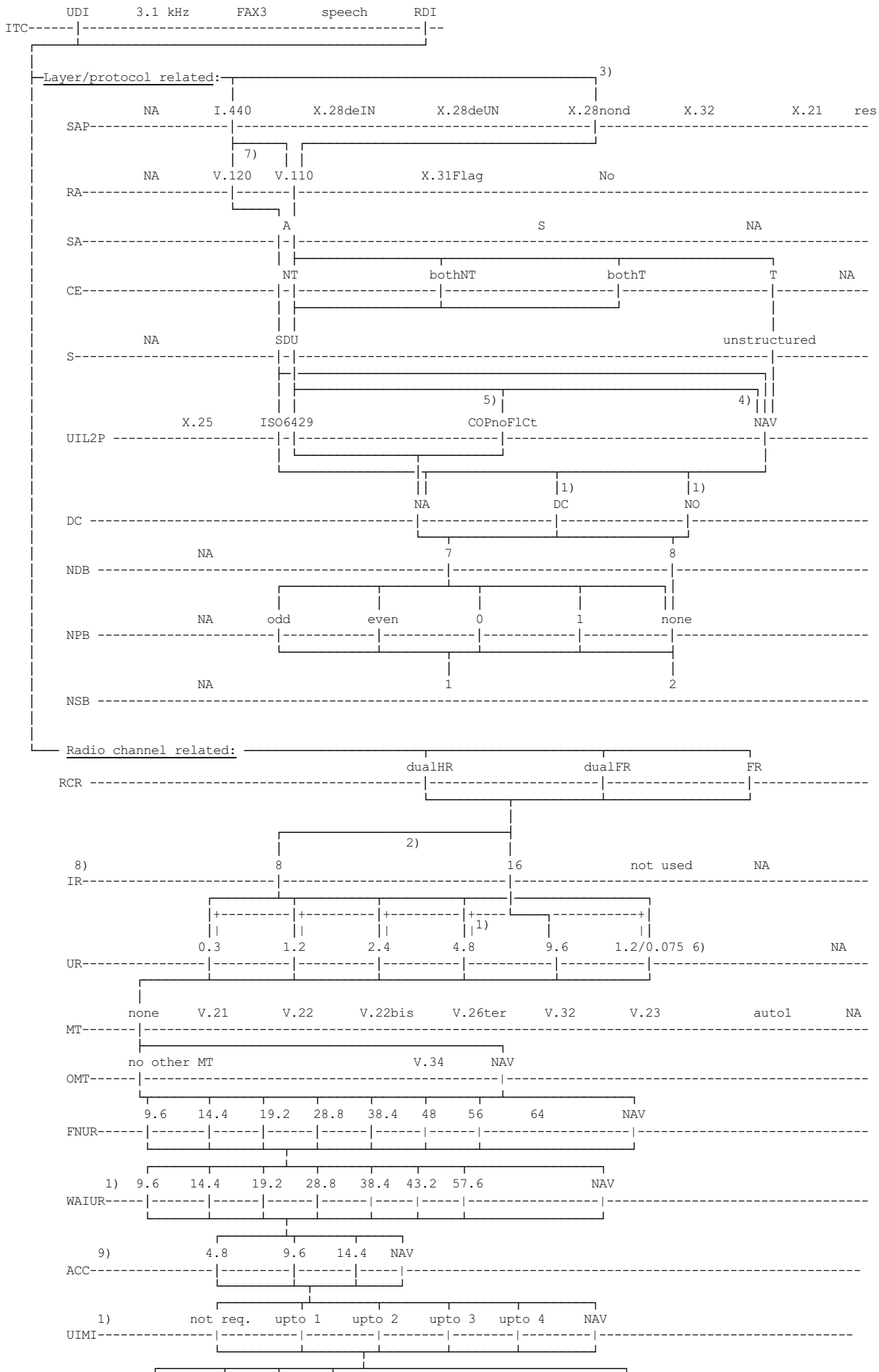

MaxNumTCH-----1-----2-----3-----4-----5-----6-----7-----8-----NAV-----

- 1) for CE:NT or "both";
- 2) for CE:T only or CE:NT and NIRR:6kb/s (not for the SETUP message);
- 3) for MOC only;
- 4) for MTC in the SETUP message or MOC/MTC with "out-band" flow control requested
- 5) for MOC/MTC with no flow control requested;
- 6) MOC only, 75 bit/s in the uplink, 1200 bit/s in the downlink direction;
- 7) the V.120 relevant BC parameters (octet 5b) shall be set according to the LLC (see annex B.2);
- 8) IR and UR are overridden if FNUR, ACC and MaxNumTCH are available.
- 9) ACC may have several values simultaneously (bit map coding).

NOTE: The parameters FNUR, OMT, AIUR, ACC, MaxNumTCH and UIMI are included for HSCSD-operations only. If included, refer to section B.1.12 for valid setting of FNUR (for CE:T) and AIUR (for CE:NT) versus combinations of MaxNumTCH and ACC values.

B.1.2.2 3.1 kHz audio ex-PLMN information transfer capability

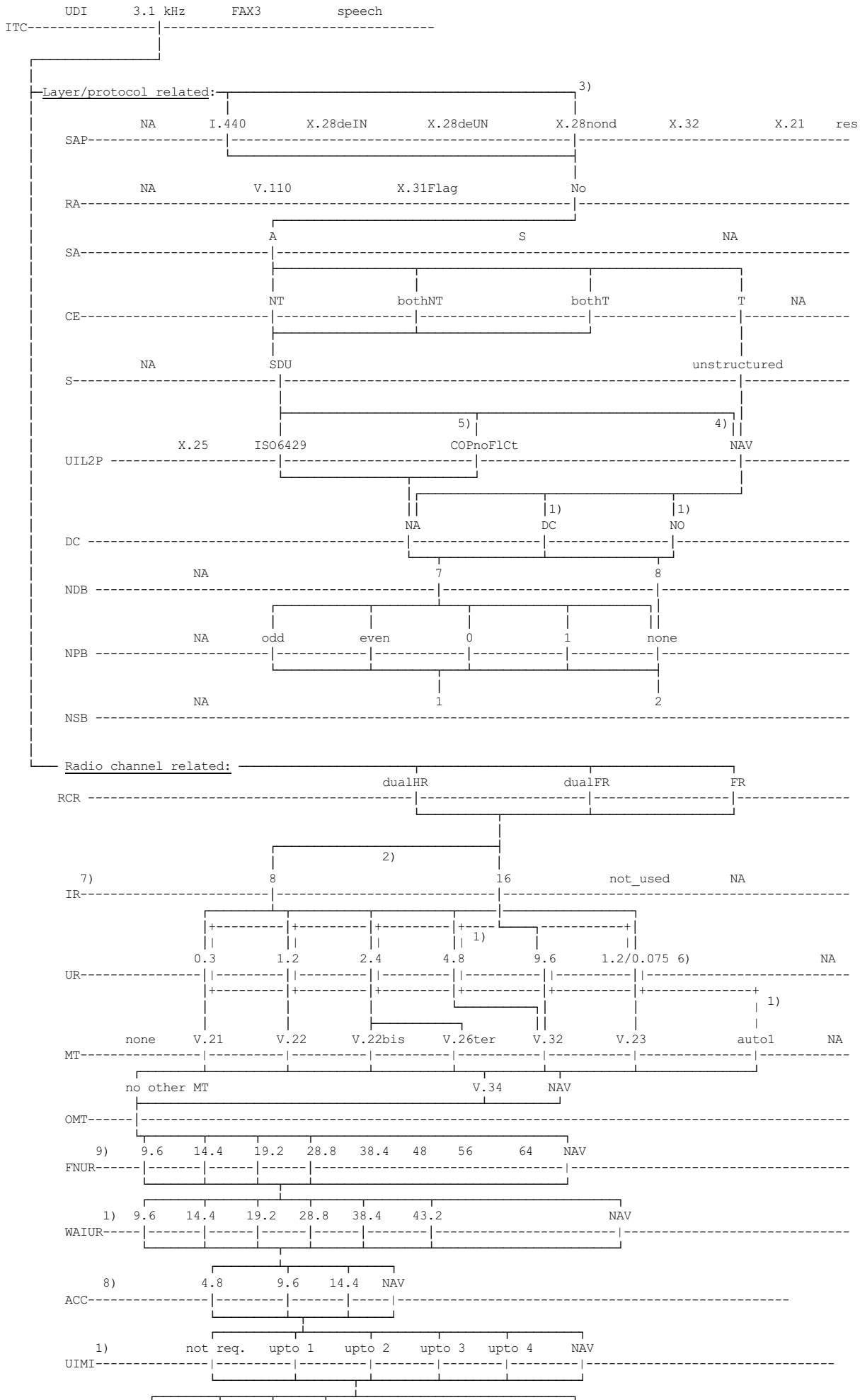

NumTCH-----|-----
1 2 3 4 5 6 7 8 NAV

- 1) for CE:NT or "both";
- 2) for CE:T only or CE:NT and NIRR:6kb/s (not for the SETUP message);
- 3) for MOC only;
- 4) for MTC in the SETUP message or MOC/MTC with "out-band" flow control requested (not for V.21 and V.23 modem types);
- 5) for MOC/MTC with no flow control requested;
- 6) MOC only, 75 bit/s in the uplink, 1200 bit/s in the downlink direction;
- 7) IR and UR are overridden if FNUR, ACC and MaxNumTCH are available.
- 8) ACC may have several values simultaneously (bit map coding).
- 9) in case of MT = auto1 the value of FNUR has no meaning.

NOTE: The parameters FNUR, OMT, AIUR, ACC, MaxNumTCH and UIMI are included for HSCSD-operations only. If included, refer to section B.1.12 for valid setting of FNUR (for CE:T) and AIUR (for CE:NT) versus combinations of MaxNumTCH and ACC values.

B.1.3 Bearer Service 30 ... 34, Data Circuit Duplex Synchronous

B.1.3.1 Unrestricted digital information transfer capability

B.1.3.1.1 Non-X.32 Cases

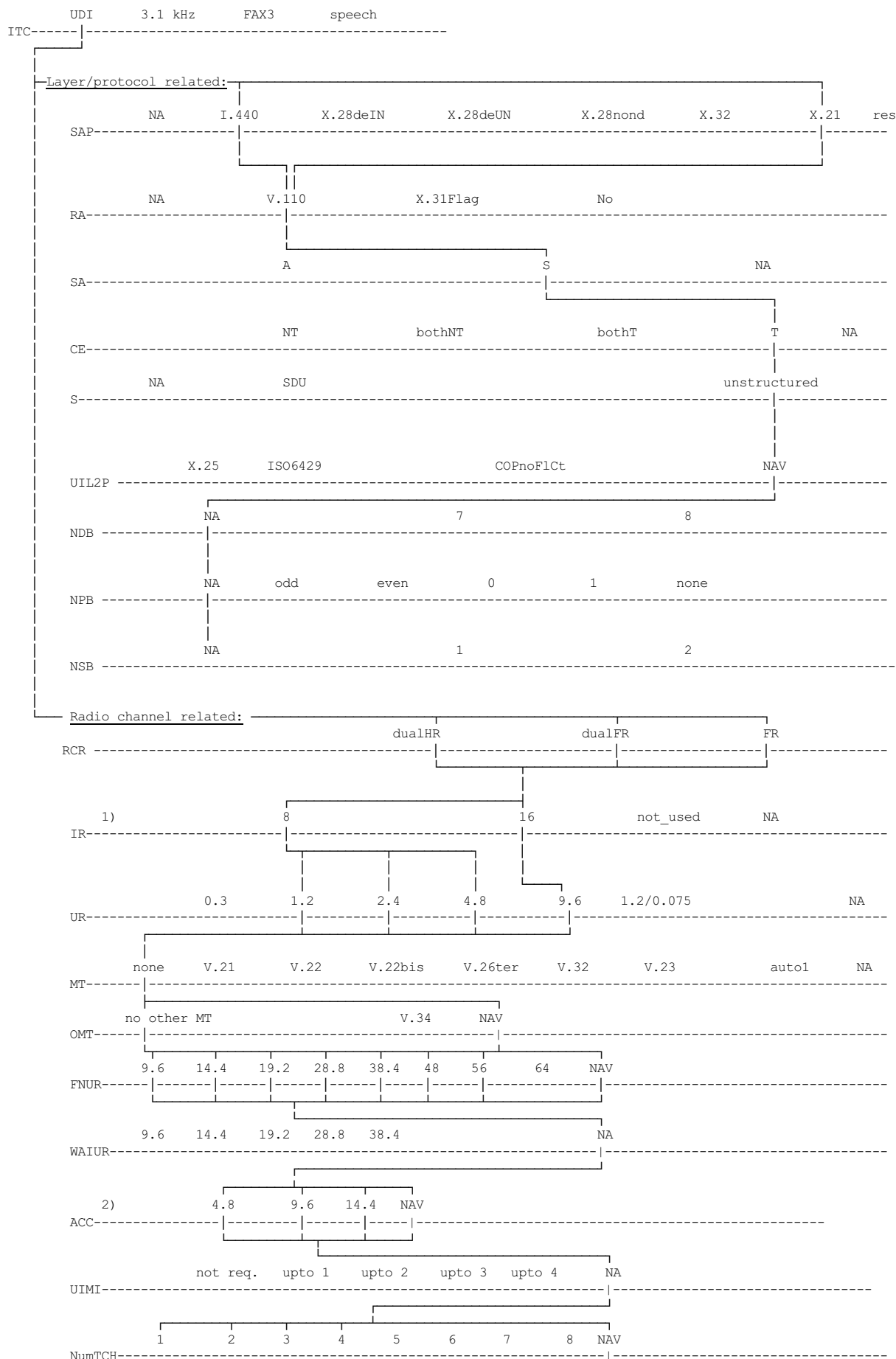

- 1) IR and UR are overridden if FNUR, ACC and MaxNumTCH are available
- 2) ACC may have several values simultaneously (bit map coding).

NOTE: The parameters FNUR, OMT, ACC and MaxNumTCH are included for HSCSD-operations only. If included, refer to section B.1.12 for valid setting of FNUR versus combinations of MaxNumTCH and ACC values.

Page 46
ETS 300 913 (GSM 07.01 version 5.6.1): March 1998
B.1.3.1.2 X.32 Case (Packet Service)

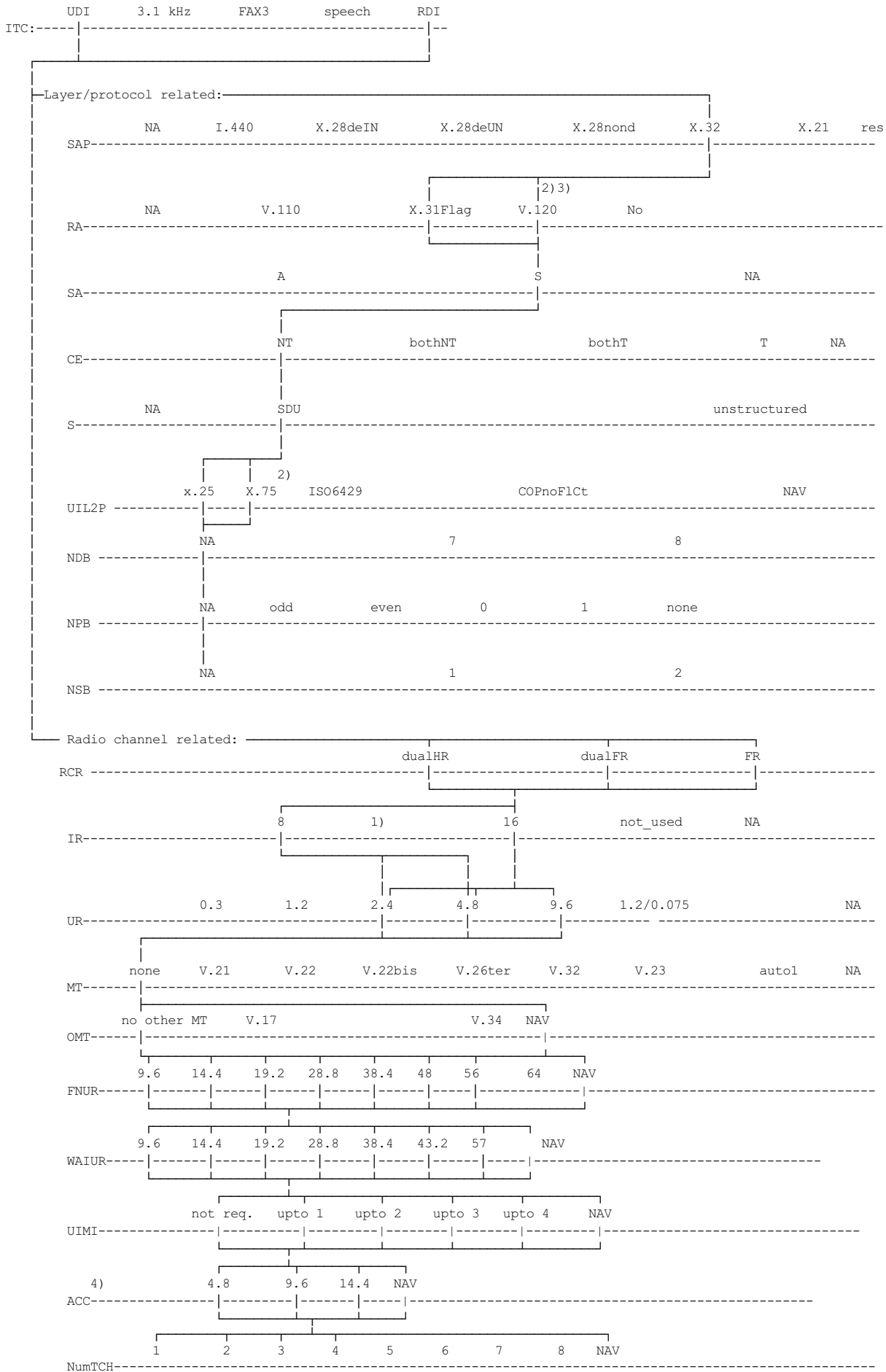

- 1) for NIRR:6kb/s (not for the SETUP message)
- 2) not for packet handler access
- 3) the V.120 relevant BC parameters (octet 5b) shall be set according to the LLC (see annex B.2)
- 4) ACC may have several values simultaneously (bit map coding).

NOTE: The parameters FNUR, OMT, AIUR, ACC, MaxNumTCH and UIMI are included for HSCSD-operations only. If included, refer to section B.1.12 for valid settings of AIUR versus combinations of MaxNumTCH and ACC values.

Page 48
ETS 300 913 (GSM 07.01 version 5.6.1): March 1998
B.1.3.1.4 48kbit/s and 56 kbit/s transparent Case

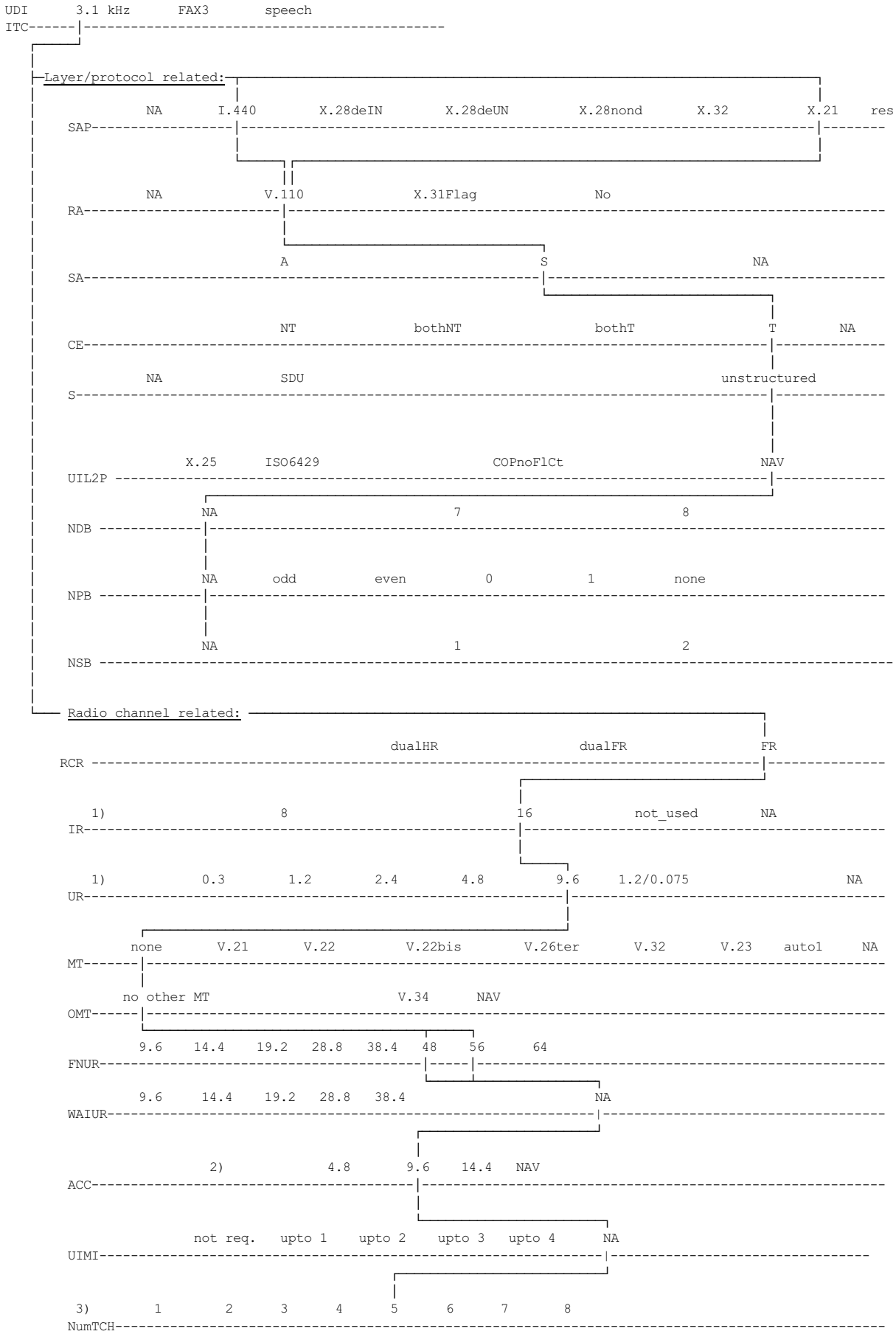

- 1) IR and UR are overridden by FNUR, ACC and MaxNumTCH are available
- 2) ACC may have several values simultaneously (bit map coding).
- 3) For a 4 channel operation see table B.1.3.1.1.

NOTE: The parameters FNUR, OMT, ACC and MaxNumTCH are mandatory for this service.

Page 50
ETS 300 913 (GSM 07.01 version 5.6.1): March 1998
B.1.3.1.5 64kbit/s bit transparent Case

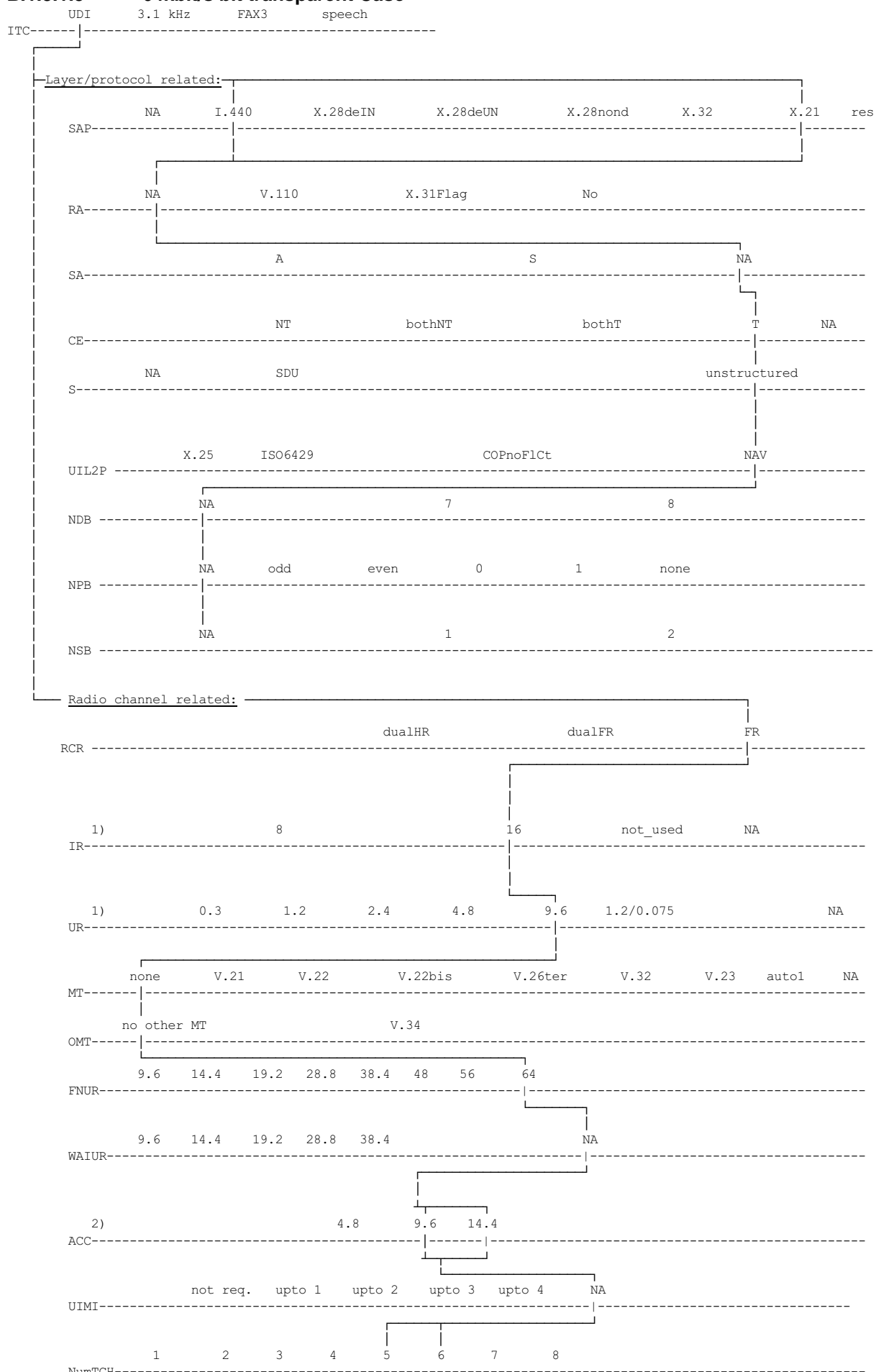

- 1) IR and UR are overridden by FNUR, ACC and MaxNumTCH are available
 2) ACC may have several values simultaneously (bit map coding).
 NOTE: The parameters FNUR, OMT, ACC and MaxNumTCH are mandatory for this service.

B.1.3.2 3.1 kHz audio ex-PLMN information transfer capability

B.1.3.2.1 Non-X.32 Cases

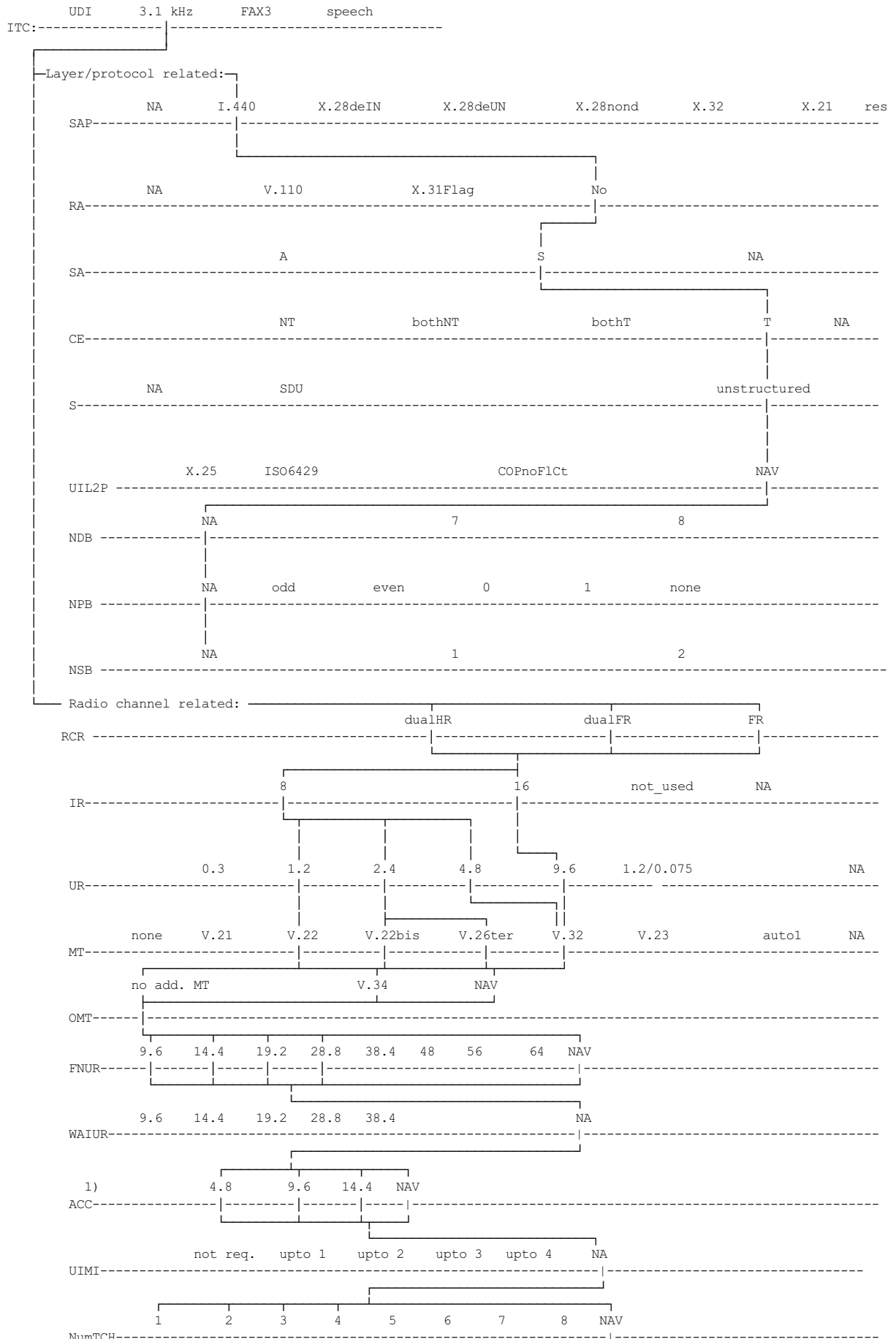

1) ACC may have several values simultaneously (bit map coding).

NOTE: The parameters FNUR, OMT, AIUR, ACC, MaxNumTCH and UIMI are included for HSCSD-operations only. If included, refer to section B.1.12 for valid setting of FNUR versus combinations of MaxNumTCH and ACC values.

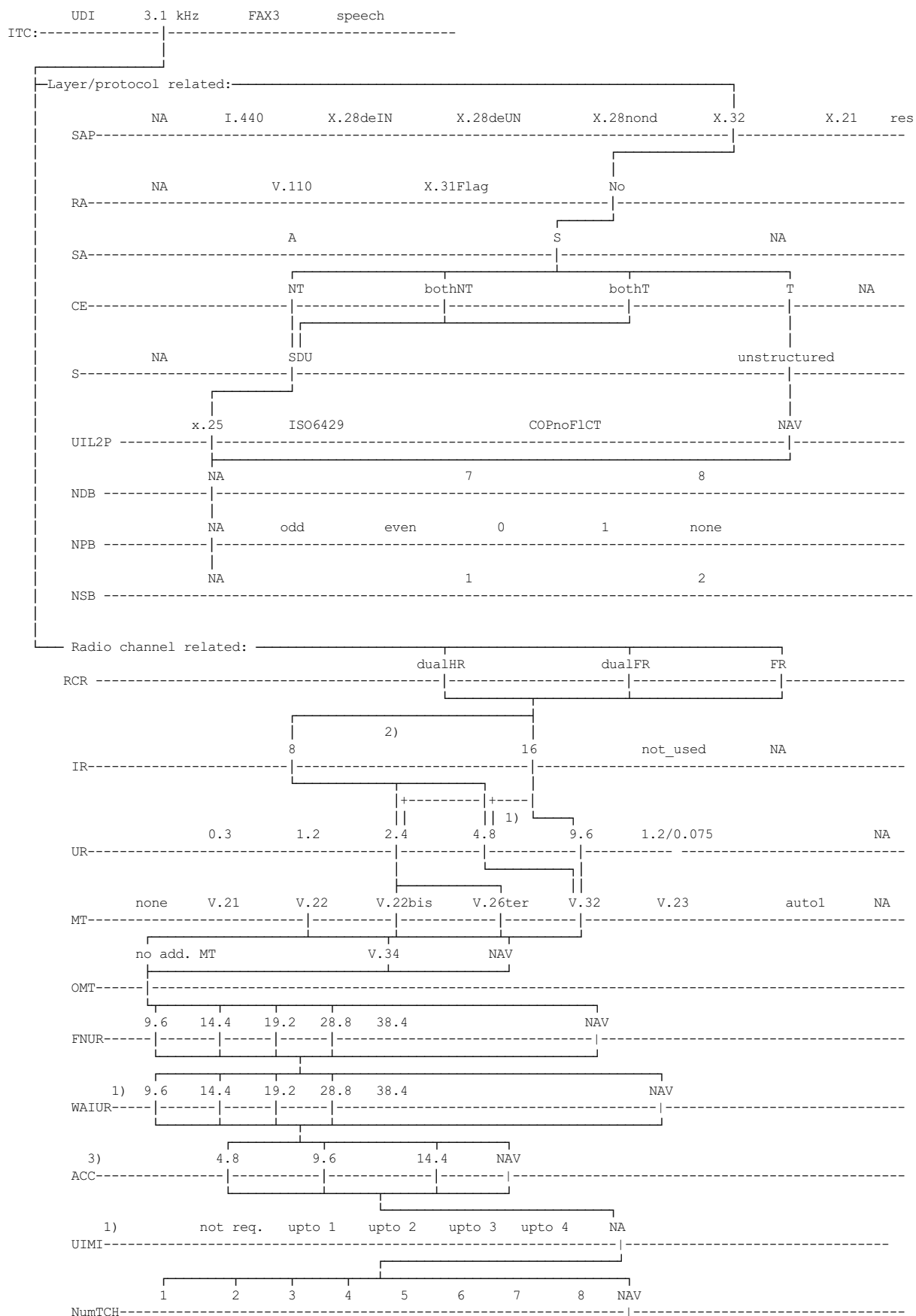

- 1) for CE:NT or "both"
- 2) for CE:T or CE:NT and NIRR:6kb/s (not for the SETUP message)
- 3) ACC may have several values simultaneously (bit map coding).

B.1.4 Bearer Service 40 ... 46, PAD Access Asynchronous

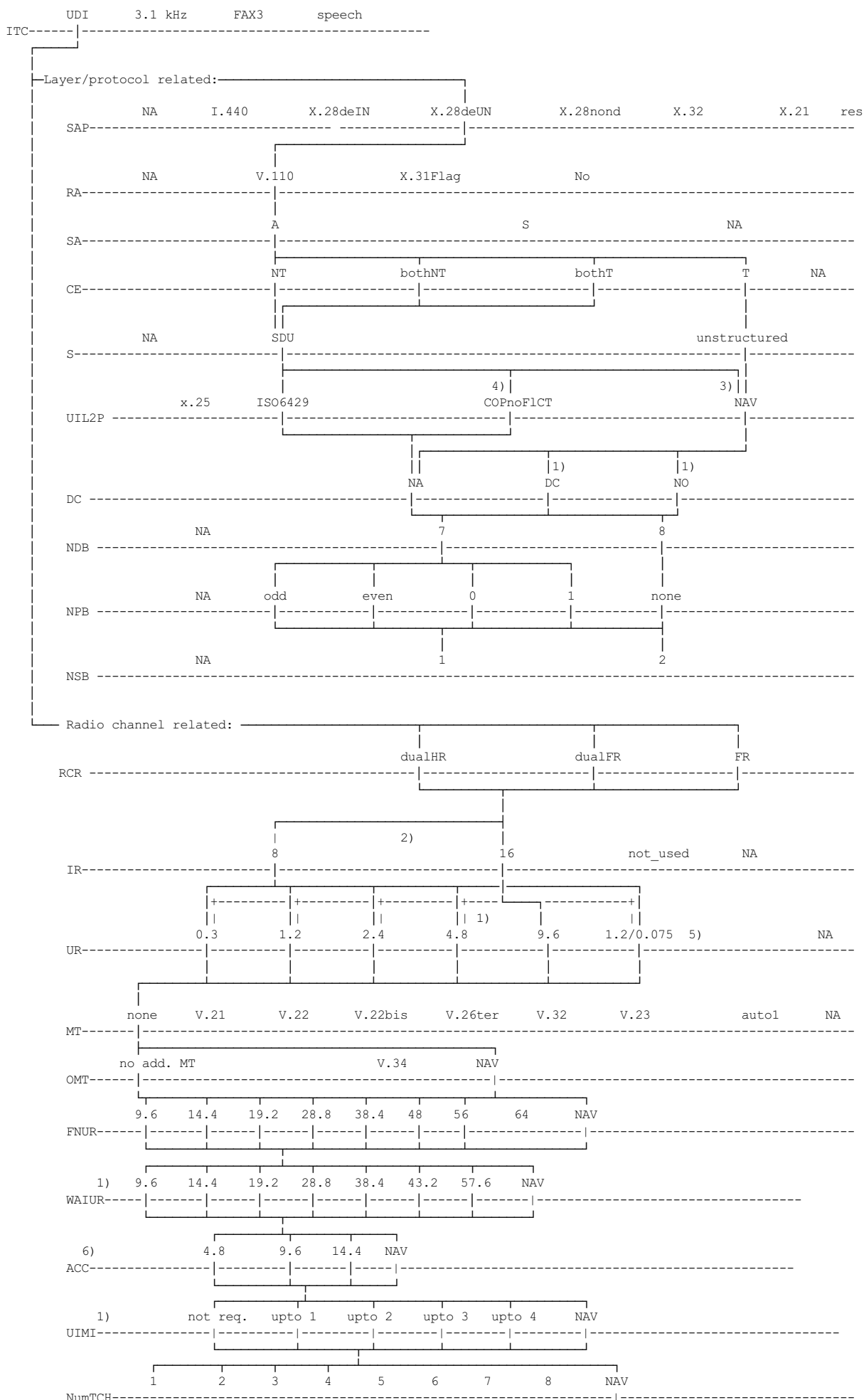

- 1) for CE:NT or "both";
- 2) for CE:T only or CE:NT and NIRR:6kb/s (not for the SETUP message);
- 3) for MOC with "outband" flow control requested;
- 4) for MOC with no flow control requested;
- 5) MOC only, 75 bit/s in the uplink, 1200 bit/s in the downlink direction.
- 6) ACC may have several values simultaneously (bit map coding).

NOTE: The parameters FNUR, OMT, AIUR, ACC, MaxNumTCH and UIMI are included for HSCSD-operations only. If included, refer to section B.1.12 for valid setting of FNUR (for CE:T) and AIUR (for CE:NT) versus combinations of MaxNumTCH and ACC values.

B.1.5 Bearer Service 50 ... 53 ,Data Packet Duplex Synchronous, Unrestricted digital information transfer capability

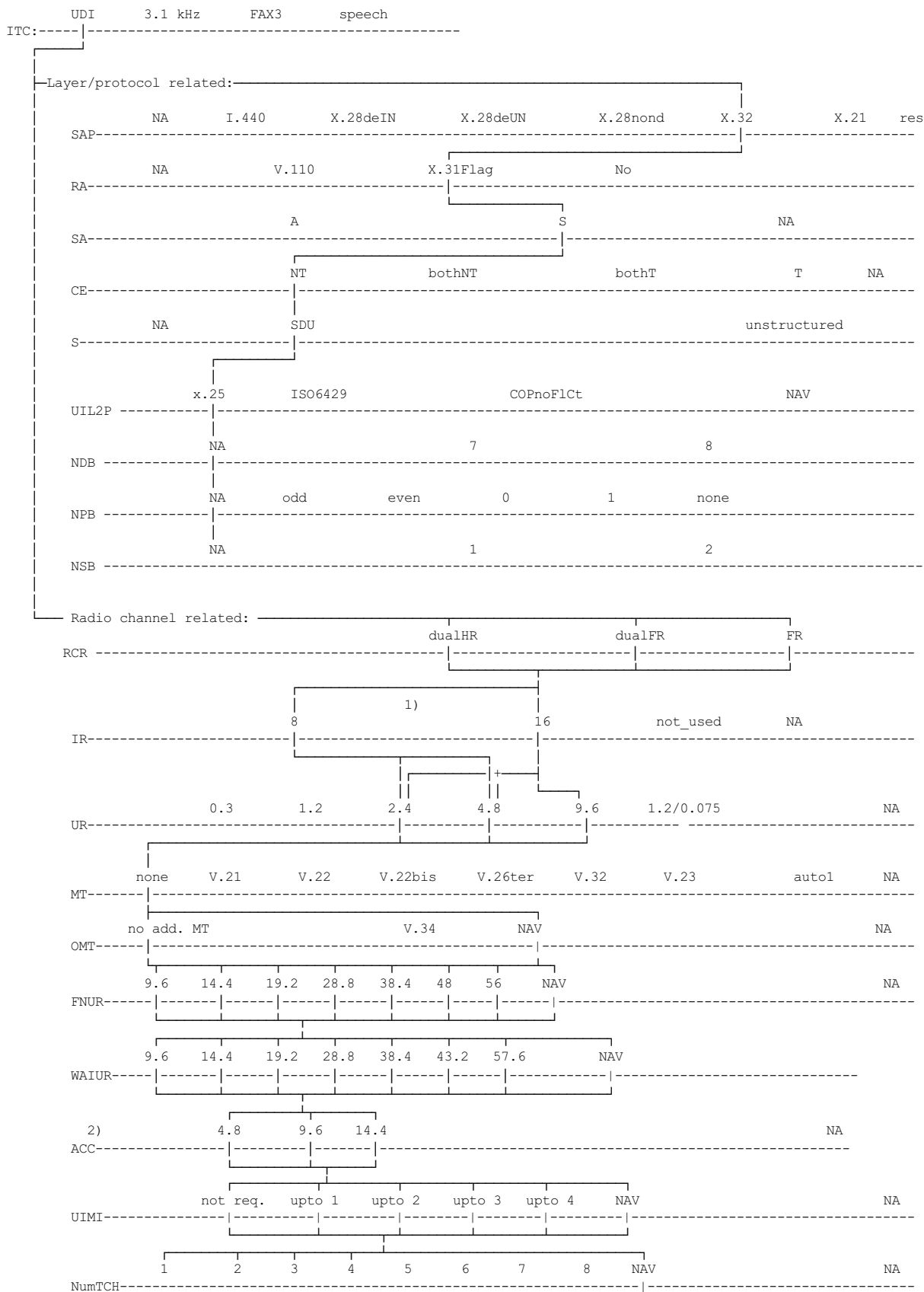

- 1) for NIRR:6kb/s (not for the SETUP message)
- 2) ACC may have several values simultaneously (bit map coding).

NOTE: The parameters FNUR, OMT, AUIR, ACC, MaxNumTCH and UIMI are included for HSCSD-operations only. If included, refer to section B.1.12 for valid setting of WAIUR versus combinations of MaxNumTCH and ACC values.

The information element of the "repeat indicator" is set to the value "circular for successive selection (alternate)".

B.1.6.1 Bearer Service 61, Speech

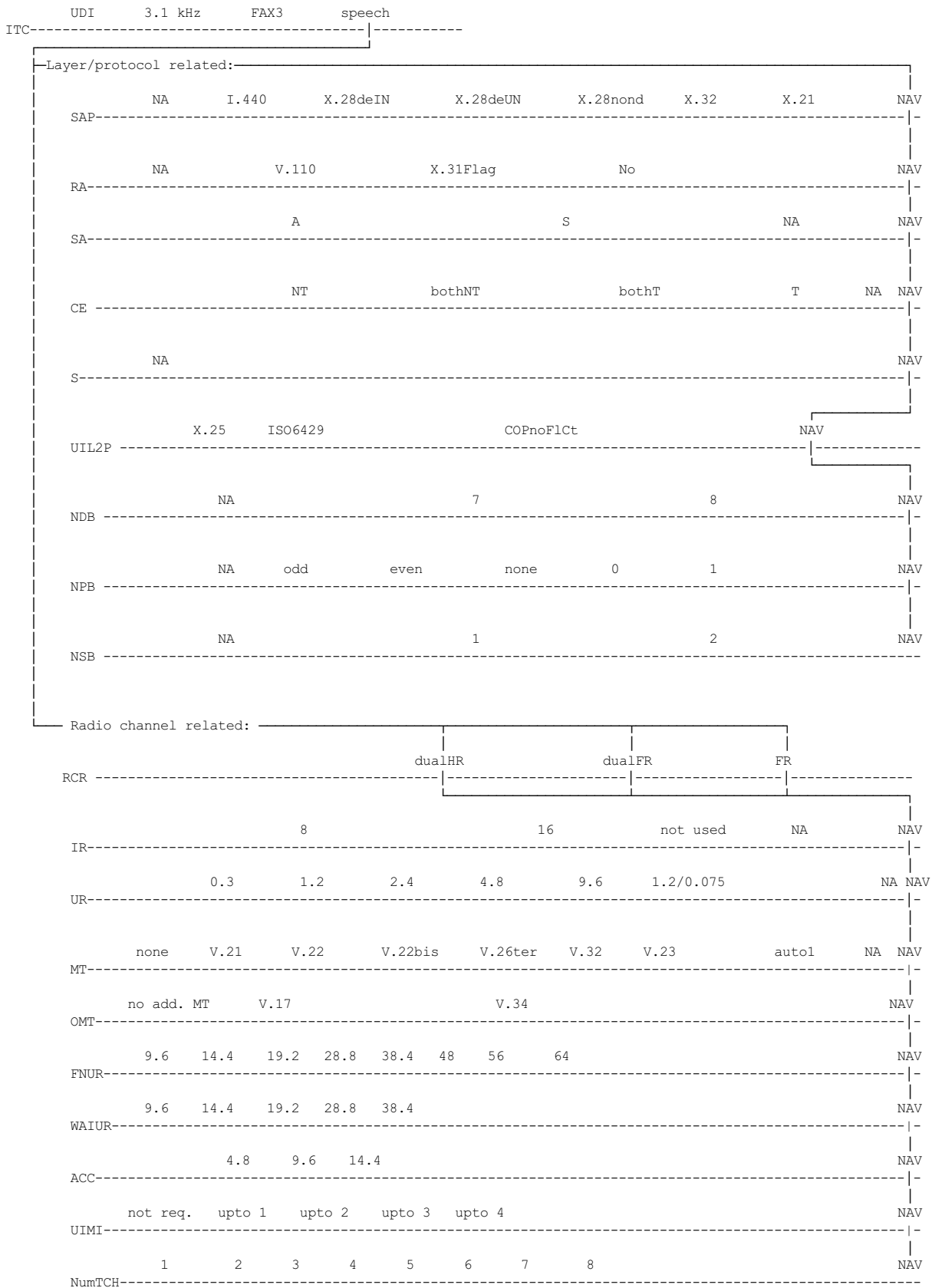

B.1.6.2 Bearer Service 61, 3.1 kHz audio ex-PLMN information transfer capability

B.1.6.2.1 Asynchronous

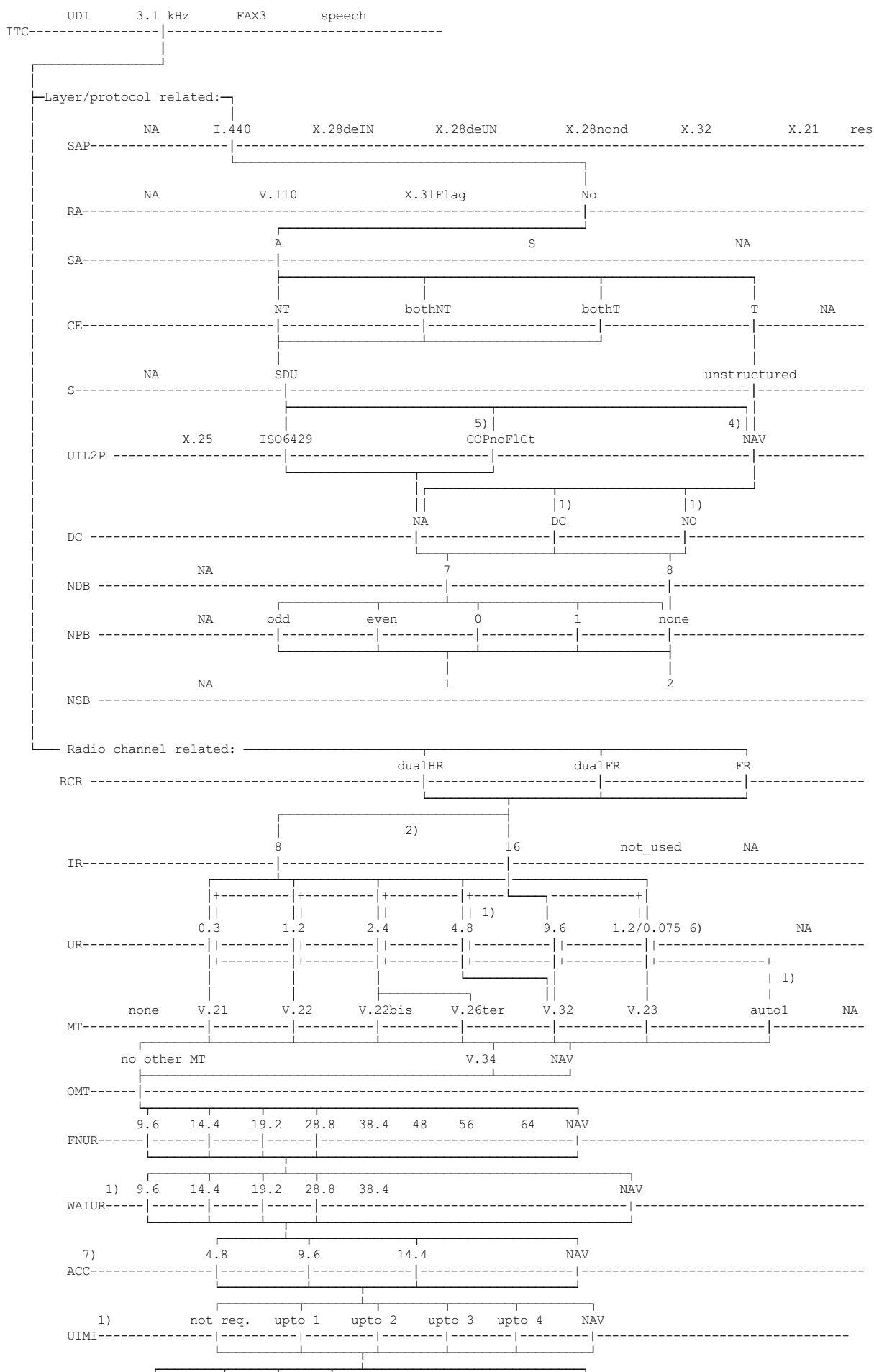

- 1) for CE:NT or "both"
- 2) for CE:T only or CE:NT and NIRR:6kb/s (not for the SETUP message)
- 3) for MOC only
- 4) for MTC in the SETUP message or MOC/MTC with "out-band" flow control requested (not for V.21 and V.23 modem types)
- 5) for MOC/MTC with no flow control requested
- 6) MOC only, 75 bit/s in the uplink, 1200 bit/s in the downlink direction
- 7) ACC may have several values simultaneously (bit map coding).

NOTE: The parameters FNUR, OMT, AIUR, ACC, MaxNumTCH and UIMI are included for HSCSD-operations only. If included, refer to section B.1.12 for valid setting of FNUR (for CE:T) and AIUR (for CE:NT) versus combinations of MaxNumTCH and ACC values.

B.1.6.2.2 Synchronous

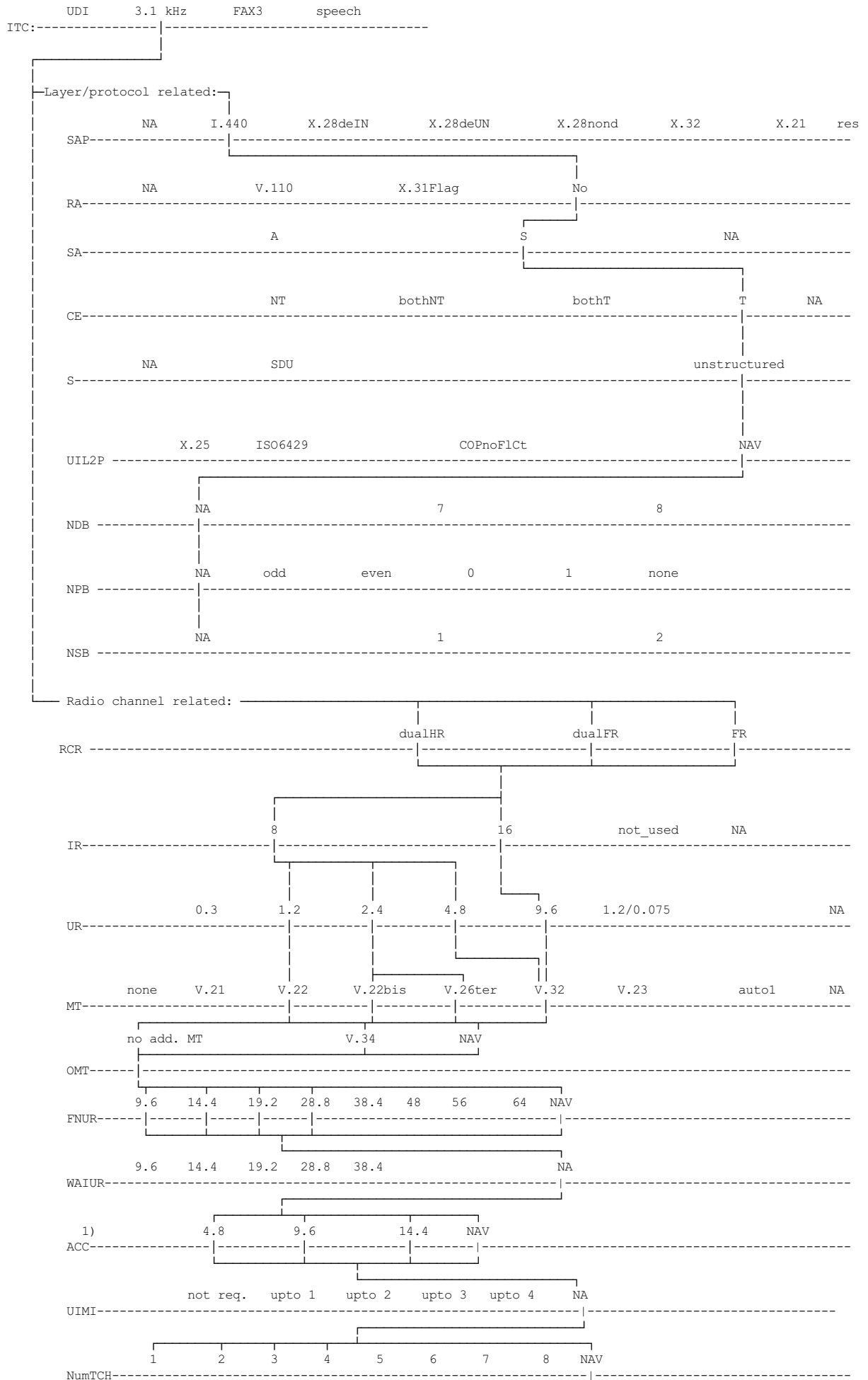

1) ACC may have several values simultaneously (bit map coding).

NOTE: The parameters FNUR, OMT, AUIR, ACC, MaxNumTCH and UIMI are included for HSCSD-operations only. If included, refer to section B.1.12 for valid setting of FNUR versus combinations of MaxNumTCH and ACC values.

B.1.7 Bearer Service 81, Speech followed by Data

The information element of the "repeat indicator" is set to the value "sequential for successive selection (followed by)".

B.1.7.1 Bearer Service 81, Speech

Ref. section B.1.6.1.

B.1.7.2 Bearer Service 81, 3.1 kHz audio ex-PLMN information transfer capability

B.1.7.2.1 Asynchronous

Ref. section B.1.6.2.1.

B.1.7.2.2 Synchronous

Ref. section B.1.6.2.2.

B.1.8 Teleservice 11 ... 12, Speech

Ref. section B.1.6.1.

B.1.9 Teleservice 21 ... 23, Short Message

not applicable.

B.1.10 Teleservice 61, Alternate Speech and Facsimile group 3

The information element of the "repeat indicator" is set to the value "circular for successive selection (alternate)".

B.1.10.1 Teleservice 61, Speech

Ref. section B.1.6.1.

B.1.10.2 Teleservice 61, Facsimile group 3

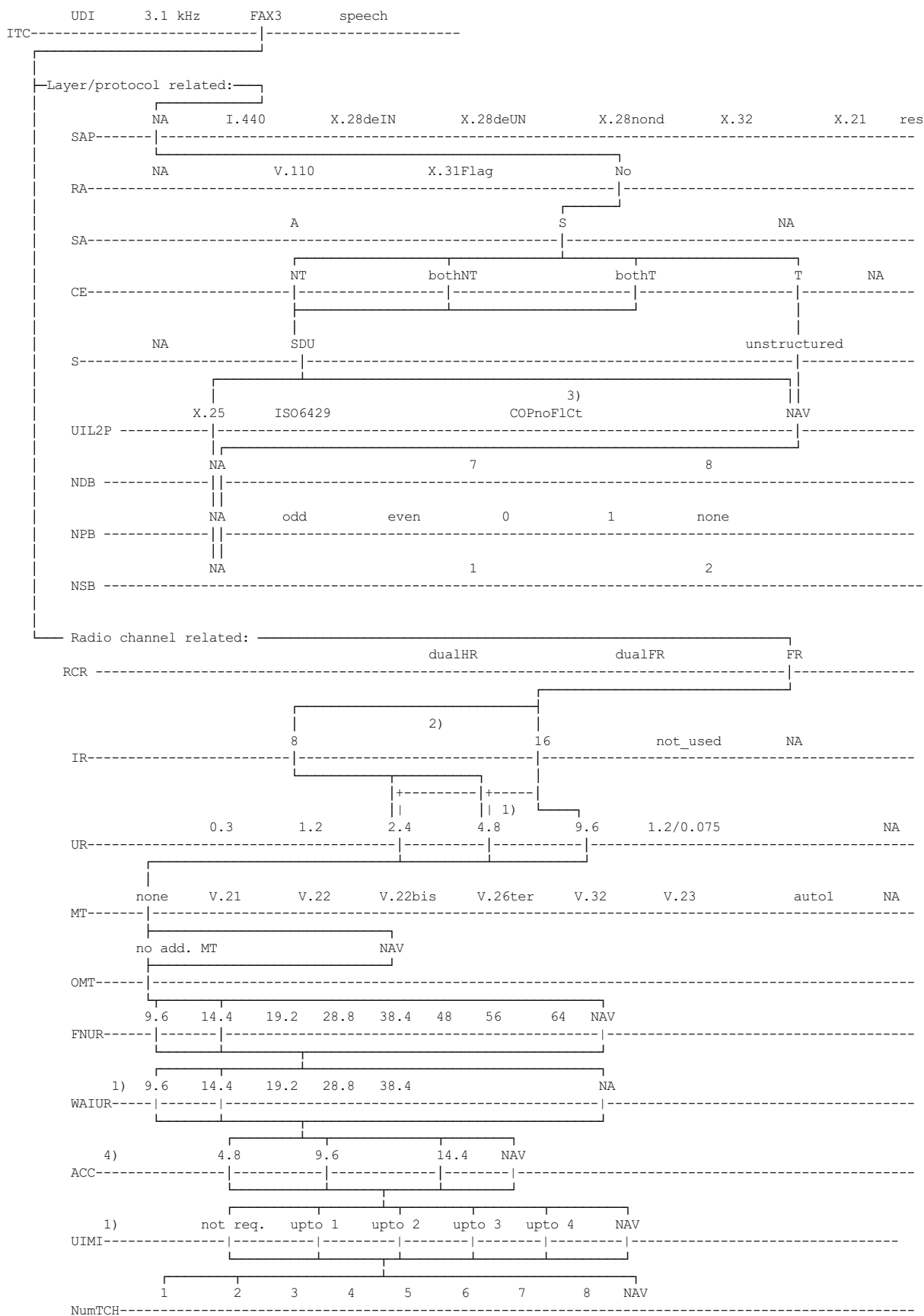

- 1) for CE:NT or "both";
- 2) for CE:T only;
- 3) for MTC in the SETUP message only;
- 4) ACC may have several values simultaneously (bit map coding).

ETS 300 913 (GSM 07.01 version 5.6.1): March 1998

NOTE: The parameters FNUR, OMT, AIUR, ACC, MaxNumTCH and UIMI are included for HSCSD- operations only. If included, refer to section B.1.12 for valid setting of FNUR (for CE:T) and AIUR (for CE:NT) versus combinations of MaxNumTCH and ACC values.

B.1.11 Teleservice 62, Automatic Facsimile group 3

Ref. section B.1.10, the information element "repeat indicator" is not available/valid.

B.1.12 Valid combinations of FNUR, AIUR, ACC and MaxNumTCH**B.1.12.1 Transparent services**

The MS is allowed to signal any combination of FNUR, ACC and MaxNumTCH with at least one compliant to the following table. Final decision of radio interface configuration will be taken by the BSS during the Assignment procedure (see GSM 02.34).

FNUR	MaxNumTCH	ACC
9.6 kbit/s	1	9.6
	2	4.8
14.4 kbit/s	1	14.4
	2	9.6 (Note1)
	3	4.8
19.2 kbit/s	2	9.6
	4	4.8
28.8 kbit/s	2	14.4
	3	9.6
38.4 kbit/s	3	14.4 (Note1)
	4	9.6
48.0 kbit/s	4	14.4 (Note1)
	5	9.6 (Note1, note2)
56.0 kbit/s	4	14.4 (Note1)
	5	9.6 (Note2)
64.0 kbit/s	5	14.4 (Note1)
	6	9.6 (Note1, note2)

NOTE 1: Padding required, ref GSM 04.21

NOTE 2: Air interface user rate 11.2 kbit/s, ref. GSM 04.21.

B.1.12.2 Non-transparent services

The MS is allowed to signal any combination of WAIUR, ACC and MaxNumTCH. Final decision of radio interface configuration will be taken by the BSS during the Assignment procedure and shall be one of the following combinations (see GSM 02.34).

AIUR	Number of TCH	Channel Coding
9.6 kbit/s	1	9.6
	2	4.8
14.4 kbit/s	1	14.4
	3	4.8
19.2 kbit/s	2	9.6
	4	4.8
28.8 kbit/s	2	14.4
	3	9.6
38.4 kbit/s	4	9.6
43.2 kbit/s	3	14.4
57.6 kbit/s	4	14.4

B.2 Low Layer/High Layer Compatibility Information Element

B.2.1 Introduction

B.2.1.1 General Consideration

The purpose of the Low Layer/High Layer Compatibility Information Element (LLC/HLC-IE) is to provide a means for additional end-to-end compatibility checking by an addressed entity (e.g. a remote user, an interworking unit or a high layer function network node). The LLC/HLC-IE is transferred transparently by the GSM PLMN and an ISDN between the call originating entity (e.g. the calling user) and the addressed entity.

With respect to the individual parameter settings at the MS the following cases may be distinguished (ref. GSM 07.02 and GSM 07.03):

- Mobile-originated call set up by a MS consisting of a MT with R interface:
The setting results from respective MMI actions and/or MT internal settings.
- Mobile-originated call set up by a MS consisting of a MT with S interface:
The LLC/HLC-IEs which are contained in the ISDN SETUP message received from the terminal are passed unchanged to the MSC.
- Mobile-terminated call set up to a MS consisting of a MT with R interface:
The LLC/HLC related part of the compatibility check is carried out according to the knowledge of the MT concerning its implemented functions (i.e. answering the call). The offered field values determine the selection of the terminal function for the intended connection.
- Mobile-terminated call set up to a MS consisting of a MT with S interface:
The LLC/HLC received from the MSC is passed to the terminal by the MT. The LLC/HLC related part of the compatibility check is up to the terminal connected to the S interface of the MT, as is the selection of the terminal function (i.e. answering the call).

Where applicable, the same settings and rules concerning LLC and/or HLC apply as for ISDN use (ref. ETS 300 102-1 and ETR 018). However, considering that GSM PLMN data transmission is based on CCITT V.110 rate adaptation, the MS shall provide the LLC-IE for mobile-originated calls when using unrestricted or restricted digital information transfer capability. This is to assure the conveyance of the e.g. "V.110" indication towards the called entity, as the comparable indication in the ISDN BC-IE may be lost. It shall also be possible to choose whether or not the LLC-IE is provided for the case of an information transfer capability "3.1 kHz audio ex PLMN".

There shall be no contradiction of the information between the BC-IE and LLC-IE at the originating side. However, as some parts of the bearer capability may be modified during the transport of the call, there should be minimum duplication of this information between the BC-IE and the LLC-IE.

If as a result of duplication, a contradiction occurs between the BC-IE and the LLC-IE at the terminating side, the receiving entity shall ignore the conflicting information in the LLC-IE.

B.2.1.2 Interpretation of the Tables

The individual contents of the LLC/HLC-IE are represented in the following tables. The indication of the applicable service group defines the link between the GSM BC-IE and its associated LLC/HLC-IEs.

If the appropriate message includes multiple BC-IEs and if LLC and/or HLC information is available, multiple LLCs and HLCs shall be included in the message. The LLC/HLC associated with the BC-IE indicating speech shall be marked as "not applicable" (see GSM 04.08).

Legend:	{ xxxx yyyy }	choice of values
	----	not relevant for this service (set to appropriate value)
	[zzzz]	optional

B.2.2 LLC Bearer Service 21 ... 26

B.2.2.1 Unrestricted / restricted digital information transfer capability

Low layer compatibility information element:

Octet	Information element field	field value
3	Coding standard Information transfer capability	CCITT { unrestricted digital restricted digital }
4	Transfer mode Information transfer rate	circuit mode 64 kbit/s
5	User information layer 1 protocol	{ V.110/X.30 V.120 }
5a	Synchronous / asynchronous Negotiation User rate	asynchronous in-band not possible { 0.3 1.2 2.4 4.8 9.6 1.2/0.075 14.4 19.2 28.8 38.4 48 56 } kbit/s
5b 2)	Intermediate rate NIC on Tx NIC on Rx Flow control on Tx Flow control on Rx	{ 8 16 } kbit/s ----- ----- { not required 1 required } { not accepted 1 accepted }
5b 3)	Rate adaption header / no header Multiple frame establishment support Mode of operation Assignor / assignee In-band / out-band negotiation	Rate adaption header included Multiple frame establishment supported Protocol sensitive mode of operation ----- -----
5c	Number of stop bits Number of data bits Parity	{ 1 2 } bits { 7 8 } bits { odd even none forced to 0 forced to 1 }
5d	Duplex mode Modem type	[duplex] -----

- 1) only these values are applicable to Mobile Originated Calls
- 2) octet 5b for V.110/X.30
- 3) octet 5b for V.120

B.2.2.2 3.1 kHz audio ex-PLMN information transfer capability

Low layer compatibility information element:

Octet	Information element field	field value
3	Coding standard Information transfer capability	CCITT 3.1kHz audio
4	Transfer mode Information transfer rate	circuit mode 64 kbit/s
5	User information layer 1 protocol	G.711 A-law
5a	Synchronous / asynchronous Negotiation User rate	(may be set depending on user's requirement)
5b	Intermediate rate NIC on Tx NIC on Rx Flow control on Tx Flow control on Rx	not relevant but cannot be omitted in order to have octet 5d
5c	Number of stop bits Number of data bits Parity	(may be set depending on the user's requirement)
5d	Duplex mode Modem type	[duplex] [{ V.21 V.22 V.22bis V.23 V.26ter V.32 V.34 }]

NOTE: If octet 5d is not specified, the whole LLC is not required.

B.2.3 LLC Bearer Service 31 ... 34**B.2.3.1 Unrestricted / restricted digital information transfer capability**

Low layer compatibility information element:

Octet	Information element field	field value
3	Coding standard Information transfer capability	CCITT { digital unrestricted restricted digital }
4	Transfer mode Information transfer rate	circuit mode 64 kbit/s
5	User information layer 1 protocol	{ V.110/X.30 X.31 flag stuffing V.120 }
5a	Synchronous / asynchronous Negotiation User rate	synchronous in-band not possible { 1.2 2.4 4.8 9.6 14.4 19.2 28.8 38.4 48 56 } kbit/s
5b 2)	Intermediate rate NIC on Tx NIC on Rx Flow control on Tx Flow control on Rx	{ 8 16 } kbit/s { not required required } { not accepted accepted } ----- -----
5b 3)	Rate adaption header / no header Multiple frame establishment support Mode of operation Assignor / assignee In-band / out-band negotiation	Rate adaption header included Multiple frame establishment supported Protocol sensitive mode of operation ----- -----
5c 1)	Number of stop bits Number of data bits Parity	not relevant but cannot be omitted in order to have octet 5d
5d 1)	Duplex mode Modem type	[duplex] -----
6	User information layer 2 protocol	[X.25]
7	User information layer 3 protocol	[X.25]

- 1) If octet 5d is not specified, octet 5c may be omitted.
- 2) octet 5b for V.110/X.30
- 3) octet 5b for V.120

B.2.3.2 3.1kHz audio ex-PLMN information transfer capability

Low layer compatibility information element:

Octet	Information element field	field value
3	Coding standard Information transfer capability	CCITT 3.1kHz audio
4	Transfer mode Information transfer rate	circuit mode 64 kbit/s
5	User information layer 1 protocol	G.711 A-law
5a	Synchronous / asynchronous Negotiation User rate	(may be set depending on the user's requirement)
5b	Intermediate rate NIC on Tx NIC on Rx Flow control on Tx Flow control on Rx	not relevant but cannot be omitted in order to have octet 5d
5c	Number of stop bits Number of data bits Parity	(may be set depending on the user's requirement)
5d	Duplex mode Modem type	[duplex] { { V.22 V.22bis V.26ter V.32 V.34 } }
6	User information layer 2 protocol	[X.25]
7	User information layer 3 protocol	[X.25]

NOTE: If octet 5d is not specified, octets 5a..5d may be omitted.

B.2.4 LLC Bearer Services 41 ... 46

May be optionally available with the settings according to B.2.2.1.

B.2.5 LLC Bearer Services 51 ... 53**B.2.5.1 Unrestricted digital information transfer capability**

Low layer compatibility information element:

Octet	Information element field	field value
3	Coding standard Information transfer capability	CCITT unrestricted digital
4	Transfer mode Information transfer rate	circuit mode 64 kbit/s
5	User information layer 1 protocol	X.31 flag stuffing
5a	Synchronous / asynchronous Negotiation User rate	synchronous in-band not possible { 2.4 4.8 9.6 14.4 19.2 28.8 38.4 48 56 } kbit/s
6	User information layer 2 protocol	X.25
7	User information layer 3 protocol	X.25

B.2.6 LLC Bearer Service 61**B.2.6.1 3,1 kHz audio ex-PLMN information transfer capability, Asynchronous**

Ref. section B.2.2.2.

B.2.6.2 3,1 kHz audio ex-PLMN information transfer capability, Synchronous

Ref. section B.2.3.2.

B.2.7 LLC Bearer Service 81**B.2.7.1 3,1 kHz audio ex-PLMN information transfer capability, Asynchronous**

Ref. section B.2.2.2.

B.2.7.2 3,1 kHz audio ex-PLMN information transfer capability, Synchronous

Ref. section B.2.3.2.

B.2.8 HLC Teleservices 11 ... 12

High layer compatibility information element:

Octet	Information element field	Field value
3	Coding standard Interpretation Presentation method of protocol profile	CCITT first high layer characteristic identification to be used in the call high layer protocol profile
4	High layer characteristics identific.	Telephony

B.2.9 HLC Teleservices 21 ... 23

Not applicable.

B.2.10 HLC Teleservice 61

High layer compatibility information element:

Octet	Information element field	Field value
3	Coding standard Interpretation Presentation method of protocol profile	CCITT first high layer characteristic identification to be used in the call high layer protocol profile
4	High layer characteristics identific.	Facsimile G2/G3

B.2.11 HLC Teleservice 62

High layer compatibility information element:

Octet	Information element field	Field value
3	Coding standard Interpretation Presentation method of protocol profile	CCITT first high layer characteristic identification to be used in the call high layer protocol profile
4	High layer characteristics identific.	Facsimile G2/G3

Document history	
December 1995	Publication of GTS 07.01 version 5.0.0
March 1996	Publication of GTS 07.01 version 5.0.1
May 1996	Publication of GTS 07.01 version 5.1.0
July 1996	Publication of GTS 07.01 version 5.2.0
November 1996	Unified Approval Procedure UAP 58: 1996-11-18 to 1997-03-14
April 1997	One-step Approval Procedure OAP 9733 1997-04-18 to 1997-08-15 (Second Edition)
August 1997	One-step Approval Procedure OAP 9752: 1997-08-29 to 1997-12-26 (Third Edition)
November 1997	One-step Approval Procedure OAP 9813: 1997-11-28 to 1998-03-27 (Fourth Edition)
January 1998	Third Edition
March 1998	Fourth Edition