



**E**UROPEAN  
**T**ELECOMMUNICATION  
**S**TANDARD

**ETS 300 908**

August 1999

Sixth Edition

---

Source: SMG

Reference: RE/SMG-020502QR6

ICS: 33.020

**Key words:** Digital cellular telecommunications system, Global System for Mobile communications (GSM)



**Digital cellular telecommunications system (Phase 2+);  
Multiplexing and multiple access on the radio path  
(GSM 05.02 version 5.8.1 Release 1996)**

**ETSI**

European Telecommunications Standards Institute

**ETSI Secretariat**

**Postal address:** F-06921 Sophia Antipolis CEDEX - FRANCE

**Office address:** 650 Route des Lucioles - Sophia Antipolis - Valbonne - FRANCE

**Internet:** [secretariat@etsi.fr](mailto:secretariat@etsi.fr) - <http://www.etsi.org>

Tel.: +33 4 92 94 42 00 - Fax: +33 4 93 65 47 16

---

**Copyright Notification:** No part may be reproduced except as authorized by written permission. The copyright and the foregoing restriction extend to reproduction in all media.

© European Telecommunications Standards Institute 1999. All rights reserved.



## Contents

Intellectual Property Rights.....	5
Foreword .....	5
1 Scope .....	7
1.1 Normative references .....	7
1.2 Abbreviations .....	7
2 General.....	8
3 Logical channels.....	8
3.1 General .....	8
3.2 Traffic channels .....	8
3.2.1 General.....	8
3.2.2 Speech traffic channels .....	8
3.2.3 Circuit switched data traffic channels .....	8
3.3 Control channels.....	9
3.3.1 General.....	9
3.3.2 Broadcast channels.....	9
3.3.2.1 Frequency correction channel (FCCH).....	9
3.3.2.2 Synchronization channel (SCH).....	9
3.3.2.3 Broadcast control channel (BCCH) .....	9
3.3.3 Common control type channels.....	10
3.3.3.1 Common control type channels, known when combined as a common control channel (CCCH).....	10
3.3.4 Dedicated control channels .....	10
3.3.4.1 Circuit switched dedicated control channels.....	10
3.3.5 Cell Broadcast Channel (CBCH) .....	10
3.4 Combination of channels .....	10
4 The physical resource .....	11
4.1 General .....	11
4.2 Radio frequency channels .....	11
4.2.1 Cell allocation and mobile allocation .....	11
4.2.2 Downlink and uplink .....	11
4.3 Timeslots and TDMA frames .....	11
4.3.1 General.....	11
4.3.2 Timeslot number .....	11
4.3.3 TDMA frame number.....	11
5 Physical channels.....	12
5.1 General .....	12
5.2 Bursts.....	12
5.2.1 General.....	12
5.2.2 Types of burst and burst timing.....	12
5.2.3 Normal burst (NB) .....	12
5.2.4 Frequency correction burst (FB).....	13
5.2.5 Synchronization burst (SB).....	14
5.2.6 Dummy burst .....	14
5.2.7 Access burst (AB).....	15
5.2.8 Guard period .....	15
5.3 Physical channels and bursts .....	15
5.4 Radio frequency channel sequence.....	15
5.5 Timeslot and TDMA frame sequence.....	16
5.6 Parameters for channel definition and assignment .....	16
5.6.1 General.....	16
5.6.2 General parameters .....	16

5.6.3	Specific parameters .....	16
6	Mapping of logical channels onto physical channels .....	16
6.1	General .....	16
6.2	Mapping in frequency of logical channels onto physical channels .....	17
6.2.1	General .....	17
6.2.2	Parameters .....	17
6.2.3	Hopping sequence generation .....	17
6.2.4	Specific cases .....	18
6.2.5	Change in the frequency allocation of a base transceiver station .....	18
6.3	Mapping in time of logical channels onto physical channels .....	18
6.3.1	Mapping in time of circuit switched logical channels onto physical channels .....	18
6.3.1.1	General .....	18
6.3.1.2	Key to the mapping table of clause 7 .....	18
6.3.1.3	Mapping of BCCH data .....	19
6.3.1.4	Mapping of SID Frames .....	20
6.4	Permitted channel combinations .....	20
6.4.1	Permitted channel combinations onto a basic physical channel .....	20
6.4.2	Multislot configurations .....	20
6.4.2.1	Multislot configurations for circuit switched connections .....	21
6.5	Operation of channels and channel combinations .....	21
6.5.1	General .....	21
6.5.2	Determination of CCCH_GROUP and PAGING_GROUP for MS in idle mode .....	22
6.5.3	Determination of specific paging multiframe and paging block index .....	22
6.5.4	Short Message Service Cell Broadcast (SMSCB) .....	23
6.5.5	Voice group and voice broadcast call notifications .....	23
Annex A (normative):	Phase 2 mobiles in a phase 1 infrastructure .....	38
A.1	Scope .....	38
A.2	Implementation options for TCH channels .....	38
A.2.1	C0 filling on the TCH .....	38
A.2.1.1	A dummy burst with (BN61, BN62, BN86) = training sequence bits of normal bursts .....	38
A.2.1.2	A dummy burst with the "C0 filling training sequence .....	38
A.2.1.3	A dummy burst with (BN61, BN62, BN86) mapped from the TSC bits of normal bursts according to the table; below .....	38
A.2.1.4	Partial SID information .....	38
A.2.2	Half burst filling .....	38
A.2.2.1	Partial SID information from any associated SID frame; or .....	38
A.2.2.2	The mixed bits of the dummy bursts (encrypted or not encrypted) .....	38
A.2.3	Dummy burst Stealing flag .....	38
A.2.4	Half burst Filling Stealing flag .....	38
A.2.5	Allowed combinations .....	39
A.3	Idle Channels .....	39
Annex B (normative):	Multislot capability .....	40
B.1	MS classes for multislot capability .....	40
B.2	Constraints imposed by the service selected .....	41
B.3	Network requirements for supporting MS multislot classes .....	41
Annex C (informative):	Change control history .....	44
History	.....	45

## Intellectual Property Rights

IPRs essential or potentially essential to the present document may have been declared to ETSI. The information pertaining to these essential IPRs, if any, is publicly available for **ETSI members and non-members**, and can be found in SR 000 314: *"Intellectual Property Rights (IPRs); Essential, or potentially Essential, IPRs notified to ETSI in respect of ETSI standards"*, which is available **free of charge** from the ETSI Secretariat. Latest updates are available on the ETSI Web server (<http://www.etsi.org/ipr>).

Pursuant to the ETSI IPR Policy, no investigation, including IPR searches, has been carried out by ETSI. No guarantee can be given as to the existence of other IPRs not referenced in SR 000 314 (or the updates on the ETSI Web server) which are, or may be, or may become, essential to the present document.

## Foreword

This European Telecommunication Standard (ETS) has been produced by the Special Mobile Group (SMG) Technical Committee of the European Telecommunications Standards Institute (ETSI).

This ETS defines the physical channels of the radio sub-system required to support the logical channels of the digital mobile cellular and personal communication systems operating in the 900 MHz and 1 800 MHz band (GSM 900 and DCS 1 800).

The contents of this ETS is subject to continuing work within SMG and may change following formal SMG approval. Should SMG modify the contents of this ETS, it will be resubmitted for OAP by ETSI with an identifying change of release date and an increase in version number as follows:

Version 5.x.y

- 5 Indicates GSM Phase 2+ Release 1996
- x the second digit is incremented for all changes of substance, i.e. technical enhancements, corrections, updates, etc.
- y the third digit is incremented when editorial only changes have been incorporated in the specification.

<b>Transposition dates</b>	
Date of adoption of this ETS:	6 August 1999
Date of latest announcement of this ETS (doa):	30 November 1999
Date of latest publication of new National Standard or endorsement of this ETS (dop/e):	31 May 2000
Date of withdrawal of any conflicting National Standard (dow):	31 May 2000

Blank page

## 1 Scope

This European Telecommunication Standard (ETS) defines the physical channels of the radio sub-system required to support the logical channels. It includes a description of the logical channels and the definition of frequency hopping, TDMA frames, timeslots and bursts.

### 1.1 Normative references

This ETS incorporates by dated and undated reference, provisions from other publications. These normative references are cited at the appropriate places in the text and the publications are listed hereafter. For dated references, subsequent amendments to or revisions of any of these publications apply to this ETS only when incorporated in it by amendment or revision. For undated references the latest edition of the publication referred to applies.

- [1] GSM 01.04 (ETR 350): "Digital cellular telecommunications system (Phase 2+); Abbreviations and acronyms".
- [2] GSM 03.03 (ETS 300 927): "Digital cellular telecommunications system (Phase 2+); Numbering, addressing and identification".
- [3] GSM 04.03: "Digital cellular telecommunications system (Phase 2+); Mobile Station - Base Station System (MS - BSS) interface Channel structures and access capabilities".
- [4] GSM 04.06 (ETS 300 938): "Digital cellular telecommunications system; Mobile Station - Base Station System (MS - BSS) interface Data Link (DL) layer specification".
- [5] GSM 04.08 (ETS 300 940): "Digital cellular telecommunications system (Phase 2+); Mobile radio interface layer 3 specification".
- [6] GSM 05.03 (ETS 300 909): "Digital cellular telecommunications system (Phase 2+); Channel coding".
- [7] GSM 05.04 (ETS 300 959): "Digital cellular telecommunications system; Modulation".
- [8] GSM 05.05 (ETS 300 910): "Digital cellular telecommunications system (Phase 2+); Radio transmission and reception".
- [9] GSM 05.08 (ETS 300 911): "Digital cellular telecommunications system (Phase 2+); Radio subsystem link control".
- [10] GSM 05.10 (ETS 300 579): "Digital cellular telecommunications system (Phase 2+); Radio subsystem synchronization".
- [11] GSM 03.64: "Digital cellular telecommunications system (Phase 2+); General Packet Radio Service (GPRS); Overall description of the GPRS Radio Interface; Stage 2".
- [12] GSM 04.60: "Digital cellular telecommunications system (Phase 2+); General Packet Radio Service (GPRS); Mobile Station (MS) - Base Station System (BSS) interface; Radio Link Control (RLC) and Medium Access Control (MAC) Layer Specification".

### 1.2 Abbreviations

Abbreviations used in this ETS are listed in GSM 01.04 [1].

## 2 General

The radio subsystem is required to support a certain number of logical channels that can be separated into categories as defined in GSM 04.03:

- i) The traffic channels (TCH's)
- ii) The control channels

More information is given about these logical channels in clause 3 which also defines a number of special channels used by the radio sub-system.

Clause 4 of this document describes the physical resource available to the radio sub-system, clause 5 defines physical channels based on that resource and clause 6 specifies how the logical channels shall be mapped onto physical channels. Figure 1 depicts this process.

## 3 Logical channels

### 3.1 General

This section describes the logical channels that are supported by the radio subsystem.

### 3.2 Traffic channels

#### 3.2.1 General

Traffic channels (TCH's) are intended to carry either encoded speech or user data in circuit switched mode. Two general forms of traffic channel are defined:

- i) Full rate traffic channel (TCH/F). This channel carries information at a gross rate of 22,8 kbit/s.
- ii) Half rate traffic channel (TCH/H). This channel carries information at a gross rate of 11,4 kbit/s.

All traffic channels are bi-directional unless otherwise stated. Unidirectional downlink full rate channels, TCH/FD, are defined as the downlink part of the corresponding TCH/F.

Multiple full rate channels can be allocated to the same MS. This is referred to as multislot configurations, which is defined in subclause 6.4.2.1.

The specific traffic channels available in the categories of speech and user data are defined in the sections following.

#### 3.2.2 Speech traffic channels

The following traffic channels are defined to carry encoded speech:

- i) Full rate traffic channel for speech (TCH/FS).
- ii) Half rate traffic channel for speech (TCH/HS).

#### 3.2.3 Circuit switched data traffic channels

The following traffic channels are defined to carry user data:

- i) Full rate traffic channel for 9,6 kbit/s user data (TCH/F9.6).
- ii) Full rate traffic channel for 4,8 kbit/s user data (TCH/F4.8).
- iii) Half rate traffic channel for 4,8 kbit/s user data (TCH/H4.8).
- iv) Half rate traffic channel for  $\leq 2,4$  kbit/s user data (TCH/H2.4).
- v) Full rate traffic channel for  $\leq 2,4$  kbit/s user data (TCH/F2.4).
- vi) Full rate traffic channel for 14,4 kbit/s user data (TCH/F14.4).



### 3.3 Control channels

#### 3.3.1 General

Control channels are intended to carry signalling or synchronization data. Three categories of control channel are defined: broadcast, common and dedicated. Specific channels within these categories are defined in the sections following.

#### 3.3.2 Broadcast channels

##### 3.3.2.1 Frequency correction channel (FCCH)

The frequency correction channel carries information for frequency correction of the mobile station. It is required only for the operation of the radio sub-system.

##### 3.3.2.2 Synchronization channel (SCH)

The synchronization channel carries information for frame synchronization of the mobile station and identification of a base transceiver station. It is required only for the operation of the radio sub-system. Specifically the synchronization channel shall contain two encoded parameters:

- a) Base transceiver station identity code (BSIC): 6 bits (before channel coding) consists of 3 bits of PLMN colour code with range 0 to 7 and 3 bits of BS colour code with range 0 to 7 as defined in GSM 03.03.
- b) Reduced TDMA frame number (RFN): 19 bits (before channel coding) =

T1	(11 bits)	range 0 to 2047	= FN div ( 26 x 51)
T2	(5 bits)	range 0 to 25	= FN mod 26
T3'	(3 bits)	range 0 to 4	= (T3 - 1) div 10

where

T3	(6 bits)	range 0 to 50	= FN mod 51
----	----------	---------------	-------------

and

FN = TDMA frame number as defined in subclause 4.3.3.

GSM 04.06 and GSM 04.08 specify the precise bit ordering, GSM 05.03 the channel coding of the above parameters and GSM 05.10 defines how the TDMA frame number can be calculated from T1, T2, and T3'.

##### 3.3.2.3 Broadcast control channel (BCCH)

The broadcast control channel broadcasts general information on a base transceiver station per base transceiver station basis. Of the many parameters contained in the BCCH, the use of the following parameters, as defined in GSM 04.08 are referred to in subclause 6.5:

- a) CCCH\_CONF which indicates the organization of the common control channels:

From this parameter, the number of common control channels (BS\_CC\_CHANS) and whether or not CCCH or SDCCH are combined (BS\_CCCH\_SDCCH\_COMB = true or false) are derived as follows:

CCCH_CONF	BS_CC_CHANS	BS_CCCH_SDCCH_COMB
000	1	false
001	1	true
010	2	false
100	3	false
110	4	false

- b) BS\_AG\_BLK\_RES which indicates the number of blocks on each common control channel reserved for access grant messages:  
3 bits (before channel coding) range 0 to 7.
- c) BS\_PA\_MFRMS which indicates the number of 51 TDMA frame multiframe between transmission of paging messages to mobiles of the same paging group:  
3 bits (before channel coding) range 2 to 9.

### 3.3.3 Common control type channels

#### 3.3.3.1 Common control type channels, known when combined as a common control channel (CCCH)

- i) Paging channel (PCH): Downlink only, used to page mobiles.
- ii) Random access channel (RACH): Uplink only, used to request allocation of a SDCCH.
- iii) Access grant channel (AGCH): Downlink only, used to allocate a SDCCH or directly a TCH.
- iv) Notification channel (NCH): Downlink only, used to notify mobile stations of voice group and voice broadcast calls.

### 3.3.4 Dedicated control channels

#### 3.3.4.1 Circuit switched dedicated control channels

- i) Slow, TCH/F associated, control channel (SACCH/TF).
- ii) Fast, TCH/F associated, control channel (FACCH/F).
- iii) Slow, TCH/H associated, control channel (SACCH/TH).
- iv) Fast, TCH/H associated, control channel (FACCH/H).
- v) Stand alone dedicated control channel (SDCCH/8).
- vi) Slow, SDCCH/8 associated, control channel (SACCH/C8)
- vii) Stand alone dedicated control channel, combined with CCCH (SDCCH/4).
- viii) Slow, SDCCH/4 associated, control channel (SACCH/C4).
- ix) slow, TCH/F associated, control channel for multislot configurations (SACCH/M).

All associated control channels have the same direction (bi-directional or unidirectional) as the channels they are associated to. The unidirectional SACCH/MD is defined as the downlink part of SACCH/M.

### 3.3.5 Cell Broadcast Channel (CBCH)

The CBCH, downlink only, is used to carry the short message service cell broadcast (SMSCB). The CBCH uses the same physical channel as the SDCCH.

## 3.4 Combination of channels

Only certain combinations of channels are allowed as defined in GSM 04.03. Subclause 6.4 lists the combinations in relation to basic physical channels.

## 4 The physical resource

### 4.1 General

The physical resource available to the radio sub-system is an allocation of part of the radio spectrum. This resource is partitioned both in frequency and time. Frequency is partitioned by radio frequency channels (RFCHs) divided into bands as defined in GSM 05.05. Time is partitioned by timeslots and TDMA frames as defined in subclause 4.3 of this ETS.

### 4.2 Radio frequency channels

#### 4.2.1 Cell allocation and mobile allocation

GSM 05.05 defines radio frequency channels (RFCHs), and allocates numbers to all the radio frequency channels available to the system. Each cell is allocated a subset of these channels, defined as the cell allocation (CA). One radio frequency channel of the cell allocation shall be used to carry synchronization information and the BCCH, this shall be known as BCCH carrier. The subset of the cell allocation, allocated to a particular mobile, shall be known as the mobile allocation (MA).

#### 4.2.2 Downlink and uplink

The downlink comprises radio frequency channels used in the base transceiver station to mobile station direction.

The uplink comprises radio frequency channels used in the mobile station to base transceiver station direction.

### 4.3 Timeslots and TDMA frames

#### 4.3.1 General

A timeslot shall have a duration of  $\frac{3}{5} 200$  seconds ( $\approx 577 \mu\text{s}$ ). Eight timeslots shall form a TDMA frame ( $\approx 4,62$  ms in duration).

At the base transceiver station the TDMA frames on all of the radio frequency channels in the downlink shall be aligned. The same shall apply to the uplink (see GSM 05.10).

At the base transceiver station the start of a TDMA frame on the uplink is delayed by the fixed period of 3 timeslots from the start of the TDMA frame on the downlink (see figure 2).

At the mobile station this delay will be variable to allow adjustment for signal propagation delay. The process of adjusting this advance is known as adaptive frame alignment and is detailed in GSM 05.10.

The staggering of TDMA frames used in the downlink and uplink is in order to allow the same timeslot number to be used in the downlink and uplink whilst avoiding the requirement for the mobile station to transmit and receive simultaneously. The period includes time for adaptive frame alignment, transceiver tuning and receive/transmit switching (see figure 4).

#### 4.3.2 Timeslot number

The timeslots within a TDMA frame shall be numbered from 0 to 7 and a particular timeslot shall be referred to by its timeslot number (TN).

#### 4.3.3 TDMA frame number

TDMA frames shall be numbered by a frame number (FN). The frame number shall be cyclic and shall have a range of 0 to FN\_MAX where FN\_MAX =  $(26 \times 51 \times 2048) - 1 = 2715647$  as defined in GSM 05.10. The frame number shall be incremented at the end of each TDMA frame.

The complete cycle of TDMA frame numbers from 0 to FN\_MAX is defined as a hyperframe. A hyperframe consists of 2048 superframes where a superframe is defined as 26 x 51 TDMA frames. A 26 TDMA frame multiframe is used to support traffic and associated control channels and a 51 TDMA frame multiframe is used to support broadcast, common control and stand alone dedicated control (and their associated control) channels. Hence a superframe may be considered as 51 traffic/associated control multiframes or 26 broadcast/common control multiframes.

The need for a hyperframe of a substantially longer period than a superframe arises from the requirements of the encryption process which uses FN as an input parameter.

## 5 Physical channels

### 5.1 General

A physical channel uses a combination of frequency and time division multiplexing and is defined as a sequence of radio frequency channels and time slots. The complete definition of a particular physical channel consists of a description in the frequency domain, and a description in the time domain.

The description in the frequency domain is addressed in subclause 5.4, the description in the time domain is addressed in subclause 5.5.

### 5.2 Bursts

#### 5.2.1 General

A burst is a period of R.F carrier which is modulated by a data stream. A burst therefore represents the physical content of a timeslot.

#### 5.2.2 Types of burst and burst timing

A timeslot is divided into 156,25 bit periods. A particular bit period within a timeslot is referenced by a bit number (BN), with the first bit period being numbered 0, and the last (1/4) bit period being numbered 156. In the sections following the transmission timing of a burst within a timeslot is defined in terms of bit number. The bit with the lowest bit number is transmitted first.

Different types of burst exist in the system. One characteristic of a burst is its useful duration. This document, in the sections following, defines four full bursts of 147 bits useful duration, and one short burst of 87 bits useful duration. The useful part of a burst is defined as beginning from half way through bit number 0. The definition of the useful part of a burst needs to be considered in conjunction with the requirements placed on the phase and amplitude characteristics of a burst as specified in GSM 05.04 and 05.05.

The period between bursts appearing in successive timeslots is termed the guard period. Subclause 5.2.8 details constraints which relate to the guard period.

#### 5.2.3 Normal burst (NB)

Bit Number (BN)	Length of field	Contents of field	Definition
0 - 2	3	tail bits	(below)
3 - 60	58	encrypted bits (e0 . e57)	05.03
61 - 86	26	training sequence bits	(below)
87 - 144	58	encrypted bits (e58 . e115)	05.03
145 - 147	3	tail bits	(below)
(148 - 156)	8,25	guard period (bits)	subclause 5.2.8)

- where the "tail bits" are defined as modulating bits with states as follows:

(BN0, BN1, BN2) = (0, 0, 0) and  
 (BN145, BN146, BN147) = (0, 0, 0)

- where the "training sequence bits" are defined as modulating bits with states as given in the following table according to the training sequence code, TSC. For broadcast and common control channels, the TSC must be equal to the BCC, as defined in GSM 03.03 and as described in this technical specification in subclause 3.3.2.

Training Sequence Code (TSC)	Training sequence bits (BN61, BN62 .. BN86)
0	(0,0,1,0,0,1,0,1,1,1,0,0,0,0,1,0,0,0,1,0,0,1,0,1,1,1)
1	(0,0,1,0,1,1,0,1,1,1,0,1,1,1,1,0,0,0,1,0,1,1,0,1,1,1)
2	(0,1,0,0,0,0,1,1,1,0,1,1,1,0,1,0,0,1,0,0,0,0,1,1,1,0)
3	(0,1,0,0,0,1,1,1,1,0,1,1,0,1,0,0,0,1,0,0,0,1,1,1,1,0)
4	(0,0,0,1,1,0,1,0,1,1,1,0,0,1,0,0,0,0,0,1,1,0,1,0,1,1)
5	(0,1,0,0,1,1,1,0,1,0,1,1,0,0,0,0,0,1,0,0,1,1,1,0,1,0)
6	(1,0,1,0,0,1,1,1,1,1,0,1,1,0,0,0,1,0,1,0,0,1,1,1,1,1)
7	(1,1,1,0,1,1,1,1,0,0,0,1,0,0,1,0,1,1,1,0,1,1,1,1,0,0)

Under certain circumstances only half the encrypted bits present in a normal burst will contain complete information. For downlink DTX operation on TCH-FS and TCH-HS, when a traffic frame (as defined in GSM 06.31) is scheduled for transmission and one of its adjacent traffic frames is not scheduled for transmission, the other half of the encrypted bits in the normal bursts associated with the scheduled traffic frame shall contain partial SID information from any associated SID frame, with the appropriate stealing flags BN60 or BN87 set to 0. In other cases the binary state of the remaining bits is not specified.

#### 5.2.4 Frequency correction burst (FB)

Bit Number (BN)	length of field	Contents of field	Definition
0 - 2	3	tail bits	(below)
3 - 144	142	fixed bits	(below)
145 - 147	3	tail bits	(below)
(148 - 156)	8,25	guard period (bits)	subclause 5.2.8)

- where the "tail bits" are defined as modulating bits with states as follows:

(BN0, BN1, BN2) = (0, 0, 0) and  
(BN145, BN146, BN147) = (0, 0, 0)

- where the "fixed bits" are defined as modulating bits with states as follows:

(BN3, BN4 .. BN144) = (0, 0 .. 0)

NOTE: This burst is equivalent to unmodulated carrier with a +1 625/24 kHz frequency offset, above the nominal carrier frequency.

## 5.2.5 Synchronization burst (SB)

Bit Number (BN)	Length of field	Contents of field	Definition
0 - 2	3	tail bits	(below)
3 - 41	39	encrypted bits (e0 . e38)	05.03
42 - 105	64	extended training sequence bits	(below)
106 - 144	39	encrypted bits (e39 .. e77)	05.03
145 - 147	3	tail bits	(below)
(148 - 156	8,25	guard period (bits)	subclause 5.2.8)

- where the "tail bits" are defined as modulating bits with states as follows:

$$\begin{aligned} (\text{BN0}, \text{BN1}, \text{BN2}) &= (0, 0, 0) \quad \text{and} \\ (\text{BN145}, \text{BN146}, \text{BN147}) &= (0, 0, 0) \end{aligned}$$

- where the "extended training sequence bits" are defined as modulating bits with states as follows:

$$(\text{BN42}, \text{BN43} \dots \text{BN105}) = (1, 0, 1, 1, 1, 0, 0, 1, 0, 1, 1, 0, 0, 0, 1, 0, 0, 0, 0, 0, 0, 1, 0, 0, 0, 0, 0, 0, 0, 1, 0, 0, 0, 0, 0, 1, 1, 1, 1, 0, 0, 1, 0, 1, 1, 0, 1, 0, 1, 0, 1, 0, 0, 0, 1, 0, 1, 0, 1, 1, 1, 0, 1, 1, 0, 1, 1, 0, 0, 0, 0, 1, 1, 0, 1, 1)$$

## 5.2.6 Dummy burst

Bit Number (BN)	Length of field	Contents of field	Definition
0 - 2	3	tail bits	(below)
3 - 144	142	mixed bits	(below)
145 - 147	3	tail bits	(below)
(148 - 156	8,25	guard period (bits)	subclause 5.2.8)

- where the "tail bits" are defined as modulating bits with states as follows:

$$\begin{aligned} (\text{BN0}, \text{BN1}, \text{BN2}) &= (0, 0, 0) \quad \text{and} \\ (\text{BN145}, \text{BN146}, \text{BN147}) &= (0, 0, 0) \end{aligned}$$

- where the "mixed bits" are defined as modulating bits with states as follows:



The detailed hopping generation algorithm is given in subclause 6.2.

## 5.5 Timeslot and TDMA frame sequence

A given physical channel shall always use the same timeslot number in every TDMA frame. Therefore a timeslot sequence is defined by:

- i) a timeslot number (TN); and
- ii) a TDMA frame number sequence.

The detailed definitions of TDMA frame number sequences are given in clause 7.

The physical channels where the TDMA frame number sequence is 0,1, . . . FN\_MAX (where FN\_MAX is defined in subclause 4.3.3) are called "basic physical channels".

## 5.6 Parameters for channel definition and assignment

### 5.6.1 General

This section describes the set of parameters necessary to describe fully the mapping of any logical channel onto a physical channel. These parameters may be divided into general parameters, that are characteristic of a particular base transceiver station, and specific parameters, that are characteristic of a given physical channel.

### 5.6.2 General parameters

These are:

- i) the set of radio frequency channels used in the cell (CA), together with the identification of the BCCH carrier.
- ii) the TDMA frame number (FN), which can be derived from the reduced TDMA frame number (RFN) which is in the form T1, T2, T3', see 3.3.2.

These parameters are broadcast (or derived from parameters broadcast) in the BCCH and SCH.

### 5.6.3 Specific parameters

These parameters define a particular physical channel in a base transceiver station. They are:

- o) the training sequence Code (TSC);
- i) the timeslot number (TN);
- ii) the mobile radio frequency channel allocation (MA);
- iii) the mobile allocation index offset (MAIO);
- iv) the hopping sequence number (HSN);
- v) the type of logical channel;
- vi) the sub-channel number (SCN).

The last two parameters allow the determination of the frame sequence.

## 6 Mapping of logical channels onto physical channels

### 6.1 General

The detailed mapping of logical channels onto physical channels is defined in the following sections. Section 6.2 defines the mapping from TDMA frame number (FN) to radio frequency channel (RFCH). Section 6.3 defines the mapping of the physical channel onto TDMA frame number. Subclause 6.4 lists the permitted channel combinations and subclause 6.5 defines the operation of channels and channel combinations.



## 6.2 Mapping in frequency of logical channels onto physical channels

### 6.2.1 General

The parameters used in the function which maps TDMA frame number onto radio frequency channel are defined in subclause 6.2.2. The definition of the actual mapping function, or as it is termed, hopping sequence generation is given in subclause 6.2.3.

### 6.2.2 Parameters

The following parameters are required in the mapping from TDMA frame number to radio frequency channel for a given assigned channel.

General parameters of the BTS, specific to one BTS, and broadcast in the BCCH and SCH:

- i) CA: Cell allocation of radio frequency channels.
- ii) FN: TDMA frame number, broadcast in the SCH, in form T1, T2, T3' (see subclause 3.3.2).

Specific parameters of the channel, defined in the channel assignment message:

- i) MA: Mobile allocation of radio frequency channels, defines the set of radio frequency channels to be used in the mobiles hopping sequence. The MA contains N radio frequency channels, where  $1 \leq N \leq 64$ .
- ii) MAIO: Mobile allocation index offset.(0 to N-1, 6 bits).
- iii) HSN: Hopping sequence (generator) number (0 to 63, 6 bits).

### 6.2.3 Hopping sequence generation

For a given set of parameters, the index to an absolute radio frequency channel number (ARFCN) within the mobile allocation (MAI from 0 to N-1, where MAI=0 represents the lowest absolute radio frequency channel number (ARFCN) in the mobile allocation, ARFCN is in the range 0 to 7023 and the frequency value can be determined according to GSM 05.05 sec 2 with  $n = \text{ARFCN}$ ), is obtained with the following algorithm:

**if** HSN = 0 (cyclic hopping) **then**:

MAI, integer (0 .. N-1) : MAI = (FN + MAIO) modulo N

**else**:

M, integer (0 .. 152) : M = T2 + RNTABLE((HSN xor T1R) + T3)

S, integer (0 .. N-1) : M' = M modulo (2 ^ NBIN)  
T' = T3 modulo (2 ^ NBIN)

**if** M' < N **then**:

S = M'

**else**:

S = (M'+T') modulo N

MAI, integer (0 .. N-1) : MAI = (S + MAIO) modulo N

NOTE: Due to the procedure used by the mobile for measurement reporting when DTX is used, the use of cyclic hopping where  $(N) \bmod 13 = 0$  should be avoided.

where:

T1R: time parameter T1, reduced modulo 64 (6 bits)

T3: time parameter, from 0 to 50 (6 bits)

T2: time parameter, from 0 to 25 (5 bits)

NBIN: number of bits required to represent  $N = \text{INTEGER}(\log_2(N)+1)$

^: raised to the power of

xor: bit-wise exclusive or of 8 bit binary operands

RNTABLE: Table of 114 integer numbers, defined below:

Address	Contents									
000...009:	48,	98,	63,	1,	36,	95,	78,	102,	94,	73,
010...019:	0,	64,	25,	81,	76,	59,	124,	23,	104,	100,
020...029:	101,	47,	118,	85,	18,	56,	96,	86,	54,	2,
030...039:	80,	34,	127,	13,	6,	89,	57,	103,	12,	74,
040...049:	55,	111,	75,	38,	109,	71,	112,	29,	11,	88,
050...059:	87,	19,	3,	68,	110,	26,	33,	31,	8,	45,
060...069:	82,	58,	40,	107,	32,	5,	106,	92,	62,	67,
070...079:	77,	108,	122,	37,	60,	66,	121,	42,	51,	126,
080...089:	117,	114,	4,	90,	43,	52,	53,	113,	120,	72,
090...099:	16,	49,	7,	79,	119,	61,	22,	84,	9,	97,
100...109:	91,	15,	21,	24,	46,	39,	93,	105,	65,	70,
110...113:	125,	99,	17,	123,						

The hopping sequence generation algorithm is represented diagrammatically in figure 6.

#### 6.2.4 Specific cases

On the RFCH carrying a BCCH (C0), frequency hopping is not permitted on any timeslot supporting a BCCH according to table 3 of clause 7. A non-hopping radio frequency channel sequence is characterized by a mobile allocation consisting of only one radio frequency channel, i.e. with  $N=1$ ,  $MAIO=0$ . In this instance sequence generation is unaffected by the value of the value HSN.

#### 6.2.5 Change in the frequency allocation of a base transceiver station

The consequence of adding or removing a number of radio frequency channels in a base transceiver station is a modification of the cell allocation (CA) and the mobile allocation (MA). In order to achieve this without disruption to mobile stations with currently assigned channels it is necessary to send a message to all mobiles with assigned channels. The message, as defined in 04.08, will contain a new cell allocation (if necessary), mobile allocation and a time (in the form of a TDMA frame number) at which the change is to occur. A new cell allocation may not be necessary if channels are only being removed, and not added.

### 6.3 Mapping in time of logical channels onto physical channels

#### 6.3.1 Mapping in time of circuit switched logical channels onto physical channels

##### 6.3.1.1 General

The mapping in time of circuit switched logical channels is defined in the tables of clause 7, which also defines the relationship of the air interface frames to the multiframe.

##### 6.3.1.2 Key to the mapping table of clause 7

The following relates to the tables of clause 7. The columns headed:

- i) "Channel designation" gives the precise acronym for the channel to which the mapping applies.

- ii) "Sub-channel number" identifies the particular sub-channel being defined where a basic physical channel supports more than one channel of this type.
- iii) "Direction" defines whether the mapping given applies identically to downlink and uplink (D&U), or to downlink (D) or uplink (U) only.
- iv) "Allowable timeslots assignments" defines whether the channel can be supported on, or assigned to, any of the timeslots, or only on specific timeslots.
- v) "Allowable RF channel assignments" defines whether the channel can use any or all of the radio frequency channels in the cell allocation (CA), or only the BCCH carrier (C0). It should be noted that any allocated channel Cx within CA could be any radio frequency channel, and that no ordering of radio frequency channel number is implied. For example, allocated channel C0 need not have the lowest radio frequency channel number of the allocation.
- vi) "Burst type" defines which type of burst as defined in clause 5.2 is to be used for the physical channel.
- vii) "Repeat length in TDMA frames" defines how many TDMA frames occur before the mapping for the interleaved blocks repeats itself e.g. 51.
- viii) "Interleaved block TDMA frame mapping" defines, within the parentheses, the TDMA frames used by each interleaved block (e.g. 0..3). The numbers given equate to the TDMA frame number (FN) modulo the number of TDMA frames per repeat length; Therefore, the frame is utilized when:

$$\text{TDMA frame mapping number} = (\text{FN}) \bmod \text{repeat length given}$$

Where there is more than one block shown, each block is given a separate designation e.g. B0, B1. Where diagonal interleaving is employed then all of the TDMA frames included in the block are given, and hence the same TDMA frame number can appear more than once (see GSM 05.03). It should be noted that the frame mapping for the SACCH/T channel differs according to the timeslot allocated in order to lower the peak processing requirements of the BSS.

### 6.3.1.3 Mapping of BCCH data

In order to facilitate the MS operation, it is necessary to transmit some System Information messages in defined multiframes and defined blocks within one multiframe, as follows (where  $TC = (\text{FN} \text{ DIV } 51) \bmod (8)$ ):

System Information Message	Sent when TC =	Allocation
Type 1	0	BCCH Norm
Type 2	1	BCCH Norm
Type 2 bis	5	BCCH Norm
Type 2 ter	5 or 4	BCCH Norm
Type 3	2 and 6	BCCH Norm
Type 4	3 and 7	BCCH Norm
Type 7	7	BCCH Ext
Type 8	3	BCCH Ext
Type 9	4	BCCH Norm

This subclause defines requirements on minimum scheduling: the network may send any System Information message when sending of a specific System Information message is not required. The following rules apply:

- i) BCCH Ext may share the resource with PCH and AGCH (see subclause 6.5.1).
- ii) System Information Type 1 need only be sent if frequency hopping is in use or when the NCH is present in a cell. If the MS finds another message when  $TC = 0$ , it can assume that System Information Type 1 is not in use.

- iii) System information type 2 bis or 2 ter messages are sent if needed, as determined by the system operator. If only one of them is needed, it is sent when  $TC = 5$ . If both are needed, 2bis is sent when  $TC = 5$  and 2ter is sent at least once within any of 4 consecutive occurrences of  $TC = 4$ . A SI 2 message will be sent at least every time  $TC = 1$ .
- iv) The definitions of BCCH Norm and BCCH Ext are given in clause 7 table 3 of 5.
- v) Use of System Information type 7 and 8 is not always necessary. It is necessary if System Information type 4 does not contain all information needed for cell selection.
- vi) System Information type 9 is sent in those blocks with  $TC = 4$  which are specified in system information type 3 as defined in GSM 04.08.

All the allowable timeslot assignments in a frame (see table 3 of 5 in clause 7) shall contain the same information.

#### 6.3.1.4 Mapping of SID Frames

When the DTX mode of operation is active, it is required to transmit Silence Descriptor (SID) information, or equivalent dummy information, during the SACCH/T block period (104 TDMA frames). As the SID frames do not constitute a logical channel and their use is specific to DTX operation, the mapping of SID frames onto the TDMA frames is specified in GSM 05.08.

### 6.4 Permitted channel combinations

#### 6.4.1 Permitted channel combinations onto a basic physical channel

The following are the permitted ways, as defined by GSM 04.03, in which channels can be combined onto basic physical channels (numbers appearing in parenthesis after channel designations indicate sub-channel numbers; channels and sub-channels need not necessarily be assigned):

- i) TCH/F + FACCH/F + SACCH/TF
- ii) TCH/H(0,1) + FACCH/H(0,1) + SACCH/TH(0,1)
- iii) TCH/H(0,0) + FACCH/H(0,1) + SACCH/TH(0,1) + TCH/H(1,1)
- iv) FCCH + SCH + BCCH + CCCH
- v) FCCH + SCH + BCCH + CCCH + SDCCH/4(0..3) + SACCH/C4(0..3)
- vi) BCCH + CCCH
- vii) SDCCH/8(0..7) + SACCH/C8(0..7)
- viii) TCH/F + FACCH/F + SACCH/M
- ix) TCH/F + SACCH/M
- x) TCH/FD + SACCH/MD

where  $CCCH = PCH + RACH + AGCH + NCH$ .

NOTE 1: Where the SMSCB is supported, the CBCH replaces SDCCH number 2 in cases v) and vii) above.

NOTE 2: A combined CCCH/SDCCH allocation (case v) above) may only be used when no other CCCH channel is allocated.

NOTE 3: Combinations viii), ix) and x) are used in multislot configurations as defined in subclause 6.4.2.

#### 6.4.2 Multislot configurations

A multislot configuration consists of multiple

- circuit

traffic channels together with associated control channels, allocated to the same MS. The multislot configuration occupies up to 8 basic physical channels, with different timeslots numbers (TN) but with the same frequency parameters (ARFCN or MA, MAIO and HSN) and the same training sequence (TSC).

### 6.4.2.1 Multislot configurations for circuit switched connections

Two types of multislot configurations exist, symmetric and asymmetric. The symmetric case consists of only bi-directional channels. The asymmetric case consists of both bi-directional and unidirectional downlink channels.

The occupied physical channels shall consist of the following channel combinations as defined in subclause 6.4.1.

one main channel of type viii) +  
 x secondary channels of type ix) +  
 y secondary channels of type x)

where  $0 \leq x \leq 7, y = 0$  for symmetric multislot configuration  
 $0 \leq x \leq 6, 1 \leq y \leq 7, x+y \leq 7$  for asymmetric multislot configuration

The main channel is the bi-directional channel that carries the main signalling (FACCH and SACCH) for the multislot configuration. The position of the main channel is indicated by the allocation message (GSM 04.08). Secondary channels may be added or removed without changing the main channel.

The allocation of channels to a Multislot Configuration must always consider the multislot capability of the MS, as defined by the multislot class described in annex B.

There is no limitation in this TS to the possible TCH types (see subclause 3.2) which may be used in a Multislot Configuration.

High Speed Circuit Switched Data (HSCSD) is one case of multislot configuration. The full rate traffic channels of a HSCSD configuration shall convey the same user bit rate (see subclause 3.2.3).

NOTE: For the maximum number of timeslots to be used for a HSCSD, see GSM 03.34.

## 6.5 Operation of channels and channel combinations

### 6.5.1 General

- i) A base transceiver station must transmit a burst in every timeslot of every TDMA frame in the downlink of radio frequency channel C0 of the cell allocation (to allow mobiles to make power measurements of the radio frequency channels supporting the BCCH, see GSM 05.08). In order to achieve this requirement a dummy burst is defined in subclause 5.2.6 which shall be transmitted by the base transceiver station on all timeslots of all TDMA frames of radio frequency channel C0 for which no other channel requires a burst to be transmitted.
- ii) Timeslot number 0 of radio frequency channel C0 of the cell allocation must support either channel combinations iv) or v) in subclause 6.4.1. No other timeslot or allocated channel from the cell allocation is allowed to support channel combinations iv) or v) in subclause 6.4.1.
- iii) The parameter BS\_CC\_CHANS in the BCCH defines the number of basic physical channels supporting common control channels (CCCHs). All shall use timeslots on radio frequency channel C0 of the cell allocation. The first CCCH shall use timeslot number 0, the second timeslot number 2, the third timeslot number 4 and the fourth timeslot number 6. Each CCCH carries its own CCCH\_GROUP of mobiles in idle mode. Mobiles in a specific CCCH\_GROUP will listen for paging messages and make random accesses only on the specific CCCH to which the CCCH\_GROUP belongs. The method by which a mobile determines the CCCH\_GROUP to which it belongs is defined in subclause 6.5.2.
- iv) The parameter BS\_CCCH\_SDCCH\_COMB in the BCCH (see subclause 3.3.2) defines whether the common control channels defined are combined with SDCCH/4(0.3) + SACCH/C4(0.3) onto the same basic physical channel. If they are combined then the number of available random access channel blocks (access grant channel blocks and paging channel blocks; see following), are reduced as defined in table 5 of clause 7.

- v) The PCH, AGCH, NCH and BCCH Ext may share the same TDMA frame mapping (considered modulo 51) when combined onto a basic physical channel. The channels are shared on a block by block basis, and information within each block, when de-interleaved and decoded allows a mobile to determine whether the block contains paging messages, system information messages or access grants. However, to ensure a mobile satisfactory access to the system a variable number of the available blocks in each 51 multiframe can be reserved for access grants and system information messages, only. The number of blocks not used for paging (BS\_AG\_BLK\_RES) starting from, and including block number 0 is broadcast in the BCCH (see subclause 3.3.2). As above the number of paging blocks per 51 TDMA frame multiframe considered to be "available" shall be reduced by the number of blocks reserved for access grant messages.

If system information messages are sent on BCCH Ext, BS\_AG\_BLK\_RES shall be set to a value greater than zero.

Table 5 of clause 7 defines the access grant blocks and paging blocks available per 51 TDMA frame multiframe.

- vi) Another parameter in the BCCH, BS\_PA\_MFRMS indicates the number of 51 TDMA frame multiframe between transmissions of paging messages to mobiles in idle mode of the same paging group. The "available" paging blocks per CCCH are then those "available" per 51 TDMA frame multiframe on that CCCH (determined by the two above parameters) multiplied by BS\_PA\_MFRMS. Mobiles are normally only required to monitor every Nth block of their paging channel, where N equals the number of "available" blocks in total (determined by the above BCCH parameters) on the paging channel of the specific CCCH which their CCCH\_GROUP is required to monitor. Other paging modes (e.g. page reorganize or paging overload conditions described in GSM 04.08) may require the mobile to monitor paging blocks more frequently than this. All the mobiles listening to a particular paging block are defined as being in the same PAGING\_GROUP. The method by which a particular mobile determines to which particular PAGING\_GROUP it belongs and hence which particular block of the available blocks on the paging channel is to be monitored is defined in subclause 6.5.2.
- vii) An MS which has its membership of at least one voice group or voice broadcast call group set to the active state shall, in addition to monitoring the paging blocks as described above, monitor the notification channel, NCH. This logical channel is always mapped onto contiguous blocks reserved for access grants, in a position and number as given by the parameter NCP, defined in GSM 04.08, broadcast on the BCCH. The channel may be present when a cell supports voice group or voice broadcast calls. The coding of the various structural parameters described above in this section is not changed. Information within a block, when deinterleaved and decoded, allows the MS to determine whether the block contains access grant messages or notification messages.

### 6.5.2 Determination of CCCH\_GROUP and PAGING\_GROUP for MS in idle mode

$$\text{CCCH\_GROUP} (0 \dots \text{BS\_CC\_CHANS}-1) = ((\text{IMSI mod } 1000) \text{ mod } (\text{BS\_CC\_CHANS} \times N)) \text{ div } N$$

$$\text{PAGING\_GROUP} (0 \dots N-1) = ((\text{IMSI mod } 1000) \text{ mod } (\text{BS\_CC\_CHANS} \times N)) \text{ mod } N$$

where

N = number of paging blocks "available" on one CCCH = (number of paging blocks "available" in a 51 frame TDMA multiframe on one CCCH) x BS\_PA\_MFRMS.

IMSI = International Mobile Subscriber Identity, as defined in GSM 03.03.

mod = Modulo.

div = Integer division.

### 6.5.3 Determination of specific paging multiframe and paging block index

The required 51 TDMA frame multiframe occurs when:

$$\text{PAGING\_GROUP div } (N \text{ div } \text{BS\_PA\_MFRMS}) = (FN \text{ div } 51) \text{ mod } (\text{BS\_PA\_MFRMS})$$

The index to the required paging block of the "available" blocks in the 51 TDMA frame multiframe:

$$\text{Paging block index} = \text{PAGING\_GROUP} \bmod (\text{N div BS\_PA\_MFRMS})$$

where the index is then used with the look-up table 5 of clause 7 to determine the actual paging channel interleaved block to be monitored.

#### **6.5.4 Short Message Service Cell Broadcast (SMSCB)**

When a short message service cell broadcast (SMSCB) message is to be sent, the message shall be sent on one of the two cell broadcast channels (CBCH): the basic and the extended cell broadcast channel in four consecutive multiframe blocks using the block defined in table 3 of clause 7. The multiframe blocks used for the basic cell broadcast channel shall be those in which TB = 0,1,2 and 3. The multiframe blocks used for the extended cell broadcast channel shall be those in which TB = 4, 5, 6 and 7 where:

$$\text{TB} = (\text{FN DIV } 51) \bmod(8)$$

The SMSCB header shall be sent in the multiframe in which TB = 0 for the basic, and TB = 4 for the extended cell broadcast channel. When SMSCB is in use, this is indicated within the BCCH data (see GSM 04.08), and the parameter BS\_AG\_BLK\_RES shall be set to one or greater. When the CBCH is mapped onto a CCCH+SDCCH/4 channel, use of SMSCB does not place any constraint on the value of BS\_AG\_BLK\_RES.

NOTE: The MS reading of the extended CBCH is occasionally interrupted by MS idle mode procedures.

#### **6.5.5 Voice group and voice broadcast call notifications**

When mobile stations are to be alerted on a voice group or voice broadcast call, notification messages shall be sent on the notification channel (NCH), using the blocks defined in subclause 6.5.1.

When the NCH is in use, the parameter BS\_AG\_BLK\_RES shall be set to a value not lower than the number of blocks used for the NCH, see subclause 6.5.1 vii).

Channel designation	Sub-channel number	Direction	Allowable time slot assignments	Allowable RF channel assignments	Burst type	Repeat length in TDMA frames	Interleaved TDMA frame mapping	block
TCH/FS TCH/F2.4		D&U <sup>2</sup>	0 ... 7	C0 ... Cn	NB <sup>1</sup>	13	B0(0...7),B1(4...11),B2(8...11,0...3)	
TCH/HS	0 1	D&U <sup>2</sup>	0 ... 7	C0 ... Cn	NB <sup>1</sup>	13	B0(0,2,4,6),B1(4,6,8,10),B2(8,10,0,2) B0(1,3,5,7),B1(5,7,9,11),B2(9,11,1,3)	
FACCH/F		D&U	0 ... 7	C0 ... Cn	NB <sup>1</sup>	13	B0(0...7),B1(4...11),B2(8...11,0...3)	
FACCH/H	0	U	0 ... 7	C0 ... Cn	NB <sup>1</sup>	26	B0(0,2,4,6,8,10),B1(8,10,13,15,17,19),B2(17,19,21,23,0,2)	
FACCH/H	0	D	0 ... 7	C0 ... Cn	NB <sup>1</sup>	26	B0(4,6,8,10,13,15),B1(13,15,17,19,21,23),B2(21,23,0,2,4,6)	
FACCH/H	1	U	0 ... 7	C0 ... Cn	NB <sup>1</sup>	26	B0(1,3,5,7,9,11),B1(9,11,14,16,18,20),B2(18,20,22,24,1,3)	
FACCH/H	1	D	0 ... 7	C0 ... Cn	NB <sup>1</sup>	26	B0(5,7,9,11,14,16),B1(14,16,18,20,22,24),B2(22,24,1,3,5,7)	
SACCH/TF		D&U <sup>2</sup>	0	C0 ... Cn	NB <sup>3</sup>	104	B(12, 38, 64, 90)	NOTE 1: An Access Burst (AB) is used on the uplink during handover and on channels used for voice group calls when a request to talk is made.
SACCH/TF		D&U <sup>2</sup>	1	C0 ... Cn	NB <sup>3</sup>	104	B(25, 51, 77, 103)	
SACCH/TF		D&U <sup>2</sup>	2	C0 ... Cn	NB <sup>3</sup>	104	B(38, 64, 90, 12)	
SACCH/TF		D&U <sup>2</sup>	3	C0 ... Cn	NB <sup>3</sup>	104	B(51, 77, 103, 25)	
SACCH/TF		D&U <sup>2</sup>	4	C0 ... Cn	NB <sup>3</sup>	104	B(64, 90, 12, 38)	
SACCH/TF		D&U <sup>2</sup>	5	C0 ... Cn	NB <sup>3</sup>	104	B(77, 103, 25, 51)	
SACCH/TF		D&U <sup>2</sup>	6	C0 ... Cn	NB <sup>3</sup>	104	B(90, 12, 38, 64)	
SACCH/TF		D&U <sup>2</sup>	7	C0 ... Cn	NB <sup>3</sup>	104	B(103, 25, 51, 77)	
SACCH/M		D&U <sup>2</sup>	0 ... 7	C0 ... Cn	NB <sup>3</sup>	104	B(12, 38, 64, 90)	
SACCH/TH	0	D&U <sup>2</sup>	0	C0 ... Cn	NB <sup>3</sup>	104	B(12, 38, 64, 90)	NOTE 2: The uplink of a channel used for voice broadcast or a voice group call may actually not be used.
SACCH/TH	1	D&U <sup>2</sup>	0	C0 ... Cn	NB <sup>3</sup>	104	B(25, 51, 77, 103)	
SACCH/TH	0	D&U <sup>2</sup>	1	C0 ... Cn	NB <sup>3</sup>	104	B(12, 38, 64, 90)	
SACCH/TH	1	D&U <sup>2</sup>	1	C0 ... Cn	NB <sup>3</sup>	104	B(25, 51, 77, 103)	
SACCH/TH	0	D&U <sup>2</sup>	2	C0 ... Cn	NB <sup>3</sup>	104	B(38, 64, 90, 12)	
SACCH/TH	1	D&U <sup>2</sup>	2	C0 ... Cn	NB <sup>3</sup>	104	B(51, 77, 103, 25)	
SACCH/TH	0	D&U <sup>2</sup>	3	C0 ... Cn	NB <sup>3</sup>	104	B(38, 64, 90, 12)	
SACCH/TH	1	D&U <sup>2</sup>	3	C0 ... Cn	NB <sup>3</sup>	104	B(51, 77, 103, 25)	
SACCH/TH	0	D&U <sup>2</sup>	4	C0 ... Cn	NB <sup>3</sup>	104	B(64, 90, 12, 38)	
SACCH/TH	1	D&U <sup>2</sup>	4	C0 ... Cn	NB <sup>3</sup>	104	B(77, 103, 25, 51)	
SACCH/TH	0	D&U <sup>2</sup>	5	C0 ... Cn	NB <sup>3</sup>	104	B(64, 90, 12, 38)	
SACCH/TH	1	D&U <sup>2</sup>	5	C0 ... Cn	NB <sup>3</sup>	104	B(77, 103, 25, 51)	
SACCH/TH	0	D&U <sup>2</sup>	6	C0 ... Cn	NB <sup>3</sup>	104	B(90, 12, 38, 64)	
SACCH/TH	1	D&U <sup>2</sup>	6	C0 ... Cn	NB <sup>3</sup>	104	B(103, 25, 51, 77)	
SACCH/TH	0	D&U <sup>2</sup>	7	C0 ... Cn	NB <sup>3</sup>	104	B(90, 12, 38, 64)	
SACCH/TH	1	D&U <sup>2</sup>	7	C0 ... Cn	NB <sup>3</sup>	104	B(103, 25, 51, 77)	

NOTE 3: An Access Burst (AB) may be used on the uplink during handover.



Channel designation	Sub-channel number	Direction	Allowable timeslot assignments	Allowable RF channel assignments	Burst type	Repeat length in TDMA frames	Interleaved TDMA mapping	block frame
TCH/F4.8 TCH/F9.6 TCH/F14.4		D&U	0 ... 7	C0 ... Cn	NB <sup>1</sup>	26	B0(0 ... 11, 13 ... 22) B1(4 ... 11, 13 ... 24, 0, 1) B2(8 ... 11, 13 ... 24, 0 ... 5) B3(13 ... 24, 0 ... 9) B4(17 ... 24, 0 ... 11, 13, 14) B5(21 ... 24, 0 ... 11, 13 ... 18)	
TCH/H2.4 TCH/H4.8	0	D&U	0 ... 7	C0 ... Cn	NB <sup>1</sup>	26	B0(0,2,4,6,8,10,13,15,17,19,21,23,0,2,4,6,8,10,13,15,17,19) B1(8,10,13,15,17,19,21,23,0,2,4,6,8,10,13,15,17,19,21,23,0,2), B2(17,19,21,23,0,2,4,6,8,10,13,15,17,19,21,23,0,2,4,6,8,10)	
	1						B0(1,3,5,7,9,11,14,16,18,20,22,24,1,3,5,7,9,11,14,16,18,20), B1(9,11,14,16,18,20,22,24,1,3,5,7,9,11,14,16,18,20,22,24,1,3), B2(18,20,22,24,1,3,5,7,9,11,14,16,18,20,22,24,1,3,5,7,9,11)	

NOTE: An Access Burst (AB) is used on the uplink during handover.

Clause 7 Table 2 of 6: Mapping of logical channels onto physical channels (see subclauses 6.3, 6.4, 6.5)

Channel designation	Sub-channel number	Direction	Allowable timeslot assignments	Allowable RF channel assignments	Burst type	Repeat length in TDMA frames	Interleaved TDMA mapping	block frame
FCCH		D	0	C0	FB	51	B0(0),B1(10),B2(20),B3(30),B4(40)	
SCH		D	0	C0	SB	51	B0(1),B1(11),B2(21),B3(31),B4(41)	
BCCH Norm		D	0,2,4,6	C0	NB	51	B(2..5)	
BCCH Ext		D	0,2,4,6	C0	NB	51	B(6..9)	
PCH AGCH		D	0,2,4,6	C0	NB	51	B0(6..9),B1(12..15),B2(16..19) B3(22..25),B4(26..29),B5(32..35), B6(36..39),B7(42..45),B8(46..49)	
NCH		D	0	C0	NB	51	B0(6..9),B1(12..15),B2(16..19) B3(22..25),B4(26..29),B5(32..35), B6(36..39)	
RACH		U	0,2,4,6	C0	AB	51	B0(0),B1(1)..B50(50)	
CBCH(SDCCH/4)		D	0	C0	NB	51	B(32..35)	
CBCH(SDCCH/8)		D	0 ... 3	C0 ... Cn	NB	51	B(8..11)	
SDCCH/4	0	D	0	C0	NB <sup>1</sup>	51	B(22..25)	NOTE 1: An Access Burst (AB) is used On the uplink during handover
	1	U					B(37..40)	
	2	D					B(26..29)	
	3	U					B(41..44)	
		U					B(32..35)	
		D					B(47..50)	
		U					B(36..39)	
		D					B(0..3)	
SACCH/C4	0	D	0	C0	NB <sup>3</sup>	102	B(42..45)	
	1	U					B(57..60)	
	2	D					B(46..49)	
	3	U					B(61..64)	
		D					B(93..96)	
		U					B(6..9)	
		D					B(97..100)	
		U					B(10..13)	

NOTE 3:An Access Burst (AB) may be used on the uplink during handover.

Clause 7 Table 3 of 6: Mapping of logical channels onto physical channels (see subclauses 6.3, 6.4, 6.5)

Channel designation	Sub-channel number	Direction	Allowable timeslot assignments	Allowable RF channel assignments	Burst type	Repeat length in TDMA frames	Interleaved TDMA mapping	block frame	
SDCCH/8	0	D	0 ... 7	C0 ... Cn	NB <sup>1</sup>	51	B (0	...	3)
		U					B (15	...	18)
	1	D					B (4	...	7)
		U					B (19	...	22)
	2	D					B (8	...	11)
		U					B (23	...	26)
	3	D					B (12	...	15)
		U					B (27	...	30)
4	D			B (16	...	19)			
	U			B (31	...	34)			
5	D			B (20	...	23)			
	U			B (35	...	38)			
6	D			B (24	...	27)			
	U			B (39	...	42)			
	7	D			B (28	...	31)		
		U			B (43 ... 46)				
SACCH/C8	0	D	0 ... 7	C0 ... Cn	NB <sup>3</sup>	102	B (32	...	35)
		U					B (47	...	50)
	1	D					B (36	...	39)
		U					B (51	...	54)
	2	D					B (40	...	43)
		U					B (55	...	58)
	3	D					B (44	...	47)
		U					B (59	...	62)
4	D			B (83	...	86)			
	U			B (98	...	101)			
5	D			B (87	...	90)			
	U			B (0	...	3)			
6	D			B (91	...	94)			
	U			B (4	...	7)			
	7	D			B (95	...	98)		
		U			B (8 ... 11)				

NOTE 1: An Access Burst (AB) is used on the uplink during handover.

NOTE 3: An Access Burst (AB) may be used on the uplink during handover.

**Clause 7 Table 4 of 6: Mapping of logical channels onto physical channels (see subclauses 6.3, 6.4, 6.5)**

BS\_CCCH\_SDCCH\_COMB

	Random access channel blocks available		Access grant blocks available (NOTE: Some access grant blocks may also be used for the NCH)		BS_AG_BLK_RES		Number of paging blocks available per 51 multiframe	
							Paging channel blocks available (Paging block index = 0, 1, 2, 3, 4, 5, 6, 7, 8)	
False	B0, B1 ... B50		B0, B1 ... B8	0	9	B0, B1, B2, B3, B4, B5, B6, B7, B8		
False				1	8	B1, B2, B3, B4, B5, B6, B7, B8		
False				2	7	B2, B3, B4, B5, B6, B7, B8		
False				3	6	B3, B4, B5, B6, B7, B8		
False				4	5	B4, B5, B6, B7, B8		
False				5	4	B5, B6, B7, B8		
False				6	3	B6, B7, B8		
False				7	2	B7, B8		
True	B4, B5, B14, B15 ... B36, B45, B46		B0, B1, B2	0	3	B0, B1, B2		
True				1	2	B1, B2		
True				2	1	B2		

Clause 7 Table 5 of 6: Mapping of logical channels onto physical channels (see subclauses 6.3, 6.4, 6.5)

Channel designation	Sub-channel number	Direction	Time-slot assignment	Allowable RF channel assignment	Allowable type	Multiframe length in TDMA frames	Interleaved block TDMA frame mapping
PDTCH, PACCH		D&U	0...7	C0...Cn	NB1	52	B0(0...3), B1(4...7), B2(8...11), B3(13...16), B4(17...20), B5(21..24), B6(26...29), B7(30...33), B8(34...37), B9(39...42), B10(43...46), B11(47...50)
PBCCH		D	0...7	C0...Cn	NB	52	B0(0... 3), B6(26...29), B3(13...16), B9(39...42)
PBCCH		D	0...7	C0...Cn	NB	51	B0(2... 5)
PRACH		U	0...7	C0...Cn	AB	52	B0(0)...B11(11), B12(13)...B23(24), B24(26)... B35(37), B36(39)...B47(50)
PAGCH, PPCH, PNCH		D	0...7	C0...Cn	NB	52	B1(4 ... 7), B2(8...11), B3(13...16), B4(17...20), B5(21..24), B6(26...29), B7(30...33), B8(34...37), B9(39...42), B10(43...46), B11(47...50)
PAGCH, PPCH, PNCH		D	0...7	C0...Cn	NB	51	B0(6..9), B1(12..15), B2(16..19), B3(22..25), B4(26..29), B5(32..35), B6(36..39), B7(42..45), B8(46..49) B6(36..39), B7(42..45), B8(46..49)
PTCCH/D		D	0...7	C0...Cn	NB	416	B0(12,38,64,90), B2(116,142,168,194), B3(220,246,272,298), B4(324,350,376,402)
PTCCH/U	0 1 2 3 4 5 6 7 8 9 10 11 12 13 14 15	U	0...7	C0...Cn	AB	416	B0(12) B0(38) B0(64) B0(90) B0(116) B0(142) B0(168) B0(194) B0(220) B0(246) B0(272) B0(298) B0(324) B0(350) B0(376) B0(402)

Clause 7 Table 6 of 6: Interleaved block TDMA frame mapping

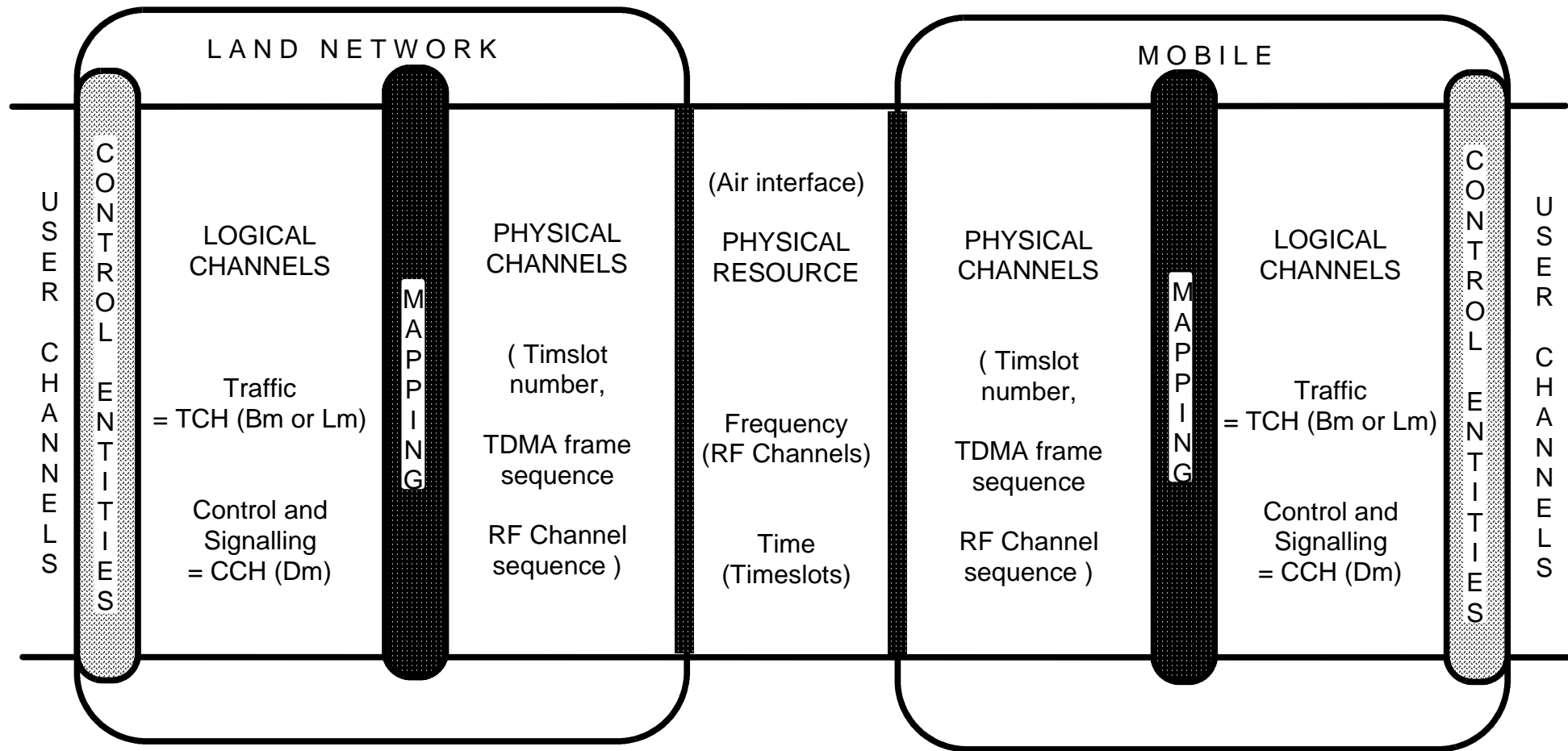
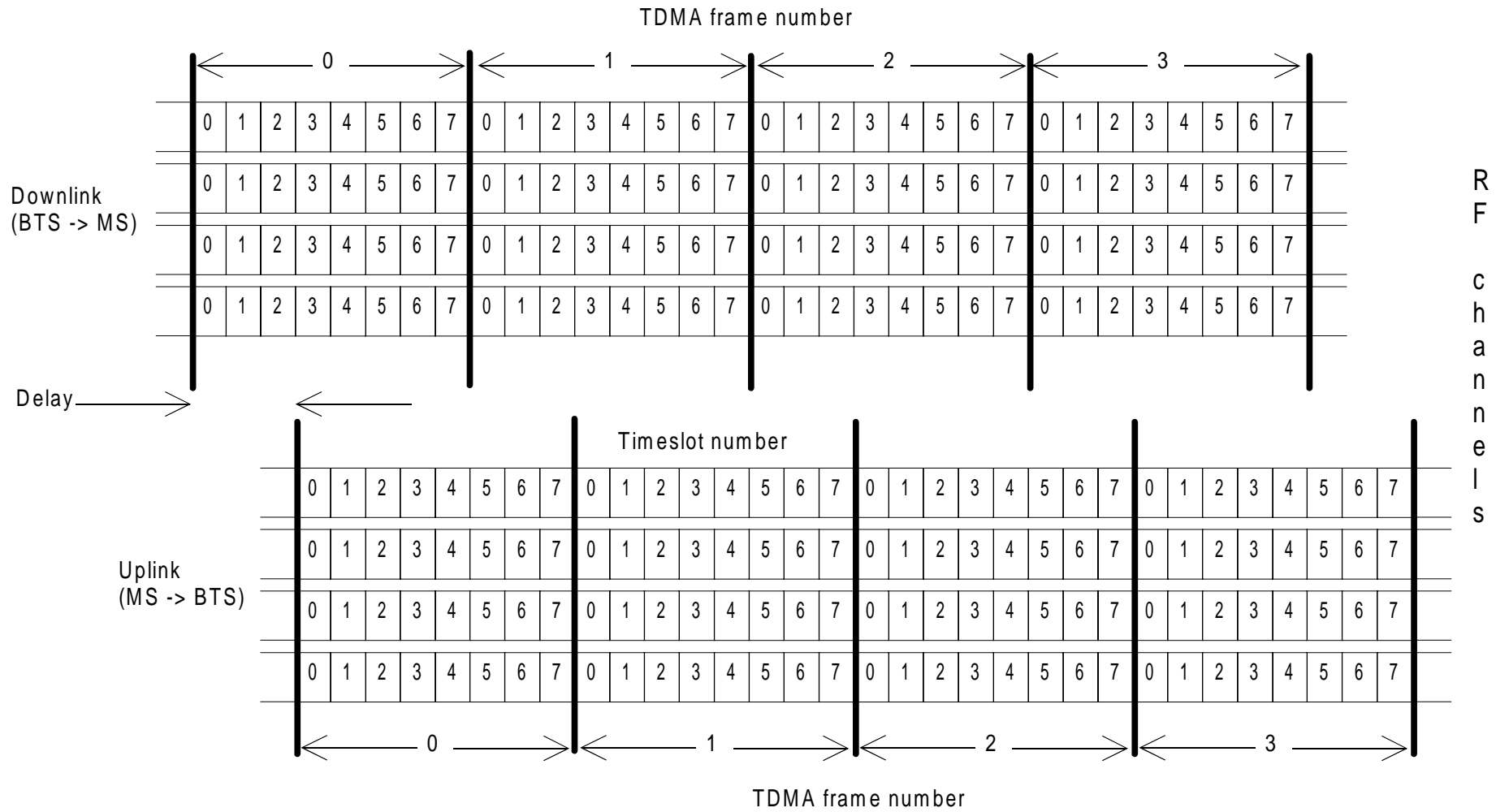

Figure 1: Mapping of logical channels onto physical channels based on the physical resource



**Figure 2: The structure imposed on the physical resource: Timeslots, TDMA Frames and Radio Frequency channels (in this example the cell has an allocation of 4 RF Channels pairs)**

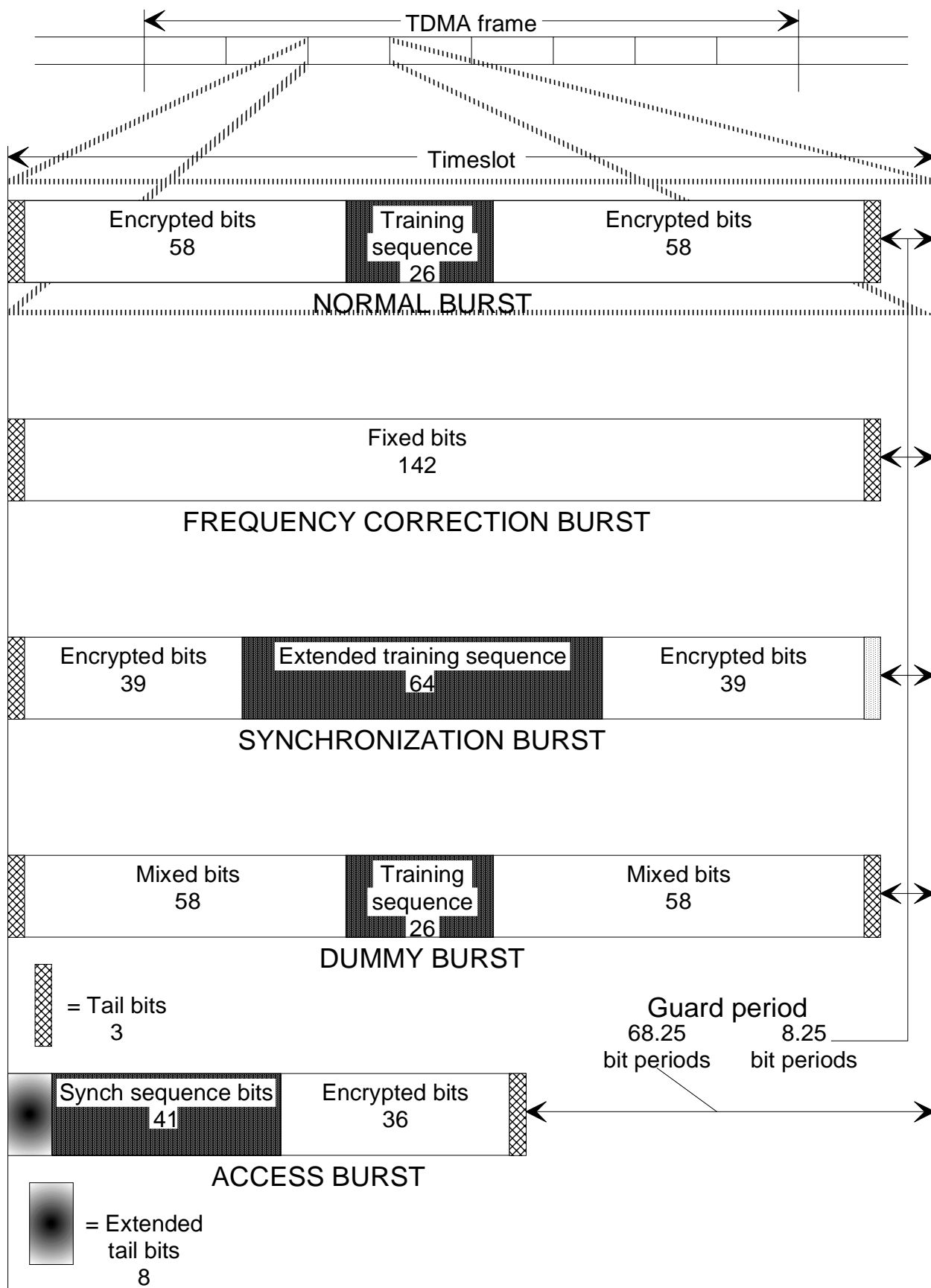

Figure 3: Timeslot and format of bursts



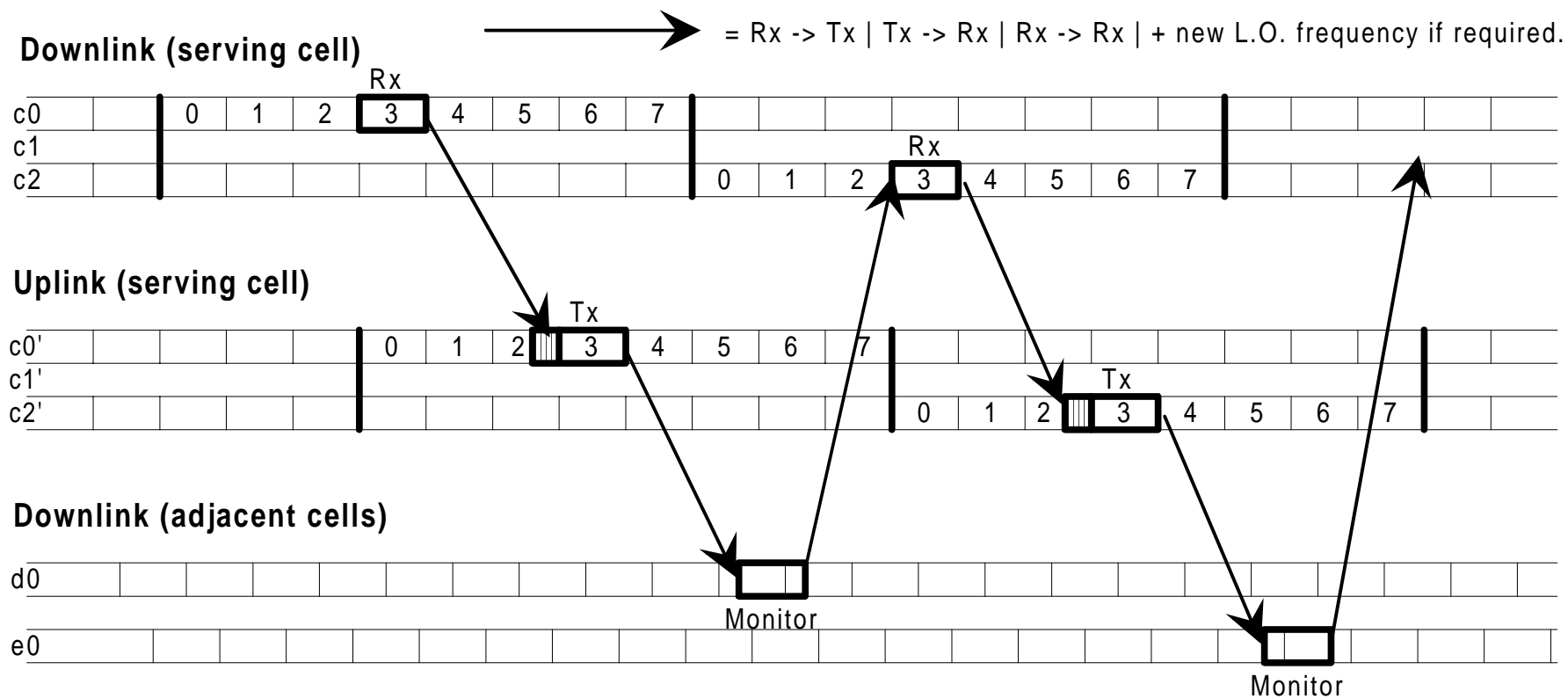
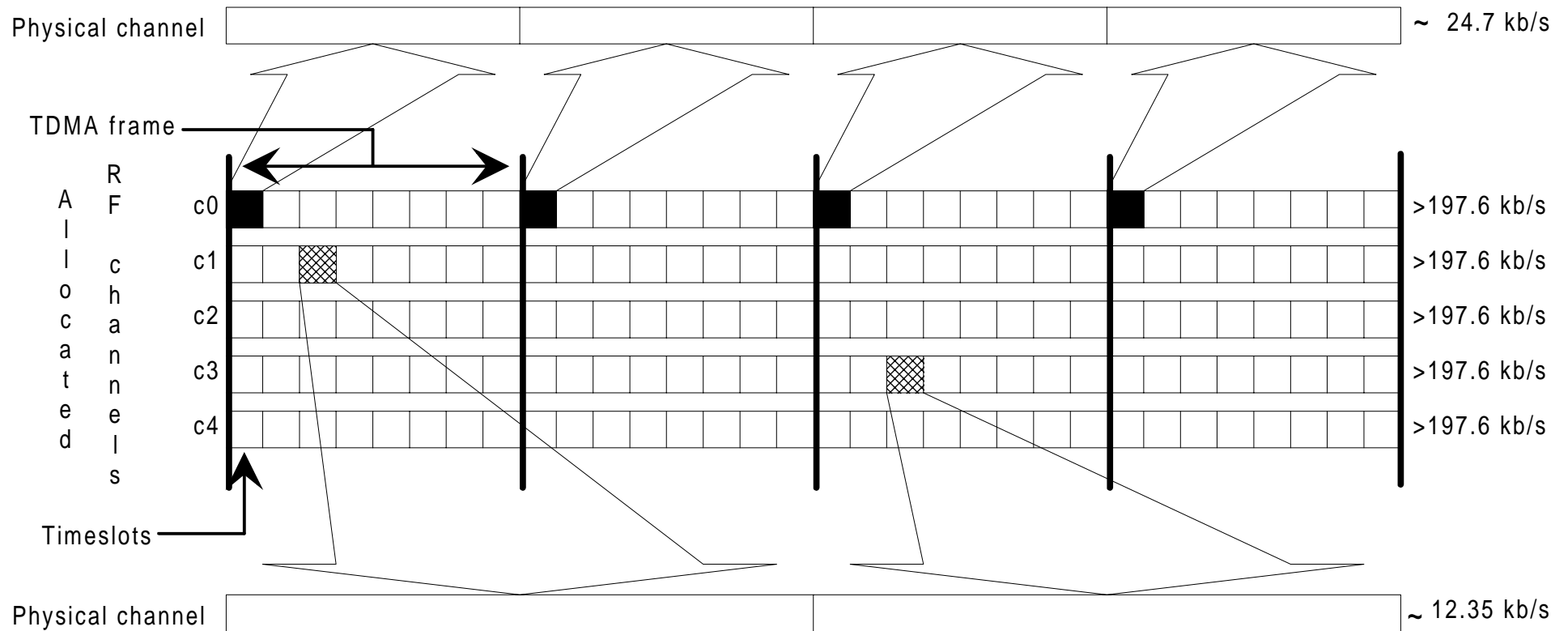

Figure 4: Mobile station usage of physical channel timeslots (For a full-rate hopping traffic channel assigned timeslot 3)

(This example of a physical channel is non-hopping using timeslot 0 of every TDMA frame)



(This example of a physical channel is hopping using 3 of every other TDMA frame)

**Figure 5: Example of two different physical channels**

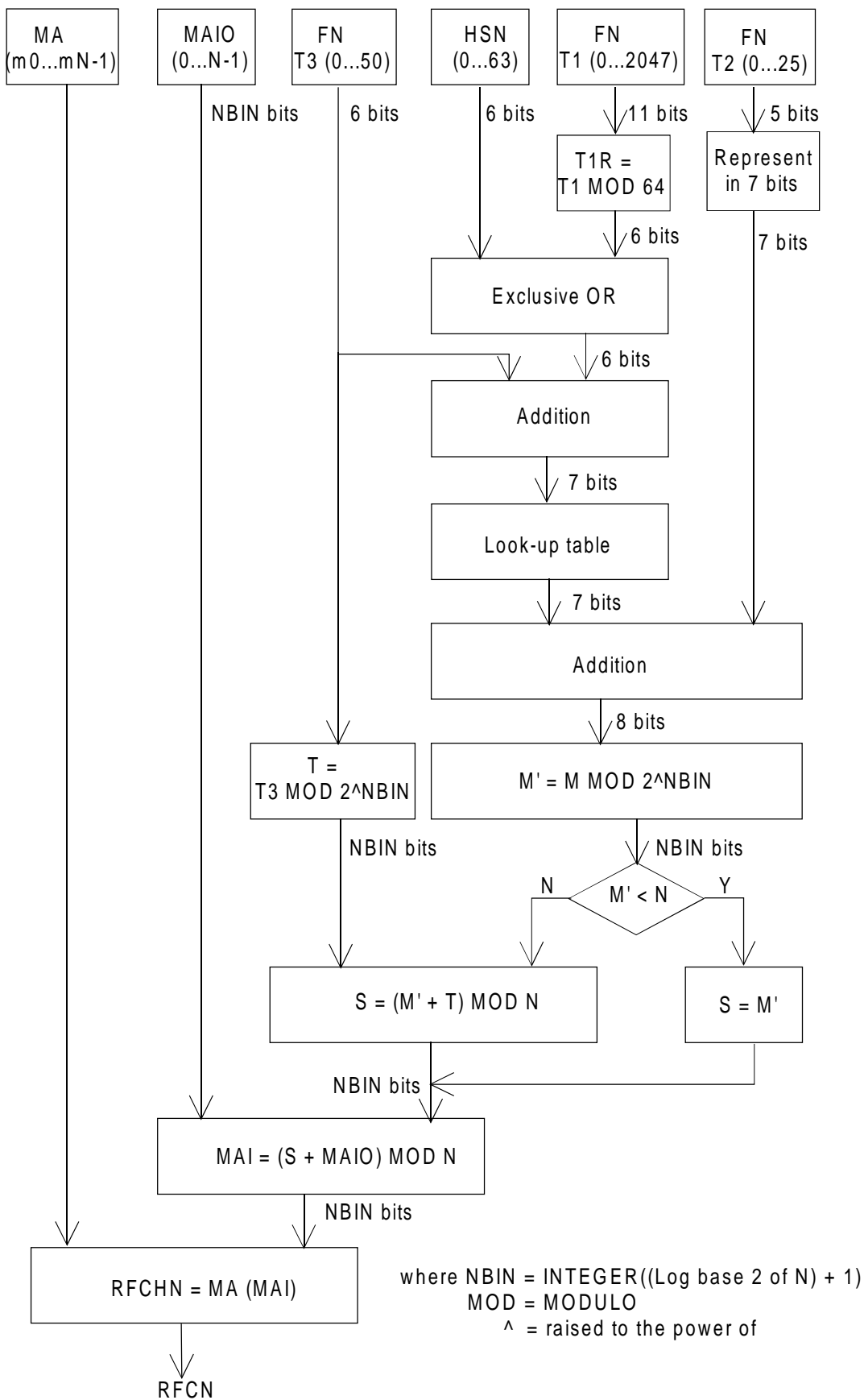

Figure 6: Block diagram of the frequency hopping algorithm when HSN ≠ 0

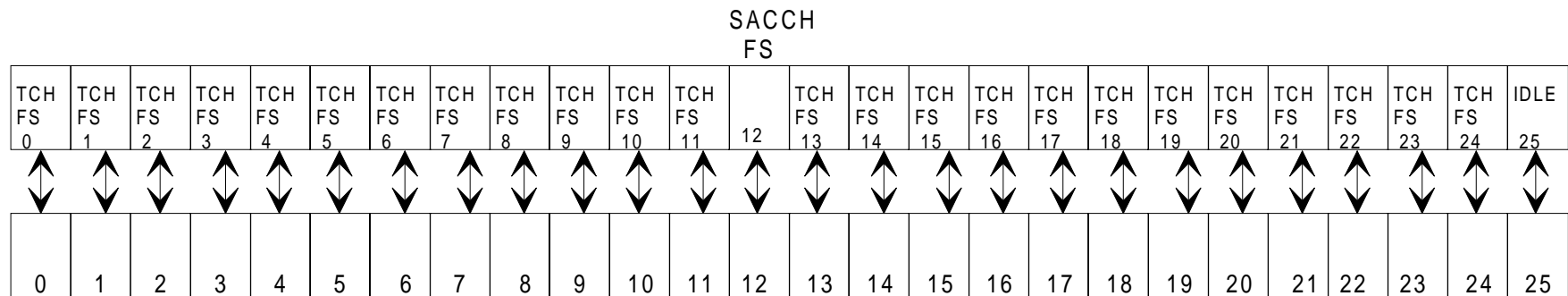

Figure 7a: TDMA frame mapping for TCH/FS + SACCH/FS

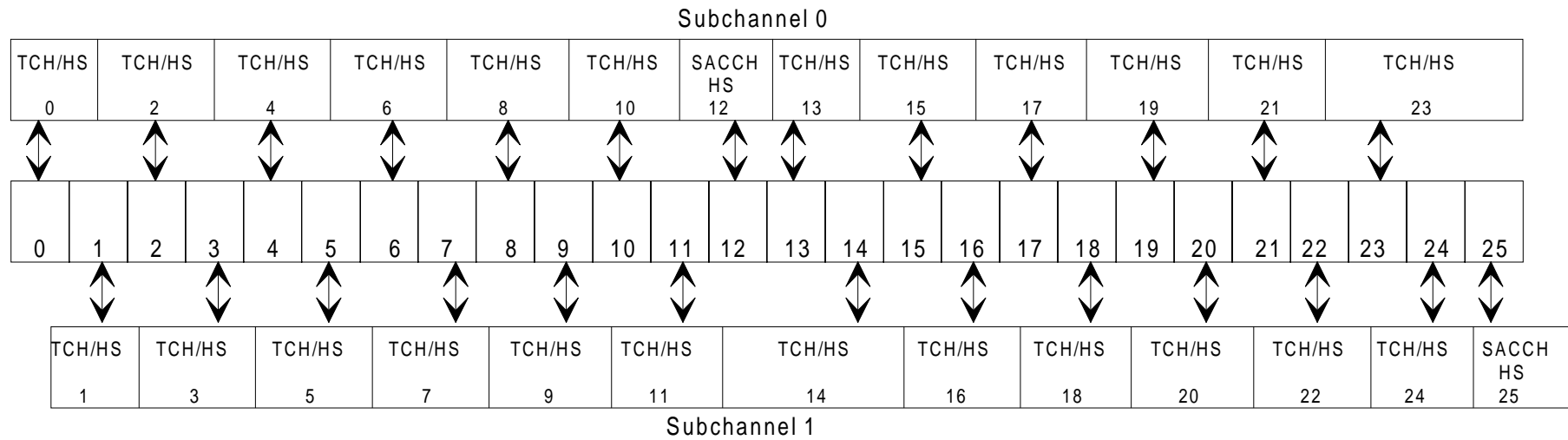

Figure 7b: TDMA frame mapping for TCH/HS + SACCH/HS sub-channels 0 and 1

Figure 7: Example of a TDMA frame mapping for traffic channels



**Annex A (normative): Phase 2 mobiles in a phase 1 infrastructure****A.1 Scope**

Phase 2 mobiles are required to behave properly in a Phase 1 networks, when downlink DTX is used in conjunction with frequency hopping.

**A.2 Implementation options for TCH channels****A.2.1 C0 filling on the TCH**

When the TCH is active, and no associated traffic frame is scheduled for transmission, the following options apply for filling the burst on the C0 radio frequency channel.

**A.2.1.1 A dummy burst with (BN61, BN62, BN86) = training sequence bits of normal bursts****A.2.1.2 A dummy burst with the "C0 filling training sequence**

(BN61, BN62, BN86) = (0,1,1,1,0,0,0,1,0,1,1,1,0,0,0,1,0,1,1,1,0,0,0,1,0,1).

**A.2.1.3 A dummy burst with ( BN61, BN62, BN86) mapped from the TSC bits of normal bursts according to the table; below**

TSC for other bursts on TCH	Dummy bursts (BN61, BN62 BN86)	Corresponding TSC
0	(0,1,0,0,0,0,1,1,1,0,1,1,1,0,1,0,0,1,0,0,0,0,1,1,1,0)	2
1	(0,1,0,0,1,1,1,0,1,0,1,1,0,0,0,0,0,1,0,0,1,1,1,0,1,0)	5
2	(0,0,1,0,0,1,0,1,1,1,0,0,0,0,1,0,0,0,1,0,0,1,0,1,1,1)	0
3	(0,0,0,1,1,0,1,0,1,1,1,0,0,1,0,0,0,0,0,1,1,0,1,0,1,1)	4
4	(0,1,0,0,1,1,1,0,1,0,1,1,0,0,0,0,0,1,0,0,1,1,1,0,1,0)	5
5	(0,1,0,0,0,0,1,1,1,0,1,1,1,0,1,0,0,1,0,0,0,0,1,1,1,0)	2
6	(0,1,0,0,0,1,1,1,1,0,1,1,0,1,0,0,0,1,0,0,0,1,1,1,1,0)	3
7	(0,1,0,0,1,1,1,0,1,0,1,1,0,0,0,0,0,1,0,0,1,1,1,0,1,0)	5

**A.2.1.4 Partial SID information**

The BTS transmits bursts containing parts of the SID frames provided by the speech encoder. The bits transmitted in such bursts on C0 carrier contain the same bits that would have been transmitted in those bursts in those if the associated traffic frames were scheduled for transmission.

**A.2.2 Half burst filling**

For downlink DTX, when a given traffic frame is scheduled for transmission and one of its adjacent traffic frames is not scheduled for transmission, half of the "encrypted bits" belonging to the normal bursts associated with the scheduled traffic frame need to be filled. These bits are referred to as "half burst filling bits". These half bursts filling bits contain either:

**A.2.2.1 Partial SID information from any associated SID frame; or****A.2.2.2 The mixed bits of the dummy bursts (encrypted or not encrypted)****A.2.3 Dummy burst Stealing flag**

The dummy burst stealing flag are set to either 1 or 0.

**A.2.4 Half burst Filling Stealing flag**

BN60 or BN87 corresponding to the "encrypted bits" of a filled half burst, defined as the "half burst filling stealing flag", are jointly set to a value of either 1 or 0.

### A.2.5 Allowed combinations

Table A.2.5.1 below provides the allowed combinations for phase 1 networks supporting downlink DTX in conjunction with frequency hopping.

**Table A.2.5.1: Possible combinations for networks supporting downlink DTX in conjunction with frequency hopping**

Combination	C0 filling on the TCH	Half Burst filling	Dummy Bursts Stealing Flag	Half Burst Filling Stealing Flag
1	Dummy bursts with (BN61-BN86) equal to the bits of the TSC of the other normal bursts (A 2.1.1)	not defined	0	0
2	Dummy burst with "C0 filling training sequence" (A 2.1.2)	Partial SID information (A 2.2.1)	0	0
3	Dummy burst with (BN61, BN62....BN86) mapped from the TSC bits of normal bursts (A 2.1.3)	Partial SID information (A 2.2.1)	0	0
4	Partial SID information (A 2.1.4)	Partial SID information (A 2.2.1)	1	1
5	Dummy burst with "C0 filling training sequence" (A 2.1.2)	Dummy burst mixed bits (A 2.2.2)	1	1
6 (for DCS 1 800 only)	Partial SID information (A 2.1.4)	Partial SID information (A 2.2.1)	0	0

### A.3 Idle Channels

When a channel is idle, a dummy burst may be transmitted on C0 frequency channel with any options described in subclauses A 2.1.1, A 2.1.2, A 2.1.3.

**Annex B (normative): Multislot capability****B.1 MS classes for multislot capability**

When an MS supports the use of multiple timeslots it shall belong to a multislot class between 1 and 18 as defined below:

**Table B.1**

Multislot class	Maximum number of slots			Minimum number of slots			Type
	Rx	Tx	Sum	T <sub>t</sub>	T <sub>ra</sub>	T <sub>rb</sub>	
1	1	1	2	2	4	2	1
2	2	1	3	2	3	1	1
3	2	2	3	2	3	1	1
4	3	1	4	1	3	1	1
5	2	2	4	1	3	1	1
6	3	2	4	1	3	1	1
7	3	3	4	1	3	1	1
8	4	1	5	1	2	1	1
9	3	2	5	1	2	1	1
10	4	2	5	1	2	1	1
11	4	3	5	1	2	1	1
12	4	4	5	1	2	1	1
13	3	3	6	1	3	1	2
14	4	4	8	1	3	1	2
15	5	5	10	1	3	1	2
16	6	6	12	1	2	1	2
17	7	7	14	1	1	0	2
18	8	8	16	0	0	0	2

Type 2 MS are required to be able to transmit and receive at the same time.

**Rx:**

Rx describes the maximum number of receive timeslots that the MS can use per TDMA frame. The MS must be able to support all integer values of receive TS from 0 to Rx (depending on the services supported by the MS). The receive TS need not be contiguous. For type 1 MS, no transmit TS shall occur between receive TS within a TDMA frame.

**Tx:**

Tx describes the maximum number of transmit timeslots that the MS can use per TDMA frame. The MS must be able to support all integer values of transmit TS from 0 to Tx (depending on the services supported by the MS). The transmit TS need not be contiguous. For type 1 MS, no receive TS shall occur between transmit TS within a TDMA frame.

**Sum:**

Sum is the total number of uplink and downlink TS that can actually be used by the MS per TDMA frame. The MS must be able to support all combinations of integer values of Rx and Tx TS where  $1 \leq Rx + Tx \leq Sum$  (depending on the services supported by the MS).

**T<sub>t</sub>:**

T<sub>t</sub> relates to the time needed for the MS to get ready to transmit.

For type 1 MS it is the minimum number of timeslots that will be allowed between the last receive TS and the first transmit TS. It should be noted that, in practise, the minimum time allowed will be reduced by the amount of the timing advance.

For type 2 MS it is the minimum number of timeslots that will be allowed between the end of the last transmit burst in a TDMA frame and the first transmit burst in the next TDMA frame.



$T_{ra}$ :

$T_{ra}$  relates to the time needed for the MS to perform adjacent cell power measurement and get ready to receive.

For type 1 MS it is the minimum number of timeslots that will be allowed between the last transmit TS and the first receive TS in the next TDMA frame.

For type 2 MS it is the minimum number of timeslots that will be allowed between the end of the last receive burst in a TDMA frame and the first receive burst in the next TDMA frame.

$T_{rb}$ :

$T_{rb}$  relates to the time needed for the MS to get ready to receive. This minimum requirement will only be used when adjacent cell power measurements are not required by the service selected.

For type 1 MS it is the minimum number of timeslots that will be allowed between the last transmit TS and the first receive TS in the next TDMA frame.

For type 2 MS it is the minimum number of timeslots that will be allowed between the end of the last receive burst in a TDMA frame and the first receive burst in the next TDMA frame.

## B.2 Constraints imposed by the service selected

The service selected will impose certain restrictions on the allowed combinations of transmit and receive timeslots. Such restrictions are not imposed by this annex but should be derived from the description of the services. For example, in the case of circuit switched data the TS numbers used in the uplink will be a subset of those used in the downlink.

The service selected will determine whether or not adjacent cell power measurements are required and therefore whether  $T_{ra}$  or  $T_{rb}$  is allowed for.

## B.3 Network requirements for supporting MS multislot classes

The multislot class of the MS will limit the combinations and configurations allowed when supporting multislot communication.

It is necessary for the network to decide whether the MS needs to perform adjacent cell power measurement for the type of multislot communication intended and whether the service imposes any other constraints before the full restrictions on TS assignments can be resolved. This is best shown by example:

For a multislot class 5 MS in circuit switched configuration (adjacent cell power measurements required) five basic configurations of channels are possible which can occur in six different positions in the TDMA frame. The service itself may determine that asymmetry must be downlink biased, in which case the last two solutions would not be allowed.

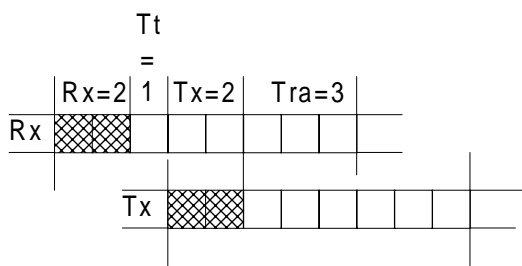

All possible timeslots used

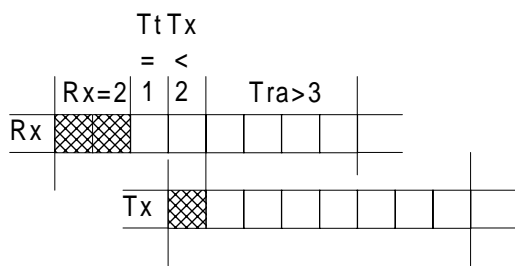

Downlink biased asymmetry

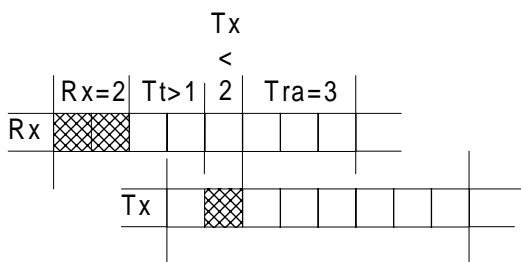

Alternative downlink biased asymmetry

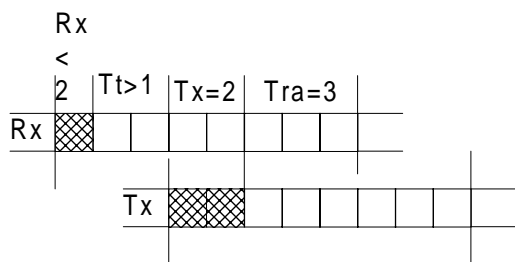

Uplink biased asymmetry  
(not prohibited by multislot class)

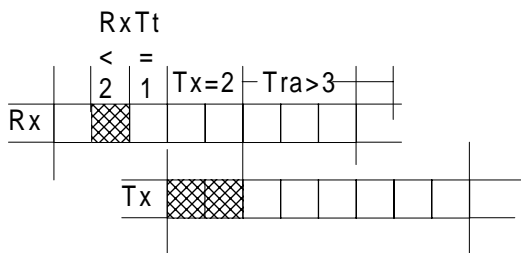

Alternative uplink biased asymmetry  
(not prohibited by multislot class)

These five combinations can be repeated at the six other positions that can be fitted within the same TDMA frame

Figure B.1

For a multislot class 13 MS when adjacent cell power measurements are not required and the service does not constrain the transmit and receive timeslots to use the same timeslot number. Many configurations of channels are possible so long as the 5 constraints of the MS are catered for. [Currently services envisaged only allow for the last example here.]

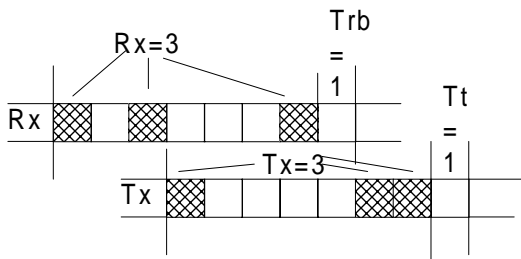

There is no requirement for relative timing of Tx timeslots in relation to Rx timeslots

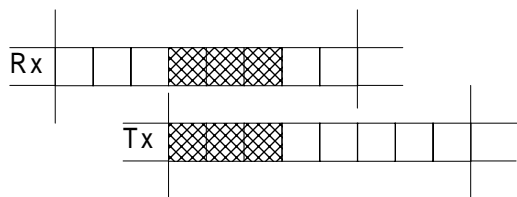

Many configurations are possible

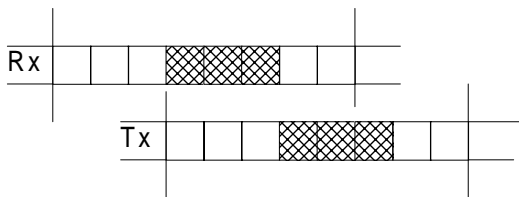
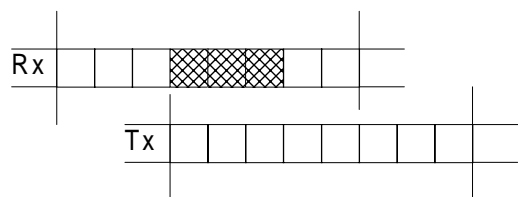
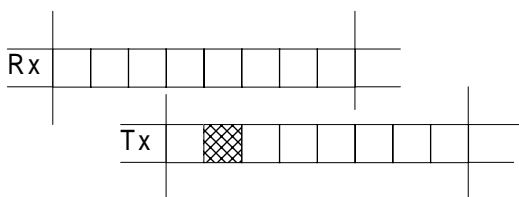

This configuration could be used for HSCSD or GPRS

Figure B.2

**Annex C (informative): Change control history**

SPEC	SMG	CR	PHA	VERS	NEW_VE	SUBJECT
05.02	S18	A003	2+	4.7.0	5.0.0	Addition of ASCI features
05.02	S19	A006	2+	5.0.0	5.1.0	SMS Cell broadcast channel
05.02	S20	A008	2+	5.1.0	5.2.0	Introduction of high speed circuit switched data
05.02	S20	A010	2+	5.1.0	5.2.0	Bcch Scheduling
05.02	S20	A012	2+	5.1.0	5.2.0	Definition of multi-slot classes
05.02	s21	A013	2+	5.2.0	5.3.0	Multislot configuration
05.02	s21	A014	2+	5.2.0	5.3.0	Support of 14.4 kbit/s (Radio interface related)
05.02	s22	A016	2+	5.3.0	5.4.0	Correction to errors in example figure of TDMA
05.02	s22	A017	2+	5.3.0	5.4.0	Mapping of BCCH data
05.02	s22	A018	2+	5.3.0	5.4.0	NCH only to be sent on TS 0
05.02	s25	A027	R96	5.5.0	5.6.0	Clarification of the definition of multislot classes
05.02	s25	A029	R96	5.5.0	5.6.0	14.4kbps Data Service
05.02	s26	A038	R96	5.6.0	5.7.0	Mapping of SI2 and SI2ter on BCCH
05.02				5.7.0	5.7.1	Version update for publication
05.02	s28	A063	R96	5.7.1	5.8.0	Removal of inconsistency in Table 7

**History**

<b>Document history</b>	
May 1996	Publication of GSM 05.02 version 5.0.0
August 1996	Publication of GSM 05.02 version 5.1.0
November 1996	Unified Approval Procedure (First Edition)      UAP 58:      1996-11-18 to 1997-03-14
March 1997	One-step Approval Procedure (Second Edition)      OAP 9729:      1997-03-21 to 1997-07-18
April 1997	First Edition
July 1997	One-step Approval Procedure (Third Edition)      OAP 9747:      1997-07-21 to 1997-11-28
August 1997	Second Edition
December 1997	Third Edition
May 1998	One-step Approval Procedure (Fourth Edition)      OAP 9841:      1998-05-20 to 1998-10-16
July 1998	One Step Approval Procedure (Fifth Edition)      OAP 9848:      1998-07-31 to 1998-11-27
October 1998	Fourth Edition
December 1998	Fifth Edition
April 1999	One Step Approval Procedure (Sixth Edition)      OAP 9931:      1999-04-02 to 1999-07-30
August 1999	Sixth Edition