



EUROPEAN
TELECOMMUNICATION
STANDARD

FINAL DRAFT
pr **ETS 300 813**

September 1997

Source: EBU/CENELEC/ETSI JTC

Reference: DE/JTC-00DVB-28

ICS: 33.020

Key words: DVB, broadcasting, digital, video, PDH, MPEG, TV

European Broadcasting Union



Union Européenne de Radio-Télévision



Digital Video Broadcasting (DVB);
DVB interfaces to Plesiochronous Digital Hierarchy (PDH)
networks

ETSI

European Telecommunications Standards Institute

ETSI Secretariat

Postal address: F-06921 Sophia Antipolis CEDEX - FRANCE

Office address: 650 Route des Lucioles - Sophia Antipolis - Valbonne - FRANCE

X.400: c=fr, a=atlas, p=etsi, s=secretariat - **Internet:** secretariat@etsi.fr

Tel.: +33 4 92 94 42 00 - Fax: +33 4 93 65 47 16

Copyright Notification: No part may be reproduced except as authorized by written permission. The copyright and the foregoing restriction extend to reproduction in all media.

© European Telecommunications Standards Institute 1997.

© European Broadcasting Union 1997.

All rights reserved.

Contents

Foreword	5
1 Scope	7
2 Normative references	7
3 Definitions and abbreviations	8
3.1 Definitions	8
3.2 Abbreviations	9
4 Baseline specification	9
4.1 MPEG Physical Interface (MPI)	11
4.1.1 Signal processing in the transmitter	12
4.1.2 Signal processing in the receiver	13
4.2 MPEG/ATM Adaptation (MAA)	15
4.2.1 Signal processing in the transmitter	15
4.2.2 Signal processing in the receiver	17
4.3 Virtual Path Entity (VPE)	18
4.3.1 Signal processing in the transmitter	18
4.3.2 Signal processing in the receiver	19
4.4 Virtual Path Multiplexing Entity (VPME)	19
4.4.1 Signal processing in the transmitter	20
4.4.2 Signal processing in the receiver	21
4.5 PDH Path Termination (PPT)	22
4.5.1 Path termination 1 544 kbit/s	23
4.5.1.1 Signal processing in the transmitter	23
4.5.1.2 Signal processing in the receiver	23
4.5.2 Path termination 2 048 kbit/s	24
4.5.2.1 Signal processing in the transmitter	25
4.5.2.2 Signal processing in the receiver	26
4.5.3 Path termination 6 312 kbit/s	28
4.5.3.1 Signal processing in the transmitter	28
4.5.3.2 Signal processing in the receiver	29
4.5.4 Path termination 8 448 kbit/s	31
4.5.4.1 Signal processing in the transmitter	31
4.5.4.2 Signal processing in the receiver	32
4.5.5 Path termination 34 368 kbit/s	33
4.5.5.1 Signal processing in the transmitter	34
4.5.5.2 Signal processing in the receiver	35
4.5.6 Path termination 44 736 kbit/s	37
4.5.6.1 Signal processing in the transmitter	37
4.5.6.2 Signal processing in the receiver	38
4.5.7 Path termination 139 264 kbit/s	41
4.5.7.1 Signal processing in the transmitter	41
4.5.7.2 Signal processing in the receiver	42
4.6 PDH Physical Interface (PPI)	44
4.6.1 Interface at 1 544 kbit/s	44
4.6.1.1 Signal processing in the transmitter	44
4.6.1.2 Signal processing in the receiver	44
4.6.2 Interface at 2 048 kbit/s	45
4.6.2.1 Signal processing in the transmitter	45
4.6.2.2 Signal processing in the receiver	45
4.6.3 Interface at 6 312 kbit/s	45
4.6.3.1 Signal processing in the transmitter	46
4.6.3.2 Signal processing in the receiver	46
4.6.4 Interface at 8 448 kbit/s	46
4.6.4.1 Signal processing in the transmitter	46

	4.6.4.2	Signal processing in the receiver	47
4.6.5		Interface at 34 368 kbit/s	47
	4.6.5.1	Signal processing in the transmitter	47
	4.6.5.2	Signal processing in the receiver	47
4.6.6		Interface at 44 736 kbit/s	48
	4.6.6.1	Signal processing in the transmitter	48
	4.6.6.2	Signal processing in the receiver	48
4.6.7		Interface at 139 264 kbit/s	48
	4.6.7.1	Signal processing in the transmitter	48
	4.6.7.2	Signal processing in the receiver	49
4.7		Equipment Management Function (EMF)	49
	4.7.1	Overview of the EMF	49
	4.7.2	Configuration	51
	4.7.3	Fault (maintenance) management.....	51
	4.7.4	Performance management.....	52
Annex A (informative): Mechanism of the adaptive clock method			56
Annex B (informative): Enabling/disabling the HEC functions.....			57
Annex C (informative): Transmission capacity of the Network Adapter			58
Annex D (informative): Definition of codes			59
D.1	Alternate Mark Inversion (AMI)		59
D.2	High Density Bipolar of order 3 (HDB3).....		59
D.3	Bipolar with 3 Zero Substitution (B3ZS).....		59
D.4	Bipolar with 6(8) Zero Substitution (B6ZS and B8ZS)		59
D.5	Coded Mark Inversion (CMI)		59
History			60

Foreword

This final draft European Telecommunication Standard (ETS) has been produced by the Joint Technical Committee (JTC) of the European Broadcasting Union (EBU), Comité Européen de Normalisation ELECTrotechnique (CENELEC) and the European Telecommunications Standards Institute (ETSI), and is now submitted for the Voting phase of the ETSI standards approval procedure.

NOTE: The EBU/ETSI JTC was established in 1990 to co-ordinate the drafting of standards in the specific field of broadcasting and related fields. Since 1995 the JTC became a tripartite body by including in the Memorandum of Understanding also CENELEC, which is responsible for the standardization of radio and television receivers. The EBU is a professional association of broadcasting organizations whose work includes the co-ordination of its members' activities in the technical, legal, programme-making and programme-exchange domains. The EBU has active members in about 60 countries in the European broadcasting area; its headquarters is in Geneva.

* European Broadcasting Union
Case Postale 67
CH-1218 GRAND SACONNEX (Geneva)
Switzerland

Tel: +41 22 717 21 11
Fax: +41 22 717 24 81

Digital Video Broadcasting (DVB) Project

Founded in September 1993, the DVB Project is a market-led consortium of public and private sector organizations in the television industry. Its aim is to establish the framework for the introduction of MPEG-2 based digital television services. Now comprising over 200 organizations from more than 25 countries around the world, DVB fosters market-led systems, which meet the real needs, and economic circumstances, of the consumer electronics and the broadcast industry.

Proposed transposition dates	
Date of latest announcement of this ETS (doa):	3 months after ETSI publication
Date of latest publication of new National Standard or endorsement of this ETS (dop/e):	6 months after doa
Date of withdrawal of any conflicting National Standard (dow):	6 months after doa

Blank page

1 Scope

This European Telecommunication Standard (ETS) specifies the transmission of MPEG-2 Transport Streams (TS) between two DVB interfaces as defined in EN 50083-9 [7] within Plesiochronous Digital Hierarchy (PDH) networks working at the ITU-T Recommendation G.702 [8] hierarchical bit-rates of 1 544 kbit/s, 2 048 kbit/s, 6 312 kbit/s, 8 448 kbit/s, 34 368 kbit/s, 44 736 kbit/s and 139 264 kbit/s. The use of any of these bit rates is optional, if however one or more rates are selected the complete specification applies. The definition of the network aspects of the transmission of MPEG-2-TSs is based to the maximum extent on existing international and European standards.

The equipment considered in this ETS is the Network Adapter performing the adaptation between MPEG-2-TSs and the interfaces of PDH networks.

2 Normative references

This ETS incorporates by dated and undated reference, provisions from other publications. These normative references are cited at the appropriate places in the text and the publications are listed hereafter. For dated references, subsequent amendments to or revisions of any of these publications apply to this ETS only when incorporated in it by amendment or revision. For undated references the latest edition of the publication referred to applies.

- [1] ETS 300 417-1-1: "Transmission and Multiplexing (TM); generic functional requirements for Synchronous Digital Hierarchy (SDH) equipment; Part 1: Generic processes and performance".
- [2] ETS 300 417-2-1: "Transmission and Multiplexing (TM); generic requirements of transport functionality of equipment; Part 2-1: SDH and PDH physical section layer functions".
- [3] prETS 300 417-5-1: "Transmission and Multiplexing (TM); generic requirements of transport functionality of equipment; Part 5-1: Plesiochronous Digital Hierarchy (PDH) path layer functions".
- [4] EN 300 421: "Digital Video Broadcasting (DVB); Framing structure, channel coding and modulation for 11/12 GHz satellite services".
- [5] EN 300 429: "Digital Video Broadcasting (DVB); Framing structure, channel coding and modulation for cable systems".
- [6] ETR 290: "Digital Video Broadcasting (DVB); Measurement guidelines for DVB systems".
- [7] EN 50083-9: "Interfaces for CATV/SMATV headends and similar professional equipment".
- [8] ITU-T Recommendation G.702: "Digital hierarchy bit rates".
- [9] ITU-T Recommendation G.703: "Physical/electrical characteristics of hierarchical digital interfaces".
- [10] ITU-T Recommendation G.704: "Synchronous frame structures used at 1544, 6312, 2048, 8 488 and 44 736 kbit/s hierarchical levels".
- [11] ITU-T Recommendation G.706: "Frame alignment and caclic redundancy check (CRC) procedures relating to basic frame structures defined in ITU-T Recommendation G.704".
- [12] ITU-T Recommendation G.707: "Network node interface for the synchronous digital hierarchy".
- [13] ITU-T Recommendation G.783: "Characteristics of Synchronous Digital Hierarchy (SDH) equipment functional blocks".

- [14] ITU-T Recommendation G.804: "ATM cell mapping into plesiochronous digital hierarchy (PDH)".
- [15] ITU-T Recommendation G.823: "The control of jitter and wander within digital networks which are based on the 2 048 kbit/s hierarchy".
- [16] ITU-T Recommendation G.824: "The control of jitter and wander within digital networks which are based on the 1 544 kbit/s hierarchy".
- [17] ITU-T Recommendation G.826: "Error performance parameters and objectives for international, constant bit rate digital paths at or above the primary rate".
- [18] ITU-T Recommendation G.832: "Transport of SDH elements on PDH networks: Frame and multiplexing structure".
- [19] ITU-T Recommendation H.222.0: "Information technology - Generic coding of moving pictures and associated audio information: Systems".
- [20] ITU-T Recommendation I.361: "B-ISDN ATM layer specification".
- [21] ITU-T Recommendation I.363.1: "B-ISDN ATM adaptation layer (AAL) specification".
- [22] ITU-T Recommendation I.432: "B-ISDN user-network interface - physical layer specification".
- [23] ITU-T Recommendation I.732: "Functional characteristics of ATM equipment".
- [24] ITU-T Recommendation J.82: "Transport of MPEG-2 constant bit rate television signals in B-ISDN".
- [25] ITU-T Recommendation M.2120: "Digital paths, section and transmission system fault detection and localization procedures".
- [26] ITU-T Recommendation Q.822: "Stage 1, stage 2 and stage 3 description for the Q3 interface - performance management".

3 Definitions and abbreviations

3.1 Definitions

For the purposes of this ETS, the following definitions apply:

MPEG-2 Transport Stream (TS) packet: A data packet possessing a length of 188 bytes including 4 bytes of header information. The header contains MPEG related data.

RS coded MPEG-2 Transport Stream (TS) packet: A data packet possessing a length of 204 bytes. Bytes 1 to 188 contain an MPEG-2-TS packet. Bytes 189 to 204 contain the parity-check bytes for the error correction of the preceding bytes of this packet. These parity-check bytes are generated using a shortened Reed-Solomon code RS(204,188).

3.2 Abbreviations

For the purposes of this ETS, the following abbreviations apply:

AAL	ATM Adaptation Layer
ASI	Asynchronous Serial Interface
ATM	Asynchronous Transfer Mode
BER	Bit Error Rate
CRC	Cyclic Redundancy Check
CS	Convergence Sublayer
DVB	Digital Video Broadcasting
EMF	Equipment Management Function
FAS	Frame Alignment Signal
FEC	Forward Error Correction
LOF	Loss Of Frame
MAA	MPEG ATM Adaptation
MPEG	Motion Picture Expert Group
MPI	MPEG Physical Interface
NE	Network Element
PDH	Plesiochronous Digital Hierarchy
PDU	Protocol Data Unit
PPI	PDH Physical Interface
PPT	PDH Path Termination
RDI	Remote Defect Indication
RS	Reed-Solomon
SAR	Segmentation And Re-assembly Sublayer
SDH	Synchronous Digital Hierarchy
SN	Sequence Number
SPI	Synchronous Parallel Interface
SSI	Synchronous Serial Interface
TS	Transport Stream
VP	Virtual Path
VPE	VP Entity
VPME	VP Multiplexing Entity

4 Baseline specification

The Network Adapter is an equipment which performs the adaptation of data structured as an MPEG-2-TS to the characteristics of a PDH link (see ITU-T Recommendation H.222.0 [19]). The solution selected for the transmission of MPEG-2-TS packets, respectively RS coded MPEG-2-TS packets, over PDH links is based on the use of ATM cells. Therefore, the adaptation of the transport of an MPEG-2-TS basically consists in:

- adaptation of MPEG-2-TS packets or RS coded MPEG-2-TS packets to ATM cells;
- adaptation of ATM cells to PDH framing.

The normative references applicable to the adaptation unless specifically mentioned are given here below:

- the adaptation of MPEG-2-TS packets into ATM cells using an AAL type 1 shall be performed as described in ITU-T Recommendation J.82 [24].
AAL type 1 is specified in ITU-T Recommendation I.363.1 [21], the ATM layer is specified in ITU-T Recommendation I.361 [20];
- the adaptation of ATM cells into PDH framing shall be performed as described in ITU-T Recommendation G.804 [14].

There is no normative reference for the adaptation of RS coded MPEG-2-TS packets to ATM cells. This adaptation shall be performed as described in ITU-T Recommendation J.82 [24] for MPEG-2-TS packets, with the only exception that the RS coded MPEG-2-TS packets are not aligned with the structure of the AAL1 interleaving matrix.

The Network Adapter is described as a group of functional blocks. The partitioning into functional blocks is based on existing recommendations on Synchronous Digital Hierarchy (SDH) equipment (ITU-T

Recommendation G.783 [13]) and ATM equipment (ITU-T Recommendation I.732 [23]). The equipment consists of the following blocks (see also figure 1):

- MPEG Physical Interface;
- MPEG/ATM Adaptation;
- ATM/VP Termination;
- VP Multiplexing Entity;
- PDH Path Termination;
- PDH Physical Interface; and
- Equipment Management Function.

The present description is a functional description and does not imply any specific equipment implementation but it allows for the implementation of a separate transmitter and receiver as well as a combined transmitter/receiver.

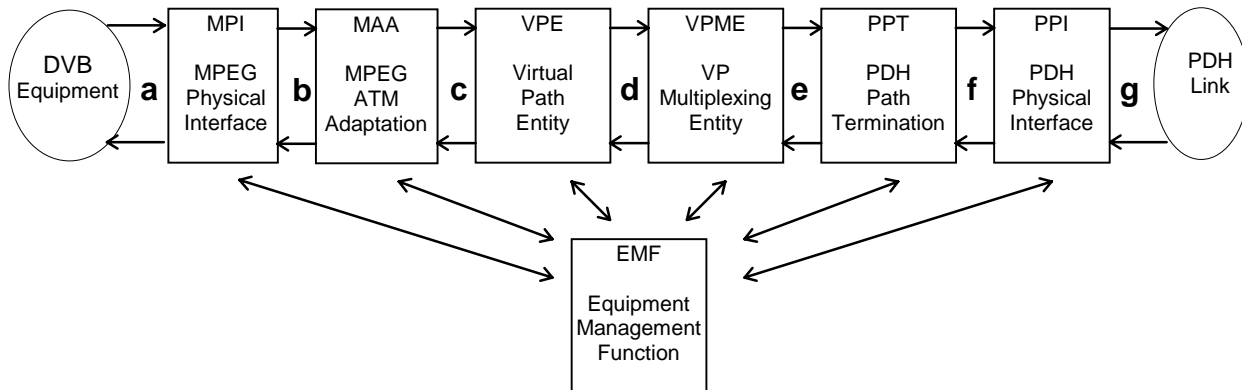

Figure 1: Functional blocks of the Network Adapter

It should be noticed that most of ATM functional blocks contained in ITU-T Recommendation I.732 [23] do not appear in figure 1 as they are not relevant for the adaptation.

This adaptation corresponds to the protocol stack shown in figure 2:

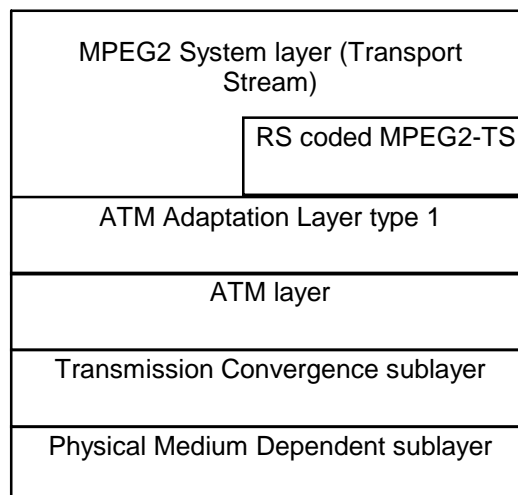

Figure 2: Protocol stack for the adaptation process

The following functional blocks are identified:

- the MPEG-2-TS Physical Interface:

the Network Adapter accepts, at its input port, either an MPEG-2-TS consisting of consecutive MPEG-2-TS packets, or an extended version of an MPEG-2-TS that already contains error protection (RS coded MPEG-2-TS packets). Packets length of 188 bytes and 204 bytes can be handled;

- the MPEG/ATM Adaptation:
 - this corresponds to the adaptation between the MPEG-2-TS respectively the RS coded MPEG-2-TS and the ATM cells via an AAL type 1. This adaptation, besides format adaptation, provides functions for the MPEG-2-TS clock transmission transparency (adaptive clock method) and information transparency using the clock and data recovery mechanism of AAL1. It is expected that under normal transmission conditions the received MPEG-2-TS will be quasi error free, corresponding to a Bit Error Rate (BER) of about 10^{-10} to 10^{-11} at the input of an MPEG-2 equipment at the receiver site. This requirement is in accordance with DVB systems using satellite services EN 300 421 [4] and cable systems EN 300 429 [5];
- the ATM Virtual Path (VP) Termination:
 - the only function performed is the VP setting. It allows the simultaneous transmission of several independent MPEG-2-TS on one PDH link;
- the VP Multiplexing Entity:
 - if different MPEG-2-TS have to be simultaneously transported, the ATM cells belonging to different VPs are multiplexed in the transmitter respectively demultiplexed in the receiver. If only one MPEG-2-TS has to be transported, only one VP is used. The adaptation to the useful bit-rate offered by the PDH link is performed by adding respectively removing idle cells. At the receiver, this block also performs cell delineation and ATM cell header checking;
- the PDH Path Termination:
 - this block generates and terminates all the overhead of the PDH frames carrying ATM cells. The overhead contains information providing Operation Administration and Maintenance functions;
- the PDH Physical Interface:
 - this block prepares the signal for the transmission on the physical medium. Channel encoding is used as described in ITU-T Recommendation G.703 [9] that allows a network clock recovery directly from the received signal;
- the Equipment Management Function:
 - this block manages all the other functional blocks. It ensures the Man Machine Interface.

4.1 MPEG Physical Interface (MPI)

This function provides the interface between the Network Adapter and the MPEG-2-TS sources or receivers. The physical characteristics of this interface shall follow the specification given in EN 50083-9 [7]. Three different types of interfaces are specified. They are called:

- Synchronous Parallel Interface (SPI);
- Synchronous Serial Interface (SSI);
- Asynchronous Serial Interface (ASI).

The interfaces use the MPEG-2-TS Packet structure (188 bytes) or the RS-coded packet structure (204 bytes). For the SPI and the SSI, the 204-byte format may be used either for the transmission of 188-byte MPEG-2-TS packets with 16 dummy bytes, or for the transmission of 204-byte RS-coded packets.

In order to prevent alarms being raised and failures being reported during set-up procedures or if the input port is not in use (in the case of a multi-port equipment), the MPI function shall have the ability to enable

or disable fault case declaration. The MPI shall be either monitored (MON) or not monitored (NMON). The state MON or NMON is provisioned by the equipment manager to the MPI via the EMF function.

4.1.1 Signal processing in the transmitter

Signal flow from a-to-b (figure 1).

a) Recovery of MPEG-2 packets

This function recovers the data bytes and their clock from the received signals:

- for the SPI, this recovery is based on the use of the Data (0-7), the DVALID , PSYNC and clock signals, as specified in subclause 4.1 of EN 50083-9 [7];
- for the SSI interface, the processing includes optical receiver (for fibre-optic-based link) or coupling/impedance matching (for coaxial cable), amplifier/buffer, clock recovery and bi-phase decoding, serial to parallel conversion, as specified in annex A of EN 50083-9 [7];
- for the ASI interface, the processing includes optical receiver (for fibre-optic-based link) or coupling/impedance matching (for coaxial cable), amplifier/buffer, clock/data recovery and serial-to-parallel conversion, FC comma deletion, 8B/10B decoding, as specified in annex B of EN 50083-9 [7]. In the next step, the recovery of the TS clock is performed (see annex E of EN 50083-9 [7]: Implementation guidelines and deriving clocks from the MPEG-2 packets for the ASI).

The function also realizes the sync acquisition of the MPEG-2-TS packets respectively of the RS-coded MPEG-2-TS packets, on the basis of the method proposed in subclause 3.2 of ETR 290 [6] (five consecutive correct sync bytes for sync acquisition; two or more consecutive corrupted sync bytes should indicate sync loss).

The packet size (188 bytes or 204 bytes) may be recovered from the received signals, on the basis of the PSYNC signal for the parallel interface, or on the basis of periodicity of the synchronization bytes for the serial interfaces. For the case of the SPI and of the SSI interface, the decision between 204-byte format for MPEG-2-TS packets with 16 dummy bytes and 204-byte format for RS-coded MPEG-2-TS packets can be made:

- on the basis of the DVALID signal for the SPI: a high level during the last 16 bytes indicate RS redundancy bytes (subclause 4.1.1 of EN 50083-9 [7]); or
- on the basis of the value of received synchronization bytes for the SSI interface: 47H indicates 204-byte format with 16 dummy bytes and B8H indicates 204-byte RS coded (subclause A.3.2 of EN 50083-9 [7]).

For the case of the ASI Interface, the following decision is taken: if the packet size is 204 bytes, it is an RS-coded MPEG-2-TS packet.

Dummy bytes are discarded by the MPI function in the case of the 204-byte format with 16 dummy bytes.

The function passes the recovered MPEG-2-TS packets or the RS coded MPEG-2-TS packets and the timing information to point b of figure 1.

The function shall meet the electrical/optical characteristics, return loss and jitter requirements specified in EN 50083-9 [7].

This function shall also detect:

- the absence of valid input signals;
- the absence of clock;
- a DVALID signal constantly low in the case of the SPI.

If any of these defects is detected, a Loss Of Signal (LOS) is reported at the EMF if the function is in MON state.

If a loss of synchronization of MPEG-2-TS packets or RS coded MPEG-2-TS packets is detected according to the procedure proposed in ETR 290 [6] subclause 3.2 (i.e. two or more consecutive corrupted sync bytes are found), a TS-sync_loss error on the input signal (TSLE_I) is reported at the EMF if the function is in MON state.

b) Performance monitoring

Errored blocks are detected on the basis of the transport_error_indicator present in the headers of the incoming MPEG-2-TS packets, in accordance to ETR 290 [6]. One second filters perform a simple integration of errored blocks by counting during one second interval. The function generates the following performance parameters concerning the input MPEG-2-TS signal received on the interface:

- N_EBC_I: every second, the number of errored blocks within that second is counted as the Near-End Error Block Count (N_EBC_I);
- N_DS_I: every second with at least one occurrence of TSLE_I or LOS (corresponding to the notion of Severely Disturbed Period introduced in ETR 290 [6]) shall be indicated as Near-End Defect Second (N_DS_I).

If the function is in the MON state, at the end of each one second interval, the contents of the N_EBC_I counter and of the N_DS_I indicator are reported to the EMF. Furthermore, on request of the EMF block, the MPI block evaluates and reports to the EMF the number of received MPEG-2-TS packets within one second (BC_I).

4.1.2 Signal processing in the receiver

Signal flow from b-to-a (figure 1).

a) Generation of the signals at the MPEG physical interface

This function receives the data bytes provided at the reference point b of figure 1 by the MAA block and recovers the synchronization of the MPEG-2-TS packets or of the RS coded MPEG-2-TS packets on the basis of the method proposed in subclause 3.2 of ETR 290 [6] (five consecutive correct sync bytes for sync acquisition; two or more consecutive corrupted sync bytes should indicate sync loss). The type of packet (MPEG-2-TS packet or RS-coded MPEG-2-TS packet) is determined on the basis of the periodicity of the synchronization bytes. After the recovery of the packet structure and only in the case of a MPEG-2-TS packet structure, the function shall use the status indicator of the AAL-SAP (available at reference point b) to set the transport_error_indicator of the MPEG-2-TS packets.

The function determines the transmission format to be used at the output interface according to the following table 1:

Table 1: Transmission format of the output interface

Type of packets received by the MPI block	Transmission format on the physical interface	
MPEG-2-TS packets (188 bytes)	SPI; SSI:	188-byte packets or 204-byte packets with 16 dummy bytes, according to the parameter FORMAT provided by the EMF block
	ASI:	188-byte packets
RS-coded MPEG-2-TS packets (204 bytes)	SPI; SSI; ASI:	204-byte packets

The function generates the appropriate signals at the output interface, according to the type of physical interface and to the transmission format selected:

- For the SPI, the function generates the data (0-7), the DVALID, PSYNC and clock signals, as specified in subclause 4.1 of EN 50083-9 [7];

- For the SSI interface, the processing includes parallel to serial conversion, bi-phase coding, amplifier/buffer and optical emitter (for fibre-optic-based link) or coupling/impedance matching (for coaxial cable), as specified in annex A of EN 50083-9 [7];
- For the ASI interface, the processing includes 8B/10B coding, FC comma symbols insertion, parallel-to-serial conversion, amplifier buffer and optical emitter (for fibre-optic-based link) or coupling/impedance matching (for coaxial cable), as specified in annex B of EN 50083-9 [7].

The function shall meet the electrical/optical characteristics, return loss and jitter requirements specified in EN 50083-9 [7].

If a loss of synchronization of MPEG-2-TS packets or of the RS coded MPEG-2-TS packets is detected according to the procedure proposed in the subclause 3.2 of ETR 290 [6] (i.e. two or more consecutive corrupted sync bytes are found), a TS-sync_loss error for the output signal (TSLE_O) is reported at the EMF if the function is in MON state.

b) Performance monitoring

Errored blocks are detected on the basis of the transport_error_indicator present in the headers of the MPEG-2-TS packets regenerated in the MPI block, in accordance to ETR 290 [6]. One second filters perform a simple integration of errored blocks by counting during one second interval. The function generates the following performance parameters concerning the output MPEG-2-TS signal delivered by the interface:

- N_EBC_O: every second, the number of errored blocks within that second is counted as the Near-End Error Block Count N_(EBC_O);
- N_DS_O: every second with at least one occurrence of TSLE_O or LOS (corresponding to the notion of Severely Disturbed Period introduced in ETR 290 [6]) shall be indicated as Near-End Defect Second (N_DS_O).

If the function is in the MON state, at the end of each one second interval, the contents of the N_EBC_O counter and of the N_DS_O indicator are reported to the EMF. Furthermore, on request of the EMF block, the MPI block evaluates and reports at the EMF the number of received MPEG-2-TS packets within one second (BC_O).

4.2 MPEG/ATM Adaptation (MAA)

The MAA utilizes the AAL type 1. The AAL type 1 is described in ITU-T Recommendation I.363.1 [21] where its functions are described for all corresponding applications. Specifically, the utilization of the AAL 1 for the transport of MPEG-2 constant bit rate television signals is described in ITU-T Recommendation J.82 [24] section 7. As a result, the description of the MPEG/ATM Adaptation is based on ITU-T Recommendation J.82 [24] subclause 7. The structure of AAL type 1 is given in figure 3. The Segmentation And Re-assembly - Protocol Data Unit (SAR-PDU) payload of 47 octets is headed by an SAR-PDU header of 8 bits. For the transmission the payload data is protected by an FEC scheme.

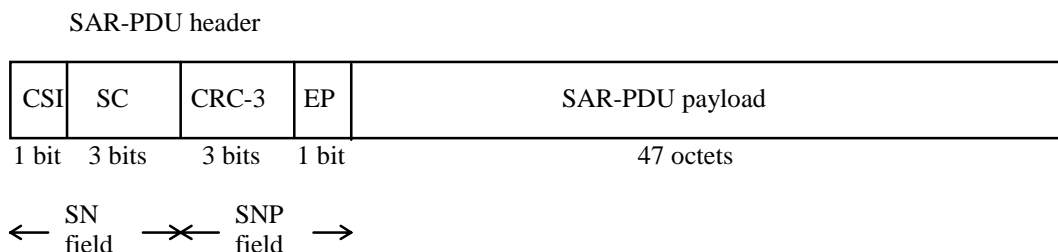

Figure 3: Structure of AAL type 1

To prevent alarms being raised and failures being reported during set-up procedures, or if the input port is not in use (in the case of a multi-port equipment), the MAA function shall have the ability to enable or disable fault case declaration. The MAA shall either be monitored (MON) or not monitored (NMON). The state MON or NMON is provisioned by the equipment manager to the MAA via the EMF function.

4.2.1 Signal processing in the transmitter

Signal flow from b-to-c (figure 1).

The MAA accepts signals from the MPI and conveys them to the VPE by using a transmitting AAL1. From the protocol stack point of view, signals are transported from the AAL-SAP (AAL-Service Access Point) to the ATM-SAP.

Functions to be performed are those of the AAL1-CS (Convergence Sublayer) and of the AAL1-SAR (Segmentation and Re-assembly). The results of this functions are used to set the appropriate fields of the SAR-PDU header. The SAR Sublayer accepts a 47 octet block of data from the CS layer and prepends a one-octet SAR-PDU header.

a) Handling of user information (CS function)

In compliance with ITU-T Recommendation J.82 [24] paragraph 7.1 the length of the AAL-SDU (Service Data Unit) is one octet.

b) Handling of lost and mis-inserted cells (SC field) (CS function)

In the transmitting CS this function is related to the Sequence Count (SC) processing. After processing, the 3-bit sequence count value is passed to the transmitting SAR in order to be inserted in the SC field of the SAR-PDU header (see ITU-T Recommendation J.82 [24] subclause 7.3).

c) Handling of the timing relationship (CS function)

As it is stated in ITU-T Recommendation J.82 [24] subclause 7.4., the adaptive clock method shall be used. In this method, no function is to be performed in the transmitting CS.

d) Forward error correction for SAR-PDU payload (CS function)

This function is performed by the method described in detail in ITU-T Recommendation I.363.1 [21] subclause 2.5.2.4.2. As stated in ITU-T Recommendation J.82 [24], subclause 7.5, this method shall be used.

Basically the method combines octet interleaving (the size of the inter-leaver is 128×47 octets), and FEC using RS (124,128) codes.

In the transmitting CS, 4 octets of RS code are appended to 124 successive octets of incoming data from the AAL-SAP. The resulting 128 octet long blocks are then forwarded to the octet inter-leaver. See figure 4 for the format of the inter-leaver matrix.

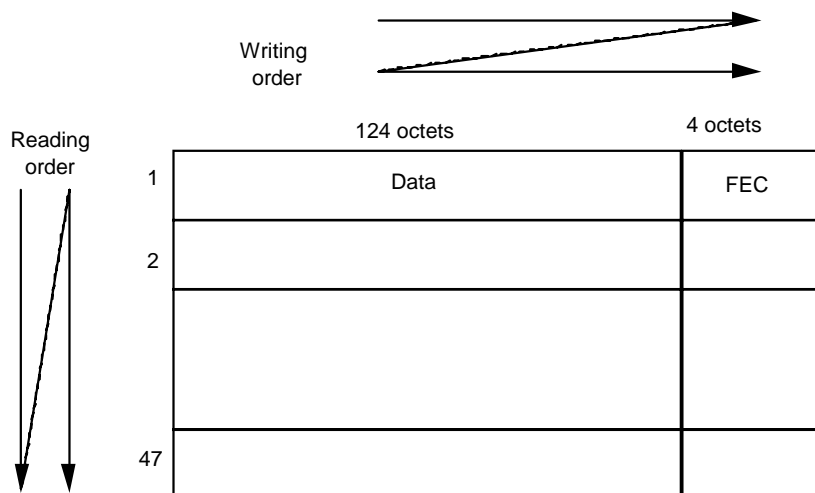

Figure 4: Structure and format of the inter-leaver matrix

The octet inter-leaver is organized as a matrix of 128 columns and 47 rows. In the transmitting CS, the inter-leaver is operated as follows: at the input, incoming 128 octet long blocks are stored row by row (one block corresponding to one row); at the output, octets are read out column by column. The matrix has $128 \times 47 = 6\ 016$ octets, corresponding to 128 SAR-PDU payloads. These 128 SAR-PDU payloads constitute one CS-PDU.

When MPEG-2-TS packets of 188 octets are transmitted by the MPI, then the inter-leaver contains exactly 31 MPEG-2-TS packets. In the case when RS coded MPEG-2-TS packets of 204 octets are transmitted, then the number of RS coded MPEG-2-TS packets contained in the inter-leaver is not an integer number. This has no impact on the processing.

Columns from the inter-leaver are then passed to the SAR where a SAR-PDU header is put in front of each of them.

e) Synchronization of the CS-PDU (CS function)

The CSI bit is used to synchronize the interleaving matrix, i.e. the CS-PDU. Following ITU-T Recommendation J.82 [24], subclause 7.5, the CSI bit is set to "1" for the first SAR-PDU payload of the CS-PDU.

f) Protection of the sequence number field (SAR function)

The first four bits of every SAR-PDU header form the Sequence Number (SN) field. This SN field is protected by a 3-bit CRC code following the calculation described in subclause 2.4.2.2 of ITU-T Recommendation I.363.1 [21]. The result of this calculation, the remainder of the division (modulo 2) by the generator polynomial $x^3 + x + 1$ of the product x^3 multiplied by the content of the SN field, is written into the CRC field.

g) Protection of the SAR-PDU header (SAR function)

The first seven bits of each SAR-PDU header are protected by an even parity check bit that is written into bit EP of the actual SAR-PDU header.

The AAL1 SAR passes 48 octet blocks to the VPE.

4.2.2 Signal processing in the receiver

Signal flow from c-to-b (figure 1).

The MAA receives signals from the VPE block and conveys them to the MPI block by using a receiving AAL1. From the protocol stack point of view, signals are transported from the ATM-SAP (ATM-Service Access Point) to the AAL-SAP.

Functions to be performed are those of the AAL1-SAR (Segmentation and Re-assembly) and of the AAL1-CS (Convergence Sublayer). The content of the SAR-PDU header is evaluated in order to specify relevant functions of the AAL1-SAR respectively of the AAL1-CS.

The MAA receives from the VPE 48 octet long blocks corresponding to cell payloads. The SAR separates the SAR-PDU header (one octet) and passes the 47 octet block of data to the receiving CS.

a) Evaluation of the SNP field (CRC-3 field and EP bit) (SAR function)

The SAR protocol is described in ITU-T Recommendation I.363.1 [21] subclause 2.4.2. After processing of the SNP field (Sequence Number Protection) the Sequence Count field and the CSI bit are passed to the receiving CS together with the SN check status indicator (valid or invalid). The use of the SN check status together with the considered processing is described in detail in ITU-T Recommendation I.363.1 [21] subclause 2.4.2.2 and in table 1.

If the SN check status indicator has been set to invalid, a SNI (Sequence Number Invalid) indication is forwarded to the EMF.

b) Handling of user information (CS function)

In compliance with ITU-T Recommendation J.82 [24] paragraph 7.1, the length of the AAL-SDU (Service Data Unit) is one octet and the status parameter is used.

As mentioned in ITU-T Recommendation I.361.1 [21], the status parameter possesses two values: "valid" and "invalid". "Invalid" is used in the case where errors have been detected and have not been corrected (for the use of this parameter see description under e)).

c) Handling of lost and mis-inserted cells (CS function)

Detection of lost and mis-inserted cell events is performed by using the Sequence Count (SC) value transmitted by the receiving SAR. The CS processing for SC operation is described in detail in ITU-T Recommendation I.363.1 [21] subclause 2.5.2.1.2.

In the receiving AAL1-CS, the processing is as follows: the SC is processed in order to detect cell loss events. In case of a detected cell loss, 47 dummy octets are inserted in the signal flow in order to maintain bit count integrity. Detected mis-inserted cells are merely discarded.

Lost and Mis-inserted Cells (LMC) events are transmitted to the EMF.

d) Handling of the timing relationship (CS function)

The end to end synchronization function is performed by the adaptive clock method described in ITU-T Recommendation I.363.1 [21] subclause 2.5.2.2.2. A short description of the method is given in informative annex A. It is pointed out that the adaptive clock method does not need any external clock to be operated.

e) Correction of bit errors and lost cells (CS function)

In the receiving AAL1-CS, the mechanism in the inter-leaver is the inverse of that of the transmitting inter-leaver, i.e. the writing order is vertically and the reading order is horizontally. Information is stored in the receiving inter-leaver column by column. In the case of insertion of dummy octets, an indication is provided in order to enable the use of the erasure mode of the RS codes. After the whole interleaving matrix has been stored, it is read out block by block to the RS decoder where errors and erasures are corrected.

Correction capabilities are up to 4 cell losses in a group of 128 cells and up to 2 errored octets in a block of 128 octets. It ensures that under normal transmission condition, the received MPEG-2-TS flow is quasi error free.

If the RS decoder is unable to correct the errors, then the "status" indicator of the AAL-SAP shall be used (see ITU-T Recommendation J.82 [24] paragraph 7.1) in order to signal this error. The indicator is passed to the MPI block and to the EMF.

4.3 Virtual Path Entity (VPE)

Among all the functions referenced in ITU-T Recommendation I.732 [23] for this functional block, only the VP setting is ensured. This function only concerns the signal flow from point c to point d in figure 1. The ATM cell header that contains the virtual path identifier VPI is organized as shown in figure 5.

8	7	6	5	4	3	2	1	bit / / byte
Generic Flow Control GFC				Virtual Path Identifier VPI				1
Virtual Path Identifier VPI				Virtual Channel Identifier VCI				2
Virtual Channel Identifier VCI								3
Virtual Channel Identifier VCI				Payload Type Field PT		CLP		4
Header Error Control HEC								5

Figure 5: Structure of an ATM cell header

4.3.1 Signal processing in the transmitter

Signal flow from c-to-d (figure 1).

VP setting:

The VPI value is processed in accordance with the assigned values. As far as no VC related block is implemented in the Network Adapter, VC setting is also performed in this block to the fixed value 0020h. Besides, the three bits of the PT field are set to 000 (user data cell, congestion not experienced, ATM -user-to-ATM-user indication = 0, in ATM terminology). VPI value 00h is forbidden. Any other value may be used. However, it is suggested to use the VPI values listed in table 2:

Table 2: Default values for the setting of the VPI

Number of MPEG-2-TS to be simultaneously transported	MPEG-2-TS number	VPI value
1	MPEG-2-TS n° 1	11h
2	MPEG-2-TS n° 1 MPEG-2-TS n° 2	11h 12h
3	MPEG-2-TS n° 1 MPEG-2-TS n° 2 MPEG-2-TS n° 3	11h 12h 13h
4	MPEG-2-TS n° 1 MPEG-2-TS n° 2 MPEG-2-TS n° 3 MPEG-2-TS n° 4	11h 12h 13h 14h
5	MPEG-2-TS n° 1 ... MPEG-2-TS n° 4 MPEG-2-TS n° 5	11h ... 14h 15h
6	MPEG-2-TS n° 1 ... MPEG-2-TS n° 5 MPEG-2-TS n° 6	11h ... 15h 16h
7	MPEG-2-TS n° 1 ... MPEG-2-TS n° 6 MPEG-2-TS n° 7	11h ... 16h 17h
8	MPEG-2-TS n° 1 ... MPEG-2-TS n° 7 MPEG-2-TS n° 8	11h ... 17h 18h

The VPI values used are setable by the EMF. The default values used are in accordance with table 2.

4.3.2 Signal processing in the receiver

Signal flow from d-to-c (figure 1).

No function of the VPE is implemented in this direction.

4.4 Virtual Path Multiplexing Entity (VPME)

This functional block is responsible for the adaptation between an ATM cell structure and a PDH transmission path structure. The partitioning of the VPME into functional blocks as described below is in accordance with ITU-T Recommendation I.732 [23]. The organization of the ATM cell header which content is partly set in this functional block is shown in figure 5.

In order to prevent alarms being raised and failures being reported during path provisioning, the VPME function shall have the ability to enable or disable fault cause declaration. The Virtual Path Multiplexing Entity shall be either monitored (MON) or not monitored (NMON). The state MON or NMON is provisioned by the equipment manager to the VPME via the EMF function. The state of the VPME and the associated PPT and PPI shall be identical.

4.4.1 Signal processing in the transmitter

Signal flow from d-to-e (figure 1).

VP multiplexing:

This function enables individual cell flows to be logically combined into a single cell flow according to the VPI values.

Congestion control:

This function is not used in this equipment. The cell loss priority bit CLP shall be set to "0" (corresponding to high cell priority in ATM terminology).

GFC: This function is not used in this equipment. The GFC field shall be set to "0000" (corresponding to uncontrolled equipment in ATM technology).

PT field:

This function is not used in this equipment. The three bits of the PT field shall be set to "000".

Cell rate decoupling:

Idle cells are inserted into the cell stream in order to match the rate of the PDH transmission path payload (i.e. the useful rate of the PDH path) in accordance with ITU-T Recommendation I.432 [22]. The format of the idle cell shall be in accordance with ITU-T Recommendation I.432 [22] (figure 6).

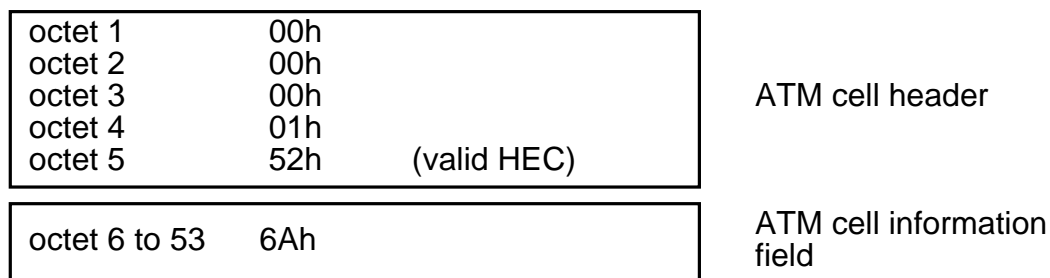

Figure 6: Cell rate decoupling

HEC processing:

The HEC value for each cell is calculated and inserted into the HEC field. The method of HEC value calculation shall be in accordance with ITU-T Recommendation I.432 [22]. Basically the HEC field is the remainder of the division (modulo 2) by the generator polynomial $x^8 + x^2 + x + 1$ of the product x^8 multiplied by the content of the header excluding the HEC field, to which is added the value 55h.

Scrambling:

The information field of each cell is scrambled with a self synchronizing scrambler $x^{43} + 1$. The operation of the scrambler shall be in accordance with ITU-T Recommendation I.432 [22].

Cell stream mapping:

The cell stream shall be inserted into PDH transmission path payload which shall be in accordance with ITU-T Recommendation G.804 [14] wherever possible. The mapping into 44 736 kbit/s shall occur HEC-based as described in subclause 7.3 of ITU-T Recommendation G.804 [14]. The frame structure for each transmission data rate considered is shown in subclause 4.5. The cell boundaries are aligned with the transmission path octet boundaries if an octet structure is considered.

4.4.2 Signal processing in the receiver

Signal flow from e-to-d (figure 1).

Cell stream de-mapping:

The cell stream shall be extracted from PDH transmission path payload which shall be in accordance with ITU-T Recommendation G.804 [14] wherever possible. The de-mapping of cells out of the 44 736 kbit/s data stream has to take into account the HEC-based mapping scheme mentioned above. The frame structure for each transmission data rate considered is shown in subclause 4.5. The cell boundaries are aligned with the transmission path octet boundaries if an octet structure is considered.

Cell delineation:

Cell delineation is performed on the continuous cell stream extract from the transmission path frames. The cell delineation algorithm shall be in accordance with ITU-T Recommendation I.432 [22]. Basically it bases on the correlation between the header bits to be protected (32 bits) and the relevant control bits (8 bits) introduced in the header by the HEC. Cell delineation is deemed to be lost causing a LCD defect after 7 consecutive incorrect HECs. Cell delineation is deemed to be recovered after 6 consecutive correct HECs. If the function is in the MON state, the LCD defect is reported to the EMF.

Descrambling:

The information field of each cell is descrambled with a self-synchronizing scrambler polynomial $x^{43} + 1$. The operation of the descrambler shall be in accordance with ITU-T Recommendation G.804 [14].

HEC processing:

HEC verification and correction bases on the methods described in ITU-T Recommendation I.432 [22]. The HEC correction mode may be activated/deactivated by the EMF. In case of cells determined to have an invalid and un-correctable HEC pattern, two options are possible. Either the invalid cells may be discarded (in accordance with ITU-T Recommendation I.432 [22]) or the invalid cells may not be discarded (not in accordance with ITU-T Recommendation I.432 [22]). The wanted option is selected by the EMF. Further information is given in the informative annex B.

Cell rate decoupling:

Idle cells are extracted from the cell stream. They are identified by the standardized pattern for the cell header.

PT identification:

This function is not implemented. The corresponding bits are ignored.

Cell header verification:

The receiving Network Adapter shall verify that the first four octets of the ATM cell header are recognizable as being a valid header pattern. Invalid header pattern are (p = any value):

GFC	VPI	VCI	PT	CLP
pppp	0000 0000	0000 0000 0000 0000	ppp	1

Figure 7: Cell header verification

Idle cells are discarded.

GFC check:

This function is not implemented. The corresponding bits of the GFC field are ignored.

VPI verification:

The receiving Network Adapter shall verify that the VPI of the received cell is valid. If the VPI is determined to be invalid (i.e. out of range or unassigned - see subclause 4.3, item "VP setting"), the cell shall be discarded.

Congestion control:

This function is not implemented. The corresponding bit CLP is ignored.

VP demultiplexing:

This function enables the flow of cells which have to be logically separated into individual data flows according to their VP values.

4.5 PDH Path Termination (PPT)

This function acts as a source and sink for the overhead information and for data reserved for future use.

Seven types of PPT are defined for the following digital hierarchy bit rates of ITU-T Recommendation G.702 [8]:

- 1 544 kbit/s path termination;
- 2 048 kbit/s path termination;
- 6 312 kbit/s path termination;
- 8 448 kbit/s path termination;
- 34 368 kbit/s path termination;
- 44 736 kbit/s path termination;
- 139 264 kbit/s path termination.

The transmission capacity at each hierarchical bit rate for the MPEG-2-TS respectively the RS-coded MPEG-2-TS is given in informative annex C taking into account the RS (128, 124) code, the data amount of the SAR-PDU header and the overhead information at each hierarchical level.

To prevent alarms being raised and failures being reported during path provision, the PPT function shall have the ability to enable or disable fault cause declaration. The PPT shall be either monitored (MON) or not monitored (NMON). The state MON or NMON is provided by the equipment manager to the PPT via the EMF function. The state of the PPT and the associated PPI and the associated VPME shall be identical.

4.5.1 Path termination 1 544 kbit/s

The multiframe structure for the 24 frame multiframe at 1 544 kbit/s as specified in subclause 2.1 of ITU-T Recommendation G.704 [10] shall be used. A multiframe comprises 24 bits of overhead as shown in figure 8. The data are mapped into bits 2 to 129 of successive frames with the octet structure of the data word aligned with the octet structure of the frame.

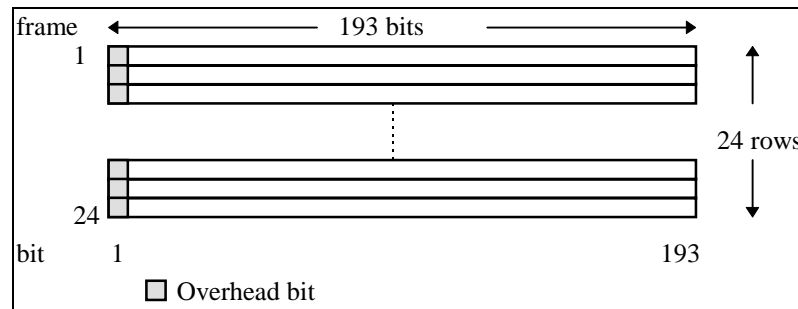

Figure 8: Multiframe at 1 544 kbit/s

4.5.1.1 Signal processing in the transmitter

Signal flow from e-to-f (figure 1).

Data at point e is a 1 544 kbit/s signal with the first bit of each frame, the F-bit, undefined. This bit is used for such purposes as frame alignment, performance monitoring and data link.

a) Multiframe Alignment Signal (MAS)

The function shall insert the 1 544 kbit/s multiframe frame alignment signal according to subclause 2.1.3.1.1 of ITU-Recommendation G.704 [10].

b) CRC-6 code (CRC)

The function shall compute the CRC-6 code value and shall insert it into the following multiframe according to subclause 2.1.3.1.2 of ITU-T Recommendation G.704 [10].

c) Data Link (DL)

The F-bit of every odd frame within a multiframe is undefined.

4.5.1.2 Signal processing in the receiver

Signal flow from f-to-e (figure 1).

Data at point f is a 1 544 kbit/s signal with a frame structure and overhead bits as described in ITU-T Recommendation G.704 [10].

a) Multiframe alignment

The function shall perform the multiframe alignment of the 1 544 kbit/s signal in order to recover the multiframe alignment signal according to subclause 2 of ITU-T Recommendation G.706 [11].

Frame alignment is deemed to have been lost (entering Out Of Frame (OOF) state) when 3 consecutive FAS are detected in error (i.e. one or more errors in each FAS).

Frame alignment is deemed to have been recovered (entering In Frame state, IF) when for the first time the presence of the correct FAS is detected.

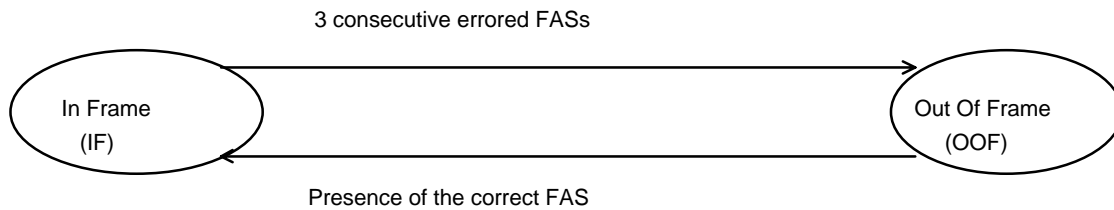

Figure 9: Frame alignment state diagram

If the frame alignment is deemed to be lost (OOF state), a LOF (Loss Of Frame) defect shall be set-up. The LOF defect shall be cleared when the frame alignment is deemed to have been recovered (IF state). On declaration of LOF, the function shall output an all-ONEs (AIS) signal within 250 μ s. On clearing of LOF, the function shall output normal data within 250 μ s. If the function is in the MON state, the LOF defect is reported to the EMF.

b) CRC-6 monitoring

According to subclause 2.1.3.1.2 of ITU-T Recommendation G.704 [10], the CRC-6 value is computed for each bit of the previous multiframe and compared with the value recovered from the current multiframe. A difference between the computed and the recovered value is taken as evidence of one or more errors in the computation block.

c) Alarm Indication Signal (AIS)

The criteria for detection and clearance of an AIS are given in subclause 8.2.1.7 of ETS 300 417-1-1 [1] for 1,5 Mbit/s with $X = 2$, $Y = 4$ 632 and $Z = 3$. On declaration of AIS, the function shall output an all-ONEs (AIS) signal within 250 μ s. On clearing of AIS, the function shall output normal data within 250 μ s. If the function is in the MON state, in the event of an AIS, an AIS defect is reported at the EMF.

d) Performance monitoring

For performance monitoring, the information passed to the EMF is the one second count.

One second filters perform a simple integration of errored blocks by counting during a one second interval. In addition, defects are filtered by the one second filter.

This function generates the following performance parameters:

- N_EBC: Every second, the number of errored Near-end Blocks (N_B) within that second is counted as the Near-end Error Block Count (N_EBC). A N_B is errored if one or more CRC-6 violations are detected.
- N_DS: Every second with at least one occurrence of LOF or AIS shall be indicated as a Near-end Defect Second (N_DS).

If the function is in the MON state, at the end of each one second interval the contents of N_EBC and N_DS counters are reported to the EMF.

4.5.2 Path termination 2 048 kbit/s

The multiframe structure at 2 048 kbit/s as specified in subclause 2.3 of ITU-T Recommendation G.704 [10] shall be used. One basic frame comprises 30 octets of payload and one octet of overhead. One octet is reserved for future use. A multiframe comprises 16 octets of overhead as shown in figure 10. The data is mapped into the time slots 1 to 15 and 17 to 31 of successive frames with the octet structure of the data word aligned with the octet structure of the frame.

Each multiframe is divided into two 8-frame Sub-MultiFrames (SMF), designated SMF I and SMF II, which signifies their respective order of occurrence within the multiframe structure. SMF I includes frame numbers 0 to 7, SMF II the frame numbers 8 to 15 of each multiframe.

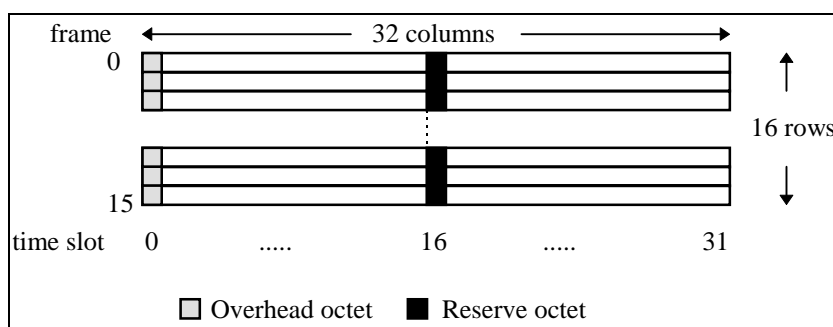

Figure 10: Multiframe at 2 048 kbit/s

4.5.2.1 Signal processing in the transmitter

Signal flow from e-to-f (figure 1).

Data at point e is a 2 048 kbit/s signal with undefined time slot 0 (TS0) and a reserved time slot 16 (TS16) for signalling. The CRC-4 multiframe structure is used basing on the specifications given in ITU-T Recommendation G.704 [10].

Data in time slot 0

a) Frame Alignment Signal (FAS)

The function shall insert the 2 048 kbit/s frame alignment signal as defined in ITU-T Recommendation G.704 [10]. Additionally, bit 2 in frames not containing the frame alignment signal shall be fixed at "1".

b) CRC4 Multiframe Alignment Signal (MFAS)

The function shall insert the CRC-4 multiframe alignment signal as indicated in ITU-T Recommendation G.704 [10].

c) CRC-4 Code

The function shall compute the CRC-4 code value and shall insert it into the following sub-multiframe according to subclause 2.3.3.5 of the ITU-T Recommendation G.704 [10].

d) Remote Defect Indication (A bit)

The A bit shall be set to "1" until both basic frame and CRC-4 multiframe alignment are established. Thereafter, the A bit shall be used as RDI: If a Loss Of Frame (LOF) or an AIS defect is detected in the receiving direction, a logical "1" shall be inserted in the A bit within 250 μ s.

NOTE: In case of unidirectional transmission, there is no associated receiving path termination and the A bit shall be set to a logical "0".

e) Remote Error Indication (E bits)

The E bits shall be used for remote error indication as described in subclause 2.3.3.4 of ITU-T Recommendation G.704 [10].

NOTE: In case of unidirectional transmission, there is no associated receiving path termination and the E bits shall be set to a logical "1".

f) Sa bits

Sa bits are undefined.

Data in time slot 16

Data in time slot 16 is undefined.

4.5.2.2 Signal processing in the receiver

Signal flow from f-to-e (figure 1).

Data at point f is a 2 048 kbit/s signal with a CRC-4 multiframe structure as described in ITU-T Recommendation G.704 [10].

a) Frame alignment

The function shall perform the (multi)frame alignment of the 2 048 kbit/s signal in order to recover the (multi)frame start signal (M)FS according to subclause 4 of ITU-T Recommendation G.706 [11].

Frame alignment is deemed to have been lost (entering Out Of Frame (OOF) state) when either:

- 3 consecutive FAS are detected in error (i.e. 1 or more errors in each FAS);
- 3 consecutive bit 2 in TS0 of frames not containing FAS are detected in error;
- CRC-4 multiframe alignment is not found in 8 ms; or
- 915 or more errored CRC-4 blocks are detected in one second.

Frame alignment is deemed to have been recovered (entering In Frame (IF) state) when the conditions described in subclause 4.1.2 of ITU-T Recommendation G.706 [11] are fulfilled (see also figure 11).

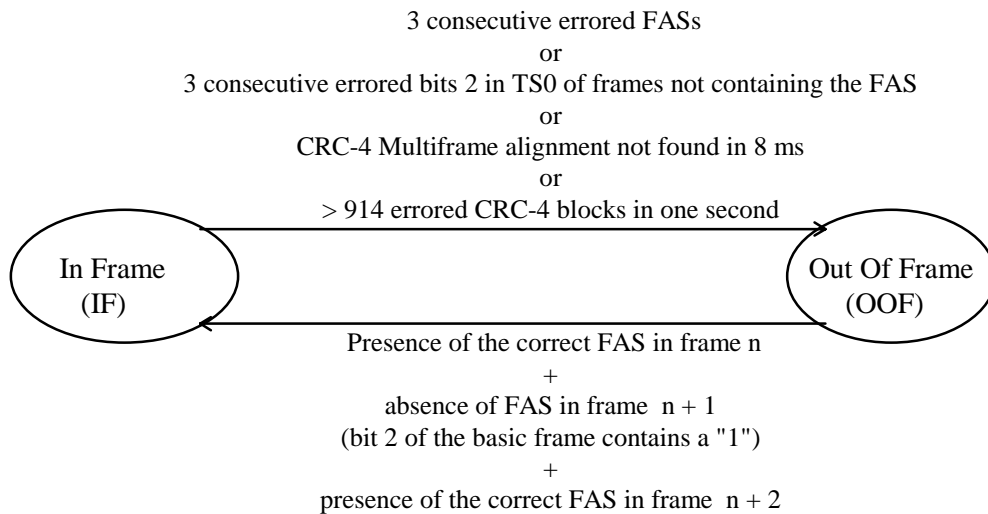

Figure 11: Frame alignment state diagram

NOTE 1: This frame alignment algorithm is based on the assessment that all PDH path termination at 2 048 kbit/s process the CRC-4.

If the frame alignment is deemed to be lost (OOF state), a Loss Of Frame (LOF) defect shall be set-up. The LOF defect shall be cleared when the frame alignment is deemed to have been recovered (IF state). On declaration of LOF, the function shall output an all-ONEs (AIS) signal within 250 μs. On clearing of LOF, the function shall output normal data within 250 μs. If the function is in the MON state, the LOF defect is reported to the EMF.

b) CRC-4 Monitoring

According to subclause 2.3.3.5 of ITU-T Recommendation G.704 [10], the CRC-4 value is computed for each bit of the previous sub-multiframe and compared with the value recovered from the current sub-multiframe. A difference between the computed and the recovered value is taken as evidence of one or more errors in the computation block.

c) Remote Defect Indication (RDI)

The RDI is recovered from bit A in order to enable single ended maintenance of a bi-directional path. The RDI provides information on the status of the remote receiver. A "1" indicates a RDI state, while a "0" indicates the normal working state. If 5 consecutive frames contain the value "1" in bit 1 of MA byte, a RDI defect shall be declared. The RDI defect shall be cleared if 5 consecutive frames contain the value "0" in bit 1 of MA byte. If the function is in the MON state, the RDI is reported to the EMF.

NOTE 2: In case of unidirectional transmission, the A bit is ignored.

d) Remote Error Indication (REI)

The REI is recovered from bits E in order to enable single ended maintenance of a bi-directional path. The REI shall be used to monitor performance of the reverse direction of transmission.

NOTE 3: In case of unidirectional transmission, the E bits are ignored.

e) Alarm Indication Signal (AIS)

The criteria for detection and clearance of an AIS are given in subclause 8.2.1.7 of ETS 300 417-1-1 [1] for 2 Mbit/s with $X = 2$, $Y = 512$ and $Z = 3$. On declaration of AIS, the function shall output an all-ONES (AIS) signal within 250 μ s. On clearing of AIS, the function shall output normal data within 250 μ s. If the function is in the MON state, in the event of an AIS, an AIS defect is reported at the EMF.

f) Sa Bits

Sa bits are ignored.

g) Performance monitoring

For performance monitoring, the information passed to the EMF is the 1 second count.

One second filters perform a simple integration of errored blocks by counting during a one second interval. In addition, defects are filtered by the one second filter.

This function generates the following performance parameters:

- N_EBC: Every second, the number of errored Near-end Blocks (N_B) within that second is counted as the Near-end Error Block Count (N_EBC). A N_B is errored if one or more CRC-4 violations are detected.
- N_DS: Every second with at least one occurrence of LOF or AIS shall be indicated as a Near-end Defect Second (N_DS).
- F_EBC: Every second, the number of errored far-end blocks (F_B) within that second is counted as the Far-end Error Block Count (F_EBC). A F_B is errored if the REI count indicates one or more errors.
- F_DS: Every second with at least one occurrence of RDI defect shall be indicated as a Far-end Defect Second (F_DS).

If the function is in the MON state, at the end of each one second interval the contents of N_EBC, N_DS, F_EBC and F_DS counters are reported to the EMF.

NOTE 4: In case of unidirectional transmission, only Near-end performance monitoring is processed.

Data in Time Slot 16

Data in time slot 16 is ignored.

4.5.3 Path termination 6 312 kbit/s

The frame structure at 6 312 kbit/s as specified in subclause 2.2 of ITU-T Recommendation G.704 [10] shall be used. Four frames form a 500 ms multiframe as shown in figure 12. A frame comprises 768 bits of payload and 21 bits of overhead reserved for signalling and OAM. The data are mapped into bits 1 to 768 of successive frames with the octet structure of the data word aligned with the octet structure of the frame.

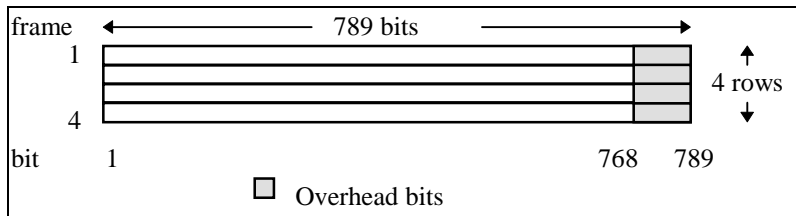

Figure 12: Multiframe at 6 312 kbit/s

4.5.3.1 Signal processing in the transmitter

Signal flow from e-to-f (figure 1).

Data at point e is a synchronous 6 312 kbit/s signal with the bits 769 to 789 of every frame undefined. Bits 769 to 784 are reserved for signalling, the last five bits of each frame are designated as F-bits and will be used for such purposes as frame alignment, performance monitoring and providing a data link. The allocation of these F-bits within a multiframe is given in table 3.

Table 3: Allocation of F-bits at 6 312 kbit/s

Frame number	Bit number				
	785	786	787	788	789
1	1	1	0	0	m
2	1	0	1	0	0
3	x	x	x	a	m
4	e ₁	e ₂	e ₃	e ₄	e ₅

a) Signalling

Bits 769 to 784 of every frame are undefined.

b) Frame Alignment Signal (FAS)

The function shall insert the frame and multiframe alignment signal according to subclause 2.2.3.1 of ITU-T Recommendation G.704 [10].

c) CRC-5 code (CRC)

The function shall compute the CRC-5 code value and shall insert it into the actual multiframe according to subclause 2.2.3.2 of ITU-T Recommendation G.704 [10].

d) Data Link (m bit)

The F-bit m located at bit number 789 of the odd frames within a multiframe is undefined.

e) Spare Bit (x bit)

The F-bit x at frame number 3 under bit position 785 to 787 shall be set to a logical "1".

f) Remote End Alarm Indication (a bit)

The a bit shall be set to "1" until the multiframe alignment is established. Thereafter, the a bit is used as a remote end alarm indication: If a Loss Of Frame (LOF) or an AIS defect is detected in the receiving direction, a logical "1" shall be inserted in the a bit within 250 µs.

NOTE: In case of unidirectional transmission, there is no associated receiving path termination and the a bit shall be set to a logical "0".

4.5.3.2 Signal processing in the receiver

Signal flow from f-to-e (figure 1).

Data at point f is a 6 312 kbit/s signal with a frame structure and overhead bits as described in ITU-T Recommendation G.704 [10].

a) Signalling

The bits 769 to 784 of every frame are ignored.

b) Frame Alignment

The function shall perform the (multi)frame alignment of the 6 312 kbit/s signal in order to recover the frame alignment signal FAS according to subclause 3 of ITU-T Recommendation G.706 [11].

Frame alignment is deemed to have been lost (entering Out Of Frame state, OOF) when either:

- 7 consecutive FAS are detected in error (i.e. 1 or more errors in each FAS); or
- 32 consecutive errored CRC-5 blocks are found.

Frame alignment is deemed to have been recovered (entering In Frame state, IF) when the conditions described in subclause 3.1.2.2 of ITU-T Recommendation G.706 [11] are fulfilled (see also figure 13).

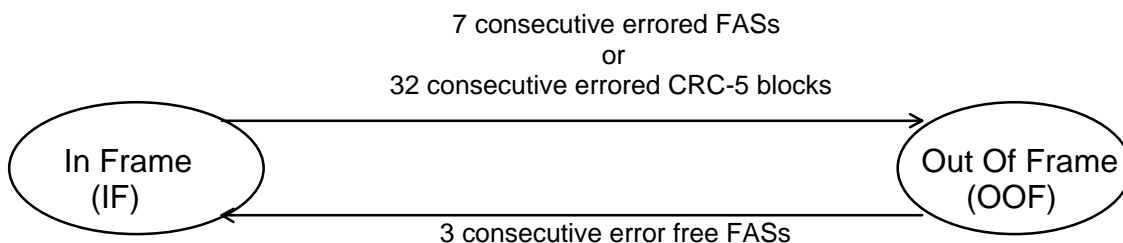

Figure 13: Frame alignment state diagram

If the frame alignment is deemed to be lost (OOF state), a LOF (Loss Of Frame) defect shall be set-up. The LOF defect shall be cleared when the frame alignment is deemed to have been recovered (IF state). On declaration of LOF, the function shall output an all-ONEs (AIS) signal within 250 µs. On clearing of LOF, the function shall output normal data within 250 µs. If the function is in the MON state, the LOF defect is reported to the EMF.

c) CRC-5 monitoring

According to subclause 2.2.3.2 of ITU-T Recommendation G.704 [10] the actual multiframe is checked for transmission errors. If the result of this check is another result than "00000", this is taken as evidence of one or more errors in the computation block.

d) Data Link (m bit)

The m bits of the multiframe are ignored.

e) Spare Bit (x bit)

The spare bits of the multiframe are ignored.

f) Remote End Alarm (REA)

The REA is recovered from bit a to enable single ended maintenance of a bi-directional path. The REA provides information on the status of the remote receiver. A logical "1" indicates a REA state, while a logical "0" indicates the normal working state. If 5 consecutive multiframes contain the value "1" in the a bit, a REA defect shall be declared. The REA defect shall be cleared if 5 consecutive multiframes contain the value "1" in the a bit. If the function is in the MON state, the REA is reported to the EMF.

NOTE 1: In case of unidirectional transmission, the a bit is ignored.

g) Alarm Indication Signal (AIS)

The criteria for detection and clearance of an AIS are given in subclause 8.2.1.7 of ETS 300 417-1-1 [1] for 6 Mbit/s with $X = 4$, $Y = 3$ 156 and $Z = 5$. On declaration of AIS, the function shall output an all-ONES (AIS) signal within 250 μ s. On clearing of AIS, the function shall output normal data within 250 μ s. If the function is in the MON state, in the event of an AIS, an AIS defect is reported at the EMF.

h) Performance monitoring

For performance monitoring, the information passed to the EMF is the 1 second count.

One second filters perform a simple integration of errored blocks by counting during a one second interval. In addition, defects are filtered by the one second filter.

This function generates the following performance parameters:

- N_EBC: Every second, the number of errored Near-end Blocks (N_B) within that second is counted as the Near-end Error Block Count (N_EBC). A N_B is errored if one or more CRC-5 violations are detected.
- N_DS: Every second with at least one occurrence of LOF or AIS shall be indicated as a Near-end Defect Second (N_DS).
- F_DS: Every second with at least one occurrence of REA defect shall be indicated as a Far-end Defect Second (F_DS).

If the function is in the MON state, at the end of each one second interval the contents of N_EBC, N_DS and F_DS counters are reported to the EMF.

NOTE 2: In case of unidirectional transmission, only Near-end performance monitoring is processed.

4.5.4 Path termination 8 448 kbit/s

The basic frame structure at 8 448 kbit/s as described in subclause 2.4 of ITU-T Recommendation G.704 [10] shall be used. Six 8 448 kbit/s frames form a 750 ms multiframe. A basic frame comprises 128 payload octets and 4 overhead octets. A multiframe comprises 24 overhead octets as shown in figure 14. The data are mapped into time slots 1 to 32, 34 to 65, 67 to 98 and 100 to 131 of the successive frames with the octet structure of the data word aligned with the octet structure of the frame.

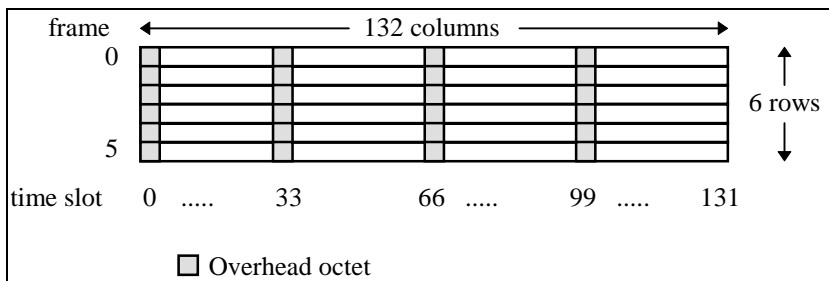

Figure 14: Multiframe at 8 448 kbit/s

4.5.4.1 Signal processing in the transmitter

Signal flow from e-to-f (figure 1).

Data at point e is a 8 448 kbit/s signal with undefined time slots 0, 33, 66 and 99.

Data in time slot 0

a) Frame Alignment Signal (FAS)

The frame alignment signal is "11100110 100000". Frame 0 of each multiframe contains the first 8 bits of the frame alignment signal.

b) Remaining data in time slot 0

The data of frames 1 to 5 of each multiframe is reserved for future OAM functions and is therefore undefined.

Data in time slot 33

c) The data in time slot 33 is reserved for future use and is therefore undefined.

Data in time slot 66

d) Frame Alignment Signal (FAS)

The frame alignment signal is "11100110 100000". Frame 0 of each multiframe contains at bit positions 529 to 539 the last 6 bits of the frame alignment signal.

e) Remote End Alarm Indication

Bit 535 in frame 0 of each multiframe shall be set to "1" until the multiframe alignment is established. Thereafter, this bit is used as a remote end alarm indication: If a Loss Of Frame (LOF) or an AIS defect is detected in the receiving direction, a logical "1" shall be inserted in the a bit within 250 µs.

NOTE: In case of unidirectional transmission, there is no associated receiving path termination and bit 535 shall be set to a logical "0".

f) Signalling

Bit 536 in frame 0 of each multiframe is undefined.

g) Remaining data in time slot 66

The data of frames 1 to 5 of each multiframe is reserved for future OAM functions and is therefore undefined.

Data in time slot 99

h) The data in time slot 99 is reserved for future use and is therefore undefined.

4.5.4.2 Signal processing in the receiver

Signal flow from f-to-e (figure 1).

Data at point f is a 8 448 kbit/s signal possessing a multiframe structure and overhead information as described at the beginning of this subclause.

a) Frame Alignment

The function shall perform a frame alignment of the 8 448 kbit/s signal in order to recover the frame alignment signal FAS.

Frame alignment is deemed to have been lost (entering Out Of Frame state, OOF) when 3 consecutive FAS are detected in error (i.e. one or more errors in each FAS).

Frame alignment is deemed to have been recovered (entering In Frame state, IF) when for the first time the presence of the correct FAS is detected.

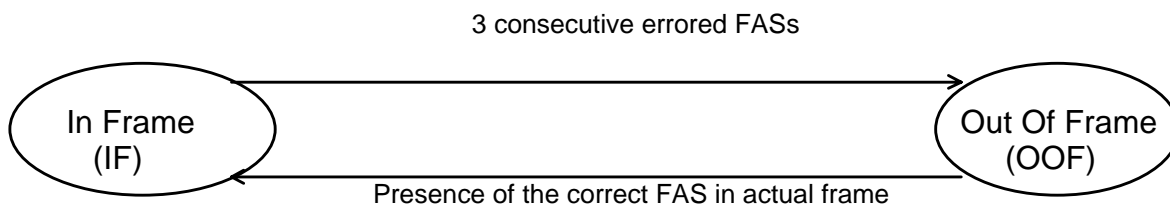

Figure 15: Frame alignment state diagram

If the frame alignment is deemed to be lost (OOF state), a LOF (Loss Of Frame) defect shall be set-up. The LOF defect shall be cleared when the frame alignment is deemed to have been recovered (IF state). On declaration of LOF, the function shall output an all-ONES (AIS) signal within 250 μ s. On clearing of LOF, the function shall output normal data within 250 μ s. If the function is in the MON state, the LOF defect is reported to the EMF.

b) Remote End Alarm (REA)

The REA is recovered from bit 535 in frame 0 of each multiframe in order to enable single ended maintenance of a bi-directional path. The REA provides information on the status of the remote receiver. A logical "1" indicates a REA state, while a logical "0" indicates the normal working state. If 5 consecutive multiframe contain the value "1" in bit 535 of frame 0, a REA defect shall be declared. The REA defect shall be cleared if 5 consecutive multiframe contain the value "0" in this bit. If the function is in the MON state, the REA is reported to the EMF.

NOTE 1: In case of unidirectional transmission, the a bit is ignored.

c) Signalling

Bit 536 in frame 0 of each multiframe is ignored.

d) Remaining Data in Time Slot 0

The data of frames 1 to 5 in time slot 0 of each multiframe is ignored.

e) Data in Time Slot 33

The data of time slot 33 is ignored.

f) Remaining Data in Time Slot 66

The data of frames 1 to 5 in time slot 66 of each multiframe is ignored.

g) Data in Time Slot 99

The data of time slot 99 is ignored.

h) Alarm Indication Signal (AIS)

The criteria for detection and clearance of an AIS are given in subclause 8.2.1.7 of ETS 300 417-1-1 [1] for 8 Mbit/s with $X = 7$, $Y = 6\ 336$ and $Z = 8$. On declaration of AIS, the function shall output an all-ONES (AIS) signal within 250 μ s. On clearing of AIS, the function shall output normal data within 250 μ s. If the function is in the MON state, in the event of an AIS, an AIS defect is reported at the EMF.

i) Performance monitoring

For performance monitoring, the information passed to the EMF is the 1 second count.

One second filters perform a simple integration of errored blocks by counting during a one second interval. In addition, defects are filtered by the one second filter.

This function generates the following performance parameters:

- N_DS: Every second with at least one occurrence of LOF or AIS shall be indicated as a Near-end Defect Second (N_DS).
- F_DS: Every second with at least one occurrence of REA defect shall be indicated as a Far-end Defect Second (F_DS).

If the function is in the MON state, at the end of each one second interval the contents of N_DS and F_DS counters are reported to the EMF.

NOTE 2: In case of unidirectional transmission, only Near-end performance monitoring is processed.

4.5.5 Path termination 34 368 kbit/s

The frame structure at 34 368 kbit/s as specified in subclause 2.1 of ITU-T Recommendation G.832 [18] shall be used. The frame comprises 530 octets of payload and 7 octets of generic path overhead as shown in figure 16.

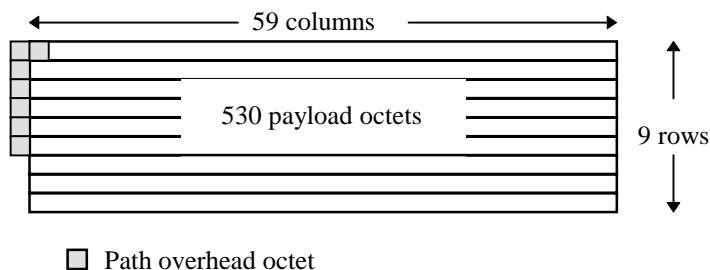

Figure 16: Frame structure at 34 368 kbit/s

4.5.5.1 Signal processing in the transmitter

Signal flow from e-to-f (figure 1).

Data at point e is a synchronous 34 368 kbit/s signal with undefined bytes FA1, FA2, EM, TR, NR, GC and MA. The location of these bytes inside the frame structure is given in figure 17.

FA1	FA2
EM	
TR	
MA	
NR	
GC	

Figure 17: Overhead bytes at 34 368 kbit/s

a) Frame Alignment

The frame alignment bytes FA1 and FA2 are inserted according to subclause 2.1.2 of ITU-T Recommendation G.832 [18].

b) BIP-8 Calculation (EM)

The calculation for the error monitoring shall be done according to subclause 2.1.2 of ITU-T Recommendation G.832 [18].

c) Trail Trace

The TR byte is undefined.

d) Remote Defect Indication (RDI)

If a Loss Of Frame (LOF) or an AIS defect is detected in the receiving direction, a logical "1" shall be inserted in the Far End Receive Failure (FERF) bit (bit 1 of the MA byte) within 250 μ s.

NOTE 1: In case of unidirectional transmission, there is no associated receiving path termination and the RDI shall be set to a logical "0".

e) Remote Error Indication (Bit 2 of MA byte)

This function shall perform the remote error indication as specified in subclause 2.1.2 of ITU-T Recommendation G.832 [18].

NOTE 2: In case of unidirectional transmission, there is no associated receiving path termination and the REI shall be set to a logical "0".

f) Payload Type (Bits 3 to 5 of MA byte)

This function shall signal an ATM payload type as specified in subclause 2.1.2 of ITU-T Recommendation G.832 [18].

g) Multiframe Indicator (MI)

MI is not used and so bits 6 and 7 of the MA byte are undefined.

h) Timing Marker

Bit 8 of the MA byte is set to 1.

i) Network Operator Byte

The NR byte is undefined.

j) General Purpose Communication Channel

The GC byte is undefined.

4.5.5.2 Signal processing in the receiver

Signal flow from f-to-e (figure 1).

Data at point f is a 34 368 kbit/s signal with a frame structure and overhead bytes as described in subclause 2.1 of ITU-T Recommendation G.832 [18].

a) Frame Alignment

The function shall perform the frame alignment of the 34 368 kbit/s signal in order to recover the frame start signal as specified in subclause 10.3.6 of ETS 300 417-2-1 [2]. The appropriate state diagram is shown in figure 18.

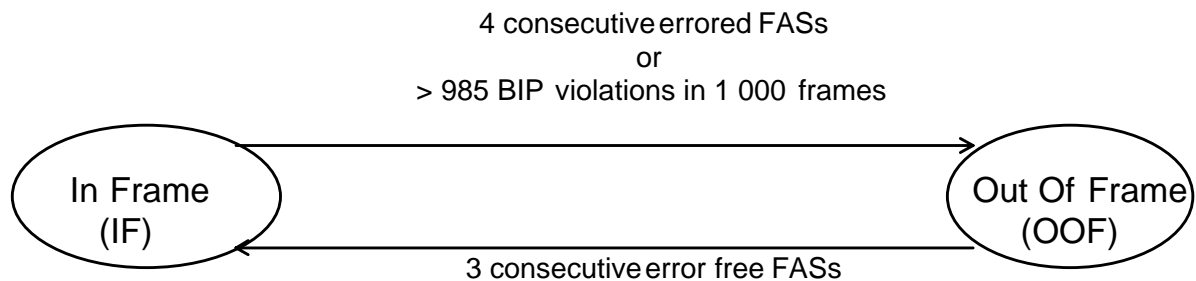

Figure 18: Frame alignment state diagram

If the frame alignment is deemed to be lost (OOF state), a LOF (Loss Of Frame) defect shall be set-up. The LOF defect shall be cleared when the frame alignment is deemed to have been recovered (IF state). On declaration of LOF, the function shall output an all-ONES (AIS) signal within 250 μ s. On clearing of LOF, the function shall output normal data within 250 μ s. If the function is in the MON state, the LOF defect is reported to the EMF.

b) Error Monitoring (EM) byte

This function shall perform the error monitoring as described in subclause 8.2.2 of ETS 300 417-5-1 [3].

c) Trail Trace

The TR byte is ignored.

d) Remote Defect Indication (RDI)

In order to enable single ended maintenance of a bi-directional path, this function performs the process as described in subclause 8.2.2 of ETS 300 417-5-1 [3]. If the function is in the MON state, the RDI is reported to the EMF.

NOTE 2: In case of unidirectional transmission, the indication bit a are ignored.

e) Payload Type

Bits 3 to 5 of the MA byte are ignored.

f) Multiframe Indicator

Bits 6 and 7 of the MA byte are ignored.

g) Timing Marker

Bit 8 of the MA byte is ignored.

h) Network Operator Byte

The NR byte is ignored.

i) General Purpose Communication Channel

The GC byte is ignored.

j) Alarm Indication Signal (AIS)

The criteria for detection and clearance of an AIS are given in subclause 8.2.1.7 of ETS 300 417-1-1 [1] for 34 Mbit/s with $X = 7$, $Y = 4296$ and $Z = 8$. On declaration of AIS, the function shall output an all-ONES (AIS) signal within 250 μ s. On clearing of AIS, the function shall output normal data within 250 μ s. If the function is in the MON state, in the event of an AIS, an AIS defect is reported at the EMF.

k) Performance monitoring

For performance monitoring, the information passed to the EMF is the 1 second count.

One second filters perform a simple integration of errored blocks by counting during a one second interval. In addition, defects are filtered by the one second filter.

This function generates the following performance parameters:

- N_EBC: Every second, the number of errored Near-end Blocks (N_B) within that second is counted as the Near-end Error Block Count (N_EBC). A N_B is errored if one or more BIP-8 violations are detected.
- N_DS: Every second with at least one occurrence of LOF or AIS shall be indicated as a Near-end Defect Second (N_DS).
- F_EBC: Every second, the number of errored far-end blocks (F_B) within that second is counted as the Far-end Error Block Count (F_EBC). A F_B is errored if the REI count indicates one or more errors.
- F_DS: Every second with at least one occurrence of RDI defect shall be indicated as a Far-end Defect Second (F_DS).

If the function is in the MON state, at the end of each one second interval, the contents of N_EBC, N_DS, F_EBC and F_DS counters are reported to the EMF.

NOTE 3: In case of unidirectional transmission, only Near-end performance monitoring is processed.

4.5.6 Path termination 44 736 kbit/s

The frame structure at 44 736 kbit/s as specified in subclause 7.1 of ITU-T Recommendation G.804 [14] shall be used. The frame comprises 588 octets of payload and 56 bits of generic overhead as shown in figure 19.

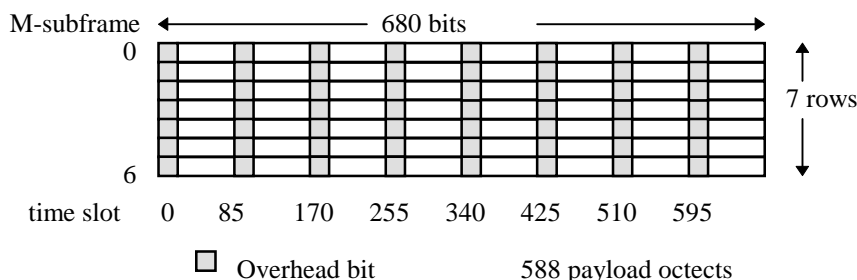

Figure 19: Multiframe structure at 44 736 kbit/s

4.5.6.1 Signal processing in the transmitter

Signal flow from e-to-f (figure 1).

Data at point e is a synchronous 44 736 kbit/s signal with undefined X-bits, P-bits, M-bits, F-bits and C-bits. The location of these bits within the overhead bits of a multiframe is given in table 4. The meaning of these bits follows the description given in annex A of ITU-T Recommendation G.804 [14].

Table 4: Positions of overhead bits in a 44 736 kbit/s multiframe

Positions of the 56 overhead bits of a multiframe							
X1	F1	C11	F2	C12	F3	C13	F4
X2	F1	C21	F2	C22	F3	C23	F4
P1	F1	C31	F2	C32	F3	C33	F4
P2	F1	C41	F2	C42	F3	C43	F4
M1	F1	C51	F2	C52	F3	C53	F4
M2	F1	C61	F2	C62	F3	C63	F4
M3	F1	C71	F2	C72	F3	C73	F4

a) X-bits (X1, X2)

These bits are used for remote alarm indication and shall be set to "0" until both frame and multiframe alignment are established. Thereafter, these bits shall be used to indicate received errored multiframes to the remote-end. These bits shall be set to "1" during error free condition, and to "0" if a loss of frame (LOF) or an AIS defect is detected in the receiving direction.

NOTE 1: In case of unidirectional transmission, there is no associated receiving path termination and the X-bits shall be set to a logical "1".

b) P-bits (P1, P2)

These bits carry parity information calculated over the 4 704 payload bits in the preceding multiframe. P1 and P2 are set to "1" if the digital sum of all payload bits modulo 2 is one. P1 and P2 are set to "0" if the digital sum of all payload bits modulo 2 is zero.

c) Multiframe Alignment Signal MFAS (M1, M2, M3)

The function shall insert the multiframe alignment signal MFAS "010" into the M1, M2, M3 bits (M1 = 0, M2 = 1, M3 = 0) of each multiframe.

d) M-subframe Alignment Signal MAS (F1, F2, F3, F4)

The function shall insert the M-subframe alignment signal MAS "1001" into the F1, F2, F3, F4bits (F1 = 1, F2 = 0, F3 = 0, F4 = 1) of each M-subframe.

Allocation of C-bits

e) Application Identification Channel AIC(Bit C11)

According to ITU-T Recommendation G.804 [14], bit C11 shall be set to "1".

f) Network Requirements (Bit C12)

This bit is reserved for future use according to ITU-T Recommendation G.804 [14]. It shall be set to "1".

g) Far-End Alarm and Control FEAC (Bit C13)

Bit C13 has to be defined as binary "0" or "1" depending on the planned usage (see ITU-T Recommendation G.804 [14]).

h) Parity Information CP-Bits (C31, C32 and C33)

These bits are used to carry parity information. All three bits shall be set to the same value as the P-bits transmitted in the same multiframe. The CP-bits shall not be modified along the 44 736 kbit/s facility path.

i) Far-End Block Error Information FEBE Bits (C41, C42 and C43)

If no errors are detected in the receiving direction in the M-bits, or F-bits, or indicated by the CP-bits, all three FEBE bits shall be set to a logical "1". If any error condition (errored M-bits, errored F-bits or parity in CP-bits) is detected within the multiframe, the FEBE bits shall be set to any combination of 1s and 0s (except 111).

NOTE 2: In case of unidirectional transmission, there is no associated receiving path termination and all the FEBE bits shall be set to a logical "1".

j) Data Link (Bits C51, C52 and C53)

These bits are reserved for a terminal-to-terminal path maintenance data link. If the data link function is not implemented all three bits shall be set to binary "1".

k) Remaining Overhead Bits of a Multiframe

Bits C21, C22, C23, C61, C62, C63, C71, C72 and C73 are not used and shall be set to a logical "1" according to ITU-T Recommendation G.804 [14].

4.5.6.2 Signal processing in the receiver

Signal flow from f-to-e (figure 1).

Data at point f is a 44 736 kbit/s signal with a frame structure and overhead bits as described in annex A of ITU-T Recommendation G.804 [14].

a) Frame Alignment

The function shall perform the (multi)frame alignment of the 44 736 kbit/s signal in order to recover the MFAS and the MAS signal.

Frame alignment is deemed to have been lost (entering Out Of Frame state, OOF) when either

- 4 consecutive MASs are detected in error (i.e. one or more errors in each MAS); or
- multiframe alignment signal MFAS is not found in two consecutive multiframes.

Frame alignment is deemed to have been recovered (entering In Frame (IF) state) when for the first time, the presence of the correct MAS and MFAS in two consecutive M-subframes is detected.

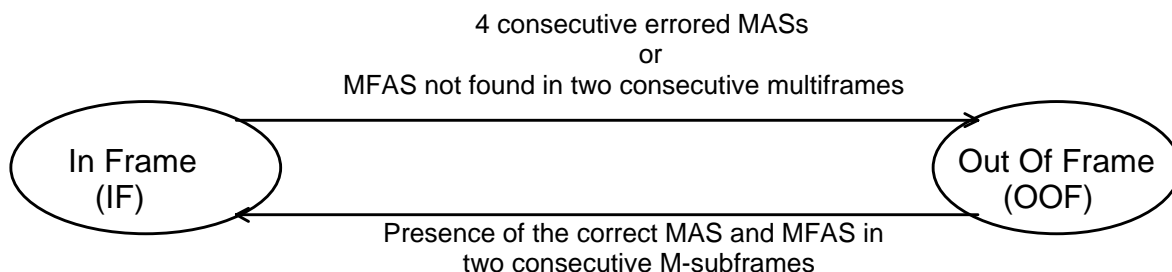

Figure 20: Frame alignment state diagram

If the frame alignment is deemed to be lost (OOF state), a LOF (Loss Of Frame) defect shall be set-up. The LOF defect shall be cleared when the frame alignment is deemed to have been recovered (IF state). On declaration of LOF, the function shall output an AIS signal within 250 μ s possessing a data structure as described in annex A.1.3.6.1 of ITU-T Recommendation G.804 [14]. On clearing of LOF, the function shall output normal data within 250 μ s. If the function is in the MON state, the LOF defect is reported to the EMF.

b) Parity Check (P-bits)

The P-bits are recovered. The computed parity information for the current multiframe is compared with the P-bits of the following multiframe. A different value for each P-bit or a difference between the computed value and the recovered value is taken as evidence of one or more errors in the multiframe.

c) Remote Alarm Indication RAI (X-bits)

The RAI is recovered from the X-bits to enable single ended maintenance of a bi-directional path. The RAI provides information on the status of the remote receiver. If both X-bits contain a "1", normal working state is indicated. If 3 consecutive multiframes contain pairs of X-bits having another value than "1", a RAI defect shall be declared. The RAI defect shall be cleared if 3 consecutive multiframes contain in their X-bits the value "1". If the function is in the MON state, the RAI is reported to the EMF.

NOTE 1: In case of unidirectional transmission, the X-bits are ignored.

d) Application Identification Channel AIC (Bit C11)

Bit C11 is ignored.

e) Network Requirements (Bit C12)

Bit C12 is ignored.

f) Far-End Alarm and Control FEAC (Bit C13)

Evaluation of bit C13 according to the description given in annex A.1.3.5.1 of ITU-T Recommendation G.804 [14].

g) Parity Control CP-Bits (C31, C32 and C33)

The CP-bits are recovered in each multiframe. A majority decision is carried out and its result is compared with the contents of each P-bit. If differences are found, this is taken as evidence of an error in the multiframe.

h) Far-End Block Error Indication FEBE (Bits C41, C42 and C43)

The Far-End block error information is recovered from bits C41, C42 and C43 of each multiframe in order to enable single ended maintenance of a bi-directional path. The FEBE provides information on the status of the remote receiver. The normal working state with no errors detected in the receiving direction in the M-bits, or F-bits, or indicated by the CP-bits is indicated if all three bits contain the value "1". Any other combination of these three bits indicates a FEBE state.

NOTE 2: In case of unidirectional transmission, bits C41, C42 and C43 are ignored.

i) Data Link

Bits C51, C52 and C53 are evaluated. If they are all set to binary "1", no terminal-to-terminal data link is implemented. Otherwise, the interpretation is done following table A.3 in ITU-T Recommendation G.804 [14].

j) Remaining Overhead Bits of a Multiframe

Bits C21, C22, C23, C61, C62, C63, C71, C72 and C73 are ignored.

k) Alarm Indication Signal (AIS)

The criteria for detection and clearance of an AIS are given in subclause 8.2.1.7 of ETS 300 417-1-1 [1] for 45 Mbit/s with $X = 1$, $Y = 680$ and $Z = 2$. On declaration of AIS, the function shall output an all-ONES (AIS) signal within 250 μ s. On clearing of AIS, the function shall output normal data within 250 μ s. If the function is in the MON state, in the event of an AIS, an AIS defect is reported at the EMF.

m) Performance monitoring

For performance monitoring, the information passed to the EMF is the 1 second count.

One second filters perform a simple integration of errored blocks by counting during a one second interval. In addition, defects are filtered by the one second filter.

This function generates the following performance parameters:

- N_EBC: Every second, the number of errored Near-end Blocks (N_B) within that second is counted as the Near-end Error Block Count (N_EBC). A N_B is errored if one or more parity control information errors or parity check errors are detected.
- N_DS: Every second with at least one occurrence of LOF or AIS shall be indicated as a Near-end Defect Second (N_DS).
- F_EBC: Every second, the number of errored far-end blocks (F_B) within that second is counted as the Far-end Error Block Count (F_EBC). A F_B is errored if the FEBEI count indicates one or more errors.
- F_DS: Every second with at least one occurrence of RAI defect shall be indicated as a Far-end Defect Second (F_DS).

If the function is in the MON state, at the end of each one second interval, the contents of N_EBC, N_DS, F_EBC and F_DS counters are reported to the EMF.

NOTE 3: In case of unidirectional transmission, only Near-end performance monitoring is processed.

4.5.7 Path termination 139 264 kbit/s

The frame structure as specified in ITU-T Recommendation G.832 [18] shall be used. The frame comprises 2 160 octets of payload and 16 octets of path overhead as shown in figure 21.

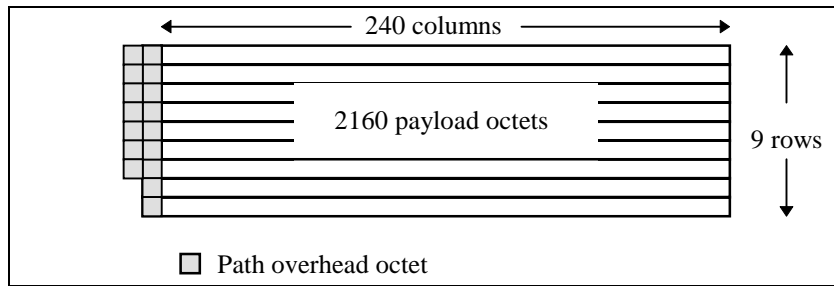

Figure 21: Frame structure at 139 264 kbit/s

4.5.7.1 Signal processing in the transmitter

Signal flow from e-to-f (figure 1).

Data at point e is a synchronous 139 264 kbit/s signal with undefined bytes FA1, FA2, EM, TR, NR, GC and MA. The location of these bytes inside the frame structure is given in figure 22.

FA1	FA2	
EM	P1	
TR	P2	
MA		
NR		
GC		

not yet defined

Figure 22: Overhead bytes at 139 264 kbit/s

a) Frame Alignment

The frame alignment bytes FA1 and FA2 are inserted according to subclause 2.4.2 of ITU-T Recommendation G.832 [18].

b) BIP-8 Calculation (EM)

The calculation for the error monitoring shall be done according to subclause 2.4.2 of ITU-T Recommendation G.832 [18].

c) Trail Trace

The TR byte is undefined.

d) Remote Defect Indication (RDI)

If a loss of frame (LOF) or an AIS defect is detected in the receiving direction, a logical "1" shall be inserted in the FERF (Far End Receive Failure) bit (bit 1 of the MA byte) within 250 µs.

NOTE 1: In case of unidirectional transmission, there is no associated receiving path termination and the RDI shall be set to a logical "0".

e) Remote Error Indication (REI) (Bit 2 of MA byte)

This function shall perform the remote error indication as specified in subclause 2.4.2 of ITU-T Recommendation G.832 [18].

NOTE 2: In case of unidirectional transmission, there is no associated receiving path termination and the REI shall be set to a logical "0".

f) Payload Type (Bits 3 to 5 of MA byte)

This function shall signal an ATM payload type as specified in subclause 2.4.2 of ITU-T Recommendation G.832 [18].

g) Multiframe Indicator (MI)

MI is not used and so bits 6 and 7 of the MA byte are undefined.

h) Timing Marker

Bit 8 of the MA byte is set to 1.

i) Network Operator Byte

The NR byte is undefined.

j) General Purpose Communication Channel

The GC byte is undefined.

k) Automatic Protection Switching

The P1 byte and the P2 byte are undefined.

4.5.7.2 Signal processing in the receiver

Signal flow from f-to-e (figure 1).

Data at point f is a 139 264 kbit/s with a frame structure and overhead bytes as described in ITU-T Recommendation G.832 [18].

a) Frame Alignment

The function shall perform the frame alignment of the 139 264 kbit/s signal in order to recover the frame start signal as specified in subclause 9.3.6 of ETS 300 417-2-1 [2]. The appropriate state diagram is shown in figure 23.

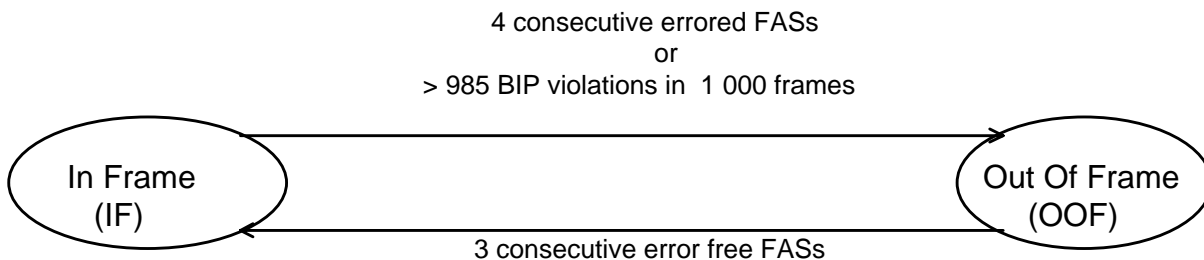

Figure 23: Frame alignment state diagram

If the frame alignment is deemed to be lost (OOF state), a LOF (Loss Of Frame) defect shall be set-up. The LOF defect shall be cleared when the frame alignment is deemed to have been recovered (IF state). On declaration of LOF, the function shall output an all-ONES (AIS) signal within 250 μs. On clearing of LOF, the function shall output normal data within 250 μs. If the function is in the MON state, the LOF defect is reported to the EMF.

b) Error Monitoring Byte (EM)

This function shall perform the error monitoring as described in subclause 9.2.2 of ETS 300 417-5-1 [3].

c) Trail Trace

The TR byte is ignored.

d) Remote Defect Indication (RDI) and Remote Error Indication (REI) (Bits 1 and 2 of MA byte)

In order to enable single ended maintenance of a bi-directional path, this function performs the process as described in subclause 9.2.2 of ETS 300 417-5-1 [3]. If the function is in the MON state, the RDI is reported to the EMF.

NOTE 1: In case of unidirectional transmission, the indication bits are ignored.

e) Payload Type

Bits 3 to 5 of the MA byte are ignored.

f) Multiframe Indicator

Bits 6 and 7 of the MA byte are ignored.

g) Timing Marker

Bit 8 of the MA byte is ignored.

h) Network Operator Byte

The NR byte is ignored.

i) General Purpose Communication Channel

The GC byte is ignored.

j) Automatic Protection Switching

The P1 byte and the P2 byte are ignored.

k) Alarm Indication Signal (AIS)

The criteria for detection and clearance of an AIS are given in the subclause 8.2.1.7 of ETS 300 417-1-1 [1] for 140 Mbit/s with $X = 7$, $Y = 17\ 408$ and $Z = 8$. On declaration of AIS, the function shall output an all-ONEs (AIS) signal within 250 μ s. On clearing of AIS, the function shall output normal data within 250 μ s. If the function is in the MON state, in the event of an AIS, an AIS defect is reported at the EMF.

m) Performance monitoring

For performance monitoring, the information passed to the EMF is the 1 second count.

One second filters perform a simple integration of errored blocks by counting during a one second interval. In addition, defects are filtered by the one second filter.

This function generates the following performance parameters:

- N_EBC: Every second, the number of errored Near-end Blocks (N_B) within that second is counted as the Near-end Error Block Count (N_EBC). A N_B is errored if one or more BIP-8 violations are detected.
- N_DS: Every second with at least one occurrence of LOF or AIS shall be indicated as a Near-end Defect Second (N_DS).
- F_EBC: Every second, the number of errored far-end blocks (F_B) within that second is counted as the Far-end Error Block Count (F_EBC). A F_B is errored if the REI count indicates one or more errors.
- F_DS: Every second with at least one occurrence of RDI defect shall be indicated as a Far-end Defect Second (F_DS).

If the function is in the MON state, at the end of each one second interval the contents of N_EBC, N_DS, F_EBC and F_DS counters are reported to the EMF.

NOTE 2: In case of unidirectional transmission, only Near-end performance monitoring is processed.

4.6 PDH Physical Interface (PPI)

The PPI provides the physical medium dependent functions between the PDH Path Termination and the physical medium. Interfaces are defined for the PDH hierarchical bit rates 1 544 kbit/s, 2 048 kbit/s, 6 312 kbit/s, 8 448 kbit/s, 34 368 kbit/s, 44 736 kbit/s and 139 264 kbit/s. The physical characteristics are described in ITU-T Recommendation G.703 [9].

To prevent alarms being raised and failures being reported during path provisioning, the interface shall have the ability to enable or disable fault cause declaration. The interface shall be either in the "Monitored (MON)" or the "Not monitored (NMON)" state provisioned by the equipment manager. The states of the PDH Physical Interface and the associated PDH Path Termination and the Virtual Path Multiplexing Entity VPME shall be identical.

4.6.1 Interface at 1 544 kbit/s

The physical characteristics of this interface shall follow the specifications given in ITU-T Recommendation G.703 [9].

4.6.1.1 Signal processing in the transmitter

Signal flow from f-to-g (figure 1).

This interface provides the line encoding of the 1 544 kbit/s information signal and generates the electrical signal at the output port in transmitting direction.

The function shall perform an AMI or a B8ZS encoding (for a description see informative annex D) and it shall generate the electrical signal according to the descriptions given in ITU-T Recommendation G.703 [9].

4.6.1.2 Signal processing in the receiver

Signal flow from g-to-f (figure 1).

The interface regenerates the received 1 544 kbit/s signal at the input port, recovers the bit timing and provides the line decoding in receiving direction by applying an appropriate function. The interface passes the regenerated information signal and the recovered clock to the PDH Path Termination.

The function shall operate without any error when any combination of the following signal conditions exists at the input:

- an input electrical level with any value in the range as specified in ITU-T Recommendation G.703 [9];
- jitter modulation applied to the input signal with any value as specified in ITU-T Recommendation G.824 [16];
- signal bit rate within the range as specified in ITU-T Recommendation G.703 [9].

A Loss Of Signal (LOS) defect shall be detected according to subclause 8.2.1.6 of ETS 300 417-1-1 [1] for a 1 544 kbit/s signal. In the event of LOS defect, an all-ONE's (AIS) DATA signal - complying to the frequency limits of this interface - shall be applied at reference point f accompanied by a suitable reference timing signal within 250 μ s. Upon termination of LOS, the all_ONE's signal shall be terminated within 250 μ s. If the function is in the MON state, the LOS defect is reported to the EMF.

4.6.2 Interface at 2 048 kbit/s

The physical characteristics of this interface shall follow ITU-T Recommendation G.703 [9].

4.6.2.1 Signal processing in the transmitter

Signal flow from f-to-g (figure 1).

This interface provides the line encoding of the 2 048 kbit/s information signal and generates the electrical signal at the output port in transmitting direction.

The function shall perform an HDB3 encoding (for a description see informative annex D) and it shall generate the electrical signal according to the descriptions given in ITU-T Recommendation G.703 [9].

4.6.2.2 Signal processing in the receiver

Signal flow from g-to-f (figure 1).

The interface regenerates the received 2 048 kbit/s signal at the input port, recovers the bit timing and provides the line decoding in receiving direction by applying an appropriate function. The interface passes the regenerated information signal and the recovered clock to the PDH Path Termination.

The function shall operate without any error when any combination of the following signal conditions exists at the input:

- an input electrical level with any value in the range as specified in ITU-T Recommendation G.703 [9];
- jitter modulation applied to the input signal with any value as specified in ITU-T Recommendation G.823 [15];
- signal bit rate within the range as specified in ITU-T Recommendation G.703 [9];
- addition of an interfering signal as described in ITU-T Recommendation G.703 [9].

A Loss Of Signal (LOS) defect shall be detected according to subclause 8.2.1.6 of ETS 300 417-1-1 [1] for a 2 048 kbit/s signal. In the event of LOS defect, an all-ONE's (AIS) DATA signal - complying to the frequency limits of this interface - shall be applied at reference point f accompanied by a suitable reference timing signal within 250 μ s. Upon termination of LOS, the all_ONE's signal shall be terminated within 250 μ s. If the function is in the MON state, the LOS defect is reported to the EMF.

4.6.3 Interface at 6 312 kbit/s

The physical characteristics of this interface shall follow the specifications given in ITU-T Recommendation G.703 [9].

4.6.3.1 Signal processing in the transmitter

Signal flow from f-to-g (figure 1).

This interface provides the line encoding of the 6 312 kbit/s information signal and generates the electrical signal at the output port in transmitting direction.

The function shall perform a B6ZS encoding or an B8ZS encoding (for a description see informative annex D) and it shall generate the electrical signal according to the descriptions given in ITU-T Recommendation G.703 [9].

4.6.3.2 Signal processing in the receiver

Signal flow from g-to-f (figure 1)

The interface regenerates the received 6 312 kbit/s signal at the input port, recovers the bit timing and provides the line decoding in receiving direction by applying an appropriate function. The interface passes the regenerated information signal and the recovered clock to the PDH Path Termination (PPT).

The function shall operate without any error when any combination of the following signal conditions exists at the input:

- an input electrical level with any value in the range as specified in ITU-T Recommendation G.703 [9];
- jitter modulation applied to the input signal with any value as specified in ITU-T Recommendation G.824 [16];
- signal bit rate within the range as specified in ITU-T Recommendation G.703 [9].

A Loss Of Signal (LOS) defect shall be detected according to subclause 8.2.1.6 of ETS 300 417-1-1 [1] for a 6 312 kbit/s signal. In the event of LOS defect, an all-ONE's (AIS) DATA signal - complying to the frequency limits of this interface - shall be applied at reference point f accompanied by a suitable reference timing signal within 250 μ s. Upon termination of LOS, the all_ONE's signal shall be terminated within 250 μ s. If the function is in the MON state, the LOS defect is reported to the EMF.

4.6.4 Interface at 8 448 kbit/s

The physical characteristics of this interface shall follow the specifications given in ITU-T Recommendation G.703 [9].

4.6.4.1 Signal processing in the transmitter

Signal flow from f-to-g (figure 1).

This interface provides the line encoding of the 8 448 kbit/s information signal and generates the electrical signal at the output port in transmitting direction.

The function shall perform an HDB3 encoding (for a description see informative annex D) and it shall generate the electrical signal according to the descriptions given in ITU-T Recommendation G.703 [9].

4.6.4.2 Signal processing in the receiver

Signal flow from g-to-f (figure 1).

The interface regenerates the received 8 448 kbit/s signal at the input port, recovers the bit timing and provides the line decoding in receiving direction by applying an appropriate function. The interface passes the regenerated information signal and the recovered clock to the PDH Path Termination.

The function shall operate without any error when any combination of the following signal conditions exists at the input:

- an input electrical level with any value in the range as specified in ITU-T Recommendation G.703 [9];
- jitter modulation applied to the input signal with any value as specified in ITU-T Recommendation G.823 [15];
- signal bit rate within the range as specified in ITU-T Recommendation G.703 [9];
- addition of an interfering signal as described in ITU-T Recommendation G.703 [9].

A Loss Of Signal (LOS) defect shall be detected according to subclause 8.2.1.6 of ETS 300 417-1-1 [1] for a 8 448 kbit/s signal. In the event of LOS defect, an all-ONE's (AIS) DATA signal - complying to the frequency limits of this interface - shall be applied at reference point f accompanied by a suitable reference timing signal within 250 μ s. Upon termination of LOS, the all_ONE's signal shall be terminated within 250 μ s. If the function is in the MON state, the LOS defect is reported to the EMF.

4.6.5 Interface at 34 368 kbit/s

The physical characteristics of this interface shall follow the specifications given in ITU-T Recommendation G.703 [9].

4.6.5.1 Signal processing in the transmitter

Signal flow from f-to-g (figure 1).

This interface provides the line encoding of the 34 368 kbit/s information signal and generates the electrical signal at the output port in transmitting direction.

The function shall perform an HDB3 encoding (for a description see informative annex D) and it shall generate the electrical signal according to the descriptions given in ITU-T Recommendation G.703 [9].

4.6.5.2 Signal processing in the receiver

Signal flow from g-to-f (figure 1).

The interface regenerates the received 34 368 kbit/s signal at the input port, recovers the bit timing and provides the line decoding in receiving direction by applying an appropriate function. The interface passes the regenerated information signal and the recovered clock to the PDH Path Termination.

The function shall operate without any error when any combination of the following signal conditions exists at the input:

- an input electrical level with any value in the range as specified in ITU-T Recommendation G.703 [9];
- jitter modulation applied to the input signal with any value as specified in ITU-T Recommendation G.823 [15];
- signal bit rate within the range as specified in ITU-T Recommendation G.703 [9];
- addition of an interfering signal as described in ITU-T Recommendation G.703 [9].

A Loss Of Signal (LOS) defect shall be detected according to subclause 8.2.1.6 of ETS 300 417-1-1 [1] for a 34 368 kbit/s signal. In the event of LOS defect, an all-ONE's (AIS) DATA signal - complying to the frequency limits of this interface - shall be applied at reference point f accompanied by a suitable reference timing signal within 250 μ s. Upon termination of LOS, the all_ONE's signal shall be terminated within 250 μ s. If the function is in the MON state, the LOS defect is reported to the EMF.

4.6.6 Interface at 44 736 kbit/s

The physical characteristics of this interface shall follow the specifications given in ITU-T Recommendation G.703 [9].

4.6.6.1 Signal processing in the transmitter

Signal flow from f-to-g (figure 1).

This interface provides the line encoding of the 44 736 kbit/s information signal and generates the electrical signal at the output port in transmitting direction.

The function shall perform a B3ZS encoding (for a description see informative annex D) and it shall generate the electrical signal according to the descriptions given in ITU-T Recommendation G.703 [9].

4.6.6.2 Signal processing in the receiver

Signal flow from g-to-f (figure 1).

The interface regenerates the received 44 736 kbit/s signal at the input port, recovers the bit timing and provides the line decoding by applying an appropriate function. The interface passes the regenerated information signal and the recovered clock to the PDH Path Termination.

The function shall operate without any error when any combination of the following signal conditions exists at the input:

- an input electrical level with any value in the range as specified in ITU-T Recommendation G.703 [9],
- jitter modulation applied to the input signal with any value as specified in ITU-T Recommendation G.824 [16],
- signal bit rate within the range as specified in ITU-T Recommendation G.703 [9].

A Loss Of Signal (LOS) defect shall be detected according to subclause 8.2.1.6 of ETS 300 417-1-1 [1] for a 44 736 kbit/s signal. In the event of LOS defect, an all-ONE's (AIS) DATA signal - complying to the frequency limits of this interface - shall be applied at reference point f accompanied by a suitable reference timing signal within 250 μ s. Upon termination of LOS, the all_ONE's signal shall be terminated within 250 μ s. If the function is in the MON state, the LOS defect is reported to the EMF.

4.6.7 Interface at 139 264 kbit/s

The physical characteristics of this interface shall follow the specifications given in ITU-T Recommendation G.703 [9].

4.6.7.1 Signal processing in the transmitter

Signal flow from f-to-g (figure 1).

This interface provides the line encoding of the 139 264 kbit/s information signal and generates the electrical signal at the output port in transmitting direction.

The function shall perform a CMI encoding (for a description see informative annex D) and it shall generate the electrical signal according to the descriptions given in ITU-T Recommendation G.703 [9].

4.6.7.2 Signal processing in the receiver

Signal flow from g-to-f (figure 1).

The interface regenerates the received 139 264 kbit/s signal at the input port, recovers the bit timing and provides the line decoding in receiving direction. It passes the regenerated information signal and the recovered clock to the PDH Path Termination.

The function shall operate without any error when any combination of the following signal conditions exists at the input:

- an input electrical level with any value in the range as specified in ITU-T Recommendation G.703 [9];
- jitter modulation applied to the input signal with any value as specified in ITU-T Recommendation G.823 [15];
- signal bit rate within the range as specified in ITU-T Recommendation G.703 [9].

A Loss Of Signal (LOS) defect shall be detected according to subclause 8.2.1.6 of ETS 300 417-1-1 [1] for a 139 264 kbit/s signal. In the event of LOS defect, an all-ONE's (AIS) DATA signal - complying to the frequency limits of this interface - shall be applied at reference point f accompanied by a suitable reference timing signal within 250 μ s. Upon termination of LOS, the all_ONE's signal shall be terminated within 250 μ s. If the function is in the MON state, the LOS defect is reported to the EMF.

4.7 Equipment Management Function (EMF)

4.7.1 Overview of the EMF

The Equipment Management Function (EMF) provides the means through which the Network Element (NE) is managed by an external manager. The EMF interacts with the other basic functions by exchanging information across the MP (Management Points) reference points. The EMF contains a number of filters that provide a data reduction mechanism on the information received across the MP reference points.

The interface between the processing in the basic functions and the equipment management function is indicated by the dashed line in figure 24 and represents the MP reference points. For performance monitoring the signals passed over this interface are the 1 second Near (Far)-end Errored Block Counts (N_EBC, F_EBC) and the 1 second Near (Far)-end Defect Seconds (N_DS, F_DS). For fault management the signals passed over this interface are the defects.

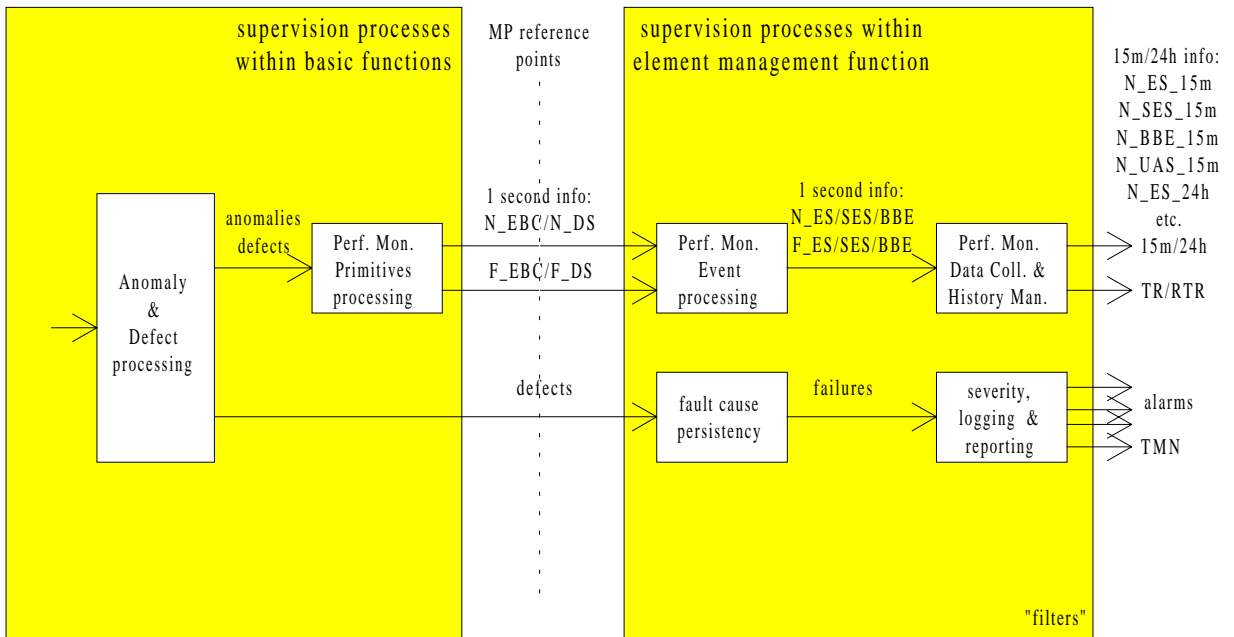

Figure 24: Supervision process within equipment management function

The filtering functions provide a data reduction mechanism on the defect and performance monitoring primitives information presented at the MP reference points. Two types of techniques can be distinguished:

- The fault cause persistency filter will provide a persistency check on the fault causes that are reported across the MP reference points. In addition to the transmission failures listed in table 12, hardware failures with signal transfer interruption are also reported at the input of the fault cause filter for further processing.
- The performance monitoring events processing processes the information available from the one second window and reported across the MP reference points in order to derive errored seconds and severely errored seconds, and background block errors (see ITU-T Recommendation G.826 [17]).

Table 5: Basic function associated failure list

Basic functions	Failure
PPI	LOS
PPT	AIS LOF RAI REA RDI
VPME	LCD
VPE	
MAA	STATUS SNI LMC
MPI	LOS TSLE_I TSLE_O

Time-stamping

Events, performance reports and registers containing event counts that require time-stamping shall be time stamped with a resolution of one second. The time shall be as indicated by the local real time clock of the NE. The required accuracy and precise details of the time-stamping of events/reports relative to UTC is the subject of further study (A maximum value in the range 1 to 10 seconds is being considered). The start of 15 minutes and 24 hours counts should be accurate to within ± 10 seconds with respect to the NE clock.

4.7.2 Configuration

The information flow over the MP reference points that arises from configuration and provisioning data is given in table 13. The information listed under "Set" refers to configuration and provisioning data that is passed from the EMF to the other basic functions. The information listed under "Get" refers to status reports made in response to a request from the EMF for such information.

Table 6: Command, configuration information flow over MP

	GET	SET
PPI	Supervision State: MON or NMON	Supervision State: MON or NMON (note 1)
PPT		Supervision State: MON or NMON (note 1)
VPME	Cell Discarded: Active or Not_Active HEC correction mode: Active or Not_Active VPI value	Supervision State: MON or NMON (note 1) Cell Discarded: Active or Not_Active HEC correction mode: Active or Not_Active
VPE		Supervision State: MON or NMON (note 2) VPI value
MAA		Supervision State: MON or NMON (note 2)
MPI	Supervision State: MON or NMON Number of packets per second FORMAT: 188 or 204 bytes packet with 16 dummy bytes (note 3)	Supervision State: MON or NMON (note 2) FORMAT: 188 or 204 bytes packet with 16 dummy bytes (note 3)
NOTE 1:	PPI and associated PPT and VPME are always in the same state.	
NOTE 2:	For a given MPEG interface, MPI and associated MAA and VPE are in the same state.	
NOTE 3:	This status is only relevant for the selection of the transmission format (188 bytes or 204 with 16 dummy bytes) to be used at an output SSI or SPI interface for the delivery of MPEG-2-TS packets.	

4.7.3 Fault (maintenance) management

Fault cause persistency filter

The equipment management function within the network element performs a persistency check on the fault causes before it declares a fault cause a failure. A transmission failure shall be declared if the fault cause persists continuously for $2,5 \pm 0,5$ seconds. The failure shall be cleared if the fault cause is absent continuously for $10 \pm 0,5$ seconds. Transmission failures associated with the basic functions are listed in table 12.

Alarm history management

Alarm history management is concerned with the recording of alarms. Historical data shall be stored in registers in the NE. Each register contains all the parameters of an alarm message. Registers shall be readable on demand or periodically. The operator can define the operating mode of the registers as wrapping or stop when full. The operator may also flush the registers or stop recording at any time.

NOTE: Wrapping is the deletion of the earliest record to allow a new record when a register is full. Flushing is the deletion of all the records.

4.7.4 Performance management

Performance management consists of performance monitoring event processes, data collection and history processes along with thresholding and reporting functions. Performance monitoring consists of the first three items.

Within performance monitoring the concepts of "Near-end" and "far-end" are used to refer to performance monitoring information associated with the two directions of transport in the case of a bi-directional transmission path. For a trail from A to Z:

- at node A the Near-end information represents the performance of the unidirectional trail from Z to A, while the far-end information represents the performance of the unidirectional trail from A to Z;
- at node Z the Near-end information represents the performance of the unidirectional trail from A to Z, while the far-end information represents the performance of the unidirectional trail from Z to A.

At either end of the trail (A or Z) the combination of Near-end and far-end information present the performance of the two directions of the trail.

Performance monitoring event process

The performance monitoring event processing processes the information available from the performance monitoring primitives processing (basic functions) giving the performance primitives (EBC and DS) to derive the performance events (errored seconds, severely errored seconds and background block errors).

Near-end Performance Monitoring Event (NPME) function

Figure 25 presents the processes and their interconnect within the Near-end Performance Monitoring Event (NPME) function. This function processes information from PPT and MPI functional blocks.

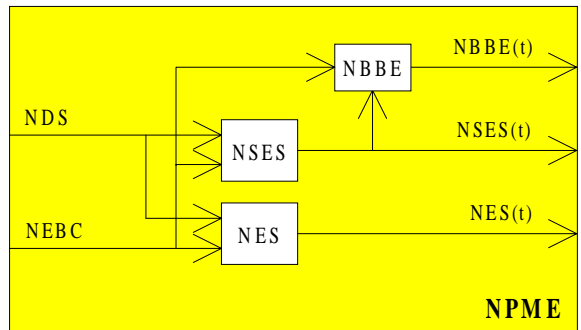

Figure 25: Near-end performance monitoring event (NPME) function

A Near-end Errored Second (NES) shall be generated if the defect second (NDS) is set or if the Near end Errored Block Count (NEBC) is greater or equal to 1: $NES(t) \leftarrow (NDS = true) \text{ or } (NEBC \geq 1)$.

A Near-end Severely Errored Second (NSES) shall be generated if the Near end Defect Second (NDS) is set or if the Near end Errored Block Count (NEBC) is greater or equal to 30 % of the blocks in a one second period: $NSES(t) \leftarrow (NDS = true) \text{ or } (NEBC \geq "30 \% \text{ of blocks in a one second period}")$.

The number of Near end Background Block Errors (NBBE) in a one second period shall be equal to the Near end Errored Block Count (NEBC) if the second is not a Near end Severely Errored Second (NSES). Otherwise (NSES is set), NBBE shall be zero. $NBBE(t) \leftarrow NEBC (NSES=false) \text{ or } 0 (NSES=true)$.

Far-end Performance Monitoring Event (FPME) function

Figure 26 presents the processes and their interconnect within the FPME function. This function processes information from PPT functional blocks in case of bi-directional transmission.

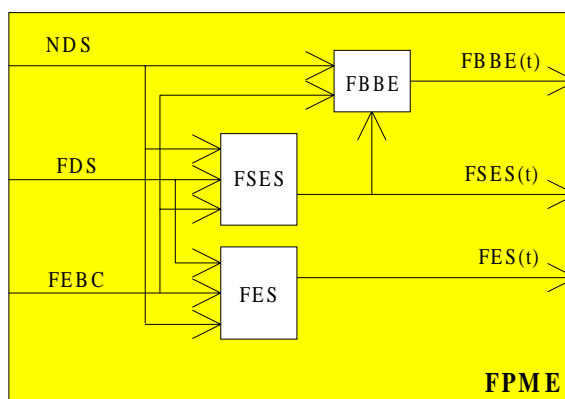

Figure 26: Far-end performance monitoring event (FPME) function

A Far-end Errored Second (FES) shall be generated if the Far end Defect Second (FDS) is set or if the Far end Errored Block Count (FEBC) is greater or equal to 1, and if that second is not a Near-end Defect Second (NDS): $FES(t) \leftarrow (NDS = \text{false}) \text{ and } ((FDS = \text{true}) \text{ or } (FEBC \geq 1))$.

A far-end Severely Errored Second (FSES) shall be generated if the Far end Defect Second (FDS) is set or if the Far end Errored Block Count (FEBC) is greater or equal to 30 % of the blocks in a one second period, and that second is not a Near-end Defect Second (NDS): $FSES(t) \leftarrow (NDS = \text{false}) \text{ and } ((FDS = \text{true}) \text{ or } (FEBC \geq "30 \% \text{ of blocks in a one second period}"))$.

The number of Far end Background Block Errors (FBBE) in a one second period shall be equal to the Far end Errored Block Count (FEBC) if the second is not a Far end Severely Errored Second (FSES), and if that second is not a Near-end Defect Second (NDS). Otherwise, FBBE shall be zero. $FBBE(t) \leftarrow FEBC$ ($FSES = \text{false}$ and $NDS = \text{false}$) or 0 ($FSES = \text{true}$ or $NDS = \text{true}$).

Performance data collection

Performance data collection refers to the event counting associated with each of the performance events BBE, ES, SES as defined in ITU-T Recommendation G.826 [17], and any additional performance parameter defined in this ETS. The collection as specified in ITU-T Recommendation M.2120 [25] bases on information for each direction of transport independently. This type is further referred to as performance data collection for maintenance purposes. This type of collection counts the events over fixed time periods of 15 minutes and 24 hours. Counting is stopped during unavailable time. These counters operate as follows:

15 minute counter:

The performance events (e.g. SES) are counted in a counter per event. These counters are called the current registers. At the end of the 15 minute period the contents of the current registers are transferred to the first of the recent registers, with a time stamp to identify the 15 minute period (including the day), after which the current register shall be reset to zero (note 1). It is an option not to transfer the content of a current register to a recent register if this content is zero.

NOTE 1: A capability should be provided to insure that, in the absence of reports, the reporting process is functioning properly.

It shall be possible to reset an individual current register to zero by means of an external command. Any register the content of which is suspect shall be flagged, using the "suspect interval flag" provided in ITU-T Recommendation Q.822 [26]. This flag shall be raised independently for far-end and Near-end counts. Examples of conditions to raise this flag are provided in ITU-T Recommendation Q.822 [26].

24 hour counter:

The performance events (e.g. SES) are counted in a counter per event, independent of the 15 minute counters. These counters are called the current registers. It was agreed that it is up to the NE implementation to update the register counts. It is not required that it shall be done second by second basis. At the end of the 24 hour period the contents of the current registers are transferred to recent registers, with a time stamp to identify the 24 hour period, after which the current register shall be reset to zero. It shall be possible to reset an individual current register to zero by means of an external command.

Any register the content of which is suspect shall be flagged, using the "suspect interval flag" provided in ITU-T Recommendation Q.822 [26]. This flag shall be raised independently for far-end and Near-end counts. Examples of conditions to raise this flag are provided in ITU-T Recommendation Q.822 [26].

Performance data collection during unavailable time:

The onset and exit of unavailable time is defined in annex A of ITU-T Recommendation G.826 [17] and in ITU-T Recommendation M.2120 [25]. A period of unavailable time begins at the onset of ten consecutive SES. These ten seconds are part of unavailable time. A period of available time begins at the onset of ten consecutive non-SES. These ten seconds are part of available time. Performance monitoring event counting for ES, SES, and BBE shall be inhibited during unavailable time.

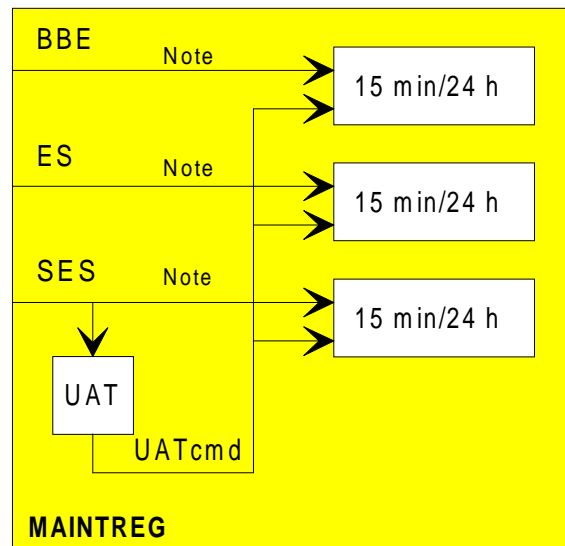

NOTE: The determination of (un)available time introduces (functionally) a delay of 10 seconds. This delay should be considered when counting BBE, ES, SES.

Figure 27: Performance monitoring data collection and history for maintenance purposes

Availability data collection

When a period of unavailability occurs, the beginning and ending of this period should be stored in a log in the NE, and as a consequence time-stamped. The NE should be able to store these data for at least 6 periods of unavailability.

Performance monitoring history

Performance history data are necessary to assess the recent performance of transmission systems. Such information can be used to sectionalise faults and to locate the source of intermittent errors. Historical data, in the form of performance monitoring event counts, may be stored in registers in the NE or in mediation devices associated with the NE. For specific applications, for example when only Quality Of Service alarms are used, historical data may not be stored. All the history registers shall be time stamped. The history registers operate as follows (see also figure 27).

15 minute registers:

The history of the 15 minute monitoring is contained in a stack of 16 registers per monitored event. These registers are called the recent registers. Every 15 minutes the contents of the current registers are moved to the first of the recent registers. When all 15 minute registers are used, the oldest information will be discarded.

24 hour registers:

The history of the 24 hour monitoring is contained in a single register per monitored event. This register is called the recent register. Every 24 hours the contents of the current registers are moved to the recent register.

NOTE 2: This implies that all 24 hour data is discarded after 24 hours.

Performance data reporting

Performance data stored in the NE may be collected by the operator for analysis without affecting the content of the register.

Annex A (informative): Mechanism of the adaptive clock method

The adaptive clock method is a general method for source clock frequency recovery. No explicit timing information of the source clock is transported by the network, the method is based on the fact that the amount of transmitted data is an indication of the source frequency, and this information can be used at the receiver to recover the source clock frequency.

The adaptive clock method is implemented at the receiving AAL. The implementation of the method is not standardized. One possible method to measure the amount of data is to use the fill level of the AAL user data buffer. The following is the general description of this method and does not preclude other adaptive clock methods.

The receiver writes the received data into a buffer, and then reads it out using a locally generated clock. Therefore the fill level of the buffer depends on the source frequency and it is used to control the frequency of the local clock. Operations are the following: the fill level of the buffer is continuously measured and the measure is used to drive the phase-locked loop generating the local clock. The method maintains the fill level of the buffer around its medium position. To avoid buffer underflow or overflow, the fill level is maintained between two limits. When the level in the buffer goes to the lower limit, this means the frequency of the local clock is too high compared to the one of the source and so it has to be decreased; when the level in the buffer goes to upper limit, the frequency of the local clock is too low compared to the one of the source, and so it has to be increased.

It is pointed out that the compensation of cell delay variation is also performed by the adaptive clock method. However, a cell delay variation is not to be expected if no ATM network is to be crossed.

Annex B (informative): Enabling/disabling the HEC functions

The Header Error Control (HEC) functions of the ATM cells, as described in ITU-T Recommendation I.432 [22], can correct single errors and detect almost all multiple errors in the header. In an ATM network, when the HEC detects errors that it cannot correct, the whole cell is discarded and its payload is lost for an end-to-end connection.

When a FEC is applied on a link, it can generate error bursts if it fails to correct errors. In presence of error bursts, the single-bit correcting code of the HEC is unable to correct most errors encountered. In an error bursts environment the probability of discarding cells is proportional to the BER and not to the square of the BER as in a random error environment. Although bursts of errors due to error correction failures have different lengths and rate of occurrence according to the different FEC schemes, this behaviour would apply to all transmission systems using FEC.

Therefore for a given bit error probability, the discarded cell probability in presence of error bursts is definitely different from the discarded cell probability in presence of randomly distributed errors.

It is then recommended to disable the HEC functions when using the ATM cell format for transporting an MPEG-2-TS over a PDH network based on transmission systems using FEC (e.g. radio relays, satellites). This measure avoids unwanted and unnecessary degradation of the end-to-end quality.

Annex C (informative): Transmission capacity of the Network Adapter

Transmission capacity of the Network Adapter for MPEG-2-TSs respectively RS-coded MPEG-2-TSs at specified digital hierarchy bit rates of ITU-T Recommendation G.702 [8].

Table C.1: Command, configuration information flow over MP

Transmission capacity for MPEG-2-TSs respectively RS-coded MPEG-2-TSs	PDH link transmission capacity
1 320 kbit/s	1 544 kbit/s
1 649 kbit/s	2 048 kbit/s
5 279 kbit/s	6 312 kbit/s
7 038 kbit/s	8 448 kbit/s
29 140 kbit/s	34 368 kbit/s
37 980 kbit/s	44 736 kbit/s
118 759 kbit/s	139 264 kbit/s

Annex D (informative): Definition of codes

D.1 Alternate Mark Inversion (AMI)

This code is a three amplitude level code in which binary 1 bits are represented by alternate positive and negative pulses and binary 0 bits are represented by spaces.

In the further definitions, exceptions are made when strings of successive 0 bits occur in the binary signal. In these definitions, B represents an inserted pulse conforming to the AMI rule and V represents an AMI violation.

D.2 High Density Bipolar of order 3 (HDB3)

This code is an AMI code with the exception, that each block of 4 successive zeros is replaced by 000V or B00V. The choice of 000V or B00V is made in such a way that the number of pulses conforming to the AMI rule between consecutive V pulses is odd. In other words, successive V pulses are of alternate polarity.

D.3 Bipolar with 3 Zero Substitution (B3ZS)

This code is an AMI code with the exception that each block of 3 successive zeros is replaced by 00V or B0V. The choice of 00V or B0V is made in such a way that the number of pulses conforming to the AMI rule between consecutive V pulses is odd. In other words, successive V pulses are of alternate polarity.

D.4 Bipolar with 6(8) Zero Substitution (B6ZS and B8ZS)

This code is an AMI code with the exception that each block of 6 (or 8) successive zeros is replaced by 0VB0VB (or 000VB0VB respectively).

D.5 Coded Mark Inversion (CMI)

This code is a two amplitude level code. The binary 1 bits are represented by either of the amplitude levels, for one binary unit time interval, in such a way that the level alternates for successive binary ones. The binary 0 bits are represented by both amplitude levels, each for half a binary unit time interval, in such a way that there is always a positive transition at the midpoint of this time interval.

History

Document history			
February 1997	Public Enquiry	PE 9724:	1997-02-14 to 1997-06-13
September 1997	Vote	V 9746:	1997-09-16 to 1997-11-14