



EUROPEAN
TELECOMMUNICATION
STANDARD

FINAL DRAFT
pr **ETS 300 765-1**

May 1997

Source: ETSI EP-DECT

Reference: DE/DECT-050075-1

ICS: 33.020

Key words: DECT, GSM, RLL

**Digital Enhanced Cordless Telecommunications (DECT);
Radio in the Local Loop (RLL) Access Profile (RAP);
Part 1: Basic telephony services**

ETSI

European Telecommunications Standards Institute

ETSI Secretariat

Postal address: F-06921 Sophia Antipolis CEDEX - FRANCE

Office address: 650 Route des Lucioles - Sophia Antipolis - Valbonne - FRANCE

X.400: c=fr, a=atlas, p=etsi, s=secretariat - **Internet:** secretariat@etsi.fr

Tel.: +33 4 92 94 42 00 - Fax: +33 4 93 65 47 16

Copyright Notification: No part may be reproduced except as authorized by written permission. The copyright and the foregoing restriction extend to reproduction in all media.

© European Telecommunications Standards Institute 1997. All rights reserved.

Contents

Foreword	7
1 Scope	9
2 Normative references	9
3 Definitions, abbreviations and symbols	10
3.1 Definitions	10
3.2 Abbreviations	12
3.3 Symbols	13
4 Introduction	14
4.1 Reference model	14
4.2 Services & facilities	14
5 Feature definitions	14
5.1 Network (NWK) features (only differences to GAP)	14
5.2 Application features (only differences to GAP)	15
6 Service definitions	16
6.1 Data Link Control (DLC) service definitions	16
6.1.1 Reference to GAP	16
6.1.2 LU 7 service	16
6.2 Medium Access Control (MAC) service definitions	16
6.2.1 Reference to GAP	16
6.2.2 MAC service definitions (additional to GAP)	16
7 Interoperability requirements	17
7.1 General	17
7.2 NWK features	18
7.3 DLC services	19
7.4 MAC services	19
7.5 Physical Layer (PHL) services	20
7.6 Application features	20
7.7 NWK feature to procedure mapping	21
7.8 DLC service to procedure mapping	26
7.9 MAC service to procedure mapping	27
7.10 Application feature to procedure mapping	28
7.11 General requirements	28
8 Procedure description	28
9 NWK layer procedures	28
9.1 Reference to GAP	29
9.1.1 Release procedure for "On-hook (conditional release)"	29
9.1.2 CLIP, inband	30
9.2 Maintenance calls	31
9.2.1 Incoming maintenance call	31
9.2.2 Outgoing maintenance call	31
9.2.3 Outgoing call during maintenance call	31
9.2.4 Incoming call during maintenance call	31
9.3 Sending OA&M information	31
9.3.1 Physical resources fault	31
9.3.2 Remote test	32
9.3.3 Alarms	32
9.3.4 On-air modification of user parameters	33

	9.3.4.1	Modification of existing users parameters	33
	9.3.4.2	Additional subscriptions to the same fixed part.....	33
	9.3.4.3	Derivation of AC for additional subscriptions	34
	9.3.5	Remote configuration.....	34
	9.3.6	Claim actions	35
	9.3.7	Remote resynchronization	36
	9.3.8	Advanced file transfer	37
9.4	RLL-CC		37
	9.4.1	Metering pulses	37
	9.4.2	Switch from voice to data service FT initiated	38
	9.4.3	Switch from voice to data service CTA initiated.....	39
	9.4.4	Coin collection	39
	9.4.5	Ground start.....	39
	9.4.6	Line polarity reversal.....	39
	9.4.7	Switch from 32 kbit/s to 64 kbit/s bearer service (FT initiated).....	40
	9.4.8	Switching from 32 kbit/s to 64 kbit/s bearer service CTA initiated.....	42
	9.4.9	Line parked	44
	9.4.10	Switching from 64 kbit/s to 32 kbit/s bearer service FT initiated.....	45
	9.4.11	Switching from 64 kbit/s to 32 kbit/s bearer service CTA initiated.....	46
9.5	Analogue leased line establishment.....		48
10	DLC layer procedures.....		49
	10.1	General.....	49
	10.2	Reference to GAP	49
	10.3	LU7 64 kbit/s data bearer service	49
11	MAC layer procedures		49
	11.1	Reference to GAP	49
	11.2	Advance timing.....	49
	11.3	LU7 64 kbit/s data bearer service	50
	11.4	Downlink broadcast, Extended Fixed Part Capabilities.....	50
	11.5	Blind slot information.....	50
	11.6	Improved channel selection rules.....	50
12	Physical layer requirements.....		51
	12.1	General.....	51
	12.2	Reference to GAP	51
	12.3	LU7 64 kbit/s data bearer service	51
13	Requirements regarding the speech transmission		51
	13.1	General.....	51
	13.2	Echo control requirements for CTAs intended for 2-wire connections.....	51
	13.3	Disabling the echo control functions	52
	13.3.1	General	52
	13.3.2	Modem services.....	52
14	Requirements regarding fax and data transmission.....		52
	14.1	General.....	52
	14.2	Requirements.....	52
	14.2.1	Implementation of the LU7 PCM services.....	52
15	Management procedures.....		52
16	Interworking with WRS applications		52
	16.1	General.....	52
	16.2	Requirements.....	53
	16.3	WRS maintenance calls.....	53
	16.3.1	Incoming WRS maintenance call	53
	16.3.2	Outgoing WRS maintenance call.....	53
	16.3.3	Maintenance during WRS MM operation.....	53

17	Application procedures.....	53
17.1	General	53
17.2	Reference to GAP.....	53
17.3	Manual entry of the PARK and AC to CTAs	53
	17.3.1 Entering the PARK	54
	17.3.2 Entering the AC	54
	Annex A (informative): PP locking procedure for on air subscription.....	56
	Annex B (informative): Tones, progress indicator and U-plane connection.....	57
	Annex C (informative): ETS 300 175 additions/modifications	58
C.1	NWK layer additions/modifications (part 5).....	58
	Annex D (normative): Codings for "OA&M" and "RAP-CC" messages	61
D.1	General structure for RAP <<IWU-to-IWU>> IE	61
D.2	RAP IWU-TO-IWU contents proprietary	62
	D.2.1 RAP-OA&M service type coding	62
D.3	RAP IWU-TO-IWU contents standardized.....	63
	D.3.1 RAP-CC service type coding	63
	D.3.2 RAP-OA&M service type coding	63
	Annex E (normative): Description of remote tests and quality measurement	66
	Annex F (informative): LU8 service.....	67
F.1	Physical layer service	67
F.2	MAC layer service	67
F.3	DLC layer service	67
	Annex G (normative): Interworking with wireless relay stations	68
G.1	Definitions of features, services and procedures	68
	G.1.1 NWK features	68
	G.1.2 MAC services.....	68
G.2	Interoperability requirements.....	68
	G.2.1 NWK features	68
	G.2.2 DLC services.....	69
	G.2.3 MAC services.....	69
	G.2.4 Physical Layer (PHL) services	70
	G.2.5 NWK feature to procedure mapping	71
	G.2.6 DLC service to procedure mapping	73
	G.2.7 MAC service to procedure mapping	74
G.3	NWK layer procedures	76
	G.3.1 NWK layer transparency between FT and PT	76
	G.3.2 Cipher key transfer to CRFP	76

G.4	MAC layer procedures	76
G.4.1	Extended Fixed Part capabilities	76
G.4.2	Hop control	76
G.4.3	Normal C/O bearer set-up	76
G.4.4	Dual C/O bearer set-up	76
G.4.5	CRFP connection suspend and resume	76
G.4.6	CRFP C/O release	76
G.4.7	Bearer handover request	76
G.4.8	Connection handover request	76
Annex H (normative):	Synchronization requirements for FPs	77
History		78

Foreword

This final draft European Telecommunication Standard (ETS) has been produced by the Digital Enhanced Cordless Telecommunications (DECT) Project of the European Telecommunications Standards Institute (ETSI), and is now submitted for the Voting phase of the ETSI standards approval procedure.

Every standard prepared by ETSI is a voluntary standard. This ETS may contain text concerning conformance testing of the equipment to which it relates. This text should be considered as guidance only and does not make this ETS mandatory.

This ETS is based on ETS 300 175, parts 1 to 8 [1] - [8] and ETS 300 444 [14]. This ETS has been developed in accordance to the rules of documenting a profile specification as described in ISO/IEC 9646-6 [11].

This ETS consists of 2 parts as follows:

Part 1: **"Part 1: Basic telephony services";**

Part 2: "Advanced telephony services".

Proposed transposition dates	
Date of latest announcement of this ETS (doa):	3 months after ETSI publication
Date of latest publication of new National Standard or endorsement of this ETS (dop/e):	6 months after doa
Date of withdrawal of any conflicting National Standard (dow):	6 months after doa

Blank page

1 Scope

This European Telecommunication Standard (ETS) specifies that set of technical requirements for Digital Enhanced Cordless Telecommunications (DECT) Fixed Part (FP) and DECT Cordless Terminal Adapter (CTA) necessary for the support of the Radio in the Local Loop (RLL) Access Profile (RAP).

The objective of the ETS is to ensure the air interface interoperability of DECT RAP CTAs and DECT RAP FPs and Wireless Relay Stations (WRSs) if applied.

In addition, this ETS defines the features, services, procedures etc. for the CTA and the FT, which are provision mandatory either in the CTA or in the FT, as well as some elements that are provision optional but still process mandatory.

Another objective is to use as much as possible from the existing Generic Access Profile (GAP), but to exclude the not applicable GAP features. Therefore most of the RAP features refer to GAP features and the necessary additional features (for example Operation, Administration, and Maintenance (OA&M)) are listed and explained in this document.

This ETS contains the so-called "Plain Old Telephone Service (POTS)" services including leased lines and 64 kbit/s bearer service.

2 Normative references

This ETS incorporates, by dated or undated reference, provisions from other publications. These normative references are cited at the appropriate places in the text and the publications are listed hereafter. For dated references, subsequent amendments to or revisions of any of these publications apply to this ETS only when incorporated in it by amendment or revision. For undated references the latest edition of the publication referred to applies.

- [1] ETS 300 175-1: "Digital Enhanced Cordless Telecommunications (DECT); Common Interface (CI); Part 1: Overview".
- [2] ETS 300 175-2: "Digital Enhanced Cordless Telecommunications (DECT); Common Interface (CI); Part 2: Physical layer (PHL)".
- [3] ETS 300 175-3: "Digital Enhanced Cordless Telecommunications (DECT); Common Interface (CI); Part 3: Medium Access Control (MAC) layer".
- [4] ETS 300 175-4: "Digital Enhanced Cordless Telecommunications (DECT); Common Interface (CI); Part 4: Data Link Control (DLC) layer".
- [5] ETS 300 175-5: "Digital Enhanced Cordless Telecommunications (DECT); Common Interface (CI); Part 5: Network (NWK) layer".
- [6] ETS 300 175-6: "Digital Enhanced Cordless Telecommunications (DECT); Common Interface (CI); Part 6: Identities and addressing".
- [7] ETS 300 175-7: "Digital Enhanced Cordless Telecommunications (DECT); Common Interface (CI); Part 7: Security features".
- [8] ETS 300 175-8: "Digital Enhanced Cordless Telecommunications (DECT); Common Interface (CI); Part 8: Speech coding and transmission".
- [9] ETS 300 176: "Radio Equipment and Systems (RES); Digital Enhanced Cordless Telecommunications (DECT); Approval test specification".
- [10] TBR 6: "Radio Equipment and Systems (RES); Digital Enhanced Cordless Telecommunications (DECT); General terminal attachment requirements".
- [11] ISO/IEC 9646-6: "Information technology - Open Systems Interconnection - Conformance testing methodology and framework - Part 6: Protocol profile test specification".

- [12] ISO/IEC 9646-7: "Information technology - Open Systems Interconnection - Conformance testing methodology and framework - Part 7: Implementation conformance statement".
- [13] TBR 10: "Radio Equipment and Systems (RES); Digital Enhanced Cordless Telecommunications (DECT); General terminal attachment requirements; Telephony applications".
- [14] ETS 300 444 (1995): "Radio Equipment and Systems (RES); Digital European Cordless Telecommunications (DECT); Generic Access Profile (GAP)".
- [15] ETS 300 700: "Radio Equipment and Systems (RES); Digital European Cordless Telecommunications (DECT); Wireless Relay Station (WRS)".
- [16] ETR 308: "Digital Enhanced Cordless Telecommunications (DECT); Services, facilities and configurations for DECT in the local loop".
- [17] ETR 246: "Radio Equipment and Systems (RES); Digital European Cordless Telecommunications (DECT); Application of DECT Wireless Relay Station (WRS)".
- [18] CCIR Recommendation 723: "Transmission of component-coded digital television signals for contribution-quality applications at the third hierarchical level of CCITT Recommendation G.702".
- [19] ITU-T Recommendation V.25: "Automatic answering equipment and/or parallel automatic calling equipment on the general switched telephone network including procedures for disabling of echo control devices for both manually and automatically established calls".
- [20] ITU-T Recommendation G.164: "Echo suppressors".
- [21] ITU-T Recommendation G.165: " Echo cancellers".

3 Definitions, abbreviations and symbols

3.1 Definitions

For the purposes of this ETS, the following definitions apply:

authentication: The process whereby a DECT subscriber is positively verified to be a legitimate user of a particular FP.

NOTE 1: Authentication is generally performed at call set-up, but may also be done at any other time (e.g. during a call).

bearer service: A type of telecommunication service that provides a defined capability for the transmission of signals between user-network interfaces.

NOTE 2: The DECT user-network interface corresponds to the top of the network layer (layer 3).

C-plane: The control plane of the DECT protocol stacks, which contains all of the internal DECT protocol control, but may also include some external user information.

NOTE 3: The C-plane stack always contains protocol entities up to and including the network layer.

call: All of the NWK layer processes involved in one network layer peer-to-peer association.

NOTE 4: Call may sometimes be used to refer to processes of all layers, since lower layer processes are implicitly required.

Cordless Terminal Adapter (CTA): Physical grouping that contains a DECT portable termination and a line interface.

DECT network: A network that uses the DECT air interface to interconnect a local network to one or more portable applications. The logical boundaries of the DECT network are defined to be at the top of the DECT network layer.

NOTE 5: A DECT network is a logical grouping that contains one or more fixed radio terminations plus their associated portable radio termination. The boundaries of the DECT network are not physical boundaries.

Fixed Part (DECT Fixed Part) (FP): A physical grouping that contains all of the elements in the DECT network between the local network and the DECT air interface.

NOTE 6: A DECT FP contains the logical elements of at least one FT, plus additional implementation specific elements.

Fixed radio Termination (FT): A logical group of functions that contains all of the DECT processes and procedures on the fixed side of the DECT air interface.

NOTE 7: A FT only includes elements that are defined in the DECT CI standard. This includes radio transmission elements together with a selection of layer 2 and layer 3 elements.

NOTE 8: A FT can also be the FT side of a WRS.

handover: The process of switching a call in progress from one physical channel to another physical channel.

NOTE 9: There are two physical forms of handover, intracell handover and intercell handover.

incoming call: A call received at a CTA.

intercell handover: The switching of a call in progress from one cell to another cell.

internal handover: Handover processes that are completely internal to one FT. Internal handover reconnects the call at the lower layers, while maintaining the call at the NWK layer.

NOTE 10: The lower layer reconnection can either be at the DLC layer (connection handover) or at the Medium Access Control (MAC) layer (bearer handover).

interoperability: The capability of FPs and CTAs, that enable a CTA to obtain access to teleservices in more than one location area and/or from more than one operator (more than one service provider).

Intracell handover: The switching of a call in progress from one physical channel of one cell to another physical channel of the same cell.

Local Exchange (LE): A local switch connecting the end-user to the public network.

Local Network (LNW): A telecommunication network capable of offering local telecommunication services.

NOTE 11: The term does not include legal or regulatory aspects, nor does it indicate if the network is a public network or a private network.

location area: The domain in which a PP may receive (and/or make) calls as a result of a single location registration.

location registration: The process whereby the position of a DECT PT is determined to the level of one location area, and this position is updated in one or more databases.

NOTE 12: These databases are not included within a DECT FT.

MAC connection (connection): An association between one source MAC Multi-Bearer Control (MBC) entity and one destination MAC MBC entity. This provides a set of related MAC services (a set of logical channels), and it can involve one or more underlying MAC bearers.

outgoing call: A call originating from a PP.

Portable Application (PA): A logical grouping that contains all the elements that lie beyond the DECT network boundary on the portable side.

NOTE 13: The functions contained in the PA may be physically distributed, but any such distribution is invisible to the DECT network.

Portable Part (DECT Portable Part) (PP): A physical grouping that contains all elements between the user and the DECT air interface. PP is a generic term that may describe one or several physical pieces.

NOTE 14: A DECT PP is logically divided into one PT plus one or more PAs.

Portable radio Termination (PT): A logical group of functions that contains all of the DECT processes and procedures on the portable side of the DECT air interface.

NOTE 15: A PT only includes elements that are defined in the DECT CI standard. This includes radio transmission elements (layer 1) together with a selection of layer 2 and layer 3 elements.

NOTE 16: A PT can also be the PT side of a WRS or the PT side of a CTA.

Radio Fixed Part (RFP): One physical sub-group of a FP that contains all the radio end points (one or more) that are connected to a single system of antennas.

registration: An ambiguous term, that should always be qualified. See either location registration or subscription registration.

subscription registration: The infrequent process whereby a subscriber obtains access rights to one or more FPs.

NOTE 17: Subscription registration is usually required before a user can make or receive calls.

Wireless Relay Station (WRS): A physical grouping that combines elements of both PTs and FTs to relay information on a physical channel from one DECT termination to a physical channel to another DECT termination.

NOTE 18: The DECT termination can be a PT or an FT or another WRS.

3.2 Abbreviations

For the purposes of this ETS, the following abbreviations apply:

AC	Authentication Code
ADPCM	Adaptive Differential Pulse Code Modulation
ARI	Access Rights Identity
ARQ	Automatic Retransmission Request
CC	Call Control
CI	Common Interface
CLIP	Calling Line Identification Presentation
CPE	Customer Premises Equipment
CRFP	Cordless Radio Fixed Part
CTA	Cordless Terminal Adapter
C/O	Connection Oriented mode
DCK	Derived Cipher Key
DECT	Digital Enhanced Cordless Telecommunications
DLC	Data Link Control
DTMF	Dual Tone Multi-Frequency

FEC	Forward Error Control
FP	Fixed Part
FT	Fixed radio Termination
GAP	Generic Access Profile
GPS	Global Position System
GSM	Global System for Mobile communications
IE	Information Element
IPUI	International Portable User Identity
ISDN	Integrated Services Digital Network
IWU	Interworking Unit
LE	Local Exchange
LNW	Local Network
LLME	Lower Layer Management Entity
MAC	Medium Access Control
MCEI	MAC Connection Endpoint Identification
MM	Mobility Management
NWK	Network
OA&M	Operation, Administration, and Maintenance
P	Public (environment)
PA	Portable Application
PABX	Private Automatic Branch Exchange
PARK	Portable Access Rights Key
PCM	Pulse Code Modulation
PD	Protocol Discriminator (value)
PHL	Physical Layer
PLI	PARK Length Indicator
POTS	Plain Old Telephone Service
PP	Portable Part
PT	Portable radio Termination
RAP	Radio in the local loop Access Profile
RFP	Radio Fixed Part
RFPI	Radio Fixed Part Identity
RLL	Radio in the Local Loop
RS	Reed Solomon code
SARI	Secondary Access Rights Identity
TDMA	Time Division Multiple Access
TE	Terminal Equipment
UAK	User Authentication Key
WRS	Wireless Relay Station

3.3 Symbols

The symbols defined in this subclause are applied for procedures, features, services in this ETS if not explicitly otherwise stated. The interpretation of status columns in all tables is as follows:

- M for mandatory to support (provision mandatory, process mandatory);
- O for optional to support (provision optional, process mandatory);
- I for out-of-scope (provision optional, process optional) not subject for testing;
- C for conditional to support (process mandatory);
- N/A for not-applicable (in the given context the specification makes it impossible to use this capability).

Provision mandatory, process mandatory means that the indicated feature, service or procedure shall be implemented as described in this ETS, and may be subject to testing.

Provision optional, process mandatory means that the indicated feature, service or procedure may be implemented, and if implemented, the feature, service or procedure shall be implemented as described in this ETS, and may be subject to testing.

NOTE: The used notation is based on the notation proposed in ISO/IEC 9646-7 [12].

4 Introduction

4.1 Reference model

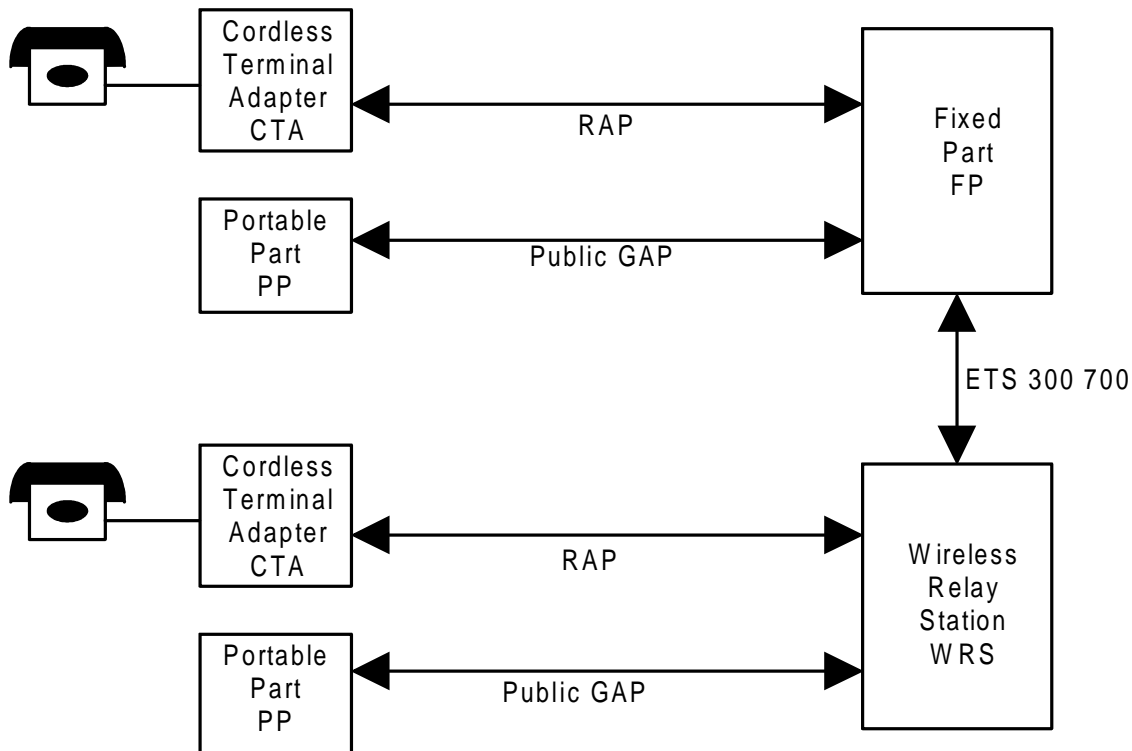

Figure 1: Reference model

4.2 Services & facilities

This ETS provides a minimum service level, i.e. the so-called "POTS" services, and optional extensions including 64 kbit/s bearer service and leased lines. A FP that supports the RLL Access Profile (RAP) may additionally support GAP and can in this way support both CTAs and GAP PPs as well as the respective RAP and GAP WRSs, and also CTAs with embedded GAP WRS functionality (see ETS 300 700 [15]).

Another part of the RAP is expected to describe ISDN services, non-voiceband data services and support of digital leased lines.

5 Feature definitions

For the purposes of this ETS, the feature definitions in the following subclauses apply.

The number given in square brackets after the name of a feature is the item number used in the tables of this ETS.

5.1 Network (NWK) features (only differences to GAP)

64 kbit/s bearer service using DLC LU7 service [N.116]: The ability to offer the DLC LU7 service suitable for a 64 kbit/s bearer service and transparent ISDN services using double slots at the physical layer.

Advanced file transfer [N.121]: The ability to transfer file to the CTA.

Alarms [N.109]: The ability of the CTA to indicate to the FP that a significant system event occurs or is about to occur which may seriously affect the systems ability to function.

Analogue Leased Line [N.106]: The ability to provide an analogue leased line.

Calling Line Identification Presentation, inband (CLIP, inband) [N.101]: The ability to provide the calling party number to the POTS CTA by transmitting DTMF or modem tones to the CTA within the speech channel before off hook during incoming call.

Coin collection [N.113]: The ability to transmit the result of coin collection via RAP-CC message.

Ground start [N.114]: The ability to transmit the ground start signal via a RAP-CC message.

Incoming maintenance transaction [N.102]: The ability of the CTA to receive, and the FP to send OA&M messages.

Incoming WRS maintenance transaction [N.119]: The ability of the WRS to receive OA&M messages from the FP.

Line polarity reversal [N.118]: The ability to transmit the line polarity reversal signal via a RAP-CC message.

Line parked [N.117]: The ability of the FP to indicate to the CTA that the LE has parked the line.

Maintenance during call [N.104]: The ability of the CTA and FT to exchange OA&M messages during an active call.

Maintenance during WRS MM operation [N.122]: The ability of the WRS to exchange OA&M messages with the FP during an ongoing MM operation.

Metering pulses [N.105]: The ability of the CTA to generate metering pulses on reception of a corresponding RAP-CC message.

On-air modification of user parameters [N.110]: The ability of the CTA to accept FP initiated changes of subscription data.

On-Hook (CONDITIONAL Release) [N.100]: The ability of the CTA to indicate the action of going on-hook (e.g. to terminate a call) to the DECT FP. On reception of the "on hook" indication, the DECT FP may terminate the call, and release the radio resource.

Outgoing maintenance transaction [N.103]: The ability of the CTA to send, and the FP to receive OA&M messages.

Outgoing WRS maintenance transaction [N.120]: The ability of the WRS to send OA&M messages to the FP.

Physical resources fault [N.107]: The ability of the CTA to corresponding OA&M messages to indicate the location of faults in the Physical resources to the network management.

Remote configuration [N.115]: The ability to configure the parameters of the CTA via OA&M messages.

Remote Test [N.108]: The ability of the FP to request the CTA to run specific tests.

Switch from voice to data service FT initiated [N.111]: The ability of the FT of detecting the 2,1 kHz tone in the Audio-Channel and of switching an existing speech call in a data call sending a RAP-CC message to the CTA and the ability of the CTA to process this message.

Switch from voice to data service CTA initiated [N.112]: The ability of the CTA of detecting the 2,1 kHz tone in the Audio-Channel and of switching an existing speech call in a data call sending a RAP-CC message to the FT and the ability of the FT to process this message.

5.2 Application features (only differences to GAP)

Manual entry of the PARK and AC to a CTA [A.100]: The ability of the CTA to accept a manual entry of the PARK for ensuring attachment to the right FP in a physical area covered by many providers and a manual entry of the AC via the keypad of a connected CPE.

6 Service definitions

For the purposes of this ETS, the following service definitions apply:

6.1 Data Link Control (DLC) service definitions

6.1.1 Reference to GAP

See ETS 300 444 [14], subclause 5.1.

6.1.2 LU 7 service

The LU-7 service is used to protect the transmission signal by an RS (255,249) code which may be used to correct up to 3 errors within a double slot connection. The generator polynomial to encode and decode the information has 6th degree. The same type as proposed in CCIR Recommendation 723 [18] shall be used:

$$p(X) = \prod_{i=0}^5 (X + \alpha^i)$$

where α is a root of the binary primitive polynomial

$$g(X) = X^8 + X^4 + X^3 + X^2 + 1$$

A data byte

$$(d_7, d_6, d_5, d_4, d_3, d_2, d_1, d_0)$$

is identified with the element

$$d_7\alpha^7 + d_6\alpha^6 + d_5\alpha^5 + d_4\alpha^4 + d_3\alpha^3 + d_2\alpha^2 + d_1\alpha^1 + d_0\alpha^0$$

in GF(256), the finite field with 256 elements.

6.2 Medium Access Control (MAC) service definitions

6.2.1 Reference to GAP

See ETS 300 444 [14], subclause 5.2.

6.2.2 MAC service definitions (additional to GAP)

LU7 MAC service [M.100]: See ETS 300 175-4 [4], clause E.3.

Advance Timing [M.101]: Information sent from FT to PT which the PT can use to adjust its timing reference for subsequent transmissions, in order to control the link quality.

Continuous broadcast, Extended Fixed Part Capabilities [M.102]: Information broadcast from FT to CTAs to indicate the support of the RAP 1 profile.

Improved channel selection rules [M.103]: An algorithm used to improve the channel selection procedure in mixed environment.

7 Interoperability requirements

7.1 General

The tables listed in this subclause define all the protocol elements i.e. features, services, and procedures which are mandatory, optional, and conditional under the provision of another protocol element, or out of the scope of this ETS, or in some context not-applicable according to the definition of the status column as defined in subclause 3.3 for the RAP FP and CTA. All optional elements shall be process mandatory according to the procedures described in this ETS.

Protocol elements defined as mandatory, optional or conditional in this subclause shall further be defined in clauses 8, 9, 10, 11, 12, 13, 14, 15, 16, 17 and annex D in detail either explicitly and/or as references to the DECT base standard ETS 300 175, parts 2 to 8 [2] to [8] , ETS 300 444 [14] and ETS 300 176 [9].

NOTE: Annexes A, B and C are informative and may be used as additional information, but do not mandate requirements.

The requirements of TBR 6 [10] shall be met by all equipment conforming to this ETS.

7.2 NWK features

Table 1: NWK features status

Feature supported				Status	
Item no.	Name of feature	ETS 300 444 [14] reference	ETS 300 765 reference	CTA	FT
N.1	Outgoing call	4.1		M	M
N.2	Off Hook	4.1		M	M
N.4	Dialled digits (basic)	4.1		M	M
N.5	Register recall (notes 1 and 2)	4.1		M	O
N.8	Incoming call	4.1		M	M
N.9	Authentication of the PP	4.1		M	M
N.11	Location registration	4.1		M	M
N.12	On air key allocation (note 3)	4.1		M	O
N.13	Identification of PP	4.1		M	O
N.15	Alerting	4.1		M	M
N.17	Encryption activation FT initiated	4.1		M	M
N.18	Subscription registration procedure on-air	4.1		M	M
N.19	Link control	4.1		M	M
N.20	Terminate access rights FT initiated (note 3)	4.1		M	O
N.21	Partial release	4.1		M	M
N.26	Authentication of FT	4.1		O	O
N.27	Encryption activation PT initiated	4.1		O	O
N.28	Encryption deactivation FT initiated	4.1		O	O
N.29	Encryption deactivation PT initiated	4.1		O	O
N.30	CLIP	4.1		O	O
N.100	On Hook (conditional release)		5.1	M	M
N.101	CLIP, inband		5.1	O	O
N.102	Incoming maintenance transaction		5.1	M	M
N.103	Outgoing maintenance transaction		5.1	M	M
N.104	Maintenance during call		5.1	M	M
N.105	Metering Pulses		5.1	M	M
N.106	Analogue Leased Lines		5.1	O	O
N.107	Physical resources fault		5.1	M	M
N.108	Remote test		5.1	M	M
N.109	Alarms		5.1	M	M
N.110	On-air modification of user parameters		5.1	O	O
N.111	Switch from voice to data service FT initiated		5.1	M	M
N.112	Switch from voice to data service CTA initiated		5.1	O	O
N.113	Coin collection		5.1	O	O
N.114	Ground start		5.1	O	O
N.115	Remote configuration		5.1	O	O
N.116	64 kbit/s bearer service using DLC LU7 service		5.1	O	O
N.117	Line parked		5.1	O	O
N.118	Line polarity reversal		5.1	O	O
N.119	Incoming WRS maintenance transaction		5.1	N/A	O
N.120	Outgoing WRS maintenance transaction		5.1	N/A	O
N.121	Advanced file transfer		5.1	O	O
N.122	Maintenance during WRS MM operation		5.1	N/A	O
NOTE 1:	This feature uses keypad code 15 hex.				
NOTE 2:	The FT is not mandated to receive and understand the register recall DECT character. However, if a FT supports it there may be no corresponding action that the FT can take with the local network as a result of this function.				
NOTE 3:	This feature is required to be supported in the PT to guarantee the same level of security among all the handsets that operates in a system. The invocation of the feature is however optional to the operator.				

7.3 DLC services

Table 2: DLC services status

Service supported				Status	
Item no.	Name of service	ETS 300 444 [14] reference	ETS 300 765 reference	CTA	FT
D.1	LAPC class A service and Lc	5.1		M	M
D.2	Cs channel fragmentation and recombination	5.1		M	M
D.3	Broadcast Lb service	5.1		M	M
D.4	Intracell voluntary connection handover	5.1		M	C201
D.5	Intercell voluntary connection handover (note)	5.1		M	O
D.6	Encryption activation	5.1		M	M
D.7	LU1 TRUP Class 0/min_delay	5.1		M	M
D.8	FU1	5.1		M	M
D.9	Encryption deactivation	5.1		C202	C202
D.100	LU7 service		6.1.2	C203	C203

NOTE: The PT is required to be able to support handover between RFPs. The invocation of the feature is however optional to the operator.

C201: IF service M.9 THEN O ELSE M;
C202: IF feature N.29 OR N.28 THEN M ELSE I;
C203: IF feature N.116 THEN M ELSE I.

7.4 MAC services

Table 3: MAC services status

Service supported				Status	
Item no.	Name of service	ETS 300 444 [14] reference	ETS 300 765 reference	CTA	FT
M.1	General	5.2		M	M
M.2	Continuous broadcast	5.2		M	M
M.3	Paging broadcast	5.2		M	M
M.4	Basic connections	5.2		M	M
M.5	Cs higher layer signalling	5.2		M	M
M.6	Quality control	5.2		M	M
M.7	Encryption activation	5.2		M	M
M.8	Extended frequency allocation (note)	5.2		M	O
M.9	Bearer handover, intracell	5.2		M	C301
M.10	Bearer handover, intercell	5.2		M	O
M.11	Connection handover, intracell	5.2		M	C302
M.12	Connection handover, intercell	5.2		M	O
M.13	SARI support	5.2		M	O
M.14	Encryption deactivation	5.2		C303	C303
M.100	LU7 service		6.2.2	C304	C304
M.101	Advance Timing		6.2.2	O	O
M.102	Continuous broadcast, Extended Fixed Part Capabilities		6.2.2	M	M
M.103	Improved channel selection rules		6.2.2	O	N/A

NOTE: Handsets not supporting these extra frequencies need only adapt scanning to allow continued use of the standard DECT frequencies.

C301: IF service M.12 THEN O ELSE M;
C302: IF service M.9 THEN O ELSE M;
C303: IF feature N.29 OR N.N.28 THEN M ELSE I;
C304: IF feature N.116 THEN M ELSE I.

7.5 Physical Layer (PHL) services

See subclause 6.5 of ETS 300 444 [14].

If the LU7 64 kbit/s data bearer service is supported [N.116], the double slot physical packet P80 (see ETS 300 175-2 [2]) shall be used.

7.6 Application features**Table 4: Application features status**

Feature supported					
Item no.	Name of feature	ETS 300 444 [14] reference	ETS 300 765 reference	Status	
				RAP	
				CTA	FT
A.1	AC_bitstring_mapping	4.2		M	M
A.2	Multiple subscription registration	4.2		O	N/A
A.100	Manual entry of the PARK and AC to CTAs		5.2	O	N/A

7.7 NWK feature to procedure mapping

Table 5: NWK feature to procedure mapping

Feature/procedure mapping				Status	
Feature	Procedure	ETS 300 444 [14] reference	ETS 300 765 reference	RAP	
				CTA	FT
N.1 Outgoing call		4.1		M	M
	Outgoing call request	8.2		M	M
	Overlap sending	8.3		M	O
	Outgoing call proceeding	8.4		M	O
	Outgoing call confirmation	8.5		M	O
	Outgoing call connection	8.6		M	M
	Sending keypad information	8.10		M	M
N.2 Off Hook		4.1		M	M
	Outgoing call request	8.2		M	M
	Incoming call connection	8.15		M	M
N.4 Dialed digits (basic)		4.1		M	M
	Sending keypad information	8.10		M	M
N.5 Register recall (Hook flash)		4.1		M	O
	Sending keypad information	8.10		M	M
N.8 Incoming call		4.1		M	M
	Incoming call request	8.12		M	M
	Incoming call confirmation	8.13		M	M
	PT alerting	8.14		M	M
	Incoming call connection	8.15		M	M
N.9 Authentication of the PP		4.1		M	M
	Authentication of PT	8.24		M	M
N.11 Location registration		4.1		M	M
	Location registration	8.28		M	M
	Location update	8.29		M	O
N.12 On air key allocation		4.1		M	O
	Key allocation	8.32		M	M
N.13 Identification of PP		4.1		M	O
	Identification of PT	8.22		M	M
N.15 Alerting		4.1		M	M
	PT alerting	8.14		M	M
N.17 Encryption activation FT initiated		4.1		M	M
	Cipher-switching initiated by FT	8.33		M	M
	Storing the DCK	8.27		M	M
N.18 Subscription registration user procedure on-air		4.1		M	M
	Obtaining access rights	8.30		M	M
N.19 Link control		4.1		M	M
	Indirect FT initiated link establishment	8.35		M	M
	Direct PT initiated link establishment	8.36		M	M
	Link release "normal"	8.37		M	M
	Link release "abnormal"	8.38		M	M
	Link release "maintain"	8.39		M	M

(continued)

Table 5 (continued): NWK feature to procedure mapping

Feature/procedure mapping				Status	
Feature	Procedure	ETS 300 444 [14] reference	ETS 300 765 reference	RAP	
				CTA	FT
N.20 Terminate access rights FT initiated		4.1		M	O
	FT terminating access rights	8.31		M	M
	Authentication of FT	8.23		O	M
N.21 Partial release		4.1		M	M
	Partial release	8.9		M	M
N.26 Authentication of FT		4.1		O	O
	Authentication of FT	8.23		M	M
N.27 Encryption activation PT initiated		4.1		O	O
	Cipher-switching initiated by PT	8.34		M	M
	Storing the DCK	8.27		M	M
N.28 Encryption deactivation FT initiated		4.1		O	O
	Cipher-switching initiated by FT	8.33		M	M
N.29 Encryption deactivation PT initiated		4.1		O	O
	Cipher-switching initiated by PT	8.34		M	M
N.30 Calling Line Identification Presentation (CLIP)		4.1		O	O
	Incoming call request	8.12		M	M
N.100 On Hook (conditional release)			5.1	M	M
	Sending on hook information		9.1.1	M	M
N.101 Calling Line Identification Presentation (CLIP), inband			5.1	O	O
	Incoming call request	8.12		M	M
	U-plane connection by CC_ALERTING		9.1.2	M	M
	U-plane connection after initial ring		9.1.2	M	M
	U-plane connection after pulsed line reversal		9.1.2	M	M
N.102 Incoming maintenance transaction			5.1	M	M
	Incoming maintenance call		9.2.1	M	M
	Sending OA&M information		9.3	M	M
	Outgoing call during maintenance call		9.2.3	M	M
	Incoming call during maintenance call		9.2.4	M	M
	Claim enable/claim disable		9.3.6	M	O
N.103 Outgoing maintenance transaction			5.1	M	M
	Outgoing maintenance call		9.2.2	M	M
	Sending OA&M information		9.3	M	M
	Outgoing call during maintenance call		9.2.3	M	M
	Incoming call during maintenance call		9.2.4	M	M
	Claim enable/claim disable		9.3.6	M	O

(continued)

Table 5 (continued): NWK feature to procedure mapping

Feature/procedure mapping					
Feature	Procedure	ETS 300 444 [14] reference	ETS 300 765 reference	Status	
				RAP	
				CTA	FT
N.104 Maintenance during call			5.1	M	M
	Sending OA&M information		9.3	M	M
N.105 Metering Pulses			5.1	M	M
	Metering pulses		9.4.1	M	M
N.106 Analogue Leased Lines			5.1	O	O
	Analogue leased line establishment		9.5	M	M
N.107 Physical resources fault			5.1	M	M
	Antenna fault		9.3.1	O	O
	RF unit plus logic fault		9.3.1	O	O
	Line interface unit fault		9.3.1	O	O
	Power supply unit fault		9.3.1	O	O
	Backup battery fault		9.3.1	O	O
	Network terminating fault		9.3.1	O	O
	General unit fault		9.3.1	M	M
N.108 Remote test			5.1	M	M
	Detect network terminating unit test		9.3.2	O	O
	Detect presence of telephone test		9.3.2	O	O
	Check for leakage to earth test		9.3.2	O	O
	Detect hazardous voltage test		9.3.2	O	O
	Detect mains power at CTA test		9.3.2	O	O
	Link quality test		9.3.2	O	O
	RSSI test		9.3.2	O	O
	Ring/ Ring trip test		9.3.2	O	O
	Dialled digit test		9.3.2	O	O
	Deliver number failed remote call attempts made by CTA		9.3.2	M	M
	A-CRC test		9.3.2	O	O
	Frame error test		9.3.2	O	O
	Result on test Detect network terminating unit		9.3.2	O	O
	Result on test Detect presence of telephone		9.3.2	O	O
	Result on test Check for leakage to earth		9.3.2	O	O
	Result on test Detect hazardous voltage		9.3.2	O	O
	Result on test Detect mains power at CTA		9.3.2	O	O
	Result on test Link quality		9.3.2	O	O
	Result on test RSSI		9.3.2	O	O
	Result on test Ring/Ring trip		9.3.2	O	O
	Result on test Dialled digit		9.3.2	O	O
	Delivery of number of failed remote call attempts made by CTA		9.3.2	M	M
	Result on test A-CRC		9.3.2	O	O
	Result on test Frame error		9.3.2	O	O

(continued)

Table 5 (continued): NWK feature to procedure mapping

Feature/procedure mapping				Status	
Feature	Procedure	ETS 300 444 [14] reference	ETS 300 765 reference	RAP	
				CTA	FT
N.109 Alarms			5.1	M	M
	Mains failure alarm		9.3.3	M	M
	Power supply failure alarm		9.3.3	O	O
	Low battery voltage alarm		9.3.3	O	O
	Opening of CTA enclosure alarm		9.3.3	O	O
N.110 On-air modification of user parameters			5.1	O	O
	On-air modification of user parameters		9.3.4	M	M
N.109 Alarms			5.1	M	M
	Mains failure alarm		9.3.3	M	M
	Power supply failure alarm		9.3.3	O	O
	Low battery voltage alarm		9.3.3	O	O
	Opening of CTA enclosure alarm		9.3.3	O	O
N.110 On-air modification of user parameters			5.1	O	O
	On-air modification of user parameters		9.3.4	M	M
	Remote resynchronization		9.3.7	M	M
N.111 Switch from voice to data service FT initiated			5.1	M	M
	Switch from voice to data service FT initiated		9.4.2	M	M
N.112 Switch from voice to data service CTA initiated			5.1	O	O
	Switch from voice to data service CTA initiated		9.4.3	M	M
N.113 Coin collection			5.1	O	O
	Coin collection		9.4.3	M	M
N.114 Ground start			5.1	O	O
	Ground start		9.4.4	M	M
	Sending keypad information	8.10		M	M
N.115 Remote configuration			5.1	O	O
	Remote configuration		9.3.5	M	M
N.116 64 kbit/s bearer service using DLC LU7 service			5.1	O	O
	Switch from 32 kbit/s to 64 kbit/s bearer service FT initiated		9.4.7	M	M
	Switch from 32 kbit/s to 64 kbit/s bearer service CTA initiated		9.4.8	O	O
	Switch from 64 kbit/s to 32 kbit/s bearer service FT initiated		9.4.10	O	O
	Switch from 64 kbit/s to 32 kbit/s bearer service CTA initiated		9.4.11	O	O
N.117 Line parked			5.1	O	O
	Line parking		9.4.7	M	M

(continued)

Table 5 (concluded): NWK feature to procedure mapping

Feature/procedure mapping					
Feature	Procedure	ETS 300 444 [14] reference	ETS 300 765 reference	Status	
				RAP	
				CTA	FT
N.118 Line polarity reversal			5.1	O	O
	Line polarity reversal		9.4.5	M	M
N.119 Incoming WRS maintenance transaction			5.1	N/A	O
	Incoming WRS maintenance call		16.3.1	N/A	M
	Sending OA&M information		9.3	N/A	M
N.120 Outgoing WRS maintenance transaction			5.1	N/A	O
	Outgoing WRS maintenance call		16.3.2	N/A	M
	Sending OA&M information		9.3	N/A	M
N.121 Advanced file transfer			5.1	O	O
	Advanced file transfer		9.3.8	M	M
N.122 Maintenance during WRS MM operation			5.1	N/A	O
	Maintenance during WRS MM operation		16.3.3	N/A	M

7.8 DLC service to procedure mapping

Table 6: DLC service to procedure mapping

Service/procedure mapping				Status	
Service	Procedure	ETS 300 444 [14] reference	ETS 300 765 reference	CTA	FT
D.1 LAPC class A service and Lc		5.1		M	M
	Class A link establishment	9.1		M	M
	Class A acknowledged information transfer	9.2		M	M
	Class A link release	9.3		M	M
	Class A link re-establishment	9.4		M	M
D.2 Cs channel fragmentation and recombination		5.1		M	M
	Cs channel fragmentation and recombination	9.5		M	M
D.3 Broadcast Lb service		5.1		M	M
	Normal broadcast	9.6		M	M
D.4 Intracell voluntary connection handover		5.1		M	C601
	Class A basic connection handover	9.7		M	M
D.5 Intercell voluntary connection handover		5.1		M	O
	Class A basic connection handover	9.7		M	M
D.6 Encryption activation		5.1		M	M
	Encryption switching	9.8		M	M
D.7 LU1 TRUP Class 0/min_delay		5.1		M	M
	U-plane Class 0/min delay	9.9		M	M
D.8 FU1		5.1		M	M
	FU1 frame operation	9.10		M	M
D.9 Encryption deactivation		5.1		C602	C602
	Encryption switching	9.8		M	M
D.100 LU7 Service			6.1.2	C603	C603
	LU7 DLC procedure		10.3	M	M

C601: IF service M.9 THEN O ELSE M;

C602: IF feature N.29 OR N.N.28 THEN M ELSE I;

C603: IF feature N.116 THEN M ELSE I.

7.9 MAC service to procedure mapping

Table 7: MAC service to procedure mapping

Service/procedure mapping				Status	
Service	Procedure	ETS 300 444 [14] reference	ETS 300 765 reference	CTA	FT
M.1 General		5.2		M	M
	General	10.1		M	M
M.2 Continuous broadcast		5.2		M	M
	Downlink broadcast	10.2		M	M
M.3 Paging broadcast		5.2		M	M
	Paging broadcast	10.3		M	M
M.4 Basic connections		5.2		M	M
	Set-up of basic connection, basic bearer set-up (A-field)	10.4		M	M
	Connection/bearer release	10.5		M	M
M.5 Cs higher layer signalling		5.2		M	M
	Cs channel data	10.8		M	M
	Q2 bit setting	10.9		M	M
M.6 Quality control		5.2		M	M
	RFPI handshake	10.10		M	M
	Antenna diversity	10.11		M	O
	Sliding collision detection	10.12		O	M
M.7 Encryption activation		5.2		M	M
	Encryption process - initialization and synchronization	10.13		M	M
	Encryption mode control	10.14		M	M
	Handover encryption process	10.15		M	M
M.8 Extended frequency allocation		5.2		M	O
	Extended frequency allocation	10.16		M	M
M.9 Bearer handover, intracell		5.2		M	C70 1
	Bearer handover request	10.6		M	M
M.10 Bearer handover, intercell		5.2		M	O
	Bearer handover request	10.6		M	M
M.11 Connection handover, intracell		5.2		M	C70 2
	Connection handover request	10.7		M	M
M.12 Connection handover, intercell		5.2		M	O
	Connection handover request	10.7		M	M
M.13 SARI support		5.2		M	O
	Downlink broadcast	10.2		M	M
M.14 Encryption deactivation		5.2		C703	C70 3
	Encryption mode control	10.14		M	M

(continued)

Table 7 (concluded): MAC service to procedure mapping

Service/procedure mapping					
Service	Procedure	ETS 300 444 [14] reference	ETS 300 765 reference	Status	
				CTA	FT
M.100 LU7 service			6.2.2	C704	C704
	LU7 MAC procedure		11.3	M	M
M.101 Advance Timing			6.2.2	O	O
	Advance Timing		11.2	M	M
M.102 Continuous broadcast, Extended Fixed Part Capabilities			6.2.2	M	M
	Downlink broadcast, Extended Fixed Part Capabilities		11.4	M	M
M.103 Improved channel selection rules			6.2.2	O	N/A
	Improved channel selection rules		11.6	M	N/A

C701: IF service M.11 THEN O ELSE M;
 C702: IF service M.9 THEN O ELSE M;
 C703: IF feature N.29 OR N.N.28 THEN M ELSE I;
 C704: IF feature N.116 THEN M ELSE I.

7.10 Application feature to procedure mapping

Table 8: Application feature to procedure mapping

Feature/procedure mapping					
Service	Procedure	ETS 300 444 [14] reference	ETS 300 765 reference	Status	
				RAP	
				CTA	FT
A.1 AC to bitstring mapping		4.2		M	M
	AC to bitstring mapping	14.2		M	M
A.2 Multiple subscription registration		4.2		O	N/A
	Subscription control	14.1		M	N/A
A.100 Manual entry of the PARK and AC for CTA			5.2	O	N/A
	Manual entry of the PARK and AC for CTA		17.3	M	N/A

7.11 General requirements

See subclauses 6.9.1 - 6.9.7 of ETS 300 444 [14].

8 Procedure description

See clause 7 of ETS 300 444 [14].

9 NWK layer procedures

This clause specifies the NWK layer procedures, messages and Information Elements (IEs) required in the RAP.

This profile does not prevent any PT or FT transmitting or receiving and processing any other NWK layer message or IE not specified in the profile. A PT or FT receiving an unsupported NWK layer message or IE which it does not recognize shall ignore it, as specified in clause 17 of ETS 300 175-5 [5].

9.1 Reference to GAP

The following subclauses of ETS 300 444 [14] are part of the description of the NWK-Layer Procedures for the RAP (see also table 5 of this ETS): subclauses 8.1 - 8.7 (only normal call release, FT initiated), subclauses 8.8 - 8.15, 8.17, 8.22 - 8.24, 8.27 - 8.39.

9.1.1 Release procedure for "On-hook (conditional release)"

The procedure shall be performed as defined in subclause 9.5.1 of ETS 300 175-5 [5]. The following text together with the associated subclauses define the mandatory requirements with regard to this ETS.

The CTA shall be capable of sending "on hook" information which shall be included in the <<IWU-TO-IWU>> IE using protocol discriminator "RAP" which can be sent with every CC-message or MM-message which is allowed to carry the <<IWU-TO-IWU>> IE on the established call. The CTA is mandated to be able to perform this procedure in states T-03, T-04, T-08 and T-10. In all other states the CTA uses the normal release procedures as defined in ETS 300 444 [14], subclause 8.7.

The normal reaction of the FT will be to initiate the normal call release procedures. The FT can also decide not to release the call directly for example in case of emergency calls.

If the CPE goes Off Hook after the conditional release was sent by the CTA and if the call is still established (the FT has not released it yet) the CTA shall send to the FT the "Off Hook" which shall be included in the <<IWU-TO-IWU>> IE using protocol discriminator "RAP" which can be sent with every CC-message or MM-message which is allowed to carry the <<IWU-TO-IWU>> IE on the established call.

If the Terminal Equipment (TE) at the CTA goes on-hook while a call is not established (after line parking etc.), the CTA shall establish a normal call and send "on hook".

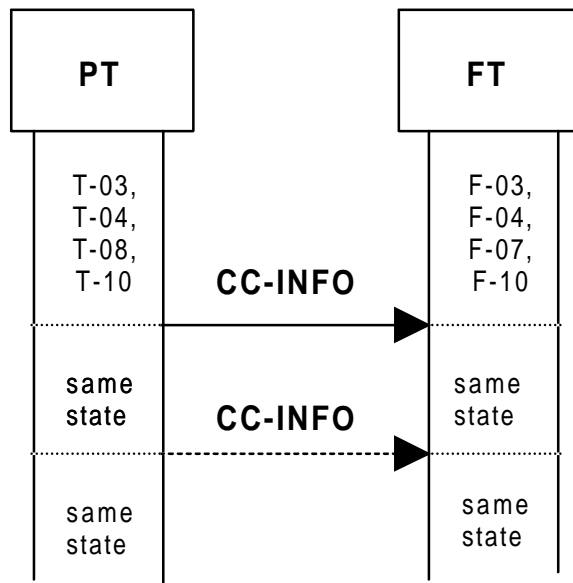

Figure 2: Sending on-hook information

Table 9: Values used within the {CC-INFO} message

IE	Field within the IE	Standard values within the field/IE	Normative action/comment
<<IWU-to-IWU>>			
	<Protocol Discriminator>	15H	RAP indication
	<IWU-to-IWU information>	See annex D	On hook

Table 10: Values used within the {CC-INFO} message

IE	Field within the IE	Standard values within the field/IE	Normative action/comment
<<IWU-to-IWU>>			
	<Protocol Discriminator>	15 H	RAP indication
	<IWU-to-IWU information>	See annex D	Off hook

9.1.2 CLIP, inband

If the GAP feature "CLIP [N.30]" is also applied for CTAs to transmit CLIP information, it requires conversion between DECT messages and inband signalling in the CTA, and possibly the opposite conversion in the FP. In contrast to that, the RAP feature "CLIP, inband [N.101]" allows to transmit inband CLIP signals (DTMF or modem tones in the speech channel) transparently from the LE via the FP and the CTA to the TE during an incoming call set-up before off-hook. However, some notification from the CTA to the LE via the FP about the availability of the speech channel may be required for synchronization and timing. Therefore the procedure N.101 is best suited under the following conditions:

- if the LE provides the CLIP inband tones; and
- if the LE can be notified by the FP about the availability of the speech channel.

Depending on the type of CLIP procedure applied by the LE and supported by the TE, the inband CLIP signals to be sent to the TE may or may not be preceded by either of the following:

- an initial ring;
- a pulsed line polarity reversal.

In any case the LE should be informed about the execution of these pulsed signals, and of the availability of the speech channel. Therefore the NWK feature "CLIP, inband [N.101]" requires the following procedures:

- incoming call request;
- U-plane connection within the CTA (receive side) by CC_ALERTING;
- U-plane connection within the CTA (receive side) and pulse notification after initial ring;
- U-plane connection within the CTA (receive side) and pulse notification after pulsed line polarity reversal.

Hence a CTA supporting N.101 shall connect the speech channel to the TE for an incoming call under the following conditions:

- in case of an incoming SETUP for a normal call without ringing information: By sending CC_ALERTING;
- in case of an incoming SETUP with initial ring information: At the end of the initial ring. The end of initial ring shall be notified to the FP;
- in case of an incoming SETUP with a request for pulsed line polarity reversal: At the end of that line reversal pulse. The CTA shall notify the FP of the end of that pulse.

In addition any CTA shall connect the U-plane as soon as it receives a message (e.g. a SETUP message) containing the "Progress Indicator" element with Cause 8, as described in ETS 300 175-5 [5], subclause 9.3.2, i.e. in subclause 9.3.2.4 (U-plane connection) the CTA is required to request the LLME to connect its receive U-plane as soon as it receives a message containing the <<PROGRESS-INDICATOR>> element indicating Cause 8 ("in-band information or appropriate pattern is now available in band").

If this <<PROGRESS-INDICATOR>> element is not used, and none of the CLIP procedures described above applies, then the CTA may delay the connection of the U-plane for incoming calls until receiving the {CC-CONNECT-ACK} message.

9.2 Maintenance calls

For the following maintenance calls the special call class "OA&M call" is required in the IE <<Basic service>> of the {CC_SETUP} message.

9.2.1 Incoming maintenance call

The incoming call procedures as defined in GAP shall be used. The FT is not required to send the <<SIGNAL>> IE during the incoming maintenance call procedure.

9.2.2 Outgoing maintenance call

The outgoing call procedures as defined in GAP shall be used. The CTA is not required to send the <<KEYPAD>> IE during the outgoing maintenance call procedure.

9.2.3 Outgoing call during maintenance call

The CTA shall release the maintenance call with partial release and shall initiate afterwards the outgoing call.

NOTE: The operator may wish to prohibit new services such as outgoing calls at the CTA by using the claim actions as specified in subclause 9.3.6.

9.2.4 Incoming call during maintenance call

The FT shall release the maintenance call with partial release and shall initiate afterwards the incoming call.

9.3 Sending OA&M information

The FT and the CTA shall be capable of exchanging "OA&M" information which shall be included in the <<IWU-TO-IWU>> IE using protocol discriminator "RAP" which can be sent with every CC-message or MM-message which is allowed to carry the <<IWU-TO-IWU>> IE on an established call. In the case no call is established, the CTA can set-up an outgoing maintenance call, and the FT can set-up an incoming maintenance call to transmit the OA&M messages.

Table 11: Values used within the {CC-INFO} message

IE	Field within the IE	Standard values within the field/IE	Normative action/comment
<<IWU-to-IWU>>			
	<Protocol Discriminator>	15H	RAP indication
	<IWU-to-IWU information>	See annex D	Codings for OA&M information

9.3.1 Physical resources fault

If the CTA wants to inform the FT about a physical resources fault it shall send "physical resources fault" which shall be included in the <<IWU-TO-IWU>> IE using protocol discriminator "RAP".

Table 12: Values used within the {CC-INFO} message

IE	Field within the IE	Standard values within the field/IE	Normative action/comment
<<IWU-to-IWU>>			
	<Protocol Discriminator>	15H	RAP indication
	<IWU-to-IWU information>	See annex D	Physical resources fault

9.3.2 Remote test

If the FT wants the CTA to perform remote controlled tests it shall send "remote test activation" which shall be included in the <<IWU-TO-IWU>> IE using protocol discriminator "RAP".

Table 13: Values used within the {CC-INFO} message

IE	Field within the IE	Standard values within the field/IE	Normative action/comment
<<IWU-to-IWU>>			
	<Protocol Discriminator>	15H	RAP indication
	<IWU-to-IWU information>	See annex D	Remote test activation

Depending on the test to be performed the CTA may answer to the remote CTA test activation with a remote test information which shall be included in the <<IWU-TO-IWU>> IE using protocol discriminator "RAP".

Table 14: Values used within the {CC-INFO} message

IE	Field within the IE	Standard values within the field/IE	Normative action/comment
<<IWU-to-IWU>>			
	<Protocol Discriminator>	15H	RAP indication
	<IWU-to-IWU information>	See annex D	Remote test information

9.3.3 Alarms

If the CTA wants to inform the FT about alarms it shall send "alarms" which shall be included in the <<IWU-TO-IWU>> IE using protocol discriminator "RAP".

Table 15: Values used within the {CC-INFO} message

IE	Field within the IE	Standard values within the field/IE	Normative action/comment
<<IWU-to-IWU>>			
	<Protocol Discriminator>	15H	RAP indication
	<IWU-to-IWU information>	See annex D	Alarms

9.3.4 On-air modification of user parameters

9.3.4.1 Modification of existing users parameters

The procedure shall be performed as defined in subclause 13.5 of ETS 300 175-5 [5].

The following text together with the associated subclauses define the mandatory requirement with regard to this ETS.

The procedure consists of two consecutive MM transactions: one access rights modify suggest and subsequently an obtaining access rights with its own independent transaction identifier.

An access rights **modify suggest** results in a modification (of the subscription data) of the active IPUI and PARK pair.

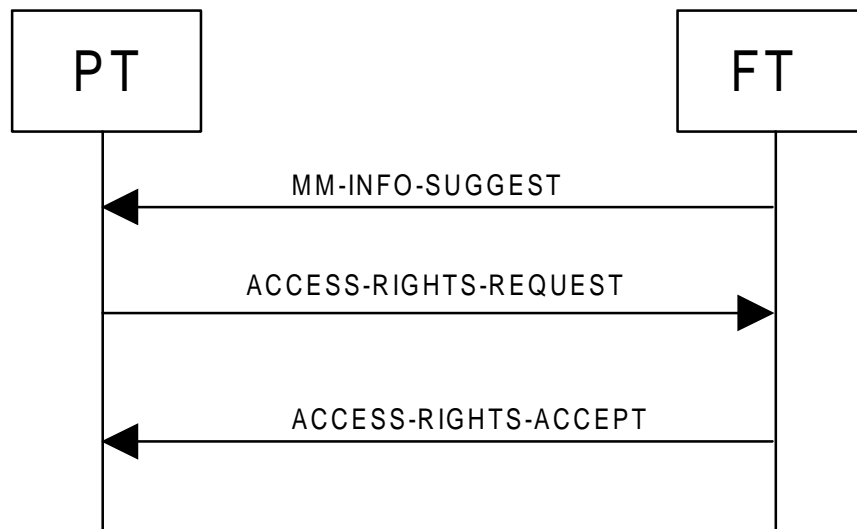

Figure 3: On air modification of user parameters

Table 16: Values used within the {MM-INFO-SUGGEST} message

IE	Field within the IE	Standard values within the field/IE	Normative action/comment
<<Info-type>>			
	<ext>	0/1	1 if last octet, 0 if not
	<Parameter type>	1	Access rights modify suggest

The PT shall initiate the on-air subscription procedure after the receipt of the {MM-INFO-SUGGEST} message, containing the access rights modify suggest. A PT may reject the access rights modify suggest using the {MM-INFO-REJECT}.

The values used within the {ACCESS-RIGHTS-REQUEST} and {ACCESS-RIGHTS-ACCEPT} messages shall be compatible with subclause 8.30 of ETS 300 444 [14].

If the FT does assign a new PARK to the PT in {ACCESS-RIGHTS-ACCEPT} message, it is necessary that the FT invokes the remote resynchronization procedure as described in subclause 9.3.7, to force the PT to lock to a system whose ARI matches the new PARK.

9.3.4.2 Additional subscriptions to the same fixed part

If the FT wants a new port of a multiport CTA to be subscribed to itself it can send "subscription suggest" which shall be included in the <<IWU-TO-IWU>> IE using protocol discriminator "RAP".

Table 17: Values used within the {CC-INFO} message

IE	Field within the IE	Standard values within the field/IE	Normative action/comment
<<IWU-to-IWU>>			
	<Protocol Discriminator>	15H	RAP indication
	<IWU-to-IWU information>	See annex D	Subscription suggest (port nr)

On reception of this message the CTA shall perform the obtaining access rights procedure at the requested port given with the Subscription suggest. This obtaining access rights procedure shall be carried out only to the system that invoked the subscription suggest message. The FT shall set bit a44 of the higher layer capabilities-bits to "access_rights_supported" when sending the subscription suggest message. The CTA will assume this bit to be set when starting the obtain access rights procedure and will not check if it is set.

The AC required for this additional subscription is derived using the procedure as described in subclause 9.3.4.3.

9.3.4.3 Derivation of AC for additional subscriptions

The CTA shall derive the needed AC for the requested port in the following way: The AC for the requested port is derived from the 4 most significant Bytes of the UAK of the port at which the request for an additional subscription was received . The most significant Bit of this UAK will also be the most significant bit of the new AC.

To avoid ambiguity problems in calculating the AC from the UAK, the following rule shall be used: When, as stated in subclause 4.5.2 of ETS 300 175-7 [7], both AC and UAK are input into the B1-process in the Form described below, then the new AC shall be derived from the UAK as shown in "rule 1" in the figure below.

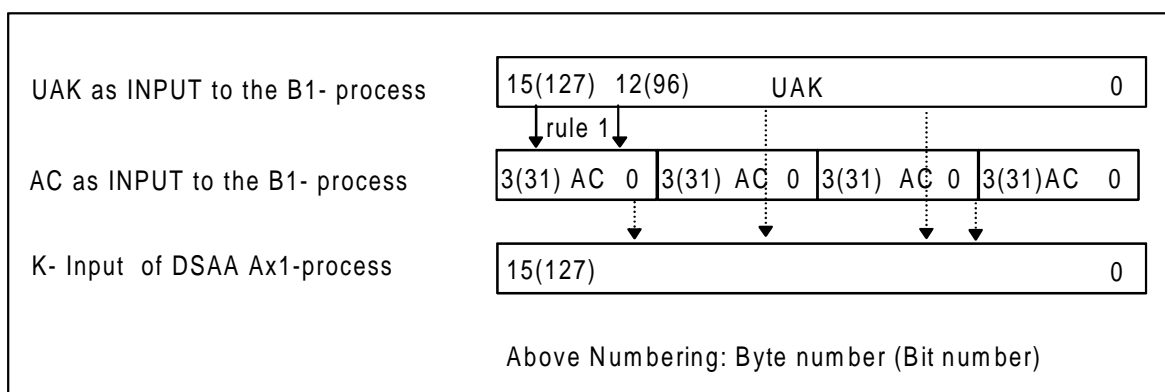

Figure 4: AC and UAK in B1 process

9.3.5 Remote configuration

If the FT wants to do a remote configuration parameter downloading in the CTA it shall send "remote configuration (request)" which shall be included in the <<IWU-TO-IWU>> IE using protocol discriminator "RAP" which can be sent with every CC-message or MM-message which is allowed to carry the <<IWU-TO-IWU>> IE on an established call. In the case no call is established, the FT can set-up an incoming maintenance call.

Table 21: Values used within the {CC-INFO} message

IE	Field within the IE	Standard values within the field/IE	Normative action/comment
<<IWU-to-IWU>>			
	<Protocol Discriminator>	15 H	RAP indication
	<IWU-to-IWU information>	See annex D	Remote configuration (request)

To indicate to the FT its MODEL (MANIC + MODIC) code the CTA shall answer to the remote configuration (request) with a remote configuration (confirm) which shall be included in the <<IWU-TO-IWU>> IE using protocol discriminator "RAP" which can be sent with every CC-message or MM-message which is allowed to carry the <<IWU-TO-IWU>> IE on an established call. In the case no call is established, the CTA can set-up an outgoing maintenance call.

Table 22: Values used within the {CC-INFO} message

IE	Field within the IE	Standard values within the field/IE	Normative action/comment
<<IWU-to-IWU>>			
	<Protocol Discriminator>	15 H	RAP indication
	<IWU-to-IWU information>	See annex D	Remote configuration (confirm) with MANIC and MODIC codes

Then the FT shall transmit the parameters for the remote configuration sending the "remote configuration information" command which shall be included in the <<IWU-TO-IWU>> IE using protocol discriminator "RAP" which can be sent with every CC-message or MM-message which is allowed to carry the <<IWU-TO-IWU>> IE on an established call. In the case no call is established, the FT can set-up an incoming maintenance call.

The <<IWU-TO-IWU>> IE shall include the remote configurations parameters as it is indicated in annex D.

9.3.6 Claim actions

Claiming a CTA implies imposing restrictions on the CTAs normal operation. With the claiming imposed restrictions the CTA is not allowed to initiate any new procedure as part of features N.1, N.2, N.5, N.8, N.11 and N.18. Ongoing procedures are allowed to continue.

If the FT wants to claim a CTA for maintenance purposes, it shall send "claim enable" which shall be included in the <<IWU-TO-IWU>> IE using protocol discriminator "RAP" in a {CC-INFO}-message.

If the FT wants to disable a claim, it shall send "claim disable" which shall be included in the <<IWU-TO-IWU>> IE using protocol discriminator "RAP" in a {CC-INFO}-message.

The {CC-INFO} message shall be send during an established call. If no call is established the FT can set-up an incoming maintenance call to transmit this OA&M message.

Table 23: Values used within the {CC-INFO} message

IE	Field within the IE	Standard values within the field/IE	Normative action/comment
<<IWU-to-IWU>>			
	<Protocol Discriminator>	15H	RAP indication
	<IWU-to-IWU information>	See annex D	Claim enable/Claim disable

Upon reception of the "claim disable", the CTA shall have no restrictions on the invocation of new procedures.

Upon reception of the "claim enable", the CTA shall block all new procedure invocations (procedure part of the features listed above), but without termination of any ongoing procedures.

NOTE: The user of a CPE attached to a claimed CTA may be informed of the claimed situation by e.g. a congestion tone.

Once ongoing procedures have terminated, the CTA shall report this to the FP by sending "claim active" which shall be included in the <<IWU-TO-IWU>> IE using protocol discriminator "RAP" in a {CC-INFO}-message. As no call is established, the CTA shall set-up an outgoing maintenance call to transmit this OA&M message.

The CTA can send the "claim active" also to indicate its claim active status to the FT.

Table 24: Values used within the {CC-INFO} message

IE	Field within the IE	Standard values within the field/IE	Normative action/comment
<<IWU-to-IWU>>			
	<Protocol Discriminator>	15H	RAP indication
	<IWU-to-IWU information>	See annex D	Claim active

If the FP wants to cancel the claim enable request on the CTA, it shall send "claim disable".

9.3.7 Remote resynchronization

If the FT wants the CTA to perform resynchronization it shall send "resynchronization request" which shall be included in the <<IWU-TO-IWU>> IE using protocol discriminator "RAP".

Table 25: Values used within the {CC-INFO} message

IE	Field within the IE	Standard values within the field/IE	Normative action/comment
<<IWU-to-IWU>>			
	<Protocol Discriminator>	15H	RAP indication
	<IWU-to-IWU information>	See annex D	Resynchronization request

The remote resynchronization is used to inform a locked CTA about new static system information or new arrangements of carriers etc.

NOTE: The operator may wish to terminate any ongoing services, and prohibit new services at the CTA by using the Claim actions as specified in subclause 9.3.6, before issuing the resynchronization request.

9.3.8 Advanced file transfer

If the FT wants to perform an advanced file transfer in the CTA it shall send "advanced file transfer (request)" which shall be included in the <<IWU-TO-IWU>> IE using protocol discriminator "RAP" which can be sent with every CC-message or MM-message which is allowed to carry the <<IWU-TO-IWU>> IE on an established call. If the case no call is established, the FT can set-up an incoming maintenance call.

Table 26: Values used within the {CC-INFO} message

IE	Field within the IE	Standard values within the field/IE	Normative action/comment
<<IWU-to-IWU>>			
	<Protocol Discriminator>	15 H	RAP indication
	<IWU-to-IWU information>	See annex D	Advanced file transfer (request)

To indicate to the FT its MODEL (MANIC + MODIC) code the CTA shall answer to the advanced file transfer (request) with an advanced file transfer (confirm) which shall be included in the <<IWU-TO-IWU>> IE using protocol discriminator "RAP" which can be sent with every CC-message or MM-message which is allowed to carry the <<IWU-TO-IWU>> IE on an established call. If the case no call is established, the CTA can set-up an outgoing maintenance call.

Table 27: Values used within the {CC-INFO} message

IE	Field within the IE	Standard values within the field/IE	Normative action/comment
<<IWU-to-IWU>>			
	<Protocol Discriminator>	15 H	RAP indication
	<IWU-to-IWU information>	See annex D	Advanced file transfer (confirm) with MANIC and MODIC codes

NOTE: The procedure which needs to be used for the file transfer phase, which will follow this first phase, is not defined in this ETS. The main application of this procedure is for software download. For good performance, the B-field could be used.

9.4 RLL-CC

The FT and the CTA shall be capable of exchanging "RAP-CC" information which shall be included in the <<IWU-TO-IWU>> IE using protocol discriminator "RAP" which can be sent with every CC-message which is allowed to carry the <<IWU-TO-IWU>> IE on an established call.

9.4.1 Metering pulses

If the FT wants the CTA to generate metering pulses towards the CPE, it shall send "metering pulse indication". This "metering pulse indication" contains the number of metering pulses to be generated. The "metering pulse indication" shall be included in the <<IWU-TO-IWU>> IE using protocol discriminator "RAP".

Table 28: Values used within the {CC-INFO} message

IE	Field within the IE	Standard values within the field/IE	Normative action/comment
<<IWU-to-IWU>>			
	<Protocol Discriminator>	15H	RAP indication
	<IWU-to-IWU information>	See annex D	Metering pulse indication

Upon receipt of the "metering pulse indication", the CTA shall generate the indicated amount of metering pulses towards the CPE. After the last metering pulse has been generated, the CTA shall send "pulse notification" towards the FT, to acknowledge the proper execution of the request. The "pulse notification" shall be included in the <<IWU-TO-IWU>> IE using protocol discriminator "RAP".

Table 29: Values used within the {CC-INFO} message

IE	Field within the IE	Standard values within the field/IE	Normative action/comment
<<IWU-to-IWU>>			
	<Protocol Discriminator>	15H	RAP indication
	<IWU-to-IWU information>	See annex D	Pulse notification

9.4.2 Switch from voice to data service FT initiated

The FT shall detect the 2,1 kHz modem tone during an established call in the audio channel.

If the modem tone is detected and the feature N.116 is supported the procedure described in subclause 9.4.7 shall apply otherwise the FT shall send "modem tone detection" to the CTA. This command shall be included in the <<IWU-TO-IWU>> IE using protocol discriminator "RAP" which can be sent with every CC-message or MM-message which is allowed to carry the <<IWU-TO-IWU>> IE on the established call.

The FT shall disable all the echo control functions without matter if the tone contains phase reversal or not (see subclause 13.3.2).

The CTA shall be capable to receive and process the "modem tone detection" and receiving it the CTA shall disable all the existing echo control functions without matter if the tone contains phase reversal or not (see subclause 13.3.2).

Table 30: Values used within the {CC-INFO} message

IE	Field within the IE	Standard values within the field/IE	Normative action/comment
<<IWU-to-IWU>>			
	<Protocol Discriminator>	15 H	RAP indication
	<IWU-to-IWU information>	See annex D	Modem tone detection

9.4.3 Switch from voice to data service CTA initiated

The CTA shall detect the 2,1 kHz modem tone during an established call in the audio channel.

If the modem tone is detected and the feature N.116 is supported the procedure described in subclause 9.4.8 shall apply otherwise the CTA shall send "modem tone detection" to the FT. This command shall be included in the <<IWU-TO-IWU>> IE using protocol discriminator "RAP" which can be sent with every CC-message or MM-message which is allowed to carry the <<IWU-TO-IWU>> IE on the established call.

The CTA shall disable all the existing echo control functions without matter if the tone contains phase reversal or not (see subclause 13.3.2).

The FT shall be capable to receive and process the "modem tone detection" and receiving it the FT shall disable all the echo control functions without matter if the tone contains phase reversal or not (see subclause 13.3.2).

Table 31: Values used within the {CC-INFO} message

IE	Field within the IE	Standard values within the field/IE	Normative action/comment
<<IWU-to-IWU>>			
	<Protocol Discriminator>	15 H	RAP indication
	<IWU-to-IWU information>	See annex D	Modem tone detection

9.4.4 Coin collection

If the CTA wants to notify the result of coin collection to the FT during an established call it shall send "coin collection" which shall be included in the <<IWU-TO-IWU>> IE using protocol discriminator "RAP".

Table 32: Values used within the {CC-INFO} message

IE	Field within the IE	Standard values within the field/IE	Normative action/comment
<<IWU-to-IWU>>			
	<Protocol Discriminator>	15H	RAP indication
	<IWU-to-IWU information>	See annex D	Coin collection

9.4.5 Ground start

If the CTA wants to indicate ground start to the FT it shall send keypad information following the procedure defined in subclause 8.10 of the GAP using the keypad information for register recall (15H).

9.4.6 Line polarity reversal

If the FT wants the CTA to generate a line polarity reversal during an established call it shall send "line polarity reversal" which shall be included in the <<IWU-TO-IWU>> IE using protocol discriminator "RAP".

Table 33: Values used within the {CC-INFO} message

IE	Field within the IE	Standard values within the field/IE	Normative action/comment
<<IWU-to-IWU>>			
	<Protocol Discriminator>	15H	RAP indication
	<IWU-to-IWU information>	See annex D	Line polarity reversal

9.4.7 Switch from 32 kbit/s to 64 kbit/s bearer service (FT initiated)

This service is required to switch, during a call (i.e. ACTIVE state), from a 32 kbit/s LU1 bearer service, basic connection "LCNx, full slot, In minimum delay", to a 64 kbit/s LU7 bearer service, advanced connection "LCNx, double slot, In normal delay".

The FT shall detect the 2,1 kHz modem tone during an established call in the audio channel and after detecting it, the FT shall start the switching LU1 to LU7 procedure which is managed by the NWK, DLC and MAC layers with the co-ordination of the LLME entity.

Procedure description:

The FT after detecting the 2,1 kHz modem tone shall send the "switch to 64 kbit/s bearer service request" which shall be included in the <<IWU-TO-IWU>> IE using protocol discriminator "RAP" which can be sent with every CC-message or MM-message which is allowed to carry the <<IWU-TO-IWU>> IE on the established call.

The FT shall disable all the echo control functions without matter if the tone contains phase reversal or not (see subclause 13.3.2).

The CTA after receiving the "switch to 64 kbit/s bearer service" request, informs the LLME of the request. If the request is accepted the LLME starts the switching procedure at the DLC and MAC layer. If the request is accepted the CTA shall disable all the existing echo control functions without matter if the tone contains phase reversal or not (see subclause 13.3.2) and shall start the DLC and MAC layer switching procedure.

If the request is rejected the CTA shall send "switch to 64 kbit/s bearer service reject" which shall be included in the <<IWU-TO-IWU>> IE using protocol discriminator "RAP" which can be sent with every CC-message or MM-message which is allowed to carry the <<IWU-TO-IWU>> IE on the established call.

The DLC and MAC layer procedure is started at the CTA side. At first, the connection type is changed from basic to advanced, without changing the slot format, using the connection type modification procedure and then the slot type is changed from full to double, performing a bearer handover or a connection handover. The handover procedure is always started by the CTA.

If the intracell bearer handover procedure is supported at both sides it shall be used otherwise the intracell connection handover procedure shall be used.

The MAC layer in the CTA receives a MAC_MOD-req primitive for switching the connection characteristics from:

- a basic connection, identified by a MAC Connection Endpoint Identification (MCEI), to an advanced connection, identified by the pair: MCEI and ECN;
- full slot to double slot;
- "In minimum delay" to "In normal delay".

This initiates a switching process.

Table 34: Values used within the {CC-INFO} message

IE	Field within the IE	Standard values within the field/IE	Normative action/comment
<<IWU-to-IWU>>			
	<Protocol Discriminator>	15 H	RAP indication
	<IWU-to-IWU information>	See annex D	switch to 64 kbit/s bearer service request/reject

Switching collision:

A switching collision occurs when both sides detect the modem tone and starts the switching sending the "switch to 64 kbit/s bearer service request". In this case the switching FT initiated takes priority. If the FT, after having sent the "switch to 64 kbit/s bearer service request" receives from the CTA the "switch to 64 kbit/s bearer service request" it shall ignore it. If the CTA, after having sent the "switch to 64 kbit/s bearer service request" receives from the FT the "switch to 64 kbit/s bearer service request" it shall process it and discharge its one.

9.4.8 Switching from 32 kbit/s to 64 kbit/s bearer service CTA initiated

This service is required to switch, during a call (i.e. ACTIVE state), from a 32 kbit/s LU1 bearer service, basic connection LCNx, full slot, In minimum delay, to a 64 kbit/s LU7 bearer service, advanced connection LCNx, double slot, In normal delay.

The CTA shall detect the 2,1 kHz modem tone during an established call in the audio channel and after detecting it, the CTA shall start the switching LU1 to LU7 procedure which is managed by the NWK, DLC and MAC layers with the co-ordination of the LLME entity.

Procedure description:

The CTA after detecting the 2,1 kHz modem tone shall send the "switch to 64 kbit/s bearer service request" which shall be included in the <<IWU-TO-IWU>> IE using protocol discriminator "RAP" which can be sent with every CC-message or MM-message which is allowed to carry the <<IWU-TO-IWU>> IE on the established call.

The CTA shall disable all the existing echo control functions without matter if the tone contains phase reversal or not (see subclause 13.3.2).

The FT after receiving the "switch to 64 kbit/s bearer service" request, informs the LLME of the request. If the request is accepted the LLME starts the switching procedure at the DLC and MAC layer. If the request is accepted the FT shall disable all the echo control functions without matter if the tone contains phase reversal or not (see subclause 13.3.2) and shall start the DLC and MAC layer switching procedure.

If the request is rejected the FT shall send "switch to 64 kbit/s bearer service reject" which shall be included in the <<IWU-TO-IWU>> IE using protocol discriminator "RAP" which can be sent with every CC-message or MM-message which is allowed to carry the <<IWU-TO-IWU>> IE on the established call.

The DLC and MAC layer procedure is started at the FT side: at first the connection type is changed from basic to advanced, without changing the slot format, using the connection type modification procedure and then the slot type is changed from full to double performing a bearer handover or a connection handover: the handover procedure is always started by the CTA.

If the intracell bearer handover procedure is supported at both sides it shall be used otherwise the connection handover procedure shall be used.

The MAC layer in the FT receives a MAC_MOD-req primitive for switching the connection characteristics from:

- a basic connection, identified by an MCEI, to an advanced connection, identified by the pair: MCEI and ECN;
- full slot to double slot;
- In minimum delay to In normal delay.

This initiates a switching process.

The FT starts to transmit in the next odd numbered frame the attributes_T_request (basic connection control set). This is repeated in five successive odd numbered frames or until the FT receives the attributes_T_confirm (basic connection control set).

The FT shall acknowledge the receipt of the attributes_T_confirm message by the transmission of an other message in the next TDMA frame and after that shall start the T218 timer and waits for the handover procedure started by the CTA: the handover procedure shall be completed within the T218 timer otherwise the FT shall release the connection and the DLC layer is informed using the MAC_DIS-ind primitive.

If the attributes_T_confirm is not received than the FT shall release the connection and the DLC layer is informed using the MAC_DIS-ind primitive.

The CTA after receiving the attributes_T_request message from the FT, shall send the attributes_T_confirm to the FT and shall wait until the next odd frame occurs: if in the next odd frame the attributes_T_request message is received from the FT (repetition) the CTA shall retransmit the attributes_T_confirm otherwise, if an other message is received, the CTA shall start the handover procedure.

If the handover procedure fails, the connection is released and the DLC is informed using the MAC_DIS-ind primitive.

The MAC at both sides, after the handover procedure has been performed successfully, sends to the DLC the MAC_MOD primitive, confirm or indication indicating that the old connection identified by the MCEI has changed its service profile as requested and is now identified by the pair old MCEI and new ECN and that the procedure has been successfully completed. The DLC can now perform the switching of the U-plane channel. The DLC at both sides indicates to the LLME that the procedure has been correctly done: the LLME reports this indication to the NWK layer.

Message flow:

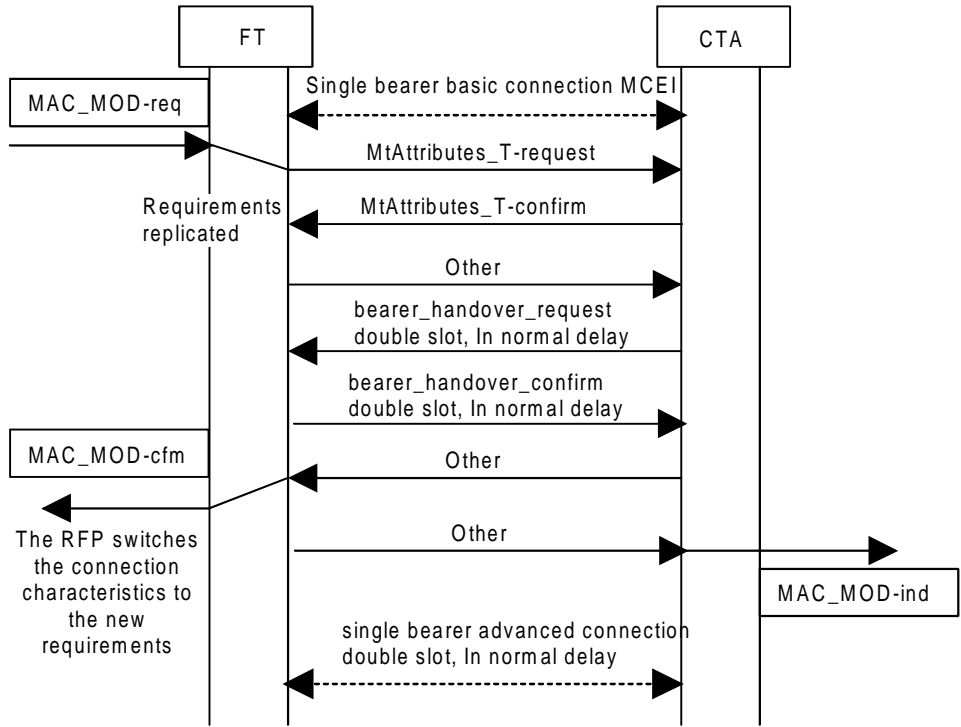

Figure 6: 32 to 64 kbit/s switch, CTA initiated

Table 35: Values used within the {CC-INFO} message

IE	Field within the IE	Standard values within the field/IE	Normative action/comment
<<IWU-to-IWU>>			
	<Protocol Discriminator>	15 H	RAP indication
	<IWU-to-IWU information>	See annex D	switch to 64 kbit/s bearer service request/reject

Switching collision:

A switching collision occurs when both sides detect the modem tone and starts the switching sending the "switch to 64 kbit/s bearer service request". In this case the switching FT initiated takes priority. If the FT, after having sent the "switch to 64 kbit/s bearer service request" receives from the CTA the "switch to 64 kbit/s bearer service request" it shall ignore it. If the CTA, after having sent the "switch to 64 kbit/s bearer service request" receives from the FT the "switch to 64 kbit/s bearer service request" it shall process it and discharge its one.

9.4.9 Line parked

If the LE wants to park a line after a specified period without because there is no an end to end connection between from a TE on the CTA and to another subscriber, it uses the line parked feature.

The FT, after receiving the line parked request from the LE, shall send "line parked" which shall be included in the <<IWU-TO-IWU>> IE using protocol discriminator "RAP" and release the call to the CTA using the normal link release procedures.

Table 36: Values used within the {CC-INFO} message

IE	Field within the IE	Standard values within the field/IE	Normative action/comment
<<IWU-to-IWU>>			
	<Protocol Discriminator>	15H	RAP indication
	<IWU-to-IWU information>	See annex D	Line parked

9.4.10 Switching from 64 kbit/s to 32 kbit/s bearer service FT initiated

This procedure is included here without defining the event which may trigger the procedure - it is left to the FP or CTA implementation which is the triggering event.

This service is required to switch, during a call (i.e. ACTIVE state), from a 64 kbit/s LU7 bearer service, advanced connection LCNx, double slot, In normal delay, to a 32 kbit/s LU1 bearer service, advanced connection LCNx, full slot, In minimum delay.

The FT after receiving the switching request, starts the switching LU7 to LU1 procedure which is managed by the NWK, DLC and MAC layers with the co-ordination of the LLME entity.

Procedure description:

The IWU in the FT, after detecting the switching LU7 to LU1 request, sends the MNCC_INFO-req primitive to the NWK layer starting the switching procedure.

The NWK in the FT shall send the "switch to 32 kbit/s bearer service request" which shall be included in the <<IWU-TO-IWU>> IE using protocol discriminator "RAP" which can be sent with every CC-message or MM-message which is allowed to carry the <<IWU-TO-IWU>> IE on the established call.

The NWK layer in the CTA after receiving the "switch to 32 kbit/s bearer service request" request, informs the LLME of the request. If the request is accepted the LLME starts the switching procedure at the DLC and MAC layer.

If the request is rejected the CTA shall send "switch to 32 kbit/s bearer service reject" which shall be included in the <<IWU-TO-IWU>> IE using protocol discriminator "RAP" which can be sent with every CC-message or MM-message which is allowed to carry the <<IWU-TO-IWU>> IE on the established call.

The DLC and MAC layer procedure is started at the CTA side.

The CTA starts to transmit in the next even numbered frame the attributes_T_request (advanced connection control set). This is repeated in five successive even numbered frames or until the CTA receives the attributes_T_confirm (advanced connection control set): the slot is still a double.

The CTA shall acknowledge the receipt of the attributes_T_confirm message by the transmission of an other message in the next TDMA frame. The MAC layer then switches from double to full slot releasing the second part of the double slot and sends to its DLC the MAC_MOD-cfm primitive with the "result" parameter sets to accept and the "slot type" parameter sets to full.

If the attributes_T_confirm is not received than the CTA shall release the connection and the DLC layer is informed using the MAC_DIS-ind primitive.

The FT after receiving the attributes_T_request message from the CTA, shall transmit the attributes_T_confirm message: the slot type is still double. Every time the attributes_T_request is received from the CTA (repeated) the attributes_T_confirm shall be retransmitted to the CTA.

The FT after receiving the other message switches to a full slot releasing the second part of the double slot and sends to the DLC the MAC_MOD-ind with the "result" parameter sets to accept and the "slot type" parameter sets to full.

At both DLC layers, the receipt of this primitive (MAC_MOD-cfm or ind) acts as a synchronization signal for the U-Plane switching procedure. Then, the DLC in both CTA and FT shall switch correctly the C-Plane link and U-plane service and release the old link. The DLC at both sides indicates to the LLME that the procedure has been correctly done: the LLME reports this indication to the NWK layer.

Message flow:

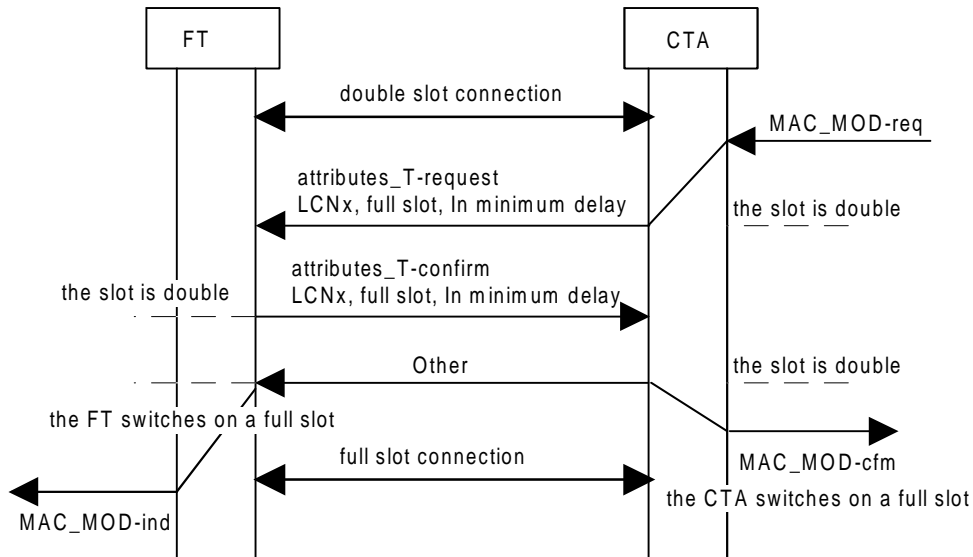

Figure 7: 64 to 32 kbit/s switch, FT initiated

Table 37: Values used within the {CC-INFO} message

IE	Field within the IE	Standard values within the field/IE	Normative action/comment
<<IWU-to-IWU>>			
	<Protocol Discriminator>	15H	RAP indication
	<IWU-to-IWU information>	See annex D	switch to 32 kbit/s bearer service request/reject

Switching collision:

A switching collision occurs when both sides detect the triggering event and starts the switching sending the "switch to 32 kbit/s bearer service request". In this case the switching FT initiated takes priority. If the FT, after having sent the "switch to 32 kbit/s bearer service request" receives from the CTA the "switch to 32 kbit/s bearer service request" it shall ignore it. If the CTA, after having sent the "switch to 32 kbit/s bearer service request" receives from the FT the "switch to 32 kbit/s bearer service request" it shall process it and discharge its one.

9.4.11 Switching from 64 kbit/s to 32 kbit/s bearer service CTA initiated

This procedure is included here without defining the event which may trigger the procedure - it is left to the FP or CTA implementation which is the triggering event.

This service is required to switch, during a call (i.e. ACTIVE state), from a 64 kbit/s LU7 bearer service, advanced connection LCNx, double slot, In normal delay, to a 32 kbit/s LU1 bearer service, advanced connection LCNx, full slot, In minimum delay.

The CTA after receiving the switching request, starts the switching LU7 to LU1 procedure which is managed by the NWK, DLC and MAC layers with the co-ordination of the LLME entity.

Procedure description:

The IWU in the CTA, after detecting the switching LU7 to LU1 request, sends the MNCC_INFO-req primitive to the NWK layer starting the switching procedure.

The NWK in the CTA shall send the "switch to 32 kbit/s bearer service request" which shall be included in the <<IWU-TO-IWU>> IE using protocol discriminator "RAP" which can be sent with every CC-message or MM-message which is allowed to carry the <<IWU-TO-IWU>> IE on the established call.

The NWK layer in the FT after receiving the "switch to 32 kbit/s bearer service request" request, informs the LLME of the request. If the request is accepted the LLME starts the switching procedure at the DLC and MAC layer.

If the request is rejected the FT shall send "switch to 32 kbit/s bearer service reject" which shall be included in the <<IWU-TO-IWU>> IE using protocol discriminator "RAP" which can be sent with every CC-message or MM-message which is allowed to carry the <<IWU-TO-IWU>> IE on the established call.

The DLC and MAC layer procedure is started at the FT side.

The FT starts to transmit in the next odd numbered frame the attributes_T_request (advanced connection control set). This is repeated in five successive odd numbered frames or until the FT receives the attributes_T_confirm (advanced connection control set). The slot is still a double.

The FT shall acknowledge the receipt of the attributes_T_confirm message by the transmission of an other message in the next TDMA frame. The MAC layer then switches from double to full slot releasing the second part of the double slot and sends to its DLC the MAC_MOD-cfm primitive with the "result" parameter sets to accept and the "slot type" parameter sets to full.

If the attributes_T_confirm is not received than the FT shall release the connection and the DLC layer is informed using the MAC_DIS-ind primitive.

The CTA after receiving the attributes_T_request message from the FT, shall transmit the attributes_T_confirm message: the slot type is still double. Every time the attributes_T_request is received from the FT (repeated) the attributes_T_confirm shall be retransmitted to the FT.

The CTA after receiving the other message switches to a full slot releasing the second part of the double slot and sends to the DLC the MAC_MOD-ind with the "result" parameter sets to accept and the "slot type" parameter sets to full.

At both DLC layers, the receipt of this primitive (MAC_MOD-cfm or ind) acts as a synchronization signal for the U-Plane switching procedure. Then, the DLC in both CTA and FT shall switch correctly the C-Plane link and U-plane service and release the old link. The DLC at both sides indicates to the LLME that the procedure has been correctly done: the LLME reports this indication to the NWK layer.

Message flow:

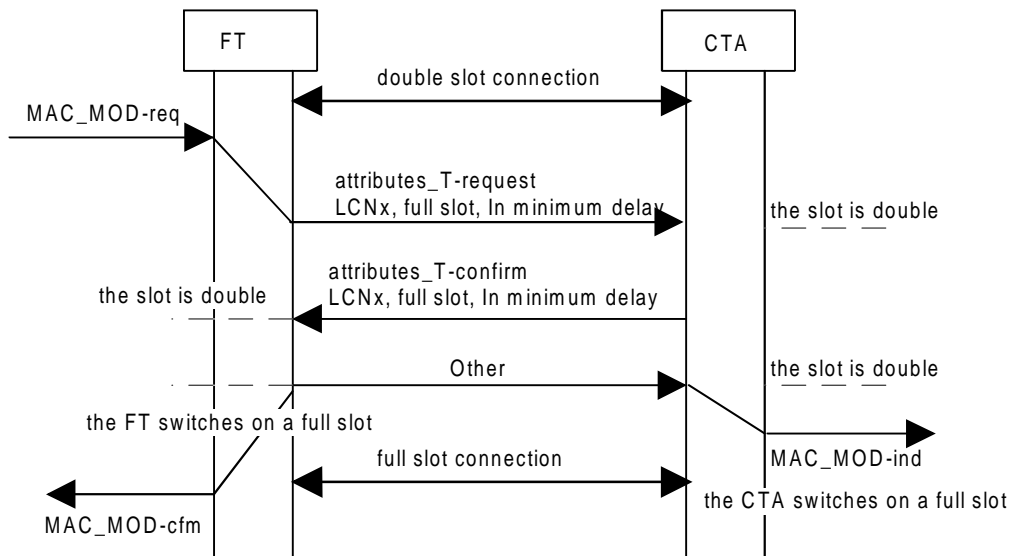

Figure 8: 64 to 32 kbit/s switch, CTA initiated

Table 38: Values used within the {CC-INFO} message

IE	Field within the IE	Standard values within the field/IE	Normative action/comment
<<IWU-to-IWU>>			
	<Protocol Discriminator>	15 H	RAP indication
	<IWU-to-IWU information>	See annex D	switch to 32 kbit/s bearer service request/reject

Switching collision:

A switching collision occurs when both sides detect the triggering event and starts the switching sending the "switch to 32 kbit/s bearer service request". In this case the switching FT initiated takes priority. If the FT, after having sent the "switch to 32 kbit/s bearer service request" receives from the CTA the "switch to 32 kbit/s bearer service request" it shall ignore it. If the CTA, after having sent the "switch to 32 kbit/s bearer service request" receives from the FT the "switch to 32 kbit/s bearer service request" it shall process it and discharge its one.

9.5 Analogue leased line establishment

The analogue leased line service can be provided only for one of the following services:

1. 32 kbit/s speech service (echo devices on);
2. 32 kbit/s data service (echo devices off);
3. 64 kbit/s LU7 data service (echo devices off).

The operator shall select one of the previous services for each analogue leased line on subscription base and is not possible to switch between these services during the active state of the leased line.

An analogue leased line is established as a normal speech call using the outgoing call GAP features N.1 (see subclause 7.2): the call is maintained all the time providing the normal analogue leased line service. The connection established to provide the type 1 and 2 service leased line is a full slot 32 kbit/s with the LU1 DLC service.

The connection established to provide the type 3 service leased line is a double slot 64 kbit/s with the LU7 DLC service.

For the leased line services types 2 and 3 the echo control devices shall be disabled at both sides FT and CTA.

NOTE 1: It could also be possible to provide a leased line service of type 4: LU8 64 kbit/s speech service. The description of the LU8 service is provided in the informative annex F.

NOTE 2: If only linear echo control processing is provided it may be possible to use the 32 kbit/s speech (leased line type 1) and 64 kbit/s LU8 speech (leased line type 4) speech leased line services also for data services.

NOTE 3: Operators may wish to provide a more spectrum efficient and lower cost virtual leased line service where the user activates the radio bearer only when the leased line is used.

10 DLC layer procedures

10.1 General

10.2 Reference to GAP

The complete clause 9 of ETS 300 444 [14] is part of the description of the DLC-layer procedures for the RAP profile.

10.3 LU7 64 kbit/s data bearer service

When the LU7 data bearer service is supported, the complete clause E.4 of the annex E of the ETS 300 175-4 [4] is part of the description of the DLC-layer procedures for the RAP.

11 MAC layer procedures

11.1 Reference to GAP

The complete clause 10 of ETS 300 444 [14] is part of the description of the MAC-layer procedures for the RAP.

11.2 Advance timing

If the FT wants to align the PT transmission to the FT frame timing of a link by requesting the PT to compensate for the propagation delay in the active bearers with an FT, it shall send the MAC quality control message "advance timing request" (A field or B field, see ETS 300 175-3 [3], subclause 7.2.5.5).

The FT should send an advance timing message request as soon as it has a reliable measurement of the PT transmit timing.

It is recommended that the FT sends the advance timing request message only if the FT detects a PT timing difference from the nominal one greater than $(2 + 2^{0,868}) \mu\text{s}$ (see ETS 300 175-3 [3]), i.e. if the FT receives the PT transmission outside the nominal FT receive window. It is recommended that the FT chooses the number of compensate bits in the advanced timing request message such that FT will finally receive the PT transmission in the FT receive window.

To guarantee a stable control loop, the FT shall not be allowed to use timing measurements older than 10 frames, at the transmission of the advance timing request message. Within a 10 frame time interval, the advance timing request message can be retransmitted; until an acknowledged reception of the frame (Q-bit setting) has been received. In this time interval the PT is required to interpret only one of the received advance timing request messages. After receiving an acknowledged reception of the frame (Q-bit setting) upon transmission of the advanced timing request message, the FT shall not send any advance timing request message during the next 10 s. If the FT receives an advance timing reject message from a PT, it shall not send any more advance timing request messages to that specific PT.

NOTE 1: Retransmissions of the advance timing request message are allowed if the PT indicates a bad reception of the message (through Q-bit setting).

NOTE 2: The 10s timer is required to save signalling capacity and to allow PTs to alter the length of successive frames by up to 2 bits if they are not able to adjust the length of a single frame by the amount indicated in the advanced timing request message (ETS 300 175-2 [2], subclause 4.2.7).

At the reception of the advance timing message, the PT can correct consequently its reference timer or send back to the FT an advance timing reject message, if the requested action is not supported. If advance timing is supported, the PT should update the transmit timing on the first occasion after the reception of the advance timing request message.

NOTE 3: In case the advance timing messages and procedure are not contemplated, the PT is expected to do nothing.

The advance timing increment and decrement parameters in the advance timing request message shall be interpreted as follows:

A positive value shall result in an earlier transmission of the PT and a negative value shall result in a later transmission of the PT.

11.3 LU7 64 kbit/s data bearer service

When the LU7 data bearer service is supported, the complete clause E.3 in annex E of the ETS 300 175-4 [4] is part of the description of the MAC-layer procedures for the RAP.

11.4 Downlink broadcast, Extended Fixed Part Capabilities

The FT shall be capable to send and the PT shall be capable to receive and process the QT message as defined in subclause 7.2.3.5 of ETS 300 175-3 [3].

Table 39: Values used within Extended FP capabilities

MAC message	Field within the message	Standard values within the MAC message	Normative action/comment
<<Extended FP capabilities>>			
	<a36>	1	RAP 1 profile

11.5 Blind slot information

It is mandatory for RFPs that have blind slots, due to non-duplex bearer operation on that slot (i.e. those RFPs that have technological limitations such as a slow synthesizer), to periodically announce these blind slots (at least every 10 s). In the event the RFP announces blind slot information, such information may also include all blind slots due to an active bearer as well.

Not available (blind) slot means that the FP recommends the CTA not to attempt a set-up on this slot.

If the CTA receives blind slot information, it is mandatory for that CTA to use it in the process of channel selection. The CTA does not have to wait for the blind slot information before making the channel selection.

11.6 Improved channel selection rules

In addition of using the blind slot information before making the channel selection as defined in clause 11.5, it is recommended for the CTA to follow the algorithm defined below for single slot channel selection.

Without violating the basic DECT channel selection rules, for single slot channel selection the PP should give priority to the following types of channels:

Available channel candidates on even slot positions with an active channel on the adjacent slot position to the right;

Available channel candidates on odd slot positions with an active channel on the adjacent slot position to the left.

NOTE 1: This algorithm results in packing of single slots into double slot locations (double slots are only allowed to start on even slot positions).

NOTE 2: The DECT channel rules shall not be violated. This implies that the rules described above can only be applied to the channels that are within the same RSSI band.

12 Physical layer requirements

12.1 General

12.2 Reference to GAP

The complete clause 11 of ETS 300 444 [14] is part of the description of the PHL-layer procedures for the RAP profile.

12.3 LU7 64 kbit/s data bearer service

When the LU7 data bearer service is supported, the complete clause E.2 of ETS 300 175-4 [4] is part of the description of the PHL-layer procedures for the RAP.

13 Requirements regarding the speech transmission

13.1 General

The applicable requirements specified in ETS 300 175-8 [8] second edition and TBR 10 [13] second edition shall be applied for the FP. The encoding requirements of ETS 300 175-8 [8] subclause 5.1 shall apply for the CTA. Furthermore, the CTA shall conform to applicable requirements of national regulations. If a national requirement conflicts with the requirements of this ETS, the requirements of this ETS shall have precedence.

13.2 Echo control requirements for CTAs intended for 2-wire connections

The echo from the 4-wire to 2-wire hybrid of the CTA towards the network shall be controlled by inserting an echo loss into the CTA. The weighted echo loss, LE, shall be >34 dB referred to the uniform PCM reference point of the CTA. This requirement shall be met for the whole range of 2-wire cable equivalents and termination impedances Z (see the note in subclause 7.30.2.2.1 of TBR 10 [13]) specified by the national authority. The required echo loss shall be met for any echo with a maximum delay of at least 0 - 4 ms.

A 2-wire connection to a CTA may be direct and/or indirect, for example via a Private Automatic Branch Exchange (PABX). Echoes from indirect 2-wire connections shall also meet the 34 dB LE requirement. This may require a control range beyond 4 ms. The manufacturer shall declare the control range of the echo control device.

NOTE 1: General information on requirements for local loop applications are found in annex B of ETS 300 175-8 [8].

NOTE 2: The means how to achieve the echo loss is not specified. It is recommended to use a simple echo canceller (see ETS 300 175-8 [8], subclause A.2.2) in the implementation of the echo control function of the CTA.

13.3 Disabling the echo control functions

13.3.1 General

A CTA may be tested for LE >46 dB. Compare with the two options on terminal coupling loss for PPs (ETS 300 175-8 [8] subclause 7.4.1). If the >46 dB requirement is met, it is allowed to disable the artificial echo loss or echo control device (ETS 300 175-8 [8] subclause 7.4.1.2) in the FP. This information can be included in the subscription procedure.

13.3.2 Modem services

The echo control functions shall be disabled at both the CTA and the FP upon detection of a 2,1 kHz modem answering tone. ITU-T Recommendations V.25 [19], G.164 [20] and G.165 [21] define the requirements for modem answering tone including timing requirements. The tone can be without or with phase reversals, indicating if only echo suppressors or also echo cancellers shall be disabled. In this application all echo control functions shall be disabled no matter if the tone contains phase reversals or not.

14 Requirements regarding fax and data transmission

14.1 General

Generally the RLL transport will be transparent to modem and fax services up to a certain rate. The maximum rate is limited to 9,6 kbit/s for the standard 32 kbit/s Adaptive Differential Pulse Code Modulation (ADPCM) full slot duplex channel. The optional feature N.116, 64 kbit/s Pulse Code Modulation (PCM) bearer service using the double slot LU7 service, supports rates up to 28,8 kbit/s.

NOTE: It has been experienced that some equipment using the 32 kbit/s ADPCM channel, agree during the negotiation phase on a transfer rate, that is higher than the rate that gives the highest throughput. A manual setting of a limit for the maximum rate would help.

14.2 Requirements

14.2.1 Implementation of the LU7 PCM services.

If feature N.116, table 1, is supported, the LU7 service shall be implemented in the CTA, FP and WRS, as defined in ETS 300 175-4 [4], annex E.

NOTE: For the WRS, only Physical and MAC layer requirements as defined in ETS 300 175-4 [4], annex E are applicable.

15 Management procedures

The complete clause 13 of ETS 300 444 [14] is part of the description of the management procedures for the RAP.

16 Interworking with WRS applications

16.1 General

FP support of WRSs is optional. ETR 308 [16] describes different applications of WRS. The WRS is an important component to provide cost effective infra structures. If both RAP and GAP are supported by the FP and the WRS, the WRS may provide GAP mobility options including combined CTA and GAP residential service with intercom functions. WRS applications and features are also described in ETR 246 [17].

16.2 Requirements

WRS shall support RAP and GAP. This implies that the WRS shall conform to applicable GAP requirements. In addition WRSs shall support the implementation of RAP features as indicated in annex G. The relevant codings are indicated in annex D. For the related procedures, see subclause 16.3 below.

NOTE: The procedures differ from those for the CTA in order not to mandate a NWK CC and DLC inside the WRS.

16.3 WRS maintenance calls

16.3.1 Incoming WRS maintenance call

For incoming maintenance calls the FT shall use <<IWU-TO-IWU>> as defined in annex D, included in the {MM-INFO-SUGGEST} message, using the procedures as defined in ETS 300 175-5 [5], subclause 13.7.

NOTE: A special value for the <<INFO-TYPE>> shall be used, indicating "OA&M call".

16.3.2 Outgoing WRS maintenance call

For outgoing maintenance calls the WRS shall use <<IWU-TO-IWU>> as defined in annex D, included in the {MM-INFO-REQUEST} message, using the procedures as defined in ETS 300 175-5 [5], subclause 13.7. The FT shall respond according to these procedures with a {MM-INFO-ACCEPT}, which may include a <<IWU-TO-IWU>> as defined in annex D.

NOTE: A special value for the <<INFO-TYPE>> shall be used, indicating "OA&M call".

16.3.3 Maintenance during WRS MM operation

If the FT or the WRS need to transfer OA&M information, and there is an MM procedure ongoing, the FT or WRS may add the <<IWU-TO-IWU>> IE containing the OA&M information as defined in annex D, to the MM-messages part of the ongoing MM procedure, if it is allowed by the coding of the relevant MM-message, as given in ETS 300 175-5 [5]. Otherwise, the FT or WRS shall wait until the ongoing MM procedure is completed, and initiate an incoming or outgoing maintenance call.

17 Application procedures

17.1 General

17.2 Reference to GAP

The following subclauses of ETS 300 444 [14] is part of the description of the application procedures for the RAP (subclauses 14.1 and 14.2).

17.3 Manual entry of the PARK and AC to CTAs

A procedure similar to that of TBR 6 [10], subclause 14.3 (manual entry of the PARK) and ETS 300 444 [14], subclause 14.2 (AC to bitstream mapping) is proposed.

These number shall be entered via a pulse dialling telephone set if the CTA is not equipped with an optional DTMF receiver; otherwise any dialling mode is possible.

At first power on, the CTA is in the state "ready for subscription" (see also [GAP], annex A, figure A.1: PP "subscription mode" for MAC layer). The codes are input via the POTS telephone. The restriction exists that via POTS only decimal digits in the range 0 - 9 can be entered, therefore excluding "*" or "#", since these are not mandatory for pulse dialling phone sets.

17.3.1 Entering the PARK

The following sequence is proposed:

!!LLPP...PC#

where:

!! is an activation sequence which shall be "11".

LL two-digit decimal number being the length of the PARK (i.e. the PARK Length Indicator, PLI) in bits (within 00 .. 36)

PPP..P up to 12 octal digits - this is the PARK itself.

C checksum based on LL and PP..P as specified in GAP, ch. 14.3. It is the sum of each digit multiplied by its position in the string, modulo 11. If the result of the modulo operation should be "10", this is replaced by 0 (since "*" as in TBR 6 [13], subclause 14.3 is not available).

stop sign - it shall be "9".

EXAMPLE: PARK = 101 110 010 001 1 (i.e. 13 bits, PARK length LL = 13)

This is padded by two "0" at the end to yield a number of bits which is a multiple of 3:

PARK* = 101 110 010 001 100 = 5 6 2 1 4 (Octal) = P P P P P

Hence L L P P P P P = 13 56214

$C = (1*1 + 2*3 + 3*5 + 4*6 + 5*2 + 6*1 + 7*4) \text{ mod } 11 = (1+6+15+24+10+6+28) \text{ mod } 11 = 90 \text{ mod } 11 = 90 - 88 = 2$

Thus the input key sequence is:

!	!	L	L	P	P	P	P	P	C	#
1	1	1	3	5	6	2	1	4	2	9

17.3.2 Entering the AC

The AC shall always have a length of 32 bits. The user may enter between 0 and 8 digits. Each decimal digit is translated into one semi-octet in the range "0000" to "1001".

The resulting string of semi-octets is padded with a number of leading all-one semi-octets ("1111") to achieve a total of 8 semi-octets.

EXAMPLE 1: Entering the digits 0 1 3 results in an AC of:

"1111 1111 1111 1111 1111 0000 0001 0011"

Extension for CTA: AC-Checksum:

The CTA shall be able to detect "syntax errors" in the entered digit sequence. To this end, a checksum is calculated from the digits entered.

Let A...A be the digits representing the AC;

C = checksum of A...A;

then A...AC would have to be entered.

EXAMPLE 2: For A...A = 0 1 3 the checksum is $(1*0 + 2*1 + 3*3) \text{ mod } 11 = 11 \text{ mod } 11 = C = 0$
Hence A...AC = 0 1 3 0
The entire input sequence for PARK and AC is given by: !!LLPPPPPC#A...AC.

EXAMPLE 3: <OFF-HOOK> 11 13 56214 2 9 013 0 <ON-HOOK> has to be entered for the above examples.

After entering the digits, the subscription registration procedure is started by the ON-HOOK event.

If the procedure is successful, subsequent call processing is possible.

If the subscription registration procedure fails, the CTA adopts the initial state where another subscription registration procedure is possible based on newly entered AC and PARK data.

Annex A (informative): PP locking procedure for on air subscription

See annex A of ETS 300 444 [14].

Annex B (informative): Tones, progress indicator and U-plane connection

See annex B of ETS 300 444 [14].

Annex C (informative): ETS 300 175 additions/modifications

C.1 NWK layer additions/modifications (part 5)

For the purposes of this ETS, the following changes are required to ETS 300 175-5 [5].

A broadcast bit in the higher layer capabilities of the extended FP capabilities has to be reserved for indicating ETS 300 765-1 profile support. The proposed value is a36.

If ETS 300 765-1 is supported, then the bit a36 corresponding to that profile is set to 1; otherwise the bit is set to 0.

For the <<IWU-TO-IWU >> IE (ETS 300 175-5 [5] subclause 7.7.23), a Protocol Discriminator (PD) value shall be allocated, indicating "RLL Access Profile". Detailed coding for this protocol discriminator is given in annex D of this ETS.

The protocol discriminator field has to be updated as follows:

Protocol Discriminator (PD):

Bits	6 5 4 3 2 1	Meaning
	0 1 0 1 0 1	RAP indication

NOTE 1: Only the codings which are used in this ETS are included in this update table. Other codings given in ETS 300 175-5 [5] are unchanged.

For the <<BASIC-SERVICE >> IE (ETS 300 175-5 [5] subclause 7.6.4), a call class shall be allocated, indicating "OA&M call set-up".

The call class field has to be updated as indicated as follows:

Call class:

Bits	8 7 6 5	Meaning
	1 1 1 0	OA&M call set-up

NOTE 2: Only the codings which are used in this ETS are included in this update table. Other codings given in ETS 300 175-5 [5] are unchanged.

For the <<INFO-TYPE >> IE (ETS 300 175-5 [5] subclause 7.7.20), a parameter type coding shall be allocated indicating "OA&M call".

The parameter type coding field has to be updated as indicated as follows:

Parameter type coding:

Bits	7 6 5 4 3 2 1	Meaning
	0 1 0 0 1 0 0	OA&M call

NOTE 3: Only the codings which are used in this ETS are included in this update table. Other codings given in ETS 300 175-5 [5] are unchanged.

For the <<Terminal Capability >> IE (ETS 300 175-5 [5] subclause 7.7.41), one new code shall be allocated in the Profile Indicator_2 Coding field and one new code shall be allocated in the Profile Indicator_3 Coding field as follows:

Profile Indicator_2 Coding (Octet 4a):

Bits	7 6 5 4 3 2 1	Meaning
	1 XXXXXX	RAP 1 profile

Profile Indicator_3 Coding (Octet 4b):

Bits	7 6 5 4 3 2 1	Meaning
	XXXXXX1	multiport CTA

NOTE 4: Only the codings which are used in this ETS are included in this update table. Other codings given in ETS 300 175-5 [5] are unchanged.

C.2 MAC layer additions/modifications (part 3)

For the purposes of this ETS, the following changes are required to ETS 300 175-3 [3].

The MAC_MOD primitive has to be changed as follows:

Connection modification: MAC_MOD {req, cfm, ind}

Parameter	req	ind	cfm
MCEI	X	X	X
ECN	X	X	X
switching	X	X	-
slot type	X	X	-
service type	X	X	-
max lifetime	X	X	-
target number of uplink simplex bearers	X	-	-
target number of downlink simplex bearers	X	-	-
minimum acceptable uplink simplex bearers	X	-	-
minimum acceptable downlink simplex bearers	X	-	-
result	-	X	X
X = parameter exists - = parameter optional			

MCEI = local matter;

ECN = {0, 1, ... 15};

switching: {full to double, double to full, full to full, full to half, half to full, basic to advanced, none }

slot type = {double, full, half with j=0};

service type = {I_N_minimum_delay, I_N_normal_delay, I_P_error_detection, I_P_error_correction, C-channel only};

maximum lifetime = {unlimited, 1, 2, ... , 7};

target number of uplink simplex bearers = {1,2, ... 30};

target number of downlink simplex bearers = {1,2, ... 30};

minimum acceptable uplink simplex bearers = {1,2, ... 30};

minimum acceptable downlink simplex bearers= {1,2, ... 30};

result = {accept, reject}

A new timer T218 has to be added in annex A.1 as follows:

T218 = 3 seconds; 32 kbit/s to 64 kbit/s switching timer

Two new MAC messages, attributes_T_request and attributes_T_confirm has to be added to the Basic connection control set. The subclauses under the subclause 7.2.5.2 has to be changed as follows:

- add in Table 30, subclause 7.2.5.2.2 two new messages attributes_T_request with 0110 command value and attributes_T_confirm with 0111 command value;
- add a new subclause after the existing 7.2.5.2.3 as follows:

7.2.5.2.4 ATTRIBUTES_T {Req;Cfm}

Fill this new subclause with the same text of the subclause 7.2.5.3.8 of ETS 300 175-3 [3].

Annex D (normative): Codings for "OA&M" and "RAP-CC" messages

The FT and the CTA shall be capable of exchanging RAP-OA&M and RAP-CC information which shall be included in the <<IWU-TO-IWU>> IE using protocol discriminator "RAP" which can be sent with every CC-message or MM-message which is allowed to carry the <<IWU-TO-IWU>> IE on an established call. If the case no call is established, the CTA can set-up an outgoing maintenance call, and the FT can set-up an incoming maintenance call to transmit the OA&M message.

IE	Field within the IE	Standard values within the field/IE	Normative action/comment
<<IWU-to-IWU>>			
	<Protocol Discriminator>	15 H	RAP indication
	<IWU-to-IWU information>		Codings for RAP-OA&M and RAP-CC

D.1 General structure for RAP <<IWU-to-IWU>> IE

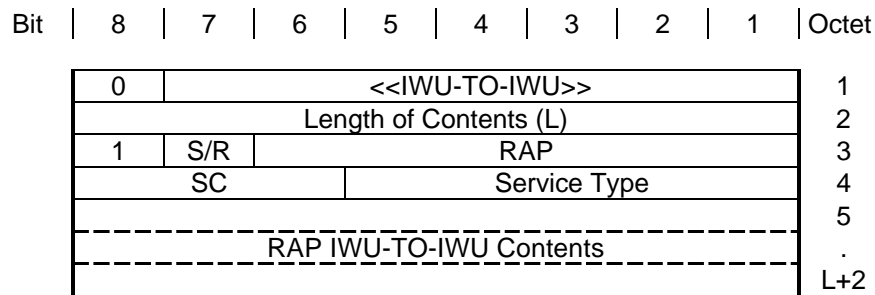

Service Category (SC):

Bits	8	7	6	Meaning
	0	0	1	RAP-CC
	0	1	0	RAP-OA&M
				All other values reserved

Service type:

If SC indicates RAP-CC

Bits	5	4	3	2	1	Meaning
	0	0	0	0	0	Reserved
	0	0	0	0	1	On hook
	0	0	0	1	0	Off hook
	0	0	0	1	1	Coin collection
	0	0	1	0	0	Line polarity reversal
	0	0	1	0	1	Switch to 64 kbit/s bearer service
	0	0	1	1	0	Switch to 32 kbit/s bearer service
	0	0	1	1	1	Line parked
	0	1	0	0	0	Modem tone detection
	0	1	0	0	1	Metering pulse indication
	0	1	0	1	0	Pulse notification
						Reserved

if SC indicates RAP/OA&M

Bits	5	4	3	2	1	Meaning
	0	0	0	0	0	Claim enable
	0	0	0	0	1	Claim disable
	0	0	0	1	0	Claim active
	0	0	0	1	1	Physical resource fault
	0	0	1	0	0	Remote test activation/information
	0	0	1	0	1	Alarm
	0	0	1	1	0	Resynchronization request
	0	0	1	1	1	Remote configuration
	0	1	0	0	0	Remote configuration information
	0	1	0	0	1	Advanced file transfer
	0	1	0	1	0	Subscription suggest
	1	1	1	1	1	Escape
						Reserved

D.2 RAP IWU-TO-IWU contents proprietary

D.2.1 RAP-OA&M service type coding

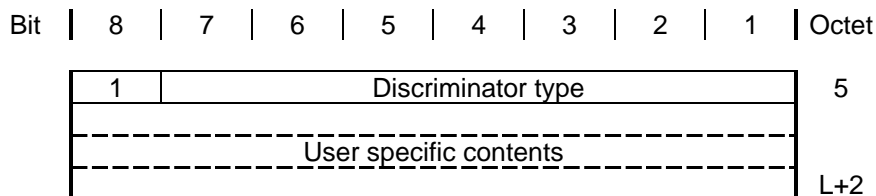

Discriminator type (octet 5):

Bits	7	6	5	4	3	2	1	Meaning
	0	0	0	0	0	0	0	Unspecified
	0	0	0	0	0	0	1	EMC

All other values reserved

User specific contents field (octets 6 to L+2) for Discriminator type "EMC":

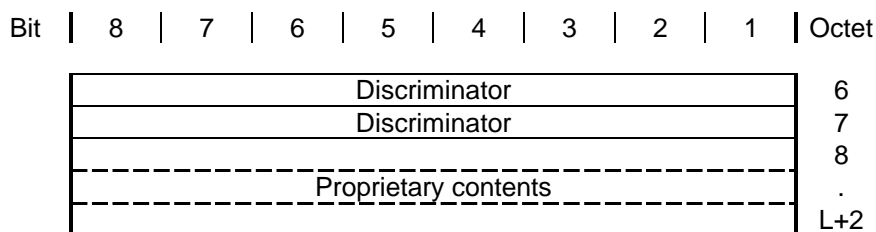

The discriminator consists of 2 octets (octets 6 and 7) and contains the EMC.

This proprietary structure of the RAP IWU-TO-IWU contents can be used only for RAP-OA&M service type commands except for the ones listed below.

- claim enable;
- claim disable;
- claim active;
- resynchronization request.

For these commands and for all the RAP-CC service type commands, only the standardized structure (see clause D.3) can be used.

D.3 RAP IWU-TO-IWU contents standardized

D.3.1 RAP-CC service type coding

Coin collection:

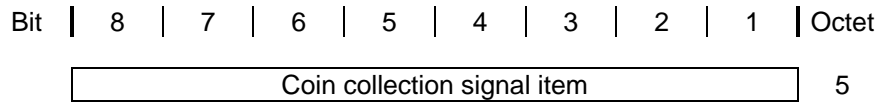

Bits	8	7	6	5	4	3	2	1	Meaning
	0	X	X	X	X	X	X	1/0	Coin absent/present
	0	X	X	X	X	X	1/0	X	High denomination coin/Low denomination coin
	All other values								Reserved
									X: do not care

Switch to 64 kbit/s bearer service:

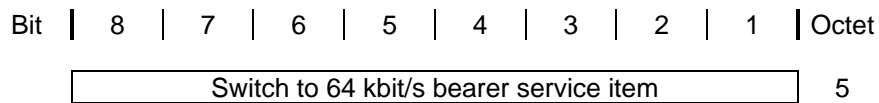

Bits	8	7	6	5	4	3	2	1	Meaning
	0	X	X	X	X	X	X	1/0	Switch to 64 kbit/s bearer service request/reject
	All other values								Reserved
									X: do not care

Switch to 32 kbit/s bearer service:

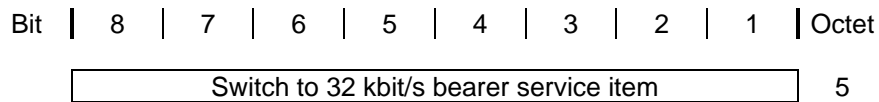

Bits	8	7	6	5	4	3	2	1	Meaning
	0	X	X	X	X	X	X	1/0	Switch to 32 kbit/s bearer service request/reject
	All other values								Reserved
									X: do not care

Metering pulse indication:

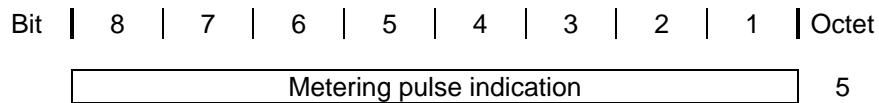

Bits	8	7	6	5	4	3	2	1	Meaning
	0	nr of pulses							indicating 0-127 metering pulses
	All other values								Reserved

D.3.2 RAP-OA&M service type coding

Physical resource fault:

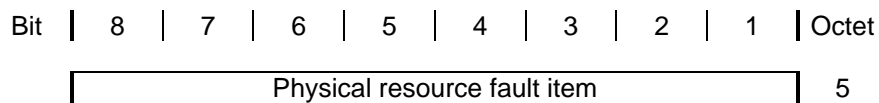

Bits	8	7	6	5	4	3	2	1	Meaning
0	X	X	X	X	X	X	X	1/0	Antenna fault present/absent
0	X	X	X	X	X	X	1/0	X	RF unit plus logic fault present/absent
0	X	X	X	X	1/0	X	X	X	Line interface unit fault present/absent
0	X	X	X	1/0	X	X	X	X	Power supply unit fault present/absent
0	X	X	1/0	X	X	X	X	X	Backup battery fault present/absent
0	X	1/0	X	X	X	X	X	X	Network terminating unit fault present/absent
0	1/0	X	X	X	X	X	X	X	General unit fault present/absent

X: do not care

Remote test activation:

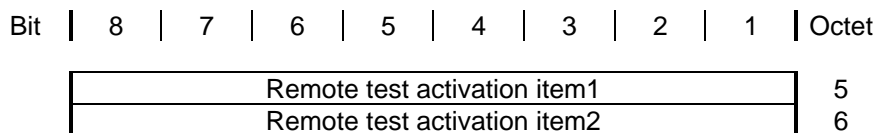

Remote test activation item1:

Bits	8	7	6	5	4	3	2	1	Meaning
0	X	X	X	X	X	X	X	1/0	Detect network terminating unit test activated/deactivated
0	X	X	X	X	X	X	1/0	X	Detect presence of telephone test activated/deactivated
0	X	X	X	X	1/0	X	X	X	Check for leakage to earth test activated/deactivated
0	X	X	X	1/0	X	X	X	X	Detect hazardous voltage test activated/deactivated
0	X	X	1/0	X	X	X	X	X	Detect mains power at CTA test activated/deactivated
0	X	1/0	X	X	X	X	X	X	Check for dial tone from exchange at CTA test activated/deactivated
0	1/0	X	X	X	X	X	X	X	Link Quality test activated/deactivated

X: do not care

Remote test activation item2:

Bits	8	7	6	5	4	3	2	1	Meaning
X	X	X	X	X	X	X	X	1/0	Ring/Ring trip test activated/deactivated
X	X	X	X	X	X	X	1/0	X	Dialled digit test activated/deactivated
X	X	X	X	X	1/0	X	X	X	Deliver number of failed remote call attempts made by CTA
X	X	X	X	1/0	X	X	X	X	RSSI test activated/deactivated
X	X	X	1/0	X	X	X	X	X	A-CRC test
X	X	1/0	X	X	X	X	X	X	Frame error test
X	1/0	X	X	X	X	X	X	X	Reserved

X: do not care

Remote test information:

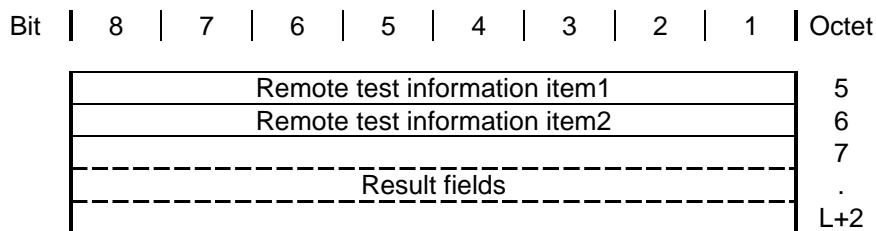

Remote test information item1:

Bits	8	7	6	5	4	3	2	1	Meaning
0	0	0	0	0	0	0	0	1	Results on test Detect network terminating unit
0	0	0	0	0	0	0	1	0	Results on test Detect presence of telephone
0	0	0	0	0	1	0	0	0	Results on test Check for leakage to earth
0	0	0	0	1	0	0	0	0	Results on test Detect hazardous voltage
0	0	0	1	0	0	0	0	0	Results on test Detect mains power at CTA
0	0	1	0	0	0	0	0	0	Results on test Check for dial tone from exchange at CTA
0	1	0	0	0	0	0	0	0	Results on test Link Quality

Remote test information item2:

Bits	8	7	6	5	4	3	2	1	Meaning
	0	0	0	0	0	0	0	1	Results on test Ring/Ring trip test activated/deactivated
	0	0	0	0	0	0	1	0	Results on test Dialed digit test activated/deactivated
	0	0	0	0	0	1	0	0	Delivery of number of failed remote call attempts made by CTA
	0	0	0	0	1	0	0	0	Results on test RSSI test
	0	0	0	1	0	0	0	0	Results on A-CRC test
	0	0	1	0	0	0	0	0	Results on Frame error test
	0	1	0	0	0	0	0	0	Reserved

Alarm:

Bit | 8 | 7 | 6 | 5 | 4 | 3 | 2 | 1 | Octet

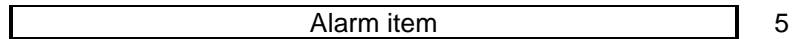

Bits	8	7	6	5	4	3	2	1	Meaning
	0	X	X	X	X	X	X	1/0	Mains failure alarm present/absent
	0	X	X	X	X	X	1/0	X	Power supply failure alarm present/absent
	0	X	X	X	X	1/0	X	X	Low battery voltage alarm present/absent
	0	X	X	X	1/0	X	X	X	Opening of CTA enclosure alarm present/absent
	0	X	X	1/0	X	X	X	X	Reserved
	0	X	1/0	X	X	X	X	X	Reserved
	0	1/0	X	X	X	X	X	X	Reserved

X: do not care

Subscription suggest:

Bit | 8 | 7 | 6 | 5 | 4 | 3 | 2 | 1 | Octet

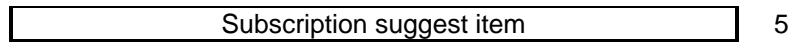

Bits	8	7	6	5	4	3	2	1	Meaning
	0	X	X	X	X	X	X	X	Desired port number (0-7FH)

Annex E (normative): Description of remote tests and quality measurement

The procedures and results of the remote tests and quality measurements other than those specified elsewhere in this ETS are manufacturer specific, and not described as part of this ETS.

Annex F (informative): LU8 service

This annex defines the LU8 64 kbit/s speech and data service specified for the DECT radio interface.

F.1 Physical layer service

The used physical packet is the double slot (packet P80).

F.2 MAC layer service

The duplex unprotected normal delay MAC service with the B-field multiplex U80a shall be used. A symmetric single bearer MAC connection shall be used.

F.3 DLC layer service

The Forward Error Control (FEC) defined in ETS 300 175-4 [4] shall be used.

The frame format FU8 used in the LU8 service is defined in figure F.1.

2 bytes	80 bytes	10 bytes	2 bytes	6 bytes
spare bits	user data	spare bits	spare bits	RS parity symbol (FEC)

Figure F.1: FU8 frame structure

This framing format is directly derived from the FU7 framing format removing the Automatic Retransmission Request (ARQ) bytes and maintaining the FEC bytes.

The RS (255, 249) code provided by the FEC, may be used to correct up to 3 errors within a double slot connection and uses the generator polynomial defined in subclause 6.1.2.

NOTE: If the error correction algorithm can not correct the errors in a double slot, the LU8 service should transmit the received user data to the Interworking Unit (IWU) with a FEC error indication.

Annex G (normative): Interworking with wireless relay stations

This annex describes:

- additional requirements for WRSs;
- additional requirements for FTs with respect to support of WRSs.

RAP part1 compliance can only be obtained for the Cordless Radio Fixed Part (CRFP) type WRS. For European approval, no more than one hop shall be allowed in a network with WRSs. On a national base, multi-hop architectures can be allowed after agreement with the national authority. In this case, to provide a RAP compliant interface to the FT, the first WRS in the chain is of the CRFP type.

G.1 Definitions of features, services and procedures

G.1.1 NWK features

Transparency between FT and PT [N.201]: The ability of the CRFP to be transparent for all NWK layer messages exchanged between FT and PT.

Encryption of relayed connections [N.202]: The ability of the CRFP and the FT to support encryption of relayed connections.

G.1.2 MAC services

Extended Fixed Part Capabilities [M.201]: A service which indicates the extended capabilities of the FP to the PT or to the CRFP-PT.

Hop Control [M.202]: A service used by the FP to control the number of WRS hops.

Normal relay operation [M.203]: A service that only provides unencrypted relayed connections.

Dual relay operation [M.204]: A service that provides encryption of relayed connections.

G.2 Interoperability requirements

G.2.1 NWK features

There are no NWK requirements for the CRFP-FT.

For this ETS (RAP part 1), the following NWK features shall be supported by the CRFP-PT and the FT supporting a CRFP.

Table G.1: NWK features status

Feature supported				Status	
Item no.	Name of feature	ETS 300 444 [14] reference	ETS 300 765 reference	CRFP-PT	FT
N.9	Authentication of PP or CRFP-PT	4.1		M	7.2
N.11	Location registration	4.1		M	7.2
N.12	On air key allocation	4.1		M	7.2
N.13	Identification of PP or CRFP-PT	4.1		M	7.2
N.17	Encryption activation FT initiated	4.1		M	7.2
N.18	Subscription registration procedure on-air	4.1		M	7.2
N.19	Link control	4.1		M	7.2
N.20	Terminate access rights FT initiated	4.1		M	7.2
N.21	Partial release	4.1		I	7.2
N.26	Authentication of FT	4.1		O	7.2
N.27	Encryption activation PP or CRFP-PT initiated	4.1		O	7.2
N.28	Encryption deactivation FT initiated	4.1		O	7.2
N.29	Encryption deactivation PP or CRFP-PT initiated	4.1		O	7.2
N.116	64 kbit/s bearer service using DLC LU7 service		5.1	O	7.2
N.119	Incoming WRS maintenance transaction		5.1	O	7.2
N.120	Outgoing WRS maintenance transaction		5.1	O	7.2
N.122	Maintenance during WRS MM operation		5.1	O	7.2
N.201	Transparency between FT and PT		G.1.1	M	I
N.202	Encryption of relayed connections (procedure: Cipher key transfer to CRFP)		G.1.1	M	O

G.2.2 DLC services

There are no DLC requirements for the CRFP-FT. For this ETS (RAP part 1), the following DLC features shall be supported by the CRFP-PT and the FT supporting a CRFP.

Table G.2: DLC service status

Feature supported				Status	
Item no.	Name of feature	ETS 300 444 [14] reference	ETS 300 765 reference	CRFP-PT	FT
D.1	LAPC class A service and Lc	5.1		M	7.3
D.2	Cs channel fragmentation and recombination	5.1		M	7.3
D.3	Broadcast Lb service	5.1		M	7.3
D.4	Intracell Connection handover	5.1		M	7.3
D.5	Intercell Connection handover	5.1		M	7.3
D.6	Encryption activation	5.1		M	7.3
D.9	Encryption deactivation	5.1		C201	7.3
D.100	LU7 service		6.1.2	C202	7.3

C201: IF feature N.28 or N.29 THEN M ELSE I;

C202: IF feature N.116 THEN M ELSE I.

G.2.3 MAC services

For this ETS (RAP part 1), the following MAC services shall be supported by the CRFP-PT and the FT supporting a CRFP.

The CRFP-FT shall support the Blind slot information service as described in subclause 11.5.

Providing the Improved Channel Selection Rules service as described in subclause 11.6 is optional for the CRFP.

Table G.3: MAC services status

Feature supported						
Item no.	Name of feature	ETS 300 444 [14] reference	ETS 300 765 reference	Status		
				CRFP- PT	CRFP- FT	FT
M.1	General	5.2		M	M	7.4
M.2	Continuous broadcast	5.2		M	M	7.4
M.3	Paging broadcast	5.2		M	M	7.4
M.4	Basic connections	5.2		M	M	7.4
M.5	Cs higher layer signalling	5.2		M	M	7.4
M.6	Quality control	5.2		M	M	7.4
M.7	Encryption activation	5.2		M	M	7.4
M.8	Extended frequency allocation (note)	5.2		M	M	7.4
M.9	Intracell Bearer handover	5.2		M	C302	7.4
M.10a	Intercell Bearer handover of PT to/from CRFP	5.2		M	O	O
M.10b	Intercell Bearer handover of CRFP to/from RFP	5.2		O	I	O
M.11	Intracell Connection handover	5.2		M	C303	7.4
M.12a	Intercell Connection handover of PT to/from CRFP	5.2		M	O	O
M.12b	Intercell Connection handover of CRFP to/from RFP	5.2		O	I	O
M.13	SARI support	5.2		M	M	7.4
M.14	Encryption deactivation	5.2		C301	C301	7.4
M.100	LU7 service		6.2.2	C304	C304	7.4
M.101	Advance Timing		6.2.2	O	O	7.4
M.103	Improved channel selection rules		6.2.2	O	O	7.4
M.201	Extended Fixed Part Capabilities		G.1.3	M	M	O
M.202	Hop Control		G.1.3	M	M	O
M.203	Normal relay operation		G.1.3	M	I	O
M.204	Dual relay operation		G.1.3	M	I	O

C301: IF feature N.28 or N.29 THEN M ELSE I;

C302: IF C303 THEN O ELSE M;

C303: IF C302 THEN O ELSE M;

C304: IF feature N.116 then M else I.

G.2.4 Physical Layer (PHL) services

For the CRFP-PT and the CRFP-FT the PHL services specified in subclause 6.5 of ETS 300 444 [14] apply.

Additionally, for the CRFP-PT and CRFP-FT the PHL requirements as specified in subclause 4.2.1 of ETS 300 700 [15] apply.

If the LU7 64 kbit/s data bearer service is supported [N.116], the double slot physical packet P80 (see ETS 300 175-2 [2]) shall be used.

G.2.5 NWK feature to procedure mapping

Table G.4: NWK feature to procedure mapping

Feature supported				Status	
Feature	Procedure	ETS 300 444 [14] reference	ETS 300 765 reference	CRFP -PT	FT
N.9 Authentication of PP		4.1		M	7.7
	Authentication of PT	8.24		M	7.7
N.11 Location registration		4.1		M	7.7
	Location registration	8.28		M	7.7
	Location update	8.29		M	7.7
N.12 On air key allocation		4.1		M	7.7
	Key allocation	8.32		M	7.7
N.13 Identification of PP		4.1		M	7.7
	Identification of PT	8.22		M	7.7
N.17 Encryption activation FT initiated		4.1		M	7.7
	Cipher switching initiated by FT	8.33		M	7.7
	Storing the DCK	8.27		M	7.7
N.18 Subscription registration procedure on- air		4.1		M	7.7
	Obtaining access rights	8.30		M	7.7
N.19 Link control		4.1		M	7.7
	Indirect FT initiated link establishment	8.35		M	7.7
	Direct FT initiated link establishment	8.36		M	7.7
	Link release "normal"	8.37		M	7.7
	Link release "abnormal"	8.38		M	7.7
	Link release "maintain"	8.39		M	7.7
N.20 Terminate access rights FT initiated		4.1		M	7.7
	FT terminating access rights	8.31		M	7.7
	Authentication of FT	8.23		M	7.7
N.21 Partial release		4.1		I	7.7
	Partial release	8.9		I	7.7
N.26 Authentication of FT		4.1		O	7.7
	Authentication of FT	8.23		M	7.7
N.27 Encryption activation PP or CRFP-PT initiated		4.1		O	7.7
	Cipher-switching initiated by PT	8.34		M	7.7
	Storing the DCK	8.27		M	7.7
N.28 Encryption deactivation FT initiated		4.1		O	7.7
	Cipher-switching initiated by FT	8.33		M	7.7
N.29 Encryption deactivation PP or CRFP- PT initiated		4.1		O	7.7
	Cipher-switching initiated by PT	8.34		M	7.7
N.116 64 kbit/s bearer service using DLC LU7 service			5.1	O	7.7
	Switch from 32 kbit/s to 64 kbit/s bearer service FT initiated		9.4.7	M	7.7
	Switch from 32 kbit/s to 64 kbit/s bearer service CTA initiated		9.4.8	O	7.7
	Switch from 64 kbit/s to 32 kbit/s bearer service FT initiated		9.4.10	O	7.7
	Switch from 64 kbit/s to 32 kbit/s bearer service CTA initiated		9.4.11	O	7.7

(continued)

Table G.4 (concluded): NWK feature to procedure mapping

Feature supported					
Feature	Procedure	ETS 300 444 [14] reference	ETS 300 765 reference	Status	
				CRFP -PT	FT
N.119 Incoming WRS maintenance transaction			5.1	O	7.7
	Incoming WRS maintenance call		16.3.1	M	7.7
	Sending OA&M information		9.3	M	7.7
N.120 Outgoing WRS maintenance transaction			5.1	O	7.7
	Outgoing WRS maintenance call		16.3.2	M	7.7
	Sending OA&M information		9.3	M	7.7
N.122 Maintenance during WRS MM operation			5.1	O	7.7
	Maintenance during WRS MM operation		16.3.3	M	7.7
N.201 Transparency between FT and PT			G1.1	M	I
	Transparency between FT and PT		G.3.1	M	I
N.202 Encryption of relayed connections			G1.1	M	O
	Cipher key transfer to CRFP		G.3.2	M	M

G.2.6 DLC service to procedure mapping

Table G.5 : DLC service to procedure mapping

Feature supported					
Feature	Procedure	Feature supported		Status	
		ETS 300 444 [14] reference	ETS 300 765 reference	CRFP-PT	FT
D.1 LAPC class A service and Lc		5.1		M	ETS 300 444 [14], 6.8.1
	Class A link establishment	9.1		M	ETS 300 444 [14], 6.8.1
	Class A acknowledge information transfer	9.2		M	ETS 300 444 [14], 6.8.1
	Class A link release	9.3		M	ETS 300 444 [14], 6.8.1
	Class A link re-establishment	9.4		M	ETS 300 444 [14], 6.8.1
D.2 Cs channel fragmentation and recombination		5.1		M	ETS 300 444 [14], 6.8.1
	Cs channel fragmentation and recombination	9.5		M	ETS 300 444 [14], 6.8.1
D.3 Broadcast Lb service		5.1		M	ETS 300 444 [14], 6.8.1
	Normal broadcast			M	ETS 300 444 [14], 6.8.1
D.4 Intracell Connection handover		5.1		M	ETS 300 444 [14], 6.8.1
	Class A basic connection handover	9.7		M	ETS 300 444 [14], 6.8.1
D.5 Intercell Connection handover		5.1		M	ETS 300 444 [14], 6.8.1
	Class A basic connection handover	9.7		M	ETS 300 444 [14], 6.8.1
D.6 Encryption activation		5.1		M	ETS 300 444 [14], 6.8.1
	Encryption switching	9.8		M	ETS 300 444 [14], 6.8.1
D.9 Encryption deactivation		5.1		C501	ETS 300 444 [14], 6.3
	Encryption switching	9.8		M	ETS 300 444 [14], 6.8.1
D.100 LU7 service			6.1.2	C502	C502
	LU7 service		10.3	M	M

C501: IF N.28 OR N.29 THEN M ELSE I;
C502: IF feature N.116 THEN M ELSE I.

G.2.7 MAC service to procedure mapping

Table G.6: MAC service to procedure mapping

Feature supported						
Feature	Procedure	ETS 300 444 [14] reference	ETS 300 765 reference	Status		
				CRFP- PT	CRFP -FT	FT
M.1 General		5.2		M	M	ETS 300 444 [14], 6.8.2
	General	10.1		M	M	ETS 300 444 [14], 6.8.2
M.2 Continuous broadcast		5.2		M	M	ETS 300 444 [14], 6.8.2
	Downlink broadcast	10.2		M	M	ETS 300 444 [14], 6.8.2
M.3 Paging broadcast		5.2		M	M	ETS 300 444 [14], 6.8.2
	Paging broadcast	10.3		M	M	ETS 300 444 [14], 6.8.2
M.4 Basic connections		5.2		M	M	ETS 300 444 [14], 6.8.2
	Set-up of basic connection, basic bearer set-up (A-field)	10.4		M	M	ETS 300 444 [14], 6.8.2
	Connection/bearer release	10.5		M	M	ETS 300 444 [14], 6.8.2
M.5 Cs higher layer signalling		5.2		M	M	ETS 300 444 [14], 6.8.2
	Cs channel data	10.8		M	M	ETS 300 444 [14], 6.8.2
	Q2 bit setting	10.9		M	M	ETS 300 444 [14], 6.8.2
M.6 Quality control		5.2		M	M	ETS 300 444 [14], 6.8.2
	RFPI handshake	10.10		M	M	ETS 300 444 [14], 6.8.2
	Antenna diversity	10.11		M	O	ETS 300 444 [14], 6.8.2
	Sliding collision detection	10.12		O	M	ETS 300 444 [14], 6.8.2
M.7 Encryption activation		5.2		M	M	ETS 300 444 [14], 6.8.2
	Encryption process - initialization and synchronization	10.13		M	M	ETS 300 444 [14], 6.8.2
	Encryption mode control	10.14		M	M	ETS 300 444 [14], 6.8.2
	Handover encryption process	10.15		M	M	ETS 300 444 [14], 6.8.2
M.8 Extended frequency allocation		5.2		M	M	ETS 300 444 [14], 6.8.2
	Extended frequency allocation	10.16		M	M	ETS 300 444 [14], 6.8.2
M.9 Intracell Bearer handover		5.2	G.4.7	M	C602	ETS 300 444 [14], 6.8.2
	Bearer handover request		G.4.7	M	M	ETS 300 444 [14], 6.8.2
M.10a Intercell Bearer handover of PT to/from CRFP		5.2	G.4.7	M	O	O
	Bearer handover request of PT	10.6	G.4.7	M	M	M

(continued)

Table G.6 (concluded): MAC service to procedure mapping

		Feature supported				Status	
Feature	Procedure	ETS 300 444 [14] reference	ETS 300 765 reference	CRFP-PT	CRFP-FT	FT	
M.10b Intercell Bearer handover of CRFP to/from RFP		5.2	G.4.7	O	I	O	
	Bearer handover request of CRFP	10.6	G.4.7	M	I	M	
M.11 Intracell Connection handover		5.2		M	C603	ETS 300 444 [14], 6.8.2	
	Connection handover request	10.7	G.4.8	M	M	ETS 300 444 [14], 6.8.2	
M.12a Intercell Connection handover of PT to/from CRFP		5.2		M	O	O	
	Connection handover request of PT	10.7	G.4.8	M	M	M	
M.12b Intercell Connection handover of CRFP to/from RFP		5.2		O	I	O	
	Connection handover request of CRFP	10.7	G.4.8	M	I	M	
M.13 SARI support		5.2		M	M	ETS 300 444 [14], 6.8.2	
	Downlink broadcast	10.2		M	M	ETS 300 444 [14], 6.8.2	
M.14 Encryption deactivation		5.2		C601	C601	ETS 300 444 [14], 6.8.2	
	Encryption mode control	10.14		M	M	ETS 300 444 [14], 6.8.2	
M.100 LU7 service			6.2.2	C604	C604	ETS 300 765, 7.9	
	LU7 service		11.3	M	M	ETS 300 765, 7.9	
M.101 Advance timing			6.2.2	O	O	ETS 300 765, 7.9	
	Advance timing		11.3	M	M	ETS 300 765, 7.9	
M.103 Improved channel selection rules			6.2.2	O	I	I	
	Improved channel selection rules		6.2.2	M	I	I	
M.201 Extended Fixed Part Capabilities			G.1.2	M	M	M	
	Extended Fixed Part Capabilities		G.4.1	M	M	M	
M.202 Hop Control			G.1.2	M	M	O	
	Hop Control		G.4.2	M	M	M	
M.203 Normal relay operation			G.1.2	M	N/A	O	
	Normal C/O bearer set-up		G.4.3	M	N/A	M	
	C/O connection release		G.4.6	M	N/A	M	
M.204 Dual relay operation			G.1.2	M	N/A	O	
	Dual C/O bearer set-up		G.4.4	M	N/A	M	
	CRFP connection suspend and resume		G.4.5	M	N/A	M	
	C/O connection release		G.4.6	M	N/A	M	

C601: IF feature N.28 OR N.29 THEN M ELSE I;
C602: IF C603 THEN O ELSE M;
C603: IF C602 THEN O ELSE M;
C604: IF feature N.116 THEN M ELSE I.

G.3 NWK layer procedures

G.3.1 NWK layer transparency between FT and PT

The CRFP shall provide full transparency for all NWK layer messages exchanged between FT and PT.

G.3.2 Cipher key transfer to CRFP

The procedure shall be performed as defined in subclauses 5.3.4.1 and 5.3.4.2 of ETS 300 700 [15].

G.4 MAC layer procedures

G.4.1 Extended Fixed Part capabilities

The procedure shall be performed as defined in subclause 4.4.2.1 of ETS 300 700 [15].

G.4.2 Hop control

The procedure shall be performed as defined in subclause 4.4.2.2 of ETS 300 700 [15].

G.4.3 Normal C/O bearer set-up

The procedure shall be performed as defined in subclause 5.3.1.1.2 of ETS 300 700 [15].

G.4.4 Dual C/O bearer set-up

The procedure shall be performed as defined in subclause 5.3.1.1.3 of ETS 300 700 [15].

G.4.5 CRFP connection suspend and resume

The procedure shall be performed as defined in subclause 5.3.1.2 of ETS 300 700 [15].

G.4.6 CRFP C/O release

The procedure shall be performed as defined in subclause 5.3.1.4 of ETS 300 700 [15].

G.4.7 Bearer handover request

The procedures for:

- bearer handover, intracell of PT within CRFP;
- bearer handover, intracell of CRFP within one RFP;
- bearer handover, intercell of CRFP from one RFP to an RFP;
- bearer handover, intercell of PT from a CRFP to an RFP;
- bearer handover, intercell of PT from an RFP to a CRFP;
- bearer handover, intercell of PT from a CRFP to a CRFP,

shall be performed as defined in subclause 5.3.1.3 of ETS 300 700 [15].

G.4.8 Connection handover request

The procedures for:

- connection handover, intercell of CRFP from one RFP to an RFP;
- connection handover, intercell of PT from a CRFP to an RFP;
- connection handover, intercell of PT from an RFP to a CRFP;
- connection handover, intercell of PT from a CRFP to a CRFP,

shall be performed as defined in subclause 5.3.2.1 of ETS 300 700 [15].

Annex H (normative): Synchronization requirements for FPs

Public systems shall provide intrasystem cluster synchronization and shall have either GPS synchronization and a synchronization output port or a complete synchronization port (both input and output). This will allow absolute time synchronization via GPS or wired mutual synchronization, if an operator requires local synchronization between FPs.

Table H.1: Synchronization requirements

Synchronization requirements			
Item no.	Name of feature	Reference (ETS 300 175-2 [2])	Status FT (Public)
S.1	GPS multiframe time synchronization	C.5.1	O
S.2	DECT SYNC output port, Class 1	annex C.	M
S.3	DECT SYNC input port, Class 1	annex C.	C101

C101: IF S.1 THEN O ELSE M.

History

Document history			
July 1996	Public Enquiry	PE 109:	1996-07-08 to 1996-11-01
May 1997	Vote	V 9731:	1997-05-20 to 1997-08-01