



EUROPEAN
TELECOMMUNICATION
STANDARD

ETS 300 646-1

May 1997

Source: ETSI TC-SPS and ETSI TC-SMG

Reference: DE/SPS-01023

ICS: 33.020

Key words: ISDN, SS7, ISUP, GSM, mobile, radio, PLMN, interworking



**Integrated Services Digital Network (ISDN);
Signalling System No.7;
Digital cellular telecommunications system (Phase 2);
Application of ISDN User Part (ISUP) version 2 for the
ISDN-Public Land Mobile Network (PLMN) signalling interface;
Part 1: Protocol specification
(GSM 09.12 version 4.1.1)**

ETSI

European Telecommunications Standards Institute

ETSI Secretariat

Postal address: F-06921 Sophia Antipolis CEDEX - FRANCE

Office address: 650 Route des Lucioles - Sophia Antipolis - Valbonne - FRANCE

X.400: c=fr, a=atlas, p=etsi, s=secretariat - **Internet:** secretariat@etsi.fr

Tel.: +33 4 92 94 42 00 - Fax: +33 4 93 65 47 16

Copyright Notification: No part may be reproduced except as authorized by written permission. The copyright and the foregoing restriction extend to reproduction in all media.

© European Telecommunications Standards Institute 1997. All rights reserved.

Contents

Foreword	5
1 Scope	7
2 Normative references	8
3 Definitions and abbreviations	10
3.1 Definitions	10
3.2 Abbreviations	11
4 General principles	12
5 Exceptions and clarifications for basic call	12
5.1 Formats and codes	12
5.2 Basic call signalling procedures	12
5.2.1 Signalling procedures for connection type allowing fallback	12
5.2.2 Echo control procedure	12
5.2.3 Calls from the PLMN to the fixed network	12
5.2.3.1 Gateway in the PLMN	12
5.2.3.1.1 Initial address message	12
5.2.4 Calls from the fixed network to the PLMN	13
5.2.4.1 Gateway in the fixed network	13
5.2.4.1.1 Initial address message	13
5.2.4.2 Gateway in the PLMN	13
5.2.4.2.1 Address complete message	13
6 Exceptions and clarifications for supplementary services	14
6.1 Considerations on ISDN supplementary services	14
6.1.1 Handling of number parameters related to supplementary services	14
6.1.1.1 Calling Line Identification Presentation/Restriction (CLIP/CLIR) supplementary services	14
6.1.1.2 Connected Line Identification Presentation/Restriction (COLP/COLR) supplementary services	14
6.1.1.3 Terminal Portability (TP) supplementary service	15
6.1.1.4 User-to-User Signalling (UUS) supplementary service	15
6.1.1.5 Closed User Group (CUG) supplementary service	15
6.1.1.6 Subaddressing (SUB) supplementary service	15
6.1.1.7 Malicious Call Identification (MCID) supplementary service	15
6.1.1.8 Conference call, add-on (CONF) supplementary service	15
6.1.1.9 Explicit Call Transfer (ECT) supplementary service	15
6.1.1.10 Diversion supplementary services (Call Forwarding Unconditional (CFU)/Call Forwarding on Busy (CFB)/Call Forwarding on No Reply (CFNR)/Call Deflection (CD))	16
6.1.1.11 Call Hold (HOLD) supplementary service	16
6.1.1.12 Call Waiting (CW) supplementary service	16
6.1.1.13 Completion of Calls to Busy Subscriber (CCBS) supplementary service	16
6.1.1.14 Three party (3PTY) supplementary service	16
6.2 Considerations on GSM unique supplementary services	16
6.2.1 Call Forwarding on Mobile Subscriber Not Reachable (CFNRc) supplementary service	16
6.2.2 Advice of Charge (AoC) supplementary service	16
6.2.3 Call Barring (CB) supplementary service	17
6.2.4 Unstructured Supplementary Service Data (USSD)	17
7 Message Transfer Part (MTP) protocol requirements	17

Annex A (informative):	Considerations on teleservices	18
A.1	Relation between ISDN teleservices and GSM teleservices	18
Annex B (informative):	Considerations on bearer services	19
Annex C (informative):	Mapping of parameters between ISUP and MAP	20
C.1	Mapping of parameters from IAM to MAP_SEND_ROUTING_INFORMATION req.	20
C.2	Mapping of parameters from MAP_SEND_ROUTING_INFORMATION rsp. to IAM	20
Annex D (normative):	Formats and codes	21
D.1	Exceptions to table 4/Q.763 of ITU-T Recommendation Q.763 as modified by ETS 300 356-1	21
D.2	Exceptions to table 5/Q.763 of ITU-T Recommendation Q.763 as modified by ETS 300 356-1	21
D.3	Exceptions and clarifications to clause 3 of ITU-T Recommendation Q.763 as modified by ETS 300 356-1	21
Annex E (informative):	Examples of echo control procedures	23
E.1	Outgoing call in a Mobile-service Switching Centre (MSC)	23
E.2	Incoming call in the MSC	23
E.3	Examples of echo control procedure	24
E.3.1	Call from a mobile station to a mobile station via the fixed network	24
E.3.2	Call from a mobile station to fixed network with no echo control device	24
E.3.3	Call from a mobile station to fixed network with echo control device	25
E.3.4	Call from fixed network with no echo control device to a mobile station roaming in a PLMN of another country	25
E.3.5	Call from fixed network with echo control device to a mobile station roaming in a PLMN of another country	25
E.3.6	Call from fixed network with no echo control device to a mobile station	25
E.3.7	Call from fixed network with echo control device to a mobile station	26
E.3.8	Call forwarded by the VMSC	26
E.3.9	Call forwarded by the VMSC to the fixed network with no echo control device	26
E.3.10	Call with no outgoing echo control device included in a preceding exchange forwarded by the VMSC to the fixed network with no echo control device in the terminating network. The VMSC knows that an outgoing half echo control device is not necessary ..	26
E.3.11	Call with no outgoing echo control device included in a preceding exchange forwarded by the VMSC to the fixed network with echo control device in the terminating network. The VMSC knows that an outgoing half echo control device is not necessary	27
E.3.12	Call with no outgoing echo control device included in a preceding exchange forwarded by the VMSC to the fixed network with no echo control device in the terminating network. The VMSC knows that an outgoing half echo control device is necessary	27
E.3.13	Call with no outgoing echo control device included in a preceding exchange forwarded by the VMSC to the fixed network with echo control device in the terminating network. The VMSC knows that an outgoing half echo control device is necessary	27
History		28

Foreword

This European Telecommunication Standard (ETS) has been produced by the Signalling Protocols and Switching (SPS) and the Special Mobile Group (SMG) Technical Committees of the European Telecommunications Standards Institute (ETSI).

This ETS is part 1 of a multi-part standard covering the application of Integrated Services Digital Network (ISDN) User Part (ISUP) version 2 for the ISDN-Public Land Mobile Network (PLMN) signalling interface as described below:

Part 1: "Protocol specification";

Part 2: "Protocol Implementation Conformance Statement (PICS) proforma specification";

Part 3: "Test Suite Structure and Test Purposes (TSS&TP) specification";

Part 4: "Abstract Test Suite (ATS) and partial Protocol Implementation eXtra Information for Testing (PIXIT) proforma specification".

This ETS corresponds to GSM Technical Specification (GSM-TS) GSM 09.12 version 4.1.1.

ETS 300 303 (1994) covers the application of ISUP version 1 for the ISDN-PLMN interface.

Transposition dates	
Date of adoption:	2 May 1997
Date of latest announcement of this ETS (doa):	31 August 1997
Date of latest publication of new National Standard or endorsement of this ETS (dop/e):	28 February 1998
Date of withdrawal of any conflicting National Standard (dow):	28 February 1998

Blank page

1 Scope

This first part of ETS 300 646 specifies the second version of the Integrated Services Digital Network (ISDN) - Global System for Mobile communications (GSM) Public Land Mobile Network (PLMN) signalling interface. This ETS is applicable to the interconnection of PLMN and ISDN.

The ISUP interface defined is the trunk signalling interface between the PLMN and the ISDN. It is assumed that the interface between PLMN and ISDN can occur at any point in a national network, provided that the exchange in the national network has this ISDN-PLMN signalling interface.

This signalling interface is based on ISUP version 2 (as given in ETS 300 356-1 to ETS 300 356-19 ([1] to [18])). The functionality in the GSM system is based on GSM Phase 2.

NOTE 1: Support of new functionality in the GSM system applicable for this interface may be included in this ETS as amendments or be published as a new ETS.

Connection types:

The following ISUP version 2 connection types can be supported:

- speech;
- 3,1 kHz audio;
- 64 kbit/s unrestricted;
- 64 kbit/s unrestricted preferred;
- 2 × 64 kbit/s unrestricted;
- 384 kbit/s unrestricted;
- 1 536 kbit/s unrestricted;
- 1 920 kbit/s unrestricted.

NOTE 2: 2 × 64 kbit/s, 384 kbit/s, 1 536 kbit/s, 1 920 kbit/s unrestricted and 64 kbit/s unrestricted preferred connection types are not supported by the GSM access, however the connection types may be used in order to support other access methods via the GSM network.

Supplementary services:

The following ISUP version 2 supplementary services can be supported:

- Calling Line Identification Presentation (CLIP)/
Calling Line Identification Restriction (CLIR);
- Connected Line Identification Presentation (COLP)/
Connected Line Identification Restriction (COLR);
- Terminal portability (TP);
- User-to-User Signalling (UUS);
- Closed User Group (CUG);
- Subaddressing (SUB);
- Malicious Call Identification (MCID);
- Conference call, add-on (CONF);
- Explicit Call Transfer (ECT);
- Call Forwarding Unconditional (CFU)/
Call Forwarding on Busy (CFB)/
Call Forwarding on No Reply (CFNR);
- Call Deflection (CD);
- Call Hold (HOLD);
- Call Waiting (CW);
- Completion of Calls to Busy Subscriber (CCBS);
- Three party (3PTY).

The support of supplementary services on this interface does not necessarily imply that the supplementary services are supported in one or the other of the networks interconnected.

The Direct Dialling In (DDI) supplementary service and Multiple Subscriber Number (MSN) supplementary service have no impact on this interface.

This interface can be used within national networks, however messages and parameters that are marked for national use (@) in ETS 300 356-1 [1] are not described in this ETS.

2 Normative references

This ETS incorporates by dated and undated reference, provisions from other publications. These normative references are cited at the appropriate places in the text and the publications are listed hereafter. For dated references, subsequent amendments to or revisions of any of these publications apply to this ETS only when incorporated in it by amendment or revision. For undated references the latest edition of the publication referred to applies.

- [1] ETS 300 356-1 (1995): "Integrated Services Digital Network (ISDN); Signalling System No.7; ISDN User Part (ISUP) version 2 for the international interface; Part 1: Basic services [ITU-T Recommendations Q.761 to Q.764 (1993), modified]".
- [2] ETS 300 356-2 (1995): "Integrated Services Digital Network (ISDN); Signalling System No.7; ISDN User Part (ISUP) version 2 for the international interface; Part 2: ISDN supplementary services [ITU-T Recommendation Q.730 (1993), modified]".
- [3] ETS 300 356-3 (1995): "Integrated Services Digital Network (ISDN); Signalling System No.7; ISDN User Part (ISUP) version 2 for the international interface; Part 3: Calling Line Identification Presentation (CLIP) supplementary service [ITU-T Recommendation Q.731, clause 3 (1993), modified]".
- [4] ETS 300 356-4 (1995): "Integrated Services Digital Network (ISDN); Signalling System No.7; ISDN User Part (ISUP) version 2 for the international interface; Part 4: Calling Line Identification Restriction (CLIR) supplementary service [ITU-T Recommendation Q.731, clause 4 (1993), modified]".
- [5] ETS 300 356-5 (1995): "Integrated Services Digital Network (ISDN); Signalling System No.7; ISDN User Part (ISUP) version 2 for the international interface; Part 5: Connected Line Identification Presentation (COLP) supplementary service [ITU-T Recommendation Q.731, clause 5 (1993), modified]".
- [6] ETS 300 356-6 (1995): "Integrated Services Digital Network (ISDN); Signalling System No.7; ISDN User Part (ISUP) version 2 for the international interface; Part 6: Connected Line Identification Restriction (COLR) supplementary service [ITU-T Recommendation Q.731, clause 6 (1993), modified]".
- [7] ETS 300 356-7 (1995): "Integrated Services Digital Network (ISDN); Signalling System No.7; ISDN User Part (ISUP) version 2 for the international interface; Part 7: Terminal Portability (TP) supplementary service [ITU-T Recommendation Q.733, clause 4 (1993), modified]".
- [8] ETS 300 356-8 (1995): "Integrated Services Digital Network (ISDN); Signalling System No.7; ISDN User Part (ISUP) version 2 for the international interface; Part 8: User-to-User Signalling (UUS) supplementary service [ITU-T Recommendation Q.737, clause 1 (1993), modified]".
- [9] ETS 300 356-9 (1995): "Integrated Services Digital Network (ISDN); Signalling System No.7; ISDN User Part (ISUP) version 2 for the international interface; Part 9: Closed User Group (CUG) supplementary service [ITU-T Recommendation Q.735, clause 1 (1993), modified]".

- [10] ETS 300 356-10 (1995): "Integrated Services Digital Network (ISDN); Signalling System No.7; ISDN User Part (ISUP) version 2 for the international interface; Part 10: Subaddressing (SUB) supplementary service [CCITT Recommendation Q.731, section 8 (1992), modified]".
- [11] ETS 300 356-11 (1995): "Integrated Services Digital Network (ISDN); Signalling System No.7; ISDN User Part (ISUP) version 2 for the international interface; Part 11: Malicious Call Identification (MCID) supplementary service".
- [12] ETS 300 356-12 (1995): "Integrated Services Digital Network (ISDN); Signalling System No.7; ISDN User Part (ISUP) version 2 for the international interface; Part 12: Conference call, add-on (CONF) supplementary service [ITU-T Recommendation Q.734, clause 1 (1993), modified]".
- [13] ETS 300 356-14 (1995): "Integrated Services Digital Network (ISDN); Signalling System No.7; ISDN User Part (ISUP) version 2 for the international interface; Part 14: Explicit Call Transfer (ECT) supplementary service".
- [14] ETS 300 356-15 (1995): "Integrated Services Digital Network (ISDN); Signalling System No.7; ISDN User Part (ISUP) version 2 for the international interface; Part 15: Diversion supplementary services [ITU-T Recommendation Q.732, clauses 2 to 5 (1993), modified]".
- [15] ETS 300 356-16 (1995): "Integrated Services Digital Network (ISDN); Signalling System No.7; ISDN User Part (ISUP) version 2 for the international interface; Part 16: Call Hold (HOLD) supplementary service [ITU-T Recommendation Q.733, clause 2 (1993), modified]".
- [16] ETS 300 356-17 (1995): "Integrated Services Digital Network (ISDN); Signalling System No.7; ISDN User Part (ISUP) version 2 for the international interface; Part 17: Call Waiting (CW) supplementary service [CCITT Recommendation Q.733, section 1 (1992), modified]".
- [17] ETS 300 356-18 (1995): "Integrated Services Digital Network (ISDN); Signalling System No.7; ISDN User Part (ISUP) version 2 for the international interface; Part 18: Completion of Calls to Busy Subscriber (CCBS) supplementary service".
- [18] ETS 300 356-19 (1995): "Integrated Services Digital Network (ISDN); Signalling System No.7; ISDN User Part (ISUP) version 2 for the international interface; Part 19: Three party (3PTY) supplementary service [ITU-T Recommendation Q.734, clause 2 (1993), modified]".
- [19] ETS 300 121 (1992): "Integrated Services Digital Network (ISDN); Application of the ISDN User Part (ISUP) of CCITT Signalling System No.7 for international ISDN interconnections (ISUP version 1)".
- [20] ETS 300 008 (1991): "Integrated Services Digital Network (ISDN); CCITT Signalling System No.7; Message Transfer Part (MTP) to support international interconnection".
- [21] ETS 300 540 (GSM 03.50): "Digital cellular telecommunications system (Phase 2); Transmission planning aspects of the speech service in the GSM Public Land Mobile Network (PLMN) system".
- [22] ITU-T Recommendation Q.763 (1993): "Formats and codes of the ISDN User Part of Signalling System No. 7".
- [23] ETS 300 542 (GSM 03.81): "Digital cellular telecommunications system (Phase 2); Line identification supplementary services - Stage 2".
- [24] ETS 300 543 (GSM 03.82): "Digital cellular telecommunications system (Phase 2); Call Forwarding (CF) supplementary services - Stage 2".

- [25] ETS 300 544 (GSM 03.83): "Digital cellular telecommunications system (Phase 2); Call Waiting (CW) and Call Hold (HOLD) supplementary services - Stage 2".
- [26] ETS 300 545 (GSM 03.84): "Digital cellular telecommunications system (Phase 2); MultiParty (MPTY) supplementary services - Stage 2".
- [27] ETS 300 546 (GSM 03.85): "Digital cellular telecommunications system (Phase 2); Closed User Group (CUG) supplementary services - Stage 2".
- [28] ETS 300 547 (GSM 03.86): "Digital cellular telecommunications system (Phase 2); Advice of Charge (AoC) supplementary services - Stage 2".
- [29] ETS 300 548 (GSM 03.88): "Digital cellular telecommunications system (Phase 2); Call Barring (CB) supplementary services - Stage 2".
- [30] ETS 300 549 (GSM 03.90): "Digital cellular telecommunications system (Phase 2); Unstructured Supplementary Service Data (USSD) - Stage 2".
- [31] ETS 300 601 (GSM 09.04): "Digital cellular telecommunications system (Phase 2); Interworking between the Public Land Mobile Network (PLMN) and the Packet Switched Public Data Network (CSPDN)".
- [32] ETS 300 602 (GSM 09.05): "Digital cellular telecommunications system (Phase 2); Interworking between the Public Land Mobile Network (PLMN) and the Packet Switched Public Data Network (PSPDN) for Packet Assembly/Disassembly facility (PAD) access".
- [33] ETS 300 603 (GSM 09.06): "Digital cellular telecommunications system (Phase 2); Interworking between the Public Land Mobile Network (PLMN) and the Packet Switched Public Data Network/Integrated Services Digital Network (PSPDN/ISDN) for the support of packet switched data transmission services".
- [34] ETS 300 604 (GSM 09.07): "Digital cellular telecommunications system (Phase 2); Interworking between the Public Land Mobile Network (PLMN) and the Integrated Services Digital Network (ISDN) or Public Switched Telephone Network (PSTN)".
- [35] ETS 300 599 (GSM 09.02): "Digital cellular telecommunications system (Phase 2); Mobile Application Part (MAP) specification".

3 Definitions and abbreviations

3.1 Definitions

For the purposes of this ETS, the following definitions apply:

Gateway: The exchange which switches the call to or from another network.

Gateway Mobile-service Switching Centre (GMSC): GMSC is an exchange with the functional entity which performs interrogation to the Home Location Register (HLR).

International gateway: The exchange (at the end of an international circuit) which switches a call destined to or originating from another country.

Public Land Mobile Network (PLMN): PLMN is in this ETS referring to the GSM network.

3.2 Abbreviations

For the purposes of this ETS, the following abbreviations apply:

3PTY	Three-Party
ACM	Address Complete Message
AoC	Advice of Charge
CB	Call Barring
CCBS	Completion of Calls to Busy Subscriber
CD	Call Deflection
CFB	Call Forwarding Busy
CFNR	Call Forwarding No Reply
CFNRc	Call Forwarding on Mobile Subscriber Not Reachable
CFU	Call Forwarding Unconditional
CLIP	Calling Line Identification Presentation
CLIR	Calling Line Identification Restriction
COLP	Connected Line Identification Presentation
COLR	Connected Line Identification Restriction
CONF	Conference calling
CPG	Call Progress message
CUG	Closed User Group
CW	Call Waiting
DDI	Direct Dialling In
ECT	Explicit Call Transfer
GMSC	Gateway MSC
GSM	Global System for Mobile communications
HLC	High Layer Compatibility
HLR	Home Location Register
HOLD	Call Hold
HPLMN	Home Public Land Mobile Network
IAM	Initial Address Message
ISDN	Integrated Services Digital Network
ISUP	ISDN User Part
MAP	Mobile Application Part
MCID	Malicious Call Identification
MPTY	MultiParty
MS	Mobile Station
MSC	Mobile-service Switching Centre
MSISDN	Mobile Station ISDN number
MSN	Multiple Subscriber Number
MSRN	Mobile Station Roaming Number
MTP	Message Transfer Part
NI	Network Indicator
PLMN	Public Land Mobile Network
SUB	Subaddressing
TP	Terminal Portability
USSD	Unstructured Supplementary Service Data
UUS	User-to-User Signalling
UUS1	UUS service 1
UUS2	UUS service 2
UUS3	UUS service 3
VLR	Visitor Location Register
VMSC	Visited MSC

4 General principles

The gateway exchanges in both networks behave like international incoming or outgoing gateways in the relevant cases as described in ETS 300 356-1 to ETS 300 356-19 ([1] to [18]), with the exceptions indicated within this ETS.

5 Exceptions and clarifications for basic call

5.1 Formats and codes

The formats and codes specified in ETS 300 356-1 [1] with the exceptions and clarifications described in the tables in annex D shall be applicable.

5.2 Basic call signalling procedures

The basic call procedures of ETS 300 356-1 [1] apply with the following exceptions and clarifications.

5.2.1 Signalling procedures for connection type allowing fallback

The gateway in the preceding network (PLMN or ISDN) will always perform fallback according to the procedures defined in ETS 300 356-1 [1] when the succeeding network does not support fallback.

5.2.2 Echo control procedure

The dynamic echo control procedure according to ETS 300 356-1 [1] is not supported. Instead the echo control procedure described in ETS 300 121 [19] is applicable.

According to ETS 300 540 [21], for speech and 3,1 kHz audio connection types an acoustic echo control shall be provided in the MS. The PLMN may provide electric echo control.

Echo control procedures are not applicable to 64 kbit/s, 2 × 64 kbit/s, 384 kbit/s, 1 536 kbit/s or 1 920 kbit/s unrestricted connection types.

Examples of echo control procedures are shown in annex E.

5.2.3 Calls from the PLMN to the fixed network

5.2.3.1 Gateway in the PLMN

The Initial Address Message (IAM) sent by the gateway in the PLMN is coded taking into account the following exceptions and clarifications.

5.2.3.1.1 Initial address message

Called party number

The called party number parameter may contain a Mobile Station Roaming Number (MSRN).

- Internal network number indicator:
 - 0 if the MSRN is included;
 - 1 otherwise.

User service information

The IAM shall always include a user service information parameter for calls to the fixed network when the ISDN access indicator is set to ISDN.

5.2.4 Calls from the fixed network to the PLMN

5.2.4.1 Gateway in the fixed network

5.2.4.1.1 Initial address message

Called party number

The called party number parameter contains the MSISDN or MSRN.

- Internal network number indicator:

0	if MSRN is included;
1	if MSISDN is included.

NOTE: The value of the internal network number indicator is set in the exchange having the relevant knowledge, and is passed transparently through the fixed network. Due to interworking with old signalling systems, an MSRN may be received with the internal network number indicator set to "0" or "1".

5.2.4.2 Gateway in the PLMN

5.2.4.2.1 Address complete message

Significant delays may be incurred while interrogating location registers and while paging the terminating MS.

Due to the possible delays involved in setting up mobile calls, the PLMN needs to take special action to ensure that timer T7 (awaiting address complete timer) does not expire.

For this reason, whenever a call enters the PLMN, the PLMN should run a timer, the PLMN/ISDN early Address Complete Message (ACM) timer (value 5 to 20 seconds). The timer is started after receiving the complete number. If the timer expires, an address complete message is sent. The PLMN should stop the timer on sending a first backward message (address complete message or connect message).

The ACM shall contain the backward call indicators set to "0" except for:

Backward call indicators

- Charge indicator:

00	(no indication),
01	(no charge) or
10	(charge);

NOTE: The setting of the charge indicator is network specific.

- ISDN access indicator:

1	(ISDN) (preferred value, see table D.3);
---	--

- Echo control device indicator:

set according to echo control procedure described in annex E;

- ISDN user part indicator:

1	(ISDN user part used all the way).
---	------------------------------------

NOTE: Information in a subsequent ACM received in the PLMN gateway is mapped to a call progress message. The Event indicator in the CPG message is set according to the mapping rules defined in ETS 300 356-15 [14].

6 Exceptions and clarifications for supplementary services

Supplementary services are used according to ETS 300 356-1 to ETS 300 356-19 ([1] to [18]). When considering supplementary services, there exists a symmetry about this interface although the ISDN services may not be the same as the PLMN services. For each service supported by ETS 300 356-2 to ETS 300 356-19 ([1] to [18]) or ETS 300 542 to ETS 300 549 ([23] to [30]), the operation of the service in each direction needs to be considered. Supplementary services supported by the interface but not by one of the connected networks shall be handled according to ETS 300 356-1 to ETS 300 356-19 ([1] to [18]), i.e. the gateway concerned acts like an international gateway.

Exceptions and clarifications for the coding are described in table D.3, unless otherwise stated.

6.1 Considerations on ISDN supplementary services

6.1.1 Handling of number parameters related to supplementary services

The following text applies when referenced for the appropriate parameters:

Number parameters related to supplementary services sent across the ISDN-PLMN interface shall have the following coding of the nature of address indicator:

National significant number (000 0011) should be used in the following cases:

- for a number allocated to a fixed access when the fixed access, the sending gateway and the receiving gateway are in the same country;
- for a number allocated to an MS registered in its HPLMN when the MS, the sending gateway and the receiving gateway are in the same country.

International number (000 0100) should be used for all other cases.

If necessary, the gateway sending the number parameter shall modify the nature of address indicator. If this occur the number shall be modified in accordance to the nature of address indicator.

6.1.1.1 Calling Line Identification Presentation/Restriction (CLIP/CLIR) supplementary services

ETS 300 356-3 [3] and ETS 300 356-4 [4] apply with the exceptions below:

Calling Party Number and Generic Number:

Handling of calling party number and the appropriate generic number shall be made according to subclause 6.1.1.

NOTE: The generic number parameter may be discarded by the mobile access in the PLMN when received. For mobile originated calls the calling line identity is mapped into the calling party number parameter.

6.1.1.2 Connected Line Identification Presentation/Restriction (COLP/COLR) supplementary services

ETS 300 356-5 [5] and ETS 300 356-6 [6] apply with the exceptions below:

Connected Number and Generic Number:

Handling of connected number and the appropriate generic number shall be made according to subclause 6.1.1.

NOTE: The generic number parameter may be discarded by the mobile access in the PLMN when received in the answer message or connect message. For mobile terminated calls the connected line identity is mapped into the connected number parameter.

6.1.1.3 Terminal Portability (TP) supplementary service

ETS 300 356-7 [7] applies.

NOTE: Terminal Portability is supported by the protocol, however the service is not provided for the GSM access.

6.1.1.4 User-to-User Signalling (UUS) supplementary service

ETS 300 356-8 [8] applies.

NOTE: UUS1 explicit non-essential, UUS2 non-essential and UUS3 non-essential may be supported for calls that are forwarded back to the ISDN network.

6.1.1.5 Closed User Group (CUG) supplementary service

ETS 300 356-9 [9] applies.

6.1.1.6 Subaddressing (SUB) supplementary service

ETS 300 356-10 [10] applies.

6.1.1.7 Malicious Call Identification (MCID) supplementary service

ETS 300 356-11 [11] applies with the exceptions below:

Calling Party Number and Generic Number:

Handling of calling party number and the appropriate generic number shall be made according to subclause 6.1.1.

NOTE: Malicious Call Identification is supported by the protocol, however the service is not provided for the GSM access.

6.1.1.8 Conference call, add-on (CONF) supplementary service

ETS 300 356-12 [12] applies.

NOTE: Conference call is supported by the protocol, however the service is not provided for the GSM access. The corresponding service in GSM is the multiparty service defined by the GSM standards.

6.1.1.9 Explicit Call Transfer (ECT) supplementary service

ETS 300 356-14 [13] applies with the exceptions below:

Call Transfer Number:

Handling of call transfer number shall be made according to subclause 6.1.1.

NOTE: Explicit Call Transfer is supported by the protocol, however the service is not provided for the GSM access.

6.1.1.10 Diversion supplementary services (Call Forwarding Unconditional (CFU)/Call Forwarding on Busy (CFB)/Call Forwarding on No Reply (CFNR)/Call Deflection (CD))

ETS 300 356-15 [14] applies with the exceptions below:

Original Called Number, Redirecting Number and Redirection Number:

Handling of original called number, redirecting number and redirection number shall be made according to subclause 6.1.1.

NOTE: Call Deflection is supported by the protocol, however the service is not provided for the GSM access.

6.1.1.11 Call Hold (HOLD) supplementary service

ETS 300 356-16 [15] applies.

6.1.1.12 Call Waiting (CW) supplementary service

ETS 300 356-17 [16] applies.

6.1.1.13 Completion of Calls to Busy Subscriber (CCBS) supplementary service

ETS 300 356-18 [17] applies with the exception below:

If the GMSC has the knowledge that the CCBS service is not supported the diagnostics in the Release message will be set to indicate "CCBS not possible" (for cause values 17 or 34).

NOTE: Completion of Calls to Busy Subscriber is supported by the protocol, however the service is not provided for the GSM access.

6.1.1.14 Three party (3PTY) supplementary service

ETS 300 356-19 [18] applies.

NOTE: Three party is supported by the protocol, however the service is not provided for the GSM access. The 3PTY service can be a part of the multiparty service as defined by the GSM standards.

6.2 Considerations on GSM unique supplementary services

6.2.1 Call Forwarding on Mobile Subscriber Not Reachable (CFNRc) supplementary service

ETS 300 356-15 [14] applies with the exceptions below:

Original Called Number, Redirecting Number and Redirection Number:

Handling of original called number, redirecting number and redirection number shall be made according to subclause 6.1.1.

For calls that have been redirected (because of mobile subscriber not reachable) via the GSM-system, the Redirecting Reason shall be set to Mobile Subscriber Not Reachable.

6.2.2 Advice of Charge (AoC) supplementary service

No impact on the ISDN-PLMN- interface. The service is described in ETS 300 547 [28].

6.2.3 Call Barring (CB) supplementary service

No impact on the ISDN-PLMN interface. The service is described in ETS 300 548 [29].

6.2.4 Unstructured Supplementary Service Data (USSD)

No impact on the ISDN-PLMN interface. The service is described in ETS 300 549 [30].

7 Message Transfer Part (MTP) protocol requirements

The Message Transfer Part (MTP) protocol shall conform to the requirements in ETS 300 008 [20] with the appropriate value for the Network Indicator (NI).

It is preferred that NI value 10 (national network) is used within GSM networks as in the fixed national network. Based on national agreement, any NI value may be applied on the interface between GSM networks and the fixed networks.

Annex A (informative): Considerations on teleservices**A.1 Relation between ISDN teleservices and GSM teleservices**

Teleservices could be identified on the ISDN-PLMN interface in the User Teleservice Information parameter. High Layer Compatibility (HLC) information elements are passed transparently in the access transport parameter. Support of teleservices is an end-to-end aspect. However, the relationship between some ISDN teleservices and GSM teleservices are listed for information.

Table A.1: Relationship between ISDN teleservices and GSM teleservices

ISDN teleservices	GSM teleservices
Telephony	Telephony, Emergency call
Facsimile Group 2/3	Automatic facsimile group 3
Facsimile Group 4 Class 1	Not used
Teletex	Not used
Not used	Alternate speech and facsimile group 3
Not used	SMS, Point-To-Point, Mobile Originated
Not used	SMS, Point-To-Point, Mobile Terminated
Not used	SMS Cell Broadcast
Videotex	Not used
Telex	Not used
Message Handler System	Not used
Videotelephony	Not used
Videoconferencing	Not used

Annex B (informative): Considerations on bearer services

The mapping between parameters in the GSM call set up request message and the ISDN call set up request message is described in ETS 300 601 to ETS 300 604 ([31] to [34]).

Annex C (informative): Mapping of parameters between ISUP and MAP

Mapping of parameters between ISUP and MAP will take place for Mobile terminating calls where the MSC (acting as gateway MSC) has to interrogate the home location register in order to obtain routing information (the HLR needs to retrieve the routing information from the VLR).

C.1 Mapping of parameters from IAM to MAP_SEND_ROUTING_INFORMATION req.

Table C.1: Mapping of parameters from IAM to MAP_SEND_ROUTING_INFORMATION req.

IAM	MAP_SEND_ROUTING_INFORMATION req.
Called Party Number	MSISDN
Closed user group interlock code	CUG Interlock
Optional forward call indicators - Closed user group indicator	CUG Outgoing Access
Redirection information - Redirection counter	Number of Forwarding
Access Transport/User Service Information	Network signal information
NOTE: Mapping of Network signal information is described in ETS 300 599 [35].	

C.2 Mapping of parameters from MAP_SEND_ROUTING_INFORMATION rsp. to IAM

Table C.2: Mapping of parameters from MAP_SEND_ROUTING_INFORMATION rsp. to IAM

MAP_SEND_ROUTING_INFORMATION rsp.	IAM
CUG Interlock	Closed user group interlock code
CUG Outgoing Access	Optional forward call indicators - Closed user group indicator
MSRN (note 2)	Called Party Number (if no call forwarding is performed)
Forwarding Data (note 3) - ForwardedToNumber - ForwardedToSubaddress - ForwardingOptions notification to forwarding party forwarding reason	Called Party Number Access Transport - Called Party Subaddress Redirection information
NOTE 1: The interface between MSC and VLR is an internal interface, mapping of parameters on this interface will not be described in this specification.	
NOTE 2: This parameter will not be present if the parameter Forwarding Data is returned.	
NOTE 3: This parameter will not be present if the MSRN is returned.	

Annex D (normative): Formats and codes**D.1 Exceptions to table 4/Q.763 of ITU-T Recommendation Q.763 as modified by ETS 300 356-1****Table D.1: Exceptions to table 4/Q.763 of ITU-T Recommendation Q.763 [22] as modified by ETS 300 356-1 [1]**

Message type	Remarks
Forward transfer message	Not used
Network resource management message	Not used

D.2 Exceptions to table 5/Q.763 of ITU-T Recommendation Q.763 as modified by ETS 300 356-1**Table D.2: Exceptions to table 5/Q.763 of ITU-T Recommendation Q.763 [22] as modified by ETS 300 356-1 [1]**

Parameter name	Remarks
Echo control information parameter	Not used
Freephone indicators	Not used

D.3 Exceptions and clarifications to clause 3 of ITU-T Recommendation Q.763 as modified by ETS 300 356-1**Table D.3: Exceptions and clarifications to clause 3 of ITU-T Recommendation Q.763 [22] as modified by ETS 300 356-1 [1]**

Q.763 [22] clause	Title	Remarks
3.3	Access transport	The access transport parameter will be transported transparently. It is the responsibility of the end points to ensure compatibility.
3.5	Backward call indicators	Bit M: terminating PLMN subscribers should be considered as ISDN terminations (this is the preferred situation, but other coding may be agreed between the PLMN and ISDN operators).
3.8A	Call transfer number Nature of address indicator	Values used: 000 0011, 000 0100 (i.e. national and international numbers allowed).
3.10	Calling party number Nature of address indicator	Values used: 000 0011, 000 0100 (i.e. national and international numbers allowed).
3.12	Cause indicator	For the coding of the location field, the exchanges at the interface between the mobile and fixed ISDN networks need not to be considered as an international interface. The appropriate support of cause 20 within the originating network (e.g. provision of an announcement) is a matter of the network provider.
		(continued)

Table D.3 (concluded): Exceptions and clarifications to clause 3 of ITU-T Recommendation Q.763 [22] as modified by ETS 300 356-1 [1]

Q.763 [22] clause	Title	Remarks								
3.16	Connected number Nature of address indicator	Values used: 000 0011, 000 0100 (i.e. national and international numbers allowed).								
3.23	Forward call indicators	<p>Bit A: the ISDN-PLMN interface can be an interface within the national network, and then the national/international indicator should be passed on transparently on this interface. It is assumed that the national/international indicator has been set to: 1 = "call to be treated as an international call" for incoming international calls in an international gateway exchange in the fixed or mobile network, and that otherwise it is coded: 0 = "call to be treated as a national call".</p> <p>Bit I: originating PLMN subscribers should be considered as ISDN terminations (this is the preferred situation, but other codings may be agreed between the PLMN and ISDN operators).</p>								
3.26	Generic number Nature of address indicator	Values used: 000 0011, 000 0100 (i.e. national and international numbers allowed).								
3.39	Original called number Nature of address indicator	Values used: 000 0011, 000 0100 (i.e. national and international numbers allowed).								
3.44	Redirecting number Nature of address indicator	Values used: 000 0011, 000 0100 (i.e. national and international numbers allowed).								
3.45	Redirection information	The redirection counter is incremented when the call is forwarded, however the mechanism for the allocation of a Mobile Station Roaming Number (MSRN) shall not be considered as an instance of call forwarding.								
3.46	Redirection number Nature of address indicator	Values used: 000 0011, 000 0100 (i.e. national and international numbers allowed).								
3.54	Transmission medium requirement	<p>The following value of the Transmission medium requirement parameter can be used in case multi-rate access is available in the mobile network:</p> <table border="0" data-bbox="667 1570 1114 1682"> <tr> <td>0000 0111</td> <td>2 × 64 kbit/s unrestricted</td> </tr> <tr> <td>0000 1000</td> <td>384 kbit/s unrestricted</td> </tr> <tr> <td>0000 1001</td> <td>1 536 kbit/s unrestricted</td> </tr> <tr> <td>0000 1010</td> <td>1 920 kbit/s unrestricted</td> </tr> </table>	0000 0111	2 × 64 kbit/s unrestricted	0000 1000	384 kbit/s unrestricted	0000 1001	1 536 kbit/s unrestricted	0000 1010	1 920 kbit/s unrestricted
0000 0111	2 × 64 kbit/s unrestricted									
0000 1000	384 kbit/s unrestricted									
0000 1001	1 536 kbit/s unrestricted									
0000 1010	1 920 kbit/s unrestricted									

Annex E (informative): Examples of echo control procedures

E.1 Outgoing call in a Mobile-service Switching Centre (MSC)

If the requested bearer is "speech" or "3,1 kHz", the echo control device indicator is set to "1" (outgoing included) in the IAM sent by the MSC.

An incoming half echo control device is "reserved" on the outgoing circuit of the MSC.

If the backward call indicators parameter received in the ACM indicates that an incoming half echo control device is included, the "reserved" incoming half echo control device of the outgoing circuit of the MSC is disabled.

If the backward call indicators parameter received in the ACM indicates that an incoming half echo control device is not included, the "reserved" incoming half echo control device of the outgoing circuit of the MSC is enabled.

If the requested bearer is "64 kbit/s unrestricted", the echo control device indicator is set to "0" (outgoing not included). No echo devices are reserved.

E.2 Incoming call in the MSC

- 1) If the nature of the connection indicators parameter indicates that an outgoing half echo control device is included, any outgoing half echo control device on the incoming circuit of the MSC is disabled.

If the MSC is a Visited Mobile-service Switching Centre (VMSC), the backward call indicators parameter sent in the ACM indicates that an incoming half echo control device is enabled.

If the MSC is a Gateway Mobile-service Switching Centre (GMSC) or in case of call forwarding, the incoming half echo control device of the outgoing circuit is "reserved" and the echo control device indicator sent in the IAM is passed on:

- if the backward call indicators parameter received in the ACM indicates that an incoming half echo control device is included the incoming half echo control device of the outgoing circuit of the MSC is disabled;
- if the backward call indicators parameter received in the ACM indicates that an incoming half echo control device is not included the incoming half echo control device of the MSC is enabled. The backward call indicators in ACM are changed accordingly.

- 2) If the nature of the connection indicators parameter indicates that an outgoing half echo control device is not included, the outgoing half echo control device on the incoming circuit of the MSC is reserved.

If the MSC is a VMSC, the outgoing half echo control device is enabled and the backward call indicators parameter sent in the ACM indicates that an incoming half echo control device is included.

If the MSC is a GMSC or if the call is to be forwarded and the MSC knows that an outgoing half echo control device is necessary (e.g. called MS, forwarding to an international destination):

- the outgoing half echo control device on the incoming circuit is enabled and the echo control parameter sent in the IAM indicates "outgoing half echo control device included";
- the incoming half echo control device of the outgoing circuit is "reserved";
- if the backward call indicators parameter received in the ACM indicates that an incoming half echo control device is included the incoming half echo control device of the outgoing circuit of the MSC is disabled. The backward call indicators in ACM are passed on unchanged;

- if the backward call indicators parameter received in the ACM indicates that an incoming half echo control device is not included the incoming half echo control device of the MSC is enabled. The backward call indicators in ACM are changed accordingly.

If the MSC is a GMSC or if the call is to be forwarded and the MSC knows that an outgoing half echo control device is not necessary:

- the outgoing half echo control device on the incoming circuit is disabled and the echo control parameter in the IAM is passed on;
- the incoming half echo control device on the outgoing circuit is disabled.

E.3 Examples of echo control procedure

The following additional notations are used in figures E.1 to E.13:

G	Gateway in the fixed network
(o.i)	outgoing half echo control device included
(o.ni)	outgoing half echo control device not included
(i.i)	incoming half echo control device included
(i.ni)	incoming half echo control device not included
(*)	echo control device "reserved"
*	echo control device enabled
x	echo control device disabled
i	incoming half echo control device
o	outgoing half echo control device

E.3.1 Call from a mobile station to a mobile station via the fixed network

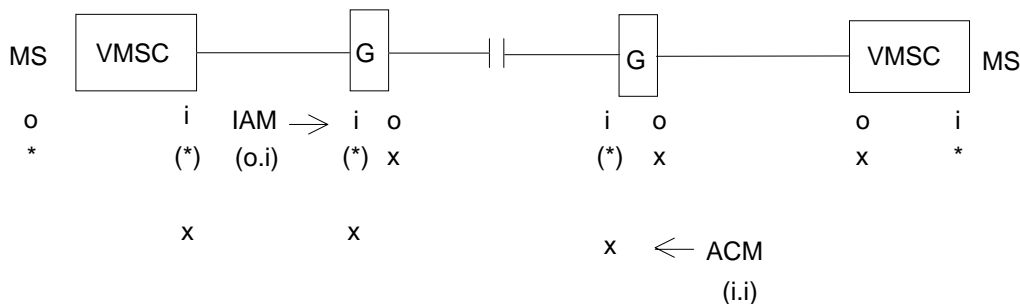

Figure E.1

E.3.2 Call from a mobile station to fixed network with no echo control device

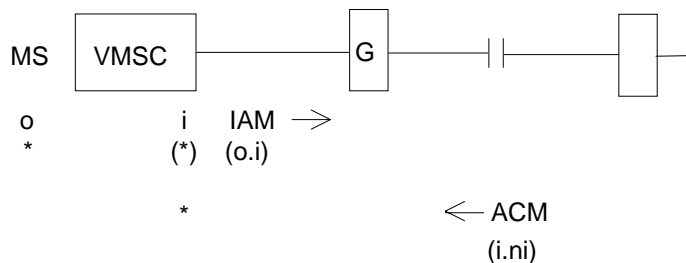

Figure E.2

E.3.3 Call from a mobile station to fixed network with echo control device

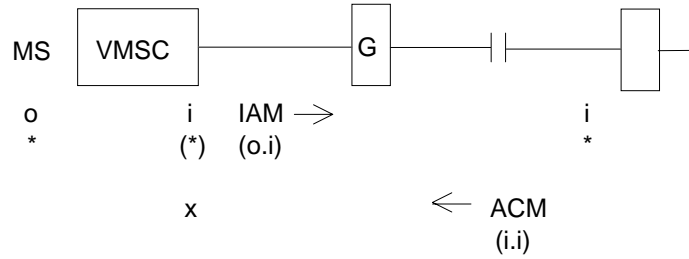

Figure E.3

E.3.4 Call from fixed network with no echo control device to a mobile station roaming in a PLMN of another country

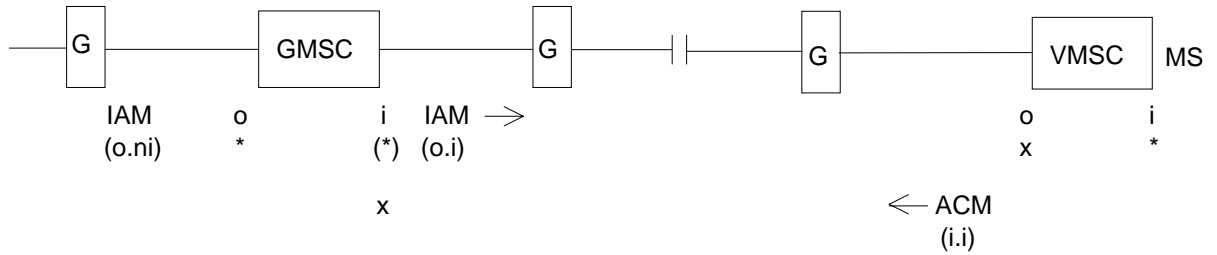

Figure E.4

E.3.5 Call from fixed network with echo control device to a mobile station roaming in a PLMN of another country

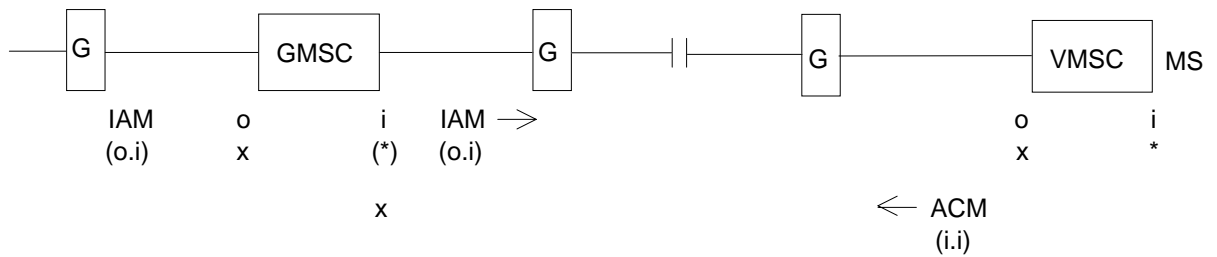

Figure E.5

E.3.6 Call from fixed network with no echo control device to a mobile station

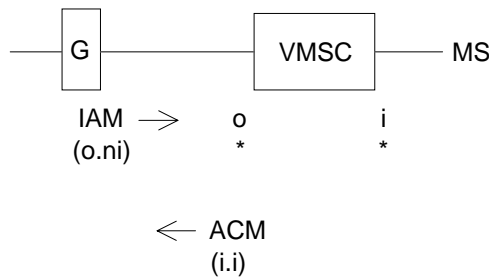

Figure E.6

E.3.7 Call from fixed network with echo control device to a mobile station

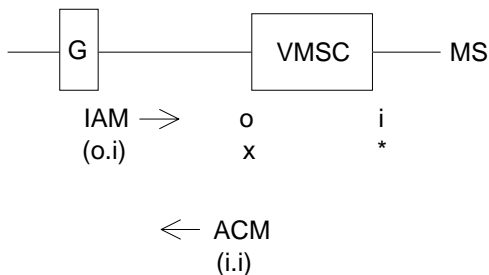

Figure E.7

E.3.8 Call forwarded by the VMSC

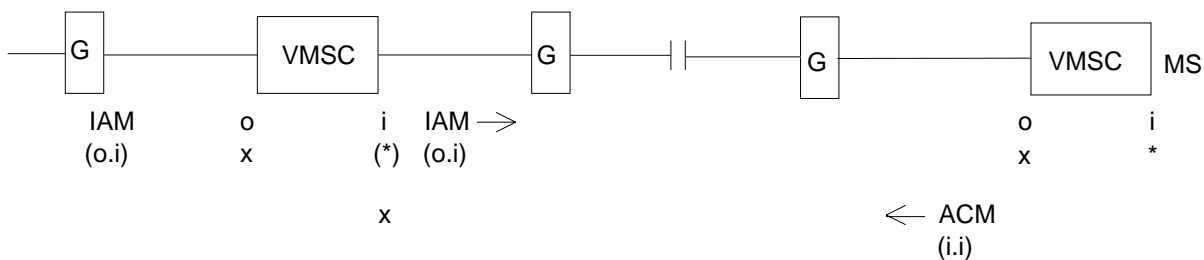

Figure E.8

E.3.9 Call forwarded by the VMSC to the fixed network with no echo control device

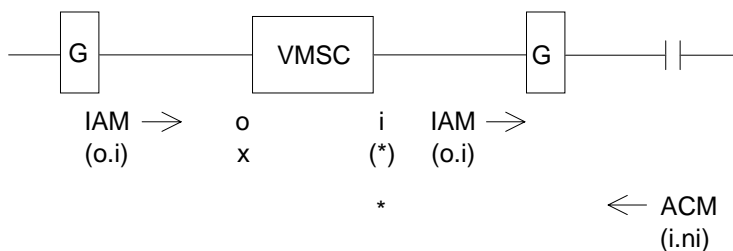

Figure E.9

E.3.10 Call with no outgoing echo control device included in a preceding exchange forwarded by the VMSC to the fixed network with no echo control device in the terminating network. The VMSC knows that an outgoing half echo control device is not necessary

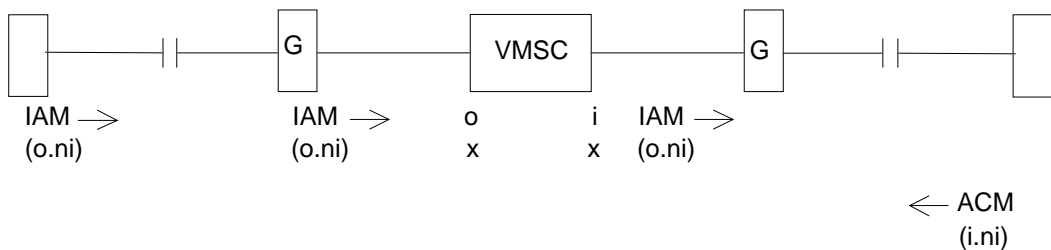

Figure E.10

E.3.11 Call with no outgoing echo control device included in a preceding exchange forwarded by the VMSC to the fixed network with echo control device in the terminating network. The VMSC knows that an outgoing half echo control device is not necessary

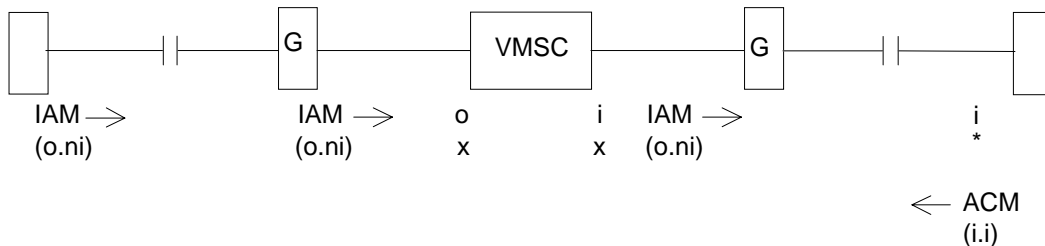

Figure E.11

E.3.12 Call with no outgoing echo control device included in a preceding exchange forwarded by the VMSC to the fixed network with no echo control device in the terminating network. The VMSC knows that an outgoing half echo control device is necessary

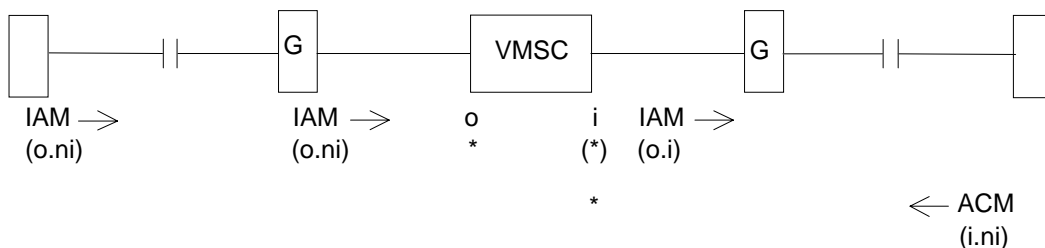

Figure E.12

E.3.13 Call with no outgoing echo control device included in a preceding exchange forwarded by the VMSC to the fixed network with echo control device in the terminating network. The VMSC knows that an outgoing half echo control device is necessary

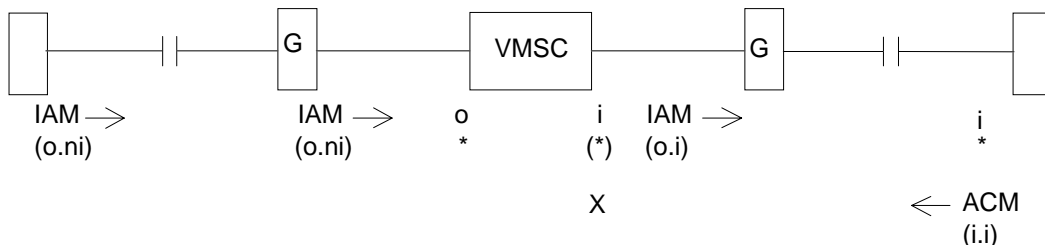

Figure E.13

History

Document history			
March 1996	Public Enquiry	PE 104:	1996-03-25 to 1996-08-16
February 1997	Vote	V 9717:	1997-02-25 to 1997-04-25
May 1997	First Edition		