



**I**NTERIM  
**E**UROPEAN  
**T**ELECOMMUNICATION  
**S**TANDARD

**I-ETS 300 609-1**

April 1997

Second Edition

Source: ETSI TC-SMG

Reference: RI/SMG-081121P

ICS: 33.020

**Key words:** Digital cellular telecommunications system, Global System for Mobile Communications (GSM)



**Digital cellular telecommunications system (Phase 2);  
Base Station System (BSS) equipment specification;  
Part 1: Radio aspects  
(GSM 11.21)**

**ETSI**

European Telecommunications Standards Institute

**ETSI Secretariat**

**Postal address:** F-06921 Sophia Antipolis CEDEX - FRANCE

**Office address:** 650 Route des Lucioles - Sophia Antipolis - Valbonne - FRANCE

**X.400:** c=fr, a=atlas, p=etsi, s=secretariat - **Internet:** secretariat@etsi.fr

Tel.: +33 4 92 94 42 00 - Fax: +33 4 93 65 47 16

**Copyright Notification:** No part may be reproduced except as authorized by written permission. The copyright and the foregoing restriction extend to reproduction in all media.

© European Telecommunications Standards Institute 1997. All rights reserved.



## Contents

Foreword .....	7
1 Scope .....	9
2 Normative references .....	10
3 Definitions, abbreviations, frequency bands and channels .....	11
3.1 Definitions .....	11
3.2 Abbreviations .....	11
3.3 Frequency bands and channels.....	11
3.3.1 Frequency bands.....	11
3.3.2 Channels and channel numbering.....	12
4 General test conditions and declarations .....	12
4.1 Output power and determination of power class .....	12
4.2 Specified frequency range .....	13
4.3 Frequency hopping .....	13
4.4 RF power control.....	13
4.5 Downlink discontinuous transmission (DTX) .....	13
4.6 Test environments .....	14
4.6.1 Normal test environment .....	14
4.6.2 Extreme test environment .....	14
4.6.2.1 Extreme temperature.....	14
4.6.3 Vibration .....	15
4.6.4 Power supply .....	15
4.7 Acceptable uncertainty of measurement equipment.....	15
4.8 Interpretation of measurement results .....	18
4.9 Selection of configurations for testing.....	19
4.10 BTS Configurations.....	19
4.10.1 Receiver diversity .....	19
4.10.2 Duplexers .....	19
4.10.3 Power supply options .....	20
5 Format and interpretation of tests .....	21
6 Transmitter .....	22
6.1 Static Layer 1 functions.....	22
6.1.1 Test purpose .....	22
6.1.2 Test case.....	22
6.1.3 Essential conformance.....	22
6.1.4 Complete conformance .....	22
6.1.5 Requirement reference .....	22
6.2 Phase error and mean frequency error.....	23
6.2.1 Test purpose .....	23
6.2.2 Test case.....	23
6.2.3 Essential conformance.....	23
6.2.4 Complete conformance .....	24
6.2.5 Requirement reference .....	24
6.3 Mean transmitted RF carrier power .....	24
6.3.1 Test purpose .....	24
6.3.2 Test case.....	24
6.3.3 Essential conformance.....	25
6.3.4 Complete conformance .....	26
6.3.5 Requirement reference .....	26
6.4 Transmitted RF carrier power versus time .....	26
6.4.1 Test purpose .....	26
6.4.2 Test case.....	26

6.4.3	Essential conformance .....	27
6.4.4	Complete conformance .....	27
6.4.5	Requirement reference .....	27
6.5	Adjacent channel power .....	27
6.5.1	Spectrum due to modulation and wideband noise .....	28
6.5.1.1	Test purpose .....	28
6.5.1.2	Test case .....	28
6.5.1.3	Essential Conformance .....	28
6.5.1.4	Complete conformance .....	30
6.5.1.5	Requirement reference .....	30
6.5.2	Switching transients spectrum .....	30
6.5.2.1	Test purpose .....	30
6.5.2.2	Test case .....	30
6.5.2.3	Essential conformance .....	32
6.5.2.4	Complete conformance .....	32
6.5.2.5	Requirement reference .....	32
6.6	Spurious emissions from the transmitter antenna connector .....	32
6.6.1	Conducted spurious emissions from the transmitter antenna connector, inside the BTS transmit band .....	33
6.6.1.1	Test Purpose .....	33
6.6.1.2	Test Case .....	33
6.6.1.3	Essential conformance .....	33
6.6.1.4	Complete conformance .....	33
6.6.1.5	Requirement Reference .....	33
6.6.2	Conducted spurious emissions from the transmitter antenna connector, outside the BTS transmit band .....	33
6.6.2.1	Test Purpose .....	33
6.6.2.2	Test Case .....	34
6.6.2.3	Essential conformance .....	34
6.6.2.4	Complete conformance .....	35
6.6.2.5	Requirement Reference .....	35
6.7	Intermodulation attenuation .....	35
6.7.1	Test purpose .....	35
6.7.2	Test case .....	35
6.7.3	Essential Conformance .....	36
6.7.4	Complete conformance .....	37
6.7.5	Requirement reference .....	38
6.8	Intra Base Station System intermodulation attenuation .....	38
6.8.1	Test purpose .....	38
6.8.2	Test case .....	38
6.8.3	Essential conformance .....	39
6.8.4	Complete conformance .....	39
6.8.5	Requirement reference .....	39
7	Receivers .....	40
7.1	Static Layer 1 receiver functions (nominal error ratios) .....	40
7.1.1	Test Purpose .....	40
7.1.2	Test Case .....	40
7.1.3	Essential conformance .....	41
7.1.4	Complete conformance .....	41
7.1.5	Requirement Reference .....	41
7.2	Erroneous Frame Indication Performance .....	41
7.2.1	Test Purpose .....	41
7.2.2	Test Case .....	41
7.2.3	Essential conformance .....	42
7.2.4	Complete conformance .....	42
7.2.5	Requirement reference .....	42
7.3	Static Reference Sensitivity Level .....	42
7.3.1	Test Purpose .....	42
7.3.2	Test Case .....	42
7.3.3	Essential conformance .....	43
7.3.4	Complete conformance .....	43
7.3.5	Requirements Reference .....	44

7.4	Multipath Reference Sensitivity Level .....	44
7.4.1	Test Purpose .....	44
7.4.2	Test Case .....	44
7.4.3	Essential conformance .....	45
7.4.4	Complete conformance .....	46
7.4.5	Requirement Reference .....	47
7.5	Reference interference level .....	47
7.5.1	Test Purpose .....	47
7.5.2	Test Case .....	47
7.5.3	Essential conformance .....	48
7.5.4	Complete conformance .....	49
7.5.5	Requirements Reference .....	51
7.6	Blocking Characteristics .....	52
7.6.1	Test Purpose .....	52
7.6.2	Test Case .....	52
7.6.3	Essential conformance .....	54
7.6.4	Complete conformance .....	54
7.6.5	Requirements reference .....	54
7.7	Intermodulation characteristics .....	54
7.7.1	Test Purpose .....	54
7.7.2	Test Case .....	54
7.7.3	Essential conformance .....	56
7.7.4	Complete conformance .....	56
7.7.5	Requirement Reference .....	56
7.8	AM suppression .....	57
7.8.1	Test Purpose .....	57
7.8.2	Test Case .....	57
7.8.3	Essential conformance .....	58
7.8.4	Complete conformance .....	58
7.8.5	Requirement Reference .....	58
7.9	Spurious emissions from the receiver antenna connector .....	58
7.9.1	Test Purpose .....	58
7.9.2	Test Case .....	58
7.9.3	Essential conformance .....	58
7.9.4	Complete conformance .....	59
7.9.5	Requirement Reference .....	59
8	Radiated spurious emissions .....	60
8.1	Test Purpose .....	60
8.2	Test Case .....	60
8.3	Essential conformance .....	61
8.4	Complete conformance .....	61
8.5	Requirement reference .....	61
9	Radio link management .....	62
	Annex A (informative): Testing of statistical parameters .....	63
A.1	General theoretical methodology .....	63
A.2	Detailed theoretical methodology .....	65
A.3	Limitations and corrections to the theoretical methodology .....	66
A.3.1	Independent errors .....	66
A.3.2	Gaussian distribution .....	66
A.3.3	Stationary random processes .....	66
A.3.4	Low error ratios .....	67
A.3.5	Total corrections .....	67
A.4	Alternative experimental methodology .....	68
A.5	Detailed definition of error events .....	69

Annex B (informative):	Description of special test equipment .....	70
B.1	Base Station System Test Equipment (BSSTE) .....	70
B.1.1	Fading and multipath propagation simulator .....	70
B.2	Measurement set ups for TX intermodulation .....	70
B.2.1	Test set-up for Intermodulation Attenuation (6.7) .....	70
B.2.1.1	RX-Band .....	71
B.2.1.2	Outside RX Band .....	71
B.2.2	Test set-up for Intra BSS Intermodulation Attenuation (6.8) .....	72
B.2.2.1	RX-Band .....	72
B.2.2.2	TX-Band .....	72
Annex C (informative):	Number of samples needed for statistical testing .....	73
C.1	GSM 900; Number of samples for testing .....	73
C.2	DCS 1 800; Number of Samples for Testing .....	77
History	.....	82

## Foreword

This Interim European Telecommunication Standard (I-ETS) has been produced by the Special Mobile Group (SMG) Technical Committee of the European Telecommunications Standards Institute (ETSI).

This I-ETS specifies the Radio Frequency (RF) test methods and conformance requirements for GSM 900 and DCS 1 800 Base Station Systems (BSS)s. within the Digital cellular telecommunications system (Phase 2). This ETS corresponds to GSM technical specification GSM 11.21 version 4.7.1.

NOTE 1: TC-SMG has produced documents which give the technical specifications for the implementation of the Digital cellular telecommunications system. Historically, these documents have been identified as GSM Technical Specifications (GSM-TSs). These TSs may have subsequently become I-ETs, or ETs (Phase 2), whilst others may become ETSI Technical Reports (ETRs). GSM-TSs are, for editorial reasons, still referred to in current GSM ETs.

An ETSI standard may be given I-ETS status either because it is regarded as a provisional solution ahead of a more advanced standard, or because it is immature and requires a "trial period". The life of an I-ETS is limited to three years after which it can be converted into an ETS, have its life extended for a further two years, be replaced by a new version, or be withdrawn.

NOTE 2: This I-ETS contains both essential conformance requirements and complete conformance requirements. Essential conformance requirements are those requirements which may be deemed sufficient for radio type approval purposes, complete conformance requirements cover all conformance aspects. This Interim standard has an I-ETS status at present as Radio link management has not been included at this stage. Radio link management tests will not need to be performed for essential conformance purposes.

<b>Proposed announcement date</b>	
Date of latest announcement of this I-ETS (doa):	31 July 1997

Blank page



## 1 Scope

This Interim European Telecommunication Standard (I-ETS) specifies the Radio Frequency (RF) test methods and conformance requirements for GSM 900 and DCS 1 800 Base Station Systems (BSS)s. These have been derived from, and are consistent with, the core GSM specifications specified in the requirements reference subclause of each test.

For each test, two conformance requirements are specified:

- essential conformance requirements;
- complete conformance requirements.

Essential conformance requirements are those which are required:

- a) to ensure compatibility between the radio channels in the same cell;
- b) to ensure compatibility between cells, both co-ordinated and uncoordinated;
- c) to ensure compatibility with existing systems in the same or adjacent frequency bands;
- d) to verify the important aspects of the transmission quality of the system.

Essential conformance requirements are sufficient to verify the performance of the equipment for radio type approval purposes, in countries where this is applicable.

Complete conformance requirements may be tested to verify all aspects of the performance of a BSS. These requirements are intended to be used by manufacturers and operators to allow conformance and acceptance testing to be performed in a consistent manner; the tests to be performed should be agreed between the parties.

In some tests there are separate requirements for micro-BTS and BTS. If there is no separate requirement for a micro-BTS, the requirements for the BTS apply to a micro-BTS.

In this I-ETS, the reference point for RF connections (except for the measurement of mean transmitted RF carrier power) is the antenna connector, as defined by the manufacturer. This I-ETS does not apply to repeaters or RF devices which may be connected to an antenna connector of a BSS.

## 2 Normative references

This I-ETS incorporates by dated and undated reference, provisions from other publications. These normative references are cited at the appropriate places in the text and the publications are listed hereafter. For dated references, subsequent amendments to or revisions of any of these publications apply to this I-ETS only when incorporated in it by amendment or revision. For undated references, the latest edition of the publication referred to applies.

- [1] GSM 01.04 (ETR 100): "Digital cellular telecommunications system (Phase 2); Abbreviations and acronyms".
- [2] GSM 04.22 (ETS 300 563): "Digital cellular telecommunications system (Phase 2); Radio Link Protocol (RLP) for data and telematic services on the Mobile Station - Base Station System (MS - BSS) interface and the Base Station System - Mobile-services Switching Centre (BSS - MSC) interface".
- [3] GSM 05.01 (ETS 300 573): "Digital cellular telecommunications system (Phase 2); Physical layer on the radio path General description".
- [4] GSM 05.02 (ETS 300 574): "Digital cellular telecommunications system (Phase 2); Multiplexing and multiple access on the radio path".
- [5] GSM 05.03 (ETS 300 575): "Digital cellular telecommunications system (Phase 2); Channel coding".
- [6] GSM 05.04 (ETS 300 576): "Digital cellular telecommunications system (Phase 2); Modulation".
- [7] GSM 05.05 (ETS 300 577): "Digital cellular telecommunications system (Phase 2); Radio transmission and reception".
- [8] GSM 05.08 (ETS 300 578): "Digital cellular telecommunications system (Phase 2); Radio subsystem link control".
- [9] GSM 05.10 (ETS 300 579): "Digital cellular telecommunications system (Phase 2); Radio subsystem synchronization".
- [10] GSM 08.20 (ETS 300 591): "Digital cellular telecommunications system (Phase 2); Rate adaption on the Base Station System - Mobile-services Switching Centre (BSS - MSC) interface".
- [11] ETS 300 019-1: "Equipment Engineering (EE); Environmental conditions and environmental tests for telecommunications equipment Part 1-0: Classification of environmental conditions Introduction".
- [12] IEC 68-2: "Basic environmental testing procedures; Part 2: Tests".
- [13] IEC 721: "Classification of environmental conditions".
- [14] ETR 027: "Radio and Equipment Systems; methods of measurement for mobile radio equipment".
- [15] ETR 028: "Radio and Equipment Systems; Uncertainties in the measurement of mobile radio equipment characteristics".
- [16] ETS 300 113: "Radio Equipment and Systems; Land mobile service; Technical characteristics and test conditions for radio equipment intended for transmission of data (and speech) and having an antenna connector".

### 3 Definitions, abbreviations, frequency bands and channels

#### 3.1 Definitions

For the purposes of this I-ETS, the following definitions apply:

**Carrier Frequency:** The centre of the ARFCN under test.

**GSM:** Unless otherwise specified, references to GSM include both GSM 900 and DCS 1 800.

**BSS:** In this I-ETS, the term BSS (or base station subsystem) applies to both a BTS and integrated BSS. If a separate BSC is required to perform tests on a BTS, the BSC may be regarded as test equipment and the environmental conditions of the BSC need not be controlled.

**micro-BTS:** As defined in GSM 05.05 (ETS 300 577) [7]. In this I-ETS, this also includes a BSS which incorporates a micro-BTS.

**normal BTS:** Any BTS or BSS as defined by GSM 05.05 (ETS 300 577) [7] which is not a micro-BTS.

**BSSTE:** Base Station System Test Equipment; see annex B.

**manufacturer:** In this I-ETS, a reference to a manufacturer shall also apply to an agent of the manufacturer.

**P-GSM:** The primary GSM 900 band.

**E-GSM:** The extended GSM 900 band (includes P-GSM band).

#### 3.2 Abbreviations

Unless otherwise stated, abbreviations used in this I-ETS shall have the meaning given in GSM 01.04 (ETR 100) [1].

B "Bottom"; the lowest frequency on which a test is performed.

M "Middle"; a frequency in the middle portion of the operating band of the BSS on which a test is performed.

T "Top"; the highest frequency on which a test is performed.

#### 3.3 Frequency bands and channels

##### 3.3.1 Frequency bands

The frequency band for the Base Station System is given in table 1.

**Table 1: Frequency bands for GSM 900 and DCS 1 800 Base Station Systems**

	<b>TX:</b>	<b>RX:</b>
<b>P-GSM 900</b>	935-960 MHz	890-915 MHz
<b>DCS 1 800</b>	1 805-1 880 MHz	1 710-1 785 MHz
<b>E-GSM 900</b>	925-960 MHz	880-915 MHz

NOTE: It is up to the operator to choose any subset of these bands (or the complete band) on a location basis within a frequency band assigned to the operator by the authority responsible for frequency management issues.

### 3.3.2 Channels and channel numbering

The channel numbers (ARFCN) for the carrier frequencies (RF channels) within the frequency bands defined above (as defined in GSM 05.05 (ETS 300 577) [7]), are given in table 2.  $F_l(n)$  is the frequency of the centre of the RF channel  $n$  in the lower band (=RX) and  $F_u(n)$  the corresponding frequency in the upper band (=TX).

**Table 2: Channel Numbering: Frequencies are in MHz**

<b>P-GSM 900</b>	$F_l(n)=890+0.2*n$	$1 \leq n \leq 124$	$F_u(n)=F_l(n)+45$
<b>E-GSM 900</b>	$F_l(n)=890+0.2*n$ $F_l(n)=890+0.2*(n-1024)$	$0 \leq n \leq 124$ $975 \leq n \leq 1023$	$F_u(n)=F_l(n)+45$
<b>DCS 1 800</b>	$F_l(n)=1710.2+0.2*(n-512)$	$512 \leq n \leq 885$	$F_u(n)=F_l(n)+95$

## 4 General test conditions and declarations

The requirements of this clause apply to all tests in this I-ETS, when applicable.

The general conditions during the tests should be according to the relevant parts of ETR 027 [14] (methods of measurement for mobile radio equipment) with the exceptions and additions defined in the individual tests.

Many of the tests in this I-ETS measure a parameter relative to a value which is not fully specified in the GSM specifications. For these tests, the conformance requirement is determined relative to a nominal value specified by the manufacturer.

Certain functions of a BTS are optional in the GSM specifications.

When specified in a test, the manufacturer shall declare the nominal value of a parameter, or whether an option is supported.

### 4.1 Output power and determination of power class

The manufacturer shall declare the rated maximum power per TRX. For a micro-BTS, this shall be specified at the antenna connector. For a normal BTS, it shall be stated whether this is specified at the input to the combiner or at the antenna connector of the BSS.

For a micro-BTS, the class of the micro-BTS shall be determined from the declared maximum power, according to table 3.

**Table 3: Definition of micro-BTS Power Classes**

<b>TRX power class</b>	<b>GSM 900 micro-BTS Maximum output power</b>	<b>DCS 1 800 micro-BTS Maximum output power</b>
M1	(> 19)-24 dBm ((> 0.08)-0.25W)	(> 27)-32 dBm ((> 0.5)-1.6W)
M2	(> 14)-19 dBm ((> 0.03)-0.08W)	(> 22)-27 dBm ((> 0.16)-0.5W)
M3	(> 9)-14 dBm ((> 0.01)-0.03W)	(> 17)-22 dBm ((> 0.05)-0.16W)

**NOTE:** For a normal BTS, the TRX power class can be determined from the manufacturers declared output power per TRX measured at the input to the combiner, according to the tables of TRX power classes in ETS 300 577 [7]. The test requirements for a normal BTS do not vary in this [ETS] with TRX power classes. The definition of TRX power class only relates to the declared power per TRX and does not impose any requirement on the measured output power of the BTS.

#### 4.2 Specified frequency range

The manufacturer shall declare the frequency range supported by the BSS.

Many tests in this I-ETS are performed with appropriate frequencies in the bottom, middle and top of the operating frequency band of the BTS. These are denoted as RF channels B (bottom), M (middle) and T (top).

When a test is performed by a test laboratory, the ARFCNs to be used for RF channels B, M and T shall be specified by the laboratory. The laboratory may consult with operators, the manufacturer or other bodies.

When a test is performed by a manufacturer, the ARFCNs to be used for RF channels B, M and T may be specified by an operator.

#### 4.3 Frequency hopping

The Manufacturer shall declare whether the BSS supports Slow Frequency Hopping (SFH) and if yes, which basic implementation or implementations is supported. If SFH is supported the BSS shall be able to switch to any frequency in the GSM band allocated to this BSS on a time slot per time slot basis.

Two basic implementations of SFH are possible:

- a) Baseband frequency hopping: frequency hopping is done by multiplexing the data of the logical channels to different TRXs according to the hopping scheme. The TRXs are fixed tuned to a dedicated ARFCN.
- b) Synthesizer frequency hopping: frequency hopping is done by tuning the TRX on a timeslot per timeslot basis. The logical channels are dedicated to a hopping TRX.

The detailed description of the frequency hopping scheme is described in GSM 05.02 (ETS 300 574) [4].

#### 4.4 RF power control

RF power control functions ("dynamic power control") may optionally be implemented in GSM Base Station Systems according to GSM 05.08 (ETS 300 578) [8] as an operator choice. If implemented, the BSS shall be able to hop between any defined power level on a time slot per time slot basis.

#### 4.5 Downlink discontinuous transmission (DTX)

Downlink discontinuous transmission (DTX), as defined in the GSM 06-series of specifications for full-rate speech channels and in GSM 04.22 (ETS 300 563) [2] and GSM 08.20 (ETS 300 591) [10] for non-transparent data, may optionally be implemented in the downlink BSS (transmitter) as an operator choice. All requirements in this I-ETS, unless otherwise stated, apply whether downlink DTX is used or not.

## 4.6 Test environments

For each test in this I-ETS, the environmental conditions under which the BSS is to be tested are defined:

### 4.6.1 Normal test environment

When a normal test environment is specified for a test, the test should be performed under any combination of conditions between the minimum and maximum limits stated in table 4.

**Table 4: Limits of conditions for Normal Test Environment**

Condition	Minimum	Maximum
Barometric pressure	86 kPa	106 kPa
Temperature	15°C	30°C
Relative Humidity	20 %	85 %
Power supply	Nominal, as declared by the manufacturer	
Vibration	Negligible	

The ranges of barometric pressure, temperature and humidity represent the maximum variation expected in the uncontrolled environment of a test laboratory. If it is not possible to maintain these parameters within the specified limits, the actual values shall be recorded in the test report.

NOTE: This may, for instance, be the case for measurements of radiated emissions performed on an open field test site.

### 4.6.2 Extreme test environment

The manufacturer shall declare one of the following:

- a) The equipment class for the equipment under test, as defined in ETS 300 019-1-3, (Equipment Engineering (EE); Environmental conditions and environmental test for telecommunications equipment, Part 1-3: Classification of environmental conditions, Stationary use at weather protected locations).
- b) The equipment class for the equipment under test, as defined in ETS 300 019-1-4, (Equipment Engineering (EE); Environmental conditions and environmental test for telecommunications equipment, Part 1-4: Classification of environmental conditions, Stationary use at non-weather protected locations).
- c) For equipment that does not comply to an ETS 300 019-1 [11] class, the relevant classes from IEC 721 [13] documentation for Temperature, Humidity and Vibration shall be declared.

NOTE: Reduced functionality for conditions that fall out side of the standard operational conditions are not tested in this I-ETS. These may be stated and tested separately.

#### 4.6.2.1 Extreme temperature

When an extreme temperature test environment is specified for a test, the test shall be performed at the standard minimum and maximum operating temperatures defined by the manufacturer's declaration for the equipment under test.

Minimum temperature:

The test shall be performed with the environmental test equipment and methods of inducing the required environmental phenomena into the equipment, conforming to the test procedure of IEC 68-2-1 [12], Environmental Testing, Part 2: Tests - Tests A: Cold. The equipment shall be maintained at the stabilized condition for the duration of the test sequence.

Maximum temperature:

The test shall be performed with the environmental test equipment and methods of inducing the required environmental phenomena in to the equipment, conforming to the test procedure of IEC 68-2-2 [12] (Environmental Testing, Part 2: Tests - Tests Bd Dry heat). The equipment shall be maintained at the stabilized condition for the duration of the test sequence.

NOTE: It is recommended that the equipment is made fully operational prior to the equipment being taken to its lower operating temperature.

#### 4.6.3 Vibration

When vibration conditions are specified for a test, the test shall be performed while the equipment is subjected to a vibration sequence as defined by the manufacturers declaration for the equipment under test. This shall use the environmental test equipment and methods of inducing the required environmental phenomena in to the equipment, conforming to the test procedure of IEC 68-2-6 [12], Environmental Testing, Part 2: Tests - Test Fc and guidance: Vibration (Sinusoidal). Other environmental conditions shall be within the ranges specified in subclause 4.6.1, Normal test environment.

NOTE: The higher levels of vibration may induce undue physical stress in to equipment after a prolonged series of tests. The testing body should only vibrate the equipment during the RF measurement process.

#### 4.6.4 Power supply

When extreme power supply conditions are specified for a test, the test shall be performed at the standard upper and lower limits of operating voltage defined by the manufacturer's declaration for the equipment under test.

##### Upper voltage limit

The equipment shall be supplied with a voltage equal to the upper limit declared by the manufacturer (as measured at the input terminals to the equipment). The tests shall be carried out at a steady state minimum and maximum limit declared by the manufacturer for the equipment, to the methods described in IEC 68-2-1 [12] Test Ab/Ad: Cold and IEC 68-2-2 Test Bb/Bd: Dry Heat.

##### Lower voltage limit

The equipment shall be supplied with a voltage equal to the lower limit declared by the manufacturer (as measured at the input terminals to the equipment). The tests shall be carried out at a steady state minimum and maximum limit declared by the manufacturer for the equipment, to the methods described in IEC 68-2-1 [12] Test Ab/Ad: Cold and IEC 68-2-2 [12] Test Bb/Bd: Dry Heat.

#### 4.7 Acceptable uncertainty of measurement equipment

The maximum acceptable uncertainty of measurement equipment is specified separately for each test, where appropriate. The measurement equipment shall enable the stimulus signals in the test case to be adjusted to within the specified tolerance, and the conformance requirement to be measured with an uncertainty not exceeding the specified values. All tolerances and uncertainties are absolute values, unless otherwise stated.

Subclause 4.6, Test environments:

Pressure	± 5 kPa
Temperature	± 2 degrees
Relative Humidity	± 5 %
DC Voltage	± 1.0 %
AC Voltage	± 1.5 %
Vibration	10 %
Vibration frequency	0.1 Hz

The above values shall apply unless the test environment is controlled and the specification for the control of the test environment specifies the uncertainty for the parameter.

**Transmitter**

Subclause 6.2, Phase error and mean frequency error:

Conformance requirement:	
Frequency	± 10 Hz
Phase	1.5 degree rms 5 degrees peak

Subclause 6.3, Mean transmitted RF carrier power:

Conformance requirement:	
RF power, for static power step 0	± 1.0 dB
Relative RF Power, for other power steps	± 0.7 dB

Subclause 6.4, Transmitted RF carrier power versus time:

Conformance requirement	
RF power (0 dB reference)	± 1.0 dB
RF power relative to 0 dB reference	± 1.0 dB

Subclause 6.5.1, Spectrum due to modulation and wideband noise:

Conformance requirement	
RF power (absolute limit values)	± 1.0 dB

NOTE 1: This may require calibration of the power levels corresponding to the limit values.

Relative RF power:

Offset from carrier, MHz	Power difference, dB	Uncertainty of relative power, dB
$\delta f \leq 0.1$ MHz	All	± 0.5 dB
$0.1$ MHz < $\delta f \leq 1.8$ MHz	< 50 dB	± 0.7 dB
$0.1$ MHz < $\delta f \leq 1.8$ MHz	≥ 50 dB	± 1.5 dB
> 1.8 MHz	All	± 2.0 dB

Subclause 6.5.2, Switching transients spectrum:

Conformance requirement:	
RF power:	± 1.5 dB
Relative RF power:	
Power difference < 50 dB	± 0.7 dB
Power difference ≥ 50 dB	± 1.5 dB

Subclause 6.6.1, Conducted spurious emissions from the transmitter antenna connector, inside the BTS transmit band:

Conformance requirement:	
RF power:	± 1.5 dB

Subclause 6.6.2, Conducted spurious emissions from the transmitter antenna connector, outside the BTS transmit band:

Conformance requirement:	
Conformance requirement i) (in the receive band of the BSS):	
RF power	± 3 dB



Conformance requirements ii), iii) and iv) (elsewhere):

RF power:	
$f \leq 2$ GHz	$\pm 1.5$ dB
$2$ GHz $< f \leq 4$ GHz	$\pm 2.0$ dB
$f > 4$ GHz	$\pm 4.0$ dB

Subclause 6.7, Intermodulation attenuation and  
Subclause 6.8, Intra base station system intermodulation attenuation:

Test case:

Relative RF power (of injected signal);	$\pm 1.5$ dB
---	--------------

Conformance requirement (outside RX band):

RF power; absolute limit values	$\pm 1.5$ dB
RF power, relative measurements	$\pm 2.0$ dB

Conformance requirement (inside RX band):

RF power; absolute limit values	+4 dB -3 dB
---------------------------------	-------------

NOTE 2: The positive limit for uncertainty is greater than the negative limit because the measurement result can be increased (but not decreased) due to intermodulation products within the measurement apparatus.

## Receiver

Where a measurement uncertainty of +5 dB -0 dB is specified for an input signal, the measured value of the input signal should be increased by an amount equal to the uncertainty with which it can be measured. This will ensure that the true value of the input signal is not below the specified nominal.

Subclause 7.1, Static layer 1 receiver functions:

Test case

RF power, lower limit	+5 - 0 dB
RF power, -40 dBm nominal	$\pm 2.5$ dB
RF power, -23 and -15 dBm nominal	$\pm 1.5$ dB

Subclause 7.2, Erroneous frame indication performance:

Test case:

RF Power	+5 -0 dB
----------	----------

Subclause 7.3, Static reference sensitivity level:

Test case:

RF power	$\pm 1.0$ dB
Relative RF power ( adjacent timeslots)	$\pm 3.0$ dB

Subclause 7.4, Multipath reference sensitivity level:

Test case:

RF power	$\pm 1.5$ dB
Relative RF power	$\pm 3.0$ dB

Subclause 7.5, Reference interference level:

Test case:

RF power	+5 - 0 dB
Relative RF power	$\pm 1.0$ dB

NOTE 3: The measurement uncertainty for a faded (multipath) input signal may depend on the time taken to average the power of the b signal from the fader. It may be possible to reduce the measurement time by measuring the power with the fader set to the same class of fade profile, but with an increased fade rate.

Subclause 7.6, Blocking characteristics:

Test case:

RF power, wanted signal	$\pm 1.0$ dB
RF power, interfering signal;	
$f \leq 2$ GHz	$\pm 0.7$ dB
$2$ GHz $< f \leq 4$ GHz	$\pm 1.5$ dB
$f > 4$ GHz	$\pm 3.0$ dB

Subclause 7.7, Intermodulation characteristics and subclause 7.8 AM suppression:

Test case:

RF power, wanted signal	$\pm 1.0$ dB
RF power, interfering signals	$\pm 0.7$ dB

Subclause 7.9, Spurious emissions from the receiver antenna connector:

Conformance requirement:

RF power;	
$f \leq 2$ GHz	$\pm 1.5$ dB
$2$ GHz $< f \leq 4$ GHz	$\pm 2.0$ dB
$f > 4$ GHz	$\pm 4.0$ dB

Clause 8, Radiated spurious emissions:

Conformance requirement:

RF power;	$\pm 6.0$ dB
-----------	--------------

Clause 9, Radio link management:

[To be defined]

#### 4.8 Interpretation of measurement results

The measurement value related to the corresponding limit shall be used to decide whether an equipment meets a requirement in this I-ETS.

The measurement uncertainty for the measurement of each parameter shall be included in the test report.

The recorded value for the measurement uncertainty shall be, for each measurement, equal to or lower than the appropriate figure in subclause 4.7 of this I-ETS.

NOTE: This procedure is recommended in ETR 028 [15].

If the measurement apparatus for a test is known to have a measurement uncertainty greater than that specified in subclause 4.7, it is still permitted to use this apparatus provided that an adjustment is made to the measured value as follows:

The adjustment is made by subtracting the modulus of the specified measurement uncertainty in subclause 4.7 from the measurement uncertainty of the apparatus. The measured value is then increased or decreased by the result of the subtraction, whichever is most unfavourable in relation to the limit.

#### 4.9 Selection of configurations for testing

Most tests in this I-ETS are only performed for a subset of the possible combinations of test conditions. For instance:

- Not all TRXs in the configuration may be specified to be tested.
- Only one RF channel may be specified to be tested.
- Only one timeslot may be specified to be tested.

When a test is performed by a test laboratory, the choice of which combinations are to be tested shall be specified by the laboratory. The laboratory may consult with operators, the manufacturer or other bodies.

When a test is performed by a manufacturer, the choice of which combinations are to be tested may be specified by an operator.

#### 4.10 BTS Configurations

This I-ETS has been written to specify tests for the standard configurations of BTS which have been assumed in GSM requirements specifications, In particular GSM 05.01, 05.02 and 05.05. However, there are other configurations of BTS which comply with these specifications, but for which the application of these specifications is not fully defined. For some such configurations there may be alternate ways to apply the requirements of this specification to testing of the configuration, or some variation in the test method may be necessary. It may therefore be necessary for the parties to the testing to reach agreement over the method of testing in advance.

Where alternative interpretations of this specification are possible for a BSS configuration under test, the interpretation which has been adopted in performing the test shall be recorded with the test results.

Where variation in the test method within this I-ETS has been necessary to enable a BSS configuration to be tested, the variation in the test method which has been made in performing the test shall be recorded with the test results. Where possible, agreement should be reached in advance about the nature of such a variation with any party who will later receive the test results.

Possible interpretations of this I-ETS for some common configurations are given in the following subclauses.

##### 4.10.1 Receiver diversity

- I) For the tests in clause 7 of this I-ETS, the specified test signals may be applied to one receiver antenna connector, with the remaining receiver antenna connectors being terminated with 50 ohms.  
or
- ii) For the tests in clause 7 of this I-ETS, the specified test signals may be simultaneously applied to each of the receiver antenna connectors.

##### 4.10.2 Duplexers

The requirements of this I-ETS shall be met with a duplexer fitted, if a duplexer is supplied as part of the BSS. If the duplexer is supplied as an option by the manufacturer, sufficient tests should be repeated with and without the duplexer fitted to verify that the BSS meets the requirements of this I-ETS in both cases.

The following tests should be performed with the duplexer fitted, and without it fitted if this is an option:

- 1) Subclause 6.3, Mean transmitted RF power, for the highest static power step only, if this is measured at the antenna connector.
- 2) Subclause 6.6.2, Conducted spurious emissions from the transmitter antenna connector; outside the BTS transmit band.
- 3) Subclause 6.8, Intra base station system intermodulation attenuation.

- 4) Subclause 7.4, Multipath reference sensitivity; for the testing of essential conformance, the ARFCNs should be selected to minimize intermodulation products from the transmitters falling in receive channels.

The remaining tests may be performed with or without the duplexer fitted.

NOTE 1: When performing receiver tests with a duplexer fitted, it is important to ensure that the output from the transmitters does not affect the test apparatus. This can be achieved using a combination of attenuators, isolators and filters.

NOTE 2: When duplexers are used, intermodulation products will be generated, not only in the duplexer but also in the antenna system. The intermodulation products generated in the antenna system are not controlled by ETSI specifications, and may degrade during operation (e.g. due to moisture ingress). Therefore, to ensure continued satisfactory operation of a BSS, an operator will normally select ARFCNs to minimize intermodulation products falling on receive channels. For testing of complete conformance, an operator may specify the ARFCNs to be used.

#### **4.10.3 Power supply options**

If the BSS is supplied with a number of different power supply configurations, it may not be necessary to test RF parameters for each of the power supply options, provided that it can be demonstrated that the range of conditions over which the equipment is tested is at least as great as the range of conditions due to any of the power supply configurations.

This applies particularly if a BSS contains a DC rail which can be supplied either externally or from an internal mains power supply. In this case, the conditions of extreme power supply for the mains power supply options can be tested by testing only the external DC supply option. The range of DC input voltages for the test should be sufficient to verify the performance with any of the power supplies, over its range of operating conditions within the BTS, including variation of mains input voltage, temperature and output current.

## 5 Format and interpretation of tests

Each test in the following clauses has a standard format:

### **X Title**

#### **X.1 Test purpose**

This subclause defines the purpose of the test.

#### **X.2 Test case**

This subclause describes the steps necessary to perform the test. The general test conditions described in clause 4 also apply.

#### **X.3 Essential conformance**

The essential conformance describes the conformance requirements necessary to ensure compatibility and to verify the important aspects of the transmission quality of the system. This subclause is divided into two parts:

##### **Test environment**

This subclause describes the test environment or environments under which the test shall be performed. Where more than one test environment is specified, the extent of testing is specified for each environment.

##### **Conformance requirement**

This subclause describes the requirement which shall be met for the specified tests.

The test case describes the testing for full conformance; for most tests a subset of these tests is specified for essential conformance. Therefore, any definition of testing in the essential conformance shall take precedence over the test case.

#### **X.4 Complete conformance**

The complete conformance describes the complete set of tests which may be performed to fully characterize all aspects of one performance parameter of the BSS.

##### **Test environment**

This subclause describes the test environment or environments under which the test shall be performed. Where more than one test environment is specified, the extent of testing is specified for each environment.

##### **Conformance requirement**

This subclause describes the requirement which shall be met for the specified tests.

#### **X.5 Requirement reference**

This subclause gives the reference to the subclauses in the GSM specifications from which the test requirements have been derived.

## 6 Transmitter

All tests in this clause shall be conducted on Base Station Systems fitted with a full complement of Transceivers for the configuration unless otherwise stated. Measurements shall be made at the BTS Tx antenna connector, unless otherwise stated.

Power levels are expressed in dBm.

### 6.1 Static Layer 1 functions

#### 6.1.1 Test purpose

To verify the following static Layer 1 transmitter functions:

- 1) The RF equipment.
- 2) The multiplexing and multiple access functions.
- 3) The interleaving and the channel encoding on the transmit side.

#### 6.1.2 Test case

The BSS shall be configured with the maximum number of TRXs, with ARFCNs which shall be distributed over the entire declared bandwidth of operation for the BSS under test. One TRX shall be configured to support the BCCH. If the manufacturer declares that slow frequency hopping is supported, this shall be enabled.

Each TRX shall transmit a normal GSM modulated signal and the BSSTE shall be connected to the transmitter antenna connector. A known bit sequence exceeding a length of a superframe (1 326 TDMA-frames) shall be input before channel encoding in the BSS and a bit sequence shall be output after channel decoding in the BSSTE.

All logical channel types supported by the BSS shall be tested. The test shall be repeated for each TRX in the BSS configuration, for each logical channel supported by it.

NOTE: Some logical channels are only supported by the TRX configured to support the BCCH.

#### 6.1.3 Essential conformance

This test need not be performed.

#### 6.1.4 Complete conformance

Test Environment:

Normal.

#### Conformance requirement

The output bit sequence shall be bit exact for all logical channel types.

#### 6.1.5 Requirement reference

GSM 05.01 (ETS 300 573) [3], GSM 05.02 (ETS 300 574) [4], GSM 05.03 (ETS 300 575) [5] and GSM 05.05 (ETS 300 577) [7].

## 6.2 Phase error and mean frequency error

### 6.2.1 Test purpose

- 1) To verify the correct implementation of the GMSK pulse shaping filtering.
- 2) To verify that the phase error during the active part of the time slot does not exceed the specified limits under normal and extreme test conditions and when subjected to vibration.
- 3) To verify that the frequency error during the active part of the time slot does not exceed the specified limits under normal and extreme test conditions and when subjected to vibration.

### 6.2.2 Test case

All TRXs in the configuration shall be switched on transmitting full power in all time slots for at least 1 hour before starting the test.

If the Manufacturer declares that Synthesizer Slow Frequency Hopping is supported by the BSS, the BSS shall be configured with the maximum number of TRXs with ARFCNs which shall be distributed over the entire declared bandwidth of operation for the BSS under test, and including B, M and T, and three tests shall be performed. These tests may either use a test apparatus which employs the same hopping sequence as the BSS, or a fixed frequency apparatus on the radio frequency channels B, M and T. If only Baseband SFH is supported or SFH is not supported, one test shall be performed for each of the radio frequency channels B, M and T, using different TRXs to the extent possible for the configuration. As a minimum, one time slot shall be tested on each TRX specified to be tested.

The transmitted signal from the TRX under test shall be extracted in the BSSTE for a pseudo-random known bit stream of encrypted bits into the TRX modulator (the BSSTE is defined in annex B.1). The pseudo-random bit stream shall be any 148 bit sub-sequence of the 511 bit pseudo-random bit stream defined in recommendation CCITT Q.153 fascicle IV.4. This pseudo-random bit stream may be generated by another pseudo-random bit stream inserted before channel encoding in the TRX and shall generate at least 200 different bursts. The phase trajectory (phase versus time) for the useful part of the time slots (147 bits in the centre of the burst - see GSM 05.04 (ETS 300 576) [6] and GSM 05.10 (ETS 300 579) [9] for further information) shall be extracted with a resolution of at least 2 samples per modulating bit. The RF receiver parts of the BSSTE shall not limit the measurement.

The theoretical phase trajectory from the known pseudo-random bit stream shall be calculated in the BSSTE.

The phase difference trajectory shall be calculated as the difference between the measured and the theoretical phase trajectory. The mean frequency error across the burst shall then be calculated as the derivative of the regression line of the phase difference trajectory. The regression line shall be calculated using the Mean Square Error (MSE) method.

The phase error is then finally the difference between the phase difference trajectory and its linear regression line.

### 6.2.3 Essential conformance

Test Environment:

Normal: One test shall be performed on each of B, M and T.

Extreme Power supply: One test shall be performed on each of B, M and T.

NOTE: tests under extreme power supply also test extreme temperature.

### Conformance requirement

The phase error shall not exceed:

5 degrees rms  
20 degrees peak

The mean frequency error across the burst shall not exceed:

0,05 ppm

#### 6.2.4 Complete conformance

Test Environment:

Normal: The test shall be repeated until 3 TRXs or all TRXs (whichever is the less) have each been tested on B, M and T.

Extreme Power supply: One test shall be performed on each of B, M and T.

NOTE: tests under extreme power supply also test extreme temperature.

Vibration : One test shall be performed on each of B, M and T.

### Conformance requirement

The phase error shall not exceed:

5 degrees rms  
20 degrees peak

The mean frequency error across the burst shall not exceed:

0,05 ppm

#### 6.2.5 Requirement reference

GSM 05.04 (ETS 300 576) [6], clause 2; GSM 05.05 (ETS 300 577) [7], subclause 4.6; GSM 05.10 (ETS 300 579) [9], subclause 5.1.

### 6.3 Mean transmitted RF carrier power

#### 6.3.1 Test purpose

To verify the accuracy of the mean transmitted RF carrier power across the frequency range and at each power step.

This test is also used to determine the parameter "power level", used in subclause 6.5.1.2.

#### 6.3.2 Test case

For a normal BTS, this measurement the power shall be measured at the input of the TX combiner or at the BSS antenna connector. For a micro-BTS, the power shall be measured at the BSS antenna connector. The Manufacturer shall declare the maximum output power of the BSS at the same reference point as the measurement is made. The TX combiner shall have the maximum number of TRXs connected to it so that the measurement can be used as a reference for the measurement of transmitted carrier power versus time in subclause 6.4.

NOTE: The value of the output power measured at the antenna connector is generally more useful for cell planning, and may be required for regulatory purposes.



All TRXs in the configuration shall be switched on transmitting full power in all time slots for at least 1 hour before starting the test.

The Manufacturer shall declare how many TRXs the BSS supports:

- 1 TRX: The TRX shall be tested at B, M and T.
- 2 TRX: The TRXs shall be each be tested at B, M and T.
- 3 TRX or more: Three TRXs shall each be tested at B, M and T.

If the Manufacturer declares that Synthesizer Slow Frequency Hopping is supported by the BSS, the BSS shall be configured with the number of TRXs and frequency allocation defined above and SFH enabled.

The BSS under test shall be set to transmit at least 3 adjacent time slots in a TDMA-frame at the same power level. The power level shall then be measured on a time slot basis over the useful part of one of the active time slots and the average of the logarithmic value taken over at least 200 time slots. Only active bursts shall be included in the averaging process. Whether SFH is supported or not, the measurement shall be carried out on all of the 3 frequencies in turn.

For the definition of the useful part of the time slot see figure 1, and for further details GSM 05.04 (ETS 300 576) [6] and GSM 05.10 (ETS 300 579) [9]. For timing on a per time slot basis each time slot may contain 156.25 modulating bits, or 2 time slots may contain 157 and 6 time slots 156 modulating bits according to GSM 05.10 (ETS 300 579) [9].

The power shall be measured at each nominal power level as specified. As a minimum, one time slot shall be tested on each TRX. Any TRX which is a dedicated BCCH shall only be tested at static power step zero.

### 6.3.3 Essential conformance

Test Environment:

Normal: Each TRX specified in the test case shall be tested.

Extreme power supply: One TRX shall be tested, on one ARFCN, for static power step zero only.

#### Conformance requirement

The BSS shall support at least  $N_{max}$  steps of Static Power Control with respect to the declared output power.  $N_{max}$  shall be at least 6.

The static power step  $N$  has the range 0 to  $N_{max}$  inclusive, where.

Static Power Level 0 corresponds to the maximum power declared by the manufacturer.

The power measured when the TRX is set to Static Power Level 0 shall have a tolerance of  $\pm 2$  dB under normal conditions and  $\pm 2.5$  dB under extreme conditions, relative to the maximum power declared by the manufacturer. In this test, this measured power is termed the maximum BTS output power. Static power control shall allow the RF output power to be reduced from the maximum BTS output power in at least 6 steps of nominally 2 dB with a tolerance of  $\pm 1$  dB referenced to the previous level. In addition, the actual absolute output power of each static RF power step ( $N$ ) shall be  $2^N$  dB below the maximum BTS output power with a tolerance of  $\pm 3$  dB under normal conditions and  $\pm 4$  dB under extreme conditions.

In addition to the Static Power Control levels the BSS may utilize up to  $M$  steps of dynamic Downlink Power Control.  $M$  can have an upper limit of 0 to 15.

Dynamic Downlink power control shall allow the RF output power to be reduced in  $M$  steps with a step size of 2 dB with a tolerance of  $\pm 1.5$  dB referenced to the previous level.

Each dynamic Downlink Power Control level shall have a tolerance of  $\pm 3$  dB under normal conditions and  $\pm 4$  dB under extreme conditions relative to  $2^Y$  dB below the maximum BTS output power, where  $Y$  is the sum of the number of static and dynamic steps below Static Power Level 0.

#### 6.3.4 Complete conformance

The requirement of essential conformance shall apply.

#### 6.3.5 Requirement reference

GSM 05.05 (ETS 300 577) [7] subclause 4.1.2.

### 6.4 Transmitted RF carrier power versus time

#### 6.4.1 Test purpose

To verify:

- 1) The time during which the transmitted power envelope should be stable (the useful part of the time slot).
- 2) The stability limits.
- 3) The maximum output power when nominally off between time slots.

It is not the purpose of this test to measure the detail of the power ramps; this is measured as adjacent channel power in subclause 6.5.

#### 6.4.2 Test case

The Manufacturer shall declare how many TRXs the BSS supports, and declare any TRXs which are a dedicated BCCH carrier:

- |                |   |
|----------------|---|
| 1 TRX:         | The BSS shall not be tested.  |
| 2 TRX:         | One TRX shall be configured to support the BCCH and the other shall be tested. Tests shall be performed on B, M and T, and both TRXs shall be tested on at least one frequency.                     |
| 3 TRX:         | One TRX shall be configured to support the BCCH and the other two shall be tested at B, T and B, M. Tests shall be performed on B, M and T and both TRXs shall be tested on at least one frequency. |
| 4 TRX or more: | One TRX shall be configured to support the BCCH and three TRXs tested, one on B, one on M and one on T.   |

If the Manufacturer declares that Synthesizer Slow Frequency Hopping is supported by the BSS, the BSS shall be configured with the number of TRXs activated and frequency allocation defined above and SFH enabled. The TRX configured to support the BCCH shall not be tested.

A single time slot in a TDMA-frame shall be activated in all TRXs to be tested, all other time slots in the TDMA-frame shall be at Pidle.

Power measurements are made with a detector bandwidth of at least 300 kHz at the BTS antenna connector, at each frequency tested. Timing is related to T<sub>0</sub> which is the transition time from bit 13 to bit 14 of the midamble training sequence for each time slot. For timing on a per time slot basis each time slot may contain 156.25 modulating bits, or 2 time slots may contain 157 and 6 time slots 156 modulating bits according to GSM 05.10 (ETS 300 579) [9]. Measurements shall be made at P<sub>max</sub> and P<sub>min</sub>. The time slots measured shall be displayed or stored for at least 100 complete cycles of the time slot power sequence for each measurement.

P<sub>max</sub> = Power measured in subclause 6.3 (Static Power Level 0).

P<sub>min</sub> = the lowest static level measured in subclause 6.3.

P<sub>idle</sub> ≤ P<sub>max</sub> -30 dB, or P<sub>min</sub> - 30 dB

As a minimum, one time slot shall be tested on each TRX under test which is not a dedicated BCCH.

**6.4.3 Essential conformance**

Test Environment:

Normal.

**Conformance requirement**

The output power of each time slot tested relative to time shall conform with that illustrated in figure 1. The residual output power, if a time slot is not activated, shall be maintained at, or below, the level of -30 dBc (300 kHz measurement bandwidth).

**6.4.4 Complete conformance**

The requirement of essential conformance shall apply.

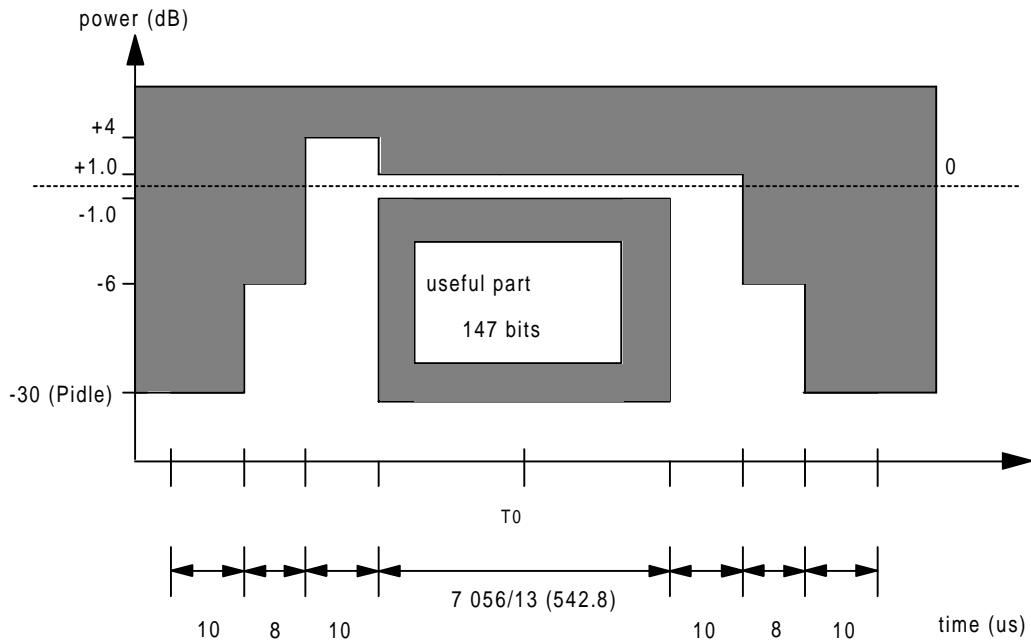

147 bits = 542.8 us = 7 056/13 us

1 timeslot = 576.9 us = 156.25 bits

NOTE: The 0 dB reference is equal to the power Pmax or Pmin.

**Figure 1: Power/time mask for power ramping of normal bursts**

**6.4.5 Requirement reference**

GSM 05.05 (ETS 300 577) [7] subclause 4.5.1.

**6.5 Adjacent channel power**

The modulation, wideband noise and power level switching spectra can produce significant interference in the GSM 900 or DCS 1 800 and adjacent bands. The requirements for adjacent channel emissions are tested in two separate tests which intend to measure different sources of emission:

- 1) continuous modulation spectrum and wideband noise;
- 2) switching transients spectrum.

NOTE: Both requirements must be met, irrespective of the source of the emission at any particular frequency.

## 6.5.1 Spectrum due to modulation and wideband noise

### 6.5.1.1 Test purpose

To verify that the output RF spectrum due to modulation and wideband noise does not exceed the specified levels for an individual transceiver.

### 6.5.1.2 Test case

The system under test shall be tested with one TRX active or with the BTS equipped with only one TRX, at three frequencies (B, M and T).

- a) All time slots shall be set up to transmit full power modulated with a pseudo-random bit sequence of encrypted bits apart from time slot 0 which shall be set up to transmit at full power but may be modulated with normal BCCH data. The pseudo-random bit sequence may be generated by another pseudo-random bit sequence inserted before channel encoding in the BSS.
- b) The power level (as used in table 5) shall be measured using the method of subclause 6.3 for each power step to be tested.
- c) Using a filter and video bandwidth of 30 kHz the power shall be measured at the antenna connector on the carrier frequency. The measurement shall be gated over 50 - 90 % of the useful part of the time slot excluding midamble, and the measured value over this part of the burst shall be averaged. The averaging shall be over at least 200 time slots and only the active burst shall be included in the averaging process.
- d) Step c) shall be repeated with the following offsets above and below the carrier frequency:  
100, 200, 250, 400 kHz; and  
600 to 1 800 kHz in steps of 200 kHz.
- e) With all time slots at the same power level, step c) and d) shall be repeated for all static power levels specified for the equipment (subclause 6.3).
- f) With a filter and video bandwidth of 100 kHz and all time slots active, the power shall be measured at the antenna connector for frequency offsets beyond 1 800 kHz up to 2 MHz outside either side of the relevant TX band. This test shall be made in a frequency scan mode, with a minimum sweep time of 75 ms and averaged over 200 sweeps.
- g) With all time slots at the same power level, step f) shall be repeated for all static power levels specified for the equipment (subclause 6.3).

### 6.5.1.3 Essential Conformance

Test Environment:

Normal.

#### Normal BTS Conformance requirement

The test shall be performed for one TRX.

For each static power step, the power measured in steps d) to g) of the test cases shall not exceed the limits shown in table 5 for the power level measured in step b), except where one or more of the following exceptions and minimum measurement levels applies:

- 1) For a GSM 900 BTS, if the limit according to table 5 is below -65 dBm, a value of -65 dBm shall be used instead.

- 2) For a DCS 1 800 BTS, if the limit according to table 5 is below -57 dBm, a value of -57 dBm shall be used instead.
- 3) In the combined range 600 kHz to 6 MHz above and below the carrier frequency, in up to three bands of 200 kHz width centred on a frequency which is an integer multiple of 200 kHz, exceptions at up to -36 dBm are allowed.
- 4) Above 6 MHz offset from the carrier frequency, in up to 12 bands of 200 kHz width centred on a frequency which is an integer multiple of 200 kHz, exceptions at up to -36 dBm are allowed.

**Table 5: Continuous modulation spectrum - maximum limits for BTS**

Power level (dBm)  as measured in step b)	Maximum relative level (dB) at specified carrier offsets (kHz), using specified measurement (filter) bandwidths (kHz):							
	100	200	250	400	600 to < 1 200	1 200 to < 1 800	1 800 to < 6 000	>6 000
	Measurement (filter) bandwidth; 30 kHz						Measurement (filter) bandwidth; 100 kHz	
≥ 43	+0.5	-30	-33	-60	-70	-73	-75	-80
41	+0.5	-30	-33	-60	-68	-71	-73	-80
39	+0.5	-30	-33	-60	-66	-69	-71	-80
37	+0.5	-30	-33	-60	-64	-67	-69	-80
35	+0.5	-30	-33	-60	-62	-65	-67	-80
≤ 33	+0.5	-30	-33	-60	-60	-63	-65	-80

The limit values in table 5, at the listed offsets from carrier frequency (kHz), are the ratio of the measured power to the measured power in step c) for the same static power step.

Table 5 provides requirements at discrete power levels. For powers between those specified, linear interpolation should be applied.

#### Micro-BTS Conformance requirement

The test shall be performed for one TRX.

For each static power step, the power measures in steps d) and e) of the test case shall not exceed the limits shown in table 5 for the power level measured in step b), except where one or more of the micro BTS exceptions and minimum measurement levels applies.

For each static power step, the ratio of the power measured in steps f) and g) of the test case to the power measured in step c) for the same static power step shall not exceed -70 dB for all GSM 900 micro-BTS classes and -76 dB for all DCS 1 800 micro-BTS classes, except where one or more of the micro BTS exceptions and minimum measurement levels applies.

The following exceptions and minimum measurement levels shall apply for the micro-BTS:

- 1) In the combined range 600 kHz to 6 MHz above and below the carrier frequency, in up to three bands of 200 kHz width centred on a frequency which is an integer multiple of 200 kHz, exceptions at up to -36 dBm are allowed.
- 2) Above 6 MHz offset from the carrier frequency, in up to 12 bands of 200 kHz width centred on a frequency which is an integer multiple of 200 kHz, exceptions at up to -36 dBm are allowed.
- 3) If the limit as specified above is below the values in table 6, then the values in the table shall be used instead.

Table 6: Continuous modulation spectrum - minimum levels for micro-BTS

Microcell BTS Power Class	Maximum spectrum due to modulation and noise in 100 kHz	
	GSM 900 (dBm)	DCS 1 800 (dBm)
M1	-59	-57
M2	-64	-62
M3	-69	-67

#### 6.5.1.4 Complete conformance

Test Environment:

Normal.

#### Conformance requirement

The test shall be repeated until each TRX in the configuration has been tested. The essential conformance requirement shall be met for each TRX.

#### 6.5.1.5 Requirement reference

GSM 05.05 (ETS 300 577) [7] subclause 4.2.1.

#### 6.5.2 Switching transients spectrum

##### 6.5.2.1 Test purpose

To verify that the output RF spectrum due to switching transients does not exceed the specified limits.

##### 6.5.2.2 Test case

The Manufacturer shall declare how many TRXs the BSS supports:

- 1 TRX: The TRX shall be tested at B, M and T.
- 2 TRX: One shall be configured to support the BCCH and the second TRX shall be activated and tested at B, M and T.
- 3 TRX: One shall be configured to support the BCCH and the other two shall be activated and tested. Tests shall be performed on B, M and T and both TRXs shall be tested on at least one frequency.
- 4 TRX or more: One shall be configured to support the BCCH and three TRXs shall be tested, one on B, one on M and one on T.

If the TRX supporting the BCCH is physically different from the remaining TRX(s), it shall also be tested on B, M and T.

- a) All active time slots shall be modulated with a pseudo-random bit sequence apart from time slot 0 of the TRX supporting the BCCH which may be modulated with normal data. The power shall be measured at the offsets listed below from one of the carrier frequencies in the configuration with the test equipment parameters below. The reference power for relative measurements is the power measured in a bandwidth of at least 300 kHz for the TRX under test for the time slot in this test with the highest power.

Resolution bandwidth: 30 kHz

Video bandwidth: 100 kHz

Zero frequency scan

Peak hold enabled

The following offsets from the carrier frequency shall be used:

400, 600, 1 200, and 1 800 kHz.

- b) All timeslots of the TRX or TRXs under test shall be activated at the highest level of static power control and the power measured as described in step a). If synthesizer SFH is supported, the test shall be repeated for the TRX or TRXs which are activated and which do not support the BCCH, with them hopping between B, M and T.
- c) All timeslots of the TRX or TRXs under test shall be activated at the lowest level of static power control and the power measured as described in step a). If synthesizer SFH is supported, the test shall be repeated for the TRX or TRXs which are activated and which do not support the BCCH, with them hopping between B, M and T.
- d) Any active TRX which does not support the BCCH shall be configured with alternate timeslots active at the highest level of static power control and the remaining timeslots idle as illustrated in figure 3 and the power measured as described in step a).
- e) Any active TRX which does not support the BCCH shall be configured with alternate timeslots active at the lowest level of static power control and the remaining timeslots idle as illustrated in figure 3 and the power measured as described in step a).
- f) If the BSS supports dynamic downlink power control, any active TRX which does not support the BCCH shall be configured with transitions between timeslots active at the highest level of static power control and timeslots active at the lowest available level of dynamic power control and idle timeslots, as illustrated in figure 2 and the power measured as described in step a).

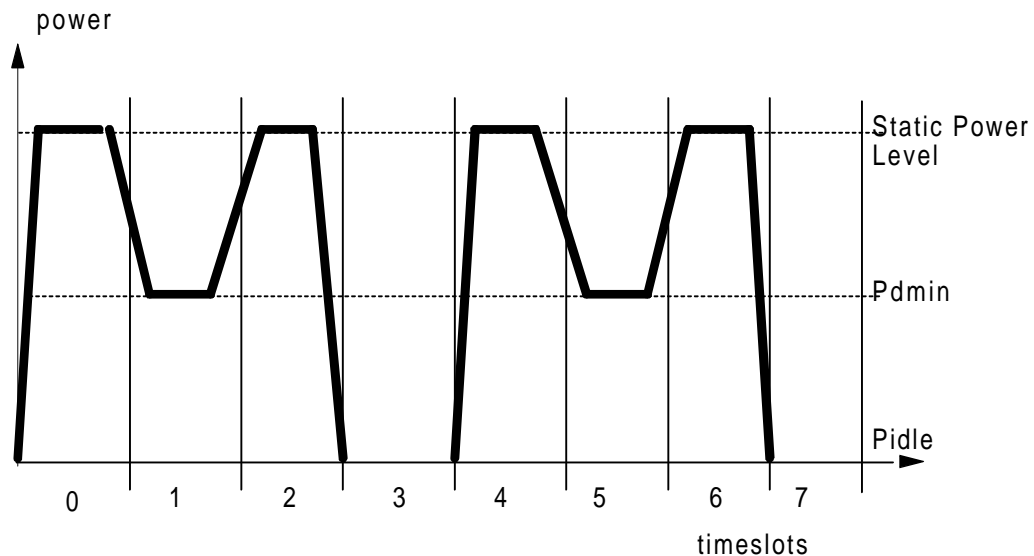

NOTE:  $P_{dmin}$  = The lowest dynamic power step measured in subclause 6.3.

**Figure 2: Power/time slot configuration (RF power control)**

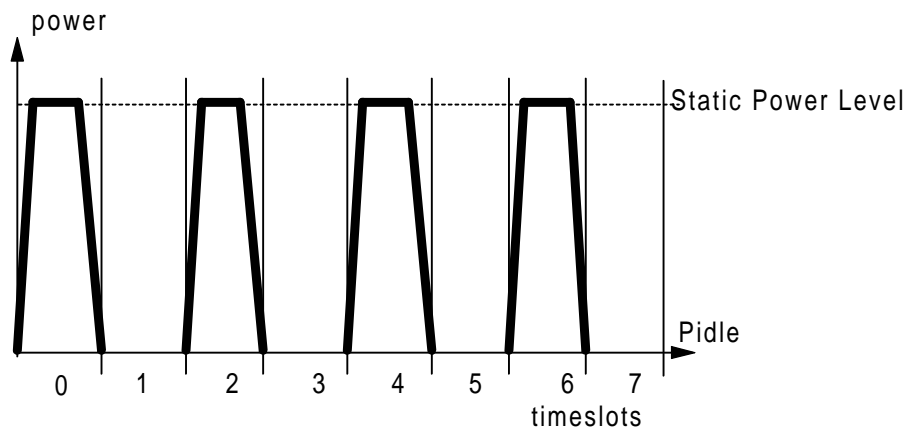

Figure 3: Power/time slot configuration (no RF power control)

**6.5.2.3 Essential conformance**

Test environment:

Normal.

**Conformance requirement**

The power measured shall not exceed the limits shown in table 7, or -36 dBm, whichever value is highest.

**6.5.2.4 Complete conformance**

Test environment:

Normal.

**Conformance requirement**

The test shall be repeated until all the TRXs specified to be tested have each been tested on the B, M and T.

The power measured shall not exceed the limits shown in table 7, or -36 dBm, whichever value is highest.

Table 7: Switching transients spectrum - maximum limits

Offset (kHz):	Power (dBc): GSM 900	Power (dBc) DCS 1 800
400	-57	-50
600	-67	-58
1 200	-74	-66
1 800	-74	-66

**6.5.2.5 Requirement reference**

GSM 05.05 (ETS 300 577) [7] subclause 4.2.2.

**6.6 Spurious emissions from the transmitter antenna connector**

The test conditions for conducted emissions are defined separately for the BTS transmit band, and elsewhere.



## **6.6.1 Conducted spurious emissions from the transmitter antenna connector, inside the BTS transmit band**

### **6.6.1.1 Test Purpose**

This test measures spurious emissions from the BSS transmitter antenna connector inside the BSS transmit band, while one transmitter is in operation.

### **6.6.1.2 Test Case**

The BTS shall be configured with one TRX active at its maximum output power on all time slots. The test shall be performed at RF channels B, M and T. Slow frequency hopping shall be disabled.

NOTE: It may be necessary to take steps to ensure that emissions from other transmitters which are not active do not influence the results. This may be achieved by, for example, equipping the BTS with only one TRX or by muting the outputs of the transmitters to a greater degree than otherwise required in GSM 05.05 (ETS 300 577) [7].

The transmitter antenna connector shall be connected to a spectrum analyser or selective voltmeter with the same characteristic impedance. Peak hold shall be enabled. The power shall be measured.

For frequencies with an offset of  $1.8 \text{ MHz} \leq f < 6 \text{ MHz}$  from the carrier frequency, and which fall within the BTS transmitter band:

The detecting device shall be configured with a resolution bandwidth of 30 kHz and a video bandwidth of approximately three times this value.

For frequencies with an offset of  $\geq 6 \text{ MHz}$  from the carrier frequency, and which fall within the BTS transmitter band:

The detecting device shall be configured with a resolution bandwidth of 100 kHz and a video bandwidth of approximately three times this value.

### **6.6.1.3 Essential conformance**

Test Environment:

Normal.

#### **Conformance requirement**

The maximum power measured shall not exceed -36 dBm.

### **6.6.1.4 Complete conformance**

The requirement of essential conformance shall apply.

### **6.6.1.5 Requirement Reference**

GSM 05.05 (ETS 300 577) [7] subclause 4.3.

## **6.6.2 Conducted spurious emissions from the transmitter antenna connector, outside the BTS transmit band**

### **6.6.2.1 Test Purpose**

This test measures spurious emissions from the BSS transmitter antenna connector outside the BSS transmit band, while the transmitters are in operation. It also tests the intra-BTS intermodulation requirements outside the BTS transmit and receive bands.

**6.6.2.2 Test Case**

- a) The BSS shall be configured with all transmitters active at their maximum output power on all time slots. If a TRX is designated as being a dedicated BCCH, it shall be allocated to RF channel M. All remaining TRXs shall be allocated in the following order; first to RF channel B, then to T, then distributed as evenly as possible throughout the BSS transmit band. Slow frequency hopping shall be disabled.
- b) The transmitter antenna connector shall be connected to a spectrum analyser or selective voltmeter with the same characteristic impedance.

The detecting device shall be configured with a resolution and video bandwidth of 100 kHz. The minimum sweep time shall be at least 75 ms and the response shall be averaged over 200 sweeps.

The power shall be measured over the BSS receive band.

- c) Step b) shall be repeated for the following frequency band:
- for a GSM 900 BSS, the band 1 805 - 1 880 MHz.
  - for a DCS 1 800 BSS, the band 925 - 960 MHz.
- d) If the manufacturer declares that the BSS is suitable for the co-siting of GSM 900 and DCS 1 800 BSSs the following test shall be performed:  
Step b) shall be repeated for the following frequency band:
- for a GSM 900 BSS, the band 1 710 - 1 785 MHz.
  - for a DCS 1 800 BSS, the band 880 - 915 MHz.
- e) The BSS shall be configured as in step a) except that each TRX which is not a dedicated BCCH shall transmit on full power on alternate time slots. The active timeslots should be the same for all TRXs. If slow frequency hopping is supported, each TRX which is not a dedicated BCCH shall hop over the full range of frequencies defined in step a).

The detecting device shall be configured as defined in table 8. Peak hold shall be enabled, and the video bandwidth shall be approximately three times the resolution bandwidth. If this video bandwidth is not available on the detecting device, it shall be the maximum available, and at least 1 MHz.

The power shall be measured over those parts of the frequency range 100 kHz to 12.75 GHz which are outside the BTS transmit band.

**Table 8: Spurious Emissions Measurements outside the transmit band**

Frequency Band	Frequency offset	Resolution Bandwidth
100 kHz - 50 MHz		10 kHz
50 MHz - 500 MHz		100 kHz
500 MHz - 12.75 GHz and outside the relevant transmit band	(offset from the edge of the relevant transmit band)	
	≥ 2 MHz	30 kHz
	≥ 5 MHz	100 kHz
	≥ 10 MHz	300 kHz
	≥ 20 MHz	1 MHz
	≥ 30 MHz	3 MHz

**6.6.2.3 Essential conformance**

Test Environment:

Normal.

**Conformance requirement**

- i) The maximum power measured at step c) shall not exceed -47 dBm for a GSM 900 BTS or -57 dBm for a DCS 1 800 BTS.
- ii) The maximum power measured at step e) shall not exceed:
  - 36 dBm for frequencies up to 1 GHz
  - 30 dBm for frequencies above 1 GHz

**6.6.2.4 Complete conformance**

Test Environment:

Normal.

**Conformance requirement**

- 1) The maximum power measured at step b) shall not exceed the requirements in table 9:

**Table 9: Requirements for transmitter spurious emissions in receiver bands**

	<b>GSM BSS receive band (dBm)</b>	<b>DCS 1 800 BSS receive band (dBm)</b>
Normal BTS	-98	-98
Micro BTS M1	-91	-96
Micro BTS M2	-86	-91
Micro BTS M3	-81	-86

- 2) The maximum power measured at step c) shall not exceed -47 dBm for a GSM 900 BSS or -57 dBm for a DCS 1 800 BSS.
- 3) The maximum power measured at step e) shall not exceed:
  - 36 dBm for frequencies up to 1 GHz
  - 30 dBm for frequencies above 1 GHz
- 4) If the manufacturer declares that the BSS is suitable for co-siting of GSM 900 and DCS 1 800 BSSs, the power measured in step d) shall not exceed the requirements in table 9.

**6.6.2.5 Requirement Reference**

GSM 05.05 (ETS 300 577) [7] subclauses 4.3, 4.7.2.

**6.7 Intermodulation attenuation****6.7.1 Test purpose**

To verify that the RF transmit equipment is able to restrict the generation of signals in its non-linear elements caused by the presence of the RF output from the transmitter and an interfering signal reaching the transmitter via its antenna to below specified levels.

**6.7.2 Test case**

If SFH is supported by the BSS, it shall be disabled during this measurement.

The Manufacturer shall declare how many TRXs the BSS supports. The BSS shall be configured with the maximum number of TRXs supported. The test shall be performed for the number of TRXs and the frequencies defined in the conformance requirement.

Only the TRX under test shall be active. All remaining TRXs shall be idle on an ARFCN within the manufacturers declared operating band for the BSS.

NOTE 1: It is particularly important, for a BSS which uses a tuned transmitter combiner, that all sections of the combiner are set to frequencies within the operating band of the BSS during this test.

The antenna output of the RF transmit equipment under test, including the combiner, shall be connected to a coupling device, presenting to the RF equipment a load with an impedance of 50 ohms. The manufacturer shall declare the upper and lower frequency of operation for the transmitter; the frequency of the test signal shall be within this band. The test signal shall be unmodulated and the frequency shall be X MHz offset from the frequency of the RF transmit equipment under test. The TRX under test shall be set to static power level zero and the test signal power level shall be adjusted 30 dB below this value. The test signals are illustrated in figure 4. The power level of the test signal shall be measured at the antenna output end of the coaxial cable, when disconnected from the RF transmit equipment and then correctly matched into 50 ohms. The antenna output power of the RF transmit equipment shall be measured directly at the antenna output terminal connected to an artificial antenna. Intermodulation product frequencies in the TX and RX band shall be identified and measured according to the following process.

#### **For the measurements in the RX band:**

Use a measurement and filter bandwidth of 100 kHz, frequency scan mode, averaged over 200 sweeps, with a sweep time of at least 75 ms. The frequency offset X shall be chosen to cause the lowest order intermodulation product to fall in the manufacturers declared RX band.

#### **For measurements in the TX band:**

The measurement shall be made for frequency offsets X of: 0.8 MHz, 2.0 MHz, 3.2 MHz, 6.2 MHz. The power of all third and fifth order intermodulation products shall be measured. The method of measurement specified below depends on the frequency offset of the intermodulation product from the carrier frequency:

For measurements at frequency offsets from the active TRX of more than 6 MHz the peak power of any intermodulation components shall be measured with a bandwidth of 300 kHz, zero frequency span, over a time slot period. This shall be measured over sufficient time slots to ensure conformance according to methodology of annex A.

For measurements at frequency offsets from the active TRX 1.8 MHz or less the intermodulation product power shall be measured selectively using video averaging over 50 to 90 % of the useful part of the time slot excluding the mid-amble. The averaging shall be over at least 200 time slots and only active bursts shall be included in the averaging process. The RF and video filter bandwidth of the measuring instrument shall be 30 kHz.

For measurements at frequency offsets in the range 1.8 to 6 MHz the intermodulation product power shall be measured in a frequency scan mode, with a minimum sweep time of 75 ms and averaged over 200 sweeps. The RF and video filter bandwidth of the measuring instrument shall be 100 kHz.

NOTE 2: When the above measurements are performed precautions should be taken, so that non-linearity in the selective measuring device does not influence the results appreciably. Furthermore it should be ensured that intermodulation components which may be generated by non-linear elements in the test equipment (e.g. signal generator, coupling device, selective measuring device) are sufficiently reduced. The RF transmit equipment under test and the test signal source should be physically separated in such a way that the measurement is not influenced by direct radiation. A possible measurement set-up is shown in annex B.2.

### **6.7.3 Essential Conformance**

Test Environment:

Normal.

The following tests shall be performed, depending on the number of TRXs supported by the BSS:

- 1TRX: The TRX shall be tested at B, M, and T.
- 2TRX: One test shall be performed on B, M, and T. Each TRX shall be tested at least once.
- 3 or more TRX: One TRX shall be tested at B, one at M and one at T.

**Conformance requirement**

At frequencies offset from the wanted signal carrier frequency by more than 6 MHz and up to the edge of the relevant transmit band, the intermodulation components measured shall not exceed -70 dBc or -36 dBm, whichever is the higher. 1 in 100 time slot periods may fail the requirement by up to 10 dB.

At frequencies offset from the wanted signal carrier frequency of less than 6 MHz, the requirements are that specified in subclause 6.5.1.3, Continuous Modulation Spectrum. The exceptions given in subclause 6.5.1.3 also apply.

**6.7.4 Complete conformance**

Test Environment:

Normal.

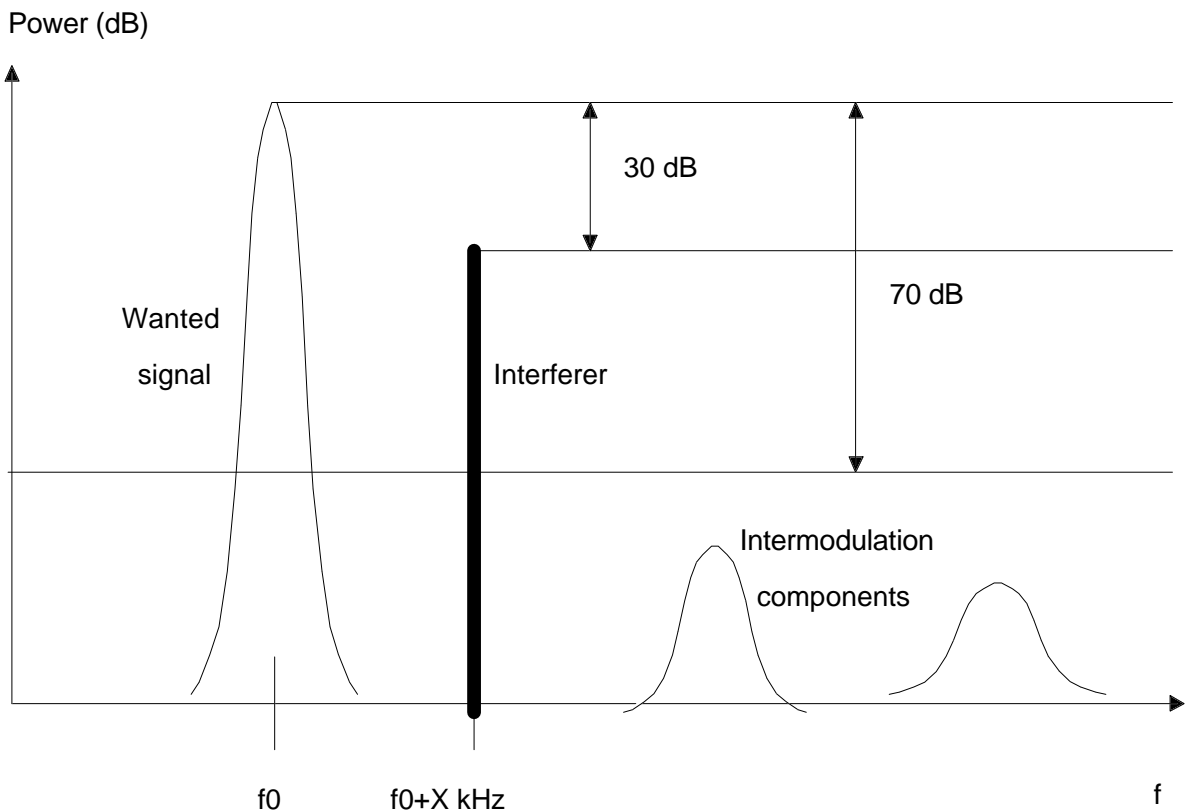

**Figure 4: Example of TX intermodulation attenuation**

**Conformance requirement**

The test shall be performed until three TRXs, or the maximum number supported by the BSS (whichever is the less) have each been tested at B, M, and T.

In the relevant receive band the measured intermodulation components shall never exceed the values given in table 10 under normal test conditions.

**Table 10: Maximum Receive Band transmitter intermodulation limits**

	<b>GSM(dBm)</b>	<b>DCS(dBm)</b>
Normal BTS	-98	-98
Micro-BTS M1	-91	-96
Micro-BTS M2	-86	-91
Micro-BTS M3	-81	-86

At frequencies offset from the wanted signal carrier frequency by more than 6 MHz and up to the edge of the relevant transmit band, the intermodulation components measured shall not exceed -70 dBc or -36 dBm, whichever is the higher. 1 in 100 time slot periods may fail the requirement by up to 10 dB.

At frequencies offset from the wanted signal carrier frequency by less than 6 MHz, the requirements are that specified in subclause 6.5.1.3, Continuous Modulation Spectrum. The exceptions given in subclause 6.5.1.3 also apply.

#### **6.7.5 Requirement reference**

GSM 05.05 (ETS 300 577) [7] subclause 4.7.1.

### **6.8 Intra Base Station System intermodulation attenuation**

#### **6.8.1 Test purpose**

To verify that the level of intermodulation products produced inside the relevant RX and TX band (due to the leakage of RF power between transmitters when transmitters are combined to feed a single antenna, or are operating in close vicinity of each other) do not exceed the specified limit.

#### **6.8.2 Test case**

If SFH is supported by the BSS, it shall be disabled during this measurement.

The BSS shall be configured with a full compliment of transceivers. Each RF transmit equipment shall be operated at the maximum power specified (Static Level 0 subclause 6.3) and with modulation applied.

In the transmit band, the intermodulation components shall be measured at frequency offsets above the uppermost and below the lowermost carrier frequencies.

All intermodulation product frequencies in the TX and RX band shall be identified and measured according to the process below.

#### **For the measurement in the RX band**

The equipment shall be operated with ARFCNs such that the lowest order intermodulation product falls into the receive band. The measurement shall be carried out at the antenna connector of the BSS, using a frequency selective instrument.

A possible measurement set-up for this test is shown in annex B.2.

For measurements in the RX band the following is the test set up:

A filter and video bandwidth of 100 kHz.

Frequency scan mode.

Minimum sweep time of 75 ms and averaged over 200 sweeps.

#### **For measurements in the TX band**

The equipment shall be operated at equal and minimum frequency spacing specified for the BSS configuration under test.

For frequency offsets from the active TRX of more than 6 MHz the peak power of any intermodulation components shall be measured with a bandwidth of 300 kHz, zero frequency span, over a time slot period. This shall be measured over sufficient time slots to ensure conformance according to methodology of annex A.1.

For frequency offsets from the active TRX 1.8 MHz or less the intermodulation product power shall be measured selectively using video averaging over 50 to 90 % of the useful part of the time slot excluding

the mid-amble. The averaging shall be over at least 200 time slots and only active bursts shall be included in the averaging process. The RF and video filter bandwidth of the measuring instrument shall be 30 kHz.

For frequency offsets in the range 1.8 to 6 MHz the intermodulation product power shall be measured in a frequency scan mode, with a minimum sweep time of 75 ms and averaged over 200 sweeps. The RF and video filter bandwidth of the measuring instrument shall be 100 kHz.

### 6.8.3 Essential conformance

Test Environment:

Normal.

#### Conformance requirement

In the relevant transmit band, at offsets greater than 0.6 MHz and up to 6 MHz, the requirements are that specified in subclause 6.5.1, Continuous Modulation Spectrum. The exceptions given there shall also apply.

At frequencies offset from the wanted signal carrier frequency by more than 6 MHz and up to the edge of the relevant transmit band, the intermodulation components measured shall not exceed -70 dBc or -36 dBm, whichever is the higher. 1 in 100 time slot periods may fail the requirement by up to 10 dB.

### 6.8.4 Complete conformance

Test Environment:

Normal.

#### Conformance requirement

In the relevant receive band the measured intermodulation components shall never exceed the values given in table 11 under normal test conditions.

**Table 11: Maximum intra-BSS Receive Band transmitter intermodulation limits**

	<b>GSM(dBm)</b>	<b>DCS(dBm)</b>
Normal BTS	-98	-98
Micro-BTS M1	-91	-96
Micro-BTS M2	-86	-91
Micro-BTS M3	-81	-86

In the relevant transmit band, at offsets greater than 0.6 MHz and up to 6 MHz, the requirements are that specified in subclause 6.5.1, Continuous Modulation Spectrum. The exceptions given there shall also apply.

At frequencies offset from the wanted signal carrier frequency by more than 6 MHz and up to the edge of the relevant transmit band, the intermodulation components measured shall not exceed -70 dBc or -36 dBm, whichever is the higher. 1 in 100 time slot periods may fail the requirement by up to 10 dB.

### 6.8.5 Requirement reference

GSM 05.05 (ETS 300 577) [7] subclause 4.7.2.

## 7 Receivers

All tests unless otherwise stated in this subclause shall be conducted on Base Station Systems fitted with a full complement of Transceivers for the configuration. The manufacturer shall provide appropriate logical or physical test access to perform all test in this subclause. Measurements shall include any RX multicoupler.

The tests in this subclause assume that the receiver is not equipped with diversity. For receivers with diversity, the tests may be performed by applying the specified signals to one of the receiver inputs, and terminating or disabling the other(s). The tests and requirements are otherwise unchanged.

For receivers with diversity, testing of essential conformance shall be performed by applying the specified signals to one of the receiver inputs, and terminating or disabling the other(s).

In all the relevant subclauses in this clause all Bit Error Ratio (BER), Residual BER (RBER) and Frame Erasure Ratio (FER) measurements shall be carried out according to the general rules for statistical testing in annex A.

### 7.1 Static Layer 1 receiver functions (nominal error ratios)

#### 7.1.1 Test Purpose

The static Layer 1 receiver functions verified in these tests are the RF parts, the multiplexing and multiple access functions, any existing equalizer, the deciphering functions, the de-interleaving and the channel decoding on the receive side. The performance of the receiver at the maximum specified input level is also verified.

The measurements are recorded as nominal error ratios (Bit Error Ratio - BER) at a logical reference point that represents the performance before channel decoding. This measurement shall be performed for TCH/FS only using unprotected class II bits extracted after channel decoding, but before any extrapolation. Therefore, the results obtained are representative of the logical reference point before channel decoding.

#### 7.1.2 Test Case

If Slow Frequency Hopping (SFH) is supported by the BSS, the BSS shall be hopping over the maximum range and number of ARFCNs possible for the test environment and which are available in the BSS configuration. If SFH is not supported, the test shall be performed for the radio frequency channels B, M and T. In both cases the tests shall be repeated until all the RF equipment in the BSS configuration is tested on all specified carrier frequencies and all available TCH/FS time slots.

A test signal with normal modulation originating from the BSSTE shall be applied to the BSS receiver input. The unprotected class II bits obtained from the BSS receiver after channel decoding and before any extrapolation shall be compared with the unprotected class II bits originating from the BSSTE.

The test shall be performed at the following power levels of test signal:

- a) A lower limit (20 dB above the reference sensitivity level of the BSS under test), as specified in table 12, for static and EQ50 propagation conditions.

**Table 12: Lower limit of RF input for testing of Static Layer 1 receiver functions**

BTS Type	Lower Limit
GSM 900/DCS 1 800 BTS	-84 dBm
GSM 900 micro-BTS M1	-77 dBm
GSM 900 micro-BTS M2	-72 dBm
GSM 900 micro-BTS M3	-67 dBm
DCS 1 800 micro-BTS M1	-82 dBm
DCS 1 800 micro-BTS M2	-77 dBm
DCS 1 800 micro-BTS M3	-72 dBm



- b) -40 dBm, for static and EQ50 propagation conditions.
- c) -15 dBm for GSM 900 and -23 dBm for DCS 1 800, for static propagation conditions only.

### 7.1.3 Essential conformance

This test need not be performed.

### 7.1.4 Complete conformance

Test Environment:

Normal: Each TRX shall be tested.

Extreme Temperature: One TRX shall be tested on one timeslot, for static propagation conditions only.

Vibration: One TRX shall be tested on one timeslot, for static propagation conditions only.

### Conformance Requirement

The bit error ratio of the unprotected bits (TCH/FS, Class II) shall not exceed:

Static propagation conditions  $BER \leq 10^{-4}$  For input levels up to -40 dBm

Static propagation conditions  $BER \leq 10^{-3}$  For input levels > -40 dBm

EQ50 propagation conditions  $BER \leq 3 \%$

### 7.1.5 Requirement Reference

GSM 05.05 (ETS 300 577) [7] subclause 6.1.

## 7.2 Erroneous Frame Indication Performance

### 7.2.1 Test Purpose

In GSM 05.03 (ETS 300 575) [5] a Cyclic Redundancy Check (CRC) is defined for detection of erroneous Layer 2 frames or speech frames. For full-rate speech channels also additional error detecting capabilities using some soft information are needed due to DTX operation when no useful signal is transmitted to the receiver. This test verifies the reliability of the overall Bad Frame Indication (BFI) presented to the full-rate speech decoder and the Frame Erasure Indication (FEI) used on control channels.

### 7.2.2 Test Case

- 1) A test signal consisting of continuous GSM modulation of a pseudo random bit stream without mid-amble, and at a level specified in table 13, shall be applied to the receiver antenna connector, on the same frequency as the TRX under test.

One TRX shall be configured to support a BCCH. The detection by the BSS of error-free RACH bursts (FEI=0) shall be monitored by the BSSTE.

**Table 13: Test Signal input level for testing of Erroneous Frame Indication performance**

BTS Type	Test signal Input Level
GSM 900/DCS 1 800 BTS	-84 dBm
GSM 900 micro-BTS M1	-77 dBm
GSM 900 micro-BTS M2	-72 dBm
GSM 900 micro-BTS M3	-67 dBm
DCS 1 800 micro-BTS M1	-82 dBm
DCS 1 800 micro-BTS M2	-77 dBm
DCS 1 800 micro-BTS M3	-72 dBm

- 2) Step 1 shall be repeated without any RF input on the TRX under test, with the receiver antenna connector terminated with 50Ω.
- 3) Step 1 shall be repeated with one timeslot on one TRX configured for TCH/FS and FACCH. The Bad Frame Indication (BFI) shall be monitored by the BSSTE.
- 4) Step 3 shall be repeated without any RF input on the TRX under test, with the receiver antenna connector terminated with 50Ω.

### 7.2.3 Essential conformance

This test need not be performed.

### 7.2.4 Complete conformance

Test Environment:

Normal.

#### Conformance requirement

In steps 1 and 2, less than 0.02 % of the frames shall be detected as error free (FEI=0).

In steps 3 and 4, less than 1 undetected bad speech frame (i.e. detected as BFI=0) shall occur on average in a period of 10 s.

### 7.2.5 Requirement reference

GSM 05.05 (ETS 300 577) [7] subclause 6.4.

## 7.3 Static Reference Sensitivity Level

### 7.3.1 Test Purpose

The static reference sensitivity level of the receiver is the level of signal at the receiver input with a standard test signal at which the receiver will produce after demodulation and channel decoding data with a Frame Erasure Ratio (FER), Residual Bit Error Ratio (RBER) or Bit Error Ratio (BER) better than or equal to that specified for a specific logical channel type under static propagation conditions.

### 7.3.2 Test Case

The test shall be performed for the specified ARFCNs. As a minimum, one time slot shall be tested on one TRX.

All TRXs in the BSS configuration shall be on and transmitting full power in all time slots.

With slow frequency hopping disabled, a test signal with normal GSM modulation shall be applied to the BSS RX antenna connector, with a power specified in table 14, on a chosen time slot. The two adjacent time slots shall have a level 50 dB above the time slot under test. The content of this signal shall allow the receiver of the TRX under test to either be activated or to detect valid GSM signals (as specified in the conformance requirement) on the adjacent timeslots for the duration of the test. No signal should be applied during the remaining timeslots.

If Synthesizer Slow Frequency Hopping is supported by the BSS, the test shall be repeated with the following changes:

- a) The BSS shall be hopping over the maximum range and number of ARFCNs possible for the test environment and which are available in the BSS configuration.
- b) The test signal should only be applied for the timeslot under test; no signal should be applied during the remaining timeslots.

**Table 14: Test Signal input level for Static reference sensitivity measurement**

<b>BTS Type</b>	<b>Test signal Input Level</b>
GSM 900/DCS 1 800 BTS	-104 dBm
GSM 900 micro-BTS M1	-97 dBm
GSM 900 micro-BTS M2	-92 dBm
GSM 900 micro-BTS M3	-87 dBm
DCS 1 800 micro-BTS M1	-102 dBm
DCS 1 800 micro-BTS M2	-97 dBm
DCS 1 800 micro-BTS M3	-92 dBm

The input signal before channel encoding in the BSSTE shall be compared with the signal which is obtained from the BSS receiver after channel decoding.

### 7.3.3 Essential conformance

Test Environment:

Normal.

#### Conformance Requirement

For tests with SFH disabled, the tests shall be performed at one ARFCN. For tests with SFH enabled, the tests shall be performed with the range of hopping frequencies centred around RF channel M.

The error performance given in table 15 shall be met for TCH/FS channel (FER and RBER for class Ib and class II bits) and TCH/HS channel (FER and RBER for class Ib and class II bits with BFI=0).

For all tests where a signal is present on adjacent timeslots, the receiver of the TRX under test shall be activated for the duration of the test on the adjacent time slots. As a minimum, this shall include the automatic gain control (AGC) of the receiver being operational on the adjacent timeslots.

### 7.3.4 Complete conformance

Test Environment:

Normal.

Extreme Temperature: TCH/FS only, for one time slot of one transceiver.

Extreme power supply: TCH/FS only, for one time slot of one transceiver.

#### Conformance Requirement

For tests with SFH disabled, the tests shall be performed at RF channels B, M, and T. For tests with SFH enabled, the tests shall be performed with the range of hopping frequencies centred around M.

The error performance given in table 15 shall be met for all logical channel types.

For all tests where a signal is present on adjacent timeslots, the BTS shall detect valid GSM signals with an RXQUAL of 6 or less for the duration of the test on the adjacent time slots.

Table 15: Static error performance limits at RX sensitivity level

Channel type:	Error Parameter	Limit Value
FACCH/H	FER	0.10 %
FACCH/F	FER	0.10 %
SDCCH and SACCH	FER	0.10 %
RACH	FER	0.50 %
TCH/F9.6	BER	$10^{-5}$
TCH/H4.8	BER	$10^{-5}$
TCH/FS	FER	0.10 $\alpha$ %
- class Ib	RBER	0.40/ $\alpha$ %
- class II	RBER	2.0 %
TCH/HS	FER	0.025 %
- class Ib, BFI=0	RBER	0.001 %
- class II, BFI=0	RBER	0.72 %
-	UFR	0.048 %
- class Ib, UFI=0	RBER	0.001 %
-	EVSIDR	0.06 %
SID=0 and BFI=0	RBER	0.001 %
-	ESIDR	0.01 %
SID=1 or 2	RBER	0.003 %

NOTE: The value of  $\alpha$  in table 15 may be between 1 and 1.6, but should be the same for both occurrences.

### 7.3.5 Requirements Reference

GSM 05.05 (ETS 300 577) [7] subclause 6.2.

## 7.4 Multipath Reference Sensitivity Level

### 7.4.1 Test Purpose

The multipath reference sensitivity level of the receiver is the level of signal at the receiver input with a standard test signal at which the receiver will produce after demodulation and channel decoding data with a Frame Erasure Ratio (FER), Residual Bit Error Ratio (RBER) or Bit Error Ratio (BER) better than or equal to that specified for a specific logical channel type, under multipath propagation conditions.

### 7.4.2 Test Case

As a minimum, one time slot shall be tested on one TRX.

A test signal with normal GSM modulation shall be applied to the BSS RX antenna connector through a Multipath Fading Simulator as described in annex B.1, on the chosen time slot. The average signal level at the receiver antenna connector shall be as specified in table 16. This shall be measured by taking the average of the logarithmic value over the useful part of the wanted burst over the integration period appropriate for the logical channel type, as defined in annex A, table A.2.

All TRXs in the BSS configuration shall be on and transmitting full power in all time slots.

For tests with TU50 (ideal SFH):

The BSS shall be hopping over the maximum range and number of ARFCNs possible for the test environment and which are available in the BSS configuration.

For TU50 (no SFH), RA250 (no SFH) and HT100 (no SFH):

If slow frequency hopping is supported by the BSS, it shall be disabled. The test shall be performed for the specified ARFCNs. A test signal with normal GSM modulation shall also be applied to the RX antenna connector on the two adjacent time slots at a static power level 50 dB above the average power level of the chosen time slot over the useful part of the burst as defined in GSM 05.05 (ETS 300 577) [7] for the MS. The content of this signal shall allow the receiver of the TRX under test to either be activated or to detect valid GSM signals (as specified in the conformance requirement) on the adjacent timeslots for the duration of the test.

**Table 16: Test signal input level for Multipath Reference Sensitivity measurements**

BTS Type	Test signal Average Input Level to receiver
GSM 900/DCS 1 800 BTS	-104 dBm
GSM 900 micro-BTS M1	-97 dBm
GSM 900 micro-BTS M2	-92 dBm
GSM 900 micro-BTS M3	-87 dBm
DCS 1 800 micro-BTS M1	-102 dBm
DCS 1 800 micro-BTS M2	-97 dBm
DCS 1 800 micro-BTS M3	-92 dBm

The input signal before channel encoding in the BSSTE shall be compared with the signal which is obtained from the BSS receiver after channel decoding.

#### 7.4.3 Essential conformance

Test Environment:

Normal.

#### Conformance Requirement

The error performance of TCH/FS shall be measured on RF channels B, M, and T for propagation profile TU50 (no SFH). The receiver of the TRX under test shall also be activated on the adjacent timeslots. As a minimum, this shall include the automatic gain control ( AGC) of the receiver being operational on the adjacent timeslots.

The error performance of each of the following logical channel types shall be measured, each on one ARFCN, for the specified propagation profiles:

TCH/FS:	TU50, HT100, RA130 or RA250
TCH/HS (FER and RBER with BFI=0):	TU50, HT100, RA130 or RA250
SDCCH:	TU50, HT100, RA130 or RA250
TCH/F9.6:	HT100, RA130 or RA250
TCH/F4.8:	HT100, RA130 or RA250

The error performance given in table 17 shall be met for all combinations of logical channel type, frequency and multipath propagation profile tested.

## 7.4.4 Complete conformance

Test Environment:

Normal.

## Conformance Requirement

The error performance given in table 17 shall be met for all logical channel types and for all the multipath propagation profiles given in table 17.

For tests without SFH, the BTS shall detect valid GSM signals with an RXQUAL of 6 or less for the duration of the test on the adjacent time slots.

**Table 17a: GSM 900 Multipath error performance limits at RX sensitivity level**

Channel Type	Error Measure	Error Ratios for the specified propagation conditions			
		TU50 (no SFH)	TU50 (ideal SFH)	RA250 (no SFH)	HT100 (no SFH)
FACCH/H	(FER)	6.9 %	6.9 %	5.7 %	10.0 %
FACCH/F	(FER)	8.0 %	3.8 %	3.4 %	6.3 %
SDCCH and SACCH	(FER)	13 %	8.0 %	8.0 %	12.0 %
RACH	(FER)	13 %	13 %	12 %	13 %
TCH/F9.6	(BER)	0.50 %	0.40 %	0.10 %	0.70 %
TCH/F4.8	(BER)	$10^{-4}$	$10^{-4}$	$10^{-4}$	$10^{-4}$
TCH/F2.4	(BER)	$2 \cdot 10^{-4}$	$10^{-5}$	$10^{-5}$	$10^{-5}$
TCH/H4.8	(BER)	0.50 %	0.40 %	0.10 %	0.70 %
TCH/H2.4	(BER)	$10^{-4}$	$10^{-4}$	$10^{-4}$	$10^{-4}$
TCH/FS	(FER)	$6.0 \alpha$ %	$3.0 \alpha$ %	$2.0 \alpha$ %	$7.0 \alpha$ %
- class Ib	(RBER)	$0.40/\alpha$ %	$0.30/\alpha$ %	$0.20/\alpha$ %	$0.50/\alpha$ %
- class II	(RBER)	8.0 %	8.0 %	7.0 %	9.0 %
TCH/HS	(FER)	4.1 %	4.1 %	4.1 %	4.5 %
- class Ib	(RBER, BFI=0)	0.36 %	0.36 %	0.28 %	0.56 %
- class II	(RBER, BFI=0)	6.9 %	6.9 %	6.8 %	7.6 %
-	(UFR)	5.6 %	5.6 %	5.0 %	7.5 %
- class Ib	(RBER, UFI=0)	0.24 %	0.24 %	0.21 %	0.32 %
-	(EVSIDR)	6.8 %	6.8 %	6.0 %	9.2 %
-	(RBER, SID=2 and BFI=0)	0.01 %	0.01 %	0.01 %	0.02 %
-	(ESIDR)	3.0 %	3.0 %	3.2 %	3.4 %
-	(RBER, SID=1 or 2)	0.3 %	0.3 %	0.21 %	0.42 %

Table 17b: DCS 1 800 Multipath error performance limits at RX sensitivity level

Channel Type	Error Measure	Error Ratios for the specified propagation conditions			
		TU50 (no SFH)	TU50 (ideal SFH)	RA130 (no SFH)	HT100 (no SFH)
FACCH/H	(FER)	7.2 %	7.2 %	5.7 %	10.4 %
FACCH/F	(FER)	3.9 %	3.9 %	3.4 %	7.4 %
SDCCH and SACCH	(FER)	9.0 %	9.0 %	8.0 %	13.0 %
RACH	(FER)	13 %	13 %	12 %	13 %
TCH/F9.6	(BER)	0.40 %	0.40 %	0.10 %	0.70 %
TCH/F4.8	(BER)	10 <sup>-4</sup>	10 <sup>-4</sup>	10 <sup>-4</sup>	10 <sup>-4</sup>
TCH/F2.4	(BER)	10 <sup>-5</sup>	10 <sup>-5</sup>	10 <sup>-5</sup>	10 <sup>-5</sup>
TCH/H4.8	(BER)	0.40 %	0.40 %	0.10 %	0.70 %
TCH/H2.4	(BER)	10 <sup>-4</sup>	10 <sup>-4</sup>	10 <sup>-4</sup>	10 <sup>-4</sup>
TCH/FS	(FER)	3.0 $\alpha$ %	3.0 $\alpha$ %	2.0 $\alpha$ %	7.0 $\alpha$ %
- class Ib	(RBER)	0.30/ $\alpha$ %	0.30/ $\alpha$ %	0.20/ $\alpha$ %	0.50/ $\alpha$ %
- class II	(RBER)	8.0 %	8.0 %	7.0 %	9.0 %
TCH/HS	(FER)	4.2 %	4.2 %	4.1 %	5.0 %
- class Ib	(RBER, BFI=0)	0.38 %	0.38 %	0.28 %	0.63 %
- class II	(RBER, BFI=0)	6.9 %	6.9 %	6.8 %	7.8 %
-	(UFR)	5.7 %	5.7 %	5.0 %	8.1 %
- class Ib	(RBER, UFI=0)	0.26 %	0.26 %	0.21 %	0.35 %
-	(EVSIDR)	7.0 %	7.0 %	6.0 %	9.9 %
-	(RBER, SID=2 and BFI=0)	0.01 %	0.01 %	0.01 %	0.02 %
-	(ESIDR)	3.0 %	3.0 %	3.2 %	3.9 %
-	(RBER, SID=1 or 2)	0.33 %	0.33 %	0.21 %	0.45 %

The value of  $\alpha$  in table 17a,b shall be between 1 and 1.6, and shall be the same for both occurrences in each propagation condition; it may be different for different propagation conditions.

NOTE: For each TU50 (ideal FH), sufficient decorrelation may be achieved with 4 frequencies spaced over 5 MHz.

#### 7.4.5 Requirement Reference

GSM 05.05 (ETS 300 577) [7] subclause 6.2.

#### 7.5 Reference interference level

##### 7.5.1 Test Purpose

The reference interference level is a measure of the capability of the receiver to receive a wanted modulated signal without exceeding a given degradation due to the presence of an unwanted modulated signal at the same carrier frequency (co-channel interference) or at any adjacent carrier frequencies (adjacent channel interference).

##### 7.5.2 Test Case

If Slow Frequency Hopping (SFH) is supported by the BSS, it shall be disabled during this measurement, except when performing tests using propagation conditions with ideal SFH.

When SFH is used in the test, the BSS shall hop over the maximum range and number of ARFCNs possible for the test environment and which are available in the BSS configuration. If SFH is not supported, the test shall be performed on the specified number of ARFCNs. As a minimum, one time slot shall be tested on one TRX.

Two input signals shall be connected to the receiver via a combining network. When testing each signal shall be connected through a Multipath Fading Simulator (MFS) as described in annex B.1, except in the cases of relative levels of +41 dB, where the interferer shall be static. The two multipath fading propagation conditions shall be uncorrelated.

The referred power level for both signals shall be the average power into the BSS RX antenna connector. This shall be measured by taking the average of the logarithmic value over the useful part of the wanted burst over the integration period appropriate for the logical channel type, as defined in annex A, table A.2.

The wanted signal shall have the power level as defined in table 18. It shall have normal GSM modulation.

**Table 18: Test signal average input level for Reference Interference Level measurements**

BTS Type	Test signal average input level to receiver
GSM 900/DCS 1 800 BTS	-84 dBm
GSM 900 micro-BTS M1	-77 dBm
GSM 900 micro-BTS M2	-72 dBm
GSM 900 micro-BTS M3	-67 dBm
DCS 1 800 micro-BTS M1	-82 dBm
DCS 1 800 micro-BTS M2	-77 dBm
DCS 1 800 micro-BTS M3	-72 dBm

The interfering signal shall be continuous and have GSM modulation of a pseudo-random bitstream without midamble. For SFH this interferer shall consist of either one signal which hops in synchronization with the time slot under test or a number of fixed frequency signal sources. In the latter case the number of interfering sources determines the number of frequencies over which the time slot under test can hop in the test environment irrespective of the upper limit of the BTS.

The test shall be performed with frequency offsets of the interfering signal from the wanted signal, for a relative level of interfering signal above the wanted signal as specified in table 19. In the case of Slow Frequency Hopping (SFH) the interfering signal shall be on the same ARFCN as the wanted signal over the useful part of the time slot burst. For offsets greater than 0 kHz only the multipath propagation condition TU50 (no SFH) need be tested.

**Table 19: Co-channel and adjacent channel interference rejections**

Interferers offset:	Relative level:	Fading of interferer
0 kHz	-9 dB	yes
200 kHz	9 dB	yes
400 kHz	41 dB	no

All TRXs in the BSS configuration shall be on and transmitting full power in all time slots

The input signal before channel encoding in the BSSTE shall be compared with the signal which is obtained from the BSS receiver after channel decoding.

### 7.5.3 Essential conformance

Test Environment:

Normal.



**Conformance Requirement**

## 1) Co-channel:

The error performance shall be measured for TCH/FS channel (FER, class Ib and class II), for TU50 propagation condition. If synthesizer SFH is supported by the BSS, this shall be enabled, with the range of hopping frequencies shall be centred around RF channel M. If synthesizer SFH is not supported, this shall be tested on one ARFCN channel.

With SFH disabled, the error performance for each of the following logical channel types supported by the BSS shall be measured, each on one ARFCN, for the specified propagation conditions:

TCH/FS:	TU1.5 or TU3
FACCH/F:	TU1.5 or TU3
FACCH/H:	TU1.5 or TU3
SDCCH:	TU1.5 or TU3
TCH/F9.6:	TU1.5 or TU3, TU50
TCH/F4.8:	TU1.5 or TU3, TU50

## 2) 200 kHz offset:

With SFH disabled, the error performance for each of the following logical channel types supported by the BSS shall be measured, each on one ARFCN, for the specified propagation conditions:

TCH/FS:	TU50
FACCH/F:	TU50

## 3) 400 kHz offset:

With SFH disabled, the error performance for each of the following logical channel types supported by the BSS shall be measured, each on RF channels B, M and T, for the specified propagation conditions:

TCH/FS:	TU50
---------	------

With SFH disabled, the error performance for each of the following logical channel types supported by the BSS shall be measured, each on one ARFCN, for the specified propagation profiles:

FACCH/F:	TU50
----------	------

In all the above cases, the error performance given in table 20a-d shall be met for all combinations of logical channel type, frequency of wanted signal, frequency offset of interfering signal and multipath propagation condition tested.

The value of  $\alpha$  in table 20a-d shall be in the range 1 to 1.6, and shall be the same for both occurrences in each propagation condition; it may be different for different propagation conditions.

**7.5.4 Complete conformance**

Test Environment:

Normal.

**Conformance Requirement**

The error performance of any logical channel type for any multipath propagation condition given in table 20a-d shall not be worse than the error ratios given in table 20a-d. For control channels not listed in table 20 the requirements for the SDCCH shall apply. The requirements for propagation conditions with ideal SFH shall only apply if SFH is supported by the BSS.

For the propagation conditions with ideal SFH, the tests shall be performed with the range of hopping frequencies centred around RF channel M. For propagation conditions with no SFH, the tests shall be performed at the RF channels B, M, and T.

The value of  $\alpha$  in table 20a-d shall be in the range 1 to 1.6, and shall be the same for both occurrences in each propagation condition; it may be different for different propagation conditions.

NOTE 1: For TU50 (ideal FH), sufficient decorrelation may be achieved with 4 frequencies spaced over 5 MHz. For TU3 (ideal FH), and TU1.5 (ideal FH), sufficient decorrelation cannot readily be achieved. These performance requirements are given for information purposes and need not be tested.

NOTE 2: The requirements in GSM 05.05 (ETS 300 577) [7] for performance with TU1.5 or TU3 (ideal FH) propagation condition need not normally be tested because these are inherently tested by TU50 (ideal FH) together with TU3 (no FH) or TU1.5 (no FH).

**Table 20a: GSM 900 Multipath error performance limits at RX interference level**

Channel Type	Error Measure	Error Ratios for the specified propagation conditions				
		TU3 (no SFH)	TU3 (ideal SFH)	TU50 (no SFH)	TU50 (ideal SFH)	RA250 (no SFH)
FACCH/H	(FER)	22 %	6.7 %	6.7 %	6.7 %	5.7 %
FACCH/F	(FER)	22 %	3.4 %	9.5 %	3.4 %	3.5 %
SDCCH & SACCH	(FER)	22 %	9.0 %	13 %	9 %	8.0 %
RACH	(FER)	15 %	15 %	16 %	16 %	13 %
TCH/F9.6	(BER)	8.0 %	0.30 %	0.80 %	0.30 %	0.2 %
TCH/F4.8	(BER)	3.0 %	10 <sup>-4</sup>	10 <sup>-4</sup>	10 <sup>-4</sup>	10 <sup>-4</sup>
TCH/F2.4	(BER)	3.0 %	10 <sup>-5</sup>	10 <sup>-4</sup>	10 <sup>-5</sup>	10 <sup>-5</sup>
TCH/H4.8	(BER)	8.0 %	0.30 %	0.80 %	0.30 %	0.20 %
TCH/H2.4	(BER)	4.0 %	10 <sup>-4</sup>	2 10 <sup>-4</sup>	10 <sup>-4</sup>	10 <sup>-4</sup>
TCH/FS	(FER)	21 $\alpha$ %	3.0 $\alpha$ %	6.0 $\alpha$ %	3.0 $\alpha$ %	3.0 $\alpha$ %
- class Ib	(RBER)	2.0/ $\alpha$ %	0.20/ $\alpha$ %	0.40/ $\alpha$ %	0.20/ $\alpha$ %	0.20/ $\alpha$ %
- class II	(RBER)	4.0 %	8.0 %	8.0 %	8.0 %	8.0 %
TCH/HS	(FER)	19.1 %	5.0 %	5.0 %	5.0 %	4.7 %
- class Ib	(RBER, BFI=0)	0.52 %	0.27 %	0.29 %	0.29 %	0.21 %
- class II	(RBER, BFI=0)	2.8 %	7.1 %	7.1 %	7.1 %	7.0 %
-	(UFR)	20.7 %	6.2 %	6.1 %	6.1 %	5.6 %
- class Ib	(RBER, UFI=0)	0.29 %	0.20 %	0.21 %	0.21 %	0.17 %
-	(EVSIDR)	21.9 %	7.1 %	7.0 %	7.0 %	6.3 %
-	(RBER, SID=2 and BFI=0)	0.02 %	0.01 %	0.01 %	0.01 %	0.01 %
-	(ESIDR)	17.1 %	3.6 %	3.6 %	3.6 %	3.4 %
-	(RBER, SID=1 or 2)	0.50 %	0.27 %	0.26 %	0.26 %	0.20 %

Table 20b: DCS 1 800 Multipath error performance limits at RX interference level

Channel Type	Error Measure	Error Ratios for the specified propagation conditions				
		TU1.5 (no SFH)	TU1.5 (ideal SFH)	TU50 (no SFH)	TU50 (ideal SFH)	RA130 (no SFH)
FACCH/H	(FER)	22 %	6.7 %	6.9 %	6.9 %	5.7 %
FACCH/F	(FER)	22 %	3.4 %	3.4 %	3.4 %	3.5 %
SDCCH & SACCH	(FER)	22 %	9.0 %	9.0 %	9.0 %	8.0 %
RACH	(FER)	15 %	15 %	16 %	16 %	13 %
TCH/F9.6	(BER)	8.0 %	0.30 %	0.80 %	0.30 %	0.2 %
TCH/F4.8	(BER)	3.0 %	10 <sup>-4</sup>	10 <sup>-4</sup>	10 <sup>-4</sup>	10 <sup>-4</sup>
TCH/F2.4	(BER)	3.0 %	10 <sup>-5</sup>	10 <sup>-5</sup>	10 <sup>-5</sup>	10 <sup>-5</sup>
TCH/H4.8	(BER)	8.0 %	0.30 %	0.80 %	0.30 %	0.20 %
TCH/H2.4	(BER)	4.0 %	10 <sup>-4</sup>	10 <sup>-4</sup>	10 <sup>-4</sup>	10 <sup>-4</sup>
TCH/FS	(FER)	21 $\alpha$ %	3.0 $\alpha$ %	3.0 $\alpha$ %	3.0 $\alpha$ %	3.0 $\alpha$ %
- class Ib	(RBER)	2.0/ $\alpha$ %	0.20/ $\alpha$ %	0.25/ $\alpha$ %	0.25/ $\alpha$ %	0.20/ $\alpha$ %
- class II	(RBER)	4.0 %	8.0 %	8.1 %	8.1 %	8.0 %
TCH/HS	(FER)	19.1 %	5.0 %	5.0 %	5.0 %	4.7 %
- class Ib	(RBER, BFI=0)	0.52 %	0.27 %	0.29 %	0.29 %	0.21 %
- class II	(RBER, BFI=0)	2.8 %	7.1 %	7.2 %	7.2 %	7.0 %
-	(UFR)	20.7 %	6.2 %	6.1 %	6.1 %	5.6 %
- class Ib	(RBER, UFI=0)	0.29 %	0.20 %	0.21 %	0.21 %	0.17 %
-	(EVSIDR)	21.9 %	7.1 %	7.0 %	7.0 %	6.3 %
-	(RBER, SID=2 and BFI=0)	0.02 %	0.01 %	0.01 %	0.01 %	0.01 %
-	(ESIDR)	17.1 %	3.6 %	3.6 %	3.6 %	3.4 %
-	(RBER, SID=1 or 2)	0.50 %	0.27 %	0.26 %	0.26 %	0.20 %

Table 20 c: GSM 900 Multipath error performance limits at RX interference level offset 400 kHz

Channel Type	Error Measure	Error Ratios for the specified propagation conditions
		TU50 (no SFH)
FACCH/F	(FER)	17.1 %
TCH/FS	(FER)	10.2 $\alpha$ %
- class Ib	(RBER)	0.72 $\alpha$ %
- class II	(RBER)	8.8 %

Table 20 d: DCS 1 800 Multipath error performance limits at RX interference level offset 400 kHz

Channel Type	Error Measure	Error Ratios for the specified propagation conditions
		TU50 (no SFH)
FACCH/F	(FER)	6.1 %
TCH/FS	(FER)	5.1 $\alpha$ %
- class Ib	(RBER)	0.45 $\alpha$ %
- class II	(RBER)	8.9 %

### 7.5.5 Requirements Reference

GSM 05.05 (ETS 300 577) [7] subclause 6.3.

## 7.6 Blocking Characteristics

### 7.6.1 Test Purpose

Blocking and spurious response rejection is a measure of the ability of a BSS receiver to receive a wanted GSM modulated signal in the presence of an interfering signal; the level of the interfering signal is higher for the test of blocking than for spurious response.

### 7.6.2 Test Case

The manufacturer shall declare any intermediate frequencies (IF1 to IFn) used within the receiver, and the frequency of the local oscillator applied to the first receiver mixer.

- 1) This measurement is carried out in three stages:
  - a) an optional preliminary test to identify frequencies of interfering signal which require more detailed investigation;
  - b) measurement of blocking performance;
  - c) measurement of spurious response performance; this test need only be performed at those frequencies of interfering signal at which the specification for blocking is not met.
- 2) The BSS shall be configured to operate as close to the centre of the band as is possible. If Slow frequency hopping is supported by the BSS, it shall be disabled during these measurements.
- 3) The two RF signals shall be fed into the receiver antenna connector of the BSS using a combining network. The wanted signal shall be at the operating frequency of the receiver, shall be modulated with normal GSM modulation, and shall be at a level as specified in table 21. The measurement is only performed under static propagation conditions.

**Table 21: Power level of wanted signal for test of Blocking Characteristics**

BTS Type	Power level of Wanted Signal
GSM 900/DCS 1 800 BTS	-101 dBm
GSM 900 micro-BTS M1	-94 dBm
GSM 900 micro-BTS M2	-89 dBm
GSM 900 micro-BTS M3	-84 dBm
DCS 1 800 micro-BTS M1	-99 dBm
DCS 1 800 micro-BTS M2	-94 dBm
DCS 1 800 micro-BTS M3	-89 dBm

### PRELIMINARY TEST

- 4) This optional test may be performed to reduce the number of measurements required in step 8. If it is performed, this shall be at the frequencies specified below.
- 5) The test shall be performed for an interfering signal at all frequencies which are integer multiples of 200 kHz, and which fall within one or more of the frequency ranges listed below, but excluding frequencies which exceed 12.75 GHz or are less than 600 kHz from the wanted signal:
  - a) from
    - PGSM 900: 790 MHz to 1 015 MHz inclusive.
    - EGSM 900: 780 MHz to 1 015 MHz inclusive.
    - DCS 1 800: 1 610 MHz to 1 885 MHz inclusive.
  - b) PGSM 900 and EGSM900:
    - from  $F_{lo} - (IF1 + IF2 + \dots + IFn + 12.5 \text{ MHz})$  to  $F_{lo} + (IF1 + IF2 + \dots + IFn + 12.5 \text{ MHz})$ .
 DCS 1 800:
    - from  $F_{lo} - (IF1 + IF2 + \dots + IFn + 37.5 \text{ MHz})$  to  $F_{lo} + (IF1 + IF2 + \dots + IFn + 37.5 \text{ MHz})$ .
  - c) from  $IF1 - 400 \text{ kHz}$  to  $IF1 + 400 \text{ kHz}$ .

- d) All of the ranges:  
 mFlo - IF1 - 200 kHz to mFlo - IF1 + 200 kHz  
 and  
 mFlo + IF1 - 200 kHz to mFlo + IF1 + 200 kHz
- e) All integer multiples of 10 MHz

Where: Flo is the frequency of the local oscillator applied to the first receiver mixer.  
 IF1 ... IFn are the n intermediate frequencies.  
 m is all positive integers.

To reduce test time, a shortened test procedure according to annex A of this I-ETS may be used, with an upper limit of measurement of 4 GHz.

- 6) The interfering signal shall be frequency modulated with a modulation frequency of 2 kHz and a peak deviation of  $\pm 100$  kHz.
- 7) For separations between the wanted and interfering signals of:  
 PGSM 900 and EGSM 900: 45 MHz or less.  
 DCS 1 800: 95 MHz or less.

the level of the interfering signal at the receiver input shall be:

GSM 900: -3 dBm.  
 DCS 1 800: -15 dBm.

For greater separations, the level of the interfering signal shall be +10 dBm.

The Residual Bit Error Ratio (RBER) for the TCH/FS channel using class II bits shall be measured. All frequencies at which the RBER exceeds 10 % shall be recorded for further study. A relaxed statistical significance may be used for this measurement, compared to that of step 9).

## BLOCKING TEST

- 8) If the preliminary test has been performed, this test shall be performed at all frequencies which have been recorded at step 7. If the preliminary test has not been performed, this test shall be performed at all frequencies specified in step 5.

The interfering signal shall be unmodulated, and shall have a level at the receiver input as specified in table 22.

- 9) The RBER for the TCH/FS channel using class II bits shall be measured. All frequencies at which the RBER exceeds 2.0 % shall be recorded.

For this test, in band frequencies are defined as follows:

PGSM900: 870 MHz to 925 MHz;  
 EGSM900: 860 MHz to 925 MHz;  
 DCS 1 800: 1 690 MHz to 1 805 MHz.

NOTE: The methodology for the measurement of BER is described in annex A.

fo is the frequency of the wanted signal

**Table 22: Level of interfering signal for blocking**

Frequency band	GSM 900 (dBm)				DCS 1 800 (dBm)			
	BTS	M1	micro-BTS M2	M3	BTS	M1	micro-BTS M2	M3
in - band:								
fo $\pm$ 600 kHz	-26	-31	-26	-21	-35	-40	-35	-30
800 kHz $\leq$  f-fo  < 3 MHz	-16	-21	-16	-11	-25	-30	-25	-20
3 MHz $\leq$  f-fo	-13	-21	-16	-11	-25	-30	-25	-20
out - of - band	8	8	8	8	0	0	0	0

For PGSM900 and EGSM900 the blocking level in the band 925 MHz to 935 MHz is relaxed to 0 dBm.

### Spurious response

- 10) This test shall be performed at all frequencies which have been recorded at step 9. The interfering signal shall be unmodulated, and shall have a level of -43 dBm.
- 11) The RBER for TCH/FS channel using class II bits shall be measured.

### 7.6.3 Essential conformance

Test environment:

Normal: One TRX shall be tested.

### Conformance Requirement

For step 9) (blocking), the recorded frequencies shall meet all of the following requirements:

- a) For measurement frequencies which are:
  - GSM 900: 45 MHz or less from the wanted signal, the total number does not exceed six.
  - DCS 1 800: 95 MHz or less from the wanted signal, the total number does not exceed twelve.
- b) For measurement frequencies which are:
  - GSM 900: 45 MHz or less from the wanted signal, no more than three are consecutive.
  - DCS 1 800: 95 MHz or less from the wanted signal, no more than three are consecutive.
- c) For measurement frequencies which are:
  - GSM 900: more than 45 MHz from the wanted signal, the total number does not exceed twenty four.
  - DCS 1 800: more than 95 MHz from the wanted signal, the total number does not exceed twenty four.
- d) For measurement frequencies which are:
  - GSM 900: more than 45 MHz below the wanted signal, no more than three are consecutive.
  - DCS 1 800: more than 95 MHz below the wanted signal, no more than three are consecutive.

For step 11) (spurious response), the RBER shall never exceed 2.0 %.

### 7.6.4 Complete conformance

The requirements of essential conformance shall apply.

### 7.6.5 Requirements reference

GSM 05.05 (ETS 300 577) [7] subclause 5.1.

## 7.7 Intermodulation characteristics

### 7.7.1 Test Purpose

This test measures the linearity of the receiver RF parts. It expresses the capability of the receiver to receive a wanted modulated signal without exceeding a given degradation due to the presence of two or more unwanted signals with a specific frequency relationship to the wanted signal frequency.

### 7.7.2 Test Case

If SFH is supported by the BSS, it shall be disabled during this measurement. The measurement is performed only under static conditions for the TCH/FS using class II bits. The measurement shall be performed for the radio frequency channels B, M and T. As a minimum, one time slot shall be tested on one TRX to be tested.

Three signals shall be applied to the receiver via a combining network. The powers of the signals are measured at the receiver antenna connector.

The wanted signal shall have normal GSM modulation originating from the BSSTE and have a power level as defined in table 23.

The second signal is an interfering signal, modulated by a pseudo-random bit sequence, and shall be 1.6 MHz above the wanted signal frequency. During the useful part of the burst of the wanted signal, the modulation of this interfering signal shall be any 148-bits subsequent of the 511-bits sequence, defined in CCITT Recommendation O.153 fascicle IV.4., and the power shall be -43 dBm for GSM and -49 dBm for DCS 1 800.

NOTE: This signal can be a continuous signal modulated by the 511-bits sequence.

The third signal is an interfering signal and shall be unmodulated. It shall be 800 kHz above the wanted signal frequency, and the power shall be -43 dBm for GSM and -49 dBm for DCS 1 800.

The various signals are illustrated in figure 5.

**Table 23: Wanted signal level for testing of Intermodulation Characteristics**

BTS Type	Power level of Wanted Signal
GSM 900/DCS 1 800 BTS	-101 dBm
GSM 900 micro-BTS M1	-94 dBm
GSM 900 micro-BTS M2	-89 dBm
GSM 900 micro-BTS M3	-84 dBm
DCS 1 800 micro-BTS M1	-99 dBm
DCS 1 800 micro-BTS M2	-94 dBm
DCS 1 800 micro-BTS M3	-89 dBm

The unprotected class II bits obtained from the BSS receiver after channel decoding and before any extrapolation shall be compared with the unprotected class II bits originating from the BSSTE.

The RBER of the TCH/FS class II bits shall be measured.

The measurement shall be repeated with the unwanted signal frequencies below the carrier frequency of the wanted signal.

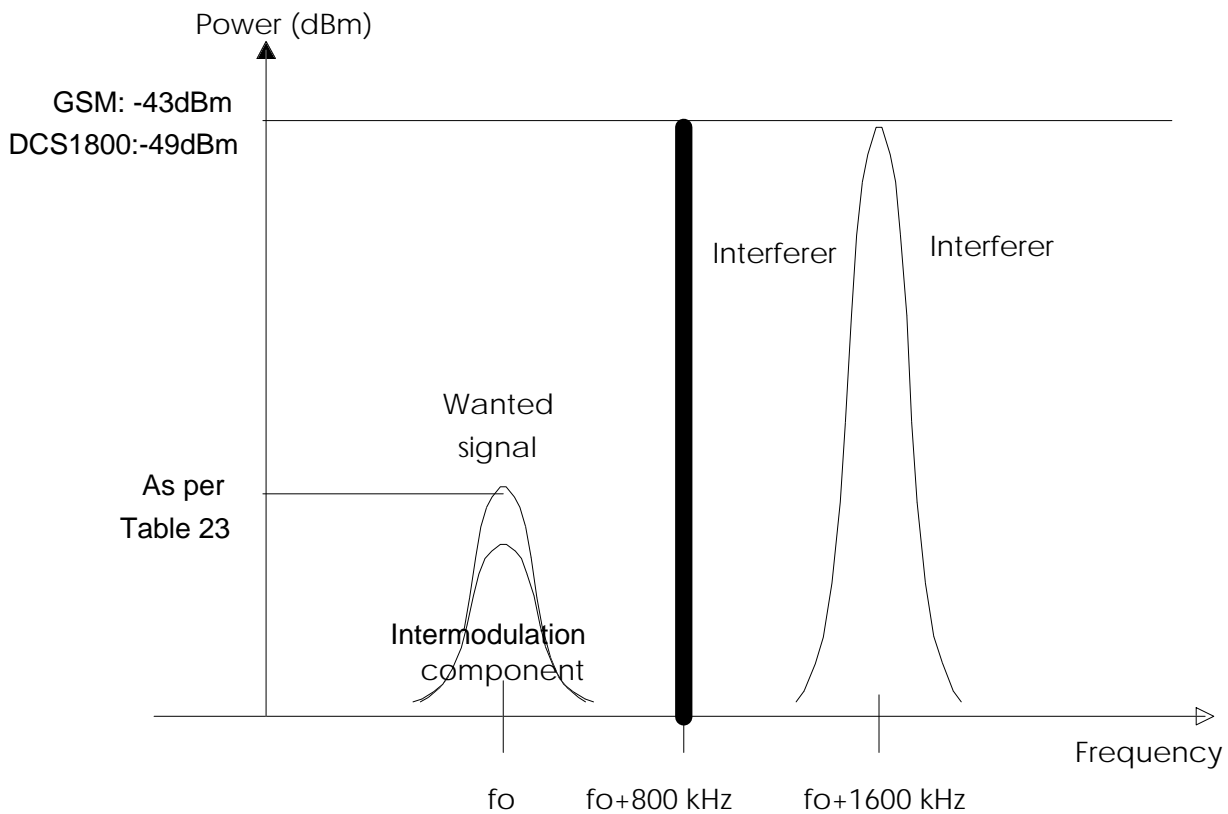

Figure 5: Example of RX intermodulation rejection

### 7.7.3 Essential conformance

Test Environment:

Normal: One TRX shall be tested.

#### Conformance Requirement

The RBER of TCH/FS Class II shall not exceed 2.0 %.

NOTE: This conformance requirement together with conformance to subclause 7.5 (Reference Interference Level) is sufficient to demonstrate compliance to GSM 05.05 (ETS 300 577) [7] subclause 5.3 for all logical channel types.

### 7.7.4 Complete conformance

Test Environment:

Normal: Each TRX shall be tested.

#### Conformance Requirement

The RBER of TCH/FS Class II shall not exceed 2.0 %.

NOTE: This conformance requirement together with conformance to subclause 7.5 (Reference Interference Level) is sufficient to demonstrate compliance to GSM 05.05 (ETS 300 577) [7] subclause 5.3 for all logical channel types.

### 7.7.5 Requirement Reference

GSM 05.05 (ETS 300 577) [7] subclause 5.3.



## 7.8 AM suppression

### 7.8.1 Test Purpose

AM suppression is a measure of the ability of a BSS receiver to receive a wanted GSM modulated signal without exceeding a given degradation due to the presence of an unwanted modulated signal.

### 7.8.2 Test Case

This test shall be performed at any one ARFCN on one TRX. If Slow Frequency Hopping (SFH) is supported by the BSS, it shall be disabled during this measurement. The measurement is performed only under static conditions.

The wanted signal shall have normal GSM modulation with a power level as defined in table 24.

**Table 24: Test signal input level**

BTS Type	Test signal Input Level to receiver
GSM 900/DCS 1 800 BTS	-101 dBm
GSM 900 micro-BTS M1	-94 dBm
GSM 900 micro-BTS M2	-89 dBm
GSM 900 micro-BTS M3	-84 dBm
DCS 1 800 micro-BTS M1	-99 dBm
DCS 1 800 micro-BTS M2	-94 dBm
DCS 1 800 micro-BTS M3	-89 dBm

The interfering signal is modulated according to GSM characteristics (with or without a midamble) with a pseudo random bit sequence of at least 511 bits length.

NOTE 1: A 148-bit sequence of the 511-bit of a pseudo-random bit sequence as defined in CCITT Recommendation 0.153 fascile IV.4 is recommended.

Its frequency (f) shall be in the relevant receive band, at least 6 MHz separated from the ARFCN under test. Frequency f is an integer multiple of 200 kHz and at least 2 ARFCNs separated from any identified spurious response in step 9 of the test case in subclause 7.6.2.

The interferer shall have one timeslot active, meeting the power/time mask of figure 1. The transmitted bursts shall be synchronized to but delayed in time between 61 and 86 bit periods relative to the bursts of the wanted signal. The mean level of the interferer over the useful part of the burst is defined in table 25.

**Table 25: Interfering signal level**

	Micro-BTS			
	BTS (dBm)	M1 (dBm)	M2 (dBm)	M3 (dBm)
GSM 900	-31	-34	-29	-24
DCS 1 800	-35	-33	-28	-23

The two input signals shall be connected to the receiver via a combining network. The referred power level for both signals shall be the power into the BSS RX antenna connector.

NOTE 2: When testing this requirement, a notch filter may be necessary to ensure that the co channel performance of the receiver is not compromised.

### **7.8.3 Essential conformance**

Test Environment:

Normal.

Conformance Requirement

For a TCH/FS the RBER of class II, class Ib and the FER the error performance shall not exceed the values given in table 15.

### **7.8.4 Complete conformance**

Test Environment:

Normal.

Conformance Requirement

The error performance given in table 15 shall be met for all logical channel types.

### **7.8.5 Requirement Reference**

GSM 05.05 [7] subclause 5.2.

## **7.9 Spurious emissions from the receiver antenna connector**

### **7.9.1 Test Purpose**

Spurious emissions are emissions at frequencies other than those of the BTS transmitter ARFCNs and adjacent frequencies. This test measures spurious emissions from the BTS receiver antenna connector.

### **7.9.2 Test Case**

The transmitter shall be configured with one TRX active. It shall be allocated to RF Channel M and shall transmit at full power on all time slots.

For a BTS equipped with diversity, the requirements of this subclause apply to each receiver antenna connector.

For a BTS equipped with a duplexer, and with only a single antenna connector for both transmitter and receiver the requirements of subclause 6.6 shall apply to this port, and this test need not be performed.

The receiver antenna connector shall be connected to a spectrum analyser or selective voltmeter with the same characteristic impedance.

The detecting device shall be configured as defined in table 26. Peak hold shall be enabled, and the video bandwidth shall be approximately three times the resolution bandwidth. If this bandwidth is not available on the detecting device, it shall be the maximum available, and at least 1 MHz.

The power shall be measured over the frequency ranges specified in table 26.

### **7.9.3 Essential conformance**

Test Environment:

Normal.

**Table 26: measurement conditions for Conducted Emissions from the Receiver Antenna Connector**

Frequency Band	Frequency offset	Resolution Bandwidth
100 kHz - 50 MHz		10 kHz
50 MHz - 500 MHz		100 kHz
500 MHz - 12.75 GHz and outside the relevant transmit band	(offset from the edge of the relevant transmit band)	
	≥ 2 MHz	30 kHz
	≥ 5 MHz	100 kHz
	≥ 10 MHz	300 kHz
	≥ 20 MHz	1 MHz
	≥ 30 MHz	3 MHz
Inside the relevant transmit band	(offset from the transmit carrier frequency)	
	≥ 1.8 MHz	30 kHz
	≥ 6 MHz	100 kHz

### Conformance Requirement

The measured power shall not exceed:

- 57 dBm for all frequencies up to 1 GHz.
- 47 dBm for all frequencies above 1 GHz.

#### 7.9.4 Complete conformance

The requirements of essential conformance shall apply.

#### 7.9.5 Requirement Reference

GSM 05.05 (ETS 300 577) [7] subclause 5.4.

## 8 Radiated spurious emissions

### 8.1 Test Purpose

This test measures radiated spurious emissions from the BSS cabinet, including emissions due to the transmitters.

### 8.2 Test Case

- a) A test site fulfilling the requirements of ETS 300 113 shall be used. The BTS shall be placed on a non-conducting support and shall be operated from a power source via an RF filter to avoid radiation from the power leads. The method of ETS 300 113 shall be used, except in any case where it conflicts with this I-ETS.

Radiation of any spurious components shall be detected by the test antenna and measuring receiver (e.g. a spectrum analyser). At each frequency at which a component is detected, the BSS shall be rotated and the height of the test antenna adjusted to obtain maximum response, and the effective radiated power of that component determined by a substitution measurement. The measurement shall be repeated with the test antenna in the orthogonal polarization plane.

- b) The BTS shall be configured with one transmitter active, at its maximum output power on all time slots, on the specified ARFCNs. Slow frequency hopping shall be disabled.

NOTE: It may be necessary to take steps to ensure that emissions from other transmitters which are not active do not influence the results. This may be achieved by, for example, equipping the BTS with only one TRX or by muting the outputs of the transmitters to a greater degree than otherwise required in GSM 05.05 (ETS 300 577) [7].

- c) The measuring receiver shall be configured with a resolution bandwidth of 30 kHz and a video bandwidth of approximately three times this value. Peak hold shall be enabled. The received power shall be measured for frequencies with an offset of  $1.8 \text{ MHz} \leq f < 6 \text{ MHz}$  from the carrier frequency, and which fall within the BTS transmitter band.

At each frequency at which a component is detected, the maximum effective radiated power of that component shall be determined, as described in step a).

- d) The measuring receiver shall be configured with a resolution bandwidth of 100 kHz and a video bandwidth of approximately three times this value. Peak hold shall be enabled. The received power shall be measured for frequencies with an offset of  $\geq 6 \text{ MHz}$  from the carrier frequency, and which fall within the BTS transmitter band.

At each frequency at which a component is detected, the maximum effective radiated power of that component shall be determined, as described in step a).

- e) The BSS shall be configured with all transmitters active at their maximum output power on all time slots. If a TRX is designated as being a dedicated BCCH, it shall be allocated to RF channel M. All remaining TRXs shall be allocated in the following order; first to RF channel B, then to T, then distributed as evenly as possible throughout the BSS transmit band. Slow frequency hopping shall be disabled.

The measuring receiver shall be configured as defined in table 27. Peak hold shall be enabled, and the video bandwidth shall be approximately three times the resolution bandwidth. If this video bandwidth is not available on the measuring receiver, it shall be the maximum available, and at least 1 MHz. The received power shall be measured over the frequency range 30 MHz to 4 GHz, excluding the BTS transmitter band.

**Table 27: Spurious Emissions Measurements outside the transmit band**

Frequency Band	Frequency offset	Resolution Bandwidth
30 MHz - 50 MHz		10 kHz
50 MHz - 500 MHz		100 kHz
500 MHz - 4 GHz and outside the relevant transmit band	(offset from the edge of the relevant transmit band)	
	≥ 2 MHz	30 kHz
	≥ 5 MHz	100 kHz
	≥ 10 MHz	300 kHz
	≥ 20 MHz	1 MHz
	≥ 30 MHz	3 MHz

At each frequency at which a component is detected, the maximum effective radiated power of that component shall be determined, as described in step a).

### 8.3 Essential conformance

Test Environment:

Normal:            Inside the TX band:        The test shall be performed with the TRX active on one ARFCN.  
                          Outside the TX band:        The test shall be performed once.

#### Conformance Requirement

- a) The power measured at steps c) and d) shall not exceed -36 dBm.
- b) The power measured at step e) shall not exceed:
  - 36 dBm for frequencies up to 1 GHz.
  - 30 dBm for frequencies above 1 GHz.

### 8.4 Complete conformance

Test Environment:

Normal:            Inside the TX band:        The test shall be performed three times with the TRX on one of the RF channels B, M, and T.  
                          Outside TX band:            The test shall be repeated until a measurement has been made with a TRX active on B, M and T.

NOTE:            For a BSS with 3 or more TRX, this requires only one measurement.

#### Conformance Requirement

- a) The power measured at steps c) and d) shall not exceed -36 dBm.
- b) The power measured at step e) shall not exceed:
  - 36 dBm for frequencies up to 1 GHz.
  - 30 dBm for frequencies above 1 GHz.

### 8.5 Requirement reference

GSM 05.05 (ETS 300 577) [7], subclause 4.3.

## **9 Radio link management**

This Interim standard has an I-ETS status at present as Radio link management has not been included at this stage. Radio link management tests will not need to be performed for essential conformance purposes.

## Annex A (informative): Testing of statistical parameters

When measuring statistical parameters like Bit Error Rates (BERs) or Frame Erasure Rates (FERs), the statistical nature of the error events may result in a natural variance in the observed test results. This variance will depend on the number of events observed. Consequently, due to such statistical limitations with the aim to reduce the test time to a minimum, some overall requirements should be met, indicating a certain confidence in the observed results.

Defining a "good" BSS as a BSS which on a long term basis (tested over an infinite time) meets the system requirement for an individual test, and a "bad" BSS as a BSS which on a long term basis fails the system requirement for an individual test, the overall requirements are the following:

- 1) The probability of passing a "good" BSS should be as high as possible.
- 2) The probability of passing a "bad" BSS should be as low as possible.

### A.1 General theoretical methodology

Statistical parameters are measured as a number of error events  $M$  within a set of observed events (or samples)  $N$ , and the ratio  $M/N$  is used as the estimated value. This estimate has a given uncertainty due to the limited statistical material, i.e. the number of samples  $N$ . The general methodology to ensure correct PASS / FAIL decisions is outlined in the following.

Given a random variable  $X_i$  output from a random process indicating error/no error, the probability of an error is  $p$  and consequently, the probability of no error is  $1-p$ . The expected value  $E(X_i)$  and variance  $Var(X_i)$  as given in (Eq 1), according to the binomial probability distribution.

$$E(X_i) = p \quad (\text{Eq 1a})$$

$$Var(X_i) = p - p^2 \quad (\text{Eq 1b})$$

If the number of samples of the event is  $N$ , the average  $X$  of the random variables  $X_i$  is of interest, which has the expected value  $E(X)$  and variance  $Var(X)$  given in (Eq 2), assuming that the random variables  $X_i$  are independent.

$$E(X) = p \quad (\text{Eq 2a})$$

$$Var(X) = (p - p^2) / N \quad (\text{Eq 2b})$$

Assuming that the error probability  $p$  is small, the formula can be simplified as in (Eq 3).

$$E(X) = p \quad (\text{Eq 3a})$$

$$Var(X) = p / N \quad (\text{Eq 3b})$$

Furthermore, if the number of samples  $N$  is great, the probability density of  $X$  may be assumed to be Gaussian and the confidence intervals needed can easily be found.

Assuming that a "good" BSS has the real performance  $P_g$  when measured over an infinite time and that a "bad" BSS has the corresponding performance  $P_b$ , the relationships to the system requirement  $P_s$  are the following:

$$P_g \leq P_s \quad (\text{Eq 4a})$$

$$P_b > P_s \quad (\text{Eq 4b})$$

Irrespective of the values of  $P_g$  and  $P_b$ , the aim would ideally be to guarantee that the probabilities of passing a "good" BSS,  $P(\text{PASS}|P_g)$  and the probability of failing a "bad" BSS,  $P(\text{FAIL}|P_b)$  are as high as possible. Given a certain  $P_g$  and a certain  $P_b$ , this can be done by increasing the number of samples  $N$  until the distributions around  $P_g$  and  $P_b$  are "narrow" enough, i.e. the variances are sufficiently reduced, so that there is sufficient space in between for a test requirement  $P_t$  with the required confidence. The principle is illustrated in figure A.1 with  $P_g=P_s$ .

In practice, the above ideal approach can not be used since when  $P_g$  or  $P_b$  get very close to  $P_s$ , the needed number of samples to reduce the variances would be infinite. However, what can be done is to represent  $P_g$  by the worst-case  $P_s$  and to have a certain confidence of failing a BSS which is a given

amount worse than  $P_s$ , i.e. with a fixed  $P_b$ . This will, however, give less confidence in failing a "bad" BSS which has a performance closer to  $P_s$ . This is the exact principle illustrated in figure A.1.

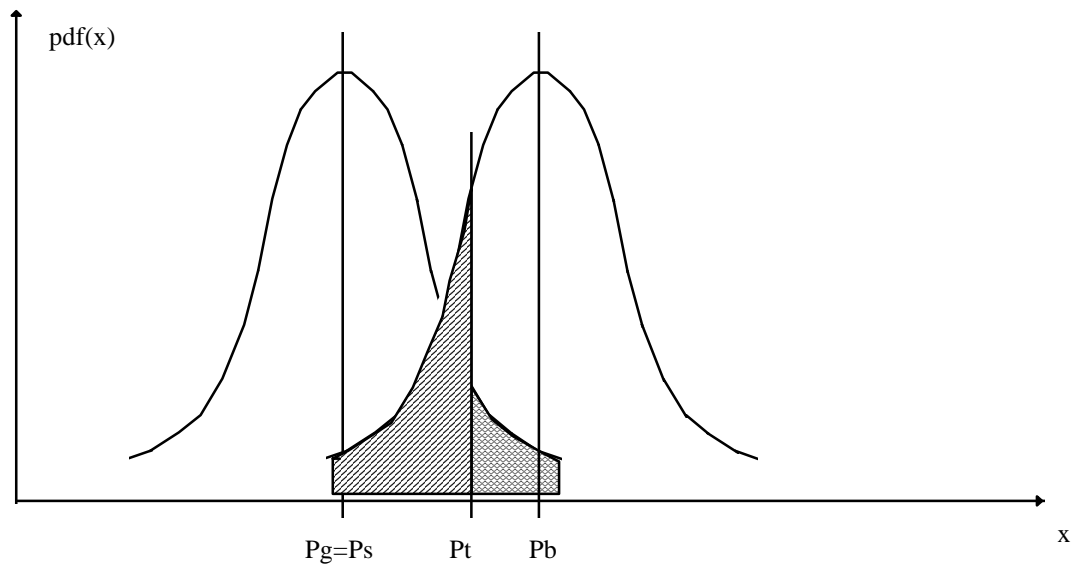

- $P_s$  = system requirement
- $P_t$  = test requirement
- $P_g$  = real performance of a "good" BTS
- $P_b$  = real performance of a "bad" BTS

**Figure A.1: Statistical testing**

The test requirement  $P_t$  will then be as in equation (Eq 5) for the overall requirements depending on  $P_s$  and  $P_b$ , and on the needed number of samples  $N$ :

$$P_t = P_s + G (P_s/N)^{1/2} \quad (\text{Eq 5a})$$

$$P_t = P_b - B (P_b/N)^{1/2} \quad (\text{Eq 5b})$$

$G$  and  $B$  are the ordinates (in fact the inverse Gaussian Q-function) giving the normalized Gaussian distribution confidence intervals required for passing a "good" BSS and failing a "bad" BSS, respectively.

Finally, if the ratio  $P_b/P_s$  is fixed, the number of samples is given by the following equations (Eq 6).

$$N = \frac{(G + K^{1/2} B)^2}{(K - 1)^2 P_s} \quad (\text{Eq6a})$$

$$P_b = K P_s \quad (\text{Eq 6b})$$



## A.2 Detailed theoretical methodology

The total number of statistical tests indicated in annex C (excluding blocking, intermodulation etc.) are:

GSM 900: 95  
DCS 1 800: 96

and the rules of the tests are as follows:

- in order to pass a BSS it should pass all tests.
- a single test which fails should be repeated once. If the BSS fails a 2nd time, the BSS has failed.

This means that the overall probability of passing a good BSS through all the tests is lower than for the individual tests.

Taking into account the total of

GSM 900: 95 tests,  
DCS 1 800: 96 tests,

assuming that the outcomes of the tests are independent, and requiring that the total probability of passing a "good" BSS should be equal to the total probability of failing a "bad" BSS, the overall confidence requirements in this annex should be as follows on a test by test basis:

$$\begin{aligned} P(\text{PASS}|\text{Ps}) &\geq 99.9 \% && (\text{i.e. } G = 3.09) \\ P(\text{FAIL}|\text{Pb}) &\geq 95.0 \% && (\text{i.e. } B = 1.65) \end{aligned}$$

With the above assumptions, the total probabilities of passing a "good" BSS and failing a "bad" BSS will be around 91.0 %.

NOTE 1: If for some reason not all tests are carried out, then the probability of failing a "bad" BSS,  $P(\text{FAIL}|\text{Pb})$ , should be increased accordingly.

Since the test requirement  $P_t$  will lie somewhere in between the system requirement  $P_s$  and  $P_b$ , and that an uncertainty in test equipment resulting from imperfections in the randomness of pseudo-random generators etc. can be expected to give errors of the order of  $\pm 5\%$ , the ratio  $P_b/P_s$  should be 2.

Under idealized assumptions, the resulting minimum number of samples needed to meet the overall confidence requirements is indicated as a function of the system requirement  $P_s$  using (Eq 6) in table A.1.

The ratio of the test requirement  $P_t$  to the system requirement  $P_s$  will in this case be:

$$P_t = 1.57 P_s$$

NOTE 2: It is possible to reduce the needed number of samples. In that case the ratio  $P_b/P_s$  should be increased, or the confidence levels should be reduced, see equation (Eq.5). It is preferable to keep the confidence and to increase  $P_b/P_s$ . However, the accepted error rate  $P_t$ , and  $P_b$ , should not deviate too much from the system requirement  $P_s$ , especially for high  $P_s$ . In order to have meaningful requirements it may even be desirable to reduce  $P_b/P_s$  for high  $P_s$ .

**Table A.1: Minimum number of samples for statistical testing**

Error rate $P_s$	Minimum number of samples
1.0 E-1	300
1.0 E-2	3 000
1.0 E-3	30 000
1.0 E-4	300 000
1.0 E-5	3 000 000

### A.3 Limitations and corrections to the theoretical methodology

The idealized assumptions resulting in table A.1 are:

- 1) All random variables  $X_i$  (error events) are assumed to be independent.
- 2) The observed random variable  $X$  is assumed to have a Gaussian distribution.
- 3) All random variables  $X_i$  (error events) are assumed to be outputs of stationary random processes with identical distributions.
- 4) The system requirement  $P_s$  is assumed to be sufficiently small.

#### A.3.1 Independent errors

The assumption that all error events are independent does not strictly hold. The fact that error events are mutually dependent, would increase the variance of the observed random variable  $X$ , and consequently, the number of samples needed for the confidence required should be multiplied by some factor indicating the number of error events which on average are completely correlated.

- For FERs the events occur so seldom that the events may be regarded as independent (factor of 1), the exception being TCH/FS and FACCH which should have a factor of 2.
- Since a convolutional decoder on average will produce burst errors of the order of the constraint length, BERs and RBERs should have a factor of 5.

Generally, the situation will be such that a "good" BSS will have a performance  $P_g$  which is better than  $P_s$ . Consequently, the number of samples found in all cases by (Eq 6) should be multiplied by an additional factor of 2.

#### A.3.2 Gaussian distribution

The assumption of a Gaussian distribution for the observed random variable  $X$  should hold in most cases due to the high number of samples used.

#### A.3.3 Stationary random processes

The assumption that the error events are outputs of stationary random processes with identical distributions holds generally for static propagation conditions. However, for multipath propagation conditions this is not true. On the other hand, the multipath propagation condition may be assumed to be stationary for short periods of time. Taking into account the worst-case situation of flat fading where the distance between fades is a wavelength, the characteristics of the propagation condition may be assumed to change e.g. 10 times per wavelength and to be short term stationary in between. This means that all the different random variables  $X_i$  (error events) have a different  $p_i$  and consequently different  $E(X_i)$  and  $\text{Var}(X_i)$ . Since all  $p_i$  are unknown and only the random variable  $X$ , which is the average of all  $X_i$ , is observed against a system requirement  $P_s$ , the statistical parameters of (Eq 7) result in the case of multipath propagation conditions assuming that all  $p_i$  are independent.

$$E(X) = 1/N \sum_{i=1}^N p_i = p \quad (\text{Eq 7a})$$

$$\text{Var}(X) = p/N - 1/N^2 \sum_{i=1}^N p_i^2 \quad (\text{Eq 7b})$$

Also in this case the variance can (and should) be simplified to  $p/N$  if all  $p_i$  are small. However, in this case the second term of (Eq 7b) is dominated by the greatest  $p_i$  and the simplification is less valid than for static propagation conditions. Nevertheless, the needed number of samples given by (Eq 6) is conservative because the variance would ideally be lower. On the other hand, if the fact that the different  $p_i$  are likely to be correlated with positive correlation is taken into account,  $\text{Var}(X)$  will increase and the simplification to  $p/N$  might be adequate.

Since under multipath conditions the observed random variable  $X$  results from an average of a set of random processes, we should ensure that the average takes into account a sufficient number of processes to get an overall stationary process. Requiring an average over 1000 wavelengths (or 10 000 processes if the multipath propagation condition is updated every 10th of a wavelength), the resulting observation period needed is indicated in table A.2 if the logical channel in question occupies the basic physical channel all the time. The percentage of the time "on the air" for the logical channel should also be taken into account and consequently, the observation period indicated in table A.2 will be increased by an inverse frame filling factor.

**Table A.2: Required observation periods under multipath**

<b>Multipath condition</b>	<b>Time per Wavelength</b>	<b>Required observation period</b>
TU1.5	800 ms	800s
TU3	400 ms	400 s
TU50	24 ms	24 s
HT100	12 ms	12 s
RA250	5 ms	5 s

#### **A.3.4 Low error ratios**

The assumption that the system requirement  $P_s$  is sufficiently small holds generally. However, when reaching a high  $P_s$ , e.g. around  $10 E^{-1}$ , the approximation in (Eq 3) is not strictly accurate. However, using the correct variance would decrease the needed number of samples, so the assumptions give conservative results.

#### **A.3.5 Total corrections**

As a conclusion, the various limitations of the assumptions discussed in the above subclauses all lead to different increases of the needed number of samples to obtain the required confidence. The different increases should all be taken into account by taking the highest increase, and calculated number of samples are indicated in annex C. The overall confidence resulting is possibly slightly lower than 99.9 % and 95.0 %, but it should be quite close. Considering as well that the different tests are likely to be correlated, will make the overall probabilities of passing a "good" BSS and failing a "bad" BSS higher than indicated.

NOTE: The worst case in terms of test time it is the static sensitivity performance for the SACCH/T, giving 7,9 hours. On average, the test times are around 35,6 min and range from 5,0 s.

#### A.4 Alternative experimental methodology

The alternative experimental methodology indicated in this subclause could be used to verify, or possibly modify, the needed number of samples indicated in the previous subclauses. This would be most useful in the case of multipath propagation conditions where the statistics are very complicated and can not easily fit into simple formulae.

The approach is indicated in the following, and should be carried out once and for all for each multipath propagation condition, for each logical channel and for each type of error event according to subclause A.5 to assess the needed number of samples. Then, it can be used ever after for any BSS.

- 1) Record the number of error events for  $N_p$  periods of  $N_s$  samples (events) under static propagation conditions for an average system requirement  $P_s$  and for a given type of error event on a given logical channel.
- 2) Estimate the error ratio  $ER_i = M_i/N_s$  for each of the  $N_p$  periods.
- 3) Consider the average ER of all  $ER_i$  and estimate the expected value  $E(ER)$  and the variance  $Var(ER)$ :

$$m = E(ER) = 1/N_p \sum_{i=1}^{N_p} ER_i \quad (\text{Eq 8a})$$

$$s^2 = Var(ER) = 1/N_p \sum_{i=1}^{N_p} ER_i^2 - m^2 \quad (\text{Eq 8b})$$

The test requirement  $P_t$  is found as follows:

$$P_t = P_s + G s \quad (\text{Eq 9a})$$

and

$$P_t = K P_s - B s \quad (\text{Eq 9b})$$

- 4) The test shall be repeated with a different number of samples  $N_s$  until the test requirement  $P_t$  differs with less than  $\pm 5\%$  in (Eq 9a) and (Eq 9b).

The initial number of samples  $N_s$  should be as indicated in annex 3 and the number of tests  $N_p$  should be 100.

The average system requirement  $P_s$  should be around  $1.0 \times 10^{-2}$ . It can then be assumed that the needed number of samples  $N_s$  is inversely proportional to  $P_s$ .

## A.5 Detailed definition of error events

### 1) Frame Erasure Ratio (FER):

The frame is defined as erased if the error detection functions in accordance with GSM 05.03 (ETS 300 575) [5] indicate an error. For full-rate speech this is the result of a 3 bit Cyclic Redundancy Check (CRC), for signalling the result of the FIRE code or other block code used. For data traffic the FER is not defined.

NOTE: For full-rate speech it would ideally be better if the Bad Frame Indication (BFI) is used as frame erasure indication since this is what is directly related to the subjective quality of the perceived speech. For the moment no requirements relate to the BFI, however, it is very difficult to assess what is subjectively the optimum combination of Frame Erasure Ratio (FER) and Residual Bit Error Ratio (RBER). This should therefore be avoided and it is essential that the BFI is optimized towards the ideal frame erasures independent of the processing to obtain it, and that the BFI is not biased towards BFI=0 or BFI=1.

### 2) Residual Bit Error Ratio (RBER):

The RBER is defined as the residual Bit Error Ratio (BER) in frames which have not been declared as erased.

### 3) Bit Error Ratio (BER):

The BER is the overall Bit Error Ratio (BER) independent of frame erasures or when erased frames are not defined.

## **Annex B (informative): Description of special test equipment**

### **B.1 Base Station System Test Equipment (BSSTE)**

The BSSTE is a functional tool for the purpose of acceptance testing of GSM Base Station Systems. The BSSTE functionally carries out all tests described in this equipment specification.

#### **B.1.1 Fading and multipath propagation simulator**

A Multipath Fading Simulator (MFS) is needed to perform some of the tests on the receiver, to simulate realistic wideband multipath propagation over the mobile radio channel (i.e. the path between the base station and mobile station antennas). The following set of standard multipath propagation conditions, as specified by COST 207 and described in GSM 05.05 (ETS 300 577) [7], are required:

- 1) Typical Urban terrain (TU).
- 2) Rural terrain (RA).
- 3) Hilly terrain (HT).

In addition the MFS needs to a special multipath profile, designed to verify the equalization capabilities of the receiver:

- 4) Equalizer (EQU)

The multipath profiles are used for a range of vehicle speeds

GSM 900: From 3 km/h to 250 km/h. The speeds 3, 50, 100 and 250 km/h are used in particular.

DCS 1 800: From 1.5 km/h to 130 km/h. The speeds 1.5, 50, 100 and 130 km/h are used in particular.

The details of the multipath conditions and the corresponding requirements on the MFS itself are to be found in GSM 11.10 (Mobile Station Conformity Specification).

The MFS is functionally a part of the BSSTE as described in this annex, but may physically be a separate piece of equipment.

### **B.2 Measurement set ups for TX intermodulation**

The following test set-ups are examples for possible solutions for the measurements according to subclauses 6.7 and 6.8. These measurements are very difficult to perform due to the extreme requirements of the dynamic range. To get reproducible measurements precautions should be taken, so that non-linearity's in the test set-up do not influence the measurement results.

NOTE 1: Care should be exercised in creating the test set-up and good quality cables and connectors should be used. Cables should be physically secured and not disturbed unless necessary.

NOTE 2: Connectors should be free of ferro-magnetic substances. Different surface materials on both connectors as well as the applied torque of the connection have an influence on the intermod-performance .

NOTE 3: Power attenuators normally have an insufficient intermod-performance at high power input levels. Therefore it is recommended to use long cables for attenuation where high power is applied.

#### **B.2.1 Test set-up for Intermodulation Attenuation (6.7)**

It is necessary to use different set-ups for the measurement of IM-products in the RX band and outside the RX band.

### B.2.1.1 RX-Band

A recommended test set-up for the intermodulation attenuation in the receive band is illustrated in figure B.1. A directional coupler is used with the measurement performed on the primary line connector. Sufficient filtering is provided by the duplexer so that the spectrum analyser operates in its linear range. The injected signal is amplified and filtered to provide sufficient isolation to inhibit self generated intermodulation products in the test set-up.

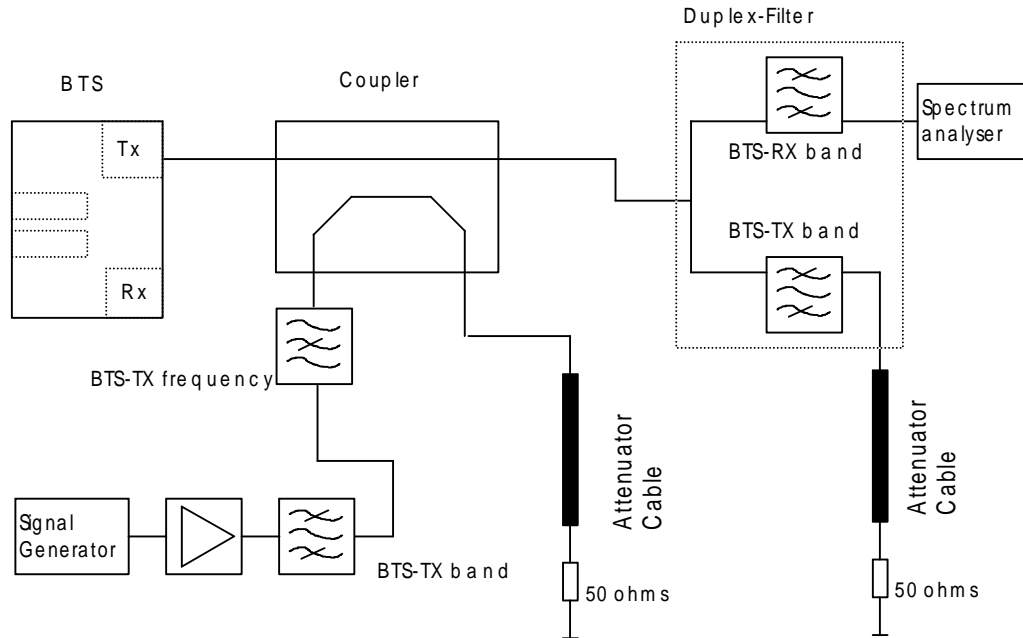

Figure B.1: Test set-up for Intermodulation Attenuation (6.7) RX-Band

### B.2.1.2 Outside RX Band

A recommended test set-up for the intermodulation attenuation outside the receive band is illustrated in figure B.2. The coupling device shall be specified to operate over sufficient bandwidth to comply with the measurement requirements.

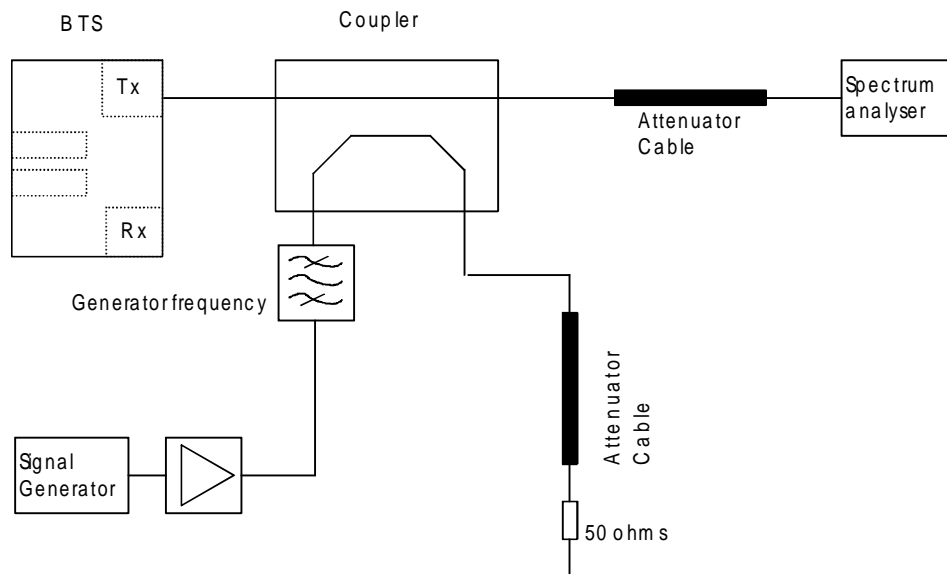

Figure B.2: Test set-up for Intermodulation Attenuation (6.7) outside RX-Band

### B.2.2 Test set-up for Intra BSS Intermodulation Attenuation (6.8)

It is necessary to use different set-ups for the measurement of IM-products in the RX band and in the TX band.

#### B.2.2.1 RX-Band

A recommended test set-up for the intra base station intermodulation attenuation in the receive band is illustrated in figure B.3.

The stop band attenuation of the duplex filter has to be high enough to guarantee that the spectrum analyser is working in its linear range.

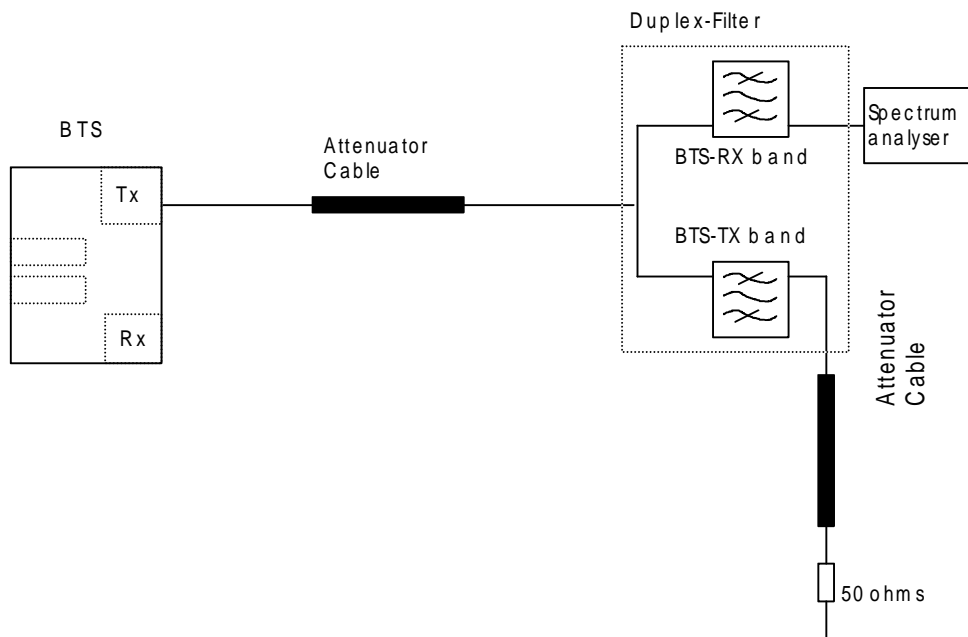

Figure B.3: Test set-up for Intra Base station Intermodulation Attenuation (6.8) RX-Band

#### B.2.2.2 TX-Band

A recommended test set-up for the intra base station intermodulation attenuation inside the transmit band is illustrated in figure B.4. To decrease the dynamic range requirement of the spectrum analyser external filters should be used.

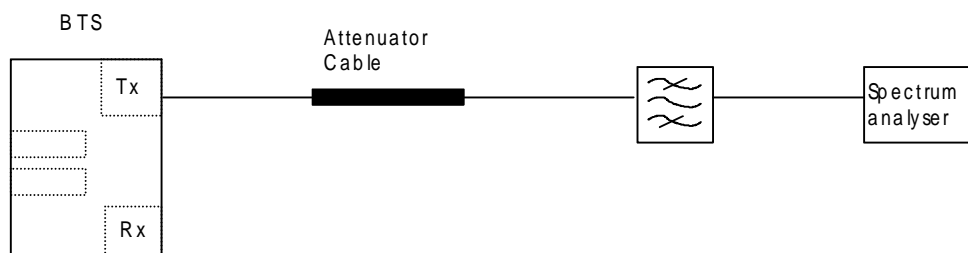

Figure B.4: Test set-up for Intra Base station Intermodulation Attenuation (6.8) TX-Band



**Annex C (informative): Number of samples needed for statistical testing****C.1 GSM 900; Number of samples for testing****GSM 900 SDCCH**

(FER: 4.25 events/s, frame filling = 4/51)

Prop. cond.	Error rate	Stat. sign.	Indep. samples	Station. proc.	Samples:	Time: (s)
static	FER=0.10%	30 000	2	-	60 000	14 117.6
TU50	FER=13%	231	2	1 301	1 301	306.1
TU50 (SFH)	FER=8%	375	2	1 301	1 301	306.1
RA250	FER=8.0%	375	2	271	750	176.5
HT100	FER=12%	250	2	651	651	153.2
TU3	FER=22%	136	2	21 675	21 675	5 100.0
TU3(SFH)	FER=9%	333	2	21 675	21 675	5 100.0
TU50	FER=13%	231	2	1 301	1 301	306.1
TU50 (SFH)	FER=9%	333	2	1 301	1 301	306.1
RA250	FER=8.0%	375	2	271	750	176.5

**GSM 900 RACH**

(FER: 217 events/s, frame filling = 1)

Prop. cond.	Error rate	Stat. sign.	Indep. samples	Station. proc.	Samples:	Time: (s)
static	FER=0.50%	6 000	2	-	12 000	55.3
TU50	FER=13%	231	2	5 208	5 208	24.0
RA250	FER=12%	250	2	1 085	1 085	5.0
HT100	FER=13%	231	2	2 604	2 604	12.0
TU3	FER=15%	200	2	86 800	86 800	400.0
TU3(SFH)	FER=15%	200	2	86 800	86 800	400.0
TU50	FER=16%	188	2	5 208	5 208	24.0
RA250	FER=13%	231	2	1 085	1 085	5.0

**GSM 900 SACCH/T**

(FER: 2.1 events/s, frame filling = 1/26)

Prop. cond.	Error rate	Stat. sign.	Indep. samples	Station. proc.	Samples:	Time: (s)
static	FER=0.10%	30 000	2	-	60 000	28 571.4
TU50	FER=13%	231	2	1 311	1 311	624.3
TU50(SFH)	FER=8%	375	2	1 311	1311	624.3
RA250	FER=8.0%	375	2	273	750	357.1
HT100	FER=12%	250	2	656	656	312.4
TU3	FER=22%	136	2	21 840	21 840	10 400.0
TU3(SFH)	FER=9%	333	2	21 840	21 840	10 400.0
TU50	FER=13%	231	2	1 311	1 311	624.3
TU50(SFH)	FER=9%	333	2	1 311	1 311	624.3
RA250	FER=8.0%	375	2	273	750	357.1

**GSM 900 SACCH/C**

(FER: 2.13 events/s, frame filling = 4/102)

Prop. cond.	Error rate	Stat. sign.	Indep. samples	Station. proc.	Samples:	Time: (s)
static	FER=0.10%	30 000	2	-	60 000	28 169.0
TU50	FER=13%	231	2	1 304	1 304	612.2
TU50(SFH)	FER=8%	375	2	1 304	1 304	612.2
RA250	FER=8.0%	375	2	272	750	352.1
HT100	FER=12%	250	2	652	652	306.1
TU3	FER=22%	136	2	21 726	21 726	10 200.0
TU3(SFH)	FER=9%	333	2	21 726	21 726	10 200.0
TU50	FER=13%	231	2	1 304	1 304	612.2
TU50(SFH)	FER=9%	333	2	1 304	1 304	612.2
RA250	FER=8.0%	375	2	272	750	352.1

**GSM 900 FACCH/F**

(FER: 50 events/s, frame filling = 24/26)

Prop. cond.	Error rate	Stat. sign.	Indep. samples	Station. proc.	Samples:	Time: (s)
static	FER=0.10%	30 000	4	-	120 000	2 400.0
TU50	FER=8%	375	4	1 300	1 500	30.0
TU50(SFH)	FER=3.8%	789	4	1 300	3 156	63.1
RA250	FER=3.4%	882	4	271	3 528	70.6
HT100	FER=6.3%	476	4	650	1 904	38.1
TU3	FER=22%	136	4	21 667	21 667	433.3
TU3(SFH)	FER=3.4%	882	4	21 667	21 667	433.3
TU50	FER=9.5%	316	4	1 300	1 300	26.0
TU50(SFH)	FER=3.4%	882	4	1 300	1 300	70.6
RA250	FER=3.5%	857	4	271	3 428	68.6

**GSM 900 FACCH/H**

(FER: 25 events/s, frame filling = 12/26)

Prop. cond.	Error rate	Stat. sign.	Indep. samples	Station. proc.	Samples:	Time: (s)
static	FER=0.10%	30 000	4	-	120 000	4 800.0
TU50	FER=6.9%	435	4	1 300	1 740	69.6
RA250	FER=5.7%	526	4	271	2 104	84.2
HT100	FER=10%	300	4	650	1 200	48.0
TU3	FER=22%	136	4	21 667	21 667	866.7
TU3(SFH)	FER=6.7%	448	4	21 667	21 667	866.7
TU50	FER=6.7%	448	4	1 300	1 792	71.7
RA250	FER=5.7%	526	4	271	2 104	84.2

**GSM 900 TCH/F9.6**

(BER: 12 000 events/s, frame filling = 24/26)

<b>Prop. cond.</b>	<b>Error rate</b>	<b>Stat. sign.</b>	<b>Indep. samples</b>	<b>Station. proc.</b>	<b>Samples:</b>	<b>Time: (s)</b>
static	BER=1.0E-5	3 000 000	10	-	30 000 000	2 500.0
TU50	BER=0.50%	6 000	10	312 000	312 000	26.0
TU50(SFH)	BER=0.4%	7 500	10	312 000	312 000	26.0
RA250	BER=0.10%	30 000	10	65 000	300 000	25.0
HT100	BER=0.70%	4 286	10	156 000	156 000	13.0
TU3	BER=8.0%	375	10	5 200 000	5 200 000	433.3
TU3(SFH)	BER=0.30%	10 000	10	5 200 000	5 200 000	433.3
TU50	BER=0.80%	3750	10	312 000	312 000	26.0
TU50(SFH)	BER=0.3%	10 000	10	312 000	312 000	26.0
RA250	BER=0.20%	15 000	10	65 000	150 000	12.5

**GSM 900 TCH/H4.8**

(BER: 6 000 events/s, frame filling = 12/26)

<b>Prop. cond.</b>	<b>Error rate</b>	<b>Stat. sign.</b>	<b>Indep. samples</b>	<b>Station. proc.</b>	<b>Samples:</b>	<b>Time: (s)</b>
static	BER=1.0E-5	3 000 000	10	-	30 000 000	5 000.0
TU50	BER=0.50%	6 000	10	312 000	312 000	52.0
TU50(SFH)	BER=0.4%	7 500	10	312 000	312 000	52.0
RA250	BER=0.10%	30 000	10	65 000	300 000	50.0
HT100	BER=0.70%	4 286	10	156 000	156 000	26.0
TU3	BER=8.0%	375	10	5 200 000	5 200 000	866.7
TU3(SFH)	BER=0.30%	10 000	10	5 200 000	5 200 000	866.7
TU50	BER=0.8%	3 750	10	312 000	312 000	52.0
TU50(SFH)	BER=0.3%	10 000	10	312 000	312 000	52.0
RA250	BER=0.20%	15 000	10	65 000	150 000	25.0

**GSM 900 TCH/F4.8**

(BER: 6 000 events/s, frame filling = 24/26)

Prop. cond.	Error rate	Stat. sign.	Indep. samples	Station. proc.	Samples:	Time: (s)
TU50	BER=1.0E-4	300 000	10	156 000	3 000 000	500.0
RA250	BER=1.0E-4	300 000	10	32 500	3 000 000	500.0
HT100	BER=1.0E-4	300 000	10	78 000	3 000 000	500.0
TU3	BER=3.0%	1 000	10	2 600 000	2 600 000	433.3
TU3(SFH)	BER=1.0E-4	300 000	10	2 600 000	3 000 000	500.0
TU50	BER=1.0E-4	300 000	10	156 000	3 000 000	500.0
RA250	BER=1.0E-4	300 000	10	32 500	3 000 000	500.0

**GSM 900 TCH/F2.4**

(BER: 3 600 events/s, frame filling = 24/26)

Prop. cond.	Error rate	Stat. sign.	Indep. samples	Station. proc.	Samples:	Time: (s)
TU50	BER=2.0E-04	150 000	10	93 600	15 000 00	416.7
RA250	BER=1.0E-5	3 000 000	10	3 900	30 000 000	8 333.3
HT100	BER=1.0E-5	3 000 000	10	46 800	30000 000	8 333.3
TU3	BER=3.0%	1 000	10	1 560 000	1 560 000	433.3
TU3(SFH)	BER=1.0E-5	3 000 000	10	1 560 000	30 000 000	8 333.3
TU50	BER=3.0E-5	1 000 000	10	93 600	10 000 000	2 777.8
TU50(SFH)	BER=1E-05	3 000 000	10	93 600	30 000 000	8 333.3
RA250	BER=1.0E-5	3 000 000	10	3 900	30 000 000	8 333.3

**GSM 900 TCH/H2.4**

(BER: 3 600 events/s, frame filling = 12/26)

Prop. cond.	Error rate	Stat. sign.	Indep. samples	Station. proc.	Samples:	Time: (s)
TU50	BER=1.0E-4	300 000	10	187 200	3 000 000	833.3
RA250	BER=1.0E-4	300 000	10	39 000	3 000 000	833.3
HT100	BER=1.0E-4	300 000	10	93 600	3 000 000	833.3
TU3	BER=4.0%	750	10	3 120 000	3 120 000	866.7
TU3(SFH)	BER=1.0E-4	300 000	10	3 120 000	3 120 000	866.7
TU50	BER=2.0E-4	150 000	10	187 200	1 500 000	416.7
TU50(SFH)	BER=1.0E-04	300 000	10	187 200	3 000 000	833.3
RA250	BER=1.0E-4	300 000	10	39 000	3 000 000	833.3

**GSM 900 TCH/FS**

(FER: 50 events/s, RBER class Ib: 6 600 events/s, RBER class II: 3 900 events/s, frame filling = 24/26)

Prop. cond.	Error rate	Stat. sign.	Indep. samples	Station. proc.	Samples:	Time: (s)
static	FER=0.10%	30 000	4	-	120 000	2 400.0
Ib	RBER=0.40%	7 500	10	-	75 000	11.4
II	RBER=2.0%	1 500	10	-	15 000	3.8
TU50	FER=6.0%	500	4	1 300	2 000	40.0
Ib	RBER=0.40%	7 500	10	171 600	171 600	26.0
II	RBER=8.0%	375	10	101 400	101 400	26.0
TU50(SFH)	FER=3%	1 000	4	1 300	4 000	80.0
Ib	RBER=0.3%	10 000	10	171 600	171 600	26.0
II	RBER=8%	375	10	101 400	101 400	26.0
RA250	FER=2.0%	1 500	4	271	6 000	120.0
Ib	RBER=0.20%	15 000	10	35 750	150 000	22.7
II	RBER=7.0%	429	10	21 125	21 125	5.4
HT100	FER=7.0%	429	4	650	1 716	34.3
Ib	RBER=0.50%	6 000	10	85 800	85 800	13.0
II	RBER=9.0%	333	10	50 700	50 700	13.0
TU3	FER=21%	143	4	21 667	21 667	433.3
Ib	RBER=2.0%	1 500	10	2 860 000	2 860 000	433.3
II	RBER=4.0%	750	10	1 690 000	1 690 000	433.3
TU3(SFH)	FER=3.0%	1 000	4	21 667	21 667	433.3
Ib	RBER=0.20%	15 000	10	2 860 000	2 860 000	433.3
II	RBER=8.0%	375	10	1 690 000	1 690 000	433.3
TU50	FER=6.0%	500	4	1 300	2 000	40.0
Ib	RBER=0.40%	7 500	10	171 600	171 600	26.0
II	RBER=8.0%	375	10	101 400	101 400	26.0
TU50(SFH)	FER=3%	1 000	4	1 300	4 000	80.0
Ib	RBER=0.2%	15 000	10	171 600	171 600	26.0
II	RBER=8%	375	10	101 400	101 400	26.0
RA250	FER=3.0%	1 000	4	271	4 000	80.0
Ib	RBER=0.20%	15 000	10	35 750	150 000	22.7
II	RBER=8.0%	375	10	21 125	21 125	5.4
static II	RBER=1.0E-4	300 000	10	-	3 000 000	769.2
EQU50 II	RBER=3.0%	1 000	10	101 400	101 400	26.0

**C.2 DCS 1 800; Number of Samples for Testing****DCS 1 800 SDCCH**

(FER: 4.25 events/s, frame filling = 4/51)

Prop. cond.	Error rate	Stat. sign.	Indep. samples	Station. proc.	Samples:	Time: (s)
static	FER=0.10%	30 000	2	-	60 000	14 117.6
TU50	FER=9.0%	333	2	1 301	1 301	306.1
RA130	FER=8.0%	375	2	521	750	176.5
HT100	FER=13.0%	231	2	651	651	153.2
TU1.5	FER=22%	136	2	43 350	43 350	10 200.0
TU1.5(SFH)	FER=9.0%	333	2	43 350	43 350	10 200.0
TU50	FER=9.0%	333	2	1 301	1 301	306.1
RA130	FER=8.0%	375	2	521	750	176.5

**DCS 1 800 RACH**

(FER: 217 events/s, frame filling = 1)

Prop. cond.	Error rate	Stat. sign.	Indep. samples	Station. proc.	Samples:	Time: (s)
static	FER=0.50%	6 000	2	-	12 000	55.3
TU50	FER=13%	231	2	5 208	5 208	24.0
RA130	FER=12%	250	2	2 087	2 087	10.0
HT100	FER=13%	231	2	2 604	2 604	12.0
TU1.5	FER=15%	200	2	173 600	173 600	800.0
TU1.5(SFH)	FER=15%	200	2	173 600	173 600	800.0
TU50	FER=16%	188	2	5 208	5 208	24.0
RA130	FER=13%	231	2	2 087	2 087	10.0

**DCS 1 800 SACCH/T**

(FER: 2.1 events/s, frame filling = 1/26)

Prop. cond.	Error rate	Stat. sign.	Indep. samples	Station. proc.	Samples:	Time: (s)
static	FER=0.10%	30 000	2	-	60 000	28 571.4
TU50	FER=9.0%	333	2	1 311	1 311	624.3
RA130	FER=8.0%	375	2	525	750	357.1
HT100	FER=13%	231	2	656	656	312.4
TU1.5	FER=22%	136	2	43 680	43 680	20 800.0
TU1.5(SFH)	FER=9.0%	333	2	43 680	43 680	20 800.0
TU50	FER=9%	333	2	1 311	1 311	624.3
RA130	FER=8.0%	375	2	525	750	357.1

**DCS 1 800 SACCH/C**

(FER: 2.13 events/s, frame filling = 4/102)

Prop. cond.	Error rate	Stat. sign.	Indep. samples	Station. proc.	Samples:	Time: (s)
static	FER=0.10%	30 000	2	-	60 000	28 169.0
TU50	FER=9%	333	2	1 304	1 304	612.2
RA130	FER=8.0%	375	2	523	750	352.1
HT100	FER=13%	251	2	652	652	306.1
TU1.5	FER=22%	136	2	43 452	43 452	20 400.0
TU1.5(SFH)	FER=9.0%	333	2	43 452	43 452	20 400.0
TU50	FER=9%	333	2	1 304	1 304	612.2
RA130	FER=8.0%	375	2	523	750	352.1

**DCS 1 800 FACCH/F**

(FER: 50 events/s, frame filling = 24/26)

Prop. cond.	Error rate	Stat. sign.	Indep. samples	Station. proc.	Samples:	Time: (s)
static	FER=0.10%	30 000	4	-	120 000	2 400.0
TU50	FER=3.9%	769	4	1 300	3 076	61.5
RA130	FER=3.4%	882	4	521	3 528	70.6
HT100	FER=7.4%	405	4	650	1 620	32.4
TU1.5	FER=22%	136	4	43 334	43 334	866.7
TU1.5(SFH)	FER=3.4%	882	4	43 334	43 334	866.7
TU50	FER=3.4%	882	4	1 300	3 528	70.6
RA130	FER=3.5%	857	4	521	3 428	68.6

**DCS 1 800 FACCH/H**

(FER: 25 events/s, frame filling = 12/26)

Prop. cond.	Error rate	Stat. sign.	Indep. samples	Station. proc.	Samples:	Time: (s)
static	FER=0.10%	30 000	4	-	120 000	4 800.0
TU50	FER=7.2%	417	4	1 300	1 668	66.7
RA130	FER=5.7%	526	4	521	2 104	84.2
HT100	FER=10.4%	288	4	650	1 152	46.1
TU1.5	FER=22%	136	4	43 334	43 334	1733.4
TU1.5(SFH)	FER=6.7%	448	4	43 334	43 334	1733.4
TU50	FER=6.9%	435	4	1 300	1 740	69.6
RA130	FER=5.7%	526	4	521	2 104	84.2

**DCS 1 800 TCH/F9.6**

(BER: 12 000 events/s, frame filling = 24/26)

Prop. cond.	Error rate	Stat. sign.	Indep. samples	Station. proc.	Samples:	Time: (s)
static	BER=1.0E-5	3 000 000	10	-	30 000 000	2 500.0
TU50	BER=0.40%	7 500	10	312 000	312 000	26.0
RA130	BER=0.10%	30 000	10	125 000	300 000	25.0
HT100	BER=0.70%	4 286	10	156 000	156 000	13.0
TU1.5	BER=8.0%	375	10	10 400 000	10 400 000	866.7
TU1.5(SFH)	BER=0.30%	10 000	10	10 400 000	10 400 000	866.7
TU50	BER=0.80%	3 750	10	312 000	312 000	26.0
TU50 (SFH)	BER=0.3%	10 000	10	312 000	312 000	26.0
RA130	BER=0.20%	15 000	10	125 000	150 000	12.5

**DCS 1 800 TCH/H4.8**

(BER: 6 000 events/s, frame filling = 12/26)

Prop. cond.	Error rate	Stat. sign.	Indep. samples	Station. proc.	Samples:	Time: (s)
static	BER=1.0E-5	3 000 000	10	-	30 000 000	5 000.0
TU50	BER=0.40%	7 500	10	312 000	312 000	52.0
RA130	BER=0.10%	30 000	10	125 000	300 000	50.0
HT100	BER=0.70%	4 286	10	156 000	156 000	26.0
TU1.5	BER=8.0%	375	10	10 400 000	10 400 000	1733.4
TU1.5(SFH)	BER=0.30%	10 000	10	10 400 000	10 400 000	1733.4
TU50	BER=0.80%	3 750	10	312 000	312 000	52.0
TU50(SFH)	BER=0.3%	10 000	10	312 000	312 000	52.0
RA130	BER=0.20%	15 000	10	125 000	150 000	25.0

**DCS 1 800 TCH/F4.8**

(BER: 6 000 events/s, frame filling = 24/26)

Prop. cond.	Error rate	Stat. sign.	Indep. samples	Station. proc.	Samples:	Time: (s)
TU50	BER=1.0E-4	300 000	10	156 000	3 000 000	500.0
RA130	BER=1.0E-4	300 000	10	62 500	3 000 000	500.0
HT100	BER=1.0E-4	300 000	10	78 000	3 000 000	500.0
TU1.5	BER=3.0%	1 000	10	5 200 000	5 200 000	866.7
TU1.5(SFH)	BER=1.0E-4	300 000	10	5 200 000	5 200 000	866.7
TU50	BER=1.0E-4	300 000	10	156 000	3 000 000	500.0
RA130	BER=1.0E-4	300 000	10	62 500	3 000 000	500.0

**DCS 1 800 TCH/F2.4**

(BER: 3600 events/s, frame filling = 24/26)

Prop. cond.	Error rate	Stat. sign.	Indep. samples	Station. proc.	Samples:	Time: (s)
TU50	BER=1.0E-5	3 000 000	10	93 600	30 000 000	8 333.3
RA130	BER=1.0E-5	3 000 000	10	7 500	30 000 000	8 333.3
HT100	BER=1.0E-5	3 000 000	10	46 800	30 000 000	8 333.3
TU1.5	BER=3.0%	1 000	10	3 120 000	3 120 000	866.7
TU1.5(SFH)	BER=1.0E-5	3 000 000	10	3 120 000	30 000 000	8 333.3
TU50	BER=1.0E-5	3 000 000	10	93 600	30 000 000	8 333.3
RA130	BER=1.0E-5	3 000 000	10	7 500	30 000 000	8 333.3



**DCS 1 800 TCH/H2.4**

(BER: 3 600 events/s, frame filling = 12/26)

Prop. cond.	Error rate	Stat. sign.	Indep. samples	Station. proc.	Samples:	Time: (s)
TU50	BER=1.0E-4	300 000	10	187 200	3 000 000	833.3
RA130	BER=1.0E-4	300 000	10	75 000	3 000 000	833.3
HT100	BER=1.0E-4	300 000	10	93 600	3 000 000	833.3
TU1.5	BER=4.0%	750	10	6 240 000	6 240 000	1733.4
TU1.5(SFH)	BER=1.0E-4	300 000	10	6 240 000	6 240 000	1733.4
TU50	BER=1.0E-4	300 000	10	187 200	3 000 000	833.3
RA130	BER=1.0E-4	300 000	10	75 000	3 000 000	833.3

**DCS 1 800 TCH/FS**

(FER: 50 events/s, RBER class Ib: 6 600 events/s, RBER class II: 3 900 events/s, frame filling = 24/26)

Prop. cond.	Error rate	Stat. sign.	Indep. samples	Station. proc.	Samples:	Time: (s)
static	FER=0.10%	30 000	4	-	120 000	2 400.0
Ib	RBER=0.40%	7 500	10	-	75 000	11.4
II	RBER=2.0%	1 500	10	-	15 000	3.8
TU50	FER=3.0%	1000	4	1 300	4 000	80.0
Ib	RBER=0.30%	10 000	10	171 600	171 600	26.0
II	RBER=8.0%	375	10	101 400	101 400	26.0
RA130	FER=2.0%	1 500	4	521	6 000	120.0
Ib	RBER=0.20%	15 000	10	68 750	150 000	22.7
II	RBER=7.0%	429	10	40 625	40 625	10.4
HT100	FER=7.0%	429	4	650	1 716	34.3
Ib	RBER=0.50%	6 000	10	85 800	85 800	13.0
II	RBER=9.0%	333	10	50 700	50 700	13.0
TU1.5	FER=21%	143	4	43 334	43 334	866.7
Ib	RBER=2.0%	1 500	10	5 720 000	5 720 000	866.7
II	RBER=4.0%	750	10	3 380 000	3 380 000	866.7
TU1.5(SFH)	FER=3.0%	1 000	4	43 334	43 334	866.7
Ib	RBER=0.20%	15 000	10	5 720 000	5 730 000	866.7
II	RBER=8.0%	375	10	3 380 000	3 380 000	866.7
TU50	FER=3.0%	1 000	4	1 300	4 000	80.0
Ib	RBER=0.25%	12 500	10	171 600	171 600	26.0
II	RBER=8.1%	370	10	101 400	101 400	26.0
RA130	FER=3.0%	1 000	4	521	4 000	80.0
Ib	RBER=0.20%	15 000	10	71 500	150 000	22.7
II	RBER=8.0%	375	10	42 250	42 250	10.8
static II	RBER=1.0E-4	300 000	10	-	3 000 000	769.2
EQU50	II RBER=3.0%	1 000	10	101 400	101 400	26.0

**History**

<b>Document history</b>			
November 1995	Public Enquiry	PE 95:	1995-11-06 to 1996-03-01
June 1996	Vote	V 105:	1996-06-10 to 1996-08-16
September 1996	First Edition		
November 1996	Unified Approval Procedure (Second Edition)	UAP 58:	1996-11-18 to 1997-03-14
April 1997	Second Edition		