



EUROPEAN
TELECOMMUNICATION
STANDARD

DRAFT

pr **ETS 300 607-1**

August 1998

Tenth edition

Source: SMG

Reference: RE/SMG-071110PR8-1

ICS: 33.020

Key words: Digital cellular telecommunications system, Global System for Mobile Communication (GSM)



**Digital cellular telecommunications system (Phase 2);
Mobile Station (MS) conformance specification;
Part 1: Conformance specification
(GSM 11.10-1 version 4.23.0)**

ETSI

European Telecommunications Standards Institute

ETSI Secretariat

Postal address: F-06921 Sophia Antipolis CEDEX - FRANCE

Office address: 650 Route des Lucioles - Sophia Antipolis - Valbonne - FRANCE

Internet: secretariat@etsi.fr - <http://www.etsi.fr> - <http://www.etsi.org>

Tel.: +33 4 92 94 42 00 - Fax: +33 4 93 65 47 16

Copyright Notification: No part may be reproduced except as authorized by written permission. The copyright and the foregoing restriction extend to reproduction in all media.

© European Telecommunications Standards Institute 1998. All rights reserved.

Contents

Foreword	29
1 Scope	31
2 Normative references	31
3 Definitions, conventions, and applicability.....	37
3.1 Mobile station definition and configurations.....	37
3.2 Applicability	37
3.2.1 Applicability of this specification.....	37
3.2.2 Applicability of the individual tests.....	38
3.2.3 Applicability to terminal equipment.....	57
3.3 Definitions.....	58
3.4 Conventions for mathematical notations	58
3.4.1 Mathematical signs	58
3.4.2 Powers to the base 10	58
3.5 Conventions on electrical terms	58
3.5.1 Radio Frequency (RF) input signal level	58
3.5.2 Reference sensitivity level.....	59
3.5.3 Power level of fading signal	59
3.6 Terms on test conditions	59
3.6.1 Radio test conditions.....	59
4 Test Equipment.....	60
4.1 Terms used to describe test equipment in this ETS.....	60
4.2 Functional requirements of test equipment	60
5 Testing methodology in general (layers 1, 2, and 3).....	60
5.1 Testing of optional functions and procedures.....	60
5.2 Test interfaces and facilities	60
5.3 Different protocol layers.....	61
5.4 Information to be provided by the apparatus supplier	61
5.5 Definitions of transmit and receive times.....	61
6 Reference test methods.....	62
6.1 General.....	62
6.2 Choice of frequencies in the frequency hopping mode	62
6.3 "Ideal" radio conditions	62
6.4 Standard test signals	62
6.5 Power (control) levels.....	62
7 Implicit testing	63
8 Measurement uncertainty	63
9 Format of tests	63
10 Generic call set up procedures	64
10.1 Generic call set-up procedure for mobile terminating speech calls.....	64
10.2 Generic call set-up procedure for mobile originating speech calls.....	69
10.3 Generic call set-up procedure for mobile terminating data calls	72
10.4 Generic call set-up procedure for mobile originating data calls.....	75
11 General tests.....	79
11.1 Verification of support and non-support of services (multiple numbering scheme or ISDN).....	79

11.1.1	Mobile Terminated (MT) calls.....	79
11.1.2	Mobile Originated (MO) calls.....	80
11.2	Verification of support of the single numbering scheme.....	81
11.3	Verification of non-support of services (Advice of Charge Charging (AoCC)).....	82
11.4	Verification of non-support of services (call hold).....	83
11.5	Verification of non-support of services (multiparty).....	84
11.6	Verification of non-support of feature (Fixed Dialling Number (FDN)).....	85
11.7	IMEI Security.....	86
11.8	Coding of the Bearer Capability information element	87
11.8.1	Network to MS Direction.....	88
11.8.1.1	BS 21 to 26 - Asynchronous Service.....	88
11.8.1.1.1	BS 21	88
11.8.1.1.2	BS 22	92
11.8.1.1.3	BS 24	92
11.8.1.1.4	BS 25	92
11.8.1.1.5	BS 26	92
11.8.1.1.6	BS 23	92
11.8.1.2	BS 31 to 34 - Synchronous Service.....	93
11.8.1.2.1	BS 32	93
11.8.1.2.2	BS 31	97
11.8.1.2.3	BS 33	98
11.8.1.2.4	BS 34	98
11.8.1.3	BS 61 - Alternate Speech / Data.....	98
11.8.1.3.1	Speech/Asynchronous Data, Transparent	99
11.8.1.3.2	Speech/Asynchronous Data, Non Transparent	101
11.8.1.3.3	Speech/Synchronous Data	103
11.8.1.4	BS 81 - Speech followed by Data	104
11.8.1.4.1	Speech followed by Asynchronous Data	104
11.8.1.4.2	Speech followed by Synchronous Data	104
11.8.1.5	TS 61 - Alternate Speech / Facsimile group 3.....	104
11.8.1.5.1	TS 61 - Alternate Speech / Facsimile group 3, Transparent	105
11.8.1.5.2	TS 61 - Alternate Speech / Facsimile group 3, Non-Transparent	106
11.8.1.6	TS 62 - Automatic Facsimile group 3	107
11.8.2	MS to SS direction.....	107
11.8.2.1	BS 21 to 26 - Asynchronous Service.....	107
11.8.2.1.1	BS 21	108
11.8.2.1.2	BS 22	112
11.8.2.1.3	BS 24	112
11.8.2.1.4	BS 25	112
11.8.2.1.5	BS 26	112
11.8.2.1.6	BS 23	112
11.8.2.2	BS 31 to 34 - Synchronous Service.....	113
11.8.2.2.1	BS 32	113
11.8.2.2.2	BS 31	117
11.8.2.2.3	BS 33	118
11.8.2.2.4	BS 34	118
11.8.2.3	BS 41 to 46 - PAD Access Asynchronous.....	119
11.8.2.3.1	2) BS 41	119
11.8.2.3.2	BS 42	120
11.8.2.3.3	BS 44	121
11.8.2.3.4	BS 45	121
11.8.2.3.5	BS 46	121
11.8.2.3.6	BS 43	121
11.8.2.4	BS 51 to 53 - Packet Service Synchronous.....	122
11.8.2.4.1	2) BS 51	122
11.8.2.4.2	BS 52	122
11.8.2.4.3	BS 53	122

11.8.2.5	BS 61 - Alternate Speech / Data	123
11.8.2.5.1	Speech/Asynchronous Data, Transparent	123
11.8.2.5.2	Speech/Asynchronous Data, Non Transparent	125
11.8.2.5.3	Speech/Synchronous Data	127
11.8.2.6	BS 81 - Speech followed by Data	128
11.8.2.6.1	Speech followed by Asynchronous Data	128
11.8.2.6.2	Speech followed by Synchronous Data	128
11.8.2.7	TS 61 - Alternate Speech / Facsimile group 3	128
11.8.2.7.1	TS 61 - Alternate Speech / Facsimile group 3, Transparent	129
11.8.2.7.2	TS 61 - Alternate Speech / Facsimile group 3, Non Transparent	130
11.8.2.8	TS 62 - Automatic Facsimile group 3	131
11.8.2.9	TS 11 and TS 12- Speech	131
11.8.2.9.1	Support of only full/half rate speech version 1	131
11.8.2.9.2	Support of speech full rate version 2 (Enhanced Full Rate)	131
12	Transceiver	133
12.1	Conducted spurious emissions	133
12.1.1	MS allocated a channel	133
12.1.2	MS in idle mode	134
12.2	Radiated spurious emissions	136
12.2.1	MS allocated a channel	136
12.2.2	MS in idle mode	138
13	Transmitter	141
13.1	Frequency error and phase error	141
13.2	Frequency error under multipath and interference conditions	144
13.3	Transmitter output power and burst timing	146
13.4	Output RF spectrum	153
13.5	Intermodulation attenuation	159
14	Receiver	161
14.1	Bad frame indication	167
14.1.1	Bad frame indication - TCH/FS	167
14.1.1.1	Bad frame indication - TCH/FS - Random RF input	167
14.1.1.2	Bad frame indication - TCH/FS - Frequency hopping and downlink DTX	168
14.1.2	Bad frame indication - TCH/HS	169
14.1.2.1	Bad frame indication - TCH/HS - Random RF input	169
14.1.2.2	Bad frame indication - TCH/HS - Frequency hopping and downlink DTX	170
14.1.3	Bad frame indication - TCH/FS - Frequency hopping and downlink DTX - Phase 2 MS in a phase 1 network	171
14.1.4	Bad frame indication - TCH/HS - Frequency hopping and downlink DTX - Phase 2 MS in a phase 1 network	173
14.2	Reference sensitivity	175
14.2.1	Reference sensitivity - TCH/FS	175
14.2.2	Reference sensitivity - TCH/HS (Speech frames)	178
14.2.3	Reference sensitivity - FACCH/F	180
14.2.4	Reference sensitivity - FACCH/H	181
14.2.5	Reference sensitivity - full rate data channels	182
14.2.6	Reference sensitivity - half rate data channels	183
14.2.7	Reference sensitivity - TCH/EFS	184
14.3	Usable receiver input level range	187
14.4	Co-channel rejection	188
14.4.1	Co-channel rejection - TCH/FS	188

14.4.2	Co-channel rejection - TCH/HS.....	190
14.4.3	Co-channel rejection - TCH/HS (SID frames).....	192
14.4.4	Co-channel rejection - FACCH/F.....	194
14.4.5	Co-channel rejection - FACCH/H.....	195
14.4.6	Co-channel rejection - TCH/EFS.....	196
14.5	Adjacent channel rejection.....	197
14.5.1	Adjacent channel rejection - speech channels.....	197
14.5.2	Adjacent channel rejection - control channels.....	200
14.6	Intermodulation rejection.....	202
14.6.1	Intermodulation rejection - speech channels.....	202
14.6.2	Intermodulation rejection - control channels.....	203
14.7	Blocking and spurious response.....	205
14.7.1	Blocking and spurious response - speech channels.....	205
14.7.2	Blocking and spurious response - control channels.....	208
14.8	AM suppression.....	211
14.8.1	AM suppression - speech channels.....	211
14.8.2	AM suppression - control channels.....	213
14.9	Paging performance at high input levels.....	214
15	Timing advance and absolute delay.....	216
16	Reception time tracking speed.....	218
17	Access times during handover.....	220
17.1	Intra cell channel change.....	220
17.2	Inter cell handover.....	222
18	Temporary reception gaps.....	225
19	Channel release after unrecoverable errors.....	227
19.1	Channel release after unrecoverable errors - 1.....	227
19.2	Channel release after unrecoverable errors - 2.....	228
19.3	Channel release after unrecoverable errors - 3.....	229
20	Cell selection and reselection.....	231
20.1	Cell selection.....	232
20.2	Cell selection with varying signal strength values.....	234
20.3	Basic cell reselection.....	236
20.4	Cell reselection using TEMPORARY_OFFSET, CELL_RESELECT_OFFSET, POWER_OFFSET and PENALTY_TIME parameters.....	238
20.5	Cell reselection using parameters transmitted in the System Information type 2bis, type 2ter, type 7 and type 8 messages.....	240
20.6	Cell reselection timings.....	242
20.7	Priority of cells.....	244
20.8	Cell reselection when C1 (serving cell) < 0 for 5 seconds.....	245
20.9	Running average of the surrounding cell BCCH carrier signal levels.....	246
20.10	Running average of the serving cell BCCH carrier signal level.....	247
20.11	Updating the list of six strongest neighbour carriers and decoding the BCCH information of a new carrier on the list.....	249
20.12	Decoding the BCCH information of the neighbour carriers on the list of six strongest neighbour carriers.....	250
20.13	Decoding the BSIC of the neighbour carriers on the list of six strongest neighbour carriers.....	251
20.14	Emergency calls.....	252
20.15	Cell reselection due to MS rejection "LA not allowed".....	253
20.16	Downlink signalling failure.....	255
20.17	Cell selection if no suitable cell found in 10 s.....	256
20.18	Cell reselection due to MS rejection "Roaming not allowed in this LA".....	257
20.19	Cell selection on release of SDCCH and TCH.....	258
20.20	Multiband cell selection and reselection.....	260
20.20.1	Multiband cell selection and reselection / Cell Selection.....	260
20.20.2	Multiband cell selection and reselection / Cell reselection.....	262

21	Received signal measurements.....	264
21.1	Signal strength.....	264
21.2	Signal strength selectivity	267
21.3	Signal quality under static conditions.....	268
21.3.1	Signal quality under static conditions - TCH/FS.....	268
21.3.2	Signal quality under static conditions - TCH/HS	270
21.4	Signal quality under TU50 propagation conditions	272
22	Transmit power control timing and confirmation.....	275
23	Single frequency reference	276
24	Tests of the layer 1 signalling functions.....	277
25	Tests of the layer 2 signalling functions.....	278
25.1	Introduction, objective and scope.....	278
25.1.1	General	278
25.1.2	Test configurations.....	278
25.1.3	Pre-conditions	278
25.1.4	Layer 2 test frames	279
25.1.5	Establishment of the dedicated physical resource.....	279
25.1.6	Release of the dedicated physical resource	280
25.2	Test sequences	280
25.2.1	Initialization	281
25.2.1.1	Initialization when contention resolution required.....	281
25.2.1.1.1	Normal initialization	281
25.2.1.1.2	Initialization failure	282
25.2.1.1.2.1	Loss of UA frame.....	282
25.2.1.1.2.2	UA frame with different information field	283
25.2.1.1.2.3	Information frame and supervisory frames in response to an SABM frame.....	284
25.2.1.1.3	Initialization denial	284
25.2.1.1.4	Total initialization failure	285
25.2.1.2	Initialization, contention resolution not required	286
25.2.1.2.1	Normal initialization without contention resolution	286
25.2.1.2.2	Initialization failure	287
25.2.1.2.3	Initialization denial	289
25.2.1.2.4	Total initialization failure	289
25.2.2	Normal information transfer	290
25.2.2.1	Sequence counting and I frame acknowledgements	290
25.2.2.2	Receipt of an I frame in the timer recovery state	293
25.2.2.3	Segmentation and concatenation.....	295
25.2.3	Normal layer 2 disconnection.....	298
25.2.4	Test of link failure.....	298
25.2.4.1	I frame loss (MS to SS)	298
25.2.4.2	RR response frame loss (SS to MS).....	299
25.2.4.3	RR response frame loss (MS to SS).....	300
25.2.5	Test of frame transmission with incorrect C/R values	301
25.2.5.1	I frame with C bit set to zero.....	301
25.2.5.2	SABM frame with C bit set to zero	302
25.2.6	Test of errors in the control field	303
25.2.6.1	N(S) sequence error.....	303
25.2.6.2	N(R) sequence error	305
25.2.6.3	Improper F bit.....	305
25.2.7	Test on receipt of invalid frames.....	306
26	Testing of layer 3 functions.....	311
26.1	Default conditions and structured sequence of tests.....	311
26.1.1	Default test conditions during layer 3 tests	311
26.1.2	Structured sequence of the tests	312
26.1.3	General rules for message parameters	313

26.1.4	General rules for layer 3 testing	313
26.1.5	Format of layer 3 test descriptions	313
26.2	Initial tests	315
26.2.1	Channel request	315
26.2.1.1	Channel request / initial time	315
26.2.1.2	Channel request / repetition time.....	316
26.2.1.3	Channel request / random reference.....	318
26.2.2	IMSI detach and IMSI attach	319
26.2.3	Sequenced MM / CM message transfer.....	323
26.2.4	Establishment cause	324
26.3	Test of MS functions in idle mode.....	333
26.3.1	Initial conditions	333
26.3.2	MS indication of available PLMNs.....	335
26.3.3	MS will send only if BSS is "on air"	336
26.3.4	Manual mode of PLMN selection	336
26.4	Lower layer failures in layer 3 testing.....	338
26.4.1	Introduction.....	338
26.4.2	Layer 1 reception failures	338
26.4.3	Data link layer failures	338
26.4.4	Lower layer failures, used for the tests in clause 25	338
26.5	Handling of unknown, unforeseen, and erroneous protocol data, and of parallel transactions.....	339
26.5.1	Handling of unknown, unforeseen, and erroneous protocol data, and of parallel transactions / unknown protocol discriminator.....	339
26.5.2	Handling of unknown, unforeseen, and erroneous protocol data, and of parallel transactions / TI and skip indicator	340
26.5.2.1	TI and skip indicator / RR	340
26.5.2.1.1	TI and skip indicator / RR / Idle Mode.....	340
26.5.2.1.2	TI and skip indicator / RR / RR-Connection established.....	341
26.5.2.2	TI and skip indicator / MM	342
26.5.2.3	TI and skip indicator / CC	344
26.5.3	Handling of unknown, unforeseen, and erroneous protocol data, and of parallel transactions / undefined or unexpected message type	346
26.5.3.1	Undefined or unexpected message type / undefined message type / CC	346
26.5.3.2	Undefined or unexpected message type / undefined message type / MM	347
26.5.3.3	Undefined or unexpected message type / undefined message type / RR	349
26.5.3.4	Undefined or unexpected message type / unexpected message type / CC	350
26.5.4	Handling of unknown, unforeseen, and erroneous protocol data, and of parallel transactions / unforeseen information elements in the non-imperative message part.....	351
26.5.4.1	Unforeseen information elements in the non-imperative message part / duplicated information elements.....	351
26.5.5	Handling of unknown, unforeseen, and erroneous protocol data, and of parallel transactions / non-semantic mandatory IE errors	353
26.5.5.1	Non-semantic mandatory IE errors / RR.....	353
26.5.5.1.1	Non-semantic mandatory IE errors / RR / missing mandatory IE error	353
26.5.5.1.1.1	Non-semantic mandatory IE errors / RR / missing mandatory IE error / special case	353
26.5.5.1.1.2	Non-semantic mandatory IE errors / RR / missing mandatory IE error / general case	354
26.5.5.1.2	Non-semantic mandatory IE errors / RR / comprehension required.....	355
26.5.5.2	Non-semantic mandatory IE errors / MM.....	356

	26.5.5.2.1	Non-semantic mandatory IE errors / MM / syntactically incorrect mandatory IE	356
	26.5.5.2.2	Non-semantic mandatory IE errors / MM / syntactically incorrect mandatory IE	357
	26.5.5.2.3	Non-semantic mandatory IE errors / MM / comprehension required.....	359
	26.5.5.3	Non-semantic mandatory IE errors / CC	361
	26.5.5.3.1	Non-semantic mandatory IE errors / CC / missing mandatory IE.....	361
	26.5.5.3.1.1	Non-semantic mandatory IE errors / CC / missing mandatory IE / disconnect message.....	361
	26.5.5.3.1.2	Non-semantic mandatory IE errors / CC / missing mandatory IE / general case	362
	26.5.5.3.2	Non-semantic mandatory IE errors / CC / comprehension required	363
26.5.6		Handling of unknown, unforeseen, and erroneous protocol data, and of parallel transactions / unknown IE, comprehension not required	364
	26.5.6.1	Unknown information elements in the non-imperative message part / MM	364
	26.5.6.1.1	Unknown IE, comprehension not required / MM / IE unknown in the protocol.....	364
	26.5.6.1.2	Unknown IE, comprehension not required / MM / IE unknown in the message	366
	26.5.6.2	Unknown information elements in the non-imperative message part / CC	367
	26.5.6.2.1	Unknown information elements in the non-imperative message part / CC / Call establishment	367
	26.5.6.2.2	Unknown information elements in the non-imperative message part / CC / disconnect	368
	26.5.6.2.3	Unknown information elements in the non-imperative message part / CC / release.....	369
	26.5.6.2.4	Unknown information elements in the non-imperative message part / CC / release complete	370
	26.5.6.3	Unknown IE in the non-imperative message part, comprehension not required / RR	371
26.5.7		Handling of unknown, unforeseen, and erroneous protocol data, and of parallel transactions / spare bits	373
	26.5.7.1	Spare bits / RR	373
	26.5.7.1.1	Spare bits / RR / paging channel.....	373
	26.5.7.1.2	Spare bits / RR / BCCH.....	374
	26.5.7.1.3	Spare bits / RR / AGCH.....	376
	26.5.7.1.4	Spare bits / RR / Connected Mode.....	378
	26.5.7.2	Spare bits / MM	380
	26.5.7.3	Spare bits / CC	381
26.5.8		Default contents of messages	384
26.6		Test of the elementary procedures for radio resource management	387
	26.6.1	Immediate assignment.....	387
	26.6.1.1	Immediate assignment / SDCCH or TCH assignment.....	387
	26.6.1.2	Immediate assignment / extended assignment.....	388
	26.6.1.3	Immediate assignment / assignment rejection.....	390
	26.6.1.4	Immediate assignment / ignore assignment	392
	26.6.1.5	Immediate assignment after immediate assignment reject.....	394
	26.6.2	Test of paging	395

	26.6.2.1	Normal paging	395
	26.6.2.1.1	Paging / normal / type 1	395
	26.6.2.1.2	Paging / normal / type 2	397
	26.6.2.1.3	Paging / normal / type 3	399
	26.6.2.2	Paging / extended	401
	26.6.2.3	Paging / reorganization	405
	26.6.2.3.1	Paging / reorganization / procedure 1	405
	26.6.2.3.2	Paging / reorganization / procedure 2	408
	26.6.2.4	Paging / same as before	409
	26.6.2.5	Paging / multislot CCCH	410
26.6.3		Test of measurement report	411
	26.6.3.1	Measurement / no neighbours	412
	26.6.3.2	Measurement / all neighbours present	415
	26.6.3.3	Measurement / barred cells and non-permitted NCCs	419
	26.6.3.4	Measurement / DTX	424
	26.6.3.5	Measurement / Frequency Formats	428
	26.6.3.6	Measurement / multiband environment	431
26.6.4		Test of the channel assignment procedure	436
	26.6.4.1	Dedicated assignment / successful case	436
	26.6.4.2	Dedicated assignment / failure	447
	26.6.4.2.1	Dedicated assignment / failure / failure during active state	447
	26.6.4.2.2	Dedicated assignment / failure / general case	448
26.6.5		Test of handover	450
	26.6.5.1	Handover / successful / active call / non-synchronized	451
	26.6.5.2	Handover / successful / call under establishment / non- synchronized	466
	26.6.5.3	Handover / successful / active call / finely synchronized	484
	26.6.5.4	Handover / successful / call under establishment / finely synchronized	489
	26.6.5.5	Pre-synchronized handovers	499
	26.6.5.5.1	Handover / successful / active call / pre-synchronized / Timing Advance IE not included	499
	26.6.5.5.2	Handover / successful / call being established / pre-synchronized / timing advance IE is included / reporting of observed time difference requested. ..	501
	26.6.5.6	Handover / successful / active call / pseudo synchronized	503
	26.6.5.7	Handover / successful / active call / non-synchronized / reporting of observed time difference requested.	505
	26.6.5.8	Handover / layer 3 failure	506
	26.6.5.9	Handover / layer 1 failure	508
26.6.6		Test of frequency redefinition	509
	26.6.6.1	Frequency redefinition	509
26.6.7		Test of the channel mode modify procedure	514
	26.6.7.1	Test of the channel mode modify procedure / full rate	515
	26.6.7.2	Test of the channel mode modify procedure / half rate	517
26.6.8		Test of ciphering mode setting	519
	26.6.8.1	Ciphering mode / start ciphering	519
	26.6.8.2	Ciphering mode / no ciphering	520
	26.6.8.3	Ciphering mode / old cipher key	522
	26.6.8.4	Ciphering mode / change of mode, algorithm and key	523
	26.6.8.5	Ciphering mode / IMEISV request	532
26.6.9		Test of additional assignment	533
26.6.10		Test of partial release	533
26.6.11		Test of classmark	533
	26.6.11.1	Classmark change	533
	26.6.11.2	Classmark interrogation	535
26.6.12		Test of channel release	537
	26.6.12.1	Channel release / SDCCH	537
	26.6.12.2	Channel release / SDCCH - no L2 ACK	538

	26.6.12.3	Channel release / TCH-F	540
	26.6.12.4	Channel release / TCH-F - no L2 ACK.....	541
26.6.13		Test of starting time	542
	26.6.13.1	Dedicated assignment with starting time / successful case / time not elapsed.....	544
	26.6.13.2	Dedicated assignment with starting time / successful case / time elapsed.....	545
	26.6.13.3	Dedicated assignment with starting time and frequency redefinition / failure case / time not elapsed.....	547
	26.6.13.4	Dedicated assignment with starting time and frequency redefinition / failure case / time elapsed.....	550
	26.6.13.5	Handover with starting time / successful case / time not elapsed.....	552
	26.6.13.6	Handover with starting time / successful case / time elapsed.....	554
	26.6.13.7	Handover with starting time and frequency redefinition / failure case / time not elapsed	556
	26.6.13.8	Handover with starting time and frequency redefinition / failure case / time elapsed	559
	26.6.13.9	Immediate assignment with starting time / successful case / time not elapsed	561
	26.6.13.10	Immediate assignment with starting time / successful case / time elapsed	563
26.6.14		Default contents of GSM 900 layer 3 messages for RR tests	565
26.6.15		Default contents of DCS 1 800 layer 3 messages for RR tests.....	576
26.7		Elementary procedures of mobility management.....	588
	26.7.1	TMSI reallocation	588
	26.7.2	Authentication	591
	26.7.2.1	Authentication accepted.....	591
	26.7.2.2	Authentication rejected.....	592
	26.7.3	Identification.....	595
	26.7.3.1	General Identification	595
	26.7.3.2	Handling of IMSI shorter than the maximum length.....	597
	26.7.4	Location updating.....	600
	26.7.4.1	Location updating / accepted	600
	26.7.4.2	Location updating / rejected	606
	26.7.4.2.1	Location updating / rejected / IMSI invalid	606
	26.7.4.2.2	Location updating / rejected / PLMN not allowed	609
	26.7.4.2.3	Location updating / rejected / location area not allowed	613
	26.7.4.2.4	Location updating / rejected / roaming not allowed in this location area	616
	26.7.4.3	Location updating / abnormal cases	623
	26.7.4.3.1	Location updating / abnormal cases / random access fails.....	623
	26.7.4.3.2	Location updating / abnormal cases / attempt counter less or equal to 4, LAI different	625
	26.7.4.3.3	Location updating / abnormal cases / attempt counter equal to 4.....	631
	26.7.4.3.4	Location updating / abnormal cases / attempt counter less or equal to 4, stored LAI equal to broadcast LAI	639
	26.7.4.4	Location updating / release / expiry of T3240	647
	26.7.4.5	Location updating / periodic	648
	26.7.4.5.1	Location updating / periodic spread....	648
	26.7.4.5.2	Location updating / periodic normal / test 1.....	650
	26.7.4.5.3	Location updating / periodic normal / test 2.....	652

	26.7.4.5.4	Location updating / periodic HPLMN search	655
	26.7.4.5.4.1	Location updating / periodic HPLMN search / MS waits time T	655
	26.7.4.5.4.2	Location updating / periodic HPLMN search / MS in manual mode	656
	26.7.4.5.4.3	Location updating / periodic HPLMN search / MS waits at least two minutes and at most T minutes	657
	26.7.4.6	Location updating / interworking of attach and periodic	659
26.7.5	MM connection		661
	26.7.5.1	Introduction	661
	26.7.5.2	MM connection / establishment with cipher	661
	26.7.5.3	MM connection / establishment without cipher	663
	26.7.5.4	MM connection / establishment rejected	664
	26.7.5.5	MM connection / establishment rejected cause 4.....	665
	26.7.5.6	MM connection / expiry T3230.....	666
	26.7.5.7	MM connection / abortion by the network	667
	26.7.5.7.1	MM connection / abortion by the network / cause #6.....	667
	26.7.5.7.2	MM connection / abortion by the network / cause not equal to #6.....	670
	26.7.5.8	MM connection / follow-on request pending	671
	26.7.5.8.1	MM connection / follow-on request pending / test 1	671
	26.7.5.8.2	MM connection / follow-on request pending / test 2	672
	26.7.5.8.3	MM connection / follow-on request pending / test 3	673
	26.7.6	Default contents of messages.....	675
26.8	Tests related to circuit switched call control		679
	26.8.1	Circuit switched Call Control (CC) state machine verification	679
	26.8.1.1	General on CC state machine verification	679
	26.8.1.2	Establishment of an outgoing call.....	680
	26.8.1.2.1	Outgoing call / U0 null state	682
	26.8.1.2.1.1	Outgoing call / U0 null state / MM connection requested	682
	26.8.1.2.2	Outgoing call / U0.1 MM connection pending	683
	26.8.1.2.2.1	Outgoing call / U0.1 MM connection pending / CM service rejected	683
	26.8.1.2.2.2	Outgoing call / U0.1 MM connection pending / CM service accepted	684
	26.8.1.2.2.3	Outgoing call / U0.1 MM connection pending / lower layer failure	686
	26.8.1.2.3	Outgoing call / U1 call initiated.....	687
	26.8.1.2.3.1	Outgoing call / U1 call initiated / receiving CALL PROCEEDING	687
	26.8.1.2.3.2	Outgoing call / U1 call initiated / rejecting with RELEASE COMPLETE.	688
	26.8.1.2.3.3	Outgoing call / U1 call initiated / T303 expiry	690
	26.8.1.2.3.4	Outgoing call / U1 call initiated / lower layer failure	691
	26.8.1.2.3.5	Outgoing call / U1 call initiated / receiving ALERTING	692
	26.8.1.2.3.6	Outgoing call / U1 call initiated / entering state U10.....	693
	26.8.1.2.3.7	Outgoing call / U1 call initiated / unknown message received	694
	26.8.1.2.4	Outgoing call / U3 MS originating call proceeding	695

26.8.1.2.4.1	Outgoing call / U3 MS originating call proceeding / ALERTING received.....	695
26.8.1.2.4.2	Outgoing call / U3 MS originating call proceeding / CONNECT received.....	696
26.8.1.2.4.3	Outgoing call / U3 MS originating call proceeding / PROGRESS received without in band information.....	698
26.8.1.2.4.4	Outgoing call / U3 MS originating call proceeding / PROGRESS with in band information.....	699
26.8.1.2.4.5	Outgoing call / U3 MS originating call proceeding / DISCONNECT with in band tones.....	701
26.8.1.2.4.6	Outgoing call / U3 MS originating call proceeding / DISCONNECT without in band tones.....	702
26.8.1.2.4.7	Outgoing call / U3 MS originating call proceeding / RELEASE received.....	703
26.8.1.2.4.8	Outgoing call / U3 MS originating call proceeding / termination requested by the user.....	704
26.8.1.2.4.9	Outgoing call / U3 MS originating call proceeding / traffic channel allocation	706
26.8.1.2.4.10	Outgoing call / U3 MS originating call proceeding / timer T310 time-out.....	707
26.8.1.2.4.11	Outgoing call / U3 MS originating call proceeding / lower layer failure.....	708
26.8.1.2.4.12	Outgoing call / U3 MS originating call proceeding / unknown message received.....	709
26.8.1.2.4.13	Outgoing call / U3 MS originating call proceeding / Internal alerting indication.....	710
26.8.1.2.5	Outgoing call / U4 call delivered.....	711
26.8.1.2.5.1	Outgoing call / U4 call delivered / CONNECT received.....	711
26.8.1.2.5.2	Outgoing call / U4 call delivered / termination requested by the user.....	713
26.8.1.2.5.3	Outgoing call / U4 call delivered / DISCONNECT with in band tones.....	714
26.8.1.2.5.4	Outgoing call / U4 call delivered / DISCONNECT without in band tones.	715
26.8.1.2.5.5	Outgoing call / U4 call delivered / RELEASE received.....	716
26.8.1.2.5.6	Outgoing call / U4 call delivered / lower layer failure.....	717
26.8.1.2.5.7	Outgoing call / U4 call delivered / traffic channel allocation.....	719
26.8.1.2.5.8	Outgoing call / U4 call delivered / unknown message received.....	720
26.8.1.2.6	U10 call active.....	721
26.8.1.2.6.1	U10 call active / termination requested by the user.....	721
26.8.1.2.6.2	U10 call active / RELEASE received..	722
26.8.1.2.6.3	U10 call active / DISCONNECT with in band tones.....	723
26.8.1.2.6.4	U10 call active / DISCONNECT without in band tones.....	725
26.8.1.2.6.5	U10 call active / RELEASE COMPLETE received.....	726
26.8.1.2.6.6	U10 call active / SETUP received.....	727
26.8.1.2.7	U11 disconnect request.....	729

	26.8.1.2.7.1	U11 disconnect request / clear collision	729
	26.8.1.2.7.2	U11 disconnect request / RELEASE received	730
	26.8.1.2.7.3	U11 disconnect request / timer T305 time-out.....	731
	26.8.1.2.7.4	U11 disconnect request / lower layer failure	733
	26.8.1.2.7.5	U11 disconnect request / unknown message received.....	734
	26.8.1.2.8	U12 disconnect indication.....	735
	26.8.1.2.8.1	U12 disconnect indication / call releasing requested by the user.....	735
	26.8.1.2.8.2	U12 disconnect indication / RELEASE received	736
	26.8.1.2.8.3	U12 disconnect indication / lower layer failure	737
	26.8.1.2.8.4	U12 disconnect indication / unknown message received.....	739
	26.8.1.2.9	Outgoing call / U19 release request ...	740
	26.8.1.2.9.1	Outgoing call / U19 release request / timer T308 time-out.....	740
	26.8.1.2.9.2	Outgoing call / U19 release request / 2nd timer T308 time-out.....	741
	26.8.1.2.9.3	Outgoing call / U19 release request / RELEASE received.....	743
	26.8.1.2.9.4	Outgoing call / U19 release request / RELEASE COMPLETE received.....	744
	26.8.1.2.9.5	Outgoing call / U19 release request / lower layer failure.....	745
26.8.1.3		Establishment of an incoming call / Initial conditions.....	746
	26.8.1.3.1	Incoming call / U0 null state.....	749
	26.8.1.3.1.1	Incoming call / U0 null state / SETUP received with a non supported bearer capability	749
	26.8.1.3.2.	Incoming call / U6 call present.....	750
	26.8.1.3.2.1	Incoming call / U6 call present / automatic call rejection	750
	26.8.1.3.3	Incoming call / U9 mobile terminating call confirmed.....	752
	26.8.1.3.3.1	Incoming call / U9 mobile terminating call confirmed / alerting or immediate connecting.....	752
	26.8.1.3.3.2	Incoming call / U9 mobile terminating call confirmed / TCH assignment.....	753
	26.8.1.3.3.3	Incoming call / U9 mobile terminating call confirmed / termination requested by the user	754
	26.8.1.3.3.4	Incoming call / U9 mobile terminating call confirmed / DISCONNECT received	755
	26.8.1.3.3.5	Incoming call / U9 mobile terminating call confirmed / RELEASE received ...	757
	26.8.1.3.3.6	Incoming call / U9 mobile terminating call confirmed / lower layer failure.....	758
	26.8.1.3.3.7	Incoming call / U9 mobile terminating call confirmed / unknown message received	759
	26.8.1.3.4	Incoming call / U7 call received	760
	26.8.1.3.4.1	Incoming call / U7 call received / call accepted	760
	26.8.1.3.4.2	Incoming call / U7 call received / termination requested by the user	762

26.8.1.3.4.3	Incoming call / U7 call received / DISCONNECT received	763
26.8.1.3.4.4	Incoming call / U7 call received / RELEASE received	764
26.8.1.3.4.5	Incoming call / U7 call received / lower layer failure	765
26.8.1.3.4.6	Incoming call / U7 call received / unknown message received.....	767
26.8.1.3.4.7	Incoming call / U7 call received / TCH assignment.....	768
26.8.1.3.4.8	Incoming call / U7 call received / RELEASE COMPLETE received.....	769
26.8.1.3.5	Incoming call / U8 connect request	770
26.8.1.3.5.1	Incoming call / U8 connect request / CONNECT acknowledged.....	770
26.8.1.3.5.2	Incoming call / U8 connect request / timer T313 time-out	771
26.8.1.3.5.3	Incoming call / U8 connect request / termination requested by the user	773
26.8.1.3.5.4	Incoming call / U8 connect request / DISCONNECT received with in-band information.....	774
26.8.1.3.5.5	Incoming call / U8 connect request / DISCONNECT received without in-band information.....	775
26.8.1.3.5.6	Incoming call / U8 connect request / RELEASE received	776
26.8.1.3.5.7	Incoming call / U8 connect request / lower layer failure	778
26.8.1.3.5.8	Incoming call / U8 connect request / TCH assignment.....	779
26.8.1.3.5.9	Incoming call / U8 connect request / unknown message received.....	780
26.8.1.4	In call functions.....	781
26.8.1.4.1	In-call functions / DTMF information transfer	781
26.8.1.4.1.1	In-call functions / DTMF information transfer / basic procedures.....	781
26.8.1.4.2	In-call functions / user notification	783
26.8.1.4.2.1	In-call functions / User notification / MS terminated	783
26.8.1.4.3	In-call functions / channel changes	784
26.8.1.4.3.1	In-call functions / channel changes / a successful channel change in active state/ Handover and Assignment Command.....	784
26.8.1.4.3.2	In-call functions / channel changes / an unsuccessful channel change in active mode/ Handover and Assignment Command.....	786
26.8.1.4.4	In-call functions / MS terminated in-call modification.....	788
26.8.1.4.4.1	In-call functions / MS terminated in-call modification / modify when new mode is not supported.....	788
26.8.1.4.5	In-call functions / MS originated in-call modification	789
26.8.1.4.5.1	In-call functions / MS originated in-call modification / a successful case of modifying	789
26.8.1.4.5.2	In-call functions / MS originated in-call modification / modify rejected.....	791

	26.8.1.4.5.3	In-call functions / MS originated in-call modification / an abnormal case of acceptance	793		
	26.8.1.4.5.4	In-call functions / MS originated in-call modification / an abnormal case of rejection	794		
	26.8.1.4.5.5	In-call functions / MS originated in-call modification / time-out of timer T323 ..	795		
	26.8.1.4.5.6	In-call functions / MS originated in-call modification / a successful channel change in state mobile originating modify	797		
	26.8.1.4.5.7	In-call functions / MS originated in-call modification / an unsuccessful channel change in state mobile originating modify	799		
	26.8.1.4.5.8	In-call functions / MS originated in-call modification / unknown message received	801		
	26.8.1.4.5.9	In-call functions / MS originated in-call modification / a release complete received	802		
	26.8.1.4.5.10	In-call functions/MS originated in-call modification/contents of some of the messages	804		
26.8.2	Call Re-establishment		806		
	26.8.2.1	Call Re-establishment/call present, re-establishment allowed.....	806		
	26.8.2.2	Call Re-establishment/call present, re-establishment not allowed.....	808		
	26.8.2.3	Call Re-establishment/call under establishment, transmission stopped.....	809		
26.8.3	User to user signalling		811		
26.8.4	Default contents of message		813		
26.9	Structured procedures		820		
	26.9.1	Structured procedures / general.....	820		
	26.9.2	Structured procedures / MS originated call / early assignment.....	820		
	26.9.3	Structured procedures / MS originated call / late assignment.....	823		
	26.9.4	Structured procedures / MS terminated call / early assignment.....	825		
	26.9.5	Structured procedures / MS terminated call / late assignment.....	828		
	26.9.6	Structured procedures / emergency call.....	831		
	26.9.6.1	Structured procedures / emergency call / idle updated	831		
		26.9.6.1.1	Structured procedures / emergency call / idle updated / preferred channel rate.....	831	
		26.9.6.1.2	Structured procedures / emergency call / idle updated, non-preferred channel rate	834	
	26.9.6.2	Structured procedures / emergency call / idle, no IMSI.....	834		
		26.9.6.2.1	Structured procedures / emergency call / idle, no IMSI / accept case	834	
		26.9.6.2.2	Structured procedures / emergency call / idle, no IMSI / reject case	836	
	26.9.7	Default contents of messages.....	838		
26.10	E-GSM signalling		844		
	26.10.1	E-GSM signalling / general considerations	844		
	26.10.2	E-GSM signalling / RR	844		
		26.10.2.1	E-GSM signalling / RR / Measurement.....	844	
		26.10.2.2	E-GSM signalling / RR / Immediate assignment	849	
		26.10.2.3	E-GSM signalling / RR / channel assignment procedure ..	850	
		26.10.2.4	E-GSM signalling / RR / Handover	853	
			26.10.2.4.1	E-GSM signalling / RR / Handover / Successful handover	853

	26.10.2.4.2	E-GSM signalling / RR / Handover / layer 1 failure	857
	26.10.2.5	E-GSM signalling / RR / Frequency Redefinition	858
26.10.3		E-GSM signalling / Structured procedure	860
	26.10.3.1	E-GSM signalling / Structured procedure / Mobile originated call	861
	26.10.3.2	E-GSM signalling / Structured procedures / emergency call	863
	26.10.3.3	Default contents of messages	866
26.10.4		E-GSM signalling / Default message contents	866
26.11		Multiband signalling	871
	26.11.1	General considerations	871
	26.11.2	Multiband signalling / RR	871
	26.11.2.1	Multiband signalling / RR / Immediate assignment procedure	871
	26.11.2.2	Multiband signalling / RR / Handover	873
	26.11.2.2.1	Multiband signalling / RR / Handover / successful / active call / non-synchronized	874
	26.11.2.2.2	Multiband signalling / RR / Handover / layer 1 failure	878
	26.11.2.2.3	Multiband signalling / RR / Handover / Multiband BCCH / successful / active call / non synchronized	881
	26.11.2.2.4	Multiband signalling / RR / Handover/ Multiband BCCH / Intracell Handover - Interband Assignment.	884
	26.11.2.3	Multiband signalling / RR / Measurement reporting	890
26.11.3		Multiband signalling / MM	893
26.11.3.1		Multiband signalling / MM / Location updating	893
	26.11.3.1.1	Location updating / accepted	893
	26.11.3.1.2	Location updating / periodic	896
26.11.4		Multiband signalling / CC	899
26.11.5		Multiband signalling / Structured procedures	899
	26.11.5.1	Multiband signalling / Structured procedures / MS originated call / early assignment	899
	26.11.5.2	Structured procedures / MS terminated call / late assignment	902
26.11.6		Multiband signalling / Default messages contents	906
26.12		Enhanced Full Rate signalling	911
	26.12.1	EFR signalling/ test of the channel mode modify procedure	911
	26.12.2	EFR signalling/ tests of handover	914
	26.12.2.1	EFR signalling / Handover / active call / successful case	915
	26.12.2.2	EFR signalling/ Handover / successful / call under establishment / non-synchronized	932
26.12.3		EFR Signalling / Structured procedures / MS originated call / late assignment	947
26.12.4		Structured procedures / MS terminated call / l early assignment	950
26.12.5		Structured procedures / emergency call	953
26.12.6		Default contents of layer 3 messages for Enhanced Full rate speech tests	956
27		Testing of the SIM/ME interface	960
	27.1	MS identification by short IMSI	963
	27.1.1	MS identification by short IMSI - Normal case	963
	27.1.2	MS identification by short IMSI, Phase 1 DCS SIM	964
	27.2	MS identification by short TMSI	965
	27.3	MS identification by long TMSI	966
	27.4	MS identification by long IMSI, TMSI updating and cipher key sequence number assignment	967
	27.5	Forbidden PLMNs, location updating and undefined cipher key	969
	27.6	MS updating forbidden PLMNs	972
	27.7	MS deleting forbidden PLMNs	974

27.8	MS updating the PLMN selector list.....	975
27.9	MS recognizing the priority order of the PLMN selector list.....	976
27.10	MS access control management.....	978
27.11	Exchange protocol tests.....	988
27.11.1	Character transmission.....	988
27.11.1.1	Bit/character duration during the transmission from the ME to the SIM.....	988
27.11.1.2	Bit/character duration during the transmission from the SIM simulator to the ME.....	988
27.11.1.3	Inter-character delay.....	989
27.11.1.4	Error handling during the transmission from the ME to the SIM.....	990
27.11.1.5	Error handling during transmission from the SIM to the ME.....	991
27.11.2	Answer to reset (RST).....	992
27.11.2.1	Acceptance of SIMs with internal RST.....	992
27.11.2.2	Acceptance of SIMs with active low RST.....	992
27.11.2.3	Characters of the answer to reset.....	993
27.11.2.4	PTS procedure.....	994
27.11.2.5	Reset repetition.....	995
27.11.3	Command processing, procedure bytes.....	996
27.12	Evaluation of directory characteristics.....	996
27.12.1	Operating speed in authentication procedure.....	996
27.12.2	Clock stop.....	997
27.13	Mechanical tests.....	999
27.13.1	Contact pressure.....	999
27.13.2	Shape of contacts for IC card SIM card reader.....	999
27.14	Secret code usage.....	1000
27.14.1	Entry of PIN.....	1000
27.14.2	Change of PIN.....	1001
27.14.3	Disabling the PIN.....	1002
27.14.4	PUK entry.....	1003
27.14.5	Entry of PIN2.....	1004
27.14.6	Change of PIN2.....	1004
27.14.7	PUK2 entry.....	1005
27.15	Abbreviated Dialling Numbers (ADN).....	1006
27.16	MMI reaction to SIM status encoding.....	1008
27.17	Electrical tests.....	1008
27.17.1	Test of the power transition phases.....	1010
27.17.1.1	Phase preceding ME power on.....	1010
27.17.1.2	Phase during SIM power on.....	1010
27.17.1.3	Phase during ME power off with clock stop forbidden.....	1012
27.17.1.4	Phase during ME power off with clock stop allowed.....	1013
27.17.1.5	SIM Type Recognition and Voltage Switching.....	1015
27.17.1.5.1	Reaction of 3V only MEs on SIM type recognition failure.....	1015
27.17.1.5.2	Reaction of 3V only MEs on type recognition of 5V only SIMs.....	1016
27.17.1.5.3	Reaction of 3V technology MEs on type recognition of 5V only SIMs.....	1017
27.17.1.5.4	Reaction of 3V technology MEs on type recognition of 3V technology SIMs.....	1018
27.17.2	Electrical tests on each ME contact.....	1019
27.17.2.1	Electrical tests on contact C1.....	1020
27.17.2.1.1	Test 1.....	1020
27.17.2.1.2	Test 2.....	1021
27.17.2.2	Electrical tests on contact C2.....	1024
27.17.2.3	Electrical tests on contact C3.....	1025
27.17.2.4	[Not used].....	1026
27.17.2.5	Electrical tests on contact C7.....	1026
27.18	Fixed Number Dialling (FND).....	1028
27.18.1	ME and SIM with FND activated.....	1028

	27.18.2	ME and SIM with FND deactivated	1029
	27.18.3	Enabling, disabling and updating of FND.....	1030
27.19		Phase identification	1032
27.20		SIM presence detection.....	1032
27.21		Advice of Charge (AoC).....	1033
	27.21.1	AoC not supported by SIM	1033
	27.21.2	Maximum frequency of ACM updating.....	1035
	27.21.3	Call terminated when ACM greater than ACMmax	1037
	27.21.4	Response codes of increase command	1040
28		Test of autocalling restrictions	1043
	28.1	General.....	1043
	28.2	Constraining the access to a single number (GSM 02.07 category 3).....	1043
	28.3	Constraining the access to a single number (GSM 02.07 categories 1 and 2)	1045
	28.4	Behaviour of the MS when its list of blacklisted numbers is full	1047
29		Testing of bearer services	1049
	29.1	General.....	1049
	29.2	Testing of transparent data services	1049
	29.2.1	Verification of synchronization	1049
	29.2.2	Filtering of channel control information for transparent BCs.....	1052
	29.2.3	Correct Terminal Compatibility Decision.....	1054
	29.2.3.1	Negotiation of Radio Channel Requirement (RCR)	1054
	29.2.3.2	Negotiation of Connection Element (CE)	1054
	29.2.3.3	Negotiation of Number of Stop Bits, Number of Data bits, and Parity	1055
	29.2.3.4	Negotiation of Modem Type	1056
	29.2.3.5	Negotiation of Intermediate Rate	1056
	29.2.3.6	Negotiation of User Information Layer 2 Protocol	1057
	29.2.3.7	Negotiation between TS 61 and TS 62: Mobile Originated call.....	1058
	29.2.3.8	Negotiation between TS 61 and TS 62: Mobile Terminated call.....	1059
	29.2.4	Data Rate Adaptation for Synchronous Transparent Bearer Capabilities.....	1059
	29.2.5	Network Independent Clocking.....	1060
	29.2.6	Asynchronous Transparent Bearer Capabilities	1060
	29.2.6.1	Data Rate Adaptation	1060
	29.2.6.2	Passage of the Break Signal.....	1062
	29.2.6.3	Overspeed/Underspeed Handling (Local Terminal).....	1063
	29.2.6.4	Overspeed/Underspeed Handling (Remote Terminal)....	1064
	29.2.7	Interchange circuit mapping for transparent bearer capabilities	1065
29.3		Testing of non transparent data services (RLP tests)	1066
	29.3.1	Initialization	1067
	29.3.1.1	Normal initialization done by the MS	1067
	29.3.1.2	Initialization failure.....	1068
	29.3.1.2.1	Loss of UA frame.....	1068
	29.3.1.2.2	Total loss of UA frame.....	1070
	29.3.2	Data transfer	1071
	29.3.2.1	Default conditions.....	1071
	29.3.2.2	MS sends I+S frames.....	1071
	29.3.2.2.1	N(S) sequence number	1071
	29.3.2.2.2	Transmission window	1072
	29.3.2.2.3	Busy condition	1075
	29.3.2.3	SS sends I+S frames	1077
	29.3.2.3.1	N(R) sequence number	1077
	29.3.2.3.2	Busy condition	1078
	29.3.2.4	SS rejects I+S frames	1080
	29.3.2.4.1	REJ frame	1080
	29.3.2.4.2	SREJ frame	1083
	29.3.2.4.3	I+S reject frame.....	1086
	29.3.2.5	MS rejects I+S frames.....	1089
	29.3.2.5.1	Rejection with REJ or SREJ supervisory frames	1089

		29.3.2.5.2	Retransmission of REJ or SREJ frames	1096
		29.3.2.5.3	I+S reject frame	1098
	29.3.2.6	Checkpoint recovery		1101
		29.3.2.6.1	SS in checkpoint recovery mode	1101
		29.3.2.6.2	End of the window	1105
		29.3.2.6.3	End of a sequence	1107
		29.3.2.6.4	Time-out of one frame	1108
		29.3.2.6.5	No response to checkpointing	1110
		29.3.2.6.6	Incorrect response to checkpointing	1112
		29.3.2.6.7	Total loss of response to checkpointing	1115
		29.3.2.6.8	Retransmission of a sequence	1117
		29.3.2.6.9	N2 retransmission of a sequence	1120
	29.3.3	Negotiation of the RLP parameters		1122
		29.3.3.1	Negotiation initiated by the SS	1122
		29.3.3.2	Negotiation initiated by the MS	1127
		29.3.3.3	Collision of XID frames	1132
		29.3.3.4	Loss of XID frames	1137
		29.3.3.5	Total loss of XID frames	1138
29.4	Facsimile tests for the transparent network support			1140
	29.4.1	General		1140
	29.4.2	Mobile originated call		1142
		29.4.2.1	Call establishment procedure	1142
			29.4.2.1.1 Alternate speech / facsimile	1142
			29.4.2.1.2 Automatic facsimile	1143
		29.4.2.2	Pre-message procedure	1144
		29.4.2.3	Message procedure	1146
		29.4.2.4	Post-message procedure	1147
		29.4.2.5	Call release procedure	1148
		29.4.2.6	CTC processing - 4th PPR for the same block	1149
		29.4.2.7	Transition from Facsimile to Speech - Procedure interrupt generated by receiving station	1151
		29.4.2.8	Transition from Facsimile to Speech - Procedure interrupt generated by transmitting station	1153
		29.4.2.9	Quality check	1154
	29.4.3	Mobile terminated call		1155
		29.4.3.1	Call Establishment Procedure	1155
			29.4.3.1.1 Alternate Speech/Facsimile	1155
			29.4.3.1.1.1 DCD Mobile Terminated	1155
			29.4.3.1.1.2 DCD mobile originated	1156
			29.4.3.1.2 Automatic facsimile	1158
		29.4.3.2	Pre-message procedure	1159
		29.4.3.3	Message procedure	1160
		29.4.3.4	Post-message procedure	1161
		29.4.3.5	Call release procedure	1162
		29.4.3.6	Speed conversion factor	1163
		29.4.3.7	Quality Check	1165
	29.4.4	Notes		1166
30	Speech teleservices			1167
	30.1	Sending sensitivity/frequency response		1167
	30.2	Sending loudness rating		1168
	30.3	Receiving sensitivity/frequency response		1169
	30.4	Receiving loudness rating		1170
	30.5	Side tones		1171
		30.5.1	Side Tone Masking Rating (STMR)	1171
		30.5.2	Listener Side Tone Rating (LSTR)	1172
	30.6	Telephone Acoustic coupling Loss (TAL)		1173
		30.6.1	Echo Loss (EL)	1173
		30.6.2	Stability margin	1174
	30.7	Distortion		1175
		30.7.1	Sending	1175

	30.7.2	Receiving	1176
30.8		Sidetone distortion	1177
30.9		Out-of-band signals	1178
	30.9.1	Sending	1178
	30.9.2	Receiving	1179
30.10		Idle channel noise.....	1180
	30.10.1	Sending.....	1180
	30.10.2	Receiving	1181
31		Test of supplementary services	1182
31.1		Number identification supplementary services.....	1182
31.2		Call offering supplementary services	1182
	31.2.1	Call forwarding supplementary services	1182
	31.2.1.1	Registration	1182
		31.2.1.1.1 Registration accepted.....	1182
		31.2.1.1.2 Registration rejected	1185
	31.2.1.2	Erase by the subscriber	1188
		31.2.1.2.1 Erasure accepted	1188
		31.2.1.2.2 Erasure rejected	1190
	31.2.1.3	Activation.....	1193
	31.2.1.4	Deactivation.....	1195
	31.2.1.5	Invocation	1197
	31.2.1.6	Interrogation	1197
		31.2.1.6.1 Interrogation accepted.....	1197
		31.2.1.6.2 Interrogation rejected	1199
	31.2.1.7	Normal operation.....	1202
		31.2.1.7.1 Served mobile subscriber side	1202
		31.2.1.7.1.1 Notification during an incoming call..	1202
		31.2.1.7.1.2 Notification during an outgoing call...	1204
		31.2.1.7.2 Forwarded-to mobile subscriber side	1206
	31.2.2	Call transfer and mobile access hunting supplementary services	1207
31.3		Call completion supplementary services	1207
31.4		Multi-party supplementary services	1207
31.5		Community of interest supplementary services.....	1207
31.6		Charging supplementary services	1208
	31.6.1	Advice of Charge Charging.....	1208
	31.6.1.1	AOC time related charging / MS originated call	1208
	31.6.1.2	AOC time related charging / MS terminated call	1211
	31.6.1.3	AOC volume related charging / MS originated call.....	1214
	31.6.1.4	AOC volume related charging / MS terminated call	1214
	31.6.1.5	Change in charging information during a call.....	1214
	31.6.1.6	Different formats of charging information.....	1217
	31.6.1.7	AOC on a Call Hold call.....	1220
	31.6.1.8	AOC on a Multi-party call	1223
	31.6.2	Charge Storage.....	1227
	31.6.2.1	Removal of SIM during an active call.....	1227
	31.6.2.2	Interruption of power supply during an active call	1230
	31.6.2.3	MS going out of coverage during an active AoCC call ...	1232
	31.6.2.4	ACMmax operation / Mobile Originating.....	1234
	31.6.2.5	ACMmax operation / Mobile Terminating.....	1237
	31.6.3	Advice of Charge Information	1240
	31.6.4	Default contents of messages	1240
31.7		Additional information transfer supplementary services.....	1241
31.8		Call restriction supplementary services	1241
	31.8.1	Registration of a password	1242
	31.8.1.1	Registration accepted.....	1242
	31.8.1.2	Registration rejected	1244
		31.8.1.2.1 Rejection after invoke of the RegisterPassword operation	1244
		31.8.1.2.2 Rejection after password check with negative result	1246
		31.8.1.2.3 Rejection after new password mismatch	1248

31.8.2	Erasure.....	1251
31.8.3	Activation.....	1251
31.8.3.1	Activation accepted.....	1251
31.8.3.2	Activation rejected.....	1254
	31.8.3.2.1 Rejection after invoke of ActivateSS operation.....	1254
	31.8.3.2.2 Rejection after use of password procedure.....	1256
31.8.4	Deactivation.....	1258
31.8.4.1	Deactivation accepted.....	1258
31.8.4.2	Deactivation rejected.....	1261
	31.8.4.2.1 Rejection after invoke of DeactivateSS operation.....	1261
	31.8.4.2.2 Rejection after use of password procedure.....	1263
31.8.5	Invocation.....	1265
31.8.6	Interrogation.....	1265
	31.8.6.1 Interrogation accepted.....	1265
	31.8.6.2 Interrogation rejected.....	1268
31.8.7	Normal operation.....	1270
31.9	Handling of undefined (future) GSM supplementary services.....	1271
31.9.1	Mobile station initiated Unstructured supplementary service data operation.....	1271
	31.9.1.1 ProcessUnstructuredSS-request/accepted.....	1271
	31.9.1.2 ProcessUnstructuredSS-request/cross phase compatibility and error handling.....	1276
31.9.2	Network initiated unstructured supplementary service operations.....	1281
	31.9.2.1 UnstructuredSS-Notify/accepted.....	1281
	31.9.2.3 UnstructuredSS-Request/accepted.....	1286
31.10	MMI input for USSD.....	1292
31.11	Specific message contents and ASN.1 codings.....	1293
32	Testing of speech transcoding functions.....	1343
32.1	Full Rate Downlink speech transcoding.....	1343
32.2	Full Rate Downlink receiver DTX functions.....	1344
32.3	Full Rate Uplink speech transcoding.....	1347
32.4	Full Rate Uplink transmitter DTX functions.....	1348
32.5	Full Rate Speech channel transmission delay.....	1349
	32.5.4 Downlink processing delay.....	1350
	32.5.5 Downlink coding delay.....	1350
	32.5.6 Uplink processing delay.....	1351
	32.5.7 Uplink coding delay.....	1351
32.6	Half Rate Downlink speech transcoding.....	1352
32.7	Half Rate Downlink receiver DTX functions.....	1353
32.8	Half Rate Uplink speech transcoding.....	1354
32.9	Half Rate Uplink transmitter DTX functions.....	1355
32.10	Half Rate Speech channel transmission delay.....	1357
	32.10.4 Downlink processing delay.....	1358
	32.10.5 Downlink coding delay.....	1358
	32.10.6 Uplink processing delay.....	1359
	32.10.7 Uplink coding delay.....	1359
32.11	Intra cell channel change from a TCH/HS to a TCH/FS.....	1360
32.12	Intra cell channel change from a TCH/FS to a TCH/HS.....	1362
33	Mobile station features.....	1365
33.1	Entry and display of called number.....	1365
33.2	Indication of call progress signals.....	1366
	33.2.4 Ringing tone.....	1366
	33.2.5 Busy tone.....	1366
	33.2.6 Congestion tone.....	1367
	33.2.7 Authentication failure tone.....	1367
	33.2.8 Number unobtainable tone.....	1368
	33.2.9 Call dropped tone.....	1368

33.3	Network selection / indication	1369
33.4	Invalid and blocked PIN indicators	1373
33.5	Service indicator	1374
33.6	Subscription identity management	1374
33.7	Barring of outgoing calls	1375
33.8	Prevention of unauthorized calls	1376
34	Short message service (SMS)	1377
34.1	General	1377
34.2	Short message service point to point	1377
34.2.1	SMS mobile terminated	1377
34.2.2	SMS mobile originated	1383
34.2.3	Test of memory full condition and memory available notification:	1388
34.2.4	Test of the status report capabilities and of SMS-COMMAND:	1393
34.2.5	Test of message class 0 to 3	1397
34.2.5.1	Short message class 0	1397
34.2.5.2	Test of class 1 short messages	1400
34.2.5.3	Test of class 2 short messages	1402
34.2.5.4	Test of class 3 short messages	1406
34.2.6	Test of short message type 0	1406
34.2.7	Test of the replace mechanism for SM type 1-7	1406
34.2.8	Test of the reply path scheme	1410
34.2.9	Multiple SMS mobile originated	1413
34.2.9.1	MS in idle mode	1413
34.2.9.2	MS in active mode	1417
34.3	Short message service cell broadcast	1420
34.4	Default message contents:	1422
35	Low battery voltage detection	1425
36	Individual equipment type requirements and interworking - special conformance testing functions	1427
36.1	General	1427
36.2	Activation and deactivation of special test functions in the MS	1427
36.2.1	Internal test loops	1427
36.2.1.1	TCH loop	1428
36.2.1.1.1	TCH loop including signalling of erased frames (A)	1429
36.2.1.1.2	Speech TCH loop without signalling of erased frames (B)	1429
36.2.1.1.3	TCH burst-by-burst loop (C)	1429
36.2.1.1.4	TCH loop including signalling of erased frames and unreliable frames (D)	1430
36.2.1.1.5	TCH loop including signalling of erased SID frames (E)	1431
36.2.1.1.6	TCH loop including signalling of erased valid SID frames (F)	1431
36.2.1.1.7	Deactivating TCH loops	1431
36.2.1.1.8	Additional non-mandatory operating characteristics	1432
36.2.2	Activating and deactivating EMMI	1432
36.2.3	Activating and deactivating DAI tests	1432
36.2.4	Message definitions and contents	1433
36.2.4.1	CLOSE_TCH_LOOP_CMD	1433
36.2.4.2	CLOSE_TCH_LOOP_ACK	1433
36.2.4.3	OPEN_LOOP_CMD	1434
36.2.4.4	Command for the activation of the EMMI, ACT_EMMI_CMD	1434
36.2.4.5	Acknowledge of the activation of the EMMI, ACT_EMMI_ACK	1434
36.2.4.6	Deactivation of the EMMI, DEACT_EMMI	1435
36.2.4.7	Test_Interface	1435
36.2.5	Timer values	1435

36.3	Electrical Man Machine Interface (EMMI).....	1435
36.3.1	Use of the EMMI.....	1435
36.3.2	Formal aspects.....	1436
36.3.3	Layered structure of the interface.....	1436
36.3.4	Terminology.....	1436
36.3.5	Description of the EMMI.....	1436
36.3.5.1	EMMI, Layer 1.....	1436
36.3.5.1.1	Mechanical and electrical characteristics.....	1436
36.3.5.1.2	Transmission and reception characteristics.....	1437
36.3.5.2	EMMI, layer 2.....	1437
36.3.5.2.1	General structure.....	1437
36.3.5.2.2	Control frames.....	1437
36.3.5.2.3	Frame structure.....	1437
36.3.5.2.4	Flow of I-frames on layer 2.....	1438
36.3.5.2.4.1	Transmission of frames.....	1438
36.3.5.2.4.2	Reception of frames.....	1438
36.3.5.2.4.3	Use of ACK and NAK on receiving side.....	1438
36.3.5.2.4.4	Use of XON and XOF.....	1438
36.3.5.2.4.5	Parameters on layer 2.....	1439
36.3.5.3	EMMI, layer 3.....	1439
36.3.5.3.1	Message structure.....	1439
36.3.5.3.2	Definition of messages.....	1440
36.4	Digital audio interface.....	1446
36.4.1	General.....	1446
36.4.2	Formal aspects.....	1446
36.4.3	Hardware aspect of the interface.....	1447
36.4.3.1	Mechanical characteristics of the interface.....	1447
36.4.3.2	Electrical characteristics of the interface.....	1447
36.4.3.3	Timing characteristics of the interface.....	1447
36.4.4	Logical interface.....	1448
36.4.5	Functionality of the DAI.....	1448
36.5	SIM/ME test interface.....	1449
36.5.1	General.....	1449
36.5.2	Formal aspects.....	1449
36.5.3	Hardware and logical aspects of the interface.....	1449
36.5.4	Mechanical characteristics of the interface.....	1449
Annex 1 (Normative):	Reference test methods.....	1451
A1.1	General Conditions (GC).....	1451
A1.1.1	Outdoor test site and general arrangements for measurements involving the use of radiated fields (GC4).....	1451
A1.1.2	Anechoic shielded chamber (GC5).....	1451
A1.1.3	Temporary antenna connector (GC7).....	1452
A1.1.4	Temporary antenna connector characteristics.....	1452
A1.1.5	Calibration of the temporary antenna connector.....	1453
A1.1.5.1	Antenna radiation pattern.....	1453
A1.1.5.2	Test range calibration.....	1455
A1.1.5.3	Temporary antenna connector coupling factor.....	1455
A1.2	Normal and extreme Test Conditions (TC).....	1456
A1.2.1	Power sources and ambient temperatures (TC2).....	1456
A1.2.2	Normal test conditions (TC2.1).....	1457
A1.2.3	Extreme test conditions (TC2.2).....	1457
A1.2.4	Vibration requirements (TC4).....	1458
Annex 2:	Not used.....	1459
Annex 3:	Protocol implementation information.....	1459

A3.1	Protocol Implementation Conformance Statement (PICS)	1459
A3.1.1	LAPDm protocol (GSM 04.05 and 04.06)	1459
A3.1.1.1	Simplified protocol - GSM 04.06 section 6	1459
A3.1.1.2	Management of SAPI = 3 - GSM 04.11 section 2.3	1459
A3.1.2	Mobility management	1459
A3.1.2.1	IMSI detach initiation by the MS - GSM 04.08 section 4.3.4.1	1459
A3.1.2.2	IMSI detach completion by the MS - GSM 04.08 section 4.3.4.3	1459
A3.1.2.3	MM specific procedures - GSM 04.08 section 4.4 and 4.5.1.1	1459
A3.1.2.4	Receiving an MM STATUS message - GSM 04.08 section 4.6	1459
A3.1.3	Call control	1460
A3.1.3.1	Status enquiry procedures - GSM 04.08 section 5.5.3.1	1460
A3.1.3.2	Receiving a STATUS message by a CC entity - GSM 04.08 section 5.5.3.2	1460
A3.1.3.3	Called side compatibility checking - GSM 04.08 annex B.3	1460
A3.1.3.4	Disconnect on incoming call	1460
A3.1.4	Layer 1	1460
A3.1.4.1	Optional storage of BCCH carrier information - GSM 05.08 section 6.3 ..	1460
A3.1.5	Autocalling - (ref.: GSM 02.07, annex 1)	1460
A3.1.6	Transient states	1460
A3.2	Protocol Implementation Extra Information for Testing (PIXIT)	1461
A3.2.0	Introduction	1461
A3.2.1	Basic characteristics	1461
A3.2.1.1	Type of antenna	1461
A3.2.1.2	Power supply	1462
A3.2.1.3	Power class of the MS	1462
A3.2.1.4	Channel modes supported	1462
A3.2.1.5	Teleservices supported	1462
A3.2.1.6	Supplementary services supported	1462
A3.2.1.7	Bearer services supported	1462
A3.2.1.8	SIM removal	1463
A3.2.1.9	Classmark	1463
A3.2.1.10	Type of SIM/ME interface (ref. GSM 11.11 and GSM 11.12)	1463
A3.2.2	Man machine interface	1463
A3.2.2.1	Mobile station features	1463
A3.2.2.2	Short message service	1464
A3.2.2.3	Supplementary services	1464
A3.2.2.3.1	Call forwarding	1464
A3.2.2.3.2	Call restriction	1465
A3.2.2.3.3	Handling of (undefined) GSM supplementary services ..	1465
A3.2.3	Electrical Man Machine Interface (EMMI)	1465
A3.2.3.1	Methods supported for activation/deactivation of EMMI	1465
A3.2.3.2	Transmission rate supported by the ME on the EMMI	1465
A3.2.3.3	Layer 3 messages supported on the EMMI	1465
A3.2.3.4	Keystroke sequence messages	1465
A3.2.3.5	Internal malfunction detected messages	1465
A3.2.4	Digital Audio Interface (DAI)	1465
A3.2.5	Characteristics related to bearer services or teleservices	1466
A3.2.5.1	Access interface	1466
A3.2.5.2	Configuration of the MT	1466
A3.2.5.3	Capability information	1466
A3.2.5.4	Subaddress or DDI number	1466
A3.2.5.5	User to user signalling	1466
A3.2.5.6	Data call set-up and data call clearing	1466
A3.2.5.7	Characteristics of non-transparent data services	1467
A3.2.5.8	Possible ways of setting-up a call from either an external interface or internally	1467
A3.2.5.9	Application layer causing automatic call termination.	1467
A3.2.5.10	Call re-establishment for MS not supporting speech	1467
A3.2.6	International mobile station equipment identity	1467
A3.2.7	Receiver intermediate frequencies	1467
A.3.2.8	Artificial ear	1467

Annex 4: Test SIM Parameters	1468
A4.1 Introduction	1468
A4.1.1 Definitions	1468
A4.1.2 Definition of the test algorithm for authentication.....	1468
A4.2 Default Parameters for the test SIM.....	1468
A4.3. Default settings for the Elementary Files (EFs).....	1468
A4.3.1 EF _{ICCID} (ICC Identification)	1469
A4.3.2 EF _{LP} (Language preference).....	1469
A4.3.3 EF _{IMSI} (IMSI).....	1469
A4.3.4 EF _{Kc} (Cipherring key Kc)	1469
A4.3.5 EF _{PLMNsel} (PLMN selector).....	1469
A4.3.6 EF _{HPLMN} (HPLMN search period)	1469
A4.3.7 EF _{ACMmax} (ACM maximum value)	1470
A4.3.8 EF _{SST} (SIM service table).....	1470
A4.3.9 EF _{ACM} (Accumulated call meter)	1470
A4.3.10 EF _{PUCT} (Price per unit and currency table).....	1470
A4.3.11 EF _{CBMI} (Cell broadcast Message Identifier Selection).....	1470
A4.3.12 EF _{BCCH} (Broadcast control channels).....	1471
A4.3.13 EF _{ACC} (Access control class)	1471
A4.3.14 EF _{FPLMN} (Forbidden PLMNs).....	1471
A4.3.15 EF _{LOCi} (Location information)	1471
A4.3.16 EF _{AD} (Administrative data)	1471
A4.3.17 EF _{Phase} (Phase identification)	1471
A4.3.18 EF _{ADN} (Abbreviated dialling numbers).....	1472
A4.3.19 EF _{FDN} (Fixed dialling numbers)	1472
A4.3.20 EF _{SMS} (Short messages).....	1472
A4.3.21 EF _{CCP} (Capability configuration parameters)	1472
A4.3.22 EF _{MSISDN} (MSISDN).....	1472
A4.3.23 EF _{SMSP} (Short message service parameters)	1472
A4.3.24 EF _{SMSS} (SMS status).....	1472
A4.3.25 EF _{EXT1} (Extension 1)	1472
A4.3.26 EF _{EXT2} (Extension 2)	1472
Annex 5: Test equipment	1473
A5.1 Introduction	1473
A5.1.1 General	1473
A5.1.2 Test equipment terms	1473
A5.1.3 Confidence level	1473
A5.2 Standard test signals.....	1473
A5.3 SS functional requirements	1474
A5.3.1 Level setting range.....	1474
A5.3.2 Level Measurement / operation range	1474
A5.3.3 MS power supply interface.....	1474
A5.3.4 MS antenna interface.....	1474
A5.3.4.1 Uplink receiver error	1474
A5.3.4.2 Power versus time measurements.....	1474
A5.3.4.3 Wideband selective power measurement	1477
A5.3.4.4 Inband selective power measurements.....	1477
A5.3.4.5 Phase trajectory and frequency error measurements	1477
A5.3.4.6 RF delay measurements relative to nominal times	1478
A5.3.4.7 The wanted signal or traffic channel of serving cell	1478
A5.3.4.8 The first interfering signal or traffic channel of the first adjacent cell	1478
A5.3.4.9 The second interfering signal	1479
A5.3.4.10 BCCH carriers of serving and adjacent cells.....	1479
A5.3.4.11 The wide frequency range signal	1480
A5.3.4.12 The multipath fading function	1480
A5.3.5 MS audio interface and DAI	1480

A5.3.5.1	General uncertainties.....	1480
A5.3.5.2	Analogue single test tone.....	1481
A5.3.5.3	Delay measurement between Um and DAI.....	1481
A5.4	SIM simulator functional requirements	1481
A5.4.1	General.....	1481
A5.4.2	Contacts C1, C2, C6, C7	1481
A5.4.2.1	Default measurement / setting uncertainties	1481
A5.4.2.2	Contact C1	1481
A5.4.2.3	Contact C7	1482
A5.4.3	Contact C3.....	1482
A5.4.4	Definition of timing	1482
History	1483

Blank page

Foreword

This draft tenth edition European Telecommunication Standard (ETS) has been produced by the Special Mobile Group (SMG) of the European Telecommunications Standards Institute (ETSI) and is now submitted for the One-step Approval Procedure (OAP) of the ETSI standards approval process.

This ETS describes the technical characteristics and methods of test for Mobile Stations (MSs), operating in the 900 MHz and 1 800 MHz frequency band (GSM 900 and DCS 1 800) within the digital cellular telecommunications system.

This ETS corresponds to GSM technical specification GSM 11.10-1 version 4.23.0.

This part of the ETS (Part 1), contains conformity specifications for which mobile stations, within the digital cellular telecommunications system (Phase 2), are tested for compliance. This ETS describes the test procedures, test conditions and test site and the provisions within the mobile station, to support the process of conformance testing.

ETS 300 607 consists of three parts, which have the following ETS numbers and titles:

ETS 300 607-1 **Digital cellular telecommunications system (Phase 2);
Mobile Station (MS) conformance specification;
Part 1: Conformance specification**

Reference: GSM 11.10-1.

ETS 300 607-2 Digital cellular telecommunications system (Phase 2);
Mobile Station (MS) conformance specification;
Part 2: Protocol Implementation Conformance Statement (PICS)
proforma specification

Reference: GSM 11.10-2.

ETS 300 607-3 Digital cellular telecommunications system (Phase 1);
Mobile Station (MS) conformance specification;
Part 3: Layer 3 (L3) Abstract Test Suite (ATS)

Reference: GSM 11.10-3.

The specification from which this ETS has been derived was originally based on CEPT documentation, hence the presentation of this ETS may not be entirely in accordance with the ETSI/PNE Rules.

Proposed transposition dates	
Date of latest announcement of this ETS (doa):	3 months after ETSI publication
Date of latest publication of new National Standard or endorsement of this ETS (dop/e):	6 months after doa
Date of withdrawal of any conflicting National Standard (dow):	6 months after doa

Blank page

1 Scope

This European Telecommunications Standard (ETS) describes the technical characteristics and methods of test for Mobile Stations (MS), for the Pan European digital cellular communications system and Personal Communication Systems (PCS) operating in the 900 MHz and 1 800 MHz band (GSM 900 and DCS 1 800), standardized by ETSI Technical Committee Special Mobile Group (SMG).

A subset of the tests is referenced in the GSM Common Technical Regulations (CTRs) and is used for regulatory conformance testing according to the EEC procedures for Telecommunications Terminal Equipment (TTE) type approval (EC Directive 91/263/EEC; also known as the "Terminal Directive" or "Second Phase Directive"). The remaining tests can be used to verify conformance with the GSM core technical specifications for those requirements that are not considered "essential" in the sense of the EC Directive 91/263/EEC (Article 4).

This ETS covers the minimum characteristics considered necessary in order to provide sufficient performance for mobile equipment and to prevent interference to other services or to other users, and to the PLMNs.

It does not necessarily include all the characteristics which may be required by a user or subscriber, nor does it necessarily represent the optimum performance achievable.

It applies to the public land mobile radio service in the GSM 900 and DCS 1 800 systems, using constant envelope modulation and operating on radio frequencies in the 900 and 1 800 MHz bands respectively with a channel separation of 200 kHz and carrying 8 full rate channels or 16 half rate channels per carrier according to the TDMA principle.

This ETS is part of the GSM-series of technical specifications. This ETS neither replaces any of the other GSM technical specifications or GSM related ETS, nor is it created to provide full understanding of (or parts of) the GSM 900 and DCS 1 800 systems. This ETS lists the requirements, and provides the methods of test for testing a MS for conformance to the GSM standard.

For a full description of the system, reference should be made to all the GSM technical specifications or GSM related ETSS. Clause 2 provides a complete list of the GSM technical specifications, GSM related ETSS, and ETRs, on which this conformance test specifications is based.

This ETS applies to the unit which includes the hardware to establish a connection across the radio interface.

If there is a difference between this conformance test ETS, and any other GSM technical specification or GSM related ETS, then the other GSM technical specification or GSM related ETS shall prevail.

2 Normative references

This ETS incorporates, by dated and undated reference, provisions from other publications. These normative references are cited at the appropriate places in the text and the publications are listed hereafter. For dated references subsequent amendments to or revision of any of these publications apply to the requirements specified in this ETS, only when incorporated in it by amendment or revision. For undated references the latest edition of the publication referred to applies.

- [1] GSM 01.04 Version 4.1.2 (ETR 350): "Digital cellular telecommunication system (Phase 2); Abbreviations and acronyms".
- [2] GSM 02.02 Version 4.2.2: "Digital cellular telecommunication system (Phase 2); Bearer Services (BS) supported by a GSM Public Land Mobile Network (PLMN)".
- [3] GSM 02.03 Version 4.3.1: "Digital cellular telecommunication system (Phase 2); Teleservices supported by a GSM Public Land Mobile Network (PLMN)".
- [4] GSM 02.04 Version 4.9.1: "Digital cellular telecommunication system (Phase 2); General on supplementary services".

- [5] GSM 02.06 Version 4.5.2: "Digital cellular telecommunication system (Phase 2); Types of Mobile Stations (MS)".
- [6] GSM 02.07 Version 4.8.2: "Digital cellular telecommunication system (Phase 2); Mobile Station (MS) features".
- [7] GSM 02.09 Version 4.4.1: "Digital cellular telecommunication system (Phase 2); Security aspects".
- [8] GSM 02.11 Version 4.9.0: "Digital cellular telecommunication system (Phase 2); Service accessibility".
- [9] GSM 02.17 Version 4.3.3: "Digital cellular telecommunication system (Phase 2); Subscriber identity modules Functional characteristics".
- [10] GSM 02.24 Version 4.5.0: "Digital cellular telecommunication system (Phase 2); Description of Charge Advice Information (CAI)".
- [11] GSM 02.30 Version 4.13.0: "Digital cellular telecommunication system (Phase 2); Man-Machine Interface (MMI) of the Mobile Station (MS)".
- [12] GSM 02.81 Version 4.6.1: "Digital cellular telecommunication system (Phase 2); Line identification supplementary services - Stage 1".
- [13] GSM 02.83 Version 4.6.7: "Digital cellular telecommunication system (Phase 2); Call Waiting (CW) and Call Hold (HOLD) supplementary services - Stage 1".
- [14] GSM 02.84 Version 4.4.7: "Digital cellular telecommunication system (Phase 2); MultiParty (MPTY) supplementary services - Stage 1".
- [15] GSM 02.86 Version 4.1.5: "Digital cellular telecommunication system (Phase 2); Advice of charge (AoC) supplementary services - Stage 1".
- [16] GSM 02.88 Version 4.4.3: "Digital cellular telecommunication system (Phase 2); Call Barring (CB) supplementary services - Stage 1".
- [17] GSM 02.90 Version 4.1.1: "Digital cellular telecommunications system (Phase 2); Stage 1 description of Unstructured Supplementary Service Data (USSD)".
- [18] GSM 03.03 Version 4.9.0: "Digital cellular telecommunication system (Phase 2); Numbering, addressing and identification".
- [19] GSM 03.11 Version 4.10.1: "Digital cellular telecommunication system (Phase 2); Technical realization of supplementary services".
- [20] GSM 03.20 Version 4.4.1: "Digital cellular telecommunication system (Phase 2); Security related network functions".
- [21] GSM 03.22 Version 4.11.0: "Digital cellular telecommunication system (Phase 2); Functions related to Mobile Station (MS) in idle mode".
- [22] GSM 03.38 Version 4.0.1: "Digital cellular telecommunications system (Phase 2); Alphabets and language-specific information".
- [23] GSM 03.40 Version 4.13.0: "Digital cellular telecommunication system (Phase 2); Technical realization of the Short Message Service (SMS) Point to Point (PP)".
- [24] GSM 03.41 Version 4.11.0: "Digital cellular telecommunication system (Phase 2); Technical realization of Short Message Service Cell Broadcast (SMSCB)".

- [25] GSM 03.45 Version 4.5.0: "Digital cellular telecommunication system (Phase 2); Technical realization of facsimile group 3 transparent".
- [26] GSM 03.50 Version 4.4.0: "Digital cellular telecommunication system (Phase 2); Transmission planning aspects of the speech service in the GSM Public Land Mobile Network (PLMN) system".
- [27] GSM 03.86 Version 4.6.1: "Digital cellular telecommunication system (Phase 2); Advice of Charge (AoC) supplementary services - Stage 2".
- [28] GSM 04.04 Version 4.0.4: "Digital cellular telecommunication system (Phase 2); layer 1 General requirements".
- [29] GSM 04.05 Version 4.0.3: "Digital cellular telecommunication system (Phase 2); Data Link (DL) layer General aspects".
- [30] GSM 04.06 Version 4.4.0: "Digital cellular telecommunication system (Phase 2); Mobile Station - Base Station System (MS - BSS) interface Data Link (DL) layer specification".
- [31] GSM 04.07 Version 4.3.1: "Digital cellular telecommunication system (Phase 2); Mobile radio interface signalling layer 3 General aspects".
- [32] GSM 04.08 Version 4.22.0: "Digital cellular telecommunication system (Phase 2); Mobile radio interface layer 3 specification".
- [33] GSM 04.10 Version 4.10.1: "Digital cellular telecommunication system (Phase 2); Mobile radio interface layer 3 Supplementary services specification General aspects".
- [34] GSM 04.11 Version 4.10.0: "Digital cellular telecommunication system (Phase 2); Point-to-Point (PP) Short Message Service (SMS) support on mobile radio interface".
- [35] GSM 04.12 Version 4.6.0: "Digital cellular telecommunication system (Phase 2); Short Message Service Cell Broadcast (SMSCB) support on the mobile radio interface".
- [36] GSM 04.13 Version 4.2.0: "Digital cellular telecommunication system (Phase 2); Performance requirements on mobile radio interface".
- [37] GSM 04.21 Version 4.6.0: "Digital cellular telecommunication system (Phase 2); Rate adaption on the Mobile Station - Base Station System (MS - BSS) interface".
- [38] GSM 04.22 Version 4.5.0: "Digital cellular telecommunication system (Phase 2); Radio Link Protocol (RLP) for data and telematic services on the Mobile Station - Base Station System (MS - BSS) interface and the Base Station System - Mobile-services Switching Centre (BSS - MSC) interface".
- [39] GSM 04.80 Version 4.11.1: "Digital cellular telecommunication system (Phase 2); Mobile radio interface layer 3 supplementary services specification Formats and coding".
- [40] GSM 04.81 Version 4.4.1: "Digital cellular telecommunication system (Phase 2); Line identification supplementary services - Stage 3".
- [41] GSM 04.82 Version 4.9.1: "Digital cellular telecommunication system (Phase 2); Call Forwarding (CF) supplementary services - Stage 3".
- [42] GSM 04.83 Version 4.6.1: "Digital cellular telecommunication system (Phase 2); Call Waiting (CW) and Call Hold (HOLD) supplementary services - Stage 3".

- [43] GSM 04.84 Version 4.3.2: "Digital cellular telecommunication system (Phase 2); MultiParty (MPTY) supplementary services - Stage 3".
- [44] GSM 04.86 Version 4.5.2: "Digital cellular telecommunication system (Phase 2); Advice of Charge (AoC) supplementary services - Stage 3".
- [45] GSM 04.88 Version 4.7.1: "Digital cellular telecommunication system (Phase 2); Call Barring (CB) supplementary services - Stage 3".
- [46] GSM 04.90 Version 4.1.1: "Digital cellular telecommunication system (Phase 2); Unstructured supplementary services operation - Stage 3".
- [47] GSM 05.02 Version 4.9.1: "Digital cellular telecommunication system (Phase 2); Multiplexing and multiple access on the radio path".
- [48] GSM 05.03 Version 4.5.1: "Digital cellular telecommunication system (Phase 2); Channel coding".
- [49] GSM 05.04 Version 4.0.3: "Digital cellular telecommunication system (Phase 2); Modulation".
- [50] GSM 05.05 Version 4.22.1: "Digital cellular telecommunication system (Phase 2); Radio transmission and reception".
- [51] GSM 05.08 Version 4.21.1: "Digital cellular telecommunication system (Phase 2); Radio subsystem link control".
- [52] GSM 05.10 Version 4.9.0: "Digital cellular telecommunication system (Phase 2); Radio subsystem synchronisation".
- [53] GSM 06.01 Version 5.0.1: "Digital cellular telecommunication system; Full rate speech processing functions".
- [54] GSM 06.02 Version 5.0.1: "Digital cellular telecommunication system; Half rate speech processing functions".
- [55] GSM 06.07 Version 5.0.1: Digital cellular telecommunications system; Half rate speech. Part 8: Test sequences for the GSM half rate speech codec".
- [56] GSM 06.10 Version 5.0.1: "Digital cellular telecommunication system (Phase 2); Full rate speech transcoding".
- [57] GSM 06.11 Version 5.0.1: "Digital cellular telecommunication system (Phase 2); Substitution and muting of lost frames for full rate speech channels".
- [58] GSM 06.12 Version 5.0.1: "Digital cellular telecommunication system (Phase 2); Comfort noise aspect for full rate speech traffic channels".
- [59] GSM 06.20 Version 5.0.1: "Digital cellular telecommunication system (Phase 2); Half rate speech transcoding".
- [60] GSM 06.21 Version 5.0.1: "Digital cellular telecommunication system (Phase 2); Substitution and muting of lost frames for half rate speech traffic channels".
- [61] GSM 06.22 Version 5.1.0: "Digital cellular telecommunication system (Phase 2); Comfort noise aspects for half rate speech traffic channels".
- [62] GSM 06.31 Version 5.0.1: "Digital cellular telecommunication system (Phase 2); Discontinuous Transmission (DTX) for full rate speech traffic channel".
- [63] GSM 06.32 Version 5.0.1: "Digital cellular telecommunication system (Phase 2); Voice Activity Detection (VAD)".

- [64] GSM 06.41 Version 5.0.1: "Digital cellular telecommunication system (Phase 2); Discontinuous Transmission (DTX) for half rate speech traffic channels".
- [65] GSM 06.42 Version 5.0.1: "Digital cellular telecommunication system (Phase 2); Voice Activity Detection (VAD) for half rate speech traffic channels".
- [66] GSM 07.01 Version 4.10.0: "Digital cellular telecommunication system (Phase 2); General on Terminal Adaptation Functions (TAF) for Mobile Stations (MS)".
- [67] GSM 07.02 Version 4.5.1: "Digital cellular telecommunication system (Phase 2); Terminal Adaptation Functions (TAF) for services using asynchronous bearer capabilities".
- [68] GSM 07.03 Version 4.5.1: "Digital cellular telecommunication system (Phase 2); Terminal Adaptation Functions (TAF) for services using synchronous bearer capabilities".
- [69] GSM 09.02 Version 4.17.1: "Digital cellular telecommunication system (Phase 2); Mobile Application Part (MAP) specification".
- [70] GSM 09.06 Version 4.5.0: "Digital cellular telecommunication system (Phase 2); Interworking between a Public Land Mobile Network (PLMN) and a Packet Switched Public Data Network/Integrated Services Digital Network (PSPDN/ISDN) for the support of packet switched data transmission services".
- [71] GSM 09.07 Version 4.12.1: "Digital cellular telecommunication system (Phase 2); General requirements on interworking between the Public Land Mobile Network (PLMN) and the Integrated Services Digital Network (ISDN) or Public Switched Telephone Network (PSTN)".
- [72] GSM 11.11 Version 4.20.0: "Digital cellular telecommunication system (Phase 2); Specification of the Subscriber Identity Module - Mobile Equipment (SIM - ME) interface".
- [73] GSM 11.12 Version 4.3.1: "Digital cellular telecommunications system (Phase 2); Specification of the 3 Volt Subscriber Identity Module - Mobile Equipment (SIM - ME) interface".
- [74] CCITT Recommendation E.164: "Numbering plan for the ISDN era".
- [75] CCITT Recommendation G.122: "Influence of national systems on stability talker echo in international connections".
- [76] CCITT Recommendation G.223: "Assumptions for the calculation of noise on hypothetical reference circuits for telephony".
- [77] CCITT Recommendation G.714: "Separate performance characteristics for the encoding and decoding sides of PCM channels applicable to 4-wire voice-frequency interfaces".
- [78] CCITT Recommendation G.721: "32 kbit/s Adaptive Differential Pulse Code Modulation (ADPCM) - General Aspects of Digital Transmission Systems; Terminal Equipments".
- [79] CCITT Recommendation O.131: "Quantizing distortion measuring equipment using a pseudo-random noise test signal".
- [80] CCITT Recommendation O.132: "Quantizing distortion measuring equipment using a sinusoidal test signal".
- [81] CCITT Recommendation O.153: "Basic parameters for the measurement of error performance at bit rates below the primary rate".

- [82] CCITT Recommendation P.34: "Transmission characteristics of hands-free telephones".
- [83] CCITT Recommendation P.35: "Handset telephones".
- [84] CCITT Recommendation P.50: "Artificial voices".
- [85] CCITT Recommendation P.51: "Artificial mouth".
- [86] CCITT Recommendation P.64: "Determination of sensitivity/frequency characteristics of local telephone systems".
- [87] CCITT Recommendation P.76: "Determination of loudness ratings fundamental principles".
- [88] CCITT Recommendation P.79: "Calculation of loudness ratings for telephone sets".
- [89] CCITT Recommendation T.4: "Standardization of group 3 facsimile apparatus for document transmission".
- [90] CCITT Recommendation T.21: "Standardized tests charts for document facsimile transmission".
- [91] CCITT Recommendation T.30: "Procedures for document facsimile transmission in the general switched telephone network".
- [92] CCITT Recommendation V.1: "Equivalence between binary notation symbols and the significant conditions of a two-condition code".
- [93] CCITT Recommendation V.14: "Transmission of start-stop characters over synchronous bearer channels".
- [94] CCITT Recommendation V.24: "List of definitions for interchange circuits between data terminal equipment (DTE) and data circuit-terminating equipment (DCE)".
- [95] CCITT Recommendation V.25bis: "Automatic calling and/or answering equipment on the general switched telephone network (GSTN) using the 100-series interchange circuits".
- [96] CCITT Recommendation V.110: "Support of data terminal equipments with V-Series type interfaces by an integrated services digital network".
- [97] CCITT Recommendation X.21: "Interface between data terminal equipment and data circuit-terminating equipment for synchronous operation on public data networks".
- [98] CCITT Recommendation X.208: "Specification of Abstract Syntax Notation One (ASN.1)".
- [99] CCITT Recommendation X.290: "OSI conformance testing methodology and framework for protocol Recommendations for ITU-T applications - General concepts".
- [100] ISO 3: "Preferred Numbers - Series of preferred Numbers".
- [101] ISO 2110: "Information Technology - Data Communication - 25-Pole DTE/DCE Interface Connector and Contact Number Assignments".
- [102] ISO 7816-3: "Identification cards - Integrated Circuit(s) Cards with Contacts - Part 3: Electronic Signals and Transmission Protocols".

- [103] IEC Publication 68-2-1: "Environmental Testing Part 2: Tests - Tests A: Cold".
- [104] IEC Publication 68-2-2: "Environmental Testing Part 2: Tests - Tests B: Dry Heat".
- [105] IEC publication 68-2-36: "Environmental Testing Part 2: Tests - Test Fdb: Random Vibration Wide Band - Reproducibility Medium".
- [106] ETR 028: "Radio Equipment and Systems (RES); Uncertainties in the measurement of mobile radio equipment characteristics
- [107] ITU-T Recommendation P.57 (1993), « Artificial ears. »

3 Definitions, conventions, and applicability

For abbreviations and acronyms, see GSM 01.04.

3.1 Mobile station definition and configurations

In this ETS, a MS can be:

- a vehicle mounted station;
- a portable station;
- a handheld station;
- a vehicle mounted/portable station;
- a vehicle mounted/handheld station.

A MS is the complete equipment configuration which may take part in a communication. However, this may not be the MS as it is offered to a test house for conformance testing.

In general, the MS, as it will be presented to a test house for conformance testing, is the station without all the additional Terminal Equipment (TE). Such a piece of hardware is also called a Mobile Termination (MT), but in this ETS, the expression MS is used for any form of MS hardware as it is offered to the test house.

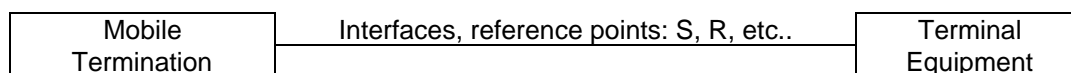

Figure 3-1

During the tests, the interfaces of the MT shall be connected to a System Simulator (SS), which will also emulate the TE. For some tests, it may be necessary to establish a pre-configured setup of the MS.

EXAMPLE: For reception of automatic fax group 3 to a fax machine on the R-interface, the MS needs configuration information about the presence of such a machine on that interface.

As an alternative, the TE may be physically integrated.

For a more detailed description of MS-configurations, see GSM 02.06.

3.2 Applicability

3.2.1 Applicability of this specification

If a MS is equipped with a connector, to connect terminal equipment on an S or R interface, then testing of the MS may include testing of appropriate functioning to and from this connector.

This ETS does not apply to TE which is to be connected to that connector (which constitutes a public interface), even if it is delivered with the MS.

3.2.2 Applicability of the individual tests

The applicability of each individual test is identified in the following table.

Table 3.1: Applicability of tests

Clause	Title	Applicability
11.1.1	Mobile Terminated (MT) calls	Each MT Bearer Service and MT Teleservice supported by the MS .
11.1.2	Mobile Originated (MO) calls	Each MO Bearer Service and MO Teleservice supported by the MS .
11.2	Verification of support of the single numbering scheme	All MS.
11.3	Verification of non-support of services (Advice of Charge Charging (AOCC))	MS which do not support AOCC.
11.4	Verification of non-support of services (call hold)	MS which support AOCC and do not support the Call Hold supplementary service.
11.5	Verification of non-support of services (multiparty)	MS which support Call Hold and AOCC, but do not support the Multi-Party supplementary service.
11.6	Verification of non-support of feature (Fixed Dialling Number (FDN))	MS which do not support FDN.
11.7	IMEI Security	All MS.
12.1.1	Conducted spurious emissions, MS allocated a channel	All MS with a permanent antenna connector.
12.1.2	Conducted spurious emissions, MS in idle mode	All MS with a permanent antenna connector.
12.2.1	Radiated spurious emissions, MS allocated a channel	All MS. The test at extreme voltages does not apply to MS where a practical connection to an external power supply is not possible.
12.2.2	Radiated spurious emissions, MS in idle mode	All MS. The test at extreme voltages does not apply to MS where a practical connection to an external power supply is not possible.
13.1	Frequency error and phase error	All MS.
13.2	Frequency error under multipath and interference conditions	All MS.
13.3	Transmitter output power and burst timing	All MS.
13.4	Output RF spectrum	All MS.
13.5	Intermodulation attenuation	DCS1800 MS.
14.1.1	Bad frame indication - TCH/FS	MS supporting speech
14.1.2	Bad frame indication - TCH/HS	MS supporting half-rate speech
14.2.1	Reference sensitivity - TCH/FS	MS supporting speech
14.2.2	Reference sensitivity - TCH/HS (Speech frames)	MS supporting half-rate speech
14.2.3	Reference sensitivity - FACCH/F	All MS
14.2.4	Reference sensitivity - FACCH/H	MS supporting half rate channels
14.2.5	Reference sensitivity - full rate data channels	MS supporting data
14.2.6	Reference sensitivity - half rate data channels	MS supporting half-rate data
14.2.7	Reference sensitivity - TCH/EFS	MS supporting TCH/EFS
14.3	Usable receiver input level range	MS supporting speech
14.4.1	Co-channel rejection - TCH/FS	MS supporting speech
14.4.2	Co-channel rejection - TCH/HS	MS supporting half-rate speech
14.4.3	Co-channel rejection - TCH/HS (SID frames)	MS supporting half-rate speech

Table 3.1: Applicability of tests (continued)

14.4.4	Co-channel rejection - FACCH/F	All MS
14.4.5	Reference sensitivity - half rate data channels	MS supporting half-rate data
14.4.6	Co-channel rejection - TCH/EFS	MS supporting TCH/EFS
14.5.1	Adjacent channel rejection - speech channels	MS supporting speech
14.5.2	Adjacent channel rejection - control channels	MS not supporting speech
14.6.1	Intermodulation rejection - speech channels	MS supporting speech
14.6.2	Intermodulation rejection - control channels	MS not supporting speech
14.7.1	Blocking and spurious response - speech channels	MS supporting speech
14.7.2	Blocking and spurious response - control channels	MS not supporting speech
14.8.1	AM suppression - speech channels	MS supporting speech
14.8.2	AM suppression - control channels	MS not supporting speech
15	Timing advance and absolute delay	All MS
16	Reception time tracking speed	All MS
17.1	Intra cell channel change	All MS
17.2	Inter cell handover	All MS
18	Temporary reception gaps	MS which do not have an application layer always running which performs a normal release of the call due to loss of traffic
19.1	Channel release after unrecoverable errors -1	MS which do not have an application layer always running which performs a normal release of the call due to loss of traffic
19.2	Channel release after unrecoverable errors - 2	MS which do not have an application layer always running which performs a normal release of the call due to loss of traffic
19.3	Channel release after unrecoverable errors - 3	MS which do not have an application layer always running which performs a normal release of the call due to loss of traffic
20.1	Cell selection	All MS
20.2	Cell selection with varying signal strength values	All MS
20.3	Basic cell reselection	All MS
20.4	Cell reselection using TEMPORARY_OFFSET, CELL_RESELECT_OFFSET, POWER_OFFSET and PENALTY_TIME parameters	All MS
20.5	Cell reselection using parameters transmitted in the System Information type 2bis, type 7 and type 8 messages	All MS. Test purpose 2 is only applicable to EGSM900 and DCS1800 MS
20.6	Cell reselection timings	All MS
20.7	Priority of cells	All MS
20.8	Cell reselection when C1 (serving cell) < 0 for 5 seconds	All MS
20.9	Running average of the surrounding cell BCCH carrier signal levels	All MS
20.10	Running average of the serving cell BCCH carrier signal level	All MS

Table 3.1: Applicability of tests (continued)

20.11	Updating the list of six strongest neighbour carriers and decoding the BCCH information of a new carrier on the list	All MS
20.12	Decoding the BCCH information of the neighbour carriers on the list of six strongest neighbour carriers	All MS
20.13	Decoding the BSIC of the neighbour carriers on the list of six strongest neighbour carriers	All MS
20.14	Emergency calls	MS supporting speech
20.15	Cell reselection due to MS rejection "LA not allowed"	All MS
20.16	Downlink signalling failure	All MS
20.17	Cell selection if no suitable cell found in 10 s	All MS
20.18	Cell reselection due to MS rejection "Roaming not allowed in this LA"	All MS
20.19	Cell selection on release of SDCCH and TCH	All MS
20.20.1	Multiband cell selection and reselection / Cell selection	MS supporting simultaneous multiband operation.
20.20.2	Multiband cell selection and reselection / Cell reselection	MS supporting simultaneous multiband operation.
21.1	Signal strength	All MS
21.2	Signal strength selectivity	All MS
21.3	Signal quality under static conditions	MS supporting speech
21.4	Signal quality under TU50 propagation conditions	All MS
22	Transmit power control timing and confirmation	All MS
23	Single frequency reference	All MS
25.2.1.1.1	Initialization when contention resolution required, Normal initialization	All MS
25.2.1.1.2.1	Initialization failure, Loss of UA frame	All MS
25.2.1.1.2.2	Initialization failure, UA frame with different information field	All MS
25.2.1.1.2.3	Initialization failure, Information frame and supervisory frames in response to an SABM frame	All MS
25.2.1.1.3	Initialization denial	All MS
25.2.1.1.4	Total initialization failure	All MS
25.2.1.2.1	Normal initialization without contention resolution	All MS
25.2.1.2.2	Initialization failure	All MS
25.2.1.2.3	Initialization denial	All MS
25.2.1.2.4	Total initialization failure	All MS
25.2.2.1	Sequence counting and I frame acknowledgements	All MS
25.2.2.2	Receipt of an I frame in the timer recovery state	All MS
25.2.2.3	Segmentation and concatenation	All MS
25.2.3	Normal layer 2 disconnection	All MS
25.2.4.1	I frame loss (MS to SS)	All MS
25.2.4.2	RR response frame loss (SS to MS)	All MS
25.2.4.3	RR response frame loss (MS to SS)	All MS
25.2.5.1	I frame with C bit set to zero	All MS
25.2.5.2	SABM frame with C bit set to zero	All MS

Table 3.1: Applicability of tests (continued)

25.2.6.1	N(S) sequence error	All MS
25.2.6.2	N(R) sequence error	All MS
25.2.6.3	Improper F bit	All MS
25.2.7	Test on receipt of invalid frames	All MS
26.2.1.1	Channel request / initial time	All MS
26.2.1.2	Channel request / repetition time	All MS
26.2.1.3	Channel request / random reference	All MS
26.2.2	IMSI detach and IMSI attach	Procedure 1, All MS Procedure 2, MS where SIM removal is possible without powering down Procedure 3, All MS
26.2.3	Sequenced MM / CC message transfer	All MS
26.2.4	Establishment cause, Procedure 1	MS supporting a service on a traffic channel
26.2.4	Establishment cause, Procedure 2	MS supporting a service on a half-rate channel
26.2.4	Establishment cause, Procedure 3	MS supporting speech
26.2.4	Establishment cause, Procedure 4	MS supporting a data service
26.2.4	Establishment cause, Procedure 5	All MS
26.2.4	Establishment cause, Procedure 6	All MS
26.2.4	Establishment cause, Procedure 7	MS supporting a non call related supplementary service operation
26.2.4	Establishment cause, Procedure 8	MS supporting SMS/PP MO
26.3.2	MS indication of available PLMNs	All MS
26.3.3	MS will send only if BSS is "on air", steps a - c	All MS
26.3.3	MS will send only if BSS is "on air", step d	MS supporting speech
26.3.4	Manual mode of PLMN selection	All MS
26.5.1	Handling of unknown, unforeseen, and erroneous protocol data, and of parallel transactions / unknown protocol discriminator	All MS
26.5.2.1.1	TI and skip indicator / RR / Idle Mode	All MS
26.5.2.1.2	TI and skip indicator / RR / RR-Connection established	All MS
26.5.2.2	TI and skip indicator / MM	All MS
26.5.2.3	TI and skip indicator / CC	MS supporting CC protocol for at least one Bearer Capability
26.5.3.1	Undefined or unexpected message type / undefined message type / CC	MS supporting CC protocol for at least one Bearer Capability
26.5.3.2	Undefined or unexpected message type / undefined message type / MM	MS supporting CC protocol for at least one Bearer Capability
26.5.3.3	Undefined or unexpected message type / undefined message type / RR	All MS
26.5.3.4	Undefined or unexpected message type / unexpected message type / CC	MS supporting CC protocol for at least one Bearer Capability
26.5.4.1	Unforeseen information elements in the non-imperative message part / duplicated information elements	All MS
26.5.5.1.1.1	Non-semantical mandatory IE errors / RR / missing mandatory IE error / special case	All MS
26.5.5.1.1.2	Non-semantical mandatory IE errors / RR / missing mandatory IE error / general case	All MS
26.5.5.1.2	Non-semantical mandatory IE errors / RR / comprehension required	All MS
26.5.5.2.1	Non-semantical mandatory IE errors / MM / syntactically incorrect mandatory IE	MS supporting CC protocol for at least one Bearer Capability

Table 3.1: Applicability of tests (continued)

26.5.5.2.2	Non-semantic mandatory IE errors / MM / syntactically incorrect mandatory IE	All MS
26.5.5.2.3	Non-semantic mandatory IE errors / MM / comprehension required	All MS
26.5.5.3.1.1	Non-semantic mandatory IE errors / CC / missing mandatory IE / disconnect message	MS supporting CC protocol for at least one Bearer Capability
26.5.5.3.1.2	Non-semantic mandatory IE errors / CC / missing mandatory IE / general case	MS supporting CC protocol for at least one Bearer Capability
26.5.5.3.2	Non-semantic mandatory IE errors / CC / comprehension required	MS supporting CC protocol for at least one Bearer Capability
26.5.6.1.1	Unknown IE, comprehension not required / MM / IE unknown in the protocol	All MS
26.5.6.1.2	Unknown IE, comprehension not required / MM / IE unknown in the message	All MS
26.5.6.2.1	Unknown information elements in the non-imperative message part / CC / Call establishment	MS supporting CC protocol for at least one Bearer Capability
26.5.6.2.2	Unknown information elements in the non-imperative message part / CC / disconnect	MS supporting CC protocol for at least one Bearer Capability
26.5.6.2.3	Unknown information elements in the non-imperative message part / CC / release	MS supporting CC protocol for at least one Bearer Capability
26.5.6.2.4	Unknown information elements in the non-imperative message part / CC / release complete	MS supporting CC protocol for at least one Bearer Capability
26.5.6.3	Unknown IE in the non-imperative message part, comprehension not required / RR	All MS
26.5.7.1.1	Spare bits / RR / paging channel	All MS
26.5.7.1.2	Spare bits / RR / BCCH	All MS
26.5.7.1.3	Spare bits / RR / AGCH	All MS
26.5.7.1.4	Spare bits / RR / Connected Mode	All MS
26.5.7.2	Spare bits / MM	All MS
26.5.7.3	Spare bits / CC	All MS
26.6.1.1	Immediate assignment / SDCCH or TCH assignment	First test, All MS Second test, MS supporting TCH/F Third test, MS supporting TCH/H
26.6.1.2	Immediate assignment / extended assignment	All MS
26.6.1.3	Immediate assignment / assignment rejection	All MS
26.6.1.4	Immediate assignment / ignore assignment	All MS
26.6.1.5	Immediate assignment after immediate assignment reject	All MS
26.6.2.1.1	Paging / normal / type 1	All MS
26.6.2.1.2	Paging / normal / type 2	All MS
26.6.2.1.3	Paging / normal / type 3	All MS
26.6.2.2	Paging / extended	All MS
26.6.2.3.1	Paging / reorganization / procedure 1	All MS
26.6.2.3.2	Paging / reorganization / procedure 2	All MS
26.6.2.4	Paging / same as before	All MS
26.6.2.5	Paging / multislots CCCH	All MS
26.6.3.1	Measurement / no neighbours	MS supporting CC protocol for at least one Bearer Capability
26.6.3.2	Measurement / all neighbours present	MS supporting CC protocol for at least one Bearer Capability
26.6.3.3	Measurement / barred cells and non-permitted NCCs	MS supporting CC protocol for at least one Bearer Capability

Table 3.1: Applicability of tests (continued)

26.6.3.4	Measurement / DTX	MS supporting CC protocol for at least one Bearer Capability
26.6.3.5	Measurement / Frequency Formats	MS supporting CC protocol for at least one Bearer Capability
26.6.3.6	Measurement / Multiband environment	MS supporting CC protocol for at least one bearer capability
26.6.4.1	Dedicated assignment / successful case	MS supporting a TCH
26.6.4.2.1	Dedicated assignment / failure / failure during active state, k = 1	MS supporting TCH/F and supporting CC-state U10
26.6.4.2.1	Dedicated assignment / failure / failure during active state, k = 2	MS supporting TCH/H and supporting CC-state U10
26.6.4.2.2	Dedicated assignment / failure / general case	MS supporting TCH
26.6.5.1	Handover / successful / active call / non-synchronized, M = 1	MS supporting TCH/F and supporting CC-state U10
26.6.5.1	Handover / successful / active call / non-synchronized, M = 2	MS supporting TCH/F and supporting CC-state U10
26.6.5.1	Handover / successful / active call / non-synchronized, M = 3	MS supporting TCH/F and supporting CC-state U10
26.6.5.1	Handover / successful / active call / non-synchronized, M = 4	MS supporting TCH/H and supporting CC-state U10
26.6.5.1	Handover / successful / active call / non-synchronized, M = 5	MS supporting TCH/H and supporting CC-state U10
26.6.5.1	Handover / successful / active call / non-synchronized, M = 6	MS supporting TCH/H and supporting CC-state U10
26.6.5.1	Handover / successful / active call / non-synchronized, M = 7	MS supporting TCH/H and supporting CC-state U10
26.6.5.1	Handover / successful / active call / non-synchronized, M = 8	MS supporting TCH/H and supporting CC-state U10
26.6.5.2	Handover / successful / call under establishment / non-synchronized, M = 1	MS supporting TCH/F and supporting CC-state U10
26.6.5.2	Handover / successful / call under establishment / non-synchronized, M = 2	MS supporting TCH/F and supporting CC-state U10
26.6.5.2	Handover / successful / call under establishment / non-synchronized, M = 3	MS supporting CC-state U10
26.6.5.2	Handover / successful / call under establishment / non-synchronized, M = 4	MS supporting CC-state U10
26.6.5.2	Handover / successful / call under establishment / non-synchronized, M = 5	MS supporting TCH/H and supporting CC-state U10
26.6.5.2	Handover / successful / call under establishment / non-synchronized, M = 6	MS supporting TCH/F and supporting CC-state U10
26.6.5.2	Handover / successful / call under establishment / non-synchronized, M = 7	MS supporting TCH/F and supporting CC-state U10
26.6.5.2	Handover / successful / call under establishment / non-synchronized, M = 8	MS supporting TCH/F and supporting CC-state U10
26.6.5.2	Handover / successful / call under establishment / non-synchronized, M = 9	MS supporting TCH/F and supporting CC-state U10
26.6.5.2	Handover / successful / call under establishment / non-synchronized, M = 10	MS supporting TCH/H and supporting CC-state U10
26.6.5.3	Handover / successful / active call / finely synchronized, M = 1	MS supporting TCH/F and supporting CC-state U10
26.6.5.3	Handover / successful / active call / finely synchronized, M = 2	MS supporting TCH/H and supporting CC-state U10
26.6.5.4	Handover / successful / call under establishment / finely synchronized, M = 1	MS supporting CC-state U10
26.6.5.4	Handover / successful / call under establishment / finely synchronized, M = 2	MS supporting CC-state U10
26.6.5.4	Handover / successful / call under establishment / finely synchronized, M = 3	MS supporting TCH/F and supporting CC-state U10

Table 3.1: Applicability of tests (continued)

26.6.5.4	Handover / successful / call under establishment / finely synchronized, M = 4	MS supporting TCH/H and supporting CC-state U10
26.6.5.5.1	Handover / successful / active call / pre-synchronized / Timing Advance IE not included	MS supporting TCH/F and supporting CC-state U10
26.6.5.5.2	Handover / successful / call being established / pre-synchronized / timing advance IE is included / reporting of observed time difference requested.	MS supporting TCH/F and supporting CC-state U10
26.6.5.6	Handover / successful / active call / pseudo synchronized	MS supporting TCH/F and supporting the pseudo synchronized handover procedure and supporting CC-state U10
26.6.5.7	Handover / successful / active call / non-synchronized / reporting of observed time difference requested.	MS supporting TCH/F and supporting CC-state U10
26.6.5.8	Handover / layer 3 failure	MS supporting TCH/F and supporting CC-state U10
26.6.5.9	Handover / layer 1 failure	MS supporting CC-state U10
26.6.6.1	Frequency redefinition, R = 1	All MS
26.6.6.1	Frequency redefinition, R = 2	MS supporting TCH/F
26.6.6.1	Frequency redefinition, R = 3	MS supporting TCH/H
26.6.7.1	Test of the channel mode modify procedure / full rate	MS supporting TCH/H
26.6.7.2	Test of the channel mode modify procedure / half rate	MS supporting TCH/F
26.6.8.1	Ciphering mode / start ciphering, k = 1	MS supporting CC state U10 and supporting encryption algorithm A5/1
26.6.8.1	Ciphering mode / start ciphering, k = 2	MS supporting CC state U10 and supporting encryption algorithm A5/2
26.6.8.2	Ciphering mode / no ciphering	MS supporting CC state U10
26.6.8.3	Ciphering mode / old cipher key	MS supporting CC state U10 and supporting encryption algorithm A5/1 and/or A5/2
26.6.8.4	Ciphering mode / change of mode, algorithm and key	MS supporting CC state U10 and supporting encryption algorithm A5/1 and/or A5/2
26.6.8.5	Ciphering mode / IMEISV request	All MS
26.6.11.1	Classmark change	MS supporting CC-state U10 and supporting more than one power class
26.6.11.2	Classmark interrogation	All MS
26.6.12.1	Channel release / SDCCH	All MS
26.6.12.2	Channel release / SDCCH - no L2 ACK	All MS
26.6.12.3	Channel release / TCH-F	MS supporting TCH/F
26.6.12.4	Channel release / TCH-F - no L2 ACK	MS supporting TCH/F
26.6.13.1	Dedicated assignment with starting time / successful case / time not elapsed	All MS
26.6.13.2	Dedicated assignment with starting time / successful case / time elapsed	All MS
26.6.13.3	Dedicated assignment with starting time and frequency redefinition / failure case / time not elapsed	All MS
26.6.13.4	Dedicated assignment with starting time and frequency redefinition / failure case / time elapsed	All MS
26.6.13.5	Handover with starting time / successful case / time not elapsed	All MS
26.6.13.6	Handover with starting time / successful case / time elapsed	All MS

Table 3.1: Applicability of tests (continued)

26.6.13.7	Handover with starting time and frequency redefinition / failure case / time not elapsed	All MS
26.6.13.8	Handover with starting time and frequency redefinition / failure case / time elapsed	All MS
26.6.13.9	Immediate assignment with starting time / successful case / time not elapsed	All MS
26.6.13.10	Immediate assignment with starting time / successful case / time elapsed	All MS
26.7.1	TMSI reallocation	All MS
26.7.2.1	Authentication accepted	All MS
26.7.2.2	Authentication rejected	All MS
26.7.3.1	General Identification	All MS
26.7.3.2	Handling of IMSI shorter than the maximum length	All MS
26.7.4.1	Location updating / accepted	All MS
26.7.4.2.1	Location updating / rejected / IMSI invalid	All MS
26.7.4.2.2	Location updating / rejected / PLMN not allowed, test 1	MS supporting speech
26.7.4.2.2	Location updating / rejected / PLMN not allowed, test 2	All MS
26.7.4.2.3	Location updating / rejected / location area not allowed	All MS
26.7.4.2.4	Location updating / rejected / national roaming, Procedure 1	All MS
26.7.4.2.4	Location updating / rejected / national roaming, Procedure 2	MS supporting speech
26.7.4.2.4	Location updating / rejected / national roaming, Procedure 3	All MS
26.7.4.2.4	Location updating / rejected / national roaming, Procedure 4	All MS
26.7.4.2.4	Location updating / rejected / national roaming, Procedure 5	MS supporting SIM removal without powering down
26.7.4.3.1	Location updating / abnormal cases / random access fails	All MS
26.7.4.3.2	Location updating / abnormal cases / attempt counter less or equal to 4, LAI different	All MS
26.7.4.3.3	Location updating / abnormal cases / attempt counter equal to 4	All MS
26.7.4.3.4	Location updating / abnormal cases / attempt counter less or equal to 4, stored LAI equal to broadcast LAI	All MS
26.7.4.4	Location updating / release / expiry of T3240	All MS
26.7.4.5.1	Location updating / periodic spread	All MS
26.7.4.5.2	Location updating / periodic normal / test 1	All MS
26.7.4.5.3	Location updating / periodic normal / test 2	All MS
26.7.4.5.4.1	Location updating / periodic HPLMN search / MS waits time T	All MS
26.7.4.5.4.2	Location updating / periodic HPLMN search / MS in manual mode	All MS
26.7.4.5.4.3	Location updating / periodic HPLMN search / MS waits at least two minutes and at most T minutes	All MS
26.7.4.6	Location updating / interworking of attach and periodic	All MS
26.7.5.2	MM connection / establishment with cipher	All MS

Table 3.1: Applicability of tests (continued)

26.7.5.3	MM connection / establishment without cipher	All MS
26.7.5.4	MM connection / establishment rejected	All MS
26.7.5.5	MM connection / establishment rejected cause 4	All MS
26.7.5.6	MM connection / expiry T3230	All MS
26.7.5.7.1	MM connection / abortion by the network / cause #6	All MS
26.7.5.7.2	MM connection / abortion by the network / cause not equal to #6	MS supporting a non call related supplementary service operation
26.7.5.8.1	MM connection / follow-on request pending / test 1	All MS
26.7.5.8.2	MM connection / follow-on request pending / test 2	MS supporting the follow on request procedure
26.7.5.8.3	MM connection / follow-on request pending / test 3	All MS
26.8.1.2.1.1	Outgoing call / U0 null state / MM connection requested	MS supporting at least one MO circuit switched basic service
26.8.1.2.2.1	Outgoing call / U0.1 MM connection pending / CM service rejected	MS supporting at least one MO circuit switched basic service
26.8.1.2.2.2	Outgoing call / U0.1 MM connection pending / CM service accepted	MS supporting at least one MO circuit switched basic service
26.8.1.2.2.3	Outgoing call / U0.1 MM connection pending / lower layer failure	MS supporting at least one MO circuit switched basic service
26.8.1.2.3.1	Outgoing call / U1 call initiated / receiving CALL PROCEEDING	MS supporting at least one MO circuit switched basic service
26.8.1.2.3.2	Outgoing call / U1 call initiated / rejecting with RELEASE COMPLETE	MS supporting at least one MO circuit switched basic service
26.8.1.2.3.3	Outgoing call / U1 call initiated / T303 expiry	MS supporting at least one MO circuit switched basic service
26.8.1.2.3.4	Outgoing call / U1 call initiated / lower layer failure	MS supporting at least one MO circuit switched basic service
26.8.1.2.3.5	Outgoing call / U1 call initiated / receiving ALERTING	MS supporting at least one MO circuit switched basic service
26.8.1.2.3.6	Outgoing call / U1 call initiated / entering state U10	MS supporting at least one MO circuit switched basic service
26.8.1.2.3.7	Outgoing call / U1 call initiated / unknown message received	MS supporting at least one MO circuit switched basic service
26.8.1.2.4.1	Outgoing call / U3 MS originating call proceeding / ALERTING received	MS supporting at least one MO circuit switched basic service
26.8.1.2.4.2	Outgoing call / U3 MS originating call proceeding / CONNECT received	MS supporting at least one MO circuit switched basic service
26.8.1.2.4.3	Outgoing call / U3 MS originating call proceeding / PROGRESS received without in band information	MS supporting at least one MO circuit switched basic service
26.8.1.2.4.4	Outgoing call / U3 MS originating call proceeding / PROGRESS with in band information	MS supporting at least one MO circuit switched basic service
26.8.1.2.4.5	Outgoing call / U3 MS originating call proceeding / DISCONNECT with in band tones	MS supporting at least one MO circuit switched basic service
26.8.1.2.4.6	Outgoing call / U3 MS originating call proceeding / DISCONNECT without in band tones	MS supporting at least one MO circuit switched basic service
26.8.1.2.4.7	Outgoing call / U3 MS originating call proceeding / RELEASE received	MS supporting at least one MO circuit switched basic service

Table 3.1: Applicability of tests (continued)

26.8.1.2.4.8	Outgoing call / U3 MS originating call proceeding / termination requested by the user	MS supporting at least one MO circuit switched basic service
26.8.1.2.4.9	Outgoing call / U3 MS originating call proceeding / traffic channel allocation	MS supporting at least one MO circuit switched basic service
26.8.1.2.4.10	Outgoing call / U3 MS originating call proceeding / timer T310 time-out	MS supporting at least one MO circuit switched basic service
26.8.1.2.4.11	Outgoing call / U3 MS originating call proceeding / lower layer failure	MS supporting at least one MO circuit switched basic service
26.8.1.2.4.12	Outgoing call / U3 MS originating call proceeding / unknown message received	MS supporting at least one MO circuit switched basic service
26.8.1.2.4.13	Outgoing call / U3 MS originating call proceeding / Internal alerting indication	MS supporting at least one MO circuit switched basic service for telephony
26.8.1.2.5.1	Outgoing call / U4 call delivered / CONNECT received	MS supporting at least one MO circuit switched basic service
26.8.1.2.5.2	Outgoing call / U4 call delivered / termination requested by the user	MS supporting at least one MO circuit switched basic service
26.8.1.2.5.3	Outgoing call / U4 call delivered / DISCONNECT with in band tones	MS supporting at least one MO circuit switched basic service
26.8.1.2.5.4	Outgoing call / U4 call delivered / DISCONNECT without in band tones	MS supporting at least one MO circuit switched basic service
26.8.1.2.5.5	Outgoing call / U4 call delivered / RELEASE received	MS supporting at least one MO circuit switched basic service
26.8.1.2.5.6	Outgoing call / U4 call delivered / lower layer failure	MS supporting at least one MO circuit switched basic service
26.8.1.2.5.7	Outgoing call / U4 call delivered / traffic channel allocation	MS supporting at least one MO circuit switched basic service
26.8.1.2.5.8	Outgoing call / U4 call delivered / unknown message received	MS supporting at least one MO circuit switched basic service
26.8.1.2.6.1	U10 call active / termination requested by the user	MS supporting at least one MO circuit switched basic service
26.8.1.2.6.2	U10 call active / RELEASE received	MS supporting at least one MO circuit switched basic service
26.8.1.2.6.3	U10 call active / DISCONNECT with in band tones	MS supporting at least one MO circuit switched basic service
26.8.1.2.6.4	U10 call active / DISCONNECT without in band tones	MS supporting at least one MO circuit switched basic service
26.8.1.2.6.5	U10 call active / RELEASE COMPLETE received	MS supporting at least one MO circuit switched basic service
26.8.1.2.6.6	U10 call active / SETUP received	MS supporting at least one MO circuit switched basic service
26.8.1.2.7.1	U11 disconnect request / clear collision	MS supporting at least one MO circuit switched basic service
26.8.1.2.7.2	U11 disconnect request / RELEASE received	MS supporting at least one MO circuit switched basic service
26.8.1.2.7.3	U11 disconnect request / timer T305 time-out	MS supporting at least one MO circuit switched basic service
26.8.1.2.7.4	U11 disconnect request / lower layer failure	MS supporting at least one MO circuit switched basic service
26.8.1.2.7.5	U11 disconnect request / unknown message received	MS supporting at least one MO circuit switched basic service
26.8.1.2.8.1	U12 disconnect indication / call releasing requested by the user	MS supporting bearer capability for speech
26.8.1.2.8.2	U12 disconnect indication / RELEASE received	MS supporting bearer capability for speech
26.8.1.2.8.3	U12 disconnect indication / lower layer failure	MS supporting bearer capability for speech

Table 3.1: Applicability of tests (continued)

26.8.1.2.8.4	U12 disconnect indication / unknown message received	MS supporting bearer capability for speech
26.8.1.2.9.1	Outgoing call / U19 release request / timer T308 time-out	MS supporting at least one MO circuit switched basic service
26.8.1.2.9.2	Outgoing call / U19 release request / 2nd timer T308 time-out	MS supporting at least one MO circuit switched basic service
26.8.1.2.9.3	Outgoing call / U19 release request / RELEASE received	MS supporting at least one MO circuit switched basic service
26.8.1.2.9.4	Outgoing call / U19 release request / RELEASE COMPLETE received	MS supporting at least one MO circuit switched basic service
26.8.1.2.9.5	Outgoing call / U19 release request / lower layer failure	MS supporting at least one MO circuit switched basic service
26.8.1.3.1.1	Incoming call / U0 null state / SETUP received with a non supported bearer capability	All MS
26.8.1.3.2.1	Incoming call / U6 call present / automatic call rejection	MS supporting at least one MT circuit switched basic service
26.8.1.3.3.1	Incoming call / U9 mobile terminating call confirmed / alerting or immediate connecting	MS supporting at least one MT circuit switched basic service
26.8.1.3.3.2	Incoming call / U9 mobile terminating call confirmed / TCH assignment	MS supporting at least one MT circuit switched basic service for which immediate connect is not used
26.8.1.3.3.3	Incoming call / U9 mobile terminating call confirmed / termination requested by the user	MS supporting at least one MT circuit switched basic service for which immediate connect is not used, and supporting sending DISCONNECT when in CC-state U9
26.8.1.3.3.4	Incoming call / U9 mobile terminating call confirmed / DISCONNECT received	MS supporting at least one MT circuit switched basic service for which immediate connect is not used
26.8.1.3.3.5	Incoming call / U9 mobile terminating call confirmed / RELEASE received	MS supporting at least one MT circuit switched basic service for which immediate connect is not used
26.8.1.3.3.6	Incoming call / U9 mobile terminating call confirmed / lower layer failure	MS supporting at least one MT circuit switched basic service for which immediate connect is not used
26.8.1.3.3.7	Incoming call / U9 mobile terminating call confirmed / unknown message received	MS supporting at least one MT circuit switched basic service for which immediate connect is not used
26.8.1.3.4.1	Incoming call / U7 call received / call accepted	MS supporting at least one MT circuit switched basic service for which immediate connect is not used
26.8.1.3.4.2	Incoming call / U7 call received / termination requested by the user	MS supporting at least one MT circuit switched basic service for which immediate connect is not used
26.8.1.3.4.3	Incoming call / U7 call received / DISCONNECT received	MS supporting at least one MT circuit switched basic service for which immediate connect is not used
26.8.1.3.4.4	Incoming call / U7 call received / RELEASE received	MS supporting at least one MT circuit switched basic service for which immediate connect is not used
26.8.1.3.4.5	Incoming call / U7 call received / lower layer failure	MS supporting at least one MT circuit switched basic service for which immediate connect is not used
26.8.1.3.4.6	Incoming call / U7 call received / unknown message received	MS supporting at least one MT circuit switched basic service for which immediate connect is not used

Table 3.1: Applicability of tests (continued)

26.8.1.3.4.7	Incoming call / U7 call received / TCH assignment	MS supporting at least one MT circuit switched basic service for which immediate connect is not used
26.8.1.3.4.8	Incoming call / U7 call received / RELEASE COMPLETE received	MS supporting at least one MT circuit switched basic service for which immediate connect is not used
26.8.1.3.5.1	Incoming call / U8 connect request / CONNECT acknowledged	MS supporting at least one MT circuit switched basic service
26.8.1.3.5.2	Incoming call / U8 connect request / timer T313 time-out	MS supporting at least one MT circuit switched basic service
26.8.1.3.5.3	Incoming call / U8 connect request / termination requested by the user	MS supporting at least one MT circuit switched basic service
26.8.1.3.5.4	Incoming call / U8 connect request / DISCONNECT received with in-band information	MS supporting at least one MT circuit switched basic service
26.8.1.3.5.5	Incoming call / U8 connect request / DISCONNECT received without in-band information	MS supporting at least one MT circuit switched basic service
26.8.1.3.5.6	Incoming call / U8 connect request / RELEASE received	MS supporting at least one MT circuit switched basic service
26.8.1.3.5.7	Incoming call / U8 connect request / lower layer failure	MS supporting at least one MT circuit switched basic service
26.8.1.3.5.8	Incoming call / U8 connect request / TCH assignment	MS supporting at least one MT circuit switched basic service
26.8.1.3.5.9	Incoming call / U8 connect request / unknown message received	MS supporting at least one MT circuit switched basic service
26.8.1.4.1.1	In-call functions / DTMF information transfer / basic procedures	MS supporting MO DTMF protocol control procedure
26.8.1.4.2.1	In-call functions / User notification / MS terminated	MS supporting at least one circuit switched basic service
26.8.1.4.3.1	In-call functions / channel changes / a successful channel change in active state/ Handover and Assignment Command	MS supporting at least one MT circuit switched basic service
26.8.1.4.3.2	In-call functions / channel changes / an unsuccessful channel change in active mode/ Handover and Assignment Command	MS supporting at least one MT circuit switched basic service
26.8.1.4.4.1	In-call functions / MS terminated in-call modification / modify when new mode is not supported	MS supporting at least one circuit switched basic service
26.8.1.4.5.1	In-call functions / MS originated in-call modification / a successful case of modifying	MS supporting at least one dual mode bearer capability service (BS61, BS81 or TS61)
26.8.1.4.5.2	In-call functions / MS originated in-call modification / modify rejected	MS supporting at least one dual mode bearer capability service (BS61, BS81 or TS61)
26.8.1.4.5.3	In-call functions / MS originated in-call modification / an abnormal case of acceptance	MS supporting at least one dual mode bearer capability service (BS61, BS81 or TS61)
26.8.1.4.5.4	In-call functions / MS originated in-call modification / an abnormal case of rejection	MS supporting at least one dual mode bearer capability service (BS61, BS81 or TS61)
26.8.1.4.5.5	In-call functions / MS originated in-call modification / time-out of timer T323	MS supporting at least one dual mode bearer capability service (BS61, BS81 or TS61)
26.8.1.4.5.6	In-call functions / MS originated in-call modification / a successful channel change in state mobile originating modify	MS supporting at least one dual mode bearer capability service (BS61, BS81 or TS61)

Table 3.1: Applicability of tests (continued)

26.8.1.4.5.7	In-call functions / MS originated in-call modification / an unsuccessful channel change in state mobile originating modify	MS supporting at least one dual mode bearer capability service (BS61, BS81 or TS61)
26.8.1.4.5.8	In-call functions / MS originated in-call modification / unknown message received	MS supporting at least one dual mode bearer capability service (BS61, BS81 or TS61)
26.8.1.4.5.9	In-call functions / MS originated in-call modification / a release complete received	MS supporting at least one dual mode bearer capability service (BS61, BS81 or TS61)
26.8.2.1	Call Re-establishment/call present, re-establishment allowed	MS supporting at least one bearer capability
26.8.2.2	Call Re-establishment/call present, re-establishment not allowed	MS supporting at least one MO circuit switched basic service
26.8.2.3	Call Re-establishment/call under establishment, transmission stopped	MS supporting at least one MO circuit switched basic service
26.8.3	User to user signalling	MS supporting at least one MT circuit switched basic service
26.9.2	Structured procedures / MS originated call / early assignment	MS supporting at least one MO teleservice
26.9.3	Structured procedures / MS originated call / late assignment	MS supporting at least one MO teleservice
26.9.4	Structured procedures / MS terminated call / early assignment	MS supporting at least one MT basic service
26.9.5	Structured procedures / MS terminated call / late assignment	MS supporting at least one MT teleservice
26.9.6.1.1	Structured procedures / emergency call / idle updated / preferred channel rate	MS supporting speech
26.9.6.1.2	Structured procedures / emergency call / idle updated, non-preferred channel rate	MS supporting half-rate speech
26.9.6.2.1	Structured procedures / emergency call / idle, no IMSI / accept case	MS supporting speech
26.9.6.2.2	Structured procedures / emergency call / idle, no IMSI / reject case	MS supporting speech
26.10.2.1	E-GSM signalling / RR / Measurement	MS supporting EGSM and supporting CC-state U10
26.10.2.2	E-GSM signalling / RR / Immediate assignment	MS supporting EGSM
26.10.2.3	E-GSM signalling / RR / channel assignment procedure	MS supporting EGSM
26.10.2.4.1	E-GSM signalling / RR / Handover / Successful handover	MS supporting EGSM and supporting CC-state U10
26.10.2.4.2	E-GSM signalling / RR / Handover / layer 1 failure	MS supporting EGSM and supporting CC-state U10
26.10.2.5	E-GSM signalling / RR / Frequency Redefinition	MS supporting EGSM
26.10.3.1	E-GSM signalling / Structured procedure / Mobile originated call	MS supporting EGSM and supporting at least one MO teleservice
26.10.3.2	E-GSM signalling / Structured procedures / emergency call	MS supporting EGSM and supporting speech
26.11.2.1	Multiband signalling / RR / Immediate assignment procedure	MS supporting simultaneous multiband operation
26.11.2.2.1	Multiband signalling / RR / Handover / successful / active call / non-synchronized	MS supporting simultaneous multiband operation and supporting TCH/F and supporting CC-state U10
26.11.2.2.2	Multiband signalling / RR / Handover / layer 1 failure	MS supporting simultaneous multiband operation and supporting CC-state U10

Table 3.1: Applicability of tests (continued)

26.11.2.3	Multiband signalling / RR / Measurement reporting	MS supporting simultaneous multiband operation and supporting CC protocol for at least one Bearer Capability
26.11.3.1.1	Multiband signalling / MM / Location updating / accepted	MS supporting simultaneous multiband operation
26.11.3.1.2	Multiband signalling / MM / Location updating / periodic	MS supporting simultaneous multiband operation
26.11.5.1	Multiband signalling / Structured procedures / MS originated call / early assignment	MS supporting simultaneous multiband operation and supporting at least one MO teleservice
26.11.5.2	Multiband signalling / Structured procedures / MS terminated call / late assignment	MS supporting simultaneous multiband operation and supporting at least one MT teleservice
26.12.1	EFR signalling / test of the channel mode modify procedure	MS supporting EFR speech
26.12.2.1	EFR signalling / Handover / active call / successful case	MS supporting EFR speech
26.12.2.2	EFR signalling / Handover / successful / call under establishment / non-synchronized	MS supporting EFR speech
26.12.3	EFR signalling / Structured procedures / MS originated call / late assignment	MS supporting EFR speech
26.12.4	EFR signalling / Structured procedures / MS terminated call / early assignment	MS supporting EFR speech
26.12.5	EFR signalling / Structured procedures / emergency call	MS supporting EFR speech
27.1.1	MS identification by short IMSI - Normal case	ME supporting either ID-1 or Plug-in SIM.
27.1.2	MS identification by short IMSI - Phase 1 DCS SIM	DCS ME supporting either ID-1 or Plug-in SIM.
27.2	MS identification by short TMSI	ME supporting either ID-1 or Plug-in SIM.
27.3	MS identification by long TMSI	ME supporting either ID-1 or Plug-in SIM.
27.4	MS identification by long IMSI, TMSI updating and cipher key sequence number assignment	ME supporting either ID-1 or Plug-in SIM.
27.5	Forbidden PLMNs, location updating and undefined cipher key	ME supporting either ID-1 or Plug-in SIM.
27.6	MS updating forbidden PLMNs	ME supporting either ID-1 or Plug-in SIM.
27.7	MS deleting forbidden PLMNs	ME supporting either ID-1 or Plug-in SIM.
27.8	MS updating the PLMN selector list	ME supporting either ID-1 or Plug-in SIM.
27.9	MS recognizing the priority order of the PLMN selector list	ME supporting either ID-1 or Plug-in SIM.
27.10	MS access control management	ME supporting either ID-1 or Plug-in SIM.
27.11.1.1	Bit/character duration during the transmission from the ME to the SIM	ME supporting either ID-1 or Plug-in SIM.
27.11.1.2	Bit/character duration during the transmission from the SIM simulator to the ME	ME supporting either ID-1 or Plug-in SIM.
27.11.1.3	Inter-character delay	ME supporting either ID-1 or Plug-in SIM.
27.11.1.4	Error handling during the transmission from the ME to the SIM simulator	ME supporting either ID-1 or Plug-in SIM.
27.11.1.5	Error handling during transmission from the SIM simulator to the ME	ME supporting either ID-1 or Plug-in SIM.
27.11.2.1	Acceptance of SIMs with internal RST	ME supporting either ID-1 or Plug-in SIM.
27.11.2.2	Acceptance of SIMs with active low RST	ME supporting either ID-1 or Plug-in SIM.
27.11.2.3	Characters of the answer to reset	ME supporting either ID-1 or Plug-in SIM.
27.11.2.4	PTS procedure	ME supporting either ID-1 or Plug-in SIM.
27.11.2.5	Reset repetition	ME supporting either ID-1 or Plug-in SIM.

Table 3.1: Applicability of tests (continued)

27.11.3	Command processing, procedure bytes	ME supporting either ID-1 or Plug-in SIM.
27.12.1	Operating speed in authentication procedure	ME supporting either ID-1 or Plug-in SIM.
27.12.2	Clock stop	ME supporting either ID-1 or Plug-in SIM.
27.13.1	Contact pressure	ME supporting either ID-1 or Plug-in SIM.
27.13.2	Shape of contacts for IC card SIM card reader	ME supporting either ID-1 or Plug-in SIM.
27.14.1	Entry of PIN	All ME
27.14.2	Change of PIN	All ME
27.14.3	Disabling the PIN	ME supporting either ID-1 or Plug-in SIM and supporting a feature to disable the PIN.
27.14.4	PUK entry	ME supporting either ID-1 or Plug-in SIM.
27.14.5	Entry of PIN2	ME supporting a feature requiring entry of PIN2 (e.g. AoC or FDN).
27.14.6	Change of PIN2	ME supporting PIN2
27.14.7	PUK2 entry	ME supporting either ID-1 or Plug-in SIM and supporting PIN2.
27.15	Abbreviated Dialling Numbers (ADN)	ME supporting either ID-1 or Plug-in SIM and supporting ADN.
27.16	MMI reaction to SIM status encoding	ME supporting either ID-1 or Plug-in SIM.
27.17.1.1	Phase preceding ME power on	All ME
27.17.1.2	Phase during SIM power on	ME with either 5V SIM interface, 3V SIM interface or 5V/3V SIM interface.
27.17.1.3	Phase during ME power off with clock stop forbidden	ME with either 5V SIM interface, 3V SIM interface or 5V/3V SIM interface.
27.17.1.4	Phase during ME power off with clock stop allowed	ME with either 5V SIM interface, 3V SIM interface or 5V/3V SIM interface.
27.17.1.5.1	Reaction of 3V only MEs on SIM type recognition failure	ME with a 3V SIM interface.
27.17.1.5.2	Reaction of 3V only MEs on type recognition of 5V only SIMs	ME with a 3V SIM interface.
27.17.1.5.3	Reaction of 3V technology MEs on type recognition of 5V only SIMs	ME with a 5V/3V SIM interface.
27.17.1.5.4	Reaction of 3V technology MEs on type recognition of 3V technology SIMs	ME with a 5V/3V SIM interface.
27.17.2.1.1	Electrical tests on contact C1, Test 1	ME with either 5V SIM interface, 3V SIM interface or 5V/3V SIM interface.
27.17.2.1.2	Electrical tests on contact C1, Test 2	ME with either 5V SIM interface, 3V SIM interface or 5V/3V SIM interface.
27.17.2.2	Electrical tests on contact C2	ME with either 5V SIM interface, 3V SIM interface or 5V/3V SIM interface.
27.17.2.3	Electrical tests on contact C3	ME with either 5V SIM interface, 3V SIM interface or 5V/3V SIM interface.
27.17.2.5	Electrical tests on contact C7	ME with either 5V SIM interface, 3V SIM interface or 5V/3V SIM interface.
27.18.1	ME and SIM with FND activated	ME supporting either ID-1 or Plug-in SIM and supporting FDN.
27.18.2	ME and SIM with FND deactivated	ME supporting either ID-1 or Plug-in SIM and supporting FDN.
27.18.3	Enabling, disabling and updating of FND	ME supporting either ID-1 or Plug-in SIM and supporting FDN.
27.19	Phase identification	ME supporting either ID-1 or Plug-in SIM.
27.20	SIM presence detection	All ME
27.21.1	AoC not supported by SIM	ME supporting AoCC.
27.21.2	Maximum frequency of ACM updating	ME supporting AoC
27.21.3	Call terminated when ACM greater than ACMmax	ME supporting AoCC

Table 3.1: Applicability of tests (continued)

27.21.4	Response codes of increase command	ME supporting AoC
28.2	Constraining the access to a single number (GSM 02.07 category 3)	MS supporting autocalling
28.3	Constraining the access to a single number (GSM 02.07 categories 1 and 2)	MS supporting autocalling
28.4	Behaviour of the MS when its list of blacklisted numbers is full	MS supporting autocalling
29.2.1	Verification of synchronisation	MS supporting data services in transparent mode.
29.2.2	Filtering of channel control information for transparent BCs	MS supporting the MT2 configuration.
29.2.3.1	Negotiation of Radio Channel Requirement (RCR)	MS with an external data interface.
29.2.3.2	Negotiation of Connection Element (CE)	MS with an external data interface
29.2.3.3	Negotiation of Number of Stop Bits, Number of Data bits, and Parity	MS supporting asynchronous data services.
29.2.3.4	Negotiation of Modem Type	MS supporting non-transparent data services.
29.2.3.5	Negotiation of Intermediate Rate	MS supporting non-transparent services on a TCH/F with a user rate of 4,8 kbit/s or lower.
29.2.3.6	Negotiation of User Information Layer 2 Protocol	MS supporting asynchronous bearer services in non-transparent mode.
29.2.3.7	Negotiation between TS 61 and TS 62: Mobile Originated call.	MS supporting TS 61
29.2.3.8	Negotiation between TS 61 and TS 62: Mobile Terminated call.	MS supporting TS 62 and not supporting TS 61.
29.2.4	Data Rate Adaptation for Synchronous Transparent Bearer Capabilities	MS supporting data over the Um-interface.
29.2.6.1	Data Rate Adaptation	MS supporting MT0 or MT2 configuration and supporting data over the Um-interface and supporting asynchronous data Bearer services
29.2.6.2	Passage of the Break Signal	MS supporting MT2 configuration
29.2.6.3	Overspeed/Underspeed Handling (Local Terminal)	MS supporting MT2 configuration
29.2.6.4	Overspeed/Underspeed Handling (Remote Terminal)	MS supporting MT2 configuration
29.2.7	Interchange circuit mapping for transparent bearer capabilities	MS supporting MT2 configuration
29.3.1.1	Normal initialization done by the MS	MS supporting at least one non-transparent bearer service
29.3.1.2.1	Loss of UA frame	MS supporting at least one non-transparent bearer service
29.3.1.2.2	Total loss of UA frame	MS supporting at least one non-transparent bearer service
29.3.2.2.1	N(S) sequence number	MS supporting at least one non-transparent bearer service
29.3.2.2.2	Transmission window	MS supporting at least one non-transparent bearer service
29.3.2.2.3	Busy condition	MS supporting at least one non-transparent bearer service
29.3.2.3.1	N(R) sequence number	MS supporting at least one non-transparent bearer service
29.3.2.3.2	Busy condition	MS supporting at least one non-transparent bearer service

Table 3.1: Applicability of tests (continued)

29.3.2.4.1	REJ frame	MS supporting at least one non-transparent bearer service
29.3.2.4.2.	SREJ frame	MS supporting at least one non-transparent bearer service
29.3.2.4.3	I+S reject frame	MS supporting at least one non-transparent bearer service
29.3.2.5.1	Rejection with REJ or SREJ supervisory frames	MS supporting at least one non-transparent bearer service
29.3.2.5.2	Retransmission of REJ or SREJ frames	MS supporting at least one non-transparent bearer service
29.3.2.5.3	I+S reject frame	MS supporting at least one non-transparent bearer service
29.3.2.6.1	SS in checkpoint recovery mode	MS supporting at least one non-transparent bearer service
29.3.2.6.2	End of the window	MS supporting at least one non-transparent bearer service
29.3.2.6.3	End of a sequence	MS supporting at least one non-transparent bearer service
29.3.2.6.4	Time-out of one frame	MS supporting at least one non-transparent bearer service
29.3.2.6.5	No response to checkpointing	MS supporting at least one non-transparent bearer service
29.3.2.6.6	Incorrect response to checkpointing	MS supporting at least one non-transparent bearer service
29.3.2.6.7	Total loss of response to checkpointing	MS supporting at least one non-transparent bearer service
29.3.2.6.8	Retransmission of a sequence	MS supporting at least one non-transparent bearer service
29.3.2.6.9	N2 retransmission of a sequence	MS supporting at least one non-transparent bearer service
29.3.3.1	Negotiation initiated by the SS	MS supporting at least one non-transparent bearer service
29.3.3.2	Negotiation initiated by the MS	MS supporting at least one non-transparent bearer service
29.3.3.3	Collision of XID frames	MS supporting at least one non-transparent bearer service
29.3.3.4	Loss of XID frames	MS supporting at least one non-transparent bearer service
29.3.3.5	Total loss of XID frames	MS supporting at least one non-transparent bearer service
29.4.2.1.1	Mobile originated call, Call establishment procedure, Alternate speech / facsimile	MS supporting TS61
29.4.2.1.2	Mobile originated call, Call establishment procedure, Automatic facsimile	MS supporting TS62
29.4.2.2	Pre-message procedure	MS supporting TS 61 and/or TS62
29.4.2.3	Message procedure	MS supporting TS 61 and/or TS62
29.4.2.4	Post-message procedure	MS supporting TS 61 and/or TS62
29.4.2.5	Call release procedure	MS supporting TS 61 and/or TS62
29.4.2.6	CTC processing - 4th PPR for the same block	MS supporting TS 61 and/or TS62 and supporting the error correction mode
29.4.2.7	Transition from Facsimile to Speech - Procedure interrupt generated by receiving station	MS supporting TS61
29.4.2.8	Transition from Facsimile to Speech - Procedure interrupt generated by transmitting station	MS supporting TS61

Table 3.1: Applicability of tests (continued)

29.4.2.9	Quality check	MS supporting transparent facsimile group 3
29.4.3.1.1.1	Mobile terminated call, Call Establishment Procedure, Alternate Speech/Facsimile, DCD Mobile Terminated	MS supporting TS61
29.4.3.1.1.2	Mobile terminated call, Call Establishment Procedure, Alternate Speech/Facsimile, DCD mobile originated	MS supporting TS61
29.4.3.1.2	Mobile terminated call, Call Establishment Procedure, Automatic facsimile	MS supporting TS62
29.4.3.2	Pre-message procedure	MS supporting TS 61 and/or TS62
29.4.3.3	Message procedure	MS supporting TS 61 and/or TS62
29.4.3.4	Post-message procedure	MS supporting TS 61 and/or TS62
29.4.3.5	Call release procedure	MS supporting TS 61 and/or TS62
29.4.3.6	Speed conversion factor	MS supporting TS 61 and/or TS62
29.4.3.7	Quality Check	??
29.4.3	Notes	
30.1	Sending sensitivity/frequency response	MS with handset and supporting speech
30.2	Sending loudness rating	MS with handset and supporting speech
30.3	Receiving sensitivity/frequency response	MS with handset and supporting speech
30.4	Receiving loudness rating	MS with handset and supporting speech
30.5.1	Side Tone Masking Rating (STMR)	MS with handset and supporting speech
30.5.2	Listener Side Tone Rating (LSTR)	MS with handset and supporting speech
30.6.1	Echo Loss (EL)	MS with handset and supporting speech
30.6.2	Stability margin	MS supporting speech
30.7.1	Distortion, Sending	MS with handset and supporting speech
30.7.2	Distortion, Receiving	MS with handset and supporting speech
30.8	Sidetone distortion	MS with handset and supporting speech
30.9.1	Out-of-band signals, Sending	MS with handset and supporting speech
30.9.2	Out-of-band signals, Receiving	MS with handset and supporting speech
30.10.1	Idle channel noise, Sending	MS with handset and supporting speech
30.10.2	Idle channel noise, Receiving	MS with handset and supporting speech
31.2.1.1.1	Call forwarding supplementary services, Registration accepted	All MS
31.2.1.1.2	Call forwarding supplementary services, Registration rejected	All MS
31.2.1.2.1	Call forwarding supplementary services, Erasure accepted	All MS
31.2.1.2.2	Call forwarding supplementary services, Erasure rejected	All MS
31.2.1.3	Call forwarding supplementary services, Activation	All MS
31.2.1.4	Call forwarding supplementary services, Deactivation	All MS
31.2.1.6.1	Call forwarding supplementary services, Interrogation accepted	All MS
31.2.1.6.2	Call forwarding supplementary services, Interrogation rejected	All MS
31.2.1.7.1.1	Call forwarding supplementary services, Notification during an incoming call	MS supporting CFB and/or CFNRy
31.2.1.7.1.2	Call forwarding supplementary services, Notification during an outgoing call	All MS
31.2.1.7.2	Call forwarding supplementary services, Forwarded-to mobile subscriber side	All MS
31.6.1.1	AOC time related charging / MS originated call	MS supporting AOCC and CC-state U10

Table 3.1: Applicability of tests (continued)

31.6.1.2	AOC time related charging / MS terminated call	MS supporting AOCC and CC-state U10
31.6.1.5	Change in charging information during a call	MS supporting AOCC and CC-state U10
31.6.1.6	Different formats of charging information	MS supporting AOCC and CC-state U10
31.6.1.7	AOC on a Call Hold call	MS supporting AOCC and CC-state U10
31.6.1.8	AOC on a Multi-party call	MS supporting AOCC and CC-state U10
31.6.2.1	Removal of SIM during an active call	MS supporting AOCC and CC-state U10
31.6.2.2	Interruption of power supply during an active call	MS supporting AOCC and CC-state U10
31.6.2.3	MS going out of coverage during an active AOCC call	MS supporting AOCC and CC-state U10
31.6.2.4	ACMmax operation / Mobile Originating	MS supporting AOCC and CC-state U10
31.6.2.5	ACMmax operation / Mobile Terminating	MS supporting AOCC and CC-state U10
31.8.1	Registration of a password	All MS
31.8.1.1	Registration accepted	All MS
31.8.1.2.1	Rejection after invoke of the RegisterPassword operation	All MS
31.8.1.2.2	Rejection after password check with negative result	All MS
31.8.1.2.3	Rejection after new password mismatch	All MS
31.8.3.1	Activation accepted	All MS
31.8.3.2.1	Rejection after invoke of ActivateSS operation	All MS
31.8.3.2.2	Rejection after use of password procedure	All MS
31.8.4.1	Deactivation accepted	All MS
31.8.4.2.1	Rejection after invoke of DeactivateSS operation	All MS
31.8.4.2.2	Rejection after use of password procedure	All MS
31.8.6.1	Interrogation accepted	All MS
31.8.6.2	Interrogation rejected	All MS
31.8.7	Normal operation	All MS
31.9.1.1	ProcessUnstructuredSS-request/accepted	MS supporting USSD, supporting TCH/F and supporting CC-state U10
31.9.1.2	ProcessUnstructuredSS-request/cross phase compatibility and error handling	MS supporting USSD, supporting TCH/F and supporting CC-state U10
31.9.2.1	UnstructuredSS-Notify/accepted	MS supporting USSD, supporting TCH/F and supporting CC-state U10
31.9.2.2	UnstructuredSS-Notify/rejected on user busy	MS supporting USSD, supporting TCH/F and supporting CC-state U10
31.9.2.3	UnstructuredSS-Request/accepted	MS supporting USSD, supporting TCH/F and supporting CC-state U10
31.9.2.4	UnstructuredSS-Request/rejected on user busy	MS supporting USSD, supporting TCH/F and supporting CC-state U10
31.10	MMI input for USSD	All MS
32.1	Full Rate Downlink speech transcoding	MS supporting TCH/FS
32.2	Full Rate Downlink receiver DTX functions	MS supporting TCH/FS
32.3	Full Rate Uplink speech transcoding	MS supporting TCH/FS
32.4	Full Rate Uplink transmitter DTX functions	MS supporting TCH/FS
32.5	Full Rate Speech channel transmission delay	MS supporting TCH/FS
32.5.4	Downlink processing delay	MS supporting TCH/FS
32.5.5	Downlink coding delay	MS supporting TCH/FS
32.5.6	Uplink processing delay	MS supporting TCH/FS
32.5.7	Uplink coding delay	MS supporting TCH/FS
32.6	Half Rate Downlink speech transcoding	MS supporting TCH/HS
32.7	Half Rate Downlink receiver DTX functions	MS supporting TCH/HS

Table 3.1: Applicability of tests (concluded)

32.8	Half Rate Uplink speech transcoding	MS supporting TCH/HS
32.9	Half Rate Uplink transmitter DTX functions	MS supporting TCH/HS
32.10	Half Rate Speech channel transmission delay	MS supporting TCH/HS
32.10.4	Downlink processing delay	MS supporting TCH/HS
32.10.5	Downlink coding delay	MS supporting TCH/HS
32.10.6	Uplink processing delay	MS supporting TCH/HS
32.10.7	Uplink coding delay	MS supporting TCH/HS
32.11	Intra cell channel change from a TCH/HS to a TCH/FS	MS supporting TCH/HS
32.12	Intra cell channel change from a TCH/FS to a TCH/HS	MS supporting TCH/HS
33.1	Entry and display of called number	All MS
33.2.4	Ringing tone	All MS
33.2.5	Busy tone	All MS
33.2.6	Congestion tone	All MS
33.2.7	Authentication failure tone	All MS
33.2.8	Number unobtainable tone	All MS
33.2.9	Call dropped tone	All MS
33.3	Network selection / indication	All MS
33.4	Invalid and blocked PIN indicators	All MS
33.5	Service indicator	All MS
33.6	Subscription identity management	All MS
33.7	Barring of outgoing calls	MS supporting barring of outgoing calls
33.8	Prevention of unauthorized calls	MS supporting prevention of unauthorized calls
34.2.1	SMS mobile terminated	MS supporting SMS MT/PP and supporting CC-state U10
34.2.2	SMS mobile originated	MS supporting SMS MO/PP and supporting CC-state U10
34.2.3	Test of memory full condition and memory available notification:	MS supporting SMS MT/PP and storing of short messages in the SIM
34.2.4	Test of the status report capabilities and of SMS-COMMAND:	MS supporting status report capabilities
34.2.5.1	Short message class 0	MS supporting SMS MT/PP and display of received short messages
34.2.5.2	Test of class 1 short messages	MS supporting storing of received Class I Short Messages and display of stored Short Messages
34.2.5.3	Test of class 2 short messages	MS supporting storing of received Class II Short Messages in the SIM
34.2.7	Test of the replace mechanism for SM type 1-7	MS supporting Replace Short Messages and display of received Short Messages
34.2.8	Test of the reply path scheme	MS supporting reply procedures, display of received Short Messages and submitting Short Messages
34.3	Short message service cell broadcast	All MS
35	Low battery voltage detection	All MS

3.2.3 Applicability to terminal equipment

If a MS is delivered for conformance testing, and it contains physically integrated TE, then this ETS applies to the complete MS including that TE.

This ETS also applies to separate TE that is delivered for conformance testing with the MS. The MS is then tested as an MT0. In that case, the specific TE with which the MS is tested is documented in the test report.

3.3 Definitions

The following definitions are used in this ETS:

idle updated:

The MS is defined to be "idle updated" if the following three conditions are fulfilled:

- its update status is U1 UPDATED (cf. GSM 04.08);
- it is in the MM state MM-IDLE (cf. GSM 04.08);
- it is in the RR idle mode (cf. GSM 04.08).

idle not updated:

The MS is defined to be "idle not updated" if the following three conditions are fulfilled:

- its update status is U2 NOT UPDATED (cf. GSM 04.08);
- it is in the MM state MM-IDLE (cf. GSM 04.08);
- it is in the RR idle mode (cf. GSM 04.08).

arbitrary:

If for a test, a test purpose, a test group, or a test suite, which uses a certain parameter the value of that parameter has to be chosen arbitrarily in a certain set of values, this means that:

- for each value in the set the MS is required to fulfil the requirements of the test, test purpose, test group, or test suite, but that
- the test, test purpose, test group, or test suite is only performed for one value in the set, the selection of which is made by the test operator.

3.4 Conventions for mathematical notations

For the purpose of this ETS mathematical terms used throughout this ETS are given in this subclause.

3.4.1 Mathematical signs

The "plus or minus" sign is expressed by "+/-".

The sign "multiplied by" is expressed by "*".

The sign "divided by" is expressed by "/", or the common division bar.

The sign "greater than or equal to" is expressed by ">=".

The sign "less than or equal to" is expressed by "<=".

3.4.2 Powers to the base 10

Powers to the base 10 are expressed by "10Ex", where x is the exponent, e.g. 10E-5, 10E6.

3.5 Conventions on electrical terms

3.5.1 Radio Frequency (RF) input signal level

In general, the RF input signal level to the MS is expressed in terms of the received field strength E in dB μ V/m (assuming a 0 dBi gain antenna). This is related to the power level P in dBm by the following formula (see GSM 05.05)

GSM 900: $E \text{ (dB}\mu\text{V/m)} = P \text{ (dBm)} + 136,5$ (calculated for a frequency of 925 MHz).

DCS 1 800: $E \text{ (dB}\mu\text{V/m)} = P \text{ (dBm)} + 142,3$ (calculated for a frequency of 1 795 MHz).

According to annex 1 subclause A1.1.5.3, in all tests in which a handheld MS normally only equipped with integral antenna is the unit under test, the equivalent input signal level into a temporary test connector is determined from:

$$E_{in} = E_{req} + F$$

where: E_{in} = input signal level to a temporary antenna connector (dB μ Vemf);
 E_{req} = signal level required by the test (dB μ Vemf);
 F = coupling factor (dB) at the respective ARFCN.

Since F has to be determined by each test house individually, E_{in} cannot be given as a figure in test procedures.

If the case of integral antenna is applicable, the input signal level is then expressed in the test procedures as:

$$E_{req} \text{ dB}\mu\text{Vemf}(),$$

where the empty parenthesis is to be read as E_{in} .

Alternatively, the input signal level to the MS at the antenna connector can be expressed in $\text{dB}\mu\text{Vemf}()$. This is related to the power level P in dBm by the following formula, assuming a 50 ohm antenna connector:

$$\text{Input signal level (dB}\mu\text{Vemf}()) = P(\text{dBm}) + 113$$

3.5.2 Reference sensitivity level

In this ETS the term:

Reference Sensitivity level ()

is used to indicate that the SS establishes reference sensitivity level taking account of any losses associated with the RF connection to the MS.

3.5.3 Power level of fading signal

The power level of a fading signal is defined as the total signal level averaged over time.

3.6 Terms on test conditions

3.6.1 Radio test conditions

The radio propagation conditions refer to multipath propagation models of GSM 05.05.

They are expressed by typical profiles:

- static
- rural area (RA);
- hilly terrain (HT);
- urban area (TU); or for
- equalization test (EQ).

The non-static profiles are also related to typical speeds of movement of the MS expressed in km/h, e.g. TU1,5, TU3, TU50, HT100, EQ50.

In this ETS the following conventions are used:

Table 3.2

Term	for GSM 900 represents	for DCS 1 800 represents
RA	RA250	RA130
HT	HT100	HT100
TUhigh	TU50	TU50
TUlow	TU3	TU1,5
EQ	EQ50	EQ50

For tests using ARFCN ranges the following table shall be used.

Table 3.3

Term	P-GSM 900	DCS 1 800	E-GSM 900
Low ARFCN range	1 to 5	513 to 523	975 to 980
Mid ARFCN range	60 to 65	690 to 710	60 to 65
High ARFCN range	120 to 124	874 to 884	120 to 124

NOTE 1: For definitions of P-GSM 900, DCS 1 800 and E-GSM 900 refer to GSM 05.05.

NOTE 2: In this ETS the term "GSM 900" is used to cover the primary GSM band and the extended GSM band.

4 Test Equipment

4.1 Terms used to describe test equipment in this ETS

In order to perform MS conformity testing, the use of test equipment is necessary to provide the MS with stimulus signals and to analyse and record the resulting responses.

Throughout this ETS the term "System Simulator" is used to describe the suite of test equipment required to interact with the following MS interfaces:

- antenna
- acoustic
- data port
- power supply
- DAI

The term "SIM simulator" is used to describe the test equipment required to interact with the SIM/ME interface.

A "test SIM" has the physical characteristics of a standard SIM card, (see 11.11) with specific parameters defined in annex 4.

4.2 Functional requirements of test equipment

This ETS does not include a functional description of the test equipment required to perform the tests. These requirements should be deduced from the test descriptions and the information in annex 5.

Annex 5 describes the requirements for the test equipment which cannot be derived from, and which are assumed in, the conformance test descriptions described in this ETS. Specifically, stimulus setting and measurement uncertainty requirements are defined in annex 5.

5 Testing methodology in general (layers 1, 2, and 3)

5.1 Testing of optional functions and procedures

Any function or procedure which is optional, as indicated in this ETS, may be subject to a conformance test if it is implemented in the MS.

A declaration by the apparatus supplier (PICS/PIXIT) is used to determine whether an optional function/procedure has been implemented.

5.2 Test interfaces and facilities

The air interface (Um reference point) provides the main test interface for the purpose of performing conformance tests.

The SS layer 2 and layer 3 shall react with the MS on the air interface in accordance with the BSS requirements in the GSM 04.xx and 05.xx series recommendations, except where the description defines otherwise.

The provision of the following special conformance test facilities is mandatory where applicable:

- support of special conformance test functions, which are enabled by the insertion of a dedicated SIM for testing (test-SIM);
- provision of a Digital Audio Interface (only for MS which support speech services, or alternate speech/data services);
- for equipment which does not have a permanent external 50 ohm connector, a temporary 50 ohm antenna connector shall be provided in accordance with the requirements of annex 1 GC7;
- for MS supporting diversity, or for any other reason having more than one RF connector (or temporary connector in the case of integral antenna MS) the manufacturer shall supply coupling and / or terminating devices so that the tests can be performed via a single transmit / receive RF connection.

Furthermore, an optional Electrical Man Machine Interface (EMMI), is specified.

These special conformance test facilities, with the exception of the temporary antenna connector, are described in subclause 36.1.

Actions at the user side of the equipment under test (i.e. at the man-machine Interface, at the S- or R-interface, at the SIM-interface, execution of higher layer processes in the case of data services) are used to invoke actions at layers 1, 2 and 3 of the Dm-channel protocol within the equipment under test.

5.3 Different protocol layers

The conformance tests for each layer of the Dm-channel protocol are specified separately and the test configuration(s) to be used in testing each layer is specified in the subclause of this ETS relating to the conformance tests for that layer.

5.4 Information to be provided by the apparatus supplier

The apparatus supplier shall provide two kinds of information:

- information with respect to the protocol: Protocol Implementation Conformance Statement (PICS);
- information with respect to the man machine interface: Protocol Implementation Extra Information required for Testing (PIXIT).

The complete list of the information to be provided by the apparatus supplier is a matter between the apparatus supplier and the test house but an example of the information to be supplied is given in informative annex 3 of this ETS.

5.5 Definitions of transmit and receive times

The time a burst is received or transmitted is defined to be in the middle of the burst, i.e. transition from Bit Number BN74 to BN75 for all bursts except random access bursts, the middle of which is the transition from BN48 to BN49.

The reception/transmission time of speech or data blocks or a signalling frame (layer 2 and layer 3) is defined to be the reception/transmission time of the last burst containing part of the block or frame.

The start of a layer 2 or 3 frame is defined to be the time of the first burst containing part of the layer 2 or 3 frame. (The time of a burst is defined to be in the middle of the burst.)

The end of a layer 2 or 3 frame is defined to be the time of the last burst containing part of the layer 2 or 3 frame.

6 Reference test methods.

6.1 General

Annex 1 gives reference test conditions to be used throughout this ETS, unless otherwise specified. It consists of a part on general conditions, and a part on normal and extreme test conditions.

Unless otherwise specified, tests are run using the normal test conditions.

If a test is to be run using the extreme test conditions then this is identified in the test description.

For all tests, the MS is connected to the SS. This connection, unless otherwise specified, is to the permanent antenna connector for a MS which is equipped with one, or via the temporary antenna connector defined in annex 1, GC7, for a MS with an integral antenna, and not normally having a means of connecting an external antenna.

6.2 Choice of frequencies in the frequency hopping mode

For the tests using frequency hopping, 38 frequencies are used over

P-GSM 900:	a 21 MHz band
E-GSM 900:	a [21] MHz band
DCS 1 800:	a 75 MHz band

Table 6.1: Hopping frequencies

	ARFCN
P-GSM900	10, 14, 17, 18, 22, 24, 26, 30, 31, 34, 38, 42, 45, 46, 50, 52, 54, 58, 59, 62, 66, 70, 73, 74, 78, 80, 82, 86, 87, 90, 94, 98, 101, 102, 106, 108, 110, 114
E-GSM900	984, 988, 991, 992, 996, 998, 1000, 1004, 1005, 1008, 1012, 1016, 1019, 1020, 1022, 2, 6, 10, 14, 17, 18, 22, 24, 26, 30, 31, 34, 38, 42, 45, 46, 50, 52, 54, 58, 59, 62, 64
DCS1800	522, 539, 543, 556, 564, 573, 585, 590, 606, 607, 624, 627, 641, 648, 658, 669, 675, 690, 692, 709, 711, 726, 732, 743, 753, 760, 774, 777, 794, 795, 811, 816, 828, 837, 845, 858, 862, 879

NOTE: The range of frequencies available during tests under simulated fading conditions is restricted by the fading simulator bandwidth.

6.3 "Ideal" radio conditions

In this ETS the following conditions are referenced by the term "ideal" radio conditions:

No multipath conditions

MS power control level:

GSM 900: 7

DCS 1 800: 3

RF level to MS: 63 dB μ Vemf() (not tests in subclause 14.4, 14.5 or 18.1.4)

RF level to MS: 20 dB above reference sensitivity level () (subclause 14.4 and 14.5)

RF level to MS: 28 dB μ Vemf() (tests in subclause 18.1.4)

6.4 Standard test signals.

The standard test signals C0, C1, I0, I1 and I2 as used in this ETS, are defined in annex 5.

6.5 Power (control) levels.

In this ETS, except where explicitly stated otherwise, if the MS is commanded to its minimum power (control) level, the SS is allowed to signal power control level 19 for GSM 900, and 15 for DCS 1 800. Furthermore, except where explicitly stated otherwise, if the MS is commanded to its maximum power (control) level, and if MS_TXPWR_MAX_CCH is set to the maximum output power of the MS, the SS is

allowed to signal the power control level corresponding to the maximum output power for the power class of the MS. For a GSM 900 power class 2 MS, the SS is allowed to signal power control level 2.

7 Implicit testing

For some GSM features conformance is not verified explicitly in this ETS. This does not imply that correct functioning of these features is not essential, but that these are implicitly tested to a sufficient degree in other tests. Examples for implicitly tested features are frequency hopping and encryption.

It should be noted that for these features some aspects have to be and are explicitly tested, e.g. the ability to switch to frequency hopping or non-hopping, and the ability to change the encryption mode setting.

8 Measurement uncertainty

The measured value relating to the corresponding limit shall be used to determine whether or not a terminal equipment meets the requirement. (ETR 028 annex B)

This process is often referred to as "shared risk".

9 Format of tests

In general the following basic format for tests is used:

- *.*.* Title
 - *.*.*.1 Definition and applicability
 - This sections provides, if necessary, a definition of the feature/function being tested and the applicability of the test to different MS (e.g. speech only, data only etc.).
 - *.*.*.2 Conformance requirement
 - This section details the core specification requirements being tested and includes any necessary core specification references.
 - *.*.*.3 Test purpose
 - This section details the purpose of the test.
 - *.*.*.4 Method of test
 - *.*.*.4.1 Initial conditions
 - If present this section defines the initial conditions to be established before running the test.
 - *.*.*.4.2 Procedure
 - This section details the test procedure.
 - *.*.*.5 Test requirements
 - This section details the conditions to be met for successful completion of the test.

[However for the Layer 3 tests, in general, a slightly modified format, as described below, is used:

- *.*.* Title
 - *.*.*.1 Conformance requirement
 - References
 - *.*.*.2 Test purpose
 - *.*.*.3 Method of test
 - Initial conditions
 - Related PICS/PIXIT statement
 - Foreseen final state of the MS
 - Test Procedure
 - Maximum duration of the test
 - Expected sequence]

10 Generic call set up procedures

10.1 Generic call set-up procedure for mobile terminating speech calls

In the test procedures described in this ETS, unless otherwise stated in the test description, the Mobile Terminating Speech call set-up procedure shall be as described in this section.

NOTE: In test cases where a fading profile is required, a different and appropriate ARFCN may be selected, for instance if the fading simulator bandwidth does not allow use of the default ARFCN.

10.1.1 Initial conditions

System Simulator:

1 cell, default parameters.

Mobile Station:

- The MS shall be operated under normal test conditions (see annex 1 TC.2.1)
- The special Test-SIM (see annex 4) shall be inserted.
- The MS is "idle, updated", with a TMSI assigned and listening to the BCCH/CCCH of the active cell.

10.1.2 Definition of system information messages

The following parameters shall be coded into the system information messages. Parameters shall be coded according to GSM 04.08.

The RACH Control Parameters IE shall be the same in SYSTEM INFORMATION TYPE 1, TYPE 2, TYPE 3 and TYPE 4 messages.

The Location Area Identification IE, Cell Selection Parameters IE, and P1 bit shall be the same in SYSTEM INFORMATION TYPE 3 and TYPE 4 messages.

SYSTEM INFORMATION TYPE 1

Information Element	Value/remark
Cell channel description	Includes the hopping sequence ARFCNs, if hopping is used
RACH control parameters	
MAX RETRANS	Any Value
TX-INTEGER	Any Value
CELL BAR ACCESS	Not barred
CALL RE-ESTABLISHMENT	Not Allowed
EMERGENCY CALL	Allowed
ACCESS CONTROL CLASS	None Barred
(0...9, 11...15)	
SI1 rest octets	Spare Octets

SYSTEM INFORMATION TYPE 2

Information Element	Value/remark
BCCH Frequency list	Indicates seven surrounding cells on any ARFCN of the supported band, excluding ARFCNs in or immediately adjacent to those specified in section 6.2
NCC permitted NCC PERMITTED	e.g. all NCCs permitted
RACH control parameters	
MAX RETRANS	Any Value
TX-INTEGER	Any Value
CELL BAR ACCESS	Not barred
CALL RE-ESTABLISHMENT	Not Allowed
EMERGENCY CALL	Allowed
ACCESS CONTROL CLASS (0...9, 11...15)	None Barred

SYSTEM INFORMATION TYPE 3

Information Element	Value/remark
Cell identity CI VALUE	0001 hex (not relevant)
Location Area Identification	
MCC	001 decimal (not relevant)
MNC	01 decimal (not relevant)
LAC	0001 hex (not relevant)
Control Channel Description	
ATT (IMSI att/det)	MS shall not apply (not relevant)
BS-AG-BLKS-RES	0 blocks reserved (not relevant)
CCCH-CONF	Combined CCCH/SDCCH (not relevant)
BS-PA-MFRMS	5 multiframe (not relevant)
T3212	Infinite
Cell options	
PWRG	power control not set
DTX	MS must not use DTX
RADIO LINK TIME-OUT	8
Cell selection parameters	
CELL RESELECT HYSTERESIS	0 dB
MS-TXPWR-MAX-CCH	Max. output power of MS
RXLEV-ACCESS-MIN	-90 dBm
ACS	There are no additional cell parameters included in SI7 and SI8
NECI	New establishment cause not supported
RACH control parameters	
MAX RETRANS	Any Value
TX-INTEGER	Any Value
CELL BAR ACCESS	Not barred
CALL RE-ESTABLISHMENT	Not Allowed
EMERGENCY CALL	Allowed
ACCESS CONTROL CLASS (0...9, 11...15)	None Barred
SI3 rest octets P1	C2 parameters not present

SYSTEM INFORMATION TYPE 4

Information Element	Value/remark
Location Area Identification	
MCC	001 decimal (not relevant)
MNC	01 decimal (not relevant)
LAC	0001 hex (not relevant)
Cell selection parameters	
CELL RESELECT HYSTERESIS	0 dB
MS-TXPWR-MAX-CCH	Max. output power of MS
RXLEV-ACCESS-MIN	-90 dBm
RACH control parameters	
MAX RETRANS	Any Value
TX-INTEGGER	Any Value
CELL BAR ACCESS	Not barred
CALL RE-ESTABLISHMENT	Not Allowed
EMERGENCY CALL	Allowed
ACCESS CONTROL CLASS (0...9, 11...15)	None Barred
CBCH Channel Description	Omitted
CBCH Mobile Allocation	Omitted
SI4 rest octets P1	C2 parameters not present

SYSTEM INFORMATION TYPE 5

Information Element	Value/remark
Neighbour cell description	As Cell Channel Description in SI 1

SYSTEM INFORMATION TYPE 6

Information Element	Value/remark
Cell identity	
CI VALUE	0001 hex (not relevant)
Location Area Identification	
MCC	001 decimal (not relevant)
MNC	01 decimal (not relevant)
LAC	0001 hex (not relevant)
Cell options	
PWRG	power control not set
DTX	MS must not use DTX
RADIO LINK TIME-OUT	8
NCC permitted	
NCC PERMITTED	e.g. all NCCs permitted

10.1.3 Procedure

An MS terminating call on a TCH/FS shall be established under ideal radio conditions and with Timing advance set to 0, as follows:

Step	Direction	Message	Comments
1	SS -> MS	PAGING REQUEST TYPE 1	Sent on the correct paging subchannel
2	MS -> SS	CHANNEL REQUEST	Establishment cause indicates "answer to paging".
3	SS -> MS	IMMEDIATE ASSIGNMENT	
4	MS -> SS	PAGING RESPONSE	Message is contained in SABM.
5	SS -> MS	AUTHENTICATION REQUEST	
6	MS -> SS	AUTHENTICATION RESPONSE	SRES specifies correct value.
7	SS -> MS	CIPHERING MODE COMMAND	SS starts deciphering after sending the message.
8	MS -> SS	CIPHERING MODE COMPLETE	Shall be sent enciphered. All following messages shall be sent enciphered.
9	SS		SS starts ciphering.
10	SS -> MS	SETUP	Message contains the signal IE
11	MS -> SS	CALL CONFIRMED	
A12	MS -> SS	CONNECT	
B12	MS -> SS	ALERTING	
B13	MS		An alerting indication as defined in a PICS/PIXIT statement given by the MS.
B14	MS		The MS is made to accept the call in a way described in a PICS/PIXIT statement.
B15	MS -> SS	CONNECT	
16	SS -> MS	ASSIGNMENT COMMAND	
17	MS -> SS	ASSIGNMENT COMPLETE	
18	MS		The TCH is through connected in both directions.
19	SS -> MS	CONNECT ACKNOWLEDGE	

10.1.4 Specific message contents**PAGING REQUEST TYPE 1 (GSM 04.08, 9.1.22) to the MS**

Information Element	Value/remark
Protocol Discriminator	RR
Skip Indicator	0000
Message Type	
Page Mode	Normal Paging
Channel Needed	spare, any channel
Mobile Identity 1	
Odd/even no of digits	As applicable for TMSI
Type of Identity	TMSI
Identity digits	As applicable
Mobile Identity 2	Omitted
P1 rest octets	Spare octets

IMMEDIATE ASSIGNMENT (GSM 04.08, 9.1.18) to the MS

Information Element	Value/remark
Protocol Discriminator	RR
Skip Indicator	0000
Message Type	
Page Mode	Normal
Channel Description	
Channel Type	SDCCH/SACCH 1(4)
Time slot number	zero
Training seq. code	same as BCCH
Hopping	No
ARFCN	ARFCN of the BCCH
Random Reference	
Random access info	As in CHAN REQ
N51, N32, N26	As applicable
Timing Advance	0
Mobile allocation	length 0 due to hopping
IA rest octets	Spare octets

AUTHENTICATION REQUEST (GSM 04.08, 9.2.2) to the MS

Information Element	Value/remark
Protocol Discriminator	MM
Skip Indicator	0000
Message Type	
Ciphering key seq. number	Arbitrary
Authent. parameter RAND	Arbitrary

CIPHERING MODE COMMAND (GSM 04.08, 9.1.9) to the MS

Information Element	Value/remark
Protocol Discriminator	RR
Skip Indicator	0000
Message Type	
Ciphering mode setting	Start ciphering
Algorithm Identifier	Supported by the MS
Cipher Response	IMEISV shall not be included

SETUP (GSM 04.08, 9.3.23) to the MS

Information Element	Value/remark
Protocol Discriminator	CC
Transaction Identifier	SS orig.
Message Type	
Signal	any non-reserved value
Bearer capability 1	Appropriate for the basic service selected for the test or omitted

ASSIGNMENT COMMAND (GSM 04.08, 9.1.2) to the MS

Information Element	Value/remark
Protocol Discriminator	RR
Skip Indicator	0000
Message Type	
Channel Description	
Channel type	Bm + ACCHs
Time slot number	Arbitrary
Training seq. code	Default
Hopping	No
ARFCN	Default
Power level	Power control level 7
Channel mode	Speech full rate version 1

CONNECT ACKNOWLEDGE (GSM 04.08, 9.3.6) to the MS

Information Element	Value/remark
Protocol Discriminator	CC
Transaction Identifier	SS orig.
Message Type	

10.2 Generic call set-up procedure for mobile originating speech calls

In the test procedures described in this ETS, unless otherwise stated in the test description, the Mobile Originating Speech (MOC) call set-up procedure shall be as described in this clause.

NOTE: In test cases where a fading profile is required, a different and appropriate ARFCN may be selected, for instance if the fading simulator bandwidth does not allow use of the default ARFCN.

10.2.1 Initial conditions

System Simulator:

1 cell, default parameters.

Mobile Station:

- The MS shall be operated under normal test conditions (see [Annex 1 TC.2.1])
- The special Test-SIM (see annex 4) shall be inserted.
- The MS is "idle, updated", with a TMSI assigned and listening to the BCCH/CCCH of the active cell.

10.2.2 Definition of system information messages

See clause 10.1.2.

10.2.3 Procedure

An MS originating call on a TCH/FS shall be established under ideal radio conditions and with Timing advance set to 0, as follows:

Step	Direction	Message	Comments
1	MS		"called number" entered
2	MS -> SS	CHANNEL REQUEST	Establishment cause indicates "originating call, NECI <> 1".
3	SS -> MS	IMMEDIATE ASSIGNMENT	
4	MS -> SS	CM SERVICE REQUEST	Message is contained in SABM.
5	SS -> MS	AUTHENTICATION REQUEST	
6	MS -> SS	AUTHENTICATION RESPONSE	SRES specifies correct value.
7	SS -> MS	CIPHERING MODE COMMAND	SS starts deciphering after sending the message.
8	MS -> SS	CIPHERING MODE COMPLETE	Shall be sent enciphered. All following messages shall be sent enciphered.
9	SS		SS starts ciphering.
10	MS -> SS	SETUP	
11	SS -> MS	CALL PROCEEDING	
12	SS -> MS	ALERTING	
13	MS		An alerting indication as defined in an PICS/PIXIT statement is given by the MS.
14	SS -> MS	ASSIGNMENT COMMAND	
15	MS -> SS	ASSIGNMENT COMPLETE	
16	SS -> MS	CONNECT	
17	MS -> SS	CONNECT ACKNOWLEDGE	
18	MS		The TCH is through connected in both directions

10.2.4 Specific message contents**IMMEDIATE ASSIGNMENT (GSM 04.08, 9.1.18) to the MS**

Information Element	Value/remark
Protocol Discriminator	RR
Skip Indicator	0000
Message Type	
Page Mode	Normal
Channel Description	
Channel Type	SDCCH/SACCH 1(4)
Time slot number	zero
Training seq. code	same as BCCH
Hopping	No
ARFCN	ARFCN of the BCCH
Random Reference	
Random access info	As in CHAN REQ
N51, N32, N26	As applicable
Timing Advance	0
Mobile allocation	length 0 due to hopping
IA rest octets	Spare octets

AUTHENTICATION REQUEST (GSM 04.08, 9.2.2) to the MS

Information Element	Value/remark
Protocol Discriminator	MM
Skip Indicator	0000
Message Type	
Ciphering key seq. number	Arbitrary
Authent. parameter RAND	Arbitrary

CIPHERING MODE COMMAND (GSM 04.08, 9.1.9) to the MS

Information Element	Value/remark
Protocol Discriminator	RR
Skip Indicator	0000
Message Type	
Ciphering mode setting	Start ciphering
Algorithm Identifier	Supported by the MS
Cipher Response	IMEISV shall not be included

CALL PROCEEDING (GSM 04.08, 9.3.3) to the MS

Information Element	Value/remark
Protocol Discriminator	CC
Transaction Identifier	As derived from SETUP
Message Type	
Repeat Indicator	Omitted
Bearer Capability 1	Omitted
Bearer Capability 2	Omitted
Facility	Omitted
Progress Indicator	Omitted

ALERTING (GSM 04.08, 9.3.1) to the MS

Information Element	Value/remark
Protocol Discriminator	CC
Transaction Identifier	As derived from SETUP
Message Type	
Facility	Omitted
Progress Indicator	Omitted
User-user	Omitted

ASSIGNMENT COMMAND (GSM 04.08, 9.1.2) to the MS

Information Element	Value/remark
Protocol Discriminator	RR
Skip Indicator	0000
Message Type	
Channel Description	
Channel type	Bm + ACCHs
Time slot number	Arbitrary
Training seq. code	Default
Hopping	No
ARFCN	Default
Power level	Power control level 7
Channel mode	Speech full rate version 1

CONNECT (GSM 04.08, 9.3.5) to the MS

Information Element	Value/remark
Protocol Discriminator	CC
Transaction Identifier	As derived from SETUP
Message Type	
Facility	Omitted
Progress Indicator	Omitted
Connected number	Omitted
Connected Subaddress	Omitted
User-user	Omitted

10.3 Generic call set-up procedure for mobile terminating data calls

In the test procedures described in this ETS, unless otherwise stated in the test description, the Mobile Terminating Data call set-up procedure shall be as described in this section.

NOTE: In test cases where a fading profile is required, a different and appropriate ARFCN may be selected, for instance if the fading simulator bandwidth does not allow use of the default ARFCN.

10.3.1 Initial conditions

System Simulator:

1 cell, default parameters.

Mobile Station:

- The MS shall be operated under normal test conditions (see Annex 1 TC.2.1)
- The special Test-SIM (see annex 4) shall be inserted.
- The MS is "idle, updated", with a TMSI assigned and listening to the BCCH/CCCH of the active cell.

10.3.2 Definition of system information messages

See clause 10.1.2.

10.3.3 Procedure

An MS terminating call on a TCH shall be established under ideal radio conditions and with Timing advance set to 0, as follows:

Step	Direction	Message	Comments
1	SS -> MS	PAGING REQUEST TYPE 1	Sent on the correct paging subchannel
2	MS -> SS	CHANNEL REQUEST	Establishment cause indicates "answer to paging".
3	SS -> MS	IMMEDIATE ASSIGNMENT	
4	MS -> SS	PAGING RESPONSE	Message is contained in SABM.
5	SS -> MS	AUTHENTICATION REQUEST	
6	MS -> SS	AUTHENTICATION RESPONSE	SRES specifies correct value.
7	SS -> MS	CIPHERING MODE COMMAND	SS starts deciphering after sending the message.
8	MS -> SS	CIPHERING MODE COMPLETE	Shall be sent enciphered. All following messages shall be sent enciphered.
9	SS		SS starts ciphering.
10	SS -> MS	SETUP	A call is set up according to the required characteristics of the test procedure. Bearer Capability and Signal IEs included
11	MS -> SS	CALL CONFIRMED	Bearer Capability shall or shall not be included according to the rules given in GSM 04.08 and GSM 07.01.
A12	MS -> SS	CONNECT	
B12	MS -> SS	ALERTING	
B13	MS		An alerting indication as defined in a PICS/PIXIT statement given by the MS.
B14	MS		The MS is made to accept the call in a way described in a PICS/PIXIT statement.
B15	MS -> SS	CONNECT	
16	SS -> MS	ASSIGNMENT COMMAND	
17	MS -> SS	ASSIGNMENT COMPLETE	
18	MS		
19	SS -> MS	CONNECT ACKNOWLEDGE	The TCH is through connected in both directions.

10.3.4 Specific message contents

PAGING REQUEST TYPE 1 (GSM 04.08, 9.1.22) to the MS

Information Element	Value/remark
Protocol Discriminator	RR
Skip Indicator	0000
Message Type	
Page Mode	Normal Paging
Channel Needed	spare, any channel
Mobile Identity 1	
Odd/even no of digits	As applicable for TMSI
Type of Identity	TMSI
Identity digits	As applicable
Mobile Identity 2	Omitted
P1 rest octets	Spare octets

IMMEDIATE ASSIGNMENT (GSM 04.08, 9.1.18) to the MS

Information Element	Value/remark
Protocol Discriminator	RR
Skip Indicator	0000
Message Type	
Page Mode	Normal
Channel Description	
Channel Type	SDCCH/SACCH 1(4)
Time slot number	zero
Training seq. code	same as BCCH
Hopping	No
ARFCN	ARFCN of the BCCH
Random Reference	
Random access info	As in CHAN REQ
N51, N32, N26	As applicable
Timing Advance	0
Mobile allocation	length 0 due to hopping
IA rest octets	Spare octets

AUTHENTICATION REQUEST (GSM 04.08, 9.2.2) to the MS

Information Element	Value/remark
Protocol Discriminator	MM
Skip Indicator	0000
Message Type	
Ciphering key seq. number	Arbitrary
Authent. parameter RAND	Arbitrarily selected

CIPHERING MODE COMMAND (GSM 04.08, 9.1.9) to the MS

Information Element	Value/remark
Protocol Discriminator	RR
Skip Indicator	0000
Message Type	
Ciphering mode setting	Start ciphering
Algorithm Identifier	Supported by the MS
Cipher Response	IMEISV shall not be included

SETUP (GSM 04.08, 9.3.23) to the MS

Information Element	Value/remark
Protocol Discriminator	CC
Transaction Identifier	SS orig.
Message Type	
Bearer Capability	
Radio Channel Requirement	
Connection Element	T or NT and declared as supported by the MS (Not "Both ...")
NIRR	No meaning
Other parameters	Declared as supported by the MS
Signal	any non-reserved value

ASSIGNMENT COMMAND (GSM 04.08, 9.1.2) to the MS

Information Element	Value/remark
Protocol Discriminator	RR
Skip Indicator	0000
Message Type	
Channel Description	
Channel type	Bm + ACCHs
Time slot number	Arbitrary
Training seq. code	Default
Hopping	No
ARFCN	Default
Power level	Power control level 7
Channel mode	Proper data rate, according to BC-IE included in the Set-Up and to the following table

Table 10-1: Correspondence between User rate (UR) and Channel Mode (CM) for transparent (T) and non transparent (NT) connections

UR	9,6kbit/s	4,8kbit/s	2,4kbit/s	1,2kbit/s	1,2/0,075kbit/s	0,3kbit/s
CM T FR	12 FR	6 FR	3,6 FR	3,6 FR	3,6 FR	3,6 FR
CM T HR	n.a	6 HR	3,6 HR	3,6 HR	3,6 HR	3,6 HR
CM NT FR	12 FR	12 FR	12 FR	12 FR	12 FR	12 FR
CM NT HR	n.a	6 HR	6 HR	6 HR	6 HR	6 HR

CONNECT ACKNOWLEDGE (GSM 04.08, 9.3.6) to the MS

Information Element	Value/remark
Protocol Discriminator	CC
Transaction Identifier	SS orig.
Message Type	

10.4 Generic call set-up procedure for mobile originating data calls

In the test procedures described in this ETS, unless otherwise stated in the test description, the Mobile Originating Data call set-up procedure shall be as described in this clause.

NOTE: In test cases where a fading profile is required, a different and appropriate ARFCN may be selected, for instance if the fading simulator bandwidth does not allow use of the default ARFCN.

10.4.1 Initial conditions

System Simulator:
1 cell, default parameters.

Mobile Station:

- The MS shall be operated under normal test conditions (see [Annex 1 TC.2.1])
- The special Test-SIM (see annex 4) shall be inserted.
- The MS is "idle, updated", with a TMSI assigned and listening to the BCCH/CCCH of the active cell.

10.4.2 Definition of system information messages

See clause 10.1.2.

10.4.3 Procedure

An MS originating call on a TCH shall be established under ideal radio conditions and with Timing advance set to 0, as follows:

Step	Direction	Message	Comments
1	MS		"called number" entered
2	MS -> SS	CHANNEL REQUEST	Establishment cause indicates "originating call, NECI <> 1".
3	SS -> MS	IMMEDIATE ASSIGNMENT	
4	MS -> SS	CM SERVICE REQUEST	Message is contained in SABM.
5	SS -> MS	AUTHENTICATION REQUEST	
6	MS -> SS	AUTHENTICATION RESPONSE	SRES specifies correct value.
7	SS -> MS	CIPHERING MODE COMMAND	SS starts deciphering after sending the message.
8	MS -> SS	CIPHERING MODE COMPLETE	Shall be sent enciphered. All following messages shall be sent enciphered.
9	SS		SS starts ciphering.
10	MS -> SS	SETUP	
11	SS -> MS	CALL PROCEEDING	
12	SS -> MS	ALERTING	
13	MS		An alerting indication as defined in an PICS/PIXIT statement is given by the MS.
14	SS -> MS	ASSIGNMENT COMMAND	
15	MS -> SS	ASSIGNMENT COMPLETE	
16	SS -> MS	CONNECT	
17	MS -> SS	CONNECT ACKNOWLEDGE	
18	MS		The TCH is through connected in both directions

10.4.4 Specific message contents**IMMEDIATE ASSIGNMENT (GSM 04.08, 9.1.18) to the MS**

Information Element	Value/remark
Protocol Discriminator	RR
Skip Indicator	0000
Message Type	
Page Mode	Normal
Channel Description	
Channel Type	SDCCH/SACCH 1(4)
Time slot number	zero
Training seq. code	same as BCCH
Hopping	No
ARFCN	ARFCN of the BCCH
Random Reference	
Random access info	As in CHAN REQ
N51, N32, N26	As applicable
Timing Advance	0
Mobile allocation	length 0 due to hopping
IA rest octets	Spare octets

AUTHENTICATION REQUEST (GSM 04.08, 9.2.2) to the MS

Information Element	Value/remark
Protocol Discriminator	MM
Skip Indicator	0000
Message Type	
Ciphering key seq. number	Arbitrary
Authent. parameter RAND	Arbitrarily selected.

CIPHERING MODE COMMAND (GSM 04.08, 9.1.9) to the MS

Information Element	Value/remark
Protocol Discriminator	RR
Skip Indicator	0000
Message Type	
Ciphering mode setting	Start ciphering
Algorithm Identifier	Supported by the MS
Cipher Response	IMEISV shall not be included

CALL PROCEEDING (GSM 04.08, 9.3.3) to the MS

Information Element	Value/remark
Protocol Discriminator	CC
Transaction Identifier	As derived from SETUP
Message Type	
Repeat Indicator	Present if and only if Bearer Capability 1 and Bearer Capability 2 are present in this message
Bearer Capability 1	Present if negotiation of BC 1 or BC 2 necessary (e.g. reception of "Both" for CE parameter in SETUP), else omitted
Radio Channel Requirement	spare
Connection element	T (in case of "Both T (NT) preferred" received)
NIRR	No meaning
Other parameters	Same as sent by the MS in the SETUP, where applicable
Bearer Capability 2	Present if dual BC-IE received and negotiation of either BC 1 or BC 2 necessary, else omitted
Radio Channel Requirement	spare
Connection element	T in case of "Both, T (NT) preferred" in the SETUP message else same as in the SETUP message
NIRR	No meaning
Other parameters	Same as sent by the MS in the SETUP, where applicable
NOTE:	If both BC 1 and BC 2 are present, then one and only one of them shall indicate speech.
Facility	Omitted
Progress Indicator	Omitted

ALERTING (GSM 04.08, 9.3.1) to the MS

Information Element	Value/remark
Protocol Discriminator	CC
Transaction Identifier	As derived from SETUP
Message Type	
Facility	Omitted
Progress Indicator	Omitted
User-user	Omitted

ASSIGNMENT COMMAND (GSM 04.08, 9.1.2) to the MS

Information Element	Value/remark
Protocol Discriminator	RR
Transaction Identifier	Not used
Message Type	
Channel Description	
Channel type	Bm + ACCHs
Time slot number	Arbitrary
Training seq. code	Default
Hopping	No
FB no	Band no 0
ARFCN	Default
Power level	Power control level 7
Channel mode	If no negotiation took place: - Speech FR version 1 or HR version 1 if first BC IE in the SETUP indicated speech, - Set according to the table below if first BC - IE in the SETUP indicates data or fax If negotiation took place - Speech FR version 1 or HR version 1 if first BC-IE in the CALL PROCEEDING indicated speech - Set according to the table below if first BC - IE in the CALL PROCEEDING indicates data or fax

Table 10-2: Correspondence between User rate (UR) and Channel Mode (CM) for transparent (T) and non transparent (NT) connections

UR	9,6kbit/s	4,8kbit/s	2,4kbit/s	1,2kbit/s	1,2/0,075kbit/s	0,3kbit/s
CM T FR	12FR	6 FR	3,6 FR	3,6 FR	3,6 FR	3,6 FR
CM T HR	n.a	6 HR	3,6 HR	3,6 HR	3,6 HR	3,6 HR
CM NT FR	12 FR	12 FR	12 FR	12 FR	12 FR	12 FR
CM NT HR	n.a	6 HR	6 HR	6 HR	6 HR	6 HR

CONNECT (GSM 04.08, 9.3.5) to the MS

Information Element	Value/remark
Protocol Discriminator	CC
Transaction Identifier	As derived from SETUP
Message Type	
Facility	Omitted
Progress Indicator	Omitted
Connected number	Omitted
Connected Subaddress	Omitted
User-user	Omitted

11 General tests

11.1 Verification of support and non-support of services (multiple numbering scheme or ISDN)

11.1.1 Mobile Terminated (MT) calls

11.1.1.1 Definition and applicability

This test applies to all MS. It is repeated for all Mobile Terminated Bearer Services / Teleservices according to GSM 02.02 and GSM 02.03 except Teleservices 21, 22 and 23.

11.1.1.2 Conformance requirement

1. The MS shall check the Information Elements for Bearer Capability in a received SETUP message, and if it agrees to the proposed set, it shall respond with a CALL CONFIRMED message.

GSM 04.08, 5.2.2.2; GSM 04.08, 5.2.2.3.

2. The MS in the "Null" state, U0, ready to receive a SETUP shall reject a SETUP with Information Elements for Bearer Capability which are incompatible with the Bearer Services / Teleservices supported by the MS, and shall send a RELEASE COMPLETE message.

GSM 04.08, 5.2.2.2; GSM 04.08, 5.2.2.3.1; GSM 07.01, 8.3.1; GSM 04.08, B.3.2.

11.1.1.3 Test purpose

1. To verify that the MS, for the case of the Multinumbering scheme or ISDN, accepts a SETUP message, where the Information Elements for Bearer Capability are compatible with the Bearer Services / Teleservices declared as supported by the MS, by sending a CALL CONFIRMED message.

This is verified for all Mobile Terminated Bearer Services / Teleservices declared as supported by the MS.

2. To verify that the MS in the "Null" state, U0, when receiving a SETUP message containing incompatible Information Elements for Bearer Capability will respond with a RELEASE COMPLETE message.

This is verified for all Mobile Terminated Bearer Services / Teleservices not declared as supported by the MS.

11.1.1.4 Method of test

11.1.1.4.1 Initial conditions

For an MS with an external interface the interface shall be setup in such a way that the MS is able to successfully receive the call for the service in question. The manufacturer shall state how this is done in a PIXIT statement. The same applies to features which must be activated by MMI before an incoming call can be accepted.

The PIXIT statement for the service in question shall be consistent with the PICS statement made by the manufacturer and will result for this tests in one or several valid BC codings as presented in section 11.8.

The generic call set-up procedure shall be followed up to and including the reception of the CIPHERING MODE COMPLETE message from the MS.

11.1.1.4.2 Procedure

- a) For a Mobile Terminated Bearer Service / Teleservice declared as supported by the MS. The SS transmits a SETUP message.

The SETUP shall contain a single or dual BC-IE where the parameter values are arbitrarily selected among those declared as supported by the MS in PIXIT statements and corresponding to the Bearer Service / Teleservice being tested.

- b) If more than one BC-IE (or pair of) correspond to the Bearer Service / Teleservice being tested, step a) is repeated once (and only once) with another single or dual BC-IE. The BC-IE shall be chosen in such a way that as many parameters as possible are different from the previous BC-IE. In particular, if more than one value for the "Connection Element" parameter is possible, the new BC-IE shall contain a different value from the previous one for this parameter.
- c) Step a) and b) are repeated for all Bearer Services / Teleservices declared as supported by the MS.
- d) For an Mobile Terminated Bearer Service / Teleservice not declared as supported by the MS. The SS transmits SETUP. If the MS supports TS62 but not TS61, then TS61 is not tested.

The SETUP shall contain a single or dual BC-IE where the parameter values are arbitrarily selected among those defined in GSM 07.01 Annex II and corresponding to the Bearer Service / Teleservice being tested. The complete coding of the corresponding BC-IE(s) can be found in section 11.8.

- e) Step d) is repeated for all Bearer Services / Teleservices not declared as supported by the MS.

11.1.1.5 Test requirement

- 1) After steps a), b) and c), the MS shall send a CALL CONFIRMED message. The MS may contain a single or dual BC-IE. If present these IEs are not checked.
- 2) After steps d) and e), the MS shall send a RELEASE COMPLETE message with cause value 88 - incompatible destination.

11.1.2 Mobile Originated (MO) calls

11.1.2.1 Definition and applicability

This test applies to all MS able to initiate an MO call. It is repeated for all Mobile Originated Bearer Services / Teleservices according to GSM 02.02 and GSM 02.03 except Teleservices 21, 22 and 23, which are supported by the MS.

11.1.2.2 Conformance requirement

1. The MS shall set up a call with a SETUP message containing a single or multiple BC-IE and if required by the service, a single or multiple LLC according to the actual configuration of the MS. Two bearer capabilities can be present only in the cases described in GSM 07.01.

GSM 04.08, 5.2.2.2; GSM 04.08, 5.2.2.3.1; GSM 04.08, 9.3.2; GSM 07.01, 8.3.3.

2. The Repeat Indicator Information Element shall be included in the SETUP message, when the in-call modification procedure is used.

GSM 04.08, 9.3.2.

11.1.2.3 Test purpose

1. To verify that the MS generates a SETUP message which includes a single or multiple Bearer Capability and if required by the service, a single or multiple LLC, according to the actual configuration on the MS.

This is verified for all Mobile Originated Bearer Services / Teleservices described in GSM 07.01 and declared as supported by the MS.

2. To verify that the MS includes a correctly encoded Repeat Indicator if it includes multiple Bearer Capabilities in the SETUP message.

11.1.2.4 Method of test**11.1.2.4.1 Initial conditions**

If possible, the MS shall be configured to initiate an outgoing call with a specified BC and with the corresponding LLC when the ITC value is "unrestricted digital" in the SETUP message. The manufacturer must state how this is done in a PIXIT statement. The same applies to features which must be activated by MMI before an outgoing call can be initiated.

The PIXIT statement for the service in question shall be consistent with the PICS statement made by the manufacturer and will result for this test in one valid BC coding as presented in section 11.8.

11.1.2.4.2 Procedure

- a) The MS shall be made to initiate a call.
- b) If the MS can be configured to send a specific BC, the test is repeated with the MS configured for all possible preferred Bearer Services and Teleservices declared as supported by the MS. The complete coding of the corresponding BC-IE(s) can be found in section 11.8.

11.1.2.5 Test requirement

The MS shall send a SETUP message, which shall contain the BC among those declared as supported by the MS. If the MS is configured to send a specific BC, the SETUP message shall contain this particular BC. The BC-IE(s) shall be set according to GSM 07.01. When an ITC value is set to "unrestricted digital" the MS shall include the corresponding LLC information element.

Where two BCs are contained in the SETUP message, it shall be checked that the combination is allowed, according to GSM 07.01 and that a Repeat Indicator is also included.

11.2 Verification of support of the single numbering scheme**11.2.1 Definition and applicability**

This test applies to all MS.

11.2.2 Conformance requirement

1. The MS shall respond to a SETUP message containing no BC-IE with a CALL CONFIRMED message including the single or multiple Bearer Capability, according to the actual configuration of the MS. Two bearer capabilities can be present only in the cases described in GSM 07.01.

GSM 04.08, 5.2.2.2; GSM 04.08, 5.2.2.3.1; GSM 04.08, 9.3.2; GSM 07.01, 8.3.3

2. The Repeat Indicator Information Element shall be included in the CALL CONFIRMED message, when the in-call modification procedure is used, and no Bearer Capability Information Element is included in the received SETUP message.

GSM 04.08, 9.3.2

11.2.3 Test purpose

1. To verify that the MS, for the case of the Single Numbering Scheme, accepts a SETUP message, where the Information Elements for Bearer Capability and Lower and Higher Layer Compatibility are not present by sending a CALL CONFIRMED message, which includes the single or multiple Bearer Capabilities, according to the actual configuration on the MS.

This is verified for one Mobile Terminated Bearer Service / Teleservice described in GSM 07.01 and declared as supported by the MS.

2. To verify that the MS includes a correctly encoded Repeat Indicator if it includes multiple Bearer Capabilities in the CALL CONFIRMED message.

11.2.4 Method of test

11.2.4.1 Initial conditions

The MS is setup to receive a call. If possible, the MS shall be configured to respond to an incoming call with a specified BC selected arbitrarily from those declared as supported by the MS, in the CALL CONFIRMED message, in reply to a SETUP message with no BC, LLC or HLC elements. The manufacturer must state how this is done in a PIXIT statement. The same applies to features which must be activated by MMI before an incoming call can be accepted.

The generic call set-up procedure shall be followed up to and including the reception of the CIPHERING MODE COMPLETE message from the MS.

The PIXIT statement for the service in question shall be consistent with the PICS statement made by the manufacturer and will result for this tests in one or several valid BC codings as presented in section 11.8.

11.2.4.2 Procedure

The SS transmits a SETUP message with no BC, LLC or HLC elements.

11.2.5 Test requirement

The MS shall send a CALL CONFIRMED message, which shall contain the BC among those declared as supported by the MS. If the MS is configured to respond with a specific BC, the CALL CONFIRMED message shall contain this particular BC. The BC-IE shall be coded according to GSM 07.01.

Where two BCs are contained in the CALL CONFIRMED message, it shall be checked that the combination is allowed, according to GSM 07.01 and that a Repeat Indicator is also included.

11.3 Verification of non-support of services (Advice of Charge Charging (AoCC))

11.3.1 Definition and applicability

This test applies to MS which do **not** support AoCC.

Test procedures (a) and (b) apply to MS which support MT calls.

Test procedure (c) applies to MS which support MO calls.

Test procedure (d) applies to MS which support at least one circuit switched basic service.

11.3.2 Conformance requirement

1. An MS claiming to **not** support AoCC and in the outgoing call / U4 call delivered state, on receipt of a CONNECT message containing AoCC information shall acknowledge the CONNECT message but ignore and not acknowledge the AoCC information sent within the CONNECT.
2. An MS claiming to **not** support AoCC and in the outgoing call / U4 call delivered state, on receipt of a FACILITY message containing AoCC information shall ignore and not acknowledge the AoCC information contained within the FACILITY.
3. An MS claiming to **not** support AoCC and in the incoming call / U9 call confirmed state, on receipt of a FACILITY message containing AoCC information shall ignore and not acknowledge the AoCC information contained within the FACILITY.
4. An MS claiming to **not** support AoCC and in the U10 call active state, on receipt of a FACILITY message containing AoCC information shall ignore and not acknowledge the AoCC information contained within the FACILITY.

GSM 03.86 sections 1.2, 1.3, 2.2, 2.3; GSM 04.86 section 2.

11.3.3 Test purpose

1. To verify that an MS claiming to **not** support AoCC and in the outgoing call / U4 call delivered state, on receipt of a CONNECT message containing AoCC information acknowledges the CONNECT message but ignores and does not acknowledge the AoCC information sent within the CONNECT.
2. To verify that an MS claiming to **not** support AoCC and in the outgoing call / U4 call delivered state, on receipt of a FACILITY message containing AoCC information ignores and does not acknowledge the AoCC information contained within the FACILITY.
3. To verify that an MS claiming to not support AoCC and in the incoming call / U9 call confirmed state, on receipt of a FACILITY message containing AoCC information ignores and does not acknowledge the AoCC information contained within the FACILITY.
4. To verify that an MS claiming to **not** support AoCC and in the U10 call active state, on receipt of a FACILITY message containing AoCC information ignores and does not acknowledge the AoCC information contained within the FACILITY.

11.3.4 Method of test**11.3.4.1 Initial conditions**

The generic call set up procedures are followed up to and including the reception, or transmission, of the ALERTING message by the MS.

11.3.4.2 Procedure

- a) For an Mobile Originated call in the U4 state the SS transmits CONNECT containing AoCC information.
- b) For an Mobile Originated call in the U4 state the SS transmits FACILITY containing AoCC information.
- c) For an Mobile Terminated call in the U9 state the SS transmits a FACILITY containing AoCC information.
- d) For a call in the U10 state the SS transmits a FACILITY containing AoCC information

11.3.5 Test requirement

The MS shall ignore the AoCC information sent to it in the Facility information elements as part of the CONNECT/FACILITY messages and not send any AoCC information acknowledgement. It shall be checked for 15 seconds that the MS does not transmit any AoCC information acknowledgement after the receipt of AoCC information.

11.4 Verification of non-support of services (call hold)**11.4.1 Definition and applicability**

Applicable to MS which do **not** support the Call-Hold supplementary service. This test applies only to MSs that claim to support AoCC. This test applies only to MS which support MO calls.

11.4.2 Conformance requirement

An MS claiming to **not** support the Call Hold supplementary service and in the U10 call active state shall, when the appropriate Call Hold MMI command is entered:

- Fail to put the first call on hold.
- Fail to place the second call.
- Optionally provide some indication to the user of an error.

GSM 02.83; GSM 04.83

11.4.3 Test purpose

To verify that an MS claiming to **not** support the Call Hold supplementary service and in the U10 call active state, reacts in the following manner when the appropriate call hold MMI command is entered:

- MS fails to put the first call on hold
- MS fails to place the second call.
- Optionally provides some indication to the user of an error.

11.4.4 Method of test

11.4.4.1 Initial conditions

The mobile originating generic call set up procedures shall be followed up to and including the transmission by the MS of the CONNECT ACKNOWLEDGE to place the call in the U10 call active state.

11.4.4.2 Procedure

A second directory number is entered followed by "SEND" via the MMI.

11.4.5 Test requirement

The MS shall not send any HOLD messages on the dedicated channel. This is checked for 3 seconds.

The MS may however send other messages.

The MS may also give the user an indication of the error that has occurred.

11.5 Verification of non-support of services (multiparty)

11.5.1 Definition and applicability

Applicable for MSs that support the Call-Hold supplementary service but **not** the MultiParty supplementary service. This test applies only to MSs that support AoCC. This test applies only to MS which support MO calls.

11.5.2 Conformance requirement

An MS claiming to not support the MultiParty supplementary service and in the U10 call active state with one call and in the held state with another call shall, when the appropriate MultiParty MMI command is entered:

- Fail to combine the three parties in a MultiParty call.
- Optionally provide some indication to the user of an error.

GSM 02.83, 02.84; GSM 04.83, GSM 04.84.

11.5.3 Test purpose

To verify that an MS claiming to not support the MultiParty supplementary service and in the U10 call active state with one call and another call on hold, reacts in the following manner when the appropriate MultiParty MMI command is entered:

- Fails to combine the three parties in a MultiParty call.
- Optionally provides some indication to the user of an error.

11.5.4 Method of test**11.5.4.1 Initial conditions**

The mobile originating generic call set up procedures shall be followed up to and including the transmission by the MS of the CONNECT ACKNOWLEDGE to place the call in the U10 call active state. A second directory number is then entered followed by send to put the first call on hold and place a second call.

11.5.4.2 Procedure

"3" followed by "SEND" is entered via the MMI.

11.5.5 Test requirement

The MS shall not send a FACILITY message, containing the build multiparty request, on the dedicated channel. This is checked for 3 seconds.

The MS may however send other messages.

The MS may also give the user an indication of the error that has occurred.

11.6 Verification of non-support of feature (Fixed Dialling Number (FDN))**11.6.1 Definition and applicability**

This test applies to MS which do **not** support FDN. This test applies only to MS which support MO calls.

11.6.2 Conformance requirement

1. An MS claiming to **not** support FDN that has a SIM with FDN allocated and activated in its SIM Service Table (Service Number 3) and has FDN "enabled" shall refuse a request from the user to attempt an outgoing call.
2. An MS claiming to **not** support FDN that has a SIM with FDN allocated and activated in its SIM Service Table (Service Number 3) and has FDN "enabled" shall not respond to paging.
3. An MS claiming **not** to support FDN that has a SIM with FDN allocated and activated shall not attempt to rehabilitate the IMSI and Location Information Elementary Files of the SIM.

GSM 02.07 section B3.2, GSM 11.11 section 11.2.1.

11.6.3 Test purpose

1. To verify that an MS claiming to **not** support FDN and that has a SIM with FDN allocated and activated in its SIM Service Table and has FDN "enabled". i.e. AND, IMSI and Location Information Elementary Files are Invalidated inserted, it refuses an attempt to make an outgoing call made by the user.
2. To verify that an MS claiming to **not** support FDN and that has a SIM with FDN allocated and activated in its SIM Service Table and has FDN "enabled". i.e. AND, IMSI and Location Information Elementary Files are Invalidated inserted, it does not answer to paging.
3. To verify that an MS claiming **not** to support FDN and that has a SIM with FDN allocated and activated in its SIM Service Table and has FDN "enabled". i.e. AND, IMSI and Location Information Elementary Files are Invalidated inserted, does not attempt to rehabilitate IMSI and Location Information.

11.6.4 Method of test

11.6.4.1 Initial conditions

The ME is powered off. No SIM is inserted in the ME.

11.6.4.2 Procedure

- a) A SIM with FDN allocated and activated in its SIM Service Table and has FDN "enabled" is inserted in the ME and the MS is powered on.
- b) An outgoing CM connection is attempted by the user.
- c) The MS paged with its IMSI.
- d) The MS is powered off and the SIM is examined using a suitable tool to determine if the IMSI and Location Information Elementary Files have been Rehabilitated.

11.6.5 Test requirement

- 1) in step b), the MS shall not send a CHANNEL REQUEST message.
- 2) in step c), the MS shall not send a CHANNEL REQUEST message.
- 3) in step d), the IMSI an Location Information Elementary Files shall be Invalidated.

11.7 IMEI Security

11.7.1 Conformance requirements

11.7.1.1 Programming security

The manufacturer declares that concerning the programming security he has taken necessary and sufficient steps to ensure that either, the IMEI cannot be electrically changed once initially programmed, or, secure password techniques have been adopted to prevent unauthorized re-programming of the IMEI.

GSM 02.09, GSM 03.20.

11.7.1.2 Mechanical security

The manufacturer declares that he has taken necessary and sufficient steps to ensure that unauthorized individuals or organizations cannot economically replace the component in which the IMEI is stored and thereby provide the MS with a different IMEI.

GSM 02.09, GSM 03.20

11.7.1.3 Technical knowledge and availability of programme

The manufacturer declares that he takes the necessary measures to ensure that the technical knowledge for changing the IMEI (where applicable) will remain securely under his control and that the knowledge of the programme content will be restricted to his authorized representative(s) on a need to know basis.

GSM 02.09, GSM 03.20.

11.7.2 Test purpose

To verify that the physical protection of the IMEI is sufficiently secure.

11.7.3 Method of test

The manufacturer submitting his equipment for Type Approval shall make the declarations listed in the "Conformance Requirements".

The manufacturer shall give justification to support a claim that the requirements are met.

11.8 Coding of the Bearer Capability information element

This section describes the coding of the bearer capability IE in a SETUP and in a CALL CONFIRMED message according to GSM 07.01 and GSM 04.08.

More precisely, the matter of section 11.8.1 is the coding of the bearer capability IE in a mobile terminating SETUP and section 11.8.2 deals with the coding of the bearer capability IE in a mobile originating SETUP and in a CALL CONFIRMED message.

In the whole section "x", "y" and "X" have the following meanings:

- when a field is coded with values of "x", it means that several bit combinations are authorized and the allowable ones are described in the relevant paragraph or section;
- "y" means that the value of the spare bit can be set to either 0 or 1 at the sending side and that the receiving side shall accept either of these values;
- "X" in the hexadecimal coding of the Bearer Capability IE reflects all the possible values taken by an octet taking account of the number of bits coded as "x" or "y" and their place in the octet.

11.8.1 Network to MS Direction

11.8.1.1 BS 21 to 26 - Asynchronous Service

11.8.1.1.1 BS 21

11.8.1.1.1.1 3,1 kHz Audio, Transparent

BC GSM = 04 07 AX X8 81 21 X1 4X 81

Octet 1	0	0	0	0	0	1	0	0	Information Element: Bearer Capability
Octet 2	0	0	0	0	0	1	1	1	Length
Octet 3	1	y	y	0	0	0	1	0	Extension Radio Channel Requirement: Spare Coding Standard: GSM Transfer Mode: Circuit Info. Transfer Cap.: 3,1 kHz Audio
Octet 4	1	y	1	1	1	0	0	0	Extension Spare Structure: Unstructured Duplex Mode: Full duplex Configuration: Point to Point Negotiation of Intermediate Rate Requested: No meaning Establishment: Demand
Octet 5	1	0	0	0	0	0	0	1	Extension Access Id Rate Adaptation: No Signalling Access Protocol: I.440 / I.450
Octet 6	0	0	1	0	0	0	0	1	Extension Layer 1 Id: Default User Information Layer 1 Protocol Synchronous / Asynchronous: Asynchronous
Octet 6a	0	x	0	x	0	0	0	1	Extension Number of Stop Bits, Depending of the TE Configuration Negotiation: In band Negotiation not possible Number of Data Bits, Depending of the TE Configuration User Rate: 0,3 kbit/s
Octet 6b	0	1	0	0	0	x	x	x	Extension Intermediate Rate: 8kbit/s NIC on TX: Not Required NIC on RX: Not Supported Parity, Depending of the TE Configuration
Octet 6c	1	0	0	0	0	0	0	1	Extension Connection Element: Transparent Modem Type: V.21

The following configuration is also authorized:

Structure in Octet 4:	-	0	0	-	-	-	-	-	SDU Integrity
Intermediate rate in Octet 6b:	-	1	1	-	-	-	-	-	16 kbit/s
Connection element in Octet 6c:	-	1	x	-	-	-	-	-	Both T or NT preferred

11.8.1.1.2 3,1 kHz Audio, Non Transparent

BC GSM = 04 0X X2 XX 81 21 X1 6X A1 (CX)

Octet 1	0	0	0	0	0	1	0	0	Information Element: Bearer Capability
Octet 2	0	0	0	0	x	x	x	x	Length (7 or 8) depending on presence of octet 7.
Octet 3	1	y	y	0	0	0	1	0	Extension Radio Channel Requirement: Spare Coding Standard: GSM Transfer Mode: Circuit Info. Transfer Cap.: 3,1 kHz Audio
Octet 4	1	y	0	0	1	0	x	0	Extension Spare Structure: SDU Integrity Duplex Mode: Full duplex Configuration: Point to Point Negotiation of Intermediate Rate Requested Establishment: Demand
Octet 5	1	0	0	0	0	0	0	1	Extension Access Id Rate Adaptation: No Signalling Access Protocol: I.440 / I.450
Octet 6	0	0	1	0	0	0	0	1	Extension Layer 1 Id: Default User Information Layer 1 Protocol Synchronous / Asynchronous: Asynchronous
Octet 6a	0	x	0	x	0	0	0	1	Extension Number of Stop Bits, Depending of the TE Configuration Negotiation: In band Negotiation not possible Number of Data Bits, Depending of the TE Configuration User Rate: 0,3 kbit/s
Octet 6b	0	1	1	0	0	x	x	x	Extension Intermediate Rate: 16kbit/s NIC on TX: Not Required NIC on RX: Not Supported Parity, Depending of the TE Configuration
Octet 6c	1	0	1	0	0	0	0	1	Extension Connection Element: Non transparent Modem Type: V.21
Octet 7 (NOTE 1)	1	1	0	0	1	x	0	0	Extension Layer 2 Id. User Inform. layer 2 protocol, Depending on the TE Configuration

NOTE 1: Because Modem Type is V.21, Octet7 shall be present.

Depending of the type of flow control supported by the TE, the coding of octet 7 is different. The value ISO 6429 (0 1000) means "Inband flow control" and the value COPnoFLCT (0 1100) means "No flow control".

The following configuration is also authorized:

Connection element in Octet 6c: - 1 x - - - - - - Both T or NT preferred

11.8.1.1.1.3 UDI, Transparent

BC GSM = 04 07 X1 X8 89 21 X1 4X 80

Octet 1	0	0	0	0	0	1	0	0	Information Element: Bearer Capability
Octet 2	0	0	0	0	0	1	1	1	Length
Octet 3	1	y	y	0	0	0	0	1	Extension Radio Channel Requirement: Spare Coding Standard: GSM Transfer Mode: Circuit Info. Transfer Cap.: UDI
Octet 4	1	y	1	1	1	0	0	0	Extension Spare Structure: Unstructured Duplex Mode: Full duplex Configuration: Point to Point Negotiation of Intermediate Rate Requested: No meaning Establishment: Demand
Octet 5	1	0	0	0	1	0	0	1	Extension Access Id Rate Adaptation: V.110 Signalling Access Protocol: I.440 / I.450
Octet 6	0	0	1	0	0	0	0	1	Extension Layer 1 Id: Default User Information Layer 1 Protocol Synchronous / Asynchronous: Asynchronous
Octet 6a	0	x	0	x	0	0	0	1	Extension Number of Stop Bits, Depending of the TE Configuration Negotiation: In band Negotiation not possible Number of Data Bits, Depending of the TE Configuration User Rate: 0,3 kbit/s
Octet 6b	0	1	0	0	0	x	x	x	Extension Intermediate Rate: 8kbit/s NIC on TX: Not Required NIC on RX: Not Supported Parity, Depending of the TE Configuration
Octet 6c	1	0	0	0	0	0	0	0	Extension Connection Element: Transparent Modem Type: None

The following configuration is also authorized:

Structure in Octet 4:	-	0	0	-	-	-	-	-	SDU Integrity
Intermediate rate in Octet 6b:	-	1	1	-	-	-	-	-	16 kbit/s
Connection element in Octet 6c:	-	1	x	-	-	-	-	-	Both T or NT preferred

11.8.1.1.4 UDI, Non Transparent

BC GSM = 04 0X X1 XX 89 21 X1 6X A0 (CX)

Octet 1	0	0	0	0	0	1	0	0	Information Element: Bearer Capability
Octet 2	0	0	0	0	x	x	x	x	Length (7 or 8) depending on presence of octet 7.
Octet 3	1	y	y	0	0	0	0	1	Extension Radio Channel Requirement : Spare Coding Standard: GSM Transfer Mode: Circuit Info. Transfer Cap.: UDI
Octet 4	1	y	0	0	1	0	x	0	Extension Spare Structure: SDU Integrity Duplex Mode: Full duplex Configuration: Point to Point Negotiation of Intermediate Rate Requested Establishment: Demand
Octet 5	1	0	0	0	1	0	0	1	Extension Access Id Rate Adaptation: V.110 Signalling Access Protocol: I.440 / I.450
Octet 6	0	0	1	0	0	0	0	1	Extension Layer 1 Id: Default User Information Layer 1 Protocol Synchronous / Asynchronous: Asynchronous
Octet 6a	0	x	0	x	0	0	0	1	Extension Number of Stop Bits, Depending of the TE Configuration Negotiation: In band Negotiation not possible Number of Data Bits, Depending of the TE Configuration User Rate: 0,3 kbit/s
Octet 6b	0	1	1	0	0	x	x	x	Extension Intermediate Rate: 16kbit/s NIC on TX: Not Required NIC on RX: Not Supported Parity, Depending of the TE Configuration
Octet 6c	1	0	1	0	0	0	0	0	Extension Connection Element: Non Transparent Modem Type: None
Octet 7 (need not be present)	1	1	0	0	1	x	0	0	Extension Layer 2 Id. User Inform. layer 2 protocol, Depending of the TE Configuration

Depending of the type of flow control supported by the TE, octet 7 is present or not. If not present, it means "outband flow control". If octet 7 is present, the value ISO 6429 (0 1000) means "Inband flow control" and the value COPnoFLCT (0 1100) means "No flow control".

The following configuration is also authorized:

Connection element in Octet 6c: - 1 x - - - - - - Both T or NT preferred

11.8.1.1.2 BS 22

Same as BS 21 except

	User Rate in Octet 6a:	-	-	-	-	0	0	1	0	1,2 kbit/s
If different from "none",	Modem Type Octet 6c:	-	-	-	0	0	0	1	0	Modem V.22

In case of 3,1kHz Audio non transparent service, depending of the type of flow control supported by the TE, octet 7 is present or not. If not present, it means "outband flow control".

11.8.1.1.3 BS 24

Same as BS 21 except

	User Rate in Octet 6a:	-	-	-	-	0	0	1	1	2,4 kbit/s
If different from "none",	Modem Type Octet 6c:	-	-	-	0	0	0	1	1	Modem V.22bis

In case of 3,1kHz Audio non transparent service, depending of the type of flow control supported by the TE, octet 7 is present or not. If not present, it means "outband flow control".

11.8.1.1.4 BS 25

Same as BS 21 except

	User Rate in Octet 6a:	-	-	-	-	0	1	0	0	4,8 kbit/s
If different from "none",	Modem Type Octet 6c:	-	-	-	0	0	1	1	0	Modem V.32

In case of 3,1kHz Audio non transparent service, depending of the type of flow control supported by the TE, octet 7 is present or not. If not present, it means "outband flow control".

11.8.1.1.5 BS 26

Same as BS 21 except

	NIRR in Octet 4	-	-	-	-	-	-	0	-	no meaning
	User Rate in Octet 6a:	-	-	-	-	0	1	0	1	9,6 kbit/s
	Interm. Rate in Octet 6b:	-	1	1	-	-	-	-	-	16 kbit/s
If different from "none",	Modem Type Octet 6c:	-	-	-	0	0	1	1	0	Modem V.32

In case of 3,1kHz Audio non transparent service, depending of the type of flow control supported by the TE, octet 7 is present or not. If not present, it means "outband flow control".

11.8.1.1.6 BS 23

For MOC only.

11.8.1.2 BS 31 to 34 - Synchronous Service

11.8.1.2.1 BS 32

11.8.1.2.1.1 3,1 kHz Audio, Transparent, non-X.32 case

BC GSM = 04 07 X2 X8 81 20 13 43 83

Octet 1	0	0	0	0	0	1	0	0	Information Element: Bearer Capability
Octet 2	0	0	0	0	0	1	1	1	Length
Octet 3	1	y	y	0	0	0	1	0	Extension Radio Channel Requirement : Spare Coding Standard: GSM Transfer Mode: Circuit Info. Transfer Cap.: 3,1 kHz Audio
Octet 4	1	y	1	1	1	0	0	0	Extension Spare Structure: Unstructured Duplex Mode: Full duplex Configuration: Point to Point Negotiation of Intermediate Rate Requested: No meaning Establishment: Demand
Octet 5	1	0	0	0	0	0	0	1	Extension Access Id Rate Adaptation: No Signalling Access Protocol: I.440 / I.450
Octet 6	0	0	1	0	0	0	0	0	Extension Layer 1 Id: Default User Information Layer 1 Protocol Synchronous / Asynchronous: Synchronous
Octet 6a	0	0	0	1	0	0	1	1	Extension Number of Stop Bits: NA Negotiation: In band Negotiation not possible Number of Data Bits: NA User Rate: 2,4 kbit/s
Octet 6b	0	1	0	0	0	0	1	1	Extension Intermediate Rate: 8kbit/s NIC on TX: Not Required NIC on RX: Not Supported Parity: NA
Octet 6c	1	0	0	0	0	0	1	1	Extension Connection Element: Transparent Modem Type: V.22 bis

11.8.1.2.1.2 UDI, Transparent mode, non-X.32 case

BC GSM = 04 07 X1 X8 8X 20 13 43 80

Octet 1	0	0	0	0	0	1	0	0	Information Element: Bearer Capability
Octet 2	0	0	0	0	0	1	1	1	Length
Octet 3	1	y	y	0	0	0	0	1	Extension Radio Channel Requirement : Spare Coding Standard: GSM Transfer Mode: Circuit Info. Transfer Cap.: UDI
Octet 4	1	y	1	1	1	0	0	0	Extension Spare Structure: Unstructured Duplex Mode: Full duplex Configuration: Point to Point Negotiation of Intermediate Rate Requested: No meaning Establishment: Demand
Octet 5	1	0	0	0	1	0	x	x	Extension Access Id Rate Adaptation: V.110 Signalling Access Protocol
Octet 6	0	0	1	0	0	0	0	0	Extension Layer 1 Id: Default User Information Layer 1 Protocol Synchronous / Asynchronous: Synchronous
Octet 6a	0	0	0	1	0	0	1	1	Extension Number of Stop Bits: NA Negotiation: In band Negotiation not possible Number of Data Bits: NA User Rate: 2,4 kbit/s
Octet 6b	0	1	0	0	0	0	1	1	Extension Intermediate Rate: 8kbit/s NIC on TX: Not Required NIC on RX: Not Supported Parity: NA
Octet 6c	1	0	0	0	0	0	0	0	Extension Connection Element: Transparent Modem Type: none

If the mobile station supports only SAP I.440/450, the System Simulator sets SAP field value to::

SAP in Octet 5: - - - - - 0 0 1 I.440/I.450

If the MS supports only SAP X.21 , SAP field is set to:

SAP in Octet 5: - - - - - 0 1 0 X.21

Else, the MS supports both values and SAP is set to:

either

SAP in Octet 5: - - - - - 0 0 1 I.440/I.450

or

SAP in Octet 5: - - - - - 0 1 0 X.21

11.8.1.2.1.3 3,1 kHz Audio, Transparent mode, X.32 case (Packet Service)

BC GSM = 04 07 X2 X8 86 20 13 43 83

Octet 1	0	0	0	0	0	1	0	0	Information Element: Bearer Capability
Octet 2	0	0	0	0	0	1	1	1	Length
Octet 3	1	y	y	0	0	0	1	0	Extension Radio Channel Requirement : Spare Coding Standard: GSM Transfer Mode: Circuit Info. Transfer Cap.: 3,1 kHz Audio
Octet 4	1	y	1	1	1	0	0	0	Extension Spare Structure: unstructured Duplex Mode: Full duplex Configuration: Point to Point Negotiation of Intermediate Rate Requested: No meaning Establishment: Demand
Octet 5	1	0	0	0	0	1	1	0	Extension Access Id Rate Adaptation: No Signalling Access Protocol: X.32
Octet 6	0	0	1	0	0	0	0	0	Extension Layer 1 Id: Default User Information Layer 1 Protocol Synchronous / Asynchronous: Synchronous
Octet 6a	0	0	0	1	0	0	1	1	Extension Number of Stop Bits: NA Negotiation: In band Negotiation not possible Number of Data Bits: NA User Rate: 2,4 kbit/s
Octet 6b	0	1	0	0	0	0	1	1	Extension Intermediate Rate: 8kbit/s NIC on TX: Not Required NIC on RX: Not Supported Parity: NA
Octet 6c	1	0	0	0	0	0	1	1	Extension Connection Element: Transparent Modem Type: V.22 bis

The following configuration is also authorized:

Structure in Octet 4:	-	0	0	-	-	-	-	-	-	SDU Integrity
Intermediate rate in Octet 6b:	-	1	1	-	-	-	-	-	-	16 kbit/s
Connection element in Octet 6c:	-	1	x	-	-	-	-	-	-	Both T or NT preferred
UIL2P in Octet 7	-	-	-	0	0	1	1	0		X.25

11.8.1.2.1.4 3,1 kHz Audio, Non Transparent mode, X.32 case (Packet Service)

BC GSM = 04 07 X2 XX 86 20 13 63 A3 C6

Octet 1	0	0	0	0	0	1	0	0	Information Element: Bearer Capability
Octet 2	0	0	0	0	1	0	0	0	Length
Octet 3	1	y	y	0	0	0	1	0	Extension Radio Channel Requirement : Spare Coding Standard: GSM Transfer Mode: Circuit Info. Transfer Cap.: 3,1 kHz Audio
Octet 4	1	y	0	0	1	0	x	0	Extension Spare Structure: SDU integrity Duplex Mode: Full duplex Configuration: Point to Point Negotiation of Intermediate Rate Requested Establishment: Demand
Octet 5	1	0	0	0	0	1	1	0	Extension Access Id Rate Adaptation: No Signalling Access Protocol: X.32
Octet 6	0	0	1	0	0	0	0	0	Extension Layer 1 Id: Default User Information Layer 1 Protocol Synchronous / Asynchronous: Synchronous
Octet 6a	0	0	0	1	0	0	1	1	Extension Number of Stop Bits: NA Negotiation: In band Negotiation not possible Number of Data Bits: NA User Rate: 2,4 kbit/s
Octet 6b	0	1	1	0	0	0	1	1	Extension Intermediate Rate: 16kbit/s NIC on TX: Not Required NIC on RX: Not Supported Parity: NA
Octet 6c	1	0	1	0	0	0	1	1	Extension Connection Element: Non Transparent Modem Type: V.22 bis
Octet 7	1	1	0	0	0	1	1	0	Extension Layer 2 Id. X.25

The following configuration is also authorized:

Connection element in Octet 6c: - 1 x - - - - - Both T or NT preferred

11.8.1.2.1.5 UDI, Non Transparent mode, X.32 case (Packet Service)

BC GSM = 04 08 X1 XX 96 20 13 63 A0 C6

Octet 1	0	0	0	0	0	1	0	0	Information Element: Bearer Capability
Octet 2	0	0	0	0	1	0	0	0	Length
Octet 3	1	y	y	0	0	0	0	1	Extension Radio Channel Requirement : Spare Coding Standard: GSM Transfer Mode: Circuit Info. Transfer Cap.: UDI
Octet 4	1	y	0	0	1	0	x	0	Extension Spare Structure: SDU integrity Duplex Mode: Full duplex Configuration: Point to Point Negotiation of Intermediate Rate Requested Establishment: Demand
Octet 5	1	0	0	1	0	1	1	0	Extension Access Id Rate Adaptation: X.31 flagstuffing Signalling Access Protocol: X.32
Octet 6	0	0	1	0	0	0	0	0	Extension Layer 1 Id: Default User Information Layer 1 Protocol Synchronous / Asynchronous: Synchronous
Octet 6a	0	0	0	1	0	0	1	1	Extension Number of Stop Bits: NA Negotiation: In band Negotiation not possible Number of Data Bits: NA User Rate: 2,4 kbit/s
Octet 6b	0	1	1	0	0	0	1	1	Extension Intermediate Rate: 16kbit/s NIC on TX: Not Required NIC on RX: Not Supported Parity: NA
Octet 6c	1	0	1	0	0	0	0	0	Extension Connection Element: Non Transparent Modem Type: None
Octet 7	1	1	0	0	0	1	1	0	Extension Layer 2 Id. X.25

11.8.1.2.2 BS 31

For non X.32 case only, same as BS 32 except

	User Rate in Octet 6a:	-	-	-	-	0	0	1	0	1,2 kbit/s
If different from "none",	Modem Type Octet 6c:	-	-	-	0	0	0	1	0	Modem V.22

BS31 for Packet Service does not exist.

11.8.1.2.3 BS 33

Same as BS 32 except

	User Rate in Octet 6a:	-	-	-	-	0	1	0	0	4,8 kbit/s
If different from "none",	Modem Type Octet 6c:	-	-	-	0	0	1	1	0	Modem V.32

11.8.1.2.4 BS 34

Same as BS 32 except

	NIRR in Octet 4	-	-	-	-	-	-	0	-	no meaning
	User Rate in Octet 6a:	-	-	-	-	0	1	0	1	9,6 kbit/s
	Interm. Rate in Octet 6b:	-	1	1	-	-	-	-	-	16 kbit/s
If different from "none",	Modem Type Octet 6c:	-	-	-	0	0	1	1	0	Modem V.32

11.8.1.3 BS 61 - Alternate Speech / Data

The first BC in the Setup message is coded "Speech": 04 01 A0

The repeat Indicator in the Setup message is coded "Circular for successive selection (alternate)": D1

The second BC in the Setup message is coded as described below.

11.8.1.3.1 Speech/Asynchronous Data, Transparent

BC GSM = 04 07 X2 X8 81 21 XX XX 8X

Octet 1	0	0	0	0	0	1	0	0	Information Element: Bearer Capability
Octet 2	0	0	0	0	0	1	1	1	Length
Octet 3	1	y	y	0	0	0	1	0	Extension Radio Channel Requirement : Spare Coding Standard: GSM Transfer Mode: Circuit Info. Transfer Cap.: 3,1 kHz Audio
Octet 4	1	y	1	1	1	0	0	0	Extension Spare Structure: Unstructured Duplex Mode: Full duplex Configuration: Point to Point Negotiation of Intermediate Rate Requested: No meaning Establishment: Demand
Octet 5	1	0	0	0	0	0	0	1	Extension Access Id Rate Adaptation: No Signalling Access Protocol: I.440 / I.450
Octet 6	0	0	1	0	0	0	0	1	Extension Layer 1 Id: Default User Information Layer 1 Protocol Synchronous / Asynchronous: Asynchronous
Octet 6a	0	x	0	x	x	x	x	x	Extension Number of Stop Bits, Depending of the TE Configuration Negotiation: In band Negotiation not possible Number of Data Bits, Depending of the TE Configuration User Rate
Octet 6b	0	1	x	0	0	x	x	x	Extension Intermediate Rate NIC on TX: Not Required NIC on RX: Not Supported Parity, Depending of the TE Configuration
Octet 6c	1	0	0	0	x	x	x	x	Extension Connection Element: Transparent Modem Type

Depending of the user rate supported by the MS, the user rate, the modem type and the intermediate rate change:

User Rate in Octet 6a:	-	-	-	-	0	0	0	1	0,3 kbit/s
Intermediate rate in Octet 6b:	-	1	0	-	-	-	-	-	8 kbit/s
Modem type in Octet 6c:	-	-	-	0	0	0	0	1	Modem V.21

User Rate in Octet 6a:	-	-	-	-	0	0	1	0	1,2 kbit/s
Intermediate rate in Octet 6b:	-	1	0	-	-	-	-	-	8 kbit/s
Modem type in Octet 6c:	-	-	-	0	0	0	1	0	Modem V.22

User Rate in Octet 6a:	-	-	-	-	0	0	1	1	2,4 kbit/s
Intermediate rate in Octet 6b:	-	1	0	-	-	-	-	-	8 kbit/s
Modem type in Octet 6c:	-	-	-	0	0	0	1	1	Modem V.22bis

User Rate in Octet 6a:	-	-	-	-	0	1	0	0	4,8 kbit/s
Intermediate rate in Octet 6b:	-	1	0	-	-	-	-	-	8 kbit/s
Modem type in Octet 6c:	-	-	-	0	0	1	1	0	Modem V.32

NIRR in Octet 4	-	-	-	-	-	-	0	-	no meaning
User Rate in Octet 6a:	-	-	-	-	0	1	0	1	9,6 kbit/s
Intermediate rate in Octet 6b:	-	1	1	-	-	-	-	-	16 kbit/s
Modem type in Octet 6c:	-	-	-	0	0	1	1	0	Modem V.32

The following configuration is also authorized:

Structure in Octet 4:	-	0	0	-	-	-	-	-	SDU Integrity
Intermediate rate in Octet 6b:	-	1	1	-	-	-	-	-	16 kbit/s
Connection element in Octet 6c:	-	1	x	-	-	-	-	-	Both T or NT preferred
User Information L2 Protocol (see Non Transparent service)									

11.8.1.3.2 Speech/Asynchronous Data, Non Transparent

BC GSM = 04 0X X2 XX 81 21 XX 6X AX (CX)

Octet 1	0	0	0	0	0	1	0	0	Information Element: Bearer Capability
Octet 2	0	0	0	0	x	x	x	x	Length (7 or 8) depending on presence of octet 7.
Octet 3	1	y	y	0	0	0	1	0	Extension Radio Channel Requirement : Spare Coding Standard: GSM Transfer Mode: Circuit Info. Transfer Cap.: 3,1 kHz Audio
Octet 4	1	y	0	0	1	0	x	0	Extension Spare Structure: SDU Integrity Duplex Mode: Full duplex Configuration: Point to Point Negotiation of Intermediate Rate Requested Establishment: Demand
Octet 5	1	0	0	0	0	0	0	1	Extension Access Id Rate Adaptation: No Signalling Access Protocol: I.440 / I.450
Octet 6	0	0	1	0	0	0	0	1	Extension Layer 1 Id: Default User Information Layer 1 Protocol Synchronous / Asynchronous: Asynchronous
Octet 6a	0	x	0	x	x	x	x	x	Extension Number of Stop Bits, Depending of the TE Configuration Negotiation: In band Negotiation not possible Number of Data Bits, Depending of the TE Configuration User Rate
Octet 6b	0	1	1	0	0	x	x	x	Extension Intermediate Rate: 16kbit/s NIC on TX: Not Required NIC on RX: Not Supported Parity, Depending of the TE Configuration
Octet 6c	1	0	1	0	x	x	x	x	Extension Connection Element: Non transparent Modem Type
Octet 7 (may not be present)	1	1	0	0	1	x	0	0	Extension Layer 2 Id. User Inform. layer 2 protocol, Depending of the TE Configuration

Depending of the type of flow control supported by the TE, the coding of octet 7 is different. The value ISO 6429 (0 1000) means "Inband flow control" and the value COPnoFLCT (0 1100) means "No flow control". The "Outband Flow control is not allowed with V.21 modem).

Depending of the user rate supported by the MS, the user rate and the modem type change:

	User Rate in Octet 6a:	-	-	-	-	0	0	0	1	0,3 kbit/s
	Modem type in Octet 6c:	-	-	-	0	0	0	0	1	Modem V.21

	User Rate in Octet 6a:	-	-	-	-	0	0	1	0	1,2 kbit/s
	Modem type in Octet 6c:	-	-	-	0	0	0	1	0	Modem V.22

	User Rate in Octet 6a:	-	-	-	-	0	0	1	1	2,4 kbit/s
	Modem type in Octet 6c:	-	-	-	0	0	0	1	1	Modem V.22bis

	User Rate in Octet 6a:	-	-	-	-	0	1	0	0	4,8 kbit/s
	Modem type in Octet 6c:	-	-	-	0	0	1	1	0	Modem V.32

	NIRR in Octet 4	-	-	-	-	-	-	0	-	no meaning
	User Rate in Octet 6a:	-	-	-	-	0	1	0	1	9,6 kbit/s
	Modem type in Octet 6c:	-	-	-	0	0	1	1	0	Modem V.32

The following configuration is also authorized:

Connection element in Octet 6c: - 1 x - - - - - - Both T or NT preferred

11.8.1.3.3 Speech/Synchronous Data

BC GSM = 04 07 X2 X8 81 20 1X X3 8X

Octet 1	0	0	0	0	0	1	0	0	Information Element: Bearer Capability
Octet 2	0	0	0	0	0	1	1	1	Length
Octet 3	1	y	y	0	0	0	1	0	Extension Radio Channel Requirement : Spare Coding Standard: GSM Transfer Mode: Circuit Info. Transfer Cap.: 3,1 kHz Audio
Octet 4	1	y	1	1	1	0	0	0	Extension Spare Structure: Unstructured Duplex Mode: Full duplex Configuration: Point to Point Negotiation of Intermediate Rate Requested: No meaning Establishment: Demand
Octet 5	1	0	0	0	0	0	0	1	Extension Access Id Rate Adaptation: No Signalling Access Protocol: I.440 / I.450
Octet 6	0	0	1	0	0	0	0	0	Extension Layer 1 Id: Default User Information Layer 1 Protocol Synchronous / Asynchronous: Synchronous
Octet 6a	0	0	0	1	x	x	x	x	Extension Number of Stop Bits: NA Negotiation: In band Negotiation not possible Number of Data Bits: NA User Rate
Octet 6b	0	1	x	0	0	0	1	1	Extension Intermediate Rate NIC on TX: Not Required NIC on RX: Not Supported Parity: NA
Octet 6c	1	0	0	0	x	x	x	x	Extension Connection Element: Transparent Modem Type

Depending of the user rate supported by the MS, the user rate, the modem type and the intermediate rate change:

User Rate in Octet 6a:	-	-	-	-	0	0	1	0	1,2 kbit/s
Intermediate rate in Octet 6b:	-	1	0	-	-	-	-	-	8 kbit/s
Modem type in Octet 6c:	-	-	-	0	0	0	1	0	Modem V.22

User Rate in Octet 6a:	-	-	-	-	0	0	1	1	2,4 kbit/s
Intermediate rate in Octet 6b:	-	1	0	-	-	-	-	-	8 kbit/s
Modem type in Octet 6c:	-	-	-	0	0	0	1	1	Modem V.22bis

User Rate in Octet 6a:	-	-	-	-	0	1	0	0	4,8 kbit/s
Intermediate rate in Octet 6b:	-	1	0	-	-	-	-	-	8 kbit/s
Modem type in Octet 6c:	-	-	-	0	0	1	1	0	Modem V.32

NIRR in Octet 4	-	-	-	-	-	-	0	-	no meaning
User Rate in Octet 6a:	-	-	-	-	0	1	0	1	9,6 kbit/s
Intermediate rate in Octet 6b:	-	1	1	-	-	-	-	-	16 kbit/s
Modem type in Octet 6c:	-	-	-	0	0	1	1	0	Modem V.32

11.8.1.4 BS 81 - Speech followed by Data

The first BC in the Setup message is coded "Speech": 04 01 A0

The repeat Indicator in the Setup message is coded "Sequential for successive selection (followed by)": D3

The second BC in the Setup message is coded as described below.

11.8.1.4.1 Speech followed by Asynchronous Data

See chapters 11.8.1.3.1 and 11.8.1.3.2

11.8.1.4.2 Speech followed by Synchronous Data

See chapter 11.8.1.3.3

11.8.1.5 TS 61 - Alternate Speech / Facsimile group 3

The first BC in the Setup message is coded "Speech": 04 01 A0

The repeat Indicator in the Setup message is coded "Circular for successive selection (alternate)": D1

The second BC in the Setup message is coded as described below.

11.8.1.5.1 TS 61 - Alternate Speech / Facsimile group 3, Transparent

BC GSM = 04 07 X3 X8 81 20 1X X3 80

Octet 1	0	0	0	0	0	1	0	0	Information Element: Bearer Capability
Octet 2	0	0	0	0	0	1	1	1	Length
Octet 3	1	y	y	0	0	0	1	1	Extension Radio Channel Requirement : Spare Coding Standard: GSM Transfer Mode: Circuit Info. Transfer Cap.: FAX3
Octet 4	1	y	1	1	1	0	0	0	Extension Spare Structure: Unstructured Duplex Mode: Full duplex Configuration: Point to Point Negotiation of Intermediate Rate Requested: No meaning Establishment: Demand
Octet 5	1	0	0	0	0	0	0	1	Extension Access Id Rate Adaptation: No Signalling Access Protocol: NA
Octet 6	0	0	1	0	0	0	0	0	Extension Layer 1 Id: Default User Information Layer 1 Protocol Synchronous / Asynchronous: synchronous
Octet 6a	0	0	0	1	x	x	x	x	Extension Number of Stop Bits: NA Negotiation: In band Negotiation not possible Number of Data Bits: NA User Rate
Octet 6b	0	1	x	0	0	0	1	1	Extension Intermediate Rate NIC on TX: Not Required NIC on RX: Not Supported Parity: NA
Octet 6c	1	0	0	0	0	0	0	0	Extension Connection Element: Transparent Modem Type: None

Depending of the user rate supported by the MS, the user rate and the intermediate rate change:

	User Rate in Octet 6a:	-	-	-	-	0	0	1	1	2,4 kbit/s
	Intermediate rate in Octet 6b:	-	1	0	-	-	-	-	-	8 kbit/s

	User Rate in Octet 6a:	-	-	-	-	0	1	0	0	4,8 kbit/s
	Intermediate rate in Octet 6b:	-	1	0	-	-	-	-	-	8 kbit/s

	NIRR in Octet 4	-	-	-	-	-	-	0	-	no meaning
	User Rate in Octet 6a:	-	-	-	-	0	1	0	1	9,6 kbit/s
	Intermediate rate in Octet 6b:	-	1	1	-	-	-	-	-	16 kbit/s

11.8.1.5.2 TS 61 - Alternate Speech / Facsimile group 3, Non-Transparent

BC GSM = 04 07 X3 XX 81 20 1X 63 X0

Octet 1	0	0	0	0	0	1	0	0	Information Element: Bearer Capability
Octet 2	0	0	0	0	0	1	1	1	Length
Octet 3	1	y	y	0	0	0	1	1	Extension Radio Channel Requirement : Spare Coding Standard: GSM Transfer Mode: Circuit Info. Transfer Cap.: FAX3
Octet 4	1	y	0	0	1	0	x	0	Extension Spare Structure: SDU integrity Duplex Mode: Full duplex Configuration: Point to Point Negotiation of Intermediate Rate Requested Establishment: Demand
Octet 5	1	0	0	0	0	0	0	1	Extension Access Id Rate Adaptation: No Signalling Access Protocol: NA
Octet 6	0	0	1	0	0	0	0	0	Extension Layer 1 Id: Default User Information Layer 1 Protocol Synchronous / Asynchronous: synchronous
Octet 6a	0	0	0	1	x	x	x	x	Extension Number of Stop Bits: NA Negotiation: In band Negotiation not possible Number of Data Bits: NA User Rate
Octet 6b	0	1	1	0	0	0	1	1	Extension Intermediate Rate: 16 kbit/s NIC on TX: Not Required NIC on RX: Not Supported Parity: NA
Octet 6c	1	x	x	0	0	0	0	0	Extension Connection Element Modem Type: None

Depending of the user rate supported by the MS, the MS may have the following values:

User Rate in Octet 6a:	-	-	-	-	0	0	1	1	2,4 kbit/s
------------------------	---	---	---	---	---	---	---	---	------------

User Rate in Octet 6a:	-	-	-	-	0	1	0	0	4,8 kbit/s
------------------------	---	---	---	---	---	---	---	---	------------

User Rate in Octet 6a:	-	-	-	-	0	1	0	1	9,6 kbit/s
------------------------	---	---	---	---	---	---	---	---	------------

Depending on the support or not of both modes, Non Transparent and Transparent, the connection element field may have the following values:

Connection element in Octet 6c:	-	0	1	-	-	-	-	-	-	Non transparent
---------------------------------	---	---	---	---	---	---	---	---	---	-----------------

Connection element in Octet 6c:	-	1	x	-	-	-	-	-	-	Both T or NT preferred
---------------------------------	---	---	---	---	---	---	---	---	---	------------------------

If present, Octet 7 shall have the following value:

Octet 7	1	1	0	0	0	1	1	0	Extension Layer 2 id X.25
---------	---	---	---	---	---	---	---	---	---------------------------

11.8.1.6 TS 62 - Automatic Facsimile group 3

The repeat Indicator in the Setup message is not available.

The BC GSM is coded as described in chapter 11.8.1.5.

11.8.2 MS to SS direction

In the whole section 11.8.2, "1)" and "2)" stand for:

¹⁾ Not applicable in a CALL CONFIRMED message.

²⁾ Not applicable in a CALL CONFIRMED message responding to a SETUP message with no BC-IE (PSTN-originated call with single numbering scheme).

If the MS supports only Full Rate

Radio Channel Requirement in Octet 3: - 0 1 - - - - - Full rate support only mobile station

Else

Radio Channel Requirement in Octet 3: - 1 x - - - - - Dual rate mobile station

11.8.2.1 BS 21 to 26 - Asynchronous Service

If the MS supports only SAP I.440/I.450

SAP in Octet 5: - - - - - 0 0 1 I.440/I.450

If the MS supports only SAP X.28 non dedicated PAD

SAP in Octet 5: - - - - - 1 0 1 X.28 nond

Else

SAP in Octet 5: - - - - - x 0 1 I.440/I.450 or X.28 nond

11.8.2.1.1 BS 21

11.8.2.1.1.1 3,1 kHz Audio, Transparent

BC GSM = 04 0X X2 X8 8X 21 X1 XX X1 (CX)

Octet 1	0	0	0	0	0	1	0	0	Information Element: Bearer Capability
Octet 2	0	0	0	0	x	x	x	x	Length (7 or 8) depending on the presence of octet 7.
Octet 3	1	x	x	0	0	0	1	0	Extension Radio Channel Requirement Coding Standard: GSM Transfer Mode: Circuit Info. Transfer Cap.: 3,1 kHz Audio
Octet 4	1	y	x	x	1	0	0	0	Extension Spare Structure Duplex Mode Configuration: Point to Point Negotiation of Intermediate Rate Requested: No meaning Establishment: Demand
Octet 5	1	0	0	0	0	x	0	1	Extension Access Id Rate Adaptation: No Signalling Access Protocol
Octet 6	0	0	1	0	0	0	0	1	Extension Layer 1 Id: Default User Information Layer 1 Protocol Synchronous / Asynchronous: Asynchronous
Octet 6a	0	x	0	x	0	0	0	1	Extension Number of Stop Bits, Depending of the TE Configuration Negotiation: In band Negotiation not possible Number of Data Bits, Depending of the TE Configuration User Rate: 0,3 kbit/s
Octet 6b	0	1	x	0	0	x	x	x	Extension Intermediate Rate: 8kbit/s NIC on TX: Not Required NIC on RX: Not Supported Parity, Depending of the TE Configuration
Octet 6c	1	x	x	0	0	0	0	1	Extension Connection Element Modem Type: V.21

If the mobile station supports only Transparent mode or responds with a CALL CONFIRMED message:

Structure in Octet 4: - 1 1 - - - - - Unstructured
Intermediate rate in Octet 6b: - 1 0 - - - - - 8 kbit/s
Connection element in Octet 6c: - 0 0 - - - - - Transparent

¹⁾ If the mobile station supports both Transparent and Non Transparent modes

Structure in Octet 4: - 0 0 - - - - - SDU Integrity
Intermediate rate in Octet 6b: - 1 1 - - - - - 16 kbit/s
Connection element in Octet 6c: - 1 x - - - - - Both T or NT preferred
User Information L2 protocol in Octet 7 (see Non Transparent service)

11.8.2.1.1.2 3,1 kHz Audio, Non Transparent

BC GSM = 04 0X X2 XX 8X 21 X1 6X X1 (CX)

Octet 1	0	0	0	0	0	1	0	0	Information Element: Bearer Capability
Octet 2	0	0	0	0	x	x	x	x	Length (7 or 8) depending on presence of octet 7.
Octet 3	1	x	x	0	0	0	1	0	Extension Radio Channel Requirement Coding Standard: GSM Transfer Mode: Circuit Info. Transfer Cap.: 3,1 kHz Audio
Octet 4	1	y	0	0	1	0	x	0	Extension Spare Structure: SDU Integrity Duplex Mode: Full duplex Configuration: Point to Point Negotiation of Intermediate Rate Requested Establishment: Demand
Octet 5	1	0	0	0	0	x	0	1	Extension Access Id Rate Adaptation: No Signalling Access Protocol
Octet 6	0	0	1	0	0	0	0	1	Extension Layer 1 Id: Default User Information Layer 1 Protocol Synchronous / Asynchronous: Asynchronous
Octet 6a	0	x	0	x	0	0	0	1	Extension Number of Stop Bits, Depending of the TE Configuration Negotiation: In band Negotiation not possible Number of Data Bits, Depending of the TE Configuration User Rate: 0,3 kbit/s
Octet 6b	0	1	1	0	0	x	x	x	Extension Intermediate Rate: 16kbit/s NIC on TX: Not Required NIC on RX: Not Supported Parity, Depending of the TE Configuration
Octet 6c	1	x	x	0	0	0	0	1	Extension Connection Element: NT, (Both T or Both NT) ¹⁾ Modem Type: V.21
Octet 7 (need not be present)	1	1	0	0	1	x	0	0	Extension Layer 2 Id. User Inform. layer 2 protocol, Depending on the TE Configuration

Depending of the type of flow control supported by the TE, the coding of octet 7 is different. The value ISO 6429 (0 1000) means "Inband flow control" and the value COPnoFLCT (0 1100) means "No flow control".

11.8.2.1.1.3 2) UDI, Transparent

BC GSM = 04 0X X1 X8 8X 21 X1 XX X0

Octet 1	0	0	0	0	0	1	0	0	Information Element: Bearer Capability
Octet 2	0	0	0	0	x	x	x	x	Length (7 or 8) depending on the presence of octet 7
Octet 3	1	x	x	0	0	0	0	1	Extension Radio Channel Requirement Coding Standard: GSM Transfer Mode: Circuit Info. Transfer Cap.: UDI
Octet 4	1	y	x	x	1	0	0	0	Extension Spare Structure Duplex Mode: Full duplex Configuration: Point to Point Negotiation of Intermediate Rate Requested: No meaning Establishment: Demand
Octet 5	1	0	0	0	1	x	0	1	Extension Access Id Rate Adaptation: V.110 Signalling Access Protocol
Octet 6	0	0	1	0	0	0	0	1	Extension Layer 1 Id: Default User Information Layer 1 Protocol Synchronous / Asynchronous: Asynchronous
Octet 6a	0	x	0	x	0	0	0	1	Extension Number of Stop Bits, Depending of the TE Configuration Negotiation: In band Negotiation not possible Number of Data Bits, Depending of the TE Configuration User Rate: 0,3 kbit/s
Octet 6b	0	1	x	0	0	x	x	x	Extension Intermediate Rate NIC on TX: Not Required NIC on RX: Not Supported Parity, Depending of the TE Configuration
Octet 6c	1	x	x	0	0	0	0	0	Extension Connection Element Modem Type: None

If the mobile station supports only Transparent mode or responds with a CALL CONFIRMED message:

Structure in Octet 4: - 1 1 - - - - - Unstructured
Intermediate rate in Octet 6b: - 1 0 - - - - - 8 kbit/s
Connection element in Octet 6c: - 0 0 - - - - - Transparent

¹⁾ If the mobile station supports both Transparent and Non Transparent modes

Structure in Octet 4: - 0 0 - - - - - SDU Integrity
Intermediate rate in Octet 6b: - 1 1 - - - - - 16 kbit/s
Connection element in Octet 6c: - 1 x - - - - - Both T or NT preferred
User Information L2 protocol in Octet 7 (see Non Transparent service)

11.8.2.1.1.4 2) UDI, Non Transparent

BC GSM = 04 0X X1 XX 8X 21 X1 6X X0 (CX)

Octet 1	0	0	0	0	0	1	0	0	Information Element: Bearer Capability
Octet 2	0	0	0	0	x	x	x	x	Length (7 or 8) depending on presence of octet 7.
Octet 3	1	x	x	0	0	0	0	1	Extension Radio Channel Requirement Coding Standard: GSM Transfer Mode: Circuit Info. Transfer Cap.: UDI
Octet 4	1	y	0	0	1	0	x	0	Extension Spare Structure: SDU Integrity Duplex Mode: Full duplex Configuration: Point to Point Negotiation of Intermediate Rate Requested Establishment: Demand
Octet 5	1	0	0	0	1	x	0	1	Extension Access Id Rate Adaptation: V.110 Signalling Access Protocol
Octet 6	0	0	1	0	0	0	0	1	Extension Layer 1 Id: Default User Information Layer 1 Protocol Synchronous / Asynchronous: Asynchronous
Octet 6a	0	x	0	x	0	0	0	1	Extension Number of Stop Bits, Depending of the TE Configuration Negotiation: In band Negotiation not possible Number of Data Bits, Depending of the TE Configuration User Rate: 0,3 kbit/s
Octet 6b	0	1	1	0	0	x	x	x	Extension Intermediate Rate: 16kbit/s NIC on TX: Not Required NIC on RX: Not Supported Parity, Depending of the TE Configuration
Octet 6c	1	x	x	0	0	0	0	0	Extension Connection Element: NT, (Both T or Both NT) ¹⁾ Modem Type: None
Octet 7 (need not be present)	1	1	0	0	1	x	0	0	Extension Layer 2 Id. User Inform. layer 2 protocol, Depending of the TE Configuration

Depending of the type of flow control supported by the TE, octet 7 is present or not. If not present, it means "outband flow control". If octet 7 is present, the value ISO 6429 (0 1000) means "Inband flow control" and the value COPnoFLCT (0 1100) means "No flow control".

11.8.2.1.2 BS 22

Same as BS 21 except

	User Rate in Octet 6a:	-	-	-	-	0	0	1	0	1,2 kbit/s
If different from "none",	Modem Type Octet 6c:	-	-	-	0	0	0	1	0	Modem V.22

In case of 3,1kHz Audio non transparent service, depending of the type of flow control supported by the TE, octet 7 is present or not. If not present, it means "outband flow control".

11.8.2.1.3 BS 24

Same as BS 21 except

	User Rate in Octet 6a:	-	-	-	-	0	0	1	1	2,4 kbit/s
If different from "none",	Modem Type Octet 6c:	-	-	-	0	0	0	1	1	Modem V.22bis
						1	0	1		Modem V.26ter

In case of 3,1kHz Audio non transparent service, depending of the type of flow control supported by the TE, octet 7 is present or not. If not present, it means "outband flow control".

11.8.2.1.4 BS 25

Same as BS 21 except

	User Rate in Octet 6a:	-	-	-	-	0	1	0	0	4,8 kbit/s
If different from "none",	Modem Type Octet 6c:	-	-	-	0	0	1	1	0	Modem V.32

In case of 3,1kHz Audio non transparent service, depending of the type of flow control supported by the TE, octet 7 is present or not. If not present, it means "outband flow control".

11.8.2.1.5 BS 26

Same as BS 21 except

	NIRR in Octet 4:	-	-	-	-	-	-	0	-	no meaning
	User Rate in Octet 6a:	-	-	-	-	0	1	0	1	9,6 kbit/s
	Interm. Rate in Octet 6b:	-	1	1	-	-	-	-	-	16 kbit/s
If different from "none",	Modem Type Octet 6c:	-	-	-	0	0	1	1	0	Modem V.32

In case of 3,1kHz Audio non transparent service, depending of the type of flow control supported by the TE, octet 7 is present or not. If not present, it means "outband flow control".

11.8.2.1.6 BS 23

Same as BS 21 except

	User Rate in Octet 6a:	-	-	-	-	0	1	1	1	1,2 kbit/s/75 bit/s
If different from "none",	Modem Type Octet 6c:	-	-	-	0	0	1	0	0	Modem V.23

In case of 3,1kHz Audio non transparent service, depending of the type of flow control supported by the TE, octet 7 is present or not. If not present, it means "outband flow control".

11.8.2.2 BS 31 to 34 - Synchronous Service

11.8.2.2.1 BS 32

11.8.2.2.1.1 3,1 kHz Audio, Transparent, non-X.32 case

BC GSM = 04 07 X2 X8 81 20 13 43 83

Octet 1	0	0	0	0	0	1	0	0	Information Element: Bearer Capability
Octet 2	0	0	0	0	0	1	1	1	Length
Octet 3	1	x	x	0	0	0	1	0	Extension Radio Channel Requirement : Spare Coding Standard: GSM Transfer Mode: Circuit Info. Transfer Cap.: 3,1 kHz Audio
Octet 4	1	y	1	1	1	0	0	0	Extension Spare Structure: Unstructured Duplex Mode: Full duplex Configuration: Point to Point Negotiation of Intermediate Rate Requested: No meaning Establishment: Demand
Octet 5	1	0	0	0	0	0	0	1	Extension Access Id Rate Adaptation: No Signalling Access Protocol: I.440 / I.450
Octet 6	0	0	1	0	0	0	0	0	Extension Layer 1 Id: Default User Information Layer 1 Protocol Synchronous / Asynchronous: Synchronous
Octet 6a	0	0	0	1	0	0	1	1	Extension Number of Stop Bits: NA Negotiation: In band Negotiation not possible Number of Data Bits: NA User Rate: 2,4 kbit/s
Octet 6b	0	1	0	0	0	0	1	1	Extension Intermediate Rate: 8kbit/s NIC on TX: Not Required NIC on RX: Not Supported Parity: NA
Octet 6c	1	0	0	0	0	x	x	1	Extension Connection Element: Transparent Modem Type: V.22 bis or V.26 ter

11.8.2.2.1.2 2) UDI, Transparent mode, non-X.32 case

BC GSM = 04 07 X1 X8 8X 20 13 43 80

Octet 1	0	0	0	0	0	1	0	0	Information Element: Bearer Capability
Octet 2	0	0	0	0	0	1	1	1	Length
Octet 3	1	x	x	0	0	0	0	1	Extension Radio Channel Requirement Coding Standard: GSM Transfer Mode: Circuit Info. Transfer Cap.: UDI
Octet 4	1	y	1	1	1	0	0	0	Extension Spare Structure: Unstructured Duplex Mode: Full duplex Configuration: Point to Point Negotiation of Intermediate Rate Requested: No meaning Establishment: Demand
Octet 5	1	0	0	0	1	0	x	x	Extension Access Id Rate Adaptation: V.110 Signalling Access Protocol
Octet 6	0	0	1	0	0	0	0	0	Extension Layer 1 Id: Default User Information Layer 1 Protocol Synchronous / Asynchronous: Synchronous
Octet 6a	0	0	0	1	0	0	1	1	Extension Number of Stop Bits: NA Negotiation: In band Negotiation not possible Number of Data Bits: NA User Rate: 2,4 kbit/s
Octet 6b	0	1	0	0	0	0	1	1	Extension Intermediate Rate: 8kbit/s NIC on TX: Not Required NIC on RX: Not Supported Parity: NA
Octet 6c	1	0	0	0	0	0	0	0	Extension Connection Element: Transparent Modem Type: none

If the mobile station supports only SAP I.440/450

SAP in Octet 5: - - - - - 0 0 1 I.440/I.450

If the MS supports only SAP X.21

SAP in Octet 5: - - - - - 0 1 0 X.21

Else

SAP in Octet 5: - - - - - 0 x x I.440/I.450 or X.21

11.8.2.2.1.3 3,1 kHz Audio, Transparent mode, X.32 case (Packet Service)

BC GSM = 04 0X X2 X8 86 20 13 X3 X3 (C6)

Octet 1	0	0	0	0	0	1	0	0	Information Element: Bearer Capability
Octet 2	0	0	0	0	0	1	1	1	Length
Octet 3	1	x	x	0	0	0	1	0	Extension Radio Channel Requirement Coding Standard: GSM Transfer Mode: Circuit Info. Transfer Cap.: 3,1 kHz Audio
Octet 4	1	y	x	x	1	0	0	0	Extension Spare Structure Duplex Mode: Full duplex Configuration: Point to Point Negotiation of Intermediate Rate Requested: No meaning Establishment: Demand
Octet 5	1	0	0	0	0	1	1	0	Extension Access Id Rate Adaptation: No Signalling Access Protocol: X.32
Octet 6	0	0	1	0	0	0	0	0	Extension Layer 1 Id: Default User Information Layer 1 Protocol Synchronous / Asynchronous: Synchronous
Octet 6a	0	0	0	1	0	0	1	1	Extension Number of Stop Bits: NA Negotiation: In band Negotiation not possible Number of Data Bits: NA User Rate: 2,4 kbit/s
Octet 6b	0	1	x	0	0	0	1	1	Extension Intermediate Rate NIC on TX: Not Required NIC on RX: Not Supported Parity: NA
Octet 6c	1	x	x	0	0	x	x	1	Extension Connection Element: Transparent Modem Type: V.22 bis or V.26 ter

If the mobile station supports only Transparent mode or responds with a CALL CONFIRMED message:

Structure in Octet 4:	-	1	1	-	-	-	-	-	Unstructured
Intermediate rate in Octet 6b:	-	1	0	-	-	-	-	-	8 kbit/s
Connection element in Octet 6c:	-	0	0	-	-	-	-	-	Transparent

¹⁾ If the mobile station supports both Transparent and Non Transparent modes

Structure in Octet 4:	-	0	0	-	-	-	-	-	SDU Integrity
Intermediate rate in Octet 6b:	-	1	1	-	-	-	-	-	16 kbit/s
Connection element in Octet 6c:	-	1	x	-	-	-	-	-	Both T or NT preferred
UIL2P in Octet 7	-	-	-	0	0	1	1	0	X.25

11.8.2.2.1.4 3,1 kHz Audio, Non Transparent mode, X.32 case (Packet Service)

BC GSM = 04 08 A2 XX 86 20 13 63 X3 C6

Octet 1	0	0	0	0	0	1	0	0	Information Element: Bearer Capability
Octet 2	0	0	0	0	1	0	0	0	Length
Octet 3	1	x	x	0	0	0	1	0	Extension Radio Channel Requirement Coding Standard: GSM Transfer Mode: Circuit Info. Transfer Cap.: 3,1 kHz Audio
Octet 4	1	y	0	0	1	0	x	0	Extension Spare Structure: SDU integrity Duplex Mode: Full duplex Configuration: Point to Point Negotiation of Intermediate Rate Requested Establishment: Demand
Octet 5	1	0	0	0	0	1	1	0	Extension Access Id Rate Adaptation: No Signalling Access Protocol: X.32
Octet 6	0	0	1	0	0	0	0	0	Extension Layer 1 Id: Default User Information Layer 1 Protocol Synchronous / Asynchronous: Synchronous
Octet 6a	0	0	0	1	0	0	1	1	Extension Number of Stop Bits: NA Negotiation: In band Negotiation not possible Number of Data Bits: NA User Rate: 2,4 kbit/s
Octet 6b	0	1	1	0	0	0	1	1	Extension Intermediate Rate: 16kbit/s NIC on TX: Not Required NIC on RX: Not Supported Parity: NA
Octet 6c	1	x	x	0	0	x	x	1	Extension Connection Element: NT, (Both T or Both NT) ¹⁾ Modem Type: V.22 bis or V.26 ter
Octet 7	1	1	0	0	0	1	1	0	Extension Layer 2 Id. X.25

11.8.2.2.1.5 2) UDI, Non Transparent mode, X.32 case (Packet Service)

BC GSM = 04 08 X1 XX 96 20 13 63 A0 C6

Octet 1	0	0	0	0	0	1	0	0	Information Element: Bearer Capability
Octet 2	0	0	0	0	1	0	0	0	Length
Octet 3	1	x	x	0	0	0	0	1	Extension Radio Channel Requirement Coding Standard: GSM Transfer Mode: Circuit Info. Transfer Cap.: UDI
Octet 4	1	y	0	0	1	0	x	0	Extension Spare Structure: SDU integrity Duplex Mode: Full duplex Configuration: Point to Point Negotiation of Intermediate Rate Requested Establishment: Demand
Octet 5	1	0	0	1	0	1	1	0	Extension Access Id Rate Adaptation: X.31 flagstuffing Signalling Access Protocol: X.32
Octet 6	0	0	1	0	0	0	0	0	Extension Layer 1 Id: Default User Information Layer 1 Protocol Synchronous / Asynchronous: Synchronous
Octet 6a	0	0	0	1	0	0	1	1	Extension Number of Stop Bits: NA Negotiation: In band Negotiation not possible Number of Data Bits: NA User Rate: 2,4 kbit/s
Octet 6b	0	1	1	0	0	0	1	1	Extension Intermediate Rate: 16kbit/s NIC on TX: Not Required NIC on RX: Not Supported Parity: NA
Octet 6c	1	0	1	0	0	0	0	0	Extension Connection Element: Non Transparent Modem Type: None
Octet 7	1	1	0	0	0	1	1	0	Extension Layer 2 Id. X.25

11.8.2.2.2 BS 31

For non X.32 case only, same as BS 32 except

	User Rate in Octet 6a:	-	-	-	-	0	0	1	0	1,2 kbit/s
If different from "none",	Modem Type Octet 6c:	-	-	-	0	0	0	1	0	Modem V.22

BS31 for Packet Service does not exist.

11.8.2.2.3 BS 33

Same as BS 32 except

	User Rate in Octet 6a:	-	-	-	-	0	1	0	0	4,8 kbit/s
If different from "none",	Modem Type Octet 6c:	-	-	-	0	0	1	1	0	Modem V.32

11.8.2.2.4 BS 34

Same as BS 32 except

	NIRR in Octet 4:	-	-	-	-	-	-	0	-	no meaning
	User Rate in Octet 6a:	-	-	-	-	0	1	0	1	9,6 kbit/s
	Interm. Rate in Octet 6b:	-	1	1	-	-	-	-	-	16 kbit/s
If different from "none",	Modem Type Octet 6c:	-	-	-	0	0	1	1	0	Modem V.32

11.8.2.3 BS 41 to 46 - PAD Access Asynchronous

11.8.2.3.1 2) BS 41

11.8.2.3.1.1 2) UDI, Transparent

BC GSM = 04 0X X1 X8 8C 21 X1 XX X0 (CX)

Octet 1	0	0	0	0	0	1	0	0	Information Element: Bearer Capability
Octet 2	0	0	0	0	0	1	1	1	Length
Octet 3	1	x	x	0	0	0	0	1	Extension Radio Channel Requirement Coding Standard: GSM Transfer Mode: Circuit Info. Transfer Cap.: UDI
Octet 4	1	y	x	x	1	0	0	0	Extension Spare Structure Duplex Mode: Full duplex Configuration: Point to Point Negotiation of Intermediate Rate Requested: No meaning Establishment: Demand
Octet 5	1	0	0	0	1	1	0	0	Extension Access Id Rate Adaptation: V.110 Signalling Access Protocol: X.28 dedicated universal NUI
Octet 6	0	0	1	0	0	0	0	1	Extension Layer 1 Id: Default User Information Layer 1 Protocol Synchronous / Asynchronous: Asynchronous
Octet 6a	0	x	0	x	0	0	0	1	Extension Number of Stop Bits, Depending of the TE Configuration Negotiation: In band Negotiation not possible Number of Data Bits, Depending of the TE Configuration User Rate: 0,3 kbit/s
Octet 6b	0	1	x	0	0	x	x	x	Extension Intermediate Rate NIC on TX: Not Required NIC on RX: Not Supported Parity, Depending of the TE Configuration
Octet 6c	1	x	x	0	0	0	0	0	Extension Connection Element Modem Type: None

If the mobile station supports only Transparent mode or responds with a CALL CONFIRMED message:

Structure in Octet 4: - 1 1 - - - - - Unstructured
Intermediate rate in Octet 6b: - 1 0 - - - - - 8 kbit/s
Connection element in Octet 6c: - 0 0 - - - - - Transparent

¹⁾ If the mobile station supports both Transparent and Non Transparent modes

Structure in Octet 4: - 0 0 - - - - - SDU Integrity
Intermediate rate in Octet 6b: - 1 1 - - - - - 16 kbit/s
Connection element in Octet 6c: - 1 x - - - - - Both T or NT preferred
User Information L2 Protocol (see Non Transparent service)

11.8.2.3.1.2 2) UDI, Non transparent

BC GSM = 04 08 X1 XX 8C 21 X1 6X X0 CX

Octet 1	0	0	0	0	0	1	0	0	Information Element: Bearer Capability
Octet 2	0	0	0	0	1	0	0	0	Length.
Octet 3	1	x	x	0	0	0	0	1	Extension Radio Channel Requirement Coding Standard: GSM Transfer Mode: Circuit Info. Transfer Cap.: UDI
Octet 4	1	y	0	0	1	0	x	0	Extension Spare Structure: SDU Integrity Duplex Mode: Full duplex Configuration: Point to Point Negotiation of Intermediate Rate Requested Establishment: Demand
Octet 5	1	0	0	0	1	1	0	0	Extension Access Id Rate Adaptation: V.110 Signalling Access Protocol: X.28 dedicated PAD, universal NUI
Octet 6	0	0	1	0	0	0	0	1	Extension Layer 1 Id: Default User Information Layer 1 Protocol Synchronous / Asynchronous: Asynchronous
Octet 6a	0	x	0	x	0	0	0	1	Extension Number of Stop Bits, Depending of the TE Configuration Negotiation: In band Negotiation not possible Number of Data Bits, Depending of the TE Configuration User Rate: 0,3 kbit/s
Octet 6b	0	1	1	0	0	x	x	x	Extension Intermediate Rate: 16kbit/s NIC on TX: Not Required NIC on RX: Not Supported Parity, Depending of the TE Configuration
Octet 6c	1	x	x	0	0	0	0	0	Extension Connection Element: NT, (Both T or Both NT) ¹⁾ Modem Type: None
Octet 7	1	1	0	0	1	x	0	0	Extension Layer 2 Id. User Inform. layer 2 protocol: Depending on the TE Configuration

Depending on the type of flow control supported by the TE, octet 7 is present or not. If not present, it means "outband flow control". If octet 7 is present, the value COPnoFLCT (01100) means "No flow control".

11.8.2.3.2 BS 42

Same as BS 41 except

User Rate in Octet 6a:	-	-	-	-	0	0	1	0	1,2 kbit/s
------------------------	---	---	---	---	---	---	---	---	------------

11.8.2.3.3 BS 44

Same as BS 41 except

	User Rate in Octet 6a:	-	-	-	-	0	0	1	1	2,4 kbit/s
--	------------------------	---	---	---	---	---	---	---	---	------------

11.8.2.3.4 BS 45

Same as BS 41 except

	User Rate in Octet 6a:	-	-	-	-	0	1	0	0	4,8 kbit/s
--	------------------------	---	---	---	---	---	---	---	---	------------

11.8.2.3.5 BS 46

Same as BS 41 except

	NIRR in Octet 4	-	-	-	-	-	-	0	-	no meaning
	User Rate in Octet 6a:	-	-	-	-	0	1	0	1	9,6 kbit/s
	Interm. Rate in Octet 6b:	-	1	1	-	-	-	-	-	16 kbit/s

11.8.2.3.6 BS 43

Same as BS 41 except

	User Rate in Octet 6a:	-	-	-	-	0	1	1	1	1,2 kbit/s 75bit/s
--	------------------------	---	---	---	---	---	---	---	---	-----------------------

11.8.2.4 BS 51 to 53 - Packet Service Synchronous

11.8.2.4.1 2) BS 51

BC GSM = 04 08 X1 X8 96 20 13 63 A0 C6

Octet 1	0	0	0	0	0	1	0	0	Information Element: Bearer Capability
Octet 2	0	0	0	0	1	0	0	0	Length
Octet 3	1	x	x	0	0	0	0	1	Extension Radio Channel Requirement Coding Standard: GSM Transfer Mode: Circuit Info. Transfer Cap.: UDI
Octet 4	1	y	0	0	1	0	0	0	Extension Spare Structure: Unstructured Duplex Mode: Full duplex Configuration: Point to Point Negotiation of Intermediate Rate Requested: No meaning Establishment: Demand
Octet 5	1	0	0	1	0	1	1	0	Extension Access Id Rate Adaptation: X.31 flag. Signalling Access Protocol: X.32
Octet 6	0	0	1	0	0	0	0	0	Extension Layer 1 Id: Default User Information Layer 1 Protocol Synchronous / Asynchronous: Synchronous
Octet 6a	0	0	0	1	0	0	1	1	Extension Number of Stop Bits: NA Negotiation: In band Negotiation not possible Number of Data Bits: NA User Rate: 2,4 kbit/s
Octet 6b	0	1	1	0	0	0	1	1	Extension Intermediate Rate: 16kbit/s NIC on TX: Not Required NIC on RX: Not Supported Parity: NA
Octet 6c	1	0	1	0	0	0	0	0	Extension Connection Element: Non Transparent Modem Type: None
Octet 7	1	1	0	0	0	1	1	0	Extension Layer 2 Id. X.25

11.8.2.4.2 BS 52

Same as BS 51 except

	User Rate in Octet 6a:	-	-	-	-	0	1	0	0	4,8 kbit/s
--	------------------------	---	---	---	---	---	---	---	---	------------

11.8.2.4.3 BS 53

Same as BS 51 except

	User Rate in Octet 6a:	-	-	-	-	0	1	0	1	9,6 kbit/s
--	------------------------	---	---	---	---	---	---	---	---	------------

11.8.2.5 BS 61 - Alternate Speech / Data

The first BC is coded as follows :

IF speech full rate version 2 is supported by the mobile, see 11.8.2.9.2

ELSE see 11.8.2.9.1

The repeat Indicator in the Setup message is coded "Circular for successive selection (alternate)": D1.

The second BC in the Setup message is coded as described below.

11.8.2.5.1 Speech/Asynchronous Data, Transparent

BC GSM = 04 0X X2 X8 81 21 XX XX XX (CX)

Octet 1	0	0	0	0	0	1	0	0	Information Element: Bearer Capability
Octet 2	0	0	0	0	0	1	1	1	Length
Octet 3	1	x	x	0	0	0	1	0	Extension Radio Channel Requirement Coding Standard: GSM Transfer Mode: Circuit Info. Transfer Cap.: 3,1 kHz Audio
Octet 4	1	y	x	x	1	0	0	0	Extension Spare Structure Duplex Mode: Full duplex Configuration: Point to Point Negotiation of Intermediate Rate Requested: No meaning Establishment: Demand
Octet 5	1	0	0	0	0	0	0	1	Extension Access Id Rate Adaptation: No Signalling Access Protocol: I.440 / I.450
Octet 6	0	0	1	0	0	0	0	1	Extension Layer 1 Id: Default User Information Layer 1 Protocol Synchronous / Asynchronous: Asynchronous
Octet 6a	0	x	0	x	x	x	x	x	Extension Number of Stop Bits, Depending of the TE Configuration Negotiation: In band Negotiation not possible Number of Data Bits, Depending of the TE Configuration User Rate
Octet 6b	0	1	x	0	0	x	x	x	Extension Intermediate Rate NIC on TX: Not Required NIC on RX: Not Supported Parity, Depending of the TE Configuration
Octet 6c	1	x	x	0	x	x	x	x	Extension Connection Element Modem Type

If the mobile station supports only Transparent mode or responds with a CALL CONFIRMED message:

Structure in Octet 4:	-	1	1	-	-	-	-	-	Unstructured
Intermediate rate in Octet 6b:	-	1	x	-	-	-	-	-	Depending on the user rate
Connection element in Octet 6c:	-	0	0	-	-	-	-	-	Transparent

1) If the mobile station supports both Transparent and Non Transparent modes

Structure in Octet 4: - 0 0 - - - - - SDU Integrity
 Intermediate rate in Octet 6b: - 1 1 - - - - - 16 kbit/s
 Connection element in Octet 6c: - 1 x - - - - - Both T or NT preferred
 User Information L2 protocol in Octet 7 (see Non Transparent service)

Depending of the user rate supported by the MS, the user rate, the modem type and the intermediate rate change:

User Rate in Octet 6a:	-	-	-	-	0	0	0	1	0,3 kbit/s
Intermediate rate in Octet 6b:	-	1	0	-	-	-	-	-	8 kbit/s in Transparent mode
Modem type in Octet 6c:	-	-	-	0	0	0	0	1	Modem V.21

User Rate in Octet 6a:	-	-	-	-	0	0	1	0	1,2 kbit/s
Intermediate rate in Octet 6b:	-	1	0	-	-	-	-	-	8 kbit/s in Transparent mode
Modem type in Octet 6c:	-	-	-	0	0	0	1	0	Modem V.22

User Rate in Octet 6a:	-	-	-	-	0	0	1	1	2,4 kbit/s
Intermediate rate in Octet 6b:	-	1	0	-	-	-	-	-	8 kbit/s in Transparent mode
Modem type in Octet 6c:	-	-	-	0	0	0	1	1	Modem V.22bis
						1	0	1	Modem V.26ter

User Rate in Octet 6a:	-	-	-	-	0	1	0	0	4,8 kbit/s
Intermediate rate in Octet 6b:	-	1	0	-	-	-	-	-	8 kbit/s in Transparent mode
Modem type in Octet 6c:	-	-	-	0	0	1	1	0	Modem V.32

NIRR in Octet 4:	-	-	-	-	-	-	0	-	no meaning
User Rate in Octet 6a:	-	-	-	-	0	1	0	1	9,6 kbit/s
Intermediate rate in Octet 6b:	-	1	1	-	-	-	-	-	16 kbit/s in Transparent mode
Modem type in Octet 6c:	-	-	-	0	0	1	1	0	Modem V.32

User Rate in Octet 6a:	-	-	-	-	0	1	1	1	1,2 kbts/s 75bit/2
Intermediate rate in Octet 6b:	-	1	0	-	-	-	-	-	8 kbit/s in Transparent mode
Modem type in Octet 6c:	-	-	-	0	0	1	0	0	Modem V.23

11.8.2.5.2 Speech/Asynchronous Data, Non Transparent

BC GSM = 04 0X X2 XX 81 21 XX 6X XX (CX)

Octet 1	0	0	0	0	0	1	0	0	Information Element: Bearer Capability
Octet 2	0	0	0	0	x	x	x	x	Length (7 or 8) depending on presence of octet 7.
Octet 3	1	x	x	0	0	0	1	0	Extension Radio Channel Requirement Coding Standard: GSM Transfer Mode: Circuit Info. Transfer Cap.: 3,1 kHz Audio
Octet 4	1	y	0	0	1	0	x	0	Extension Spare Structure: SDU Integrity Duplex Mode: Full duplex Configuration: Point to Point Negotiation of Intermediate Rate Requested Establishment: Demand
Octet 5	1	0	0	0	0	0	0	1	Extension Access Id Rate Adaptation: No Signalling Access Protocol: I.440 / I.450
Octet 6	0	0	1	0	0	0	0	1	Extension Layer 1 Id: Default User Information Layer 1 Protocol Synchronous / Asynchronous: Asynchronous
Octet 6a	0	x	0	x	x	x	x	x	Extension Number of Stop Bits, Depending of the TE Configuration Negotiation: In band Negotiation not possible Number of Data Bits, Depending of the TE Configuration User Rate
Octet 6b	0	1	1	0	0	x	x	x	Extension Intermediate Rate: 16kbit/s NIC on TX: Not Required NIC on RX: Not Supported Parity, Depending of the TE Configuration
Octet 6c	1	x	x	0	x	x	x	x	Extension Connection Element: NT, (Both T or Both NT) ¹⁾ Modem Type
Octet 7 (may not be present)	1	1	0	0	1	x	0	0	Extension Layer 2 Id. User Inform. layer 2 protocol, Depending of the TE Configuration

Depending of the type of flow control supported by the TE, the coding of octet 7 is different. The value ISO 6429 (0 1000) means "Inband flow control" and the value COPnoFLCT (0 1100) means "No flow control". The "Outband Flow control is not allowed with V.21 modem).

Depending of the user rate supported by the MS, the user rate and the modem type change:

	User Rate in Octet 6a:	-	-	-	-	0	0	0	1	0,3 kbit/s
	Modem type in Octet 6c:	-	-	-	0	0	0	0	1	Modem V.21

	User Rate in Octet 6a:	-	-	-	-	0	0	1	0	1,2 kbit/s
	Modem type in Octet 6c:	-	-	-	0	0	0	1	0	Modem V.22

	User Rate in Octet 6a:	-	-	-	-	0	0	1	1	2,4 kbit/s
	Modem type in Octet 6c:	-	-	-	0	0	0	1	1	Modem V.22bis
							1	0	1	Modem V.26ter

	User Rate in Octet 6a:	-	-	-	-	0	1	0	0	4,8 kbit/s
	Modem type in Octet 6c:	-	-	-	0	0	1	1	0	Modem V.32

	NIRR in Octet 4:	-	-	-	-	-	-	0	-	no meaning
	User Rate in Octet 6a:	-	-	-	-	0	1	0	1	9,6 kbit/s
	Modem type in Octet 6c:	-	-	-	0	0	1	1	0	Modem V.32

	User Rate in Octet 6a:	-	-	-	-	0	1	1	1	1,2 kbit/s 75bit/s
	Modem type in Octet 6c:	-	-	-	0	0	1	0	0	Modem V.23

11.8.2.5.3 Speech/Synchronous Data

BC GSM = 04 07 X2 X8 81 20 1X X3 8X

Octet 1	0	0	0	0	0	1	0	0	Information Element: Bearer Capability
Octet 2	0	0	0	0	0	1	1	1	Length
Octet 3	1	x	x	0	0	0	1	0	Extension Radio Channel Requirement Coding Standard: GSM Transfer Mode: Circuit Info. Transfer Cap.: 3,1 kHz Audio
Octet 4	1	y	1	1	1	0	0	0	Extension Spare Structure: Unstructured Duplex Mode: Full duplex Configuration: Point to Point Negotiation of Intermediate Rate Requested: No meaning Establishment: Demand
Octet 5	1	0	0	0	0	0	0	1	Extension Access Id Rate Adaptation: No Signalling Access Protocol: I.440 / I.450
Octet 6	0	0	1	0	0	0	0	0	Extension Layer 1 Id: Default User Information Layer 1 Protocol Synchronous / Asynchronous: Synchronous
Octet 6a	0	0	0	1	x	x	x	x	Extension Number of Stop Bits: NA Negotiation: In band Negotiation not possible Number of Data Bits: NA User Rate
Octet 6b	0	1	x	0	0	0	1	1	Extension Intermediate Rate NIC on TX: Not Required NIC on RX: Not Supported Parity: NA
Octet 6c	1	0	0	0	x	x	x	x	Extension Connection Element: Transparent Modem Type

Depending of the user rate supported by the MS, the user rate, the modem type and the intermediate rate change:

	User Rate in Octet 6a:	-	-	-	-	0	0	1	0	1,2 kbit/s
	Intermediate rate in Octet 6b:	-	1	0	-	-	-	-	-	8 kbit/s
	Modem type in Octet 6c:	-	-	-	0	0	0	1	0	Modem V.22

	User Rate in Octet 6a:	-	-	-	-	0	0	1	1	2,4 kbit/s
	Intermediate rate in Octet 6b:	-	1	0	-	-	-	-	-	8 kbit/s
	Modem type in Octet 6c:	-	-	-	0	0	0	1	1	Modem V.22bis
							1	0	1	Modem V.26ter

	User Rate in Octet 6a:	-	-	-	-	0	1	0	0	4,8 kbit/s
	Intermediate rate in Octet 6b:	-	1	0	-	-	-	-	-	8 kbit/s
	Modem type in Octet 6c:	-	-	-	0	0	1	1	0	Modem V.32

	NIRR in Octet 4:	-	-	-	-	-	-	0	-	no meaning
	User Rate in Octet 6a:	-	-	-	-	0	1	0	1	9,6 kbit/s
	Intermediate rate in Octet 6b:	-	1	1	-	-	-	-	-	16 kbit/s
	Modem type in Octet 6c:	-	-	-	0	0	1	1	0	Modem V.32

11.8.2.6 BS 81 - Speech followed by Data

The first BC is coded as follows :

IF speech full rate version 2 is supported by the mobile, see 11.8.2.9.2

ELSE see 11.8.2.9.1

The repeat Indicator in the Setup message is coded "Sequential for successive selection (followed by)": D3.

The second BC in the Setup message is coded as described below.

11.8.2.6.1 Speech followed by Asynchronous Data

See chapters 11.8.2.5.1 and 11.8.2.5.2.

11.8.2.6.2 Speech followed by Synchronous Data

See chapter 11.8.2.5.3.

11.8.2.7 TS 61 - Alternate Speech / Facsimile group 3

The first BC is coded as follows :

IF speech full rate version 2 is supported by the mobile, see 11.8.2.9.2

ELSE see 11.8.2.9.1

The repeat Indicator in the Setup message is coded "Circular for successive selection (alternate)": D1.

The second BC in the Setup message is coded as described below.

11.8.2.7.1 TS 61 - Alternate Speech / Facsimile group 3, Transparent

BC GSM = 04 07 X3 X8 81 20 1X X3 80

Octet 1	0	0	0	0	0	1	0	0	Information Element: Bearer Capability
Octet 2	0	0	0	0	0	1	1	1	Length
Octet 3	1	y	y	0	0	0	1	1	Extension Radio Channel Requirement: Spare Coding Standard: GSM Transfer Mode: Circuit Info. Transfer Cap.: FAX3
Octet 4	1	y	1	1	1	0	0	0	Extension Spare Structure: Unstructured Duplex Mode: Full duplex Configuration: Point to Point Negotiation of Intermediate Rate Requested: No meaning Establishment: Demand
Octet 5	1	0	0	0	0	0	0	1	Extension Access Id Rate Adaptation: No Signalling Access Protocol: NA
Octet 6	0	0	1	0	0	0	0	0	Extension Layer 1 Id: Default User Information Layer 1 Protocol Synchronous / Asynchronous: synchronous
Octet 6a	0	0	0	1	x	x	x	x	Extension Number of Stop Bits: NA Negotiation: In band Negotiation not possible Number of Data Bits: NA User Rate
Octet 6b	0	1	x	0	0	0	1	1	Extension Intermediate Rate NIC on TX: Not Required NIC on RX: Not Supported Parity: NA
Octet 6c	1	0	0	0	0	0	0	0	Extension Connection Element: Transparent Modem Type: None

Depending of the user rate supported by the MS, the user rate and the intermediate rate change:

	User Rate in Octet 6a:	-	-	-	-	0	0	1	1	2,4 kbit/s
	Interm. Rate in Octet 6b:	-	1	0	-	-	-	-	-	8 kbit/s

	User Rate in Octet 6a:	-	-	-	-	0	1	0	0	4,8 kbit/s
	Interm. Rate in Octet 6b:	-	1	0	-	-	-	-	-	8 kbit/s

	NIRR in Octet 4:	-	-	-	-	-	-	0	-	no meaning
	User Rate in Octet 6a:	-	-	-	-	0	1	0	1	9,6 kbit/s
	Interm. Rate in Octet 6b:	-	1	1	-	-	-	-	-	16 kbit/s

11.8.2.7.2 TS 61 - Alternate Speech / Facsimile group 3, Non Transparent

BC GSM = 04 07 X3 XX 81 20 1X 63 X0 66

Octet 1	0	0	0	0	0	1	0	0	Information Element: Bearer Capability
Octet 2	0	0	0	0	0	1	1	1	Length
Octet 3	1	y	y	0	0	0	1	1	Extension Radio Channel Requirement: Spare Coding Standard: GSM Transfer Mode: Circuit Info. Transfer Cap.: FAX3
Octet 4	1	y	0	0	1	0	x	0	Extension Spare Structure: SDU Integrity Duplex Mode: Full duplex Configuration: Point to Point Negotiation of Intermediate Rate Requested Establishment: Demand
Octet 5	1	0	0	0	0	0	0	1	Extension Access Id Rate Adaptation: No Signalling Access Protocol: NA
Octet 6	0	0	1	0	0	0	0	0	Extension Layer 1 Id: Default User Information Layer 1 Protocol Synchronous / Asynchronous: synchronous
Octet 6a	0	0	0	1	x	x	x	x	Extension Number of Stop Bits: NA Negotiation: In band Negotiation not possible Number of Data Bits: NA User Rate
Octet 6b	0	1	1	0	0	0	1	1	Extension Intermediate Rate: 16 kbit/s NIC on TX: Not Required NIC on RX: Not Supported Parity: NA
Octet 6c	1	x	x	0	0	0	0	0	Extension Connection Element Modem Type: None
Octet 7	1	1	0	0	0	1	1	0	Extension Layer 2 Id X.25

The user rate supported by the MS may have the following values:

User Rate in Octet 6a:	-	-	-	-	0	0	1	1	2,4 kbit/s
------------------------	---	---	---	---	---	---	---	---	------------

User Rate in Octet 6a:	-	-	-	-	0	1	0	0	4,8 kbit/s
------------------------	---	---	---	---	---	---	---	---	------------

NIRR in Octet 4:	-	-	-	-	-	-	0	-	no meaning
User Rate in Octet 6a:	-	-	-	-	0	1	0	1	9,6 kbit/s

If present, Octet 7 shall have the following value:

UI2LP in Octet 7	-	-	-	0	0	1	1	0	X.25
------------------	---	---	---	---	---	---	---	---	------

11.8.2.8 TS 62 - Automatic Facsimile group 3

The repeat Indicator in the Setup message is not available.

The BC GSM is coded as described in chapter 11.8.2.7.

11.8.2.9 TS 11 and TS 12- Speech**11.8.2.9.1 Support of only full/half rate speech version 1**

The BC in the Setup message is coded as described below.

BC GSM = 04 01 X0

Octet 1	0	0	0	0	0	1	0	0	Information Element : Bearer Capability
Octet 2	0	0	0	0	0	0	0	1	Length
Octet 3	1	x	x	0	0	0	0	0	Extension Radio Channel Requirement Coding Standard : GSM Transfer Mode : Circuit Info. Transfer Cap. : speech

11.8.2.9.2 Support of speech full rate version 2 (Enhanced Full Rate)

This BC will be used by MS supporting EFR as the most advanced speech version. Those supporting EFR and newer codec speech version such as speech version 3, half rate speech version 2 will not use this BC.

The BC in the Setup message is coded as described below.

BC GSM = 04 0X X0 0X XX (1X)

Octet 1	0	0	0	0	0	1	0	0	Information Element : Bearer Capability
Octet 2	0	0	0	0	0	x	x	x	Length
Octet 3	0	x	x	0	0	0	0	0	Extension Radio Channel Requirement Coding Standard : GSM Transfer Mode : Circuit Info. Transfer Cap. : speech
Octet_3a_1	0	0	0	0	0	x	x	x	Extension Coding Spare Speech version indication
Octet_3a_2	x	0	0	0	0	x	x	x	Extension Coding Spare Speech version indication
Octet_3a_3	1	0	0	0	0	x	x	x	Extension Coding Spare Speech version indication

IF the MS supports only Full Rate

Octet 2	0	0	0	0	0	0	1	1	Length
Radio Channel Requirement in Octet 3:	-	0	1	-	-	-	-	-	Full rate support only mobile station/preference as in octets3a_etc

Octet_3a_1	-	-	-	-	-	0	x	0	x=0 : full rate speech version 1 x=1 : full rate speech version 2
------------	---	---	---	---	---	---	---	---	--

Octet_3a_2	1	-	-	-	-	0	x	0	x=0 : full rate speech version 1 x=1 : full rate speech version 2
------------	---	---	---	---	---	---	---	---	--

the speech indication in Octet_3a_1 shall be different from the one in Octet_3a_2.

Octet_3a_3 is not present.

ELSE

Octet 2	0	0	0	0	0	1	0	0	Length
Radio Channel Requirement in Octet 3:	-	1	x	-	-	-	-	-	x=0 or 1 :Dual rate mobile station/ preference as in octets3a_etc

Octet_3a_1	-	-	-	-	-	0	x	x	(0,0) :full rate speech version 1 (1,0) : full rate speech version 2 (0,1) : half rate speech version 1
------------	---	---	---	---	---	---	---	---	---

Octet_3a_2	0	-	-	-	-	0	x	x	(0,0) :full rate speech version 1 (1,0) : full rate speech version 2 (0,1) : half rate speech version 1
------------	---	---	---	---	---	---	---	---	---

Octet_3a_3	1	-	-	-	-	0	x	x	(0,0) :full rate speech version 1 (1,0) : full rate speech version 2 (0,1) : half rate speech version 1
------------	---	---	---	---	---	---	---	---	---

Each speech indication in Octet_3a_i shall be different from the one in Octet_3a_j, i≠j.

12 Transceiver

12.1 Conducted spurious emissions

12.1.1 MS allocated a channel

12.1.1.1 Definition and applicability

Conducted spurious emissions, when the MS has been allocated a channel, are emissions from the antenna connector at frequencies other than those of the carrier and sidebands associated with normal modulation.

The requirements and this test apply to all types of GSM 900 and DCS 1 800 MS with a permanent antenna connector.

12.1.1.2 Conformance requirement

1. The conducted spurious power emitted by the MS, when allocated a channel, shall be no more than the levels in table 12.1.

1.1 Under normal voltage conditions; GSM 05.05, 4.3/4.3.3.

1.2 Under extreme voltage conditions; GSM 05.05, 4.3/4.3.3/Annex D.2.

Table 12.1

Frequency range	Power level in dBm	
	GSM900	DCS1800
9 kHz to 1 GHz	-36	-36
1 GHz to 12,75 GHz	-30	
1 GHz to 1710 MHz		-30
1710 MHz to 1785 MHz		-36
1785 MHz to 12,75 GHz		-30

12.1.1.3 Test purpose

1. To verify that conducted spurious emissions, in the frequency band 100 kHz to 12,75 GHz excluding the GSM900 and DCS 1 800 receive bands, from the MS when allocated a channel do not exceed the conformance requirements.

1.1 Under normal voltage conditions.

1.2 Under extreme voltage conditions.

NOTE: The band 9 - 100 kHz is not tested, because of test implementation problems.

12.1.1.4 Method of test

12.1.1.4.1 Initial conditions

A call is set up by the SS according to the generic call set up procedure on a channel in the Mid ARFCN range.

The SS commands the MS to loop back its channel decoder output to channel encoder input.

The SS sends Standard Test Signal C1.

The SS sets the MS to operate at its maximum output power.

12.1.1.4.2 Procedure

a) Measurements are made in the frequency range 100 kHz to 12,75 GHz. Spurious emissions are measured at the connector of the transceiver, as the power level of any discrete signal, higher than the requirement in table 12.1 minus 6 dB, delivered into a 50 Ohm load.

The measurement bandwidth based on a 5 pole synchronously tuned filter is according to table 12.2. The power indication is the peak power detected by the measuring system.

The measurement on any frequency shall be performed for at least one TDMA frame period with the exception of the idle frame.

NOTE: This ensures that both the active times (MS transmitting) and the quiet times are measured.

- b) The test is repeated under extreme voltage test conditions ([Annex 1, TC2.2 and TC3]).

Table 12.2

Frequency range	Frequency offset	Filter bandwidth	Approx video bandwidth
100 kHz to 50 MHz	-	10 kHz	30 kHz
50 to 500 MHz	-	100 kHz	300 kHz
500 MHz to 12,75 GHz, excl. relevant TX band: P-GSM: 890 to 915 MHz; E-GSM: 880 to 915 MHz; DCS: 1710 to 1785 MHz, and the RX bands: 925 to 960 MHz; 1805 to 1880 MHz.	0 to 10 MHz >= 10 MHz >= 20 MHz >= 30 MHz (offset from edge of relevant TX band)	100 kHz 300 kHz 1 MHz 3 MHz	300 kHz 1 MHz 3 MHz 3 MHz
relevant TX band: P-GSM: 890 to 915 MHz E-GSM: 880 to 915 MHz DCS: 1710 to 1785 MHz	1,8 to 6,0 MHz > 6,0 MHz (offset from carrier)	30 kHz 100 kHz	100 kHz 300 kHz

NOTE 1: The frequency ranges 925 MHz to 960 MHz and 1 805 MHz to 1 880 MHz are excluded as these ranges are tested in section [13.4].

NOTE 2: The filter and video bandwidths, and frequency offsets are only correct for measurements on an MS transmitting on a channel in the Mid ARFCN range.

NOTE 3: Due to practical implementation, the video bandwidth is restricted to a maximum of 3 MHz.

12.1.1.5 Test requirement

The power of any spurious emission shall not exceed the levels given in table 12.3.

Table 12.3

Frequency range	Power level in dBm	
	GSM900	DCS1800
100 kHz to 1 GHz	-36	-36
1 GHz to 12,75 GHz	-30	
1 GHz to 1710 MHz		-30
1710 MHz to 1785 MHz		-36
1785 MHz to 12,75 GHz		-30

12.1.2 MS in idle mode

12.1.2.1 Definition and applicability

Conducted spurious emissions are any emissions from the antenna connector, when the MS is in idle mode.

The requirements and this test apply to all types of GSM 900 and DCS 1 800 MS with a permanent antenna connector.

12.1.2.2 Conformance requirement

1. The conducted spurious power emitted by the MS, when in idle mode, shall be no more than the levels in table 12.4.
 - 1.1 Under normal voltage conditions; GSM 05.05, 4.3/4.3.3.
 - 1.2 Under extreme voltage conditions; GSM 05.05, 4.3/4.3.3/Annex D.2.

Table 12.4

Frequency range		Power level in dBm
9 kHz to	880 MHz	-57
880 MHz to	915 MHz	-59
915 MHz to	1000 MHz	-57
1 GHz to	1710 MHz	-47
1710 MHz to	1785 MHz	-53
1785 MHz to	12,75 GHz	-47

12.1.2.3 Test purpose

1. To verify that conducted spurious emissions, in the frequency band 100 kHz to 12,75 GHz from the MS when in idle mode do not exceed the conformance requirements.
 - 1.1 Under normal voltage conditions.
 - 1.2 Under extreme voltage conditions.

NOTE: The band 9 - 100 kHz is not tested, because of test implementation problems.

12.1.2.4 Method of test

12.1.2.4.1 Initial conditions

The BCCH message content from the serving cell shall ensure that Periodic Location Updating is not used and that page mode is continuously set to Paging Reorganization and BS_AG_BLKES_RES is set to 0 so that the MS receiver will operate continually.

The CCCH_CONF shall be set to 000. 1 basic physical channel used for CCCH not combined with SDCCHs.

The BCCH allocation shall either be empty or contain only the serving cell BCCH.

NOTE: This is to ensure that the receiver does not scan other ARFCN. Scanning other ARFCN could lead to a moving in frequency of the spurious and therefore to the possibility of either not measuring a spurious emission or measuring it more than once.

The MS is in MM state "idle, updated".

12.1.2.4.2 Procedure

- a) Measurements are made in the frequency range 100 kHz to 12,75 GHz. Spurious emissions are measured as the power level of any discrete signal, higher than the requirement in table 12.4 minus 6 dB, delivered into a 50 Ohm load.

The measurement bandwidth based on a 5 pole synchronously tuned filter is set according to table 12.5. The power indication is the peak power detected by the measuring system.

The measurement time on any frequency shall be such that it includes the time during which the MS receives a TDMA frame containing the paging channel.

Table 12.5

Frequency range	Filter bandwidth	Video bandwidth
100 kHz to 50 MHz	10 kHz	30 kHz
50 MHz to 12,75 GHz	100 kHz	300 kHz

b) The test is repeated under extreme voltage test conditions ([Annex 1, TC2.2 and TC3]).

12.1.2.5 Test requirement

The power of any spurious emission shall not exceed the levels given in table 12.6.

Table 12.6

Frequency range	Power level in dBm
100 kHz to 880 MHz	-57
880 MHz to 915 MHz	-59
915 MHz to 1000 MHz	-57
1 GHz to 1710 MHz	-47
1710 MHz to 1785 MHz	-53
1785 MHz to 12,75 GHz	-47

12.2 Radiated spurious emissions

This test is performed either on an outdoor test site, fulfilling the requirements of [GC4 of Annex 1], or in an anechoic shielded chamber, fulfilling the requirements of ([GC5 of Annex 1]). Performing the measurement in the anechoic shielded chamber is preferred. The sample shall be placed at the specified height on the support.

NOTE: The test method described has been written for measurement in an anechoic shielded chamber. If an outdoor test site is used then additional precautions are necessary to ensure correct measurement. These measures are familiar to test houses which perform spurious emissions tests and are:

- a) Raise/lower the test antenna through the specified height range during both the emission detection and substitution parts of the test.
- b) Perform a qualitative pre-search in a shielded environment for test sites where the ambient RF environment can prevent the detection of spurious emissions which exceed the limit.
- c) Detect emissions at a more sensitive threshold to that specified in section 12.2.1.4 to allow for destructive interference due to ground plane reflections at the test antenna search height.

12.2.1 MS allocated a channel

12.2.1.1 Definition and applicability

Radiated spurious emissions, when the MS has been allocated a channel, are any emissions radiated by the cabinet and structure of the mobile station, including all interconnecting cables.

This is also known as "cabinet radiation".

The requirements apply to all types of GSM 900 and DCS 1 800 MS. The test applies to all types of GSM 900 and DCS 1 800 MS with the exception of the test at extreme voltages for an MS where a practical connection, to an external power supply, is not possible.

NOTE: A "practical connection" shall be interpreted to mean it is possible to connect extreme voltages to the MS without interfering with the configuration of the MS in a way which could invalidate the test.

12.2.1.2 Conformance requirement

1. The radiated spurious power emitted by the MS, when allocated a channel, shall be no more than the levels in table 12.7 under normal voltage conditions; GSM 05.05, 4.3/4.3.3.
2. The radiated spurious power emitted by the MS, when allocated a channel, shall be no more than the levels in table 12.7 under extreme voltage conditions; GSM 05.05, 4.3/4.3.3/annex D.2.

Table 12.7

Frequency range	Power level in dBm	
	GSM900	DCS1800
30 MHz to 1 GHz	-36	-36
1 GHz to 4 GHz	-30	
1 GHz to 1710 MHz		-30
1710 MHz to 1785 MHz		-36
1785 MHz to 4 GHz		-30

12.2.1.3 Test purpose

1. To verify that radiated spurious emissions from the MS when allocated a channel do not exceed the conformance requirements under normal voltage conditions.
2. To verify that radiated spurious emissions from the MS when allocated a channel do not exceed the conformance requirements under extreme voltage conditions.

12.2.1.4 Method of test

12.2.1.4.1 Initial conditions

A call is set up by the SS according to the generic call set up procedure on a channel in the Mid ARFCN range.

NOTE: The power supply shall be connected to the MS such that the physical configuration does not change in a way that could have an effect on the measurement. In particular, the battery pack of the MS should not normally be removed. In cases where no practical connection can be made to the power supply, the MS's intended battery source shall be used.

The SS commands the MS to loop back its channel decoder output to its channel encoder input.

The SS sends Standard Test Signal C1.

The SS sets the MS to operate at its maximum output power.

12.2.1.4.2 Procedure

- a) Initially the test antenna is closely coupled to the MS and any spurious emission radiated by the MS is detected by the test antenna and receiver in the range 30 MHz to 4 GHz.

NOTE: This is a qualitative step to identify the frequency and presence of spurious emissions which are to be measured in subsequent steps.

- b) The test antenna separation is set to the appropriate measurement distance and at each frequency at which an emission has been detected, the MS shall be rotated to obtain maximum response and the effective radiated power of the emission determined by a substitution measurement. In case of an anechoic shielded chamber pre-calibration may be used instead of a substitution measurement.
- c) The measurement bandwidth, based on a 5 pole synchronously tuned filter, is set according to table 12.8. The power indication is the peak power detected by the measuring system.

The measurement on any frequency shall be performed for at least one TDMA frame period, with the exception of the idle frame.

NOTE 1: This ensures that both the active times (MS transmitting) and the quiet times are measured.

NOTE 2: For these filter bandwidths some difficulties may be experienced with noise floor above required measurement limit. This will depend on the gain of the test antenna, and adjustment of the measuring system bandwidth is permissible. Alternatively, for test frequencies above 900 MHz, the test antenna separation from the MS may be reduced to 1 metre.

- d) The measurements are repeated with the test antenna in the orthogonal polarization plane.
- e) The test is repeated under extreme voltage test conditions (see [Annex 1, TC2.2]).

Table 12.8

Frequency range	Frequency offset	Filter bandwidth	Approx video bandwidth
30 to 50 MHz	-	10 kHz	30 kHz
50 to 500 MHz	-	100 kHz	300 kHz
500 MHz to 4 GHz,	0 to 10 MHz	100 kHz	300 kHz
excl. relevant TX band:	>= 10 MHz	300 kHz	1 MHz
P-GSM: 890 to 915 MHz;	>= 20 MHz	1 MHz	3 MHz
E-GSM: 880 to 915 MHz;	>= 30 MHz	3 MHz	3 MHz
DCS: 1710 to 1785 MHz.	(offset from edge of relevant TX band)		
relevant TX band:			
P-GSM: 890 to 915 MHz	1,8 to 6,0 MHz	30 kHz	100 kHz
E-GSM: 880 to 915 MHz	> 6,0 MHz	100 kHz	300 kHz
DCS: 1710 to 1785 MHz	(offset from carrier)		

NOTE 1: The filter and video bandwidths, and frequency offsets are only correct for measurements on an MS transmitting on a channel in the Mid ARFCN range.

NOTE 2: Due to practical implementation of a SS, the video bandwidth is restricted to a maximum of 3 MHz.

12.2.1.5 Test requirement

The power of any spurious emission shall not exceed the levels given in table 12.7.

12.2.2 MS in idle mode

12.2.2.1 Definition and applicability

Radiated spurious emissions, when the MS is in idle mode, are any emissions radiated by the cabinet and structure of the mobile station, including all interconnecting cables.

This is also known as "cabinet radiation".

The requirements apply to all types of GSM 900 and DCS 1 800 MS. The test applies to all types of GSM 900 and DCS 1 800 MS with the exception of the test at extreme voltages for an MS where a practical connection, to an external power supply, is not possible.

NOTE: A "practical connection" shall be interpreted to mean it is possible to connect extreme voltages to the MS without interfering with the configuration of the MS in a way which could invalidate the test.

12.2.2.2 Conformance requirement

1. The radiated spurious power emitted by the MS, when in idle mode, shall be no more than the levels in table 12.9. under normal voltage conditions; GSM 05.05, 4.3/4.3.3.
2. The radiated spurious power emitted by the MS, when in idle mode, shall be no more than the levels in table 12.9. under extreme voltage conditions; GSM 05.05, 4.3/4.3.3/Annex D.2.

Table 12.9

Frequency range		Power level in dBm
30 MHz to	880 MHz	-57
880 MHz to	915 MHz	-59
915 MHz to	1000 MHz	-57
1 GHz to	1710 MHz	-47
1710 MHz to	1785 MHz	-53
1785 MHz to	4 GHz	-47

12.2.2.3 Test purpose

1. To verify that radiated spurious emissions from the MS when in idle mode do not exceed the requirements under normal voltage conditions.
2. To verify that radiated spurious emissions from the MS when in idle mode do not exceed the requirements under extreme voltage conditions.

12.2.2.4 Method of test

12.2.2.4.1 Initial conditions

NOTE: The power supply shall be connected to the MS such that the physical configuration does not change in a way that could have an effect on the measurement. In particular, the battery pack of the MS should not normally be removed. In cases where no practical connection can be made to the power supply, the MS's intended battery source shall be used.

The BCCH message content from the serving cell shall ensure that Periodic Location Updating is not used and that page mode is continuously set to Paging Reorganization and BS_AG_BLK_RES is set to 0 so that the MS receiver will operate continually.

The CCCH_CONF shall be set to 000. 1 basic physical channel used for CCCH not combined with SDCCHs.

The BCCH allocation shall either be empty or contain only the serving cell BCCH.

NOTE: This is to ensure that the receiver does not scan other ARFCN. Scanning other ARFCN could lead to a moving in frequency of the spurious and therefore to the possibility of either not measuring a spurious emission or measuring it more than once.

The MS is in MM state "idle, updated".

12.2.2.4.2 Procedure

- a) Initially the test antenna is closely coupled to the MS and any spurious emission radiated by the MS are detected by the test antenna and receiver in the range 30 MHz to 4 GHz.

NOTE: This is a qualitative step to identify the frequency and presence of spurious emissions which are to be measured in subsequent steps.

- b) The test antenna separation is set to the appropriate measurement distance and at each frequency at which a spurious emission has been detected the MS is rotated to obtain a maximum response. The effective radiated power of the emission is determined by a substitution measurement. In case of an anechoic shielded chamber pre-calibration may be used instead of a substitution measurement.
- c) The measurement bandwidth based on a 5 pole synchronously tuned filter shall be according to table 12.10. The power indication is the peak power detected by the measuring system.

The measurement time on any frequency shall be such that it includes the time during which the MS receives a TDMA frame containing the paging channel.

NOTE: For these filter bandwidths some difficulties may be experienced with noise floor above required measurement limit. This will depend on the gain of the test antenna, and adjustment of the measuring system bandwidth is permissible. Alternatively, for test frequencies above 900 MHz, the test antenna separation from the MS may be reduced to 1 metre.

Table 12.10

Frequency range	Filter bandwidth	Video bandwidth
30 MHz to 50 MHz	10 kHz	30 kHz
50 MHz to 4 GHz	100 kHz	300 kHz

- d) The measurements are repeated with the test antenna in the orthogonal polarization plane.
- e) The test is repeated under extreme voltage test conditions (see [Annex 1, TC2.2]).

12.2.2.5 Test requirement

The power of any spurious emission shall not exceed the levels given in table 12.9.

13 Transmitter

13.1 Frequency error and phase error

13.1.1 Definition and applicability

The frequency error is the difference in frequency, after adjustment for the effect of the modulation and phase error, between the RF transmission from the MS and either:

- the RF transmission from the BS, or
- the nominal frequency for the ARFCN used.

The phase error is the difference in phase, after adjustment for the effect of the frequency error, between the RF transmission from the MS and the theoretical transmission according to the intended modulation.

The requirements and this test apply to all types of GSM 900 and DCS 1 800 MS.

13.1.2 Conformance requirement

1. The MS carrier frequency shall be accurate to within 0,1 ppm, or accurate to within 0,1 ppm compared to signals received from the BS.
 - 1.1 Under normal conditions; GSM 05.10, 6.1.
 - 1.2 Under vibration conditions; GSM 05.10, 6.1; GSM 05.05, annex D D.2.3.
 - 1.3 Under extreme conditions; GSM 05.10, 6.1; GSM 05.05, 4.4; GSM 05.05, annex D D.2.1, D.2.2.
2. The RMS phase error (difference between the phase error trajectory and its linear regression on the active part of the time slot) for each burst shall not be greater than 5 degrees.
 - 2.1 Under normal conditions; GSM 05.05, 4.6.
 - 2.2 Under vibration conditions; GSM 05.05, 4.6; GSM 05.05, annex D D.2.3.
 - 2.3 Under extreme conditions; GSM 05.05, 4.6; GSM 05.05, annex D D.2.1, D.2.2.
3. The maximum peak deviation during the useful part of each burst shall not be greater than 20 degrees.
 - 3.1 Under normal conditions; GSM 05.05, 4.6.
 - 3.2 Under vibration conditions; GSM 05.05, 4.6; GSM 05.05, annex D D.2.3.
 - 3.3 Under extreme conditions; GSM 05.05, 4.6; GSM 05.05, annex D D.2.1, D.2.2.

13.1.3 Test purpose

1. To verify that the MS carrier frequency error does not exceed 0,1 ppm:
 - 1.1 Under normal conditions.
 - 1.2 When the MS is being vibrated.
 - 1.3 Under extreme conditions.

NOTE: The transmit frequency accuracy of the SS is expected to be sufficient to ensure that the difference between 0,1 ppm absolute and 0,1 ppm compared to signals received from the BS would be small enough to be considered insignificant.

- 2 To verify that the RMS phase error on the useful part of the bursts transmitted by the MS does not exceed conformance requirement 2:
 - 2.1 Under normal conditions.
 - 2.2 When the MS is being vibrated.
 - 2.3 Under extreme conditions.
- 3 To verify that the maximum phase error on the useful part of the bursts transmitted by the MS does not exceed conformance requirement 3.
 - 3.1 Under normal conditions.
 - 3.2 When the MS is being vibrated.
 - 3.3 Under extreme conditions.

13.1.4. Method of test

NOTE: In order to measure the accuracy of the frequency and phase error a sampled measurement of the transmitted phase trajectory is obtained. This is compared with the theoretically expected phase trajectory. The regression line of the difference between the expected trajectory and the measured trajectory is an indication of the frequency error (assumed constant through the burst), whilst the departure of the phase differences from this trajectory is a measure of the phase error. The peak phase error is the value furthest from the regression line and the RMS phase error is the root mean square average of the phase error of all samples.

13.1.4.1 Initial conditions

A call is set up according to the Generic call setup procedure.

The SS commands the MS to hopping mode (table 6.1).

NOTE: It is not necessary to test in hopping mode but is done here as a simple means of making the MS change channel, it would be sufficient to test in non hopping mode and to make sure bursts are taken from a few different channels.

The SS activates ciphering mode.

NOTE: Ciphering mode is active during this test to give a pseudo-random bit stream to the modulator.

The SS commands the MS to complete the traffic channel loop back without signalling of erased frames (see 36.2.1.1).

The SS generates Standard Test Signal C1 of annex 5.

13.1.4.2 Procedure

- a) For one transmitted burst, the SS captures the signal as a series of phase samples over the period of the burst. These samples are evenly distributed over the duration of the burst with a minimum sampling rate of $2/T$, where T is the modulation symbol period. The received phase trajectory is then represented by this array of at least 294 samples.
- b) The SS then calculates, from the known bit pattern and the formal definition of the modulator contained in GSM 05.04, the expected phase trajectory.
- c) From a) and b) the phase trajectory error is calculated, and a linear regression line computed through this phase trajectory error. The slope of this regression line is the frequency error of the mobile transmitter relative to the simulator reference. The difference between the regression line and the individual sample points is the phase error of that point.

- c.1) The sampled array of at least 294 phase measurements is represented by the vector:

$$\varnothing_m = \varnothing_m(0) \dots \varnothing_m(n)$$

where the number of samples in the array $n+1 \geq 294$.

- c.2) The calculated array, at the corresponding sampling instants, is represented by the vector:

$$\varnothing_c = \varnothing_c(0) \dots \varnothing_c(n).$$

- c.3) The error array is represented by the vector:

$$\varnothing_e = \{\varnothing_m(0) - \varnothing_c(0)\} \dots \dots \dots \{\varnothing_m(n) - \varnothing_c(n)\} = \varnothing_e(0) \dots \varnothing_e(n).$$

- c.4) The corresponding sample numbers form a vector $t = t(0) \dots t(n)$.

- c.5) By regression theory the slope of the samples with respect to t is k where:

$$k = \frac{\sum_{j=0}^{j=n} t(j) * \varnothing_e(j)}{\sum_{j=0}^{j=n} t(j)^2}$$

- c.6) The frequency error is given by $k/(360 * \gamma)$, where γ is the sampling interval in s and all phase samples are measured in degrees.

- c.7) The individual phase errors from the regression line are given by:

$$\varnothing_e(j) - k * t(j).$$

- c.8) The RMS value \varnothing_e of the phase errors is given by:

$$\varnothing_e(\text{RMS}) = \left[\frac{\sum_{j=0}^{j=n} \{\varnothing_e(j) - k * t(j)\}^2}{n+1} \right]^{1/2}$$

- d) Steps a) to c) are repeated for 20 bursts, not necessarily contiguous.
- e) The SS instructs the MS to its maximum power control level, all other conditions remaining constant. Steps a) to d) are repeated.
- f) The SS instructs the MS to the minimum power control level, all other conditions remaining constant. Steps a) to d) are repeated.
- g) The MS is hard mounted on a vibration table and vibrated at the frequency/amplitudes specified in annex 1, TC4.

During the vibration steps a) to f) are repeated.

NOTE: If the call is terminated when mounting the MS to the vibration table, it will be necessary to establish the initial conditions again before repeating steps a) to f).

- h) The MS is re-positioned on the vibration table in the two orthogonal planes to the plane used in step g). For each of the orthogonal planes step g) is repeated.

- i) Steps a) to f) are repeated under extreme test conditions (see annex 1, TC2.2).

NOTE: The series of samples taken to determine the phase trajectory could also be used, with different post-processing, to determine the transmitter burst characteristics of 13.3. Although described independently, it is valid to combine the tests of 13.1 and 13.3, giving both answers from single sets of captured data.

13.1.5 Test requirements

13.1.5.1 Frequency error

For all measured bursts, the frequency error, derived in step c.6), shall be less than $10E-7$.

13.1.5.2 Phase error

For all measured bursts, the RMS phase error, derived in step c.8), shall not exceed 5 degrees.

For all measured bursts, each individual phase error, derived in step c.7), shall not exceed 20 degrees.

13.2 Frequency error under multipath and interference conditions

13.2.1 Definition and applicability

The frequency error under multipath and interference conditions is a measure of the ability of the MS to maintain frequency synchronization with the received signal under conditions of Doppler shift, multipath reception and interference.

The requirements and this test apply to all types of GSM 900 and DCS 1 800 MS.

13.2.2 Conformance requirement

1. The MS carrier frequency error for each burst shall be accurate to within 0,1 ppm, or 0,1 ppm compared to signals received from the BS for signal levels down to 3 dB below the reference sensitivity level.
 - 1.1 Under normal conditions; GSM 05.10, 6/6.1.
 - 1.2 Under extreme conditions; GSM 05.10, 6/6.1; GSM 05.05 annex D D.2.1, D.2.2.
2. The MS carrier frequency error for each burst shall be accurate to within 0,1 ppm, or 0,1 ppm compared to signals received from the BS for 3 dB less carrier to interference ratio than the reference interference ratios (GSM 05.10, 6/6.1).

13.2.3 Test purpose

1. To verify that the MS carrier frequency error at reference sensitivity, under conditions of multipath and Doppler shift does not exceed 0,1 ppm + the frequency error due to the Doppler shift of the received signal and the assessment error in the MS.
 - 1.1 Under normal conditions.
 - 1.2 Under extreme conditions.

NOTE: Although the conformance requirement states that frequency synchronization should be maintained for input signals 3 dB below reference sensitivity. Due to the Radio Link Failure counter this test condition cannot be established. Hence all tests in this section are conducted at reference sensitivity level.

2. To verify that the MS carrier frequency error, under interference conditions and TUlow fading profile, does not exceed 0,1 ppm + the frequency error due to the Doppler shift of the received signal and the assessment error in the MS.

NOTE: The test adds the effect of Doppler shift to the requirements as the conformance requirement refers to signals input to the MS receiver whereas the frequency reference for measurement will not take account of the Doppler shift.

13.2.4 Method of test

This test uses the same measurement process as test 13.1 for the MS operating under various RF conditions.

NOTE: The BA list sent on the BCCH and the SACCH will indicate at least six surrounding cells with at least one near to each band edge. It is not necessary to generate any of these BCCH but if they are provided none will be within 5 channels of the ARFCN used for the serving BCCH or TCH.

13.2.4.1 Initial conditions

The MS is brought into the idle updated state on a serving cell with BCCH in the mid ARFCN range.

13.2.4.2 Procedure

- a) The level of the serving cell BCCH is set to 10 dB above the reference sensitivity level() and the fading function set to RA. The SS waits 30 s for the MS to stabilize to these conditions. The SS is set up to capture the first burst transmitted by the MS during call establishment. A call is initiated by the SS on a channel in the mid ARFCN range as described for the generic call set up procedure but to a TCH at level 10 dB above the reference sensitivity level() and fading function set to RA.
- b) The SS calculates the frequency accuracy of the captured burst as described in test 13.1.
- c) The SS sets the serving cell BCCH and TCH to the reference sensitivity level() applicable to the type of MS, still with the fading function set to RA and then waits 30 s for the MS to stabilize to these conditions.
- d) The SS shall capture subsequent bursts from the traffic channel in the manner described in test 13.1.

NOTE: Due to the very low signal level at the MS receiver input the MS receiver is liable to error. The "looped back" bits are therefore also liable to error, and hence the SS does not know the expected bit sequence. The SS will have to demodulate the received signal to derive (error free) the transmitter burst bit pattern. Using this bit pattern the SS can calculate the expected phase trajectory according to the definition within GSM 05.04.

- e) The SS calculates the frequency accuracy of the captured burst as described in test 13.1.
- f) Steps d) and e) are repeated for 5 traffic channel bursts spaced over a period of not less than 20 s.
- g) The initial conditions are established again and steps a) to f) are repeated but with the fading function set to HT100.
- h) The initial conditions are established again and steps a) to f) are repeated but with the fading function set to TU50.
- i) The initial conditions are established again and steps a) and b) are repeated but with the following differences:
 - the levels of the BCCH and TCH are set to 18 dB above reference sensitivity level().
 - two further independent interfering signals are sent on the same nominal carrier frequency as the BCCH and TCH and at a level 10 dB below the level of the TCH and modulated with random data, including the midamble.
 - the fading function for all channels is set to TULow.
- j) The SS waits 100 s for the MS to stabilize to these conditions.

- k) Repeat steps d) to f), except that at step f) the measurement period must be extended to 200 s and the number of measurements increased to 20.
- l) The initial conditions are established again and steps a) to k) are repeated for ARFCN in the Low ARFCN range.
- m) The initial conditions are established again and steps a) to k) are repeated for ARFCN in the High ARFCN range.
- n) Repeat step h) under extreme test conditions (see annex 1, TC2.2).

13.2.5 Test requirements

The frequency error, with reference to the SS carrier frequency as measured in repeats of step e), for each measured burst shall be less than the values shown in table 13-1.

Table 13-1: Requirements for frequency error under multipath, Doppler shift and interference conditions

GSM 900		DCS 1 800	
Propagation condition	Permitted frequency error	Propagation condition	Permitted frequency error
RA250	+/- 300 Hz	RA130	+/- 400 Hz
HT100	+/- 180 Hz	HT100	+/- 350 Hz
TU50	+/- 160 Hz	TU50	+/- 260 Hz
TU3	+/- 230 Hz	TU1,5	+/- 320 Hz

13.3 Transmitter output power and burst timing

13.3.1 Definition and applicability

The transmitter output power is the average value of the power delivered to an artificial antenna or radiated by the MS and its integral antenna, over the time that the useful information bits of one burst are transmitted.

The transmit burst timing is the envelope of the RF power transmitted with respect to time. The timings are referenced to the transition from bit 13 to bit 14 of the Training Sequence ("midamble") before differential decoding. The timing of the modulation is referenced to the timing of the received signal from the SS.

The requirements and this test apply to all types of GSM 900 and DCS 1 800 MS.

13.3.2 Conformance requirement

1. The MS maximum output power shall be as defined in GSM 05.05, 4.1.1, first table, according to its power class, with a tolerance of +/- 2 dB under normal conditions; GSM 05.05, 4.1.1, first table.
2. The MS maximum output power shall be as defined in GSM 05.05, 4.1.1, first table, according to its power class, with a tolerance of +/- 2,5 dB under extreme conditions; GSM 05.05, 4.1.1, first table; GSM 05.05 annex D D.2.1, D.2.2.
3. The power control levels shall have the nominal output power levels as defined in GSM 05.05, 4.1.1, second table (for GSM 900) or third table (for DCS 1 800), from the lowest power control level up to the maximum output power corresponding to the class of the MS (for tolerance on maximum output power see conformance requirements 1), with a tolerance of +/- 3, 4 or 5 dB under normal conditions; GSM 05.05, 4.1.1, second or third table.
4. The power control levels shall have the nominal output power levels as defined in GSM 05.05, 4.1.1, second table (for GSM 900) or third table (for DCS 1 800), from the lowest power control level up to the maximum output power corresponding to the class of the MS (for tolerance on maximum

output power see conformance requirements 2), with a tolerance of +/- 4, 5 or 6 dB under extreme conditions; GSM 05.05, 4.1.1, second or third table; GSM 05.05 annex D D.2.1, D.2.2.

5. The output power actually transmitted by the MS at consecutive power control levels shall form a monotonic sequence and the interval between power control levels shall be 2 +/- 1,5 dB; GSM 05.05, 4.1.1.
6. The transmitted power level relative to time for a normal burst shall be within the power/time template given in GSM 05.05, annex B top figure:
 - 6.1 Under normal conditions; GSM 05.05, 4.5.2..
 - 6.2 Under extreme conditions; GSM 05.05, 4.5.2, GSM 05.05 annex D D.2.1, D.2.2.
7. When accessing a cell on the RACH and before receiving the first power command during a communication on a DCCH or TCH (after an IMMEDIATE ASSIGNMENT), all GSM and class 2 DCS 1 800 MS shall use the power control level defined by the MS_TXPWR_MAX_CCH parameter broadcast on the BCCH of the cell, or if MS_TXPWR_MAX_CCH corresponds to a power control level not supported by the MS as defined by its power class, the MS shall act as though the closest supported power control level had been broadcast. A Class 3 DCS 1 800 MS shall use the POWER_OFFSET parameter.
8. The transmissions from the MS to the BS, measured at the MS antenna, shall be 468,75 - TA bit periods behind the transmissions received from the BS, where TA is the last timing advance received from the current serving BS. The tolerance on these timings shall be +/- 1 bit period:
 - 8.1 Under normal conditions; GSM 05.10, 6.4.
 - 8.2 Under extreme conditions; GSM 05.10, 6.4, GSM 05.05 annex D D.2.1, D.2.2.
9. The transmitted power level relative to time for a random access burst shall be within the power/time template given in GSM 05.05, annex B bottom figure:
 - 9.1 Under normal conditions; GSM 05.05, 4.5.2.
 - 9.2 Under extreme conditions; GSM 05.05, 4.5.2, GSM 05.05 annex D D.2.1, D.2.2.
- 10 The MS shall use a TA value of 0 for the Random Access burst sent:
 - 10.1 Under normal conditions; GSM 05.10, 6.6.
 - 10.2 Under extreme conditions; GSM 05.10, 6.6, GSM 05.05 annex D D.2.1, D.2.2.

13.3.3 Test purpose

1. To verify that the maximum output power of the MS, under normal conditions, is within conformance requirement 1.
2. To verify that the maximum output power of the MS, under extreme conditions, is within conformance requirement 2.
3. To verify that all power control levels, relevant to the class of MS, are implemented in the MS and have output power levels, under normal conditions, within conformance requirement 3.
4. To verify that all power control levels have output power levels, under extreme conditions, within conformance requirement 4.
5. To verify that the step in the output power transmitted by the MS at consecutive power control levels is within conformance requirement 5 under normal conditions.
6. To verify that the output power relative to time, when sending a normal burst is within conformance requirement 6:
 - 6.1 Under normal conditions.

- 6.2 Under extreme conditions.
- 7. To verify that the MS uses the maximum power control level according to its power class if commanded to a power control level exceeding its power class.
- 8. To verify that, for normal bursts, the MS transmissions to the BS are timed within conformance requirement 8:
 - 8.1 Under normal conditions.
 - 8.2 Under extreme conditions.
- 9. To verify that the output power relative to time, when sending an access burst is within conformance requirement 9:
 - 9.1 Under normal conditions.
 - 9.2 Under extreme conditions.
- 10. To verify that, for an access burst, the MS transmission to the BS is timed within conformance requirement 10:
 - 10.1 Under normal conditions.
 - 10.2 Under extreme conditions.

13.3.4 Methods of test

Two methods of test are described, separately for:

- 1) equipment fitted with a permanent antenna connector and for
- 2) equipment fitted with an integral antenna, and which cannot be connected to an external antenna except by the fitting of a temporary test connector as a test fixture.

NOTE: The behaviour of the MS in the system is determined to a high degree by the antenna, and this is the only transmitter test in this ETS using the integral antenna. Further studies are ongoing on improved testing on the integral antenna, taking practical conditions of MS use into account.

13.3.4.1 Method of test for equipment with a permanent antenna connector

13.3.4.1.1 Initial conditions

A call is set up by the SS according to the generic call set up procedure on a channel with ARFCN in the Mid ARFCN range, power control level set to Max power. MS TXPWR_MAX_CCH is set to the maximum value supported by the Power Class of the Mobile under test. For DCS 1 800 mobile stations the POWER_OFFSET parameter is set to 6 dB.

13.3.4.1.2 Procedure

- a) Measurement of normal burst transmitter output power

The SS takes power measurement samples evenly distributed over the duration of one burst with a sampling rate of at least $2/T$, where T is the bit duration. The samples are identified in time with respect to the modulation on the burst. The SS identifies the centre of the useful 147 transmitted bits, i.e. the transition from bit 13 to bit 14 of the midamble, as the timing reference.

The transmitter output power is calculated as the average of the samples over the 147 useful bits. This is also used as the 0 dB reference for the power/time template.

- b) Measurement of normal burst timing delay

The burst timing delay is the difference in time between the timing reference identified in a) and the corresponding transition in the burst received by the MS immediately prior to the MS transmit burst sampled.

- c) Measurement of normal burst power/time relationship

The array of power samples measured in a) are referenced in time to the centre of the useful transmitted bits and in power to the 0 dB reference, both identified in a).

- d) Steps a) to c) are repeated with the MS commanded to operate on each of the power control levels defined, even those not supported by the MS.

- e) The SS commands the MS to the maximum power control level supported by the MS and steps a) to c) are repeated for ARFCN in the Low and High ranges.

- f) Measurement of access burst transmitter output power

The SS causes the MS to generate an Access Burst on an ARFCN in the Mid ARFCN range, this could be either by a handover procedure or a new request for radio resource. In the case of a handover procedure the Power Level indicated in the HANDOVER COMMAND message is the maximum power control level supported by the MS. In the case of an Access Burst the MS shall use the Power Level indicated in the MS_TXPWR_MAX_CCH parameter. If the power class of the MS is DCS 1 800 Class 3, the MS shall also use the POWER_OFFSET parameter.

The SS takes power measurement samples evenly distributed over the duration of the access burst as described in a). However, in this case the SS identifies the centre of the useful bits of the burst by identifying the transition from the last bit of the synch sequence. The centre of the burst is then five data bits prior to this point and is used as the timing reference.

The transmitter output power is calculated as the average of the samples over the 87 useful bits of the burst. This is also used as the 0 dB reference for the power/time template.

- g) Measurement of access burst timing delay

The burst timing delay is the difference in time between the timing reference identified in f) and the MS received data on the common control channel.

- h) Measurement of access burst power/time relationship

The array of power samples measured in f) are referenced in time to the centre of the useful transmitted bits and in power to the 0 dB reference, both identified in f).

- i) Depending on the method used in step f) to cause the MS to send an Access Burst, the SS sends either a HANDOVER COMMAND with power control level set to 10 or it changes the System Information elements MS_TXPWR_MAX_CCH and for DCS 1 800 the POWER_OFFSET on the serving cell BCCH in order to limit the MS transmit power on the Access Burst to power control level 10 (+23 dBm for GSM 900 or +10 dBm for DCS 1 800) and then steps f) to h) are repeated.

- j) Steps a) to i) are repeated under extreme test conditions (annex 1, TC2.2) except that the repeats at step d) are only performed for power control level 10 and the minimum power control level of the MS.

13.3.4.2 Method of test for equipment with an integral antenna

NOTE: If the MS is equipped with a permanent connector, such that the antenna can be disconnected and the SS be connected directly, then the method of section 13.3.4.1 will be applied.

The tests in this section are performed on an unmodified test sample.

13.3.4.2.1 Initial conditions

The MS is placed in the anechoic shielded chamber (annex 1, GC5) or on the outdoor test site, on an isolated support, in the position for normal use, at a distance of at least 3 metres from a test antenna, connected to the SS.

NOTE: The test method described has been written for measurement in an anechoic shielded chamber. If an outdoor test site is used then, in addition, it is necessary to raise/lower the test antenna through the specified height range to maximize the received power levels from both the test sample and the substitution antenna.

A call is set up by the SS according to the generic call set up procedure on a channel with ARFCN in the Mid ARFCN range, power control level set to Max power. MS_TXPWR_MAX_CCH is set to the maximum value supported by the Power Class of the Mobile under test. For DCS 1 800 mobile stations the POWER_OFFSET parameter is set to 6 dB.

13.3.4.2.2 Procedure

- a) With the initial conditions set according to subclause 13.3.4.2.1 the test procedure in 13.3.4.1.2 is followed up to and including step i), except that in step a), when measurements are done at maximum power for ARFCN in the Low, Mid and High range, the measurement is made eight times with the MS rotated by $n \cdot 45$ degrees for all values of n in the range 0 to 7.

The measurements taken are received transmitter output power measurements rather than transmitter output power measurements, the output power measurement values can be derived as follows.

- b) Assessment of test site loss for scaling of received output power measurements.

The MS is replaced by a half-wave dipole, resonating at the centre frequency of the transmit band, connected to an RF generator.

The frequency of the RF signal generator is set to the frequency of the ARFCN used for the 24 measurements in step a), the output power is adjusted to reproduce the received transmitter output power averages recorded in step a).

For each indication the power, delivered by the generator (in Watts) to the half-wave dipole, is recorded. These values are recorded in the form P_{nc} , where n = MS rotation and c = channel number.

For each channel number used compute:

$$P_{ac}(\text{Watts into dipole}) = \frac{1}{8} * \sum_{n=0}^{n=7} P_{nc}$$

$$\text{from which: } P_{ac}(\text{Tx dBm}) = 10 \log_{10}(P_{ac}) + 30 + 2,15$$

The difference, for each of the three channels, between the actual transmitter output power averaged over the 8 measurement orientations and the received transmitter output power at orientation $n = 0$ is used to scale the received measurement results to actual transmitter output powers for all measured power control levels and ARFCN, which can then be checked against the requirements.

- c) Temporary antenna connector calibration factors (transmit)

A modified test sample equipped with a temporary antenna connector is placed in a climatic test chamber and is linked to the SS by means of the temporary antenna connector.

Under normal test conditions, the power measurement and calculation parts of steps a) to i) of 13.3.4.1.2 are repeated except that the repeats at step d) are only performed for power control level 10 and the minimum power control level of the MS.

NOTE: The values noted here are related to the output transmitter carrier power levels under normal test conditions, which are known after step b). Therefore frequency dependent calibration factors that account for the effects of the temporary antenna connector can be determined.

d) Measurements at extreme test conditions.

NOTE: Basically the procedure for extreme conditions is:

- the power/time template is tested in the "normal" way,
- the radiated power is measured by measuring the difference with respect to the radiated power under normal test conditions.

Under extreme test conditions steps a) to i) of 13.3.4.1.2 are repeated except that the repeats at step d) are only performed for power control level 10 and the minimum power control level of the MS.

The transmitter output power under extreme test conditions is calculated for each burst type, power control level and for every frequency used by adding the frequency dependent calibration factor, determined in c), to the values obtained at extreme conditions in this step.

13.3.5 Test requirements

a) The transmitter output power, under every combination of normal and extreme test conditions, for normal bursts and access bursts, at each frequency and for each power control level applicable to the MS power class, shall be at the relevant level shown in table 13-2 or table 13-3 within the tolerances also shown in table 13-2 or table 13-3.

GSM 900 only - begin

Table 13-2: GSM 900 transmitter output power for different power classes

Power class					Power control level	Transmitter output power dBm	Tolerances	
2	3	4	5	normal			extreme	
•				2	39	+/-2 dB	+/-2,5 dB	
•	•			3	37	+/-3 dB*)	+/-4 dB*)	
•	•			4	35	+/-3 dB	+/-4 dB	
•	•	•		5	33	+/-3 dB*)	+/-4 dB*)	
•	•	•		6	31	+/-3 dB	+/-4 dB	
•	•	•	•	7	29	+/-3 dB*)	+/-4 dB*)	
•	•	•	•	8	27	+/-3 dB	+/-4 dB	
•	•	•	•	9	25	+/-3 dB	+/-4 dB	
•	•	•	•	10	23	+/-3 dB	+/-4 dB	
•	•	•	•	11	21	+/-3 dB	+/-4 dB	
•	•	•	•	12	19	+/-3 dB	+/-4 dB	
•	•	•	•	13	17	+/-3 dB	+/-4 dB	
•	•	•	•	14	15	+/-3 dB	+/-4 dB	
•	•	•	•	15	13	+/-3 dB	+/-4 dB	
•	•	•	•	16	11	+/-5 dB	+/-6 dB	
•	•	•	•	17	9	+/-5 dB	+/-6 dB	
•	•	•	•	18	7	+/-5 dB	+/-6 dB	
•	•	•	•	19	5	+/-5 dB	+/-6 dB	

*) When the power control level corresponds to the power class of the MS, then the tolerances shall be 2,0 dB under normal test conditions and 2,5 dB under extreme test conditions.

GSM 900 only - end

DCS 1 800 only - begin

Table 13-3: DCS 1 800 transmitter output power for different power classes

Power class			Power control level	Transmitter output power	Tolerances	
1	2	3		dBm	normal	extreme
		•	29	36	+/-2,0 dB	+/-2,5 dB
		•	30	34	+/-3,0 dB	+/-4,0 dB
		•	31	32	+/-3,0 dB	+/-4,0 dB
•	•	•	0	30	+/-3,0 dB*)	+/-4 dB*)
•	•	•	1	28	+/-3 dB	+/-4 dB
•	•	•	2	26	+/-3 dB	+/-4 dB
•	•	•	3	24	+/-3 dB*)	+/-4 dB*)
•	•	•	4	22	+/-3 dB	+/-4 dB
•	•	•	5	20	+/-3 dB	+/-4 dB
•	•	•	6	18	+/-3 dB	+/-4 dB
•	•	•	7	16	+/-3 dB	+/-4 dB
•	•	•	8	14	+/-3 dB	+/-4 dB
•	•	•	9	12	+/-4 dB	+/-5 dB
•	•	•	10	10	+/-4 dB	+/-5 dB
•	•	•	11	8	+/-4 dB	+/-5 dB
•	•	•	12	6	+/-4 dB	+/-5 dB
•	•	•	13	4	+/-4 dB	+/-5 dB
•	•	•	14	2	+/-5 dB	+/-6 dB
•	•	•	15	0	+/-5 dB	+/-6 dB

*) When the power control level corresponds to the power class of the MS, then the tolerances shall be 2,0 dB under normal test conditions and 2,5 dB under extreme test conditions.

DCS 1 800 only - end

- b) The difference between the transmitter output power at two adjacent power control levels, measured at the same frequency, shall not be less than 0,5 dB and not be more than 3,5 dB.
- c) The power/time relationship of the measured samples for normal bursts shall be within the limits of the power time template of figure 13-1 at each frequency, under every combination of normal and extreme test conditions and at each power control level measured.

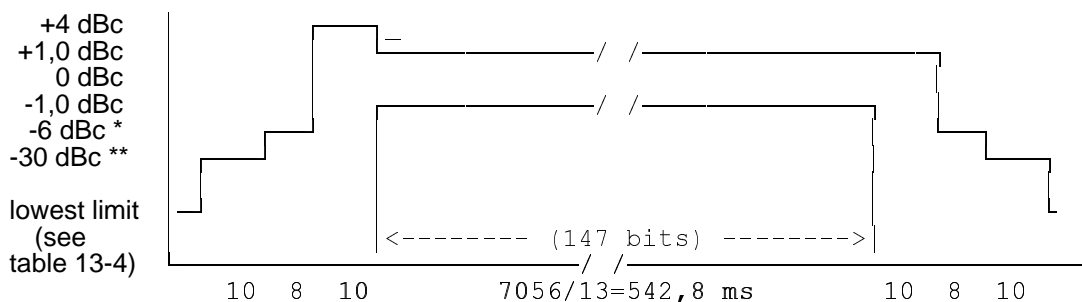

Figure 13-1: Power / time template for normal bursts

- * For GSM900 MS: -4 dBc for power control level 16
 -2 dBc for power control level 17
 -1 dBc for power control levels 18 and 19
- For DCS1800 MS: -4 dBc for power control level 11
 -2 dBc for power control level 12
 -1 dBc for power control levels 13, 14 and 15
- ** For GSM900 MS: -30 dBc or -17 dBm, whichever is the higher
- For DCS1800 MS: -30 dBc or -20 dBm, whichever is the higher

Table 13-4: Lowest measurement limit for power / time template

	lowest limit
GSM900	-59 dBc or -54 dBm whichever is the highest, except for the timeslot preceding the active slot, for which the allowed level is equal to -59 dBc or -36 dBm, whichever is the highest
DCS1800	-48 dBc or -48 dBm whichever is the highest

- d) All the power control levels, for the type and power class of the MS as stated by the manufacturer, shall be implemented in the MS.
- e) When the transmitter is commanded to a power control level outside of the capability corresponding to the type and power class of the MS as stated by the manufacturer, then the transmitter output power shall be within the tolerances for the closest power control level corresponding to the type and power class as stated by the manufacturer.
- f) The centre of the transmitted normal burst as defined by the transition of bits 13/14 of the midamble shall be 3 timeslot periods (1731 μ s) \pm 1 bit period (\pm 3,69 μ s) after the centre of the corresponding received burst.
- g) The power/time relationship of the measured samples for access bursts shall be within the limits of the power time template of figure 13-2 at each frequency, under every combination of normal and extreme test conditions and at each power control level measured.

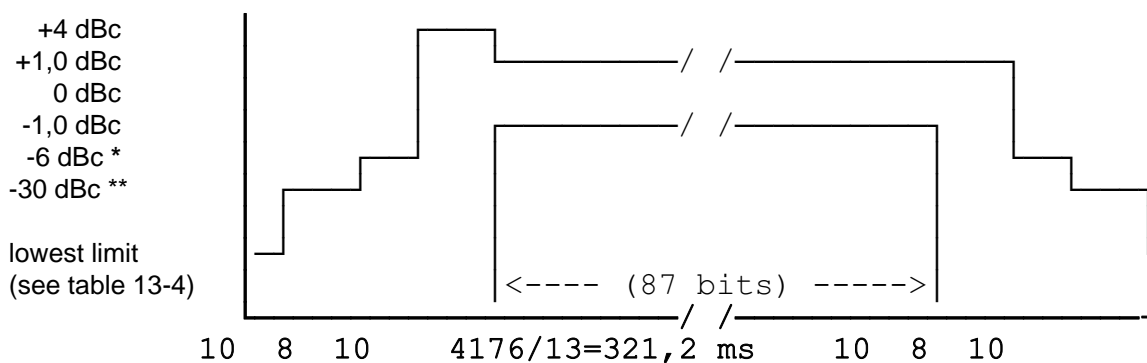

Figure 13-2: Power / time template for access burst

- * For GSM900 MS: -4 dBc for power control level 16
 -2 dBc for power control level 17
 -1 dBc for power control levels 18 and 19
- For DCS1800 MS: -4 dBc for power control level 11
 -2 dBc for power control level 12
 -1 dBc for power control levels 13, 14 and 15
- ** For GSM900 MS: -30 dBc or -17 dBm, whichever is the higher
 For DCS1800 MS: -30 dBc or -20 dBm, whichever is the higher

- h) The centre of the transmitted access burst shall be an integer number of timeslot periods less 30 bit periods relative to any CCCH midamble centre with a tolerance of \pm 1 bit period (\pm 3,69 μ s).

13.4 Output RF spectrum

13.4.1 Definition and applicability

The output RF spectrum is the relationship between the frequency offset from the carrier and the power, measured in a specified bandwidth and time, produced by the MS due to the effects of modulation and power ramping.

The requirements and this test apply to all types of GSM 900 and DCS 1 800 MS.

13.4.2 Conformance requirement

1. The level of the output RF spectrum due to modulation shall be no more than that given in GSM 05.05, 4.2.1, table a) for GSM 900 or table b) for DCS 1 800, with the following lowest measurement limits:

- -36 dBm below 600 kHz offset from the carrier,
- -51 dBm for GSM 900 or -56 dBm for DCS 1 800 from 600 kHz out to less than 1 800 kHz offset from the carrier,
- -46 dBm for GSM 900 or -51 dBm for DCS 1 800 at and beyond 1 800 kHz offset from the carrier,

but with the following exceptions at up to -36 dBm:

- up to three bands of 200 kHz width centred on a frequency which is an integer multiple of 200 kHz in the combined range 600 kHz to 6000 kHz above and below the carrier,
- up to 12 bands of 200 kHz width centred on a frequency which is an integer multiple of 200 kHz at more than 6 000 kHz offset from the carrier.

1.1 Under normal conditions; GSM 05.05, 4.2.1.

1.2 Under extreme conditions; GSM 05.05, 4.2.1; GSM 05.05, annex D D.2.1, D.2.2.

2. The level of the output RF spectrum due to switching transients shall be no more than given in GSM 05.05, 4.2.2, table "a) Mobile Station:".

2.1 Under normal conditions; GSM 05.05, 4.2.2.

2.2 Under extreme conditions; GSM 05.05, 4.2.2; GSM 05.05 annex D D.2.1, D.2.2.

3. When allocated a channel, the power emitted by the MS, in the band 935 to 960 MHz shall be no more than -79 dBm, in the band 925 to 935 MHz shall be no more than -67 dBm and in the band 1 805 to 1 880 MHz shall be no more than -71 dBm except in five measurements in each of the bands 925 to 960 MHz and 1 805 to 1 880 MHz where exceptions at up to -36 dBm are permitted. Under normal conditions; GSM 05.05, 4.3.3.

13.4.3 Test purpose

1. To verify that the output RF spectrum due to modulation does not exceed conformance requirement 1.

1.1 Under normal conditions.

1.2 Under extreme conditions.

2. To verify that the output RF spectrum due to switching transients does not exceed conformance requirement 2 when a reasonable margin is allowed for the effect of spectrum due to modulation.

2.1 Under normal conditions.

2.2 Under extreme conditions.

3. To verify that the MS spurious emissions in the MS receive band do not exceed conformance requirement 3.

13.4.4 Method of test

13.4.4.1 Initial conditions

A call is set up according to the generic call set up procedure.

The SS commands the MS to hopping mode. The hopping pattern includes only three channels, namely one with an ARFCN in the Low ARFCN range, a second one with an ARFCN in the Mid ARFCN range and the third one with an ARFCN in the High ARFCN range.

NOTE 1: Although the measurement is made whilst the MS is in hopping mode, each measurement is on one single channel.

NOTE 2: This test is specified in hopping mode as a simple means of making the MS change channel, it would be sufficient to test in non hopping mode and to handover the MS between the three channels tested at the appropriate time.

The SS commands the MS to complete the traffic channel loop back without signalling of erased frames (see 36.2.1.1). This is to set a defined random pattern for the transmitter.

The SS sends Standard Test Signal C1 (annex 5) to the MS at a level of 23 dB μ Vemf().

13.4.4.2 Procedure

NOTE: When averaging is in use during frequency hopping mode, the averaging only includes bursts transmitted when the hopping carrier corresponds to the nominal carrier of the measurement.

- a) In steps b) to h) the FT is equal to the hop pattern ARFCN in the Mid ARFCN range.
- b) The other settings of the spectrum analyser are set as follows:
 - Zero frequency scan
 - Resolution bandwidth: 30 kHz
 - Video bandwidth: 30 kHz
 - Video averaging: may be used, depending on the implementation of the test

The video signal of the spectrum analyser is "gated" such that the spectrum generated by at least 40 of the bits 87 to 132 of the burst is the only spectrum measured. This gating may be analogue or numerical, dependent upon the design of the spectrum analyser. Only measurements during transmitted bursts on the nominal carrier of the measurement are included. The spectrum analyser averages over the gated period and over 200 or 50 such bursts, using numerical and/or video averaging.

The MS is commanded to its maximum power control level.

- c) By tuning the spectrum analyser centre frequency to the measurement frequencies the power level is measured over 50 bursts at all multiples of 30 kHz offset from FT to < 1 800 kHz.
- d) The resolution and video bandwidth on the spectrum analyser are adjusted to 100 kHz and the measurements are made at the following frequencies:
 - on every ARFCN from 1 800 kHz offset from the carrier to the edge of the relevant transmit band for each measurement over 50 bursts.
 - at 200 kHz intervals over the 2 MHz either side of the relevant transmit band for each measurement over 50 bursts.
 - at 200 kHz intervals over the band 925 - 960 MHz for each measurement over 50 bursts.
 - at 200 kHz intervals over the band 1805 - 1880 MHz for each measurement over 50 bursts.
- e) The MS is commanded to its minimum power control level. The spectrum analyser is set again as in b).
- f) By tuning the spectrum analyser centre frequency to the measurement frequencies the power level is measured over 200 bursts at the following frequencies:

FT	
FT + 100 kHz	FT - 100 kHz
FT + 200 kHz	FT - 200 kHz
FT + 250 kHz	FT - 250 kHz
FT + 200 kHz * N	FT - 200 kHz * N

where N = 2, 3, 4, 5, 6, 7, and 8
and FT = RF channel nominal centre frequency.

g) The spectrum analyser settings are adjusted to:

- Zero frequency scan
- Resolution bandwidth: 30 kHz
- Video bandwidth: 100 kHz
- Peak hold

The spectrum analyser gating of the signal is switched off.

The MS is commanded to its maximum power control level.

h) By tuning the spectrum analyser centre frequency to the measurement frequencies the power level is measured at the following frequencies:

FT + 400 kHz	FT - 400 kHz
FT + 600 kHz	FT - 600 kHz
FT + 1,2 MHz	FT - 1,2 MHz
FT + 1,8 MHz	FT - 1,8 MHz

where FT = RF channel nominal centre frequency.

The duration of each measurement (at each frequency) will be such as to cover at least 10 burst transmissions at FT.

- i) Step h) is repeated for power control levels 7 and 11.
- j) Steps b), f), g) and h) are repeated with FT equal to the hop pattern ARFCN in the Low ARFCN range except that in step g) the MS is commanded to power control level 11 rather than maximum power.
- k) Steps b), f), g) and h) are repeated with FT equal to the hop pattern ARFCN in the High ARFCN range except that in step g) the MS is commanded to power control level 11 rather than maximum power.
- l) Steps a) b) f) g) and h) are repeated under extreme test conditions (annex 1, TC2.2). except that at step g) the MS is commanded to power control level 11.

13.4.5 Test requirements

For absolute measurements, performed on a temporary antenna connector, in the frequency band 880 to 915 MHz or 1710 to 1785 MHz, the temporary antenna connector coupling factor, determined according to 13.3.4.2.2 and annex 1 GC7, for the nearest relevant frequency, will be used.

For absolute measurements, performed on a temporary antenna connector, in the frequency band 925 to 960 MHz, the temporary antenna connector coupling factor, will be as determined according to annex 1 GC7 for GSM 900 MS. For a DCS 1 800 MS 0 dB will be assumed.

For absolute measurements, performed on a temporary antenna connector, in the frequency band 1805 to 1880 MHz, the temporary antenna connector coupling factor, will be as determined according to annex 1 GC7 for DCS 1 800 MS. For GSM 900 MS 0 dB will be assumed.

The figures in the tables below, at the listed frequencies from the carrier (kHz), are the maximum level (dB) relative to a measurement in 30 kHz bandwidth on the carrier (reference GSM 05.05 section 4.2.1).

- a) For the modulation sidebands out to less than 1 800 kHz offset from the carrier frequency (FT) measured in step c), f), h), j), k) and l) the measured power level in dB relative to the power level measured at FT, for all types of MS, shall not exceed the limits derived from the values shown in table 13-5 for GSM 900 or table 13-6 for DCS 1 800 according to the actual transmit power and frequency offset from FT. However any failures in the combined range 600 kHz to less than 1 800 kHz above and below the carrier may be counted towards the exceptions allowed in test requirements c) below.

Table 13-5a: GSM 900 Spectrum due to modulation out to less than 1 800 kHz offset

	power levels in dB relative to the measurement at FT				
Power level	Frequency offset (kHz)				
(dBm)	0-100	200	250	400	600 to <1800
39	+0,5	-30	-33	-60	-66
37	+0,5	-30	-33	-60	-64
35	+0,5	-30	-33	-60	-62
<= 33	+0,5	-30	-33	-60	-60
The values above are subject to the minimum absolute levels (dBm) below.					
	-36	-36	-36	-36	-51

Table 13-6: DCS 1 800 Spectrum due to modulation out to less than 1 800 kHz offset

	power levels in dB relative to the measurement at FT				
Power level	Frequency offset (kHz)				
(dBm)	0-100	200	250	400	600 to <1800
<= 36	+0,5	-30	-33	-60	-60
The values above are subject to the minimum absolute levels (dBm) below.					
	-36	-36	-36	-36	-56

NOTE 1: For frequency offsets between 100 kHz and 600 kHz the requirement is derived by a linear interpolation between the points identified in the table with linear frequency and power in dB relative.

- b) For the modulation sidebands from 1 800 kHz offset from the carrier frequency (FT) and out to 2 MHz beyond the edge of the relevant transmit band, measured in step d), the measured power level in dB relative to the power level measured at FT, shall not exceed the values shown in table 13-7 according to the actual transmit power, frequency offset from FT and system on which the MS is designed to operate. However any failures in the combined range 1 800 kHz to 6 MHz above and below the carrier may be counted towards the exceptions allowed in test requirements c) below, and any other failures may be counted towards the exceptions allowed in test requirements d) below.

Table 13-7: Spectrum due to modulation from 1 800 kHz offset to the edge of the transmit band (wideband noise)

power levels in dB relative to the measurement at FT						
GSM900				DCS1800		
Power level (dBm)	Frequency offset kHz			Power level (dBm)	Frequency offset kHz	
	1800 to < 3000	3000 to < 6000	>= 6000		1800 to < 6000	>= 6000
39	-69	-71	-77	36	-71	-79
37	-67	-69	-75	34	-69	-77
35	-65	-67	-73	32	-67	-75
<= 33	-63	-65	-71	30	-65	-73
				28	-63	-71
				26	-61	-69
				<= 24	-59	-67
The values above are subject to the minimum absolute levels (dBm) below.						
	-46	-46	-46		-51	-51

- c) Any failures (from a) and b) above) in the combined range 600 kHz to 6 MHz above and below the carrier should be re-checked for allowed spurious emissions. For each of the three ARFCN used, spurious emissions are allowed in up to three 200 kHz bands centred on an integer multiple of 200 kHz so long as no spurious emission exceeds -36 dBm. Any spurious emissions measured in a 30 kHz bandwidth which spans two 200 kHz bands can be counted towards either 200 kHz band, whichever minimizes the number of 200 kHz bands containing spurious exceptions.
- d) Any failures (from b) above) beyond 6 MHz offset from the carrier should be re-checked for allowed spurious emissions. For each of the three ARFCN used, up to twelve spurious emissions are allowed so long as no spurious emission exceeds -36 dBm.
- e) The MS spurious emissions in the bands 925 - 935 MHz, 935 - 960 MHz and 1 805 - 1 880 MHz, measured in step d), for all types of MS, shall not exceed the values shown in table 13-8 except in up to five measurements in the band 925 to 960 MHz and five measurements in the band 1 805 to 1 880 MHz where a level up to -36 dBm is permitted.

Table 13-8: Spurious emissions in the MS receive bands

Band (MHz)	Spurious emissions level (dBm)
925 to 935	-67
935 to 960	-79
1805 to 1880	-71

- f) For the power ramp sidebands of steps h) and i) the power levels must not exceed the values shown in table 13-9 for GSM 900 or table 13-10 for DCS 1 800.

Table 13-9: GSM Spectrum due to switching transients

Power level	Maximum level for various offsets from carrier frequency			
	400 kHz	600 kHz	1200 kHz	1800 kHz
39 dBm	-13 dBm	-21 dBm	-21 dBm	-24 dBm
37 dBm	-15 dBm	-21 dBm	-21 dBm	-24 dBm
35 dBm	-17 dBm	-21 dBm	-21 dBm	-24 dBm
33 dBm	-19 dBm	-21 dBm	-21 dBm	-24 dBm
31 dBm	-21 dBm	-23 dBm	-23 dBm	-26 dBm
29 dBm	-23 dBm	-25 dBm	-25 dBm	-28 dBm
27 dBm	-23 dBm	-26 dBm	-27 dBm	-30 dBm
25 dBm	-23 dBm	-26 dBm	-29 dBm	-32 dBm
23 dBm	-23 dBm	-26 dBm	-31 dBm	-34 dBm
<= +21 dBm	-23 dBm	-26 dBm	-32 dBm	-36 dBm

Table 13-10: DCS 1 800 Spectrum due to switching transients

Power level	Maximum level for various offsets from carrier frequency			
	400 kHz	600 kHz	1200 kHz	1800 kHz
36 dBm	-16 dBm	-21 dBm	-21 dBm	-24 dBm
34 dBm	-18 dBm	-21 dBm	-21 dBm	-24 dBm
32 dBm	-20 dBm	-22 dBm	-22 dBm	-25 dBm
30 dBm	-22 dBm	-24 dBm	-24 dBm	-27 dBm
28 dBm	-23 dBm	-25 dBm	-26 dBm	-29 dBm
26 dBm	-23 dBm	-26 dBm	-28 dBm	-31 dBm
24 dBm	-23 dBm	-26 dBm	-30 dBm	-33 dBm
22 dBm	-23 dBm	-26 dBm	-31 dBm	-35 dBm
<= +20 dBm	-23 dBm	-26 dBm	-32 dBm	-36 dBm

NOTE 2: These figures are different from the requirements in GSM 05.05 because at higher power levels it is the modulation spectrum which is being measured using a peak hold measurement. This allowance is given in the table.

NOTE 3: The figures for table 13-9 and table 13-10 assume that, using the peak hold measurement, the lowest level measurable is 8 dB above the level of the modulation specification using the 30 kHz bandwidth gated average technique for 400 kHz offset from the carrier. At 600 and 1200 kHz offset the level is 6 dB above and at 1 800 kHz offset the level is 3 dB above. The figures for 1 800 kHz have assumed the 30 kHz bandwidth spectrum due to modulation specification at <1 800 kHz.

13.5 Intermodulation attenuation

13.5.1 Definition and applicability

The intermodulation attenuation is the ratio, in dB, of the power level of the wanted signal to the power level of the highest intermodulation component.

The requirements and this test apply to all types of DCS 1 800 MS.

13.5.2 Conformance requirement

The maximum level of any intermodulation product shall be no less than 50 dB below the level of the wanted signal when an interfering CW signal is applied, within the transmit band, at a frequency offset of 800 kHz and with a power level 40 dB below the power level of the wanted signal; GSM 05.05, 4.7.3.

13.5.3 Test purpose

To verify that the MS intermodulation attenuation is no less than conformance requirement 1.

13.5.4 Method of test

NOTE 1: When the measurements are performed precautions must be taken, so that non-linearities in the selective measuring device do not influence the results appreciably. Furthermore it should be ensured that intermodulation components which may be generated by non-linear elements in the test equipment (e.g. signal generator, circulators, selective measuring device) are sufficiently reduced. The RF transmit equipment under test and the test signal source should be physically separated in such a way that the measurement is not influenced by direct radiation.

NOTE 2: In the case of an MS which does not normally include an antenna connector, the coupling loss of the temporary antenna connector must be taken into account.

13.5.4.1 Initial conditions

The antenna output of the MS is connected to the SS via a coupling device, presenting to the MS a load with an impedance of 50 ohms. The coupling device may consist of a circulator with one port connected

by a coaxial cable to the output terminal of the MS, the second port correctly terminated with 50 ohms into a selective measuring device (e.g. a spectrum analyser) and the third port connected to the interfering test signal source via an isolator.

A call is set up by the SS according to the generic call set up procedure on a channel with ARFCN in the Mid ARFCN range, power control level set to Max power.

13.5.4.2 Procedure

- a) The interfering test signal will be unmodulated and the frequency will be 800 kHz above the transmit frequency of the MS under test. the power level is adjusted to give the equivalent of 40 dB below the transmit power level of the MS, if both the MS transmit power and the interfering test signal were measured with a correct termination but with the other signal absent.
- b) The frequency selective measuring device is set to measure peak hold in a bandwidth of 300 kHz. Any intermodulation components in the MS transmit band, are then measured.
- c) Steps a) and b) are repeated with the test signal at a frequency 800 kHz below the transmitted frequency.

13.5.5 Test requirements

The level of each intermodulation component, in the MS transmit band, shall be no less than 50 dB below the level of the transmit power of the wanted MS carrier.

14 Receiver

In this section on receiver measurements, the procedures to test equipment which is fitted with a permanent antenna connector, and the procedures to test equipment which is designed to only be used with an integral antenna, are in general combined into one single test description.

Tests on Mobile Stations fitted with an integral antenna and having no means of connecting an external antenna are specified in terms of received field strength. In order to perform tests on such Mobile Stations without the need for separated access to a calibrated test site a temporary antenna connector is used as defined in annex 1 section 1.1.3 (General Conditions).

In practice the temporary antenna connector may be used for transmitter measurements described in section 3, but the calibration factors determined in [Annex 1] will not be directly usable. The detailed calibration, when needed, for transmission tests are described in the relevant sections of 3.

Wherever in this section, for FACCH tests, the SS is required to send a Layer 3 message not requiring a Layer 3 response from the MS the message can be a TEST INTERFACE message or a STATUS message, possibly with an unknown Protocol Discriminator.

Testing philosophy

Certain assumptions concerning the functional mechanisms of GSM receivers have been made in order to define tests that will verify the receiver performance without excessive redundancy and excessive test times.

The receiver functions can be divided into:

- Analogue RF and IF stages that are affected by input levels, temperature and power supply levels.
- Demodulator that is affected by input levels and interfering signals.
- Decoders that are affected by the different logical channels and input levels.

The tests are designed to stress each of these blocks with a minimum of redundancy.

Statistical testing of receiver BER/FER performance

Error Definition

1) Frame Erasure Ratio (FER)

A frame is defined as erased if the error detection functions in the receiver, operating in accordance with GSM 05.03, indicate an error (BFI = 1). For full rate or half rate speech this is the result of the 3 bit cyclic redundancy check (CRC) as well as other processing functions that cause a Bad Frame Indication (BFI). For signalling channels it is the result of the FIRE code or any other block code used. For data traffic FER is not defined.

2) Residual Bit Error Ratio (RBER)

The Residual Bit Error Ratio is defined as the Bit Error Ratio (BER) in frames which have not been declared as erased.

3) Bit Error Ratio (BER)

The Bit Error Ratio is defined as the ratio of the bits wrongly received to all data bits sent.

4) Unreliable Frame Ratio (UFR)

The Unreliable Frame Ratio is defined as the ratio of frames declared as erased (BFI=1), or unreliable (UFI=1), to the total number of frames transmitted. An unreliable frame is indicated by setting the UFI flag (UFI=1) and an erased frame is indicated by setting the BFI flag (BFI=1). (See GSM 06.21.)

5) Erased SID Frame Ratio (ESIDR)

A SID Frame is erased (SID=0) when the MS does not detect a valid transmitted SID frame as a valid SID frame (SID=2), or an invalid SID frame (SID=1). The Erased SID Frame Ratio is defined as the ratio of erased SID frames (SID=0), to the total number of valid SID frames transmitted. (See GSM 06.41.)

6) Erased Valid SID Frame Ratio (EVSIDR).

An Erased Valid SID Frame is declared when the MS does not detect a valid transmitted SID frame as a valid SID frame (SID=2) and (BFI=0 and UFI=0). The Erased Valid SID Frame Ratio is defined as the ratio of erased valid SID frames (SID=0), or (SID=1), or ((BFI or UFI)=1), to the total number of valid SID frames transmitted. (See GSM 06.41.)

Test method

Each test is performed in the following manner:

- a) Set up the required test conditions.
- b) Perform the test for at least the minimum number of samples (frames, bits or bits from non erased frames) and record the number of offered samples and the number of occurred events (frame, bit or residual bit errors).
- c) Terminate the test and determine the test result ("pass" or "fail") by comparing the measured error rate against the test limit error rate.

It is permitted to run the test over more samples than the value stated for minimum number of samples. The effect of increasing the number of samples is always to give a higher probability that a good unit will pass and a lower risk that a bad unit will pass, according to the definitions of good and bad unit in this section.

Test criteria

The limits on number of samples and test limit error rate shall be defined in order to comply with different requirements:

- 1) to keep reasonably low the risk of passing a bad unit for each individual test;
- 2) to have high probability of passing a good unit for each individual test;
- 3) to perform measurements with a high degree of statistical significance;
- 4) to keep the test time as low as possible.

The risk of passing a bad unit (point 1) should be kept lower than 0,2 %. The performance on a full rate channel, or a half rate data channel, is generally considered "bad" if its BER (or FER) performance is 1,5 times worse than that specified in AWGN (Additive White Gaussian Noise) and 1,26 times worse than that specified in multipath environment. These values have been adopted (taking into account the expected shapes of the BER performance) in order not to pass a unit with performance worse than the specifications by more than 1 dB.

The performance on a half rate speech channel, is generally considered "bad" if the BER (or FER, or UFR) is worse than that specified, multiplied by the factors given in table 14-1. These values have been adopted (taking into account the expected shapes of the BER performance) in order not to pass a unit with performance worse than the specifications by more than 1 dB.

Table 14-1: TCH/HS "bad" unit multiplication factors

Propagation Conditions	GSM 900				DCS 1 800			
	TUlow (No FH)	TUhigh (FH/ No FH)	HT (No FH)	RA (No FH)	TUlow (No FH)	TUhigh (FH/ No FH)	HT (No FH)	RA (No FH)
Reference sensitivity:								
TCH/HS FER		1,7				1,7		
TCH/HS class Ib (BFI=0)		2,2				2,0		
TCH/HS class II (BFI=0)		1,2	1,2	1,2		1,2	1,2	1,2
TCH/HS UFR		2,0				1,9		
TCH/HS class Ib (BFI=0 and UFI=0)		1,8				1,7		
Reference interference:								
TCH/HS FER		1,6				1,6		
TCH/HS class Ib (BFI=0)		1,8				1,8		
TCH/HS class II (BFI=0)		1,2				1,2		
TCH/HS UFR		1,6				1,6		
TCH/HS class Ib (BFI or UFI)=0		1,4				1,4		
EVSDR	1,2				1,2			
RBBER (SID=2 & (BFI or UFI)=0	1,3				1,3			
ESDR	1,3				1,3			
RBBER (SID=1 or SID=2)	1,3				1,3			

The probability of passing a good unit operating on the specification limit of performance (point 2) should be at least 99,7 %.

If the error events can be assumed to be random independent variables, outputs of stationary random processes with identical Gaussian distributions, the previous figures suggest a number of events (point 3) not lower than 200 in AWGN channel and not lower than 600 in a multipath environment, and to test a BER (or FER) performance 1,22 times worse than that specified in AWGN and 1,12 times worse than that specified in a multipath environment (this corresponds to testing a performance, at the most, 0,5 dB worse than that specified).

For multipath propagation conditions the hypothesis of stationary random processes does not generally hold. In case of non frequency hopping operation mode, the radio channel may be assumed to change 10 times per wavelength of travelled distance and to be short term stationary in between. So, in this case, the required observation time for having good statistical properties should not be lower (with some rounding) than that reported in table 14-1.

Table 14-2: Minimum test time according to propagation profile

Propagation Conditions	GSM 900				DCS 1 800			
	TUlow	TUhigh	HT	RA	TUlow	TUhigh	HT	RA
Min. test time (s)	500	30	15	6	500	15	7,5	6

Tables 14-3 and 14-4 detail, for the different test conditions, the minimum number of samples required in order to meet points 1) to 3): the corresponding test time (point 4) can be consequently computed.

As can be seen in the tables, in some of the cases in which both FER and RBBER have to be tested on the same channel, the length of time for the FER measurement has been adopted for the RBBER measurement. This is longer than that required for the RBBER only according to the discussed criteria, but allows the use of a test limit error rate closer to the specified error rate while maintaining the same statistical significance. When, as is normal, it is desired to perform the FER and RBBER tests, the closer test limit error rate for the RBBER measurement can be achieved without increasing the total test time. It is always possible to extend the length of any test and further improve the statistical significance of that test.

Table 14-3: Test conditions for GSM 900

Type of test	Type of channel	Propagation/ frequency conditions	Speci- fied FER/ BER %	Test limit FER/ BER %	Minimum No of samples	Prob that good unit will pass %	Bad unit BER/ FER %	Risk that bad unit will pass
BFI	TCH/FS	Static	0,033	0,044	492000	99,813	0,050	0,140
	TCH/FS	Static / FH	0,033	0,041	492000	99,813	0,050	0,140
Sensitivity	TCH/FS	Static/FH	0,100* α	0,122* α	164000	99,717	0,150* α	0,140
„	TCH/FS Class Ib	Static/FH	0,400/ α	0,410/ α	20000000	100,000	0,600/ α	<0,001
„	TCH/FS Class II	Static/FH	2,000	2,439	8200	99,714	3,000	0,001
„	TCH/FS	TUhigh/No FH	6,000* α	6,742* α	8900	99,825	7,560* α	0,162
„	TCH/FS Class Ib	TUhigh/No FH	0,400/ α	0,420/ α	1000000	99,919	0,504/ α	<0,001
„	TCH/FS Class II	TUhigh/No FH	8,000	8,333	120000	99,999	10,080	<0,001
„	TCH/FS Class II	HT/No FH	9,000	9,333	60000	99,779	11,340	<0,001
„	TCH/FS Class II	RA/No FH	7,000	7,500	24000	99,873	8,694	<0,001
„	TCH/EFS	Static/FH	0,100	0,122	164000	99,758	0,150	0,171
„	TCH/EFS Class Ib	Static/FH	0,100	0,110	20000000	100	0,150	<0,001
„	TCH/EFS Class II	Static/FH	2,000	2,439	8200	99,753	3,000	0,168
„	TCH/EFS	TUhigh/No FH	8,000	8,867	8900	99,808	10,080	0,016
„	TCH/EFS Class Ib	TUhigh/No FH	0,210	0,224	1000000	99,887	0,265	<0,001
„	TCH/EFS Class II	TUhigh/No FH	7,000	7,500	120000	99,999	8,820	<0,001
„	TCH/EFS Class II	HT/No FH	9,000	9,350	60000	99,787	11,340	<0,001
„	TCH/EFS Class II	RA/No FH	7,000	7,500	24000	99,829	8,820	<0,001
„	TCH/HS (FER)	TUhigh/No FH	4,100	4,598	13050	99,776	6,970	<0,001
„	TCH/HS Class Ib	TUhigh/No FH	0,360	0,404	148500	99,750	0,792	<0,001
„	(BFI=0)							
„	TCH/HS Class II	TUhigh/No FH	6,900	7,725	25500	100,00	8,280	0,061
„	(BFI=0)							
„	TCH/HS Class II	HT/No FH	7,600	8,500	20000	100,00	9,120	0,110
„	(BFI=0)							
„	TCH/HS Class II	RA/No FH	6,800	7,600	20000	100,00	8,160	0,182
„	(BFI=0)							
„	TCH/HS (UFR)	TUhigh/No FH	5,600	6,250	9600	99,702	11,200	<0,001
„	TCH/HS Class Ib (BFI or UFI=0)	TUhigh/No FH	0,240	0,269	227000	99,721	0,432	<0,001
„	FACCH/F	TUhigh/No FH	8,000	8,961	6696	99,798	10,080	0,108
„	FACCH/H	TUhigh/No FH	6,900	7,728	7764	99,785	8,694	0,115
„	TCH/F9,6&H4,8	HT/No FH	0,700	0,778	180000	99,995	0,882	<0,001
„	TCH/F4,8	HT/No FH	0,010	0,011	5350000	99,732	0,013	0,197
„	TCH/F2,4	HT/No FH	0,001	0,001	11900000	99,734	0,002	<0,001
„	TCH/H2,4	HT/No FH	0,010	0,011	5350000	99,732	0,013	0,197
Input level	TCH/FS Class II	Static<-40dBm	0,010	0,012	1640000	99,716	0,015	0,141
Input level	TCH/FS Class II	Static<-15dBm	0,100	0,122	164000	99,717	0,150	0,140
range	TCH/FS Class II	EQ	3,000	3,250	120000	100,000	3,780	<0,001
Co-channel rejection	TCH/FS	TUlow/No FH	21,000* α	24,000* α	25000	100,000	27,720* α	<0,001
„	TCH/FS Class Ib	TUlow/No FH	2,000/ α	2,091/ α	3300000	100,000	2,520/ α	<0,001
„	TCH/FS Class II	TUlow/No FH	4,000	4,300	2000000	100,000	5,040	<0,001
„	TCH/FS	TUhigh/FH	3,000* α	3,371* α	17800	99,797	3,780* α	0,194
„	TCH/FS Class Ib	TUhigh/FH	0,200/ α	0,215/ α	2000000	100,000	0,252/ α	<0,001
„	TCH/FS Class II	TUhigh/FH	8,000	8,333	1200000	100,000	10,080	<0,001
„	TCH/EFS	TUlow/No FH	23,000	24,000	25000	99,951	27,720	<0,001
„	TCH/EFS Class Ib	TUlow/No FH	0,2000	0,209	3300000	99,987	0,252	<0,001
„	TCH/EFS Class II	TUlow/No FH	3,000	3,039	2000000	99,927	3,780	<0,001
„	TCH/EFS	TUhigh/FH	3,000	3,357	17800	99,702	3,780	0,185
„	TCH/EFS Class Ib	TUhigh/FH	0,100	0,115	2000000	100,00	0,126	<0,001
„	TCH/EFS Class II	TUhigh/FH	8,000	8,333	1200000	99,998	10,08	<0,001
„	FACCH/F	TUlow/No FH	22,000	24,000	25000	100,000	27,720	<0,001
„	FACCH/H	TUlow/No FH	22,000	24,000	25000	100,000	27,720	<0,001
„	TCH/F9,6 or H4,8	TUhigh/FH	0,300	0,336	178500	99,716	0,378	0,180
„	TCH/F4,8	TUhigh/FH	0,010	0,011	5350000	99,732	0,013	0,197
„	TCH/F2,4	TUhigh/FH	0,001	0,001	11900000	99,734	0,002	<0,001
„	TCH/H2,4	TUhigh/FH	0,010	0,011	5350000	99,732	0,013	0,197

Table 14-3: Test conditions for DCS 900 (concluded)

Type of test	Type of channel	Propagation/ frequency conditions	Specified FER/BER %	Test limit FER/BER %	Minimum No of samples	Prob that good unit will pass %	Bad unit FER/BER %	Risk that bad unit will pass
Adjacent channel 200 kHz	TCH/FS	TUhigh/No FH	6,000* α	6,742* α	8900	99,825	7,560* α	0,162
	TCH/FS Class Ib	TUhigh/No FH	0,400/ α	0,420/ α	1000000	99,919	0,504/ α	<0,001
	TCH/FS Class II	TUhigh/No FH	8,000	8,333	600000	100,000	10,080	<0,001
	TCH/HS (FER)	TUhigh/FH	5,000	5,607	10700	99,787	8,000	<0,001
	TCH/HS Class Ib (BFI=0)	TUhigh/FH	0,290	0,325	184700	99,711	0,522	<0,001
	TCH/HS Class II (BFI=0)	TUhigh/FH	7,100	7,961	25500	100,00	8,520	0,065
	TCH/HS (UFR)	TUhigh/FH	6,100	6,834	8780	99,781	9,760	<0,001
	TCH/HS Class Ib (BFI or UFI)=0	TUhigh/FH	0,210	0,235	255000	99,715	0,294	<0,001
	ESIDR	TUlow/No FH	21,900	24,000	25000	100,000	26,280	<0,001
	SID RBER (SID=2 and (BFI or UFI=0)	TUlow/No FH	0,020	0,022	2678500	99,705	0,026	0,010
	ESIDR	TUlow/No FH	17,100	19,152	25000	100,000	22,230	<0,001
	SID RBER (SID=1 or SID=2)	TUlow/No FH	0,500	0,560	500000	100,000	0,650	<0,001
	FACCH/F	TUhigh/No FH	9,500	10,640	5639	99,812	11,970	0,096
Adjacent channel 400 kHz	TCH/FS	TUhigh/No FH	10,200* α	11,461* α	8900	99,995	12,852* α	0,004
	TCH/FS Class Ib	TUhigh/No FH	0,720/ α	0,756/ α	1000000	99,999	0,9077/ α	<0,001
	TCH/FS Class II	TUhigh/No FH	8,800	9,167	600000	100,000	11,088	<0,001
	FACCH/F	TUhigh/No FH	17,100	19,152	3133	99,878	21,546	<0,052
Intermod.	TCH/FS Class II	Static	2,000	2,439	8200	99,741	3,000	0,122
	FACCH/F	TUhigh/No FH	8,000	8,961	6696	99,798	10,080	0,108
Blocking & spurious resp.	TCH/FS Class II	Static	2,000	2,439	8200	99,741	4,000	<0,001
	FACCH/F	TUhigh/No FH	8,000	8,961	6696	99,798	10,080	0,108

Table 14-4: Test conditions for DCS 1 800

Type of test	Type of channel	Propagation/ Frequency conditions	Speci- fied FER/ BER	Test limit FER/BER %	Mini-mum No of samples	Prob that good unit will pass %	Bad unit FER/BER %	Risk that bad unit will pass
BFI	TCH/FS	Static	0,033	0,041	492000	99,813	0,050	0,140
	TCH/FS	Static/FH	0,033	0,041	492000	99,813	0,050	0,140
Sensitivity	TCH/FS	Static/FH	0,100* α	0,122* α	164000	99,717	0,150* α	0,140
	TCH/FS Class Ib	Static/FH	0,400/ α	0,410/ α	2000000	100,000	0,600/ α	<0,001
	TCH/FS Class II	Static/FH	2,000	2,439	8200	99,714	3,000	0,001
	TCH/FS	TUhigh/No FH	4,000* α	4,478* α	13400	99,743	5,040* α	0,133
	TCH/FS Class Ib	TUhigh/No FH	0,300/ α	0,320/ α	1500000	100,000	0,378/ α	<0,001
	TCH/FS Class II	TUhigh/No FH	8,000	8,333	60000	99,865	10,080	<0,001
	TCH/FS Class II	HT/No FH	9,000	9,333	30000	97,826	11,340	<0,001
	TCH/FS Class II	RA/No FH	7,000	7,500	24000	99,873	8,820	<0,001
	TCH/EFS	Static/FH	0,100	0,122	164000	99,758	0,150	0,171
	TCH/EFS Class Ib	Static/FH	0,100	0,110	2000000	100,00	0,150	<0,001
	TCH/EFS Class II	Static/FH	2,000	2,439	8200	99,753	3,000	0,168
	TCH/EFS	TUhigh/No FH	4,000	4,475	13400	99,701	5,040	0,179
	TCH/EFS Class Ib	TUhigh/No FH	0,120	0,130	1500000	99,979	0,151	<0,001
	TCH/EFS Class II	TUhigh/No FH	8,000	8,333	60000	99,804	10,080	<0,001
	TCH/EFS Class II	HT/No FH	9,000	9,498	30000	99,798	11,340	<0,001
	TCH/EFS Class II	RA/No FH	7,000	7,500	24000	99,829	8,820	<0,001
	TCH/HS (FER)	TUhigh/No FH	4,200	4,706	12750	99,763	7,140	<0,001
	TCH/HS Class Ib (BFI=0)	TUhigh/No FH	0,380	0,426	141000	99,706	0,760	<0,001
	TCH/HS Class II (BFI=0)	TUhigh/No FH	6,900	7,725	25500	100,00	8,280	0,061
	TCH/HS Class II (BFI=0)	HT/No FH	7,800	8,735	20000	100,00	9,360	0,114
	TCH/HS Class II (BFI=0)	RA/No FH	6,800	7,600	20000	100,00	8,160	0,182
	TCH/HS (UFR)	TUhigh/No FH	5,700	6,383	9400	99,769	10,830	<0,001
	TCH/HS Class Ib (BFI or UFI=0)	TUhigh/No FH	0,260	0,291	206000	99,712	0,442	<0,001
	FACCH/F	TUhigh/No FH	3,900	4,368	13736	99,752	4,914	0,140
	FACCH/H	TUhigh/No FH	7,200	7,752	7440	97,027	9,072	0,002

Table 14-4: Test conditions for DCS 1 800 (concluded)

Type of test	Type of channel	Propagation/frequency conditions	Speci-fied FER/ BER %	Test limit FER/ BER %	Minimum No of samples	Prob that good unit will pass %	Bad unit BER/ FER %	Risk that bad unit will pass
„	TCH/F9,6	HT/No FH	0,700	0,784	76500	99,721	0,882	0,176
„	TCH/F4,8	HT/No FH	0,010	0,011	5350000	99,732	0,013	0,197
„	TCH/F2,4	HT/No FH	0,001	0,001	11900000	99,734	0,002	<0,001
Input level range	TCH/FS Class II	Static-23dBm	0,100	0,122	164000	99,717	0,150	0,140
	TCH/FS Class II	Static<-40dBm	0,010	0,012	1640000	99,716	0,015	0,141
	TCH/FS Class II	EQ	3,000	3,250	60000	99,981	3,780	<0,001
Co-channel rejection	TCH/FS	TUlow/No FH	21,00* α	24,00* α	25000	100,000	26,460* α	<0,001
	TCH/FS Class Ib	TUlow/No FH	2,000/ α	2,091/ α	3300000	100,000	2,520/ α	<0,001
	TCH/FS Class II	TUlow/No FH	4,000	4,300	2000000	100,000	5,040	<0,001
„	TCH/FS	TUhigh/FH	3,000* α	3,371* α	17800	99,797	3,780* α	0,194
„	TCH/FS Class Ib	TUhigh/FH	0,200/ α	0,215/ α	2000000	100,000	0,252/ α	<0,001
„	TCH/FS Class II	TUhigh/FH	8,000	8,333	1200000	100,000	10,080	<0,001
„	TCH/EFS	TUlow/No FH	23,000	24,000	25000	99,999	26,680	<0,001
„	TCH/EFS Class Ib	TUlow/No FH	0,200	0,209	3300000	100,000	0,252	<0,001
„	TCH/EFS Class II	TUlow/No FH	3,000	3,039	2000000	100,000	3,780	<0,001
„	TCH/EFS	TUhigh/FH	3,000	3,357	17800	99,815	3,780	0,185
„	TCH/EFS Class Ib	TUhigh/FH	0,100	0,115	2000000	99,999	0,126	<0,001
„	TCH/EFS Class II	TUhigh/FH	8,000	8,333	1200000	100,000	10,080	<0,001
„	FACCH/F	TUlow/No FH	22,000	24,000	25000	100,000	27,720	<0,001
„	FACCH/H	TUlow/No FH	22,000	24,000	25000	100,000	27,720	<0,001
„	TCH/F9,6 or H4,8	TUhigh/FH	0,300	0,336	178500	99,716	0,378	0,180
„	TCH/F4,8	TUhigh/FH	0,010	0,011	5350000	99,732	0,013	0,197
„	TCH/F2,4	TUhigh/FH	0,001	0,001	11900000	99,734	0,002	<0,001
„	TCH/H2,4	TUhigh/FH	0,010	0,011	5350000	99,732	0,013	0,197
Adjacent channel 200 kHz	TCH/FS	TUhigh/No FH	3,000* α	3,371* α	17800	99,797	3,780* α	0,194
	TCH/FS Class Ib	TUhigh/No FH	0,250/ α	0,270/ α	2000000	100,000	0,315/ α	<0,001
	TCH/FS Class II	TUhigh/No FH	8,100	8,333	1200000	100,000	10,206	<0,001
„	TCH/HS (FER)	TUhigh/FH	5,000	5,607	10700	99,787	8,000	<0,001
„	TCH/HS Class Ib (BFI=0)	TUhigh/FH	0,290	0,325	184700	99,711	0,522	<0,001
„	TCH/HS Class II (BFI=0)	TUhigh/FH	7,200	8,078	25500	100,000	8,640	0,066
„	TCH/HS (UFR)	TUhigh/FH	6,100	6,834	8780	99,781	9,760	<0,001
„	TCH/HS Class Ib ((BFI or UFI)=0)	TUhigh/FH	0,210	0,235	255000	99,715	0,294	<0,001
„	EVSIDR	TUlow/No FH	21,900	24,000	25000	100,000	26,280	<0,001
„	SID RBER (SID=2 and (BFI or UFI)=0)	TUlow/No FH	0,020	0,022	2678500	99,705	0,026	0,010
„	ESIDR	TUlow/No FH	17,100	19,152	25000	100,000	22,230	<0,001
„	SID RBER (SID=1 or SID=2)	TUlow/No FH	0,500	0,560	500000	100,000	0,650	<0,001
„	FACCH/F	TUhigh/No FH	3,400	3,808	15756	99,746	4,284	0,145
Adjacent channel 400 kHz	TCH/FS	TUhigh/No FH	5,100* α	5,714* α	10500	99,773	6,426* α	0,134
	TCH/FS Class Ib	TUhigh/No FH	0,450/ α	0,483/ α	1200000	100,000	0,567/ α	<0,001
	TCH/FS Class II	TUhigh/No FH	8,900	9,167	720000	100,000	11,214	<0,001
„	FACCH/F	TUhigh/No FH	6,100	6,832	8782	99,777	7,686	0,122
Intermod,	TCH/FS Class II	Static	2,000	2,439	8200	99,741	3,000	0,122
	FACCH/F	TUhigh/No FH	3,900	4,368	13736	99,752	4,914	0,140
Blocking & spurious resp.	TCH/FS Class II	Static	2,000	2,439	8200	99,741	4,000	<0,001
	FACCH/F	TUhigh/No FH	3,900	4,368	13736	99,752	4,914	0,140

NOTE 1: α is a parameter which ranges from 1 to 1,6. The value of α for a RBER test on TCH/FS class Ib bits under particular measurement conditions shall be the same as that determined in the FER test on TCH/FS under the same conditions. For example, the value of α may be different for a TUhigh sensitivity test and an RA sensitivity test. The value of α is determined by dividing the measured error rate for the FER test by the value of the test limit error rate listed in the limits section of the test corresponding to $\alpha=1$; if the result of the division is lower than 1, a value of $\alpha=1$ shall be used, if the value of $\alpha > 1,6$ the FER test has failed (the normal treatment of stimulus uncertainties applies). The probabilities that a good unit will pass and the risks that a bad unit will pass, listed in the table are valid for $\alpha=1$, and would be slightly different for other values of α .

NOTE 2: In order to save time the sensitivity and co-channel rejection tests for the TCH/F2,4 channel does not comply with the above said constraints.

In fact, a bad unit which performs 2 times (instead of 1,26) worse than that specified is accounted for, so reducing the required number of events to 150, instead of 600. On the other hand, the specified RBER is in this case $10E-5$ and, on the basis of simulations and hardware validation results, doubling this RBER results in a drop in performance of less than 1 dB.

14.1 Bad frame indication

14.1.1 Bad frame indication - TCH/FS

14.1.1.1 Bad frame indication - TCH/FS - Random RF input

14.1.1.1.1 Definition and applicability

The performance of the Bad Frame Indication (BFI) is a measure of the effectiveness of the MS under DTX conditions. It includes the effect of the 3 bit Cyclic Redundancy Check (CRC) and all other processing associated with the DTX function. The BFI is measured on a full rate speech TCH (TCH/FS) by counting the number of undetected bad frames whilst the input signal is a randomly modulated carrier.

The requirements and this test only apply to MS supporting speech.

14.1.1.1.2 Conformance requirement

On a full rate speech TCH (TCH/FS) with a random RF input, the overall reception performance shall be such that, on average, less than one undetected bad speech frame (false bad frame indication) in 60 seconds will be measured; GSM 05.05, 6.4 b

14.1.1.1.3 Test purpose

1. To verify that the BFI performance does not exceed the conformance requirement with an allowance for the statistical significance of the test.
2. To verify that on reception of a SID frame the BFI is not set.

14.1.1.1.4 Method of test

14.1.1.1.4.1 Initial conditions

A call is set up according to the generic call set up procedure on a TCH/FS with an ARFCN in the Mid ARFCN range, power control level set to maximum power.

The SS commands the MS to complete the traffic channel loop back and signal the bad frame indication.

NOTE: DTX is used during the test to prevent the MS dropping the call.

14.1.1.1.4.2 Procedure

- a) The SS simulates a BSS in DTX mode. During the period when no transmission would occur the SS transmits a GSM carrier modulated with random data at a level 11 dB above reference sensitivity level(). The SACCH is transmitted normally at a level 20 dB above reference sensitivity(). The SID frame is transmitted in its correct time interval with valid information at a level 20 dB above reference sensitivity level(). During transmission of SACCH or SID frames the random data is discontinued.
- b) The SS transmits at least the minimum number of samples of frames of TCH/FS information and checks the BFI of the looped back signal from the MS. The SS records the number of frames where the bad frame indication is not set. During transmission by the SS of SID frames the SS checks that the BFI is not set.

NOTE 1: Further explanations on the mechanism of signalling the BFI to the SS will be found in clause 36.

NOTE 2: In some cases the MS decodes half SID frames correctly even if these are not transmitted completely. Therefore, in case that a MS detects a good SID frame, the SS has to consider the received bits in detail.

14.1.1.1.5 Test requirements

The BFI performance is accepted if the measured rate of undetected bad frames does not exceed the test limit error rate:

Test limit error rate: 0,041 %
Minimum number of samples: 492 000 (excluding SID frames).

During loop back of SID frames no BFI shall be set.

14.1.1.2 Bad frame indication - TCH/FS - Frequency hopping and downlink DTX

14.1.1.2.1 Definition and applicability

The performance of the Bad Frame Indication (BFI) is a measure of the effectiveness of the MS under DTX conditions. It includes the effect of the 3 bit Cyclic Redundancy Check (CRC) and all other processing associated with the DTX function. The BFI is measured on a full rate speech TCH (TCH/FS) by counting the number of undetected bad frames whilst the input signal is a randomly modulated carrier.

The requirements and this test only apply to MS supporting speech.

14.1.1.2.2 Conformance requirement

On a speech TCH (TCH/FS or TCH/HS), when DTX is activated with frequency hopping through C0 where bursts comprising SID frames, SACCH frames and dummy bursts are received at a level 20 dB above the reference sensitivity level and with no transmissions at the other bursts of the TCH, the overall reception performance shall be such that, on average less than one undetected bad speech frame (false bad frame indication BFI) shall be measured in one minute for MS. GSM 05.05, 6.4 c.

14.1.1.2.3 Test purpose

1. To verify that the BFI performance in case of frequency hopping including the C0 radio frequency does not exceed the conformance requirement with an allowance for the statistical significance of the test.
2. To verify that on reception of a SID frame the BFI is not set.

14.1.1.2.4 Method of test

14.1.1.2.4.1 Initial conditions

A call is set up according to the generic call set up procedure on a TCH/FS with a transmitted burst 20 dB above reference sensitivity. Random frequency hopping on two channels including the C0 radio frequency with ARFCNs with at least 5 channels separation shall be used, power control level set to maximum power.

The SS commands the MS to complete the traffic channel loop back and signal the bad frame indication.

NOTE: DTX is used during the test to prevent the MS dropping the call.

14.1.1.2.4.2 Procedure

- a) The SS sets downlink DTX on.
- b) The SS performs the measurement over at least the minimum number of samples of frames of TCH/FS information and checks the BFI of the looped back signal from the MS. The SS only transmits SID frames, SACCH frames and dummy bursts, with no transmission of TCH bursts. The

SS records the number of frames where the bad frame indication is not set. During transmission by the SS of SID frames the SS checks that the BFI is not set.

NOTE 1: Further explanations on the mechanism of signalling the BFI to the SS will be found in clause 36.

NOTE 2: In some cases the MS decodes half SID frames correctly even if these are not transmitted completely. Therefore, in case that a MS detects a good SID frame, the SS has to consider the received bits in detail.

14.1.1.2.5 Test requirements

The BFI performance is accepted if the measured rate of undetected bad frames does not exceed the test limit error rate:

Test limit error rate:	0,041 %	
Minimum number of samples:	492 000	(excluding SID frames).

During loop back of SID frames no BFI shall be set.

14.1.2 Bad frame indication - TCH/HS

14.1.2.1 Bad frame indication - TCH/HS - Random RF input

14.1.2.1.1 Definition and applicability

The performance of the Bad Frame Indication (BFI) is a measure of the effectiveness of the MS under DTX conditions. It includes the effect of the 3 bit Cyclic Redundancy Check (CRC) and all other processing associated with the DTX function. The BFI is measured on a half rate speech TCH (TCH/HS) by counting the number of undetected bad frames whilst the input signal is a randomly modulated carrier.

The requirements and this test only apply to MS supporting half rate speech.

14.1.2.1.2 Conformance requirement

On a half rate speech TCH (TCH/HS) with a random RF input, the overall reception performance shall be such that, on average, less than one undetected bad speech frame (false bad frame indication) in 60 seconds will be measured; GSM 05.05, 6.4 b.

14.1.2.1.3 Test purpose

1. To verify that the BFI performance does not exceed the conformance requirement with an allowance for the statistical significance of the test.
2. To verify that on reception of a SID frame the BFI is not set.

14.1.2.1.4 Method of test

14.1.2.1.4.1 Initial conditions

A call is set up according to the generic call set up procedure on a TCH/HS with an ARFCN in the Mid ARFCN range, power control level set to maximum power.

The SS commands the MS to complete traffic channel loop back A and signal frames detected with BFI=1 as erased.

NOTE 1: Test loop A is defined in clause 36. Frames detected with BFI=1 are signalled as erased on the uplink.

NOTE 2: DTX is used during the test to prevent the MS dropping the call.

14.1.2.1.4.2 Procedure

- a) The SS simulates a BSS in DTX mode. During the periods when no transmission would occur, the SS transmits a GSM carrier modulated with random data, at a level 11 dB above reference sensitivity level(). The SACCH is transmitted normally, at a level 20 dB above reference sensitivity(). The SID frame is transmitted in its correct time interval, with valid information, at a level 20 dB above reference sensitivity level(). During transmission of SACCH or SID frames, the random data is discontinued.
- b) The SS transmits at least the minimum number of samples of frames of TCH/HS information and checks the BFI of the looped back signal from the MS. The SS records the number of frames where the bad frame indication is not set. During transmission by the SS of SID frames the SS checks that the BFI is not set.

14.1.2.1.5 Test requirements

The BFI performance is accepted if the measured rate of undetected bad frames does not exceed the test limit error rate:

Test limit error rate:	0,041 %	
Minimum number of samples:	492 000	(excluding SID frames).

During loop back of SID frames no BFI shall be set.

14.1.2.2 Bad frame indication - TCH/HS - Frequency hopping and downlink DTX**14.1.2.2.1 Definition and applicability**

The performance of the Bad Frame Indication (BFI) is a measure of the effectiveness of the MS under DTX conditions. It includes the effect of the 3 bit Cyclic Redundancy Check (CRC) and all other processing associated with the DTX function. The BFI is measured on a half rate speech TCH (TCH/HS) by counting the number of undetected bad frames whilst the input signal is a randomly modulated carrier.

The requirements and this test only apply to MS supporting half rate speech.

14.1.2.2.2 Conformance requirement

On a half rate speech TCH (TCH/HS), when DTX is activated with frequency hopping through C0 where bursts comprising SID frames, SACCH frames and dummy bursts are received at a level 20 dB above the reference sensitivity level and with no transmissions at the other bursts of the TCH, the overall reception performance shall be such that, on average less than one undetected bad speech frame (false bad frame indication BFI) shall be measured in one minute for MS. GSM 05.05, 6.4 c.

14.1.2.2.3 Test purpose

1. To verify that the BFI performance in case of frequency hopping including the C0 radio frequency does not exceed the conformance requirement with an allowance for the statistical significance of the test.
2. To verify that on reception of a SID frame the BFI is not set.

14.1.2.2.4 Method of test**14.1.2.2.4.1 Initial conditions**

A call is set up according to the generic call set up procedure on a TCH/HS with a transmitted burst 20 dB above reference sensitivity. Random frequency hopping on two channels including the C0 radio frequency with ARFCNs with at least 5 channels separation shall be used, power control level set to maximum power.

The SS commands the MS to complete the traffic channel loop back and signal the bad frame indication.

NOTE: DTX is used during the test to prevent the MS dropping the call.

14.1.2.2.4.2 Procedure

- a) The SS sets downlink DTX on.
- b) The SS performs the measurement over at least the minimum number of samples of frames of TCH/HS information and checks the BFI of the looped back signal from the MS. The SS only transmits SID frames, SACCH frames and dummy bursts, with no transmission of TCH bursts. The SS records the number of frames where the bad frame indication is not set. During transmission by the SS of SID frames the SS checks that the BFI is not set.

NOTE 1: Further explanations on the mechanism of signalling the BFI to the SS will be found in clause 36.

NOTE 2: In some cases the MS decodes half SID frames correctly even if these are not transmitted completely. Therefore, in case that a MS detects a good SID frame, the SS has to consider the received bits in detail.

14.1.2.2.5 Test requirements

The BFI performance is accepted if the measured rate of undetected bad frames does not exceed the test limit error rate:

Test limit error rate:	0,041 %	
Minimum number of samples:	492 000	(excluding SID frames).

During loop back of SID frames no BFI shall be set.

14.1.3 Bad frame indication - TCH/FS - Frequency hopping and downlink DTX - Phase 2 MS in a phase 1 network

14.1.3.1 Definition and applicability

The performance of the Bad Frame Indication (BFI) is a measure of the effectiveness of the MS under DTX conditions. It includes the effect of the 3 bit Cyclic Redundancy Check (CRC) and all other processing associated with the DTX function. The BFI is measured on a full rate speech TCH (TCH/FS) by counting the number of undetected bad frames whilst the input signal is a randomly modulated carrier.

Annex A of GSM 05.02 requires that a phase 2 MS behave properly in a phase 1 network.

The requirements and this test only apply to MS supporting speech.

14.1.3.2 Conformance requirement

On a full rate speech TCH (TCH/FS) in DTX conditions with a transmitted burst 20 dB above reference sensitivity and static conditions, the overall reception performance shall be such that, on average, less than one undetected bad speech frame (false bad frame indication) in 60 seconds will be measured; GSM 05.05, 6.4 b.

14.1.3.3 Test purpose

1. To verify that the BFI performance in case of frequency hopping including the C0 radio frequency does not exceed the conformance requirement with an allowance for the statistical significance of the test.
2. To verify that on reception of a SID frame the BFI is not set.

14.1.3.4 Method of test**14.1.3.4.1 Initial conditions**Initial conditions 1

A call is set up according to the generic call set up procedure on a TCH/FS with a transmitted burst 20 dB above reference sensitivity. Random frequency hopping on two channels including the C0 radio frequency with ARFCNs with at least 5 channels separation shall be used, power control level set to maximum power.

When downlink DTX is activated with frequency hopping including the C0 radio frequency, the following configuration applies for filling the bursts on the C0 carrier:

C0 filling on the TCH	Half burst filling	Dummy bursts stealing flag	Half burst Filling stealing flag
Dummy bursts with (BN61, BN 62,...) mapped from the TSC bits of normal bursts. See section A.2.1.3 of GSM 05.02	Partial SID information. See section A.2.2.1 of GSM 05.02.	0	0

The SS commands the MS to complete the traffic channel loop back and signal the bad frame indication.

Initial conditions 2

A call is set up according to the generic call set up procedure on a TCH/FS with a transmitted burst 20 dB above reference sensitivity. Random frequency hopping on two channels including the C0 radio frequency with ARFCNs with at least 5 channels separation shall be used, power control level set to maximum power.

When downlink DTX is activated with frequency hopping including the C0 radio frequency, the following configuration applies for filling the bursts on the C0 carrier:

C0 filling on the TCH	Half burst filling	Dummy bursts stealing flag	Half burst Filling stealing flag
Partial SID information. See section A.2.1.4 of GSM 05.02	Partial SID information. See section A.2.2.1 of GSM 05.02.	1	1

The SS commands the MS to complete the traffic channel loop back and signal the bad frame indication.

Initial conditions 3

A call is set up according to the generic call set up procedure on a TCH/FS with a transmitted burst 20 dB above reference sensitivity. Random frequency hopping on two channels including the C0 radio frequency with ARFCNs with at least 5 channels separation shall be used, power control level set to maximum power.

When downlink DTX is activated with frequency hopping including the C0 radio frequency, the following configuration applies for filling the bursts on the C0 carrier:

C0 filling on the TCH	Half burst filling	Dummy bursts stealing flag	Half burst Filling stealing flag
Dummy bursts with 'C0 filling training sequence'. See section A.2.1.4 of GSM 05.02	Dummy bursts mixed bits. See section A.2.2.2 of GSM 05.02.	1	1

The SS commands the MS to complete the traffic channel loop back and signal the bad frame indication.

NOTE: DTX is used during the test to prevent the MS dropping the call.

14.1.3.4.2 Procedure

The two following steps are repeated 3 times, once for each initial condition specified in the previous clause.

- a) The SS sets downlink DTX on.
- b) The SS transmits at least the minimum number of samples of frames of TCH/FS information and checks the BFI of the looped back signal from the MS. The SS records the number of frames where the bad frame indication is not set. During transmission by the SS of SID frames the SS checks that the BFI is not set.

NOTE 1: Further explanations on the mechanism of signalling the BFI to the SS will be found in clause 36.

NOTE 2: In some cases the MS decodes half SID frames correctly even if these are not transmitted completely. Therefore, in case that a MS detects a good SID frame, the SS has to consider the received bits in detail.

14.1.3.5 Test requirements

after each repetition of steps a) + b) the following requirements are applied:

The BFI performance is accepted if the measured rate of undetected bad frames does not exceed the test limit error rate:

Test limit error rate:	0,041 %	
Minimum number of samples:	492 000	(excluding SID frames).

During loop back of SID frames no BFI shall be set.

14.1.4 Bad frame indication - TCH/HS - Frequency hopping and downlink DTX - Phase 2 MS in a phase 1 network

14.1.4.1 Definition and applicability

The performance of the Bad Frame Indication (BFI) is a measure of the effectiveness of the MS under DTX conditions. It includes the effect of the 3 bit Cyclic Redundancy Check (CRC) and all other processing associated with the DTX function. The BFI is measured on a half rate speech TCH (TCH/HS) by counting the number of undetected bad frames whilst the input signal is a randomly modulated carrier.

Annex A of GSM 05.02 requires that a phase 2 MS behave properly in a phase 1 network.

The requirements and this test only apply to MS supporting half rate speech.

14.1.4.2 Conformance requirement

On a half rate speech TCH (TCH/HS) in DTX conditions with a transmitted burst 20 dB above reference sensitivity and static conditions, the overall reception performance shall be such that, on average, less than one undetected bad speech frame (false bad frame indication) in 60 seconds will be measured; GSM 05.05, 6.4 b.

14.1.4.3 Test purpose

1. To verify that the BFI performance in case of frequency hopping including the C0 radio frequency does not exceed the conformance requirement with an allowance for the statistical significance of the test.
2. To verify that on reception of a SID frame the BFI is not set.

14.1.4.4 Method of test**14.1.4.4.1 Initial conditions**Initial conditions 1

A call is set up according to the generic call set up procedure on a TCH/HS with a transmitted burst 20 dB above reference sensitivity. Random frequency hopping on two channels including the C0 radio frequency with ARFCNs with at least 5 channels separation shall be used, power control level set to maximum power.

When downlink DTX is activated with frequency hopping including the C0 radio frequency, the following configuration applies for filling the bursts on the C0 carrier:

C0 filling on the TCH	Half burst filling	Dummy bursts stealing flag	Half burst Filling stealing flag
Dummy bursts with (BN61, BN 62,...) mapped from the TSC bits of normal bursts. See section A.2.1.3 of GSM 05.02	Partial SID information. See section A.2.2.1 of GSM 05.02.	0	0

The SS commands the MS to complete the traffic channel loop back and signal the bad frame indication.

Initial conditions 2

A call is set up according to the generic call set up procedure on a TCH/HS with a transmitted burst 20 dB above reference sensitivity. Random frequency hopping on two channels including the C0 radio frequency with ARFCNs with at least 5 channels separation shall be used, power control level set to maximum power.

When downlink DTX is activated with frequency hopping including the C0 radio frequency, the following configuration applies for filling the bursts on the C0 carrier:

C0 filling on the TCH	Half burst filling	Dummy bursts stealing flag	Half burst Filling stealing flag
Partial SID information. See section A.2.1.4 of GSM 05.02	Partial SID information. See section A.2.2.1 of GSM 05.02.	1	1

The SS commands the MS to complete the traffic channel loop back and signal the bad frame indication.

Initial conditions 3

A call is set up according to the generic call set up procedure on a TCH/HS with a transmitted burst 20 dB above reference sensitivity. Random frequency hopping on two channels including the C0 radio frequency with ARFCNs with at least 5 channels separation shall be used, power control level set to maximum power.

When downlink DTX is activated with frequency hopping including the C0 radio frequency, the following configuration applies for filling the bursts on the C0 carrier:

C0 filling on the TCH	Half burst filling	Dummy bursts stealing flag	Half burst Filling stealing flag
Dummy bursts with 'C0 filling training sequence'. See section A.2.1.4 of GSM 05.02	Dummy bursts mixed bits. See section A.2.2.2 of GSM 05.02.	1	1

The SS commands the MS to complete the traffic channel loop back and signal the bad frame indication.

NOTE: DTX is used during the test to prevent the MS dropping the call.

14.1.4.4.2 Procedure

The two following steps are repeated 3 times, once for each initial condition specified in the previous clause.

- a) The SS sets downlink DTX on.
- b) The SS transmits at least the minimum number of samples of frames of TCH/HS information and checks the BFI of the looped back signal from the MS. The SS records the number of frames where the bad frame indication is not set. During transmission by the SS of SID frames the SS checks that the BFI is not set.

NOTE 1: Further explanations on the mechanism of signalling the BFI to the SS will be found in clause 36.

NOTE 2: In some cases the MS decodes half SID frames correctly even if these are not transmitted completely. Therefore, in case that a MS detects a good SID frame, the SS has to consider the received bits in detail.

14.1.4.5 Test requirements

After each repetition of steps a) + b) the following requirements are applied:

The BFI performance is accepted if the measured rate of undetected bad frames does not exceed the test limit error rate:

Test limit error rate:	0,041 %	
Minimum number of samples:	492 000	(excluding SID frames).

During loop back of SID frames no BFI shall be set.

14.2 Reference sensitivity**14.2.1 Reference sensitivity - TCH/FS****14.2.1.1 Definition and applicability**

The reference sensitivity is the signal level at the MS receiver input at which a certain BER and FER must be achieved.

The requirements and this test apply to MS supporting speech.

For E-GSM 900 MS this test is only performed in the P-GSM band.

14.2.1.2 Conformance requirement

1. At reference sensitivity level, the TCH/FS FER shall meet the reference sensitivity performance of table 1 in GSM 05.05; GSM 05.05, 6.2.
2. At reference sensitivity level, the TCH/FS class I RBER shall meet the reference sensitivity performance of table 1 in GSM 05.05; GSM 05.05, 6.2.
3. At reference sensitivity level, the TCH/FS class II RBER shall meet the reference sensitivity, performance of table 1 in GSM 05.05: GSM 05.05, 6.2.
4. At reference sensitivity level, the TCH/FS class II RBER shall meet the reference sensitivity, performance of table 1 in GSM under extreme conditions; GSM 05.05, 6.2, GSM 05.05, annex D D.2.1, D.2.2.

14.2.1.3 Test purpose

NOTE: This test is performed under STATIC propagation conditions to allow implicit testing of the ability of the MS to hop over the full band. The tests under dynamic propagation conditions are better suited to test the reference sensitivity conformance but cannot test hopping over the full band due to limited bandwidth of available fading simulators.

1. To verify that the MS does not exceed conformance requirement 1 under STATIC and TUhigh propagation conditions with an allowance for the statistical significance of the test.
2. To verify that the MS does not exceed conformance requirement 2 under STATIC and TUhigh propagation conditions with an allowance for the statistical significance of the test.
3. To verify that the MS does not exceed conformance requirement 3 under STATIC, TUhigh, RA and HT propagation conditions with an allowance for the statistical significance of the test.
4. To verify that the MS does not exceed conformance requirement 4 under STATIC and TUhigh propagation conditions with an allowance for the statistical significance of the test.

14.2.1.4 Method of test

NOTE 1: The BA list sent on the BCCH and SACCH will indicate at least six surrounding cells with at least one near to each band edge. It is not necessary to generate any of these BCCHs but, if provided the signal strengths of BCCHs shall be in the range $15 \text{ dB}\mu\text{Vemf}(\)$ to $35 \text{ dB}\mu\text{Vemf}(\)$.

NOTE 2: The ARFCN of any BCCH shall not be co-channel or on adjacent channels to the wanted traffic channel.

NOTE 3: When frequency hopping is used, the traffic channel may fall on any of the ARFCNs defined in section 6.

14.2.1.4.1 Initial conditions

A call is set up according to the generic call set up procedure on a TCH/FS with an ARFCN in the Mid ARFCN range for DCS 1800 and ARFCN 70 for GSM 900, power control level set to maximum power.

NOTE: For GSM 900 ARFCN 70 is tested since this is the 73rd harmonic of the 13 MHz clock normally used internally in a MS.

The SS transmits Standard Test Signal C1 on the traffic channel.

The SS commands the MS to create traffic channel loop back signalling erased frames.

14.2.1.4.2 Procedure

- a) The fading function is set to TUhigh.
- b) the SS sets the amplitude of the wanted signal to reference sensitivity level ().
- c) The SS compares the data of the signal that it sends to the MS with the signal which is looped back from the receiver after demodulation and decoding, and checks the frame erasure indication.
- d) The SS determines the number of residual bit error events for the bits of class II, by examining sequences of at least the minimum number of samples of consecutive bits of class II. Bits are taken only from those frames not signalled as erased.
- e) The SS determines the number of residual bit error events for the bits of the class Ib, by examining sequences of at least the minimum number of samples of consecutive bits of class Ib. Bits are only taken from those frames not signalled as erased.
- f) The SS also determines the frame erasure events by examining sequences of at least the minimum number of samples of consecutive frames and assuming a frame is received successfully, if it is not signalled as erased.
- g) Steps a) to d) are repeated under extreme test conditions.
- h) Steps a) to g) are repeated for TCH/FS with ARFCNs in the Low ARFCN range for DCS 1800 and ARFCN 5 for GSM 900 and the High ARFCN range.

NOTE: For GSM 900 ARFCN 5 is tested since this is the 72nd harmonic of the 13 MHz clock normally used internally in a MS.

- i) Steps b) to d) are repeated with the SS fading function set in turn to RA and HT.
- j) Steps b) to g) are repeated, with the SS fading function set to static and the MS is commanded by the SS into hopping mode using the hopping sequence defined in section 6.

The amplitude of the wanted signal is set according to step b). All the other time slots, except the active ones, are set to 20 dB above reference sensitivity level(). This implicitly tests adjacent time slot rejection.

14.2.1.5 Test requirements

The error rates measured for different channels and under the different propagation conditions, under any combination of normal and extreme test voltages and ambient temperatures, shall not exceed the test limit error rate values given in table 14-4 or 14-5:

Table 14-5: Limits for GSM 900 sensitivity

Channels	Propagation conditions TUhigh		Propagation conditions RA		Propagation conditions HT		Static conditions	
	Test limit error rate %	Minimum No. of samples	Test limit error rate %	Minimum No. of samples	Test limit error rate %	Minimum No. of samples	Test limit error rate %	Minimum No. of samples
TCH/FS								
FER	6,742* α	8900					0,122* α	164000
class Ib(RBER)	0,42/ α	1000000					0,41/ α	2000000
class II(RBER)	8,33	120000	7,5	24000	9,333	60000	2,439	8200

Table 14-5: Limits for DCS 1 800 sensitivity

Channels	Propagation conditions TUhigh		Propagation conditions RA		Propagation conditions HT		Static conditions	
	Test limit error rate %	Minimum No. of samples	Test limit error rate %	Minimum No. of samples	Test limit error rate %	Minimum No. of samples	Test limit error rate %	Minimum No. of samples
TCH/FS								
FER	$4,478 \cdot \alpha$	13400					$0,122 \cdot \alpha$	164000
class Ib(RBER)	$0,32/\alpha$	1500000					$0,41/\alpha$	2000000
class II(RBER)	8,333	60000	7,5	24000	9,333	30000	2,439	8200

where α is a parameter which can range from 1 to 1.6. The value of α for a RBER test on TCH/FS class Ib bits under particular measurement conditions shall be the same as that determined in the FER test on TCH/FS under the same conditions.

14.2.2 Reference sensitivity - TCH/HS (Speech frames)

14.2.2.1 Definition and applicability

The reference sensitivity level is the signal level at the MS receiver input at which a certain BER and FER and UFR for speech frames must be achieved.

The requirements and this test apply to MS supporting half rate speech.

14.2.2.2 Conformance requirement

1. At reference sensitivity level, the TCH/HS FER shall meet the reference sensitivity performance of table 1 in GSM 05.05; GSM 05.05, 6.2.
2. At reference sensitivity level, the TCH/HS class Ib RBER (BFI=0) shall meet the reference sensitivity performance of table 1 in GSM 05.05; GSM 05.05 6.2.
3. At reference sensitivity level, the TCH/HS class II RBER (BFI=0) shall meet the reference sensitivity performance of table 1 in GSM 05.05; GSM 05.05, 6.2.
4. At reference sensitivity level, the TCH/HS UFR shall meet the reference sensitivity performance of table 1 in GSM 05.05; GSM 05.05 6.2.
5. At reference sensitivity level, the TCH/HS class Ib RBER ((BFI or UFI)=0) shall meet the reference sensitivity performance of table 1 in GSM 05.05; GSM 05.05, 6.2.

14.2.2.3 Test purpose

1. To verify that the MS does not exceed conformance requirement 1 under TUhigh propagation conditions with an allowance for the statistical significance of the test.
2. To verify that the MS does not exceed conformance requirement 2 under TUhigh propagation conditions with an allowance for the statistical significance of the test.
3. To verify that the MS does not exceed conformance requirement 3 under TUhigh, RA and HT propagation conditions with an allowance for the statistical significance of the test.
4. To verify that the MS does not exceed conformance requirement 4 under TUhigh propagation conditions with an allowance for the statistical significance of the test.
5. To verify that the MS does not exceed conformance requirement 5 under TUhigh propagation conditions with an allowance for the statistical significance of the test.

14.2.2.4 Method of test**14.2.2.4.1 Initial conditions**

The BA list sent on the BCCH and SACCH indicates at least six surrounding cells, with at least one near to each band edge. It is not necessary to generate any of these BCCHs, but if provided, the signal strengths of BCCHs shall be in the range $15 \text{ dB}\mu\text{Vemf}(\)$ to $35 \text{ dB}\mu\text{Vemf}(\)$.

The ARFCN of any BCCH shall not be co-channel or on adjacent channels to the wanted traffic channel.

A call is set up according to the generic call set up procedure on a TCH/HS with an ARFCN in the mid ARFCN range, power control level set to maximum power.

The SS transmits Standard Test Signal C1 on the traffic channel.

14.2.2.4.2 Procedure

- a) The SS commands the MS to create traffic channel loop back signalling erased frames using test loop A.

NOTE: Test loop A is defined in clause 36. Frames detected with BFI=1 are signalled as erased on the uplink.

- b) The fading function is set to TUhigh.
- c) The SS sets the amplitude of the wanted signal to reference sensitivity level ().
- d) The SS compares the data of the signal that it sends to the MS with the signal which is looped back from the receiver after demodulation and decoding, and checks the frame erasure indication.
- e) The SS determines the number of residual bit error events for the bits of class II, by examining sequences of at least the minimum number of samples of consecutive bits of class II. Bits are taken only from those frames not signalled as erased.
- f) The SS determines the number of residual bit error events for the bits of the class Ib, by examining sequences of at least the minimum number of samples of consecutive bits of class Ib. Bits are only taken from those frames not signalled as erased.
- g) The SS also determines the frame erasure events by examining sequences of at least the minimum number of samples of consecutive frames and assuming a frame is received successfully, if it is not signalled as erased.
- h) Steps d) and e) are repeated, with the SS fading function set in turn to RA and HT.
- j) The SS increases the amplitude of the wanted signal to 20 dB above reference sensitivity level.
- k) The SS commands the MS to open test loop A and close test loop D.

NOTE: Test loop D is defined in clause 36. Frames marked as erased (BFI=1) or unreliable (UFI=1) are signalled to the SS on the uplink.

- l) The fading function is set to TUhigh.
- m) The SS sets the amplitude of the wanted signal to reference sensitivity level ().
- n) The SS compares the data of the signal that it sends to the MS with the signal which is looped back from the receiver after demodulation and decoding, and checks the erased/unreliable frame indication.
- p) The SS determines the number of residual bit error events for the bits of the class Ib, by examining sequences of at least the minimum number of samples of consecutive bits of class Ib. Bits are only taken from those frames not signalled as erased/unreliable.

- q) The SS also determines the unreliable frame events by examining sequences of at least the minimum number of samples of consecutive frames and assuming a frame is received successfully it is not signalled as erased/unreliable.

14.2.2.5 Test requirements

The error rates measured for different channels and under the different propagation conditions, shall not exceed the test limit error rate values given in table 14-7 or 14-8:

Table 14-7: Limits for GSM 900 sensitivity

Channels	Propagation conditions TUhigh		Propagation conditions RA		Propagation conditions HT	
	Test limit error rate %	Minimum No. of samples	Test limit error rate %	Minimum No. of samples	Test limit error rate %	Minimum No. of samples
TCH/HS (FER)	4,598	13050				
TCH/HS Class Ib (BFI=0)	0,404	148500				
TCH/HS Class II (BFI=0)	7,725	25500	8,500	20000	7,600	20000
TCH/HS (UFR)	6,250	9600				
TCH/HS Class Ib ((BFI or UFI)=0)	0,269	227000				

Table 14-8: Limits for DCS 1800 sensitivity

Channels	Propagation conditions TUhigh		Propagation conditions RA		Propagation conditions HT	
	Test limit error rate %	Minimum No. of samples	Test limit error rate %	Minimum No. of samples	Test limit error rate %	Minimum No. of samples
TCH/HS (FER)	4,706	12750				
TCH/HS Class Ib (BFI=0)	0,426	141000				
TCH/HS Class II (BFI=0)	7,725	25500	8,735	20000	7,600	20000
TCH/HS (UFR)	6,383	9400				
TCH/HS Class Ib ((BFI or UFI)=0)	0,291	206000				

14.2.3 Reference sensitivity - FACCH/F

14.2.3.1 Definition and applicability

The reference sensitivity for control channels is the signal level at the MS receiver input at which a certain FER must be achieved.

The requirements and this test apply to all types of MS.

14.2.3.2 Conformance requirement.

At reference sensitivity level, the FACCH/F FER shall meet the reference sensitivity performance of table 1 in GSM 05.05; (GSM 05.05, 6.2).

14.2.3.3 Test purpose.

To verify that the MS does not exceed the conformance requirement under TUhigh propagation condition with an allowance for the statistical significance of the test.

14.2.3.4 Method of test**14.2.3.4.1 Initial conditions**

A call is set up according to the generic call set up procedure on a TCH/F with an ARFCN in the Low ARFCN range, power control level set to maximum power.

The SS transmits Standard Test Signal C1 on the traffic channel.

14.2.3.4.2 Procedure

- a) The fading function is set to TUhigh.
- b) The SS sets the amplitude of the wanted signal to reference sensitivity level ().
- c) The SS sends a Layer 3 message which does not require a Layer 3 response from the MS. Due to the low signal level the MS may not be able to acknowledge the Layer 2 frame with an RR frame and the SS will repeat the Layer 2 frame. Each repeated L2 frame will be counted and will indicate a frame erasure event.
- d) The SS determines the frame erasure events during at least the minimum number of samples of FACCH/F frames.

NOTE: These frames will not be consecutive but it is expected that the statistical significance of the tests will not be unduly degraded.

14.2.3.5 Test Requirements

The error rates measured shall not exceed the test limit error rate values given in table 14-9.

Table 14-9: Limits for FACCH/F sensitivity

Channels	Type of measurements	Propagation	GSM 900		DCS 1 800	
			Test limit error rate %	Minimum No of samples	Test limit error rate %	Minimum No of samples
FACCH/F	FER	TUhigh	8,961	6696	4,368	13736

14.2.4 Reference sensitivity - FACCH/H**14.2.4.1 Definition and applicability**

The reference sensitivity for control channels is the signal level at the MS receiver input at which a certain FER must be achieved.

The requirements and this test apply to MS supporting half rate channels.

14.2.4.2 Conformance requirement.

At reference sensitivity level, the FACCH/H FER shall meet the reference sensitivity performance of table 1 in GSM 05.05; (GSM 05.05, 6.2).

14.2.4.3 Test purpose.

To verify that the MS does not exceed the conformance requirement under TUhigh propagation condition with an allowance for the statistical significance of the test.

14.2.4.4 Method of test**14.2.4.4.1 Initial conditions**

A call is set up according to the generic call set up procedure on a TCH/H with an ARFCN in the Mid ARFCN range, power control level set to maximum power.

The SS transmits Standard Test Signal C1 on the traffic channel.

14.2.4.4.2 Procedure

- a) The fading function is set to TUhigh.
- b) The SS sets the amplitude of the wanted signal to reference sensitivity level ().
- c) The SS sends a Layer 3 message which does not require a Layer 3 response from the MS. Due to the low signal level the MS may not be able to acknowledge the Layer 2 frame with an RR frame and the SS will repeat the Layer 2 frame. Each repeated L2 frame will be counted and will indicate a frame erasure event.
- d) The SS determines the frame erasure events during at least the minimum number of samples of FACCH/H frames.

NOTE: These frames will not be consecutive but it is expected that the statistical significance of the tests will not be unduly degraded.

14.2.4.5 Test requirements

The error rates measured shall not exceed the test limit error rate values given in table 14-10.

Table 14-10: Limits for FACCH/H sensitivity

Channels	Type of measurements	Propagation	GSM 900		DCS 1 800	
			Test limit error rate %	Minimum No of samples	Test limit error rate %	Minimum No of samples
FACCH/H	FER	TUhigh	7,728		8,064	

14.2.5 Reference sensitivity - full rate data channels**14.2.5.1 Definition and applicability**

The reference sensitivity for data channels is the signal level at the MS receiver input at which a certain BER must be achieved.

The requirements and this test apply to MS supporting data.

14.2.5.2 Conformance Requirement.

1. At reference sensitivity level, the TCH/F9,6, TCH/F4,8 and TCH/F2,4 BER shall meet the reference sensitivity performance of table 1 in GSM 05.05; (GSM 05.05, 6,2).

14.2.5.3 Test purpose

1. To verify that the MS does not exceed conformance requirement 1 under HT propagation condition with an allowance for the statistical significance of the test.

14.2.5.4 Method of test**14.2.5.4.1 Initial conditions**

A call is set up according to the generic call set up procedure on a TCH with an ARFCN in the Mid ARFCN range. One of the supported TCH/(F9,6, F4,8, or F2,4) shall be used. The power control level is set to maximum power.

The SS transmits Standard Test Signal C1 on the traffic channel.

The SS commands the MS to create the traffic channel loop back signalling erased frames. (36.2.1.1.1).

14.2.5.4.2 Procedure

- a) The fading function is set to HT.
- b) The SS sets the amplitude of the wanted signal level to reference sensitivity level ().
- c) The SS compares transmitted data with received data for at least the minimum number of samples of consecutive bits and records every error bit as an error event.
- d) The SS sets the wanted signal level to 28 dB μ V_{ref}.
- e) The SS commands the MS to open the TCH loop.
- f) The SS commands the MS to another of the supported data channels.
- g) Steps b) to f) are repeated for all supported full rate data channels.

14.2.5.5 Test requirements

The Max-events measured for different channels shall not exceed the values given in table 14-11.

Table 14-11: Limits for full rate data channel sensitivity

Channels	Type of measurements	Propagation	GSM 900		DCS 1 800	
			Test limit error rate %	Minimum No of samples	Test limit error rate %	Minimum No of samples
TCH/F9,6	BER	HT	0,778	180000	0,784	76500
TCH/F4,8	BER	HT	0,011	5350000	0,011	5350000
TCH/F2,4	BER	HT	0,001	11900000	0,001	11900000

14.2.6 Reference sensitivity - half rate data channels**14.2.6.1 Definition and applicability**

The reference sensitivity for data channels is the signal level at the MS receiver input at which a certain BER must be achieved.

The requirements and this test apply to MS supporting half rate data.

14.2.6.2 Conformance Requirement.

1. At reference sensitivity level, the TCH/H4,8 and TCH/H2,4 BER shall meet the reference sensitivity performance of table 1 in GSM 05.05; (GSM 05.05, 6.2).

14.2.6.3 Test purpose

1. To verify that the MS does not exceed conformance requirement 1 under HT propagation condition with an allowance for the statistical significance of the test.

14.2.6.4 Method of test**14.2.6.4.1 Initial conditions**

A call is set up according to the generic call set up procedure on a TCH with an ARFCN in the Mid ARFCN range. One of the supported TCH/(H4,8 or H2,4) shall be used. The power control level is set to maximum power.

The SS transmits Standard Test Signal C1 on the traffic channel.

The SS commands the MS to create the traffic channel loop back signalling erased frames. (36.2.1.1.1).

14.2.6.4.2 Procedure

- a) The fading function is set to HT.
- b) The SS sets the amplitude of the wanted signal level to reference sensitivity level ().
- c) The SS compares transmitted data with received data for at least the minimum number of samples of consecutive bits and records every error bit as an error event.
- d) The SS sets the wanted signal level to 28 dB μ Vemf.
- e) The SS commands the MS to open the TCH loop.
- f) The SS commands the MS to another of the supported data channels.
- g) Steps b) to f) are repeated for all supported data channels.

14.2.6.5 Test requirements

The Max-events measured for different channels shall not exceed the values given in table 14-12.

Table 14-12: Limits for half rate data channel sensitivity

			GSM 900		DCS 1 800	
Channels	Type of measurements	Propagation	Test limit error rate %	Minimum No of samples	Test limit error rate %	Minimum No of samples
TCH/H4,8	BER	HT	0,778	180000	-	-
TCH/H2,4	BER	HT	0,011	5350000	-	-

14.2.7 Reference sensitivity - TCH/EFS**14.2.7.1 Definition and applicability**

The reference sensitivity is the signal level at the MS receiver input at which a certain BER and FER must be achieved.

The requirements and this test apply to MS supporting speech.

For E-GSM 900 MS this test is only performed in the P-GSM band.

14.2.7.2 Conformance requirement

1. At reference sensitivity level, the TCH/EFS FER shall meet the reference sensitivity performance of table 1 in GSM 05.05; GSM 05.05, 6.2.
2. At reference sensitivity level, the TCH/EFS class I RBER shall meet the reference sensitivity performance of table 1 in GSM 05.05; GSM 05.05, 6.2.

- 3 At reference sensitivity level, the TCH/EFS class II RBER shall meet the reference sensitivity, performance of table 1 in GSM 05.05: GSM 05.05, 6.2.
4. At reference sensitivity level, the TCH/EFS class II RBER shall meet the reference sensitivity, performance of table 1 in GSM under extreme conditions; GSM 05.05, 6.2, GSM 05.05, annex D D.2.1, D.2.2.

14.2.7.3 Test purpose

NOTE: This test is performed under STATIC propagation conditions to allow implicit testing of the ability of the MS to hop over the full band. The tests under dynamic propagation conditions are better suited to test the reference sensitivity conformance but cannot test hopping over the full band due to limited bandwidth of available fading simulators.

1. To verify that the MS does not exceed conformance requirement 1 under STATIC and TUhigh propagation conditions with an allowance for the statistical significance of the test.
2. To verify that the MS does not exceed conformance requirement 2 under STATIC and TUhigh propagation conditions with an allowance for the statistical significance of the test.
3. To verify that the MS does not exceed conformance requirement 3 under STATIC, TUhigh, RA and HT propagation conditions with an allowance for the statistical significance of the test.
4. To verify that the MS does not exceed conformance requirement 4 under STATIC and TUhigh propagation conditions with an allowance for the statistical significance of the test.

14.2.7.4 Method of test

NOTE 1: The BA list sent on the BCCH and SACCH will indicate at least six surrounding cells with at least one near to each band edge. It is not necessary to generate any of these BCCHs but, if provided the signal strengths of BCCHs shall be in the range 15 dBmVemf() to 35 dBmVemf().

NOTE 2: The ARFCN of any BCCH shall not be co-channel or on adjacent channels to the wanted traffic channel.

NOTE 3: When frequency hopping is used, the traffic channel may fall on any of the ARFCNs defined in section 6.

14.2.7.4.1 Initial conditions

A call is set up according to the generic call set up procedure on a TCH/EFS with an ARFCN in the Mid ARFCN range for DCS 1800 and ARFCN 70 for GSM 900, power control level set to maximum power.

NOTE: For GSM 900 ARFCN 70 is tested since this is the 73rd harmonic of the 13 MHz clock normally used internally in a MS.

The SS transmits Standard Test Signal C1 on the traffic channel.

The SS commands the MS to create traffic channel loop back signalling erased frames.

14.2.7.4.2 Procedure

- a) The fading function is set to TUhigh.
- b) the SS sets the amplitude of the wanted signal to reference sensitivity level ().
- c) The SS compares the data of the signal that it sends to the MS with the signal which is looped back from the receiver after demodulation and decoding, and checks the frame erasure indication.

- d) The SS determines the number of residual bit error events for the bits of class II, by examining sequences of at least the minimum number of samples of consecutive bits of class II. Bits are taken only from those frames not signalled as erased.
- e) The SS determines the number of residual bit error events for the bits of the class Ib, by examining sequences of at least the minimum number of samples of consecutive bits of class Ib. Bits are only taken from those frames not signalled as erased.
- f) The SS also determines the frame erasure events by examining sequences of at least the minimum number of samples of consecutive frames and assuming a frame is received successfully, if it is not signalled as erased.
- g) Steps a) to d) are repeated under extreme test conditions.
- h) Steps a) to g) are repeated for TCH/EFS with ARFCNs in the Low ARFCN range for DCS 1800 and ARFCN 5 for GSM 900 and the High ARFCN range.

NOTE: For GSM 900 ARFCN 5 is tested since this is the 72nd harmonic of the 13 MHz clock normally used internally in a MS.

- i) Steps b) to d) are repeated with the SS fading function set in turn to RA and HT.
- j) Steps b) to g) are repeated, with the SS fading function set to static and the MS is commanded by the SS into hopping mode using the hopping sequence defined in section 6.

The amplitude of the wanted signal is set according to step b). All the other time slots, except the active ones, are set to 20 dB above reference sensitivity level(). This implicitly tests adjacent time slot rejection.

14.2.7.5 Test requirements

The error rates measured for different channels and under the different propagation conditions, under any combination of normal and extreme test voltages and ambient temperatures, shall not exceed the test limit error rate values given in table 14-4 or 14-13a, 14-13b:

Table 14-13a: Limits for GSM 900 sensitivity

Channels	Propagation conditions TUhigh		Propagation conditions RA		Propagation conditions HT		Static conditions	
	Test limit error rate %	Minimum No. of samples	Test limit error rate %	Minimum No. of samples	Test limit error rate %	Minimum No. of samples	Test limit error rate %	Minimum No. of samples
TCH/EFS								
FER	8,867	8900					0,122	164000
class Ib(RBER)	0,224	1000000					0,110	20000000
class II (RBER)	7,500	120000	7,500	24000	9,350	60000	2,439	8200

Table 14-13b: Limits for DCS 1 800 sensitivity

Channels	Propagation conditions TUhigh		Propagation conditions RA		Propagation conditions HT		Static conditions	
	Test limit error rate %	Minimum No. of samples	Test limit error rate %	Minimum No. of samples	Test limit error rate %	Minimum No. of samples	Test limit error rate %	Minimum No. of samples
TCH/EFS								
FER	4,475	13400					0,122	164000
class Ib(RBER)	0,130	1500000					0,110	20000000
class II(RBER)	8,333	60000	7,500	24000	9,498	30000	2,439	8200

14.3 Usable receiver input level range

14.3.1 Definition and applicability

The usable receiver input level range is the range of the radio frequency input level of a specified modulated signal over which bit error ratio or frame erasure ratios stay between specified limits.

The requirements and this test apply to MS supporting speech.

14.3.2 Conformance requirement

1. The receiver input level range requirements of GSM 05.05 section 6.1 for TCH/FS class II RBER under static and EQ propagation conditions shall be met:
 - 1.1 Under normal conditions.
 - 1.2 Under extreme conditions.

14.3.3 Test purpose

1. To verify that the MS does not exceed the conformance requirement with an allowance for the statistical significance of the test.
 - 1.1 Under normal conditions.
 - 1.2 Under extreme conditions.

14.3.4 Method of test

14.3.4.1 Initial conditions

A call is set up according to the generic call set up procedure on a TCH/FS with an ARFCN in the Mid ARFCN range, power control level set to maximum.

The SS transmits Standard Test Signal C1 on the TCH/FS.

The SS commands the MS to create traffic channel loop back signalling erased frames. (36.2.1.1.2).

14.3.4.2 Procedure

- a) The SS compares the data that it sends to the MS with the signal which is looped back from the receiver after demodulation and decoding.

The SS tests the bit error ratio for the non-protected bits of TCH/FS class II, by examining sequences of at least the minimum number of samples of consecutive bits of class II. The number of error events is recorded.

- b) Step a) is repeated with the amplitude of the wanted signal increased to an input level at the receiver input of $73 \text{ dB}\mu\text{Vemf}$ ().
- c) Step a) is repeated with the amplitude of the wanted signal increased to an input level at the receiver input of:

GSM 900: $98 \text{ dB}\mu\text{Vemf}$ ()
 DCS 1 800: $90 \text{ dB}\mu\text{Vemf}$ ().

- d) The SS fading function is set to EQ.
- e) Step a) is repeated with the amplitude of the wanted signal set to respectively 20 dB above reference sensitivity level() and $73 \text{ dB}\mu\text{Vemf}$ () at the receiver input.
- f) The test is repeated under extreme test conditions.

14.3.5 Test requirements

The error rate measured in this test shall not exceed the test limit error rate values given in table 14-14. This shall apply for any combination of normal and extreme test voltages and ambient temperature, for the different propagation conditions and for any level of input signal to the receiver.

Table 14-14: Limits for input level range

Propagation conditions	GSM 900		DCS 1 800	
	Test limit error rate %	Minimum No. of samples	Test limit error rate %	Minimum No. of samples
Static ≤ 73 dB μ Vemf()	0,012	1640000	0,012	1640000
Static 98 dB μ Vemf()	0,122	164000		
Static 90 dB μ Vemf()			0,122	164000
EQ	3,25	120000	3,25	60000

14.4 Co-channel rejection

14.4.1 Co-channel rejection - TCH/FS.

14.4.1.1 Definition and applicability

The co-channel rejection is a measure of the capability of the receiver to receive a wanted modulated signal without exceeding a given degradation due to the presence of an unwanted modulated signal, both signals being at the nominal frequency of the receiver.

The requirements and this test apply to MS supporting speech.

14.4.1.2 Conformance requirement

1. At reference co-channel interference the TCH/FS FER shall meet the reference interference performance of table 2 in GSM 05.05; GSM 05.05, 6.3.
2. At reference co-channel interference the TCH/FS class Ib BER shall meet the reference interference performance of table 2 in GSM 05.05; GSM 05.05, 6.3.
3. At reference co-channel interference the TCH/FS class II BER shall meet the reference interference performance of table 2 in GSM 05.05; GSM 05.05, 6.3.

14.4.1.3 Test purpose

1. To verify that the MS does not exceed conformance requirement 1 under propagation condition TUhigh with frequency hopping and TULow with no frequency hopping with an allowance for the statistical significance of the test.
2. To verify that the MS does not exceed conformance requirement 2 under propagation condition TUhigh with frequency hopping and TULow with no frequency hopping, with an allowance for the statistical significance of the test.
3. To verify that the MS does not exceed conformance requirement 3 under propagation condition TUhigh with frequency hopping and TULow with no frequency hopping with an allowance for the statistical significance of the test.

14.4.1.4 Method of test**14.4.1.4.1 Initial conditions**

A call is set up according to the generic call set up procedure on a TCH/FS with an ARFCN in the mid ARFCN range, power control level set to maximum power.

The SS transmits Standard Test Signal C1 on the traffic channel (wanted signal).

The SS commands the MS to create the traffic channel loop back, signalling erased frames. (36.1.2.1.1.1).

14.4.1.4.2 Procedure

- a) In addition to the wanted signal, the SS produces an independent, uncorrelated interfering signal, Standard Test Signal I1 (unwanted signal).

The unwanted signal is continuous and has no fixed relationship with the bit transitions of the wanted signal. Its amplitude is 9 dB below that of the wanted signal.

The fading characteristic of the wanted and the interfering signal is TUlow.

- b) The SS compares the modulation of the signal that it sends to the MS with the signal which is looped back from the receiver after demodulation and decoding, and checks the frame erasure indication.
- c) The SS determines the number of residual bit error events for the bits of class II, by examining at least the minimum number of samples of consecutive bits of class II. Bits are taken only from those frames not signalled as erased.
- d) The SS determines the number of residual bit error events for the bits of the class Ib, by examining at least the minimum number of samples of consecutive bits of class Ib. Bits are only taken from those frames not signalled as erased.
- e) The SS also determines the frame erasure events by examining at least the minimum number of samples of consecutive frames and assuming a frame is received successfully it is not signalled as erased.
- f) Steps a) to e) are repeated except that in step a) both the wanted and interfering signal are TUhigh hopping and the SS commands the MS into hopping mode. A hop pattern covering at least 10 frequencies in a range not exceeding 5 MHz is used.

The hopping band is centred around an ARFCN in the Mid ARFCN range. The hopping frequencies are chosen from those defined in section 6.

14.4.1.5 Test requirements

The error rate measured in this test shall not exceed the test limit error rate values given in table 14-15.

Table 14-15: Limits for co-channel rejection

Channel	Type of measurement	Propagation condition	Test limit error rate %	Minimum No. of samples
TCH/FS	FER	TUlow/No FH	$24^* \alpha$	25000
TCH/FS Class Ib	RBER	TUlow/No FH	$2,091/\alpha$	3300000
TCH/FS Class II	RBER	TUlow/No FH	4,3	2000000
TCH/FS	FER	TUhigh/FH	$3,371^* \alpha$	17800
TCH/FS class Ib	RBER	TUhigh/FH	$0,215/\alpha$	2000000
TCH/FS class II	RBER	TUhigh/FH	8,333	1200000

The parameter α can range from 1 to 1.6. The value of α for the RBER test on TCH/FS class Ib bits under particular measurement conditions shall be the same as that determined in the FER test on TCH/FS under the same conditions.

14.4.2 Co-channel rejection - TCH/HS

14.4.2.1 Definition and applicability

The requirements and this test apply to MS supporting half rate speech.

14.4.2.2 Conformance requirement

1. At reference cochannel interference, the TCH/HS FER (shall meet the reference interference performance of table 2 in GSM 05.05; GSM 05.05, 6.3.
2. At reference cochannel interference, the TCH/HS class Ib BER (BFI=0) shall meet the reference interference performance of table 2 in GSM 05.05; GSM 05.05, 6.3.
3. At reference cochannel interference, the TCH/HS class II BER (BFI=0) shall meet the reference interference performance of table 2 in GSM 05.05; GSM 05.05, 6.3.
4. At reference cochannel interference, the TCH/HS UFR shall meet the reference interference performance of table 2 in GSM 05.05; GSM 05.05, 6.3.
5. At reference cochannel interference, the TCH/HS class Ib RBER ((BFI or UFI)=0) shall meet the reference interference performance of table 2 in GSM 05.05; GSM 05.05, 6.3.

14.4.2.3 Test purpose

1. To verify that the MS does not exceed conformance requirement 1, under propagation conditions TUhigh with frequency hopping, with an allowance for the statistical significance of the test.
2. To verify that the MS does not exceed conformance requirement 1, under propagation conditions TUhigh with frequency hopping, with an allowance for the statistical significance of the test.
3. To verify that the MS does not exceed conformance requirement 1, under propagation conditions TUhigh with frequency hopping, with an allowance for the statistical significance of the test.
4. To verify that the MS does not exceed conformance requirement 4, under propagation condition TUhigh with frequency hopping, with an allowance for the statistical significance of the test.
5. To verify that the MS does not exceed conformance requirement 4, under propagation condition TUhigh with frequency hopping, with an allowance for the statistical significance of the test.

14.4.2.4 Method of test

14.4.2.4.1 Initial conditions

A call is set up according to the generic call set up procedure on a TCH/HS with an ARFCN in the mid ARFCN range, power control level set to maximum power.

The SS transmits Standard Test Signal C1 on the traffic channel (wanted signal).

14.4.2.4.2 Procedure

- a) In addition to the wanted signal, the SS produces an independent, uncorrelated interfering signal, Standard Test Signal I1 (unwanted signal).

The unwanted signal is continuous and has no fixed relationship with the bit transitions of the wanted signal. Its amplitude is 9 dB below that of the wanted signal.

- b) The fading characteristic of the wanted and the interfering signal is set to TUhigh. The SS commands the MS into hopping mode. A hop pattern covering at least 10 frequencies in a range not exceeding 5 MHz is used.

The hopping pattern is centred around an ARFCN in the Mid ARFCN range. The hopping frequencies are chosen from those defined in section 6.

- c) The SS commands the MS to create traffic channel loop back signalling erased frames using test loop A.

NOTE: Test loop A is defined in clause 36. Frames marked with BFI=1 are signalled as erased on the uplink.

- d) The SS compares the modulation of the signal that it sends to the MS with the signal which is looped back from the receiver after demodulation and decoding, and checks the frame erasure indication.
- e) The SS determines the number of residual bit error events for the bits of class II, by examining at least the minimum number of samples of consecutive bits of class II. Bits are taken only from those frames not signalled as erased.
- f) The SS determines the number of residual bit error events for the bits of the class Ib, by examining at least the minimum number of samples of consecutive bits of class Ib. Bits are only taken from those frames not signalled as erased.
- g) The SS also determines the frame erasure events by examining at least the minimum number of samples of consecutive frames and assuming a frame is received successfully it is not signalled as erased.
- h) The SS commands the MS to open test loop A and close test loop D.
- NOTE: Test loop D is defined in clause 36. Frames marked as erased (BFI=1), or unreliable (UFI=1), are signalled to the SS on the uplink.
- j) The SS compares the data of the signal that it sends to the MS with the signal which is looped back from the receiver after demodulation and decoding, and checks the erased/unreliable frame indication.
- k) The SS determines the number of residual bit error events for the bits of the class Ib, by examining sequences of at least the minimum number of samples of consecutive bits of class Ib. Bits are only taken from those frames not signalled as erased/unreliable.
- l) The SS also determines the unreliable frame events by examining sequences of at least the minimum number of samples of consecutive frames and assuming a frame is received successfully it is not signalled as erased/unreliable.

14.4.2.5 Test requirements

The error rate measured in this test shall not exceed the test limit error rate values given in table 14-16 or table 14-17.

Table 14-16: Limits for GSM 900 co-channel rejection

Channel/Type of measurement	Propagation condition	Test limit error rate %	Minimum No. of samples
TCH/HS FER	TUhigh/FH	5,607	10700
TCH/HS Class Ib RBER (BFI=0)	TUhigh/FH	0,325	184700
TCH/HS Class II RBER (BFI=0)	TUhigh/FH	7,961	25500
TCH/HS UFR	TUhigh/FH	6,834	8780
TCH/HS Class Ib RBER ((BFI or UFI)=0)	TUhigh/FH	0,235	255000

Table 14-17: Limits for DCS 1800 co-channel rejection

Channel/Type of measurement	Propagation condition	Test limit error rate %	Minimum No. of samples
TCH/HS FER	TUhigh/FH	5,607	10700
TCH/HS Class Ib RBER (BFI=0)	TUhigh/FH	0,325	184700
TCH/HS Class II RBER (BFI=0)	TUhigh/FH	7,961	25500
TCH/HS UFR	TUhigh/FH	6,834	8780
TCH/HS Class Ib RBER ((BFI or UFI)=0)	TUhigh/FH	0,235	255000

14.4.3 Co-channel rejection - TCH/HS (SID frames)

14.4.3.1 Definition and applicability

The requirements and this test apply to MS supporting half rate speech.

14.4.3.2 Conformance requirement

1. At reference cochannel interference, the TCH/HS ESIDR, for SID frames indicated as SID=0 shall meet the reference interference performance of table 2 in GSM 05.05; GSM 05.05, 6.3.
2. At reference cochannel interference, the TCH/HS RBER for SID frames indicated as SID=1 or SID=2, shall meet the reference interference performance of table 2 in GSM 05.05; GSM 05.05, 6.3.
3. At reference cochannel interference, the TCH/HS EVSIDR for SID frames indicated as (SID=0), or (SID=1), or ((BFI or UFI)=1), shall meet the reference interference performance of table 2 in GSM 05.05; GSM 05.05, 6.3.
4. At reference cochannel interference, the TCH/HS RBER for SID frames indicated as SID=2 and (BFI or UFI)=0, shall meet the reference interference performance of table 2 in GSM 05.05; GSM 05.05, 6.3.

14.4.3.3 Test purpose

1. To verify that the MS does not exceed conformance requirement 1 under propagation condition TUlow, with an allowance for the statistical significance of the test.
2. To verify that the MS does not exceed conformance requirement 2 under propagation condition TUlow, with an allowance for the statistical significance of the test.
3. To verify that the MS does not exceed conformance requirement 3 under propagation condition TUlow, with an allowance for the statistical significance of the test.
4. To verify that the MS does not exceed conformance requirement 4 under propagation condition TUlow, with an allowance for the statistical significance of the test.

14.4.3.4 Method of test

14.4.3.4.1 Initial conditions

The BCCH data indicates that uplink DTX shall be disabled.

A call is set up according to the generic call set up procedure on a TCH/HS with an ARFCN in the mid ARFCN range, power control level set to maximum power.

The SS transmits Standard Test Signal C1 on the traffic channel.

14.4.3.4.2 Procedure

- a) In addition to the wanted signal, the SS produces an independent, uncorrelated interfering signal, Standard Test Signal I1 (unwanted signal).

The unwanted signal is continuous and has no fixed relationship with the bit transitions of the wanted signal. Its amplitude is 9 dB below that of the wanted signal.

- b) The fading function is set to TUlow.
- c) The SS commands the MS to create traffic channel loop back signalling erased frames using test loop E.

NOTE: Test loop E is defined in clause 36. Frames marked with (SID=0) shall be signalled as erased on the uplink.

- d) The SS transmits continuously SID frames on the downlink. The SID codeword is transmitted correctly, but the SID information contains random data.
- e) The SS compares the data of the signal that it sends to the MS with the signal which is looped back from the receiver after demodulation and decoding, and checks the frame erasure indication.
- f) The SS determines the number of residual bit error events for the class 1 SID bits, which do not belong to the SID codeword, by examining sequences of at least the minimum number of samples of consecutive class 1 SID bits. Bits are taken only from those frames not signalled as erased.
- g) The SS also determines the erased SID events by examining sequences of at least the minimum number of samples of consecutive frames and assuming a frame is received successfully it is not signalled as erased. Bits comprising the SID codeword are excluded.
- h) The SS commands the MS to open test loop E and close test loop F.

NOTE: Test loop F is defined in clause 36. Frames marked with (SID=0), or (SID=1), or ((BFI or UFI)=1), shall be signalled as erased on the uplink.

- j) The SS compares the data of the signal that it sends to the MS with the signal which is looped back from the receiver after demodulation and decoding, and checks the frame erasure indication.
- k) The SS determines the number of residual bit error events for the class 1 SID bits, which do not belong to the SID codeword, by examining sequences of at least the minimum number of samples of consecutive class 1 SID bits. Bits are taken only from those frames not signalled as erased.
- l) The SS also determines the erased valid SID events by examining sequences of at least the minimum number of samples of consecutive frames and assuming a frame is received successfully it is not signalled as erased.

14.4.3.5 Test requirements

The error rates measured in this test shall not exceed the test limit error rate values given in table 14-18.

Table 14-18: Limits for co-channel rejection

Channel/Type of measurement	Propagation condition	Test limit error rate %	Minimum No. of samples
ESIDR	TUlow	19,152	25000
SID RBER (SID=1 or 2)	TUlow	0,560	50000
EVSIDR	TUlow	24,000	25000
SID RBER (SID=2 and (BFI or UFI)=0)	TUlow	0,022	2678000

14.4.4 Co-channel rejection - FACCH/F**14.4.4.1 Definition and applicability**

The co-channel rejection is a measure of the capability of the receiver to receive a wanted modulated signal without exceeding a given degradation due to the presence of an unwanted modulated signal, both signals being at the nominal frequency of the receiver.

The requirements and this test apply to all types of MS.

14.4.4.2 Conformance requirement

At reference cochannel interference the FACCH/F FER shall meet the reference interference performance of table 2 in GSM 05.05; (GSM 05.05, 6.3).

14.4.4.3 Test purpose

To verify that the MS does not exceed the conformance requirement under propagation condition TUlow with an allowance for the statistical significance of the test.

14.4.4.4 Method of test**14.4.4.4.1 Initial conditions**

A call is set up according to the generic call set up procedure on a TCH with an ARFCN in the mid ARFCN range. For MS supporting speech this shall be a TCH/FS. For MS not supporting speech one of the supported TCH/ (F9,6, F4,8, or F2,4) shall be used. The power control level is set to maximum power.

The SS transmits Standard Test Signal C1 on the traffic channel (wanted signal).

14.4.4.4.2 Procedure

- a) In addition to the wanted signal, the SS produces an independent, uncorrelated interfering signal, Standard Test Signal I1 (unwanted signal).

The unwanted signal is continuous and has no fixed relationship with the bit transitions of the wanted signal. Its amplitude is 9 dB below that of the wanted signal.

The fading characteristic of the wanted and the interfering signal is TUlow.

- d) The SS sends a Layer 3 message which does not require a Layer 3 response from the MS. Due to the co-channel interference, the MS may not be able to acknowledge the Layer 2 frame. Each repeated L2 frame indicates a frame erasure event. The SS determines the number of frame erasure events during at least the minimum number of samples of FACCH/F frames.

NOTE: These frames will not be consecutive but it is expected that the statistical significance of the tests will not be unduly degraded.

14.4.4.5 Test requirements

The error rate measured in this test shall not exceed the test limit error rate values given in table 14-14.

Table 14-19: Limits for co-channel rejection

Channel	Type of measurement	Propagation condition	Test limit error rate %	Minimum No. of samples
FACCH/F	FER	TUlow/No FH	24	25000

14.4.5 Co-channel rejection - FACCH/H**14.4.5.1 Definition and applicability**

The requirements and this test apply to MS supporting half rate channels.

14.4.5.2 Conformance requirement

At reference cochannel interference the FACCH/H FER shall meet the reference interference performance of table 2 in GSM 05.05; (GSM 05.05, 6.3).

14.4.5.3 Test purpose

To verify that the MS does not exceed the conformance requirement under propagation condition TUlow with an allowance for the statistical significance of the test.

14.4.5.4 Method of test**14.4.5.4.1 Initial conditions**

A call is set up according to the generic call set up procedure on a TCH with an ARFCN in the mid ARFCN range. For MS supporting half rate speech this shall be a TCH/HS. For MS not supporting speech one of the supported TCH/(H4,8, or H2,4) shall be used. The power control level is set to maximum power.

The SS transmits Standard Test Signal C1 on the traffic channel (wanted signal).

14.4.5.4.2 Procedure

- a) In addition to the wanted signal, the SS produces an independent, uncorrelated interfering signal, Standard Test Signal I1 (unwanted signal).

The unwanted signal is continuous and has no fixed relationship with the bit transitions of the wanted signal. Its amplitude is 9 dB below that of the wanted signal.

The fading characteristic of the wanted and the interfering signal is TUlow.

- d) The SS sends a Layer 3 message which does not require a Layer 3 response from the MS. Due to the co-channel interference, the MS may not be able to acknowledge the Layer 2 frame. Each repeated L2 frame indicates a frame erasure event. The SS determines the number of frame erasure events during at least the minimum number of samples of FACCH/H frames.

NOTE: These frames will not be consecutive but it is expected that the statistical significance of the tests will not be unduly degrade.

14.4.5.5 Test requirements

The error rate measured in this test shall not exceed the test limit error rate values given in table 14-20.

Table 14-20: Limits for co-channel rejection

Channel	Type of measurement	Propagation condition	Test limit error rate %	Minimum No. of samples
FACCH/H	FER	TUlow/No FH	24,000	25000

14.4.6 Co-channel rejection - TCH/EFS.

14.4.6.1 Definition and applicability

The co-channel rejection is a measure of the capability of the receiver to receive a wanted modulated signal without exceeding a given degradation due to the presence of an unwanted modulated signal, both signals being at the nominal frequency of the receiver.

The requirements and this test apply to MS supporting speech.

14.4.6.2 Conformance requirement

1. At reference co-channel interference the TCH/EFS FER shall meet the reference interference performance of table 2 in GSM 05.05; GSM 05.05, 6.3.
2. At reference co-channel interference the TCH/EFS class Ib BER shall meet the reference interference performance of table 2 in GSM 05.05; GSM 05.05, 6.3.
3. At reference co-channel interference the TCH/EFS class II BER shall meet the reference interference performance of table 2 in GSM 05.05; GSM 05.05, 6.3.

14.4.6.3 Test purpose

1. To verify that the MS does not exceed conformance requirement 1 under propagation condition TUhigh with frequency hopping and TULow with no frequency hopping with an allowance for the statistical significance of the test.
2. To verify that the MS does not exceed conformance requirement 2 under propagation condition TUhigh with frequency hopping and TULow with no frequency hopping, with an allowance for the statistical significance of the test.
3. To verify that the MS does not exceed conformance requirement 3 under propagation condition TUhigh with frequency hopping and TULow with no frequency hopping with an allowance for the statistical significance of the test.

14.4.6.4 Method of test

14.4.6.4.1 Initial conditions

A call is set up according to the generic call set up procedure on a TCH/EFS with an ARFCN in the mid ARFCN range, power control level set to maximum power.

The SS transmits Standard Test Signal C1 on the traffic channel (wanted signal).

The SS commands the MS to create the traffic channel loop back, signalling erased frames. (36.1.2.1.1.1).

14.4.6.4.2 Procedure

- a) In addition to the wanted signal, the SS produces an independent, uncorrelated interfering signal, Standard Test Signal I1 (unwanted signal).

The unwanted signal is continuous and has no fixed relationship with the bit transitions of the wanted signal. Its amplitude is 9 dB below that of the wanted signal.

The fading characteristic of the wanted and the interfering signal is TULow.

- b) The SS compares the modulation of the signal that it sends to the MS with the signal which is looped back from the receiver after demodulation and decoding, and checks the frame erasure indication.

- c) The SS determines the number of residual bit error events for the bits of class II, by examining at least the minimum number of samples of consecutive bits of class II. Bits are taken only from those frames not signalled as erased.
- d) The SS determines the number of residual bit error events for the bits of the class Ib, by examining at least the minimum number of samples of consecutive bits of class Ib. Bits are only taken from those frames not signalled as erased.
- e) The SS also determines the frame erasure events by examining at least the minimum number of samples of consecutive frames and assuming a frame is received successfully it is not signalled as erased.
- f) Steps a) to e) are repeated except that in step a) both the wanted and interfering signal are TUhigh hopping and the SS commands the MS into hopping mode. A hop pattern covering at least 10 frequencies in a range not exceeding 5 MHz is used.

The hopping band is centred around an ARFCN in the Mid ARFCN range. The hopping frequencies are chosen from those defined in section 6.

14.4.6.5 Test requirements

The error rate measured in this test shall not exceed the test limit error rate values given in table 14-21.

Table 14-21: Limits for co-channel rejection

Channel	Type of measurement	Propagation condition	Test limit error rate %	Minimum No. of samples
TCH/EFS	FER	TUlow/No FH	24	25000
TCH/EFS Class Ib	RBER	TUlow/No FH	0,209	3300000
TCH/EFS Class II	RBER	TUlow/No FH	3,039	2000000
TCH/EFS	FER	TUhigh/FH	3,357	17800
TCH/EFS class Ib	RBER	TUhigh/FH	0,115	2000000
TCH/EFS class II	RBER	TUhigh/FH	8,333	1200000

14.5 Adjacent channel rejection

14.5.1 Adjacent channel rejection - speech channels

14.5.1.1 Definition and applicability

The adjacent channel selectivity is a measure of the capability of the receiver to receive a wanted modulated signal without exceeding a given degradation due to the presence of an unwanted signal in the adjacent channel.

The adjacent channel can be adjacent in the RF spectrum or in time. There are therefore two types of adjacent channel selectivity:

- 1) Adjacent RF channel selectivity which is specifically tested in this section.
- 2) Adjacent Time Slot selectivity, which is implicitly tested in test .2.1.

The requirements and this test apply to MS supporting speech.

14.5.1.2 Conformance requirement

1. With adjacent channel interference at 200 kHz above and below the wanted signal and signal level 9 dB above the wanted signal level:
 - 1.1 For a TUhigh faded wanted signal and a TUhigh adjacent channel interferer, the FER for TCH/FS shall be within the requirements of table 2 in GSM 05.05; GSM 05.05, 6.3.

- 1.2 For a TUhigh faded wanted signal and a TUhigh adjacent channel interferer, the Class Ib RBER shall be within the requirements of table 2 in GSM 05.05; GSM 05.05, 6.3.
 - 1.3 For a TUhigh faded wanted signal and a TUhigh adjacent channel interferer, the Class II RBER shall be within the requirements of table 2 in GSM 05.05; GSM 05.05, 6.3.
 - 1.4 For a TUhigh faded wanted signal and a TUhigh adjacent channel interferer, the Class II RBER shall be within the requirements of table 2 in GSM 05.05 under extreme test conditions; GSM 05.05, 6.3, GSM 05.05, annex D D.2.1, D.2.2.
2. For adjacent channel interference at 400 kHz above and below the wanted signal frequency and signal level 41 dB above the wanted signal level:
 - 2.1 For a TUhigh faded wanted signal and a static adjacent channel interferer, the FER for TCH/FS shall be better than:
 GSM 900: $10,2 \cdot \alpha$ %; GSM 05.05, 6.3
 DCS 1 800: $5,1 \cdot \alpha$ %; GSM 05.05, 6.3.
 - 2.2 For a TUhigh faded wanted signal and a static adjacent channel interferer, the Class Ib RBER shall be better than:
 GSM 900: $0,72/\alpha$ %; GSM 05.05, 6.3
 DCS 1 800: $0,45/\alpha$ %; GSM 05.05, 6.3.
 - 2.3 For a TUhigh faded wanted signal and a static adjacent channel interferer, the Class II RBER shall be better than:
 GSM 900: 8,8 %; GSM 05.05, 6.3
 DCS 1 800: 8,9 %; GSM 05.05, 6.3.
 - 2.4 For a TUhigh faded wanted signal and a static adjacent channel interferer, the Class II RBER shall be better than:
 GSM 900: 8,8 %;
 DCS 1 800: 8,9 %;.

under extreme test conditions; GSM 05.05, 6.3, annex D D.2.1, D.2.2.

14.5.1.3 Test purpose

- 1 To verify that with a TUhigh adjacent channel interferer at 200 kHz above and below the wanted TUhigh signal frequency and signal level 9 dB above the wanted signal level:
 - 1.1 Conformance requirement 1.1 is met with an allowance for the statistical significance of the test.
 - 1.2 Conformance requirement 1.2 is met with an allowance for the statistical significance of the test.
 - 1.3 Conformance requirement 1.3 is met with an allowance for the statistical significance of the test.
 - 1.4 Conformance requirement 1.4 is met with an allowance for the statistical significance of the test.
2. To verify that with a static adjacent channel interferer at 400 kHz above and below a TUhigh wanted signal frequency and signal level 41 dB above the wanted signal level:
 - 2.1 Conformance requirement 2.1 is met with an allowance for the statistical significance of the test.
 - 2.2 Conformance requirement 2.2 is met with an allowance for the statistical significance of the test.
 - 2.3 Conformance requirement 2.3 is met with an allowance for the statistical significance of the test.
 - 2.4 Conformance requirement 2.4 is met with an allowance for the statistical significance of the test.

14.5.1.4 Method of test**14.5.1.4.1 Initial conditions**

A call is set up according to the generic call set up procedure on a TCH/FS with an ARFCN in the mid ARFCN range, power control level set to maximum power.

The SS commands the MS to create the traffic channel loop back signalling erased frames.

The SS transmits Standard Test Signal C1 on the TCH (wanted signal).

14.5.1.4.2 Procedure

- a) In addition to the wanted signal, the SS transmits an independent, uncorrelated interfering signal, Standard Test Signal I1 (unwanted signal).

The unwanted signal is continuous and has no fixed relationship with the bit transitions of the wanted signal.

The fading characteristic of the wanted and the unwanted signal is set to TUhigh.

The unwanted signal is transmitted at a nominal frequency 200 kHz above the nominal frequency of the wanted signal. Its amplitude is set to 9dB above that of the wanted signal.

- b) The SS compares the data of the signal that it sends to the MS with the signal which is looped back from the receiver after demodulation and decoding, and checks the frame erasure indication.
- c) The SS tests the frame erasure compliance for the TCH/FS by examining at least the minimum number of samples of consecutive frames. The number of frame erasure events is recorded.
- d) The SS determines the number of residual bit error events for the bits of the class Ib and class II, by examining sequences of at least the minimum number of samples of consecutive bits of class Ib and class II, Bits are only taken from those frames for which no bad frame indication was given.
- e) The measurement of steps c) and d) is repeated with the unwanted signal on a frequency at the same displacement from, but below, the frequency of the wanted signal.
- f) The measurement of steps c) to e) shall be repeated for a displacement of the unwanted signal of 400 kHz, and with the amplitude of the unwanted signal 41 dB above the level of the wanted input signal, and the unwanted signal static.
- g) Steps c) to f) are repeated under extreme test conditions.

14.5.1.5 Test requirements**Table 14-22: Limits for adjacent channel selectivity**

Interference at	Channel	Type of measurement	GSM 900		DCS 1 800	
			Test limit error rate %	Minimum No. of samples	Test limit error rate %	Minimum No. of samples
200 kHz	TCH/FS	FER	6,742* α	8900	3,371* α	17800
	class Ib	RBER	0,420/ α	1000000	0,270/ α	2000000
	class II	RBER	8,333	600000	8,333	1200000
400 kHz	TCH/FS	FER	11,461* α	8900	5,714* α	10500
	class Ib	RBER	0,756/ α	1000000	0,483/ α	1200000
	class II	RBER	9,167	600000	9,167	720000

The error rates measured in this test shall not exceed the test limit error rate given in table 14-22. This shall apply for any combination of normal and extreme test voltages and ambient temperature, and with the interfering signals at either side of the wanted frequency.

The parameter α can range from 1 to 1,6. The value of α for the RBER test on TCH/FS class 1b bits under particular measurement conditions shall be the same as that determined in the FER test on TCH/FS under the same conditions.

NOTE: A static unwanted signal is used to avoid a potential problem with the implementation of the fading simulator.

14.5.2 Adjacent channel rejection - control channels

14.5.2.1 Definition and applicability

The adjacent channel selectivity is a measure of the capability of the receiver to receive a wanted modulated signal without exceeding a given degradation due to the presence of an unwanted signal in the adjacent channel.

The adjacent channel can be the adjacent in the RF spectrum or in time. There are therefore two types of adjacent channel selectivity:

- 1) Adjacent RF channel selectivity which is specifically tested in this section.
- 2) Adjacent Time Slot selectivity, which is implicitly tested in test 14.2.1.

The requirements and this test apply to MS not supporting speech.

14.5.2.2 Conformance requirement

1. For adjacent channel interference at 200 kHz above and below the wanted signal frequency and signal level 9 dB above the wanted signal level:
 - 1.1 For a TUhigh faded wanted signal and a TUhigh adjacent channel interferer, the FER for the FACCH/F does not exceed the requirements of table 2 in GSM 05.05; GSM 05.05, 6.3.
 - 1.2 For a TUhigh faded wanted signal and a TUhigh adjacent channel interferer, the FER for the FACCH/F does not exceed the requirements of table 2 in GSM 05.05 under extreme test conditions; GSM 05.05, 6.3, annex D D.2.1, D.2.2.
2. With adjacent channel interference at 400 kHz above and below the wanted signal frequency and signal level 41 dB above the wanted signal level:
 - 2.1 For a TUhigh faded wanted signal and a static adjacent channel interferer, the FER for the FACCH/F shall be better than:
GSM 900: 17,1 %; GSM 05.05, 6.3
DCS 1 800: 6,1 %; GSM 05.05, 6.3.
 - 2.2 For a TUhigh faded wanted signal and a static adjacent channel interferer, the FACCH/F shall be better than:
GSM 900: 17,1 %
DCS 1 800: 6,1 %.

under extreme test conditions; GSM 05.05, 6.3, annex D D.2.1, D.2.2.

14.5.2.3 Test purpose

1. To verify that with TUhigh adjacent channel interference at 200 kHz above and below a TUhigh wanted signal frequency and signal level 9 dB above the wanted signal level:
 - 1.1 Conformance requirement 1.1 is met with an allowance for the statistical significance of the test.
 - 1.2 Conformance requirement 1.2 is met with an allowance for the statistical significance of the test.
2. To verify that with static adjacent channel interference at 400 kHz above and below a TUhigh wanted signal frequency and signal level 41 dB above the wanted signal level:

- 2.1 Conformance requirement 2.1 is met with an allowance for the statistical significance of the test.
- 2.2 Conformance requirement 2.2 is met with an allowance for the statistical significance of the test.

14.5.2.4 Method of test

14.5.2.4.1 Initial conditions

A call is set up according to the generic call set up procedure on a TCH in the mid ARFCN range. Any one of the supported TCH/(F9,6, F4,8, or F2,4) shall be used.

The SS transmits the Standard Test Signal C1 on the TCH (wanted signal).

14.5.2.4.2 Procedure

- a) In addition to the wanted signal, the SS transmits an independent, uncorrelated interfering signal, Standard Test Signal I1 (unwanted signal).

The unwanted signal is continuous and has no fixed relationship with the bit transitions of the wanted signal. The fading characteristic of the wanted and the unwanted signal is TUhigh.

The unwanted signal is transmitted at a nominal frequency 200 kHz above the nominal frequency of the wanted signal. Its amplitude is set to 9dB above that of the wanted signal.

- b) The SS sends a Layer 3 message which does not require a Layer 3 response from the MS. Due to the adjacent channel interference, the MS may not be able to acknowledge the Layer 2 frame. Each repeated L2 frame indicates a frame erasure event. The SS determines the number of frame erasure events during at least the minimum number of samples of FACCH/F frames.

NOTE: These frames will not be consecutive but it is expected that the statistical significance of the tests will not be unduly degraded.

- c) The measurement of step b) is repeated with the unwanted signal on a frequency at the same displacement from, but below, the frequency of the wanted signal.
- d) The measurement of steps a) to c) is repeated for a displacement of the unwanted signal of 400 kHz, and with the amplitude of the unwanted signal 41 dB above the level of the wanted input signal, and the unwanted signal static.
- e) Steps a) to d) are repeated under extreme test conditions.

14.5.2.5 Test requirements

Table 14-23: Limits for adjacent channel selectivity

Interference at	Channel	Type of measurement	GSM 900		DCS 1 800	
			Test limit error rate %	Minimum No. of samples	Test limit error rate %	Minimum No. of samples
200 kHz	FACCH/F	FER	10,640	5639	3,808	15756
400 kHz	FACCH/F	FER	19,152	3133	6,832	8782

The error rates measured in this test shall not exceed the test limit error rates given in table 14-23. This shall apply for any combination of normal and extreme test voltages and ambient temperature, and with the interfering signals at either side of the wanted frequency.

NOTE: A static unwanted signal is used to avoid a potential problem with the noise floor of the fading simulator.

14.6 Intermodulation rejection

14.6.1 Intermodulation rejection - speech channels

14.6.1.1 Definition and applicability

The intermodulation rejection is a measure of the capability of the receiver to receive a wanted modulated signal without exceeding a given degradation due to the presence of two or more unwanted signals with a specific frequency relationship to the wanted signal frequency.

The requirements and this test apply to MS supporting speech.

For E-GSM 900 MS this test is only performed in the P-GSM band.

14.6.1.2 Conformance requirement

In the presence of two unwanted signals with a specific frequency relationship to the wanted signal frequency the Class II RBER for TCH/FS shall meet the reference sensitivity performance of table 1 in GSM 05.05; GSM 05.05, 5.2.

14.6.1.3 Test purpose

To verify that the MS does not exceed the conformance requirement with an allowance for the statistical significance of the test.

14.6.1.4 Method of test

NOTE: The measurements address the third order intermodulation, which represents the most serious case.

14.6.1.4.1 Initial conditions

A call is set up according to the generic call set up procedure on a TCH with an ARFCN in the Mid ARFCN range, power control level set to maximum power.

The SS transmits Standard Test Signal C1 on the traffic channel.

14.6.1.4.2 Procedure

- a) The amplitude of the wanted signal is set to 4 dB above the reference sensitivity level (see table 14-24).
- b) The SS commands the MS to create the loop back facility signalling erased frames.
- c) The SS produces a static wanted signal, and two static interfering (unwanted) signals at the same time. There is no correlation in the modulation between the signals.

The first interfering signal is on a frequency equal to the centre frequency of an ARFCN four above that of the receiver. This signal is static and unmodulated.

The second interfering signal is on an ARFCN eight above that of the receiver. This signal is static, continuous and modulated by random data.

The amplitude of both the interfering signals is set according to table 14-24.

- d) The SS compares the data of the signal that it sends to the MS with the signal which is looped back from the receiver after demodulation and decoding, and checks the frame erasure indication.

The SS tests the RBER compliance of class II bits by examining at least the minimum number of samples of consecutive bits. Bits only taken from those frames which do not signal frame erasure. The number of error events is recorded.

- e) The measurement of step d) is repeated with the two unwanted signals having frequencies corresponding to ARFCN four and eight below the ARFCN of the wanted signal.
- f) Steps b) to e), are repeated but with the receiver operating on an ARFCN in the Low ARFCN range.
- g) Steps b) to e), are repeated but with the receiver operating on an ARFCN in the High ARFCN range.
- h) Steps a) to g) are repeated under extreme test conditions.

Table 14-24: Intermodulation test signal levels

	GSM 900		DCS 1 800	
	Small MS	Other MS	Class 1 & 2	Class 3
WANTED SIGNAL dB μ Vemf()	15	13	17	15
FIRST INTERFERER dB μ Vemf()	64	74	64	68
SECOND INTERFERER dB μ Vemf()	63	63	64	68

NOTE: Some of the levels in table 14-24 are different to those specified in GSM 05.05 due to the consideration of the effect of modulation sideband noise from the second interferer.

14.6.1.5 Test requirements

The error rate measured in this test shall not exceed the test limit error rate values given in table 14-25.

This shall apply under normal condition and under any combination of normal and extreme test voltages and ambient temperature, and with the two interfering signals at either side of the wanted frequency.

Table 14-25: Limits for intermodulation rejection

Channel	Propagation conditions	Type of measurement	Test limit error rate %	Minimum No. of samples
TCH/FS Class II	Static	RBER	2,439	8200

14.6.2 Intermodulation rejection - control channels

14.6.2.1 Definition and applicability

The intermodulation rejection is a measure of the capability of the receiver to receive a wanted modulated signal without exceeding a given degradation due to the presence of two or more unwanted signals with a specific frequency relationship to the wanted signal frequency.

The requirements and this test apply to MS not supporting speech.

For E-GSM 900 MS this test is only performed in the P-GSM band.

14.6.2.2 Conformance requirement

In the presence of two unwanted signals with a specific frequency relationship to the wanted signal frequency the FER for FACCH/F shall meet the reference sensitivity performance of table 1 in GSM 05.05; GSM 05.05, 5.2.

14.6.2.3 Test purpose

To verify that the MS does not exceed the conformance requirement with an allowance for the statistical significance of the test.

14.6.2.4 Method of test

NOTE: The measurements address the third order intermodulation, which represents the most serious case.

14.6.2.4.1 Initial conditions

A call is set up according to the generic call set up procedure on a TCH with an ARFCN in the Mid ARFCN range, power control level set to maximum.

The SS transmits Standard Test Signal C1 on the traffic channel. The amplitude of the wanted signal is set to 4 dB above the reference sensitivity level (see table 14-25).

14.6.2.4.2 Procedure

- a) The SS produces a TUhigh wanted signal, and two static interfering (unwanted) signals at the same time. There is no correlation in the modulation between the signals. The first interfering signal is on a frequency equal to the centre frequency of an ARFCN four above that of the receiver. This signal is static and unmodulated.

The second interfering signal is on an ARFCN eight above that of the receiver. This signal is static, continuous and modulated by random data.

The amplitude of both the interfering signals is set according to table 14-26.

- b) The SS sends a Layer 3 message which does not require a Layer 3 response from the MS. The SS determines the number of frame erasure events during at least the minimum number of samples of FACCH/F frames.

NOTE: These frames will not be consecutive but it is expected that the statistical significance of the tests will not be unduly degraded.

- c) The measurement of step b) is repeated with the two unwanted signals having frequencies corresponding to ARFCN four and eight below the ARFCN of the wanted signal.
- d) Steps a) to c), are repeated but with the receiver operating on an ARFCN in the Low ARFCN range.
- e) Steps a) to c), are repeated but with the receiver operating on an ARFCN in the High ARFCN range.
- f) Steps a) to e) are repeated under extreme test conditions.

Table 14-26: Intermodulation test signal levels

	GSM 900		DCS 1 800	
	Small MS	Other MS	Class 1 & 2	Class 3
WANTED SIGNAL dB μ Vemf()	15	13	17	15
FIRST INTERFERER dB μ Vemf()	64	74	64	68
SECOND INTERFERER dB μ Vemf()	63	63	64	68

NOTE: Some of the levels in table 14-26 are different to those specified in GSM 05.05 due to the consideration of the effect of modulation sideband noise from the second interferer.

14.6.2.5 Test requirements

The error rate measured in this test shall not exceed the test limit error rate values given in table 14-27.

This shall apply under normal condition and under any combination of normal and extreme test voltages and ambient temperature, and with the two interfering signals at either side of the wanted frequency.

Table 14-27: Limits for intermodulation rejection

Channel	Propagation conditions	Type of measurement	GSM 900		DCS 1 800	
			Test limit error rate %	Minimum No. of max-samples	Test limit error rate %	Min No. of max-samples
FACCH/F	TUhigh/No FH	FER	8,961	6696	4,368	13736

14.7 Blocking and spurious response

14.7.1 Blocking and spurious response - speech channels

14.7.1.1 Definition and applicability

Blocking is a measure of the ability of the receiver to receive a modulated wanted input signal in the presence of an unwanted input signal, on frequencies other than those of the spurious responses or the adjacent channels, without exceeding a given degradation.

The requirements and this test apply to MS supporting speech.

14.7.1.2 Conformance requirement

- The blocking characteristics of the receiver are specified separately for in-band and out-of-band performance as identified in GSM 05.05 section 5.1.

The reference sensitivity performance as specified in table 1 of GSM 05.05 shall be met when the following signals are simultaneously input to the receiver:

- a useful signal at frequency f_0 , 3 dB above the reference sensitivity level as specified in GSM 05.05 section 6.2;
- a continuous, static sine wave signal at a level as in the table of GSM 05.05 section 5.1 and at a frequency (f) which is an integer multiple of 200 kHz.

with the following exceptions, called spurious response frequencies:

- a) GSM 900: in band, for a maximum of six occurrences (which if grouped shall not exceed three contiguous occurrences per group);
DCS 1 800: in band, for a maximum of twelve occurrences (which if grouped shall not exceed three contiguous occurrences per group);
- b) out of band, for a maximum of 24 occurrences (which if below f_0 and grouped shall not exceed three contiguous occurrences per group).

where the above performance shall be met when the continuous sine wave signal (f) is set to a level of 70 dB μ V (emf) (i.e. -43 dBm). GSM 05.05, 5.1.

14.7.1.3 Test purpose

1. To verify that the in band blocking performance is met without exceeding the total number of allowed in band spurious responses. An allowance is made for the statistical significance of the test.
2. To verify that at selected out of band frequencies, the out of band blocking performance is met without exceeding the total number of allowed out of band spurious responses. An allowance is made for the statistical significance of the test.

NOTE: Not all of the possible out of band frequencies are tested as this results in excessive test time. However, the total number of out of band spurious responses, specified in GSM 05.05, are allowed to ensure a fair test of the MS.

14.7.1.4 Method of test**14.7.1.4.1 Initial conditions**

A call is set up according to the generic call set up procedure, except the BCCH frequency list shall be empty, on a TCH with an arbitrary ARFCN in the range supported by the MS. The power control level is set to maximum power.

The SS transmits Standard Test Signal C1 on the traffic channel. (TCH frequency FR).

The SS commands the MS to create traffic channel loop back signalling erased frames.

14.7.1.4.2 Procedure

- a) The SS produces a static wanted signal and a static interfering signal at the same time. The amplitude of the wanted signal is set to 4 dB above the reference sensitivity level.
- b) The unwanted signal is a C.W. signal (Standard test signal IO) of frequency FB. It is applied in turn on the subset of frequencies calculated in step c) in the overall range 100 kHz to 12,75 GHz, where FB is an integer multiple of 200 kHz.

However, frequencies in the range FR +/- 600 kHz are excluded.

NOTE: Allowance must be made for possible spurious signals arising from the SS. These are particularly likely at sub harmonic frequencies nFB where n = 2, 3, 4, 5, etc.

- c) The frequencies at which the test is performed (adjusted to an integer multiple of 200 kHz channels most closely approximating the absolute frequency of the calculated blocking signal frequency) are the combined frequencies from i), ii) and iii) below:-

- i) The total frequency range formed by:-
P-GSM 900 the frequencies between $F_{lo} + (IF_1 + IF_2 + \dots + IF_n + 12,5 \text{ MHz})$
and $F_{lo} - (IF_1 + IF_2 + \dots + IF_n + 12,5 \text{ MHz})$.

E-GSM 900 the frequencies between $F_{lo} + (IF_1 + IF_2 + \dots + IF_n + 17,5 \text{ MHz})$
and $F_{lo} - (IF_1 + IF_2 + \dots + IF_n + 17,5 \text{ MHz})$.

DCS 1 800 the frequencies between $F_{lo} + (IF_1 + IF_2 + \dots + IF_n + 37,5 \text{ MHz})$
and $F_{lo} - (IF_1 + IF_2 + \dots + IF_n + 37,5 \text{ MHz})$.

and
the frequencies + 100 MHz and - 100 MHz from the edge of the relevant receive band.

Measurements are made at 200 kHz intervals.

- ii) The three frequencies IF_1 , $IF_1 + 200 \text{ kHz}$, $IF_1 - 200 \text{ kHz}$.

- iii) The frequencies:
 $mF_{lo} + IF_1$,
 $mF_{lo} - IF_1$,
 mFR ,

where m is all positive integers greater than or equal to 2 such that either sum lies in the range 100 kHz to 12,75 GHz.

The frequencies in step ii) and iii) lying in the range of frequencies defined by step i) above need not be repeated.

Where:-

F_{lo} - local oscillator applied to first receiver mixer
 $IF_1 \dots IF_n$ - are the n intermediate frequencies
 $F_{lo}, IF_1, IF_2 \dots IF_n$ shall be declared by the manufacturer in the PIXIT statement GSM 11.10 annex 3.

- d) The level of the unwanted signal is set according to table 14-28.

Table 14-28: Level of unwanted signals

	GSM 900		DCS 1 800
	Small MS	Other MS	
FREQUENCY	LEVEL IN dB μ Vemf()		
FR +/- 600 kHz to FR +/- 800 kHz	70	75	70
FR +/- 800 kHz to FR +/- 1,6 MHz	70	80	70
FR +/- 1,6 MHz to FR +/- 3 MHz	80	90	80
915 MHz to FR - 3 MHz	90	90	-
FR + 3 MHz to 980 MHz	90	90	-
1785 MHz to FR - 3 MHz	-	-	87
FR + 3 MHz to 1920 MHz	-	-	87
835 MHz to <915 MHz	113	113	
>980 MHz to 1000 MHz	113	113	
100 kHz to <835 MHz	90	90	
>1000 MHz to 12,75 GHz	90	90	
100 kHz to 1705 MHz	-	-	113
>1705 MHz to <1785 MHz	-	-	101
>1920 MHz to 1980 MHz	-	-	101
>1980 MHz to 12,75 GHz	-	-	90

NOTE: These values differ from GSM 05.05 because of practical generator limits in the SS.

- e) The SS compares the data of the signal that it sends to the MS with the signal which is looped back from the receiver after demodulation and decoding, and checks the frame erasure indication.

The SS tests the RBER compliance for the bits of class II, by examining sequences of at least the minimum number of samples of consecutive bits of class II, where bits are taken only from those frames for which no bad frame indication was given. The number of error events is recorded.

If a failure is indicated it is noted and counted towards the allowed exemption totals.

In the case of failures discovered at the predicted frequencies at steps f ii), iii) or iv) the test is repeated on the adjacent channels +/- 200 kHz away. If either of these two frequencies fail then the next channel 200 kHz beyond is also tested. This process is repeated until all channels constituting the group of failures is known.

14.7.1.5 Test requirements

The error rate measured in this test shall not exceed the test limit error rate values given in table 14-29.

This shall apply under normal test voltage and ambient temperature, and with the interfering signal at any frequency in the range specified.

Table 14-29: Limits for blocking

Channel	Type of measurement	Test limit error rate %	Minimum number of samples
TCH/FS Class II	RBER	2,439	8200

The following exceptions are allowed:

GSM 900: A maximum of six failures in the frequency band 915 MHz to 980 MHz (which, if grouped, shall not exceed three 200 kHz channels per group).

A maximum of 24 failures in the combined bands 100 kHz to 915 MHz and 980 MHz to 12,75 GHz (which, if below FR and grouped, shall not exceed three 200 kHz channels per group).

DCS 1 800: A maximum of twelve failures in the band 1785 MHz to 1920 MHz (which, if grouped, shall not exceed three 200 kHz channels per group).

A maximum of 24 in the combined bands 100 kHz to 1785 MHz and 1920 MHz to 12,75 GHz (which, if below FR and grouped, shall not exceed three 200 kHz channels per group).

If the number of failures do not exceed the maximum allowed figures stated above, the test of 14.7.1.4 is repeated at the frequencies at which the failures occurred. The level of the unwanted signal is set to 70 dB μ Vemf() and the performance requirement is once again that that stated in the table above.

The number Error rate measured in this test shall not exceed the test limit error rate values given in table 14-29.

No failures are allowed at this lower unwanted signal level.

14.7.2 Blocking and spurious response - control channels

14.7.2.1 Definition and applicability

Blocking is a measure of the ability of the receiver to receive a modulated wanted input signal in the presence of an unwanted input signal, on frequencies other than those of the spurious responses or the adjacent channels, without exceeding a given degradation.

The requirements and this test apply to MS not supporting speech.

14.7.2.2 Conformance requirement

- The blocking characteristics of the receiver are specified separately for in-band and out-of-band performance as identified in GSM 05.05 section 5.1.

The reference sensitivity performance as specified in table 1 of GSM 05.05 shall be met when the following signals are simultaneously input to the receiver:

- a useful signal at frequency f_0 , 3 dB above the reference sensitivity level as specified in GSM 05.05 section 6.2;
- a continuous, static sine wave signal at a level as in the table of GSM 05.05 section 5.1 and at a frequency (f) which is an integer multiple of 200 kHz.

with the following exceptions, called spurious response frequencies:-

- a) GSM 900: in band, for a maximum of six occurrences (which if grouped shall not exceed three contiguous occurrences per group),

DCS 1 800: in band, for a maximum of twelve occurrences (which if grouped shall not exceed three contiguous occurrences per group).

- b) out of band, for a maximum of 24 occurrences (which if below f_0 and grouped shall not exceed three contiguous occurrences per group).

where the above performance shall be met when the continuous sine wave signal (f) is set to a level of 70 dB μ V (emf) (i.e. -43 dBm). GSM 05.05, 5.1.

14.7.2.3 Test purpose

1. To verify that the in band blocking performance is met without exceeding the total number of allowed in band spurious responses. An allowance is made for the statistical significance of the test.
2. To verify that at selected out of band frequencies, the out of band blocking performance is met without exceeding the total number of allowed out of band spurious responses. An allowance is made for the statistical significance of the test.

NOTE: Not all of the possible out of band frequencies are tested as this results in excessive test time. However, the total number of out of band spurious responses, specified in GSM 05.05, are allowed to ensure a fair test of the MS.

14.7.2.4 Method of test

14.7.2.4.1 Initial conditions

A call is set up according to the generic call set up procedure, except the BCCH frequency list shall be empty, on a TCH with an arbitrary ARFCN in the range supported by the MS. The power control level is set to maximum power.

The SS transmits Standard Test Signal C1 on the traffic channel. (TCH frequency FR).

14.7.2.4.2 Procedure

- a) The SS sends a Layer 3 message which does not require a Layer 3 response from the MS. Due to interfering signals, the MS may not be able to acknowledge the Layer 2 frame. Frame erasures are indicated by repeated L2 frames.
- b) The SS is set to produce a TUhigh wanted signal and a static interfering signal at the same time. The SS sets the amplitude of the wanted signal to 4 dB above the reference sensitivity level.
- c) The unwanted signal is a C.W. signal (Standard test signal IO) of frequency FB. It is applied in turn on the subset of frequencies calculated at step f) in the overall range 100 kHz to 12,75 GHz, where FB is an integer multiple of 200 kHz.

However, frequencies in the range FR +/- 600 kHz are excluded.

NOTE: Allowance must be made for possible spurious signals arising from the SS. These are particularly likely at sub harmonic frequencies nFB where $n = 2, 3, 4, 5$, etc.

- d) The frequencies at which the test is performed (adjusted to an integer multiple of 200 kHz channels most closely approximating the absolute frequency of the calculated blocking signal frequency) are the combined frequencies from i), ii) and iii) which follow:

- i) The total frequency range formed by:-

P-GSM 900 the frequencies between $F_{10} + (IF_1 + IF_2 + \dots + IF_n + 12,5 \text{ MHz})$
and $F_{10} - (IF_1 + IF_2 + \dots + IF_n + 12,5 \text{ MHz})$.

E-GSM 900 the frequencies between $F_{10} + (IF_1 + IF_2 + \dots + IF_n + 17,5 \text{ MHz})$
and $F_{10} - (IF_1 + IF_2 + \dots + IF_n + 17,5 \text{ MHz})$.

DCS 1 800 the frequencies between $F_{10} + (IF_1 + IF_2 + \dots + IF_n + 37,5 \text{ MHz})$
and $F_{10} - (IF_1 + IF_2 + \dots + IF_n + 37,5 \text{ MHz})$.

and

the frequencies + 100 MHz and - 100 MHz from the edge of the relevant receive band.
Measurement are made at 200 kHz intervals.

ii) The three frequencies IF_1 , $IF_1 + 200 \text{ kHz}$, $IF_1 - 200 \text{ kHz}$.

iii) The frequencies:

$mF_{10} + IF_1$,
 $mF_{10} - IF_1$,
 mFR ,

where m is all positive integers greater than or equal to 2 such that either sum lies in the range 100 kHz to 12,75 GHz.

The frequencies in step ii) and iii) lying in the range of frequencies defined by step i) above need not be repeated.

Where:-

F_{10} - local oscillator applied to first receiver mixer
 $IF_1 \dots IF_n$ - are the n intermediate frequencies
 F_{10} , IF_1 , $IF_2 \dots IF_n$ shall be declared by the manufacturer in the PIXIT statement GSM 11.10 annex 3.

e) The level of the unwanted signal is set according to table 14-30.

Table 14-30: Level of unwanted signals

FREQUENCY	GSM 900		DCS 1 800
	Small MS	Other MS	
	LEVEL IN $\text{dB}\mu\text{Vemf}(\)$		
FR +/- 600 kHz to FR +/- 800 kHz	70	75	70
FR +/- 800 kHz to FR +/- 1,6 MHz	70	80	70
FR +/- 1,6 MHz to FR +/- 3 MHz	80	90	80
915 MHz to FR - 3 MHz	90	90	-
FR + 3 MHz to 980 MHz	90	90	-
1785 MHz to FR - 3 MHz	-	-	87
FR + 3 MHz to 1920 MHz	-	-	87
835 MHz to <915 MHz	113	113	
>980 MHz to 1000 MHz	113	113	
100 kHz to <835 MHz	90	90	
>1000 MHz to 12,75 GHz	90	90	
100 kHz to 1705 MHz	-	-	113
>1705 MHz to <1785 MHz	-	-	101
>1920 MHz to 1980 MHz	-	-	101
>1980 MHz to 12,75 GHz	-	-	90

NOTE: These values differ from GSM 05.05 because of practical generator limits in the SS.

f) The SS determines the number of frame erasure events during at least the minimum number of samples. If a failure is indicated, it is noted and counted towards the allowed exemption total.

In the case of failures discovered at the predicted frequencies at steps f ii), iii) or iv) the test is repeated on the adjacent channels +/- 200 kHz away. If either of these two frequencies fail then the

next channel 200 kHz beyond is also be tested. This process is repeated until all channels constituting the group of failures is known.

14.7.2.5 Test requirements

The error rate measured in this test shall not exceed the test limit error rate given in table 14-31.

This shall apply under normal test voltage and ambient temperature, and with the interfering signal at any frequency in the range specified.

Table 14-31: Limits for blocking

Channel	Type of measurement	GSM 900		DCS 1 800	
		Test limit error rate	Minimum No. of samples	Test limit error rate	Minimum No. of samples
FACCH/F	FER	8,961	6696	4,368	13736

The following exceptions are allowed:

GSM 900: A maximum of six failures in the band 915 MHz to 980 MHz (which, if grouped, shall not exceed three 200 kHz channels per group).

A maximum of 24 in the combined bands 100 kHz to 915 MHz and 980 MHz to 12,75 GHz (which, if below FR and grouped, shall not exceed three 200 kHz channels per group).

DCS 1 800: A maximum of twelve failures in the band 1785 MHz to 1 920 MHz (which, if grouped, shall not exceed three 200 kHz channels per group).

A maximum of 24 in the combined bands 100 kHz to 1785 MHz and 1 920 MHz to 12,75 GHz (which, if below FR and grouped, shall not exceed three 200 kHz channels per group).

If the number of failures do not exceed the maximum allowed figures stated above, the test of 14.7.2.4 is repeated at the frequencies at which the failures occurred. The level of the unwanted signal is set to 70 dB μ Vemf() and the performance requirement is once again that stated above.

The number of Error Events recorded in this test shall not exceed the test limit error rate values given above, when using the maximum number of samples.

No failures are allowed at this lower unwanted signal level.

14.8 AM suppression

14.8.1 AM suppression - speech channels

14.8.1.1 Definition and applicability

AM suppression is a measure of the ability of the receiver to receive a modulated wanted input signal in the presence of an unwanted TDMA modulated interferer.

The requirements and this test apply to MS supporting speech.

14.8.1.2 Conformance requirement

The reference sensitivity performance as specified in table 1 shall be met when the following signals are simultaneously input to the receiver:

- a useful signal at frequency f_0 , 3 dB above the reference sensitivity level as specified in GSM 05.05 section 5.2.

- a single frequency (f), in the relevant receive band, $|f - f_0| \geq 6\text{MHz}$, which is an integer multiple of 200 kHz, a GSM TDMA signal modulated by any 148-bits subsequence of the 511-bits pseudo random bit sequence, defined in CCITT Recommendation O.153 fascicle IV.4, at a level as defined in the table below. The interferer shall have one timeslot active and the frequency shall be at least 2 channels separated from any identified spurious responses. The transmitted bursts shall be synchronized to but, delayed in time between 61 and 86 bit periods relative to the bursts of the wanted signal. GSM 05.05, 5.2.

MS type	Signal level
GSM900	-31 dBm
DCS1800	-29 dBm

14.8.1.3 Test purpose

To verify that the AM suppression performance of the MS meets the conformance requirement with an allowance for the statistical significance of the test.

14.8.1.4 Method of test

14.8.1.4.1 Initial conditions

A call is set up according to the generic call set up procedure, on a TCH/FS with an ARFCN in the mid ARFCN range. The power control level is set to maximum power.

The SS transmits standard Test Signal C1 on the traffic channel (TCH frequency FR).

The SS commands the MS to create traffic channel loop back signalling erased frames.

This test is performed after test 14.7.

14.8.1.4.2 Procedure

- The SS produces a static wanted signal with an amplitude 4 dB above reference sensitivity level.
- The SS produces an interfering signal as described below:
 - static fading profile;
 - at an in band frequency greater than 6 MHz separated from FR and separated by at least two ARFCNs from any spurious responses.

NOTE: Spurious responses are identified by test cases 14.7.1 and 14.7.2.

- at a level as described in table 14-32.
- GSM TDMA modulated by random data with one timeslot active.
- synchronized to, but delayed between 61 and 86 bit periods to the bursts of the wanted signal.

Table 14-32: Interferer signal level

MS type	Signal level (dB μ V emf)
GSM900	82
DCS1800	84

- The SS compares the data of the signal that it sends to the MS with the signal which is looped back from the receiver after demodulation and decoding, and checks the frame erasure indication.
- The SS tests the RBER compliance of class II bits by examining at least the minimum number of samples of consecutive bits. Bits only taken from those frames which do not signal frame erasure. The number of error events is recorded.

14.8.1.5 Test requirements

The error rates measured in this test shall not exceed the test limit error rate values given in table 14.27.

Table 14-33: Limits for AM suppression

Channel	Propagation conditions	Type of measurement	Test limit error rate %	Minimum No. of samples
TCH/FS Class II	Static	RBER	2,439	8200

14.8.2 AM suppression - control channels**14.8.2.1 Definition and applicability**

AM suppression is a measure of the ability of the receiver to receive a modulated wanted input signal in the presence of an unwanted TDMA modulated interferer.

The requirements and this test apply to MS not supporting speech.

14.8.2.2 Conformance requirement

The reference sensitivity performance as specified in table 1 shall be met when the following signals are simultaneously input to the receiver:

- a useful signal at frequency f_0 , 3 dB above the reference sensitivity level as specified in GSM 05.05 section 5.2.
- a single frequency (f), in the relevant receive band, $|f - f_0| \geq 6\text{MHz}$, which is an integer multiple of 200 kHz, a GSM TDMA signal modulated by any 148-bits subsequence of the 511-bits pseudo random bit sequence, defined in CCITT Recommendation O.153 fascicle IV.4, at a level as defined in the table below. The interferer shall have one timeslot active and the frequency shall be at least 2 channels separated from any identified spurious responses. The transmitted bursts shall be synchronized to but, delayed in time between 61 and 86 bit periods relative to the bursts of the wanted signal. GSM 05.05, 5.2.

MS type	Signal level
GSM900	-31 dBm
DCS1800	-29 dBm

14.8.2.3 Test purpose

To verify that the AM suppression performance of the MS meets the conformance requirement with an allowance for the statistical significance of the test.

14.8.2.4 Method of test**14.8.2.4.1 Initial conditions**

A call is set up according to the generic call set up procedure, on a TCH with an ARFCN in the mid ARFCN range. The power control level is set to maximum power.

The SS transmits standard Test Signal C1 on the traffic channel (TCH frequency FR).

This test is performed after test 14.7.

14.8.2.4.2 Procedure

- a) The SS produces a TUhigh wanted signal with an amplitude 4 dB above reference sensitivity level.

b) The SS produces an interfering signal as described below:

- static fading profile;
- at an in band frequency greater than 6 MHz separated from FR and separated by at least two ARFCNs from any spurious responses.

NOTE: Spurious responses are identified by test cases 14.7.1 and 14.7.2.

- at a level as described in table 14-34.
- GSM TDMA modulated by random data with one timeslot active.
- synchronized to, but delayed between 61 and 86 bit periods to the bursts of the wanted signal.

Table 14-34: Interferer signal level

MS type	Signal level (dB μ Vemf)
GSM900	82
DCS1800	84

- c) The SS sends the status message. Due to interfering signals, the MS may not be able acknowledge the Layer 2 frame. Frame erasures are indicated by repeated L2 frames.
- d) The SS determines the number of frame erasure events during at least the minimum number of samples. If a failure is indicated, it is noted and counted towards the allowed exemption total.

14.8.2.5 Test requirements

The error rates measured in this test shall not exceed the test limit error rate values given in table 14-35.

Table 14-35: Limits for AM suppression

Channel	Propagation conditions	Type of measurement	GSM 900		DCS 1 800	
			Test limit error rate %	Minimum No. of max-samples	Test limit error rate %	Min No. of max-samples
FACCH/F	TUhigh/No FH	FER	8,961	6696	4,368	13736

14.9 Paging performance at high input levels

14.9.1 Definition and applicability

The paging performance at high input levels is the signal level at the MS receiver input at which a certain FER for the PCH must be achieved.

The requirements and this test apply to all types of MS.

14.9.2 Conformance requirement

The paging performance at high input levels requirements of GSM 05.05 section 6.5 a) for PCH under static propagation conditions shall be met from 20 dB above reference sensitivity level up to -15 dBm for GSM900 and -23 dBm for DCS1800.

14.9.3 Test purpose

To verify that the MS does not exceed the conformance requirement with an allowance for the statistical significance of the test.

14.9.4 Method of test**14.9.4.1 Initial conditions**

System Simulator:

1 cell, Tx-Integer = 3, MAX RETRANS is set to minimum. The CCCH is combined with SDCCH. BS_PA_MFRMS = 9 to achieve worst case sleep mode (DRX). The signal level at the receiver input is set to:

GSM 900: -15 dBm
DCS 1800: -23 dBm.

Mobile Station:

The MS has a valid TMSI. It is "idle updated". The MS should have been powered up immediately before running the test, i.e. if a Location update is necessary the MS must be switched off and on again.

14.9.4.2 Procedure

The MS is paged and the SS starts timer T3113. If a CHANNEL REQUEST is received before expiry of T3113 the SS sends an IMMEDIATE ASSIGNMENT REJECT. The sequence is performed 4 times.

Between two consecutive executions the SS must wait for an amount of time which is enough to guarantee that the MS is in service (listening to its paging subchannel).

14.9.5 Test requirements

If the MS answers all pagings with a CHANNEL REQUEST the requirements are met.

NOTE: The probability for a good MS to fail this test is less than 1%.

15 Timing advance and absolute delay

15.1 Definition and applicability

Timing advance (TA) is a time offset in bits as sent to the MS by the BS. The MS shall advance its transmissions to the BS by the timing advance relative to 3 timeslots behind transmissions received from the BS.

The absolute delay is the delay between a common burst reference point within the received and the transmitted RF burst.

NOTE: For normal or dummy bursts, the common burst reference point is defined to be the transition from bit 13 to bit 14 of the midamble. For an access burst it is defined to be the transition from bit 48 to bit 49 of the burst.

Equivalently the delay can be referenced to the modulator input vs. the demodulator output or to the differential encoder input vs. the differential decoder output, provided the measured delay is corrected for the additional delays in the signal path.

The requirement and this test apply to all types of GSM 900 and DCS 1 800 MS.

15.2 Conformance requirement

- 1) The random access burst transmission, measured at the MS antenna, shall use a TA of 0, and therefore be 3 timeslots behind the transmissions received from the BTS, with an absolute tolerance of +/- 1 bit period.
GSM 05.10, 6.4; GSM 05.10, 6.6.
- 2) The normal burst transmission, measured at the MS antenna, shall be 3 timeslots - TA behind the transmissions received from the BTS, with an absolute tolerance of +/- 1 bit period.
GSM 05.10, 6.4.
- 3) When the MS receives a new value of TA on the SACCH, it shall implement the new value of TA at the first TDMA frame belonging to the next reporting period, after the SACCH frame containing the new TA value.
GSM 05.10, 6.5.
- 4) The MS shall signal the used TA to the BS, in the L1 header of the uplink SACCH message.
GSM 05.10, 6.4, GSM 04.04, 7.2.

15.3 Test purpose

- 1) To verify that the MS uses a TA value of 0 for the access burst.
- 2) To verify that the MS meets the absolute receive/transmit delay requirement for the access burst.
- 3) To verify that the MS meets the absolute receive/transmit delay requirement for normal bursts.
- 4) To verify that the MS implements a new timing advance value as signalled on the SACCH as in the requirement.
- 5) To verify that the MS sends the TA used on the uplink SACCH as in the requirement.

15.4 Method of test

15.4.1 Initial conditions

The SS sends "MAXRETRANS = 7" and "TX-INTEGGER = 3" on the BCCH.

The MS is brought into MM state "idle, updated".

15.4.2 Procedure

- a) The SS pages the MS after 10 s.
- b) The SS does not respond to the first 7 CHANNEL REQUEST messages from the MS. The SS responds to the 8th CHANNEL REQUEST from the MS on the RACH by sending an IMMEDIATE ASSIGNMENT message, with TA set to 0.
- c) The SS continues to set up a call according to the generic call set up procedure.
- d) The SS signals the TA values 10, 20, 30, 40, 50, 60, 63, and one random value other than these values to the MS in consecutive SACCH blocks.

The SS determines the TA value set in the L1 header on the uplink SACCH for each timing advance.

The SS measures the absolute delay for all bursts.

15.5 Test requirement

The measured receive/transmit delay for each burst shall equal the following nominal values with an absolute tolerance of +/- 1 bit period:

access bursts: 3 timeslots (= 45/26 ms)

normal bursts: 3 timeslots (= 45/26 ms) minus the last TA value received from the SS.

The MS shall use the new timing advance at the first TDMA frame belonging to the next reporting period after the SACCH frame containing the new TA value.

The TA field in the uplink SACCH L1 header shall contain to the most recently ordered TA value.

16 Reception time tracking speed

16.1 Definition and applicability

Reception time tracking speed is the speed at which the MS adapts its transmit time to a change in the timing of the received signal.

The requirement and this test apply to all types of GSM 900 and DCS 1 800 MS.

16.2 Conformance requirement

If the MS determines that the timing difference with signals received from the BS exceeds 2 μ s, the MS shall adjust its timebase in steps of 1/4 bit period, in intervals not less than 1 s and not greater than 2 s until the timing difference is less than 1/2 bit period at 3 dB below reference sensitivity and 3 dB less carrier to interference ratio than the reference interference ratios.
GSM 05.10, 6/6.2.

16.3 Test purpose

- 1) To verify that the MS adapts its transmit time to the timing of the received signal as in the conformance requirement under TUHigh propagation conditions at 2 dB above reference sensitivity level().
- 2) To verify that the MS adapts its transmit time to the timing of the received signal as in the conformance requirement under RA propagation conditions at 2 dB above reference sensitivity level().

NOTE: This test is performed at a level higher than in the conformance requirement because of test implementation problems.

16.4 Method of test

16.4.1 Initial conditions

The SS sets up a call according to the generic call set up procedure on a channel in the Mid ARFCN range.

The SS sets TUHigh.

16.4.2 Procedure

- a) After 10 s the SS sets the input signal level to 2 dB above reference sensitivity level().
- b) For the last second before step c) the SS takes an average receive/transmit delay of all bursts in that 1 s.
- c) The SS increases the delay of the transmitted signal to the MS by a 2 bit step (about 7,4 μ s) and keeps this delay for 20 s.
- d) The SS measures the absolute receive/transmit delay for each burst.
- e) The SS increases the input signal level to 5 dB above reference sensitivity level() and sets propagation condition RA.
- f) The SS repeats steps a) to d).

16.5 Test requirement

The MS shall adjust the timing of its transmit burst back to the correct receive/transmit timing delay. All burst timings shall be within the shaded part of 16.1.

bits change
of transmit
timing

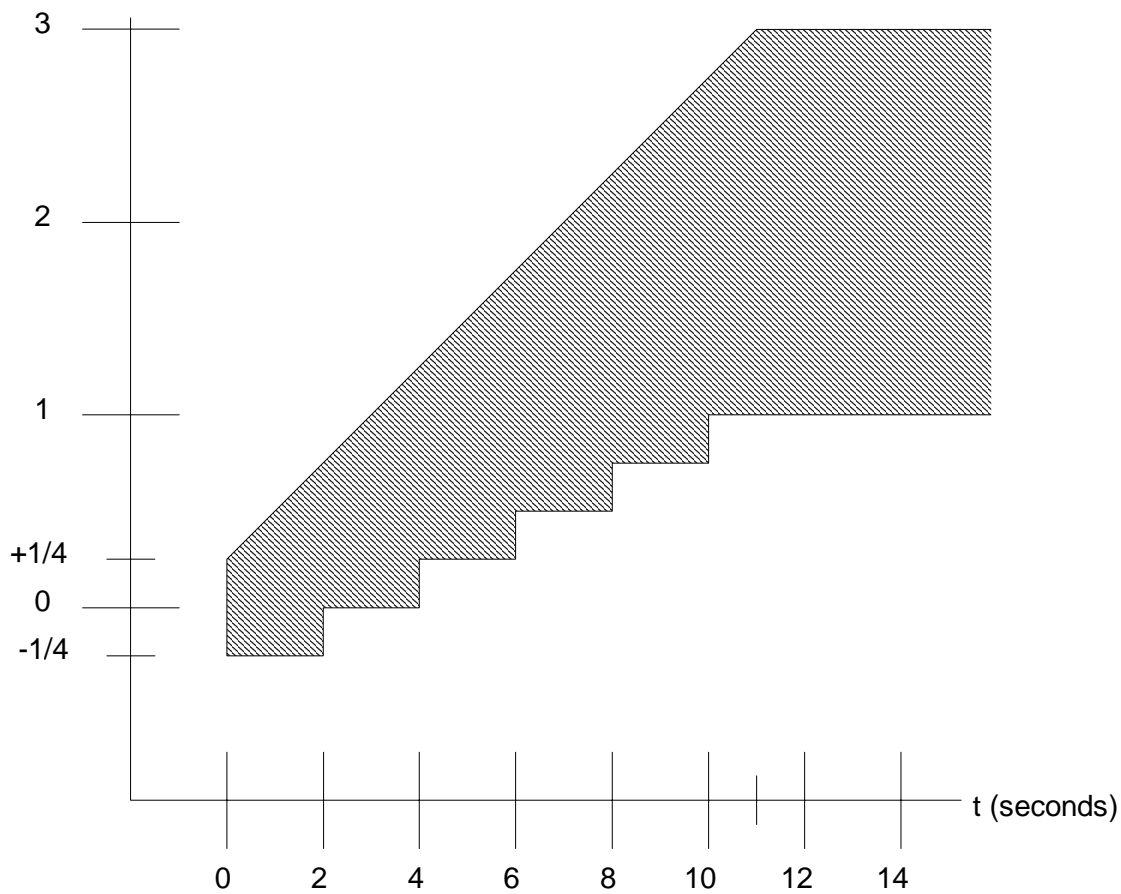

t=0 is the time at which the SS makes the transmission timing step change in c) of subclause 16.4.2.

Figure 16.1

17 Access times during handover

17.1 Intra cell channel change

17.1.1 Definition and applicability

The access times are:

- the time between either receipt by the MS of the last timeslot of the message block containing an ASSIGNMENT COMMAND or HANDOVER COMMAND and the time it has to be ready to transmit on the new channel, and
- the time between the end of the last complete speech or data frame or message block sent on the old channel and the time the MS is ready to transmit on the new channel.

The requirement and this test apply to all types of GSM 900 and DCS 1 800 MS. For E-GSM 900MS this test is performed in the P-GSM band (ref. table 3.3 P-GSM 900ARFCN ranges).

17.1.2 Conformance requirement

- 1) When for an intracell channel change, the MS receives an ASSIGNMENT COMMAND command or a HANDOVER COMMAND it shall be ready to transmit on the new channel within 120 ms of the last timeslot of the message block containing the command.
GSM 05.10, 6.8.
- 2) For an intracell channel change, the time between the end of the last complete speech or data frame or message block sent on the old channel and the time the MS is ready to transmit on the new channel shall be less than 20 ms.
GSM 05.10, 6.8.

17.1.3 Test purpose

- 1) To verify that the MS, when commanded to perform an intracell channel change to a new ARFCN and/or a new timeslot number within the same cell, if the starting time is not used in the ASSIGNMENT COMMAND, is ready to transmit on the new channel within 120 ms of the last timeslot containing the ASSIGNMENT COMMAND.
- 2) To verify that the MS, when commanded to perform an intracell channel change to a new ARFCN and/or a new timeslot number within the same cell, if the starting time is not used in the ASSIGNMENT COMMAND, is ready to transmit on the new channel within 20 ms of the last complete speech/data frame or message block sent on the old channel.

17.1.4 Method of test

17.1.4.1 Initial conditions

The SS sets up a call according to the generic call set up procedure on a channel in the Low ARFCN range on timeslot 1.

17.1.4.2 Procedure

- a) The SS sends an ASSIGNMENT COMMAND to the MS allocating a channel in the high ARFCN range on timeslot 2, and with a power command of 7. These old and new carriers have a relative frequency tolerance of 0, and a relative timing tolerance of 1/4 bit.
- b) The SS, after it has sent the ASSIGNMENT COMMAND, measures the reception time of bursts received on the new channel, and the time at which transmission ceases on the old channel.

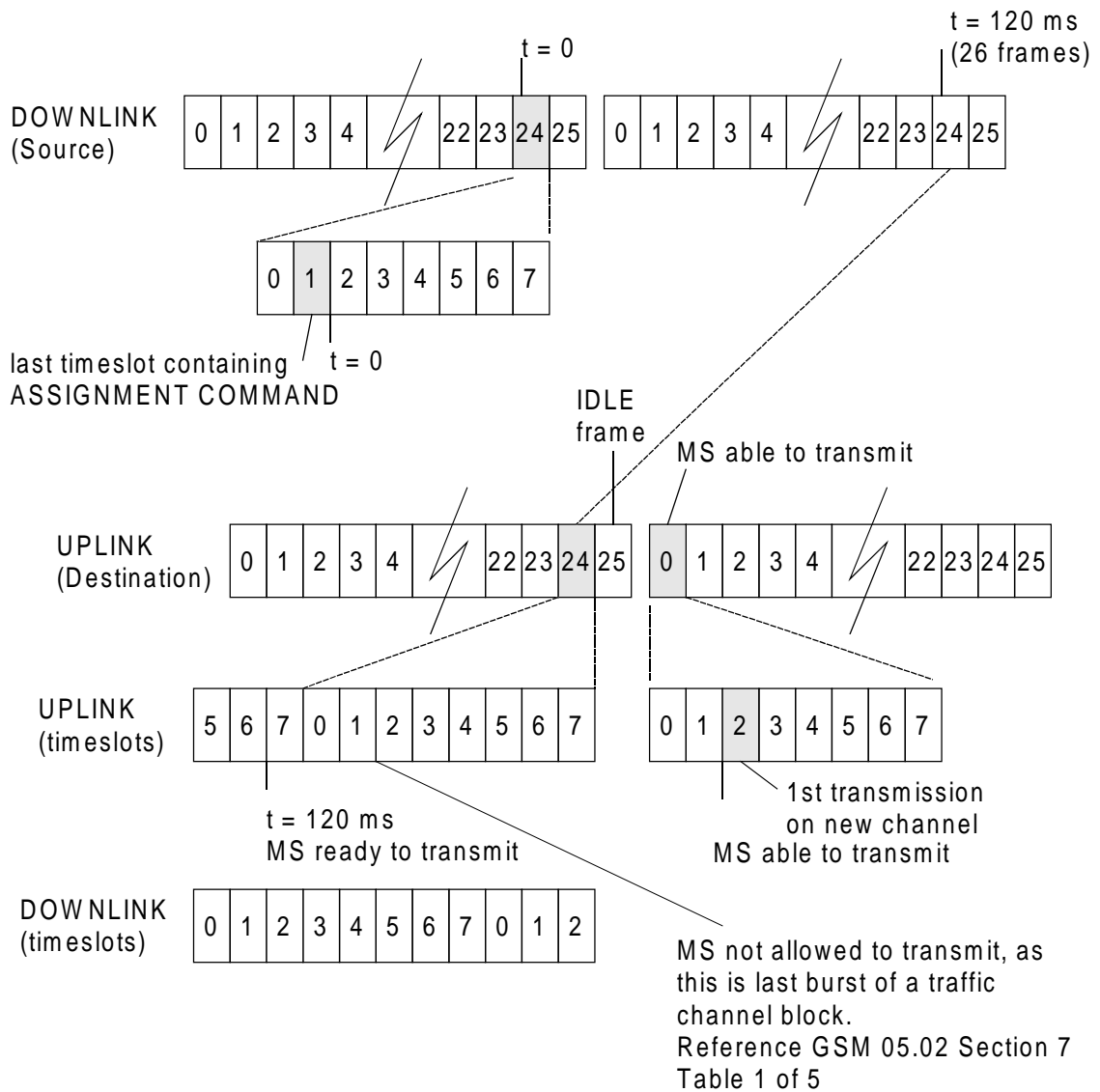

Timing difference between Downlink and Uplink is 3 timeslots.

Relative timing difference between the 2 carriers is a $1/4$ bit period.

Maximum time to first transmission on the new channel is 131 ms (120ms + 2 frames + 3 timeslots + $1/4$ bit period)

Figure 17-1: Access time - Intra cell channel change (Test Requirement 1)

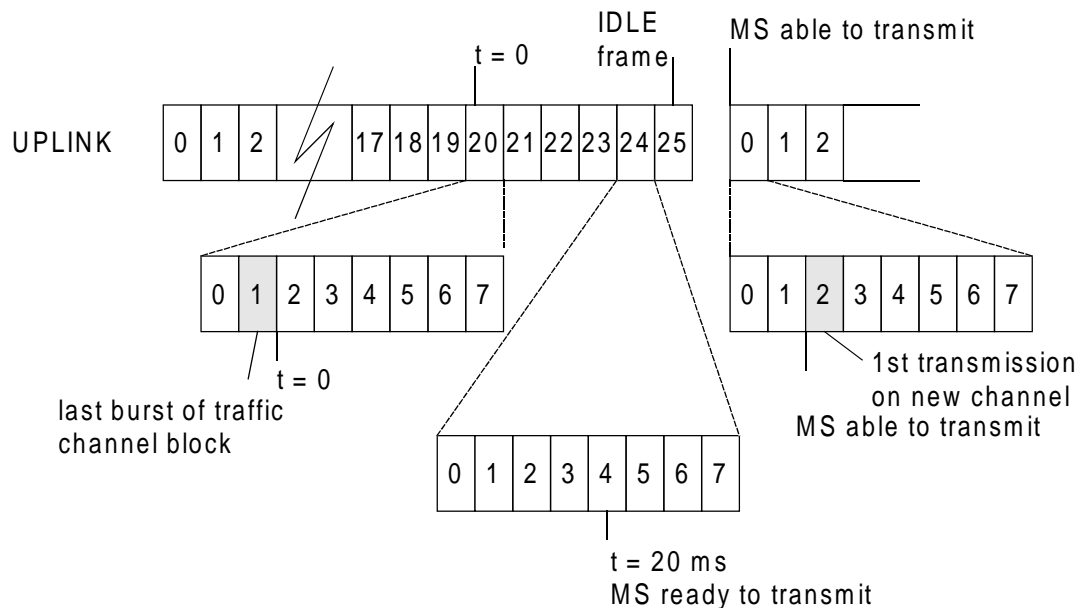

Figure 17-2: Access time - Intra cell channel change (Test Requirement 2)

17.1.5 Test requirement

- 1) The MS shall transmit its first burst on the new channel within 131 ms from the last timeslot of the message block containing the ASSIGNMENT COMMAND.

NOTE 1: The requirement time of 120 ms, at which the MS shall be ready to transmit, will expire right at the beginning of a new downlink burst on timeslot 2, which will be the last burst of a traffic channel block. The following frame could be an IDLE frame and the MS would then transmit in the next frame. Taking into account the 3 timeslot shift between up and downlink, and the 1/4 bit relative timing tolerance between the carriers, means that the MS may first transmit on the new channel after 131 ms (120 ms + 2 frames + 3 timeslots + 1/4 bit period). See figure 17-1.

- 2) The MS shall transmit its first burst on the new channel within 27,7 ms from the last complete speech or data frame or message block sent on the old channel.

NOTE 2: The requirement time of 20 ms, at which the MS shall be ready to transmit, will expire at just over 4 frames after the sending of the last bit on the old channel. The next frame could be an IDLE frame and the MS would then transmit in the following frame. This equates to 6 frames so in the worst case, including the 1/4 bit relative timing tolerance between the carriers, the MS may take 27,7 ms before starting transmissions on the new channel.

17.2 Inter cell handover

17.2.1 Definition and applicability

The access times are:

- the time between receipt by the MS of the last timeslot of the message block containing a HANDOVER COMMAND and the time it has to be ready to transmit on the new channel, and
- the time between the end of the last complete speech or data frame or message block sent on the old channel and the time the MS is ready to transmit on the new channel.

The requirement and this test apply to all types of GSM 900 and DCS 1 800 MS.

17.2.2 Conformance requirement

- 1) When the MS receives a HANDOVER COMMAND it shall be ready to transmit on the new channel within 120 ms of the last timeslot of the message block containing the HANDOVER COMMAND.
 GSM 05.10, 6.8

- 2) The time between the end of the last complete speech or data frame or message block sent on the old channel and the time the MS is ready to transmit on the new channel shall be less than 20 ms.
GSM 05.10, 6.8.
- 3) When the MS receives a new TA value in response to a handover access burst, the MS shall be ready to transmit using the new TA value within 40 ms of the end of the last timeslot of the message block containing the new TA.
GSM 05.10, 6.9.
- 4) The MS shall use a TA value of 0 for the handover access bursts sent.
GSM 05.10, 6.6.

17.2.3 Test purpose

- 1) To verify that the MS, when commanded to handover on a new ARFCN and a new timeslot number in a new, not synchronized cell, starting time not used in the HANDOVER COMMAND, will be ready to transmit on the new channel within 120 ms of the last timeslot containing the HANDOVER COMMAND.
- 2) To verify that the MS, when commanded to handover on a new ARFCN and a new timeslot number in a new, not synchronized cell, starting time not used in the HANDOVER COMMAND, will be ready to transmit on the new channel within 20 ms of the last complete speech or data frame or message block sent on the old channel.
- 3) To verify that the MS, when it receives a new TA value in response to a handover access burst, is ready to transmit using the new TA value within 50 ms of the end of the last timeslot of the message block containing the new TA value.
- 4) To verify that the MS uses a TA value of 0 for the handover access burst sent.

17.2.4 Method of test

17.2.4.1 Initial conditions

The SS establishes two non-synchronized cells, A and B, under ideal radio conditions. A is the old cell and B is the target for the handover.

The SS uses two traffic channels with the following properties:

		GSM900	DCS1800
Cell A	TN	2	2
	ARFCN	1	512
	offset	+267 Hz	+320 Hz
Cell B	TN	0	0
	ARFCN	124	885
	offset	-267 Hz	-320 Hz

NOTE: This offset is representing worst cases for Doppler shift at 250 km/h and 130 km/h for GSM and DCS respectively, and a frequency inaccuracy of 0,05 ppm.

The BCCH for the two cells have the following differences in timing:

Timer T1	50
Timer T2	15
Timer T3	40
1/4 bit number	17
Timeslots	2

The SS sets up a call according to the generic call set up procedure on the channel in cell A.

17.2.4.2 Procedure

- a) The SS sends a HANOVER COMMAND on the main DCCH on cell A ordering the MS to go to the channel in cell B. The power command is set to 7.
- b) After the SS has sent HANOVER COMMAND it measures the reception time of bursts received on the new channel and the time at which transmission ceases on the old channel.
- c) The SS also measures the absolute transmit/receive delay for the access bursts on the new channel.
- d) The SS sends the PHYSICAL INFORMATION with TA set to 50. The SS then measures the reception time and absolute delay of the bursts transmitted on the new cell.

17.2.5 Test requirement

- 1) The MS shall transmit its first burst on cell B within 142,6 ms from the last timeslot of the message block containing the HANOVER COMMAND.

NOTE 1: The requirement time of 120 ms, at which the MS shall be ready to transmit, will expire right at the end of the last burst of a downlink traffic channel block on the old channel. Due to the two timeslot difference in cell timing, the two timeslots difference in the channel allocation and the 15 frames difference in multiframe timing, this point could occur 2,5 frames before the end of the last burst of a downlink traffic channel block on the new channel. The following frame could be an IDLE frame and the MS would then transmit in the next frame. Taking into account the three timeslot shift between up and downlink, and the 17 1/4 bit periods timing difference between the two carriers, means that the MS may first transmits on the new channel after 142,6 ms (120 ms + 2,5 frames + 2 frames + 3 timeslots + 17 1/4 bit periods).

- 2) The MS shall transmit its first burst on cell B within 39,2 ms from the last complete speech or data frame or message block sent on cell A.

NOTE 2: The requirement time of 20 ms, at which the MS shall be ready to transmit, will expire at just over 4 frames after the sending of the last bit on the old channel. Due to the two timeslot difference in cell timing, the two timeslots difference in the channel allocation and the 15 frames difference in multiframe timing, this point could occur 2 frames before the end of the last burst of an uplink traffic channel block on the new channel. The following frame could be an IDLE frame and the MS would then transmit in the next frame. This equates to 8,5 frames so in the worst case the MS may take 39,2 ms between cessation of transmission on the old channel and transmission beginning on the new channel.

- 3) The MS shall transmit using the TA value in the PHYSICAL INFORMATION within 50 ms from the end of the last timeslot of the message block containing the new TA value.
- 4) The measured absolute delay for the access bursts in steps c) and d) shall equal 3 timeslots (=45/26 ms), with an absolute tolerance of +/- 1 bit.

18 Temporary reception gaps

18.1 Definition and applicability

A temporary reception gap is a limited period of time in which the RF reception is interrupted. During this gap the MS shall maintain the frequency and timing of its transmission within specifications.

The requirement and this test apply to all types of GSM 900 and DCS 1 800 MS, except where an application layer is always running which would perform a normal release of the call due to loss of traffic (see PICS/PIXIT).

18.2 Conformance requirement

- 1) During a temporary total loss of signal, of up to 64 SACCH block periods, the MS shall update its timebase with a clock which is accurate to within 0,2 ppm, or to within 0,2 ppm of the signals previously received from the BTS. The MS shall use the same frequency source for both RF frequency generation and clocking the timebase.
GSM 05.10, 6.7; GSM 05.10 6.1.
- 2) The MS shall time its transmissions to the BTS according to signals received from the BTS. The MS transmissions to the BTS, measured at the MS antenna, shall be 3 timeslots - TA behind the transmissions received from the BTS, where TA is the last timing advance received from the current serving BTS.
GSM 05.10, 6.4.
- 3) During a temporary total loss of signal, of up to 64 SACCH block periods, the MS shall update its timebase with a clock which is accurate to within 0,2 ppm, or to within 0,2 ppm of the signals previously received from the BTS.
GSM 05.10, 6.7.

18.3 Test purpose

- 1) To verify that, during a temporary total loss of signal of up to 63 SACCH block periods, the MS carrier frequency is accurate to within 0,2 ppm of the signals previously received from the BTS.
- 2) To verify that, the MS transmissions to the BTS, measured at the MS antenna, is 3 timeslots behind the transmissions received from the BTS, with a tolerance of +/-1 bit period.
- 3) To verify that, during a temporary total loss of signal, of up to 63 SACCH block periods, the MS transmission timing may have drifted resulting in an error not greater than +/- 6,048 μ s (0,2 ppm of 63 SACCH blocks).

18.4 Method of test

18.4.1 Initial conditions

The SS signals RADIO_LINK_TIMEOUT = 64 and "DTX OFF" on the BCCH.

The MS is brought into MM state "idle, updated".

After 10 s, the SS continues to set up a call according to the generic call set up procedure.

18.4.2 Procedure

- a) The SS, in a TDMA frame immediately following the transmission of a complete SACCH block, removes the downlink signal for 63 SACCH blocks.

NOTE: This gives the maximum temporary reception gap.

- b) The SS measures the frequency and timing of the MS transmissions immediately before, and at least 5 times at approximately equally spaced intervals during the gap, one of these measurements being at the end of the gap.

- c) The SS resumes transmission for a period sufficient to allow the MS reception of 1 SACCH block.
- d) The SS again removes downlink transmission for a period equal to at least 3 SACCH blocks. The SS measures the frequency and timing of the MS transmissions immediately before and during this second reception gap.

18.5 Test requirement

- 1) The MS carrier frequency shall be accurate to within 0,2 ppm compared to signals received from the SS.
- 2) The receive/transmit delay timing shall be 3 timeslots +/- 1 bit.
- 3) During the second reception gap the MS shall maintain transmission for a period up to but not exceeding 3 SACCH blocks.
- 4) During the first, maximum, reception gap the MS transmission timing may have drifted resulting in an error of not greater than +/- 6,048 μ s.

NOTE: The SS determines the error at the start of the reception gap from the first measurement of MS transmission frequency and timing.

19 Channel release after unrecoverable errors

NOTE: It is not possible to explicitly verify the correct functioning of all aspects of the radio link failure algorithm in the MS. Therefore 3 tests are used to implicitly verify correct implementation.

19.1 Channel release after unrecoverable errors -1

19.1.1 Definition and applicability

Channel release after unrecoverable errors is a procedure to abort the call if the radio link has been severely corrupted for some time, according to a link failure criterion.

The requirement and this test apply to all types of GSM 900 and DCS 1 800 MS, except where an application layer is always running which would perform a normal release of the call due to loss of traffic (see PICS/PIXIT).

19.1.2 Conformance requirement

- 1) If the MS is unable to decode a SACCH message, the radio link counter S is decreased by 1. In the case of a successful reception of a SACCH message S is increased by 2. In any case S shall not exceed the value of RADIO_LINK_TIMEOUT. If S reaches 0 a radio link failure shall be declared. GSM 05.08, 5.2.
- 2) The MS shall continue transmitting as normal on the uplink until S reaches 0. GSM 05.08, 5.2.
- 3) The algorithm shall start after the assignment of a dedicated channel and S shall be initialized to RADIO_LINK_TIMEOUT. GSM 05.08, 5.2.
- 4) (Re-)initialization and start of the algorithm shall be done whenever the MS switches to a new channel (this includes the old channel in assignment and handover failure cases), at the latest when the main signalling link (see GSM 04.08) has been established. GSM 05.08, 5.2.

19.1.3 Test purpose

- 1) To verify correct handling of the radio link counter S.
- 2) To verify that the MS that is transmitting continues to transmit as normal on the uplink until S reaches 0.
- 3) To verify that the algorithm starts after the assignment of a dedicated channel, with S initialized to RADIO_LINK_TIMEOUT.
- 4) To verify that the MS declares RADIO_LINK_FAILURE, and clears the RR connection when S = 0.

19.1.4 Method of test

19.1.4.1 Initial conditions

The SS sends a randomly chooses value N for the parameter RADIO_LINK_TIMEOUT on the BCCH. CALL RE-ESTABLISHMENT is not allowed.

19.1.4.2 Procedure

- a) A MS originated call is set up according to the generic call set up procedure.
- b) The SS sends 32 error free SACCH messages, followed by N SACCH messages that contain unrecoverable errors, and then continuously sends error free SACCH messages.

NOTE: The SS shall continue sending error free SACCH messages for a time that allows the MS to release the RR connection.

- c) The SS sets N to a different but randomly chosen value, and broadcasts this on the BCCH. The SS repeats steps a) to b).

19.1.5 Test requirement

After receiving the N SACCH messages with unrecoverable errors, the MS shall abort the RR-connection, i.e. there is no more MS activity on the SACCH channel.

19.2 Channel release after unrecoverable errors - 2

19.2.1 Definition and applicability

Channel release after unrecoverable errors is a procedure to abort the call if the radio link has been severely corrupted for some time, according to a link failure criterion.

The requirement and this test apply to all types of GSM 900 and DCS 1 800 MS, except where an application layer is always running which would perform a normal release of the call due to loss of traffic (see PICS/PIXIT).

19.2.2 Conformance requirement

- 1) If the MS is unable to decode a SACCH message, the radio link counter S is decreased by 1. In the case of a successful reception of a SACCH message S is increased by 2. In any case S shall not exceed the value of RADIO_LINK_TIMEOUT. If S reaches 0 a radio link failure shall be declared.
GSM 05.08, 5.2.
- 2) The MS shall continue transmitting as normal on the uplink until S reaches 0.
GSM 05.08, 5.2.
- 3) The algorithm shall start after the assignment of a dedicated channel and S shall be initialized to RADIO_LINK_TIMEOUT.
GSM 05.08, 5.2.
- 4) (Re-)initialization and start of the algorithm shall be done whenever the MS switches to a new channel (this includes the old channel in assignment and handover failure cases), at the latest when the main signalling link (see GSM 04.08) has been established.
GSM 05.08, 5.2.

19.2.3 Test purpose

- 1) To verify correct handling of the radio link counter S.
- 2) To verify that the MS that is transmitting continues to transmit as normal on the uplink until S reaches 0.
- 3) To verify that the algorithm starts after the assignment of a dedicated channel, with S initialized to RADIO_LINK_TIMEOUT.

19.2.4 Method of test**19.2.4.1 Initial conditions**

The SS sends a randomly chooses value N for the parameter RADIO_LINK_TIMEOUT on the BCCH. CALL RE-ESTABLISHMENT is not allowed.

19.2.4.2 Procedure

- a) A MS originated call is set up according to the generic call set up procedure.
- b) The SS sends 2 SACCH messages with unrecoverable errors followed by one error free SACCH message. This step is repeated 64 times.
- c) The SS sets N to a different but randomly chosen value, and broadcasts this on the BCCH. The SS repeats steps a) to b).

19.2.5 Test requirement

The MS shall not abort the RR-connection.

19.3 Channel release after unrecoverable errors - 3**19.3.1 Definition and applicability**

Channel release after unrecoverable errors is a procedure to abort the call if the radio link has been severely corrupted for some time, according to a link failure criterion.

The requirement and this test apply to all types of GSM 900 and DCS 1 800 MS, except where an application layer is always running which would perform a normal release of the call due to loss of traffic (see PICS/PIXIT).

19.3.2 Conformance requirements

- 1) If the MS is unable to decode a SACCH message, the radio link counter S is decreased by 1. In the case of a successful reception of a SACCH message S is increased by 2. In any case S shall not exceed the value of RADIO_LINK_TIMEOUT. If S reaches 0 a radio link failure shall be declared. GSM 05.08, 5.2.
- 2) The MS shall continue transmitting as normal on the uplink until S reaches 0. GSM 05.08, 5.2.
- 3) The algorithm shall start after the assignment of a dedicated channel and S shall be initialized to RADIO_LINK_TIMEOUT. GSM 05.08, 5.2.
- 4) (Re-)initialization and start of the algorithm shall be done whenever the MS switches to a new channel (this includes the old channel in assignment and handover failure cases), at the latest when the main signalling link (see GSM 04.08) has been established. GSM 05.08, 5.2.

19.3.3 Test purpose

- 1) To verify correct handling of the radio link counter S.
- 2) To verify that the MS that is transmitting continues to transmit as normal on the uplink until S reaches 0.
- 3) To verify that the algorithm starts after the assignment of a dedicated channel, with S initialized to RADIO_LINK_TIMEOUT.
- 4) To verify that the MS declares RADIO_LINK_FAILURE, and clears the RR connection when S = 0.

19.3.4 Method of test

19.3.4.1 Initial conditions

The SS sends a randomly chooses value N for the parameter RADIO_LINK_TIMEOUT on the BCCH. CALL RE_ESTABLISHMENT is not allowed.

19.3.4.2 Procedure

- a) A MS originated call is set up according to the generic call set up procedure.
- b) The SS sends 32 error free SACCH messages, followed by 3 SACCH messages with unrecoverable errors, and the sends 1 error free SACCH message. This step is repeated N - 2 times.
- c) The SS shall continuously send error free SACCH messages.

NOTE: The SS shall continue sending error free SACCH messages for a time that allows the MS to release the RR connection.

- d) The SS sets N to a different but randomly chosen value, and broadcasts this on the BCCH. The SS repeats steps a) to c).

19.3.5 Test requirement

After receiving the $3 * (N - 2)$ erroneous SACCH messages the MS shall abort the RR-connection, i.e. there is no more activity on the SACCH channel.

20 Cell selection and reselection

In the following paragraphs some explanatory text is given concerning the nature of the tests in this section and the general behaviour of the SS is described.

Since the conformance requirements of most of the tests in this section cannot be tested explicitly, testing is done implicitly by testing the MS behaviour from its responses to the SS.

The SS transmits one BCCH carrier per cell as indicated in the initial conditions for each test. These are referred to as carrier 1, carrier 2, etc. It is assumed that the SS can simultaneously transmit seven BCCH carriers and monitor three random access channels. For multiband tests it is assumed that at least one of the BCCH carriers and one of the monitored random access channels is in a different frequency band from the others. In some cases, a test is performed in multiple stages in order that the requirements can be tested within the above constraints.

For any MS all the carriers are in its supported band(s) of operation. For an E-GSM mobile station at least one of the carriers is in the extension band and one of the carriers is in the primary band.

Unless otherwise stated in the method of test, in all of the tests of this section/

- The SS is continuously paging the MS on all carriers at the start of the test and does not respond to RACH requests from the MS. Where a test specifies that the MS is not paged on a particular carrier, only idle paging is transmitted according to GSM 04.08, 3.2.2.2.
- The default values of the system information data fields given in table 20.1 are used.
- The SIM is in the idle updated state in the default location area with a TMSI assigned at the beginning of each test.
- The ARFCNs used for the carriers in each test are chosen from those in table 20.1 with adjacent carriers separated by a minimum of three channels.

The absolute accuracy of the MS signal level measurements is assumed to be ± 6 dB. A difference of at least 8 dB is allowed for cases of discrimination between C1 or C2 values and 0.

The relative accuracy of the MS signal level measurements is assumed to be ± 3 dB for the signal levels used in the tests of this section, except for section 20.20, where the relative accuracy is assumed to be ± 5 dB if the measurements are on different frequency bands. A difference of at least 5 dB is allowed for cases of discrimination between C1 or C2 values on different carriers, except for section 20.20, where a difference of at least 10 dB is allowed if the measurements are on different frequency bands.

NOTE 1: The accuracy of MS signal level measurements is specified in GSM 05.08. For all of the tests in this section, the signal levels used are greater than 1 dB above reference sensitivity level.

NOTE 2: The tolerance on timers specified in GSM 05.08 is ± 10 % except for PENALTY_TIME where it is ± 2 seconds. In the tests of this section, the test requirements include these tolerances. Consequently, the times stated in the test requirement sometimes differ from the corresponding timer in the conformance requirement.

Where pulsed signals are specified, the SS tolerance on pulse width is ± 2 % and the SS tolerance on power level ± 1 dB.

Table 20.1: Default values of the system information fields

Parameter	GSM 04.08 reference	Abbr.	Normal Setting
Cell channel description	10.5.2.1	-	Any values
MAX retrans	10.5.2.29	-	1
TX-integer	10.5.2.29	-	Any value
CELL_BAR_QUALIFY	10.5.2.35	CBQ	0
CELL_BAR_ACCESS	10.5.2.29	CBA	0 (not barred)
AC CN	10.5.2.29	AC	All 0
RE	10.5.2.29	RE	0 (re-establishment allowed)
NCC	10.5.2.2	NCC	Any value
Cell Identity	10.5.1.1	-	Any value
MCC, MNC	10.5.1.3	PLMN	MS Home PLMN
LAC	10.5.1.3	LAC	1111 (Hex)
ATT	10.5.2.11	-	0 (Attach/Detach not allowed)
BS_AG_BLK_RES	10.5.2.11	-	Any values
T3212	10.5.2.11	-	Any values
BS_PA_MFRMS	10.5.2.11	BPM	5 frames
Cell Options	10.5.2.3	-	Any values
CELL_RESELECT_HYSTERESIS	10.5.2.4	CRH	4 dB
MS_TXPWR_MAX_CCH	10.5.2.4	MTMC	Max. output power of MS
RXLEV_ACCESS_MIN	10.5.2.4	RAM	-90 dBm
CELL_RESELECT_OFFSET	10.5.2.35	CRO	0
TEMPORARY_OFFSET	10.5.2.35	TO	0
PENALTY_TIME	10.5.2.35	PT	0
Power Offset	10.5.2.35	PO	0
BA ARFCN	10.5.2.22	BA	All 0 except:
			For GSM900, both P-GSM and E-GSM ARFCNs are broadcast: GSM ARFCNs 3, 9, 18, 25, 41, 43, 49, 50, 54, 58, 62, 66, 70, 80, 92, 124, broadcast in SYSTEM INFORMATION type 2 E-GSM ARFCNs 985, 989, 995, 1010, 1014 broadcast in SYSTEM INFORMATION type 2bis
			For DCS1800 ARFCNs 512, 543, 568, 589, 602, 641, 662, 683, 696, 711, 732, 754, 794, 851, 870, 871, 872, 884 broadcast in SYSTEM INFORMATION TYPE 2.
			For multiband tests, ARFCNs 3, 18, 41, 49, 62, 70, 92, 124 broadcast in SYSTEM INFORMATION TYPE 2 (GSM cell) and TYPE 2ter (DCS cell), and ARFCNs 512, 568, 602, 662, 696, 732, 794, 870 broadcast in SYSTEM INFORMATION TYPE 2 (DCS cell) and TYPE 2ter (GSM cell)

20.1 Cell selection

20.1.1 Definition and applicability

Cell selection is a process in which a MS, whenever a new PLMN is selected, attempts to find a suitable cell of that PLMN to camp on. Two methods of searching for a suitable cell are possible, normal cell selection and stored list cell selection. The process ensures that the MS is camped on a cell from which it can reliably decode downlink data and with which it has a high probability of communications on the uplink. Once the MS is camped on a cell, access to the network is allowed.

This test is applicable for all types of GSM 900 and DCS 1 800 MSs.

20.1.2 Conformance requirement

1. The MS shall be able to select the correct (fourth strongest) cell and be able to respond to paging on that cell within 30 seconds of switch on, when the three strongest cells are not suitable. This assumes a valid SIM, with PIN disabled and ideal radio conditions; GSM 05.08, 6.1.
2. There are various requirements that a cell must satisfy before an MS can perform normal camping on it:
 - 2.1 (i) It should be a cell of the selected PLMN
 - 2.2 (ii) It should not be "barred" (see section 3.5.1)
 - 2.3 (iv) The radio path loss between MS and BTS must be below a threshold set by the PLMN operator. This is estimated as shown in section 3.6.

GSM 03.22, 3.2.1.

NOTE: Criteria (iii) is not applicable for Cell Selection.

3. Initially the MS looks for a cell which satisfies these 4 constraints ("suitable cell") by checking cells in descending order of received signal strength. If a suitable cell is found, the MS camps on it; GSM 03.22, 3.2.1.
4. The MS shall be able to calculate correctly the path loss criterion parameter C1, used for cell selection and reselection; GSM 05.08, 6.4.

20.1.3 Test purpose

1. To verify that the MS meets conformance requirement 1.
2. To verify that:
 - 2.1 The MS does not select a cell of a PLMN which is not the selected PLMN.
 - 2.2 The MS does not select a cell which is "barred".
 - 2.3 The MS does not select a cell with $C1 < 0$.
3. To verify that the MS selects suitable cells in descending order of received signal strength.
4. To verify that the MS does not select a cell with $C1 < 0$.

20.1.4 Method of test**20.1.4.1 Initial conditions**

Parameters changed from the default values in table 20.1.

Parameter	Carrier 1	Carrier 2	Carrier 3	Carrier 4	Carrier 5	Carrier 6
RF Signal Level (dB μ V emf() / dBm)	48 / -65	38 / -75	43 / -70	33 / -80	28 / -85	OFF
CBA	1	0	0	0	0	
RXLEV_ACCESS_MIN (dBm)	-90	-67	-90	-88	-98	
MNC			01			
MCC			002			
C1	25	-8	20	8	13	
C2	25	-8	20	8	13	

For an E-GSM MS carrier 2 and carrier 4 ARFCNs are chosen in the E-GSM band, carrier 1 and carrier 3 ARFCNs in the P-GSM band.

20.1.4.2 Procedure

- a) The SS activates the carriers and monitors carriers 2, 4 and 5 for RA requests from the MS.
- b) The MS is switched on.
- c) The MS is switched off.
- d) The SS monitors carriers 1 and 3 for RA requests from the MS
- e) The MS is switched on.

20.1.5 Test requirements

- 1) After step b), the first response from the MS shall be on carrier 4 within 33 seconds. There shall be no response from the MS on carrier 2.
- 2) After step e), there shall be no response from the MS on either carrier 1 or carrier 3 within 33 seconds.

20.2 Cell selection with varying signal strength values

20.2.1 Definition and applicability

For definition see conformance requirement.

This test is applicable for all types of GSM 900 and DCS 1 800 MSs.

20.2.2 Conformance requirement

1. The MS shall:

The MS shall search all RF channels in the system (124 for GSM, 174 for E-GSM and 374 for DCS 1 800), take readings of received RF signal strength on each RF channel, and calculate the received level average for each. The averaging is based on at least five measurement samples per RF carrier spread over 3 to 5 s, the measurement samples from the different RF carriers being spread evenly during this period. GSM 05.08, 6.2.

- 1.1 The MS shall search all RF channels in the system (124 for GSM, 174 for E-GSM and 374 for DCS 1 800), take readings of received RF signal strength on each RF channel, and calculate the received level average for each.
 - 1.2 The averaging is based on at least five measurement samples per RF carrier spread over T_{av} (3 to 5 s).
 - 1.3 The measurement samples from the different RF carriers being spread evenly during this period.
2. These quantities are termed the "receive level averages", shall be unweighted averages of the received signal strengths measured in dBm. GSM 05.08, 6.1.

20.2.3 Test purpose

1. To verify that:
 - 1.1 The MS meets conformance requirement 1.1.
 - 1.2 The MS meets conformance requirement 1.2.
 - 1.3 The MS meets conformance requirement 1.3.
2. To verify that the MS meets conformance requirement 2.

20.2.4 Method of test**20.2.4.1 Initial conditions**

Parameters changed from the default values in table 20.1.

Parameter	Carrier 1	Carrier 2	Carrier 3	Carrier 4	Carrier 5	Carrier 6
RF Signal Level (dB μ V emf() / dBm)	23 / -90	58 / -55	OFF	OFF	OFF	OFF
RXLEV_ACCESS_MIN (dB μ V emf() / dBm)	13 / -100	13 / -100				
C1	10	53				

For an E-GSM MS carrier 1 ARFCN is chosen in the E-GSM band.

The manufacturer of the equipment shall declare his averaging time T_{av} . This time is the time between the first and the last measurement sample taken on one carrier during one averaging period.

20.2.4.2 Procedure

- a) The SS transmits on carriers 1 and 2. After a period of $b \cdot T_{av}$ carrier 2 reduces its transmit level to -85 dBm (28 dB μ V emf()). After a further period of $a \cdot T_{av}$, carrier 2 increases its transmit level again to -55 dBm (58 dB μ V emf()). Switching of carrier 2 continues with these levels and duty cycle until the end of the test.

T_{av} is the averaging time declared by the manufacturer.

The parameters a and b are chosen according to the following rules:

$$\begin{aligned} (a + b) \cdot T_{av} &> T_{av} \\ 0 < a \cdot T_{av} &< 2/3 \cdot T_{av} \\ 0,5 \cdot T_{av} < b \cdot T_{av} &< T_{av} \end{aligned}$$

In the equations < and > means at least one TDMA frame less or greater than the given value.

While satisfying the conditions given above:

- a is chosen to be as close as possible to 2/3.
- b is chosen to be as close as possible to 0,5.

- b) The MS is switched on.
- c) The SS monitors all RA requests from MS on carriers 1 and 2.

20.2.5 Test requirements

In step c), the first response from the MS shall be on carrier 2 within 33 seconds.

NOTE 1: With the selected duty cycle it can be guaranteed that a "good" MS passes the test even at the worst case situations. The minimum averaged value of carrier 2 is in any case higher or equal to -75 dBm which is still 6 dB above carrier 1's level (for a "good" MS).

NOTE 2: With the selected levels and duty cycle the probability that a "bad" MS (i.e. MS that averages over shorter period than 3 s) fails the test is maximized. However, it can not be guaranteed that all the MSs not fulfilling the conformance requirement of averaging or uniform sampling will fail this test.

20.3 Basic cell reselection

20.3.1 Definition and applicability

While camped on a cell of the selected PLMN the MS may need to select a different cell in order to fulfil the normal service state. This ensures that the MS is camped on a cell from which it can reliably decode downlink data and with which it has a high probability of communications on the uplink.

This test is applicable for all types of GSM 900 and DCS 1 800 MSs.

20.3.2 Conformance requirement

1. While camped on a cell of the selected PLMN ("camped normally"), the MS may need to select a different cell ("normal cell reselection" state). The following events trigger a cell reselection:

- 1.1 (iii) The cell camped on (current serving cell) has become barred.

- 1.2 (iv) There is a better cell (in terms of the path loss criterion C2) in the same LA, or a much better cell in another LA of the selected PLMN (using the CRH parameter).

The MS will then reselect a new cell in order to fulfil the process goal.; GSM 03.22, 4.5.

NOTE 1: Criterion (i) is tested in section 20.8 (Cell reselection when $C1(\text{serving cell}) < 0$ for 5 seconds).

NOTE 2: Criterion (ii) is tested section 20.16 (Downlink signalling failure).

NOTE 3: Criterion (v) is tested in section 20.6 (Cell reselection timings).

2. There are various requirements that a cell must satisfy before an MS can perform normal camping on it:

- 2.1 (ii) It should not be "barred".

- 2.2 (iv) The radio path loss between MS and BTS must be below a threshold set by the PLMN operator. GSM 03.22, 3.2.1.

NOTE 4: Criterion (i) is not relevant for cell reselection and for cell selection it is tested in section 20.1.

NOTE 5: Criterion (iv) refers to the C1 parameter.

3. The MS shall be able to calculate correctly the path loss criterion parameter C2 used for cell reselection; GSM 05.08, 6.4.

4. At least every 5 s the MS shall calculate the value of C1 and C2 for the serving cell and recalculate C1 and C2 values for non serving cells (if necessary). The MS shall then check whether:

- i) The path loss criterion (C1) for current serving cell falls below zero for a period of 5 seconds. This indicates that the path loss to the cell has become too high.

- ii) The calculated value of C2 for a non-serving suitable cell exceeds the value of C2 for the serving cell for a period of 5 seconds, except in the case of the new cell being in a different location area in which case the C2 value for the new cell shall exceed the C2 value of the serving cell by at least CELL_RESELECT_HYSTERESIS dB as defined by the BCCH data from the current serving cell, for a period of 5 seconds. This indicates that it is a better cell. GSM 05.08, 6.6.2.

5. The MS shall attempt to decode the full BCCH data of the serving cell at least every 30 seconds; GSM 05.08, 6.6.1.

20.3.3 Test purpose

1. To verify that:
 - 1.1 The MS meets conformance requirement 1.1.
 - 1.2 The MS meets conformance requirement 1.2.
2. To verify that:
 - 2.1 The MS does not reselect a cell which is barred.
 - 2.2 The MS does not reselect a cell which has a $C1 < 0$.
3. To verify that the MS calculates the C2 parameter correctly when the CELL_RESELECT_OFFSET, TEMPORARY_OFFSET and PENALTY_TIME parameters are not used.
4. To verify that the MS takes into account the CELL_RESELECT_HYSTERESIS parameter when reselecting a cell in a different location area.
5. To verify that the MS decodes the CELL_BAR_ACCESS and CELL_BAR_QUALIFY parameters from the BCCH every 30 seconds.

20.3.4 Method of test**20.3.4.1 Initial conditions**

Parameters changed from the default values in table 20.1.

Parameter	Carrier 1	Carrier 2	Carrier 3	Carrier 4	Carrier 5	Carrier 6
RF Signal Level (dB μ V emf() / dBm)	43 / -70	33 / -80	43 / -70	38 / -75	38 / -75	
RXLEV_ACCESS_MIN (dBm)	-85	-90	-90	-85	-67	
CRH	10 dB					
LAC			different from other carriers			
CBA				1		
CBQ				0		
C1	15	10	20	10	-8	
C2	15	10	20	10	-8	

The BA(BCCH) list only contains the ARFCNs of the carriers used during the test.

20.3.4.2 Procedure

- a) The SS activates carriers 1, 2, 4 and 5. The MS is not paged on carrier 1. The SS monitors carriers 2, 4 and 5 for RA requests from the MS.
- b) The MS is switched on.
- c) The SS stops paging on all carriers except carrier 2. The level of carrier 2 is increased to 43 dB μ Vemf (C2 becomes 20 dB), and the SS monitors carrier 2 for RA requests from the MS.
- d) When the SS receives a response from the MS on carrier 2, it stops paging the MS on this carrier.
- e) The MS is switched off.
- f) The SS is reconfigured and sets CBA = 1 on carriers 1 and 5.
- g) The MS is switched on.

- h) After 33 seconds, the SS starts paging continuously on carrier 1 and sets CBA=1 on carrier 2 and CBA=0 on carriers 1, 4 and 5.
- i) When the SS receives a response on carrier 1, it stops paging the MS and waits for 25 seconds. (The MS should reselect and camp onto carrier 1).
- j) The SS activates carrier 3, pages the MS continuously on this carrier and monitors carrier 3 for RA requests from the MS.
- k) The SS increases the level of carrier 3 to 53 dB μ V_{emf} (C2 increases to 30 dB).

20.3.5 Test requirements

- 1) After step b), there shall be no response from the MS on carriers 2, 4, or 5 within 50 seconds.
- 2) In step c), the MS shall respond on carrier 2 within 20 seconds of increasing the level of carrier 2.

NOTE 1: 5 seconds to perform running average, 10 seconds to detect C2 differences, 2,4 seconds to read BCCH of carrier 2, 1 second to perform RA. Total 18,4 seconds, allow 20 seconds.
- 3) In step h), the MS shall respond on carrier 1 within 50 seconds of setting CBA=1 on carrier 2.

NOTE 2: 33 seconds for the MS to read the BCCH of carrier 2 (30 seconds + 10 %), 15 seconds for the MS to reselect cell 1, since the MS already has a running average on carrier 1, allow 50 seconds.
- 4) After step j), there shall be no response from the MS within 50 seconds.
- 5) After step k), the MS shall respond on carrier 3 within 20 seconds.

20.4 Cell reselection using TEMPORARY_OFFSET, CELL_RESELECT_OFFSET, POWER_OFFSET and PENALTY_TIME parameters

20.4.1 Definition and applicability

This test is applicable for all types of GSM 900 and DCS 1 800 MSs

20.4.2 Conformance requirement

- 1. The MS shall be able to calculate correctly the path loss criterion parameter C2 used for cell reselection; GSM 05.08, 6.4.

20.4.3 Test purpose

- 1. To verify that the MS calculates the C2 parameter correctly when the CELL_RESELECT_OFFSET, TEMPORARY_OFFSET and PENALTY_TIME parameters are used.
- 2. To verify DCS 1 800 MS correctly calculate the C2 parameter when the POWER_OFFSET parameter is present.

20.4.4 Method of test

20.4.4.1 Initial conditions

Parameters changed from the default values in table 20.1.

Parameter	Carrier 1	Carrier 2	Carrier 3	Carrier 4	Carrier 5	Carrier 6
RF Signal Level (dB μ V emf() / dBm)	53 / -60	43 / -70	48 / -65	48 / -65		
RXLEV_ACCESS_MIN (dBm)	-80	-100	-85	-85		
PT		11111	40 s	60 s		
CRO		16 dB	20 dB	20 dB		
TO			20 dB	20 dB		
K = 1						
C1	20	30	20	20		
C2	20	14	20 -> 40	20 -> 40		
K = 2 (DCS1800 Class 3 MS only)						
POWER_OFFSET	0	2	6	6		

The BA(BCCH) list only contains the ARFCNs of the carriers used during the test.

20.4.4.2 Procedure

For testing of GSM MS, the test procedure is performed for execution counter K = 1.

For testing of DCS 1 800 MS, the test procedure is performed for execution counter K = 1 and 2

On execution counter K = 1, the POWER_OFFSET Parameter is not present.

On execution counter K = 2, the POWER_OFFSET parameter is present.

- a) The SS activates carriers 1 and 2. The MS is not paged on carrier 1. The SS monitors carrier 2 for RA requests from the MS.
- b) The MS is switched on.
- c) The SS increases the level of carrier 2 to 54 dB μ Vemf (C2 becomes 25 dB).
- d) When the SS receives a response on carrier 2, the SS stops paging on that carrier and waits for 20 seconds (The MS should reselect and camp onto carrier 2).
- e) The SS activates carriers 3 and 4 and continuously pages the MS on these carriers. The SS monitors carriers 3 and 4 for RA requests from the MS.

20.4.4.3 Requirements

For execution counter K = 1 and K = 2.

- 1) After step b), there shall be no response from the MS on carrier 2 within 50 seconds.
- 2) After step c), the MS shall respond on carrier 2 within 20 seconds of increasing the level of carrier 2.
- 3) After step e), there shall be no response from the MS on carrier 3 within 38 seconds of activating the carriers but, the MS shall respond on carrier 3 within 90 seconds. The response on carrier 3 shall be before any response on carrier 4.

NOTE: Minimum time of 38 seconds set by penalty timer on carrier 3 less 2 second tolerance. Maximum time, total of 33 seconds to read BCCH of carrier 3, 42 seconds for expiry of penalty timer on carrier 3, 15 seconds for reselection, since the MS will already have running averages on carriers 3 and 4, when the penalty timers expire, allow 90 seconds.

20.5 Cell reselection using parameters transmitted in the System Information type 2bis, type 2ter, type 7 and type 8 messages.

20.5.1 Definition and applicability

System information (SI) type 7 and 8 are transmitted on the BCCH Ext when the system information type 4 message does not contain all information needed for cell selection.

The system information type 2 bis message is used when the system information type 2 message does not contain all neighbour cell ARFCNs.

The system information type 2 ter message is used when system information type 2 messages broadcast by one cell which are system information 2 or both system information 2 and 2bis do not contain all neighbour cell ARFCNs.

Test purposes 1 and 3 are applicable to all types of GSM900 and DCS1800 MS.

Test purpose 2 is only applicable for E-GSM and DCS 1 800 MS. This is reflected in initial conditions step d).

Test purpose 4 is only applicable to an E-GSM MS. This is reflected in initial conditions step f), test procedures d) and e) and test requirements clause 3).

20.5.2 Conformance requirement

1. The MS shall be able to calculate correctly the path loss criterion parameter C2 used for cell reselection. GSM 05.08, 6.4.
2. Whilst in idle mode, an MS shall continue to monitor all BCCH carriers as indicated by the BCCH allocation. GSM 05.08, 6.6.1.
3. Mobile stations shall treat all ARFCNs in the set {0, 1, 2 ... 1023} as valid ARFCN values even if the mobile station is unable to transmit or receive on that ARFCN. GSM 04.08, 10.5.2.1b.
4. An E-GSM MS shall correctly decodes parameters transmitted in the system information type 2 ter message. GSM 04.08, 9.1.34:

20.5.3 Test purpose

1. To verify that the MS correctly calculates the C2 criterion when the parameters affecting cell reselection are transmitted in the system information type 7 and 8 messages.
2. To verify that E-GSM and DCS 1 800 MS decode parameters transmitted in the system information type 2 bis message.
3. To verify that the MS treats ARFCNs as valid ARFCNs even if the MS is unable to transmit or receive on that ARFCN.
4. To verify that an E-GSM mobile correctly decode parameters transmitted in the system information type 2 ter message.

20.5.4 Method of test

20.5.4.1 Initial conditions

- a) Parameters changed from the default values in table 20.1.

Parameter	Carrier 1	Carrier 2	Carrier 3 *)	Carrier 4	Carrier 5	Carrier 6
RF Signal Level (dB μ V emf() / dBm)	53 / -60	32 / -81	40 / -73	OFF	OFF	OFF
RXLEV_ACCESS_MIN (dB μ V emf() / dBm)	23 / -90	23 / -90	30 / -83			
BS_AG_BLKES_RES	1	1	1			
PT		0	0			
CRO		16 dB	10 dB			
TO		0 dB	0 dB			
C1	30	9	10			
C2	30	25	20			

*) : Carrier 3 is off for P-GSM and DCS 1800 MS. Carrier 3 is only required for E-GSM MS.

- b) The ARFCNs of carriers 1, 2 and 3 are chosen from those in table 20.1.
- c) The cell reselection parameters PENALTY_TIME, CELL_RESELECT_OFFSET and TEMPORARY_OFFSET are transmitted in the SI3, SI7 and SI8 messages on carrier 2. They are not transmitted in SI4 and the ADDITIONAL RESELECT PARAM IND parameter is set to 1.
- d) The SI2bis message is transmitted on carrier 1 and contains the ARFCN of carrier 2 and ARFCNs 43, 70, 500, 550, 990 and 995. For an E-GSM MS and a DCS 1 800 MS, the ARFCN of carrier 2 is not transmitted in the SI2 message.
- e) Carriers 1 and 2 are synchronized, but staggered in frame number so that the transmission of the SI3 message on carrier 2, coincides with the paging block which the MS is listening to on carrier 1.

NOTE: Under these conditions, the MS can only decode the parameters affecting cell reselection from the SI7 or SI8 messages.

To achieve this, the following conditions are used:

BS_PA_MFRMS = 4

IMSI mod 1000 = 12

FN carrier 1 = FN carrier 2-27, for simultaneously transmitted frames.

- f) For an E-GSM MS, the SI3 message on carrier 2 indicates that SI2ter is used on carrier 2. SI2ter message contains the ARFCN of carrier 3 and ARFCNs 45, 76, 891, 905. The ARFCN of carrier 3 is transmitted neither in the SI2 nor in the SI2bis messages on carriers 1 and 2.

20.5.4.2 Test Procedure

- a) The SS activates the channels. The MS is not paged on carrier 1.
- b) The MS is switched on.
- c) After 50 seconds, the SS increases the level of carrier 2 to 42 dB μ Vemf().
- d) For an E-GSM MS only, after 30 seconds, the SS increases the level of carrier 3 to 60 dB μ Vemf().

20.5.5 Test Requirements

- 1) After step b), there shall be no response from the MS on carrier 2. For an E-GSM MS there shall also be no response on carrier 3.
- 2) After increasing the level of carrier 2 in step c), the MS shall respond on carrier 2 within 20 seconds.
- 3) After increasing the level of carrier 3 in step d), an E-GSM mobile shall respond on carrier 3 within 20 seconds.

20.6 Cell reselection timings

20.6.1 Definition and applicability

This test is applicable for all types of GSM 900 and DCS 1 800 MSs.

20.6.2 Conformance requirement

1. At least every 5 s the MS shall calculate the value of C1 and C2 for the serving cell and recalculate C1 and C2 values for non serving cells (if necessary). The MS shall then check whether:
 - 1.1 ii) The calculated value of C2 for a non-serving suitable cell exceeds the value of C2 for the serving cell for a period of 5 seconds,
 - 1.2 In case ii) above, cell reselection shall not take place if there was a cell reselection within the previous 15 seconds.
 - 1.3 Cell reselection for any other reason (see GSM 03.22) shall take place immediately, but the cell that the MS was camped on shall not be returned to within 5 seconds if another suitable cell can be found.;

GSM 05.08, 6.6.2.

20.6.3 Test purpose

1. To verify that:
 - 1.1 The MS does not perform a cell reselection when the C2 value for a non serving cell does not exceed the C2 value of the serving cell for a period of at least 5 seconds.
 - 1.2 The MS meets conformance requirement 1.2 with an allowance for the uncertainty of the test.
 - 1.3 When the MS performs an immediate cell reselection due to an unsuccessful random access attempt, the cell that the MS was camped onto is not returned to within 5 seconds when another suitable cell exists.

20.6.4 Method of test

20.6.4.1 Initial conditions

Parameters changed from the default values in table 20.1.

Parameter	Carrier 1	Carrier 2	Carrier 3	Carrier 4	Carrier 5	Carrier
RF Signal Level (dB μ V emf() / dBm)	56 / -57	46 / -67	OFF	OFF	OFF	OFF
RXLEV_ACCESS_MIN (dB μ V emf() / dBm)	29 / -84	33 / -80				
Max. Retrans	00	00				
C1	27	13				
C2	27	13				

Below is an alternative table of parameters for use with test equipment that cannot reach the upper RF levels as specified in the table above. These carrier levels are reduced by 5 dB and will not effect the purpose of the test case:

Parameter	Carrier 1	Carrier 2	Carrier 3	Carrier 4	Carrier 5	Carrier
RF Signal Level (dB μ V emf() / dBm)	51 / -62	41 / -72	OFF	OFF	OFF	OFF
RXLEV_ACCESS_MIN (dB μ V emf() / dBm)	24 / -89	28 / -85				
Max. Retrans	00	00				
C1	27	13				
C2	27	13				

The BA(BCCH) list only contains 5 ARFCNs including the ARFCNs of the carriers used during the test.

NOTE: With 5 ARFCNs in the BA(BCCH) list and BS_PA_MFRMS=5 (default value) the MS will maintain a running average on surrounding cells over a period of 5 seconds.

20.6.4.2 Procedure

- a) The SS activates the channels. The MS is not paged on any of the carriers.
- b) The MS is switched on.
- c) After 50 seconds, the SS starts paging continuously on carriers 1 and 2 for 20 seconds. The SS monitors carriers 1 and 2 for RA requests from the MS.
- d) The SS stops paging on carriers 1 and 2 and waits for 20 seconds. (The MS should revert to carrier 1 due to cell reselection.)
- e) The SS starts paging continuously on carrier 2.
- f) The SS increases the transmit level of carrier 2 by 20 dB for a period of 4 s and then reduces the level back to the original value.
- g) The SS increases the transmit level of carrier 2 by 20 dB and waits for the MS to access on carrier 2. The SS records the time t from the increase in the level of carrier 2 to the first response from the MS.
- h) The SS stops paging on carrier 2 and decreases the transmit level of carrier 2 back to the original value.
- j) The SS waits 20 seconds. (The MS should revert to carrier 1 due to cell reselection.)
- k) The SS increases the transmit level of carrier 2 by 20 dB. After $t+2$ seconds, the SS starts paging continuously on carrier 1 and reduces the level of carrier 2 back to the original level.

20.6.5 Test requirements

- 1) In step c), the MS shall transmit 2 RA requests on carrier 1 followed by 2 RA requests on carrier 2. Subsequent RA requests on carrier 1 shall not occur within 4,5 s of the second RA request on carrier 1.
- 2) In step f), there shall be no access on carrier 2 within 34 seconds of increasing the level of carrier 2.
- 3) After step g), the MS shall respond on carrier 2.
- 4) In step k), there shall be no response on carrier 1 within 11 seconds after the level of carrier 2 is reduced back to the original level.

NOTE: The 11 seconds is derived from $(t+15)$ seconds minimum cell reselection timer minus $(t+2)$ seconds from the start of step k) up to the reduction of the level of carrier 2. A further 2 seconds are subtracted to cover for any uncertainty introduced by the RA process occurring after step g).

20.7 Priority of cells

20.7.1 Definition and applicability

In general, cell prioritization is a means of encouraging MSs to select some suitable cells in preference to others.

This test is applicable for all types of GSM 900 and DCS 1 800 MSs.

20.7.2 Conformance requirement

1. During cell selection a cell with low priority indication will only be selected if a suitable cell of normal priority cannot be found; GSM 03.22, 3.5.2.1.
2. Table 1a. Parameters affecting cell priority for cell selection

CELL_BAR_QUALIFY	CELL_BAR_ACCESS	Cell selection priority	Status for cell reselection
0	0	normal	normal
0	1	barred	barred
1	0	low	normal (see note 2)
1	1	low	normal (see note 2)

GSM 05.08, table 1.a

3. If all the following conditions are met then the "Cell selection priority" and the "Status for cell reselection" shall be set to normal:
 - the cell belongs to the MS HPLMN
 - the MS is in cell test operation mode
 - the CELL_BAR_ACCESS is set to "1"
 - the CELL_BAR_QUALIFY is set to "0"
 - the Access Control class 15 is barred

GSM 05.08, table 1.a

20.7.3 Test purpose

1. To verify that the MS does not select a cell of low priority when a suitable cell of normal priority exists with a lower received signal strength.
2. To verify that the MS takes into account CELL_BAR_ACCESS and CELL BAR _QUALIFY when performing cell selection and reselection.
3. To verify that the MS meets conformance requirement 3.

20.7.4 Method of test

20.7.4.1 Initial conditions

Parameters changed from Default values table 20.1

Parameter	Carrier 1	Carrier 2	Carrier 3	Carrier 4	Carrier 5	Carrier 6
RF Signal Level (dBµV emf) / dBm)	33 / -80	43 / -70	33 / -80	23 / -90	OFF	OFF
RXLEV_ACCESS_MIN (dBµV emf) / dBm)	3 / -110	23 / -90	13 / -100	13 / -100		
CBA	0	1	1	0		
CBQ	1	1	0	0		
Access class 15	barred	barred	barred	barred		
C1	30	20	20	10		

20.7.4.2 Procedure

- a) The SS activates the carriers and monitors for RA requests from the MS on carriers 1, 2, and 4.
- b) The MS is switched on.
- c) The MS is switched off. The SS deactivates the carriers.
- d) The MS is placed in cell test operation mode.

NOTE: Cell test mode is a mode of operation defined in SIM administrative data field.

- e) The SS activates the carriers and monitors for RA requests from the MS on carriers 1, 2, and 3.
- f) The MS is switched on.

20.7.5 Test requirements

- 1) After step b), the first response from the MS shall be on carrier 4 within 33 seconds, followed by a response on carrier 1 before a response (if any) on carrier 2 within 50 seconds.
- 2) After step f), the first response from the MS shall be on carrier 3 within 33 seconds, followed by a response on carrier 1 before a response (if any) on carrier 2 within 50 seconds.

20.8 Cell reselection when C1 (serving cell) < 0 for 5 seconds**20.8.1 Definition and applicability**

This test is applicable for all types of GSM 900 and DCS 1 800 MSs.

20.8.2 Conformance requirement

1. At least every 5 s the MS shall calculate the value of C1 and C2 for the serving cell and recalculate C1 and C2 values for non serving cells (if necessary). The MS shall then check whether:
 - i) The path loss criterion (C1) for current serving cell falls below zero for a period of 5 seconds. This indicates that the path loss to the cell has become too high. GSM 05.08, 6.6.2.
2. While camped on a cell of the selected PLMN ("camped normally"), the MS may need to select a different cell ("normal cell reselection" state). The following events trigger a cell reselection:
 - (i) The path loss criterion parameter C1 (see section 3.6) indicates that the path loss to the cell has become too high.; GSM 03.22, 4.5.

20.8.3 Test purpose

1. To verify that the MS meets conformance requirement 1.
2. To verify that the MS meets conformance requirement 2.

20.8.4 Method of test**20.8.4.1 Initial conditions**

Parameters changed from Default values table 20.1

Parameter	Carrier 1	Carrier 2	Carrier 3	Carrier 4	Carrier 5	Carrier 6
RF Signal Level (dB μ V emf() / dBm)	63 / -50	33 / -80	OFF	OFF	OFF	OFF
RXLEV_ACCESS_MIN (dB μ V emf() / dBm)	43 / -70	23 / -90				
CRO	30 dB					
TO	0					
PT	0					
C1	20	10				
C2	50	10				

NOTE: With BS_PA_MFRMS = 5 (default value), the averaging time of the MS on the serving cell BCCH is 5,9s.

20.8.4.2 Procedure

- a) The SS activates the carriers. The MS is not paged on carrier 1. The SS monitors carriers 1 and 2 for RA requests from the MS.
- b) The MS is switched on.
- c) The SS reduces signal level on carrier 1 to -80 dBm / 33 dB μ V emf() for 4 s. Then, the SS raises the level back to -50 dBm / 63 dB μ V emf(). (C1 becomes -10 dB and C2, 20 dB during this period).
- d) The SS reduces signal level on carrier 1 to -80 dBm / 33 dB μ V emf()

20.8.5 Test requirements

- 1) After step b), there shall be no access on carrier 1 or carrier 2, within 50 seconds.
- 2) After step c), there shall be no access on carrier 2 within 30 seconds.
- 3) After step d), the MS shall access on carrier 2 within 20 seconds.

20.9 Running average of the surrounding cell BCCH carrier signal levels

20.9.1 Definition and applicability

This test is applicable for all types of GSM 900 and DCS 1 800 MSs.

20.9.2 Conformance requirement

1. Whilst in idle mode an MS shall continue to monitor all BCCH carriers as indicated by the BCCH allocation (BA - See table 1). A running average of received level in the preceding 5 to

Max. $\{5, ((5 * N + 6) \text{ DIV } 7) * \text{BS_PA_MFRMS} / 4\}$

seconds shall be maintained for each carrier in the BCCH allocation. N is the number of non-serving cell BCCH carriers in BA and the parameter BS_PA_MFRMS is defined in GSM 05.02; GSM 05.08, 6.6.1.

2. The same number of measurement samples shall be taken for all non-serving cell BCCH carriers of the BA list, and the samples allocated to each carrier shall as far as possible be uniformly distributed over each evaluation period.; GSM 05.08, 6.6.1

20.9.3 Test purpose

1. To verify that if the MS calculates a received level average (over 5 seconds) for a non-serving suitable cell which results in the value of C2 exceeding the value of C2 for the serving cell, then cell reselection takes place to the non-serving cell.

2. To verify that by using suitable varying levels of signal strength for non serving cells, the MS samples on non serving cell BCCH carriers are as far as possible distributed uniformly over each evaluation period.

20.9.4 Method of test

20.9.4.1 Initial conditions

Parameters changed from Default values table 20.1

Parameter	Carrier 1	Carrier 2	Carrier 3	Carrier 4	Carrier 5	Carrier 6
RF Signal Level (dB μ V emf() / dBm)	53 / -60	33 / -80	OFF	OFF	OFF	OFF
RXLEV_ACCESS_MIN (dB μ V emf() / dBm)	23 / -90	23 / -90				
C1	30	10				
C2	30	10				

BS_PA_MFRMS is set to 4 for this test.

The BA(BCCH) list only contains 7 ARFCNs including the ARFCNs of the carriers used during the test.

NOTE: With 7 ARFCNs in the BA(BCCH) list and BS_PA_MFRMS=4 the MS will maintain a running average on surrounding cells over a period of 5 seconds.

20.9.4.2 Procedure

- The SS activates the carriers. The MS is not paged on carrier 1. The SS monitors carriers 1 and 2.
- The MS is switched on.
- The SS starts switching the level of carrier 2 between -80 dBm and -57 dBm every 2,7 seconds and continues to do so until the end of the test.
- The SS decreases the level of carrier 1 to -76 dBm.

NOTE: As a result of the switching in levels, the running average on carrier 2 will be between -66dBm and -71dBm, assuming that samples are distributed over five consecutive paging blocks.

20.9.5 Test requirements

- After step b), there shall be no access from the MS on carrier 1 or carrier 2, within 50 seconds..
- After step c), there shall be no access from the MS on carrier 1 or 2 within 25 seconds

NOTE: Any potential access on is likely to occur within 20 seconds.

- After step d), the MS shall access on carrier 2 within 20 seconds.

20.10 Running average of the serving cell BCCH carrier signal level

20.10.1 Definition and applicability

The MS is required to monitor continuously the BCCH carrier signal level of the serving cell (and to compare it to the BCCH carrier signal levels of the non-serving cells) to guarantee that it is camped on the most suitable cell.

This test is applicable for all types of GSM 900 and DCS 1 800 MSs.

20.10.2 Conformance requirement

1. For the serving cell, receive level measurement samples shall be taken at least for each paging block of the MS. The receive level average shall be a running average determined using samples collected over a period of 5 s or five consecutive paging blocks of that MS, whichever is the greater period. New receiving level average values shall be calculated as often as possible.; GSM 05.08, 6.6.1.

20.10.3 Test purpose

1. To verify that by using suitable varying levels of signal strength for the serving cell, the MS performs a running average over 5 consecutive paging blocks.

20.10.4 Method of test**20.10.4.1 Initial conditions**

Parameters changed from Default values table 20.1 are below,

Parameter	Carrier 1	Carrier 2	Carrier 3	Carrier 4	Carrier 5	Carrier 6
RF signal level (dB μ V emf() / dBm)	63 / -50	39 / -74	OFF	OFF	OFF	OFF
RXLEV_ACCESS_MIN (dB μ V emf() / dBm)	23 / -90	23 / -90				
C1	40	16				
C2	40	16				

NOTE: With BS_PA_MFRMS = 5 (default value), the averaging time of the MS on the serving cell BCCH is 5,9s.

20.10.4.2 Procedure

- a) The SS activates the carriers. The MS is not paged on carrier 1. The SS monitors carriers 1 and 2 for RA requests from the MS.
- b) The MS is switched on.
- c) After 50 seconds the SS starts switching the level of carrier 1 between -80 dBm and -50 dBm every 3 seconds.

NOTE: As a result of the switching in levels, the running average on carrier 1 will be between -62 dBm and -68 dBm over five consecutive paging blocks.

- d) The SS increases the level of carrier 2 to -56 dBm.

20.10.5 Test requirement

- 1) After step c), the MS shall not access on carrier 2, within 25 seconds.
- 2) After step d), the MS shall access on carrier 2, within 30 seconds.

NOTE 1: 13,75 seconds to perform running average, 10 seconds to detect C2 differences, 2,4 seconds to read BCCH of carrier 2, 1 second to perform RA. Total 27,15 seconds, allow 30 seconds.

20.11 Updating the list of six strongest neighbour carriers and decoding the BCCH information of a new carrier on the list

20.11.1 Definition and applicability

This test is applicable for all types of GSM 900 and DCS 1 800 MSs.

20.11.2 Conformance requirement

1. The list of the 6 strongest non-serving carriers shall be updated at least as often as the duration of the running average defined for measurements on the BCCH allocation and may be updated more frequently; GSM 05.08, 6.6.1.
2. When the MS recognizes that a new BCCH carrier has become one of the 6 strongest, the BCCH data shall be decoded for the new carrier within 30 seconds; GSM 05.08, 6.6.1.

20.11.3 Test purpose

1. To verify that MS meets conformance requirement 1.
2. To verify that MS meets conformance requirement 2.

20.11.4 Method of test

20.11.4.1 Initial conditions

Six BCCH carriers are established with the system information contents of table 20.1.

Parameters changed from Default values table 20.1 are below,

Parameter	Carrier 1	Carrier 2	Carrier 3	Carrier 4	Carrier 5	Carrier 6	Carrier 7
RF signal level (dB μ V emf ()/dBm)	53 / -60	48 / -65	43 / -70	38 / -75	33 / -80	33 / -80	38 / -75
RXLEV_ACCESS_MIN	-90	-90	-90	-90	-90	-90	-110
C1	30	25	20	15	10	10	35
C2	30	25	20	15	10	10	35

The BA(BCCH) list contains only eight ARFCNs and includes those of carriers 1 to 7.

BS_PA_MFRMS is set to 3 during this test.

NOTE: The combination of 8 carriers on the BA list and BS_PA_MFRMS = 3 leads to averaging time of 5 seconds. Hence 5 seconds is also the updating time of the list of six strongest neighbour carriers.

20.11.4.2 Procedure

- a) The SS activates carriers 1 to 6. The MS is not paged on any of the carriers.
- b) The MS is switched on.
- c) After 60 seconds, the SS activates carrier 7 and pages the MS continuously on this carrier. The SS monitors carrier 7 for RA requests from the MS.

20.11.5 Test requirements

- 1) The MS shall access on carrier 7 within 55 s of activating carrier 7.

NOTE: 5,5 seconds to notice new strongest carrier in top 6 (because the updating time for six strongest is 5 seconds (+10 %)), 33 seconds to read BCCH, 15 seconds for reselection, since the MS has already performed the running average on the new strongest carrier, allow 55 seconds.

20.12 Decoding the BCCH information of the neighbour carriers on the list of six strongest neighbour carriers

20.12.1 Definition and applicability

This test is applicable for all types of GSM 900 and DCS 1 800 MSs.

20.12.2 Conformance requirement

1. The MS shall attempt to decode the BCCH data block that contains the parameters affecting cell reselection for each of the 6 strongest non-serving cell BCCH carriers at least every 5 minutes; GSM 05.08, 6.6.1.

NOTE: Verification of cell reselection as implicitly tested here is performed in section 20.3.

20.12.3 Test purpose

1. To verify that the MS decodes the BCCH data block that contains the parameters affecting cell reselection for a non-serving cell BCCH carrier, (which is in the list of six strongest neighbour cells), at least every 5 minutes. This is achieved by changing the BCCH data such that the value of C2 for the non serving cell exceeds the value of C2 for the serving cell, and observing that the MS performs cell reselection within 5 minutes plus the time allowed for cell reselection after the change of the BCCH data.

20.12.4 Method of test

20.12.4.1 Initial conditions

Parameters changed from Default values table 20.1 are below,

Parameter	Carrier 1	Carrier 2	Carrier 3	Carrier 4	Carrier 5	Carrier 6
RF signal level (dB μ V emf() / dBm)	38 / -75	33 / -80	OFF	OFF	OFF	OFF
C1	15	10				
C2	15	10				

20.12.4.2 Procedure

- a) The SS activates the carriers. The MS is not paged on carrier 1. The SS monitors carriers 1 and 2.
- b) The MS is switched on.
- c) The SS changes the RXLEV_ACCESS_MIN in the BCCH data of carrier 2 to be -100 dBm.

NOTE: With the above change the C2 of carrier 2 becomes 20 whereas the C2 of carrier 1 stays at 15.

20.12.5 Test requirements

- 1) After step b), there shall be no access from the MS on carrier 1 or carrier 2 within 50 seconds.
- 2) After step c), the MS shall access on carrier 2 within 345 s of the change in the BCCH data of carrier 2.

NOTE: 330 s for decode of BCCH of carrier 2 (300 s +10 %), 15 seconds for reselection of carrier 2, since the MS already has a running average on carrier 2.

20.13 Decoding the BSIC of the neighbour carriers on the list of six strongest neighbour carriers

20.13.1 Definition and applicability

This test is applicable for all types of GSM 900 and DCS 1 800 MSs.

20.13.2 Conformance requirement

1. The MS shall attempt to check the BSIC for each of the 6 strongest non-serving cell BCCH carriers at least every 30 seconds, to confirm that it is monitoring the same cell. If a change of BSIC is detected then the carrier shall be treated as a new carrier and the BCCH data redetermined; GSM 05.08, 6.6.1.

NOTE: Verification of cell reselection as implicitly tested here is performed in section 20.3.

20.13.3 Test purpose

1. To verify that the MS will check the BSIC of the non-serving cell, which is in the list of six strongest neighbour cells, by changing the BSIC and the BCCH data of the non-serving cell such that the value of C2 for that cell exceeds the value of C2 of the serving cell, and observing that the MS performs cell reselection within the time allowed to check the BSIC, redetermine the BCCH data and perform cell reselection.

20.13.4 Method of test

20.13.4.1 Initial conditions

Parameters changed from Default values table 20.1 are below:

Parameter	Carrier 1	Carrier 2	Carrier 3	Carrier 4	Carrier 5	Carrier 6
RF signal level (dB μ V emf() / dBm)	38 / -75	33 / -80	OFF	OFF	OFF	OFF
C1	15	10				
C2	15	10				

20.13.4.2 Procedure

- a) The SS activates the carriers. The MS is not paged on carrier 1. The SS monitors carriers 1 and 2.
- b) The MS is switched on.
- c) The SS changes the BSIC of carrier 2 by changing the Base Station Colour Code (BCC) part of the BSIC. The SS also changes the RXLEV_ACCESS_MIN in the BCCH data of carrier 2 to be -100 dBm.

NOTE: With the above change to the BCCH data the C2 of carrier 2 becomes 20 whereas the C2 of carrier 1 stays at 15.

20.13.5 Test requirements

- 1) In step b), there shall be no access from the MS on carrier 1 or carrier 2 within 50 seconds.
- 2) After step c), the MS shall access on carrier 2 within 85 s of the change in the BSIC value (and BCCH data) of carrier 2.

NOTE: 33 seconds for check of BSIC on carrier 2, 33 seconds for decode of BCCH of carrier 2, 15 seconds for reselection of carrier 2, since the MS already has a running average on carrier 2, allow 85 seconds.

20.14 Emergency calls

20.14.1 Definition and applicability

This test is applicable for GSM 900 and DCS 1 800 MSs supporting speech.

20.14.2 Conformance requirement

1. When in a limited service state, the MS shall be able to initiate emergency calls; GSM 05.08, 6.8.
2. When in a limited service state and if not camped on a cell, the MS shall monitor the signal strength of all 124 (for GSM), all 174 (for E-GSM) or all 374 (for DCS 1 800) RF channels, and search for a BCCH carrier which has $C1 > 0$ and which is not barred. When such a carrier is found, the MS shall camp on that cell, irrespective of the PLMN identity; GSM 05.08, 6.8.
3. The MS shall perform cell reselection at least among the cells of the PLMN of the cell on which the MS has camped, according to the algorithm of GSM 03.22, 4.5 & 3.7, except that a zero value of CELL_RESELECT_HYSTERESIS shall be used; GSM 05.08, 6.8.

20.14.3 Test purpose

1. To verify that the MS shall be able to initiate emergency calls when no suitable cells of the selected PLMN are available, but at least one acceptable cell is available.
2. To verify that the MS selects a cell with $C1 > 0$ and $CBA = 0$ when no suitable cells of the selected PLMN are available.
3. To verify that the MS, when performing cell reselection in the limited service state, uses $CELL_RESELECT_HYSTERESIS = 0$.

20.14.4 Method of test

20.14.4.1 Initial conditions

Parameters changed from Default values table 20.1 are below

Parameter	Carrier 1	Carrier 2	Carrier 3	Carrier 4	Carrier 5	Carrier 6
RF signal level (dB μ V emf) / dBm)	38 / -75	33 / -80	33 / -80	OFF	OFF	OFF
RXLEV_ACCESS_MIN (dB μ V emf) / dBm)	23 / -90	43 / -70	23 / -90			
CELL_BAR_ACCESS MCC,MNC	1 (barred)	0	0			
CELL_RESELECT_HYST	0	0	14 dB			
C1	15	-10	10			

NOTE: All the BCCH carriers belong to the same PLMN, which is not the MS's home PLMN and is in the SIM's forbidden PLMN's list.

20.14.4.2 Procedure

- a) The SS activates the carriers. The SS monitors for RA attempts from the MS on carriers 1, 2 and 3 for the duration of the test.
- b) The MS is switched on.
- c) 50 seconds after switch on, an emergency call is initiated on the MS.

- d) The SS changes the CBA of carrier 1 to 0.

NOTE: The MS should reselect to carrier 1 because it should not take into account the CELL_RESELECT_HYST value of 14 but use 0 instead.

- e) After 345 s an emergency call is initiated on the MS.

NOTE: 330 seconds to detect change of BCCH data, 15 seconds to perform reselection of carrier 1, since the MS already has a running average on carrier 1.

20.14.5 Test requirements

- 1) In step c), the first access by the MS shall be on carrier 3.
- 2) In step e), the first access from the MS shall be on carrier 1.

20.15 Cell reselection due to MS rejection "LA not allowed"

20.15.1 Definition and applicability

While camped on a cell of the selected PLMN the MS may need to select a different cell in order to fulfil the normal service state. This ensures that the MS is camped on a cell from which it can reliably decode downlink data and with which it has a high probability of communications on the uplink.

This process goes on while camping on a cell which pertains to an LA which is placed in the list of "forbidden LAIs for regional provision of service".

This test is applicable for all types of GSM 900 and DCS 1 800 MSs.

20.15.2 Conformance requirement

1. In response to a registration attempt, when receiving an LU reject with cause value "LA not allowed", the MS stores this LAI in a list of "forbidden LAIs for regional provision of service", to prevent repeated attempts to access a cell of the forbidden LA, GSM 03.22, 3.3.
2. If the MS has received the cause 'LA not allowed', it shall ignore this fact when selecting a cell to camp on, i.e. it shall not reject a cell for camping on because that cell is part of a LA where this cause has been received, GSM 03.22, 3.5.4.
3. In response to a registration attempt, when receiving an LU reject with cause value "LA not allowed", the MS continues to perform normal cell-reselection, GSM 03.22, 4.4.2
4. A new LU attempt shall only be performed when a new LA (or new PLMN) is entered according to the cell reselection procedure, GSM 03.22, 3.3 & figure 4.

NOTE: LA stands for "Location Area" and LU stands for "Location Update".

20.15.3 Test purpose

1. To verify that if an LU is rejected with cause "LA not allowed" that the LAI of that cell is written into a forbidden list which prevents the MS from performing LU onto another cell in that LA. This is verified indirectly in test purposes 2,3 and 4.
2. To verify that the MS will not reject a cell for camping on because that cell is part of a LA in the list of "forbidden LAIs for regional provision of service". This is verified indirectly by making the MS attempt an emergency call and checking that the channel request message is transmitted on the correct cell.
3. To verify that the MS when receiving an LU reject with cause value "LA not allowed", the MS continues to perform normal cell-reselection:

Cell reselection is triggered if there is a better cell (in terms of the path loss criterion C2) in the same LA, or a much better cell in another LA of the selected PLMN (using the CRH parameter). GSM 03.22, 3.4 & 4.5.

4. To verify that a new LU attempt will be performed when a new LA (or new PLMN) is entered, GSM 03.22, 3.3 & figure 4.

20.15.4 Method of test

20.15.4.1 Initial conditions

Parameters changed from Default values table (table 20.1)

Parameter	Carrier 1	Carrier 2	Carrier 3	Carrier 4	Carrier 5	Carrier 6
RF Signal Level (dB μ V emf() / dBm)	63 / -50	54 / -59	44 / -69	OFF	OFF	OFF
RXLEV_ACCESS_MIN (dB μ V emf() / dBm)	53 / -60	35 / -78	29 / -84			
CRH	14	0	10			
LAC	H1111	H2222	H1111			
ATT	1	1	1			
C1	10	19	15			
C2	10	19	15			

20.15.4.2 Procedure

- The SS activates the carriers. The SS monitors all RA requests from MS on carriers 1, 2 & 3 until step e) has been completed. Only idle-paging is sent on all channels.
- The MS is switched on.
- When the MS performs an IMSI attach onto carrier 1, the SS shall reject it with cause "LA not allowed"
- 30 seconds after the MS has returned to idle mode (channel release after LU reject), the MS is manually commanded to set up an emergency call.

NOTE 1: C2 of carrier 3 > C2 of carrier 1. Carriers 1 and 3 belong to the same LA.

- The SS rejects the CM service request from the MS, with a CM service reject message with cause value #17 (Network Failure).

NOTE 2: Cause values #4 (IMSI unknown in VLR) or #6 (Illegal ME) lead to unwanted behaviour of the mobile.

- 10 seconds after the MS has returned to idle mode (channel release after CM service reject), the SS increases the level of carrier 2 to 65 dB μ V emf().

NOTE 3: C2 of carrier 2 = 30, now larger than C2 of carrier 3 + CRH.

- The SS shall accept any LU on carrier 2.

20.15.5 Test requirements

- After step b), the MS shall respond on carrier 1 within 33 s.
- In step d), the MS shall access on carrier 3 with a channel request message, within 15 seconds of being commanded to set up the emergency call.
- After increasing the level of carrier 2 in step f), the MS shall reselect and access onto carrier 2 requesting an LU within 30 seconds.

NOTE 1: 13,75 seconds to perform running average, 10 seconds to detect C2 differences, 2,4 seconds to read BCCH of carrier 2, 1 second to perform RA. Total 27,15 seconds, allow 30 seconds.

20.16 Downlink signalling failure

20.16.1 Definition and applicability

See conformance requirement.

20.16.2 Conformance requirement

The downlink signalling failure criterion is based on the downlink signalling failure counter DSC.

1. When the MS camps on a cell, DSC shall be initialized to a value equal to the nearest integer to $90/N$ where N is the BS_PA_MFRMS parameter for that cell (see GSM 05.02).
2. Thereafter, whenever the MS attempts to decode a message in its paging subchannel; if a message is successfully decoded DSC is increased by 1,(however never beyond the nearest integer to $90/N$).
3. Whenever the MS can not successfully decode a message in its paging subchannel the DSC is decreased by 4.
4. When DSC reaches 0, a downlink signalling failure shall be declared. A downlink signalling failure shall result in cell reselection, GSM 03.22, 4.5 (ii) and GSM 05.08, 6.5.

NOTE: The network sends the paging subchannel for a given MS every BS_PA_MFRMS multiframes. The requirement for network transmission on the paging subchannel is specified in GSM 04.08. The MS is required to attempt to decode a message every time its paging subchannel is sent.

20.16.3 Test purpose

1. To verify that the MS initializes the DSC counter in accordance with the conformance requirement. This is verified indirectly.
2. To verify that whenever the MS successfully decodes a message on paging subchannel, the DSC is increased by 1, (however never beyond the nearest integer to $90/N$). This is verified indirectly.
3. To verify that whenever the MS can not successfully decode a message on paging subchannel, the DSC decreased by 4. This is verified indirectly.
4. To verify that when the DSC reaches 0, a downlink signalling failure shall be declared and the MS will perform cell reselection.

20.16.4 Method of test

20.16.4.1 Initial conditions

Two BCCH carriers are established with the system information contents of table 20.1.

Parameters changed from Default values table (table 20.1) are below

Parameter	Carrier 1	Carrier 2	Carrier 3	Carrier 4	Carrier 5	Carrier 6
RF signal level (dB μ V emf() / dBm)	43 / -70	33 / -80	OFF	OFF	OFF	OFF
C1 = C2	20	10				

NOTE: The DSC counter will have a value 18 (90/5).

20.16.4.2 Procedure

- a) The MS is switched on. On carrier 1 valid layer 3 messages shall be sent in the paging blocks, but not paging the MS (idle paging). On carrier 2 the MS is paged continuously in all paging blocks.
- b) After 40 s the SS sends corrupted data (using random data, wrong parity bits see GSM 05.03, 4.3 & 4.1.2 or other lower layer error) in four successive paging blocks to carrier 1 and then reverts to sending normal data.

NOTE 1: Sending corrupted, i.e. non-decodable data on four successive paging blocks should decrease the DSC to 2.

- c) The SS monitors all accesses on both carriers for 30 s.
- d) The SS sends corrupted data in five successive paging blocks to carrier 1 and then reverts to sending normal data.

NOTE 2: Sending random, data on five successive paging blocks should decrease the DSC to < 0 and cause a cell reselection.

- e) The SS monitors all accesses on both carriers for 30 s.

20.16.5 Test requirements

- 1) There shall be no access to carrier 2 in test steps a) and c).
- 2) The MS shall access on carrier 2 at test step e) within 15 seconds.

20.17 Cell selection if no suitable cell found in 10 s**20.17.1 Definition and applicability**

See conformance requirement.

20.17.2 Conformance requirement

If no suitable cell is found in cell reselection process within 10 seconds, the cell selection algorithm of GSM 03.22 shall be performed, GSM 05.08; 6.6.2.

20.17.3 Test purpose

To verify that the MS fulfils the conformance requirement

20.17.4 Method of test**20.17.4.1 Initial conditions**

One BCCH carrier is established with the system information contents of table 20.1.

Parameters changed from Default values table (table 20.1) are below

Parameter	Carrier 1	Carrier 2	Carrier 3	Carrier 4	Carrier 5	Carrier 6
RF signal level (dB μ V emf() / dBm)	43 / -70	OFF	OFF	OFF	OFF	OFF
C1 = C2	20					

20.17.4.2 Procedure

- a) The MS is switched on. Idle paging is sent on carrier 1.

- b) After the MS indicates service the SS reduces the transmit level of carrier 1 to 13 dB μ V emf() (so that C1 of carrier 1 becomes -10) and turns on a new carrier (carrier 2) at a level of 33 dB μ V emf(). Carrier 2 shall not be in the MS BA list (i.e. it shall not be one of the carriers that MS has been monitoring after camped on carrier 1)
- c) The SS shall monitor all accesses on carriers 1 and 2 for 60 s.

NOTE: The access on carrier 2 should not take longer than 50 s. (5 seconds to rxlev averages, 5 s for C1<0 duration, 10 s for searching another suitable cell, 30 s for cell selection), 60 s is a safe time to wait.

20.17.5 Test requirements

The MS shall access on carrier 2 at test step c) within 60 s.

20.18 Cell reselection due to MS rejection "Roaming not allowed in this LA"

20.18.1 Definition and applicability

While camped on a cell of the selected PLMN the MS may need to select a different cell in order to fulfil the normal service state. This ensures that the MS is camped on a cell from which it can reliably decode downlink data and with which it has a high probability of communications on the uplink.

The MS looks for suitable neighbour cells which satisfies 4 constraints including that It should not be in an LA which is in the list of "forbidden LAs for roaming".

This test is applicable for all types of GSM 900 and DCS 1 800 MSs.

20.18.2 Conformance requirement

1. To prevent repeated attempts to have roaming service on a not allowed LA, when the MS is informed that an LA is forbidden, the LA is added to a list of "forbidden LAs for roaming" which is stored in the MS, GSM 03.22; 3.1.
2. If the MS has received the cause "Roaming not allowed in this LA", in response to a LU attempt, the Network Selection Procedure shall be started, GSM 03.22; 4.3.3 L3, GSM 04.08; 4.4.4.7.
3. The MS can only perform camping on a suitable cell, which:
 - should not be in an LA which is in the list of "forbidden LAs for roaming" GSM 03.22, 3.2.1.

NOTE: LA stands for "Location Area" and LU stands for "Location Update".

20.18.3 Test purpose

1. To verify that if an LU is rejected with cause "Roaming not allowed in this LA", that the LAI of that cell is written into a forbidden list which prevents the MS from camping onto any cell in that LA.
2. To verify that if the MS has received the cause "Roaming not allowed in this LA", in response to a LU attempt, the Network Selection Procedure is initiated. This is verified indirectly by test purpose 3, in that the new LA is accessed as part of cell selection, hence CRH is disregarded.
3. To verify that if an LU is rejected, when attempting LU in a LA with LAI = LAI1, with cause "Roaming not allowed in this LA" and only cells of the selected PLMN are available, the MS will only camp and attempt LU in any LA \neq LAI1.

20.18.4 Method of test**20.18.4.1 Initial conditions**

Parameters changed from Default values table (table 20.1)

Parameter	Carrier 1	Carrier 2	Carrier 3	Carrier 4	Carrier 5	Carrier 6
RF Signal Level (dB μ V emf() / dBm)	63 / -50	53 / -60	OFF	OFF	OFF	OFF
RXLEV_ACCESS_MIN (dB μ V emf() / dBm)	23 / -90	23 / -90				
MNC	MNC <> HPLMN	MNC <> HPLMN				
MCC	MCC of HPLMN	MCC of HPLMN				
CRH	0	0				
LAC	H1111	H2222				
ATT	1	1				
C1	40	30				
C2	40	30				

20.18.4.2 Procedure

- a) The MS is switched on. Idle paging is sent on all carriers.
- b) The SS monitors all RA requests from MS on carriers 1 & 2.
- c) When the MS performs an IMSI attach onto carrier 1, the SS shall reject it with cause "Roaming not allowed in this LA".
- d) The SS shall accept any LU on carrier 2.
- e) The SS monitors all RA requests from MS on carriers 1 to 2.

20.18.5 Test requirements

- 1) The MS should respond on carrier 1 within 33 s of switch on.
- 2) After LU reject, the MS shall initiate the Network Selection Procedure and access onto Carrier 2 as part of cell selection within 33 seconds from returning to idle mode after the LU reject.

NOTE: The timing requirement in b) is given only for testing purposes only. No timing requirements are defined for the Network Selection Procedure, but the time allowed for cell selection (see 20.1) should be adequate.

- 3) After the LU reject on carrier 1, there shall be no more access attempts on this carrier.

20.19 Cell selection on release of SDCCH and TCH**20.19.1 Definition and applicability****20.19.2 Conformance requirement**

1. When the SS releases a TCH or SDCCH and returns to idle mode, it shall, as quickly as possible camp on the BCCH carrier of the cell whose channel has just been released. If the full BCCH data for that cell was not decoded in the preceding 30s, the MS shall then attempt to decode the full BCCH data. Until the MS has decoded the BCCH data required for determining the paging group, it shall also monitor all paging blocks on timeslot 0 of the BCCH carrier for possible paging messages that might address it. If the MS receives a page before having decoded the full BCCH data for the

cell, the MS shall store the page and respond once the full BCCH data has been decoded, provided that the cell is not barred and the MSs access class is allowed. GSM 05.08, 6.7.

20.19.3 Test purpose

1. To verify that on release of a TCH or an SDCCH, the MS camps as quickly as possible on the BCCH carrier of the cell whose channel has just been released.

NOTE: This is implicitly tested by the MS responding to a paging request. The decoding of BCCH data cannot be explicitly tested. However, the MS shall monitor for paging messages which may address it if it decodes the BCCH.

20.19.4 Method of test

20.19.4.1 Initial conditions

- a) Parameters changed from default values in table 20.1

Parameter	Carrier 1	Carrier 2	Carrier 3	Carrier 4	Carrier 5	Carrier 6
RF Signal Level (dBmV emf() / dBm)	53 / -60	33 / -80	OFF	OFF	OFF	OFF
RXLEV_ACCESS_MIN (dBmV emf() / dBm)	23 / -90	23 / -90				
BS_PA_MFRMS	2	2				
ATT	1					
C1	30	10				
C2	30	10				

- b) Carrier 1 is configured to have a combined control channel.
- c) Carrier 2 is configured to have a non combined control channel.

20.19.4.2 Test procedure

- a) The SS activates the carriers. No paging messages are transmitted on carrier 1 or carrier 2.
- b) The MS is switched on.
- c) In response to the MS access for IMSI attach, the SS allocates a combined SDDCH/4, accepts the IMSI attach procedure and then releases the link. After 0,5 seconds but within 1 second of transmitting the UA frame on completion of the IMSI attach procedure, the SS transmits a single PAGING REQUEST in the appropriate paging block of the MS on carrier 1.
- d) When the MS responds to paging, the SS establishes a call on a traffic channel.
- e) The SS increases the level of carrier 2 to 63 dBmV emf().
- f) After 10 seconds the SS performs a handover to another TCH, with the parameters of carrier 2 indicated in the CELL DESCRIPTION information element of the HANDOVER COMMAND message.
- g) After a further 10 seconds, the SS clears down the call. After 0,5 seconds but within 1 second of transmitting the UA frame, the SS transmits a single PAGING REQUEST on carrier 2 in the appropriate paging block of the MS.

20.19.5 Test requirements

- 1) After step b) the MS shall access in order to commence an IMSI attach procedure on carrier 1 within 33 seconds.
- 2) In step c), the MS shall respond to paging within 3 seconds of transmitting the PAGING REQUEST.

- 3) In step g), the MS shall respond to paging within 3 seconds of transmitting the PAGING REQUEST.

20.20 Multiband cell selection and reselection

20.20.1 Multiband cell selection and reselection / Cell Selection

20.20.1.1 Definition and applicability

Multiband cell selection is a process in which a multiband MS, whenever a new PLMN is selected, attempts to find a suitable cell of that PLMN to camp on, irrespective of frequency band. Two methods of searching for a suitable cell are possible, normal cell selection and stored list cell selection. The process ensures that the MS is camped on a cell from which it can reliably decode downlink data and with which it has a high probability of communications on the uplink. Once the MS is camped on a cell, access to the network is allowed.

This test is applicable for multiband GSM 900 / DCS 1 800 MSs supporting simultaneous multiband operation.

20.20.1.2 Conformance requirement

1. A multiband MS shall search all channels within its bands of operation (124 for P-GSM, 174 for E-GSM and 374 for DCS). The number of channels searched will be the sum of channels on each band of operation; GSM 05.08, 6.2.
2. The MS shall be able to select the correct (fourth strongest) cell and be able to respond to paging on that cell within 30 seconds of switch on, when the three strongest cells are not suitable. This assumes a valid SIM, with PIN disabled and ideal radio conditions; GSM 05.08, 6.1.
3. There are various requirements that a cell must satisfy before an MS can perform normal camping on it:
 - 3.1 (i) It should be a cell of the selected PLMN
 - 3.2 (ii) It should not be "barred" (see section 3.5.1)
 - 3.3 (iv) The radio path loss between MS and BTS must be below a threshold set by the PLMN operator. This is estimated as shown in section 3.6.

GSM 03.22, 3.2.1.

NOTE: Criteria (iii) is not applicable for Cell Selection

4. Initially the MS looks for a cell which satisfies these 4 constraints ("suitable cell") by checking cells in descending order of received signal strength. If a suitable cell is found, the MS camps on it; GSM 03.22, 3.2.1.
5. The MS shall be able to calculate correctly the path loss criterion parameter C1, used for cell selection and reselection; GSM 05.08, 6.4.

20.20.1.3 Test purpose

1. To verify that the MS meets conformance requirement 1.
2. To verify that the MS meets conformance requirement 2 in a multiband environment.
3. To verify that:
 - 3.1 The MS does not select a cell of a PLMN which is not the selected PLMN.
 - 3.2 The MS does not select a cell which is "barred".
 - 3.3 The MS does not select a cell with $C1 < 0$.
4. To verify that the MS selects suitable cells in descending order of received signal strength, irrespective of frequency band.

5. To verify that the MS does not select a cell with $C1 < 0$.

20.20.1.4 Method of test

20.20.1.4.1 Initial conditions

Parameters changed from the default values in table 20.1.

Parameter	Carrier 1 (GSM)	Carrier 2 (GSM)	Carrier 3 (DCS)	Carrier 4 (GSM)	Carrier 5 (DCS)	Carrier 6
RF Signal Level (dBmV emf() / dBm)	48 / -65	36 / -77	43 / -70	33 / -80	23 / -90	OFF
CBA	1	0	0	0	0	
RXLEV_ACCESS_MIN (dBm)	-90	-69	-90	-88	-98	
MNC			01			
MCC			002			
MS_TXPWR_MAX_CCH	7	7		7		
C1	25	-8	20	8	8	
C2	25	-8	20	8	8	

Carrier 1, carrier 2 and carrier 4 ARFCNs are chosen in the GSM 900 band, carrier 3 and carrier 5 ARFCNs in the DCS 1 800 band.

20.20.1.4.2 Procedure

- a) The SS activates the carriers and monitors carriers 2, 4 and 5 for RA requests from the MS.
- b) The MS is switched on.
- c) The MS is switched off.
- d) The SS monitors carriers 1 and 3 for RA requests from the MS
- e) The MS is switched on.
- f) The MS is switched off.
- g) The SS is reconfigured and sets MCC of carrier 3 to 001 (same as the other carriers).
- h) The SS activates the carriers and monitors carriers 3, 4 and 5 for RA requests from the MS.
- i) The MS is switched on.
- j) The MS is switched off.

20.20.1.5 Test requirements

- 1) After step b), the first response from the MS shall be on carrier 4 within 33 seconds. There shall be no response from the MS on carrier 2.
- 2) After step e), there shall be no response from the MS on either carrier 1 or carrier 3 within 33 seconds.
- 3) After step i), the first response from the MS shall be on carrier 3 within 33 seconds.

20.20.2 Multiband cell selection and reselection / Cell reselection**20.20.2.1 Definition and applicability**

While camped on a cell of the selected PLMN the multiband MS may need to select a different cell (irrespective of frequency band used) in order to fulfil the normal service state. This ensures that the MS is camped on a cell from which it can reliably decode downlink data and with which it has a high probability of communications on the uplink.

This test is applicable for multiband GSM 900 / DCS 1 800 MSs supporting simultaneous multiband operation.

20.20.2.2 Conformance requirement

1. The list of the 6 strongest non-serving carriers shall be updated at least as often as the duration of the running average defined for measurements on the BCCH allocation and may be updated more frequently; GSM 05.08, 6.6.1.
2. When the MS recognizes that a new BCCH carrier has become one of the 6 strongest, the BCCH data shall be decoded for the new carrier within 30 seconds; GSM 05.08, 6.6.1.
3. The MS shall be able to calculate correctly the path loss criterion parameter C2 used for cell reselection; GSM 05.08, 6.4.

20.20.2.3 Test purpose

1. To verify that MS meets conformance requirement 1.
2. To verify that MS meets conformance requirement 2.
3. To verify that the MS calculates the C2 parameter correctly when the CELL_RESELECT_OFFSET, and PENALTY_TIME parameters are used to give different priorities to different frequency bands.

20.20.2.4 Method of test**20.20.2.4.1 Initial conditions**

Six BCCH carriers are established with the system information contents of table 20.1.

Parameters changed from Default values table 20.1 are below:

Parameter	Carrier 1 (GSM)	Carrier 2 (GSM)	Carrier 3 (GSM)	Carrier 4 (DCS)	Carrier 5 (DCS)	Carrier 6 (DCS)	Carrier 7 (DCS)
RF signal level (dBmV emf ()/dBm)	53 / -60	48 /-65	43 / -70	38 / -75	33 / -80	33 /-80	43 / -70
RXLEV_ACCESS_MIN (dBm)	-90	-90	-90	-90	-90	-90	-110
PT							11111
CRO							20 dB
MS_TXPWR_MAX_CCH	7	7	7				
C1	30	25	20	15	10	10	40
C2	30	25	20	15	10	10	20

Carrier 1, 2 and 3 ARFCNs are chosen in the GSM 900 band, carrier 4, 5, 6 and 7 ARFCNs in the DCS 1 800 band.

The BA(BCCH) list contains only eight ARFCNs and includes those of carriers 1 to 7.

BS_PA_MFRMS is set to 3 during this test.

NOTE: The combination of 8 carriers on the BA list and BS_PA_MFRMS = 3 leads to averaging time of 5 seconds. Hence 5 seconds is also the updating time of the list of six strongest neighbour carriers.

20.20.2.4.2 Procedure

- a) The SS activates carriers 1 to 6. The MS is not paged on any of the carriers.
- b) The MS is switched on.
- c) After 60 seconds, the SS deactivates carrier 4 and activates carrier 7 and pages the MS continuously on carrier 7. The SS monitors carrier 7 for RA requests from the MS.
- d) The MS is switched off.
- e) The SS is reconfigured and sets PT = 0 and CRO = 0 on carrier 7 (thus increasing C2 to 40 dB).
- f) The SS activates carriers 1 to 6. The MS is not paged on any of the carriers.
- g) The MS is switched on.
- h) After 60 seconds, the SS deactivates carrier 4 and activates carrier 7 and pages the MS continuously on carrier 7. The SS monitors carrier 7 for RA requests from the MS.
- i) 20 seconds after receiving an RA request on carrier 7 the SS sets PT = 11111 and CRO = 20 dB on carrier 7 (thus decreasing C2 to 20dB), stops paging on carrier 7, and pages the MS continuously on carrier 1. The SS monitors carrier 1 for RA requests from the MS.
- j) The MS is switched off.

20.20.2.5 Test requirements

- 1) After step c) there shall be no response from the MS on carrier 7 within 55 s of activating carrier 7.
- 2) After step h) the MS shall access on carrier 7 within 55 s of activating carrier 7.

NOTE: 5,5 seconds to notice new strongest carrier in top 6 (because the updating time for six strongest is 5 seconds (+10 %)), 33 seconds to read BCCH, 15 seconds for reselection, since the MS has already performed the running average on the new strongest carrier, allow 55 seconds.

- 3) After step i) the MS shall access on carrier 1 within 55 s of setting PT and CRO on carrier 7.

21 Received signal measurements

For evaluating the reception quality (the basis for handover and power control) the following two criteria are used:

- signal strength (RXLEV)
- signal quality (RXQUAL).

21.1 Signal strength

21.1.1 Definition and applicability

The MS reports RXLEV values related to the apparent received RF signal strength. It is necessary for these levels to attain sufficient accuracy for the correct functioning of the system.

The requirements and this test apply to all types of GSM 900, DCS 1 800 and multiband GSM 900 / DCS 1 800 MS.

21.1.2 Conformance requirement

1. The RMS received signal level at the receiver input shall be measured by the MS over the full range of -110 dBm to -48 dBm with a relative accuracy between signals with levels up to 20 dB difference according to table 21-1
 - 1.1 under normal conditions, GSM 05.08, 8.1.2 and GSM 05.05, 6.2.
 - 1.2 under extreme conditions, GSM 05.08, 8.1.2, GSM 05.05, annex D.1, D.2.

Table 21-1: Tolerance for relative accuracy of receive signal measurement

Absolute level of lower level signal dBm				Tolerance dB			
GSM Small MS	GSM Other MS	DCS1800 Class 1 & 2	DCS1800 Class 3	Lower limit Single	Lower limit Multi	Upper limit Single	Upper limit Multi
>= -88	>= -90	>= -86	>= -88	2	4	2	4
>= -101	>= -103	>= -99	>= -101	3	5	2	5
< -101	< -103	< -99	< -101	4	6	2	6

Single means that the measurements are on the same or different RF channel within the same frequency band.

Multi means that the measurements are on different RF channel on different frequency bands.

For measurements between ARFCN in different bands the 'Absolute level of lower level signal' column for the band including the lower level signal shall be used to determine which tolerance applies.

At extreme temperature conditions an extra 2 dB shall be added to the Multi limits in above table.

2. The RMS received signal level at the receiver input shall be measured with an absolute accuracy of +/-4 dB from -110 dBm to -70 dBm under normal conditions; GSM 05.08, 8.1.2.
3. The RMS received signal level at the receiver input shall be measured with an absolute accuracy of +/-6 dB over the full range of -110 dBm to -48 dBm under both normal and extreme conditions; GSM 05.08, 8.1.2.
4. If the received signal level falls below the reference sensitivity level for the type of MS then the MS shall report a level between the reference sensitivity level and the actual received level, but with the tolerances given in conformance requirements 2. and 3. above.
5. The measured signal level shall be mapped to an RXLEV value between 0 and 63 as specified in GSM 05.08; GSM 05.08, 8.1.4.

21.1.3 Test purpose

1. To verify that the RXLEV reported by the MS does not exceed conformance requirement 1.
 - 1.1 under normal conditions;
 - 1.2 under extreme conditions.
2. To verify that the RXLEV reported by the MS does not exceed conformance requirement 2 under normal conditions.
3. To verify that the RXLEV reported by the MS does not exceed conformance requirement 3 under extreme conditions and under normal conditions from -48 dBm to -70 dBm.
4. To verify that the RXLEV reported by the MS does not exceed conformance requirement 4.

NOTE: Conformance requirement 5 is inherently tested in each of the test purposes 1. to 4.

21.1.4 Method of test

21.1.4.1 Initial conditions

The SS is set to produce the BCCH of the serving cell at $63 \text{ dB}\mu\text{Vemf}(\)$ and the BCCHs of 6 surrounding cells at $28 \text{ dB}\mu\text{Vemf}(\)$. The BCCH of the serving cell indicates these BCCHs, but not the BCCH of the serving cell. The ARFCN of the serving cell BCCH is chosen so as not to interfere with the other channels as shown in table 21-2. The fading profile for the BCCHs of the serving and surrounding cells will be set to static.

After 30 s, a call is set up according to the generic call set up procedure to an ARFCN, within the supported band of operation. The SACCH indicates the same surrounding cell BCCHs as the BCCH of the serving cell.

NOTE: The 30 s is to allow the MS to scan and find all BCCHs.

21.1.4.2 Procedure

- a) The levels of the TCH and BCCHs are set according to table 21-2 step 1. The SS waits 20 s before continuing.

Table 21-2: Signal levels at receiver input in $\text{dB}\mu\text{Vemf}(\)$

Step	ARFCN	TCH	BCCH1	BCCH2	BCCH3	BCCH4	BCCH5	BCCH6
	GSM900:	1	62	124	20	40	80	100
	DCS1800	512	700	885	585	660	790	835
	Multiband	1	885	62	124	40	100	512
1+m*21		64,5-m*10	64,5-m*10	64,5-m*10	64,5-m*10	64,5-m*10	64,5-m*10	64,5-m*10
2+m*21		54,5-m*10	63,5-m*10	54,5-m*10	54,5-m*10	54,5-m*10	54,5-m*10	54,5-m*10
3+m*21		54,5-m*10	62,5-m*10	44,5-m*10	44,5-m*10	44,5-m*10	44,5-m*10	44,5-m*10
.		44,5-m*10	44,5-m*10
17+m*21		54,5-m*10	44,5-m*10	44,5-m*10
18+m*21		44,5-m*10	44,5-m*10	44,5-m*10
.		44,5-m*10	44,5-m*10
21+m*21		44,5-m*10	44,5-m*10	44,5-m*10	44,5-m*10	44,5-m*10	44,5-m*10	44,5-m*10

m = 0, 1, 2, 3, 4.

- b) The measurement is done in 105 steps. The initial signal levels of the TCH of the serving cell and the BCCHs of the surrounding cells are adjusted according to table 21-2. At each step the SS keeps the signal levels stable for one reporting period, except at steps 21+m*21 where the level is held stable for 1,75 reporting periods. The RXLEV value for the period in which the change occurs (reported in the following period) is discarded. The SS records the RXLEV values reported for the surrounding cell BCCHs in steps 1 + m * 21 and 21 + m * 21. The RXLEV values for BCCH 1 are recorded by the SS for all 105 steps.

NOTE: This extension at steps $21+m*21$ is to allow an extra quarter reporting period for the MS to stabilize for steps $1+m*21$.

At steps 1 to 30 the SS simulates a base station with DTX off and at steps 31 to 105 the SS simulates a base station with DTX on.

At steps 1 to 30 the SS checks the accuracy of the measured signal strength of TCH by checking the values of the parameters RXLEV_FULL and RXLEV_SUB. At steps 31 to 105 the SS shall check only the value of the parameter RXLEV_SUB.

At step 64, within every 480 ms reporting period, out of the 4 SACCH and 8 SID timeslots the SS transmits the first six active timeslots of the TCH with signal level $39,5 \text{ dB}\mu\text{Vemf}(\)$ and the last six active timeslots of the TCH with signal level $29,5 \text{ dB}\mu\text{Vemf}(\)$.

c) Step b) is repeated under extreme conditions (annex 1, TC2,2 and TC3).

21.1.5 Test requirements

21.1.5.1 Relative accuracy of measurements on different ARFCN

For normal and each of the 4 extreme conditions tested the following applies;

- a) For each of the steps 1, 21, 22, 42, 43, and 64, of the 7 reported RXLEV values checked, the difference between the minimum reported RXLEV value and the maximum reported RXLEV value shall be no more than 4 if the measurements are on the same or on different RF channel within the same frequency band and no more than 8 (12 for extreme temperature conditions) if the measurements are on different frequency bands.
- b) For each of the steps 63 and 85, of the 7 reported RXLEV values checked, the difference between the minimum reported RXLEV value and the maximum reported RXLEV value shall be no more than 5 for small MS and DCS 1 800 MS or 4 for other MS if the measurements are on the same or on different RF channel within the same frequency band and no more than 9 for small MS and DCS 1 800 MS or 8 for other MS (13 and 12 for extreme temperature conditions) if the measurements are on different frequency bands.
- c) For step 84, of the 7 reported RXLEV values checked, the difference between the minimum reported RXLEV value and the maximum reported RXLEV value shall be no more than 5 if the measurements are on the same or on different RF channel within the same frequency band and no more than 9 (13 for extreme temperature conditions) if the measurements are on different frequency bands.
- d) For step 105, of the reported RXLEV values checked, the difference between the minimum reported RXLEV value and the maximum reported RXLEV value shall be no more than 6 if the measurements are on the same or on different RF channel within the same frequency band and no more than 10 (14 for extreme temperature conditions) if the measurements are on different frequency bands.

NOTE: It is not mandatory for the MS to report any of the BCCHs in step 105.

21.1.5.2 Relative accuracy at a single frequency (BCCH1)

For normal and each of the 4 extreme conditions tested the following applies;

For $n \leq 21$ and $\text{RXLEV}_1 = 63$

$\text{RXLEV}_n - (63 - n + r)$ shall be between:

-2 and +2

NOTE: This formula allows for an MS with an absolute accuracy worse than +0,5 dB and therefore reporting an RXLEV of 63 for more than one step. The formula checks the relative accuracy from the lowest input level for which the MS last reports RXLEV of 63.

Otherwise

$RXLEV_{(m*21+1)} - RXLEV_{(m*21+n)} - n + 1$ shall be between:

-2 and +2

for steps 2 to 62 and 65 to 71 for DCS 1 800 class 1/2 MS; or steps 2 to 62 and 65 to 73 for DCS 1 800 class 3 and Small GSM MS; or 2 to 75 for other MS.

-3 and +2

for steps 63 and 72 to 96 for DCS 1 800 class 1/2 MS; or steps 63 and 74 to 98 for DCS 1 800 class 3 and Small GSM MS; or 76 to 100 for other MS.

-4 and +2

for steps 97 to 105 for DCS 1 800 class 1/2 MS; or steps 99 to 105 for DCS 1 800 class 3 and Small GSM MS; or 101 to 105 for other MS.

where: $1 < n \leq 21$ and $0 \leq m \leq 4$ as identified in table 21-2, and r is the number of the last step where $RXLEV$ of 63 was reported.

NOTE: It is not mandatory for the MS to report BCCH1 for steps greater than 99 for GSM 900 Small MS or 101 for other GSM MS or 97 for a DCS 1 800 Class 1 or Class 2 MS and 99 for DCS 1 800 Class 3 MS. If the MS reports a level and the upper limit for this step in the above formulae implies a level below the reference sensitivity level for the type of MS, then the upper limit shall be considered as equal to a value corresponding to the reference sensitivity level.

21.1.5.3 Absolute accuracy

For each BCCH reported, $|RXLEV_{MS} + m * 10 - 62|$ shall be no more than:

4 for steps 64 and 85 under normal conditions.

6 for steps 64 and 85 under extreme conditions.

6 for steps 1, 22 and 43 under normal and extreme conditions.

where: $0 \leq m \leq 4$ as identified in table 21-2.

21.2 Signal strength selectivity

21.2.1 Definition and applicability

The signal strength selectivity is a measure of the ability of the signal strength measuring part of the MS to discriminate against RF power from adjacent ARFCN. The $RXLEV$ selectivity figure corresponds to the amount by which the adjacent channel power shall be attenuated.

The requirements and this test apply to all types of GSM 900 and DCS 1 800 MS.

21.2.2 Conformance requirement

The selectivity of the received signal measurement shall be as follows:

- for adjacent (200 kHz) channel; ≥ 16 dB
- for adjacent (400 kHz) channel; ≥ 48 dB
- for adjacent (600 kHz) channel; ≥ 56 dB

GSM 05.08, 8.1.2.

21.2.3 Test purpose

To verify that the MS meets the conformance requirement at the 200 kHz adjacent channel above and below the wanted.

21.2.4 Method of test

21.2.4.1 Initial conditions

For GSM 900:

A call is set up according to the generic call set up procedure on ARFCN 40 and with surrounding cell BCCH3 indicated in the BA list at ARFCN 80.

The RF level of the TCH and BCCH3 is set to 20 dB above reference sensitivity level().

BCCH1 and 2 at ARFCN 41 and 79 are off.

These conditions are kept for 30 s to ensure the MS has time to decode the BCCH.

For DCS 1 800:

A call is set up according to the generic call set up procedure on ARFCN 690 and with surrounding cell BCCH3 indicated in the BA list at ARFCN 790.

The RF level of the TCH and BCCH3 is set to 20 dB above reference sensitivity level().

BCCH1 and 2 at ARFCN 691 and 789 are off.

These conditions are kept for 30 s to ensure the MS has time to decode the BCCH.

21.2.4.2 Procedure

- a) The SS records the RXLEV values reported for the TCH and BCCH3.
- b) BCCH1 and 2 are set to 9 dB above the signal level of the TCH and BCCH3.

NOTE: The first adjacent channel interference requirement limits the level of BCCHs 1 and 2 to 9 dB. This ensures that the MS can maintain the call, and read BCCH3.

- c) These conditions are kept for 30 s.
- d) The SS records the RXLEV values reported for the TCH and BCCH3.

21.2.5 Test requirements

The values of RXLEV recorded in step d) shall be no more than 1 above the values recorded in step a).

NOTE: This one change in the reported value of RXLEV is calculated as follows: The level of the first adjacent interfering signal is such that C/I is -9 dB. With an RXLEV selectivity for the first adjacent channel of 16 dB, the power from the adjacent channel is equal to -7 dB with respect to the power level of the useful signal. The increase in power therefore is equal to $10\log(1 + 10^{-0.7}) = 0,71$ dB. Thus, the value of RXLEV could increase by 1.

21.3 Signal quality under static conditions

21.3.1 Signal quality under static conditions - TCH/FS

21.3.1.1 Definition and applicability

The MS must be capable of measuring the received signal quality, which is specified in terms of bit error ratio (BER) before channel decoding averaged over the reporting period of length of one SACCH multiframe defined in section 8.4 of GSM 05.08. The MS has to map this BER into RXQUAL values using the coding scheme defined in section 8.2.4 of GSM 05.08. For the full rate channel without downlink DTX, the error assessment is based on 104 TDMA frames: RXQUAL_FULL. In case downlink DTX is used, the assessment is based on 12 TDMA frames: RXQUAL_SUB.

The requirement and this test apply to all types of GSM 900 and DCS 1 800 MS supporting speech on a full rate channel.

21.3.1.2 Conformance requirement

1. The received signal quality shall be measured by the MS in a manner that can be related to an equivalent average BER before channel decoding (i.e. chip error ratio), assessed over the reporting period of one SACCH multiframe. When the quality is assessed over the full-set and sub-set of frames, eight levels of RXQUAL are defined and shall be mapped to the equivalent BER before channel decoding as per the table in GSM 05.08, 8.2.4; GSM 05.08, 8.2.2 & 8.2.4.
2. The reported parameters (RXQUAL) shall be the received signal quality, averaged over the reporting period of length one SACCH multiframe; GSM 05.08, 8.2.3.

21.3.1.3 Test purpose

1. To verify, under static propagation conditions, that the received signal quality is measured and mapped to the eight levels of RXQUAL_FULL by the MS in a manner that can be related to an equivalent average BER before channel decoding (i.e. chip error ratio), assessed over the reporting period of one SACCH multiframe. The probability that the correct RXQUAL band is reported shall meet the values given in as per the table in GSM 05.08, 8.2.4.
2. To verify that the reported parameters (RXQUAL) are the received signal quality, averaged over the reporting period of length one SACCH multiframe.
3. To verify that, for downlink DTX, the reported parameter RXQUAL_SUB is the received signal quality, averaged over the correct frames (SID).

21.3.1.4 Method of test

21.3.1.4.1 Initial conditions

A call is set up by the SS according to the generic call set up procedure on a full rate speech channel in the mid ARFCN range. The RADIO_LINK_TIMEOUT parameter value is set to maximum.

The SS commands the MS to establish the TCH burst-by-burst loop, see subclause 36.2.1.1.3.

The SS produces a wanted signal and an independent uncorrelated interfering (unwanted) signal, both with static propagation characteristics. The wanted signal is the standard test signal C1. It is at the nominal frequency of the receiver and its level is $28 \text{ dB}\mu\text{Vemf}$ (). The unwanted signal is the standard test signal I1, on the same timeslot on a nominal frequency 200 kHz above the nominal frequency of the wanted signal.

21.3.1.4.2 Procedure

- a) The SS sets the level of the unwanted signal at a value for which the BER of the looped back bursts, averaged over the reporting period as defined in GSM 05.08, clause 8.4, is in the "Range of actual BER" for "Quality band" RXQUAL_i, given in the table of GSM 05.08, subclause 8.2.4, with i equal to 0.
- b) The SS verifies that the MS reports RXQUAL and whether or not the reported level is correct by comparison with the RXQUAL level of the corresponding looped back bursts. The SS increases an event counter for each incorrect MS reported RXQUAL level and continues the test for Max-samples, as given in subclause 21.3.1.5 for every i. For i = 7, the test is performed in steps using 60 SACCH blocks. In between steps, at least 35 SACCH blocks, are transmitted with a level of the unwanted signal that allows the radio link counter in the MS to reach the maximum value.

NOTE 1: This special procedure for i = 7 is due to the high error rates involved with testing RXQUAL₇, that could lead to the MS experiencing a radio link time-out.

- c) The SS repeats steps a) to b) for i equals 1, 2, ...,7.
- d) The SS removes the unwanted signal and sets downlink DTX on.

- e) The SS verifies that the MS reports RXQUAL_SUB = 0 and RXQUAL_FULL = 7.

NOTE 2: When testing RXQUAL_SUB, on a full rate speech channel, the MS has approximately twice as many bits as the SS to assess BER. The MS has both SID and SACCH bits, whereas the SS only has the looped back SID bits. Therefore it is only tested that the MS uses the correct frames for RXQUAL_SUB reporting by checking both RXQUAL_SUB and RXQUAL_FULL reports. No quantitative assessment is done.

- f) The SS releases the call.

21.3.1.5 Test requirements

The number of errors in reporting the RXQUAL bands recorded in each of the considered cases shall not exceed the corresponding value of max-events shown in the following tables, when the number of samples relevant to the case under test is equal to max-samples.

Table 21.3: Maximum number of incorrectly reported RXQUAL_FULL for TCH/FS

CASE	Expected RXQUAL_FULL	Specified reporting error rate	Max-events	Max-samples
0	RXQUAL_0	10%	200	1640
1	RXQUAL_1	25%	200	666
2	RXQUAL_2	15%	200	1093
3	RXQUAL_3	10%	200	1640
4	RXQUAL_4	10%	200	1640
5	RXQUAL_5	5%	200	3279
6	RXQUAL_6	5%	200	3279
7	RXQUAL_7	5%	201	3300

NOTE: In order to have a testing performance corresponding to that in clause 14 for high error rates, the multiplication factor of the tested error rate with respect to the specified error rate, and the minimum number for Max-events, need to be increased. The following figures are used for static propagation conditions:

specified error rate	multiplication factor	min. Max-events
≤ 25 %	1,22	200

21.3.2 Signal quality under static conditions - TCH/HS

21.3.2.1 Definition and applicability

The MS shall be capable of measuring the received signal quality, which is specified in terms of bit error ratio (BER) before channel decoding averaged over the reporting period of length of one SACCH multiframe defined in section 8.4 of GSM 05.08. The MS shall map this BER into RXQUAL values using the coding scheme defined in section 8.2.4 of GSM 05.08. For the half rate channel without downlink DTX, the error assessment is based on 52 TDMA frames: RXQUAL_FULL. In case downlink DTX is used, the assessment is based on 12 TDMA frames: RXQUAL_SUB.

The requirement and this test apply to all types of GSM 900 and DCS 1 800 MS supporting speech on a half rate channel.

21.3.2.2 Conformance requirement

1. The received signal quality shall be measured by the MS in a manner that can be related to an equivalent average BER before channel decoding (i.e. chip error ratio), assessed over the reporting period of one SACCH multiframe. When the quality is assessed over the full-set and sub-set of

frames, eight levels of RXQUAL are defined and shall be mapped to the equivalent BER before channel decoding as per the table in GSM 05.08, 8.2.4; GSM 05.08, 8.2.2 & 8.2.4.

2. The reported parameters (RXQUAL) shall be the received signal quality, averaged over the reporting period of length one SACCH multiframe; GSM 05.08, 8.2.3.

21.3.2.3 Test purpose

1. To verify, under static propagation conditions, that the received signal quality is measured and mapped to the eight levels of RXQUAL_FULL by the MS in a manner that can be related to an equivalent average BER before channel decoding (i.e. chip error ratio), assessed over the reporting period of one SACCH multiframe. The probability that the correct RXQUAL band is reported shall meet the values given as per the table in GSM 05.08, 8.2.4.
2. To verify that the reported parameters (RXQUAL) are the received signal quality, averaged over the reporting period of length one SACCH multiframe.
3. To verify that, for downlink DTX, the reported parameter RXQUAL_SUB is the received signal quality, averaged over the correct frames (SID).

21.3.2.4 Method of test

21.3.2.4.1 Initial conditions

A call is set up by the SS according to the generic call set up procedure on a half rate speech channel in the mid ARFCN range. The RADIO_LINK_TIMEOUT parameter value is set to maximum.

The SS commands the MS to establish the TCH burst-by-burst loop, see subclause 36.2.1.1.3.

The SS produces a wanted signal and an independent uncorrelated interfering (unwanted) signal, both with static propagation characteristics. The wanted signal is the standard test signal C1. It is at the nominal frequency of the receiver and its level is 28 dB μ V_{emf}(). The unwanted signal is the standard test signal I1, on the same timeslot on a nominal frequency 200 kHz above the nominal frequency of the wanted signal.

21.3.2.4.2 Procedure

- a) The SS sets the level of the unwanted signal at a value for which the BER of the looped back bursts, averaged over the reporting period as defined in GSM 05.08, clause 8.4, is in the "Range of actual BER" for "Quality band" RXQUAL_i, given in the table of GSM 05.08, subclause 8.2.4, with i equal to 0.
- b) The SS verifies that the MS reports RXQUAL and whether or not the reported level is correct by comparison with the RXQUAL level of the corresponding looped back bursts. The SS increases an event counter for each incorrect MS reported RXQUAL level and continues the test for Max-samples, as given in subclause 21.3.2.5 for every i. For i = 7, the test is performed in steps using 60 SACCH blocks. In between steps, at least 35 SACCH blocks, are transmitted with a level of the unwanted signal that allows the radio link counter in the MS to reach the maximum value.

NOTE1: This special procedure for i = 7 is due to the high error rates involved with testing RXQUAL₇, that could lead to the MS experiencing a radio link time-out.

- c) The SS repeats steps a) to b) for i equals 1, 2, ...,7.
- d) The SS removes the unwanted signal and sets downlink DTX on.
- e) The SS verifies that the MS reports RXQUAL_SUB = 0 and RXQUAL_FULL = 7.

NOTE 2: When testing RXQUAL_SUB, on a half rate speech channel, the MS has approximately twice as many bits as the SS to assess BER. The MS has both SID and SACCH bits, whereas the SS only has the looped back SID bits. Therefore it is only tested that the MS uses the correct frames for RXQUAL_SUB reporting by checking both RXQUAL_SUB and RXQUAL_FULL reports. No quantitative assessment is done.

f) The SS releases the call.

21.3.2.5 Test requirements

The number of errors in reporting the RXQUAL bands recorded in each of the considered cases shall not exceed the corresponding value of max-events shown in the following tables, when the number of samples relevant to the case under test is equal to max-samples.

Table 21.4: Maximum number of incorrectly reported RXQUAL_FULL for TCH/HS

CASE	Expected RXQUAL_FULL	Specified reporting error rate	Max-events	Max-samples
0	RXQUAL_0	10%	200	1640
1	RXQUAL_1	40%	300	660
2	RXQUAL_2	30%	300	870
3	RXQUAL_3	15%	200	1093
4	RXQUAL_4	15%	200	1093
5	RXQUAL_5	5%	200	3279
6	RXQUAL_6	5%	200	3279
7	RXQUAL_7	5%	201	3300

NOTE: In order to have a testing performance corresponding to that in clause 14 for high error rates, the multiplication factor of the tested error rate with respect to the specified error rate, and the minimum number for Max-events, need to be increased. The following figures are used for static propagation conditions:

specified error rate	multiplication factor	min. Max-events
≤ 25 %	1,22	200
30 - 40 %	1,15	300
> 40 %	1,1	400

21.4 Signal quality under TU50 propagation conditions

21.4.1 Definition and applicability

The MS must be capable of measuring the received signal quality, which is specified in terms of bit error ratio (BER) before channel decoding averaged over the reporting period of length of one SACCH multiframe defined in section 8.4 of GSM 05.08. The MS has to map this BER into RXQUAL values using the coding scheme defined in section 8.2.4 of GSM 05.08. For the full rate channel without downlink DTX, the error assessment is based on 104 TDMA frames: RXQUAL_FULL.

The requirement and this test apply to all types of GSM 900 and DCS 1800 MS supporting speech on a full rate channel.

21.4.2 Conformance requirement

1. The received signal quality shall be measured by the MS in a manner that can be related to an equivalent average BER before channel decoding (i.e. chip error ratio), assessed over the reporting period of 1 SACCH multiframe. The assessed equivalent BER before channel decoding shall be mapped to the eight levels of RXQUAL using the coding scheme defined in section 8.2.4 of GSM 05.08; GSM 05.08 8.2.2, 8.2.4.

2. The reported parameters (RXQUAL) shall be the received signal quality, averaged over the reporting period of length one SACCH multiframe.

GSM 05.08, 8.2.3.

21.4.3 Test purpose

1. To verify, under TUhigh conditions, that the received signal quality is measured and reported to the eight levels of RXQUAL_FULL by the MS in a manner that can be related to an equivalent average BER before channel decoding (i.e. chip error ratio), assessed over the reporting period of length one SACCH multiframe for the TCH/FS. The probability that the correct RXQUAL band is reported shall meet the values given as per the Table in GSM 05.08 8.2.
2. To verify that the reported parameters (RXQUAL) is the received signal quality, averaged over the reporting period of length one SACCH multiframe.

21.4.4 Method of test

21.4.4.1 Initial conditions

The SS sets up a call according to the generic call set up procedure on a full rate speech channel in the mid ARFCN range. The RADIO_LINK_TIMEOUT parameter is set to maximum.

The SS commands the MS to establish the TCH burst-by-burst loop, see subclause 36.2.1.1.3.

The SS produces the standard test signal C1, with TUhigh propagation profile. It shall be at the nominal frequency of the receiver at a level of 28 dB μ Vemf().

21.4.4.2 Procedure

- a) The SS counts the number of bit errors occurring in 50 SACCH multiframes and the relevant BER is computed. If this BER does correspond to one out of the 8 different cases shown in Table 21.5, the procedure is continued from step c).

Table 21.5

CASE	Average BER (%)
0	< 0,10
1	0,26 to 0,30
2	0,51 to 0,64
3	1,0 to 1,3
4	1,9 to 2,7
5	3,8 to 5,4
6	7,6 to 11
7	> 15

- b) The SS generates an independent, uncorrelated interfering (unwanted) signal with TUhigh propagation profile. The unwanted signal is on the same channel as the wanted signal but has no fixed relationship with the bit transitions of the wanted signal, and is modulated with random data. The SS sets the level of this signal such that the BER computed on the basis of the number of bit errors occurring in 50 SACCH multiframes corresponds to one of the cases: case_i in Table 21.5.
- c) The SS verifies that the MS reports RXQUAL. The SS also computes the RXQUAL level for the multiframe based on the looped back bits. The SS compares the RXQUAL level it computed based on the looped back bits of the multiframe with the RXQUAL level reported by the MS for that multiframe. The reported level is considered correct if RXQUAL reported by the MS is equal to RXQUAL_i (with i = 0, 1, ... 7), or to one of the adjacent bands RXQUAL_(i-1) (with i = 1, 2, ..., 7) and RXQUAL_(i+1) (with i = 0, 1, ..., 6). For each failure (to be in the correct or one of the adjacent bands) that is found, if any, a counter Max-events_i is increased by one. This step is continued for Max_samples_i RXQUAL_i based on the looped back bits.

If the MS reports RXQUAL = 7 during the test period, then at least 35 SACCH multiframes, are transmitted with a level of the unwanted signal that allows the radio link counter in the MS to reach the maximum value.

NOTE: This special procedure for RXQUAL = 7 is due to the high error, that could lead to the MS experiencing a radio link time-out.

d) The SS repeats steps b) and c) for all of the eight case_i.

21.4.5 Test requirements

The number of errors in reporting the RXQUAL bands recorded in each of the considered cases shall not exceed the corresponding value of Max-events shown in Table 21.6, when the number of samples relevant for the case is equal to Max_samples.

Table 21.6: Maximum number of incorrectly reported RXQUAL_FULL for TCH/FS

CASE	Expected RXQUAL_FULL	Specified reporting error rate	Max-events	Max_samples
0	RXQUAL_0/1	15%	200	1093
1	RXQUAL_1/0/2	15%	200	1093
2	RXQUAL_2/1/3	15%	200	1093
3	RXQUAL_3/2/4	10%	200	1640
4	RXQUAL_4/3/5	10%	200	1640
5	RXQUAL_5/4/6	10%	200	1640
6	RXQUAL_6/5/7	10%	200	1640
7	RXQUAL_7/6	10%	200	1640

22 Transmit power control timing and confirmation

22.1 Definition and applicability

The RF power level to be employed by the MS is indicated by means of the 5 bit TXPWR field sent in the layer 1 header of each downlink SACCH message block and may be sent in a dedicated signalling block.

When a power change is signalled the MS must change its power control level to the new level at a certain rate of change.

The MS shall confirm the power level that it is currently employing by setting the MS_TXPWR_CONF field in the uplink SACCH L1 header.

The requirements and this test apply to all types of GSM 900 and DCS 1 800 MS.

22.2 Conformance requirement

1. The RF power control level to be employed by the MS is indicated by means of the power control information sent in the layer 1 header of each downlink SACCH message block and may be sent in a dedicated signalling block; GSM 05.08, 4.2.
2. The MS shall confirm the power level that it is currently employing in the uplink SACCH L1 header. The indicated value shall be the power control level actually used by the MS for the last burst of the previous SACCH period; GSM 05.08, 4.2.
3. Upon receipt of a command on the SACCH to change its RF power level, the MS shall change to the new level at a rate of one nominal 2 dB power control step every 60 ms; GSM 05.08, 4.7.
4. The change (in conformance requirement 3) shall commence at the first TDMA frame belonging to the next reporting period; GSM 05.08, 4.7.
5. In case of channel change the commanded power level shall be applied on the new channel immediately; GSM 05.08, 4.7.

22.3 Test purpose

1. To verify that the MS will set its transmitter output power in accordance with conformance requirement 1.
2. To verify that the MS will confirm the power level it is currently employing according to conformance requirement 2.
3. To verify that the MS, upon receipt of a command from the SACCH to change its RF power level, will change according to conformance requirement 3.
4. To verify that the MS will commence the change of power level at least by the sixth TDMA frame belonging to the next reporting period.
5. To verify that in case of new channel assignment the commanded power level is applied on the new channel according to conformance requirement 5.

22.4 Method of test

NOTE: The method of measuring the MS transmitter output power is given in section 13.3.

22.4.1 Initial conditions

A call is set up by the SS according to the generic call set up procedure on a channel with ARFCN in the Mid ARFCN range (ref. table 3.3), power control level set to maximum power.

22.4.2 Procedure

- a) The SS signals minimum power control level to the MS in the SACCH.
- b) The SS measures the MS transmitter output power on TDMA frames 6, 19, 32 and every subsequent 13th TDMA frame to TDMA frame 214. The SS also monitors the MS_TXPWR_CONF field in the uplink SACCH L1 header for the four SACCH multiframes after the SS signals the power change.
- c) The SS now sets TXPWR in the SACCH to the maximum peak power appropriate to the class of the MS.
- d) The SS measures the MS transmitter output power on TDMA frames 6, 19, 32 and every subsequent 13th TDMA frame to TDMA frame 214. The SS also monitors the MS_TXPWR_CONF field in the uplink SACCH L1 header for the four SACCH multiframes after the SS signals the power change.
- e) The SS now sets the SACCH TXPWR to 8.
- f) After 3 s the SS sets the SACCH TXPWR to 9.
- g) The SS measures the MS transmitter output power on TDMA frame 6.
- h) The SS sets the SACCH TXPWR to 8.
- i) The SS measures the MS transmitter output power on TDMA frame 6.
- j) The channel assignment is changed and the demanded power within the channel assignment is set to the minimum power control level of the MS.
- k) When the MS has changed channel its output power is measured on the first burst on the new channel.

22.5 Test requirements

NOTE: Refer to tables 13-2 and 13-4 for relationship between the power class, power control level, transmitter output power and the relevant tolerances.

- a) In steps b) and d), the transmitter output power shall change by one power step towards the new level signalled for each measured burst until the MS is operating at the closest supported power control level and from then on, all transmissions shall be at that level.
- b) In steps b) and d), the value of the MS_TXPWR_CONF field in the uplink SACCH L1 header shall correspond to the actual power control level used for the last transmitted burst of the previous SACCH multiframe. The first one shall indicate the initial transmitted power control level, the subsequent ones shall change by 8 each time until the final power control level has been reached in which case that value shall be indicated.
- c) In steps g) and i) the transmitter output power of TDMA frame 6 shall correspond to the new commanded power control level.
- d) In step k) the MS output power, measured on the new channel shall correspond to the power control level in the channel assignment.

23 Single frequency reference

23.1 Definition and applicability

The MS is required to use one single frequency reference for both RF generation/reception and baseband signals. A test method to verify this is not available.

The requirement applies to all types of GSM 900 and DCS 1 800 MS.

23.2 Conformance requirement

The MS shall use the same frequency source for both RF frequency generation and clocking the timebase; GSM 05.10, 6.1.

23.3 Test purpose

There is no test specified.

24 Tests of the layer 1 signalling functions

Testing of Layer 1 signalling functions is included in the tests in sections 15, 16, 17, 18, 19, 20, 21, 22, 23. Other Layer 1 functions are tested in sections 12, 13 and 14. Some testing of Layer 1 functions is integrated with Layer 3 signalling testing (26).

25 Tests of the layer 2 signalling functions

References:

- 1 ETSI ETS 300 555 (GSM 04.06) and ETS 300 557 (GSM 04.08), GSM 04.05.
- 2 CCITT Rec. X.290: OSI Conformance Testing Methodology and Framework for CCITT applications, Part 2: Abstract Test Suite Specification.

25.1 Introduction, objective and scope

25.1.1 General

The objective of section 25 is to provide detail of how Layer 2 of the MS is tested to verify conformance to the testable parameters given in GSM 04.06. The tests cover SAPI = 0, and they will be carried out on SDCCH and FACCH/F and on FACCH/H if the MS supports half-rate. Testing of unnumbered information transfer on SACCHs is covered implicitly by the test in section 26.6.3.

The testing is performed using the test configuration described in section 25.1.1.2. This configuration does not provide for testing of conformance of any maintenance functions.

The MS under test shall conform to the test configuration, and the Remote Single layer (RS) test method (CCITT X.290, section 8.1.4) will be used.

25.1.2 Test configurations

The Layer 2 test configuration defines the Layer 2 functional blocks of a MS being tested and the access arrangement between MS and tester.

NOTE: These functional blocks provide the Layer 2 basic capabilities which have to be implemented in accordance with the specification given in GSM 04.06. However, the definition of Layer 2 in the form of a number of functional blocks places no requirements on the Layer 2 implementation in a MS.

An example of a functional composition of the MS Layer 2 is given in GSM 04.05. These function blocks provide basic capabilities which have to be implemented in accordance with GSM 04.05 and GSM 04.06.

Also there are alternatives or options included in GSM 04.05 and GSM 04.06, these are provided as complementary capabilities.

25.1.3 Pre-conditions

Before carrying out any Layer 2 tests the tests specified in section 12, 13, 14 and 15 to 23 (Layer 1 tests) shall be performed.

Apart from powering up the MS to be tested and being able to establish a call the only access to the MS needed and used for Layer 2 testing is the radio interface. It therefore is necessary that the MS is able to synchronize to the System Simulator and to decode its BCCH and CCCH. Furthermore, the MS must be able to perform the following elementary Layer 3 procedures:

- Paging
- Immediate Assignment
- Dedicated Channel Assignment
- Handover
- Channel Release.

It is necessary that the tests are performed in the order specified, except where the starting point is set (25.1.5).

The data link is maintained by the MS and the SS sending fill frames (c.f. GSM 04.06, sect. 5.4.2.3) on the SDCCH when no other frames are to be transmitted. Fill frames are also sent on the FACCH while the channel mode is set to signalling. The default mode is signalling. The tests will normally be performed with the MS sending fill frames on the main DCCH (i.e. FACCH or SDCCH). Consequently throughout the tests

fill frames will be sent and received even while waiting for other Layer 2 frames. The scheduling of the fill frame sending cannot be specified as this sending is closely linked to the processing times in the MS. Therefore, the instants of transmission of fill frames cannot be tested nor the number of these transmissions however, in certain circumstances, the fact that a fill frame is sent can be used as proof that the MS requirement has been fulfilled.

25.1.4 Layer 2 test frames

The Layer 2 conformance test is accomplished by sequences of those frames which are contained in GSM 04.06 (Layer 2 frame repertoire etc.).

These frame sequences are under control of the System Simulator and are related to the state that the System Simulator perceives the MS to be in as a result of frames transferred across the MS-BS interface.

These frame sequences shall comply with the following rules:

- 1) The test sequences exchanged between the System Simulator and MS are assumed to be free from transmission errors.
- 2) The tester may introduce errors in the direction tester to MS by inserting wrong parameters in the address, control and length indication field.
- 3) The tester may simulate errors in the direction MS to tester by ignoring the receipt of frames from the MS.
- 4) The tester may violate the protocol rules related to the control of state variables to provoke sequence gaps.
- 5) There is no contention on the Dm channel at Layer 1 (Layer 1 point-to-point).
- 6) With respect to contention on the Dm channel at Layer 2, two distinct situations are defined:
 - i) Test of the protocol procedure supported by a single entity. In this case there is no contention on the Dm channel (one peer-to-peer information transfer invoked at a time). This test applies to all MSs and is performed for SAPI = 0.
 - ii) Test of Layer 2 multiplexing and MS processing capacity in terms of the number of SAPs and links which a MS is able to support simultaneously. In this case there is contention on the Dm channel at Layer 2 and this contention is resolved within Layer 2 based on the SAPI. This test applies to MSs which are designed for supporting SAPI in addition to SAPI = 0.

Examples of special GSM Layer 2 functions to be tested:

- Correct L2 functions on specific GSM control channels;
- Length indication;
- Fill bits;
- Segmentation, more data bit;
- SABM/UA containing information for contention resolution;
- Abnormal release.

25.1.5 Establishment of the dedicated physical resource

The System Simulator shall simulate a BS with BCCH/CCCH on one carrier. The MS shall be listening to this CCCH and able to respond to paging messages. The system simulator sends Paging Request to the MS on the paging channel. The MS shall respond with Channel Request on the random access channel. The system simulator sends Immediate Assign to the MS, thereby ordering the MS either to a SDCCH or to a TCH, that is FACCH. Each test is performed once on SDCCH, once on FACCH/F and once on FACCH/H if the MS supports half-rate. However tests that explicitly check SDCCH and FACCH are performed once if the MS does not support half-rate and twice (once with FACCH/F and once with FACCH/H) if the MS supports half-rate.

25.1.6 Release of the dedicated physical resource

After a test has been performed the System Simulator shall initiate the release of the SDCCH or FACCH, as laid out in GSM 04.08, section 7.1.6. This shall return the MS to the idle mode, i.e. the MS shall again be listening to the CCCH of the System Simulator.

25.2 Test sequences**Timing requirement:**

The MS shall respond to a command within T200 as defined in GSM 04.06.

The MS shall repeat a command after time-out of T200 if the command has not been acknowledged as defined in GSM 04.06.

Constant bit values:

In each frame from the MS:

- bits 6 through 8 of the address field shall be set to zero as defined in GSM 04.06.
- except for test 25.2.7, the address extension bit (EA bit) shall be set to 1 as defined in GSM 04.06.
- except for test 25.2.7, the length indicator field extension bit (EL bit) shall be set to 1 as defined in GSM 04.06.

This shall be checked each time a frame from the MS is received.

Fill bits:

The fill bits transmitted with each frame from the MS whose length indicator L is less than N201 as defined in GSM 04.06 shall be set as defined in GSM 04.06.

Frame format description

The frames are described by the following parameter sets:

SABM (C, P, M = 0, L = 0) (* SABM without an information field*)
 SABM (C, P, M = 0, L > 0) (* SABM with an information field*)
 DISC (C, P, M = 0, L = 0)
 UA, (F, M = 0, L = 0) (* UA without an information field*)
 UA, (F, M = 0, L > 0) (* UA with an information field*)
 DM (R, F, M = 0, L = 0)
 RR (C, P, M = 0, L = 0, N(R))
 RR (R, F, M = 0, L = 0, N(R))
 REJ (C, P, M = 0, L = 0, N(R))
 REJ (R, F, M = 0, L = 0, N(R))
 I (C, P, M = 0, L < N201, N(S), N(R))
 I (C, P, M = 1, L = N201, N(S), N(R))
 UI (C, P = 0, M = 0, L = 0)
 UI (C, P = 0, M = 0, L < N201)

where:

C = command
 R = response
 P = poll
 F = final
 M = M bit
 L = length indicator
 N(S) = send sequence number
 N(R) = receive sequence number.

25.2.1 Initialization

25.2.1.1 Initialization when contention resolution required

25.2.1.1.1 Normal initialization

25.2.1.1.1.1 Test purpose

To test the normal establishment of multiple frame operation between the SS and the MS when contention resolution is required.

25.2.1.1.1.2 Method of test

The MS is paged as described in the Layer 2 tests general section at 25.1.5.

The MS shall then continue the setup by sending a SABM frame.

The SS responds with a UA frame.

The MS shall send a UI fill frame.

The SS waits for at least T200 after the UA to ensure the SABM frame is not repeated. This confirms that the UA has been received.

The MS is returned to the idle state as described in 25.1.1.6.

Expected sequence

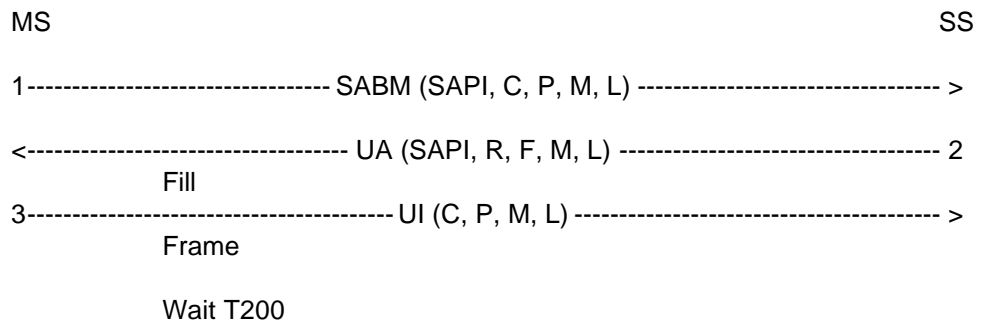

The frames from the SS will be:

2: One UA frame containing:

SAPI = 0, R = 0, F = 1, M = 0, L = L of SABM
 information field = information field of SABM

25.2.1.1.1.3 Test requirements

The frames from the MS shall be:

1: One SABM frame containing:

SAPI = 0, C = 0, P = 1, M = 0, 0 <= L <= N201
 information field = Page Response

3: One UI frame containing:

C = 0, P = 0, M = 0, L = 0

25.2.1.1.2 Initialization failure

25.2.1.1.2.1 Loss of UA frame

25.2.1.1.2.1.1 Test purpose

To test the MS response to the loss of a Layer 2 UA frame during initialization.

25.2.1.1.2.1.2 Method of test

The MS is paged as described in the Layer 2 tests general section at 25.1.5.

The MS shall then continue the setup by sending an SABM frame.

The SS ignores the first SABM frame from the MS.

The MS shall wait for time-out of timer T200 and then send a second SABM frame.

The SS responds with a UA frame.

The MS shall send a UI fill frame.

The SS waits for at least T200 to ensure the SABM frame is not repeated

The MS is returned to the initial condition by clearing of the call (not part of this test).

Expected sequence

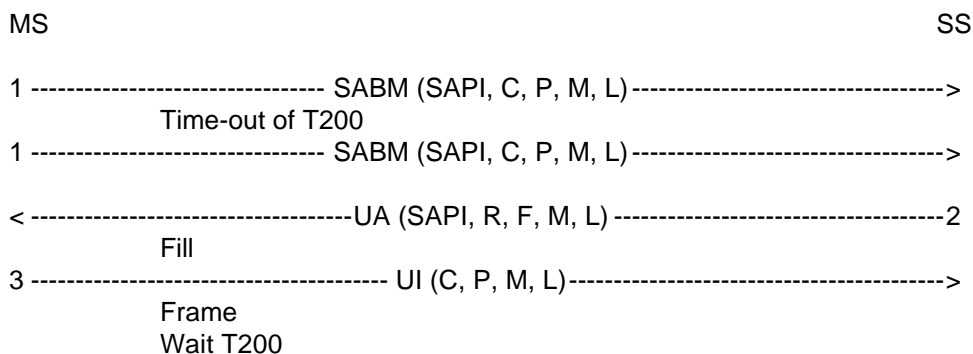

The frames from the SS will be:

2: One UA frame containing:

SAPI = 0, R = 0, F = 1, M = 0, L = L of SABM
 information field = information field of SABM

25.2.1.1.2.1.3 Test requirements

The frames from the MS shall be:

1: One SABM frame (occurs twice) containing:

SAPI = 0, C = 0, P = 1, M = 0, 0 <= L <= N201
 information field = Page Response

The second SABM frame shall follow the first SABM frame after time-out of timer T200.

3: One UI frame containing:

C = 0, P = 0, M = 0, L = 0

25.2.1.1.2.2 UA frame with different information field**25.2.1.1.2.2.1 Test purpose**

To test that the MS will leave the channel and return to the idle state when multiple frame establishment fails because a UA frame with a different information field is received in response to the SABM frame.

25.2.1.1.2.2.2 Method of test

The MS is paged as described in the general section for Layer 2 testing in section 25.1.5. The MS is now in a condition to test the Layer 2 aspects of multiple frame establishment with contention resolution and a UA frame with an information field different from the one in its SABM frame.

The MS shall send an SABM frame.

The SS shall respond with an UA frame whose information field is different from the one in the SABM frame.

The SS shall wait for $3 \cdot T_{200}$ to check that the MS does not send any L2 frames other than L2 fill frames on the assigned channel.

After a time equal to $3 \cdot T_{200}$ the SS checks that there are no more Layer 2 frames on the assigned channel, for a period of 1 second.

NOTE: Possible fill frames are allowed in order to take into account processing time inside the MS.

15 seconds after sending the UA frame the SS pages the MS according to 25.2.1.1.1, to make sure that the MS has returned to the idle state.

Expected sequence

MS		SS
1	----- SABM (SAPI, C, P, M, L) -----	>
	<----- UA (SAPI, R, F, M, L) -----	2

Wait for at least $3 \cdot T_{200}$

The frames from the SS will be:

2: One UA frame containing:

SAPI = 0, R = 0, F = 1, M = 0, L = 0

25.2.1.1.2.2.3 Test requirements

The frames from the MS shall be:

1: One SABM frame containing:

SAPI = 0, C = 0, P = 1, M = 0, $0 \leq L \leq N_{201}$
information field = Page Response

3: Fill frames may occur.

25.2.1.1.2.3 Information frame and supervisory frames in response to an SABM frame**25.2.1.1.2.3.1 Test purpose**

To test that the MS will ignore receipt of frames other than a UA when received in response to the SABM frame.

25.2.1.1.2.3.2 Method of test

As in 25.2.1.1.2.2, but instead of returning a UA frame the SS will respond with an I frame, RR frame, REJ frame. (So this test will actually be performed 3 times.). The MS shall ignore receipt of the frames sent by the SS and therefore resend its SABM frame after time-out of T200.

Expected Sequence

```

MS                                                    SS
1 ----- SABM (SAPI, C, P, M, L)----->
< -----I, RR, REJ (SAPI, C, P, M, L, N(R), N(S)) -----2
      Time-out of T200
1 ----- SABM (SAPI, C, P, M, L)----->

```

The frames from the SS will be:

2: One I frame containing:

SAPI = 0, C = 1, P = 1, M = 0, $0 \leq L \leq N201$ (arbitrary), N(R), N(S) arbitrary
information field arbitrary

or One RR frame containing:

SAPI = 0, C = 1, P = 1, N(R) arbitrary

or One REJ frame containing:

SAPI = 0, C = 1, P = 1, N(R) arbitrary

25.2.1.1.2.3.3 Test requirements

The frames from the MS shall be:

1: One SABM frame (occurs twice) containing:

SAPI = 0, C = 0, P = 1, M = 0, $0 \leq L \leq N201$
information field = Page Response

The second SABM frame shall follow the first SABM frame after time-out of timer T200.

25.2.1.1.3 Initialization denial**25.2.1.1.3.1 Test purpose**

To test that the MS takes appropriate action if the network side indicates that it can not enter the multiple frame established state.

25.2.1.1.3.2 Method of test

The MS is paged as described in the Layer 2 tests general section at 25.1.5.

The MS shall then continue the setup by sending a SABM frame.

The SS responds with a DM frame.

The SS then waits at least T200 for the MS to transmit.

The MS shall not repeat the SABM frame.

Expected Sequence

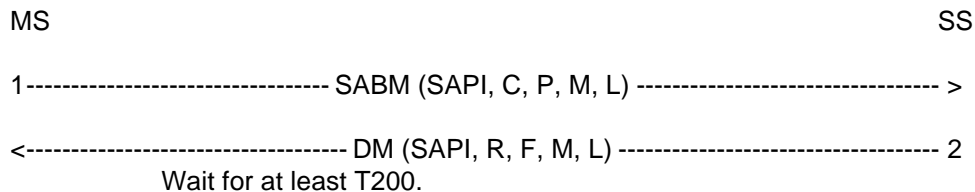

The frames from the SS will be:

2: One DM frame containing:

SAPI = 0, R = 0, F = 1, M = 0, L = 0

25.2.1.1.3.3 Test requirements

The frames from the MS shall be:

1: One SABM frame containing:

SAPI = 0, C = 0, P = 1, M = 0, 0 <= L <= N201
information field = Page Response

25.2.1.1.4 Total initialization failure

25.2.1.1.4.1 Test purpose

To test the MS response to the lack of the system to respond to requests to initialize the data link.

25.2.1.1.4.2 Method of test

The MS is paged as described in the Layer 2 tests general section at 25.1.5.

The MS shall then continue the setup by sending a SABM frame.

The SS ignores the first SABM frame from the MS.

The MS shall wait for time-out of timer T200 and then send a second SABM frame.

This is repeated until the MS has sent the SABM frame six times. The MS shall not send the SABM any more than six times.

The SS continues to send paging messages on the BCCH/CCCH and the test continues as in test 25.2.1.1.1.

Expected Sequence

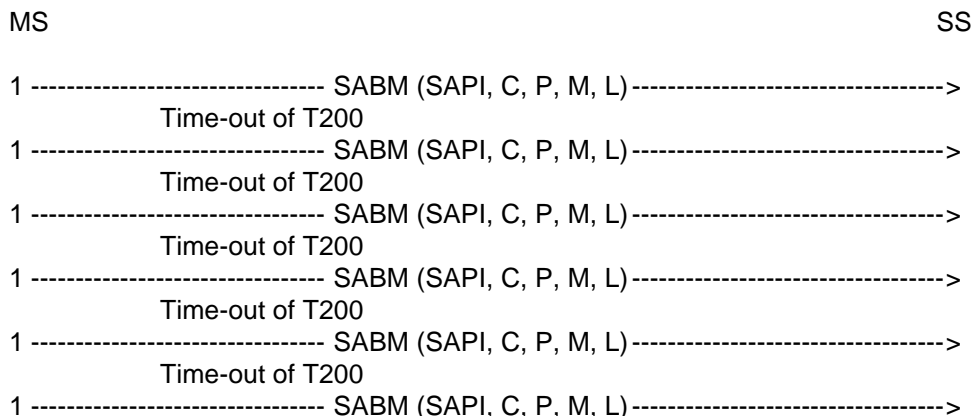

25.2.1.1.4.3 Test requirements

The frames from the MS shall be:

1: One SABM frame (occurs six times) containing:

SAPI = 0, C = 0, P = 1, M = 0, <= L <= N201
 information field = Page Response

The subsequent SABM frames shall follow the previous SABM frame after time-out of timer T200.

25.2.1.2 Initialization, contention resolution not required

This procedure is used after a data link has been established with contention resolution and a new data link is established on a new channel e.g. handover, dedicated channel assignment.

25.2.1.2.1 Normal initialization without contention resolution

25.2.1.2.1.1 Test purpose

To test the normal initialization of multiple-frame operation when contention resolution is not required.

25.2.1.2.1.2 Method of test

The data link is setup between the MS and the SS as in test 25.2.1.1.1.

After the MS has sent the UI frame the SS initiates the dedicated channel assignment procedure to assign an SDCCH.

The MS shall then continue the setup by sending a SABM frame without contention resolution.

The SS responds with a UA frame.

The MS shall then send an I frame containing the assignment complete message.

The SS shall acknowledge the I frame with an RR frame.

The SS then waits for the MS to send a UI fill frame.

The SS then initiates the dedicated channel assignment procedure to assign an FACCH.

The expected sequence is then repeated. The SS waits for at least T200 to ensure that the SABM is not repeated.

Expected Sequence

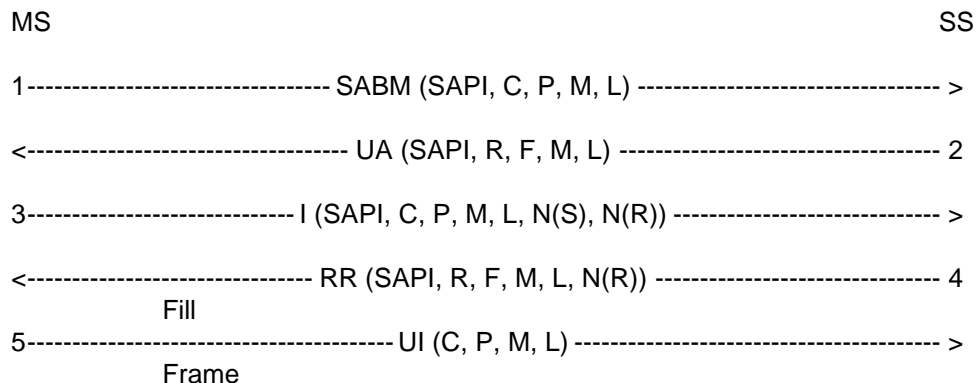

The frames from the SS will be:

2: One UA frame containing:

$$SAPI = 0, R = 0, F = 1, M = 0, L = 0$$

4: One RR frame containing:

$$SAPI = 0, R = 0, F = 0, M = 0, L = 0, N(R) = 1$$

25.2.1.2.1.3 Test requirements

The frames from the MS shall be:

1: One SABM frame containing:

$$SAPI = 0, C = 0, P = 1, M = 0, L = 0$$

3: One I frame containing:

$$SAPI = 0, C = 0, P = 0, M = 0, 0 \leq L \leq N201, N(S) = 0, N(R) = 0$$

Information field = Assignment Complete

5 One UI frame containing:

$$C = 0, P = 0, M = 0, L = 0$$

25.2.1.2.2 Initialization failure

25.2.1.2.2.1 Test purpose

To test the MS response to the loss of a Layer 2 UA frame during initialization.

25.2.1.2.2.2 Method of test

The SS initiates the dedicated channel assignment procedure to assign an SDCCH.

The MS shall then continue the setup by sending a SABM frame.

The SS ignores the first SABM frame from the MS.

The MS shall wait for time-out of timer T200 and then send a second SABM frame.

The SS responds with a UA frame.

The MS shall then send an I frame containing the assignment complete message.

The SS shall acknowledge the I frame with an RR frame.

The SS then waits for the MS to send a UI fill frame.

The SS then initiates the dedicated channel assignment procedure to assign a FACCH.

The expected sequence is then repeated. The SS waits for at least T200 to ensure that the SABM is not repeated.

The MS is returned to the idle state as described in 25.1.1.6.

Expected Sequence

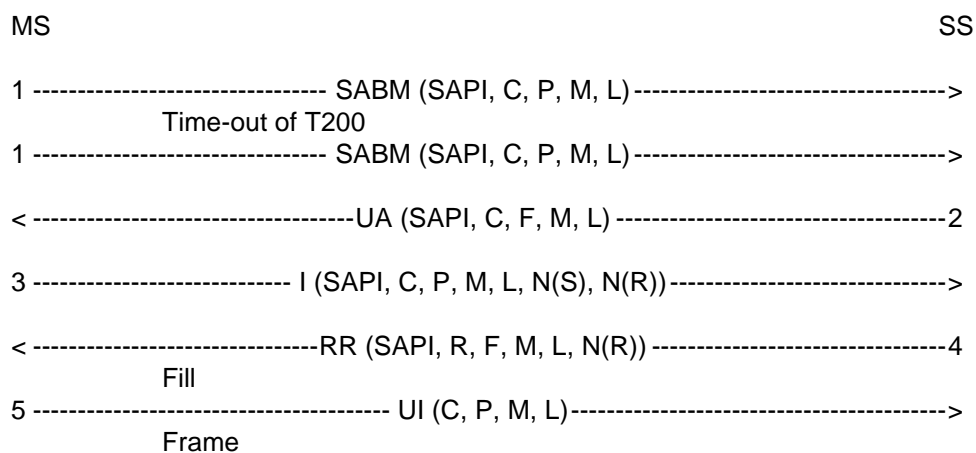

The frames from the SS will be:

2: One UA frame containing:

$$\text{SAPI} = 0, \text{R} = 0, \text{F} = 1, \text{M} = 0, \text{L} = 0$$

4: One RR frame containing:

$$\text{SAPI} = 0, \text{R} = 0, \text{F} = 0, \text{M} = 0, \text{L} = 0, \text{N(R)} = 1$$

25.2.1.2.2.3 Test requirements

The frames from the MS shall be:

1: One SABM frame (occurs twice) containing:

$$\text{SAPI} = 0, \text{C} = 0, \text{P} = 1, \text{M} = 0, \text{L} = 0$$

The second SABM frame shall follow the first SABM frame after time-out of timer T200.

3: One I frame containing:

$$\text{SAPI} = 0, \text{C} = 0, \text{P} = 0, \text{M} = 0, 0 \leq \text{L} \leq \text{N201}, \text{N(S)} = 0, \text{N(R)} = 0$$

Information field = Assignment Complete

5: One UI frame containing:

$$\text{C} = 0, \text{P} = 0, \text{M} = 0, \text{L} = 0$$

25.2.1.2.3 Initialization denial

25.2.1.2.3.1 Test purpose

To test that the MS takes appropriate action if the data link can not be initialized if the network side indicates the Layer 3 process is busy.

25.2.1.2.3.2 Method of test

The data link is setup between the MS and the SS as in test 25.2.1.1.1.

After the MS has sent the UI frame the SS initiates the dedicated channel assignment procedure to assign a SDCCH.

The MS shall then continue the setup by sending a SABM frame.

The SS responds with a DM frame.

The SS then waits at least T200.

The MS shall not repeat the SABM frame. However the MS will attempt to re-establish the link on the previous channel.

The test is repeated, but a FACCH is assigned in place of the SDCCH.

Expected Sequence

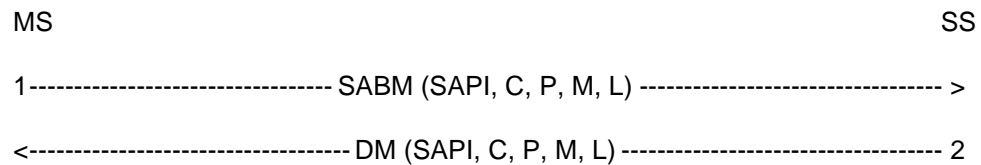

The frames from the SS will be:

2: One DM frame containing:

SAPI = 0, R = 0, F = 1, M = 0, L = 0

25.2.1.2.3.3 Test requirements

The frames from the MS shall be:

1: One SABM frame containing:

SAPI = 0, C = 0, P = 1, M = 0, L = 0

25.2.1.2.4 Total initialization failure

25.2.1.2.4.1 Test purpose

To test the MS response to the lack of the system to respond to requests to initialize the data link.

25.2.1.2.4.2 Method of test

The data link is setup between the MS and the SS as in test 25.2.1.1.1.

After the MS has sent the UI frame the SS initiates the dedicated channel assignment procedure to assign a SDCCH.

The MS shall then continue the setup by sending a SABM frame.

The SS ignores the first SABM frame from the MS.

The MS shall wait for time-out of timer T200 and then send a second SABM frame.

This is repeated until the MS has sent the SABM frame six times.

The MS shall not send the SABM any more than six times.

The test is repeated, but a FACCH is assigned in place of the SDCCH.

Expected Sequence

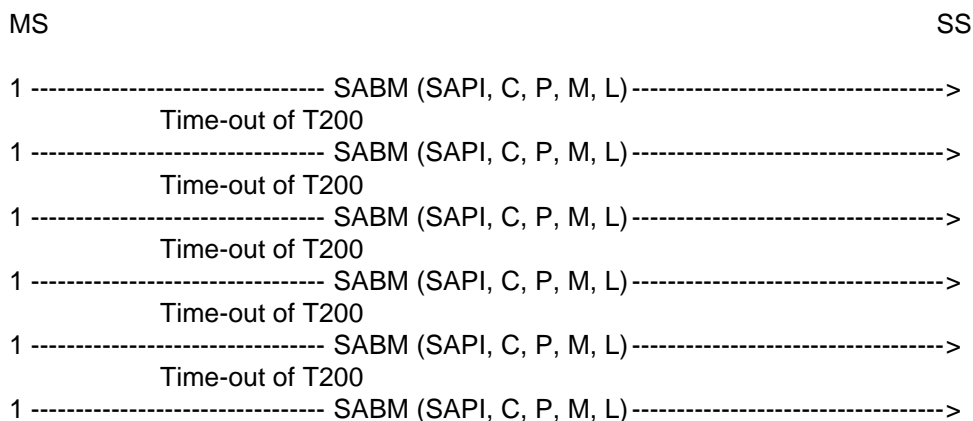

25.2.1.2.4.3 Test requirements

The frames from the MS shall be:

1: One SABM frame (occurs six times) containing:

$$SAPI = 0, C = 0, P = 1, M = 0, L = 0$$

The subsequent SABM frames shall follow the previous SABM frame after time-out of timer T200.

25.2.2 Normal information transfer

25.2.2.1 Sequence counting and I frame acknowledgements

25.2.2.1.1 Test purpose

To test the operation of Layer 2 sequence numbering. Since there are 8 sequence numbers the test cycles through 9 information frame transfers.

25.2.2.1.2 Method of test

The MS is brought into the multiple frame established state as described in test 25.2.1.1.1.

The SS sends an Identity Request message asking for IMEI to the MS.

The MS shall acknowledge this I frame with an Identity Response I frame or a RR frame.

This is repeated a further 8 times as rapidly as possible assuming a window size 1.

The MS Layer 3 response time should be less than 4*T200 and therefore the MS responses to at least the 5th, 6th, 7th, 8th and 9th I frames must be an I frame on the SDCCH. On the FACCH it is possible that all MS responses at Layer 2 will be RR frames.

The frames from the SS will be:

1,3,5,7,9,11,13,15,17: One I frame (occurs nine times) containing:

SAPI = 0, C = 1, P = 0, M = 0, $0 \leq L \leq N201$

$N(S) = 0, 1, 2, 3 \dots 7, 0$

$N(R) = (\text{number of I frames received in the test sequence hitherto}) \bmod 8$

information field = Identity Request (IMEI)

19, 21, and so on, until the SS has received 9 I frames from the MS: One RR frame containing:

SAPI = 0, R = 0, F = 0, M = 0, L = 0

$N(R) = (\text{number of I frames received in the test sequence hitherto}) \bmod 8$

25.2.2.1.3 Test requirements

There shall be an integer $k \geq 0$ such that for $i = 1, 2, \dots, k + 9$ the following conditions (a) and (b) both hold:

- (a) The MS sends 9 I frames and k RR frames during the test.
- (b) The frames sent by the MS in step $2*i$ are:
 - (b1) If the frame is an RR frame (occurs k times): one RR frame containing:
 - SAPI = 0, R = 1, F = 0, M = 0, L = 0
 - $N(R) = ((\text{Value of } N(S) \text{ in the last received I frame from the SS}) + 1) \bmod 8$
 - (b2) If the frame is an I frame (occurs 9 times): one I frame containing:
 - SAPI = 0, C = 0, P = 0, M = 0, $0 \leq L \leq N201$
 - $N(R) = ((\text{Value of } N(S) \text{ in the last received I frame from the SS}) + 1) \bmod 8$
 - $N(S) = (\text{number of I frame sent hitherto by the MS to SS excluding the actual I frame}) \bmod 8$
 - information field = Identity Response (IMEI)

Example of expected sequence (assuming $3 \times T_{200} < L_3$ reaction time $< 4 \times T_{200}$):

MS	SS
<----- I (SAPI, C, P, M, L, N(S), N(R))-----	1
2-----RR (SAPI, R, M, L, N(R), F)----->	
<----- I (SAPI, C, P, M, L, N(S), N(R))-----	3
4-----RR (SAPI, R, M, L, N(R), F)----->	
<----- I (SAPI, C, P, M, L, N(S), N(R))-----	5
6-----RR (SAPI, R, M, L, N(R), F)----->	
<----- I (SAPI, C, P, M, L, N(S), N(R))-----	7
8-----RR (SAPI, R, M, L, N(R), F)----->	
<----- I (SAPI, C, P, M, L, N(S), N(R))-----	9
10----- I (SAPI, C, P, M, L, N(S), N(R))----->	
<----- I (SAPI, C, P, M, L, N(S), N(R))-----	11
12----- I (SAPI, C, P, M, L, N(S), N(R))----->	
<----- I (SAPI, C, P, M, L, N(S), N(R))-----	13
14----- I (SAPI, C, P, M, L, N(S), N(R))----->	
<----- I (SAPI, C, P, M, L, N(S), N(R))-----	15
16----- I (SAPI, C, P, M, L, N(S), N(R))----->	
<----- I (SAPI, C, P, M, L, N(S), N(R))-----	17
18----- I (SAPI, C, P, M, L, N(S), N(R))----->	
<-----RR (SAPI, R, M, L, N(R), F)-----	19
20----- I (SAPI, C, P, M, L, N(S), N(R))----->	
<-----RR (SAPI, R, M, L, N(R), F)-----	21
22----- I (SAPI, C, P, M, L, N(S), N(R))----->	
<-----RR (SAPI, R, M, L, N(R), F)-----	23
24----- I (SAPI, C, P, M, L, N(S), N(R))----->	
<-----RR (SAPI, R, M, L, N(R), F)-----	25
26----- I (SAPI, C, P, M, L, N(S), N(R))----->	
<-----RR (SAPI, R, M, L, N(R), F)-----	27

The frames from the SS will be:

1, 3, 5, 7, 9, 11, 13, 15, 17: One I frame (occurs nine times) containing:

SAPI = 0, C = 1, P = 0, M = 0, $0 \leq L \leq N201$
 N(S) = 0, 1, 2, 3...7, 0
 N(R) = 0, 0, 0, 0, 0, 1, 2, 3, 4
 information field = Identity Request (IMEI)

19, 21, 23, 25, 27: One RR frame (occurs five times) containing:

SAPI = 0, R = 0, F = 0, M = 0, L = 0
 N(R) = 5, 6, 7, 0, 1

The frames from the MS shall be:

2, 4, 6, 8: One RR frame (occurs four times) containing:

SAPI = 0, R = 1, F = 0, M = 0, L = 0
 N(R) = 1, 2, 3, 4

10, 12, 14, 16, 18, 20, 22, 24, 26: One I frame (occurs nine times) containing:

SAPI = 0, C = 0, P = 0, M = 0, $0 \leq L \leq N201$
 N(R) = 5, 6, 7, 0, 1, 1, 1, 1, 1
 N(S) = 0, 1, 2, 3, 4, 5, 6, 7, 0
 information field = Identity Response (IMEI)

25.2.2.2 Receipt of an I frame in the timer recovery state

25.2.2.2.1 Test purpose

To test that the MS is able to respond to I frames whilst in the timer recovery state.

25.2.2.2.2 Method of test

The MS is brought into the multiple frame established state as described in test 25.2.1.1.1.

The SS sends an Identity Request message asking for IMEI to the MS.

The MS shall respond with a RR frame though this may be incorporated with the Identity Response I frame.

The SS does not respond to the I frame.

The MS shall wait for expiry of timer T200 and then repeat the I frame but with the P bit set to 1.

The SS then sends a valid Identity Request I frame asking for IMEI which does not acknowledge receipt of the I frame from the MS.

On the FACCH the MS may send an RR frame acknowledging the I frame.

The MS shall repeat the I frame, this frame will acknowledge receipt of the second I frame from the SS.

The SS then acknowledges receipt of the MS I frame by sending a RR frame.

The MS shall send the next I frame. The SS acknowledges this I frame.

Expected Sequence

MS	SS
<----- I (SAPI, C, P, M, L, N(S), N(R))-----	-----1
2-----RR (SAPI, R, M, L, N(R), F)----->	
May be incorporated	
3----- I (SAPI, C, P, M, L, N(S), N(R))----->	
Time-out of T200	
4----- I (SAPI, C, P, M, L, N(S), N(R))----->	
<----- I (SAPI, C, P, M, L, N(S), N(R))-----	-----5
5 bis-----RR(SAPI, R, M, L, N(R), F)----->	
6----- I (SAPI, C, P, M, L, N(S), N(R))----->	
<-----RR (SAPI, R, M, L, N(R), F)-----	-----7
Time-out of T200	
8----- I (SAPI, C, P, M, L, N(S), N(R))----->	
<-----RR (SAPI, R, M, L, N(R), F)-----	-----9

The frames from the SS will be:

1, 5: One I frame (occurs twice) containing:

SAPI = 0, C = 1, P = 0, M = 0, $0 \leq L \leq N201$, N(S) = 0, 1, N(R) = 0
 information field = Identity Request

7, 9: One RR frame (occurs twice) containing:

SAPI = 0, R = 0, F = 1, 0, M = 0, L = 0, N(R) = 1, 2

25.2.2.2.3 Test requirements

The frames from the MS shall be:

2: One RR frame containing:

SAPI = 0, R = 1, F = 0, M = 0, L = 0, N(R) = 1

3, 8: One I frame (occurs twice) containing:

SAPI = 0, C = 0, P = 0, M = 0, $0 \leq L \leq N201$, N(R) = 1, 2, N(S) = 0, 1
 information field = Identity Response

4, 6: One I frame (occurs twice) containing:

SAPI = 0, C = 0, P = 1, M = 0, $0 \leq L \leq N201$, N(R) = 1, 2, N(S) = 0
 information field = Identity Response

5 bis: (possible only on the FACCH) One RR frame containing:

SAPI = 0, R = 1, F = 0, M = 0, L = 0, N(R) = 2

25.2.2.3 Segmentation and concatenation

25.2.2.3.1 Test purpose

To test the proper use of segmentation and concatenation, suspend and resume.

25.2.2.3.2 Method of test

If the MS supports the UnStructuredSSData operation, then the MS is made to activate an unknown supplementary service as defined in GSM 02.30 with the following sequence *NN*si#: NN is chosen to be undefined in GSM 02.30 annex 2 and is an IA5. Total length of *NN*si# shall be 20 characters.

If the MS does not support the UnStructuredSSData operation, then the MS is made to initiate a call.

The SS responds with the Immediate Assign procedure firstly allocating a SDCCH and on the second repeat of the test a TCH.

The MS is brought into the multiple frame established state by continuing as described in test 25.2.1.1.1. The layer three message element in the SABM will be CM Serv Request.

The SS sends the UA and waits for 10 s. The SS then sends an I frame with CM Serv Accept.

The MS sends either:

- a REGISTER message which is segmented between two I frames;
- or
- a SETUP message.

The SS shall acknowledge only the I frame with more bit set to 1 (if any) but it shall not acknowledge the I frame with more bit set to 0.

The SS then performs a handover (in the case of SDCCH this shall be finely synchronized) while still on the assigned channel and without acknowledging the last I frame of the MS layer 3 message, making sure to fill the handover command to more than 21 octets (for example by using the cell channel description element).

On the SDCCH the MS will go into timer recovery and resend the last I frame of the layer 3 message with the P bit set to 1 when it acknowledges the two I frames of the handover command. On the FACCH the MS may simply acknowledge both I frames.

The MS does not attempt to resend the last I frame of the REGISTER or SETUP message on the old channel but instead goes to the new channel where it performs a random access using the Handover Access message and then multiple frame establishment without contention resolution as described in test 25.2.1.2.1.

The MS shall then send an I frame with the Handover complete message. Assuming this is a finely synchronized handover.

The SS acknowledges this I frame.

The MS shall then resend the previous REGISTER or SETUP message, that is all frames which are acknowledged in the usual way.

The test has to be repeated on the FACCH.

Expected Sequence

MS	SS
1 ----- SABM (SAPI, C, P, M, L)----->	
<-----UA (SAPI, R, F, M, L)-----2	
<----- I (SAPI, C, P, M, L, N(S), N(R))-----3	
4 -----RR (SAPI, R, F, M, L, N(R))----->	
May be incorporated	
5 ----- I (SAPI, C, P, M, L, N(S), N(R))----->	
May be absent	
<-----RR (SAPI, R, M, L, N(R), F)-----6	
7 ----- I (SAPI, C, P, M, L, N(S), N(R))----->	
<----- I (SAPI, C, P, M, L, N(S), N(R))-----8	
9 ----- I (SAPI, C, P, M, L, N(S), N(R))----->	
(see Note 1)	
<----- I (SAPI, C, P, M, L, N(S), N(R))----- 10	
11----- I (SAPI, C, P, M, L, N(S), N(R))----->	
(see Note 2)	
***** Channel Change *****	
***** including Handover Access *****	
12----- SABM (SAPI, C, P, M, L)----->	
<-----UA (SAPI, R, F, M, L)----- 13	
14----- I (SAPI, C, P, M, L, N(S), N(R))----->	
<-----RR (SAPI, R, F, M, L, N(R))----- 15	
16----- I (SAPI, C, P, M, L, N(S), N(R))----->	
May be absent	
<-----RR (SAPI, R, M, L, N(R), F)----- 17	
18----- I (SAPI, C, P, M, L, N(S), N(R))----->	
<-----RR (SAPI, R, M, L, N(R), F)----- 19	
Fill	
20----- UI (C, P, M, L)----->	
Frame	

NOTE 1: The MS may send RR frames on the FACCH in addition to the I frames in 9 and 11.

NOTE 2: The I frame in 11 is optional.

The frames from the SS will be:

2: One UA frame containing:

SAPI = 0, R = 0, F = 1, M = 0, L = L of SABM
 information field = information field of SABM

3: One I frame containing:

SAPI = 0, C = 1, P = 0, M = 0, $0 < L < N201$, N(S) = 0, N(R) = 0
information field = CM Service Accept

6: One RR frame containing: (This frame is sent only if frame 5 was received)

SAPI = 0, R = 0, F = 0, M = 0, L = 0, N(R) = 1

8, 10: Two I frames containing:

SAPI = 0, C = 1, P = 0, M = 1, $0 < L = N201, \leq N201$, N(S) = 1, 2, N(R) = 1 or 0
information field = Handover

13: One UA frame containing:

SAPI = 0, R = 0, F = 1, M = 0, L = 0

15, 17, 19: Two or three RR frames containing:

SAPI = 0, R = 0, F = 0, M = 0, L = 0, N(R) = 1, 2 or 1, 2, 3

25.2.2.3.3 Test requirements

The frames from the MS shall be:

1: One SABM frame containing:

SAPI = 0, C = 0, P = 1, M = 0, $0 \leq L \leq N201$
information field = CM Service Request

4: One RR frame containing:

SAPI = 0, R = 1, F = 0, M = 0, L = 0, N(R) = 1

5, 7: Two I frames containing: (The first I frame may be missing)

SAPI = 0, C = 0, P = 0, M = 1, $0 < L = N201, \leq N201$, N(S) = 0, 1 or 0, N(R) = 1
information field = Register or Setup

9, 11: Two I frames containing:

SAPI = 0, C = 0, P = 1, M = 0, $0 < L \leq N201$, N(S) = 1 or 0, N(R) = 2, 3
information field = Register or Setup

NOTE: The I frame in 11 is optional.

12: One SABM frame containing:

SAPI = 0, C = 0, P = 1, M = 0, L = 0

14: One I frame containing:

SAPI = 0, C = 0, P = 0, M = 0, $0 < L < N201$, N(S) = 0, N(R) = 0
information field = Handover Complete

16, 18: Two I frames containing: (The first I frame may be missing)

SAPI = 0, C = 0, P = 0, M = 1, $0 < L = N201, 0 < L \leq N201$, N(S) = 1, 2 or 1, N(R) = 0
information field = Register or Setup

20: UI frame containing:

C = 0, P = 0, M = 0, L = 0

25.2.3 Normal layer 2 disconnection

25.2.3.1 Test purpose

To test the normal data link disconnection sequences.

25.2.3.2 Method of test

The data link is setup between the MS and the SS as in test 25.2.1.1.1.

The SS sends a Layer 2 Disconnect message to the MS.

The MS shall respond with a UA frame and return to the idle state; no more Layer 2 (I, S or U) frames, except possibly one or more "Fill" frames, shall be sent. The SS may receive "Fill" frames after the sending of the DISC frame. If this occurs this may only happen for up to T200 after the sending of the DISC frame. The checking for Layer 2 frames, and the recording of any "Fill" frames, is done for a time defined as 4 * T200.

The SS confirms that the MS has returned to the idle state by performing test 25.2.1.1.1.

Expected Sequence

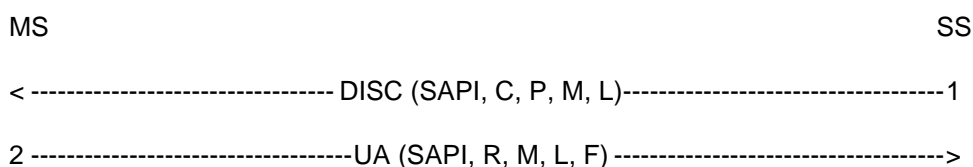

The frames from the SS will be:

1: One DISC frame containing:

SAPI = 0, C = 1, P = 1, M = 0, L = 0

25.2.3.3 Test requirements

The frames from the MS shall be:

2: One UA frame containing:

SAPI = 0, R = 1, F = 1, M = 0, L = 0

No other Layer 2 (I, S or U) frames shall occur. If "Fill" frames are sent this may only be done for up to T200 after the sending of the DISC frame.

25.2.4 Test of link failure

25.2.4.1 I frame loss (MS to SS)

25.2.4.1.1 Test purpose

To test that the MS repeats an I frame N200 times with T200 between two I frames and that the MS releases the layer 2 link after N200 repetitions of the I frame in the case when no answer to the I frame is received.

25.2.4.1.2 Method of test

The MS is brought into the multiple frame established state as described in test 25.2.1.1.1.

The SS sends an Identity Request message asking for IMEI to the MS.

The MS shall respond with a RR frame though this may be incorporated with the Identity Response I frame.

The SS does not respond to the I frame.

The MS shall wait for expiry of timer T200 and then repeat the I frame but with the P bit set to 1.

This is repeated until the MS has sent the I frame N200+1 times. The MS shall not send any layer 2 frame. This is checked for a time of $4 * T200$. The MS shall return to the idle state. This is checked by performing test 25.2.1.1.1.

Expected Sequence

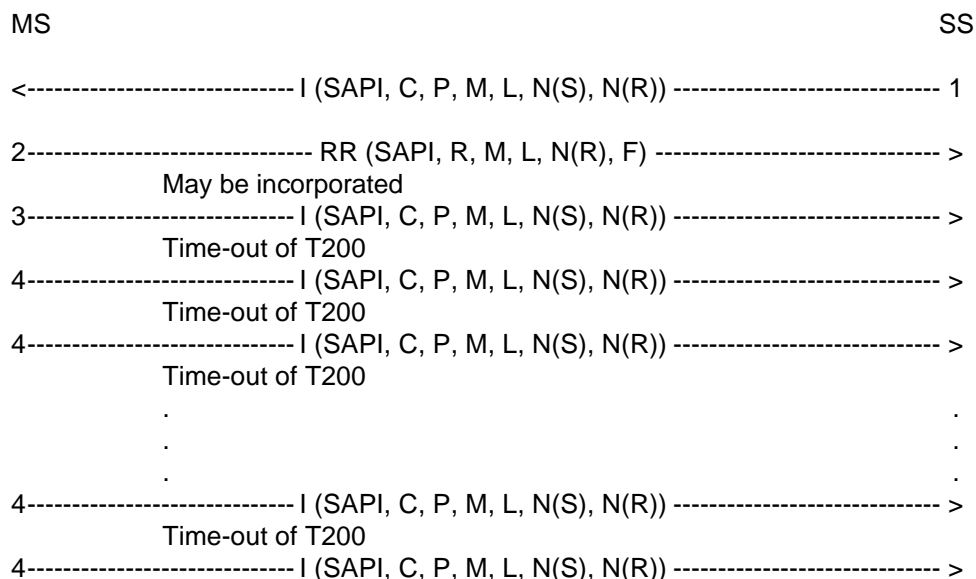

The frames from the SS will be:

1: One I frame containing:

SAPI = 0, C = 1, P = 0, M = 0, $0 \leq L \leq N201$, N(S) = 0, N(R) = 0
information field = Identity Request

25.2.4.1.3 Test requirements

The frames from the MS shall be:

2: One RR frame containing:

SAPI = 0, R = 1, F = 0, M = 0, L = 0, N(R) = 1

3: One I frame containing:

SAPI = 0, C = 0, P = 0, M = 0, $0 \leq L \leq N201$, N(R) = 1, N(S) = 0
information field = Identity Response

4: One I frame (occurs N200 times) containing:

SAPI = 0, C = 0, P = 1, M = 0, $0 \leq L \leq N201$, N(R) = 1, N(S) = 0
information field = Identity Response

25.2.4.2 RR response frame loss (SS to MS)

Covered in test 25.2.2.2.

25.2.4.3 RR response frame loss (MS to SS)**25.2.4.3.1 Test purpose**

To test the Layer 2 recovery mechanism in the event of RR frame loss.

25.2.4.3.2 Method of test

The MS is brought into the multiple frame established state as described in test 25.2.1.1.1.

The SS sends a I frame containing a Layer 3 message using PD=1111 (e.g. 0FH) to the MS. The L3 message is TEST INTERFACE with tested device equal to 0.

The MS shall respond with a RR frame.

The SS ignores the RR frame from the MS but after T200 from the I frame sent by the SS the SS repeats the I frame but with the P bit set to 1. This simulates loss of the RR from the MS.

The MS shall respond with either an RR or REJ frame.

NOTE: This requirement is less restrictive than GSM 04.06.

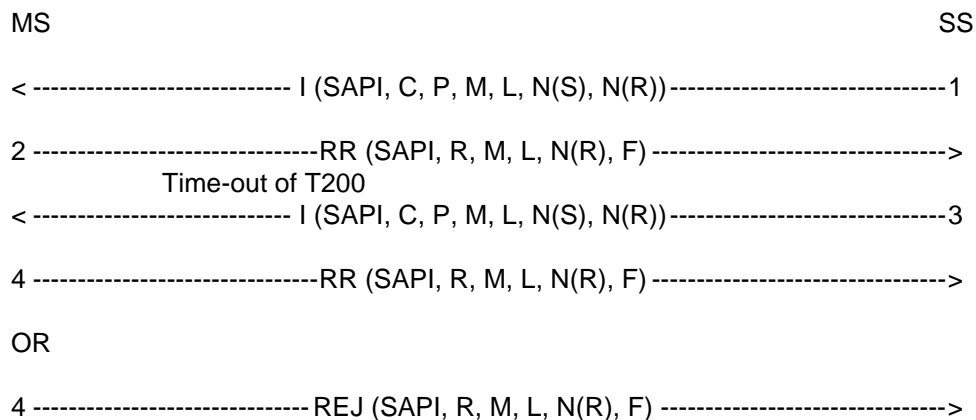
Expected Sequence

The frames from the SS will be:

1: One I frame containing:

SAPI = 0, C = 1, P = 0, M = 0, L = 3, N(S) = 0, N(R) = 0

3: One I frame containing:

SAPI = 0, C = 1, P = 1, M = 0, L = 3, N(S) = 0, N(R) = 0

25.2.4.3.3 Test requirements

The frames from the MS shall be:

2: One RR frame containing:

SAPI = 0, R = 1, F = 0, M = 0, L = 0, N(R) = 1

4: One RR frame containing:

SAPI = 0, R = 1, F = 1, M = 0, L = 0, N(R) = 1

OR

4: One REJ frame containing:

$$\text{SAPI} = 0, \text{R} = 1, \text{F} = 1, \text{M} = 0, \text{L} = 0, \text{N(R)} = 1$$

25.2.5 Test of frame transmission with incorrect C/R values

Purpose of tests

To test that the MS will react correctly upon the reception of a frame with incorrect C/R value.

Initial Conditions

Perform the establishment of the dedicated physical resource according to 25.1.5 and initialize the link as in 25.2.1.1.1. Then proceed as stated below.

25.2.5.1 I frame with C bit set to zero

25.2.5.1.1 Test purpose

To test that the MS will take no action when it receives an I frame with the C bit set to zero (R).

25.2.5.1.2 Method of test

The data link is set up between the MS and the SS as in test 25.2.1.1.1.

The SS shall send an I frame with the C bit set to zero to the MS.

The SS shall then wait for at least 4 times T200 to make sure that the MS does not respond to that I frame but that the MS keeps sending fill frames.

The SS shall after 4 times T200 send a RR command, P bit set to 1.

The MS shall respond with a RR response, F bit set to 1.

Expected Sequence

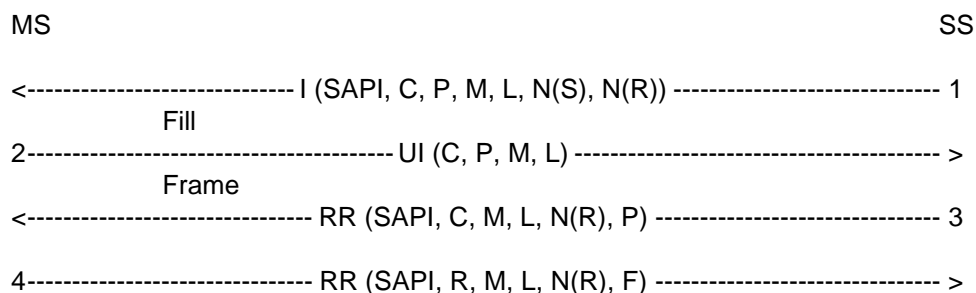

The frames from the SS will be:

1: One I frame containing:

$$\text{SAPI} = 0, \text{C} = 0, \text{P} = 1, \text{M} = 0, 0 \leq \text{L} \leq \text{N201}, \text{N(R)} = 0, \text{N(S)} = 0$$

Information field = Identity Request

3: One RR frame containing:

$$\text{SAPI} = 0, \text{C} = 1, \text{P} = 1, \text{M} = 0, \text{L} = 0, \text{N(R)} = 0$$

25.2.5.1.3 Test requirements

The frames from the MS shall be:

2: UI frames containing:

$$C = 0, P = 0, M = 0, L = 0$$

4: One RR frame containing:

$$SAPI = 0, R = 1, F = 1, M = 0, L = 0, N(R) = 0$$

25.2.5.2 SABM frame with C bit set to zero

25.2.5.2.1 Test purpose

To test that the MS will take no action when it receives an SABM frame with the C bit set to zero (R).

25.2.5.2.2 Method of test

The MS is brought into the multiple frame established state as described in test 25.2.1.1.1.

The SS sends an I frame containing a Layer 3 message using PD=1111 (e.g. 0FH) in order to raise V(R) in the MS to 1. The L3 message is TEST INTERFACE with tested device equal to 0.

The MS shall acknowledge this by the appropriate RR frame.

The SS sends SABM with the C bit set to zero.

The SS shall after 4 times T200 send a RR command, P bit set to 1.

The MS shall respond with a RR response, F bit set to 1.

The MS is returned to the idle state as described in 25.2.1.1.6.

Expected Sequence

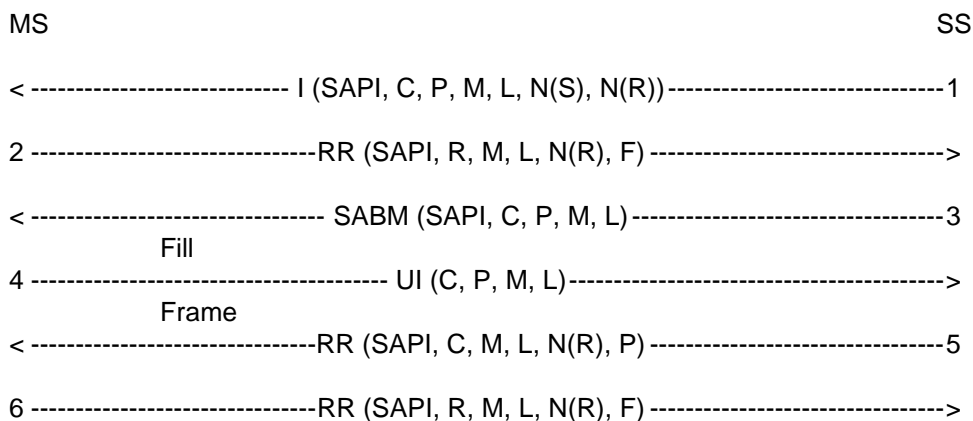

The frames from the SS will be:

1: One I frame containing:

$$SAPI = 0, C = 1, P = 0, M = 0, L = 3, N(S) = 0, N(R) = 0$$

3: One SABM frame containing:

$$SAPI = 0, C = 0, P = 1, M = 0, L = 0$$

5: One RR frame containing:

$$SAPI = 0, C = 1, P = 1, M = 0, L = 0, N(R) = 0$$

25.2.5.2.3 Test requirements

The frames from the MS shall be:

2: One RR frame containing:

$$\text{SAPI} = 0, \text{R} = 1, \text{F} = 0, \text{M} = 0, \text{L} = 0, \text{N(R)} = 1$$

4: One UI frame containing:

$$\text{C} = 0, \text{P} = 0, \text{M} = 0, \text{L} = 0$$

6: One RR frame containing:

$$\text{SAPI} = 0, \text{R} = 1, \text{F} = 1, \text{M} = 0, \text{L} = 0, \text{N(R)} = 1$$

25.2.6 Test of errors in the control field

Purpose of tests

To test that the MS will react in the proper way to errors in the Control Field.

25.2.6.1 N(S) sequence error

25.2.6.1.1 Test purpose

To test that the MS will ignore the contents of the I field of an out-of-sequence I frame from the SS.

25.2.6.1.2 Method of test

The MS is brought into the multiple frame established state as described in test 25.2.1.1.1.

The SS shall send a correct I frame containing Identity Request.

The MS shall acknowledge this in a RR frame or piggy back the acknowledgement onto the I frame carrying Identity Response.

The SS shall then send an I frame containing Identity Request with incorrect N(S) but correctly acknowledging the MS's I frame; P bit set to zero.

The MS shall send a REJ frame.

The SS shall, after T200, send another I frame with incorrect N(S), P bit set to 1 this time.

The MS shall respond with a REJ, F bit set to 1.

The MS shall resume the transmission of fill frames.

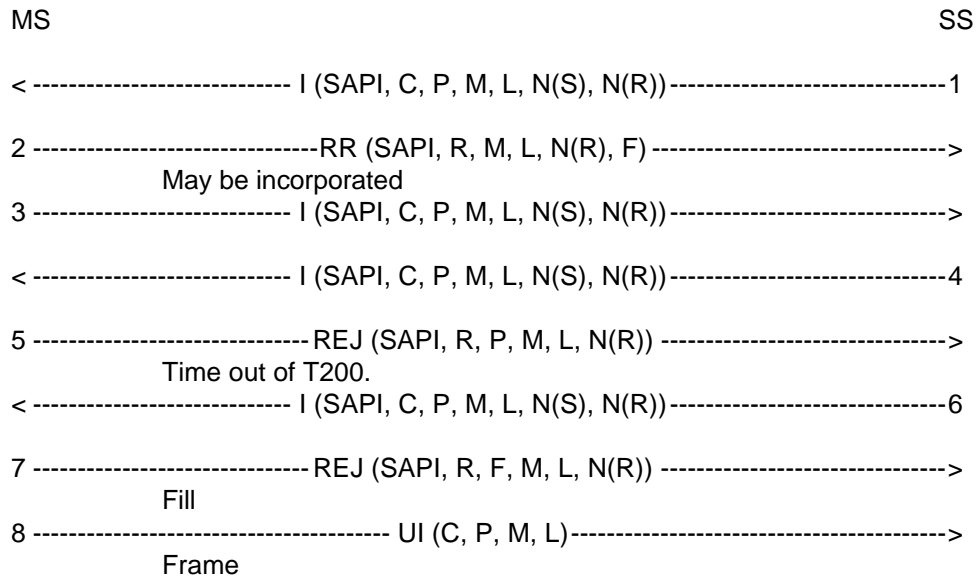
Expected Sequence

The frames from the SS will be:

1: One I frame containing:

SAPI = 0, C = 1, P = 0, M = 0, $0 \leq L \leq N201$, N(S) = 0, N(R) = 0
information field = Identity Request

4: One I frame containing:

SAPI = 0, C = 1, P = 0, M = 0, $0 \leq L \leq N201$, N(S) = 0, N(R) = 1
information field = Identity Request

6: One I frame containing:

SAPI = 0, C = 1, P = 1, M = 0, $0 \leq L \leq N201$, N(S) = 0, N(R) = 1
information field = Identity Request

25.2.6.1.3 Test requirements

The frames from the MS shall be:

2: One RR frame containing:

SAPI = 0, R = 1, F = 0, M = 0, L = 0, N(R) = 1

3: One I frame containing:

SAPI = 0, C = 0, P = 0, M = 0, $0 \leq L \leq N201$, N(R) = 1, N(S) = 0
information field = Identity Response

5: One REJ frame containing:

SAPI = 0, R = 1, P = 0, M = 0, L = 0, N(R) = 1

7: One REJ frame containing:

SAPI = 0, R = 1, F = 1, M = 0, L = 0, N(R) = 1

8: One UI frame containing:

C = 0, P = 0, M = 0, L = 0

25.2.6.2 N(R) sequence error

25.2.6.2.1 Test purpose

To test that the MS will detect a N(R) sequence error and react in the proper way to it.

25.2.6.2.2 Method of test

The MS is brought into the multiple frame established state as described in test 25.2.1.1.1.

The SS shall send an I frame containing an information field of length N201 and an incorrect receive sequence number.

The MS may

- a) send a DISC frame within $N200 \cdot T200$ or
- b) perform a "local end release".

In case a) the SS shall respond with a UA frame. In case b) it detects a lower layer failure.

NOTE: The delay $N200 \cdot T200$ is specified for test purpose only. It is assumed that the L3 reaction time within the MS to command a release is less than this delay, which is less than the delay before the SS would detect a L2 failure.

Expected Sequence

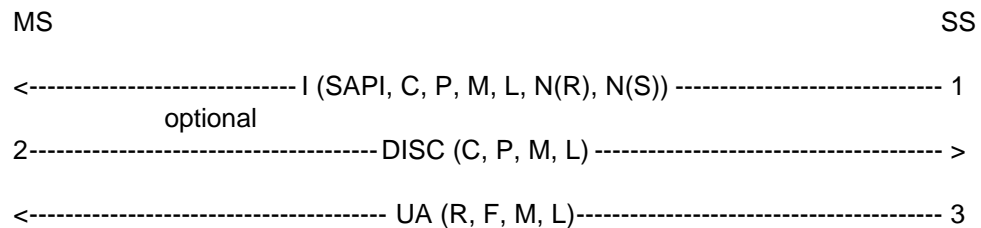

The frames from the SS are:

1: One I frame:

$SAPI = 0, C = 1, P = 0, M = 1, L = N201, N(R) = 1, N(S) = 0$

In case a):

3: One UA frame:

$SAPI = 0, R = 0, F = 1, M = 0, L = 0$

25.2.6.2.3 Test requirements

The frame from the MS in case a) shall be:

2: One DISC frame:

$SAPI = 0, C = 0, P = 1, M = 0, L = 0$

25.2.6.3 Improper F bit

25.2.6.3.1 Test purpose

To test that the MS, being in the timer recovery state, will return to the multiple frame established state only after having received an RR response with the F bit set to 1. This test is covered in test 25.2.2.2.

25.2.7 Test on receipt of invalid frames

25.2.7.1 Test purpose

To test that the MS will ignore all invalid frames.

25.2.7.2 Method of test

The data link is set up between the MS and the SS as in test 25.2.1.1.1.

The SS shall then transmit an:

- RR frame with the Length indicator greater than zero and a faulty N(R)
- REJ frame with the EA bit set to zero and a faulty N(R)
- SABM frame with the EL bit set to zero
- DM frame with the Length indicator greater than zero
- DISC frame with the M bit set to 1
- UA frame with the EA bit set to zero
- I frame with the Length indicator greater than N201
- I frame with the M bit set to 1 and the Length indicator less than N201.
- command frames with correct Address and Length indicator field and a non-implemented control field.

After T200 the SS shall in every case transmit an RR command, P bit set to 1.

The MS shall respond with an RR response, F bit set to 1.

Expected Sequence

MS		SS
	<----- RR (SAPI, R, F, M, L, N(R)) -----	1
	Fill	
2	----- UI (C, P, M, L) ----->	
	Frame	
	<----- RR (SAPI, C, P, M, L, N(R)) -----	10
11	----- RR (SAPI, R, F, M, L, N(R)) ----->	
	<----- REJ (SAPI, R, F, M, L, N(R)) -----	3
	Fill	
2	----- UI (C, P, M, L) ----->	
	Frame	
	<----- RR (SAPI, C, P, M, L, N(R)) -----	10
11	----- RR (SAPI, R, F, M, L, N(R)) ----->	
	<----- SABM (SAPI, C, P, M, L) -----	4
	Fill	
2	----- UI (C, P, M, L) ----->	
	Frame	
	<----- RR (SAPI, C, P, M, L, N(R)) -----	10
11	----- RR (SAPI, R, F, M, L, N(R)) ----->	
	<----- DM (SAPI, R, F, M, L) -----	5
	Fill	
2	----- UI (C, P, M, L) ----->	
	Frame	
	<----- RR (SAPI, C, P, M, L, N(R)) -----	10
11	----- RR (SAPI, R, F, M, L, N(R)) ----->	
	<----- DISC (SAPI, C, P, M, L) -----	6
	Fill	
2	----- UI (C, P, M, L) ----->	
	Frame	
	<----- RR (SAPI, C, P, M, L, N(R)) -----	10
11	----- RR (SAPI, R, F, M, L, N(R)) ----->	
	<----- UA (SAPI, R, F, M, L) ----->	7
	Fill	
2	----- UI (C, P, M, L) ----->	
	Frame	
	<----- RR (SAPI, C, P, M, L, N(R)) -----	10
11	----- RR (SAPI, R, F, M, L, N(R)) ----->	
	<----- I (SAPI, C, P, M, L, N(R), N(S)) -----	8
	Fill	
2	----- UI (C, P, M, L) ----->	
	Frame	
	<----- RR (SAPI, C, P, M, L, N(R)) -----	10
11	----- RR (SAPI, R, F, M, L, N(R)) ----->	

<----- I (SAPI, C, P, M, L, N(R), N(S))-----9
Fill
2----- UI (C, P, M, L)----->
Frame
<-----RR (SAPI, C, P, M, L, N(R))----- 10
11-----RR (SAPI, R, F, M, L, N(R))----->

<----- ----- 12
Fill
2----- UI (C, P, M, L)----->
Frame
<-----RR (SAPI, C, P, M, L, N(R))----- 10
11-----RR (SAPI, R, F, M, L, N(R))----->

<----- ----- 13
Fill
2----- UI (C, P, M, L)----->
Frame
<-----RR (SAPI, C, P, M, L, N(R))----- 10
11-----RR (SAPI, R, F, M, L, N(R))----->

<----- ----- 14
Fill
2----- UI (C, P, M, L)----->
Frame
<-----RR (SAPI, C, P, M, L, N(R))----- 10
11-----RR (SAPI, R, F, M, L, N(R))----->

<----- ----- 15
Fill
2----- UI (C, P, M, L)----->
Frame
<-----RR (SAPI, C, P, M, L, N(R))----- 10
11-----RR (SAPI, R, F, M, L, N(R))----->

<----- ----- 16
Fill
2----- UI (C, P, M, L)----->
Frame
<-----RR (SAPI, C, P, M, L, N(R))----- 10
11-----RR (SAPI, R, F, M, L, N(R))----->

<----- ----- 17
Fill
2----- UI (C, P, M, L)----->
Frame
<-----RR (SAPI, C, P, M, L, N(R))----- 10
11-----RR (SAPI, R, F, M, L, N(R))----->

<----- ----- 18
Fill
2----- UI (C, P, M, L)----->
Frame

<----- RR (SAPI, C, P, M, L, N(R)) -----10

11 ----- RR (SAPI, R, F, M, L, N(R)) ----- >

The frames from the SS are:

1: One RR frame:

SAPI = 0, R = 0, F = 0, M = 0, L > 0, N(R) = 1

3: One REJ frame:

SAPI = 0, R = 0, F = 0, M = 0, L = 0, N(R) = 1, EA = 0

4: One SABM frame:

SAPI = 0, C = 1, P = 1, M = 0, L = 0, EL = 0

5: One DM frame:

SAPI = 0, R = 0, F = 1, M = 0, L > 0

6: One DISC frame:

SAPI = 0, C = 1, P = 1, M = 1, L = 0,

7: One UA frame:

SAPI = 0, R = 0, F = 0, M = 0, L = 0, EA = 0

8: One I frame:

SAPI = 0, C = 1, P = 0, M = 0, L > N201, N(R) = 0, N(S) = 6

9: One I frame:

SAPI = 0, C = 1, P = 0, M = 1, L < N201, N(R) = 0, N(S) = 7

10: One RR frame:

SAPI = 0, C = 1, P = 1, M = 0, L = 0, N(R) = 0

12: One command frame with

Control Field = xxx1 1101

13: One command frame with

Control field = xxx1 1011

14: One command frame with

Control field = xxx1 0111

15: One command frame with

Control field = 01x1 1111

16: One command frame with

Control field = 1xx1 1111

17: One command frame with

Control field = 0011 0011

18: One command frame with

Control field = 1xx1 0011

NOTE: An "x" stands for an arbitrary bit value.

25.2.7.3 Test requirements

The frames from the MS shall be:

2: One UI frame (occurs fifteen times):

C = 0, P = 0, M = 0, L = 0

11: One RR frame (occurs fifteen times):

SAPI = 0, R = 1, F = 1, M = 0, L = 0, N(R) = 0

26 Testing of layer 3 functions

Ref.: GSM 04.08

NOTE: The tests on functioning of the elementary procedures in the MS are grouped as the description of those procedures in GSM 04.08. However, the test procedures are carried out in an order which is more logic for the purpose of testing.

26.1 Default conditions and structured sequence of tests

26.1.1 Default test conditions during layer 3 tests

During tests in section 26 the following default test conditions shall apply if not otherwise stated within the test description. In the table below, decimal values are normally used. Sometimes a hexadecimal value, indicated with a "H", or a binary value, indicated with a "B" is given.

	GSM 900	DCS 1 800
General signalling conditions for all carriers		
Ciphering	yes	yes
General RF-conditions for all carriers		
Frequency hopping mode	Non-hopping	Non-hopping
Propagation profile	Static	Static
Downlink Input Level	63 dB μ Vemf()	63 dB μ Vemf()
Uplink output power	Minimum according to MS power class	Minimum according to MS power class
Serving cell, BCCH/CCCH carrier		
Channel ARFCN	20	590
Alternative channels	40 or 60	690 or 830
Serving cell, Traffic channel, SDCCH		
Channel ARFCN	30	650
Alternative channels	50 or 70	750 or 850
Power Control Indicator	0	0
Neighbouring cells BCCH/CCCH carriers		
Channel ARFCN	10, 80, 90, 100, 110, 120	520, 600, 700, 780, 810, 870
Alternative channels	15, 85, 95, 105, 115, 122	530, 610, 710, 790, 820, 880
Input level	53 dB μ Vemf()	53 dB μ Vemf()
Network dependent parameters		
Cell identity	0001H	0001H
Mobile country code, MCC	001 (decimal)	001 (decimal)
Mobile network code, MNC	01 (decimal)	01 (decimal)
Location area code, LAC	0001H	0001H
Frequency List	Bit Map 0	Range 512
BCCH allocation sequence number(BA_IND)	0	0
Cell Channel Descriptor	Bit Map 0	Range 512
PLMN colour code, NCC	1	1
BS colour code, BCC	5	5
SMS Cell Broadcast	not active	not active
DTX	MS must not use	MS must not use
IMSI Attach-detach	MS shall not apply	MS shall not apply
CCCH_CONF	1 basic physical channel for CCCH combined with SDCCH	1 basic physical channel for CCCH combined with SDCCH
BS_AG_BLKS_RES	0 blocks reserved	0 blocks reserved
BS_PA_MFRMS	5 paging subgroups	5 paging subgroups

	GSM 900	DCS 1 800
CELL_BAR_ACCESS Call-reestablishment (RE) Emergency Call allowed Access Control Class (AC) (0..9, 11..15) Network dependent timers Radio_Link_Time-out T3212 Periodic updating in decihours	(not barred) (allowed) allowed allowed 8 Infinite	(not barred) (allowed) same same 8 Infinite
Access control parameters Max retrans Tx-integer, nr. of slots CELL_RESELECT_HYSTERESIS MS_TXPWR_MAX_CCH RXLEV_ACCESS_MIN NECI ACS (ADDITIONAL RESELECTION PARAM IND) P1 and C2 parameters POI and POWER OFFSET	1 5 12 dB minimum level minimum New establishment causes are not supported No additional cell parameters are present in SI messages 7 and 8 C2 parameters not present N/A	1 5 12 dB minimum level minimum same same same POWER OFFSET Parameter not present.

These informations are provided by system information 1, 2, 3 and 4 messages.

The system information elements which are broadcast on the SACCH during the dedicated mode should be consistent with those sent on the BCCH when the MS was in idle mode prior to the channel request.

In addition, all fill paging messages sent on the paging sub-channels will have by default, their page mode set to NORMAL PAGING.

26.1.2 Structured sequence of the tests

The tests shall be performed in the order as indicated in the following table.

The validity of the tests depends upon the results of the tests performed before.

Channel request (basic test)	RR	26.2.1
Immediate assignment	RR	26.6.1
IMSI attach/detach (basic)	RR	26.2.2
Paging	RR	26.6.2
Test of the mobile station functions in idle mode	RR	26.3
Frequency redefinition	RR	26.6.6
Measurement report (incl. system info not idle)	RR	26.6.3
Authentication	MM	26.7.2
Cipher mode setting	RR	26.6.8
Identification	MM	26.7.3
Sequenced MM/CM message transfer	..	26.2.3
Channel release	RR	26.6.12
Location updating	MM	26.7.4
TMSI reallocation	MM	26.7.1
Classmark change	RR	26.6.11
Call control (verification on CC state diagram)	CC	26.8.1.1 and 26.8.1.2
Call rearrangement	CC	26.8.1.4.4
DTMF information transfer	CC	26.8.1.4.1
Handover	RR	26.6.5
Additional assignment	RR	26.6.9
Partial release	RR	26.6.10
Re-establishment	CC	26.8.2

Dedicated channel assignment (during calls)	RR	26.6.4
Transmission mode change	RR	26.6.7
Mobility management connection establishment	MM	26.7.5
Test of Layer 3 error handling		26.5
User to user signalling	CC	26.8.3
Testing of structured procedures		26.9
E-GSM signalling		26.10
Multiband signalling		26.11

26.1.3 General rules for message parameters

The following rules concerning message parameters apply to section 26:

- 1) Those values of parameters which are a consequence of the context of a test and which are not specific to that test need not be defined.
- 2) If the value of a parameter of an uplink message (MS to Network) is specified in a test, the implicit meaning is that it has to be checked; if the value is not specified, it is not to be checked unless stated otherwise.
- 3) An optional field or optional Information Element of a downlink message (Network to MS), the presence of which is not a consequence of a test description, shall be absent in that test.
- 4) If an optional field or Information Element is not indicated for the uplink (MS to Network) - unless specified otherwise -, it may be included or not.
- 5) The Protocol Discriminator, Transaction Identifier and Message Type of all uplink messages have to be checked.

26.1.4 General rules for layer 3 testing

Unless otherwise specified, before the SS pages the MS, the MS must be given the necessary time to be able to receive paging (see section 20). In addition and unless otherwise specified, the SS must wait at least 1s after the last time slot of the message block containing a CHANNEL RELEASE, before sending a PAGING to the mobile (see 04.13).

In the signalling tests, where the following statement is used:

‘the RF level of cell x is set sufficiently low to ensure that cell x is not suitable as defined in GSM 05.08 section 6.6.2’

this means that for the cell to be “not suitable” by virtue of its RF level, the RF level is to be lowered until C1 is below 0.

26.1.5 Format of layer 3 test descriptions

In sections 26.2, 26.5, 26.6, 26.7, 26.9, 26.10 and 26.11 a rigorous description technique is used which is defined here.

For every test, a subsection titled "method of test" and a subsection titled "expected sequence" define the exact test steps and the verifications to be performed in the test. These sections are normative and give requirements for the MS behaviour. The information of both subsections applies.

For the message contents further normative requirements for the MS behaviour are defined in the following parts which apply in the following order (starting with the highest) on basis of the general rules of 26.1.3:

- specifications in the "method of test" and "expected sequence" subsections;
- specifications in the subsection titled "specific message contents";
- specifications in the subsection "default message contents" at the end of the relevant sections 26.5, 26.6, 26.7, 26.9, 26.10 or 26.11;
- specifications of default conditions in 26.1.

The relevant section may contain the definition of abbreviations of L3 message names that are used in that section.

In many cases, a test description contains an introductory subsection explaining the background of the relevant procedures and explaining why the tests of that description are essential.

For every test, test purposes are given. In general conformance testing methodology, the correspondence between test purposes and test cases can be n to m: To one test purpose more than one test case may correspond (e.g. different test cases checking data variations); also a test case may serve more than one test purpose. In some contexts a structure of conformance test descriptions is advisable which specifies in one part (non-duplicated) test purposes with references to corresponding test suites serving the test purposes, in another part test suites realizing the test purposes; this structuring is especially useful for gaining completeness and avoiding duplications. In this specification, however, it is preferred to group descriptions by test cases. The reasons are:

- The structure is more sought to assist the test execution and evaluation than test development. It must be easy to determine why a wrong behaviour leads to a verdict.
- The structure is to be close to GSM 11.10 phase 1.

For every test purpose of a test, a conformance requirement is given.

For each conformance requirement in a test description, references to core specifications are given.

For every test, the related PICS/PIXIT statements that are necessary for performing the test are given.

For every test, initial conditions for both the System Simulator and the Mobile Station are given. Unless otherwise specified, these initial conditions apply together with the default conditions of 26.1, the initial conditions of the test prevailing over the default conditions of 26.1.

For every test, the foreseen final state of the MS after the test and the maximum duration of the test are specified. These parts are non-normative and do not contain a description of verifications to be performed. The contained information might be used for sequencing different tests and for the decision when a test is to be interrupted.

The expected sequence specifies the actions in numbered steps in a tabular form. In the column "direction", "SS -> MS" denotes a message sent from the SS to the MS, "MS -> SS" denotes a message sent from the MS to the SS, "SS" denotes an action at the SS, "MS" denotes an action at the MS (e.g. interaction with the user or higher layers). The column "message" defines the L3 messages to be sent or expected by the SS. In the "comments" column, further normative information is to be found, e.g. message parameters. In some cases, different alternative behaviours are possible in a test. Then test steps in alternative sequences are numbered as:

"A n", "A n+1", ..., "A n+k"
 "B n", "B n+1", ..., "B n+l"
 "C n", "C n+1", ..., "C n+m"
 etc. (n,m,l,k integers > 0)

and step numbering of a re-unified sequence resumes with the lowest of n+k+1, n+l+1, n+m+1.

In some cases the test steps of a test are to be repeated. Then an execution counter is introduced for the test.

26.2 Initial tests

26.2.1 Channel request

The random access procedure is used by the MS to ask for resources to the network. If it is not performed correctly, the MS could prevent other MSs from obtaining resources, or the network could be overloaded if the MS does not respect the duration between 2 CHANNEL REQUEST messages.

26.2.1.1 Channel request / initial time

26.2.1.1.1 Conformance requirement

- 1) The MS shall start the initial access procedure at the latest 0,7 second after reception of the paging message.
- 2) The MS shall spread the initial CHANNEL REQUEST with equal probability on the correct number of time slots.

Reference(s)

GSM 04.08 sections 3.3.1.2 and 3.3.2.2.

26.2.1.1.2 Test purpose

- 1) To verify that the MS answers to a PAGING message by sending a CHANNEL REQUEST message within 0,7 seconds after reception of the PAGING message.
- 2) To verify that the MS does not always use the same delay between reception of paging message and sending of the CHANNEL REQUEST message. If an MS uses a fixed delay, there is a high probability that different MSs of the same product series use the same delay. There would then be a high risk of collision.

26.2.1.1.3 Method of test

Initial Conditions

System Simulator:

1 cell, Tx-Integer = 5. The CCCH is either combined or not with SDCCH. This is arbitrarily chosen.

Mobile Station:

The MS has a valid TMSI. It is "idle updated".

Related PICS/PIXIT Statement(s)

None.

Foreseen Final State of the MS

The MS has a valid TMSI. It is "idle updated".

Test Procedure

Specific test parameters:

K = 200.

The MS is paged. The SS measures and stores the number of CCCH RACH slots between the sending of the PAGING REQUEST message and the reception of the CHANNEL REQUEST from the MS, excluding the slots containing the messages themselves. The SS sends an IMMEDIATE ASSIGNMENT REJECT. The sequence is performed K times.

Maximum Duration of Test

30 min.

Between two consecutive executions (for k and $k+1$), the SS must wait for an amount of time which is enough to guarantee that the MS is in service (listening to its paging subchannel).

Expected Sequence

The sequence is executed for execution counter $k = 1, \dots, K$.

Step	Direction	Message	Comments
1	SS -> MS	PAGING REQUEST TYPE 1	"Mobile Identity" IE contains the TMSI allocated to the MS.
2	SS		The SS measures the number f of CCCH RACH slots between the sending of PAGING REQUEST message and the reception of a CHANNEL REQUEST message from the MS.
3	SS		The SS stores f . $f(k)$ shall be lower than 700/4,615+8 if the CCCH is not combined or lower than 81+8 if the CCCH is combined with SDCCH.
4	MS -> SS	CHANNEL REQUEST	"Establishment Cause" = Answer to paging.
5	SS -> MS	IMMEDIATE ASSIGNMENT REJECT	the first "request reference" corresponds to the CHANNEL REQUEST sent by the MS.

NOTE: The test limit has been computed to give a confidence of [99,74 %] that a unit which follows the requirements will pass. The number of samples (200) has been chosen to get a good compromise between the test time and the risk of passing a bad unit.

26.2.1.1.4 Test requirements

$S(n) = \text{CARD} \{k \mid f(k) = n\}$

The following requirements shall be met:

$S(n) \leq 41$ for all n .

NOTE: $\text{CARD} \{k \mid f(k) = n\}$ is mathematical notation for the number of times that $f(k)$ equals n .

26.2.1.2 Channel request / repetition time**26.2.1.2.1 Conformance requirement**

- 1) The MS shall spread retransmissions of a CHANNEL REQUEST message, with equal probability on Tx-Integer timeslots and with the correct delay after the reception of the PAGING REQUEST.
- 2) The MS shall not retransmit another CHANNEL REQUEST message when Max-retrans is reached.

Reference(s)

GSM 04.08 section 3.3.1.2.

26.2.1.2.2 Test purpose

- 1) To verify that the MS spreads retransmission of a CHANNEL REQUEST message with equal probability on Tx-Integer time slots and correctly applies the fixed delay when the following conditions apply:
 - the CCCH is combined or not combined with SDCCHs;
 - the maximum number of retransmissions is equal to one of the following values: 1, 2, 4, 7;
 - Tx-Integer is put to any of the allowed values among those which are greater or equal to 6.

- 2) To verify that the MS retransmits exactly Max_Retrans times a CHANNEL REQUEST message if the network never responds to the CHANNEL REQUEST message.

26.2.1.2.3 Method of test

Initial Conditions

System Simulator:

1 cell.

Tx-Integer is arbitrarily chosen in the set {6, 7, 8, 9, 10, 11, 12, 14, 16, 20, 25, 32, 50}.

Max_Retrans is arbitrarily chosen in the set {1,2,4,7}.

Mobile Station:

The MS has a valid TMSI. It is "idle updated".

Related PICS/PIXIT Statement(s)

None.

Foreseen Final State of the MS

The MS has a valid TMSI. It is "idle updated".

Test Procedure

Specific test parameters

K equals the upper rounded value of $230/\text{Max_Retrans}$.

m equals the upper rounded value of $0,5 \cdot \text{Tx-Integer}$.

Counter M = 0.

Parameter S: according to table 3.1/GSM 04.08 (this parameter depend on the value chosen for Tx-Integer).

$N0 = \max(8, \text{Tx-Integer})$

The MS is paged. The MS sends a CHANNEL REQUEST message. The MS retransmits CHANNEL REQUEST messages Max_Retrans times. The SS measures the number of CCCH RACH slots $f(i,k)$ between the moment where a CHANNEL REQUEST message has been received, and the reception of the following CHANNEL REQUEST message, excluding the slots containing the messages themselves. The SS updates the counter M. The SS does not answer to the CHANNEL REQUEST messages Max_Retrans times. After the last CHANNEL REQUEST message in every sequence where k is lower than K, the SS sends an IMMEDIATE ASSIGNMENT REJECT . In the last sequence ($k = K$), the SS does not respond to the MS. The MS shall not send any other CHANNEL REQUEST message.

Maximum Duration of Test

The execution of one sequence (for one value k): 10s.

Between two consecutive executions (for k and k+1), the SS must wait for an amount of time which is enough to guarantee that the MS is in service (listening to its paging subchannel).

Expected Sequence

The sequence is executed for execution counter $k = 1, \dots, K$ for each of the 2 test cases.

Step	Direction	Message	Comments
1	SS -> MS	PAGING REQUEST TYPE 1	"Mobile Identity" = TMSI of the MS.
2	MS -> SS	CHANNEL REQUEST	"Establishment Cause" = Answer to paging.
3	MS -> SS	CHANNEL REQUEST	Steps 3, 4, 5 are executed for execution counter $i = 1, \dots, \text{Max_Retrans}$.
4			"Establishment Cause" = Answer to paging. The SS measures the number $f(i,k)$ of CCCH RACH slots between: - the moment where the last CHANNEL REQUEST message has been received, and - the reception of the new CHANNEL REQUEST message from the MS, excluding the slots containing the messages themselves. $f(i,k)$ shall be in the set $\{S, S+1, \dots, S+T-1\}$
5	SS		If $f(i,k) - S \geq m$, $M = M+1$
A6	SS -> MS	IMMEDIATE ASSIGNMENT REJECT	Depending on the value of k , step A6 or B6 is performed: $k < K$ The third "Request Reference" IE corresponds to the last CHANNEL REQUEST message received. The third "Wait Indication" IE specifies 0 second. Other fields do not address the MS under test.
B6	SS		$k = K$ The SS checks that the MS sends no more CHANNEL REQUEST messages. This is verified during 3 seconds.
7	SS		$M / (K * \text{Max_Retrans})$ shall be inside the following interval: $[0,8 - m/\text{Tx-Integer} ; 1,2 - m/\text{Tx-Integer}]$

NOTE: The confidence interval in step 7, and the number of samples are chosen in such a way that the possibility of non accepting a correct MS is less than $[0,26 \%$].

26.2.1.3 Channel request / random reference**26.2.1.3.1 Conformance requirement**

A CHANNEL REQUEST message sent by the MS shall include a random reference randomly drawn from a uniform probability distribution for every new transmission.

Reference(s)

GSM 04.08 section 3.3.1.2.

26.2.1.3.2 Test purpose

To verify that an MS produces different random references for a CHANNEL REQUEST. If a MS always produces the same random reference, it makes possible that different MSs of the same product series produce the same random reference.

26.2.1.3.3 Method of test**Initial Conditions**

System Simulator:

1 cell, CCCH not combined with SDCCH.

Mobile Station:

The MS has a valid TMSI. It is "idle updated".

Related PICS/PIXIT Statement(s)

None.

Foreseen Final State of the MS

The MS has a valid TMSI. It is in the MM-state "idle, updated" and in the RR idle-mode.

Test Procedure

Specific test parameters:

K = 7.

D = 4.

The SS sends a PAGING REQUEST message. The SS stores the "Random Reference" $r(k)$ contained as a parameter in the CHANNEL REQUEST message sent by the MS. This sequence is performed K times, and it is verified that the MS produces different values $r(k)$.

Maximum Duration of Test

6 min

Between two consecutive executions (for k and $k+1$), the SS must wait for an amount of time which is enough to guarantee that the MS is in service (listening to its paging subchannel).

Expected Sequence

The sequence is executed for execution counter $k = 1, \dots, K$.

Step	Direction	Message	Comments
1	SS -> MS	PAGING REQUEST TYPE 1	
2	MS -> SS	CHANNEL REQUEST	"Establishment Cause" = Answer to paging.
3	SS		The SS stores the "Random Reference" contained in the CHANNEL REQUEST message.

26.2.1.3.4 Test requirements

At least D values of $r(1), \dots, r(k)$ shall be different.

NOTE: D has been computed such that the probability of refusing a correct MS is less than [0,027 %].

26.2.2 IMSI detach and IMSI attach

The IMSI detach/attach procedures are used to indicate to the network that the MS is deactivated/activated. These procedures are allowed or not by the network (ATT flag set to "MSs in the cell shall apply IMSI attach and detach procedure" or "MSs in the cell are not allowed to apply IMSI attach and detach procedure").

If the IMSI attach procedure does not work correctly then the network would in certain situations not try to establish Mobile Terminating call even if the MS is "idle updated".

If an MS performs an unwanted IMSI detach procedure or does not perform IMSI detach when required, network resources are wasted.

26.2.2.1 Conformance requirement

- 1) When the Attach-detach flag in the Control Channel Description of the System Information Type 3 indicates "MSs in the cell are not allowed to apply IMSI attach and detach procedure", the MS shall not perform the IMSI detach procedure upon deactivation.

- 2) When the Attach-detach flag in the Control Channel Description of the System Information Type 3 indicates "MSs in the cell are not allowed to apply IMSI attach and detach procedure", the MS shall not perform the IMSI attach procedure upon activation.
- 3) The MS shall not perform the IMSI detach procedure if the Subscriber Identity Module is removed when the Attach-detach flag in the Control Channel Description of the System Information Type 3 indicates "MSs in the cell are not allowed to apply IMSI attach and detach procedure".
- 4) The MS shall not perform the IMSI attach procedure if the Subscriber Identity Module is inserted, when the Attach-detach flag in the Control Channel Description of the System Information Type 3 indicates "MSs in the cell are not allowed to apply IMSI attach and detach procedure".
- 5) The MS shall correctly perform the IMSI detach procedure, upon switch off, when it is required by the network to do so.
- 6) The MS shall correctly perform the IMSI attach procedure upon switch on when the IMSI attach procedure is required by the network. The MS shall correctly acknowledge the implicit TMSI reallocation procedure, which is part of this IMSI attach procedure, this means that the MS shall send a TMSI REALLOCATION COMPLETE message.
- 7) The MS shall correctly perform the IMSI detach procedure upon SIM removal when it is required by the network to do so.
- 8) The MS shall correctly perform the IMSI attach procedure, following SIM insertion and switch on when the IMSI attach procedure is required by the network. The MS shall correctly acknowledge the implicit TMSI reallocation procedure which is part of this IMSI attach procedure. This means that the MS shall send a TMSI REALLOCATION COMPLETE message.

Reference(s):

GSM 02.07, normative annex B, section B1.17.

GSM 04.08 sections 4.4.3 and 4.4.4.

26.2.2.2 Test purpose

- 1) To verify that the MS correctly performs IMSI detach/attach procedures when it is required by the network and upon deactivation/activation or SIM removal/insertion and does not perform these procedures when not required.
- 2) To verify that the mobile station acknowledges a re-allocated TMSI during IMSI attach.

26.2.2.3 Method of test

Initial Conditions

System Simulator:

1 cell, default parameters.

For procedures 1 and 2 ATT flag is set to "MSs in the cell are not allowed to apply IMSI attach and detach procedure".

For procedures 3 and 4 ATT flag is set to "MSs in the cell should apply IMSI attach and detach procedure".

Mobile Station:

The MS has a valid TMSI. It is "idle updated".

Related PICS/PIXIT Statement(s)

- a: SIM removal possible without removing power source Yes / No.
- b: On/off switch Yes / No.
- c: IMSI detach after SIM removal Yes / No.
- d: IMSI detach after removing power source Yes / No.

Foreseen Final State of the MS

The MS has a valid TMSI which may be different from the initial one. It is "idle updated".

Test Procedure

The SS indicates that IMSI detach/attach is not allowed. If possible the MS is switched off, then switched on, otherwise it has its power source removed and then restored (see b in PICS). The SS checks that the MS does not perform IMSI detach/attach procedures. If possible (if a = Yes, see PICS), the SIM is removed, then the SIM is inserted. The SS checks that the MS does not perform IMSI detach/attach procedures. The SS indicates now, that IMSI detach/attach is allowed. If possible (if b = Yes, see PICS) the MS is switched off, otherwise it has its power source removed (if d = Yes, see PICS). The MS initiates an IMSI detach procedure. Then depending on what has been performed before, the MS is switched on or has its power source restored. It initiates an IMSI attach procedure. The location updating procedure contains an implicit TMSI reallocation. The SIM is removed. If (a = yes and c = yes) or (a = no and d = yes) the MS initiates an IMSI detach procedure. Then the SIM is inserted, it initiates an IMSI attach procedure, the location updating procedure contains an implicit TMSI reallocation.

The SS indicates that IMSI detach/attach is not allowed. If possible the MS is switched off, then switched on, otherwise it has its power source removed and then restored (see b in PICS). The SS checks that the MS does not perform IMSI detach/attach procedures. If possible (if a = Yes, see PICS), the SIM is removed, then the SIM is inserted. The SS checks that the MS does not perform IMSI detach/attach procedures. The SS indicates now, that IMSI detach/attach is allowed. If possible (if b = Yes, see PICS) the MS is switched off, otherwise it has its power source removed (if d = Yes, see PICS). The MS initiates an IMSI detach procedure. Then depending on what has been performed before, the MS is switched on or powered on. It initiates an IMSI attach procedure. The location updating procedure contains an implicit TMSI reallocation. The SIM is removed. If (a = yes and c = yes) or (a = no and d = yes) the MS initiates an IMSI detach procedure. Then the SIM is inserted, it initiates an IMSI attach procedure, the location updating procedure contains an implicit TMSI reallocation.

Maximum Duration of Test

4 min

Expected Sequence**Procedure 1**

Step	Direction	Message	Comments
1	MS		If possible the MS is switched off (see b in PICS), otherwise the MS has its power source removed.
2	MS		The MS shall not initiate the IMSI detach procedure. This is checked by the SS during 5 seconds.
3	MS		Depending on what has been performed in step 1, the MS is brought back to operation.
4	MS		The MS shall not initiate an IMSI attach procedure. This is checked by the SS during 30 seconds.

Procedure 2

1	MS		If possible (a = Yes, see PICS), the SIM is removed from the MS. The MS shall not initiate the IMSI detach procedure. This is checked by the SS during 5 seconds. The SIM is inserted in the MS. The MS shall not initiate an IMSI attach procedure. This is checked by the SS during 30 seconds.
2	MS		
3	MS		
4	MS		

Procedure 3

1	MS		The MS is switched off, or has its power source removed, depending on value b in the PICS file. If b = Yes or d = Yes the MS initiates an IMSI detach procedure (steps A2, A3, A4, A5), otherwise the SS goes straight to step 6.
A2	MS -> SS	CHANNEL REQUEST	After the sending of this message, the SS waits the disconnection of the main signalling link.
A3	SS -> MS	IMMEDIATE ASSIGNMENT	
A4	MS -> SS	IMSI DETACH INDICATION	
A5	SS -> MS	CHANNEL RELEASE	
6	MS		Depending on what has been performed in step 1, the MS is brought back to operation.
7	MS -> SS	CHANNEL REQUEST	The MS initiates an IMSI attach procedure.
8	SS -> MS	IMMEDIATE ASSIGNMENT	
9	MS -> SS	LOCATION UPDATING REQUEST	"Location Updating Type" = IMSI attach.
10	SS -> MS	LOCATION UPDATING ACCEPT	The SS allocates a new TMSI
11	MS -> SS	TMSI REALLOCATION COMPLETE	After the sending of this message, the SS waits the disconnection of the main signalling link.
12	SS -> MS	CHANNEL RELEASE	

Specific message contents:**SYSTEM INFORMATION TYPE 3 message:**

Information Element	value/remark
Control Channel Description - Attach/Detach allowed	MS shall apply IMSI attach and detach procedures.

Procedure 4

1	MS		The SIM is removed from the MS. If (a = Yes and c= Yes) or (a = no and d = yes) in PICS, the MS initiates an IMSI detach procedure (steps A2, A3, A4, A5), otherwise the SS goes straight to step 6.
A2 A3 A4 A5	MS -> SS SS -> MS MS -> SS SS -> MS	CHANNEL REQUEST IMMEDIATE ASSIGNMENT IMSI DETACH INDICATION CHANNEL RELEASE	After the sending of this message, the SS waits the disconnection of the main signalling link.
6 7 8 9 10 11 12	MS MS -> SS SS -> MS MS -> SS SS -> MS MS -> SS SS -> MS	CHANNEL REQUEST IMMEDIATE ASSIGNMENT LOCATION UPDATING REQUEST LOCATION UPDATING ACCEPT TMSI REALLOCATION COMPLETE CHANNEL RELEASE	The SIM is inserted in the MS. The MS initiates a IMSI attach procedure. "Location Updating Type" = IMSI attach. The SS allocates a new TMSI After the sending of this message, the SS waits the disconnection of the main signalling link.

Specific message contents:**SYSTEM INFORMATION TYPE 3 message:**

Information Element	value/remark
Control Channel Description - Attach/Detach allowed	MS shall apply IMSI attach and detach procedures.

26.2.3 Sequenced MM / CM message transfer

The RR sublayer of the MS shall have an associated send state variable V(SD) for sending MM and CM messages. This send state variable has been introduced to avoid the duplication of MM and CM messages. It is useful for the network after a handover or a change of channel to identify duplicated messages.

If the MS started V(SD) with 1 instead of 0 the network would incorrectly diagnose loss of message.

If the MS later on does not handle correctly incrementation of V(SD) the network would not be able to continue the dialogue.

26.2.3.1 Conformance requirement

The MS shall implement correctly the "send state variable V(SD)" ("Send duplicated"), included in transmitted MM and CM messages.

Reference(s)

GSM 04.08 section 3.1.4.3.

26.2.3.2 Test purpose

To verify that V(SD) is correctly set to 0 at the beginning of the establishment of the first RR connection and to verify that the MS handles correctly this variable in the special case of IDENTITY REQUEST messages, which are MM messages.

26.2.3.3 Method of test**Initial Conditions**

System Simulator:

1 cell, default parameters.

Mobile Station:

The MS has a valid TMSI. It is "idle updated".

Related PICS/PIXIT Statement(s)

None.

Foreseen Final State of the MS

The MS has a valid TMSI. It is "idle updated".

Test Procedure

The MS is paged. After reception of the PAGING RESPONSE message from the MS, the SS sends an IDENTITY REQUEST message. The MS sends an IDENTITY RESPONSE message where N(SD) = 0. The SS repeats its IDENTITY REQUEST message 10 times. The MS transmits IDENTITY RESPONSE message with the value 1 and 0 in the N(SD) field alternately.

Maximum Duration of Test

1 min

Expected Sequence

Step	Direction	Message	Comments
1	SS -> MS	PAGING REQUEST TYPE 1	
2	MS -> SS	CHANNEL REQUEST	
3	SS -> MS	IMMEDIATE ASSIGNMENT	
4	MS -> SS	PAGING RESPONSE	
5	SS -> MS	IDENTITY REQUEST	
6	MS -> SS	IDENTITY RESPONSE	N(SD) = 0
7	SS -> MS	IDENTITY REQUEST	Steps 7, 8, 9 and 10 are repeated 5 times.
8	MS -> SS	IDENTITY RESPONSE	N(SD) = 1.
9	SS -> MS	IDENTITY REQUEST	
10	MS -> SS	IDENTITY RESPONSE	N(SD) = 0.
11	SS -> MS	CHANNEL RELEASE	After the sending of this message, the SS waits the disconnection of the main signalling link.

26.2.4 Establishment cause

The establishment cause set by the MS in the CHANNEL REQUEST message shall be consistent with the requested service or function, with the capabilities of the MS and with the indications given by the network.

If the MS uses a wrong establishment cause, the network might assign an inappropriate or incompatible resource.

In the case of Emergency call a wrong priority might be used.

If a reserved value is used, the network may discard the channel request.

26.2.4.1 Conformance requirements

In the CHANNEL REQUEST message, the MS shall include an establishment cause which correspond to the establishment cause given by the MM sublayer and the broadcasted NECI value, or which correspond

to one of the establishment causes "answer to paging" given by the RR entity in response to a PAGING REQUEST message including the Channel Needed information.

Reference(s)

GSM 04.08 section 3.3.1.2.

26.2.4.2 Test purpose

To verify that the establishment cause sent by the MS in the Max-Retrans+1 CHANNEL REQUEST messages is consistent with the requested service, with the capabilities of the MS and with the indications of the network in the following cases:

- 1) If the MS supports a service on a traffic channel:
 - when the NECI bit is set to 0 and call re-establishment is attempted and the call was established on TCH/H if the MS supports a service on half rate channel or on TCH/F otherwise.
- 2) If the MS supports a service on half rate channel:
 - when the NECI bit is set to 1 and call re-establishment is attempted and the call was established on TCH/H.
- 3) If the MS supports speech:
 - 3.1 when the NECI bit is set to 0 and a speech call is attempted.
 - 3.2 when the NECI bit is set to 1 and a speech call is attempted.
- 4) If the MS supports a data service:
 - 4.1 when the NECI bit is set to 0 and a data call is attempted.
 - 4.2 when the NECI bit is set to 1 and a data call is attempted for a service supported on half rate channel (if the MS does not support any data call on half rate channel any data service is used).
- 5)
 - 5.1 when the NECI bit is set to 0 and the MS is paged with the paging indication set to "any channel".
 - 5.2 when the NECI bit is set to 0 and the MS is paged with the paging indication set to "SDCCH".
 - 5.3 when the NECI bit is set to 0 and the MS is paged with the paging indication set to "TCH/F".
 - 5.4 when the NECI bit is set to 0 and the MS is paged with the paging indication set to "TCH/H or TCH/F".
- 6)
 - 6.1 when the NECI bit is set to 0 and IMSI attach is attempted.
 - 6.2 when the NECI bit is set to 0 and normal location updating is attempted.
 - 6.3 when the NECI bit is set to 0 and periodic location updating is attempted.
 - 6.4 when the NECI bit is set to 0 and IMSI detach is attempted.
 - 6.5 when the NECI bit is set to 1 and IMSI attach is attempted.
 - 6.6 when the NECI bit is set to 1 and normal location updating is attempted.
 - 6.7 when the NECI bit is set to 1 and periodic location updating is attempted.
 - 6.8 when the NECI bit is set to 1 and IMSI detach is attempted.
- 7) If the MS supports a non call related supplementary service operation:
 - when the NECI bit is set to 0 and a supplementary service operation is attempted at the MS.
 - when the NECI bit is set to 1 and a supplementary service operation is attempted at the MS.
- 8) If the MS supports SMS/PP MO:
 - when the NECI bit is set to 0 and a mobile originated short message service transaction is attempted.
 - when the NECI bit is set to 1 and a mobile originated short message service transaction is attempted.

NOTE: To verify that when the MS supports speech and an emergency call is attempted and the NECI bit is set to 0, then the MS sends a CHANNEL REQUEST message with an establishment cause consistent with the requested service, with the capabilities of the MS and with the indications of the network is done in test 26.9.6.1.1 test purpose 1.

26.2.4.3 Method of test

Initial Conditions

System Simulator:

for all procedures: 1 cell, Max-Retrans = 7 slots. The NECI bit is set to 0.

Mobile Station:

The MS has a valid TMSI. It is "idle updated".

Related PICS/PIXIT Statement(s)

a:	MS supports speech on TCH/F	Yes / No
b:	MS supports speech on TCH/H	Yes / No
c:	MS supports data on TCH/F	Yes / No
d:	MS supports data on TCH/H	Yes / No
e:	MS only supports SDCCH	Yes / No
f:	MS supports a supplementary service operation	Yes / No
g:	MS supports SMS/PP MO	Yes / No
h:	On/Off switch	Yes / No

NOTE: In the above PICS, data and speech refer to the Radio Resource Channel Mode.

Foreseen Final State of the MS

The MS has a valid TMSI. It is "idle updated".

Test Procedures

NOTE: If the procedures are chained, the SS shall ensure that at the beginning of each procedure, the initial conditions are reached and that the MS had enough time to decode the broadcasted parameters.

Procedure 1

If the MS supports a service on a traffic channel:

A call is established on TCH/H if the MS supports a service on half rate channel or on TCH/F otherwise. The SS stops transmission on the SACCH. The MS attempts call reestablishment. The SS does not answer to Max-Retrans CHANNEL REQUEST messages and answers to the next CHANNEL REQUEST with an IMMEDIATE ASSIGNMENT REJECT message. The SS checks that all CHANNEL REQUEST messages contain an establishment cause with the value "110".

Procedure 2

If the MS supports a service on half rate channel:

The NECI bit is set to 1. A call is established on TCH/H. The SS stops transmission on the SACCH. The MS attempts call reestablishment. The SS does not answer to Max-Retrans CHANNEL REQUEST messages and answers to the next CHANNEL REQUEST with an IMMEDIATE ASSIGNMENT REJECT message. The SS checks that all CHANNEL REQUEST messages contain an establishment cause with the value "011010".

Procedure 3

If the MS supports speech:

A speech call is attempted. The SS does not answer to Max-Retrans CHANNEL REQUEST messages and answers to the next CHANNEL REQUEST with an IMMEDIATE ASSIGNMENT REJECT message. The SS checks that all CHANNEL REQUEST messages contain an establishment cause with the value "111". The NECI bit is set to 1. A speech call is attempted. The SS does not answer to Max-Retrans CHANNEL REQUEST messages and answers to the next CHANNEL REQUEST with an IMMEDIATE ASSIGNMENT REJECT message. The SS checks that all CHANNEL REQUEST messages contain an establishment cause with the value "111" if the MS does not support speech on half rate channel or "0100" if the MS supports speech on half rate channel.

Procedure 4

If the MS supports a data service:

A data call is attempted. The SS does not answer to Max-Retrans CHANNEL REQUEST messages and answers to the next CHANNEL REQUEST with an IMMEDIATE ASSIGNMENT REJECT message. The SS checks that all CHANNEL REQUEST messages contain an establishment cause with the value "111". The NECI bit is set to 1. A data call is attempted for a service supported on half rate channel (if the MS does not support any data call on half rate channel any data service is used). The SS does not answer to Max-Retrans CHANNEL REQUEST messages and answers to the next CHANNEL REQUEST with an IMMEDIATE ASSIGNMENT REJECT message. The SS checks that all CHANNEL REQUEST messages contain an establishment cause with the value "111" if the MS does not support a data service on half rate channel or "0101" if the MS supports a data service on half rate channel.

Procedure 5

The MS is paged with the paging indication set to "any channel". The SS does not answer to Max-Retrans CHANNEL REQUEST messages and answers to the next CHANNEL REQUEST with an IMMEDIATE ASSIGNMENT REJECT message. The SS checks that all CHANNEL REQUEST messages contain an establishment cause with the value "100". The SS waits for a time sufficient for the MS to be "idle updated". The MS is paged with the paging indication set to "SDCCH". The SS does not answer to Max-Retrans CHANNEL REQUEST messages and answers to the next CHANNEL REQUEST with an IMMEDIATE ASSIGNMENT REJECT message. The SS checks that all CHANNEL REQUEST messages contain an establishment cause with the value "0001". The SS waits for a time sufficient for the MS to be "idle updated". The MS is paged with the paging indication set to "TCH/F". The SS does not answer to Max-Retrans CHANNEL REQUEST messages and answers to the next CHANNEL REQUEST with an IMMEDIATE ASSIGNMENT REJECT message. The SS checks that all CHANNEL REQUEST messages contain an establishment cause with the value "100" if the MS capability is full rate only, "0010" if the MS capability is dual rate and "0001" if the MS capability is SDCCH only. The SS waits for a time sufficient for the MS to be "idle updated". The MS is paged with the paging indication set to "TCH/H or TCH/F". The SS does not answer to Max-Retrans CHANNEL REQUEST messages and answers to the next CHANNEL REQUEST with an IMMEDIATE ASSIGNMENT REJECT message. The SS checks that all CHANNEL REQUEST messages contain an establishment cause with the value "100" if the MS capability is full rate only, "0011" if the MS capability is dual rate and "0001" if the MS capability is SDCCH only.

Procedure 6

This procedure is performed twice. Once for NECI = 0 and once for NECI = 1.

The MS is switched off or powered off. Then system information messages are altered so that IMSI attach/detach is allowed in the cell. The MS is switched on or powered on. The MS performs IMSI attach. The SS does not answer to Max-Retrans CHANNEL REQUEST messages and answers to the next CHANNEL REQUEST with an IMMEDIATE ASSIGNMENT message. The SS checks that all CHANNEL REQUEST messages contain an establishment cause with the values "0000" when NECI = 1, or "000" when NECI = 0. The IMSI attach procedure is followed. The location area code of the cell is changed, T3212 is set to 1 deci-hour. The MS performs a location updating. The SS does not answer to Max-Retrans CHANNEL REQUEST messages and answers to the next CHANNEL REQUEST with an IMMEDIATE ASSIGNMENT message. The SS checks that all CHANNEL REQUEST messages contain an establishment cause with the values "0000" when NECI = 1, or "000" when NECI = 0. The location updating procedure is followed. The SS waits for at least 7 minutes. The MS performs a periodic updating. The SS does not answer to Max-Retrans CHANNEL REQUEST messages and answers to the next CHANNEL REQUEST with an IMMEDIATE ASSIGNMENT message. The SS checks that all CHANNEL

REQUEST messages contain an establishment cause with the values "0000". The location updating procedure is followed. The MS is switched off or powered off. If the MS has an On/off switch (see PICS), it attempts IMSI detach. The SS does not answer to Max-Retrans CHANNEL REQUEST messages and answers to the next CHANNEL REQUEST with an IMMEDIATE ASSIGNMENT REJECT message. The SS checks that all CHANNEL REQUEST messages contain an establishment cause with the value "0001" when NECI = 1, or "111" when NECI = 0.

Procedure 7

This procedure is performed twice. Once for NECI = 0 and once for NECI = 1.

If the MS supports a non call related supplementary service operation:

A supplementary service operation is attempted at the MS. The SS does not answer to Max-Retrans CHANNEL REQUEST messages and answers to the next CHANNEL REQUEST with an IMMEDIATE ASSIGNMENT REJECT message. The SS checks that all CHANNEL REQUEST messages contain an establishment cause with the value "0001".

Procedure 8

If the MS supports SMS/PP MO:

A mobile originated short message service transaction is attempted. The SS does not answer to Max-Retrans CHANNEL REQUEST messages and answers to the next CHANNEL REQUEST with an IMMEDIATE ASSIGNMENT REJECT message. The SS checks that all CHANNEL REQUEST messages contain an establishment cause with the value "0001" when NECI = 1, or "111" when NECI = 0.

Maximum Duration of Test

For procedures 1, 2, 3, 4 and 5: 5 minutes, including 1 minute for any necessary operator actions.

For procedure 6: 20 minutes, including 2 minutes for any necessary operator actions.

For procedures 7, 8: 10 minutes, including 2 minutes for any necessary operator actions.

Expected Sequence

Procedure 1

This procedure is performed if the MS supports a service on a traffic channel.

Step	Direction	Message	Comments
1			a call is established on TCH/H if the MS supports a service on half rate channel or on TCH/F otherwise. The generic call setup procedure is used.
2	SS		the SS stops transmission on the SACCH.
3	MS -> SS	8 CHANNEL REQUEST	all messages have establishment cause set to "110"
4	SS -> MS	IMMEDIATE ASSIGNMENT REJECT	

Procedure 2

This procedure is performed if the MS supports a service on half rate channel.

Step	Direction	Message	Comments
1	SS		The NECI bit is set to 1, a call is established on TCH/H. The generic call setup procedure is used. the SS stops transmission on the SACCH. all messages have establishment cause set to "011010"
2			
3	SS		
4	MS -> SS	8 CHANNEL REQUEST	
5	SS -> MS	IMMEDIATE ASSIGNMENT REJECT	

Procedure 3

This procedure is performed if the MS supports speech.

Step	Direction	Message	Comments
1	MS		a speech call is attempted all messages have establishment cause set to "111"
2	MS -> SS	8 CHANNEL REQUEST	
3	SS -> MS	IMMEDIATE ASSIGNMENT REJECT	
4	SS		The NECI bit is set to 1 The SS waits for 30 s a speech call is attempted all messages have establishment cause set to "0100" if the MS supports speech on half rate or set to "111" otherwise
5	SS		
6	MS		
7	MS -> SS	8 CHANNEL REQUEST	
8	SS -> MS	IMMEDIATE ASSIGNMENT REJECT	

Procedure 4

This procedure is performed if the MS supports a data service.

Step	Direction	Message	Comments
1	MS		a data call is attempted all messages have establishment cause set to "111"
2	MS -> SS	8 CHANNEL REQUEST	
3	SS -> MS	IMMEDIATE ASSIGNMENT REJECT	
4	SS		The NECI bit is set to 1 The SS waits for 30 s a data call is attempted for a service supported by the MS on half rate (for any data service if the MS does not support any data service on half rate) all messages have establishment cause set to "0101" if the MS supports a data service on half rate or set to "111" otherwise
5	SS		
6	MS		
7	MS -> SS	8 CHANNEL REQUEST	
8	SS -> MS	IMMEDIATE ASSIGNMENT REJECT	

Procedure 5

Step	Direction	Message	Comments
1 2 3	SS -> MS MS -> SS SS -> MS	PAGING REQUEST TYPE 1 8 CHANNEL REQUEST IMMEDIATE ASSIGNMENT REJECT	paging indication = any channel all messages have establishment cause set to "100"
4 5 6 7	SS SS -> MS MS -> SS SS -> MS	PAGING REQUEST TYPE 1 8 CHANNEL REQUEST IMMEDIATE ASSIGNMENT REJECT	The SS waits for 5 seconds paging indication = SDCCH all messages have establishment cause set to "0001"
8 9 10 11	SS SS -> MS MS -> SS SS -> MS	PAGING REQUEST TYPE 1 8 CHANNEL REQUEST IMMEDIATE ASSIGNMENT REJECT	The SS waits for 5 seconds paging indication = TCH/F all messages have establishment cause set to "100" if the MS capability is full rate only or "0010" if the MS capability is dual rate or "0001" if the MS capability is SDCCH only
12 13 14 15	SS SS -> MS MS -> SS SS -> MS	PAGING REQUEST TYPE 1 8 CHANNEL REQUEST IMMEDIATE ASSIGNMENT REJECT	The SS waits for 5 seconds paging indication = TCH/H or TCH/F all messages have establishment cause set to "100" if the MS capability is full rate only or "0011" if the MS capability is dual rate or "0001" if the MS capability is SDCCH only

Procedure 6

The sequence is executed for execution counter k = 1, 2.

Step	Direction	Message	Comments
0	SS		When k = 1, NECI set to 0 When k = 2, NECI set to 1
1	MS		The MS is switched off or has its power source removed
2	SS		IMSI attach/detach is set to "MSs in the cell shall apply IMSI attach and detach procedure"
3	MS		The MS is switched on or powered on
4	MS -> SS	8 CHANNEL REQUEST	all messages have establishment cause set to: "000" when k = 1 "0000" when k = 2
5	SS -> MS	IMMEDIATE ASSIGNMENT	
6	MS -> SS	LOCATION UPDATING REQUEST	"location updating type" = IMSI attach
7	SS -> MS	LOCATION UPDATING ACCEPT	with no mobile identity
8	SS -> MS	CHANNEL RELEASE	
9	SS		the LAC of the cell is changed and T3212 is set to 6 minutes
10	MS -> SS	8 CHANNEL REQUEST	all messages have establishment cause set to: "000" when k = 1 "0000" when k = 2. The MS must send its first Channel Request within 33s after the LAC has been changed.
11	SS -> MS	IMMEDIATE ASSIGNMENT	
12	MS -> SS	LOCATION UPDATING REQUEST	"location updating type" = Normal location updating
13	SS -> MS	LOCATION UPDATING ACCEPT	with no mobile identity
14	SS -> MS	CHANNEL RELEASE	
15	MS -> SS	8 CHANNEL REQUEST	all messages have establishment cause set to: "000" when k = 1 "0000" when k = 2. The MS must send its first Channel Request within 7 minutes after the preceding Channel Release
16	SS -> MS	IMMEDIATE ASSIGNMENT	
17	MS -> SS	LOCATION UPDATING REQUEST	"location updating type" = Periodic updating
18	SS -> MS	LOCATION UPDATING ACCEPT	with no mobile identity
19	SS -> MS	CHANNEL RELEASE	
20	MS		If possible (see PICS), the MS is switched off, otherwise it has its power source removed
21	MS		If the MS was switched off it attempts IMSI detach
22	MS -> SS	8 CHANNEL REQUEST	all messages have establishment cause set to: "111" when k = 1 "0001" when k = 2
23	SS -> MS	IMMEDIATE ASSIGNMENT REJECT	

Procedure 7

The sequence is executed for execution counter k = 1, 2.

This procedure is performed if the MS supports a non call related supplementary service operation.

Step	Direction	Message	Comments
1	MS		a non call related supplementary service operation is attempted
2	MS -> SS	8 CHANNEL REQUEST	all messages have establishment cause set to: "111" when k = 1 "0001" when k = 2
3	SS -> MS	IMMEDIATE ASSIGNMENT REJECT	

Procedure 8

This procedure is performed if the MS supports SMS/PP MO.

The sequence is executed for execution counter k = 1, 2.

Step	Direction	Message	Comments
0	SS		When k = 1, NECI set to 0 When k = 2, NECI set to 1
1	MS		a mobile originated short message service transaction is attempted
2	MS -> SS	8 CHANNEL REQUEST	all messages have establishment cause set to: "111" when k = 1 "0001" when k = 2
3	SS -> MS	IMMEDIATE ASSIGNMENT REJECT	

26.3 Test of MS functions in idle mode

26.3.1 Initial conditions

The SIM shall contain a PLMN-Selector that contains only the HPLMN of the MS, and an empty forbidden PLMN list.

Related PICS/PIXIT statements

Type of mobile station (P-GSM 900 or E-GSM 900 or DCS 1 800)

During the tests in 26.3.2 and 26.3.3, the following parameters apply according to the above PICS/PIXIT statement:

RACH control parameters

In cells

GSM 900: 1 to 7

DCS 1 800: 1 to 6:

Multiband GSM/DCS: 1 to 7:

Max retrans	= 01	2 retransmissions
Tx-integer	= 0111	(10) slots for spreading
CB, Cell Barred	= 0	access is allowed
RE	= 1	re-establishment not allowed
AC C00 to AC C15	= 0	access is not barred

In cell

GSM 900: 8

DCS 1 800: 7:

Multiband GSM/DCS: 8:

Max retrans	= 01	2 retransmissions
Tx-integer	= 0111	(10) slots for spreading
CB, Cell Barred	= 1	access is not allowed
RE	= 1	re-establishment not allowed
AC C00 to AC C15	= 0	access is not barred

Cell	PLMN perm.	GSM 900						DCS 1 800							
		BA - ARFCN bit = 1													
1	00000100	7	39	65	66	85	97	124	520	580	610	702	703	830	885
2	00000100	8	40	67	68	86	98	123	521	581	612	704	705	831	884
3	00000100	9	41	69	70	87	99	122	522	582	614	706	707	832	883
4	00000100	10	42	71	72	88	100	121	523	583	616	708	709	833	882
5	00000100	11	43	73	74	89	101	120	524	584	618	710	711	844	881
6	00000100	12	44	75	76	90	102	119	525	585	620	712	713	835	880
7	00000100	13	45	77	78	91	103	118	526	586	622	714	715	836	879
8	00000100	124													

Cell	PLMN perm.	Multiband GSM/DCS							
		BA - ARFCN bit = 1							
1	00000100	7	39	702	66	85	885	124	
2	00000100	8	40	67	68	86	98	123	
3	00000100	9	41	69	70	87	99	122	
4	00000100	523	583	616	708	709	833	882	
5	00000100	520	7	39	702	85	885	124	
6	00000100	12	44	75	76	90	102	119	
7	00000100	526	586	622	714	715	836	879	
8	00000100	124							

Location area identification**GSM 900 only - begin**

Cell	MCC1	MCC2	MCC3	MNC1	MNC2	LAC	
1	0	0	2	0	F	x	
2	0	0	3	2	F	x	
3	0	0	4	3	F	x	
4	0	0	5	4	F	x	
5	0	0	6	5	F	x	
6	0	0	7	6	F	x	
7	0	0	8	7	F	x	
8	0	0	1	0	1	x	The HPLMN of the MS

GSM 900 only - end**DCS 1 800 only - begin**

Cell	MCC1	MCC2	MCC3	MNC1	MNC2	LAC	
1	0	0	2	0	F	x	
2	0	0	3	2	F	x	
3	0	0	4	3	F	x	
4	0	0	5	4	F	x	
5	0	0	6	5	F	x	
6	0	0	7	6	F	x	
7	0	0	1	0	1	x	The HPLMN of the MS

DCS 1 800 only - end**Multiband GSM/DCS only - begin**

Cell	MCC1	MCC2	MCC3	MNC1	MNC2	LAC	
1	0	0	2	0	F	x	
2	0	0	3	2	F	x	
3	0	0	4	3	F	x	
4	0	0	5	4	F	x	
5	0	0	2	0	F	x	
6	0	0	7	6	F	x	
7	0	0	8	7	F	x	
8	0	0	1	0	1	x	The HPLMN of the MS

Multiband GSM/DCS only - end

NOTE 1: 'x' denotes any value.

NOTE 2: The MS representation of the MCC, MNC on the handset can be manufacturer dependant.

NOTE 3: The NCC values of each cell must be different.

Control channel description and BS options

All

GSM 900: 8 cells

DCS 1 800: 7 cells:

Multiband GSM/DCS: 8 cells:

CELL_RESELECT_HYSTERESIS = 010

MS_TXPWR_MAX_CCH =

4dB RXLEV hysteresis
value corresponding to the maximum
available output power from MS

RXLEV_ACCESS_MIN	= 30	
ATT	= 0	no IMSI attach and detach
DTX	= 0	no discontinuous transmission
BS_AG_BLKES_RES	= 1	1 block reserved for access grant
CCCH_CONF	= 001	1 SDCCH combined with the CCCH
RADIO_LINK_TIMEOUT	= 5	10 s time-out
BS_PA_MFRMS	= 010	4 multiframes periods for paging
T3212 time-out value	= H'00	

Cell	GSM 900		DCS 1 800	
	level dB μ Vemf()	BCCH ARFCN	level dB μ Vemf()	BCCH ARFCN
1	+65	1	+65	520
2	+63	7	+63	580
3	+61	39	+61	610
4	+55	65	+55	702
5	+59	66	+59	703
6	+57	85	+57	830
7	+55	97	+55	885
8	+53	124		

Cell	Multiband			
	level dB μ Vemf()	BCCH ARFCN		
1	+65	520		
2	+63	7		
3	+61	39		
4	+55	702		
5	+59	66		
6	+57	85		
7	+55	885		
8	+53	124		

For testing an E-GSM Mobile station (see PICS/PIXIT), the BCCH ARFCN of call 7 shall be 985 (instead of 97).

NOTE 4: The SIM should contain a PLMN-Selector that contains only the HPLMN of the MS, and an empty forbidden PLMN list.

26.3.2 MS indication of available PLMNs

26.3.2.1 Test purpose

To verify that a MS can present the available PLMNs to the user when asked to do so in manual mode according to the requirements of GSM 05.08 and GSM 02.11.

26.3.2.2 Method of test

- The MS is switched on, equipped with a SIM containing default values except for those values listed under section 26.3.1 (initial conditions).
- The MS is put into manual network selection mode (see PIXIT).

26.3.2.3 Test requirements

- On entering manual network selection mode, the MS shall present a list of available PLMNs in all its bands of operation (MCC and MNC values, or any other valid indications, see PIXIT), within 2 minutes. Any PLMN shall only be presented once. The list shall include the MCC and MNC of:

GSM 900: cells 1 to 7, but not of cell 8.

DCS 1 800: cells 1 to 6, but not of cell 7.

Multiband: cells 2, 3, 4, 6, 7 and 1 or 5 (cell 1 and 5 have the same MCC and MNC), but not of cell 8.

26.3.3 MS will send only if BSS is "on air"

26.3.3.1 Test purpose

To verify that the MS will not produce any RF transmission if no BSS is received.

26.3.3.2 Method of test

a) The RF-signal for the BCCHs of:

GSM 900: cell 1 to 8 is switched off.

DCS 1 800: cell 1 to 7 is switched off.

Multiband GSM/DCS: cell 1 to 8 is switched off.

b) The SS shall wait 20 s to allow the MS to detect the loss of cells.

c) By MMI, an attempt to originate a call is made.

d) By MMI, an attempt to originate an emergency call is made.

Step d) is only performed if the MS supports speech (see PICS/PIXIT statement).

26.3.3.3 Test requirements

1) The MS must not give "service indication".

2) In steps c) and d) the MS shall not produce any RF output.

26.3.4 Manual mode of PLMN selection

26.3.4.1 Conformance requirements

In manual mode, the MS can try to obtain normal service on any available VPLMN and it shall try to obtain normal service on a VPLMN if and only if the user makes a manual selection of this VPLMN.

Reference

GSM 03.22 section 3.1.

26.3.4.2 Test purpose

To check that in manual mode the MS is able to obtain normal service on a PLMN which is neither the better nor a preferred PLMN and that it tries to obtain service on VPLMN if and only if the user selects it manually.

26.3.4.3 Method of test

Initial conditions

System Simulator:

2 cells, defaults parameter unless otherwise specified.

The SS transmits 2 BCCH carriers in the supported band(s) of the mobile station (for a multiband MS carrier A and B shall be in different bands) with the initial following parameters:

		level (dB μ Vemf)
carrier A	PLMN 1	38
carrier B	PLMN 2	33

Mobile Station:

The MS is "idle updated" on PLMN1 (HPLMN) and is in manual mode.

The preferred PLMN list does not contain PLMN2, it contains PLMN 3.

Related PICS/PIXIT statement(s)

Description of the manual PLMN selector.

Support of multiband functionality

Foreseen final state of the MS

The MS is "idle updated".

Test procedure

For the different networks and during the whole test, "IMSI attach" flag is set in the BCCH data.

Carrier A is turned off. The MS does not attempt a location updating during 2 minutes.

Carrier A is turned back on with a different MCC-MNC (indicating PLMN 3) and with a higher level (48 dBmVemf) than PLMN 2. The MS does not attempt a location updating during 2 minutes.

PLMN 2 is selected manually. The MS performs a location updating on PLMN 2. Carrier B is turned off. The MS does not attempt a location updating during 2 minutes.

Maximum duration of test

10 minutes

Expected Sequence

Step	Direction	Message	Comments
1	SS		carrier A is turned off
2			wait 2 min: the MS shall not send any CHANNEL REQUEST messages during this time
3	SS		carrier A is turned on with a different MNC-NCC (PLMN3) and with a high level (48dBmVemf)
4			wait 2 min: the MS shall not send any CHANNEL REQUEST messages during this time
5	MS		PLMN 2 selected manually
6	MS -> SS	CHANNEL REQUEST	
7	SS -> MS	IMMEDIATE ASSIGNMENT	
8	MS -> SS	LOCATION UPDATING REQUEST	on carrier B
9	SS -> MS	LOCATION UPDATING ACCEPT	
10	SS -> MS	CHANNEL RELEASE	
11	SS		carrier B is turned off
12			wait 2 min: the MS shall not send any CHANNEL REQUEST messages during this time

Specific message contents

None

26.4 Lower layer failures in layer 3 testing

26.4.1 Introduction

The text in this section is intended to develop a standardized way of creating lower layer failures whilst testing the performance of Layer 3 signalling.

There are two groups of lower layer failures:

- 1) Detected by analysis of reception at Layer 1 (GSM 05.08, GSM 04.08),
- 2) Data link layer failures.

References

GSM 04.08, GSM 04.06, GSM 05.08

26.4.2 Layer 1 reception failures

The absence of reception of correct frames on the SACCH until the S counter reaches value 0 will be interpreted as a Layer 1 failure.

26.4.3 Data link layer failures

Many kinds of error cases can be caused in Layer 2. For example too many "T200 - time-out/retrying" - pairs.

NOTE 1: All types of data link failures are indicated similarly to the RR layer (Release Indication).

NOTE 2: All types of L1 failures are indicated similarly to each layer (Abort Indication, Error Indication).

26.4.4 Lower layer failures, used for the tests in clause 25

For L3 testing different lower layer failures are performed:

- 1) T100 time-out in Layer 1.
- 2) Too many T200 time-outs consecutively in Layer 2.

26.5 Handling of unknown, unforeseen, and erroneous protocol data, and of parallel transactions

26.5.1 Handling of unknown, unforeseen, and erroneous protocol data, and of parallel transactions / unknown protocol discriminator

An MS ignores messages with unknown protocol discriminator. This allows for the introduction of new messages which will be ignored by MS of earlier phases.

26.5.1.1 Conformance requirements

If the mobile station receives a standard L3 message with a protocol discriminator different from those specified in table 9.2/GSM 04.07, the mobile station shall ignore the message.

References

GSM 04.07, section 11.2.1.

26.5.1.2 Test purpose

To verify that a MS supporting TCH and the call control protocol ignores a message containing an undefined protocol discriminator in the special case of a message coded otherwise like a CC STATUS ENQUIRY message received by the MS having a mobile terminating call in CC-state U10, "active".

26.5.1.3 Method of test

Initial conditions

System Simulator:

1 cell, default parameters.

Mobile Station:

The MS has been paged and an RR connection has been established.

If the MS supports the call control protocol, the test may alternatively be performed with the MS having a mobile terminating call in the CC-state U10, "active".

Related PICS/PIXIT statements

- At least one circuit switched basic service supported(Y/N).

Foreseen Final State of the MS

Same as in the initial conditions.

Test Procedure

The SS sends a message to the MS which is coded like a CC STATUS ENQUIRY message relating to the active call except for the fact that the protocol discriminator of the message is undefined.

Maximum duration of test

11 seconds.

Expected sequence

Step	Direction	Message	Comments
1	SS -> MS	UNKNOWN MESSAGE	
2	SS		The SS waits between 5 and 10 seconds verifying during this period that the MS does not send a L3 message on the main signalling link.

Specific message contents**UNKNOWN MESSAGE**

Information element	Value/remark
Protocol discriminator	0000
TI flag	transaction originated by SS
TI value	TI value of the active call if the test is performed in state U10 otherwise the value is arbitrary.
Message Type	H'34

26.5.2 Handling of unknown, unforeseen, and erroneous protocol data, and of parallel transactions / TI and skip indicator**26.5.2.1 TI and skip indicator / RR**

The MS ignores RR messages with skip indicator different to 0. This allows for the introduction of new RR messages which will be ignored by MS of earlier phases, especially on the downlink CCCH and BCCH.

26.5.2.1.1 TI and skip indicator / RR / Idle Mode**26.5.2.1.1.1 Conformance requirements**

A radio resource message received with skip indicator different from 0000 shall be ignored.

Reference(s):

GSM 04.08, section 10.3.1.

26.5.2.1.1.2 Test purpose

To verify that the MS ignores an RR message with skip indicator different from H'0 in the special case of a PAGING REQUEST TYPE 1 message received in the MM-state "idle, updated" and in RR-idle mode.

26.5.2.1.1.3 Method of test**Initial conditions**

System Simulator:

1 cell, default parameters.

Mobile Station:

The MS is in the MM-state "idle, updated" and in RR-idle mode. It has a valid TMSI.

Related PICS/PIXIT statements

None.

Foreseen Final State of the MS

The MS is in the MM-state "idle, updated" and in RR-idle mode. It has a valid TMSI.

Test Procedure

For every binary value x in the range 0001 - 0110 (binary) and for binary value x = 1000, the following procedure is performed: The SS sends a PAGING REQUEST TYPE 1 message to the MS with skip indicator set to x. It is verified that the MS does not answer to the paging request message.

Maximum duration of test

5 seconds for each execution.

Expected sequence

The sequence is executed for execution counter $k = 1,2,3,4,5,6,8$.

Step	Direction	Message	Comments
1	SS -> MS	PAGING REQUEST TYPE 1	The value of the skip indicator IE is the binary encoding of k .
2	SS		During 3 seconds the SS verifies that the MS does not send any message on the RACH.

Specific message contents

None.

26.5.2.1.2 TI and skip indicator / RR / RR-Connection established**26.5.2.1.2.1 Conformance requirements**

A radio resource message received with skip indicator different from H'0 shall be ignored.

Reference(s):

GSM 04.08, section 10.3.1.

26.5.2.1.2.2 Test purpose

To verify that the MS ignores RR messages with skip indicator different from H'0 in the case of a message being received during the RR-connection establishment in the MM-state "idle, updated" / "wait for network command" and in RR-connected mode.

26.5.2.1.2.3 Method of test**Initial conditions**

System Simulator:

1 cell, default parameters, max retrans = 2.

Mobile Station:

The MS is in the MM-state "idle, updated" and in RR-idle mode. It has a valid TMSI.

Related PICS/PIXIT statements

None.

Foreseen Final State of the MS

The MS is in the MM-state "idle, updated" and in RR-idle mode. It has a valid TMSI.

Test Procedure

The SS sends a PAGING REQUEST TYPE 1 message to the MS with skip indicator set to H'0. The first CHANNEL REQUEST message will be answered with an IMMEDIATE ASSIGNMENT addressing the MS but with skip indicator set to H'1. Transmission of the second CHANNEL REQUEST message verifies that the MS has ignored the IMMEDIATE ASSIGNMENT message.

The second CHANNEL REQUEST message is answered by an IMMEDIATE ASSIGNMENT REJECT message addressing the MS but with skip indicator set to H'2 and a reject time set to 255 seconds. Transmission of the third CHANNEL REQUEST message verifies that the MS has ignored the IMMEDIATE ASSIGNMENT REJECT message.

The third CHANNEL REQUEST message from the MS will be answered with a correct IMMEDIATE ASSIGNMENT addressing the MS and having skip indicator set to H'0.

In the RR-Connected mode messages such as CIPHERING MODE COMMAND, HANDOVER COMMAND, ASSIGNMENT COMMAND and CHANNEL RELEASE are sent with the skip indicator <> H'0 and it is checked that the MS does not take any action on these commands.

Maximum duration of test

40 seconds.

Expected sequence

Step	Direction	Message	Comments
1	SS -> MS	PAGING REQUEST TYPE 1	The value of the skip indicator IE is H'0
2	MS -> SS	CHANNEL REQUEST	
3	SS -> MS	IMMEDIATE ASSIGNMENT	skip indicator set to H'1
4	MS -> SS	CHANNEL REQUEST	
5	SS -> MS	IMMEDIATE ASSIGNMENT REJECT	skip indicator = H'2, reject time = 255 seconds
6	MS -> SS	CHANNEL REQUEST	Cause, answer to paging
7	SS -> MS	IMMEDIATE ASSIGNMENT	skip indicator = H'0
8	MS -> SS	PAGING RESPONSE	RR connection established
9	SS -> MS	AUTHENTICATION REQUEST	
10	MS -> SS	AUTHENTICATION RESPONSE	
11	SS -> MS	CIPHERING MODE COMMAND	skip indicator = H'3
12	SS		the SS neither starts ciphering nor deciphering
13	SS -> MS	IDENTITY REQUEST	with IMSI requested
14	MS -> SS	IDENTITY RESPONSE	to check the MS still uses unciphered mode
15	SS -> MS	ASSIGNMENT COMMAND	skip indicator = H'4
16	SS		SS checks no SABM is sent by the MS on the new channel
17	SS -> MS	HANDOVER COMMAND	skip indicator = H'5
18	SS		During 3 seconds the SS verifies that the MS does not send a handover failure or RR STATUS message on the old channel
19	SS -> MS	CHANNEL RELEASE	skip indicator = H'6
20	SS -> MS	IDENTITY REQUEST	with IMSI requested
21	MS -> SS	IDENTITY RESPONSE	to check the RR connection is still established
22	SS -> MS	CHANNEL RELEASE	skip indicator = H'0
23	SS		The SS checks that the layer 2 connection is released

Specific message contents

None.

26.5.2.2 TI and skip indicator / MM

The MS ignores MM messages with skip indicator different to 0. This allows for the introduction of new MM messages which will be ignored by MS of earlier phases.

26.5.2.2.1 Conformance requirements

A mobility management message received with skip indicator different from 0000 shall be ignored.

References

GSM 04.08, section 10.3.1.

26.5.2.2.2 Test purpose

To verify that the MS ignores an MM message with skip indicator different from H'0 in the special case of an IDENTITY REQUEST message received.

26.5.2.2.3 Method of test**Initial conditions**

System Simulator:

1 cell, default parameters.

Mobile Station:

The MS has a mobile terminating call in CC-state U10, "active", or alternatively, the MS has been paged and an RR connection has been established.

Related PICS/PIXIT statements

At least one circuit switched basic service supported (Y/N).

Foreseen Final State of the MS

Same as in the initial conditions.

Test Procedure

For every binary value x in the range 0001 - 0110 and for the binary value x = 1000, the following procedure is performed: The SS sends an IDENTITY REQUEST message to the MS with skip indicator set to x. It is verified during 5 seconds that the MS does not answer to the IDENTITY REQUEST message.

Maximum duration of test

15 seconds.

Expected sequence

Step	Direction	Message	Comments
1	SS -> MS	IDENTITY REQUEST	Skip indicator IE has value H'1.
2	SS		The SS starts verifying that the MS does not send any L3 message on the main signalling link. This verification continues until step 16 of this test sequence.
3	SS		The SS waits 1 second.
4	SS -> MS	IDENTITY REQUEST	Skip indicator IE has value H'2.
5	SS		The SS waits 1 second.
6	SS -> MS	IDENTITY REQUEST	Skip indicator IE has value H'3.
7	SS		The SS waits 1 second.
8	SS -> MS	IDENTITY REQUEST	Skip indicator IE has value H'4.
9	SS		The SS waits 1 second.
10	SS -> MS	IDENTITY REQUEST	Skip indicator IE has value H'5.
11	SS		The SS waits 1 second.
12	SS -> MS	IDENTITY REQUEST	Skip indicator IE has value H'6.
13	SS		The SS waits 1 second.
14	SS -> MS	IDENTITY REQUEST	Skip indicator IE has value H'8.
15	SS		The SS waits 5 seconds.
16	SS		The SS stops verifying that the MS does not send any L3 message on the main signalling link.

Specific message contents

None.

26.5.2.3 TI and skip indicator / CC

26.5.2.3.1 Conformance requirements

- a) Whenever any call control message except SETUP or RELEASE COMPLETE is received specifying a transaction identifier with a value different from 111, which is not recognized as relating to an active call or to a call in progress, the receiving entity shall send a RELEASE COMPLETE message with cause value #81 "invalid transaction identifier value" using the received transaction identifier value and remain in the Null state.
- b1) When a RELEASE COMPLETE message is received specifying a transaction identifier with a value different from 111, which is not recognized as relating to an active call or to a call in progress, the MM-connection associated with that transaction identifier shall be released.
- b2) When a SETUP message is received with a transaction identifier flag set to "1", this message shall be ignored.
- b3) When a SETUP message is received specifying a transaction identifier which is recognized as relating to an active call or to a call in progress, this SETUP message shall be ignored.
- c) When a CC message with a TI value = 111 is received, this message shall be ignored.

References

GSM 04.08, section 8.3.

26.5.2.3.2 Test purpose

- a) To verify that the MS having a mobile terminating call in CC-state U10, "active", on receipt of a DISCONNECT message which includes a transaction identifier with a value different from 111, which is not recognized as relating to an active call or a call in progress, sends a RELEASE COMPLETE message with cause value #81 and referring to the latter TI without changing the state of the active call (this is verified by use of the status enquiry procedure).
- b) To verify that the MS having a mobile terminating call in CC-state U10, "active", on receipt of a
 - b1) RELEASE COMPLETE message which includes a transaction identifier with a value different from 111, which is not recognized as relating to an active call or a call in progress, or a
 - b2) SETUP message with TI flag referring to a transaction originated by the MS (in the special case where the TI value is equal to the TI value relating to the active call), or a
 - b3) SETUP message with TI referring to the active call,

ignores that message without changing the state of the active call (this is verified by use of the status enquiry procedure).

- c) To verify that the MS ignores a CC message with a TI value of 111.

The test is only applicable to an MS supporting the call control protocol for at least one BC.

26.5.2.3.3 Method of test

Initial conditions

System Simulator:

1 cell, default parameters.

Mobile Station:

The MS has a mobile terminating call in CC-state U10, "active". No other call is active or in progress.

Related PICS/PIXIT statements

At least one circuit switched basic service supported (Y/N).

Foreseen Final State of the MS

The MS has a mobile terminating call in CC-state U10, "active". No other call is active or in progress.

Test Procedure

The SS sends a DISCONNECT message to the MS with a TI not relating to the active call. The MS shall respond with a RELEASE COMPLETE message including cause value #81 and specifying the same transaction. By means of the status enquiry procedure the SS checks that the CC-state of the active call did not change.

Then the SS sends the following call control messages to the MS;

- a RELEASE COMPLETE message, where the TI does not refer to the active call,
- a SETUP message with TI flag set to 1,
- a SETUP message with TI referring to the active call,
- a DISCONNECT message with a TI value of 111.

Each time the SS verifies that the MS does not respond to the message and each time the SS verifies by means of the status enquiry procedure that the CC-state of the active call has not been changed.

Maximum duration of test

40 seconds.

Expected sequence

Step	Direction	Message	Comments
1	SS -> MS	DISCONNECT	TI flag = 0; TI does not refer to the active call.
2	MS -> SS	RELEASE COMPLETE	TI flag = 1; TI value is equal to TI value received in step 1; Cause IE indicates cause value #81.
3	SS -> MS	STATUS ENQUIRY	TI refers to the active call.
4	MS -> SS	STATUS	TI refers to the active call; Cause IE indicates cause value #30. Call state IE indicates state U10
5	SS -> MS	RELEASE COMPLETE	TI flag = 0; TI does not refer to the active call.
6	SS		The SS verifies during 5 seconds that the MS does not send any L3 message on the main signalling link.
7	SS -> MS	STATUS ENQUIRY	TI refers to the active call.
8	MS -> SS	STATUS	TI refers to the active call; Cause IE indicates cause value #30. Call state IE indicates state U10
9	SS -> MS	SETUP	TI flag = 1; TI value is equal to TI value of the active call.
10	SS		The SS verifies during 5 seconds that the MS does not send any L3 message on the main signalling link.
11	SS -> MS	STATUS ENQUIRY	TI refers to the active call.
12	MS -> SS	STATUS	TI refers to the active call; Cause IE indicates cause value #30. Call state IE indicates state U10
13	SS -> MS	SETUP	TI flag = 0; TI refers to the active call.
14	SS		The SS verifies during 5 seconds that the MS does not send any L3 message on the main signalling link.
15	SS -> MS	STATUS ENQUIRY	TI refers to the active call.
16	MS -> SS	STATUS	TI refers to the active call; Cause IE indicates cause value #30. Call state IE indicates state U10
17	SS -> MS	DISCONNECT	TI flag = 0; TI value is 111.
18	SS		The SS verifies during 5 seconds that the MS does not send any L3 message on the main signalling link.
19	SS -> MS	STATUS ENQUIRY	TI refers to the active call.
20	MS -> SS	STATUS	TI refers to the active call; Cause IE indicates cause value #30. Call state IE indicates state U10

Specific message contents

None.

26.5.3 Handling of unknown, unforeseen, and erroneous protocol data, and of parallel transactions / undefined or unexpected message type**26.5.3.1 Undefined or unexpected message type / undefined message type / CC****26.5.3.1.1 Conformance requirements**

If the Mobile Station receives a message with message type not defined for the PD, it shall ignore the message except for the fact that, if an RR-connection exists, it returns a status message (STATUS, RR STATUS or MM STATUS depending on the protocol discriminator) with cause value #97 "message type non-existent or not implemented".

References

GSM 04.08, section 8.4; GSM 04.07, section 11.2.4.

26.5.3.1.2 Test purpose

To verify that a MS supporting the call control protocol for at least one BC, having a mobile terminating call in CC-state U10, "active", on receipt of a message with CC protocol discriminator and an arbitrary undefined message type, returns a STATUS message with cause value #97 to the peer CC entity without changing the state of the active call (this is verified by use of the status enquiry procedure).

26.5.3.1.3 Method of test**Initial conditions**

System Simulator:

1 cell, default parameters.

Mobile Station:

The MS has a mobile terminating call in CC-state U10, "active".

Related PICS/PIXIT statements

At least one circuit switched basic service supported(Y/N).

Foreseen Final State of the MS

The MS has a mobile terminating call in CC-state U10, "active".

Test Procedure

The SS sends a message to the MS the PD of which refers to call control, the TI of which refers to the active call, and the message type of which is undefined in the call control protocol (however bit 7 of the message type is "0"). The SS then checks that the MS responds with a STATUS message specifying cause value #97. The SS then sends a STATUS ENQUIRY message to the MS and verifies that the MS responds with a STATUS message specifying cause value #30 and call state U10, "active".

Maximum duration of test

10 s.

Expected sequence

Step	Direction	Message	Comments
1	SS -> MS	see comments	PD = "call control; call related SS messages" TI is that of the active call Message type is undefined for call control, bit 7 of the message type is "0"
2	MS -> SS	STATUS	Cause IE indicates cause value #97.
3	SS -> MS	STATUS ENQUIRY	
4	MS -> SS	STATUS	TI refers to the active call; Cause IE indicates cause value #30. Call state IE indicates state U10

Specific message contents

None.

26.5.3.2 Undefined or unexpected message type / undefined message type / MM**26.5.3.2.1 Conformance requirements**

If the Mobile Station receives a message with message type not defined for the PD, it shall ignore the message except for the fact that, if an RR-connection exists, it returns a status message (STATUS, RR STATUS or MM STATUS depending on the protocol discriminator) with cause value #97 "message type non-existent or not implemented".

References

GSM 04.08, section 8.4.

26.5.3.2.2 Test purpose

To verify that a MS supporting the call control protocol for at least one BC, having a mobile terminating call in CC-state U10, "active", on receipt of a message with MM protocol discriminator and message type undefined for the mobility management protocol, returns an MM STATUS message with reject cause value #97 without changing the state of the active call (this is verified by use of the status enquiry procedure.) This is tested in the special case where the CC TI has value 0 (so that it has the same encoding as the skip indicator when sent from the SS) and where the message type has the same encoding as DISCONNECT in CC.

26.5.3.2.3 Method of test**Initial conditions**

System Simulator:

1 cell, default parameters.

Mobile Station:

The MS has a mobile terminating call in CC-state U10, "active". The TI of that mobile terminating call has value 0.

Related PICS/PIXIT statements

At least one circuit switched basic service supported(Y/N).

Foreseen Final State of the MS

The MS has a mobile terminating call in CC-state U10, "active".

Test Procedure

The SS sends a message to the MS the PD of which refers to mobility management, the skip indicator of which is "0000", and the message type of which is "0010 0101". The SS then checks that the MS responds with an MM STATUS message specifying reject cause value #97. The SS then sends a STATUS ENQUIRY message to the MS and verifies that the MS responds with a STATUS message specifying cause #30 and call state U10, "active".

Maximum duration of test

10 s.

Expected sequence

Step	Direction	Message	Comments
1	SS -> MS	see comments	PD = "mobility management messages" Skip indicator = "0000" Message type = "0010 0101" rest of the message is H'02 H'E0 H'90
2	MS -> SS	MM STATUS	Reject cause IE indicates reject cause value #97.
3	SS -> MS	STATUS ENQUIRY	
4	MS -> SS	STATUS	TI refers to the active call; Cause IE indicates cause value #30. Call state IE indicates state U10

Specific message contents

None.

26.5.3.3 Undefined or unexpected message type / undefined message type / RR**26.5.3.3.1 Conformance requirements**

If the Mobile Station receives a message with message type not defined for the PD, it shall ignore the message except for the fact that, if an RR-connection exists, it returns a status message (STATUS, RR STATUS or MM STATUS depending on the protocol discriminator) with cause value #97 "message type non-existent or not implemented".

Reference(s)

GSM 04.08, section 8.4.

26.5.3.3.2 Test purpose

To verify that an MS in RR connected mode on receipt of a message with RR protocol discriminator and message type undefined for the RR protocol, returns an RR STATUS message with reject cause value #97 without changing its state (this is checked by observing that the MS does not send L3 messages.)

26.5.3.3.3 Method of test**Initial conditions**

System Simulator:
1 cell, default parameters.

Mobile Station:
The MS has been paged and an RR connection has been established.

Related PICS/PIXIT statement(s)

- At least one circuit switched basic service supported(p = Y/N)

Foreseen Final State of the MS

The MS is in "idle updated" state.

Test Procedure

The SS sends a message to the MS the PD of which refers to radio resources management, the skip indicator of which is "0000", and the message type of which is "0010 1010". The SS then checks that the MS responds with an RR STATUS message specifying reject cause value #97. The SS then verifies during 5 seconds that the MS does not send a L3 message on the main signalling link but continues sending L2 fill frames on the main signalling link. Then the SS sends a SETUP message to the MS. This message specifies a BC that is supported by the MS, if there exists any; if the MS does not support any BC, the SETUP message specifies an arbitrary BC. The SS then verifies that the MS responds with a CALL CONFIRMED message if the SETUP had specified a BC supported by the MS, and that the MMS responds with a RELEASE COMPLETE message otherwise. Then the SS sends a CHANNEL RELEASE to the MS and waits for the disconnection of the main signalling link.

Maximum duration of test

15 s.

Expected sequence

Step	Direction	Message	Comments
1	SS->MS	see comments	PD = "radio resources management messages" Skip indicator = "0000" Message type = "0010 0101" rest of the message is H'02 H'E0 H'90
2	MS->SS	RR STATUS	RR cause IE indicates RR cause value #97.
3	SS		During 5 seconds the SS verifies that the MS does not send a L3 message on the main signalling link but still continues to send L2 fill frames on the main signalling link.
4	SS->MS	SETUP	If the MS supports at least one BC (p = Y), the SETUP specifies a bearer capability supported by the MS. Otherwise (p = N) the SETUP message specifies any bearer capability.
A5	MS->SS	CALL CONFIRMED	This message shall be sent by the MS if p = Y.
B5	MS->SS	RELEASE COMPLETE	This message shall be sent by the MS if p = N.
6	SS->MS	CHANNEL RELEASE	The SS waits for disconnection of the main signalling link.

Specific message contents

None.

26.5.3.4 Undefined or unexpected message type / unexpected message type / CC**26.5.3.4.1 Conformance requirements**

If the Mobile Station receives a message not consistent with the protocol state, the Mobile Station shall ignore the message except for the fact that, if an RR-connection exists, it returns a status message (STATUS, RR STATUS or MM STATUS depending on the protocol discriminator) with cause value #98 "Message type not compatible with protocol state".

References

GSM 04.08, section 8.4.

26.5.3.4.2 Test purpose

To verify that a MS supporting the call control protocol for at least one BC, having a call in CC-state U10, "active", on receipt of an inopportune CC message, returns a STATUS message with reject cause value #98 without changing the state of the active call (this is verified by use of the status enquiry procedure.) This is tested in the special case where the inopportune CC message is a CALL PROCEEDING message relating to the active call.

26.5.3.4.3 Method of test**Initial conditions**

System Simulator:
1 cell, default parameters.

Mobile Station:
The MS has a call in CC-state U10, "active".

Related PICS/PIXIT statements

At least one circuit switched basic service supported(Y/N).

Foreseen Final State of the MS

The MS has a call in CC-state U10, "active".

Test Procedure

The SS sends a CALL PROCEEDING message to the MS. The SS then checks that the MS responds with a STATUS message specifying reject cause value #98. The SS then sends a STATUS ENQUIRY message to the MS and verifies that the MS responds with a STATUS message specifying cause #30 and call state U10, "active".

Maximum duration of test

10 s.

Expected sequence

Step	Direction	Message	Comments
1	SS -> MS	CALL PROCEEDING	
2	MS -> SS	STATUS	Cause IE indicates cause value #98.
3	SS -> MS	STATUS ENQUIRY	
4	MS -> SS	STATUS	TI refers to the active call; Cause IE indicates cause value #30. Call state IE indicates state U10

Specific message contents

None.

26.5.4 Handling of unknown, unforeseen, and erroneous protocol data, and of parallel transactions / unforeseen information elements in the non-imperative message part

26.5.4.1 Unforeseen information elements in the non-imperative message part / duplicated information elements

26.5.4.1.1 Conformance requirements

If an information element with format T, TV, or TLV is repeated in a message in which repetition of the information element is not specified, only the contents of the information element appearing first shall be handled and all subsequent repetitions of the information element shall be ignored.

References

GSM 04.08, section 8.6.3.

26.5.4.1.2 Test purpose

To verify that the MS ignores an unforeseen second occurrence of an information element with format T, TV, or TLV in the special case of the mobile identity IE which has format TLV in the LOCATION UPDATING ACCEPT message.

26.5.4.1.3 Method of test

Initial conditions

System Simulator:

2 cells A and B belonging to different location areas, default parameters.

Mobile Station:

The MS is in the MM-state "idle, updated" and in RR-idle mode, listening to the BCCH/CCCH of cell A. It has a valid TMSI.

Related PICS/PIXIT statements

None.

Foreseen Final State of the MS

The MS is in the MM-state "idle, updated" and in RR-idle mode, listening to the BCCH/CCCH of cell B. It does not have a valid TMSI.

Test Procedure

The RF level of cell A is lowered until the MS selects cell B (according to the cell-reselection procedures of GSM 05.08). The MS shall establish an RR connection and initiate the normal location updating procedure (using TMSI). The SS responds to the location update request with the LOCATION UPDATING ACCEPT message containing the mobile identity IE specifying the IMSI of the MS followed by an additional mobile identity IE specifying the TMSI that was assigned to the MS in the initial conditions (i.e. duplication of information element).

The SS then pages the MS using the PAGING REQUEST TYPE 1 message including the TMSI which was previously used in the LOCATION UPDATE ACCEPT message. The SS then verifies during 5 seconds that the MS does not answer to paging. The SS then pages the MS with its IMSI. The SS verifies that the MS responds on cell B by initiating the immediate assignment procedure using the CHANNEL REQUEST message.

Maximum duration of test

20 s.

Expected sequence

During 3 seconds the SS verifies that the MS does not send any message on the RACH.

Step	Direction	Message	Comments
1	SS		The RF level of cell A is lowered until the MS selects cell B.
2	MS -> SS	CHANNEL REQUEST	
3	SS -> MS	IMMEDIATE ASSIGNMENT	
4	MS -> SS	LOCATION UPDATING REQUEST	Mobile identity IE specifies the TMSI of the MS.
5	SS -> MS	LOCATION UPDATING ACCEPT	(see below)
6	SS -> MS	CHANNEL RELEASE	
7	SS		The SS waits at least 5 s to give the MS time to become pageable
8	SS -> MS	PAGING REQUEST TYPE 1	Mobile identity 1 IE specifies the TMSI of the MS. Mobile identity 2 is omitted.
9	SS		The SS waits at least 5 seconds During that period the SS verifies that the MS does not send any message on the RACH.
10	SS -> MS	PAGING REQUEST TYPE 1	Mobile identity 1 IE specifies the IMSI of the MS. Mobile identity 2 is omitted.
11	MS -> SS	CHANNEL REQUEST	Establishment cause = answer to paging.
12	SS -> MS	IMMEDIATE ASSIGNMENT REJECT	

Specific message contents**LOCATION UPDATING ACCEPT**

Information element	value/remark
location area identification	LAI of cell B
Mobile identity	coded TLV, specifies the IMSI of the MS
Type of identity	IMSI
Odd/even indication	corresponding to IMSI
Identity digit 1 etc.	corresponding to IMSI
Mobile identity (duplication)	coded TLV
Type of identity	TMSI of the MS
Odd/even indication	corresponding to TMSI
Identity digit 1 etc.	corresponding to TMSI

26.5.5 Handling of unknown, unforeseen, and erroneous protocol data, and of parallel transactions / non-semantical mandatory IE errors**26.5.5.1 Non-semantical mandatory IE errors / RR****26.5.5.1.1 Non-semantical mandatory IE errors / RR / missing mandatory IE error****26.5.5.1.1.1 Non-semantical mandatory IE errors / RR / missing mandatory IE error / special case**

The MS shall accept a CHANNEL RELEASE message whether it contains an RR cause or not. This allows for the shortening of the message in the future.

26.5.5.1.1.1.1 Conformance requirements

When on receipt of a message a "missing mandatory IE" error is diagnosed the MS shall proceed as follows: If the message is a CHANNEL RELEASE message, the actions taken shall be the same as specified for a normal RR-connection release.

References

GSM 04.08, section 8.5.

26.5.5.1.1.1.2 Test purpose

To verify that the MS in RR connected mode releases the connection upon receipt of a CHANNEL RELEASE message with missing RR cause (which is "mandatory" in that message).

26.5.5.1.1.1.3 Method of test**Initial conditions**

System Simulator:
1 cell, default parameters.

Mobile Station:
The MS is in the MM-state "idle, updated" and in RR-idle mode. It has a valid TMSI.

Related PICS/PIXIT statements

None.

Foreseen Final State of the MS

The MS is in the MM-state "idle, updated" and in RR-idle mode. It has a valid TMSI.

Test Procedure

A mobile terminating RR connection is established. Then the SS sends a CHANNEL RELEASE message in which the RR cause IE is missing. It is verified that the MS releases the main signalling link by sending a L2 DISC frame. The main signalling link release is then completed.

Maximum duration of test

10 s.

Expected sequence

Step	Direction	Message	Comments
1	SS -> MS	PAGING REQUEST TYPE 1	
2	MS -> SS	CHANNEL REQUEST	
3	SS -> MS	IMMEDIATE ASSIGNMENT	
4	MS -> SS	PAGING RESPONSE	
5	SS -> MS	CHANNEL RELEASE	
6	MS -> SS		The mandatory RR cause IE is missing (the message consists only of protocol discriminator, skip indicator, and message type). The main signalling link is released (this is observed by a L2 DISC frame sent from the MS to the SS).

Specific message contents

None.

26.5.5.1.1.2 Non-semantical mandatory IE errors / RR / missing mandatory IE error / general case

In the general case, the MS has to report an RR message with missing mandatory IE by the use of an RR STATUS message, but otherwise to ignore it. This is a recovery mechanism for unforeseen states.

26.5.5.1.1.2.1 Conformance requirements

When on receipt of a message a "missing mandatory IE" error is diagnosed the MS shall proceed as follows: If the message is not one of the messages listed in sections 8.5.1, 8.5.2, and 8.5.3 of GSM 04.08, the Mobile Station shall ignore the message except for the fact that, if an RR-connection exists, it returns a status message (STATUS, RR STATUS or MM STATUS depending on the protocol discriminator) with cause value #96 "invalid mandatory information".

References

GSM 04.08, section 8.5.

26.5.5.1.1.2.2 Test purpose

To verify that the MS in RR connected mode ignores a ciphering mode command message in which the ciphering mode setting IE and cipher response IE are missing except for the fact that it returns a RR STATUS message.

26.5.5.1.1.2.3 Method of test**Initial conditions**

System Simulator:
1 cell, default parameters.

Mobile Station:
The MS is in the MM-state "idle, updated" and in RR-idle mode. It has a valid TMSI.

Related PICS/PIXIT statements

None.

Foreseen Final State of the MS

The MS is in RR-connected mode.

Test Procedure

A mobile terminating RR connection is established. Then the SS sends a ciphering mode command message in which the ciphering mode setting IE and cipher response IE are missing. The SS verifies that the MS does not start ciphering and returns a RR STATUS message.

Maximum duration of test

10 s.

Expected sequence

Step	Direction	Message	Comments
1	SS -> MS	PAGING REQUEST TYPE 1	
2	MS -> SS	CHANNEL REQUEST	
3	SS -> MS	IMMEDIATE ASSIGNMENT	
4	MS -> SS	PAGING RESPONSE	
5	SS -> MS	CIPHERING MODE COMMAND	The mandatory ciphering mode setting IE and cipher response IE are missing.
6	MS -> SS	RR STATUS	RR cause IE specifies RR cause value #96.

Specific message contents

None.

26.5.5.1.2 Non-semantic mandatory IE errors / RR / comprehension required

26.5.5.1.2.1 Conformance requirements

When an RR message containing an IE unknown in the message, but encoded as "comprehension required" (see subclause 10.5 / GSM 04.08) is received, the MS shall proceed as follows: When the message is not one of the messages listed in GSM 04.08 sections 8.5.1, 8.5.2, and 8.5.3, the Mobile Station shall ignore the message except for the fact that, if an RR-connection exists, it returns a RR STATUS message with cause value #96 "invalid mandatory information".

References

GSM 04.08, section 8.5.

26.5.5.1.2.2 Test purpose

To verify that the MS having an RR-connection established ignores a HANDOVER COMMAND message containing in the non-imperative part an IE encoded as comprehension required except for the fact that it returns a RR STATUS message with cause # 96 "invalid mandatory information".

26.5.5.1.2.3 Method of test

Initial conditions

System Simulator:
1 cell, default parameters.

Mobile Station:

The MS has an MT call in state U10, "active"; or alternatively, the MS has been paged and an RR-connection has been established.

Related PICS/PIXIT statements

At least one circuit switched basic service supported(Y/N).

Foreseen Final State of the MS

As in the initial conditions.

Test Procedure

The SS sends a HANDOVER command message containing in the non-imperative part an IE encoded as comprehension required. The SS verifies that the MS returns a RR STATUS message with cause value #96 without changing the dedicated channel.

Maximum duration of test

10 s.

Expected sequence

Step	Direction	Message	Comments
1	SS -> MS	HANDOVER COMMAND	See below.
2	MS -> SS	RR STATUS	Sent on the old channel. RR cause IE specifies RR cause value #96.

Specific message contents**HANDOVER COMMAND**

Information element	value/remark
cell description	as required
channel description	as required
handover reference	as required
power command	as required
comprehension required IEI	0000 0000
length	0000 0001
unrecognized IE contents	xxxx xxxx

26.5.5.2 Non-semantic mandatory IE errors / MM

The MS shall ignore MM messages with syntactically incorrect mandatory IE. This allows to use reserved values in later phases.

26.5.5.2.1 Non-semantic mandatory IE errors / MM / syntactically incorrect mandatory IE

Test 26.5.5.2.1 is only applicable for an MS supporting at least one BC, whereas test 26.5.5.2.2 is applicable to all types of MS.

26.5.5.2.1.1 Conformance requirements

When an MM message containing a syntactically incorrect mandatory IE is received, the Mobile Station shall ignore the message except for the fact that, if an RR-connection exists, it returns a MM STATUS message with cause value #96 "invalid mandatory information".

References

GSM 04.08, section 8.5.

26.5.5.2.1.2 Test purpose

To verify that an MS supporting at least one BC, having a CC entity in state U10, "active", ignores an MM message with syntactically incorrect IE except for the fact that it sends an MM STATUS message with reject cause #96. This is tested in the special case of an IDENTITY REQUEST message in which the (mandatory) identity type IE specifies a reserved value for the type of identity; that the MS otherwise ignores the message is checked by means of the status enquiry procedure.

26.5.5.2.1.3 Method of test**Initial conditions**

System Simulator:

1 cell, default parameters.

Mobile Station:

The MS has a mobile terminating call in the CC-state U10, "active".

Related PICS/PIXIT statements

At least one circuit switched basic service supported(Y/N).

Foreseen Final State of the MS

The MS has a mobile terminating call in the CC-state U10, "active".

Test Procedure

The SS sends an IDENTITY REQUEST message in which the (mandatory) identity type IE specifies a reserved value for the type of identity. The SS verifies that the MS returns an MM STATUS message specifying cause value #96 but does not change its state (this is verified by use of the status enquiry procedure).

Maximum duration of test

10 s.

Expected sequence

Step	Direction	Message	Comments
1	SS -> MS	IDENTITY REQUEST	The identity type IE is encoded as "1111" (so that the type of identity contains the reserved value "111").
2	MS -> SS	MM STATUS	Reject cause IE indicates reject cause value #96.
3	SS -> MS	STATUS ENQUIRY	TI refers to the active call.
4	MS -> SS	STATUS	TI refers to the active call; Cause IE indicates cause value #30. Call state IE indicates state U10.

Specific message contents

None.

26.5.5.2.2 Non-semantic mandatory IE errors / MM / syntactically incorrect mandatory IE

Test 26.5.5.2.1 is only applicable for an MS supporting at least one BC, whereas this test (26.5.5.2.2) is applicable to all types of MS.

26.5.5.2.2.1 Conformance requirement(s)

When an MM message containing a syntactically incorrect mandatory IE is received, the Mobile Station shall ignore the message except for the fact that, if an RR-connection exists, it returns an MM STATUS message with cause value #96 "invalid mandatory information".

Reference(s)

GSM 04.08, section 8.5.

26.5.5.2.2.2 Test purpose

To verify that an MS having been paged and having an RR connection established ignores an MM message with syntactically incorrect IE except for the fact that it sends an MM STATUS message with reject cause #96. This is tested in the special case of an IDENTITY REQUEST message in which the (mandatory) *identity type* IE specifies a reserved value for the type of identity; the fact that the MS otherwise ignores the message is checked by testing that it answers as usual to an incoming SETUP message.

26.5.5.2.2.3 Method of test

Initial conditions

System Simulator:

1 cell, default parameters.

Mobile Station:

The MS has been paged; an RR connection has been established.

The MS has a valid TMSI.

Related PICS/PIXIT statements

At least one circuit switched basic service supported(p=Y/N).

Foreseen final state of the MS

The MS is in the MM-state "idle updated" listening to the BCCH/CCCH of the cell. It has a valid TMSI.

Test Procedure

The SS sends an IDENTITY REQUEST message in which the (mandatory) identity type IE specifies a reserved value for the type of identity. The SS verifies that the MS returns an MM STATUS message specifying cause value #96 but does not change its state; this is verified as follows:

The SS sends a SETUP message to the MS. This message specifies a BC that is supported by the MS, if there exists any; if the MS does not support any BC, the SETUP message specifies an arbitrary BC. The SS then verifies that the MS responds with a CALL CONFIRMED message if the SETUP had specified a BC supported by the MS, and that the MS responds with a RELEASE COMPLETE message otherwise.

Then the SS sends a CHANNEL RELEASE to the MS and waits for the disconnection of the main signalling link.

Maximum duration of test

10 s.

Expected sequence

Step	Direction	Message	Comments
1	SS -> MS	IDENTITY REQUEST	The identity type IE is encoded as "1111" (so that the type of identity contains the reserved value "111").
2	MS -> SS	MM STATUS	Reject cause IE indicates reject cause value #96.
3	SS -> MS	SETUP	If the MS supports at least one BC (p = Y), the SETUP specifies a bearer capability supported by the MS. Otherwise (p = N) the SETUP message specifies any bearer capability.
A4	MS -> SS	CALL CONFIRMED	This message shall be sent by the MS if p = Y.
B4	MS -> SS	RELEASE COMPLETE	This message shall be sent by the MS if p = N.
5	SS -> MS	CHANNEL RELEASE	The SS waits for disconnection of the main signalling link.

Specific message contents

None.

26.5.5.2.3 Non-semantical mandatory IE errors / MM / comprehension required

The "comprehension required" mechanism allows for the introduction of essential new information elements into messages, such that a message is ignored and a report is sent if the new information element is not understood.

26.5.5.2.3.1 Conformance requirements

When an MM message containing an IE unknown in the message, but encoded as "comprehension required" (see subclause 10.5 / GSM 04.08) is received, the MS shall ignore the message except for the fact that, if an RR-connection exists, it returns an MM STATUS message with cause value #96 "invalid mandatory information".

References

GSM 04.08, section 8.5.

26.5.5.2.3.2 Test purpose

To verify that the MS on receipt of an MM message containing an IE unknown in the message, but encoded as "comprehension required" ignores the message except for the fact that it returns an MM STATUS message with cause value #96 "invalid mandatory information"; this in the special case of the MM message being a LOCATION UPDATING ACCEPT responding to a LOCATION UPDATING REQUEST from the MS.

26.5.5.2.3.3 Method of test

Initial conditions

System Simulator:

The SS simulates two cells, A and B, belonging to different location areas, default parameters.

Mobile Station:

The MS is in the MM-state "idle, updated" listening to the BCCH/CCCH of cell A. It has a valid TMSI.

Related PICS/PIXIT statements

None.

Foreseen Final State of the MS

The MS is in the MM-state "idle, updated" listening to the BCCH/CCCH of cell B. It has a valid TMSI.

Test Procedure

The Rf level of cell A is lowered until the MS selects cell B. The SS verifies that the MS establishes an RR connection and performs the normal location updating procedure using its TMSI. The SS responds to the location updating request with the LOCATION UPDATING ACCEPT message containing an optional information element coded as "comprehension required". The SS verifies that the MS returns the MM STATUS message with cause #96 in response to the LOCATION UPDATING ACCEPT. The SS then waits for the MS to abort the RR-connection. The SS verifies that the MS establishes a new RR connection and starts a new location updating procedure.

On receipt of the new LOCATION UPDATING REQUEST, the SS sends a correctly coded LOCATION UPDATING ACCEPT allocating a new TMSI.

The SS verifies that the MS sends a TMSI REALLOCATION COMPLETE message. The SS then initiates the RR connection release.

Maximum duration of test

30 s.

Expected sequence

Step	Direction	Message	Comments
1	SS		The RF level of cell A is lowered until the MS selects cell B.
2	MS -> SS	CHANNEL REQUEST	
3	SS -> MS	IMMEDIATE ASSIGNMENT	
4	MS -> SS	LOCATION UPDATING REQUEST	The mobile identity IE specifies the TMSI of the MS.
5	SS -> MS	LOCATION UPDATING ACCEPT	See below.
6	MS -> SS	MM STATUS	Reject cause IE specifies reject cause value #96.
7	MS		The MS aborts the RR connection (it initiates release of L2 on SAPI 0) using the L2 DISC / UA exchange.
8	MS -> SS	CHANNEL REQUEST	
9	SS -> MS	IMMEDIATE ASSIGNMENT	
10	MS -> SS	LOCATION UPDATING REQUEST	The mobile identity IE specifies the IMSI of the MS.
11	SS -> MS	LOCATION UPDATING ACCEPT	see below
12	MS -> SS	TMSI REALLOCATION COMPLETE	
13	SS -> MS	CHANNEL RELEASE	The RR connection is released.

Specific message contents

LOCATION UPDATING ACCEPT - first occurrence

Information element	value/remark
Location area identification	LAI of cell B
Comprehension required IEI	0000 0000
length	1
unrecognized IE contents	xxxx xxxx (arbitrary octet)

LOCATION UPDATING ACCEPT - second occurrence

Information element	value/remark
Location area identification	specifies LAI of cell B
Mobile Identity	specifies a TMSI

26.5.5.3 Non-semantical mandatory IE errors / CC

26.5.5.3.1 Non-semantical mandatory IE errors / CC / missing mandatory IE

26.5.5.3.1.1 Non-semantical mandatory IE errors / CC / missing mandatory IE / disconnect message

26.5.5.3.1.1.1 Conformance requirements

When on receipt of a message a "missing mandatory IE" error is diagnosed, the MS shall proceed as follows: If the message is a DISCONNECT message, a RELEASE message shall be returned with cause value # 96 "invalid mandatory information" and normal call clearing applies.

References

GSM 04.08, section 8.5.

26.5.5.3.1.1.2 Test purpose

To verify that the MS having an MT call in state U10, "active", on receipt of a DISCONNECT message in which the mandatory cause IE is missing shall return a RELEASE message with cause value #96 "invalid mandatory information".

26.5.5.3.1.1.3 Method of test

Initial conditions

System Simulator:
1 cell, default parameters.

Mobile Station:
The MS has an MT call in the CC-state U10, "active".

Related PICS/PIXIT statements

At least one circuit switched basic service supported(Y/N).

Foreseen Final State of the MS

The MS is in the MM-state "idle, updated" and in RR-idle mode.

Test Procedure

The SS sends a DISCONNECT message in which the (mandatory) cause IE is missing. The SS verifies that the MS returns a RELEASE message specifying cause value #96. The SS then sends a RELEASE COMPLETE message and performs the RR connection release.

Maximum duration of test

15 s.

Expected sequence

Step	Direction	Message	Comments
1	SS -> MS	DISCONNECT	The mandatory cause IE is missing.
2	MS -> SS	RELEASE	The cause IE indicates cause value #96
3	SS -> MS	RELEASE COMPLETE	
4	SS -> MS	CHANNEL RELEASE	The RR connection is released.

Specific message contents

None.

26.5.5.3.1.2 Non-semantic mandatory IE errors / CC / missing mandatory IE / general case**26.5.5.3.1.2.1 Conformance requirements**

When on receipt of a message a "missing mandatory IE" error is diagnosed, the MS shall proceed as follows: If the message is not a SETUP, RELEASE, DISCONNECT, RELEASE COMPLETE, HOLD REJECT or RETRIEVE REJECT message, it shall ignore the message except for the fact that it returns a STATUS message specifying cause value #96.

References

GSM 04.08, section 8.5.

26.5.5.3.1.2.2 Test purpose

To verify that the MS having an MT call in state U10, "active", on receipt of a STATUS message in which the mandatory cause IE and call state IE are missing shall ignore the message except for the fact that it return a STATUS message with cause value #96 "invalid mandatory information" (that the MS does not change state is checked by use of the status enquiry procedure).

26.5.5.3.1.2.3 Method of test**Initial conditions**

System Simulator:
1 cell, default parameters.

Mobile Station:
The MS has an MT call in the CC-state U10, "active".

Related PICS/PIXIT statements

At least one circuit switched basic service supported(Y/N).

Foreseen Final State of the MS

The MS has an MT call in the CC-state U10, "active".

Test Procedure

The SS sends a STATUS message in which the mandatory cause IE and call state IE are missing. The SS verifies that the MS returns a STATUS message with cause value #96 "invalid mandatory information". Then the SS sends a STATUS ENQUIRY message and checks that the MS returns a STATUS message indicating cause value #30 and call state U10, "active".

Maximum duration of test

15 s.

Expected sequence

Step	Direction	Message	Comments
1	SS -> MS	STATUS	The mandatory cause IE and call state IE are missing.
2	MS -> SS	STATUS	The cause IE indicates cause value #96
3	SS -> MS	STATUS ENQUIRY	TI refers to the active call.
4	MS -> SS	STATUS	TI refers to the active call; Cause IE indicates cause value #30. Call state IE indicates state U10

Specific message contents

None.

26.5.5.3.2 Non-semantical mandatory IE errors / CC / comprehension required

This test is applicable to all MS which support at least one MO circuit switched basic service.

26.5.5.3.2.1 Conformance requirements

When a CC message containing an IE unknown in the message, but encoded as "comprehension required" (see GSM 04.08, section 10.5) is received, the MS shall proceed as follows: When the message is not one of the messages listed in GSM 04.08 sections 8.5.1, 8.5.2, and 8.5.3, the Mobile Station shall ignore the message except for the fact that, if an RR-connection exists, it returns a STATUS message with cause value #96 "invalid mandatory information".

References

GSM 04.08, sections 8.5 and 10.5.

26.5.5.3.2.2 Test purpose

To verify that an MS supporting the call control protocol for at least one BC having a call control entity in state U3 ignores a CONNECT message containing in the non-imperative part an IE encoded as comprehension required except for the fact that it returns a STATUS message with cause value #96 "invalid mandatory information".

26.5.5.3.2.3 Method of test

Initial conditions

System Simulator:
1 cell, default parameters.

Mobile Station:
The MS has a call control entity in CC state U3.

Related PICS/PIXIT statements

At least one circuit switched basic service supported(Y/N).

The MS supports MO calls.

Foreseen Final State of the MS

The MS has a call control entity in CC state U3.

Test Procedure

The SS sends a CONNECT message containing an optional information element coded as "comprehension required". The SS verifies that the MS returns a STATUS message specifying cause value #96 "invalid mandatory information". The SS checks by use of the status enquiry procedure that the MS did not change the state.

Maximum duration of test

5 s.

Expected sequence

Step	Direction	Message	Comments
1	SS -> MS	CONNECT	See below.
2	MS -> SS	STATUS	TI refers to the call in progress; cause IE indicates cause value #96.
3	SS -> MS	STATUS ENQUIRY	TI refers to the call in progress.
4	MS -> SS	STATUS	TI refers to the call in progress; Cause IE indicates cause value #30. Call state IE indicates state U3.

Specific message contents

CONNECT

Information element	value/remark
Unknown IEI	0000 0000
length	1
unknown IE contents	xxxx xxxx (arbitrary octet)

26.5.6 Handling of unknown, unforeseen, and erroneous protocol data, and of parallel transactions / unknown IE, comprehension not required

26.5.6.1 Unknown information elements in the non-imperative message part / MM

26.5.6.1.1 Unknown IE, comprehension not required / MM / IE unknown in the protocol

26.5.6.1.1.1 Conformance requirements

The MS shall ignore all IEs unknown in a message which are not encoded as "comprehension required".

References

GSM 04.08, sections 8.6.1, 8.6.2 and 10.5.

26.5.6.1.1.2 Test purpose

To verify that the MS on receipt of an MM message containing an IE unknown in the message and unknown in the MM protocol which is not encoded as "comprehension required" ignores that IE; this in the special case of the MM message being a LOCATION UPDATING ACCEPT responding to a LOCATION UPDATING REQUEST from the MS.

26.5.6.1.1.3 Method of test**Initial conditions**

System Simulator:

The SS simulates two cells, A and B, belonging to different location areas, default parameters.

Mobile Station:

The MS is in the MM-state "idle, updated" listening to the BCCH/CCCH of cell B. It has a valid TMSI.

Related PICS/PIXIT statements

None.

Foreseen Final State of the MS

The MS is in the MM-state "idle, updated" listening to the BCCH/CCCH of cell A. It has a valid TMSI.

Test Procedure

The RF level of cell B is lowered until the MS selects cell A. The SS verifies that the MS establishes an RR connection and performs the normal location updating procedure using its TMSI. The SS responds to the location updating request with the LOCATION UPDATING ACCEPT message containing an optional information element not coded as "comprehension required" the IE of which is unknown in the MM protocol. The LOCATION UPDATING ACCEPT message contains a new TMSI in the mobile identity IE which is placed after the unknown IE. The MS shall send the TMSI REALLOCATION COMPLETE message.

Maximum duration of test

20 s.

Expected sequence

Step	Direction	Message	Comments
1	SS		The RF level of cell B is lowered until the MS selects cell A.
2	MS -> SS	CHANNEL REQUEST	
3	SS -> MS	IMMEDIATE ASSIGNMENT	
4	MS -> SS	LOCATION UPDATING REQUEST	The mobile identity IE specifies the TMSI of the MS.
5	SS -> MS	LOCATION UPDATING ACCEPT	See below.
6	MS -> SS	TMSI REALLOCATION COMPLETE	
7	SS -> MS	CHANNEL RELEASE	The main signalling link is released.

Specific message contents**LOCATION UPDATING ACCEPT**

Information element	value/remark
Location area identification	LAI of cell A
Unknown IEI	1010 xxx0 (where x is arbitrary)
Mobile Identity IEI	
length	5
Type of identity	TMSI
Identity	4 octets of "new" TMSI

26.5.6.1.2 Unknown IE, comprehension not required / MM / IE unknown in the message

26.5.6.1.2.1 Conformance requirements

The MS shall ignore all IEs unknown in a message which are not encoded as "comprehension required".

References

GSM 04.08, sections 8.6.1, 8.6.2 and 10.5.

26.5.6.1.2.2 Test purpose

To verify that the MS on receipt of an MM message containing an IE unknown in the message, but known in the MM protocol, which is not encoded as "comprehension required" ignores that IE; this in the special case of the MM message being a LOCATION UPDATING ACCEPT responding to a LOCATION UPDATING REQUEST from the MS.

26.5.6.1.2.3 Method of test

Initial conditions

System Simulator:

The SS simulates two cells, A and B, belonging to different location areas, default parameters.

Mobile Station:

The MS is in the MM-state "idle, updated" listening to the BCCH/CCCH of cell B. It has a valid TMSI.

Related PICS/PIXIT statements

None.

Foreseen Final State of the MS

The MS is in the MM-state "idle, updated" listening to the BCCH/CCCH of cell A. It has a valid TMSI.

Test Procedure

The RF level of cell B is lowered until the MS selects cell A. The SS verifies that the MS establishes an RR connection and performs the normal location updating procedure using its TMSI. The SS responds to the location updating request with the LOCATION UPDATING ACCEPT message containing an optional information element not coded as "comprehension required" the IEI of which is unknown in the message but is used as the location area identification IEI in other messages of the MM protocol. The LOCATION UPDATING ACCEPT message contains a new TMSI in the mobile identity IE which is placed after the unknown IE. The MS shall send the TMSI REALLOCATION COMPLETE message.

Maximum duration of test

20 s.

Expected sequence

Step	Direction	Message	Comments
1	SS		The RF level of cell B is lowered until the MS selects cell A.
2	MS -> SS	CHANNEL REQUEST	
3	SS -> MS	IMMEDIATE ASSIGNMENT	
4	MS -> SS	LOCATION UPDATING REQUEST	The mobile identity IE specifies the TMSI of the MS.
5	SS -> MS	LOCATION UPDATING ACCEPT	See below.
6	MS -> SS	TMSI REALLOCATION COMPLETE	
7	SS -> MS	CHANNEL RELEASE	The main signalling link is released.

Specific message contents

LOCATION UPDATING ACCEPT

Information element	value/remark
Location area identification	LAI of cell A
Unknown IEI	0001 0011
length	2
unknown IE contents	xxxx xxxx xxxx xxxx (2 arbitrary octets)
Mobile Identity IEI	
length	5
Type of identity	TMSI
Identity	4 octets of "new" TMSI

26.5.6.2 Unknown information elements in the non-imperative message part / CC

26.5.6.2.1 Unknown information elements in the non-imperative message part / CC / Call establishment

This test is applicable to all MS which support at least one MO circuit switched basic service.

26.5.6.2.1.1 Conformance requirements

The MS shall ignore all IEs unknown in a message which are not encoded as "comprehension required".

References

GSM 04.08, section 8.6.1.

26.5.6.2.1.2 Test purpose

To verify that an MS supporting the CC protocol for at least one BC receiving a CC message containing an IE unknown in the message which is not encoded as "comprehension required" ignores that IE; this in the special case of the CC message being a CALL PROCEEDING message received by the MS in state U1.

26.5.6.2.1.3 Method of test

Initial conditions

System Simulator:
1 cell, default parameters.

Mobile Station:
The MS has a call control entity in CC state U1.

Related PICS/PIXIT statements

At least one circuit switched basic service supported (Y/N).

Foreseen Final State of the MS

The MS has a call control entity in CC state U3.

Test Procedure

The SS sends a CALL PROCEEDING message containing an optional information element not coded as "comprehension required" the IEI of which is unknown in the message, but used for a called party BCD number IE in other messages of the protocol. The SS verifies by use of the status enquiry procedure that the MS did not change the state.

Maximum duration of test

30 s.

Expected sequence

Step	Direction	Message	Comments
1	SS -> MS	CALL PROCEEDING	See below.
2	SS -> MS	STATUS ENQUIRY	TI refers to the call in progress.
3	MS -> SS	STATUS	TI refers to the active call; Cause IE indicates cause value #30. Call state IE indicates state U3.

Specific message contents**CALL PROCEEDING**

Information element	value/remark
Unknown IEI length unknown IE contents	0101 1110 1 xxxx xxxx (arbitrary octet)

26.5.6.2.2 Unknown information elements in the non-imperative message part / CC / disconnect**26.5.6.2.2.1 Conformance requirements**

The MS shall ignore all IEs unknown in a message which are not encoded as "comprehension required".

References

GSM 04.08, section 8.6.1.

26.5.6.2.2.2 Test purpose

To verify that an MS supporting the CC protocol for at least one BC receiving a CC message containing an IE unknown in the message which is not encoded as "comprehension required" ignores that IE; this in the special case of a DISCONNECT message received by the MS in state U10.

26.5.6.2.2.3 Method of test**Initial conditions**

System Simulator:

1 cell, default parameters.

Mobile Station:

The MS has a call control entity in CC state U10.

Related PICS/PIXIT statements

At least one circuit switched basic service supported (Y/N).

Foreseen Final State of the MS

The MS has a call control entity in CC state U19.

Test Procedure

The SS sends a DISCONNECT message containing an optional information element not coded as "comprehension required" the IEI of which is unknown in the message, but used for a connected number IE in other messages of the protocol. The SS verifies that the MS responds with a RELEASE message; the SS verifies by use of the status enquiry procedure that the MS has entered state U19.

Maximum duration of test

5 s.

Expected sequence

Step	Direction	Message	Comments
1	SS -> MS	DISCONNECT	See below. Cause IE indicates cause value #30. Call state IE indicates state U19.
2	MS -> SS	RELEASE	
3	SS -> MS	STATUS ENQUIRY	
4	MS -> SS	STATUS	

Specific message contents

DISCONNECT

Information element	value/remark
Unknown IEI	0100 1100
length	1
unknown IE contents	xxxx xxxx (arbitrary octet)

26.5.6.2.3 Unknown information elements in the non-imperative message part / CC / release

26.5.6.2.3.1 Conformance requirements

The MS shall ignore all IEs unknown in a message which are not encoded as "comprehension required".

References

GSM 04.08, section 8.6.1.

26.5.6.2.3.2 Test purpose

To verify that an MS supporting the CC protocol for at least one BC receiving a CC message containing an IE unknown in the message which is not encoded as "comprehension required" ignores that IE; this in the special case of a RELEASE message received by the MS having sent in state U10 a DISCONNECT message.

26.5.6.2.3.3 Method of test

Initial conditions

System Simulator:
1 cell, default parameters.

Mobile Station:
The MS has a call control entity in CC state U10.

Related PICS/PIXIT statements

At least one circuit switched basic service supported(Y/N).

Foreseen Final State of the MS

The MS is in the MM-state "idle, updated" and in RR-idle mode.

Test Procedure

The MS is made to send a DISCONNECT message. The SS responds with a RELEASE message containing an optional information element not coded as "comprehension required" the IEI of which is unknown in the message, but used for a high layer compatibility IE in other messages of the protocol. The SS verifies that the MS responds with a RELEASE COMPLETE message; the SS then releases the RR connection.

Maximum duration of test

10 s.

Expected sequence

Step	Direction	Message	Comments
1	MS		The MS is made to initiate call clearing.
2	MS -> SS	DISCONNECT	
3	SS -> MS	RELEASE	See below.
4	MS -> SS	RELEASE COMPLETE	
5	SS -> MS	CHANNEL RELEASE	The RR connection is released.

Specific message contents

RELEASE

Information element	value/remark
Unknown IEI	0111 1101
length	1
unknown IE contents	1 arbitrary octet

26.5.6.2.4 Unknown information elements in the non-imperative message part / CC / release complete

26.5.6.2.4.1 Conformance requirements

The MS shall ignore all IEs unknown in a message which are not encoded as "comprehension required".

References

GSM 04.08, section 8.6.1.

26.5.6.2.4.2 Test purpose

To verify that an MS supporting the CC protocol for at least one BC receiving a CC message containing an IE unknown in the message which is not encoded as "comprehension required" ignores that IE; this in the special case of a RELEASE COMPLETE message received by the MS in state U19.

26.5.6.2.4.3 Method of test**Initial conditions**

System Simulator:

1 cell, default parameters.

Mobile Station:

The MS has a call control entity in CC state U10.

Related PICS/PIXIT statements

At least one circuit switched basic service supported(Y/N).

Foreseen Final State of the MS

The MS is in the MM-state "idle, updated" and in RR-idle mode.

Test Procedure

The SS sends a DISCONNECT message. The SS verifies that the MS responds with a RELEASE message. The SS answers with a RELEASE COMPLETE message containing an optional information element not coded as "comprehension required" the IEI of which is unknown in the message, but used for an auxiliary states IE in other messages of the protocol. The SS verifies that the MS releases the link after some time.

Maximum duration of test

20 s.

Expected sequence

Step	Direction	Message	Comments
1	SS -> MS	DISCONNECT	
2	MS -> SS	RELEASE	
3	SS -> MS	RELEASE COMPLETE	See below.
4	MS		The MS aborts the RR connection (it initiates release of L2 on SAPI 0)

Specific message contents**RELEASE COMPLETE**

Information element	value/remark
Unknown IEI	0010 0100
length	1
unknown IE contents	1 arbitrary octet

26.5.6.3 Unknown IE in the non-imperative message part, comprehension not required / RR**26.5.6.3.1 Conformance requirements**

The MS shall ignore all IEs unknown in a message which are not encoded as "comprehension required".

References

GSM 04.08, sections 8.6.1, 8.6.2 and 10.5.

26.5.6.3.2 Test purpose

To verify that the MS ignores an IE which is unknown in a message for Radio Resource Management in the special cases of CIPHERING MODE COMMAND, ASSIGNMENT COMMAND and CHANNEL RELEASE.

26.5.6.3.3 Method of test**Initial conditions**

System Simulator:

1 cell, default parameters.

Mobile Station:

The MS is in the MM-state "idle, updated" and in the RR-idle mode. It has a valid TMSI.

Related PICS/PIXIT statements

Supported frequency bands, PGSM or EGSM or DCS 1 800.

Foreseen Final State of the MS

The MS is in the MM-state "idle, updated" and in the RR-idle mode. It has a valid TMSI.

Test Procedure

In the normal call establishment the CIPHERING MODE COMMAND and ASSIGNMENT COMMAND contain additional IEs unknown in the message which are not encoded as "comprehension required", and therefore should be ignored by the MS. After sending an ASSIGNMENT COMPLETE, the subsequent CHANNEL RELEASE received by the MS also contains an IE unknown in a message which is not encoded as "comprehension required". The MS should ignore this IE.

Maximum duration of test

10 s.

Expected sequence

Step	Direction	Message	Comments
1	SS -> MS	PAGING REQUEST TYPE 1	
2	MS -> SS	CHANNEL REQUEST	
3	SS -> MS	IMMEDIATE ASSIGNMENT	
4	MS -> SS	PAGING RESPONSE	
5	SS -> MS	CIPHERING MODE COMMAND	See specific message contents
6	MS -> SS	CIPHERING MODE COMPLETE	
7	SS -> MS	ASSIGNMENT COMMAND	See specific message contents
8	MS -> SS	ASSIGNMENT COMPLETE	On the dedicated channel
9	SS -> MS	CHANNEL RELEASE	See specific message contents
10	SS		The SS checks the release of the main signalling link at layer 2 level.

Specific message contents

None.

Step 5: CIPHERING MODE COMMAND

Cipher mode setting - algorithm identifier - SC Cipher Response Unknown IE (type 2)	cipher with A5/1 start ciphering IMEI shall not be included 1001 0010
---	--

Step 7: ASSIGNMENT COMMAND

Channel Description Channel Type Timeslot number Training sequence code Hopping MAIO HSN Power Command First Unknown IE (Type 2) Cell Channel Description Second Unknown IE (Type 4) - IEI - length - contents Mobile Allocation	TCH/F + ACCHs arbitrarily selected, but not zero arbitrarily selected RF hopping channel 0 0 arbitrarily selected 1101 1010 For PGSM and EGSM mobiles, bit map 0 encodes ARFCNs 30 and 50. For DCS 1 800 mobiles, the variable bit map format encodes ARFCNs 650 and 750. 0110 1001 2 xxxx xxxx xxxx xxxx, where x is arbitrarily coded. For PGSM and EGSM mobiles, indicates ARFCN 50, only. For DCS 1 800 mobiles, indicates ARFCN 750, only.
--	---

Step 9: CHANNEL RELEASE

RR Cause Unknown IE (type 4) - IEI - length - contents	normal event 0110 0010 5 xxxx xxxx xxxx xxxx xxxx xxxx xxxx xxxx xxxx, where x is arbitrarily coded.
--	--

26.5.7 Handling of unknown, unforeseen, and erroneous protocol data, and of parallel transactions / spare bits**26.5.7.1 Spare bits / RR****26.5.7.1.1 Spare bits / RR / paging channel****26.5.7.1.1.1 Conformance requirements**

The MS shall ignore the value of spare bits.

References

GSM 04.08, section 10.5.

26.5.7.1.1.2 Test purpose

To verify that the MS in the MM-state "idle, updated" and in RR-idle mode ignores the value of spare bits in the special case of the spare bits occurring in the P1 Rest Octets IE of a PAGING REQUEST TYPE 1 message. That the spare bits are ignored is checked by addressing the MS in that PAGING REQUEST message and verifying that the MS responds to that paging.

26.5.7.1.1.3 Method of test**Initial conditions**

System Simulator:

1 cell, default parameters.

Mobile Station:

The MS is in the MM-state "idle, updated" and in RR-idle mode.

Related PICS/PIXIT statements

None.

Foreseen Final State of the MS

The MS is in the MM-state "idle, updated" and in RR-idle mode.

Test Procedure

The SS sends a PAGING REQUEST TYPE 1 message containing at least one octet in the P1 rest octets IE that is different from 0010 1011.

Maximum duration of test

10 s.

Expected sequence

Step	Direction	Message	Comments
1	SS -> MS	PAGING REQUEST TYPE 1	See below.
2	MS -> SS	CHANNEL REQUEST	
3	SS -> MS	IMMEDIATE ASSIGNMENT REJECT	

Specific message contents**PAGING REQUEST TYPE 1**

Information element	Value/remark
L2 pseudo length	k+3 where k is the sum of the length of the mobile identity 1 IE
Page Mode	Normal paging
Channels needed for Mobiles 1 and 2	
Channel (first)	Any channel
Channel (second)	(spare)
Mobile identity 1	IMSI or TMSI of MS under test
Mobile identity 2	Omitted
P1 rest octets	not all octets are "0010 1011"

26.5.7.1.2 Spare bits / RR / BCCH**26.5.7.1.2.1 Conformance requirements**

The MS shall ignore the value of spare bits.

References

GSM 04.08, section 10.5.

26.5.7.1.2.2 Test purpose

To verify that the MS in the MM-state "idle, updated" and in RR-idle mode ignores the value of spare bits in the special case where these spare bits are contained in the SI3 and SI4 messages. That the MS ignores the value of the spare bits is checked by changing the LAI in those message and observing the MS initiating a location update though the spare bits do not all have the default value.

26.5.7.1.2.3 Method of test**Initial conditions**

System Simulator:

1 cell, default parameters.

Mobile Station:

The MS is in the MM-state "idle, updated" and in RR-idle mode.

Related PICS/PIXIT statements

None.

Foreseen Final State of the MS

The MS is in the MM-state "idle, updated" and in RR-idle mode.

Test Procedure

The SS simulates a BCCH where continuously for at least 30 seconds at least one octet of the SI3 Rest Octets IE in all SYSTEM INFORMATION TYPE 3 messages and at least one octet of the SI4 Rest Octets IE in all SYSTEM INFORMATION TYPE 4 messages is different from 0010 1011 and the location area identification IE denotes a location area different from the current location area held by the MS. The SS verifies that the MS sends a CHANNEL REQUEST message on the RACH including the establishment cause "location updating". The SS responds with an IMMEDIATE ASSIGNMENT REJECT message.

Maximum duration of test

10 s.

Expected sequence

Step	Direction	Message	Comments
1	SS -> MS		The SS starts sending modified SYSTEM INFORMATION TYPE 3 and SYSTEM INFORMATION TYPE 4 messages (as defined below) continuously for at least 30 seconds on the BCCH.
2	MS -> SS	CHANNEL REQUEST	Establishment cause = "location updating (SDCCH needed). This message may be received during the 30 seconds.
3	SS -> MS	IMMEDIATE ASSIGNMENT REJECT	

Specific message contents**SYSTEM INFORMATION TYPE 3**

Information element	value/remark
L2 pseudo length	18
cell identity	as required
location area identification	denoting a new location area
control channel description	as required, but with the spare bits arbitrarily selected and at least one spare bit set to 1.
cell options	as required, but with (spare) bit 8 set to 1
cell selection parameters	as required
RACH control parameters	as required
SI3 rest octets	at least one octet is different from "0010 1011"

SYSTEM INFORMATION TYPE 4

Information element	value/remark
L2 pseudo length	12
location area identification	denoting a new location area
cell selection parameters	as required
RACH control parameters	as required
SI4 rest octets	at least one octet is different from "0010 1011"

26.5.7.1.3 Spare bits / RR / AGCH**26.5.7.1.3.1 Conformance requirements**

The MS shall ignore the value of spare bits.

References

GSM 04.08, section 10.5.

26.5.7.1.3.2 Test purpose

To verify that the MS in the MM-state "idle, updated" and in RR-idle mode ignores the value of spare bits in the special case of the spare bits occurring in the Page Mode IE, the Spare Half Octet IE, the Channel Description IE, the Timing Advance IE, the IA Rest Octet IE, and in the IAR Rest Octet IE.

26.5.7.1.3.3 Method of test**Initial conditions**

System Simulator:
1 cell, default parameters.

Mobile Station:
The MS is in the MM-state "idle, updated" and in RR-idle mode.

Related PICS/PIXIT statements

None.

Foreseen Final State of the MS

The MS is in the MM-state "idle, updated" and in RR-idle mode.

Test Procedure

The SS sends an IMMEDIATE ASSIGNMENT message containing arbitrary spare bits in the Page Mode IE, in the Spare Half Octet IE, in the Channel Description IE, in the Timing Advance IE, and in the IA Rest Octet IE.

It is checked that the MS answers on the dedicated channel with a PAGING RESPONSE message and releases the main signalling link after a CHANNEL RELEASE message.

After a new paging of the MS an IMMEDIATE ASSIGNMENT REJECT is sent to test the spare bits in the IAR Rest Octet IE.

The MS is then paged again to check the idle state.

Maximum duration of test

20 s.

Expected sequence

Step	Direction	Message	Comments
1	SS -> MS	PAGING REQUEST TYPE 1	Addressing the MS under test
2	MS -> SS	CHANNEL REQUEST	
3	SS -> MS	IMMEDIATE ASSIGNMENT	see below
4	MS -> SS	PAGING RESPONSE	
5	SS -> MS	CHANNEL RELEASE	
6	SS		The SS checks that the MS releases the main signalling link and waits 10 seconds for a cell reselection of the MS
7	SS -> MS	PAGING REQUEST TYPE 1	Addressing the MS under test
8	MS -> SS	CHANNEL REQUEST	
9	SS -> MS	IMMEDIATE ASSIGNMENT REJECT	normal, waiting time = 0, except the IAR Rest Octet IE (see below)
10	SS		The SS waits six seconds
11	SS -> MS	PAGING REQUEST TYPE 1	Addressing the MS under test
12	MS -> SS	CHANNEL REQUEST	To check that the MS has reached the idle state after the IMMEDIATE ASSIGNMENT REJECT

Specific message contents

IMMEDIATE ASSIGNMENT

Information element	Value/remark
L2 pseudo length	sum of the length of all IE except L2 pseudo length and IA Rest Octets
Protocol Discriminator	RR
Skip Indicator	0000
Message Type	Immediate Assignment
Page mode	xx00 (where "xx" is arbitrary, with at least 1 bit set to 1)
Spare half octet	xxxx (where "xxxx" is arbitrary, with at least 1 bit set to 1)
Channel description	normal, no hopping, the two spare bits before ARFCN are chosen arbitrarily with at least one bit set to 1.
Request reference	normal (derived from the CHANNEL REQUEST)
Timing advance	xx00 0000 (where "xx" is arbitrary, with at least 1 bit set to 1)
Mobile allocation	chosen so that, together with the channel description
Length	0
IA rest octets	
first octet	00xx xxxx (where "xx xxxx" is arbitrary but different to 10 1011)
other octets	xxxx xxxx (where "xxxx xxxx" is arbitrary but different to 0010 1011)

IMMEDIATE ASSIGNMENT REJECT

Information element	Value/remark
L2 pseudo length	19
Page mode	normal
Spare half octet	xxxx (where "xxxx" is arbitrary, with at least 1 bit is set to 1)
Request reference 1	addressing the MS under test
Wait indication 1	0 seconds
...	Other Request References and Wait Indications arbitrary
IAR rest octets	
Octet 1 to 3	xxxx xxxx (where "xxxx xxxx" is arbitrary but different to 0010 1011)

26.5.7.1.4 Spare bits / RR / Connected Mode

26.5.7.1.4.1 Conformance requirements

The MS shall ignore the value of spare bits.

References

GSM 04.08, section 10.5.

26.5.7.1.4.2 Test purpose

To verify that the MS in the MM-state "MM-Connection active" and in RR-Connected mode ignores the value of spare bits in the special case of the spare bits occurring in the Cell Channel Description IE and in the Power Command IE.

26.5.7.1.4.3 Method of test**Initial conditions**

System Simulator:

- 1 cell, default parameters, except:
 - PGSM and EGSM mobiles are assigned to ARFCN 124 in step 10.
 - DCS 1 800 mobiles are assigned to ARFCN 801 in step 10.

Mobile Station:

The MS is in the MM-state "idle, updated" and in RR-idle mode.

Related PICS/PIXIT statements

Mobile's frequency capabilities, PGSM or EGSM or DCS 1 800.

Foreseen Final State of the MS

The MS is in the MM-state "idle, updated" and in RR-idle mode.

Test Procedure

In the procedure of a normal call establishment the ASSIGNMENT COMMAND will be modified to test the spare bits in the Cell Channel Description IE and in the Power Command IE.

Maximum duration of test

10 s.

Expected sequence

Step	Direction	Message	Comments
1	SS -> MS	PAGING REQUEST TYPE 1	Addressing the MS under test
2	MS -> SS	CHANNEL REQUEST	
3	SS -> MS	IMMEDIATE ASSIGNMENT	
4	MS -> SS	PAGING RESPONSE	
5	SS -> MS	CIPHERING MODE COMMAND	
6	MS -> SS	CIPHERING MODE COMPLETE	
7	SS -> MS	SETUP	
8	MS -> SS	CALL CONFIRMED	
A9	MS -> SS	ALERTING	
B9	MS -> SS	CONNECT	
10	SS -> MS	ASSIGNMENT COMMAND	see below on the dedicated channel
11	MS -> SS	ASSIGNMENT COMPLETE	
12	SS -> MS	CHANNEL RELEASE	
13	SS		
			The SS checks that the MS release the main signalling link

Specific message contents

ASSIGNMENT COMMAND

For PGSM and EGSM mobiles

Information element	Value/remark
Channel Description	normal, hopping HSN=63, MAIO=0
Power Command	xxx0 0111 (where "xxx" is arbitrary, with at least 1 bit set to 1)
Cell Channel Description octet 2	00xx 1000 (where "xx" is arbitrary, with at least 1 bit set to 1)
octet 3 to 17 (inclusive)	all bits set to zero
Mobile Allocation	indicates ARFCN 124 only

For DCS 1 800 mobiles

Information element	Value/remark
Channel Description	normal, hopping, HSN=63, MAIO=0
Power Command	xxx0 0111 (where "xxx" is arbitrary, with at least 1 bit set to 1)
Cell Channel Description octet 2	10xx 111? (where "xx" is arbitrary, with at least 1 bit set to 1). Bit 1 of octet 2 and all of octets 3 to 17 (inclusive) indicate ARFCN 801 only (using the variable bit map format).
Mobile Allocation	indicates ARFCN 801 only

26.5.7.2 Spare bits / MM

26.5.7.2.1 Conformance requirements

The MS shall ignore the value of spare bits.

References

GSM 04.08, section 10.5.

26.5.7.2.2 Test purpose

To verify that the MS in the MM-state "wait net cmd" and in RR-Connected mode ignores the value of spare bits in the special case of the spare bits occurring in the Cipher Key Seq. Number IE or in the Identity Type IE.

26.5.7.2.3 Method of test

Initial conditions

System Simulator:

1 cell, default parameters.

Mobile Station:

The MS is in the MM-state "idle, updated" and in RR-idle mode.

Related PICS/PIXIT statements

None.

Foreseen Final State of the MS

The MS is in the MM-state "idle, updated" and in RR-idle mode.

Test Procedure

After the establishment of the RR-connection, in the AUTHENTICATION REQUEST message the spare bits of the Ciphering Key Sequence Number and of the Spare Half Octet IE will be randomly chosen. The spare bits of the Identity Type IE and the Spare Half Octet IE in the IDENTITY REQUEST message will also be chosen arbitrarily.

Maximum duration of test

10 s.

Expected sequence

Step	Direction	Message	Comments
1	SS -> MS	PAGING REQUEST TYPE 1	Addressing the MS under test
2	MS -> SS	CHANNEL REQUEST	
3	SS -> MS	IMMEDIATE ASSIGNMENT	see below
4	MS -> SS	PAGING RESPONSE	
5	SS -> MS	AUTHENTICATION REQUEST	see below
6	MS -> SS	AUTHENTICATION RESPONSE	
7	SS -> MS	IDENTITY REQUEST	see below with the right TMSI
8	MS -> SS	IDENTITY RESPONSE	
9	SS -> MS	CHANNEL RELEASE	The SS checks that the MS release the main signalling link
10	SS		

Specific message contents

AUTHENTICATION REQUEST

Information element	Value/remark
Ciphering Key Sequence Number	x000 (where "x" is set to 1)
Spare Half Octet	xxxx (where "xxxx" is arbitrary, with at least 1 bit set to 1)
Auth. Parameter RAND	standard value

IDENTITY REQ

Information element	Value/remark
Identity Type	x100 (where "x" is set to 1)
Spare Half Octet	xxxx (where "xxxx" is arbitrary, with at least 1 bit set to 1)

26.5.7.3 Spare bits / CC

This test is applicable to all MS supporting at least one MT circuit switched basic service.

26.5.7.3.1 Conformance requirements

The MS shall ignore the value of spare bits.

References

GSM 04.08, section 10.5.

26.5.7.3.2 Test purpose

To verify that the MS in the MM-state "connection established" and in RR-Connected mode ignores the value of spare bits in the special case of the spare bits occurring in the Calling Party BCD Number IE, Calling Party Subaddress IE, Called Party Subaddress IE, Cause IE and Progress Indicator IEs.

26.5.7.3.3 Method of test

Initial conditions

System Simulator:

1 cell, default parameters.

Mobile Station:

The MS is in the MM-state "idle, updated" and in RR-idle mode.

Related PICS/PIXIT statements

At least one circuit switched basic service supported.

MT calls supported.

Foreseen Final State of the MS

The MS is in the MM-state "idle, updated" and in RR-idle mode.

Test Procedure

After the establishment of the MM-connection, in the SETUP message the spare bits of the Calling Party BCD Number, Calling Party Subaddress and Called Party Subaddress will be arbitrarily chosen and also in the DISCONNECT message the spare bits of the Progress Indicator IE and of the Cause IE will be arbitrarily chosen.

Maximum duration of test

10 s.

Expected sequence

Step	Direction	Message	Comments	
1	SS -> MS	PAGING REQUEST TYPE 1	Addressing the MS under test	
2	MS -> SS	CHANNEL REQUEST		
3	SS -> MS	IMMEDIATE ASSIGNMENT		
4	MS -> SS	PAGING RESPONSE		
5	SS -> MS	AUTHENTICATION REQUEST		
6	MS -> SS	AUTHENTICATION RESPONSE		
7	SS -> MS	CIPHERING MODE COMMAND		
8	MS -> SS	CIPHERING MODE COMPLETE		
9	SS -> MS	SETUP		see below
10	MS -> SS	CALL CONFIRMED		
A11	MS -> SS	CONNECT		
B11	MS -> SS	ALERTING		
B12	MS -> SS	CONNECT		
13	SS -> MS	ASSIGNMENT COMMAND	see below with actual call state U12	
14	MS -> SS	ASSIGNMENT COMPLETE		
15	SS -> MS	CONNECT ACKNOWLEDGE		
16	SS -> MS	DISCONNECT		
17	SS -> MS	STATUS ENQUIRY		
18	MS -> SS	STATUS		
19	SS -> MS	RELEASE		
20	MS -> SS	RELEASE COMPLETE		
21	SS -> MS	CHANNEL RELEASE		

Specific message contents

SETUP

Information element	Value/remark
Calling Party BCD Number	
IEI	
length	3
octet 3	0000 0000
octet 3a	100x xx00 (where "x" is chosen arbitrarily, with at least one bit set to 1)
octet 4	0000 0001
Calling Party Subaddress	
IEI	
length	3
octet 3	1000 0xxx (where "x" is chosen arbitrarily, with at least one bit set to 1)
octet 4	0101 0000 (AFI: request IA5 character)
octet 5	0000 0001
Called Party Subaddress	
IEI	
length	3
octet 3	1000 0xxx (where "x" is chosen arbitrarily, with at least one bit set to 1)
octet 4	0101 0000 (AFI: request IA5 character)
octet 5	0000 0001

DISCONNECT

Information element	Value/remark
Cause	
Length	2
octet 3	111x 0000 (where "x" is set to 1)
octet 4	1000 0001
Progress Indicator	
IEI	
Length	2
octet 3	111x 0000 (where "x" is set to 1)
progress description	8 (in band info now available)

26.5.8 Default contents of messages

Default requirements for messages that are not mentioned in this section are given in section 26.8.4.

CHANNEL RELEASE

Information element	Value/remark
RR cause	Normal event

CHANNEL REQUEST**DISCONNECT (SS -> MS)**

Information element	Value/remark
Cause	
Coding standard	Standard defined for the GSM PLMNS
Location	user
Cause value	#16

IDENTITY REQUEST

Information element	Value/remark
Identity type	Depending on test
Spare half octet	0000

IMMEDIATE ASSIGNMENT

Information element	Value/remark
L2 pseudo length	n, where n is the L2 pseudo length of the message
Page mode	arbitrary
Spare half octet	0000
Channel description	a valid description of an SDCCH + SACCH
Request reference	Corresponding to the last CHANNEL REQUEST received from the MS
Timing advance	arbitrary
Mobile allocation	chosen so that, together with the channel description IE, it describes a valid SDCCH + SACCH
Starting time	Omitted
IA rest octets	m octets, each coded as H'2B, where $m = 22 - n$

IMMEDIATE ASSIGNMENT REJECT

Information element	Value/remark
L2 pseudo length	19
Page mode	arbitrary
Spare half octet	0000
Request reference 1	corresponding to the last CHANNEL REQUEST received from the MS
Wait indication 1	0 seconds
Request reference 2	arbitrary
Wait indication 2	0 seconds
Request reference 3	arbitrary
Wait indication 3	0 seconds
Request reference 4	arbitrary
Wait indication 4	0 seconds
IA rest octets	3 octets, each coded as H'2B

PAGING REQUEST TYPE 1

Information element	Value/remark
L2 pseudo length	n where n is the sum of the mobile identity 1 IE and 3
Page Mode	Normal paging
Channels needed for Mobiles 1 and 2	
Channel (first)	Any channel
Channel (second)	(spare)
Mobile identity 1	IMSI or TMSI of MS under test
Mobile identity 2	Omitted
P1 rest octets	m octets, each coded as H'2B, where $m = 22 - n$

PAGING RESPONSE**RELEASE COMPLETE (MS -> SS)**

No default requirements defined for this message.

RELEASE COMPLETE (SS -> MS)

Information element	Value/remark
Cause	
Coding standard	Standard defined for the GSM PLMNS
Location	user
Cause value	#16

STATUS (MS -> SS)

Information element	Value/remark
Cause	
Length	length of cause IE
Coding standard	Standard defined for the GSM PLMNS
Location	user
Cause value	as defined in test
Call state	as defined in test

STATUS ENQUIRY (SS -> MS)

Information element	Value/remark
Transaction identifier	relating to the active call

26.6 Test of the elementary procedures for radio resource management

NOTE: For SS implementor: if tests are concatenated, it is important that unused fields in IMMEDIATE ASSIGNMENT REJECT messages do not use Request References that relate to CHANNEL REQUEST messages recently transmitted by the MS.

26.6.1 Immediate assignment

The immediate assignment procedure is used by the network to establish a dedicated control channel for the MS and network to communicate the detail of the service requested. If the Mobile Station does not implement the procedure correctly, radio resources can be wasted as the Mobile Station might use the wrong channels.

26.6.1.1 Immediate assignment / SDCCH or TCH assignment

26.6.1.1.1 Conformance requirement

1. Following a PAGING REQUEST message, the MS shall correctly set up an RR connection on the SDCCH/8 described in the IMMEDIATE ASSIGNMENT message.
2. Following a PAGING REQUEST message, the MS shall correctly set up an RR connection on the TCH/FACCH described in the IMMEDIATE ASSIGNMENT message.

Reference(s)

GSM 04.08 section 3.3.1.2.1.

26.6.1.1.2 Test purpose

To verify that the MS can correctly set up a dedicated SDCCH control channel and that the MS can correctly set up a dedicated TCH/FACCH control channel.

26.6.1.1.3 Method of test

Initial Conditions

System Simulator:

1 cell, except that CCCH_CONF is set to "1 basic physical channel used for CCCH not combined with SDCCHs".

Mobile Station:

The MS is in the "idle, updated" state, with a TMSI allocated.

Related PICS/PIXIT Statement(s)

Type of MS (P-GSM 900 or EGSM or DCS 1 800).

Support rate(s) of TCH: TCH/F and/or TCH/H.

Foreseen Final State of the MS

"Idle, updated", with TMSI allocated.

Test Procedure

The System Simulator pages the MS and after the MS has responded with a CHANNEL REQUEST message the SS assigns an SDCCH. The MS shall go to the correct channel and send a PAGING RESPONSE message. Then the SS initiates RR-release by sending a CHANNEL RELEASE message.

If TCH/F is supported by the MS, the test is repeated with the SS assigning a TCH/F.

If TCH/H is supported by the MS, the test is repeated with the SS assigning a TCH/H.

Maximum Duration of Test

6 seconds per value of the execution timer.

Expected Sequence

This sequence is performed for execution counter, K = 1, 2, 3 (unless the TCH is not supported).

Step	Direction	Message	Comments
1	SS -> MS	PAGING REQUEST TYPE 1	Channel Type: see below Shall be sent on the correct channel
2	MS -> SS	CHANNEL REQUEST	
3	SS -> MS	IMMEDIATE ASSIGNMENT	
4	MS -> SS	PAGING RESPONSE	
5	SS -> MS	CHANNEL RELEASE	

Specific Message Contents

IMMEDIATE ASSIGNMENT

K=1, SDCCH test: Channel Type = SDCCH/8

K=2, TCH/F test: Channel Type = Bm + ACCHs

K=3, TCH/H test: Channel Type = Lm + ACCHs, subchannel arbitrarily chosen

26.6.1.2 Immediate assignment / extended assignment

NOTE 2: In these tests the SS must send the immediate assignment messages in due time to allow for the MS to receive them and send a PAGING RESPONSE rather than another random access. This applies to the whole of section 26.

26.6.1.2.1 Conformance requirements

1. The MS shall go to the allocated SDCCH/4 and send a PAGING RESPONSE message containing its identity and its classmark.
2. The MS shall go to the allocated SDCCH/8 and send a PAGING RESPONSE message containing its identity and its classmark.
3. The MS shall correctly identify its own assignment in either the Request Reference 1 or the Request Reference 2 information element in an extended assignment message.
4. The MS shall only react to an Immediate Assignment which references one of the last 3 CHANNEL REQUEST messages from the MS.

References

GSM 04.08 section 3.3.

26.6.1.2.2 Test purpose

To verify that the MS goes to the allocated SDCCH/4 and sends a PAGING RESPONSE message containing its identity and its classmark.

To verify that the MS goes to the allocated SDCCH/8 and sends a PAGING RESPONSE message containing its identity and its classmark.

To verify that the MS can correctly identify its own assignment in either the Request Reference 1 or the Request Reference 2 information element in an extended assignment message.

To verify that the MS only reacts to an Immediate Assignment which references one of the last 3 CHANNEL REQUEST messages from the MS.

26.6.1.2.3 Method of test

Initial Conditions

System Simulator:

1 cell, Max-retrans is set to 7.

Mobile Station:

The MS is in the "idle, updated" state. with a TMSI allocated.

Related PICS/PIXIT Statements

Type of MS (P-GSM 900 or EGSM or DCS 1 800).

Foreseen Final State of the MS

"Idle, updated", with a TMSI allocated.

Test Procedure

In the first part of the test, the SS pages the MS, which shall react by sending CHANNEL REQUEST messages. Immediately after reception of the n-th CHANNEL REQUEST message (n being arbitrarily chosen by the SS from the set {1, 2 ... 8}) the SS sends an IMMEDIATE ASSIGNMENT EXTENDED message, which references one of the last 3 CHANNEL REQUEST messages from the MS. The MS shall then go to the correct channel and send a PAGING RESPONSE message. The SS will then release the channel.

In the second part of the test, the SS again pages the MS, which shall react by sending CHANNEL REQUEST messages. Immediately after reception of the k-th CHANNEL REQUEST message (k being arbitrarily chosen by the SS from the set {4, 5 ... 8}) the SS sends an IMMEDIATE ASSIGNMENT EXTENDED message which, instead of referencing one of the last 3 CHANNEL REQUEST messages from the MS, references an earlier CHANNEL REQUEST message. The MS shall then ignore the IMMEDIATE ASSIGNMENT EXTENDED message and continue to send CHANNEL REQUEST messages until the Max-Retrans value has been reached. Then a period of 7 seconds shall elapse in order to allow the MS to perform cell reselection (this allows for the time between the last CHANNEL REQUEST message and the beginning of cell reselection).

In the third part of the test, the CCCH_CONF of the SS is set to non-combined and the SS pages the MS, which shall react by sending CHANNEL REQUEST messages. Immediately after reception of the r-th CHANNEL REQUEST message (r being arbitrarily chosen by the SS from the set {4, 5 ... 8}) the SS sends an IMMEDIATE ASSIGNMENT EXTENDED message which, in the second request reference, references one of the last 3 CHANNEL REQUEST messages from the MS. The associated Channel Description allocates SDCCH(S) (S being arbitrarily chosen by the SS from the set {0,1 ... 7}). The MS shall then go to the correct channel and send a PAGING RESPONSE message. The SS will then release the channel.

Maximum Duration of Test

90 seconds.

Expected Sequence

Step	Direction	Message	Comments
1	SS -> MS	PAGING REQUEST TYPE 1	
2	MS -> SS	CHANNEL REQUEST	n CHANNEL REQUESTs (n being arbitrarily chosen from {1... 8}) are sent, all with Establ. Cause = "Answer to paging".
3	MS -> SS	CHANNEL REQUEST	
4	SS -> MS	IMMEDIATE ASSIGNMENT EXTENDED	see note 3.
5	MS -> SS	PAGING RESPONSE	
6	SS -> MS	CHANNEL RELEASE	
7	-----	-----	The SS waits 12 seconds to allow the MS to perform cell reselection.
8	SS -> MS	PAGING REQUEST TYPE 1	
9	MS -> SS	CHANNEL REQUEST	k CHANNEL REQUESTs (k being arbitrarily chosen from the set {4, 5, 8}) are sent all with Establ. Cause = "Answer to paging".
10	MS -> SS	CHANNEL REQUEST	
11	SS -> MS	IMMEDIATE ASSIGNMENT EXTENDED	see note 4.
12	MS -> SS	CHANNEL REQUEST	8-k CHANNEL REQUESTs are sent, all with Establ. Cause = "Answer to paging".
13	MS -> SS	CHANNEL REQUEST	
14	SS		The SS verifies that the MS does not transmit any Layer 2 frames for at least 3 seconds.
15	SS		The SS sets CCCH_CONF to non-combined.
16	SS		The SS waits 40 seconds to allow the MS to perform cell reselection and to read the BCCH information.
17	SS -> MS	PAGING REQUEST TYPE 1	
18	MS -> SS	CHANNEL REQUEST	r CHANNEL REQUESTs (r being arbitrarily chosen from {4, 5... 8}) are sent, all with Establ. Cause = "Answer to paging".
19	MS -> SS	CHANNEL REQUEST	
20	SS -> MS	IMMEDIATE ASSIGNMENT EXTENDED	see note 5.
21	MS -> SS	PAGING RESPONSE	
22	SS -> MS	CHANNEL RELEASE	

Specific Message Contents

NOTE 3: The first Request Reference is the one which pertains to the i-th CHANNEL REQUEST sent by the MS, where i is an integer in the set {max (1,n-2) ... n}, its value being arbitrarily chosen by the SS. The second Request Reference shall be different from any Request Reference the MS has generated in this test.

NOTE 4: The first Request Reference is the one which pertains to the i-th CHANNEL REQUEST sent by the MS, where i is an integer in the set {1 ... k-3}, its value being arbitrarily chosen by the SS. The second Request Reference shall be different from any Request Reference the MS has generated in this test.

NOTE 5: The second Request Reference is the one which pertains to the i-th CHANNEL REQUEST sent by the MS, where i is an integer in the set {r-2, r-1, r}, its value being arbitrarily chosen by the SS. The first Request Reference shall be different from any Request Reference the MS has generated in this test.

26.6.1.3 Immediate assignment / assignment rejection

26.6.1.3.1 Conformance requirements

1. The MS shall respond to the Paging Request message by sending a Channel Request message with establishment cause set to "Answer to Paging". After the reception of IMMEDIATE

ASSIGNMENT REJECT, the MS shall not transmit during the time indicated in the "Wait Indication" field of the IMMEDIATE ASSIGNMENT REJECT message, and then it shall answer to the new paging requests.

2. After an assignment rejection, the MS shall perform a cell reselection (idle mode operation) and the MS shall not transmit unless a different cell is selected.

References

GSM 04.08, section 3.3.1.3 and GSM 04.13 section 5.2.2.

26.6.1.3.2 Test purpose

To verify that the MS can accept an IMMEDIATE ASSIGNMENT REJECT.

To verify that the MS can respond to paging after an IMMEDIATE ASSIGNMENT REJECT is received on a different cell.

26.6.1.3.3 Method of test

Initial Conditions

System Simulator:

2 cells with the same LAI, Max-Retrans is 7.

Mobile Station:

The MS is camped on cell A and is in the "idle, updated" state, with a TMSI allocated.

Related PICS/PIXIT Statements

Type of MS (P-GSM 900 or EGSM or DCS 1 800).

Foreseen Final State of the MS

The MS is camped on cell B and is in the "idle, updated" state, with a TMSI allocated.

Test Procedure

The SS pages the MS, which shall react by sending CHANNEL REQUESTs. Immediately after reception of the n-th CHANNEL REQUEST (n being an integer from the set {1, 2 ... 8}, arbitrarily chosen by the SS) the SS sends an IMMEDIATE ASSIGNMENT REJECT message, which references one of the last 3 CHANNEL REQUESTs from the MS, and with the Wait Indication set to x seconds (x being an integer from the set {5, 6 ... 255}, arbitrarily chosen by the SS). The SS continues to send paging messages for that mobile station in every block of the mobile station's paging subgroup for x+2 seconds. The MS shall not answer to the PAGING REQUEST TYPE 1 messages sent before x seconds have elapsed. The MS may respond to any one of the PAGING REQUEST TYPE 1 messages sent after x seconds have elapsed, but at the latest it shall respond to the first PAGING REQUEST TYPE 1 sent after x+1 seconds have elapsed.

The SS responds to this CHANNEL REQUEST with an IMMEDIATE ASSIGNMENT REJECT message with the Wait Indication set to 255 seconds.

Immediately afterwards the SS changes the power levels so the MS selects cell B. After 12 seconds have elapsed the SS pages the MS in cell B and the MS shall answer to this page. In order to avoid another cell reselection the SS then sends another IMMEDIATE ASSIGNMENT REJECT.

Maximum Duration of Test

5 minutes.

Expected Sequence

Step	Direction	Message	Comments
1	SS -> MS	PAGING REQUEST TYPE 1	<p>n CHANNEL REQUESTs (n being arbitrarily chosen from the set {1, 2 ... 8}) are sent, all with Establ. Cause = "Answer to paging"</p> <p>1st, 3rd and 4th Request References are different to all n Request References received from the MS under test. 2nd Request Reference: see note 6. 2nd Wait Indication = x seconds (x being arbitrarily chosen from the set {5, 6 ... 255}).</p> <p>The SS repeatedly pages the MS (on its paging subchannel) until a CHANNEL REQUEST message is received from the MS.</p> <p>(note 7).</p> <p>Establ. Cause = "Answer to paging".</p> <p>The MS may respond to any one of the PAGING REQUEST TYPE 1 messages sent after x seconds expire, but at the latest the MS shall respond to the first PAGING REQUEST TYPE 1 message sent after x+1 seconds expire.</p> <p>1st, 2nd and 4th Request References are different to all n Request References received from the MS. The 3rd Request Reference pertains to the last CHANNEL REQUEST sent by the MS. The 3rd Wait Indication is 255 seconds.</p> <p>Raise power level of cell B, lower power level of cell A until the MS selects cell B.</p> <p>Sent once, 12 seconds after the change of levels.</p> <p>Establ. Cause = "Answer to paging".</p>
2	MS -> SS	CHANNEL REQUEST	
.	.	.	
.	.	.	
1+n	MS -> SS	CHANNEL REQUEST	
2+n	SS -> MS	IMMEDIATE ASSIGNMENT REJECT	
3+n	SS -> MS	PAGING REQUEST TYPE 1	
.	.	.	
.	.	.	
k	SS -> MS	PAGING REQUEST TYPE 1	
k+1	MS -> SS	CHANNEL REQUEST	
k+2	SS -> MS	IMMEDIATE ASSIGNMENT REJECT	
k+3	-----	-----	
k+4	SS -> MS	PAGING REQUEST TYPE 1	
k+5	MS -> SS	CHANNEL REQUEST	
k+6	SS -> MS	IMMEDIATE ASSIGNMENT REJECT	

NOTE 6: The Request Reference is the one which pertains to the i-th CHANNEL REQUEST sent by the MS, where i is an integer from the set {max(1,n-2) ... n}, its value being arbitrarily chosen by the SS.

NOTE 7: the value of k is not important in this test.

Specific Message Contents

None.

26.6.1.4 Immediate assignment / ignore assignment

26.6.1.4.1 Conformance requirements

1. An MS waiting for a response from the network, following the sending of a CHANNEL REQUEST, shall ignore an IMMEDIATE ASSIGNMENT message with a request reference containing a wrong frame number.
2. An MS is waiting for an assignment of its own, shall ignore an IMMEDIATE ASSIGNMENT message with a request reference containing a wrong random access information.

References

GSM 04.08 section 3.3.1.2.1.

26.6.1.4.2 Test purpose

To verify that the MS ignores an assignment for another MS while it is waiting for an assignment of its own.

26.6.1.4.3 Method of test**Initial Conditions**

System Simulator:
1 cell.

Mobile Station:
The MS is in the "idle, updated" state, with a TMSI allocated.

Related PICS/PIXIT Statements

Type of MS (P-GSM 900 or EGSM or DCS 1 800).

Foreseen Final State of the MS

"Idle, updated", with TMSI allocated.

Test Procedure

The SS pages the MS, which reacts with CHANNEL REQUESTs. The SS responds to the first CHANNEL REQUEST with an IMMEDIATE ASSIGNMENT containing a wrong Request Reference (in the first run of the test the frame number is wrong, in the repetition it is the random access info that is wrong). It is verified for 2 seconds that the MS does not start signalling on the SDCCH. The MS shall ignore the assignment and send another CHANNEL REQUEST message. In order to avoid cell reselection the SS now answers with a correct IMMEDIATE ASSIGNMENT REJECT and repeats the test once.

Maximum Duration of Test

12 seconds.

Expected Sequence

Step	Direction	Message	Comments
1	SS -> MS	PAGING REQUEST TYPE 1	Establ. Cause = "Answer to paging". Frame number in Request Reference is 2 too high. The MS shall not start signalling on the assigned SDCCH. This is verified for a period of 2 seconds.
2	MS -> SS	CHANNEL REQUEST	
3	SS -> MS	IMMEDIATE ASSIGNMENT	
4	MS -> SS	CHANNEL REQUEST	Establ. Cause = "Answer to paging".
5	SS -> MS	IMMEDIATE ASSIGNMENT REJECT	
6	SS		SS waits for 6 seconds.
7	SS -> MS	PAGING REQUEST TYPE 1	Establ. Cause = "Answer to paging". Random access info in Request Reference is wrong. The MS shall not start signalling on the assigned SDCCH. This is verified for a period of 2 seconds.
8	MS -> SS	CHANNEL REQUEST	
9	SS -> MS	IMMEDIATE ASSIGNMENT	
10	MS -> SS	CHANNEL REQUEST	Establ. Cause = "Answer to paging".
11	SS -> MS	IMMEDIATE ASSIGNMENT REJECT	

Specific Message Contents

None.

26.6.1.5 Immediate assignment after immediate assignment reject

26.6.1.5.1 Conformance requirement

Following an IMMEDIATE ASSIGNMENT REJECT message, the MS shall listen for IMMEDIATE ASSIGNMENTS until T3126 expires.

Reference

GSM 04.08 section 3.3.1.3.2.

26.6.1.5.2 Test purpose

To verify that the MS correctly responds to an IMMEDIATE ASSIGNMENT message sent after an IMMEDIATE ASSIGNMENT REJECT message.

26.6.1.5.3 Method of test

Initial conditions

System Simulator:

- 1 cell;
- CCCH_CONF is set to "1 basic physical channel used for CCCH not combined with SDCCHs";
- Max retrans is set to 7;
- TX-integer is set to 7;

Mobile Station:

The MS is in "idle, updated" state, with a TMSI allocated.

Related PICS/PIXIT statement(s)

Type of MS (P-GSM 900 or EGSM or DCS 1 800).

Foreseen final state of the MS

"idle, updated", with TMSI allocated.

Test Procedure

The SS pages the MS, which shall react by sending CHANNEL REQUESTs. Immediately after reception of the third CHANNEL REQUEST the SS sends an IMMEDIATE ASSIGNMENT REJECT message which references the first CHANNEL REQUEST from the MS and has the Wait Indication IE set to 6 seconds.

Between 0,75 seconds and 1,25 seconds after sending the IMMEDIATE ASSIGNMENT REJECT message the SS sends an IMMEDIATE ASSIGNMENT message referencing the second CHANNEL REQUEST message, and assigning an SDCCH. The MS shall go to the correct channel and send a PAGING RESPONSE message. Then the SS initiates RR-release by sending a CHANNEL RELEASE message.

Maximum duration of test

10 seconds.

Expected Sequence

Step	Direction	Message	Comments
1	SS -> MS	PAGING REQUEST TYPE 1	
2	MS -> SS	CHANNEL REQUEST	first request.
3	MS -> SS	CHANNEL REQUEST	second request.
4	MS -> SS	CHANNEL REQUEST	third request.
5	SS -> MS	IMMEDIATE ASSIGNMENT REJ	references the first request from MS, Wait Indication IE set to 6 seconds.
6	SS -> MS	IMMEDIATE ASSIGNMENT	references the second request from the MS Channel type set to SDCCH/8 message sent between 0,75 s and 1,25 s after the completion of step 5.
7	MS -> SS	PAGING RESPONSE	
8	SS -> MS	CHANNEL RELEASE	shall be sent on the correct channel.

Specific message contents

None.

26.6.2 Test of paging

The Paging procedure is used by the network to cause the Mobile Station to establish a radio connection. Normally the Mobile Station listens to its paging subchannel, but this can be modified by the use of different page modes. The correct implementation of the paging procedure in the Mobile Station is essential for the basic establishment of a connection.

26.6.2.1 Normal paging**26.6.2.1.1 Paging / normal / type 1****26.6.2.1.1.1 Conformance requirements**

1. The MS shall respond correctly to various PAGING REQUEST TYPE 1 messages, when the page mode is set to normal paging, in the following cases:
 - 1.1 The MS is addressed with its IMSI in the first Mobile Identity field. The optional Mobile Identity field is not present.
 - 1.2. The MS is addressed with its TMSI in the first Mobile Identity field. The optional Mobile Identity field specifies an IMSI different from that of the MS.
 - 1.3. The first Mobile Identity field specifies a TMSI different from that of the MS. The optional Mobile Identity field addresses the MS by its IMSI.
 - 1.4 The first Mobile Identity field specifies a TMSI different from that of the MS. The optional Mobile Identity field contains the correct TMSI of the MS.
2. An MS shall ignore PAGING REQUEST TYPE 1 messages with incorrect information, when the page mode is set to normal paging, in the following case:
 - 2.1 The MS is addressed with its TMSI in the first Mobile Identity field, but the type of identity in this field is set to "No Identity". The optional Mobile Identity field is not present.

References

GSM 04.08 section 3.3.2, GSM 05.02 section 6.5.

26.6.2.1.1.2 Test purpose

To test that the MS is able to determine its CCCH group and paging group correctly and that the MS responds correctly to various PAGING REQUEST TYPE 1 messages when the page mode is set to normal paging. All valid ways of addressing the MS are tested. It is tested that the MS responds with the same type of identity that is used in the PAGING REQUEST TYPE 1 message. It is tested that the MS ignores fill paging.

26.6.2.1.1.3 Method of test

Initial Conditions

System Simulator:

1 cell, Max-Retrans = 2, a legal combination of CCCH_CONF, BS_AG_BLKES_RES and BS_PA_MFRMS is chosen arbitrarily by the SS.

Mobile Station:

The MS is in the "idle, updated" state, with a TMSI allocated.

Related PICS/PIXIT Statements

Type of MS (P-GSM 900 or EGSM or DCS 1 800).

Foreseen Final State of the MS

"Idle, updated", with TMSI allocated.

Test Procedure

The SS pages the MS 5 times with different PAGING REQUEST TYPE 1 messages on the paging subchannel which corresponds to the MS's IMSI.

In the first 4 cases, where the MS is addressed by its IMSI or its TMSI, the MS shall answer to the paging by sending CHANNEL REQUESTs. The SS responds to the second CHANNEL REQUEST by assigning a channel, and the MS shall then send a correct PAGING RESPONSE. The SS then releases the channel.

In the last case, it is tested that the MS does not answer to paging that does not address it.

Maximum Duration of Test

2 min.

Expected Sequence

Step	Direction	Message	Comments
1	SS -> MS	PAGING REQUEST TYPE 1	1st Mobile Ident contains IMSI of MS, 2nd Mobile Ident not present.
2	MS -> SS	CHANNEL REQUEST	Establ. Cause = "Answer to paging".
3	MS -> SS	CHANNEL REQUEST	Establ. Cause = "Answer to paging".
4	SS -> MS	IMMEDIATE ASSIGNMENT	Request Reference = pertaining to the message received in step 3.
5	MS -> SS	PAGING RESPONSE	Mobile Ident: IMSI.
6	SS -> MS	CHANNEL RELEASE	
	-----	-----	The SS waits 12 seconds to allow the MS to perform cell reselection.
7	SS -> MS	PAGING REQUEST TYPE 1	1st Mobile Ident contains TMSI of MS, 2nd Mobile Ident contains IMSI of another MS.
8	MS -> SS	CHANNEL REQUEST	Establ. Cause = "Answer to paging".
9	MS -> SS	CHANNEL REQUEST	Establ. Cause = "Answer to paging".
10	SS -> MS	IMMEDIATE ASSIGNMENT	Request Reference = pertaining to the message received in step 9.
11	MS -> SS	PAGING RESPONSE	Mobile Ident: TMSI.
12	SS -> MS	CHANNEL RELEASE	
	-----	-----	The SS waits 12 seconds to allow the MS to perform cell reselection.
13	SS -> MS	PAGING REQUEST TYPE 1	1st Mobile Ident contains TMSI of another MS, 2 nd Mobile Ident contains IMSI of MS.
14	MS -> SS	CHANNEL REQUEST	Establ. Cause = "Answer to paging".
15	MS -> SS	CHANNEL REQUEST	Establ. Cause = "Answer to paging".
16	SS -> MS	IMMEDIATE ASSIGNMENT	Request Reference = pertaining to the message received in step 15.
17	MS -> SS	PAGING RESPONSE	Mobile Ident: IMSI.
18	SS -> MS	CHANNEL RELEASE	
	-----	-----	The SS waits 12 seconds to allow the MS to perform cell reselection.
19	SS -> MS	PAGING REQUEST TYPE 1	1st Mobile Ident contains TMSI of another MS, 2 nd Mobile Ident contains TMSI of MS.
20	MS -> SS	CHANNEL REQUEST	Establ. Cause = "Answer to paging".
21	MS -> SS	CHANNEL REQUEST	Establ. Cause = "Answer to paging".
22	SS -> MS	IMMEDIATE ASSIGNMENT	Request Reference = pertaining to the message received in step 21.
23	MS -> SS	PAGING RESPONSE	Mobile Ident: TMSI.
24	SS -> MS	CHANNEL RELEASE	
	-----	-----	The SS waits 12 seconds to allow the MS to perform cell reselection.
25	SS -> MS	PAGING REQUEST TYPE 1	1st Mobile Ident contains TMSI of MS but with type of identity set to "no identity", second Mobile Ident not present.
26	-----	-----	During 1 second, the SS checks that the MS does not produce any Layer 3 messages.

Specific Message Contents

None.

26.6.2.1.2 Paging / normal / type 2

26.6.2.1.2.1 Conformance requirements

1. The MS shall respond correctly (by sending CHANNEL REQUEST messages with an Establishment Cause set to "Answer to Paging") to various PAGING REQUEST TYPE 2 messages, when the page mode is set to normal paging, in the following cases:
 - 1.1 The MS is addressed in the first TMSI field.
 - 1.2 The MS is addressed in the second TMSI field.
 - 1.3 The MS is addressed in the optional Mobile Identity field with its TMSI.

- 1.4 The MS is addressed in the optional Mobile Identity field with its IMSI.
2. The MS shall ignore PAGING REQUEST TYPE 2 messages with incorrect information, when the page mode is set to normal paging, in the following case:
 - 2.1 The MS is addressed in the optional Mobile Identity field with its TMSI, but the type of identity in this field is set to "No Identity".

References

GSM 04.08 section 3.3.2.

26.6.2.1.2.2 Test purpose

To test that the MS is able to determine its CCCH group and paging group correctly and that the MS responds correctly to various PAGING REQUEST TYPE 2 messages when the page mode is set to normal paging. All valid ways of addressing the MS are tested. It is tested that the MS responds with the same type of identity that is used in the PAGING REQUEST TYPE 2 message. It is tested that the MS ignores a PAGING REQUEST TYPE 2 message that does not address it.

26.6.2.1.2.3 Method of test

Initial Conditions

System Simulator:

1 cell, Max-Retrans = 2, a legal combination of CCCH_CONF, BS_AG_BLKES_RES and BS_PA_MFRMS is chosen arbitrarily by the SS.

Mobile Station:

The MS is in the "idle, updated" state, with a TMSI allocated.

Related PICS/PIXIT Statements

Type of MS (P-GSM 900 or EGSM or DCS 1 800).

Foreseen Final State of the MS

"Idle, updated", with TMSI allocated.

Test Procedure

The SS pages the MS 5 times with different PAGING REQUEST TYPE 2 messages on the paging subchannel which corresponds to the MS's IMSI.

In the first 4 cases, where the MS is addressed by its IMSI or by its TMSI, the MS shall answer to the paging by sending CHANNEL REQUESTs. The SS responds to the second request by assigning a channel, and the MS shall then send a correct PAGING RESPONSE. The SS then releases the channel.

In the last case, it is tested that the MS does not answer to paging that does not address it.

Maximum Duration of Test

5 minutes, including 1 minute for any necessary operator actions.

Expected Sequence

Step	Direction	Message	Comments
1	SS -> MS	PAGING REQUEST TYPE 2	1st TMSI addresses MS, 2nd TMSI addresses another MS, Mobile Identity IE not present.
2	MS -> SS	CHANNEL REQUEST	Establ. Cause = "Answer to paging".
3	MS -> SS	CHANNEL REQUEST	Establ. Cause = "Answer to paging".
4	SS -> MS	IMMEDIATE ASSIGNMENT	Request Reference = pertaining to the message received in step 3.
5	MS -> SS	PAGING RESPONSE	Mobile Ident: TMSI.
6	SS -> MS	CHANNEL RELEASE	
	-----	-----	The SS waits 12 seconds to allow the MS to perform cell reselection.
7	SS -> MS	PAGING REQUEST TYPE 2	1st TMSI addresses another MS, 2nd TMSI addresses MS, Mobile Identity IE not present.
8	MS -> SS	CHANNEL REQUEST	Establ. Cause = "Answer to paging".
9	MS -> SS	CHANNEL REQUEST	Establ. Cause = "Answer to paging".
10	SS -> MS	IMMEDIATE ASSIGNMENT	Request Reference = pertaining to the message received in step 9.
11	MS -> SS	PAGING RESPONSE	Mobile Ident: TMSI.
12	SS -> MS	CHANNEL RELEASE	
	-----	-----	The SS waits 12 seconds to allow the MS to perform cell reselection.
13	SS -> MS	PAGING REQUEST TYPE 2	1st TMSI addresses another MS, 2nd TMSI addresses another MS, Mobile Identity IE contains TMSI of MS.
14	MS -> SS	CHANNEL REQUEST	Establ. Cause = "Answer to paging".
15	MS -> SS	CHANNEL REQUEST	Establ. Cause = "Answer to paging".
16	SS -> MS	IMMEDIATE ASSIGNMENT	Request Reference = pertaining to the message received in step 15
17	MS -> SS	PAGING RESPONSE	Mobile Ident: TMSI.
18	SS -> MS	CHANNEL RELEASE	
	-----	-----	The SS waits 12 seconds to allow the MS to perform cell reselection
19	SS -> MS	PAGING REQUEST TYPE 2	1st TMSI addresses another MS, 2nd TMSI addresses another MS, Mobile Identity IE contains IMSI of MS.
20	MS -> SS	CHANNEL REQUEST	Establ. Cause = "Answer to paging"
21	MS -> SS	CHANNEL REQUEST	Establ. Cause = "Answer to paging"
22	SS -> MS	IMMEDIATE ASSIGNMENT	Request Reference = pertaining to the message received in step 21
23	MS -> SS	PAGING RESPONSE	Mobile Ident: IMSI.
24	SS -> MS	CHANNEL RELEASE	
	-----	-----	The SS waits 12 seconds to allow the MS to perform cell reselection
25	SS -> MS	PAGING REQUEST TYPE 2	1st TMSI addresses another MS, 2nd TMSI addresses another MS, Mobile Identity IE contains TMSI of MS but with type of identity set to "no identity".
26	-----	-----	During 1 second, the SS checks that the MS does not produce any Layer 3 messages.

Specific Message Contents

None.

26.6.2.1.3 Paging / normal / type 3**26.6.2.1.3.1 Conformance requirements**

An MS shall respond correctly to various PAGING REQUEST TYPE 3 messages, when the page mode is set to normal paging. The MS shall send CHANNEL REQUEST messages, with an Establishment Cause set to "Answer to Paging", until the network answers. The number of CHANNEL REQUEST messages

shall be limited by the parameter Max-retrans. After the assignment procedure, the MS shall send a PAGING RESPONSE message on the channel assigned by the network.

References

GSM 04.08 section 3.3.2.

26.6.2.1.3.2 Test purpose

To test that the MS is able to determine its CCCH group and paging group correctly and that the MS responds correctly to various PAGING REQUEST TYPE 3 messages when the page mode is set to normal paging. All valid ways of addressing the MS are tested.

26.6.2.1.3.3 Method of test

Initial Conditions

System Simulator:

1 cell, Max-Retrans = 2, a legal combination of CCCH_CONF, BS_AG_BLKES_RES and BS_PA_MFRMS is chosen arbitrarily by the SS.

Mobile Station:

The MS is in the "idle, updated" state, with a TMSI allocated.

Related PICS/PIXIT Statements

Type of MS (P-GSM 900 or EGSM or DCS 1 800).

Foreseen Final State of the MS

"Idle, updated", with TMSI allocated.

Test Procedure

The SS pages the MS 4 times with different PAGING REQUEST TYPE 3 messages on the paging subchannel which corresponds to the MS's IMSI.

In all the cases the MS shall answer to the paging by sending CHANNEL REQUESTs. The SS responds to the second request by assigning a channel, and the MS shall then send a correct PAGING RESPONSE. The SS then releases the channel.

Maximum Duration of Test

5 minutes, including 1 minute for any necessary operator actions.

Expected Sequence

Step	Direction	Message	Comments
1	SS -> MS	PAGING REQUEST TYPE 3	1st TMSI addresses MS; 2nd, 3rd and 4th TMSIs address other MSs.
2	MS -> SS	CHANNEL REQUEST	Establ. Cause = "Answer to paging".
3	MS -> SS	CHANNEL REQUEST	Establ. Cause = "Answer to paging".
4	SS -> MS	IMMEDIATE ASSIGNMENT	Request Reference = pertaining to the message received in step 3.
5	MS -> SS	PAGING RESPONSE	Mobile Ident: TMSI.
6	SS -> MS	CHANNEL RELEASE	
	-----	-----	The SS waits 12 seconds to allow the MS to perform cell reselection.
7	SS -> MS	PAGING REQUEST TYPE 3	2nd TMSI addresses MS; 1st, 3rd and 4th TMSIs address other MSs.
8	MS -> SS	CHANNEL REQUEST	Establ. Cause = "Answer to paging".
9	MS -> SS	CHANNEL REQUEST	Establ. Cause = "Answer to paging".
10	SS -> MS	IMMEDIATE ASSIGNMENT	Request Reference = pertaining to the message received in step 9.
11	MS -> SS	PAGING RESPONSE	Mobile Ident: TMSI.
12	SS -> MS	CHANNEL RELEASE	
	-----	-----	The SS waits 12 seconds to allow the MS to perform cell reselection.
13	SS -> MS	PAGING REQUEST TYPE 3	3rd TMSI addresses MS; 1st, 2nd and 4th TMSIs address other MSs.
14	MS -> SS	CHANNEL REQUEST	Establ. Cause = "Answer to paging".
15	MS -> SS	CHANNEL REQUEST	Establ. Cause = "Answer to paging".
16	SS -> MS	IMMEDIATE ASSIGNMENT	Request Reference = pertaining to the message received in step 15.
17	MS -> SS	PAGING RESPONSE	Mobile Ident: TMSI.
18	SS -> MS	CHANNEL RELEASE	
	-----	-----	The SS waits 12 seconds to allow the MS to perform cell reselection.
19	SS -> MS	PAGING REQUEST TYPE 3	4th TMSI addresses MS; 1st, 2nd and 3rd TMSIs address other MSs.
20	MS -> SS	CHANNEL REQUEST	Establ. Cause = "Answer to paging".
21	MS -> SS	CHANNEL REQUEST	Establ. Cause = "Answer to paging".
22	SS -> MS	IMMEDIATE ASSIGNMENT	Request Reference = pertaining to the message received in step 21.
23	MS -> SS	PAGING RESPONSE	Mobile Ident: TMSI.
24	SS -> MS	CHANNEL RELEASE	

Specific Message Contents

None.

26.6.2.2 Paging / extended**26.6.2.2.1 Conformance requirements**

1. The MS shall operate in the extended page mode when this is ordered by the network in a PAGING REQUEST TYPE 1 message not addressing the MS but on the paging subchannel which corresponds to the MS's identity.
2. The MS shall operate in the extended page mode when this is ordered by the network in a PAGING REQUEST TYPE 2 message not addressing the MS but on the paging subchannel which corresponds to the MS's identity.
3. The MS shall operate in the extended page mode when this is ordered by the network in a PAGING REQUEST TYPE 3 message not addressing the MS but on the paging subchannel which corresponds to the MS's identity.

4. The MS shall operate in the extended page mode when this is ordered by the network in an IMMEDIATE ASSIGNMENT message on the paging subchannel which corresponds to the MS's identity.
5. The MS shall operate in the extended page mode when this is ordered by the network in an IMMEDIATE ASSIGNMENT EXTENDED message on the paging subchannel which corresponds to the MS's identity.

References

GSM 04.08 section 3.3.2.1; GSM 05.02, section 6.5.

26.6.2.2.2 Test purpose

To test that the MS is operating in the extended page mode when this is ordered by the SS in either a PAGING REQUEST message or an IMMEDIATE ASSIGNMENT message.

26.6.2.2.3 Method of test

Initial Conditions

System Simulator:

1 cell, Max-Retrans = 2, a legal combination of CCCH_CONF, BS_AG_BLKs_RES and BS_PA_MFRMS is chosen arbitrarily by the SS.

Mobile Station:

The MS is in the "idle, updated" state, with a TMSI allocated.

Related PICS/PIXIT Statements

Type of MS (P-GSM 900 or EGSM or DCS 1 800).

Foreseen Final State of the MS

"Idle, updated", with TMSI allocated.

Test Procedure

The SS sends a PAGING REQUEST TYPE 1 message not addressing the MS under test but on the paging subchannel which corresponds to the MS's identity. The page mode is set to "extended paging". In the next but one paging subblock on the same CCCH the SS sends a PAGING REQUEST TYPE 1 message specifying an arbitrarily chosen page mode and addressing the MS by its TMSI. The MS shall respond to the last page by sending CHANNEL REQUESTs. The SS responds to the second CHANNEL REQUEST with an IMMEDIATE ASSIGNMENT REJECT message.

The SS then sends an IMMEDIATE ASSIGNMENT on the paging subchannel which corresponds to the MS's identity. The random reference is different to those used by the Mobile Station in the last two CHANNEL REQUEST messages. (Phase 2 requires a Mobile Station to react on an IMMEDIATE ASSIGNMENT after a rejection.) The page mode is again set to "extended paging". In the next but one paging subblock on the same CCCH the SS sends a PAGING REQUEST TYPE 2 message specifying an arbitrarily chosen page mode and addressing the MS by its TMSI. The MS shall respond with CHANNEL REQUESTs. The SS responds to the second CHANNEL REQUEST with an IMMEDIATE ASSIGNMENT REJECT message.

The SS then sends an IMMEDIATE ASSIGNMENT EXTENDED on the paging subchannel which corresponds to the MS's identity. The random references are different to those used by the Mobile Station in the last three CHANNEL REQUEST messages. The page mode is again set to "extended paging". In the next but one paging subblock on the same CCCH the SS sends a PAGING REQUEST TYPE 3 message specifying an arbitrarily chosen page mode and addressing the MS by its TMSI. The MS shall respond with CHANNEL REQUESTs. The SS responds to the second CHANNEL REQUEST with an IMMEDIATE ASSIGNMENT REJECT message.

The SS then sends a PAGING REQUEST TYPE 3 message not addressing the MS under test but on the paging subchannel which corresponds to the MS's identity. The page mode is set to "extended paging". In the next but one paging subblock on the same CCCH the SS sends a PAGING REQUEST TYPE 2 message specifying an arbitrarily chosen page mode and addressing the MS by its IMSI. The MS shall respond to the last page by sending CHANNEL REQUESTs. The SS responds to the second CHANNEL REQUEST with an IMMEDIATE ASSIGNMENT REJECT message.

The SS then sends a PAGING REQUEST TYPE 2 message not addressing the MS under test but on the paging subchannel which corresponds to the MS's identity. The page mode is set to "extended paging". In the next but one paging subblock on the same CCCH the SS sends a PAGING REQUEST TYPE 1 message specifying an arbitrarily chosen page mode and addressing the MS by its IMSI. The MS shall respond to the last page by sending CHANNEL REQUESTs. The SS responds to the second CHANNEL REQUEST with an IMMEDIATE ASSIGNMENT REJECT message.

Maximum Duration of Test

10 sec.

Expected Sequence

Step	Direction	Message	Comments
1	SS -> MS	PAGING REQUEST TYPE 1	Mobile Ident: IMSI of another MS, page mode = "extended paging".
2	SS -> MS	PAGING REQUEST TYPE 1	Sent in the next but one paging subblock. Page mode is arbitrarily chosen Mobile Ident: TMSI of the MS.
3	MS -> SS	CHANNEL REQUEST	
4	MS -> SS	CHANNEL REQUEST	
5	SS -> MS	IMMEDIATE ASSIGNMENT REJECT	Wait indication = 5 seconds. page mode = normal.
6	SS	--	SS waits for 5 seconds.
	SS -> MS	IMMEDIATE ASSIGNMENT	Sent in the paging subblock of MS under test. Page mode = "extended paging", Request reference chosen arbitrarily by the SS, but different from all references used earlier in this test sequence.
8	SS -> MS	PAGING REQUEST TYPE 1	Sent in the next but one paging subblock. Page mode is arbitrarily chosen. Mobile Ident: TMSI of the MS.
9	MS -> SS	CHANNEL REQUEST	
10	MS -> SS	CHANNEL REQUEST	
11	SS -> MS	IMMEDIATE ASSIGNMENT REJECT	Wait indication = 5 seconds. page mode = normal.
12	SS	--	SS waits for 5 seconds.
13	SS -> MS	IMMEDIATE ASSIGNMENT EXT	Sent in the paging subblock of MS under test. Page mode = "extended paging", Request references chosen arbitrarily by the SS, but different from all references used earlier in this test sequence.
14	SS -> MS	PAGING REQUEST TYPE 3	Sent in the next but one paging subblock. Page mode is arbitrarily chosen. Mobile Ident: TMSI of the MS.
15	MS -> SS	CHANNEL REQUEST	
16	MS -> SS	CHANNEL REQUEST	
17	SS -> MS	IMMEDIATE ASSIGNMENT REJECT	Wait indication = 5 seconds page mode = normal.
18	SS	--	SS waits for 5 seconds.
19	SS -> MS	PAGING REQUEST TYPE 3	Sent in the paging subblock of MS under test. Page mode = "extended paging".
20	SS -> MS	PAGING REQUEST TYPE 2	Sent in the next but one paging subblock. Page mode is arbitrarily chosen. Mobile Ident: IMSI of the MS.
21	MS -> SS	CHANNEL REQUEST	
22	MS -> SS	CHANNEL REQUEST	
23	SS -> MS	IMMEDIATE ASSIGNMENT REJECT	Wait indication = 5 seconds page mode = normal.
24	SS	--	SS waits for 5 seconds
25	SS -> MS	PAGING REQUEST TYPE 2	Sent in the paging subblock of MS under test. Page mode = "extended paging".
26	SS -> MS	PAGING REQUEST TYPE 1	Sent in the next but one paging subblock. Page mode is arbitrarily chosen. Mobile Ident: IMSI of the MS.
27	MS -> SS	CHANNEL REQUEST	
28	MS -> SS	CHANNEL REQUEST	
29	SS -> MS	IMMEDIATE ASSIGNMENT REJECT	Wait indication = 5 seconds.

Specific Message Contents

None.

26.6.2.3 Paging / reorganization

26.6.2.3.1 Paging / reorganization / procedure 1

26.6.2.3.1.1 Conformance requirements

1. An MS, after reception of a message with page mode set to "paging reorganization", shall answer to paging messages (with page mode set to "normal paging") sent on its old CCCH in paging blocks which do not belong to the MS's paging sub-channel.
2. When the network changes the paging group of the MS by modifying BCCH parameters (to CCCH_CONF set to "1 basic physical channel used for CCCH combined with SDCCH", and BS_AG_BLK_RES set to "2 blocks reserved for access grant"), the MS shall calculate its new paging group and answer to paging messages on its new paging subchannel.
3. When the network changes the paging group of the MS by modifying BCCH parameters (to CCCH_CONF set to "2 basic physical channels used for CCCH, not combined with SDCCHs" and BS_AG_BLK_RES set to "2 blocks reserved for access grant"), the MS shall calculate its new paging group and answer to paging messages on its new paging subchannel.

References

GSM 04.08 section 3.3.2.1; GSM 05.02, section 6.5.

26.6.2.3.1.2 Test purpose

To test that the MS correctly determines its new paging subchannel when the CCCH structure is changed from non-combined to combined and when the number of CCCHs is changed.

26.6.2.3.1.3 Method of test

Initial Conditions

System Simulator:

1 cell, Max-Retrans = 2, CCCH_CONF set to "1 basic physical channel used for CCCH, not combined with SDCCHs", a legal combination of BS_AG_BLK_RES and BS_PA_MFRMS is chosen arbitrarily by the SS, with the exception that BS_PA_MFRMS shall not be set to 9.

Mobile Station:

The MS is in the "idle, updated" state, with a TMSI allocated. The IMSI of the MS is from a defined/default range that ensures its paging channel changes when the broadcast parameters are changed.

Related PICS/PIXIT Statements

Type of MS (P-GSM 900 or EGSM or DCS 1 800).

Foreseen Final State of the MS

"Idle, updated", with TMSI allocated.

Test Procedure

The SS sends an IMMEDIATE ASSIGNMENT EXTENDED message on the MS's paging subchannel, with the page mode element set to "paging reorganization" and Request References that do not pertain to the MS. Before the MS's original paging subchannel re-occurs, the SS pages it on the CCCH corresponding to the Mobile Station's IMSI with a PAGING REQUEST TYPE 2 message (page mode = normal paging) containing the MS's TMSI in some paging block which does not belong to the Mobile Station's paging subchannel. The MS shall respond by sending CHANNEL REQUESTs. The SS responds to the second CHANNEL REQUEST with an IMMEDIATE ASSIGNMENT REJECT (in order to avoid a cell reselection) on an arbitrarily selected paging subchannel.

Then the SS starts sending messages (PAGING REQUEST TYPE 1 or PAGING REQUEST TYPE 2 or PAGING REQUEST TYPE 3 or IMMEDIATE ASSIGNMENT or IMMEDIATE ASSIGNMENT EXTENDED or IMMEDIATE ASSIGNMENT REJECT) with page mode set to "paging reorganization" on all paging subchannels.

After 5 seconds (to ensure T3126 expires) the SS pages the MS with its TMSI on an arbitrarily selected paging subchannel (on the CCCH corresponding to the Mobile Station's IMSI). The MS shall respond by sending CHANNEL REQUESTs. The SS responds to the second CHANNEL REQUEST with an IMMEDIATE ASSIGNMENT REJECT (in order to avoid a cell reselection).

The SS changes the paging parameters.

Then the SS sets the page mode to "normal paging".

The SS then waits for the duration of five 51-TDMA multiframes (4 to allow the MS to read all the system information type 1, 2, 3, and 4 messages on the BCCH, and one to calculate the new paging group). Not before 5 seconds after the last IMMEDIATE ASSIGNMENT REJECT message addressing the MS (to ensure T3126 expires), the MS is paged with a PAGING REQUEST TYPE 1 on its new paging subchannel. The MS shall respond by sending CHANNEL REQUESTs. The SS responds to the second CHANNEL REQUEST with an IMMEDIATE ASSIGNMENT REJECT (in order to avoid a cell reselection) and then waits 5 seconds (to ensure T3126 expires).

Then the MS is paged with a PAGING REQUEST TYPE 2 on its new paging subchannel. The MS shall respond by sending CHANNEL REQUESTs. The SS responds to the second CHANNEL REQUEST with an IMMEDIATE ASSIGNMENT REJECT (in order to avoid a cell reselection).

Maximum Duration of Test

60 sec.

Expected Sequence

This sequence is performed for execution counter, K =1, 2.

Step	Direction	Message	Comments
1	SS -> MS	IMMEDIATE ASSIGNMENT EXTENDED	Sent on the MS's paging channel. Page mode set to "paging reorganization". Request Reference not pertaining to the MS.
2	SS -> MS	PAGING REQUEST TYPE 2	Sent before the MS's original paging subchannel re-occurs, but later than the next paging block of that CCCH.
3	MS -> SS	CHANNEL REQUEST	
4	MS -> SS	CHANNEL REQUEST	
5	SS -> MS	IMMEDIATE ASSIGNMENT REJECT	Wait indication = 0 seconds.
6	-----	-----	All L3 messages sent on any paging subchannel are paging fill frames specify "paging re organization.
7	SS -> MS	PAGING REQUEST TYPE 2	Sent on an arbitrarily selected paging subchannel Page mode "paging reorganization" Not sent before 5 seconds after step 5.
8	MS -> SS	CHANNEL REQUEST	
9	MS -> SS	CHANNEL REQUEST	
10	SS -> MS	IMMEDIATE ASSIGNMENT REJECT	Wait indication = 0 seconds.
11			Change of paging parameters in SYS INFO 3 as described below for K=1, 2.
12			The SS waits until it has sent all system information messages (page mode is still paging reorganization).
13	-----	-----	All L3 messages sent on any paging subchannel specify "normal paging.
14	-----	-----	Wait 3 seconds.
15	SS -> MS	PAGING REQUEST TYPE 1	Sent on the new paging subchannel of the MS. Not sent before 5 seconds after step 10.
16	MS -> SS	CHANNEL REQUEST	
17	MS -> SS	CHANNEL REQUEST	
18	SS -> MS	IMMEDIATE ASSIGNMENT REJECT	Wait indication = 0 seconds.
19	SS -> MS	PAGING REQUEST TYPE 2	Sent on the new paging subchannel of the MS. Not sent before 5 seconds after step 18.
20	MS -> SS	CHANNEL REQUEST	
21	MS -> SS	CHANNEL REQUEST	
22	SS -> MS	IMMEDIATE ASSIGNMENT REJECT	

Specific Message Contents

For execution counter K:

K=1:

SYSTEM INFORMATION TYPE 3 shall have the Control Channel Description IE changed to:

CCCH_CONF	"1 basic physical channel used for CCCH, combined with SDCCHs"
BS_AG_BLKS_RES	2
BS_PA_MFRMS	9

K=2:

SYSTEM INFORMATION TYPE 3 shall have the Control Channel Description IE changed to:

CCCH_CONF	"2 basic physical channel used for CCCH, not combined with SDCCHs"
BS_AG_BLK_RES	2
BS_PA_MFRMS	9

26.6.2.3.2 Paging / reorganization / procedure 2

26.6.2.3.2.1 Conformance requirement

An MS, after reception of a message with page mode set to "paging reorganization", shall answer to paging messages (with page mode set to "normal paging") sent in a former Access Grant block.

References

GSM 04.08 section 3.3.2.1.

26.6.2.3.2.2 Test purpose

To test that the MS is operating in the "paging reorganization" page mode when this is ordered by the SS and the MS is paged in its former access grant channel.

26.6.2.3.2.3 Method of test

Initial Conditions

System Simulator:

1 cell, Max-Retrans = 1, with the constraint that BS_AG_BLK_RES > 0, a legal combination of CCCH_CONF, BS_AG_BLK_RES and BS_PA_MFRMS is chosen arbitrarily by the SS.

Mobile Station:

The MS is in the "idle, updated" state, with a TMSI allocated. The IMSI of the MS is from a defined/default range that ensures its paging channel changes when the broadcast parameters are changed.

Related PICS/PIXIT Statements

Type of MS (P-GSM 900 or EGSM or DCS 1 800).

Foreseen Final State of the MS

"Idle, updated", with TMSI allocated.

Test Procedure

The SS sends an IMMEDIATE ASSIGNMENT EXTENDED on the MS's paging subchannel, with the page mode element set to "paging reorganization". The MS is then paged immediately in a former Access Grant block with a PAGING REQUEST TYPE 2 message. The MS shall respond by sending CHANNEL REQUESTs. The SS responds to the second CHANNEL REQUEST with an IMMEDIATE ASSIGNMENT REJECT (in order to avoid a cell reselection).

Maximum Duration of Test

5 sec.

Expected Sequence

Step	Direction	Message	Comments
1	SS -> MS	IMMEDIATE ASSIGNMENT EXTENDED	Page mode set to "paging reorganization"
2	SS -> MS	PAGING REQUEST TYPE 2	Sent in a former access grant block.
3	MS -> SS	CHANNEL REQUEST	
4	MS -> SS	CHANNEL REQUEST	
5	SS -> MS	IMMEDIATE ASSIGNMENT REJECT	

Specific Message Contents

None.

26.6.2.4 Paging / same as before

26.6.2.4.1 Conformance requirements

An MS, after first receiving a message on its paging subchannel with page mode set to "extended paging" and then the next message on its paging subchannel with page mode set to "same as before", shall remember the page mode from the previous message and answer to paging messages in the next but one paging sub block.

References

GSM 04.08 section 3.3.2.1; GSM 05.02, section 6.5.

26.6.2.4.2 Test purpose

To test that the MS remembers the page mode from the previous paging request message.

26.6.2.4.3 Method of test

Initial Conditions

System Simulator:

1 cell, Max-Retrans = 2, a legal combination of CCCH_CONF, BS_AG_BLKs_RES and BS_PA_MFRMS is chosen arbitrarily by the SS.

Mobile Station:

The MS is in the "idle, updated" state, with a TMSI allocated.

Related PICS/PIXIT Statements

Type of MS (P-GSM 900 or EGSM or DCS 1 800).

Foreseen Final State of the MS

"Idle, updated", with TMSI allocated.

Test Procedure

The SS sends an IMMEDIATE ASSIGNMENT REJECT on the MS's paging subchannel, with the page mode element set to "extended paging". In the next but one subblock on the same CCCH, nothing addresses the MS. When the MS's specific paging subchannel reoccurs, a PAGING REQUEST TYPE 3 is sent, not addressing the MS under test and with page mode set to "same as before". In the next but one subblock on the same CCCH the SS sends a PAGING REQUEST TYPE 1 message specifying paging reorganization and addressing the MS. The MS shall respond by sending CHANNEL REQUESTs. The SS responds to the second CHANNEL REQUEST with an IMMEDIATE ASSIGNMENT REJECT (in order to avoid a cell reselection).

Maximum Duration of Test

10 sec.

Expected Sequence

Step	Direction	Message	Comments
1	SS -> MS	IMMEDIATE ASSIGNMENT REJECT	Page mode set to "extended paging".
2	SS -> MS	XXXX	In the next but one subblock nothing addresses the MS.
3	SS -> MS	PAGING REQUEST TYPE 3	This is sent in the next paging subblock on the MS's specific paging subchannel. The page mode is set to "same as before", and the MS under test is not addressed.
4	SS -> MS	PAGING REQUEST TYPE 1	The MS is addressed in this "next but one subblock". Page mode set to "paging reorganization".
5	MS -> SS	CHANNEL REQUEST	
6	MS -> SS	CHANNEL REQUEST	
7	SS -> MS	IMMEDIATE ASSIGNMENT REJECT	

Specific Message Contents

None.

26.6.2.5 Paging / multislot CCCH**26.6.2.5.1 Conformance requirements**

The MS shall respond correctly to a PAGING REQUEST TYPE 1 message, when the page mode is set to normal paging, when a multislot CCCH is used and the MS is addressed with its IMSI in the first Mobile Identity field, the optional Mobile Identity field being not present.

References

GSM 04.08 section 3.3.2, GSM 05.02 section 6.5.

26.6.2.5.2 Test purpose

- 1) To test that the MS is able to determine its CCCH group and paging group correctly in the case of a CCCH configuration on more than one timeslot when it is paged on a timeslot other than 0. The MS is addressed with a PAGING REQUEST TYPE 1 message when the page mode is set to normal paging. The MS is paged with its IMSI in the 1st Mobile Identity field, the optional Mobile Identity field being not present, is the only way of addressing tested.
- 2) To test that in such conditions the MS answers to the paging message on the timeslot on which the paging message was sent.

26.6.2.5.3 Method of test**Initial Conditions**

System Simulator:

1 cell, a legal combination of CCCH_CONF, BS_AG_BLKES_RES and BS_PA_MFRMS is chosen arbitrarily under the following constraint:

CCCH_CONF is in the set:

- 2 basic physical channels used for CCCH, not combined with SDCCHs
- 3 basic physical channels used for CCCH, not combined with SDCCHs
- 4 basic physical channels used for CCCH, not combined with SDCCHs

Mobile Station:

The IMSI last 3 digits are so that the CCCH_GROUP of the MS under test is other than 0. According to section 6.5.2 of recommendation GSM 05.02, this means that:

$(\text{IMSI} \bmod 1000) \bmod (\text{BS_CC_CHANS} \times N)$ is greater or equal to N , where $N = \text{BS_PA_MFRMS} \times (9 - \text{BS_AG_BLKS_RES})$.

The MS is in the "idle, updated" state.

Related PICS/PIXIT Statements

Type of MS (P-GSM 900 or EGSM or DCS 1 800).

Foreseen Final State of the MS

"Idle updated".

Test Procedure

The SS pages the MS once with a PAGING REQUEST TYPE 1 message on the timeslot and paging subchannel which correspond to the MS's IMSI.

The MS shall send the CHANNEL REQUEST on the same timeslot as the paging message.

The SS sends an IMMEDIATE ASSIGNMENT on the same timeslot as the paging message.

Maximum Duration of Test

10 s.

Expected Sequence

Step	Direction	Message	Comments
1	SS -> MS	PAGING REQUEST TYPE 1	1st Mobile Ident contains IMSI of MS, 2nd Mobile Ident not present.
2	MS -> SS	CHANNEL REQUEST	Establ. Cause = "Answer to paging". on the same timeslot as the paging message.
3	SS -> MS	IMMEDIATE ASSIGNMENT	on the same timeslot as the paging message.
4	MS -> SS	PAGING RESPONSE	Mobile Ident: IMSI.
5	SS -> MS	CHANNEL RELEASE	

Specific Message Contents

None.

26.6.3 Test of measurement report

When an RR-connection exists, the MS shall send measurement reports. These reports contain reception characteristics from serving and neighbouring cells. The measurement report procedure is described in section 3.4.1.2 of GSM 04.08.

NOTE 8: The capability to calculate RxLev and RxQual is tested in sections 15 and 16. In this test only the signalling aspect is verified.

26.6.3.1 Measurement / no neighbours

This test applies to both GSM 900 and DCS 1 800 mobile stations.

26.6.3.1.1 Conformance requirements

The MS shall continuously send MEASUREMENT REPORT messages on every SACCH block and the measurement valid indication shall be set to valid (0) within the second block at the latest.

References

GSM 04.08 section 3.4.1.2, GSM 05.08 section 8.4.

26.6.3.1.2 Test purpose

To test that, when the SS gives absolutely no information about neighbouring cells, the MS does not report on neighbouring cells.

26.6.3.1.3 Method of test**Initial Conditions**

System Simulator:

8 cells with the following settings:

Transmitter	Level	NCC	BCC	ARFCN (GSM900)	ARFCN (DCS1800)	Cell Identity
Serving, S1	-60	1	3	002	514	0001H
Neighbour, N1	-85	1	5	008	530	0002H
Neighbour, N2	-80	1	7	014	602	0003H
Neighbour, N3	-75	1	1	020	665	0004H
Neighbour, N4	-55	1	3	026	762	0005H
Neighbour, N5	-50	1	5	032	686	0006H
Neighbour, N6	-45	1	7	038	549	0007H
Neighbour, N7	-40	1	1	044	810	0008H

With the exception of the Cell Allocation, the rest of the parameters for all eight cells are the same as the default settings and default SYSTEM INFORMATION TYPE 1 to 4 message contents for cell A. The Cell Allocation for the serving cell is the same as the default setting for cell A. The Cell Allocations for the neighbour cells need have only one entry, consisting of the ARFCN of that cell's BCCH.

Mobile Station:

The MS is in the active state of a call (U10).

Related PICS/PIXIT Statements

Support for state U10 of the Call Control protocol.

Type of MS (P-GSM 900 or EGSM or DCS 1 800).

Foreseen Final State of the MS

Active state of a call (U10).

Test Procedure

This test procedure is performed twice.

With the MS having a call in progress, the SS sends SYSTEM INFORMATION TYPE 5 & 6 (on the second iteration of the test the SS also sends SYSTEM INFORMATION TYPE 5bis) on the SACCH. The

BA is indicated as empty. The MS shall send MEASUREMENT REPORTs back to the SS, and it shall be indicated in these that no measurement results have been obtained.

Maximum Duration of Test

5 minutes, including 1 minute for any necessary operator actions.

Expected Sequence

This sequence is performed for execution counter, $k = 1, 2$.

Since when $k = 1$, SYSTEM INFORMATION TYPE 5, SYSTEM INFORMATION TYPE 6 and MEASUREMENT REPORT (and when $k = 2$ an additional SYSTEM INFORMATION TYPE 5bis is included) are sent continuously, a table is not applicable in this test. The interval between 2 successive Layer 2 frames containing MEASUREMENT REPORTs shall not exceed one Layer 2 frame.

Specific Message Contents

GSM 900 begin:

SYSTEM INFORMATION TYPE 5:

Information Element	value/remark
Neighbour Cells Description <ul style="list-style-type: none"> - Format Identifier - BCCH Allocation Sequence number - BCCH Allocation ARFCN - EXT IND 	bit map 0 1 No channels belong to the BCCH allocation. $k = 1$. Information Element carries the complete BA. $k = 2$. Information Element carries only a part of the BA.

SYSTEM INFORMATION TYPE 5bis (Sent only when $k = 2$):

Information Element	value/remark
Protocol Discriminator Message Type Neighbour Cells Description <ul style="list-style-type: none"> - Format - EXT IND - W(i) 	RR management Sys Info 5bis. 1024 range $k = 2$. Information Element carries only a part of the BA. Only channel 500 belongs to the BCCH allocation.

MEASUREMENT REPORT:

Information Element	value/remark
Protocol Discriminator	RR Management
Transaction Identifier	0000
Message Type	MEASUREMENT REPORT
Measurement Results	
BA-used	1
DTX-used	DTX was not used
RXLEV_FULL_SERVING_CELL	See note 9
RXLEV_SUB_SERVING_CELL	See note 9
MEAS_VALID	See note 10
RXQUAL_FULL_SERVING_CELL	See note 9
RXQUAL_SUB_SERVING_CELL	See note 9
NO_NCELL_M	No neighbour cell measurement result, or Neighbour cell information not available for serving cell.
RXLEV_NCELL_1	00 0000
BCCH_FREQ_NCELL_1	0 0000
BSIC_NCELL_1	00 0000
.	.
RXLEV_NCELL_6	00 0000
BCCH_FREQ_NCELL_6	0 0000
BSIC_NCELL_6	00 0000

GSM 900 end:**DCS 1 800 begin:****SYSTEM INFORMATION TYPE 5:**

Information Element	value/remark
Protocol Discriminator	RR management
Message Type	Sys Info 5.
Neighbour Cells Description	
- Format	1024 range
- EXT IND	k = 1. Information Element carries the complete BA. k = 2. Information Element carries only a part of the BA.
- W(i)	null.

SYSTEM INFORMATION TYPE 5bis (Sent only when k = 2):

Information Element	value/remark
Protocol Discriminator	RR management
Message Type	Sys Info 5bis.
Neighbour Cells Description	
- Format	1024 range
- EXT IND	k = 2. Information Element carries only a part of the BA.
- W(i)	null.

SYSTEM INFORMATION TYPE 6:

Information Element	value/ remark
Protocol Discriminator	RR Management
Message Type	sys info 6
Cell Identity	default
LAI	default
Cell Options	
- Power Control Indicator	Power Control Indicator is set
- DTX Indicator	MS shall not use DTX
- Radio_Link_Timeout	default
PLMN permitted	only NCC 1 permitted

MEASUREMENT REPORT:

Information Element	value/remark
Protocol Discriminator	RR Management
Transaction Identifier	0000
Message Type	MEASUREMENT REPORT
Measurement Results	
BA_used	1
DTX_used	DTX was not used
RXLEV_FULL_SERVING_CELL	See NOTE 1
RXLEV_SUB_SERVING_CELL	See NOTE 1
MEAS_VALID	See NOTE 2
RXQUAL_FULL_SERVING_CELL	See NOTE 1
RXQUAL_SUB_SERVING_CELL	See NOTE 1
NO_NCELL_M	No neighbour cell measurement result, or Neighbour cell information not available for serving cell.
RXLEV_NCELL_1	00 0000
BCCH_FREQ_NCELL_1	0 0000
BSIC_NCELL_1	00 0000
.
.
RXLEV_NCELL_6	00 0000
BCCH_FREQ_NCELL_6	0 0000
BSIC_NCELL_6	00 0000

DSC1800 end:

NOTE 1: The actual values are not checked.

NOTE 2: The Measurement Valid Indication shall be set to valid within the second SACCH block at the latest.

26.6.3.2 Measurement / all neighbours present

This test applies to both GSM 900 and DCS 1 800 mobile stations.

26.6.3.2.1 Conformance requirements

The MS shall continuously send MEASUREMENT REPORT messages on every SACCH blocks and the measurement valid indication shall be set to valid (0) within the second block at the latest. After 20 seconds the values in the MEASUREMENT REPORT message shall contain measurement results for the 6 strongest BCCH carriers with known and allowed NCC part of BSIC.

References

GSM 04.08 section 3.4.1.2, GSM 05.08 section 8.4.

26.6.3.2.2 Test purpose

To test that, when the SS gives information about neighbouring cells, the MS reports appropriate results.

26.6.3.2.3 Method of test**Initial Conditions**

System Simulator:

8 cells with the following settings:

Transmitter	Level	NCC	BSCC	ARFCN (GSM900)	ARFCN (DCS1800)	Cell identity
Serving, S1	-60	1	3	002	514	0001H
Neighbour, N1	-85	1	5	008	530	0002H
Neighbour, N2	-80	1	7	014	602	0003H
Neighbour, N3	-75	1	1	020	665	0004H
Neighbour, N4	-55	1	3	026	762	0005H
Neighbour, N5	-50	1	5	032	686	0006H
Neighbour, N6	-45	1	7	038	549	0007H
Neighbour, N7	-40	1	1	044	810	0008H

With the exception of the Cell Allocation, the rest of the parameters for all eight cells are the same as the default settings and default SYSTEM INFORMATION TYPE 1 to 4 message contents for cell A. The Cell Allocation for the serving cell is the same as the default setting for cell A. The Cell Allocations for the neighbour cells need have only one entry, consisting of the ARFCN of that cell's BCCH.

Mobile Station:

The MS is in the active state of a call (U10).

Related PICS/PIXIT Statements

Support for state U10 of the Call Control protocol.
Type of MS (P-GSM 900 or EGSM or DCS 1 800).

Foreseen Final State of the MS

Active state of a call (U10).

Test Procedure

This test procedure is performed twice.

With the MS having a call in progress, the SS sends SYSTEM INFORMATION TYPE 5 & 6 (on the second iteration of the test the SS also sends SYSTEM INFORMATION TYPE 5bis) on the SACCH. All 8 of the BCCHs "on air" are indicated in the BA. The MS shall send MEASUREMENT REPORTs back to the SS, and it shall be indicated in these that measurement results for the 6 strongest carriers have been obtained.

Maximum Duration of Test

5 minutes, including 1 minute for any necessary operator actions.

Expected Sequence

This sequence is performed for execution counter, $k = 1, 2$.

Since when $k = 1$, SYSTEM INFORMATION TYPE 5, SYSTEM INFORMATION TYPE 6 and MEASUREMENT REPORT (and when $k = 2$ an additional SYSTEM INFORMATION TYPE 5bis is

included) are sent continuously, a table is not applicable in this test. The interval between 2 successive Layer 2 frames containing MEASUREMENT REPORTs shall not exceed one Layer 2 frame.

Specific Message Contents

GSM 900 begin:

SYSTEM INFORMATION TYPE 5:

Information Element	value/remark
Neighbour Cells Description Format Identifier BCCH Allocation Sequence BCCH Allocation ARFCN - EXT IND	bit map 0 1 The channel numbers 2, 4, 5, 6, 7, 8, 9, 10, 11, 12, 13, 14, 16, 17, 18, 19, 20, 21, 22, 23, 24, 26, 28, 29, 30, 32, 34, 35, 36, 38, 40 and 44 belong to the BCCH allocation. k = 1. Information Element carries complete BA. k = 2. Information Element carries only a part of the BA.

SYSTEM INFORMATION TYPE 5bis (Sent only when k = 2):

Information Element	value/remark
Protocol Discriminator Message Type Neighbour Cells Description - Format - EXT IND - W(i)	RR management Sys Info 5bis. 1024 range k = 2. Information Element carries only a part of the BA. Channel 0 and 800 belong to the BCCH allocation.

MEASUREMENT REPORT:

Information Element	value/remark
Protocol Discriminator	RR Management
Transaction Identifier	0000
Message Type	MEASUREMENT REPORT
Measurement Results	
BA_used	1
DTX_used	DTX was not used
RXLEV_FULL_SERVING_CELL	See NOTE 1
RXLEV_SUB_SERVING_CELL	See NOTE 1
MEAS_VALID	See NOTE 2
RXQUAL_FULL_SERVING_CELL	See NOTE 1
RXQUAL_SUB_SERVING_CELL	See NOTE 1
NO_NCELL_M	6 neighbour cell measurement results
RXLEV_NCELL_1	See NOTE 1
BCCH_FREQ_NCELL_1	Shall not correspond to N1 or N2
BSIC_NCELL_1	Corresponds to that of BCCH_FREQ_NCELL_1
RXLEV_NCELL_2	See NOTE 1
BCCH_FREQ_NCELL_2	Shall not correspond to N1 or N2
BSIC_NCELL_2	Corresponds to that of BCCH_FREQ_NCELL_2
RXLEV_NCELL_3	See NOTE 1
BCCH_FREQ_NCELL_3	Shall not correspond to N1 or N2
BSIC_NCELL_3	Corresponds to that of BCCH_FREQ_NCELL_3
RXLEV_NCELL_4	See NOTE 1
BCCH_FREQ_NCELL_4	Shall not correspond to N1 or N2
BSIC_NCELL_4	Corresponds to that of BCCH_FREQ_NCELL_4
RXLEV_NCELL_5	See NOTE 1
BCCH_FREQ_NCELL_5	Shall not correspond to N1 or N2
BSIC_NCELL_5	Corresponds to that of BCCH_FREQ_NCELL_5
RXLEV_NCELL_6	See NOTE 1
BCCH_FREQ_NCELL_6	Shall not correspond to N1 or N2
BSIC_NCELL_6	Corresponds to that of BCCH_FREQ_NCELL_6

GSM 900 end:**DCS 1 800 begin:****SYSTEM INFORMATION TYPE 5:**

Information Element	value/remark
Protocol Discriminator	RR management
Message Type	Sys Info 5.
Neighbour Cells Description	
- Format	1024 range
- EXT IND	k = 1. Information Element carries complete BA. k = 2. Information Element carries only a part of the BA.
- W(i)	k = 1. Non null for ARFCN 514, 530, 549, 602, 665, 686, 762, 810. k = 2. Non null for ARFCN 549, 602, 665, 686, 810.

SYSTEM INFORMATION TYPE 5bis (Sent only when k = 2):

Information Element	value/remark
Protocol Discriminator	RR management
Message Type	Sys Info 5bis.
Neighbour Cells Description	
- Format	1024 range
- EXT IND	k = 2. Information Element carries only a part of the BA.
- W(i)	k = 2. Non null ARFCN 20, 514, 530, 549, 762.

SYSTEM INFORMATION TYPE 6:

Information Element	value/ remark
Protocol Discriminator	RR Management
Message Type	sys info 6
Cell Identity	default
LAI	default
Cell Options	
- Power Control Indicator	Power Control Indicator is set
- DTX Indicator	MS shall not use DTX
- Radio_Link_Timeout	default
PLMN permitted	only NCC 1 permitted

MEASUREMENT REPORT:

Information Element	value/remark
Protocol Discriminator	RR Management
Transaction Identifier	0000
Message Type	MEASUREMENT REPORT
Measurement Results	
BA_used	1
DTX_used	DTX was not used
RXLEV_FULL_SERVING_CELL	See NOTE 1
RXLEV_SUB_SERVING_CELL	See NOTE 1
MEAS_VALID	See NOTE 2
RXQUAL_FULL_SERVING_CELL	See NOTE 1
RXQUAL_SUB_SERVING_CELL	See NOTE 1
NO_NCELL_M	6 neighbour cell measurement results
RXLEV_NCELL_1	See NOTE 1
BCCH_FREQ_NCELL_1	Shall not correspond to N1 or N2
BSIC_NCELL_1	Corresponds to that of BCCH_FREQ_NCELL_1
RXLEV_NCELL_2	See NOTE 1
BCCH_FREQ_NCELL_2	Shall not correspond to N1 or N2
BSIC_NCELL_2	Corresponds to that of BCCH_FREQ_NCELL_2
RXLEV_NCELL_3	See NOTE 1
BCCH_FREQ_NCELL_3	Shall not correspond to N1 or N2
BSIC_NCELL_3	Corresponds to that of BCCH_FREQ_NCELL_3
RXLEV_NCELL_4	See NOTE 1
BCCH_FREQ_NCELL_4	Shall not correspond to N1 or N2
BSIC_NCELL_4	Corresponds to that of BCCH_FREQ_NCELL_4
RXLEV_NCELL_5	See NOTE 1
BCCH_FREQ_NCELL_5	Shall not correspond to N1 or N2
BSIC_NCELL_5	Corresponds to that of BCCH_FREQ_NCELL_5
RXLEV_NCELL_6	See NOTE 1
BCCH_FREQ_NCELL_6	Shall not correspond to N1 or N2
BSIC_NCELL_6	Corresponds to that of BCCH_FREQ_NCELL_6

DCS 1 800 end:

NOTE 1: These actual values are not checked.

NOTE 2: The Measurement Valid Indication shall be set to valid within the second SACCH block at the latest.

26.6.3.3 Measurement / barred cells and non-permitted NCCs

This test applies to both GSM 900 and DCS 1 800 mobile stations.

26.6.3.3.1 Conformance requirements

The MS shall continuously send MEASUREMENT REPORTs on every SACCH blocks and the measurement valid indication shall be set to valid (0) within the second block at the latest. After

20 seconds the messages shall contain measurement results only for the 4 BCCH carriers on which the MS is allowed to report.

References

GSM 04.08 section 3.4.1.2, GSM 05.08 section 8.4.

26.6.3.3.2 Test purpose

To test that, when a combination of normal neighbours, barred cells and non-permitted NCCs is "on air", the MS reports only on normal neighbours.

26.6.3.3.3 Method of test

Initial Conditions

System Simulator:

8 cells with the following settings:

Transmitter	Level	NCC	BCC	ARFCN (GSM900)	ARFCN (DCS1800)	Cell identity
Serving, S1	-60	1	3	002	514	0001H
Neighbour, N1	-85	1	5	008	530	0002H
Neighbour, N2	-80	1	7	014	602	0003H
Neighbour, N3	-75	2	1	020	665	0004H
Neighbour, N4	-55	3	3	026	762	0005H
Neighbour, N5	-50	4	5	032	686	0006H
Neighbour, N6	-45	1	7	038	549	0007H
Neighbour, N7	-40	1	1	044	810	0008H

With the exception of the Cell Allocation, the rest of the parameters for all eight cells are the same as the default settings and default SYSTEM INFORMATION TYPE 1 to 4 message contents for cell A. The Cell Allocation for the serving cell is the same as the default setting for cell A. The Cell Allocations for the neighbour cells need have only one entry, consisting of the ARFCN of that cell's BCCH.

NOTE 1: The BA sent in SYSTEM INFORMATION TYPE 5 does not include N1, N4 and N5. N1 may be the case of a barred cell, N3 simulates the case where another operator is transmitting on the same frequency (e.g. in border areas), N4 & N5 simulate the case where other operators are transmitting on other frequencies.

Mobile Station:

The MS is in the active state of a call (U10).

Related PICS/PIXIT Statements

Support for state U10 of the Call Control protocol.
Type of MS (P-GSM 900 or EGSM or DCS 1 800).

Foreseen Final State of the MS

Active state of a call (U10).

Test Procedure

This test procedure is performed twice.

With the MS having a call in progress, the SS sends SYSTEM INFORMATION TYPE 5 & 6 (on the second iteration of the test the SS also sends SYSTEM INFORMATION TYPE 5bis) on the SACCH. 5 of the 8 BCCHs "on air" are indicated in the BA. The MS shall send MEASUREMENT REPORTs back to the

SS, and it shall be indicated in these that measurement results for the 4 strongest permitted carriers have been obtained (one of the carriers in the BA belongs to a non-permitted NCC).

Maximum Duration of Test

5 minutes, including 1 minute for any necessary operator actions.

Expected Sequence

This sequence is performed for execution counter, $k = 1, 2$.

Since when $k = 1$ SYSTEM INFORMATION TYPE 5, SYSTEM INFORMATION TYPE 6 and MEASUREMENT REPORT (and when $k = 2$ an additional SYSTEM INFORMATION TYPE 5bis is included) messages are sent continuously, a table is not applicable in this test. The interval between 2 successive Layer 2 frames containing MEASUREMENT REPORTs shall not exceed one Layer 2 frame.

Specific Message Contents

GSM 900 begin:

SYSTEM INFORMATION TYPE 5:

Information Element	value/remark
Neighbour Cells Description	
Format Identifier	bit map 0
BCCH Allocation Sequence	1
BCCH Allocation ARFCN	only channel numbers 2, 14, 20, 38, and 44 belong to the BCCH allocation.
- EXT IND	$k = 1$. Information Element carries complete BA. $k = 2$. Information Element carries only a part of the BA.

SYSTEM INFORMATION TYPE 5bis (Sent only when $k = 2$):

Information Element	value/remark
Protocol Discriminator	RR management
Message Type	Sys Info 5bis.
Neighbour Cells Description	
- Format	1024 range
- EXT IND	$k = 2$. Information Element carries only a part of the BA.
- W(i)	Channel 0 and 800 belong to the BCCH allocation.

MEASUREMENT REPORT:

Information Element	value/remark
Protocol Discriminator	RR Management
Transaction Identifier	0000
Message Type	MEASUREMENT REPORT
Measurement Results	
BA_used	1
DTX_used	DTX was not used
RXLEV_FULL_SERVING_CELL	See note 2
RXLEV_SUB_SERVING_CELL	See note 2
MEAS_VALID	See note 3
RXQUAL_FULL_SERVING_CELL	See note 2
RXQUAL_SUB_SERVING_CELL	See note 2
NO_NCELL_M	4 neighbour cell measurement results
RXLEV_NCELL_1	See note 2
BCCH_FREQ_NCELL_1	Corresponds to one of N7, N6, S1 or N2
BSIC_NCELL_1	Corresponds to that of BCCH_FREQ_NCELL_1
RXLEV_NCELL_2	See note 2
BCCH_FREQ_NCELL_2	Corresponds to one of N7, N6, S1 or N2
BSIC_NCELL_2	Corresponds to that of BCCH_FREQ_NCELL_2
RXLEV_NCELL_3	See note 2
BCCH_FREQ_NCELL_3	Corresponds to one of N7, N6, S1 or N2
BSIC_NCELL_3	Corresponds to that of BCCH_FREQ_NCELL_3
RXLEV_NCELL_4	See note 2
BCCH_FREQ_NCELL_4	Corresponds to one of N7, N6, S1 or N2
BSIC_NCELL_4	Corresponds to that of BCCH_FREQ_NCELL_4
RXLEV_NCELL_5	00 0000
BCCH_FREQ_NCELL_5	0 0000
BSIC_NCELL_5	00 0000
RXLEV_NCELL_6	00 0000
BCCH_FREQ_NCELL_6	0 0000
BSIC_NCELL_6	00 0000

GSM 900 end:**DCS 1 800 begin:****SYSTEM INFORMATION TYPE 5:**

Information Element	value/remark
Protocol Discriminator	RR management
Message Type	Sys Info 5.
Neighbour Cells Description	
- Format	1024 range
- EXT IND	k = 1. Information Element carries complete BA. k = 2. Information Element carries only a part of the BA.
- W(i)	k = 1. Non null for ARFCN 514, 549, 602, 665, 810. k = 2. Non null for ARFCN 549, 602, 810.

SYSTEM INFORMATION TYPE 5bis (Sent only when k = 2):

Information Element	value/remark
Protocol Discriminator	RR management
Message Type	Sys Info 5bis.
Neighbour Cells Description	
- Format	1024 range
- EXT IND	k = 2. Information Element carries only a part of the BA.
- W(i)	k = 2. Non null ARFCN 514, 665.

SYSTEM INFORMATION TYPE 6:

Information Element	value/ remark
Protocol Discriminator	RR Management
Message Type	sys info 6
Cell Identity	default
LAI	default
Cell Options	
- Power Control Indicator	Power Control Indicator is set
- DTX Indicator	MS shall not use DTX
- Radio-Link-Time-out	default
PLMN permitted	only NCC 1 permitted

MEASUREMENT REPORT:

Information Element	value/remark
Protocol Discriminator	RR Management
Transaction Identifier	0000
Message Type	MEASUREMENT REPORT
Measurement Results	
BA_used	1
DTX_used	DTX was not used
RXLEV_FULL_SERVING_CELL	See NOTE 2
RXLEV_SUB_SERVING_CELL	See NOTE 2
MEAS_VALID	See NOTE 3
RXQUAL_FULL_SERVING_CELL	See NOTE 2
RXQUAL_SUB_SERVING_CELL	See NOTE 2
NO_NCELL_M	4 neighbour cell measurement results
RXLEV_NCELL_1	See NOTE 2
BCCH_FREQ_NCELL_1	Corresponds to one of N7, N6, S1 or N2
BSIC_NCELL_1	Corresponds to that of BCCH_FREQ_NCELL_1
RXLEV_NCELL_2	See NOTE 2
BCCH_FREQ_NCELL_2	Corresponds to one of N7, N6, S1 or N2
BSIC_NCELL_2	Corresponds to that of BCCH_FREQ_NCELL_2
RXLEV_NCELL_3	See NOTE 2
BCCH_FREQ_NCELL_3	Corresponds to one of N7, N6, S1 or N2
BSIC_NCELL_3	Corresponds to that of BCCH_FREQ_NCELL_3
RXLEV_NCELL_4	See NOTE 2
BCCH_FREQ_NCELL_4	Corresponds to one of N7, N6, S1 or N2
BSIC_NCELL_4	Corresponds to that of BCCH_FREQ_NCELL_4
RXLEV_NCELL_5	00 0000
BCCH_FREQ_NCELL_5	0 0000
BSIC_NCELL_5	00 0000
RXLEV_NCELL_6	00 0000
BCCH_FREQ_NCELL_6	0 0000
BSIC_NCELL_6	00 0000

DCS 1 800 end:

NOTE 2: These actual values are not checked.

NOTE 3: The Measurement Valid Indication shall be set to valid within the second SACCH block at the latest.

26.6.3.4 Measurement / DTX

This test applies to both GSM 900 and DCS 1 800 mobile stations.

26.6.3.4.1 Conformance requirements

After the sending of the HANDOVER COMPLETE, the MS shall continuously send measurement reports in every SACCH blocks, the measurement valid indication shall be set to valid (0) within the second block at the latest. After 20 seconds the order of values in the MEASUREMENT REPORT message shall contain measurement results for the 6 strongest BCCH carriers among those monitored by the MS. Further, in a quiet environment, the DTX_USED field shall be set by the MS to "DTX used".

References

GSM 04.08 section 3.4.1.2, GSM 05.08 section 8.4.

26.6.3.4.2 Test purpose

To test that, in the case of the MS using DTX and the SS indicating that power control is in use, the MS reports appropriate results.

26.6.3.4.3 Method of test

Initial Conditions

System Simulator:

8 cells with the following settings:

Transmitter	Level	NCC	BCC	ARFCN (GSM900)	ARFCN (DCS1800)	Cell identity
Serving, S1	-60	1	3	002	514	0001H
Neighbour, N1	-85	1	5	008	530	0002H
Neighbour, N2	-80	1	7	014	602	0003H
Neighbour, N3	-75	1	1	020	665	0004H
Neighbour, N4	-55	1	3	026	762	0005H
Neighbour, N5	-50	1	5	032	686	0006H
Neighbour, N6	-45	1	7	038	549	0007H
Neighbour, N7	-40	1	1	044	810	0008H

In the serving cell, the DTX indicator is set to "MS shall use discontinuous transmission".

With the exception of the Cell Allocation, the rest of the parameters for all eight cells are the same as the default settings and default SYSTEM INFORMATION TYPE 1 to 4 message contents for cell A. The Cell Allocation for the serving cell is the same as the default setting for cell A. The Cell Allocations for the neighbour cells need have only one entry, consisting of the ARFCN of that cell's BCCH.

Mobile Station:

The MS is in the active state of a call (U10).

The MS has just completed a handover into the serving cell, S1.

Related PICS/PIXIT Statements

Support for state U10 of the Call Control protocol.

Support for transparent data services only: yes/no.

Type of MS (P-GSM 900 or EGSM or DCS 1 800).

Foreseen Final State of the MS

Active state of a call (U10).

Test Procedure

This test procedure is performed twice.

With the MS having a call in progress on an arbitrary cell, the MS is handed over to cell S1. On cell S1, the SS sends SYSTEM INFORMATION TYPE 5 & 6 (on the second iteration of the test the SS also sends SYSTEM INFORMATION TYPE 5bis) on the SACCH with all 8 of the BCCHs "on air" indicated in the BA. Cell S1 also indicates that DTX shall be used. The MS shall send MEASUREMENT REPORTs back to the SS, and it shall be indicated in these that measurement results for the 6 strongest carriers have been obtained and that DTX has been used. (The MS is positioned in an environment free from acoustic noise.)

Maximum Duration of Test

5 minutes, including 1 minute for any necessary operator actions.

Expected Sequence

This sequence is performed twice for execution counter, $k = 1, 2$.

Since when $k = 1$, SYSTEM INFORMATION TYPE 5, SYSTEM INFORMATION TYPE 6 and MEASUREMENT REPORT (and when $k = 2$ an additional SYSTEM INFORMATION TYPE 5bis is included) messages are sent continuously, a table is not applicable in this test. The interval between 2 successive Layer 2 frames containing MEASUREMENT REPORTs shall not exceed one Layer 2 frame.

Specific Message Contents**GSM 900 begin:****SYSTEM INFORMATION TYPE 5:**

Information Element	value/remark
Neighbour Cells Description - Format Identifier - BCCH Allocation Sequence - BCCH Allocation ARFCN - EXT IND	bit map 0 1 only channel numbers 2, 8, 14, 20, 26, 32, 38, and 44 belong to the BCCH allocation. $k = 1$. Information Element carries the complete BA. $k = 2$. Information Element carries only a part of the BA.

SYSTEM INFORMATION TYPE 5bis (Sent only when $k = 2$):

Information Element	value/remark
Protocol Discriminator Message Type Neighbour Cells Description - Format - EXT IND - W(i)	RR management Sys Info 5bis. 1024 range $k = 2$. Information Element carries only a part of the BA. Only channel 500 belongs to the BCCH allocation.

SYSTEM INFORMATION TYPE 6:

Information Element	value/remark
Cell Options - Power Control Indicator - DTX Indicator - Radio_Link_Timeout	Power Control Indicator is set MS shall use DTX 8

MEASUREMENT REPORT:

Information Element	value/remark
Protocol Discriminator	RR Management
Transaction Identifier	0000
Message Type	MEASUREMENT REPORT
Measurement Results	
- BA_used	0
- DTX_used	DTX was used (NOTE 3)
- RXLEV_FULL_SERVING_CELL	See NOTE 1
- RXLEV_SUB_SERVING_CELL	See NOTE 1
- MEAS_VALID	See NOTE 2
- RXQUAL_FULL_SERVING_CELL	See NOTE 1
- RXQUAL_SUB_SERVING_CELL	See NOTE 1
- NO_NCELL_M	6 neighbour cell measurement results
- RXLEV_NCELL_1	See NOTE 1
- BCCH_FREQ_NCELL_1	Shall not correspond to N1 or N2
- BSIC_NCELL_1	Corresponds to that of BCCH_FREQ_NCELL_1
- RXLEV_NCELL_2	See NOTE 1
- BCCH_FREQ_NCELL_2	Shall not correspond to N1 or N2
- BSIC_NCELL_2	Corresponds to that of BCCH_FREQ_NCELL_2
- RXLEV_NCELL_3	See NOTE 1
- BCCH_FREQ_NCELL_3	Shall not correspond to N1 or N2
- BSIC_NCELL_3	Corresponds to that of BCCH_FREQ_NCELL_3
- RXLEV_NCELL_4	See NOTE 1
- BCCH_FREQ_NCELL_4	Shall not correspond to N1 or N2
- BSIC_NCELL_4	Corresponds to that of BCCH_FREQ_NCELL_4
- RXLEV_NCELL_5	See NOTE 1
- BCCH_FREQ_NCELL_5	Shall not correspond to N1 or N2
- BSIC_NCELL_5	Corresponds to that of BCCH_FREQ_NCELL_5
- RXLEV_NCELL_6	See NOTE 1
- BCCH_FREQ_NCELL_6	Shall not correspond to N1 or N2
- BSIC_NCELL_6	Corresponds to that of BCCH_FREQ_NCELL_6

GSM 900 end:**DCS 1 800 begin:****SYSTEM INFORMATION TYPE 5:**

Information Element	value/remark
Protocol Discriminator	RR management
Message Type	Sys Info 5.
Neighbour Cells Description	
- Format	1024 range
- EXT IND	k = 1. Information Element carries complete BA. k = 2. Information Element carries only a part of the BA.
- W(i)	k = 1. Non null for ARFCN 514, 530, 549, 602 665, 686, 762, 810. k = 2. Non null for ARFCN 549, 602, 665, 686, 810.

SYSTEM INFORMATION TYPE 5bis (Sent only when k = 2):

Information Element	value/remark
Protocol Discriminator	RR management
Message Type	Sys Info 5bis.
Neighbour Cells Description	
- Format	1024 range
- EXT IND	k = 2. Information Element carries only a part of the BA.
- W(i)	k = 2. Non null ARFCN 514, 530, 762.

SYSTEM INFORMATION TYPE 6:

Information Element	value/ remark
Protocol Discriminator	RR Management
Message Type	sys info 6
Cell Identity	default
LAI	default
Cell Options	
- Power Control Indicator	Power Control Indicator is set
- DTX Indicator	MS shall use DTX
- Radio_Link_Timeout	default
PLMN permitted	only NCC 1 permitted

MEASUREMENT REPORT:

Information Element	value/remark
Protocol Discriminator	RR Management
Transaction Identifier	0000
Message Type	MEASUREMENT REPORT
Measurement Results	
BA_used	1
DTX_used	DTX was used (see NOTE 3)
RXLEV_FULL_SERVING_CELL	See NOTE 1
RXLEV_SUB_SERVING_CELL	See NOTE 1
MEAS_VALID	See NOTE 2
RXQUAL_FULL_SERVING_CELL	See NOTE 1
RXQUAL_SUB_SERVING_CELL	See NOTE 1
NO_NCELL_M	6 neighbour cell measurement results
RXLEV_NCELL_1	See NOTE 1
BCCH_FREQ_NCELL_1	Shall not correspond to N1 or N2
BSIC_NCELL_1	Corresponds to that of BCCH_FREQ_NCELL_1
RXLEV_NCELL_2	See NOTE 1
BCCH_FREQ_NCELL_2	Shall not correspond to N1 or N2
BSIC_NCELL_2	Corresponds to that of BCCH_FREQ_NCELL_2
RXLEV_NCELL_3	See NOTE 1
BCCH_FREQ_NCELL_3	Shall not correspond to N1 or N2
BSIC_NCELL_3	Corresponds to that of BCCH_FREQ_NCELL_3
RXLEV_NCELL_4	See NOTE 1
BCCH_FREQ_NCELL_4	Shall not correspond to N1 or N2
BSIC_NCELL_4	Corresponds to that of BCCH_FREQ_NCELL_4
RXLEV_NCELL_5	See NOTE 1
BCCH_FREQ_NCELL_5	Shall not correspond to N1 or N2
BSIC_NCELL_5	Corresponds to that of BCCH_FREQ_NCELL_5
RXLEV_NCELL_6	See NOTE 1
BCCH_FREQ_NCELL_6	Shall not correspond to N1 or N2
BSIC_NCELL_6	Corresponds to that of BCCH_FREQ_NCELL_6

DCS 1 800 end:

NOTE 1: These actual values are not checked.

NOTE 2: The Measurement Valid Indication shall be set to valid within the second SACCH block after the HANDOVER COMPLETE message at the latest.

NOTE 3: For an MS that only supports transparent data services, the value of DTX_used shall not be checked.

26.6.3.5 Measurement / Frequency Formats

This test applies to both GSM 900 and DCS 1 800 mobiles stations.

26.6.3.5.1 Conformance Requirement

The MS shall continuously send MEASUREMENT REPORT messages on every SACCH blocks and the measurement valid indication shall be set to valid (0) within the second block at the latest. After 20 seconds the values in the MEASUREMENT REPORT message shall contain measurement results for the cells on which the mobile is allowed to report.

References

GSM 04.08 section 3.4.1.2, GSM 05.08 section 8.4.

26.6.3.5.2 Test Purpose

To test that, when the SS gives information about neighbouring cells, the MS reports appropriate results.

26.6.3.5.3 Method of test

Initial Conditions

System Simulator:

2 cells with the following settings:

Transmitter	Level	NCC	BCC	ARFCN (GSM900)	ARFCN (DCS1800)	Cell Identity
Serving, S1	-60	1	3	002	715	0001H
Neighbour, N1	-85	1	5	008	815	0002H

With the exception of the Cell Allocation, the rest of the parameters for both cells are the same as the default settings and default SYSTEM INFORMATION TYPE 1 to 4 message contents for cell A. The Cell Allocation for the serving cell is the same as the default setting for cell A. The Cell Allocations for the neighbour cells need have only one entry, consisting of the ARFCN of that cell's BCCH.

Mobile Station:

The MS is in the active state of a call (U10).

Related PICS/PIXIT Statements

Support for state U10 of the Call Control protocol.
Type of MS (P-GSM 900 or EGSM or DCS 1 800).

Foreseen Final State of the MS

Active state of a call (U10).

Test Procedure

This test procedure is performed three times.

With the MS having a call in progress, the SS sends SYSTEM INFORMATION TYPE 5, 5bis & 6 on the SACCH. Both of the BCCHs "on air" are indicated in the BA. The MS shall send MEASUREMENT

REPORTs back to the SS, and it shall be indicated in these that no measurement results have been obtained.

For each iteration of the test the frequency format of the BA list contained in the System Information 5 and 5bis message shall change according to the specific message contents.

Maximum Duration Of Test

5 minutes, including 1 minute for any necessary operator actions.

Expected Sequence

This sequence is performed for execution counter, K = 1, 2, 3.

Since SYSTEM INFORMATION TYPE 5, SYSTEM INFORMATION 5bis, SYSTEM INFORMATION TYPE 6 and MEASUREMENT REPORT are sent continuously, a table is not applicable in this test. The interval between 2 successive Layer 2 frames containing MEASUREMENT REPORTs shall not exceed one Layer 2 frame.

Specific Message Contents

GSM 900 begin:

SYSTEM INFORMATION TYPE 5:

Information Element	value/remark
Neighbour Cells Description Format Identifier BCCH Allocation Sequence BCCH Allocation ARFCN - EXT IND	Bit Map 0. 1 Channel numbers 2, 6 and 8 belong to the BCCH allocation. Information Element carries only a part of the BA.

SYSTEM INFORMATION TYPE 5bis:

Information Element	value/remark
Protocol Discriminator Message Type Neighbour Cells Description Format Identifier - EXT IND - W(i)	RR management Sys Info 5bis. K = 1. Range 1024 Format K = 2. Range 512 Format K = 3. Variable Bit Map. Information Element carries only a part of the BA. K = 1. 500, 530, 595, 965, 1000, 715, 815, 0 K = 2. 530, 595, 965, 1000, 715, 815, 0 K = 3. 965, 1000, 0, 2, 6

MEASUREMENT REPORT:

Information Element	value/remark
Protocol Discriminator	RR Management
Message Type	MEASUREMENT REPORT
Measurement Results	
BA_used	1
DTX_used	DTX was not used
RXLEV_FULL_SERVING_CELL	See note 1
RXLEV_SUB_SERVING_CELL	See note 1
MEAS_VALID	See note 2
RXQUAL_FULL_SERVING_CELL	See note 1
RXQUAL_SUB_SERVING_CELL	See note 1
NO_NCELL_M	2 neighbour cell measurement result
RXLEV_NCELL_1	See note 1
BCCH_FREQ_NCELL_1	Shall correspond to S1 or N1, i.e., it shall be 0 or 2.
BSIC_NCELL_1	Corresponds to that of BCCH_FREQ_NCELL_1
RXLEV_NCELL_2	See note 1
BCCH_FREQ_NCELL_2	Shall correspond to S1 or N1, i.e. it shall be 0 or 2.
BSIC_NCELL_2	Corresponds to that of BCCH_FREQ_NCELL_2
RXLEV_NCELL_3	00 0000
BCCH_FREQ_NCELL_3	0 0000
BSIC_NCELL_3	00 0000
.
.
RXLEV_NCELL_6	00 0000
BCCH_FREQ_NCELL_6	0 0000
BSIC_NCELL_6	00 0000

GSM 900 end:**DCS 1 800 begin:****SYSTEM INFORMATION TYPE 5:**

Information Element	value/remark
Protocol Discriminator	RR management
Message Type	Sys Info 5.
Neighbour Cells Description	
- Format	K = 1. Range 1 024 Format K = 2. Variable Bit Map K = 3. Range 128 Format
- EXT IND	Information Element carries only a part of the BA.
- W(i)	K = 1. Non null for 500, 530, 595, 715, 815, 965, 1 000, 0 K = 2. Non null for 965, 1 000, 0, 2, 6, 8 K = 3. Non null for 695, 715, 800

SYSTEM INFORMATION TYPE 5bis:

Information Element	value/remark
Protocol Discriminator	RR management
Message Type	Sys Info 5bis.
Neighbour Cells Description	
- Format	K = 1. Bit Map 0. K = 2. Range 512 Format K = 3. Range 256 Format
- EXT IND	Information Element carries only a part of the BA.
- W(i) / BCCH Allocation	K = 1. Non null for 2, 6, 8 K = 2. Non null for 500, 530, 595, 715, 815, 965 K = 3. Non Null for 815, 965, 1000, 0, 2, 6

SYSTEM INFORMATION TYPE 6:

Information Element	value/ remark
Protocol Discriminator	RR Management
Message Type	sys info 6
Cell Identity	default
LAI	default
Cell Options	
- Power Control Indicator	Power Control Indicator is set
- DTX Indicator	MS shall not use DTX
- Radio_Link_Timeout	default
PLMN permitted	only NCC 1 permitted

MEASUREMENT REPORT:

Information Element	value/remark
Protocol Discriminator	RR Management
Message Type	MEASUREMENT REPORT
Measurement Results	
BA_used	1
DTX_used	DTX was not used
RXLEV_FULL_SERVING_CELL	See note 1
RXLEV_SUB_SERVING_CELL	See note 1
MEAS_VALID	See note 2
RXQUAL_FULL_SERVING_CELL	See note 1
RXQUAL_SUB_SERVING_CELL	See note 1
NO_NCELL_M	2 neighbour cell measurement results
RXLEV_NCELL_1	See note 1
BCCH_FREQ_NCELL_1	K= 1. Shall correspond to S1 or N1, i.e., it shall be 6 or 7 K= 2. Shall correspond to S1 or N1, i.e., it shall be 6 or 7 K= 3. Shall correspond to S1 or N1, i.e., it shall be 3 or 5
BSIC_NCELL_1	Corresponds to that of BCCH_FREQ_NCELL_1
RXLEV_NCELL_2	See note 1
BCCH_FREQ_NCELL_2	K= 1. Shall correspond to S1 or N1, i.e., it shall be 6 or 7 K= 2. Shall correspond to S1 or N1, i.e., it shall be 6 or 7 K= 3. Shall correspond to S1 or N1, i.e., it shall be 3 or 5
BSIC_NCELL_2	Corresponds to that of BCCH_FREQ_NCELL_2
RXLEV_NCELL_3	00 0000
BCCH_FREQ_NCELL_3	0 0000
BSIC_NCELL_3	00 0000
.
.
RXLEV_NCELL_6	00 0000
BCCH_FREQ_NCELL_6	0 0000
BSIC_NCELL_6	00 0000

NOTE 1: These actual values are not checked.

NOTE 2: The Measurement Valid Indication shall be set to valid within the second SACCH block at the latest.

26.6.3.6 Measurement / multiband environment

This test applies to both GSM 900 and DCS 1 800 mobile stations.

26.6.3.6.1 Conformance requirements

The MS shall continuously send MEASUREMENT REPORT messages on every SACCH blocks and the measurement valid indication shall be set to valid (0) within the second block at the latest. After 20 seconds the values in the MEASUREMENT REPORT message shall contain measurement results for up to the 6 strongest BCCH carriers among those with known and allowed NCC part of BSIC on which the mobile is asked to report.

References

GSM 04.08 section 3.4.1.2, GSM 05.08 section 8.4.

26.6.3.6.2 Test purpose

To test that, when the SS gives information about neighbouring cells using SYSTEM INFORMATION TYPE 2ter/5ter, the MS reports appropriate results.

26.6.3.6.3 Method of test**Initial Conditions**

System Simulator:

8 cells with the following settings:

Transmitter	Level	NCC	BSCC	ARFCN (GSM900)	ARFCN (DCS1800)	Cell identity
Serving, S1	-60	1	3	002	514	0001H
Neighbour, N1	-85	1	5	008	530	0002H
Neighbour, N2	-80	1	7	014	602	0003H
Neighbour, N3	-75	1	1	020	665	0004H
Neighbour, N4	-55	1	3	026	762	0005H
Neighbour, N5	-50	1	5	032	686	0006H
Neighbour, N6	-45	1	7	038	549	0007H
Neighbour, N7	-40	1	1	044	810	0008H

With the exception of the Cell Allocation, the rest of the parameters for all eight cells are the same as the default settings and default SYSTEM INFORMATION TYPE 1, 2 and 4 message contents for cell A. The Cell Allocation for the serving cell is the same as the default setting for cell A. The Cell Allocations for the neighbour cells need have only one entry, consisting of the ARFCN of that cell's BCCH.

Mobile Station:

The MS is in the active state of a call (U10).

Related PICS/PIXIT Statements

Support for state U10 of the Call Control protocol.
Type of MS (P-GSM 900 or EGSM or DCS 1 800).

Foreseen Final State of the MS

Active state of a call (U10).

Test Procedure

This test procedure is performed once.

With the MS having a call in progress, the SS sends SYSTEM INFORMATION TYPE 5, 5ter & 6 on the SACCH. All 8 of the BCCHs "on air" are indicated in the BA. The MS shall send MEASUREMENT

REPORTs back to the SS, and it shall be indicated in these that measurement results for the 6 strongest carriers, on which the mobile is asked to report, have been obtained.

Maximum Duration of Test

5 minutes, including 1 minute for any necessary operator actions.

Expected Sequence

Since SYSTEM INFORMATION TYPE 5, SYSTEM INFORMATION TYPE 5ter, SYSTEM INFORMATION TYPE 6 and MEASUREMENT REPORT are sent continuously, a table is not applicable in this test. The interval between 2 successive Layer 2 frames containing MEASUREMENT REPORTs shall not exceed one Layer 2 frame.

Specific Message Contents

GSM 900 begin:

SYSTEM INFORMATION TYPE 2ter:

Information Element	value/remark
Additional Multiband information - Multiband reporting	Minimum 2 cells reported from each band supported excluding the frequency band of the serving cell.
Extension of the BCCH Frequency list - Format identifier - BCCH Allocation Sequence - BCCH Allocation ARFCN - EXT IND	Range 512 0 ARFCN 514, 530, 549, 602, 665, 686, 762, 810 Information Element carries the complete BA.

SYSTEM INFORMATION TYPE 3:

as default except:

Information Element	value/remark
SI 3 rest octets - SI 2ter indicator - Early Classmark Sending Control	System Information 2ter is available Early Sending is explicitly accepted

SYSTEM INFORMATION TYPE 5:

Information Element	value/remark
Protocol Discriminator Message Type Neighbour Cells Description - Format Identifier - BCCH Allocation Sequence - BCCH Allocation ARFCN - EXT IND	RR management Sys Info 5. Bit map 0 1 ARFCN 2, 8, 14, 20, 26, 32, 38, 44 Information Element carries the complete BA.

SYSTEM INFORMATION TYPE 5ter:

Information Element	value/remark
Protocol Discriminator	RR management
Message Type	Sys Info 5ter.
Additional Multiband information - Multiband reporting	Minimum 2 cells reported from each band supported excluding the frequency band of the serving cell.
Extension of the BCCH Frequency list - Format identifier - BCCH Allocation Sequence - BCCH Allocation ARFCN - EXT IND	Range 512 0 ARFCN 514, 530, 549, 602, 665, 686, 762, 810 Information Element carries the complete BA.

MEASUREMENT REPORT:

Information Element	value/remark
Protocol Discriminator	RR Management
Transaction Identifier	0000
Message Type	MEASUREMENT REPORT
Measurement Results	
BA_used	1
DTX_used	DTX was not used
RXLEV_FULL_SERVING_CELL	See note 1
RXLEV_SUB_SERVING_CELL	See note 1
MEAS_VALID	See note 3
RXQUAL_FULL_SERVING_CELL	See note 1
RXQUAL_SUB_SERVING_CELL	See note 1
NO_NCELL_M	6 neighbour cell measurement results
RXLEV_NCELL_1	See note 1
BCCH_FREQ_NCELL_1	See note 2
BSIC_NCELL_1	Corresponds to that of BCCH_FREQ_NCELL_1
RXLEV_NCELL_2	See note 1
BCCH_FREQ_NCELL_2	See note 2
BSIC_NCELL_2	Corresponds to that of BCCH_FREQ_NCELL_2
RXLEV_NCELL_3	See note 1
BCCH_FREQ_NCELL_3	See note 2
BSIC_NCELL_3	Corresponds to that of BCCH_FREQ_NCELL_3
RXLEV_NCELL_4	See note 1
BCCH_FREQ_NCELL_4	See note 2
BSIC_NCELL_4	Corresponds to that of BCCH_FREQ_NCELL_4
RXLEV_NCELL_5	See note 1
BCCH_FREQ_NCELL_5	See note 2
BSIC_NCELL_5	Corresponds to that of BCCH_FREQ_NCELL_5
RXLEV_NCELL_6	See NOTE 1
BCCH_FREQ_NCELL_6	See NOTE 2
BSIC_NCELL_6	Corresponds to that of BCCH_FREQ_NCELL_6

NOTE 1: These actual values are not checked.

NOTE 2: report on ARFCNs 2, 20, 26, 32, 38 and 44

NOTE 3: The Measurement Valid Indication shall be set to valid within the second SACCH block at the latest.

GSM 900 end:

DCS 1 800 begin:

SYSTEM INFORMATION TYPE 2ter:

Information Element	value/remark
Additional Multiband information - Multiband reporting	Minimum 2 cells reported from each band supported excluding the frequency band of the serving cell.
Extension of the BCCH Frequency list - Format identifier - BCCH Allocation Sequence - BCCH Allocation ARFCN - EXT IND	Range 1024 0 ARFCN 2, 8, 14, 20, 26, 32, 38, 44 Information Element carries the complete BA.

SYSTEM INFORMATION TYPE 3:

as default except:

Information Element	value/remark
SI 3 rest octets - SI 2ter indicator - Early Sending Classmark Control	System Information 2ter is available Early Sending is explicitly accepted

SYSTEM INFORMATION TYPE 5:

Information Element	value/remark
Protocol Discriminator Message Type Neighbour Cells Description - Format Identifier - BCCH Allocation Sequence - BCCH Allocation ARFCN - EXT IND	RR management Sys Info 5 Range 512 1 ARFCN 514, 530, 549, 602, 665, 686, 762, 810 Information Element carries the complete BA.

SYSTEM INFORMATION TYPE 5ter:

Information Element	value/remark
Protocol Discriminator Message Type Additional Multiband information - Multiband reporting Extension of the BCCH Frequency list - Format identifier - BCCH Allocation Sequence - BCCH Allocation ARFCN - EXT IND	RR management Sys Info 5ter Minimum 2 cells reported from each band supported excluding the frequency band of the serving cell. Range 1024 0 ARFCN 2, 8, 14, 20, 26, 32, 38, 44 Information Element carries only a part of the BA.

MEASUREMENT REPORT:

Information Element	value/remark
Protocol Discriminator	RR Management
Transaction Identifier	0000
Message Type	MEASUREMENT REPORT
Measurement Results	
BA_used	1
DTX_used	DTX was not used
RXLEV_FULL_SERVING_CELL	See note 4
RXLEV_SUB_SERVING_CELL	See note 4
MEAS_VALID	See note 6
RXQUAL_FULL_SERVING_CELL	See note 4
RXQUAL_SUB_SERVING_CELL	See note 4
NO_NCELL_M	6 neighbour cell measurement results
RXLEV_NCELL_1	See note 4
BCCH_FREQ_NCELL_1	See note 5
BSIC_NCELL_1	Corresponds to that of BCCH_FREQ_NCELL_1
RXLEV_NCELL_2	See note 4
BCCH_FREQ_NCELL_2	See note 5
BSIC_NCELL_2	Corresponds to that of BCCH_FREQ_NCELL_2
RXLEV_NCELL_3	See note 4
BCCH_FREQ_NCELL_3	See note 5
BSIC_NCELL_3	Corresponds to that of BCCH_FREQ_NCELL_3
RXLEV_NCELL_4	See note 4
BCCH_FREQ_NCELL_4	See note 5
BSIC_NCELL_4	Corresponds to that of BCCH_FREQ_NCELL_4
RXLEV_NCELL_5	See note 4
BCCH_FREQ_NCELL_5	See note 5
BSIC_NCELL_5	Corresponds to that of BCCH_FREQ_NCELL_5
RXLEV_NCELL_6	See note 4
BCCH_FREQ_NCELL_6	See note 5
BSIC_NCELL_6	Corresponds to that of BCCH_FREQ_NCELL_6

NOTE 4: These actual values are not checked.

NOTE 5: report on ARFCNs 514, 549, 665, 686, 762, 810

NOTE 6: The Measurement Valid Indication shall be set to valid within the second SACCH block at the latest.

DCS 1 800 end:

26.6.4 Test of the channel assignment procedure

An intracell change of channel can be requested by upper layers in order to change the channel type, or it may be initiated by the RR-sublayer, e.g. for an intra cell handover. This change is performed using the channel assignment procedure. If the procedure is incorrectly implemented in the MS, the establishment and maintenance of connections is endangered. This applies for the successful case and for the assignment failure: the MS's correct return to the old channel after assignment failure is a necessary part of the GSM system design.

26.6.4.1 Dedicated assignment / successful case

This test is only applicable to an MS supporting a TCH.

26.6.4.1.1 Conformance requirements

1. Upon receipt of the ASSIGNMENT COMMAND message, the mobile station initiates a local end release of link layer connections, disconnects the physical channels, commands the switching to

the assigned channels and initiates the establishment of lower layer connections (this includes the activation of the channels, their connection and the establishment of the main signalling links).

2. MM-messages and CM-messages using SAPI=0 sent from the mobile station to the network can be duplicated by the data link layer in the following case:

a channel change of dedicated channels is required (assignment or handover procedure) and the last layer 2 frame has not been acknowledged by the peer data link layer before the mobile station leaves the old channel.

In this case, the mobile station does not know whether the network has received the message correctly. Therefore, the mobile station has to send the message again after the new dedicated channel is established.

3. An ASSIGNMENT COMMAND message may indicate a frequency change in progress, with a starting time and possibly alternative channel descriptions.

In the case of the reception of an ASSIGNMENT COMMAND message which contains only the description of a channel to be used after the starting time, and if the starting time has not already elapsed, the mobile station shall wait up to the starting time before accessing the channel.

4. The MS shall establish the link with the power level specified in the ASSIGNMENT COMMAND message.

The MS shall confirm the power control level that it is currently employing in the uplink SACCH L1 header. The indicated value shall be the power control level actually used by the mobile for the last burst of the previous SACCH period.

5. The MS shall apply the hopping frequencies specified in ASSIGNMENT COMMAND message in the Mobile Allocation IE or the Frequency List IE at the time of accessing the new channel using the last received Cell Allocation.

6. After receipt of the ASSIGNMENT COMMAND the MS shall perform the assignment and return an ASSIGNMENT COMPLETE without undue delay.

References

- | | |
|----------|---|
| 1, 3, 5. | GSM 04.08, subclause 3.4.3. |
| 2. | GSM 04.08, subclause 3.1.4.3. |
| 4. | GSM 04.08, subclause 3.4.3; GSM 05.08, subclause 4.2. |
| 6. | GSM 04.13, subclause 5.2.4. |

26.6.4.1.2 Test purpose

1. To verify that upon receipt of an ASSIGNMENT COMMAND, the MS switches to the channel defined in the ASSIGNMENT COMMAND, establishes the link and sends an ASSIGNMENT COMPLETE message. This is tested for an MS supporting TCH in the special cases of a transition.
 - 1.1 from non-hopping SDCCH to hopping TCH/F using a different timeslot;
 - 1.2 from hopping TCH/F to non-hopping TCH/F using a different timeslot;
 - 1.3 from non-hopping TCH/F to non-hopping TCH/F using a different timeslot;
 - 1.4 from non-hopping TCH/F to hopping TCH/H using a different timeslot; this test purpose is only applicable if the MS supports TCH/H;
 - 1.5 from hopping TCH/H to non-hopping TCH/H using a different timeslot; this test purpose is only applicable if the MS supports TCH/H;
 - 1.6 from non-hopping TCH/H to hopping TCH/F using a different timeslot; this test purpose is only applicable if the MS supports TCH/H.
2. To verify that an MS supporting TCH, having sent an MM- or CM message which was not acknowledged on L2 before the channel assignment procedure was initiated and before the MS has left the old channel, repeats that message after completion of the assignment procedure without incrementing N(SD). This is tested in the special case of MM message AUTHENTICATION RESPONSE.

3. To verify that, if an MS supporting TCH has received an ASSIGNMENT COMMAND message which contains only the description of a channel to be used after the starting time, and if the starting time has not already elapsed, the mobile station shall wait up to the starting time before accessing the channel.
4. To verify that an MS supporting TCH, having received an ASSIGNMENT COMMAND, having sent an SABM frame to establish the main signalling link on the assigned channel, reports the power level specified in the ASSIGNMENT COMMAND message, in the uplink SACCH L1 header of the SACCH message sent in the SACCH period following the transmission of the SABM frame.
5. To verify that an MS supporting TCH, having received an ASSIGNMENT COMMAND, is able in the case of frequency hopping to decode the Mobile Allocation and Frequency List IEs correctly and applies the specified frequencies using the correct Cell Allocation.
6. To verify that after receipt of the ASSIGNMENT COMMAND the MS returns an ASSIGNMENT COMPLETE without undue delay.

26.6.4.1.3 Method of test

Initial Conditions

System Simulator:

1 cell, default parameters except:

GSM 900:

BCCH ARFCN =20.

Throughout the test, the CA broadcast in System Information 1 is (10, 17, 20, 26, 34, 42, 45, 46, 52, 59).

Note that the actual CA of the cell contains other frequencies.

DCS 1 800:

BCCH ARFCN =747.

Throughout the test, the CA broadcast in System Information 1 is (734, 741, 747, 754, 759, 766, 773, 775, 779, 782).

Note that the actual CA of the cell contains other frequencies.

Mobile Station:

The MS is in the "idle, updated" state with a TMSI allocated.

Related PICS/PIXIT Statements

- TCH supported (Y/N).
- Supported rate(s) of TCH: (F/F+H).
- The supported channel mode(s) need to be declared.
- The supported frequencies (P-GSM or E-GSM or DCS 1 800).

Foreseen Final State of the MS

"Idle, updated", with TMSI allocated.

Test Procedure

The SS pages the MS and allocates an SDCCH. Then 2 different channels are assigned with ASSIGNMENT COMMANDS. Each time the MS shall switch to the assigned channel, establish the link and send an ASSIGNMENT COMPLETE message.

Then the SS sends a AUTHENTICATION REQUEST message. The MS shall answer with an AUTHENTICATION RESPONSE message, which is not acknowledged on L2 by the SS. Immediately after the AUTHENTICATION RESPONSE message is received, the SS sends an ASSIGNMENT COMMAND. The MS shall switch to the assigned channel, establish the link with the commanded power level and send as ASSIGNMENT COMPLETE message. Then MS shall repeat the AUTHENTICATION RESPONSE message, with the same N(SD) value.

Then the SS sends an ASSIGNMENT COMMAND, which includes a Starting Time IE. The MS shall react as specified above, but this shall be done at the time specified in Starting Time IE.

For an MS not supporting TCH/H, the SS initiates the channel release procedure and the test ends here. For an MS supporting TCH/H, the channel assignment procedure is performed another three times, with half rate channels involved, and again it is checked that the MS correctly completes the procedures, before the SS initiates the channel release procedure.

Maximum Duration of Test

30 s.

Expected Sequence

NOTE: TS GSM 04.08 appears to be unclear as to whether timer T3240 shall or shall not be started as a result of the AUTHENTICATION REQUEST message sent in step 10. To allow a variety of test equipment implementations, the IDENTITY REQUEST message is included in order to avoid an unexpected expiry of timer T3240 prior to the end of the expected sequence.

Step	Direction	Message	Comments
1	SS -> MS	PAGING REQUEST TYPE 1	See specific message contents.
2	MS -> SS	CHANNEL REQUEST	
3	SS -> MS	IMMEDIATE ASSIGNMENT	
4	MS -> SS	PAGING RESPONSE	
5	SS -> MS	ASSIGNMENT COMMAND	
6	MS -> SS	ASSIGNMENT COMPLETE	
7	SS		The SS checks that the MS reports the requested power level in the layer 1 header of the SACCH message that is sent in the first SACCH multiframe following the SABM.
8	SS -> MS	ASSIGNMENT COMMAND	See specific message contents.
9	MS -> SS	ASSIGNMENT COMPLETE	Sent on the correct channel after establishment of the main signalling link. This message shall be ready to be transmitted before 600 ms after the completion of step 5.
10	SS -> MS	AUTHENTICATION REQUEST	This message is not L2 acknowledged by the SS.
11	MS -> SS	AUTHENTICATION RESPONSE	
12	SS -> MS	ASSIGNMENT COMMAND	See specific message contents.
13	MS -> SS	ASSIGNMENT COMPLETE	Sent on the correct channel after establishment of the main signalling link. This message shall be ready to be transmitted before 600 ms after the completion of step 12.
14	MS -> SS	AUTHENTICATION RESPONSE	N(SD) shall be the same as in step 10.
15	SS -> MS	ASSIGNMENT COMMAND	See specific message contents.
16	SS		The SS checks that there is no radio transmission on the new channel before the starting time.
17	MS -> SS	ASSIGNMENT COMPLETE	Sent on the correct channel after establishment of the main signalling link.
A			This test part is performed if the MS does not support TCH/H (see PICS/PIXIT).
A18	SS -> MS	CHANNEL RELEASE	The main signalling link is released.
B			This test part is performed if the MS supports TCH/H (see PICS/PIXIT).
B18	SS -> MS	ASSIGNMENT COMMAND	See specific message contents.
B19	MS -> SS	ASSIGNMENT COMPLETE	Sent on the correct channel after establishment of the main signalling link. This message shall be ready to be transmitted before 600 ms after the completion of step 19.
B20	SS -> MS	IDENTITY REQUEST	See specific message contents.
B21	MS -> SS	IDENTITY RESPONSE	
B22	SS -> MS	ASSIGNMENT COMMAND	
B23	MS -> SS	ASSIGNMENT COMPLETE	
B24	SS -> MS	ASSIGNMENT COMMAND	See specific message contents.
B25	MS -> SS	ASSIGNMENT COMPLETE	Sent on the correct channel after establishment of the main signalling link. This message shall be ready to be transmitted before 600 ms after the completion of step 22.
B26	SS -> MS	CHANNEL RELEASE	The main signalling link is released.

Specific Message Contents**GSM 900 begin:****Step 3****IMMEDIATE ASSIGNMENT:**

As default message contents except Channel Description <ul style="list-style-type: none"> - Channel Type TDMA offset - Timeslot Number - Training Sequence Code - Hopping - ARFCN 	SDCCH/8 Chosen arbitrarily N, chosen arbitrarily Chosen arbitrarily Single RF Channel the ARFCN of the BCCH carrier
---	--

Step 5**ASSIGNMENT COMMAND:**

Channel Description <ul style="list-style-type: none"> - Channel Type and TDMA offset - Timeslot Number - Training Sequence Code - Hopping - MAIO <ul style="list-style-type: none"> - HSN Power Command <ul style="list-style-type: none"> - Power level Frequency list IE Channel Mode <ul style="list-style-type: none"> - Mode Mobile Allocation Starting Time	TCH/F (N+1) mod 8 Chosen arbitrarily RF hopping channel Chosen arbitrarily from the set (0, 1 to N-1) where N is the number of frequencies in the Mobile Allocation IE. Chosen arbitrarily from the set (1 to 63) Chosen arbitrarily but with a changed value. Not included Signalling Indicates all of the CA (broadcast on the BCCH) except for the BCCH carrier. Not included
---	--

Step 8**ASSIGNMENT COMMAND:**

Channel Description <ul style="list-style-type: none"> - Channel Type and TDMA offset - Timeslot Number - Training Sequence Code - Hopping - ARFCN Power Command <ul style="list-style-type: none"> - Power level Channel Mode Frequency list IE Cell Channel Description Mobile Allocation Starting Time	TCH/F (N+3) mod 8 Chosen arbitrarily Single RF Channel the ARFCN of the BCCH carrier Chosen arbitrarily but with a changed value. A non-signalling mode arbitrarily selected from the full rate capabilities declared for the MS Not Included Bit map zero encodes (45, 46, 52, 59, 66, 73, 74, 75, 76, 108, 114) Not included Not included
---	---

Step 12

ASSIGNMENT COMMAND:

Channel Description	TCH/F
- Channel Type and TDMA offset	(N+4) mod 8
- Timeslot Number	Chosen arbitrarily
- Training Sequence Code	RF hopping channel
- Hopping	Chosen arbitrarily from the set (0, 1 to N-1) where N is the number of frequencies in the Mobile Allocation IE.
- MAIO	Chosen arbitrarily from the set (1 to 63)
- HSN	
Power Command	Chosen arbitrarily but with a changed value.
- Power level	
Channel Mode	Not included
Frequency list IE	Not included
Cell Channel Description	Not included (thus the CA from step 8 is used to decode the MA)
Mobile Allocation	Indicates frequencies (45, 46, 73, 74, 75, 76, 108, 114)
Starting Time	Not included

Step 15

ASSIGNMENT COMMAND:

Channel Description	TCH/F
- Channel Type and TDMA offset	(N+5) mod 8
- Timeslot Number	Chosen arbitrarily
- Training Sequence Code	Single RF Channel
- Hopping	10
- ARFCN	
Power Command	Chosen arbitrarily but with a changed value.
- Power level	signalling
Channel Mode	Not included
Frequency list IE	Not included
Cell Channel Description	Not included
Mobile Allocation	Not included
Starting Time	indicates (current frame number + 100 frames) mod 42 432

Step 19**ASSIGNMENT COMMAND:**

Channel Description <ul style="list-style-type: none"> - Channel Type <ul style="list-style-type: none"> TDMA offset - Timeslot Number - Training Sequence Code - Hopping - MAIO - HSN Power Command <ul style="list-style-type: none"> - Power level Channel Mode Cell Channel Description Frequency list IE Mobile Allocation Starting Time	TCH/H Chosen arbitrarily $(N+6) \bmod 8$ Chosen arbitrarily RF hopping channel Chosen arbitrarily from the set (0, 1 to N-1) where N is the number of frequencies in the Frequency List IE. 0 Chosen arbitrarily but with a changed value. A non-signalling mode arbitrarily selected from the half rate capabilities declared for the MS Not included Uses bit map 0 to indicate (10, 34, 52, 73, 108, 114). Not included Not included
--	---

Step 21**ASSIGNMENT COMMAND:**

Channel Description <ul style="list-style-type: none"> - Channel Type <ul style="list-style-type: none"> TDMA offset - Timeslot Number - Training Sequence Code - Hopping - ARFCN Power Command <ul style="list-style-type: none"> - Power level Channel Mode Frequency list IE Cell Channel Description Mobile Allocation Starting Time	TCH/H Chosen arbitrarily $(N+7) \bmod 8$ Chosen arbitrarily Single RF Channel Chosen arbitrarily, but not the BCCH carrier Chosen arbitrarily but with a changed value. Not included Not included Not included Not included Not included
--	---

Step 23

ASSIGNMENT COMMAND:

Channel Description	TCH/F
- Channel Type and TDMA offset	(N+1) mod 8
- Timeslot Number	Chosen arbitrarily
- Training Sequence Code	RF hopping channel
- Hopping	Chosen arbitrarily from the set (0, 1 to N-1) where N is the number of frequencies in the Mobile Allocation IE.
- MAIO	Chosen arbitrarily from the set (1 to 63)
- HSN	
Power Command	Chosen arbitrarily but with a changed value.
- Power level	Uses bit map 0 to indicate (17, 20)
Cell Channel Description	Not included
Frequency list IE	Not included
Mobile Allocation	Indicates ARFCN 17 only
Starting Time	Not included

GSM 900 end:

DCS 1 800 begin:

Step 3

IMMEDIATE ASSIGNMENT:

As default message contents except	
Channel Description	SDCCH/8
- Channel Type	Chosen arbitrarily
TDMA offset	N, chosen arbitrarily
- Timeslot Number	Chosen arbitrarily
- Training Sequence Code	Single RF Channel
- Hopping	the ARFCN of the BCCH carrier
- ARFCN	

Step 5

ASSIGNMENT COMMAND:

Channel Description	TCH/F
- Channel Type and TDMA offset	(N+1) mod 8
- Timeslot Number	Chosen arbitrarily
- Training Sequence Code	RF hopping channel
- Hopping	Chosen arbitrarily from the set (0, 1 to N-1) where N is the number of frequencies in the Mobile Allocation IE.
- MAIO	Chosen arbitrarily from the set (1 to 63)
- HSN	
Power Command	Chosen arbitrarily but with a changed value.
- Power level	Not included
Frequency list IE	
Channel Mode	Signalling
- Mode	Indicates all of the CA (broadcast on the BCCH) except for the BCCH carrier.
Mobile Allocation	Not included
Starting Time	

Step 8**ASSIGNMENT COMMAND:**

Channel Description	TCH/F
- Channel Type and TDMA offset	(N+3) mod 8
- Timeslot Number	Chosen arbitrarily
- Training Sequence Code	Single RF Channel
- Hopping	the ARFCN of the BCCH carrier
- ARFCN	
Power Command	Chosen arbitrarily but with a changed value.
- Power level	A non-signalling mode arbitrarily selected from the full rate capabilities declared for the MS
Channel Mode	Not Included
Frequency list IE	Use Range 128 to encode (773, 775, 779, 782, 791, 798, 829, 832, 844)
Cell Channel Description	Not included
Mobile Allocation	Not included
Starting Time	Not included

Step 12**ASSIGNMENT COMMAND:**

Channel Description	TCH/F
- Channel Type and TDMA offset	(N+4) mod 8
- Timeslot Number	Chosen arbitrarily
- Training Sequence Code	RF hopping channel
- Hopping	Chosen arbitrarily from the set (0, 1 to N-1) where N is the number of frequencies in the Mobile Allocation IE.
- MAIO	Chosen arbitrarily from the set (1 to 63)
- HSN	
Power Command	Chosen arbitrarily but with a changed value.
- Power level	Not included
Channel Mode	Not included
Frequency list IE	Not included
Cell Channel Description	Not included (thus the CA from step 8 is used to decode the MA)
Mobile Allocation	Indicates frequencies (773, 775, 779, 829, 832, 844)
Starting Time	Not included

Step 15**ASSIGNMENT COMMAND:**

Channel Description	TCH/F
- Channel Type and TDMA offset	(N+5) mod 8
- Timeslot Number	Chosen arbitrarily
- Training Sequence Code	Single RF Channel
- Hopping	734
- ARFCN	
Power Command	Chosen arbitrarily but with a changed value.
- Power level	signalling
Channel Mode	Not included
Frequency list IE	Not included
Cell Channel Description	Not included
Mobile Allocation	Not included
Starting Time	indicates (current frame number + 100 frames) mod 42 432

Step 19

ASSIGNMENT COMMAND:

Channel Description	TCH/H
- Channel Type	Chosen arbitrarily
TDMA offset	$(N+6) \bmod 8$
- Timeslot Number	Chosen arbitrarily
- Training Sequence Code	RF hopping channel
- Hopping	Chosen arbitrarily from the set (0, 1 to N-1) where N is the number of frequencies in the Frequency List IE.
- MAIO	0
- HSN	
Power Command	Chosen arbitrarily but with a changed value.
- Power level	
Channel Mode	A non-signalling mode arbitrarily selected from the half rate capabilities declared for the MS
Cell Channel Description	Not included
Frequency list IE	Uses Range 1024 to indicate (734, 741, 759, 766, 773, 832, 844)
Mobile Allocation	Not included
Starting Time	Not included

Step 21

ASSIGNMENT COMMAND:

Channel Description	TCH/H
- Channel Type	Chosen arbitrarily
TDMA offset	$(N+7) \bmod 8$
- Timeslot Number	Chosen arbitrarily
- Training Sequence Code	Single RF Channel
- Hopping	Chosen arbitrarily, but not the BCCH carrier
- ARFCN	
Power Command	Chosen arbitrarily but with a changed value.
- Power level	
Channel Mode	Not included
Frequency list IE	Not included
Cell Channel Description	Not included
Mobile Allocation	Not included
Starting Time	Not included

Step 23**ASSIGNMENT COMMAND:**

Channel Description	TCH/F
- Channel Type and TDMA offset	(N+1) mod 8
- Timeslot Number	Chosen arbitrarily
- Training Sequence Code	RF hopping channel
- Hopping	Chosen arbitrarily from the set (0, 1 to N-1) where N is the number of frequencies in the Mobile Allocation IE.
- MAIO	Chosen arbitrarily from the set (1 to 63
- HSN	
Power Command	Chosen arbitrarily but with a changed value.
- Power level	Uses Variable Range Format to indicate (741, 747)
Cell Channel Description	Not included
Frequency list IE	Not included
Mobile Allocation	Indicates ARFCN 741 only
Starting Time	Not included

DCS 1 800 end:**26.6.4.2 Dedicated assignment / failure****26.6.4.2.1 Dedicated assignment / failure / failure during active state**

This test is only applicable to an MS supporting the call control protocol.

26.6.4.2.1.1 Conformance requirements

On the mobile station side, if a lower layer failure happens on the new channel before the ASSIGNMENT COMPLETE message has been sent, the mobile station deactivates the new channels, reactivates the old channels, reconnects the TCHs if any and triggers the establishment of the main signalling link. It then sends a ASSIGNMENT FAILURE message, cause "protocol error unspecified" on the main DCCH and resumes the normal operation, as if no assignment attempt had occurred. The operational parameters (e.g. ciphering mode) when returning on the old channel are those applied before the procedure.

References

GSM 04.08 section 3.4.3.3.
GSM 05.08 section 4.2.
GSM 05.05 section 4.1.1.

26.6.4.2.1.2 Test purpose

To test that, when the MS fails to seize the new channel, the MS reactivates the old channel, reporting use of the last power level used on the old channel.

This is tested in the special cases of a transition:

- from TCH/F to hopping TCH/F in state U10 if the MS supports TCH/F and call control;
- from TCH/H to hopping TCH/H in state U10 if the MS supports TCH/H and call control.

26.6.4.2.1.3 Method of test**Initial Conditions**

System Simulator:

1 cell, default parameters. The SS orders the MS to use a power level P. Where P is a power level within the range supported by the Type of MS.

Mobile Station:

The MS is in the active state (U10) of a mobile terminated call.

Related PICS/PIXIT Statements

- Support for TCH/F.
- Support for TCH/H.
- Support for state U10 of the Call Control protocol.
- Type of MS (P-GSM 900 or EGSM or DCS 1 800).
- Power Class of MS.

Foreseen Final State of the MS

The active state (U10) of a mobile terminated call.

Test Procedure

The MS is in the active state (U10) of a mobile terminated call. The SS sends an ASSIGNMENT COMMAND allocating a new TCH/F, but does not activate the new channel. It is checked that the MS triggers the establishment of the main signalling link on the old channel and then sends an ASSIGNMENT FAILURE.

Maximum Duration of Test

30 s.

Expected Sequence

The test is repeated for execution counter k = 1, 2 if the MS supports TCH/H.

Step	Direction	Message	Comments
1	SS -> MS	ASSIGNMENT COMMAND	Channel Type = TCH/F, if k = 1, Channel Type = TCH/H, if k = 2. Power level specified in power command is different to P, again where P is a power level within the range supported by the Type of MS. The MS attempts (and fails) to establish a signalling link on the new channel.
2			The MS re-establishes the signalling link on the old channel.
3	MS -> SS	ASSIGNMENT FAILURE	RR cause value = "protocol error unspecified".
4	SS		The SS checks that the MS reports power level P in the L1 header of the SACCH message that is sent in the first SACCH multiframe following the SABM.

Specific Message Contents

None.

26.6.4.2.2 Dedicated assignment / failure / general case**26.6.4.2.2.1 Conformance requirements**

On the mobile station side, if a lower layer failure happens on the new channel before the ASSIGNMENT COMPLETE message has been sent, the mobile station deactivates the new channels, reactivates the old

channels, reconnects the TCHs if any and triggers the establishment of the main signalling link. It then sends a ASSIGNMENT FAILURE message, cause "protocol error unspecified" on the main DCCH and resumes the normal operation, as if no assignment attempt had occurred. The operational parameters (e.g. ciphering mode) when returning on the old channel are those applied before the procedure.

References

GSM 04.08 section 3.4.3.3.

26.6.4.2.2.2 Test purpose

To test that, when the MS fails to seize the new channel, the MS reactivates the old channel.

This is tested in the special cases of a transition:

- from SDCCH to hopping TCH/F; this test part is only applicable if the MS supports TCH/F.
- from non-hopping SDCCH to hopping TCH/H; this test part is only applicable if the MS supports TCH/H.
- from hopping TCH/F to hopping TCH/H; this test part is only applicable if the MS supports TCH/H.

NOTE: 26.6.8.4 contains the case of an assignment failure SDCCH -> SDCCH.

26.6.4.2.2.3 Method of test

Initial Conditions

System Simulator:

1 cell, default parameters.

Mobile Station:

The MS is "idle updated".

Related PICS/PIXIT Statements

- Support for TCH/F.
- Support for TCH/H.
- Type of MS (P-GSM 900 or EGSM or DCS 1 800).

Foreseen Final State of the MS

The MS is "idle updated".

Test Procedure

A mobile terminated RR connection is established on an SDCCH. The SS sends an ASSIGNMENT COMMAND message allocating a hopping TCH/F, but does not activate the assigned channels. The MS shall try to activate the new channel (this is not verified) and shall then reactivate the old channel and trigger the establishment of the main signalling link on the old channel. Then the MS shall send an ASSIGNMENT FAILURE.

For an MS not supporting TCH/H, the SS initiates the channel release procedure and the test ends here. For an MS supporting TCH/H, the test sequence is repeated another two times, with half rate channels involved, and again it is checked that the MS correctly returns to the old channels, before the SS initiates the channel release procedure.

Maximum Duration of Test

30 s.

Expected Sequence

Step	Direction	Message	Comments
1	SS -> MS	PAGING REQUEST TYPE 1	
2	MS -> SS	CHANNEL REQUEST	
3	SS -> MS	IMMEDIATE ASSIGNMENT	Channel Type: SDCCH.
4	MS -> SS	PAGING RESPONSE	
5	SS -> MS	ASSIGNMENT COMMAND	Channel Type = TCH/F, hopping. The MS attempts (and fails) to establish a signalling link on the new channel.
6			The MS re-establishes the signalling link on the old channel.
7	MS -> SS	ASSIGNMENT FAILURE	RR cause value = "protocol error unspecified".
A			This test part is performed if the MS does not support TCH/H.
A8	SS -> MS	CHANNEL RELEASE	The main signalling link is released.
B			This test part is performed if the MS supports TCH/H.
B8	SS -> MS	ASSIGNMENT COMMAND	Channel Type = TCH/H, hopping. The MS attempts (and fails) to establish a signalling link on the new channel.
B9			The MS re-establishes the signalling link on the old channel.
B10	MS -> SS	ASSIGNMENT FAILURE	RR cause value = "protocol error unspecified".
B11	SS -> MS	ASSIGNMENT COMMAND	Channel Type = TCH/F, hopping.
B12	MS -> SS	ASSIGNMENT COMPLETE	Sent on the assigned channel after establishment of the main signalling link.
B13	SS -> MS	ASSIGNMENT COMMAND	Channel Type = TCH/H, hopping. The MS attempts (and fails) to establish a signalling link on the new channel.
B14			The MS re-establishes the signalling link on the old channel.
B15	MS -> SS	ASSIGNMENT FAILURE	RR cause value = "protocol error unspecified".
B16	SS -> MS	CHANNEL RELEASE	The main signalling link is released.

Specific Message Contents

None.

26.6.5 Test of handover

With the Handover procedure, it is possible to completely alter the channels allocated to a MS. This makes it possible in particular to switch a call in progress from one cell to another. The procedure is always initiated by the network and with the MS in a dedicated mode.

Sections 26.6.5.1 - 26.6.5.4 contain generic test procedures to be used for executing successful Handover tests. Table 26.6-1 contains a summary of the different combinations of parameters which have to be tested, together with a reference to the appropriate generic test procedure. If a test uses a channel rate which the MS under test does not support, the test shall be skipped.

Table 26.6-1

From	To	Timing Adv.	Start Time	Syn ?	State of call	Section	Exec Counter
TCH/F, no FH	TCH/F, no FH	20	none	no	U10	26.6.5.1	1
TCH/F, no FH	TCH/F, FH	arbitrary	none	no	U10	26.6.5.1	2
TCH/F, FH	TCH/F, no FH	20	1,1s	no	U10	26.6.5.1	3
TCH/H, FH	TCH/H, no FH	20	none	no	U10	26.6.5.1	6
TCH/H, no FH	TCH/H, FH	arbitrary	none	no	U10	26.6.5.1	7
TCH/H, FH	TCH/H, FH	20	1,1s	no	U10	26.6.5.1	5
TCH/H, no FH	TCH/H, FH	arbitrary	none	no	U10	26.6.5.1	4
TCH/H, FH	TCH/F, no FH	arbitrary	none	no	U10	26.6.5.1	8
SDCCH/4, no FH	TCH/F, FH	20	none	no	estab	26.6.5.2	1
SDCCH/4, no FH	TCH/H, FH	20	none	no	estab	26.6.5.2	2
SDCCH/4, no FH	SDCCH/8, FH	20	none	no	estab	26.6.5.2	3
SDCCH/8, no FH	SDCCH/8, FH	arbitrary	none	no	estab	26.6.5.2	4
TCH/F, no FH	TCH/H, no FH	20	none	no	estab	26.6.5.2	5
TCH/H, FH	TCH/F, FH	20	none	no	estab	26.6.5.2	6
TCH/F, FH	TCH/F, FH	arbitrary	none	no	estab	26.6.5.2	7
SDCCH/8, FH	TCH/F, no FH	20	none	no	estab	26.6.5.2	8
SDCCH/8, no FH	TCH/F, FH	20	none	no	estab	26.6.5.2	9
SDCCH/8, no FH	TCH/H, FH	arbitrary	none	no	estab	26.6.5.2	10
TCH/F, FH	TCH/F, no FH	(2k+y) mod 256	none	yes	U10	26.6.5.3	1
TCH/H, FH	TCH/H, no FH	(2k+y) mod 256	none	yes	U10	26.6.5.3	2
SDCCH/8, FH	SDCCH/8, FH	(2k+y) mod 256	none	yes	estab	26.6.5.4	1
SDCCH/8, FH	SDCCH/4, no FH	(2k+y) mod 256	1,1s	yes	estab	26.6.5.4	2
TCH/F, no FH	TCH/F, FH	(2k+y) mod 256	none	yes	estab	26.6.5.4	3
SDCCH/8, no FH	TCH/F, no FH	(2k+y) mod 256	none	yes	estab	26.6.5.4	4

Table 26.6-2

	TCH/FS	TCH/HS	SDCCH
n	10-20	5-10	2-5

In addition to the successful case of Handover, 2 unsuccessful cases shall be tested. These tests are described in 26.6.5.8 and 26.6.5.9.

26.6.5.1 Handover / successful / active call / non-synchronized

26.6.5.1.1 Conformance requirements

The MS shall correctly apply the handover procedure in the non-synchronized case when a call is in progress and when handover is performed from a TCH/F without frequency hopping towards a TCH/F without frequency hopping.

The MS shall correctly apply the handover procedure in the non-synchronized case when a call is in progress and when handover is performed from a TCH/H without frequency hopping to a TCH/H with frequency hopping. This does not apply to MSs not supporting TCH/H.

References

GSM 04.08 sections 3.4.4 and 9.1.15.
GSM 04.13 section 5.2.6.2.

26.6.5.1.2 Test purpose

To test that when the MS is ordered to make a non-synchronized handover it continuously sends access bursts on the main DCCH until it receives a PHYSICAL INFORMATION message from the SS. To test that the MS correctly handles the values of any Starting Time IE in the HANDOVER COMMAND message in the case when none of the information elements referring to before the starting time are present. To test that the MS correctly handles the Timing Advance IE in the PHYSICAL INFORMATION message. To test that the MS activates the new channel correctly and transmits the HANDOVER COMPLETE message without undue delay.

26.6.5.1.3 Method of test

Initial Conditions

System Simulator:

2 cells, A and B with same LAI, default parameters except:

GSM 900:

Cell A has:

BCCH ARFCN = 20

Cell Allocation = (10, 17, 20, 26, 34, 42, 45, 46, 52, 59, 66, 73, 74, 75, 76, 108, 114)

Cell B has:

BCCH ARFCN = 40

Cell Allocation = (14, 18, 22, 24, 30, 31, 38, 40, 60, 66, 73, 74, 75, 76, 108, 114)

The frame numbers of cells A and B shall be different by 100.

The timebase of cells A and B shall be such that the edges of their timeslots are not coincident at the antenna connector.

DCS 1 800:

Cell A has:

BCCH ARFCN = 747

Cell Allocation = (734, 741, 747, 754, 759, 762, 766, 767, 773, 775, 779, 782, 791, 798, 829, 832, 844)

Cell B has:

BCCH ARFCN = 764

Cell Allocation = (739, 743, 746, 749, 756, 758, 761, 764, 771, 779, 782, 791, 798, 829, 832, 844)

The Cell Allocation of both Cell A and Cell B shall be coded using range 256 format.

The frame numbers of cells A and B shall be different by 100.

The timebase of cells A and B shall be such that the edges of their timeslots are not coincident at the antenna connector.

Mobile Station:

The MS is in the active state (U10) of a call on cell A.

Related PICS/PIXIT Statements

Supported rate(s) of TCH: TCH/F and/or TCH/H.

Support for state U10 of the Call Control protocol.

Support for speech: yes/no.

supported radio interface rates: 12kbps, 6kbps, 3,6kbps.

Type of Mobile Station (P-GSM 900 or EGSM or DCS 1 800).

Foreseen Final State of the MS

The active state (U10) of a call on cell A.

Test Procedure

This procedure is repeated for execution counter M = 1 to 8. (See table 26.6-1.)

The MS is in the active state (U10) of a call. The SS sends a HANOVER COMMAND on the main DCCH. The MS shall (at the time defined by the Starting Time information element, if included in the message) begin to send access bursts on the new DCCH of the target cell. The SS observes the access bursts and after receiving n (n being arbitrarily chosen between values according to table 26.6-2 of section 26.6.5) access bursts, the SS sends one PHYSICAL INFORMATION message with a Timing Advance as specified in table 26.6-1 of section 26.6.5. The MS shall activate the channel in sending and receiving mode. The MS shall establish a signalling link. The MS shall be ready to transmit a HANOVER COMPLETE message, before "x" ms after the end of the PHYSICAL INFORMATION message, but not before a UA frame has been sent by the SS.

The term "ready to transmit" is defined in GSM 04.13. The value of "x" depends upon the target channel and is specified in the specific message contents section.

Maximum Duration of Test

5 minutes, including 1 minute for any necessary operator actions.

Expected Sequence

This sequence is performed for an execution counter M = 1, 2, 3 for an MS which only supports TCH/F. This sequence is performed for an execution counter M = 1, 2.. 8 for an MS which supports TCH/F and H

Step	Direction	Message	Comments
0	MS -> SS		The MS and SS are in the active state of a call on the channel described below.
1	SS -> MS	HANOVER COMMAND	See Specific message contents.
2	MS -> SS	HANOVER ACCESS	Repeated on every burst of the uplink main DCCH until reception of PHYSICAL INFORMATION. Handover Reference as included in the HANOVER COMMAND. If the HANOVER COMMAND includes a starting time IE then the first HANOVER ACCESS message shall be transmitted in the indicated frame (unless the indicated frame is not used by that channel, in which case the next frame used by that channel shall be used).
3	SS -> MS	PHYSICAL INFORMATION	Sent after reception of n HANOVER ACCESS messages. See specific message contents.
4	MS -> SS	SABM	Sent without information field.
5	SS -> MS	UA	
6	MS -> SS	HANOVER COMPLETE	The message shall be ready to be transmitted before "x" ms after the completion of step 3.
7	MS -> SS		The MS and SS are in the active state of a call on the channel described below.

Specific Message Contents For Mobiles Supporting Speech

For M = 1:

P-GSM 900

Step 0: The MS and SS are using a full rate TCH in non-hopping mode on cell A.

HANDOVER COMMAND

Information Element	value/remarks
As default message contents, except:	
Cell Description	
- Network Colour Code	1
- Base Station Colour Code	5
- BCCH Carrier Number	40
Synchronization Indication	
- Report Observed Time Difference	Shall not be included.
- Synchronization Indication	"Non synchronized".
- Normal Cell Indication	Ignore out of range timing advance.

PHYSICAL INFORMATION

Information Element	value/remarks
As default message contents.	

Step 6: x = 500

Step 7: The MS and SS are using a full rate TCH in non hopping mode on cell B.

DCS 1 800

Step 0: The MS and SS are using a full rate TCH in non-hopping mode on cell A.

HANDOVER COMMAND

Information Element	value/remarks
As default message contents, except:	
Cell Description	
- Network Colour Code	1
- Base Station Colour Code	5
- BCCH Carrier Number	764
Synchronization Indication	
- Report Observed Time Difference	Shall not be included.
- Synchronization Indication	"Non synchronized".
- Normal Cell Indication	Ignore out of range timing advance.

PHYSICAL INFORMATION

Information Element	value/remarks
As default message contents.	

Step 6: x = 500

Step 7: The MS and SS are using a full rate TCH in non hopping mode on cell B.

For M = 2:

GSM 900

Step 0: The MS and SS are using a full rate TCH in non-hopping mode on cell B.

HANDOVER COMMAND

Information Element	value/remarks
As default message contents, except: Cell Description <ul style="list-style-type: none"> - Network Colour Code - Base Station Colour Code - BCCH Carrier Number Channel Description <ul style="list-style-type: none"> - Channel Type - Timeslot number - Training Sequence Code - Hopping - MAIO - HSN Synchronization Indication IE is not included. Channel Mode IE is not included. Frequency Channel Sequence after time <ul style="list-style-type: none"> - Frequency Channel Sequence 	1 5 20 TCH/F + ACCHs Chosen arbitrarily, but not Zero. Chosen arbitrarily RF hopping channel. Chosen arbitrarily from the set (0, 1 to N-1), where N is the number of frequencies encoded in the Frequency Channel Sequence IE. Chosen arbitrarily from the set (1,2,..63). Allocates the following 12 frequencies (10, 17, 20, 26, 59, 66, 73, 74, 75, 76, 108, 114).

PHYSICAL INFORMATION

Information Element	value/remarks
As default message contents, except: Timing advance	Arbitrarily selected but different to default value.

Step 6: x = 500.

Step 7: The MS and SS are using a full rate TCH in hopping mode on cell A.

DCS 1 800

Step 0: The MS and SS are using a full rate TCH in non-hopping mode on cell B.

HANDOVER COMMAND

Information Element	value/remarks
As default message contents, except: Cell Description <ul style="list-style-type: none"> - Network Colour Code - Base Station Colour Code - BCCH Carrier Number Channel Description <ul style="list-style-type: none"> - Channel Type - Timeslot number - Training Sequence Code - Hopping - MAIO - HSN Synchronization Indication IE is not included. Channel Mode IE is not included. Frequency Short List after time <ul style="list-style-type: none"> - Frequency List 	 1 5 747 TCH/F + ACCHs Chosen arbitrarily, but not Zero. Chosen arbitrarily. RF hopping channel. Chosen arbitrarily from the set (0, 1 to N-1), where N is the number of frequencies encoded in the Frequency Short List IE. Chosen arbitrarily from the set (1,2,..63). Use Range 256 to encode the following 9 frequencies: (747, 775, 779, 782, 791, 798, 829, 832, 844).

PHYSICAL INFORMATION

Information Element	value/remarks
As default message contents, except: Timing advance	Arbitrarily selected but different to default value.

Step 6: $x = 500$.

Step 7: The MS and SS are using a full rate TCH in hopping mode on cell A.

For $M = 3$:

GSM 900

Step 0: The MS and SS are using a full rate TCH in hopping mode on cell A.

HANDOVER COMMAND

Information Element	value/remarks
As default message contents, except: Cell Description <ul style="list-style-type: none"> - Network Colour Code - Base Station Colour Code - BCCH Carrier Number Synchronization Indication <ul style="list-style-type: none"> - Report Observed Time Difference - Synchronization Indication - Normal Cell Indication Starting Time Mode of first channel	 1 5 40 Shall not be included. "Non synchronized". Out of range timing advance shall trigger a handover failure procedure. Indicates the frame number of cell B that will occur approximately 1,1 seconds (238 frames have elapsed) after the HANDOVER COMMAND is sent by cell A. Speech (full rate version 1 or half rate version 1).

PHYSICAL INFORMATION

Information Element	value/remarks
As default message contents.	

Step 6: $x = 500$.

Step 7: The MS and SS are using a full rate TCH in non-hopping mode on cell B.

DCS 1 800

Step 0: The MS and SS are using a full rate TCH in hopping mode on cell A.

HANDOVER COMMAND

Information Element	value/remarks
As default message contents, except:	
Cell Description	
- Network Colour Code	1
- Base Station Colour Code	5
- BCCH Carrier Number	764
Synchronization Indication	
- Report Observed Time Difference	Shall not be included.
- Synchronization Indication	"Non synchronized".
- Normal Cell Indication	Out of range timing advance shall trigger a handover failure procedure.
Starting Time	Indicates the frame number of cell B that will occur approximately 1,1 seconds (238 frames have elapsed) after the HANDOVER COMMAND is sent by cell A.
Mode of first channel	Speech (full rate version 1 or half rate version 1).

PHYSICAL INFORMATION

Information Element	value/remarks
As default message contents.	

Step 6: $x = 500$.

Step 7: The MS and SS are using a full rate TCH in non-hopping mode on cell B.

For M = 4:

GSM 900

Step 0: The MS and SS are using a full rate TCH in non-hopping mode on cell B.

HANDOVER COMMAND

Information Element	value/remarks
As default message contents, except: Cell Description	
- Network Colour Code	1
- Base Station Colour Code	5
- BCCH Carrier Number	20
Channel Description	
- Channel Type	TCH/H + ACCHs
- TDMA offset	Chosen arbitrarily.
- Timeslot number	Zero.
- Training Sequence Code	Chosen arbitrarily.
- Hopping	RF hopping channel.
- MAIO	Chosen arbitrarily from the set (0, 1 to N-1), where N is the number of frequencies encoded in the Mobile Allocation.
- HSN	zero (this gives cyclic hopping).
Synchronization Indication IE is not included.	
Cell Channel Description	Use bit map 0 to encode the complete CA of Cell A.
Mobile Allocation after time	Indicates all of the CA of cell A except for the BCCH frequency.

PHYSICAL INFORMATION

Information Element	value/remarks
As default message contents, except: Timing advance	Arbitrarily selected but different to default value.

Step 6: x = 500.

Step 7: The MS and SS are using a half rate TCH in hopping mode on cell A.

DCS 1 800

Step 0: The MS and SS are using a full rate TCH in non-hopping mode on cell B.

HANDOVER COMMAND

Information Element	value/remarks
As default message contents, except:	
Cell Description	
- Network Colour Code	1
- Base Station Colour Code	5
- BCCH Carrier Number	747
Channel Description	
- Channel Type	TCH/H + ACCHs
- TDMA offset	Chosen arbitrarily.
- Timeslot number	Zero.
- Training Sequence Code	Chosen arbitrarily.
- Hopping	RF hopping channel.
- MAIO	Chosen arbitrarily from the set (0, 1 to N-1), where N is the number of frequencies encoded in the Mobile Allocation.
- HSN	zero (this gives cyclic hopping).
Synchronization Indication IE is not included.	
Cell Channel Description	Use Range 512 to encode the complete CA of Cell A.
Mobile Allocation after time	Indicates all of the CA of cell A except for the BCCH frequency.

PHYSICAL INFORMATION

Information Element	value/remarks
As default message contents, except:	
Timing advance	Arbitrarily selected but different to default value.

Step 6: $x = 500$.

Step 7: The MS and SS are using a half rate TCH in hopping mode on cell A.

For M = 5:

GSM 900

Step 0: The MS and SS are using a half rate TCH in hopping mode on cell A.

HANDOVER COMMAND

Information Element	value/remarks
As default message contents, except:	
Cell Description	
- Network Colour Code	1
- Base Station Colour Code	5
- BCCH Carrier Number	40
Channel Description	
- Channel Type	TCH/H + ACCHs
- TDMA offset	Chosen arbitrarily.
- Timeslot number	Chosen arbitrarily, but not Zero.
- Training Sequence Code	Chosen arbitrarily.
- Hopping	RF hopping channel.
- MAIO	Chosen arbitrarily from the set (0, 1 to N-1), where N is the number of frequencies encoded in the Frequency List IE.
- HSN	Chosen arbitrarily from the set. (1,2,..63).
Frequency List after time	
- Frequency List	use bit map 0 to allocates the following 12 frequencies: (14, 18, 22, 24, 60, 66, 73, 74, 75, 76,108, 114).
Synchronization Indication	
- Report Observed Time Difference	Shall not be included.
- Synchronization Indication	"Non synchronized".
- Normal Cell Indication	Ignore out of range timing advance.
Starting Time	Indicates the frame number of cell B. that will occur approximately 1,1 seconds (238 frames have elapsed) after the HANDOVER COMMAND is sent by cell A.

PHYSICAL INFORMATION

Information Element	value/remarks
As default message contents.	

Step 6: x = 750.

Step 7: The MS and SS are using a half rate TCH in hopping mode on cell B.

DCS 1 800

Step 0: The MS and SS are using a half rate TCH in hopping mode on cell A.

HANDOVER COMMAND

Information Element	value/remarks
As default message contents, except:	
Cell Description	
- Network Colour Code	1
- Base Station Colour Code	5
- BCCH Carrier Number	764
Channel Description	
- Channel Type	TCH/H + ACCHs
- TDMA offset	Chosen arbitrarily.
- Timeslot number	Chosen arbitrarily but not Zero.
- Training Sequence Code	Chosen arbitrarily.
- Hopping	RF hopping channel.
- MAIO	Chosen arbitrarily from the set (0, 1 to N-1), where N is the number of frequencies encoded in the Frequency List IE.
- HSN	Chosen arbitrarily from the set (1,2,..63).
Frequency List after time	
- Frequency List	Use Range 1024 to allocate the following 12 frequencies: (749, 758, 761, 764, 771, 779, 782, 791, 798, 829, 832, 844).
Synchronization Indication	
- Report Observed Time Difference	Shall not be included.
- Synchronization Indication	"Non synchronized".
- Normal Cell Indication	Ignore out of range timing advance.
Starting Time	Indicates the frame number of cell B that will occur approximately 1,1 seconds (238 frames have elapsed) after the HANDOVER COMMAND is sent by cell A..

PHYSICAL INFORMATION

Information Element	value/remarks
As default message contents.	

Step 6: x = 750.

Step 7: The MS and SS are using a half rate TCH in hopping mode on cell B.

For M = 6:

GSM 900

Step 0: The MS and SS are using a half rate TCH in hopping mode on cell B.

HANDOVER COMMAND

Information Element	value/remarks
As default message contents, except:	
Cell Description	
- Network Colour Code	1
- Base Station Colour Code	5
- BCCH Carrier Number	20
Channel Description	
- Channel Type	TCH/H + ACCHs
- TDMA offset	Chosen arbitrarily.
- Timeslot number	Chosen arbitrarily but not Zero.
- Training Sequence Code	Chosen arbitrarily.
- Hopping	Single RF channel.
- ARFCN	Chosen arbitrarily from the Cell Allocation of Cell A.
Synchronization Indication IE not included.	

PHYSICAL INFORMATION

Information Element	value/remarks
As default message contents.	

Step 6: x = 750.

Step 7: The MS and SS are using a half rate TCH in non-hopping mode on cell A.

DCS 1 800

Step 0: The MS and SS are using a half rate TCH in hopping mode on cell B.

HANDOVER COMMAND

Information Element	value/remarks
As default message contents, except:	
Cell Description	
- Network Colour Code	1
- Base Station Colour Code	5
- BCCH Carrier Number	747
Channel Description	
- Channel Type	TCH/H + ACCHs
- TDMA offset	Chosen arbitrarily.
- Timeslot number	Chosen arbitrarily but not Zero.
- Training Sequence Code	Chosen arbitrarily.
- Hopping	Single RF channel.
- ARFCN	Chosen arbitrarily from the Cell Allocation of Cell A.
Synchronization Indication IE not included.	

PHYSICAL INFORMATION

Information Element	value/remarks
As default message contents.	

Step 6: x = 750.

Step 7: The MS and SS are using a half rate TCH in non-hopping mode on cell A.

For M = 7:

GSM 900

Step 0: The MS and SS are using a half rate TCH in non-hopping mode on cell A.

HANDOVER COMMAND

Information Element	value/remarks
As default message contents, except:	
Cell Description	
- Network Colour Code	1
- Base Station Colour Code	5
- BCCH Carrier Number	40
Channel Description	
- Channel Type	TCH/F + ACCHs
- Timeslot number	Chosen arbitrarily but not Zero.
- Training Sequence Code	Chosen arbitrarily.
- Hopping	RF hopping channel.
- MAIO	Chosen arbitrarily from the set (0, 1 to N-1), where N is the number of frequencies encoded in the Frequency Channel Sequence IE.
- HSN	Chosen arbitrarily from the set. (1,2,..63).
Frequency Channel Sequence after time	
- Frequency Channel Sequence	Allocates the following 8 frequencies: (40, 66, 73, 74, 75, 76,108, 114).
Synchronization Indication	
- Report Observed Time Difference	Shall not be included.
- Synchronization Indication	"Non synchronized".
- Normal Cell Indication	Ignore out of range timing advance.
Mode of first channel	speech (full rate version 1 or half rate version 1).

PHYSICAL INFORMATION

Information Element	value/remarks
As default message contents, except:	
Timing advance	Arbitrarily selected but different to default value.

Step 6: x = 750.

Step 7: The MS and SS are using a half rate TCH in hopping mode on cell B.

DCS 1 800

Step 0: The MS and SS are using a half rate TCH in non-hopping mode on cell A.

HANDOVER COMMAND

Information Element	value/remarks
As default message contents, except:	
Cell Description	
- Network Colour Code	1
- Base Station Colour Code	5
- BCCH Carrier Number	764
Channel Description	
- Channel Type	TCH/H + ACCHs
- TDMA offset	Chosen arbitrarily.
- Timeslot number	Chosen arbitrarily but not Zero.
- Training Sequence Code	Chosen arbitrarily.
- Hopping	RF hopping channel.
- MAIO	Chosen arbitrarily from the set (0, 1 to N-1), where N is the number of frequencies encoded in the Frequency List IE.
- HSN	Chosen arbitrarily from the set. (1,2,..63).
Frequency List after time	
- Frequency List	Use Variable Bit Map to encode the following 8 frequencies: (764, 779, 782, 791, 798, 829, 832, 844).
Synchronization Indication	
- Report Observed Time Difference	Shall not be included.
- Synchronization Indication	"Non synchronized".
- Normal Cell Indication	Ignore out of range timing advance.
Mode of first channel	speech (full rate version 1 or half rate version 1).

PHYSICAL INFORMATION

Information Element	value/remarks
As default message contents, except:	
Timing advance	Arbitrarily selected but different to default value.

Step 6: $x = 750$.

Step 7: The MS and SS are using a half rate TCH in hopping mode on cell B.

For M = 8:

GSM 900

Step 0: The MS and SS are using a half rate TCH in hopping mode on cell B.

HANDOVER COMMAND

Information Element	value/remarks
As default message contents, except: Cell Description	
- Network Colour Code	1
- Base Station Colour Code	5
- BCCH Carrier Number	20
Channel Description	
- Channel Type	TCH/F + ACCHs
- Timeslot number	Chosen arbitrarily but not Zero.
- Training Sequence Code	Chosen arbitrarily.
- Hopping	Single RF channel.
- ARFCN	20
Synchronization Indication IE not included.	

PHYSICAL INFORMATION

Information Element	value/remarks
As default message contents, except: Timing advance	Arbitrarily selected but different to default value.

Step 6: x = 500.

Step 7: The MS and SS are using a full rate TCH in non-hopping mode on cell A.

DCS 1 800

Step 0: The MS and SS are using a half rate TCH in hopping mode on cell B.

HANDOVER COMMAND

Information Element	value/remarks
As default message contents, except: Cell Description	
- Network Colour Code	1
- Base Station Colour Code	5
- BCCH Carrier Number	747
Channel Description	
- Channel Type	TCH/F + ACCHs
- Timeslot number	Chosen arbitrarily but not Zero.
- Training Sequence Code	Chosen arbitrarily.
- Hopping	Single RF channel.
- ARFCN	747
Synchronization Indication IE not included.	

PHYSICAL INFORMATION

Information Element	value/remarks
As default message contents, except: Timing advance	Arbitrarily selected but different to default value.

Step 6: x = 500.

Step 7: The MS and SS are using a full rate TCH in non-hopping mode on cell A.

Specific Message Contents For Mobiles not Supporting Speech

If the mobile station supports half rate, then the 12 kbps radio interface rate is not used for this test. With this restriction, the radio interface rate is selected arbitrarily from those support.

The message contents shall be the same for the declared type of Mobile Station (either P-GSM 900 or DCS 1 800) supporting speech , except for:

M = 3 and 7:

HANDOVER COMMAND

Information Element	value/remarks
Mode of first channel	Data, with the full rate radio interface rate that is in use.

26.6.5.2 Handover / successful / call under establishment / non-synchronized

This test is applicable to all MS which support at least one MO circuit switched basic service.

26.6.5.2.1 Conformance requirements

The MS shall correctly apply the handover procedure from SDCCH/8, TCH/F or TCH/H with or without frequency hopping to SDCCH/8, TCH/F or TCH/H with or without frequency hopping in the non-synchronized case during call establishment. The mobile shall correctly apply the handover procedures from non frequency hopping SDCCH/4 to SDCCH/8, TCH/F or TCH/H with or without frequency hopping. If during call establishment a Layer 3 MM or CC message just sent by the MS is not Layer 2 acknowledged before the channel change caused by the HANDOVER COMMAND message, the MS shall send the Layer 3 message to the new cell, using the same value in the N(SD) field, after the handover procedure.

References

GSM 04.08, sections 3.1.4.2, 3.4.4 and 9.1.15.

GSM 04.13, section 5.2.6.2.

26.6.5.2.2 Test purpose

To test that when the MS is ordered to make a non-synchronized handover, it continuously sends access bursts on the main DCCH until it receives a PHYSICAL INFORMATION message from the SS. To test that the MS correctly takes the values of the Timing Advance information element in the PHYSICAL INFORMATION message into account. To test that the MS activates the new channel correctly and transmits the HANDOVER COMPLETE message without undue delay. To test that the MS correctly retransmits Layer 3 MM or CC messages, that were not acknowledged by Layer 2 before the Handover, after completion of the Handover.

26.6.5.2.3 Method of test**Initial Conditions**

System Simulator:

2 cells A and B with same LAI, default parameters, except:

GSM 900:

Cell A has:

BCCH ARFCN = 20.

Cell Allocation = (10, 17, 20, 26, 34, 42, 45, 46, 52, 59, 66, 73, 74, 75, 76, 108, 114).

PLMN colour code, NCC = as defaults.

BS colour code, BCC = as defaults.

PLMN_PERM = 00001010.

Cell B has:

BCCH ARFCN = 40.

Cell Allocation = (14, 18, 22, 24, 30, 31, 38, 40, 60, 66, 73, 74, 75, 76, 108, 114).

PLMN colour code, NCC = 3.

BS colour code, BCC = 0.

Both cells send SYSTEM INFORMATION TYPE 1 messages containing the complete Cell Allocation of the cell, using bit map 0 format.

The timebase of Cells A and B shall be such that the edges of their timeslots are not coincident at the antenna connector.

For execution counter M = 1, 2 and 3 a combined CCH/SDCCH is used.

For execution counter M = 4 to 10 a non combined SDCCH is used.

DCS 1 800:

Cell A has:

BCCH ARFCN = 747.

Cell Allocation = (734, 741, 747, 754, 759, 762, 766, 767, 773, 775, 779, 782, 791, 798, 829, 832, 844).

PLMN colour code, NCC = as defaults.

BS colour code, BCC = as defaults.

PLMN_PERM = 00001010.

Cell B has:

BCCH ARFCN = 764.

Cell Allocation = (739, 743, 746, 749, 756, 758, 761, 764, 771, 779, 782, 791, 798, 829, 832, 844).

PLMN colour code, NCC = 3.

BS colour code, BCC = 0.

Both cells send SYSTEM INFORMATION TYPE 1 messages containing the complete Cell Allocation of the cell, using Range 512 format.

The timebase of Cells A and B shall be such that the edges of their timeslots are not coincident at the antenna connector.

For execution counter M = 1, 2 and 3 a combined CCH/SDCCH is used.

For execution counter M = 4 to 10 a non combined SDCCH is used.

Mobile Station:

The MS is in the "idle, updated" state, with a TMSI allocated and camped on cell A.

Related PICS/PIXIT Statements

Supported rate(s) of TCH: TCH/F and/or TCH/H.

Support for MO calls.

Supported speech and data rates.

Type of MS (P-GSM 900 or EGSM or DCS 1 800).

Foreseen Final State of the MS

"Idle, updated" with TMSI allocated and camped on cell B.

Test Procedure

This procedure is repeated for execution counter M = 1, 2 .. 10 (See table 26.6-1.)

A Mobile Originating Call is initiated on Cell A. After the MS has sent the SETUP message (and before the last L2 frame carrying the SETUP message is acknowledged by the SS) the SS sends a HANDOVER COMMAND message, ordering the MS to switch to cell B. The MS shall then begin to send access bursts on the new DCCH to cell B. The SS observes the access bursts and after receiving n (n being arbitrarily chosen between values according to table 26.6-2 of section 26.6.5) access bursts, the SS sends one

PHYSICAL INFORMATION message with a Timing Advance as specified in table 26.6-1 of section 26.6.5. The MS shall activate the channel in sending and receiving mode. The MS shall establish a signalling link. The MS shall be ready to transmit a HANDOVER COMPLETE message before x ms after the end of the PHYSICAL INFORMATION message, but not before a UA frame has been sent by the SS. The MS shall then again send the SETUP message to the SS, using the same value in the N(SD) field. Finally the SS sends a CHANNEL RELEASE to end the test.

The term "ready to transmit" is defined in GSM 04.13. The value of "x" depends upon the target channel and is specified in the specific message contents section.

Maximum Duration of Test

5 minutes, including 1 minute for any necessary operator actions.

Expected Sequence

The sequence is performed for execution counter M = 1, 2..10 (unless a particular TCH is not supported).

Step	Direction	Message	Comments
1	-----	-----	A MO call is initiated on cell A.
2	MS -> SS	CHANNEL REQUEST	Establish. Cause = "Originating call, NECI not set to 1
3	SS -> MS	IMMEDIATE ASSIGNMENT	See specific message contents.
4	MS -> SS	CM SERVICE REQUEST	CM Service Type = Mobile Originating Call Establishment.
5	SS -> MS	CIPHERING MODE COMMAND	
6	MS -> SS	CIPHERING MODE COMPLETE	
7	MS -> SS	SETUP	Last L2 frame not acknowledged by the SS.
8	SS -> MS	HANDOVER COMMAND	See specific message contents.
9	MS -> SS	HANDOVER ACCESS	Repeated on every burst of the uplink main DCCH until reception of PHYSICAL INFORMATION. Handover Reference as included in the HANDOVER COMMAND
10	SS -> MS	PHYSICAL INFORMATION	Sent after reception of n HANDOVER ACCESS message. Timing Advance as specified in table 26.6-1 of section 26.6.5.
11	MS -> SS	SABM	Sent without information field.
12	SS -> MS	UA	
13	MS -> SS	HANDOVER COMPLETE	This message shall be ready to be transmitted before "x" ms after the completion of step 10.
14	MS -> SS	SETUP	Same N(SD) as in step 7.
15	SS -> MS	CHANNEL RELEASE	

Specific Message Contents For Mobiles Supporting Speech

M = 1.

DCS 1 800:

IMMEDIATE ASSIGNMENT

Information Element	value/remark
As default message contents.	

HANDOVER COMMAND

Information Element	value/remarks
As default message contents, except:	
Cell Description	
- Network Colour Code	3
- Base Station Colour Code	0
- BCCH Carrier Number	764
Channel Description	
- Channel Type	TCH/F + ACCHs
- Timeslot number	zero.
- Training Sequence Code	Chosen arbitrarily.
- Hopping	RF hopping channel.
- MAIO	Chosen arbitrarily from the set (0, 1 to N-1), where N is the number of frequencies encoded in the Frequency Short List IE.
- HSN	Chosen arbitrarily from the set. (1,2,..63).
Synchronization IE is not included.	
Frequency Short List after time	
- Frequency Short List	Use Range 128 to encode the following 11 frequencies: (756, 758, 761, 771, 779, 782, 791, 798, 829, 832, 844).
Mode of the First Channel	Speech (full rate version 1 or half rate version 1).

Step 13: "x" = 500.

For GSM 900:

IMMEDIATE ASSIGNMENT

Information Element	value/remark
As default message contents.	

HANDOVER COMMAND

Information Element	value/remarks
As default message contents, except:	
Cell Description	
- Network Colour Code	3
- Base Station Colour Code	0
- BCCH Carrier Number	40
Channel Description	
- Channel Type	TCH/F + ACCHs
- Timeslot number	Zero.
- Training Sequence Code	Chosen arbitrarily.
- Hopping	RF hopping channel.
- MAIO	Chosen arbitrarily from the set (0, 1 to N-1), where N is the number of frequencies encoded in the Frequency Channel Sequence IE.
- HSN	Chosen arbitrarily from the set. (1,2,..63).
Synchronization IE is not included.	
Frequency Channel Sequence, after time	
- Frequency Channel Sequence	Allocates the following 15 frequencies: (14, 18, 22, 24, 30, 31, 38, 53, 66, 73, 74, 75, 76, 108, 114).
Mode of the First Channel	Speech (full rate version 1 or half rate version 1).

Step 13: "x" = 500.

M = 2.

DCS 1 800:**IMMEDIATE ASSIGNMENT**

Information Element	value/remark
As default message contents.	

HANDOVER COMMAND

Information Element	value/remarks
As default message contents, except:	
Cell Description	
- Network Colour Code	3
- Base Station Colour Code	0
- BCCH Carrier Number	764
Channel Description	
- Channel Type	TCH/H + ACCHs
- TDMA offset	Chosen arbitrarily.
- Timeslot number	Chosen arbitrarily but not zero.
- Training Sequence Code	Chosen arbitrarily.
- Hopping	RF hopping channel.
- MAIO	Chosen arbitrarily from the set (0, 1 to N-1), where N is the number of frequencies encoded in the Mobile Allocation.
- HSN	Chosen arbitrarily from the set (1, 2.. 63).
Synchronization Indication	
- Report Observed Time Difference	Shall not be included.
- Synchronization Indication	"Non synchronized".
- Normal Cell Indication	Ignore out of range timing advance.
Cell Channel Description	Use Range 512 to encode the following frequencies: (761, 764, 771, 779, 782, 791, 798, 829, 832).
Mobile Allocation after time	Indicates (791, 798, 829) only).
Mode of First Channel	Speech (full rate version 1 or half rate version 1).

Step 13: "x" = 750.

GSM 900:**IMMEDIATE ASSIGNMENT**

Information Element	value/remark
As default message contents.	

HANDOVER COMMAND

As default message contents, except:	
Cell Description	
- Network Colour Code	3
- Base Station Colour Code	0
- BCCH Carrier Number	40
Channel Description	
- Channel Type	TCH/H + ACCHs
- TDMA offset	Chosen arbitrarily.
- Timeslot number	Chosen arbitrarily.
- Training Sequence Code	Chosen arbitrarily.
- Hopping	RF hopping channel.
- MAIO	Chosen arbitrarily from the set (0, 1 to N-1), where N is the number of frequencies encoded in the Mobile Allocation.
- HSN	Chosen arbitrarily from the set (1, 2.. 63).
Synchronization Indication IE is not included	
Cell Channel Description	uses bit map 0 to encode: {40, 66, 73, 74, 75, 76, 108, 114} only.
Mobile Allocation after time	indicates channel {73, 74, 75} only.
Channel Mode IE	speech (full rate version 1 or half rate version 1).

Step 13: "x" = 750.

M = 3.

DCS 1 800:**IMMEDIATE ASSIGNMENT**

Information Element	value/remark
As default message contents.	

HANDOVER COMMAND

Information Element	value/remarks
As default message contents, except:	
Cell Description	
- Network Colour Code	3
- Base Station Colour Code	0
- BCCH Carrier Number	764
Channel Description	
- Channel Type	SDCCH/8
- TDMA offset	Chosen arbitrarily.
- Timeslot number	Zero.
- Training Sequence Code	Chosen arbitrarily.
- Hopping	RF hopping channel.
- MAIO	Chosen arbitrarily from the set (0, 1 to N-1), where N is the number of frequencies encoded in the Frequency Short List IE.
- HSN	Zero (this gives cyclic hopping).
Synchronization Indication IE not included.	
Frequency Short List after time	
- Frequency Short List	Use Range 128 to encode the following 2 frequencies (746, 779).
Mode of First Channel	Signalling Only.

Step 13: "x" = 1 500.

GSM 900:**IMMEDIATE ASSIGNMENT**

Information Element	value/remark
As default message contents.	

HANDOVER COMMAND

Information Element	value/remarks
As default message contents, except:	
Cell Description	
- Network Colour Code	3
- Base Station Colour Code	0
- BCCH Carrier Number	40
Channel Description	
- Channel Type	SDCCH/8
- TDMA offset	Chosen arbitrarily.
- Timeslot number	Zero.
- Training Sequence Code	Chosen arbitrarily.
- Hopping	RF hopping channel.
- MAIO	Chosen arbitrarily from the set (0, 1 to N-1), where N is the number of frequencies encoded in the Frequency List IE.
- HSN	Chosen arbitrarily from the set {1, 2, ..., 63}.
Synchronization Indication IE is not included	Frequency list after time.
- Frequency List	uses bit map 0 to allocate the following 15 frequencies {14, 18, 22, 24, 30, 31, 38, 60, 66, 73, 74, 75, 76, 108, 114}.
Channel Mode IE	signalling only.

Step 13: "x" = 1 500.

M = 4.

DCS 1 800:**IMMEDIATE ASSIGNMENT**

Information Element	value/remark
As default message contents except:	
- Timeslot number	Arbitrary value, but not zero.
- ARFCN	747

HANDOVER COMMAND

Information Element	value/remarks
As default message contents, except:	
Cell Description	
- Network Colour Code	3
- Base Station Colour Code	0
- BCCH Carrier Number	764
Channel Description	
- Channel Type	SDCCH/8
- TDMA offset	Chosen arbitrarily.
- Timeslot number	Arbitrary value but not zero.
- Training Sequence Code	Chosen arbitrarily.
- Hopping	RF hopping channel.
- MAIO	Chosen arbitrarily from the set (0, 1 to N-1), where N is the number of frequencies encoded in the Frequency List IE.
- HSN	zero (this gives cyclic hopping).
Frequency List after time	
- Frequency List	Use Range 1024 to encode the complete CA of Cell B.
Synchronization Indication	
- Report Observed Time Difference	Shall not be included.
- Synchronization Indication	"Non synchronized".
- Normal Cell Indication	Ignore out of range timing advance.
Channel Mode IE is not included.	

Step 13: "x" = 1 500.

GSM 900:**IMMEDIATE ASSIGNMENT**

Information Element	value/remark
As default message contents except:	
- Timeslot number	Arbitrary value, but not zero.
- ARFCN	20

HANDOVER COMMAND

Information Element	value/remarks
Cell Description	
- Network Colour Code	3
- Base Station Colour Code	0
- BCCH Carrier Number	40
Channel Description	
- Channel Type	SDCCH/8
- TDMA offset	Chosen arbitrarily.
- Timeslot number	Arbitrary value, but not zero.
- Training Sequence Code	Chosen arbitrarily.
- Hopping	RF hopping channel.
- MAIO	Chosen arbitrarily from the set (0, 1 to N-1), where N is the number of frequencies encoded in the Frequency Channel Sequence IE.
Frequency Channel Sequence, after time	
- Frequency channel sequence	Allocates the following 14 frequencies: {14, 18, 22, 24, 30, 31, 38, 40, 66, 73, 74, 75, 76, 108}.
Synchronization Indication	
- Report Observed Time Difference	Shall not be included.
- Synchronization Indication	"Non synchronized".
- Normal Cell Indication	Ignore out of range timing advance.
Mode of first channel	Not included

Step 13: "x" = 1 500.

M = 5.

DCS 1 800:**IMMEDIATE ASSIGNMENT**

Information Element	value/remark
As default message contents except:	
Channel Description	
- Channel Type	TCH/F + ACCH's
- Timeslot number	Arbitrary value but not zero.
- Hopping Channel	Single RF Channel.
- ARFCN	Chosen arbitrarily from the Cell Allocation of cell A.

HANDOVER COMMAND

Information Element	value/remarks
As default message contents, except:	
Cell Description	
- Network Colour Code	3
- Base Station Colour Code	0
- BCCH Carrier Number	764
Channel Description	
- Channel Type	TCH/H + ACCH's
- TDMA offset	Chosen arbitrarily.
- Timeslot number	Arbitrary value but not zero.
- Training Sequence Code	Chosen arbitrarily.
- Hopping	Single RF Channel.
- ARFCN	Chosen arbitrarily from the Cell Allocation of cell B.
Synchronization Indication	
- Report Observed Time Difference	Shall not be included.
- Synchronization Indication	"Non synchronized".
- Normal Cell Indication	Ignore out of range timing advance.
Mode of First Channel	Signalling only.

Step 13: "x" = 750.

GSM 900:

IMMEDIATE ASSIGNMENT

Information Element	value/remark
As default message contents except: Channel Description <ul style="list-style-type: none"> - Channel Type - Timeslot number - Hopping Channel - ARFCN 	TCH/F + ACCH's Arbitrary value, but not zero. Single RF Channel. Chosen arbitrarily from the Cell Allocation of cell A.

HANDOVER COMMAND

Information Element	value/remarks
As default message contents, except: Cell Description <ul style="list-style-type: none"> - Network Colour Code - Base Station Colour Code - BCCH Carrier Number Channel Description <ul style="list-style-type: none"> - Channel Type - TDMA offset - Timeslot number - Training Sequence Code - Hopping - ARFCN Synchronization Indication <ul style="list-style-type: none"> - Report Observed Time Difference - Synchronization Indication - Normal Cell Indication Mode of First Channel	3 0 40 TCH/H + ACCH's Chosen arbitrarily. Arbitrary value but not zero. Chosen arbitrarily. Single RF Channel. Chosen arbitrarily from the Cell Allocation of cell B. Shall not be included. "Non synchronized". Ignore out of range timing advance. Signalling only.

Step 13: "x" = 750.

M = 6.

DCS 1 800:

IMMEDIATE ASSIGNMENT

Information Element	value/remark
As default message contents except: L2 pseudo length Channel Description <ul style="list-style-type: none"> - Channel Type - TDMA offset - Timeslot number - Training Sequence Code - Hopping - MAIO - HSN Mobile Allocation <ul style="list-style-type: none"> - Length - Contents 	14 octets (11 + contents of the MA). Channel Description. TCH/H + ACCHs As default message contents. Arbitrary value but not zero. Chosen arbitrarily. RF hopping channel. Chosen arbitrarily from the set (0, 1 to N-1), where N is the number of frequencies encoded in the Mobile Allocation. Chosen arbitrarily from the set. (1,2,..63). 3 octets. Indicates all of the CA of cell A.

HANDOVER COMMAND

Information Element	value/remarks
As default message contents, except:	
Cell Description	
- Network Colour Code	3
- Base Station Colour Code	0
- BCCH Carrier Number	764
Channel Description	
- Channel Type	TCH/F + ACCHs
- Timeslot number	Arbitrary value but not zero.
- Training Sequence Code	Chosen arbitrarily.
- Hopping	RF hopping channel.
- MAIO	Chosen arbitrarily from the set (0, 1 to N-1), where N is the number of frequencies encoded in the Frequency List IE.
- HSN	Chosen arbitrarily from the set. (1,2,..63).
Frequency List after time	
- Frequency List	Use Range 256 to encode the following 9 frequencies: (746, 749, 756, 761, 764, 798, 829, 832,844).
Synchronization Indication IE not included.	
Channel Mode	Signalling Only.

Step 13: "x" = 500.

GSM 900:**IMMEDIATE ASSIGNMENT**

Information Element	value/remark
As default message contents except:	
L2 pseudo length	14 octets (11 + contents of the MA).
Channel Description	Channel Description.
- Channel Type	TCH/H + ACCHs.
- TDMA offset	Chosen arbitrarily.
- Timeslot number	Arbitrary value but not zero.
- Training Sequence Code	Chosen arbitrarily.
- Hopping	RF hopping channel.
- MAIO	Chosen arbitrarily from the set (0, 1 to N-1), where N is the number of frequencies encoded in the Mobile Allocation.
- HSN	Chosen arbitrarily from the set. (1,2,..63).
Mobile Allocation	
- Length	3 octets.
- Contents	Indicates all of the CA of cell A.

HANDOVER COMMAND

Information Element	value/remarks
As default message contents, except:	
Cell Description	
- Network Colour Code	3
- Base Station Colour Code	0
- BCCH Carrier Number	40
Channel Description	
- Channel Type	TCH/F + ACCHs
- Timeslot number	Arbitrary value but not zero.
- Training Sequence Code	Chosen arbitrarily.
- Hopping	RF hopping channel.
- MAIO	Chosen arbitrarily from the set (0, 1 to N-1), where N is the number of frequencies encoded in the Mobile Allocation IE.
- HSN	Chosen arbitrarily from the set (1,2,..63).
Cell Channel Description	uses bit map 0 to encode the complete CA of cell B.
Mobile Allocation after time	Indicates the following 5 frequencies: (14, 18, 22, 31, 40).
Synchronization Indication IE not included.	
Channel Mode	Signalling Only.

Step 13: "x" = 500.

M = 7:

DCS 1 800:

IMMEDIATE ASSIGNMENT

Information Element	value/remark
As default message contents except:	
L2 pseudo length	14 octets (11 + contents of the MA).
Channel Description	Channel Description.
- Channel Type	TCH/F + ACCHs
- Timeslot number	Zero.
- Training Sequence Code	Chosen arbitrarily.
- Hopping	RF hopping channel.
- MAIO	Chosen arbitrarily from the set (0, 1 to N-1), where N is the number of frequencies encoded in the Mobile Allocation.
- HSN	Zero.
Mobile Allocation	
- Length	3 octets.
- Contents	Indicates only one frequency (844).

HANDOVER COMMAND

Information Element	value/remarks
As default message contents, except:	
Cell Description	
- Network Colour Code	3
- Base Station Colour Code	0
- BCCH Carrier Number	764
Channel Description	
- Channel Type	TCH/F + ACCHs
- Timeslot number	Arbitrary value but not zero.
- Training Sequence Code	Chosen arbitrarily.
- Hopping	RF hopping channel.
- MAIO	Chosen arbitrarily from the set (0, 1 to N-1), where N is the number of frequencies encoded in the Mobile Allocation.
- HSN	Chosen arbitrarily from the set. (1,2,..63).
Cell Channel Description	Use Variable bit map to encode the complete CA of cell B.
Mobile Allocation	Indicates all of the CA of cell B except for the following three frequencies: (764, 832 and 844).
Mode of First channel	Speech (full rate version 1 or half rate version 1).

Step 13: "x" = 500.

GSM 900:**IMMEDIATE ASSIGNMENT**

Information Element	value/remark
As default message contents except:	
L2 pseudo length	14 octets (11 + contents of the MA).
Channel Description	Channel Description.
- Channel Type	TCH/F + ACCHs
- Timeslot number	Zero.
- Training Sequence Code	Chosen arbitrarily.
- Hopping	RF hopping channel.
- MAIO	Chosen arbitrarily from the set (0, 1 to N-1), where N is the number of frequencies encoded in the Mobile Allocation.
- HSN	Zero.
Mobile Allocation	
- Length	3 octets.
- Contents	Indicates only one frequency (114).

HANDOVER COMMAND

Information Element	value/remarks
As default message contents, except: Cell Description - Network Colour Code - Base Station Colour Code - BCCH Carrier Number Channel Description - Channel Type - Timeslot number - Training Sequence Code - Hopping - MAIO - HSN Synchronization Indication IE is not included: Frequency list after time. - Frequency List IE Mode of First channel	3 0 40 TCH/F + ACCHs Arbitrary value but not zero. Chosen arbitrarily. RF hopping channel. Chosen arbitrarily from the set (0, 1 to N-1), where N is the number of frequencies encoded in the Frequency List IE. Chosen arbitrarily from the set (1,2,..63). uses bit map 0 to allocate the following 16 frequencies {14, 18, 22, 24, 30, 31, 38, 40, 60, 66, 73, 74, 75, 76, 108, 114}. Speech (full rate version 1 or half rate version 1).

Step 13: "x" = 500.

M = 8:

DCS 1 800:

IMMEDIATE ASSIGNMENT

Information Element	value/remark
As default message contents except: L2 pseudo length Channel Description - Channel Type - TDMA offset - Timeslot number - Training Sequence Code - Hopping - MAIO - HSN Mobile Allocation - Length - Contents	14 octets (11 + contents of the MA). Channel Description. SDCCH/8 As default message contents. Arbitrary value but not zero. Chosen arbitrarily. RF hopping channel. Chosen arbitrarily from the set (0, 1 to N-1), where N is the number of frequencies encoded in the Mobile Allocation. Chosen arbitrarily from the set. (1,2,..63). 3octets. Indicates only three frequencies: (773, 775, 779).

HANDOVER COMMAND

Information Element	value/remarks
As default message contents, except: Cell Description - Network Colour Code - Base Station Colour Code - BCCH Carrier Number Channel Description - Channel Type - Timeslot number - Training Sequence Code - Hopping - ARFCN Synchronization Indication IE not included. Mode of First Channel	 3 0 764 TCH/F + ACCHs Zero. Chosen arbitrarily. Single RF Channel. Chosen arbitrarily from the Cell Allocation of Cell B, but not the BCCH carrier of Cell B. Speech (full rate version 1 or half rate version 1).

Step 13: "x" = 500.

GSM 900:**IMMEDIATE ASSIGNMENT**

Information Element	value/remark
As default message contents except: L2 pseudo length Channel Description - Channel Type - TDMA offset - Timeslot number - Training Sequence Code - Hopping - MAIO - HSN Mobile Allocation - Length - Contents	 14 octets (11 + contents of the MA). SDCCH/8 As default message contents. Arbitrary value, but not zero. Chosen arbitrarily. RF hopping channel. Chosen arbitrarily from the set (0, 1 to N-1), where N is the number of frequencies encoded in the Mobile Allocation. Chosen arbitrarily from the set (1,2,..63). 3 octets. Indicates only three frequencies: (73, 74, 75).

HANDOVER COMMAND

Information Element	value/remarks
As default message contents, except: Cell Description - Network Colour Code - Base Station Colour Code - BCCH Carrier Number Channel Description - Channel Type - Timeslot number - Training Sequence Code - Hopping - ARFCN Mode of First Channel	 3 0 40 TCH/F + ACCHs Zero. Chosen arbitrarily. Single RF Channel. Chosen arbitrarily from the Cell Allocation of Cell B, but not the BCCH carrier of Cell B. Speech (full rate version 1 or half rate version 1).

Step 13: "x" = 500.

M = 9:

DCS 1 800:

IMMEDIATE ASSIGNMENT

Information Element	value/remark
As default message contents.	

HANDOVER COMMAND

Information Element	value/remarks
As default message contents, except:	
Cell Description	
- Network Colour Code	3
- Base Station Colour Code	0
- BCCH Carrier Number	764
Channel Description	
- Channel Type	TCH/F + ACCHs
- Timeslot number	Arbitrary value, but not zero.
- Training Sequence Code	Chosen arbitrarily.
- Hopping	RF hopping channel.
- MAIO	Chosen arbitrarily from the set (0, 1 to N-1), where N is the number of frequencies encoded in the Frequency Short List IE.
- HSN	Zero (this gives cyclic hopping).
Frequency Short List after time	
- Frequency Short List	Use Range 256 to encode the following 3 frequencies: (764, 779, 782).
Synchronization Indication	
- Report Observed Time Difference	Shall not be included.
- Synchronization Indication	"Non synchronized".
- Normal Cell Indication	Ignore out of range timing advance.
Channel mode	Speech (full rate version 1 or half rate version 1)

Step 13: "x" = 500.

GSM 900:**IMMEDIATE ASSIGNMENT**

Information Element	value/remark
As default message contents.	

HANDOVER COMMAND

Information Element	value/remarks
As default message contents, except:	
Cell Description	
- Network Colour Code	3
- Base Station Colour Code	0
- BCCH Carrier Number	40
Channel Description	
- Channel Type	TCH/F + ACCHs
- Timeslot number	zero.
- Training Sequence Code	Chosen arbitrarily.
- Hopping	RF hopping channel
- MAIO	Chosen arbitrarily from the set {0, 1}.
- HSN	Chosen arbitrarily from the set {1, 2,..., 63}.
Synchronization Indication IE is not included	
Frequency Channel Sequence, after time.	
- Frequency Channel Sequence IE	allocates the following two frequencies {14, 114}.
Mode of the first channel	Speech (full rate version 1 or half rate version 1).

Step 13: "x" = 500.

M = 10:

DCS 1 800:**IMMEDIATE ASSIGNMENT**

Information Element	value/remark
As default message contents.	

HANDOVER COMMAND

Information Element	value/remarks
As default message contents, except:	
Cell Description	
- Network Colour Code	3
- Base Station Colour Code	0
- BCCH Carrier Number	764
Channel Description	
- Channel Type	TCH/H + ACCHs
- TDMA offset	Chosen arbitrarily.
- Timeslot number	Arbitrary value, but not zero.
- Training Sequence Code	Chosen arbitrarily.
- Hopping	RF hopping channel.
- MAIO	Chosen arbitrarily from the set (0, 1 to N-1), where N is the number of frequencies encoded in the Frequency List IE.
- HSN	Zero (this gives cyclic hopping).
Frequency List after time	
- Frequency List	Use Variable Bit Map to encode the following 15 frequencies: (739, 743, 746, 749, 756, 758, 764, 771, 779, 782, 791, 798, 829, 832, 844).
Synchronization Indication IE is not included.	
Channel mode	Speech (full rate version 1 or half rate version 1).

Step 13: "x" = 750.

GSM 900:**IMMEDIATE ASSIGNMENT**

Information Element	value/remark
As default message contents.	

HANDOVER COMMAND

Information Element	value/remarks
As default message contents, except:	
Cell Description	
- Network Colour Code	3
- Base Station Colour Code	0
- BCCH Carrier Number	40
Channel Description	
- Channel Type	TCH/H + ACCHs
- TDMA offset	Chosen arbitrarily.
- Timeslot number	Chosen arbitrarily but not zero.
- Training Sequence Code	Chosen arbitrarily.
- Hopping	RF hopping channel.
- MAIO	Chosen arbitrarily from the set {0, 1}.
- HSN	Chosen arbitrarily from the set {1, 2, ..., 63}.
Synchronization Indication IE is not included	
Frequency Channel Sequence, after time	
- Frequency Channel Sequence IE	allocates the following two frequencies {40, 114}.
Channel Mode IE	speech (full rate version 1 or half rate version 1).

Step 13: "x" = 750.

Specific Message Contents For Mobiles not Supporting Speech

The message contents shall be the same for the declared type of Mobile Station (either P-GSM 900 or DCS 1 800 supporting speech , except for:

M = 1, 7, 8 and 9:

HANDOVER COMMAND

Information Element	value/remarks
Mode of first channel	Arbitrary from those supported (12, 6, 3,6 kbps).

For M = 2 and 10 :

HANDOVER COMMAND

Information Element	value/remarks
Mode of first channel	Arbitrary from those supported (6, 3,6 kbps).

26.6.5.3 Handover / successful / active call / finely synchronized

26.6.5.3.1 Conformance requirements

The MS shall correctly apply the handover procedure from TCH/F with frequency hopping to TCH/F without frequency hopping in the finely synchronized case when a call is in progress.

The MS shall correctly apply the handover procedure from TCH/H with frequency hopping to TCH/H without frequency hopping in the finely synchronized case when a call is in progress. This requirement does not apply to MSs not supporting TCH/H.

References

GSM 04.08 sections 3.4.4, 9.1.14, 9.1.15 and 9.1.16.

GSM 04.13 section 5.2.6.

GSM 05.05 section 4.1.1.

GSM 05.10, section 6.6.

26.6.5.3.2 Test purpose

To test that when the MS is ordered to make a finely synchronized handover to a synchronized cell, it sends 4 access bursts on the main DCCH and then activates the channel correctly, taking into account the value of any Starting Time information element, power command and correctly calculating the timing advance to use. To test the MS activates the new channel correctly and transmits the HANDOVER COMPLETE message without undue delay.

26.6.5.3.3 Method of test

Initial Conditions

System Simulator:

2 cells, A and B, with same LAI, default parameters, except:

The BCCH of cell A is sent k bit periods before the BCCH of cell B. The timing advance in cell A sent to the MS is y bit periods. k and y are selected such that $0 < (2k+y) \bmod 256 < 60$.

P-GSM 900:

Cell B has BCCH ARFCN = 40.

DCS 1 800:

Cell B has BCCH ARFCN = 764.

Mobile Station:

The MS is in the active state (U10) of a call (on cell A). The MS is using a power level P. Where P is a power level within the supported range of that type of MS.

Related PICS/PIXIT Statements

Supported rate(s) of TCH: TCH/F and/or TCH/H.
Support for state U10 of the Call Control protocol.
Supported speech and data rates.
Type of Mobile Station (P-GSM 900 or EGSM or DCS 1 800).
Power class of Mobile Station.

Foreseen Final State of the MS

The active state (U10) of a mobile call (on cell B).

Test Procedure

This procedure is repeated for execution counter M = 1 to 2. (See table 26.6-1.)

The MS is in the active state (U10) of a call on cell A. The SS sends a HANOVER COMMAND on the main DCCH. The MS shall (at the time specified in the Starting Time information element, if included) send 4 access bursts, in 4 successive slots on the new DCCH to cell B. Then the MS shall establish a signalling link indicating the correct Timing Advance and power level and send a HANOVER COMPLETE message.

The MS shall be "ready to transmit" a HANOVER COMPLETE message before "x" ms after the end of the HANOVER COMMAND message, but not before a UA frame has been sent by the SS.

The term "ready to transmit" is defined in GSM 04.13. The value of "x" depends upon the target channel and is specified in the specific message contents section.

Maximum Duration of Test

5 minutes, including 1 minute for any necessary operator actions.

Expected Sequence

This sequence is performed for execution counter M = 1 for an MS which only supports TCH/F.

This sequence is performed for execution counter M = 1 to 2 for an MS which supports TCH/F and H.

Step	Direction	Message	Comments
0	MS -> SS		M = 1, The MS and SS are using a full rate TCH in hopping mode on cell A. M = 2, The MS and SS are using a half rate TCH in hopping mode on cell A.
1	SS -> MS	HANDOVER COMMAND	See Specific Message Contents.
2	MS -> SS	HANDOVER ACCESS	See specific message contents. Four messages.
3	MS -> SS	HANDOVER ACCESS	are transmitted to Cell B in 4 successive slots.
4	MS -> SS	HANDOVER ACCESS	on the new DCCH.
5	MS -> SS	HANDOVER ACCESS	
6	MS -> SS	SABM	Sent without information field.
7	SS -> MS	UA	
8	MS -> SS	HANDOVER COMPLETE	This message shall be ready to be transmitted before "x" ms after the completion of step 1. See specific message contents.
9	SS		The header of the next uplink SACCH is examined and the Timing Advance and Power Level indications are examined. The correct timing advance shall be indicated. A tolerance of +/- 2 bit periods is allowed. The power level indication shall indicate the power level used in the handover command.
10	MS, SS		M = 1, The MS and SS are using a full rate TCH in non-hopping mode on cell B M = 2, The MS and SS are using a half rate TCH in non-hopping mode on cell B.

Specific Message Contents

M = 1:

GSM 900**HANDOVER COMMAND**

Information Element	value/remark
As default message contents, except:	
Cell Description	
- Network Colour Code	1
- Base Station Colour Code	5
- BCCH Carrier Number	40
Channel Description	
- Channel type	TCH/F + ACCHs
- Timeslot Number	Arbitrary value, but not zero.
- Training Sequence Code	Chosen arbitrarily.
- Hopping	Single RF Channel.
- ARFCN	40
Handover Reference	
- Value	Chosen arbitrarily from the range (0, 1..255).
Power command	
- Power Level	Arbitrarily chosen, but different to the one already in use and within the range supported by that type of MS.
Synchronization Indication	
- Report Observed Time Difference	Shall not be included.
- Synchronization Indication	"Synchronized".
- Normal Cell Indication	Ignore out of range timing advance.

HANDOVER ACCESS

Information Element	value/remark
As default message contents except: Handover Reference - Value	Same as HANDOVER COMMAND

Step 8: x = 650 ms.

DCS 1 800**HANDOVER COMMAND**

Information Element	value/remark
As default message contents, except: Cell Description - Network Colour Code - Base Station Colour Code - BCCH Carrier Number Channel Description - Channel type - Timeslot Number - Training Sequence Code - Hopping - ARFCN Handover Reference - Value Power command - Power Level Synchronization Indication - Report Observed Time Difference - Synchronization Indication - Normal Cell Indication	1 5 764 TCH/F + ACCHs Arbitrary value, but not zero. Chosen arbitrarily. Single RF Channel. 764 Chosen arbitrarily from the range (0, 1..255). Arbitrarily chosen, but different to the one already in use and within the range supported by that type of MS. Shall not be included. "Synchronized". Ignore out of range timing advance.

HANDOVER ACCESS

Information Element	value/remark
As default message contents except: Handover Reference - Value	Same as HANDOVER COMMAND

Step 8: x = 650 ms.

M = 2:

GSM 900**HANDOVER COMMAND**

Information Element	value/remark
As default message contents, except:	
Cell Description	
- Network Colour Code	1
- Base Station Colour Code	5
- BCCH Carrier Number	40
Channel Description	
- Channel type	TCH/H + ACCHs
- TDMA offset	Chosen arbitrarily.
- Timeslot Number	Arbitrary value, but not zero.
- Training Sequence Code	Chosen arbitrarily.
- Hopping	Single RF Channel.
- ARFCN	40
Handover Reference	
- Value	Chosen arbitrarily from the range (0, 1..255).
Power command	
- Power Level	Arbitrarily chosen, but different to the one already in use and within the range supported by that type of MS.
Synchronization Indication	
- Report Observed Time Difference	Shall not be included.
- Synchronization Indication	"Synchronized".
- Normal Cell Indication	Ignore out of range timing advance.
Mode of First Channel	If speech is supported: Speech (full rate version 1 or half rate version 1). If speech is not supported: arbitrary from those supported, 12, 6, 3,6 kbps).

HANDOVER ACCESS

Information Element	value/remark
As default message contents except:	
Handover Reference	
- Value	Same as HANDOVER COMMAND

Step 8: x = 900 ms.

DCS 1 800

HANDOVER COMMAND

Information Element	value/remark
As default message contents, except: Cell Description - Network Colour Code - Base Station Colour Code - BCCH Carrier Number Channel Description - Channel type - TDMA offset - Timeslot Number - Training Sequence Code - Hopping - ARFCN Handover Reference - Value Power command - Power Level Synchronization Indication - Report Observed Time Difference - Synchronization Indication - Normal Cell Indication Mode of First Channel	1 5 764 TCH/H + ACCHs Chosen arbitrarily. Arbitrary value, but not zero. Chosen arbitrarily. Single RF Channel. 764 Chosen arbitrarily from the range (0, 1..255). Arbitrarily chosen, but different to the one already in use and within the range supported by that type of MS. Shall not be included. "Synchronized". Ignore out of range timing advance. If speech is supported: Speech (full rate version 1 or half rate version 1). If speech is not supported: arbitrary from those supported (12, 6, 3,6 kbps).

HANDOVER ACCESS

Information Element	value/remark
As default message contents except: Handover Reference - Value	Same as HANDOVER COMMAND

Step 8: $x = 900$ ms.

26.6.5.4 Handover / successful / call under establishment / finely synchronized

This test is applicable to all MS which support at least one MO circuit switched basic service.

26.6.5.4.1 Conformance requirements

The MS shall correctly apply the handover procedure from SDCCH/8 or TCH/F with or without frequency hopping to SDCCH4, SDCCH/8 or TCH/F with or without frequency hopping in the finely synchronized case, during call establishment.

If during call establishment a Layer 3 MM or CC message just sent by the MS is not Layer 2 acknowledged before the channel change caused by the HANDOVER COMMAND message, the MS shall send the Layer 3 message to the new cell, using the same value in the N(SD) field, after the handover procedure.

References

GSM 05.10, section 6.6.
GSM 04.08, section 3.4.4.
GSM 04.08, section 3.1.4.2.

GSM 04.13, section 5.2.6.

26.6.5.4.2 Test purpose

To test that when the MS is ordered to make a finely synchronized handover to a synchronized cell, it sends 4 access bursts on the main DCCH and then activates the channel correctly, taking into account the value of any Starting Time information element, power command and correctly calculating the timing advance to use. To test that the MS correctly retransmits Layer 3 MM or CC messages that were not acknowledged by Layer 2 before the Handover, after completion of the Handover. To verify the MS transmits the HANDOVER COMPLETE message without undue delay.

26.6.5.4.3 Method of test

Initial Conditions

System Simulator:

2 cells, A and B, with same LAI, default parameters, except:

The BCCH of cell A is sent k bit periods before the BCCH of cell B. The timing advance in cell A sent to the MS is y bit periods. k and y are selected such that $0 < (2k + y) \bmod 256 < 60$.

The frame numbers of cells A and B shall be different by 100.

GSM 900:

Cell A has:

BCCH ARFCN = 20.

Cell Allocation = (10, 17, 20, 26, 34, 42, 45, 46, 52, 59, 66, 73, 74, 75, 76, 108, 114).

Cell B has:

BCCH ARFCN = 40.

Cell Allocation = (14, 18, 22, 24, 30, 31, 38, 40, 60, 66, 73, 74, 75, 76, 108, 114).

DCS 1 800:

Cell A has:

BCCH ARFCN = 747.

Cell Allocation = (734, 741, 747, 754, 759, 762, 766, 767, 773, 775, 779, 782, 791, 798, 829, 832, 844).

Cell B has:

BCCH ARFCN = 764.

Cell Allocation = (739, 743, 746, 749, 756, 758, 761, 764, 771, 779, 782, 791, 798, 829, 832, 844).

Mobile Station:

The MS is in the "idle, updated" state, with a TMSI allocated and camped on cell A. The MS is using a power level P , where P is a power level within the supported range of that type of MS.

Related PICS/PIXIT Statements

Supported rate(s) of TCH: TCH/F.

Support for state MO calls.

Supported speech and data rates.

Type of Mobile Station (P-GSM 900 or EGSM or DCS 1 800).

Power class of Mobile Station.

Foreseen Final State of the MS

"Idle, updated" with TMSI allocated and camped on cell B.

Test Procedure

This procedure is repeated for execution counter $M = 1, 2, 3, 4$ (See table 26.6-1.)

A Mobile Originating Call is initiated on cell A. After the MS has sent the SETUP message (and before the last L2 frame carrying the SETUP message is acknowledged by the SS) the SS sends a HANDOVER COMMAND message, ordering the MS to switch to cell B. The MS shall then (at the time specified in the Starting Time information element, if included) send 4 access bursts, in successive slots on the new

DCCH to cell B. Then the MS shall establish a signalling link indicating the correct timing advance and power level and send a HANOVER COMPLETE message. The MS shall be "ready to transmit" the HANOVER COMPLETE message before "x" ms after the end of the HANOVER COMMAND message, but not before a UA frame has been sent by the SS. The MS shall then again send the SETUP message to the SS, using the same value in the N(SD) field. Finally the SS sends a CHANNEL RELEASE to end the test.

The term "ready to transmit" is defined in GSM 04.13. The value "x" depends upon the target channel and is specified in the specific message contents section.

Maximum Duration of Test

5 minutes, including 1 minute for any necessary operator actions.

Expected Sequence

This procedure is repeated for execution counter M = 1, 2, 3, 4 (unless a particular TCH is not supported).

Step	Direction	Message	Comments
1	-----	-----	A MO call is initiated.
2	MS -> SS	CHANNEL REQUEST	Establ. Cause = "Originating call, NECI not set to 1"
3	SS -> MS	IMMEDIATE ASSIGNMENT	See Specific Message contents.
4	MS -> SS	CM SERVICE REQUEST	CM Service Type = Mobile Origina- ting Call Establishment.
5	SS -> MS	CIPHERING MODE COMMAND	
6	MS -> SS	CIPHERING MODE COMPLETE	
7	MS -> SS	SETUP	Last L2 frame not acknowledged by the SS.
8	SS -> MS	HANOVER COMMAND	See Specific Message Contents.
9	MS -> SS	HANOVER ACCESS	
10	MS -> SS	HANOVER ACCESS	
11	MS -> SS	HANOVER ACCESS	See Specific message contents. Four.
12	MS -> SS	HANOVER ACCESS	Messages are transmitted to cell B in 4 successive slots on the new DCCH. If the HANOVER COMMAND message includes a starting time IE then the first HANOVER ACCESS message shall be transmitted in the indicated frame (unless the starting time has elapsed).
13	MS -> SS	SABM	Sent without information field.
14	SS -> MS	UA	
15	MS -> SS	HANOVER COMPLETE	The message shall be ready to be transmitted before "x" ms after the completion of step 8.
16	SS		The header of the next uplink SACCH is examined and the Timing Advance and Power Level indications are examined. The correct timing advance shall be indicated. A tolerance of +/- 2 bit periods is allowed. The power level indication shall indicate the power level used in the handover command.
17	MS -> SS	SETUP	Same N(SD) as in step 7.
18	SS -> MS	CHANNEL RELEASE	

Specific Message Contents

M = 1:

DCS 1 800:**IMMEDIATE ASSIGNMENT**

Information Element	value/remark
As default message contents except: Channel Description <ul style="list-style-type: none"> - Channel Type - TDMA offset - Timeslot number - Training Sequence Code - Hopping - MAIO - HSN Mobile Allocation	Channel Description. SDCCH/8 As default message contents. Arbitrary value, but not zero. Chosen arbitrarily. RF hopping channel. Chosen arbitrarily from the set (0, 1 to N-1), where N is the number of frequencies encoded in the Mobile Allocation. Chosen arbitrarily from the set. (1,2,..63). Indicates all of the CA of cell A except for the BCCH frequency.

HANDOVER COMMAND

Information Element	value/remark
As default message contents except: Cell Description <ul style="list-style-type: none"> - Network Colour Code - Base Station Colour Code - BCCH Carrier Number Channel Description <ul style="list-style-type: none"> - Channel Type - TDMA offset - Timeslot number - Training Sequence Code - Hopping - MAIO - HSN Frequency List after time <ul style="list-style-type: none"> - Frequency List Handover Reference <ul style="list-style-type: none"> - Value Power command <ul style="list-style-type: none"> - Power Level Synchronization Indication <ul style="list-style-type: none"> - Report Observed Time Difference - Synchronization Indication - Normal Cell Indication Mode of First Channel	 1 5 764 SDCCH/8 Chosen arbitrarily. Arbitrary value, but not zero. Chosen arbitrarily. RF hopping channel. Chosen arbitrarily from the set (0, 1 to N-1), where N is the number of frequencies encoded in the Frequency List IE. Zero (this gives cyclic hopping). Use Range 512 to encode the complete CA of Cell B. Chosen arbitrarily from the range (0, 1..255). Arbitrarily chosen, but different to the one already in use and within the range supported by the MS. Shall not be included. "Synchronized". Ignore out of range timing advance. Signalling only

HANDOVER ACCESS

Information Element	value/remark
As default message contents except: Handover Reference <ul style="list-style-type: none"> - Value 	Same as HANDOVER COMMAND

Step 15: x = 1 500 ms.

GSM 900:

IMMEDIATE ASSIGNMENT

Information Element	value/remark
As default message contents except: Channel Description <ul style="list-style-type: none"> - Channel Type - TDMA offset - Timeslot number - Training Sequence Code - Hopping - MAIO <ul style="list-style-type: none"> - HSN Mobile Allocation	Channel Description. SDCCH/8 As default message contents. Arbitrary value, but not zero. Chosen arbitrarily. RF hopping channel. Chosen arbitrarily from the set (0, 1 to N-1), where N is the number of frequencies encoded in the Mobile Allocation. Chosen arbitrarily from the set (1,2,..63). Indicates all of the CA of cell A except for the BCCH frequency.

HANDOVER COMMAND

Information Element	value/remark
As default message contents except: Cell Description <ul style="list-style-type: none"> - Network Colour Code - Base Station Colour Code - BCCH Carrier Number Channel Description <ul style="list-style-type: none"> - Channel Type - TDMA offset - Timeslot number - Training Sequence Code - Hopping - MAIO <ul style="list-style-type: none"> - HSN Frequency List after time <ul style="list-style-type: none"> - Frequency List Handover Reference <ul style="list-style-type: none"> - Value Power command <ul style="list-style-type: none"> - Power Level Synchronization Indication <ul style="list-style-type: none"> - Report Observed Time Difference - Synchronization Indication - Normal Cell Indication Mode of First Channel	 1 5 40 SDCCH/8 Chosen arbitrarily. Arbitrary value, but not zero. Chosen arbitrarily. RF hopping channel. Chosen arbitrarily from the set (0, 1 to N-1), where N is the number of frequencies encoded in the Frequency List IE. Zero (this gives cyclic hopping). Use Bit Map 0 to encode the complete CA of Cell B. Chosen arbitrarily from the range (0, 1..255). Arbitrarily chosen, but different to the one already in use and within the range supported by the MS. Shall not be included. "Synchronized". Ignore out of range timing advance. Signalling only.

HANDOVER ACCESS

Information Element	value/remark
As default message contents except: Handover Reference <ul style="list-style-type: none"> - Value 	Same as HANDOVER COMMAND

Step 15: $x = 1\ 500$ ms.

M = 2:

DCS 1 800:

IMMEDIATE ASSIGNMENT

Information Element	value/remark
As default message contents except: Channel Description <ul style="list-style-type: none"> - Channel Type - TDMA offset - Timeslot number - Training Sequence Code - Hopping - MAIO <ul style="list-style-type: none"> - HSN Mobile Allocation	Channel Description. SDCCH/8 As default message contents. zero. Chosen arbitrarily. RF hopping channel. Chosen arbitrarily from the set (0, 1 to N-1), where N is the number of frequencies encoded in the Mobile Allocation. Zero (this gives cyclic hopping). Indicates all of the CA of cell A except for the following 2 frequencies: (747 and 767).

HANDOVER COMMAND

Information Element	value/remark
As default message contents except: Cell Description <ul style="list-style-type: none"> - Network Colour Code - Base Station Colour Code - BCCH Carrier Number Channel Description <ul style="list-style-type: none"> - Channel Type - TDMA offset - Timeslot number - Training Sequence Code - Hopping - ARFCN Handover Reference <ul style="list-style-type: none"> - Value Power command <ul style="list-style-type: none"> - Power Level Synchronization Indication <ul style="list-style-type: none"> - Report Observed Time Difference - Synchronization Indication - Normal Cell Indication Starting Time	 1 5 764 SDCCH/4 Chosen arbitrarily. zero. same as the BCCH. Single RF Channel. 764 Chosen arbitrarily from the range (0, 1..255). Arbitrarily chosen, but different to the one already in use and within the range supported by the MS. Shall not be included. "Synchronized". Ignore out of range timing advance. Indicates the frame number of cell B that will occur approximately 1,1 seconds after the HANDOVER COMMAND message is sent by cell A.

HANDOVER ACCESS

Information Element	value/remark
As default message contents except: Handover Reference <ul style="list-style-type: none"> - Value 	Same as HANDOVER COMMAND

Step 15: $x = 2\ 600\ \text{ms}$.

GSM 900:

IMMEDIATE ASSIGNMENT

Information Element	value/remark
As default message contents except: Channel Description <ul style="list-style-type: none"> - Channel Type - TDMA offset - Timeslot number - Training Sequence Code - Hopping - MAIO <ul style="list-style-type: none"> - HSN Mobile Allocation	Channel Description. SDCCH/8 As default message contents. Arbitrary value, but not zero. Chosen arbitrarily. RF hopping channel. Chosen arbitrarily from the set (0, 1 to N-1), where N is the number of frequencies encoded in the Mobile Allocation. Zero (this gives cyclic hopping). Indicates all of the CA of cell A except for the following 2 frequencies: (20 and 52).

HANDOVER COMMAND

Information Element	value/remark
As default message contents except: Cell Description <ul style="list-style-type: none"> - Network Colour Code - Base Station Colour Code - BCCH Carrier Number Channel Description <ul style="list-style-type: none"> - Channel Type - TDMA offset - Timeslot number - Training Sequence Code - Hopping - ARFCN Handover Reference <ul style="list-style-type: none"> - Value Power command <ul style="list-style-type: none"> - Power Level Synchronization Indication <ul style="list-style-type: none"> - Report Observed Time Difference - Synchronization Indication - Normal Cell Indication Starting Time	 1 5 40 SDCCH/4 Chosen arbitrarily. zero. same as the BCCH. Single RF Channel. 40 Chosen arbitrarily from the range (0, 1..255). Arbitrarily chosen, but different to the one already in use and within the range supported by the MS. Shall not be included. "Synchronized". Ignore out of range timing advance. Indicates the frame number of cell B that will occur approximately 1,1 seconds after the HANDOVER COMMAND message is sent by cell A.

HANDOVER ACCESS

Information Element	value/remark
As default message contents except: Handover Reference <ul style="list-style-type: none"> - Value 	Same as HANDOVER COMMAND

Step 15: $x = 2\ 600$ ms.

M = 3:

DCS 1 800:**IMMEDIATE ASSIGNMENT**

Information Element	value/remark
As default message contents except: Channel Description <ul style="list-style-type: none"> - Channel Type - Timeslot number - Training Sequence Code - Hopping - ARFCN 	Channel Description. TCH/F + ACCHs Arbitrary value, but not zero. Chosen arbitrarily. Single RF Channel. 747

HANDOVER COMMAND

Information Element	value/remark
As default message contents except: Cell Description <ul style="list-style-type: none"> - Network Colour Code - Base Station Colour Code - BCCH Carrier Number Channel Description <ul style="list-style-type: none"> - Channel Type - Timeslot number - Training Sequence Code - Hopping - MAIO <ul style="list-style-type: none"> - HSN Frequency Short List after time <ul style="list-style-type: none"> - Frequency Short List Handover Reference <ul style="list-style-type: none"> - Value Power command <ul style="list-style-type: none"> - Power Level Synchronization Indication <ul style="list-style-type: none"> - Report Observed Time Difference - Synchronization Indication - Normal Cell Indication 	1 5 764 TCH/F + ACCHs zero Chosen arbitrarily. RF hopping channel. Chosen arbitrarily from the set (0, 1 to N-1), where N is the number of frequencies encoded in the Frequency Short list IE. Chosen arbitrarily from the set (1,2,..63). Use Range 128 to encode the following 3 frequencies: (758, 761, 771). Chosen arbitrarily from the range (0, 1..255). Arbitrarily chosen, but different to the one already in use and within the range supported by the MS. Shall not be included. "Synchronized". Ignore out of range timing advance.

HANDOVER ACCESS

Information Element	value/remark
As default message contents except: Handover Reference <ul style="list-style-type: none"> - Value 	Same as HANDOVER COMMAND

Step 15: x = 650 ms.

GSM 900:**IMMEDIATE ASSIGNMENT**

Information Element	value/remark
As default message contents except: Channel Description <ul style="list-style-type: none"> - Channel Type - Timeslot number - Training Sequence Code - Hopping - ARFCN 	Channel Description. TCH/F + ACCHs Arbitrary value, but not zero. Chosen arbitrarily. Single RF Channel. 20

HANDOVER COMMAND

Information Element	value/remark
As default message contents except: Cell Description <ul style="list-style-type: none"> - Network Colour Code - Base Station Colour Code - BCCH Carrier Number Channel Description <ul style="list-style-type: none"> - Channel Type - Timeslot number - Training Sequence Code - Hopping - MAIO <ul style="list-style-type: none"> - HSN Frequency Channel Sequence after time <ul style="list-style-type: none"> - Frequency Channel Sequence Handover Reference <ul style="list-style-type: none"> - Value Power command <ul style="list-style-type: none"> - Power Level Synchronization Indication <ul style="list-style-type: none"> - Report Observed Time Difference - Synchronization Indication - Normal Cell Indication 	 1 5 40 TCH/F + ACCHs zero. Chosen arbitrarily. RF hopping channel. Chosen arbitrarily from the set (0, 1 to N-1), where N is the number of frequencies encoded in the Frequency Channel Sequence IE. Chosen arbitrarily from the set (1,2,..63). Indicates (66, 75, 76, 108). Chosen arbitrarily from the range (0, 1..255). Arbitrarily chosen, but different to the one already in use and within the range supported by the MS. Shall not be included. "Synchronized". Ignore out of range timing advance.

HANDOVER ACCESS

Information Element	value/remark
As default message contents except: Handover Reference <ul style="list-style-type: none"> - Value 	Same as HANDOVER COMMAND

Step 15: x = 650 ms.

M = 4:

DCS 1 800:

IMMEDIATE ASSIGNMENT

Information Element	value/remark
As default message contents except: Channel Description <ul style="list-style-type: none"> - Channel Type - TDMA offset - Timeslot number - Training Sequence Code - Hopping - ARFCN 	Channel Description. SDCCH/8 As default message contents. As default message contents. Chosen arbitrarily. Single RF Channel. Chosen arbitrarily from the Cell Allocation of Cell A.

HANDOVER COMMAND

Information Element	value/remark
As default message contents except: Cell Description <ul style="list-style-type: none"> - Network Colour Code - Base Station Colour Code - BCCH Carrier Number Channel Description <ul style="list-style-type: none"> - Channel Type - Timeslot number - Training Sequence Code - Hopping - ARFCN Handover Reference <ul style="list-style-type: none"> - Value Power command <ul style="list-style-type: none"> - Power Level Synchronization Indication <ul style="list-style-type: none"> - Report Observed Time Difference - Synchronization Indication - Normal Cell Indication Channel Mode	1 5 764 TCH/F + ACCHs Arbitrary value, but not zero. Chosen arbitrarily. Single RF Channel. Chosen arbitrarily from the Cell Allocation of Cell B. Chosen arbitrarily from the range (0, 1..255). Arbitrarily chosen, but different to the one already in use and within the range supported by the MS. Shall not be included. "Synchronized". Ignore out of range timing advance. If speech is supported: Speech (full rate version 1 or half rate version 1). If speech is not supported: arbitrary from those supported (12, 6, 3,6 kbps).

HANDOVER ACCESS

Information Element	value/remark
As default message contents except: Handover Reference <ul style="list-style-type: none"> - Value 	Same as HANDOVER COMMAND

Step 15: x = 650 ms.

GSM 900:

IMMEDIATE ASSIGNMENT

Information Element	value/remark
As default message contents except: Channel Description <ul style="list-style-type: none"> - Channel Type - TDMA offset - Timeslot number - Training Sequence Code - Hopping - ARFCN 	Channel Description. SDCCH/8 As default message contents. As default message contents. Chosen arbitrarily. Single RF Channel. Chosen arbitrarily from the Cell Allocation of Cell A.

HANDOVER COMMAND

Information Element	value/remark
As default message contents except: Cell Description <ul style="list-style-type: none"> - Network Colour Code - Base Station Colour Code - BCCH Carrier Number Channel Description <ul style="list-style-type: none"> - Channel Type - Timeslot number - Training Sequence Code - Hopping - ARFCN Handover Reference <ul style="list-style-type: none"> - Value Power command <ul style="list-style-type: none"> - Power Level Synchronization Indication <ul style="list-style-type: none"> - Report Observed Time Difference - Synchronization Indication - Normal Cell Indication Channel Mode	1 5 40 TCH/F + ACCHs Arbitrary value, but not zero. Chosen arbitrarily. Single RF Channel. Chosen arbitrarily from the Cell Allocation of Cell B. Chosen arbitrarily from the range (0, 1..255). Arbitrarily chosen, but different to the one already in use and within the range supported by the MS. Shall not be included. "Synchronized". Ignore out of range timing advance. If speech is supported: Speech (full rate version 1 or half rate version 1). If speech is not supported: arbitrary from those supported (12, 6, 3,6 kbps).

HANDOVER ACCESS

Information Element	value/remark
As default message contents except: Handover Reference <ul style="list-style-type: none"> - Value 	Same as HANDOVER COMMAND

Step 15: x = 650 ms.

26.6.5.5 Pre-synchronized handovers

26.6.5.5.1 Handover / successful / active call / pre-synchronized / Timing Advance IE not included

If an MS does not implement the pre-synchronized handover procedure correctly then calls may fail.

26.6.5.5.1.1 Conformance requirements

- 1 The MS shall correctly apply the handover procedure from TCH/F without frequency hopping to TCH/F without frequency hopping in the pre-synchronized case when a call is active.
- 2 When the Timing Advance information element is not included in the HANDOVER COMMAND, the MS shall access the new cell with the default timing advance of 1 bit period.
- 3 The MS shall be ready to transmit the HANDOVER COMPLETE message within 650 ms of the end of the HANDOVER COMMAND message.

References

Conformance requirement 1: GSM 04.08 section 3.4.4.

Conformance requirement 2: GSM 05.10, section 6.6.

Conformance requirement 3: GSM 04.13, section 5.2.6.1.

26.6.5.5.1.2 Test purpose

To verify that when the MS is ordered to make a pre-synchronized handover to another cell, it sends 4 access bursts on the main DCCH and then activates the channel correctly and correctly calculates the time to transmit.

26.6.5.5.1.3 Method of test

Initial Conditions

System Simulator:

2 cells, A and B, with same LAI, default parameters.

The BCCH of cell A is sent k bit periods before the BCCH of cell B. k is arbitrarily selected.

Mobile Station:

The MS is in the active state (U10) of a call (on cell A) using a full rate TCH in non-hopping mode.

Related PICS/PIXIT Statements

Supported rate(s) of TCH: TCH/F.

Support for state U10 of the Call Control protocol.

Type of MS (P-GSM 900 or EGSM or DCS 1 800).

Foreseen Final State of the MS

The active state (U10) of a mobile call (on cell B) using a full rate TCH in non-hopping mode.

Test Procedure

The MS is in the active state (U10) of a call on cell A. The SS sends a HANDOVER COMMAND for a pre-synchronized handover without the Timing Advance IE on the main DCCH. The MS shall send 4 access bursts, at the commanded power level, in 4 successive slots of the new DCCH to cell B with a Timing Advance of zero. Then the MS shall establish a signalling link using a Timing Advance of one and send a HANDOVER COMPLETE message. The MS shall be ready to transmit the HANDOVER COMPLETE message before 650 ms after the end of the HANDOVER COMMAND message, but not before a UA frame has been sent by the SS.

The term "ready to transmit" is defined in GSM 04.13.

Maximum Duration of Test

5 seconds.

Expected Sequence

Step	Direction	Message	Comments
1	SS -> MS	HANDOVER COMMAND	See specific message contents below. Handover Reference as included in the HANDOVER COMMAND.
2	MS -> SS	HANDOVER ACCESS	
3	MS -> SS	HANDOVER ACCESS	
4	MS -> SS	HANDOVER ACCESS	
5	MS -> SS	HANDOVER ACCESS	
6	MS -> SS	SABM	Sent without information field.
7	SS -> MS	UA	
8	MS -> SS	HANDOVER COMPLETE	This message shall be ready to be transmitted before 650 ms after the completion of step 1. The SS checks that the timing advance reported in the layer 1 header of the SACCH message that is sent in the first SACCH multiframe following the SABM is 1 bit period.
9	SS	-	

Specific Message Contents

HANDOVER COMMAND

As default message contents, except: Synchronization Indication	pre-synchronized; ROT=0; NCI=0.
--	---------------------------------

26.6.5.5.2 Handover / successful / call being established / pre-synchronized / timing advance IE is included / reporting of observed time difference requested.

This test is applicable to all MS which support at least one MO circuit switched basic service.

If an MS does not implement the pre-synchronized handover procedure correctly then calls may fail.

If an MS does not report the observed time difference between cells correctly then pseudo synchronized handovers might not be possible for any MS.

26.6.5.5.2.1 Conformance requirements

- 1 The MS shall correctly apply the handover procedure from an SDCCH/4 to a TCH/F without frequency hopping in the pre-synchronized case while a call is being established.
- 2 If during call establishment a Layer 3 MM or CC message just sent by the MS is not Layer 2 acknowledged before the channel change caused by the HANDOVER COMMAND message, the MS shall send the Layer 3 message to the new cell, using the same value in the N(SD) field, after the handover procedure.
- 3 When the Timing Advance information element is included in the HANDOVER COMMAND, the MS shall access the new cell with the timing advance included in the Timing Advance IE.
- 4 The MS shall be ready to transmit the HANDOVER COMPLETE message within 650 ms of the end of the HANDOVER COMMAND message.
- 5 When requested to do so in the HANDOVER COMMAND message, the MS shall return the Mobile Time Difference IE in the HANDOVER COMPLETE message indicating the sum of the observed time difference between the cells and the timing advance used on the old cell.

References

Conformance requirement 1: GSM 04.08, section 3.4.4.

Conformance requirement 2: GSM 04.08, section 3.1.4.3.
Conformance requirement 3: GSM 05.10, section 6.6.
Conformance requirement 4: GSM 04.13, section 5.2.6.1.
Conformance requirement 5: GSM 04.08, section 10.5.2.39.

26.6.5.5.2.2 Test purpose

To test that when the MS is ordered to make a pre-synchronized handover to another cell, it sends 4 access bursts on the main DCCH and then activates the channel correctly and correctly calculates the time to transmit. To test that the MS correctly retransmits Layer 3 MM or CC messages that were not acknowledged by Layer 2 before the Handover, after completion of the Handover. To test that the MS correctly reports on the time difference between the cells.

26.6.5.5.2.3 Method of test

Initial Conditions

System Simulator:

2 cells, A and B, with same LAI, default parameters.
The BCCH of cell A is sent k bit periods before the BCCH of cell B.

Mobile Station:

The MS is in the "idle, updated" state, with a TMSI allocated and camped on cell A.

Related PICS/PIXIT Statements

Supported rate(s) of TCH: TCH/F.

Support for state MO calls.

Type of MS (P-GSM 900 or EGSM or DCS 1 800).

Foreseen Final State of the MS

"Idle, updated" with TMSI allocated and camped on cell B.

Test Procedure

A Mobile Originating Call is initiated. The SS sends an IMMEDIATE ASSIGNMENT message allocating an SDCCH/4. The MS is commanded to use a timing advance of y bit periods on cell A. After the MS has sent the SETUP message (and before the last L2 frame carrying the SETUP message is acknowledged by the SS) the SS sends a HANDOVER COMMAND, ordering the MS to switch to cell B. The MS shall then send 4 access bursts, at the commanded power level, in 4 successive slots of the new DCCH to cell B. Then the MS shall establish a signalling link using the correct timing advance and send a HANDOVER COMPLETE message. The MS shall be ready to transmit the HANDOVER COMPLETE message before 650 ms after the end of the HANDOVER COMMAND message, but not before a UA frame has been sent by the SS.

The term "ready to transmit" is defined in GSM 04.13.

The MS shall then again send the SETUP message to the SS, using the same value in the N(SD) field. Finally the SS sends a CHANNEL RELEASE to end the test.

Maximum Duration of Test

20 seconds.

Expected Sequence

Step	Direction	Message	Comments
1	-----	-----	A MO call is initiated.
2	MS -> SS	CHANNEL REQUEST	
3	SS -> MS	IMMEDIATE ASSIGNMENT	to an SDCCH/4.
4	MS -> SS	CM SERVICE REQUEST	
5	SS -> MS	CIPHERING MODE COMMAND	
6	MS -> SS	CIPHERING MODE COMPLETE	
7	MS -> SS	SETUP	Last L2 frame not acknowledged by the SS.
8	SS -> MS	HANDOVER COMMAND	See specific message contents below.
9	MS -> SS	HANDOVER ACCESS	Handover Reference as included in the
10	MS -> SS	HANDOVER ACCESS	HANDOVER COMMAND
11	MS -> SS	HANDOVER ACCESS	
12	MS -> SS	HANDOVER ACCESS	
13	MS -> SS	SABM	Sent without information field.
14	SS -> MS	UA	
15	MS -> SS	HANDOVER COMPLETE	This message shall be ready to be transmitted before 650 ms after the completion of step 8. Shall include the Mobile Time Difference IE with value $(2k+y) \bmod 2,097,152$ half bit periods. A tolerance of ± 2 half bit periods is allowed.
16	MS -> SS	SETUP	Same N(SD) as in step 7
17	SS	-	The SS checks that the timing advance reported in the layer 1 header of the SACCH message that is sent in the first SACCH multiframe following the SABM is 9 bit periods. A tolerance of ± 2 bit periods is allowed.
18	SS -> MS	CHANNEL RELEASE	

Specific Message Contents

HANDOVER COMMAND

As default message contents, except: Synchronization Indication Timing Advance	pre-synchronized; ROT=1; NCI=0. 9 bit periods.
--	---

26.6.5.6 Handover / successful / active call / pseudo synchronized

This test only applies to MSs that claim to support the pseudo synchronized handover procedure. If MSs that claim to support this procedure do not correctly implement it, then calls may fail.

26.6.5.6.1 Conformance requirements

- 1 The MS shall correctly apply the handover procedure from TCH/F without frequency hopping to TCH/F without frequency hopping in the pseudo synchronized case when a call is in progress.
- 2 The MS shall access the new cell with the correct timing advance.
- 3 The MS shall be ready to transmit the HANDOVER COMPLETE message within 650 ms of the end of the HANDOVER COMMAND message.
- 4 When requested to do so in the HANDOVER COMMAND message, the MS shall return the Mobile Time Difference IE in the HANDOVER COMPLETE message indicating the sum of the observed time difference between the cells and the timing advance used on the old cell.

References

Conformance requirement 1: GSM 04.08 section 3.4.4.
Conformance requirement 2: GSM 05.10, section 6.6.
Conformance requirement 3: GSM 04.13, section 5.2.6.1.
Conformance requirement 4: GSM 04.08, section 10.5.2.39.

26.6.5.6.2 Test purpose

To test that when the MS is ordered to make a pseudo synchronized handover to another cell, it sends 4 access bursts on the main DCCH and then activates the channel correctly and correctly calculates the time to transmit. To test that the MS correctly reports the time difference between the cells.

26.6.5.6.3 Method of test

Initial Conditions

System Simulator:

2 cells, A and B, with same LAI, default parameters.

The BCCH of cell A is sent k bit periods before the BCCH of cell B. k is arbitrarily selected.

The MS is being commanded to use a timing advance of y bit periods on cell A, where y is arbitrarily selected from the set $\{11, 12, \dots, 62\}$.

Mobile Station:

The MS is in the active state (U10) of a call (on cell A) using a full rate TCH in non-hopping mode.

Related PICS/PIXIT Statements

Supported rate(s) of TCH: TCH/F.

Support for state U10 of the Call Control protocol.

Support for pseudo synchronization.

Type of MS (P-GSM 900 or EGSM or DCS 1 800).

Foreseen Final State of the MS

The active state (U10) of a mobile call (on cell B) using a full rate TCH in non-hopping mode.

Test Procedure

The MS is in the active state (U10) of a call on cell A. The SS sends a HANDOVER COMMAND for a pseudo-synchronized handover with the Real Time Difference IE included. The Time Difference value is set to $(2k+10)$ modulo 256. The MS shall send 4 access bursts, at the commanded power level, in 4 successive slots of the new DCCH to cell B with a Timing Advance of zero. Then the MS shall establish a signalling link using a Timing Advance of $(y-10)$ bit periods and send a HANDOVER COMPLETE message. The MS shall be ready to transmit the HANDOVER COMPLETE message before 650 ms after the end of the HANDOVER COMMAND message, but not before a UA frame has been sent by the SS.

The term "ready to transmit" is defined in GSM 04.13.

Maximum Duration of Test

5 seconds.

Expected Sequence

Step	Direction	Message	Comments
1	SS -> MS	HANDOVER COMMAND	See specific message contents below. Handover Reference as included in the HANDOVER COMMAND. Sent without information field.
2	MS -> SS	HANDOVER ACCESS	
3	MS -> SS	HANDOVER ACCESS	
4	MS -> SS	HANDOVER ACCESS	
5	MS -> SS	HANDOVER ACCESS	
6	MS -> SS	SABM	
7	SS -> MS	UA	
8	MS -> SS	HANDOVER COMPLETE	
9	SS	-	This message shall be ready to be transmitted before 650 ms after the completion of step 1. Shall include the Mobile Time Difference IE with value $(2k+y) \bmod 2,097,152$ half bit periods. A tolerance of ± 2 half bit periods is allowed. The SS checks that the timing advance reported in the layer 1 header of the SACCH message that is sent in the first SACCH multiframe following the SABM is $(y-10)$ bit periods. A tolerance of ± 2 bit periods is allowed.

Specific Message Contents

HANDOVER COMMAND

As default message contents, except: Synchronization Indication Time Difference	pseudo-synchronized; ROT=1; NCI=0. $(2k+10) \bmod 256$.
---	---

26.6.5.7 Handover / successful / active call / non-synchronized / reporting of observed time difference requested.

If an MS does not report the observed time difference between cells correctly then pseudo synchronized handovers might not be possible for any MS.

26.6.5.7.1 Conformance requirements

- 1 The MS shall correctly apply the handover procedure from a TCH/F without frequency hopping to a TCH/F without frequency hopping in the non-synchronized case while a call is active.
- 2 When requested to do so in the HANDOVER COMMAND message, the MS shall return the Mobile Time Difference IE in the HANDOVER COMPLETE message indicating the sum of the observed time difference between the cells and the timing advance used on the old cell.

References

Conformance requirement 1: GSM 04.08, section 3.4.4.

Conformance requirement 2: GSM 04.08, section 10.5.2.39.

26.6.5.7.2 Test purpose

To verify that when the MS is ordered to make a non-synchronized handover to another cell and is ordered to report on the time difference between the cells, that it does so correctly.

26.6.5.7.3 Method of test

Initial Conditions

System Simulator:

2 cells, A and B with default parameters except the LAI of cell B has MNC = 02 decimal, MCC = 315 decimal, and LAC = 5344 H.

The BCCH of cell A is sent k bit periods before the BCCH of cell B.
The MS is commanded to use a timing advance of y bit periods on cell A.

Mobile Station:

The MS is in the active state (U10) of a call (on cell A) using a full rate TCH in non-hopping mode.

Related PICS/PIXIT Statements

Supported rate(s) of TCH: TCH/F.

Support for state U10 of the Call Control protocol.

Type of MS (P-GSM 900 or EGSM or DCS 1 800).

Foreseen Final State of the MS

The active state (U10) of a mobile call (on cell B) using a full rate TCH in non-hopping mode.

Test Procedure

The MS is in the active state (U10) of a call on cell A. The SS sends a HANOVER COMMAND on the main DCCH. The HANOVER COMMAND includes a Synchronization Indication IE that instructs the MS to supply the observed time difference between the cells. The MS shall begin to send access bursts on the new DCCH to cell B and the SS sends one PHYSICAL INFORMATION message. The MS shall activate the channel in sending and receiving mode and establish a signalling link using the correct timing advance. The MS shall transmit a HANOVER COMPLETE message containing the Mobile Time Difference IE with a correct value.

Maximum Duration of Test

5 seconds.

Expected Sequence

Step	Direction	Message	Comments
1	SS -> MS	HANOVER COMMAND	See specific message contents below.
2	MS -> SS	HANOVER ACCESS	Repeated on every burst of the uplink main DCCH until reception of PHYSICAL INFORMATION. Handover Reference as included in the HANOVER COMMAND.
3	SS -> MS	PHYSICAL INFORMATION	
4	MS -> SS	SABM	Sent without information field.
5	SS -> MS	UA	
6	MS -> SS	HANOVER COMPLETE	Shall include the Mobile Time Difference IE with value $(2k+y) \bmod 2,097,152$ half bit periods. A tolerance of ± 2 half bit periods is allowed.

Specific Message Contents

HANOVER COMMAND

as default message contents, except: Synchronization Indication	"not synchronized"; ROT=1; NCI=0.
--	-----------------------------------

26.6.5.8 Handover / layer 3 failure

26.6.5.8.1 Conformance requirements

The MS shall return to the old channel in the case of an handover failure caused by the non reception of the PHYSICAL INFORMATION message. On the old channel the MS shall use the Power Level that it was previously using on that channel.

References

GSM 04.08 section 3.4.4.

26.6.5.8.2 Test purpose

To verify the function of timer T3124 and the contents in the message HANDOVER FAILURE and in the layer 1 header on the SACCH.

26.6.5.8.3 Method of test

Initial Conditions

System Simulator:
2 cells with same LAI, default parameters.

Mobile Station:
The MS is in the active state (U10) of a call (on cell A). Used power level is the maximum supported by the MS.

Related PICS/PIXIT Statements

Supported rate(s) of TCH: TCH/F.
Support for state U10 of the Call Control protocol.
Type of MS (P-GSM 900 or EGSM or DCS 1 800).

Foreseen Final State of the MS

The active state (U10) of a mobile call (on cell A). Used power level is the maximum supported by the MS.

Test Procedure

The MS is in the active state (U10) of a call on cell A. The SS sends a HANDOVER COMMAND with Power Command set to 8 on the main DCCH. The MS shall begin to send access bursts at the commanded power level on the new DCCH to cell B. The SS activates the SACCH, but does not send PHYSICAL INFORMATION (thus causing a time-out of T3124). The MS shall re-establish the old link on cell A and send a HANDOVER FAILURE within 3 seconds from the transmission of HANDOVER COMMAND, using the old power level.

Maximum Duration of Test

5 minutes, including 1 minute for any necessary operator actions.

Expected Sequence

Step	Direction	Message	Comments
0	SS	-	The SS records the power level in the layer 1 header of the last SACCH message sent by the MS before step 1.
1	SS -> MS	HANDOVER COMMAND	Channel description: non-hopping, full rate Power Command: 8. Synchronization Indication: non synchronized.
2	MS -> SS	HANDOVER ACCESS	Several messages are sent, all with correct Handover References.
3	MS -> SS	HANDOVER FAILURE	Sent on old channel, RR cause value = "Abnormal release, unspecified", "Abnormal release, channel unacceptable", "Abnormal release, timer expired", "Abnormal release, no activity on the radio path" or "Protocol error unspecified". Shall be sent within 3 seconds from the transmission of HANDOVER COMMAND.
4	SS	-	The SS checks that the power level reported in the layer 1 header of the SACCH message that is sent in the first SACCH multiframe following the SABM is the same as in step 0.

Specific Message Contents

None.

26.6.5.9 Handover / layer 1 failure**26.6.5.9.1 Conformance requirements**

The MS shall return to the old channel in the case of an handover failure caused by a layer 1 failure on the target cell. On the old channel the MS shall use the Power Level that it was previously using on that channel.

References

GSM 04.08 section 3.4.4.

26.6.5.9.2 Test purpose

To verify the function of timer T3124 and the contents in the message HANDOVER FAILURE and in the layer 1 header on the SACCH.

26.6.5.9.3 Method of test**Initial Conditions**

System Simulator:
2 cells with same LAI, default parameters.

Mobile Station:
The MS is in the active state (U10) of a call (on cell A). Used power level is the maximum supported by the MS.

Related PICS/PIXIT Statements

Supported rate(s) of TCH: TCH/F.

Support for state U10 of the Call Control protocol.

Type of MS (P-GSM 900 or EGSM or DCS 1 800).

Foreseen Final State of the MS

The active state (U10) of a mobile call (on cell A). Used power level is the maximum supported by the MS.

Test Procedure

The MS is in the active state (u10) of a call on cell A. The SS sends a HANDOVER COMMAND on the main DCCH. The MS shall begin to send access bursts at the commanded power level on the new DCCH to cell B. With the exception of normal BCCH signalling, the SS does not transmit anything on cell B (thus causing a time-out of T3124). The MS shall re-establish the old link on cell A and send a HANDOVER FAILURE within 3 seconds from the transmission of HANDOVER COMMAND, using the old power level.

Maximum Duration of Test

5 minutes, including 1 minute for any necessary operator actions.

Expected Sequence

Step	Direction	Message	Comments
0	SS	-	The SS records the power level in the layer 1 header of the last SACCH message sent by the MS before step 1.
1	SS -> MS	HANDOVER COMMAND	Channel description: non-hopping, full rate. Synchronization Indication: non synchronized.
2	MS -> SS	HANDOVER ACCESS	Several messages are sent, all with correct Handover References.
3	MS -> SS	HANDOVER FAILURE	Sent on old channel, RR cause value = "Abnormal release, unspecified", "Abnormal release, channel unacceptable", "Abnormal release, timer expired", "Abnormal release, no activity on the radio path" or "Protocol error unspecified". Shall be sent within 3 seconds from the transmission of HANDOVER COMMAND.
4	SS	-	The SS checks that the power level reported in the layer 1 header of the SACCH message that is sent in the first SACCH multiframe following the SABM is the same as in step 0.

Specific Message Contents

None.

26.6.6 Test of frequency redefinition

The Frequency Redefinition procedure is used by the network to change the frequencies and hopping sequences of the allocated channels.

26.6.6.1 Frequency redefinition

26.6.6.1.1 Conformance requirements

An MS, after receiving a FREQUENCY REDEFINITION message, shall start using the new frequencies and hopping sequence in the correct time slot when the MS is allocated a dedicated channel.

The behaviour described in the test purpose is applied for each combination of the value T(k) (k = 1,2,3) and for each supported dedicated channel type.

References

GSM 04.08 sections 3.4.5, 9.1.13 and 10.5.2.13.

26.6.6.1.2 Test purpose

To verify that the MS, after receiving a Frequency Redefinition message, starts using the new frequencies and hopping sequence at the time indicated in the message.

26.6.6.1.3 Method of test

Initial Conditions

System Simulator:

1 cell, CCCH_CONF set to 1 basic physical channel used for CCCH, not combined with SDCCHs. The cell allocation is set to $CA_{PGSM}(1)$ or $CA_{DCS}(1)$, depending on the band of operation of the Mobile Station (See PICS/PIXIT), before each execution of this test.

Mobile Station:

The MS is in the "idle, updated" state, with a TMSI allocated.

Related PICS/PIXIT Statements

Supported rate(s) of TCH: TCH/F and/or TCH/H.

Type of MS (P-GSM 900 or EGSM or DCS 1 800).

Foreseen Final State of the MS

"Idle, updated", with TMSI allocated.

Test Procedure

Test parameters:

P-GSM 900:

$ca_{PGSM}(1)$ is set to 64.

An arbitrary subset $CA_{PGSM}(1)$ of the set $\{1, \dots, 124\}$ containing $ca_{PGSM}(1)$ elements is drawn.

An element B of the set $CA_{PGSM}(1)$ is arbitrarily chosen.

An arbitrary value $ca_{PGSM}(2)$ in the range 20, ..., 63 is chosen.

An arbitrary subset $CA_{PGSM}(2)$ of the set $\{1, \dots, 124\}$ with $ca_{PGSM}(2)$ elements and containing B is chosen.

An arbitrary value $ca_{PGSM}(3)$ in the range 4, ..., 19 is chosen.

An arbitrary subset $CA_{PGSM}(3)$ of the set $\{1, \dots, 124\}$ with $ca_{PGSM}(3)$ elements and containing B is chosen.

For $j = 1, 2, 3$, values $ma_{PGSM}(j)$ in the range $j, \dots, ca_{PGSM}(j)-1$ and values $MAIO_{PGSM}(j)$ in the range $0, \dots, ma_{PGSM}(j)-1$ are arbitrarily chosen.

Subsets $MA_{PGSM}(j)$ of $CA_{PGSM}(j)$ not containing B and having $ma(j)$ elements are arbitrarily chosen.

DCS 1 800:

$ca_{DCS}(1)$ is set to 64.

An arbitrary subset $CA_{DCS}(1)$ of the set $\{700, \dots, 812\}$ containing $ca_{DCS}(1)$ elements is chosen.

An element B of the set $CA_{DCS}(1)$ is arbitrarily chosen. $CA_{DCS}(1)$ is then coded using the Variable Bit Map coding scheme.

An arbitrary value $ca_{DCS}(2)$ in the range 17, ..., 63 is chosen.

An arbitrary subset $CA_{DCS}(2)$ of the set $\{700, \dots, 812\}$ with $ca_{DCS}(2)$ elements and containing B is chosen. $CA_{DCS}(2)$ is then coded using the Variable Bit Map coding scheme.

An arbitrary value $ca_{DCS}(3)$ in the range 4,...,16 is chosen.

An arbitrary subset $CA_{DCS}(3)$ of the set {700,...,812} with $ca_{DCS}(3)$ elements and containing B is chosen. $CA_{DCS}(3)$ is then coded according to the specific message contents.

For $j = 1,2,3$, values $ma_{DCS}(j)$ in the range $j, \dots, ca_{DCS}(j)-1$ and values $MAIO_{DCS}(j)$ in the range $0, \dots, ma_{DCS}(j)-1$ are arbitrarily chosen.

Subsets $MA_{DCS}(j)$ of $CA_{DCS}(j)$ not containing B and having $ma_{DCS}(j)$ elements are arbitrarily chosen.

DCS 1 800 and GSM 900

Let $T(1) = 91$, $T(2) = 42\ 000$.

An arbitrary value $T(3)$ in the range 92,...,29999 is chosen.

The System Simulator pages the MS and after the MS has responded with a CHANNEL REQUEST, the simulator assigns a dedicated channel (TCH/F, TCH/H or SDCCH, as defined by the execution counter R). Then the SS sends a FREQUENCY REDEFINITION message, which modifies the frequencies/hopping sequence to be used by the MS. The MS shall then, at the TDMA frame defined by the contents of the "Starting Time" information element, use the new frequencies/hopping sequence. (The value of $T(2)$ ensures that the MS believes the Starting Time has passed and so the MS shall start transmitting immediately. The range for $T(3)$ ensures that the MS has to wait until the designated frame before starting transmission on the new frequencies.)

The verification is performed at the RF burst level. The MS transmits the standard test signal C1 (annex 5), and for the TCH case, the SS checks the received pattern with the expected pattern. For the SDCCH case the MS transmits fill frames, and the SS checks for each burst whether the burst is transmitted at the right frequency.

Maximum Duration of Test

$3 * (\text{number of supported channels} * T(3) + 7)$

Expected Sequence

This sequence is performed for every combination of execution counters $K = 1,2,3$ and $R = 1,2,3$:

Step	Direction	Message	Comments
1	SS -> MS	PAGING REQUEST TYPE 1	
2	MS -> SS	CHANNEL REQUEST	
3	SS -> MS	IMMEDIATE ASSIGNMENT	
4	MS -> SS	PAGING RESPONSE	
5	-----	-----	The SS checks that the MS is transmitting on the correct frequencies without delay.
6	SS -> MS	FREQUENCY REDEFINITION	See description 1 below.
7	-----	-----	The SS checks that the MS is transmitting on the correct frequencies and that the transmissions started in the correct frame.
8	SS -> MS	FREQUENCY REDEFINITION	See description 2 below.
9	-----	-----	The SS checks that the MS is transmitting on the correct frequencies and that the transmissions started in the correct frame.
10	SS -> MS	CHANNEL RELEASE	

For $K=1, R = 1,2,3$ $T(K) = T(1);$
 $K=2, R = 1,2,3$ $T(K) = T(2);$
 $K=3, R = 1,2,3$ $T(K) = T(3).$

Specific Message Contents

GSM 900:

IMMEDIATE ASSIGNMENT

Information Element	value/remark
L2 pseudo length	value dependent on the length of the Mobile Allocation and thus on the number of channels in CAPGSM(1).
Channel Description	
Channel type and TDMA offset	SDCCH/8 arbitrary offset, for R=1 Bm + ACCHs for R=2 Lm + ACCHs arbitrary offset, for R=3
Timeslot number	arbitrarily selected by
TSC	arbitrarily selected
Hopping channel	RF hopping channel
MAIO	MAIOPGSM(1)
HSN	0
Request reference	corresponds to the Channel Request
Timing advance	30 bit periods
Mobile Allocation	corresponds to set MAPGSM(1)
Starting Time	not present
IA rest octets	all bits are set to spare

FREQUENCY REDEFINITION (Description 1)

Information Element	value/remark
Protocol Discriminator	RR Management
Skip Indicator	0000
Message Type	00101011
Channel Description	
Channel type and TDMA offset	SDCCH/8 offset not changed, for R=1 Bm + ACCHs for R=2 Lm + ACCHs offset not changed, for R=3
Timeslot number	not changed
TSC	not changed
Hopping channel	RF hopping channel
MAIO	MAIOPGSM(2)
HSN	0
Mobile Allocation	corresponds to set MAPGSM(2)
Starting Time	The last burst of the first L2 frame containing the beginning of this message is transmitted in frame number X. The starting time is set to frame number (X plus T(K) modulo 42 432).
Cell Channel Description	
Information element identifier contents	62H corresponds to set CAPGSM(2) with "Format ID" set to "bit map 0".

FREQUENCY REDEFINITION (Description 2)

Information Element	value/remark
Protocol Discriminator	RR Management
Skip Indicator	0000
Message Type	00101011
Channel Description	
Channel type and TDMA offset	SDCCH/8 offset not changed, for R=1 Bm + ACCHs, for R=2 Lm + ACCHs offset not changed, for R=3
Timeslot number	not changed
TSC	not changed
Hopping channel	RF hopping channel
MAIO	MAIOPGSM(3)
HSN	0
Mobile Allocation	corresponds to set MAPGSM(3)
Starting Time	The last burst of the first L2 frame containing the beginning of this message is transmitted in frame number X. The starting time is set to frame number (X plus T(K) modulo 42 432).
Cell Channel Description	
Information element identifier contents	62H corresponds to set CAPGSM(3) with "Format ID" set to "bit map 0".

DCS 1 800:

IMMEDIATE ASSIGNMENT

Information Element	value/remark
L2 pseudo length	value dependent on the length of the Mobile Allocation and thus on the number of channels in CADCS(1).
Channel Description	
Channel type and TDMA offset	SDCCH/8 arbitrary offset, for R=1 Bm + ACCHs for R=2 Lm + ACCHs arbitrary offset, for R=3
Timeslot number	arbitrarily selected
TSC	arbitrarily selected
Hopping channel	RF hopping channel
MAIO	MAIODCS(1)
HSN	0
Request reference	corresponds to the Channel Request
Timing advance	30 bit periods
Mobile Allocation	corresponds to set MADCS(1)
Starting Time	not present
IA rest octets	all bits are set to spare

FREQUENCY REDEFINITION (Description 1)

Information Element	value/remark
Protocol Discriminator	RR Management
Skip Indicator	0000
Message Type	00101011
Channel Description	
Channel type and TDMA offset	SDCCH/8 offset not changed, for R=1 Bm + ACCHs for R=2 Lm + ACCHs offset not changed, for R=3
Timeslot number	not changed
TSC	not changed
Hopping channel	RF hopping channel
MAIO	MAIODCS(2)
HSN	0
Mobile Allocation	corresponds to set MADCS(2)
Starting Time	The last burst of the first L2 frame containing the beginning of this message is transmitted in frame number X. The starting time is set to frame number (X plus T(K) modulo 42 432).
Cell Channel Description	
Information element identifier	62H
contents	K = 1 - corresponds to set CADCS(2) with "Format ID" set to " Variable Bit Map" K = 2- corresponds to set CADCS(2) with "Format ID" set to " Variable Bit Map" K = 3 - corresponds to set CADCS(2) with "Format ID" set to " Variable Bit Map"

FREQUENCY REDEFINITION (Description 2)

Information Element	value/remark
Protocol Discriminator	RR Management
Skip Indicator	0000
Message Type	00101011
Channel Description	
Channel type and TDMA offset	SDCCH/8 offset not changed, for R=1 Bm + ACCHs, for R=2 Lm + ACCHs offset not changed, for R=3
Timeslot number	not changed
TSC	not changed
Hopping channel	RF hopping channel
MAIO	MAIODCS(3)
HSN	0
Mobile Allocation	corresponds to set MADCS(3)
Starting Time	The last burst of the first L2 frame containing the beginning of this message is transmitted in frame number X. The starting time is set to frame number (X plus T(K) modulo 42 432).
Cell Channel Description	
Information element identifier	62H
contents	K = 1 - corresponds to set CADCS(3) with "Format ID" set to "Range 1024" K = 2- corresponds to set CADCS(3) with "Format ID" set to "Range 256" K = 3 - corresponds to set CADCS(3) with "Format ID" set to "Range 512"

26.6.7 Test of the channel mode modify procedure

The channel mode modify procedure allows the network to request the MS to change the channel mode for one channel. If the mobile station does not correctly respond to the CHANNEL MODE MODIFY message (with a positive acknowledgement if the new channel mode is supported, with a negative

acknowledgement if the new channel mode is not supported), the network may try to repeat the procedure, release the connection, or continue to wait for the acknowledgement (the maximum time resulting from layer two re-transmissions and MS reaction time being around 5 seconds).

26.6.7.1 Test of the channel mode modify procedure / full rate

This test is only applicable to an MS supporting TCH/F.

26.6.7.1.1 Conformance requirement

When the MS has received the CHANNEL MODE MODIFY message, the mobile station changes the mode for the indicated channel and then replies by a CHANNEL MODE MODIFY ACKNOWLEDGE message indicating the new channel mode.

If the mobile station does not support the indicated mode, it shall retain the old mode and return the associated channel mode information in the CHANNEL MODE MODIFY ACKNOWLEDGE message.

References

GSM 04.08, subclauses 3.4.6.2 and 3.4.6.3.

26.6.7.1.2 Test purpose

To verify that the MS, in an RR connected state, acknowledges a CHANNEL MODE MODIFY message by sending a CHANNEL MODE MODIFY ACKNOWLEDGEMENT message specifying and switching to the correct mode.

- the new mode if that mode is supported.
- the old mode if the new mode is not supported.

This shall be verified for the channel modes

- signalling only.
- speech full rate version 1.
- data 9,6 Kb/s.
- data 4,8 Kb/s full rate.
- data 2,4 Kb/s full rate.

26.6.7.1.3 Method of test

Initial Conditions

System Simulator:
1 cells, default parameters.

Mobile Station:
The MS is "idle updated", with TMSI allocated.

Related PICS/PIXIT Statements

- Type of MS (P-GSM 900 or EGSM or DCS 1 800).
- The MS supports TCH/F (Y/N).
- Bearer Capabilities supported by the MS.
- Channel modes supported by the MS:
 - * MS supports speech full rate version 1 (p1 = Y/N);
 - * MS supports data 9,6 Kb/s (p2 = Y/N);
 - * MS supports data 4,8 Kb/s full rate (p3 = Y/N);
 - * MS supports data 2,4 Kb/s full rate (p4 = Y/N).

Foreseen Final State of the MS

"Idle, updated", with TMSI allocated.

Test procedure

A Mobile Terminated call is initiated , however following the Channel Request received from the Mobile Station, the SS sends an Immediate Assignment to the MS commanding it to go to a TCH/F. This sets the Channel Mode automatically to "Signalling Only".

The SS then sends a series of CHANNEL MODE MODIFY messages to the MS. Each time it is checked that the MS responds with a CHANNEL MODE MODIFY ACKNOWLEDGE message specifying:

- the channel mode that has been specified in the CHANNEL MODE MODIFY message, if the MS supports that mode (this mode then becomes the "channel mode in use");
- the channel mode that was in use when the CHANNEL MODE MODIFY message has been received, if the MS does not support the channel mode specified in the CHANNEL MODE MODIFY message.

Maximum Duration of Test

30 seconds.

Expected Sequence

Step	Direction	Message	Comments
1	SS->MS	PAGING REQUEST TYPE 1	Sent on correct paging subchannel. Establishment cause indicates "answer to paging". Assignment to a non hopping TCH/F.
2	MS->SS	CHANNEL REQUEST	
3	SS->MS	IMMEDIATE ASSIGNMENT	
4	SS->MS	CHANNEL MODE MODIFY	
5	MS->SS	CHANNEL MODE MODIFY ACKNOWLEDGE	
6	SS->MS	CHANNEL MODE MODIFY	
7	MS->SS	CHANNEL MODE MODIFY ACKNOWLEDGE	
8	SS->MS	CHANNEL MODE MODIFY	
9	MS->SS	CHANNEL MODE MODIFY ACKNOWLEDGE	
10	SS->MS	CHANNEL MODE MODIFY	
11	MS->SS	CHANNEL MODE MODIFY ACKNOWLEDGE	
12	SS->MS	CHANNEL MODE MODIFY	
13	MS->SS	CHANNEL MODE MODIFY ACKNOWLEDGE	
14	SS->MS	CHANNEL RELEASE	

Specific Message Contents**CHANNEL MODE MODIFY**

Information Element	value/remark
Channel description	describes the already assigned dedicated channel.
Channel mode	
Mode	in step 4: speech full rate version 1 in step 6: data 9,6 Kb/s in step 8: data 4,8 Kb/s full rate in step 10: data 2,4 Kb/s full rate in step 12: signalling only

CHANNEL MODE MODIFY ACKNOWLEDGE

Channel mode Mode	in step 2: signalling only in step 4: if p2 = Y: data 9,6 Kb/s if p2 = N: signalling only in step 6: if p3 = Y: data 4,8 Kb/s full rate if p3 = N: same as in step 4 in step 8: if p4 = Y: data 2,4 Kb/s full rate if p4 = N: same as in step 6 in step 10: if p1 = Y: speech full rate version 1 if p1 = N: same as in step 8
----------------------	--

26.6.7.2 Test of the channel mode modify procedure / half rate

This test is only applicable to an MS supporting TCH/H.

26.6.7.2.1 Conformance requirement

When the MS has received the CHANNEL MODE MODIFY message, the mobile station changes the mode for the indicated channel and then replies by a CHANNEL MODE MODIFY ACKNOWLEDGE message indicating the new channel mode.

If the mobile station does not support the indicated mode, it shall retain the old mode and return the associated channel mode information in the CHANNEL MODE MODIFY ACKNOWLEDGE message.

References

GSM 04.08, subclauses 3.4.6.2 and 3.4.6.3.

26.6.7.2.2 Test purpose

To verify that the MS, in an RR connected state, acknowledges a CHANNEL MODE MODIFY message by sending a CHANNEL MODE MODIFY ACKNOWLEDGEMENT message specifying and switches to the correct mode:

- the new mode if that mode is supported;
- the old mode if the new mode is not supported.

This shall be verified for the channel modes:

- signalling only;
- speech half rate version 1;
- data 4,8 Kb/s half rate;
- data 2,4 Kb/s half rate.

26.6.7.2.3 Method of test**Initial Conditions**

System Simulator:

1 cells, default parameters.

Mobile Station:

The MS is "idle updated", with TMSI allocated.

Related PICS/PIXIT Statements

- Type of MS (P-GSM 900 or EGSM or DCS 1 800).
- The MS supports TCH/H (Y/N).
- Bearer Capabilities supported by the MS.
- Channel modes supported by the MS:

- * MS supports speech half rate version 1 (q1 = Y/N);
- * MS supports data 4,8 Kb/s half rate (q2 = Y/N);
- * MS supports data 2,4 Kb/s half rate (q3 = Y/N).

Foreseen Final State of the MS

"Idle, updated", with TMSI allocated.

Test procedure

A Mobile Terminated call is initiated , however following the Channel Request received from the Mobile Station, the SS sends an Immediate Assignment to the MS commanding it to go to a TCH/H. This sets the Channel Mode automatically to "Signalling Only".

The SS then sends a series of CHANNEL MODE MODIFY messages to the MS. Each time it is checked that the MS responds with a CHANNEL MODE MODIFY ACKNOWLEDGE message specifying:

- the channel mode that has been specified in the CHANNEL MODE MODIFY message, if the MS supports that mode (this mode then becomes the "channel mode in use");
- the channel mode that was in use when the CHANNEL MODE MODIFY message has been received, if the MS does not support the channel mode specified in the CHANNEL MODE MODIFY message.

Maximum Duration of Test

30 seconds.

Expected Sequence

Step	Direction	Message	Comments
1	SS->MS	PAGING REQUEST TYPE 1	Sent on the correct paging subchannel. Establishment cause indicates "answer to paging". Assignment to a non hopping TCH/H.
2	MS->SS	CHANNEL REQUEST	
3	SS->MS	IMMEDIATE ASSIGNMENT	
4	SS->MS	CHANNEL MODE MODIFY	
5	MS->SS	CHANNEL MODE MODIFY ACKNOWLEDGE	
6	SS->MS	CHANNEL MODE MODIFY	
7	MS->SS	CHANNEL MODE MODIFY ACKNOWLEDGE	
8	SS->MS	CHANNEL MODE MODIFY	
9	MS->SS	CHANNEL MODE MODIFY ACKNOWLEDGE	
10	SS->MS	CHANNEL MODE MODIFY	
11	MS->SS	CHANNEL MODE MODIFY ACKNOWLEDGE	
12	SS->MS	CHANNEL RELEASE	

Specific Message Contents

CHANNEL MODE MODIFY

Information Element	value/remark
Channel description	describes the already assigned dedicated channel. in step 4: signalling only in step 6: data 4,8 Kb/s half rate in step 8: data 2,4 Kb/s half rate in step 10: speech half rate version 1
Channel mode	
Mode	

CHANNEL MODE MODIFY ACKNOWLEDGE

Information Element	value/remark
Channel mode Mode	in step 5: if q1 = Y: Speech half rate version 1 if q1 = N: signalling only in step 7: if q2 = Y: data 4,8 Kb/s half rate if q2 = N: same as in step 5 in step 9: if q3 = Y: data 2,4 Kb/s half rate if q3 = N: same as in step 7 in step 11: if q1 = Y: signalling only if q1 = N: same as in step 6.

26.6.8 Test of ciphering mode setting

The Ciphering Mode Setting Procedure can be used by the network to trigger the start and stop of stream ciphering.

The SS shall start and synchronize ciphering and deciphering according to GSM 03.20. The bitstream shall be generated by algorithm A5 (A5/1 or A5/2 as defined by the test case) using the encryption key Kc.

26.6.8.1 Ciphering mode / start ciphering**26.6.8.1.1 Conformance requirements**

1. When the MS receives the CIPHERING MODE COMMAND message with Ciphering Mode Setting information element set to "start ciphering", the MS starts ciphering and deciphering with the algorithm indicated by the "algorithm identifier" field:
 - the MS responds with a CIPHERING MODE COMPLETE message in ciphered mode;
 - the ciphering uses the cipher key determined during the authentication procedure.
2. The MS responds to the AUTHENTICATION REQUEST message with an AUTHENTICATION RESPONSE message and continues to use the ciphering key obtained from the previous authentication procedure.

References

GSM 04.08 section 3.4.7.

26.6.8.1.2 Test purpose

To verify that the MS starts ciphering when it receives a CIPHERING MODE COMMAND message with Cipher Mode Setting = "Start Ciphering". To verify that it continues to use the old cipher key after it receives an AUTHENTICATION REQUEST whilst in ciphered mode.

26.6.8.1.3 Method of test**Initial Conditions**

System Simulator:
1 cells, Radio_Link_Timeout set to 64.

Mobile Station:
The MS is in the "idle, updated" state, with a TMSI allocated.

Related PICS/PIXIT Statements

Type of MS (P-GSM 900 or EGSM or DCS 1 800).

Support for state U10 of the Call Control protocol.

Supported encryption algorithms: A5/1 and/or A5/2.

Foreseen Final State of the MS

"Idle, updated", with TMSI allocated.

Test Procedure

The MS is made to originate a call. It shall send at least one CHANNEL REQUEST message. The SS sends an IMMEDIATE ASSIGNMENT and the MS shall answer with a CM SERVICE REQUEST. The SS sends an AUTHENTICATION REQUEST and the MS shall answer with AUTHENTICATION RESPONSE. Then the SS sends a CIPHERING MODE COMMAND, ordering the MS to start ciphering with an algorithm supported by the MS. After transmission of this command the SS starts ciphering. The MS shall respond with a CIPHERING MODE COMPLETE message in ciphered mode using the cipher key determined during the authentication procedure, and continue to establish the call with a SETUP message. After reception of the CIPHERING MODE COMPLETE the SS starts enciphering.

The SS then sends another AUTHENTICATION REQUEST and the MS shall respond with an AUTHENTICATION RESPONSE. The MS shall continue to use the old cipher key.

Finally the SS sends a CHANNEL RELEASE to end the test.

Maximum Duration of Test

5 minutes, including 1 minute for any necessary operator actions.

Expected Sequence

This sequence is performed for execution counter, K=1, 2.

Step	Direction	Message	Comments
1	MS -> SS	CHANNEL REQUEST	Establ. Cause = "Originating Call" NECI not set to 1
2	SS -> MS	IMMEDIATE ASSIGNMENT	
3	MS -> SS	CM SERVICE REQUEST	
4	SS -> MS	AUTHENTICATION REQUEST	
5	MS -> SS	AUTHENTICATION RESPONSE	
6	SS -> MS	CIPHERING MODE COMMAND	Cipher Mode Setting = "Start Ciphering; cipher with algorithm A5/K". The SS starts deciphering. Sent in ciphered mode using the cipher key determined in between steps 4&5. The SS start enciphering.
7	MS -> SS	CIPHERING MODE COMPLETE	
8	MS -> SS	SETUP	Determines a new cipher key. Sent in ciphered mode using the cipher key determined in between steps 4&5.
9	SS -> MS	AUTHENTICATION REQUEST	
10	MS -> SS	AUTHENTICATION RESPONSE	
11	SS -> MS	CHANNEL RELEASE	

Specific Message Contents

CIPHERING MODE COMMAND

For	k = 1, A5/k = A5/1
For	k = 2, A5/k = A5/2

26.6.8.2 CIPHERING mode / no ciphering

26.6.8.2.1 Conformance requirements

When the MS receives a CIPHERING MODE COMMAND message with Ciphering Mode Setting information element set to "no ciphering" the MS shall respond in non ciphered mode with a CIPHERING MODE COMPLETE message.

When the CIPHERING MODE COMMAND with CIPHERING Mode Setting information element set to "no ciphering" is received as a response to a CM SERVICE REQUEST, the MS shall continue the establishment of the CM service.

References

GSM 04.08 section 3.4.7.

26.6.8.2.2 Test purpose

To verify that the MS does not start ciphering when it receives a CIPHERING MODE COMMAND message with Cipher Mode Setting = "No Ciphering".

26.6.8.2.3 Method of test

Initial Conditions

System Simulator:

1 cells, Radio_Link_Timeout set to 64.

Mobile Station:

The MS is in the "idle, updated" state, with a TMSI allocated.

Related PICS/PIXIT Statements

Type of MS (P-GSM 900 or EGSM or DCS 1 800).

Support for state U10 of the Call Control protocol.

Foreseen Final State of the MS

"Idle, updated", with TMSI allocated.

Test Procedure

The MS is made to originate a call. It shall send at least one CHANNEL REQUEST message. The SS sends an IMMEDIATE ASSIGNMENT and the MS shall answer with a CM SERVICE REQUEST. The SS sends an AUTHENTICATION REQUEST and the MS shall answer with an AUTHENTICATION RESPONSE. Then the SS sends a CIPHERING MODE COMMAND, ordering the MS not to start ciphering. The MS shall respond with a CIPHERING MODE COMPLETE message in non-ciphered mode and continue to establish the call with a SETUP message.

Finally the SS sends a CHANNEL RELEASE to end the test.

Maximum Duration of Test

5 minutes, including 1 minute for any necessary operator actions.

Expected Sequence

Step	Direction	Message	Comments
1	MS -> SS	CHANNEL REQUEST	Establ. Cause = "Originating call; NECI not equal to 1.
2	SS -> MS	IMMEDIATE ASSIGNMENT	
3	MS -> SS	CM SERVICE REQUEST	Cipher Mode Setting = "No Ciphering".
4	SS -> MS	AUTHENTICATION REQUEST	
5	MS -> SS	AUTHENTICATION RESPONSE	
6	SS -> MS	CIPHERING MODE COMMAND	Sent in non-ciphered mode.
7	MS -> SS	CIPHERING MODE COMPLETE	
8	MS -> SS	SETUP	
11	SS -> MS	CHANNEL RELEASE	

Specific Message Contents

None.

26.6.8.3 Ciphering mode / old cipher key**26.6.8.3.1 Conformance requirements**

When the MS receives the CIPHERING MODE COMMAND message with Ciphering Mode Setting information element set to "start ciphering", the MS starts ciphering and deciphering with the algorithm indicated by the "algorithm identifier" field. Also;

- the MS responds with a CIPHERING MODE COMPLETE message in the correct ciphered mode;
- the ciphering shall use the previously stored cipher key;
- in the case of a mobile originating speech call, the MS shall send a SETUP message after the completion of the ciphering procedure.

References

GSM 04.08 section 3.4.7.

26.6.8.3.2 Test purpose

To verify that the MS uses the stored cipher key when it receives a CIPHERING MODE COMMAND without a preceding authentication procedure.

26.6.8.3.3 Method of test**Initial Conditions**

System Simulator:

1 cells, Radio_Link_Timeout = 64.

Mobile Station:

The MS is in the "idle, updated" state, with a TMSI allocated and a known cipher key stored.

Related PICS/PIXIT Statements

Type of MS (P-GSM 900 or EGSM or DCS 1 800).

Support for state U10 of the Call Control protocol.

Supported encryption algorithms: A5/1 and/or A5/2.

Foreseen Final State of the MS

"Idle, updated", with TMSI allocated.

Test Procedure

The MS is made to originate a call. It shall send at least one CHANNEL REQUEST message. The SS sends an IMMEDIATE ASSIGNMENT and the MS shall answer with a CM SERVICE REQUEST. The SS sends a CIPHERING MODE COMMAND, ordering the MS to start ciphering with a supported algorithm. After transmission of this command the SS starts deciphering. The MS shall respond with a CIPHERING MODE COMPLETE message in the commanded ciphered mode using the stored cipher key and continue to establish the call with a SETUP message. After reception of the CIPHERING MODE COMPLETE the SS starts enciphering.

Finally the SS sends a CHANNEL RELEASE to end the test.

Maximum Duration of Test

5 minutes, including 1 minute for any necessary operator actions.

Expected Sequence

Step	Direction	Message	Comments
1	MS -> SS	CHANNEL REQUEST	Establ. Cause = "Originating Call: NECI not equal to 1.
2	SS -> MS	IMMEDIATE ASSIGNMENT	
3	MS -> SS	CM SERVICE REQUEST	Cipher Mode Setting = "Start Ciphering", algorithm arbitrarily selected from those supported by the MS. The SS starts deciphering.
4	SS -> MS	CIPHERING MODE COMMAND	
5	MS -> SS	CIPHERING MODE COMPLETE	
6	MS -> SS	SETUP	Sent in commanded ciphered mode with the stored cipher key. The SS starts enciphering.
7	SS -> MS	CHANNEL RELEASE	

Specific Message Contents

None.

26.6.8.4 Ciphering mode / change of mode, algorithm and key

Networks can be implemented that do not have the same ciphering algorithms on all base stations. In such networks changes of algorithms and ciphering mode may occur and calls will fail if MSs incorrectly handle commands or use an incorrect cipher key.

26.6.8.4.1 Conformance requirements

- 1 When the MS in the "not ciphered" mode, receives a CIPHERING MODE COMMAND message with the Ciphering Mode Setting information element set to "start ciphering", the MS shall load the cipher key stored in the SIM into the ME, use this key to start ciphering and deciphering with the algorithm indicated by the "algorithm identifier" field and, respond with a CIPHERING MODE COMPLETE message.
- 2 If the last timeslot of the message block containing a CIPHERING MODE COMMAND message occurs at time T, then the MS shall be ready to transmit the CIPHERING MODE COMPLETE message before T+500 ms.
- 3 When the MS receives an ASSIGNMENT COMMAND message containing a Cipher Mode Setting IE after receipt of a CIPHERING MODE COMMAND message, the MS shall perform the

- assignment, use the commanded mode and/or algorithm on the new channel, and not change the ciphering key.
- 4 When the MS receives a HANDOVER COMMAND message containing a Cipher Mode Setting IE after receipt of a CIPHERING MODE COMMAND message, the MS shall perform the handover, use the commanded mode and/or algorithm on the new channel, and not change the ciphering key.
 - 5 When the MS in the "ciphered" mode receives a CIPHERING MODE COMMAND message with Cipher Mode Setting IE set to "no ciphering", the MS shall load the cipher key stored in the SIM into the ME, load the cipher key stored in the SIM into the ME, stop ciphering and deciphering and, respond with a CIPHERING MODE COMPLETE message.
 - 6 When the MS receives an AUTHENTICATION REQUEST message, it shall process the challenge information and send back an AUTHENTICATION RESPONSE message to the network. The new ciphering key calculated from the challenge information shall overwrite the previous one and be stored on the SIM before the AUTHENTICATION RESPONSE message is transmitted. The ciphering key stored in the SIM shall be loaded in to the ME when any valid CIPHERING MODE COMMAND is received.
 - 7 When the MS in the not ciphered mode receives a CIPHERING MODE COMMAND message with Cipher Mode Setting IE set to "no ciphering", the MS shall load the cipher key stored in the SIM into the ME, stop ciphering and deciphering and, respond with a CIPHERING MODE COMPLETE message.
 - 8 If a handover fails then the operational parameters used when returning to the old channel are those applied before the HANDOVER COMMAND message was received.
 - 9 If an assignment fails then the operational parameters used when returning to the old channel are those applied before the ASSIGNMENT COMMAND message was received.

References

- Conformance requirement 1: GSM 04.08 sections 3.4.7.2 and 4.3.2.2.
Conformance requirement 2: GSM 04.13 section 5.2.7.
Conformance requirement 3: GSM 04.08 section 3.4.3.1.
Conformance requirement 4: GSM 04.08 section 3.4.4.1.
Conformance requirement 5: GSM 04.08 sections 3.4.7.2 and 4.3.2.2.
Conformance requirement 6: GSM 04.08 section 4.3.2.2.
Conformance requirement 7: GSM 04.08 section 3.4.7.2.
Conformance requirement 8: GSM 04.08 section 3.4.4.4.
Conformance requirement 9: GSM 04.08 section 3.4.3.3.

26.6.8.4.2 Test purpose

- 1 To verify that when the MS is in the "not ciphered" mode and receives the CIPHERING MODE COMMAND message with Ciphering Mode Setting information element set to "start ciphering", the MS uses the cipher key stored in the SIM to start ciphering and deciphering with the algorithm indicated by the "algorithm identifier" field and that the MS responds with a CIPHERING MODE COMPLETE message.
- 2 To verify that the MS is ready to transmit the CIPHERING MODE COMPLETE message before 500 ms after the end of the CIPHERING MODE COMMAND message.
- 3 To verify that when the MS receives an ASSIGNMENT COMMAND message containing a Cipher Mode Setting IE after receipt of a CIPHERING MODE COMMAND message, the MS shall perform the assignment, use the commanded mode and/or algorithm on the new channel, and not change the ciphering key.
- 4 To verify that when the MS receives a HANDOVER COMMAND message containing a Cipher Mode Setting IE after receipt of a CIPHERING MODE COMMAND message, the MS shall perform the handover, use the commanded mode and/or algorithm on the new channel, and not change the ciphering key.

- 5 To verify that when the MS is in the "ciphered" mode and receives the CIPHERING MODE COMMAND message with Cipher Mode Setting IE set to "no ciphering", the MS loads the cipher key stored in the SIM into the ME, stops ciphering and deciphering and, responds with a CIPHERING MODE COMPLETE message.
- 6 To verify that the MS responds to an AUTHENTICATION REQUEST message with an AUTHENTICATION RESPONSE message and continues to use the cipher key obtained from the previous authentication procedure.
- 7 To verify that when the MS is in the "not ciphered" mode and receives the CIPHERING MODE COMMAND message with Ciphering Mode Setting information element set to "no ciphering", the MS does not start ciphering or deciphering, but does respond with a CIPHERING MODE COMPLETE message.
- 8 To verify that when the MS receives a HANDOVER COMMAND message and the handover fails, the MS sends a HANDOVER FAILURE message on the old channel using the old ciphering mode and (if ciphered) the old algorithm and old key.
- 9 To verify that when the MS receives an ASSIGNMENT COMMAND message and the assignment fails, the MS sends an ASSIGNMENT FAILURE message on the old channel using the old ciphering mode and (if ciphered) the old algorithm and old key.

26.6.8.4.3 Method of test

Initial Conditions

System Simulator:

1 cell, with a legal combination of CCCH_CONF with SDCCH/4s or SDCCH/8s is chosen arbitrarily by the SS.

Mobile Station:

The MS is in the "idle, updated" state, with a TMSI allocated and a known cipher key, K, stored in the SIM.

Related PICS/PIXIT Statements

Type of MS (P-GSM 900 or EGSM or DCS 1 800).

Supported ciphering algorithms: A5/1 and/or A5/2.

Power class of mobile station.

Foreseen Final State of the MS

"Idle, updated", with TMSI allocated.

Test Procedure

The MS is paged. The MS shall send at least one CHANNEL REQUEST message. The SS sends an IMMEDIATE ASSIGNMENT and the MS shall answer with a PAGING RESPONSE message.

The SS sends a CIPHERING MODE COMMAND, ordering the MS to start ciphering with a supported algorithm. After transmission of this command the SS starts deciphering. The MS shall respond with a CIPHERING MODE COMPLETE message in the commanded ciphered mode using the cipher key K. After reception of the CIPHERING MODE COMPLETE the SS starts enciphering. The MS shall be ready to transmit the CIPHERING MODE COMPLETE message before 500 ms after the end of the CIPHERING MODE COMMAND message.

The term "ready to transmit" is defined in GSM 04.13.

The SS sends an AUTHENTICATION REQUEST message to the MS. Cipher key L is calculated. The MS shall send an AUTHENTICATION RESPONSE message to the SS.

The SS sends a HANDOVER COMMAND (for a finely synchronized intra-BTS handover) with the Cipher Mode Setting IE set to "no ciphering". The MS shall transmit the HANDOVER COMPLETE on the commanded channel in non ciphered mode.

The SS sends an ASSIGNMENT COMMAND message containing a Cipher Mode Setting IE set to "start ciphering". The MS shall start transmitting on the commanded channel using the commanded algorithm and cipher key K. The MS shall transmit the ASSIGNMENT COMPLETE message.

The SS sends a CIPHERING MODE COMMAND, ordering the MS to stop ciphering. After transmission of this command the SS stops deciphering. The MS shall respond with a CIPHERING MODE COMPLETE message in non ciphered mode. After reception of the CIPHERING MODE COMPLETE the SS stops enciphering.

The SS sends a HANDOVER COMMAND (for a finely synchronized intra-BTS handover) with the Cipher Mode Setting IE set to "start ciphering". The MS shall transmit the HANDOVER COMPLETE on the commanded channel in ciphered mode using cipher key L and command algorithm.

The SS sends a HANDOVER COMMAND (for a finely synchronized intra-BTS handover) with the Cipher Mode Setting IE set to "start ciphering" and the algorithm identifier indicating the algorithm currently in use. The MS shall transmit the HANDOVER COMPLETE on the commanded channel in ciphered mode using the same algorithm as before the handover.

The SS sends an ASSIGNMENT COMMAND message containing a Cipher Mode Setting IE set to "no ciphering". The MS shall start transmitting on the commanded channel in non-ciphered mode. The MS shall transmit the ASSIGNMENT COMPLETE message.

The SS sends a CIPHERING MODE COMMAND, containing a Cipher Mode Setting IE set to "no ciphering". The MS shall respond with a CIPHERING MODE COMPLETE message.

The SS sends an AUTHENTICATION REQUEST message to the MS. Cipher key M is calculated. The MS shall send an AUTHENTICATION RESPONSE message to the SS.

The SS sends a HANDOVER COMMAND (for a finely synchronized intra-BTS handover) with the Cipher Mode Setting IE set to "start ciphering". The MS shall transmit the HANDOVER COMPLETE on the commanded channel using the commanded algorithm and cipher key L.

The SS sends a HANDOVER COMMAND (for a finely synchronized intra-BTS handover) with the Cipher Mode Setting IE set to "no ciphering". The SS does not activate the commanded channel. The MS's transmissions on the new channel need not be monitored. The MS shall transmit the HANDOVER FAILURE message on the "old" channel using the "old" algorithm and cipher key L and commanded algorithm.

The SS sends an ASSIGNMENT COMMAND message containing a Cipher Mode Setting IE set to "start ciphering". The SS does not activate the commanded channel. The MS's transmissions on the new channel need not be monitored. The MS shall transmit the ASSIGNMENT FAILURE message on the "old" channel using the "old" algorithm and cipher key L.

If the MS only supports one ciphering algorithm then the SS sends a CHANNEL RELEASE message.

If the MS supports more than one ciphering algorithm then the following steps are performed:

The SS sends an ASSIGNMENT COMMAND message containing a Cipher Mode Setting IE set to "start ciphering" and the Algorithm Identifier indicating a different supported algorithm to the one in use. The MS shall start transmitting on the commanded channel using the commanded algorithm. The MS shall transmit the ASSIGNMENT COMPLETE message.

The SS sends a HANDOVER COMMAND (for a finely synchronized intra-BTS handover) containing a Cipher Mode Setting IE set to "start ciphering" and the Algorithm Identifier indicating a different supported algorithm to the one in use. The MS shall transmit the HANDOVER COMPLETE on the commanded channel using the commanded algorithm.

The SS sends a CHANNEL RELEASE to end the test.

Maximum Duration of Test

3 minutes.

Expected Sequence

For MSs that only support one ciphering algorithm, the SS shall use step 61A. For MSs that support more than one ciphering algorithm, the SS shall use step 61B and the subsequent steps.

NOTE: TS GSM 04.08 appears to be unclear as to whether timer T3240 shall or shall not be started as a result of the AUTHENTICATION REQUEST messages sent in steps 8 and 44. To allow a variety of test equipment implementations, the IDENTITY REQUEST messages are included in order to avoid an unexpected expiry of timer T3240 prior to the end of the expected sequence.

Step	Direction	Message	Comments
1	SS -> MS	PAGING REQUEST TYPE 1	
2	MS -> SS	CHANNEL REQUEST	
3	SS -> MS	IMMEDIATE ASSIGNMENT	To either SDCCH4 or SDCCH8 depending upon CCCH_CONF arbitrarily chosen.
4	MS -> SS	PAGING RESPONSE	
5	SS -> MS	CIPHERING MODE COMMAND	Cipher Mode Setting = "Start Ciphering", algorithm arbitrarily selected from those supported by the MS. The SS starts deciphering with the selected algorithm.
6	MS -> SS	CIPHERING MODE COMPLETE	Sent in ciphered mode using key "K", the stored cipher key, and the commanded algorithm. This message shall be ready to be transmitted before 500 ms after the completion of step 5.
7	SS		- The SS starts enciphering using key "K".
8	SS -> MS	AUTHENTICATION REQUEST	Contains a new Ciphering Key Sequence Number which is associated with the new cipher key, "L".
9	MS -> SS	AUTHENTICATION RESPONSE	
10	SS -> MS	HANDOVER COMMAND	Includes Cipher Mode Setting IE set to "No Ciphering".
11	SS	-	The SS activates the new channel without ciphering.
12	MS -> SS	HANDOVER ACCESS	
13	MS -> SS	HANDOVER ACCESS	
14	MS -> SS	HANDOVER ACCESS	These four HANDOVER ACCESS messages are sent on the new channel in non ciphered mode.
15	MS -> SS	HANDOVER ACCESS	
16	MS -> SS	HANDOVER COMPLETE	
17	SS -> MS	ASSIGNMENT COMMAND	Sent in non ciphered mode on the new channel. Includes Cipher Mode Setting IE set to "Start Ciphering", with algorithm arbitrarily selected from those supported by the MS.
18	SS		The SS activates the new channel with enciphering and deciphering enabled and using cipher key "K".
19	MS -> SS	ASSIGNMENT COMPLETE	Sent on the new channel in ciphered mode using key "K" and the commanded algorithm.
20	SS -> MS	CIPHERING MODE COMMAND	Cipher Mode Setting = "No Ciphering". The SS starts receiving in non ciphered mode.
21	MS -> SS	CIPHERING MODE COMPLETE	Sent in non ciphered mode. This message shall be ready to be transmitted before 500 ms after the completion of step 20.
22	SS	-	The SS starts transmitting in non ciphered mode.
23	SS -> MS	HANDOVER COMMAND	Includes Cipher Mode Setting IE set to "Start Ciphering", with algorithm "X" arbitrarily selected from those supported by the MS.
24	SS		The SS activates the new channel with enciphering and deciphering enabled and using cipher key "L".
25	MS -> SS	HANDOVER ACCESS	
26	MS -> SS	HANDOVER ACCESS	
27	MS -> SS	HANDOVER ACCESS	These four HANDOVER ACCESS messages are sent on the new channel in the non ciphered mode.
28	MS -> SS	HANDOVER ACCESS	
29	MS -> SS	HANDOVER COMPLETE	
30	SS -> MS	IDENTITY REQUEST	Sent on the new channel in ciphered mode using key "L" and algorithm "X".
31	MS -> SS	IDENTITY RESPONSE	
32	SS -> MS	HANDOVER COMMAND	Includes Cipher Mode Setting IE set to "Start Ciphering", with algorithm identifier set to "X".
33	SS		The SS activates the new channel with enciphering and deciphering enabled.
34	MS -> SS	HANDOVER ACCESS	
35	MS -> SS	HANDOVER ACCESS	
36	MS -> SS	HANDOVER ACCESS	These four HANDOVER ACCESS messages are sent on the new channel in the non ciphered mode.

37	MS -> SS	HANDOVER ACCESS	
38	MS -> SS	HANDOVER COMPLETE	Sent on the new channel in ciphered mode using algorithm "X".
39	SS -> MS	ASSIGNMENT COMMAND	Includes Cipher Mode Setting IE set to "No Ciphering".
40	SS		The SS activates the new channel without ciphering.
41	MS -> SS	ASSIGNMENT COMPLETE	Sent in non-ciphered mode on the new channel.
42	SS -> MS	CIPHERING MODE COMMAND	Cipher Mode Setting = "No Ciphering".
43	MS -> SS	CIPHERING MODE COMPLETE	Sent in non ciphered mode. This message shall be ready to be transmitted before 500 ms after the completion of step 42.
44	SS -> MS	AUTHENTICATION REQUEST	Contains a new Ciphering Key Sequence Number which is associated with the new cipher key, "M".
45	MS -> SS	AUTHENTICATION RESPONSE	
46	SS -> MS	HANDOVER COMMAND	Includes Cipher Mode Setting IE set to "Start Ciphering", with algorithm "Y" arbitrarily selected from those supported by the MS.
47	SS		The SS activates the new channel with enciphering and deciphering enabled and using cipher key "L".
48	MS -> SS	HANDOVER ACCESS	These four HANDOVER ACCESS messages are sent on the new channel in the non ciphered mode.
49	MS -> SS	HANDOVER ACCESS	
50	MS -> SS	HANDOVER ACCESS	
51	MS -> SS	HANDOVER ACCESS	
52	MS -> SS	HANDOVER COMPLETE	Sent on the new channel in ciphered mode using key "L"
53	SS -> MS	HANDOVER COMMAND	Includes Cipher Mode Setting IE set to "No Ciphering".
54	SS, MS		The SS does not activate the new channel The MS's transmissions on the new channel need not be monitored.
55	MS -> SS	HANDOVER FAILURE	sent on old channel using algorithm "Y" and key "L".
56	SS -> MS	IDENTITY REQUEST	
57	MS -> SS	IDENTITY RESPONSE	
58	SS -> MS	ASSIGNMENT COMMAND	Includes Cipher Mode Setting IE set to "No Ciphering".
59	SS, MS		The SS does not activate the new channel The MS's transmissions on the new channel need not be monitored.
60	MS -> SS	ASSIGNMENT FAILURE	sent on old channel using algorithm "Y" and key "L".
61A	SS -> MS	CHANNEL RELEASE	
61B	SS -> MS	ASSIGNMENT COMMAND	Includes Cipher Mode Setting IE set to "Start Ciphering", with algorithm "Z" arbitrarily selected from those supported by the MS but different to algorithm "Y".
62B	SS		The SS activates the new channel with enciphering and deciphering enabled.
63B	MS -> SS	ASSIGNMENT COMPLETE	Sent on the new channel in ciphered mode using key "L" and algorithm "Z".
64B	SS -> MS	HANDOVER COMMAND	Includes Cipher Mode Setting IE set to "Start Ciphering" and the algorithm identifier set to "Y".
65B	SS		The SS activates the new channel with enciphering and deciphering enabled.
66B	MS -> SS	HANDOVER ACCESS	These four HANDOVER ACCESS messages are sent on the new channel in the non ciphered mode.
67B	MS -> SS	HANDOVER ACCESS	
68B	MS -> SS	HANDOVER ACCESS	
69B	MS -> SS	HANDOVER ACCESS	
70B	MS -> SS	HANDOVER COMPLETE	Sent on the new channel in ciphered mode using key "L" and algorithm "Y".
71B	SS -> MS	CHANNEL RELEASE	

Specific Message Contents

ASSIGNMENT COMMAND

Information Element	value/remark
Protocol Discriminator	RR Management.
Skip Indicator	0000
Message Type	00101110
Channel Description	
- Channel Type	SDCCH/8 or SDCCH4 (same type as old channel)
- TDMA offset	Chosen arbitrarily, but different to the one in use (SDCCH4), otherwise arbitrary.
- Timeslot Number	Chosen arbitrarily, but different to the one in use (SDCCH8) or Timeslot zero.(SDCCH4)
- Training Sequence Code	5 (same as the BCC).
- Hopping	Single RF channel.
- ARFCN	Channel number 30.
Power Command	
- Power level	Chosen arbitrarily but within the range supported by the MS.
Cipher Mode Setting	As specified above.
All other information elements:	Not present.

HANDOVER COMMAND

Information Element	value/remark
Protocol Discriminator	RR Management.
Skip Indicator	0000
Message Type	00101011
Cell Description	
- Network Colour Code	1
- Base station Colour Code	5
- BCCH Carrier Number	Channel Number 30.
Channel Description	
- Channel Type	SDCCH/8 or SDCCH4(same type as old channel)
- TDMA offset	Chosen arbitrarily, but different to the one in use(SDCCH4), otherwise arbitrary.
- Timeslot Number	Chosen arbitrarily, but different to the one in use (SDCCH8) or Timeslot zero.(SDCCH4)
- Training Sequence Code	5 (same as the BCC).
- Hopping	Single RF channel.
- ARFCN	Channel Number 30.
Handover Reference	
- Handover Reference Value	Chosen arbitrarily.
Power Command	
- Power level	Chosen arbitrarily, but within the range supported by the MS.
Synchronization Indication	
- Synchronization indication	synchronized.
- Report observed time difference	not included.
- Normal cell indication	out of range ignored.
Cipher Mode setting	As specified above.
All other information elements:	Not present.

CIPHER MODE COMMAND

Information Element	value/remark
As default message contents, except: Cipher Mode Setting - Algorithm Identifier - Cipher Mode Set	As specified above. As specified above.

DCS 1 800:**ASSIGNMENT COMMAND**

Information Element	value/remark
Protocol Discriminator	RR Management.
Skip Indicator	0000
Message Type	00101110
Channel	
- Channel Type	SDCCH/8 or SDCCH4(same type as old channel)
- TDMA offset	Chosen arbitrarily, but different to the one in use (SDCCH4), otherwise arbitrary.
- Timeslot Number	Chosen arbitrarily, but different to the one in use (SDCCH8) or Timeslot zero.(SDCCH4)
- Training Sequence Code	5 (same as the BCC).
- Hopping	Single RF channel.
- ARFCN	Channel number 650.
Power Command	
- Power level	Chosen arbitrarily, but within the range supported by the MS.
Cipher Mode Setting	As specified above.
All other information elements:	Not present.

HANDOVER COMMAND

Information Element	value/remark
Protocol Discriminator	RR Management.
Skip Indicator	0000
Message Type	00101011
Cell Description	
- Network Colour Code	1
- Base station Colour Code	5
- BCCH Carrier Number	Channel Number 650.
Channel Description	
- Channel Type	SDCCH/8 or SDCCH4(same type as old channel)
- TDMA offset	Chosen arbitrarily, but different to the one in use (SDCCH4), otherwise arbitrary.
- Timeslot Number	Chosen arbitrarily, but different to the one in use (SDCCH8) or Timeslot zero.(SDCCH4).
- Training Sequence Code	5 (same as the BCC).
- Hopping	Single RF channel.
- ARFCN	Channel Number 650.
Handover Reference	
- Handover Reference Value	Chosen arbitrarily.
Power Command	
- Power level	Chosen arbitrarily, but within the range supported by the MS.
Synchronization Indication	
- Synchronization indication	synchronized.
- Report observed time difference	not included.
- Normal cell indication	out of range ignored.
Cipher Mode setting	As specified above.
All other information elements:	Not present.

26.6.8.5 Cipherring mode / IMEISV request

If the MS does not supply the IMEISV when requested, the network will not know whether or not the MS is type approved, i.e. whether or not it has passed any tests.

If the MS supplies its IMEISV when not requested, this may cause calls to systematically fail.

26.6.8.5.1 Conformance requirements

1. When the MS receives the CIPHERING MODE COMMAND message with Cipher Response bit set to "IMEISV shall be included", the MS shall include the IMEISV in the Mobile Identity IE in the CIPHERING MODE COMPLETE message.
2. When the MS receives the CIPHERING MODE COMMAND message with Cipher Response bit set to "IMEISV shall not be included", the MS shall not include the Mobile Identity IE in the CIPHERING MODE COMPLETE message.

References

Conformance requirement 1: GSM 04.08 sections 3.4.7.2 and 9.1.10.1.

Conformance requirement 2: GSM 04.08 section 9.1.10.1.

26.6.8.5.2 Test purpose

To verify that the MS supplies its IMEISV in the CIPHERING MODE COMPLETE message when it receives a CIPHERING MODE COMMAND message with a Cipher Response bit set to "IMEISV shall be included".

To verify that the MS does not supply any Mobile Identity IE in the CIPHERING MODE COMPLETE message when it receives a CIPHERING MODE COMMAND message with a Cipher Response bit set to "IMEISV shall not be included".

26.6.8.5.3 Method of test

Initial Conditions

System Simulator:
1 cell.

Mobile Station:
The MS is in the "idle, updated" state, with a TMSI allocated.

Related PICS/PIXIT Statements

IMEISV of the MS.
Type of MS (P-GSM 900 or EGSM or DCS 1 800).

Foreseen Final State of the MS

"Idle, updated", with TMSI allocated.

Test Procedure

The MS is paged. It shall send at least one CHANNEL REQUEST message. The SS sends an IMMEDIATE ASSIGNMENT and the MS shall answer with a PAGING RESPONSE. Then the SS sends a CIPHERING MODE COMMAND indicating "No cipherring" and with the Cipher Response bit set to "IMEISV shall not be included". The MS shall respond with a CIPHERING MODE COMPLETE message that does not include the Mobile Identity IE.

Then the SS sends a CIPHERING MODE COMMAND indicating "No cipherring" and with the Cipher Response bit set to "IMEISV shall be included". The MS shall respond with a CIPHERING MODE COMPLETE message that carries the IMEISV in the Mobile Identity IE.

Finally the SS sends a CHANNEL RELEASE to end the test.

Maximum Duration of Test

10 seconds.

Expected Sequence

Step	Direction	Message	Comments
1	SS -> MS	PAGING REQUEST TYPE 1	
2	MS -> SS	CHANNEL REQUEST	
3	SS -> MS	IMMEDIATE ASSIGNMENT	
4	MS -> SS	PAGING RESPONSE	
5	SS -> MS	CIPHERING MODE COMMAND	Cipher Mode Setting = "No Ciphering". Cipher Response = "IMEISV shall not be included". Shall not include Mobile Identity IE.
6	MS -> SS	CIPHERING MODE COMPLETE	
7	SS -> MS	CIPHERING MODE COMMAND	Cipher Mode Setting = "No Ciphering". Cipher Response = "IMEISV shall be included".
8	MS -> SS	CIPHERING MODE COMPLETE	Shall include one Mobile Identity IE carrying the MS's IMEISV.
9	SS -> MS	CHANNEL RELEASE	

Specific Message Contents

None.

26.6.9 Test of additional assignment

The Additional Assignment procedure is used to change an MS's channel configuration from Lm + ACCH to Lm + Lm + ACCH. It is therefore only relevant to those mobiles which perform such an operation.

No tests are specified at the moment.

26.6.10 Test of partial release

The Partial Release procedure is used to change an MS's channel configuration from Lm + Lm + ACCH to Lm + ACCH. It is therefore only relevant to those mobiles which perform such an operation.

No tests are specified at the moment.

26.6.11 Test of classmark

26.6.11.1 Classmark change

This procedure allows the MS to indicate to the network that a change in the classmark (e.g. due to addition of power amplification) has taken place.

26.6.11.1.1 Conformance requirements

If the RF power capability of the MS is changed during a call, this change shall be signalled to the network.

If the RF power capability of the MS is changed in idle mode, the up to date RF power capability shall be signalled to the network during RR connection establishment.

References

GSM 04.08 section 3.4.10.

26.6.11.1.2 Test purpose

To verify that if the RF power capability or any other capability indicated in a Classmark IE of the MS is changed during a call, the change is communicated on the DCCH to the network.

To verify that if the RF power capability or any other capability indicated in a Classmark IE of the MS is changed in idle mode, the out of date capabilities are not communicated to the network during RR connection establishment.

26.6.11.1.3 Method of test

Initial Conditions

System Simulator:

1 cell, default parameters.

Mobile Station:

The MS is in the "idle, updated" state, with a TMSI allocated and with no additional power amplification applied.

Related PICS/PIXIT Statements

Type of MS (P-GSM 900 or EGSM or DCS 1 800).

Support for more than one RF power class: yes/no.

Support for state U10 of the Call Control protocol.

Full rate channel modes supported by the MS

Foreseen Final State of the MS

"Idle, updated", with TMSI allocated and with no additional power amplification applied.

Test Procedure

With the MS in idle mode, the RF power capability shall be changed by the addition of power amplification, after which the MS is made to originate a call. The new RF power capability shall be included in the CM SERVICE REQUEST message. After the call has reached the Call Control state U10, the RF power capability of the MS is changed by removal of the additional power amplification. The MS shall send a CLASSMARK CHANGE message indicating the new RF power capability. The RF power capability is then changed by adding the power amplification. The MS shall again send a CLASSMARK CHANGE message indicating the new RF power capability. The call is then released by the SS.

With the MS in idle mode, the power amplification is removed. The SS then pages the MS, which in the PAGING RESPONSE message shall indicate the correct RF power capability.

Finally the SS transmits a CHANNEL RELEASE to end the test.

Maximum Duration of Test

5 minutes, including 1 minute for any necessary operator actions.

Expected Sequence

Step	Direction	Message	Comments
1	-----	-----	Add power amplification.
2	-----	-----	The MS shall be made to originate a call.
3	MS -> SS	CHANNEL REQUEST	Establ. Cause = "Originating call" NECI not equal to one.
4	SS -> MS	IMMEDIATE ASSIGNMENT	
5	MS -> SS	CM SERVICE REQUEST	The "Mobile Station Classmark 2" IE shall indicate the new RF power capability.
6	SS -> MS	CM SERVICE ACCEPT	
7	MS -> SS	SETUP	
8	SS -> MS	CALL PROCEEDING	
9	SS -> MS	ALERTING	
10	SS -> MS	ASSIGNMENT COMMAND	The Channel Mode is a non-signalling mode arbitrarily selected from the full rate capabilities declared for the MS
11	MS -> SS	ASSIGNMENT COMPLETE	
12	SS -> MS	CONNECT	
13	MS -> SS	CONNECT ACKNOWLEDGE	
14	-----	-----	Remove the power amplification.
15	MS -> SS	CLASSMARK CHANGE	The "Mobile Station Classmark 2" IE shall indicate the new power capability.
16	-----	-----	Add power amplification.
17	MS -> SS	CLASSMARK CHANGE	The "Mobile Station Classmark 2" IE shall indicate the new power capability.
18	SS -> MS	CHANNEL RELEASE	
19	-----	-----	Remove the power amplification.
	-----	-----	The SS waits 12 seconds to allow the MS to perform cell reselection.
20	SS -> MS	PAGING REQUEST TYPE 1	
21	MS -> SS	CHANNEL REQUEST	Establ. Cause = "Answer to paging".
22	SS -> MS	IMMEDIATE ASSIGNMENT	
23	MS -> SS	PAGING RESPONSE	The "Mobile Station Classmark 2" IE shall indicate the new power capability.
24	SS -> MS	CHANNEL RELEASE	

Specific Message Contents

None.

26.6.11.2 Classmark interrogation

This procedure allows the network to request the MS to supply all its classmark information to the network.

Networks may systematically use this procedure (e.g. during location updating) and, if it is incorrectly implemented in the MS, the basic connection establishment procedure may systematically fail.

26.6.11.2.1 Conformance requirements

On receipt of a CLASSMARK ENQUIRY message, the MS sends a CLASSMARK CHANGE message to the network containing the Mobile Station Classmark 2 information element and depending upon the contents of this information element, possibly the Mobile Station Classmark 3 information element.

References

GSM 04.08 sections 3.4.11 and 9.1.11.1.

GSM 04.13 section 5.2.9.

26.6.11.2.2 Test purpose

To verify that if the network requests the MS to supply all its classmark information then this information is communicated on the DCCH to the network.

26.6.11.2.3 Method of test

Initial Conditions

System Simulator:

1 cell, default parameters.

Mobile Station:

"Idle, updated", with TMSI allocated.

Related PICS/PIXIT Statements

Type of MS (P-GSM 900 or EGSM or DCS 1 800).

Contents of Mobile Station Classmark 2 information element.

Existence of Mobile Station Classmark 3 information element: yes/no.

Contents of Mobile Station Classmark 3 information element.

Switch off button: yes/no.

Foreseen Final State of the MS

"Idle, updated", with TMSI allocated.

Test Procedure

The MS is switched off (or has its power removed).

The SS then sets the IMSI attach-detach flag in the SYSTEM INFORMATION messages so that the MS shall perform a location update when switched on.

The MS is switched on (or its power is re-applied). The MS then initiates a location update attempt. After the mobile has sent the LOCATION UPDATING REQUEST message, the SS transmits a CLASSMARK ENQUIRY message. The MS shall be ready to transmit the CLASSMARK CHANGE message before 300 ms after the end of the CLASSMARK ENQUIRY message.

The term "ready to transmit" is defined in GSM 04.13.

Then the SS transmits a LOCATION UPDATING ACCEPT message that does not contain a Mobile Identity IE.

Maximum Duration of Test

2 minutes.

Expected Sequence

Step	Direction	Message	Comments
1	MS		The MS is switched off (or has its power removed). IMSI attach-detach flag changed.
2	SS		
3	MS		
4	MS -> SS	CHANNEL REQUEST	The MS is switched on (or its power is re-applied). Contents as defined for default message. This message shall be ready to be transmitted before 300 ms after the completion of step 7.
5	SS -> MS	IMMEDIATE ASSIGNMENT	
6	MS -> SS	LOCATION UPDATING REQUEST	
7	SS -> MS	CLASSMARK ENQUIRY	
8	MS -> SS	CLASSMARK CHANGE	
9	SS -> MS	LOCATION UPDATING ACCEPT	
10	SS -> MS	CHANNEL RELEASE	

Specific Message Contents

None.

Default Message Contents

Contents of LOCATION UPDATING ACCEPT message:

Protocol Discriminator	MM message
Skip Indicator	0000
Message Type	00000010
Location Area Identification	
- Mobile Country Code	001 decimal
- Mobile Network Code	01 decimal
- Location Area Code	0001H
Mobile Identity	Not present
Follow on proceed	Not present

26.6.12 Test of channel release

The purpose of this procedure is to deactivate the dedicated channels in use. When the channels are released, the MS returns to the CCCH configuration, idle mode.

26.6.12.1 Channel release / SDCCH

26.6.12.1.1 Conformance requirements

After the acknowledgement of the Layer 2 disconnection by the network, the MS shall not produce any further RF-transmission.

References

GSM 04.08 section 3.5.1.

26.6.12.1.2 Test purpose

To verify that the MS is able to correctly release an SDCCH after having received a CHANNEL RELEASE message.

26.6.12.1.3 Method of test**Initial Conditions**

System Simulator:

1 cell, default parameters.

Mobile Station:

The MS is in the "idle, updated" state, with a TMSI allocated.

Related PICS/PIXIT Statements

Type of MS (P-GSM 900 or EGSM or DCS 1 800).

Foreseen Final State of the MS

"Idle, updated", with TMSI allocated.

Test Procedure

The MS is paged and allocated a dedicated channel and the Layer 2 signalling link is established. The SS then sends a CHANNEL RELEASE message, after which the MS shall initiate a Layer 2 disconnection process on the main signalling link. After the acknowledgement of the Layer 2 disconnection by the SS, the MS shall stop transmission of Layer 2 messages. This is verified for 3 seconds. The MS shall return to the idle state, which is verified through the paging procedure to which the MS shall respond.

Maximum Duration of Test

20 seconds.

Expected Sequence

Step	Direction	Message	Comments
1	SS -> MS	PAGING REQUEST TYPE 1	
2	MS -> SS	CHANNEL REQUEST	Establ. Cause = "Answer to paging".
3	SS -> MS	IMMEDIATE ASSIGNMENT	Channel Type = SDCCH/8
4	MS -> SS	PAGING RESPONSE	
5	SS -> MS	CHANNEL RELEASE	With a valid RR cause value.
6	MS -> SS	DISC	The MS may send the DISC message without performing a layer 2 acknowledgement of the CHANNEL RELEASE message.
7	SS -> MS	UA	
	-----	-----	The SS verifies for 3 seconds that the MS does not produce any Layer 2 messages.
	-----	-----	The SS waits 12 seconds to allow the MS to perform cell reselection.
8	SS -> MS	PAGING REQUEST TYPE 1	
9	MS -> SS	CHANNEL REQUEST	Establ. Cause = "Answer to paging".
10	SS -> MS	IMMEDIATE ASSIGNMENT	
11	MS -> SS	PAGING RESPONSE	
12	SS -> MS	CHANNEL RELEASE	

Specific Message Contents

None.

26.6.12.2 Channel release / SDCCH - no L2 ACK**26.6.12.2.1 Conformance requirements**

After the expiry of timer T3110 the MS shall not produce any further RF-transmission.

References

GSM 04.08 section 3.5.1.

26.6.12.2.2 Test purpose

To verify that the MS is able to correctly release a SDCCH after having received a CHANNEL RELEASE message, even if the SS does not L2 acknowledge the L2 DISC frame.

26.6.12.2.3 Method of test

Initial Conditions

System Simulator:

1 cell, default parameters.

Mobile Station:

The MS is in the "idle, updated" state, with a TMSI allocated.

Related PICS/PIXIT Statements

Type of MS (P-GSM 900 or EGSM or DCS 1 800).

Foreseen Final State of the MS

"Idle, updated", with TMSI allocated.

Test Procedure

The MS is paged and allocated a dedicated channel and the Layer 2 signalling link is established. The SS then sends a CHANNEL RELEASE message, after which the MS shall send at least 2 L2 DISC frames. The SS does not acknowledge any of the L2 DISC frames. After 2 seconds, the SS verifies for 3 seconds that the MS has stopped transmission of Layer 2 messages. The MS shall return to the idle state, which is verified through the paging procedure to which the MS shall respond.

Maximum Duration of Test

25 seconds.

Expected Sequence

Step	Direction	Message	Comments
1	SS -> MS	PAGING REQUEST TYPE 1	Establ. Cause = "Answer to paging". Channel Type = SDCCH/8. With a valid RR cause value. The MS may send the DISC message without performing a layer 2 acknowledgement of the CHANNEL RELEASE message. The MS shall send at least 2 L2 DISC frames, to which the SS does not respond. After a period of 2 seconds, the SS verifies for 3 seconds that the MS does not produce any further Layer 2 messages. The SS waits 12 seconds to allow the MS to perform cell reselection.
2	MS -> SS	CHANNEL REQUEST	
3	SS -> MS	IMMEDIATE ASSIGNMENT	
4	MS -> SS	PAGING RESPONSE	
5	SS -> MS	CHANNEL RELEASE	
6	MS -> SS	DISC	
	-----	-----	
7	SS -> MS	PAGING REQUEST TYPE 1	Establ. Cause = "Answer to paging".
8	MS -> SS	CHANNEL REQUEST	
9	SS -> MS	IMMEDIATE ASSIGNMENT	
10	MS -> SS	PAGING RESPONSE	
11	SS -> MS	CHANNEL RELEASE	

Specific Message Contents

None.

26.6.12.3 Channel release / TCH-F

26.6.12.3.1 Conformance requirements

After the acknowledgement of the Layer 2 disconnection by the network the MS shall not produce any further RF-transmission.

References

GSM 04.08 section 3.5.1.

26.6.12.3.2 Test purpose

To verify that the MS is able to correctly release a full-rate TCH after having received a CHANNEL RELEASE message.

26.6.12.3.3 Method of test

Initial Conditions

System Simulator:
1 cell, default parameters.

Mobile Station:
The MS is in the "idle, updated" state, with a TMSI allocated.

Related PICS/PIXIT Statements

Type of MS (P-GSM 900 or EGSM or DCS 1 800).

Supported rate of TCH: TCH/F.

Foreseen Final State of the MS

"Idle, updated", with TMSI allocated.

Test Procedure

The MS is paged and allocated a dedicated channel and the Layer 2 signalling link is established. The SS then sends a CHANNEL RELEASE message, after which the MS shall initiate a Layer 2 disconnection process on the main signalling link. After the acknowledgement of the Layer 2 disconnection by the SS, the MS shall stop transmission of Layer 2 messages. This is verified for 3 seconds. The MS shall return to the idle state, which is verified through the paging procedure to which the MS shall respond.

Maximum Duration of Test

20 seconds.

Expected Sequence

Step	Direction	Message	Comments
1	SS -> MS	PAGING REQUEST TYPE 1	Establ. Cause = "Answer to paging". Channel Type = "Bm + ACCHs" With a valid RR cause value. The MS may send the DISC message without performing a layer 2 acknowledgement of the CHANNEL RELEASE message.
2	MS -> SS	CHANNEL REQUEST	
3	SS -> MS	IMMEDIATE ASSIGNMENT	
4	MS -> SS	PAGING RESPONSE	
5	SS -> MS	CHANNEL RELEASE	
6	MS -> SS	DISC	
7	SS -> MS	UA	The SS verifies for 3 seconds that the MS does not produce any Layer 2 messages. The SS waits 12 seconds to allow the MS to perform cell reselection.
	-----	-----	
	-----	-----	
8	SS -> MS	PAGING REQUEST TYPE 1	Establ. Cause = "Answer to paging".
9	MS -> SS	CHANNEL REQUEST	
10	SS -> MS	IMMEDIATE ASSIGNMENT	
11	MS -> SS	PAGING RESPONSE	
12	SS -> MS	CHANNEL RELEASE	

Specific Message Contents

None.

26.6.12.4 Channel release / TCH-F - no L2 ACK

26.6.12.4.1 Conformance requirements

After the expiry of timer T3110 the MS shall not produce any further RF-transmission.

References

GSM 04.08 section 3.5.1.

26.6.12.4.2 Test purpose

To verify that the MS is able to correctly release a TCH/F after having received a CHANNEL RELEASE message, even if the SS does not L2 acknowledge the L2 DISC frame.

26.6.12.4.3 Method of test

Initial Conditions

System Simulator:
1 cell, default parameters.

Mobile Station:
The MS is in the "idle, updated" state, with a TMSI allocated.

Related PICS/PIXIT Statements

Type of MS (P-GSM 900 or EGSM or DCS 1 800).

Supported rate of TCH: TCH/F.

Foreseen Final State of the MS

"Idle, updated", with TMSI allocated.

Test Procedure

The MS is paged and allocated a dedicated channel and the Layer 2 signalling link is established. The SS then sends a CHANNEL RELEASE message (with cause "abnormal release, unspecified"), after which the MS shall send at least 2 L2 DISC frames. The SS does not acknowledge any of the L2 DISC frames. After 2 seconds, the SS verifies for 3 seconds that the MS has stopped transmission of Layer 2 messages. The MS shall return to the idle state, which is verified through the paging procedure to which the MS shall respond.

Maximum Duration of Test

25 seconds.

Expected Sequence

Step	Direction	Message	Comments
1	SS -> MS	PAGING REQUEST TYPE 1	Establ. Cause = "Answer to paging". Channel Type = "Bm + ACCHs". Cause value = "Abnormal release, unspecified". The MS may send the DISC message without performing a layer 2 acknowledgement of the CHANNEL RELEASE message. The MS shall send at least 2 L2 DISC frames, to which the SS does not respond. After a period of 2 seconds, the SS verifies for 3 seconds that the MS does not produce any further Layer 2 messages. The SS waits 12 seconds to allow the MS to perform cell reselection.
2	MS -> SS	CHANNEL REQUEST	
3	SS -> MS	IMMEDIATE ASSIGNMENT	
4	MS -> SS	PAGING RESPONSE	
5	SS -> MS	CHANNEL RELEASE	
6	MS -> SS	DISC	
	-----	-----	
7	SS -> MS	PAGING REQUEST TYPE 1	Establ. Cause = "Answer to paging". Channel Type = SDCCH/8.
8	MS -> SS	CHANNEL REQUEST	
9	SS -> MS	IMMEDIATE ASSIGNMENT	
10	MS -> SS	PAGING RESPONSE	
11	SS -> MS	CHANNEL RELEASE	

Specific Message Contents

None.

26.6.13 Test of starting time

The Assignment, Handover and immediate assignment procedures can include a delayed change of frequency list, MAIO and HSN. This series of tests checks the behaviour of the Mobile Station when receiving channel allocation messages with a starting time and channel description for both before and after the starting time. Tests checking the phase 1 usage of the starting time (that is without a channel description for before the time) are included in the series related to immediate assignment, dedicated assignment and handover.

Throughout section 26.6.13 the defaults in section 26.6.14 for GSM 900 and 26.6.15 for DCS 1 800 are used with the following exceptions:

Contents of IMMEDIATE ASSIGNMENT message, unless otherwise defined in the individual test cases:

L2 pseudo length	This is the sum of the lengths of all the information elements present in the message except for the IA rest octets and L2 pseudo length IEs. For the default message the L2 pseudo length is 11.
Protocol Discriminator	RR Management.
Skip Indicator	0000
Message Type	00111111
Page Mode	
- Page Mode	Normal Paging.
Channel Description	
- Channel Type and TDMA offset	Chosen arbitrarily (see initial conditions).
- Timeslot Number	Chosen arbitrarily by the test house;
- Training Sequence Code	Chosen arbitrarily by the test house
- Hopping	Yes.
- Hopping parameters	Chosen arbitrarily.
Request Reference	Pertaining to last Channel Request sent by the MS.
Timing Advance	
- Timing advance value	30 bit periods.
Mobile Allocation	Chosen arbitrarily, at least one frequency. In case of an MA with just one frequency, the frequency should be different from the BCCH carrier.
Starting Time	Not present.
IA rest octets	Not used (all bits set to spare).

GSM 900:

Cell A has:

BCCH ARFCN = 20.

Cell Allocation = (10, 17, 20, 26, 34, 42, 45, 46, 52, 59, 66, 73, 74, 75, 76, 108, 114).

Cell B has:

BCCH ARFCN = 40.

Cell Allocation = (14, 18, 22, 24, 30, 31, 38, 40, 60, 66, 73, 74, 75, 76, 108, 114).

Base station Colour Code = different to Cell A

The Cell Allocation of both Cell A and Cell B shall be coded using bit map 0 format.

(The BCCH ARFCNs are already included in the default BA-List.)

DCS 1 800:

Cell A has:

BCCH ARFCN = 747.

Cell Allocation = (737, 741, 747, 754, 759, 762, 766, 767, 773, 775, 779, 782, 791, 798, 829, 832, 844).

Base station Colour Code = different to Cell A

Cell B has:

BCCH ARFCN = 764.

Cell Allocation = (739, 743, 746, 749, 756, 758, 761, 764, 771, 779, 782, 791, 798, 829, 832, 844).

The Cell Allocation of both Cell A and Cell B shall be coded using range 256 format.

The BCCH ARFCNs shall be added to the default BA-List.

26.6.13.1 Dedicated assignment with starting time / successful case / time not elapsed

26.6.13.1.1 Conformance requirement

A Mobile Station receiving an ASSIGNMENT COMMAND message with a starting time and channel descriptions for both after and before the starting time, and ready to access before the indicated time has elapsed, shall perform the assignment on the channels as described for before the starting time and shall start using the new frequency parameters (frequencies and hopping sequence, or single frequency) in the correct time slot indicated by the starting time.

The Mobile Station shall accept the ASSIGNMENT COMMAND message for different message formatting, differing by the information elements used to describe frequency lists.

Reference(s)

GSM 04.08 sub-clauses 3.4.3.1, 9.1.2.

26.6.13.1.2 Test purpose

To verify that the MS, after receiving an ASSIGNMENT COMMAND message with a starting time and channel descriptions both for before and after the starting time, and ready to access before the indicated time, performs correctly the assignment using the description for before the time, and eventually starts using the frequency parameters for after the time at the time indicated in the message.

26.6.13.1.3 Method of test

Initial condition(s)

System Simulator:

1 cell, CCCH_CONF set to 1 basic physical channel used for CCCH, not combined with SDCCHs.

Mobile Station:

The MS is in the "idle, updated" state, with a TMSI allocated.

Related PICS/PIXIT statement(s)

- TCH supported (Y/N)
- Supported rate(s) of TCH: (F/F+H).
- The supported channel mode(s) need to be declared.
- Supported frequencies (P-GSM or E-GSM or DCS 1 800).

Foreseen final state of the MS

"Idle, updated", with TMSI allocated.

Test procedure

The System Simulator pages the MS and after the MS has responded with a CHANNEL REQUEST, the simulator assigns a hopping SDCCH. Then the SS sends an ASSIGNMENT COMMAND message allocating a channel (TCH/F, TCH/H or SDCCH, arbitrarily chosen among the channels supported), with a starting time and channel descriptions (hopping case) for both before and after the starting time, as detailed in the "specific message contents" clause. The indicated time is such that the Mobile Station is ready to access before that time. The Mobile Station then accesses the channel as described for before the starting time. The MS shall eventually, at the TDMA frame defined by the contents of the "Starting Time" information element of the ASSIGNMENT COMMAND message, use the new frequency parameters. The verification is performed at the RF burst level.

Test parameters:

T1 is set to T0+60 and T0+1000 (mod 42 432), where T0 is the frame number at which the first burst of the ASSIGNMENT COMMAND message is sent.

Maximum duration of test

45 sec.

Expected sequence

Step	Direction	Message	Comments
1	SS -> MS	PAGING REQUEST TYPE 1	
2	MS -> SS	CHANNEL REQUEST	
3	SS -> MS	IMMEDIATE ASSIGNMENT	Hopping channel.
4	MS -> SS	PAGING RESPONSE	
5	SS -> MS	ASSIGNMENT COMMAND	See specific message contents.
6	MS -> SS	ASSIGNMENT COMPLETE	Sent on the correct channel (before time parameters) after establishment of the main signalling link.
7	-----	Time T1	The SS checks that the MS is transmitting now on the correct frequencies (after time parameters) and that the transmission started in the correct frame.
8	SS -> MS	CHANNEL RELEASE	

Specific message contents**ASSIGNMENT COMMAND**

Information element	Value/remark
Channel Description, after time Channel Type and TDMA offset	Chosen arbitrarily among that supported by the Mobile Station.
Timeslot Number	Chosen arbitrarily.
Training Sequence Code	Chosen arbitrarily.
Hopping	Yes.
Hopping parameters	Chosen arbitrarily.
Power Command Power level	Chosen arbitrarily.
Channel Mode Mode	Arbitrarily selected from capabilities declared for the MS for the chosen type of channel.
Mobile Allocation, after time	Chosen arbitrarily, at least one frequency. In case of an MA with just one frequency, the frequency should be different from the BCCH carrier.
Starting Time	T1
Channel Description, before time Channel Type and TDMA offset	Same as after time.
Timeslot Number	Same as after time.
Training Sequence Code	Same as after time.
Hopping	Yes.
Hopping parameters	Chosen arbitrarily, different from "after time".
Mobile Allocation, before time	Chosen arbitrarily, at least one frequency and different from "Mobile Allocation, after time". In case of an MA with just one frequency, the frequency should be different from the BCCH carrier.

26.6.13.2 Dedicated assignment with starting time / successful case / time elapsed**26.6.13.2.1 Conformance requirement**

A Mobile Station receiving an ASSIGNMENT COMMAND message with a starting time and channel descriptions for both after and before the starting time, and ready to access after the indicated time has elapsed, shall perform the assignment on the channels as described for after the starting time.

The Mobile Station shall accept the ASSIGNMENT COMMAND message for different message formatings, differing by the information elements used to describe frequency lists.

Reference(s):

GSM 04.08 sub-clauses 3.4.3.1, 9.1.2.

26.6.13.2.2 Test purpose

To verify that the MS, after receiving an ASSIGNMENT COMMAND message with a starting time and channel descriptions both for before and after the starting time, performs correctly the assignment using the frequency parameters for after the time if the indicated time has already elapsed when the Mobile Station is ready to transmit.

26.6.13.2.3 Method of test

Initial condition(s)

System Simulator:

1 cell, CCCH_CONF set to 1 basic physical channel used for CCCH, not combined with SDCCHs.

Mobile Station:

The MS is in the "idle, updated" state, with a TMSI allocated.

Related PICS/PIXIT statement(s)

- TCH supported (Y/N).
- Supported rate(s) of TCH: (F/F+H).
- The supported channel mode(s) need to be declared.
- Supported frequencies (P-GSM or E-GSM or DCS 1 800).

Foreseen final state of the MS

"Idle, updated", with TMSI allocated.

Test procedure

The System Simulator pages the MS and after the MS has responded with a CHANNEL REQUEST, the simulator assigns a hopping SDCCH. Then the SS sends an ASSIGNMENT COMMAND message allocating a channel (TCH/F, TCH/H or SDCCH, arbitrarily chosen among the channels supported), with a starting time and channel descriptions (hopping case) for both before and after the starting time, as detailed in the "specific message contents" clause. The indicated time is such that the Mobile Station is ready to access only after that time. The Mobile Station then accesses the channel as described for after the starting time. The verification is performed at the RF burst level.

Test parameters:

T1 is set to $T0+5 \pmod{42432}$, where T0 is the frame number at which the first burst of the ASSIGNMENT COMMAND message is sent.

Maximum duration of test

45 sec.

Expected sequence

Step	Direction	Message	Comments
1	SS -> MS	PAGING REQUEST TYPE 1	Hopping channel.
2	MS -> SS	CHANNEL REQUEST	
3	SS -> MS	IMMEDIATE ASSIGNMENT	
4	MS -> SS	PAGING RESPONSE	See specific message contents. Sent on the correct channel (after time parameters) after establishment of the main signalling link.
5	SS -> MS	ASSIGNMENT COMMAND	
6	MS -> SS	ASSIGNMENT COMPLETE	
7	SS -> MS	CHANNEL RELEASE	

Specific message contents**ASSIGNMENT COMMAND**

Information element	Value/remark
Channel Description, after time Channel Type and TDMA offset	Chosen arbitrarily among that supported by the Mobile Station.
Timeslot Number	Chosen arbitrarily.
Training Sequence Code	Chosen arbitrarily.
Hopping	Yes.
Hopping parameters	Chosen arbitrarily.
Power Command Power level	Chosen arbitrarily.
Channel Mode Mode	Arbitrarily selected from capabilities declared for the MS for the chosen type of channel.
Mobile Allocation, after time	Chosen arbitrarily, at least one frequency. In case of an MA with just one frequency, the frequency should be different from the BCCH carrier.
Starting Time	T1
Channel Description, before time Channel Type and TDMA offset	Same as after time.
Timeslot Number	Same as after time.
Training Sequence Code	Same as after time.
Hopping	Yes.
Hopping parameters	Chosen arbitrarily, different from "after time".
Mobile Allocation, before time	Chosen arbitrarily, at least one frequency and different from "Mobile Allocation, after time". In case of an MA with just one frequency, the frequency should be different from the BCCH carrier.

26.6.13.3 Dedicated assignment with starting time and frequency redefinition / failure case / time not elapsed**26.6.13.3.1 Conformance requirement**

An MS, after receiving a FREQUENCY REDEFINITION message, shall keep the provided information until the time is elapsed. The Mobile Station must accept an intervening dedicated assignment, and, in case of failure of this assignment resulting in a return to the old channel before the time indicated in the FREQUENCY REDEFINITION message, shall return on the old channel with the frequency parameters in use at the moment of the reception of the FREQUENCY REDEFINITION message, and shall eventually start using the new frequency parameters in the correct time slot indicated by the starting time of the FREQUENCY REDEFINITION message.

Reference(s):

GSM 04.08 sub-clauses 3.4.3 and 3.4.5.

26.6.13.3.2 Test purpose

To verify that the MS, after receiving a FREQUENCY REDEFINITION and then an ASSIGNMENT COMMAND message with a starting time and channel descriptions both for before and after the starting time, failing the assignment and returning on the old channel, and ready to access before the time indicated in the FREQUENCY REDEFINITION, resumes transmission on the channels used at the time of the reception of the FREQUENCY REDEFINITION message and eventually starts using the new frequency parameters at the time indicated in the FREQUENCY REDEFINITION message.

26.6.13.3.3 Method of test

Initial condition(s)

System Simulator:

1 cell, CCCH_CONF set to 1 basic physical channel used for CCCH, not combined with SDCCHs.

Mobile Station:

The MS is in the "idle, updated" state, with a TMSI allocated.

Related PICS/PIXIT statement(s)

- TCH supported (Y/N).
- Supported rate(s) of TCH: (F/F+H).
- The supported channel mode(s) need to be declared.
- Supported frequencies (P-GSM or E-GSM or DCS 1 800).

Foreseen final state of the MS

"Idle, updated", with TMSI allocated.

Test procedure

The System Simulator pages the MS and after the MS has responded with a CHANNEL REQUEST, the simulator assigns allocating a hopping channel (TCH/F, TCH/H or SDCCH, arbitrarily chosen among the channels supported). Then the SS sends a FREQUENCY REDEFINITION message (starting time T1), which modifies the frequency parameters to be used by the MS. Then the SS sends an ASSIGNMENT COMMAND message, with a starting time (T2) and channel descriptions for both before and after the starting time. The channels and hopping sequences so allocated are distinct from those used and from those described by the FREQUENCY REDEFINITION message. The System Simulator does not activate the channels defined in the ASSIGNMENT COMMAND. The MS shall try to activate the new channel (this is not verified) and shall then reactivate the old channel and trigger the establishment of the main signalling link on the old channel. Then the MS shall send an ASSIGNMENT FAILURE message. Time T1 is chosen so it is reached only after the sending of the ASSIGNMENT FAILURE message. The MS shall eventually, at the TDMA frame defined by the contents of the "Starting Time" information element of the FREQUENCY REDEFINITION message, use the new frequency parameters. The verification is performed at the RF burst level.

Test parameters:

T1 is set to $T0+5000 \pmod{42\,432}$, where T0 is the frame number at which the first burst of the FREQUENCY REDEFINITION message is sent.

T2 is set to $T0+4000 \pmod{42\,432}$, where T0 is the frame number at which the first burst of the FREQUENCY REDEFINITION message is sent.

Maximum duration of test

180 sec.

Expected sequence

Step	Direction	Message	Comments
1	SS -> MS	PAGING REQUEST TYPE 1	
2	MS -> SS	CHANNEL REQUEST	
3	SS -> MS	IMMEDIATE ASSIGNMENT	Hopping channel.
4	MS -> SS	PAGING RESPONSE	
5	SS -> MS	FREQUENCY REDEFINITION	
6	SS -> MS	ASSIGNMENT COMMAND	Hopping channel, type among possible, signalling mode.
7	MS -> SS	ASSIGNMENT FAILURE	Sent on the correct channel (original parameters) after establishment of the main signalling link.
8	-----	Time T1	The SS checks that the MS is transmitting now on the correct frequencies (parameters of the FREQUENCY REDEFINITION message) and that the transmissions started in the correct frame.
9	SS -> MS	CHANNEL RELEASE	

Specific message contents**FREQUENCY REDEFINITION**

Information element	Value/remark
Channel Description	
Channel Type and TDMA offset	Same as in IMMEDIATE ASSIGNMENT
Timeslot Number	Same as in IMMEDIATE ASSIGNMENT
Training Sequence Code	Same as in IMMEDIATE ASSIGNMENT
Hopping	Yes
Hopping parameters	Chosen arbitrarily, different than those of the IMMEDIATE ASSIGNMENT message, HSN same as in IMMEDIATE ASSIGNMENT.
Mobile Allocation	Chosen arbitrarily, at least two frequencies, different than those of the IMMEDIATE ASSIGNMENT message.
Starting Time	T1

ASSIGNMENT COMMAND:

Information element	Value/remark
Channel Description, after time Channel Type and TDMA offset	Chosen arbitrarily among that supported by the Mobile Station.
Timeslot Number	Chosen arbitrarily.
Training Sequence Code	Chosen arbitrarily.
Hopping	Yes.
Hopping parameters	Chosen arbitrarily.
Power Command	
Power level	Chosen arbitrarily.
Channel Mode	
Mode	Arbitrarily selected from capabilities declared for the MS for the chosen type of channel.
Mobile Allocation, after time	Chosen arbitrarily, at least two frequency.
Starting Time	T2
Channel Description, before time Channel Type and TDMA offset	Same as after time.
Timeslot Number	Same as after time.
Training Sequence Code	Same as after time.
Hopping	Yes.
Hopping parameters	Chosen arbitrarily, different from "after time".
Mobile Allocation, before time	Chosen arbitrarily, at least two frequencies, different from "Mobile Allocation, after time".

26.6.13.4 Dedicated assignment with starting time and frequency redefinition / failure case / time elapsed**26.6.13.4.1 Conformance requirement**

An MS, after receiving a FREQUENCY REDEFINITION message, shall keep the provided information until the time is elapsed. The Mobile Station must accept an intervening dedicated assignment, and, in case of failure of this assignment resulting in a return to the old channel after the time indicated in the FREQUENCY REDEFINITION message, shall return on the old channel with the frequency parameters indicated in the FREQUENCY REDEFINITION message.

Reference(s):

GSM 04.08 sub-clauses 3.4.3 and 3.4.5.

26.6.13.4.2 Test purpose

To verify that the MS, after receiving a FREQUENCY REDEFINITION and then an ASSIGNMENT COMMAND message with a starting time and channel descriptions both for before and after the starting time, failing the assignment and returning on the old channel, and ready to access after the time indicated in the FREQUENCY REDEFINITION, resumes transmission using the new frequency parameters indicated in the FREQUENCY REDEFINITION message.

26.6.13.4.3 Method of test**Initial condition(s)**

System Simulator:

1 cell, CCCH_CONF set to 1 basic physical channel used for CCCH, not combined with SDCCHs.

Mobile Station:

The MS is in the "idle, updated" state, with a TMSI allocated.

Related PICS/PIXIT statement(s)

- Supported frequencies (P-GSM or E-GSM or DCS 1 800).

Foreseen final state of the MS

"Idle, updated", with TMSI allocated.

Test procedure

The System Simulator pages the MS and after the MS has responded with a CHANNEL REQUEST, the simulator assigns allocating a hopping channel (SDCCH). Then the SS sends a FREQUENCY REDEFINITION message (starting time T1), which modifies the frequency parameters to be used by the MS. Then the SS sends an ASSIGNMENT COMMAND message, with a starting time (T2) and channel descriptions for both before and after the starting time. Time T1 is chosen so it is reached after the sending of the ASSIGNMENT COMMAND message, but before the return on the old channel. The System Simulator does not activate the channels defined in the ASSIGNMENT COMMAND. The MS shall try to activate the new channel (this is not verified) and shall then reactivate the old channel with the new frequency parameters as indicated by the FREQUENCY REDEFINITION message, and trigger the establishment of the main signalling link on the old channel. Then the MS shall send an ASSIGNMENT FAILURE message. The verification is performed at the RF burst level.

Test parameters:

i.e. for SDCCH

T2 is set to $T0+5000 \pmod{42\,432}$, where T0 is the frame number at which the first burst of the FREQUENCY REDEFINITION message is sent.

T1 is set to $T0+214 \pmod{42\,432}$, where T0 is the frame number at which the first burst of the FREQUENCY REDEFINITION message is sent.

NOTE: T0 + 214 is calculated for a maximum execution time of:

FREQUENCY REDEFINITION	using 1 L2 frame	51 frames
ASSIGNMENT COMMAND	using 2 L2 frames	102 frames
+ 120 ms maximum time for a channel change		25 frames
+ some frames contention (here 36)		

Maximum duration of test

180 sec.

Expected sequence

Step	Direction	Message	Comments
1	SS -> MS	PAGING REQUEST TYPE 1	
2	MS -> SS	CHANNEL REQUEST	
3	SS -> MS	IMMEDIATE ASSIGNMENT	Hopping channel.
4	MS -> SS	PAGING RESPONSE	
5	SS -> MS	FREQUENCY REDEFINITION	
6	SS -> MS	ASSIGNMENT COMMAND	Hopping channel, type among possible, signalling mode.
7	MS -> SS	ASSIGNMENT FAILURE	Sent on the correct channel (parameters from the FREQUENCY REDEFINITION message) after establishment of the main signalling link.
8	SS -> MS	CHANNEL RELEASE	

Specific message contents

FREQUENCY REDEFINITION

Information element	Value/remark
Channel Description	
Channel Type and TDMA offset	Same as in IMMEDIATE ASSIGNMENT
Timeslot Number	Same as in IMMEDIATE ASSIGNMENT
Training Sequence Code	Same as in IMMEDIATE ASSIGNMENT
Hopping	Yes
Hopping parameters	Chosen arbitrarily, different than those of the IMMEDIATE ASSIGNMENT message.
Mobile Allocation	Chosen arbitrarily, at least two frequencies, different than those of the IMMEDIATE ASSIGNMENT message, HSN same as in IMMEDIATE ASSIGNMENT.
Starting Time	T1

ASSIGNMENT COMMAND

Information element	Value/remark
Channel Description, after time	
Channel Type and TDMA offset	Chosen arbitrarily among that supported by the Mobile Station.
Timeslot Number	Chosen arbitrarily.
Training Sequence Code	Chosen arbitrarily.
Hopping	Yes.
Hopping parameters	Chosen arbitrarily.
Power Command	
Power level	Chosen arbitrarily.
Channel Mode	
Mode	Arbitrarily selected from capabilities declared for the MS for the chosen type of channel.
Mobile Allocation, after time	Chosen arbitrarily, at least two frequencies.
Starting Time	T2
Channel Description, before time	
Channel Type and TDMA offset	Same as after time.
Timeslot Number	Same as after time.
Training Sequence Code	Same as after time.
Hopping	Yes.
Hopping parameters	Chosen arbitrarily, different from "after time".
Mobile Allocation, before time	Chosen arbitrarily, at least two frequencies, different from "Mobile Allocation, after time".

26.6.13.5 Handover with starting time / successful case / time not elapsed

26.6.13.5.1 Conformance requirement

A Mobile Station receiving an HANDOVER COMMAND message with a starting time and channel descriptions for both after and before the starting time, and ready to access before the indicated time has elapsed, shall perform the handover on the channels as described for before the starting time and shall, if specified, use the parameters in the frequency list, MAIO and HSN, in the correct time slot indicated by the starting time.

The Mobile Station shall accept the HANDOVER COMMAND message for different message formatting, differing by the information elements used to describe frequency lists.

Reference(s):

GSM 04.08 sub-clauses 3.4.4.1 and 9.1.15.

26.6.13.5.2 Test purpose

To verify that the MS, after receiving a HANOVER COMMAND message with a starting time and channel descriptions both for before and after the starting time, and ready to access before the indicated time, performs correctly the handover using the description for before the time, and then starts using the frequency parameters for after the time at the time indicated in the message.

26.6.13.5.3 Method of test**Initial condition(s)**

System Simulator:

2 cells, CCCH_CONF set to 1 basic physical channel used for CCCH, not combined with SDCCHs.

Mobile Station:

The MS is in the "idle, updated" state, with a TMSI allocated.

Related PICS/PIXIT statement(s)

- TCH supported (Y/N).
- Supported rate(s) of TCH: (F/F+H).
- The supported channel mode(s) need to be declared.
- Supported frequencies (P-GSM or E-GSM or DCS 1 800).

Foreseen final state of the MS

"Idle, updated", with TMSI allocated, and camped on cell B.

Test procedure

The System Simulator pages the MS and after the MS has responded with a CHANNEL REQUEST, the simulator assigns a hopping SDCCH. After the SS has received measurements concerning cell B, the SS sends a HANOVER COMMAND message allocating a channel (TCH/F, TCH/H or SDCCH, arbitrarily chosen among the channels supported), with a starting time and channel descriptions (hopping case) for both before and after the starting time, as detailed in the "specific message contents" clause. The indicated time is such that the Mobile Station is ready to access before that time. The Mobile Station then accesses the channel as described for before the starting time. The MS shall eventually, at the TDMA frame defined by the contents of the "Starting Time" information element of the HANOVER COMMAND message, use the new frequency parameters. The verification is performed at the RF burst level.

Test parameters:

T1 is set to $T0+1000 \pmod{42\,432}$, where T0 is the frame number at which the first burst of the HANOVER COMMAND message is sent.

Maximum duration of test

120 sec.

Expected sequence

Step	Direction	Message	Comments
1	SS -> MS	PAGING REQUEST TYPE 1	
2	MS -> SS	CHANNEL REQUEST	
3	SS -> MS	IMMEDIATE ASSIGNMENT	Hopping channel.
4	MS -> SS	PAGING RESPONSE	
5	SS -> MS	HANDOVER COMMAND	See specific message contents.
6	MS -> SS	HANDOVER ACCESS	Repeated on every burst of the uplink main DCCH until reception of PHYSICAL INFORMATION.
7	SS -> MS	PHYSICAL INFORMATION	
8	MS -> SS	HANDOVER COMPLETE	Sent on the correct channel (before time parameters) after establishment of the main signalling link.
9	-----	Time T1	The SS checks that the MS is transmitting now on the correct frequencies (after time parameters) and that the transmissions started in the correct frame.
10	SS -> MS	CHANNEL RELEASE	

Specific message contents**HANDOVER COMMAND:**

Information element	Value/remark
Cell Description	As for cell B.
Channel Description, after time	
Channel Type and TDMA offset	Chosen arbitrarily among that supported by the Mobile Station.
Timeslot Number	Chosen arbitrarily.
Training Sequence Code	Chosen arbitrarily.
Hopping	Yes.
Hopping parameters	Chosen arbitrarily.
Power Command	
Power level	Chosen arbitrarily.
Synchronization indication	Non synchronized.
Cell Channel Description	As for cell B.
Channel Mode	
Mode	Arbitrarily selected from capabilities declared for the MS for the chosen type of channel.
Mobile Allocation, after time	Chosen arbitrarily, at least one frequency. In case of an MA with just one frequency, the frequency should be different from the BCCH carrier.
Starting Time	T1
Channel Description, before time	
Channel Type and TDMA offset	Same as after time.
Timeslot Number	Same as after time.
Training Sequence Code	Same as after time.
Hopping	Yes.
Hopping parameters	Chosen arbitrarily, different from "after time".
Mobile Allocation, before time	Chosen arbitrarily, at least one frequency, different from "Mobile Allocation, after time". In case of an MA with just one frequency, the frequency should be different from the BCCH carrier.

26.6.13.6 Handover with starting time / successful case / time elapsed**26.6.13.6.1 Conformance requirement**

A Mobile Station receiving a HANDOVER COMMAND message with a starting time and channel descriptions for both after and before the starting time, and ready to access after the indicated time has elapsed, shall perform the handover on the channels as described for after the starting time.

The Mobile Station shall accept the HANOVER COMMAND message for different message formattings, differing by the information elements used to describe frequency lists.

Reference(s):

GSM 04.08 sub-clauses 3.4.4.1 and 9.1.15.

26.6.13.6.2 Test purpose:

To verify that the MS, after receiving a HANOVER COMMAND message with a starting time and channel descriptions both for before and after the starting time, and ready to transmit after the indicated time, performs correctly the handover using the frequency parameters for after the time.

26.6.13.6.3 Method of test**Initial condition(s)**

System Simulator:

2 cells, CCCH_CONF set to 1 basic physical channel used for CCCH, not combined with SDCCHs.

Mobile Station:

The MS is in the "idle, updated" state, with a TMSI allocated, and camped on cell A

Related PICS/PIXIT statement(s)

- TCH supported (Y/N).
- Supported rate(s) of TCH: (F/F+H).
- The supported channel mode(s) need to be declared.
- Supported frequencies (P-GSM or E-GSM or DCS 1 800).

Foreseen final state of the MS

"Idle, updated", with TMSI allocated, and camped on cell B.

Test procedure

The System Simulator pages the MS and after the MS has responded with a CHANNEL REQUEST, the simulator assigns a hopping SDCCH. After the SS has received measurements concerning cell B, the SS sends a HANOVER COMMAND message allocating a channel (TCH/F, TCH/H or SDCCH, arbitrarily chosen among the channels supported), with a starting time and channel descriptions (hopping case) for both before and after the starting time., as detailed in the "specific message contents" clause. The indicated time is such that the Mobile Station is ready to access only after that time. The Mobile Station then accesses the channel as described for after the starting time. The verification is performed at the RF burst level.

Test parameters:

T1 is set to $T0+5 \pmod{42\,432}$, where T0 is the frame number at which the first burst of the HANOVER COMMAND message is sent.

Maximum duration of test

120 sec.

Expected sequence

Step	Direction	Message	Comments
1	SS -> MS	PAGING REQUEST TYPE 1	
2	MS -> SS	CHANNEL REQUEST	
3	SS -> MS	IMMEDIATE ASSIGNMENT	Hopping channel.
4	MS -> SS	PAGING RESPONSE	
5	SS -> MS	HANDOVER COMMAND	See specific message contents.
6	MS -> SS	HANDOVER ACCESS	Repeated on every burst of the uplink main DCCH until reception of PHYSICAL INFORMATION.
7	SS -> MS	PHYSICAL INFORMATION	
8	MS -> SS	HANDOVER COMPLETE	Sent on the correct channel (after time parameters) after establishment of the main signalling link.
9	SS -> MS	CHANNEL RELEASE	

Specific message contents**HANDOVER COMMAND:**

Information element	Value/remark
Cell Description	As for cell B.
Channel Description, after time	
Channel Type and TDMA offset	Chosen arbitrarily among that supported by the Mobile Station.
Timeslot Number	Chosen arbitrarily.
Training Sequence Code	Chosen arbitrarily.
Hopping	Yes.
Hopping parameters	Chosen arbitrarily.
Power Command	
Power level	Chosen arbitrarily.
Synchronization indication	Non synchronized.
Cell Channel Description	As for cell B.
Channel Mode	
Mode	Arbitrarily selected from capabilities declared for the MS for the chosen type of channel.
Mobile Allocation, after time	Chosen arbitrarily, at least one frequency. In case of an MA with just one frequency, the frequency should be different from the BCCH carrier.
Starting Time	T1
Channel Description, before time	
Channel Type and TDMA offset	Same as after time.
Timeslot Number	Same as after time.
Training Sequence Code	Same as after time.
Hopping	Yes.
Hopping parameters	Chosen arbitrarily, different from "after time".
Mobile Allocation, before time	Chosen arbitrarily, at least one frequency and different from "Mobile Allocation, after time". In case of an MA with just one frequency, the frequency should be different from the BCCH carrier.

26.6.13.7 Handover with starting time and frequency redefinition / failure case / time not elapsed**26.6.13.7.1 Conformance requirement**

An MS, after receiving a FREQUENCY REDEFINITION message, shall keep the provided information until the time is elapsed. The Mobile Station must accept an intervening handover, and, in case of failure of this handover resulting in a return to the old channel before the time indicated in the FREQUENCY REDEFINITION message, shall return on the old channel with the frequency parameters in use at the moment of the reception of the FREQUENCY REDEFINITION message, and shall eventually start using

the new frequency parameters in the correct time slot indicated by the starting time of the FREQUENCY REDEFINITION message.

Reference(s):

GSM 04.08 sub-clauses 3.4.4 and 3.4.5.

26.6.13.7.2 Test purpose:

To verify that the MS, after receiving a FREQUENCY REDEFINITION and then a HANDOVER COMMAND message with a starting time and channel descriptions both for before and after the starting time, failing the handover, and ready to access on the old channel before the time indicated in the FREQUENCY REDEFINITION, resumes transmission on the channels used at the time of the reception of the FREQUENCY REDEFINITION message and eventually starts using the new frequency parameters at the time indicated in the FREQUENCY REDEFINITION message.

26.6.13.7.3 Method of test**Initial condition(s)**

System Simulator:

2 cells, CCCH_CONF set to 1 basic physical channel used for CCCH, not combined with SDCCHs.

Mobile Station:

The MS is in the "idle, updated" state, with a TMSI allocated, and camped on cell A.

Related PICS/PIXIT statement(s)

- TCH supported (Y/N).
- Supported rate(s) of TCH: (F/F+H).
- The supported channel mode(s) need to be declared.
- Supported frequencies (P-GSM or E-GSM or DCS 1 800).

Foreseen final state of the MS

"Idle, updated", with TMSI allocated, and camped on cell A.

Test procedure

The System Simulator pages the MS and after the MS has responded with a CHANNEL REQUEST, the simulator assigns allocating a hopping channel (TCH/F, TCH/H or SDCCH, arbitrarily chosen among the channels supported). Then the SS sends a FREQUENCY REDEFINITION message (starting time T1), which modifies the frequency parameters to be used by the MS. Then the SS sends a HANDOVER COMMAND message, with a starting time (T2) and channel descriptions for both before and after the starting time. The MS shall try to activate the new channel (this is not verified) and shall then reactivate the old channel and trigger the establishment of the main signalling link on the old channel. The System Simulator does not activate the channels defined in the HANDOVER COMMAND. Then the MS shall send a HANDOVER FAILURE message. Time T1 is chosen so it is reached only after the sending of the HANDOVER FAILURE message. The MS shall eventually, at the TDMA frame defined by the contents of the "Starting Time" information element of the FREQUENCY REDEFINITION message, use the new frequency parameters. The verification is performed at the RF burst level.

Test parameters:

T1 is set to $T0+5000 \pmod{42\,432}$, where T0 is the frame number at which the first burst of the FREQUENCY REDEFINITION message is sent.

T2 is set to $T0+4000 \pmod{42\,432}$, where T0 is the frame number at which the first burst of the FREQUENCY REDEFINITION message is sent.

Maximum duration of test

180 sec.

Expected sequence

Step	Direction	Message	Comments
1	SS -> MS	PAGING REQUEST TYPE 1	Hopping channel. Hopping channel, type among possible, signalling mode. Not checked. Sent on the correct channel (original parameters) after establishment of the main signalling link. The SS checks that the MS is transmitting now on the correct frequencies (parameters of the FREQUENCY REDEFINITION message) and that the transmissions started in the correct frame.
2	MS -> SS	CHANNEL REQUEST	
3	SS -> MS	IMMEDIATE ASSIGNMENT	
4	MS -> SS	PAGING RESPONSE	
5	SS -> MS	FREQUENCY REDEFINITION	
6	SS -> MS	HANDOVER COMMAND	
7	MS -> SS	HANDOVER ACCESS	
8	MS -> SS	HANDOVER FAILURE	
9	-----	Time T1	
10	SS -> MS	CHANNEL RELEASE	

Specific message contents**FREQUENCY REDEFINITION**

Information element	Value/remark
Channel Description	
Channel Type and TDMA offset	Same as in IMMEDIATE ASSIGNMENT
Timeslot Number	Same as in IMMEDIATE ASSIGNMENT
Training Sequence Code	Same as in IMMEDIATE ASSIGNMENT
Hopping	Yes
Hopping parameters	Chosen arbitrarily, different than those of the IMMEDIATE ASSIGNMENT message, HSN same as in IMMEDIATE ASSIGNMENT.
Mobile Allocation	Chosen arbitrarily, at least two frequencies, different than those of the IMMEDIATE ASSIGNMENT message.
Starting Time	T1

HANDOVER COMMAND:

Information element	Value/remark
Cell Description	As for cell B.
Channel Description, after time	
Channel Type and TDMA offset	Chosen arbitrarily among that supported by the Mobile Station.
Timeslot Number	Chosen arbitrarily.
Training Sequence Code	Chosen arbitrarily.
Hopping	Yes.
Hopping parameters	Chosen arbitrarily.
Power Command	
Power level	Chosen arbitrarily.
Synchronization indication	Non synchronized.
Cell Channel Description	As for cell B.
Channel Mode	
Mode	Arbitrarily selected from capabilities declared for the MS for the chosen type of channel.
Mobile Allocation, after time	Chosen arbitrarily, at least one frequency. In case of an MA with just one frequency, the frequency should be different from the BCCH carrier.
Starting Time	T2
Channel Description, before time	
Channel Type and TDMA offset	Same as after time.
Timeslot Number	Same as after time.
Training Sequence Code	Same as after time.
Hopping	Yes.
Hopping parameters	Chosen arbitrarily, different from "after time".
Mobile Allocation, before time	Chosen arbitrarily, at least one frequency and different from "Mobile Allocation, after time". In case of an MA with just one frequency, the frequency should be different from the BCCH carrier.

26.6.13.8 Handover with starting time and frequency redefinition / failure case / time elapsed**26.6.13.8.1 Conformance requirement**

An MS, after receiving a FREQUENCY REDEFINITION message, shall keep the provided information until the time is elapsed. The Mobile Station must accept an intervening handover, and, in case of failure of this handover resulting in a return to the old channel after the time indicated in the FREQUENCY REDEFINITION message, shall return on the old channel with the frequency parameters indicated in the FREQUENCY REDEFINITION message.

Reference(s):

GSM 04.08 sub-clauses 3.4.4 and 3.4.5.

26.6.13.8.2 Test purpose:

To verify that the MS, after receiving a FREQUENCY REDEFINITION and then a HANDOVER COMMAND message with a starting time and channel descriptions both for before and after the starting time, failing the handover and returning on the old channel, and ready to access after the time indicated in the FREQUENCY REDEFINITION, resumes transmission using the new frequency parameters indicated in the FREQUENCY REDEFINITION message.

26.6.13.8.3 Method of test**Initial condition(s)**

System Simulator:

2 cells, CCCH_CONF set to 1 basic physical channel used for CCCH, not combined with SDCCHs.

Mobile Station:

The MS is in the "idle, updated" state, with a TMSI allocated, and camped on cell A.

Related PICS/PIXIT statement(s)

- Supported frequencies (P-GSM or E-GSM or DCS 1 800).

Foreseen final state of the MS

"Idle, updated", with TMSI allocated, and camped on cell A.

Test procedure

The System Simulator pages the MS and after the MS has responded with a CHANNEL REQUEST, the simulator assigns a hopping channel (SDCCH). Then the SS sends a FREQUENCY REDEFINITION message (starting time T1), which modifies the frequency parameters to be used by the MS. Then the SS sends a HANOVER COMMAND message, with a starting time (T2) and channel descriptions for both before and after the starting time. Time T1 is chosen so it is reached after the sending of the HANOVER COMMAND message, but before the return on the old channel. The System Simulator does not activate the channels defined in the HANOVER COMMAND. The MS shall try to activate the new channel (this is not verified) and shall then reactivate the old channel with the new frequency parameters as indicated by the FREQUENCY REDEFINITION message, and trigger the establishment of the main signalling link on the old channel. Then the MS shall send a HANOVER FAILURE message. The verification is performed at the RF burst level.

Test parameters:

i.e. for SDCCH

T2 is set to $T0+5000 \pmod{42\,432}$, where T0 is the frame number at which the first burst of the FREQUENCY REDEFINITION message is sent.

T1 is set to $T0+265 \pmod{42\,432}$, where T0 is the frame number at which the first burst of the FREQUENCY REDEFINITION message is sent.

NOTE: T0 + 265 is calculated for a maximum execution time of:

FREQUENCY REDEFINITION	using 1 L2 frame	51 frames
HANOVER COMMAND	using 3 L2 frames	153 frames
+ 120 ms maximum time for a channel change		25 frames
+ some frames contention (here 36)		

Maximum duration of test

180 sec.

Expected sequence

Step	Direction	Message	Comments
1	SS -> MS	PAGING REQUEST TYPE 1	
2	MS -> SS	CHANNEL REQUEST	
3	SS -> MS	IMMEDIATE ASSIGNMENT	Hopping channel.
4	MS -> SS	PAGING RESPONSE	
5	SS -> MS	FREQUENCY REDEFINITION	
6	SS -> MS	HANOVER COMMAND	Hopping channel, type among possible, signalling mode.
7	MS -> SS	HANOVER ACCESS	Not checked.
8	MS -> SS	HANOVER FAILURE	Sent on the correct channel (parameters from the FREQUENCY REDEFINITION message) after establishment of the main signalling link.
9	SS -> MS	CHANNEL RELEASE	

Specific message contents**FREQUENCY REDEFINITION**

Information element	Value/remark
Channel Description	
Channel Type and TDMA offset	Same as in IMMEDIATE ASSIGNMENT
Timeslot Number	Same as in IMMEDIATE ASSIGNMENT
Training Sequence Code	Same as in IMMEDIATE ASSIGNMENT
Hopping	Yes.
Hopping parameters	Chosen arbitrarily, different than those of the IMMEDIATE ASSIGNMENT message, HSN same as in IMMEDIATE ASSIGNMENT.
Mobile Allocation	Chosen arbitrarily, at least two frequencies, different than those of the IMMEDIATE ASSIGNMENT message
Starting Time	T1

HANDOVER COMMAND

Information element	Value/remark
Cell Description	As for cell B.
Channel Description, after time	
Channel Type and TDMA offset	Chosen arbitrarily among that supported by the Mobile Station.
Timeslot Number	Chosen arbitrarily.
Training Sequence Code	Chosen arbitrarily.
Hopping	Yes.
Hopping parameters	Chosen arbitrarily.
Power Command	
Power level	Chosen arbitrarily.
Synchronization indication	Non synchronized.
Cell Channel Description	As for cell B.
Channel Mode	
Mode	Arbitrarily selected from capabilities declared for the MS for the chosen type of channel.
Mobile Allocation, after time	Chosen arbitrarily, at least one frequency. In case of an MA with just one frequency, the frequency should be different from the BCCH carrier.
Starting Time	T2
Channel Description, before time	
Channel Type and TDMA offset	Same as after time.
Timeslot Number	Same as after time.
Training Sequence Code	Same as after time.
Hopping	Yes.
Hopping parameters	Chosen arbitrarily, different from "after time".
Mobile Allocation, before time	Chosen arbitrarily, at least one frequency and different from "Mobile Allocation, after time". In case of an MA with just one frequency, the frequency should be different from the BCCH carrier.

26.6.13.9 Immediate assignment with starting time / successful case / time not elapsed**26.6.13.9.1 Conformance requirement**

A Mobile Station receiving an IMMEDIATE ASSIGNMENT message with a starting time and channel descriptions for both after and before the starting time, and ready to access before the indicated time has elapsed, shall perform the assignment on the channels as described for before the starting time and shall start using the new frequencies and hopping sequence in the correct time slot when the MS is allocated a dedicated channel.

Reference(s):

GSM 04.08 sub-clauses 3.3.1.3.1 and 9.1.18.

26.6.13.9.2 Test purpose

To verify that the MS, after receiving an IMMEDIATE ASSIGNMENT message with a starting time and channel descriptions both for before and after the starting time, and ready to access before the indicated time, performs correctly the assignment using the description for before the time, and then starts using the frequency parameters for after the time at the time indicated in the message.

26.6.13.9.3 Method of test

Initial condition(s)

System Simulator:

1 cell, CCCH_CONF set to 1 basic physical channel used for CCCH, not combined with SDCCHs.

Mobile Station:

The MS is in the "idle, updated" state, with a TMSI allocated.

Related PICS/PIXIT statement(s)

- TCH supported (Y/N).
- Supported rate(s) of TCH: (F/F+H).
- The supported channel mode(s) need to be declared.
- Supported frequencies (P-GSM or E-GSM or DCS 1 800).

Foreseen final state of the MS

"Idle, updated", with TMSI allocated.

Test procedure

The System Simulator pages the MS and after the MS has responded with a CHANNEL REQUEST, the simulator sends an IMMEDIATE ASSIGNMENT message allocating a hopping channel (TCH/F, TCH/H or SDCCH, arbitrarily chosen among the channels supported), with a starting time and channel descriptions for both before and after the starting time. The indicated time is such that the Mobile Station is ready to access before that time. The Mobile Station then accesses the channel as described for before the starting time. The MS shall eventually, at the TDMA frame defined by the contents of the "Starting Time" information element of the IMMEDIATE ASSIGNMENT message, use the new frequency parameters. The verification is performed at the RF burst level.

Test parameters:

T1 is chosen arbitrarily to be between T0+60 and T0+100 (mod 42 432), where T0 is the frame number at which the first burst of the IMMEDIATE ASSIGNMENT COMMAND message is sent.

Maximum duration of test

45 sec.

Expected sequence

Step	Direction	Message	Comments
1	SS -> MS	PAGING REQUEST TYPE 1	See specific message contents. The SS checks that the MS is transmitting now on the correct frequencies (after time parameters) and that the transmissions started in the correct frame.
2	MS -> SS	CHANNEL REQUEST	
3	SS -> MS	IMMEDIATE ASSIGNMENT	
4	MS -> SS	PAGING RESPONSE	
5	-----	Time T1	
6	SS -> MS	CHANNEL RELEASE	

Specific message contents**IMMEDIATE ASSIGNMENT**

Information element	Value/remark
Page Mode	Normal.
Channel Description	
Channel Type and TDMA offset	Chosen arbitrarily among that supported by the Mobile Station.
Timeslot Number	Chosen arbitrarily.
Training Sequence Code	Chosen arbitrarily.
Hopping	Yes.
Hopping parameters	Chosen arbitrarily.
Timing Advance	As needed.
Mobile Allocation (after time)	Chosen arbitrarily, at least one frequency. In case of an MA with just one frequency, the frequency should be different from the BCCH carrier.
Starting Time	T1
IA Rest Octet	
MAIO	Chosen arbitrarily, different from "after time".
Mobile Allocation (before time)	Chosen arbitrarily, at least one frequency and different from "Mobile Allocation, after time". In case of an MA with just one frequency, the frequency should be different from the BCCH carrier.

26.6.13.10 Immediate assignment with starting time / successful case / time elapsed**26.6.13.10.1 Conformance requirement**

A Mobile Station receiving an IMMEDIATE ASSIGNMENT message with a starting time and channel descriptions for both after and before the starting time, and ready to access after the indicated time has elapsed, shall perform the assignment on the channels as described for after the starting time.

Reference(s):

GSM 04.08 sub-clauses 3.3.1.3.1 and 9.1.18.

26.6.13.10.2 Test purpose

To verify that the MS, after receiving an IMMEDIATE ASSIGNMENT message with a starting time and channel descriptions both for before and after the starting time, performs correctly the assignment using the frequencies and hopping sequence for after the time if the indicated time has already elapsed when the Mobile Station is ready to transmit.

26.6.13.10.3 Method of test**Initial condition(s)**

System Simulator:

1 cell, CCCH_CONF set to 1 basic physical channel used for CCCH, not combined with SDCCHs.

Mobile Station:

The MS is in the "idle, updated" state, with a TMSI allocated.

Related PICS/PIXIT statement(s)

- Type of MS (P-GSM 900 or EGSM or DCS 1 800).
- TCH supported (Y/N).
- Supported rate(s) of TCH: (F/F+H).
- The supported channel mode(s) need to be declared.

Foreseen final state of the MS

"Idle, updated", with TMSI allocated.

Test procedure

The System Simulator pages the MS and after the MS has responded with a CHANNEL REQUEST, the simulator sends an IMMEDIATE ASSIGNMENT message allocating a hopping channel (TCH/F, TCH/H or SDCCH, arbitrarily chosen among the channels supported), with a starting time and channel descriptions for both before and after the starting time. The indicated time is such that the Mobile Station is ready to access only after that time. The Mobile Station then accesses the channel as described for after the starting time. The verification is performed at the RF burst level.

Test parameters:

T1 is set to $T0+5 \pmod{42\,432}$, where T0 is the frame number at which the first burst of the IMMEDIATE ASSIGNMENT COMMAND message is sent.

Maximum duration of test

45 sec

Expected sequence

Step	Direction	Message	Comments
1	SS -> MS	PAGING REQUEST TYPE 1	
2	MS -> SS	CHANNEL REQUEST	
3	SS -> MS	IMMEDIATE ASSIGNMENT	See specific message contents.
4	MS -> SS	PAGING RESPONSE	The SS checks that the MS is transmitting now on the correct frequencies (after time parameters).
5	SS -> MS	CHANNEL RELEASE	

Specific message contents**IMMEDIATE ASSIGNMENT:**

Information element	Value/remark
Page Mode	Normal.
Channel Description	
Channel Type and TDMA offset	Chosen arbitrarily among that supported by the Mobile Station.
Timeslot Number	Chosen arbitrarily.
Training Sequence Code	Chosen arbitrarily.
Hopping	Yes.
Hopping parameters	Chosen arbitrarily.
Timing Advance	As needed.
Mobile Allocation (after time)	Chosen arbitrarily, at least one frequency. In case of an MA with just one frequency, the frequency should be different from the BCCH carrier.
Starting Time	T1
IA Rest Octet	
MAIO	Chosen arbitrarily, different from "after time".
Mobile Allocation (before time)	Chosen arbitrarily, at least one frequency and different from "Mobile Allocation, after time". In case of an MA with just one frequency, the frequency should be different from the BCCH carrier.

26.6.14 Default contents of GSM 900 layer 3 messages for RR tests

This section contains the default values of GSM 900 L3 messages, which unless indicated otherwise in section 26.6 shall be transmitted by the system simulator and which are required to be received from the GSM 900 MS under test. These values are used in order to be consistent with the phase 2 version of 26.6.

The necessary L3 messages are listed in alphabetic order, with the exception of the SYSTEM INFORMATION messages, where it is the information elements which are listed in alphabetic order (this is because some information elements occur in several SYSTEM INFORMATION types).

In this section, decimal values are normally used. However, sometimes a hexadecimal value, indicated by an "H", or a binary value, indicated by a "B" is used.

Default SYSTEM INFORMATION:

NOTE 1: SYSTEM INFORMATION 2 bis, SYSTEM INFORMATION 5 bis, SYSTEM INFORMATION 7, and SYSTEM INFORMATION 8 messages are not used.

Cell A

Contents of information elements in SYSTEM INFORMATION TYPE 1 to 6 messages for cell A.

(CBCH) Channel Description	Not present.
(CBCH) Mobile Allocation	Not present.
Cell Channel Description	
- Format identifier	bit map 0.
- Cell Allocation ARFCN	Channel Numbers 20, 30, 50 and 70.
Cell Identity	
- Cell Identity Value	0001H
Cell Options	
- Power Control Indicator	Power Control Indicator is not set.
- DTX Indicator	MS shall not use DTX.
- Radio_Link_Timeout	8 SACCH blocks.
Cell Selection Parameters	
- Cell_Reselect_Hysteresis	12 dB.
- MX_TXPWR_MAX_CCH	Minimum level.
- ACS	No addition cell parameters are present in SYSTEM INFORMATION messages 7 and 8.
- NECI	New establishment causes not supported.
- RXLEV_ACCESS_MIN	Minimum level.
Control Channel Description	
- Attach-Detach allowed	No Attach/Detach.
- BS_AG_BLK_RES	0 blocks reserved for access grant.
- CCCH_CONF	1 basic physical channel used for CCCH, combined with SDCCHs.
- BS_PA_MFRMS	5 multiframe periods for transmission of paging messages.
- T3212 Time-out value	Infinite.
L2 pseudo length	
- System information 1	21
- System information 2	22
- System information 3	18
- System information 4	12
Location Area Identification	
- Mobile Country Code	001 decimal
- Mobile Network Code	01 decimal
- Location Area Code	0001H
Message Type	
- System information 1	00011001
- System information 2	00011010
- System information 3	00011011
- System information 4	00011100
- System information 5	00011101
- System information 6	00011110
Neighbour Cells Description	
- Format identifier	bit map 0.
- BCCH Allocation Sequence	0
- BCCH Allocation ARFCN	Channels numbers 10, 20, 40, 80, 90, 100, 110 and 120.
- EXT-IND	This IE carries the complete BA.
NCC Permitted	0000 0010
RACH Control Parameters	
- Max Retrans	Max 1 retrans.
- Tx-integer	5 slots used.
- Cell Barred for Access	Cell is not barred.
- Call Reestablishment Allowed	Not allowed.
- Access Control Class	Access is not barred.
- Emergency Call allowed	Yes.
SI 1 rest octets	Not used (all bits are set to spare).
SI 2 rest octets	Not used (all bits are set to spare).
SI 3 rest octets	Not used (all bits are set to spare).

SI 4 rest octets	Not used (all bits are set to spare).
------------------	---------------------------------------

Default settings for cell A:

Downlink input level	63 dBmicroVolt emf.
Uplink output power	minimum supported by the MS's power class.
Propagation profile	static.
BCCH/CCCH carrier number	20

Cell B

The contents of SYSTEM INFORMATION TYPE 1 to 6 messages for cell B are identical to those of cell A with the following exceptions:

Cell Channel Description - Format Identifier - Cell Allocation ARFCN	Bit map 0. Channel Number 10.
--	----------------------------------

NOTE 2: This IE needs modification when used in handover tests which command the MS to go to a frequency hopping channel in cell B.

Cell Identity
- Cell Identity Value 0002H

Default settings for cell B:

Downlink input level	53 dBmicroVolt emf.
Uplink output power	minimum supported by the MS's power class.
Propagation profile	static.
BCCH/CCCH carrier number	10

Contents of ALERTING message (SS to MS):

Protocol Discriminator	Call Control.
Transaction Identifier	
TI value	As used in the SETUP message.
TI flag	1 (destination side).
Message Type	00000001
All other information elements	Not present.

Contents of ASSIGNMENT COMMAND message:

Protocol Discriminator	RR Management.
Skip Indicator	0000
Message Type	00101110
Channel Description	
- Channel Type and TDMA offset	Bm + ACCHs
- Timeslot Number	Chosen arbitrarily by the test house.
- Training Sequence Code	Chosen arbitrarily by the test house.
- Hopping	Single RF channel.
- ARFCN	Channel number 30.
Power Command	
- Power level	Chosen arbitrarily by the test house.
All other information elements	Not present.

Contents of ASSIGNMENT COMPLETE message:

Protocol Discriminator	RR Management.
Skip Indicator	0000
Message Type	00101001
RR Cause	
- RR Cause Value	Normal event.

Contents of ASSIGNMENT FAILURE message:

Protocol Discriminator	RR Management.
Skip Indicator	0000
Message Type	00101111
RR Cause	
- RR Cause Value	Depending on test.

Contents of AUTHENTICATION REQUEST message:

Protocol Discriminator	MM message.
Skip Indicator	0000
Message Type	00010010
Ciphering Key Sequence Number	
- Key Sequence	Chosen arbitrarily by the test house from the range 0 to 6.
Authentication Parameter RAND	
- RAND value	Chosen arbitrarily by the test house.

Contents of AUTHENTICATION RESPONSE message:

Protocol Discriminator	MM message.
Skip Indicator	0000
Message Type	0X010100
Other information element(s)	Not checked.

Contents of CALL PROCEEDING message:

Protocol Discriminator	Call Control.
Transaction Identifier	
TI value	As used in the SETUP message.
TI flag	1 (destination side).
Message Type	00000010
All other information elements	Not present.

Contents of CHANNEL MODE MODIFY message:

Protocol Discriminator	RR Management.
Skip Indicator	0000
Message Type	00010000
Channel Description	
- Channel Type and TDMA offset	Depending on test.
- Timeslot Number	Chosen arbitrarily by the test house.
- Training Sequence Code	Chosen arbitrarily by the test house.
- Hopping	Single RF channel.
- ARFCN	Channel number 30.
Channel Mode	
- Mode	Depending on test.

Contents of CHANNEL MODE MODIFY ACKNOWLEDGE message:

Protocol Discriminator	RR Management.
Skip Indicator	0000
Message Type	00010111
Channel Description	Depending on test.
- Channel Type and TDMA offset	Same as in the CHANNEL MODE MODIFY message.
- Timeslot Number	Same as in the CHANNEL MODE MODIFY message.
- Training Sequence Code	Single RF channel.
- Hopping	Band number 0.
- Frequency Band	Channel number 30.
- ARFCN	
Channel Mode	Same as in the CHANNEL MODE MODIFY message.
- Mode	

Contents of CHANNEL RELEASE message:

Protocol Discriminator	RR Management.
Skip Indicator	0000
Message Type	00001101
RR Cause	
- RR Cause Value	Normal event.

Contents of CHANNEL REQUEST message

Establishment Cause	Not checked.
Random Reference	Not checked.

Contents of CIPHERING MODE COMMAND message:

Protocol Discriminator	RR Management.
Skip Indicator	0000
Message Type	00110101
Cipher Mode Setting	
- algorithm identifier	cipher with A5/1.
- SC	Start ciphering.
Cipher Response	IMEI shall not be included.

Contents of CIPHERING MODE COMPLETE message:

Protocol Discriminator	RR Management.
Skip Indicator	0000
Message Type	00110010
Mobile Identity	Not present.

Contents of the CLASSMARK CHANGE message:

Protocol Discriminator	RR Management.
Skip Indicator	0000
Message Type	000100110
Mobile Station Classmark 2	See PICS/PIXIT.
Mobile Station Classmark 3	For presence and contents see PICS/PIXIT.

Contents of CM SERVICE ACCEPT message:

Protocol Discriminator	Mobility Management.
Skip Indicator	0000
Message Type	00100001

Contents of CM SERVICE REQUEST message

Protocol Discriminator	Mobility Management.
Skip Indicator	0000
Message Type	0X100100
Other information elements	Not checked.

Contents of CONNECT message (SS to MS)

Protocol Discriminator	Call Control.
Transaction Identifier	As used in the SETUP message.
TI value	1
TI flag	
Message Type	00000111
All other information elements	Not present.

Contents of CONNECT ACKNOWLEDGE message (MS to SS)

Protocol Discriminator	Call Control.
Transaction Identifier	As used in the SETUP message.
TI value	0
TI flag	
Message Type	0X001111

Contents of HANDOVER ACCESS message:

Handover Reference	Equal to the value included in the Handover Command message.
--------------------	--

Contents of HANDOVER COMMAND message:

Protocol Discriminator	RR Management.
Skip Indicator	0000
Message Type	00101011
Cell Description	1
- Network Colour Code	Corresponding to target cell
- Base station Colour Code	Set to the BCCH carrier number of cell B. (one of 10, 20, 80, 90, 100, 110 or 120).
- BCCH Carrier Number	
Channel Description	Bm + ACCHs.
- Channel Type and TDMA offset	Chosen arbitrarily by the test house.
- Timeslot Number	Chosen arbitrarily by the test house.
- Training Sequence Code	Single RF channel.
- Hopping	Chosen arbitrarily by the test house from those supported on the target cell.
- ARFCN	
Handover Reference	
- Handover Reference Value	Chosen arbitrarily by the test house.
Power Command	
- Power level	Chosen arbitrarily by the test house.
All other information elements	Not present.

Contents of HANDOVER COMPLETE message:

Protocol Discriminator	RR Management.
Skip Indicator	0000
Message Type	00101100
RR cause	Normal event.
Time difference	Not present.

Contents of HANDOVER FAILURE message:

Protocol Discriminator	RR Management.
Skip Indicator	0000
Message Type	00101000
RR cause	Dependent on the test.

IDENTITY REQUEST

Information element	Value/remark
Identity type	IMEI
Spare half octet	0000

IDENTITY RESPONSE

Information element	Value/remark
Mobile identity	not checked

Contents of IMMEDIATE ASSIGNMENT message:

L2 pseudo length	This is the sum of the lengths of all the information elements present in the message except for the IA rest octets and L2 pseudo length IEs. For the default message the L2 pseudo length is 11.
Protocol Discriminator	RR Management.
Skip Indicator	0000
Message Type	00111111
Page Mode	
- Page Mode	Normal Paging.
Channel Description	
- Channel Type and TDMA offset	For non-combined CCCH/SDCCH (see initial conditions), SDCCH/8, with subchannel chosen arbitrarily by the test house For combined CCCH/SDCCH (default SS conditions), SDCCH/4, with subchannel chosen arbitrarily by the test house.
- Timeslot Number	For non-combined CCCH/SDCCH (see initial conditions), chosen arbitrarily by the test house; For combined CCCH/SDCCH (default SS conditions), SDCCH/4, timeslot zero.
- Training Sequence Code	For non-combined CCCH/SDCCH (see initial conditions), chosen arbitrarily by the test house; For combined CCCH/SDCCH (default SS conditions), SDCCH/4, TSC=5 (same as the BCC). Single RF channel.
- Hopping	For non-combined CCCH/SDCCH (see initial conditions), Channel number 30; For combined CCCH/SDCCH (default SS conditions), SDCCH/4, Channel number 20.
- ARFCN	Pertaining to last Channel Request sent by the MS.
Request Reference	
Timing Advance	
- Timing advance value	30 bit periods.
Mobile Allocation	
- Length	0
Starting Time	Not present.
IA rest octets	Not used (all bits set to spare).

Contents of IMMEDIATE ASSIGNMENT EXTENDED message:

L2 pseudo length	This is the sum of the lengths of all the information elements present in the message except for the IAX rest octets and L2 pseudo length IEs. For the default message the L2 pseudo length is 18.
Protocol Discriminator	RR Management.
Skip Indicator	0000
Message Type	00111001
Page Mode	Normal Paging.
- Page Mode	
Channel Description 1	For non-combined CCCH/SDCCH (see test conditions), SDCCH/8, with subchannel chosen arbitrarily by the test house; For combined CCCH/SDCCH (default SS conditions), SDCCH/4, with subchannel chosen arbitrarily by the test house.
- Channel Type and TDMA offset	
	For non-combined CCCH/SDCCH (see test conditions), chosen arbitrarily by the test house; For combined CCCH/SDCCH (default SS conditions), SDCCH/4, timeslot zero.
- Timeslot Number	
	For non-combined CCCH/SDCCH (see initial conditions), chosen arbitrarily by the test house; For combined CCCH/SDCCH (default SS conditions), SDCCH/4, TSC=5 (same as the BCC). Single RF channel.
- Training Sequence Code	
	For non-combined CCCH/SDCCH (see initial conditions), Channel number 30; For combined CCCH/SDCCH (default SS conditions), SDCCH/4, Channel number 20.
- Hopping	
- ARFCN	
Request Reference 1	Pertaining to last Channel Request sent by the MS.
Timing Advance 1	Chosen arbitrarily by the test house.
- Timing advance value	
Channel Description 2	Same channel type as in Channel Description 1, but different TDMA offset to that in Channel Description 1.
- Channel Type and TDMA offset	
	equal to the value in Channel Description 1.
- Timeslot Number	
- Training Sequence Code	
- Hopping	
- ARFCN	
Request Reference 2	Not pertaining to any Channel Requests sent by the MS.
Timing Advance 2	Chosen arbitrarily by the test house.
- Timing advance value	
Mobile Allocation	0
- Length	
Starting Time	Not present.
IAX rest octets	Not used (all bits set to spare).

Contents of IMMEDIATE ASSIGNMENT REJECT message:

L2 pseudo length	19
Protocol Discriminator	RR Management.
Skip Indicator	0000
Message Type	00111010
Page Mode	
- Page Mode	Normal Paging.
Request Reference	Pertaining to last Channel Request sent by the MS.
Wait Indication	0 seconds.
Request Reference	Not pertaining to the MS under test.
Wait Indication	0 seconds.
Request Reference	Not pertaining to the MS under test.
Wait Indication	0 seconds.
Request Reference	Not pertaining to the MS under test.
Wait Indication	0 seconds.
IAR rest octets	Not used (all bits set to spare).

Contents of LOCATION UPDATING REQUEST message:

Protocol Discriminator	MM message.
Skip Indicator	0000
Message Type	0X001000
Other information elements	Not checked.

Contents of PAGING REQUEST TYPE 1 message:

L2 pseudo length	This is the sum of the lengths of all the information elements present in the message except for the P1 rest octets and L2 pseudo length IEs. For the default message the L2 pseudo length is 9.
Protocol Discriminator	RR Management.
Skip Indicator	0000
Message Type	00100001
Page Mode	
- Page Mode	Normal Paging.
Channels needed	
- first channel	any channel.
- second channel	any channel.
Mobile Identity 1	
- odd/even indication	Even.
- Type of Identity	TMSI.
- Identity Digits	TMSI previously allocated to MS.
Mobile Identity 2	Not present.
P1 rest octets	Not used (all bits set to spare).

Contents of PAGING REQUEST TYPE 2 message:

L2 pseudo length	This is the sum of the lengths of all the information elements present in the message except for the P2 rest octets and L2 pseudo length IEs. For the default message the L2 pseudo length is 11.
Protocol Discriminator	RR Management..
Skip Indicator	0000
Message Type	00100010
Page Mode	
- Page Mode	Normal Paging.
Channels needed	
- first channel	any channel.
- second channel	any channel.
Mobile Identity 1	
- TMSI value	TMSI previously allocated to MS.
Mobile Identity 2	
- TMSI value	TMSI not allocated to MS.
Mobile Identity	Not present.
P2 rest octets	Not used (all bits set to spare).

Contents of PAGING REQUEST TYPE 3 message:

L2 pseudo length	19
Protocol Discriminator	RR Management.
Skip Indicator	0000
Message Type	00100100
Page Mode	
- Page Mode	Normal Paging.
Channels needed	
- first channel	any channel.
- second channel	any channel.
Mobile identity 1	
- TMSI value	TMSI previously allocated to MS.
Mobile identity 2	
- TMSI value	TMSI not allocated to MS.
Mobile identity 3	
- TMSI value	TMSI not allocated to MS.
Mobile identity 4	
- TMSI value	TMSI not allocated to MS.
P3 rest octets	Not used (all bits set to spare).

Contents of PAGING RESPONSE message:

Protocol Discriminator	RR Management.
Skip Indicator	0000
Message Type	00100111
Ciphering Key Sequence Number	
- Key Sequence	Key sequence number previously allocated to MS, or "111" if no key is available.
Mobile Station Classmark 2	
Mobile Identity	
- odd/even indication	Even
- Type of identity	TMSI
- Identity Digits	TMSI previously allocated to MS.

Contents of PHYSICAL INFORMATION message:

Protocol Discriminator	RR Management.
Skip Indicator	0000
Message Type	00101101
Timing advance	20 bit periods.

Contents of SETUP message; (MS to SS):

Protocol Discriminator	Call Control.
Transaction Identifier	
TI value	any value from the set {0, ..., 6}.
TI flag	0
Message Type	0X000101
Other information elements	Not checked.

26.6.15 Default contents of DCS 1 800 layer 3 messages for RR tests

This section contains the default values of DCS 1 800 L3 messages, which unless indicated otherwise in section 26.6 shall be transmitted by the system simulator and which are required to be received from the DCS 1 800 MS under test. These values are used in order to be consistent with the phase 2 version of 26.6.

The necessary L3 messages are listed in alphabetic order, with the exception of the SYSTEM INFORMATION messages, where it is the information elements which are listed in alphabetic order (this is because some information elements occur in several SYSTEM INFORMATION types).

In this section, decimal values are normally used. However, sometimes a hexadecimal value, indicated by an "H", or a binary value, indicated by a "B" is used.

Default SYSTEM INFORMATION:

NOTE 1: SYSTEM INFORMATION 2 bis, SYSTEM INFORMATION 7, and SYSTEM INFORMATION 8 messages are not used.

SYSTEM INFORMATION 5 bis is not sent as a default message. For those tests which require SYSTEM INFORMATION 5 bis see the specific message contents for that test.

Cell A

Contents of information elements in SYSTEM INFORMATION TYPE 1 to 6 messages for cell A.

(CBCH) Channel Description	Not present.
(CBCH) Mobile Allocation	Not present.
Cell Channel Description	
- Format identifier	Range 512.
- Cell Allocation ARFCN	Channel Numbers, 590, 650, 750 and 850.
Cell Identity	
- Cell Identity Value	0001H
Cell Options	
- Power Control Indicator	Power Control Indicator is not set, 0
- DTX Indicator	MS shall not use DTX.
- Radio_Link_Timeout	8 SACCH blocks.
Cell Selection Parameters	
- Cell_Reselect_Hysteresis	12 dB
- MX_TXPWR_MAX_CCH	Minimum level.
- ACS	No addition cell parameters are present in SYSTEM INFORMATION messages 7 and 8.
- NECI	New establishment causes not supported.
- RXLEV_ACCESS_MIN	Minimum level.
Control Channel Description	
- Attach-Detach allowed	MS shall not apply.
- BS_AG_BLK_RES	0 blocks reserved for access grant.
- CCCH_CONF	1 basic physical channel used for CCCH, combined with SDCCHs.
- BS_PA_MFRMS	5 multiframe periods for transmission of paging messages.
- T3212 Time-out value	Infinite.
L2 pseudo length	
- System information 1	21
- System information 2	22
- System information 3	18
- System information 4	12
Location Area Identification	
- Mobile Country Code	001 decimal.
- Mobile Network Code	01 decimal.
- Location Area Code	0001H
Message Type	
- System information 1	00011001
- System information 2	00011010
- System information 3	00011011
- System information 4	00011100
- System information 5	00011101
- System information 6	00011110
Neighbour Cells Description	
- Format identifier	Range 512.
- BCCH Allocation Sequence	0
- BCCH Allocation ARFCN	Channels numbers, 520, 590, 600, 700, 780, 810, 870.
- EXT-IND	This IE carries the complete BA. EXT-IND is 0.
NCC Permitted	0000 0010
RACH Control Parameters	
- Max Retrans	Max 1 retrans.
- Tx-integer	5 slots used.
- Cell Barred for Access	Cell is not barred.
- Call Reestablishment Allowed	Not Allowed.
- Access Control Class	Access is not barred.
- Emergency Call allowed	Yes.
SI 1 rest octets	Not used (all bits are set to spare).
SI 2 rest octets	Not used (all bits are set to spare).
SI 3 rest octets	Not used (all bits are set to spare).
SI 4 rest octets	Not used (all bits are set to spare).

Default settings for cell A:

Downlink input level Uplink output power Propagation profile BCCH/CCCH carrier number	63 dBmicroVolt emf(). minimum supported by the MS's power class static. ARFN 590.
--	--

Cell B

The contents of SYSTEM INFORMATION TYPE 1 to 6 messages for cell B are identical to those of cell A with the following exceptions:

Cell Channel Description - Format Identifier - Cell Allocation ARFCN	Range 512. Channel Number 520.
--	-----------------------------------

NOTE 2: This IE needs modification when used in handover tests which command the MS to go to a frequency hopping channel in cell B.

Cell Identity - Cell Identity Value	0002H
--	-------

Default settings for cell B:

Downlink input level Uplink output power Propagation profile BCCH/CCCH carrier number	53 dBmicroVolt emf(). minimum supported by the MS's power class static. 520
--	--

Contents of ALERTING message (SS to MS):

Protocol Discriminator Transaction Identifier TI value TI flag Message Type All other information elements	Call Control. As used in the SETUP message. 1 (destination side). 00000001 Not present.
---	---

Contents of ASSIGNMENT COMMAND message:

Protocol Discriminator Skip Indicator Message Type Channel Description - Channel Type and TDMA offset - Timeslot Number - Training Sequence Code - Hopping - ARFCN Power Command - Power level All other information elements	RR Management. 0000 00101110 Bm + ACCHs. Chosen arbitrarily by the test house. Chosen arbitrarily by the test house. Single RF channel. Channel number 650. Chosen arbitrarily by the test house. Not present.
--	---

Contents of ASSIGNMENT COMPLETE message:

Protocol Discriminator Skip Indicator Message Type RR Cause - RR Cause Value	RR Management. 0000 00101001 Normal event.
--	---

Contents of ASSIGNMENT FAILURE message:

Protocol Discriminator	RR Management.
Skip Indicator	0000
Message Type	00101111
RR Cause	
- RR Cause Value	Depending on test.

Contents of AUTHENTICATION REQUEST message:

Protocol Discriminator	MM message.
Skip Indicator	0000
Message Type	00010010
Ciphering Key Sequence Number	
- Key Sequence	Chosen arbitrarily by the test house from the range 0 to 6.
Authentication Parameter RAND	
- RAND value	Chosen arbitrarily by the test house.

Contents of AUTHENTICATION RESPONSE message:

Protocol Discriminator	MM message.
Skip Indicator	0000
Message Type	0X010100
Other information element(s)	Not checked.

Contents of CALL PROCEEDING message:

Protocol Discriminator	Call Control.
Transaction Identifier	
TI value	As used in the SETUP message.
TI flag	1 (destination side).
Message Type	00000010
All other information elements	Not present.

Contents of CHANNEL MODE MODIFY message:

Protocol Discriminator	RR Management.
Skip Indicator	0000
Message Type	00010000
Channel Description	
- Channel Type and TDMA offset	Depending on test.
- Timeslot Number	Chosen arbitrarily by the test house.
- Training Sequence Code	Chosen arbitrarily by the test house.
- Hopping	Single RF channel.
- ARFCN	Channel number 650.
Channel Mode	
- Mode	Depending on test.

Contents of CHANNEL MODE MODIFY ACKNOWLEDGE message:

Protocol Discriminator	RR Management.
Skip Indicator	0000
Message Type	00010111
Channel Description	Depending on test.
- Channel Type and TDMA offset	Same as in the CHANNEL MODE MODIFY message.
- Timeslot Number	Same as in the CHANNEL MODE MODIFY message.
- Training Sequence Code	Single RF channel.
- Hopping	Band number 0.
- Frequency Band	Channel number 650.
- ARFCN	
Channel Mode	
- Mode	Same as in the CHANNEL MODE MODIFY message.

Contents of CHANNEL RELEASE message:

Protocol Discriminator	RR Management.
Skip Indicator	0000
Message Type	00001101
RR Cause	
- RR Cause Value	Normal event.

Contents of CHANNEL REQUEST message:

Establishment Cause	Not checked.
Random Reference	Not checked.

Contents of CIPHERING MODE COMMAND message:

Protocol Discriminator	RR Management.
Skip Indicator	0000
Message Type	00110101
Cipher Mode Setting	
- algorithm identifier	cipher with A5/1.
- SC	Start ciphering.
Cipher Response	IMEI shall not be included.

Contents of CIPHERING MODE COMPLETE message:

Protocol Discriminator	RR Management.
Skip Indicator	0000
Message Type	00110010
Mobile Identity	Not present.

Contents of the CLASSMARK CHANGE message:

Protocol Discriminator	RR Management.
Skip Indicator	0000
Message Type	000100110
Mobile Station Classmark 2	
- RF Power Capability	See PICS/PIXIT.
- Frequency Capability	Set to 0.
Mobile Station Classmark 3	For presence and contents see PICS/PIXIT.

Contents of CM SERVICE ACCEPT message:

Protocol Discriminator	Mobility Management.
Skip Indicator	0000
Message Type	00100001

Contents of CM SERVICE REQUEST message:

Protocol Discriminator	Mobility Management.
Skip Indicator	0000
Message Type	0X100100
Other information elements	Not checked.

Contents of CONNECT message (SS to MS):

Protocol Discriminator	Call Control.
Transaction Identifier	
TI value	As used in the SETUP message.
TI flag	1
Message Type	00000111
All other information elements	Not present.

Contents of CONNECT ACKNOWLEDGE message (MS to SS):

Protocol Discriminator	Call Control.
Transaction Identifier	
TI value	As used in the SETUP message.
TI flag	0
Message Type	0X001111

Contents of HANDOVER ACCESS message:

Handover Reference	Equal to the value included in the Handover Command message.
--------------------	--

Contents of HANDOVER COMMAND message:

Protocol Discriminator	RR Management.
Skip Indicator	0000
Message Type	00101011
Cell Description	
- Network Colour Code	1
- Base station Colour Code	Corresponding to target cell
- BCCH Carrier Number	Set to the BCCH carrier number of cell B. (one of 520, 590, 600, 700, 780, 810 or 870).
Channel Description	
- Channel Type and TDMA offset	Bm + ACCHs.
- Timeslot Number	Chosen arbitrarily by the test house.
- Training Sequence Code	Chosen arbitrarily by the test house.
- Hopping	Single RF channel.
- ARFCN	Chosen arbitrarily by the test house from those supported on the target cell.
Handover Reference	
- Handover Reference Value	Chosen arbitrarily by the test house.
Power Command	
- Power level	Chosen arbitrarily by the test house.
All other information elements	Not present.

Contents of HANDOVER COMPLETE message:

Protocol Discriminator	RR Management.
Skip Indicator	0000
Message Type	00101100
RR cause	Normal event.
Time difference	Not present.

Contents of HANDOVER FAILURE message:

Protocol Discriminator	RR Management.
Skip Indicator	0000
Message Type	00101000
RR cause	Dependent on the test.

IDENTITY REQUEST

Information element	Value/remark
Identity type	IMEI
Spare half octet	0000

IDENTITY RESPONSE

Information element	Value/remark
Mobile identity	not checked

Contents of IMMEDIATE ASSIGNMENT message:

L2 pseudo length	This is the sum of the lengths of all the information elements present in the message except for the IA rest octets and L2 pseudo length IEs. For the default message the L2 pseudo length is 11.
Protocol Discriminator	RR Management.
Skip Indicator	0000
Message Type	00111111
Page Mode	
- Page Mode	Normal Paging.
Channel Description	
- Channel Type and TDMA offset	For non-combined CCCH/SDCCH (see initial conditions), SDCCH/8, with subchannel chosen arbitrarily by the test house For combined CCCH/SDCCH (default SS conditions), SDCCH/4, with subchannel chosen arbitrarily by the test house.
- Timeslot Number	For non-combined CCCH/SDCCH (see initial conditions), chosen arbitrarily by the test house; For combined CCCH/SDCCH (default SS conditions), SDCCH/4, timeslot zero.
- Training Sequence Code	For non-combined CCCH/SDCCH (see initial conditions), chosen arbitrarily by the test house; For combined CCCH/SDCCH (default SS conditions), SDCCH/4, TSC=5 (same as the BCC). Single RF channel.
- Hopping	For non-combined CCCH/SDCCH (see initial conditions), Channel number 650; For combined CCCH/SDCCH (default SS conditions), SDCCH/4, Channel number 590.
- ARFCN	Pertaining to last Channel Request sent by the MS.
Request Reference	
Timing Advance	
- Timing advance value	30 bit periods.
Mobile Allocation	
- Length	0
Starting Time	Not present.
IA rest octets	Not used (all bits set to spare).

Contents of IMMEDIATE ASSIGNMENT EXTENDED message:

L2 pseudo length	This is the sum of the lengths of all the information elements present in the message except for the IAX rest octets and L2 pseudo length IEs. For the default message the L2 pseudo length is 18.
Protocol Discriminator	RR Management.
Skip Indicator	0000
Message Type	00111001
Page Mode	Normal Paging.
- Page Mode	
Channel Description 1	For non-combined CCCH/SDCCH (see test conditions), SDCCH/8, with subchannel chosen arbitrarily by the test house; For combined CCCH/SDCCH (default SS conditions), SDCCH/4, with subchannel chosen arbitrarily by the test house.
- Channel Type and TDMA offset	
	For non-combined CCCH/SDCCH (see test conditions), chosen arbitrarily by the test house; For combined CCCH/SDCCH (default SS conditions), SDCCH/4, timeslot zero.
- Timeslot Number	
	For non-combined CCCH/SDCCH (see initial conditions), chosen arbitrarily by the test house; For combined CCCH/SDCCH (default SS conditions), SDCCH/4, TSC=5 (same as the BCC). Single RF channel.
- Training Sequence Code	
	For non-combined CCCH/SDCCH (see initial conditions), Channel number 650; For combined CCCH/SDCCH (default SS conditions), SDCCH/4, Channel number 590.
- Hopping	
- ARFCN	
Request Reference 1	Pertaining to last Channel Request sent by the MS.
Timing Advance 1	Chosen arbitrarily by the test house.
- Timing advance value	
Channel Description 2	Same channel type as in Channel Description 1, but different TDMA offset to that in Channel Description 1.
- Channel Type and TDMA offset	
	equal to the value in Channel Description 1.
- Timeslot Number	
- Training Sequence Code	equal to the value in Channel Description 1.
- Hopping	Single RF channel.
- ARFCN	equal to the value in Channel Description 1.
Request Reference 2	Not pertaining to any Channel Requests sent by the MS.
Timing Advance 2	Chosen arbitrarily by the test house.
- Timing advance value	
Mobile Allocation	0
- Length	
Starting Time	Not present.
IAX rest octets	Not used (all bits set to spare).

Contents of IMMEDIATE ASSIGNMENT REJECT message:

L2 pseudo length	19
Protocol Discriminator	RR Management.
Skip Indicator	0000
Message Type	00111010
Page Mode	
- Page Mode	Normal Paging.
Request Reference	Pertaining to last Channel Request sent by the MS.
Wait Indication	0 seconds.
Request Reference	Not pertaining to the MS under test.
Wait Indication	0 seconds.
Request Reference	Not pertaining to the MS under test.
Wait Indication	0 seconds.
Request Reference	Not pertaining to the MS under test.
Wait Indication	0 seconds.
IAR rest octets	Not used (all bits set to spare).

Contents of LOCATION UPDATING REQUEST message:

Protocol Discriminator	MM message.
Skip Indicator	0000
Message Type	0X001000
Other information elements	Not checked.

Contents of PAGING REQUEST TYPE 1 message:

L2 pseudo length	This is the sum of the lengths of all the information elements present in the message except for the P1 rest octets and L2 pseudo length IEs. For the default message the L2 pseudo length is 9.
Protocol Discriminator	RR Management.
Skip Indicator	0000
Message Type	00100001
Page Mode	
- Page Mode	Normal Paging.
Channels needed	
- first channel	any channel.
- second channel	any channel.
Mobile Identity 1	
- odd/even indication	Even.
- Type of Identity	TMSI.
- Identity Digits	TMSI previously allocated to MS.
Mobile Identity 2	Not present.
P1 rest octets	Not used (all bits set to spare).

Contents of PAGING REQUEST TYPE 2 message:

L2 pseudo length	This is the sum of the lengths of all the information elements present in the message except for the P2 rest octets and L2 pseudo length IEs. For the default message the L2 pseudo length is 11.
Protocol Discriminator	RR Management.
Skip Indicator	0000
Message Type	00100010
Page Mode	
- Page Mode	Normal Paging.
Channels needed	
- first channel	any channel.
- second channel	any channel.
Mobile Identity 1	
- TMSI value	TMSI previously allocated to MS.
Mobile Identity 2	
- TMSI value	TMSI not allocated to MS.
Mobile Identity	Not present.
P2 rest octets	Not used (all bits set to spare).

Contents of PAGING REQUEST TYPE 3 message:

L2 pseudo length	19
Protocol Discriminator	RR Management.
Skip Indicator	0000
Message Type	00100100
Page Mode	
- Page Mode	Normal Paging.
Channels needed	
- first channel	any channel.
- second channel	any channel.
Mobile identity 1	
- TMSI value	TMSI previously allocated to MS.
Mobile identity 2	
- TMSI value	TMSI not allocated to MS.
Mobile identity 3	
- TMSI value	TMSI not allocated to MS.
Mobile identity 4	
- TMSI value	TMSI not allocated to MS.
P3 rest octets	Not used (all bits set to spare).

Contents of PAGING RESPONSE message:

Protocol Discriminator	RR Management.
Skip Indicator	0000
Message Type	00100111
Ciphering Key Sequence Number	
- Key Sequence	Key sequence number previously allocated to MS, or "111" if no key is available.
Mobile Station Classmark 2	
Mobile Identity	
- odd/even indication	Even.
- Type of identity	TMSI
- Identity Digits	TMSI previously allocated to MS.

Contents of PHYSICAL INFORMATION message:

Protocol Discriminator	RR Management.
Skip Indicator	0000
Message Type	00101101
Timing advance	20 bit periods.

Contents of SETUP message; (MS to SS):

Protocol Discriminator	Call Control.
Transaction Identifier	
TI value	any value from the set {0, ..., 6}.
TI flag	0
Message Type	0X000101
Other information elements	Not checked.

26.7 Elementary procedures of mobility management

The tests are based on GSM 04.08 and GSM 03.03.

In this section, when the expected sequence require that "a mobile originated CM connection is attempted", it shall be for a service other than emergency call.

In this section, a initial CM message is either a SETUP message, a REGISTER message or a CP-DATA message (in that case the acknowledged mode of operation on SAPI 3 will have be established and this message will be sent on SAPI 3).

26.7.1 TMSI reallocation

The intention of the TMSI Reallocation procedure is to assign a new temporary identity for the MS. If the message is not understood by the MS, the network could not establish a link to the MS. As this is a common MM procedure, it can be initiated at any time.

26.7.1.1 Conformance requirement

- 1) A Mobile Station shall acknowledge a new TMSI when explicitly allocated during a location updating procedure or an incoming call.
- 2) The TMSI shall be updated on the SIM when the Mobile Station is correctly deactivated in accordance with the manufacturer's instructions.
- 3) A Mobile Station shall answer paging with this TMSI and includes it in the Paging Response message.

Reference(s):

GSM 04.08 section 4.3.1, GSM 03.03 section 2, GSM 02.17 section 6.1.

26.7.1.2 Test purpose

To verify that the MS is able to receive and acknowledge a new TMSI by means of an explicit TMSI reallocation procedure.

To verify that the MS has stored the TMSI in a non-volatile memory.

The implicit reallocation procedure is tested in section 26.7.4.1.

26.7.1.3 Method of test

Initial conditions

System Simulator:

Two cells A and B, belonging to different location areas a and b, default parameters.

Mobile Station:

The MS has valid TMSI (= TMSI1), CKSN, Kc. It is "idle updated" on cell B.

Related PICS/PIXIT statement(s)

Switch off button Yes/No.

Way to bring the MS into service.

Foreseen final state of the MS

The MS has a valid TMSI (= TMSI1), CKSN, Kc. It is "idle updated" on cell A.

Test Procedure

The MS is paged in cell B and the ciphering mode is established. An explicit TMSI reallocation procedure is performed. The channel is released. The MS is switched off and then its power supply is interrupted for 10 seconds. The power supply is resumed and then the MS is switched on. The system simulator checks, by paging, whether the MS has stored the received TMSI.

The MS is made to select cell A. A normal location updating procedure is performed in cell A. An explicit TMSI reallocation procedure is performed and then the location updating procedure is accepted by the SS. The system simulator checks, by paging, whether the MS has stored the allocated TMSI.

Maximum duration of test

2 minutes.

Expected sequence

Step	Direction	Message	Comments
1	SS -> MS	PAGING REQUEST TYPE 1	The following messages are sent and shall be received on cell B.
2	MS -> SS	CHANNEL REQUEST	"Mobile identity" = TMSI1.
3	SS -> MS	IMMEDIATE ASSIGNMENT	Establishment Cause: Answer to paging.
4	MS -> SS	PAGING RESPONSE	
5	SS -> MS	CIPHERING MODE COMMAND	The SS starts deciphering.
6	MS -> SS	CIPHERING MODE COMPLETE	The SS starts enciphering.
7	SS -> MS	TMSI REALLOCATION COMMAND	"Mobile identity" = new TMSI (TMSI2) different from TMSI 1.
8	MS -> SS	TMSI REALLOCATION COMPLETE	
9	SS -> MS	CHANNEL RELEASE	After the sending of this message, the SS waits for the disconnection of the main signalling link.
10	MS		If possible (see PICS), the MS is switched off.
10a	MS		The power supply is interrupted for 10 seconds.
11	MS		The MS is brought into service.
12	SS		The SS waits an amount of time which is enough to guarantee that the MS is in service (listening to its paging subchannel).
13	SS -> MS	PAGING REQUEST TYPE 1	"Mobile identity" = TMSI2.
14	MS -> SS	CHANNEL REQUEST	Establishment Cause: Answer to paging.
15	SS -> MS	IMMEDIATE ASSIGNMENT	
16	MS -> SS	PAGING RESPONSE	"Mobile identity" = TMSI2.
17	SS -> MS	CHANNEL RELEASE	After the sending of this message, the SS waits for the disconnection of the main signalling link. The following messages are sent and shall be received on cell A
18	SS		The RF level of cell B is lowered until the MS selects cell A. The RF level of cell B is set sufficiently low to ensure that cell B is not suitable as defined in GSM 05.08 section 6.6.2.
19	MS -> SS	CHANNEL REQUEST	Establishment cause: Location updating.
20	SS -> MS	IMMEDIATE ASSIGNMENT	
21	MS -> SS	LOCATION UPDATING REQUEST	location updating type = normal, "ciphering key sequence number" = CKSN, LAI = b, "mobile identity" = TMSI2.
22	SS -> MS	TMSI REALLOCATION COMMAND	TMSI = TMSI1.
23	MS -> SS	TMSI REALLOCATION COMPLETE	
24	SS -> MS	LOCATION UPDATING ACCEPT	This message does not contain the optional Mobile Identity field.
25	SS -> MS	CHANNEL RELEASE	After the sending of this message, the SS waits for the disconnection of the main signalling link. The SS waits an amount of time which is enough to guarantee that the MS is "idle updated" on cell A.
26	SS -> MS	PAGING REQUEST TYPE 1	"Mobile identity" IE contains the new TMSI (= TMSI1).
27	MS -> SS	CHANNEL REQUEST	"Establishment cause": Answer to paging.
28	SS -> MS	IMMEDIATE ASSIGNMENT	
29	MS -> SS	PAGING RESPONSE	"Mobile identity" IE contains the new TMSI (= TMSI1).
30	SS -> MS	CHANNEL RELEASE	After the sending of this message, the SS waits for the disconnection of the main signalling link.

Specific message contents:

None.

26.7.2 Authentication

The purpose of this procedure is to verify the user identity. A correct response is essential to guarantee the establishment of the connection. If not, the connection will drop.

The SS shall be able to handle vectors of Kc, RAND, and SRES in a similar way as the MSC/BSS entities. The SS shall incorporate a test algorithm for generating SRES and Kc from RAND and Ki which operates as described in annex 4.

26.7.2.1 Authentication accepted**26.7.2.1.1 Conformance requirement**

- 1) A Mobile Station shall correctly respond to an Authentication Request message by sending an Authentication Response message with the SRES information field set to the same value as the one produced by the authentication algorithm in the network.
- 2) A Mobile Station shall indicate in a Paging Response message the ciphering key sequence number which was allocated to it through the authentication procedure.

Reference(s)

GSM 04.08 section 4.3.2, GSM 03.03 section 2.

26.7.2.1.2 Test purpose

- 1) To check that a Mobile Station correctly responds to an Authentication Request message by sending an Authentication Response message with the SRES information field set to the same value as the one produced by the authentication algorithm in the network.
- 2) To check that a Mobile Station indicates in a Paging Response message the ciphering key sequence number which was allocated to it through the authentication procedure.

26.7.2.1.3 Method of test**Initial conditions**

System Simulator:
1 cell, default parameters.

Mobile Station:
The MS has valid TMSI, CKSN (CKSN1), Kc. It is "idle updated" on the cell.

Related PICS/PIXIT statement(s)

None.

Foreseen final state of the MS

The MS has valid TMSI, CKSN and Kc. It is "idle updated" on the cell.

Test Procedure

The MS is paged. After the MS has sent a PAGING RESPONSE message to the SS, the SS initiates an authentication procedure and checks the value SRES sent by the MS in the AUTHENTICATION RESPONSE message. The channel is released. The MS is paged and the SS checks the value of the ciphering key sequence number sent by the MS in the PAGING RESPONSE message.

Maximum duration of test

1 minute.

Expected sequence

Step	Direction	Message	Comments
1	SS -> MS	PAGING REQUEST TYPE 1	
2	MS -> SS	CHANNEL REQUEST	Establishment Cause: Answer to paging.
3	SS -> MS	IMMEDIATE ASSIGNMENT	
4	MS -> SS	PAGING RESPONSE	CKSN = CKSN1
5	SS -> MS	AUTHENTICATION REQUEST	The SS initiates authentication with CKSN2 different from CKSN1.
6	MS -> SS	AUTHENTICATION RESPONSE	"Auth. parameter SRES" IE shall be bit exact with the value as produced by the authentication algorithm.
7	SS -> MS	CHANNEL RELEASE	After the sending of this message, the SS waits for the disconnection of the main signalling link. The SS waits an amount of time which is enough to guarantee that the MS is in service.
8	SS -> MS	PAGING REQUEST TYPE 1	
9	MS -> SS	CHANNEL REQUEST	Establishment Cause: Answer to paging.
10	SS -> MS	IMMEDIATE ASSIGNMENT	
11	MS -> SS	PAGING RESPONSE	"Ciphering key sequence number" shall be the same as the value that was sent in the last AUTHENTICATION REQUEST message (= CKSN2).
12	SS -> MS	CHANNEL RELEASE	After the sending of this message, the SS waits for the disconnection of the main signalling link.

Specific message contents:

None.

26.7.2.2 Authentication rejected**26.7.2.2.1 Conformance requirement**

- 1) After reception of an Authentication Reject message the Mobile Station shall:
 - 1.1 not perform normal location updating.
 - 1.2 not perform periodic location updating.
 - 1.3 not respond to paging with TMSI.
 - 1.4 reject any request from CM entity for MM connection except for emergency call.
 - 1.5 not perform IMSI detach if deactivated.
- 2) After reception of an Authentication Reject message the Mobile Station, if it supports speech, shall accept a request for an emergency call by sending a CHANNEL REQUEST message with the establishment cause set to "emergency call" and include an IMEI as mobile identity in the CM SERVICE REQUEST message.
- 3) After reception of an Authentication Reject message the Mobile Station shall delete the stored LAI, CKSN and TMSI.

Reference(s)

GSM 04.08 sections 4.3.2.5.

26.7.2.2.2 Test purpose

- 1) To check that ,after reception of an Authentication Reject message, the Mobile Station:
 - 1.1 does not perform normal location updating.
 - 1.2 does not perform periodic location updating.
 - 1.3 does not respond to paging with TMSI.
 - 1.4 rejects any request from CM entity for MM connection except for emergency call.
 - 1.5 does not perform IMSI detach if deactivated.
- 2) To check that, after reception of an Authentication Reject message the Mobile Station, if it supports speech, accepts a request for an emergency call by sending a CHANNEL REQUEST message with the establishment cause set to "emergency call" and includes an IMEI as mobile identity in the CM SERVICE REQUEST message.
- 3) To check that, after reception of an Authentication Reject message and after having been deactivated and reactivated, the MS performs location updating using its IMSI as mobile identity and indicates deleted LAI and CKSN.

26.7.2.2.3 Method of test**Initial conditions**

System Simulator:

Two cells: A and B, belonging to different location areas a and b.

IMSI attach/detach is allowed in both cells.

The T3212 time-out value is 1/10 hour in both cells.

Mobile Station:

The MS has valid TMSI, CKSN (CKSN2) and Kc. It is "idle updated" on cell B.

Related PICS/PIXIT statement(s)

SIM removal possible while MS is powered Yes/No.

Switch off on button Yes/No.

Support of speech Yes/No.

Foreseen final state of the MS

The MS has valid TMSI, CKSN (CKSN1) and Kc. It is "idle updated" on cell A.

Test procedure

The SS rejects an authentication. The channel is released. The SS checks that the MS has entered the state MM IDLE substate NO IMSI, i.e. does not perform normal location updating, does not perform periodic updating, does not respond to paging, rejects any requests from CM entities except emergency calls and does not perform IMSI detach if SIM detachment is performed, switch off is performed, or the power is removed, depending on the MS (see PICS/PIXIT).

Maximum duration of test

10 minutes.

Expected sequence

Step	Direction	Message	Comments
The following messages are sent and shall be received on cell B			
1	SS -> MS	PAGING REQUEST TYPE 1	Establishment Cause: Answer to paging. "Ciphering key sequence number" shall be the same as the value that was sent in the last AUTHENTICATION REQUEST message (= CKSN2).
2	MS -> SS	CHANNEL REQUEST	
3	SS -> MS	IMMEDIATE ASSIGNMENT	
4	MS -> SS	PAGING RESPONSE	
5	SS -> MS	AUTHENTICATION REQUEST	
6	MS -> SS	AUTHENTICATION RESPONSE	
7	SS -> MS	AUTHENTICATION REJECT	After the sending of this message, the SS waits for the disconnection of the main signalling link.
8	SS -> MS	CHANNEL RELEASE	
9	SS -> MS	PAGING REQUEST TYPE 1	The MS is paged in cell B. "Mobile identity" IE contains TMSI.
10	MS		The MS shall ignore this message. This is verified during 3 seconds.
11	SS		The SS waits for at least for 15 s.
12	MS		A MO CM connection is attempted.
13	MS		The MS shall not initiate an RR connection establishment on cell A or cell B. This is checked during 3 seconds.
14	MS		If the MS supports speech (see PICS), an emergency call is attempted.
15	MS -> SS	CHANNEL REQUEST	"Establishment cause": Emergency call.
16	SS -> MS	IMMEDIATE ASSIGNMENT	"CM service type": Emergency call establishment. "Mobile identity": type of identity is set to IMEI.
17	MS -> SS	CM SERVICE REQUEST	
18	SS -> MS	CM SERVICE ACCEPT	"Cause" = unassigned number. After the sending of this message, the SS waits for the disconnection of the main signalling link.
19	MS -> SS	EMERGENCY SETUP	
20	SS -> MS	RELEASE COMPLETE	
21	SS -> MS	CHANNEL RELEASE	
The following messages are sent and shall be received on cell A.			
22	SS		The RF levels are changed to make the MS reselect the cell A.
23	MS		The MS performs cell reselection according to procedure as specified in GSM 05.08 (this however is not checked until step 29). The MS shall not initiate an RR connection establishment on cell A or on cell B.
24	SS		The SS waits at least 7 minutes for a possible periodic updating.
25	MS		The MS shall not initiate an RR connection establishment on cell A or on cell B.
26	MS		If possible (see PICS) SIM detachment is performed. Otherwise if possible (see PICS) switch off is performed. Otherwise the power is removed.
27	MS		The MS shall not initiate an RR connection establishment on cell A or on cell B. This is checked during 3 seconds.
28	MS		Depending on what has been performed in step 26 the MS is brought back to operation.
29	MS -> SS	CHANNEL REQUEST	"Establishment cause": Location updating.
30	SS -> MS	IMMEDIATE ASSIGNMENT	"location updating type" = normal, "CKSN" = no key available, "Mobile Identity" = IMSI, "LAI" = deleted LAI (the MCC and MNC hold the previous values, the LAC is coded FFFE).
31	MS -> SS	LOCATION UPDATING REQUEST	

32	SS -> MS	AUTHENTICATION REQUEST	"CKSN" = CKSN1.
33	MS -> SS	AUTHENTICATION RESPONSE	
34	SS -> MS	LOCATION UPDATING ACCEPT	"Mobile Identity" = TMSI.
35	MS -> SS	TMSI REALLOCATION COMPLETE	
36	SS -> MS	CHANNEL RELEASE	After the sending of this message, the SS waits for the disconnection of the main signalling link.

Specific message contents

None.

26.7.3 Identification

The purpose of this procedure is to check that the MS gives its identity as requested by the network. If this procedure does not work, it will not be possible for the network to rely on the identity claimed by the MS.

26.7.3.1 General Identification

26.7.3.1.1 Conformance requirement

- 1) When requested by the network the Mobile Station shall send its IMSI.
- 2) When requested by the network the Mobile Station shall send the TMSI which it was previously allocated.
- 3) When requested by the network the Mobile Station shall send its IMEI as stored in the Mobile Equipment.
- 4) When requested by the network the Mobile Station shall send its IMEISV as stored in the Mobile Equipment.

Reference(s)

GSM 04.08 sections 4.3.3.

26.7.3.1.2 Test purpose

- 1) To verify that the MS sends identity information as requested by the system in the following cases: IMSI and TMSI are requested in non-ciphered mode, IMEI is requested in ciphered mode.
- 2) To verify that the MS sends its IMEI, when requested to do so, in non-ciphered mode.
- 3) To verify that the MS sends its IMEISV, when requested to do so, in non-ciphered mode.

26.7.3.1.3 Method of test

26.7.3.1.3.1 Identification / test 1

Initial conditions

System Simulator:
1 cell, default values.

Mobile Station:
The MS has a valid TMSI. It is "idle updated" on the cell.

Related PICS/PIXIT statement(s)

IMEI of the ME.

Foreseen final state of the MS

The MS has a valid TMSI. It is "idle updated" on the cell.

Test Procedure

The SS requests identity information from the MS:

- IMSI in non ciphering mode,
- allocated TMSI in non ciphering mode,
- IMEI in ciphering mode.

Maximum duration of test

30 seconds.

Expected sequence

Step	Direction	Message	Comments
1	SS -> MS	PAGING REQUEST TYPE 1	Establishment Cause: Answer to paging.
2	MS -> SS	CHANNEL REQUEST	
3	SS -> MS	IMMEDIATE ASSIGNMENT	
4	MS -> SS	PAGING RESPONSE	"Identity type" IE is IMSI. "Mobile identity" IE specifies the IMSI of the MS.
5	SS -> MS	IDENTITY REQUEST	
6	MS -> SS	IDENTITY RESPONSE	"Identity type" IE is TMSI. "Mobile identity" IE specifies the allocated TMSI of the MS.
7	SS -> MS	IDENTITY REQUEST	
8	MS -> SS	IDENTITY RESPONSE	"Identity type" IE is IMEI. "Mobile identity" IE specifies the IMEI stored in the Mobile Equipment.
9	SS -> MS	CIPHERING MODE COMMAND	
10	MS -> SS	CIPHERING MODE COMPLETE	After the sending of this message, the SS waits for the disconnection of the main signalling link.
11	SS -> MS	IDENTITY REQUEST	
12	MS -> SS	IDENTITY RESPONSE	
13	SS -> MS	CHANNEL RELEASE	

Specific message contents:

None.

26.7.3.1.3.2 Identification / test 2**Initial conditions**

System Simulator:
1 cell, default values.

Mobile Station:
The MS has a valid TMSI. It is in "idle updated".

Related PICS/PIXIT statement(s)

IMEI of the ME.
IMEISV of the ME.

Foreseen final state of the MS

The MS has a valid TMSI. It is "idle updated".

Test Procedure

The SS requests identity information from the MS:

- IMEI in non ciphering mode;
- IMEISV in non ciphering mode.

Maximum duration of test

30 second;

Expected sequence

Step	Direction	Message	Comments	
1	SS -> MS	PAGING REQUEST TYPE 1	Establishment Cause: Answer to paging.	
2	MS -> SS	CHANNEL REQUEST		
3	SS -> MS	IMMEDIATE ASSIGNMENT		
4	MS -> SS	PAGING RESPONSE		
5	SS -> MS	IDENTITY REQUEST		"Identity type" IE is IMEI.
6	MS -> SS	IDENTITY RESPONSE		"Mobile identity" IE specifies the IMEI of the MS.
7	SS -> MS	IDENTITY REQUEST		"Identity type" IE is IMEIS.
8	MS -> SS	IDENTITY RESPONSE		"Mobile identity" IE specifies the IMEISV of the MS.
9	SS -> MS	CHANNEL RELEASE		After the sending of this message, the SS waits for the disconnection of the main signalling link.

Specific message contents:

None.

26.7.3.2 Handling of IMSI shorter than the maximum length

26.7.3.2.1 Conformance requirement

The MS shall be capable of handling an IMSI that is not of the maximum length.

Reference(s)

GSM 04.08 clause 10.5.1.4.

26.7.3.2.2 Test purpose

To check that the MS behaves correctly when activated with an IMSI of length less than the maximum length.

In this condition, the MS shall:

- perform location updating;
- answer to paging with IMSI;
- give the correct IMSI when asked by an IDENTITY REQUEST;
- attempt CM connection establishment when requested to;
- attempt call re-establishment when needed;
- attempt IMSI detach when needed;
- erase its TMSI when the IMSI is sent by the network in a LOCATION UPDATING ACCEPT or a TMSI REALLOCATION COMMAND message.

26.7.3.2.3 Method of test

Initial conditions

System Simulator:

- 1 cell, default values.
- IMSI attach/detach bit set to "1".

Mobile Station:

The MS has no valid TMSI.
It is "idle updated".
The IMSI has the value 001011234.

Related PICS/PIXIT statement(s)

On/Off switch - Yes/No.

Foreseen final state of MS

The MS has no valid TMSI. It is in "idle, updated".

Test Procedure

The MS is paged with its IMSI. The MS shall answer to paging and include the correct IMSI in the PAGING RESPONSE message. During call establishment, the SS asks for the IMSI of the MS. The MS shall answer by an IDENTITY RESPONSE message including the correct IMSI. During the active phase of the call, the SS stops sending valid SACCH frames. The MS performs call re-establishment. The MS shall include the correct IMSI in the CM RE-ESTABLISHMENT message. a TMSI REALLOCATION COMMAND including a TMSI is sent to the MS. The MS acknowledges this message. The call is release.

The MS is paged with its TMSI. The MS shall answer to paging and includes its TMSI in the PAGING RESPONSE message. During call establishment, the SS sends a TMSI REALLOCATION COMMAND including the IMSI to the MS. The MS shall acknowledge this message. The MS shall erase its TMSI. The call is released.

The MS is switched off or has its power source removed. The MS performs IMSI detach. The MS shall include the correct IMSI in the IMSI DETACH INDICATION message.

The MS is switched on or powered on. The MS performs IMSI attach. The MS shall include the correct IMSI in the LOCATION UPDATING REQUEST message. A TMSI is allocated to the MS.

The LAC of the cell is changed. The MS performs location updating. The SS includes the IMSI in the LOCATION UPDATING ACCEPT message.

A mobile originated CM connection is attempted. The MS shall include the correct IMSI in the CM SERVICE REQUEST message.

Maximum duration of test

5 minutes.

Expected sequence

Step	Direction	Message	Comments
1	SS -> MS	PAGING REQUEST TYPE 1	"mobile identity 1" contains IMSI of MS.
2	MS -> SS	CHANNEL REQUEST	Establishment cause: Answer to paging.
3	SS -> MS	IMMEDIATE ASSIGNMENT	
4	MS -> SS	PAGING RESPONSE	"mobile identity" contains the IMSI of the MS.
5	SS -> MS	IDENTITY REQUEST	"identity type" IE is IMSI.
6	MS -> SS	IDENTITY RESPONSE	"mobile identity" IE contains the IMSI of the MS.
7			The call is established using the sequence of the generic terminating call set-up procedure.
8	SS		The SS stops sending valid SACCH frames.
9	MS -> SS	CHANNEL REQUEST	
10	SS -> MS	IMMEDIATE ASSIGNMENT	
11	MS -> SS	CM REESTABLISHMENT REQUEST	"mobile identity" IE contains IMSI of the MS.
12	SS -> MS	TMSI REALLOCATION COMMAND	"mobile identity" contains a TMSI.
13	MS -> SS	TMSI REALLOCATION COMPLETE	
14	SS -> MS	CHANNEL RELEASE	After sending this message, the SS waits for the disconnection of the main signalling link.
15	SS -> MS	PAGING REQUEST TYPE 1	"mobile identity 1" contains TMSI of MS.
16	MS -> SS	CHANNEL REQUEST	Establishment cause: Answer to paging.
17	SS -> MS	IMMEDIATE ASSIGNMENT	
18	MS -> SS	PAGING RESPONSE	"mobile identity" contains the TMSI of the MS.
19	SS -> MS	AUTHENTICATION REQUEST	
20	MS -> SS	AUTHENTICATION RESPONSE	
21	SS -> MS	TMSI REALLOCATION COMMAND	"mobile identity" contains a IMSI of MS.
22	MS -> SS	TMSI REALLOCATION COMPLETE	
23	SS -> MS	CHANNEL RELEASE	
24	MS		If possible (see PICS) the MS is switched off, otherwise the MS has its power source removed.
25	MS -> SS	CHANNEL REQUEST	If the MS was switched off it performs IMSI detach.
26	SS -> MS	IMMEDIATE ASSIGNMENT	
27	MS -> SS	IMSI DETACH INDICATION	"mobile identity" contains IMSI of MS.
28	SS -> MS	CHANNEL RELEASE	
29	MS		The MS is switched on or has power restored.
30	MS -> SS	CHANNEL REQUEST	
31	SS -> MS	IMMEDIATE ASSIGNMENT	
32	MS -> SS	LOCATION UPDATING REQUEST	"mobile identity" contains IMSI of MS.
33	SS -> MS	LOCATION UPDATING ACCEPT	"mobile identity" contains a TMSI.
34	MS -> SS	TMSI REALLOCATION COMPLETE	
35	SS -> MS	CHANNEL RELEASE	
36	SS		The SS changes the LAC of the cell.
37	MS -> SS	CHANNEL REQUEST	Shall be sent within 35s of the LAC being changed.
38	SS -> MS	IMMEDIATE ASSIGNMENT	
39	MS -> SS	LOCATION UPDATING REQUEST	"mobile identity" contains TMSI of the MS.
40	SS -> MS	LOCATION UPDATING ACCEPT	"mobile identity" contains IMSI of the MS.
41	SS -> MS	CHANNEL RELEASE	
42	MS		a mobile originated CM connection is attempted.
43	MS -> SS	CHANNEL REQUEST	
44	SS -> MS	IMMEDIATE ASSIGNMENT	
45	MS -> SS	CM SERVICE REQUEST	"mobile identity" contains IMSI of the MS.

Specific message contents

None.

26.7.4 Location updating

This procedure is used to register the MS in the network. If it is not performed correctly, no call can be established.

26.7.4.1 Location updating / accepted**26.7.4.1.1 Conformance requirement**

1.
 - 1.1 If the network accepts a location updating from the Mobile Station and reallocates a TMSI in the Location Updating Accept message the Mobile Station shall acknowledge the reception of the new TMSI.
 - 1.2 The Mobile Station shall answer to paging with this TMSI and include it in a Paging Response message.
- 2 If the network accepts a location updating from the Mobile Station and the Location Updating Accept message contains neither TMSI nor IMSI, the Mobile Station shall answer to paging when addressed with the last allocated TMSI and include it in the Paging Response message.
3.
 - 3.1 If the network accepts a location updating from the Mobile Station by use of a Location Updating Accept message containing the IMSI of the Mobile Station, the Mobile Station shall not answer paging with the last allocated TMSI.
 - 3.2 The Mobile Station shall still answer paging with IMSI.
4. A mobile station that supports either:
only the primary GSM band P-GSM 900 (cf. GSM 05.05), or
only the DCS 1800 band (cf. GSM 05.05)

may ignore SYSTEM INFORMATION TYPE 2ter messages ; if it does so it shall assume that the SYSTEM INFORMATION TYPE 2 carries the complete BA, for selection of the cell , where it performs the location updating procedure .

This SYSTEM INFORMATION TYPE 2ter message may be sent by the network with either a L2 pseudo length of 18 or some other value.

see 04.08, section 9.1.34, and 3.2.2.1.

Reference(s)

GSM 04.08 section 4.4.4.6.

26.7.4.1.2 Test purpose

1)To test the behaviour of the MS if the network accepts the location updating of the MS.

For the network response three different cases are identified:

- 1.1) TMSI is allocated,
- 1.2) Location updating accept contains neither TMSI nor IMSI,

1.3) Location updating accept contains IMSI.

2) To verify that the MS, that supports only the primary GSM900 band or only the DCS1800 band is not disturbed by SYSTEM INFORMATION 2ter messages, with different values of L2pseudolength.

26.7.4.1.3 Method of test

26.7.4.1.3.1 Location Updating/accepted/test1

Initial conditions:

System Simulator:

Two cells, A and B, belonging to different location areas with location area identification a and b of the same PLMN.

IMSI attach/detach is allowed in both cells.

The T3212 time-out value is 1/10 hour in both cells.

Mobile Station:

The MS has a valid TMSI (=TMSI1) and CKSN (=CKSN1). It is "idle updated" on cell A.

Related PICS/PIXIT statement(s)

None.

Foreseen final state of the MS

The MS has no valid TMSI. It has valid CKSN and Kc. It is "idle, updated" on cell B.

Test Procedure

The MS is made to select cell B. A normal location updating with TMSI reallocation is performed in cell B. The channel is released. The SS checks, by paging, that the MS has stored the newly allocated TMSI. The channel is released. The MS is made to select cell A. A normal location updating is performed in cell A. The LOCATION UPDATING ACCEPT message contains neither IMSI nor TMSI. The SS checks, by paging, that the MS has kept the old TMSI. The channel is released. The MS is made to select cell B. A normal location updating is performed in cell B. The LOCATION UPDATING ACCEPT message contains an IMSI. The SS checks, by paging, that the MS has deleted its TMSI and responds to paging with IMSI.

Maximum duration of test

4 minutes.

Expected sequence

Step	Direction	Message	Comments
1	SS		The RF level of cell A is lowered until the MS selects cell B.
2	MS -> SS	CHANNEL REQUEST	"Establishment cause": Location updating.
3	SS -> MS	IMMEDIATE ASSIGNMENT	
4	MS -> SS	LOCATION UPDATING REQUEST	"location updating type" = normal, "CKSN" = CKSN1, "location area identification" = a, "mobile station classmark 1" as given by the PICS and "mobile identity" = TMSI1.
5	SS -> MS	LOCATION UPDATING ACCEPT	"Mobile identity" = new TMSI (=TMSI2), LAI = b.
6	MS -> SS	TMSI REALLOCATION COMPLETE	
7	SS -> MS	CHANNEL RELEASE	After the sending of this message, the SS waits for the disconnection of the main signalling link. The SS waits an amount of time which is enough to guarantee that the MS is in service.
8	SS -> MS	PAGING REQUEST TYPE 1	"Mobile identity" IE contains the new TMSI (= TMSI2).
9	MS -> SS	CHANNEL REQUEST	
10	SS -> MS	IMMEDIATE ASSIGNMENT	
11	MS -> SS	PAGING RESPONSE	"Mobile identity" IE contains the new TMSI (= TMSI2).
12	SS -> MS	CHANNEL RELEASE	After the sending of this message, the SS waits for the disconnection of the main signalling link.
13	SS		The RF level of cell B is lowered until the MS selects cell A.
14	MS -> SS	CHANNEL REQUEST	"Establishment cause": Location updating
15	SS -> MS	IMMEDIATE ASSIGNMENT	
16	MS -> SS	LOCATION UPDATING REQUEST	"location updating type" = normal, "CKSN" = CKSN1, "location area identification" = b, "mobile station classmark 1" as given by the PICS and "mobile identity" = TMSI2.
17	SS -> MS	LOCATION UPDATING ACCEPT	"Mobile identity" IE not included.
18	SS -> MS	CHANNEL RELEASE	After the sending of this message, the SS waits for the disconnection of the main signalling link. The SS waits an amount of time which is enough to guarantee that the MS is in service.
19	SS -> MS	PAGING REQUEST TYPE 1	"Mobile identity" IE contains the TMSI (= TMSI2).
20	MS -> SS	CHANNEL REQUEST	
21	SS -> MS	IMMEDIATE ASSIGNMENT	
22	MS -> SS	PAGING RESPONSE	"Mobile identity" IE contains the TMSI (=TMSI2).
23	SS -> MS	CHANNEL RELEASE	After the sending of this message, the SS waits for the disconnection of the main signalling link.
24	SS		The RF level of cell A is lowered until the MS selects cell B.
25	MS -> SS	CHANNEL REQUEST	"Establishment cause": Location updating.
26	SS -> MS	IMMEDIATE ASSIGNMENT	
27	MS -> SS	LOCATION UPDATING REQUEST	"location updating type" = normal, "CKSN" = CKSN1, "location area identification" = a, "mobile station classmark 1" as given by the PICS and "mobile identity" = TMSI2.
28	SS -> MS	LOCATION UPDATING ACCEPT	"Mobile identity" IE contains IMSI.
29	SS -> MS	CHANNEL RELEASE	After the sending of this message, the SS waits for the disconnection of the main signalling link. The SS waits an amount of time which is enough to guarantee that the MS is in service.
30	SS -> MS	PAGING REQUEST TYPE 1	"Mobile identity" IE contains the old TMSI (= TMSI2).

31	MS		The MS shall ignore this message. This is checked during 5 seconds.
32	SS -> MS	PAGING REQUEST TYPE 1	"Mobile identity" IE contains the IMSI.
33	MS -> SS	CHANNEL REQUEST	
34	SS -> MS	IMMEDIATE ASSIGNMENT	
35	MS -> SS	PAGING RESPONSE	"Mobile identity" IE contains the IMSI.
36	SS -> MS	CHANNEL RELEASE	After the sending of this message, the SS waits for the disconnection of the main signalling link.

Specific message contents:

None.

26.7.4.1.3.2 Location Updating/accepted/test2**Initial conditions:****System Simulator:**

Two cells, A and B, belonging to different location areas with location area identification a and b of the same PLMN.

System information2ter is broadcasted on the two cells (Cell A with L2pseudolength=18, Cell B with L2pseudolength=0) .

IMSI attach/detach is allowed in both cells.

The T3212 time-out value is 1/10 hour in both cells.

Mobile Station:

The MS has a valid TMSI (=TMSI1) and CKSN (=CKSN1). It is "idle updated" on cell A.

Related PICS/PIXIT statement(s)

None.

Foreseen final state of the MS

The MS has no valid TMSI. It has valid CKSN and Kc. It is "idle, updated" on cell B.

Test Procedure

The MS is made to select cell B. A normal location updating with TMSI reallocation is performed in cell B. The channel is released. The SS checks, by paging, that the MS has stored the newly allocated TMSI. The channel is released. The MS is made to select cell A. A normal location updating is performed in cell A. The LOCATION UPDATING ACCEPT message contains neither IMSI nor TMSI. The SS checks, by paging, that the MS has kept the old TMSI. The channel is released. The MS is made to select cell B. A normal location updating is performed in cell B. The LOCATION UPDATING ACCEPT message contains an IMSI. The SS checks, by paging, that the MS has deleted its TMSI and responds to paging with IMSI.

Maximum duration of test

4 minutes.

Expected sequence

Step	Direction	Message	Comments
1	SS		The RF level of cell A is lowered until the MS selects cell B.
2	MS -> SS	CHANNEL REQUEST	"Establishment cause": Location updating.
3	SS -> MS	IMMEDIATE ASSIGNMENT	
4	MS -> SS	LOCATION UPDATING REQUEST	"location updating type" = normal, "CKSN" = CKSN1, "location area identification" = a, "mobile station classmark 1" as given by the PICS and "mobile identity" = TMSI1.
5	SS -> MS	LOCATION UPDATING ACCEPT	"Mobile identity" = new TMSI (=TMSI2), LAI = b.
6	MS -> SS	TMSI REALLOCATION COMPLETE	
7	SS -> MS	CHANNEL RELEASE	After the sending of this message, the SS waits for the disconnection of the main signalling link. The SS waits an amount of time which is enough to guarantee that the MS is in service.
8	SS -> MS	PAGING REQUEST TYPE 1	"Mobile identity" IE contains the new TMSI (= TMSI2).
9	MS -> SS	CHANNEL REQUEST	
10	SS -> MS	IMMEDIATE ASSIGNMENT	
11	MS -> SS	PAGING RESPONSE	"Mobile identity" IE contains the new TMSI (= TMSI2).
12	SS -> MS	CHANNEL RELEASE	After the sending of this message, the SS waits for the disconnection of the main signalling link.
13	SS		The RF level of cell B is lowered until the MS selects cell A.
14	MS -> SS	CHANNEL REQUEST	"Establishment cause": Location updating
15	SS -> MS	IMMEDIATE ASSIGNMENT	
16	MS -> SS	LOCATION UPDATING REQUEST	"location updating type" = normal, "CKSN" = CKSN1, "location area identification" = b, "mobile station classmark 1" as given by the PICS and "mobile identity" = TMSI2.
17	SS -> MS	LOCATION UPDATING ACCEPT	"Mobile identity" IE not included.
18	SS -> MS	CHANNEL RELEASE	After the sending of this message, the SS waits for the disconnection of the main signalling link. The SS waits an amount of time which is enough to guarantee that the MS is in service.
19	SS -> MS	PAGING REQUEST TYPE 1	"Mobile identity" IE contains the TMSI (= TMSI2).
20	MS -> SS	CHANNEL REQUEST	
21	SS -> MS	IMMEDIATE ASSIGNMENT	
22	MS -> SS	PAGING RESPONSE	"Mobile identity" IE contains the TMSI (=TMSI2).
23	SS -> MS	CHANNEL RELEASE	After the sending of this message, the SS waits for the disconnection of the main signalling link.
24	SS		The RF level of cell A is lowered until the MS selects cell B.
25	MS -> SS	CHANNEL REQUEST	"Establishment cause": Location updating.
26	SS -> MS	IMMEDIATE ASSIGNMENT	
27	MS -> SS	LOCATION UPDATING REQUEST	"location updating type" = normal, "CKSN" = CKSN1, "location area identification" = a, "mobile station classmark 1" as given by the PICS and "mobile identity" = TMSI2.
28	SS -> MS	LOCATION UPDATING ACCEPT	"Mobile identity" IE contains IMSI.
29	SS -> MS	CHANNEL RELEASE	After the sending of this message, the SS waits for the disconnection of the main signalling link. The SS waits an amount of time which is enough to guarantee that the MS is in service.
30	SS -> MS	PAGING REQUEST TYPE 1	"Mobile identity" IE contains the old TMSI (= TMSI2).

31	MS		The MS shall ignore this message. This is checked during 5 seconds.
32	SS -> MS	PAGING REQUEST TYPE 1	"Mobile identity" IE contains the IMSI.
33	MS -> SS	CHANNEL REQUEST	
34	SS -> MS	IMMEDIATE ASSIGNMENT	
35	MS -> SS	PAGING RESPONSE	"Mobile identity" IE contains the IMSI.
36	SS -> MS	CHANNEL RELEASE	After the sending of this message, the SS waits for the disconnection of the main signalling link.

Specific message contents:**SYSTEM INFORMATION TYPE 2ter Cell A :**

Information Element	Value/remark
L2 Pseudolength	18
Neighbour Cells Description 2	0
Multiband reporting	
For Cell A	
- Format notation	Range 512
- BA_IND	0
- BCCH Allocation ARFCN	ARFCN 520, 870 (for GSM 900 tests), ARFCN 43,85 (For GSM 1800 tests)
SI 2ter rest octets	Not used (All bits set to spare)

SYSTEM INFORMATION TYPE 2ter Cell B :

Information Element	Value/remark
L2 Pseudolength	0
Neighbour Cells Description 2	0
Multiband reporting	
For Cell B	
- Format notation	Range 512
- BA_IND	0
- BCCH Allocation ARFCN	ARFCN 590, 810(for GSM 900 tests), ARFCN 44,86 (for GSM 1800 tests),
SI 2ter rest octets	Not used (All bits set to spare)

SYSTEM INFORMATION TYPE 3 Cell A and cell B :

Same as default content in 26.7.6 except :

Information Element	Value/remark
SI3 rest octets	All bits are set to spare except,
SI 2ter Indicator	System Information 2ter is available

26.7.4.2 Location updating / rejected

26.7.4.2.1 Location updating / rejected / IMSI invalid

26.7.4.2.1.1 Conformance requirement

- 1) If the network rejects a location updating from the Mobile Station with the cause "IMSI unknown in HLR", "Illegal MS" or "Illegal ME" the Mobile Station shall:
 - 1.1 not perform normal location updating;
 - 1.2 not perform periodic location updating;
 - 1.3 not respond to paging with IMSI;
 - 1.4 not respond to paging with TMSI;
 - 1.5 reject any request from CM entity for MM connection other than for emergency call;
 - 1.6 not perform IMSI detach if it is switched off or has its power source removed.
- 2) If the network rejects a location updating from the Mobile Station with the cause "IMSI unknown in HLR", "Illegal MS" or "Illegal ME" the Mobile Station, if it supports speech, shall accept a request for an emergency call by sending a Channel Request message with the establishment cause set to "emergency call" and include an IMEI as mobile identity in the CM SERVICE REQUEST message.
- 3) If the network rejects a location updating from the Mobile Station with the cause "IMSI unknown in HLR", "Illegal MS" or "Illegal ME" the Mobile Station shall delete the stored LAI, CKSN and TMSI.

Reference(s)

GSM 04.08 sections 4.4.4.7.

26.7.4.2.1.2 Test purpose

To test the behaviour of the MS if the network rejects the location updating of the MS with the cause "IMSI unknown in HLR", "illegal MS" or "Illegal ME".

26.7.4.2.1.3 Method of test

Initial conditions

System Simulator:

Two cells: A and B, belonging to different location areas of the same PLMN.
IMSI attach/detach is allowed in both cells.
The T3212 time-out value is 1/10 hour in both cells.

Mobile Station:

The MS has valid TMSI, CKSN and Kc. It is "idle updated" on cell A.

Related PICS/PIXIT statement(s)

SIM removal possible while the MS is powered Yes/No.

Switch off on button Yes/No.

Support for speech Yes/No.

Foreseen final state of the MS

The MS has valid TMSI, CKSN and Kc. It is "idle updated" on cell A.

Test Procedure

The SS rejects a normal location updating with the cause value "IMSI unknown in HLR". The channel is released. The SS checks that the MS has entered the state MM IDLE and the substate NO IMSI, i.e. does not perform normal location updating when a new cell of the same or another PLMN is entered, does not perform periodic updating, does not respond to paging, rejects any requests from CM entities except emergency calls and does not perform IMSI detach if it is switched off or has its power source removed.

The test is repeated with cause value "Illegal MS" and with cause value "Illegal ME".

Maximum duration of test

35 minutes.

Expected sequence

The sequence is executed for execution counter k = 1, 2, 3.

Step	Direction	Message	Comments
1	SS		The following messages are sent and shall be received on cell B. The RF level of cell A is lowered until the MS selects cell B.
2	MS -> SS	CHANNEL REQUEST	"Establishment cause": Location updating.
3	SS -> MS	IMMEDIATE ASSIGNMENT	
4	MS -> SS	LOCATION UPDATING REQUEST	
5	SS -> MS	LOCATION UPDATING REJECT	"Reject cause" IE is "IMSI unknown in HLR" for k = 1, "Illegal MS" for k = 2, "Illegal ME" for k = 3.
6	SS -> MS	CHANNEL RELEASE	After the sending of this message, the SS waits for the disconnection of the main signalling link.
7	SS		The following messages are sent and shall be received on cell A. The RF levels are then changed again to make the MS reselect the cell A.
8	MS		The MS performs cell reselection according to procedure as specified in GSM 05.08 (this however is not checked until step 18). The MS shall not initiate an RR connection establishment on cell A or on cell B.
9	SS		The SS waits at least 7 minutes for a possible periodic updating.
10	MS		The MS shall not initiate an RR connection establishment on cell A or on cell B.
11	SS -> MS	PAGING REQUEST TYPE 1	The MS is paged in cell A. "Mobile identity" IE contains IMSI.
12	MS		The MS shall ignore this message. This is verified during 3 seconds.
13	SS -> MS	PAGING REQUEST TYPE 1	The MS is paged in cell A. "Mobile identity" IE contains TMSI.
14	MS		The MS shall ignore this message. This is verified during 3 seconds.
15	MS		A MO CM connection is attempted.
16	MS		The MS shall not initiate an RR connection establishment on cell A or on cell B. This is checked during 3 seconds.
17	MS		If the MS supports speech (see PICS), it is made to perform an emergency call.
18	MS -> SS	CHANNEL REQUEST	"Establishment cause": Emergency call. This message is sent in cell A.
19	SS -> MS	IMMEDIATE ASSIGNMENT	
20	MS -> SS	CM SERVICE REQUEST	"CM service type": Emergency call establishment. "Mobile identity": type of identity is set to IMEI.
21	SS -> MS	CM SERVICE ACCEPT	
22	MS -> SS	EMERGENCY SETUP	
23	SS -> MS	RELEASE COMPLETE	"Cause" = unassigned number.
24	SS -> MS	CHANNEL RELEASE	After the sending of this message, the SS waits for the disconnection of the main signalling link.
25	MS		If possible (see PICS) SIM detachment is performed. Otherwise if possible (see PICS) switch off is performed. Otherwise the power is removed.
26	MS		The MS shall not initiate an RR connection establishment on cell A or on cell B. This is checked during 3 seconds.
27	MS		Depending on what has been performed in step 25 the MS is brought back to operation.
28	MS -> SS	CHANNEL REQUEST	"Establishment cause": Location updating.

29	SS -> MS	IMMEDIATE ASSIGNMENT	
30	MS -> SS	LOCATION UPDATING REQUEST	"location updating type" = normal, "CKSN" = no key available, "mobile station classmark 1" as given by the PICS, "Mobile Identity" = IMSI, "LAI" = deleted LAI (the MCC and MNC hold the previous values, the LAC is coded FFFE).
31	SS -> MS	AUTHENTICATION REQUEST	"CKSN" = CKSN1.
32	MS -> SS	AUTHENTICATION RESPONSE	
33	SS -> MS	LOCATION UPDATING ACCEPT	"Mobile Identity" = TMSI.
32	MS -> SS	TMSI REALLOCATION COMPLETE	
33	SS -> MS	CHANNEL RELEASE	After the sending of this message, the SS waits for the disconnection of the main signalling link.

Specific message contents:

None.

26.7.4.2.2 Location updating / rejected / PLMN not allowed**26.7.4.2.2.1 Conformance requirement**

- 1) If the network reject a location updating from the Mobile Station with the cause "PLMN not allowed" the Mobile Station shall:
 - 1.1 not perform periodic updating;
 - 1.2 not perform IMSI detach when switched off;
 - 1.3 not perform IMSI attach when switched on in the same location area;
 - 1.4 not perform normal location updating when in the same PLMN and when that PLMN is not selected manually;
 - 1.5 reject any request from CM entity for MM connection other than for emergency call.
- 2) If the network rejects a location updating from the Mobile Station with the cause "PLMN not allowed" the Mobile Station shall:
 - 2.1 perform normal location updating when a new PLMN is entered;
 - 2.2 accept a request for an emergency call, if it supports speech, by sending a Channel Request message with the establishment cause set to "emergency call".
- 3) If the network rejects a location updating from the Mobile Station with the cause "PLMN not allowed" and if after that the PLMN from which this rejection was received, is manually selected, the Mobile Station shall perform a normal location updating procedure.

Reference(s)

GSM 04.08 section 4.4.4.7.

26.7.4.2.2.2 Test purpose

To test the behaviour of the MS if the network rejects the location updating of the MS with the cause "PLMN not allowed".

26.7.4.2.2.3 Method of test**26.7.4.2.2.3.1 Location updating / rejected / PLMN not allowed / test 1****Initial conditions**

System Simulator:

One cell: C, belonging to PLMN1.

Two cells: A and B, belonging to different location areas a and b and belonging to PLMN2. PLMN2 is different from HPLMN and from PLMN1.

IMSI attach/detach is allowed in cells A and B but not in cell C.
The T3212 time-out value is 1/10 hour in cells A and B.

Mobile Station:

The MS has a valid TMSI. It is "idle updated" on cell C.
The MS is in manual mode for PLMN selection.

Related PICS/PIXIT statement(s)

SIM removal possible while the MS is powered Yes/No.
Switch off on button Yes/No.
The MS is automatically in automatic mode after switch on Yes/No.
Support for speech Yes/No.

Foreseen final state of the MS

The MS has a valid TMSI. It is "idle updated" on cell C. The MS is in automatic mode for PLMN selection.

Test Procedure

The SS rejects a normal location updating with the cause value "PLMN not allowed". The channel is released. The SS checks that the MS does not perform periodic updating, does not perform IMSI detach, does not perform IMSI attach if activated in the same location area, rejects any request for CM connection establishment other than emergency call, accepts a request for an emergency call and performs normal location updating only when a new PLMN is entered.

Maximum duration of test

12 minutes.

Expected sequence

Step	Direction	Message	Comments
1	MS		The following messages are sent and shall be received on cell B.
2	SS		The MS is switched off (or power is removed). The SS activates cells A and B and deactivates cell C. Cell B has a level higher by at least 5 dB than cell A.
3	MS		The MS is switched on. (or power is reapplied) If necessary the MS is put in manual selection mode. The MS shall offer the new PLMN as available to the user. The PLMN is manually selected. "Establishment cause": Location updating.
4	MS -> SS	CHANNEL REQUEST	
5	SS -> MS	IMMEDIATE ASSIGNMENT	
6	MS -> SS	LOCATION UPDATING REQUEST	
7	SS -> MS	LOCATION UPDATING REJECT	"Reject cause" = PLMN not allowed.
8	SS -> MS	CHANNEL RELEASE	After the sending of this message, the SS waits for the disconnection of the main signalling link.
9	SS		The SS waits for a possible periodic updating for 7 minutes.
10	MS		The MS shall not initiate an RR connection establishment on cell A or on cell B.
11	MS		If possible (see PICS) SIM detachment is performed. Otherwise if possible (see PICS) switch off is performed. Otherwise the power is removed.
12	MS		The MS shall not initiate an RR connection establishment on cell A or on cell B. This is checked during 3 seconds.
13	MS		Depending on what has been performed in step 11 the MS is brought back to operation. The MS is not made to select PLMN 2.
14	MS		The MS shall not initiate an RR connection establishment. This is checked during 3 seconds.
15	SS		The following message are sent and shall be received on cell A. The RF level of cell B is lowered to make the MS reselect cell A.
16	MS		No access to the network shall be registered by the SS within one minute.
17	MS		If the MS supports speech (see PICS) it is made to perform an emergency.
18	MS -> SS	CHANNEL REQUEST	"Establishment cause": Emergency call.
19	SS -> MS	IMMEDIATE ASSIGNMENT	
20	MS -> SS	CM SERVICE REQUEST	"CM service type" = Emergency call establishment.
21	SS -> MS	CM SERVICE ACCEPT	
22	MS -> SS	EMERGENCY SETUP	
23	SS -> MS	RELEASE COMPLETE	Cause IE: "unassigned number".
24	SS -> MS	CHANNEL RELEASE	After the sending of this message, the SS waits for the disconnection of the main signalling link.
25	MS		A MO CM connection is attempted.
26	MS		The MS shall not initiate an RR connection establishment. This is checked during 3 seconds.
27	MS		The following messages are sent and shall be received on cell C.
28	SS		The MS is switched off. The SS activates cell C and deactivates cells A and B.
29	MS		The MS is switched on. If necessary the MS is placed into the automatic mode.
30	MS -> SS	CHANNEL REQUEST	"Establishment cause": Location updating.

31	SS -> MS	IMMEDIATE ASSIGNMENT	"location updating type" = normal, "CKSN" = no key available, "LAI" = deleted LAI (the MCC and MNC hold the values of PLMN1, the LAC is coded FFFE)
32	MS -> SS	LOCATION UPDATING REQUEST	
33	SS -> MS	LOCATION UPDATING ACCEPT	"mobile identity" = IMSI.
34	MS -> SS	TMSI REALLOCATION COMPLETE	"Mobile identity" = TMSI.
35	SS -> MS	CHANNEL RELEASE	After the sending of this message, the SS waits for the disconnection of the main signalling link.

Specific message contents:

None.

26.7.4.2.2.3.2 Location updating / rejected / PLMN not allowed / test 2**Initial conditions**

System Simulator:

One cell C, belonging to PLMN1.

Two cells A and B, belonging to different location areas a and b and belonging to PLMN2. PLMN2 is different from HPLMN.

IMSI attach/detach is allowed in cells A and B but not in cell C.

The T3212 time-out value is 1/10 hour in cells A and B.

Mobile Station:

The MS has a valid TMSI. It is "idle updated" on cell C.

Related PICS/PIXIT statement(s)

SIM removal possible while MS is powered Yes/No.

Switch off on button Yes/No.

The MS is automatically in automatic mode after switch on Yes/No.

Foreseen final state of the MS

The MS has a valid TMSI. It is "idle, updated" on cell C.

The MS is in automatic mode for PLMN selection.

Test Procedure

The SS rejects a normal location updating with the cause value "PLMN not allowed". The channel is released. Then the PLMN from which this rejection was received is manually selected and the SS checks that a normal location updating is performed.

Maximum duration of test

5 minutes.

Expected sequence

Step	Direction	Message	Comments
1	MS		The following messages are sent and shall be received on cell B.
2	SS		The MS is switched off (or power is removed).
3	MS		The SS activates cells A and B and deactivates cell C. Cell B has a level higher by at least 5 dB than cell A.
3a	MS		The MS is switched on (or power is reapplied).
4	MS -> SS	CHANNEL REQUEST	If the MS is in manual mode, it shall offer the new PLMN as available to the user. In this case the PLMN is manually selected.
5	SS -> MS	IMMEDIATE ASSIGNMENT	"Establishment cause": Location updating.
6	MS -> SS	LOCATION UPDATING REQUEST	
7	SS -> MS	LOCATION UPDATING REJECT	"Reject cause" = PLMN not allowed.
8	SS -> MS	CHANNEL RELEASE	After the sending of this message, the SS waits for the disconnection of the main signalling link.
9	MS		The MS is made to search for PLMNs and the PLMN indicated by the SS is manually selected.
10	MS -> SS	CHANNEL REQUEST	"Establishment cause": Location updating.
11	SS -> MS	IMMEDIATE ASSIGNMENT	
12	MS -> SS	LOCATION UPDATING REQUEST	"location updating type" = normal, "CKSN" = no key available, "LAI" = deleted LAI (the MCC and MNC hold the values of PLMN1, the LAC is coded FFFE) "mobile identity" = IMSI.
13	SS -> MS	CHANNEL RELEASE	After the sending of this message, the SS waits for the disconnection of the main signalling link. The following messages are sent and shall be received on cell C.
14	MS		The MS is switched off.
15	SS		The SS activates cell C and deactivates cells A and B.
16	MS		The MS is switched on. If necessary, the MS is put into the automatic mode.
17	MS -> SS	CHANNEL REQUEST	"Establishment cause": Location updating.
18	SS -> MS	IMMEDIATE ASSIGNMENT	
19	MS -> SS	LOCATION UPDATING REQUEST	"location updating type" = normal, "CKSN" = no key available, "LAI" = deleted LAI (the MCC and MNC hold the values of PLMN1, the LAC is coded FFFE) "mobile identity" = IMSI.
20	SS -> MS	LOCATION UPDATING ACCEPT	"Mobile identity" = TMSI.
21	MS -> SS	TMSI REALLOCATION COMPLETE	
22	SS -> MS	CHANNEL RELEASE	After the sending of this message, the SS waits for the disconnection of the main signalling link.

Specific message contents:

None.

26.7.4.2.3 Location updating / rejected / location area not allowed

26.7.4.2.3.1 Conformance requirement

- 1) If the network rejects a location updating from the Mobile Station with the cause "Location Area not allowed" the Mobile Station shall:
 - 1.1 not perform periodic updating;
 - 1.2 not respond to paging with TMSI;

- 1.3 reject any request from CM entity for MM connection other than for emergency call;
 - 1.4 not perform IMSI detach.
- 2) If the network rejects a location updating from the Mobile Station with the cause "Location Area not allowed" the Mobile Station shall:
- 2.1 perform normal location updating when a new location area is entered;
 - 2.2 accept a request for an emergency call, if it supports speech, by sending a Channel Request message with the establishment cause set to "emergency call";
 - 2.3 delete the list of forbidden LAs after switch off (power off).

Reference(s)

GSM 04.08 sections 4.4.4.7.

26.7.4.2.3.2 Test purpose

To test the behaviour of the MS if the network rejects the location updating of the MS with the cause "Location Area not allowed".

To test that the MS deletes the list of forbidden LAs after switch off (power off).

26.7.4.2.3.3 Method of test

Initial conditions

System Simulator:

- Two cells: A and B, belonging to different location areas a and b.
- IMSI attach/detach is allowed in both cells.
- The T3212 time-out value is 1/10 hour in both cells.

Mobile Station:

- The MS has a valid TMSI. It is "idle updated" on cell A.

Related PICS/PIXIT statement(s)

- Switch off on button Yes/No.
- Support for speech Yes/No.
- Method to clear the list of forbidden location areas periodically.

Foreseen final state of the MS

The MS has a valid TMSI. It is "idle updated" on cell A.

Test Procedure

The SS rejects a normal location updating with the cause value "Location Area not allowed". The channel is released. The SS checks that the MS does not perform periodic updating, does not respond to paging with TMSI, rejects any requests from CM entities for MM-connections except emergency calls, does not perform IMSI detach, performs normal location updating when a new location area is entered and deletes the list of forbidden LAs when switched off.

Different types of MS may use different methods to periodically clear the list of forbidden location areas (e.g. every day at 12am). If the list is cleared while the test is being run, it may be necessary to re-run the test.

Maximum duration of test

12 minutes.

Expected sequence

Step	Direction	Message	Comments
1	SS		The following messages are sent and shall be received on cell B. The RF level of cell A is lowered so that cell B is selected, while keeping the C1 and C2 of cell A greater than 10.
2	MS -> SS	CHANNEL REQUEST	"Establishment cause": Location updating.
3	SS -> MS	IMMEDIATE ASSIGNMENT	
4	MS -> SS	LOCATION UPDATING REQUEST	
5	SS -> MS	LOCATION UPDATING REJECT	"Reject cause" = "Location Area not allowed".
6	SS -> MS	CHANNEL RELEASE	After the sending of this message, the SS waits for the disconnection of the mainsignalling link. The SS waits for a possible location updating for 7 minutes.
7	SS		
8	MS		The MS shall not initiate an RR-connection establishment either on cell A or cell B.
9	SS -> MS	PAGING REQUEST TYPE 1	The MS is paged in cell B. "Mobile identity" = TMSI.
10	MS		The MS shall ignore this message. This is checked during 3 seconds.
11	MS		A MO CM connection is attempted.
12	MS		The MS shall not initiate an RR connection establishment on cell A or cell B. This is checked during 3 seconds.
13	MS		If the MS supports speech (see PICS), it is made to perform an emergency call.
14	MS -> SS	CHANNEL REQUEST	"Establishment cause": Emergency call.
15	SS -> MS	IMMEDIATE ASSIGNMENT	
16	MS -> SS	CM SERVICE REQUEST	"CM service type": Emergency call establishment.
17	SS -> MS	CM SERVICE ACCEPT	
18	MS -> SS	EMERGENCY SETUP	
19	SS -> MS	RELEASE COMPLETE	Cause: "unassigned number".
20	SS -> MS	CHANNEL RELEASE	After the sending of this message, the SS waits for the disconnection of the main signalling link.
21	MS		If possible (see PICS) switch off is performed. Otherwise the power is removed.
22	MS		The MS shall not initiate an RR connection establishment on cell A or on cell B (check for IMSI detach) This is checked during 3 seconds.
23	MS		Depending on what has been performed in step 21 the MS is brought back to operation.
24	MS -> SS	CHANNEL REQUEST	"Establishment cause": Location updating.
25	SS -> MS	IMMEDIATE ASSIGNMENT	
26	MS -> SS	LOCATION UPDATING REQUEST	"location updating type" = normal, "CKSN" = no key available, "LAI" = deleted LAI, "mobile identity" = IMSI (This checks the deletion of the forbidden lists)
27	SS -> MS	LOCATION UPDATING REJECT	"Reject cause" = "Location Area not allowed".
28	SS -> MS	CHANNEL RELEASE	After the sending of this message, the SS waits for the disconnection of the main signalling link. The following messages are sent and shall be received on cell A.
29	SS		The RF level of cell B is lowered until the MS selects cell A.
30	MS -> SS	CHANNEL REQUEST	"Establishment cause": Location updating.
31	SS -> MS	IMMEDIATE ASSIGNMENT	
32	MS -> SS	LOCATION UPDATING REQUEST	
33	SS -> MS	AUTHENTICATION REQUEST	

34	MS -> SS	AUTHENTICATION RESPONSE	
35	SS -> MS	LOCATION UPDATING ACCEPT	Mobile identity = TMSI.
36	MS -> SS	TMSI REALLOCATION COMPLETE	
37	SS -> MS	CHANNEL RELEASE	After the sending of this message, the SS waits for the disconnection of the main signalling link.

Specific message contents:

None.

26.7.4.2.4 Location updating / rejected / roaming not allowed in this location area**26.7.4.2.4.1 Conformance requirement**

- 1) If the network rejects a location updating from the Mobile Station with the cause "Roaming not allowed in this area" the Mobile Station shall:
 - 1.1 not perform periodic updating;
 - 1.2 not respond to paging with TMSI;
 - 1.3 reject any request from CM entity for MM connection other than for emergency call;
 - 1.4 not perform IMSI detach.
- 2) If the network rejects a location updating from the Mobile Station with the cause "Roaming not allowed in this area" the Mobile Station shall:
 - 2.1 perform normal location updating when a new location area is entered;
 - 2.2 accept a request for an emergency call, if it supports speech, by sending a Channel Request message with the establishment cause set to "emergency call";
 - 2.3 periodically search for its HPLMN.
- 3) The mobile station shall reset the list of "Forbidden location areas for roaming" when it is switched off or has its power source removed or when the SIM is removed.
- 4) The MS shall be capable of storing at least 6 entries in the list of "Forbidden location areas for roaming".

Reference(s)

GSM 04.08 section 4.4.4.7.

26.7.4.2.4.2 Test purposes**Test purpose 1**

To test that on receipt of a rejection using the Roaming cause code, the MS ceases trying to update on that cell, that this situation continues for at least one periodic location interval period, and that the corresponding list is re-set by switching off the MS or removing its power source.

Test purpose 2

To test that if no cell is available, the MS does not answer to paging with TMSI, rejects a request from CM entity other than for emergency calls.

Test purpose 3

To test that at least 6 entries can be held in the list of "forbidden location areas for roaming" (the requirement in GSM 04.08 is to store at least 10 entries. This is not fully tested by the third procedure).

Test purpose 4

To test that if a cell of the Home PLMN is available then the MS returns to it in preference to any other available cell.

Test purpose 5

To test that if the SIM is removed the list of "forbidden location areas for roaming" is cleared.

26.7.4.2.4.3 Method of test

Initial conditions

The initial conditions shall be met before each of the different procedures.

System Simulator:

For procedures 1, 2, 3 and 5: Two cells A and B, belonging to different location areas of the same PLMN with LAI a and b. The MCC of that PLMN is the same as that of the HPLMN. The MNC of that PLMN is different from that of the HPLMN.

For procedure 4: three cells A, B, C of the same PLMN which is not the HPLMN with 3 different location area codes. Cells should differ in signal strength by 10 dB with cell A being the strongest and cell C the weakest. There should be a 20 dB range between A and C. A should be set to a level of - 40 dBm.

IMSI attach/detach is allowed in every cell.

The T3212 time-out value is 1/10 hour in every cell.

Mobile Station:

Procedures 1, 2, 3 and 5: The MS has valid TMSI, CKSN and Kc. It is "idle updated" on cell B.

Procedure 4: The MS has valid TMSI, CKSN and Kc. It is "idle updated" on cell A.

The list of "forbidden location areas for roaming" shall be empty (this may be achieved by either removing the SIM or switching the MS OFF then ON or removing the MS power source depending on PICS).

Related PICS/PIXIT statement(s)

SIM removal possible while MS is powered Yes/No.

Switch off on button Yes/No.

Support of speech Yes/No.

Method to clear the list of location areas for roaming periodically.

The MS is automatically in automatic mode after switch on Yes/No.

Foreseen final state of the MS

Procedures 1 and 5: The MS has no valid TMSI and no CKSN. It is "idle updated" on cell A.

Procedure 2 and 3: The MS has no valid TMSI and no CKSN. It is in the "limited service" state on cell A.

Procedure 4: The MS has no valid TMSI and no CKSN. It is "idle updated" on cell C.

Test Procedures

Procedure 1:

The SS rejects a normal location updating with the cause value "Roaming not allowed in this area". The channel is released. The SS checks that the MS does not perform periodic location updating procedure. The MS is turned off and then on. The SS checks that the MS performs location updating on the cell on which its location update request had been rejected (this checks that the LA

is not the forbidden list after switch on). This procedure is performed another time but the deletion of the list is checked while removing the SIM (instead of turning off the MS).

Procedure 2:

The SS rejects a normal location updating with the cause value "Roaming not allowed in this area". The channel is released. The SS checks that the MS does not answer to a paging message with TMSI, rejects a request from CM entity but supports an emergency call.

Procedure 3:

The SS rejects a normal location updating with the cause value "Roaming not allowed in this area". This is done for 6 different location areas. Then the SS checks that the MS does not attempt to begin a location updating procedure on the non-allowed location areas.

Procedure 4:

The SS accepts a periodic location updating on a cell not belonging to the HPLMN. Then when the MS attempts to perform a periodic location updating to this cell, the SS rejects this location updating with the cause value "Roaming not allowed in this area". Two cells are then available, one belonging to the HPLMN but with the weakest level. It is checked that the MS returns to its HPLMN.

Procedure 5: If SIM removal is possible while MS is powered:

The SS rejects a normal location updating with the cause value "Roaming not allowed in this area". The channel is released. The SS checks that the MS does not perform periodic location updating procedure. The SIM is removed and inserted in the MS. The SS checks that the MS performs location updating on the cell on which its location update request had been rejected (this checks that the LA is not the forbidden list after switch on).

Different types of MS may use different methods to periodically clear the list of forbidden areas (e.g. every day at 12am) for roaming. If the list is cleared while the test is being run, it may be necessary to re-run the test.

Maximum duration of test

Procedures 1 and 5: 12 minutes each.

Procedure 2: 6 minutes.

Procedure 3: 17 minutes.

Procedure 4: 16 minutes.

Expected sequence

The following procedure is used during the test:

Change_LAI (x):

- The purpose of this procedure is to change the value of Location Area Identifier of cell x.
- The Location Area Identifier of cell x shall be changed. The code shall be chosen arbitrarily but shall be different from any previously used in this procedure. The code shall have the same MCC as the Home PLMN and shall not have the same MNC as the Home PLMN.

Procedure 1

Step	Direction	Message	Comments
1	SS		The following messages are sent and shall be received on cell A. The RF level of cell B is lowered until cell B is no more suitable and the MS selects cell A. "Establishment cause": Location updating.
2	MS -> SS	CHANNEL REQUEST	
3	SS -> MS	IMMEDIATE ASSIGNMENT	
4	MS -> SS	LOCATION UPDATING REQUEST	
5	SS -> MS	LOCATION UPDATING REJECT	"Reject cause" IE is "Roaming not allowed in this location area".
6	SS -> MS	CHANNEL RELEASE	After the sending of this message, the SS waits for the disconnection of the main signalling link.
7	SS		The SS waits at least 7 minutes for a possible location updating.
8	MS		The MS shall not initiate an RR connection establishment on cell A or on cell B.
9	MS		If possible (see PICS) the MS is switched off. Otherwise if possible the power is removed.
10	MS		Depending on what has been performed in step 9 the MS is brought back to operation and placed in a automatic mode.
11	MS -> SS	CHANNEL REQUEST	"Establishment cause": Location updating.
12	SS -> MS	IMMEDIATE ASSIGNMENT	
13	MS -> SS	LOCATION UPDATING REQUEST	Location Updating Type = normal.
14	SS -> MS	LOCATION UPDATING ACCEPT	IE Mobile Identity not present.
15	SS -> MS	CHANNEL RELEASE	After the sending of this message, the SS waits for the disconnection of the main signalling link.

Procedure 2

Step	Direction	Message	Comments
1	SS		The following messages are sent and shall be received on cell A.
2	MS -> SS	CHANNEL REQUEST	The RF level of cell B is lowered until the MS selects cell A. The level of cell B shall be such that cell B is suitable for cell selection.
3	SS -> MS	IMMEDIATE ASSIGNMENT	"Establishment cause": Location updating This message is sent on cell A.
4	MS -> SS	LOCATION UPDATING REQUEST	
5	SS -> MS	LOCATION UPDATING REJECT	"Reject cause" IE is "Roaming not allowed in this location area".
6	SS -> MS	CHANNEL RELEASE	After the sending of this message, the SS waits for the disconnection of the main signalling link.
7	MS -> SS	CHANNEL REQUEST	The following messages are sent and shall be received on cell B.
8	SS -> MS	IMMEDIATE ASSIGNMENT	"Establishment cause": Location updating.
9	MS -> SS	LOCATION UPDATING REQUEST	
10	SS -> MS	LOCATION UPDATING REJECT	"Reject cause" IE is "Roaming not allowed in this location area".
11	SS -> MS	CHANNEL RELEASE	After the sending of this message, the SS waits for the disconnection of the main signalling link.
12	SS		The SS waits for a possible location updating procedure on both cells A and B for 2 minutes.
13	MS		The MS shall not initiate an RR connection establishment on cell A or on cell B within 2 minutes after the end of step 11.
14	SS -> MS	PAGING REQUEST TYPE 1	"Mobile identity" = TMSI. This message is sent on cell A and on cell B.
15	MS		The MS shall not initiate an RR connection on cell A or on cell B. This is checked during 3 seconds.
16	MS		A MO CM connection is attempted.
17	MS		The MS shall not initiate an RR connection establishment on cell A or on cell B. This is checked during 3 seconds.
18	MS		The following messages are sent and shall be received on cell A Steps 20 to 27 are performed if the MS supports speech.
19	MS -> SS	CHANNEL REQUEST	An emergency call is attempted.
20	SS -> MS	IMMEDIATE ASSIGNMENT	"Establishment cause":
21	MS -> SS	CM SERVICE REQUEST	"CM service type": Emergency call establishment.
22	SS -> MS	CM SERVICE ACCEPT	
23	MS -> SS	EMERGENCY SETUP	
24	SS -> MS	RELEASE COMPLETE	"Cause" = unassigned number.
25	SS -> MS	CHANNEL RELEASE	After the sending of this message, the SS waits for the disconnection of the main signalling link.

Procedure 3

Step	Direction	Message	Comments
1	SS		The following messages are sent and shall be received on cell A The RF level of cell B is lowered until the MS selects cell A. The level of cell B shall be such that cell B is suitable for cell selection.
2	MS -> SS	CHANNEL REQUEST	"Establishment cause": Location updating.
3	SS -> MS	IMMEDIATE ASSIGNMENT	
4	MS -> SS	LOCATION UPDATING REQUEST	
5	SS -> MS	LOCATION UPDATING REJECT	"Reject cause" IE is "Roaming not allowed in this location area".
6	SS -> MS	CHANNEL RELEASE	After the sending of this message, the SS waits for the disconnection of the main signalling link.
9	MS -> SS	CHANNEL REQUEST	The following messages are sent and shall be received on cell B. "Establishment cause": Location updating.
10	SS -> MS	IMMEDIATE ASSIGNMENT	
11	MS -> SS	LOCATION UPDATING REQUEST	
12	SS -> MS	LOCATION UPDATING REJECT	"Reject cause" IE is "Roaming not allowed in this location area".
13	SS -> MS	CHANNEL RELEASE	After the sending of this message, the SS waits for the disconnection of the main signalling link.
14	SS		Change_LAI (A) within 5 seconds after step 12.
17	MS -> SS	CHANNEL REQUEST	The following messages are sent and shall be received on cell A. "Establishment cause": Location updating.
18	SS -> MS	IMMEDIATE ASSIGNMENT	
19	MS -> SS	LOCATION UPDATING REQUEST	
20	SS -> MS	LOCATION UPDATING REJECT	"Reject cause" IE is "Roaming not allowed in this location area".
21	SS -> MS	CHANNEL RELEASE	After the sending of this message, the SS waits for the disconnection of the main signalling link.
22	SS		Change_LAI (B) within 5 seconds after step 20.
25	MS -> SS	CHANNEL REQUEST	The following messages are sent and shall be received on cell B. "Establishment cause": Location updating.
26	SS -> MS	IMMEDIATE ASSIGNMENT	
27	MS -> SS	LOCATION UPDATING REQUEST	
28	SS -> MS	LOCATION UPDATING REJECT	"Reject cause" IE is "Roaming not allowed in this location area".
29	SS -> MS	CHANNEL RELEASE	After the sending of this message, the SS waits for the disconnection of the main signalling link.
30	SS		Change_LAI (A) within 5 seconds after step 28.
33	MS -> SS	CHANNEL REQUEST	The following messages are sent and shall be received on cell A. "Establishment cause": Location updating.
34	SS -> MS	IMMEDIATE ASSIGNMENT	
35	MS -> SS	LOCATION UPDATING REQUEST	
36	SS -> MS	LOCATION UPDATING REJECT	"Reject cause" IE is "Roaming not allowed in this location area".
37	SS -> MS	CHANNEL RELEASE	After the sending of this message, the SS waits for the disconnection of the main signalling link.
38	SS		Change_LAI (B) within 5 seconds after step 36.
41	MS -> SS	CHANNEL REQUEST	The following messages are sent and shall be received on cell B. "Establishment cause": Location updating.

42	SS -> MS	IMMEDIATE ASSIGNMENT	<p>"Reject cause" IE is "Roaming not allowed in this location area".</p> <p>After the sending of this message, the SS waits for the disconnection of the main signalling link.</p> <p>The SS waits for a possible location updating procedure on both cells A and B for 7 minutes.</p> <p>The MS shall not initiate an RR connection establishment on cell A or on cell B within 7 minutes after the end of step 45.</p>
43	MS -> SS	LOCATION UPDATING REQUEST	
44	SS -> MS	LOCATION UPDATING REJECT	
45	SS -> MS	CHANNEL RELEASE	
46	SS		
47	MS		

Procedure 4

Step	Direction	Message	Comments
1	SS		The following messages are sent and shall be received on cell A. The SS waits for a periodic location updating procedure on cell A for 7 minutes after the initial conditions have been established.
2	MS -> SS	CHANNEL REQUEST	"Establishment cause": Location updating.
3	SS -> MS	IMMEDIATE ASSIGNMENT	
4	MS -> SS	LOCATION UPDATING REQUEST	Location Updating Type = periodic.
5	SS -> MS	LOCATION UPDATING ACCEPT	IE Mobile Identity not present.
6	SS -> MS	CHANNEL RELEASE	After the sending of this message, the SS waits for the disconnection of the main signalling link.
7	SS		The location area identity of cell C shall be changed to that of a location area in the Home PLMN.
8	SS		The SS waits for a periodic location updating procedure on cell A for 7 minutes.
9	MS -> SS	CHANNEL REQUEST	"Establishment cause": Location updating This message is sent on cell A within 7 minutes after the end of step 6.
10	SS -> MS	IMMEDIATE ASSIGNMENT	
11	MS -> SS	LOCATION UPDATING REQUEST	"Location updating type" = periodic.
12	SS -> MS	LOCATION UPDATING REJECT	"Reject cause" IE is "Roaming not allowed in this location area".
13	SS -> MS	CHANNEL RELEASE	After the sending of this message, the SS waits for the disconnection of the main signalling link.
16	MS -> SS	CHANNEL REQUEST	The following messages are sent and shall be received on cell C. "Establishment cause": Location updating.
17	SS -> MS	IMMEDIATE ASSIGNMENT	
18	MS -> SS	LOCATION UPDATING REQUEST	
19	SS -> MS	LOCATION UPDATING ACCEPT	IE Mobile Identity not present.
20	SS -> MS	CHANNEL RELEASE	After the sending of this message, the SS waits for the disconnection of the main signalling link.

Procedure 5

Step	Direction	Message	Comments
1	SS		The following messages are sent and shall be received on cell A. The RF level of cell B is lowered until cell B is no longer suitable and the MS selects cell A. "Establishment cause": Location updating.
2	MS -> SS	CHANNEL REQUEST	
3	SS -> MS	IMMEDIATE ASSIGNMENT	
4	MS -> SS	LOCATION UPDATING REQUEST	
5	SS -> MS	LOCATION UPDATING REJECT	"Reject cause" IE is "Roaming not allowed in this location area".
6	SS -> MS	CHANNEL RELEASE	After the sending of this message, the SS waits for the disconnection of the main signalling link.
7	SS		The SS waits at least 7 minutes for a possible location updating.
8	MS		The MS shall not initiate an RR connection establishment on cell A or on cell B.
9	MS		The SIM is removed.
10	MS		The SIM is inserted into the ME.
11	MS -> SS	CHANNEL REQUEST	"Establishment cause": Location updating.
12	SS -> MS	IMMEDIATE ASSIGNMENT	
13	MS -> SS	LOCATION UPDATING REQUEST	Location Updating Type = normal.
14	SS -> MS	LOCATION UPDATING ACCEPT	IE Mobile Identity not present.
15	SS -> MS	CHANNEL RELEASE	After the sending of this message, the SS waits for the disconnection of the main signalling link.

Specific message contents:

None.

26.7.4.3 Location updating / abnormal cases**26.7.4.3.1 Location updating / abnormal cases / random access fails****26.7.4.3.1.1 Conformance requirement**

If during the RR connection establishment phase of a normal location updating procedure, channel requests are not answered by the network, the Mobile Station shall:

1. send (Max-Retrans+1) Channel Request messages;
2. not try to establish a connection during a period of T3213;
3. then perform a normal location updating procedure as it is still necessary;
4. not repeat the complete procedure if the original cause of the location updating procedure has disappeared.

Reference(s):

GSM 04.08 section 4.4.4.9 and GSM 05.08 section 6.6.2.

26.7.4.3.1.2 Test purpose

To verify that when during the RR connection establishment phase of a location updating procedure, channel requests are not answered by the network, after expiry of T3213 (= 4s in Phase 2) and when the cell reselection procedure is finished the complete procedure is repeated if still necessary.

26.7.4.3.1.3 Method of test

Initial conditions

System Simulator:

Two cells: A and B of the same PLMN, belonging to different location areas with LAI a and b.
The RF power level of cell B is higher than the one of cell A.
IMSI attach/detach is not allowed in both cells.
The T3212 time-out value is set to infinite in both cells.

Mobile Station:

The MS has a valid TMSI, CKSN and Kc. It is "Idle updated" on cell B.

Related PICS/PIXIT statement(s)

None.

Foreseen final state of the MS

The MS is "Idle updated" on cell A.

Test Procedure

The SS causes a random access failure in the MS during a normal location updating procedure. After the expiry of T3213 and when the cell reselection procedure is finished the MS will try to restart the normal location updating procedure.

The test is repeated but the original cause of the location updating procedure has disappeared. The SS then checks that the MS will not restart the location updating procedure.

Maximum duration of test

1 minute.

Expected sequence

Step	Direction	Message	Comments
1	MS		The following messages are sent and shall be received on cell A. The RF level of cell B is lowered until the MS selects cell A. The RF level of cell B is set sufficiently low to ensure that cell B is not suitable as defined in GSM 05.08 section 6.6.2..
2	MS -> SS	CHANNEL REQUEST	Establishment cause: Location updating. This message is sent by the MS (Max_Retrans + 1) times.
3	SS		The SS waits for 4 seconds.
4	MS		The MS shall not send any layer 3 message during this time.
5	MS -> SS	CHANNEL REQUEST	Establishment cause: Location updating. The time difference between this message and the last CHANNEL REQUEST sent in step 2 shall be in the range 4 s - 9 s.
6	SS -> MS	IMMEDIATE ASSIGNMENT	
7	MS -> SS	LOCATION UPDATING REQUEST	location updating type = normal, CKSN = initial value, LAI = b, mobile station classmark 1 and mobile identity = TMSI.
8	SS -> MS	LOCATION UPDATING ACCEPT	Optional IE Mobile Identity not included
9	SS -> MS	CHANNEL RELEASE	After the sending of this message, the SS waits for the disconnection of the main signalling link.
10	SS		The RF level of cell B is set to the same value as for cell A.
11	SS		The RF level of cell A is lowered until the MS selects cell B. The RF level of cell A is kept sufficiently high to ensure that cell A is still suitable as defined in GSM 05.08 section 6.6.2.
12	MS -> SS	CHANNEL REQUEST	The following messages are sent and shall be received on cell B. Establishment cause: Location updating. This message is sent by the MS (Max_Retrans + 1) times.
13	SS		Immediately after the end of step 12 the RF level of cell A is set to the same value as for cell B.
14	MS		The MS shall not initiate an RR connection establishment on cell A or on cell B. This is checked during 15 s.

Specific message contents:

None.

26.7.4.3.2 Location updating / abnormal cases / attempt counter less or equal to 4, LAI different

26.7.4.3.2.1 Conformance requirement

- 1) When a failure such as cases d), f) and g) of section 4.4.4.9 of GSM 04.08 has occurred during a normal location updating procedure, if the attempt counter is smaller than 4 and after expiry of T3211, the Mobile Station shall resend its Location Updating Request message with the Mobile Identity IE set to its IMSI, CKSN IE set to "no key is available" and the Location Updating type set to "normal location updating".
- 2) When a failure such as cases d), f) and g) of section 4.4.4.9 of GSM 04.08 has occurred during a normal location updating procedure the Mobile Station shall:
 - 2.1 not answer to paging with the previously allocated TMSI;
 - 2.2 not perform the IMSI detach procedure, when switched off.

- 3) When a failure such as case e) of section 4.4.4.9 of GSM 04.08 has occurred during a normal location updating procedure and when an emergency call establishment is requested by the user the Mobile Station, if it supports speech, shall send a CM Service Request message with CM Service Type IE set to "emergency call establishment", CKSN IE set to "no key available" and Mobile Identity IE set to its IMSI and after acceptance by the network it shall send an Emergency Setup message.
- 4) When a failure such as cases d), f) and g) of section 4.4.4.9 of GSM 04.08 has occurred during a normal location updating procedure the Mobile Station shall use a request from CM entity other than emergency call as a trigger for a normal location updating procedure and shall send a Location Updating Request message with the Mobile Identity IE set to its IMSI, CKSN IE set to "no key is available" and the Location Updating type IE set to "normal location updating".
- 5) When a failure such as cases d), f) and g) of section 4.4.4.9 of GSM 04.08 has occurred during a normal location updating procedure the Mobile Station shall answer to paging with IMSI and shall send a Paging Response message with CKSN IE set to "no key available" and Mobile Identity IE set to its IMSI.
- 6) When a failure such as cases d), f) and g) of section 4.4.4.9 of GSM 04.08 has occurred during a normal location updating procedure the Mobile Station shall perform a normal location updating procedure as soon as it enters a new cell.

References

GSM 04.08 section 4.4.4.2 and 4.4.4.9 and GSM 05.08 section 6.6.2.

26.7.4.3.2.2 Test purpose

To verify that the MS performs normal location updating procedures when its attempt counter is smaller than 4.

To check that the MS does not perform the IMSI detach procedure when "idle not updated".

To verify that when "idle not updated" the MS can perform an emergency call.

To verify that when "idle not updated" the MS uses requests from CM layer other than emergency call as triggering of a normal location updating procedure.

To verify that the MS performs a normal location updating procedure if it enters a new cell while being "idle not updated".

26.7.4.3.2.3 Method of test

Initial conditions

System Simulator:

Two cells: A and B of the same PLMN, belonging to different location areas with LAI a and b.
ATT flag shall be set to IMSI attach/detach allowed.

Mobile Station:

The MS is "idle updated" on cell A. A valid CKSN value is stored in the SIM and is noted "initial CKSN". A TMSI is allocated.

Related PICS/PIXIT statements

SIM removal possible while MS is powered Yes/No.

Switch off on button Yes/No.

Support for speech Yes/No.

Foreseen final state of the MS

The MS is "Idle updated" on cell A with a valid CKSN and a TMSI.

Test Procedure

The MS is made to perform a normal location updating procedure. Four types of failure cases are triggered:

- sending of a Location Updating Reject with cause randomly chosen between all defined cause values except 2, 3, 6, 11, 12 and 13 (which trigger a different action) (case g of GSM 04.08 section 4.4.4.9);
- RR-connection failure (case d);
- sending of a CHANNEL RELEASE message before the normal end of the procedure (case f);
- T3210 time-out (case e).

As there is no stored LAI or the stored LAI is different from the broadcast LAI, and the attempt counter in the MS shall be lower than 4, the MS enters the state MM IDLE and substate ATTEMPTING TO UPDATE and waits for T3211 seconds before trying again a location updating procedure.

Then the behaviour of the MS in the MM IDLE ATTEMPTING TO UPDATE SERVICE state is checked, that is:

- not answer to paging with TMSI;
- not perform an IMSI detach procedure;
- support request for emergency call;
- use requests from CM layer other than emergency call as triggering of a normal location updating procedure;
- perform normal location updating procedure when a new cell is entered.

Maximum duration of test

9 minutes.

Expected sequence

Step	Direction	Message	Comments
The following messages are sent and shall be received on cell B.			
1	MS		The RF level of cell A is lowered until the MS selects cell B. The RF level of cell A is set sufficiently low to ensure that cell A is not suitable as defined in GSM 05.08 section 6.6.2.
2	MS -> SS	CHANNEL REQUEST	Establishment cause: Location updating.
3	SS -> MS	IMMEDIATE ASSIGNMENT	
4	MS -> SS	LOCATION UPDATING REQUEST	location updating type = normal, CKSN = initial value, LAI = a, mobile station classmark 1 as given by the PICS and mobile identity = TMSI.
5	SS -> MS	LOCATION UPDATING REJECT	IE Reject cause is set to a value arbitrarily chosen: * in table 10.66 of GSM 04.08, causes #2, #3, #6, #11, #12 and #13 being excluded.
6	SS -> MS	CHANNEL RELEASE	After the sending of this message, the SS waits for the disconnection of the main signalling link.
7	MS		The MS shall not initiate an RR connection establishment on cell A or on cell B during T3211 seconds at least after the channel release.
8	MS -> SS	CHANNEL REQUEST	Establishment cause: Location updating.
9	SS -> MS	IMMEDIATE ASSIGNMENT	
10	MS -> SS	LOCATION UPDATING REQUEST	location updating type = normal, CKSN = no key available, LAI = deleted LAI (the MCC and MNC hold the previous values, the LAC is coded FFFE), Mobile Identity = IMSI.
11	SS		The SS deactivates the SACCH on the dedicated channel. The SS waits until there are no more SACCH frames in the uplink direction. This release connection is done within 8 SACCH frames.
12	MS		The MS shall not initiate an RR connection establishment on cell A or on cell B within T3211 + RadioLinkTimeout after the SS deactivates the SACCH.
13	MS -> SS	CHANNEL REQUEST	Establishment cause: Location updating.
14	SS -> MS	IMMEDIATE ASSIGNMENT	
15	MS -> SS	LOCATION UPDATING REQUEST	location updating type = normal, CKSN = no key available, LAI = deleted LAI (the MCC and MNC hold the previous values, the LAC is coded FFFE), Mobile Identity = IMSI.
16	SS -> MS	CHANNEL RELEASE	After the sending of this message, the SS waits for the disconnection of the main signalling link.
17	MS		The MS shall not initiate an RR connection establishment on cell A or on cell B during T3211 seconds at least after the channel release.
18	MS -> SS	CHANNEL REQUEST	Establishment cause: Location updating.
19	SS -> MS	IMMEDIATE ASSIGNMENT	
20	MS -> SS	LOCATION UPDATING REQUEST	location updating type = normal, CKSN = no key available, LAI = deleted LAI (the MCC and MNC hold the previous values, the LAC is coded FFFE), Mobile Identity = IMSI.
21	SS -> MS	AUTHENTICATION REQUEST	CKSN = initial CKSN.
22	MS -> SS	AUTHENTICATION RESPONSE	
23	SS -> MS	LOCATION UPDATING ACCEPT	IE mobile Identity = new TMSI.
24	MS -> SS	TMSI REALLOCATION COMPLETE	
25	SS -> MS	CHANNEL RELEASE	After the sending of this message, the SS waits for the disconnection of the main signalling link. MS is now "idle updated" in cell B.
The following messages are sent and shall be received on cell A.			

26	MS		The RF level of cell B is lowered until the MS selects cell A. The RF level of cell B is set sufficiently low to ensure that cell B is not suitable as defined in GSM 05.08 section 6.6.2.
27	MS -> SS	CHANNEL REQUEST	Establishment cause: Location updating.
28	SS -> MS	IMMEDIATE ASSIGNMENT	
29	MS -> SS	LOCATION UPDATING REQUEST	location updating type = normal, CKSN = initial value, LAI = b, mobile station classmark 1 as given by the PICS and mobile identity = TMSI.
30	SS		performs step 5 with reject cause #100 and step 6.
31	SS -> MS	PAGING REQUEST TYPE 1	Mobile identity = old TMSI of the MS. This message is sent continuously to the MS during 8 seconds.
32	SS		The SS checks that there is no answer from the MS during 12 seconds.
33	SS		If during steps 31 and 32 the MS attempts to perform a location updating procedure the SS will perform step 30 and then continue the procedure.
34	MS		If possible (see PICS) SIM detachment is performed. Otherwise if possible (see PICS) mobile switch off is performed. Otherwise the power is removed.
35	MS		The MS shall not initiate an RR connection establishment on cell A or on cell B. This is checked during 30 seconds.
36	MS		Depending on what has been performed in step 34 the MS is brought back to operation.
37	MS -> SS	CHANNEL REQUEST	Establishment cause: Location updating.
38	SS -> MS	IMMEDIATE ASSIGNMENT	
39	MS -> SS	LOCATION UPDATING REQUEST	location updating type = normal, CKSN = no key available, LAI = deleted LAI (the MCC and MNC hold the previous values, the LAC is coded FFFE), Mobile Identity = IMSI.
40	SS -> MS	AUTHENTICATION REQUEST	CKSN = initial CKSN.
41	MS -> SS	AUTHENTICATION RESPONSE	
42	SS -> MS	LOCATION UPDATING ACCEPT	IE mobile Identity = new TMSI.
43	MS -> SS	TMSI REALLOCATION COMPLETE	
44	SS -> MS	CHANNEL RELEASE	After the sending of this message, the SS waits for the disconnection of the main signalling link. MS is now "idle updated" in cell A.
45	MS		The RF level of cell A is lowered until the MS selects cell B. The RF level of cell A is set sufficiently low to ensure that cell A is not suitable as defined in GSM 05.08 section 6.6.2.
46	MS -> SS	CHANNEL REQUEST	Establishment cause: Location updating.
47	SS -> MS	IMMEDIATE ASSIGNMENT	
48	MS -> SS	LOCATION UPDATING REQUEST	location updating type = normal, CKSN = initial value, LAI = a, mobile station classmark 1 as given by the PICS and mobile identity = TMSI.
49	SS -> MS	AUTHENTICATION REQUEST	
50	MS->SS	AUTHENTICATION RESPONSE	steps 49 and 50 are performed N times. N shall be chosen in such a way that T3210 expires. Depending on when T3210 expires in the MS, it is possible that on the Nth occurrence of step 50 the MS may send a L2 DISC rather than the AUTHENTICATION RESPONSE message.
51	SS		The SS checks that there is no more activity from the MS on the channel after the DISC/UA exchange has been completed.
52	MS		If the MS supports speech it is made to perform an emergency call.

53	MS -> SS	CHANNEL REQUEST	Establishment cause: Emergency call.
54	SS -> MS	IMMEDIATE ASSIGNMENT	
55	MS -> SS	CM SERVICE REQUEST	
56	SS -> MS	CM SERVICE ACCEPT	CM service type = Emergency call establishment; CKSN = no key available; Mobile Identity = IMSI.
57	MS -> SS	EMERGENCY SETUP	
58	SS -> MS	RELEASE COMPLETE	Cause = unassigned number.
59	SS -> MS	CHANNEL RELEASE	
60	MS -> SS	CHANNEL REQUEST	Establishment cause: Location updating The SS will wait at most 15 seconds for this message.
61	SS -> MS	IMMEDIATE ASSIGNMENT	
62	MS -> SS	LOCATION UPDATING REQUEST	location updating type = normal, CKSN = no key available, LAI = deleted LAI (the MCC and MNC hold the previous values, the LAC is coded FFFE), Mobile Identity = IMSI.
63	SS -> MS	AUTHENTICATION REQUEST	
64	MS -> SS	AUTHENTICATION RESPONSE	CKSN = initial CKSN.
65	SS -> MS	LOCATION UPDATING ACCEPT	
66	MS -> SS	TMSI REALLOCATION COMPLETE	IE mobile Identity = new TMSI.
67	SS -> MS	CHANNEL RELEASE	
68	MS		After the sending of this message, the SS waits for the disconnection of the main signalling link. MS is now "idle updated" in cell B.
69	MS -> SS	CHANNEL REQUEST	
70	SS -> MS	IMMEDIATE ASSIGNMENT	The RF level of cell B is lowered until the MS selects cell A. The RF level of cell B is set sufficiently low to ensure that cell B is not suitable as defined in GSM 05.08 section 6.6.2.
71	MS -> SS	LOCATION UPDATING REQUEST	
72	SS		Establishment cause: Location updating.
73	MS		
74	MS -> SS	CHANNEL REQUEST	location updating type = normal, CKSN = initial value, LAI = b, mobile station classmark 1 as given by the PICS and mobile identity = TMSI.
75	SS -> MS	IMMEDIATE ASSIGNMENT	
76	MS -> SS	LOCATION UPDATING REQUEST	performs step 11. A MO CM connection is attempted before T3211 expiry.
77	SS -> MS	LOCATION UPDATING ACCEPT	
78	MS -> SS	TMSI REALLOCATION COMPLETE	Establishment cause: Location updating.
79	SS -> MS	CHANNEL RELEASE	
80	MS -> SS	CHANNEL REQUEST	location updating type = normal, CKSN = no key available, LAI = deleted LAI (the MCC and MNC hold the previous values, the LAC is coded FFFE), Mobile Identity = IMSI.
81	SS -> MS	IMMEDIATE ASSIGNMENT	
82	MS -> SS	CM SERVICE REQUEST	IE mobile Identity = new TMSI.
83	SS -> MS	CHANNEL RELEASE	
84	MS		Steps 80 to 83 are optional as the MS may have memorized the request for CM connection attempt Wait 10 s to decide whether to go directly to step 84.
85	MS -> SS	CHANNEL REQUEST	
86	SS -> MS	IMMEDIATE ASSIGNMENT	Establishment cause: Not checked.
			CKSN = no key available, Mobile identity = TMSI. After the sending of this message, the SS waits for the disconnection of the main signalling link. MS is now "idle updated" in cell A.
			The RF level of cell A is lowered until the MS selects cell B. The RF level of cell A is set sufficiently low to ensure that cell A is not suitable as defined in GSM 05.08 section 6.6.2.
			Establishment cause: Location updating.

87	MS -> SS	LOCATION UPDATING REQUEST	location updating type = normal, CKSN = no key available LAI = a, mobile station classmark 1 as given by the PICS and mobile identity = TMSI.
88	SS		performs step 16.
89	MS		The RF level of cell B is lowered until the MS selects cell A. The RF level of cell B is set sufficiently low to ensure that cell B is not suitable as defined in GSM 05.08 section 6.6.2.
90	MS -> SS	CHANNEL REQUEST	Establishment cause: Location updating. The time interval between Cell B being set sufficiently low to ensure that Cell B is not suitable and this message shall be less than 20s.
91	SS -> MS	IMMEDIATE ASSIGNMENT	
92	MS -> SS	LOCATION UPDATING REQUEST	location updating type = normal, CKSN = no key available, LAI = deleted LAI (the MCC and MNC hold the previous values, the LAC is coded FFFE), mobile station classmark 1 as given by the PICS and mobile identity = IMSI.
93	SS -> MS	AUTHENTICATION REQUEST	CKSN = initial CKSN.
94	MS -> SS	AUTHENTICATION RESPONSE	
95	SS -> MS	LOCATION UPDATING ACCEPT	Mobile identity = TMSI.
96	MS -> SS	TMSI REALLOCATION COMPLETE	
97	SS -> MS	CHANNEL RELEASE	After the sending of this message, the SS waits for the disconnection of the main signalling link. MS is now "Idle, updated" in cell A.

Specific message contents

None.

26.7.4.3.3 Location updating / abnormal cases / attempt counter equal to 4

26.7.4.3.3.1 Conformance requirement

- 1) When four failures such as cases d) to g) of section 4.4.4.9 of GSM 04.08 have occurred during a normal location updating procedure the Mobile Station shall:
 - 1.1 perform location updating after T3212 expiry by sending a Location Updating Request message with the Mobile Identity IE set to its IMSI, CKSN IE set to "no key is available" and the Location Updating type set to "normal updating".
 - 1.2 if the T3212 initiated location updating was unsuccessful, then after T3211 expiry the Mobile Station shall send a Location Updating Request message with the Mobile Identity IE set to its IMSI, CKSN IE set to "no key is available" and the Location Updating type IE set to "normal location updating".
- 2) When four failures such as cases d), f), g) of section 4.4.4.9 of GSM 04.08 have occurred during a normal location updating procedure the Mobile Station, if it supports speech, shall be able to perform an emergency call i.e. the Mobile Station is able to send a CM Service Request message with the CM Service Type IE set to "emergency call establishment", CKSN IE set to "no key is available" and Mobile Identity IE set to its IMSI and then send an Emergency Setup message.
- 3) When four failures such as cases d), f), g) of section 4.4.4.9 of GSM 04.08 have occurred during a normal location updating procedure:
 - 3.1 the Mobile Station shall use a request from CM entity for MM connection for a service other than emergency call as a trigger for a normal location updating procedure and shall send a Location Updating Request message with the Mobile Identity IE set to its IMSI, CKSN IE set to "no key is available" and the Location Updating type IE set to "normal location updating".

- 3.2 after a location updating triggered by a request from the CM layer which was .unsuccessful, after T3211 expiry the Mobile Station shall send a Location Updating Request message with the Mobile Identity IE set to its IMSI, CKSN IE set to "no key is available" and the Location Updating type IE set to "normal location updating".
- 4) When four failures such as cases d), f), g) of section 4.4.4.9 of GSM 04.08 have occurred during a normal location updating procedure:
- 4.1 the Mobile Station shall perform a normal location updating procedure if it enters a new cell.
- 4.2 if this location updating is unsuccessful, after T3211 expiry the Mobile Station shall send a Location Updating Request message with the Mobile Identity IE set to its IMSI, CKSN IE set to "no key is available" and the Location Updating type IE set to "normal location updating".

References

GSM 04.08 section 4.4.4.9 and GSM 05.08 section 6.6.2.

26.7.4.3.3.2 Test purpose

To verify that the MS performs normal location updating procedures after T3212 expiry, when its attempt counter has reached value 4 and that the MS reset its attempt counter after a timer T3212 expiry.

To verify that the MS still follows the MM IDLE ATTEMPTING TO UPDATE state requirements after its attempt counter has reached value 4.

To verify that the attempt counter is reset in the cases where it has to be done.

26.7.4.3.3.3 Method of test

Initial conditions

System Simulator:

- Two cells: A and B, belonging to different location areas a and b.
- IMSI attach/detach is allowed in both cells.
- T3212 is set to 6 minutes.

Mobile Station:

- The MS is "Idle updated" on cell B with a valid CKSN and a TMSI.

Related PICS/PIXIT statements

SIM removal possible while MS is powered Yes/No.

Switch off on button Yes/No.

Support of speech Yes/No.

Foreseen final state of the MS

The MS is "Idle updated" on cell A with a valid CKSN and a TMSI.

Test Procedure

The MS is made to perform a normal location updating. The SS triggers a failure in this procedure. After T3211 expiry the MS will try again the location updating procedure. The SS triggers again a failure. This is done again 2 times. At this point the attempt counter shall be equal to 4. It is then checked that T3212 has been started and that at its expiry the MS will try a normal location updating procedure. It is verified that the MS has reset its attempt counter after timer T3212 expiry.

Then it is checked that, when the attempt counter has reached the value of 4, the MS is in the MM IDLE state and ATTEMPTING TO UPDATE substate, that is:

- not perform an IMSI detach procedure;
- support request for emergency call;
- use requests from CM layer other than emergency call as triggering of a normal location updating procedure;
- perform normal location updating procedure when a new cell is entered.

Maximum duration of test

20 minutes.

Expected sequence

Step	Direction	Message	Comments
1	MS		The following messages are sent and shall be received on cell A. The RF level of cell B is lowered until the MS selects cell A. The RF level of cell B is set sufficiently low to ensure that cell B is not suitable as defined in GSM 05.08 section 6.6.2. Establishment cause: Location updating.
2	MS -> SS	CHANNEL REQUEST	
3	SS -> MS	IMMEDIATE ASSIGNMENT	
4	MS -> SS	LOCATION UPDATING REQUEST	location updating type = normal, CKSN = initial value, LAI = b, mobile station classmark 1 as given by the PICS and mobile identity = TMSI.
5	SS -> MS	LOCATION UPDATING REJECT	IE Reject cause is set to #22 * in table 10.66 of GSM 04.08, causes #2, #3, #6, #11, #12 and #13 being excluded.
6	SS -> MS	CHANNEL RELEASE	The SS waits for the disconnection of the main signalling link.
7	MS		The MS shall not initiate an RR connection establishment on cell A or on cell B within T3211.
8	MS -> SS	CHANNEL REQUEST	Establishment cause: Location updating.
9	SS -> MS	IMMEDIATE ASSIGNMENT	
10	MS -> SS	LOCATION UPDATING REQUEST	location updating type = normal, CKSN = no key available, LAI = deleted LAI (the MCC and MNC hold the previous values, the LAC is coded FFFE), Mobile Identity = IMSI.
11	SS		The SS deactivates the SACCH on the dedicated channel and waits until there are no more SACCH frames in the uplink. This is done within 8 SACCH frames.
12	MS		The MS shall not initiate an RR connection establishment on cell A or on cell B with T3211 + RadioLinkTimeout after the SS deactivates the SACCH.
13	MS -> SS	CHANNEL REQUEST	Establishment cause: Location updating.
14	SS -> MS	IMMEDIATE ASSIGNMENT	
15	MS -> SS	LOCATION UPDATING REQUEST	location updating type = normal, CKSN = no key available, LAI = deleted LAI (the MCC and MNC hold the previous values, the LAC is coded FFFE), Mobile Identity = IMSI.
16	SS -> MS	AUTHENTICATION REQUEST	
17	MS -> SS	AUTHENTICATION RESPONSE	these steps (16 and 17) are performed N times. N shall be chosen in such a way that T3210 expires. Depending on when T3210 expires in the MS, it is possible that on the Nth occurrence of step 50 the MS may send a L2 DISC rather than the AUTHENTICATION RESPONSE message.
18	MS		The MS shall cease transmission (after the DISC/UA exchange has been completed) and then shall not initiate an RR connection establishment on cell A or on cell B during T3211 seconds at least after the expiry of T3210.
19	MS -> SS	CHANNEL REQUEST	Establishment cause: Location updating.
20	SS -> MS	IMMEDIATE ASSIGNMENT	
21	MS -> SS	LOCATION UPDATING REQUEST	location updating type = normal, CKSN = no key available, LAI = deleted LAI (the MCC and MNC hold the previous values, the LAC is coded FFFE), Mobile Identity = IMSI.
22	SS -> MS	CHANNEL RELEASE	The SS waits for the disconnection of the main signalling link.

23	MS		The MS shall not initiate an RR connection establishment on cell A or on cell B during T3212 (tolerance -15s; 45s) at least after the channel release.
24	MS -> SS	CHANNEL REQUEST	Establishment cause: Location updating. location updating type: "normal location update" CKSN = no key available, LAI = deleted LAI (the MCC and MNC hold the previous values, the LAC is coded FFFE) mobile station classmark 1 as given by the PICS and mobile identity = IMSI. IE Reject cause = #17 "network failure".
25	SS -> MS	IMMEDIATE ASSIGNMENT	
26	MS -> SS	LOCATION UPDATING REQUEST	
27	SS -> MS	LOCATION UPDATING REJECT	
28	SS -> MS	CHANNEL RELEASE	The SS waits for the disconnection of the main signalling link.
29	MS		The MS shall not initiate an RR connection establishment on cell A or on cell B during T3211 seconds at least after the channel release.
30	MS -> SS	CHANNEL REQUEST	Establishment cause: Location updating. location updating type = normal, CKSN = no key available, LAI = deleted LAI (the MCC and MNC hold the previous values, the LAC is coded FFFE) mobile station classmark 1 as given by the PICS and mobile identity = IMSI. CKSN = initial CKSN.
31	SS -> MS	IMMEDIATE ASSIGNMENT	
32	MS -> SS	LOCATION UPDATING REQUEST	
33	SS -> MS	AUTHENTICATION REQUEST	
34	MS -> SS	AUTHENTICATION RESPONSE	
35	SS -> MS	LOCATION UPDATING ACCEPT	IE mobile Identity = new TMSI.
36	MS -> SS	TMSI REALLOCATION COMPLETE	
37	SS -> MS	CHANNEL RELEASE	After the sending of this message, the SS waits for the disconnection of the main signalling link. MS is now "idle, updated" in cell A.
38	MS		The RF level of cell A is lowered until the MS selects cell B. The RF level of cell A is set sufficiently low to ensure that cell A is not suitable as defined in GSM 05.08 section 6.6.2.
39	MS -> SS	CHANNEL REQUEST	Establishment cause: Location updating. location updating type = normal, CKSN = initial value, LAI = a, mobile station classmark 1 as given by the PICS and mobile identity = TMSI. IE Reject cause is set to #42 * in table 10.66 of GSM 04.08, causes #2, #3, #6, #11, #12 and #13 being excluded.
40	SS -> MS	IMMEDIATE ASSIGNMENT	
41	MS -> SS	LOCATION UPDATING REQUEST	
42	SS -> MS	LOCATION UPDATING REJECT	
43	SS -> MS	CHANNEL RELEASE	The SS waits for the disconnection of the main signalling link.
44	MS		The MS shall not initiate an RR connection establishment on cell A or on cell B during T3211 seconds at least after the channel release.
45	MS -> SS	CHANNEL REQUEST	Establishment cause: Location updating. location updating type = normal, CKSN = no key available, LAI = deleted LAI (the MCC and MNC hold the previous values, the LAC is coded FFFE), Mobile Identity = IMSI.
46	SS -> MS	IMMEDIATE ASSIGNMENT	
47	MS -> SS	LOCATION UPDATING REQUEST	
48	SS		The SS deactivates the SACCH on the dedicated channel and waits until there is no more SACCH frames in the uplink. This is done within 8 SACCH frames.

48a	MS		The MS shall not initiate an RR connection establishment on cell A or on cell B within T3211 + RadioLinkTimeOut after the SS deactivates the SACCH.
49	MS -> SS	CHANNEL REQUEST	Establishment cause: Location updating. location updating type = normal, CKSN = no key available, LAI = deleted LAI (the MCC and MNC hold the previous values, the LAC is coded FFFE), Mobile Identity = IMSI.
50	SS -> MS	IMMEDIATE ASSIGNMENT	
51	MS -> SS	LOCATION UPDATING REQUEST	
52	SS -> MS	CHANNEL RELEASE	The SS waits for the disconnection of the main signalling link.
53	MS		The MS shall not initiate an RR connection establishment on cell A or on cell B during T3211 seconds at least after the channel release.
54	MS -> SS	CHANNEL REQUEST	Establishment cause: Location updating. location updating type = normal, CKSN = no key available, LAI = deleted LAI (the MCC and MNC hold the previous values, the LAC is coded FFFE) mobile station classmark 1 as given by the PICS and mobile identity = IMSI.
55	SS -> MS	IMMEDIATE ASSIGNMENT	
56	MS -> SS	LOCATION UPDATING REQUEST	
57	SS		performs step 42 with cause #38 and step 43.
58	MS		If the MS supports speech, it is made to perform an emergency call.
59	MS -> SS	CHANNEL REQUEST	Establishment cause: Emergency call. CM service type = Emergency call establishment; CKSN = no key available; Mobile Identity = IMSI.
60	SS -> MS	IMMEDIATE ASSIGNMENT	
61	MS -> SS	CM SERVICE REQUEST	
62	SS -> MS	CM SERVICE ACCEPT	
63	MS -> SS	EMERGENCY SETUP	
64	SS -> MS	RELEASE COMPLETE	
65	SS -> MS	CHANNEL RELEASE	Cause = unassigned number. The SS waits for the disconnection of the main signalling link.
66	MS		If possible (see PICS) SIM detachment is performed. Otherwise if possible (see PICS) switch off is performed. Otherwise the power is removed.
67	MS		The MS shall not initiate an RR connection establishment on cell A or on cell B. This is checked during 3 seconds.
68	MS		Depending on what has been performed in step 66 the MS is brought back to operation.
69	MS -> SS	CHANNEL REQUEST	Establishment cause: Location updating. location updating type = normal, CKSN = no key available, LAI = deleted LAI (the MCC and MNC hold the previous values, the LAC is coded FFFE), Mobile Identity = IMSI.
70	SS -> MS	IMMEDIATE ASSIGNMENT	
71	MS -> SS	LOCATION UPDATING REQUEST	
72	SS -> MS	AUTHENTICATION REQUEST	CKSN = initial CKSN.
73	MS -> SS	AUTHENTICATION RESPONSE	
74	SS -> MS	LOCATION UPDATING ACCEPT	IE mobile Identity = new TMSI.
75	MS -> SS	TMSI REALLOCATION COMPLETE	
76	SS -> MS	CHANNEL RELEASE	After the sending of this message, the SS waits for the disconnection of the main signalling link. MS is now "idle, updated" in cell B.
77	MS		The RF level of cell B is lowered until the MS selects cell A. The RF level of cell B is set sufficiently low to ensure that cell B is not suitable as defined in GSM 05.08 section 6.6.2.
78	MS -> SS	CHANNEL REQUEST	Establishment cause: Location updating.

79	SS -> MS	IMMEDIATE ASSIGNMENT	
80	MS -> SS	LOCATION UPDATING REQUEST	location updating type = normal, CKSN = initial value, LAI = b, mobile station classmark 1 as given by the PICS and mobile identity = TMSI.
81	SS -> MS	LOCATION UPDATING REJECT	IE Reject cause is set to #38 * in table 10.66 of GSM 04.08, causes #2, #3, #6, #11, #12, and #13 being excluded.
82	SS -> MS	CHANNEL RELEASE	The SS waits for the disconnection of the main signalling link.
83	MS		The MS shall not initiate an RR connection establishment on cell A or on cell B during T3211 seconds at least after the channel release.
84	MS -> SS	CHANNEL REQUEST	Establishment cause: Location updating.
85	SS -> MS	IMMEDIATE ASSIGNMENT	
86	MS -> SS	LOCATION UPDATING REQUEST	location updating type = normal, CKSN = no key available, LAI = deleted LAI (the MCC and MNC hold the previous values, the LAC is coded FFFE), Mobile Identity = IMSI.
87	SS		The SS deactivates the SACCH on the dedicated channel and waits until there is no more SACCH frames in the uplink. This is done within 8 SACCH frames.
88	MS		The MS shall not initiate an RR connection establishment on cell A or on cell B within T3211 +RadioLinkTimeout seconds after the SS deactivates the SACCH.
89	MS -> SS	CHANNEL REQUEST	Establishment cause: Location updating.
90	SS -> MS	IMMEDIATE ASSIGNMENT	
91	MS -> SS	LOCATION UPDATING REQUEST	location updating type = normal, CKSN = no key available, LAI = deleted LAI (the MCC and MNC hold the previous values, the LAC is coded FFFE), Mobile Identity = IMSI.
92	SS -> MS	CHANNEL RELEASE	The SS waits for the disconnection of the main signalling link.
93	MS		The MS shall not initiate an RR connection establishment on cell A or on cell B during T3211 seconds at least after the channel release.
94	MS -> SS	CHANNEL REQUEST	Establishment cause: Location updating.
95	SS -> MS	IMMEDIATE ASSIGNMENT	
96	MS -> SS	LOCATION UPDATING REQUEST	location updating type = normal, CKSN = no key available, LAI = deleted LAI (the MCC and MNC hold the previous values, the LAC is coded FFFE) mobile station classmark 1 as given by the PICS and mobile identity = IMSI.
97	SS		performs step 48.
98	MS		A MO CM connection is attempted.
99	MS -> SS	CHANNEL REQUEST	Establishment cause: Location updating.
100	SS -> MS	IMMEDIATE ASSIGNMENT	
101	MS -> SS	LOCATION UPDATING REQUEST	location updating type = normal, CKSN = no key available, LAI = deleted LAI (the MCC and MNC hold the previous values, the LAC is coded FFFE), Mobile Identity = IMSI.
102	SS		performs step 52.
103	MS		The MS shall not initiate an RR connection establishment on cell A or on cell B during T3211 seconds at least after the channel release.
104	MS -> SS	CHANNEL REQUEST	Establishment cause: Location updating.
105	SS -> MS	IMMEDIATE ASSIGNMENT	
106	MS -> SS	LOCATION UPDATING REQUEST	location updating type = normal, CKSN = no key available, LAI = deleted LAI (the MCC and MNC hold the previous values, the LAC is coded FFFE), Mobile Identity = IMSI.
107	SS -> MS	AUTHENTICATION REQUEST	CKSN = initial CKSN.

108	MS -> SS	AUTHENTICATION RESPONSE	
109	SS -> MS	LOCATION UPDATING ACCEPT	IE mobile Identity = new TMSI.
110	MS -> SS	TMSI REALLOCATION COMPLETE	
111	SS -> MS	CHANNEL RELEASE	MS is now "idle, updated" in cell A The MS may or may not have memorized the request for CM connection. The steps 112 to 116 are therefore optional for the MS. The SS waits 10 second whether to decide to go directly to step 117.
112	MS -> SS	CHANNEL REQUEST	
113	SS -> MS	IMMEDIATE ASSIGNMENT	
114	MS -> SS	CM SERVICE REQUEST	CKSN = initial value, Mobile identity = TMSI.
115	SS -> MS	CM SERVICE REJECT	cause #17 (network failure).
116	SS -> MS	CHANNEL RELEASE	The SS waits for the disconnection of the main signalling link.
117	MS		The RF level of cell A is lowered until the MS selects cell B. The RF level of cell A is set sufficiently low to ensure that cell A is not suitable as defined in GSM 05.08 section 6.6.2. Establishment cause: Location updating.
118	MS -> SS	CHANNEL REQUEST	
119	SS -> MS	IMMEDIATE ASSIGNMENT	
120	MS -> SS	LOCATION UPDATING REQUEST	location updating type = normal, CKSN = initial value, LAI = a, mobile station classmark 1 as given by the PICS and mobile identity = TMSI.
121	SS -> MS	LOCATION UPDATING REJECT	IE Reject cause is set to #38 * in table 10.66 of GSM 04.08, causes #2, #3, #6, #11, #12 and #13 being excluded.
122	SS -> MS	CHANNEL RELEASE	The SS waits for the disconnection of the main signalling link
123	MS		The MS shall not initiate an RR connection establishment on cell A or on cell B during T3211 seconds at least after the channel release.
124	MS -> SS	CHANNEL REQUEST	Establishment cause: Location updating.
125	SS -> MS	IMMEDIATE ASSIGNMENT	
126	MS -> SS	LOCATION UPDATING REQUEST	location updating type = normal, CKSN = no key available, LAI = deleted LAI (the MCC and MNC hold the previous values, the LAC is coded FFFE), Mobile Identity = IMSI.
127	SS		The SS stops any RF transmission on the dedicated channel and waits until there is no more SACCH in the uplink.
128	MS		The MS shall not initiate an RR connection establishment on cell A or on cell B within T3211 + RadiolinkTimeOut seconds after the SS stops RF transmission.
129	MS -> SS	CHANNEL REQUEST	Establishment cause: Location updating.
130	SS -> MS	IMMEDIATE ASSIGNMENT	
131	MS -> SS	LOCATION UPDATING REQUEST	location updating type = normal, CKSN = no key available, LAI = deleted LAI (the MCC and MNC hold the previous values, the LAC is coded FFFE), Mobile Identity = IMSI.
132	SS -> MS	CHANNEL RELEASE	The SS waits for the disconnection of the main signalling link.
133	MS		The MS shall not initiate an RR connection establishment on cell A or on cell B during T3211 seconds at least after the channel release.
134	MS -> SS	CHANNEL REQUEST	
135	SS -> MS	IMMEDIATE ASSIGNMENT	Establishment cause: Location updating.

136	MS -> SS	LOCATION UPDATING REQUEST	location updating type = normal, CKSN = no key available, LAI = deleted LAI (the MCC and MNC hold the previous values, the LAC is coded FFFE) mobile station classmark 1 as given by the PICS and mobile identity = IMSI. performs steps 42 and 43.
137 138	SS MS		
139 140 141	MS -> SS SS -> MS MS -> SS	CHANNEL REQUEST IMMEDIATE ASSIGNMENT LOCATION UPDATING REQUEST	The RF level of cell B is lowered until the MS selects cell A. The RF level of cell B is set sufficiently low to ensure that cell B is not suitable as defined in GSM 05.08 section 6.6.2. Establishment cause: Location updating.
142 143	SS MS		location updating type = normal, CKSN = no key available, LAI = deleted LAI (the MCC and MNC hold the previous values, the LAC is coded FFFE) mobile station classmark 1 as given by the PICS and mobile identity = IMSI. performs the step 48. The MS shall not initiate an RR connection establishment on cell A or on cell B until T3211 + RadiolinkTimeout after the SS deactivates the SACCH.
144 145 146	MS -> SS SS -> MS MS -> SS	CHANNEL REQUEST IMMEDIATE ASSIGNMENT LOCATION UPDATING REQUEST	Establishment cause: Location updating.
147 148	SS -> MS MS -> SS	AUTHENTICATION REQUEST AUTHENTICATION RESPONSE	location updating type = normal, CKSN = no key available, LAI = deleted LAI (the MCC and MNC hold the previous values, the LAC is coded FFFE), Mobile Identity = IMSI. CKSN = initial CKSN.
149	SS -> MS	LOCATION UPDATING ACCEPT	IE mobile Identity = new TMSI.
150	MS -> SS	TMSI REALLOCATION COMPLETE	
151	SS -> MS	CHANNEL RELEASE	After the sending of this message, the SS waits for the disconnection of the main signalling link. MS is now "idle, updated" in cell A.

Specific message contents

None.

26.7.4.3.4 Location updating / abnormal cases / attempt counter less or equal to 4, stored LAI equal to broadcast LAI

26.7.4.3.4.1 Conformance requirement

- 1) When a failure such as cases d), f) and g) of section 4.4.4.9 of GSM 04.08 has occurred during a periodic location updating procedure (the broadcast LAI is equal to the stored LAI):
 - 1.1 the Mobile Station shall be able to establish an MM connection i.e. send a Channel Request and then a CM Service Request message, CKSN and LAI set to those which have been allocated to the Mobile Station, Mobile Identity IE set to the TMSI which has been allocated to the Mobile Station;
 - 1.2 then the Mobile Station shall not attempt a location updating procedure.
- 2) When a failure such as cases d), f) and g) of section 4.4.4.9 of GSM 04.08 has occurred during an IMSI attach procedure (the broadcast LAI is equal to the stored LAI):
 - 2.1 the Mobile Station shall be able to establish an MM connection i.e. send a Channel Request and then a CM Service Request message, CKSN and LAI set to those which have been

allocated to the Mobile Station, Mobile Identity IE set to the TMSI which has been allocated to the Mobile Station;

2.2 then the Mobile Station shall not attempt a location updating procedure.

- 3) When a failure such as cases d), f) and g) of section 4.4.4.9 of GSM 04.08 has occurred during a periodic location updating procedure and the attempt counter is smaller than 4 the Mobile Station shall send, after T3211 expiry, a Location Updating Request message with the Mobile Identity IE set to the TMSI which has been allocated to the Mobile Station, CKSN IE and LAI set to those which have been allocated to the Mobile Station and the Location Updating type set to "periodic updating".

When the Mobile Station's attempt counter reaches the value 4 (four failures such as cases d), f) and g) of section 4.4.4.9 of GSM 04.08 have occurred during a periodic location updating procedure) after T3212 expiry it shall send a Location Updating Request message with the Mobile Identity IE set to its IMSI, CKSN IE set to "no key is available" and the Location Updating type set to "normal".

- 4) When the Mobile Station's attempt counter reaches the value 4 (four failures such as cases d), f) and g) of section 4.4.4.9 of GSM 04.08 have occurred during a periodic location updating procedure) it shall use a request for a CM connection other than emergency call as a trigger for a location updating procedure.
- 5) When a failure such as cases d), f) and g) of section 4.4.4.9 of GSM 04.08 has occurred during an IMSI attach procedure and the attempt counter is smaller than 4 the Mobile Station shall send, after T3211 expiry, a Location Updating Request message with the Mobile Identity IE set to the TMSI which has been allocated to the Mobile Station, CKSN IE and LAI set to those which have been allocated to the Mobile Station and the Location Updating type set to "IMSI attach".

When the Mobile Station's attempt counter reaches the value 4 (four failures such as cases d), f) and g) of section 4.4.4.9 of GSM 04.08 have occurred during an IMSI attach procedure) after T3212 expiry it shall send a Location Updating Request message with the Mobile Identity IE set to its IMSI, CKSN IE set to "no key is available" and the Location Updating type set to "normal".

- 6) When the Mobile Station's attempt counter reaches the value 4 (four failures such as cases d), f) and g) of section 4.4.4.9 of GSM 04.08 have occurred during an IMSI attach procedure) it shall use a request for a CM connection other than emergency call as a trigger for a location updating procedure.

References

GSM 04.08 section 4.4.4.9.

26.7.4.3.4.2 Test purpose

To verify that in the case when the attempt counter is smaller than 4 and the broadcast LAI is equal to the stored LAI, the MS is in the MM IDLE state and NORMAL SERVICE substate. To verify that timer T3211 is stopped after a MM connection establishment.

To verify that the MS uses the T3211 timer. and that it enters the MM IDLE state and NORMAL SERVICE substate when its attempt counter reaches value 4 even in the case where the stored LAI is equal to the broadcast LAI.

26.7.4.3.4.3 Method of test

Initial conditions

System Simulator:

- One cell: B, belonging to location area b.
- IMSI attach/detach is allowed.
- T3212 is set to 6 minutes.

Mobile Station:

The MS is "Idle updated" on cell B with a valid CKSN and a TMSI.

Related PICS/PIXIT statements

SIM removal possible while MS is powered Yes/No.

Switch off on button Yes/No.

Foreseen final state of the MS

The MS is "idle updated" on cell B with a valid CKSN and a TMSI.

Test Procedure

A failure during the periodic location updating is triggered: as the broadcast LAI is equal to the stored LAI, the MS is still in the MM IDLE state and NORMAL SERVICE substate and timer T3211 is started. A CM connection other than for emergency call is attempted. It is checked that this is possible and that T3211 is stopped. Same test is performed with a failure during an IMSI attach procedure.

Then failures are triggered during the periodic location updating to let the attempt counter to reach the value of 4. The MS shall enter the MM IDLE LIMITED SERVICE state and delete any TMSI, stored LAI, ciphering key sequence number and ciphering key. When the attempt counter reaches the value of 4, timer T3212 shall be started. At timer T3212 expiry a location updating procedure is started. A request for CM connection other for than emergency call shall trigger a location updating procedure.

Same tests are performed when the failures are triggered during an IMSI attach procedure.

Maximum duration of test

40 minutes.

Expected sequence

Step	Direction	Message	Comments
1	SS		The SS shall wait at most T3212 + 45 seconds.
2	MS -> SS	CHANNEL REQUEST	Establishment cause: Location updating.
3	SS -> MS	IMMEDIATE ASSIGNMENT	
4	MS -> SS	LOCATION UPDATING REQUEST	location updating type = periodic, CKSN = initial value, LAI = b, mobile station classmark 1 as given by the PICS and mobile identity = TMSI.
5	SS		performs step 5, of 26.7.4.3.2 with cause #17 and step 6 of 26.7.4.3.2.
6	MS		A MO CM connection is attempted.
7	MS -> SS	CHANNEL REQUEST	
8	SS -> MS	IMMEDIATE ASSIGNMENT	
9	MS -> SS	CM SERVICE REQUEST	CKSN = initial CKSN, Mobile Identity = TMSI.
10	SS -> MS	CM SERVICE ACCEPT	
11	MS -> SS	An initial CM message	
12	SS -> MS	CHANNEL RELEASE	The SS waits for the disconnection of the main signalling link.
13	SS		The MS shall not initiate an RR connection establishment. This is checked during 2*T3211.
14	MS		If possible (see PICS) SIM detachment is performed. Otherwise if possible (see PICS) switch off is performed. Otherwise the power is removed.
15	MS -> SS	CHANNEL REQUEST	Steps 15 to 19 are optional.
16	SS -> MS	IMMEDIATE ASSIGNMENT	
17	MS -> SS	IMSI DETACH INDICATION	
18	SS -> MS	CHANNEL RELEASE	
19	MS		Depending on what has been performed in step 14 the MS is brought back to operation.
20	MS -> SS	CHANNEL REQUEST	Establishment cause: Location updating.
21	SS -> MS	IMMEDIATE ASSIGNMENT	
22	MS -> SS	LOCATION UPDATING REQUEST	location updating type = IMSI attach, CKSN = initial value, LAI = b, mobile station classmark 1 as given by the PICS and mobile identity = TMSI.
23	SS		performs step 11 of 26.7.4.3.2.
24	MS		A MO CM connection is attempted.
25	MS -> SS	CHANNEL REQUEST	
26	SS -> MS	IMMEDIATE ASSIGNMENT	
27	MS -> SS	CM SERVICE REQUEST	CKSN = initial CKSN, Mobile Identity = TMSI.
28	SS -> MS	CIPHERING MODE COMMAND	
29	MS -> SS	CIPHERING MODE COMPLETE	
30	MS -> SS	An initial CM message	
31	SS -> MS	CHANNEL RELEASE	The SS waits for the disconnection of the main signalling link.
32	SS		The MS shall not initiate an RR connection establishment. This is checked during 2*T3211 MS is "idle, updated" in cell B.
32/1	MS		If possible (see PICS) SIM detachment is performed. Otherwise if possible (see PICS) switch off is performed. Otherwise the power is removed.
32/2	MS -> SS	CHANNEL REQUEST	Steps 32/2 to 32/5 are optional.
32/3	SS -> MS	IMMEDIATE ASSIGNMENT	
32/4	MS -> SS	IMSI DETACH INDICATION	
32/5	SS -> MS	CHANNEL RELEASE	
32/6	MS		Depending on what has been performed in step 32/1, the MS is brought back to operation.
32/7	MS -> SS	CHANNEL REQUEST	Establishment cause: Location updating.
32/8	SS -> MS	IMMEDIATE ASSIGNMENT	

32/9	MS -> SS	LOCATION UPDATING REQUEST	location updating type = IMSI attach, CKSN = initial value, LAI = b, mobile station classmark 1 as given by the PICS and mobile identity = TMSI.
32/10	SS -> MS	LOCATION UPDATING ACCEPT	without mobile identity
32/11	SS -> MS	CHANNEL RELEASE	The SS shall wait at most T3212 + 15 seconds.
33	SS		Establishment cause: Location updating.
34	MS -> SS	CHANNEL REQUEST	
35	SS -> MS	IMMEDIATE ASSIGNMENT	
36	MS -> SS	LOCATION UPDATING REQUEST	location updating type = periodic, CKSN = initial value, LAI = b, mobile station classmark 1 as given by the PICS and mobile identity = TMSI.
37	SS		performs step 16 of 26.7.4.3.2.
38	MS		The MS shall not initiate an RR connection establishment during T3211 at least after the channel release.
39	MS -> SS	CHANNEL REQUEST	Establishment cause: Location updating.
40	SS -> MS	IMMEDIATE ASSIGNMENT	
41	MS -> SS	LOCATION UPDATING REQUEST	location updating type = periodic, CKSN = initial value, LAI = b, mobile station classmark 1 as given by the PICS and mobile identity = TMSI.
42	SS		performs step 5 of 26.7.4.3.2 with cause #17 and step 6 of 26.7.4.3.2.
43	MS		The MS shall not initiate an RR connection establishment during T3211 at least after the channel release.
44	MS -> SS	CHANNEL REQUEST	Establishment cause: Location updating.
45	SS -> MS	IMMEDIATE ASSIGNMENT	
46	MS -> SS	LOCATION UPDATING REQUEST	location updating type = periodic, CKSN = initial value, LAI = b, mobile station classmark 1 as given by the PICS and mobile identity = TMSI.
47	SS		performs step 11 of 26.7.4.3.2.
48	MS		The MS shall not initiate an RR connection establishment within T3211 + RadioLinkTimeout after the SS deactivates the SACCH.
49	MS -> SS	CHANNEL REQUEST	Establishment cause: Location updating.
50	SS -> MS	IMMEDIATE ASSIGNMENT	
51	MS -> SS	LOCATION UPDATING REQUEST	location updating type = periodic, CKSN = initial value, LAI = b, mobile station classmark 1 as given by the PICS and mobile identity = TMSI.
52	SS		performs step 16 of 26.7.4.3.2.
53	MS		The MS shall not initiate an RR connection establishment during T3212 - 15 seconds at least after the channel release.
54	MS -> SS	CHANNEL REQUEST	Establishment cause: Location updating.
55	SS -> MS	IMMEDIATE ASSIGNMENT	
56	MS -> SS	LOCATION UPDATING REQUEST	location updating type = periodic or normal (see Note 1), CKSN = no key available, LAI = deleted LAI (the MCC and MNC hold the previous values, the LAC is coded FFFE) mobile station classmark 1 as given by the PICS and mobile identity = IMSI.
57	SS -> MS	AUTHENTICATION REQUEST	
58	MS -> SS	AUTHENTICATION RESPONSE	
59a	SS -> MS	LOCATION UPDATING ACCEPT	IE mobile Identity = TMSI.
59b	MS->SS	TMSI REALLOCATION COMPLETE	
60	SS -> MS	CHANNEL RELEASE	The SS waits for the disconnection of the main signalling link.

61	MS		The MS shall not initiate an RR connection establishment earlier than T3212 - 15 seconds after the transmission of the CHANNEL RELEASE in step 60.
62	MS -> SS	CHANNEL REQUEST	Establishment cause: Location updating. location updating type = periodic, CKSN = initial value, LAI = b, mobile station classmark 1 as given by the PICS and mobile identity = TMSI. performs step 5 of 26.7.4.3.2 with cause #17 and step 6 of 26.7.4.3.2.
63	SS -> MS	IMMEDIATE ASSIGNMENT	
64	MS -> SS	LOCATION UPDATING REQUEST	
65	SS		
66	MS		The MS shall not initiate an RR connection establishment during T3211 at least after the channel release.
67	MS -> SS	CHANNEL REQUEST	Establishment cause: Location updating. location updating type = periodic, CKSN = initial value, LAI = b, mobile station classmark 1 as given by the PICS and mobile identity = TMSI. performs step 11 of 26.7.4.3.2.
68	SS -> MS	IMMEDIATE ASSIGNMENT	
69	MS -> SS	LOCATION UPDATING REQUEST	
70	SS		
71	MS		The MS shall not initiate an RR connection establishment within T3211 + RadioLinkTimeout after the SS deactivates the SACCH.
72	MS -> SS	CHANNEL REQUEST	Establishment cause: Location updating. location updating type = periodic, CKSN = initial value, LAI = b, mobile station classmark 1 as given by the PICS and mobile identity = TMSI. performs step 16 of 26.7.4.3.2.
73	SS -> MS	IMMEDIATE ASSIGNMENT	
74	MS -> SS	LOCATION UPDATING REQUEST	
75	SS		
76	MS		The MS shall not initiate an RR connection establishment during T3211 at least after the channel release.
77	MS -> SS	CHANNEL REQUEST	Establishment cause: Location updating. location updating type = periodic, CKSN = initial value, LAI = b, mobile station classmark 1 as given by the PICS and mobile identity = TMSI. performs step 5 of 26.7.4.3.2 with cause #17 and step 6 of 26.7.4.3.2.
78	SS -> MS	IMMEDIATE ASSIGNMENT	
79	MS -> SS	LOCATION UPDATING REQUEST	
80	SS		
81	MS		A MO CM connection is attempted.
82	MS -> SS	CHANNEL REQUEST	Establishment cause: Location updating. location updating type = normal, CKSN = no key available, LAI = deleted LAI (the MCC and MNC hold the previous values, the LAC is coded FFFE) mobile station classmark 1 as given by the PICS and mobile identity = IMSI. IE mobile identity = TMSI.
83	SS -> MS	IMMEDIATE ASSIGNMENT	
84	MS -> SS	LOCATION UPDATING REQUEST	
85	SS -> MS	LOCATION UPDATING ACCEPT	
86	MS -> SS	TMSI REALLOCATION COMPLETE	
87	SS -> MS	CHANNEL RELEASE	
88	MS -> SS	CHANNEL REQUEST	Steps 88 to 92 are optional Wait 10 s to decide whether to go directly to step 93. CKSN = no key available, Mobile identity = TMSI cause #17 (network failure).
89	SS -> MS	IMMEDIATE ASSIGNMENT	
90	MS -> SS	CM SERVICE REQUEST	
91	SS -> MS	CM SERVICE REJECT	
92	SS -> MS	CHANNEL RELEASE	
93	MS		If possible (see PICS) SIM detachment is performed. Otherwise if possible (see PICS) switch off is performed. Otherwise the power is removed.
			Steps 94 to 97 are optional.

94	MS -> SS	CHANNEL REQUEST	
95	SS -> MS	IMMEDIATE ASSIGNMENT	
96	MS -> SS	IMSI DETACH INDICATION	
97	SS -> MS	CHANNEL RELEASE	
98	MS		Depending on what has been performed in step 97 the MS is brought back to operation. Establishment cause: Location updating.
99	MS -> SS	CHANNEL REQUEST	
100	SS -> MS	IMMEDIATE ASSIGNMENT	
101	MS -> SS	LOCATION UPDATING REQUEST	location updating type = IMSI attach, CKSN = no key available, LAI = b, mobile station classmark 1 as given by the PICS and mobile identity = TMSI. performs step 11 of 26.7.4.3.2.
102	SS		The MS shall not initiate an RR connection establishment within T3211 + RadioLinkTimeout after the SS deactivates the SACCH.
103	MS		Establishment cause: Location updating.
104	MS -> SS	CHANNEL REQUEST	
105	SS -> MS	IMMEDIATE ASSIGNMENT	
106	MS -> SS	LOCATION UPDATING REQUEST	location updating type = IMSI attach, CKSN = no key available, LAI = b, mobile station classmark 1 as given by the PICS and mobile identity = TMSI.
107	SS -> MS	CHANNEL RELEASE	After the sending of the message the SS waits for the disconnection of the main signalling link.
108	MS		The MS shall not initiate an RR connection establishment during T3211 at least after the channel release.
109	MS -> SS	CHANNEL REQUEST	
110	SS -> MS	IMMEDIATE ASSIGNMENT	Establishment cause: Location updating.
111	MS -> SS	LOCATION UPDATING REQUEST	location updating type = IMSI attach, CKSN = no key available, LAI = b, mobile station classmark 1 as given by the PICS and mobile identity = TMSI.
112a	SS -> MS	LOCATION UPDATING REJECT	IE Reject cause is set to a value arbitrarily chosen: * in table 10.66 of GSM 04.08, causes #2, #3, #6, #11, #12, and #13 being excluded.
112b	MS -> SS	CHANNEL RELEASE	After the sending of this message, the SS waits for the disconnection of the main signalling link.
113	MS		The MS shall not initiate an RR connection establishment during T3211 at least after the channel release.
114	MS -> SS	CHANNEL REQUEST	
115	SS -> MS	IMMEDIATE ASSIGNMENT	Establishment cause: Location updating.
116	MS -> SS	LOCATION UPDATING REQUEST	location updating type = IMSI attach, CKSN = no key available, LAI = b, mobile station classmark 1 as given by the PICS and mobile identity = TMSI.
117	SS		performs step 11 of 26.7.4.3.2.
118	MS		The MS shall not initiate an RR connection establishment during T3212 - 15 seconds at least after the channel release.
119	MS -> SS	CHANNEL REQUEST	
120	SS -> MS	IMMEDIATE ASSIGNMENT	Establishment cause: Location updating.
121	MS -> SS	LOCATION UPDATING REQUEST	location updating type = periodic or normal or IMSI attach (see Note 2), CKSN = no key available, LAI = deleted LAI (the MCC and MNC hold the previous values, the LAC is coded FFFE) mobile station classmark 1 as given by the PICS and mobile identity = IMSI.
122	SS -> MS	AUTHENTICATION REQUEST	
123	MS -> SS	AUTHENTICATION RESPONSE	
124	SS -> MS	LOCATION UPDATING ACCEPT	IE mobile Identity = TMSI.
125	MS -> SS	TMSI REALLOCATION COMPLETE	
126	SS -> MS	CHANNEL RELEASE	

127	MS		If possible (see PICS) SIM detachment is performed. Otherwise if possible (see PICS) switch off is performed. Otherwise the power is removed.
128 129 130 131	MS -> SS SS -> MS MS -> SS SS -> MS	CHANNEL REQUEST IMMEDIATE ASSIGNMENT IMSI DETACH INDICATION CHANNEL RELEASE	Steps 128 to 131 are optional.
132 133 134 135 136 137	MS MS -> SS SS -> MS MS -> SS SS MS	 CHANNEL REQUEST IMMEDIATE ASSIGNMENT LOCATION UPDATING REQUEST 	Depending on what has been performed in step 130 the MS is brought back to operation. Establishment cause: Location updating. location updating type = IMSI attach, CKSN = initial value, LAI = b, mobile station classmark 1 as given by the PICS and mobile identity = TMSI. performs step 16 of 26.7.4.3.2. The MS shall not initiate an RR connection establishment during T3211 at least after the channel release.
138 139 140 141 142 143 144	MS -> SS SS -> MS MS -> SS SS MS MS -> SS SS -> MS	CHANNEL REQUEST IMMEDIATE ASSIGNMENT LOCATION UPDATING REQUEST CHANNEL REQUEST IMMEDIATE ASSIGNMENT	Establishment cause: Location updating. location updating type = IMSI attach, CKSN = initial value, LAI = b, mobile station classmark 1 as given by the PICS and mobile identity = TMSI. performs step 5 of 26.7.4.3.2 with cause #17 and step 6 of 26.7.4.3.2. The MS shall not initiate an RR connection establishment during T3211 at least after the channel release. Establishment cause: Location updating.
145 146 147 148 149 150 151 152 153 154 155 156 157 158 159 160	MS -> SS SS MS MS -> SS SS -> MS MS -> SS SS MS MS -> SS SS -> MS MS -> SS SS -> MS MS -> SS SS -> MS MS -> SS SS -> MS	LOCATION UPDATING REQUEST CHANNEL REQUEST IMMEDIATE ASSIGNMENT LOCATION UPDATING REQUEST CHANNEL REQUEST IMMEDIATE ASSIGNMENT LOCATION UPDATING REQUEST AUTHENTICATION REQUEST AUTHENTICATION RESPONSE LOCATION UPDATING ACCEPT TMSI REALLOCATION COMPLETE CHANNEL RELEASE	location updating type = IMSI attach, CKSN = initial value, LAI = b, mobile station classmark 1 as given by the PICS and mobile identity = TMSI. performs step 11 of 26.7.4.3.2. The MS shall not initiate an RR connection establishment within T3211 + RadioLinkTimeout after the SS deactivates the SACCH. Establishment cause: Location updating. location updating type = IMSI attach, CKSN = initial value, LAI = b, mobile station classmark 1 as given by the PICS and mobile identity = TMSI. performs step 16 of 26.7.4.3.2. The MS is made to perform a MO call. Establishment cause: Location updating. location updating type = normal, CKSN = no key available, LAI = deleted LAI (the MCC and MNC hold the previous values, the LAC is coded FFFE) mobile station classmark 1 as given by the PICS and mobile identity = IMSI. IE mobile Identity = TMSI.
161	MS		Steps 161 to 166 are optional. An MO CM connection is attempted.

162	MS -> SS	CHANNEL REQUEST	
163	SS -> MS	IMMEDIATE ASSIGNMENT	
164	MS -> SS	CM SERVICE REQUEST	CKSN = initial value, Mobile identity = TMSI. cause #17 (network failure).
165	SS -> MS	CM SERVICE REJECT	
166	SS -> MS	CHANNEL RELEASE	

NOTE 1: the MS can include both types of Location updating. As T3212 expires it can be a periodic location updating procedure and as there is no stored LAI it can be a normal one.

NOTE 2: same problem as in note 1. Three types of location updating procedures should be allowed.

Specific message contents

None.

26.7.4.4 Location updating / release / expiry of T3240

26.7.4.4.1 Conformance requirement

The mobile station receiving a LOCATION UPDATING REJECT message shall start T3240: it shall abort the RR connection at the expiry of timer T3240.

References

GSM 04.08 section 4.4.4.8, 11.2.

26.7.4.4.2 Test purpose

To verify that the MS aborts the RR-connection at the expiry of timer T3240.

26.7.4.4.3 Method of test

Initial conditions

System Simulator:

Two cells: A and B, belonging to different location areas a and b.

Mobile Station:

The MS has a valid TMSI. It is "idle updated" on cell A.

Related PICS/PIXIT statements

None.

Foreseen final state of the MS

The MS is "idle updated" on cell B.

Test Procedure

A normal location updating procedure is performed. The RR-connection is not released by the SS within the timer T3240. It is checked that the MS aborts the RR-connection.

Maximum duration of test

1 minute.

Expected sequence

Step	Direction	Message	Comments
1	SS		The RF level of cell A is lowered until the MS selects cell B.
2	MS -> SS	CHANNEL REQUEST	"Establishment cause": Location updating.
3	SS -> MS	IMMEDIATE ASSIGNMENT	
4	MS -> SS	LOCATION UPDATING REQUEST	
5	SS -> MS	LOCATION UPDATING ACCEPT	
6	SS		
7	MS		The MS shall abort the RR connection (disconnection of layer 2).

Specific message contents

None.

26.7.4.5 Location updating / periodic**26.7.4.5.1 Location updating / periodic spread****26.7.4.5.1.1 Conformance requirement**

- 1) The Mobile Stations shall perform spreading of the time before performing a periodic location updating when the location updating timer value is reduced.
- 2) The Mobile Station shall reset timer T3212 when the Mobile Station is deactivated, and shall start with a value between zero and the broadcasted value when reactivated in the same cell, IMSI attach being forbidden.
- 3) When activated the Mobile Station shall start timer T3212 with a value randomly drawn in the allowed range.

NOTE: This conformance requirement is not covered by a test purpose. It is intended to be covered by a manufacturer declaration.

References

GSM 04.08 section 4.4.2.

26.7.4.5.1.2 Test purpose

- 1) To check that when the location updating timer is reduced, the timer running in the MS is started with a value depending on the current timer value and the new broadcasted T3212 value.
- 2) To verify that when the MS is reactivated in the same cell (as the one in which it was deactivated), IMSI attach being forbidden, the MS starts the timer T3212 with a value between zero and the broadcasted value.

NOTE: It is not tested that the value is random.

26.7.4.5.1.3 Method of test**Initial conditions**

System Simulator:

One cell, T3212 is set to 30 minutes.
IMSI attach is allowed in the cell.

Mobile Station:

The MS is deactivated. The stored MCC, MNC and LAC correspond to the broadcasted values. The stored update status is "updated".

Related PICS/PIXIT statements

None.

Foreseen final state of the MS

The MS has a valid TMSI. It is "idle updated".

Test procedure

The MS is activated. It performs IMSI attach. 3 minutes after the end of the IMSI attach procedure, the value of T3212 is set to 6 minutes. The MS shall perform periodic location updating 6 minutes after the end of the IMSI attach procedure.

Then, the IMSI attach/detach is forbidden. T3212 is still set to 6 minutes.

The MS is deactivated. The MS is reactivated. It is checked that the MS performs a periodic location updating during the 6 minutes following activation.

Maximum duration of test

20 minutes.

Expected sequence

Step	Direction	Message	Comments
1	MS		The MS is activated.
2	MS -> SS	CHANNEL REQUEST	"Establishment cause": Location updating.
3	SS -> MS	IMMEDIATE ASSIGNMENT	
4	MS -> SS	LOCATION UPDATING REQUEST	"location updating type": IMSI attach.
5	SS -> MS	LOCATION UPDATING ACCEPT	
6	SS -> MS	CHANNEL RELEASE	After the sending of this message, the SS waits for the disconnection of the main signalling link.
7	SS		3 minutes after step 6 the value of T3212 is set to 6 minutes.
8	MS -> SS	CHANNEL REQUEST	"Establishment cause": Location updating This message shall be sent by the MS between 5minutes 45s and 6minutes 15s after step 6.
9	SS -> MS	IMMEDIATE ASSIGNMENT	
10	MS -> SS	LOCATION UPDATING REQUEST	"location updating type": periodic updating.
11	SS -> MS	LOCATION UPDATING ACCEPT	
12	SS -> MS	CHANNEL RELEASE	After the sending of this message, the SS waits for the disconnection of the main signalling link.
13	SS		IMSI attach/detach is not allowed.
14	MS		The MS is deactivated.
15	MS		The MS is activated.
16	SS		The SS waits until the periodic location updating.
17	MS -> SS	CHANNEL REQUEST	"Establishment cause": Location updating This message shall arrive during the 7 minutes following the MS activation.
18	SS -> MS	IMMEDIATE ASSIGNMENT	
19	MS -> SS	LOCATION UPDATING REQUEST	"Location updating type" = periodic.
20	SS -> MS	LOCATION UPDATING ACCEPT	
21	SS -> MS	CHANNEL RELEASE	After the sending of this message, the SS waits for the disconnection of the main signalling link.

Specific message contents

None.

26.7.4.5.2 Location updating / periodic normal / test 1**26.7.4.5.2.1 Conformance requirement**

- 1 The Mobile Station shall stop and reset the timer T3212 of the periodic location updating procedure when the first MM message is received or ciphering mode setting is completed in the case of MM connection establishment.
- 2 The Mobile Station shall stop and reset the timer T3212 of the periodic location updating procedure when the Mobile Station has responded to paging and thereafter has received the first correct L3 message that is not an RR message.

References

GSM 04.08 section 4.4.2.

26.7.4.5.2.2 Test purpose

To verify that the MS stops and resets the timer T3212 of the periodic location updating procedure when:

- the first MM-message is received in the case of MM-connection establishment, ciphering mode being not set;
- the MS has responded to paging and the first correct L3 message that is not an RR message is received.

NOTE: T3212 is stopped when the MM-idle state is left and restarted when the MM sublayer returns to that state, substate NORMAL SERVICE or ATTEMPTING TO UPDATE. As a consequence, the exact time when T3212 is reset between those two events cannot be tested.

26.7.4.5.2.3 Method of test

Initial conditions

System Simulator:

- 1 cell, default parameters.
- IMSI attach/detach is not allowed.
- The T3212 time-out value is 2/10 hour.

Mobile Station:

The MS has a valid TMSI. It is "idle updated".

Related PICS/PIXIT statements

None.

Foreseen final state of the MS

The MS has a valid TMSI. It is "idle updated".

Test procedure

An MS originated MM connection is established and cleared. The channel is released. It is checked that the MS performs a periodic location updating 12 minutes after the release of the channel.

One minute after the periodic location updating, the MS is paged, it sends a CHANNEL REQUEST message and the SS responds with an IMMEDIATE ASSIGNMENT message, a call is established and then cleared. It is checked that the MS performs a periodic location updating 12 minutes after the release of the link.

Maximum duration of test

30 minutes.

Expected sequence

Step	Direction	Message	Comments
1	MS		A MO CM connection is attempted.
2	MS -> SS	CHANNEL REQUEST	
3	SS -> MS	IMMEDIATE ASSIGNMENT	
4	MS -> SS	CM SERVICE REQUEST	
5	SS -> MS	CM SERVICE REJECT	cause #17 (network failure).
6	SS -> MS	CHANNEL RELEASE	After the sending of this message, the SS waits for the disconnection of the main signalling link.
7	SS		The SS waits until the periodic location updating.
8	MS -> SS	CHANNEL REQUEST	"Establishment cause": Location updating This message shall arrive between 11 minutes 45 s and 12 minutes 15 s after the last release of the RR connection by the SS.
9	SS -> MS	IMMEDIATE ASSIGNMENT	
10	MS -> SS	LOCATION UPDATING REQUEST	"Location updating type" = periodic.
11	SS -> MS	LOCATION UPDATING ACCEPT	
12	SS -> MS	CHANNEL RELEASE	After the sending of this message, the SS waits for the disconnection of the main signalling link.
13	SS		The SS waits 1 minute.
14	SS -> MS	PAGING REQUEST TYPE 1	"Mobile identity" = IMSI.
15	MS -> SS	CHANNEL REQUEST	"Establishment cause": Answer to paging.
16	SS -> MS	IMMEDIATE ASSIGNMENT	
17	MS -> SS	PAGING RESPONSE	
18	SS -> MS	AUTHENTICATION REQUEST	
19	MS -> SS	AUTHENTICATION RESPONSE	
20	SS - MS	CHANNEL RELEASE	After the sending of this message, the SS waits for the disconnection of the main signalling link.
21	SS		The SS waits until the periodic location updating.
22	MS -> SS	CHANNEL REQUEST	"Establishment cause": Location updating This message shall arrive between 11 minutes 45 s and 12 minutes 15 s after the last release of the RR connection by the SS.
23	SS -> MS	IMMEDIATE ASSIGNMENT	
24	MS -> SS	LOCATION UPDATING REQUEST	"Location updating type" = periodic.
25	SS -> MS	LOCATION UPDATING ACCEPT	
26	SS -> MS	CHANNEL RELEASE	After the sending of this message, the SS waits for the disconnection of the main signalling link.

Specific message contents

None.

26.7.4.5.3 Location updating / periodic normal / test 2

26.7.4.5.3.1 Conformance requirement

When a LOCATION UPDATING ACCEPT or a LOCATION UPDATING REJECT message is received, the timer T3212 is stopped and reset and the Mobile Station shall perform a periodic location updating after T3212 expiry.

References

GSM 04.08 section 4.4.2.

26.7.4.5.3.2 Test purpose

To verify that the MS stops and resets the timer T3212 of the periodic location updating procedure when a LOCATION UPDATING ACCEPT message is received.

NOTE: T3212 is stopped when the MM-idle state is left and restarted when the MM sublayer returns to that state, substate NORMAL SERVICE or ATTEMPTING TO UPDATE. As a consequence, the exact time when T3212 is reset between those two events cannot be tested.

26.7.4.5.3.3 Method of test**Initial conditions**

System Simulator:

2 cells, IMSI attach/detach is allowed in both cells.

T3212 is set to 6 minutes.

Mobile Station:

The MS has a valid TMSI. It is "idle updated" on cell A.

Related PICS/PIXIT statements

SIM removal possible while MS is powered Yes/No

Switch off on button yes/No

Foreseen final state of the MS

The MS has a valid TMSI. It is "idle updated" on cell B.

Test procedure

A normal location updating is performed. The channel is released. One minute later, the MS is deactivated, then reactivated in the same cell. It is checked that the MS performs an IMSI attach and a periodic location updating 6 minutes after the IMSI attach.

Maximum duration of test

20 minutes.

Expected sequence

Step	Direction	Message	Comments
1	SS		The following messages are sent and shall be received on cell B. The RF level of cell A is lowered until the MS selects cell B.
2	MS -> SS	CHANNEL REQUEST	"establishment cause": Location updating.
3	SS -> MS	IMMEDIATE ASSIGNMENT	
4	MS -> SS	LOCATION UPDATING REQUEST	"location updating type" = normal.
5	SS -> MS	LOCATION UPDATING ACCEPT	
6	SS ->MS	CHANNEL RELEASE	After the sending of this message, the SS waits for the disconnection of the main signalling link.
7	SS		The SS waits until the periodic location updating.
8	MS -> SS	CHANNEL REQUEST	"Establishment cause": Location updating This message shall arrive between 5 minutes 45s and 6 minutes 15 s after the last release of the RR connection by the SS.
9	SS -> MS	IMMEDIATE ASSIGNMENT	
10	MS -> SS	LOCATION UPDATING REQUEST	"Location updating type" = periodic.
11	SS -> MS	LOCATION UPDATING ACCEPT	
12	SS -> MS	CHANNEL RELEASE	After the sending of this message, the SS waits for the disconnection of the main signalling link.
13	MS		If possible (see PICS) SIM removal is performed. Otherwise if possible (see PICS) switch off is performed. Otherwise the power is removed. steps 14 to 17 may be performed or not depending on the action made in step 13.
14	MS -> SS	CHANNEL REQUEST	
15	SS -> MS	IMMEDIATE ASSIGNMENT	
16	MS -> SS	IMSI DETACH INDICATION	
17	SS -> MS	CHANNEL RELEASE	After the sending of this message, the SS waits for the disconnection of the main signalling link.
18	MS		Depending on what has been performed in step 13 the MS is brought back to operation.
19	MS -> SS	CHANNEL REQUEST	"Establishment cause": Location updating.
20	SS -> MS	IMMEDIATE ASSIGNMENT	
21	MS -> SS	LOCATION UPDATING REQUEST	"Location updating type" = IMSI attach.
22	SS -> MS	LOCATION UPDATING ACCEPT	
23	SS -> MS	CHANNEL RELEASE	After the sending of this message, the SS waits for the disconnection of the main signalling link.
24	SS		The SS waits until the periodic location updating.
25	MS -> SS	CHANNEL REQUEST	"Establishment cause": Location updating This message shall arrive between 5 minutes 45 s and 6 minutes 15s after the last release of the RR connection by the SS.
26	SS -> MS	IMMEDIATE ASSIGNMENT	
27	MS -> SS	LOCATION UPDATING REQUEST	"Location updating type" = periodic.
28	SS -> MS	LOCATION UPDATING ACCEPT	
29	SS -> MS	CHANNEL RELEASE	After the sending of this message, the SS waits for the disconnection of the main signalling link.

Specific message contents

None.

26.7.4.5.4 Location updating / periodic HPLMN search**26.7.4.5.4.1 Location updating / periodic HPLMN search / MS waits time T****26.7.4.5.4.1.1 Conformance requirement**

When in automatic mode and roaming in the home country, the MS shall make an attempt to access the HPLMN, if the MS is on the VPLMN at time T after since the last attempt.

NOTE: This test is not intended to test every value in the range 6 minutes to 8 hours or the default of 30 minutes, but is intended to check that the mobile is capable of using the value stored on the SIM.

References

GSM 02.11 section 3.2.2.5.2.

GSM 03.22 section 4.4.3.3.

26.7.4.5.4.1.2 Test purpose

To verify that when a cell of the HPLMN becomes available, following the successful location request on the VPLMN of the home country and after the first search the mobile has failed to find its HPLMN, that the MS shall perform a location update request on the HPLMN after time T. Where T is the HPLMN Search Period stored in the SIM.

26.7.4.5.4.1.3 Method of test**Initial conditions**

System Simulator:

Two cells A and B, belonging to different location areas with location identification a and b. Cell A shall be a cell of the HPLMN and Cell B shall be a cell of the VPLMN with a Country Code the same as that of Cell A. Initially Cell A shall not be broadcasting. IMSI attach/detach is not allowed on either cell.

Mobile Station:

The MS is switched off. The HPLMN Search Period on the SIM shall be set to 6 minutes. The location area information on the SIM is "deleted".

Related PICS/PIXIT statements

Switch on/off button Yes/No.

Foreseen final state of the MS

The MS is "idle updated" on Cell A.

Test Procedure

Only Cell B shall be broadcasting. The MS shall be switched on either by using the Power Switch or by applying power. A normal location updating is performed on Cell B. Cell A shall be made available after 8 minutes, thus ensuring the MS fails to find the HPLMN during its first attempt. It is verified that the MS performs a location update request on Cell A, within 6 minutes after broadcasting of Cell A.

Maximum duration of test

17 minutes.

Expected sequence

Step	Direction	Message	Contents
1	MS		The following messages shall be sent and received on Cell B. The MS is switched on by either using the Power Switch or by applying power.
2	MS -> SS	CHANNEL REQUEST	"Establishment cause": Location updating.
3	SS -> MS	IMMEDIATE ASSIGNMENT	
4	MS -> SS	LOCATION UPDATING REQUEST	"Location Update Type": Normal.
5	SS -> MS	LOCATION UPDATING ACCEPT	
6	SS -> MS	CHANNEL RELEASE	After sending this message the SS waits for the disconnection of the main signalling link. The SS waits a period of 8 minutes, this allowing the MS to make its first periodic search.
8	SS		Cell A is made available. Within 8 minutes after step 8 the following messages shall be sent and received on Cell A.
9	MS -> SS	CHANNEL REQUEST	"Establishment cause": Location updating.
10	SS -> MS	IMMEDIATE ASSIGNMENT	
11	MS -> SS	LOCATION UPDATING REQUEST	"Location Update Type": normal.
12	SS -> MS	LOCATION UPDATING ACCEPT	
13	SS -> MS	CHANNEL RELEASE	After sending this message the SS waits for the disconnection of the main signalling link.

Specific message contents

None.

26.7.4.5.4.2 Location updating / periodic HPLMN search / MS in manual mode**26.7.4.5.4.2.1 Conformance requirement**

The periodic attempts shall only be performed if in automatic mode when the MS is roaming in its home country.

References

GSM 02.11 section 3.2.2.5.2.

GSM 03.22 section 4.4.3.3.

26.7.4.5.4.2.2 Test purpose

To verify that no HPLMN Search is performed when the MS is not in automatic mode.

26.7.4.5.4.2.3 Method of test**Initial conditions**

System Simulator:

Two cells A and B, belonging to different location areas with location identification a and b. Cell A shall be a cell of the HPLMN and Cell B shall be a cell of the VPLMN with a Country Code the same as that of Cell A. Initially Cell A shall not be broadcasting. IMSI attach/detach is not allowed on either cell.

Mobile Station:

The MS is switched off. The HPLMN Search Period on the SIM shall be set to 6 minutes. The location area information on the SIM is "deleted".

Related PICS/PIXIT statements

Switch on/off button Yes/No.

Foreseen final state of the MS

The MS is "idle updated" on Cell B.

Test Procedure

Only Cell B shall be broadcasting. The MS shall be switched on either by using the Power Switch or by applying power. A normal location updating is performed on Cell B. The MS is forced into manual selection mode. Cell A is made available. It is verified that the MS does not attempt to perform a location update on Cell A.

Maximum duration of test

7 minutes.

Expected sequence

Step	Direction	Message	Contents
1	MS		The following messages shall be sent and received on Cell B. The MS is switched on by either using the Power Switch or by applying power.
2	MS -> SS	CHANNEL REQUEST	"Establishment cause": Location updating.
3	SS -> MS	IMMEDIATE ASSIGNMENT	
4	MS -> SS	LOCATION UPDATING REQUEST	"Location Update Type": Normal.
5	SS -> MS	LOCATION UPDATING ACCEPT	
6	SS -> MS	CHANNEL RELEASE	After sending this message the SS waits for the disconnection of the main signalling link.
8	MS		The MS is forced into manual selection mode.
9	SS		Cell A is made available.
10	SS		The SS waits a period of 7 minutes. During this time no messages shall be received on Cell A.

Specific message contents

None.

26.7.4.5.4.3 Location updating / periodic HPLMN search / MS waits at least two minutes and at most T minutes

26.7.4.5.4.3.1 Conformance requirement

After switch on, the MS waits at least 2 minutes and at most T minutes before the first HPLMN Search is attempted.

References

GSM 02.11 section 3.2.2.5.2.

GSM 03.22 section 4.4.3.3.

26.7.4.5.4.3.2 Test purpose

To verify that the MS waits at least 2 minutes and at most T minutes before attempting its first HPLMN Search.

26.7.4.5.4.3.3 Method of test

Initial Conditions

System Simulator:

Two cells A and B, belonging to different location areas with location identification a and b. Cell A shall be a cell of the HPLMN and Cell B shall be a cell of the VPLMN with a Country Code the same as that of Cell A. Initially Cell A shall not be broadcasting. IMSI attach/detach is not allowed on either cell.

Mobile Station:

The MS is switched off. The HPLMN Search Period on the SIM shall be set to 6 minutes. The location area information on the SIM is "deleted".

Related PICS/PIXIT statements

Switch on/off button Yes/No.

Foreseen final state of the MS

The MS is "idle updated" on Cell A.

Test Procedure

Only Cell B shall be broadcasting. The MS shall be switched on either by using the Power Switch or by applying power. A normal location updating is performed on Cell B. Cell A is made available. It is verified that the MS attempts to perform a location update on Cell A, after at least 2 minutes and at most T minutes have passed following power on.

Maximum duration of test

8 minutes.

Expected sequence

Step	Direction	Message	Contents
1	MS		The following messages shall be sent and received on Cell B. The MS is switched on by either using the Power Switch or by applying power.
2	MS -> SS	CHANNEL REQUEST	"Establishment cause": Location updating.
3	SS -> MS	IMMEDIATE ASSIGNMENT	
4	MS -> SS	LOCATION UPDATING REQUEST	"Location Update Type": Normal.
5	SS -> MS	LOCATION UPDATING ACCEPT	
6	SS -> MS	CHANNEL RELEASE	After sending this message the SS waits for the disconnection of the main signalling link.
8	SS		Cell A is made available.
9	SS		The SS waits a period of 2 minutes after the MS is switched on. During this time no messages shall be received on Cell A. The following messages shall be sent and received on cell A. Within T minutes after the MS is switched on the following messages shall be sent and received on cell A.
10	MS -> SS	CHANNEL REQUEST	"Establishment cause": Location updating This message shall be sent between 2 and 7 minutes after step 1
11	SS -> MS	IMMEDIATE ASSIGNMENT	
12	MS -> SS	LOCATION UPDATING REQUEST	"Location Update Type": normal.
13	SS -> MS	LOCATION UPDATING ACCEPT	
14	SS -> MS	CHANNEL RELEASE	After sending this message the SS waits for the disconnection of the main signalling link.

Specific message contents

None.

26.7.4.6 Location updating / interworking of attach and periodic

26.7.4.6.1 Conformance requirement

- 1) If the Mobile Station is in service state NO CELL AVAILABLE, LIMITED SERVICE, PLMN SEARCH or PLMN SEARCH-NORMAL SERVICE when the timer expires the location updating procedure is delayed until this service state is left.
- 2) The T3212 time-out value shall not be changed in the NO CELL AVAILABLE, LIMITED SERVICE, PLMN SEARCH and PLMN SEARCH-NORMAL SERVICE states.
- 3) If the selected cell is in the location area where the mobile station is registered and IMSI ATTACH is not required and timer T3212 has not expired, then the state is NORMAL SERVICE.

References

- 1 GSM 04.08 section 4.4.2.
- 2 GSM 04.08 section 4.4.2.
- 3 GSM 04.08 section 4.2.1.1

26.7.4.6.2 Test purpose

- 1) To check that if the PLU timer expires while the MS is out of coverage, the MS informs the network of its return to coverage.
- 2) To check that the PLU timer is not disturbed by cells of forbidden PLMNs.
- 3) To check that if the PLU timer does not expire while out of coverage and if the mobile returns to the LA where it is updated, the mobile does not inform the network of its return to coverage.

26.7.4.6.3 Method of test

Initial conditions

System Simulator:

- Two cells, a and b, of different PLMNs.
- T3212 is set to 12 minutes on cell a.
- T3212 is set to 6 minutes on cell b.
- IMSI attach is allowed in both cells.

Mobile Station:

- The MS is deactivated. The PLMN of cell b is entered in the SIM's forbidden PLMN list.

Related PICS/PIXIT statements

None.

Foreseen final state of the MS

The MS is "idle updated". The PLMN of cell b is entered in the SIM's forbidden PLMN list.

Test procedure

The MS is activated and placed in automatic network selection mode. It performs IMSI attach. 1 minute after the end of the IMSI attach procedure, cell a is switched off. The MS shall not location update on cell b. 8 minutes after the end of the IMSI attach procedure, cell a is switched on. The MS shall not location update on cell a before 11,75 minutes after the end of the IMSI attach procedure. The MS shall perform a periodic location update on cell a between 11,75 minutes and 12,25 minutes after the end of the IMSI attach procedure.

3 minutes after the end of the periodic location updating procedure, cell a is switched off. The MS shall not location update on cell b. 14 minutes after the end of the periodic location updating procedure, cell a is switched on and cell b is switched off. The MS shall perform a location update on cell a before 17 minutes after the end of the periodic location updating procedure.

Maximum duration of test

35 minutes.

Expected sequence

Step	Direction	Message	Comments
1	MS		The MS is activated in automatic network selection mode.
2	MS -> SS	CHANNEL REQUEST	
3	SS -> MS	IMMEDIATE ASSIGNMENT	
4	MS -> SS	LOCATION UPDATING REQUEST	"location updating type": IMSI attach.
5	SS -> MS	LOCATION UPDATING ACCEPT	
6	SS -> MS	CHANNEL RELEASE	After the sending of this message, the SS waits for the disconnection of the main signalling link.
7	SS		1 minute after step 6, cell a is switched off.
8	SS		8 minutes after step 6, cell a is switched on.
9	MS -> SS	CHANNEL REQUEST	This message shall be sent by the MS between 11 minutes 45s and 12 minutes 15s after step 6.
10	SS -> MS	IMMEDIATE ASSIGNMENT	
11	MS -> SS	LOCATION UPDATING REQUEST	"location updating type": periodic updating.
12	SS -> MS	LOCATION UPDATING ACCEPT	
13	SS -> MS	CHANNEL RELEASE	After the sending of this message, the SS waits for the disconnection of the main signalling link.
14	SS		3 minutes after step 13, cell a is switched off.
15	SS		14 minutes after step 13, cell a is switched on and cell b is switched off.
16	MS -> SS	CHANNEL REQUEST	This message shall be sent by the MS before 17 minutes after step 13.
17	SS -> MS	IMMEDIATE ASSIGNMENT	
18	MS -> SS	LOCATION UPDATING REQUEST	"Location updating type" = periodic.
19	SS -> MS	LOCATION UPDATING ACCEPT	
22	SS -> MS	CHANNEL RELEASE	After the sending of this message, the SS waits for the disconnection of the main signalling link.

Specific message contents

None.

26.7.5 MM connection

26.7.5.1 Introduction

[tbd]

26.7.5.2 MM connection / establishment with cipher

26.7.5.2.1 Conformance requirement

- 1) The Mobile Station shall be able to correctly set up an MM connection in a Mobile Originating CM connection attempt and send a CM Service Request message with CKSN information element as stored in the SIM and Mobile Identity information element set to the TMSI.
- 2) The Mobile Station shall be able to interpret cipher mode setting as acceptance of its CM service request i.e. send a CM message.

References

GSM 04.08 sections 4.5.1.1.

26.7.5.2.2 Test purpose

To verify that the MS can correctly set up an MM connection in an origination and interpret cipher mode setting as acceptance of its CM service request.

26.7.5.2.3 Method of test**Initial conditions**

System Simulator:

1 cell, default parameters.

Mobile Station:

The MS has a valid TMSI. It is "idle updated".

Related PICS/PIXIT statements

None.

Foreseen final state of the MS

The MS has valid TMSI, CKSN. It is "idle updated".

Test Procedure

A mobile originating CM connection is initiated. After the MS has sent the CM SERVICE REQUEST message to the SS, an authentication procedure and a ciphering mode setting procedure are performed. Then, the MS sends a CM message and the SS clears the call and releases the channel.

Maximum duration of test

One minute.

Expected sequence

Step	Direction	Message	Comments
1	MS		A MO CM connection is attempted.
2	MS -> SS	CHANNEL REQUEST	
3	SS -> MS	IMMEDIATE ASSIGNMENT	
4	MS -> SS	CM SERVICE REQUEST	
5	SS -> MS	AUTHENTICATION REQUEST	
6	MS -> SS	AUTHENTICATION RESPONSE	
7	SS -> MS	CIPHERING MODE COMMAND	The SS starts deciphering.
8	MS -> SS	CIPHERING MODE COMPLETE	The SS starts enciphering.
A9	MS -> SS	SETUP	
A10	SS -> MS	RELEASE COMPLETE	"Cause" IE: "unassigned number".
B9	MS -> SS	REGISTER	
B10	SS -> MS	RELEASE COMPLETE	
C9	MS -> SS	CP-DATA	
C10	SS -> MS	CP-ACK	
C11	SS -> MS	CP-DATA	
C12	MS -> SS	CP-ACK	
13	SS -> MS	CHANNEL RELEASE	After the sending of this message, the SS waits for the disconnection of the main signalling link.

Specific message contents

None.

26.7.5.3 MM connection / establishment without cipher**26.7.5.3.1 Conformance requirement**

Upon reception of the CM SERVICE ACCEPT message, the MS shall send a CM message.

References

GSM 04.08 sections 4.5.1.1.

26.7.5.3.2 Test purpose

To verify that the MS can correctly set up an MM connection in an originating CM connection establishment when ciphering mode setting is not required.

26.7.5.3.3 Method of test**Initial conditions**

System Simulator:

1 cell, default parameters.

Mobile Station:

The MS has a valid TMSI. It is "idle updated".

Related PICS/PIXIT statements

None.

Foreseen final state of the MS

The MS has a valid TMSI. It is "idle updated".

Test Procedure

A mobile originating CM connection is attempted. The MM-connection is established without invoking the ciphering mode setting procedure.

Then, the MS sends a CM message and the SS releases the channel.

Maximum duration of test

one minute.

Expected sequence

Step	Direction	Message	Comments
1	MS		A MO CM connection is attempted.
2	MS -> SS	CHANNEL REQUEST	
3	SS -> MS	IMMEDIATE ASSIGNMENT	
4	MS -> SS	CM SERVICE REQUEST	
5	SS -> MS	CM SERVICE ACCEPT	
A6	MS -> SS	SETUP	
B6	MS -> SS	REGISTER	
C6	MS -> SS	CP-DATA	
C7	SS -> MS	CP-ACK	
C8	SS -> MS	CP-DATA	
C9	MS -> SS	CP-ACK	
10	SS -> MS	CHANNEL RELEASE	After the sending of this message, the SS waits for the disconnection of the main signalling link.

Specific message contents

None.

26.7.5.4 MM connection / establishment rejected**26.7.5.4.1 Conformance requirement**

Upon reception of a CM SERVICE REJECT message, the MS shall not send any layer 3 message, start timer T3240 and enter the "wait for network command" state.

References

GSM 04.08 sections 4.5.1.1.

26.7.5.4.2 Test purpose

To verify that the MS does not send a layer 3 message when the service request is rejected by the SS.

26.7.5.4.3 Method of test**Initial conditions**

System Simulator:
1 cell, default parameters.

Mobile Station:
The MS has a valid TMSI. It is "idle updated".

Related PICS/PIXIT statements

None.

Foreseen final state of the MS

The MS has a valid TMSI; It is "idle updated".

Test Procedure

A mobile originating CM connection is attempted. After the MS has sent the CM SERVICE REQUEST message to the SS, the SS responds with a CM SERVICE REJECT message with reject cause "requested service option not subscribed". It is checked that the MS does not send a layer 3 message.

Maximum duration of test

1 minute.

Expected sequence

Step	Direction	Message	Comments
1	MS		A MO CM connection is attempted
2	MS -> SS	CHANNEL REQUEST	
3	SS -> MS	IMMEDIATE ASSIGNMENT	
4	MS -> SS	CM SERVICE REQUEST	
5	SS -> MS	CM SERVICE REJECT	"Reject cause" IE: "requested service option not subscribed".
6	SS		The MS shall not send a layer 3 message. This is checked during 5 seconds.
7	SS -> MS	CHANNEL RELEASE	After the sending of this message, the SS waits for the disconnection of the main signalling link.

Specific message contents

None.

26.7.5.5 MM connection / establishment rejected cause 4

26.7.5.5.1 Conformance requirement

- 1) The Mobile Station shall be able to correctly set up an MM connection in a Mobile Originating CM connection attempt and send a CM Service Request message with CKSN information element as stored in the SIM and Mobile Identity information element set to the TMSI.
- 2) The Mobile Station, when receiving a CM SERVICE REJECT message with reject cause "IMSI unknown in VLR" shall wait for the network to release the RR connection.
- 3) The Mobile Station shall then be able to perform a location updating procedure.

References

GSM 04.08 sections 4.5.1.1.

26.7.5.5.2 Test purpose

To verify that the MS can correctly accept a CM SERVICE REJECT message with reject cause "IMSI unknown in VLR".

26.7.5.5.3 Method of test

Initial conditions

System Simulator:

1 cell, default parameters.

Mobile Station:

The MS has a valid TMSI. It is "idle updated".

Related PICS/PIXIT statements

None.

Foreseen final state of the MS

The MS has valid TMSI, CKSN. It is "idle updated".

Test Procedure

A mobile originating CM connection is attempted. After the MS has sent the CM SERVICE REQUEST message to the SS, the SS responds with a CM SERVICE REJECT message with reject cause "IMSI unknown in VLR". On receipt of this message, the MS shall delete any TMSI, LAI, cipher key and cipher key sequence number. The channel is released. It is checked that the MS performs a normal location updating procedure.

Maximum duration of test

One minute.

Expected sequence

Step	Direction	Message	Comments
1	MS		A MO CM connection is attempted.
2	MS -> SS	CHANNEL REQUEST	
3	SS -> MS	IMMEDIATE ASSIGNMENT	
4	MS -> SS	CM SERVICE REQUEST	
5	SS -> MS	CM SERVICE REJECT	"Reject cause" = "IMSI unknown in VLR".
6	SS -> MS	CHANNEL RELEASE	After the sending of this message, the SS waits for the disconnection of the main signalling link.
7	MS -> SS	CHANNEL REQUEST	"Establishment cause": Location updating.
8	SS -> MS	IMMEDIATE ASSIGNMENT	
9	MS -> SS	LOCATION UPDATING REQUEST	"Ciphering key sequence number" = "No key is available". "Mobile identity" = IMSI. "Location area identification" = deleted LAI (the MCC and MNC hold the previous values, the LAC is coded FFFE).
10	SS -> MS	AUTHENTICATION REQUEST	
11	MS -> SS	AUTHENTICATION RESPONSE	
12	SS -> MS	LOCATION UPDATING ACCEPT	"Mobile identity" = new TMSI.
13	MS -> SS	TMSI REALLOCATION COMPLETE	
14	SS -> MS	CHANNEL RELEASE	After the sending of this message, the SS waits for the disconnection of the main signalling link.

Specific message contents

None.

26.7.5.6 MM connection / expiry T3230**26.7.5.6.1 Conformance requirement**

At T3230 expiry (i.e. no response is given but an RR connection is available) the MM connection establishment shall be aborted.

References

GSM 04.08 sections 4.5.1.2 and 11.2.

26.7.5.6.2 Test purpose

To verify that at T3230 expiry, the MS aborts the MM-connection establishment.

26.7.5.6.3 Method of test**Initial conditions**

System Simulator:
1 cell, default parameters.

Mobile Station:
The MS has a valid TMSI. It is "idle updated".

Related PICS/PIXIT statements

None.

Foreseen final state of the MS

The MS has a valid TMSI. It is "idle updated".

Test Procedure

A mobile originating CM connection is attempted. After the MS has sent the CM SERVICE REQUEST message to the SS, the SS waits for expiry of timer T3230. It is checked that the MS does not send a layer 3 message but waits for the release of the RR-connection.

Maximum duration of test

1 minute.

Expected sequence

Step	Direction	Message	Comments
1	MS		A MO CM connection is attempted.
2	MS -> SS	CHANNEL REQUEST	
3	SS -> MS	IMMEDIATE ASSIGNMENT	
4	MS -> SS	CM SERVICE REQUEST	
5	SS		The SS waits for expiry of timer T3230.
6	SS -> MS	CM SERVICE ACCEPT	
7	MS -> SS	MM STATUS	"Reject cause " IE is "message not compatible with the call state or not implemented".
8	SS -> MS	CHANNEL RELEASE	After the sending of this message, the SS waits for the disconnection of the main signalling link.

Specific message contents

None.

26.7.5.7 MM connection / abortion by the network

26.7.5.7.1 MM connection / abortion by the network / cause #6

26.7.5.7.1.1 Conformance requirement

- 1) Upon reception of an ABORT message, the MS shall release any ongoing MM connection and enter the "wait for network command" state.
- 2) If the cause in the ABORT message was cause #6, the Mobile Station shall:
 - 2.1 not perform normal location updating;
 - 2.2 not perform periodic location updating;
 - 2.3 not respond to paging with TMSI;
 - 2.4 reject any request for Mobile Originating call establishment except Emergency call;
 - 2.5 not perform IMSI detach if deactivated.
- 3) After reception of an ABORT message with cause #6, the Mobile Station, if it supports speech, shall accept a request for an emergency call by sending a Channel Request message with the establishment cause set to "emergency call".
- 4) After reception of an ABORT message with cause #6, the Mobile Station shall delete the stored LAI, CKSN and TMSI.

Reference(s)

GSM 04.08 section 4.3.5.

26.7.5.7.1.2 Test purpose

To check that upon reception of an ABORT message with cause #6 during call establishment:

- the MS does not send any layer 3 message;
- after reception of an ABORT message and after having been deactivated and reactivated, the MS performs location updating using its IMSI as mobile identity and indicates deleted LAI and CKSN;

- the MS does not perform location updating, does not answer to paging with TMSI, rejects any request for mobile originating call except emergency call, does not perform IMSI detach;
- the MS accepts a request for emergency call.

26.7.5.7.1.3 Method of test

Initial Conditions

System Simulator:

2 cells, default parameters.

Mobile Station:

The MS has a valid TMSI, CKSN and Kc. It is "idle updated" on cell B.

Related PICS/PIXIT Statement(s)

SIM removal possible while MS is powered Yes/No.

Switch off on button Yes/No.

Support of speech Yes/No.

Foreseen final state of the MS

The MS has a valid TMSI. It is "idle updated" on cell A.

Test procedure

A mobile originating CM connection is attempted. Upon reception of the AUTHENTICATION RESPONSE message, the SS sends an ABORT message with cause #6. The SS waits for 5 seconds. The MS shall not send any layer 3 message. The SS releases the RR connection.

The SS checks that the MS has entered the state MM IDLE substate NO IMSI, i.e. does not perform normal location updating, does not perform periodic updating, does not respond to paging, rejects any requests from CM entities except emergency calls and does not perform IMSI detach if deactivated.

Maximum Duration Of Test

10 minutes.

Expected Sequence

Step	Direction	Message	Comments
The following messages are sent and shall be received on cell B			
1	MS		A mobile originating CM connection is attempted.
2	MS -> SS	CHANNEL REQUEST	
3	SS -> MS	IMMEDIATE ASSIGNMENT	
4	MS -> SS	CM SERVICE REQUEST	
5	SS -> MS	AUTHENTICATION REQUEST	
6	MS -> SS	AUTHENTICATION RESPONSE	
7	SS -> MS	ABORT	"reject cause" = #6.
8	SS		The SS waits for 5 seconds.
9	MS		The MS shall not send any layer 3 message during that time.
10	SS -> MS	CHANNEL RELEASE	After the sending of this message, the SS waits for the disconnection of the main signalling link.
The following messages are sent and shall be received on cell A.			
11	SS		The RF levels are changed to make the MS reselect cell A.
12	MS		The MS performs cell reselection according to procedure as specified in GSM 05.08 (this however is not checked until step 22). The MS shall not initiate an RR connection establishment on cell A or on cell B.
13	SS		The SS waits at least 7 minutes for a possible periodic updating.
14	MS		The MS shall not initiate an RR connection establishment on cell A or on cell B.
15	SS -> MS	PAGING REQUEST TYPE 1	"Mobile identity" IE contains TMSI.
16	MS		The MS shall not initiate an RR connection establishment on cell A or on cell B. This is verified during 3 seconds.
17	MS		A MO CM connection is attempted.
18	MS		The MS shall not initiate an RR connection establishment on cell A or on cell B. This is checked during 3 seconds.
19	MS		If the MS supports speech (see PICS), an emergency call is attempted.
20	MS -> SS	CHANNEL REQUEST	"Establishment cause": Emergency call.
21	SS -> MS	IMMEDIATE ASSIGNMENT	
22	MS -> SS	CM SERVICE REQUEST	"CM service type": Emergency call establishment.
23	SS -> MS	CM SERVICE ACCEPT	
24	MS -> SS	EMERGENCY SETUP	
25	SS -> MS	RELEASE COMPLETE	"Cause" = unassigned number.
26	SS -> MS	CHANNEL RELEASE	After the sending of this message, the SS waits for the disconnection of the main signalling link.
27	MS		If possible (see PICS) SIM detachment is performed. Otherwise if possible (see PICS) switch off is performed. Otherwise the power is removed.
28	MS		The MS shall not initiate an RR connection establishment on cell A or on cell B. This is checked during 3 seconds.
29	MS		Depending on what has been performed in step 29 the MS is brought back to operation.
30	MS -> SS	CHANNEL REQUEST	"Establishment cause": Location updating.
31	SS -> MS	IMMEDIATE ASSIGNMENT	
32	MS -> SS	LOCATION UPDATING REQUEST	"location updating type" = normal, "CKSN" = no key available, "Mobile Identity" = IMSI, "LAI" = deleted LAI (the MCC and MNC hold the previous values, the LAC is coded FFFE).

33	SS -> MS	AUTHENTICATION REQUEST	"CKSN" = CKSN1.
34	MS -> SS	AUTHENTICATION RESPONSE	
35	SS -> MS	LOCATION UPDATING ACCEPT	"Mobile Identity" = TMSI.
36	MS -> SS	TMSI REALLOCATION COMPLETE	
37	SS -> MS	CHANNEL RELEASE	After the sending of this message, the SS waits for the disconnection of the main signalling link.

Specific message contents

None.

26.7.5.7.2 MM connection / abortion by the network / cause not equal to #6

26.7.5.7.2.1 Conformance requirement

Upon reception of an ABORT message, the MS shall release any ongoing MM connection and enter the "wait for network command" state.

Reference(s)

GSM 04.08 section 4.3.5.

26.7.5.7.2.2 Test purpose

To check that when multiple MM connections are established, the MS releases all MM connections upon reception of an ABORT message, in the case when the two MM connections are established for a mobile terminating call and a non call related supplementary service operation.

26.7.5.7.2.3 Method of test

Initial Conditions

System Simulator:
1 cell, default parameters.

Mobile Station:
The MS is in state U10 of a mobile terminating call.

Related PICS/PIXIT Statement(s)

The MS supports a non call related supplementary service operation during an active call Yes/No.

Foreseen final state of the MS

The MS has a valid TMSI. It is "idle updated".

Test procedure

A non call related supplementary service operation is attempted at the MS. Upon reception of the REGISTER message, the SS sends an ABORT message with cause # 17. The SS sends a DISCONNECT using the TI of the mobile terminating call. The MS shall send a RELEASE COMPLETE message with the PD and TI of the DISCONNECT message and with cause #81. The SS releases the RR connection.

Maximum Duration Of Test

15 seconds.

Expected Sequence

This procedure is performed if the MS supports non call related supplementary service operation.

Step	Direction	Message	Comments
1	MS		A non call related supplementary service operation is attempted at the MS.
2	MS -> SS	CM SERVICE REQUEST	
3	SS -> MS	CM SERVICE ACCEPT	
4	MS -> SS	REGISTER	
5	SS -> MS	ABORT	"reject cause" = #17.
6	SS -> MS	DISCONNECT	with the TI of the mobile terminating call.
7	MS -> SS	RELEASE COMPLETE	"cause" = #81. Same PD and TI as the DISCONNECT message.
8	SS -> MS	CHANNEL RELEASE	After the sending of this message, the SS waits for the disconnection of the main signalling link.

Specific message contents

None.

26.7.5.8 MM connection / follow-on request pending

26.7.5.8.1 MM connection / follow-on request pending / test 1

26.7.5.8.1.1 Conformance requirement

The MS shall not attempt to establish a new MM connection after location updating on the same RR connection if not allowed by the network.

Reference(s)

GSM 04.08 section 4.4.4.6.

26.7.5.8.1.2 Test purpose

To check that when the network does not include the follow on proceed IE in a LOCATION UPDATING ACCEPT message, a MS that has a CM application request pending does not attempt to establish a new MM connection on that RR connection.

26.7.5.8.1.3 Method of test

Initial Conditions

System Simulator:

1 cell, ATT flag is set to "MSs in the cell shall apply IMSI attach and detach procedure".

Mobile Station:

The MS has a valid TMSI and is deactivated.

Related PICS/PIXIT Statement(s)

None.

Foreseen final state of the MS

The MS has a valid TMSI. It is "idle updated".

Test procedure

The MS is activated and a CM connection is attempted during the location updating procedure. The SS does not include the follow on proceed information element in the LOCATION UPDATING ACCEPT message. The SS waits for at least 8 seconds. The MS shall not send any layer 3 message for 8 seconds.

Maximum Duration of Test

60 s.

Expected Sequence

Step	Direction	Message	Comments
1	MS		The MS is activated.
2	MS -> SS	CHANNEL REQUEST	
3	SS -> MS	IMMEDIATE ASSIGNMENT	
4	MS -> SS	LOCATION UPDATING REQUEST	location updating type = IMSI attach. Then the SS waits for 15 s. During this delay a CM connection is attempted.
5	SS -> MS	LOCATION UPDATING ACCEPT	follow on proceed IE not included.
6	SS		The SS wait for at least 8 seconds.
7	MS		The MS shall not send any layer 3 message for 8 seconds after reception of the LOCATION UPDATING ACCEPT message.
8	SS -> MS	CHANNEL RELEASE	After the sending of this message, the SS waits for the disconnection of the main signalling link.

Specific message contents

None.

26.7.5.8.2 MM connection / follow-on request pending / test 2**26.7.5.8.2.1 Conformance requirement**

A MS supporting the follow-on request procedure and having a CM connection request pending shall correctly establish an MM connection following a location update when allowed by the network.

Reference(s)

GSM 04.08 section 4.4.4.6.

26.7.5.8.2.2 Test purpose

To check that when the network includes the follow on proceed IE in a LOCATION UPDATING ACCEPT message, a MS that supports the follow on request procedure and that has a CM application request pending establishes successfully a new MM connection on that RR connection.

26.7.5.8.2.3 Method of test**Initial Conditions**

System Simulator:

1 cell, ATT flag is set to "MSs in the cell shall apply IMSI attach and detach procedure".

Mobile Station:

The MS has a valid TMSI and is deactivated.

Related PICS/PIXIT Statement(s)

MS supports the follow on request procedure Yes/No.

Foreseen final state of the MS

The MS has a valid TMSI. It is "idle updated".

Test procedure

The MS is activated and a CM connection is attempted during the location updating procedure. The SS includes the follow on proceed information element in the LOCATION UPDATING ACCEPT message. The SS waits for at least 8 seconds.

If the MS supports the follow on request procedure:

The MS shall send a CM SERVICE REQUEST. Upon reception of that message, the SS sends a CM SERVICE ACCEPT message. The MS shall send an initial CM message. Upon reception of that message, the SS releases the RR connection.

If the MS does not support the follow on request procedure:

The MS shall not send any layer 3 message for 8 seconds.

Maximum Duration of Test

60 s.

Expected Sequence

Step	Direction	Message	Comments
1	MS		The MS is activated.
2	MS -> SS	CHANNEL REQUEST	
3	SS -> MS	IMMEDIATE ASSIGNMENT	
4	MS -> SS	LOCATION UPDATING REQUEST	Location updating type = IMSI attach. Then the SS waits for 15 s. During this delay a CM connection is attempted.
5	SS -> MS	LOCATION UPDATING ACCEPT	follow on proceed IE included.
			If the MS supports the follow on request procedure (see PICS) steps A6 to A8 are performed, otherwise steps B6 to B7 are performed.
A6	MS -> SS	CM SERVICE REQUEST	
A7	SS -> MS	CM SERVICE ACCEPT	
A8	MS -> SS	An initial CM message	
B6	SS		The SS wait for at least 8 seconds.
B7	MS		The MS shall not send any layer 3 message for 8 seconds after reception of the LOCATION UPDATING ACCEPT message.
9	SS -> MS	CHANNEL RELEASE	After the sending of this message, the SS waits for the disconnection of the main signalling link.

Specific message contents

None.

26.7.5.8.3 MM connection / follow-on request pending / test 3**26.7.5.8.3.1 Conformance requirement**

- 1) The MS shall not set the follow on request bit in a LOCATION UPDATING REQUEST message if no MM connection request is pending.
- 2) When the network includes the follow on proceed IE in a LOCATION UPDATING ACCEPT message, a MS that has no CM application request pending shall not attempt to establish a new MM connection on that RR connection.

- 3) The MS shall correctly handle a CM connection established by the network on the RR connection that was used for the location updating procedure.

Reference(s)

GSM 04.08 section 4.4.4.6.

26.7.5.8.3.2 Test purpose

- 1) To check that a MS that has no CM application request pending sets the Follow-On-Request bit to No follow-on request pending in a LOCATION UPDATING REQUEST message.
- 2) To check that when the network includes the follow on proceed IE in a LOCATION UPDATING ACCEPT message, a MS that has no CM application request pending does not attempt to establish a new MM connection on that RR connection.
- 3) To check that the MS accepts establishment by the network of a new MM connection on the existing RR connection.

26.7.5.8.3.3 Method of test

Initial Conditions

System Simulator:

1 cell, ATT flag is set to "MSs in the cell shall apply IMSI attach and detach procedure".

Mobile Station:

The MS has a valid TMSI and is deactivated.

Related PICS/PIXIT Statement(s)

Supported services on TCH.

Foreseen final state of the MS

The MS has a valid TMSI. It is "idle updated".

Test procedure

The MS is activated. The MS performs location updating. The MS shall set the FOR bit to No follow-on request pending in the LOCATION UPDATING REQUEST message. The SS includes the follow on proceed information element in the LOCATION UPDATING ACCEPT message. The SS waits for 5 seconds. The MS shall not send any layer 3 message for 5 seconds. The SS sends a SETUP message to the MS requesting a basic service supported by the MS. The MS shall send either a CALL CONFIRMED message if it supports a service on TCH or a RELEASE COMPLETE with cause #88.

Maximum Duration of Test

20 s.

Expected Sequence

Step	Direction	Message	Comments
1	MS		The MS is activated.
2	MS -> SS	CHANNEL REQUEST	
3	SS -> MS	IMMEDIATE ASSIGNMENT	
4	MS -> SS	LOCATION UPDATING REQUEST	"Location updating type" = IMSI attach. The FOR bit is set to No follow-on request pending.
5	SS -> MS	LOCATION UPDATING ACCEPT	follow on proceed IE is included.
6	SS		The SS wait for 5 seconds.
7	MS		The MS shall not send any layer 3 message for 5 seconds after reception of the LOCATION UPDATING ACCEPT message.
8	SS -> MS	SETUP	
A9	MS -> SS	CALL CONFIRMED	If the MS supports a basic service on TCH.
B9	MS -> SS	RELEASE COMPLETE	If the MS does not support any basic service on TCH. cause #88.
10	SS -> MS	CHANNEL RELEASE	After the sending of this message, the SS waits for the disconnection of the main signalling link.

Specific message contents

None.

26.7.6 Default contents of messages**Default contents SYSTEM INFORMATION messages and default settings**

For cell A and B

For GSM use 26.6.14.

For DCS use 26.6.15.

Cell C

The contents of SYSTEM INFORMATION TYPE 1 to 6 messages for cell C are identical to those of cell A with the following exceptions:

Cell Channel Description - Format Identifier - Cell Allocation ARFCN	Bit map 0 for GSM Range 512 for DCS. Channel Number 30 for GSM, Channel Number 700 for DCS.
Cell Identity - Cell Identity Value	0003H

Default settings for cell C:

Downlink input level Uplink output power Propagation profile BCCH/CCCH carrier number	53 dBmicroVolt emf minimum supported by the MS's power class static. 30 for GSM 700 for DCS.
--	---

ABORT

Information element	Value/remark
Reject cause	Depending on the test one of either: #6 - Illegal ME #17 - Network Failure.

AUTHENTICATION REQUEST

Information element	Value/remark
Cipher Key Sequence Number	Arbitrary
Authentication parameter RAND	Arbitrarily chosen by the test house

AUTHENTICATION RESPONSE

Information element	Value/remark
Authentication parameter SRES	As applicable

AUTHENTICATION REJECT

Information element	Value/remark
None but message head	

CHANNEL RELEASE

Information element	Value/remark
RR cause	Normal release

CIPHERING MODE COMMAND

Information element	Value/remark
Cipher mode setting	Start ciphering
Cipher Response	IMEI must not be included

CM RE-ESTABLISHMENT REQUEST

Information element	Value/remark
Cipher Key Sequence Number	According to SIM contents
Mobile station classmark 2	See PICS/PIXIT
Mobile Identity	IMSI of MS under test
Location area identification	As in section 26.1.1

CM SERVICE ACCEPT

Information element	Value/remark
None but message head	Omitted

CM SERVICE REQUEST

Information element	Value/remark
CM service type	Mobile originating call establishment unless otherwise specified in test.
Ciphering key sequence number	According to SIM contents
Mobile station classmark 2	See PICS/PIXIT
Mobile identity	TMSI of the MS under test

CM SERVICE REJECT

Information element	Value/remark
Reject cause	Depending on test

IDENTITY REQUEST

Information element	Value/remark
Identity type	Depending on test
Spare half octet	0000

IDENTITY RESPONSE

Information element	Value/remark
Mobile identity	Depending on test

IMMEDIATE ASSIGNMENT

Information element	Value/remark
L2 pseudo length	Normal Paging 0000
Page mode	
Spare half octet	SDCCH/4 or SDCCH/8 Arbitrary legal value
Channel description	
- Channel type and TDMA offset	
- Time slot number	As received from MS Corresponding to the frame in which the Channel Request was sent
- Subsequent fields of the Channel description IE depend upon the Type of MS under test (either DCS 1 800 or GSM), as specified in section 26.1.1	
Request reference	
- Random access information	
- N51,N32,N26	0 Empty (L=0) Omitted all bits set to spare
Timing advance	
Mobile allocation	
Starting time	
IA rest octets	

IMSI DETACH INDICATION

Information element	Value/remark
Mobile station classmark 1	See PICS/PIXIT
Mobile identity	TMSI of the MS under test

LOCATION UPDATING ACCEPT

Information element	Value/remark
Location area identification	As in section 26.1.1
Mobile identity	Omitted
Follow on proceed	Omitted

LOCATION UPDATING REJECT

Information element	Value/remark
Reject cause	As specified in test

LOCATION UPDATING REQUEST

Information element	Value/remark
Location updating type	Normal location updating
Cipher Key Sequence Number	According to SIM contents
Location area identification	As in section 26.1.1
Mobile station classmark	See PICS/PIXIT
Mobile identity	TMSI of the MS

PAGING REQUEST TYPE 1

Information element	Value/remark
L2 pseudo length	Normal paging
Page Mode	
Channels needed	"any channel"
- mobile 1	
- mobile 2	spare
Mobile identity 1	TMSI of MS under test
Mobile identity 2	Omitted
P1 rest octets	All bits set to spare

PAGING RESPONSE

Information element	Value/remark
Ciphering key sequence number	According to SIM contents
Spare half octet	0000
Mobile station classmark 2	See PICS/PIXIT
Mobile identity	TMSI of the MS under test

TMSI REALLOCATION COMMAND

Information element	Value/remark
Location area identification	As in section 26.1.1
Mobile identity	TMSI of the MS under test

TMSI REALLOCATION COMPLETE

Information element	Value/remark
None but message head	omitted

26.8 Tests related to circuit switched call control

26.8.1 Circuit switched Call Control (CC) state machine verification

26.8.1.1 General on CC state machine verification

The principle of checking the call control functions consists in the validation of each call control identified state.

State U0 as an initial state is not verified in the tests of 26.8.1.2 (establishment of an outgoing call).

State U0.1 is never verified.

The steps to be followed within each performed test are:

- bring the MS into the required state;
- trigger the tested event;
- check the MS response and new state.

In sections 26.8.1.2 and 26.8.1.3 different tables are defined to bring the MS into the required initial state. The exact table to be chosen is specified individually in section "Initial conditions" of "Method of test" for each test case.

For each test, unless otherwise specified, a circuit switched basic service among those supported by the MS but excluding the emergency call teleservice shall be chosen arbitrarily, and the test shall be performed according to that basic service. If the only circuit switched basic service supported by the mobile is emergency call, then the incoming call tests shall not be performed and the other call control tests shall be performed with the EMERGENCY SETUP message replacing the SETUP message.

The initial states are to be checked through STATUS ENQUIRY messages sent by the SS, when feasible. This is not explicitly stated in the tables of expected sequences of signalling messages. The checking of final states are explicitly included into the expected sequences of signalling messages.

The following postamble may be used by the SS to bring MS back to idle mode in those test cases, in which it is not already included into expected sequence of signalling messages:

Table 26.8.1.1/1: A postamble to bring the MS back to idle mode.

Step	Direction	Message	Comments
n	SS -> MS	CHANNEL RELEASE	
n+1	MS		the MS shall release the main signalling link (DISC/UA)

The postamble has not been included into the all of the tests in order to leave an option to concatenate the procedures in the future by using a final state of a test case as an initial state to another one.

For the special case of U0, the state is checked by sending STATUS ENQUIRY message with all possible values of transaction identifier (seven values) as U0 is the only state in which for every TI the MS will answer with release complete with cause #81. If U0 is to be verified when no RR connection exists, first a mobile terminating radio connection must be established.

The MS responses are either call management messages received by the SS or lower layers functions activated within the MS or MMI actions (e.g. the buzzing of an alerting tone).

A time-out within the MS is triggered by the SS when it does not answer back an MS expected response.

The test sequences may be split in 3 main groups:

- establishment and release of an outgoing call;
- establishment and release of an incoming call;
- in-call functions.

Remark on verification of transient states:

Some call control states of the mobile station may be transient, depending on implementation, configuration of the MS and previous messages (see annex 3, subclause 3.1.6).

If a test starts in a transient state, then the test is executed without verification of the starting state.

26.8.1.2 Establishment of an outgoing call**Initial conditions**

As a minimum requirement the MS is updated and has been given a TMSI, a ciphering key and cipher key sequence number, and the layer 2, RR and MM functionalities have been verified.

There are as many CM initial conditions as states to be checked.

The tables below describe message exchanges which bring the MS in the requested initial states.

A state may be taken as initial only when all the states which lead to this initial states have been validated. The order followed in the test procedure will be U0, U0.1, U1, U3, U4, U10, U12, U19, U11 as seen in the table underneath.

The MS is brought again in the initial state starting with U0 at each new test performed.

Table 26.8.1.2/1: Establishment of an outgoing call, procedure 1 (late assignment)

Step	Direction	Message	Comments/actions/next state
1	MS -> SS	CHANNEL REQUEST	initiate outgoing call
2	SS -> MS	IMMEDIATE ASSIGNMENT	SDCCH, U0
3	MS -> SS	CM SERVICE REQUEST	U0.1
4	SS -> MS	CIPHERING MODE COMMAND	
5	MS -> SS	CIPHERING MODE COMPLETE	
6	MS -> SS	SETUP	U1
7	SS -> MS	CALL PROCEEDING	U3
8	SS -> MS	ALERTING	U4
9	SS -> MS	ASSIGNMENT COMMAND	TCH
10	MS -> SS	ASSIGNMENT COMPLETE	
11	SS -> MS	CONNECT	
12	MS -> SS	CONNECT ACKNOWLEDGE	U10
A13	SS -> MS	DISCONNECT	U12 (note 1)
B13	SS -> MS	DISCONNECT	U12 (note 2)
B14	MS -> SS	RELEASE	U19
C13			MMI action, terminate call
C14	MS -> SS	DISCONNECT	U11

NOTE 1: The Progress Indicator IE with progress description #8 "in band information or appropriate pattern now available" is included.

NOTE 2: The Progress Indication IE is not included.

Table 26.8.1.2/2: Establishment of an outgoing call, procedure 2

Step	Direction	Message	Comments/actions/next state
1	MS -> SS	CHANNEL REQUEST	initiate outgoing call
2	SS -> MS	IMMEDIATE ASSIGNMENT	TCH, U0
3	MS -> SS	CM SERVICE REQUEST	U0.1
4	SS -> MS	CHANNEL MODE MODIFY	(note 3)
5	MS -> SS	CHANNEL MODE MODIFY ACKNOWLEDGE	
6	SS -> MS	CIPHERING MODE COMMAND	
7	MS -> SS	CIPHERING MODE COMPLETE	
8	MS -> SS	SETUP	U1
9	SS -> MS	CALL PROCEEDING	U3
10	SS -> SS	ALERTING	U4
11	SS -> MS	CONNECT	
12	MS -> SS	CONNECT ACKNOWLEDGE	U10
A13	SS -> MS	DISCONNECT	U12 (note 4)
B13	SS -> MS	DISCONNECT	U12 (note 5)
B14	MS -> SS	RELEASE	U19
C13			MMI action, terminate call
C14	MS -> SS	DISCONNECT	U11

NOTE 3: Assigned channel is appropriate for the chosen bearer capability (see 26.8.1).

NOTE 4: The Progress Indicator IE with progress description #8 'in band information or appropriate pattern now available' is included.

NOTE 5: The Progress Indicator IE is not included.

Table 26.8.1.2/3: Establishment of an outgoing call, procedure 3

Step	Direction	Message	Comments/actions/next state
1	MS -> SS	CHANNEL REQUEST	initiate outgoing call
2	SS -> MS	IMMEDIATE ASSIGNMENT	SDCCH, U0
3	MS -> SS	CM SERVICE REQUEST	U0.1
4	SS -> MS	CIPHERING MODE COMMAND	
5	MS -> SS	CIPHERING MODE COMPLETE	
6	MS -> SS	SETUP	U1
7	SS -> MS	AUTHENTICATION REQUEST	
8	MS -> SS	AUTHENTICATION RESPONSE	
9	SS -> MS	CALL PROCEEDING	U3
10	SS -> MS	ASSIGNMENT COMMAND	TCH
11	MS -> SS	ASSIGNMENT COMPLETE	
12	SS -> MS	ALERTING	U4
13	SS -> MS	CONNECT	
14	MS -> SS	CONNECT ACKNOWLEDGE	U10
A15	SS -> MS	DISCONNECT	U12 (note 6)
B15	SS -> MS	DISCONNECT	U12 (note 7)
B16	MS -> SS	RELEASE	U19
C15			MMI action, terminate call
C16	MS -> SS	DISCONNECT	U11

NOTE 6: The Progress Indicator IE with progress description #8 'in band information or appropriate pattern now available' is included.

NOTE 7: The Progress indicator IE is not included.

Table 26.8.1.2/4: Establishment of an outgoing call, procedure 4

Step	Direction	Message	Comments
1	MS -> SS	CHANNEL REQUEST	initiate outgoing call
2	SS -> MS	IMMEDIATE ASSIGNMENT	TCH, U0
3	MS -> SS	CM SERVICE REQUEST	U0.1
4	SS -> MS	IDENTITY REQUEST	
5	MS -> SS	IDENTITY RESPONSE	
6	SS -> MS	CIPHERING MODE COMMAND	
7	MS -> SS	CIPHERING MODE COMPLETE	
8	MS -> SS	SETUP	U1
9	SS -> MS	CHANNEL MODE MODIFY	(note 8)
10	MS -> SS	CHANNEL MODE MODIFY ACKNOWLEDGE	
11	SS -> MS	CALL PROCEEDING	U3
12	SS -> MS	ALERTING	U4
13	SS -> MS	CONNECT	
14	MS -> SS	CONNECT ACKNOWLEDGE	U10
A15	SS -> MS	DISCONNECT	U12 (note 9)
B15	SS -> MS	DISCONNECT	U12 (note 10)
B16	MS -> SS	RELEASE	U19
C15			MMI action, terminate call
C16	MS -> SS	DISCONNECT	U11

NOTE 8: Assigned channel is appropriate for the chosen bearer capability (see 26.8.1).

NOTE 9: The Progress Indicator IE with progress description #8 "in band information or appropriate pattern now available" is included.

NOTE 10: The Progress Indicator IE is not included.

26.8.1.2.1 Outgoing call / U0 null state

26.8.1.2.1.1 Outgoing call / U0 null state / MM connection requested

26.8.1.2.1.1.1 Definition and applicability

The call control entity of the Mobile Station requests the MM-sublayer to establish a mobile originating MM-connection. This test is applicable for any equipment supporting at least one mobile originated circuit switched basic service.

26.8.1.2.1.1.2 Conformance requirement

- 1) Upon initiation of an outgoing basic call by user the MS shall initiate establishment of an MM connection, using as first MM message a CM SERVICE REQUEST message with CM service type "Mobile originating call establishment or packet mode connection establishment".

References

GSM 04.08 section 5.2.1.1, GSM 04.08 section 4.5.1.1, GSM 04.08 section 3.3.1.

26.8.1.2.1.1.3 Test purpose

To verify that upon initiation of an outgoing basic call by user the MS initiates establishment of an MM connection, using as first MM message a CM SERVICE REQUEST message with CM service type "Mobile originating call establishment or packet mode connection establishment".

26.8.1.2.1.1.4 Method of test**Related PICS/PIXIT statements**

- supported MO circuit switched basic services.

Initial conditions

System Simulator:

1 cell, default parameters.

Mobile Station:

The MS is in MM-state "idle, updated" with valid TMSI and CKSN.

Foreseen final state of the MS

U0, null.

Test procedure

An MO circuit switched basic service is selected that is supported by the MS; if the MS supports MO telephony, the selected basic service is telephony. If necessary, the MS is configured for that basic service. Then, the MS is made to initiate a call. When the SS receives CM SERVICE REQUEST, the contents of it shall be checked.

Maximum duration of test

30 s.

Expected sequence

Step	Direction	Message	Comments
1	MS -> SS	CHANNEL REQUEST	initiate outgoing call
2	SS -> MS	IMMEDIATE ASSIGNMENT	TCH
3	MS -> SS	CM SERVICE REQUEST	verify the type of call which is asked for "basic" or "emergency by the MS
4	SS -> MS	CHANNEL RELEASE	
5	MS		the MS shall release the main signalling link (DISC/UA)

Specific message contents:

None.

26.8.1.2.2 Outgoing call / U0.1 MM connection pending**26.8.1.2.2.1 Outgoing call / U0.1 MM connection pending / CM service rejected****26.8.1.2.2.1.1 Definition and applicability**

A request for MM connection is rejected by the SS. This test is applicable for any equipment supporting at least one mobile originated circuit switched basic service.

26.8.1.2.2.1.2 Conformance requirement

Upon receiving indication of an MM-connection establishment being rejected, CC entity should inform upper layer of this rejection.

References

GSM 04.08, section 4.5.1.1 , GSM 04.07, section 6.2.2.

26.8.1.2.2.1.3 Test purpose

To verify that a CC entity of the MS in CC-state U0.1, "MM-connection pending", upon the MS receiving a CM SERVICE REJECT message, returns to CC state U0, "Null".

26.8.1.2.2.1.4 Method of test**Related PICS/PIXIT statements**

- supported MO circuit switched basic services.

Initial conditions

System Simulator:

1 cell, default parameters.

Mobile Station:

The MS is in MM-state "idle, updated" with valid TMSI and CKSN.

The MS is brought into the state U0.1 by using table 26.8.1.2/1.

Foreseen final state of the MS

U0, null.

Maximum duration of test

30 s.

Test procedure

An MO circuit switched basic service is selected that is supported by the MS; if the MS supports MO telephony, the selected basic service is telephony. If necessary, the MS is configured for that basic service. Then, the MS is made to initiate a call. When the SS receives CM SERVICE REQUEST, the contents of it shall be checked. The SS rejects it by CM SERVICE REJECT. Then the SS will check the state of the MS by using STATUS ENQUIRY with all the relevant transaction identifiers.

Expected sequence

Step	Direction	Message	Comments
1	SS -> MS	CM SERVICE REJECT	
2	SS -> MS	STATUS ENQUIRY	
3	MS -> SS	RELEASE COMPLETE	
4	SS		cause shall be 81# (invalid TI value) repeat steps 2-3 to cover all the transaction identifiers from 000 ...110
5	SS -> MS	CHANNEL RELEASE	
6	MS		the MS shall release the main signalling link (DISC/UA)

Specific message contents:

None.

26.8.1.2.2.2 Outgoing call / U0.1 MM connection pending / CM service accepted**26.8.1.2.2.2.1 Definition and applicability**

A CM request is accepted for the MM-connection by the SS. This test is applicable for any equipment supporting at least one mobile originated circuit switched basic service.

26.8.1.2.2.2.2 Conformance requirement

A CC entity of the MS in CC-state U0.1, "MM-connection pending", upon the MS receiving a CM SERVICE ACCEPT message, shall send a SETUP message specifying the Called party BCD number that was entered into the MS and then enter CC state U1, "Call initiated".

References

GSM 04.08, section 4.5.1.1, GSM 04.08, section 5.2.1.1.

26.8.1.2.2.2.3 Test purpose

To verify that a CC entity of the MS in CC-state U0.1, "MM-connection pending", upon the MS receiving a CM SERVICE ACCEPT message, sends a SETUP message specifying the Called party BCD number that was entered into the MS and then enters CC state U1, "Call initiated".

26.8.1.2.2.2.4 Method of test**Related PICS/PIXIT statements**

- supported MO circuit switched basic services.

Initial conditions

System Simulator:

1 cell, default parameters.

Mobile Station:

The MS is in MM-state "idle, updated" with valid TMSI and CKSN.

The MS is brought into the state U0.1 by using table 26.8.1.2/1.

Foreseen final state of the MS

U1, call initiated.

Maximum duration of test

30 s.

Test procedure

An MO circuit switched basic service is selected that is supported by the MS; if the MS supports MO telephony, the selected basic service is telephony. If necessary, the MS is configured for that basic service. Then, the MS is made to initiate a call. When the MS is requesting a MM-connection, the SS will indicate acceptance by sending a CM SERVICE ACCEPT message. The MS shall respond with SETUP. Then the SS will check the state of the call control entity by STATUS ENQUIRY with the relevant transaction identifiers.

Expected sequence

Step	Direction	Message	Comments
1	SS -> MS	CM SERVICE ACCEPT	
2	MS -> SS	SETUP	with called party BCD number.
3	SS -> MS	STATUS ENQUIRY	
4	MS -> SS	STATUS	cause shall be 30# (response to enq.) and state U1 call initiated.

Specific message contents:

None.

26.8.1.2.2.3 Outgoing call / U0.1 MM connection pending / lower layer failure

26.8.1.2.2.3.1 Definition and applicability

The call control entity of the MS being in the state, U0.1, a lower layer failure is accomplished at the MS and consequently, communication at layer 3 level with the peer entity is terminated. This test is applicable for any equipment supporting at least one mobile originated circuit switched basic service.

26.8.1.2.2.3.2 Conformance requirement

- 1) Upon a lower layer failure the MS releases the MM connection in progress and returns to idle mode. In that state no call exists, and the CC entities relating to the seven mobile originating transaction identifiers are in state U0, "Null".

References

GSM 04.08, section 4.5.1.2, GSM 04.08, section 5.2.1.1., GSM 04.08 section 5.5.3.2. and GSM 04.08 section 8.3.

26.8.1.2.2.3.3 Test purpose

To verify that after the MS with a CC entity in state U0.1, "MM-connection pending", has detected a lower layer failure and has returned to idle mode, the CC entities relating to the seven mobile originating transaction identifiers are in state U0, "Null".

26.8.1.2.2.3.4 Method of test

Related PICS/PIXIT statements

- supported MO circuit switched basic services.

Initial conditions

System Simulator:

1 cell, default parameters.

Mobile Station:

The MS is in MM-state "idle, updated" with valid TMSI and CKSN.

The MS is brought into the state U0.1 by using table 26.8.1.2/1.

Foreseen final state of the MS

U0, null.

Maximum duration of test

1 min.

Test procedure

An MO circuit switched basic service is selected that is supported by the MS; if the MS supports MO telephony, the selected basic service is telephony. If necessary, the MS is configured for that basic service. Then, the MS is made to initiate a call. When the MS has sent a CM SERVICE REQUEST message, the SS generates a lower layer failure at the MS. The SS waits long enough to enable the MS to return to idle state listening to paging, and then pages MS to create RR-connection. Finally, the SS will check the state of the MS by using STATUS ENQUIRY with the relevant transaction identifiers.

Expected sequence

Step	Direction	Message	Comments
1	SS		SS generates lower layer failure.
2	SS		SS waits 20 s for the MS to return to listening to paging.
3	SS -> MS	PAGING REQUEST	
4	MS -> SS	CHANNEL REQUEST	
5	SS -> MS	IMMEDIATE ASSIGNMENT	
6	MS -> SS	PAGING RESPONSE	
7	SS -> MS	STATUS ENQUIRY	
8	MS -> SS	RELEASE COMPLETE	cause shall be 81# (invalid TI value).
9	SS		repeat steps 7-8 to cover all the transaction identifiers from 000 ... 110.
10	SS -> MS	CHANNEL RELEASE	the main signalling link shall be released by the MS (L2: DISC/UA).

Specific message contents:

None.

26.8.1.2.3 Outgoing call / U1 call initiated

26.8.1.2.3.1 Outgoing call / U1 call initiated / receiving CALL PROCEEDING

26.8.1.2.3.1.1 Definition and applicability

The call control entity of the MS being in the state, U1, a CALL PROCEEDING message is sent by the SS. This test is applicable for any equipment supporting at least one mobile originated circuit switched basic service.

26.8.1.2.3.1.2 Conformance requirement

- 1) A CC entity of the MS in CC-state U1, "Call initiated", upon receipt of a CALL PROCEEDING message, shall enter CC state U3, "Mobile originating call proceeding".

References

GSM 04.08, sections 5.2.1.1, 5.2.1.2 and 5.2.1.3.

26.8.1.2.3.1.3 Test purpose

To verify that a CC entity of the MS in CC-state U1, "Call initiated", upon receipt of a CALL PROCEEDING message, enters CC state U3, "Mobile originating call proceeding".

26.8.1.2.3.1.4 Method of test

Related PICS/PIXIT statements

- supported MO circuit switched basic services.

Initial conditions

System Simulator:
1 cell, default parameters.

Mobile Station:
The MS is in MM-state "idle, updated" with valid TMSI and CKSN.
The MS is brought into the state U1 by using table 26.8.1.2/2.

Foreseen final state of the MS

U3, Mobile originating call proceeding.

Maximum duration of test

30 s.

Test procedure

An MO circuit switched basic service is selected that is supported by the MS; if the MS supports MO telephony, the selected basic service is telephony. If necessary, the MS is configured for that basic service. Then, the MS is made to initiate a call. The CC entity of the MS is brought to the state U1. The SS sends a CALL PROCEEDING message to the MS. The SS checks by using the status enquiry procedure that the CC entity has entered the state U3.

Expected sequence

Step	Direction	Message	Comments
1	SS -> MS	CALL PROCEEDING	tone generation not mandatory
2	SS -> MS	STATUS ENQUIRY	
3	MS -> SS	STATUS	cause 30#, state U3

Specific message contents:

None.

26.8.1.2.3.2 Outgoing call / U1 call initiated / rejecting with RELEASE COMPLETE**26.8.1.2.3.2.1 Definition and applicability**

The call control entity of the MS being in the state, U1, the call is rejected by a RELEASE COMPLETE message sent by the SS. This test is applicable for any equipment supporting at least one mobile originated circuit switched basic service.

26.8.1.2.3.2.2 Conformance requirement

- 1) A CC entity of the MS in CC-state U1, "Call initiated", upon receipt of a RELEASE COMPLETE message with valid cause value, shall enter CC state U0, "Null".
- 2) On returning to idle mode, the CC entities relating to the seven mobile originating transaction identifiers shall be in state U0, "Null".
- 3) On releasing the MM-connection, the MS shall wait for MM layer release initiated by the network.

References

Conformance requirement 1: GSM 04.08, section 5.4.2, GSM 04.08, section 5.4.4.
 Conformance requirement 2: GSM 04.08, section 5.5.3.2.
 Conformance requirement 3: GSM 04.08, section 5.4.4.3, GSM 04.08, section 4.5.3, GSM 04.08, section 3.5.1.

26.8.1.2.3.2.3 Test purpose

- 1) To verify that a CC entity of the MS in CC-state U1, "Call initiated", upon receipt of a RELEASE COMPLETE message with valid cause value, enters CC state U0, "Null".
- 2) To verify that in returning to idle mode, the CC entities relating to the seven mobile originating transaction identifiers are in state U0, "Null".
- 3) To verify that in releasing the MM-connection, the MS shall wait for MM layer release initiated by SS.

26.8.1.2.3.2.4 Method of test**Related PICS/PIXIT statements**

- supported MO circuit switched basic services.

Initial conditions

System Simulator:

1 cell, default parameters.

Mobile Station:

The MS is in MM-state "idle, updated" with valid TMSI and CKSN.

The MS is brought into the state U1 by using table 26.8.1.2/2.

Foreseen final state of the MS

U0, null.

Maximum duration of test

30 s.

Test procedure

An MO circuit switched basic service is selected that is supported by the MS; if the MS supports MO telephony, the selected basic service is telephony. If necessary, the MS is configured for that basic service. Then, the MS is made to initiate a call. The CC entity of the MS is brought to the state U1. The SS sends a RELEASE COMPLETE message to the MS. The SS checks by using the status enquiry procedure that the CC entity has entered the state U0 with all the relevant transaction identifiers.

Expected sequence

Step	Direction	Message	Comments
1	SS -> MS	RELEASE COMPLETE	See specific message content below.
2	SS -> MS	STATUS ENQUIRY	
3	MS -> SS	RELEASE COMPLETE	cause 81# (invalid TI value)
4	SS		repeat steps 2-3 to cover all the transaction identifiers from 000...110
5	SS -> MS	CHANNEL RELEASE	the main signalling link shall be released by the MS (L2: DISC/UA).

Specific message contents:

RELEASE COMPLETE

- 1) With a valid cause value among:

related to numbering,
 #1 unallocated number
 #3 no route to destination
 #22 number changed
 #28 invalid number format

related to bearer capabilities,
 #8 operator determined barring
 #57 bearer capability not authorized
 #58 bearer capability not presently available
 #63 service or option not available
 #65 bearer service not implemented
 #34 no circuit/channel available (call queuing).

26.8.1.2.3.3 Outgoing call / U1 call initiated / T303 expiry

26.8.1.2.3.3.1 Definition and applicability

The call control entity of the MS being in the state, U1, if no response is then received from the SS, timer T303 expires at the MS side. This test is applicable for any equipment supporting at least one mobile originated circuit switched basic service.

26.8.1.2.3.3.2 Conformance requirement

- 1) A CC entity of the MS in CC-state U1, "Call initiated", upon expiry of T303 shall send a DISCONNECT message to its peer entity and enter state U11, "Disconnect request".

References

GSM 04.08, section 5.2.1.1, GSM 04.08, section 5.4.

26.8.1.2.3.3.3 Test purpose

- 1) To verify that a CC entity of the MS in CC-state U1, "Call initiated", upon expiry of T303 (accuracy +/-20 % between reception of CM SERVICE REQUEST and DISCONNECT by SS) sends a DISCONNECT message to its peer entity and enters state U11, "Disconnect request".

26.8.1.2.3.3.4 Method of test

Related PICS/PIXIT statements

- supported MO circuit switched basic services.

Initial conditions

System Simulator:

1 cell, default parameters.

Mobile Station:

The MS is in MM-state "idle, updated" with valid TMSI and CKSN.

The MS is brought into the state U1 by using table 26.8.1.2/2.

Foreseen final state of the MS

U11, disconnect request.

Maximum duration of test

1 minute.

Test procedure

An MO circuit switched basic service is selected that is supported by the MS; if the MS supports MO telephony, the selected basic service is telephony. If necessary, the MS is configured for that basic service. Then, the MS is made to initiate a call. The CC entity of the MS is brought to the state U1. When T303 expires at the MS, the MS shall send DISCONNECT. The SS checks by using the status enquiry procedure that the CC entity has entered the state U11, disconnect request.

Expected sequence

Step	Direction	Message	Comments
1	SS		SS waits for T303 expiry.
2	MS -> SS	DISCONNECT	Shall be transmitted between 24 s and 36 s after the CM SERVICE REQUEST.
3	SS -> MS	STATUS ENQUIRY	
4	MS -> SS	STATUS	cause 30#, status U11

Specific message contents:

None.

26.8.1.2.3.4 Outgoing call / U1 call initiated / lower layer failure

26.8.1.2.3.4.1 Definition and applicability

The call control entity of the MS being in the state, U1, a lower layer failure is accomplished at the MS and consequently, communication at layer 3 level with the peer entity is terminated. This test is applicable for any equipment supporting at least one mobile originated circuit switched basic service.

26.8.1.2.3.4.2 Conformance requirement

Upon a lower layer failure MM informs the relevant CM entities that the MM connection has been interrupted. As call re-establishment is not allowed, the CC entity must perform a local release. The MS returns to idle mode. In that state no call exists, and the CC entities relating to the seven mobile originating transaction identifiers are in state U0, "Null".

References

GSM 04.08, section 4.5.2.3, GSM 04.08, section 5.2.1.1, GSM 04.08 section 5.5.3.2.

26.8.1.2.3.4.3 Test purpose

To verify that after the MS with a CC entity in state U1 "Call initiated", has detected a lower layer failure and has returned to idle mode, the CC entities relating to the seven mobile originating transaction identifiers are in state U0, "Null".

26.8.1.2.3.4.4 Method of test

Related PICS/PIXIT statements

- supported MO circuit switched basic services.

Initial conditions

System Simulator:

1 cell, default parameters.

Mobile Station:

The MS is in MM-state "idle, updated" with valid TMSI and CKSN.

The MS is brought into the state U1 by using table 26.8.1.2/4.

Foreseen final state of the MS

U0, null.

Maximum duration of test

1 min.

Test procedure

An MO circuit switched basic service is selected that is supported by the MS; if the MS supports MO telephony, the selected basic service is telephony. If necessary, the MS is configured for that basic service. Then, the MS is made to initiate a call. The MS is brought to the state U1. The SS generates a lower layer failure at the MS. The SS waits long enough to enable the MS to return to idle state listening to paging, and then pages MS to create RR-connection. Finally, the SS will check the state of the MS by using STATUS ENQUIRY with the relevant transaction identifiers.

Expected sequence

Step	Direction	Message	Comments
1	SS		SS generates lower layer failure.
2	SS		SS waits 20 s for the MS to return to listening to paging.
3	SS -> MS	PAGING REQUEST	
4	MS -> SS	CHANNEL REQUEST	
5	SS -> MS	IMMEDIATE ASSIGNMENT	
6	MS -> SS	PAGING RESPONSE	
7	SS -> MS	STATUS ENQUIRY	
8	MS -> SS	RELEASE COMPLETE	cause 81# (invalid TI value).
9	SS		repeat steps 7-8 to cover all the transaction identifiers from 000...110.
10	SS -> MS	CHANNEL RELEASE	
11	MS		the MS shall release the main signalling link (DISC/UA).

Specific message contents:

None.

26.8.1.2.3.5 Outgoing call / U1 call initiated / receiving ALERTING**26.8.1.2.3.5.1 Definition and applicability**

The call control entity of the MS being in the state, U1, an ALERTING message is sent to the MS as a indication that a call is being alerted at a called end. This test is applicable for any equipment supporting at least one mobile originated circuit switched basic service.

26.8.1.2.3.5.2 Conformance requirement

- 1) A CC entity of the MS in CC-state U1, "Call initiated", upon receipt of an ALERTING message, shall enter CC state U4, "Call delivered".

References

GSM 04.08, section 5.2.1.1.

26.8.1.2.3.5.3 Test purpose

To verify that a CC entity of the MS in CC-state U1, "Call initiated", upon receipt of an ALERTING message, enters CC state U4, "Call delivered".

26.8.1.2.3.5.4 Method of test**Related PICS/PIXIT statements**

- supported MO circuit switched basic services.

Initial conditions

System Simulator:

1 cell, default parameters.

Mobile Station:

The MS is in MM-state "idle, updated" with valid TMSI and CKSN.

The MS is brought into the state U1 by using table 26.8.1.2/4.

Foreseen final state of the MS

U4, call delivered.

Maximum duration of test

30 s.

Test procedure

An MO circuit switched basic service is selected that is supported by the MS; if the MS supports MO telephony, the selected basic service is telephony. If necessary, the MS is configured for that basic service. Then, the MS is made to initiate a call. The CC entity of the MS is brought to the state U1. The SS sends an ALERTING message to the MS. The SS checks by using the status enquiry procedure that the CC entity has entered the state U4, call delivered.

Expected sequence

Step	Direction	Message	Comments
1	SS -> MS	ALERTING	
2	SS -> MS	STATUS ENQUIRY	
3	MS -> SS	STATUS	cause 30#, state U4

Specific message contents:

None.

26.8.1.2.3.6 Outgoing call / U1 call initiated / entering state U10

26.8.1.2.3.6.1 Definition and applicability

The call control entity of the MS being in the state, U1, a CONNECT message is received by the MS. This test is applicable for any equipment supporting at least one mobile originated circuit switched basic service.

26.8.1.2.3.6.2 Conformance requirement

- 1) A CC entity of the MS in CC-state U1, "Call initiated", upon receipt of a CONNECT message, shall send a CONNECT ACKNOWLEDGE message to its peer entity and enter CC state U10, "Active".

References

GSM 04.08, section 5.2.1.1, GSM 04.08, section 5.2.1.6.

26.8.1.2.3.6.3 Test purpose

To verify that a CC entity of the MS in CC-state U1, "Call initiated", upon receipt of a CONNECT message, sends a CONNECT ACKNOWLEDGE message to its peer entity and enters CC state U10, "Active".

26.8.1.2.3.6.4 Method of test

Related PICS/PIXIT statements

- supported MO circuit switched basic services.

Initial conditions

System Simulator:

1 cell, default parameters.

Mobile Station:

The MS is in MM-state "idle, updated" with valid TMSI and CKSN.

The MS is brought into the state U1 by using table 26.8.1.2/4.

Foreseen final state of the MS

U10, call active.

Maximum duration of test

30 s.

Test procedure

An MO circuit switched basic service is selected that is supported by the MS; if the MS supports MO telephony, the selected basic service is telephony. If necessary, the MS is configured for that basic service. Then, the MS is made to initiate a call. The CC entity of the MS is brought to the state U1. The SS sends a CONNECT message to the MS. The MS shall respond by sending a CONNECT ACKNOWLEDGE message. The SS checks by using the status enquiry procedure that the CC entity has entered the state U10, active.

Expected sequence

Step	Direction	Message	Comments
1	SS -> MS	CONNECT	
2	MS -> SS	CONNECT ACKNOWLEDGE	
3	SS -> MS	STATUS ENQUIRY	
4	MS -> SS	STATUS	cause 30#, state U10

Specific message contents:

None.

26.8.1.2.3.7 Outgoing call / U1 call initiated / unknown message received**26.8.1.2.3.7.1 Definition and applicability**

The call control entity of the MS being in the state, U1, an unknown message is received by the MS. This test is applicable for any equipment supporting at least one mobile originated circuit switched basic service.

26.8.1.2.3.7.2 Conformance requirement

- 1) A CC entity of the MS in CC-state U1, "Call initiated", upon receipt of a message with message type not defined for the protocol discriminator from its peer entity shall return a STATUS message.

References

GSM 04.08 section 8.4.

26.8.1.2.3.7.3 Test purpose

To verify that a CC entity of the MS in CC-state U1, "Call initiated", upon receipt of a message with message type not defined for the protocol discriminator unknown message from its peer entity returns a STATUS message.

26.8.1.2.3.7.4 Method of test**Related PICS/PIXIT statements**

- supported MO circuit switched basic services.

Initial conditions

System Simulator:

1 cell, default parameters.

Mobile Station:

The MS is in MM-state "idle, updated" with valid TMSI and CKSN.

The MS is brought into the state U1 by using table 26.8.1.2/1.

Foreseen final state of the MS

U1, call initiated.

Maximum duration of test

30 s.

Test procedure

An MO circuit switched basic service is selected that is supported by the MS; if the MS supports MO telephony, the selected basic service is telephony. If necessary, the MS is configured for that basic service. Then, the MS is made to initiate a call. The CC entity of the MS is brought to the state U1. The SS sends a message with message type not defined for the protocol discriminator to the MS. The MS shall respond with a STATUS message, and finally the SS checks by using the status enquiry procedure that the state of the CC entity has remained unchanged.

Expected sequence

Step	Direction	Message	Comments
1	SS -> MS	unknown message	message type not defined for PD
2	MS -> SS	STATUS	cause 97#, state U1
3	SS -> MS	STATUS ENQUIRY	
4	MS -> SS	STATUS	cause 30#, state U1

Specific message contents:

None.

26.8.1.2.4 Outgoing call / U3 MS originating call proceeding**26.8.1.2.4.1 Outgoing call / U3 MS originating call proceeding / ALERTING received****26.8.1.2.4.1.1 Definition and applicability**

The call control entity of the MS being in the state, U3, an ALERTING message is sent to the MS as a indication that a call is being alerted at a called end. This test is applicable for any equipment supporting at least one mobile originated circuit switched basic service.

26.8.1.2.4.1.2 Conformance requirement

- 1) A CC-entity of the MS in CC-state U3, "Mobile Originating Call Proceeding", upon receipt of a ALERTING message shall enter CC-state U4, "Call Delivered".

References

GSM 04.08 section 5.2.1.5.

26.8.1.2.4.1.3 Test purpose

To verify that a CC-entity of the MS in CC-state U3, "Mobile Originating Call Proceeding", upon receipt of a ALERTING message enters CC-state U4, "Call Delivered".

26.8.1.2.4.1.4 Method of test

Related PICS/PIXIT statements

- supported MO circuit switched basic services.

Initial conditions

System Simulator:
1 cell, default parameters.

Mobile Station:
The MS is in MM-state "idle, updated" with valid TMSI and CKSN.
The MS is brought into the state U3 by using table 26.8.1.2/2.

Foreseen final state of the MS

U4, call delivered.

Maximum duration of test

30 s.

Test procedure

An MO circuit switched basic service is selected that is supported by the MS; if the MS supports MO telephony, the selected basic service is telephony. If necessary, the MS is configured for that basic service. Then, the MS is made to initiate a call. The CC entity of the MS is brought to the state U3. The SS sends an ALERTING message to the MS. The SS checks by using the status enquiry procedure that the CC entity has entered the state U4, call delivered.

Expected sequence

Step	Direction	Message	Comments
1	SS -> MS	ALERTING	
2	SS -> MS	STATUS ENQUIRY	
3	MS -> SS	STATUS	cause 30#, state U4

Specific message contents:

None.

26.8.1.2.4.2 Outgoing call / U3 MS originating call proceeding / CONNECT received

26.8.1.2.4.2.1 Definition and applicability

The call control entity of the MS being in the state, U3, a CONNECT message is received by the MS. This test is applicable for any equipment supporting at least one mobile originated circuit switched basic service.

26.8.1.2.4.2.2 Conformance requirement

- 1) A CC-entity of the MS in CC-state U3, "Mobile Originating Call Proceeding", upon receipt of a CONNECT message shall return a "CONNECT ACKNOWLEDGE" message to its peer entity and enter the CC state U10, "Active".
- 2) The MS shall then stop any locally generated indication.

References

Conformance requirement 1: GSM 04.08 section 5.2.1.6.

Conformance requirement 2: GSM 04.08 section 5.2.1.6.

26.8.1.2.4.2.3 Test purpose

- 1) To verify that a CC-entity of the MS in CC-state U3, "Mobile Originating Call Proceeding", upon receipt of a CONNECT message returns a "CONNECT ACKNOWLEDGE" message to its peer entity and enters the CC state U10, "Active".
- 2) To verify that the MS stops locally generated indication, if any.

26.8.1.2.4.2.4 Method of test**Related PICS/PIXIT statements**

- supported MO circuit switched basic services.

Initial conditions

System Simulator:

1 cell, default parameters.

Mobile Station:

The MS is in MM-state "idle, updated" with valid TMSI and CKSN.

The MS is brought into the state U3 by using table 26.8.1.2/2.

Foreseen final state of the MS

U10, active.

Maximum duration of test

30 s.

Test procedure

An MO circuit switched basic service is selected that is supported by the MS; if the MS supports MO telephony, the selected basic service is telephony. If necessary, the MS is configured for that basic service. Then, the MS is made to initiate a call. The CC entity of the MS is brought to the state U3. The SS sends a CONNECT message to the MS. The MS shall respond by sending a CONNECT ACKNOWLEDGE message. The SS checks by using the status enquiry procedure that the CC entity has entered the state U10, active.

Expected sequence

Step	Direction	Message	Comments
1	SS -> MS	CONNECT	the MS shall stop tone generation, if any
2	MS -> SS	CONNECT ACKNOWLEDGE	
3	SS -> MS	STATUS ENQUIRY	cause 30#, state U10
4	MS -> SS	STATUS	

Specific message contents:

None.

26.8.1.2.4.3 Outgoing call / U3 MS originating call proceeding / PROGRESS received without in band information

26.8.1.2.4.3.1 Definition and applicability

The call control entity of the MS being in the state, U3, a PROGRESS message is received by the MS. The PROGRESS message does not contain indication of in-band information availability. This test is applicable for any equipment supporting at least one mobile originated circuit switched basic service.

26.8.1.2.4.3.2 Conformance requirement

- 1) A CC-entity of the MS in CC-state U3, "Mobile Originating Call Proceeding", upon receipt of a PROGRESS message with valid cause values shall stay in CC-state U3.
- 2) After receipt of the PROGRESS message timer T310 shall be stopped.

References

Conformance requirement 1: GSM 04.08 section 5.2.1.4.

Conformance requirement 2: GSM 04.08 section 11.3.

26.8.1.2.4.3.3 Test purpose

- 1) To verify that a CC-entity of the MS in CC-state U3, "Mobile Originating Call Proceeding", upon receipt of a PROGRESS message with valid cause values stays in CC-state U3.
- 2) To verify that after receipt of the PROGRESS message timer T310 is stopped.

26.8.1.2.4.3.4 Method of test

Related PICS/PIXIT statements

- supported MO circuit switched basic services.

Initial conditions

System Simulator:

1 cell, default parameters.

Mobile Station:

The MS is in MM-state "idle, updated" with valid TMSI and CKSN.

The MS is brought into the state U3 by using table 26.8.1.2/2.

Foreseen final state of the MS

U3, mobile originating call proceeding.

Maximum duration of test

1 min.

Test procedure

An MO circuit switched basic service is selected that is supported by the MS; if the MS supports MO telephony, the selected basic service is telephony. If necessary, the MS is configured for that basic service. Then, the MS is made to initiate a call. The CC entity of the MS is brought to the state U3. The SS sends a PROGRESS message not containing indication of in-band information availability to the MS. The SS checks that the MS has stopped T310, i.e. at T310 time-out no DISCONNECT message is sent by the

MS. Then the SS checks by using the status enquiry procedure that the state of the CC entity has remained unchanged.

Expected sequence

Step	Direction	Message	Comments
1	SS -> MS	PROGRESS	(note)
2	SS -> MS	STATUS ENQUIRY	
3	MS -> SS	STATUS	cause 30#, state U3
4	SS		SS waits at least 45 seconds and checks no DISCONNECT is sent by the MS
5	SS -> MS	STATUS ENQUIRY	
6	MS -> SS	STATUS	cause 30#, state U3

NOTE: Tested with a valid cause value among:

#4 call has returned to PLMN/ISDN
 #32 call is end-to-end PLMN/ISDN or
 any value in the set #(21-127)

Specific message contents:

None.

26.8.1.2.4.4 Outgoing call / U3 MS originating call proceeding / PROGRESS with in band information

26.8.1.2.4.4.1 Definition and applicability

The call control entity of the MS being in the state, U3, a PROGRESS message indicating availability of in band information is received by the MS. This test is applicable for any equipment supporting at least one mobile originated circuit switched basic service.

26.8.1.2.4.4.2 Conformance requirement

- 1) A CC-entity of the MS in CC-state U3, "Mobile Originating Call Proceeding", upon receipt of a PROGRESS message indicating in-band announcement shall through-connect the traffic channel for speech, if TCH is in a speech mode. If TCH is not in speech mode, the MS shall not through-connect the TCH.
- 2) After receipt of the PROGRESS message, T310 shall be stopped.

References

GSM 04.08 section 3.4.3., GSM 04.08 section 5.1.3, GSM 04.08 section 5.2.1.4., GSM 04.08 section 5.2.1.9, GSM 04.08 section 5.5.1., GSM 04.08 section 11.3.

26.8.1.2.4.4.3 Test purpose

- 1) To verify that a CC-entity of the MS in CC-state U3, "Mobile Originating Call Proceeding", upon receipt of a PROGRESS message indicating in-band announcement through-connects the traffic channel for speech, if TCH is in speech mode. If TCH is not in a speech mode, the MS does not through-connect the TCH.
- 2) To verify that after receipt of the PROGRESS message, T310 is stopped.

26.8.1.2.4.4.4 Method of test

Related PICS/PIXIT statements

- supported MO circuit switched basic services.

Initial conditions

System Simulator:

1 cell, default parameters.

Mobile Station:

The MS is in MM-state "idle, updated" with valid TMSI and CKSN.

The MS is brought into the state U3 by using table 26.8.1.2/2.

Foreseen final state of the MS

U3, mobile originating call proceeding.

Maximum duration of test

1 minute.

Test procedure

An MO circuit switched basic service is selected that is supported by the MS; if the MS supports MO telephony, the selected basic service is telephony. If necessary, the MS is configured for that basic service. Then, the MS is made to initiate a call. The CC entity of the MS is brought to the state U3. The SS sends a PROGRESS message containing indication of in-band information availability to the MS. The SS checks that if channel mode is speech, the TCH shall be through connected. If channel mode is not speech, the TCH shall not be through connected. Also the SS checks that the MS has stopped T310, i.e. at T310 time-out no DISCONNECT message is sent by the MS. Then the SS checks by using the status enquiry procedure that the state of the CC entity has remained unchanged.

Expected sequence

Step	Direction	Message	Comments
1	SS -> MS	PROGRESS 1)	the MS shall stop all the CC timers (note), if channel mode is speech, the TCH shall be through connected. If channel mode is not speech, the TCH shall not be through connected.
2	SS -> MS	STATUS ENQUIRY	cause 30#, state U3 SS waits at least 45 seconds and checks no DISCONNECT is sent by the MS.
3	MS -> SS	STATUS	
4	SS		
5	SS -> MS	STATUS ENQUIRY	cause 30#, state U3 If the channel mode is speech the SS will check that the user connection for speech is attached (both downlink and uplink).
6	MS -> SS	STATUS	
7	SS		

Specific message contents:

NOTE: Tested with a valid cause value among:

#1 call is not end to end PLMN/ISDN

#2 destination address is non PLMN/ISDN

#3 originating address is non PLMN/ISDN

#8 in band information or appropriate pattern now available or any value in the set #(6-20).

26.8.1.2.4.5 Outgoing call / U3 MS originating call proceeding / DISCONNECT with in band tones**26.8.1.2.4.5.1 Definition and applicability**

The call control entity of the MS being in the state, U3, a DISCONNECT message indicating availability of in band information is received by the MS. This test is applicable for any equipment supporting at least one mobile originated circuit switched basic service.

26.8.1.2.4.5.2 Conformance requirement

- 1) A CC-entity of the MS in CC-state U3, "Mobile Originating Call Proceeding", upon receipt of a DISCONNECT with progress indicator #8, shall through-connect the speech channel to make in-band announcements available, if traffic channel is in speech mode. If TCH is not in speech mode, the MS shall send a RELEASE message.

References

GSM 04.08 section 5.2.1.4., GSM 04.08 section 5.4.4.

26.8.1.2.4.5.3 Test purpose

To verify that a CC-entity of the MS in CC-state U3, "Mobile Originating Call Proceeding", upon receipt of a DISCONNECT with progress indicator #8 through-connects the speech channel to make in-band announcements available, if traffic channel is in speech mode. If TCH is not in speech mode, the MS sends a RELEASE message.

26.8.1.2.4.5.4 Method of test**Related PICS/PIXIT statements**

- supported MO circuit switched basic services.

Initial conditions

System Simulator:

1 cell, default parameters.

Mobile Station:

The MS is in MM-state "idle, updated" with valid TMSI and CKSN.

The MS is brought into the state U3 by using table 26.8.1.2/2.

Foreseen final state of the MS

U12, disconnect indication.

Maximum duration of test

30 s.

Test procedure

An MO circuit switched basic service is selected that is supported by the MS; if the MS supports MO telephony, the selected basic service is telephony. If necessary, the MS is configured for that basic service. Then, the MS is made to initiate a call. The CC entity of the MS is brought to the state U3. The SS sends a DISCONNECT message containing indication of in-band information availability to the MS. The SS checks that if channel mode is speech, the TCH shall be through connected and the MS enters state U12, disconnect indication. If channel mode is not speech, the TCH shall not be through connected and the MS shall enter state U19, release request.

Expected sequence

Step	Direction	Message	Comments
1	SS -> MS	DISCONNECT	(note)
B2	SS		TCH in speech mode: the SS will check that the audio path for in band tones is attached.
B3	SS -> MS	STATUS ENQUIRY	
B4	MS -> SS	STATUS	cause 30#, state U12
C2	MS -> SS	RELEASE	TCH is not in speech mode:
C3	SS -> MS	STATUS ENQUIRY	
C4	MS -> SS	STATUS	cause 30#, state U19

Specific message contents:

NOTE: the cause value:

#8 in band information or appropriate pattern now available.

26.8.1.2.4.6 **Outgoing call / U3 MS originating call proceeding / DISCONNECT without in band tones**

26.8.1.2.4.6.1 **Definition and applicability**

The call control entity of the MS being in the state, U3, a DISCONNECT message is received by the MS. The DISCONNECT message does not contain indication of in-band information availability. This test is applicable for any equipment supporting at least one mobile originated circuit switched basic service.

26.8.1.2.4.6.2 **Conformance requirement**

- 1) A CC-entity of the MS in CC-state U3, "Mobile Originating Call Proceeding", upon receipt of a DISCONNECT without progress indicator shall return a RELEASE message and enter the CC-state U19, "Release Request"

References

GSM 04.08 section 5.4.4.

26.8.1.2.4.6.3 **Test purpose**

To verify that a CC-entity of the MS in CC-state U3, "Mobile Originating Call Proceeding", upon receipt of a DISCONNECT without progress indicator returns a RELEASE message and enters the CC-state U19, "Release Request".

26.8.1.2.4.6.4 **Method of test**

Related PICS/PIXIT statements

- supported MO circuit switched basic services.

Initial conditions

System Simulator:

1 cell, default parameters.

Mobile Station:

The MS is in MM-state "idle, updated" with valid TMSI and CKSN.

The MS is brought into the state U3 by using table 26.8.1.2/2.

Foreseen final state of the MS

U19, release request.

Maximum duration of test

30 s.

Test procedure

An MO circuit switched basic service is selected that is supported by the MS; if the MS supports MO telephony, the selected basic service is telephony. If necessary, the MS is configured for that basic service. Then, the MS is made to initiate a call. The CC entity of the MS is brought to the state U3. The SS sends a DISCONNECT message not containing indication of in-band information availability to the MS. The MS shall respond with a RELEASE message. The SS checks by using the status enquiry procedure that the CC entity of the MS has entered the state U19, release request.

Expected sequence

Step	Direction	Message	Comments
1	SS -> MS	DISCONNECT	
2	MS -> SS	RELEASE	
3	SS -> MS	STATUS ENQUIRY	
4	MS -> SS	STATUS	cause 30#, state U19

Specific message contents:

None.

26.8.1.2.4.7 Outgoing call / U3 MS originating call proceeding / RELEASE received**26.8.1.2.4.7.1 Definition and applicability**

The call control entity of the MS being in the state, U3, a RELEASE message is received by the MS. This test is applicable for any equipment supporting at least one mobile originated circuit switched basic service.

26.8.1.2.4.7.2 Conformance requirement

- 1) A CC-entity of the MS in CC-state U3, "Mobile Originating Call Proceeding", upon receipt of a RELEASE will return a RELEASE COMPLETE and enter the CC-state U0, "Null".
- 2) The MS on returning to the idle mode shall release the MM-connection and the CC-entities relating to the seven mobile originating transaction identifiers shall be in CC-state U0, "Null".
- 3) On releasing the MM-connection, the MS shall wait for MM layer release initiated by the network.

References

Conformance requirement 1: GSM 04.08 section 5.4.2., GSM 04.08 section 5.4.4.
 Conformance requirement 2: GSM 04.08 section 4.5.3., GSM 04.08 section 5.5.3.2.
 Conformance requirement 3: GSM 04.08, section 5.4.4.3, GSM 04.08, section 4.5.3,
 GSM 04.08, section 3.5.1.

26.8.1.2.4.7.3 Test purpose

- 1) To verify that a CC-entity of the MS in CC-state U3, "Mobile Originating Call Proceeding", upon receipt of a RELEASE will return a RELEASE COMPLETE and enter the CC-state U0, "Null".
- 2) To verify that the MS on returning to the idle mode releases the MM-connection and that the CC-entities relating to the seven mobile originating transaction identifiers are in CC-state U0, "Null".

- 3) To verify that in releasing the MM-connection, the MS shall wait for MM layer release initiated by SS.

26.8.1.2.4.7.4 Method of test

Related PICS/PIXIT statements

- supported MO circuit switched basic services.

Initial conditions

System Simulator:

1 cell, default parameters.

Mobile Station:

The MS is in MM-state "idle, updated" with valid TMSI and CKSN.

The MS is brought into the state U3 by using table 26.8.1.2/2.

Foreseen final state of the MS

U0, null.

Maximum duration of test

1 min 30 s.

Test procedure

An MO circuit switched basic service is selected that is supported by the MS; if the MS supports MO telephony, the selected basic service is telephony. If necessary, the MS is configured for that basic service. Then, the MS is made to initiate a call. The CC entity of the MS is brought to the state U3. The SS sends a RELEASE message to the MS. The MS shall respond with a RELEASE COMPLETE message. The SS checks by using the status enquiry procedure that the CC entity has entered the state U0 with all the relevant transaction identifiers.

Expected sequence

Step	Direction	Message	Comments
1	SS -> MS	RELEASE	with cause "Normal, unspecified"
2	MS -> SS	RELEASE COMPLETE	
3	SS -> MS	STATUS ENQUIRY	cause 81# (invalid TI value) repeat steps 3-4 to cover all the transaction identifiers from 000...110
4	MS -> SS	RELEASE COMPLETE	
5	SS		
6	SS -> MS	CHANNEL RELEASE	the main signalling link shall be released by the MS (L2: DISC/UA).

Specific message contents:

None.

26.8.1.2.4.8 Outgoing call / U3 MS originating call proceeding / termination requested by the user

26.8.1.2.4.8.1 Definition and applicability

The call control entity of the MS being in the state, U3, the user requests to terminate the call. This test is applicable for any equipment supporting at least one mobile originated circuit switched basic service.

26.8.1.2.4.8.2 Conformance requirement

- 1) A CC-entity of the MS in CC-state U3, "Mobile Originating Call Proceeding", upon request by the user to terminate will send a DISCONNECT message and enter the CC-state U11, "Disconnect Request".

References

GSM 04.07 section 6.2.2., GSM 04.08 section 5.4.3.

26.8.1.2.4.8.3 Test purpose

To verify that a CC-entity of the MS in CC-state U3, "Mobile Originating Call Proceeding", upon request by the user to terminate will send a DISCONNECT message and enter the CC-state U11, "Disconnect Request".

26.8.1.2.4.8.4 Method of test**Related PICS/PIXIT statements**

- supported MO circuit switched basic services.

Initial conditions

System Simulator: 1 cell, default parameters.

Mobile Station: The MS is in MM-state "idle, updated" with valid TMSI and CKSN.

The MS is brought into the state U3 by using table 26.8.1.2/3.

Foreseen final state of the MS

U11, disconnect request.

Maximum duration of test

30 s.

Test procedure

An MO circuit switched basic service is selected that is supported by the MS; if the MS supports MO telephony, the selected basic service is telephony. If necessary, the MS is configured for that basic service. Then, the MS is made to initiate a call. The CC entity of the MS is brought to the state U3. The user requests termination of the call. The MS shall send a DISCONNECT message. The SS checks by using the status enquiry procedure that the CC entity has entered the state U11, disconnect request.

Expected sequence

Step	Direction	Message	Comments
1			MMI action, terminate call
2	MS -> SS	DISCONNECT	
3	SS -> MS	STATUS ENQUIRY	
4	MS -> SS	STATUS	cause 30#, state U11

Specific message contents:

None.

26.8.1.2.4.9 Outgoing call / U3 MS originating call proceeding / traffic channel allocation

26.8.1.2.4.9.1 Definition and applicability

The call control entity of the MS being in the state, U3, a traffic channel assignment procedure is performed. This test is applicable for any equipment supporting at least one mobile originated circuit switched basic service.

26.8.1.2.4.9.2 Conformance requirement

- 1) A CC-entity of the MS in CC-state U3, "Mobile Originating Call Proceeding", when allocated a traffic channel by the network performing the assignment procedure, shall perform a layer 2 establishment on the FACCH without changing the state of the call in progress.

References

GSM 04.08 section 3.4.3., GSM 04.08 section 5.2.1.9.

26.8.1.2.4.9.3 Test purpose

To verify that a CC-entity of the MS in CC-state U3, "Mobile Originating Call Proceeding", when allocated a traffic channel by the network performing the assignment procedure, performs a layer 2 establishment on the FACCH without changing the state of the call in progress.

26.8.1.2.4.9.4 Method of test

Related PICS/PIXIT statements

- supported MO circuit switched basic services.

Initial conditions

System Simulator:

1 cell, default parameters.

Mobile Station:

The MS is in MM-state "idle, updated" with valid TMSI and CKSN.

The MS is brought into the state U3 by using table 26.8.1.2/3.

Foreseen final state of the MS

U3, mobile originating call proceeding.

Maximum duration of test

30 s.

Test procedure

An MO circuit switched basic service is selected that is supported by the MS; if the MS supports MO telephony, the selected basic service is telephony. If necessary, the MS is configured for that basic service. Then, the MS is made to initiate a call. The CC entity of the MS is brought to the state U3. The SS sends an ASSIGNMENT COMMAND for traffic channel to the MS. The MS shall establish layer 2 link on the newly allocated channel and respond with an ASSIGNMENT COMPLETE message. The SS checks by using the status enquiry procedure that the state of the CC entity has remained unchanged.

Expected sequence

Step	Direction	Message	Comments
1	SS -> MS	ASSIGNMENT COMMAND	(TCH) the MS shall perform L2 establishment on the FACCH cause 30#, state U3
2	MS -> SS	ASSIGNMENT COMPLETE	
3	SS -> MS	STATUS ENQUIRY	
4	MS -> SS	STATUS	

Specific message contents:

None.

26.8.1.2.4.10 Outgoing call / U3 MS originating call proceeding / timer T310 time-out

26.8.1.2.4.10.1 Definition and applicability

The call control entity of the MS being in the state, U3, if no response is then received from the SS, timer T310 expires at the MS side. This test is applicable for any equipment supporting at least one mobile originated circuit switched basic service.

26.8.1.2.4.10.2 Conformance requirement

- 1) A CC-entity of the MS in CC-state U3, "Mobile Originating Call Proceeding" shall, upon expiry of timer T310, and not before, initiate call release by sending DISCONNECT and enter the CC-state U11, "Disconnect Request".

References

GSM 04.08 section 5.2.1.3./Abnormal case, GSM 04.08 section 5.4.3, GSM 04.08 section 11.3.

26.8.1.2.4.10.3 Test purpose

To verify that a CC-entity of the MS in CC-state U3, "Mobile Originating Call Proceeding" will, upon expiry of timer T310 (accuracy minus 2 %, plus 50 %), initiate call release by sending DISCONNECT and enter the CC-state U11, "Disconnect Request".

26.8.1.2.4.10.4 Method of test

Related PICS/PIXIT statements

- supported MO circuit switched basic services.

Initial conditions

System Simulator:

1 cell, default parameters.

Mobile Station:

The MS is in MM-state "idle, updated" with valid TMSI and CKSN.

The MS is brought into the state U3 by using table 26.8.1.2/3.

Foreseen final state of the MS

U11, disconnect request.

Maximum duration of test

1 min.

Test procedure

An MO circuit switched basic service is selected that is supported by the MS; if the MS supports MO telephony, the selected basic service is telephony. If necessary, the MS is configured for that basic service. Then, the MS is made to initiate a call. The CC entity of the MS is brought to the state U3. The T310 expires at the MS and the MS shall send DISCONNECT. The SS checks timer T310 accuracy and that the CC entity has entered the state U11, disconnect request.

Expected sequence

Step	Direction	Message	Comments
1	SS		
2	MS -> SS	DISCONNECT	the SS waits for T310 time-out check the timer T310 accuracy (minus 2 % to plus 50 %)
3	SS -> MS	STATUS ENQUIRY	
4	MS -> SS	STATUS	cause 30#, state U11

Specific message contents:

None.

26.8.1.2.4.11 Outgoing call / U3 MS originating call proceeding / lower layer failure**26.8.1.2.4.11.1 Definition and applicability**

The call control entity of the MS being in the state, U3, a lower layer failure is accomplished at the MS and consequently, communication at layer 3 level with the peer entity is terminated. This test is applicable for any equipment supporting at least one mobile originated circuit switched basic service.

26.8.1.2.4.11.2 Conformance requirement

- 1) If a CC-entity of the MS in CC-state U3, "Mobile Originating Call Proceeding" has detected a lower layer failure and has returned to idle mode, the CC entities relating to the seven mobile originating transaction identifiers shall be in state U0, "Null".

References

GSM 04.08 section 4.5.2.3., GSM 04.08 section 4.5.3., GSM 04.08 section 5.5.3.2., GSM 04.08 section 3.5.2.1.

26.8.1.2.4.11.3 Test purpose

To verify that a CC-entity of the MS in CC-state U3, "Mobile Originating Call Proceeding" having detected a lower layer failure and having returned to idle mode, the CC entities relating to the seven mobile originating transaction identifiers are in state U0, "Null".

26.8.1.2.4.11.4 Method of test**Related PICS/PIXIT statements**

- supported MO circuit switched basic services.

Initial conditions

System Simulator:

1 cell, default parameters.

Mobile Station:

The MS is in MM-state "idle, updated" with valid TMSI and CKSN.
The MS is brought into the state U3 by using table 26.8.1.2/4.

Foreseen final state of the MS

U0, null.

Maximum duration of test

1 min 30 s.

Test procedure

An MO circuit switched basic service is selected that is supported by the MS; if the MS supports MO telephony, the selected basic service is telephony. If necessary, the MS is configured for that basic service. Then, the MS is made to initiate a call. The MS is brought to the state U3. The SS generates a lower layer failure at the MS. The SS waits long enough to enable the MS to return to idle state listening to paging, and then pages MS to create RR-connection. Finally, the SS will check the state of the MS by using STATUS ENQUIRY with the relevant transaction identifiers.

Expected sequence

Step	Direction	Message	Comments
1	SS		SS generates lower layer failure
2	SS		SS waits 20 s for the MS to return to listening to paging
3	SS -> MS	PAGING REQUEST	
4	MS -> SS	CHANNEL REQUEST	
5	SS -> MS	IMMEDIATE ASSIGNMENT	
6	MS -> SS	PAGING RESPONSE	
7	SS -> MS	STATUS ENQUIRY	
8	MS -> SS	RELEASE COMPLETE	cause 81# (invalid TI value)
9	SS		repeat steps 18-19 to cover all the transaction identifiers from 000...110
10	SS -> MS	CHANNEL RELEASE	the main signalling link shall be released by the MS (L2: DISC/UA).

Specific message contents:

None.

26.8.1.2.4.12 Outgoing call / U3 MS originating call proceeding / unknown message received

26.8.1.2.4.12.1 Definition and applicability

The call control entity of the MS being in the state, U3, an unknown message is received by the MS. This test is applicable for any equipment supporting at least one mobile originated circuit switched basic service.

26.8.1.2.4.12.2 Conformance requirement

- 1) A CC-entity of the MS in CC-state U3, "Mobile Originating Call Proceeding" having received an unknown message from its peer entity shall return a STATUS message.

References

GSM 04.08 section 8.5.

26.8.1.2.4.12.3 Test purpose

To verify that a CC-entity of the MS in CC-state U3, "Mobile Originating Call Proceeding" having received an unknown message from its peer entity returns a STATUS message.

26.8.1.2.4.12.4 Method of test**Related PICS/PIXIT statements**

- supported MO circuit switched basic services.

Initial conditions

System Simulator:

1 cell, default parameters.

Mobile Station:

The MS is in MM-state "idle, updated" with valid TMSI and CKSN.

The MS is brought into the state U3 by using table 26.8.1.2/1.

Foreseen final state of the MS

U3, mobile originating call proceeding.

Maximum duration of test

30 s.

Test procedure

An MO circuit switched basic service is selected that is supported by the MS; if the MS supports MO telephony, the selected basic service is telephony. If necessary, the MS is configured for that basic service. Then, the MS is made to initiate a call. The CC entity of the MS is brought to the state U3. The SS sends a message with message type not defined for the protocol discriminator to the MS. The MS shall respond with a STATUS message, and finally the SS checks by using the status enquiry procedure that the state of the CC entity has remained unchanged.

Expected sequence

Step	Direction	Message	Comments
1	SS -> MS	unknown message	message type not defined for PD
2	MS -> SS	STATUS	cause 97#, state U3
3	SS -> MS	STATUS ENQUIRY	
4	MS -> SS	STATUS	cause 30#, state U3

Specific message contents:

None.

26.8.1.2.4.13 Outgoing call / U3 MS originating call proceeding / Internal alerting indication**26.8.1.2.4.13.1 Definition and applicability**

The call control entity of the MS being in the state, U3, an ALERTING message is sent to the MS when the user connection is not attached to the radio path. This test is applicable for any equipment supporting mobile originated circuit switched basic service for telephony.

26.8.1.2.4.13.2 Conformance requirement

- 1) When the call control entity of the MS in the "mobile originating call proceeding" state receives an ALERTING message then it shall enter "call delivered" state and, for speech calls, if the user connection is not attached to the radio path, the MS shall internally generate an alerting indication.

References

GSM 04.08 section 5.2.1.5.

26.8.1.2.4.13.3 Test purpose

When the call control entity of the MS in the "mobile originating call proceeding" state receives an ALERTING message then it enters "call delivered" state and, for speech calls, if the user connection is not attached to the radio path, the MS generates internally an alerting indication.

26.8.1.2.4.13.4 Method of test**Related PICS/PIXIT statements**

- supported MO circuit switched basic services.
- way to give internally generated alerting indication for outgoing calls

Initial conditions

System Simulator:

1 cell, default parameters.

Mobile Station:

The MS is in MM-state "idle, updated" with valid TMSI and CKSN.

The MS is brought into the state U3 by using table 26.8.1.2/1.

Foreseen final state of the MS

U4, call delivered.

Maximum duration of test

30 s.

Test procedure

The SS sends an ALERTING message to the MS. The SS checks by using the status enquiry procedure that the CC entity has entered the state U4, call delivered. Also it is checked that the MS generates internally alerting indication to the user in the way described in the PICX/PIXIT statements.

Expected sequence

Step	Direction	Message	Comments
1	SS -> MS	ALERTING	the MS shall generate an alerting indication to the user in the way described in the PICS/PIXIT statements
2	SS -> MS	STATUS ENQUIRY	
3	MS -> SS	STATUS	cause 30#, state U4

Specific message contents:

None.

26.8.1.2.5 Outgoing call / U4 call delivered**26.8.1.2.5.1 Outgoing call / U4 call delivered / CONNECT received****26.8.1.2.5.1.1 Definition and applicability**

The call control entity of the MS being in the state, U4, a CONNECT message is received by the MS. This test is applicable for any equipment supporting at least one mobile originated circuit switched basic service.

26.8.1.2.5.1.2 Conformance requirement

- 1) A CC-entity of the MS in CC-state U4, "Call Delivered", upon receipt of the CONNECT message shall return a CONNECT ACKNOWLEDGE to its peer entity and enter the CC-state U10, "Active".

References

GSM 04.08 section 5.2.1.6.

26.8.1.2.5.1.3 Test purpose

To verify that a CC-entity of the MS in CC-state U4, "Call Delivered", upon receipt of the CONNECT message returns a CONNECT ACKNOWLEDGE to its peer entity and enters the CC-state U10, "Active".

26.8.1.2.5.1.4 Method of test**Related PICS/PIXIT statements**

- supported MO circuit switched basic services.

Initial conditions

System Simulator:

1 cell, default parameters.

Mobile Station:

The MS is in MM-state "idle, updated" with valid TMSI and CKSN.

The MS is brought into the state U4 by using table 26.8.1.2/3.

Foreseen final state of the MS

U10, active.

Maximum duration of test

30 s.

Test procedure

An MO circuit switched basic service is selected that is supported by the MS; if the MS supports MO telephony, the selected basic service is telephony. If necessary, the MS is configured for that basic service. Then, the MS is made to initiate a call. The CC entity of the MS is brought to the state U4. The SS sends a CONNECT message to the MS. The MS shall respond by sending a CONNECT ACKNOWLEDGE message. The SS checks by using the status enquiry procedure that the CC entity has entered the state U10, active.

Expected sequence

Step	Direction	Message	Comments
1	SS -> MS	CONNECT	
2	MS -> SS	CONNECT ACKNOWLEDGE	MS stops alerting, if applicable
3	SS -> MS	STATUS ENQUIRY	
4	MS -> SS	STATUS	cause 30#, state U10

Specific message contents:

None.

26.8.1.2.5.2 Outgoing call / U4 call delivered / termination requested by the user**26.8.1.2.5.2.1 Definition and applicability**

The call control entity of the MS being in the state, U4, the user requests to terminate the call. This test is applicable for any equipment supporting at least one mobile originated circuit switched basic service.

26.8.1.2.5.2.2 Conformance requirement

- 1) A CC-entity of the MS in CC-state U4, "Call Delivered", upon request by the user to terminate shall send a DISCONNECT message and enter the CC-state U11, "Disconnect Request".

References

GSM 04.07 section 6.2.2., GSM 04.08 section 5.4.3.

26.8.1.2.5.2.3 Test purpose

To verify that a CC-entity of the MS in CC-state U4, "Call Delivered", upon request by the user to terminate will send a DISCONNECT message and enter the CC-state U11, "Disconnect Request".

26.8.1.2.5.2.4 Method of test**Related PICS/PIXIT statements**

- supported MO circuit switched basic services.

Initial conditions

System Simulator:

1 cell, default parameters.

Mobile Station:

The MS is in MM-state "idle, updated" with valid TMSI and CKSN.

The MS is brought into the state U4 by using table 26.8.1.2/3.

Foreseen final state of the MS

U11, disconnect request.

Maximum duration of test

30 s.

Test procedure

An MO circuit switched basic service is selected that is supported by the MS; if the MS supports MO telephony, the selected basic service is telephony. If necessary, the MS is configured for that basic service. Then, the MS is made to initiate a call. The CC entity of the MS is brought to the state U4. The user requests termination of the call. The MS shall send a DISCONNECT message. The SS checks by using the status enquiry procedure that the CC entity has entered the state U11, disconnect request.

Expected sequence

Step	Direction	Message	Comments
1			MMI action, terminate call cause 30#, state U11
2	MS -> SS	DISCONNECT	
3	SS -> MS	STATUS ENQUIRY	
4	MS -> SS	STATUS	

Specific message contents:

None.

26.8.1.2.5.3 Outgoing call / U4 call delivered / DISCONNECT with in band tones

26.8.1.2.5.3.1 Definition and applicability

The call control entity of the MS being in the state, U4, a DISCONNECT message indicating availability of in band information is received by the MS. This test is applicable for any equipment supporting at least one mobile originated circuit switched basic service.

26.8.1.2.5.3.2 Conformance requirement

- 1) A CC-entity of the MS in CC-state U4, "Call Delivered" shall, upon receipt of a DISCONNECT with a progress indicator indicating in-band information, shall through-connect the speech channel to make in-band announcements available, if traffic channel is in speech mode. If TCH is not in speech mode, the MS shall send a RELEASE message.

References

GSM 04.08 section 3.4.3, GSM 04.08 section 5.4.4.1., GSM 04.08 section 5.5.1., GSM 04.08 section 5.2.1.9.

26.8.1.2.5.3.3 Test purpose

To verify that a CC-entity of the MS in CC-state U4, "Call Delivered", upon receipt of a DISCONNECT with a progress indicator indicating in-band information, through-connects the speech channel to make in-band announcements available, if traffic channel is in speech mode. If TCH is not in speech mode, the MS shall send a RELEASE message.

26.8.1.2.5.3.4 Method of test

Related PICS/PIXIT statements

- supported MO circuit switched basic services.

Initial conditions

System Simulator:

1 cell, default parameters.

Mobile Station:

The MS is in MM-state "idle, updated" with valid TMSI and CKSN.

The MS is brought into the state U4 by using table 26.8.1.2/2.

Foreseen final state of the MS

U12, disconnect indication.

Maximum duration of test

30 s.

Test procedure

An MO circuit switched basic service is selected that is supported by the MS; if the MS supports MO telephony, the selected basic service is telephony. If necessary, the MS is configured for that basic service. Then, the MS is made to initiate a call. The CC entity of the MS is brought to the state U4. The SS sends a DISCONNECT message containing indication of in-band information availability to the MS. The SS checks that if channel mode is MO telephony, the TCH shall be through connected and the MS enters

state U12, disconnect indication. If channel mode is not speech, the TCH shall not be through connected and the MS shall enter state U19, release request.

Expected sequence

Step	Direction	Message	Comments
1	SS -> MS	DISCONNECT	(note)
A2	SS		TCH in speech mode: the SS will check that the audio path for in band tones is attached.
A3	SS -> MS	STATUS ENQUIRY	
A4	MS -> SS	STATUS	cause 30#, state U12
B2	MS -> SS	RELEASE	TCH is not in speech mode:
B3	SS -> MS	STATUS ENQUIRY	
B4	MS -> SS	STATUS	cause 30#, state U19

Specific message contents:

NOTE: the Progress Indicator, Progress Description:

#8 in band information or appropriate pattern now available.

26.8.1.2.5.4 Outgoing call / U4 call delivered / DISCONNECT without in band tones

26.8.1.2.5.4.1 Definition and applicability

The call control entity of the MS being in the state, U4, a DISCONNECT message is received by the MS. The DISCONNECT message does not contain indication of in-band information availability. This test is applicable for any equipment supporting at least one mobile originated circuit switched basic service.

26.8.1.2.5.4.2 Conformance requirement

- 1) A CC-entity of the MS in CC-state U4, "Call Delivered", upon receipt of a DISCONNECT without progress indicator, shall return a RELEASE message and enter the CC-state U19, "Release Request".

References

GSM 04.08 section 5.4.4.

26.8.1.2.5.4.3 Test purpose

To verify that a CC-entity of the MS in CC-state U4, "Call Delivered", upon receipt of a DISCONNECT without progress indicator, returns a RELEASE message and enters the CC-state U19, "Release Request".

26.8.1.2.5.4.4 Method of test

Related PICS/PIXIT statements

- supported MO circuit switched basic services.

Initial conditions

System Simulator:
1 cell, default parameters.

Mobile Station:
The MS is in MM-state "idle, updated" with valid TMSI and CKSN.
The MS is brought into the state U4 by using table 26.8.1.2/2.

Foreseen final state of the MS

U19, release request.

Maximum duration of test

30 s.

Test procedure

An MO circuit switched basic service is selected that is supported by the MS; if the MS supports MO telephony, the selected basic service is telephony. If necessary, the MS is configured for that basic service. Then, the MS is made to initiate a call. The CC entity of the MS is brought to the state U4. The SS sends a DISCONNECT message not containing indication of in-band information availability to the MS. The MS shall respond with a RELEASE message. The SS checks by using the status enquiry procedure that the CC entity of the MS has entered the state U19, release request.

Expected sequence

Step	Direction	Message	Comments
1	SS -> MS	DISCONNECT	
2	MS -> SS	RELEASE	
3	SS -> MS	STATUS ENQUIRY	
4	MS -> SS	STATUS	cause 30#, state U19

Specific message contents:

None.

26.8.1.2.5.5 Outgoing call / U4 call delivered / RELEASE received**26.8.1.2.5.5.1 Definition and applicability**

The call control entity of the MS being in the state, U4, a RELEASE message is received by the MS. This test is applicable for any equipment supporting at least one mobile originated circuit switched basic service.

26.8.1.2.5.5.2 Conformance requirement

- 1) A CC-entity of the MS in CC-state U4, "Call Delivered", upon receipt of the RELEASE message shall respond with the RELEASE COMPLETE message and enter the CC-state U0, "Null".
- 2) The MS on returning to idle mode shall release the MM-connection and the CC-entities relating to the seven mobile originating transaction identifiers shall be in CC-state U0, "Null".

References

Conformance requirement 1: GSM 04.08 section 5.4.2., GSM 04.08 section 5.4.4.
 Conformance requirement 2: GSM 04.08 section 4.5.3., GSM 04.08 section 5.5.3.2.

26.8.1.2.5.5.3 Test purpose

- 1) To verify that a CC-entity of the MS in CC-state U4, "Call Delivered", upon receipt of the RELEASE message will respond with the RELEASE COMPLETE message and enter the CC-state U0, "Null".
- 2) To verify that the MS on returning the idle mode releases the MM-connection and that the CC-entities relating to the seven mobile originating transaction identifiers are in CC-state U0, "Null".

26.8.1.2.5.5.4 Method of test**Related PICS/PIXIT statements**

- supported MO circuit switched basic services.

Initial conditions

System Simulator:

1 cell, default parameters.

Mobile Station:

The MS is in MM-state "idle, updated" with valid TMSI and CKSN.

The MS is brought into the state U4 by using table 26.8.1.2/2.

Foreseen final state of the MS

U0, null.

Maximum duration of test

1 min 30 s.

Test procedure

An MO circuit switched basic service is selected that is supported by the MS; if the MS supports MO telephony, the selected basic service is telephony. If necessary, the MS is configured for that basic service. Then, the MS is made to initiate a call. The CC entity of the MS is brought to the state U4. The SS sends a RELEASE message to the MS. The MS shall respond with a RELEASE COMPLETE message. The SS checks by using the status enquiry procedure that the CC entity has entered the state U0 with all the relevant transaction identifiers.

Expected sequence

Step	Direction	Message	Comments
1	SS -> MS	RELEASE	with cause "Normal, unspecified"
2	MS -> SS	RELEASE COMPLETE	
3	SS -> MS	STATUS ENQUIRY	
4	MS -> SS	RELEASE COMPLETE	
5	SS		
6	SS -> MS	CHANNEL RELEASE	

Specific message contents:

None.

26.8.1.2.5.6 Outgoing call / U4 call delivered / lower layer failure**26.8.1.2.5.6.1 Definition and applicability**

The call control entity of the MS being in the state, U4, a lower layer failure is accomplished at the MS and consequently, communication at layer 3 level with the peer entity is terminated. This test is applicable for any equipment supporting at least one mobile originated circuit switched basic service.

26.8.1.2.5.6.2 Conformance requirement

- 1) When CC-entity of the MS in CC-state U4, "Call Delivered" has detected a lower layer failure and has returned to idle mode, the CC-entities relating to the seven mobile originating transaction identifiers shall be in CC-state U0, "Null".

References

GSM 04.08 section 4.5.2.3., GSM 04.08 section 4.5.3., GSM 04.08 section 5.5.3.2., GSM 04.08 section 3.5.2.1.

26.8.1.2.5.6.3 Test purpose

To verify that a CC-entity of the MS in CC-state U4, "Call Delivered" having detected a lower layer failure and has returned to idle mode, the CC-entities relating to the seven mobile originating transaction identifiers are in CC-state U0, "Null".

26.8.1.2.5.6.4 Method of test**Related PICS/PIXIT statements**

- supported MO circuit switched basic services.

Initial conditions

System Simulator:

1 cell, default parameters.

Mobile Station:

The MS is in MM-state "idle, updated" with valid TMSI and CKSN.

The MS is brought into the state U4 by using table 26.8.1.2/2.

Foreseen final state of the MS

U0, null.

Maximum duration of test

1 min 30 s.

Test procedure

An MO circuit switched basic service is selected that is supported by the MS; if the MS supports MO telephony, the selected basic service is telephony. If necessary, the MS is configured for that basic service. Then, the MS is made to initiate a call. The MS is brought to the state U4. The SS generates a lower layer failure at the MS. The SS waits long enough to enable the MS to return to idle state listening to paging, and then pages MS to create RR-connection. Finally, the SS will check the state of the MS by using STATUS ENQUIRY with the relevant transaction identifiers.

Expected sequence

Step	Direction	Message	Comments
1	SS		SS generates lower layer failure
2	SS		SS waits 20 s for the MS to return to listening to paging
3	SS -> MS	PAGING REQUEST	
4	MS -> SS	CHANNEL REQUEST	
5	SS -> MS	IMMEDIATE ASSIGNMENT	
6	MS -> SS	PAGING RESPONSE	
7	SS -> MS	STATUS ENQUIRY	
8	MS -> SS	RELEASE COMPLETE	cause 81# (invalid TI value)
9	SS		repeat steps 7-8 to cover all the transaction identifiers from 000...110
10	SS -> MS	CHANNEL RELEASE	the main signalling link shall be released by the MS (L2: DISC/UA).

Specific message contents:

None.

26.8.1.2.5.7 Outgoing call / U4 call delivered / traffic channel allocation

26.8.1.2.5.7.1 Definition and applicability

The call control entity of the MS being in the state, U4, a traffic channel assignment procedure is performed. This test is applicable for any equipment supporting at least one mobile originated circuit switched basic service.

26.8.1.2.5.7.2 Conformance requirement

- 1) A CC-entity of the MS in CC-state U4, "Call Delivered", when allocated a traffic channel by the network performing the assignment procedure, shall perform a layer 2 establishment on the FACCH without changing the state of the call in progress.

References

GSM 04.08 section 3.4.3., GSM 04.08 section 5.2.1.9.

26.8.1.2.5.7.3 Test purpose

To verify that a CC-entity of the MS in CC-state U4, "Call Delivered", when allocated a traffic channel by the network performing the assignment procedure, shall perform a layer 2 establishment on the FACCH without changing the state of the call in progress.

26.8.1.2.5.7.4 Method of test

Related PICS/PIXIT statements

- supported MO circuit switched basic services.

Initial conditions

System Simulator:
1 cell, default parameters.

Mobile Station:
The MS is in MM-state "idle, updated" with valid TMSI and CKSN.
The MS is brought into the state U4 by using table 26.8.1.2/1.

Foreseen final state of the MS

U4, call delivered.

Maximum duration of test

30 s.

Test procedure

An MO circuit switched basic service is selected that is supported by the MS; if the MS supports MO telephony, the selected basic service is telephony. If necessary, the MS is configured for that basic service. Then, the MS is made to initiate a call. The CC entity of the MS is brought to the state U4. The SS sends an ASSIGNMENT COMMAND for traffic channel to the MS. The MS shall establish layer 2 link on the newly allocated channel and respond with an ASSIGNMENT COMPLETE message. The SS checks by using the status enquiry procedure that the state of the CC entity has remained unchanged.

Expected sequence

Step	Direction	Message	Comments
1	SS -> MS	ASSIGNMENT COMMAND	TCH, the MS shall perform L2 establishment on the FACCH cause 30#, state U4
2	MS -> SS	ASSIGNMENT COMPLETE	
3	SS -> MS	STATUS ENQUIRY	
4	MS -> SS	STATUS	

Specific message contents:

None.

26.8.1.2.5.8 Outgoing call / U4 call delivered / unknown message received**26.8.1.2.5.8.1 Definition and applicability**

The call control entity of the MS being in the state, U4, an unknown message is received by the MS. This test is applicable for any equipment supporting at least one mobile originated circuit switched basic service.

26.8.1.2.5.8.2 Conformance requirement

- 1) A CC-entity of the MS in CC-state U4, "Call Delivered", having received an unknown message from its peer entity shall return a STATUS message.

References

GSM 04.08 section 8.4.

26.8.1.2.5.8.3 Test purpose

To verify that a CC-entity of the MS in CC-state U4, "Call Delivered", having received an unknown message from its peer entity returns a STATUS message.

26.8.1.2.5.8.4 Method of test**Related PICS/PIXIT statements**

- supported MO circuit switched basic services.

Initial conditions

System Simulator:

1 cell, default parameters.

Mobile Station:

The MS is in MM-state "idle, updated" with valid TMSI and CKSN.

The MS is brought into the state U4 by using table 26.8.1.2/4.

Foreseen final state of the MS

U4, call delivered.

Maximum duration of test

30 s.

Test procedure

An MO circuit switched basic service is selected that is supported by the MS; if the MS supports MO telephony, the selected basic service is telephony. If necessary, the MS is configured for that basic service. Then, the MS is made to initiate a call. The CC entity of the MS is brought to the state U4. The SS sends a message with message type not defined for the protocol discriminator to the MS. The MS shall respond with a STATUS message, and finally the SS checks by using the status enquiry procedure that the state of the CC entity has remained unchanged.

Expected sequence

Step	Direction	Message	Comments
1	SS -> MS	unknown message	message type not defined for PD
2	MS -> SS	STATUS	cause 97#, state U4
3	SS -> MS	STATUS ENQUIRY	
4	MS -> SS	STATUS	cause 30#, state U4

Specific message contents:

None.

26.8.1.2.6 U10 call active

26.8.1.2.6.1 U10 call active / termination requested by the user

26.8.1.2.6.1.1 Definition and applicability

The call control entity of the MS being in the state, U10, the user requests to terminate the call. This test is applicable for any equipment supporting at least one mobile originated circuit switched basic service.

26.8.1.2.6.1.2 Conformance requirement

- 1) A CC-entity of the MS in CC-state U10, "Call Active", upon request by the user to terminate shall send a DISCONNECT message and enter the CC-state U11, "Disconnect Request".

References

GSM 04.07 section 6.2.2., GSM 04.08 section 5.4.3.

26.8.1.2.6.1.3 Test purpose

To verify that the a CC-entity of the MS in CC-state U10, "Call Active", upon request by the user to terminate will send a DISCONNECT message and enter the CC-state U11, "Disconnect Request".

26.8.1.2.6.1.4 Method of test

Related PICS/PIXIT statements

- supported MO circuit switched basic services.

Initial conditions

System Simulator:

1 cell, default parameters.

Mobile Station:

The MS is in MM-state "idle, updated" with valid TMSI and CKSN.

The MS is brought into the state U10 by using table 26.8.1.2/1.

Foreseen final state of the MS

U11, disconnect request.

Maximum duration of test

30 s.

Test procedure

An MO circuit switched basic service is selected that is supported by the MS; if the MS supports MO telephony, the selected basic service is telephony. If necessary, the MS is configured for that basic service. Then, the MS is made to initiate a call. The CC entity of the MS is brought to the state U10. The user requests termination of the call. The MS shall send a DISCONNECT message. The SS checks by using the status enquiry procedure that the CC entity has entered the state U11, disconnect request.

Expected sequence

Step	Direction	Message	Comments
1			MMI action, terminate call
2	MS -> SS	DISCONNECT	U11
3	SS -> MS	STATUS ENQUIRY	
4	MS -> SS	STATUS	cause 30#, state U11

Specific message contents:

None.

26.8.1.2.6.2 U10 call active / RELEASE received**26.8.1.2.6.2.1 Definition and applicability**

The call control entity of the MS being in the state, U10, a RELEASE message is received by the MS. This test is applicable for any equipment supporting at least one mobile originated circuit switched basic service.

26.8.1.2.6.2.2 Conformance requirement

- 1) A CC-entity of the MS in CC-state U10, "Call Active", upon receipt of the RELEASE shall respond with the RELEASE COMPLETE message and enter the CC-state U0, "Null"
- 2) When the MS returns to the idle mode it shall release the MM-connection and the CC-entities relating to the seven mobile originating transaction identifiers shall be in CC-state U0, "Null"

References

Conformance requirement 1: GSM 04.08 section 5.4.2., GSM 04.08 section 5.4.4.
 Conformance requirement 2: GSM 04.08 section 4.5.3., GSM 04.08 section 5.5.3.2.

26.8.1.2.6.2.3 Test purpose

- 1) To verify that the a CC-entity of the MS in CC-state U10, "Call Active", upon receive of the RELEASE will respond with the RELEASE COMPLETE message and enter the CC-state U0, "Null"
- 2) To verify that the MS on returning to the idle mode releases the MM-connection and that the CC-entities relating to the seven mobile originating transaction identifiers are in CC-state U0, "Null"

26.8.1.2.6.2.4 Method of test**Related PICS/PIXIT statements**

- supported MO circuit switched basic services.

Initial conditions

System Simulator:

1 cell, default parameters.

Mobile Station:

The MS is in MM-state "idle, updated" with valid TMSI and CKSN.

The MS is brought into the state U10 by using table 26.8.1.2/1.

Foreseen final state of the MS

U0, null.

Maximum duration of test

1 min 30 s.

Test procedure

An MO circuit switched basic service is selected that is supported by the MS; if the MS supports MO telephony, the selected basic service is telephony. If necessary, the MS is configured for that basic service. Then, the MS is made to initiate a call. The CC entity of the MS is brought to the state U10. The SS sends a RELEASE message to the MS. The MS shall respond with a RELEASE COMPLETE message. The SS checks by using the status enquiry procedure that the CC entity has entered the state U0 with all the relevant transaction identifiers.

Expected sequence

Step	Direction	Message	Comments
1	SS -> MS	RELEASE	with cause "Normal, unspecified"
2	MS -> SS	RELEASE COMPLETE	the MS starts T3240
3	SS -> MS	STATUS ENQUIRY	
4	MS -> SS	RELEASE COMPLETE	cause 81# (invalid TI value)
5	SS		repeat steps 3-4 to cover all the transaction identifiers from 000...110
6	SS -> MS	CHANNEL RELEASE	the main signalling link shall be released by the MS (L2: DISC/UA)

Specific message contents:

None.

26.8.1.2.6.3 U10 call active / DISCONNECT with in band tones**26.8.1.2.6.3.1 Definition and applicability**

The call control entity of the MS being in the state, U10, a DISCONNECT message indicating availability of in band information is received by the MS. This test is applicable for any equipment supporting at least one mobile originated circuit switched basic service.

26.8.1.2.6.3.2 Conformance requirement

- 1) A CC-entity of the MS in CC-state U10, "Call Active", upon receipt of a DISCONNECT message with a Progress Indicator indicating in-band information, shall through-connect the speech channel to make in-band announcements available, if traffic channel is in speech mode. If TCH is not in speech mode, the MS shall send a RELEASE message.

References

GSM 04.08 section 5.4.4.1., GSM 04.08 section 5.5.1.

26.8.1.2.6.3.3 Test purpose

To verify that a CC-entity of the MS in CC-state U10, "Call Active", upon receipt of a DISCONNECT message with a Progress Indicator indicating in-band information, through-connects the speech channel to make in-band announcements available, if traffic channel is in speech mode. If TCH is not in speech mode, the MS sends a RELEASE message.

26.8.1.2.6.3.4 Method of test

Related PICS/PIXIT statements

- supported MO circuit switched basic services.

Initial conditions

System Simulator:

1 cell, default parameters.

Mobile Station:

The MS is in MM-state "idle, updated" with valid TMSI and CKSN.

The MS is brought into the state U10 by using table 26.8.1.2/2.

Foreseen final state of the MS

U12, disconnect indication.

Maximum duration of test

30 s.

Test procedure

An MO circuit switched basic service is selected that is supported by the MS; if the MS supports MO telephony, the selected basic service is telephony. If necessary, the MS is configured for that basic service. Then, the MS is made to initiate a call. The CC entity of the MS is brought to the state U10. The SS sends a DISCONNECT message containing indication of in-band information availability to the MS. The SS checks that if channel mode is speech, the TCH shall be through connected and the MS enters state U12, disconnect indication. If channel mode is not speech, the TCH shall not be through connected and the MS enters state U19, release request.

Expected sequence

Step	Direction	Message	Comments
1	SS -> MS	DISCONNECT	(note)
A2	SS		TCH in speech mode: the SS will check that the audio path for in band tones is attached.
A3	SS -> MS	STATUS ENQUIRY	
A4	MS -> SS	STATUS	cause 30#, state U12
B2	MS -> SS	RELEASE	TCH is not in speech mode:
B3	SS -> MS	STATUS ENQUIRY	
B4	MS -> SS	STATUS	cause 30#, state U19

Specific message contents:

NOTE: the Progress Indicator, Progress Description:

#8 in band information or appropriate pattern now available.

26.8.1.2.6.4 U10 call active / DISCONNECT without in band tones

26.8.1.2.6.4.1 Definition and applicability

The call control entity of the MS being in the state, U10, a DISCONNECT message is received by the MS. The DISCONNECT message does not contain indication of in-band information availability. This test is applicable for any equipment supporting at least one mobile originated circuit switched basic service.

26.8.1.2.6.4.2 Conformance requirement

- 1) A CC-entity of the MS in CC-state U10, "Call Active", upon receipt of a DISCONNECT message without progress indicator, shall return a RELEASE message and enter the CC-state U19, "Release Request".

References

GSM 04.08 section 5.4.4.

26.8.1.2.6.4.3 Test purpose

To verify that the a CC-entity of the MS in CC-state U10, "Call Active", upon receipt of a DISCONNECT message without progress indicator, returns a RELEASE message and enters the CC-state U19, "Release Request".

26.8.1.2.6.4.4 Method of test

Related PICS/PIXIT statements

- supported MO circuit switched basic services.

Initial conditions

System Simulator:
1 cell, default parameters.

Mobile Station:
The MS is in MM-state "idle, updated" with valid TMSI and CKSN.
The MS is brought into the state U10 by using table 26.8.1.2/2.

Foreseen final state of the MS

U19, release request.

Maximum duration of test

30 s.

Test procedure

An MO circuit switched basic service is selected that is supported by the MS; if the MS supports MO telephony, the selected basic service is telephony. If necessary, the MS is configured for that basic service. Then, the MS is made to initiate a call. The CC entity of the MS is brought to the state U10. The SS sends a DISCONNECT message not containing indication of in-band information availability to the MS. The MS shall respond with a RELEASE message. The SS checks by using the status enquiry procedure that the CC entity of the MS has entered the state U19, release request.

Expected sequence

Step	Direction	Message	Comments
1	SS -> MS	DISCONNECT	
2	MS -> SS	RELEASE	
3	SS -> MS	STATUS ENQUIRY	
4	MS -> SS	STATUS	cause 30#, state U19

Specific message contents:

None.

26.8.1.2.6.5 U10 call active / RELEASE COMPLETE received**26.8.1.2.6.5.1 Definition and applicability**

The call control entity of the MS being in the state, U10, the call is cleared by a RELEASE COMPLETE message sent by the SS. This test is applicable for any equipment supporting at least one mobile originated circuit switched basic service.

26.8.1.2.6.5.2 Conformance requirement

- 1) A CC entity of the MS in CC-state U10, "active", upon receipt of a RELEASE COMPLETE message with valid cause value, shall enter CC state U0, "Null".
- 2) On returning to idle mode, the CC entities relating to the seven mobile originating transaction identifiers shall be in state U0, "Null".

References

Conformance requirement 1: GSM 04.08, section 5.4.2, GSM 04.08, section 5.4.4.
 Conformance requirement 2: GSM 04.08, section 5.4.4.3.

26.8.1.2.6.5.3 Test purpose

- 1) To verify that a CC entity of the MS in CC-state U10, "Call active" upon receipt of a RELEASE COMPLETE message with valid cause value, enters CC state U0, "Null".
- 2) To verify that in returning to idle mode, the CC entities relating to the seven mobile originating transaction identifiers are in state U0, "Null".

26.8.1.2.6.5.4 Method of test**Related PICS/PIXIT statements**

- supported MO circuit switched basic services.

Initial conditions

System Simulator:

1 cell, default parameters.

Mobile Station:

The MS is in MM-state "idle, updated" with valid TMSI and CKSN.

The MS is brought into the state U10 by using table 26.8.1.2/2.

Foreseen final state of the MS

U0, null.

Maximum duration of test

30 s.

Test procedure

The SS sends a RELEASE COMPLETE message to the MS. The SS checks by using the status enquiry procedure that the CC entity has entered the state U0 with all the relevant transaction identifiers.

Expected sequence

Step	Direction	Message	Comments
1	SS -> MS	RELEASE COMPLETE	note 1
2	SS -> MS	STATUS ENQUIRY	note 2
3	MS -> SS	RELEASE COMPLETE	cause 81# (invalid TI value),
4	SS		repeat steps 2-3 to cover all the transaction identifiers from 000...110
5	SS -> MS	CHANNEL RELEASE	the main signalling link shall be released by the MS (L2: DISC/UA).

Specific message contents:

NOTE 1: With the cause value chosen arbitrarily.

NOTE 2: TI flag has the value indicating the MS as a originator of the call.

26.8.1.2.6.6 U10 call active / SETUP received**26.8.1.2.6.6.1 Definition and applicability**

If the MS does not react correctly when receiving a SETUP message on a new Transaction Identifier during an active call, the active call may be lost.

This test is applicable for all GSM 900 and DCS 1 800 MS supporting at least one mobile originated circuit switched basic service.

26.8.1.2.6.6.2 Conformance requirement

- 1) A Mobile Station that has a call established when receiving a SETUP message shall respond either with a CALL CONFIRMED message or a RELEASE COMPLETE message, both with cause #17 "user busy".

- 2) The call control state of the existing transaction shall not be affected by the incoming SETUP message.

Reference(s):

Conformance requirement 1: GSM 04.08, section 5.2.2.3.1.
Conformance requirement 2: GSM 04.08, section 5.1.1.

26.8.1.2.6.6.3 Test purpose

- 1) To verify that a Mobile Station that has a call established and receives a SETUP message answers either with a CALL CONFIRMED message with cause "user busy" if it supports call waiting, or with a RELEASE COMPLETE message with cause "user busy" otherwise.
- 2) To verify that after having sent this message, the MS is still in state U10 for the established call.

26.8.1.2.6.6.4 Method of test

Initial conditions

System Simulator:
1 cell, default parameters.

Mobile Station:
The MS is idle updated with valid TMSI and CKSN.
The MS is brought into the state U10 by using table 26.8.1.2/14.

Related PICS/PIXIT statement(s)

- supported MO circuit switched basic services.
- support of call waiting Y/N.

Foreseen final state of the MS

U10, call active.

Maximum duration of test

30 s.

Test Procedure

The MS has a mobile originated call in the U10 state.

The SS sends a SETUP message to the MS (with signal IE indicating "call waiting tone on").

If the MS does not support call waiting it shall answer by a RELEASE COMPLETE message.

If the MS supports call waiting it shall answer by a CALL CONFIRMED message followed by an ALERTING. The second transaction is then released by the SS with a RELEASE COMPLETE message.

In both cases the SS checks by using the status enquiry procedure that the CC entity of the MS is still in state U10, active call for the original call.

Expected sequence

Step	Direction	Message	Comments
1	SS -> MS	SETUP	this message establishes a second transaction The TI value shall be the same as the one that is in use for the MO call. The TI flag shall have the value specified for an MT call.
A2	MS -> SS	RELEASE COMPLETE	if the MS does not support call waiting with cause user busy" with the TI of the second transaction
B2	MS -> SS	CALL CONFIRMED	if the MS supports call waiting with cause user busy" with the TI of the second transaction
B3	MS -> SS	ALERTING	with the TI of the second transaction
B4	SS -> MS	RELEASE COMPLETE	with the TI of the second transaction
5	SS -> MS	STATUS ENQUIRY	with the TI of the original transaction
6	MS -> SS	STATUS	cause 30#, state U10 with the TI of the original transaction

NOTE: The Transaction Identifier of the second transaction shall be different from the one of the already established transaction.

Specific message contents

SETUP message contains a Signal IE with value "call waiting tone on" (H'07).

26.8.1.2.7 U11 disconnect request

26.8.1.2.7.1 U11 disconnect request / clear collision

26.8.1.2.7.1.1 Definition and applicability

The call control entity of the MS being in the state, U11, a DISCONNECT message is received by the MS. This test is applicable for any equipment supporting at least one mobile originated circuit switched basic service.

26.8.1.2.7.1.2 Conformance requirement

- 1) A CC-entity of the MS in CC-state U11, "Disconnect Request", upon receipt of a DISCONNECT message, shall return to its peer entity the RELEASE message and enter the CC-state U19, "Release Request".

References

GSM 04.08 section 5.4.5.

26.8.1.2.7.1.3 Test purpose

To verify that the a CC-entity of the MS in CC-state U11, "Disconnect Request", upon receipt of a DISCONNECT message, returns to its peer entity the RELEASE message and enters the CC-state U19, "Release Request".

26.8.1.2.7.1.4 Method of test

Related PICS/PIXIT statements

- supported MO circuit switched basic services.

Initial conditions

System Simulator:
1 cell, default parameters.

Mobile Station:

The MS is in MM-state "idle, updated" with valid TMSI and CKSN.

The MS is brought into the state U11 by using table 26.8.1.2/3.

Foreseen final state of the MS

U19, release request.

Maximum duration of test

30 s.

Test procedure

An MO circuit switched basic service is selected that is supported by the MS; if the MS supports MO telephony, the selected basic service is telephony. If necessary, the MS is configured for that basic service. Then, the MS is made to initiate a call. The CC entity of the MS is brought to the state U11. The SS sends a DISCONNECT message to the MS. The MS shall respond with a RELEASE message. The SS checks by using the status enquiry procedure that the CC entity of the MS has entered the state U19, release request.

Expected sequence

Step	Direction	Message	Comments
1	SS -> MS	DISCONNECT	
2	MS -> SS	RELEASE	
3	SS -> MS	STATUS ENQUIRY	
4	MS -> SS	STATUS	cause 30#, state U19

Specific message contents:

None.

26.8.1.2.7.2 U11 disconnect request / RELEASE received**26.8.1.2.7.2.1 Definition and applicability**

The call control entity of the MS being in the state, U11, a RELEASE message is received by the MS. This test is applicable for any equipment supporting at least one mobile originated circuit switched basic service.

26.8.1.2.7.2.2 Conformance requirement

- 1) A CC-entity of the MS in CC-state U11, "Disconnect Request", upon receipt of the RELEASE message shall return RELEASE COMPLETE and enter the CC-state U0, "Null".
- 2) On returning to the idle mode the MS shall release the MM-connection and the CC-entities relating to the seven mobile originating transaction identifiers shall be in CC-state U0, "Null".

References

Conformance requirement 1: GSM 04.08 section 5.4.3.

Conformance requirement 2: GSM 04.08 section 4.5.3., GSM 04.08 section 5.5.3.2., GSM 04.08 section 8.3.

26.8.1.2.7.2.3 Test purpose

- 1) To verify that the a CC-entity of the MS in CC-state U11, "Disconnect Request", upon receipt of the RELEASE message shall return RELEASE COMPLETE and enter the CC-state U0, "Null".

- 2) To verify that the MS on returning to the idle mode releases the MM-connection and that the CC-entities relating to the seven mobile originating transaction identifiers are in CC-state U0, "Null".

26.8.1.2.7.2.4 Method of test

Related PICS/PIXIT statements

- supported MO circuit switched basic services.

Initial conditions

System Simulator:

1 cell, default parameters.

Mobile Station:

The MS is in MM-state "idle, updated" with valid TMSI and CKSN.

The MS is brought into the state U11 by using table 26.8.1.2/3.

Foreseen final state of the MS

U0, null.

Maximum duration of test

1 min 30 s.

Test procedure

An MO circuit switched basic service is selected that is supported by the MS; if the MS supports MO telephony, the selected basic service is telephony. If necessary, the MS is configured for that basic service. Then, the MS is made to initiate a call. The CC entity of the MS is brought to the state U11. The SS sends a RELEASE message to the MS. The MS shall respond with a RELEASE COMPLETE message. The SS checks by using the status enquiry procedure that the CC entity has entered the state U0 with all the relevant transaction identifiers.

Expected sequence

Step	Direction	Message	Comments
1	SS -> MS	RELEASE	
2	MS -> SS	RELEASE COMPLETE	
3	SS -> MS	STATUS ENQUIRY	
4	MS -> SS	RELEASE COMPLETE	
5	SS		cause 81# (invalid TI value) repeat steps 3-4 to cover all the transaction identifiers from 000...110
6	SS -> MS	CHANNEL RELEASE	the main signalling link shall be released by the MS (L2: DISC/UA).

Specific message contents:

None.

26.8.1.2.7.3 U11 disconnect request / timer T305 time-out

26.8.1.2.7.3.1 Definition and applicability

The call control entity of the MS being in the state, U11, if no response is then received from the SS, timer T305 expires at the MS side. This test is applicable for any equipment supporting at least one mobile originated circuit switched basic service.

26.8.1.2.7.3.2 Conformance requirement

- 1) A CC-entity of the MS in CC-state U11, "Disconnect Request" shall on expiry of T305, proceed with the connection release procedure by sending the RELEASE message to its peer entity and shall enter the CC-state U19, "Release Request".

References

GSM 04.08 section 5.4.3., GSM 04.08 section 11.3.

26.8.1.2.7.3.3 Test purpose

To verify that the CC-entity of the MS in CC-state U11, "Disconnect Request" shall on expiry of T305 (accuracy +/- 10 %), proceed with the connection release procedure by sending the RELEASE message to its peer entity and enters the CC-state U19, "Release Request".

26.8.1.2.7.3.4 Method of test**Related PICS/PIXIT statements**

- supported MO circuit switched basic services.

Initial conditions

System Simulator:

1 cell, default parameters.

Mobile Station:

The MS is in MM-state "idle, updated" with valid TMSI and CKSN.

The MS is brought into the state U11 by using table 26.8.1.2/3.

Foreseen final state of the MS

U19, release request.

Maximum duration of test

1 minute.

Test procedure

An MO circuit switched basic service is selected that is supported by the MS; if the MS supports MO telephony, the selected basic service is telephony. If necessary, the MS is configured for that basic service. Then, the MS is made to initiate a call. The CC entity of the MS is brought to the state U11. Then T305 expires at the MS and the MS shall send a RELEASE message. The SS checks timer T305 accuracy and that the CC entity has entered the state U19, release request.

Expected sequence

Step	Direction	Message	Comments
1	SS		SS waits until T305 expires at the MS
2	MS -> SS	RELEASE	SS checks the time between DISCONNECT and RELEASE (note), (T305 +/- 10 %)
3	SS -> MS	STATUS ENQUIRY	
4	MS -> SS	STATUS	cause 30#, state U19

Specific message contents:

NOTE: With the same cause value as originally contained in the DISCONNECT message. An additional cause information element (#102 recovery on timer expiry) may be included.

26.8.1.2.7.4 U11 disconnect request / lower layer failure**26.8.1.2.7.4.1 Definition and applicability**

The call control entity of the MS being in the state, U11, a lower layer failure is accomplished at the MS and consequently, communication at layer 3 level with the peer entity is terminated. This test is applicable for any equipment supporting at least one mobile originated circuit switched basic service.

26.8.1.2.7.4.2 Conformance requirement

- 1) A CC-entity of the MS in CC-state U11, "Disconnect Request" having detected a lower layer failure shall return to the idle mode. The CC entities relating to the seven mobile originating transaction identifiers shall be in state U0, "Null".

References

GSM 04.08 section 4.5.2.3., GSM 04.08 section 4.5.3., GSM 04.08 section 5.5.3.2., GSM 04.08 section 3.5.2.1., GSM 04.08 section 8.3.

26.8.1.2.7.4.3 Test purpose

To verify that the a CC-entity of the MS in CC-state U11, "Disconnect Request" having detected a lower layer failure returns to the idle mode. The CC entities relating to the seven mobile originating transaction identifiers are thus in state U0, "Null".

26.8.1.2.7.4.4 Method of test**Related PICS/PIXIT statements**

- supported MO circuit switched basic services.

Initial conditions

System Simulator:

1 cell, default parameters.

Mobile Station:

The MS is in MM-state "idle, updated" with valid TMSI and CKSN.

The MS is brought into the state U11 by using table 26.8.1.2/4.

Foreseen final state of the MS

U0, null.

Maximum duration of test

1 min 30 s.

Test procedure

An MO circuit switched basic service is selected that is supported by the MS; if the MS supports MO telephony, the selected basic service is telephony. If necessary, the MS is configured for that basic service. Then, the MS is made to initiate a call. The MS is brought to the state U11. The SS generates a lower layer failure at the MS. The SS waits long enough to enable the MS to return to idle state listening to paging, and then pages MS to create RR-connection. Finally, the SS will check the state of the MS by using STATUS ENQUIRY with the relevant transaction identifiers.

Expected sequence

Step	Direction	Message	Comments
1	SS		SS generates lower layer failure
2	SS		SS waits 20 s for the MS to return to listening to paging
3	SS -> MS	PAGING REQUEST	
4	MS -> SS	CHANNEL REQUEST	
5	SS -> MS	IMMEDIATE ASSIGNMENT	
6	MS -> SS	PAGING RESPONSE	
7	SS -> MS	STATUS ENQUIRY	
8	MS -> SS	RELEASE COMPLETE	cause 81# (invalid TI value)
9	SS		repeat steps 7-8 to cover all the transaction identifiers from 000...110
10	SS -> MS	CHANNEL RELEASE	the main signalling link shall be released by the MS (L2: DISC/UA).

Specific message contents:

None.

26.8.1.2.7.5 U11 disconnect request / unknown message received**26.8.1.2.7.5.1 Definition and applicability**

The call control entity of the MS being in the state, U4, an unknown message is received by the MS. This test is applicable for any equipment supporting at least one mobile originated circuit switched basic service.

26.8.1.2.7.5.2 Conformance requirement

- 1) A CC-entity of the MS in CC-state U100, "Call Delivered", having received an unknown message from its peer entity shall return a STATUS message.

References

GSM 04.08 section 8.4.

26.8.1.2.7.5.3 Test purpose

To verify that a CC-entity of the MS in CC-state U11, "Call Delivered", having received an unknown message from its peer entity returns a STATUS message.

26.8.1.2.7.5.4 Method of test**Related PICS/PIXIT statements**

- supported MO circuit switched basic services.

Initial conditions

System Simulator:
1 cell, default parameters.

Mobile Station:
The MS is in MM-state "idle, updated" with valid TMSI and CKSN.
The MS is brought into the state U11 by using table 26.8.1.2/4.

Foreseen final state of the MS

U11, disconnect request.

Maximum duration of test

30 s.

Test procedure

An MO circuit switched basic service is selected that is supported by the MS; if the MS supports MO telephony, the selected basic service is telephony. If necessary, the MS is configured for that basic service. Then, the MS is made to initiate a call. The CC entity of the MS is brought to the state U11. The SS sends a message with message type not defined for the protocol discriminator to the MS. The MS shall respond with a STATUS message, and finally the SS checks by using the status enquiry procedure that the state of the CC entity has remained unchanged.

Expected sequence

Step	Direction	Message	Comments
1	SS -> MS	unknown message	message type not defined for PD
2	MS -> SS	STATUS	cause 97#, state U11
3	SS -> MS	STATUS ENQUIRY	
4	MS -> SS	STATUS	cause 30#, state U11

Specific message contents:

None.

26.8.1.2.8 U12 disconnect indication**26.8.1.2.8.1 U12 disconnect indication / call releasing requested by the user****26.8.1.2.8.1.1 Definition and applicability**

The call control entity of the MS being in the state, U12, the user requests to terminate the call. This test is applicable only for mobile stations supporting bearer capability for speech.

26.8.1.2.8.1.2 Conformance requirement

- 1) A CC-entity of the MS in CC-state U12, "Disconnect Indication" being in network initiated call release phase, shall, upon receiving a call release request from the user send a RELEASE to its peer entity and enter CC-state U19, "Release Request".

References

GSM 04.07 section 6.2.2., GSM 04.08 section 5.4.4.

26.8.1.2.8.1.3 Test purpose

To verify that a CC-entity of the MS in CC-state U12, "Disconnect Indication" being in network initiated call release phase, shall, upon receiving a call release request from the user sends a RELEASE to its peer entity and enters CC-state U19, "Release Request"

26.8.1.2.8.1.4 Method of test**Related PICS/PIXIT statements**

- supported MO circuit switched basic services.

Initial conditions

System Simulator:

1 cell, default parameters.

Mobile Station:

The MS is in MM-state "idle, updated" with valid TMSI and CKSN.

The MS is brought into the state U12 by using Option A of table 26.8.1.2/1.

Foreseen final state of the MS

U19, release request.

Maximum duration of test

30 s.

Test procedure

An MO circuit switched basic service is selected that is supported by the MS; if the MS supports MO telephony, the selected basic service is telephony. If necessary, the MS is configured for that basic service. Then, the MS is made to initiate a call. The CC entity of the MS is brought to the state U12. The user requests termination of the call. The MS shall send a RELEASE message. The SS checks by using the status enquiry procedure that the CC entity has entered the state U19, release request.

Expected sequence

Step	Direction	Message	Comments
1			MMI action, "on hook"
2	MS -> SS	RELEASE	
3	SS -> MS	STATUS ENQUIRY	
4	MS -> SS	STATUS	

Specific message contents:

None.

26.8.1.2.8.2 U12 disconnect indication / RELEASE received**26.8.1.2.8.2.1 Definition and applicability**

The call control entity of the MS being in the state, U12, a RELEASE message is received by the MS. This test is applicable only for mobile stations supporting bearer capability for speech.

26.8.1.2.8.2.2 Conformance requirement

- 1) A CC-entity of the MS in CC-state U12, "Disconnect Indication", upon receipt of a RELEASE message shall return to its peer entity the RELEASE COMPLETE message and enter the CC-state U0, "Null".
- 2) On returning to the idle mode the MS shall release the MM-connection and the CC-entities relating to the seven mobile originating transaction identifiers shall be in CC-state U0, "Null".

References

Conformance requirement 1: GSM 04.08 section 5.4.2

Conformance requirement 2: GSM 04.08 section 4.5.3., GSM 04.08 section 5.5.3.2., GSM 04.08 section 8.3.

26.8.1.2.8.2.3 Test purpose

- 1) To verify that a CC-entity of the MS in CC-state U12, "Disconnect Indication", upon receipt of a RELEASE message returns to its peer entity the RELEASE COMPLETE message and enters the CC-state U0, "Null".

- 2) To verify that the MS on returning to the idle mode releases the MM-connection and that the CC-entities relating to the seven mobile originating transaction identifiers are in CC-state U0, "Null".

26.8.1.2.8.2.4 Method of test

Related PICS/PIXIT statements

- supported MO circuit switched basic services.

Initial conditions

System Simulator:

1 cell, default parameters.

Mobile Station:

The MS is in MM-state "idle, updated" with valid TMSI and CKSN.

The MS is brought into the state U12 by using Option A of table 26.8.1.2/1.

Foreseen final state of the MS

U0, null.

Maximum duration of test

1 min.

Test procedure

An MO circuit switched basic service is selected that is supported by the MS; if the MS supports MO telephony, the selected basic service is telephony. If necessary, the MS is configured for that basic service. Then, the MS is made to initiate a call. The CC entity of the MS is brought to the state U12. The SS sends a RELEASE message to the MS. The MS shall respond with a RELEASE COMPLETE message. The SS checks by using the status enquiry procedure that the CC entity has entered the state U0 with all the relevant transaction identifiers.

Expected sequence

Step	Direction	Message	Comments
1	SS -> MS	RELEASE	
2	MS -> SS	RELEASE COMPLETE	
3	SS -> MS	STATUS ENQUIRY	
4	MS -> SS	RELEASE COMPLETE	
5	SS		cause 81# (invalid TI value) repeat steps 3-4 to cover all the transaction identifiers from 000...110
6	SS -> MS	CHANNEL RELEASE	the main signalling link shall be released by the MS (L2: DISC/UA).

Specific message contents:

None.

26.8.1.2.8.3 U12 disconnect indication / lower layer failure

26.8.1.2.8.3.1 Definition and applicability

The call control entity of the MS being in the state, U12, a lower layer failure is accomplished at the MS and consequently, communication at layer 3 level with the peer entity is terminated. This test is applicable only for mobile stations supporting bearer capability for speech.

26.8.1.2.8.3.2 Conformance requirement

- 1) A CC-entity of the MS in CC-state U12, "Disconnect Indication" having detected a lower layer failure shall return to idle mode. The CC-entities relating to the seven mobile originating transaction identifiers shall be in state U0, "Null".

References

GSM 04.08 section 4.5.3.2., GSM 04.08 section 4.5.3., GSM 04.08 section 5.5.3.2., GSM 04.08 section 3.5.2.1., GSM 04.08 section 8.3.

26.8.1.2.8.3.3 Test purpose

To verify that a CC-entity of the MS in CC-state U12, "Disconnect Indication" having detected a lower layer failure returns to idle mode. The CC-entities relating to the seven mobile originating transaction identifiers are thus in state U0, "Null".

26.8.1.2.8.3.4 Method of test

Related PICS/PIXIT statements

- supported MO circuit switched basic services.

Initial conditions

System Simulator:

1 cell, default parameters.

Mobile Station:

The MS is in MM-state "idle, updated" with valid TMSI and CKSN.

The MS is brought into the state U12 by using Option A of table 26.8.1.2/2.

Foreseen final state of the MS

U0, null.

Maximum duration of test

1 min 30 s.

Test procedure

An MO circuit switched basic service is selected that is supported by the MS; if the MS supports MO telephony, the selected basic service is telephony. If necessary, the MS is configured for that basic service. Then, the MS is made to initiate a call. The MS is brought to the state U12. The SS generates a lower layer failure at the MS. The SS waits long enough to enable the MS to return to idle state listening to paging, and then pages MS to create RR-connection. Finally, the SS will check the state of the MS by using STATUS ENQUIRY with the relevant transaction identifiers.

Expected sequence

Step	Direction	Message	Comments
1	SS		SS generates lower layer failure
2	SS		SS waits 20 s for the MS to return to listening to paging
3	SS -> MS	PAGING REQUEST	
4	MS -> SS	CHANNEL REQUEST	
5	SS -> MS	IMMEDIATE ASSIGNMENT	
6	MS -> SS	PAGING RESPONSE	
7	SS -> MS	STATUS ENQUIRY	
8	MS -> SS	RELEASE COMPLETE	cause 81# (invalid TI value)
9	SS		repeat steps 7-8 to cover all the transaction identifiers from 000...110
10	SS -> MS	CHANNEL RELEASE	the main signalling link shall be released by the MS (L2: DISC/UA).

Specific message contents:

None.

26.8.1.2.8.4 U12 disconnect indication / unknown message received

26.8.1.2.8.4.1 Definition and applicability

The call control entity of the MS being in the state, U12, an unknown message is received by the MS. This test is applicable only for mobile stations supporting bearer capability for speech.

26.8.1.2.8.4.2 Conformance requirement

A CC-entity of the MS in CC-state U12, "Disconnect Indication" having received an unknown message from its peer entity shall return a STATUS message.

References

GSM 04.08 section 8.4.

26.8.1.2.8.4.3 Test purpose

To verify that a CC-entity of the MS in CC-state U12, "Disconnect Indication" having received an unknown message from its peer entity returns a STATUS message.

26.8.1.2.8.4.4 Method of test

Related PICS/PIXIT statements

- supported MO circuit switched basic services.

Initial conditions

System Simulator:
1 cell, default parameters.

Mobile Station:
The MS is in MM-state "idle, updated" with valid TMSI and CKSN.
The MS is brought into the state U12 by using Option A of table 26.8.1.2/3.

Foreseen final state of the MS

U12, disconnect indication.

Maximum duration of test

30 s.

Test procedure

An MO circuit switched basic service is selected that is supported by the MS; if the MS supports MO telephony, the selected basic service is telephony. If necessary, the MS is configured for that basic service. Then, the MS is made to initiate a call. The CC entity of the MS is brought to the state U12. The SS sends a message with message type not defined for the protocol discriminator to the MS. The MS shall respond with a STATUS message, and finally the SS checks by using the status enquiry procedure that the state of the CC entity has remained unchanged.

Expected sequence

Step	Direction	Message	Comments
1	SS -> MS	unknown message	message type not defined for PD
2	MS -> SS	STATUS	cause 97#, state U12
3	SS -> MS	STATUS ENQUIRY	
4	MS -> SS	STATUS	cause 30#, state U12

Specific message contents:

None.

26.8.1.2.9 Outgoing call / U19 release request**26.8.1.2.9.1 Outgoing call / U19 release request / timer T308 time-out****26.8.1.2.9.1.1 Definition and applicability**

The call control entity of the MS being in the state, U19, if no response is then received from the SS, timer T308 expires at the MS side. This test is applicable for any equipment supporting at least one mobile originated circuit switched basic service.

26.8.1.2.9.1.2 Conformance requirement

- 1) A CC-entity of the MS in CC-state U19, "Release Request" will, upon the first expiry of timer T308 send the RELEASE message to its peer entity and remain in the CC-state U19.

References

GSM 04.08 section 5.4.4.3.1, GSM 04.08 section 11.3.

26.8.1.2.9.1.3 Test purpose

To verify that a CC-entity of the MS in CC-state U19, "Release Request" will, upon the first expiry of timer T308 (accuracy +/- 10 %) send the RELEASE message to its peer entity and remain in the CC-state U19.

26.8.1.2.9.1.4 Method of test**Related PICS/PIXIT statements**

- supported MO circuit switched basic services.

Initial conditions

System Simulator:

1 cell, default parameters.

Mobile Station:

The MS is in MM-state "idle, updated" with valid TMSI and CKSN.
The MS is brought into the state U19 by using table 26.8.1.2/4.

Foreseen final state of the MS

U19, release request.

Maximum duration of test

1 min.

Test procedure

An MO circuit switched basic service is selected that is supported by the MS; if the MS supports MO telephony, the selected basic service is telephony. If necessary, the MS is configured for that basic service. Then, the MS is made to initiate a call. The CC entity of the MS is brought to the state U19. When T308 expires at the MS, the MS shall send a RELEASE message. The SS checks timer T308 accuracy and that the state of the CC entity has remained unchanged.

Expected sequence

Step	Direction	Message	Comments
1	SS		SS waits until T308 at the MS
2	MS -> SS	RELEASE	SS checks the time between the two RELEASE messages (T308 +/- 10 %)
3	SS -> MS	STATUS ENQUIRY	
4	MS -> SS	STATUS	cause 30#, state U19

Specific message contents:

None.

26.8.1.2.9.2 Outgoing call / U19 release request / 2nd timer T308 time-out

26.8.1.2.9.2.1 Definition and applicability

The call control entity of the MS being in the state, U19, if no response is then received after timer T308 has expired two times in success at the MS. This test is applicable for any equipment supporting at least one mobile originated circuit switched basic service.

26.8.1.2.9.2.2 Conformance requirement

- 1) A CC-entity of the MS in CC-state U19, "Release Request", upon the 2nd expiry of the timer T308, shall enter the CC-state U0, "Null".
- 2) Subsequently the MS shall proceed with releasing the MM-connection and enter the idle mode with the CC entities relating to the seven mobile originating transaction identifiers in state U0, "Null".

References

Conformance requirement 1: GSM 04.08 section 5.4.4.3.1., GSM 04.08 section 11.3.
Conformance requirement 2: GSM 04.08 section 4.5.3., GSM 04.08 section 5.5.3.2.

26.8.1.2.9.2.3 Test purpose

- 1) To verify that a CC-entity of the MS in CC-state U19, "Release Request", upon the 2nd expiry of the timer T308, enters the CC-state U0, "Null".

- 2) To verify that subsequently the MS proceeds with releasing the MM-connection and enters the idle mode with the CC entities relating to the seven mobile originating transaction identifiers in state U0, "Null".

26.8.1.2.9.2.4 Method of test

Related PICS/PIXIT statements

- supported MO circuit switched basic services.

Initial conditions

System Simulator:

1 cell, default parameters.

Mobile Station:

The MS is in MM-state "idle, updated" with valid TMSI and CKSN.

The MS is brought into the state U19 by using table 26.8.1.2/4.

Foreseen final state of the MS

U0, null.

Maximum duration of test

2 min 30 s.

Test procedure

An MO circuit switched basic service is selected that is supported by the MS; if the MS supports MO telephony, the selected basic service is telephony. If necessary, the MS is configured for that basic service. Then, the MS is made to initiate a call. The CC entity of the MS is brought to the state U19. The SS allows T308 expiry at the MS, and the MS shall repeat sending the RELEASE message and start timer T308 again. The SS allows again T308 expiry at the MS. The MS shall abort the RR-connection (DISC/UA). The SS waits long enough to enable the MS to return to idle state listening to paging, and then pages MS to create RR-connection. Finally, the SS will check the state of the MS by using STATUS ENQUIRY with the relevant transaction identifiers.

Expected sequence

Step	Direction	Message	Comments
1	SS		SS waits until T308 expiry at the MS
2	MS -> SS	RELEASE	
3	SS -> MS	STATUS ENQUIRY	
4	MS -> SS	STATUS	cause 30#, state U19
5	SS		SS waits until the second T308 expiry at the MS
6	SS		SS waits T3240 expiry at the MS
7	MS		the main signalling link shall be released by the MS (L2: DISC/UA).
8	SS		SS waits 10 s for the MS to return to listening to paging
9	SS -> MS	PAGING REQUEST	
10	MS -> SS	CHANNEL REQUEST	
11	SS -> MS	IMMEDIATE ASSIGNMENT	
12	MS -> SS	PAGING RESPONSE	
13	SS -> MS	STATUS ENQUIRY	
14	MS -> SS	RELEASE COMPLETE	cause 81# (invalid TI value)
15	SS		repeat steps 13-14 to cover all the transaction identifiers from 000...110
16	SS -> MS	CHANNEL RELEASE	the main signalling link shall be released by the MS (L2: DISC/UA).

Specific message contents:

None.

26.8.1.2.9.3 Outgoing call / U19 release request / RELEASE received**26.8.1.2.9.3.1 Definition and applicability**

The call control entity of the MS being in the state, U19, a RELEASE message is received by the MS. This test is applicable for any equipment supporting at least one mobile originated circuit switched basic service.

26.8.1.2.9.3.2 Conformance requirement

- 1) A CC-entity of the MS in CC-state U19, "Release Request", upon receipt of a RELEASE, shall release the MM-connection and enter the CC-state U0, "Null" with the CC entities relating to the seven mobile originating transaction identifiers in state U0, "Null".

References

GSM 04.08 section 5.4.5., GSM 04.08 section 11.3, GSM 04.08 section 5.5.3.2.

26.8.1.2.9.3.3 Test purpose

To verify that a CC-entity of the MS in CC-state U19, "Release Request", upon receipt of a RELEASE, shall release the MM-connection and enters the CC-state U0, "Null" with the CC entities relating to the seven mobile originating transaction identifiers in state U0, "Null".

26.8.1.2.9.3.4 Method of test**Related PICS/PIXIT statements**

- supported MO circuit switched basic services.

Initial conditions

System Simulator:

1 cell, default parameters.

Mobile Station:

The MS is in MM-state "idle, updated" with valid TMSI and CKSN.

The MS is brought into the state U19 by using table 26.8.1.2/4.

Foreseen final state of the MS

U0, null.

Maximum duration of test

1 min 30 s.

Test procedure

An MO circuit switched basic service is selected that is supported by the MS; if the MS supports MO telephony, the selected basic service is telephony. If necessary, the MS is configured for that basic service. Then, the MS is made to initiate a call. The CC entity of the MS is brought to the state U19. The SS sends a RELEASE message to the MS. The MS shall release the MM-connection. The SS checks by using the status enquiry procedure that the CC entity has entered the state U0 with all the relevant transaction identifiers.

Expected sequence

Step	Direction	Message	Comments
1	SS -> MS	RELEASE	(note)
2	SS -> MS	STATUS ENQUIRY	
3	MS -> SS	RELEASE COMPLETE	cause 81# (invalid TI value)
4	SS		repeat steps 2-3 to cover all the transaction identifiers from 000...110
5	SS -> MS	CHANNEL RELEASE	the main signalling link shall be released by the MS (L2: DISC/UA).

Specific message contents:

NOTE: With the same cause number as originally contained in DISC and optional cause #102 recovery on timer expiry.

26.8.1.2.9.4 Outgoing call / U19 release request / RELEASE COMPLETE received**26.8.1.2.9.4.1 Definition and applicability**

The call control entity of the MS being in the state, U19, a RELEASE COMPLETE message is received by the MS. This test is applicable for any equipment supporting at least one mobile originated circuit switched basic service.

26.8.1.2.9.4.2 Conformance requirement

- 1) A CC-entity of the MS in CC-state U19, "Release Request", upon receipt of a RELEASE COMPLETE, shall release the MM-connection and enter the CC-state U0, "Null" with the CC entities relating to the seven mobile originating transaction identifiers in state U0, "Null".

References

GSM 04.08 section 5.4.4.3., GSM 04.08 section 4.5.3, GSM 04.08 section 8.3.

26.8.1.2.9.4.3 Test purpose

To verify that a CC-entity of the MS in CC-state U19, "Release Request", upon receipt of a RELEASE COMPLETE, shall release the MM-connection and enters the CC-state U0, "Null" with the CC entities relating to the seven mobile originating transaction identifiers in state U0, "Null".

26.8.1.2.9.4.4 Method of test**Related PICS/PIXIT statements**

- supported MO circuit switched basic services.

Initial conditions

System Simulator:

1 cell, default parameters.

Mobile Station:

The MS is in MM-state "idle, updated" with valid TMSI and CKSN.

The MS is brought into the state U19 by using table 26.8.1.2/1.

Foreseen final state of the MS

U0, null.

Maximum duration of test

1 min 30 s.

Test procedure

An MO circuit switched basic service is selected that is supported by the MS; if the MS supports MO telephony, the selected basic service is telephony. If necessary, the MS is configured for that basic service. Then, the MS is made to initiate a call. The CC entity of the MS is brought to the state U19. The SS sends a RELEASE COMPLETE message to the MS. The MS shall release the MM-connection. The SS checks by using the status enquiry procedure that the CC entity has entered the state U0 with all the relevant transaction identifiers.

Expected sequence

Step	Direction	Message	Comments
1	SS -> MS	RELEASE COMPLETE	
2	SS -> MS	STATUS ENQUIRY	
3	MS -> SS	RELEASE COMPLETE	cause 81# (invalid TI value)
4	SS		repeat steps 2-3 to cover all the transaction identifiers from 000...110
5	SS -> MS	CHANNEL RELEASE	the main signalling link shall be released by the MS (L2: DISC/UA).

Specific message contents:

None.

26.8.1.2.9.5 Outgoing call / U19 release request / lower layer failure**26.8.1.2.9.5.1 Definition and applicability**

The call control entity of the MS being in the state, U19, a lower layer failure is accomplished at the MS and consequently, communication at layer 3 level with the peer entity is terminated. This test is applicable for any equipment supporting at least one mobile originated circuit switched basic service.

26.8.1.2.9.5.2 Conformance requirement

A CC-entity of the MS in CC-state U19, "Release Request", having detected a lower layer failure, shall return to the idle mode, the CC entities relating to the seven mobile originating transaction identifiers shall be in state U0, "Null".

References

GSM 04.08 section 4.5.2.3., GSM 04.08 section 4.5.3., GSM 04.08 section 5.5.3.2., GSM 04.08 section 8.3.

26.8.1.2.9.5.3 Test purpose

To verify that a CC-entity of the MS in CC-state U19, "Release Request", having detected a lower layer failure, returns to the idle mode, the CC entities relating to the seven mobile originating transaction identifiers are in state U0, "Null".

26.8.1.2.9.5.4 Method of test**Related PICS/PIXIT statements**

- supported MO circuit switched basic services.

Initial conditions

System Simulator:

1 cell, default parameters.

Mobile Station:

The MS is in MM-state "idle, updated" with valid TMSI and CKSN.

The MS is brought into the state U19 by using table 26.8.1.2/1.

Foreseen final state of the MS

U0, null.

Maximum duration of test

1 min 30 s.

Test procedure

An MO circuit switched basic service is selected that is supported by the MS; if the MS supports MO telephony, the selected basic service is telephony. If necessary, the MS is configured for that basic service. Then, the MS is made to initiate a call. The MS is brought to the state U19. The SS generates a lower layer failure at the MS. The SS waits long enough to enable the MS to return to idle state listening to paging, and then pages MS to create RR-connection. Finally, the SS will check the state of the MS by using STATUS ENQUIRY with the relevant transaction identifiers.

Expected sequence

Step	Direction	Message	Comments
1	SS		SS generates lower layer failure
2	SS		SS waits 20 s for the MS to return to listening to paging
3	SS -> MS	PAGING REQUEST	
4	MS -> SS	CHANNEL REQUEST	
5	SS -> MS	IMMEDIATE ASSIGNMENT	
6	MS -> SS	PAGING RESPONSE	
7	SS -> MS	STATUS ENQUIRY	
8	MS -> SS	RELEASE COMPLETE	cause 81# (invalid TI value)
9	SS		repeat steps 7-8 to cover all the transaction identifiers from 000...110
10	SS -> MS	CHANNEL RELEASE	the main signalling link shall be released by the MS (L2: DISC/UA).

Specific message contents:

None.

26.8.1.3 Establishment of an incoming call / Initial conditions

The tables below describe message exchanges which bring the MS in the requested initial states in case of an incoming call.

A state may be taken as initial only when all the states which lead to this initial states have been validated. The order will be U0, U6, U9, U7, U8, U10, U26 etc. as in the following tables.

Table 26.8.1.3/1: Establishment of an incoming call, procedure 1

Step	Direction	Message	Comments	
1	SS -> MS	PAGING REQUEST	U0, SDCCH	
2	MS -> SS	CHANNEL REQUEST		
3	SS -> MS	IMMEDIATE ASSIGNMENT		
4	MS -> SS	PAGING RESPONSE		
5	SS -> MS	AUTHENTICATION REQUEST		
6	MS -> SS	AUTHENTICATION RESPONSE		
7	SS -> MS	CIPHERING MODE COMMAND		
8	MS -> SS	CIPHERING MODE COMPLETE		
9	SS -> MS	SETUP		U6, (note 1)
10	MS -> SS	CALL CONFIRMED		U9
A11	MS -> SS	CONNECT	U8, p = Y, (note 2)	
B11	MS -> SS	ALERTING	U7, p = N, (note 2)	
B12	MS		(note 3)	
B13	MS -> SS	CONNECT	U8	
14	SS -> MS	ASSIGNMENT COMMAND	TCH	
15	MS -> SS	ASSIGNMENT COMPLETE		
16	SS -> MS	CONNECT ACKNOWLEDGE	U10	

NOTE 1: With signal information included in the SETUP message.

NOTE 2: The MS is supporting immediate connect (p = Y/N). See PICS/PIXIT statement.

NOTE 3: If necessary (see PICS/PIXIT statement), the MS is made to accept the call in the way described in a PICS/PIXIT statement.

Table 26.8.1.3/2: Establishment of an incoming call, procedure 2

Step	Direction	Message	Comments	
1	SS -> MS	PAGING REQUEST	U0, SDCCH	
2	MS -> SS	CHANNEL REQUEST		
3	SS -> MS	IMMEDIATE ASSIGNMENT		
4	MS -> SS	PAGING RESPONSE		
5	SS -> MS	CIPHERING MODE COMMAND		
6	MS -> SS	CIPHERING MODE COMPLETE		
7	SS -> MS	SETUP		U6, (note 4)
8	MS -> SS	CALL CONFIRMED		U9
A9	MS -> SS	CONNECT		U8, p = Y, (note 5)
A10	SS -> MS	ASSIGNMENT COMMAND		TCH
A11	MS -> SS	ASSIGNMENT COMPLETE		
B9	MS -> SS	ALERTING	U7, p = N, (note 5)	
B10	SS -> MS	ASSIGNMENT COMMAND	TCH	
B11	MS -> SS	ASSIGNMENT COMPLETE		
B12	MS		(note 6)	
B13	MS -> SS	CONNECT	U8	
14	SS -> MS	AUTHENTICATION REQUEST		
15	MS -> SS	AUTHENTICATION RESPONSE		
16	SS -> MS	CONNECT ACKNOWLEDGE	U10	

NOTE 4: With signal information included in the SETUP message.

NOTE 5: The MS is supporting immediate connect (p = Y/N). See PICS/PIXIT statement.

NOTE 6: If necessary (see PICS/PIXIT statement), the MS is made to accept the call in the way described in a PICS/PIXIT statement.

Table 26.8.1.3/3: Establishment of an incoming call, procedure 3

Step	Direction	Message	Comments	
1	SS -> MS	PAGING REQUEST	U0, TCH	
2	MS -> SS	CHANNEL REQUEST		
3	SS -> MS	IMMEDIATE ASSIGNMENT		
4	MS -> SS	PAGING RESPONSE		
5	SS -> MS	AUTHENTICATION REQUEST		
6	MS -> SS	AUTHENTICATION RESPONSE		
7	SS -> MS	CIPHERING MODE COMMAND		
8	MS -> SS	CIPHERING MODE COMPLETE		
9	SS -> MS	CHANNEL MODE MODIFY		(note 7)
10	MS -> SS	CHANNEL MODE MODIFY ACKNOWLEDGE		
11	SS -> MS	SETUP		U6, (note 8)
12	MS -> SS	CALL CONFIRMED		U9
A13	MS -> SS	CONNECT	U8, p = Y, (note 9)	
B13	MS -> SS	ALERTING	U7, p = N, (note 9)	
B14	MS		(note 10)	
B15	MS -> SS	CONNECT	U8	
16	SS -> MS	CONNECT ACKNOWLEDGE	U10	

NOTE 7: Assigned channel is appropriate for the chosen mobile originated circuit switched basic service.

NOTE 8: With signal information included in the SETUP message.

NOTE 9: The MS is supporting immediate connect (p = Y/N). See PICS/PIXIT statement.

NOTE 10: If necessary (see PICS/PIXIT statement), the MS is made to accept the call in the way described in a PICS/PIXIT statement.

Table 26.8.1.3/4: Establishment of an incoming call, procedure 4

Step	Direction	Message	Comments	
1	SS -> MS	PAGING REQUEST	U0, SDCCH	
2	MS -> SS	CHANNEL REQUEST		
3	SS -> MS	IMMEDIATE ASSIGNMENT		
4	MS -> SS	PAGING RESPONSE		
5	SS -> MS	CIPHERING MODE COMMAND		
6	MS -> SS	CIPHERING MODE COMPLETE		
7	SS -> MS	SETUP		U6, (note 11)
8	MS -> SS	CALL CONFIRMED		U9
9	SS -> MS	ASSIGNMENT COMMAND		TCH
10	MS -> SS	ASSIGNMENT COMPLETE		
A11	MS -> SS	CONNECT	U8, p = Y, (note 12)	
B11	MS -> SS	ALERTING	U7, p = N, (note 12)	
B12	MS		(note 13)	
B13	MS -> SS	CONNECT	U8	
14	SS -> MS	AUTHENTICATION REQUEST		
15	MS -> SS	AUTHENTICATION RESPONSE		
16	SS -> MS	CONNECT ACKNOWLEDGE		U10

NOTE 11: The signal information element is not included in the SETUP message.

NOTE 12: The MS is supporting immediate connect (p = Y/N). See PICS/PIXIT statement.

NOTE 13: If necessary (see PICS/PIXIT statement), the MS is made to accept the call in the way described in a PICS/PIXIT statement.

26.8.1.3.1 Incoming call / U0 null state

26.8.1.3.1.1 Incoming call / U0 null state / SETUP received with a non supported bearer capability

26.8.1.3.1.1.1 Definition and applicability

The call control entity of the MS being in the state, U0, a SETUP message is received with only one bearer capability and this bearer capability is not supported by the MS. This test is applicable for all equipment.

26.8.1.3.1.1.2 Conformance requirement

- 1) A CC entity of the MS, upon receipt of SETUP containing one bearer capability and this bearer capability is not supported, shall return a RELEASE COMPLETE with correct cause value to its peer entity and return to the idle mode. The CC-entities relating to the seven mobile terminating transaction identifiers shall be in the state U0,"Null".

References

GSM 04.08 section 5.2.2.2., GSM 04.08 annex B.

26.8.1.3.1.1.3 Test purpose

To verify that a CC entity of the MS, upon receipt of SETUP containing one bearer capability and this bearer capability is not supported, returns a RELEASE COMPLETE with correct cause value to its peer entity, and returns to the idle mode. To verify that the CC-entities relating to the seven mobile terminating transaction identifiers are then in the state U0,"Null".

26.8.1.3.1.1.4 Method of test

Related PICS/PIXIT statements

- supported MO circuit switched basic services.

Initial conditions

System Simulator:
1 cell, default parameters.

Mobile Station:
The MS is in MM-state "idle, updated" with valid TMSI and CKSN.

Foreseen final state of the MS

U0, null.

Maximum duration of test

30 s.

Test procedure

A mobile terminated call is initiated. The MS receives a SETUP message that contains a bearer capability not supported by the MS. The MS returns a RELEASE COMPLETE message. The SS checks by using the status enquiry procedure that the CC entity is still in the state U0 with all the relevant transaction identifiers.

Expected sequence

Step	Direction	Message	Comments
1	SS -> MS	PAGING REQUEST	SS sends paging
2	MS -> SS	CHANNEL REQUEST	
3	SS -> MS	IMMEDIATE ASSIGNMENT	(SDCCH)
4	MS -> SS	PAGING RESPONSE	
5	SS -> MS	AUTHENTICATION REQUEST	
6	MS -> SS	AUTHENTICATION RESPONSE	
7	SS -> MS	CIPHERING MODE COMMAND	
8	MS -> SS	CIPHERING MODE COMPLETE	
9	SS -> MS	SETUP	(note 1)
10	MS -> SS	RELEASE COMPLETE	(note 2)
11	SS -> MS	STATUS ENQUIRY	
12	MS -> SS	RELEASE COMPLETE	Cause #81 (invalid TI value).
13	SS		Repeat steps 11-12 to cover all the transaction identifiers from 000... 110.

Specific message contents:

NOTE 1: With one bearer capability and that bearer capability is not supported by the MS.

NOTE 2: With cause #88 incompatible destination.

26.8.1.3.2. Incoming call / U6 call present**26.8.1.3.2.1 Incoming call / U6 call present / automatic call rejection****26.8.1.3.2.1.1 Definition and applicability**

Although the state U6 is transient, the ability to refuse a call (automatically) in this state is tested, if it is implemented at the MS. The test is applicable for those equipments described above supporting at least one mobile terminating circuit switched basic service.

26.8.1.3.2.1.2 Conformance requirement

- 1) A CC entity of the MS in CC-state U6, "Call Present", upon receipt of a rejection indication of the incoming call from the user, send RELEASE COMPLETE with the appropriate cause value to its peer entity and enter the CC-state U0, "Null". The CC entities relating to the seven mobile terminating transaction identifiers shall be in state U0, "Null".

References

GSM 11.10, annex B (for PICS/PIXIT statement), GSM 04.07 section 6.2.2., GSM 04.08 section 5.2.2.3.1., GSM 04.08 section 5.5.3.2, GSM 04.08 section 8.3.

26.8.1.3.2.1.3 Test purpose

To verify that a CC entity of the MS in CC-state U6, "Call Present", shall upon receipt of a rejection indication of the incoming call from the user, shall send RELEASE COMPLETE with the appropriate cause value to its peer entity and enter the CC-state U0, "Null". The CC entities relating to the seven mobile terminating transaction identifiers are then in state U0, "Null".

26.8.1.3.2.1.4 Method of test**Related PICS/PIXIT statements**

- supported teleservices;
- the MS supports an ability to refuse a call after receipt of a SETUP message.

Initial conditions

System Simulator:
1 cell, default parameters.

Mobile Station:
The MS is in MM-state "idle, updated" with valid TMSI and CKSN.
The MS is brought into the state U6 by using table 26.8.1.3/2.

Foreseen final state of the MS

U0, null.

Maximum duration of test

1 min 30 s.

Test procedure

A teleservice is selected that is supported by the MS; if the MS supports speech, the selected teleservice is speech. If necessary, the MS is configured for that teleservice. Then a mobile terminated call is initiated. The call control entire of the MS is brought to the state U6 (Note: The state U6 is not checked, since it is not stable). The MS is made to refuse the call (the refusal may require some preliminary preparations in order to achieve refusal at this point). The MS shall send a RELEASE COMPLETE message and enter a call control state U0. The SS checks by using the status enquiry procedure that the CC entity has entered the state U0 with all the relevant transaction identifiers.

Expected sequence

Step	Direction	Message	Comments
1			the MS is made to refuse the call
2	MS -> SS	RELEASE COMPLETE	(note)
3	SS -> MS	STATUS ENQUIRY	
4	MS -> SS	RELEASE COMPLETE	cause 81# (invalid TI value)
5	SS		repeat steps 3-4 to cover all the transaction identifiers from 000...110
6	SS -> MS	CHANNEL RELEASE	the main signalling link shall be released by the MS (L2: DISC/UA).

Specific message contents:

NOTE: With cause value #21 call rejected.

26.8.1.3.3 Incoming call / U9 mobile terminating call confirmed

26.8.1.3.3.1 Incoming call / U9 mobile terminating call confirmed / alerting or immediate connecting

26.8.1.3.3.1.1 Definition and applicability

The call control entity of the MS having entered the state, U9, with signal information received in the preceding SETUP message, the subsequent behaviour of the MS is tested. This test is applicable for any equipment supporting at least one mobile terminating circuit switched basic service.

26.8.1.3.3.1.2 Conformance requirement

- 1) A CC entity in CC-state U9, "MS Terminating Call Confirmed", (if signalled by the network in previous SETUP message that it may alert) shall either send a ALERTING message to its peer entity and enter state U7, or send a CONNECT message to its peer entity and enter U8.

References

GSM 04.08 section 5.2.2.3.2., GSM 11.10, annex 3 - section 2.2.

26.8.1.3.3.1.3 Test purpose

To verify that a CC entity in CC-state U9, "MS Terminating Call Confirmed", (if signalled by the network in previous SETUP message that it may alert) will either send a ALERTING message to its peer entity and enter state U7, or send a CONNECT message to its peer entity and enter U8.

26.8.1.3.3.1.4 Method of test

Related PICS/PIXIT statements

- supported MT circuit switched basic services;
- MT circuit switched basic services for which immediate connect is not used.

Initial conditions

System Simulator:
1 cell, default parameters.

Mobile Station:
The MS is in MM-state "idle, updated" with valid TMSI and CKSN.
The MS is brought into the state U9 by using table 26.8.1.3/2.

Foreseen final state of the MS

- U8, connect request, if the MS supports immediate connect for the selected basic service;
- otherwise U7, call received.

Maximum duration of test

30 s.

Test procedure

An MT circuit switched basic service is selected that is supported by the MS; if the MS supports MT telephony, the selected basic service is telephony. If necessary, the MS is configured for that basic service. Then a mobile terminated call is initiated. The CC entity of the MS is brought to the state U9 by using a SETUP message containing signalling information element. (The state U9 is not a stable state in this case, and consequently it is not checked as an initial state.) If the MS supports immediate connect for the selected basic service ($p = Y$), it sends a CONNECT message and enters the state U8, connect request. Otherwise ($p = N$) the MS sends an ALERTING message and enters the state U7, call receiving.

The SS checks by using the status enquiry procedure that the CC entity has entered its state as described.

Expected sequence

Step	Direction	Message	Comments
A11	MS -> SS	CONNECT	p = Y
A12	SS -> MS	STATUS ENQUIRY	
A13	MS -> SS	STATUS	cause 30#, state U8
B11	MS -> SS	ALERTING	p = N
B12	SS -> MS	STATUS ENQUIRY	
B13	MS -> SS	STATUS	cause 30#, state U7

Specific message contents:

None.

26.8.1.3.3.2 Incoming call / U9 mobile terminating call confirmed / TCH assignment

26.8.1.3.3.2.1 Definition and applicability

The call control entity of the MS being in the state, U9, an assignment procedure is performed for traffic channel. This test is applicable for any equipment supporting at least one MT circuit switched basic service, for which immediate connect is not used.

26.8.1.3.3.2.2 Conformance requirement

- 1) A CC-entity of the MS in CC-state U9, "MS Terminating Call Confirmed", when allocated a traffic channel by the network performing the assignment procedure, shall perform a layer 2 establishment on the FACCH, send a ALERTING message and enter state U7.

References

GSM 04.08 section 3.4.3., GSM 04.08 section 5.2.2.7., GSM 04.08 section 5.2.2.3.2.

26.8.1.3.3.2.3 Test purpose

To verify that a CC-entity of the MS in CC-state U9, "MS Terminating Call Confirmed", when allocated a traffic channel by the network performing the assignment procedure, performs a layer 2 establishment on the FACCH, sends a ALERTING message and enters state U7.

26.8.1.3.3.2.4 Method of test

Related PICS/PIXIT statements

- supported MT circuit switched basic services;
- MT circuit switched basic services for which immediate connect is not used.

Initial conditions

System Simulator:
1 cell, default parameters.

Mobile Station:
The MS is in MM-state "idle, updated" with valid TMSI and CKSN.
The MS is brought into the state U9 by using table 26.8.1.3/4.

Foreseen final state of the MS

U9, mobile terminating call confirmed.

Maximum duration of test

30 s.

Test procedure

An MT circuit switched basic service is selected that is supported by the MS and for which the MS does not use immediate connection; if the MS supports MT telephony without immediate connection, the selected basic service is telephony. If necessary, the MS is configured for that basic service. Then a mobile terminated call is initiated. The CC entity of the MS is brought to the state U9 (by using a SETUP message not containing the signal information element). The SS sends an ASSIGNMENT COMMAND for traffic channel to the MS. The MS shall establish layer 2 link on the newly allocated channel and respond with an ASSIGNMENT COMPLETE message. The MS sends an ALERTING message and enters state U7, call received. The SS verifies by using the status enquiry procedure that the MS has entered the correct state.

Expected sequence

Step	Direction	Message	Comments
1	SS -> MS	ASSIGNMENT COMMAND	TCH, an appropriate non-signalling mode the MS shall establish L2 link
2	MS		
3	MS -> SS	ASSIGNMENT COMPLETE	
4	MS -> SS	ALERTING	
5	SS -> MS	STATUS ENQUIRY	
6	MS -> SS	STATUS	cause 30#, state U7

Specific message contents:

None.

26.8.1.3.3.3 Incoming call / U9 mobile terminating call confirmed / termination requested by the user**26.8.1.3.3.3.1 Definition and applicability**

The call control entity of the MS being in the state, U9, the user requests for releasing of the call. This test is applicable for any equipment supporting at least one MT circuit switched basic service for which immediate connection is not used and, in addition to this, the facility to send a DISCONNECT message in state U9.

26.8.1.3.3.3.2 Conformance requirement

- 1) A CC-entity of the MS in CC-state U9, "MS Terminating Call Confirmed", upon request by the user to terminate shall send a DISCONNECT message and enter the CC-state U11, "Disconnect Request".

References

GSM 04.07 section 6.2.2., GSM 04.08 section 5.4.3.

26.8.1.3.3.3.3 Test purpose

To verify that a CC-entity of the MS in CC-state U9, "MS Terminating Call Confirmed", upon request by the user to terminate will send a DISCONNECT message and enter the CC-state U11, "Disconnect Request".

26.8.1.3.3.3.4 Method of test**Related PICS/PIXIT statements**

- supported MT circuit switched basic services;
- MT circuit switched basic services for which immediate connect is not used;
- the MS supports user requested call clearing in the state U9.

Initial conditions

System Simulator:

1 cell, default parameters.

Mobile Station:

The MS is in MM-state "idle, updated" with valid TMSI and CKSN.

The MS is brought into the state U9 by using table 26.8.1.3/4.

Foreseen final state of the MS

U11, disconnect request.

Maximum duration of test

30 s.

Test procedure

An MT circuit switched basic service is selected that is supported by the MS and for which the MS does not use immediate connection; if the MS supports MT telephony without immediate connection, the selected basic service is telephony. If necessary, the MS is configured for that basic service. Then a mobile terminated call is initiated. The CC entity of the MS is brought to the state U9 (by using a SETUP message not containing the signal information element). Then the user requests termination of the call, if possible. The MS sends a DISCONNECT message and enters state U11, disconnect request. The SS verifies by using the status enquiry procedure that the MS has entered the correct state.

Expected sequence

Step	Direction	Message	Comments
1			the MS is made to clear the call
2	MS -> SS	DISCONNECT	
3	SS -> MS	STATUS ENQUIRY	
4	MS -> SS	STATUS	cause 30#, state U11

Specific message contents:

None.

26.8.1.3.3.4 Incoming call / U9 mobile terminating call confirmed / DISCONNECT received**26.8.1.3.3.4.1 Definition and applicability**

The call control entity of the MS being in the state, U9, a DISCONNECT message is received by the MS. This test is applicable for any equipment supporting at least one MT circuit switched basic service, for which immediate connect is not used.

26.8.1.3.3.4.2 Conformance requirement

- 1) A CC-entity of the MS in CC-state U9, "MS Terminating Call Confirmed", upon receipt of a DISCONNECT shall return a RELEASE message and enter the CC-state U19, "Release Request".

References

GSM 04.08 section 5.4.4.

26.8.1.3.3.4.3 Test purpose

To verify that a CC-entity of the MS in CC-state U9, "MS Terminating Call Confirmed", upon receipt of a DISCONNECT returns a RELEASE message and enters the CC-state U19, "Release Request".

26.8.1.3.3.4.4 Method of test**Related PICS/PIXIT statements**

- supported MT circuit switched basic services;
- MT circuit switched basic services for which immediate connect is not used.

Initial conditions

System Simulator:

1 cell, default parameters.

Mobile Station:

The MS is in MM-state "idle, updated" with valid TMSI and CKSN.

The MS is brought into the state U9 by using table 26.8.1.3/4.

Foreseen final state of the MS

U19, release request.

Maximum duration of test

30 s.

Test procedure

An MT circuit switched basic service is selected that is supported by the MS and for which the MS does not use immediate connection; if the MS supports MT telephony without immediate connection, the selected basic service is telephony. If necessary, the MS is configured for that basic service. Then a mobile terminated call is initiated. The CC entity of the MS is brought to the state U9. The SS sends a DISCONNECT message to the MS. The MS responds by sending a RELEASE message and enters state U19, release request. The SS verifies by using the status enquiry procedure that the MS has entered the correct state.

Expected sequence

Step	Direction	Message	Comments
1	SS -> MS	DISCONNECT	
2	MS -> SS	RELEASE	
3	SS -> MS	STATUS ENQUIRY	
4	MS -> SS	STATUS	cause 30#, state U19

Specific message contents:

None.

26.8.1.3.3.5 Incoming call / U9 mobile terminating call confirmed / RELEASE received**26.8.1.3.3.5.1 Definition and applicability**

The call control entity of the MS being in the state, U9, a RELEASE message is received by the MS. This test is applicable for any equipment supporting at least one MT circuit switched basic service, for which immediate connect is not used.

26.8.1.3.3.5.2 Conformance requirement

- 1) A CC-entity of the MS in CC-state U9, "MS Terminating Call Confirmed", upon receipt of a RELEASE shall return a RELEASE COMPLETE and enter the CC-state U0, "Null".
GSM 04.08 section 5.4.4.
- 2) On returning to the idle mode the MS shall release the MM-connection and the CC-entities relating to the seven mobile terminating transaction identifiers shall be in CC-state U0, "Null".

References

Conformance requirement 1: GSM 04.08 section 5.4.4.
 Conformance requirement 2: GSM 04.08 section 4.5.3., GSM 04.08 section 5.5.3.2.,
 GSM 04.08 section 8.3.

26.8.1.3.3.5.3 Test purpose

- 1) To verify that a CC-entity of the MS in CC-state U9, "MS Terminating Call Confirmed", upon receipt of a RELEASE will return a RELEASE COMPLETE and enter the CC-state U0, "Null".
- 2) To verify that the MS on returning to the idle mode releases the MM-connection and that the CC-entities relating to the seven mobile terminating transaction identifiers are in CC-state U0, "Null".

26.8.1.3.3.5.4 Method of test**Related PICS/PIXIT statements**

- supported MT circuit switched basic services;
- MT circuit switched basic services for which immediate connect is not used.

Initial conditions

System Simulator:
 1 cell, default parameters.

Mobile Station:
 The MS is in MM-state "idle, updated" with valid TMSI and CKSN.
 The MS is brought into the state U9 by using table 26.8.1.3/4.

Foreseen final state of the MS

U0, null.

Maximum duration of test

1 min 30 s.

Test procedure

An MT circuit switched basic service is selected that is supported by the MS and for which the MS does not use immediate connection; if the MS supports MT telephony without immediate connection, the selected basic service is telephony. If necessary, the MS is configured for that basic service. Then a mobile terminated call is initiated. The CC entity of the MS is brought to the state U9. The SS sends a

RELEASE message to the MS. The MS responds by sending a RELEASE COMPLETE message and enters state U0, null. The SS verifies by using the status enquiry procedure that the MS has entered the correct state with the relevant transaction identifiers.

Expected sequence

Step	Direction	Message	Comments
1	SS -> MS	RELEASE	with cause "Normal, unspecified"
2	MS -> SS	RELEASE COMPLETE	
3	SS -> MS	STATUS ENQUIRY	
4	MS -> SS	RELEASE COMPLETE	cause 81# (invalid TI value)
5	SS		repeat steps 3-4 to cover all the transaction identifiers from 000...110
6	SS -> MS	CHANNEL RELEASE	the main signalling link shall be released by the MS (L2: DISC/UA).

Specific message contents:

None.

26.8.1.3.3.6 Incoming call / U9 mobile terminating call confirmed / lower layer failure

26.8.1.3.3.6.1 Definition and applicability

The call control entity of the MS being in the state, U9, a lower layer failure is accomplished at the MS and consequently, communication at layer 3 level with the peer entity is terminated. This test is applicable for any equipment supporting at least one MT circuit switched basic service, for which immediate connect is not used.

26.8.1.3.3.6.2 Conformance requirement

- 1) A CC entity of the MS in CC-state U9, "MS Terminating Call Confirmed", having detected a lower layer failure shall return to idle mode with the CC entities relating to the seven mobile terminating transaction identifiers in CC-state U0, "Null".

References

GSM 04.08 section 4.5.2.3., GSM 04.08 section 4.5.3., GSM 04.08 section 5.5.3.2., GSM 04.08 section 8.3.

26.8.1.3.3.6.3 Test purpose

To verify that a CC entity of the MS in CC-state U9, "MS Terminating Call Confirmed", having detected a lower layer failure returns to idle mode with the CC entities relating to the seven mobile terminating transaction identifiers in CC-state U0, "Null".

26.8.1.3.3.6.4 Method of test

Related PICS/PIXIT statements

- supported MT circuit switched basic services;
- MT circuit switched basic services for which immediate connect is not used.

Initial conditions

System Simulator:

1 cell, default parameters.

Mobile Station:

The MS is in MM-state "idle, updated" with valid TMSI and CKSN.

The MS is brought into the state U9 by using table 26.8.1.3/4.

Foreseen final state of the MS

U0, null.

Maximum duration of test

1 min 30 s.

Test procedure

An MT circuit switched basic service is selected that is supported by the MS and for which the MS does not use immediate connection; if the MS supports MT telephony without immediate connection, the selected basic service is telephony. If necessary, the MS is configured for that basic service. Then a mobile terminated call is initiated. The MS is brought to the state U9. The SS generates a lower layer failure at the MS. The SS waits long enough to enable the MS to return to idle state listening to paging, and then pages MS to create RR-connection. Finally, the SS will check the state of the MS by using STATUS ENQUIRY with the relevant transaction identifiers.

Expected sequence

Step	Direction	Message	Comments
1	SS		SS generates lower layer failure
2	SS		SS waits 20 s for the MS to return to listening to paging
3	SS -> MS	PAGING REQUEST	
4	MS -> SS	CHANNEL REQUEST	
5	SS -> MS	IMMEDIATE ASSIGNMENT	
6	MS -> SS	PAGING RESPONSE	
7	SS -> MS	STATUS ENQUIRY	
8	MS -> SS	RELEASE COMPLETE	cause 81# (invalid TI value)
9	SS		repeat steps 7-8 to cover all the transaction identifiers from 000...110
10	SS -> MS	CHANNEL RELEASE	the main signalling link shall be released by the MS (L2: DISC/UA).

Specific message contents:

None.

26.8.1.3.3.7 Incoming call / U9 mobile terminating call confirmed / unknown message received

26.8.1.3.3.7.1 Definition and applicability

The call control entity of the MS being in the state, U9, an unknown message is received by the MS. This test is applicable for any equipment supporting at least MT circuit switched basic service, for which immediate connect is not used.

26.8.1.3.3.7.2 Conformance requirement

- 1) A CC-entity of the MS in CC-state U9, "MS Terminating Call Confirmed" having received an unknown message from its peer entity shall return a STATUS message.

References

GSM 04.08 section 8.4.

26.8.1.3.3.7.3 Test purpose

To verify that a CC-entity of the MS in CC-state U9, "MS Terminating Call Confirmed" having received an unknown message from its peer entity returns a STATUS message.

26.8.1.3.3.7.4 Method of test**Related PICS/PIXIT statements**

- supported MT circuit switched basic services;
- MT circuit switched basic services for which immediate connect is not used.

Initial conditions

System Simulator:

1 cell, default parameters.

Mobile Station:

The MS is in MM-state "idle, updated" with valid TMSI and CKSN.

The MS is brought into the state U9 by using table 26.8.1.3/4.

Foreseen final state of the MS

U9, mobile terminating call proceeding.

Maximum duration of test

30 s.

Test procedure

A MT circuit switched basic service is selected that is supported by the MS and for which the MS does not use immediate connection; if the MS supports MT telephony without immediate connection, the selected basic service is telephony. If necessary, the MS is configured for that basic service. Then a mobile terminated call is initiated. The CC entity of the MS is brought to the state U9. The SS sends a message with message type not defined for the protocol discriminator to the MS. The MS shall respond with a STATUS message, and finally the SS checks by using the status enquiry procedure that the state of the CC entity has remained unchanged.

Expected sequence

Step	Direction	Message	Comments
1	SS -> MS	unknown message	message type not defined for PD
2	MS -> SS	STATUS	cause 97#, state U9
3	SS -> MS	STATUS ENQUIRY	
4	MS -> SS	STATUS	cause 30#, state U9

Specific message contents:

None.

26.8.1.3.4 Incoming call / U7 call received**26.8.1.3.4.1 Incoming call / U7 call received / call accepted****26.8.1.3.4.1.1 Definition and applicability**

The call control entity of the MS being in the state, U7, a user accepts the incoming call. This test is applicable for any equipment supporting at least one mobile terminating circuit switched basic service for which immediate connect is not used.

26.8.1.3.4.1.2 Conformance requirement

- 1) A CC entity of a MS in CC-state U7, "Call Received", upon a user accepting the incoming call, shall send a CONNECT message to its peer entity and enter the CC-state U8, "Connect Request".

References

GSM 04.07 section 6.2.2., GSM 04.08 section 5.2.2.5.

26.8.1.3.4.1.3 Test purpose

To verify that a CC entity of a MS in CC-state U7, "Call Received", upon a user accepting the incoming call, shall send a CONNECT message to its peer entity and enter the CC-state U8, "Connect Request"

26.8.1.3.4.1.4 Method of test**Related PICS/PIXIT statements**

- supported MT circuit switched basic services;
- MT circuit switched basic services for which immediate connect is not used.

Initial conditions

System Simulator:

1 cell, default parameters.

Mobile Station:

The MS is in MM-state "idle, updated" with valid TMSI and CKSN.

The MS is brought into the state U7 by using table 26.8.1.3/3.

Foreseen final state of the MS

U8, connect request.

Maximum duration of test

30 s.

Test procedure

An MT circuit switched basic service is selected that is supported by the MS and for which the MS does not use immediate connection; if the MS supports MT telephony without immediate connection, the selected basic service is telephony. If necessary, the MS is configured for that basic service. Then a mobile terminated call is initiated. The CC entity of the MS is brought to the state U7. The user accepts the incoming call. The MS sends a CONNECT message. The SS checks by using the status enquiry procedure that the CC entity has entered state U8, connect request.

Expected sequence

Step	Direction	Message	Comments
1			the MS is made to accept the call by the user
2	MS -> SS	CONNECT	
3	SS -> MS	STATUS ENQUIRY	
4	MS -> SS	STATUS	cause 30#, state U8

Specific message contents:

None.

26.8.1.3.4.2 Incoming call / U7 call received / termination requested by the user

26.8.1.3.4.2.1 Definition and applicability

The call control entity of the MS being in the state, U7, a user requests to terminate incoming call. This test is applicable for any equipment supporting at least one mobile terminating circuit switched basic service for which immediate connect is not used.

26.8.1.3.4.2.2 Conformance requirement

- 1) A CC entity of a MS in CC-state U7, "Call Received", upon request by the user to terminate shall send a DISCONNECT message and enter the CC-state U11, "Disconnect Request".

References

GSM 04.07 section 6.2.2., GSM 04.08 section 5.4.3.

26.8.1.3.4.2.3 Test purpose

To verify that a CC entity of a MS in CC-state U7, "Call Received", upon request by the user to terminate will send a DISCONNECT message and enter the CC-state U11, "Disconnect Request".

26.8.1.3.4.2.4 Method of test

Related PICS/PIXIT statements

- supported MT circuit switched basic services;
- MT circuit switched basic services for which immediate connect is not used.

Initial conditions

System Simulator:

1 cell, default parameters.

Mobile Station:

The MS is in MM-state "idle, updated" with valid TMSI and CKSN.

The MS is brought into the state U7 by using table 26.8.1.3/3.

Foreseen final state of the MS

U11, disconnect request.

Maximum duration of test

30 s.

Test procedure

An MT circuit switched basic service is selected that is supported by the MS and for which the MS does not use immediate connection; if the MS supports MT telephony without immediate connection, the selected basic service is telephony. If necessary, the MS is configured for that basic service. Then a mobile terminated call is initiated. The CC entity of the MS is brought to the state U7. The user initiates clearing the incoming call. The MS sends a DISCONNECT message. The SS checks by using the status enquiry procedure that the CC entity has entered state U11, disconnect request.

Expected sequence

Step	Direction	Message	Comments
1			the MS is made to terminate/reject the call
2	MS -> SS	DISCONNECT	
3	SS -> MS	STATUS ENQUIRY	
4	MS -> SS	STATUS	cause 30#, state U11

Specific message contents:

None.

26.8.1.3.4.3 Incoming call / U7 call received / DISCONNECT received

26.8.1.3.4.3.1 Definition and applicability

The call control entity of the MS being in the state, U7, a DISCONNECT message is received by the MS. This test is applicable for any equipment supporting at least one mobile terminating circuit switched basic service for which immediate connect is not used.

26.8.1.3.4.3.2 Conformance requirement

- 1) A CC entity of a MS in CC-state U7, "Call Received", upon receipt of a DISCONNECT with a progress indicator indicating in-band information from network, if a TCH was not assigned, shall return a RELEASE message and enter the CC-state U19, "Release Request".

References

GSM 04.08 section 5.4.4.

26.8.1.3.4.3.3 Test purpose

To verify that a CC entity of a MS in CC-state U7, "Call Received", upon receipt of a DISCONNECT with a progress indicator indicating in-band information from network, if a TCH was not assigned, returns a RELEASE message and enters the CC-state U19, "Release Request".

26.8.1.3.4.3.4 Method of test

Related PICS/PIXIT statements

- supported MT circuit switched basic services;
- MT circuit switched basic services for which immediate connect is not used.

Initial conditions

System Simulator:

1 cell, default parameters.

Mobile Station:

The MS is in MM-state "idle, updated" with valid TMSI and CKSN.

The MS is brought into the state U7 by using table 26.8.1.3/1.

Foreseen final state of the MS

U19, release request.

Maximum duration of test

30 s.

Test procedure

An MT circuit switched basic service is selected that is supported by the MS and for which the MS does not use immediate connection; if the MS supports MT telephony without immediate connection, the selected basic service is telephony. If necessary, the MS is configured for that basic service. Then a mobile terminated call is initiated. The CC entity of the MS is brought to the state U7. The SS sends a DISCONNECT message. The MS responds with a RELEASE message. The SS checks by using the status enquiry procedure that the CC entity has entered state U19, release request.

Expected sequence

Step	Direction	Message	Comments
1	SS -> MS	DISCONNECT	(note)
2	MS -> SS	RELEASE	
3	SS -> MS	STATUS ENQUIRY	
4	MS -> SS	STATUS	cause 30#, state U19

Specific message contents:

NOTE: With a progress indicator indicating in-band information; Progress Indicator, Progress Description #8.

26.8.1.3.4.4 Incoming call / U7 call received / RELEASE received**26.8.1.3.4.4.1 Definition and applicability**

The call control entity of the MS being in the state, U7, a RELEASE message is received by the MS. This test is applicable for any equipment supporting at least one mobile terminating circuit switched basic service for which immediate connect is not used.

26.8.1.3.4.4.2 Conformance requirement

- 1) A CC entity of a MS in CC-state U7, "Call Received", upon receipt of a RELEASE shall return a RELEASE COMPLETE and enter the CC-state U0, "Null".
- 2) On returning to the idle mode the MS shall release the MM-connection and the CC-entities relating to the seven mobile terminating transaction identifiers shall be in CC-state U0, "Null".

References

Conformance requirement 1: GSM 04.08 section 5.4.4.
 Conformance requirement 2: GSM 04.08 section 4.5.3., GSM 04.08 section 5.5.3.2.

26.8.1.3.4.4.3 Test purpose

- 1) To verify that a CC entity of a MS in CC-state U7, "Call Received", upon receipt of a RELEASE will return a RELEASE COMPLETE and enter the CC-state U0, "Null".
- 2) To verify that the MS on returning to the idle mode releases the MM-connection and that the CC-entities relating to the seven mobile terminating transaction identifiers are in CC-state U0, "Null".

26.8.1.3.4.4.4 Method of test**Related PICS/PIXIT statements**

- supported MT circuit switched basic services;
- MT circuit switched basic services for which immediate connect is not used.

Initial conditions

System Simulator:

1 cell, default parameters.

Mobile Station:

The MS is in MM-state "idle, updated" with valid TMSI and CKSN.
The MS is brought into the state U7 by using table 26.8.1.3/1.

Foreseen final state of the MS

U0, null.

Maximum duration of test

1 min.

Test procedure

An MT circuit switched basic service is selected that is supported by the MS and for which the MS does not use immediate connection; if the MS supports MT telephony without immediate connection, the selected basic service is telephony. If necessary, the MS is configured for that basic service. Then a mobile terminated call is initiated. The CC entity of the MS is brought to the state U7. The SS sends a RELEASE message. The MS responds with a RELEASE COMPLETE message. The SS checks by using the status enquiry procedure that the CC entity has entered state U0, null, with the relevant transaction identifiers.

Expected sequence

Step	Direction	Message	Comments
1	SS -> MS	RELEASE	with cause "Normal, unspecified"
2	MS -> SS	RELEASE COMPLETE	
3	SS -> MS	STATUS ENQUIRY	
4	MS -> SS	RELEASE COMPLETE	
5	SS		
6	SS -> MS	CHANNEL RELEASE	

Specific message contents:

None.

26.8.1.3.4.5 Incoming call / U7 call received / lower layer failure

26.8.1.3.4.5.1 Definition and applicability

The call control entity of the MS being in the state, U7, a lower layer failure is accomplished at the MS and consequently, communication at layer 3 level with the peer entity is terminated. This test is applicable for any equipment supporting at least one mobile terminating circuit switched basic service for which immediate connect is not used.

26.8.1.3.4.5.2 Conformance requirement

- 1) A CC entity of a MS in CC-state U7, "Call Received", having detected a lower layer failure shall return to idle mode with the CC entities relating to the seven mobile terminating transaction identifiers in CC-state U0, "Null".

References

GSM 04.08 section 4.5.2.3., GSM 04.08 section 4.5.3., GSM 04.08 section 5.5.3.2., GSM 04.08 section 8.3.

26.8.1.3.4.5.3 Test purpose

To verify that a CC entity of a MS in CC-state U7, "Call Received", having detected a lower layer failure returns to idle mode with the CC entities relating to the seven mobile terminating transaction identifiers in CC-state U0, "Null".

26.8.1.3.4.5.4 Method of test**Related PICS/PIXIT statements**

- supported MT circuit switched basic services;
- MT circuit switched basic services for which immediate connect is not used.

Initial conditions

System Simulator:

1 cell, default parameters.

Mobile Station:

The MS is in MM-state "idle, updated" with valid TMSI and CKSN.

The MS is brought into the state U7 by using table 26.8.1.3/2.

Foreseen final state of the MS

U0, null.

Maximum duration of test

1 min 30 s.

Test procedure

An MT circuit switched basic service is selected that is supported by the MS and for which the MS does not use immediate connection; if the MS supports MT telephony without immediate connection, the selected basic service is telephony. If necessary, the MS is configured for that basic service. Then a mobile terminated call is initiated. The MS is brought to the state U7. The SS generates a lower layer failure at the MS. The SS waits long enough to enable the MS to return to idle state listening to paging, and then pages MS to create RR-connection. Finally, the SS will check the state of the MS by using STATUS ENQUIRY with the relevant transaction identifiers.

Expected sequence

Step	Direction	Message	Comments
1	SS		SS generates lower layer failure
2	SS		SS waits 20 s for the MS to return to listening to paging
3	SS -> MS	PAGING REQUEST	
4	MS -> SS	CHANNEL REQUEST	
5	SS -> MS	IMMEDIATE ASSIGNMENT	
6	MS -> SS	PAGING RESPONSE	
7	SS -> MS	STATUS ENQUIRY	
8	MS -> SS	RELEASE COMPLETE	cause 81# (invalid TI value)
9	SS		repeat steps 7-8 to cover all the transaction identifiers from 000...110
10	SS -> MS	CHANNEL RELEASE	the main signalling link shall be released by the MS (L2: DISC/UA).

Specific message contents:

None.

26.8.1.3.4.6 Incoming call / U7 call received / unknown message received**26.8.1.3.4.6.1 Definition and applicability**

The call control entity of the MS being in the state, U7, an unknown message is received by the MS. This test is applicable for any equipment supporting at least one mobile terminating circuit switched basic service for which immediate connect is not used.

26.8.1.3.4.6.2 Conformance requirement

- 1) A CC entity of a MS in CC-state U7, "Call Received", having received an unknown message from its peer entity shall return a STATUS message.

References

GSM 04.08 section 8.4.

26.8.1.3.4.6.3 Test purpose

To verify that a CC entity of a MS in CC-state U7, "Call Received", having received an unknown message from its peer entity returns a STATUS message.

26.8.1.3.4.6.4 Method of test**Related PICS/PIXIT statements**

- supported MT circuit switched basic services;
- MT circuit switched basic services for which immediate connect is not used.

Initial conditions

System Simulator:

1 cell, default parameters.

Mobile Station:

The MS is in MM-state "idle, updated" with valid TMSI and CKSN.

The MS is brought into the state U7 by using table 26.8.1.3/3.

Foreseen final state of the MS

U7, call received.

Maximum duration of test

30 s.

Test procedure

An MT circuit switched basic service is selected that is supported by the MS and for which the MS does not use immediate connection; if the MS supports MT telephony without immediate connection, the selected basic service is telephony. If necessary, the MS is configured for that basic service. Then a mobile terminated call is initiated. The CC entity of the MS is brought to the state U7. The SS sends a message with message type not defined for the protocol discriminator to the MS. The MS shall respond with a STATUS message, and finally the SS checks by using the status enquiry procedure that the state of the CC entity has remained unchanged.

Expected sequence

Step	Direction	Message	Comments
1	SS -> MS	unknown message	message type not defined for PD
2	MS -> SS	STATUS	cause 97#, state U7
3	SS -> MS	STATUS ENQUIRY	
4	MS -> SS	STATUS	cause 30#, state U7

Specific message contents:

None.

26.8.1.3.4.7 Incoming call / U7 call received / TCH assignment**26.8.1.3.4.7.1 Definition and applicability**

The call control entity of the MS being in the state, U7, an assignment procedure is performed for traffic channel. This test is applicable for any equipment supporting at least one mobile terminating circuit switched basic service for which immediate connect is not used.

26.8.1.3.4.7.2 Conformance requirement

- 1) A CC entity of a MS in CC-state U7, "Call Received", when allocated a traffic channel by the network performing the assignment procedure, shall perform a layer 2 establishment on the FACCH without changing the state of the call in progress.

References

GSM 04.08 section 3.4.3., GSM 04.08 section 5.2.2.7.

26.8.1.3.4.7.3 Test purpose

To verify that a CC entity of a MS in CC-state U7, "Call Received", when allocated a traffic channel by the network performing the assignment procedure, shall perform a layer 2 establishment on the FACCH without changing the state of the call in progress.

26.8.1.3.4.7.4 Method of test**Related PICS/PIXIT statements**

- supported MT circuit switched basic services;
- MT circuit switched basic services for which immediate connect is not used.

Initial conditions

System Simulator:

1 cell, default parameters.

Mobile Station:

The MS is in MM-state "idle, updated" with valid TMSI and CKSN.

The MS is brought into the state U7 by using table 26.8.1.3/1.

Foreseen final state of the MS

U7, call received.

Maximum duration of test

30 s.

Test procedure

An MT circuit switched basic service is selected that is supported by the MS and for which the MS does not use immediate connection; if the MS supports MT telephony without immediate connection, the selected basic service is telephony. If necessary, the MS is configured for that basic service. Then a mobile terminated call is initiated. The CC entity of the MS is brought to the state U7. The SS sends an ASSIGNMENT COMMAND for traffic channel to the MS. The MS shall establish layer 2 link on the newly allocated channel and respond with an ASSIGNMENT COMPLETE message. The SS verifies by using the status enquiry procedure that the state of the CC entity has remained unchanged.

Expected sequence

Step	Direction	Message	Comments
1	SS -> MS	ASSIGNMENT COMMAND	TCH
2	MS		the MS shall establish L2 link
3	MS -> SS	ASSIGNMENT COMPLETE	
4	SS -> MS	STATUS ENQUIRY	
5	MS -> SS	STATUS	cause 30#, state U7

Specific message contents:

None.

26.8.1.3.4.8 Incoming call / U7 call received / RELEASE COMPLETE received

26.8.1.3.4.8.1 Definition and applicability

The call control entity of the MS being in the state, U7, the call is cleared by a RELEASE COMPLETE message sent by the SS. This test is applicable for any equipment supporting at least one mobile terminating circuit switched basic service, for which immediate connect is not used.

26.8.1.3.4.8.2 Conformance requirement

- 1) A CC entity of the MS in CC-state U7, "call received", upon receipt of a RELEASE COMPLETE message with valid cause value, shall enter CC state U0, "Null".
- 2) On returning to idle mode, the CC entities relating to the seven mobile terminating transaction identifiers shall be in state U0, "Null".

References

Conformance requirement 1: GSM 04.08, section 5.4.2, GSM 04.08, section 5.4.4.

Conformance requirement 2: GSM 04.08, section 5.4.4.3.

26.8.1.3.4.8.3 Test purpose

- 1) To verify that a CC entity of the MS in CC-state U7, "Call received", upon receipt of a RELEASE COMPLETE message with valid cause value, enters CC state U0, "Null".
- 2) To verify that in returning to idle mode, the CC entities relating to the seven mobile terminating transaction identifiers are in state U0, "Null".

26.8.1.3.4.8.4 Method of test

Related PICS/PIXIT statements

- supported MT circuit switched basic services;
MT circuit switched basic services for which immediate connect is not used.

Initial conditions

System Simulator:

1 cell, default parameters.

Mobile Station:

The MS is in MM-state "idle, updated" with valid TMSI and CKSN.

The MS is brought into the state U7 by using table 26.8.1.3/1.

Foreseen final state of the MS

U0, null.

Maximum duration of test

30 s.

Test procedure

An MT circuit switched basic service is selected that is supported by the MS and for which the MS does not use immediate connection; if the MS supports MT telephony without immediate connection, the selected service is telephony. If necessary, the MS is configured for that basic service. The a mobile terminated call is initiated. the CC entity of the MS is brought to U7. The SS sends a RELEASE COMPLETE message to the MS. The SS checks by using the status enquiry procedure that the CC entity has entered the state U0 with all the relevant transaction identifiers.

Expected sequence

Step	Direction	Message	Comments
1	SS -> MS	RELEASE COMPLETE	note 1
2	SS -> MS	STATUS ENQUIRY	
3	MS -> SS	RELEASE COMPLETE	cause 81# (invalid TI value), note 2
4	SS		repeat steps 2-3 to cover all the transaction identifiers from 000...110
5	SS -> MS	CHANNEL RELEASE	the main signalling link shall be released by the MS (L2: DISC/UA).

Specific message contents:

NOTE 1: With the cause value chosen arbitrarily.

NOTE 2: TI flag has the value indicating the SS as a originator of the call.

26.8.1.3.5 Incoming call / U8 connect request**26.8.1.3.5.1 Incoming call / U8 connect request / CONNECT acknowledged****26.8.1.3.5.1.1 Definition and applicability**

The call control entity of the MS being in the state, U8, a CONNECT ACKNOWLEDGE message is received by the MS. This test is applicable for any equipment supporting at least one mobile terminating circuit switched basic service.

26.8.1.3.5.1.2 Conformance requirement

A CC entity of a MS in CC-state U8, "Connect Request", upon receipt of CONNECT ACKNOWLEDGE shall enter the CC-state U10, "Call Active".

References

GSM 04.08 section 5.2.2.6.

26.8.1.3.5.1.3 Test purpose

To verify that a CC entity of a MS in CC-state U8, "Connect Request", upon receipt of CONNECT ACKNOWLEDGE shall enter the CC-state U10, "Call Active".

26.8.1.3.5.1.4 Method of test**Related PICS/PIXIT statements**

- supported MT circuit switched basic services;
- MT circuit switched basic services for which immediate connect is not used.

Initial conditions

System Simulator:

1 cell, default parameters.

Mobile Station:

The MS is in MM-state "idle, updated" with valid TMSI and CKSN.

The MS is brought into the state U8 by using table 26.8.1.3/2.

Foreseen final state of the MS

U10, active.

Maximum duration of test

30 s.

Test procedure

An MT circuit switched basic service is selected that is supported by the MS; if the MS supports MT telephony, the selected basic service is telephony. If necessary the MS is configured for that basic service. Then a mobile terminated call is initiated. The CC entity of the MS is brought to the state U8 (if the MS uses immediate connection for the selected basic service then p = Y, otherwise p = N). The SS sends a CONNECT ACKNOWLEDGE message. The SS checks by using the status enquiry procedure that the CC entity of the MS has entered state U10, active.

Expected sequence

Step	Direction	Message	Comments
A1	SS -> MS	ASSIGNMENT COMMAND	p = Y
A2	MS -> SS	ASSIGNMENT COMPLETE	
3	SS -> MS	CONNECT ACKNOWLEDGE	cause 30#, state U10
4	SS -> MS	STATUS ENQUIRY	
5	MS -> SS	STATUS	

Specific message contents:

None.

26.8.1.3.5.2 Incoming call / U8 connect request / timer T313 time-out**26.8.1.3.5.2.1 Definition and applicability**

The call control entity of the MS being in the state, U8, if no response is then received from the SS, timer T313 expires at the MS side. This test is applicable for any equipment supporting at least one mobile terminating circuit switched basic service.

26.8.1.3.5.2.2 Conformance requirement

A CC entity of a MS in CC-state U8, "Connect Request", having waited for a reasonable length of time (e.g. expiry of timer T313) without receiving the appropriate protocol message to complete the incoming call, shall initiate the clearing of that incoming call by sending the CC message DISCONNECT and enter the CC-state U11, "Disconnect Request".

If an MS disconnects too early then, in the case of very late assignment of a traffic channel, systematic waste of radio resources may occur.

References

GSM 04.08 section 5.2.2.6., GSM 04.08 section 5.4.3.

26.8.1.3.5.2.3 Test purpose

To verify that a CC entity of a MS in CC-state U8, "Connect Request", having waited for a reasonable length of time (e.g. expiry of timer T313) without receiving the appropriate protocol message to complete the incoming call, shall initiate the clearing of that incoming call by sending the CC message DISCONNECT and enter the CC-state U11, "Disconnect Request"

26.8.1.3.5.2.4 Method of test

Related PICS/PIXIT statements

- supported MT circuit switched basic services;
- MT circuit switched basic services for which immediate connect is not used.

Initial conditions

System Simulator:

1 cell, default parameters.

Mobile Station:

The MS is in MM-state "idle, updated" with valid TMSI and CKSN.

The MS is brought into the state U8 by using table 26.8.1.3/2.

Foreseen final state of the MS

U11, disconnect request.

Maximum duration of test

45 s.

Test procedure

An MT circuit switched basic service is selected that is supported by the MS; if the MS supports MT telephony, the selected basic service is telephony. If necessary the MS is configured for that basic service. Then a mobile terminated call is initiated. The CC entity of the MS is brought to the state U8 (if the MS uses immediate connection for the selected basic service then p = Y, otherwise p = N). The T313 expires at the MS and the MS sends a DISCONNECT message and enters state U11, disconnect request. The SS checks by using the status enquiry procedure that the MS has entered the correct state.

Expected sequence

Step	Direction	Message	Comments
A1	SS -> MS	ASSIGNMENT COMMAND	p = Y
A2	MS -> SS	ASSIGNMENT COMPLETE	
3	MS -> SS	DISCONNECT	Shall not be sent before 15 seconds after entry into state U8. But, shall be sent before 1,1 * T313 after entry into state U8. cause 30#, state U11
4	SS -> MS	STATUS ENQUIRY	
5	MS -> SS	STATUS	

Specific message contents:

None.

26.8.1.3.5.3 Incoming call / U8 connect request / termination requested by the user

26.8.1.3.5.3.1 Definition and applicability

The call control entity of the MS being in the state, U10, the user requests for releasing of the call. This test is applicable for any equipment supporting at least one mobile terminating circuit switched basic service.

26.8.1.3.5.3.2 Conformance requirement

- 1) A CC entity of a MS in CC-state U8, "Connect Request", upon request by the user to terminate shall send a DISCONNECT message and enter the CC-state U11, "Disconnect Request".

References

GSM 04.07 section 6.2.2., GSM 04.08 section 5.4.3., GSM 11.10, annex 3 - section 2.2.

26.8.1.3.5.3.3 Test purpose

To verify that a CC entity of a MS in CC-state U8, "Connect Request", upon request by the user to terminate will send a DISCONNECT message and enter the CC-state U11, "Disconnect Request".

26.8.1.3.5.3.4 Method of test

Related PICS/PIXIT statements

- supported MT circuit switched basic services;
- MT circuit switched basic services for which immediate connect is not used.

Initial conditions

System Simulator:
1 cell, default parameters.

Mobile Station:
The MS is in MM-state "idle, updated" with valid TMSI and CKSN.
The MS is brought into the state U8 by using table 26.8.1.3/2.

Foreseen final state of the MS

U11, disconnect request.

Maximum duration of test

30 s.

Test procedure

An MT circuit switched basic service is selected that is supported by the MS; if the MS supports MT telephony, the selected basic service is telephony. If necessary the MS is configured for that basic service. Then a mobile terminated call is initiated. The CC entity of the MS is brought to the state U8 (if the MS uses immediate connection for the selected basic service then $p = Y$, otherwise $p = N$). Then the user requests termination of the call. The MS sends a DISCONNECT message and enters state U11, disconnect request. The SS verifies by using the status enquiry procedure that the MS has entered the correct state.

Expected sequence

Step	Direction	Message	Comments
A1	SS -> MS	ASSIGNMENT COMMAND	$p = Y$
A2	MS -> SS	ASSIGNMENT COMPLETE	
3			the user requests to clear the call
4	MS -> SS	DISCONNECT	
5	SS -> MS	STATUS ENQUIRY	
6	MS -> SS	STATUS	
			cause 30#, state U11

Specific message contents:

None.

26.8.1.3.5.4 Incoming call / U8 connect request / DISCONNECT received with in-band information**26.8.1.3.5.4.1 Definition and applicability**

The call control entity of the MS being in the state, U8, a DISCONNECT message indicating availability of in band information is received by the MS. This test is applicable for any equipment supporting at least one mobile terminating circuit switched basic service.

26.8.1.3.5.4.2 Conformance requirement

A CC entity of a MS in CC-state U8, "Connect Request", upon receipt of a DISCONNECT with progress indicator #8 shall enter CC-state U12, if the traffic channel is in speech mode. If the TCH is not in speech mode, the MS shall send a RELEASE message and enter CC-state U19.

References

GSM 04.08 section 5.4.4., GSM 04.08 section 5.5.1.

26.8.1.3.5.4.3 Test purpose

To verify that a CC entity of a MS in CC-state U8, "Connect Request", upon receipt of a DISCONNECT with progress indicator #8 enters CC-state U12, if the traffic channel is in speech mode, and that the MS sends a RELEASE message and enters CC-state U19 if the TCH is not in speech mode.

26.8.1.3.5.4.4 Method of test**Related PICS/PIXIT statements**

- supported MT circuit switched basic services.

Initial conditions

System Simulator:
1 cell, default parameters.

Mobile Station:

The MS is in MM-state "idle, updated" with valid TMSI and CKSN. The MS is brought into the state U8 by using table 26.8.1.3/3.

Foreseen final state of the MS

U12, disconnect indication or U19 depending on the bearer capabilities.

Maximum duration of test

30 s.

Test procedure

An MT circuit switched basic service is selected that is supported by the MS; if the MS supports MT telephony, the selected basic service is telephony. If necessary the MS is configured for that basic service. Then a mobile terminated call is initiated. The CC entity of the MS is brought to the state U8. The SS sends a DISCONNECT message containing indication of in-band information availability to the MS. If channel mode is speech, the MS enters state U12, disconnect indication. If channel mode is not speech, the MS sends a RELEASE message and enters state U19, release request.

Expected sequence

Step	Direction	Message	Comments
1	SS -> MS	DISCONNECT	(note)
A2 A3	SS -> MS MS -> SS	STATUS ENQUIRY STATUS	TCH in speech mode: cause 30#, state U12
B2 B3 B4	MS -> SS SS -> MS MS -> SS	RELEASE STATUS ENQUIRY STATUS	TCH is not in speech mode: cause 30#, state U19

Specific message contents:

NOTE: With a progress indicator indicating in-band information; Progress Indicator, Progress description #8.

26.8.1.3.5.5 Incoming call / U8 connect request / DISCONNECT received without in-band information**26.8.1.3.5.5.1 Definition and applicability**

The call control entity of the MS being in the state, U8, a DISCONNECT message is received by the MS. The DISCONNECT message does not contain indication of in-band information availability. This test is applicable for any equipment supporting at least one mobile terminating circuit switched basic service.

26.8.1.3.5.5.2 Conformance requirement

- 1) A CC entity of a MS in CC-state U8, "Connect Request", upon receipt of a DISCONNECT without progress indicator, shall return a RELEASE message and enter the CC-state U19, "Release Request".

References

GSM 04.08 section 5.4.4., GSM 04.08 section 5.4.4.2.

26.8.1.3.5.5.3 Test purpose

To verify that a CC entity of a MS in CC-state U8, "Connect Request", upon receipt of a DISCONNECT without progress indicator, returns a RELEASE message and enters the CC-state U19, "Release Request".

26.8.1.3.5.5.4 Method of test**Related PICS/PIXIT statements**

- supported MT circuit switched basic services.

Initial conditions

System Simulator:

1 cell, default parameters.

Mobile Station:

The MS is in MM-state "idle, updated" with valid TMSI and CKSN.

The MS is brought into the state U8 by using table 26.8.1.3/3.

Foreseen final state of the MS

U19, release request.

Maximum duration of test

30 s.

Test procedure

An MT circuit switched basic service is selected that is supported by the MS; if the MS supports MT telephony, the selected basic service is telephony. If necessary the MS is configured for that basic service. Then a mobile terminated call is initiated. The CC entity of the MS is brought to the state U8. The SS sends a DISCONNECT message not containing indication of in-band information availability to the MS. The MS shall respond with a RELEASE message. The SS checks by using the status enquiry procedure that the CC entity of the MS has entered the state U19, release request.

Expected sequence

Step	Direction	Message	Comments
1	SS -> MS	DISCONNECT	(note)
2	MS -> SS	RELEASE	
3	SS -> MS	STATUS ENQUIRY	
4	MS -> SS	STATUS	cause 30#, state U19

Specific message contents:

NOTE: Without a progress indicator indicating in-band information.

26.8.1.3.5.6 Incoming call / U8 connect request / RELEASE received**26.8.1.3.5.6.1 Definition and applicability**

The call control entity of the MS being in the state, U8, a RELEASE message is received by the MS. This test is applicable for any equipment supporting at least one mobile terminating circuit switched basic service.

26.8.1.3.5.6.2 Conformance requirement

- 1) A CC entity of a MS in CC-state U8, "Connect Request", upon receipt of a RELEASE shall return a RELEASE COMPLETE and enter the CC-state U0, "Null".
- 2) On returning to the idle mode the MS shall release the MM-connection and the CC-entities relating to the seven mobile terminating transaction identifiers shall be in CC-state U0, "Null".

References

Conformance requirement 1: GSM 04.08 section 5.4.4.

Conformance requirement 2: GSM 04.08 section 4.5.3., GSM 04.08 section 5.5.3.2.

26.8.1.3.5.6.3 Test purpose

- 1) To verify that a CC entity of a MS in CC-state U8, "Connect Request", upon receipt of a RELEASE will return a RELEASE COMPLETE and enter the CC-state U0, "Null".
- 2) To verify that the MS on returning to the idle mode releases the MM-connection and that the CC-entities relating to the seven mobile terminating transaction identifiers are in CC-state U0, "Null".

26.8.1.3.5.6.4 Method of test**Related PICS/PIXIT statements**

- supported MT circuit switched basic services.

Initial conditions

System Simulator:

1 cell, default parameters.

Mobile Station:

The MS is in MM-state "idle, updated" with valid TMSI and CKSN.

The MS is brought into the state U8 by using table 26.8.1.3/3.

Foreseen final state of the MS

U0, null.

Maximum duration of test

1 min.

Test procedure

An MT circuit switched basic service is selected that is supported by the MS; if the MS supports MT telephony, the selected basic service is telephony. If necessary the MS is configured for that basic service. Then a mobile terminated call is initiated. The CC entity of the MS is brought to the state U8. The SS sends a RELEASE message. The MS responds with a RELEASE COMPLETE message. The SS checks by using the status enquiry procedure that the CC entity has entered state U0, null, with the relevant transaction identifiers.

Expected sequence

Step	Direction	Message	Comments
1	SS -> MS	RELEASE	with cause "Normal, unspecified"
2	MS -> SS	RELEASE COMPLETE	
3	SS -> MS	STATUS ENQUIRY	cause 81# (invalid TI value) repeat steps 3-4 to cover all the transaction identifiers from 000...110
4	MS -> SS	RELEASE COMPLETE	
5	SS		
6	SS -> MS	CHANNEL RELEASE	the main signalling link shall be released by the MS (L2: DISC/UA).

Specific message contents:

None.

26.8.1.3.5.7 Incoming call / U8 connect request / lower layer failure**26.8.1.3.5.7.1 Definition and applicability**

The call control entity of the MS being in the state, U8, a lower layer failure is accomplished at the MS and consequently, communication at layer 3 level with the peer entity is terminated. This test is applicable for any equipment supporting at least one mobile terminating circuit switched basic service.

26.8.1.3.5.7.2 Conformance requirement

- 1) A CC entity of a MS in CC-state U8, "Connect Request", having detected a lower layer failure shall return to idle mode with the CC entities relating to the seven mobile terminating transaction identifiers in CC-state U0, "Null".

References

GSM 04.08 section 4.5.2.3., GSM 04.08 section 4.5.3., GSM 04.08 section 5.5.3.2.

26.8.1.3.5.7.3 Test purpose

To verify that a CC entity of a MS in CC-state U8, "Connect Request", having detected a lower layer failure returns to idle mode with the CC entities relating to the seven mobile terminating transaction identifiers in CC-state U0, "Null".

26.8.1.3.5.7.4 Method of test**Related PICS/PIXIT statements**

- supported MT circuit switched basic services.

Initial conditions

System Simulator:

1 cell, default parameters.

Mobile Station:

The MS is in MM-state "idle, updated" with valid TMSI and CKSN.

The MS is brought into the state U8 by using table 26.8.1.3/1.

Foreseen final state of the MS

U0, null.

Maximum duration of test

1 min 30 s.

Test procedure

An MT circuit switched basic service is selected that is supported by the MS; if the MS supports MT telephony, the selected basic service is telephony. If necessary the MS is configured for that basic service. Then a mobile terminated call is initiated. The MS is brought to the state U8. The SS generates a lower layer failure at the MS. The SS waits long enough to enable the MS to return to idle state listening to paging, and then pages MS to create RR-connection. Finally, the SS will check the state of the MS by using STATUS ENQUIRY with the relevant transaction identifiers.

Expected sequence

Step	Direction	Message	Comments
1	SS		SS generates lower layer failure
2	SS		SS waits 20 s for the MS to return to listening to paging
3	SS -> MS	PAGING REQUEST	
4	MS -> SS	CHANNEL REQUEST	
5	SS -> MS	IMMEDIATE ASSIGNMENT	
6	MS -> SS	PAGING RESPONSE	
7	SS -> MS	STATUS ENQUIRY	
8	MS -> SS	RELEASE COMPLETE	cause 81# (invalid TI value)
9	SS		repeat steps 7-8 to cover all the transaction identifiers from 000...110
10	SS -> MS	CHANNEL RELEASE	the main signalling link shall be released by the MS (L2: DISC/UA).

Specific message contents:

None.

26.8.1.3.5.8 Incoming call / U8 connect request / TCH assignment**26.8.1.3.5.8.1 Definition and applicability**

The call control entity of the MS being in the state, U8, an assignment procedure is performed for traffic channel. This test is applicable for any equipment supporting at least one mobile terminating circuit switched basic service.

26.8.1.3.5.8.2 Conformance requirement

- 1) A CC entity of a MS in CC-state U8, "Connect Request", when allocated a traffic channel by the network performing the assignment procedure, shall perform a layer 2 establishment on the FACCH without changing the state of the call in progress.

References

GSM 04.08 section 3.4.3., GSM 04.08 section 5.2.2.7.

26.8.1.3.5.8.3 Test purpose

To verify that a CC entity of a MS in CC-state U8, "Connect Request", when allocated a traffic channel by the network performing the assignment procedure, shall perform a layer 2 establishment on the FACCH without changing the state of the call in progress.

26.8.1.3.5.8.4 Method of test**Related PICS/PIXIT statements**

- supported MT circuit switched basic services.

Initial conditions

System Simulator:

1 cell, default parameters.

Mobile Station:

The MS is in MM-state "idle, updated" with valid TMSI and CKSN.

The MS is brought into the state U8 by using table 26.8.1.3/1.

Foreseen final state of the MS

U8, connect request.

Maximum duration of test

30 s.

Test procedure

An MT circuit switched basic service is selected that is supported by the MS; if the MS supports MT telephony, the selected basic service is telephony. If necessary the MS is configured for that basic service. Then a mobile terminated call is initiated. The CC entity of the MS is brought to the state U8. The SS sends an ASSIGNMENT COMMAND for traffic channel to the MS. The MS shall establish layer 2 link on the newly allocated channel and respond with an ASSIGNMENT COMPLETE message. The SS verifies by using the status enquiry procedure that the state of the CC entity has remained unchanged.

Expected sequence

Step	Direction	Message	Comments
1	SS -> MS	ASSIGNMENT COMMAND	TCH
2	MS -> SS	ASSIGNMENT COMPLETE	
3	SS -> MS	STATUS ENQUIRY	
4	MS -> SS	STATUS	cause 30#, state U8

Specific message contents:

None.

26.8.1.3.5.9 Incoming call / U8 connect request / unknown message received**26.8.1.3.5.9.1 Definition and applicability**

The call control entity of the MS being in the state, U8, an unknown message is received by the MS. This test is applicable for any equipment supporting at least one mobile terminating circuit switched basic service.

26.8.1.3.5.9.2 Conformance requirement

- 1) A CC entity of a MS in CC-state U8, "Connect Request", having received an unknown message from its peer entity shall return a STATUS message.

References

GSM 04.08 section 8.4.

26.8.1.3.5.9.3 Test purpose

To verify that a CC entity of a MS in CC-state U8, "Connect Request", having received an unknown message from its peer entity returns a STATUS message.

26.8.1.3.5.9.4 Method of test**Related PICS/PIXIT statements**

- supported MT circuit switched basic services.

Initial conditions

System Simulator:

1 cell, default parameters.

Mobile Station:

The MS is in MM-state "idle, updated" with valid TMSI and CKSN.

The MS is brought into the state U8 by using table 26.8.1.3/1.

Foreseen final state of the MS

U8, connect request.

Maximum duration of test

30 s.

Test procedure

An MT circuit switched basic service is selected that is supported by the MS; if the MS supports MT telephony, the selected basic service is telephony. If necessary the MS is configured for that basic service. Then a mobile terminated call is initiated. The CC entity of the MS is brought to the state U8. The SS sends a message with message type not defined for the protocol discriminator to the MS. The MS shall respond with a STATUS message, and finally the SS checks by using the status enquiry procedure that the state of the CC entity has remained unchanged.

Expected sequence

Step	Direction	Message	Comments
1	SS -> MS	unknown message	message type not defined for PD
2	MS -> SS	STATUS	cause 97#, state U8
3	SS -> MS	STATUS ENQUIRY	
4	MS -> SS	STATUS	cause 30#, state U8

Specific message contents:

None.

26.8.1.4 In call functions**26.8.1.4.1 In-call functions / DTMF information transfer****26.8.1.4.1.1 In-call functions / DTMF information transfer / basic procedures****26.8.1.4.1.1.1 Definition and applicability**

Dual Tone Multi Frequency (DTMF) is an inband one out of four plus one out of four signalling system primarily used from terminal instruments in telecommunication networks.

The support of DTMF is only permitted when a bearer capability for speech is in use or during the speech phase of alternate speech/data and alternate speech/facsimile teleservices.

26.8.1.4.1.1.2 Conformance requirement

- 1) An MS supporting the Mobile originating DTMF protocol control procedure, having a CC entity for speech in state U10, "Active": when made to send a DTMF tone, shall send a START DTMF message on the correct DCCH.

References

GSM 04.08, 5.3.3.

- 2) An MS supporting the Mobile originating DTMF protocol control procedure, having a CC entity for speech in state U10, "Active": when made to send a DTMF tone (the corresponding IA5 character being selected from among the ones supported), shall send a START DTMF message specifying the correct IA5 character in the "keypad information" field of the keypad facility information element.
2.1 GSM 04.08, 5.3.3.

26.8.1.4.1.1.3 Test purpose

- 1) To verify that an MS supporting the Mobile originating DTMF protocol control procedure, having a CC entity for speech in state U10, "Active": when made to send a DTMF tone, sends a START DTMF message on the correct DCCH.
- 2) To verify that an MS supporting the Mobile originating DTMF protocol control procedure, having a CC entity for speech in state U10, "Active": when made to send a DTMF tone (the corresponding IA5 character being selected from among the ones supported), sends a START DTMF message specifying the correct IA5 character in the "keypad information" field of the keypad facility information element.

26.8.1.4.1.1.4 Method of test

Related PICS/PIXIT statements

- supported teleservices;
- supported character set (e.g. 0-9, #, *, A, B, C, D);
- if and how DTMF tone is indicated to the user.

Initial conditions

System Simulator:

1 cell, default parameters.

Mobile Station:

The MS is in CC-state "active".

Foreseen final state of the MS

CC-state "active".

Maximum duration of test

1 min.

Test procedure

The MS being in the call active state, a user causes a DTMF tone to be generated e.g. by depression of a key in the MS. A DTMF digit corresponding to the digit indicated by the user is sent in a START DTMF message by the MS. The SS will return a START DTMF ACKNOWLEDGE message to the MS. This acknowledgement may be used in the MS to generate an indication as a feedback for a successful

transmission. Then the user indicates that the DTMF sending should cease e.g. by releasing the key. The MS will send a STOP DTMF message to the network which is acknowledged with STOP DTMF ACKNOWLEDGE by the SS.

The sequence described above is repeated for each of the applicable characters 0-9, #, *, A, B, C, and D.

Then a case of rejecting a DTMF tone is tested and the state of the MS is verified.

Expected sequence

Step	Direction	Message	Comments
1	MS -> SS SS	START DTMF	the user causes DTMF tone to be generated the SS will verify that the transmitted information corresponds to the digit pressed
2	SS -> MS	START DTMF ACKNOWLEDGE	possible indication of a DTMF tone depending the PICS/PIXIT statements
3	SS -> MS	STATUS ENQUIRY	
4	MS -> SS	STATUS	cause 30#, state U10
5	MS -> SS	STOP DTMF	
6	SS -> MS	STOP DTMF ACKNOWLEDGE	the DTMF tone indication shall be stopped
7			the steps 1-4 shall be repeated for each of the applicable characters 0-9, #, *, A, B, C, D.
8	SS -> MS	STATUS ENQUIRY	
9	MS -> SS	STATUS	cause 30#, state U10
10	MS -> SS	START DTMF	
11	SS -> MS	START DTMF REJECT	
12	SS -> MS	STATUS ENQUIRY	
13	MS -> SS	STATUS	cause 30#, state U10

Specific message contents:

None.

26.8.1.4.2 In-call functions / user notification

User notification procedure allows the network to notify a MS of any call-related event during the "active" state of a call. It also may allow a MS to notify the remote user of any appropriate call-related event during the "active" state of a call by sending a NOTIFY message containing a notification indicator to the network. No state change occurs at any of the interface sides during this procedure.

26.8.1.4.2.1 In-call functions / User notification / MS terminated

26.8.1.4.2.1.1 Definition and applicability

This is a case for testing user notification procedure terminated by the mobile station. The test is applicable for those equipments supporting at least one circuit switched basic service.

26.8.1.4.2.1.2 Conformance requirement

- 1) A CC entity of a MS in CC-state U10, "active", upon receiving of a NOTIFY message shall remain in the active state.

References

GSM 04.08, 5.3.1.

26.8.1.4.2.1.3 Test purpose

To verify that a CC entity of a MS in CC-state U10, "active", upon receiving of a NOTIFY message remains in the active state.

26.8.1.4.2.1.4 Method of test**Related PICS/PIXIT statements**

- supported circuit switched basic services.

Initial conditions

System Simulator:

1 cell, default parameters.

Mobile Station:

The MS is in CC-state "active".

Foreseen final state of the MS

CC-state "active".

Maximum duration of test

10 s.

Test procedure

The MS being in the call active state, the SS will send a NOTIFY message to the MS. The state of the MS is checked after that.

Expected sequence

Step	Direction	Message	Comments
1	SS -> MS	NOTIFY	
2	SS -> MS	STATUS ENQUIRY	
3	MS -> SS	STATUS	cause 30#, state U10

Specific message contents:

None.

26.8.1.4.3 In-call functions / channel changes

The two following test cases are for testing some elementary radio resource level procedures during an active state of a call to ensure call maintenance also during physical channel changes.

26.8.1.4.3.1 In-call functions / channel changes / a successful channel change in active state/ Handover and Assignment Command**26.8.1.4.3.1.1 Definition and applicability**

This is a case to test a change of a physical channel during active state of a call. This test is applicable for any equipment supporting at least one mobile terminating circuit switched basic service.

26.8.1.4.3.1.2 Conformance requirement

- 1) The MS being in the call active state after having successfully completed a channel assignment or a handover command, shall remain in the call active state.

References

GSM 04.08, section 5.3.4.3.2, GSM 04.08, section 3.4.6.

26.8.1.4.3.1.3 Test purpose

To verify that the MS being in the call active state after having successfully completed a channel assignment or having completed a handover command remains in the call active state.

26.8.1.4.3.1.4 Method of test**Related PICS/PIXIT statements**

- supported MT circuit switched basic services;
- Type of MS (P-GSM 900 or EGSM or DCS 1 800).

Initial conditions

System Simulator:
1 cell, default parameters.

Mobile Station:
The MS is in CC-state "active".

Foreseen final state of the MS

CC-state "active".

Maximum duration of test

10 s.

Test procedure

The SS initiates a call to the Mobile Station, using an arbitrarily chosen MT circuit switched basic service (see section 10 for generic call set up procedures).

The MS being in the call active state, the SS initiated channel assignment procedure causing an intracell change of channel by sending ASSIGNMENT COMMAND message to the MS. The MS performs channel assignment procedure and after the main signalling link is successfully established, the MS returns an ASSIGNMENT COMPLETE message. The state of the MS is then checked.

The SS then initiates a Finely Synchronized handover intra cell procedure. On the successful completion of this procedure the state of the MS is checked.

Expected sequence

Step	Direction	Message	Comments
0			Generic call set up procedure defined in sections 10.1 and 10.3, depending on choice of Bearer Capability.
1	SS -> MS	ASSIGNMENT COMMAND	
2	MS -> SS	ASSIGNMENT COMPLETE	
3	SS -> MS	STATUS ENQUIRY	
4	MS -> SS	STATUS	cause 30#, state U10
5	SS -> MS	HANDOVER COMMAND	See Specific message contents.
6	MS -> SS	HANDOVER ACCESS	Four HANDOVER ACCESS
7	MS -> SS	HANDOVER ACCESS	
8	MS -> SS	HANDOVER ACCESS	
9	MS -> SS	HANDOVER ACCESS	
10	MS -> SS	HANDOVER COMPLETE	
11	SS -> MS	STATUS ENQUIRY	
12	MS -> SS	STATUS	cause 30#, state U10

Specific message contents:

ASSIGNMENT COMMAND

Information Element	value/remark
Channel Description As used in Assignment Command when setting up the call, except: - Timeslot Number	Arbitrary value, but different to originally used.

HANDOVER COMMAND

Information Element	value/remark
Cell Description - Network Colour Code - Base Station Colour Code - BCCH Carrier Number	1 5 P-GSM 900 - ARFCN 30 DCS 1 800 - ARFCN 650
Channel Description As used in Assignment Command when setting up the call, except: - Timeslot Number	Arbitrary value, but different to originally used.
Synchronization Indication - Report Observed Time Difference - Synchronization Indication - Normal Cell Indication	Shall not be included. "Synchronized". Ignore out of range timing advance.

STATUS

Information Element	value/remark
cause	#30, statue U10.

26.8.1.4.3.2 In-call functions / channel changes / an unsuccessful channel change in active mode/ Handover and Assignment Command**26.8.1.4.3.2.1 Definition and applicability**

This is a case to test an unsuccessful change of a physical channel during active state of a call. This test is applicable for any equipment supporting at least one mobile terminating circuit switched basic service.

26.8.1.4.3.2.2 Conformance requirement

- 1) The MS, when returning to the old channel after handover or Assignment failure and having established the link, shall remain in the call active state.

References

GSM 04.08, section 5.3.4.3.

26.8.1.4.3.2.3 Test purpose

To verify that the MS, when returning to the old channel after handover or Assignment failure and correctly establishing the link, will remain in the call active state.

26.8.1.4.3.2.4 Method of test**Related PICS/PIXIT statements**

- supported MT circuit switched basic services;
- Type of Mobile Station (P-GSM 900 or EGSM or DCS 1 800).

Initial conditions

System Simulator:

1 cell, default parameters.

Mobile Station:

The MS is in CC-state "active".

Foreseen final state of the MS

CC-state "active".

Maximum duration of test

30 s.

Test procedure

The SS initiates a call to the Mobile Station, using an arbitrarily chosen circuit switched basic service (see section 10 for generic call set up procedures).

The MS being in the call active state, the SS initiates non synchronized handover procedure to cell B. The MS begins to send access bursts on the new DCCH. The SS activates the SACCH, but does not send a PHYSICAL INFORMATION MESSAGE, thus causing timer T3124 to time-out. Then the MS shall return back to the old channel and re-establish the signalling link on cell A and send a HANDOVER FAILURE message. The state of the MS is then checked.

The SS sends an Assignment command message allocating a hopping TCH/F, but does not activate the assigned channel. The MS shall attempt try to activate the new channel (this is not verified) and shall then reactivate the "old" channel and trigger the establishment of the main signalling link on the old channel. The MS shall send an ASSIGNMENT FAILURE message. The state of the MS is then checked.

Expected sequence

Step	Direction	Message	Comments
0			Generic call set up procedure defined in sections 10.1 and 10.3, depending on choice of Bearer Capability.
1	SS -> MS	HANDOVER COMMAND	Several messages are sent, all with the handover reference sent in the HANDOVER COMMAND message.
2	MS -> SS	HANDOVER ACCESS	
3	MS -> SS	HANDOVER FAILURE	cause 30#, state U10 Channel type = TCH/F, hopping. The MS attempts and fails to establish a signalling link on the new channel. The MS re-establishes the signalling link on the "old" channel. RR cause value = "protocol error unspecified"
4	SS -> MS	STATUS ENQUIRY	
5	MS -> SS	STATUS	
6	SS -> MS	ASSIGNMENT COMMAND	
7			
8	MS -> SS	ASSIGNMENT FAILURE	
9	SS -> MS	STATUS ENQUIRY	cause 30#, state U10
10	MS -> SS	STATUS	

Specific message contents:**ASSIGNMENT FAILURE**

Information Element	value/remark
RR cause	"protocol error unspecified"

HANDOVER FAILURE

Information Element	value/remark
RR cause	Not checked, as tested elsewhere.

STATUS

Information Element	value/remark
cause	#30, statue U10.

26.8.1.4.4 In-call functions / MS terminated in-call modification**26.8.1.4.4.1 In-call functions / MS terminated in-call modification / modify when new mode is not supported****26.8.1.4.4.1.1 Definition and applicability**

This is to test a special case of a in-call modification procedure, in which the new mode is not supported (and consequently not one of those negotiated and agreed during the establishment phase of the call). This test is applicable for any equipment supporting at least one circuit switched basic service.

26.8.1.4.4.1.2 Conformance requirement

- 1) In the case that the MS supports the network originated in-call modification procedure, the MS after having received a MODIFY message with a new mode which is not the actual one and cannot be supported by the MS shall reject it by sending a MODIFY REJECT message or a STATUS message.
- 2) In the case that the MS does not support the network originated in-call modification procedure, the MS shall, when receiving a MODIFY message, treat the message as unknown and respond with a STATUS message.

References

- 1) GSM 04.08, sections 5.3.4.3.4.2 and 5.3.4.4.
- 2) GSM 04.08, section 5.3.4.

26.8.1.4.4.1.3 Test purpose

- 1) To verify that an MS supporting the network originated in-call modification procedure, after having received a MODIFY message with a new mode which is not the actual one and cannot be supported by the MS, rejects it by sending a MODIFY REJECT.
- 2) To verify that an MS not supporting the network originated in-call modification procedure, after having received a MODIFY message, responds with a STATUS message.

26.8.1.4.4.1.4 Method of test**Related PICS/PIXIT statements**

- supported circuit switched basic services;
- the MS supports the network originated in-call modification procedure (p = Yes/No).

Initial conditions

System Simulator:
1 cell, default parameters.

Mobile Station:
The MS is in CC-state "active".

Foreseen final state of the MS

CC-state "active".

Maximum duration of test

10 s.

Test procedure

The MS being in the call active state, the SS initiates in-call modification procedure by sending a MODIFY message with new mode different from actual mode and one of those not supported by the MS. The MS either returns a MODIFY REJECT message with the old bearer capability or a STATUS message with reject cause #97, depending on the PICS/PIXIT statement. The state of the MS is then checked.

Expected sequence

Step	Direction	Message	Comments
1	SS -> MS	MODIFY	with new mode different from actual one
2a	MS -> SS	MODIFY REJECT	with the old call mode included OR, p = Yes
2b	MS -> SS	STATUS	cause #97, state U10, p = No
3	SS -> MS	STATUS ENQUIRY	
4	MS -> SS	STATUS	cause 30#, state U10

Specific message contents:

None.

26.8.1.4.5 In-call functions / MS originated in-call modification

26.8.1.4.5.1 In-call functions / MS originated in-call modification / a successful case of modifying

26.8.1.4.5.1.1 Definition and applicability

This test is to test a successful case of in-call modification, which is triggered by the calling tone identification (CNG) received by the MS. This test is applicable for any equipment supporting any dual mode bearer capability service (BS61 - Alternate Speech/Data, BS81 - Speech followed by Data, Teleservice 61 - Alternate Speech/Group 3 fax).

26.8.1.4.5.1.2 Conformance requirement

- 1) The procedure shall be initiated by the MS in the "active" state of the call. It shall send a MODIFY message including the new mode to be changed to; and enter the "mobile originating modify" state. The new mode given in the MODIFY message shall be one of those already negotiated and agreed during the establishment phase of the call. The MS shall stop sending Bm-channel information according to the old mode and enter the state U26 "Mobile Originating Modify".
- 2) Upon receipt of the MODIFY COMPLETE message the MS shall start sending channel information according to the new call mode and enter the "active" state.

References

- Conformance requirement 1: GSM 04.08, section 5.3.4.3.1.
Conformance requirement 2: GSM 04.08, section 5.3.4.3.2.

26.8.1.4.5.1.3 Test purpose

- 1) To verify that the procedure is initiated by the MS in the "active" state of the call. It sends a MODIFY message including the new mode to be changed to; and enters the "mobile originating modify" state. The new mode given in the MODIFY message is one of those already negotiated and agreed during the establishment phase of the call. The MODIFY originating side stops sending Bm-channel information.
- 2) To verify that upon receipt of the MODIFY COMPLETE message the MS starts sending channel information according to the new call mode and enters the "active" state.

26.8.1.4.5.1.4 Method of test

Related PICS/PIXIT statements

- a way to activate a dual mode call;
- a way to activate in-call modification;
- support of dual bearer capability services.

Initial conditions

System Simulator:
1 cell, default parameters.

Mobile Station:
The MS is in MM-state "idle, updated" with valid TMSI and CKSN.

Foreseen final state of the MS

CC-state "active".

Maximum duration of test

10 s.

Test procedure

The MS initiates a call for one of the supported dual mode services. The MS being in the call active state, in-call modification procedure is initiated for the selected service from the MS side. The MS shall send a MODIFY message with the new mode to the SS and the state of the MS is checked. The channel mode is modified with the CHANNEL MODE MODIFY message including the appropriate channel mode for the new service. The SS then returns a MODIFY COMPLETE message. The state of the MS is then checked.

NOTE: ICM can be initiated by manual intervention at the MS.

Expected sequence

Step	Direction	Message	Comments
1	MS		The MS is made to initiate a dual mode call
2	MS -> SS	CHANNEL REQUEST	
3	SS -> MS	IMMEDIATE ASSIGNMENT	SDCCH
4	MS -> SS	CM SERVICE REQUEST	
5	SS -> MS	CIPHERING MODE COMMAND	
6	MS -> SS	CIPHERING MODE COMPLETE	
7	MS -> SS	SETUP	as specified in specific message contents
8	SS -> MS	AUTHENTICATION REQUEST	
9	MS -> SS	AUTHENTICATION RESPONSE	
10	SS -> MS	CALL PROCEEDING	as specified in specific message contents
11	SS -> MS	ASSIGNMENT COMMAND	channel mode: see section 10.4
12	MS -> SS	ASSIGNMENT COMPLETE	
13	SS -> MS	ALERTING	
14	SS -> MS	CONNECT	
15	MS -> SS	CONNECT ACKNOWLEDGE	
16	MS -> SS	MODIFY	as specified in specific message contents
17	SS -> MS	STATUS ENQUIRY	
18	MS -> SS	STATUS	cause 30#, state U26
19	SS -> MS	CHANNEL MODE MODIFY	as specified in specific message contents
20	MS -> SS	CHANNEL MODE MODIFY ACKNOWLEDGE	
21	SS -> MS	MODIFY COMPLETE	contains the new mode as bearer capability
22	SS		allow at least 2 seconds for the MS to adapt for the new mode
23	SS -> MS	STATUS ENQUIRY	
24	MS -> SS	STATUS	cause 30#, state U10
25	SS		verify that the MS starts sending Bm channel information according to the new mode

Specific message contents:

As specified in 26.8.1.4.5.10.

26.8.1.4.5.2 In-call functions / MS originated in-call modification / modify rejected

26.8.1.4.5.2.1 Definition and applicability

This is to test a special case of a in-call modification procedure, in which the in-call modification is rejected. This test is applicable for any equipment supporting any dual mode bearer capability service (BS61 - Alternate Speech/Data, BS81 - Speech followed by Data, Teleservice 61 - Alternate Speech/Group 3 fax).

26.8.1.4.5.2.2 Conformance requirement

- 1) Upon receipt of the MODIFY REJECT message with the old bearer capability the MS shall: resume sending Bm-channel information according to the present call mode; resume interpreting received Bm-channel information according to the present call mode; and enter the "active" state.

References

GSM 04.08, section 5.3.4.3.4.1.

26.8.1.4.5.2.3 Test purpose

To verify that upon receipt of the MODIFY REJECT message with the old bearer capability the MS resumes sending Bm-channel information according to the present call mode; resumes interpreting received Bm-channel information according to the present call mode; and enters the "active" state.

26.8.1.4.5.2.4 Method of test**Related PICS/PIXIT statements**

- supported teleservices;
- support of dual bearer capability services.

Initial conditions

System Simulator:

1 cell, default parameters.

Mobile Station:

The MS is in MM-state "idle, updated" with valid TMSI and CKSN.

Foreseen final state of the MS

CC-state "active".

Maximum duration of test

10 s.

Test procedure

The MS initiates a call for one of the supported dual mode services. The MS being in the call active state, in-call modification procedure is initiated for the selected service from the MS side. The MS shall send a MODIFY message with new mode to the SS. The SS returns a MODIFY REJECT message. The state of the MS is then checked.

Expected sequence

Step	Direction	Message	Comments
1	MS -> SS	CHANNEL REQUEST	MMI action to initiate a dual mode call SDCCH
2	SS -> MS	IMMEDIATE ASSIGNMENT	
3	MS -> SS	CM SERVICE REQUEST	as specified in specific message contents
4	SS -> MS	CIPHERING MODE COMMAND	
5	MS -> SS	CIPHERING MODE COMPLETE	
6	MS -> SS	SETUP	
7	SS -> MS	AUTHENTICATION REQUEST	agreeing bearer capabilities for dual mode call TCH
8	MS -> SS	AUTHENTICATION RESPONSE	
9	SS -> MS	CALL PROCEEDING	MMI action to change the mode with cause #58 bearer capability not available and with old bearer capabilities
10	SS -> MS	ASSIGNMENT COMMAND	
11	MS -> SS	ASSIGNMENT COMPLETE	cause 30#, state U10
12	SS -> SS	ALERTING	
13	SS -> MS	CONNECT	
14	MS -> SS	CONNECT ACKNOWLEDGE	
15	MS -> SS	MODIFY	
16	SS -> MS	MODIFY REJECT	
17	SS -> MS	STATUS ENQUIRY	
18	MS -> SS	STATUS	

Specific message contents:

As specified in 26.8.1.4.5.10.

26.8.1.4.5.3 In-call functions / MS originated in-call modification / an abnormal case of acceptance

26.8.1.4.5.3.1 Definition and applicability

This is to test a special case of a in-call modification procedure, in which the in-call modification is accepted incorrectly. This test is applicable for any equipment supporting any dual mode bearer capability service (BS61 - Alternate Speech/Data, BS81 - Speech followed by Data, Teleservice 61 - Alternate Speech/Group 3 fax).

26.8.1.4.5.3.2 Conformance requirement

- 1) Upon receipt of the MODIFY COMPLETE message indicating a call mode which does not correspond to the requested one the MS shall discard it and take no action.

References

GSM 04.08, section 5.3.4.4.

26.8.1.4.5.3.3 Test purpose

To verify that upon receipt of the MODIFY COMPLETE message indicating a call mode which does not correspond to the requested one the MS discards it and takes no action.

26.8.1.4.5.3.4 Method of test

Related PICS/PIXIT statements

- supported teleservices;
- support of dual bearer capability services.

Initial conditions

System Simulator:
1 cell, default parameters.

Mobile Station:
The MS is in MM-state "idle, updated" with valid TMSI and CKSN.

Foreseen final state of the MS

CC-state U26 "Mobile Originating Modify".

Maximum duration of test

10 s.

Test procedure

The MS initiates a call for one of the supported dual mode services. The MS being in the call active state, in-call modification procedure is initiated for the selected service from the MS side. The MS shall send a MODIFY message with new mode to the SS. The SS returns a MODIFY COMPLETE message specifying a mode that does not correspond to the requested one. It will be verified then that the MS shall not take any action and the state of the MS will be checked.

Expected sequence

Step	Direction	Message	Comments
1	MS -> SS	CHANNEL REQUEST	MMI action to initiate a dual mode call SDCCH
2	SS -> MS	IMMEDIATE ASSIGNMENT	
3	MS -> SS	CM SERVICE REQUEST	
4	SS -> MS	CIPHERING MODE COMMAND	
5	MS -> SS	CIPHERING MODE COMPLETE	as specified in specific message contents
6	MS -> SS	SETUP	
7	SS -> MS	AUTHENTICATION REQUEST	
8	MS -> SS	AUTHENTICATION RESPONSE	agreeing bearer capabilities for dual mode call TCH
9	SS -> MS	CALL PROCEEDING	
10	SS -> MS	ASSIGNMENT COMMAND	
11	MS -> SS	ASSIGNMENT COMPLETE	
12	SS -> SS	ALERTING	MMI action to change the mode with a mode that does not correspond to the requested one
13	SS -> MS	CONNECT	
14	MS -> SS	CONNECT ACKNOWLEDGE	
15	MS -> SS	MODIFY	
16	SS -> MS	MODIFY COMPLETE	
17	SS -> MS	STATUS ENQUIRY	cause 30#, state U26
18	MS -> SS	STATUS	

Specific message contents:

As specified in 26.8.1.4.5.10.

26.8.1.4.5.4 In-call functions / MS originated in-call modification / an abnormal case of rejection

26.8.1.4.5.4.1 Definition and applicability

This is to test a special case of a in-call modification procedure, in which the in-call modification is rejected incorrectly. This test is applicable for any equipment supporting any dual mode bearer capability service (BS61 - Alternate Speech/Data, BS81 - Speech followed by Data, Teleservice 61 - Alternate Speech/Group 3 fax).

26.8.1.4.5.4.2 Conformance requirement

- 1) Upon receipt of the MODIFY REJECT message indicating a call mode which does not correspond to the actual one the MS shall discard it and take no action.

References

GSM 04.08, section 5.3.4.4.

26.8.1.4.5.4.3 Test purpose

To verify that upon receipt of the MODIFY REJECT message indicating a call mode which does not correspond to the actual one the MS discards it and takes no action.

26.8.1.4.5.4.4 Method of test

Related PICS/PIXIT statements

- supported teleservices;
- support of dual bearer capability services.

Initial conditions

System Simulator:
1 cell, default parameters.

Mobile Station:
The MS is in MM-state "idle, updated" with valid TMSI and CKSN.

Foreseen final state of the MS

CC-state U26 "Mobile Originating Modify".

Maximum duration of test

10 s.

Test procedure

The MS initiates a call for one of the supported dual mode services. The MS being in the call active state, in-call modification procedure is initiated for the selected service from the MS side. The MS shall send a MODIFY message with new mode to the SS. The SS returns a MODIFY REJECT message specifying a mode that does not correspond to the actual one. The state of the MS is then checked.

Expected sequence

Step	Direction	Message	Comments
1	MS -> SS	CHANNEL REQUEST	MMI action to initiate a dual mode call SDCCH
2	SS -> MS	IMMEDIATE ASSIGNMENT	
3	MS -> SS	CM SERVICE REQUEST	
4	SS -> MS	CIPHERING MODE COMMAND	
5	MS -> SS	CIPHERING MODE COMPLETE	as specified in specific message contents
6	MS -> SS	SETUP	
7	SS -> MS	AUTHENTICATION REQUEST	
8	MS -> SS	AUTHENTICATION RESPONSE	agreeing bearer capabilities for dual mode call TCH
9	SS -> MS	CALL PROCEEDING	
10	SS -> MS	ASSIGNMENT COMMAND	MMI action to change the mode with a mode that does not correspond to the actual one
11	MS -> SS	ASSIGNMENT COMPLETE	
12	SS -> SS	ALERTING	cause 30#, state U26
13	SS -> MS	CONNECT	
14	MS -> SS	CONNECT ACKNOWLEDGE	
15	MS -> SS	MODIFY	
16	SS -> MS	MODIFY REJECT	
17	SS -> MS	STATUS ENQUIRY	
18	MS -> SS	STATUS	

Specific message contents:

As specified in 26.8.1.4.5.10.

26.8.1.4.5.5 In-call functions / MS originated in-call modification / time-out of timer T323

26.8.1.4.5.5.1 Definition and applicability

This is to test a special case of a in-call modification procedure, in which timer T323 expires in state U26, mobile originating modify. This test is applicable for any equipment supporting any dual mode bearer capability service (BS61 - Alternate Speech/Data, BS81 - Speech followed by Data, Teleservice 61 - Alternate Speech/Group 3 fax).

26.8.1.4.5.5.2 Conformance requirement

- 1) Upon expiration of T323 the MS shall initiate the procedures for call clearing with cause #102 "recovery on timer expiry".

References

GSM 04.08, section 5.3.4.3.4.3.

26.8.1.4.5.5.3 Test purpose

To verify that upon expiration of T323 (accuracy +/- 10 %) the MS shall initiate the procedures for call clearing with cause #102 "recovery on timer expiry".

26.8.1.4.5.5.4 Method of test

Related PICS/PIXIT statements

- supported circuit switched basic services;
- support of dual bearer capability services.

Initial conditions

System Simulator:

1 cell, default parameters.

Mobile Station:

The MS is in MM-state "idle, updated" with valid TMSI and CKSN.

Foreseen final state of the MS

CC-state U11 "disconnect request".

Maximum duration of test

1 minute.

Test procedure

The MS initiates a call for one of the supported dual mode services. The MS being in the call active state, in-call modification procedure is initiated for the selected service from the MS side. The MS shall send a MODIFY message with new mode to the SS. The SS does not respond until timer T323 expires at the MS. The MS is expected to respond with a DISCONNECT message. The SS checks timer T323 accuracy between emission of MODIFY and reception of DISCONNECT messages, the state of the MS and a cause value from the DISCONNECT message.

Expected sequence

Step	Direction	Message	Comments
1	MS -> SS	CHANNEL REQUEST	MMI action to initiate a dual mode call SDCCH
2	SS -> MS	IMMEDIATE ASSIGNMENT	
3	MS -> SS	CM SERVICE REQUEST	as specified in specific message contents
4	SS -> MS	CIPHERING MODE COMMAND	
5	MS -> SS	CIPHERING MODE COMPLETE	
6	MS -> SS	SETUP	
7	SS -> MS	AUTHENTICATION REQUEST	
8	MS -> SS	AUTHENTICATION RESPONSE	agreeing bearer capabilities for dual mode call TCH
9	SS -> MS	CALL PROCEEDING	
10	SS -> MS	ASSIGNMENT COMMAND	
11	MS -> SS	ASSIGNMENT COMPLETE	MMI action to change the mode the SS waits for the timer T323 expiry cause value #102, the SS checks timer T323 accuracy (+/- 10 %) between MODIFY and DISCONNECT messages
12	SS -> MS	ALERTING	
13	SS -> MS	CONNECT	
14	MS -> SS	CONNECT ACKNOWLEDGE	
15	MS -> SS	MODIFY	
16	SS		
17	MS -> SS	DISCONNECT	
18	SS -> MS	STATUS ENQUIRY	cause 30#, state U11
19	MS -> SS	STATUS	

Specific message contents:

As specified in 26.8.1.4.5.10.

26.8.1.4.5.6 In-call functions / MS originated in-call modification / a successful channel change in state mobile originating modify

26.8.1.4.5.6.1 Definition and applicability

This is to test a special case of a in-call modification procedure, in which a change of a physical channel occurs in state U26, mobile originating modify. This test is applicable for any equipment supporting any dual mode bearer capability service (BS61 - Alternate Speech/Data, BS81 - Speech followed by Data, Teleservice 61 - Alternate Speech/Group 3 fax).

26.8.1.4.5.6.2 Conformance requirement

- 1) A CC-entity of the MS in CC-state U26, "Mobile Originating Modify", after successful completion of a channel assignment procedure or channel mode modify procedure shall remain in the call state U26.
- 2) Upon receipt of the MODIFY COMPLETE message the MS shall start sending channel information according to the new call mode and enter the "active" state.

References

- 1) GSM 04.08, section 5.3.4.3.2, GSM 04.08, section 3.4.6.
- 2) GSM 04.08, section 5.3.4.3.2.

26.8.1.4.5.6.3 Test purpose

- 1) To verify that a CC-entity of the MS in CC-state U26, "Mobile Originating Modify", after successful completion of a channel assignment procedure remains in the call state U26.

- 2) To verify that upon receipt of the MODIFY COMPLETE message the MS starts sending channel information according to the new call mode and enters the "active" state.

26.8.1.4.5.6.4 Method of test

Related PICS/PIXIT statements

- supported circuit switched basic services;
- support of dual bearer capability services.

Initial conditions

System Simulator:

1 cell, default parameters.

Mobile Station:

The MS is in MM-state "idle, updated" with valid TMSI and CKSN.

Foreseen final state of the MS

CC-state U10, active.

Maximum duration of test

10 s.

Test procedure

The MS initiates a call for one of the supported dual mode services. The MS being in the call active state, in-call modification procedure is initiated for the selected service from the MS side. The MS shall send a MODIFY message with a new mode to the SS. The SS does not respond immediately, but performs channel assignment procedure including the appropriate channel mode for the new service. The state of the MS is then checked. The SS then returns a MODIFY COMPLETE message. The state of the MS is checked finally.

Expected sequence

Step	Direction	Message	Comments
1	MS -> SS	CHANNEL REQUEST	MMI action to initiate a dual mode call
2	SS -> MS	IMMEDIATE ASSIGNMENT	SDCCH
3	MS -> SS	CM SERVICE REQUEST	
4	SS -> MS	CIPHERING MODE COMMAND	
5	MS -> SS	CIPHERING MODE COMPLETE	
6	MS -> SS	SETUP	as specified in specific message contents
7	SS -> MS	AUTHENTICATION REQUEST	
8	MS -> SS	AUTHENTICATION RESPONSE	
9	SS -> MS	CALL PROCEEDING	agreeing bearer capabilities for dual mode call
10	SS -> MS	ASSIGNMENT COMMAND	TCH
11	MS -> SS	ASSIGNMENT COMPLETE	
12	SS -> MS	ALERTING	
13	SS -> MS	CONNECT	
14	MS -> SS	CONNECT ACKNOWLEDGE	
15	MS -> SS	MODIFY	MMI action to change the mode
16	SS -> MS	ASSIGNMENT COMMAND	channel mode implied by the MODIFY message
17	MS -> SS	ASSIGNMENT COMPLETE	
18	SS -> MS	STATUS ENQUIRY	
19	MS -> SS	STATUS	cause 30#, state U26
20	SS -> MS	MODIFY COMPLETE	
21	SS -> MS	STATUS ENQUIRY	
22	MS -> SS	STATUS	cause 30#, state U10

Specific message contents:

As specified in 26.8.1.4.5.10.

26.8.1.4.5.7 In-call functions / MS originated in-call modification / an unsuccessful channel change in state mobile originating modify

26.8.1.4.5.7.1 Definition and applicability

This is to test a special case of a in-call modification procedure, in which an unsuccessful change of a physical channel occurs in state U26, mobile originating modify. This test is applicable for any equipment supporting any dual mode bearer capability service (BS61 - Alternate Speech/Data, BS81 - Speech followed by Data, Teleservice 61 - Alternate Speech/Group 3 fax).

26.8.1.4.5.7.2 Conformance requirement

- 1) A CC-entity of the MS in CC-state U26, "Mobile Originating Modify", when returning to the old channel after handover failure and having established the link, shall remain in the call state U26.

References

GSM 04.08, section 5.3.4.3.2.

26.8.1.4.5.7.3 Test purpose

To verify that a CC-entity of the MS in CC-state U26, "Mobile Originating Modify", when returning to the old channel after handover failure and having established the link, remains in the call state U26.

26.8.1.4.5.7.4 Method of test**Related PICS/PIXIT statements**

- supported teleservices;
- support of dual bearer capability services.

Initial conditions

System Simulator:

1 cell, default parameters.

Mobile Station:

The MS is in MM-state "idle, updated" with valid TMSI and CKSN.

Foreseen final state of the MS

CC-state U26, mobile originating modify.

Maximum duration of test

10 s.

Test procedure

The MS initiates a call for one of the supported dual mode services. The MS being in the call active state, in-call modification procedure is initiated for the selected service from the MS side. The MS shall send a MODIFY message with a new mode to the SS. The SS initiates handover procedure. When the MS tries to establish the main signalling link, it is prohibited by the SS. Then the MS shall return back to the old channel and re-establish correctly the link. The state of the MS is then checked.

Expected sequence

Step	Direction	Message	Comments
1	MS -> SS	CHANNEL REQUEST	MMI action to initiate a dual mode call SDCCH
2	SS -> MS	IMMEDIATE ASSIGNMENT	
3	MS -> SS	CM SERVICE REQUEST	as specified in specific message contents
4	SS -> MS	CIPHERING MODE COMMAND	
5	MS -> SS	CIPHERING MODE COMPLETE	
6	MS -> SS	SETUP	
7	SS -> MS	AUTHENTICATION REQUEST	
8	MS -> SS	AUTHENTICATION RESPONSE	agreeing bearer capabilities for dual mode call TCH
9	SS -> MS	CALL PROCEEDING	
10	SS -> MS	ASSIGNMENT COMMAND	
11	MS -> SS	ASSIGNMENT COMPLETE	MMI action to change the mode
12	SS -> SS	ALERTING	
13	SS -> MS	CONNECT	
14	MS -> SS	CONNECT ACKNOWLEDGE	
15	MS -> SS	MODIFY	
16	SS -> MS	HANDOVER COMMAND	
17	MS -> SS	HANDOVER ACCESS	
18	MS -> SS	HANDOVER FAILURE	
19	SS -> MS	STATUS ENQUIRY	the SS does not respond after the MS has re-established the main signalling link in the old channel cause 30#, state U26
20	MS -> SS	STATUS	

Specific message contents:

As specified in 26.8.1.4.5.10.

26.8.1.4.5.8 In-call functions / MS originated in-call modification / unknown message received

26.8.1.4.5.8.1 Definition and applicability

This is to test a special case of a in-call modification procedure, in which an unknown message is received in state U26, mobile originating modify. This test is applicable for any equipment supporting any dual mode bearer capability service (BS61 - Alternate Speech/Data, BS81 - Speech followed by Data, Teleservice 61 - Alternate Speech/Group 3 fax).

26.8.1.4.5.8.2 Conformance requirement

A CC entity of a MS in CC-state U26, "Mobile Originating Modify", having received an unknown message from its peer entity shall return a STATUS message.

References

GSM 04.08, section 8.4.

26.8.1.4.5.8.3 Test purpose

To verify that a CC entity of a MS in CC-state U26, "Mobile Originating Modify", having received an unknown message from its peer entity returns a STATUS message.

26.8.1.4.5.8.4 Method of test

Related PICS/PIXIT statements

- supported teleservices;
- support of dual bearer capability services.

Initial conditions

System Simulator:
1 cell, default parameters.

Mobile Station:
The MS is in MM-state "idle, updated" with valid TMSI and CKSN.

Foreseen final state of the MS

CC-state U26, mobile originating modify.

Maximum duration of test

10 s.

Test procedure

The MS initiates a call for one of the supported dual mode services. The MS being in the call active state, in-call modification procedure is initiated for the selected service from the MS side. The MS shall send a MODIFY message with a new mode to the SS. The SS sends a message with message type not defined for the protocol discriminator. The state of the MS is then checked.

Expected sequence

Step	Direction	Message	Comments
1	MS -> SS	CHANNEL REQUEST	MMI action to initiate a dual mode call SDCCH
2	SS -> MS	IMMEDIATE ASSIGNMENT	
3	MS -> SS	CM SERVICE REQUEST	as specified in specific message contents
4	SS -> MS	CIPHERING MODE COMMAND	
5	MS -> SS	CIPHERING MODE COMPLETE	
6	MS -> SS	SETUP	
7	SS -> MS	AUTHENTICATION REQUEST	
8	MS -> SS	AUTHENTICATION RESPONSE	agreeing bearer capabilities for dual mode call TCH
9	SS -> MS	CALL PROCEEDING	
10	SS -> MS	ASSIGNMENT COMMAND	MMI action to change the mode message type not defined for PD cause 30#, state U26
11	MS -> SS	ASSIGNMENT COMPLETE	
12	SS -> SS	ALERTING	
13	SS -> MS	CONNECT	
14	MS -> SS	CONNECT ACKNOWLEDGE	
15	MS -> SS	MODIFY	
16	SS -> MS	unknown message	
17	MS -> SS	STATUS	

Specific message contents:

As specified in 26.8.1.4.5.10.

26.8.1.4.5.9 In-call functions / MS originated in-call modification / a release complete received

26.8.1.4.5.9.1 Definition and applicability

The call control entity of the MS being in the state, U26, the call is cleared by a RELEASE COMPLETE message sent by the SS. This test is applicable for any equipment supporting any dual mode bearer capability service (BS61 - Alternate Speech / Data, BS81 - Speech followed by Data, Teleservice 61 - Alternate Speech / Group 3 fax).

26.8.1.4.5.9.2 Conformance requirement

- 1) A CC entity of the MS in CC-state U26, "mobile originating modify", upon receipt of a RELEASE COMPLETE message with valid cause value, shall enter CC state U0, "Null".
- 2) On returning to idle mode, the CC entities relating to the seven mobile originating transaction identifiers shall be in state U0, "Null".

Reference(s)

Conformance requirement 1: GSM 04.08 section 5.4.2, GSM 04.08 section 5.4.4.

Conformance requirement 2: GSM 04.08 section 5.4.4.3.

26.8.1.4.5.9.3 Test purpose

- 1) To verify that a CC entity of the MS in CC-state U26, "mobile originating modify", upon receipt of a RELEASE COMPLETE message with valid cause value, enters CC state U0, "Null".
- 2) To verify that on returning to idle mode, the CC entities relating to the seven mobile originating transaction identifiers are in state U0, "Null".

26.8.1.4.5.9.4 **Method of test**

Related PICS/PIXIT statements

- a way to activate a dual mode call;
- a way to activate in-call modification;
- support of dual bearer capability services.

Initial conditions

System Simulator:

1 cell, default parameters.

Mobile Station:

The MS is in MM-state "idle, updated" with valid TMSI and CKSN.

Foreseen final state of the MS

The MS is in MM-state "idle, updated" with valid TMSI and CKSN.

Maximum duration of test

30 seconds.

Test Procedure

The MS initiates a call for one of the supported dual mode services. The MS being in the call active state, in-call modification procedure is initiated for the selected service from the MS side. The MS shall send a MODIFY message with the new mode to the SS and the state of the MS is checked. The SS sends a RELEASE COMPLETE message to the MS. The SS checks by using the status enquiry procedure that the CC entity has entered the state U0 with all the relevant transaction identifiers.

NOTE: ICM can be initiated by manual intervention at the MS.

Expected sequence

Step	Direction	Message	Comments
1	MS		The MS is made to initiate a dual mode call
2	MS -> SS	CHANNEL REQUEST	
3	SS -> MS	IMMEDIATE ASSIGNMENT	SDCCH
4	MS -> SS	CM SERVICE REQUEST	
5	SS -> MS	CIPHERING MODE COMMAND	
6	MS -> SS	CIPHERING MODE COMPLETE	
7	MS -> SS	SETUP	as specified in specific message contents
8	SS -> MS	AUTHENTICATION REQUEST	
9	MS -> SS	AUTHENTICATION RESPONSE	
10	SS -> MS	CALL PROCEEDING	as specified in specific message contents
11	SS -> MS	ASSIGNMENT COMMAND	channel mode: see section 10.4
12	MS -> SS	ASSIGNMENT COMPLETE	
13	SS -> MS	ALERTING	
14	SS -> MS	CONNECT	
15	MS -> SS	CONNECT ACKNOWLEDGE	
16	MS -> SS	MODIFY	as specified in specific message contents
17	SS -> MS	STATUS ENQUIRY	
18	MS -> SS	STATUS	cause #30, state U26
19	SS -> MS	RELEASE COMPLETE	
20	SS -> MS	STATUS ENQUIRY	
21	MS -> SS	RELEASE COMPLETE	cause #81 (invalid TI value)
22	SS		repeat steps 20 - 21 to cover all the transaction identifiers from 000 ... 110
23	SS -> MS	CHANNEL RELEASE	the main signalling link shall be released by the MS (L2: DISC/UA)

Specific message contents:

As specified in 26.8.1.4.5.10.

26.8.1.4.5.10 In-call functions/MS originated in-call modification/contents of some of the messages

The following messages are used for testing in-call modification procedures, test cases 26.8.1.4.5.*, as default messages for those ones defined below. If any other values are defined in the expected sequence of the actual test cases, those values take precedence over the ones defined hereafter.

SETUP (MS to SS)

Information element	Value/remark
BC Repeat indicator	Sequential, if BS81 is being tested, otherwise circular for successive selection
Repeat indication	
Bearer capability 1	Appropriate for the teleservice/Bearer Service selected as an initial call mode
Bearer capability 2	Appropriate for the teleservice/Bearer Service to be selected as a new call mode
Facility	Omitted
Calling party subaddress	Omitted
Called party BCD number	As entered
Called party subaddress	Omitted
LLC repeat indicator	The same repeat indication as the one for BC. Present if and only if LLC I and LLC II are present
Low layer compatibility I	See note 1
Low layer compatibility II	See note 1
HLC repeat indicator	The same repeat indication as the one for BC. Present if and only if HLC i and HLC ii are present.
High layer compatibility i	See note
High layer compatibility ii	See note
User-user	Omitted
SS version	Omitted
CLIR suppression	Omitted
CC Capabilities	present, but contents not checked

NOTE 1: HLC/LLC may or may not be present. The contents of HLC/LLC are not verified. If LLC I is present then LLC II shall be present. If HLC i is present then HLC ii shall be present.

CALL PROCEEDING

If the MS offers a choice in a SETUP message with respect to its bearer capabilities (this choice is restricted to the connection element), the bearer capabilities 1 and 2 and BC repeat indicator must all be present in this message. Otherwise, all three IEs are omitted.

Information element	Value/remark
Repeat Indicator	See above
Repeat indication	As received in the SETUP message
Bearer Capability 1	Same as in section 10.4
Bearer Capability 2	Same as in section 10.4
Facility	Omitted
Progress indicator	Omitted

MODIFY

Information element	Value/remark
Bearer capability	If the bearer capability IEs were present in the CALL PROCEEDING message, then as it was specified in the bearer capability 2 of the CALL PROCEEDING message. Otherwise as in the bearer capability 2 of the SETUP message.
Reverse Call Setup Direction	Presence and value not checked
Low layer compatibility	See note 2
High layer compatibility	See note 2

NOTE 2: HLC (LLC) shall be included if the HLC (LLC) was included in the SETUP message. The contents of LLC/HLC are not verified.

MODIFY COMPLETE

Information element	Value/remark
Bearer capability	If the bearer capability IEs were present in the CALL PROCEEDING message, then as it was specified in the bearer capability 2 of the CALL PROCEEDING message. Otherwise as in the bearer capability 2 of the SETUP message. Same as in MODIFY See note 3 See note 3
Reverse Call Setup Direction	
Low layer compatibility	
High layer compatibility	

NOTE 3: HLC (LLC) shall be included if the HLC (LLC) was included in the SETUP message. The contents of LLC/HLC are not verified.

MODIFY REJECT

Information element	Value/remark
Bearer capability	If the bearer capability IEs were present in the CALL PROCEEDING message, then as it was specified in the bearer capability 1 of the CALL PROCEEDING message. Otherwise as in the bearer capability 1 of the SETUP message. #58 "bearer capability not presently available". See note 4 See note 4
Cause	
Low layer compatibility	
High layer compatibility	

NOTE 4: HLC (LLC) shall be included if the HLC (LLC) was included in the SETUP message. The contents of LLC/HLC are not verified.

CHANNEL MODE MODIFY

Information element	Value/remark
Channel description	describes non-hopping Bm+ACCHs or Lm+ACCHs as appropriate for the test appropriate for the BC in the MODIFY
Channel Mode	

CHANNEL MODE MODIFY ACKNOWLEDGE

Information element	Value/remark
Channel description	as sent by the SS in the corresponding CHANNEL MODE MODIFY message as sent by the SS in the corresponding CHANNEL MODE MODIFY message
Channel mode	

26.8.2 Call Re-establishment**26.8.2.1 Call Re-establishment/call present, re-establishment allowed****26.8.2.1.1 Definition and applicability**

This is to test a successful case of a call re-establishment procedure. This test is applicable for any equipment supporting at least one bearer capability. If the MS does not perform call re-establishment procedure correctly, the network will waste resources.

26.8.2.1.2 Conformance requirement

- 1) If the call is in the "active" state or "mobile originating modify" state, the indication from MM that re-establishment is possible shall cause call control to request re-establishment from the MM-connection, suspend any further message to be sent and await the completion of the re-establishment procedure.
- 2) When the call control entity is notified that the MM-connection is re-established, it shall then resume the transmission of possibly suspended messages and resume user data exchange when an appropriate channel is available.

References

- 1) GSM 04.08, subclauses 4.5.1.6 and 5.5.4.2.
- 2) GSM 04.08, subclauses 4.5.1.6 and 5.5.4.3.

26.8.2.1.3 Test purpose

The purpose of this test is to verify that the MS can correctly perform a call re-establishment procedure.

26.8.2.1.4 Method of test**Related PICS/PIXIT statements**

- supported teleservices.

Initial conditions

System Simulator:

The SS simulates cells A and B. The LAC of cell A is different from the LAC of cell B. The PLMN identities of cell A and B are equal.

The call re-establishment parameter concerning cell A is set to an arbitrary value.

Cell B is not barred, the RACH control parameters information element sent in SYSTEM INFORMATION TYPE 1 to 4 messages of cell A and B specifies "call reestablishment allowed in the cell", the NCC of cell B is indicated as permitted in the PLMN permitted information element of SYSTEM INFORMATION TYPE 2 and 6 messages of cell A. Cell B is indicated as a neighbour cell of cell A in SYSTEM INFORMATION TYPE 2 and 5 messages of cell A. Cell reselect hysteresis parameter of cell A is set to zero.

Mobile Station:

The MS is in MM-state "idle, updated" with valid TMSI and CKSN on cell A.

Foreseen final state of the MS

The MS is in MM-state "idle, updated" with valid TMSI and CKSN.

Maximum duration of test

1 minute.

Test procedure

The MS is brought to active state by using procedure 26.9.2, "structured procedures, MS originated call, early assignment". The RF level of cell A is lowered so that cell B is to be selected (when the MS performs re-establishment after radio link failure), while keeping the C1 and C2 of cell A greater than zero. SS waits for at least 5 seconds. Then the SS stops transmission on the TCH/SACCH. The MS shall re-establish the call on cell B using a CM RE-ESTABLISHMENT message. The SS performs ciphering mode setting and assignment procedures. The MS shall through-connect the appropriate bearer channel. Then, the call is cleared by the SS.

Expected sequence

Step	Direction	Message	Comments
1			Steps 1-19 of test case 26.9.2 are performed (the appropriate bearer channel is through connected in both directions in TCH)
2	SS		The RF level of cell A is lowered. The SS waits at least 5 seconds. The SS stops transmission on the TCH/SACCH.
3	MS -> SS	CHANNEL REQUEST	this is sent on cell B. Establ. cause shall be "call re-establishment; TCH/F was in use,..."
4	SS -> MS	IMMEDIATE ASSIGNMENT	
5	MS -> SS	CM REESTABLISHMENT REQUEST	note specific message contents
6	SS -> MS	CIPHERING MODE COMMAND	SS starts deciphering after sending the message.
7	MS -> SS	CIPHERING MODE COMPLETE	Shall be sent enciphered. All following messages shall be sent enciphered.
8	SS		SS starts ciphering.
9	SS -> MS	ASSIGNMENT COMMAND	
10	MS -> SS	ASSIGNMENT COMPLETE	
11	MS		The appropriate bearer channel is through connected in both directions.
12	SS -> MS	DISCONNECT	with cause value "Normal"
13	MS -> SS	RELEASE	
14	SS -> MS	RELEASE COMPLETE	
15	SS -> MS	CHANNEL RELEASE	The main signalling link is released.

Specific message contents:**CM RE-ESTABLISHMENT REQUEST**

Information element	Value/remark
Protocol discriminator	Mobility Management
Skip indicator	Encoded as zeroes
Message type	CM RE-ESTABLISHMENT REQUEST
Ciphering key sequence number	The CKSN which the MS was allocated in step 6 of the procedure of section 26.9.2.
Spare half octet	zero
Mobile station classmark 2	as declared in the PICS/PIXIT
Mobile identity	The TMSI that the MS is having initially
Location area identification	Corresponding the LAI of cell A

26.8.2.2 Call Re-establishment/call present, re-establishment not allowed**26.8.2.2.1 Definition and applicability**

This is to test a special case of a call re-establishment, in which it is not allowed for a MS to attempt re-establishment of a call. This test is applicable for any equipment supporting at least one mobile originated circuit switched basic service.

26.8.2.2.2 Conformance requirement

When a lower layer failure occurs while an MM-connection is active, if a cell allowing call re-establishment is not available, the MS shall release the MM-connection and shall not attempt call re-establishment.

References

GSM 04.08, subclauses 4.5.1.6 and 5.5.4.

26.8.2.2.3 Test purpose

The purpose of this test is to verify that the MS does not attempt call re-establishment when it is not allowed to take place because of the unavailability of a cell allowing call re-establishment.

26.8.2.2.4 Method of test**Related PICS/PIXIT statements**

- supported MO circuit switched basic services.

Initial conditions

System Simulator:

The SS simulates cell A.

Cell A is not barred, the NCC of cell A is indicated as permitted in the PLMN permitted information element of SYSTEM INFORMATION TYPE 2 and 6 messages. The RE field of the RACH control parameters information element broadcast in messages SYSTEM INFORMATION TYPE 1, 2, 3 and 4 of cell A are set to "call reestablishment not allowed in the cell".

Mobile Station:

The MS is in MM-state "idle, updated" with valid TMSI and CKSN.

Foreseen final state of the MS

The MS is in MM-state "idle, updated" with valid TMSI and CKSN.

Maximum duration of test

1 minute.

Test procedure

The MS is brought to active state by using procedure 26.9.2, "structured procedures, MS originated call, early assignment". The SS stops transmission on the TCH/SACCH. The MS shall not require re-establishment of the call.

Expected sequence

Step	Direction	Message	Comments
1			Steps 1-19 of test case 26.9.2 are performed (the appropriate bearer channel is through connected in both directions in TCH)
2	SS 3	MS	the SS stops transmission on the TCH/SACCH the MS shall not attempt re-establishment on cell A. This is checked for 30 seconds after the radio link failure.

Specific message contents:

None.

26.8.2.3 Call Re-establishment/call under establishment, transmission stopped**26.8.2.3.1 Definition and applicability**

This is to test a special case of a call re-establishment, in which it is not allowed for a MS to attempt re-establishment of a call, since the call has not been established yet. This test is applicable for any equipment supporting at least one mobile originated circuit switched basic service.

26.8.2.3.2 Conformance requirement

When a lower layer failure occurs while an MM-connection is active, if the state of the call control entity is not "active", the MS shall release the MM-connection and shall not attempt call re-establishment.

References

GSM 04.08, subclauses 4.5.1.6 and 5.5.4.2.

26.8.2.3.3 Test purpose

The purpose of this test is to verify that the MS does not attempt call re-establishment when it is not allowed to take place because of the call control state.

26.8.2.3.4 Method of test

Related PICS/PIXIT statements

- supported MO circuit switched basic services.

Initial conditions

System Simulator:

The SS simulates cell A.

Cell A is not barred, the RACH control parameters information element sent in SYSTEM INFORMATION TYPE 1 to 4 messages of cell A specifies "call reestablishment allowed in the cell", the NCC of cell A is indicated as permitted in the PLMN permitted information element of SYSTEM INFORMATION TYPE 2 and 6 messages.

Mobile Station:

The MS is in MM-state "idle, updated" with valid TMSI and CKSN.

Foreseen final state of the MS

The MS is in MM-state "idle, updated" with valid TMSI and CKSN.

Maximum duration of test

1 minute.

Test procedure

The call control entity of the MS is brought to state U4, "call delivered" by using initial part of procedure 26.9.2, "structured procedures, MS originated call, early assignment". The SS stops transmission on the TCH/SACCH. The MS shall not require re-establishment of the call on cell A.

Expected sequence

Step	Direction	Message	Comments
1			the MS is made to initiate a call
2	MS -> SS	CHANNEL REQUEST	
3	SS -> MS	IMMEDIATE ASSIGNMENT	
4	MS -> SS	CM SERVICE REQUEST	
5	SS -> MS	AUTHENTICATION REQUEST	
6	MS -> SS	AUTHENTICATION RESPONSE	
7	SS -> MS	CIPHERING MODE COMMAND	SS starts deciphering after sending the message.
8	MS -> SS	CIPHERING MODE COMPLETE	All following messages shall be sent enciphered.
9	SS		SS starts ciphering.
10	MS -> SS	SETUP	
11	SS -> MS	CALL PROCEEDING	
12	SS -> MS	ASSIGNMENT COMMAND	
13	MS -> SS	ASSIGNMENT COMPLETE	
14	SS -> MS	ALERTING	
15	SS		the SS stops transmission on the TCH/SACCH
16	MS		the MS shall not attempt re-establishment on cell A. This is checked for 30 seconds after the radio link failure.

Specific message contents:

None.

26.8.3 User to user signalling

26.8.3.1 Definition and applicability

The "user to user" information element is used to convey information between the mobile user and a remote ISDN user. This test is therefore applicable for any equipment supporting at least one mobile terminating circuit switched basic service.

NOTE: There is no test for an MS originating call including a "user-user" information element since it is not a mandatory MS feature.

26.8.3.2 Conformance requirement

The inclusion of the "user-user" information element in downlink call control messages shall cause no adverse effects on the operation of the MS.

References

GSM 04.08 sections 5.2.2, 9.3.7, 9.3.23.1 and 10.5.4.25

26.8.3.3 Purpose of the test

The purpose of this test is to verify that inclusion of the "user-user" information element in either of the down link messages, SETUP or DISCONNECT causes no adverse effects on the operation of the MS.

26.8.3.4 Method of test

Related PICS/PIXIT statement(s)

Supported MT circuit switched basic services.
Support of user-user information element, and details of suitable codings.

Initial conditions.

System Simulator:

The SS simulates 1 cell, with default parameters.

Mobile Station:

The MS is in MM-state "idle updated", with a valid TMSI and CKSN.

Foreseen final state of the MS

The MS is in MM-state "idle updated", with a valid TMSI and CKSN.

Maximum duration of test

2 minutes.

Test procedure

The SS attempts to set up a mobile terminated call, with one of the supported circuit switched basic services which has been arbitrarily chosen, using one of the generic call set up procedures, (either speech or data) as specified in section 10. The default SETUP message contents are modified to include the user-user Information Element. The MS shall not respond adversely to the inclusion of the user-user information element.

After 30 seconds the SS sends a DISCONNECT message, again the MS shall not respond adversely to the inclusion of the user-user information element, but shall continue to clear down the call normally.

Expected sequence

Step	Direction	Message	Comments
1			Generic Call Setup procedure defined in sections in 10.1 or 10.3, depending on choice of Bearer Capability. The SETUP message in either case contains the user-user IE, see Specific message contents.
2			The SS waits 30 seconds.
3	SS -> MS	DISCONNECT	Message contains the user-user IE, see Specific message contents
4	MS -> SS	RELEASE	As defined in section 26.8.4
5	SS-> MS	RELEASE COMPLETE	As defined in section 26.8.4
6	SS-> MS	CHANNEL RELEASE	As defined in section 26.8.4

Specific message contents:**SETUP**

As default message contents as defined in the Generic Call setup procedures section 10.1 or 10.3 except:

Information Element	value/remark
Bearer Capability	Bearer capability arbitrarily chosen from those supported by the Mobile Station under test.
user-user	
- length	Length of user-user contents (note)
- PD	IA5 characters (note)
- user-user	The following string coded in IA5 characters: "Call Setup" (note)

DISCONNECT

As default message contents as defined in section 26.8.4, except:

Information Element	value/remark
user-user - length - PD - user-user	Length of user-user contents (note) IA5 characters (note) The following string coded in IA5 characters: "Call Disconnect" (note)

NOTE: The codings above are for example only. For the case of an MS which supports "user-user" signalling it may be necessary to add meaning to the data fields, see PICS/PIXIT statement(s).

26.8.4 Default contents of message**ALERTING (mobile station to network direction)**

No default requirements defined for this message.

ALERTING (network to mobile station direction)

Information element	Value/remark
Facility	Omitted
Progress indicator	Omitted
User-user	Omitted

ASSIGNMENT COMMAND

Information element	Value/remark
Description of the first channel	describes non-hopping Bm+ACCHs or Lm+ACCHs as appropriate for the test
Power Command	As in section 6.3
Frequency list	Omitted
Cell channel description	Omitted
Mode of the first channel	appropriate for the bearer capability chosen for the test
Description of the second channel	Omitted
Mode of the second channel	Omitted
Mobile allocation	Omitted
Starting time	Omitted
Cipher mode setting	Omitted

ASSIGNMENT COMPLETE

Information element	Value/remark
RR cause	not checked

AUTHENTICATION REQUEST

Information element	Value/remark
Ciphering key sequence number	Arbitrary excluding 111B
Spare half octet	(spare bits)
Authentication parameter RAND	Arbitrary

AUTHENTICATION RESPONSE

Information element	Value/remark
Authentication parameter SRES	not checked

CALL CONFIRMED

No default requirements defined for this message.

CALL PROCEEDING

Information element	Value/remark
Repeat Indicator	Omitted
Bearer Capability 1	Omitted if the SETUP message did not specify in the bearer capability 1 IE a connection element value "both, transparent preferred" or "both, non-transparent preferred". Otherwise included; in that case the connection element specifies the value that is appropriate for the selected basic service (either value "transparent" or value "non transparent (RLP)"), all other parameters are same as in the bearer capability 1 IE of the received SETUP message.
Bearer Capability 2	Omitted
Facility	Omitted
Progress indicator	Omitted

CHANNEL MODE MODIFY

Information element	Value/remark
Channel description	describes non-hopping Bm+ACCHs or Lm+ACCHs as appropriate for the test
Channel mode	appropriate for the bearer capability chosen for the test

CHANNEL MODE MODIFY ACKNOWLEDGE

Information element	Value/remark
Channel description	as sent by the SS in the corresponding CHANNEL MODE MODIFY message
Channel mode	as sent by the SS in the corresponding CHANNEL MODE MODIFY message

CHANNEL RELEASE

Information element	Value/remark
RR cause	Normal event

CHANNEL REQUEST

Information element	Value/remark
Establishment cause	If in response to paging, then "100"; if a mobile originating call, then "111"
Random reference	Arbitrary value of 5 bits length

CIPHERING MODE COMMAND

Information element	Value/remark
Cipher mode setting algorithm identifier SC	indicates a supported algorithm Start ciphering
Cipher response CR	IMEI must not be included

CIPHERING MODE COMPLETE

No default requirements defined for this message.

CM SERVICE ACCEPT

No default values defined for this message.

CM SERVICE REJECT

Information element	Value/remark
Reject cause	Service or option not available, unspecified

CM SERVICE REQUEST

No default requirements defined for this message.

CONNECT (network to mobile station direction)

Information element	Value/remark
Facility	Omitted
Progress indicator	Omitted
Connected number	Omitted
Connected subaddress	Omitted
User-user	Omitted

CONNECT (mobile station to network direction)

No default requirements defined for this message.

CONNECT ACKNOWLEDGE

No default requirements defined for this message.

DISCONNECT (network to mobile station direction)

Information element	Value/remark
Cause	
Coding standard	GSM
Location	User
Cause value	Normal clearing
Facility	Omitted
Progress indicator	Omitted
User-user	Omitted

DISCONNECT (mobile station to network direction)

Information element	Value/remark
Cause	Shall be present, contents not checked
Facility	Omitted
User-user	Omitted
SS version	Omitted

HANDOVER ACCESS

No default requirements defined for this message.

HANDOVER COMMAND

Information element	Value/remark
Cell Description	a BCCH frequency, which is one of the neighbour cells
Description of the first channel	describes non-hopping Bm+ACCHs or Lm+ACCHs as appropriate for the test
Handover Reference	an arbitrary value
Power Command	as in 6.3
Synchronization indication	Omitted
Frequency short list	Omitted
Frequency List	Omitted
Cell Channel Description	Omitted
Channel Mode	Omitted
Channel Description	Omitted
Channel Mode 2	Omitted
Frequency Channel Sequence	Omitted
Mobile Allocation	Omitted
Starting Time	Omitted
Real time difference	Omitted
Timing advance	Omitted
Cipher Mode setting	Omitted

HANDOVER FAILURE

No default requirements defined for this message.

IMMEDIATE ASSIGNMENT

Information element	Value/remark
Page mode	Normal paging
Channel description	describes a valid SDCCH+SACCH in non-hopping mode
Request reference	As received from MS
Random access information	Corresponding to frame number of the CHANNEL REQUEST
T1', T2, T3	
Timing advance	corresponding the timing difference between the MS and the SS
Mobile allocation	Empty (L=0)
Starting time	Omitted

MODIFY

No default values defined for this message.

MODIFY COMPLETE

No default requirements defined for this message.

MODIFY REJECT

No default values defined for this message.

NOTIFY (network to mobile station direction)

Information element	Value/remark
Notification indicator	one of the valid values chosen arbitrarily

PAGING REQUEST TYPE 1

Information element	Value/remark
L2 pseudo length	L2 pseudo length of the message
Page Mode	Normal Paging
Channels needed for Mobiles 1 and 2	
channel (first)	any channel
channel (second)	any channel
Mobile identity 1	TMSI of MS under test
Mobile identity 2	Omitted
P1 rest octets	(spare octets)

PAGING RESPONSE

No default requirements defined for this message.

PROGRESS

No default values defined for this message.

RELEASE (network to mobile station direction)

Information element	Value/remark
Cause	Omitted
Second cause	Omitted
Facility	Omitted
User-user	Omitted

RELEASE (mobile station to network direction)

No default requirements defined for this message.

RELEASE COMPLETE (network to mobile station direction)

Information element	Value/remark
Cause	Omitted
Facility	Omitted
User-user	Omitted

RELEASE COMPLETE (mobile station to network direction)

No default requirements defined for this message.

SETUP (mobile station to network direction)

Information element	Value/remark
BC Repeat indicator	Omitted
Bearer capability 1	Appropriate for the basic service selected for the test
Bearer capability 2	Omitted
Facility	Omitted
Calling party subaddress	Omitted
Called party BCD number	As entered
Called party subaddress	Omitted
LLC repeat indicator	Omitted
Low layer compatibility I	Appropriate for the basic service selected for the test
Low layer compatibility II	Omitted
HLC repeat indicator	Omitted
High layer compatibility i	Appropriate for the basic service selected for the test
High layer compatibility ii	Omitted
User-user	Omitted
SS version	Omitted
CLIR suppression	Omitted
CC Capabilities	present, shall indicate support for DTMF as per section 5.5.7 of GSM 04.08

SETUP (network to mobile station direction)

Information element	Value/remark
BC repeat indicator	Omitted
Bearer capability 1	Appropriate for the basic service selected for the test
Bearer capability 2	Omitted
Facility	Omitted
Progress indicator	Omitted
Signal	Any defined value as described for Signal IE in GSM 04.08
Calling party BCD number	Omitted
Calling party subaddress	Omitted
Called party BCD number	Omitted
Called party subaddress	Omitted
LLC repeat indicator	Omitted
Low layer compatibility I	Appropriate for the basic service selected for the test
Low layer compatibility II	Omitted
HLC repeat indicator	Omitted
High layer compatibility i	Appropriate for the basic service selected for the test
High layer compatibility ii	Omitted
User-user	Omitted

START DTMF

No default requirements defined for this message.

START DTMF ACKNOWLEDGE

Information element	Value/remark
Keypad facility	corresponding to the DTMF digit indicated in the START DTMF message

START DTMF REJECT

Information element	Value/remark
Cause	value "Resources unavailable, unspecified"

STATUS

Information element	Value/remark
Cause	Value "Response to STATUS ENQUIRY"
Call state	Specified separately in each test case
Auxiliary states	Omitted

STATUS ENQUIRY

No default values defined for this message, except that when this message is used to check that "all the transaction identifiers from 000 to 110" are in the null state, the TI flag shall take the value "1" in mobile originating call tests and shall take the value "0" in mobile terminating call tests.

STOP DTMF

No default requirements defined for this message.

STOP DTMF ACKNOWLEDGE

No default values defined for this message.

Unknown Message

Protocol Discriminator	Call Control; Call Related SS
Transaction Identifier	same as in use in the test
Message Type	0000 0100

26.9 Structured procedures

26.9.1 Structured procedures / general

The purpose of these tests is to verify that the MS performs certain elementary procedures of the RR, MM, and CC protocol correctly within a structured procedure. The term "structured procedure" is defined in GSM 04.08, section 7, where also examples of structured procedures are given.

The reason for this test purposes is twofold:

- The behaviour of the MS in an elementary procedure may depend on the preamble which precedes the elementary procedure.
- Structured procedures tested in this section are used in other parts of this Technical Specification as preambles to establish the initial conditions for other tests; correct behaviour of an implementation under test in a preamble is essential for the validity of a test.

Mobile originating and terminating calls are tested in cases of both early and late assignment of the traffic channel; in one of the cases call release initiated by the network is tested, in another one, call release initiated by the MS. The tests in this section only cover the successful outcome of elementary procedures (i.e. they do not deal with abnormal cases).

In this section, the emergency call service is tested for mobile stations that do not support the full rate speech version 2 in the following cases:

- emergency call initiated in the idle, updated state with authentication and ciphering, for speech full rate version 1 and if supported, speech half rate version 1;
- emergency call initiated in the idle, no IMSI state (hence without authentication and without ciphering), the network accepting the call, for either speech full rate version 1 or, provided it is supported, speech half rate version 1;
- emergency call initiated in the idle, no IMSI state (hence without authentication and without ciphering), the network rejecting the call, for either speech full rate version 1 or, provided it is supported, speech half rate version 1.

These tests on emergency calls are only applicable to an MS supporting speech.

For an MS supporting speech the test procedures in 26.9.2, 26.9.3, 26.9.4 and 26.9.5 are performed for speech (teleservice 11, telephony), once for speech full rate version 1 and, if supported, once for speech half rate version 1.

For an MS not supporting speech but supporting at least one teleservice, for each of the test procedures in 26.9.2, 26.9.3, 26.9.4, and 26.9.5 and each supported rate (full rate/half rate) a teleservice supported by the MS (see PICS/PIXIT statement) is chosen, and the test is performed corresponding to that teleservice (note that this teleservice is never a dual service).

In cases where a mobile originated call for the tested teleservice can be initiated both

- via the MMI and
- via the R or S interface,

procedure 26.9.2 shall be performed when initiating the mobile originated call via the MMI and procedure 26.9.3 shall be performed when initiating the mobile originated call via an appropriate interface (R or S).

26.9.2 Structured procedures / MS originated call / early assignment

26.9.2.1 Conformance requirements

- 1) An MS in MM state "idle, updated" and in RR idle mode, when made to initiate a call, if it provides a human interface, shall display the dialled number.

- 2) An MS in MM state "idle, updated" and in RR idle mode, when made to initiate a call for a selected teleservice that is supported by the MS, shall start to initiate the immediate assignment procedure by sending a CHANNEL REQUEST message with correct establishment cause.
- 3) Subsequently after establishment of an MM connection, the MS shall send a SETUP message with correct parameters.
- 4) The call control entity of the Mobile Station in the "call initiated" state, in the "mobile originating call proceeding" state or in the "call delivered" state, shall, upon receipt of a CONNECT message:
 - attach the user connection to the radio path;
 - return a CONNECT ACKNOWLEDGE message.
- 5) Subsequently when the network initiates call clearing by sending a DISCONNECT message, the MS shall proceed to release the call by sending a RELEASE message.
- 6) On receipt of a CHANNEL RELEASE message, the MS shall disconnect the main signalling link.

References

- Conformance requirement 1: GSM 02.07.
 Conformance requirement 2: GSM 04.08 section 3.3.1.
 Conformance requirement 3: GSM 04.08 section 5.2.1.1.
 Conformance requirement 4: GSM 04.08 section 5.2.1.6.
 Conformance requirement 5: GSM 04.08 section 5.4.4.
 Conformance requirement 6: GSM 04.08, section 3.5.1.

26.9.2.2 Test purpose

- 1) To verify that the MS in MM state "idle, updated" with a TMSI assigned, when made to initiate a call for a selected teleservice that is supported by the MS as declared in a PICS/PIXIT statement, displays the dialled number in the way described in a PICS/PIXIT statement.
- 2) To verify that the MS in MM state "idle, updated" and in RR idle mode, with a TMSI assigned, when made to initiate a call for a selected teleservice that is supported by the MS as declared in a PICS/PIXIT statement, starts to initiate an immediate assignment procedure by sending the CHANNEL REQUEST message with correct establishment cause.
- 3) To verify that subsequently after receipt of an IMMEDIATE ASSIGNMENT message allocating an SDCCH, after completion of establishment of the main signalling link, after having sent a CM SERVICE REQUEST message, after having successfully performed the authentication and cipher mode setting procedures, the MS sends a SETUP message with correct parameters.
- 4) To verify that subsequently, after receipt of a CALL PROCEEDING message and of an ASSIGNMENT COMMAND message allocating an appropriate TCH, after having completed the traffic channel early assignment procedure by replying with the ASSIGNMENT COMPLETE message, after receipt of an ALERTING message and a CONNECT message, the MS returns a CONNECT ACKNOWLEDGE message.
- 5) To verify that subsequently the MS has attached the user connection to the radio path. (This is checked by verifying that there is a point in time after transmission of the first L2 frame containing the (complete) CONNECT message, where the MS is sending appropriate speech or data frames whenever it does not have to transmit or acknowledge an I frame on layer 2 of the FACCH.)
- 6) To verify that subsequently upon the network initiating call clearing by sending a DISCONNECT message, the MS proceed to release the call with RELEASE.
- 7) To verify that subsequently, on receipt of a RELEASE COMPLETE message followed by a CHANNEL RELEASE message, the MS disconnects the main signalling link.

These test purposes are tested for all rates supported by the MS (full rate/half rate).

26.9.2.3 Method of test

Related PICS/PIXIT Statements

- Supported rates (full rate/half rate).
- Supported speech versions (full rate version 1, full rate version 2, half rate version 1)
- Interface to the human user (p1 = Y/N).
- Way to display the called number (only applicable if the MS has an interface to the human user).
- Way to indicate alerting (only applicable if the MS supports the feature).
- SS version
- Supported teleservices.
- Classmark.

Initial Conditions

System Simulator:

1 cell, default parameters.

Mobile Station:

The MS is in MM-state "idle, updated" with valid TMSI and CKSN.

Foreseen Final State of the MS

The MS is in MM-state "idle, updated" with valid TMSI and CKSN.

Test procedure

The following test is performed for all rates (full rate/half rate) supported by the MS:

A teleservice is selected that is supported by the MS; if the MS supports speech, the selected teleservice is speech. If necessary, the MS is configured for that teleservice.

The MS is made to initiate a call. The call is established with early assignment. Having reached the active state, the call is cleared by the SS.

Maximum Duration of Test

1 minute.

Expected Sequence

Step	Direction	Message	Comments
1	MS		The "called number" is entered.
2	MS		If p1 = Y, the MS must display the called number in the way defined in PICS/PIXIT.
3	MS -> SS	CHANNEL REQUEST	Establishment cause is "originating call and the network does not set the NECI bit to 1".
4	SS -> MS	IMMEDIATE ASSIGNMENT	
5	MS -> SS	CM SERVICE REQUEST	Message is contained in SABM.
6	SS -> MS	AUTHENTICATION REQUEST	
7	MS -> SS	AUTHENTICATION RESPONSE	SRES specifies correct value.
8	SS -> MS	CIPHERING MODE COMMAND	SS starts deciphering after sending the message.
9	MS -> SS	CIPHERING MODE COMPLETE	Shall be sent enciphered. All following messages shall be sent enciphered.
10	SS		SS starts ciphering.
11	MS -> SS	SETUP	
12	SS -> MS	CALL PROCEEDING	
13	SS -> MS	ASSIGNMENT COMMAND	
14	MS -> SS	ASSIGNMENT COMPLETE	
15	SS -> MS	ALERTING	
16	MS		Depending on the PICS, an alerting indication is given.
17	SS -> MS	CONNECT	
18	MS -> SS	CONNECT ACKNOWLEDGE	
19	MS		The appropriate bearer channel is through connected in both directions.
20	SS -> MS	DISCONNECT	
21	MS -> SS	RELEASE	
22	SS -> MS	RELEASE COMPLETE	
23	SS -> MS	CHANNEL RELEASE	The main signalling link is released.

Specific Message Contents:

None.

26.9.3 Structured procedures / MS originated call / late assignment

26.9.3.1 Conformance requirement

- 1) An MS in MM state "idle, updated" and in RR idle mode with a TMSI assigned, when made to initiate a call for a selected teleservice that is supported by the MS, shall start to initiate an immediate assignment procedure by sending the CHANNEL REQUEST message with correct establishment cause.
- 2) Upon receipt of the ASSIGNMENT COMMAND message, the Mobile Station initiates a local end release of link layer connections, disconnects the physical channels, commands the switching to the assigned channels and initiates the establishment of lower layer connections (this includes the activation of the channels, their connection and the establishment of the data links). After the main signalling link is successfully established, the MS returns an ASSIGNMENT COMPLETE message, specifying cause "normal event", to the network on the main DCCH.
- 3, 4) The call control entity of the Mobile Station in the "call initiated" state, in the "mobile originating call proceeding" state or in the "call delivered" state, shall, upon receipt of a CONNECT message:
 - attach the user connection to the radio path;
 - return a CONNECT ACKNOWLEDGE message.

References

- Conformance requirement 1: GSM 04.08 section 3.3.1.
Conformance requirement 2: GSM 04.08 sections 3.4.3.1 and 3.4.3.2.
Conformance requirement 3: GSM 04.08 section 5.2.1.6.

26.9.3.2 Test purpose

- 1) To verify that the MS in MM state "idle, updated" and in RR idle mode with a TMSI assigned, when made to initiate a call for a selected teleservice that is supported by the MS as declared in a PICS/PIXIT statement, starts to initiate an immediate assignment procedure by sending the CHANNEL REQUEST message.
- 2) To verify that subsequently after receipt of an IMMEDIATE ASSIGNMENT message allocating an SDCCH, after completion of establishment of the main signalling link, after having sent a CM SERVICE REQUEST message, after having successfully performed authentication and cipher mode setting procedures, after having sent a SETUP message, after having received a CALL PROCEEDING message followed by an ALERTING message and an ASSIGNMENT COMMAND message allocating an appropriate TCH, the MS sends an ASSIGNMENT COMPLETE message.
- 3) To verify that subsequently, after the suite of actions specified in test purposes 1 and 2, the MS after receiving a CONNECT message returns a CONNECT ACKNOWLEDGE message.
- 4) To verify that after the suite of actions specified in test purposes 1 and 2, the MS after receiving a CONNECT message attaches the user connection to the radio path. (This is checked by verifying that there is a point in time after transmission of the first L2 frame containing the (complete) CONNECT message, where the MS is sending appropriate speech or data frames whenever it does not have to transmit or acknowledge an I frame on layer 2 of the FACCH.)

These test purposes are tested for all rates supported by the MS (full rate/half rate).

26.9.3.3 Method of test

Related PICS/PIXIT statements

- Supported rates (full rate/half rate).
- Interface to the human user (p1 = Y/N).
- Way to display the called number (only applicable if the MS has an interface to the human user).
- Way to indicate alerting (only applicable if the MS supports the feature).
- Supported teleservices.
- Classmark.

Initial Conditions

System Simulator:
1 cell, default parameters.

Mobile Station:
The MS is in MM-state "idle, updated" with valid TMSI and CKSN.

Foreseen Final State of the MS

The MS has a MO call in state U10, "active".

Test procedure

The following test is performed for all rates (full rate/half rate) supported by the MS:

A teleservice is selected that is supported by the MS; if the MS supports speech, the selected teleservice is speech. If necessary, the MS is configured for that teleservice.

The MS is made to initiate a call. The call is established with late assignment.

Maximum Duration of Test

30 seconds.

Expected Sequence

Step	Direction	Message	Comments
1	MS		The "called number" is entered.
2	MS		
3	MS -> SS	CHANNEL REQUEST	Establishment cause is "originating call and the network does not set the NECI bit to 1".
4	SS -> MS	IMMEDIATE ASSIGNMENT	
5	MS -> SS	CM SERVICE REQUEST	Message is contained in SABM.
6	SS -> MS	AUTHENTICATION REQUEST	
7	MS -> SS	AUTHENTICATION RESPONSE	SRES specifies correct value.
8	SS -> MS	CIPHERING MODE COMMAND	SS starts deciphering after sending the message.
9	MS -> SS	CIPHERING MODE COMPLETE	Shall be sent enciphered. All following messages shall be sent enciphered.
10	SS		SS starts ciphering.
11	MS -> SS	SETUP	
12	SS -> MS	CALL PROCEEDING	
13	SS -> MS	ALERTING	
14	MS		Depending on the PICS, an alerting indication is given.
15	SS -> MS	ASSIGNMENT COMMAND	
16	MS -> SS	ASSIGNMENT COMPLETE	
17	SS -> MS	CONNECT	
18	MS -> SS	CONNECT ACKNOWLEDGE	
19	MS		The appropriate bearer channel is through connected in both directions.

Specific Message Contents:

None.

26.9.4 Structured procedures / MS terminated call / early assignment**26.9.4.1 Conformance requirements**

- 1) The MS shall acknowledge the SETUP message with a CALL CONFIRMED message, if compatibility checking was successful, the MS is not busy, and the user does not refuse the call.
- 2, 3) Upon receipt of the ASSIGNMENT COMMAND message the MS continues a mobile terminating call establishment with early establishment of the traffic channel
 - a) by replying to the ASSIGNMENT COMMAND with an ASSIGNMENT COMPLETE message, and
 - b) if the MS supports immediate connect, by continuing the call establishment by through-connecting the traffic channel in both directions, or if the MS does not support immediate connect, by sending an ALERTING message
- 4) An MS indicates acceptance of a MT call by sending CONNECT.
- 5) For speech calls:
The mobile station shall attach the user connection at latest when sending the connect message, except if there is no compatible radio resource available at this time. In this case the attachment shall be delayed until such a resource becomes available.

For data calls:

The mobile station shall attach the user connection when receiving the CONNECT ACKNOWLEDGE message from the network.

- 6) The MS initiates call clearing of an active call by sending a DISCONNECT message.
- 7) The MS in this phase of call release, upon receipt of a RELEASE message, shall return a RELEASE COMPLETE message.
- 8) Subsequently the MS, upon receipt of a CHANNEL RELEASE message, shall disconnect the main signalling link.

References

Conformance requirement 1:	GSM 04.08, section 5.2.2.3.1.
Conformance requirements 2, 3:	GSM 04.08, sections 5.2.2.3.2 and 3.4.3.1.
Conformance requirement 4:	GSM 04.08 section 5.2.2.5.
Conformance requirement 5:	GSM 04.08, sections 5.2.2.6 and 5.2.2.9.
Conformance requirements 6, 7, 8:	GSM 04.08, section 5.4.

26.9.4.2 Test purpose

- 1) To verify that the MS in MM state "idle, updated" and in RR idle mode with a TMSI assigned, after being paged by the network on the correct paging subchannel, after initiating the immediate assignment procedure by sending the CHANNEL REQUEST message, after receipt of an IMMEDIATE ASSIGNMENT message allocating an SDCCH, after having sent a PAGING RESPONSE message on the allocated SDCCH, after having performed successful authentication and cipher mode setting procedures, after receipt of a SETUP message not containing a signal information element, returns a CALL CONFIRMED message.
- 2) To verify that subsequently, the SS sending an ASSIGNMENT COMMAND message, the MS successfully continues a mobile terminating call establishment with early assignment of traffic channel:
 - a) by replying to the ASSIGNMENT COMMAND with an ASSIGNMENT COMPLETE message, and
 - b) by continuing the call establishment by either
 - sending a CONNECT messages and through connecting the TCH in both directions,
 - or
 - sending an ALERTING message.
- 3) To verify that if after sending a CALL PROCEEDING message, the MS sends an ALERTING message during MTC establishment with early assignment, it generates an alerting indication.
- 4) To verify that if an ALERTING had been sent, subsequently, when the user accepts the call (possibly internal action as declared in PICS/PIXIT statement), the MS returns a CONNECT message.
- 5) To verify that the MS:
 - if the call is a speech call: after sending the CONNECT message has through connected the TCH in both directions (this is checked by verifying that after transmission of the first L2 frame containing the (complete) CONNECT message, the MS is sending appropriate speech or data frames whenever it does not have to transmit or acknowledge an I frame on layer 2 of the FACCH.)
 - if the call is a data call: after receipt of a subsequent CONNECT ACKNOWLEDGE message through connects the TCH in both directions (this is checked by verifying that there is a point in time after transmission of the first L2 frame containing the (complete) CONNECT ACKNOWLEDGE message, where the MS is sending appropriate speech or data frames whenever it does not have to transmit or acknowledge an I frame on layer 2 of the FACCH.)
- 6) To verify that subsequently, the MS can initiate call clearing by sending a DISCONNECT message.

- 7) To verify that the MS in this phase of call release, upon receipt of a RELEASE message, returns a RELEASE COMPLETE message.
- 8) To verify that subsequently the MS, upon receipt of a CHANNEL RELEASE message, disconnects the main signalling link.

These test purposes are tested for all rates supported by the MS (full rate/half rate).

26.9.4.3 Method of test

Related PICS/PIXIT statements

- Supported rates (full rate/half rate).
- Supported speech versions (full rate version 1, full rate version 2, half rate version 1)
- Interface to the human user (p1 = Y/N).
- Way to display the called number (only applicable if the MS has an interface to the human user).
- Way to indicate alerting (only applicable if the MS supports the feature).
- Way to make the MS accept an incoming call after alerting (possibly dependent on teleservice and configuration).
- Supported teleservices.
- Classmark.
- Immediate connect supported (Y/N).

Initial Conditions

System Simulator:

1 cell, default parameters.

Mobile Station:

The MS is in MM-state "idle, updated" with valid TMSI and CKSN.

Foreseen Final State of the MS

The MS is in MM-state "idle, updated" with valid TMSI and CKSN.

Test procedure

The following test is performed for all rates (full rate/half rate) supported by the MS:

A teleservice is selected that is supported by the MS; if the MS supports speech, the selected teleservice is speech. If necessary, the MS is configured for that teleservice.

The MS is paged and the resulting call is established. Having reached the active state, the MS is made to clear the call.

Maximum Duration of Test

1 minute.

Expected Sequence

Step	Direction	Message	Comments
1	SS -> MS	PAGING REQUEST TYPE 1	Sent on the correct paging subchannel.
2	MS -> SS	CHANNEL REQUEST	
3	SS -> MS	IMMEDIATE ASSIGNMENT	
4	MS -> SS	PAGING RESPONSE	Message is contained in SABM.
5	SS -> MS	AUTHENTICATION REQUEST	
6	MS -> SS	AUTHENTICATION RESPONSE	SRES specifies correct value.
7	SS -> MS	CIPHERING MODE COMMAND	SS starts deciphering after sending the message.
8	MS -> SS	CIPHERING MODE COMPLETE	Shall be sent enciphered. All following messages shall be sent enciphered.
9	SS		SS starts ciphering.
10	SS -> MS	SETUP	Message does not contain the signal IE.
11	MS -> SS	CALL CONFIRMED	If the MS supports immediate connect then branch A applies. If the MS does not support immediate connect then branch B applies
A12	MS -> SS	CONNECT	sent on the old channel
A13	SS -> MS	ASSIGNMENT COMMAND	
A14	MS -> SS	ASSIGNMENT COMPLETE	
B12	SS -> MS	ASSIGNMENT COMMAND	sent on the new channel
B13	MS -> SS	ASSIGNMENT COMPLETE	
B14	MS -> SS	ALERTING	
B15	MS		An alerting indication as defined in a PICS/PIXIT statement is given by the MS
B16	MS		The MS is made to accept the call in the way described in a PICS/PIXIT statement
B17	MS -> SS	CONNECT	
18	MS		If the call is a speech call, the TCH shall be through connected in both directions.
19	SS -> MS	CONNECT ACKNOWLEDGE	
20	MS		If the call is a data call, the TCH shall be through connected in both directions.
21	MS		The MS is made to release the call.
22	MS -> SS	DISCONNECT	
23	SS -> MS	RELEASE	
24	MS -> SS	RELEASE COMPLETE	
25	SS -> MS	CHANNEL RELEASE	The main signalling link is released.

Specific Message Contents:

None.

26.9.5 Structured procedures / MS terminated call / late assignment**26.9.5.1 Conformance requirement**

TP1,TP2: The MS shall acknowledge the SETUP message with a CALL CONFIRMED message, if compatibility checking was successful, the MS is not busy, and the user does not refuse the call. The MS on acceptance of the call sends a CONNECT, otherwise user alerting is initiated.

TP3: The MS indicates acceptance of a call by sending a CONNECT message.

TP4: ASSIGNMENT COMMAND is answered by ASSIGNMENT COMPLETE.

TP5:

For speech calls:

The mobile station shall attach the user connection at latest when sending the connect message, except if there is no compatible radio resource available at this time. In this case the attachment shall be delayed until such a resource becomes available.

For data calls:

The mobile station shall attach the user connection when receiving the CONNECT ACKNOWLEDGE message from the network.

Requirement reference:

Conformance requirements 1, 2, 3: GSM 04.08, sections 5.2.2.3.1, 5.2.2.3.2 and 5.2.2.5.
 Conformance requirement 4: GSM 04.08, section 3.4.3.1.
 Conformance requirement 5: GSM 04.08, section 5.2.2.9.

26.9.5.2 Test purpose

- 1) To verify that the MS in "Idle, Updated" state with a TMSI assigned, after being paged by the network on the correct paging subchannel, after initiating the immediate assignment procedure by sending the CHANNEL REQUEST message, after receipt of an IMMEDIATE ASSIGNMENT message allocating an SDCCH, after having established the main signalling link, after having sent a PAGING RESPONSE message, after having performed successful authentication and cipher mode setting procedures, after receipt of a SETUP message containing a signal information element, returns a CALL CONFIRMED message followed by:
 - an ALERTING message;
 - or a CONNECT message.
- 2) To verify that in the situation of test purpose 1, if the MS sends an ALERTING message, the MS generates an alerting indication in the way described in a PICS/PIXIT statement.
- 3) To verify that subsequently the MS, if it had not yet sent a CONNECT message, upon acceptance of the call, sends a CONNECT message.
- 4) To verify that subsequently after receipt of an ASSIGNMENT COMMAND, the MS sends an ASSIGNMENT COMPLETE message.
- 5) To verify that subsequently the MS:
 - if the call is a speech call: after sending the ASSIGNMENT COMPLETE message has through connected the TCH in both directions (this is checked by verifying that after transmission of the first L2 frame containing the (complete) ASSIGNMENT COMPLETE message, the MS is sending appropriate speech or data frames whenever it does not have to transmit or acknowledge an I frame on layer 2 of the FACCH.)
 - if the call is a data call: after receipt of a subsequent CONNECT ACKNOWLEDGE message through connects the TCH in both directions (this is checked by verifying that there is a point in time after transmission of the first L2 frame containing the (complete) CONNECT ACKNOWLEDGE message, where the MS is sending appropriate speech or data frames whenever it does not have to transmit or acknowledge an I frame on layer 2 of the FACCH.)

These test purposes are tested for all rates supported by the MS (full rate/half rate).

26.9.5.3 Method of test

Related PICS/PIXIT statements

- Supported rates (full rate/half rate).
- Supported speech versions (full rate version 1, full rate version 2, half rate version 1)

- Interface to the human user (p1 = Y/N).
- Way to display the called number (only applicable if the MS has an interface to the human user).
- Way to indicate alerting (only applicable if the MS supports the feature).
- Way to make the MS accept an incoming call after alerting (possibly dependent on teleservice and configuration).
- Supported teleservices.
- Classmark.
- Immediate connect supported (Y/N).

Initial Conditions

System Simulator:

1 cell, default parameters.

Mobile Station:

The MS is in MM-state "idle, updated" with valid TMSI and CKSN.

Foreseen Final State of the MS

CC state U10-call active.

Test procedure

The following test is performed for all rates (full rate/half rate) supported by the MS:

A teleservice is selected that is supported by the MS; if the MS supports speech, the selected teleservice is speech. If necessary, the MS is configured for that teleservice.

The MS is paged and a MT call is established with late assignment (after CONNECT).

Maximum Duration of Test

40 seconds.

Expected Sequence

Step	Direction	Message	Comments
1	SS -> MS	PAGING REQUEST TYPE 1	Sent on the correct paging subchannel.
2	MS -> SS	CHANNEL REQUEST	Establishment cause indicates "answer to paging".
3	SS -> MS	IMMEDIATE ASSIGNMENT	
4	MS -> SS	PAGING RESPONSE	Message is contained in SABM.
5	SS -> MS	AUTHENTICATION REQUEST	
6	MS -> SS	AUTHENTICATION RESPONSE	SRES specifies correct value.
7	SS -> MS	CIPHERING MODE COMMAND	SS starts deciphering after sending the message.
8	MS -> SS	CIPHERING MODE COMPLETE	Shall be sent enciphered. All following messages shall be sent enciphered.
9	SS		SS starts ciphering.
10	SS -> MS	SETUP	Message contains the signal IE.
11	MS -> SS	CALL CONFIRMED	
A12	MS -> SS	CONNECT	
B12	MS -> SS	ALERTING	
B13	MS		An alerting indication as defined in an PICS/PIXIT statement is given by the MS.
B14	MS		The MS is made to accept the call in the way described in a PICS/PIXIT statement.
B15	MS -> SS	CONNECT	
16	SS -> MS	ASSIGNMENT COMMAND	
17	MS -> SS	ASSIGNMENT COMPLETE	
18	MS		If the call is a speech call, the TCH shall be through connected in both directions.
19	SS -> MS	CONNECT ACKNOWLEDGE	
20	MS		If the call is a data call, the MS shall through connect the TCH in both directions.

Specific Message Contents:

None.

26.9.6 Structured procedures / emergency call

Emergency call establishment can be initiated by an MS whether location updating has been successful or not and whether a SIM is inserted into the MS or not; but only if the MS is equipped for speech.

If the procedures tested in this section are not correctly implemented in the MS, establishment, maintenance and clearing of connections might fail in the essential case of emergency calls.

The tests of this section are only applicable to an MS supporting speech.

26.9.6.1 Structured procedures / emergency call / idle updated**26.9.6.1.1 Structured procedures / emergency call / idle updated / preferred channel rate****26.9.6.1.1.1 Conformance requirement**

- 1) The MS in the "idle, updated" state, as after a successful location update, after the number 112 has been entered by user, shall send a CHANNEL REQUEST message with correct establishment cause ("emergency call").
- 2) After assignment of a dedicated channel the first layer message sent by the MS on the assigned dedicated channel shall be a CM SERVICE REQUEST message specifying the correct CKSN and TMSI, with CM Service Type "emergency call establishment".
- 3) Authentication and cipher mode setting shall be performed successfully.

- 4) After cipher mode setting acceptance by the network, the MS shall send an EMERGENCY SETUP message.
- 5), 6) The emergency call shall be correctly established. The assignment procedure shall be correctly performed.
- 7) After receipt of a CONNECT ACKNOWLEDGE message during correct establishment of the emergency call the TCH shall be through connected in both directions if an appropriate TCH is available.
- 8) The call shall be cleared correctly.

Requirement Reference:

For conformance requirement 1 and 2:

GSM 04.08 section 3.3.1, GSM 04.08 section 5.2.1, GSM 04.08 section 4.5.1.5., GSM 02.30 section 4.

For conformance requirement 3:

GSM 04.08, section 3.4.7, GSM 04.08 section 4.3.2.

For conformance requirement 4:

GSM 04.08, section 5.2.1.1.

For conformance requirement 5 and 6:

GSM 04.08, sections 5.2.1.1 and 3.4.3.

For conformance requirement 7:

GSM 04.08, sections 5.2.1.6 and 5.1.3.

For conformance requirement 8:

GSM 04.08, section 5.4.

26.9.6.1.1.2 Test purpose

- 1) To verify that an MS supporting speech in the MM state "idle, updated", when made to call the number 112, sends a CHANNEL REQUEST message with establishment cause "emergency call".
- 2) To verify that after assignment of a dedicated channel the first layer message sent by the MS on the assigned dedicated channel is a CM SERVICE REQUEST message specifying the correct CKSN and TMSI, with CM Service Type "emergency call establishment".
- 3) To verify that authentication and cipher mode setting are performed successfully.
- 4) To verify that after cipher mode setting acceptance by the SS, the MS sends an EMERGENCY SETUP message.
- 5) To verify that subsequently, the SS having sent a CALL PROCEEDING message and then an ALERT message and having initiated the assignment procedure of an appropriate speech traffic channel, which, if the MS supports both TCH/FS and TCH/HS, is at the preferred rate, the MS performs correctly that assignment procedure.
- 6) To verify subsequent correct performance of a connect procedure.
- 7) To verify that subsequently the MS has through connected the TCH in both directions.
- 8) To verify that the call is cleared correctly.

26.9.6.1.1.3 Method of test

Related PICS/PIXIT Statements

- Speech supported (Y/N).
- Supported rate for speech: (p1 = F/H, F).
- Classmark.

Initial Conditions

System Simulator:

1 cell, default parameters.

Mobile Station:

The MS is in MM-state "idle, updated" with valid TMSI and CKSN.

Foreseen Final State of the MS

The MS is in MM-state "idle, updated" with valid TMSI and CKSN.

Test procedure

The MS is made to initiate an emergency call. The call is established with late assignment. Having reached the active state, the call is cleared by the SS.

Maximum Duration of Test

1 minute.

Expected Sequence

Step	Direction	Message	Comments
1	MS		The "called number" 112 is entered.
3	MS -> SS	CHANNEL REQUEST	Establishment cause is emergency call establishment.
4	SS -> MS	IMMEDIATE ASSIGNMENT	
5	MS -> SS	CM SERVICE REQUEST	Message is contained in SABM. The CM service type IE indicates "emergency call establishment".
6	SS -> MS	AUTHENTICATION REQUEST	
7	MS -> SS	AUTHENTICATION RESPONSE	SRES specifies correct value.
8	SS -> MS	CIPHERING MODE COMMAND	SS starts deciphering after sending the message.
9	MS -> SS	CIPHERING MODE COMPLETE	Shall be sent enciphered. All following messages shall be sent enciphered.
10	SS		SS starts ciphering.
11	MS -> SS	EMERGENCY SETUP	If p1 = F/H, the message must contain one bearer capability IE indicating in the radio channel requirement field "dual rate/half rate preferred" or "dual rate/full rate preferred". If p1 = F, the message must either contain no bearer capability IE or contain one bearer capability IE indicating in the radio channel requirement field "full rate channel".
12	SS -> MS	CALL PROCEEDING	
13	SS -> MS	ALERTING	
14	SS -> MS	ASSIGNMENT COMMAND	The rate of the channel is that one indicated by the EMERGENCY SETUP message, if that message did not offer a choice, and the rate is the preferred one else.
15	MS -> SS	ASSIGNMENT COMPLETE	
16	SS -> MS	CONNECT	
17	MS -> SS	CONNECT ACKNOWLEDGE	
18	MS		The TCH is through connected in both directions.
19	SS -> MS	DISCONNECT	
20	MS -> SS	RELEASE	
21	SS -> MS	RELEASE COMPLETE	
23	SS -> MS	CHANNEL RELEASE	The main signalling link is released.

Specific Message Contents:

None.

26.9.6.1.2 Structured procedures / emergency call / idle updated, non-preferred channel rate

The test is performed if the MS supports both TCH/HS and TCH/FS see PICS/PIXIT statement).

It is identical to the test in 26.9.6.1.1 except that in step 14 the assigned TCH has the non-preferred rate.

26.9.6.2 Structured procedures / emergency call / idle, no IMSI

26.9.6.2.1 Structured procedures / emergency call / idle, no IMSI / accept case

26.9.6.2.1.1 Conformance requirement

- 1) The MS in the "idle, updated" state, as after a successful location update, after the number 112 has been entered by user, shall send a CHANNEL REQUEST message with correct establishment cause ("emergency call").
- 2) After assignment of a dedicated channel the first layer message sent by the MS on the assigned dedicated channel shall be a CM SERVICE REQUEST message specifying the correct IMEI and a non-available CKSN, with CM Service Type "emergency call establishment".
- 3) After cipher mode setting acceptance by the network, the MS shall send an EMERGENCY SETUP message.
- 4),5) The emergency call shall be correctly established. The assignment procedure shall be correctly performed.
- 6) After receipt of a CONNECT ACKNOWLEDGE message during correct establishment of the emergency call the TCH shall be through connected in both directions if an appropriate TCH is available.
- 7) The call shall be cleared correctly.

Requirement Reference:

For conformance requirement 1 and 2:

GSM 04.08 section 3.3.1, GSM 04.08 section 5.2.1, GSM 04.08 section 4.5.1.5., GSM 02.30 section 4.

For conformance requirement 3:

GSM 04.08, section 5.2.1.1.

For conformance requirements 4 and 5:

GSM 04.08, sections 5.2.1.1 and 3.4.3.

For conformance requirement 6:

GSM 04.08, sections 5.2.1.6 and 5.1.3.

For conformance requirement 7:

GSM 04.08, section 5.4.

26.9.6.2.1.2 Test purpose

- 1) To verify that the MS in the "idle, no IMSI" state (no SIM inserted) when made to call the number 112, sends a CHANNEL REQUEST message with establishment cause "emergency call".

- 2) To verify that after assignment of a dedicated channel the first layer message sent by the MS on the assigned dedicated channel is a CM SERVICE REQUEST message in which the cipher key sequence number IE indicates "no key is available", the CM service type IE indicates "emergency number establishment", and the mobile identity IE specifies the IMEI of the MS.
- 3) To verify that after receipt of a CM SERVICE ACCEPT message from the SS, the MS sends an EMERGENCY SETUP message.
- 4) To verify that subsequently, the SS having sent a CALL PROCEEDING message and then an ALERT message and having initiated the assignment procedure of an appropriate speech traffic channel, which, if the MS supports both TCH/FS and TCH/HS, is at the preferred rate, the MS performs correctly that assignment procedure.
- 5) To verify subsequent correct performance of a connect procedure.
- 6) To verify that subsequently the MS has through connected the TCH in both directions.
- 7) To verify that the call is cleared correctly.

26.9.6.2.1.3 Method of test

Related PICS/PIXIT Statements

- Speech supported (Y/N).
- Classmark.

Initial Conditions

System Simulator:
1 cell, default parameters.

Mobile Station:
The MS is in MM-state "idle, no IMSI", no SIM inserted.

Foreseen Final State of the MS

The MS is in MM-state "idle, no IMSI", no SIM inserted.

Test procedure

The MS is made to initiate an emergency call. The call is established without authentication, without ciphering, with late assignment. Having reached the active state, the call is cleared by the SS.

Maximum Duration of Test

1 minute.

Expected Sequence

Step	Direction	Message	Comments
1	MS		The "called number" 112 is entered.
3	MS -> SS	CHANNEL REQUEST	Establishment cause is "emergency call".
4	SS -> MS	IMMEDIATE ASSIGNMENT	
5	MS -> SS	CM SERVICE REQUEST	Message is contained in SABM. The CM service type IE indicates "emergency call establishment". The mobile identity IE specifies the IMEI of the MS. The cipher key sequence number IE indicates "no key is available". The mobile station classmark IE is as specified by the manufacturer in a PICS/PIXIT statement.
4	SS -> MS	CM SERVICE ACCEPT	
11	MS -> SS	EMERGENCY SETUP	
12	SS -> MS	CALL PROCEEDING	
13	SS -> MS	ALERTING	
14	SS -> MS	ASSIGNMENT COMMAND	The rate of the channel is one indicated by the EMERGENCY SETUP message.
15	MS -> SS	ASSIGNMENT COMPLETE	
16	SS -> MS	CONNECT	
17	MS -> SS	CONNECT ACKNOWLEDGE	
18	MS		The TCH is through connected in both directions.
19	SS -> MS	DISCONNECT	
20	MS -> SS	RELEASE	
21	SS -> MS	RELEASE COMPLETE	
23	SS -> MS	CHANNEL RELEASE	The main signalling link is released.

Specific Message Contents:

None.

26.9.6.2.2 Structured procedures / emergency call / idle, no IMSI / reject case**26.9.6.2.2.1 Conformance requirement**

- 1) The MS in the "idle, no IMSI" state (no SIM inserted), after the number 112 has been entered, shall send a CHANNEL REQUEST message with correct establishment cause ("emergency call").
- 2) After assignment of a dedicated channel the first layer message sent by the MS on the assigned dedicated channel shall be a CM SERVICE REQUEST message specifying the correct IMEI and a non-available CKSN, with CM Service Type "emergency call establishment".
- 3) In the situation at the end of test purpose 2, when the MS receives a CM SERVICE REJECT message, it shall abandon the emergency call.

Requirement Reference:

For conformance requirement 1 and 2:

GSM 04.08 section 3.3.1, GSM 04.08 section 5.2.1, GSM 04.08 section 4.5.1.5., GSM 02.30 section 4.

For conformance requirement 3:

GSM 04.08 section 3.4.7, GSM 04.08 section 4.5.1.1.

26.9.6.2.2.2 Test purpose

- 1) To verify that the MS in the "idle, no IMSI" state (no SIM inserted) when made to call the number 112, sends a CHANNEL REQUEST message with establishment cause "emergency call".

- 2) To verify that after assignment of a dedicated channel the first layer message sent by the MS on the assigned dedicated channel is a CM SERVICE REQUEST message in which the cipher key sequence number IE indicates "no key is available", the CM service type IE indicates "emergency call establishment", and the mobile identity IE specifies the IMEI of the MS.
- 3) To verify that after receipt of a CM SERVICE REJECT message from the SS, the MS abandons the emergency call establishment.

26.9.6.2.2.3 Method of test

Related PICS/PIXIT statements

- Speech supported (Y/N).
- Classmark.

Initial Conditions

System Simulator:

1 cell, default parameters.

Mobile Station:

The MS is in MM-state "idle, no IMSI", no SIM inserted.

Foreseen Final State of the MS

The MS is in MM-state "idle, no IMSI", no SIM inserted.

Test procedure

The MS is made to initiate an emergency call. The call is established without authentication, without ciphering, with early assignment. The SS responds to the CM SERVICE REQUEST from the MS with a CM SERVICE REJECT message specifying in the reject cause IE the reject cause value "IMEI not accepted". The SS then verifies for during 5 seconds that the MS does not send a layer 3 message. Then the call is cleared by the SS. The SS verifies during 20 seconds after disconnection of the main signalling link that the MS does not initiate an RR connection establishment.

Maximum Duration of Test

1 minute.

Expected Sequence

Step	Direction	Message	Comments
1	MS		The "called number" 112 is entered.
3	MS -> SS	CHANNEL REQUEST	Establishment cause is "emergency call".
4	SS -> MS	IMMEDIATE ASSIGNMENT	
5	MS -> SS	CM SERVICE REQUEST	Message is contained in SABM. The CM service type IE indicates "emergency call establishment". The mobile identity IE specifies the IMEI of the MS. The cipher key sequence number IE indicates "no key is available". The mobile station classmark IE is as specified by the manufacturer in a PICS/PIXIT statement.
4	SS -> MS	CM SERVICE REJECT	the reject cause IE specifies reject cause value #5, "IMEI not accepted".
5	SS		During 5 seconds, the SS verifies that the MS does not send L3 messages.
6	SS -> MS	CHANNEL RELEASE	The main signalling link is released.
7	SS		During 20 seconds, the SS verifies that the MS does not initiate an RR connection establishment.

Specific Message Contents:

-

26.9.7 Default contents of messages**ALERTING (mobile station to network direction)**

Information element	Value/remark
Facility	Not checked
User-user	Not checked
SS version	Not checked

ALERTING (network to mobile station direction)

Information element	Value/remark
Facility	Omitted
Progress indicator	Omitted
User-user	Omitted

ASSIGNMENT COMMAND

Information element	Value/remark
Description of the first channel	describes non-hopping Bm+ACCHs or Lm+ACCHs as appropriate for the test
Power Command	As in section 26.1.1
Frequency list	Omitted
Cell channel description	Omitted
Mode of the first channel	appropriate for one bearer capability chosen for the test
Description of the second channel	Omitted
Mode of the second channel	Omitted
Mobile allocation	Omitted
Starting time	Omitted
Cipher mode setting	Omitted

ASSIGNMENT COMPLETE

Information element	Value/remark
RR cause	normal event

AUTHENTICATION REQUEST

Information element	Value/remark
Ciphering key sequence number	Arbitrary
Spare half octet	(spare bits)
Authentication parameter RAND	Arbitrary

AUTHENTICATION RESPONSE

Information element	Value/remark
Authentication parameter SRES	Correct for given SRES

CALL CONFIRMED

Information element	Value/remark
Repeat indicator	Omitted
Bearer capability 1	The <i>bearer capability 1</i> information element shall be included if and only if at least one of the following cases holds: <ul style="list-style-type: none"> - the mobile station wishes another bearer capability than that given by the <i>bearer capability 1</i> information element of the incoming SETUP message; - the <i>bearer capability 1</i> information element received in the SETUP message is accepted and the "radio channel requirement" of the Mobile Station is other than "full rate support only mobile station". - the <i>bearer capability 1</i> information element received in the SETUP message indicates speech and is accepted and the Mobile Station supports other speech versions than GSM full rate version 1/ half rate version 1.
Bearer capability 2	Omitted
Cause	Omitted
CC Capabilities	may be present

CALL PROCEEDING

Information element	Value/remark
Repeat Indicator	Omitted
Bearer Capability 1	Omitted if the SETUP message did not specify in the bearer capability 1 IE a connection element value "both, transparent preferred" or "both, non-transparent preferred". Otherwise included; in that case the connection element specifies the value that is appropriate for the selected teleservice (either value "transparent" or value "non transparent (RLP)"), all other parameters are same as in the bearer capability 1 IE of the received SETUP message.
Bearer Capability 2	Omitted
Facility	Omitted
Progress indicator	Omitted

CHANNEL RELEASE

Information element	Value/remark
RR cause	Normal event

CHANNEL REQUEST

Information element	Value/remark
Establishment cause	Answer to paging (100)
Random reference	Arbitrary value of 5 bits length

CIPHERING MODE COMMAND

Information element	Value/remark
Cipher mode setting algorithm identifier SC	indicates a supported algorithm Start ciphering
Cipher response CR	IMEI must not be included

CIPHERING MODE COMPLETE

Information element	Value/remark
Mobile equipment identity	Omitted

CM SERVICE ACCEPT

Information element	Value/remark
none but message head	

CM SERVICE REQUEST

Information element	Value/remark
CM service type	Mobile originating call establishment or packet mode connection establishment
Ciphering key sequence number	CKSN of the MS
Mobile station classmark 2	as given by PICS.
Mobile identity	TMSI of MS

CONNECT (network to mobile station direction)

Information element	Value/remark
Facility	Omitted
Progress indicator	Omitted
Connected number	Omitted
Connected subaddress	Omitted
User-user	Omitted

CONNECT (mobile station to network direction)

Information element	Value/remark
Facility	Not checked
Connected subaddress	Not checked
User-user	Not checked
SS version	Not checked

CONNECT ACKNOWLEDGE

Information element	Value/remark
none but message head	

DISCONNECT (network to mobile station direction)

Information element	Value/remark
Cause	
Coding standard	GSM
Location	User
Cause value	Normal clearing
Facility	Omitted
Progress indicator	Omitted
User-user	Omitted

DISCONNECT (mobile station to network direction)

Information element	Value/remark
Cause	
Coding standard	GSM
Location	User
Cause value	Normal clearing
Facility	Not checked
User-user	Not checked
SS version	Not checked

EMERGENCY SETUP

Information element	Value/remark
Bearer Capability	May be present or omitted. If present, it shall indicate speech, the appropriate speech version(s) and have the appropriate value of radio channel requirement field

IMMEDIATE ASSIGNMENT

Information element	Value/remark
Page mode	Normal paging
Channel description	describes a valid SDCCH+SACCH in non-hopping mode
Request reference	
Random access information	As received from MS
N51, N32, N26	Corresponding to frame number of the CHANNEL REQUEST
Timing advance	Arbitrary
Mobile allocation	Empty (L=0)
Starting time	Omitted

PAGING REQUEST TYPE 1

Information element	Value/remark
L2 pseudo length	L2 pseudo length of the message
Page Mode	Normal Paging
Channels needed for Mobiles 1 and 2	
channel (first)	any channel
channel (second)	any channel
Mobile identity 1	TMSI of MS under test
Mobile identity 2	Omitted
P1 rest octets	(spare octets)

PAGING RESPONSE

Information element	Value/remark
Ciphering key sequence number	Value assigned to MS in the initial conditions (spare bits) as given by PICS specifies TMSI of MS
Spare half octet	
Mobile station classmark 2	
Mobile identity	

RELEASE (network to mobile station direction)

Information element	Value/remark
Cause	Omitted
Second cause	Omitted
Facility	Omitted
User-user	Omitted

RELEASE (mobile station to network direction)

Information element	Value/remark
Cause	Not checked
Second cause	Not checked
Facility	Not checked
User-user	Not checked
SS version	Not checked

RELEASE COMPLETE (network to mobile station direction)

Information element	Value/remark
Cause	Omitted
Facility	Omitted
User-user	Omitted

RELEASE COMPLETE (mobile station to network direction)

Information element	Value/remark
Cause	Not checked
Facility	Not checked
User-user	Not checked
SS version	Not checked

SETUP (MS to SS)

Information element	Value/remark
BC Repeat indicator	Omitted
Bearer capability 1	Appropriate for the teleservice selected for the test
Bearer capability 2	Omitted
Facility	Not checked
Calling party subaddress	Not checked
Called party BCD number	As entered
Called party subaddress	Omitted
LLC repeat indicator	Omitted
Low layer compatibility I	Appropriate for teleservice selected for the test
Low layer compatibility II	Omitted
HLC repeat indicator	Omitted
High layer compatibility i	Appropriate for teleservice selected for the test
High layer compatibility ii	Omitted
User-user	Not checked
SS version	Not checked
CLIR suppression	Not checked
CC Capabilities	may be present

SETUP (SS to MS)

Information element	Value/remark
BC repeat indicator	Omitted
Bearer capability 1	Appropriate for teleservice selected for the test
Bearer capability 2	Omitted
Facility	Omitted
Progress indicator	Omitted
Signal	Omitted
Calling party BCD number	Omitted
Calling party subaddress	Omitted
Called party BCD number	Omitted
Called party subaddress	Omitted
LLC repeat indicator	Omitted
Low layer compatibility I	Appropriate for teleservice selected for the test
Low layer compatibility II	Omitted
HLC repeat indicator	Omitted
High layer compatibility i	Appropriate for the teleservice selected for the test
High layer compatibility ii	Omitted
User-user	Omitted

26.10 E-GSM signalling

26.10.1 E-GSM signalling / general considerations

Section 26.10 only applies to E-GSM mobile stations.

Conformance requirements of section 26 fully apply to any mobile station (P-GSM, E-GSM or DCS) in the whole supported band of the mobile station.

Besides, as an E-GSM mobile station shall support the P-GSM band, it shall pass successfully every test of section 26 under the described GSM 900 conditions.

The purpose of this extra section is to test the different procedures which may be impacted when some channel uses E-GSM frequency(s).

26.10.2 E-GSM signalling / RR

26.10.2.1 E-GSM signalling / RR / Measurement

This test applies E-GSM mobile stations.

Conformance requirements of section 26.6.3 fully apply to any mobile station (P-GSM, E-GSM or DCS) in the whole supported band of the mobile station.

Besides, as an E-GSM mobile station shall support the P-GSM band, it shall pass successfully every test of section 26.6.3 under the described GSM 900 conditions.

The purpose of this extra section is to test the reporting of measurements in the case where cells use E-GSM frequency(s). Several coding formats may be used by the network in the SYSTEM INFORMATION message.

26.10.2.1.1 Conformance requirements

The MS shall continuously send MEASUREMENT REPORT messages on every SACCH blocks and the measurement valid indication shall be set to valid (0) within the second block at the latest. After 20 seconds the values in the MEASUREMENT REPORT message shall contain measurement results for the 6 th strongest cells belonging to the set of cells indicated either in SI5 and SI5bis messages or in SI5 and SI5ter messages.

References

GSM 04.08 sections 3.4.1.2 and 9.1.39, GSM 05.08 section 8.4.

26.10.2.1.2 Test purpose

To test that, when the SS gives information about neighbouring cells indicated either in SI5 and SI5bis messages or in SI5 and SI5ter messages, the MS reports appropriate results.

26.10.2.1.3 Method of test**Initial Conditions**

System Simulator:

8 cells with the following settings:

Transmitter	Level	NCC	BSCC	ARFCN	Cell identity
Serving, S1	-60	1	3	002	0001H
Neighbour, N1	-85	1	5	990	0002H
Neighbour, N2	-80	1	7	1005	0003H
Neighbour, N3	-75	1	1	000	0004H
Neighbour, N4	-55	1	3	026	0005H
Neighbour, N5	-50	1	5	1020	0006H
Neighbour, N6	-45	1	7	038	0007H
Neighbour, N7	-40	1	1	1003	0008H

With the exception of the Cell Allocation, the rest of the parameters for all eight cells are the same as the default settings and default SYSTEM INFORMATION TYPE 1 to 4 message contents for cell A. The Cell Allocation for the serving cell is the same as the default setting for cell A. The Cell Allocations for the neighbour cells need have only one entry, consisting of the ARFCN of that cell's BCCH.

Mobile Station:

The MS is in the active state of a call (U10).

Related PICS/PIXIT Statements

Support for state U10 of the Call Control protocol.

Foreseen Final State of the MS

Active state of a call (U10).

Test Procedure

The test is performed for execution counter, c=1 to 9

For c=1 to 6, the following procedure applies .

With the MS having a call in progress, the SS sends SYSTEM INFORMATION TYPE 5, 5bis & 6 on the SACCH. The MS shall send MEASUREMENT REPORTs back to the SS, and it shall be indicated in these that measurement results for the 6 strongest present carriers of the supported band have been obtained.

For c=7 to 9, the following procedure applies :

With the MS having a call in progress, the SS sends SYSTEM INFORMATION TYPE 5, 5ter & 6 on the SACCH. The MS shall send MEASUREMENT REPORTs back to the SS, and it shall be indicated in these that measurement results for the 6 strongest present carriers of the supported band have been obtained.

Maximum Duration of Test

8 minutes, including 1 minute for any necessary operator actions.

Expected Sequence

This sequence is performed for execution counter, c= 1 to 9.

Since SYSTEM INFORMATION TYPE 5, SYSTEM INFORMATION TYPE 6 and MEASUREMENT REPORT are sent continuously, a table is not applicable in this test. The interval between 2 successive Layer 2 frames containing MEASUREMENT REPORTs shall not exceed one Layer 2 frame.

Specific Message Contents

SYSTEM INFORMATION TYPE 5:

Information Element	value/remark
Protocol Discriminator Message Type Neighbour Cells Description - EXT IND - BA-IND	RR management Sys Info 5. Information Element carries only a part of the BA. 0 for c=1, use range 128 to encode the following frequencies: (26, 38) for c=2, use range 256 to encode the following frequencies (990, 1 003, 1 005) for c=3, use range 512 to encode the following frequencies (520, 990, 1 003, 1 005, 1 020) for c=4, use range 1 024 to encode the following frequencies (0, 26, 38, 990, 1 003, 1 005) for c=5, use variable Bitmap to encode the following frequencies (0, 26, 38) for c=6, use Bitmap 0 to encode the following frequencies (26) for c=7, use range 512 to encode the following frequencies : (520, 990, 1020) for c=8, use range 1024 to encode the following frequencies : (0, 26, 38, 990, 1005, 1020) for c=9, use range 256 to encode the following frequencies : (38)

SYSTEM INFORMATION TYPE 5bis:

Information Element	value/remark
Protocol Discriminator Message Type Neighbour Cells Description - EXT IND - BA-IND	RR management Sys Info 5bis. Information Element carries only a part of the BA. 0 for c=1, use range 512 to encode the following frequencies: (520, 990, 1 003, 1 005, 1 020) for c=2, use range 128 to encode the following frequencies (0, 26, 38) for c=3, use range 256 to encode the following frequencies (0, 26, 38) for c=4, use range 1 024 to encode the following frequencies (520, 1 000, 1 020) for c=5, use variable Bitmap to encode the following frequencies (884, 990, 1 003, 1 005) for c=6, use range 512 to encode the following frequencies (520, 990, 1 003)

SYSTEM INFORMATION TYPE 5ter:

Information Element	value/remark
Protocol Discriminator Additional Multiband information - multiband reporting Message Type Neighbour Cells Description - EXT IND - BA-IND	RR management normal reporting of the six strongest cells, irrespective of the band used. Sys Info 5ter. Information Element carries only a part of the BA. 0 for c=7, use range 1024 to encode the following frequencies (0,26,1003, 1005) for c=8, use variable bitmap to encode the following frequencies (1000,1003) for c=9,, use range 256 to encode the following frequencies (26, 1003, 1020)

SYSTEM INFORMATION TYPE 6:

Information Element	value/ remark
Protocol Discriminator Message Type Cell Identity LAI Cell Options - Power Control Indicator - DTX Indicator - Radio-Link-Time-out PLMN permitted	RR Management sys info 6 default default Power Control Indicator is set MS shall not use DTX default only NCC 1 permitted

MEASUREMENT REPORT:

Information Element	value/remark
Protocol Discriminator	RR Management
Transaction Identifier	0000
Message Type	MEASUREMENT REPORT
Measurement Results	
BA-used	1
DTX-used	DTX was not used
RXLEV-FULL-SERVING-CELL	See note 1
RXLEV-SUB-SERVING-CELL	See note 1
MEAS-VALID	See note 3
RXQUAL-FULL-SERVING-CELL	See note 1
RXQUAL-SUB-SERVING-CELL	See note 1
NO-NCELL-M	n (see note 2)
RXLEV-NCELL-1	See note 1
BCCH-FREQ-NCELL-1	See note 2
BSIC-NCELL-1	Corresponds to that of BCCH-FREQ-NCELL-1
RXLEV-NCELL-2	See note 1
BCCH-FREQ-NCELL-2	See note 2
BSIC-NCELL-2	Corresponds to that of BCCH-FREQ-NCELL-2
RXLEV-NCELL-3	See note 1
BCCH-FREQ-NCELL-3	See note 2
BSIC-NCELL-3	Corresponds to that of BCCH-FREQ-NCELL-3
RXLEV-NCELL-4	See note 1
BCCH-FREQ-NCELL-4	See note 2
BSIC-NCELL-4	Corresponds to that of BCCH-FREQ-NCELL-4
RXLEV-NCELL-5	See note 1
BCCH-FREQ-NCELL-5	See note 2
BSIC-NCELL-5	Corresponds to that of BCCH-FREQ-NCELL-5
RXLEV-NCELL-6	See note 1
BCCH-FREQ-NCELL-6	See note 2
BSIC-NCELL-6	Corresponds to that of BCCH-FREQ-NCELL-6

NOTE 1: These actual values are not checked.

NOTE 2: ARFCN 2 is the serving cell carrier.

c=1 report on ARFCNs 2, 26, 38, 990, 1 003, 1 005, 1 020, n=6

c=2 report on ARFCNs 2, 26, 38, 990, 1 003, 1 005, 0, 1 020 stronger than 1 005 but not broadcasted in SYS INFO), n=6

c=3 report on ARFCNs 2, 20, 26, 38, 1 003, 1 005, 1 020, 0 (990 less strong, 520 DCS), n=6

c=4 report on ARFCNs 2, 26, 38, 990, 1 003, 1 005, 0 (1 000 less strong, 520 DCS, 1 020 not broadcasted in SYS INFO), n=6

c=5 report on ARFCNs 2, 26, 38, 990, 1 003, 1 005, 0 (884 DCS), n=6

c=6 report on 2, 26, 990, 1 003, n=6

c=7 report on ARFCNs 2, 26, 990, 1003, 1005, 1020, 0 (520 DCS), n=6

c=8 report on ARFCNs 2, 26, 38, 1003, 1005, 1020, 0 (990 and 1000 less strong), n=6

c=9 report on ARFCNs 2, 26,38, 1003, 1020, n=4.

NOTE 3: The Measurement Valid Indication shall be set to valid within the second SACCH block at the latest.

26.10.2.2 E-GSM signalling / RR / Immediate assignment

This section only applies to E-GSM mobile stations.

Conformance requirements of section 26.6.1 fully apply to any mobile station (P-GSM, E-GSM or DCS) in the whole supported band of the mobile station.

Besides, as an E-GSM mobile station shall support the P-GSM band, it shall pass successfully every test of section 26.6.1 under the described GSM 900 conditions.

The purpose of this extra section is to test the immediate assignment procedure in the case where the target channel is E-GSM frequency.

26.10.2.2.1 Conformance requirement

Following a PAGING REQUEST message, the MS shall correctly set up an RR connection on a supported channel described in the IMMEDIATE ASSIGNMENT message, using some E-GSM frequency.

Reference(s)

GSM 04.08 section 3.3.1.2.1.

26.10.2.2.2 Test purpose

To verify that the MS can correctly set up a dedicated control channel when E-GSM frequencies are used.

This tested for a SDCCH/8.

26.10.2.2.3 Method of test

Initial Conditions

System Simulator:

1 cell.

CCCH-CONF is set to "1 basic physical channel used for CCCH not combined with SDCCHs".

SYSTEM INFORMATION type 1 message contains the following frequencies in the Cell Channel Description IE: 0, 30, 40, 66, 80, 1 005, 1 010, 1 015 (use range 1 024 to encode).

BCCH carrier number 1 015.

Mobile Station:

The MS is in the "idle, updated" state, with a TMSI allocated.

Related PICS/PIXIT Statement(s)

None.

Foreseen Final State of the MS

"Idle, updated", with TMSI allocated.

Test Procedure

This test procedure is performed twice.

The System Simulator pages the MS and after the MS has responded with a CHANNEL REQUEST message the SS assigns an SDCCH channel using some E-GSM frequencies. The MS shall go to the correct channel and send a PAGING RESPONSE message. Then the SS initiates RR-release by sending a CHANNEL RELEASE message.

Maximum Duration of Test

15 seconds.

Expected Sequence

The sequence is performed for execution counter k=1,2.

Step	Direction	Message	Comments
1	SS -> MS	PAGING REQUEST TYPE 1	
2	MS -> SS	CHANNEL REQUEST	cause "answer to paging"
3	SS -> MS	IMMEDIATE ASSIGNMENT	Channel Type: see below
4	MS -> SS	PAGING RESPONSE	Shall be sent on the correct channel
5	SS -> MS	CHANNEL RELEASE	

Specific Message Contents**IMMEDIATE ASSIGNMENT**

As default except:

Information element	remark/value
Channel description	
- Channel Type	SDCCH/8
- Timeslot number	arbitrary but not zero
- Training sequence code	arbitrary
- Hopping channel	k=1 Single RF
	k=2 RF hopping channel
- Channel Selector	k=1 ARFCN=1 015
	k=2 MAIO = arbitrarily chosen HSN arbitrary
	chosen from the set (1,..63)
Mobile allocation	k=1 empty
	k=2 indicates the following frequencies (0, 80,
	1 005, 1 010)

26.10.2.3 E-GSM signalling / RR / channel assignment procedure

This test is only applicable to an E-GSM mobile station.

Conformance requirements of section 26.6.4 fully apply to any mobile station (P-GSM, E-GSM or DCS) in the whole supported band of the mobile station.

Besides, as an E-GSM mobile station shall support the P-GSM band, it shall pass successfully every test of section 26.6.4 under the described GSM 900 conditions.

The purpose of this extra section is to test the assignment in the case where the allocated channel uses E-GSM frequency(s): in the case of frequency hopping several coding formats may be used by the network in the ASSIGNMENT COMMAND message.

26.10.2.3.1 Conformance requirements

1. Upon receipt of the ASSIGNMENT COMMAND message, the mobile station initiates a local end release of link layer connections, disconnects the physical channels, commands the switching to the assigned channels and initiates the establishment of lower layer connections (this includes the activation of the channels, their connection and the establishment of the main signalling links).
2. The MS shall apply the hopping frequencies specified in ASSIGNMENT COMMAND message in the mobile allocation or frequency list or frequency short list at the time accessing the new channel.

References

- GSM 04.08, subclause 3.4.3.
- GSM 04.08, subclause 9.1.2.

26.10.2.3.2 Test purpose

1. To verify that upon receipt of an ASSIGNMENT COMMAND, the MS switches to the channel defined in the ASSIGNMENT COMMAND, establishes the link and sends an ASSIGNMENT COMPLETE message.
2. To verify that an MS, having received an ASSIGNMENT COMMAND, is able in case of frequency hopping to decode the mobile allocation and frequency list correctly and applies the specified frequencies.

26.10.2.3.3 Method of test**Initial Conditions**

System Simulator:

1 cell, default parameters.

Mobile Station:

The MS is in the "idle, updated" state with a TMSI allocated.

Related PICS/PIXIT Statements

- TCH supported (Y/N).
- The supported channel mode(s) need to be declared.

Foreseen Final State of the MS

"Idle, updated", with TMSI allocated.

Test Procedure

The test procedure is performed 2 times.

The SS pages the MS and allocates an SDCCH. Then a channel is assigned with ASSIGNMENT COMMAND. Each time the MS shall switch to the assigned channel, establish the link and send an ASSIGNMENT COMPLETE message.

The SS initiates the channel release procedure.

Maximum Duration of Test

3 min.

Expected Sequence

The test sequence is performed for execution counter k=1 to 2.

Step	Direction	Message	Comments
1	SS -> MS	PAGING REQUEST TYPE 1	
2	MS -> SS	CHANNEL REQUEST	
3	SS -> MS	IMMEDIATE ASSIGNMENT	Timeslot Number = n.
4	MS -> SS	PAGING RESPONSE	
5	SS -> MS	ASSIGNMENT COMMAND	See specific message contents Timeslot Number = (n+1) mod 8
6	MS -> SS	ASSIGNMENT COMPLETE	Sent on the correct channel after establishment of the main signalling link. Steps 5 and 6 are repeated cmax times, where cmax is the number of frequency formats allowed for each value of k. Use repetition counter c: See specific message content.
7	SS -> MS	CHANNEL RELEASE	The main signalling link is released.

Specific Message Contents

ASSIGNMENT COMMAND:

Information element	value/remark
Protocol Discriminator Skip indicator Message type Channel Description <ul style="list-style-type: none"> - Channel type - Timeslot number - Training sequence code - Hopping - MAIO - HSN Power Command <ul style="list-style-type: none"> - Power level For k=1 Cell Channel Description IE is not included Frequency list	RR 0000 ASSIGNMENT COMMAND TCH/F + ACCHs if supported by the MS or SDCCH/8 if not arbitrary chosen arbitrarily RF hopping channel arbitrary arbitrarily chosen from the set (1,2...63) Arbitrarily chosen
For k=2 Cell Channel Description	for c=1, use range 128 to encode the following frequencies: (1 005, 1 010, 1 015) for c=2, use range 256 to encode the following frequencies (73, 74, 75, 76, 77) for c=3, use range 512 to encode the following frequencies (980, 981, 982, 983) for c=4, use range 1 024 to encode the following frequencies (30, 40, 1 010, 1 015) for c=5, use variable Bitmap to encode the following frequencies (980, 991, 992, 993, 994, 1 015) with an encoding origin set to 980 for c=6, use Bitmap 0 to encode the following frequencies (20, 40, 66)
For k=2 Mobile Allocation	for c=1, use range 128 to encode the following 13 frequencies: (980, 981, 982, 983, 990, 991, 992, 993, 994, 1 000, 1 005, 1 010, 1 015) for c=2, use range 256 to encode the following 13 frequencies (20, 40, 66, 73, 74, 75, 76, 77, 78, 79, 108, 114, 115) for c=3, use range 512 to encode the following 13 frequencies (980, 981, 982, 983, 990, 991, 992, 993, 994, 1 000, 1 005, 1 010, 1 015) for c=4, use range 1 024 to encode the following 8 frequencies (0, 30, 40, 66, 80, 1 005, 1 010, 1 015) for c=5, use variable Bitmap to encode the following frequencies (980, 981, 982, 983, 990, 991, 992, 993, 994, 1 000, 1 005, 1 010, 1 015) for c=6, use Bitmap 0 to encode the following 12 frequencies (20, 40, 66, 73, 74, 75, 76, 77, 78, 79, 108, 114)
For k = 2 Mobile Allocation	indicates the following the frequencies: for c=1 (1 005, 1 010, 1 015) for c=2 (73, 74, 75, 76, 77) for c=3 (980, 981, 982, 983) for c=4 (0, 30, 40, 1 010, 1015) for c=5 (990, 991, 992, 993, 994) for c=6 (20, 40, 66)
Mode of the First channel	speech full rate version 1 for TCH/F except if speech is not supported: arbitrary from those supported
Starting Time	not included

26.10.2.4 E-GSM signalling / RR / Handover

This section only applies to E-GSM mobile stations.

Conformance requirements of section 26.6.5 fully apply to any mobile station (P-GSM, E-GSM or DCS) in the whole supported band of the mobile station.

Besides, as an E-GSM mobile station shall support the P-GSM band, it shall pass successfully every test of section 26.6.5 under the described GSM 900 conditions.

The purpose of this extra section is to test the handover in the case where the target channel uses E-GSM frequency(s): in the case of frequency hopping several coding formats may be used by the network in the HANDOVER COMMAND message.

26.10.2.4.1 E-GSM signalling / RR / Handover / Successful handover

26.10.2.4.1.1 Conformance requirements

The MS shall correctly apply the handover procedure from a channel without frequency hopping in the primary band to a channel with frequency hopping using P-GSM and E-GSM frequencies whatever the coding used for the frequency hopping description.

References

GSM 04.08, sections 3.4.4 and 9.1.15.

26.10.2.4.1.2 Test purpose

To check that the MS correctly performs a non-synchronized handover, from a non hopping primary band SDCCH to a hopping TCH or SDCCH using E-GSM frequencies, whatever the coding used for the hopping sequence description and that it activates the new channel correctly.

This is tested in the following case:

E-GSM signalling / Handover / successful / call under establishment / non-synchronized /

- from SDCCH/8 to TCH/F if the MS supports a TCH

- from SDCCH/8 to SDCCH/8 if not

26.10.2.4.1.3 Method of test

Initial Conditions

System Simulator:

2 cells A and B with same LAI, default parameters;
except for Cell A: the broadcasted Cell Channel Description in SYSTEM INFORMATION type 1 message contains the following frequencies: 20, 40, 66, 73, 74, 75, 76, 77, 78, 79, 108, 114 (encoded using Bit Map 0 format).

Mobile Station:

The MS is in the "idle, updated" state, with a TMSI allocated and camped on cell A.

Related PICS/PIXIT Statements

Support of TCH (Y/N).

Support of speech (Y/N).

Support for state U10 of the Call Control protocol.

Foreseen Final State of the MS

"Idle, updated" with TMSI allocated and camped on cell B.

Test Procedure

The test procedure is performed 18 times.

A Mobile Originating Call is initiated on cell A. After the MS has sent the SETUP message (and before the last L2 frame carrying the SETUP message is acknowledged by the SS) the SS sends a HANDOVER COMMAND message, ordering the MS to switch to cell B.

The MS shall then begin to send access bursts on the new channel, a TCH/F if supported (see PICS/PIXIT) or an SDCCH if not, to cell B.

The SS observes the access bursts. After receiving n access bursts, n being randomly drawn between 10 and 20 for the TCH case, 2 and 5 for the SDCCH (see table 26.6-2 of section 26.6.5) , the SS sends one PHYSICAL INFORMATION message with a Timing Advance of 20 (see table 26.6-1 of section 26.6.5).

The MS shall activate the channel in sending and receiving mode. Then the MS shall establish a signalling link using the correct timing advance. The MS shall be ready to transmit a HANDOVER COMPLETE message before x ms after the end of the PHYSICAL INFORMATION message but not before a UA frame has been sent by the SS. The MS shall then again send the SETUP message to the SS, using the same value in the N(SD) field. Finally the SS sends a CHANNEL RELEASE to end the test.

The term "ready to transmit" is specified in GSM 04.13. The value of "x" depends upon the target channel:

case SDCCH/8 x = 750.

case TCH/F x=500.

Maximum Duration of Test

10 min.

Expected Sequence

The sequence is performed for execution counter k=1 to 3 and c=1 to 6.

Step	Direction	Message	Comments
1	-----	-----	A MO call is initiated on cell A
2	MS -> SS	CHANNEL REQUEST	Establish. Cause = "Originating call, NECI not set to 1
3	SS -> MS	IMMEDIATE ASSIGNMENT	see specific message contents
4	MS -> SS	CM SERVICE REQUEST	CM Service Type = Mobile Originating Call Establishment.
5	SS -> MS	CIPHERING MODE COMMAND	
6	MS -> SS	CIPHERING MODE COMPLETE	
7	MS -> SS	SETUP	Last L2 frame not acknowledged by the SS.
8	SS -> MS	HANDOVER COMMAND	see specific message contents
9	MS -> SS	HANDOVER ACCESS	Repeated on every burst of the uplink main DCCH until reception of PHYSICAL INFORMATION. Handover Reference as included in the HANDOVER COMMAND
10	SS -> MS	PHYSICAL INFORMATION	Sent after reception of n HANDOVER ACCESS. Timing Advance: 20
11	MS -> SS	SABM	Sent without information field
12	SS -> MS	UA	
13	MS -> SS	HANDOVER COMPLETE	This message shall be ready to be transmitted before "x" ms after the completion of step 10
14	MS -> SS	SETUP	Same N(SD) as in step 7.
15	SS -> MS	CHANNEL RELEASE	

Specific Message Contents**IMMEDIATE ASSIGNMENT**

Information Element	Value/remark
As default message contents, except:	
Cell Description	
- BCCH carrier number	20
Channel Description	
- Channel type	TCH/F + ACCHs if supported by the MS or SDCCH/8 if not
- Timeslot number	arbitrary but not zero
- Training sequence code	chosen arbitrarily
- Hopping	RF hopping channel
- MAIO	arbitrary
- HSN	arbitrarily chosen from the set (1,2...63)
Mobile Allocation	indicates the following frequencies: (20, 66, 78)

HANDOVER COMMAND

Information Element	Value/remark
<p>As default message contents, except:</p> <p>Cell Description - BCCH carrier number</p> <p>Channel Description - Channel type</p> <p>- Timeslot number - Training sequence code - Hopping - MAIO - HSN</p> <p>Synchronization Indication IE is not included</p> <p>For k = 1, Cell Channel Description IE is not included Frequency short list</p> <p>For k=2 Cell Channel Description IE is not included Frequency list</p> <p>For k=3 Cell Channel Description</p> <p>For k = 3 Mobile Allocation</p>	<p>40</p> <p>TCH/F + ACCHs if supported by the MS or SDCCH/8 if not arbitrary but not zero chosen arbitrarily RF hopping channel arbitrary arbitrarily chosen from the set (1,2...63)</p> <p>for c=1, use range 128 to encode the following frequencies: (1 005, 1 010, 1 015) for c=2, use range 256 to encode the following frequencies (73, 74, 75, 76, 77) for c=3, use range 512 to encode the following frequencies (980, 981, 982, 983) for c=4, use range 1 024 to encode the following frequencies (30, 40, 1 010, 1 015) for c=5, use variable Bitmap to encode the following frequencies (980, 991, 992, 993, 994, 1 015)</p> <p>for c=1, use range 128 to encode the following frequencies: (1 005, 1 010, 1 015) for c=2, use range 256 to encode the following frequencies (73, 74, 75, 76, 77) for c=3, use range 512 to encode the following frequencies (980, 981, 982, 983) for c=4, use range 1 024 to encode the following frequencies (30, 40, 1 010, 1 015) for c=5, use variable Bitmap to encode the following frequencies (980, 991, 992, 993, 994, 1 015) for c=6, use Bitmap 0 to encode the following frequencies (20, 40, 66)</p> <p>for c=1, use range 128 to encode the following 13 frequencies: (980, 981, 982, 983, 990, 991, 992, 993, 994, 1 000, 1 005, 1 010, 1 015) for c=2, use range 256 to encode the following 13 frequencies (20, 40, 66, 73, 74, 75, 76, 77, 78, 79, 108, 114, 115) for c=3, use range 512 to encode the following 13 frequencies (980, 981, 982, 983, 990, 991, 992, 993, 994, 1 000, 1 005, 1 010, 1 015) for c=4, use range 1 024 to encode the following 8 frequencies (0, 30, 40, 66, 80, 520, 975, 1 005, 1 010, 1 015) for c=5, use variable Bitmap to encode the following frequencies (980, 981, 982, 983, 990, 991, 992, 993, 994, 1 000, 1 005, 1 010, 1 015) for c=6, use Bitmap 0 to encode the following 12 frequencies (20, 40, 66, 73, 74, 75, 76, 77, 78, 79, 108, 114)</p> <p>indicates the following the frequencies: for c=1 (1 005, 1 010, 1 015)</p>

Mode of the First channel	for c=2 (73, 74, 75, 76, 77) for c=3 (980, 981, 982, 983) for c=4 (30, 40, 1 010, 1 015) for c=5 (990, 991, 992, 993, 994) for c=6 (20, 40, 66) if SDCCH/8: signalling if TCH/F: speech full rate version 1 if speech is supported, otherwise arbitrary from those supported
---------------------------	--

26.10.2.4.2 E-GSM signalling / RR / Handover / layer 1 failure

26.10.2.4.2.1 Conformance requirements

During a handover from a channel in the E-GSM band to a channel in the P-GSM band, or the contrary, the MS shall correctly return to the old channel in the case of an handover failure caused by a layer 1 failure on the target cell.

References

GSM 04.08 section 3.4.4.

26.10.2.4.2.2 Test purpose

To check that the MS correctly returns to the old channel in the case of an handover failure caused by a layer 1 failure on the target cell, even if the origin is in the P-GSM band and the target in the E-GSM band.

26.10.2.4.2.3 Method of test

Initial Conditions

System Simulator:

2 cells with same LAI, default parameters.

Mobile Station:

The MS is in the active state (U10) of a call on a P-GSM channel of cell A. power level = 10.

Related PICS/PIXIT Statements

Supported rate(s) of TCH: TCH/F.

Supported mode(s).

Support for state U10 of the Call Control protocol.

Foreseen Final State of the MS

The active state (U10) of a mobile call (on cell A), used power level 10.

Test Procedure

The MS is in the active state (U10) of a call on a P-GSM channel of cell A (used power level 10). The SS sends a HANOVER COMMAND on the main DCCH. The MS shall begin to send access bursts at the commanded power level on the new DCCH to cell B (power level 12). With the exception of normal BCCH signalling, the SS does not transmit anything on cell B (thus causing a time-out of T3124). The MS shall re-establish the old link on cell A and send a HANOVER FAILURE within 3 seconds from the transmission of HANOVER COMMAND, using the old power level.

Maximum Duration of Test

1 min.

Expected Sequence

Step	Direction	Message	Comments
1	SS -> MS	HANDOVER COMMAND	to an E-GSM channel see specific message contents
2	MS -> SS	HANDOVER ACCESS	Several messages are sent, all with correct Handover References.
3	MS -> SS	HANDOVER FAILURE	Sent on old channel, RR cause value = "Abnormal release, unspecified", "Abnormal release, channel unacceptable", "Abnormal release, timer expired", "Abnormal release, no activity on the radio path" or "Protocol error unspecified". Layer 1 header has the same power level as the layer 1 header in step 1. Shall be sent within 3 seconds from the transmission of HANDOVER COMMAND.

Specific Message Contents**HANDOVER COMMAND**

Information Element	Value/remark
As default message contents, except: Cell Description - BCCH carrier number Channel Description - Channel type - Timeslot number - Training sequence code - Hopping - MAIO - HSN Synchronization Indication IE is not included Cell Channel Description IE is not included Frequency short list Mode of the first channel	40 TCH/F + ACCHs if supported by the MS arbitrary but not zero chosen arbitrarily RF hopping channel arbitrary chosen randomly from the set (1,2...63) use range 128 to encode the following frequencies: (1 005, 1 010, 1 015) Full rate speech version 1 if supported. If not, arbitrary from those supported except signalling.

26.10.2.5 E-GSM signalling / RR / Frequency Redefinition

This section only applies to E-GSM mobile stations.

Conformance requirements of section 26.6.6 fully apply to any mobile station (P-GSM, E-GSM or DCS) in the whole supported band of the mobile station.

Besides, as an E-GSM mobile station shall support the P-GSM band, it shall pass successfully every test of section 26.6.6 under the described GSM 900 conditions.

The purpose of this extra section is to test the frequency redefinition procedure in the case where the target channel uses E-GSM frequency(s): in the case of frequency hopping several coding formats may be used by the network in the FREQUENCY REDEFINITION message.

26.10.2.5.1 Conformance requirements

- 1) To verify that the MS, after receiving a FREQUENCY REDEFINITION message, correctly starts using the new frequencies, and hopping sequence when some E-GSM frequencies are used.
- 2) The last received Cell Channel Description information element is used to decode the Mobile Allocation IE received on the FREQUENCY REDEFINITION message.

References

GSM 04.08, 3.4.5 and 9.1.13.

26.10.2.5.2 Test purpose

- 1) To verify that the MS, after receiving a FREQUENCY REDEFINITION message, starts using the new frequencies and hopping sequence when some E-GSM frequencies are used.
- 2) To check that the last received Cell Channel Description information element is used to decode the Mobile Allocation IE received in the FREQUENCY REDEFINITION message.

26.10.2.5.3 Method of test

Initial conditions

System Simulator:
1 cell; default parameters.

Mobile Station:
The MS is in "idle, updated" state with TMSI allocated.

Related PICS/PIXIT statement(s)

- Support of a TCH (Y/N)

Foreseen final state of the MS

"Idle, updated", with TMSI allocated.

Test procedure

The test procedure is performed six times.

The System Simulator pages the MS and after the MS has responded with a CHANNEL REQUEST, the simulator assigns a TCH/F if supported otherwise a SDCCH/8. Then the SS sends to MS a FREQUENCY REDEFINITION. The MS shall then use the new frequencies/hopping sequence.

Maximum duration of test

3 min.

Expected sequence

The sequence is performed for execution counter c=1 to 6.

Step	Direction	Message	Comments
1	SS->MS	PAGING REQUEST TYPE 1	
2	MS->SS	CHANNEL REQUEST	
3	SS->MS	IMMEDIATE ASSIGNMENT	Hopping channel, Channel type = TCH/F if a TCH is supported otherwise, Channel type=SDCCH/8.
4	MS->SS	PAGING RESPONSE	Sent on the correct channel after establishment of the main signalling link
5	SS->MS	FREQUENCY REDEFINITION	See specific message contents.
6	-----	-----	The SS checks that the MS is transmitting on the correct frequencies.
7	SS->MS	CHANNEL RELEASE	The main signalling link is released.

Specific Message Contents

FREQUENCY REDEFINITION

Information Element	Value/remark
As default message contents, except:	
Channel Description	
- Channel type	Same as in IMMEDIATE ASSIGNMENT
- Timeslot number	Same as in IMMEDIATE ASSIGNMENT
- Training sequence code	Same as in IMMEDIATE ASSIGNMENT
- Hopping	RF hopping channel
- MAIO	arbitrary
- HSN	Same as in IMMEDIATE ASSIGNMENT
Cell Channel Description	for c=1, use range 128 to encode the following 13 frequencies: (980, 981, 982, 983, 990, 991, 992, 993, 994, 1 000, 1 005, 1 010, 1 015) for c=2, use range 256 to encode the following 13 frequencies (20, 40, 66, 73, 74, 75, 76, 77, 78, 79, 108, 114, 115) for c=3, use range 512 to encode the following 13 frequencies (980, 981, 982, 983, 990, 991, 992, 993, 994, 1 000, 1 005, 1 010, 1 015) for c=4, use range 1 024 to encode the following 8 frequencies (0, 30, 40, 66, 80, 1 005, 1 010, 1 015) for c=5, use variable Bitmap to encode the following frequencies (980, 981, 982, 983, 990, 991, 992, 993, 994, 1 000, 1 005, 1 010, 1 015) for c=6, not present (the mobile station will use the last Cell Channel Description IE received, i.e. the one broadcast in the SYSTEM INFORMATION TYPE 1 message).
Mobile Allocation	indicates the following frequencies: for c=1 (1 005, 1 010, 1 015) for c=2 (73, 74, 75, 76, 77) for c=3 (980, 981, 982, 983) for c=4 (30, 40, 1 010, 1 015) for c=5 (990, 991, 992, 993, 994) for c=6 (30, 50, 70)
Starting time	indicates (current frame number + 100 frames) mod 42432

26.10.3 E-GSM signalling / Structured procedure

Conformance requirements of section 26.9 fully apply to any mobile station (P-GSM, E-GSM or DCS) in the whole supported band of the mobile station.

Besides, as an E-GSM mobile station shall support the P-GSM band, it shall pass successfully every test of section 26.9 under the described GSM 900 conditions.

The purpose of these tests is to verify that the MS performs certain elementary procedures of the RR, MM, and CC protocol correctly within a structured procedure. This tested here in an E-GSM context to evaluate the global behaviour of an E-GSM mobile station using its specific frequency capability.

One mobile originated call and one emergency call are performed.

In one of the different cases the different following situations occur: early and late assignments, call release initiated by the network and by the MS.

26.10.3.1 E-GSM signalling / Structured procedure / Mobile originated call**26.10.3.1.1 Conformance requirement**

- 1) An MS in MM state "idle, updated" and in RR idle mode with a TMSI assigned, when made to initiate a call for a selected teleservice that is supported by the MS, shall start to initiate an immediate assignment procedure by sending the CHANNEL REQUEST message with correct establishment cause.
- 2) Upon receipt of the ASSIGNMENT COMMAND message, the Mobile Station initiates a local end release of link layer connections, disconnects the physical channels, commands the switching to the assigned channels and initiates the establishment of lower layer connections (this includes the activation of the channels, their connection and the establishment of the data links). After the main signalling link is successfully established, the MS returns an ASSIGNMENT COMPLETE message, specifying cause "normal event", to the network on the main DCCH.
- 3,4) The call control entity of the Mobile Station in the "call initiated" state, in the "mobile originating call proceeding" state or in the "call delivered" state, shall, upon receipt of a CONNECT message:
 - attach the user connection to the radio path;
 - return a CONNECT ACKNOWLEDGE message.

References

- Conformance requirement 1: GSM 04.08 section 3.3.1.
Conformance requirement 2: GSM 04.08 sections 3.4.3.1 and 3.4.3.2.
Conformance requirement 3: GSM 04.08 section 3.4.3.
Conformance requirement 4: GSM 04.08 section 5.2.1.1.6.
Conformance requirement 5: GSM 02.07.
Conformance requirement 6: GSM 04.08 sections 5.2.1.1.6 and 5.1.3.

26.10.3.1.2 Test purpose

- 1) To verify that the MS in MM state "idle, updated" and in RR idle mode with a TMSI assigned, when made to initiate a call for a selected teleservice that is supported by the MS as declared in a PICS/PIXIT statement, starts to initiate an immediate assignment procedure by sending the CHANNEL REQUEST message.
- 2) To verify that subsequently after receipt of an IMMEDIATE ASSIGNMENT message allocating an SDCCH, after completion of establishment of the main signalling link, after having sent a CM SERVICE REQUEST message, after having successfully performed authentication and cipher mode setting procedures, after having sent a SETUP message, after having received a CALL PROCEEDING message followed by an ALERTING message and an ASSIGNMENT COMMAND message allocating an appropriate TCH, the MS sends an ASSIGNMENT COMPLETE message.
- 3) To verify that subsequently, after the suite of actions specified in test purposes 1 and 2, the MS after receiving a CONNECT message returns a CONNECT ACKNOWLEDGE message.
- 4) To verify that after the suite of actions specified in test purposes 1 and 2, the MS after receiving a CONNECT message attaches the user connection to the radio path. (This is checked by verifying that there is a point in time after transmission of the first L2 frame containing the (complete) CONNECT message, where the MS is sending appropriate speech or data frames whenever it does not have to transmit or acknowledge an I frame on layer 2 of the FACCH.)

26.10.3.1.3 Method of test

Related PICS/PIXIT statements

- Interface to the human user (p1 = Y/N).
- Way to display the called number (only applicable if the MS has an interface to the human user).
- Way to indicate alerting (only applicable if the MS supports the feature).
- Way to make the MS accept an incoming call after alerting (possibly dependent on teleservice and configuration).
- Supported teleservices.
- Classmark.

Initial Conditions

System Simulator:

1 cell, default parameters.

Mobile Station:

The MS is in MM-state "idle, updated" with valid TMSI and CKSN.

Foreseen Final State of the MS

The MS is in MM state "idle updated".

Test procedure

The following test is performed for one teleservice supported by the MS:

A teleservice is selected that is supported by the MS; if the MS supports speech, the selected teleservice is speech. If necessary, the MS is configured for that teleservice.

The MS is made to initiate a call. The call is established with late assignment. The release of the call is initiated by the MS.

Maximum Duration of Test

1 minute.

Expected Sequence

Step	Direction	Message	Comments
1	MS		The "called number" is entered
3	MS		
4	MS -> SS	CHANNEL REQUEST	Establishment cause is "originating call and the network does not set the NECI bit to 1".
5	SS -> MS	IMMEDIATE ASSIGNMENT	
6	MS -> SS	CM SERVICE REQUEST	Message is contained in SABM.
7	SS -> MS	AUTHENTICATION REQUEST	
8	MS -> SS	AUTHENTICATION RESPONSE	SRES specifies correct value.
9	SS -> MS	CIPHERING MODE COMMAND	SS starts deciphering after sending the message.
10	MS -> SS	CIPHERING MODE COMPLETE	Shall be sent enciphered. All following messages shall be sent enciphered.
11	SS		SS starts ciphering.
12	MS -> SS	SETUP	
13	SS -> MS	CALL PROCEEDING	
14	SS -> MS	ALERTING	
15	MS		Depending on the PICS, an alerting indication is given.
16	SS -> MS	ASSIGNMENT COMMAND	
17	MS -> SS	ASSIGNMENT COMPLETE	
18	SS -> MS	CONNECT	
19	MS -> SS	CONNECT ACKNOWLEDGE	
20	MS		The appropriate bearer channel is through connected in both directions.
21	MS		If the call is a data call, the TCH shall be through connected in both directions.
22	MS		The MS is made to release the call.
23	MS -> SS	DISCONNECT	
24	SS -> MS	RELEASE	
25	MS -> SS	RELEASE COMPLETE	
26	SS -> MS	CHANNEL RELEASE	The main signalling link is released.

Specific Message Contents:

None.

26.10.3.2 E-GSM signalling / Structured procedures / emergency call

Emergency call establishment can be initiated by an MS whether location updating has been successful or not and whether a SIM is inserted into the MS or not; but only if the MS is equipped for speech.

This section is only applicable to an MS supporting speech.

26.10.3.2.1 Conformance requirement

- 1) The MS in the "idle, updated" state, as after a successful location update, after the number 112 has been entered by user, shall send a CHANNEL REQUEST message with correct establishment cause ("emergency call").
- 2) After assignment of a dedicated channel the first layer message sent by the MS on the assigned dedicated channel shall be a CM SERVICE REQUEST message specifying the correct IMEI and a non-available CKSN, with CM Service Type "emergency call establishment".
- 3) After cipher mode setting acceptance by the network, the MS shall send an EMERGENCY SETUP message.
- 4),5) The emergency call shall be correctly established. The assignment procedure shall be correctly performed.

After receipt of a CONNECT ACKNOWLEDGE message during correct establishment of the emergency call the TCH shall be through connected in both directions if an appropriate TCH is available.

- 7) The call shall be cleared correctly.

Requirement Reference:

For conformance requirement 1 and 2:

GSM 04.08 section 3.3.1, GSM 04.08 section 5.2.1, GSM 04.08 section 4.5.1.5., GSM 02.30 section 4.

For conformance requirement 3:

GSM 04.08, section 5.2.1.2.

For conformance requirements 4 and 5:

GSM 04.08, sections 5.2.1.1 and 3.4.3.

For conformance requirement 6:

GSM 04.08, sections 5.2.1.1.6 and 5.1.3.

For conformance requirement 7:

GSM 04.08, section 5.4.

26.10.3.2.2 Test purpose

- 1) To verify that the MS in the "idle, no IMSI" state (no SIM inserted) when made to call the number 112, sends a CHANNEL REQUEST message with establishment cause "emergency call".
- 2) To verify that after assignment of a dedicated channel the first layer message sent by the MS on the assigned dedicated channel is a CM SERVICE REQUEST message specifying the correct CKSN and TMSI, with CM Service Type "emergency call establishment".
- 3) To verify that after receipt of a CM SERVICE ACCEPT message from the SS, the MS sends an EMERGENCY SETUP message.
- 4) To verify that subsequently, the SS having sent a CALL PROCEEDING message and then an ALERT message and having initiated the assignment procedure, the MS performs correctly that assignment procedure.
- 5) To verify subsequent correct performance of a connect procedure.
- 6) To verify that subsequently the MS has through connected the TCH in both directions.
- 7) To verify that the call is cleared correctly.

This is tested in the following case:

Structured procedures / emergency call / idle, no IMSI / accept case.

26.10.3.2.3 Method of test

Related PICS/PIXIT Statements

- Speech supported (Y/N).

- Classmark.

Initial Conditions

System Simulator:

1 cell, default parameters except:
BCCH ARFCN = 990.

Mobile Station:

The MS is in MM-state "idle, no IMSI", no SIM inserted.

Foreseen Final State of the MS

The MS is in MM-state "idle, no IMSI", no SIM inserted.

Test procedure

The MS is made to initiate an emergency call. The call is established without authentication, without ciphering, with early assignment. Having reached the active state, the call is cleared by the SS.

Maximum Duration of Test

1 minute.

Expected Sequence

Step	Direction	Message	Comments
1	MS		The "called number" 112 is entered
2	MS -> SS	CHANNEL REQUEST	Establishment cause is "emergency call".
3	SS -> MS	IMMEDIATE ASSIGNMENT	
4	MS -> SS	CM SERVICE REQUEST	Message is contained in SABM. The CM service type IE indicates "emergency call establishment". The mobile identity IE specifies the IMEI of the MS. The cipher key sequence number IE indicates "no key is available". The mobile station classmark IE is as specified by the manufacturer in a PICS/PIXIT statement.
5	SS -> MS	CM SERVICE ACCEPT	
6	MS -> SS	EMERGENCY SETUP	
7	SS -> MS	CALL PROCEEDING	
8	SS -> MS	ASSIGNMENT COMMAND	The rate of the channel is one indicated by the EMERGENCY SETUP message.
9	MS -> SS	ASSIGNMENT COMPLETE	
10	SS -> MS	ALERTING	
11	SS -> MS	CONNECT	
12	MS -> SS	CONNECT ACKNOWLEDGE	
13	MS		The TCH is through connected in both directions.
14	SS -> MS	DISCONNECT	
15	MS -> SS	RELEASE	
16	SS -> MS	RELEASE COMPLETE	
17	SS -> MS	CHANNEL RELEASE	The main signalling link is released.

Specific Message Contents:

None.

26.10.3.3 Default contents of messages

Same as in 26.9.7 except for the following:

ASSIGNMENT COMMAND

Information element	Value/remark
Description of the first channel	describes non-hopping Bm+ACCHs or Lm+ACCHs as appropriate for the test ARFCN = 990
Power Command -	Chosen arbitrarily but within the range supported by the MS.
Frequency list	Omitted
Cell channel description	Omitted
Mode of the first channel	appropriate for one bearer capability chosen for the test
Description of the second channel	Omitted
Mode of the second channel	Omitted
Mobile allocation	Omitted
Starting time	Omitted
Cipher mode setting	Omitted

IMMEDIATE ASSIGNMENT

Information element	Value/remark
Page mode Channel description	Normal paging describes a valid SDCCH+SACCH in non-hopping mode ARFCN = 40
Request reference Random access information N51, N32, N26	As received from MS Corresponding to frame number of the CHANNEL REQUEST
Timing advance	Arbitrary
Mobile allocation	Empty (L=0)
Starting time	Omitted

26.10.4 E-GSM signalling / Default message contents**Default SYSTEM INFORMATION:**

NOTE: SYSTEM INFORMATION 7, and SYSTEM INFORMATION 8 messages are not used.

SYSTEM INFORMATION type 1 message

Information elements	Value/Remark
Cell Channel Description For Cell A - Format identifier - Cell Allocation ARFCN	Bit Map 0 Channel Numbers 20, 30, 50 and 70.
For Cell B - Format identifier - Cell Allocation ARFCN	Bit Map 0 Channel Numbers 10, 12, 40, 60, 62, 63
RACH Control parameters	see below
SI1 Rest octets	see below

SYSTEM INFORMATION type 2 message

Information elements	Value/Remark
BCCH frequency list For cell A - Format identifier - BCCH Allocation Sequence - BCCH Allocation ARFCN - EXT-IND For cell B - Format identifier - BCCH Allocation Sequence - BCCH Allocation ARFCN - EXT-IND NCC permitted RACH control parameters	bit map 0 0 Channels numbers 10, 20, 80, 90, 100, 110 and 120 This IE does not carry the complete BA bit map 0 0 Channels numbers 10, 36, 40, 114, 118 This IE does not carry the complete BA see below see below

SYSTEM INFORMATION type 2bis message

Information elements	Value/Remark
Extended BCCH frequency list For cell A - Format identifier - BCCH Allocation Sequence - BCCH Allocation ARFCN - EXT-IND For cell B - Format identifier - BCCH Allocation Sequence - BCCH Allocation ARFCN - EXT-IND RACH control parameters SI 2bis rest octets	range 256 0 988, 990, 1 003 This IE does not carry the complete BA range 128 0 Channels numbers 1 005, 1 010, 1 015 This IE does not carry the complete BA see below see below

SYSTEM INFORMATION type 3 message

Information elements	Value/Remark
Cell identity LAI Control channel description Cell options Cell Selection parameters RACH control parameter SI3 Rest octets	see below see below see below see below see below see below see below

SYSTEM INFORMATION type 4 message

Information elements	Value/Remark
LAI Cell selection parameters RACH control parameters CBCH Channel Description CBCH MA SI4 Rest octets	see below see below see below see below see below see below

SYSTEM INFORMATION type 5 message

Information elements	Value/Remark
BCCH frequency list For cell A - Format identifier - BCCH Allocation Sequence - BCCH Allocation ARFCN - EXT-IND For cell B - Format identifier - BCCH Allocation Sequence - BCCH Allocation ARFCN - EXT-IND	bit map 0 0 Channels numbers 10, 20, 80, 90, 100, 110 and 120 This IE does not carry the complete BA Bit map 0 0 Channels numbers 10, 36, 40, 114, 118 This IE does not carry the complete BA

SYSTEM INFORMATION type 5bis message

Information elements	Value/Remark
Extension of BCCH frequency list description For cell A - Format identifier - BCCH Allocation Sequence - BCCH Allocation ARFCN - EXT-IND For cell B - Format identifier - BCCH Allocation Sequence - BCCH Allocation ARFCN - EXT-IND	Range 256 0 Channels numbers 988, 990, 1 003 This IE does not carry the complete BA range 128 0 Channels numbers 1 005, 1 010, 1 015 This IE does not carry the complete BA

SYSTEM INFORMATION type 6 message

Information elements	Value/Remark
Cell identity LAI Cell options NCC permitted	see below see below see below see below

Common contents of information elements in SYSTEM INFORMATION TYPE 1 to 6 messages

(CBCH) Channel Description	Not present
(CBCH) Mobile Allocation	Not present
Cell Identity	
- Cell Identity Value	0001H for cell A, 0002H for cell B
Cell Options	
- Power Control Indicator	Power Control Indicator is not set
- DTX Indicator	MS shall not use DTX
- Radio-Link-Time-out	8 SACCH blocks
Cell Selection Parameters	
- Cell-Reselect-Hysteresis	12 dB
- MX-TXPWR-MAX-CCH	Minimum level
- ACS	No addition cell parameters are present in SYSTEM INFORMATION messages 7 and 8.
- NECI	New establishment causes not supported
- RXLEV-ACCESS-MIN	Minimum level
Control Channel Description	
- Attach-Detach allowed	No Attach/Detach
- BS-AG-BLKS-RES	0 blocks reserved for access grant
- CCCH-CONF	1 basic physical channel used for CCCH, combined with SDCCHs
- BS-PA-MFRMS	5 multiframe periods for transmission of paging messages
- T3212 Time-out value	Infinite
L2 pseudo length	
- System information 1	21
- System information 2	22
- System information 2bis	21
- System information 3	18
- System information 4	12
Location Area Identification	
- Mobile Country Code	001 decimal
- Mobile Network Code	01 decimal
- Location Area Code	0001H
Message Type	
- System information 1	00011001
- System information 2	00011010
- System information 2bis	00000010
- System information 3	00011011
- System information 4	00011100
- System information 5	00011101
- System information 5bis	00000101
- System information 6	00011110
NCC Permitted	0000 0010
RACH Control Parameters	
- Max Retrans	Max 1 retrans
- Tx-integer	5 slots used
- Cell Barred for Access	Cell is not barred
- Call Reestablishment Allowed	Not allowed
- Access Control Class	Access is not barred
- Emergency Call allowed	Yes
SI 1 rest octets	Not used (all bits are set to spare)
SI 2 rest octets	Not used (all bits are set to spare)
SI 3 rest octets	Not used (all bits are set to spare)
SI 4 rest octets	Not used (all bits are set to spare)

Default settings for cell A:

Downlink input level	63 dBmicroVolt emf
Uplink output power	minimum supported by the MS's power class
Propagation profile	static
BCCH/CCCH carrier number	20

Default settings for cell B:

Downlink input level	53 dBmicroVolt emf
Uplink output power	minimum supported by the MS's power class
Propagation profile	static
BCCH/CCCH carrier number	10

Default message contents for other messages

For sections 26.10.1 to 26.10.2.5	same as in 26.6.14
For section 26.10.3	same as in 26.9.7

26.11 Multiband signalling

26.11.1 General considerations

This section applies only to Multiband mobile stations, as defined in GSM 02.06 section 3.2.1.

Conformance requirements of section 26 fully apply to any Multiband GSM/DCS MS in the whole supported band(s) of operation of the mobile station.

A Multiband mobile station has the functionality to perform handover, channel assignment, cell selection and re-selection between all its bands of operation within a PLMN.

A Multiband mobile station shall meet all requirements specified for each individual band. In addition it shall meet the extra functional requirements for multiband mobile stations.

The purpose of this section is to test these extra functional requirements for a multiband mobile station.

26.11.2 Multiband signalling / RR

26.11.2.1 Multiband signalling / RR / Immediate assignment procedure

To inform the multiband network of the MSs additional frequency and power capability, the multiband MS has to send a CLASSMARK CHANGE as soon as possible in a connection establishment.

26.11.2.1.1 Conformance requirement

Following a PAGING REQUEST message, the MS shall correctly set up an RR connection on a supported channel described in the IMMEDIATE ASSIGNMENT message. On the MS side, the procedure is terminated when the establishment of the main signalling link is confirmed. When the ES bit is set to 1 in the Classmark 1 or the Classmark 2 information element and the Early Sending Classmark Control bit is set to 0 in SI3 Rest Octets, then the MS shall send, on the first occasion, the CLASSMARK CHANGE message.

During a contention resolution procedure, if the last timeslot of the block containing a L2 UA frame occurs at time T, then the MS shall be ready to transmit the CLASSMARK CHANGE before T + 40 ms.

Reference(s)

GSM 04.08 sections 3.3.1.2.1 and 3.3.1.4.

GSM 04.13 section 5.2.11.

GSM 05.10 section 06.10

26.11.2.1.2 Test purpose

To verify that the MS can correctly set up a dedicated control channel and that a multi band MS is able to perform early sending of CLASSMARK CHANGE.

To verify the performance requirement on early sending of the CLASSMARK CHANGE message.

26.11.2.1.3 Method of test

Initial Conditions

System Simulator:

1 cell.

CCCH-CONF is set to "1 basic physical channel used for CCCH not combined with SDCCHs".

BCCH carrier number 20.

Mobile Station:

The MS is in the "idle, updated" state, with a TMSI allocated.

Related PICS/PIXIT Statement(s)

Type of MS (Multiband).
 Frequency bands supported.
 Support rate(s) of TCH: TCH/F and/or TCH/H.

Foreseen Final State of the MS

"Idle, updated", with TMSI allocated.

Test Procedure

The test is performed twice, first time in the GSM 900 band (BCCH carrier number 20) and second time in the DCS 1 800 band (BCCH carrier number 590).

The System Simulator pages the MS and after the MS has responded with a CHANNEL REQUEST message the SS assigns an SDCCH. The MS shall go to the correct channel and send a PAGING RESPONSE message followed by a CLASSMARK CHANGE message. Then the SS initiates RR-release by sending a CHANNEL RELEASE message.

Before the procedure is repeated, the SS is reconfigured to transmit BCCH carrier number 590.

Maximum Duration of Test

6 seconds per value of the execution timer and 1 min for reconfiguring the SS.

Expected Sequence

This sequence is performed for execution counter k = 1, 2.

Step	Direction	Message	Comments
1	SS -> MS	PAGING REQUEST TYPE 1	
2	MS -> SS	CHANNEL REQUEST	
3	SS -> MS	IMMEDIATE ASSIGNMENT	Channel Type: SDCCH/8
4	MS -> SS	SABM (PAGING RESPONSE)	Shall be sent on the correct channel
5	SS -> MS	UA (PAGING RESPONSE)	
6	MS -> SS	CLASSMARK CHANGE	Shall be ready to transmit (see GSM 05.10 section 06.10) within 40 ms after the completion of step 4. Shall indicate the MS frequency and power capabilities. Note: In this case 'ready to transmit' shall result in the actual transmission of the Classmark Change 51 frames later (51 * 4.62ms = 235.62 ms). Therefore receipt of the Classmark Change within 250ms of step 4 is required.
7	SS -> MS	CHANNEL RELEASE	

Specific Message Contents**IMMEDIATE ASSIGNMENT**

As default except:

Information element	Value/remark
Channel description <ul style="list-style-type: none"> - Channel Type - Timeslot number - Training sequence code - Hopping channel - Channel selector 	SDCCH/8 Arbitrary but not zero Arbitrary Single RF k=1; ARFCN 20 k=2; ARFCN 590
Mobile Allocation	empty

PAGING RESPONSE

Information element	Value/remark
Protocol Discriminator	RR management
Ciphering Key Sequence number <ul style="list-style-type: none"> - Key Sequence 	Key sequence number previously allocated to MS, or "111" if no key is available
Mobile station Classmark 2 <ul style="list-style-type: none"> - ES IND - RF power capability 	Shall indicate early autonomous sending of CLASSMARK CHANGE corresponding to the frequency band in use k=1; GSM 900 power capability k=2; DCS 1 800 power capability
Mobile Identity <ul style="list-style-type: none"> - odd/even - Type of identity - Identity digits 	Even TMSI TMSI previously allocated to MS

CLASSMARK CHANGE

Information element	Value/remark
Protocol Discriminator	RR management
Mobile station Classmark 2 <ul style="list-style-type: none"> - ES IND - RF power capability 	Shall indicate early autonomous sending of CLASSMARK CHANGE corresponding to the frequency band in use k=1; GSM 900 power capability k=2; DCS 1 800 power capability
Additional MS Classmark information <ul style="list-style-type: none"> - Band 1 (P-GSM) supported - Band 2 (E-GSM) supported - Band 3 (DCS 1 800) supported - Associated radio capability 1 - Associated radio capability 2 	According to PICS/PIXIT statement According to PICS/PIXIT statement According to PICS/PIXIT statement Corresponding to GSM 900 band Corresponding to DCS 1 800 band

26.11.2.2 Multiband signalling / RR / Handover

This section only applies to GSM 900 / DCS 1 800 multiband mobile stations.

The purpose of this extra section is to test the handover where the target cell uses frequencies outside the frequency band of the serving cell.

26.11.2.2.1 Multiband signalling / RR / Handover / successful / active call / non-synchronized

26.11.2.2.1.1 Conformance requirements

The MS shall correctly apply the handover procedure in the non-synchronized case when a call is in progress and when handover is performed from a TCH/F without frequency hopping in one band towards a TCH/F without frequency hopping in another band.

When the MS releases a TCH or SDCCH and returns to idle mode, it shall, as quickly as possible, camp on the BCCH carrier of the cell whose channel has just been released, ie the BCCH carrier indicated in the HANDOVER COMMAND.

A multi band mobile station shall not consider a HANDOVER COMMAND as invalid because it indicates target channel frequencies that are all in a different frequency band to that of the ARFCN in the Cell Description IE.

References

GSM 04.08 sections 3.4.4 and 9.1.15.

GSM 04.13 section 5.2.6.2.

GSM 05.08 section 6.7.1.

26.11.2.2.1.2 Test purpose

To test that when the MS is ordered to make a non-synchronized handover it continuously sends access bursts on the main DCCH until it receives a PHYSICAL INFORMATION message from the SS. To test that the MS correctly handles the Timing Advance IE in the PHYSICAL INFORMATION message. To test that the MS activates the new channel correctly and transmits the HANDOVER COMPLETE message without undue delay. To test that upon release of the TCH, the mobile camps on the BCCH carrier of the cell indicated in the HANDOVER COMMAND.

26.11.2.2.1.3 Method of test

Initial Conditions

For execution counter M =1, 2

System Simulator:

2 cells, A and B with same LAI, default parameters except:

Cell A has:

BCCH ARFCN = 20

Cell Allocation = (10, 17, 20, 26, 34, 42, 45, 46, 52, 59, 66, 73, 74, 75, 76, 108, 114)

Cell B has:

BCCH ARFCN = 764

Cell Allocation = (739, 743, 746, 749, 756, 758, 761, 764, 771, 779, 782, 791, 798, 829, 832, 844)

The frame numbers of cells A and B shall be different by 100.

The timebase of cells A and B shall be such that the edges of their timeslots are not coincident at the antenna connector.

Mobile Station:

The MS is in the active state (U10) of a call on cell A. (for execution counter M = 1) and on cell B (for execution counter M=2)

For execution counter M = 3

System Simulator:

2 cells, A and B with different LAI, default parameters except:

Cell A has :

BCCH ARFCN = 20

Cell Allocation = (10, 17, 20, 26, 34, 42, 45, 46, 52, 59, 66, 73, 74, 75, 76, 108, 114)

Cell B has :

LAI = 0003 H

BCCH ARFCN = 764

Cell Allocation = (739, 743, 746, 749, 756, 758, 761, 764, 771, 779, 782, 791, 798, 829, 832, 844)

The frame numbers of cells A and B shall be the same. The timebase of cells A and B shall be such that the edges of their timeslots are coincident at the antenna connector. ie cells A and B shall be fully synchronised.

Mobile Station:

The MS is successfully registered in the LA of cell A and the MS is in the active state (U10) of a call on cell A.

Related PICS/PIXIT Statements

Supported rate(s) of TCH: TCH/FS and/or TCH/HS.

Support for state U10 of the Call Control protocol.

Support for speech: yes/no

Support of multiband functionality

Foreseen Final State of the MS

For execution counter M = 1

The active state (U10) of a call on cell B.

For execution counter M = 2

The active state (U10) of a call on cell A.

For execution counter M = 3

The MM idle state on cell A.

Test Procedure

The MS is in the active state (U10) of a call on cell A. The SS sends a HANDOVER COMMAND on the main DCCH. The MS shall begin to send access bursts on the new DCCH of the target cell. The SS observes the access bursts and after receiving n (n being randomly drawn between values according to table 26.6-2 of section 26.6.5) access bursts, the SS sends one PHYSICAL INFORMATION message with a Timing Advance as specified in table 26.6-1 of section 26.6.5. The MS shall activate the channel in sending and receiving mode. The MS shall establish a signalling link. The MS shall be ready to transmit a HANDOVER COMPLETE message, before "x" ms after the end of the PHYSICAL INFORMATION message, but not before a UA frame has been sent by the SS.

The term "ready to transmit" is defined in GSM 04.13. The value of "x" depends upon the target channel and is specified in the specific message contents section.

For execution counter M = 3, the call is then released and then the SS sends a CHANNEL RELEASE message. It is then checked for 2 minutes that the MS does not access Cell B.

Maximum Duration of Test

5 minutes, including 1 minute for any necessary operator actions.

Expected Sequence

This sequence is performed for an execution counter M = 1, 2, 3 for an MS which supports TCH/F.

Steps after step 7 are only performed for execution counter M = 3.

Step	Direction	Message	Comments
0	MS -> SS		The MS and SS are in the active state of a call on the channel described below.
1	SS -> MS	HANDOVER COMMAND	See Specific message contents
2	MS -> SS	HANDOVER ACCESS	Repeated on every burst of the uplink main DCCH until reception of PHYSICAL INFORMATION. Handover Reference as included in the HANDOVER COMMAND.
3	SS -> MS	PHYSICAL INFORMATION	Sent after reception of n HANDOVER ACCESS messages. See specific message contents.
4	MS -> SS	SABM	Sent without information field
5	SS -> MS	UA	
6	MS -> SS	HANDOVER COMPLETE	The message shall be ready to be transmitted before "x" ms after the completion of step 3.
7	MS -> SS		The MS and SS are in the active state of a call on the channel described below.
8	SS -> MS	RELEASE COMPLETE	steps 8-10 are only performed for execution counter M = 3.
9	SS -> MS	CHANNEL RELEASE	
10	SS		The SS checks that for a period of 2 minutes, the MS does not access cell B.

Specific Message Contents For Mobiles Supporting Speech**SYSTEM INFORMATION TYPE 5ter**

Information Element	Value/remark
Neighbour Cells Description 2 Multiband reporting For Cell A	0
- Format notation	Range 512
- BA_IND	0
- BCCH Allocation ARFCN	ARFCN 520, 590, 600, 700, 764, 780, 810 and 870

For M = 1:

Step 0: The MS and SS are using a full rate TCH in non-hopping mode on cell A.

HANDOVER COMMAND

Information Element	value/remarks
As default message contents, except:	
Cell Description	
- Network Colour Code	1
- Base Station Colour Code	5
- BCCH Carrier Number	764
Channel description	
- Channel type	TCH/F + ACCHs
- Timeslot number	Chosen arbitrarily, but not zero
- Training Sequence Code	Chosen arbitrarily
- Hopping	Single RF.
- ARFCN	Chosen arbitrarily from Cell Allocation for cell B.
Synchronization Indication	
- Report Observed Time Difference	Shall not be included.
- Synchronization Indication	"Non synchronized".
- Normal Cell Indication	Ignore out of range timing advance.

PHYSICAL INFORMATION

Information Element	value/remarks
As default message contents.	

Step 6: x = 500.

Step 7: The MS and SS are using a full rate TCH in non hopping mode on cell B.

For M = 2:

Step 0: The MS and SS are using a full rate TCH in non-hopping mode on cell B.

HANDOVER COMMAND

Information Element	value/remarks
As default message contents, except:	
Cell Description	
- Network Colour Code	1
- Base Station Colour Code	5
- BCCH Carrier Number	20
Channel Description	
- Channel Type	TCH/F + ACCHs
- Timeslot number	Chosen arbitrarily, but not Zero
- Training Sequence Code	Chosen arbitrarily
- Hopping	RF hopping channel.
- MAIO	Chosen arbitrarily from the set (0, 1 to N-1), where N is the number of frequencies encoded in the Frequency Channel Sequence IE.
- HSN	Chosen arbitrarily from the set (1,2,..63)
Synchronization Indication IE is not included.	
Channel Mode IE is not included.	
Frequency Channel Sequence after time	
- Frequency Channel Sequence	Allocates the following 12 frequencies (10, 17, 20, 26, 59, 66, 73, 74, 75, 76, 108, 114)

PHYSICAL INFORMATION

Information Element	value/remarks
As default message contents, except: Timing advance	Arbitrarily selected but different to default value.

Step 6: $x = 500$.

Step 7: The MS and SS are using a full rate TCH in hopping mode on cell A.

For $M = 3$:

Step 0 : The MS and SS are using a full rate TCH in hopping mode on cell A.

HANDOVER COMMAND

Information Element	value/remarks
As default message contents, except :	
Cell Description	
- Network Colour Code	1
- Base Station Colour Code	5
- BCCH Carrier Number	20
Channel description	
- Channel type	TCH/F + ACCHs
- Timeslot number	Chosen arbitrarily, but not zero
- Training Sequence Code	Chosen arbitrarily
- Hopping	Single RF.
- ARFCN	Chosen arbitrarily from Cell Allocation for cell B.
Synchronisation Indication	
- Report Observed Time Difference	Shall not be included.
- Synchronisation Indication	'Non synchronised'.
- Normal Cell Indication	Ignore out of range timing advance.

PHYSICAL INFORMATION

Information Element	value/remarks
As default message contents.	

Step 6 : $x = 500$

Step 7 : The MS and SS are using a full rate TCH in non hopping mode on cell B.

26.11.2.2.2 Multiband signalling / RR / Handover / layer 1 failure**26.11.2.2.2.1 Conformance requirements**

During a handover from a channel in the GSM 900 band to a channel in the DCS 1 800 band, or the contrary, the MS shall correctly return to the old channel in the case of an handover failure caused by a layer 1 failure on the target cell.

References

GSM 04.08 section 3.4.4.

26.11.2.2.2.2 Test purpose

To check that the MS correctly returns to the old channel in the case of an handover failure caused by a layer 1 failure on the target cell, if the origin is in the GSM 900 band and the target is in the DCS 1 800 band or the contrary.

26.11.2.2.2.3 Method of test

Initial Conditions

System Simulator:

2 cells, A and B with same LAI, default parameters except:

Cell A has:
BCCH ARFCN = 20.

Cell B has:
BCCH ARFCN = 764.

Mobile Station:

The MS is in the active state (U10) of a call on cell A. Used power level is the maximum supported by the MS in the band in use.

Related PICS/PIXIT Statements

Supported rate(s) of TCH: TCH/F.
Support for state U10 of the Call Control protocol.
Support for multiband functionality.

Foreseen Final State of the MS

The active state (U10) of a mobile call on cell A. Used power level is the maximum supported by the MS in the band in use.

Test Procedure

The MS is in the active state (U10) of a call on cell A. The SS sends a HANDOVER COMMAND on the main DCCH. The MS shall begin to send access bursts at the commanded power level on the new DCCH to cell B. With the exception of normal BCCH signalling, the SS does not transmit anything on cell B (thus causing a time-out of T3124). The MS shall re-establish the old link on cell A and send a HANDOVER FAILURE within 3 seconds from the transmission of HANDOVER COMMAND, using the old power level.

Maximum Duration of Test

5 minutes, including 1 minute for any necessary operator actions.

Expected Sequence

Step	Direction	Message	Comments
0	SS	-	The SS records the power level in the layer 1 header of the last SACCH message sent by the MS before step 1.
1	SS -> MS	HANDOVER COMMAND	Channel description: non-hopping, full rate. SynchronisationIndication: non synchronized.
2	MS -> SS	HANDOVER ACCESS	Several messages are sent, all with correct Handover References.
3	MS -> SS	HANDOVER FAILURE	Sent on old channel, RR cause value ="Abnormal release, unspecified", "Abnormal release, channel unacceptable", "Abnormal release, timer expired", "Abnormal release, no activity on the radio path" or "Protocol error unspecified". Layer 1 header has the same power level as the layer 1 header in step 1. Shall be sent within 3 seconds from the transmission of HANDOVER COMMAND.
4	SS	-	The SS checks that the power level reported in the layer 1 header of the SACCH message that is sent in the first SACCH multiframe following the SABM is the same as in step 0.

Specific Message Contents

SYSTEM INFORMATION TYPE 5ter

Information Element	Value/remark
Neighbour Cells Description 2 Multiband reporting For Cell A	0
- Format notation	Range 512
- BA_IND	0
- BCCH Allocation ARFCN	ARFCN 520, 590, 600, 700, 764, 780, 810 and 870

HANDOVER COMMAND

Information Element	value/remarks
As default message contents, except:	
Cell Description	
- Network Colour Code	1
- Base Station Colour Code	5
- BCCH Carrier Number	764
Channel description	
- Channel type	TCH/F + ACCHs
- Timeslot number	Chosen arbitrarily, but not zero
- Training Sequence Code	Chosen arbitrarily
- Hopping	Single RF.
- ARFCN	Chosen arbitrarily from Cell Allocation for cell B.
Synchronization Indication	
- Report Observed Time Difference	Shall not be included.
- Synchronization Indication	"Non synchronized".
- Normal Cell Indication	Ignore out of range timing advance.

26.11.2.2.3 Multiband signalling / RR / Handover / Multiband BCCH / successful / active call / non synchronized.**26.11.2.2.3.1 Conformance requirements**

This test relates to cells supporting frequencies in both GSM and DCS 1800 bands.

The MS shall correctly apply the handover procedure in the non synchronized case when a call is in progress and when handover is performed from a TCH/F without frequency hopping in one band towards a TCH/F without frequency hopping in another band.

References

GSM 04.08 sections 3.4.4 and 9.1.15.

GSM 04.13 section 5.2.6.2.

GSM 05.08 section 6.7.1.

26.11.2.2.3.2 Test purpose

To test that when the MS is ordered to make a non synchronized handover it sends continuously access bursts on the main DCCH until it receives a PHYSICAL INFORMATION message from the SS. To test that the MS correctly handles the Timing Advance IE in the PHYSICAL INFORMATION. To test that the MS activates the new channel correctly and transmits the HANDOVER COMPLETE message without undue delay.

26.11.2.2.3.3 Method of test**Initial Conditions**

For execution counter M =1, 2.

System Simulator:

2 cells, A and B with same LAI, default parameters except:

Cell A has:

BCCH ARFCN = 20

System Information 1 Cell Allocation = 10, 20, 34, 45, 52, 66, 74, 114.

GSM 900 frequencies: 10, 20, 34, 45, 52, 66, 74, 114.

DCS 1800 frequencies: 739, 746, 756, 761, 771, 782, 798, 832.

Cell B has:

BCCH ARFCN = 32

System Information 1 Cell Allocation = 14, 17, 32, 59, 73, 76, 87, 108.

GSM 900 frequencies: 14, 17, 32, 59, 73, 76, 87, 108.

DCS 1800 frequencies: 743, 749, 758, 764, 779, 791, 829, 844.

Mobile Station:

For execution counter M = 1, the MS is in the active state (U10) of a call on cell A, using a TCH in the GSM band.

For execution counter M = 2, the MS is in the active state (U10) of a call on cell B, using a TCH in the DCS 1800 band.

Related PICS/PIXIT Statements

Supported rate(s) of TCH: TCH/FS and/or TCH/HS.
Support for state U10 of the Call Control protocol.
Support for speech: yes/no
Support of multiband functionality

Foreseen Final State of the MS

For execution counter M = 1

The active state (U10) of a call with a TCH in the DCS band on cell B.

For execution counter M = 2

The active state (U10) of a call in hopping mode in the DCS 1800 band on cell A.

Test Procedure

The MS is in the active state (U10) of a call. The SS sends a HANDOVER COMMAND on the main DCCH. The MS shall begin to send access bursts on the new DCCH of the target cell. The SS observes the access bursts and after receiving n (n being randomly drawn between values [10-20]) access bursts, the SS sends one PHYSICAL INFORMATION message with an arbitrary Timing Advance. The MS shall activate the channel in sending and receiving mode. The MS shall establish a signalling link. The MS shall be ready to transmit a HANDOVER COMPLETE message, before " x " ms after the end of the PHYSICAL INFORMATION message, but not before a UA frame has been sent by the SS.

The term "ready to transmit" is defined in GSM 04.13. The value of " x " depends upon the target channel and is specified in the specific message contents section.

Maximum Duration of Test

5 minutes, including 1 minute for any necessary operator actions.

Expected Sequence

This sequence is performed for an execution counter M = 1 and 2 for an MS which supports TCH/F.

Step	Direction	Message	Comments
0	MS -> SS		M=1, The MS and SS are using a full rate TCH in GSM band, in non hopping mode on cell A. M=2, the MS and SS are using a full rate TCH in DCS 1800 band, in non hopping mode on cell B.
1	SS -> MS	HANDOVER COMMAND	See Specific message contents
2	MS -> SS	HANDOVER ACCESS	Repeated on every burst of the uplink main DCCH until reception of PHYSICAL INFORMATION. Handover Reference as included in the HANDOVER COMMAND.
3	SS -> MS	PHYSICAL INFORMATION	Sent after reception of n HANDOVER ACCESS messages. See specific message contents.
4	MS -> SS	SABM	Sent without information field
5	SS -> MS	UA	
6	MS -> SS	HANDOVER COMPLETE	The message shall be ready to be transmitted before "x" ms after the completion of step 3.
7	MS -> SS		The MS and SS are in the active state of a call.

For M = 1:

Step 0: The MS and SS are using a full rate TCH in the GSM band, in non-hopping mode on cell A.

HANDOVER COMMAND

Information Element	value/remarks
As default message contents, except:	
Cell Description	
- Network Colour Code	1
- Base Station Colour Code	5
- BCCH Carrier Number	32
Channel description	
- Channel type	TCH/F + ACCHs
- Timeslot number	Chosen arbitrarily
- Training Sequence Code	Chosen arbitrarily
- Hopping	Single RF Channel.
- ARFCN	Chosen arbitrarily from the DCS 1800 frequencies allocated to the cell.
Handover Reference	
- Value	Chosen arbitrarily from the range (0, 1..255)
Power command	
- Power Level	Arbitrarily chosen, but different to the one already in use and within the range supported by that type of MS.
Synchronization Indication	
- Report Observed Time Difference	Shall not be included.
- Synchronization Indication	"Non Synchronized".
- Normal Cell Indication	Ignore out of range timing advance.

PHYSICAL INFORMATION

Information Element	value/remarks
As default message contents, except:	

Step 6: $x = 650$ ms.

Step 7: The MS and SS are using a full rate TCH in the DCS 1800 band, in non hopping mode on cell B.

For $M = 2$:

Step 0: The MS and SS are using a full rate TCH in the DCS 1800 band, in non-hopping mode on cell B.

HANDOVER COMMAND

Information Element	value/remarks
As default message contents, except:	
Cell Description	
- Network Colour Code	1
- Base Station Colour Code	5
- BCCH Carrier Number	20
Channel Description	
- Channel Type	TCH/F + ACCHs
- Timeslot number	Chosen arbitrarily
- Training Sequence Code	Chosen arbitrarily
- Hopping	RF hopping channel.
- MAIO	Chosen arbitrarily from the set (0, 1 to N-1), where N is the number of frequencies in the Mobile Allocation IE.
- HSN	Chosen arbitrarily from the set (1,2,..63)
Handover Reference	
- Value	Chosen arbitrarily from the range (0, 1..255)
Power command	
- Power Level	Arbitrarily chosen, but different to the one already in use and within the range supported by that type of MS.
Synchronization Indication.	
- Report Observed Time Difference	Shall not be included
- Synchronization Indication	"Non Synchronized".
- Normal Cell Indication	Ignore out of range timing advance
Channel Mode IE is not included.	
Mobile Allocation	Indicates DCS 1800 frequencies (743, 758, 764, 791, 844).

PHYSICAL INFORMATION

Information Element	value/remarks
As default message contents, except:	
Timing Advance	Arbitrarily selected but different to default value.

Step 6: $x = 650$ ms.

Step 7: The MS and SS are using a full rate TCH in hopping mode in the DCS band on cell A.

26.11.2.2.4 Multiband signalling / RR / Handover/ Multiband BCCH / Intracell Handover - Interband Assignment.

In case of multi-band networks, an intracell change of channel can be requested by upper layers in order to change the channel type (Directed Retry from a channel belonging to one frequency band to a channel belonging to another frequency band), or it may be initiated by the RR-sublayer for an intra cell and inter-band handover for cells supporting both GSM and DCS 1800 frequencies. This change is performed using the channel assignment procedure.

26.11.2.2.4.1 Dedicated assignment / successful case

This test is only applicable to an MS supporting a TCH.

26.11.2.2.4.1.1 Conformance requirements

1. Upon receipt of the ASSIGNMENT COMMAND message, the mobile station initiates a local end release of link layer connections, disconnects the physical channels, commands the switching to the assigned channels and initiates the establishment of lower layer connections (this includes the activation of the channels, their connection and the establishment of the main signalling links).
2. MM-messages and CM-messages using SAPI=0 sent from the mobile station to the network can be duplicated by the data link layer in the following case:

a channel change of dedicated channels is required (assignment or handover procedure) and the last layer 2 frame has not been acknowledged by the peer data link layer before the mobile station leaves the old channel.

In this case, the mobile station does not know whether the network has received the message correctly. Therefore, the mobile station has to send the message again after the new dedicated channel is established.

3. The MS shall establish the link with the power level specified in the ASSIGNMENT COMMAND message.

The MS shall confirm the power control level that it is currently employing in the uplink SACCH L1 header. The indicated value shall be the power control level actually used by the mobile for the last burst of the previous SACCH period.

4. The MS shall apply the hopping frequencies specified in ASSIGNMENT COMMAND message in the Mobile Allocation IE or the Frequency List IE at the time of accessing the new channel using the last received Cell Allocation.
5. After receipt of the ASSIGNMENT COMMAND the MS shall perform the assignment and return an ASSIGNMENT COMPLETE without undue delay.

References

- | | |
|----------|---|
| 1, 3, 5. | GSM 04.08, subclause 3.4.3. |
| 2. | GSM 04.08, subclause 3.1.4.3. |
| 4. | GSM 04.08, subclause 3.4.3; GSM 05.08, subclause 4.2. |
| 6. | GSM 04.13, subclause 5.2.4. |

26.11.2.2.4.2 Test purpose

1. To verify that upon receipt of an ASSIGNMENT COMMAND, the MS switches to the channel defined in the ASSIGNMENT COMMAND, establishes the link and sends an ASSIGNMENT COMPLETE message. This is tested for an MS supporting TCH in the special cases of a transition.

NOTE: In all cases the old and the new channel assigned belong to different frequency bands.

- 1.1 from non-hopping SDCCH in the GSM band to hopping TCH/F in the DCS 1800 band using a different timeslot;
- 1.2 from hopping TCH/F in the DCS 1800 band to non-hopping TCH/F in the GSM band using a different timeslot;
- 1.3 from non-hopping TCH/F in the GSM band to hopping TCH/F in the DCS 1800 band using a different timeslot.
- 1.4 from hopping TCH/F in the DCS 1800 band to hopping TCH/H in the GSM band using a different timeslot; this test purpose is only applicable if the MS supports TCH/H;
- 1.5 from hopping TCH/H in the GSM band to non-hopping TCH/H in the DCS 1800 band using a different timeslot; this test purpose is only applicable if the MS supports TCH/H;
- 1.6 from non-hopping TCH/H in the DCS 1800 band to hopping TCH/F in the GSM band using a different timeslot; this test purpose is only applicable if the MS supports TCH/H.

2. To verify that an MS supporting TCH, having received an ASSIGNMENT COMMAND, is able in the case of frequency hopping to decode the Mobile Allocation and Frequency List IEs correctly and applies the specified frequencies using the correct Cell Allocation.
3. To verify that after receipt of the ASSIGNMENT COMMAND the MS returns an ASSIGNMENT COMPLETE without undue delay.

26.11.2.2.4.3 Method of test

Initial Conditions

System Simulator:

1 cell with GSM and DCS 1800 frequencies, using a BCCH in the GSM band, default parameters except:

BCCH ARFCN =20.

System Information 1 Cell Allocation = 10, 20, 34, 45, 52, 66, 76, 114, 739, 746, 756, 761, 771, 782, 798, 832.

NOTE: Cell Allocation IE broadcasted in SYSTEM INFORMATION 1 shall be coded with a format so that frequencies belonging to both GSM and DCS 1800 frequency band can be included. Format Identifier of Cell Channel Description IE will thus be Range 1024.

Mobile Station:

The MS is in the "idle, updated" state with a TMSI allocated.

Related PICS/PIXIT Statements

- TCH supported (Y/N).
- Supported rate(s) of TCH: TCH/F and/or TCH/H.
- The supported channel mode(s) need to be declared.
- Support of multiband functionality.

Foreseen Final State of the MS

"Idle, updated", with TMSI allocated.

Test Procedure

The SS pages the MS and allocates an SDCCH. Then three channels are assigned with ASSIGNMENT COMMANDs messages. Each time the MS shall switch to the assigned channel, establish the link and send an ASSIGNMENT COMPLETE message.

For an MS not supporting TCH/H, the SS initiates the channel release procedure and the test ends here. For an MS supporting TCH/H, the channel assignment procedure is performed another three times, with half rate channels involved, and again it is checked that the MS correctly completes the procedures, before the SS initiates the channel release procedure.

Maximum Duration of Test

60 s.

Expected Sequence

Step	Direction	Message	Comments
1	SS -> MS	PAGING REQUEST TYPE 1	
2	MS -> SS	CHANNEL REQUEST	
3	SS -> MS	IMMEDIATE ASSIGNMENT	See specific message contents.
4	MS -> SS	PAGING RESPONSE	
5	SS -> MS	ASSIGNMENT COMMAND	See specific message contents.
6	MS -> SS	ASSIGNMENT COMPLETE	Sent on the correct channel after establishment of the main signalling link. This message shall be ready to be transmitted before 600 ms after the completion of step 5.
7	SS -> MS	ASSIGNMENT COMMAND	See specific message contents.
8	MS -> SS	ASSIGNMENT COMPLETE	Sent on the correct channel after establishment of the main signalling link. This message shall be ready to be transmitted before 600 ms after the completion of step 7.
9	SS -> MS	ASSIGNMENT COMMAND	See specific message contents.
10	MS -> SS	ASSIGNMENT COMPLETE	Sent on the correct channel after establishment of the main signalling link. This message shall be ready to be transmitted before 600 ms after the completion of step 9.
A			This test part is performed if the MS doesn't support TCH/H (see PICS/PIXIT)
A 11	SS -> MS	CHANNEL RELEASE	The main signalling link is released.
B			This test part is performed if the MS supports TCH/H (see PICS/PIXIT).
B11	SS -> MS	ASSIGNMENT COMMAND	See specific message contents.
B12	MS -> SS	ASSIGNMENT COMPLETE	Sent on the correct channel after establishment of the main signalling link. This message shall be ready to be transmitted before 600 ms after the completion of step 11.
B13	SS -> MS	ASSIGNMENT COMMAND	See specific message contents.
B14	MS -> SS	ASSIGNMENT COMPLETE	Sent on the correct channel after establishment of the main signalling link. This message shall be ready to be transmitted before 600 ms after the completion of step 13.
B15	SS -> MS	ASSIGNMENT COMMAND	See specific message contents.
B16	MS -> SS	ASSIGNMENT COMPLETE	Sent on the correct channel after establishment of the main signalling link. This message shall be ready to be transmitted before 600 ms after the completion of step 15.
B17	SS -> MS	CHANNEL RELEASE	The main signalling link is released.

Specific Message Contents

Step 3

IMMEDIATE ASSIGNMENT:

As default message contents except Channel Description	
- Channel Type	SDCCH/8
TDMA offset	Chosen arbitrarily
- Timeslot Number	N, chosen arbitrarily
- Training Sequence Code	Chosen arbitrarily
- Hopping	Single RF Channel
- ARFCN	chosen arbitrarily from CA of the common BCCH in the GSM part of the list.

Step 5

ASSIGNMENT COMMAND:

<p>Channel Description</p> <ul style="list-style-type: none"> - Channel Type and TDMA offset - Timeslot Number - Training Sequence Code - Hopping - MAIO <p>- HSN</p> <p>Power Command</p> <ul style="list-style-type: none"> - Power level <p>Frequency list IE</p> <p>Channel Mode</p> <ul style="list-style-type: none"> - Mode <p>Mobile Allocation</p> <p>Starting Time</p>	<p>TCH/F (N+1) mod 8 Chosen arbitrarily RF hopping channel Chosen arbitrarily from the set (0, 1 to N-1) where N is the number of frequencies in the Mobile Allocation IE. Chosen arbitrarily from the set (1 to 63)</p> <p>Chosen arbitrarily but with a changed value.</p> <p>Not included</p> <p>Signalling Indicates only DCS 1800 frequencies of the CA (broadcast on the BCCH). (739, 746, 761, 771, 782, 832)</p> <p>Not included</p>
---	--

Step 7

ASSIGNMENT COMMAND:

<p>Channel Description</p> <ul style="list-style-type: none"> - Channel Type and TDMA offset - Timeslot Number - Training Sequence Code - Hopping - ARFCN <p>Power Command</p> <ul style="list-style-type: none"> - Power level <p>Channel Mode</p> <p>Frequency list IE</p> <p>Cell Channel Description</p> <p>Mobile Allocation</p> <p>Starting Time</p>	<p>TCH/F (N+2) mod 8 Chosen arbitrarily Single RF Channel chosen arbitrarily from CA of the common BCCH in the GSM part of the list.</p> <p>Chosen arbitrarily but with a changed value. A non-signalling mode arbitrarily selected from the full rate capabilities declared for the MS</p> <p>Not Included Range 1024 format encodes: (45, 52, 66, 76, 114, 739, 746, 756, 761, 771, 782, 798, 832.).</p> <p>Not included</p> <p>Not included</p>
--	--

Step 9**ASSIGNMENT COMMAND:**

Channel Description <ul style="list-style-type: none"> - Channel Type and TDMA offset - Timeslot Number - Training Sequence Code - Hopping <ul style="list-style-type: none"> - MAIO - HSN Power Command <ul style="list-style-type: none"> - Power level Channel Mode Frequency list IE Mobile Allocation Starting Time	TCH/F $(N+3) \bmod 8$ Chosen arbitrarily RF Hopping Channel Chosen arbitrarily from the set (0, 1 to N-1) where N is the number of frequencies in the Mobile Allocation IE. Chosen arbitrarily from the set (1 to 63). Chosen arbitrarily but with a changed value. A non-signalling mode arbitrarily selected from the full rate capabilities declared for the MS Not Included Indicates DCS frequencies (739, 761, 832). Not included
--	---

Step 11**ASSIGNMENT COMMAND:**

Channel Description <ul style="list-style-type: none"> - Channel Type and TDMA offset - Timeslot Number - Training Sequence Code - Hopping <ul style="list-style-type: none"> - MAIO - HSN Power Command <ul style="list-style-type: none"> - Power level Channel Mode Frequency list IE Cell Channel Description Mobile Allocation Starting Time	TCH/H $(N+4) \bmod 8$ Chosen arbitrarily RF hopping channel Chosen arbitrarily from the set (0, 1 to N-1) where N is the number of frequencies in the Mobile Allocation IE. Chosen arbitrarily from the set (1 to 63) Chosen arbitrarily but with a changed value. Not included Not included Range 1024 format encodes: (10, 20, 34, 45, 52, 66, 76, 114, 739, 746, 756, 761, 771, 782, 798, 832.). Indicates frequencies (10, 20, 34, 45, 52, 66, 76, 114). Not included
---	---

Step 13

ASSIGNMENT COMMAND:

Channel Description	TCH/H
- Channel Type and TDMA offset	(N+5) mod 8
- Timeslot Number	Chosen arbitrarily
- Training Sequence Code	Single RF Channel
- Hopping	chosen arbitrarily from CA of the BCCH in the DCS 1800 part of the list.
- ARFCN	
Power Command	
- Power level	Chosen arbitrarily but with a changed value.
Channel Mode	signalling
Frequency list IE	Not included
Cell Channel Description	Not included
Mobile Allocation	Not included
Starting Time	not included

Step 15

ASSIGNMENT COMMAND:

Channel Description	TCH/F
- Channel Type	Chosen arbitrarily
TDMA offset	(N+6) mod 8
- Timeslot Number	Chosen arbitrarily
- Training Sequence Code	RF hopping channel
- Hopping	Chosen arbitrarily from the set (0, 1 to N-1) where N is the number of GSM frequencies in the Frequency List IE.
- MAIO	Chosen arbitrarily from the set (1 to 63)
- HSN	
Power Command	
- Power level	Chosen arbitrarily but with a changed value.
Channel Mode	A non-signalling mode arbitrarily selected from the half rate capabilities declared for the MS
Cell Channel Description	Not included
Frequency list IE	Uses Bitmap 0 to indicate (10, 20, 34, 45, 52, 66, 76, 114).
Mobile Allocation	Not included
Starting Time	Not included

26.11.2.3 Multiband signalling / RR / Measurement reporting

This test applies to multiband GSM 900/DCS 1 800 MSs supporting simultaneous multiband operation.

26.11.2.3.1 Conformance requirements

The MS shall continuously send MEASUREMENT REPORT messages on every SACCH blocks and the measurement valid indication shall be set to valid (0) within the second block at the latest. After 20 seconds the values in the MEASUREMENT REPORT message shall contain measurement results for up to the 6 strongest BCCH carriers among those with known and allowed NCC part of BSIC on which the mobile is asked to report. For a multi band MS the number of neighbour cells, for each frequency band supported, which shall be included is indicated by the parameter MULTIBAND_REPORTING.

References

GSM 04.08 section 3.4.1.2, GSM 05.08 section 8.4.

26.11.2.3.2 Test purpose

To test that, when the SS gives information about neighbouring cells, the MS reports the appropriate results and correctly orders the BA list made from System Information 5 and System Information 5ter.

26.11.2.3.3 Method of test**Initial Conditions**

System Simulator:
8 cells with the following settings:

Transmitter	Level	NCC	BCC	ARFCN	Cell identity
Serving, S1	-60	1	3	002	0001H
Neighbour, N1	-85	1	5	520	0002H
Neighbour, N2	-79	1	7	014	0003H
Neighbour, N3	-75	1	1	020	0004H
Neighbour, N4	-55	1	3	780	0005H
Neighbour, N5	-50	1	5	032	0006H
Neighbour, N6	-45	1	7	880	0007H
Neighbour, N7	-40	1	1	044	0008H

With the exception of the Cell Allocation, the rest of the parameters for all eight cells are the same as the default settings and default SYSTEM INFORMATION TYPE 1, 2 and 4 message contents for cell A. The Cell Allocation for the serving cell is the same as the default setting for cell A. The Cell Allocations for the neighbour cells need have only one entry, consisting of the ARFCN of that cell's BCCH.

Mobile Station:

The MS is in the active state of a call (U10).

Related PICS/PIXIT Statements

Support for state U10 of the Call Control protocol.

Type of MS (multiband GSM 900/DCS 1 800 MS supporting simultaneous multiband operation).

Foreseen Final State of the MS

Active state of a call (U10).

Test Procedure

This test procedure is performed three times.

With the MS having a call in progress, the SS sends SYSTEM INFORMATION TYPE 5, 5ter & 6 on the SACCH. All 8 of the BCCHs "on air" are indicated in the BA. The MS shall send MEASUREMENT REPORTs back to the SS, and it shall be indicated in these that measurement results for the 6 strongest carriers, on which the mobile is asked to report (indicated by the parameter MULTIBAND_REPORTING), have been obtained.

Maximum Duration of Test

5 minutes, including 1 minute for any necessary operator actions.

Expected Sequence

This sequence is performed for execution counter, k = 1, 2, 3.

Since SYSTEM INFORMATION TYPE 5, SYSTEM INFORMATION TYPE 5ter, SYSTEM INFORMATION TYPE 6 and MEASUREMENT REPORT are sent continuously, a table is not applicable in this test. The interval between 2 successive Layer 2 frames containing MEASUREMENT REPORTs shall not exceed one Layer 2 frame.

Specific Message Contents

SYSTEM INFORMATION TYPE 2ter:

Information Element	value/remark
As defaults except: Neighbour Cells Description 2 Multiband reporting	k=1,3: Minimum 3 cells reported from each band supported excluding the frequency band of the serving cell. k=2: Normal reporting of six strongest cells, irrespective of the band used.

SYSTEM INFORMATION TYPE 3:

Information Element	value/remark
as default except: - SI 2ter indicator - Early Classmark Sending Control	SI 3 rest octets System Information 2ter is available Early Sending is explicitly accepted

SYSTEM INFORMATION TYPE 5:

Information Element	value/remark
Protocol Discriminator Message Type Neighbour Cells Description - Format Identifier - BCCH Allocation Sequence - BCCH Allocation ARFCN - EXT IND	RR management Sys Info 5. k=1, 2: Bit map 0 k=3: Bit map 512 1 k=1, 2: ARFCN 14, 20, 32, 44 k=3: ARFCN 520, 780, 880 Information Element carries the complete BA.

SYSTEM INFORMATION TYPE 5ter:

Information Element	value/remark
Protocol Discriminator Message Type Neighbour Cells Description 2 Multiband reporting Format notation BA_IND BCCH Allocation ARFCN	RR management Sys Info 5ter. k=1, 3: Normal reporting of six strongest cells, irrespective of the band used k=2: Minimum 3 cells reported from each band supported excluding the frequency band of the serving cell. Range 512 1 k=1, 2: ARFCN 520, 780, 880 k=3: ARFCN 14,20, 32,44

MEASUREMENT REPORT:

Information Element	value/remark
Protocol Discriminator	RR Management
Transaction Identifier	0000
Message Type	MEASUREMENT REPORT
Measurement Results	
BA-used	1
DTX-used	DTX was not used
RXLEV-FULL-SERVING-CELL	See note 1
RXLEV-SUB-SERVING-CELL	See note 1
MEAS-VALID	See note 3
RXQUAL-FULL-SERVING-CELL	See note 1
RXQUAL-SUB-SERVING-CELL	See note 1
NO-NCELL-M	6 neighbour cell measurement results
RXLEV-NCELL-1	See note 1
BCCH-FREQ-NCELL-1	See note 2
BSIC-NCELL-1	Corresponds to that of BCCH-FREQ-NCELL-1
RXLEV-NCELL-2	See note 1
BCCH-FREQ-NCELL-2	See note 2
BSIC-NCELL-2	Corresponds to that of BCCH-FREQ-NCELL-2
RXLEV-NCELL-3	See note 1
BCCH-FREQ-NCELL-3	See note 2
BSIC-NCELL-3	Corresponds to that of BCCH-FREQ-NCELL-3
RXLEV-NCELL-4	See note 1
BCCH-FREQ-NCELL-4	See note 2
BSIC-NCELL-4	Corresponds to that of BCCH-FREQ-NCELL-4
RXLEV-NCELL-5	See note 1
BCCH-FREQ-NCELL-5	See note 2
BSIC-NCELL-5	Corresponds to that of BCCH-FREQ-NCELL-5
RXLEV-NCELL-6	See note 1
BCCH-FREQ-NCELL-6	See note 2
BSIC-NCELL-6	Corresponds to that of BCCH-FREQ-NCELL-6

NOTE 1: These actual values are not checked.

NOTE 2: k=1; report on ARFCNs 14, 20, 32, 44, 780, 880
 ie: BSIC-NCELL values of 0, 1, 2, 3, 5 and 6 but not 4
 k=2; report on ARFCNs 20, 32, 44, 520, 780, 880
 ie: BSIC-NCELL values of 1, 2, 3, 4, 5 and 6 but not 0
 k=3; report on ARFCNs 780, 880, 14, 20, 32, 44
 ie: BSIC-NCELL values of 1, 2, 3, 4, 5 and 6 but not 0

NOTE 3: The Measurement Valid Indication shall be set to valid within the second SACCH block at the latest.

26.11.3 Multiband signalling / MM**26.11.3.1 Multiband signalling / MM / Location updating**

This procedure is used to register the MS in the network. If it is not performed correctly, no call can be established.

26.11.3.1.1 Location updating / accepted

This test is applicable for Multiband GSM 900 / DCS 1 800 MSs supporting simultaneous multiband operation.

26.11.3.1.1.1 Conformance requirement

If the network accepts a location updating from the Mobile, the Mobile Station shall, after receiving a Location updating Accept message, store the received LAI, stop timer T3210, reset the attempt counter and set the update status in the SIM to updated.

A mobile station that makes use of System information 2ter (to choose correct cell for location updating) , shall not ignore this message if it has a L2 pseudolength different from 18 .

Reference(s)

GSM 04.08 section 4.4.4.6.

26.11.3.1 1.2 Test purpose

To test the behaviour of the MS if the network accepts the location updating of the MS, irrespective of frequency band used.

To test the behaviour of the MS if it receives a System information 2ter with L2pseudolength different from 18 .

26.11.3.1.1.3 Method of test

Initial conditions:

System Simulator:

Two cells, A and B, belonging to different location areas with location area identification a and b of the same PLMN and using frequencies from different frequency bands.

IMSI attach/detach is allowed in both cells.

The T3212 time-out value is 1/10 hour in both cells.

Mobile Station:

The MS has a valid TMSI. It is "idle updated" on cell A.

Related PICS/PIXIT statement(s)

Frequency bands supported (P-GSM, E-GSM, DCS 1 800).

Foreseen final state of the MS

The MS has a valid TMSI. It is "idle, updated" on cell A.

Test Procedure

The MS is made to select cell B. A normal location updating is performed in cell B. The channel is released. The MS is made to select cell A. A normal location updating is performed in cell A.

The LOCATION UPDATING ACCEPT message contains neither IMSI nor TMSI.

Maximum duration of test

3 minutes.

Expected sequence

Step	Direction	Message	Comments
1	SS		The RF level of cell A is lowered but kept suitable , and the RF level of cell B is set higher, in order that the MS can choose cell B as a better cell than cell A , if it correctly read the information broadcasted on the BCCH. The following message are received and sent on cell B .
2	MS -> SS	CHANNEL REQUEST	"Establishment cause": Location updating.
3	SS -> MS	IMMEDIATE ASSIGNMENT	
4	MS -> SS	LOCATION UPDATING REQUEST	"location updating type" = normal, "CKSN" = CKSN1, "location area identification" = a and "mobile identity" = TMSI.
5	SS -> MS	UA(LOCATION UPDATING REQUEST)	
6	MS -> SS	CLASSMARK CHANGE	Indicating the frequency and power capability of the MS
7	SS -> MS	LOCATION UPDATING ACC	"Mobile identity" IE not included.
8	SS -> MS	CHANNEL RELEASE	After the sending of this message, the SS waits for the disconnection of the main signalling link.
9	SS		The RF level of cell B is lowered but kept suitable , and the RF level of cell A is set higher, in order that the MS can choose cell A as a better cell than cell B , if it correctly read the information broadcasted on the BCCH. The following message are received and sent on cell A .
10	MS -> SS	CHANNEL REQUEST	"Establishment cause": Location updating
11	SS -> MS	IMMEDIATE ASSIGNMENT	
12	MS -> SS	LOCATION UPDATING REQUEST	"location updating type" = normal, "CKSN" = CKSN1, "location area identification" = b and "mobile identity" = TMSI.
13	SS -> MS	UA(LOCATION UPDATING REQUEST)	
14	MS -> SS	CLASSMARK CHANGE	Indicating the frequency and power capability of the MS
15	SS -> MS	LOCATION UPDATING ACC	"Mobile identity" IE not included
16	SS -> MS	CHANNEL RELEASE	After the sending of this message, the SS waits for the disconnection of the main signalling link.

Specific message contents:

SYSTEM INFORMATION 2TER of CELL B

Information element	Value/remark
as default except: L2 pseudolength	= 0

LOCATION UPDATING REQUEST

Information element	Value/remark
as default except: Mobile station Classmark 1 - ES IND - RF power capability	Controlled Early Classmark Sending option is implemented corresponding to frequency band used

CLASSMARK CHANGE

Information element	Value/remark
as default except: Mobile station Classmark 2 -ES IND -RF power capability Additional MS Classmark information -Band 1 (P-GSM) supported -Band 2 (E-GSM) supported -Band 3 (DCS) supported -Associated radio capability -Associated radio capability	Controlled Early Classmark Sending is implemented. corresponding to the frequency band in use According to PICS/PIXIT statement According to PICS/PIXIT statement According to PICS/PIXIT statement Corresponding to GSM 900 band Corresponding to DCS 1 800 band

26.11.3.1.2 Location updating / periodic

This test is applicable for Multiband GSM 900 / DCS 1 800 MSs supporting simultaneous multiband operation.

26.11.3.1.2.1 Conformance requirement

- 1) If the Mobile Station is in service state NO CELL AVAILABLE, LIMITED SERVICE, PLMN SEARCH or PLMN SEARCH-NORMAL SERVICE when the timer expires the location updating procedure is delayed until this service state is left.
- 2) The T3212 time-out value shall not be changed in the NO CELL AVAILABLE, LIMITED SERVICE, PLMN SEARCH and PLMN SEARCH-NORMAL SERVICE states.
- 3) If the selected cell is in the location area where the mobile station is registered and IMSI ATTACH is not required and timer T3212 has not expired, then the state is NORMAL SERVICE.

References

- 1 GSM 04.08 section 4.4.2.
- 2 GSM 04.08 section 4.4.2.
- 3 GSM 04.08 section 4.2.1.1.

26.11.3.1.2.2 Test purpose

- 1) To check that if the PLU timer expires while the MS is out of coverage, the MS informs the network of its return to coverage, irrespective of frequency band used.
- 2) To check that the PLU timer is not disturbed by cells of forbidden PLMNs.
- 3) To check that if the PLU timer does not expire while out of coverage and if the mobile returns to the LA where it is updated, the mobile does not inform the network of its return to coverage.

26.11.3.1.2.3 Method of test**Initial conditions**

System Simulator:

Two cells, A and B, belonging to the same location area but using different frequency bands.

Cell A is switched on and cell B is switched off.

T3212 is set to 12 minutes on cell A and cell B.

IMSI attach is allowed in both cells.

Mobile Station:

The MS has a valid TMSI. It is "idle updated" on cell A.

Related PICS/PIXIT statements

Frequency bands supported (P-GSM, E-GSM, DCS 1 800).

Foreseen final state of the MS

The MS is "idle updated" on cell A.

Test procedure

The MS is deactivated. The MS is then activated and placed in automatic network selection mode. It performs IMSI attach. 1 minute after the end of the IMSI attach procedure, cell A is switched off. 8 minutes after the end of the IMSI attach procedure, cell B is switched on. The MS shall not location update on cell B before 11,75 minutes after the end of the IMSI attach procedure. The MS shall perform a periodic location update on cell B between 11,75 minutes and 12,25 minutes after the end of the IMSI attach procedure.

3 minutes after the end of the periodic location updating procedure, cell B is switched off. 14 minutes after the end of the periodic location updating procedure, cell A is switched on. The MS shall perform a location update on cell A before 17 minutes after the end of the periodic location updating procedure.

Maximum duration of test

35 minutes.

Expected sequence

Step	Direction	Message	Comments
1	MS		The MS is activated in automatic network selection mode
2	MS -> SS	CHANNEL REQUEST	
3	SS -> MS	IMMEDIATE ASSIGNMENT	
4	MS -> SS	LOCATION UPDATING REQUEST	"location updating type": IMSI attach
5	SS -> MS	UA(LOCATION UPDATING REQUEST)	
6	MS -> SS	CLASSMARK CHANGE	Indicating the frequency and power capability of the MS
7	SS -> MS	LOCATION UPDATING ACC	
8	SS -> MS	CHANNEL RELEASE	After the sending of this message, the SS waits for the disconnection of the main signalling link.
9	SS		1 minute after step 6, cell A is switched off
10	SS		8 minutes after step 6, cell B is switched on
11	MS -> SS	CHANNEL REQUEST	This message shall be sent on cell B by the MS between 11 minutes 45s and 12 minutes 15s after step 6.
12	SS -> MS	IMMEDIATE ASSIGNMENT	
13	MS -> SS	LOCATION UPDATING REQUEST	"location updating type": periodic updating
14	SS -> MS	UA(LOCATION UPDATING REQUEST)	
15	MS -> SS	CLASSMARK CHANGE	Indicating the frequency and power capability of the MS
16	SS -> MS	LOCATION UPDATING ACC	
17	SS -> MS	CHANNEL RELEASE	After the sending of this message, the SS waits for the disconnection of the main signalling link.
18	SS		3 minutes after step 13, cell B is switched off
19	SS		14 minutes after step 13, cell A is switched on.
20	MS -> SS	CHANNEL REQUEST	This message shall be sent on cell A by the MS before 17 minutes after step 13.
21	SS -> MS	IMMEDIATE ASSIGNMENT	
22	MS -> SS	LOCATION UPDATING REQUEST	"Location updating type" = periodic
23	SS -> MS	UA(LOCATION UPDATING REQUEST)	
24	MS -> SS	CLASSMARK CHANGE	Indicating the frequency and power capability of the MS
25	SS -> MS	LOCATION UPDATING ACC	
26	SS -> MS	CHANNEL RELEASE	After the sending of this message, the SS waits for the disconnection of the main signalling link.

Specific message contents

LOCATION UPDATING REQUEST

Information element	Value/remark
as default except: Mobile station Classmark 1 - ES IND - RF power capability	Controlled Early Classmark Sending option is implemented corresponding to frequency band used

CLASSMARK CHANGE

Information element	Value/remark
as default except: Mobile station Classmark 2 -ES IND -RF power capability Additional MS Classmark information -Band 1 (P-GSM) supported -Band 2 (E-GSM) supported -Band 3 (DCS) supported -Associated radio capability -Associated radio capability	Controlled Early Classmark Sending is implemented. corresponding to the frequency band in use According to PICS/PIXIT statement According to PICS/PIXIT statement According to PICS/PIXIT statement Corresponding to GSM 900 band Corresponding to DCS 1 800 band

26.11.4 Multiband signalling / CC

Reserved for future use.

26.11.5 Multiband signalling / Structured procedures

These tests applies only to multiband mobile stations.

26.11.5.1 Multiband signalling / Structured procedures / MS originated call / early assignment**26.11.5.1.1 Conformance requirements**

- 1) An MS in MM state "idle, updated" and in RR idle mode, when made to initiate a call, if it provides a human interface, shall display the dialled number.
- 2) An MS in MM state "idle, updated" and in RR idle mode, when made to initiate a call for a selected teleservice that is supported by the MS, shall start to initiate the immediate assignment procedure by sending a CHANNEL REQUEST message with correct establishment cause.
- 3) After the initial message the multiband MS shall send a CLASSMARK CHANGE message in the uplink block followed direct after the Layer 2 UA message sent from the network. The CLASSMARK CHANGE message shall contain information elements Mobile Station Classmark 2 and Mobile Station Classmark 3.
- 4) Subsequently after establishment of an MM connection, the MS shall send a SETUP message with correct parameters.
- 5) The call control entity of the Mobile Station in the "call initiated" state, in the "mobile originating call proceeding" state or in the "call delivered" state, shall, upon receipt of a CONNECT message:
 - attach the user connection to the radio path;
 - return a CONNECT ACKNOWLEDGE message.
- 6) Subsequently when the network initiates call clearing by sending a DISCONNECT message, the MS shall proceed to release the call by sending a RELEASE message.
- 7) On receipt of a CHANNEL RELEASE message, the MS shall disconnect the main signalling link.

References

- Conformance requirement 1: GSM 02.07.
 Conformance requirement 2: GSM 04.08 section 3.3.1.
 Conformance requirement 3: GSM 04.08 section 3.3.1.4
 Conformance requirement 4: GSM 04.08 section 5.2.1.1.
 Conformance requirement 5: GSM 04.08 section 5.2.1.6.
 Conformance requirement 6: GSM 04.08 section 5.4.4.
 Conformance requirement 7: GSM 04.08, section 3.5.1.

26.11.5.1.2 Test purpose

- 1) To verify that the MS in MM state "idle, updated" with a TMSI assigned, when made to initiate a call for a selected teleservice that is supported by the MS as declared in a PICS/PIXIT statement, displays the dialled number in the way described in a PICS/PIXIT statement.
- 2) To verify that the MS in MM state "idle, updated" and in RR idle mode, with a TMSI assigned, when made to initiate a call for a selected teleservice that is supported by the MS as declared in a PICS/PIXIT statement, starts to initiate an immediate assignment procedure by sending the CHANNEL REQUEST message with correct establishment cause.
- 3) To verify that a multiband MS is able to send an early CLASSMARK CHANGE on the DCCH uplink.
- 4) To verify that subsequently after receipt of an IMMEDIATE ASSIGNMENT message allocating an SDCCH, after completion of establishment of the main signalling link, after having sent a CM SERVICE REQUEST message, after having successfully performed the authentication and cipher mode setting procedures, the MS sends a SETUP message with correct parameters.
- 5) To verify that subsequently, after receipt of a CALL PROCEEDING message and of an HANDOVER COMMAND message allocating an appropriate TCH in another band, after having completed the traffic channel early assignment procedure by replying with the HANDOVER COMPLETE message, after receipt of an ALERTING message and a CONNECT message, the MS returns a CONNECT ACKNOWLEDGE message.
To verify that subsequently the MS has attached the user connection to the radio path. (This is checked by verifying that there is a point in time after transmission of the first L2 frame containing the (complete) CONNECT message, where the MS is sending appropriate speech or data frames whenever it does not have to transmit or acknowledge an I frame on layer 2 of the FACCH.)
- 6) To verify that subsequently upon the network initiating call clearing by sending a DISCONNECT message, the MS proceed to release the call with RELEASE.
- 7) To verify that subsequently, on receipt of a RELEASE COMPLETE message followed by a CHANNEL RELEASE message, the MS disconnects the main signalling link.

26.11.5.1.3 Method of test

Related PICS/PIXIT Statements

- Interface to the human user (p1 = Y/N).
- Way to display the called number (only applicable if the MS has an interface to the human user).
- Way to indicate alerting (only applicable if the MS supports the feature).
- Way to make the MS accept an incoming call after alerting (possibly dependent on teleservice and configuration).
- Supported teleservices.
- Classmark.
- Frequency bands supported.

Initial Conditions

System Simulator:

- 2 cells, A and B, with same LAI.
- Cell A is a GSM 900 cell with default parameters.
- Cell B is a DCS 1 800 cell with default parameters.

Mobile Station:

The MS is in MM-state idle, updated on cell A with valid TMSI.

Foreseen Final State of the MS

The MS is in MM-state idle, updated on cell B with valid TMSI.

Test procedure

The following test is performed for one teleservice supported by the MS:

A teleservice is selected that is supported by the MS; if the MS supports speech, the selected teleservice is speech. If necessary, the MS is configured for that teleservice.

The MS is made to initiate a call on any frequency band supported by the MS. The call is established with early assignment. Having reached the active state, the call is cleared by the SS.

Maximum Duration of Test

1 minute.

Expected Sequence

Step	Direction	Message	Comments
1	MS		The "called number" is entered
2	MS -> SS	CHANNEL REQUEST	Establishment cause is "originating call and the network does not set the NECI bit to 1".
3	SS -> MS	IMMEDIATE ASSIGNMENT	
4	MS -> SS	CM SERVICE REQUEST	Message is contained in SABM. Indicating early sending of CLASSMARK CHANGE
5	SS -> MS	UA (CM SERVICE REQUEST)	
6	MS -> SS	CLASSMARK CHANGE	Indicating the frequency and power capability of the MS
7	SS -> MS	AUTHENTICATION REQUEST	
8	MS -> SS	AUTHENTICATION RESP	SRES specifies correct value.
9	SS -> MS	CIPHERING MODE COMMAND	SS starts deciphering after sending the message.
10	MS -> SS	CIPHERING MODE COMPLETE	Shall be sent enciphered. All following messages shall be sent enciphered.
11	SS		SS starts ciphering.
12	MS -> SS	SETUP	
13	SS -> MS	CALL PROCEEDING	
14	SS -> MS	HANDOVER COMMAND	See specific message contents below.
15	MS -> SS	HANDOVER ACCESS	May or may not be sent. The sending of the HANDOVER ACCESS is optional as indicated in HANDOVER COMMAND.
	MS -> SS	HANDOVER ACCESS	
	MS -> SS	HANDOVER ACCESS	Handover Reference is included in the HANDOVER COMMAND.
16	MS -> SS	SABM	Sent without information field
17	SS -> MS	UA	
18	MS -> SS	HANDOVER COMPLETE	
19	SS -> MS	ALERTING	
20	MS		Depending on the PICS, an alerting indication is given
21	SS -> MS	CONNECT	
22	MS -> SS	CONNECT ACKNOWLEDGE	
23	MS		The appropriate bearer channel is through connected in both directions.
24	SS -> MS	DISCONNECT	
25	MS -> SS	RELEASE	
26	SS -> MS	RELEASE COMPLETE	
27	SS -> MS	CHANNEL RELEASE	The main signalling link is released.

Specific Message Contents:**CM SERVICE REQUEST**

as default except:

Information element	Value/remark
Mobile station Classmark 2 - ES IND - RF power capability	Shall indicate early autonomous sending of CLASSMARK CHANGE corresponding to the frequency band in use

CLASSMARK CHANGE

as default except:

Information element	Value/remark
Protocol Discriminator	RR management
Mobile station Classmark 2 - ES IND - RF power capability	Shall indicate early autonomous sending of CLASSMARK CHANGE corresponding to the frequency band in use
Additional MS Classmark information - Band 1 (P-GSM) supported - Band 2 (E-GSM) supported - Band 3 (DCS 1 800) supported - Associated radio capability 1 - Associated radio capability 2	According to PICS/PIXIT statement According to PICS/PIXIT statement According to PICS/PIXIT statement Corresponding to GSM 900 band Corresponding to DCS 1 800 band

HANDOVER COMMAND

Information element	Value/remark
Protocol Discriminator	RR management
Cell Description - NCC - BCC - BCCH Carrier Number	1 5 590
Channel description - Channel type - Timeslot number - Training sequence code - Hopping - ARFCN	TCH/F + ACCH's Arbitrary value Chosen arbitrarily Single RF channel 650
Handover Reference	Chosen arbitrarily from the range (0,1...255)
Power Command & Access type - Power level - Access type control	Arbitrarily chosen, but different to the one already in use and within the range supported by the MS. Sending of HANDOVER ACCESS is optional
Synchronization Indication	pre-synchronized; ROT=0; NCI=0.
Timing Advance	same as in IMMEDIATE ASSIGNMENT
Mode of the First Channel	appropriate for the selected bearer service

26.11.5.2 Structured procedures / MS terminated call / late assignment**26.11.5.2.1 Conformance requirement**

- 1) After the initial message the multiband MS shall send a CLASSMARK CHANGE message in the uplink block followed direct after Layer 2 UA message sent from the network.

- 2) The MS shall acknowledge the SETUP message with a CALL CONFIRMED message, if compatibility checking was successful, the MS is not busy, and the user does not refuse the call.
- 3) The MS on acceptance of the call sends a CONNECT, otherwise user alerting is initiated.
- 4) The MS indicates acceptance of a call by sending a CONNECT message.
- 5) HANDOVER COMMAND is answered by HANDOVER COMPLETE.
- 6) For speech calls:
The mobile station shall attach the user connection at latest when sending the connect message, except if there is no compatible radio resource available at this time. In this case the attachment shall be delayed until such a resource becomes available.
For data calls:
The mobile station shall attach the user connection when receiving the CONNECT ACKNOWLEDGE message from the network.

Requirement reference:

Conformance requirement 1:	GSM 04.08, section 3.3.1.4.
Conformance requirements 2, 3, 4:	GSM 04.08, sections 5.2.2.3.1, 5.2.2.3.2 and 5.2.2.5.
Conformance requirement 5:	GSM 04.08, section 3.4.3.1.
Conformance requirement 6:	GSM 04.08, section 5.2.2.9.

26.11.5.2.2 Test purpose

- 1) To verify that a multiband MS is able to send an early CLASSMARK CHANGE message on the DCCH uplink.
- 2) To verify that the MS in "Idle, Updated" state with a TMSI assigned, after being paged by the network on the correct paging subchannel, after initiating the immediate assignment procedure by sending the CHANNEL REQUEST message, after receipt of an IMMEDIATE ASSIGNMENT message allocating an SDCCH, after having established the main signalling link, after having sent a PAGING RESPONSE message, after having performed successful authentication and cipher mode setting procedures, after receipt of a SETUP message containing a signal information element, returns a CALL CONFIRMED message followed by:
 - an ALERTING message;
 - or a CONNECT message.
- 3) To verify that in the situation of test purpose 1, if the MS sends an ALERTING message, the MS generates an alerting indication in the way described in a PICS/PIXIT statement.
- 4) To verify that subsequently the MS, if it had not yet sent a CONNECT message, upon acceptance of the call, sends a CONNECT message.
- 5) To verify that subsequently after receipt of an HANDOVER COMMAND ALLOCATING A tch IN another band, the MS sends an HANDOVER COMPLETE message.
- 6) To verify that subsequently the MS
 - if the call is a speech call: after sending the HANDOVER COMPLETE message has through connected the TCH in both directions (this is checked by verifying that after transmission of the first L2 frame containing the (complete) HANDOVER COMPLETE message, the MS is sending appropriate speech or data frames whenever it does not have to transmit or acknowledge an I frame on layer 2 of the FACCH.)
 - if the call is a data call: after receipt of a subsequent CONNECT ACKNOWLEDGE message through connects the TCH in both directions (this is checked by verifying that there is a point in time after transmission of the first L2 frame containing the (complete) CONNECT ACKNOWLEDGE message, where the MS is sending appropriate speech or data frames whenever it does not have to transmit or acknowledge an I frame on layer 2 of the FACCH.)

26.11.5.2.3 Method of test

Related PICS/PIXIT statements

- Interface to the human user (p1 = Y/N).
- Way to display the called number (only applicable if the MS has an interface to the human user).
- Way to indicate alerting (only applicable if the MS supports the feature).
- Way to make the MS accept an incoming call after alerting (possibly dependent on teleservice and configuration).
- Supported teleservices.
- Classmark.
- Frequency bands supported.
- Immediate connect supported (Y/N).

Initial Conditions

System Simulator:

- 2 cells, A and B, with same LAI.
- Cell A is a GSM 900 cell with default parameters.
- Cell B is a DCS 1 800 cell with default parameters.

Mobile Station:

The MS is in MM-state idle, updated on cell A with valid TMSI.

Foreseen Final State of the MS

The MS is in MM-state idle, updated on cell B with valid TMSI.

Test procedure

A teleservice is selected that is supported by the MS; if the MS supports speech, the selected teleservice is speech. If necessary, the MS is configured for that teleservice.

The MS is paged on any frequency band supported by the MS and a MT call is established with late assignment (after CONNECT). The release of the call is initiated by the MS.

Maximum Duration of Test

40 seconds.

Expected Sequence

Step	Direction	Message	Comments
1	SS -> MS	PAGING REQUEST TYPE 1	Sent on the correct paging subchannel
2	MS -> SS	CHANNEL REQUEST	Establishment cause indicates "answer to paging".
3	SS -> MS	IMMEDIATE ASSIGNMENT	
4	MS -> SS	PAGING RESPONSE	Message is contained in SABM.
5	SS -> MS	UA (PAGING RESPONSE)	
6	MS -> SS	CLASSMARK CHANGE	Indicating the frequency and power capability of the MS
7	SS -> MS	AUTHENTICATION REQUEST	
8	MS -> SS	AUTHENTICATION RESP	SRES specifies correct value.
9	SS -> MS	CIPHERING MODE COMMAND	SS starts deciphering after sending the message.
10	MS -> SS	CIPHERING MODE COMPLETE	Shall be sent enciphered. All following messages shall be sent enciphered.
11	SS		SS starts ciphering.
12	SS -> MS	SETUP	Message contains the signal IE.
13	MS -> SS	CALL CONFIRMED	
A14	MS -> SS	CONNECT	
B14	MS -> SS	ALERTING	
B15	MS		An alerting indication as defined in an PICS/PIXIT statement is given by the MS.
B16	MS		The MS is made to accept the call in the way described in a PICS/PIXIT statement.
B18	MS -> SS	CONNECT	
19	SS -> MS	HANDOVER COMMAND	See specific message contents below.
20	MS -> SS	HANDOVER ACCESS	Handover Reference is included in the
21	MS -> SS	HANDOVER ACCESS	HANDOVER COMMAND.
22	MS -> SS	HANDOVER ACCESS	
23	MS -> SS	HANDOVER ACCESS	
24	MS -> SS	SABM	Sent without information field
25	SS -> MS	UA	
26	MS -> SS	HANDOVER COMPLETE	
27	MS		If the call is a speech call, the TCH shall be through connected in both directions.
28	SS -> MS	CONNECT ACKNOWLEDGE	
29	MS		If the call is a data call, the MS shall through connect the TCH in both directions
30	MS		The MS is made to release the call.
31	MS -> SS	DISCONNECT	
32	SS -> MS	RELEASE	
33	MS -> SS	RELEASE COMPLETE	
34	SS -> MS	CHANNEL RELEASE	The main signalling link is released.

Specific Message Contents:**PAGING RESPONSE**

Information element	Value/remark
Mobile station Classmark 2 - ES IND - RF power capability	Shall indicate early autonomous sending of CLASSMARK CHANGE corresponding to the frequency band in use

CLASSMARK CHANGE

Information element	Value/remark
Protocol Discriminator	RR management
Mobile station Classmark	
- ES IND	Shall indicate early autonomous sending of CLASSMARK CHANGE
- RF power capability	corresponding to the frequency band in use
Additional MS Classmark information	
- Band 1 (P-GSM) supported	According to PICS/PIXIT statement
- Band 2 (E-GSM) supported	According to PICS/PIXIT statement
- Band 3 (DCS 1 800) supported	According to PICS/PIXIT statement
- Associated radio capability 1	Corresponding to GSM 900 band
- Associated radio capability 2	Corresponding to DCS 1 800 band

HANDOVER COMMAND

Information element	Value/remark
Protocol Discriminator	RR management
Cell Description	
- NCC	1
- BCC	5
- BCCH Carrier Number	590
Channel description	
- Channel type	TCH/F + ACCH's
- Timeslot number	Arbitrary value
- Training sequence code	Chosen arbitrarily
- Hopping	Single RF channel
- ARFCN	650
Handover Reference	Chosen arbitrarily from the range (0,1...255)
Power Command & Access type	
- Power level	Arbitrarily chosen, but different to the one already in use and within the range supported by the MS.
- Access type control	Sending of HANDOVER ACCESS is mandatory.
Synchronization Indication	pre-synchronized; ROT=0; NCI=0.
Timing Advance	same as in IMMEDIATE ASSIGNMENT
Mode of the first channel	appropriate for the selected bearer service

26.11.6 Multiband signalling / Default messages contents**Default SYSTEM INFORMATION**

The following parameters shall be coded into the system information messages. Parameters shall be coded according to GSM 04.08.

SYSTEM INFORMATION TYPE 2bis, SYSTEM INFORMATION TYPE 5bis, SYSTEM INFORMATION TYPE 7 and SYSTEM INFORMATION TYPE 8 messages are not used.

SYSTEM INFORMATION TYPE 1

Information Element	Value/remark
Cell channel description For Cell A - Format identifier - Cell Allocation ARFCN For Cell B - Format identifier - Cell Allocation ARFCN RACH control parameters SI1 rest octets	Bit map 0 ARFCN 20, 30, 50 and 70 Range 512 ARFCN 590, 650, 750 and 850 see below see below

SYSTEM INFORMATION TYPE 2

Information Element	Value/remark
BCCH Frequency list For Cell A - Format identifier - BCCH Allocation Sequence - BCCH Allocation ARFCN - EXT-IND For Cell B - Format identifier - BCCH Allocation Sequence - BCCH Allocation ARFCN - EXT-IND NCC permitted RACH control parameters	Bit map 0 0 ARFCN 10, 20, 80, 90, 100, 110 and 120 "The information element carries the complete BA" Range 512 0 ARFCN 520, 590, 600, 700, 780, 810 and 870 "This IE carries the complete BA" see below see below

SYSTEM INFORMATION TYPE 2ter

Information Element	Value/remark
Neighbour Cells Description 2 Multiband reporting For Cell A - Format notation - BA_IND - BCCH Allocation ARFCN For Cell B - Format notation - BA_IND - BCCH Allocation ARFCN SI 2ter rest octets	0 Range 512 0 ARFCN 520, 590, 600, 700, 780, 810 and 870 Range 1024 0 ARFCN 10, 20, 80, 90, 100, 110 and 120 see below

SYSTEM INFORMATION TYPE 3

Information Element	Value/remark
Cell identity Location Area Identification Control Channel Description Cell options Cell selection parameters RACH control parameters SI3 rest octets SI 2ter Indicator Early Sending Classmark Control	see below see below see below see below see below see below System Information 2ter is available Early Sending is explicitly accepted

SYSTEM INFORMATION TYPE 4

Information Element	Value/remark
Location Area Identification	see below
Cell selection parameters	see below
RACH control parameters	see below
CBCH Channel Description	see below
CBCH Mobile Allocation	see below
SI4 rest octets	see below

SYSTEM INFORMATION TYPE 5

Information Element	Value/remark
BCCH Frequency list	
For Cell A	
- Format identifier	Bit map 0
- BCCH Allocation Sequence	0
- BCCH Allocation ARFCN	ARFCN 10, 20, 80, 90, 100, 110 and 120
- EXT-IND	"The information element carries the complete BA"
For Cell B	
- Format identifier	Range 512
- BCCH Allocation Sequence	0
- BCCH Allocation ARFCN	ARFCN 520, 590, 600, 700, 780, 810 and 870
- EXT-IND	This IE carries the complete BA

SYSTEM INFORMATION TYPE 5ter

Information Element	Value/remark
Neighbour Cells Description 2	0
Multiband reporting	
For Cell A	
- Format notation	Range 512
- BA_IND	0
- BCCH Allocation ARFCN	ARFCN 520, 590, 600, 700, 780, 810 and 870
For Cell B	
- Format NOTATION	Range 1024
- BA_IND	0
- BCCH Allocation ARFCN	ARFCN 10, 20, 80, 90, 100, 110 and 120

SYSTEM INFORMATION TYPE 6

Information Element	Value/remark
Cell identity	see below
Location Area Identification	see below
Cell options	see below
NCC permitted	see below

Common contents of information elements in SYSTEM INFORMATION TYPE 1 to 6 messages.

CBCH Channel Description	Not present
CBCH Mobile Allocation	Not present
Cell identity	
CI VALUE	0001H for cell A, 0002H for cell B
Cell options	
Power Control Indicator	power control indicator is not set
DTX Indicator	MS shall not use DTX
RADIO LINK TIME-OUT	8 SACCH blocks
Cell selection parameters	
CELL RESELECT HYSTERESIS	12 dB
MS-TXPWR-MAX-CCH	Minimum level
RXLEV-ACCESS-MIN	Minimum level
ACS	There are no additional cell parameters included in SI7 and SI8
NECI	New establishment cause not supported
Control Channel Description	
ATT	No Attach/Detach
BS-AG-BLKS-RES	0 blocks reserved
CCCH-CONF	Combined CCCH/SDCCH
BS-PA-MFRMS	5 multiframes
T3212	Infinite
L2 pseudo length	
SI 1	21
SI 2	22
SI 2ter	18
SI 3	18
SI 4	12
Location Area Identification	
MCC	001 decimal
MNC	01 decimal
LAC	0001H
Message Type	
SI 1	00011001
SI 2	00011010
SI 2ter	00000011
SI 3	00011011
SI 4	00011100
SI 5	00011101
SI 5ter	00000110
SI 6	00011110
NCC permitted	00000010
RACH control parameters	
MAX RETRANS	Max 1 retrans
TX-INTEGER	5 slots used
CELL BAR ACCESS	Not barred
CALL RE-ESTABLISHMENT	Not Allowed
EMERGENCY CALL	Allowed
ACCESS CONTROL CLASS (0...9, 11...15)	None Barred
SI 1 rest octets	Not used (all bits are set to spare)
SI 2 rest octets	Not used (all bits are set to spare)
SI 2ter rest octets	Not used (all bits are set to spare)
SI 4 rest octets	Not used (all bits are set to spare)

Default settings for cell A

Downlink input level	63 dBmicroVolt emf
Uplink output power	Minimum supported by the MS
Propagation profile	Static
BCCH/CCCH	ARFCN 20

Default settings for cell B

Downlink input level	53 dBmicroVolt emf
Uplink output power	Minimum supported by the MS
Propagation profile	Static
BCCH/CCCH	ARFCN 590

Default message contents for other messages

- For section 26.11.2 same as in 26.6.14 for GSM 900 messages and 26.6.15 for DCS 1 800 messages.
- For section 26.11.3 same as in 26.7.
- For section 26.11.4 no tests yet defined.
- For section 26.11.5 same as in 26.9.7.

26.12 Enhanced Full Rate signalling

This section only applies to MS supporting enhanced full rate speech.

As an EFR mobile station necessarily supports the speech full rate version 1 or both speech full rate version 1 and speech half rate version 1, conformance requirements of section 26 fully apply to this mobile.

The purpose of this extra section is to test the different procedures which may be impacted when Enhanced full rate speech codec is used.

26.12.1 EFR signalling/ test of the channel mode modify procedure

NOTE: This test is derived from the tests in sections 26.6.7.1 and 26.6.7.2 respectively entitled "Test of the channel mode modify procedure / full rate" and "Test of the channel mode modify procedure / half rate".

This test is only applicable to an enhanced full rate speech MS.

26.12.1.1 Conformance requirement

The MS with a TCH/F allocated acknowledges a CHANNEL MODE MODIFY message by sending a CHANNEL MODE MODIFY ACKNOWLEDGE message specifying the new mode and by switching to this mode when this one is set to :

- speech full rate or half rate version 1
- speech full rate or half rate version 2
- any other mode declared supported by the mobile

If the mobile station does not support the indicated mode, it shall retain the old mode and return the associated channel mode information in the CHANNEL MODE MODIFY ACKNOWLEDGE message.

References

TS GSM 02.06 , subclauses 3.2.3
TS GSM 04.08, subclauses 3.4.6.1.1 and 3.4.6.1.2

26.12.1.2 Test purpose

To verify that the MS with a TCH/F allocated acknowledges a CHANNEL MODE MODIFY message by sending a CHANNEL MODE MODIFY ACKNOWLEDGE message specifying the new mode and by switching to this mode when this one is set to :

- speech full rate or half rate version 1
- speech full rate or half rate version 2
- any other mode declared supported by the mobile

To verify that the MS, in an RR connected state, acknowledges a CHANNEL MODE MODIFY message by sending a CHANNEL MODE MODIFY ACKNOWLEDGE message specifying the old mode when the new mode is not declared as supported by the mobile

26.12.1.3 Method of test

Initial Conditions

System Simulator: 1 cell, default parameters.

Mobile Station: The MS is "idle updated", with TMSI allocated.

Related PICS/PIXIT Statements

- Type of MS (P-GSM900 or EGSM or DCS1800).
- The MS supports speech full rate version 2
 - Bearer Capabilities supported by the MS
 - Channel modes supported by the MS
 - * MS supports speech full rate version 3 (p1 = Y/N)
 - * MS supports data 12 Kb/s (p2 = Y/N)
 - * MS supports data 6 Kb/s full rate (p3 = Y/N)
 - * MS supports data 3,6 Kb/s full rate (p4 = Y/N)

Foreseen Final State of the MS

"Idle, updated", with TMSI allocated.

Test procedure

A Mobile Terminated call is initiated , however following the CHANNEL REQUEST received from the Mobile Station, the SS sends an IMMEDIATE ASSIGNMENT to the MS commanding it to go to a TCH/F. This sets the Channel Mode automatically to "Signalling Only".

The SS then sends a series of CHANNEL MODE MODIFY messages to the MS. Each time it is checked that the MS responds with a CHANNEL MODE MODIFY ACKNOWLEDGE message specifying

- the channel mode that has been specified in the CHANNEL MODE MODIFY message, if the MS supports that mode (this mode then becomes the "channel mode in use"). If necessary, the MS shall be correctly configured in order to accept this mode .
- the channel mode that was in use when the CHANNEL MODE MODIFY message has been received, if the MS does not support the channel mode specified in the CHANNEL MODE MODIFY message.

Maximum Duration of Test

50 seconds.

Expected Sequence

Step	Direction	Message	Comments
1	SS->MS	PAGING REQUEST TYPE 1	Sent on correct paging subchannel Establishment cause indicates "answer to paging" Assignment to a non hopping TCH/F
2	MS->SS	CHANNEL REQUEST	
3	SS->MS	IMMEDIATE ASSIGNMENT	
4	SS->MS	CHANNEL MODE MODIFY	
5	MS->SS	CHANNEL MODE MODIDY ACKNOWLEDGE	
6	SS->MS	CHANNEL MODE MODIFY	
7	MS->SS	CHANNEL MODE MODIDY ACKNOWLEDGE	
8	SS->MS	CHANNEL MODE MODIFY	
9	MS->SS	CHANNEL MODE MODIDY ACKNOWLEDGE	
10	SS->MS	CHANNEL MODE MODIFY	
11	MS->SS	CHANNEL MODE MODIDY ACKNOWLEDGE	
12	SS->MS	CHANNEL MODE MODIFY	
13	MS->SS	CHANNEL MODE MODIDY ACKNOWLEDGE	
14	SS->MS	CHANNEL MODE MODIFY	
15	MS->SS	CHANNEL MODE MODIDY ACKNOWLEDGE	
16	SS->MS	CHANNEL MODE MODIFY	
17	MS->SS	CHANNEL MODE MODIDY ACKNOWLEDGE	
18	SS->MS	CHANNEL MODE MODIFY	
19	MS->SS	CHANNEL MODE MODIDY ACKNOWLEDGE	
20	SS->MS	CHANNEL MODE MODIFY	
21	MS->SS	CHANNEL MODE MODIDY ACKNOWLEDGE	
22	SS->MS	CHANNEL MODE MODIFY	
23	MS->SS	CHANNEL MODE MODIDY ACKNOWLEDGE	
24	SS->MS	CHANNEL RELEASE	

Specific Message Contents**CHANNEL MODE MODIFY**

Information Element	value/remark
Channel description	describes the already assigned dedicated channel
Channel mode	
Mode	in step 4: speech full or half rate version 2 in step 6: data 3,6 Kb/s in step 8: speech full or half rate version 2 in step 10: data 6 Kb/s in step 12: speech full or half rate version 2 in step 14: data 12 Kb/s in step 16: speech full or half rate version 2 in step 18: speech full or half rate version 1 in step 20: speech full or half rate version 2 in step 22: speech full or half rate version 3

CHANNEL MODE MODIFY ACKNOWLEDGE

Channel mode Mode	in steps 5, 9, 13, 17, 21 : speech full rate version 2 in step 7: if p 4= Y: data 3,6 Kb/s if p4 = N: same as in step 5 in step 11 : if p3 = Y: data 6,0 Kb/s full rate if p3 = N: same as in step 9 in step 15: if p2 = Y: data 12 Kb/s full rate if p2 = N: same as in step 13 in step 19: speech full rate version 2 in step 23: if p1 = Y: speech full rate version 3 if p1 = N: same as in step 21
----------------------	--

26.12.2 EFR signalling/ tests of handover

With the Handover procedure, it is possible to completely alter the channels allocated to a MS. This makes it possible in particular to switch a call in progress from one cell to another. The procedure is always initiated by the network and with the MS in a dedicated mode.

Sections 26.12.2.1 - 26.12.2.2 contain generic test procedures to be used for executing successful Handover tests dealing with EFR mode.

section 26.12.2.1 deals with EFR signalling in the Handover/successful/active call/non synchronised case.

Section 26.12.2.2 deals with EFR signalling in the Handover/successful/call under establishment/non synchronised case.

Table 1 contains a summary of the different combinations of parameters which have to be tested, together with a reference to the appropriate generic test procedure. If a test uses a channel rate which the MS under test does not support, the test shall be skipped.

sv1 stands for speech full/half rate version 1.

sv2 stands for speech full/half rate version 2 (enhanced full rate).

Table 1

From	To	Timing Adv.	Start Time	Syn ?	State of call	Section	Exec Counter
TCH/F, sv2, no FH	TCH/F, sv2, no FH	20	none	no	U10	26.12.2.1	1
TCH/F, sv2, no FH	TCH/F, sv2, FH	arbitrary	none	no	U10	26.12.2.1	2
TCH/F, sv2, FH	TCH/F, sv2, no FH	20	1,1s	no	U10	26.12.2.1	3
TCH/F, sv2, no FH	TCH/F, sv1, no FH	20	none	no	U10	26.12.2.1	4
TCH/F, sv1, no FH	TCH/F, sv2, no FH	arbitrary	none	no	U10	26.12.2.1	5
TCH/F, sv2, no FH	TCH/F, sv1, FH	arbitrary	none	no	U10	26.12.2.1	6
TCH/F, sv1, FH	TCH/F, sv2, FH	20	1,1	no	U10	26.12.2.1	7
TCH/F, sv2, FH	TCH/F, sv1, FH	arbitrary	none	no	U10	26.12.2.1	8
TCH/F, sv1, FH	TCH/F, sv2, no FH	arbitrary	none	no	U10	26.12.2.1	9
TCH/F, sv2, no FH	TCH/H, sv1, FH	arbitrary	none	no	U10	26.12.2.1	10
TCH/H, sv1, FH	TCH/F, sv2, FH	20	1,1	no	U10	26.12.2.1	11
TCH/F, sv2, FH	TCH/H, sv1, FH	arbitrary	none	no	U10	26.12.2.1	12
TCH/H, sv1, FH	TCH/F, sv2, noFH	20	none	no	U10	26.12.2.1	13
TCH/F, sv2, noFH	TCH/H, sv1, noFH	20	none	no	U10	26.12.2.1	14
TCH/H, sv1, noFH	TCH/F, sv2, noFH	20	none	no	U10	26.12.2.1	15
SDCCH/4, no FH	TCH/F, sv2, FH	20	none	no	estab	26.12.2.2	1
SDCCH/8, FH	TCH/F, sv2, no FH	20	none	no	estab	26.12.2.2	2
SDCCH/8, no FH	TCH/F, sv2, FH	20	none	no	estab	26.12.2.2	3
TCH/F, no FH	TCH/F, sv2, FH	20	none	no	estab	26.12.2.2	4
TCH/F, no FH	TCH/F, sv2, no FH	20	none	no	estab	26.12.2.2	5
TCH/F, FH	TCH/F, sv2, FH	20	1,1	no	estab	26.12.2.2	6
TCH/F, FH	TCH/F, sv2, no FH	20	none	no	estab	26.12.2.2	7
TCH/H, no FH	TCH/F, sv2, FH	20	none	no	estab	26.12.2.2	8
TCH/H, no FH	TCH/F, sv2, no FH	20	1,1	no	estab	26.12.2.2	9
TCH/H, FH	TCH/F, sv2, FH	20	none	no	estab	26.12.2.2	10
TCH/H, FH	TCH/F, sv2, no FH	20	none	no	estab	26.12.2.2	11

Table 2

	TCH/FS	TCH/HS	SDCCH
n	10-20	5-10	2-5

n : number of access bursts.

26.12.2.1 EFR signalling / Handover / active call / successful case

NOTE: This test is derived from the one defined in section 26.6.5.1 "Handover/successful/active call/non-synchronized"

This test only applies for MS supporting full rate speech version 2 (enhanced full rate speech).

26.12.2.1.1 Conformance requirements

The MS shall correctly apply the handover procedure in the non-synchronized case when :

- a call is in progress and,
- handover is performed from a TCH/F with/without frequency hopping towards a TCH/F with/without frequency hopping and,
- the mode of either the current or the target channel is set to full rate speech version 2 (enhanced full rate speech).

The MS also supporting half rate shall correctly apply the handover procedure in the non-synchronized case when:

- a call is in progress and,
- a handover is performed between a TCH/H with/without frequency hopping and a TCH/F with/without frequency hopping and,
- the mode of the TCH/F is set to full rate speech version 2.

References

GSM 04.08 sections 3.4.4 and 9.1.15

GSM 04.13 section 5.2.6.2.

26.12.2.1.2 Test purpose

To test that the MS shall correctly apply the handover procedure in the non-synchronized case when :

- a call is in progress and,
- handover is performed from a TCH/F with/without frequency hopping towards a TCH/F with/without frequency hopping and,
- the mode of either the current or the target channel is set to full rate speech version 2 (enhanced full rate speech).

To test that the MS also supporting half rate shall correctly apply the handover procedure in the non-synchronized case when :

- a call is in progress and,
- a handover is performed between a TCH/H with/without frequency hopping and a TCH/F with/without frequency hopping and,
- the mode of the TCH/F is set to full rate speech version 2.

26.12.2.1.3 Method of test

Initial Conditions

System Simulator:

2 cells, A and B with same LAI, default parameters except:

GSM900 :

Cell A has : BCCH ARFCN = 20
Cell Allocation = (10, 17, 20, 26, 34, 42, 45, 46, 52, 59, 66, 73, 74, 75, 76, 108, 114)

Cell B has : BCCH ARFCN = 40
Cell Allocation = (14, 18, 22, 24, 30, 31, 38, 40, 60, 66, 73, 74, 75, 76, 108, 114)

The frame numbers of cells A and B shall be different by 100.

The timebase of cells A and B shall be such that the edges of their timeslots are not coincident at the antenna connector.

DCS1800 :

Cell A has : BCCH ARFCN = 747
Cell Allocation = (734, 741, 747, 754, 759, 762, 766, 767, 773, 775, 779, 782, 791, 798, 829, 832, 844)

Cell B has : BCCH ARFCN = 764
 Cell Allocation = (739, 743, 746, 749, 756, 758, 761, 764, 771, 779, 782, 791,
 798, 829, 832, 844)

The Cell Allocation of both Cell A and Cell B shall be coded using range 256 format.

The frame numbers of cells A and B shall be different by 100.

The timebase of cells A and B shall be such that the edges of their timeslots are not coincident at the antenna connector.

Mobile Station: The MS is in the active state (U10) of a call on cell A.

Related PICS/PIXIT Statements

Supported rate(s) of TCH: TCH/F and/or TCH/H.
Support for state U10 of the Call Control protocol.
Support for full rate speech version 2 (enhanced full rate speech)
supported radio interface rates : 12kbps, 6kbps, 3,6kbps
Type of Mobile Station (P-GSM900 or EGSM or DCS1800).

Foreseen Final State of the MS

The active state (U10) of a call on cell A.

Test Procedure

This procedure is repeated for execution counter M = 1 to 15.

The MS is in the active state (U10) of a call. The SS sends a HANOVER COMMAND on the main DCCH. The MS shall (at the time defined by the Starting Time information element, if included in the message) begin to send access bursts on the new DCCH of the target cell. The SS observes the access bursts and after receiving n (n being arbitrarily chosen between values according to table 2 of section 26.12.2) access bursts, the SS sends one PHYSICAL INFORMATION message with a Timing Advance as specified in table 1 of section 26.12.2. The MS shall activate the channel in sending and receiving mode. The MS shall establish a signalling link. The MS shall be ready to transmit a HANOVER COMPLETE message, before 'x' MS after the end of the PHYSICAL INFORMATION message, but not before a UA frame has been sent by the SS.

The term 'ready to transmit' is defined in TS GSM 04.13. The value of 'x' depends upon the target channel and is specified in the specific message contents section.

Maximum Duration of Test

10 minutes, including 1 minute for any necessary operator actions.

Expected Sequence

This sequence is performed for an execution counter M = 1, 2,9 for an MS which supports enhanced full speech codec and only TCH/F .

This sequence is performed for an execution counter M = 1, 2,15 for an MS which supports enhanced full speech codec and TCH/F and H.

Step	Direction	Message	Comments
0	MS -> SS		The MS and SS are in the active state of a call on the channel described below.
1	SS -> MS	HANDOVER COMMAND	See Specific message contents
2	MS -> SS	HANDOVER ACCESS	Repeated on every burst of the uplink main DCCH until reception of PHYSICAL INFORMATION. Handover Reference as included in the HANDOVER COMMAND. If the HANDOVER COMMAND includes a starting time IE then the first HANDOVER ACCESS message shall be transmitted in the indicated frame (unless the indicated frame is not used by that channel, in which case the next frame used by that channel shall be used)
3	SS -> MS	PHYSICAL INFORMATION	Sent after reception of n HANDOVER ACCESS messages. See specific message contents.
4	MS -> SS	SABM	Sent without information field
5	SS -> MS	UA	
6	MS -> SS	HANDOVER COMPLETE	The message shall be ready to be transmitted before 'x' ms after the completion of step 3.
7	MS -> SS		The MS and SS are in the active state of a call on the TCH described below. The SS checks that the TCH is through connected in the correct mode.

Specific Message Contents

For M = 1 :

P-GSM900

Step 0 : The MS and SS are using a full rate TCH with speech full rate version 2 and in non-hopping mode on cell A.

HANDOVER COMMAND

Information Element	value/remarks
As default message contents, except :	
Cell Description	
- Network Colour Code	1
- Base Station Colour Code	5
- BCCH Carrier Number	40
Synchronisation Indication	
- Report Observed Time Difference	Shall not be included.
- Synchronisation Indication	'Non synchronised'.
- Normal Cell Indication	Ignore out of range timing advance.

PHYSICAL INFORMATION

Information Element	value/remarks
As default message contents.	

Step 6 : x = 500

Step 7 : The MS and SS are using a full rate TCH with speech full rate version 2 and in non hopping mode on cell B.

DCS1800

Step 0 : The MS and SS are using a full rate TCH with speech full rate version 2 and in non-hopping mode on cell A.

HANDOVER COMMAND

Information Element	value/remarks
As default message contents, except :	
Cell Description	
- Network Colour Code	1
- Base Station Colour Code	5
- BCCH Carrier Number	764
Synchronisation Indication	
- Report Observed Time Difference	Shall not be included.
- Synchronisation Indication	'Non synchronised'.
- Normal Cell Indication	Ignore out of range timing advance.

PHYSICAL INFORMATION

Information Element	value/remarks
As default message contents.	

Step 6 : $x = 500$

Step 7 : The MS and SS are using a full rate TCH with speech full rate version 2 and in non hopping mode on cell B.

For $M = 2$:

GSM900

Step 0 : The MS and SS are using a full rate TCH with speech full rate version 2 and in non-hopping mode on cell B.

HANDOVER COMMAND

Information Element	value/remarks
As default message contents, except :	
Cell Description	
- Network Colour Code	1
- Base Station Colour Code	5
- BCCH Carrier Number	20
Channel Description	
- Channel Type	TCH/F + ACCHs
- Timeslot number	Chosen arbitrarily, but not Zero
- Training Sequence Code	Chosen arbitrarily
- Hopping	RF hopping channel.
- MAIO	Chosen arbitrarily from the set (0, 1 to N-1), where N is the number of frequencies encoded in the Frequency Channel Sequence IE.
- HSN	Chosen arbitrarily from the set (1,2,..63)
Synchronisation Indication IE is not included.	
Channel Mode IE is not included.	
Frequency Channel Sequence after time	
- Frequency Channel Sequence	Allocates the following 12 frequencies (10, 17, 20, 26, 59, 66, 73, 74, 75, 76, 108, 114)

PHYSICAL INFORMATION

Information Element	value/remarks
As default message contents, except :	
Timing advance	Arbitrarily selected but different to default value.

Step 6 : $x = 500$

Step 7 : The MS and SS are using a full rate TCH with speech full rate version 2 and in hopping mode on cell A.

DCS1800

Step 0 : The MS and SS are using a full rate TCH with speech full rate version 2 and in non-hopping mode on cell B.

HANDOVER COMMAND

Information Element	value/remarks
As default message contents, except : Cell Description <ul style="list-style-type: none"> - Network Colour Code - Base Station Colour Code - BCCH Carrier Number Channel Description <ul style="list-style-type: none"> - Channel Type - Timeslot number - Training Sequence Code - Hopping - MAIO - HSN Synchronisation Indication IE is not included. Channel Mode IE is not included. Frequency Short List after time <ul style="list-style-type: none"> - Frequency List 	 1 5 747 TCH/F + ACCHs Chosen arbitrarily, but not Zero Chosen arbitrarily RF hopping channel. Chosen arbitrarily from the set (0, 1 to N-1), where N is the number of frequencies encoded in the Frequency Short List IE. Chosen arbitrarily from the set (1,2,..63) Use Range 256 to encode the following 9 frequencies : (747, 775, 779, 782, 791, 798, 829, 832, 844)

PHYSICAL INFORMATION

Information Element	value/remarks
As default message contents, except : Timing advance	Arbitrarily selected but different to default value.

Step 6 : $x = 500$

Step 7 : The MS and SS are using a full rate TCH with speech full rate version 2 and in hopping mode on cell A.

For $M = 3$:

GSM900

Step 0 : The MS and SS are using a full rate TCH with speech full rate version 2 and in hopping mode on cell A.

HANDOVER COMMAND

Information Element	value/remarks
As default message contents, except :	
Cell Description	
- Network Colour Code	1
- Base Station Colour Code	5
- BCCH Carrier Number	40
Synchronisation Indication	
- Report Observed Time Difference	Shall not be included.
- Synchronisation Indication	'Non synchronised'.
- Normal Cell Indication	Out of range timing advance shall trigger a handover failure procedure.
Starting Time	Indicates the frame number of cell B that will occur approximately 1,1 seconds (238 frames have elapsed) after the HANDOVER COMMAND is sent by cell A.

PHYSICAL INFORMATION

Information Element	value/remarks
As default message contents.	

Step 6 : $x = 500$

Step 7 : The MS and SS are using a full rate TCH with speech full rate version 2 and in non-hopping mode on cell B.

DCS1800

Step 0 : The MS and SS are using a full rate TCH with speech full rate version 2 and in hopping mode on cell A.

HANDOVER COMMAND

Information Element	value/remarks
As default message contents, except :	
Cell Description	
- Network Colour Code	1
- Base Station Colour Code	5
- BCCH Carrier Number	764
Synchronisation Indication	
- Report Observed Time Difference	Shall not be included.
- Synchronisation Indication	'Non synchronised'.
- Normal Cell Indication	Out of range timing advance shall trigger a handover failure procedure.
Starting Time	Indicates the frame number of cell B that will occur approximately 1,1 seconds (238 frames have elapsed) after the HANDOVER COMMAND is sent by cell A.

PHYSICAL INFORMATION

Information Element	value/remarks
As default message contents.	

Step 6 : $x = 500$

Step 7 : The MS and SS are using a full rate TCH with speech version 2 and in non-hopping mode on cell B.

For $M = 4$:

P-GSM900

Step 0 : The MS and SS are using a full rate TCH with full rate speech version 2 and in non-hopping mode on cell B.

HANDOVER COMMAND

Information Element	value/remarks
As default message contents, except :	
Cell Description	
- Network Colour Code	1
- Base Station Colour Code	5
- BCCH Carrier Number	20
Synchronisation Indication	
- Report Observed Time Difference	Shall not be included.
- Synchronisation Indication	'Non synchronised'.
- Normal Cell Indication	Ignore out of range timing advance.
Mode of the first channel	
- Mode	speech full rate version 1

PHYSICAL INFORMATION

Information Element	value/remarks
As default message contents.	

Step 6 : x = 500

Step 7 : The MS and SS are using a full rate TCH with speech full rate version 1 and in non hopping mode on cell A.

DCS1800

Step 0 : The MS and SS are using a full rate TCH with speech full rate version 2 and in non-hopping mode on cell B.

HANDOVER COMMAND

Information Element	value/remarks
As default message contents, except :	
Cell Description	
- Network Colour Code	1
- Base Station Colour Code	5
- BCCH Carrier Number	747
Synchronisation Indication	
- Report Observed Time Difference	Shall not be included.
- Synchronisation Indication	'Non synchronised'.
- Normal Cell Indication	Ignore out of range timing advance.
Mode of the first channel	
- Mode	speech full rate version 1

PHYSICAL INFORMATION

Information Element	value/remarks
As default message contents.	

Step 6 : x = 500

Step 7 : The MS and SS are using a full rate TCH with speech full rate version 1 and in non hopping mode on cell A.

For M = 5 :

GSM900

Step 0 : The MS and SS are using a full rate TCH with full rate speech version 1 and in non-hopping mode on cell A.

HANDOVER COMMAND

Information Element	value/remarks
As default message contents, except :	
Cell Description	
- Network Colour Code	1
- Base Station Colour Code	5
- BCCH Carrier Number	40
Synchronisation Indication	
- Report Observed Time Difference	Shall not be included.
- Synchronisation Indication	'Non synchronised'.
- Normal Cell Indication	Ignore out of range timing advance.

PHYSICAL INFORMATION

Information Element	value/remarks
As default message contents, except :	
Timing advance	Arbitrarily selected but different to default value.

Step 6 : x = 500

Step 7 : The MS and SS are using a full rate TCH with speech full rate version 2 and in non hopping mode on cell B.

DCS1800

Step 0 : The MS and SS are using a full rate TCH with speech full rate version 1 and in non-hopping mode on cell A.

HANDOVER COMMAND

Information Element	value/remarks
As default message contents, except :	
Cell Description	
- Network Colour Code	1
- Base Station Colour Code	5
- BCCH Carrier Number	764
Synchronisation Indication	
- Report Observed Time Difference	Shall not be included.
- Synchronisation Indication	'Non synchronised'.
- Normal Cell Indication	Ignore out of range timing advance.

PHYSICAL INFORMATION

Information Element	value/remarks
As default message contents.	

Step 6 : x = 500

Step 7 : The MS and SS are using a full rate TCH with speech full rate version 2 mode and non hopping mode on cell B.

For M=6 :

GSM900

Step 0 : The MS and SS are using a full rate TCH with speech full rate version 2 and non-hopping mode on cell B.

HANDOVER COMMAND

Information Element	value/remarks
As default message contents, except :	
Cell Description	
- Network Colour Code	1
- Base Station Colour Code	5
- BCCH Carrier Number	20
Channel Description	
- Channel Type	TCH/F + ACCHs
- Timeslot number	Chosen arbitrarily, but not Zero
- Training Sequence Code	Chosen arbitrarily
- Hopping	RF hopping channel.
- MAIO	Chosen arbitrarily from the set (0, 1 to N-1), where N is the number of frequencies encoded in the Frequency Channel Sequence IE.
- HSN	Chosen arbitrarily from the set (1,2,..63)
Synchronisation Indication IE is not included.	
Mode of the first channel.	
- Mode	speech full rate version 1
Frequency Channel Sequence after time	
- Frequency Channel Sequence	Allocates the following 12 frequencies (10, 17, 20, 26, 59, 66, 73, 74, 75, 76,108, 114)

PHYSICAL INFORMATION

Information Element	value/remarks
As default message contents, except :	
Timing advance	Arbitrarily selected but different to default value.

Step 6 : $x = 500$

Step 7 : The MS and SS are using a full rate TCH with speech full rate version 1 and hopping mode on cell A.

DCS1800

Step 0 : The MS and SS are using a full rate TCH with full rate speech version 2 and in non-hopping mode on cell B.

HANDOVER COMMAND

Information Element	value/remarks
As default message contents, except : Cell Description - Network Colour Code - Base Station Colour Code - BCCH Carrier Number Channel Description - Channel Type - Timeslot number - Training Sequence Code - Hopping - MAIO - HSN Synchronisation Indication IE is not included. Channel Mode IE is not included. Frequency Short List after time - Frequency List	1 5 747 TCH/F + ACCHs Chosen arbitrarily, but not Zero Chosen arbitrarily RF hopping channel. Chosen arbitrarily from the set (0, 1 to N-1), where N is the number of frequencies encoded in the Frequency Short List IE. Chosen arbitrarily from the set (1,2,..63) Use Range 256 to encode the following 9 frequencies : (747, 775, 779, 782, 791, 798, 829, 832, 844)

PHYSICAL INFORMATION

Information Element	value/remarks
As default message contents, except : Timing advance	Arbitrarily selected but different to default value.

Step 6 : $x = 500$

Step 7 : The MS and SS are using a full rate TCH with full rate speech version 1 and in hopping mode on cell A.

For $M=7$:

GSM900

Step 0 : The MS and SS are using a full rate TCH with full rate speech version 1 and in hopping mode on cell A.

HANDOVER COMMAND

Information Element	value/remarks
As default message contents, except :	
Cell Description	
- Network Colour Code	1
- Base Station Colour Code	5
- BCCH Carrier Number	40
Channel Description	
- Channel Type	TCH/F + ACCHs
- TDMA offset	Chosen arbitrarily
- Timeslot number	Chosen arbitrarily, but not Zero
- Training Sequence Code	Chosen arbitrarily
- Hopping	RF hopping channel.
- MAIO	Chosen arbitrarily from the set (0, 1 to N-1), where N is the number of frequencies encoded in the Frequency List IE.
- HSN	Chosen arbitrarily from the set (1,2,..63)
Frequency List after time	
- Frequency List	use bit map 0 to allocates the following 12 frequencies : (14, 18, 22, 24, 60, 66, 73, 74, 75, 76,108, 114)
Synchronisation Indication	
- Report Observed Time Difference	Shall not be included.
- Synchronisation Indication	'Non synchronised'.
- Normal Cell Indication	Ignore out of range timing advance.
Starting Time	Indicates the frame number of cell B. that will occur approximately 1,1 seconds (238 frames have elapsed) after the HANDOVER COMMAND is sent by cell A.

PHYSICAL INFORMATION

Information Element	value/remarks
As default message contents.	

Step 6 : $x = 750$

Step 7 : The MS and SS are using a full rate TCH with full rate speech version 2 and in hopping mode on cell B.

DCS1800

Step 0 : The MS and SS are using a full rate TCH with full rate speech version 1 and in hopping mode on cell A.

HANDOVER COMMAND

Information Element	value/remarks
As default message contents, except :	
Cell Description	
- Network Colour Code	1
- Base Station Colour Code	5
- BCCH Carrier Number	764
Channel Description	
- Channel Type	TCH/F + ACCHs
- TDMA offset	Chosen arbitrarily
- Timeslot number	Chosen arbitrarily but not Zero
- Training Sequence Code	Chosen arbitrarily
- Hopping	RF hopping channel.
- MAIO	Chosen arbitrarily from the set (0, 1 to N-1), where N is the number of frequencies encoded in the Frequency List IE.
- HSN	Chosen arbitrarily from the set (1,2,..63)
Frequency List after time	
- Frequency List	Use Range 1024 to allocate the following 12 frequencies : (749, 758, 761, 764, 771, 779, 782, 791, 798, 829, 832, 844)
Synchronisation Indication	
- Report Observed Time Difference	Shall not be included.
- Synchronisation Indication	'Non synchronised'.
- Normal Cell Indication	Ignore out of range timing advance.
Starting Time	Indicates the frame number of cell B that will occur approximately 1,1 seconds (238 frames have elapsed) after the HANDOVER COMMAND is sent by cell A.

PHYSICAL INFORMATION

Information Element	value/remarks
As default message contents.	

Step 6 : $x = 750$

Step 7 : The MS and SS are using a full rate TCH with full rate speech version 2 and in hopping mode on cell B.

For $M = 8$:

GSM900

Step 0 : The MS and SS are using a full rate TCH with full rate speech version 2 and in hopping mode on cell B.

HANDOVER COMMAND

same as for $M=6$

PHYSICAL INFORMATION

same as for $M=6$

Step 6 : $x = 750$

Step 7 : The MS and SS are using a full rate TCH with speech full rate version 1 and in hopping mode on cell A.

DCS1800

Step 0 : The MS and SS are using a full rate TCH with full rate speech version 2 and in hopping mode on cell B.

HANDOVER COMMAND

same as for M=6

PHYSICAL INFORMATION

same as for M=6

Step 6 : x = 750

Step 7 : The MS and SS are using a full rate TCH with speech full rate version 1 and in hopping mode on cell A.

For M = 9 :

GSM900

Step 0 : The MS and SS are using a full rate TCH with speech full rate version 1 and in hopping mode on cell A.

HANDOVER COMMAND

same as for M=5.

PHYSICAL INFORMATION

same as For M=5.

Step 6 : x = 750

Step 7 : The MS and SS are using a full rate TCH with speech full rate version 2 and in non hopping mode on cell B.

DCS1800

Step 0 : The MS and SS are using a full rate TCH with speech full rate version 1 and in hopping mode on cell A.

HANDOVER COMMAND

same as for M=5.

PHYSICAL INFORMATION

same as for M=5.

Step 6 : x = 750

Step 7 : The MS and SS are using a full rate TCH with speech full rate version 2 and in non hopping mode on cell B.

For M=10 :

GSM900

Step 0 : The MS and SS are using a full rate TCH with full rate speech version 2 and in non hopping mode on cell B.

HANDOVER COMMAND

same as for M=6 except :

Channel Description
- Channel Type TCH/H + ACCHs

PHYSICAL INFORMATION

same as for M=6

Step 6 : $x = 750$

Step 7 : The MS and SS are using a half rate TCH with speech full rate version 1 and in hopping mode on cell A.

DCS1800

Step 0 : The MS and SS are using a full rate TCH with full rate speech version 2 and in non hopping mode on cell B.

HANDOVER COMMAND

same as for M=6 except :

Channel Description
- Channel Type TCH/H + ACCHs

PHYSICAL INFORMATION

same as for M=6

Step 6 : $x = 750$

Step 7 : The MS and SS are using a half rate TCH with speech full rate version 1 and in hopping mode on cell A.

For M = 11 :

GSM900

Step 0 : The MS and SS are using a half rate TCH with speech full rate version 1 and in hopping mode on cell A.

HANDOVER COMMAND

same as for M=7

PHYSICAL INFORMATION

same as For M=7.

Step 6 : $x = 750$

Step 7 : The MS and SS are using a full rate TCH with speech full rate version 2 and in hopping mode on cell B.

DCS1800

Step 0 : The MS and SS are using a half rate TCH with speech full rate version 1 and in hopping mode on cell A.

HANDOVER COMMAND

same as for M=7

PHYSICAL INFORMATION

same as for M=7.

Step 6 : $x = 750$

Step 7 : The MS and SS are using a full rate TCH with speech full rate version 2 and in hopping mode on cell B.

For M = 12 :

GSM900

Step 0 : The MS and SS are using a full rate TCH with full rate speech version 2 and in hopping mode on cell B.

HANDOVER COMMAND

same as for M=6 except :

Channel Description - Channel Type	TCH/H + ACCHs
---------------------------------------	---------------

PHYSICAL INFORMATION

same as for M=6

Step 6 : $x = 750$

Step 7 : The MS and SS are using a half rate TCH with speech full rate version 1 and in hopping mode on cell A.

DCS1800

Step 0 : The MS and SS are using a full rate TCH with full rate speech version 2 and in hopping mode on cell B.

HANDOVER COMMAND

same as for M=6 except :

Channel Description - Channel Type	TCH/H + ACCHs
---------------------------------------	---------------

PHYSICAL INFORMATION

same as for M=6

Step 6 : $x = 750$

Step 7 : The MS and SS are using a half rate TCH with speech full rate version 1 and in hopping mode on cell A.

For M = 13 :

GSM900

Step 0 : The MS and SS are using a half rate TCH with speech full rate version 1 and in hopping mode on cell A.

HANDOVER COMMAND

same as for M=1

PHYSICAL INFORMATION

same as For M=1.

Step 6 : $x = 750$

Step 7 : The MS and SS are using a full rate TCH with speech full rate version 2 and in non hopping mode on cell B.

DCS1800

Step 0 : The MS and SS are using a half rate TCH with speech full rate version 1 and in hopping mode on cell A.

HANDOVER COMMAND

same as for M=1

PHYSICAL INFORMATION

same as for M=1.

Step 6 : $x = 750$

Step 7 : The MS and SS are using a full rate TCH with speech full rate version 2 and in non hopping mode on cell B.

For M = 14 :

GSM900

Step 0 : The MS and SS are using a full rate TCH with full rate speech version 2 and in non hopping mode on cell B.

HANDOVER COMMAND

same as for M=4 except :

Channel Description - Channel Type	TCH/H + ACCHs
---------------------------------------	---------------

PHYSICAL INFORMATION

same as for M=4

Step 6 : $x = 750$

Step 7 : The MS and SS are using a half rate TCH with speech full rate version 1 and in non hopping mode on cell A.

DCS1800

Step 0 : The MS and SS are using a full rate TCH with full rate speech version 2 and in non hopping mode on cell B.

HANDOVER COMMAND

same as for M=4 except :

Channel Description - Channel Type	TCH/H + ACCHs
---------------------------------------	---------------

PHYSICAL INFORMATION

same as for M=4

Step 6 : $x = 750$

Step 7 : The MS and SS are using a half rate TCH with speech full rate version 1 and in non hopping mode on cell A.

For M = 15 :

GSM900

Step 0 : The MS and SS are using a half rate TCH with speech full rate version 1 and in hopping mode on cell A.

HANDOVER COMMAND

same as for M=1

PHYSICAL INFORMATION

same as For M=1.

Step 6 : $x = 750$

Step 7 : The MS and SS are using a full rate TCH with speech full rate version 2 and in non hopping mode on cell B.

DCS1800

Step 0 : The MS and SS are using a half rate TCH with speech full rate version 1 and in hopping mode on cell A.

HANDOVER COMMAND

same as for M=1

PHYSICAL INFORMATION

same as for M=1.

Step 6 : $x = 750$

Step 7 : The MS and SS are using a full rate TCH with speech full rate version 2 and in non hopping mode on cell B.

26.12.2.2 EFR signalling/ Handover / successful / call under establishment / non-synchronized

NOTE: This test is derived from the one described in section 26.6.5.2 and entitled "Handover/successful/ call under establishment/ non-synchronized".

This test only applies to MS supporting speech full rate version 2 (enhanced full rate) and at least one MO circuit switched basic service.

26.12.2.2.1 Conformance requirements

1. The MS shall correctly apply the handover procedure from SDCCH/8 with or without frequency hopping to TCH/F using full rate speech version 2 with or without frequency hopping in the non-synchronized case during call establishment. The mobile shall correctly apply the handover procedures from non frequency hopping SDCCH/4 to TCH/F using full rate speech version 2 with or without frequency hopping.
2. If during call establishment a Layer 3 MM or CC message just sent by the MS is not Layer 2 acknowledged before the channel change caused by the HANDOVER COMMAND message, the

MS shall send the Layer 3 message to the new cell, using the same value in the N(SD) field, after the handover procedure.

References

GSM 04.08, sections 3.1.4.1, 3.4.4 and 9.1.15
GSM 04.13, section 5.2.6.2

26.12.2.2.2 Test purpose

1. To verify that the MS correctly applies the handover procedure from SDCCH/8 with or without frequency hopping to TCH/F using full rate speech version 2 with or without frequency hopping in the non-synchronized case during call establishment. To verify that the mobile correctly applies the handover procedures from non frequency hopping SDCCH/4 to TCH/F using full rate speech version 2 with or without frequency hopping.
2. To verify that if during call establishment a Layer 3 MM or CC message just sent by the MS is not Layer 2 acknowledged before the channel change caused by the HANDOVER COMMAND message, the MS shall send the Layer 3 message to the new cell, using the same value in the N(SD) field, after the handover procedure.

26.12.2.2.3 Method of test

Initial Conditions

System Simulator:

2 cells A and B with same LAI, default parameters, except:

GSM900 :

Cell A has : BCCH ARFCN = 20
Cell Allocation = (10, 17, 20, 26, 34, 42, 45, 46, 52, 59, 66, 73, 74, 75, 76, 108, 114)
PLMN colour code, NCC = as defaults.
BS colour code, BCC = as defaults.

Cell B has : BCCH ARFCN = 40
Cell Allocation = (14, 18, 22, 24, 30, 31, 38, 40, 60, 66, 73, 74, 75, 76, 108, 114)
PLMN colour code, NCC = 3.
BS colour code, BCC = 0.

Both cells send SYSTEM INFORMATION TYPE 1 messages containing the complete Cell Allocation of the cell, using bit map 0 format.

The timebase of Cells A and B shall be such that the edges of their timeslots are not coincident at the antenna connector.

For execution counter M = 1 a combined CCH/SDCCH is used.

For execution counter M = 2 and 3 a non combined SDCCH is used.

DCS1800 :

Cell A has : BCCH ARFCN = 747
Cell Allocation = (734, 741, 747, 754, 759, 762, 766, 767, 773, 775, 779, 782, 791, 798, 829, 832, 844)
PLMN colour code, NCC = as defaults.
BS colour code, BCC = as defaults.

Cell B has : BCCH ARFCN = 764
Cell Allocation = (739, 743, 746, 749, 756, 758, 761, 764, 771, 779, 782, 791, 798, 829, 832, 844)

PLMN colour code, NCC = 3.
BS colour code, BCC = 0.

Both cells send SYSTEM INFORMATION TYPE 1 messages containing the complete Cell Allocation of the cell, using Range 512 format.

The timebase of Cells A and B shall be such that the edges of their timeslots are not coincident at the antenna connector.

For execution counter M = 1 a combined CCH/SDCCH is used.

For execution counter M = 2 and 3 a non combined SDCCH is used.

Mobile Station: The MS is in the "idle, updated" state, with a TMSI allocated and camped on cell A.

Related PICS/PIXIT Statements

Supported rate(s) of TCH: TCH/FS and/or TCH/HS.
Support for state U10 of the Call Control protocol.
Supported speech full rate version 2 (enhanced full rate)
Type of MS (P-GSM900 or EGSM or DCS1800).

Foreseen Final State of the MS

"Idle, updated" with TMSI allocated and camped on cell B.

Test Procedure

This procedure is repeated for execution counter M = 1 through 11 (See Table 1 of section 26.12.2)

A Mobile Originating Call is initiated on Cell A. After the MS has sent the SETUP message (and before the last L2 frame carrying the SETUP message is acknowledged by the SS) the SS sends a HANDOVER COMMAND message, ordering the MS to switch to cell B. The MS shall then begin to send access bursts on the new DCCH to cell B. The SS observes the access bursts and after receiving n (n being arbitrarily chosen between values according to table 2 of section 26.12.2) access bursts, the SS sends one PHYSICAL INFORMATION message with a Timing Advance as specified in table 1 of section 26.12.2. The MS shall activate the channel in sending and receiving mode. The MS shall establish a signalling link. The MS shall be ready to transmit a HANDOVER COMPLETE message before x ms after the end of the PHYSICAL INFORMATION message, but not before a UA frame has been sent by the SS. The MS shall then again send the SETUP message to the SS, using the same value in the N(SD) field. Finally the SS sends a CHANNEL RELEASE to end the test.

The term 'ready to transmit' is defined in TS GSM 04.13. The value of 'x' depends upon the target channel and is specified in the specific message contents section.

Maximum Duration of Test

5 minutes, including 1 minute for any necessary operator actions.

Expected Sequence

The sequence is performed for execution counter M = 1, through 11.

Step	Direction	Message	Comments
1	-----	-----	A MO call is initiated on cell A.
2	MS -> SS	CHANNEL REQUEST	Establish. Cause = "Originating call, NECI not set to 1"
3	SS -> MS	IMMEDIATE ASSIGNMENT	See specific message contents.
4	MS -> SS	CM SERVICE REQUEST	CM Service Type = Mobile Originating Call Establishment.
5	SS -> MS	CIPHERING MODE COMMAND	
6	MS -> SS	CIPHERING MODE COMPLETE	
7	MS -> SS	SETUP	Last L2 frame not acknowledged by the SS.
8	SS -> MS	HANDOVER COMMAND	See specific message contents.
9	MS -> SS	HANDOVER ACCESS	Repeated on every burst of the uplink main DCCH until reception of PHYSICAL INFORMATION. Handover Reference as included in the HANDOVER COMMAND
10	SS -> MS	PHYSICAL INFO	Sent after reception of n HANDOVER ACCESS message. Timing Advance as specified in table 1 of section 26.12.2.
11	MS -> SS	SABM	Sent without information field
12	SS -> MS	UA	
13	MS -> SS	HANDOVER COMPLETE	This message shall be ready to be transmitted before 'x' ms after the completion of step 10.
14	MS -> SS	SETUP	Same N(SD) as in step 7.
15	SS -> MS	CHANNEL RELEASE	

Specific Message Contents

M = 1

DCS1800 :

IMMEDIATE ASSIGNMENT

Information Element	value/remark
As default message contents.	

HANDOVER COMMAND

Information Element	value/remarks
As default message contents, except :	
Cell Description	
- Network Colour Code	3
- Base Station Colour Code	0
- BCCH Carrier Number	764
Channel Description	
- Channel Type	TCH/F + ACCHs
- Timeslot number	zero
- Training Sequence Code	Chosen arbitrarily
- Hopping	RF hopping channel.
- MAIO	Chosen arbitrarily from the set (0, 1 to N-1), where N is the number of frequencies encoded in the Frequency Short List IE.
- HSN	Chosen arbitrarily from the set (1,2,..63)
Synchronisation IE is not included.	
Frequency Short List after time	
- Frequency Short List	Use Range 128 to encode the following 11 frequencies : (756, 758, 761, 771, 779, 782, 791, 798, 829, 832, 844)

Step 13 : 'x' = 500

For GSM900 :

IMMEDIATE ASSIGNMENT

Information Element	value/remark
As default message contents.	

HANDOVER COMMAND

Information Element	value/remarks
As default message contents, except :	
Cell Description	
- Network Colour Code	3
- Base Station Colour Code	0
- BCCH Carrier Number	40
Channel Description	
- Channel Type	TCH/F + ACCHs
- Timeslot number	Zero
- Training Sequence Code	Chosen arbitrarily
- Hopping	RF hopping channel.
- MAIO	Chosen arbitrarily from the set (0, 1 to N-1), where N is the number of frequencies encoded in the Frequency Channel Sequence IE.
- HSN	Chosen arbitrarily from the set (1,2,..63)
Synchronisation IE is not included.	
Frequency Channel Sequence, after time	
- Frequency Channel Sequence	Allocates the following 15 frequencies : (14, 18, 22, 24, 30, 31, 38, 53, 66, 73, 74, 75, 76, 108, 114)

Step 13 : 'x' = 500

M = 2 :

DCS1800 :**IMMEDIATE ASSIGNMENT**

Information Element	value/remark
As default message contents except :	
L2 pseudo length	14 octets (11 + contents of the MA)
Channel Description	Channel Description
- Channel Type	SDCCH/8
- TDMA offset	As default message contents
- Timeslot number	Arbitrary value but not zero.
- Training Sequence Code	Chosen arbitrarily
- Hopping	RF hopping channel.
- MAIO	Chosen arbitrarily from the set (0, 1 to N-1), where N is the number of frequencies encoded in the Mobile Allocation.
- HSN	Chosen arbitrarily from the set (1,2,..63)
Mobile Allocation	
- Length	3octets.
- Contents	Indicates only three frequencies : (773, 775, 779).

HANDOVER COMMAND

Information Element	value/remarks
As default message contents, except :	
Cell Description	
- Network Colour Code	3
- Base Station Colour Code	0
- BCCH Carrier Number	764
Channel Description	
- Channel Type	TCH/F + ACCHs
- Timeslot number	Zero
- Training Sequence Code	Chosen arbitrarily
- Hopping	Single RF Channel
- ARFCN	Chosen arbitrarily from the Cell Allocation of Cell B, but not the BCCH carrier of Cell B.
Synchronisation Indication IE not included.	

Step 13 : 'x' = 500

GSM900 :**IMMEDIATE ASSIGNMENT**

Information Element	value/remark
As default message contents except :	
L2 pseudo length	14 octets (11 + contents of the MA)
Channel Description	
- Channel Type	SDCCH/8
- TDMA offset	As default message contents
- Timeslot number	Arbitrary value, but not zero.
- Training Sequence Code	Chosen arbitrarily
- Hopping	RF hopping channel.
- MAIO	Chosen arbitrarily from the set (0, 1 to N-1), where N is the number of frequencies encoded in the Mobile Allocation.
- HSN	Chosen arbitrarily from the set (1,2,..63)
Mobile Allocation	
- Length	3 octets.
- Contents	Indicates only three frequencies : (73, 74, 75).

HANDOVER COMMAND

Information Element	value/remarks
As default message contents, except :	
Cell Description	
- Network Colour Code	3
- Base Station Colour Code	0
- BCCH Carrier Number	40
Channel Description	
- Channel Type	TCH/F + ACCHs
- Timeslot number	Zero
- Training Sequence Code	Chosen arbitrarily
- Hopping	Single RF Channel
- ARFCN	Chosen arbitrarily from the Cell Allocation of Cell B, but not the BCCH carrier of Cell B.

Step 13 : 'x' = 500

M = 3 :

DCS1800 :

IMMEDIATE ASSIGNMENT

Information Element	value/remark
As default message contents.	

HANDOVER COMMAND

Information Element	value/remarks
As default message contents, except :	
Cell Description	
- Network Colour Code	3
- Base Station Colour Code	0
- BCCH Carrier Number	764
Channel Description	
- Channel Type	TCH/F + ACCHs
- Timeslot number	Arbitrary value, but not zero.
- Training Sequence Code	Chosen arbitrarily
- Hopping	RF hopping channel.
- MAIO	Chosen arbitrarily from the set (0, 1 to N-1), where N is the number of frequencies encoded in the Frequency Short List IE.
- HSN	Zero (this gives cyclic hopping)
Frequency Short List after time	
- Frequency Short List	Use Range 256 to encode the following 3 frequencies : (764, 779, 782)
Synchronisation Indication	
- Report Observed Time Difference	Shall not be included.
- Synchronisation Indication	'Non synchronised'.
- Normal Cell Indication	Ignore out of range timing advance.

Step 13 : 'x' = 500

GSM900 :

IMMEDIATE ASSIGNMENT

Information Element	value/remark
As default message contents.	

HANDOVER COMMAND

Information Element	value/remarks
As default message contents, except :	
Cell Description	
- Network Colour Code	3
- Base Station Colour Code	0
- BCCH Carrier Number	40
Channel Description	
- Channel Type	TCH/F + ACCHs
- Timeslot number	zero
- Training Sequence Code	Chosen arbitrarily
- Hopping	RF hopping channel
- MAIO	Chosen arbitrarily from the set {0, 1}.
- HSN	Chosen arbitrarily from the set {1, 2,..., 63}.
Synchronisation Indication IE is not included	
Channel Mode IE	speech full rate
Frequency Channel Sequence, after time.	
- Frequency Channel Sequence IE	allocates the following two frequencies {14, 114}

Step 13 : 'x' = 500

M =4 :

DCS1800 :**IMMEDIATE ASSIGNMENT**

Information Element	value/remark
As default message contents except : L2 pseudo length Channel Description - Channel Type - TDMA offset - Timeslot number - Training Sequence Code - Hopping - ARFCN	11 Channel Description TCH/F As default message contents Arbitrary value but not zero. Chosen arbitrarily single RF channel. 754

HANDOVER COMMAND

Information Element	value/remarks
As default message contents, except : Cell Description - Network Colour Code - Base Station Colour Code - BCCH Carrier Number Channel Description - Channel Type - TDMA offset - Timeslot number - Training Sequence Code - Hopping - MAIO - HSN Frequency List after time - Frequency List	1 5 764 TCH/F + ACCHs Chosen arbitrarily Chosen arbitrarily, but not Zero Chosen arbitrarily RF hopping channel. Chosen arbitrarily from the set (0, 1 to N-1), where N is the number of frequencies encoded in the Frequency List IE. Chosen arbitrarily from the set (1,2,..63) use bit map 0 to allocates the following 12 frequencies : (746, 756, 758, 761, 764, 771, 779, 782, 798, 829, 832, 844)

Step 13 : 'x' = 500

GSM900 :**IMMEDIATE ASSIGNMENT**

Information Element	value/remark
As default message contents except : L2 pseudo length Channel Description - Channel Type - TDMA offset - Timeslot number - Training Sequence Code - Hopping - ARFCN	11 Channel Description TCH/F As default message contents Arbitrary value but not zero. Chosen arbitrarily single RF channel. 66

HANDOVER COMMAND

Information Element	value/remarks
As default message contents, except :	
Cell Description	
- Network Colour Code	1
- Base Station Colour Code	5
- BCCH Carrier Number	40
Channel Description	
- Channel Type	TCH/F + ACCHs
- TDMA offset	Chosen arbitrarily
- Timeslot number	Chosen arbitrarily, but not Zero
- Training Sequence Code	Chosen arbitrarily
- Hopping	RF hopping channel.
- MAIO	Chosen arbitrarily from the set (0, 1 to N-1), where N is the number of frequencies encoded in the Frequency List IE.
- HSN	Chosen arbitrarily from the set (1,2,..63)
Frequency List after time	
- Frequency List	use bit map 0 to allocates the following 12 frequencies : (14, 18, 22, 24, 60, 66, 73, 74, 75, 76,108, 114)
Synchronisation Indication	
- Report Observed Time Difference	Shall not be included.
- Synchronisation Indication	'Non synchronised'.
- Normal Cell Indication	Ignore out of range timing advance.

Step 13 : 'x' = 500 ??

For M=5

DCS1800 :**IMMEDIATE ASSIGNMENT**

Information Element	value/remark
As default message contents except :	
L2 pseudo length	11
Channel Description	Channel Description
- Channel Type	TCH/F
- TDMA offset	As default message contents
- Timeslot number	Arbitrary value but not zero.
- Training Sequence Code	Chosen arbitrarily
- Hopping	single RF channel.
- ARFCN	791

HANDOVER COMMAND

Information Element	value/remarks
As default message contents, except :	
Cell Description	
- Network Colour Code	1
- Base Station Colour Code	5
- BCCH Carrier Number	40
Channel Description	
- Channel Type	TCH/F + ACCHs
- TDMA offset	Chosen arbitrarily
- Timeslot number	Chosen arbitrarily, but not Zero
- Training Sequence Code	Chosen arbitrarily
- Hopping	single RF channel.
- ARFCN	749

Step 13 : 'x' = 500

GSM900 :**IMMEDIATE ASSIGNMENT**

Information Element	value/remark
As default message contents except :	
L2 pseudo length	11
Channel Description	Channel Description
- Channel Type	TCH/F
- TDMA offset	As default message contents
- Timeslot number	Arbitrary value but not zero.
- Training Sequence Code	Chosen arbitrarily
- Hopping	single RF channel.
- ARFCN	66

HANDOVER COMMAND

Information Element	value/remarks
As default message contents, except :	
Cell Description	
- Network Colour Code	1
- Base Station Colour Code	5
- BCCH Carrier Number	40
Channel Description	
- Channel Type	TCH/F + ACCHs
- TDMA offset	Chosen arbitrarily
- Timeslot number	Chosen arbitrarily, but not Zero
- Training Sequence Code	Chosen arbitrarily
- Hopping	single RF channel.
- ARFCN	31

Step 13 : 'x' = 500

M=6

DCS1800 :

IMMEDIATE ASSIGNMENT

Information Element	value/remark
As default message contents except : L2 pseudo length Channel Description - Channel Type - TDMA offset - Timeslot number - Training Sequence Code - Hopping - MAIO - HSN Mobile Allocation - Length - Contents	14 octets (11 + contents of the MA) Channel Description TCH/F As default message contents Arbitrary value but not zero. Chosen arbitrarily RF hopping channel. Chosen arbitrarily from the set (0, 1 to N-1), where N is the number of frequencies encoded in the Mobile Allocation. Chosen arbitrarily from the set (1,2,..63) 3 octets. Indicates only five frequencies : (734, 741, 762, 791, 832).

HANDOVER COMMAND

Information Element	value/remarks
As default message contents, except : Cell Description - Network Colour Code - Base Station Colour Code - BCCH Carrier Number Channel Description - Channel Type - TDMA offset - Timeslot number - Training Sequence Code - Hopping - MAIO - HSN Frequency List after time - Frequency List Synchronisation Indication - Report Observed Time Difference - Synchronisation Indication - Normal Cell Indication Starting Time	3 0 764 TCH/F + ACCHs Chosen arbitrarily Chosen arbitrarily, but not Zero Chosen arbitrarily RF hopping channel. Chosen arbitrarily from the set (0, 1 to N-1), where N is the number of frequencies encoded in the Frequency List IE. Chosen arbitrarily from the set (1,2,..63) use range 256 to allocates the following 8 frequencies : (739, 743, 746, 749, 761, 771, 782, 791) Shall not be included. 'Non synchronised'. Ignore out of range timing advance. Indicates the frame number of cell B. that will occur approximately 1,1 seconds (238 frames have elapsed) after the HANDOVER COMMAND is sent by cell A.

Step 13 : 'x' = 500

GSM900 :**IMMEDIATE ASSIGNMENT**

Information Element	value/remark
As default message contents except : L2 pseudo length	14 octets (11 + contents of the MA)
Channel Description	TCH/F
- Channel Type	As default message contents
- TDMA offset	Arbitrary value, but not zero.
- Timeslot number	Chosen arbitrarily
- Training Sequence Code	RF hopping channel.
- Hopping	Chosen arbitrarily from the set (0, 1 to N-1), where N is the number of frequencies encoded in the Mobile Allocation.
- MAIO	Chosen arbitrarily from the set (1,2,..63)
- HSN	
Mobile Allocation	
- Length	3 octets.
- Contents	Indicates five frequencies : (17, 34, 52, 46, 73).

HANDOVER COMMAND

Information Element	value/remarks
As default message contents, except :	
Cell Description	
- Network Colour Code	3
- Base Station Colour Code	0
- BCCH Carrier Number	40
Channel Description	
- Channel Type	TCH/F + ACCHs
- Timeslot number	Zero
- Training Sequence Code	Chosen arbitrarily
- Hopping	hopping RF channel
- MAIO	Chosen arbitrarily from the set (0, 1 to N-1), where N is the number of frequencies encoded in the Frequency List IE.
- HSN	Chosen arbitrarily from the set (1,2,..63)
Frequency List after time	
- Frequency List	use bit map 0 to allocates the following 8 frequencies : (14, 18, 24, 30, 38, 60, 73, 74)
Synchronisation Indication	
- Report Observed Time Difference	Shall not be included.
- Synchronisation Indication	'Non synchronised'.
- Normal Cell Indication	Ignore out of range timing advance.
Starting Time	Indicates the frame number of cell B. that will occur approximately 1,1 seconds (238 frames have elapsed) after the HANDOVER COMMAND is sent by cell A.

Step 13 : 'x' = 500

M = 7

DCS1800 :

IMMEDIATE ASSIGNMENT

Information Element	value/remark
As default message contents except : L2 pseudo length Channel Description - Channel Type - TDMA offset - Timeslot number - Training Sequence Code - Hopping - MAIO - HSN Mobile Allocation - Length - Contents	14 octets (11 + contents of the MA) Channel Description TCH/F As default message contents Arbitrary value but not zero. Chosen arbitrarily RF hopping channel. Chosen arbitrarily from the set (0, 1 to N-1), where N is the number of frequencies encoded in the Mobile Allocation. Chosen arbitrarily from the set (1,2,..63) 3 octets. Indicates only three frequencies : (734, 762, 791).

HANDOVER COMMAND

Information Element	value/remarks
As default message contents, except : Cell Description - Network Colour Code - Base Station Colour Code - BCCH Carrier Number Channel Description - Channel Type - Timeslot number - Training Sequence Code - Hopping - ARFCN	3 0 764 TCH/F + ACCHs Zero Chosen arbitrarily Single RF Channel Chosen arbitrarily from the Cell Allocation of Cell B, but not the BCCH carrier of Cell B.

Step 13 : 'x' = 500

GSM900 :

IMMEDIATE ASSIGNMENT

Information Element	value/remark
As default message contents except : L2 pseudo length Channel Description - Channel Type - TDMA offset - Timeslot number - Training Sequence Code - Hopping - MAIO - HSN Mobile Allocation - Length - Contents	14 octets (11 + contents of the MA) SDCCH/8 As default message contents Arbitrary value, but not zero. Chosen arbitrarily RF hopping channel. Chosen arbitrarily from the set (0, 1 to N-1), where N is the number of frequencies encoded in the Mobile Allocation. Chosen arbitrarily from the set (1,2,..63) 3 octets. Indicates only three frequencies : (73, 74, 75).

HANDOVER COMMAND

Information Element	value/remarks
As default message contents, except :	
Cell Description	
- Network Colour Code	3
- Base Station Colour Code	0
- BCCH Carrier Number	40
Channel Description	
- Channel Type	TCH/F + ACCHs
- Timeslot number	Zero
- Training Sequence Code	Chosen arbitrarily
- Hopping	Single RF Channel
- ARFCN	Chosen arbitrarily from the Cell Allocation of Cell B, but not the BCCH carrier of Cell B.

Step 13 : 'x' = 500

M = 8

DCS1800 :

IMMEDIATE ASSIGNMENT

same as for M= 4
except :

Channel Description - Channel Type	TCH/H + ACCHs
---------------------------------------	---------------

HANDOVER COMMAND

same as for M= 4

GSM 900 :

IMMEDIATE ASSIGNMENT

same as for M= 4
except :

Channel Description - Channel Type	TCH/H + ACCHs
---------------------------------------	---------------

HANDOVER COMMAND

same as for M= 4

M = 9

DCS1800 :

IMMEDIATE ASSIGNMENT

same as for M= 5
except :

Channel Description - Channel Type	TCH/H + ACCHs
---------------------------------------	---------------

HANDOVER COMMAND

same as for M= 5
except :

Starting Time	Indicates the frame number of cell B. that will occur approximately 1,1 seconds (238 frames have elapsed) after the HANDOVER COMMAND is sent by cell A.
---------------	---

GSM 900 :**IMMEDIATE ASSIGNMENT**

same as for M= 5

except :

Channel Description - Channel Type	TCH/H + ACCHs
---------------------------------------	---------------

HANDOVER COMMAND

same as for M= 5

M = 10

DCS1800 :**IMMEDIATE ASSIGNMENT**

same as for M= 6

except :

Channel Description - Channel Type	TCH/H + ACCHs
---------------------------------------	---------------

HANDOVER COMMAND

same as for M= 6

GSM 900 :**IMMEDIATE ASSIGNMENT**

same as for M= 6

except :

Channel Description - Channel Type	TCH/H + ACCHs
---------------------------------------	---------------

HANDOVER COMMAND

same as for M= 6

M = 11

DCS1800 :**IMMEDIATE ASSIGNMENT**

same as for M= 7

except :

Channel Description - Channel Type	TCH/H + ACCHs
---------------------------------------	---------------

HANDOVER COMMAND

same as for M= 7

GSM 900 :**IMMEDIATE ASSIGNMENT**

same as for M= 7

except :

Channel Description - Channel Type	TCH/H + ACCHs
---------------------------------------	---------------

HANDOVER COMMAND

same as for M= 7

26.12.3 EFR Signalling / Structured procedures / MS originated call / late assignment

NOTE: this test is derived from the one defined in section 26.9.3 and entitled "Structured procedures / MS originated call / late assignment"

26.12.3.1 Conformance requirement

- 1) The MS shall indicate and include in the mobile originating SETUP for speech call all the speech versions that it supports.
- 2) Upon receipt of the ASSIGNMENT COMMAND message specifying either speech full rate version 1 or speech full rate version 2 or speech half rate version 1 (for an MS also supporting half rate), the Mobile Station starts a normal channel assignment procedure. It means that the MS initiates a local end release of link layer connections, disconnects the physical channels, commands the switching to the assigned channels and initiates the establishment of lower layer connections (this includes the activation of the channels, their connection and the establishment of the data links). After the main signalling link is successfully established, the MS returns an ASSIGNMENT COMPLETE message, specifying cause 'normal event', to the network on the main DCCH.
- 3,4) The call control entity of the Mobile Station in the "call initiated" state, in the "mobile originating call proceeding" state or in the "call delivered" state, shall, upon receipt of a CONNECT message:
 - attach the user connection to the radio path;
 - return a CONNECT ACKNOWLEDGE message.

References

Conformance requirement 1: TS GSM 04.08 sections 10.5.4.5 and 10.5.4.5.1 and TS GSM 02.06 section 3.2.3

Conformance requirement 2: TS GSM 04.08 section 3.4.3.1, 3.4.3.2

Conformance requirement 3: TS GSM 04.08 section 5.2.1.6.

26.12.3.2 Test purpose

- 1) To verify that the MS indicates and includes in the mobile originating SETUP for speech call all the speech versions that it supports.
- 2) To verify that subsequently after receipt of an IMMEDIATE ASSIGNMENT message allocating an SDCCH, after completion of establishment of the main signalling link, after having sent a CM SERVICE REQUEST message, after having successfully performed authentication and cipher mode setting procedures, after having sent a SETUP message, after having received a CALL PROCEEDING message followed by an ALERTING message and an ASSIGNMENT COMMAND message allocating either speech full rate version 1 TCH or speech full rate version 2 TCH or speech half rate version 1 TCH (for an MS also supporting half rate), the MS sends an ASSIGNMENT COMPLETE message.
- 3) To verify that subsequently, after the suite of actions specified in test purposes 1 and 2, the MS after receiving a CONNECT message returns a CONNECT ACKNOWLEDGE message.

- 4) To verify that after the suite of actions specified in test purposes 1 and 2, the MS after receiving a CONNECT message attaches the user connection to the radio path. (This is checked by verifying that there is a point in time after transmission of the first L2 frame containing the (complete) CONNECT message, where the MS is sending appropriate speech or data frames whenever it doesn't have to transmit or acknowledge an L frame on layer 2 of the FACCH.)

26.12.3.3 Method of test

Related PICS/PIXIT statements

- Enhanced full rate speech MS
- Supported speech versions
- Interface to the human user (p1 = Y/N)
- Way to display the called number (only applicable if the MS has an interface to the human user)
- Way to indicate alerting (only applicable if the MS supports the feature)
- Supported teleservices
- Classmark

Initial Conditions

System Simulator:

1 cell, default parameters.

Mobile Station:

The MS is in MM-state "idle, updated" with valid TMSI and CKSN.

Foreseen Final State of the MS

The MS has a MO call in state U10, "active".

Test procedure

The following test is performed for all rates (full rate/half rate) supported by the MS:

The MS is made to initiate a speech call. The call is established with late assignment.

Maximum Duration of Test

3 minutes.

Expected Sequence

This test is repeated for execution counter M=1, 2 for an MS supporting full rate channels only.

This test is repeated for execution counter M=1, 2, 3 for an MS supporting both half and full rate channels.

Step	Direction	Message	Comments
1	MS		The "called number" is entered
2	MS		
3	MS -> SS	CHANNEL REQUEST	Establishment cause is "originating call and the network does not set the NECI bit to 1".
4	SS -> MS	IMMEDIATE ASSIGNMENT	
5	MS -> SS	CM SERVICE REQUEST	Message is contained in SABM.
6	SS -> MS	AUTHENTICATION REQ	
7	MS -> SS	AUTHENTICATION RESP	SRES specifies correct value.
8	SS -> MS	CIPHER MODE COMMAND	SS starts deciphering after sending the message.
9	MS -> SS	CIPHER MODE COMPLETE	Shall be sent enciphered. All following messages shall be sent enciphered.
10	SS		SS starts ciphering.
11	MS -> SS	SETUP	If the mobile only supports full rate speech , it is checked that it indicates support of full rate speech version 1 and version 2. If the mobile supports both rates, it is checked that it indicates full rate speech version 1, half rate speech version 1 and full rate speech version 2.
12	SS -> MS	CALL PROCEEDING	
13	SS -> MS	ALERTING	
14	MS		Depending on the PICS, an alerting indication is given.
15	SS -> MS	ASSIGNMENT COMMAND	
16	MS -> SS	ASSIGNMENT COMPLETE	
17	SS -> MS	CONNECT	
18	MS -> SS	CONNECT ACKNOWLEDGE	
19	MS		The appropriate bearer channel is through connected in both directions.

Specific Message Contents:

For M = 1 :

ASSIGNMENT COMMAND

see default message contents section 26.12.6.

SETUP

Same contents as 26.12.6 but all the speech versions supported by the MS shall be indicated in octet_3a_etc(s).

For M = 2 :

ASSIGNMENT COMMAND

same as for default message contents except :

Mode of the first channel - Mode	speech full rate or half rate version 1
-------------------------------------	---

SETUP

Same contents as 26.12.6 but all the speech versions supported by the MS shall be indicated in octet_3a_etc(s).

For M = 3 :

ASSIGNMENT COMMAND

same as for default message contents except :

Channel Description - TDMA offset Mode of the first channel - Mode	TCH/H+ACCHs speech full rate or half rate version 1
---	--

SETUP

same contents as 26.12.6 but the supported speech versions and their preferred order indicated in octet_3a_etc(s) shall be as declared by the manufacturer.

26.12.4 Structured procedures / MS terminated call / I early assignment

NOTE: this test is derived from the one described in section 26.9.4 and entitled "Structured procedures / MS terminated call / early assignment"

26.12.4.1 Conformance requirement

- 1) In acceptance to a SETUP message indicating speech, the MS shall indicate and include in the CALL CONFIRMED message all the speech versions that it supports.
- 2) Upon receipt of the ASSIGNMENT COMMAND message specifying either speech full rate version 1 or speech full rate version 2 or speech half rate version 1 (for an MS also supporting half rate), the Mobile Station continues a mobile terminating call establishment with early assignment of traffic channel
 - a) by replying to the ASSIGNMENT command with an ASSIGNMENT COMPLETE message and ,
 - b) by continuing the call establishment by through connecting TCH in both directions if it supports immediate connect or by sending an ALERTING message otherwise,
- 3) for speech calls, the mobile station shall attach the user connection at latest when sending the connect message, except if there is no compatible radio resource available at this time. In this case the attachment shall be delayed until such a resource becomes available.

References

- Conformance requirement 1: TS GSM 04.08 sections 10.5.4.5, and 10.5.4.5.1
TS GSM 02.06 section 3.2.3
- Conformance requirement 2: TS GSM 04.08 section 3.4.3.1, 3.4.3.2
- Conformance requirement 3: TS GSM 04.08 section 5.2.2.9

26.12.4.2 Test purpose

- 1) To verify that, in acceptance to a SETUP message indicating speech, the MS indicates and includes in the CALL CONFIRMED message all the speech versions that it supports.
- 2) To verify that upon receipt of the ASSIGNMENT COMMAND message specifying either speech full rate version 1 or speech full rate version 2 or speech half rate version 1 (for an MS also supporting half rate), the Mobile Station continues a mobile terminating call establishment with early assignment of traffic channel
 - a) by replying to the ASSIGNMENT command with an ASSIGNMENT COMPLETE message and ,
 - b) by continuing the call establishment by through connecting TCH in both directions if it supports immediate connect or by sending an ALERTING message otherwise,

- 3) To verify that for speech calls, the mobile station shall attach the user connection at latest when sending the connect message, except if there is no compatible radio resource available at this time. In this case the attachment shall be delayed until such a resource becomes available.

26.12.4.3 Method of test

Related PICS/PIXIT statements

- Enhanced full rate speech MS
- Supported speech versions
- Interface to the human user (p1 = Y/N)
- Way to indicate alerting (only applicable if the MS supports the feature)
- Way to make the MS accept an incoming call after alerting (possibly dependent on teleservice and configuration)
- Supported teleservices
- Classmark
- Immediate connect supported (Y/N)

Initial Conditions

System Simulator: 1 cell, default parameters.

Mobile Station: The MS is in MM-state "idle, updated" with valid TMSI and CKSN.

Foreseen Final State of the MS

CC state U10-call active.

Test procedure

The following test is performed for all rates (full rate/half rate) supported by the MS:

A teleservice is selected that is supported by the MS; if the MS supports speech, the selected teleservice is speech. If necessary, the MS is configured for that teleservice.

The MS is paged and the resulting call is established. Having reached the active state, the MS is made to clear the call.

Maximum Duration of Test

3 minutes.

Expected Sequence

This test is repeated for execution counter M=1, 2 for an MS supporting full rate channels only.

This test is repeated for execution counter M=1, 2, 3 for an MS supporting both half and full rate channels.

Step	Direction	Message	Comments
1	SS -> MS	PAGING REQUEST TYPE 1	Sent on the correct paging subchannel Message is contained in SABM. SRES specifies correct value. SS starts deciphering after sending the message. Shall be sent enciphered. All following messages shall be sent enciphered. SS starts ciphering. Message does not contain the signal IE. If the mobile only supports full rate speech, it is checked that it indicates support of full rate speech version 1 and version 2. If the mobile supports both rates, it is checked that it indicates full rate speech version 1, half rate speech version 1 and full rate speech version 2. If the MS supports an Immediate connection then branch A applies. If the MS doesn't support an immediate connection then branch B applies.
2	MS -> SS	CHANNEL REQUEST	
3	SS -> MS	IMMEDIATE ASSIGNMENT	
4	MS -> SS	PAGING RESPONSE	
5	SS -> MS	AUTHENTICATION REQUEST	
6	MS -> SS	AUTHENTICATION RESPONSE	
7	SS -> MS	CIPHERING MODE COMMAND	
8	MS -> SS	CIPHERING MODE COMPLETE	
9	SS		
10	SS -> MS	SETUP	
11	MS -> SS	CALL CONFIRMED	
A12	MS -> SS	CONNECT	sent on the old channel
A13	SS -> MS	ASSIGNMENT COMMAND	
A14	MS -> SS	ASSIGNMENT COMPLETE	
B12	SS -> MS	ASSIGNMENT COMMAND	Sent on the new channel. An alerting indication as defined in an PICS/PIXIT statement is given by the MS. The MS is made to accept the call in the way described in a PICS/PIXIT statement.
B13	MS -> SS	ASSIGNMENT COMPLETE	
B14	MS -> SS	ALERTING	
B15	MS		
B16	MS		
B17	MS -> SS	CONNECT	
18	MS		
19	SS -> MS	CONNECT ACKNOWLEDGE	The TCH shall be through connected in both directions. in the indicated mode. The MS is made to release the call. The main signalling link is released.
20	MS		
21	MS -> SS	DISCONNECT	
22	SS -> MS	RELEASE	
23	MS -> SS	RELEASE COMPLETE	
24	SS -> MS	CHANNEL RELEASE	

Specific Message Contents:

For M = 1 :

ASSIGNMENT COMMAND

see default message contents section 26.12.6.

CALL CONFIRMED

Same contents as 26.12.6 but all the speech versions supported by the MS shall be indicated in octet_3a_etc(s).

For M = 2 :

ASSIGNMENT COMMAND

same as for default message contents except :

Mode of the first channel - Mode	speech full rate or half rate version 1
-------------------------------------	---

CALL CONFIRMED

Same contents as 26.12.6 but all the speech versions supported by the MS shall be indicated in octet_3a_etc(s).

For M = 3 :

ASSIGNMENT COMMAND

same as for default message contents except :

Channel Description - TDMA offset Mode of the first channel - Mode	TCH/H+ACCHs speech full rate or half rate version 1
---	--

CALL CONFIRMED

same contents as 26.12.6 but all the speech versions supported by the MS shall be indicated in octet_3a_etc(s).

26.12.5 Structured procedures / emergency call

NOTE : This test is derived from the ones described in sections 26.9.6.1.1 and 26.9.6.1.2 and respectively entitled "Structured procedures / emergency call / idle updated, preferred channel rate " and "Structured procedures / emergency call / idle updated, non-preferred channel rate".

This test applies to mobiles supporting Enhanced Full Rate speech.

26.12.5.1 Conformance requirement

- 1) The MS in the "idle, updated" state, as after a successful location update, after the number 112 has been entered by user, shall send a CHANNEL REQUEST message with correct establishment cause ("emergency call").
- 2) After assignment of a dedicated channel the first layer message sent by the MS on the assigned dedicated channel shall be a CM SERVICE REQUEST message specifying the correct CKSN and TMSI , with CM Service Type "emergency call establishment".
- 3) Authentication and cipher mode setting shall be performed successfully.
- 4) After cipher mode setting acceptance by the network, the MS shall send an EMERGENCY SETUP message.
- 5) TheEFR mobile station shall accept channel assignment to a TCH full rate speech version 1 or 2 and if it supports half rate, in addition it shall accept channel assignment to a TCH half rate speech version 1.
- 6) After receipt of a CONNECT ACKNOWLEDGE message during correct establishment of the emergency call the TCH shall be through connected in both directions if an appropriate TCH is available.
- 7) The call shall be cleared correctly.

Requirement Reference:

For conformance requirement 1 and 2: TS GSM 04.08 section 3.3.1, TS GSM 04.08 section 5.2.1, TS GSM 04.08 section 4.5.1.5., TS GSM 02.30 section 4.
For conformance requirement 3: TS GSM 04.08, section 3.4.7, TS GSM 04.08 section 4.3.2.
For conformance requirement 4: TS GSM 04.08, section 5.2.1.1.
For conformance requirement 5 : TS GSM 04.08, sections 5.2.1.1 and 3.4.3.
TS GSM 02.06 , subclause 3.2.3.
For conformance requirement 6: TS GSM 04.08, section 5.2.1.6
For conformance requirement 7: TS GSM 04.08, section 5.4.

26.12.5.2 Test purpose

- 1) To verify that an MS supporting speech in the MM state "idle, updated", when made to call the number 112, sends a CHANNEL REQUEST message with establishment cause "emergency call".
- 2) To verify that after assignment of a dedicated channel the first layer message sent by the MS on the assigned dedicated channel is a CM SERVICE REQUEST message specifying the correct CKSN and TMSI, with CM Service Type "emergency call establishment" .
- 3) To verify that authentication and cipher mode setting are performed successfully.
- 4) To verify that after cipher mode setting acceptance by the SS, the MS sends an EMERGENCY SETUP message.
- 5) To verify that the EFR mobile station shall both accept channel assignment to a TCH full rate speech version 1 or 2 and if it supports half rate, in addition it shall accept channel assignment to a TCH half rate speech version 1.
- 6) To verify that subsequently the MS has through connected the TCH in both directions.
- 7) To verify that the call is cleared correctly.

26.12.5.3 Method of test

Related PICS/PIXIT Statements

- Speech supported (Y/N).
- Supported rate for speech: (F/H, F).
- Speech version supported :
- Classmark.
- Inclusion of the bearer capability IE in the emergency setup

Initial Conditions

System Simulator:
1 cell, default parameters.

Mobile Station:
The MS is in MM-state "idle, updated" with valid TMSI and CKSN.

Foreseen Final State of the MS

The MS is in MM-state "idle, updated" with valid TMSI and CKSN.

Test procedure

The MS is made to initiate an emergency call. The call is established with late assignment. Having reached the active state, the call is cleared by the SS. This procedure is repeated so that the assignment is made with all the channel rates and speech versions supported by the mobile station.

Maximum Duration of Test

3 minutes

Expected Sequence

The expected sequence is executed for M=1 and 2, for a full rate only mobile station which includes the bearer capability IE in the emergency setup message .

The expected sequence is executed for M=1, 2 and 3, for a dual rate mobile station which includes the bearer capability IE in the emergency setup message.

The expected sequence is executed for M=1, for a mobile which does not include the bearer capability IE in the emergency setup message.

Step	Direction	Message	Comments
1	MS		The "called number" 112 is entered
3	MS -> SS	CHANNEL REQUEST	Establishment cause is emergency call establishment.
4	SS -> MS	IMMEDIATE ASSIGNMENT	
5	MS -> SS	CM SERVICE REQUEST	Message is contained in SABM. The CM service type IE indicates "emergency call establishment".
6	SS -> MS	AUTHENTICATION REQUEST	
7	MS -> SS	AUTHENTICATION RESPONSE	SRES specifies correct value.
8	SS -> MS	CIPHERING MODE COMMAND	SS starts deciphering after sending the message.
9	MS -> SS	CIPHERING MODE COMPLETE	Shall be sent enciphered. All following messages shall be sent enciphered.
10	SS		SS starts ciphering.
11	MS -> SS	EMERGENCY SETUP	If the bearer capability IE is including, it shall be checked that all the speech versions supported by the MS are present.
12	SS -> MS	CALL PROCEEDING	
13	SS -> MS	ALERTING	
14	SS -> MS	ASSIGNMENT COMMAND	See specific message contents.
15	MS -> SS	ASSIGNMENT COMPLETE	
16	SS -> MS	CONNECT	
17	MS -> SS	CONNECT ACKNOWLEDGE	
18	MS		The TCH is through connected in both directions in the correct mode.
19	SS -> MS	DISCONNECT	
20	MS -> SS	RELEASE	
21	SS -> MS	RELEASE COMPLETE	
23	SS -> MS	CHANNEL RELEASE	The main signalling link is released.

Specific Message Contents:

For M= 1

ASSIGNMENT COMMAND

same as for default message contents except :

Mode of the first channel - Mode	Speech full rate or half rate version 1
-------------------------------------	---

For M= 2

ASSIGNMENT COMMAND

same as for default message contents

For M= 3

ASSIGNMENT COMMAND

same as for default message contents except :

Channel Description - TDMA offset Mode of the first channel - Mode	TCH/H+ACCHs Speech full rate or half rate version 1
---	--

26.12.6 Default contents of layer 3 messages for Enhanced Full rate speech tests

same as section 26.6.14 for GSM900 MS and 26.6.15 for DCS1800 MS except for :

Contents of ASSIGNMENT COMMAND message in the GSM900 band:

Protocol Discriminator Skip Indicator Message Type Channel Description - Channel Type and TDMA offset - Timeslot Number - Training Sequence Code - Hopping - ARFCN Power Command - Power level Mode of the first channel - Mode All other information elements	RR Management 0000 00101110 TCH/F + ACCHs Chosen arbitrarily by the test house Chosen arbitrarily by the test house Single RF channel Channel number 30 Chosen arbitrarily by the test house speech full rate or half rate version 2 Not present
---	--

Contents of ASSIGNMENT COMMAND message in the DCS1800 band :

Protocol Discriminator Skip Indicator Message Type Channel Description - Channel Type and TDMA offset - Timeslot Number - Training Sequence Code - Hopping - ARFCN Power Command - Power level Mode of the first channel - Mode All other information elements	RR Management 0000 00101110 TCH/F + ACCHs Chosen arbitrarily by the test house Chosen arbitrarily by the test house Single RF channel Channel number 650 Chosen arbitrarily by the test house speech full rate or half rate version 2 Not present
---	---

CALL CONFIRMED

Information element	Value/remark
Repeat indicator	Omitted
Bearer capability 1	coding as described in section 11.8.2.9.2
Bearer capability 2	Omitted
Cause	Omitted

Contents of CHANNEL MODE MODIFY message in the GSM900 band :

Protocol Discriminator	RR Management
Skip Indicator	0000
Message Type	00010000
Channel Description	same as the dedicated channel currently allocated
Channel Mode	
- Mode	speech full rate version 2

Contents of CHANNEL MODE MODIFY ACKNOWLEDGE message in the GSM900 band :

Protocol Discriminator	RR Management
Skip Indicator	0000
Message Type	00010111
Channel Description	same as the dedicated channel currently allocated
Channel Mode	
- Mode	Speech full rate version 2

Contents of CHANNEL MODE MODIFY message in the DCS1800 band :

Protocol Discriminator	RR Management
Skip Indicator	0000
Message Type	00010000
Channel Description	same as the dedicated channel currently allocated
Channel Mode	
- Mode	speech full rate version 2

Contents of CHANNEL MODE MODIFY ACKNOWLEDGE message in DCS 1800 band :

Protocol Discriminator	RR Management
Skip Indicator	0000
Message Type	00010111
Channel Description	same as the dedicated channel currently allocated
Channel Mode	
- Mode	Speech full/half rate version 2

Contents of HANDOVER COMMAND message in the GSM900 band :

Protocol Discriminator	RR Management
Skip Indicator	0000
Message Type	00101011
Cell Description	
- Network Colour Code	1
- Base station Colour Code	5
- BCCH Carrier Number	Set to the BCCH carrier number of cell B. (one of 10, 20, 80, 90, 100, 110 or 120)
Channel Description	
- Channel Type and TDMA offset	TCH/F + ACCHs
- Timeslot Number	Chosen arbitrarily by the test house
- Training Sequence Code	Chosen arbitrarily by the test house
- Hopping	Single RF channel
- ARFCN	Chosen arbitrarily by the test house from those supported on the target cell
Handover Reference	
- Handover Reference Value	Chosen arbitrarily by the test house.
Power Command	
- Power level	Chosen arbitrarily by the test house
Mode of the first channel	
- Mode	speech full/half rate version 2
All other information elements	Not present

Contents of HANDOVER COMMAND message in the DCS 1800 band :

Protocol Discriminator	RR Management
Skip Indicator	0000
Message Type	00101011
Cell Description	
- Network Colour Code	1
- Base station Colour Code	5
- BCCH Carrier Number	Set to the BCCH carrier number of cell B. (one of 520, 590, 600, 700, 780, 810 or 870)
Channel Description	
- Channel Type and TDMA offset	TCH/F + ACCHs
- Timeslot Number	Chosen arbitrarily by the test house
- Training Sequence Code	Chosen arbitrarily by the test house
- Hopping	Single RF channel
- ARFCN	Chosen arbitrarily by the test house from those supported on the target cell
Handover Reference	
- Handover Reference Value	Chosen arbitrarily by the test house.
Power Command	
- Power level	Chosen arbitrarily by the test house
Mode of the first channel	
- Mode	speech full/half rate version 2
All other information elements	Not present

Contents of SETUP message; (MS to SS);

Protocol Discriminator	Call Control
Transaction Identifier	
TI value	any value from the set {0, ..., 6}
TI flag	0
Message Type	0X000101
Other information elements	Not checked
Protocol Discriminator	Call Control
Transaction Identifier	set {0, ..., 6}
TI flag	0
BC repeat indicator	Not present
Bearer capability 1	codind as described in section 11.8.2.9.2
All other information elements	Not present

Contents of SETUP message; (SS to MS for speech teleservice)

Protocol Discriminator	Call Control
Transaction Identifier	
TI value	any value from the set {0, ..., 6}
TI flag	0
Message Type	0X000101
Other information elements	Not checked
Protocol Discriminator	Call Control
Transaction Identifier	set {0, ..., 6}
TI flag	0
BC repeat indicator	Not present
Bearer capability 1	
octet 2	
length	01 H
octet 3	
extension	1
radio channel requirement	01
coding standard	GSM standardized coding
transfer mode	circuit mode
information transfer capability	speech
All other information elements	Not present

27 Testing of the SIM/ME interface

The following sequence of tests confirms:

- a) the correct interpretation of data read from the SIM (Subscriber Identification Module) by the ME;
- b) the correct writing of data to the SIM by the ME;
- c) the initiation of appropriate procedures by the ME;
- d) low level protocols;
- e) electrical characteristics;
- f) physical characteristics.

All tests apply to GSM and DCS 1 800 MEs using either ID-1 or Plug-in SIM.

A SIM simulator will be required as part of the SS. Alternatively, to perform the logical tests, SIMs programmed with specific data may be used. The SIM data is not defined within the initial conditions of the tests unless it differs from the default values defined below.

Definition of default values for SIM/ME interface testing

A SIM containing the following default values is used for all tests of this section unless otherwise stated.

For each data item, the logical default values and the coding within the elementary files (EF) of the SIM follow.

NOTE 1: Bx represents Byte x of the coding.

NOTE 2: Unless otherwise defined, the coding values are hexadecimal.

EF_{IMSI} (IMSI)

Logically: 246813579

Coding:	B1	B2	B3	B4	B5	B6	B7	B8	B9
	05	29	64	18	53	97	FF	FF	FF

EF_{LocI} (Location Information)

Logically: LAI-MCC: 246
 LAI-MNC: 81
 LAI-LAC: 0001
 TMSI: "FF .. FF"

Coding:	B1	B2	B3	B4	B5	B6	B7	B8	B9	B10	B11
	FF	FF	FF	FF	42	F6	18	00	01	FF	00

EF_{Kc} (Cipherring Key Kc)

Logically: Key Kc: xx
 Sequence No: 1

Coding:	B1	B2	B3	B4	B5	B6	B7	B8	B9
	xx	xx	xx	xx	xx	xx	xx	xx	01

EF_{ACC} (Access Control Class)

Logically: One and only one access class from 0 - 9, e.g. class 7 for which the coding is "00 80".

EF_{FPLMN} (Forbidden PLMNs)

Logically: PLMN1: 234 02 (MCC MNC)
 PLMN2: 234 03
 PLMN3: 234 04
 PLMN4: 234 05

Coding:	B1	B2	B3	B4	B5	B6	B7	B8	B9	B10	B11	B12
	32	F4	20	32	F4	30	32	F4	40	32	F4	50

EF_{SST} (SIM Service Table)

Logically: CHV1 disable function allocated and activated.
 Abbreviated dialling numbers allocated and activated.
 PLMN selector allocated and activated.
 Fixed dialling numbers not activated.

Coding:	B1	B2	B3	B4
	xx0x1111	0011xxxx	xxxxxxx	0000xxxx (binary)

The coding of EF_{SST} shall conform with the capabilities of the SIM used.

EF_{ADN} (Abbreviated Dialling Number)

Logically:

At least 10 records.

Record 1:

Length of alpha identifier: 32 characters

Alpha identifier: "ABCDEFGHJKLMNOPQRSTUVWXYZABCDEF"

Length of BCD number: "03"

TON and NPI: Telephony and Unknown

Dialled number: 123

CCI: None

Ext1: None

Coding:	B1	B2	B3	...	B32	B33	B34	B35	B36	B37	B38	B39	...	B46
Record 1:	41	42	43	...	46	03	81	21	F3	FF	FF	FF	...	FF

EF_{Phase}

Logically: Phase 2

Coding: "02"

EF_{PLMNset} (PLMN Selector)

Logically: 1st PLMN: 234 01 (MCC MNC)

2nd PLMN: 234 02

3rd PLMN: 234 03

4th PLMN: 234 04

5th PLMN: 234 05

6th PLMN: 234 06

7th PLMN: 246 81

8th PLMN: 246 82

Coding:	B1	B2	B3	B4	B5	B6	B7	B8	B9	B10	B11	B12
	32	F4	10	32	F4	20	32	F4	30	32	F4	40
	B13	B14	B15	B16	B17	B18	B19	B20	B21	B22	B23	B24
	32	F4	50	32	F4	60	42	F6	18	42	F6	28

CHV1 (PIN)

Logically: 2468

Coding:	B1	B2	B3	B4	B5	B6	B7	B8
	32	34	36	38	FF	FF	FF	FF

CHV2 (PIN2)

Logically: 3579

Coding:	B1	B2	B3	B4	B5	B6	B7	B8
	33	35	37	39	FF	FF	FF	FF

Unblock CHV1 (PUK)

Logically: 13243546

Coding:	B1	B2	B3	B4	B5	B6	B7	B8
	31	33	32	34	33	35	34	36

Unblock CHV2 (PUK2)

Logically: 08978675

Coding:	B1	B2	B3	B4	B5	B6	B7	B8
	30	38	39	37	38	36	37	35

Definition of FDN SIM

Some test cases require a different configuration than the one described above. For that purpose a default FDN SIM is defined. In general the values of the FDN SIM are identical to the default SIM, with the following exceptions:

EF_{SST} (SIM Service Table)

Logically: CHV1 disable function allocated and activated.
Abbreviated dialling numbers allocated and activated.
PLMN selector allocated and activated.
Fixed dialling numbers allocated and activated.
Advice of Charge allocated and activated.

Coding:	B1	B2	B3	B4
	xx111111	0011xx11	xxxxxxx	0000xxxx (binary)

The coding of EF_{SST} shall conform with the capabilities of the SIM used.

EF_{FDN} (Fixed Dialling Numbers)

Logically:

Record 1:

Length of alpha identifier:	6 characters
Alpha identifier:	"FDN111"
Length of BCD number:	"06"
TON and NPI:	Telephony and International
Dialled number:	+1357924680
CCI:	None
Ext1:	None

Coding for record 1:

B1	B2	B3	B4	B5	B6	B7	B8	B9	B10	B11	B12	B13
46	44	4E	31	31	31	06	91	31	75	29	64	08
B14	B15	B16	B17	B18	B19	B20						
FF	FF	FF	FF	FF	FF	FF						

Record 2:

Length of alpha identifier: 6 characters
 Alpha identifier: "FDN222"
 Length of BCD number: "04"
 TON and NPI: Telephony and Unknown
 Dialed number: +24680
 CCI: None
 Ext1: None

Coding for record 2:

B1	B2	B3	B4	B5	B6	B7	B8	B9	B10	B11	B12	B13
46	44	4E	32	32	32	04	81	42	86	F0	FF	FF
B14	B15	B16	B17	B18	B19	B20						
FF	FF	FF	FF	FF	FF	FF						

Record 3:

Length of alpha identifier: 6 characters
 Alpha identifier: "FDN333"
 Length of BCD number: "0B"
 TON and NPI: Telephony and International
 Dialed number: +12345678901234567890
 CCI: None
 Ext1: None

Coding for record 3:

B1	B2	B3	B4	B5	B6	B7	B8	B9	B10	B11	B12	B13
46	44	4E	33	33	33	0B	91	21	43	65	87	09
B14	B15	B16	B17	B18	B19	B20						
21	43	65	87	09	FF	FF						

27.1 MS identification by short IMSI

27.1.1 MS identification by short IMSI - Normal case

27.1.1.1 Definition and applicability

The IMSI is used for unique identification of the MS by a GSM network. The IMSI is stored in the SIM and read during the SIM/ME initialization procedure.

This test applies to GSM and DCS 1 800 MEs using either ID-1 or Plug-in SIM.

27.1.1.2 Conformance requirement

On the receipt of an IMMEDIATE ASSIGNMENT message the MS shall send PAGING RESPONSE containing the IMSI of the SIM.

GSM 11.11, clause 11.2.1 and 11.4.2, GSM 04.08, clause 10.5.1.4.

27.1.1.3 Test purpose

- 1) To verify that the ME uses the IMSI of the SIM.
- 2) To verify that the ME can handle an IMSI of less than the maximum length.

27.1.1.4 Method of test

27.1.1.4.1 Initial conditions

The SS transmits on the BCCH, with the following network parameters:

Attach/detach: disabled
LAI (MCC/MNC/LAC): 246/81/0001
Access control: unrestricted.

The default SIM is installed into the ME and the MS is powered on.

27.1.1.4.2 Procedure

- a) The SS sends PAGING REQUEST to the MS using the IMSI stored in the SIM.
- b) After receipt of a CHANNEL REQUEST from the MS, the SS sends IMMEDIATE ASSIGNMENT to the MS.
- c) After receipt of a PAGING RESPONSE from the MS, the SS sends CHANNEL RELEASE to the MS.

27.1.1.5 Test requirement

After step b) the MS shall send PAGING RESPONSE to the SS containing the IMSI stored in the SIM.

27.1.2 MS identification by short IMSI, Phase 1 DCS SIM

27.1.2.1 Definition and applicability

Different from Phase 2, the IMSI in a Phase 1 DCS SIM is stored in a directory DF_{DCS1800} with the specific identifier "7F 21". To ensure backwards compatibility, if selection of the phase 2 identifier "7F 20" fails, the MS shall select "7F 21". Otherwise access to the IMSI and other data is impossible with a Phase 1 DCS SIM

This test applies to DCS 1 800 MEs.

27.1.2.2 Conformance requirement

If selection of DFGSM by the identifier "7F 20" fails, the ME shall select DF_{DCS1800} with "7F 21".

GSM 11.11, clause 10.4.

27.1.2.3 Test purpose

To verify that the ME uses the identifier "7F 21" to select DF_{DCS1800} in a Phase 1 DCS SIM.

27.1.2.4 Method of test**27.1.2.4.1 Initial conditions**

The SS transmits on the BCCH, with the following network parameters:

Attach/detach: disabled
 LAI (MCC/MNC/LAC): 246/81/0001
 Access control: unrestricted.

A phase 1 DCS SIM (identifier of $DF_{DCS1800}$ is "7F 21", DF_{GSM} not existing) with default values is installed into the ME and the MS is powered on.

27.1.2.4.2 Procedure

- a) The SS sends PAGING REQUEST to the MS using the IMSI stored in the SIM.
- b) After receipt of a CHANNEL REQUEST from the MS, the SS sends IMMEDIATE ASSIGNMENT to the MS.
- c) After receipt of a PAGING RESPONSE from the MS, the SS sends CHANNEL RELEASE to the MS.

27.1.2.5 Test requirement

After step b) the MS shall send PAGING RESPONSE to the SS containing the IMSI stored in the SIM.

27.2 MS identification by short TMSI**27.2.1 Definition and applicability**

The TMSI is temporarily used for identification of the MS by a GSM network. It will have been previously assigned by the network. The TMSI is stored in the SIM by the ME and read during the SIM/ME initialization procedure.

This test applies to GSM and DCS 1 800 MEs using either ID-1 or Plug-in SIM.

27.2.2 Conformance requirement

On the receipt of an IMMEDIATE ASSIGNMENT message the MS shall send PAGING RESPONSE containing the TMSI stored in the SIM.

GSM 11.11, clause 11.2.1 and 11.4.5, GSM 04.08, clause 10.5.1.4.

27.2.3 Test purpose

- 1) To verify that the ME uses the TMSI stored in the SIM.
- 2) To verify that the ME can handle a TMSI of less than maximum length.

27.2.4 Method of test**27.2.4.1 Initial conditions**

The SS transmits on the BCCH, with the following network parameters:

Attach/detach: disabled
 LAI (MCC/MNC/LAC): 246/81/0001
 Access control: unrestricted.

The default SIM is used with the following exception:

EF_{LOCI} (Location Information)

Logically: LAI-MCC: 246
 LAI-MNC: 81
 LAI-LAC: 0001
 TMSI: "2143"

Coding:	B1	B2	B3	B4	B5	B6	B7	B8	B9	B10	B11
	00	00	21	43	42	F6	18	00	01	FF	00

The SIM is installed into the ME and the MS is powered on.

27.2.4.2 Procedure

- a) The SS sends PAGING REQUEST to the MS using the TMSI stored in the SIM.
- b) After receipt of a CHANNEL REQUEST from the MS, the SS sends IMMEDIATE ASSIGNMENT to the MS.
- c) After receipt of a PAGING RESPONSE from the MS, the SS sends CHANNEL RELEASE to the MS.

27.2.5 Test requirement

After step b) the MS shall send PAGING RESPONSE to the SS containing the TMSI stored in the SIM.

27.3 MS identification by long TMSI

27.3.1 Definition and applicability

The TMSI is temporarily used for identification of the MS by a GSM network. It will have been previously assigned by the network. The TMSI is stored in the SIM by the ME and read during the SIM/ME initialization procedure.

This test applies to GSM and DCS 1 800 MEs using either ID-1 or Plug-in SIM.

27.3.2 Conformance requirement

On the receipt of an IMMEDIATE ASSIGNMENT message the MS shall send PAGING RESPONSE containing the correct TMSI stored in the SIM.

GSM 11.11, clause 11.2.1 and 11.4.5, GSM 04.08, clause 10.5.1.4.

27.3.3 Test purpose

- 1) To verify that the ME uses the TMSI stored in the SIM.
- 2) To verify that the ME can handle a TMSI of maximum length.
- 3) To verify that the ME does not respond to page requests containing a previous TMSI.

27.3.4 Method of test

27.3.4.1 Initial conditions

Prior to this test, the ME shall have been operated with a SIM containing TMSI "2143". This may be achieved by executing the previous test (27.2) prior to this test. Only under this condition will test purpose 3) be verified.

The SS transmits on the BCCH, with the following network parameters:

Attach/detach: disabled
 LAI (MCC/MNC/LAC): 246/81/0001
 Access control: unrestricted.

The default SIM is used with the following exception:

EF_{LOCI} (Location Information)

Logically: LAI-MCC: 246
 LAI-MNC: 81
 LAI-LAC: 0001
 TMSI: "21430000"

Coding:	B1	B2	B3	B4	B5	B6	B7	B8	B9	B10	B11
	21	43	00	00	42	F6	18	00	01	FF	00

The SIM is installed into the ME and the MS is powered on.

27.3.4.2 Procedure

- The SS sends PAGING REQUEST to the MS using the TMSI "2143".
- The SS sends PAGING REQUEST to the MS using the TMSI stored in the SIM.
- After receipt of a CHANNEL REQUEST from the MS, the SS sends IMMEDIATE ASSIGNMENT to the MS.
- After receipt of a PAGING RESPONSE from the MS, the SS sends CHANNEL RELEASE to the MS.

27.3.5 Test requirement

- After step a) the MS shall not respond to the PAGING REQUEST.
- After step c) the MS shall send PAGING RESPONSE to the SS containing the TMSI stored in the SIM.

27.4 MS identification by long IMSI, TMSI updating and cipher key sequence number assignment

27.4.1 Definition and applicability

The IMSI and TMSI are used for identification of the MS by a GSM network. They are read from the SIM during the SIM/ME initialization procedure. Within the authentication procedure the network sends a cipher key sequence number to the MS. In addition the network may allocate a new TMSI to the MS. Cipher key sequence number and TMSI are stored in the SIM after call termination and/or at GSM session termination.

Test purpose 2) will only be verified if this test sequentially follows the previous test (27.3).

The test applies to GSM and DCS 1 800 MEs using either ID-1 or Plug-in SIM.

27.4.2 Conformance requirement

- On the receipt of an IMMEDIATE ASSIGNMENT message the MS shall send PAGING RESPONSE containing the correct IMSI stored in the SIM.

GSM 11.11, clauses 11.2.1 and 11.4.2, GSM 04.08, clause 10.5.1.4.

2. After call termination the SIM shall contain the cipher key sequence number and TMSI received by the MS during the authentication and TMSI reallocation procedures.

GSM 11.11, clauses 11.2.2, 11.4.5 and 11.4.6, GSM 02.17, clause 6.1.

27.4.3 Test purpose

- 1) To verify that the ME uses the IMSI stored in the SIM.
- 2) To verify that the ME does not respond to page requests containing a previous IMSI.
- 3) To verify that the ME can handle an IMSI of maximum length.
- 4) To verify that the ME correctly updates the cipher key sequence number at call termination.
- 5) To verify that the ME correctly updates the TMSI at call termination.

27.4.4 Method of test

27.4.4.1 Initial conditions

Prior to this test, the ME shall have been operated with a SIM containing IMSI "246813579". This may be achieved by executing the previous test (27.3) prior to this test. Only under this condition will test purpose 2) be verified.

The SS transmits on the BCCH, with the following network parameters:

Attach/detach: disabled
 LAI (MCC/MNC/LAC): 246/81/0001
 Access control: unrestricted.

The default SIM is used with the following exception:

EF_{IMSI} (IMSI)

Logically: 2468111111111111

Coding:	B1	B2	B3	B4	B5	B6	B7	B8	B9
	08	29	64	18	11	11	11	11	11

The SIM is installed into the ME and the MS is powered on.

27.4.4.2 Procedure

- a) The SS sends PAGING REQUEST to the MS using the IMSI "246813579".
- b) The SS sends PAGING REQUEST to the MS using the IMSI stored in the SIM.
- c) After receipt of a CHANNEL REQUEST from the MS, the SS sends IMMEDIATE ASSIGNMENT to the MS.
- d) After receipt of a PAGING RESPONSE from the MS, the SS sends AUTHENTICATION REQUEST to the MS containing cipher key sequence number set to binary 010.
- e) After receipt of AUTHENTICATION RESPONSE from the MS, the SS sends TMSI REALLOCATION to the MS containing TMSI "32547698".
- f) Within 5 seconds after receipt of TMSI REALLOCATION COMPLETE from the MS, the SS sends CHANNEL RELEASE to the MS.

- g) To allow examination of the values in the SIM after call termination the MS shall not be soft powered down. If the test is performed with a SIM simulator, the simulation is stopped. If the test is performed with a SIM, the SIM is removed without soft powering down the MS. If this is not possible, the power supply of the ME is removed and then the SIM removed.

27.4.5 Test requirement

- 1) After step a) the MS shall not respond to the PAGING REQUEST.
- 2) After step c) the MS shall send PAGING RESPONSE to the SS containing the IMSI stored in the SIM.
- 3) After step e) the MS shall send TMSI REALLOCATION COMPLETE to the SS.
- 4) After step g) the SIM shall contain the following values:

EF_{LOCI} (Location Information)

Logically: LAI-MCC: 246
 LAI-MNC: 81
 TMSI: "32547698"

Coding:	B1	B2	B3	B4	B5	B6	B7	B8	B9	B10	B11
	32	54	76	98	42	F6	18	xx	xx	xx	xx

EF_{Kc} (Ciphering Key Kc)

Logically: Key Kc: xx (result of the authentication algorithm)
 Sequence No: 2

Coding:	B1	B2	B3	B4	B5	B6	B7	B8	B9
	xx	xx	xx	xx	xx	xx	xx	xx	02

27.5 Forbidden PLMNs, location updating and undefined cipher key

27.5.1 Definition and applicability

A list of forbidden PLMNs stored in the SIM and providing storage for up to 4 entries is managed by the MS. In automatic PLMN selection mode the MS controls location updating attempts to appropriate networks with respect to this list of forbidden PLMNs. As a result of a location update reject with the cause "PLMN not allowed" the MS stores the PLMN which rejected the update request in the SIM.

After a location update, which is not followed by an authentication procedure, the cipher key sequence number indicates that the cipher key is undefined.

This test applies to GSM and DCS 1 800 MEs using either ID-1 or Plug-in SIM.

27.5.2 Conformance requirement

1. In automatic PLMN selection mode the MS shall only attempt a LOCATION UPDATE if it receives a BCCH containing a LAI that is not indicated in the EF_{FPLMN} in the SIM.

GSM 02.11, clause 2.3, GSM 11.11, clauses 11.2.1 and 11.4.8.

2. After receipt of a LOCATION UPDATE REJECT message with the cause "PLMN not allowed" the ME shall update the EF_{FPLMN} in the SIM.

GSM 02.11, clause 2.3, GSM 11.11, clauses 11.2.1 and 11.4.8.

27.5.4.2 Procedure

- a) The MS is powered on.
- b) The SS stops all RF output on the BCCH for a long enough period of time to cause a cell reselection procedure in the MS. The BCCH is changed to contain:

LAI (MCC/MNC): 234/03

The SS then resumes RF output on the BCCH.

- c) The SS stops all RF output on the BCCH for a long enough period of time to cause a cell reselection procedure in the MS. The BCCH is changed to contain:

LAI (MCC/MNC): 234/04

The SS then resumes RF output on the BCCH.

- d) The SS stops all RF output on the BCCH for a long enough period of time to cause a cell reselection procedure in the MS. The BCCH is changed to contain:

LAI (MCC/MNC): 234/05

The SS then resumes RF output on the BCCH.

- e) The SS stops all RF output on the BCCH for a long enough period of time to cause a cell reselection procedure in the MS. The BCCH is changed to contain:

LAI (MCC/MNC): 234/01

The SS then resumes RF output on the BCCH.

- f) After receipt of a CHANNEL REQUEST from the MS, the SS sends IMMEDIATE ASSIGNMENT to the MS.
- g) After receipt of a LOCATION UPDATE REQUEST from the MS, the SS sends LOCATION UPDATE REJECT to the MS with cause "PLMN Not Allowed", followed by CHANNEL RELEASE.

The SS stops all RF output on the BCCH for a long enough period of time to cause a cell reselection procedure in the MS. The BCCH is changed to contain:

LAI (MCC/MNC): 234/06

The SS then resumes RF output on the BCCH.

- h) After receipt of a CHANNEL REQUEST from the MS, the SS sends IMMEDIATE ASSIGNMENT to the MS.
- i) After receipt of a LOCATION UPDATE REQUEST from the MS, the SS sends LOCATION UPDATE ACCEPT with:

LAI (MCC/MNC): 234/06
TMSI: "43658709"

to the MS.

- j) After receipt of a TMSI REALLOCATION COMPLETE from the MS, the SS sends CHANNEL RELEASE to the MS.
- k) The MS is soft powered down.

27.5.5 Test requirement

- 1) After each of the steps a) to d) the MS shall not attempt a LOCATION UPDATE.
- 2) After step f) the MS shall send LOCATION UPDATE REQUEST to the SS.
- 3) After step h) the MS shall send LOCATION UPDATE REQUEST to the SS.
- 4) After step i) the MS shall respond with TMSI REALLOCATION COMPLETE.
- 5) After step k) the SIM shall contain the following values:

EF_{LOCI} (Location Information)

Logically: LAI-MCC: 234
 LAI-MNC: 06
 TMSI: "43658709"

Coding: B1 B2 B3 B4 B5 B6 B7 B8 B9 B10 B11
 43 65 87 09 32 F4 60 xx xx xx 00

EF_{Kc} (Cipherring Key Kc)

Logically: Key Kc: xx
 Sequence No: 7

Coding: B1 B2 B3 B4 B5 B6 B7 B8 B9
 xx xx xx xx xx xx xx xx 07

EF_{FPLMN} (Forbidden PLMNs)

Logically: PLMN1: 234 03 (MCC MNC)
 PLMN2: 234 04
 PLMN3: 234 05
 PLMN4: 234 01

Coding: B1 B2 B3 B4 B5 B6 B7 B8 B9 B10 B11 B12
 32 F4 30 32 F4 40 32 F4 50 32 F4 10

27.6 MS updating forbidden PLMNs**27.6.1 Definition and applicability**

A list of forbidden PLMNs stored in the SIM provides storage for up to 4 entries, and is managed by the MS. In automatic PLMN selection mode the MS controls location updating attempts to appropriate networks with respect to this list of forbidden PLMNs. As a result of a location update reject with the cause "PLMN not allowed" the MS stores the PLMN which rejected the update request in the SIM.

This test applies to GSM and DCS 1 800 MEs using either ID-1 or Plug-in SIM.

27.6.2 Conformance requirement

After the receipt of a LOCATION UPDATE REJECT message with the cause "PLMN not allowed" the MS shall update the EF_{FPLMN} in the SIM.

GSM 02.11, clause 3.2.2.4.

27.6.3 Test purpose

To verify that the MS correctly updates the EF_{FPLMN}, i.e. fill up existing gaps in the elementary file before overwriting any existing entries.

27.6.4 Method of test**27.6.4.1 Initial conditions**

The SS transmits on the BCCH, with the following network parameters:

Attach/detach: disabled
 LAI (MCC/MNC/LAC): 234/03/0001
 Access control: unrestricted.

The default SIM is used with the following exception:

EF_{FPLMN} (Forbidden PLMNs)

Logically: PLMN1: 234 02 (MCC MNC)
 PLMN2: empty
 PLMN3: 234 04
 PLMN4: 234 05

Coding:	B1	B2	B3	B4	B5	B6	B7	B8	B9	B10	B11	B12
	32	F4	20	FF	FF	FF	32	F4	40	32	F4	50

The SIM is installed into the ME and the MS is set to automatic PLMN selection mode.

27.6.4.2 Procedure

- a) The MS is powered on.
- b) After receipt of a CHANNEL REQUEST from the MS, the SS sends IMMEDIATE ASSIGNMENT to the MS.
- c) After receipt of a LOCATION UPDATE REQUEST from the MS, the SS sends LOCATION UPDATE REJECT to the MS with the cause "PLMN not allowed", followed by CHANNEL RELEASE.
- d) The MS is soft powered down.

27.6.5 Test requirement

- 1) After step b) the MS shall send LOCATION UPDATE REQUEST to the SS.
- 2) After step d) the SIM shall contain:

EF_{FPLMN} (Forbidden PLMNs)

Logically: PLMN1: 234 02 (MCC MNC)
 PLMN2: 234 03
 PLMN3: 234 04
 PLMN4: 234 05

Coding:	B1	B2	B3	B4	B5	B6	B7	B8	B9	B10	B11	B12
	32	F4	20	32	F4	30	32	F4	40	32	F4	50

or

EF_{FPLMN} (Forbidden PLMNs)

Logically: PLMN1: 234 02 (MCC MNC)
 PLMN2: 234 04
 PLMN3: 234 05
 PLMN4: 234 03

Coding:	B1	B2	B3	B4	B5	B6	B7	B8	B9	B10	B11	B12
	32	F4	20	32	F4	40	32	F4	50	32	F4	30

27.7 MS deleting forbidden PLMNs

27.7.1 Definition and applicability

In manual PLMN selection mode the MS allows location update attempts to all available PLMNs, including forbidden PLMNs (as indicated by the forbidden PLMN list on the SIM). As a result of a successful location update procedure onto a PLMN which is in the forbidden PLMN list, the forbidden PLMN list is automatically updated by the MS.

This test applies to GSM and DCS 1 800 MEs using either ID-1 or Plug-in SIM.

27.7.2 Conformance requirement

1. In manual PLMN selection mode the MS shall be able to perform a LOCATION UPDATE attempt to a PLMN which is in the forbidden PLMN list.

GSM 02.11, clause 3.2.2.2.

2. After receipt of LOCATION UPDATE ACCEPT the MS shall delete the forbidden PLMN from the forbidden PLMN list.

GSM 02.11, clause 3.2.2.4.

27.7.3 Test purpose

- 1) To verify that in automatic PLMN selection mode the MS does not attempt to access PLMNs stored in EF_{FPLMN} on the SIM.
- 2) To verify that the MS is able to perform a LOCATION UPDATE on a forbidden PLMN in manual PLMN selection mode.
- 3) To verify that the MS after a successful LOCATION UPDATE deletes the PLMN in the EF_{FPLMN} on the SIM.

27.7.4 Method of test

27.7.4.1 Initial conditions

The SS transmits on the BCCH, with the following network parameters:

Attach/detach:	disabled
LAI (MCC/MNC/LAC):	234/01/0001
Access control:	unrestricted.

The default SIM is used with the following exception:

EF_{FPLMN} (Forbidden PLMNs)

Logically:	PLMN1:	empty
	PLMN2:	empty
	PLMN3:	234 01 (MCC MNC)
	PLMN4:	empty

Coding:	B1	B2	B3	B4	B5	B6	B7	B8	B9	B10	B11	B12
	FF	FF	FF	FF	FF	FF	32	F4	10	FF	FF	FF

The SIM is installed into the ME and the MS is set to automatic PLMN selection mode.

27.7.4.2 Procedure

- a) The MS is powered on.
- b) PLMN with MCC/MNC of 234/01 is manually selected.
- c) After receipt of a CHANNEL REQUEST from the MS, the SS sends IMMEDIATE ASSIGNMENT to the MS.
- d) After receipt of a LOCATION UPDATE REQUEST from the MS, the SS sends LOCATION UPDATE ACCEPT with:

LAI (MCC/MNC): 234/01
 TMSI: "12345678"

to the MS.

- e) After receipt of TMSI REALLOCATION COMPLETE from the MS, the SS sends CHANNEL RELEASE.
- f) The MS is soft powered down.

27.7.5 Test requirement

- 1) After step a) the MS shall not attempt a LOCATION UPDATE.
- 2) After step c) the MS shall send LOCATION UPDATE REQUEST to the SS.
- 3) After step d) the MS shall respond with TMSI REALLOCATION COMPLETE.
- 4) After step f) the SIM shall contain the following values:

EF_{LOCI} (Location Information)

Logically: LAI-MCC: 234
 LAI-MNC: 01
 TMSI: "12345678"

Coding:	B1	B2	B3	B4	B5	B6	B7	B8	B9	B10	B11
	12	34	56	78	32	F4	10	xx	xx	xx	00

EF_{FPLMN} (Forbidden PLMNs)

Logically: PLMN1: empty
 PLMN2: empty
 PLMN3: empty
 PLMN4: empty

Coding:	B1	B2	B3	B4	B5	B6	B7	B8	B9	B10	B11	B12
	FF	FF	FF	FF	FF	FF	FF	FF	FF	FF	FF	FF

27.8 MS updating the PLMN selector list**27.8.1 Definition and applicability**

The PLMN selector list gives in priority order the preferred PLMNs on which the MS shall register. The list is stored on the SIM in the EF_{PLMNsel}. Update and deletion of PLMNs may be performed by the subscriber.

This test applies to GSM and DCS 1 800 MEs using either ID-1 or Plug-in SIM.

27.8.2 Conformance requirement

The MS shall correctly replace the selected PLMN in the PLMN selector list.

GSM 11.11, clause 11.5.5.

27.8.3 Test purpose

To verify that the MS correctly updates the $EF_{PLMNsel}$.

27.8.4 Method of test**27.8.4.1 Initial conditions**

No SS is required for this test.

The default SIM is used.

The SIM is installed into the ME and the MS is powered on.

27.8.4.2 Procedure

- a) The user shall initiate an MMI dependent procedure to change the second PLMN in the PLMN selector list to MCC/MNC of 567/01.
- b) The MS is soft powered down.

27.8.5 Test requirement

After step b) the SIM shall contain the following values:

$EF_{PLMNsel}$ (PLMN Selector)

Logically:

1st PLMN:	234 01 (MCC MNC)
2nd PLMN:	567 01
3rd PLMN:	234 03
4th PLMN:	234 04
5th PLMN:	234 05
6th PLMN:	234 06
7th PLMN:	246 81
8th PLMN:	246 82

Coding:

B1	B2	B3	B4	B5	B6	B7	B8	B0	B10	B11	B12
32	F4	10	65	F7	10	32	F4	30	32	F4	40
B13	B14	B15	B16	B17	B18	B19	B20	B21	B22	B23	B24
32	F4	50	32	F4	60	42	F6	18	42	F6	28

27.9 MS recognizing the priority order of the PLMN selector list**27.9.1 Definition and applicability**

The PLMN selector list gives in priority order the preferred PLMNs on which the MS shall register. The list is stored on the SIM in the $EF_{PLMNsel}$. Update and deletion of PLMNs may be performed by the subscriber by the use of the PIN.

This test applies to GSM and DCS 1 800 MEs using either ID-1 or Plug-in SIM.

27.9.2 Conformance requirement

When registering onto a VPLMN the MS shall take into account the priority order of the PLMNs in the preferred list on the SIM.

GSM 02.11, clause 3.2.2.2.

27.9.3 Test purpose

To verify that the PLMN with the higher priority (defined by its position in $EF_{PLMNsel}$) takes precedence over the PLMN with the lower priority when the MS performs a network selection.

27.9.4 Method of test**27.9.4.1 Initial conditions**

The SS transmits on two BCCHs, with the following network parameters:

Attach/detach: disabled
LAI (MCC/MNC/LAC): 234/33/0001
Access control: unrestricted.

Attach/detach: disabled
LAI (MCC/MNC/LAC): 234/34/0001
Access control: unrestricted.

The default SIM is used with the following exception:

$EF_{PLMNsel}$ (PLMN Selector)

Logically:	1st PLMN:	234 01 (MCC MNC)
	2nd PLMN:	234 02

	32nd PLMN:	234 32
	33rd PLMN:	234 34
	34th PLMN:	234 33

Coding:	B1	B2	B3	B4	B5	B6			
	32	F4	10	32	F4	20			
								
								
	B94	b95	B96	B97	B98	B99	B100	B101	B102
	32	F4	23	32	F4	43	32	F4	33

The SIM is installed into the ME and the MS is set to automatic PLMN selection mode.

27.9.4.2 Procedure

- The MS is powered on.
- After receipt of a CHANNEL REQUEST from the MS, the SS sends IMMEDIATE ASSIGNMENT to the MS.
- After receipt of a LOCATION UPDATE REQUEST from the MS, the SS sends LOCATION UPDATE ACCEPT with:

LAI (MCC/MNC): 234/34
TMSI: "34567890"

to the MS

- d) After receipt of a TMSI REALLOCATION COMPLETE from the MS, the SS sends CHANNEL RELEASE to the MS.
- e) The MS is soft powered down.

27.9.5 Test requirement

- 1) After step b) the MS shall send LOCATION UPDATE REQUEST containing an MCC/MNC of 234/34 to the SS.
- 2) After step c) the MS shall respond with TMSI REALLOCATION COMPLETE.
- 3) After step e) the SIM shall contain the following values:

EF_{LOCI} (Location Information)

Logically: LAI-MCC: 234
 LAI-MNC: 34
 TMSI: "34567890"

Coding:	B1	B2	B3	B4	B5	B6	B7	B8	B9	B10	B11
	34	56	78	90	32	F4	43	xx	xx	xx	00

27.10 MS access control management

27.10.1 Definition and applicability

Access Control allows restriction of call access attempts. All mobile stations are assigned to a "low order class", and optionally (for priority uses) also to one or more "high order classes".

A "high order class" is only valid in the HPLMN or HPLMN country. Otherwise, the "low order class" is used.

The classes are programmed on the SIM. The network controls which classes at any time may be barred.

In addition, there is a separate mechanism for control of network access for emergency call attempts.

This test applies to GSM and DCS 1 800 MEs using ID-1 or Plug-in SIM.

27.10.2 Conformance requirement

- 1. The ME shall read the access control value as part of the SIM/ME initialization procedure, and subsequently adopt this value.

GSM 11.11, clause 11.2.1.

- 2. If the MS is a member of at least one access class which corresponds to the permitted classes as signalled over the air interface, and the access class is applicable in the serving network, the MS may make call attempts. Otherwise call access attempts are not allowed.

If access class 10 is barred, MS of classes 0 - 9 and ME without SIMs shall not make emergency call attempts.

MS of classes 11 - 15 are not allowed to make emergency call attempts if access class 10 and the relevant access class(es) between 11 and 15 are barred. Otherwise, emergency call attempts are allowed irrespective of the conditions of access class 10.

All options are shown in figure 27-1 and are referenced to the tests.

GSM 02.11, clauses 4.3 and 4.4.

27.10.3 Test purpose

- 1) To verify that the ME reads the access control value as part of the SIM/ME initialization procedure, and subsequently adopts this value.
- 2) To verify that the MS controls its network access in accordance with its access control class and the conditions imposed by the serving network.

The tests verify ME performance for the following:

Tests (a) and (b) No SIM in ME.

Tests (c) to (e) MS with access class 0 to 9.

Test (f) MS with access class 11 and 15 not in HPLMN, and
MS with access class 12,13 and 14 not in HPLMN country.

Test (g) and (h) MS with access class 11 and 15 in HPLMN, and
MS with access class 12,13 and 14 in HPLMN country.

Each of the above are tested against all relevant combinations of access control and emergency call bits signalled by the network, as shown in table 27-1.

27.10.4 Method of test**27.10.4.1 Initial conditions**

The SS transmits on the BCCH, with the following network parameters:

Attach/detach:	disabled
LAI (MCC/MNC/LAC):	see table 27-1
Access control:	see table 27-1
RACH:	see table 27-1

A SIM is installed in the ME containing IMSI and access control values as given in table 27-1 and the MS is powered on.

NOTE: Depending on the initial value of the EF_{LOCI} , the MS may perform a location update. This will be accepted by the SS.

Coding details

SIM IMSI: Data Field 6F 07

	Value 246813579	Value 2468135x9
byte 1	05H	05H
byte 2	29H	29H
byte 3	64H	64H
byte 4	18H	18H
byte 5	53H	53H
byte 6	97H	9xH
byte 7	FFH	FFH
byte 8	FFH	FFH
byte 9	FFH	FFH

Access class: Data field 6F 78

See GSM 11.11.

NETWORK (SS)

RACH: As defined in GSM 04.08 section 10.5.2.29.

octet 1 01111000
octet 2 00001000
octet 3 }
octet 4 } as table 27-1

27.10.4.2 Procedure

- a) Using the MMI or EMMI a normal call set-up is attempted.
- b) Using the MMI or EMMI an emergency call set-up is attempted.
- c) The test is repeated for each set of values in table 27-1.

27.10.5 Test requirement

After steps a) and b) the MS shall access the network, or shall make no access attempt, in accordance with table 27-1.

NOTE: For type approval, to limit testing, in tests (c, (d) and (e) it is only necessary that one of the access classes is tested.

Table 27-1

SIM		Network		Test result	
IMSI	Access class	RACH octet 3 octet 4	BCCH/LAI MCC MNC	Normal calls	Emergency calls
TEST (a) No SIM in ME		00000100 00000000	234 01	No	No
TEST (b) No SIM in ME		00000000 00000000	234 01	No	Yes
TEST (c)					
246813579	0	00000100 00000001	246 81	No	No
"	1	00000100 00000010	"	No	No
"	2	00000100 00000100	"	No	No
"	3	00000100 00001000	"	No	No
"	4	00000100 00010000	"	No	No
"	5	00000100 00100000	"	No	No
"	6	00000100 01000000	"	No	No
"	7	00000100 10000000	"	No	No
"	8	00000101 00000000	"	No	No
"	9	00000110 00000000	"	No	No

Table 27-1 (continued)

SIM		Network		Test result	
IMSI	Access class	RACH octet 3 octet 4	BCCH/LAI MNC MNC	Normal calls	Emergency calls
TEST (d)					
246813579	0	00000000 00000001	246 81	No	Yes
"	1	00000000 00000010	"	No	Yes
"	2	00000000 00000100	"	No	Yes
"	3	00000000 00001000	"	No	Yes
"	4	00000000 00010000	"	No	Yes
"	5	00000000 00100000	"	No	Yes
"	6	00000000 01000000	"	No	Yes
"	7	00000000 10000000	"	No	Yes
"	8	00000001 00000000	"	No	Yes
"	9	00000010 00000000	"	No	Yes

Table 27-1 (continued)

SIM		Network		Test result	
IMSI	Access class	RACH octet 3 octet 4	BCCH/LAI MNC MNC	Normal calls	Emergency calls
TEST (e)					
246813579	0	11111011 11111110	246 81	Yes	Yes
"	1	11111011 11111101	"	Yes	Yes
"	2	11111011 11111011	"	Yes	Yes
"	3	11111011 11110111	"	Yes	Yes
"	4	11111011 11101111	"	Yes	Yes
"	5	11111011 11011111	"	Yes	Yes
"	6	11111011 10111111	"	Yes	Yes
"	7	11111011 01111111	"	Yes	Yes
"	8	11111010 11111111	"	Yes	Yes
"	9	11111001 11111111	"	Yes	Yes

Table 27-1 (continued)

SIM		Network		Test result	
IMSI	Access class	RACH octet 3 octet 4	BCCH/LAI MNC MNC	Normal calls	Emergency calls
TEST (f)					
2468135x9	11 & x	00000111 11111111	246 82	No	No
"	"	00000011 11111111	"	No	Yes
"	"	00000000 00000000		Yes	Yes
Set "x" to an arbitrary value in the range 0 to 9					
2468135x9	12 & x	00000111 11111111	234 01	No	No
"	"	00000011 11111111	"	No	Yes
"	"	00000000 00000000		Yes	Yes
Set "x" to an arbitrary value in the range 0 to 9					
2468135x9	13 & x	00000111 11111111	234 01	No	No
"	"	00000011 11111111	"	No	Yes
"	"	00000000 00000000		Yes	Yes
Set "x" to an arbitrary value in the range 0 to 9					
2468135x9	14 & x	00000111 11111111	234 01	No	No
"	"	00000011 11111111	"	No	Yes
"	"	00000000 00000000		Yes	Yes
Set "x" to an arbitrary value in the range 0 to 9					
2468135x9	15 & x	00000111 11111111	246 82	No	No
"	"	00000011 11111111	"	No	Yes
"	"	00000000 00000000		Yes	Yes
Set "x" to an arbitrary value in the range 0 to 9					

Table 27-1 (continued)

SIM		Network		Test Result	
IMSI	Access Class	RACH octet 3 octet 4	BCCH/LAI MNC MNC	Normal Calls	Emergency Calls
TEST (g)					
246813579	11 & x	00001111 11111111	246 81	No	No
"	"	00001011 11111111	"	No	Yes
246813579	12 & x	00010111 11111111	246 82	No	No
"	"	00010011 11111111	"	No	Yes
246813579	13 & x	00100111 11111111	246 82	No	No
"	"	00100011 11111111	"	No	Yes
246813579	14 & x	01000111 11111111	246 82	No	No
"	"	01000011 11111111	"	No	Yes
246813579	15 & x	10000111 11111111	246 81	No	No
"	"	10000011 11111111	"	No	Yes
Set "x" to an arbitrary value in the range 0 to 9					

Table 27-1 (continued)

SIM		Network		Test Result	
IMSI	Access Class	RACH octet 3 octet 4	BCCH/LAI MNC MNC	Normal Calls	Emergency Calls
TEST (h)					
246813579	11 & x	11110011 11111111	246 81	Yes	Yes
246813579	12 & x	11101011 11111111	246 82	Yes	Yes
246813579	13 & x	11011011 11111111	246 82	Yes	Yes
246813579	14 & x	10111011 11111111	246 82	Yes	Yes
246813579	15 & x	01111011 11111111	246 81	Yes	Yes
246813579	11 & x	11110111 11111111	246 81	Yes	Yes
246813579	12 & x	11101111 11111111	246 82	Yes	Yes
246813579	13 & x	11011111 11111111	246 82	Yes	Yes
246813579	14 & x	10111111 11111111	246 82	Yes	Yes
246813579	15 & x	01111111 11111111	246 81	Yes	Yes
Set "x" to an arbitrary value in the range 0 to 9					

ACCESS CONTROL

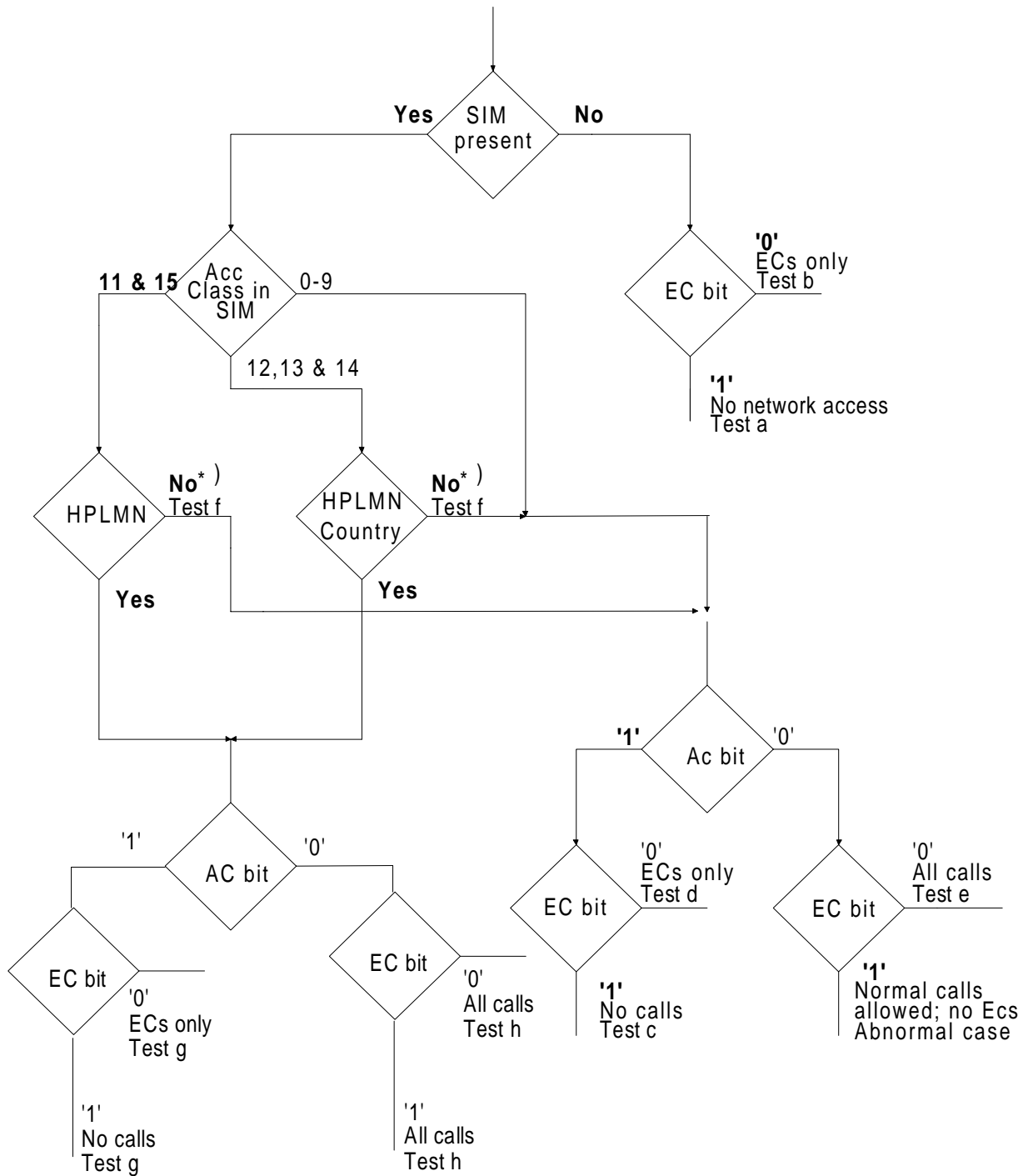

ECs = Emergency Calls

Access Class in SIM - See GSM 11.11 Data Field 6F 78

EC bit = bit3 of octet 3 of RACH Control Parameters - See GSM 04.08 Para 10.5.2.29

AC bit = See bytes 3 & 4 of RACHControl Parameters

*) Mobile adopts Access Class 0-9, based on IMSI. See GSM 02.11

27.11 Exchange protocol tests

27.11.1 Character transmission

27.11.1.1 Bit/character duration during the transmission from the ME to the SIM

27.11.1.1.1 Definition and applicability

Data is transmitted serially across the SIM/ME interface. A character comprises:

- the start bit;
- eight data bits;
- the parity bit.

This test applies to GSM and DCS 1 800 MEs using either ID-1 or Plug-in SIM.

27.11.1.1.2 Conformance requirement

The bit/character duration and the delay between two consecutive characters (between start leading edges) sent by the ME shall be in the range specified.

GSM 11.11, section 5.9.

27.11.1.1.3 Test purpose

To verify the timing during the transmission from the ME to the SIM.

27.11.1.1.4 Method of test

27.11.1.1.4.1 Initial conditions

The ME is connected to the SIM simulator, and powered on.

27.11.1.1.4.2 Procedure

A number of characters are transmitted from the ME to the SIM simulator. The SIM simulator shall measure the bit/character duration and the delay between two consecutive characters for all characters transmitted by the ME.

27.11.1.1.5 Test requirement

The timing shall be in the range specified.

27.11.1.2 Bit/character duration during the transmission from the SIM simulator to the ME

27.11.1.2.1 Definition and applicability

Data is transmitted serially across the SIM/ME interface. A character comprises:

- the start bit;
- eight data bits;
- the parity bit.

This test applies to GSM and DCS 1 800 MEs using either ID-1 or Plug-in SIM.

27.11.1.2.2 Conformance requirement

Responses with maximum and minimum bit/character duration times shall be accepted by the ME.

GSM 11.11, clause 5.9.

27.11.1.2.3 Test purpose

To verify the acceptance of maximum and minimum bit/character duration during the transmission from the SIM to the ME.

27.11.1.2.4 Method of test

27.11.1.2.4.1 Initial conditions

The ME is connected to the SIM simulator, and powered on.

27.11.1.2.4.2 Procedure

The SIM simulator shall send responses with the maximum and minimum bit/character durations specified in GSM 11.11.

27.11.1.2.5 Test requirement

The ME shall accept the response and act accordingly.

27.11.1.3 Inter-character delay

27.11.1.3.1 Definition and applicability

The inter-character delay is defined as the time between the start edge of a character and the start edge of the previous character. It is given by:

- the length of a character plus an extra guard time of N etu during transmission from the ME to the SIM. N is indicated in ATR character TC1;
- the work waiting time during transmission from the SIM to the ME.

This test applies to GSM and DCS 1 800 MEs using either ID-1 or Plug-in SIM.

27.11.1.3.2 Conformance requirement

- 1) If TC1 is 0 or 255 the ME shall work with the SIM.
- 2) If TC1 is not 0 or 255 the ME shall repeat the reset at least 2 times before it rejects the SIM.
- 3) The ME shall accept characters sent by the SIM with the work waiting time within the specified range.

GSM 11.11, clause 5.9.

27.11.1.3.3 Test purpose

- 1) To verify the correct evaluation of the character TC1 indicated in the ATR.
- 2) To verify that the ME accepts the minimum and maximum work waiting time during the transmission from the SIM to the ME.

27.11.1.3.4 Method of test

27.11.1.3.4.1 Initial conditions

The ME is connected to the SIM simulator, and powered on.

27.11.1.3.4.2 Procedure

- a) Upon reception of a reset the SIM simulator transmits the ATR as follows:

a.1) $N = 0$;

character name	content	meaning
TS	3B	direct convention
T0	40	TA1, TB1, TD1 not transmitted, TC1 transmitted, no historical characters
TA1	00	$N = 0$

a.2) $N = 255$.

character name	content	meaning
TS	3B	direct convention
T0	40	TA1, TB1, TD1 not transmitted, TC1 transmitted, no historical characters
TA1	FF	$N = 255$

a.3) $N = \text{Value other than 0 and 255}$

character name	content	meaning
TS	3B	direct convention
T0	40	TA1, TB1, TD1 not transmitted, TC1 transmitted, no historical characters
TA1	$00 < XX < FF$	$0 < N < 255$

b) The SIM simulator transmits with a work-waiting-time of 12 etu.

c) The SIM simulator transmits with a work-waiting-time of 9 600 etu.

27.11.1.3.5 Test requirement

In steps a.1) and a.2) the ME shall work with the SIM simulator.

In step a.3) the ME shall repeat the reset at least 2 times and then reject the SIM simulator.

In steps b) and c) the ME shall work with the SIM simulator.

27.11.1.4 Error handling during the transmission from the ME to the SIM

27.11.1.4.1 Definition and applicability

Error checking is done for each character transmitted by making use of the parity bit. If the SIM detects a parity error, an error signal is sent to the ME, and the ME retransmits that character.

This test applies to GSM and DCS 1 800 MEs using either ID-1 or Plug-in SIM.

27.11.1.4.2 Conformance requirement

Subsequent to Answer to Reset and the protocol type selection, the error detection and character repetition procedure specified in GSM 11.11 is mandatory for transmission on the basis of $T = 0$. On receipt of an error signal, the ME shall repeat the previously transmitted character.

GSM 11.11, clause 5.10.

27.11.1.4.3 Test purpose

To verify the error handling during the transmission from the ME to the SIM.

27.11.1.4.4 Method of test**27.11.1.4.4.1 Initial conditions**

The ME is connected to the SIM simulator, and powered on.

27.11.1.4.4.2 Procedure

The SIM simulator shall transmit an error signal in response to a received character in accordance with ISO 7816-3, section 6.1.3.

27.11.1.4.5 Test requirement

The ME shall repeat the character in accordance with ISO 7816-3, section 6.1.3.

27.11.1.5 Error handling during transmission from the SIM to the ME**27.11.1.5.1 Definition and applicability**

Error checking is done for each character transmitted by making use of the parity bit. If the ME detects a parity error, an error signal is sent to the SIM, and the SIM retransmits that character.

This test applies to GSM and DCS 1 800 MEs using either ID-1 or Plug-in SIM.

27.11.1.5.2 Conformance requirement

Subsequent to Answer to Reset and the protocol type selection, the error detection and character repetition procedure specified in GSM 11.11 is mandatory for transmission on the basis of $T = 0$. On receipt of a response with a parity error, the ME shall send an error signal and expect the previously transmitted character to be repeated.

GSM 11.11, clause 5.10.

27.11.1.5.3 Test purpose

To verify the error handling during the transmission from the SIM to the ME.

27.11.1.5.4 Method of test**27.11.1.5.4.1 Initial conditions**

The ME is connected to the SIM simulator, and powered on.

27.11.1.5.4.2 Procedure

The SIM simulator shall send a response with a parity error and check that the ME performs error handling in accordance with ISO 7816-3, section 6.1.3.

27.11.1.5.5 Test requirement

The ME shall send an error signal in accordance with ISO 7816-3, section 6.1.3, and expect a repetition of the character. The ME shall correctly evaluate the character when repeated by the SIM simulator.

27.11.2 Answer to reset (RST)

27.11.2.1 Acceptance of SIMs with internal RST

27.11.2.1.1 Definition and applicability

Internal RST is one possible implementation of reset, and MEs must be able to accept SIMs with internal reset.

This test applies to GSM and DCS 1 800 MEs using either ID-1 or Plug-in SIM.

27.11.2.1.2 Conformance requirement

The ME shall accept a SIM with internal reset by recognizing the ATR within the specified time range.

GSM 11.11, clause 5.

ISO/IEC 7816-3: 1990, section 5.2.

27.11.2.1.3 Test purpose

To verify that the ME accepts a SIM with internal reset.

27.11.2.1.4 Method of test

27.11.2.1.4.1 Initial conditions

The SIM simulator is configured for internal reset. The ME is connected to the SIM simulator and powered on.

27.11.2.1.4.2 Procedure

The SIM simulator starts its ATR between $(400/f_i)$ s and $(40\ 000/f_i)$ s after the clock signal has been detected.

NOTE: f_i is the initial frequency supplied by the ME.

27.11.2.1.5 Test requirement

The ME accepts the SIM simulator with internal reset.

27.11.2.2 Acceptance of SIMs with active low RST

27.11.2.2.1 Definition and applicability

Active low RST is one possible implementation of reset, and MEs must be able to accept SIMs with active low reset.

This test applies to GSM and DCS 1 800 MEs using either ID-1 or Plug-in SIM.

27.11.2.2.2 Conformance requirement

The ME shall accept a SIM with active low reset by putting the RST contact to state H. The signal timing shall be in accordance with the specification.

GSM 11.11, clause 5.

ISO/IEC 7816-3: 1990, section 5.2.

27.11.2.2.3 Test purpose

To verify that the ME accepts a SIM with active low reset. The timing of the RST signal shall be in accordance with the specification.

27.11.2.2.4 Method of test**27.11.2.2.4.1 Initial conditions**

The SIM simulator is configured for active low reset. The ME is connected to the SIM simulator and powered on.

27.11.2.2.4.2 Procedure

The SIM simulator measures the timing of the RST signal.

27.11.2.2.5 Test requirement

The ME shall accept the SIM simulator with active low reset. The RST signal shall be put to state H after a minimum of (40 000/fi)s.

27.11.2.3 Characters of the answer to reset**27.11.2.3.1 Definition and applicability**

When the SIM is reset, it sends up to 33 characters to the ME, containing information which must be interpreted by the ME to ascertain the transmission protocol to be used.

This test applies to GSM and DCS 1 800 MEs using either ID-1 or Plug-in SIM.

27.11.2.3.2 Conformance requirement

1. The ME shall adopt the data encoding convention and initial etu time defined in the initial character TS of the ATR.

GSM 11.11, clause 5.8.

2. The ME shall be able to receive interface characters for other transmission protocols than T = 0, historical characters and a check byte, even if only T = 0 is used by the ME.

GSM 11.11, clause 5.8.1.

27.11.2.3.3 Test purpose

1. To verify that the ME adopts the appropriate data encoding convention and initial elementary time unit (etu) defined in the initial character TS of the Answer to Reset.
2. To verify that the ME accepts interface characters for transmission protocols other than T=0, historical characters and the check byte.

27.11.2.3.4 Method of test**27.11.2.3.4.1 Initial conditions**

The ME is connected to the SIM (or SIM simulator).

27.11.2.3.4.2 Procedure

- a) The ME is powered on
- b) The SIM (or SIM simulator) sends an ATR as follows:

character name	content	meaning
TS	3B	direct convention
T0	9F	TB1, TC1 not transmitted, TA1, TD1 transmitted, 15 historical characters
TA1	11	default values F = 372, D = 1
TD1	80	TA2, TB2, TC2 not transmitted, TD2 transmitted, protocol T=0 offered
TD2	01	TA2, TB2, TC2, TD2 not transmitted, protocol T=1 offered
Ti	53 49 4D 20 53 55 42 47 52 4F 55 50 20 39 35	historical characters
TCK	4F	check byte

- c) The ME is made to send further commands to the SIM (or SIM simulator) (e.g. by entering the PIN).
- d) The ME is switched off and on. This time the SIM (or SIM simulator) sends an ATR as follows:

character name	content	meaning
TS	3F	inverse convention
T0	9F	TB1, TC1 not transmitted, TA1, TD1 transmitted, 15 historical characters
TA1	11	default values F = 372, D = 1
TD1	80	TA2, TB2, TC2 not transmitted, TD2 transmitted, protocol T=0 offered
TD2	01	TA2, TB2, TC2, TD2 not transmitted, protocol T=1 offered
Ti	53 49 4D 20 53 55 42 47 52 4F 55 50 20 39 35	historical characters
TCK	4F	check byte

- e) The ME is made to send further commands to the SIM (e.g. by entering the PIN).

27.11.2.3.5 Test requirement

- After step b), the ME shall work with the SIM (or SIM simulator).
- After step d), the ME shall work with the SIM (or SIM simulator).

27.11.2.4 PTS procedure

27.11.2.4.1 Definition and applicability

The PTS procedure is required to select the standard transmission protocol if the SIM does not use this as a default.

This test applies to GSM and DCS 1 800 MEs using either ID-1 or Plug-in SIM.

27.11.2.4.2 Conformance requirement

If the ME receives an Answer to Reset where TA1 is not equal to "11", it shall initiate the PTS procedure as defined in GSM 11.11.

GSM 11.11, clause 5.8.2.

27.11.2.4.3 Test purpose

To verify that ME uses the PTS procedure as specified in GSM 11.11.

27.11.2.4.4 Method of test**27.11.2.4.4.1 Initial conditions**

The ME is connected to the SIM (or SIM simulator).

27.11.2.4.4.2 Procedure

- a) The ME is powered on.
- b) The SIM (or the SIM simulator) sends an ATR as follows:

character name	content	meaning
TS	3B	direct convention
T0	10	TB1, TC1, TD1 not transmitted, TA1 transmitted, no historical characters
TA1	77	invalid values for F and D

27.11.2.4.5 Test requirement

After step b), the ME shall send to the SIM (or the SIM simulator) "FF00FF".

27.11.2.5 Reset repetition**27.11.2.5.1 Definition and applicability**

If transmission errors result in the ATR being unintelligible to the ME, the ME performs the reset again. The minimum number of reset attempts is three.

This test applies to GSM and DCS 1 800 MEs using either ID-1 or Plug-in SIM.

27.11.2.5.2 Conformance requirement

Following receipt of a wrong ATR, the ME shall perform a reset. The ME shall not reject the SIM until at least three consecutive wrong ATRs are received.

GSM 11.11, clause 5.10.

27.11.2.5.3 Test purpose

To verify that the ME repeats the reset procedure on receipt of a wrong ATR, and does not reject the SIM unless at least three consecutive wrong ATRs are received.

27.11.2.5.4 Method of test**27.11.2.5.4.1 Initial conditions**

The ME is connected to the SIM simulator.

27.11.2.5.4.2 Procedure

- a) The ME is powered on.
- b) The SIM simulator sends a non understandable answer to reset to the ME. (e.g. a wrong TS byte), at each reset initiated by the ME.

27.11.2.5.5 Test requirement

After step b), the ME shall repeat the reset at least two times.

27.11.3 Command processing, procedure bytes

27.11.3.1 Definition and applicability

The procedure bytes ACK, NULL, and SW1 are sent from the SIM to the ME, and give the ME an acknowledgement for the previous instruction, information concerning transfer of data and the card status at the end of the command.

This test applies to GSM and DCS 1 800 MEs using either ID-1 or Plug-in SIM.

27.11.3.2 Conformance requirement

On the basis of protocol T = 0, the ME shall correctly use the different modes of data transmission defined in ISO 7816-3, section 8.2.2.

GSM 11.11, clause 5

ISO/IEC 7816: 1990, section 8.2.2.

27.11.3.3 Test purpose

To verify that the ME uses correctly the different modes of data transmission.

27.11.3.4 Method of test

27.11.3.4.1 Initial conditions

The ME is connected to the SIM simulator and powered on.

27.11.3.4.2 Procedure

- a) The ME is made to initiate a VERIFY CHV command.
- b) The SIM simulator answers the first 3 bytes with ACK=INS complemented.
- c) The SIM simulator answers the next data byte with NULL (NULL="60").
- d) The SIM simulator then sends ACK=INS. This byte is sent when the elapsed time since step b) is greater than the work waiting time.
- e) The SIM simulator answers the transmission of the rest of the data with NULL.
- f) The SIM simulator then sends SW1 and SW2, indicating correct execution of the command ("90" and "00" for SW1 and SW2 respectively). These bytes are sent when the elapsed time since step d) is greater than the work waiting time.

27.11.3.5 Test requirement

The command shall be executed correctly.

27.12 Evaluation of directory characteristics

27.12.1 Operating speed in authentication procedure

27.12.1.1 Definition and applicability

Authentication is performed by a GSM network on the SIM, by sending a random number to the SIM. The SIM then performs a calculation on the random number, and sends the result to the network for verification.

This test applies to GSM and DCS 1 800 MEs using either ID-1 or Plug-in SIM.

27.12.1.2 Conformance requirement

If bit b2 of the file characteristics is set to 1, then the ME shall provide a clock frequency of at least 13/4 MHz to enable the SIM to run the authentication process in the required time.

GSM 11.11, clause 5.4.

27.12.1.3 Test purpose

To verify that the authentication procedure is done with a frequency of at least 13/4 MHz if the bit b2 of the file characteristics (byte 1 of the directory characteristics) is set to 1.

27.12.1.4 Method of test**27.12.1.4.1 Initial conditions**

System simulator:

1 cell, default parameters.

Mobile Equipment:

Connected to a SIM-simulator with bit b2 of the file characteristics set to 1.

ME is powered on.

27.12.1.4.2 Procedure

An authentication is made in the same way as in test [26.7.2. Authentication]. The MS is paged. After the MS has responded with a PAGING RESPONSE message to the SS, the SS initiates an authentication procedure, sending the MS the value RAND. During authentication, the SIM simulator checks the frequency of the clock supplied by the ME. Following the AUTHENTICATION RESPONSE from the MS, the SS sends CHANNEL RELEASE.

27.12.1.5 Test requirement

The frequency of the clock shall be at least 13/4 MHz during the authentication procedure.

27.12.2 Clock stop**27.12.2.1 Definition and applicability**

The ME may switch off the clock signal to the SIM, but only if the SIM indicates that it supports this feature.

This test applies to GSM and DCS 1 800 MEs using either ID-1 or Plug-in SIM.

27.12.2.2 Conformance requirement

1. The ME shall not stop the clock, unless the requirements indicated in byte 1 of the file characteristics are met.

GSM 11.11, clauses 5.6 and 9.2.1.

2. The ME shall wait at least 1 860 clock cycles after having received the last character including the minimum guard time (2 etu) of the response before switching off the clock. The ME shall wait at least 744 clock cycles before it sends the first command after having restarted the clock.

GSM 11.11, clause 5.6.

27.12.2.3 Test purpose

1. To verify that the clock is only switched off if requirements are met as indicated in the file characteristics (byte 1 of the directory characteristics).
2. To verify that the timing of the clock switching is as specified.

27.12.2.4 Method of test**27.12.2.4.1 Initial conditions**

The ME is connected to a SIM simulator. CHV 1 is enabled.

27.12.2.4.2 Procedure

- a) A SIM simulator is used with bits set as follows:

Bit b1	Bit b3	Bit b4
0	0	0
- b) The ME is powered on. When the ME is in mode PIN check, 10 seconds shall elapse before the PIN is entered.
- c) The ME is powered off, and a SIM simulator is used with bits set as follows:

Bit b1	Bit b3	Bit b4
0	1	0
- d) The ME is powered on. When the ME is in mode PIN check, 10 seconds shall elapse before the PIN is entered.
- e) The ME is powered off, and a SIM simulator is used with bits set as follows:

Bit b1	Bit b3	Bit b4
0	0	1
- f) The ME is powered on. When the ME is in mode PIN check, 10 seconds shall elapse before the PIN is entered.
- g) The ME is powered off, and a SIM simulator is used with bits set as follows:

Bit b1	Bit b3	Bit b4
1	0	0
- h) The ME is powered on. When the ME is in mode PIN check, 10 seconds shall elapse before the PIN is entered.

27.12.2.5 Test requirement

1. During step b), the ME shall not switch off the clock.
2. During step d), the ME shall not switch off the clock, unless at high level.
3. During step f), the ME shall not switch off the clock, unless at low level.
4. During steps d), f) and h), the ME shall not switch off the clock until at least 1 860 clock cycles after having received the last character of the response including the minimum guard time (2 etu).
5. During steps d), f) and h), the ME shall wait at least 744 clock cycles before it sends the first command after having restarted the clock.

27.13 Mechanical tests

27.13.1 Contact pressure

27.13.1.1 Definition and applicability

The contacts of the card reader must exert a force to maintain a good electrical contact, but the force must not be excessive and damage the SIM.

This test applies to GSM and DCS 1 800 MEs using either ID-1 or Plug-in SIM.

27.13.1.2 Conformance requirement

A contact force may not be greater than 0,5 N per contact.

GSM 11.11, clause 4.3.4.

27.13.1.3 Test purpose

To verify that the contact pressure of each contacting element is not greater than 0,5 N when each of the following types of card is used:

- i) Unembossed.
- ii) Embossed on the contact side.
- iii) Embossed on the opposite side to the contacts.

NOTE: Only type i) applies to the plug-in SIM.

27.13.1.4 Method of test

27.13.1.4.1 Initial conditions

The ME manufacturers shall provide a separate card reader (mechanical components) to make the measurement possible.

27.13.1.4.2 Procedure

The pressure of each contacting element is measured.

27.13.1.5 Test requirement

The contact pressure of each contacting element shall be not greater than 0,5 N.

27.13.2 Shape of contacts for IC card SIM card reader

27.13.2.1 Definition and applicability

The shape of the contacts is important to maintain a good electrical contact, but must not damage the SIM.

This test applies to GSM and DCS 1 800 MEs using either ID-1 or Plug-in SIM.

27.13.2.2 Conformance requirement

The radius of curvature of the contacting elements shall be greater than or equal to 0,8 mm in the contact area of both axes.

GSM 11.11, clause 4.3.4.

27.13.2.3 Test purpose

To verify that the radius of curvature of the contacting elements is greater than or equal to 0,8 mm in the contact area on both axes.

27.13.2.4 Method of test

27.13.2.4.1 Initial conditions

The ME manufacturers shall provide a separate card reader (mechanical components) to make the measurement possible.

27.13.2.4.2 Procedure

The radius of curvature of the contacting elements is measured on both axes.

27.13.2.5 Test requirement

The radius of curvature of the contacting elements shall be greater than or equal to 0,8 mm in the contact area on both axes.

27.14 Secret code usage

27.14.1 Entry of PIN

27.14.1.1 Definition and applicability

The PIN is a number used to authenticate the user to the SIM for security. Entry of the correct PIN allows PIN-protected data to be accessed over the SIM-ME interface.

This test applies to all ME.

27.14.1.2 Conformance requirement

Following insertion of the SIM and switching on the MS, the ME shall check the state of the PIN. If the PIN is enabled, the ME asks the user for PIN verification.

The VERIFY CHV function verifies the PIN presented by the ME to the SIM.

Reference:

GSM 02.30, section 4.6.1; GSM 11.11, sections 8.9, 9.2.9 and 11.3.1.

27.14.1.3 Test purpose

1. To verify that the PIN verification procedure is performed by the ME correctly.
2. To verify that the GSM basic public MMI string is supported.

27.14.1.4 Method of test

27.14.1.4.1 Initial conditions

The ME is connected to a SIM or SIM-simulator with the PIN enabled, and powered off.

The default SIM is used.

27.14.1.4.2 Procedure

- a) The ME is powered on.

- b) When the MS is in mode "PIN check" enter "2468#".

27.14.1.5 Test requirement

- 1) The ME shall send a VERIFY CHV command to the SIM, with CHV number = "01".
- 2) The MS shall give an indication "OK", following a successful execution of the command.

27.14.2 Change of PIN

27.14.2.1 Definition and applicability

The PIN may be changed by the user, by entering the old and new PINs. The length of the PIN is between 4 and 8 digits.

This test applies to all MEs.

27.14.2.2 Conformance requirement

The ME shall support the change of PIN procedure as defined in GSM 02.30 and GSM 11.11.

Reference:

GSM 02.30, section 4.6.2; GSM 11.11, sections 8.10, 9.2.10 and 11.3.2.

27.14.2.3 Test purpose

1. To verify that the PIN substitution procedure is performed correctly by the ME.
2. To verify that the GSM basic public MMI string is supported.

27.14.2.4 Method of test

27.14.2.4.1 Initial conditions

The ME is connected to a SIM or SIM-simulator with the PIN enabled.

The default SIM is used.

The ME is powered-on, with the correct PIN entered.

27.14.2.4.2 Procedure

- a) Enter "***04*2468*01234567*01234567#".
- b) The MS is switched off and on.
- c) When the MS is in mode "PIN-check", the sequence "01234567#" is entered.
- d) The MS is switched off and on.
- e) When the MS is in mode "PIN check" enter "2468#".

27.14.2.5 Test requirement

- 1) After step a), the ME shall send a CHANGE CHV command to the SIM, with CHV number set to "01".
- 2) Following the successful execution of the command, the MS shall give an indication that the new PIN is accepted.

- 3) After step c), the MS shall give an indication "OK".
- 4) After step e), the MS shall give an indication that the entered PIN is not accepted.

27.14.3 Disabling the PIN

27.14.3.1 Definition and applicability

Entry of the PIN may be disabled by the user, depending on the service table of the SIM. It is the responsibility of the ME to check the SIM service table.

This test applies to GSM and DCS 1 800 MEs using either ID-1 or Plug-in SIM that support a feature to disable the PIN.

27.14.3.2 Conformance requirement

Disabling PIN is achieved through the DISABLE CHV command. If the PIN disable function in the SIM service table is not allocated or activated, then the ME shall not attempt to disable the PIN.

Reference:

GSM 11.11, sections 8.11, 9.2.11, 10.2.7, 11 and 11.3.3.

27.14.3.3 Test purpose

To verify that the ME does not attempt to disable the PIN.

27.14.3.4 Method of test

27.14.3.4.1 Initial conditions

The ME is connected to the SIM simulator.

Elementary files in the SIM simulator shall be default, with the exception of:

EF_{SST} (SIM Service Table)

Logically: CHV1 disable function not activated.
Abbreviated dialling numbers allocated and activated.
PLMN selector allocated and activated.
Fixed dialling numbers not activated.

Coding:	B1	B2	B3	B4
	xx0x110x	0011xxxx	xxxxxxxx	0000xxxx (binary)

The coding of EF_{SST} shall conform with the capabilities of the SIM simulator.

The ME is powered on and a correct PIN entered.

27.14.3.4.2 Procedure

Using the ME's MMI procedure, an attempt is made to disable the PIN.

27.14.3.5 Test requirement

The ME shall not send a DISABLE CHV command across the SIM/ME interface.

27.14.4 PUK entry

27.14.4.1 Definition and applicability

After three consecutive wrong entries of the PIN, the PIN becomes blocked. The PUK is used to unblock the PIN. This function may be performed whether or not the PIN is blocked.

This test applies to GSM and DCS 1 800 MEs using either ID-1 or Plug-in SIM.

27.14.4.2 Conformance requirement

The ME shall support the procedure to unblock PIN using PUK, as defined in GSM 02.30 and GSM 11.11.

Reference:

GSM 02.30, section 4.6.3; GSM 11.11, sections 8.13, 9.2.13 and 11.3.5.

27.14.4.3 Test purpose

1. To verify that the CHV unblocking procedure is performed correctly.
2. To verify that the GSM basic public MMI string is supported.

27.14.4.4 Method of test

27.14.4.4.1 Initial conditions

The ME is connected to the SIM simulator.

The default SIM is used.

27.14.4.4.2 Procedure

- a) The ME is powered on.
- b) Enter "***05*13243546*1234*1234#"
- c) The ME is powered off and on.
- d) Enter the new PIN: "1234".
- e) The ME is powered off and on.
- f) Enter a wrong PIN three times.
- g) Enter "***05*13243546*2468*2468#".
- h) The ME is powered off and on.
- i) Enter the new PIN: "2468".

27.14.4.5 Test requirements

1. After step b), the ME shall send an UNBLOCK CHV command to the SIM, with CHV number = "00".
2. After step d), the ME shall indicate that the PIN has been accepted.
3. After step f), the ME shall indicate that the PIN has been blocked.
4. After step g), the ME shall send an UNBLOCK CHV command to the SIM, with CHV number = "00".

5. After step j), the ME shall indicate that the PIN has been accepted.

27.14.5 Entry of PIN2

27.14.5.1 Definition and applicability

PIN2 is a number used to authenticate the user to the SIM for security. Entry of the correct PIN2 allows PIN2-protected data to be accessed over the SIM-ME interface.

This test applies to all ME that support a feature requiring entry of PIN2, such as AoC or FDN.

27.14.5.2 Conformance requirement

Where entry of PIN2 is necessary for security access, the ME shall indicate that PIN2 is to be entered.

The VERIFY CHV function verifies the PIN presented by the ME to the SIM.

Reference:

GSM 02.30, section 4.6.1; GSM 11.11, sections 8.9, 9.2.9, and 11.3.1.

27.14.5.3 Test purpose

To verify that entry of PIN2 is processed by the ME correctly.

27.14.5.4 Method of test

27.14.5.4.1 Initial conditions

The ME is connected to a SIM or SIM-simulator and powered on, with the correct PIN entered.

A default FDN SIM is used.

27.14.5.4.2 Procedure

- a) A feature is accessed which requires the entry of PIN2, e.g. resetting ACM for Advice of Charge, or changing a Fixed Dialling Number.
- b) The MMI is used to enter PIN2: "3579".

27.14.5.5 Test requirement

- 1) After step b), the ME shall send a VERIFY CHV command to the SIM, with CHV number = "02".
- 2) Following the successful execution of the command, the MS shall give an indication that PIN2 was accepted.

27.14.6 Change of PIN2

27.14.6.1 Definition and applicability

The PIN2 may be changed by the user, by entering the old and new PIN2s. The length of the PIN is between 4 and 8 digits.

This test applies to all MEs that support PIN2.

27.14.6.2 Conformance requirement

The ME shall support the change of PIN2 procedure as defined in GSM 02.30 and GSM 11.11.

Reference:

GSM 02.30, section 4.6.2; GSM 11.11, sections 8.10, 9.2.10 and 11.3.2.

27.14.6.3 Test purpose

1. To verify that PIN2 substitution procedure is performed correctly by the ME.
2. To verify that the GSM basic public MMI string is supported.

27.14.6.4 Method of test

27.14.6.4.1 Initial conditions

The ME is connected to a SIM or SIM-simulator.

The default FDN SIM is used, with PIN enabled.

The ME is powered on, with the correct PIN entered.

27.14.6.4.2 Procedure

- a) Enter "***042*3579*12345678*12345678#".
- b) The MS is switched off and on, and PIN entered: "2468".
- c) Enter "***042*3579*12345678*12345678#".
- d) Enter "***042*12345678*3579*3579#".

27.14.6.5 Test requirement

- 1) After step a), the ME shall send a CHANGE CHV command to the SIM, with CHV number set to "02".
- 2) Following the successful execution of the command, the MS shall give an indication that the new PIN2 is accepted.
- 3) After step c), the MS shall give an indication that the new PIN2 is not accepted.
- 4) After step d), the MS shall give an indication that the new PIN2 is accepted.

27.14.7 PUK2 entry

27.14.7.1 Definition and applicability

After three consecutive wrong entries of PIN2, it becomes blocked. PUK2 is used to unblock PIN2. This function may be performed whether or not PIN2 is blocked.

This test applies to GSM and DCS 1 800 MEs using either ID-1 or Plug-in SIM, that support PIN2.

27.14.7.2 Conformance requirement

The ME shall support the procedure to unblock PIN2 using PUK2, as defined in GSM 02.30 and GSM 11.11.

Reference:

GSM 02.30, section 4.6.3; GSM 11.11, sections 8.13, 9.2.13 and 11.3.5.

27.14.7.3 Test purpose

1. To verify that the PUK2 unblock procedure is performed correctly by the ME.
2. To verify that the GSM basic public MMI string is supported.

27.14.7.4 Method of test

27.14.7.4.1 Initial conditions

The ME is connected to the SIM simulator.

The default FDN SIM is used, with PIN enabled.

27.14.7.4.2 Procedure

- a) The ME is powered on and a correct PIN entered.
- b) Enter "***052*08978675*1234*1234#"
- c) The MS is powered off and on, and PIN entered: "2468".
- d) A feature is selected requiring the entry of PIN2, and the new PIN2 "1234" is entered.
- e) A wrong PIN2 is entered three times.
- f) Enter "***052*08978675*3579*3579#"
- g) A feature is selected requiring the entry of PIN2, and the new PIN2 "3579" is entered.

27.14.7.5 Test requirements

1. After step b), the ME shall send an UNBLOCK CHV command to the SIM, with CHV number = "02"
2. After step d), the ME shall send a VERIFY CHV command, with CHV number = "02". Following the successful execution of the command, the ME shall indicate that the PIN2 has been accepted.
3. After step e), the ME shall indicate that PIN2 has been blocked.
4. After step f), the ME shall send an UNBLOCK CHV command to the SIM, with CHV number = "02"
5. After step g), the ME shall indicate that PIN2 has been accepted.

27.15 Abbreviated Dialling Numbers (ADN)

27.15.1 Definition and applicability

Abbreviated Dialling Numbers contain subscriber number and supplementary service control strings. They may also contain alpha identifiers.

This test applies to both GSM and DCS 1 800 MEs using either ID-1 or plug-in SIMs, that support ADN.

27.15.2 Conformance requirement

The ME shall be able to manage the storage and retrieval of ADNs from the SIM, and set up calls to these numbers.

Reference:

GSM 02.07, annex B.3.1; GSM 02.30 section 4.6.4; GSM 11.11, section 11.5.1.

27.15.3 Test purpose

To verify that the ME manages the storage and retrieval of ADNs from the SIM.

27.15.4 Method of Test**27.15.4.1 Initial conditions**

Coding of elementary files in the SIM shall be as default, with the addition of:

EF_{ADN} (Abbreviated Dialling Number)

Logically:

At least 101 records.

Record 1:

Length of alpha identifier:	32 characters
Alpha identifier:	"ABCDEFGHIJKLMNOPQRSTUVWXYZ"
Length of BCD number:	"03"
TON and NPI:	Telephony and Unknown
Dialled number:	123
CCI:	None
Ext1:	None

Coding for record 1:

B1	B2	B3	...	B32	B33	B34	B35	B36	B37	B38	B39	...	B46
41	42	43	...	46	03	81	21	F3	FF	FF	FF	...	FF

The ME is installed with the default SIM or SIM simulator, and switched on.

27.15.4.2 Procedure

- The code "+123456789012345" is stored (entered) in the MS as abbreviated dialling entry number 7 on the SIM.
- The code "00112233" is stored (entered) in the MS as abbreviated dialling entry number 6 on the SIM.
- The code "***21*44556677#" is stored (entered) in the MS as abbreviated dialling entry number 101 on the SIM.
- Retrieve data from SIM entry number 7 using the procedure N(N)(N)#.
- Retrieve data from SIM entry number 6 using the procedure N(N)(N)#.
- Retrieve data from SIM entry number 101 using the procedure N(N)(N)#.
- Retrieve data from SIM entry number 1 using the procedure N(N)(N)#, and display the alpha identifier.

27.15.5 Test requirements

- After step d), the number "+123456789012345" shall be displayed.
- After step e), the number "00112233" shall be displayed.
- After step f), the number "***21*44556677#" (or an equivalent representation) shall be displayed.

- 4) After step g), the ME shall display at least part of the alpha identifier, and shall sustain normal operation.

27.16 MMI reaction to SIM status encoding

27.16.1 Definition and applicability

The SIM gives status information in response to instructions, as two-byte codes. Some of these codes give valuable information to the user, and appropriate indication by the ME is mandatory.

This test applies to GSM and DCS 1 800 MEs using either ID-1 or plug-in SIMs.

27.16.2 Conformance requirement

It is mandatory to give the user an appropriate indication when any of the codes given below appear.

Reference:

GSM 02.30, section 4.6.5.

27.16.3 Test purpose

To verify that the ME gives an appropriate indication to the user in response to status information return codes from the SIM.

27.16.4 Method of test

27.16.4.1 Initial conditions

The ME is connected to the SIM simulator. All elementary files are coded as default.

The ME is powered on.

27.16.4.2 Procedure.

The SIM simulator is used to send the following error codes as reaction on an instruction from the ME:

- 9240 Memory Problem
- 9804 Access security policy not fulfilled or secret code rejected
- 9840 Secret code locked
- 6FXX Technical problem with no diagnostic given as reaction on an instruction from the ME.

27.16.5 Test requirement

For each error code, the ME shall give an appropriate MMI indication.

27.17 Electrical tests

General test purpose

Testing of electrical characteristics of the SIM/ME interface.

Whilst non-conformance in this area would be unlikely to cause difficulties to other users or the network (type approval criteria), significant deviations from the specifications (GSM 11.11 and ISO 7816) may damage the SIM. If an attempt is then made to use the SIM in a different ME, then its failure may reflect badly on both that ME and the network.

This section lists the electrical tests to be performed.

They include:

- i) tests during activation and deactivation phases; and
- ii) tests to be performed on each contact in both static and dynamic states: e.g. voltages, currents and signal characteristics.

However, due to the likely difficulty of accessing the terminals of the SIM/ME interface for the purposes of measurements, the ME manufacturer shall provide a test interface in accordance with section 36.5 for the purpose of conformance testing.

These tests apply to GSM and DCS 1 800 MEs using either ID-1 or plug-in SIMs with any one of the following types of SIM/ME interface:

- a) 5V SIM interface: The interface only supports the 5V operation mode as specified in GSM 11.11 and ISO 7816-3. The following conformance requirements apply:

27.17.1.1.2
 27.17.1.2.2 a)
 27.17.1.3.2 a)
 27.17.1.4.2 a)
 27.17.2.1.1.2 a)
 27.17.2.1.2.2 a)
 27.17.2.2.2 a)
 27.17.2.3.2 a-1,2,3,4)
 27.17.2.5.2 a-1,2,3,4)

- b) 3V SIM interface: The interface only supports the 3V operation mode as specified in GSM 11.12. The following conformance requirements apply:

27.17.1.1.2
 27.17.1.2.2 b)
 27.17.1.4.2 b)
 27.17.1.5.1.2
 27.17.1.5.2.2
 27.17.2.1.1.2 b)
 27.17.2.1.2.2 b)
 27.17.2.2.2 b)
 27.17.2.3.2 b-1,2,3,4)
 27.17.2.5.2 b-1,2,3,4)

- c) 5V/3V SIM interface: The interface supports both the 5V operation mode as specified in GSM 11.11 and ISO 7816-3 and the 3V operation mode as specified in GSM 11.12. It recognizes the type of SIM and switches the interface accordingly. The following conformance requirements apply:

27.17.1.1.2
 27.17.1.2.2 c-1,2)
 27.17.1.3.2 c)
 27.17.1.4.2 c-1,2)
 27.17.1.5.3.2
 27.17.1.5.4.2
 27.17.2.1.1.2 c-1,2)
 27.17.2.1.2.2 c-1,2)
 27.17.2.2.2 c-1,2)
 27.17.2.3.2 c-1,2,3,4,5,6,7,8)
 27.17.2.5.2 c-1,2,3,4,5,6,7,8)

General measurement conventions

For the 5V interface operation mode, the measurement conventions are specified in ISO/IEC 7816-3 section 4.2.1.

For the 3V interface operation mode these conditions apply in an analogous way.

27.17.1 Test of the power transition phases

27.17.1.1 Phase preceding ME power on

27.17.1.1.1 Definition and applicability

When the mobile equipment is switched off, the contacts of the SIM/ME interface remain in an inactive state in order to prevent any damage to the SIM.

This test applies to GSM and DCS 1 800 MEs.

27.17.1.1.2 Conformance requirement

The residual voltage across the contacts of the SIM/ME interface (C1, C2, C3, C6, C7) shall not exceed +/- 0,4 Volts referenced to GND.

Reference:

GSM 11.11, section 4.3.3

27.17.1.1.3 Test purpose

To verify that the residual voltage across the contacts of the SIM/ME interface (C1, C2, C3, C6, C7) is not greater than +/- 0,4 Volts referenced to GND.

27.17.1.1.4 Method of test

27.17.1.1.4.1 Initial condition

The ME is connected to a SIM Simulator.

The contact C1 (Vcc) of the SIM/ME interface is loaded with an impedance of 10 kOhm.

The other contacts (C2, C3, C6, C7) are loaded with an impedance of 50 kOhm.

27.17.1.1.4.2 Procedure

The residual voltage on each contact is measured.

27.17.1.1.5 Test requirement

The residual voltage on each contact shall not exceed +/- 0,4 Volts referenced to GND.

27.17.1.2 Phase during SIM power on

27.17.1.2.1 Definition and applicability

When the mobile station is switched on or when the SIM/ME interface is being activated after 3V/5V switching, the contacts shall be activated in a defined sequence in order to prevent any damage to the SIM.

The timing of this sequence is not defined, a measurement resolution better than or equivalent to 100 ns is assumed.

An ME supporting both 5V and 3V interface operation mode may switch from 3V to 5V after it has read the SIM type identification in the SIM status information by deactivating the SIM and activating it at the new supply voltage.

This test applies to GSM and DCS 1 800 MEs with:

- a) 5V SIM interface
- b) 3V SIM interface
- c) 5V/3V SIM interface

27.17.1.2.2 Conformance requirement

- a) When the MS is soft powered on, the contacts of the SIM/ME interface shall be activated in the following order:

- 1 - RST in state L,
- 2 - Vcc powered,
- 3 - I/O (ME) in reception mode,
- 4 - Clock signal provided with a suitable and stable clock.

When Vpp is connected to Vcc, as allowed by GSM 11.11 (clause 4.3.2 and 5.3), then Vpp is activated together with Vcc, at the time of Vcc (step 2 in the sequence above).

- b) When the MS is soft powered on, the contacts of the SIM/ME interface shall be activated in the following order:

- 1 - RST in state L,
- 2 - Vcc powered,
- 3 - I/O (ME) in reception mode,
- 4 - Clock signal provided with a suitable and stable clock.

- c-1) When the MS is soft powered on, the contacts of the SIM/ME interface shall be activated to 3V mode in the following order:

- 1 - RST in state L,
- 2 - Vcc powered,
- 3 - I/O (ME) in reception mode,
- 4 - Clock signal provided with a suitable and stable clock.

- c-2) When the SIM/ME interface is being activated after the 3V/5V switching the contacts shall be activated to 5V mode in the order given in c-1).

Reference:

- a): GSM 11.11, section 4.3.2
- b), c-1), c-2) GSM 11.12, section 4.4 and section 4.5

27.17.1.2.3 Test purpose

To verify that the contacts of the SIM/ME interface are activated in the correct order, as described in the conformance requirement.

27.17.1.2.4 Method of test

27.17.1.2.4.1 Initial condition

The ME is connected to a SIM Simulator.

27.17.1.2.4.2 Procedure

To test the requirements a), b) and c-1), the MS is soft powered on.

To test the requirement c-2), the ME is caused to switch the voltage on the SIM/ME interface.

The verification of each activation procedure starts with the first contact leaving the inactive state. The SIM/ME interface is monitored until it is fully activated.

27.17.1.2.5 Test requirement

The contacts of the SIM/ME interface shall be activated in the correct order, as described in the conformance requirement.

27.17.1.3 Phase during ME power off with clock stop forbidden

27.17.1.3.1 Definition and applicability

When the mobile station is soft powered off, the contacts shall be deactivated in a defined sequence in order to prevent any damage to the SIM.

The timing of this sequence is not defined, a measurement resolution better than or equivalent to 100 ns is assumed.

NOTE 1: If during MS operation the SIM is physically removed it is impractical to ensure correct sequencing of deactivation and the possible damage to the SIM cannot be safeguarded by a type approval test. Furthermore, in this situation the integrity of SIM data is not guaranteed (see GSM 02.17).

NOTE 2: Since 3V technology SIMs shall not indicate that clock stop is forbidden, this test applies only to MEs with a 5V interface and MEs with a 5V/3V interface when powered down from 5V mode.

This test applies to GSM and DCS 1 800 MEs with:

- a) 5V SIM interface
- b) [not applicable for 3V SIM interface]
- c) 5V/3V SIM interface

27.17.1.3.2 Conformance requirement

- a) When the ME is soft powered down, the contacts of the SIM/ME interface shall be deactivated in the following order:
 - 1 - RST at low state,
 - 2 - Clock stopped at low state,
 - 3 - Vpp inactive (only if Vpp is provided independent of Vcc, see GSM 11.11 clause 5.3),
 - 4 - I/O at state A,
 - 5 - Vcc inactive.

When Vpp is connected to Vcc, as allowed by GSM 11.11 (clause 5.3), then Vpp is deactivated together with Vcc, at the time of Vcc (step 5 in the sequence above).

- c) When the ME is soft powered down from 5V mode, the contacts of the SIM/ME interface shall be deactivated in the following order:
- 1 - RST at low state,
 - 2 - Clock stopped at low state,
 - 3 - I/O at status A,
 - 4 - Vcc inactive.

Reference:

a): GSM 11.11, section 4.3.2

c): GSM 11.12, section 4.5

27.17.1.3.3 Test purpose

To verify that the contacts of the SIM/ME interface become deactivated in the correct order, as given in the conformance requirement.

27.17.1.3.4 Method of test

27.17.1.3.4.1 Initial condition

The ME is connected to a SIM Simulator.

The file characteristics of the directories (byte 14 of STATUS information) shall indicate a 5V SIM with clock stop forbidden.

27.17.1.3.4.2 Procedure

The MS is soft powered off.

The SIM/ME interface is monitored until it is fully deactivated.

27.17.1.3.5 Test requirement

The contacts of the SIM/ME interface shall be deactivated in the correct order, as given in the conformance requirement.

27.17.1.4 Phase during ME power off with clock stop allowed

27.17.1.4.1 Definition and applicability

When the mobile station is soft powered off or when the SIM/ME interface is being deactivated for 3V/5V switching, the contacts shall be deactivated in a defined sequence in order to prevent any damage to the SIM.

The timing of this sequence is not defined, a measurement resolution better than or equivalent to 100 ns is assumed.

NOTE: If during MS operation the SIM is physically removed it is impractical to ensure correct sequencing of deactivation and the possible damage to the SIM cannot be safeguarded by a type approval test. Furthermore, in this situation the integrity of the SIM data is not guaranteed (see GSM 02.17).

This test applies to GSM and DCS 1 800 MEs with:

- a) 5V SIM interface
- b) 3V SIM interface
- c) 5V/3V SIM interface

27.17.1.4.2 Conformance requirement

- a) Depending on the state of the clock at the time of deactivation, the contacts of the SIM/ME shall be deactivated in one of two ways.

If the clock is running, the contacts of the SIM/ME interface shall be deactivated in the following order:

- 1 - RST at low level,
- 2 - Clock stopped at low level,
- 3 - Vpp inactive (only if Vpp is provided independent of Vcc, see GSM 11.11 clause 5.3),
- 4 - I/O at status A,
- 5 - Vcc inactive.

When Vpp is connected to Vcc, as allowed by GSM 11.11 (clause 5.3), then Vpp is deactivated together with Vcc, at the time of Vcc (step 5 in the sequence above).

If the clock is stopped and is not restarted, the ME is allowed to deactivate all the contacts in any order, provided that all signals reach low level before Vcc leaves high level.

- b) Depending on the state of the clock at the time of deactivation, the contacts of the SIM/ME shall be deactivated in one of two ways.

If the clock is running, the contacts of the SIM/ME interface shall be deactivated in the following order:

- 1 - RST at low level,
- 2 - Clock stopped at low level,
- 3. I/O at status A,
- 4.- Vcc inactive.

If the clock is stopped and is not restarted, the ME is allowed to deactivate all the contacts in any order, provided that all signals reach low level before Vcc leaves high level.

- c-1) Depending on the state of the clock at the time of deactivation, the contacts of the SIM/ME interface shall be deactivated in one of two ways.

If the clock is running, the contacts of the SIM/ME interface shall be deactivated in the following order:

- 1 - RST at low level,
- 2 - Clock stopped at low level,
- 3. I/O at status A,
- 4.- Vcc inactive.

If the clock is stopped and is not restarted, the ME is allowed to deactivate all the contacts in any order, provided that all signals reach low level before Vcc leaves high level.

- c-2) When the SIM/ME interface is deactivated for 3V/5V switching, the contacts shall be deactivated as given in c-1).

Reference:

- a): GSM 11.11, section 4.3.2
 b), c-1), c-2): GSM 11.12, section 4.5

27.17.1.4.3 Test purpose

To verify that, depending on the state of the clock (running or stopped), the contacts of the SIM/ME interface become deactivated in the correct order, as given in the conformance requirement.

27.17.1.4.4 Method of test

27.17.1.4.4.1 Initial condition

The ME is connected to a SIM Simulator.

The file characteristics of the directories (byte 14 of STATUS information) shall indicate that clock stop is allowed.

27.17.1.4.4.2 Procedure

To test the requirements a), b) and c-1), the MS is soft powered off.

To test the requirement c-2), the ME is caused to switch the voltage on the SIM/ME interface.

The SIM/ME interface is monitored until it is fully deactivated.

27.17.1.4.5 Test requirement

The contacts of the SIM/ME interface shall be deactivated in the correct order, as given in the conformance requirements.

27.17.1.5 SIM Type Recognition and Voltage Switching

27.17.1.5.1 Reaction of 3V only MEs on SIM type recognition failure

27.17.1.5.1.1 Definition and applicability

When a 3V only ME detects a failure during the SIM type recognition procedure, the ME shall reject the SIM in order to prevent any damage to the SIM.

This test applies to GSM and DCS 1 800 MEs with a 3V SIM interface.

27.17.1.5.1.2 Conformance requirement

- 1) The procedure for deriving the identification bit (SIM type recognition procedure) shall be performed by the ME immediately after the ATR and before issuing any other command. The procedure shall consist of the two commands "SELECT GSM" and "STATUS/GET RESPONSE".
- 2) If a 3V only ME cannot complete the SIM type recognition procedure the ME shall deactivate the SIM/ME interface and reject the SIM immediately without issuing any further command.

This procedure shall be finished within 5 seconds after the "STATUS/GET RESPONSE" command.

Reference:

GSM 11.12 section 4.3 and 4.5

27.17.1.5.1.3 Test purpose

- 1) To verify that a 3V only ME correctly performs the SIM type recognition procedure.
- 2) To verify that a 3V only ME deactivates the SIM/ME interface and rejects the SIM in case that the SIM does not respond to the "STATUS/GET RESPONSE" command.

27.17.1.5.1.4 Method of test

27.17.1.5.1.4.1 Initial condition

The ME is connected to a SIM Simulator simulating a 3V technology SIM with nominal test conditions according to table 27.2-2. All elementary files are coded as default.

The ME is powered on.

27.17.1.5.1.4.2 Procedure

After sending the ATR the SIM simulator checks the presence of the commands "SELECT GSM" and "STATUS/GET RESPONSE" as the first and only commands of the GSM card session.

The SIM simulator does not respond to the "STATUS/GET RESPONSE" command.

The SIM/ME interface is monitored for at least 1 minute until the MS is switched off.

27.17.1.5.1.5 Test requirement

- 1) Immediately after the ATR only the two commands "SELECT GSM" and "STATUS/GET RESPONSE" shall be sent by the ME.
- 2) The 3V only ME shall deactivate the SIM/ME interface within 5 seconds and reject the SIM (i.e. not activate the SIM/ME interface within the test procedure).

27.17.1.5.2 Reaction of 3V only MEs on type recognition of 5V only SIMs

27.17.1.5.2.1 Definition and applicability

When a 3V only ME detects a 5V only SIM during the SIM type recognition procedure, the ME shall reject the SIM in order to prevent any damage to the SIM.

This test applies to GSM and DCS 1 800 MEs with 3V SIM interface.

27.17.1.5.2.2 Conformance requirement

- 1) The procedure for deriving the identification bit (SIM type recognition procedure) shall be performed by the ME immediately after the ATR and before issuing any other command. The procedure shall consist of the two commands "SELECT GSM" and "STATUS/GET RESPONSE"
- 2) If a 3V only ME identifies a 5V only SIM during the SIM type recognition procedure the ME shall deactivate the SIM/ME interface and reject the SIM immediately without issuing any further command.

Reference:

GSM 11.12 section 4.3 and 4.5.

27.17.1.5.2.3 Test purpose

- 1) To verify that a 3V only ME correctly performs the SIM type recognition procedure.
- 2) To verify that a 3V only ME deactivates the SIM/ME interface and rejects the SIM if a 5V only SIM is applied.

27.17.1.5.2.4 Method of test**27.17.1.5.2.4.1 Initial condition**

The ME is connected to a SIM Simulator simulating a 3V technology SIM (to ensure that the ME can perform the SIM type recognition procedure) with nominal test conditions according to table 27.2-2. All elementary files are coded as default. Bit 5 in byte 14 of the status information is set to "0" (i.e. 5V only SIM).

The ME is powered on.

27.17.1.5.2.4.2 Procedure

After sending the ATR the SIM simulator checks the presence of the commands "SELECT GSM" and "STATUS/GET RESPONSE" as the first and only commands of the GSM card session.

The SIM simulator responds to the "STATUS/GET RESPONSE" command with a status information indicating a 5V only SIM.

The SIM/ME interface is monitored for at least 1 minute until the MS is switched off.

27.17.1.5.2.5 Test requirement

- 1) Immediately after the ATR only the two command "SELECT GSM" and "STATUS/GET RESPONSE" shall be sent by the ME.
- 2) The 3V only ME shall deactivate the SIM/ME interface immediately after receipt of the status information from the SIM (but not later than 5 seconds after the "STATUS/GET RESPONSE" command) and reject the SIM (i.e. not activate the SIM/ME interface again within the test procedure).

27.17.1.5.3 Reaction of 3V technology MEs on type recognition of 5V only SIMs**27.17.1.5.3.1 Definition and applicability**

When a 3V technology ME detects a 5V only SIM during the SIM type recognition procedure, the ME shall switch to 5V operation.

This test applies to GSM and DCS 1 800 MEs with the 5V/3V SIM interface.

27.17.1.5.3.2 Conformance requirement

- 1) A 3V technology ME shall initially activate the SIM at 3V (i.e. the first activation of a GSM card session).
- 2) The procedure for deriving the identification bit (SIM type recognition procedure) shall be performed by the ME immediately after the ATR procedure and before issuing any other command. The procedure shall consist of the two commands "SELECT GSM" and "STATUS/GET RESPONSE".
- 3) If a 3V technology ME identifies a 5V only SIM during the SIM type recognition procedure, the ME shall switch to 5V operation mode. Switching from 3V to 5V shall only be performed by deactivating the SIM and activating it with 5V supply voltage immediately after the SIM type recognition procedure without issuing any further command.

Reference:

GSM 11.12 section 4.3 and 4.4.

27.17.1.5.3.3 Test purpose

- 1) To verify that a 3V technology ME initially activates the SIM with 3V.
- 2) To verify that a 3V technology ME correctly performs the SIM type recognition procedure.
- 3) To verify that a 3V technology ME deactivates the SIM/ME interface immediately after the SIM type recognition procedure (in order to switch the supply voltage) without issuing any further command.

27.17.1.5.3.4 Method of test

27.17.1.5.3.4.1 Initial condition

The ME is connected to a SIM Simulator simulating a 5V only SIM with nominal test conditions according to table 27.2-1. All elementary files are coded as default. Bit 5 in byte 14 of the status information is set to "0" (i.e. 5V only SIM).

The ME is powered on.

27.17.1.5.3.4.2 Procedure

After sending the ATR the SIM simulator checks the presence of the commands "SELECT GSM" and "STATUS/GET RESPONSE" as the first and only commands of the GSM card session.

The SIM simulator responds to the "STATUS/GET RESPONSE" command with a status information indicating a 5V only SIM.

The SIM/ME interface is monitored for at least 1 minute until the MS is switched off.

27.17.1.5.3.5 Test requirement

- 1) The initial activation of the SIM/ME interface shall be performed with 3V supply voltage.
- 2) Immediately after the ATR the two commands "SELECT GSM" and "STATUS/GET RESPONSE" shall be sent by the ME before issuing further commands.
- 3) The 3V technology ME shall deactivate the SIM/ME interface immediately after receipt of the status information from the SIM.

27.17.1.5.4 Reaction of 3V technology MEs on type recognition of 3V technology SIMs

27.17.1.5.4.1 Definition and applicability

When a 3V technology ME detects a 3V technology SIM during the SIM type recognition procedure the ME may either switch to 5V operation or stay in 3V operation.

This test applies to GSM and DCS 1 800 MEs with 5V/3V SIM interface.

27.17.1.5.4.2 Conformance requirement

- 1) A 3V technology ME shall initially activate the SIM with a 3V (i.e. the first activation of a GSM card session).
- 2) The procedure for deriving the identification bit (SIM type recognition procedure) shall be performed by the ME immediately after the ATR and before issuing any other command. the procedure shall consist of the two commands "SELECT GSM" and "STATUS/GET RESPONSE".

- 3) If a 3V technology ME identifies a 3V technology SIM during the SIM type recognition the ME may switch to 5V operation. Switching from 3V to 5V shall only be performed by deactivating the SIM and activating it with 5V supply voltage immediately after the SIM type recognition procedure without issuing any further commands.

Reference:

GSM 11.12, section 4.3, 4.4 and 4.7.

27.17.1.5.4.3 Test purpose

- 1) To verify that a 3V technology ME initially activates the SIM with 3V.
- 2) To verify that a 3V technology ME correctly performs the SIM type recognition procedure.
- 3) To verify that a 3V technology ME deactivates the SIM/ME interface immediately after the recognition of a 3V technology SIM (in order to switch the supply voltage) or proceeds with the 3V operation during the whole GSM card session without switching to 5V supply voltage.

27.17.1.5.4.4 Method of test

27.17.1.5.4.4.1 Initial condition

The ME is connected to a SIM Simulator simulating a 3V technology SIM with nominal test conditions according to table 27.2-2. All elementary files are coded as default. Bit 5 in byte 14 of the status information is set to "1" (i.e. 3V technology SIM.)

The ME is powered on.

27.17.1.5.4.4.2 Procedure

After sending the ATR the SIM simulator checks the presence of commands "SELECT GSM" and "STATUS/GET RESPONSE" as the first and only commands of the GSM card session.

The SIM simulator responds to the "STATUS/GET RESPONSE" command with a status information indicating a 3V technology SIM.

The SIM/ME interface is monitored for at least 1 minute until the MS is switched off.

27.27.1.5.4.5 Test requirement

- 1) The initial activation of the SIM/ME interface shall be performed with 3V supply voltage.
- 2) Immediately after the ATR the two commands "SELECT GSM" and "STATUS/GET RESPONSE" shall be sent by the ME.
- 3) The ME shall react in one of the following ways:
 - a) The ME deactivates the SIM/ME interface immediately after the receipt of the status information from the SIM.
 - b) the ME proceeds with the GSM card session without switching to another supply voltage.

27.17.2 Electrical tests on each ME contact

The following tables give the electrical conditions that must be applied by the SIM simulator to all contacts during a test if not stated otherwise.

Table 27.2-1: Nominal test conditions on 5V SIM/ME interface

Contacts	Low level	High level	Max. capacitive load
C1 (Vcc)	---	I = 10 mA	
C2 (RST)	I = -200 μ A	I = +20 μ A	30 pF
C3 (CLK)	I = -200 μ A	I = +20 μ A	30 pF
C5 (GND)	---	---	
C6 ((Vpp)	---	I = 0 mA	
C7 (I/O)			30 pF
ME input	V = 0 V	I = +20 μ A	
ME output	I = -1 mA	I = +20 μ A	

Table 27.2-2: Nominal test conditions on 3V SIM/ME interface

Contacts	Low level	High level	Max. capacitive load
C1 (Vcc)	---	I = 6 mA	
C2 (RST)	I = -200 μ A	I = +200 μ A	30 pF
C3 (CLK)	I = -20 μ A	I = +20 μ A	30 pF
C5 (GND)	---	---	
C6 ((Vpp)	---	---	
C7 (I/O)			30 pF
ME input	V = 0 V	I = +20 μ A	
ME output	I = -1 mA	I = +20 μ A	

NOTE 1: Measurements of contacts voltage levels can be done at any time since the beginning of activation of the SIM and the end of deactivation of the SIM (ISO/IEC 7816-3 section 5.1).

NOTE 2: The reference point of all measurements is the contact C5 (Ground).

NOTE 3: Currents flowing into the SIM are considered positive.

27.17.2.1 Electrical tests on contact C1

C1 = Card power supply (Vcc)

27.17.2.1.1 Test 1

27.17.2.1.1.1 Definition and applicability

When the mobile station is activated, the supply voltage on the SIM/ME interface shall remain in the specified range in order to ensure correct operation and to prevent any damage to the SIM.

This test applies to GSM and DCS 1 800 MEs with:

- a) 5V SIM interface
- b) 3V SIM interface
- c) 5V/3V SIM interface

27.17.2.1.1.2 Conformance requirement

- a) The voltage on contact C1 of the SIM/ME interface shall be 5V +/- 10 % for Icc up to 10 mA.
- b) The voltage on contact C1 of the SIM/ME interface shall be 3V +/- 10 % for Icc up to 6 mA.
- c-1) The voltage on contact C1 of the SIM/ME interface shall be 5V +/- 10 % for Icc up to 10 mA when the interface is in 5V operation mode.

- c-2) The voltage on contact C1 of the SIM/ME interface shall be 3V +/- 10 % for Icc up to 6 mA when the interface is in 3V operation mode.

Reference:

- a), c-1): GSM 11.11, section 5.1.
b);, c-2): GSM 11.12, section 5.

27.17.2.1.1.3 Test purpose

To verify that the ME keeps the voltage on contact C1 of the SIM/ME interface within the ranges specified in the conformance requirements.

27.17.2.1.1.4 Method of test**Initial condition**

The ME is connected to a SIM Simulator.

The MS is activated.

The remaining contacts of the SIM/ME interface are in nominal test conditions (See GSM 11.10 section 27.17.2).

Test Procedure

The voltage of contact C1 (Vcc) of the SIM/ME interface is measured.

27.17.2.1.1.5 Test requirement

The voltage on contact C1 of the SIM/ME interface shall be within the ranges specified in the conformance requirements.

27.17.2.1.2 Test 2**27.17.2.1.2.1 Definition and applicability**

When the mobile station is activated, the supply voltage on the SIM/ME interface shall be able to counteract spikes in the current consumption of the SIM up to the limits given in the conformance requirement, ensuring that the supply voltage stays in the specified range.

This test applies to GSM and DCS 1 800 MEs with:

- a) 5V SIM interface
- b) 3V SIM interface
- c) 5V/3V SIM interface

27.17.2.1.2.2 Conformance requirement

- a) The voltage on contact C1 of the SIM/ME interface shall be 5V +/- 10 % for spikes in the current consumption with a maximum charge of 40 nAs with no more than 400 ns duration and an amplitude of at most 200 mA.
- b) The voltage on contact C1 of the SIM/ME interface shall be 3V +/- 10 % for spikes in the current consumption with a maximum charge of 12 nAs with no more than 400 ns duration and an amplitude of at most 60 mA.

- c-1) The voltage on contact C1 of the SIM/ME interface shall be 5V +/- 10 % for spikes in the current consumption with a maximum charge of 40 nAs with no more than 400 ns duration and an amplitude of at most 200 mA when the interface is in 5V operation mode.
- c-2) The voltage on contact C1 of the SIM/ME interface shall be 3V +/- 10 % for spikes in the current consumption with a maximum charge of 12 nAs with no more than 400 ns duration and an amplitude of at most 60 mA when the interface is in 3V operation mode.

Reference:

- a), c-1): GSM 11.11, section 5.2.
- b), c-2): GSM 11.12, section 5

27.17.2.1.2.3 Test purpose

To verify that the ME keeps the voltage on contact C1 of the SIM/ME interface within the specified range for the conditions given in the conformance requirement.

27.17.2.1.2.4 Method of test

Initial condition

The ME is connected to a SIM Simulator.

The MS is activated.

The remaining contacts of the SIM/ME interface are held in nominal test condition (See GSM 11.10 section 27.17.2).

Procedure

To test the requirements a) and c-1), the voltage on contact C1 of the SIM/ME interface is monitored and the following current spikes are applied:

- 1) continuous spikes:
 - current amplitude 20 mA
 - current offset 0 mA
 - Duration 100 ns
 - Pause 100 ns
- 2) continuous spikes:
 - current 20 mA
 - current offset 0 mA
 - Duration 400 ns
 - Pause 400 ns
- 3) continuous spikes:
 - current amplitude 15 mA
 - current offset 5 mA
 - (i.e. maximum amplitude = 5 mA + 15 mA = 20 mA)
 - Duration 150 ns
 - Pause 300 ns
- 4) random spikes:
 - current amplitude 200 mA
 - current offset 0 mA
 - Duration 200 ns
 - Pause between 0,1 ms and 500 ms, randomly varied

- 5) random spikes:
current amplitude 100 mA
current offset 0 mA
Duration 400 ns
Pause between 0,1 ms and 500 ms, randomly varied
- 6) random spikes
current amplitude 195 mA
current offset 5mA
(i.e. maximum amplitude = 5 mA + 195 mA = 200 mA)
Duration 200 ns
Pause between 0,1 ms and 500 ms, randomly varied

To test the requirements b) and c-2), the voltage on contact C1 of the SIM/ME interface is monitored and the following current spikes are applied:

- 1) continuous spikes:
current amplitude 12 mA
current offset 0 mA
Duration 100 ns
Pause 100 ns
- 2) continuous spikes:
current 12 mA
current offset 0 mA
Duration 400 ns
Pause 400 ns
- 3) continuous spikes:
current amplitude 9 mA
current offset 3 mA
(i.e. maximum amplitude = 3 mA + 9 mA = 12 mA)
Duration 150 ns
Pause 300 ns
- 4) random spikes:
current amplitude 60 mA
current offset 0 mA
Duration 200 ns
Pause between 0,1 ms and 500 ms, randomly varied
- 5) random spikes:
current amplitude 30 mA
current offset 0 mA
Duration 400 ns
Pause between 0,1 ms and 500 ms, randomly varied
- 6) random spikes
current amplitude 57 mA
current offset 3 mA
(i.e. maximum amplitude = 3 mA + 57 mA = 60 mA)
Duration 200 ns
Pause between 0,1 ms and 500 ms, randomly varied

NOTE: The specified spike durations are measured at 50 % of the spike amplitude.

27.17.2.1.2.5 Test requirement

The voltage on contact C1 of the SIM/ME interface shall be within the ranges specified in the conformance requirements.

27.17.2.2 Electrical tests on contact C2

C2 = Reset (RST)

27.17.2.2.1 Definition and applicability

When the mobile station is activated, the voltage on contact C2 of the SIM/ME interface shall remain in the specified range in order to ensure correct operation and to prevent any damage to the SIM.

This test applies to GSM and DCS 1 800 MEs with:

- a) 5V SIM interface
- b) 3V SIM interface
- c) 5V/3V SIM interface

27.17.2.2.2 Conformance requirement

- a) The voltage on contact C2 (RST) of the SIM/ME interface shall be between -0,3V and +0,6V for a current of -200 μ A in low state and between 3,8V and $V_{cc} + 0,3V$ for a current of +20 μ A in high state.
- b) The voltage on contact C2 (RST) of the SIM/ME interface shall be between -0,3V and +0,7V for a current of -200 μ A in low state and between 2,15 V and $V_{cc} + 0,3V$ for a current of +200 μ A in high state.
- c-1) The voltage on contact C2 (RST) of the SIM/ME interface shall be between -0,3V and +0,6V for a current of -200 μ A in low state and between 3,8V and $V_{cc} + 0,3V$ for a current of +20 μ A in high state when the interface is in 5V operation mode.
- c-2) The voltage on contact C2 (RST) of the SIM/ME interface shall be between -0,3V and +0,7V for a current of -200 μ A in low state and between 2,15 V and $V_{cc} + 0,3V$ for a current of +200 μ A in high state when the interface is in 3V operation mode.

Reference:

- a), c-1): GSM 11.11, section 5.
- b), c-2): GSM 11.12, section 5.

27.17.2.2.3 Test purpose

To verify that the ME keeps the voltage on contact C2 (RST) of the SIM/ME interface within the specified range, as given in the conformance requirement.

27.17.2.2.4 Method of test

27.17.2.2.4.1 Initial condition

The ME is connected to a SIM Simulator.

The MS is activated.

The remaining contacts of the SIM/ME interface are held in nominal test conditions (See GSM 11.10 section 27.17.2).

27.17.2.2.4.2 Procedure

The voltage on contact C2 (RST) of the SIM/ME interface is measured.

27.17.2.2.5 Test requirement

The voltage on contact C2 (RST) of the SIM/ME interface shall be within the range specified in the conformance requirement.

27.17.2.3 Electrical tests on contact C3

C3 = Clock (CLK)

27.17.2.3.1 Definition and applicability

When the mobile station is activated, the voltage, the rise/fall time of the signal, the clock cycle ratio and the frequency on contact C3 of the SIM/ME interface shall remain in the specified range in order to ensure correct operation and to prevent any damage to the SIM.

This test applies to GSM and DCS 1 800 MEs with:

- a) 5V SIM interface
- b) 3V SIM interface
- c) 5V/3V SIM interface

27.17.2.3.2 Conformance requirement

- a-1) The voltage on contact C3 (CLK) of the SIM/ME interface shall be between -0,3V and +0,5V for a current of -200 μ A in low state and between 3,15V and $V_{cc} + 0,3V$ for a current of +20 μ A in high state.
- a-2) The rise and the fall time of the clock signal shall not exceed 9 % of the clock period .
- a-3) The cycle ratio of the clock signal shall be between 40 % and 60 % of the period, in steady state.
- a-4) The frequency of the clock signal shall be between 1 MHz and 5 MHz.
- b-1) The voltage on contact C3 (CLK) of the SIM/ME interface shall be between -0,3V and +0,7V for a current of -20 μ A in low state and between 1,85V and $V_{cc} + 0,3V$ for a current of +20 μ A in high state.
- b-2) The rise and the fall time of the clock signal shall not exceed 50 ns.
- b-3) The cycle ratio of the clock signal shall be between 40 % and 60 % of the period, in steady state.
- b-4) The frequency of the clock signal shall be between 1 MHz and 4 MHz.
- c-1) The voltage on contact C3 (CLK) of the SIM/ME interface shall be between -0,3V and +0,5V for a current of -200 μ A in low state and between 3,15V and $V_{cc} + 0,3V$ for a current of +20 μ A in high state when the interface is in 5V operation mode.
- c-2) The rise and the fall time of the clock signal shall not exceed 9 % of the clock period when the interface is in 5V operation mode.
- c-3) The cycle ratio of the clock signal shall be between 40 % and 60 % of the period, in steady state when the interface is in 5V operation mode.
- c-4) The frequency of the clock signal shall be between 1 MHz and 5 MHz when the interface is in 5V operation mode.
- c-5) The voltage on contact C3 (CLK) of the SIM/ME interface shall be between -0,3V and +0,7V for a current of -20 μ A in low state and between 1,85V and $V_{cc} + 0,3V$ for a current of +20 μ A in high state when the interface is in 3V operation mode.

- c-6) The rise and the fall time of the clock signal shall not exceed 50 ns when the interface is in 3V operation mode.
- c-7) The cycle ratio of the clock signal shall be between 40 % and 60 % of the period, in steady state when the interface is in 3V operation mode.
- c-8) The frequency of the clock signal shall be between 1 MHz and 4 MHz when the interface is in 3V operation mode.

Reference:

- a), c-1,2,3,4) GSM 11.11, section 5 and section 5.4.
- b), c-3,5,6,7) GSM 11.12, section 4.2 and section 5.

27.17.2.3.3 Test purpose

To verify that the ME keeps the voltage, the rise and fall time, the cycle ratio and the frequency on contact C3 (CLK) of the SIM/ME interface within the ranges specified in the conformance requirements.

27.17.2.3.4 Method of test

27.17.2.3.4.1 Initial condition

The ME is connected to a SIM Simulator.

The MS is activated.

The remaining contacts of the SIM/ME interface are held in nominal test conditions (See GSM 11.10 section 27.17.2).

27.17.2.3.4.2 Procedure

The voltage, the rise/fall time, the clock cycle ratio and the frequency on contact C3 (CLK) of the SIM/ME interface are measured.

27.17.2.3.5 Test requirement

The voltage, the rise and fall time, the cycle ratio and the frequency on contact C3 (CLK) of the SIM/ME interface shall be within the ranges specified in the conformance requirements.

27.17.2.4 [Not used]

27.17.2.5 Electrical tests on contact C7

C7 = Input - output (I/O)

27.17.2.5.1 Definition and applicability

When the mobile station is activated, the ME shall keep the voltage, the current and the rise/fall time of the signal on contact C7 of the SIM/ME interface within the specified range in order to ensure correct operation and to prevent any damage to the SIM.

This test applies to GSM and DCS 1 800 MEs with:

- a) 5V SIM interface
- b) 3V SIM interface
- c) 5V/3V SIM interface

27.17.2.5.2 Conformance requirement

- a-1) ME receiving state A (low state):
With an imposed voltage of 0V the current flowing out of the ME shall not exceed 1 mA.
- a-2) ME transmitting state A (low state):
The voltage shall be between -0,3V and 0,4V when a current of 1 mA flowing into the ME is applied.
- a-3) ME transmitting or receiving state Z (high state):
The voltage shall be between +3,8V and $V_{cc} + 0,3V$ when a current of 20 μA flowing out of the ME is applied.
- a-4) The rise time and the fall time of the I/O signal shall not exceed 1 μs .
- b-1) ME receiving state A (low state):
With an imposed voltage of 0V the current flowing out of the ME shall not exceed 1 mA.
- b-2) ME transmitting state A (low state):
The voltage shall be between -0,3V and 0,4V when a current of 1 mA flowing into the ME is applied.
- b-3) ME transmitting or receiving state Z (high state):
The voltage shall be between $0,7 \cdot V_{cc}$ and $V_{cc} + 0,3V$ when a current of 20 μA flowing out of the ME is applied.
- b-4) The rise time and the fall time of the I/O signal shall not exceed 1 μs .
- c-1) ME receiving state A (low state):
With an imposed voltage of 0V the current flowing out of the ME shall not exceed 1 mA when the ME is in 5V operation mode.
- c-2) ME transmitting state A (low state):
The voltage shall be between -0,3V and 0,4V when a current of 1 mA flowing into the ME is applied when the ME is in 5V operation mode.
- c-3) ME transmitting or receiving state Z (high state):
The voltage shall be between +3,8V and $V_{cc} + 0,3V$ when a current of 20 μA flowing out of the ME is applied when the ME is in 5V operation mode.
- c-4) The rise time and the fall time of the I/O signal shall not exceed 1 μs when the ME is in 5V operation mode.
- c-5) ME receiving state A (low state):
With an imposed voltage of 0V the current flowing out of the ME shall not exceed 1 mA when the ME is in 3V operation mode.
- c-6) ME transmitting state A (low state):
The voltage shall be between -0,3V and 0,4V when a current of 1 mA flowing into the ME is applied when the ME is in 3V operation mode.
- c-7) ME transmitting or receiving state Z (high state):
The voltage shall be between $0,7 \cdot V_{cc}$ and $V_{cc} + 0,3V$ when a current of 20 μA flowing out of the ME is applied when the ME is in 3V operation mode.
- c-8) The rise time and the fall time of the I/O signal shall not exceed 1 μs when the ME is in 3V operation mode.

Reference:

- a), c-1,2,3,5) GSM 11.11, section 5.
- a), c-1,2,4,5) GSM 11.12, section 5.

27.17.2.5.3 Test purpose

To verify that the ME keeps the voltage, the current and the rise and fall times of the signal on contact C7 (I/O) of the SIM/ME interface within the ranges specified in the conformance requirements.

27.17.2.5.4 Method of test

27.17.2.5.4.1 Initial condition

The ME is connected to a SIM Simulator.

The MS is activated.

The remaining contacts of the SIM/ME interface are held in nominal test conditions (See GSM 11.10 section 27.17.2).

27.17.2.5.4.2 Procedure

The voltage, the current and the rise/fall time on contact C7 (I/O) of the SIM/ME interface are measured.

27.17.2.5.5 Test requirement

The voltage, the current and the rise and fall times of the signal on contact C7 (I/O) of the SIM/ME interface shall be within the ranges specified in the conformance requirements.

27.18 Fixed Number Dialling (FND)

27.18.1 ME and SIM with FND activated

27.18.1.1 Definition and applicability

Fixed Number Dialling (FND) is a service defined for the SIM. An activated FND service results in call restrictions for the MS. The call restrictions are controlled by the ME. To ascertain the type of SIM and state of FND the MS runs the FDN capability request procedure during SIM/ME initialization.

This test applies to GSM and DCS 1 800 MEs using either ID-1 or Plug-in SIM and supporting the FDN service.

27.18.1.2 Conformance requirement

1. Recognizing the state of the SIM (FND enabled) the MS shall perform the SIM initialization procedure as specified.
2. The MS allows call set-up to a directory number as stored in EF_{FND} .
3. The MS allows call set-up to a directory number as stored in EF_{FND} and extended by digits in the end.
4. The MS does not allow call set-up to a directory number stored in EF_{FND} but with missing digits at the end.
5. The MS does not allow call set-up to a directory number having no reference in EF_{FND} .
6. The MS allows call set-up of an emergency call.

Reference:

GSM 11.11, clauses 10.2.7, 10.3.2, 11.2.1 and 11.5.1, GSM 02.07, clause 3.2.

27.18.1.3 Test purpose

1. To verify that the ME as a result of the state of the SIM rehabilitates EF_{IMSI} and EF_{LOCI} during SIM/ME initialization procedure.
2. To verify that the ME allows call set-up to a FDN number.
3. To verify that the ME allows call set-up to a FDN number extended by some digits in the end.

4. To verify that the ME rejects call set-up to a FDN number not completely corresponding to an entry in EF_{FDN} .
5. To verify that the ME rejects call set-up to number having no reference in EF_{FDN} .
6. To verify that the ME allows emergency call set-up.

27.18.1.4 Method of test

27.18.1.4.1 Initial conditions

The SS transmits on the BCCH, with the following network parameters

Attach/detach:	disabled
LAI (MCC/MNC/LAC):	246/81/0001
Access control:	unrestricted

The default FDN-SIM with FDN service enabled is installed into the ME and the MS is powered on.

27.18.1.4.2 Procedure

- a) The MS is powered on and PIN1 is entered.
- b) Using the MMI a call set-up to the fixed dialling number 1 is attempted.
- c) Using the MMI a call set-up to the fixed dialling number 2 extended by "123" in the end is attempted.
- d) Using the MMI a call set-up to a number which is equal to the fixed dialling number 3 without the last digit is attempted, e.g. by recalling the fixed dialling number 3 and deleting the last digit (only in display).
- e) Using the MMI a call set-up to the number "1234567" is attempted.
- f) Using the MMI an emergency call set-up is attempted.

27.18.1.5 Test requirement

- 1) After step a) the MS is registered and in idle state.
- 2) After steps b) and c) the MS shall allow call set-up and send the requested number across the air interface.
- 3) After steps d) and e) the MS shall prevent call set-up.
- 4) After step f) the MS shall allow emergency call set-up and send the requested number across the air interface.

27.18.2 ME and SIM with FND deactivated

27.18.2.1 Definition and applicability

Fixed Number Dialling (FND) is a service defined for the SIM. An activated FND service results in call restrictions for the MS. Only directory numbers which are stored in the EF_{FDN} may be dialled by the MS. The call restrictions are controlled by the ME. To ascertain the type of SIM and state of FND the MS runs the FND capability request procedure during SIM/ME initialization. Deactivation of the service by the subscriber is possible under the control of PIN2 and switches the SIM into a "normal", non restrictive SIM.

This test apply to GSM and DCS 1 800 MEs using either ID-1 or Plug-in SIM and supporting the FND service.

27.18.2.2 Conformance requirement

1. Recognizing the state of the SIM (FDN disabled) the MS correctly performs the SIM initialization procedure.
2. The MS allows call set-up to a directory number as stored in EF_{FDN}.
3. The MS allows call set-up to a directory number as stored in EF_{ADN}.
4. The MS allows call set-up to a directory number given in manually.

Reference:

GSM 11.11, clauses 10.2.7, 10.3.2, 11.2.1 and 11.5.1, GSM 02.07, clause 3.2.

27.18.2.3 Test purpose

1. To verify that the ME as a result of the state of the SIM correctly performs the SIM/ME initialization procedure.
2. To verify that the ME allows call set-up to a FDN number.
3. To verify that the ME allows call set-up to a ADN number.
4. To verify that the ME allows call set-up to manually given number.

27.18.2.4 Method of test

27.18.2.4.1 Initial conditions

The SS transmits on the BCCH, with the following network parameters

Attach/detach:	disabled
LAI (MCC/MNC/LAC):	246/81/0001
Access control:	unrestricted

The default FDN SIM with FDN service disabled is installed into the ME and the MS is powered on.

27.18.2.4.2 Procedure

- a) Using the MMI a call set-up to the fixed dialling number 1 is attempted.
- b) Using the MMI a call set-up to the abbreviated dialling number 1 is attempted.
- c) Using the MMI a call set-up to the number "1234567" is attempted.

27.18.2.5 Test requirement

After steps a), b) and c) the MS shall allow call set-up and send the requested number across the air interface.

27.18.3 Enabling, disabling and updating of FND

27.18.3.1 Definition and applicability

FDN may be enabled and disabled by the subscriber under control of PIN2. Fixed dialling numbers are read with PIN and updated under control of PIN2.

This test apply to GSM and DCS 1 800 MEs using either ID-1 or Plug-in SIM and supporting the FDN service.

27.18.3.2 Conformance requirement

1. Recognizing the state of the SIM (FDN enabled) the MS shall perform the SIM initialization procedure as specified.

2. The MS shall allow updating of EF_{F_{DN}} by the use of PIN2.
3. The MS provides means to disable the FDN service by the use of PIN2.
4. The MS shall allow the use of EF_{ADN} after disabling of FDN.

Reference:

GSM 11.11, clauses 10.2.7, 10.3.2, 11.2.1 and 11.5.1, GSM 02.07, clause 3.2.

27.18.3.3 Test purpose

1. To verify that the ME as a result of the state of the SIM rehabilitates EF_{IMSI} and EF_{LOCI} during SIM/ME initialization procedure.
2. To verify that the ME correctly performs the update of a number in EF_{F_{DN}}.
3. To verify that the ME correctly disables FDN service.
4. To verify that the ME recognizes disabling of FDN and allows access to EF_{ADN}.

27.18.3.4 Method of test**27.18.3.4.1 Initial conditions**

The SS transmits on the BCCH, with the following network parameters

Attach/detach:	disabled
LAI (MCC/MNC/LAC):	246/81/0001
Access control:	unrestricted

The default FDN SIM with FDN service enabled is installed into the ME and the MS is powered on.

27.18.3.4.2 Procedure

- a) The MS is powered on and PIN 1 is entered.
- b) Using the MMI the directory number "+876543210" is stored in EF_{F_{DN}} as fixed dialling number 1 (The alpha identifier is not changed).
- c) Using the MMI the FDN disabling procedure is performed. On request of the MS PIN2 is entered.
- d) Using the MMI a call set-up to the abbreviated dialling number 1 is attempted.
- e) The MS is soft-powered down.

27.18.3.5 Test requirement

- 1) After step a) the MS is registered and in idle state.
- 2) After step c) the MS shall indicate that the FDN disabling procedure has been successful.
- 3) After step d) the MS shall allow call set-up and send the requested number across the air interface.
- 4) After step e) the value of bit 1 of byte 12 in the response data of EF_{ADN} in the SIM shall be "1" and record 1 in EF_{F_{DN}}, shall contain the following values:

B1	B2	B3	B4	B5	B6	B7	B8	B9	B10	B11	B12	B13
46	44	4E	31	31	31	06	91	78	56	34	12	F0
B14	B15	B16	B17	B18	B19	B20						
FF	FF	FF	FF	FF	FF	FF						

27.19 Phase identification

27.19.1 Definition and applicability

The phase of the SIM is indicated in the Elementary File EF_{PHASE}. This allows the ME to identify the phase of the SIM and adapt its functionality accordingly.

This test applies to GSM and DCS 1 800 MEs using either ID-1 or plug-in SIMs.

27.19.2 Conformance requirement

The phase of the card shall be determined as part of the initialization procedure.

Reference:

GSM 11.11, sections 10.2.16 and 11.2.1.

27.19.3 Test purpose

To verify that the ME requests the SIM phase as part of the initialization procedure.

27.19.4 Method of test

27.19.4.1 Initial conditions

The ME is connected to the SIM simulator, and powered off.

The default values are used.

27.19.4.2 Procedure

- a) The mobile is powered on.
- b) The SIM simulator monitors the SIM initialization procedure.

27.19.5 Test requirement

The ME shall request the phase of the SIM as part of the initialization procedure.

27.20 SIM presence detection

27.20.1 Definition and applicability

The presence of the SIM is an essential requirement for setting up and maintaining a call. The ME detects the presence of the SIM electronically.

27.20.2 Conformance requirement

To ensure that the SIM has not been removed during a card session, the ME shall send STATUS commands at frequent intervals of no longer than 30 seconds during a call. If the ME detects that the SIM has been removed, a possibly ongoing call shall be terminated by the ME within 5 seconds at the latest after having detected the SIM removal.

Reference:

GSM 11.11, section 11.2.7.

27.20.3 Test purpose

1. To verify that the ME sends STATUS messages at frequent intervals of no longer than 30 seconds during a call.
2. To verify that the ME terminates a call within 5 seconds at the latest after having received a wrong response to the STATUS command.

27.20.4 Method of test**27.20.4.1 Initial conditions**

The ME is connected to the SIM-simulator.

All elementary files are coded as default.

27.20.4.2 Procedure

- a) A call is set up using the generic call setup.
- b) The SIM simulator monitors the time interval between STATUS commands sent by the ME.
- c) After 3 minutes, the call is cleared.
- d) A call is set up using the generic call setup.
- e) After one minute after the call was successfully set up, the SIM simulator responds to a STATUS command with the response data of the MF.

27.20.5 Test requirements

1. During step b), the time interval between STATUS commands shall not be longer than 30 seconds.
2. After step e), the ME shall terminate the call within 5 seconds at the latest after having received the wrong response to the STATUS command.

27.21 Advice of Charge (AoC)**27.21.1 AoC not supported by SIM****27.21.1.1 Definition and applicability**

If the ME under test supports Advice of Charge Charging, it shall still look at the capability of the SIM, before responding to any AoCC information from the network.

This test is applicable to all MEs supporting AoCC.

27.21.1.2 Conformance requirement

1. An MS not supporting AoCC and in the outgoing call / U4 call delivered state, on receipt of a CONNECT message containing AoCC information shall acknowledge the CONNECT message but ignore and not acknowledge the AoCC information sent within the CONNECT.
2. An MS not supporting AoCC and in the outgoing call / U4 call delivered state, on receipt of a FACILITY message containing AoCC information shall ignore and not acknowledge the AoCC information sent within the FACILITY.
3. An MS not supporting AoCC and in the incoming call / U9 call confirmed state, on receipt of a FACILITY message containing AoCC information shall ignore and not acknowledge the AoCC information sent within the FACILITY.

4. An MS not supporting AoCC and in the U10 call active state, on receipt of a FACILITY message containing AoCC information, shall ignore and not acknowledge the AoCC information sent within the FACILITY.

References:

GSM 03.86, sections 1.2, 1.3, 2.2, 2.3; GSM 04.86, section 2.

27.21.1.3 Test purpose

1. To verify that an MS not supporting AoCC (where the ME does support AoCC but the SIM does not) and in the outgoing call / U4 call delivered state, on receipt of a CONNECT message containing AoCC information shall acknowledge the CONNECT message but ignore and not acknowledge the AoCC information sent within the CONNECT.
2. To verify that an MS not supporting AoCC (where the ME does support AoCC but the SIM does not) and in the outgoing call / U4 call delivered state, on receipt of a FACILITY message containing AoCC information shall ignore and not acknowledge the AoCC information sent within the FACILITY.
3. To verify that an MS not supporting AoCC (where the ME does support AoCC but the SIM does not) and in the incoming call / U9 call confirmed state, on receipt of a FACILITY message containing AoCC information shall ignore and not acknowledge the AoCC information sent within the FACILITY.
4. To verify that an MS not supporting AoCC (where the ME does support AoCC but the SIM does not) and in the U10 call active state, on receipt of a FACILITY message containing AoCC information, shall ignore and not acknowledge the AoCC information sent within the FACILITY.

27.21.1.4 Method of test

27.21.1.4.1 Initial conditions

The ME shall be installed with a SIM or SIM simulator, with all elementary files coded as for the default SIM, with the exception of:

EF_{SST} (SIM Service Table)

Logically: CHV1 disable function allocated and activated.
Abbreviated dialling numbers allocated and activated.
PLMN selector allocated and activated.
Fixed dialling numbers not activated.
AoC not activated.

Coding: B1 B2 B3 B4
 xx0x1111 0011xx0x xxxxxxx 0000xxxx (binary)

The coding of EF_{SST} shall conform with the capabilities of the SIM used.

The generic call set up procedures are followed up to and including the reception, or transmission of the ALERTING message by the MS.

27.21.1.4.2 Procedure

- a) For an MO call in the U4 state the SS transmits CONNECT containing AoCC information.
- b) For an MO call in the U4 state the SS transmits FACILITY containing AoCC information.
- c) For an MTcall in the U9 state the SS transmits FACILITY containing AoCC information.
- d) For an MO call in the U10 state the SS transmits FACILITY containing AoCC information.

27.21.1.5 Test requirement

In all cases, the MS shall ignore the AoCC information sent to it in the Facility information elements as part of the CONNECT/FACILITY messages and not send any AoCC information acknowledgement. It shall be checked for 15 seconds that the MS does not transmit any AoCC information acknowledgement after the receipt of AoCC information.

27.21.2 Maximum frequency of ACM updating**27.21.2.1 Definition and applicability**

The ACM shall be updated at the end of every interval, where the interval length is given by parameter e2. The ME shall update the ACM not more frequently than once every 5 seconds, even if the interval is less than 5 seconds. More frequent updating may affect the SIM's read/write cycles.

This test applies to all ME supporting AoC.

27.21.2.2 Conformance requirement

The ACM shall be incremented when the CCM is incremented or once every 5 seconds, whichever is the longer period.

Reference:

GSM 02.24, section 4.3, part h.

27.21.2.3 Test purpose

To verify that the interval between increments is 5 seconds.

27.21.2.4 Method of test**27.21.2.4.1 Initial conditions**

The ME shall be connected to the SIM simulator, with all elementary files coded as default with the exception of:

EF_{SST} (SIM Service Table)

Logically: CHV1 disable function allocated and activated.
Abbreviated dialling numbers allocated and activated.
PLMN selector allocated and activated.
Fixed dialling numbers not activated.
AoC allocated and activated.

Coding:	B1	B2	B3	B4
	xx0x1111	0011xx11	xxxxxxxx	0000xxxx (binary)

The coding of EF_{SST} shall conform with the capabilities of the SIM used.

EF_{ACM} (Accumulated call meter)

Logically: 50 units

EF_{ACMmax} (Accumulated call meter maximum)

Logically: 150 units

System Simulator:

1 cell, default parameters, IMSI attach/detach disabled.

Mobile Station:

The MS is in MM-state "idle, updated".

27.21.2.4.2 Procedure

- a) The MS is made to initiate a call. The call is established with AoCC e-parameters sent in a Facility IE in the CONNECT message, as given below. The MS returns the AoCC acknowledgement within 1 second of the CONNECT message. It is an implementation option whether the AoCC acknowledge is sent by the MS before or after the CONNECT ACKNOWLEDGE.
- b) The call is maintained for 90 seconds, then terminated by the SS. During the call, the SIM-simulator monitors the time intervals between successive INCREMENT commands.

Maximum Duration of Test:

2 minutes.

Expected Sequence:

Step	Direction	Message	Comments
1	MS		The MS is made to initiate a call
2	MS -> SS	CHANNEL REQUEST	
3	SS -> MS	IMMEDIATE ASSIGNMENT	
4	MS -> SS	CM SERVICE REQUEST	
5	SS -> MS	CM SERVICE ACCEPT	
6	MS -> SS	SETUP	
7	SS -> MS	CALL PROCEEDING	
8	SS -> MS	ASSIGNMENT COMMAND	to a supported channel type
9	MS -> SS	ASSIGNMENT COMPLETE	
10	SS -> MS	ALERTING	
11	SS -> MS	CONNECT	As default message except contains Facility IE with contents as indicated in i below
			Either A or B branch is taken
A12	MS -> SS	CONNECT ACKNOWLEDGE	
A13	MS -> SS	FACILITY	As default message except contains Facility IE with contents as indicated in ii below
B12	MS -> SS	FACILITY	As default message except contains Facility IE with contents as indicated in ii below
B13	MS -> SS	CONNECT ACKNOWLEDGE	
14			call duration 90 seconds after CAI information sent by SS,
15	SS -> MS	DISCONNECT	
16	MS -> SS	RELEASE	
17	SS -> MS	RELEASE COMPLETE	
18	SS -> MS	CHANNEL RELEASE	The main signalling link is released.

Specific Message Contents:

i) FACILITY Information Element with Invoke = ForwardChargelInformation component type as defined in GSM 04.80 section 3.6.1 table 3.3.

For ASN.1 description see default message contents in section 31.6.1.3.

The values of the e-parameters within the parameter part of the Facility Information Element shall be set as below:

	e-parameters						
parameter	1	2	3	4	5	6	7
value	1	1	1	0	0	0	0

Values shown in table are in the format and have units as in GSM 02.24 section 3.

ii) **FACILITY Information Element** with **Return Result** component type as defined in GSM 04.80 section 3.6.1 table 3.4.

For ASN.1 description see default message contents in section 31.6.1.3.

27.21.2.5 Test requirement

The MS shall send INCREMENT commands to the SIM every 5 seconds.

27.21.3 Call terminated when ACM greater than ACMmax

27.21.3.1 Definition and applicability

ACMmax gives the maximum value of ACM, at which the current calls shall be terminated and no further chargeable calls may be made (except emergency calls).

This test applies to all ME supporting AoCC.

27.21.3.2 Conformance requirement

ACM shall be incremented by the value of CCM.

If the ACMmax is valid, and the ACM becomes equal to or exceeds the value of the ACMmax, then all calls in progress, chargeable to the user, shall be terminated by the MS, once the chargeable interval determined by the CAI has elapsed, (except emergency calls).

Reference:

GSM 02.24, section 4.3 part h and section 4.2.2.

27.21.3.3 Test purpose

1. To verify that the ME increments the ACM by the correct number of units, even though this may take ACM above ACMmax.
2. To verify that the ME terminates the call.

27.21.3.4 Method of test

27.21.3.4.1 Initial conditions

The ME shall be connected to a SIM or the SIM simulator, with all elementary files coded as default with the exception of:

EF_{SST} (SIM Service Table)

Logically:

- CHV1 disable function allocated and activated.
- Abbreviated dialling numbers allocated and activated.
- PLMN selector allocated and activated.
- Fixed dialling numbers not activated.
- AoC allocated and activated.

Coding: B1 B2 B3 B4

xx0x1111 0011xx11 xxxxxxxx 0000xxxx (binary)

The coding of EF_{SST} shall conform with the capabilities of the SIM used.

EF_{ACM} (Accumulated call meter)

Logically: 80 units

EF_{ACMmax} (Accumulated call meter maximum)

Logically: 94 units

System Simulator:

1 cell, default parameters, IMSI attach/detach disabled.

Mobile Station:

The MS is in MM-state "idle, updated".

27.21.3.4.2 Procedure

- a) The MS is made to initiate a call. The call is established with AoCC e-parameters sent in a Facility IE in the CONNECT message, as given below. The MS returns the AoCC acknowledgement within 1 second of the CONNECT message. It is an implementation option whether the AoCC acknowledge is sent by the MS before or after the CONNECT ACKNOWLEDGE.
- b) The call is maintained until cleared by the MS (after 30 seconds).
- c) The contents of ACM are checked.

Maximum Duration of Test:

2 minutes.

Expected Sequence:

Step	Direction	Message	Comments
1	MS		The MS is made to initiate a call
2	MS -> SS	CHANNEL REQUEST	
3	SS -> MS	IMMEDIATE ASSIGNMENT	
4	MS -> SS	CM SERVICE REQUEST	
5	SS -> MS	CM SERVICE ACCEPT	
6	MS -> SS	SETUP	
7	SS -> MS	CALL PROCEEDING	
8	SS -> MS	ASSIGNMENT COMMAND to a supported channel type	
9	MS -> SS	ASSIGNMENT COMPLETE	
10	SS -> MS	ALERTING	
11	SS -> MS	CONNECT	
			As default message except contains Facility IE with contents as indicated in i below
			Either A or B branch is taken
A12	MS -> SS	CONNECT ACKNOWLEDGE	As default message except contains Facility IE with contents as indicated in ii below
A13	MS -> SS	FACILITY	
B12	MS -> SS	FACILITY	As default message except contains Facility IE with contents as indicated in ii below
B13	MS -> SS	CONNECT ACKNOWLEDGE	
14			call duration 30 seconds after CAI information sent by SS
15	MS -> SS	DISCONNECT	The main signalling link is released.
16	SS -> MS	RELEASE	
17	MS -> SS	RELEASE COMPLETE	
18	MS -> SS	CHANNEL RELEASE	

Specific Message Contents:

i) **FACILITY Information Element** with **Invoke = ForwardChargeInformation** component type as defined in GSM 04.80 section 3.6.1 table 3.3.

For ASN.1 description see default message contents in section 31.6.1.3.

The values of the e-parameters within the parameter part of the Facility Information Element shall be set as below:

parameter value	e-parameters						
	1	2	3	4	5	6	7
	10	10	1	0	0	0	0

Values shown in table are in the format and have units as in GSM 02.24 section 3.

ii) **FACILITY Information Element** with **Return Result** component type as defined in GSM 04.80 section 3.6.1 table 3.4.

For ASN.1 description see default message contents in section 31.6.1.3.

27.21.3.5 Test requirement

- 1) The MS shall terminate the call correctly 30 seconds after CAI was sent.
- 2) The value of ACM shall be 100 units.

27.21.4 Response codes of increase command

27.21.4.1 Definition and applicability

ACM has a maximum value in terms of coding, and an attempt by the ME to exceed that value by sending an INCREASE command shall result in an error message from the SIM.

This test applies to all MEs supporting AoCC.

27.21.4.2 Conformance requirement

The ME shall perform the increasing procedure, sending the amount to be increased.

The running accumulated charge shall be stored in the ACM of the SIM.

Where this charge cannot be stored in the MS, use of the telecommunications service shall be prevented.

References:

GSM 11.11, section 11.5.3; GSM 02.86, sections 2.2.1 and 2.1.

27.21.4.3 Test purpose

To verify that the ME clears a charged call if the SIM indicates that the ACM cannot be increased.

27.21.4.4 Method of test

27.21.4.4.1 Initial conditions

The ME shall be connected to the SIM simulator, with all elementary files coded as default with the exception of:

EF_{SST} (SIM Service Table)

Logically: CHV1 disable function allocated and activated.
Abbreviated dialling numbers allocated and activated.
PLMN selector allocated and activated.
Fixed dialling numbers not activated.
AoC allocated and activated.

Coding: B1 B2 B3 B4
 xx0x1111 0011xx11 xxxxxxxx 0000xxxx (binary)

The coding of EF_{SST} shall conform with the capabilities of the SIM used.

EF_{ACM} (Accumulated call meter)

Logically: (Maximum-10) units

EF_{ACMmax} (Accumulated call meter maximum)

Logically: (Maximum-2) units

System Simulator:
1 cell, default parameters, IMSI attach/detach disabled.

Mobile Station:
The MS is in MM-state "idle, updated".

27.21.4.4.2 Procedure

- a) The MS is made to initiate a call. The call is established with AoCC e-parameters sent in a Facility IE in the CONNECT message, as given below. The MS returns the AoCC acknowledgement within 1 second of the CONNECT message. It is an implementation option whether the AoCC acknowledge is sent by the MS before or after the CONNECT ACKNOWLEDGE.
- b) After an interval has elapsed, the ME increments the ACM. When an INCREASE command is received, the SIM-sim sends back the error "98 50".
- c) Conditions are reset to those described in the initial conditions. Steps a) and b) of the test are repeated, except that the error code sent by the SIM simulator at step b) is now "6F xx".
- d) Conditions are reset to those described in the initial conditions. Steps a) and b) of the test are repeated, except that the error code sent by the SIM simulator at step b) is now "92 40".

Maximum Duration of Test:

3 minutes.

Expected Sequence:

Step	Direction	Message	Comments
1	MS		The MS is made to initiate a call
2	MS -> SS	CHANNEL REQUEST	
3	SS -> MS	IMMEDIATE ASSIGNMENT	
4	MS -> SS	CM SERVICE REQUEST	
5	SS -> MS	CM SERVICE ACCEPT	
6	MS -> SS	SETUP	
7	SS -> MS	CALL PROCEEDING	
8	SS -> MS	ASSIGNMENT COMMAND to a supported channel type	
9	MS -> SS	ASSIGNMENT COMPLETE	
10	SS -> MS	ALERTING	
11	SS -> MS	CONNECT	
			As default message except contains Facility IE with contents as indicated in i below
			Either A or B branch is taken
A12	MS -> SS	CONNECT ACKNOWLEDGE	As default message except contains Facility IE with contents as indicated in ii below
A13	MS -> SS	FACILITY	
B12	MS -> SS	FACILITY	As default message except contains Facility IE with contents as indicated in ii below
B13	MS -> SS	CONNECT ACKNOWLEDGE	
14			call duration approx 10s after CAI information sent by SS
15	MS -> SS	DISCONNECT	
16	SS -> MS	RELEASE	
17	MS -> SS	RELEASE COMPLETE	
18	MS -> SS	CHANNEL RELEASE	
			The main signalling link is released.

Specific Message Contents:

i) FACILITY Information Element with **Invoke = ForwardChargelInformation** component type as defined in GSM 04.80 section 3.6.1 table 3.3.

The values of the e-parameters within the parameter part of the Facility Information Element shall be set as below:

parameter	e-parameters						
	1	2	3	4	5	6	7
value	20	10	1	0	0	0	0

Values shown in table are in the format and have units as in GSM 02.24 section 3.

ii) FACILITY Information Element with **Return Result** component type as defined in GSM 04.80 section 3.6.1 table 3.4.

27.21.4.5 Test requirement

In each of the three cases, as described in steps b), c) and d) of the procedure, the MS shall terminate the call correctly when it receives an indication from the SIM that the ACM cannot be incremented.

28 Test of autocalling restrictions

28.1 General

It is essential that all autocalling apparatus is prevented from continuously dialling a given number, to avoid machines repeatedly disturbing PSTN subscribers in error, or numerous repeat attempts to unobtainable numbers which cause waste of valuable network resources. Therefore autocalling restrictions are defined by GSM 02.07.

The tests shall be performed using all of the call methods specified by the supplier in the PIXIT statement (annex 3). The supplier shall state any autocalling procedures implemented and how many times they can be repeated to a single number and the minimum re-attempt interval(s), i.e. the complete re-try schedule or algorithm with parameter values. The supplier shall further describe any automatic methods for making repeated calls to a single number. The supplier shall also state in the PIXIT statement (annex 3) the number of B-party numbers that can be stored on the list of blacklisted numbers as described in GSM 02.07, annex A.

For an external R-interface the supplier shall state in the PIXIT statement (annex 3) the procedure for autocalling restrictions for that interface and the possible parameter settings for the number of times the LTE can make a re-attempt and the minimum accepted time between re-attempts accepted by the MS. The conditions for clearing the autocalling constraints shall be stated in the PIXIT statement (annex 3).

For external interfaces the LTE must be programmed so that it clearly attempts to violate the autocalling constraints.

It is assumed that the MS has passed the tests of section 29 before these tests are performed.

All the tests are performed using valid SETUP messages as defined in section 29.

28.2 Constraining the access to a single number (GSM 02.07 category 3)

During this test the SETUP messages shall contain the same B-party number.

No manual intervention shall be performed except to initiate and end the test.

28.2.1 Conformance requirement

A repeat call attempt may be made when a call attempt is unsuccessful for the reasons listed below (as defined in GSM 04.08).

These reasons are classified in three major categories:

1. "Busy destination".
2. "Unobtainable destination - temporary".
3. "Unobtainable destination - permanent/long term".

NOTE: Cause values for each category are defined in GSM 02.07, annex A.

The table below describes a repeat call restriction pattern to any B number. This pattern defines a maximum number (n) of call repeat attempts; when this number n is reached, the associated B number shall be blacklisted by the MT until a manual re-set at the MT is performed in respect of that B number. When a repeat attempt to anyone B number fails, or is blacklisted, this does not prevent calls being made to other B numbers.

For the categories 1 and 2 above, n shall be 10; for category 3, n shall be 1.

Call attempt	Minimum duration between call attempts
Initial call attempt	-
1st repeat attempt	5 sec
2nd repeat attempt	1 min
3rd repeat attempt	1 min
4th repeat attempt	1 min
5th repeat attempt	3 min
.	
.	
nth repeat attempt	3 min

Reference:

GSM 02.07, annex A.

Purpose of the test**28.2.2 Test purpose**

To ensure the correct behaviour of the MS to GSM 02.07 Category 3.

28.2.3 Method of test**Initial condition.**

There shall be no numbers in the list of blacklisted numbers in the MS. The time set between the first re-attempt and the next re-attempt is set to the minimum value possible. The number of re-attempts is set to the lowest possible number, greater than 1, that is supported by the MS. The autocalling function is invoked for the B-party number to be used during the test.

Related PICS/PIXIT Statement(s)

PICS: Cause number 27 implemented in:

- category 2 (preferred);
- category 3.

PIXIT:Description of auto calling management:

- selection of the auto calling;
- indication that the call failed and a re-try is attempted;
- indication that a call finally failed.

Non standard keystroke sequences to be used on the EMMI (in line with GSM 11.10, sect. 36):

Foreseen Final State of the MS

The MS has a valid TMSI. It is "idle updated".

Test Procedure

Step	Direction	Message	Comments
1	MS		"called number" entered
2	MS -> SS	CHANNEL REQUEST	Establishment cause indicates "originating call".
3	SS -> MS	IMMEDIATE ASSIGNMENT	
4	MS -> SS	CM SERVICE REQUEST	Message is contained in SABM.
5	SS -> MS	AUTHENTICATION REQUEST	
6	MS -> SS	AUTHENTICATION RESPONSE	
7	SS -> MS	CIPHERING MODE COMMAND	
8	MS -> SS	CIPHERING MODE COMPLETE	
9	SS		SS starts ciphering.
10	MS -> SS	SETUP	
11	SS -> MS	RELEASE COMPLETE	Cause value from category 3 of GSM 02.07, annex A.
12	SS -> MS	CHANNEL RELEASE	The main signalling link is released
13			The MS is invoking the auto calling function. The time between step 12 and 14 must be minimum 5 sec.
14	MS -> SS	CHANNEL REQUEST	Establishment cause indicates "originating call".
15	SS -> MS	IMMEDIATE ASSIGNMENT	
16	MS -> SS	CM SERVICE REQUEST	Message is contained in SABM.
17	SS -> MS	AUTHENTICATION REQUEST	
18	MS -> SS	AUTHENTICATION RESPONSE	
19	SS -> MS	CIPHERING MODE COMMAND	
20	MS -> SS	CIPHERING MODE COMPLETE	
21	SS		SS starts ciphering.
22	MS -> SS	SETUP	
23	SS -> MS	RELEASE COMPLETE	Cause value from category 3 of GSM 02.07, annex A.
24	SS -> MS	CHANNEL RELEASE	The main signalling link is released
25	MS		Clear the auto calling constraint by manual intervention after a minimum of 2 minutes from step 24.

28.3 Constraining the access to a single number (GSM 02.07 categories 1 and 2)

During this test the SETUP messages shall contain the same B-party number.

No manual intervention shall be performed except to initiate and end the test.

28.3.1 Conformance requirement

The MS must fulfil the requirements for category 1 and 2, see sect. 28.2.1

Reference:

GSM 02.07, annex A.

28.3.2 Test purpose

To ensure the correct behaviour of the MS to GSM 02.07 Categories 1 and 2.

28.3.3 Method of test

Initial condition.

There shall be no numbers in the list of blacklisted numbers in the MS. The re-try scheme is set to give the shortest possible intervals between re-tries. The number of re-attempts is set to the maximum possible number (N), that is supported by the MS. The autocalling function is invoked for the B-party number to be used during the test.

Related PICS/PIXIT Statement(s)

PICS: Cause number 27 implemented in:

-category 2 (preferred);

-category 3.

PIXIT:Description of auto calling management:

-selection of the auto calling;

-indication that the call failed and a re-try is attempted;

-indication that a call finally failed.

Non standard keystroke sequences to be used on the EMMI (in line with GSM 11.10, sect. 36):

Foreseen Final State of the MS

The MS has a valid TMSI. It is "idle updated".

Test Procedure

A, MS initiated, generic call setup is performed up to and including CIPHERING MODE COMPLETE. The SS then releases the establishment with a cause value from category 1 or 2 (GSM 02.07, annex A).

The MS is continuously making new generic call setup attempts invoked by the auto calling function after each CHANNEL RELEASE from the SS.

Step	Direction	Message	Comments
1	MS		"called number" entered
2	MS -> SS	CHANNEL REQUEST	Establishment cause indicates "originating call".
3	SS -> MS	IMMEDIATE ASSIGNMENT	
4	MS -> SS	CM SERVICE REQUEST	Message is contained in SABM.
5	SS -> MS	AUTHENTICATION REQUEST	
6	MS -> SS	AUTHENTICATION RESPONSE	SS starts deciphering after sending the message.
7	SS -> MS	CIPHERING MODE COMMAND	
8	MS -> SS	CIPHERING MODE COMPLETE	
9	SS		SS starts ciphering.
10	MS -> SS	SETUP	Cause value from category 1 or 2 of GSM 02.07, annex A. This shall be chosen randomly, from both categories. Cause no. 27 shall be excluded if the MS has implemented in category 3 of GSM 02.07, as declared in PIXIT statement
11	SS -> MS	RELEASE COMPLETE	
12	SS -> MS	CHANNEL RELEASE	The main signalling link is released
13			The MS is invoking the auto calling function. 1: At the first re-attempt the time between step 12 and 14 must be minimum 5 sec. 2: At the 2nd, 3rd and 4th re-attempt the time between step 12 and 14 must be minimum 1 min. 3: At the 5th to 10th re-attempt the time between step 12 and 14 must be minimum 3 min.
14	MS -> SS	CHANNEL REQUEST	Establishment cause indicates "originating call".
15	SS -> MS	IMMEDIATE ASSIGNMENT	
16	MS -> SS	CM SERVICE REQUEST	Message is contained in SABM.
17	SS -> MS	AUTHENTICATION REQUEST	
18	MS -> SS	AUTHENTICATION RESPONSE	SS starts deciphering after sending the message.
19	SS -> MS	CIPHERING MODE COMMAND	
20	MS -> SS	CIPHERING MODE COMPLETE	
21	SS		SS starts ciphering.
22	MS -> SS	SETUP	Cause value from category 1 or 2 of GSM 02.07, annex A. This shall be chosen randomly, from both categories. Cause no. 27 shall be excluded if the MS has implemented in category 3 of GSM 02.07, as declared in PIXIT statement
23	SS -> MS	RELEASE COMPLETE	
24	SS -> MS	CHANNEL RELEASE	The main signalling link is released.
25			The auto calling function shall repeat step 13 to 24 (N-1) times. The MS shall not make more than maximum 10 re-attempts.
26	MS		Clear the auto calling constraint by manual intervention after a minimum of 4 minutes from step 25. Following the final completion of step 25 the MS initiate a call prior to manual intervention.

28.4 Behaviour of the MS when its list of blacklisted numbers is full

The number of B-party numbers that can be stored in the list of blacklisted numbers, as stated in the PIXIT statement (annex 3), is M.

This test shall only apply to MS that are capable of autocalling more than M B-party numbers.

28.4.1 Conformance requirement

The number of B numbers that can be held in the blacklist is at the manufacturers discretion but there shall be at least 8. However, when the blacklist is full the MT shall prohibit further automatic call attempts to any one number until the blacklist is manually cleared at the MT in respect of one or more B numbers.

Reference:

GSM 02.07, annex A.

28.4.2 Test purpose

To ensure the correct behaviour of the MS when its list of blacklisted numbers is full.

28.4.3 Method of test

Initial condition.

The list of blacklisted numbers, in the MS, shall be full. This may be achieved as described in the procedure in 28.2, applied to M B-party numbers.

Related PICS/PIXIT Statement(s)

PICS: Cause number 27 implemented in:

- category 2 (preferred),
- category 3.

PIXIT:Description of auto calling management:

- selection of the auto calling,
- indication that the call failed and a re-try is attempted,
- indication that a call finally failed.

Non standard keystroke sequences to be used on the EMMI (in line with GSM 11.10, sect. 36):

Foreseen Final State of the MS

The MS has a valid TMSI. It is "idle updated".

Test Procedure

The autocalling function is invoked for a B-party number that is not in the list of blacklisted numbers.

Clear the autocalling constraint by manual intervention after a minimum of 10 s.

28.4.4 Test requirements

The MS must not initiate a call.

29 Testing of bearer services

29.1 General

In GSM 07.01, section 2 the reference configurations for access to the data services of a GSM PLMN are described. For testing purposes only the following classifications are used:

- MT2 configuration (Um- and R-interface available for testing)
- Configurations (only Um-interface available for testing) where it is possible to enable the MS to issue or accept a data call and send data over the Um-interface. An MT1 connected to an ISDN TE belongs to this type.

For efficient testing it is essential that such configurations have some means to specifically activate every function towards the Um-interface the MS will perform during operation.

The correctness of the data bits transferred to the Um-interface will not be tested in these configurations. However the correctness of the GSM 04.21 frames sent by the MS will be tested.

Testing the S-interface for the MT1 configuration is for further study.

For some tests it is of no importance whether the call is MO or MT. However, there might be configurations allowing the call to be established only from one side. In this case the appropriate actions shall be taken to establish the call.

In all other cases the data call shall be set up by the SS (i.e. MT) with an appropriate BC-IE which is supported by the MS.

At the beginning of all tests the MS shall be in the idle updated state.

29.2 Testing of transparent data services

During all the tests the GSM 04.21 frames received as output of the channel coder in the SS shall be checked for correctness against GSM 04.21; this means checking that:

- S bits are coded as zeroes unless otherwise specified;
- the E bits have the correct value (for the synchronous services);
- the data bits correctly include the start and stop bits (for the asynchronous services).

29.2.1 Verification of synchronization

29.2.1.1 Definition and applicability

This test applies to Mobile Stations supporting data services in transparent mode.

29.2.1.2 Conformance requirement

A Mobile Stations in MT2 configuration has to comply with all requirements whilst for other configurations some of the requirements are not relevant. These restrictions are explicitly indicated in subclause 29.2.1.5.

29.2.1.3 Test purpose

This test verifies the correct synchronization procedure of user data and status information which are mapped on modified CCITT V.110 frames (as per GSM 04.21).

As V-series interfaces are supported in full duplex mode, it will test the capability to synchronize these frames in the direction from the TAF to the IWF and vice versa.

29.2.1.4 Method of test

The test shall be carried out under ideal radio conditions for all bearer services and user rates in transparent mode that are supported by the MS in case of mobile originated and terminated calls and in-call modification. The setting of Bearer Capability Information Elements in signalling messages sent to the MS by the SS must be supported by the MS for the bearer service(s) to be tested.

NOTE 1: Since "steady state" is implementation dependent, there is no means to define a test "steady state detected". However, the whole testing procedure is limited to 1s. This includes an implicit upper time limit for the MS to detect a steady state. A MS failing this test is highly estimated to never detect a steady state under real radio conditions.

NOTE 2: t_i , as used in the description of the test procedures, are points of time, not timers.

29.2.1.4.1 Procedure for Mobile Originated Calls

- a) The MS is connected to the System Simulator at the Um interface and to the LTE using the appropriate R interface in case of MT2 only.
- b) The MS is configured for data transmission. In the case of MT2 configurations, the LTE shall set the signalling lines of the R interface Ct 105, Ct 108.2 for V-series interface to ON.
- c) A mobile originated call shall be set up.
- d) At the reception of the SETUP message sent by the MS the SS shall send a CONNECT message and starts sending "1/OFF". t_1 is at the completion of the CONNECT message.
- e) The reception of "1/OFF" at the SS side (see table 29-1) defines t_2 . t_2 will be reset at the reception of again "1/OFF" after an interruption of continuous "1/OFF" pattern.
- f) The SS checks bits S1, S3, S6 and S8 of the modified CCITT V.110 frames (as described in GSM 04.21). Let t_3 be the time when all four bits change from OFF to ON (i.e. if $t < t_3$, (S1,S3,S6,S8) \leftrightarrow (0,0,0,0) and $t \geq t_3$, (S1,S3,S6,S8) = (0,0,0,0)).

29.2.1.4.2 Procedure for Mobile Terminated Calls

- a) The MS is connected to the System Simulator at the Um interface and to the LTE using the appropriate R interface in case of MT2 only.
- b) The MS is configured for data transmission. In the case of MT2 configurations, The LTE shall set the signalling lines of the R interface Ct. 105, Ct 108.2 for V-series interface to ON.
- c) A mobile terminated call shall be set up.
- d) At the reception of CONNECT the SS sends CONNECT ACKNOWLEDGE. t_1 is at the completion of the CONNECT ACKNOWLEDGE message.
- e) The reception of "1/OFF" at the SS side (see table 29-1) defines t_2 . t_2 will be reset at the reception of again "1/OFF" after an interruption of continuous "1/OFF" pattern.
- f) The SS checks bits S1, S3, S6 and S8 of the modified CCITT V.110 frames (as described in GSM 04.21). Let t_3 be the time when all four bits change from OFF to ON (i.e. if $t < t_3$, (S1,S3,S6,S8) \leftrightarrow (0,0,0,0) and $t \geq t_3$, (S1,S3,S6,S8) = (0,0,0,0)).

29.2.1.4.3 Procedure for In Call Modification

- a) The MS is connected to the System Simulator at the Um interface and to the LTE using the appropriate R interface in case of MT2 only.
- b) The MS is configured for data transmission. In the case of MT2 configurations, the LTE shall set the signalling lines of the R interface Ct. 105, Ct 108.2 for V-series interface to ON.

- c) A speech call shall be established with a SETUP message containing two bearer capabilities for speech and the bearer service to be tested.
- d) The MS shall start the ICM procedure with a bearer capability information element supporting the bearer service to be tested.
- e) At the reception of the MODIFY message sent by the MS the SS shall send a CHANNEL MODE MODIFY message.
- f) At the reception of the CHANNEL MODE MODIFY ACKNOWLEDGE message the SS shall send a MODIFY COMPLETE message. t1 is at the completion of the MODIFY COMPLETE message.
- g) The reception of "1/OFF" (see table 29-1) defines t2. t2 will be reset at the reception of again "1/OFF" after an interruption of continuous "1/OFF" pattern.
- h) The SS checks bits S1, S3, S6 and S8 of the modified CCITT V.110 frames (as described in GSM 04.21). Let t3 be the time when all four bits change from OFF to ON (i.e. if $t < t3$, (S1,S3,S6,S8) \leftrightarrow (0,0,0,0) and $t \geq t3$, (S1,S3,S6,S8) = (0,0,0,0)).

29.2.1.5 Test requirements

29.2.1.5.1 Test requirements for Mobile Originated Calls

- 1) After step b) Cts 106, 107, 109 must be in the "OFF" condition, dataline 104 shall be set to "1".
- 2) At t1 + 500 ms Ct 107 must still be in the "OFF" condition.
- 3) Between t1 + 500ms and t1 + 1000ms Ct 107 must switch to the "ON" condition. This indicates successful synchronization of TAF towards IFE.
- 4) Between t2 and t3 the SS must receive continuous "1/OFF" frames.
- 5) The time between t2 and t3 must be more than 450ms.
- 6) At t1 +1000ms the SS must check GSM 04.21 frames sent by the MS with SA and SB bits (i.e. bits S1, S3, S4, S6, S8 and S9) set to "ON". This indicates successful synchronization of IFE towards TAF. At this point of time the whole synchronization procedure has been completed successfully.

NOTE 3: If the MS is not MT2, only requirements 4 to 6 apply.

29.2.1.5.2 Test requirements for Mobile Terminated Calls

- 1) After step b) Cts 106, 107, 109 must be in the "OFF" condition, dataline 104 shall be set to "1".
- 2) At t1 + 500 ms Ct 107 must still be in the "OFF" condition.
- 3) Between t1 + 500 ms and t1 + 1000 ms Ct 107 must switch to the "ON" condition. This indicates successful synchronization of TAF towards IFE.
- 4) Between t2 and t3 the SS must receive continuous "1/OFF" frames.
- 5) The time between t2 and t3 must be more than 450 ms.
- 6) At t1 +1000 ms the SS must check GSM 04.21 frames sent by the MS with SA and SB bits (i.e. bits S1, S3, S4, S6, S8 and S9) set to "ON". This indicates successful synchronization of IFE towards TAF. At this point of time the whole synchronization procedure has been completed successfully.

NOTE 4: If the MS is not MT2, only requirements 4 to 6 apply.

29.2.1.5.3 Test requirements for In Call Modification

- 1) After step b) Cts 106, 107, 109 must be in the "OFF" condition, dataline 104 shall be set to "1".

- 2) At $t_1 + 500$ ms Ct 107 must still be in the "OFF" condition.
- 3) Between $t_1 + 500$ ms and $t_1 + 1\,000$ ms Ct 107 must switch to the "ON" condition. This indicates successful synchronization of TAF towards IFE.
- 4) Between t_2 and t_3 the SS must receive continuous "1/OFF" frames.
- 5) The time between t_2 and t_3 must be more than 450 ms.
- 6) At $t_1 + 1\,000$ ms the SS must check GSM 04.21 frames sent by the MS with SA and SB bits (i.e. bits S1, S3, S4, S6, S8 and S9) set to "ON". This indicates successful synchronization of IFE towards TAF. At this point of time the whole synchronization procedure has been completed successfully.

NOTE 5: If the MS is not MT2, only requirements 4 to 6 apply.

Table 29-1: Definition of synchronization pattern "1/OFF"

Synch-Frame	Data-Frame
1 1 1 1 1 1 1	D1 D2 D3 D4 D5 D6 S1
1 1 1 1 1 1 1	D7 D8 D9 D10 D11 D12 X
1 1 1 1 1 1 1	D13 D14 D15 D16 D17 D18 S3
1 1 1 1 1 1 1	D19 D20 D21 D22 D23 D24 S4
1 1 1 1 1 1 1	E4 E5 E6 E7 D25 D26 S27
1 1 1 1 1 1 1	D28 D29 D30 S6 D31 D32 S33
1 1 1 1 1 1 1	D34 D35 D36 X D37 D38 S39
1 1 1 1 1 1 1	D40 D41 D42 S8 D43 D44 S45
1 1 1 1	D46 D47 D48 S9

GSM 04.21 60 bits frame

Synch-Frame	Data-Frame
1 1 1 1 1 1 1 1	D1 D2 D3 S1 D4 D5 D6 X
1 1 1 1 1 1 1 1	D7 D8 D9 S3 D10 D11 D12 S4
1 1 1 1 1 1 1 1	E4 E5 E6 E7 D13 D14 D15 S6
1 1 1 1 1 1 1 1	D16 D17 D18 X D19 D20 D21 S8
1 1 1 1 1	D22 D23 D24 S9

GSM 04.21 36 bits frame

29.2.2 Filtering of channel control information for transparent BCs

29.2.2.1 Definition and applicability

This test is only applicable to the MT2 configuration.

29.2.2.2 Conformance requirement

An MS supporting data services shall decode and filter channel control information received over the Um-interface.

- 1 GSM 04.21, section 7;
- 2 GSM 07.01, section 8.2.2;
- 3 GSM 07.02, section 3.2.1 (for asynchronous bearer services only);
- 4 GSM 07.03, sections 4.2.1 and 4.2.2 (for synchronous bearer services only).

29.2.2.3 Test purpose

The purpose of this test is to verify the correct decoding and filtering of channel control information from the GSM 04.21 frames to the V.24/X.21 interface circuits. The tests apply after synchronization has been completed.

29.2.2.4 Method of test

The Test shall be carried out for all user data rates supported by the MS (see below) and the circuits CT106 (V.24) (interface circuit bit X) and CT109 (V.24) (interface circuit bit SB) and I (X.21) (S-bits). The test shall be carried out only for those frame formats and circuits which are supported by the MS. The test is to be repeated for all circuits.

Let T(ON-OFF) and T(OFF-ON) be the timers to integrate the ON-OFF and the OFF-ON transition respectively for the circuit to be tested as stated in GSM 07.01, section 8.2.2.

Procedure:

- a) A data call shall be set up between the SS and the MS with a combination of BCIEs (see below) supported by the MS. The interface circuit bit(s) in the GSM 04.21 frame shall be set to OFF. The next step shall be entered 6 s after CT107 has been set to ON by the MS.
- b) The SS shall set the interface circuit bit(s) to continuously ON, wait half of T(OFF-ON) and then set the interface circuit bit(s) again to continuously OFF. The SS shall wait 6 s before entering the next step.
- c) The SS shall set the interface circuit bit(s) to continuously ON, wait twice T(OFF-ON) and then set the interface circuit bit(s) again to continuously OFF. The SS shall wait 6 s before entering the next step.
- d) The SS shall set interface circuit bit(s) to continuously ON and wait 6 s before entering the next step
- e) The SS shall set the interface circuit bit(s) to continuously OFF, wait half of T(ON-OFF) and then set the interface circuit bit(s) again to continuously ON. The SS shall wait 6 s before entering the next step.
- f) The SS shall set the interface circuit bit(s) to continuously OFF, wait twice T(ON-OFF) and then set the interface circuit bit(s) again to continuously ON. The SS shall wait 6 s before entering the next step.

29.2.2.5 Test requirements

- 1) After step a) the interface circuit at the R-interface shall be OFF.
- 2) During step b) the interface circuit at the R-interface shall not change.
- 3) During step c) the interface circuit at the R-interface shall change to ON and then again to OFF.
- 4) After step d) the interface circuit at the R-interface shall be ON.
- 5) During step e) the interface circuit at the R-interface shall not change.
- 6) During step f) the interface circuit at the R-interface shall change to OFF and then again to ON.

29.2.2.6 BCIE

The following combinations shall be considered (ref. GSM 07.01, annex 2):

- a) User Rate = 9,6 kbit/s;
- b) User Rate = 4,8 kbit/s;
- c) User Rate = 2,4 kbit/s;

- d) User Rate = 1,2 kbit/s;
- e) User Rate = 1 200/75 bit/s (only with asynchronous Bearer Services);
- f) User Rate = 300 bit/s (only with asynchronous Bearer Services).

The remaining parameters of the BCIE and the channel type (FR/HR) shall be set to a value supported by the MS.

29.2.3 Correct Terminal Compatibility Decision

29.2.3.1 Negotiation of Radio Channel Requirement (RCR)

29.2.3.1.1 Test purpose

To verify that the MS ignores the RCR field in a mobile terminating setup and negotiates according to its capabilities and to the service requested. A Dual Rate support MS shall accept the channel rate chosen by the network in the ASSIGNMENT COMMAND message.

29.2.3.1.2 Initial conditions

For an MS with an external interface, the interface shall be setup in such a way that the MS is able to successfully receive the call for the service in question. The manufacturer shall state how this is done in a PIXIT statement. The same applies to features which must be activated by MMI before an incoming call can be accepted.

29.2.3.1.3 Test method

- a) The SS transmits a SETUP message containing a BC-IE among those declared as supported by the MS and with the RCR field set to "01".
- b) The SS sends a ASSIGNMENT COMMAND message with a channel type set to "Full Rate" unless the CALL CONFIRM message indicates "dual rate mobile station/full rate preferred". In that case, the channel type is set to "Half Rate".
- c) The call is released and steps a) and b) are repeated with RCR field set to "00".
- d) The call is released and steps a) and b) are repeated with RCR field set to "10".
- e) The call is released and steps a) and b) are repeated with RCR field set to "11".

29.2.3.1.4 Test requirements

- 1) After step a), the MS shall send a CALL CONFIRM message. If present, the BC-IE shall be coded according to GSM 07.01. If any other parameters than those listed below have different values than those of the BC-IE included in the SETUP, then the test shall be failed:
 - Number of stop bits, number of data bits, parity;
 - Connection Element, Structure, Intermediate rate, User Information Layer 2 Protocol, Modem Type, NIRR;
 - Radio Channel Requirement.
- 2) After step b), the MS shall answer to the ASSIGNMENT COMMAND message with an ASSIGNMENT COMPLETE message.

29.2.3.2 Negotiation of Connection Element (CE)

29.2.3.2.1 Test purpose

To verify that the MS accepts a CE equal to "Both, Transparent Preferred" or "Both Non Transparent Preferred" and indicates its choice in the CALL CONFIRM message.

29.2.3.2.2 Initial condition

For an MS with an external interface, the interface shall be setup in such a way that the MS is able to successfully receive the call for the service in question. The manufacturer shall state how this is done in a PIXIT statement. The same applies to features which must be activated by MMI before an incoming call can be accepted.

29.2.3.2.3 Test method

- a) The SS transmits a SETUP message containing a BC-IE among those declared as supported by the MS and with the CE field set to "Both Transparent Preferred". The RCR parameter shall be set to "Full Rate". The UIL2P is not included (i.e. octet 7 is absent). The NIRRR is set to "no meaning" (i.e. 0). The IR is set to "16 kbit/s". The modem type is any according to declared capabilities. The user rate is any according to declared capabilities and modem type.
- b) The call is released and step a) is repeated with CE field set to "Both Non Transparent Preferred".

29.2.3.2.4 Test requirements

After step a), the MS shall send a CALL CONFIRM message. The BC-IE shall be present and shall be coded according to GSM 07.01 and shall correspond to a Bearer Service or Teleservice supported by the MS. The CE shall be set to either "Transparent" or "Non Transparent" If any other parameters than those listed bellow have different values than those of the BC-IE included in the SETUP, then the test shall be failed:

- number of stop bits, number of data bits, parity;
- Connection Element, Structure, Intermediate rate, User Information Layer 2 Protocol, Modem Type, NIRRR;
- Radio Channel Requirement.

29.2.3.3 Negotiation of Number of Stop Bits, Number of Data bits, and Parity

29.2.3.3.1 Test purpose

To verify that the MS accepts any value for the parameters Number of Stop Bits, Number of Data bits, and Parity in a mobile terminating Setup and negotiates according to its capabilities and to the service requested.

This test only applies to Mobile Stations supporting asynchronous services.

29.2.3.3.2 Initial condition

For an MS with an external interface, the interface shall be setup in such a way that the MS is able to successfully receive the call for the service in question. The manufacturer shall state how this is done in a PIXIT statement. The same applies to features which must be activated by MMI before an incoming call can be accepted.

29.2.3.3.3 Test method

- a) The SS transmits a SETUP message containing a BC-IE among those declared as supported by the MS and corresponding to an asynchronous Bearer Service, and with the Number of Stop Bits (NSB) field set to "1 bit", the Number of Data Bits (NDB) field set to "8 bits", and the Parity field set to "none".
- b) The call is released and step a) is repeated with the Number of Stop Bits (NSB) field set to "2 bit", the Number of Data Bits (NDB) field set to "7 bits", and the Parity field set to "odd".

29.2.3.3.4 Test requirements

After steps a) and b), the MS shall send a CALL CONFIRMED message. If present, the BC-IE shall be coded according to GSM 07.01 and shall correspond to a Bearer Service supported by the MS. If any

other parameters than those listed below have different values than those of the BC-IE included in the SETUP, then the test shall be failed:

- Number of stop bits, number of data bits, parity;
- Connection Element, Structure, Intermediate rate, User Information Layer 2 Protocol, Modem Type, NIRR;
- Radio Channel Requirement.

29.2.3.4 Negotiation of Modem Type

29.2.3.4.1 Test purpose

To verify that the MS accepts the value "autobauding type 1" for the parameter Modem Type in a mobile terminating Setup and negotiates according to its capabilities and to the service requested.

This test only applies to Mobile Stations supporting non transparent services.

NOTE 6: It is not clear if the MS should also accept any possible value for the Modem Type field.

29.2.3.4.2 Initial condition

For an MS with an external interface, the interface shall be setup in such a way that the MS is able to successfully receive the call for the service in question. The manufacturer shall state how this is done in a PIXIT statement. The same applies to features which must be activated by MMI before an incoming call can be accepted.

29.2.3.4.3 Test method

- a) The SS transmits a SETUP message containing a BC-IE among those declared as supported by the MS and corresponding to a non transparent Bearer Service (the Connection Element field is coded "Non transparent"), and with the Modem Type field set to "autobauding type 1".
- b) The call is released and step a) is repeated with the same BC in the SETUP message, but with the Connection Element set to "both, non-transparent preferred".

29.2.3.4.4 Test requirements

After steps a) and b), the MS shall send a CALL CONFIRMED message. If present, the BC-IE shall be coded according to GSM 07.01 and shall correspond to a Bearer Service or Teleservice supported by the MS. If any other parameters than those listed below have different values than those of the BC-IE included in the SETUP, then the test shall be failed:

- Number of stop bits, number of data bits, parity;
- Connection Element, Structure, Intermediate rate, User Information Layer 2 Protocol, Modem Type, NIRR;
- Radio Channel Requirement.

29.2.3.5 Negotiation of Intermediate Rate

29.2.3.5.1 Test purpose

To verify that the MS responds correctly to a request for a negotiation of the Intermediate Rate parameter in a mobile terminating Setup and negotiates according to its capabilities and to the service requested.

This test only applies to Mobile Stations supporting non transparent services with a full rate channel at a user rate of 4,8 kbit/s or lower.

NOTE 7: The MS may support these services with a 6 Kbit/s or (non exclusive) 12 Kbit/s radio interface rate.

29.2.3.5.2 Initial condition

For an MS with an external interface, the interface shall be setup in such a way that the MS is able to successfully receive the call for the service in question. The manufacturer shall state how this is done in a PIXIT statement. The same applies to features which must be activated by MMI before an incoming call can be accepted.

29.2.3.5.3 Test method

- a) The SS transmits a SETUP message containing a BC-IE among those declared as supported by the MS and corresponding to a non transparent Bearer Service (the Connection Element field is coded "Non transparent") with the user rate lower to or equal 4,8 kbit/s, and with the NIRR field set to "No meaning". The RCR field is set to "full rate", and the Intermediate Rate field is set to "16 kbit/s".
- b) The call is released and step a) is repeated with the same BC in the SETUP message, but with the Connection Element set to "both, non-transparent preferred".
- c) The call is released and steps a) and b) are repeated with the NIRR field of the SETUP message set to "6 kbit/s".

29.2.3.5.4 Test requirements

- 1) After steps a), b) and c), the MS shall send a CALL CONFIRMED message. If present, the BC-IE shall be coded according to GSM 07.01 and shall correspond to a Bearer Service or Teleservice supported by the MS. If any other parameters than those listed below have different values than those of the BC-IE included in the SETUP, then the test shall be failed:
 - Number of stop bits, number of data bits, parity;
 - Connection Element, Structure, Intermediate rate, User Information Layer 2 Protocol, Modem Type, NIRR;
 - Radio Channel Requirement.
- 2) If the BC-IE is present in the CALL CONFIRMED message after step c) and if the Connection Element field contains the value "non transparent", the Intermediate Rate field shall indicate:
 - 8 kbit/s if the NIRR field is set to "6 kbit/s";
 - 16 kbit/s if the NIRR field is set to "no meaning".

29.2.3.6 Negotiation of User Information Layer 2 Protocol

29.2.3.6.1 Test purpose

To verify that the MS accepts any value (including the absence of) the UIL2P parameter in a mobile terminating Setup and negotiates according to its capabilities and to the service requested.

This test only applies to Mobile Stations supporting asynchronous bearer services in non transparent mode.

29.2.3.6.2 Initial condition

For an MS with an external interface, the interface shall be setup in such a way that the MS is able to successfully receive the call for the service in question. The manufacturer shall state how this is done in a PIXIT statement. The same applies to features which must be activated by MMI before an incoming call can be accepted.

29.2.3.6.3 Test method

- a) The SS transmits a SETUP message containing a BC-IE among those declared as supported by the MS and corresponding to a non transparent Bearer Service (the Connection Element field is coded "Non transparent") and with no UIL2P parameter (i.e. octet 7 of the BC IE is absent).

- b) The call is released and step a) is repeated with the same BC in the SETUP message, but with the value "ISO6429, codeset 0 (DC1/DC3)" in the UIL2P parameter.
- c) The call is released and step b) is repeated with the same BC in the SETUP message, but with the value "COPnoFLCt" in the UIL2P parameter.
- d) The call is released and steps a), b) and c) are repeated with the same BC in the SETUP message, but with the Connection Element set to "both, non-transparent preferred".

29.2.3.6.4 Test requirements

- 1) After steps a), b) and c), the MS shall send a CALL CONFIRMED message. If present, the BC-IE shall be coded according to GSM 07.01 and shall correspond to a Bearer Service or Teleservice supported by the MS. If any other parameters than those listed below have different values than those of the BC-IE included in the SETUP, then the test shall be failed:
 - Number of stop bits, number of data bits, parity;
 - Connection Element, Structure, Intermediate rate, User Information Layer 2 Protocol, Modem Type, NIRR;
 - Radio Channel Requirement.
- 2) If the BC-IE is present in the CALL CONFIRMED message, and if the Connection Element is set to "transparent", octet 7 (containing the UIL2P parameter) shall be absent.

29.2.3.7 Negotiation between TS 61 and TS 62: Mobile Originated call.

29.2.3.7.1 Test purpose

To verify that the MS accepts a negotiation from TS 61 to TS 62.

This test only applies to Mobile Stations supporting TS 61.

29.2.3.7.2 Initial condition

For an MS with an external interface, the interface shall be setup in such a way that the MS is able to successfully set up a call for TS 61. The manufacturer shall state how this is done in a PIXIT statement. The same applies to features which must be activated by MMI before an outgoing call can be set up.

29.2.3.7.3 Test method

- a) The MS is made to set up a call for TS 61. If the MS supports it, the first phase of the call is speech.
- b) The SS responds to the SETUP message with a CALL PROCEEDING message containing a BC-IE coded according to GSM 07.01 and corresponding to TS 62.
- c) The SS sends an ALERTING message followed by a CONNECT message.
- d) If the MS supports it, steps a), b) and c) are repeated with a call setup for TS 61 with the first phase of the call being fax.

29.2.3.7.4 Test requirements

- 1) After step b), the MS shall accept the call (i.e. it shall not reject the call with a DISCONNECT message).
- 2) After step c), the MS shall answer with a CONNECT ACKNOWLEDGE message.

29.2.3.8 Negotiation between TS 61 and TS 62: Mobile Terminated call.**29.2.3.8.1 Test purpose**

To verify that an MS that does not support TS 61 accepts a Mobile Terminated call setup request for TS 61 and negotiates the demand to TS 62.

This test only applies to Mobile Stations supporting TS 62 and not supporting TS 61.

29.2.3.8.2 Initial condition

For an MS with an external interface, the interface shall be setup in such a way that the MS is able to successfully receive the call for the service in question. The manufacturer shall state how this is done in a PIXIT statement. The same applies to features which must be activated by MMI before an incoming call can be accepted.

29.2.3.8.3 Test method

- a) The SS transmits a SETUP message containing two BC-IEs: the first BC shall indicate speech, the second BC shall indicate fax group 3.
- b) The call is released, and the SS transmits a SETUP message containing two BC-IEs: the first BC shall indicate fax group 3, the second BC shall indicate speech.

29.2.3.8.4 Test requirements

After steps a) and b), the MS shall send a CALL CONFIRMED message with one and only one BC-IE. The BC-IE shall be coded according to GSM 07.01 and shall correspond to TS 62.

29.2.4 Data Rate Adaptation for Synchronous Transparent Bearer Capabilities**29.2.4.1 Definition and applicability**

This test is applicable to the MT2 configuration and, in a restricted way, to other configurations where the MS is able to send data over the Um-interface.

29.2.4.2 Conformance requirement

An MS supporting synchronous transparent bearer capabilities shall perform data rate adaptation and support the frames at the Um-interface according to the following specifications:

- 1 GSM 04.21, sections 5 and 7.

29.2.4.3 Test purpose

The purpose of these tests is to verify

- that the format and the data bits of the GSM 04.21 frames sent by the MS are consistent with the data input and data rate at the R-interface and
- that the data bits output by the MS at the R-interface are consistent with the received GSM 04.21 frames.

29.2.4.4 Method of test

The Test shall be carried out for all possible user data rates which are supported by the MS (see below). In case of an MT2 configuration, the interface circuits CT105 and CT108 shall be set to the ON condition from the start.

Procedure:

- a) A data call shall be set up between the SS and the MS with a BCIE (see below) supported by the MS. The next step shall be entered immediately after TCH synchronization has been completed at the SS side.
- b) The interface circuit bit(s) in the GSM 04.21 frame shall be set to ON and the SS shall start to transmit pseudo random data bits in the GSM 04.21 frames over the Um-interface to the MS.
- c) MT2 configuration: The SS shall input pseudo random data over the R-interface of the MS.
MT0 configuration: the transmission of data from the MS over the Um-interface shall be stimulated (if it does not start automatically).
- d) Approximately 5 s after the data have been received by the SS over the Um-interface the test shall be stopped.

29.2.4.5 Test requirements

- 1) During the test no GSM 04.21 frame with incorrect format (i.e. format not compliant to GSM 04.21 (see conformance requirement) or not corresponding to the user data rate currently under test) shall have been received by the SS.
- 2) Only MT2 configuration: the user data stream input to the R-interface shall match bit-exactly the user data stream sent to the SS over the Um-interface and the user data stream output from the R-interface shall match bit-exactly the user data stream sent by the SS over the Um-interface.

29.2.4.6 BCIE

The following combinations shall be considered (ref. GSM 07.01, annex 2):

- a) User Rate = 9,6 kbit/s
- b) User Rate = 4,8 kbit/s
- c) User Rate = 2,4 kbit/s
- d) User Rate = 1,2 kbit/s

The remaining parameters of the BCIE and the channel type (FR/HR) shall be set to a value supported by the MS.

29.2.5 Network Independent Clocking

For further study.

29.2.6 Asynchronous Transparent Bearer Capabilities

29.2.6.1 Data Rate Adaptation

29.2.6.1.1 Definition and applicability

This test is applicable to the MT2 configuration and, in a restricted way, to the MT0 configuration where the MS is able to send data over the Um-interface and to use the Bearer Services for asynchronous data.

29.2.6.1.2 Conformance requirement

An MS supporting asynchronous transparent bearer capabilities shall perform data rate adaptation and support the frames at the Um-interface according to the following specifications:

- 1 GSM 04.21, sections 4.1, 4.4, 5 and 7.

29.2.6.1.3 Test purpose

The purpose of these tests is to verify the conversion between an asynchronous data stream at the R-interface and the GSM 04.21 frames at the Um-interface.

29.2.6.1.4 Method of test

The Test shall be carried out for all possible user data rates which are supported by the MS in asynchronous mode (see below).

Procedure:

- a) A data call shall be set up between the SS and the MS with a BCIE (see below) supported by the MS. The next step shall be entered immediately after TCH synchronization has been completed at the SS side.
- b) The interface circuit bit(s) in the GSM 04.21 frame shall be set to ON and the SS shall start to transmit pseudo random characters as described below to the MS.
- c) MT2 configuration: The SS shall input pseudo random characters as described below over the R-interface to the MS.

MT0 configuration: the transmission of data from the MS over the Um-interface shall be stimulated (if it does not start automatically).

- d) Approximately 5 s after the data have been received by the SS over the Um-interface the test shall be stopped.

29.2.6.1.5 Test requirements

- 1) During the test no GSM 04.21 frame with incorrect format (i.e. format not compliant to GSM 04.21 (see conformance requirement) or not corresponding to the user data rate currently under test) shall have been received by the SS.
- 2) MT2 configuration only: the user data stream input to the R-interface shall match character by character the user data stream sent to the SS over the Um-interface and the user data streams output from the R-interface shall match character by character the user data stream sent by the SS over the Um-interface.

29.2.6.1.6 Generation of the asynchronous pseudo random characters

Downlink direction:

The GSM 04.21 frames shall contain a bit stream which consists of repeating:

- a character which is generated pseudo randomly every time;
- n stop bits, where n is drawn pseudo randomly from the interval 1..15 every time.

Uplink direction:

The data stream at the R-interface consists of repeating:

- a character which is generated pseudo randomly every time;
- 1 stop bit;
- 1,13 +/- 1 % bit frames (i.e. 1/nominal data rate) of stop polarity.

29.2.6.1.7 BCIE

Same as 29.2.3.

The Number of Data Bits per character (excl. parity) shall be 8. No parity bit shall be used. The Number of Stop Bits shall be 1. If the MS does not support these values different ones shall be chosen.

The remaining parameters of the BCIE shall and the channel type (FR/HR) be set to a value supported by the MS.

29.2.6.2 Passage of the Break Signal

29.2.6.2.1 Definition and applicability

This test is applicable to the MT2 configuration only.

29.2.6.2.2 Conformance requirement

An MS supporting asynchronous transparent bearer capabilities shall perform passage of the break signal in uplink and downlink direction according to:

- 1 GSM 04.21, sections 4.1, 4.2, 4.4, 5 and 7.

29.2.6.2.3 Test purpose

The purpose of these tests is to verify the ability of the MS to transfer a Break Signal to the R-interface and vice versa.

29.2.6.2.4 Method of test

The Test shall be carried out for all possible user data rates which are supported by the MS in asynchronous mode (see below).

Procedure:

- a) A data call shall be set up between the SS and the MS with a BCIE (see below) supported by the MS. The next step shall be entered immediately after TCH synchronization has been completed at the SS side.
- b) The interface circuit bit(s) in the GSM 04.21 frame shall be set to ON.
- c) The SS shall send pseudo random characters with start and stop bit(s) (as selected by the BCIE) in the GSM 04.21 frames to the MS for approximately 5 s. Then it shall send the following bit sequence in the GSM 04.21 frames:
 - 2M+3 bits of start polarity;
 - 2M bits of stop polarity.
- d) The SS shall send pseudo random characters with start and stop bit(s) (as selected by the BCIE) in the GSM 04.21 frames to the MS for approximately 2 s. Then it shall send the following bit sequence in the GSM 04.21 frames:
 - for 1 s bits of start polarity;
 - 2M bits of stop polarity,

where M is as defined in GSM 04.21, section 4.2, and then again pseudo random characters as above.

- e) The SS shall input pseudo random characters with start and stop bit(s) (as selected by the BCIE) over the R-interface to the MS for approximately 2 s. Then it shall input the following bit sequence to the R-interface:
- M bits of start polarity;
 - 2M bits of stop polarity.
- f) The SS shall input pseudo random characters with start and stop bit(s) (as selected by the BCIE) over the R-interface to the MS for approximately 2 s. Then it shall input the following bit sequence to the R-interface:
- for 1 s bits of start polarity;
 - 2M bits of stop polarity,
- where M is as defined in GSM 04.21, section 4.2, and then again pseudo random characters as above.
- g) the test shall be stopped 2 s later.

29.2.6.2.5 Test requirements

- 1) During the test no GSM 04.21 frame with incorrect format (i.e. format not compliant to GSM 04.21 (see conformance requirement) or not corresponding to the user data rate currently under test) shall have been received by the SS.
- 2) The user data stream sent over the Um-interface by the SS shall match character by character the user data stream output at the R-interface.
- 3) The two Break Signals shall be detectable at the R-interface between the same characters as having been sent.
- 4) The user data stream received over the Um-interface by the SS shall match character by character the user data stream input at the R-interface.
- 5) The two Break Signals shall be detectable at the Um-interface between the same characters as having been input.

29.2.6.2.6 BCIE

Same as 29.2.2.6.

29.2.6.3 Overspeed/Underspeed Handling (Local Terminal)

29.2.6.3.1 Definition and applicability

This test is applicable to the MT2 configuration only.

29.2.6.3.2 Conformance requirement

An MS supporting asynchronous transparent bearer capabilities shall handle overspeed and underspeed of the local terminal according to:

- 1 GSM 04.21, sections 4.1, 4.3, 4.4, 5 and 7.

29.2.6.3.3 Test purpose

The purpose of these tests is to verify the ability of the MS to deal with plesiosynchronous bit clocks in the MS and the TE in case of asynchronous Bearer Capabilities.

29.2.6.3.4 Method of test

The Test shall be carried out for all possible user data rates supported by the MS in asynchronous mode (see below).

Procedure:

- a) A data call shall be set up between the SS and the MS with a BCIE (see below) supported by the MS. The next step shall be entered immediately after CT107 has been set to on by the MS.
- b) The interface circuit bit(s) in the GSM 04.21 frame shall be set to ON.
- c) The SS shall input continuously pseudo random characters with a bit clock of:
 - nominal user data rate + 2,5 % bit/s in case of less than 600 bit/s user data rate;
 - nominal user data rate + 1 % in the other cases.(ref. GSM 04.21, section 4.3) to the R-interface of the MS for approximately 5 s.
- d) The SS shall input continuously pseudo random characters with a bit clock of nominal user rate - 2,5 % (ref. CCITT V.14, section 3) to the R-interface of the MS for approximately 5 s.
- e) The test shall be stopped.

29.2.6.3.5 Test requirements

- 1) During the test no GSM 04.21 frame with incorrect format (i.e. format not compliant to GSM 04.21 (see conformance requirement) or not corresponding to the user data rate currently under test) shall have been received by the SS.
- 2) The user data stream input to the R-interface shall match character by character the user data stream sent to the SS over the Um-interface.

29.2.6.3.6 BCIE

Same as 29.2.2.6.

The Number of Data Bits per character (excl. parity) shall be 8. No parity bit shall be used. The Number of Stop Bits shall be 1. If the MS does not support these values different ones shall be chosen.

The remaining parameters of the BCIE and the channel type (FR/HR) shall be set to a value supported by the MS.

29.2.6.4 Overspeed/Underspeed Handling (Remote Terminal)

29.2.6.4.1 Definition and applicability

This test is applicable to the MT2 configuration only.

29.2.6.4.2 Conformance requirement

An MS supporting asynchronous transparent bearer capabilities shall handle overspeed and underspeed of the remote terminal (which shows in the structure of the GSM 04.21 frames received over the Um-interface) according to:

- 1 GSM 04.21, sections 4.1, 4.3, 4.4, 5 and 7.

29.2.6.4.3 Test purpose

The purpose of these tests is to verify the ability of the MS to deal with plesiosynchronous bit clocks in the MS and the remote Terminal in case of asynchronous Bearer Capabilities.

The case of underspeed is covered by 29.6.1. The case of overspeed shall be tested as follows.

29.2.6.4.4 Method of test

The Test shall be carried out for all possible user data rates supported by the MS in asynchronous mode (see below).

Procedure:

- a) A data call shall be set up between the SS and the MS with a BCIE (see below) supported by the MS. The next step shall be entered immediately after CT107 has been set to on by the MS.
- b) The interface circuit bit(s) in the GSM 04.21 frame shall be set to ON.
- c) The SS shall start sending pseudo random characters in the GSM 04.21 frames over the Um-interface with minimal number of stop bits between the characters and where one stop bit is omitted every 8th character.
- e) The test shall be stopped 5 s later.

29.2.6.4.5 Test requirements

- 1) During the test no GSM 04.21 frame with incorrect format (i.e. format not compliant to GSM 04.21 (see conformance requirement) or not corresponding to the user data rate currently under test) shall have been received by the SS.
- 2) The user data stream sent by the SS over the Um-interface shall match character by character the user data stream sent by the MS over the R-interface.

29.2.6.4.6 BCIE

Same as 29.2.6.3.6.

29.2.7 Interchange circuit mapping for transparent bearer capabilities

29.2.7.1 Definition and applicability

This test is applicable to the MT2 configuration only. However, it cannot be applied fully to MSs which support e.g.:

- CT108/2 for releasing the call (e.g. support of CCITT V.25bis) and/or
- similar use of the circuit C for CCITT X.21.

Therefore the test shall be applied only for those interchange circuits which do not influence Layer 3 signalling.

In case of circuit C the X.21-byte timing circuit B shall not be used.

29.2.7.2 Conformance requirement

- 1) An MS supporting transparent bearer capabilities with a V-series R-interface shall map the interchange circuits CT105 and CT108/2 to the GSM 04.21 frames sent over the Um-interface according to:

- 1.1 GSM 04.21, sections 4.1, 4.4, 5 and 7.

1.2 GSM 07.02, section 3.2.1.

2) An MS supporting transparent bearer capabilities with an X-series R-interface shall map the interchange circuit C to the GSM 04.21 frames sent over the Um-interface according to:

2.1 GSM 04.21, sections 4.1, 4.4, 5 and 7.

2.2 GSM 07.03, sections 4.2.1 and 4.2.2.

29.2.7.3 Test purpose

The purpose of these tests is to verify the ability of the MS to correctly convey changes of the interface circuits at the R-interface to the GSM 04.21 frame sent over the Um-interface in case of Transparent Bearer Capabilities.

29.2.7.4 Method of test

The Test shall be carried out for all user data rates supported by the MS (see below) and the circuits CT105 and CT108/2 (CCITT V.24) and C (CCITT X.21). The test shall be carried out only for those frame formats and circuits which are supported by the MS (exceptions see above).

Procedure:

- a) A data call shall be set up between the SS and the MS with a BCIE (see below) supported by the MS. The next step shall be entered immediately after CT107 has been set to ON by the MS.
- b) The interface circuit bit(s) in the GSM 04.21 frame shall be set to ON and the SS shall input continuously pseudo random data to the R-interface during the following steps. The SS shall wait for approximately 1 s before entering the next step.
- c) The SS shall set the interchange circuit at the R-interface to OFF and wait for 2 s.
- d) The SS shall again set the interchange circuit at the R-interface to ON.
- e) After further 2 s the test shall be stopped.

29.2.7.5 Test requirements

- 1) During the test no GSM 04.21 frame with incorrect format (i.e. format not compliant to GSM 04.21 (see conformance requirement) or not corresponding to the user data rate currently under test) shall have been received by the SS.
- 2) The change of the interchange circuit signal level shall be indicated in the GSM 04.21 frames as required by GSM 04.21 and CCITT V.110 (i.e. OFF state shall start and end in the correct GSM 04.21 frame).

29.2.7.6 BCIE

Same as 29.2.2.5.

29.3 Testing of non transparent data services (RLP tests)

SS sends NULL (C/R=0, P/F=0) frames when it has nothing else to send in ADM mode.

SS does not use DTX if not explicitly indicated in the test and sends supervisory RR (C/R=0, P/F=0) frames when it has nothing else to send in ABM mode. N(R) is equal to N(R) of the previous frame. For the first frame N(R)=0.

The information field of the Supervisory frames sent by the SS is fully coded with "1".

The tolerance on timers or delays is +/- 10%.

The SS will check FSI (Frame Start Identifier) alignment in all received RLP frames. It will check also that the E1 bit is the same in the 4 modified V110 GSM frames containing 1 RLP frame.

The information field of the Supervisory frames sent by the MS is never verified.

The SABM-UA exchange for RLP link establishment is initiated by the MS.

Immediately upon RLP link connection, the MS may send an I+S frame containing updated status bits SA, SB and X and the SS must send it.

29.3.1 Initialization

29.3.1.1 Normal initialization done by the MS

29.3.1.1.1 Test purpose

To test the normal establishment of multiple frame operation between the SS and the MS.

This test is performed twice for testing MO and MT data calls:

29.3.1.1.2 Method of test

Initial Conditions

System Simulator:

The SS is configured to use default RLP parameters.

Mobile Station:

The MS is configured to use default RLP parameters.

MO data call:

The MS is made to establish a MO non transparent data call, so that the initial conditions are that the MS is in call state U10 ("Call Active") after having sent a CONNECT ACKNOWLEDGE message.

MT data call:

The SS establishes a MT non transparent data call, so that the initial conditions are that the MS is in call state U10 ("Call Active") after having received a CONNECT ACKNOWLEDGE message from the SS.

Case a: No negotiation will be initiated by the MS.

Case b: The MS initiates negotiation of RLP default parameters.

NOTE: The MS is allowed to initiate the negotiation of the RLP default parameters, within allowed ranges, defined in GSM 04.22. The MS shall do this in the ADM, after having sent a CONNECT ACKNOWLEDGE message (MO-case) or after having received a CONNECT ACKNOWLEDGE message from the SS (MT-case). The SS shall accept and use the new RLP parameters till the end of the test.

Procedure

The MS shall send a SABM frame.

The SS responds with a correct UA frame (within T1).

The SS waits for $2 \cdot T1$ after the UA to ensure the SABM frame is not repeated. This confirms that the UA has been received.

The MS shall be in ABM mode. After optional status bits exchange between the MS and the SS, this is verified by sending an I + S frame and waiting for the acknowledgement from the MS.

The MS is returned to the idle state by clearing the call.

Expected sequence

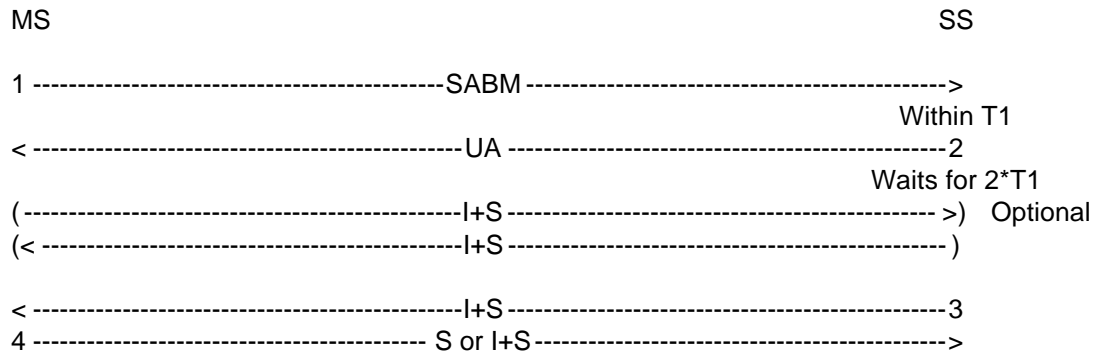

The frames from the SS will be:

2: One UA frame containing:

R=0, F=1.

3: One correct I+S frame in a RR frame with N(S)=0.

29.3.1.1.3 Test requirements

The frames from the MS shall be:

1: One SABM frame containing:

C=1, P=1.

The SABM shall not be repeated.

4: One S or I+S frame with N(R)=1 acknowledging the I+S frame.

29.3.1.2 Initialization failure

29.3.1.2.1 Loss of UA frame

29.3.1.2.1.1 Test purpose

To test the MS response to the loss of an UA frame during initialization.

29.3.1.2.1.2 Method of test

Initial Conditions

System Simulator:

The SS is configured to use default RLP parameters.

Mobile Station:

The MS is configured to use default RLP parameters. The MS is made to establish a MO non transparent data call so that the initial conditions are that the MS is in call state U10 ("Call Active") after having sent a CONNECT ACKNOWLEDGE message.

Case a: No negotiation will be initiated by the MS.

Case b: The MS initiates negotiation of RLP default parameters.

NOTE: The MS is allowed to initiate the negotiation of the RLP default parameters, within allowed ranges, defined in GSM 04.22. The MS shall do this in the ADM, after having sent a CONNECT ACKNOWLEDGE message (MO-case) or after having received a CONNECT ACKNOWLEDGE message from the SS (MT-case). The SS shall accept and use the new RLP parameters till the end of the test.

Procedure

The MS shall send an SABM frame.

The SS ignores the first SABM frame from the MS.

The MS shall wait for time-out of timer T1 and then send a second SABM frame.

The SS responds to the second SABM frame with an UA frame (within T1).

The MS enters in ABM mode. After optional status bits exchange between the MS and the SS, this is verified by sending an I+S frame and waiting for the acknowledgement from the MS.

The MS is returned to the idle state by clearing the call.

Expected sequence

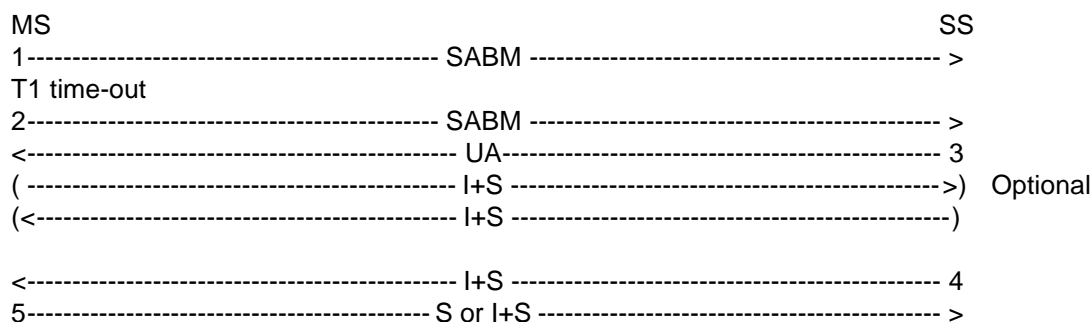

The frames from the SS will be:

3: One UA frame containing:

R=0, F=1.

within T1 after the second SABM.

4: One correct I+S frame in a RR frame with N(S)=0.

29.3.1.2.1.3 Test requirements

The frames from the MS shall be:

1, 2: One SABM frame containing:

C=1, P=1.

The second SABM frame shall follow the first SABM frame after time-out of timer T1.

5: One S or I+S frame with N(R)=1 acknowledging the I+S frame.

29.3.1.2.2 Total loss of UA frame

29.3.1.2.2.1 Test purpose

To test the MS response to a total loss of UA frame during initialization.

29.3.1.2.2.2 Method of test

Initial Conditions

System Simulator:

The SS is configured to use default RLP parameters.

Mobile Station:

The MS is configured to use default RLP parameters.

The MS is made to establish a MO non transparent data call so that the initial conditions are that the MS is in call state U10 ("Call Active") after having sent a CONNECT ACKNOWLEDGE message.

Case a: No negotiation will be initiated by the MS.

Case b: The MS initiates negotiation of RLP default parameters.

NOTE: The MS is allowed to initiate the negotiation of the RLP default parameters, within allowed ranges, defined in GSM 04.22. The MS shall do this in the ADM, after having sent a CONNECT ACKNOWLEDGE message (MO-case) or after having received a CONNECT ACKNOWLEDGE message from the SS (MT-case). The SS shall accept and use the new RLP parameters till the end of the test.

Procedure

The MS shall send an SABM frame.

The SS ignores the SABM frame from the MS.

The MS shall wait for time-out of timer T1 and then send a new SABM frame.

The SS ignores the SABM frame sent by the MS. These 2 last steps are repeated N2 times.

The SS waits for $2 * T1$ to ensure the SABM frame is not repeated.

The MS shall not enter in ABM mode. This is verified by sending an I+S frame. The MS shall ignore this frame.

The MS is returned to the idle state by clearing the call.

Expected sequence:

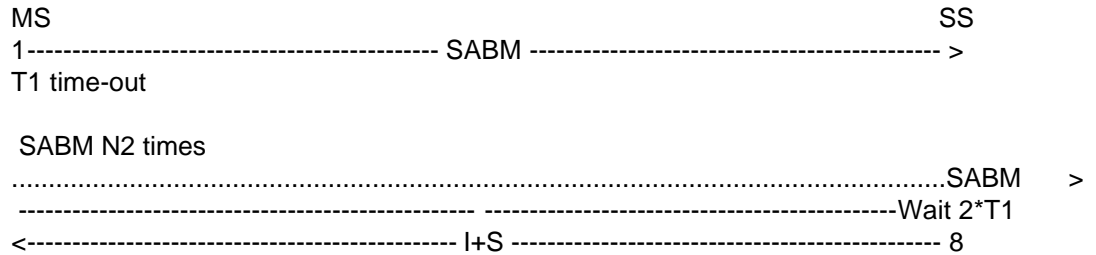

The frames from the SS will be:

8: One correct I+S frame in a RR frame containing with N(S)=0.

29.3.1.2.2.3 Test requirements:

The frames from the MS shall be:

1, N2: One SABM frame containing:

C=1, P=1.

An SABM frame follows the previous one after time-out of timer T1.

29.3.2 Data transfer

29.3.2.1 Default conditions

The initial conditions are that the MS is in call state U10 ("Call Active") and in RLP ABM mode.

During the synchronization of the traffic channel, the MS and the SS have transmitted I+S frames. Unless, other indication in the test, each test of this section will begin in the following conditions:

- the MS has previously sent I+S frames numbered N(S)=0,...,NMS-1 mod(62) and has previously sent a frame containing N(R) = Nss mod (62);
- the SS has previously sent I+S frames numbered N(S)=0,...,Nss-1 mod(62) and has previously sent a frame containing N(R) = NMS mod (62).

The first I+S frame that an MS will send in a test will be numbered N(S)= NMS and the first I+S frame that the SS will send will be numbered Nss.

29.3.2.2 MS sends I+S frames

29.3.2.2.1 N(S) sequence number

29.3.2.2.1.1 Test purpose

To test the correct handling of the N(S) sequence number.

29.3.2.2.1.2 Method of test

Initial Conditions

System Simulator:

The SS is configured to use default RLP parameters.

Mobile Station:

The MS is configured to use RLP default parameters except the window size from MS to IWF (SS), called KMI.

A non transparent data call will be established, so that the MS is in call state U10 ("Call Active").

Since some RLP parameters are different from the default parameters, a negotiation procedure will be initiated by the MS after the CONNECKT ACKNOWLEDGE message. The MS may negotiate the RLP default parameters within allowed ranges, defined in GSM 04.22, except the window size from MS to IWF (SS), called KMI, which has to be a non default value.

The SS shall accept and use the new RLP parameters till the end of the test.

After the negotiation procedure the ABM will be entered. This test is performed twice with 2 different values of KMI, randomly chosen.

Procedure

After optional status bits exchange between the MS and the SS, the MS is made to send continuously I+S frames (more than 2*64 frames). The MS shall send I+S frames with N(S) incremented by 1 mod(62) in each frame.

The SS acknowledges the I+S frames in RR frame in sequence.

The MS is returned to the idle state by clearing the call.

Expected sequence

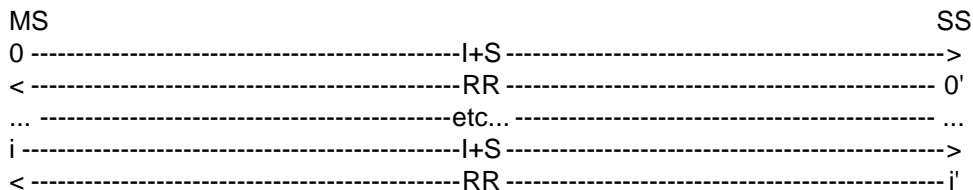

The frames from the SS will be:

0',...,i': One supervisory RR frame containing:

$$N(R) = NMS+1, \dots, NMS+i+1 \text{ mod}(62).$$

29.3.2.2.1.3 Test requirements

The frames from the MS shall be:

0, ..., i: One I+S frame containing:

$$N(S) = NMS, \dots, NMS+i \text{ mod}(62)$$

29.3.2.2.2 Transmission window

29.3.2.2.2.1 Test purpose

To test the correct handling of the transmission window.

29.3.2.2.2 Method of test

Initial Conditions

System Simulator:

The SS is configured to use default RLP parameters.

Mobile Station:

The MS is configured to use RLP default parameters except the window size from MS to IWF (SS), called KMI.

A non transparent data call will be established, so that the MS is in call state U10 ("Call Active").

Since some RLP parameters are different from the default parameters, a negotiation procedure will be initiated by the MS after the CONNECKT ACKNOWLEDGE message. The MS may negotiate the RLP default parameters within allowed ranges, defined in GSM 04.22, except the window size from MS to IWF (SS), called KMI, which has to be a non default value.

The SS shall accept and use the new RLP parameters till the end of the test.

After the negotiation procedure the ABM will be entered.

This test is performed twice with 2 different values of KMI, randomly chosen.

Procedure

The MS is made to send continuously I+S frames with a delay inferior to T1 between each frame.

The SS does not acknowledge the first KMI frames.

The MS stops sending I+S frames after having sent KMI frames, due to the window size.

The SS waits for $0,5 \cdot T1$ after the last frame of the sequence ($N(S)=NMS+KMI-1$) to acknowledge the first j frames, with $j < KMI$.

The MS shall transmit j new I+S frames and stop sending I+S frames after having sent them, due to the window size.

The SS waits for $0,5 \cdot T1$ after the last frame of the sequence ($N(S)=NMS+KMI-1+j \bmod (62)$) to acknowledge all frames transmitted by the MS.

The MS shall transmit all the following I+S frames.

The SS acknowledges the I+S frames sequentially (i.e. 1 after 1).

The MS is returned to the idle state by clearing the call.

Expected sequence

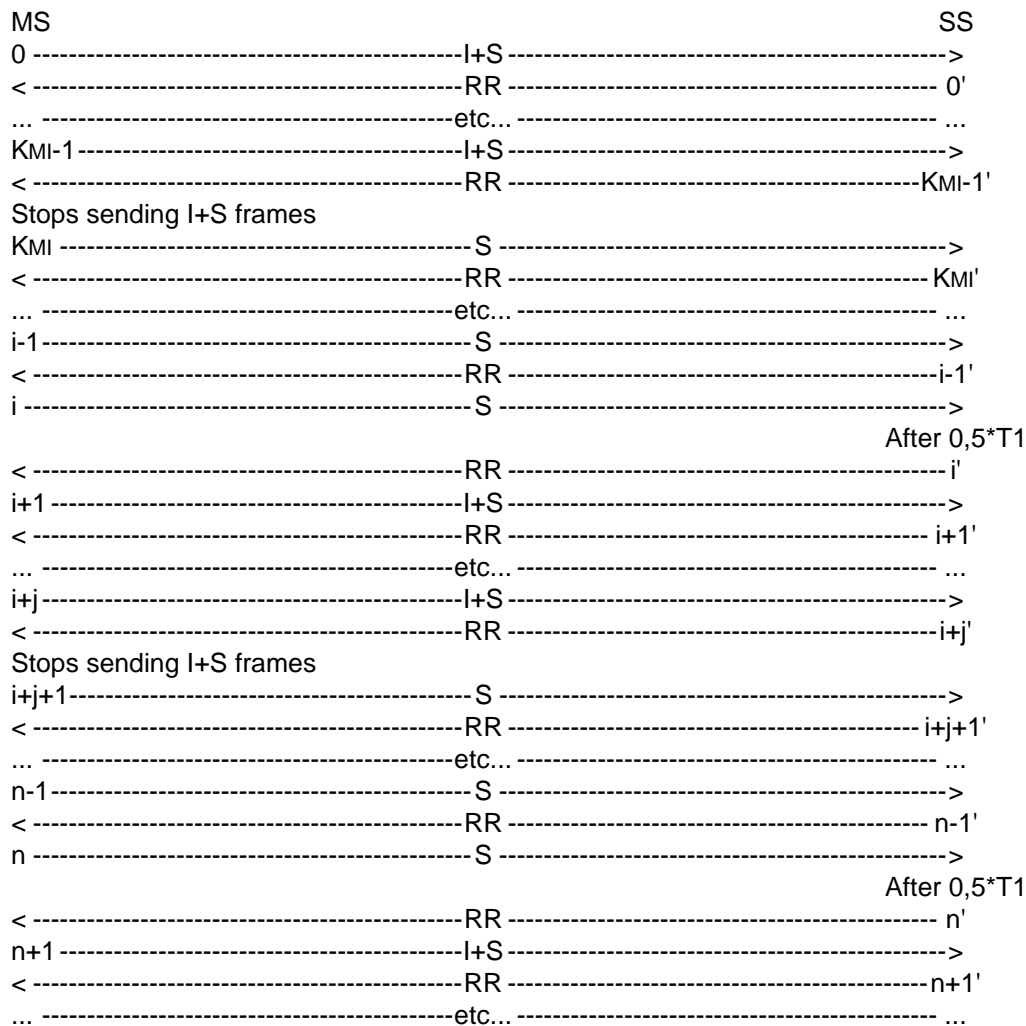

The frames from the SS will be:

0',...,i-1': One RR frame containing:

$$N(R) = NMS \text{ mod}(62).$$

i': One RR frame containing:

$N(R) = NMS + j \text{ mod}(62)$ with $j < KMI$,
after a delay of $0,5 * T1$ after the last received I+S frame.

i+1',...,n-1': One RR frame containing:

$$N(R) = NMS + j \text{ mod}(62).$$

n': One RR frame containing:

$N(R) = NMS + KMI + j \text{ mod}(62)$,
after a delay of $0,5 * T1$ after the last received I+S frame.

n+1', n+2',...: One RR frame containing:

$$N(R) = NMS + KMI + j + 1, NMS + KMI + j + 2, \dots \text{ mod}(62).$$

29.3.2.2.3 Test requirements

The frames from the MS shall be:

0,...,KMI-1: One I+S frame containing:

$$N(S) = NMS, \dots, NMS + KMI - 1 \text{ mod}(62).$$

MS stops sending I+S frames until reception of an acknowledgement of at least one I+S frame.

KMI,...,i: One S frame.

i+1,...,i+j: One I+S frame containing:

$$N(S) = NMS + KMI, \dots, NMS + KMI + j - 1 \text{ mod}(62).$$

MS stops sending I+S frames until reception of an acknowledgement of at least one I+S frame.

i+j+1,...,n: One S frame.

n+1,n+2,...: One I+S frame containing:

$$N(S) = NMS + KMI + j, NMS + KMI + j + 1, \dots \text{ mod}(62).$$

29.3.2.2.3 Busy condition

29.3.2.2.3.1 Test purpose

To test the correct handling of a RNR frame received.

29.3.2.2.3.2 Method of test

Initial Conditions

System Simulator:

The SS is configured to use default RLP parameters.

Mobile Station:

The MS is configured to use default RLP parameters.

A non transparent data call will be established, so that the MS is in call state U10 ("Call Active").

Case a: No negotiation will be initiated by the MS.

Case b: The MS initiates negotiation of RLP default parameters.

NOTE: The MS is allowed to initiate the negotiation of the RLP default parameters, within allowed ranges, defined in GSM 04.22. The MS shall do this in the ADM, after having sent a CONNECT ACKNOWLEDGE message (MO-case) or after having received a CONNECT ACKNOWLEDGE message from the SS (MT-case). The SS shall accept and use the new RLP parameters till the end of the test.

The ABM will be entered.

Procedure

The MS is made to send continuously I+S frames.

The SS acknowledges the received I+S frames in supervisory RR frames. After 1 second it acknowledged the received I+S frames in supervisory RNR frames.

After the first RNR frame, the MS shall stop sending I+S frames and shall start sending supervisory frames within T2.

After 1 second receiving supervisory frames, the SS sends RR frames instead of RNR.

After the first RR frame, the MS will restart the transmission of I+S frames within T2.

The MS is returned to the idle state by clearing the call.

Expected sequence

MS	SS
0 -----I+S----->	
<-----RR-----0'	
...-----etc...----->	...
i-1-----I+S----->	
<-----RR-----i-1'	
i-----I+S----->	
<-----RNR-----i'	
stops sending I+S frames within T2	
i+1-----S----->	
<-----RNR-----i+1'	
...-----etc...----->	...
n+i-1-----S----->	
<-----RNR-----n+i-1'	
n+i-----S----->	
<-----RR-----n+i'	
restarts sending I+S frames within T2	
n+i+1-----I+S----->	
<-----RR-----n+i+1'	
...-----etc...----->	...

The frames from the SS will be:

0',...,i-1': One RR frame containing:

$$N(R)=NMS+1,\dots,NMS+i \text{ mod}(62).$$

i',...,n+i-1': One RNR frame containing:

$$N(R)=NMS+i+1 \text{ mod}(62).$$

n+i': One RR frame containing:

$$N(R)=NMS+i+1 \text{ mod}(62).$$

n+i+1',n+i+2',...: One RR frame containing:

$$N(R)=NMS+i+2,NMS+i+3,\dots \text{ mod}(62).$$

29.3.2.2.3.3 Test requirements

The frames from the MS shall be:

0, ..., i: One I+S frame containing:

$$N(S)=NMS,\dots,NMS+i \text{ mod}(62).$$

MS stops sending I+S frames within T2 after the reception of the first RNR frame from the SS.

i+1,...,n+i: One S frame.

MS restarts sending I+S frames within T2 after the reception of the first RR frame from the SS.

n+i+1,n+i+2,...: One I+S frame containing:

$$N(S)=NMS+i+1,NMS+i+2,\dots \text{ mod}(62).$$

29.3.2.3 SS sends I+S frames

29.3.2.3.1 N(R) sequence number

29.3.2.3.1.1 Test purpose

To test the correct handling of the N(R) sequence number.

29.3.2.3.1.2 Method of test

Initial Conditions

System Simulator:

The SS is configured to use default RLP parameters.

Mobile Station:

The MS is configured to use RLP default parameters except the window size from IWF (SS) to MS, called K_{IM} .

A non transparent data call will be established, so that the MS is in call state U10 ("Call Active").

Since some RLP parameters are different from the default parameters, a negotiation procedure will be initiated by the MS after the CONNECKT ACKNOWLEDGE message. The MS may negotiate the RLP default parameters within allowed ranges, defined in GSM 04.22, except the window size from IWF (SS) to MS, called K_{IM} , which has to be a non default value.

The SS shall accept and use the new RLP parameters till the end of the test.

After the negotiation procedure the ABM will be entered. This test is performed twice with 2 different values of K_{IM} , randomly chosen.

Procedure

The SS is made to send continuously I+S frames (more than $2 \cdot 64$ frames). The delay between two I+S frames shall be superior to T2 and inferior to T1.

The MS is made to send no data i.e. no I+S frame.

NOTE 8: The MS may have previously sent I+S frames.

The SS sends I+S frames in I+S RR frames.

The MS shall acknowledge the I+S frames in RR frame sequentially within T2.

The MS is returned to the idle state by clearing the call.

Expected sequence

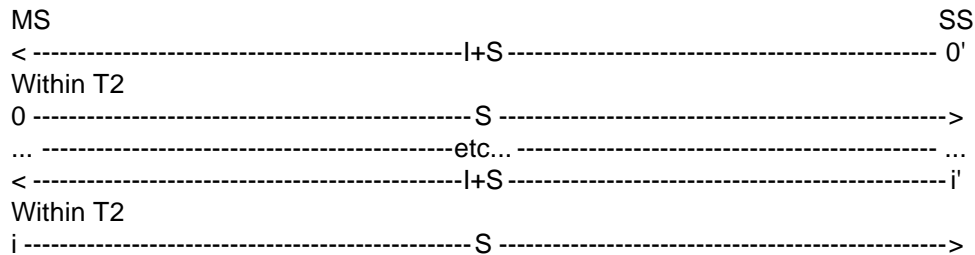

The frames from the SS will be:

0,...,i': One I+S frame containing
 $N(S)=N_{SS}, \dots, N_{SS}+i \text{ mod}(62)$.

29.3.2.3.1.3 Test requirements

The frames from the MS shall be:

0,...,i: One S frame containing:
 $N(R)=N_{SS}+1, \dots, N_{SS}+i+1 \text{ mod}(62)$.

The MS shall acknowledge the I+S frames sent by the SS within T2.

NOTE 9: If T2 parameter is equal to default T2 (<80 ms), the SS has to checked that the MS acknowledges an I+S frame within 80 ms.

29.3.2.3.2 Busy condition

29.3.2.3.2.1 Test purpose

To test the correct handling of a RNR frame with information received.

29.3.2.3.2.2 Method of test

Initial Conditions

System Simulator:

The SS is configured to use default RLP parameters.

Mobile Station:

The MS is configured to use default RLP parameters.

A non transparent data call will be established, so that the MS is in call state U10 ("Call Active").

Case a: No negotiation will be initiated by the MS.

Case b: The MS initiates negotiation of RLP default parameters.

NOTE: The MS is allowed to initiate the negotiation of the RLP default parameters, within allowed ranges, defined in GSM 04.22. The MS shall do this in the ADM, after having sent a CONNECT ACKNOWLEDGE message (MO-case) or after having received a CONNECT ACKNOWLEDGE message from the SS (MT-case). The SS shall accept and use the new RLP parameters till the end of the test.

The ABM will be entered.

Procedure

The SS is made to send continuously I+S frames. The delay between two consecutive I+S frames shall be inferior to T1.

The MS is made to send continuously I+S frames with a delay inferior to T1 between each frame.

The SS acknowledges the received I+S frames in I+S RR frames. After 1 second, it acknowledged the received I+S frames in supervisory RNR frames. The MS shall acknowledge the I+S frames in I+S RR frame sequentially.

After the first RNR frame, the MS shall stop sending I+S frames and shall acknowledge the I+S received frame in supervisory frames within T2.

After 1 second receiving supervisory frames, the SS sends I+S RR frames instead of RNR.

After the first RR frame, the MS will restart the transmission of I+S frames, it shall acknowledge the I+S received frame in I+S frame within T2.

The MS is returned to the idle state by clearing the call.

Expected sequence

MS	SS
0----->	I+S ----->
<-----	RR(I+S) ----->
...-----	etc... ----->
i-1----->	I+S ----->
<-----	RR(I+S) ----->
i----->	I+S ----->
<-----	RNR(I+S) ----->
stops sending I+S frames within T2	
i+1----->	S----->
<-----	RNR(I+S) ----->
...-----	etc... ----->
n+i-1----->	S----->
<-----	RNR(I+S) ----->
n+i----->	S----->
<-----	RR(I+S) ----->
restarts sending I+S frames within T2	
n+i+1----->	I+S ----->
<-----	RR(I+S) ----->
...-----	etc... ----->

The frames from the SS will be:

0',...,i-1': One I+S RR frame containing:

$N(S)=N_{ss}, \dots, N_{ss+i-1} \text{ mod}(62),$
 $N(R)=N_{ms}+1, \dots, N_{ms}+i \text{ mod}(62).$

i',...,n+i-1': One I+S RNR frame containing:

$N(S)=N_{ss}+i, \dots, N_{ss}+n+i-1 \text{ mod}(62),$
 $N(R)=N_{ms}+i+1 \text{ mod}(62).$

n+i',n+i+1',...: One I+S RR frame containing:

$N(S)=N_{ss}+n+i, N_{ss}+n+i+1, \dots \text{ mod}(62),$
 $N(R)=N_{ms}+i+1, N_{ms}+i+2, \dots \text{ mod}(62).$

29.3.2.3.2.3 Test requirements

The frames from the MS shall be:

0,...,i: One I+S frame containing:

$$N(S)=NMS,\dots,NMS+i \bmod(62),$$

$$N(R)=Nss,\dots,Nss+i \bmod(62).$$

MS stops sending I+S frames within T2 after the reception of the first RNR frame from the SS.

i+1,...,n+i: One S frame containing:

$$N(R)=Nss+i+1,\dots,Nss+n+i \bmod(62).$$

MS restarts sending I+S frames within T2 after the reception of the first RR frame from the SS.

n+i+1,n+i+2,...: One I+S frame containing:

$$N(S)=NMS+i+1,NMS+i+2,\dots \bmod(62),$$

$$N(R)=Nss+n+i+1,Nss+n+i+1\dots \bmod(62).$$

29.3.2.4 SS rejects I+S frames**29.3.2.4.1 REJ frame****29.3.2.4.1.1 Test purpose**

To test the correct handling of a REJ frame received.

29.3.2.4.1.2 Method of test**Initial Conditions**

The window size from MS to IWF (SS) is called KMI.

System Simulator:

The SS is configured to use default RLP parameters.

Mobile Station:

The MS is configured to use default RLP parameters.

A non transparent data call will be established, so that the MS is in call state U10 ("Call Active").

Case a: No negotiation will be initiated by the MS.

Case b: The MS initiates negotiation of RLP default parameters.

NOTE: The MS is allowed to initiate the negotiation of the RLP default parameters, within allowed ranges, defined in GSM 04.22. The MS shall do this in the ADM, after having sent a CONNECT ACKNOWLEDGE message (MO-case) or after having received a CONNECT ACKNOWLEDGE message from the SS (MT-case). The SS shall accept and use the new RLP parameters till the end of the test.

The ABM will be entered.

Procedure

The MS is made to send continuously I+S frames with a delay inferior to T_1 between each frame.

The SS acknowledges the i first I+S frames in supervisory RR frames.

The SS does not acknowledge the following I+S frames.

The SS rejects the 2 last I+S frames with a REJ and then send UI frames.

The MS shall retransmit the rejected I+S frames and the continue to send I+S frames.

The MS shall stop sending I+S frame when the transmission window is full.

The SS acknowledges all the received I+S frames with a RR frame after a delay of $0,5 * T_1$ after the last received I+S frame.

The MS restarts sending I+S frame.

The SS acknowledges the received I+S frames.

The MS is returned to the idle state by clearing of the call.

Expected sequence

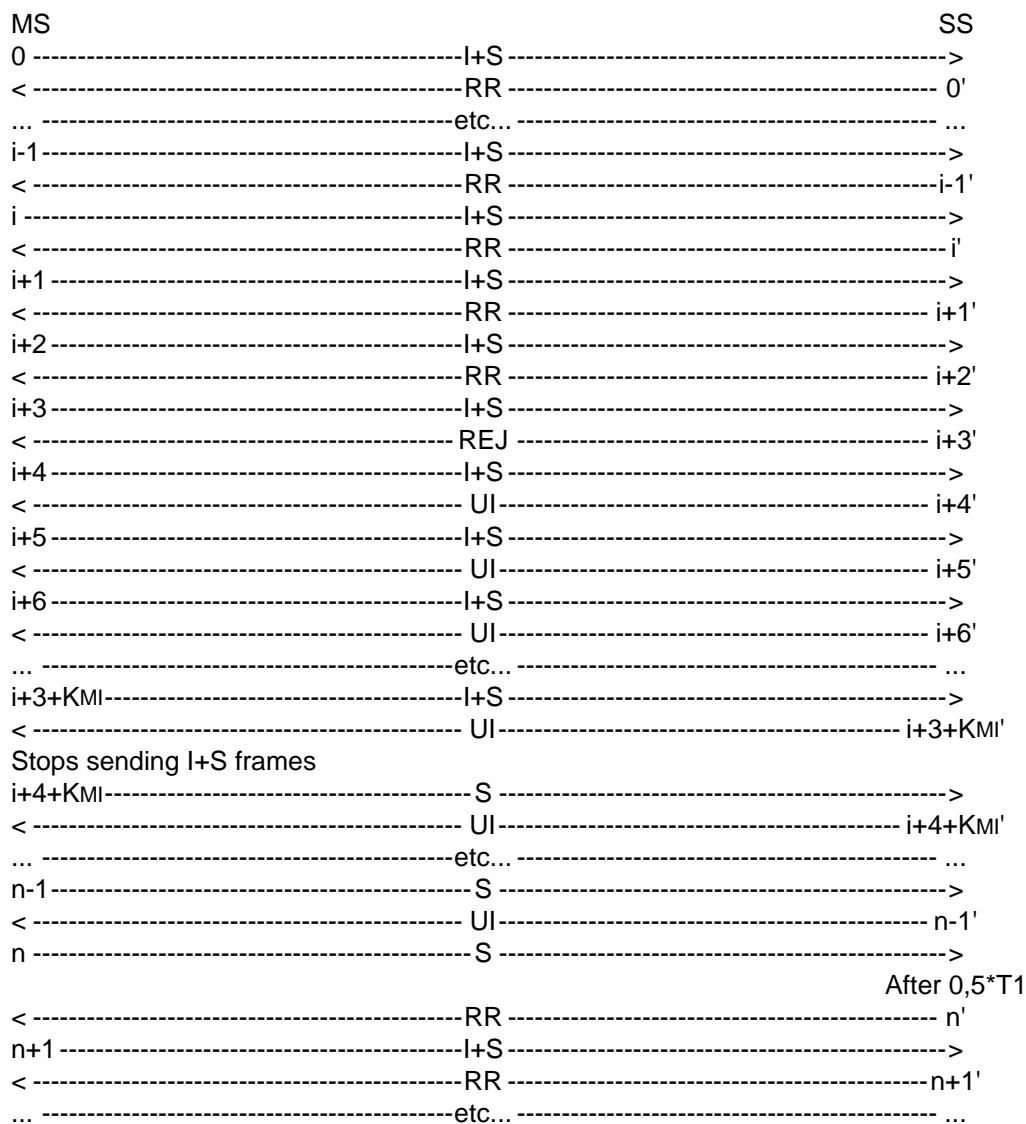

The frames from the SS will be:

0',...,i-1': One RR frame containing:

$$N(R)=NMS+1,\dots,NMS+i \text{ mod}(62).$$

i',...,i+2': One RR frame containing:

$$N(R)=NMS+i \text{ mod}(62).$$

i+3': One REJ frame containing:

$$N(R)=NMS+i+2 \text{ mod}(62).$$

i+4',...,n-1': One UI frame.

n': One RR frame containing:

$$N(R)=NMS+i+2+KMI \text{ mod}(62),$$

after a delay of 0,5*T1 after the last received I+S frame.

n+1',...: One RR frame containing

$$N(R)=NMS+i+3+KMI,\dots \text{ mod}(62).$$

29.3.2.4.1.3 Test requirements

The frames from the MS shall be:

0,...,i+3: One I+S frame containing
 $N(S)=NMS, \dots, NMS+i+3 \text{ mod}(62)$.

i+4,i+5: One I+S frame containing
 $N(S)=NMS+i+2, NMS+i+3 \text{ mod}(62)$.

i+6,...,i+3+KMI: One I+S frame containing:
 $N(S)=NMS+i+4, \dots, NMS+i+KMI+1 \text{ mod}(62)$.

i+4+KMI,...,n: One S frame.

MS stops sending I+S frames until reception of an acknowledging of at least 1 I+S frame of the window (received N(R) from NMS+i+3 to NMS+i+2+KMI mod(62)).

n+1,...: One I+S frame containing:
 $N(S)=NMS+i+KMI, \dots \text{ mod}(62)$.

29.3.2.4.2. SREJ frame

29.3.2.4.2.1 Test purpose

To test the correct handling of a SREJ frame received.

29.3.2.4.2.2 Method of test

Initial Conditions

The window size from MS to IWF (SS) is called KMI.

System Simulator:

The SS is configured to use default RLP parameters.

Mobile Station:

The MS is configured to use default RLP parameters.

A non transparent data call will be established, so that the MS is in call state U10 ("Call Active").

Case a: No negotiation will be initiated by the MS.

Case b: The MS initiates negotiation of RLP default parameters.

NOTE: The MS is allowed to initiate the negotiation of the RLP default parameters, within allowed ranges, defined in GSM 04.22. The MS shall do this in the ADM, after having sent a CONNECT ACKNOWLEDGE message (MO-case) or after having received a CONNECT ACKNOWLEDGE message from the SS (MT-case). The SS shall accept and use the new RLP parameters till the end of the test.

The ABM will be entered.

Procedure

The MS is made to send continuously I+S frames with a delay inferior to T_1 between each frame.

The SS acknowledges the i first I+S frames in supervisory RR frames.

The SS does not acknowledge the following I+S frames.

The SS rejects one I+S frame with a SREJ and then send UI frames.

The MS shall retransmit the rejected I+S frame and the continue to send I+S frames.

The MS shall stop sending I+S frame when the transmission window is full.

The SS acknowledges all the received I+S frames with a RR frame after a delay of $0,5 \cdot T_1$ after the last received I+S frame.

The MS restarts sending I+S frame.

The SS acknowledges the received I+S frames.

The MS is returned to the idle state by clearing of the call.

Expected sequence

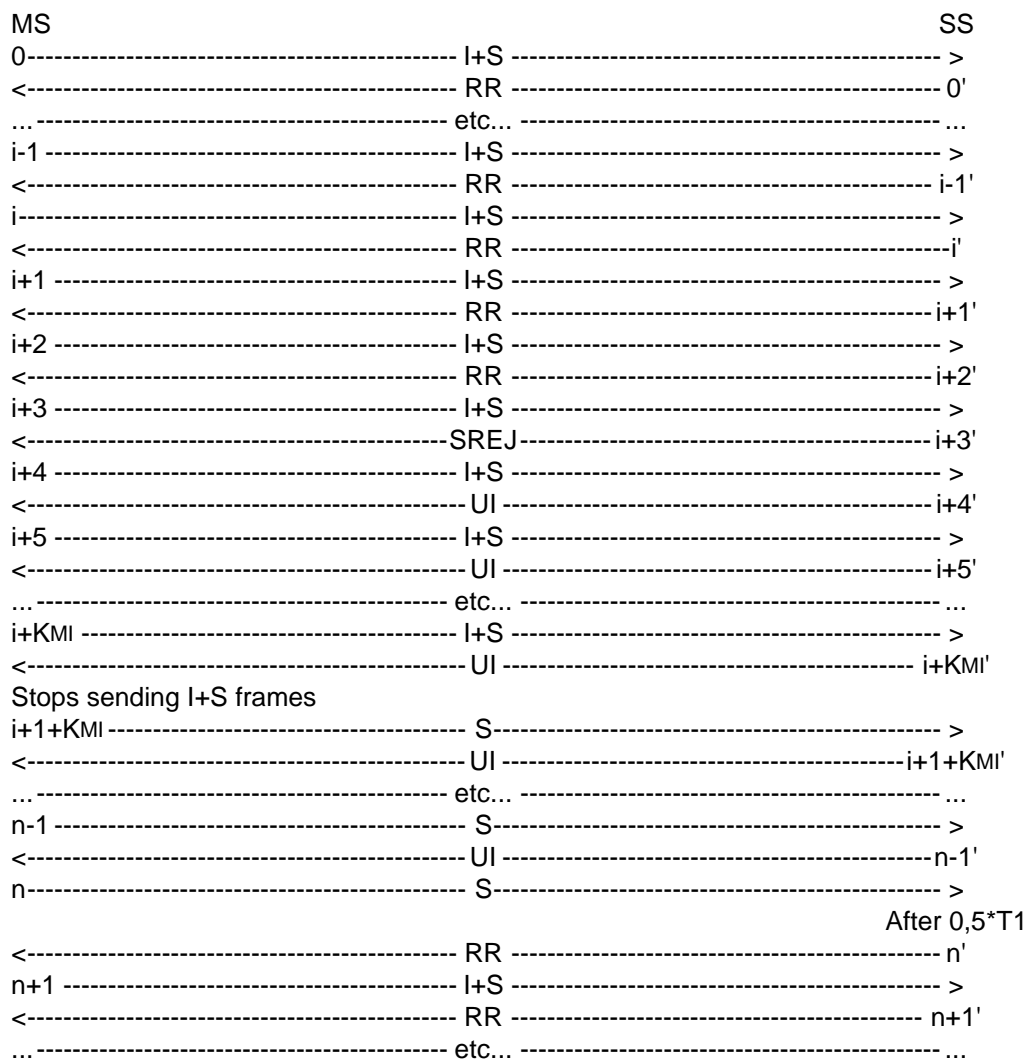

The frames from the SS will be:

0',...,i-1': One RR frame containing:

$$N(R)=NMS+1,\dots,NMS+i \text{ mod}(62).$$

i',...,i+2': One RR frame containing:

$$N(R)=NMS+i \text{ mod}(62).$$

i+3': One SREJ frame containing:

$$N(R)=NMS+i+2 \text{ mod}(62).$$

i+4',...,n-1': One UI frame.

n': One RR frame containing:

$$N(R)=NMS+i+KMI \text{ mod}(62),$$

after a delay of 0,5*T1 after the last received I+S frame.

n+1',...: One RR frame containing:

$$N(R)=NMS+i+1+KMI \text{ mod}(62).$$

29.3.2.4.2.3 Test requirements

The frames from the MS shall be:

0,...,i+3: One I+S frame containing:

$$N(S)=NMS,\dots,NMS+i+3 \text{ mod}(62).$$

i+4: One I+S frame containing:

$$N(S)=NMS+i+2 \text{ mod}(62).$$

i+5,...,i+KMI: One I+S frame containing:

$$N(S)=NMS+i+4,\dots,NMS+i+KMI-1 \text{ mod}(62).$$

i+1+KMI,...,n: One S frame.

MS stops sending I+S frames until reception of an acknowledging of at least 1 I+S frame of the window (received $N(R)$ from $NMS+i+1$ to $NMS+i+KMI \text{ mod}(62)$).

n+1,...: One I+S frame containing:

$$N(S)=NMS+i+KMI,\dots \text{ mod}(62).$$

29.3.2.4.3 I+S reject frame

29.3.2.4.3.1 Test purpose

To test the correct handling of a I+S reject frame received.

29.3.2.4.3.2 Method of test

Initial Conditions

The window size from MS to IWF (SS) is called KMI.

System Simulator:

The SS is configured to use default RLP parameters.

Mobile Station:

The MS is configured to use default RLP parameters.

A non transparent data call will be established, so that the MS is in call state U10 ("Call Active").

Case a: No negotiation will be initiated by the MS.

Case b: The MS initiates negotiation of RLP default parameters.

NOTE: The MS is allowed to initiate the negotiation of the RLP default parameters, within allowed ranges, defined in GSM 04.22. The MS shall do this in the ADM, after having sent a CONNECT ACKNOWLEDGE message (MO-case) or after having received a CONNECT ACKNOWLEDGE message from the SS (MT-case). The SS shall accept and use the new RLP parameters till the end of the test.

The ABM will be entered.

Procedure

The MS is made to send continuously I+S frames with a delay inferior to T1 between each frame.

The SS acknowledges the *i* first I+S frames in supervisory RR frames.

The SS does not acknowledge the following I+S frames.

The SS rejects the 2 last I+S frames with a REJ.

The MS shall retransmit the 2 rejected I+S frames.

The SS acknowledges these 2 frames.

The MS shall continue sending I+S frames.

The SS does not acknowledge these frames.

The SS rejects one I+S frame with a SREJ.

The MS shall retransmit the rejected I+S frame and continue sending I+S frames.

The SS acknowledges the received I+S frames.

The MS is returned to the idle state by clearing of the call.

Expected sequence

MS	SS
0----- I+S ----->	>
<----- RR -----0'	0'
...----- etc... ----->	>
i-1----- I+S ----->	>
<----- RR -----i-1'	i-1'
i----- I+S ----->	>
<----- RR -----i'	i'
i+1----- I+S ----->	>
<----- RR -----i+1'	i+1'
i+2----- I+S ----->	>
<----- REJ(I+S)-----i+2'	i+2'
i+3----- I+S ----->	>
<----- RR -----i+3'	i+3'
i+4----- I+S ----->	>
<----- RR -----i+4'	i+4'
i+5----- I+S ----->	>
<----- RR -----i+5'	i+5'
i+6----- I+S ----->	>
<----- SREJ(I+S)-----i+6'	i+6'
i+7----- I+S ----->	>
<----- RR -----i+7'	i+7'
i+8----- I+S ----->	>
<----- RR -----i+8'	i+8'
...----- etc... ----->	>

The frames from the SS will be:

0',...,i-1': One RR frame containing:

$$N(R)=NMS+1,\dots,NMS+i \text{ mod}(62).$$

i',i+1': One RR frame containing:

$$N(R)=NMS+i \text{ mod}(62).$$

i+2': One I+S REJ frame containing:

$$\begin{aligned} N(R) &= NMS+i+1 \text{ mod}(62), \\ N(S) &= Nss \text{ mod}(62). \end{aligned}$$

i+3',i+4': One RR frame containing:

$$N(R)=NMS+i+2,NMS+i+3 \text{ mod}(62).$$

i+5': One RR frame containing:

$$N(R)=NMS+i+3 \text{ mod}(62).$$

i+6': One I+S REJ frame containing:

$$\begin{aligned} N(R) &= NMS+i+3 \text{ mod}(62), \\ N(S) &= Nss+1 \text{ mod}(62). \end{aligned}$$

i+7': One RR frame containing:

$$N(R)=NMS+i+3 \text{ mod}(62).$$

i+8': One RR frame containing:

$$N(R)=NMS+i+6,\dots \text{ mod}(62).$$

29.3.2.4.3.3 Test requirements

The frames from the MS shall be:

0, ..., i+2: One I+S frame containing:

$$N(S)=NMS,\dots,NMS+i+2 \text{ mod}(62).$$

i+3,i+4: One I+S frame containing:

$$N(S)=NMS+i+1,NMS+i+2 \text{ mod}(62).$$

i+5,i+6: One I+S frame containing:

$$N(S)=NMS+i+3,NMS+i+4 \text{ mod}(62).$$

i+7: One I+S frame containing:

$$N(S)=NMS+i+3 \text{ mod}(62).$$

i+8, ...: One I+S frame containing:

$$N(S)=NMS+i+5,\dots \text{ mod}(62).$$

The MS shall acknowledge the I+S frames sent by the SS within T2.

29.3.2.5 MS rejects I+S frames

29.3.2.5.1 Rejection with REJ or SREJ supervisory frames

29.3.2.5.1.1 Conformance requirements

The MS shall be able to detect that an I+S frame is out of sequence, and to indicate to the network that some information needs to be retransmitted. This shall be done by using either a REJ or a SREJ RLP frame. The MS has the freedom to choose either one of these frames, but it shall correctly indicate which frames need to be retransmitted.

References

GSM 04.22 sections 5.2.3.4, 5.2.3.6 and 5.3.2.

29.3.2.5.1.2 Test purpose

To test that the MS is able to send correct REJ or SREJ supervisory frames to ask for the transmission of a sequence when an out of sequence information frame has been received.

29.3.2.5.1.3 Test method

Initial Conditions

The window size from IWF (SS) to MS is called K_{IM} .

System Simulator:

The SS is configured to use default RLP parameters.

Mobile Station:

The MS is configured to use default RLP parameters.

A non transparent data call will be established, so that the MS is in call state U10 ("Call Active").

Case a: No negotiation will be initiated by the MS.

Case b: The MS initiates negotiation of RLP default parameters.

NOTE: The MS is allowed to initiate the negotiation of the RLP default parameters, within allowed ranges, defined in GSM 04.22. The MS shall do this in the ADM, after having sent a CONNECT ACKNOWLEDGE message (MO-case) or after having received a CONNECT ACKNOWLEDGE message from the SS (MT-case). The SS shall accept and use the new RLP parameters till the end of the test.

The ABM will be entered.

Related PICS/PIXIT statements

Supported bearer services; characteristics of non-transparent services.

Foreseen final state of the MS

Idle.

Test procedure

The SS is made to send continuously I+S frames. The delay between two consecutive I+S frames shall be inferior to T1.

The MS is made to send no user data. It sends only supervisory frames.

The SS sends a I+S frame numbered Nss. The MS shall acknowledge this frame. Then the SS sends a I+S frame numbered Nss+2.

The MS shall ask for the retransmission of the missing frame numbered Nss+1. The MS may send a SREJ frame (see case a). If it cannot send SREJ, it shall send a REJ frame (see case b).

Case a: If the MS chooses to send a SREJ, it shall send a SREJ frame containing $N(R)=Nss+1$.
The SS sends a I+S frame numbered Nss+4.
The MS shall ask for the retransmission of the missing frame numbered Nss+3 The MS may send a SREJ frame (see case a/a If it cannot send SREJ, it shall send a REJ frame (see case a/b).

Case a/a: If the MS chooses to send a SREJ, it shall send a SREJ frame containing $N(R)=Nss+3$.
The SS sends a I+S frame numbered Nss+1 and the MS shall acknowledge this frame ($N(R)=Nss+3$).
The SS sends a I+S frame numbered Nss+3 and the MS shall acknowledge this frame ($N(R)=Nss+5$).

Case a/b: If the MS chooses to send a REJ, it shall send a REJ frame containing $N(R)=Nss+1$.
The SS sends I+S frames numbered Nss+1, ..., Nss+4 and the MS shall acknowledge these frames ($N(R)=Nss+2, \dots, Nss+5$).

Case b: If the MS chooses to send a REJ, it shall send a REJ frame containing $N(R)=Nss+1$.
The SS sends I+S frames numbered Nss+1, Nss+2 and the MS shall acknowledge this frame ($N(R)=Nss+2, Nss+3$).
The SS sends a I+S frame numbered Nss+4.
The MS shall ask for the retransmission of the missing frame numbered Nss+3 The MS may send a SREJ frame (see case b/a If it cannot send SREJ, it shall send a REJ frame (see case b/b).

Case b/a: If the MS chooses to send a SREJ, it shall send a SREJ frame containing $N(R)=Nss+3$.
The SS sends a I+S frame numbered Nss+3 and the MS shall acknowledge this frame ($N(R)=Nss+5$).

Case b/b: If the MS chooses to send a REJ, it shall send a REJ frame containing $N(R)=Nss+3$.
The SS sends I+S frames numbered Nss+3, Nss+4 and the MS shall acknowledge these frames ($N(R)=Nss+4, Nss+5$).

The SS sends a I+S frame numbered Nss+5. The MS shall acknowledge this frame. Then the SS sends a I+S frame numbered Nss+5+ K_{IM} .

The MS shall ask for the retransmission of the missing frame numbered Nss+6 to Nss+4+ K_{IM} . The MS may send a SREJ frame (see sequence c with $k=1$). If it cannot send SREJ, it shall send a REJ frame (see sequence d with $k=1$).

Sequence c: If the MS chooses to send a SREJ, it shall send a SREJ frame containing $N(R)=Nss+5+k$.
The SS sends a I+S frame numbered Nss+5+k.
When using SREJ frames, the MS shall send RR frames to acknowledge the received I+S frames. The time when these RR frames are sent is not tested.
If $k < K_{IM}-1$, the MS shall ask for the retransmission of the missing frames numbered Nss+5+k+1 to Nss+4+ K_{IM} . The MS may send a SREJ frame (see sequence c with $k=k+1$). If it cannot send SREJ, it shall send a REJ frame (see sequence d with $k=k+1$).
If $k = K_{IM}-1$, the MS has no more frame to reject. It shall acknowledge the frame numbered Nss+5+ K_{IM} . with a frame containing $N(R)=Nss+6+K_{IM},..$ The SS sends I+S frames numbered Nss+6+ K_{IM} , etc... and the MS shall acknowledge these frames ($N(R)=Nss+7+K_{IM}$, etc.

Sequence d: If the MS chooses to send a REJ, it shall send a REJ frame containing $N(R)=Nss+5+k$.

The SS sends a I+S frame numbered $N_{ss}+5+k$ and the MS shall acknowledge this frame ($N(R)=N_{ss}+5+k+1$).

The SS sends a I+S frame numbered $N_{ss}+5+K_{IM}$.

If $k < K_{IM}-1$, the MS shall ask for the retransmission of the missing frames numbered $N_{ss}+5+k+1$ to $N_{ss}+4+K_{IM}$. The MS may send a SREJ frame (see sequence c with $k=k+1$). If it cannot send SREJ, it shall send a REJ frame (see sequence d with $k=k+1$).

If $k = K_{IM}-1$, the MS has no more frame to reject. It shall acknowledge the frame numbered $N_{ss}+5+K_{IM}$ with a frame containing $N(R)=N_{ss}+6+K_{IM}$. The SS sends I+S frames numbered $N_{ss}+6+K_{IM}$, etc... and the MS shall acknowledge these frames ($N(R)=N_{ss}+7+K_{IM}$, etc.

The MS is returned to the idle state by clearing of the call.

Maximum duration of test

1 minute.

Expected sequence

	MS			SS
		<-----	I+S	----- 0'
	0	-----	RR	----->
		<-----	I+S	----- 1'
	1		SREJ(a) or REJ(b) ?	
Case a				
	a - 1	-----	SREJ	----->
		<-----	I+S	----- a - 2'
	a - 2		SREJ(a/a) or REJ(a/b) ?	
Case a/a				
	a/a - 1	-----	SREJ	----->
		<-----	I+S	----- a/a - 2'
	a/a - 2	-----	RR	----->
		<-----	I+S	----- a/a - 3'
	a/a - 3	-----	RR	----->
Case a/b				
	a/b - 1	-----	REJ	----->
		<-----	I+S	----- a/b - 2'
	a/b - 2	-----	RR	----->
		<-----	I+S	----- a/b - 3'
	a/b - 3	-----	RR	----->
		<-----	I+S	----- a/b - 4'
	a/b - 4	-----	RR	----->
		<-----	I+S	----- a/b - 5'
	a/b - 5	-----	RR	----->
Case b				
	b - 1	-----	REJ	----->
		<-----	I+S	----- b - 2'
	b - 2	-----	RR	----->

	<-----	I+S	-----	b - 3'
b - 3	-----	RR	----->	
	<-----	I+S	-----	b - 4'
b - 4		SREJ(b/a) or REJ(b/b) ?		
Case b/a				
b/a - 1	-----	SREJ	----->	
	<-----	I+S	-----	b/a - 2'
b/a - 2	-----	RR	----->	
Case b/b				
b/b - 1	-----	REJ	----->	
	<-----	I+S	-----	b/b - 2'
b/b - 2	-----	RR	----->	
	<-----	I+S	-----	b/b - 3'
b/b - 3	-----	RR	----->	
	<-----	I+S	-----	i'
i	-----	RR	----->	
	<-----	I+S	-----	i+1'
i+1		SREJ(c) or REJ(d) ?		
Sequence c (SREJ used)				
c/k - 0	-----	SREJ	----->	
	<-----	I+S	-----	c/k - 0'
c/k - 1		SREJ(c) or REJ(d) ?		
Sequence d (REJ used)				
d/k - 0	-----	REJ	----->	
	<-----	I+S	-----	d/k - 0'
d/k - 1	-----	RR	----->	
	<-----	I+S	-----	d/k - 1'
d/k - 2		SREJ(c) or REJ(d) ?		
j	-----	RR	----->	

<-----	I+S	-----	j'
...	etc...		...

The frames from the SS will be:

0': One I+S frame containing $N(S)=N_{SS} \bmod(62)$, $N(R)=N_{MS}+1 \bmod(62)$.

1': One I+S frame containing $N(S)=N_{SS}+2 \bmod(62)$, $N(R)=N_{MS}+1 \bmod(62)$.

Case a:

a - 2': One I+S frame containing $N(S)=N_{SS}+4 \bmod(62)$, $N(R)=N_{MS}+1 \bmod(62)$.

Case a/a:

a/a - 2': One I+S frame containing $N(S)=N_{SS}+1 \bmod(62)$, $N(R)=N_{MS}+1 \bmod(62)$.

a/a - 3': One I+S frame containing $N(S)=N_{SS}+3 \bmod(62)$, $N(R)=N_{MS}+1 \bmod(62)$.

Case a/b:

a/b - 2': One I+S frame containing $N(S)=N_{SS}+1 \bmod(62)$, $N(R)=N_{MS}+1 \bmod(62)$.

a/b - 3': One I+S frame containing $N(S)=N_{SS}+2 \bmod(62)$, $N(R)=N_{MS}+1 \bmod(62)$.

a/b - 4': One I+S frame containing $N(S)=N_{SS}+3 \bmod(62)$, $N(R)=N_{MS}+1 \bmod(62)$.

a/b - 5': One I+S frame containing $N(S)=N_{SS}+4 \bmod(62)$, $N(R)=N_{MS}+1 \bmod(62)$.

Case b:

b - 2': One I+S frame containing $N(S)=N_{SS}+1 \bmod(62)$, $N(R)=N_{MS}+1 \bmod(62)$.

b - 3': One I+S frame containing $N(S)=N_{SS}+2 \bmod(62)$, $N(R)=N_{MS}+1 \bmod(62)$.

b - 4': One I+S frame containing $N(S)=N_{SS}+4 \bmod(62)$, $N(R)=N_{MS}+1 \bmod(62)$.

Case b/a:

b/a - 2': One I+S frame containing $N(S)=N_{SS}+3 \bmod(62)$, $N(R)=N_{MS}+1 \bmod(62)$.

Case b/b:

b/b - 2': One I+S frame containing $N(S)=N_{SS}+3 \bmod(62)$, $N(R)=N_{MS}+1 \bmod(62)$.

b/b - 3': One I+S frame containing $N(S)=N_{SS}+4 \bmod(62)$, $N(R)=N_{MS}+1 \bmod(62)$.

i': One I+S frame containing $N(S)=N_{SS}+5 \bmod(62)$, $N(R)=N_{MS}+1 \bmod(62)$.

i+1': One I+S frame containing $N(S)=N_{SS}+5+K_{IM} \bmod(62)$, $N(R)=N_{MS}+1 \bmod(62)$.

Sequence c (with $k=1$ to $K_{IM}-1$):

c/k - 0': One I+S frame containing $N(S)=N_{SS}+5+k \bmod(62)$, $N(R)=N_{MS}+1 \bmod(62)$.

Sequence d (with $k=1$ to $K_{IM}-1$):

d/k - 0': One I+S frame containing $N(S)=N_{SS}+5+k \bmod(62)$, $N(R)=N_{MS}+1 \bmod(62)$.

d/k - 1': One I+S frame containing $N(S)=N_{SS}+5+K_{IM} \bmod(62)$, $N(R)=N_{MS}+1 \bmod(62)$.

j',...: One I+S frame containing $N(S)=N_{SS}+K_{IM}+6, \dots \bmod(62)$, $N(R)=N_{MS}+1 \bmod(62)$.

Specific message content

The frames from the MS shall be:

0: One RR frame containing $N(R)=N_{SS}+1 \bmod(62)$.

1: The MS shall reject the missing I+S frame numbered $N_{SS}+1$. It may send a SREJ frame (see case a). If it cannot send SREJ, it shall send a REJ frame (see case b).

Case a

- a - 1: One supervisory SREJ frame containing $N(R)=N_{ss}+1 \text{ mod}(62)$.
- a - 2: The MS shall reject the missing I+S frame numbered $N_{ss}+3$. It may send a SREJ frame (see case a). If it cannot send SREJ, it shall send a REJ frame (see case b).

Case a/a

- a/a - 1: One supervisory SREJ frame containing $N(R)=N_{ss}+3 \text{ mod}(62)$.
- a/a - 2: One RR frame containing $N(R)=N_{ss}+3 \text{ mod}(62)$.
- a/a - 3: One RR frame containing $N(R)=N_{ss}+5 \text{ mod}(62)$.

Case a/b

- a/b - 1: One supervisory REJ frame containing $N(R)=N_{ss}+1 \text{ mod}(62)$.
- a/b - 2: One RR frame containing $N(R)=N_{ss}+2 \text{ mod}(62)$.
- a/b - 3: One RR frame containing $N(R)=N_{ss}+3 \text{ mod}(62)$.
- a/b - 4: One RR frame containing $N(R)=N_{ss}+4 \text{ mod}(62)$.
- a/b - 5: One RR frame containing $N(R)=N_{ss}+5 \text{ mod}(62)$.

Case b

- b - 1: One supervisory REJ frame containing $N(R)=N_{ss}+1 \text{ mod}(62)$.
- b - 2: One RR frame containing $N(R)=N_{ss}+2 \text{ mod}(62)$.
- b - 3: One RR frame containing $N(R)=N_{ss}+3 \text{ mod}(62)$.
- b - 4: The MS shall reject the missing I+S frame numbered $N_{ss}+2$. It may send a SREJ frame (see case a). If it cannot send SREJ, it shall send a REJ frame (see case b).

Case b/a

- b/a - 1: One supervisory SREJ frame containing $N(R)=N_{ss}+2 \text{ mod}(62)$.
- b/a - 2: One RR frame containing $N(R)=N_{ss}+5 \text{ mod}(62)$.

Case b/b

- b/b - 1: One supervisory REJ frame containing $N(R)=N_{ss}+2 \text{ mod}(62)$.
- b/b - 2: One RR frame containing $N(R)=N_{ss}+4 \text{ mod}(62)$.
- b/b - 3: One RR frame containing $N(R)=N_{ss}+5 \text{ mod}(62)$.

i: One RR frame containing $N(R)=N_{ss}+6 \text{ mod}(62)$.

i+1: The MS shall reject all missing I+S frames (i.e. $K_{IM}-1$ frames). It may send a SREJ frame (see sequence c with $k=1$). If it cannot send SREJ, it shall send a REJ frame (see sequence d with $k=1$).

Sequence c (with $k=1$ to $K_{IM}-1$):

- c/k - 0: One SREJ frame containing $N(R)=N_{ss}+5+k \text{ mod}(62)$.
- c/k - 1: If $k < K_{IM}-1$, the MS shall reject all missing I+S frames (i.e. $K_{IM}-1$ frames). It may send a SREJ frame (see sequence c with $k=k+1$). If it cannot send SREJ, it shall send a REJ frame (see sequence d with $k=k+1$). If $k=K_{IM}-1$, the MS has no more frame to reject (see frame numbered j).

Sequence d (with $k=1$ to $K_{IM}-1$):

- d/k - 0: One REJ frame containing $N(R)=N_{ss}+5+k \text{ mod}(62)$.
- d/k - 1: One RR frame containing $N(R)=N_{ss}+5+k+1 \text{ mod}(62)$.
- d/k - 2: If $k < K_{IM}-1$, the MS shall reject all missing I+S frames (i.e. $K_{IM}-1$ frames). It may send a SREJ frame (see sequence c with $k=k+1$). If it cannot send SREJ, it shall send a REJ frame (see sequence d with $k=k+1$). If $k=K_{IM}-1$, the MS has no more frame to reject (see frame numbered j).

j,...: One RR frame containing $N(R)=N_{ss}+K_{IM}+6, \dots \text{ mod}(62)$.

29.3.2.5.2 Retransmission of REJ or SREJ frames

29.3.2.5.2.1 Conformance requirements

The MS shall not retransmit a REJ frame upon time-out. It may repeat SREJ frames.

References

GSM 04.22 sections 5.2.3.4 and 5.2.3.6.

29.3.2.5.2.2 Test purpose

To test that the MS is able to retransmit a SREJ supervisory frames, and does not retransmit a REJ frame.

29.3.2.5.2.3 Test method

Initial Conditions

The window size from IWF (SS) to MS is called K_{IM} .

System Simulator:

The SS is configured to use default RLP parameters.

Mobile Station:

The MS is configured to use default RLP parameters.

A non transparent data call will be established, so that the MS is in call state U10 ("Call Active").

Case a: No negotiation will be initiated by the MS.

Case b: The MS initiates negotiation of RLP default parameters.

NOTE: The MS is allowed to initiate the negotiation of the RLP default parameters, within allowed ranges, defined in GSM 04.22. The MS shall do this in the ADM, after having sent a CONNECT ACKNOWLEDGE message (MO-case) or after having received a CONNECT ACKNOWLEDGE message from the SS (MT-case). The SS shall accept and use the new RLP parameters till the end of the test.

The ABM will be entered.

Related PICS/PIXIT statements

Supported bearer services; characteristics of non-transparent services.

Foreseen final state of the MS

Idle.

Test procedure

After optional status bits exchange between the MS and the SS, the SS is made to send continuously I+S frames. The delay between two consecutive I+S frames shall be inferior to T1.

The MS is made to send no user data. It sends only supervisory frames.

The SS sends a I+S frame numbered Nss. The MS shall acknowledge this frame. Then the SS sends a I+S frame numbered Nss+2.

The MS shall ask for the retransmission of the missing frame numbered $N_{ss}+1$. The MS may send a SREJ frame (see case a). If it cannot send SREJ, it shall send a REJ frame (see case b).

Case a: If the MS chooses to send a SREJ, it shall send a SREJ frame containing $N(R)=N_{ss}+1$.
The SS does not retransmit the rejected frame.
The MS may repeat (see case a1) or not (see case a2) the reject SREJ frame.

Case a1: If the MS chooses to retransmit the SREJ, it shall send a SREJ frame containing $N(R)=N_{ss}+1$, at the expiry of T_1 .
The SS sends a I+S frame numbered $N_{ss}+1$ and the MS shall acknowledge this frame ($N(R)=N_{ss}+3$).
The SS sends a I+S frame numbered $N_{ss}+4$.
The MS shall ask for the retransmission of the missing frame numbered $N_{ss}+3$. The MS shall send a SREJ frame containing $N(R)=N_{ss}+3$.
At expiry of T_1 , the MS shall send a new SREJ frame containing $N(R)=N_{ss}+3$. This step is repeated N_2 times.
The SS checks for $2 \cdot T_1$ that the SREJ frame is not repeated by the MS.

Case a2: If the MS chooses not to repeat the SREJ frame, , The SS checks for $2 \cdot T_1$ that the SREJ frame is not repeated by the MS.

Case b: If the MS chooses to send a REJ, it shall send a REJ frame containing $N(R)=N_{ss}+1$.
The SS does not retransmit the rejected frame.
The MS shall not repeat the reject REJ frame.
The SS checks for $2 \cdot T_1$ that the SREJ frame is not repeated by the MS.

The MS is returned to the idle state by clearing of the call.

Maximum duration of test

1 minute.

Expected sequence

	MS		SS
		<----- I+S	----- 0'
	0	----- RR	----->
		<----- I+S	----- 1'
	1	SREJ(a) or REJ(b) ?	
Case a	a - 1	----- SREJ	----->
	a - 2	SREJ repeated (a1) or not (a2) ?	
Case a1			
T1 Time-out	a1 - 1	----- SREJ	----->
		<----- I+S	----- a1 - 1'
	a1 - 2	----- RR	----->
		<----- I+S	----- a1 - 2'
	a1 - 3	----- SREJ	----->
T1 Time-out	a1 - 4	----- SREJ	----->
	...	etc...	...
T1 Time-out	a1 - 3+N2	----- SREJ	----->

T1 Time-out SREJ not repeated

Case a2

T1 Time-out SREJ not repeated

Case b

b - 1 ----- REJ ----->

T1 Time-out SREJ not repeated

The frames from the SS will be:

0': One I+S frame containing $N(S)=N_{ss} \bmod(62)$, $N(R)=N_{ms}+1 \bmod(62)$.

1': One I+S frame containing $N(S)=N_{ss}+2 \bmod(62)$, $N(R)=N_{ms}+1 \bmod(62)$.

Case a:

Case a1:

a1 - 1': One I+S frame containing $N(S)=N_{ss}+1 \bmod(62)$, $N(R)=N_{ms}+1 \bmod(62)$.

a1 - 2': One I+S frame containing $N(S)=N_{ss}+4 \bmod(62)$, $N(R)=N_{ms}+1 \bmod(62)$.

Specific message content

The frames from the MS shall be:

0: One RR frame containing $N(R)=N_{ss}+1 \bmod(62)$.

1: The MS shall reject the missing I+S frame numbered $N_{ss}+1$. It may send a SREJ frame (see case a). If it cannot send SREJ, it shall send a REJ frame (see case b).

Case a

a - 1: One supervisory SREJ frame containing $N(R)=N_{ss}+1 \bmod(62)$.

a - 2: SREJ frame may be repeated, (see case a1) or not (see case a2).

Case a1

a1 - 1: On T1 Time-out, one supervisory SREJ frame containing $N(R)=N_{ss}+1 \bmod(62)$.

a1 - 2: One RR frame containing $N(R)=N_{ss}+3 \bmod(62)$.

a1 - 3,...,b2 - 3+N2: On T1 Time-out, one supervisory SREJ frame containing $N(R)=N_{ss}+3 \bmod(62)$.

Case b

b - 1: One supervisory REJ frame containing $N(R)=N_{ss}+1 \bmod(62)$.

29.3.2.5.3 I+S reject frame

29.3.2.5.3.1 Conformance requirements

The MS shall be able to use I+S frames to carry a REJ or SREJ frame when it detects that one or more numbered information frame is received out of sequence.

References

GSM 04.22 sections 5.2.3.4, 5.2.3.6

29.3.2.5.3.2 Test purpose

To test the MS is able to send SREJ or REJ frames in I+S frames when an out of sequence information frame has been received.

29.3.2.5.3.3 Test method

Initial Conditions

The window size from IWF (SS) to MS is called K_{IM} .

System Simulator:

The SS is configured to use default RLP parameters.

Mobile Station:

The MS is configured to use default RLP parameters.

A non transparent data call will be established, so that the MS is in call state U10 ("Call Active").

Case a: No negotiation will be initiated by the MS.

Case b: The MS initiates negotiation of RLP default parameters.

NOTE: The MS is allowed to initiate the negotiation of the RLP default parameters, within allowed ranges, defined in GSM 04.22. The MS shall do this in the ADM, after having sent a CONNECT ACKNOWLEDGE message (MO-case) or after having received a CONNECT ACKNOWLEDGE message from the SS (MT-case). The SS shall accept and use the new RLP parameters till the end of the test.

The ABM will be entered.

Related PICS/PIXIT statements

Supported bearer services; characteristics of non-transparent services.

Foreseen final state of the MS

Idle.

Test procedure

The SS is made to send continuously I+S frames. The delay between two consecutive I+S frames shall be inferior to T1.

The SS acknowledges all the received I+S frames.

The MS is made to send continuously I+S frames.

The SS sends a I+S frame numbered Nss. The MS shall acknowledge this frame. Then the SS sends a I+S frame numbered Nss+2.

The MS shall ask for the retransmission of the missing frame numbered Nss+1. The MS may send a SREJ frame (see case a). If it cannot send SREJ, it shall send a REJ frame (see case b). The MS has user data to transmit, it shall use an I+S frame (instead of supervisory frame) to reject the missing frame.

Case a: If the MS chooses to send a SREJ, it shall send a I+S SREJ frame containing $N(R)=Nss+1$. The SS sends a I+S frame numbered Nss+1 and the MS acknowledges this frame ($N(R)=Nss+3$).

The SS sends a I+S frame numbered $N_{ss}+3$, etc... and the MS acknowledges these frames ($N(R)=N_{ss}+4$, etc...).

Case b: If the MS chooses to send a REJ, it shall send a I+S REJ frame containing $N(R)=N_{ss}+1$. The SS sends I+S frames numbered $N_{ss}+1$, $N_{ss}+2$, etc... and the MS shall acknowledge this frame ($N(R)=N_{ss}+2$, $N_{ss}+3$, etc...). The MS is returned to the idle state by clearing of the call.

Maximum duration of test

1 minute.

Expected sequence

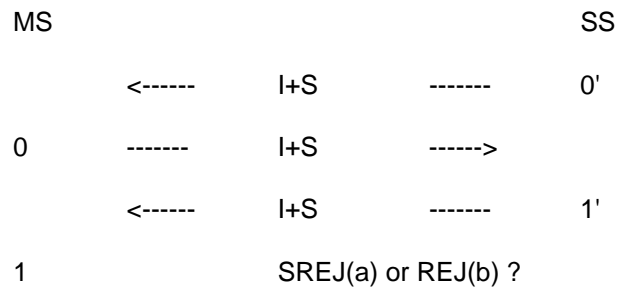

Case a

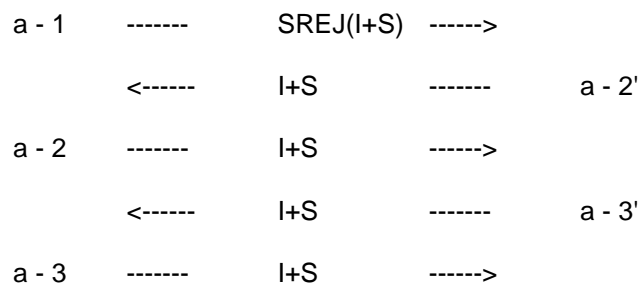

Case b

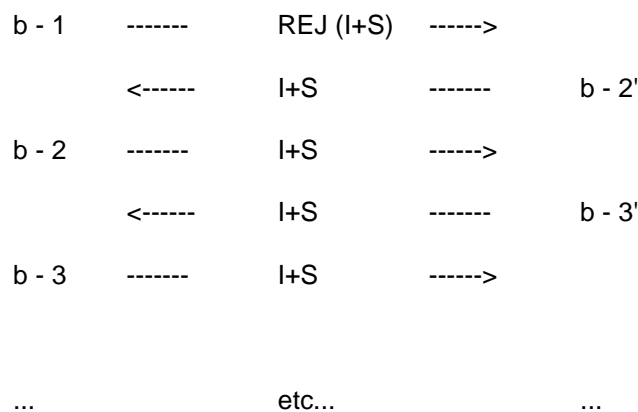

The frames from the SS will be:

- 0': One I+S frame containing $N(S)=N_{ss} \text{ mod}(62)$, $N(R)=N_{ms}+1 \text{ mod}(62)$.
- 1': One I+S frame containing $N(S)=N_{ss}+2 \text{ mod}(62)$, $N(R)=N_{ms}+2 \text{ mod}(62)$.

Case a:

- a - 2': One I+S frame containing $N(S)=N_{ss}+1 \text{ mod}(62)$, $N(R)=N_{MS}+3 \text{ mod}(62)$.
- a - 3': One I+S frame containing $N(S)=N_{ss}+3 \text{ mod}(62)$, $N(R)=N_{MS}+4 \text{ mod}(62)$.

Case b:

- b - 2': One I+S frame containing $N(S)=N_{ss}+1 \text{ mod}(62)$, $N(R)=N_{MS}+3 \text{ mod}(62)$.
- b - 3': One I+S frame containing $N(S)=N_{ss}+2 \text{ mod}(62)$, $N(R)=N_{MS}+4 \text{ mod}(62)$.

Specific message content

The frames from the MS shall be:

- 0: One I+S RR frame containing $N(S)=N_{MS}+1$, $N(R)=N_{ss}+1 \text{ mod}(62)$.
- 1: The MS shall reject the missing I+S frame numbered $N_{ss}+1$. It may send a I+S SREJ frame (see case a). If it cannot send SREJ, it shall send a I+S REJ frame (see case b).

Case a

- a - 1: One I+S SREJ frame containing $N(S)=N_{MS}+2$, $N(R)=N_{ss}+1 \text{ mod}(62)$.
- a - 2: One I+S RR frame containing $N(S)=N_{MS}+3$, $N(R)=N_{ss}+3 \text{ mod}(62)$.
- a - 3: One I+S RR frame containing $N(S)=N_{MS}+4$, $N(R)=N_{ss}+4 \text{ mod}(62)$.

Case b

- b - 1: One I+S REJ frame containing $N(S)=N_{MS}+2$, $N(R)=N_{ss}+1 \text{ mod}(62)$.
- b - 2: One I+S RR frame containing $N(S)=N_{MS}+3$, $N(R)=N_{ss}+2 \text{ mod}(62)$.
- b - 3: One I+S RR frame containing $N(S)=N_{MS}+4$, $N(R)=N_{ss}+3 \text{ mod}(62)$.

29.3.2.6 Checkpoint recovery

29.3.2.6.1 SS in checkpoint recovery mode

29.3.2.6.1.1 Test purpose

To test the correct handling of received frame with $P=1$.

29.3.2.6.1.2 Method of test

Initial Conditions

System Simulator:

The SS is configured to use default RLP parameters.

Mobile Station:

The MS is configured to use default RLP parameters.

A non transparent data call will be established, so that the MS is in call state U10 ("Call Active").

Case a: No negotiation will be initiated by the MS.

Case b: The MS initiates negotiation of RLP default parameters.

NOTE: The MS is allowed to initiate the negotiation of the RLP default parameters, within allowed ranges, defined in GSM 04.22. The MS shall do this in the ADM, after having sent a CONNECT ACKNOWLEDGE message (MO-case) or after having received a CONNECT ACKNOWLEDGE message from the SS (MT-case). The SS shall accept and use the new RLP parameters till the end of the test.

The ABM will be entered.

Procedure

The MS is made to send continuously I+S frames with a delay inferior to T1 between each frame.

The SS is made to send continuously I+S frames with a delay superior to T2 and inferior to T1 between each frame.

The SS acknowledges the received I+S frames in its sending I+S frames.

The MS shall acknowledge the received I+S frames in its sending I+S frames.

After having sent i I+S frames, the SS sends a I+S frame with P bit set to 1.

The MS shall answer with a supervisory RR or RNR frame with F bit set to 1 and N(R) coded to the next frame waited by the MS.

The SS continue sending I+S frames and acknowledging the I+S frames received from the MS.

The MS shall continue sending I+S frames and acknowledging the I+S frames received from the SS.

The SS rejects 1 I+S frame in a supervisory SREJ frame with P bit set to 1.

The MS shall answer with a supervisory RR or RNR frame with F bit set to 1 and N(R) coded to the next frame waited by the MS.

Then the MS shall retransmit the rejected I+S frame.

The SS continue sending I+S frames and acknowledging the I+S frames received from the MS.

The MS shall continue sending I+S frames and acknowledging the I+S frames received from the SS.

After having sent j I+S frames, the SS sends a supervisory RR frame with P bit set to 1.

The MS shall answer with a supervisory RR or RNR frame with F bit set to 1 and N(R) coded to the next frame waited by the MS.

The SS continue sending I+S frames and acknowledging the I+S frames received from the MS.

The MS shall continue sending I+S frames and acknowledging the I+S frames received from the SS.

The MS is returned to the idle state by clearing of the call.

Expected sequence

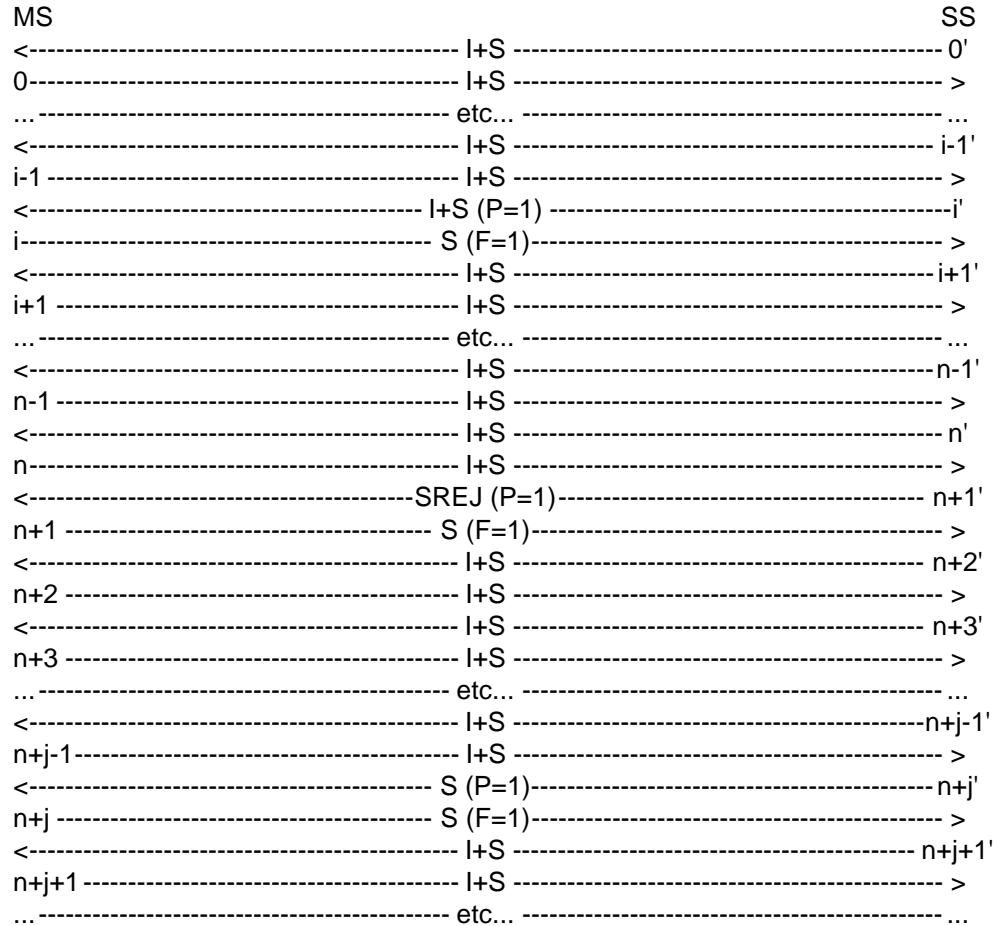

The frames from the SS will be:

0',...,i-1': One I+S RR frame containing:

$$N(S)=N_{SS}, \dots, N_{SS+i-1} \text{ mod}(62),$$

$$N(R)=N_{MS}, \dots, N_{MS+i-1} \text{ mod}(62).$$

i': One I+S RR frame containing:

$$C/R=1,$$

$$P/F=1,$$

$$N(S)=N_{SS+i} \text{ mod}(62),$$

$$N(R)=N_{MS+i} \text{ mod}(62).$$

i+1',...,n-1': One I+S RR frame containing:

$$N(S)=N_{SS+i+1}, \dots, N_{SS+n-1} \text{ mod}(62),$$

$$N(R)=N_{MS+i-1}, \dots, N_{MS+n-3} \text{ mod}(62).$$

n: One I+S RR frame containing:

$$N(S)=N_{SS+n} \text{ mod}(62),$$

$$N(R)=N_{MS+n-3} \text{ mod}(62).$$

n+1: One supervisory SREJ frame containing:

$$C/R=1,$$

$$P/F=1,$$

$$N(R)=N_{MS+n-2} \text{ mod}(62).$$

$n+2'$: One I+S RR frame containing:

$$\begin{aligned} N(S) &= N_{SS} + n + 1 \pmod{62}, \\ N(R) &= N_{MS} + n - 2 \pmod{62}. \end{aligned}$$

$n+3', \dots, n+j-1'$: One I+S RR frame containing:

$$\begin{aligned} N(S) &= N_{SS} + n + 2, \dots, N_{SS} + n + j \pmod{62}, \\ N(R) &= N_{MS} + n, \dots, N_{MS} + n + j - 3 \pmod{62}. \end{aligned}$$

$n+j$: One supervisory SREJ frame containing:

$$\begin{aligned} C/R &= 1, \\ P/F &= 1, \\ N(R) &= N_{MS} + n - 2 \pmod{62}. \end{aligned}$$

$n+j+1', \dots$: One I+S RR frame containing:

$$\begin{aligned} N(S) &= N_{SS} + n + j + 1, \dots \pmod{62}, \\ N(R) &= N_{MS} + n + j - 2, \dots \pmod{62}. \end{aligned}$$

29.3.2.6.1.3 Test requirements

The frames from the MS shall be:

$0, \dots, i-1$: One I+S frame containing:

$$\begin{aligned} N(S) &= N_{MS}, \dots, N_{MS} + i - 1 \pmod{62}, \\ N(R) &= N_{SS} + 1, \dots, N_{SS} + i \pmod{62}. \end{aligned}$$

i' : One supervisory RR frame containing:

$$\begin{aligned} C/R &= 0, \\ P/F &= 1, \\ N(R) &= N_{SS} + i + 1 \pmod{62}. \end{aligned}$$

$i+1, \dots, n$: One I+S frame containing:

$$\begin{aligned} N(S) &= N_{MS} + i, \dots, N_{MS} + n - 1 \pmod{62}, \\ N(R) &= N_{SS} + i + 2, \dots, N_{SS} + n + 1 \pmod{62}. \end{aligned}$$

$n+1$: One supervisory RR frame containing:

$$\begin{aligned} C/R &= 0, \\ P/F &= 1, \\ N(R) &= N_{SS} + n + 1 \pmod{62}. \end{aligned}$$

$n+2$: One I+S frame containing:

$$\begin{aligned} N(S) &= N_{MS} + n - 2 \pmod{62}, \\ N(R) &= N_{SS} + n + 2 \pmod{62}. \end{aligned}$$

$n+3, \dots, n+j-1$: One I+S frame containing:

$$\begin{aligned} N(S) &= N_{MS} + n, \dots, N_{MS} + n + j - 3 \pmod{62}, \\ N(R) &= N_{SS} + n + 3, \dots, N_{SS} + n + j + 1 \pmod{62}. \end{aligned}$$

$n+j$: One supervisory RR frame containing:

$$\begin{aligned} C/R &= 0, \\ P/F &= 1, \\ N(R) &= N_{SS} + n + j + 1 \pmod{62}. \end{aligned}$$

$n+j+1, \dots$: One I+S frame containing:

$$N(S) = N_{MS} + n + j - 2 \pmod{62},$$

$$N(R) = N_{SS} + n + j + 2, \dots \pmod{62}.$$

29.3.2.6.2 End of the window

29.3.2.6.2.1 Test purpose

To test the correct handling of checkpoint recovery at the end of the window.

29.3.2.6.2.2 Method of test

Initial Conditions

System Simulator:

The SS is configured to use default RLP parameters.

Mobile Station:

The MS is configured to use RLP default parameters except the window size from MS to IWF (SS), called KMI.

A non transparent data call will be established, so that the MS is in call state U10 ("Call Active").

Since some RLP parameters are different from the default parameters, a negotiation procedure will be initiated by the MS after the CONNECKT ACKNOWLEDGE message. The MS may negotiate the RLP default parameters within allowed ranges, defined in GSM 04.22, except the window size from MS to IWF (SS), called KMI, which has to be a non default value.

The SS shall accept and use the new RLP parameters till the end of the test.

After the negotiation procedure the ABM will be entered. This test is repeated twice with 2 different values of KMI, randomly chosen.

Procedure

The MS is made to send continuously I+S frames with a delay inferior to T1 between each frame.

The SS does not acknowledge the received I+S frames in RR frames.

The MS stops sending I+S frames after having sent KMI frames without acknowledgement, due to the window size.

At the expiry of T1 after the last sending I+S frame, the MS shall send a supervisory command RR frame with P bit set to 1.

The SS answer in a RR response frame with F bit set to 1 and acknowledging $j < KMI$ frames (j is randomly chosen).

The MS shall retransmit the $KMI - j$ lost I+S frames and then shall continue to send I+S frames.

The SS acknowledges the received I+S frames in RR frames.

The MS is returned to the idle state by clearing of the call.

Expected sequence

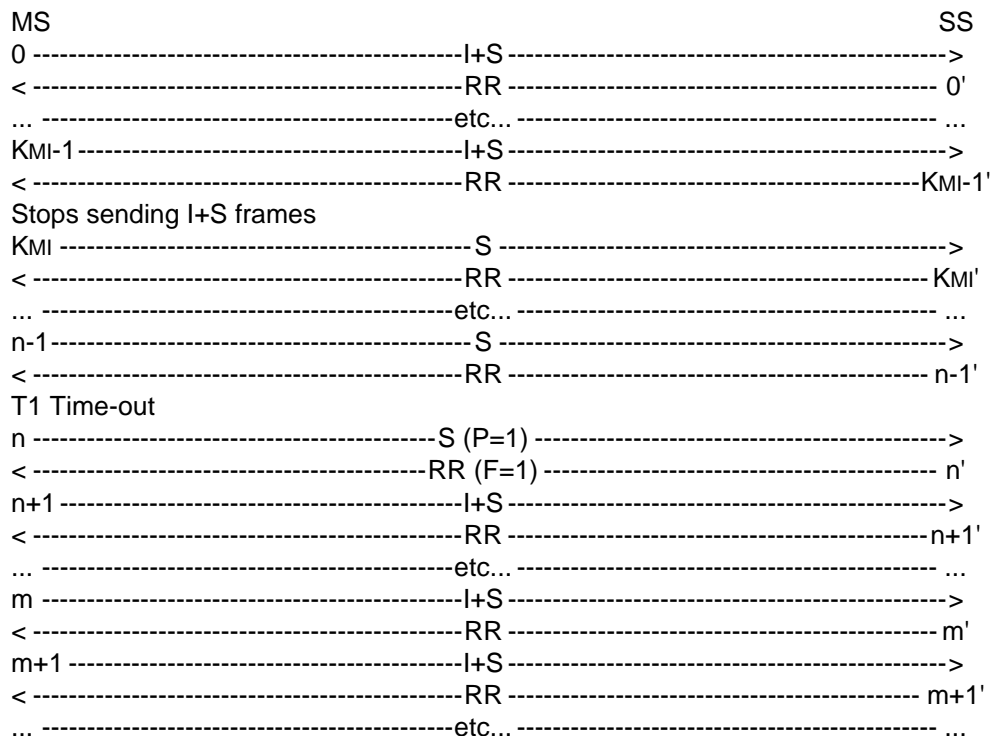

The frames from the SS will be:

0',...,n-1': One RR frame containing:

$$N(R)=NMS \text{ mod}(62).$$

n': One supervisory RR frame containing:

$$\begin{aligned} C/R=0, \\ P/F=1, \\ N(R)=NMS+i-1+j \text{ mod}(62). \end{aligned}$$

n+1',...: One supervisory RR frame containing:

$$N(R)=NMS+i+j \text{ mod}(62).$$

29.3.2.6.2.3 Test requirements

The frames from the MS shall be:

0, ..., KMI-1: One I+S frame containing:

$$N(S)=NMS, \dots, NMS+KMI-1 \text{ mod}(62).$$

KMI, ..., n-1: The MS stops sending I+S frames. It sends S frames.

n: On T1 Time-out after the last sent I+S frame, the MS sends a S frame containing C/R=1 and P/F=1.

n+1, ..., m: The MS retransmits the lost I+S frames, it send I+S frames containing $N(S)=NMS-1+j, \dots, NMS+KMI-1 \text{ mod}(62)$.

m+1,...: One I+S frames containing:

$$N(S)=NMS+KMI,\dots \text{ mod}(62)$$

29.3.2.6.3 End of a sequence

29.3.2.6.3.1 Test purpose

To test the correct handling of checkpoint recovery at the end of a sequence of frames

29.3.2.6.3.2 Method of test

Initial Conditions

System Simulator:

The SS is configured to use default RLP parameters.

Mobile Station:

The MS is configured to use RLP default parameters except the window size from MS to IWF (SS), called KMI.

A non transparent data call will be established, so that the MS is in call state U10 ("Call Active").

Since some RLP parameters are different from the default parameters, a negotiation procedure will be initiated by the MS after the CONNECKT ACKNOWLEDGE message. The MS may negotiate the RLP default parameters within allowed ranges, defined in GSM 04.22, except the window size from MS to IWF (SS), called KMI, which has to be a non default value.

The SS shall accept and use the new RLP parameters till the end of the test.

After the negotiation procedure the ABM will be entered.

This test is repeated twice with 2 different values of KMI, randomly chosen.

Procedure

The MS is made to send a sequence of i I+S frames ($1 < i < K_{IM}$) with a delay inferior to T1 between each frame.

The SS does not acknowledge the received I+S frames.

The MS sends S frames.

At the expiry of T1 after the last sending I+S frame, the MS shall send a supervisory command RR frame with P bit set to 1.

The SS answer in a RR response frame with F bit set to 1 and acknowledging j<i frames (j is randomly chosen).

The MS shall retransmit the i-j lost I+S frames.

The SS acknowledges the received I+S frames in RR frames.

The MS is returned to the idle state by clearing of the call.

Expected sequence

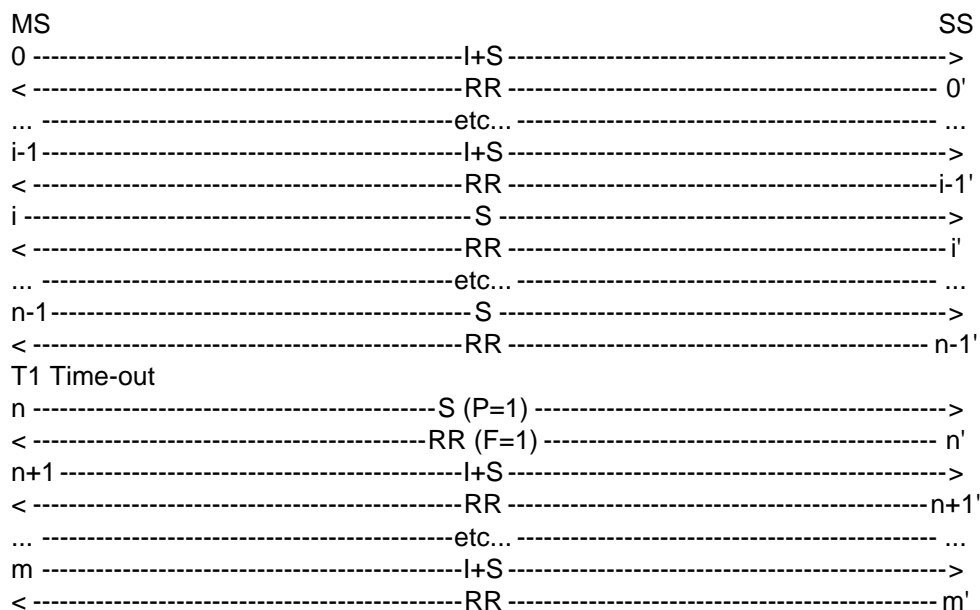

The frames from the SS will be:

0',...,n-1': One RR frame containing:

$$N(R)=NMS \text{ mod}(62).$$

n': One supervisory RR frame containing:

$$\begin{aligned} C/R=0, \\ P/F=1, \\ N(R)=NMS+j \text{ mod}(62). \end{aligned}$$

n+1',...: One supervisory RR frame containing:

$$N(R)=NMS+j \text{ mod}(62).$$

29.3.2.6.3.3 Test requirements

The frames from the MS shall be:

0,...,i-1: One I+S frame containing:

$$N(S)=NMS, \dots, NMS+i-1 \text{ mod}(62).$$

i-1,...,n-1: The MS sends S frames.

n: On T1 Time-out after the last sent I+S frame, the MS sends a S frame containing C/R=1 and P/F=1.

n+1,...,m: The MS retransmits the lost I+S frames, it send I+S frames containing $N(S)=NMS+j, \dots, NMS+i-1 \text{ mod}(62)$.

29.3.2.6.4 Time-out of one frame

29.3.2.6.4.1 Test purpose

To test the correct handling of checkpoint recovery when a frame is not acknowledge.

29.3.2.6.4.2 Method of test**Initial Conditions**

System Simulator:

The SS is configured to use default RLP parameters.

Mobile Station:

The MS is configured to use default RLP parameters.

A non transparent data call will be established, so that the MS is in call state U10 ("Call Active").

Case a: No negotiation will be initiated by the MS.

Case b: The MS initiates negotiation of RLP default parameters.

NOTE: The MS is allowed to initiate the negotiation of the RLP default parameters, within allowed ranges, defined in GSM 04.22. The MS shall do this in the ADM, after having sent a CONNECT ACKNOWLEDGE message (MO-case) or after having received a CONNECT ACKNOWLEDGE message from the SS (MT-case). The SS shall accept and use the new RLP parameters till the end of the test.

The ABM will be entered.

Procedure

The MS is made to send only one I+S frames.

The SS does not acknowledge the received I+S frame.

At the expiry of T1 after the sending of the I+S frame, the MS shall send a supervisory command RR frame with P bit set to 1.

The SS answer in a RR response frame with F bit set to 1 and N(R) corresponding to the I+S frame sent by the MS.

The MS shall retransmit the I+S frame.

The SS acknowledges the received I+S frame in RR frame.

The MS is returned to the idle state by clearing of the call.

Expected sequence

MS	SS
0----- I+S ----->	>
<----- RR -----0'	0'
1----- S ----->	>
<----- RR -----1'	1'
...----- etc... ----->	>
n-1----- S ----->	>
<----- RR -----n-1'	n-1'
T1 Time-out	
n----- S (P=1)----->	>
<----- RR (F=1) -----n'	n'
n+1----- I+S ----->	>
<----- RR -----n+1'	n+1'

The frames from the SS will be:

0',...,n-1': One RR frame containing:

$$N(R)=NMS \text{ mod}(62).$$

n': One supervisory RR frame containing:

$$\begin{aligned} C/R &= 0, \\ P/F &= 1, \\ N(R) &= NMS \text{ mod}(62). \end{aligned}$$

n+1': One supervisory RR frame containing:

$$N(R)=NMS+1 \text{ mod}(62).$$

29.3.2.6.4.3 Test requirements

The frames from the MS shall be:

0,: One I+S frame containing:

$$N(S)=NMS \text{ mod}(62).$$

1,...,n-1: The MS sends S frames.

n: On T1 Time-out after the I+S frame, the MS sends a S frame containing C/R=1 and P/F=1.

n+1: The MS retransmits the I+S frame containing $N(S)=NMS \text{ mod}(62)$.

29.3.2.6.5 No response to checkpointing

29.3.2.6.5.1 Test purpose

To test the correct repetition of a frame with P=1 if SS does not answer to checkpointing.

29.3.2.6.5.2 Method of test

Initial Conditions

System Simulator:

The SS is configured to use default RLP parameters.

Mobile Station:

The MS is configured to use default RLP parameters.

A non transparent data call will be established, so that the MS is in call state U10 ("Call Active").

Case a: No negotiation will be initiated by the MS.

Case b: The MS initiates negotiation of RLP default parameters.

NOTE: The MS is allowed to initiate the negotiation of the RLP default parameters, within allowed ranges, defined in GSM 04.22. The MS shall do this in the ADM, after having sent a CONNECT ACKNOWLEDGE message (MO-case) or after having received a CONNECT ACKNOWLEDGE message from the SS (MT-case). The SS shall accept and use the new RLP parameters till the end of the test.

The ABM will be entered.

Procedure

The MS is made to send only one I+S frames.

The SS does not acknowledge the received I+S frame.

At the expiry of T1 after the sending of the I+S frame, the MS shall send a supervisory command RR frame with P bit set to 1.

The SS answer in a RR response frame with F bit set to 0 and N(R) acknowledging the I+S frame sent by the MS.

At the expiry of T1 after the sending of the frame with P=1, the MS shall send a new supervisory command RR frame with P bit set to 1.

The SS answer in a RR response frame with F bit set to 1 and N(R) corresponding to the I+S frame sent by the MS.

The MS shall retransmit the I+S frame.

The SS acknowledges the received I+S frame in RR frame.

The MS is returned to the idle state by clearing of the call.

Expected sequence

MS	SS
0----- I+S ----->	>
<----- RR ----->	0'
1----- S ----->	>
<----- RR ----->	1'
...----- etc... ----->	...
n-1----- S ----->	>
<----- RR ----->	n-1'
T1 Time-out	
n----- S (P=1)----->	>
<----- RR (F=0) ----->	n'
T1 Time-out	
n+1----- S (P=1)----->	>
<----- RR (F=1) ----->	n+1'
n+2----- I+S ----->	>
<----- RR ----->	n+2'

The frames from the SS will be:

0',...,n-1': One RR frame containing:

$$N(R)=NMS \text{ mod}(62).$$

n': One supervisory RR frame containing:

$$\begin{aligned} C/R &= 0, \\ P/F &= 0, \\ N(R) &= NMS + 1 \text{ mod}(62). \end{aligned}$$

n+1': One supervisory RR frame containing:

$$C/R = 0,$$

$P/F=1$,
 $N(R)=NMS \bmod(62)$.

n+2': One supervisory RR frame containing:

$N(R)=NMS+1 \bmod(62)$.

29.3.2.6.5.3 Test requirements

The frames from the MS shall be:

0,: One I+S frame containing:

$N(S)=NMS \bmod(62)$.

1,...,n-1: The MS sends S frames.

n: On T1 Time-out after the I+S frame, the MS sends a S frame containing C/R=1 and P/F=1.

n+1: On T1 Time-out after the sending of the first frame with P=1, the MS sends a S frame containing C/R=1 and P/F=1.

n+2: The MS retransmits the I+S frame containing $N(S)=NMS \bmod(62)$.

29.3.2.6.6 Incorrect response to checkpointing

29.3.2.6.6.1 Test purpose

To test the correct repetition of a frame with P=1 if the answer to checkpointing is incorrect.

29.3.2.6.6.2 Method of test

Initial Conditions

System Simulator:

The SS is configured to use default RLP parameters.

Mobile Station:

The MS is configured to use default RLP parameters.

A non transparent data call will be established, so that the MS is in call state U10 ("Call Active").

Case a: No negotiation will be initiated by the MS.

Case b: The MS initiates negotiation of RLP default parameters.

NOTE: The MS is allowed to initiate the negotiation of the RLP default parameters, within allowed ranges, defined in GSM 04.22. The MS shall do this in the ADM, after having sent a CONNECT ACKNOWLEDGE message (MO-case) or after having received a CONNECT ACKNOWLEDGE message from the SS (MT-case). The SS shall accept and use the new RLP parameters till the end of the test.

The ABM will be entered.

Procedure

The MS is made to send only one I+S frames.

The SS does not acknowledge the received I+S frame.

The MS sends supervisory frame with P set to 0 when it has nothing else to send.

At the expiry of T1 after the sending of the I+S frame, the MS shall send a supervisory command RR frame with P bit set to 1.

The SS answer in a supervisory SREJ response frame with F bit set to 1 and N(R) rejecting the I+S frame sent by the MS.

At the expiry of T1 after the sending of the frame with P=1, the MS shall send a new supervisory command RR frame with P bit set to 1.

The SS answer in a supervisory REJ response frame with F bit set to 1 and N(R) rejecting the I+S frame sent by the MS.

At the expiry of T1 after the sending of the frame with P=1, the MS shall send a new supervisory command RR frame with P bit set to 1.

The SS answer in a RR response frame with F bit set to 1 and N(R) corresponding to the I+S frame sent by the MS.

The MS shall retransmit the I+S frame.

The SS acknowledges the received I+S frame in RR frame.

The MS is returned to the idle state by clearing of the call.

Expected sequence

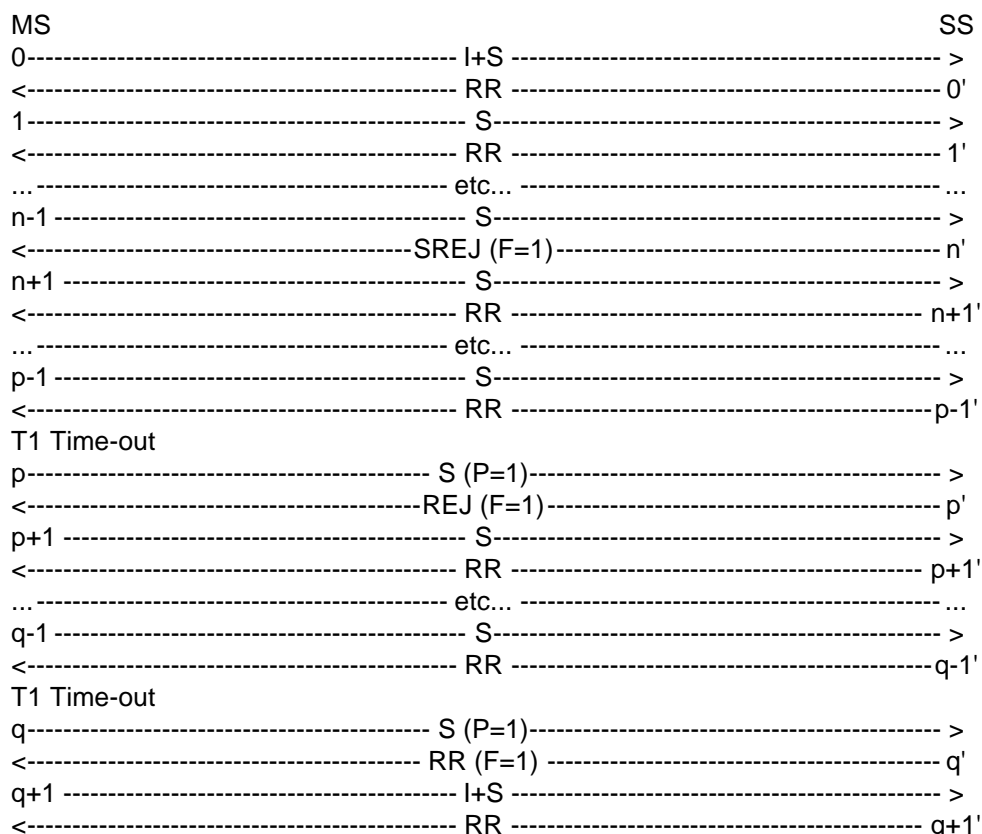

The frames from the SS will be:

0',...,n-1': One RR frame containing:

$$N(R)=NMS \bmod(62).$$

n': One supervisory SREJ frame containing:

C/R=0,
P/F=1,
N(R)=NMSmod(62).

m+1',...,p-1': One RR frame containing:

N(R)=NMS mod(62).

p': One supervisory REJ frame containing:

C/R=0,
P/F=1,
N(R)=NMSmod(62).

p+1',...,q-1': One RR frame containing:

N(R)=NMS mod(62).

q': One supervisory RR frame containing:

C/R=0,
P/F=1,
N(R)=NMSmod(62).

q+1': One RR frame containing:

N(R)=NMS+1 mod(62).

29.3.2.6.6.3 Test requirements

The frames from the MS shall be:

0,: One I+S frame containing:

N(S)=NMS mod(62).

1,...,n-1: The MS sends S frames.

n: On T1 Time-out after the I+S frame, the MS sends a S frame containing:

C/R=1,
P/F=1.

n+1',...,p-1: The MS sends S frames.

p: On T1 Time-out after the I+S frame, the MS sends a S frame containing:

C/R=1,
P/F=1.

p+1',...,q-1: The MS sends S frames.

q: On T1 Time-out after the I+S frame, the MS sends a S frame containing:

C/R=1,
P/F=1.

q+1: The MS retransmits the I+S frame containing:

$N(S)=NMS \bmod(62)$.

29.3.2.6.7 Total loss of response to checkpointing

29.3.2.6.7.1 Test purpose

To test the correct handling of a total loss of response to checkpointing.

29.3.2.6.7.2 Method of test

Initial Conditions

System Simulator:

The SS is configured to use default RLP parameters.

Mobile Station:

The MS is configured to use RLP default parameters except the number of retransmission N2.

A non transparent data call will be established, so that the MS is in call state U10 ("Call Active").

Since some RLP parameters are different from the default parameters, a negotiation procedure will be initiated by the MS after the CONNECKT ACKNOWLEDGE message. The MS may negotiate the RLP default parameters within allowed ranges, defined in GSM 04.22, except the number of retransmission N2, which has to be a non default value.

The SS shall accept and use the new RLP parameters till the end of the test.

After the negotiation procedure the ABM will be entered.

This test is repeated twice with 2 different values of N2, randomly chosen.

Procedure

The MS is made to send only one I+S frames.

The SS does not acknowledge the received I+S frame.

At the expiry of T1 after the sending of the I+S frame, the MS shall send a supervisory command RR frame with P bit set to 1.

The SS answer in a RR response frame with F bit set to 0 and N(R) acknowledging the I+S frame sent by the MS.

At the expiry of T1 after the sending of the frame with P=1, the MS shall send a new supervisory command RR frame with P bit set to 1.

The SS answer in a RR response frame with F bit set to 0 and N(R) corresponding to the I+S frame sent by the MS.

These 2 last steps are repeated N2 times.

At the expiry of T1 after the sending of the frame with P=1, the MS shall reset (SABM) or disconnect (DISC) the link.

The SS answer with an UA frame.

The MS is returned to the idle state by clearing of the call.

Expected sequence

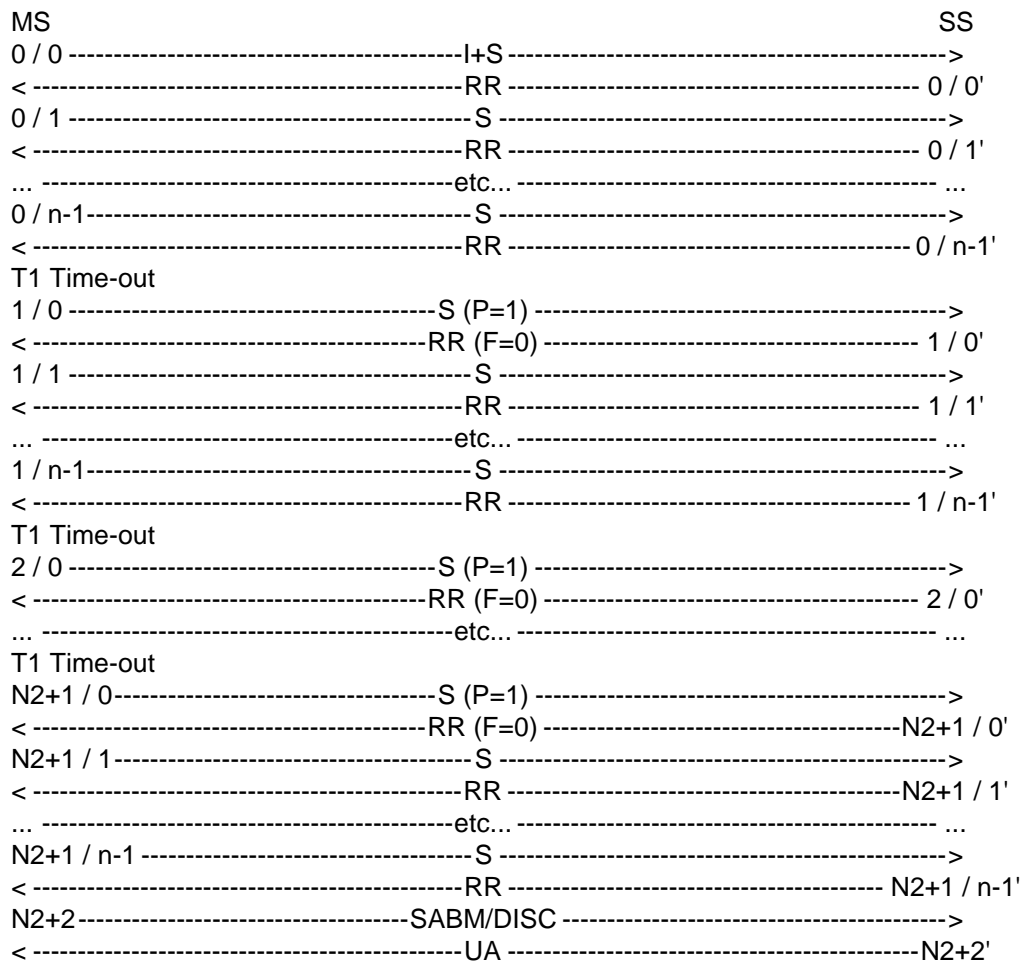

The frames from the SS will be:

0 / i',...,0 / i': One RR frame containing:

P/F=0,
 N(R)=NMS mod(62).
 i = 0, ..., n-1.

k / i',...,k / i': One RR frame containing:

P/F=0,
 N(R)=NMS mod(62).
 k = 1, ..., N2+1, i = 0, ..., n-1.

N2+2': One UA frame containing:

C/R=0,
 P/F=P/F received in the DISC or SABM.

29.3.2.6.7.3 Test requirements

The frames from the MS shall be:

0 / 0: One I+S frame containing:

N(S)=NMS mod(62).

0 / 1, ..., 0 / n-1: The MS sends S frames.

k / 0: On T1 Time-out after the I+S frame, the MS sends a S frame containing:

C/R=1,
P/F=1.
k = 1,..., N2+1.

k / 1,..., k / n-1: The MS sends S frames.

N2+2: The MS sends a SABM (C/R=1, P/F=1) or a DISC(C/R=1) frame.

29.3.2.6.8 Retransmission of a sequence

29.3.2.6.8.1 Test purpose

To test the correct repetition of a sequence of frame.

29.3.2.6.8.2 Method of test

Initial Conditions

System Simulator:

The SS is configured to use default RLP parameters.

Mobile Station:

The MS is configured to use RLP default parameters except the number of retransmission N2.

A non transparent data call will be established, so that the MS is in call state U10 ("Call Active").

Since some RLP parameters are different from the default parameters, a negotiation procedure will be initiated by the MS after the CONNECKT ACKNOWLEDGE message. The MS may negotiate the RLP default parameters within allowed ranges, defined in GSM 04.22, except the number of retransmission N2, which has to be a non default value.

The SS shall accept and use the new RLP parameters till the end of the test.

After the negotiation procedure the ABM will be entered.

This test is repeated twice with 2 different values of N2, randomly chosen. The window size from MS to IWF (SS) is called K_M.

Procedure

The MS is made to send a sequence of i I+S frames ($1 < i < K_M$) with a delay inferior to T1 between each frame.

The SS does not acknowledge the received I+S frames.

The MS starts sending supervisory frames after having sent i frames.

At the expiry of T1 after the last sending I+S frame, the MS shall send a supervisory command RR frame with P bit set to 1.

The SS answers in a RR response frame with F bit set to 1 and acknowledging no frames.

The MS shall retransmit the all I+S frames. Then the MS shall sends supervisory frames.

At the expiry of T1 after the last sending I+S frame, the MS shall send a supervisory command RR frame with P bit set to 1.

The SS answers in a RR response frame with F bit set to 1 and acknowledging $j < i$ frames. (j randomly chosen).

The MS shall retransmit the $i-j$ lost I+S frames.

$0,25 \cdot T_1$ after the last I+S frame of the sequence, the SS acknowledges all the received I+S frames in RR frame.

The MS is returned to the idle state by clearing of the call.

Expected sequence

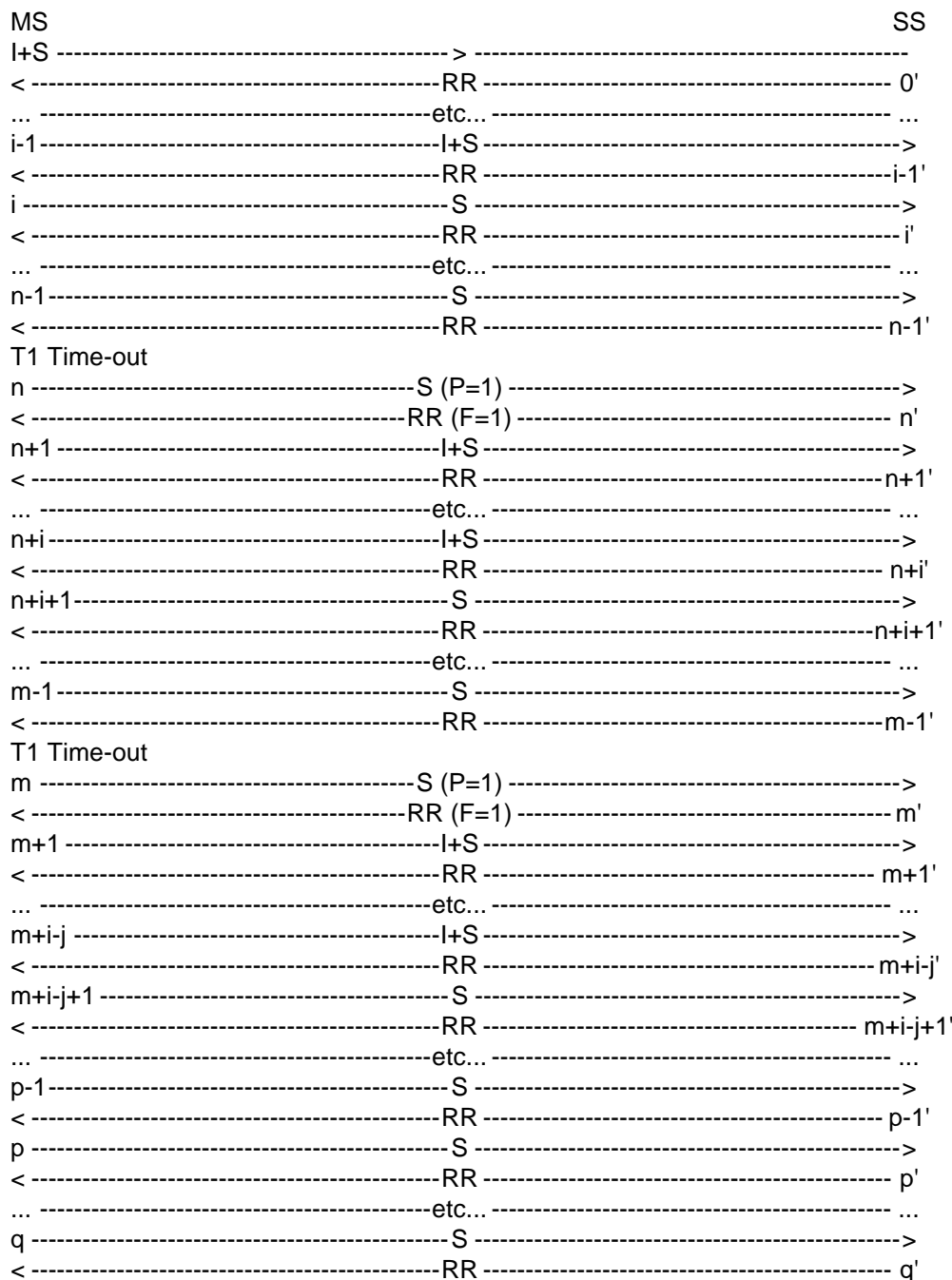

The frames from the SS will be:

0',...,n-1': One RR frame containing:

$$N(R)=NMS \bmod(62).$$

n': One supervisory RR frame containing:

$$\begin{aligned} C/R &= 0, \\ P/F &= 1, \\ N(R) &= NMS \bmod(62). \end{aligned}$$

n+1', ..., m-1': One supervisory RR frame containing:

$$N(R)=NMS \bmod(62).$$

m': One supervisory RR frame containing:

$$\begin{aligned} C/R &= 0, \\ P/F &= 1, \\ N(R) &= NMS+j \bmod(62). \end{aligned}$$

m+1, ..., p-2': One supervisory RR frame containing:

$$N(R)=NMS+j \bmod(62).$$

p-1': 0,25*T1 after the last received I+S frame, the SS sends a supervisory RR frame containing:

$$N(R)=NMS+i \bmod(62).$$

p', ..., q': during at least T1, the SS sends supervisory frames.

29.3.2.6.8.3 Test requirements

The frames from the MS shall be:

0, ..., i-1: One I+S frame containing:

$$N(S)=NMS, \dots, NMS+i-1 \bmod(62).$$

i, ..., n-1: The MS sends S frames with P bit set to 0.

n: On T1 Time-out after the I+S frame, the MS sends a S frame containing:

$$\begin{aligned} C/R &= 1, \\ P/F &= 1. \end{aligned}$$

n+1, ..., n+i: The MS retransmits the I+S frames containing:

$$N(S)=NMS, \dots, NMS+i-1 \bmod(62).$$

n+i+1, ..., m-1: The MS sends S frames with P bit set to 0.

m: On T1 Time-out after the I+S frame, the MS sends a S frame containing:

$$\begin{aligned} C/R &= 1, \\ P/F &= 1. \end{aligned}$$

m+1, ..., m+i-j: The MS retransmits the I+S frames containing:

$$N(S)=NMS+j, \dots, NMS+i-1 \bmod(62).$$

m+i-j+1, ..., q: The MS sends S frames with P bit set to 0.

29.3.2.6.9 N2 retransmission of a sequence

29.3.2.6.9.1 Test purpose

To test the correct repetition of a sequence of frame.

29.3.2.6.9.2 Method of test

Initial Conditions

System Simulator:

The SS is configured to use default RLP parameters.

Mobile Station:

The MS is configured to use RLP default parameters except the number of retransmission N2.

A non transparent data call will be established, so that the MS is in call state U10 ("Call Active").

Since some RLP parameters are different from the default parameters, a negotiation procedure will be initiated by the MS after the CONNECKT ACKNOWLEDGE message. The MS may negotiate the RLP default parameters within allowed ranges, defined in GSM 04.22, except the number of retransmission N2, which has to be a non default value.

The SS shall accept and use the new RLP parameters till the end of the test.

After the negotiation procedure the ABM will be entered.

This test is repeated twice with 2 different values of N2, randomly chosen.

The window size from MS to IWF (SS) is called KMI. Procedure

The MS is made to send a sequence of i I+S frames ($1 < i < KMI$, and $i > N2$) with a delay inferior to T1 between each frame.

The SS does not acknowledge the received I+S frames.

The MS shall send S frames after having sent the i I+S frames.

At the expiry of T1 after the last sending I+S frame, the MS shall send a supervisory command RR frame with P bit set to 1.

The SS answer in a RR response frame with F bit set to 1 and acknowledging 1 frame.

The MS shall retransmit the $i-1$ lost I+S frames.

The SS does not acknowledge the received I+S frames.

The MS shall send S frames after having sent the i I+S frames.

The 5 last steps are repeated N2 times.

At the expiry of T1 after the last sending I+S frame, the MS shall reset or disconnect the RLP link by sending an SABM (C/R=1, P/F=1) or a DISC (C/R=1) frame.

The SS answer with an UA frame.

The MS is returned to the idle state by clearing of the call.

Expected sequence

```

MS                                                    SS
0----- I+S ----->
<----- RR -----0'
...----- etc... -----...
i-1----- I+S ----->
<----- RR -----i-1'
i----- S ----->
<----- RR -----i'
...----- etc... -----...
n----- S ----->
<----- RR -----n'
T1 Time-out
1 / 0----- S (P=1)----->
<----- RR (F=1) -----1 / 0'
1 / 1----- I+S ----->
<----- RR -----1 / 1'
...----- etc... -----...
1 / i-1----- I+S ----->
<----- RR -----1 / i-1'
1 / i----- S ----->
<----- RR -----1 / i'
...----- etc... -----...
1 / n1----- S ----->
<----- RR -----1 / n1'
T1 Time-out
2 / 0----- S (P=1)----->
<----- RR (F=1) -----2 / 0'
2 / 1----- I+S ----->
<----- RR -----2 / 1'
...----- etc... -----...
2 / i-2----- I+S ----->
<----- RR -----2 / i-2'
2 / i-1----- S ----->
<----- RR -----2 / i'
...----- etc... -----...
2 / n2----- S ----->
<----- RR -----2 / n2'
...----- etc... -----...
T1 Time-out
N2 / 0----- S (P=1)----->
<----- RR (F=1) -----N2 / 0'
N2 / 1----- I+S ----->
<----- RR -----N2 / 1'
...----- etc... -----...
N2 / i-N2----- I+S ----->
<----- RR -----N2 / i-N2'
N2 / i-N2+1----- S ----->
<----- RR -----N2 / i-N2+1'
...----- etc... -----...
N2 / nN2----- S ----->
<----- RR -----2 / nN2'
T1 Time-out
N2+1 / 0----- SABM/DISC ----->
<----- UA -----N2+1 / 0'

```

The frames from the SS will be:

0',...,n': One RR frame containing:

$$N(R)=NMS \bmod(62).$$

k / 0': One supervisory RR frame containing:

$$\begin{aligned} C/R &= 0, \\ P/F &= 1, \\ N(R) &= NMS+k \bmod(62). \\ k &= 1, \dots, N2. \end{aligned}$$

k / 1',...,k / nk': One RR frame containing:

$$\begin{aligned} N(R) &= NMS+k \bmod(62). \\ k &= 1, \dots, N2. \end{aligned}$$

N2+1 / 0': One UA frame with P/F bit equal to the P/F received.

29.3.2.6.9.3 Test requirements

The frames from the MS shall be:

0, ..., i-1: One I+S frame containing:

$$N(S)=NMS, \dots, NMS+i-1 \bmod(62).$$

i, ..., n: The MS sends S frames.

k / 0: The MS stops sending I+S frames. It sends S frames. On T1 Time-out after the last sent I+S frame, the MS sends a S frame containing:

$$\begin{aligned} C/R &= 1, \\ P/F &= 1. \\ k &= 1, \dots, N2. \end{aligned}$$

k / 1, ..., k / i-k: The MS retransmits the I+S frames containing:

$$\begin{aligned} N(S) &= NMS+k, \dots, NMS+i-1 \bmod(62). \\ k &= 0, \dots, N2. \end{aligned}$$

k / i-k+1, ..., k / nk: The MS sends S frames. k= 1, ..., N2.

N2+1 / 0: The MS shall reset to disconnect the RLP link. It shall send an SABM (C/R=1, P/F=1) or a DISC (C/R=1).

29.3.3 Negotiation of the RLP parameters

29.3.3.1 Negotiation initiated by the SS

29.3.3.1.1 Conformance requirements

The MS shall be able to respond to a negotiation request from the network and to configure its RLP parameters accordingly. It shall do so in ABM mode as well as in ADM mode.

References

GSM 04.22 section 5.2.2.6.

29.3.3.1.2 Test purpose

To test the correct handling of the MS to a received XID frame in ADM or ABM mode.

29.3.3.1.3 Test method

Initial Conditions

System Simulator:

The SS is configured to use default RLP parameters.

Mobile Station:

The MS is configured to use RLP default parameters. The window size from IWF (SS) to MS is called K_{IM} .

The MS is made to establish a MO non transparent data call. In initial conditions MS is in call state U10 ("Call Active") after having sent a CONN_ACK message.

Case a: No negotiation will be initiated by the MS.

Case b: The MS initiates negotiation of RLP default parameters.

NOTE: The MS is allowed to initiate the negotiation of the RLP default parameters, within allowed ranges, defined in GSM 04.22. The MS shall do this in the ADM, after having sent a CONNECT ACKNOWLEDGE message (MO-case) or after having received a CONNECT ACKNOWLEDGE message from the SS (MT-case.)

Related PICS/PIXIT statements

Supported bearer services; characteristics of non-transparent services.

Foreseen final state of the MS

Idle.

Test procedure

Case 1: Testing of the correct handling of the MS to a received XID frame in ADM

Immediately after having received the "CONN_ACK", the SS sends a correct XID frame containing randomly chosen parameters different from the default parameters and supported by the MS.

If the MS initiates a negotiation procedure, before the SS is able to transmit the XID frame (timing conflict), the SS should accept this - XID frame from the MS and start his own negotiation afterwards.

The MS shall respond with a XID frame. If parameters sent in this frame are different from those chosen by the SS, the correct sense of negotiation is checked. The final parameters are noted (T_1 , T_2 , N_2 , K_{IM} (window IWF (SS) -> MS), K_{MI} (window MS -> IWF (SS))).

The MS sends a SABM and the SS answers with an UA. Note: the SABM frame may be sent by the MS before the XID response frame. In such a case, the SS waits for the XID response before sending the UA.

Case 2: Testing of the correct handling of the MS to a received XID frame in ABM

The MS sends a SABM and the SS answer with an UA.

The SS sends a correct XID frame containing parameters different from the default parameters and supported by the MS.

The MS shall respond with a XID frame. If parameters sent in this frame are different from those chosen by the SS, the correct sense of negotiation is checked. The final parameters are noted (T_1 , T_2 , N_2 , K_{IM} (window IWF (SS) \rightarrow MS), K_{MI} (window MS \rightarrow IWF (SS))).

The SS checks that the MS uses the new parameters determined during the negotiation procedure.

Verification of T_2

After optional status bits exchange between the MS and the SS, the SS is configured to send I+S frames with a delay inferior to T_1 between each frame. The MS is made to send no user data, it sends only supervisory frame.

The SS sends an I+S frame numbered $N(S)=N_{ss} \bmod(62)$, the MS shall acknowledge this frame within T_2 .

Verification of K_{IM}

The SS sends an I+S frame numbered $N_{ss}+K_{IM}+1 \bmod(62)$. The MS shall ignore this frame (out of the window), it shall not acknowledge or reject it. This is checked during at least T_2 .

The SS sends an I+S frame numbered $N(S)=N_{ss}+1 \bmod(62)$, the MS shall acknowledge this frame.

The SS sends an I+S frame numbered $N_{ss}+K_{IM}+1 \bmod(62)$. The MS shall reject all the lost frames numbered $N_{ss}+2 \bmod(62)$ to $N_{ss}+K_{IM} \bmod(62)$. It shall send a REJ or SREJ frame with $N(R)=N_{ss}+2 \bmod(62)$.

If REJ frame is used by the MS, the SS restarts the transmission of I+S frames from frame numbered $N_{ss}+2 \bmod(62)$. The MS shall acknowledge these frames. After having sent at least the frame numbered $N_{ss}+K_{IM}+2 \bmod(62)$, the SS stops sending I+S frames.

If SREJ frame is used by the MS, the SS restarts the transmission of I+S frames from frame numbered $N_{ss}+2 \bmod(62)$. It does send the frame numbered $N_{ss}+K_{IM}+1 \bmod(62)$ a second time. The MS shall acknowledge these frames. After having sent at least the frame numbered $N_{ss}+K_{IM}+2 \bmod(62)$, the SS stops sending I+S frames.

Verification of K_{MI}

The MS is now configured to send continuously I+S frames with a delay inferior to T_1 between each frame.

The MS sends I+S frames, the SS does not acknowledge these frames.

After having sent K_{MI} I+S frames, the MS shall stop sending I+S frames (end of the window).

Verification of T_1

At the expiry of T_1 after the last I+S frame, the MS shall enter in "checkpoint recovery" mode, it shall send a supervisory RR frame with $C=1$ and $P=1$.

The SS does not answer to checkpointing.

Verification of N_2

At the expiry of T_1 after the last RR ($C=1$, $P=1$) frame, the MS shall resend a supervisory RR frame with $C=1$ and $P=1$. The SS does not answer to checkpointing. This is repeated N_2 times.

After N_2 retransmissions of the same RR frame ($C=1$, $P=1$), The MS shall reset or disconnect the RLP link by sending a SABM ($C=1$, $P=1$) or a DISC ($C=1$) frame. The SS answers with an UA ($R=0$) frame with F bit set to P bit received in SABM or DISC frame.

The MS is returned to the idle state by clearing of the call.

The test is performed for case 1 and 2.

Maximum duration of test

1 minute.

Expected sequence

	MS				SS
Case 1					
	optionally:				
		-----	XID	----->	
		<-----	XID	-----	
				
		<-----	XID	-----	0'
	0	-----	XID	----->	
	1	-----	SABM	----->	
		<-----	UA	-----	1'
Case 2					
	optionally:				
		-----	XID	----->	
		<-----	XID	-----	
				
	0	-----	SABM	----->	
		<-----	UA	-----	0'
		(-----	I+S	----->)	Optional
		(<-----	S	-----)	
		<-----	XID	-----	1'
	1	-----	XID	----->	
		<-----	I+S	-----	2'
	2	-----	RR	----->	
		<-----	I+S	-----	3'
	3	-----	RR	----->	
		<-----	I+S	-----	4'
	4	-----	RR	----->	
		<-----	I+S	-----	5'
	5	-----	REJ or SREJ	----->	
		<-----	I+S	-----	6'
	6	-----	RR	----->	
	...		etc...		...
		<-----	I+S	-----	i-1'
	i-1	-----	RR	----->	

	<-----	RR	-----	i'
i	-----	RR	----->	
...		etc...		...
	<-----	RR	-----	j-1'
j-1	-----	RR	----->	
j	-----	I+S	----->	
	<-----	RR	-----	j'
...		etc...		...
j+K _{MI} -1	-----	I+S	----->	
	<-----	RR	-----	j+K _{MI} -1'
j+K _{MI}	-----	RR (P=1)	----->	
	<-----	RR	-----	j+K _{MI} '
j+K _{MI} +1	-----	RR (P=1)	----->	
	<-----	RR	-----	j+K _{MI} +1'
...		etc...		...
j+K _{MI} +N ₂	-----	RR (P=1)	----->	
	<-----	RR	-----	j+K _{MI} +N ₂ '
j+K _{MI} +N ₂ +1	-----	SABM / DISC	----->	
	<-----	UA	-----	j+K _{MI} +N ₂ +1'

The frame from the SS will be:

Case 1:

0': One XID frame containing: C=1, P=1.

1': One UA frame containing: R=0, F=1. Note: If SABM is received before the reception of the XID response frame, the SS will wait for the XID before sending the UA frame.

Case 2:

0': One UA frame containing: R=0, F=1.

1': One XID frame containing: C=1, P=1.

2': One I+S frame containing $N(S)=N_{ss} \bmod(62)$, $N(R)=N_{ms} \bmod(62)$.

3': One I+S frame containing $N(S)=N_{ss}+K_{IM}+1 \bmod(62)$, $N(R)=N_{ms} \bmod(62)$.

4': A delay D ($T_2 < D < T_1$) after step 3', one I+S frame containing $N(S)=N_{ss}+1 \bmod(62)$, $N(R)=N_{ms} \bmod(62)$.

5': One I+S frame containing $N(S)=N_{ss}+K_{IM}+1 \bmod(62)$, $N(R)=N_{ms} \bmod(62)$.

If REJ frame is used by the MS:

6',..., K_{IM}+5': One I+S frame containing $N(S)=N_{ss}+2, \dots, N_{ss}+K_{IM}+1 \bmod(62)$, $N(R)=N_{ms} \bmod(62)$.

K_{IM}+6',...,i-1': One I+S frame containing $N(S)=N_{ss}+K_{IM}+2, \dots, k-1 \bmod(62)$, $N(R)=N_{ms} \bmod(62)$.

If SREJ frame is used by the MS:

6',..., K_{IM}+4': One I+S frame containing $N(S)=N_{ss}+2, \dots, N_{ss}+K_{IM} \bmod(62)$, $N(R)=N_{ms} \bmod(62)$.

K_{IM}+5',...,i-1': One I+S frame containing $N(S)=N_{ss}+K_{IM}+2, \dots, k-1 \bmod(62)$, $N(R)=N_{ms} \bmod(62)$.

The SS stops sending I+S frames.

i',...,j-1': One RR frame containing, $N(R)=N_{ms} \bmod(62)$.

- $j', \dots, j+K_{MI}-1'$: One RR frame containing $N(R)=N_{MS} \bmod (62)$.
 $j+K_{MI}', \dots, j+K_{MI}+N_2'$: One RR ($R=0, F=0$) frame containing $N(R)=N_{MS} \bmod (62)$.
 $j+K_{MI}+N_2+1'$: One UA ($R=0$) frame with F bit set to P bit received in SABM or DISC frame.

Specific message content

The frame from the MS shall be:

Case 1:

- 0: One XID frame containing: $R=0, F=1$. The MS may changed the RLP parameters. In this case the SS verifies the correct sense of negotiation. The final parameters are noted ($T_1, T_2, N_2, K_{IM}, K_{MI}$).
 1: One SABM frame containing: $C=1, P=1$.

NOTE: The MS may send an SABM frame before the XID.

Case 2:

- 0: One SABM frame containing: $C=1, P=1$.
 1: One XID frame containing: $R=0, F=1$. The MS may changed the RLP parameters. In this case the SS verifies the correct sense of negotiation. The final parameters are noted ($T_1, T_2, N_2, K_{IM}, K_{MI}$).
 2: One RR frame containing $N(R)=N_{SS}+1 \bmod (62)$ within T_2 .
 3: One RR frame containing $N(R)=N_{SS}+1 \bmod (62)$.
 4: One RR frame containing $N(R)=N_{SS}+2 \bmod (62)$.
 5: One REJ or SREJ frame containing $N(R)=N_{SS}+2 \bmod (62)$.

If REJ frame is used by the MS:

- $6, \dots, K_{IM}+5$: One RR frame containing $N(R)=N_{SS}+3, \dots, N_{SS}+K_{IM}+2 \bmod (62)$.
 $K_{IM}+6, \dots, i-1$: One RR frame containing $N(R)=N_{SS}+K_{IM}+3, \dots, k \bmod (62)$.

If SREJ frame is used by the MS:

- $6, \dots, K_{IM}+3$: One RR frame containing $N(R)=N_{SS}+3, \dots, N_{SS}+K_{IM} \bmod (62)$.
 $K_{IM}+4$: One RR frame containing $N(R)=N_{SS}+K_{IM}+2 \bmod (62)$.
 $K_{IM}+5, \dots, i-1$: One RR frame containing $N(R)=N_{SS}+K_{IM}+3, \dots, k \bmod (62)$.

$i, \dots, j-1$: One RR frame containing, $N(R)=k \bmod (62)$.

The MS starts sending data.

- $j, \dots, j+K_{MI}-1$: One I+S frame containing $N(S)=N_{MS}, \dots, N_{MS}+K_{MI}-1 \bmod (62), N(R)=k \bmod (62)$.
 $j+K_{MI}$: T_1 after the last I+S frame sent, one supervisory RR ($C=1, P=1$) frame containing $N(R)=k \bmod (62)$.
 $j+K_{MI}+1, \dots, j+K_{MI}+N_2$: At T_1 expiry, one supervisory RR ($C=1, P=1$) frame containing $N(R)=k \bmod (62)$.
 $j+K_{MI}+N_2+1$: One SABM ($C=1, P=1$) or DISC ($C=1$) frame.

29.3.3.2 Negotiation initiated by the MS

29.3.3.2.1 Conformance requirements

The MS shall be able to initiate a negotiation with the network when its RLP parameters are set to non default values. It shall then configure its RLP parameters accordingly. It shall do so in ABM mode as well as in ADM mode.

References

GSM 04.22 section 5.2.2.6.

29.3.3.2.2 Test purpose

To test that the MS initiate the negotiation if RLP parameters are different from default parameters.

29.3.3.2.3 Test method

Initial Conditions

System Simulator:

The SS is configured to use default RLP parameters.

Mobile Station:

The MS is configured to use RLP arbitrary chosen parameters different from the default parameters.

- 1 - The MS is made to establish a MO non transparent data call. In initial conditions MS is in call state U10 ("Call Active") after having sent a CONN_ACK message.
- 2 - The MS is made to establish a MT non transparent data call. In initial conditions MS is in call state U10 ("Call Active") after having received a CONN_ACK message.

This test is performed for initial conditions 1 and 2.

Related PICS/PIXIT statements

Supported bearer services; characteristics of non-transparent services.

Foreseen final state of the MS

Idle.

Test procedure

The MS shall send an XID (C=1, P=1) frame containing a set of RLP parameters different from the default set. The SS answers with XID (R=0, F=1) containing new parameters randomly chosen, the sense of negotiation is correct. Optionally, a renegotiation initiated by the MS should be possible, if the parameters, randomly chosen by the SS are not supported by the MS. In this case, the SS should accept the parameters renegotiated by the MS, if they are within the allowed range defined in GSM 04.22. The final parameters are noted (T1, T2, N2, K_{IM} (window IWF (SS) -> MS), K_{MI} (window MS -> IWF (SS))).

The MS established the ABM mode by sending a SABM (C=1, P=1) frame. The SS answers with a UA (R=0, F=1) frame. The SABM frame may be sent by the MS before the XID. In such a case, the SS answers to the XID after having established the ABM mode (i.e. after having sent the UA).

The SS checks that the MS uses the new parameters determined during the negotiation procedure.

Verification of T2

The SS is configured to send I+S frames with a delay inferior to T1 between each frame. The MS is made to send no user data, it sends only supervisory frame.

The SS sends an I+S frame numbered N(S)=N_{ss} mod(62), the MS shall acknowledge this frame within T2.

Verification of K_{IM}

The SS sends an I+S frame numbered N_{ss}+K_{IM}+1 mod(62). The MS shall ignore this frame (out of the window), it shall not acknowledge or reject it. This is checked during at least T2.

The SS sends an I+S frame numbered N(S)=N_{ss}+1 mod(62), the MS shall acknowledge this frame.

The SS sends an I+S frame numbered $N_{SS}+K_{IM}+1 \bmod(62)$. The MS shall reject all the lost frames numbered $N_{SS}+2 \bmod(62)$ to $N_{SS}+K_{IM} \bmod(62)$. It shall send a REJ or SREJ frame with $N(R)=N_{SS}+2 \bmod(62)$

If REJ frame is used by the MS, the SS restarts the transmission of I+S frames from frame numbered $N_{SS}+2 \bmod(62)$. The MS shall acknowledge these frames. After having sent at least the frame numbered $N_{SS}+K_{IM}+2 \bmod(62)$, the SS stops sending I+S frames.

If SREJ frame is used by the MS, the SS restarts the transmission of I+S frames from frame numbered $N_{SS}+2 \bmod(62)$. It does send the frame numbered $N_{SS}+K_{IM}+1 \bmod(62)$ a second time. The MS shall acknowledge these frames. After having sent at least the frame numbered $N_{SS}+K_{IM}+2 \bmod(62)$, the SS stops sending I+S frames.

Verification of K_{MI}

The MS is now configured to send continuously I+S frames with a delay inferior to T_1 between each frame.

The MS sends I+S frames, the SS does not acknowledge these frames.

After having sent K_{MI} I+S frames, the MS shall stop sending I+S frames (end of the window).

Verification of T_1

At the expiry of T_1 after the last I+S frame, the MS shall enter in "checkpoint recovery" mode, it shall send a supervisory RR frame with $C=1$ and $P=1$.

The SS does not answer to checkpointing.

Verification of N_2

At the expiry of T_1 after the last RR ($C=1$, $P=1$) frame, the MS shall resend a supervisory RR frame with $C=1$ and $P=1$. The SS does not answer to checkpointing. This is repeated N_2 times.

After N_2 retransmissions of the same RR ($C=1$, $P=1$), The MS shall reset or disconnect the RLP link by sending a SABM ($C=1, P=1$) or a DISC ($C=1$) frame. The SS answers with an UA ($R=0$) frame with F bit set to P bit received in SABM or DISC frame.

The MS is returned to the idle state by clearing of the call.

Maximum duration of test

1 minute.

Expected sequence

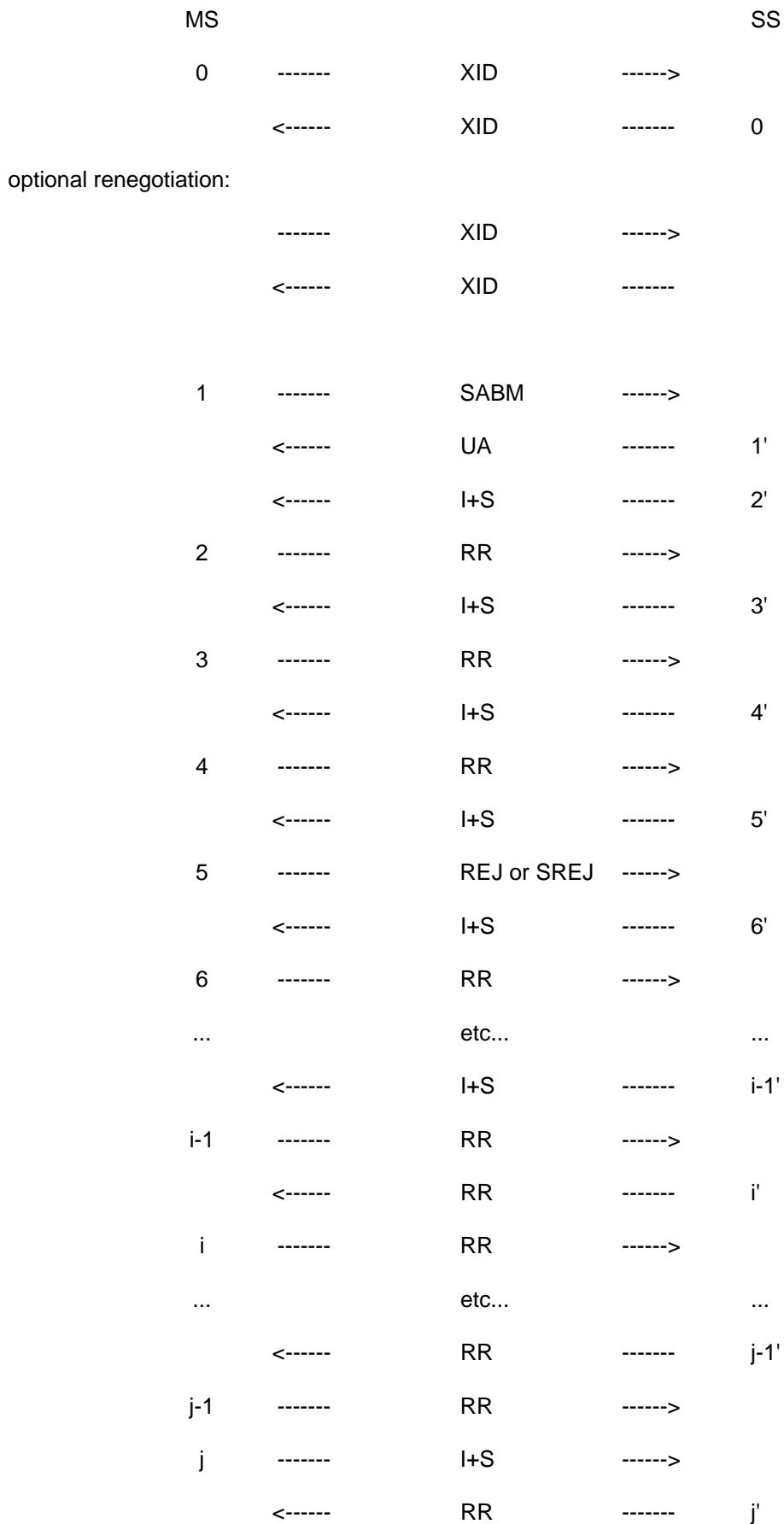

...		etc...		...
$j+K_{MI}-1$	-----	I+S	----->	
	<-----	RR	-----	$j+K_{MI}-1'$
$j+K_{MI}$	-----	RR	----->	
	<-----	RR	-----	$j+K_{MI}'$
$j+K_{MI}+1$	-----	RR	----->	
	<-----	RR	-----	$j+K_{MI}+1'$
...		etc...		...
$j+K_{MI}+N_2$	-----	RR	----->	
	<-----	RR	-----	$j+K_{MI}+N_2'$
$j+K_{MI}+N_2+1$	-----	SABM / DISC	----->	
	<-----	UA	-----	$j+K_{MI}+N_2+1'$

The frame from the SS will be:

- 0': One XID frame containing: $R=0, F=1$. The RLP parameters are changed by the SS, the sense of negotiation is correct. The final parameters are noted ($T_1, T_2, N_2, K_{IM}, K_{MI}$).
- 1': One UA frame containing: $R=0, F=1$. Note: If SABM is received before the XID, the SS answers to the XID after having established the ABM mode (i.e. after having sent the UA).
- 2': One I+S frame containing $N(S)=N_{SS} \bmod(62), N(R)=N_{MS} \bmod(62)$.
- 3': One I+S frame containing $N(S)=N_{SS}+K_{IM}+1 \bmod(62), N(R)=N_{MS} \bmod(62)$.
- 4': A delay D ($T_2 < D < T_1$) after step 3', one I+S frame containing $N(S)=N_{SS}+1 \bmod(62), N(R)=N_{MS} \bmod(62)$.
- 5': One I+S frame containing $N(S)=N_{SS}+K_{IM}+1 \bmod(62), N(R)=N_{MS} \bmod(62)$.

If REJ frame is used by the MS:

- 6',..., $K_{IM}+5'$: One I+S frame containing $N(S)=N_{SS}+2, \dots, N_{SS}+K_{IM}+1 \bmod(62), N(R)=N_{MS} \bmod(62)$.
- $K_{IM}+6', \dots, i-1'$: One I+S frame containing $N(S)=N_{SS}+K_{IM}+2, \dots, k-1 \bmod(62), N(R)=N_{MS} \bmod(62)$.

If SREJ frame is used by the MS:

- 6',..., $K_{IM}+4'$: One I+S frame containing $N(S)=N_{SS}+2, \dots, N_{SS}+K_{IM} \bmod(62), N(R)=N_{MS} \bmod(62)$.
- $K_{IM}+5', \dots, i-1'$: One I+S frame containing $N(S)=N_{SS}+K_{IM}+2, \dots, k-1 \bmod(62), N(R)=N_{MS} \bmod(62)$.

The SS stops sending I+S frames.

- $i', \dots, j-1'$: One RR frame containing, $N(R)=N_{MS} \bmod(62)$.
- $j', \dots, j+K_{MI}-1'$: One RR frame containing $N(R)=N_{MS} \bmod(62)$.
- $j+K_{MI}', \dots, j+K_{MI}+N_2'$: One RR ($R=0, F=0$) frame containing $N(R)=N_{MS} \bmod(62)$.
- $j+K_{MI}+N_2+1'$: One UA ($R=0$) frame with F bit set to P bit received in SABM or DISC frame.

Specific message content

The frame from the MS shall be:

- 0: One XID frame containing: $C=1, P=1$.
- 1: One SABM frame containing: $C=1, P=1$.

NOTE: The MS may send the SABM frame before the XID.

- 2: One RR frame containing $N(R)=N_{ss}+1 \bmod (62)$ within T_2 .
- 3: One RR frame containing $N(R)=N_{ss}+1 \bmod (62)$.
- 4: One RR frame containing $N(R)=N_{ss}+2 \bmod (62)$.
- 5: One REJ or SREJ frame containing $N(R)=N_{ss}+2 \bmod (62)$.

If REJ frame is used by the MS:

- 6,..., $K_{IM}+5$: One RR frame containing $N(R)=N_{ss}+3, \dots, N_{ss}+K_{IM}+2 \bmod(62)$.
- $K_{IM}+6, \dots, i-1$: One RR frame containing $N(R)=N_{ss}+K_{IM}+3, \dots, k \bmod(62)$.

If SREJ frame is used by the MS:

- 6,..., $K_{IM}+3$: One RR frame containing $N(R)=N_{ss}+3, \dots, N_{ss}+K_{IM} \bmod(62)$.
- $K_{IM}+4$: One RR frame containing $N(R)=N_{ss}+K_{IM}+2 \bmod(62)$.
- $K_{IM}+5, \dots, i-1$: One RR frame containing $N(R)=N_{ss}+K_{IM}+3, \dots, k \bmod(62)$.

$i, \dots, j-1$: One RR frame containing, $N(R)=k \bmod (62)$.

The MS starts sending data.

- $j, \dots, j+K_{MI}-1$: One I+S frame containing $N(S)=N_{MS}, \dots, N_{MS}+K_{MI}-1 \bmod(62)$, $N(R)=k \bmod (62)$.
- $j+K_{MI}$: T_1 after the last I+S frame sent, one supervisory RR ($C=1, P=1$) frame containing $N(R)=k \bmod (62)$.
- $j+K_{MI}+1, \dots, j+K_{MI}+N_2$: At T_1 expiry, one supervisory RR ($C=1, P=1$) frame containing $N(R)=k \bmod (62)$.
- $j+K_{MI}+N_2+1$: One SABM ($C=1, P=1$) or DISC ($C=1$) frame.

29.3.3.3 Collision of XID frames

29.3.3.3.1 Conformance requirements

The MS shall be able to ignore an XID frame from the network in the case where it has sent a XID frame asking for a negotiation to the network, and to restart the negotiation procedure after expiry of timer T_1 .

References

GSM 04.22 section 5.2.2.6..

29.3.3.3.2 Test purpose

To test that the correct reaction of the MS to a collision of XID frames.

29.3.3.3.3 Test method

Initial Conditions

System Simulator:

The SS is configured to use default RLP parameters.

Mobile Station:

The MS is configured to use RLP parameters different from the default parameters and arbitrary chosen.

The MS is made to establish a MO non transparent data call. In initial conditions MS is in call state U10 ("Call Active") after having sent a CONN_ACK message.

Related PICS/PIXIT statements

Supported bearer services; characteristics of non-transparent services.

Foreseen final state of the MS

Idle.

Test procedure

The MS shall send an XID (C=1, P=1) frame containing a set of RLP parameters different from the default set. The SS sends a XID (C=1, P=1) command frame containing new parameters. After a delay the MS shall resend the same XID that it has previously sent. The SS answers with XID (R=0, F=1) accepting the parameters chosen by the MS. These parameters are noted (T1, T2, N2, K_{IM} (window IWF (SS) -> MS), K_{MI} (window MS -> IWF (SS))).

The MS established the ABM mode by sending a SABM (C=1, P=1) frame. The SS answers with a UA (R=0, F=1) frame. The SABM frame may be sent by the MS at any instant (i.e. just after having received an XID, before having sent the response). In such a case, the SS answers to the XID after having established the ABM mode (i.e. after having sent the UA).

The SS checks that the MS uses the new parameters determined during the negotiation procedure.

Verification of T2

The SS is configured to send I+S frames with a delay inferior to T1 between each frame. The MS is made to send no user data, it sends only supervisory frame.

The SS sends an I+S frame numbered $N(S)=N_{ss} \bmod(62)$, the MS shall acknowledge this frame within T2.

Verification of K_{IM}

The SS sends an I+S frame numbered $N_{ss}+K_{IM}+1 \bmod(62)$. The MS shall ignore this frame (out of the window), it shall not acknowledge or reject it. This is checked during at least T2.

The SS sends an I+S frame numbered $N(S)=N_{ss}+1 \bmod(62)$, the MS shall acknowledge this frame.

The SS sends an I+S frame numbered $N_{ss}+K_{IM}+1 \bmod(62)$. The MS shall reject all the lost frames numbered $N_{ss}+2 \bmod(62)$ to $N_{ss}+K_{IM} \bmod(62)$. It shall send a REJ or SREJ frame with $N(R)=N_{ss}+2 \bmod(62)$.

If REJ frame is used by the MS, the SS restarts the transmission of I+S frames from frame numbered $N_{ss}+2 \bmod(62)$. The MS shall acknowledge these frames. After having sent at least the frame numbered $N_{ss}+K_{IM}+2 \bmod(62)$, the SS stops sending I+S frames.

If SREJ frame is used by the MS, the SS restarts the transmission of I+S frames from frame numbered $N_{ss}+2 \bmod(62)$. It does send the frame numbered $N_{ss}+K_{IM}+1 \bmod(62)$ a second time. The MS shall acknowledge these frames. After having sent at least the frame numbered $N_{ss}+K_{IM}+2 \bmod(62)$, the SS stops sending I+S frames.

Verification of K_{MI}

The MS is now configured to send continuously I+S frames with a delay inferior to T1 between each frame.

The MS sends I+S frames, the SS does not acknowledge these frames.

After having sent K_{MI} I+S frames, the MS shall stop sending I+S frames (end of the window).

Verification of T1

At the expiry of T1 after the last I+S frame, the MS shall enter in "checkpoint recovery" mode, it shall send a supervisory RR frame with C=1 and P=1.

The SS does not answer to checkpointing.

Verification of N2

At the expiry of T1 after the last RR (C=1, P=1) frame, the MS shall resend a supervisory RR frame with C=1 and P=1. The SS does not answer to checkpointing. This is repeated N2 times.

After N2 retransmissions of the same RR frame (C=1, P=1), The MS shall reset or disconnect the RLP link by sending a SABM (C=1,P=1) or a DISC (C=1) frame. The SS answers with an UA (R=0) frame with F bit set to P bit received in SABM or DISC frame.

The MS is returned to the idle state by clearing of the call.

Maximum duration of test

1 minute.

Expected sequence

MS			SS
0	-----	XID ----->	
	<-----	XID	0'
1	-----	XID ----->	
	<-----	XID	1'
2	-----	SABM ----->	
	<-----	UA	2'
	<-----	I+S	3'
3	-----	RR ----->	
	<-----	I+S	4'
4	-----	RR ----->	
	<-----	I+S	5'
5	-----	RR ----->	
	<-----	I+S	6'
6	-----	REJ or SREJ ----->	
	<-----	I+S	7'
7	-----	RR ----->	
...		etc...	...
	<-----	I+S	i-1'
i-1	-----	RR ----->	
	<-----	RR	i'
i	-----	RR ----->	
...		etc...	...
	<-----	RR	j-1'
j-1	-----	RR ----->	
j	-----	I+S ----->	
	<-----	RR	j'
...		etc...	...
j+K _{MI} -1	-----	I+S ----->	
	<-----	RR	j+K _{MI} -1'
j+K _{MI}	-----	RR ----->	
	<-----	RR	j+K _{MI} '
j+K _{MI} +1	-----	RR ----->	
	<-----	RR	j+K _{MI} +1'
...		etc...	...
j+K _{MI} +N ₂	-----	RR ----->	
	<-----	RR	j+K _{MI} +N ₂ '
j+K _{MI} +N ₂ +1	-----	SABM / DISC ----->	
	<-----	UA	j+K _{MI} +N ₂ +1'

The frame from the SS will be:

0': One XID frame containing: C=1, P=1.

1': One XID frame containing: R=0, F=1. The RLP parameters are changed by the SS, the sense of negotiation is correct. The final parameters are noted (T1, T2, N2, K_{IM}, K_{MI}).

2': One UA frame containing: R=0, F=1. Note: If SABM is received before one of the XID frames, the SS will answer to the XID after having established the ABM mode (i.e. after having sent the UA).

3': One I+S frame containing $N(S)=N_{SS} \bmod(62)$, $N(R)=N_{MS} \bmod(62)$.

4': One I+S frame containing $N(S)=N_{SS}+K_{IM}+1 \bmod(62)$, $N(R)=N_{MS} \bmod(62)$.

5': A delay D ($T_2 < D < T_1$) after step 3', one I+S frame containing $N(S)=N_{SS}+1 \bmod(62)$, $N(R)=N_{MS} \bmod(62)$.

6': One I+S frame containing $N(S)=N_{SS}+K_{IM}+1 \bmod(62)$, $N(R)=N_{MS} \bmod(62)$.

If REJ frame is used by the MS:

7',..., K_{IM}+6': One I+S frame containing $N(S)=N_{SS}+2, \dots, N_{SS}+K_{IM}+1 \bmod(62)$, $N(R)=N_{MS} \bmod(62)$.

K_{IM}+7',...,i-1': One I+S frame containing $N(S)=N_{SS}+K_{IM}+2, \dots, k-1 \bmod(62)$, $N(R)=N_{MS} \bmod(62)$.

If SREJ frame is used by the MS:

7',..., K_{IM}+5': One I+S frame containing $N(S)=N_{SS}+2, \dots, N_{SS}+K_{IM} \bmod(62)$, $N(R)=N_{MS} \bmod(62)$.

K_{IM}+6',...,i-1': One I+S frame containing $N(S)=N_{SS}+K_{IM}+2, \dots, k-1 \bmod(62)$, $N(R)=N_{MS} \bmod(62)$.

The SS stops sending I+S frames.

i',...,j-1': One RR frame containing, $N(R)=N_{MS} \bmod(62)$.

j',...,j+K_{MI}-1': One RR frame containing $N(R)=N_{MS} \bmod(62)$.

j+K_{MI}',...,j+K_{MI}+N₂': One RR (R=0, F=0) frame containing $N(R)=N_{MS} \bmod(62)$.

j+K_{MI}+N₂+1': One UA (R=0) frame with F bit set to P bit received in SABM or DISC frame.

Specific message content

The frame from the MS shall be:

0: One XID frame containing: C=1, P=1.

1: After T1(def) expiry, one XID frame containing: C=1, P=1.

NOTE: The MS may send an SABM frame before the 1st or the 2nd XID frame.

2: One SABM frame containing: C=1, P=1.

3: One RR frame containing $N(R)=N_{SS}+1 \bmod(62)$ within T2.

4: One RR frame containing $N(R)=N_{SS}+1 \bmod(62)$.

5: One RR frame containing $N(R)=N_{SS}+2 \bmod(62)$.

6: One REJ or SREJ frame containing $N(R)=N_{SS}+2 \bmod(62)$.

If REJ frame is used by the MS:

7, ..., K_{IM}+6: One RR frame containing $N(R)=N_{SS}+3, \dots, N_{SS}+K_{IM}+2 \bmod(62)$.

K_{IM}+7, ..., i-1: One RR frame containing $N(R)=N_{SS}+K_{IM}+3, \dots, k \bmod(62)$.

If SREJ frame is used by the MS:

7, ..., K_{IM}+4: One RR frame containing $N(R)=N_{SS}+3, \dots, N_{SS}+K_{IM} \bmod(62)$.

K_{IM}+5: One RR frame containing $N(R)=N_{SS}+K_{IM}+2 \bmod(62)$.

K_{IM}+6, ..., i-1: One RR frame containing $N(R)=N_{SS}+K_{IM}+3, \dots, k \bmod(62)$.

i, ..., j-1: One RR frame containing, $N(R)=k \bmod(62)$.

The MS starts sending data.

$j, \dots, j+K_{MI}-1$: One I+S frame containing $N(S)=N_{MS}, \dots, N_{MS}+K_{MI}-1 \pmod{62}$, $N(R)=k \pmod{62}$.
 $j+K_{MI}$: T1 after the last I+S frame sent, one supervisory RR (C=1, P=1) frame containing $N(R)=k \pmod{62}$.
 $j+K_{MI}+1, \dots, j+K_{MI}+N_2$: At T1 expiry, one supervisory RR (C=1, P=1) frame containing $N(R)=k \pmod{62}$.
 $j+K_{MI}+N_2+1$: One SABM (C=1, P=1) or DISC (C=1) frame.

29.3.3.4 Loss of XID frames

29.3.3.4.1 Conformance requirements

The MS shall repeat an XID frame upon expiry of RLP timer T1 if the network has not acknowledged it by a correct XID frame.

References

GSM 04.22 section 5.2.2.6.

29.3.3.4.2 Test purpose

To test that the MS repeats the XID frame if the SS does not answer correctly.

29.3.3.4.3 Test method

Initial Conditions

System Simulator:

The SS is configured to use default RLP parameters.

Mobile Station:

The MS is configured to use RLP parameters different from the default parameters (T1 different from T1(def)).

The MS is made to establish a MO non transparent data call. In initial conditions MS is in call state U10 ("Call Active") after having sent a CONN_ACK message.

Related PICS/PIXIT statements

Supported bearer services; characteristics of non-transparent services.

Foreseen final state of the MS

Idle.

Test procedure

The MS shall send an XID (C=1, P=1) frame containing a set of RLP parameters different from the default set. The SS sends a XID (R=0, F=0) command frame. The MS shall ignore this frame.

After a delay the MS shall resend the same XID that it has previously sent. The SS does not answer.

After a delay the MS shall resend the same XID that it has previously sent. The SS answers with XID (R=0, F=1) accepting the parameters chosen by the MS.

The MS established the ABM mode by sending a SABM (C=1, P=1) frame. The answer with a UA (R=0, F=1) frame. The SABM frame may be sent by the MS at any instant (i.e. just after having received an XID). In such a case, the SS answers to the XID after having established the ABM mode (i.e. after having sent the UA).

The MS is returned to the idle state by clearing of the call.

Maximum duration of test

1 minute.

Expected sequence

MS				SS
0	-----	XID	----->	
	<-----	XID	-----	0'
1	-----	XID	----->	
2	-----	XID	----->	
	<-----	XID	-----	2'
3	-----	SABM	----->	
	<-----	UA	-----	3'

The frame from the SS will be:

- 0': One XID frame containing: R=0, F=0.
- 2': One XID frame containing: R=0, F=1. The RLP parameters are accepted by the SS.
- 3': One UA frame containing: R=0, F=1. Note: If SABM is received before the XID, the SS will answer to the XID after having established the ABM mode (i.e. after having sent the UA).

Specific message content

The frame from the MS shall be:

- 0: One XID frame containing: C=1, P=1.
- 1: After T1(def) expiry, one XID frame containing: C=1, P=1.
- 2: After T1(def) expiry, one XID frame containing: C=1, P=1.
- 3: One SABM frame containing: C=1,P=1.

NOTE: The MS may send the SABM frame before XID(s), at any moment.

29.3.3.5 Total loss of XID frames

29.3.3.5.1 Conformance requirements

The MS shall not repeat an unacknowledged XID frame more than N2 times. After N2 repetition it shall disconnect the RLP link if it had been connected earlier.

References

GSM 04.22 section 5.2.2.6.

29.3.3.5.2 Test purpose

To test that the MS repeats the XID frame no more than N2 times, if the SS does not answer correctly.

29.3.3.5.3 Test method

Initial Conditions

System Simulator:

The SS is configured to use default RLP parameters.

Mobile Station:

The MS is configured to use RLP parameters different from the default parameters.

The MS is made to establish a MO non transparent data call. In initial conditions MS is in call state U10 ("Call Active") after having sent a CONN_ACK message.

Related PICS/PIXIT statements

Supported bearer services; characteristics of non-transparent services.

Foreseen final state of the MS

Idle.

Test procedure

Case a: The MS sends an XID (C=1, P=1) frame in ADM mode

Case b: The MS enters the ABM mode and sends an XID (C=1, P=1) frame after optional status bits exchange between the MS and the SS.

The SS does not answer.

After a delay T_1 (def), the MS shall resend the same XID that it has previously sent. The SS does not answer. This step is repeated N_2 (def) times.

Case a: After N_2 (def) retransmissions the SS waits for $2 * T_1$ to ensure that the XID frame is not repeated any more.

Case b: , After N_2 (def) retransmissions the link shall be disconnected. The MS shall send a DISC (C=1) frame, and the SS answers with a UA (R=0, F equal to the P bit received in the DISC).

The MS is returned to the idle state by clearing of the call.

Maximum duration of test

1 minute.

Expected sequence

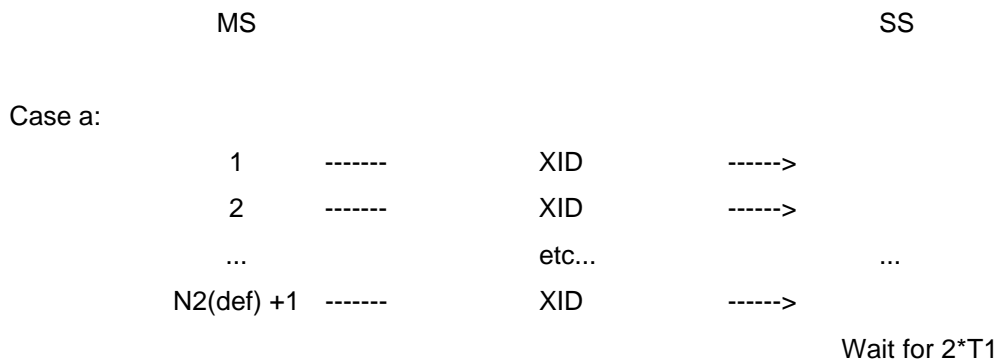

Case b:

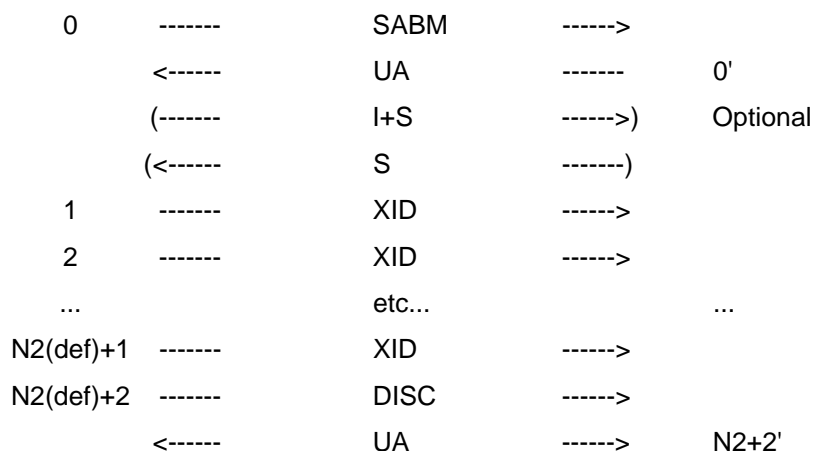

The frame from the SS will be:

- 0': One UA frame containing: R=0, F=1, if the MS sends a SABM.
- N2+2': One UA frame containing: R=0, F equal to P bit received in DISC frame.

Specific message content

The frame from the MS shall be:

- 0: The MS may send a SABM frame containing: C=1,P=1. This frame may be sent at any instant. This is not verified.
- 1: One XID frame containing: C=1, P=1.
- 2,...,N2(def)+1: After T1 (def) expiry, one XID frame containing: C=1, P=1.
- N2(def)+2: If the MS has previously established the ABM mode (SABM/UA exchange), it shall disconnect the link by sending a DISC (C=1) frame.

29.4 Facsimile tests for the transparent network support

29.4.1 General

According to CCITT T.30 a facsimile call can be divided into the following phases:

- Phase A - call establishment procedure;
- Phase B - pre-message procedure (identification and selection of required facilities);
- Phase C - message transmission according to CCITT T.4;
- Phase D - post-message procedure;
- Phase E - call release procedure.

For each phase a single test sequence was drafted, i.e. the verification of the basic procedures of a fax call will at least consist of 5 tests, in order to verify the above described phases.

In the IDLE state the fax adapter, originating or terminating, will send continuously SYNC frames containing the pattern specified in GSM 03.45 (CT105 (see note 2) and 109 (see note 2) are in OFF condition).

For the test of the facsimile data transmission, .i.e. the phase C, test chart #2 according to CCITT T.21 should be used.

The T.4/30 messages marked with the '*' sign indicate that for the transmission across the radio interface in case of the BCS phase STATUS frames are used, and in case of the message phase the usage of DATA frames is implied.

Manufacturer-declared fax equipment should be connected to the MS, i.e. where possible a fax adapter and a fax machine Group 3. Measuring devices to monitor the T.4/T.30 protocol, the circuits and the SYNC, STATUS and DATA frames should be provided. Configurations, where no access to the interfaces to monitor the protocol and circuits is possible, might exist.

Abbreviations used:

BC-IE	Bearer Capability Information Element
BCS	Binary Coded Signalling
BCS-REC	BCS Reception State of the FA
BCS-TRA	BCS Transmission State of the FA
CED	Called Station Identification
CFR	Confirmation To Receive
CMM	Channel Mode Modify
CMM ACK	Channel Mode Modify Acknowledge
CNG	Calling Tone
DCD	Data Call Direction
DCS	Digital Command Signal
DIS	Digital Identification Signal
EOM	End Of Message
EOP	End Of Procedure
FA	Fax Adapter
Fax	Facsimile App. or PC-Fax (e.g. fax softw. running on a notebook)
ICM	In-Call Modification
IDLE	Idle State of the FA
MCF	Message Confirmation
MO	Mobile Originating
MPS	Multi Page Signal
MSG-REC	Message Reception State of the FA
MT	Mobile Terminating
RCSD-IE	Reverse Call Setup Direction Information Element
TCF	Training Check Frame
TCH	Traffic Channel
TS 61	Teleservice 61 (alternate speech/fax)
TS 62	Teleservice 62 (automatic fax)

29.4.2 Mobile originated call

29.4.2.1 Call establishment procedure

29.4.2.1.1 Alternate speech / facsimile

29.4.2.1.1.1 Definition and applicability

This test is applicable to an MS supporting TS 61.

29.4.2.1.1.2 Conformance requirement

An MS supporting transparent facsimile group 3 shall perform the ICM and shall support the frames and circuits at the Um-, R- and 2w-interface according to the specifications referred to in the section "Reference".

Reference

GSM 03.45, GSM 07.01, CCITT T.30.

29.4.2.1.1.3 Test purpose

To verify the transition from speech to fax in case of an MS supporting TS 61 and that the circuit and tone handling of the MT and FA is correct.

29.4.2.1.1.4 Method of test

Initial conditions

A TS 61 s/f call is set up. The speech phase is active.

Test procedure

The transition from speech to fax is initiated by manual intervention at both ends of the connection. The data call direction DCD is mobile originated. Upon connection to line the FA turns on CT108.2 (see note 2) as a basic requirement for the transition from speech to fax. Now, within the next 3 seconds the FA has to detect the DCD, which is in this case is mobile originated, i.e. CT105 is set to ON (see note 2) condition. The following ICM procedure via the MODIFY message is carried out by the MT 3 seconds after circuit CT108.2 was set to ON (see note 2) condition. On completion of the ICM procedure the synchronization of the TCH begins and after its completion the MT has to set CT107 to ON (see note 2) condition and the FA has to send the CED tone (see note 2) towards the connected fax. When CT106/109 are set to ON (see note 2) phase A is completed. Then the call is cleared by manual intervention at the MT or the activity progress of the call proceeds to the next phase.

Expected sequence

MS:	SS:																								
Step	Direction																								

1	<table border="0" style="width: 100%;"> <tr> <td style="width: 10%;">MS-->SS</td> <td style="width: 40%;">Fax: Connect to line (see note 1)</td> <td style="width: 10%;"></td> <td style="width: 40%;">Connect to line (see note 1)</td> </tr> <tr> <td></td> <td>FA: CT108.2 ON (see note 2)</td> <td></td> <td></td> </tr> <tr> <td></td> <td>Detect DCD</td> <td></td> <td></td> </tr> <tr> <td></td> <td>CT105 ON (see note 2)</td> <td></td> <td></td> </tr> <tr> <td></td> <td>MT: Send MODIFY message</td> <td style="text-align: center;">-----></td> <td>Receive MODIFY message</td> </tr> <tr> <td></td> <td>3 seconds after CT108.2 ON (see note 2)</td> <td></td> <td></td> </tr> </table>	MS-->SS	Fax: Connect to line (see note 1)		Connect to line (see note 1)		FA: CT108.2 ON (see note 2)				Detect DCD				CT105 ON (see note 2)				MT: Send MODIFY message	----->	Receive MODIFY message		3 seconds after CT108.2 ON (see note 2)		
MS-->SS	Fax: Connect to line (see note 1)		Connect to line (see note 1)																						
	FA: CT108.2 ON (see note 2)																								
	Detect DCD																								
	CT105 ON (see note 2)																								
	MT: Send MODIFY message	----->	Receive MODIFY message																						
	3 seconds after CT108.2 ON (see note 2)																								
2	SS-->MS	<-----	Send MODIFY COMPLETE																						
3	MS<->SS	<----->	TCH Synchronization																						
	MT: CT107 ON (see note 2), when synchronized																								
	FA: Generate CED (see note 2)																								
	Fax: Detect CED (see note 2)																								
4	SS-->MS	<-----	Set X and SB bit in V.110 frame																						
	MT: CT106/109 ON (see note 2)																								
	FA: Enter BCS-TRA state		Enter BCS-REC state																						

29.4.2.1.1.5 Test requirements

1. The condition of CT108.2 and CT105 is verified (see note 2); CT106, 107, 109 have to be in OFF (see note 2) condition. The MODIFY message has to be sent 3 seconds after circuit CT108.2 has gone to ON condition (see note 2).
2. To be verified that the MT begins the synchronization phase by sending the pattern 1/OFF after the reception of the MODIFY COMPLETE message, that CT107 is turned on (see note 2) by the MT after successful synchronization and that the CED tone (see note 2) is transmitted by the FA after CT107 has gone to ON condition (see note 2).
3. To be verified that CT106 and CT109 are turned on (see note 2), when in the modified V.110 frames received from the SS the X and SB bits are set. The state of the FA shall be verified (-> BCS-TRA).

29.4.2.1.2 Automatic facsimile**29.4.2.1.2.1 Definition and applicability**

This test is applicable to an MS supporting TS 62.

29.4.2.1.2.2 Conformance requirement

The MS supporting transparent facsimile group 3 shall perform the call setup procedure and shall support the frames and the circuits at the Um-,R- and 2w-interface according the specifications referred to in the section "Reference".

Reference

GSM 03.45, GSM 07.01, CCITT T.30.

29.4.2.1.2.3 Test purpose

To verify that the circuit and tone handling of the MT and FA is correct.

29.4.2.1.2.4 Method of test**Initial conditions**

The MS, configured for the TS 62 fax call, is updated. Then the call establishment phase A begins.

Test procedure

The FA sets CT108.2 to ON (see note 2) condition and passes the dialling information to the MT. A SETUP message is then sent by the MT towards the SS. When the TCH is available (indicated by the CONNECT message) the synchronization phase begins, i.e. both entities start sending the synchronization pattern 1/OFF. CT106, 107, 109 have to be in OFF condition (see note 2). Upon completion of the synchronization phase the MT sets CT107 to ON condition (see note 2) causing the FA to connect the fax to line. The SS sets CT106 and CT109 to ON at the MT by means of the V.110 X and SB bits. The FA then generates the CED tone (see note 2), which completes phase A. Then the call is cleared by manual intervention at the MT or the activity progress of the call proceeds to the next phase.

Expected sequence

MS:		SS:
Step	Direction	

1	MS-->SS	Fax: Dial
	FA:	Pass dialling info, CT108.2 ON (see note 2)
	MT:	Send SETUP message -----> Receive SETUP message
2	SS-->MS	<----- Send CONNECT message
3	MS<->SS	TCH Synchronization <-----> TCH Synchronization
	MT:	CT107 ON (see note 2), when synchronized
4	SS-->MS	<----- Set X and SB bit in V.110 frame
		MT: CT106/109 ON (see note 2)
		FA: Generate CED (see note 2)
		Fax: Detect CED (see note 2)
5		FA: Enter BCS-TRA state (see note 3) Enter BCS-REC state

29.4.2.1.2.5 Test requirements

1. The condition of CT108.2 (see note 2) is verified and the SETUP message should contain the BC-IE for TS 62.
2. To be verified that at the MT CT106, 107, 109 are in OFF (see note 2) condition, that the MT begins the synchronization phase by sending the pattern 1/OFF and that CT107 (see note 2) is turned on by the MT after successful synchronization.
3. To be verified that CT106 and CT109 are turned on (see note 2), when in the V.110 frames received from the SS the X and SB bits are set and that the FA sends the CED (see note 2) tone towards the fax machine.
4. The state of the FA shall be verified (-> BCS-TRA).

29.4.2.2 Pre-message procedure**29.4.2.2.1 Definition and applicability**

This test is applicable to an MS supporting TS 61 and/or TS 62.

29.4.2.2.2 Conformance requirement

The MS supporting transparent facsimile group 3 shall perform the pre-message procedure and shall support the frames and the circuits at the Um-, R- and 2w-interface according the specifications referred to in the section "Reference".

Reference

GSM 03.45, CCITT T.30.

29.4.2.2.3 Test purpose

To verify the correct handling of the T.30 DIS/DCS/TCF frames.

29.4.2.2.4 Method of test

Initial conditions

The activity progress of the fax call is brought to the beginning of Phase B.

Test procedure

After phase A the FA is in BCS-TRA state and sends SYNC frames. The SS being in BCS-REC state sends the T.30 DIS embedded in STATUS frames indicating its capabilities. The received DIS is checked, if necessary edited by the FA and sent to the fax. Then the FA returns to the idle state. The fax checks whether the indicated capabilities are in line with its own or not, and chooses the capabilities which are supported end-to-end by the connected fax machines by answering with the DCS frame preceded by the preamble. The FA enters the BCS-REC state and the BCS information is transmitted using the STATUS frames. Afterwards the FA returns to the idle state. Upon reception of the training sequence the FA enters the MSG-REC state without waiting for an acknowledge from the SS, i.e. the TCF is conveyed by means of the DATA frames. The FA enters the idle state and sends at least 5 SYNC frames to indicate that the message phase is over. Then the CFR frame is received, i.e. the FA enters the BCS-TRA state and receives the CFR in STATUS frames. Now, phase B is completed and the data transfer phase C begins. Then the call is cleared by manual intervention at the MT or the activity progress of the call proceeds to the next phase.

Expected sequence

MS:	SS:
Step	Direction
1	SS-->MS
	FA: BCS-TRA Monitor DIS Generate preamble,DIS CT105 OFF (see note 2) IDLE
	Fax: Receive preamble,DIS
2	MS-->SS
	Fax: Send preamble,DCS FA: CT109 ON (see note 2) BCS-REC Monitor DCS Send preamble*,DCS* CT109 OFF (see note 2) IDLE
	-----> Receive preamble*,DCS*
3	MS-->SS
	Fax: Send training,TCF FA: CT109 ON (see note 2) MSG-REC Send TCF* CT109 OFF (see note 2)
	-----> Receive TCF*
4	SS<--MS
	FA: CT105 ON (see note 2) BCS-TRA Generate preamble, CFR CT105 OFF (see note 2) IDLE Fax: Receive preamble, CFR
	<----- Send preamble*,CFR*

29.4.2.2.5 Test requirements

1. To be verified that SYNC frames are transmitted across the radio interface in BCS-TRA and in the IDLE state and that CT105 is set to OFF (see note 2) . The correct generation of the T.30 BCS shall be verified (down-conversion to the BCS speed according to GSM 03.45).

2. The condition of CT109 shall be verified (see note 2); that the DCS is correctly inserted into the STATUS frames and that the IDENT octet contains the BCS-REC identifier. At CT109=OFF (see note 2), the FA returns to the idle state and sends SYNC frames (pattern according to GSM 03.45).
3. To be verified that the FA turns on CT109 (see note 2), enters the MSG-REC state and sends the TCF embedded in DATA frames without waiting for the confirmation that the SS has entered the MSG-TRA state. The ident octet has to be checked (-> MSG-REC). CT109 shall be in OFF condition (see note 2).
4. The condition of CT105 (see note 2) is to be verified. The correct generation of the T.30 BCS shall be checked. In IDLE state SYNC frames have to be sent.

29.4.2.3 Message procedure

29.4.2.3.1 Definition and applicability

This test is applicable to an MS supporting TS 61 and/or TS 62.

29.4.2.3.2 Conformance requirement

The MS supporting transparent facsimile group 3 shall perform the message procedure and shall support the frames and the circuits at the Um-,R- and 2w-interface according the specifications referred to in the section "Reference".

Reference

GSM 03.45, CCITT T.30, CCITT T.4, CCITT T.21.

29.4.2.3.3 Test purpose

To verify the facsimile data transmission phase.

29.4.2.3.4 Method of test

Initial conditions

The activity progress of the fax call is brought to the beginning of Phase C. The ECM shall not be used.

Test procedure

The FA is in IDLE state. The connected fax starts transmitting the fax message. Upon reception of the training sequence the FA enters the MSG-REC state and sends STATUS frames, which contain the ident octet set to MSG-REC, interleaved with SYNC frames to the SS. When the SS has entered the MSG-TRA state, which is indicated to the FA by means of the ident octet set to MSG-TRA, the FA starts sending the fax coded data (received from the connected fax) embedded in DATA frames. When the transmission is finished the FA is again in the idle state for at least 5 SYNC frames to indicate that the message phase is over and Phase D begins. Then the call is cleared by manual intervention at the MT or the activity progress of the call proceeds to the next phase.

Expected sequence

MS:	Direction	FA:	SS:

1	MS-->SS	Fax: Send training, fax message FA: CT109 ON (see note 2) MSG-REC Send STATUS frames (MSG-REC) interleaved with SYNC frames Wait for MSG-TRA indication from SS	
2	SS-->MS		<----- Send STATUS frames with MSG-TRA identifier
3	MS-->SS	Send fax message* " " " CT109 OFF (see note 2) IDLE	-----> Receive fax message* " " "
4	MS-->SS	FA: Send at least 5 SYNC frames	-----> Receive SYNC frames

29.4.2.3.5 Test requirements

1. To be verified that the FA enters the MSG-REC state and inserts the correct ident octet in the STATUS frames interleaved with SYNC frames.
2. To be verified that the FA sends the fax message after the SS has sent the STATUS frames containing the MSG-TRA identifier.
3. At the end of the document transmission the condition of CT109 (see note 2) shall be checked.
4. It shall be verified that at least 5 SYNC frames are sent in order to indicate the end of phase C.

29.4.2.4 Post-message procedure**29.4.2.4.1 Definition and applicability**

This test is applicable to an MS supporting TS 61 and/or TS 62.

29.4.2.4.2 Conformance requirement

The MS supporting transparent facsimile group 3 shall perform the post-message procedure and shall support the frames and the circuits at the Um-, R- and 2w-interface according the specifications referred to in the section "Reference".

Reference

GSM 03.45, CCITT T.30.

29.4.2.4.3 Test purpose

To verify phase D of the facsimile transmission.

29.4.2.4.4 Method of test**Initial conditions**

The activity progress of the fax call is brought to the beginning of Phase D. The ECM shall not be used.

Test procedure

The fax sends the preamble followed by the EOP frame. The FA then enters the BCS-REC state after having transmitted at least 5 SYNC frames since the last transition to the idle state and sends the EOP frame embedded in STATUS frames to the SS. The FA enters the idle state again. Upon detection of the BCS-REC identifier octet the BCS-TRA state is entered in order to receive the MCF frame issued by the SS. Then the preamble and the MCF frame are conveyed to the connected fax by the FA. The FA enters the idle state. Phase D of the fax transmission is completed. Then the call is cleared by manual intervention at the MT or the activity progress of the call proceeds to the next phase.

Expected sequence

MS:	SS:
Step Direction	

1 MS-->SS Fax: Send preamble, EOP FA: CT109 ON (see note 2) BCS-REC Send preamble*, EOP* CT109 OFF (see note 2) IDLE	-----> Receive preamble*, EOP*
2 SS-->MS FA: CT105 ON (see note 2) BCS-TRA Transmit preamble, MCF CT105 OFF (see note 2) IDLE Fax: Receive preamble, MCF	<----- Send preamble*, MCF*

29.4.2.4.5 Test requirements

1. To be verified that the FA enters the BCS-REC state and inserts the correct ident octet in the STATUS frames. The up-conversion to the message speed has to be checked.. The condition of CT109 has to be verified (see note 2). The contents of the SYNC frames shall be checked.
2. To be verified that the FA enters the BCS-TRA state upon detection of the BCS-REC identifier and that the correct T.30 message is conveyed to the connected fax machine (down-conversion to the BCS speed). The condition of CT105 should be checked (see note 2).

29.4.2.5 Call release procedure**29.4.2.5.1 Definition and applicability**

This test is applicable to an MS supporting TS 61 and/or TS 62.

29.4.2.5.2 Conformance requirement

The MS supporting transparent facsimile group 3 shall perform the call release procedure and shall support the frames and the circuits at the Um-,R- and 2w-interface according the specifications referred to in the section "Reference".

Reference

GSM 03.45, CCITT T.30.

29.4.2.5.3 Test purpose

To verify phase E of the facsimile transmission.

29.4.2.5.4 Method of test**Initial conditions**

The activity progress of the fax call is brought to the beginning of Phase E.

Test procedure

The fax sends the preamble followed by the DCN frame. The FA then enters the BCS-REC state and sends the DCN frame embedded in STATUS frames to the SS. The FA enters the IDLE state again. CT108.2 will go OFF condition (see note 2) and after 200ms CT109 will go to OFF condition (see note 2) too. The MT then sends the DISC message and the call is cleared.

Expected sequence

MS:	SS:
Step	Direction

1	MS-->SS
	Fax: Send preamble, DCN
	FA: CT109 ON (see note 2)
	BCS-REC
	CT108.2 OFF (see note 2)
	Transmit preamble*, DCN*
	CT109 OFF (see note 2)
	after 200 ms
	IDLE
	MT: Send DISC message
	-----> Receive preamble*, DCN*
	-----> Receive DISC message

29.4.2.5.5 Test requirements

To be verified that CT108.2 is turned off (see note 2) and that CT109 is set to OFF (see note 2) 200ms after the DCN frame has been sent. The contents of the STATUS frames including the ident octet has to be checked (up-conversion to the message speed according to GSM 03.45). The MT shall send the DISC message.

29.4.2.6 CTC processing - 4th PPR for the same block**29.4.2.6.1 Definition and applicability**

This test is applicable to an MS supporting TS 61 and/or TS 62. The FA and the facsimile device have to support the error correction mode.

29.4.2.6.2 Conformance requirement

The MS supporting transparent facsimile group 3 shall perform the CTC processing procedure and shall support the frames and the circuits at the Um-,R- and 2w-interface according the specifications referred to in the section "Reference".

Reference

GSM 03.45, CCITT T.30.

29.4.2.6.3 Test purpose

To verify phase D of the facsimile transmission in case of a 4th PPR for the same block.

29.4.2.6.4 Method of test

Initial conditions

The activity progress of the fax call is brought to the beginning of Phase C. The ECM shall be used. The fax transmission shall start a speed of 9,6 kBit/s.

Test procedure

The fax sends the preamble followed by the PPS-NULL(0,0) frame. The FA then enters the BCS-REC state and sends the PPS* frame embedded in STATUS frames to the SS. The SS responds with the PPR* frame requesting corrupted frames to be retransmitted. This test sequence is repeated 4 times causing the fax machine to send the CTC frame which indicates the fallback bit rate of 7 200 kBit/s. The FA sends the CTC* after recognizing the new message speed to the SS. The SS responds with the CTR* frame and the fax machine retransmits the corrupted frames which are inserted into DATA frames by the FA. After every third DATA frame the FA has to insert a SYNC frame. After the retransmission, the fax machine sends the PPS-NULL(0,0) which is answered by the SS with the MCF* frame. Phase D of the fax transmission is completed. Then the call is cleared by manual intervention at the MT or the activity progress of the call proceeds to the next phase.

Expected sequence

MS:	SS:
Step	Direction
1	MS-->SS
	Fax: Send training, fax message
	FA: CT109 ON (see note 2)
	MSG-REC
	Send fax message*
	-----> Receive fax message*
	" "
	" "
	" "
	CT109 OFF (see note 2)
	IDLE
2	MS-->SS
	FA: Send at least
	5 SYNC frames
	-----> Receive SYNC frames
3	MS-->SS
	Fax: Send preamble, PPS-NULL
	FA: CT109 ON (see note 2)
	BCS-REC
	Send preamble*, PPS-NULL*
	CT109 OFF (see note 2)
	-----> Receive preamble*, PPS-NULL*
	IDLE
4	SS-->MS
	FA: CT105 ON (see note 2)
	BCS-TRA
	Transmit preamble, PPR
	CT105 OFF (see note 2)
	IDLE
	Fax: Receive preamble, PPR
5	Repeat steps 1 to 4 four times
6	MS-->SS
	Fax: Send preamble, CTC
	FA: CT109 ON (see note 2)
	BCS-REC
	Monitor CTC
	Send preamble*, CTC*
	CT109 OFF (see note 2)
	-----> Receive preamble*, CTC*
	IDLE
7	SS-->MS
	FA: CT105 ON (see note 2)
	BCS-TRA
	Transmit preamble, CTR
	CT105 OFF (see note 2)
	<----- Send preamble*, CTR*

		IDLE	
8	MS-->SS	Fax: Receive preamble, CTR	
		Fax: Send training, fax message	
		FA: CT109 ON (see note 2)	
		MSG-REC	
		Send fax message*	-----> Receive fax message*
		"	"
		"	"
		"	"
		CT109 OFF (see note 2)	
		IDLE	
9	MS-->SS	FA: Send at least	-----> Receive SYNC frames
		5 SYNC frames	
10	MS-->SS	Fax: Send preamble, PPS-NULL	
		FA: CT109 ON (see note 2)	
		BCS-REC	
		Send preamble*, PPS-NULL*	
		CT109 OFF (see note 2)	-----> Receive preamble*, PPS-NULL*
		IDLE	
11	SS-->MS		<----- Send preamble*, MCF*
		FA: CT105 ON (see note 2)	
		BCS-TRA	
		Transmit preamble, MCF	
		CT105 OFF (see note 2)	
		IDLE	
		Fax: Receive preamble, MCF	

29.4.2.6.5 Test requirement

It shall be verified that the FA transmits 1 SYNC frame every 3 DATA frames.

29.4.2.7 Transition from Facsimile to Speech - Procedure interrupt generated by receiving station

29.4.2.7.1 Definition and applicability

This test is applicable to an MS supporting TS 61.

29.4.2.7.2 Conformance requirement

The MS supporting transparent facsimile group 3 shall perform the ICM procedure and shall support the frames and the circuits at the Um-,R- and 2w-interface according the specifications referred to in the section "Reference".

Reference

GSM 03.45, CCITT T.30.

29.4.2.7.3 Test purpose

To verify the transition from fax to speech in case of an MS supporting TS 61.

29.4.2.7.4 Method of test

Initial conditions

The activity progress of the fax call is brought to phase C (message phase). The ECM shall not be used.

Test procedure

During the message phase a procedure interrupt is generated by the SS, which is executed as soon as phase D is entered. The SS then sends the PIP frame causing an alert at the mobile side. When the operator at the mobile side goes on line the PRI-Q frame is generated and results in an alarm at the SS side. The operator at this side going on line completes the PRI handshaking by causing the PIP frame to be sent. Upon completion of the PRI handshaking the MT executes the MODIFY procedure, which leads to the speech phase. Then the call is cleared by manual intervention at the MT or the facsimile phase maybe reselected.

Expected sequence

MS:	SS:
Step Direction	

1	Message Procedure (as described above) Operator intervention requested
2	MS-->SS Fax: Send preamble, EOP FA: CT109 ON (see note 2) BCS-REC Send preamble*, EOP* CT109 OFF (see note 2) -----> Receive preamble*, EOP* IDLE
3	SS-->MS <----- Send preamble*, PIP* FA: CT105 ON (see note 2) BCS-TRA Transmit preamble, PIP CT105 OFF (see note 2) IDLE Fax: Receive preamble, PIP Alert operator
4	MS-->SS Operator goes on line Fax: Send preamble, PRI-EOP FA: CT109 ON (see note 2) BCS-REC Send preamble*, PRI-EOP* CT109 OFF (see note 2) -----> Receive preamble*, PRI-EOP* IDLE Alert operator MT: CT106/109 OFF (see note 2)
5	SS-->MS <----- Operator goes on line Send preamble*, PIP* FA: CT105 ON (see note 2) BCS-TRA Transmit preamble, PIP CT105 OFF (see note 2) IDLE Fax: Receive preamble, PIP
6	MS-->SS FA: CT108.2 OFF (see note 2) MT: Send MODIFY message -----> Receive MODIFY m. <----- Send MODIFY COMPLETE CT107 OFF (see note 2)

SPEECH PHASE**29.4.2.7.5 Test requirements**

1. To be verified that CT106/109 are in OFF (see note 2) condition.
2. To be verified that CT108.2 goes to OFF (see note 2) upon completion of the PRI handshaking, that this transition to OFF triggers the MODIFY message to be sent and that the reception of the MODIFY COMPLETE message causes CT107 to be set to OFF (see note 2) condition by the MT. In addition the availability of the speech channel shall be checked.

29.4.2.8 Transition from Facsimile to Speech - Procedure interrupt generated by transmitting station**29.4.2.8.1 Definition and applicability**

This test is applicable to an MS supporting TS 61.

29.4.2.8.2 Conformance requirement

The MS supporting transparent facsimile group 3 shall perform the ICM procedure and shall support the frames and the circuits at the Um-,R- and 2w-interface according the specifications referred to in the section "Reference".

Reference

GSM 03.45, CCITT T.30.

29.4.2.8.3 Test purpose

To verify the transition from fax to speech in case of an MS supporting TS 61.

29.4.2.8.4 Method of test**Initial conditions**

The activity progress of the fax call is brought to phase C (message phase). The ECM shall not be used.

Test procedure

During the message phase a procedure interrupt is generated at the MS side, which is executed as soon as phase D is entered. The fax then sends the PRI-EOP frame causing an alert at the SS side. When the operator at the SS side goes on line the PIP frame is generated and results in an alarm at the MS side. The operator at this side going on line completes the PRI handshaking by causing the PRI-EOP frame to be sent. Upon completion of the PRI handshaking the MT executes the MODIFY procedure, which leads to the speech phase. Then the call is cleared by manual intervention at the MT or the facsimile phase maybe reselected.

Expected sequence

MS:		SS:
Step	Direction	
1	Message Procedure (as described above) Operator intervention requested	
2	MS-->SS Fax: Send preamble, PRI-EOP FA: CT109 ON (see note 2) BCS-REC Send preamble*, PRI-EOP* CT109 OFF (see note 2) IDLE	-----> Receive preamble*, PRI-EOP*
3	SS-->MS FA: CT105 ON (see note 2) BCS-TRA Transmit preamble, PIP CT105 OFF (see note 2) IDLE Fax: Receive preamble, PIP Alert operator	<----- Send preamble*, PIP*
4	MS-->SS Operator goes on line MT: CT106/109 OFF (see note 2) Fax: Send preamble, PRI-EOP FA: CT109 ON (see note 2) BCS-REC Send preamble*, PRI-EOP* CT109 OFF (see note 2) IDLE	-----> Receive preamble*, PRI-EOP*
5	MS-->SS FA: CT108.2 OFF (see note 2) MT: Send MODIFY message CT107 OFF (see note 2)	-----> Receive MODIFY m. <----- Send MODIFY COMPLETE
	SPEECH PHASE	

29.4.2.8.5 Test requirements

1. To be verified that CT106/109 are in OFF (see note 2) condition.
2. To be verified that CT108.2 goes to OFF (see note 2) upon completion of the PRI handshaking, that this transition to OFF triggers the MODIFY message to be sent and that the reception of the MODIFY COMPLETE message causes CT107 to be set to OFF (see note 2) condition by the MT. In addition the availability of the speech channel shall be checked.

29.4.2.9 Quality check**29.4.2.9.1 Definition and applicability**

This test is applicable to all configurations supporting transparent facsimile group 3.

29.4.2.9.2 Conformance requirement

The configuration supporting transparent facsimile group 3 shall decode the T.4 coding and shall generate a document.

Reference

GSM 03.45, CCITT T.21, CCITT T.4.

29.4.2.9.3 Test purpose

To verify the quality of the received document.

29.4.2.9.4 Method of test**Initial conditions**

The document has been received at the called side.

Test procedure

The quality of the received document at the SS side shall be checked.

29.4.2.9.5 Test requirement

The contents of the transmitted and the received document shall be the same.

29.4.3 Mobile terminated call**29.4.3.1 Call Establishment Procedure****29.4.3.1.1 Alternate Speech/Facsimile****29.4.3.1.1.1 DCD Mobile Terminated****29.4.3.1.1.1.1 Definition and applicability**

This test is applicable to an MS supporting TS 61.

29.4.3.1.1.1.2 Conformance requirement

The MS supporting transparent facsimile group 3 shall perform the ICM procedure and shall support the frames and the circuits at the Um-,R- and 2w-interface according the specifications referred to in the section "Reference".

Reference

GSM 03.45, CCITT T.30

29.4.3.1.1.1.3 Test purpose

To verify the transition from speech to fax in case of an MS supporting TS 61 and that the circuit and tone handling of the MT and FA is correct in case of an MT DCD.

29.4.3.1.1.1.4 Method of test**Initial conditions**

A TS 61 s/f call is set up. The speech phase is active.

Test procedure

The transition from speech to fax is initiated by manual intervention at both ends of the connection, i.e. the data call direction DCD is mobile terminated. Upon connection to line the FA turns on CT108.2 (see note 2) as a basic requirement for the transition from speech to fax. Now, within the next 3 seconds the FA has to detect the DCD, which is in this case mobile terminated, i.e. CT105 is set to OFF condition (see note 2). The following ICM procedure via the MODIFY message is carried out by the MT 3 seconds after circuit CT108.2 (see note 2) was set to ON condition. On completion of the ICM the synchronization of the TCH begins and after its completion the MT has to set CT107 to ON condition (see note 2). When CT106/109

are set to ON (see note 2) phase A is completed. Then the call is cleared by manual intervention at the MT or the activity progress of the call proceeds to the next phase.

Expected sequence

MS:	SS:
Step Direction	

1 MS-->SS	Fax: Connect to line (see note 1) Connect to line (see note 1)
	FA: CT108.2 ON (see note 2)
	Detect DCD
	CT105 OFF (see note 2)
	MT: Send MODIFY message <-----> Receive MODIFY message
	3 seconds after CT108.2 ON (see note 2)
2 SS-->MS	<-----> Send MODIFY COMPLETE
3 MS<->SS	TCH Synchronization <-----> TCH Synchronization
	MT: CT107 ON (see note 2), when synchronized
4 SS-->MS	<-----> Set X and SB bit in V.110 frame
	MT: CT106/109 ON (see note 2)
	FA: Enter BCS-REC state Enter BCS-TRA state

29.4.3.1.1.1.5 Test requirements

1. The condition of CT108.2 and CT105 is verified (see note 2); CT106, 107, 109 have to be in OFF (see note 2) condition. The MODIFY message has to be sent 3 seconds +/- 10% after circuit CT108.2 has gone to ON (see note 2) condition.
2. The RCSD-IE shall not be included in the MODIFY message.
3. To be verified that the MT begins the synchronization phase by sending the pattern 1/OFF after the reception of the MODIFY COMPLETE message, that CT107 is turned on (see note 2) by the MT after successful synchronization.
4. To be verified that CT106 and CT109 are turned on (see note 2), when in the V.110 frames received from the SS the X and SB bits are set. The state of the FA shall be verified (->BCS-REC).

29.4.3.1.1.2 DCD mobile originated

29.4.3.1.1.2.1 Definition and applicability

This test is applicable to an MS supporting TS 61.

29.4.3.1.1.2.2 Conformance requirement

The MS supporting transparent facsimile group 3 shall perform the ICM procedure and shall support the frames and the circuits at the Um-,R- and 2w-interface according the specifications referred to in the section "Reference".

Reference

GSM 03.45, CCITT T.30.

29.4.3.1.1.2.3 Test purpose

To verify the transition from speech to fax in case of an MS supporting TS 61 and that the circuit and tone handling of the MT and FA is correct in case of an MO DCD.

29.4.3.1.1.2.4 Method of test**Initial conditions**

A TS 61 s/f call is set up. The speech phase is active.

Test procedure

The transition from speech to fax is initiated by manual intervention at both ends of the connection, i.e. the data call direction DCD is mobile originated. Upon connection to line the FA turns on CT108.2 (see note 2) as a basic requirement for the transition from speech to fax. Now, within the next 3 seconds the FA has to detect the DCD, which is in this case mobile originated, i.e. CT105 is set to ON condition (see note 2), indicating that the MT has to include the RCSD-IE in the MODIFY message. The following ICM procedure via the MODIFY message is carried out by the MT 3 seconds after circuit CT108.2 (see note 2) was set to ON condition. On completion of the ICM the synchronization of the TCH begins and after its completion the MT has to set CT107 to ON condition (see note 2). When CT106/109 are set to ON (see note 2), phase A is completed. Then the call is cleared by manual intervention at the MT or the activity progress of the call proceeds to the next phase.

Expected sequence

MS: Step	Direction		SS:
1	MS-->SS	Fax: Connect to line (see note 1) FA: CT108.2 ON (see note 2) Detect DCD CT105 ON (see note 2)	Connect to line (see note 1)
		MT: Send MODIFY message with RCSD-IE 3 seconds after CT108.2 ON (see note 2)	-----> Receive MODIFY message
2	SS-->MS		<----- Send MODIFY COMPLETE with RCSD-IE
3	MS<->SS	TCH Synchronization MT: CT107 ON (see note 2), when synchronized FA: Generate CED (see note 2)	<-----> TCH Synchronization
4	SS-->MS	Fax: Detect CED (see note 2)	<----- Set X and SB bit in modified V.110 frame
		MT: CT106/109 ON (see note 2) FA: Enter BCS-TRA state	Enter BCS-REC state

29.4.3.1.1.2.5 Test requirements

1. The condition of CT108.2 and CT105 is verified (see note 2); CT106, 107, 109 have to be in OFF (see note 2) condition.
2. The MODIFY message containing the RCSD-IE has to be sent 3 seconds +/- 10% after circuit CT108.2 has gone to ON (see note 2) condition.
3. To be verified that the MT begins the synchronization phase by sending the pattern 1/OFF after the reception of the MODIFY COMPLETE message, that CT107 is turned on (see note 2) by the MT after successful synchronization. The CED (see note 2) tone has to be transmitted by the FA.
4. To be verified that CT106 and CT109 are turned on (see note 2), when in the modified V.110 frames received from the SS the X and SB bits are set. The state of the FA shall be verified (-> BCS-TRA).

29.4.3.1.2 Automatic facsimile**29.4.3.1.2.1 Definition and applicability**

This test is applicable to an MS supporting TS 62.

29.4.3.1.2.2 Conformance requirement

The MS supporting transparent facsimile group 3 shall perform the call setup procedure and shall support the frames and the circuits at the Um-,R- and 2w-interface according the specifications referred to in the section "Reference".

Reference

GSM 03.45, GSM 07.01, CCITT T.30.

29.4.3.1.2.3 Test purpose

To verify that the circuit and tone handling of the MT and FA is correct.

29.4.3.1.2.4 Method of test**Initial conditions**

The MS, configured for the fax call, is updated. Then the call establishment phase begins.

Test procedure

The SS will send the SETUP message causing CT125 (see note 2) going to ON condition at the MT. The FA then sends ring current (see note 2) to the fax machine, which will connect to line. The FA sets CT108.2 (see note 2) to ON condition which causes the MT to send the CONNECT message towards the SS. When the TCH is available (indicated by the CONNECT ACK message) the synchronization phase begins, i.e. both entities start sending the synchronization pattern 1/OFF. CT106, 107, 109 have to be in OFF (see note 2) condition. Upon completion of the synchronization phase the MT sets CT107 (see note 2) to ON condition causing the FA to send the CNG tone (see note 2) while the SS turns on CT108.2 causing the CED tone to be sent. Then the SS sets CT106 and 109 to ON (see note 2) at the MT by means of the modified V.110 X and SB bits, which completes Phase A. Then the call is cleared by manual intervention at the MT or the activity progress of the call proceeds to the next phase.

Expected sequence

MS:	SS:
Step Direction	
1 SS-->MS	<----- Send SETUP message
2 MS-->SS	MT: CT125 ON (see note 2) FA: Cause ring current to flow (see note 2) Fax: Connect to line (see note 1) FA: CT108.2 ON (see note 2) MT: Send CONNECT message
3 SS-->MS	-----> Receive CONNECT message
4 MS<->SS	-----> Send CONN ACK message
5 SS-->MS	TCH Synchronization <-----> TCH Synchronization MT: CT107 ON (see note 2), when completed FA: Generate CNG (see note 2) Fax: Receive CNG (see note 2)
6	<----- Set X and SB bit in modified V.110 frame MT: CT106/109 ON (see note 2) FA: Enter BCS-REC state
	Enter BCS-TRA state

29.4.3.1.2.5 Test requirements

1. The condition of CT125 (see note 2) shall be verified.
2. CT108.2 to be verified (see note 2) and the CONNECT message has to be sent by the MT.
3. To be verified that at the MT CT106, 107, 109 are in OFF (see note 2) condition, that the MT begins the synchronization phase by sending the pattern 1/OFF, that CT107 is turned on (see note 2) by the MT after successful synchronization and that the CNG tone (see note 2) is sent.
4. It shall be verified that CT106 and CT109 are turned on (see note 2), when in the modified V.110 frames received from the SS the X and SB bits are set.
5. The state of the FA shall be verified (-> BCS-REC).

29.4.3.2 Pre-message procedure**29.4.3.2.1 Definition and applicability**

This test is applicable to an MS supporting TS 61 and/or TS 62.

29.4.3.2.2 Conformance requirement

The MS supporting transparent facsimile group 3 shall perform the pre-message procedure and shall support the frames and the circuits at the Um-, R- and 2w-interface according the specifications referred to in the section "Reference".

Reference

GSM 03.45, CCITT T.30.

29.4.3.2.3 Test purpose

To verify the correct handling of the T.30 DIS/DCS/TCF frames.

29.4.3.2.4 Method of test**Initial conditions**

The activity progress of the fax call is brought to the beginning of Phase B. The fax transmission shall start using a speed of 9,6 kBit/s.

Test procedure

After phase A the FA being in BCS-REC state, sends the DIS* frame in order to indicate the capabilities of the connected fax and the FA and returns to the idle state. The SS's answer to the DIS is the DCS*. Upon detection of the BCS-REC identifier the FA enters the BCS-TRA state, receives the DCS* and transmits the DCS to the fax. After being for 75 ± 20 ms in IDLE state the FA autonomously enters the MSG-TRA state and begins transmitting the training sequence towards the fax without being triggered by the remote FA/SS. Meanwhile the SS sends the TCF*, which is buffered by the FA. When the training is done the FA transmits the buffered TCF towards the fax. Then the CFR* frame is transmitted to the SS. Now, phase B is completed and the data transfer phase C begins. Then the call is cleared by manual intervention at the MT or the call activity progress proceeds to the next phase.

Expected sequence

MS:	SS:
Step	Direction
1	MS-->SS
	Fax: Send preamble,DIS FA: BCS-REC Filter DIS Send preamble*,DIS* -----> Receive preamble*,DIS* CT109 OFF (see note 2) IDLE
2	SS-->MS
	FA: CT105 ON (see note 2) BCS-TRA Monitor DCS Transmit preamble,DCS <----- Send preamble*,DCS* CT105 OFF (see note 2) IDLE
3	SS-->MS
	Fax: Receive preamble,DCS <----- Send TCF* FA: CT105 ON (see note 2) MSG-TRA Initiate training after 75 ms +-20 ms in IDLE Transmit TCF CT105 OFF (see note 2) IDLE
4	MS-->SS
	Fax: Receive training,TCF Send preamble, CFR FA: CT109 ON (see note 2) BCS-REC Send preamble*,CFR* -----> Receive preamble*,CFR* CT109 OFF (see note 2) IDLE

29.4.3.2.5 Test requirements

- To be verified that the DIS is filtered and that the correct up-conversion to the message speed is applied. CT109 should go to OFF (see note 2).
- The DCS shall indicate a message speed of 7 200 bit/s and the down-conversion to the BCS speed shall be verified.
- The FA, after the reception of the DCS, sends SYNC frames for 75 ± 20 ms and changes to the MSG-TRA state without being triggered by the SS. When the training is over the TCF is transmitted to the fax.
- The condition of CT109 (see note 2), the ident octet of the STATUS frames and the up-conversion to the message speed shall be verified.

29.4.3.3 Message procedure**29.4.3.3.1 Definition and applicability**

This test is applicable to an MS supporting TS 61 and/or TS 62.

29.4.3.3.2 Conformance requirement

The MS supporting transparent facsimile group 3 shall perform the message procedure and shall support the frames and the circuits at the Um-,R- and 2w-interface according the specifications referred to in the section "Reference".

Reference

GSM 03.45, CCITT T.30, CCITT T.4, CCITT T.21.

29.4.3.3.3 Test purpose

To verify the facsimile data transmission phase.

29.4.3.3.4 Method of test**Initial conditions**

The activity progress of the fax call is brought to the beginning of Phase C. The ECM shall not be used.

Test procedure

The FA is in idle state. Upon reception of the MSG-REC identifier the FA enters the MSG-TRA state, sends the MSG-TRA identifier and initiates the training. While the training is in progress data being received is buffered and conveyed to the connected fax upon end of training. When the transmission is finished the FA is again in the IDLE state and Phase D begins. Then the call is cleared by manual intervention at the MT or the activity progress of the call will proceed to the next phase.

Expected sequence

MS: Step	Direction		SS:
1	SS-->MS		<----- Transmit STATUS interleaved with SYNC frames
2	MS-->SS	FA: CT105 ON (see note 2) MSG-TRA Initiate training Send STATUS interleaved with SYNC frames	----->
3	SS-->MS	FA: Buffer received data during training Receive fax message* " " " CT105 OFF (see note 2) IDLE Fax: Receive training, fax message	<----- Send fax message* " " "

29.4.3.3.5 Test requirements

- To be verified that the FA enters the MSG-TRA state and inserts the correct ident octet in the STATUS frames. Training has to be initiated (see note 2). STATUS frames have to be sent interleaved with SYNC frames.
- The condition of CT105 (see note 2) shall be checked.

29.4.3.4 Post-message procedure**29.4.3.4.1 Definition and applicability**

This test is applicable to an MS supporting TS 61 and/or TS 62.

29.4.3.4.2 Conformance requirement

The MS supporting transparent facsimile group 3 shall perform the post-message procedure and shall support the frames and the circuits at the Um-,R- and 2w-interface according the specifications referred to in the section "Reference".

Reference

GSM 03.45, CCITT T.30

29.4.3.4.3 Test purpose

To verify phase D of the facsimile transmission.

29.4.3.4.4 Method of test**Initial conditions**

The activity progress of the fax call is brought to the beginning of Phase D. The ECM shall not be used.

Test procedure

The SS sends the EOP* frame. The FA then enters the BCS-TRA state and conveys the EOP frame to the fax machine. The fax answers the EOP with the MCF frame. The FA will enter the BCS-REC state, transmit the BCS-REC identifier and will convey the MCF* frame to the SS. Afterwards the FA enters the IDLE state. Phase D of the fax transmission is completed. Then the call is cleared by manual intervention at the MT or the activity progress of the call will proceed to the next phase.

Expected sequence

MS:	Direction	SS:

1	SS-->MS	<----- Send preamble*, EOP*
	FA: CT105 ON (see note 2)	
	BCS-TRA	
	Transmit preamble, EOP	
	CT105 OFF (see note 2)	
	IDLE	
2	MS-->SS	-----> Receive preamble*, MCF*
	Fax: Receive preamble, EOP	
	Fax: Send preamble, MCF	
	FA: CT109 ON (see note 2)	
	BCS-REC	
	Send preamble*, MCF*	
	CT109 OFF (see note 2)	
	IDLE	

29.4.3.4.5 Test requirements

1. To be verified that the FA enters the BCS-TRA state upon detection of the BCS-REC identifier and that the correct T.30 message (down conversion to the message speed) is conveyed to the connected fax.
2. To be verified that the FA enters the BCS-REC state and that the correct STATUS frames are sent (up-conversion to the message speed).

29.4.3.5 Call release procedure**29.4.3.5.1 Definition and applicability**

This test is applicable to an MS supporting TS 61 and/or TS 62.

29.4.3.5.2 Conformance requirement

The MS supporting transparent facsimile group 3 shall perform the call release procedure and shall support the frames and the circuits at the Um-,R- and 2w-interface according the specifications referred to in the section "Reference".

Reference

GSM 03.45, CCITT T.30.

29.4.3.5.3 Test purpose

To verify phase E of the facsimile transmission.

29.4.3.5.4 Method of test**Initial conditions**

The activity progress of the fax call is brought to the beginning of Phase E.

Test procedure

The SS sends the preamble followed by the DCN frame. The FA then enters the BCS-TRA state and sends the DCN frame to the fax terminal. The FA enters the idle state again. CT108.2 (see note 2) will go OFF condition. The MT then sends the DISC message and the call is cleared.

Expected sequence

MS:		SS:
Step	Direction	
1	SS-->MS	<----- Send preamble*, DCN*
	FA: CT105 ON (see note 2)	
	BCS-TRA	
	CT108.2 OFF (see note 2)	
	Generate preamble, DCN	
	CT105 OFF (see note 2)	
	IDLE	
	Fax: Receive preamble, DCN	
	MT: Send DISC message	-----> Receive DISC message

29.4.3.5.5 Test requirements

To be verified that CT108.2 is turned off (see note 2) and that the correct down-conversion to the BCS speed is applied. The MT shall send the DISC message.

29.4.3.6 Speed conversion factor**29.4.3.6.1 Definition and applicability**

This test is applicable to an MS supporting TS 61 and/or TS 62.

29.4.3.6.2 Conformance requirement

The MS supporting transparent facsimile group 3 shall perform the up- and down-conversion procedure and shall support the frames and the circuits at the Um-,R- and 2w-interface according the specifications referred to in the section "Reference".

Reference

GSM 03.45, CCITT T.30.

29.4.3.6.3 Test purpose

To verify the correct speed conversion for the BCS phases.

29.4.3.6.4 Method of test**Initial conditions**

The activity progress of the fax call is brought to the beginning of Phase B. The ECM shall not be used.

Test procedure

The following test sequence is repeated 5 times with 5 different DCS frames indicating a message speed of 9,6/7,2/4,8/2,4 and 9,6 kBit/s. This test is done to verify that the FA detects a change of the TCH access rate and due to this updates the speed conversion factor, which is used for the up-conversion of the BCS signalling to the message speed and vice versa. Then the call is cleared by manual intervention at the MT or the activity progress of the call proceeds to the next phase.

Expected sequence

MS:	SS:
Step	Direction
1	MS-->SS
	Fax: Send preamble,DIS FA: BCS-REC Monitor DIS Send preamble*,DIS* -----> Receive preamble*,DIS* CT109 OFF (see note 2) IDLE
2	SS-->MS
	FA: CT105 ON (see note 2) BCS-TRA Monitor DCS Transmit preamble,DCS <----- Send preamble*,DCS* CT105 OFF (see note 2) IDLE
3	SS<->MS
	Fax: Receive preamble,DCS Execution of the CMM procedure **): The SS sends the CMM message 150 ms after the DCS has been sent and the MT completes the procedure by sending the CMM ACK message
4	SS-->MS
	FA: CT105 ON (see note 2) MSG-TRA Initiate training after 75 ms +/- 20 ms in idle Generate TCF <----- Send TCF* CT105 OFF (see note 2) IDLE
5	MS-->SS
	Fax: Receive training,TCF Fax: Send preamble,CFR FA: CT109 ON (see note 2) BCS-REC Send preamble*,CFR* -----> Receive preamble*,CFR* CT109 OFF (see note 2) IDLE
6	SS-->MS
	FA: CT105 ON (see note 2) MSG-TRA Initiate training Buffer received data during training Receive fax message* <----- Send fax message* "

			"		"
			"		"
			CT105 OFF (see note 2)		
			IDLE		
7	SS-->MS	Fax:	Receive training, fax message	<-----	Send preamble*, EOM*
		FA:	CT105 ON (see note 2)		
			BCS-TRA		
			Transmit preamble, EOM		
			CT105 OFF (see note 2)		
			IDLE		
8	MS-->SS	Fax:	Receive preamble, EOM		
		Fax:	Send preamble, MCF		
		FA:	CT109 ON (see note 2)		
			BCS-REC		
			Send preamble*, MCF*		
			CT109 OFF (see note 2)	----->	Receive preamble*, MCF*
			IDLE		
9	Repeat steps 2 to 8 four times				

**)

only if the requested rate in the DCS differs from the existing radio channel rate (when the radio channel rate equals 9 600 kbit/s and the DCS requests 7 200 kbit/s no CMM will be executed)

29.4.3.6.5 Test requirements

1. The MT shall send the CMM ACK message.
2. For 7,2/9,6 kBit/s:
The correct up- and down-conversion shall be verified (4 STATUS frames for 1 BCS octet)
- For 4,8 kBit/s:
The correct up- and down-conversion shall be verified (2 STATUS frames for 1 BCS octet)
- For 2,4 kBit/s:
The correct up- and down-conversion shall be verified (1 STATUS frame for 1 BCS octet)

The IDENT octet shall be set to BCS-REC in case of the up-conversion.

29.4.3.7 Quality Check

29.4.3.7.1 Definition and applicability

This test is applicable to all configurations supporting transparent facsimile group 3.

29.4.3.7.2 Conformance requirement

The configuration supporting transparent facsimile group 3 shall decode the T.4 coding and shall generate a document.

Reference

GSM 03.45, CCITT T.21, CCITT T.4.

29.4.3.7.3 Test purpose

To verify the quality of the received document.

29.4.3.7.4 Method of test

Initial conditions

The document has been received at the called side.

Test procedure

The quality of the document at the receiving side shall be checked.

29.4.3.7.5 Test requirements

The contents of the transmitted and the received document shall be the same.

29.4.4 Notes

The following notes apply throughout the clause 29.4.

NOTE 1: By pressing the START button on the facsimile apparatus or in case of PC fax by selecting the appropriate software menu point or automatically.

NOTE 2: Or equivalent function/means having the same result.

NOTE 3: Tested by monitoring the contents of the STATUS frame ident octet identifier.

NOTE 4: If no access is available to the 2w interface, this requirement cannot always be verified.

30 Speech teleservices

When an artificial ear is required, the ITU-T Recommendation P.57 [107] Type 1 artificial ear shall be used.

If requested by the terminal supplier, the ITU-T Recommendation P.57 [107] Type 3.2 artificial ear shall be used. In this case the following apply:

- The low leakage option of Type 3.2 artificial ear shall be adopted;
- The force against the ear shall be as specified in ITU-T Recommendation P.57 [107].
- Sound pressure measurements shall be referred to the ERP as specified in ITU-T Recommendation P.57 [107].
- No leakage correction shall be made in the calculation of RLR (i.e. $L_E=0$).

The manufacturer declares in the IXIT statement which type of artificial ear will be used for teleservices speech testings.

NOTE 1: An MS may be either a handset MS, a handsfree MS or a combined handset and handsfree MS. The test description for handsfree operation, however, at the moment only covers the stability margin as no test method could be defined for the other parameter.

NOTE 2: Frequency settings in the following tests are taken from ISO 3, R10 series or R40 series or from table 2 of CCITT P.79. A departure from the nominal frequencies of +5 % below 240 Hz and + 2 % at 240 Hz and above is accepted. Any sub-multiple of the sampling frequency of 8 kHz shall be avoided. In the case of 4 kHz the departure is restricted to -2 %.

NOTE 3: The measurement accuracy for signal level is +/- 0,2 dB and for sound pressure +/-0,6 dB.

NOTE 4: The digital test signals shall be generated as 8 bit A-law companded PCM signals, which internally in the SS are expanded according to CCITT Rec. G.721 (Law=1) to 13 bit linear before being applied to the MS via the DAI.

NOTE 5: When measuring signal levels on the DAI, a digital measuring instrument is connected to the 64 kbit/s output of the A-law compression equipment in the SS, which is in turn connected to the DAI in the MS.

NOTE 6: Measurements shall be possible with and without psophometric weighting according to Rec. CCITT G.223, table 4.

30.1 Sending sensitivity/frequency response

30.1.1 Definition and applicability

The sending sensitivity frequency response is, as a function of the input test tone frequency, the ratio expressed in dB between the output level, represented by the PCM bit stream at the Digital Audio Interface (DAI) and the input sound pressure in the artificial mouth required to obtain this.

The requirements and this test apply to all types of GSM 900 and DCS 1 800 handset MS supporting speech.

30.1.2 Conformance requirement

The sending sensitivity frequency response shall be within the mask given in GSM 03.50. GSM 03.50; 3.8.1.1, table 1.

30.1.3 Test purpose

To verify that the sending sensitivity frequency response from the MRP to the DAI is within the mask given in GSM 03.50, 3.8.1.1, table 1.

30.1.4 Method of test**30.1.4.1 Initial conditions**

- a) The handset is mounted in the LRGP (see annex A of CCITT Recommendation P.76). The earpiece is sealed to the knife-edge of the artificial ear.
- b) A pure tone with a sound pressure of -4,7 dBPa (in accordance with CCITT Recommendation P.64) is applied at the mouth reference point (MRP) as described in CCITT Recommendation P.64 using an artificial mouth conforming to CCITT Recommendation P.51.
- c) A digital measuring instrument, or high quality digital decoder followed by an analogue level measuring set, is connected to the Digital Audio Interface (DAI). The DAI is set to the operating mode "Test of acoustic devices and A/D & D/A".

30.1.4.2 Procedure

The SS measures the output level represented by the PCM bit stream at the DAI (pin 23) at one-twelfth-octave intervals as given by the R40 series of preferred numbers in ISO 3 for frequencies from 100 Hz to 4 000 Hz inclusive.

30.1.5 Test requirement

The sending sensitivity/frequency response (from MRP to the DAI) shall be within a mask given in table 30.1. The mask can be drawn with straight lines between the breaking points in the table on a logarithmic (frequency) vs linear (dB sensitivity) scale.

All sensitivity levels are dB on an arbitrary scale.

Table 30.1

Frequency (Hz)	Upper Limit (dB)	Lower Limit (dB)
100	-12	
200	0	
300	0	-12
1000	0	-6
2000	4	-6
3000	4	-6
3400	4	-9
4000	0	

30.2 Sending loudness rating**30.2.1 Definition and applicability**

The Sending Loudness Rating (SLR) is a means of expressing the sending frequency response based on objective single tone measurements in a way which relates to how a speech signal would be perceived by a listener.

The requirements and this test apply to all types of GSM 900 and DCS 1 800 handset MS supporting speech.

30.2.2 Conformance requirement

The Sending Loudness Rating (SLR) shall be 8 +/- 3 dB.
GSM 03.50; 3.1.1.

30.2.3 Test Purpose

To verify that the Sending Loudness Rating (SLR) is 8 +/- 3 dB.

30.2.4 Method of test**30.2.4.1 Initial conditions**

The DAI of the MS is connected to the SS and is set to the operating mode "Test of acoustic devices and A/D & D/A".

30.2.4.2 Procedure

- a) The sending sensitivity is measured at each of the 14 frequencies given in table 2 of CCITT P.79, bands 4 to 17.
- b) The sensitivity is expressed in terms of dBV/Pa and the SLR is calculated according to CCITT Recommendation P.79 formula 4.19 b of CCITT P.79, over bands 4 to 17, using the sending weighting factors from CCITT Recommendation P.79 table 2, adjusted according to table 3 of CCITT Recommendation P.79.

30.2.5 Test requirement

The SLR shall be 8 +/- 3 dB.

30.3 Receiving sensitivity/frequency response**30.3.1 Definition and applicability**

The receiving sensitivity frequency response is, as a function of the input test tone frequency, the ratio expressed in dB between the output sound pressure in the artificial ear and the input level, represented by the PCM bit stream at the Digital Audio Interface (DAI), required to obtain this.

The requirements and this test apply to all types of GSM 900 and DCS 1 800 handset MS supporting speech.

30.3.2 Conformance requirement

The receiving sensitivity frequency response shall be within the mask given in GSM 03.50. GSM 03.50; 3.8.1.2, table 2.

30.3.3 Test purpose

To verify that the receiving sensitivity frequency response from the DAI to the ERP is within the mask given in GSM 03.50; 3.8.1.2, table 2.

30.3.4 Method of test**30.3.4.1 Initial conditions**

- a) The handset is mounted in the LRGP and the earpiece is sealed to the knife-edge of the artificial ear.
- b) A digital signal generator is connected at the digital interface delivering a signal equivalent to a pure tone level of -16 dBm0, see CCITT Recommendation P.64.
- c) The DAI of the MS is connected to the SS and is set to the operating mode "Test of acoustic devices and A/D & D/A".

30.3.4.2 Procedure

Measurements are made at one twelfth-octave intervals as given in the R.40 series of preferred numbers in ISO 3 for frequencies from 100 Hz to 4 kHz inclusive. At each frequency, the sound pressure in the artificial ear is measured by connecting a suitable measuring set to the artificial ear.

30.3.5 Test requirement

The receiving sensitivity/frequency response (from the DAI to the ERP) shall be within the mask given by table 30.2. The mask can be drawn with straight lines between the breaking points in the following table on a logarithmic (frequency) vs linear (dB sensitivity) scale.

All sensitivity levels are dB on an arbitrary scale.

Table 30.2

Frequency (Hz)	Upper Limit (dB)	Lower Limit (dB)
100	-12	
200	0	
300	2	-7
500	*	-5
1000	0	-5
3000	2	-5
3400	2	-10
4000	2	

NOTE: * The limit at intermediate frequencies lies on a straight line drawn between the given values on a log (frequency) vs linear (dB) scale.

30.4 Receiving loudness rating**30.4.1 Definition and applicability**

The Receiving Loudness Rating (RLR) is a means of expressing the receiving frequency response based on objective single tone measurements in a way which relates to how a speech signal would be perceived by a listener.

The requirements and this test apply to all types of GSM 900 and DCS 1 800 handset MS supporting speech.

30.4.2 Conformance requirement

- 1) The nominal Receiving Loudness Rating (RLR) shall be 2 +/- 3 dB.
If a user controlled receive volume control is provided the equipment shall meet this nominal value for at least one setting of the control.
GSM 03.50; 3.1.1.
- 2) If a user controlled receive volume control is provided the Receive Loudness Rating (RLR) shall not be less than -13 dB when the control is set to maximum.
GSM 03.50; 3.1.1.

30.4.3 Test purpose

- 1) To verify that the nominal Receiving Loudness Rating (RLR) is 2 +/- 3 dB.
- 2) To verify that if a user controlled receive volume control is provided the Receive Loudness Rating (RLR) is not less than -13 dB when the control is set to maximum.

30.4.4 Method of test

30.4.4.1 Initial conditions

The DAI of the MS is connected to the SS and is set to the operating mode "Test of acoustic devices and A/D & D/A".

30.4.4.2 Procedure

- a) The receiving sensitivity is measured at each of the 14 frequencies listed in table 2 of CCITT Recommendation P.79, bands 4 to 17.
- b) The sensitivity is expressed in terms of dBPa/V and the RLR is calculated according to CCITT Recommendation P.79 formula 4.19 c, over bands 4 to 17, using the receiving weighting factors from table 2 of CCITT Recommendation P.79, adjusted according to table 3 of CCITT Recommendation P.79.
- c) The artificial ear sensitivity must be corrected according to the real ear correction of table 4 of CCITT Recommendation P.79.

NOTE: The values of real ear correction in CCITT Recommendation P.79 table 4 were derived for one type of handset conforming to the shape defined in CCITT Recommendation P.35.

These values are used in this ETS because there is no measurement method agreed for the real ear correction. If a method of measurement is agreed, it is intended to change this ETS to use the values appropriate to each handset.

30.4.5 Test requirement

If no user controlled receive volume control is provided, the RLR shall be 2 +/- 3 dB.

If a user controlled receive volume control is provided, the RLR shall meet this nominal value for (at least) one setting of the receive volume control.

When the receive volume control is set to maximum the RLR shall not be less than (i.e. louder than) -13 dB.

30.5 Side tones

30.5.1 Side Tone Masking Rating (STMR)

30.5.1.1 Definition and applicability

The sidetone loudness ratings are a means of expressing the path loss from the artificial mouth to the artificial ear based on objective single tone measurements in a way that relates to how a speaker will perceive his own voice when speaking (talker sidetone, expressed by the sidetone masking rating - STMR), or how a listener will perceive the background noise picked up by the microphone (listener sidetone rating - LSTR).

The requirements and this test apply to all types of GSM 900 and DCS 1 800 handset MS supporting speech.

30.5.1.2 Conformance requirement

The nominal value of the Side Tone Masking Rating (STMR) shall be 13 +/- 5 dB. Where a user controlled receiving volume control is provided the STMR shall meet the requirement at the setting where the RLR is equal to the nominal value.
GSM 03.50; 3.10.1.

30.5.1.3 Test purpose

- 1) To verify that the Side Tone Masking Rating (STMR) is 13 +/- 5 dB.

- 2) To verify that a user controlled receiving volume control is provided, the STMR is 13 +/- 5 dB at the setting where the RLR is equal to the nominal value.

30.5.1.4 Method of test

30.5.1.4.1 Initial conditions

- a) The DAI of the MS is connected to the SS and is set to the operating mode "Test of acoustic devices and A/D & D/A".
- b) The handset is mounted in the LRGP (see annex 1 of CCITT P.76) and the earpiece is sealed to the knife-edge of the artificial ear conforming to CCITT P.51.

30.5.1.4.2 Procedure

- a) The SS sends a PCM bit stream coded with the value No 1 over the DAI (pin 25). Or alternatively the activation of the A/D and D/A converters is performed via a call setup, in which case the DAI connection between the MS and SS, and the PCM bit stream are optional.

NOTE: The idle channel noise in the receiving direction is the acoustic sound pressure in the artificial ear when the digital input signal at the DAI is the PCM coded value No. 1.

- b) The SS applies a pure tone with a sound pressure of -4,7 dBPa at the mouth reference point as described in CCITT P.64 using an artificial mouth conforming to CCITT P 51.
- c) For each frequency given in table 2 of CCITT P.79, bands 4 to 17, the sound pressure in the artificial ear is measured.
- d) The sidetone path loss (LmeST) is expressed in dB and the STMR (in dB) is calculated from the formula 8.4 of CCITT Recommendation P.79, using the weighting factors of column (3) in table 6 of CCITT Recommendation P.79 (unsealed), and values of LE in accordance with table 4 of CCITT Recommendation P.79.

30.5.1.5 Test requirement

The STMR shall be 13 +/- 5 dB.

Where a user controlled receive volume control is provided, the STMR shall meet the requirement given above at the setting where the RLR is equal to the nominal value.

30.5.2 Listener Side Tone Rating (LSTR)

30.5.2.1 Definition and applicability

The Listener Sidetone Rating (LSTR) is considered a major parameter affecting the user perception of the system.

The requirements and this test is applicable to all types of GSM 900 and DCS 1 800 handset MS supporting speech.

30.5.2.2 Conformance requirement

The value of the Listener Sidetone Rating (LSTR) shall not be less than 15 dB.

GSM 03.50, 3.10.1.

30.5.2.3 Test purpose

To verify that the value of LSTR is not less than 15dB.

30.5.2.4 Method of test**30.5.2.4.1 Initial conditions**

The DAI of the MS is connected to the SS and is set to the operating mode "Test of acoustic devices and A/D & D/A".

The SS sends a PCM bit stream coded with the value No. 1 over the DAI (pin 25) to the MS.

30.5.2.4.2 Procedure

- a) The sound field is calibrated in the absence of any local obstacles. The averaged field shall be uniform to within +4 dB/-2 dB within a radius of 0,15 m of the MRP, when measured in one-third octave bands from 100 Hz to 8 kHz (bands 1 to 20).
- b) A calibrated half-inch microphone is mounted at MRP. The sound field is measured in one-third octave bands. The spectrum shall be "Pink noise" as described in CCITT recommendation P.64 annex B to within +/-1 dB and the level shall be adjusted to 70 dBA (-24 dBPa(A)). The tolerance on this level is +/-1 dB.
- c) The artificial mouth and ear are placed in the correct position relative to MRP, the handset is mounted at LRGP and the earpiece is sealed to the knife-edge of the artificial ear.
- d) Measurements are made in one-third octave bands for the 14 bands centred at 200 Hz to 4 kHz (bands 4 to 17). For each band the sound pressure in the artificial ear shall be measured by connecting a suitable measuring set to the artificial ear.
- e) The listener sidetone path loss is expressed in dB and the LSTR shall be calculated from the CCITT Recommendation P.79 formula 8-4, using the weighting factors in column (3) in table 6 of the Recommendation, and the values of LE; in accordance with table 4 of the Recommendation.

30.5.2.5 Test requirement

The LSTR shall not be less than 15 dB.

30.6 Telephone Acoustic coupling Loss (TAL)**30.6.1 Echo Loss (EL)****30.6.1.1 Definition and applicability**

The echo loss is the path loss from the input of the reference speech encoder of the SS to the output of the reference speech decoder of the SS.

The requirements and this test apply to all types of GSM 900 and DCS 1 800 handset MS supporting speech.

30.6.1.2 Conformance requirement

The echo loss from the input to the output of the reference speech codec in the SS shall be at least 46 dB.
GSM 03.50; 3.4.3.2.

30.6.1.3 Test purpose

To verify that the echo loss from the input to the output of the reference speech codec in the SS is at least 46 dB.

30.6.1.4 Method of test

30.6.1.4.1 Initial conditions

The DAI of the MS is connected to the SS and is set to the operating mode "Normal operation".

The SS sets up a speech call according to the generic call set up procedure.

The handset is mounted in the LRGP (see annex 1 of CCITT P.76) and the earpiece is sealed to the knife-edge of the artificial ear conforming to CCITT P.51.

Where a user controlled volume control is provided it is set to maximum.

30.6.1.4.2 Procedure

An implementation of the CCITT P.50 artificial speech is connected to the analogue or digital input of the reference speech encoder of the SS. This implementation is either a real time algorithm producing the artificial speech or a pre-recorded tape of artificial speech. Both "male" and "female" artificial speech is required.

A ten second segment of the "male" artificial speech is applied to the analogue or digital input of the reference speech encoder of the SS. The third octave power of the input signal is measured. The echo loss signal is not measured at this stage as the first ten second segment is used to allow any acoustic echo cancellation devices within the MS to adapt to the echo path.

Immediately after a second ten second segment of the "male" artificial speech is applied to the analogue or digital input of the reference speech encoder of the SS. The third octave power of the echo signal is measured at the analogue or digital output of the reference speech decoder of the SS.

The difference between the third octave input power and the third octave output power is entered into the CCITT G.122 TCL algorithm and the acoustic echo loss calculated.

The test is repeated with the "female" artificial speech and the results of both "male" and "female" averaged to give the final result.

30.6.1.5 Test requirement

The echo loss from the input to the output of the reference speech codec in the SS shall be at least 46 dB.

30.6.2 Stability margin

30.6.2.1 Definition and applicability

The receive-transmit stability margin is a measure of the gain that would have to be inserted between the go and return paths of the reference speech coder in the SS for oscillation to occur.

The requirements and this test apply to all types of GSM 900 and DCS 1 800 MS supporting speech.

30.6.2.2 Conformance requirement

The stability margin shall be at least 6 dB.
GSM 03.50; 3.2.

30.6.2.3 Test purpose

To verify that the stability margin is at least 6 dB.

30.6.2.4 Method of test

30.6.2.4.1 Initial conditions

For handset operation the handset is placed on a hard plane surface with the transducers facing the surface.

For handsfree operation the test setup is shown in CCITT P.34 (Fig 3/CCITT P.34), but omitting the test table.

Where a user controlled volume control is provided it is set to maximum.

30.6.2.4.2 Procedure

- a) A gain equivalent to the minimum stability margin is inserted in the loop between the go and return paths of the reference speech coder in the SS and any acoustic echo control is enabled.
- b) A test signal according to CCITT O.131 is injected into the loop at the analogue or digital input of the reference speech codec of the SS and the stability is measured. The test signal has a level of -10 dBm0 and a duration of 1 s.

30.6.2.5 Test requirement

The minimum stability margin shall be 6 dB and no audible oscillation shall be detected.

30.7 Distortion

30.7.1 Sending

30.7.1.1 Definition and applicability

The transmit signal to total distortion ratio is a measure of the linearity of the transmitter equipment (excluding the speech codec).

The requirements and this test apply to all types of GSM 900 and DCS 1 800 handset MS supporting speech.

30.7.1.2 Conformance requirement

The ratio of signal to total distortion power in the sending direction measured at the DAI with psophometric filter shall be above the limits given in GSM 03.50; 3.9.1, table 3, unless the sound pressure at MRP exceeds +10 dBPa.
GSM 03.50; 3.9.1.

30.7.1.3 Test purpose

To verify that the ratio of signal to total distortion power in the sending direction measured at the DAI with psophometric filter is above the limits given in GSM 03.50; 3.9.1, table 3.

30.7.1.4 Method of test

30.7.1.4.1 Initial conditions

The handset is mounted in the LRGP (see annex 1 of CCITT P.76) and the earpiece is sealed to the knife-edge of the artificial ear conforming to CCITT P.51.

The DAI of the MS is connected to the SS and is set to the operating mode "Test of acoustic devices and A/D & D/A".

30.7.1.4.2 Procedure

- a) A sine-wave signal with a frequency in the range 1004 Hz to 1025 Hz is applied to the MRP. The level of this signal is adjusted until the PCM bitstream at the DAI output (pin 23) corresponds to -10 dBm0. The level of the signal at the MRP is then the acoustic reference level (ARL).
- b) The test signal is applied at the following levels: -35, -30, -25, -20, -15, -10, -5, 0, 5, 10 dB relative to the ARL.
- c) The ratio of signal to total distortion power is measured at the DAI with the psophometric noise weighting (see CCITT G.714 and O.132) at each signal level.

NOTE: The measurement is not to be carried out at sound pressures exceeding +10 dBPa.

30.7.1.5 Test requirement

The ratio of signal to total distortion power measured at the DAI with the psophometric noise weighting (see table 4/CCITT G.223) shall be above the limits given in table 30.3.

Table 30.3

dB relative to ARL	Level ratio
-35 dB	17,5 dB
-30 dB	22,5 dB
-20 dB	30,7 dB
-10 dB	33,3 dB
0 dB	33,7 dB
7 dB	31,7 dB
10 dB	25,5 dB

Limits for the signal to total distortion ratio (sending) when using the sine wave method.

Limits for intermediate levels are found by drawing a straight line between breaking points in a linear (dB signal level) vs linear (dB ratio) scale.

30.7.2 Receiving**30.7.2.1 Definition and applicability**

The receive signal to total distortion ratio is a measure of the linearity in the receive equipment (excluding the speech decoder).

The requirements and this test apply to all types of GSM 900 and DCS 1 800 handset MS supporting speech.

30.7.2.2 Conformance requirement

The ratio of signal to total distortion power in the receiving direction measured at the ERP with psophometric filter shall be above the limits given in GSM 03.50; 3.9.2, table 5. GSM 03.50; 3.9.2.

30.7.2.3 Test purpose

To verify that the ratio of signal to total distortion power in the receiving direction measured at the ERP with psophometric filter is above the limits given in GSM 03.50; 3.9.2, table 5.

30.7.2.4 Method of test**30.7.2.4.1 Initial conditions**

The handset is mounted in the LRGP (see annex 1 of CCITT P.76) and the earpiece is sealed to the knife-edge of the artificial ear conforming to CCITT P.51.

The DAI of the MS is connected to the SS and is set to the operating mode "Test of acoustic devices and A/D & D/A".

30.7.2.4.2 Procedure

- a) The SS sends, via the DAI (Pin 25), a PCM bit stream simulating a sine-wave signal with a frequency in the range 1 004 Hz to 1 025 Hz corresponding to CCITT O.132 at the following levels: -45, -40, -35, -30, -25, -20, -15, -10, -5, 0 dBm0.
- b) The ratio of signal to total distortion power is measured with the psophometric noise weighting in the artificial ear (see CCITT G.714 and O.132) at each signal level.
- c) The measurement is only carried out at sound pressures between -50 dBPa and +10 dBPa.

30.7.2.5 Test requirement

The ratio of signal to total distortion power measured at the artificial ear with the psophometric noise weighting (see table 4/CCITT G.223) shall be above the limits given in table 30.4.

Table 30.4

Level at the digital audio interface	Level ratio
-45 dBm0	17,5 dB
-40 dBm0	22,5 dB
-30 dBm0	30,5 dB
-20 dBm0	33,0 dB
-10 dBm0	33,5 dB
-3 dBm0	31,2 dB
0 dBm0	25,5 dB

Limits for the signal to total distortion ratio (receiving) when using the sine wave method.

Limits for intermediate levels are found by drawing a straight line between breaking points in a linear (dB signal level) vs linear (dB ratio) scale.

30.8 Sidetone distortion

30.8.1 Definition and applicability

The sidetone distortion expresses the linearity of the sidetone path in the handset.

The requirements and this test apply to all types of GSM 900 and DCS 1 800 handset MS supporting speech.

30.8.2 Conformance requirement

The third harmonic distortion of the sidetone shall not be greater than 10 %.
GSM 03.50; 3.10.2.

30.8.3 Test purpose

To verify that the third harmonic distortion of the sidetone is not greater than 10 %.

30.8.4 Method of test

30.8.4.1 Initial conditions

The DAI of the MS is connected to the SS and is set to the operating mode "Test of acoustic devices and A/D & D/A".

The handset is mounted in the LRGP (see annex 1 of CCITT P.76) and the earpiece is sealed to the knife-edge of the artificial ear conforming to CCITT P.51.

30.8.4.2 Procedure

- a) The SS sends the PCM bit stream coded with the value No 1 over the DAI (pin 25) to the MS.
- b) An instrument capable of measuring the third harmonic distortion of signals with fundamental frequencies in the range 315 Hz to 1000 Hz is connected to the artificial ear.
- c) A pure-tone signal of -4,7 dBPa is applied at the mouth reference point at frequencies of 315 Hz, 500 Hz, and 1 000 Hz. For each frequency the third harmonic distortion is measured in the artificial ear.

30.8.5 Test requirement

The third harmonic distortion generated shall not be greater than 10 %.

30.9 Out-of-band signals

30.9.1 Sending

30.9.1.1 Definition and applicability

The discrimination against out-of-band input signals in the sending direction is a requirement on the in-band image frequencies created by any out-of-band input signals.

The requirements and this test apply to all types of GSM 900 and DCS 1 800 handset MS supporting speech.

30.9.1.2 Conformance requirement

With any sine wave signal above 4,6 kHz and up to 8 kHz applied at the MRP at a level of -4,7 dBPa, the level of any image frequency produced at the digital interface shall be below a reference level obtained at 1 kHz (-4,7 dBPa at MRP) by at least the amount (in dB) specified in GSM 03.50; 3.11.1, table 7.

GSM 03.50; 3.11.1.

30.9.1.3 Test purpose

To verify that the conformance requirement is met for input signals with frequencies of 4,65, 5, 6, 6,5, 7 and 7,5 kHz.

30.9.1.4 Method of test

30.9.1.4.1 Initial conditions

The handset is mounted in the LRGP (see annex 1 of CCITT P.76) and the earpiece is sealed to the knife-edge of the artificial ear conforming to CCITT P.51.

The DAI of the MS is connected to the SS and is set to the operating mode "Test of acoustic devices and A/D & D/A".

30.9.1.4.2 Procedure

- a) A pure tone with a sound pressure of -4,7 dBPa is applied at the mouth reference point as described in CCITT P.64 using an artificial mouth conforming to CCITT P 51.
- b) For input signals at frequencies of 4,65, 5, 6, 6,5, 7, and 7,5 kHz, the level represented by the PCM bit stream at the DAI (Pin 23) of any image frequency is measured.

30.9.1.5 Test requirement

The level of any image frequency shall be below a reference obtained at 1 kHz by at least the amount as specified in table 30.5.

Table 30.5

Applied sine-wave frequency	Limit (minimum)
4,6 kHz	30 dB
8 kHz	40 dB

Limits for the image frequency discrimination.

The limit at intermediate frequencies lies on a straight line drawn between the given values on a log(frequency) vs linear(dB) scale.

30.9.2 Receiving

30.9.2.1 Definition and applicability

The discrimination against out-of-band signals in the receiving direction is a requirement on the out-of-band signals generated in the artificial ear from in-band input signals.

The requirements and this test apply to all types of GSM 900 and DCS 1 800 handset MS supporting speech.

30.9.2.2 Conformance requirement

With a digitally simulated sine wave signal in the frequency range of 300 Hz to 3,4 kHz and at a level of 0 dBm applied at the digital interface, the level of spurious out-of-band image signals in the frequency range of 4,6 to 8 kHz measured selectively in the artificial ear shall be lower than the in-band acoustic level produced by a digital signal at 1 kHz set at the level specified in GSM 03.50; 3.11.2, table 8.

GSM 03.50; 3.11.2.

30.9.2.3 Test purpose

To verify that the conformance requirement is met for input signals at the nominal frequencies 500, 1 000, 2 000, and 3 350 Hz.

30.9.2.4 Method of test

30.9.2.4.1 Initial conditions

The handset is mounted in the LRGP (see annex 1 of CCITT P.76) and the earpiece is sealed to the knife-edge of the artificial ear conforming to CCITT P.51.

The DAI of the MS is connected to the SS and is set to the operating mode "Test of acoustic devices and A/D & D/A".

30.9.2.4.2 Procedure

- a) The SS sends over the DAI (pin 25) a PCM bit stream simulating a sine-wave signal with a level of 0 dBm0.
- b) For input signals at the nominal frequencies 500, 1 000, 2 000, and 3 350 Hz (bearing in mind the restriction on sub-multiples of the sampling frequency) the level of any out-of-band signals at frequencies up to 8 kHz is measured in the artificial ear.

30.9.2.5 Test requirement

The level of out-of-band signals shall be lower than the in-band acoustic level obtained by a digital signal at 1 kHz set at the level specified in table 30.6.

Table 30.6

Image signal frequency	Equivalent input signal level
4,6 kHz	-35 dBm0
8 kHz	-45 dBm0

Limits for the image frequency discrimination.

The limit at intermediate frequencies lies on a straight line drawn between the given values on a log(frequency) vs linear(dB) scale.

30.10 Idle channel noise

30.10.1 Sending

30.10.1.1 Definition and applicability

The idle channel noise in the sending direction is the equivalent noise level produced at the DAI, when the mouth reference point is in a quiet environment.

The requirements and this test apply to all types of GSM 900 and DCS 1 800 handset MS supporting speech.

30.10.1.2 Conformance requirement

The idle noise in the sending direction shall not exceed - 64 dBm0p at the UPCMI under silent conditions.

GSM 03.50; 3.6.1.

30.10.1.3 Test purpose

To verify that the idle noise in the sending direction does not exceed -64 dBm0p at the UPCMI under silent conditions.

30.10.1.4 Method of test

30.10.1.4.1 Initial conditions

The handset is mounted in the LRGP (see annex 1 of CCITT P.76) and the earpiece is sealed to the knife-edge of the artificial ear conforming to CCITT P.51 in a quiet environment (ambient noise less than 30 dBA).

The DAI of the MS is connected to the SS and is set to the operating mode "Test of acoustic devices and A/D & D/A".

30.10.1.4.2 Procedure

The noise level represented by the PCM bit stream output at the DAI (pin 23) is measured with psophometric weighting according to CCITT G.223, table 4.

NOTE: The ambient noise criterion should be met if the ambient noise does not exceed NR20.

30.10.1.5 Test requirement

The noise produced by the MS in the sending direction shall not exceed -64 dBm0p.

30.10.2 Receiving

30.10.2.1 Definition and applicability

The idle channel noise in the receiving direction is the acoustic sound pressure in the artificial ear when the digital input signal at the DAI, is the PCM coded value No 1.

The requirements and this test apply to all types of GSM 900 and DCS 1 800 handset MS supporting speech.

30.10.2.2 Conformance requirement

1. If no user controlled receiving volume control is provided, or if it is provided, at the setting of the user controlled receiving volume at which the RLR is equal to the nominal value, the noise measured in the artificial ear contributed by the receiving equipment alone shall not exceed -57 dBPa (A) when driven by a PCM signal corresponding to the decoder output value No. 1.

GSM 03.50; 3.6.2.

2. Where a volume control is provided, the measured noise shall not exceed -54 dBPa(A) at the maximum setting of the volume control.

GSM 03.50; 3.6.2.

30.10.2.3 Test purpose

1. To verify that the idle noise in the receiving direction does not exceed -57 dBPa (A). If a user controlled receive volume control is provided it shall be set to the position where RLR is equal to the nominal value.
2. To verify that if a user controlled receive volume control is provided, the idle noise in the receiving direction does not exceed -54 dBPa(A) when the control is set to maximum.

30.10.2.4 Method of test

30.10.2.4.1 Initial conditions

The handset is mounted in the LRGP (see annex 1 of CCITT P.76) and the earpiece is sealed to the knife-edge of the artificial ear conforming to CCITT P.51.

The DAI of the MS is connected to the SS and is set to the operating mode "Test of acoustic devices and A/D & D/A".

30.10.2.4.2 Procedure

- a) The SS sends a PCM bit stream coded with the value No 1 over the DAI (Pin 25) to the MS.
- b) The level of the noise is measured in the artificial ear with any volume control set at the position at which the RLR is equal to the nominal value.
- c) Where a volume control is provided, the level of the noise is measured in the artificial ear with the volume control set to maximum.

30.10.2.5 Test requirement

In step b) the measured noise generated by the MS shall not exceed -57 dBPa (A).

In step c) the measured noise shall not exceed -54 dBPa (A).

31 Test of supplementary services

The general aspects of the specification of supplementary services at the layer 3 radio interface are given in GSM 04.10.

The formats and coding are given in GSM 04.80. If the value of a parameter of an uplink message (MS to network) is specified in a test, the implicit meaning is that it has to be checked; if the value is not specified, it is not to be checked unless otherwise stated.

Unless otherwise stated, the MS shall be in the idle updated state at the beginning of each test (including repetition of a test).

In each test, before the MS sends the first REGISTER message, a MM connection is established.

GSM 04.81 to GSM 04.88 give the procedures used at the radio interface for normal operation, registration, erasure, activation, deactivation, invocation and interrogation of supplementary services.

The supplementary services are described in GSM 02.04 and GSM 02.81 to GSM 02.88.

Whenever activation via the standard MMI is mentioned, if the MS does not support it but supports a different procedure, this different procedure is used. In the supplementary services tests, only the applicable (see GSM 02.8x series) MMI service code groups (GSM 02.30 annex 4), of the basic service code in GSM 09.02, which are supported by the MAP, will be used.

31.1 Number identification supplementary services

(Reserved).

31.2 Call offering supplementary services

The following abbreviations are used:

CFU:	Call Forwarding Unconditional
CFB:	Call Forwarding on mobile subscriber Busy
CFNRy:	Call Forwarding on No Reply
CFNRc:	Call Forwarding on mobile subscriber Not Reachable
CFC:	Call Forwarding Conditional (common name for CFB, CFNRy and CFNRc)
CF:	Call Forwarding (common name for CFU, CFB, CFNRy and CFNRc).

NOTE: These abbreviations are also used to represent the corresponding SS-Code; e.g. CFC is the SS-Code for all conditional forwarding services.

31.2.1 Call forwarding supplementary services

31.2.1.1 Registration

31.2.1.1.1 Registration accepted

31.2.1.1.1.1 Conformance requirements

For registration of any type of call forwarding with any parameters, the MS shall transmit successively

- 1) a CHANNEL REQUEST with establishment cause set to "other services requested by the mobile user";
- 2) a CM SERVICE REQUEST with CM service type indicating "supplementary service activation";
- 3) and then the REGISTER message containing a facility IE that includes an invoke of the RegisterSS operation with parameter values according to the user's request (MMI action);
- 4) Upon receipt of the RELEASE COMPLETE message, the MS shall provide the appropriate user indication (which is to be described by the manufacturer).

References

- 1) GSM 04.08 sections 3.3.1.2 and 9.1.9.
- 2) GSM 04.08 sections 4.5.1.1, 9.2.9 and 10.5.33.
- 3) GSM 04.82, GSM 04.80 sections 2.3 and 3.6.
- 4) GSM 02.30 section 4.5.

31.2.1.1.1.2 Test purpose

- 1) To check that the MS correctly requests a supplementary service transaction for registration of call forwarding in CHANNEL REQUEST message.
- 2) To check that the MS correctly requests a supplementary service transaction for registration of call forwarding in the subsequent CM SERVICE REQUEST.
- 3) To check that the MS sends a REGISTER message containing the invoke of the RegisterSS operation with the expected parameter values for registration of call forwarding.
- 4) To check that upon receipt of the result of the operation (in a RELEASE COMPLETE message), the MS provides the appropriate user indication (as described by the manufacturer).

These checks are done for:

- a) CFNRy, for basic service group speech.
- b) CFU, for basic service group all facsimile.

31.2.1.1.1.3 Method of test

Initial conditions

System Simulator:
1 cell, default parameters.

Mobile Station:
The MS is "idle updated".

Related PICS/PIXIT statement(s)

Description of the user's commands and of display of the answers from the network for call forwarding.

Foreseen final state of the MS

The MS is "idle updated".

Test procedure

By means of appropriate MMI functions (using either GSM 02.30 or manufacturer defined MMI), the user requests registration of CFNRy for Speech, to a number arbitrarily selected and with a no reply time value arbitrarily selected.

Upon receipt of the operation (in a REGISTER message), the system simulator answers with a RELEASE COMPLETE message with the Facility information element containing the return result of the RegisterSS operation.

The SS transaction is released and the dedicated channel is released.

Then again, by means of appropriate MMI functions as defined by the basic public MMI described in GSM 02.30, the user requests registration of CFU for all facsimile, to a number arbitrarily selected.

Upon receipt of the REGISTER message, the system simulator answers with the RELEASE COMPLETE message with the Facility information element containing the return result of the RegisterSS operation.

Maximum duration of test

3 min.

Expected sequence

Step	Direction	Message	Comments
1	MS		The MS is made to initiate a registration of call forwarding service for CFNRy (Speech) with establishment cause "Other procedures which can be completed with an SDCCH"
2	MS -> SS	CHANNEL REQUEST	
3	SS -> MS	IMMEDIATE ASSIGNMENT	
4	MS -> SS	CM SERVICE REQUEST	cause: "supplementary service activation"
5	SS -> MS	CM SERVICE ACCEPT	
6	MS -> SS	REGISTER	
7	SS -> MS	RELEASE COMPLETE	CNFRySS operation Return_result
8	MS		provide correct MMI user indication
9	SS -> MS	CHANNEL RELEASE	
10	MS		The MS is made to initiate a registration of call forwarding service for CFU (all facsimile) with establishment cause "Other procedures which can be completed with an SDCCH"
11	MS -> SS	CHANNEL REQUEST	
12	SS -> MS	IMMEDIATE ASSIGNMENT	
13	MS -> SS	CM SERVICE REQUEST	cause: "supplementary service activation"
14	SS -> MS	CM SERVICE ACCEPT	
15	MS -> SS	REGISTER	
16	SS -> MS	RELEASE COMPLETE	RegisterSS operation Return result
17	MS		provide correct MMI user indication
18	SS -> MS	CHANNEL RELEASE	

Specific message content

step 6 - CFNRy

- protocol discriminator: non call related SS message
- message type: REGISTER
- facility

invoke = Registration

Supplementary service code = CFNRy

Forwarded to number: as selected,

No reply condition time: as selected,

Basic service code: TeleService (AllSpeechTransmissionServices), no Bearerservice present.

step 7 - CFU

- protocol discriminator: non call related SS message
- transaction identifier: same as at step 6
- message type: RELEASE COMPLETE
- facility

Return Result = Registration

Supplementary service code = CFNRy

Forwarded to number

No Reply condition time

Basic service code: TeleService (AllSpeechTransmissionServices), no Bearerservice present.

step 15 - CFU

- protocol discriminator: non call related SS message
- message type: REGISTER
- facility

invoke = Registration

Supplementary service code = CFU

Forwarded to number: as selected,

Basic service code: no bearer service present, teleservice (all facsimile).

step 16 - CFU

- protocol discriminator: non call related SS message
- transaction identifier: same as at step 15
- message type: RELEASE COMPLETE
- facility

Return Result = Registration

Supplementary service code = CFU

Forwarded to number

Basic service code: TeleService (all facsimile), no BearerService present.

31.2.1.1.2 Registration rejected**31.2.1.1.2.1 Conformance requirements**

- 1) A transaction of any kind being already established, for registration of any type of call forwarding with any parameters, the MS shall establish a parallel MM transaction, sending a CM SERVICE REQUEST with CM service type indicating "supplementary service activation".
- 2) Then the MS shall send a REGISTER message related to the present SS transaction containing a facility IE that includes an invoke of the RegisterSS operation with parameter values according to the user's request (MMI action).
- 3) Upon receipt of the RELEASE COMPLETE message related to the present SS transaction, the SS transaction shall be released but the first transaction shall remain unaffected.
- 4) Upon receipt of the RELEASE COMPLETE message, the MS shall provide the appropriate user indication (which is to be described by the Manufacturer).

References

- 1) GSM 04.08 sections 3.3.1.2 and 9.1.9.
- 2) GSM 04.08 sections 4.5.1.1, 9.2.9 and 10.5.33.
- 3) GSM 04.82, GSM 04.80 sections 2.3 and 3.6.
- 4) GSM 02.30 section 4.5.

31.2.1.1.2.2 Test purpose

- 1) To check that the MS correctly requests the establishment of a parallel MM transaction for supplementary service transaction of registration of call forwarding, sending a CM SERVICE REQUEST.
- 2) To check that the MS sends a REGISTER message containing the invoke of the RegisterSS operation with the expected parameter values for registration of call forwarding.
- 3) To check that upon receipt of the RELEASE COMPLETE message related to the present SS transaction, the first transaction remains unaffected.
- 4) To check that upon receipt of the RELEASE COMPLETE message, the MS provides the appropriate user indication (as described by the Manufacturer).

These checks are performed with a call transaction already established for:

- a) CFB, for all asynchronous services, the RELEASE COMPLETE message being sent with a facility IE containing a return_error(error) where error is "Bearer Service not provisioned".
- b) CF, for all facsimile, the RELEASE COMPLETE message being sent with a facility IE containing a reject(invoke_problem) where invoke_problem is "resource limitation".

31.2.1.1.2.3 Method of test

Initial conditions

System Simulator:

1 cell, default parameters.

Mobile Station:

The MS is in CC state U10.

Related PICS/PIXIT statement(s)

Description of the user's commands and of display of the answers from the network for call forwarding.

Foreseen final state of the MS

The MS is in CC state U10.

Test procedure

By means of appropriate MMI functions (using either GSM 02.30 or manufacturer defined MMI), the user requests registration of CFB for all asynchronous services, to a number arbitrarily selected.

Upon receipt of the operation (in a REGISTER message), the system simulator answers with a RELEASE COMPLETE message with the Facility information element containing a Return_error(error: BearerService not provisioned) of the RegisterSS operation.

The system simulator sends STATUS ENQUIRY, the MS responds with STATUS message indicating CC state U10.

Then again, by means of appropriate MMI functions as defined by the basic public MMI described in GSM 02.30, the user requests registration of CF for all facsimile, to a number arbitrarily selected.

Upon receipt of the REGISTER message, the system simulator answers with the RELEASE COMPLETE message with the Facility information element containing a reject(invoke_problem: resource limitation) of the RegisterSS operation.

The system simulator sends STATUS ENQUIRY, the MS responds with STATUS message indicating CC state U10.

Maximum duration of test

3 min.

Expected sequence

Step	Direction	Message	Comments
1	MS		The MS is made to initiate a registration of call forwarding service for CFB (all asynchronous services)
2	MS -> SS	CM SERVICE REQUEST	cause: "supplementary service activation"
3	SS -> MS	CM SERVICE ACCEPT	
4	MS -> SS	REGISTER	
5	SS -> MS	RELEASE COMPLETE	RegisterSS operation Return_error
6	SS -> MS	STATUS ENQUIRY	
7	MS -> SS	STATUS	CC state U10
8	MS		The MS is made to initiate a registration of call forwarding service for CF (all facsimile)
9	MS -> SS	CM SERVICE REQUEST	cause: "supplementary service activation"
10	SS -> MS	CM SERVICE ACCEPT	
11	MS -> SS	REGISTER	
12	SS -> MS	RELEASE COMPLETE	RegisterSS operation Reject
13	MS		provide correct MMI user indication
14	SS -> MS	STATUS ENQUIRY	
15	MS -> SS	STATUS	CC state U10

Specific message content

step 4 - CFB

- protocol discriminator: non call related SS message
- message type: REGISTER
- facility

invoke = Registration

Supplementary service code = CFB

Forwarded to number: as selected,

Basic service code: Bearer Service (all asynchronous services), no teleservice present

step 5 -

- protocol discriminator: non call related SS message
- transaction identifier: same TI as previous REGISTER message
- message type: RELEASE COMPLETE
- facility:
 - return error code: BearerService not provisioned

For the return error the invoke ID must be the same as in the invoke of the RegisterSS operation.

step 11 - CF

- protocol discriminator: non call related SS message
- message type: REGISTER
- facility

invoke = Registration

Supplementary service code = CF

Forwarded to number: as selected,

Basic service code: no bearer service present, teleservice (all facsimile)).

step 12 -

- protocol discriminator: non call related SS message
- transaction identifier: same TI as previous REGISTER message
- message type: RELEASE COMPLETE
- facility:
 - reject code: resource limitation

For the reject the invoke ID must be the same as in the invoke of the Register SS operation.

31.2.1.2 Erasure by the subscriber

31.2.1.2.1 Erasure accepted

31.2.1.2.1.1 Conformance requirements

For erasure of any type of call forwarding, the MS shall transmit successively

- 1) a CHANNEL REQUEST with establishment cause set to "other services requested by the mobile user";
- 2) a CM SERVICE REQUEST with CM service type indicating "supplementary service activation";
- 3) and then the REGISTER message containing a facility that includes an invoke of the EraseSS operation with the expected parameter values according to the user request (MMI action).
- 4) Upon receipt of the RELEASE COMPLETE message, the MS shall provide the appropriate user indication (which is to be described by the manufacturer).

References

- 1) GSM 04.08 sections 3.3.1.2 and 9.1.9.
- 2) GSM 04.08 sections 4.5.1.1, 9.2.9 and 10.5.33.
- 3) GSM 04.82, GSM 04.80 sections 2.3 and 3.6.
- 4) GSM 02.30 section 4.5.

31.2.1.2.1.2 Test purpose

- 1) To check that the MS correctly requests supplementary service transaction for erasure of call forwarding in CHANNEL REQUEST message.
- 2) To check that the MS correctly requests supplementary service transaction for erasure of call forwarding in the subsequent CM SERVICE REQUEST.
- 3) To check that the MS sends a REGISTER message containing the invoke of the EraseSS operation with the expected parameter values for erasure of call forwarding.
- 4) To check that upon receipt of the result of the operation (in a RELEASE COMPLETE message), the MS provides the appropriate user indication (as described by the manufacturer).

These checks are done for:

- a) CFC, for basic service group all facsimile.
- b) CFNRc, for all basic service groups.

31.2.1.2.1.3 Method of test

Initial conditions

System Simulator:
1 cell, default parameters.

Mobile Station:

The MS is "idle updated".

Related PICS/PIXIT statement(s)

Description of the user's commands and of display of the answers from the network for call forwarding.

Foreseen final state of the MS

The MS is "idle updated".

Test procedure

By means of appropriate MMI functions (using either GSM 02.30 or manufacturer defined MMI), the user requests erasure of CFC for all facsimile.

Upon receipt of the operation (in a REGISTER message), the system simulator answers with a RELEASE COMPLETE message with the facility information element containing a return result of the EraseSS operation.

The SS transaction is released and the dedicated channel is released.

Then again, by means of appropriate MMI functions as defined by the basic public MMI described in GSM 02.30, the user requests erasure of CFNRc for all basic service groups.

Upon receipt of the REGISTER message, the system simulator answers with the RELEASE COMPLETE message with the Facility information element containing the return result of the EraseSS operation.

The dedicated channel is released.

Maximum duration of test

3 min.

Expected sequence

Step	Direction	Message	Comments
1	MS		The MS is made to initiate erasure of call forwarding for CFC (all facsimile)
2	MS -> SS	CHANNEL REQUEST	with establishment cause "Other procedures which can be completed with an SDCCH"
3	SS -> MS	IMMEDIATE ASSIGNMENT	
4	MS -> SS	CM SERVICE REQUEST	cause: "supplementary service activation"
5	SS -> MS	CM SERVICE ACCEPT	
6	MS -> SS	REGISTER	
7	SS -> MS	RELEASE COMPLETE	EraseSS operation Return_result
8	MS		provide user MMI indication
9	SS -> MS	CHANNEL RELEASE	
10	MS		The MS is made to initiate a erasure of call forwarding service for CFNRc (all basic services)
11	MS -> SS	CHANNEL REQUEST	with establishment cause "Other procedures which can be completed with an SDCCH"
12	SS -> MS	IMMEDIATE ASSIGNMENT	
13	MS -> SS	CM SERVICE REQUEST	cause: "supplementary service activation"
14	SS -> MS	CM SERVICE ACCEPT	
15	MS -> SS	REGISTER	
16	SS -> MS	RELEASE COMPLETE	EraseSS operation Return result
17	MS		provide correct MMI user indication
18	SS -> MS	CHANNEL RELEASE	

Specific message content

step 6 - CFC

- protocol discriminator: non call related SS message
- message type: REGISTER
- facility

invoke = Erasure

Supplementary service code = CFC

Basic service code: no Bearer Service, teleservice (all facsimile).

step 15 - CFNRc

- protocol discriminator: non call related SS message
- message type: REGISTER
- facility

invoke = Erasure

Supplementary service code = CFNRc

Basic service code: no bearer service present, no teleservice present.

31.2.1.2.2 Erasure rejected

31.2.1.2.2.1 Conformance requirements

- 1) A transaction of any kind being already established, for erasure of any type of call forwarding with any parameters, the MS shall establish a parallel MM transaction, sending a CM SERVICE REQUEST with CM service type indicating "supplementary service activation",
- 2) Then the MS shall send a REGISTER message related to the present SS transaction containing a facility IE that includes an invoke of the EraseSS operation with parameter values according to the user's request (MMI action).
- 3) Upon receipt of the RELEASE COMPLETE message related to the present SS transaction, the SS transaction shall be released but the first transaction shall remain unaffected.
- 4) Upon receipt of the RELEASE COMPLETE message, the MS shall provide the appropriate user indication (which is to be described by the Manufacturer).

References

- 1) GSM 04.08 sections 3.3.1.2, 9.1.9
- 2) GSM 04.08 sections 4.5.1.1, 9.2.9, 10.5.33
- 3) GSM 04.82, GSM 04.80 sections 2.3, 3.6
- 4) GSM 02.30 section 4.5

31.2.1.2.2.2 Test purpose

- 1) To check that the MS correctly requests the establishment of a parallel MM transaction for supplementary service transaction of erasure of call forwarding, sending a CM SERVICE REQUEST.
- 2) To check that the MS sends a REGISTER message containing the invoke of the EraseSS operation with the expected parameter values for erasure of call forwarding.
- 3) To check that upon receipt of the RELEASE COMPLETE message related to the present SS transaction, the first transaction remains unaffected.
- 4) To check that upon receipt of the RELEASE COMPLETE message, the MS provides the appropriate user indication (as described by the Manufacturer).

These checks are performed with a call transaction already established for:

- a) CFU, for Speech, the RELEASE COMPLETE message being sent with a facility IE containing a return_error(error) where error is "Teleservice not provisioned".
- b) CFNRy, for all facsimile, the RELEASE COMPLETE message being sent with a facility IE containing a reject(invoked_problem) where invoked_problem is "resource limitation".

31.2.1.2.2.3 Method of test

Initial conditions

System Simulator:

1 cell, default parameters.

Mobile Station:

The MS is in CC state U10.

Related PICS/PIXIT statement(s)

Description of the user's commands and of display of the answers from the network for call forwarding.

Foreseen final state of the MS

The MS is in CC state U10.

Test procedure

By means of appropriate MMI functions (using either GSM 02.30 or manufacturer defined MMI), the user requests erasure of CFU for Speech.

Upon receipt of the operation (in a REGISTER message), the system simulator answers with a RELEASE COMPLETE message with the Facility information element containing a Return_error(error: TeleService not provisioned) of the EraseSS operation.

The system simulator sends STATUS ENQUIRY, the MS responds with STATUS message indicating CC state U10.

Then again, by means of appropriate MMI functions as defined by the basic public MMI described in GSM 02.30, the user requests erasure of CFNRy for all facsimile.

Upon receipt of the REGISTER message, the system simulator answers with the RELEASE COMPLETE message with the Facility information element containing a reject(invoked_problem: resource limitation) of the EraseSS operation.

The system simulator sends STATUS ENQUIRY, the MS responds with STATUS message indicating CC state U10.

Maximum duration of test

3 min.

Expected sequence

Step	Direction	Message	Comments
1	MS		The MS is made to initiate a erasure of call forwarding service for CFU (speech)
2	MS -> SS	CM SERVICE REQUEST	cause: "supplementary service activation"
3	SS -> MS	CM SERVICE ACCEPT	
4	MS -> SS	REGISTER	
5	SS -> MS	RELEASE COMPLETE	EraseSS operation Return_error
6	SS -> MS	STATUS ENQUIRY	
7	MS -> SS	STATUS	CC state U10
8	MS		The MS is made to initiate a erasure of call forwarding service for CFNRy (all facsimile)
9	MS -> SS	CM SERVICE REQUEST	cause: "supplementary service activation"
10	SS -> MS	CM SERVICE ACCEPT	
11	MS -> SS	REGISTER	
12	SS -> MS	RELEASE COMPLETE	EraseSS operation Reject
13	MS		provide correct MMI user indication
14	SS -> MS	STATUS ENQUIRY	
15	MS -> SS	STATUS	CC state U10

Specific message content

step 4 - CFU

- protocol discriminator: non call related SS message
- message type: REGISTER
- facility

invoke = Erasure

Supplementary service code = CFU

Basic service code: Tele Service (AllSpeechTransmissionServices), no Bearer service present

step 5 -

- protocol discriminator: non call related SS message
- transaction identifier: same TI as previous REGISTER message
- message type: RELEASE COMPLETE
- facility:
 - return error code: TeleService not provisioned

For the return error the invoke ID must be the same as in the invoke of the EraseSS operation.

step 11 - CFNRy

- protocol discriminator: non call related SS message
- message type: REGISTER
- facility

invoke = Erasure

Supplementary service code = CFNRy

Basic service code: no bearer service present, teleservice (all facsimile)).

step 12 -

- protocol discriminator: non call related SS message
- transaction identifier: same TI as previous REGISTER message
- message type: RELEASE COMPLETE
- facility:
 - reject code: resource limitation

For the reject the invoke ID must be the same as in the invoke of the EraseSS operation.

31.2.1.3 **Activation**

31.2.1.3.1 **Conformance requirements**

For activation of any type of call forwarding with any parameters, the MS shall transmit successively

- 1) a CHANNEL REQUEST with establishment cause set to "other services requested by the mobile user";
- 2) a CM SERVICE REQUEST with CM service type indicating "supplementary service activation";
- 3) and then the REGISTER message containing a facility IE that includes an invoke of the ActivateSS operation with parameter values according to the user's request (MMI action).
- 4) Upon receipt of the RELEASE COMPLETE message, the MS shall provide the appropriate user indication (which is to be described by the manufacturer).

References

- 1) GSM 04.08 sections 3.3.1.2 and 9.1.9.
- 2) GSM 04.08 sections 4.5.1.1, 9.2.9 and 10.5.33.
- 3) GSM 04.82, GSM 04.80 sections 2.3 and 3.6.
- 4) GSM 02.30 section 4.5.

31.2.1.3.2 **Test purpose**

- 1) To check that the MS correctly requests a supplementary service transaction for activation of call forwarding in CHANNEL REQUEST message.
- 2) To check that the MS correctly requests a supplementary service transaction for activation of call forwarding in the subsequent CM SERVICE REQUEST.
- 3) To check that the MS sends a REGISTER message containing the invoke of the ActivateSS operation with the expected parameter values for activation of call forwarding.
- 4) To check that upon receipt of the result of the operation (in a RELEASE COMPLETE message), the MS provides the appropriate user indication (as described by the manufacturer).

These checks are done for:

- a) CF, for basic service group "all synchronous services".
- b) CFU, for all basic service groups.

31.2.1.3.3 **Method of test**

Initial conditions

System Simulator:
1 cell, default parameters.

Mobile Station:
The MS is "idle updated".

Related PICS/PIXIT statement(s)

Description of the user's commands and of display of the answers from the network for call forwarding.

Foreseen final state of the MS

The MS is "idle updated".

Test procedure

By means of appropriate MMI functions (using either GSM 02.30 or manufacturer defined MMI), the user requests activation of CF for all synchronous services.

Upon receipt of the operation (in a REGISTER message), the system simulator answers with the FACILITY message with the Facility information element containing the return result of the ActivateSS operation.

The SS transaction is released and the dedicated channel is released.

Then again, by means of appropriate MMI functions as defined by the basic public MMI described in GSM 02.30, the user requests activation of CFU for all basic service groups.

Upon receipt of the REGISTER message, the system simulator answers with the RELEASE COMPLETE message with the Facility information element containing the return result of the ActivateSS operation.

Maximum duration of test

3 min.

Expected sequence

Step	Direction	Message	Comments
1	MS		The MS is made to initiate a activation of call forwarding service for CF (all synchronous services) with establishment cause "Other procedures which can be completed with an SDCCH"
2	MS -> SS	CHANNEL REQUEST	
3	SS -> MS	IMMEDIATE ASSIGNMENT	
4	MS -> SS	CM SERVICE REQUEST	cause: "supplementary service activation"
5	SS -> MS	CM SERVICE ACCEPT	
6	MS -> SS	REGISTER	
7	SS -> MS	RELEASE COMPLETE	ActivateSS operation Return_result
8	MS		provide user MMI indication
9	SS -> MS	CHANNEL RELEASE	
10	MS		The MS is made to initiate a activation of call forwarding service for CFU (all basic service groups) with establishment cause "Other procedures which can be completed with an SDCCH"
11	MS -> SS	CHANNEL REQUEST	
12	SS -> MS	IMMEDIATE ASSIGNMENT	
13	MS -> SS	CM SERVICE REQUEST	cause: "supplementary service activation"
14	SS -> MS	CM SERVICE ACCEPT	
15	MS -> SS	REGISTER	
16	SS -> MS	RELEASE COMPLETE	ActivateSS operation Return result
17	MS		provide correct MMI user indication
18	SS -> MS	CHANNEL RELEASE	

Specific message contents:

step 6 - CF

- protocol discriminator: non call related SS message
- message type: REGISTER
- facility

invoke = Activation

Supplementary service code = CF

Basic service code: Bearer Service (all synchronous services), no teleservice present.

step 15 - CFU

- protocol discriminator: non call related SS message
- message type: REGISTER
- facility

invoke = Activation

Supplementary service code = CFU

Basic service code: no bearer service present, no teleservice present.

31.2.1.4 Deactivation

31.2.1.4.1 Conformance requirements

For deactivation of any type of call forwarding with any parameters, the MS shall transmit successively.

- 1) a CHANNEL REQUEST with establishment cause set to "other services requested by the mobile user";
- 2) a CM SERVICE REQUEST with CM service type indicating "supplementary service activation";
- 3) and then the REGISTER message containing a facility IE that includes an invoke of the DeactivateSS operation with parameter values according to the user's request (MMI action).
- 4) Upon receipt of the RELEASE COMPLETE message, the MS shall provide the appropriate user indication (which is to be described by the manufacturer).

References

- 1) GSM 04.08 sections 3.3.1.2 and 9.1.9.
- 2) GSM 04.08 sections 4.5.1.1, 9.2.9 and 10.5.33.
- 3) GSM 04.82, GSM 04.80 sections 2.3 and 3.6.
- 4) GSM 02.30 section 4.5.

31.2.1.4.2 Test purpose

- 1) To check that the MS correctly requests a supplementary service transaction for deactivation of call forwarding in CHANNEL REQUEST message.
- 2) To check that the MS correctly requests a supplementary service transaction for deactivation of call forwarding in the subsequent CM SERVICE REQUEST.
- 3) To check that the MS sends a REGISTER message containing the invoke of the DeactivateSS operation with the expected parameter values for deactivation of call forwarding.
- 4) To check that upon receipt of the result of the operation (in a RELEASE COMPLETE message), the MS provides the appropriate user indication (as described by the manufacturer).

These checks are done for:

- a) CFC, for basic service group speech.
- b) CFNRc, for basic service group all facsimile.

31.2.1.4.3 Method of test

Initial conditions

System Simulator:

1 cell, default parameters.

Mobile Station:

The MS is "idle updated".

Related PICS/PIXIT statement(s)

Description of the user's commands and of display of the answers from the network for call forwarding.

Foreseen final state of the MS

The MS is "idle updated".

Test procedure

By means of appropriate MMI functions (using either GSM 02.30 or manufacturer defined MMI), the user requests deactivation of CFC for speech.

Upon receipt of the operation (in a REGISTER message), the system simulator answers with a RELEASE COMPLETE message with the Facility information element containing the return result of the DeactivateSS operation.

The SS transaction is released and the dedicated channel is released.

Then again, by means of appropriate MMI functions as defined by the basic public MMI described in GSM 02.30, the user requests deactivation of CFNRc for all facsimile.

Upon receipt of the REGISTER message, the system simulator answers with the RELEASE COMPLETE message with the Facility information element containing the return result of the DeactivateSS operation.

The dedicated channel is released.

Maximum duration of test

3 min.

Expected sequence

Step	Direction	Message	Comments
1	MS		The MS is made to initiate a deactivation of call forwarding service for CFC (speech)
2	MS -> SS	CHANNEL REQUEST	with establishment cause "Other procedures which can be completed with an SDCCH"
3	SS -> MS	IMMEDIATE ASSIGNMENT	
4	MS -> SS	CM SERVICE REQUEST	cause: "supplementary service activation"
5	SS -> MS	CM SERVICE ACCEPT	
6	MS -> SS	REGISTER	
7	SS -> MS	RELEASE COMPLETE	DeactivateSS operation Return_result
8	MS		provide user MMI indication
9	SS -> MS	CHANNEL RELEASE	
10	MS		The MS is made to initiate a deactivation of call forwarding service for CFNRc (all facsimile)
11	MS -> SS	CHANNEL REQUEST	with establishment cause "Other procedures which can be completed with an SDCCH"
12	SS -> MS	IMMEDIATE ASSIGNMENT	
13	MS -> SS	CM SERVICE REQUEST	cause: "supplementary service activation"
14	SS -> MS	CM SERVICE ACCEPT	
15	MS -> SS	REGISTER	
16	SS -> MS	RELEASE COMPLETE	DeactivateSS operation Return result
17	MS		provide correct MMI user indication
18	SS -> MS	CHANNEL RELEASE	

Specific message content

step 6 - CFC

- protocol discriminator: non call related SS message
- message type: REGISTER
- facility

invoke = Deactivation

Supplementary service code = CFC

Basic service code: Bearer Service (speech), no teleservice present.

step 15 - CFNRc

- protocol discriminator: non call related SS message
- message type: REGISTER
- facility

invoke = Deactivation

Supplementary service code = CFNRc

Basic service code: no bearer service present, teleservice (all facsimile).

31.2.1.5 Invocation

Invocation is not applicable to the MS and causes no signalling on the radio path.

31.2.1.6 Interrogation**31.2.1.6.1 Interrogation accepted****31.2.1.6.1.1 Conformance requirements**

For interrogation of any specific call forwarding service (not applicable to a group of services) with any parameters, the MS shall transmit successively:

- 1) a CHANNEL REQUEST with establishment cause set to "other services requested by the mobile user";
- 2) a CM SERVICE REQUEST with CM service type indicating "supplementary service activation";
- 3) and then the REGISTER message containing a facility IE that includes an invoke of the InterrogateSS operation with parameter values according to the user's request (MMI action).
- 4) Upon receipt of the RELEASE COMPLETE message, the MS shall provide the appropriate user indication (which is to be described by the manufacturer).

References

- 1) GSM 04.08 sections 3.3.1.2 and 9.1.9.
- 2) GSM 04.08 sections 4.5.1.1, 9.2.9 and 10.5.33.
- 3) GSM 04.82, GSM 04.80 sections 2.3 and 3.6.
- 4) GSM 02.30 section 4.5.

31.2.1.6.1.2 Test purpose

- 1) To check that the MS correctly requests a supplementary service transaction for interrogation of a specific call forwarding in CHANNEL REQUEST message.
- 2) To check that the MS correctly requests a supplementary service transaction for interrogation of call forwarding in the subsequent CM SERVICE REQUEST.
- 3) To check that the MS sends a REGISTER message containing the invoke of the InterrogateSS operation with the expected parameter values for interrogation of call forwarding.

- 4) To check that upon receipt of the result of the operation (in a RELEASE COMPLETE message), the MS provides the appropriate user indication (as described by the manufacturer).

These checks are done for:

- a) CFB, for all basic service groups.
- b) CFNRy, for basic service group speech.

31.2.1.6.1.3 Method of test

Initial conditions

System Simulator:

1 cell, default parameters.

Mobile Station:

The MS is "idle updated".

Related PICS/PIXIT statement(s)

Description of the user's commands and of display of the answers from the network for call forwarding.

Foreseen final state of the MS

The MS is "idle updated".

Test procedure

By means of appropriate MMI functions (using either GSM 02.30 or manufacturer defined MMI), the user requests interrogation of CFB for all basic service groups.

Upon receipt of the operation (in a REGISTER message), the system simulator answers with a RELEASE COMPLETE message with the Facility information element containing the return result of the InterrogateSS operation.

The SS transaction is released and the dedicated channel is released.

Then again, by means of appropriate MMI functions as defined by the basic public MMI described in GSM 02.30, the user requests interrogation of CFNRy for speech.

Upon receipt of the REGISTER message, the system simulator answers with the RELEASE COMPLETE message with the Facility information element containing the return result of the InterrogateSS operation.

The dedicated channel is released.

Maximum duration of test

3 min.

Expected sequence

Step	Direction	Message	Comments
1	MS		The MS is made to initiate a registration of call forwarding service for CFB (all)
2	MS -> SS	CHANNEL REQUEST	with establishment cause "Other procedures which can be completed with an SDCCH"
3	SS -> MS	IMMEDIATE ASSIGNMENT	
4	MS -> SS	CM SERVICE REQUEST	cause: "supplementary service activation"
5	SS -> MS	CM SERVICE ACCEPT	
6	MS -> SS	REGISTER	
7	SS -> MS	RELEASE COMPLETE	InterrogateSS operation Return_result
8	MS		provide user MMI indication
9	SS -> MS	CHANNEL RELEASE	
10	MS		The MS is made to initiate a registration of call forwarding service for CFNRy(speech)
11	MS -> SS	CHANNEL REQUEST	with establishment cause "Other procedures which can be completed with an SDCCH"
12	SS -> MS	IMMEDIATE ASSIGNMENT	
13	MS -> SS	CM SERVICE REQUEST	cause: "supplementary service activation"
14	SS -> MS	CM SERVICE ACCEPT	
16	MS -> SS	REGISTER	
17	SS -> MS	RELEASE COMPLETE	InterrogateSS operation Return result
18	MS		provide correct MMI user indication
19	SS -> MS	CHANNEL RELEASE	

Specific message content

step 6 - CFB

- protocol discriminator: non call related SS message
- message type: REGISTER
- facility

invoke = Interrogation

Supplementary service code = CFB

Basic service code: no Bearer Service present, no teleservice present.

step 15 - CFNRy

- protocol discriminator: non call related SS message
- message type: REGISTER
- facility

invoke = Interrogation

Supplementary service code = CFNRy

Basic service code: no bearer service present, teleservice (speech).

31.2.1.6.2 Interrogation rejected**31.2.1.6.2.1 Conformance requirements**

- 1) A transaction of any kind being already established, for interrogation of any specific call forwarding service with any parameters, the MS shall establish a parallel MM transaction, sending a CM SERVICE REQUEST with CM service type indicating "supplementary service activation".
- 2) Then the MS shall send a REGISTER message related to the present SS transaction containing a facility IE that includes an invoke of the InterrogateSS operation with parameter values according to the user's request (MMI action).
- 3) Upon receipt of the RELEASE COMPLETE message related to the present SS transaction, the SS transaction shall be released but the first transaction shall remain unaffected.

- 4) Upon receipt of the RELEASE COMPLETE message, the MS shall provide the appropriate user indication (which is to be described by the Manufacturer).

References

- 1) GSM 04.08 sections 3.3.1.2 and 9.1.9.
- 2) GSM 04.08 sections 4.5.1.1, 9.2.9 and 10.5.33.
- 3) GSM 04.82, GSM 04.80 sections 2.3 and 3.6.
- 4) GSM 02.30 section 4.5.

31.2.1.6.2.2 Test purpose

- 1) To check that the MS correctly requests the establishment of a parallel MM transaction for supplementary service transaction of interrogation of a specific call forwarding service, sending a CM SERVICE REQUEST.
- 2) To check that the MS sends a REGISTER message containing the invoke of the InterrogateSS operation with the expected parameter values for interrogation of call forwarding.
- 3) To check that upon receipt of the RELEASE COMPLETE message related to the present SS transaction, the first transaction remains unaffected.
- 4) To check that upon receipt of the RELEASE COMPLETE message, the MS provides the appropriate user indication (as described by the Manufacturer).

These checks are performed with a call transaction already established for:

- a) CFNRc, for all basic service group, the RELEASE COMPLETE message being sent with a facility IE containing a return_error(error) where error is "SS not available".
- b) CFB, for all facsimile, the RELEASE COMPLETE message being sent with a facility IE containing a reject(invoke_problem) where invoke_problem is "resource limitation".

31.2.1.6.2.3 Method of test

Initial conditions

System Simulator:
1 cell, default parameters.

Mobile Station:
The MS is in CC state U10.

Related PICS/PIXIT statement(s)

Description of the user's commands and of display of the answers from the network for call forwarding.

Foreseen final state of the MS

The MS is in CC state U10.

Test procedure

By means of appropriate MMI functions (using either GSM 02.30 or manufacturer defined MMI), the user requests interrogation of CFNRc for all basic service groups.

Upon receipt of the operation (in a REGISTER message), the system simulator answers with a RELEASE COMPLETE message with the Facility information element containing a Return_error(error: SS not available) of the InterrogateSS operation.

The system simulator sends STATUS ENQUIRY, the MS responds with STATUS message indicating CC state U10.

Then again, by means of appropriate MMI functions as defined by the basic public MMI described in GSM 02.30, the user requests interrogation of CFB for all facsimile.

Upon receipt of the REGISTER message, the system simulator answers with the RELEASE COMPLETE message (same PD and TI that in the REGISTER message) with the Facility information element containing a reject(involve_problem: resource limitation) of the InterrogateSS operation.

The system simulator sends STATUS ENQUIRY, the MS responds with STATUS message indicating CC state U10.

Maximum duration of test

3 min.

Expected sequence

Step	Direction	Message	Comments
1	MS		The MS is made to initiate a registration of call forwarding service for CFNRc (all)
2	MS -> SS	CM SERVICE REQUEST	cause: "supplementary service activation"
3	SS -> MS	CM SERVICE ACCEPT	
4	MS -> SS	REGISTER	
5	SS -> MS	RELEASE COMPLETE	InterrogateSS operation Return_error
6	SS -> MS	STATUS ENQUIRY	
7	MS -> SS	STATUS	CC state U10
8	MS		The MS is made to initiate a interrogation of call forwarding service for CFB (all facsimile)
9	MS -> SS	CM SERVICE REQUEST	cause: "supplementary service activation"
10	SS -> MS	CM SERVICE ACCEPT	
11	MS -> SS	REGISTER	
12	SS -> MS	RELEASE COMPLETE	InterrogateSS operation Reject
13	MS		provide correct MMI user indication
14	SS -> MS	STATUS ENQUIRY	
15	MS -> SS	STATUS	CC state U10

Specific message content

step 4 - CFNRc

- protocol discriminator: non call related SS message
- message type: REGISTER
- facility

invoke = Interrogation

Supplementary service code = CFNRc

Basic service code: no Bearer Service present, no teleservice present

step 5 -

- protocol discriminator: non call related SS message
- transaction identifier: same TI as previous REGISTER message
- message type: RELEASE COMPLETE
- facility:
 - return error code: SS not available

For the return error the invoke ID must be the same as in the invoke of the InterrogateSS operation.

step 11 - CFB

- protocol discriminator: non call related SS message
- message type: REGISTER
- facility

invoke = Interrogation

Supplementary service code = CFB

Basic service code: no bearer service present, teleservice (all facsimile)).

step 12 -

- protocol discriminator: non call related SS message
- transaction identifier: same TI as previous REGISTER message
- message type: RELEASE COMPLETE
- facility:
 - reject code: resource limitation

For the reject the invoke ID must be the same as in the invoke of the InterrogateSS operation.

31.2.1.7 Normal operation

31.2.1.7.1 Served mobile subscriber side

31.2.1.7.1.1 Notification during an incoming call

This subscription option is only applicable to CFB and CFNRy.

31.2.1.7.1.1.1 Conformance requirements

- 1) During a call transaction, call establishment or not, upon receipt of a FACILITY message notifying an incoming call, the MS shall provide the appropriate user indication (which is to be described by the manufacturer).
- 2) If a call transaction is being established or is already established when the notification of incoming call is received, the receipt of the notification has no effect on its state.

References

- 1) GSM 02.30 section 4.5.
- 2) GSM 04.82 section 1.

31.2.1.7.1.1.2 Test purpose

- 1) To check that, in state U7 or U10, upon receipt of a FACILITY message notifying an incoming call, the MS shall provide the appropriate user indication (which is to be described by the manufacturer).
- 2) To check that when the notification of incoming call is received while the MS is in CC state U7 and U10 of another incoming call, it has no effect on its state.

These checks are performed in the case of CFB.

31.2.1.7.1.1.3 Method of test

Initial conditions

System Simulator:

1 cell, default parameters.

Mobile Station:

The MS is "idle updated".

Related PICS/PIXIT statement(s)

Description of the user's commands and of display of the answers from the network for call forwarding.

Foreseen final state of the MS

The MS is "idle updated".

Test procedure

The MS is brought to the call state U7 of an incoming call.

The system simulator transmits a FACILITY message with the facility information element containing an invoke of the NotifySS operation for CFB.

The system simulator sends STATUS ENQUIRY, the MS responds with STATUS message indicating CC state U7.

The MS is brought into the call state U10 of an incoming call.

The system simulator transmits a FACILITY message with the facility information element containing an invoke of the NotifySS operation for CFB.

The system simulator sends STATUS ENQUIRY, the MS responds with STATUS message indicating CC state U10.

The transaction and the channel are released by the SS.

Maximum duration of test

1 min.

Expected sequence

Step	Direction	Message	Comments
1	SS -> MS	PAGING	
2	MS -> SS	CHANNEL REQUEST	with establishment cause "answer to paging"
3	SS -> MS	IMMEDIATE ASSIGNMENT	
4	MS -> SS	PAGING RESPONSE	
5	SS -> MS	SETUP	
6	MS -> SS	CALL CONFIRMED	
7	SS -> MS	ASSIGNMENT COMMAND	
8	MS -> SS	ASSIGNMENT COMPLETE	
9	MS -> SS	ALERTING	
10	SS -> MS	FACILITY	(invoke NotifySS)
11	SS -> MS	STATUS ENQUIRY	
12	MS -> SS	STATUS	(U7)
13	MS -> SS	CONNECT	MS off hook
14	SS -> MS	CONNECT ACKNOWLEDGE	
15	SS -> MS	FACILITY	(invoke NotifySS)
16	SS -> MS	STATUS ENQUIRY	
17	MS -> SS	STATUS	(U10)
18	SS -> MS	RELEASE COMPLETE	
19	SS -> MS	CHANNEL RELEASE	

Specific message contents

Steps 10 and 15

- protocol discriminator: CC
- transaction identifier: same as for the call transaction already established
- message type: FACILITY
- facility

invoke = notification

Supplementary service code = CFB

SS notification = incoming call is forwarded

(call is forwarded indication to B subscriber).

31.2.1.7.1.2 Notification during an outgoing call

31.2.1.7.1.2.1 Conformance requirements

- 1) As an outgoing call is being established, if the ALERTING message is received with the facility information element containing an SS notification (for CFU or CFC), the MS shall correctly reach CC state U4.
- 2) As an outgoing call is being established, if the ALERTING message is received with the facility information element containing an SS notification (for CFU or CFC), the MS shall provide the appropriate user indication (which is to be described by the manufacturer).
- 3) As an outgoing call is being established, if the CONNECT message is received with the facility information element containing an SS notification (for CFU or CFC), the MS shall normally send a CONNECT ACKNOWLEDGE message and enter CC state U10.
- 4) As an outgoing call is being established, if the CONNECT message is received with the facility information element containing an SS notification (for CFU or CFC), the MS shall provide the appropriate user indication (which is to be described by the manufacturer).

References

- 1) GSM 04.82, GSM 04.80 section 3.6.
- 2) GSM 04.82, TBS. GSM 04.80 section 3.6.

31.2.1.7.1.2.2 Test purpose

- 1) To check that when an outgoing call is being established, if the ALERTING message is received with the facility information element containing an SS notification, the MS correctly reaches CC state U4. This is tested for CFU.
- 2) As an outgoing call is being established, if the ALERTING message is received with the facility information element containing an SS notification, the MS provides the appropriate user indication (which is to be described by the manufacturer). This is tested for CFU.
- 3) As an outgoing call is being established, if the CONNECT message is received with the facility information element containing an SS notification, the MS normally sends a CONNECT ACKNOWLEDGE message and enter CC state U10. This is tested for CFC.
- 4) As an outgoing call is being established, if the CONNECT message is received with the facility information element containing an SS notification (for CFU or CFC), the MS provides the appropriate user indication (which is to be described by the manufacturer). This is tested for CFC.

31.2.1.7.1.2.3 Method of test

Initial conditions

System Simulator:

1 cell, default parameters.

Mobile Station:

The MS is "idle updated".

Related PICS/PIXIT statement(s)

Description of the user's commands and of display of the answers from the network for call forwarding.

Foreseen final state of the MS

The MS is "idle updated".

Test procedure

The MS is made to place an outgoing call.

After having received a SETUP message and sent a CALL PROCEEDING message and after a TCH has been allocated the system simulator transmits an ALERTING message with the facility information element containing a notification.

The system simulator send then a STATUS ENQUIRY message. On receipt of the STATUS ENQUIRY message the MS shall send a STATUS message with CC-state U4.

After that, the system simulator transmits a CONNECT with the facility information element containing a notification.

After reception of a CONNECT ACKNOWLEDGE message the system simulator sends a STATUS ENQUIRY message.

The MS shall respond with a STATUS message indicating CC-state U10.

The transaction and the channel are released by the SS.

Maximum duration of test

1 min.

Expected sequence

Step	Direction	Message	Comments
1	MS -> SS	CHANNEL REQUEST	
2	SS -> MS	IMMEDIATE ASSIGNMENT	
3	MS -> SS	CM SERVICE REQUEST	"mobile originating call establishment"
4	SS -> MS	CM SERVICE ACCEPT	
5	MS -> SS	SETUP	
6	SS -> MS	CALL PROCEEDING	
7	SS -> MS	ASSIGNMENT COMMAND	
8	MS -> SS	ASSIGNMENT COMPLETE	
9	SS -> MS	ALERTING	containing facility IE
10	SS -> MS	STATUS ENQUIRY	
11	MS -> SS	STATUS	(U4)
12	SS -> MS	CONNECT	containing facility IE
13	MS -> SS	CONNECT ACKNOWLEDGE	
14	SS -> MS	STATUS ENQUIRY	
15	MS -> SS	STATUS	(U10)
16	SS -> MS	RELEASE COMPLETE	
17	SS -> MS	CHANNEL RELEASE	

Specific message contents

At step 9 -

Facility invoke = notification

- SS-Code (CFU)
- SS-Status (indicating:
Provisioned, registered and active).

At step 12 -

Facility invoke = notification

- SS-Code (CFC)
- SS-Status (indicating:
Provisioned, registered and active).

31.2.1.7.2 Forwarded-to mobile subscriber side

31.2.1.7.2.1 Conformance requirements

- 1) Upon receipt of the SETUP message containing a notification indication that the call is a forwarded one (with any SS code except CFC), the MS shall correctly continue call establishment and enter CC state U6.
- 2) Upon receipt of the SETUP message containing a notification indication that the call is a forwarded one, the MS shall provide the appropriate user indication (which is to be described by the manufacturer).

References

- 1) GSM 04.82.
- 2) GSM 02.30 section 4.5.

31.2.1.7.2.2 Test purpose

- 1) To check that, upon receipt of the SETUP message containing a notification indication that the call is a forwarded one, the MS correctly continues call establishment and enters CC state U6.
- 2) Upon receipt of the SETUP message containing a notification indication that the call is a forwarded one, the MS provides the appropriate user indication (which is to be described by the manufacturer).

31.2.1.7.2.3 Method of test

Initial conditions

System Simulator:

1 cell, default parameters.

Mobile Station:

The MS is "idle updated".

Related PICS/PIXIT statement(s)

Description of the user's commands and of display of the answers from the network for call forwarding.

Foreseen final state of the MS

The MS is "idle updated".

Test procedure

An incoming call is given to the MS with the SETUP message with the facility information element containing an invoke of the NotifySS operation with the indication that the call is forwarded.

Then the network sends a STATUS ENQUIRY message: the MS responds indicating CC state U6.

The transaction and the channel are released by the SS.

Maximum duration of test

1 min.

Expected sequence

Step	Direction	Message	Comments
1	SS -> MS	PAGING	
2	MS -> SS	CHANNEL REQUEST	with establishment cause "answer to paging"
3	SS -> MS	IMMEDIATE ASSIGNMENT	
4	MS -> SS	PAGING RESPONSE	
5	SS -> MS	SETUP	containing the notification that the call is a forwarded one
6	SS -> MS	STATUS ENQUIRY	
7	MS -> SS	STATUS	(U6)
8	SS -> MS	RELEASE COMPLETE	
9	SS -> MS	CHANNEL RELEASE	

Specific message contents

at step 6 -

- protocol discriminator: CC
- transaction identifier:
- message type: SETUP
- facility

invoke = notification

- SS-Code (CFU, CFB, CFNRy, CFNRc or CF)
- SS-Notification (indicating: call is forwarded i.e. Call is forwarded indication to C-subscriber).

31.2.2 Call transfer and mobile access hunting supplementary services

(Reserved).

31.3 Call completion supplementary services

(Reserved).

31.4 Multi-party supplementary services

(Reserved).

31.5 Community of interest supplementary services

(Reserved).

31.6 Charging supplementary services

The following Advice of Charge abbreviations are used in this section:

AOC	Advice of Charge
AoCC	Advice of Charge Charging
AOCI	Advice of Charge Information
ACM	Accumulated Charge Meter
ACMmax	Accumulated Charge Meter Maximum
CCM	Current Call Meter
CAI	Charge Advice Information
CDUR	Chargeable Duration

The following other abbreviations are used:

IE	Information Element
FIE	Facility Information Element
TCH	Traffic CHannel

General on Advice of Charge.

The purpose of these tests is to verify that the MS under test correctly performs procedures related to the AOC supplementary service.

The reasons for these test purposes are:

- One example of a possible use for AoCC is in applications where the subscriber hires out a GSM ME and SIM to a user and bills the user according to the charge stored on the SIM at the end of the hire period. If a mobile station claims to support AoCC but does so incorrectly or not at all, this may cause the subscriber to mischarge the user of the hire phone. Hence an MS claiming to support AoCC must be shown to be reliable in that context.
- Since AoCC offers the use of telecommunication services according to the charge stored independently in the MS, the AoCC service must not be susceptible to fraud at the MS end.
- To ensure that a mobile station **not** claiming to support AoCC does not respond with a signal to the network indicating that it does. This could cause the network to allow the call to be placed without any charge being inserted on to the SIM.

Mobile originating and terminating speech AOC calls are tested and if supported, Call Hold and Multi-party calls. The type testing of data calls (i.e. those calls with a volume related charging component) will not be specified at the phase 2 stage but will be deferred to phase 2+ since the interaction of AOC with packet services is not yet defined in GSM 09.06 and GSM 09.07.

Tests are made on the ME-SIM interface to ensure that call charges are being correctly stored in the ACM field of the SIM in several situations. The AOC ACMmax function is also tested for incoming and outgoing calls.

Basic service verification tests for the AoCC, Call Hold, and Multi-party supplementary services which have direct relevance to the testing of AOC have been added to GSM 11.10, sections 11.3, 11.4 and 11.5 respectively.

31.6.1 Advice of Charge Charging

31.6.1.1 AOC time related charging / MS originated call

Purpose:

- 1) To verify that when the MS receives the AoCC parameters in a Facility IE which is contained in the CONNECT message and when a TCH has already been assigned, the MS returns a FACILITY message containing the acknowledgement within 1 second.

- 2) To verify that when the MS receives the AoCC parameters in a Facility IE which is contained in a CONNECT message and when a TCH has already been assigned, the MS stores the correct value in the ACM field of the SIM.
- 3) To verify that the when the call has no volume related component the MS ignores non-zero AoCC e5, e6 parameters sent to it.

Conformance Requirement(s):

- 1) When the MS receives the AoCC parameters in a Facility IE which is contained in a CONNECT message and when a TCH has already been assigned, the MS shall return a FACILITY message containing the acknowledgement within 1 second.
- 2) When the MS receives the AoCC parameters in a Facility IE which is contained in a CONNECT or FACILITY message and when a TCH has already been assigned, the MS shall store the correct value in the ACM field of the SIM.
- 3) When the call has no volume related component the MS shall ignore non-zero AOC e5 and e6 parameters sent to it.

Reference(s):

Conformance requirement 1: GSM 03.86, GSM 04.13, GSM 04.86.
Conformance requirement 2: GSM 02.24.
Conformance requirement 3: GSM 02.24.

Related PICS/PIXIT Statement(s):

- Support of AoCC.
- Supported rates (full rate/half rate).
- Method of reading ACM from the SIM via the ME.
- Supported teleservices.
- Support for active state of the call control protocol (U10).

Initial Conditions:

System Simulator:

1 cell, default parameters, IMSI attach/detach disabled.

Mobile Station:

The MS is in MM-state "idle, updated".

Foreseen Final State of the MS:

The MS is in MM-state "idle, updated".

Method of Test:

The MS is made to initiate a call. The call is established with certain AoCC e-parameters sent in a Facility IE in the CONNECT message. The MS shall return the AoCC acknowledgement within 1 second of the CONNECT message. It is an implementation option whether the AoCC acknowledge is sent by the MS before or after the CONNECT ACKNOWLEDGE.

The SS sends the DISCONNECT y seconds after sending the CONNECT message containing the CAI. The MS shall have stored the correct amount on the SIM according to the e-parameters sent. The test is repeated for several different sets of e-parameters as defined below.

Maximum Duration of Test:

[z] minutes.

Expected Sequence:

The sequence step 1-20 is executed for execution counter $k = 1, \dots, 5$.

Step	Direction	Message	Comments
0			At start of test only, read and note value of ACM on SIM
1	MS		The MS is made to initiate a call
2	MS -> SS	CHANNEL REQUEST	
3	SS -> MS	IMMEDIATE ASSIGNMENT	
4	MS -> SS	CM SERVICE REQUEST	
5	SS -> MS	CM SERVICE ACCEPT	
6	MS -> SS	SETUP	
7	SS -> MS	CALL PROCEEDING	
8	SS -> MS	ASSIGNMENT COMMAND	to a supported channel type
9	MS -> SS	ASSIGNMENT COMPLETE	
10	SS -> MS	ALERTING	
11	SS -> MS	CONNECT	As default message except contains Facility IE with contents as indicated in i below
			Either A or B branch is taken
A12	MS -> SS	CONNECT ACKNOWLEDGE	
A13	MS -> SS	FACILITY	As default message except contains Facility IE with contents as indicated in ii below
B12	MS -> SS	FACILITY	As default message except contains Facility IE with contents as indicated in ii below
B13	MS -> SS	CONNECT ACKNOWLEDGE	
14			call duration y seconds after CAI information sent by SS
15	SS -> MS	DISCONNECT	
16	MS -> SS	RELEASE	
17	SS -> MS	RELEASE COMPLETE	
18	SS -> MS	CHANNEL RELEASE	The main signalling link is released.
19	MS		SIM contents checked (either via MMI or by removing the SIM and using SIM reader). ACM shall have been incremented correctly.

NOTE: The value of y is given below.

The correct value of the ACM is found from the general AOC formula given in GSM 02.24 section 4 with CDUR = y seconds and e parameters as defined below.

Specific Message Contents:

i) FACILITY Information Element with Invoke = ForwardChargelInformation component type as defined in GSM 04.80 section 3.6.1 table 3.3.

For ASN.1 description see default message contents in section 31.6.4.

y is set to a constant value of 90 seconds.

The values of the e-parameters within the parameter part of the Facility Information Element shall be set as below:

k-value	e-parameter							CCM total at call end	Step 0 ACM value increased by
	1	2	3	4	5	6	7		
1	6	14	1	25	0	0	60	43	43
2	0	0	1	100	0	0	0	100	143
3	250	16	2	500	0	0	60	2000	2143
4	1	1	1	0	10	10	1	89 or 90	2232 or 2233
5	12,5	30	1	25	10	10	30	50 or 62,5	2295, 2296, 2282 or 2283

Values shown in table are in the format and have units as in GSM 02.24 section 3.

The ASN.1 description for each e-parameter allows integers in the range 0 to 8191 to be transmitted but some e-parameters have different actual ranges (e.g. e1 can take any value 0..819,1 with 0,1 resolution). The MS knows how to interpret the received parameter (e.g. received e1 refers to 10 times actual e1, see GSM 04.80 section 4.4.3). Therefore e1=12,5 would be sent to the MS as 125. The MS knows the value sent is 10 times the "real" e1 and hence interprets the value as 12,5.

The non-zero e5 and e6 values for the k=4 and k=5 execution of the test are to check that the MS ignores the volume related parameters when carrying out time only related charging.

ii) FACILITY Information Element with Return Result component type as defined in GSM 04.80 section 3.6.1 table 3.4.

For ASN.1 description see default message contents in section 31.6.4.

31.6.1.2 AOC time related charging / MS terminated call

Purpose:

- 1) To verify that when the MS receives certain AoCC e-parameters in a Facility IE which is contained in a FACILITY message sent after the CONNECT message and when a TCH has already been assigned, the MS returns a FACILITY message containing the acknowledgement within 1 second.
- 2) To verify that when the MS receives the AoCC parameters in a Facility IE which is contained in a FACILITY message and when a TCH has already been assigned, the MS stores the correct value in the ACM field of the SIM.

Conformance Requirement(s):

- 1) When the MS receives the AoCC parameters in a Facility IE which is contained in a FACILITY message sent after the CONNECT message and when a TCH has already been assigned, the MS shall return a Facility message containing the acknowledgement within 1 second.
- 2) When the MS receives the AoCC parameters in a Facility IE which is contained in a FACILITY message and when a TCH has already been assigned, the MS shall store the correct value in the ACM field of the SIM.

Reference(s):

Conformance requirement 1: GSM 03.86, GSM 04.13, GSM 04.86.
Conformance requirement 2: GSM 02.24.

Related PICS/PIXIT Statement(s):

- Support of AoCC.
- Supported rates (full rate/half rate).
- Method of reading ACM from the SIM via the ME.
- Supported teleservices.
- Support for active state of the call control protocol (U10).

Initial Conditions:

System Simulator:

1 cell, default parameters, IMSI attach/detach disabled.

Mobile Station:

The MS is in MM-state "idle, updated".

Foreseen Final State of the MS:

The MS is in MM-state "idle, updated".

Method of Test:

The SS is made to initiate a call. The call is established and certain AoCC e-parameters are sent to the MS in a Facility IE contained within a FACILITY message. The MS shall return the AoCC acknowledgement within 1 second of the FACILITY message. It is an implementation option whether the AoCC e-parameters and the AoCC acknowledge are sent before or after the CONNECT ACKNOWLEDGE.

The SS sends the DISCONNECT y seconds after sending the FACILITY message. The MS shall have stored the correct amount on the SIM according to the e-parameters sent. The test is repeated for several different sets of e-parameters as defined below.

Maximum Duration of Test:

[z] minutes.

Expected Sequence:

The sequence step 1-20 is executed for execution counter k = 1, ..., 5.

Step	Direction	Message	Comments
0			At start of test only, read and note value of ACM on SIM
1	SS		The SS is made to initiate a call
2	SS -> MS	PAGING REQUEST	
3	MS -> SS	CHANNEL REQUEST	
4	SS -> MS	IMMEDIATE ASSIGNMENT	
5	MS -> SS	PAGING RESPONSE	
6	SS -> MS	SETUP	
7	MS -> SS	CALL CONFIRMED	
8	SS -> MS	ASSIGNMENT COMMAND	to a supported channel type
9	MS -> SS	ASSIGNMENT COMPLETE	
10	MS -> SS	ALERTING	
11	MS -> SS	CONNECT	
12	SS -> MS	FACILITY	As default message except contains Facility IE with contents as indicated in i below
			Either A or B branch is taken
A13	SS -> MS	CONNECT ACKNOWLEDGE	
A14	MS -> SS	FACILITY	As default message except contains Facility IE with contents as indicated in ii below
B13	MS -> SS	FACILITY	As default message except contains Facility IE with contents as indicated in ii below
B14	SS -> MS	CONNECT ACKNOWLEDGE	
15			call duration y seconds after CAI information sent by SS
16	SS -> MS	DISCONNECT	
17	MS -> SS	RELEASE	
18	SS -> MS	RELEASE COMPLETE	
19	SS -> MS	CHANNEL RELEASE	The main signalling link is released.
20	MS		SIM contents checked (either via MMI or by removing the SIM and using SIM reader) ACM shall have been incremented correctly.

NOTE: The value of y is given below.

The correct value of the ACM is found from the general AOC formula given in GSM 02.24 section 4 with CDUR = y seconds and e parameters as defined below.

Specific Message Contents:

i) FACILITY Information Element with Invoke = ForwardChargelInformation component type as defined in GSM 04.80 section 3.6.1 table 3.3.

For ASN.1 description see default message contents in section 31.6.4.

y is set to a constant value of 90 seconds.

The values of the e-parameters within the parameter part of the Facility Information Element shall be set as below:

k-value	e-parameter							CCM total at call end	Step 0 ACM value increased by
	1	2	3	4	5	6	7		
1	0	0	0	0	0	0	0	0	0
2	0	0	1	100	0	0	0	100	100
3	6	14	1	25	0	0	60	43	143
4	1	1	1	0	0	0	1	89 or 90	233 or 232
5	12,5	30	1	25	0	0	30	50 or 62,5	296, 295, 282 or 283

Values shown in table are in the format and have units as in GSM 02.24 section 3.

ii) FACILITY Information Element with Return Result component type as defined in GSM 04.80 section 3.6.1 table 3.4.

For ASN.1 description see default message contents in section 31.6.4.

31.6.1.3 AOC volume related charging / MS originated call

Future addition at GSM Phase 2+ stage.

31.6.1.4 AOC volume related charging / MS terminated call

Future addition at GSM Phase 2+ stage.

31.6.1.5 Change in charging information during a call

Purpose:

- 1) To verify that when the MS receives new AoCC parameters mid-way through a call in a Facility IE which is contained within a FACILITY message the MS returns a FACILITY message containing the acknowledgement within 1 second.
- 2) To verify that when the MS receives new charging information mid-way through a call in the form of a Facility IE contained within a FACILITY message the MS correctly indicates the total charge considering both sets of charging information.

Conformance Requirement(s):

- 1) When the MS receives new AoCC parameters mid-way through a call in a Facility IE which is contained within a FACILITY message the MS shall return a FACILITY message containing the acknowledgement within 1 second.
- 2) When the MS receives new charging information mid-way through a call in the form of a Facility IE contained within a FACILITY message the MS correctly indicates the total charge considering both sets of charging information.

Reference(s):

Conformance requirement 1: GSM 03.86, GSM 04.13, GSM 04.86.

Conformance requirement 2: GSM 02.24.

Related PICS/PIXIT Statement(s):

- Support of AoCC.
- Supported rates (full rate/half rate).
- Method of reading ACM from the SIM via the ME.
- Supported teleservices.
- Support for active state of the call control protocol (U10).

Initial Conditions:

System Simulator:

1 cell, default parameters, IMSI attach/detach disabled.

Mobile Station:

The MS is in MM-state "idle, updated".

Foreseen Final State of the MS:

The MS is in MM-state "idle, updated".

Method of Test:

The MS is made to initiate a call. The call is established with certain AoCC e-parameters sent in a Facility IE in a FACILITY message sent after the CONNECT message. The MS shall return the AoCC acknowledgement within 1 second of the FACILITY message. x seconds after sending the original CAI, new (and different) e-parameters are sent to the MS in a Facility IE contained within a FACILITY message. The MS shall return the AoCC acknowledge within 1 second of the FACILITY message.

The SS sends the DISCONNECT y seconds after sending the first CAI in the FACILITY message. The MS shall have stored the correct amount on the SIM according to the two sets of e-parameters sent and the times for the two parts of the call.

Maximum Duration of Test:

[z] minutes.

Expected Sequence:

Step	Direction	Message	Comments
0			At start of test only, read and note value of ACM on SIM
1	MS		The MS is made to initiate a call
2	MS -> SS	CHANNEL REQUEST	
3	SS -> MS	IMMEDIATE ASSIGNMENT	
4	MS -> SS	CM SERVICE REQUEST	
5	SS -> MS	CM SERVICE ACCEPT	
6	MS -> SS	SETUP	
7	SS -> MS	CALL PROCEEDING	
8	SS -> MS	ASSIGNMENT COMMAND	to a supported channel type
9	MS -> SS	ASSIGNMENT COMPLETE	
10	SS -> MS	ALERTING	
11	SS -> MS	CONNECT	
			Either A, B or C branch is taken
A12	SS -> MS	FACILITY	As default message except contains Facility IE with contents as indicated in i below
A13	MS -> SS	CONNECT ACKNOWLEDGE	
A14	MS -> SS	FACILITY	As default message except contains Facility IE with contents as indicated in ii below
B12	MS -> SS	CONNECT ACKNOWLEDGE	
B13	SS -> MS	FACILITY	As default message except contains Facility IE with contents as indicated in i below
B14	MS -> SS	FACILITY	As default message except contains Facility IE with contents as indicated in ii below
C12	SS -> MS	FACILITY	As default message except contains Facility IE with contents as indicated in i below
C13	MS -> SS	FACILITY	As default message except contains Facility IE with contents as indicated in ii below
C14	MS-> SS	CONNECT ACKNOWLEDGE	
15	SS -> MS	FACILITY	Second CAI sent x sec after first CAI As default message except contains Facility IE with contents as indicated in iii below
16	MS -> SS	FACILITY	As default message except contains Facility IE with contents as indicated in ii below New CAI held in abeyance until CDUR has timed out present e2 value
17			Call duration y seconds after first CAI information sent by SS
18	SS -> MS	DISCONNECT	
19	MS -> SS	RELEASE	
20	SS -> MS	RELEASE COMPLETE	
21	SS -> MS	CHANNEL RELEASE	The main signalling link is released.
22	MS		SIM contents checked (either via MMI or by removing the SIM and using SIM reader) ACM shall have been incremented correctly

NOTE The values of x and y are given below.

The correct value of the ACM is found from the general AOC formula given in GSM 02.24 section 4 with CDUR = x, y seconds and e parameters as defined below.

Specific Message Contents:

i) FACILITY Information Element with Invoke = ForwardChargelInformation component type as defined in GSM 04.80 section 3.6.1 table 3.3.

For ASN.1 description see default message contents in section 31.6.4.

The values of the e-parameters within the parameter part of the Facility Information Element shall be set as defined below:

	e-parameter							CCM total at call end	Step 0 ACM value increased by
	1	2	3	4	5	6	7		
	10	28	1	10	0	0	60	(30)	(30)

Values shown in table are in the format and have units as in GSM 02.24 section 3.

ii) FACILITY Information Element with Return Result component type as defined in GSM 04.80 section 3.6.1 table 3.4.

For ASN.1 description see default message contents in section 31.6.4.

iii) FACILITY Information Element with Invoke = ForwardChargeInformation component type as defined in GSM 04.80 section 3.6.1 table 3.3.

For ASN.1 description see default message contents in section 31.6.4.

x is set to a constant value of 80 seconds.

y is set to a constant value of 180 seconds.

The values of the e-parameters within the parameter part of the Facility Information Element shall be set to:

	e-parameter							CCM total at call end	Step 0 ACM value increased by
	1	2	3	4	5	6	7		
	10	14	1	5	0	0	60	65	65

Values shown in table are in the format and have units as in GSM 02.24 section 3.

31.6.1.6 Different formats of charging information

Purpose:

- 1) To verify that when the MS receives a Facility IE in which certain e-parameters are set to zero the total charge accumulated is the same as that when the same e-parameters are completely omitted from the Facility IE.
- 2) To verify the operation of a shortened channel release procedure where the SS does not send DISCONNECT but only the RELEASE COMPLETE and CHANNEL RELEASE messages or just the CHANNEL RELEASE message.

Conformance Requirement(s):

- 1) When the MS receives a Facility IE in which certain e-parameters are set to zero the total charge accumulated shall be the same as that when the same e-parameters are completely omitted from the Facility IE.
- 2) The channel shall be correctly released when a shortened channel release procedure is used - the SS does not send DISCONNECT but only the RELEASE COMPLETE and CHANNEL RELEASE messages or just the CHANNEL RELEASE message.

Reference(s):

- Conformance requirement 1: GSM 02.24.
Conformance requirement 2: GSM 04.08.

Related PICS/PIXIT Statement(s):

- Support of AoCC.
- Supported rates (full rate/half rate).
- Method of reading ACM from the SIM via the ME.
- Supported teleservices.
- Support for active state of the call control protocol (U10).

Initial Conditions:

System Simulator:

1 cell, default parameters, IMSI attach/detach disabled.

Mobile Station:

The MS is in MM-state "idle, updated".

Foreseen Final State of the MS:

The MS is in MM-state "idle, updated".

Method of Test:

Part 1:

The MS is made to initiate a call. The call is established with certain AoCC e-parameters sent in a Facility IE in a FACILITY message sent before the CONNECT message.

The SS sends the DISCONNECT y seconds after sending the FACILITY message containing the e-parameters. The MS shall have stored the correct amount on the SIM according to the e-parameters sent.

Part 2:

Part 1 is repeated twice with the e-parameters that were set to zero above now omitted completely from the Facility IE. The shortened release procedures are used. The MS shall have stored the correct amount on the SIM.

The results of parts 1 and 2 are compared. The value for the charge calculated by the MS shall be identical for parts 1 and 2.

Maximum Duration of Test:

[z] minutes.

Expected Sequence:

The sequence step 1-20 is executed for execution counter k = 1,..3.

Step	Direction	Message	Comments
0			At start of test only, read and note value of ACM on SIM
1	MS		The MS is made to initiate a call
2	MS -> SS	CHANNEL REQUEST	
3	SS -> MS	IMMEDIATE ASSIGNMENT	
4	MS -> SS	CM SERVICE REQUEST	
5	SS -> MS	CM SERVICE ACCEPT	
6	MS -> SS	SETUP	
7	SS -> MS	CALL PROCEEDING	
8	SS -> MS	ASSIGNMENT COMMAND	to a supported channel type
9	MS -> SS	ASSIGNMENT COMPLETE	
10	SS -> MS	ALERTING	
11	SS -> MS	FACILITY	As default message except contains Facility IE with contents as indicated in i below
			Either A, B or C branch is taken
A12	SS -> MS	CONNECT	
A13	MS -> SS	CONNECT ACKNOWLEDGE	
A14	MS -> SS	FACILITY	As default message except contains Facility IE with contents as indicated in ii below
B12	SS -> MS	CONNECT	
B13	MS -> SS	FACILITY	As default message except contains Facility IE with contents as indicated in ii below
B14	MS -> SS	CONNECT ACKNOWLEDGE	
C12	MS -> SS	FACILITY	As default message except contains Facility IE with contents as indicated in ii below
C13	SS -> MS	CONNECT	
C14	MS -> SS	CONNECT ACKNOWLEDGE	
15			call duration y seconds after CAI information sent by SS
			Branch D, E and F shall be taken for k= 1,2 and 3 respectively
D16	SS -> MS	DISCONNECT	
D17	MS -> SS	RELEASE	
D18	SS -> MS	RELEASE COMPLETE	
D19	SS -> MS	CHANNEL RELEASE	The main signalling link is released.
E16	SS -> MS	RELEASE COMPLETE	Shortened channel release procedure
E17	SS -> MS	CHANNEL RELEASE	The main signalling link is released.
F16	SS -> MS	CHANNEL RELEASE	
20	MS		SIM contents checked (either via MMI or by removing the SIM and using SIM reader) ACM shall have been incremented correctly.

NOTE The value of y is given below.

The correct value of the ACM is found from the general AOC formula given in GSM 02.24 section 4 with CDUR = y seconds and e parameters as defined below.

Specific Message Contents:

i) FACILITY Information Element with Invoke = ForwardChargelInformation component type as defined in GSM 04.80 section 3.6.1 table 3.3.

For ASN.1 description see default message contents in section 31.6.4.

y is set to a constant value of 90 seconds.

The values of the e-parameters within the parameter part of the Facility Information Element shall be set to:

k-value	e-parameter							CCM total at call end	Step 0 ACM value increased by
	1	2	3	4	5	6	7		
1	10	40	1	0	0	0	0	20	20
2	10	40	1	-----omitted-----				20	40
3	10	40	1	-----omitted-----				20	60

Values shown in table are in the format and have units as in GSM 02.24 section 3.

ii) FACILITY Information Element with Return Result component type as defined in GSM 04.80 section 3.6.1 table 3.4.

For ASN.1 description see default message contents in section 31.6.4.

31.6.1.7 AOC on a Call Hold call

Purpose:

- 1) To verify that when the MS invokes a Call Hold call and hence receives Facility IEs containing AoCC e-parameters for each chargeable call the MS returns a FACILITY message containing the AoCC acknowledgement within 1 second of transmission of each set of e-parameters.
- 2) To verify that when the MS invokes a Call Hold call and hence receives Facility IEs containing CAI elements for each chargeable call the CCM records the sum of all the charges for the services currently being used and hence that the ME inserts the correct charge in the ACM field of the SIM.

Conformance Requirement(s):

- 1) When the MS invokes a Call Hold call and hence receives Facility IEs containing AoCC e-parameters for each chargeable call the MS shall return a FACILITY message containing the AoCC acknowledgement within 1 second of receiving each set of e-parameters.
- 2) When the MS invokes a Call Hold call and hence receives Facility IEs containing CAI elements for each chargeable call the CCM shall record the sum of all the charges for the services currently being used and hence the ME shall insert the correct charge in the ACM field of the SIM.

Reference(s):

- Conformance requirement 1: GSM 04.13.
 Conformance requirement 2: GSM 02.24, GSM 04.83, GSM 04.84, GSM 04.86.

Related PICS/PIXIT Statement(s):

- Support of AoCC.
- Supported rates (full rate/half rate).
- Method of reading ACM from the SIM via the ME.
- Supported teleservices.
- Support for active state of the call control protocol (U10).

Initial Conditions:

System Simulator:
 1 cell, default parameters, IMSI attach/detach disabled.

Mobile Station:
 The MS is in MM-state "idle, updated".

Foreseen Final State of the MS:

The MS is in MM-state "idle, updated".

Method of Test:

The MS is made to initiate a call. The call is established with certain AoCC e-parameters sent in a Facility IE in the CONNECT message. The MS shall return the AoCC acknowledgement within 1 second of transmission of the CONNECT message.

The call (call B) is then put on hold by sending a HOLD message from the MS to the SS. The SS shall reply with a HOLD ACKNOWLEDGE. The traffic channel is now available to originate another call.

The MS is made to initiate a second call (call C). The call is established with certain AoCC e-parameters sent in a Facility IE in the CONNECT message. The MS shall return the AoCC acknowledgement in a FACILITY message within 1 second of transmission of the CONNECT message.

The SS sends the DISCONNECT to the MS for call B x seconds after sending the call B CAI in the CONNECT/FACILITY message and the DISCONNECT for call C y seconds after sending the call C CAI in the CONNECT/FACILITY message. The MS shall have stored the correct amount on the SIM according to the two sets of e-parameters sent and call times x and y.

Maximum Duration of Test:

[z] minutes.

Expected Sequence:

Step	Direction	Message	Comments
0			At start of test only, read and note value of ACM on SIM
1	MS		The MS is made to initiate a call
2	MS -> SS	CHANNEL REQUEST	
3	SS -> MS	IMMEDIATE ASSIGNMENT	
4	MS -> SS	CM SERVICE REQUEST	
5	SS -> MS	CM SERVICE ACCEPT	
6	MS -> SS	SETUP	
7	SS -> MS	CALL PROCEEDING	
8	SS -> MS	ASSIGNMENT COMMAND	to a supported channel type
9	MS -> SS	ASSIGNMENT COMPLETE	
10	SS -> MS	ALERTING	
11	SS -> MS	CONNECT	As default message except contains Facility IE with contents as indicated in i below
			Either D or E branch is taken
D12	MS -> SS	CONNECT ACKNOWLEDGE	
D13	MS -> SS	FACILITY	As default message except contains Facility IE with contents as indicated in ii below
E12	MS -> SS	FACILITY	As default message except contains Facility IE with contents as indicated in ii below
E13	MS -> SS	CONNECT ACKNOWLEDGE	
14	MS		The MS is made to initiate a second call, and the first call is placed on hold . DTMF signalling may occur, when MMI keys are depressed
15	MS -> SS	HOLD	
16	SS -> MS	HOLD ACKNOWLEDGE	
17	MS -> SS	CM SERVICE REQUEST	
18	SS -> MS	CM SERVICE ACCEPT	
19	MS -> SS	SETUP	TI arbitrary but different from existing TI
20	SS -> MS	CALL PROCEEDING	
21	SS -> MS	ALERTING	
22	SS -> MS	CONNECT	As default message except contains Facility IE with contents as indicated in i below
			Either F or G branch is taken
F23	MS -> SS	CONNECT ACKNOWLEDGE	
F24	MS -> SS	FACILITY	As default message except contains Facility IE with contents as indicated in ii below
G23	MS -> SS	FACILITY	As default message except contains Facility IE with contents as indicated in ii below
G24	MS -> SS	CONNECT ACKNOWLEDGE	
25			Call durations x and y seconds after respective CAI information sent by SS
			Branch H and I branch are taken, the sequence depending on the durations x and y
H26	SS -> MS	DISCONNECT	For call C
H27	MS -> SS	RELEASE	y seconds after call C CAI sent
H28	SS -> MS	RELEASE COMPLETE	
I26	SS -> MS	DISCONNECT	For call B
I27	MS -> SS	RELEASE	x seconds after call B CAI sent
I28	SS -> MS	RELEASE COMPLETE	
29	SS -> MS	CHANNEL RELEASE	The main signalling link is released
30	MS		SIM contents checked (either via MMI or by removing the SIM and using SIM reader) ACM shall have been incremented correctly.

NOTE The value of x and y are given below.

The correct value of the ACM is found from the general AOC formula given in GSM 02.24 section 4 with CDUR = x,y seconds and e parameters as defined below.

Specific Message Contents:

i) FACILITY Information Element with Invoke = ForwardChargelInformation component type as defined in GSM 04.80 section 3.6.1 table 3.3.

For ASN.1 description see default message contents in section 31.6.4.

x set to 180 s, y is set to 90 s.

The values of the e-parameters within the parameter part of the Facility Information Element shall be set to:

Call	e-parameter							CCM total at call end	Step 0 ACM value increased by
	1	2	3	4	5	6	7		
B(time x)	7	40	1	0	0	0	0	54	54
C(time y)	13	40	1	0	0	0	0		

Values shown in table are in the format and have units as in GSM 02.24 section 3.

ii) FACILITY Information Element with Return Result component type as defined in GSM 04.80 section 3.6.1 table 3.4.

For ASN.1 description see default message contents in section 31.6.4.

31.6.1.8 AOC on a Multi-party call

Purpose:

- 1) To verify that when the MS invokes a Multi-party call and hence receives Facility IEs containing AoCC e-parameters for each chargeable call the MS returns a FACILITY message containing the AoCC acknowledgement within 1 second of transmission of each set of e-parameters.
- 2) To verify that when the MS originates a Multi-party call and hence receives Facility IEs containing CAI elements for each chargeable call the CCM records the sum of all the charges for the services currently being used and hence the ME inserts the correct charge in the ACM field of the SIM.

Conformance Requirement(s):

- 1) When the MS invokes a Multi-party call and hence receives Facility IEs containing AoCC e-parameters for each chargeable call the MS shall return a FACILITY message containing the AoCC acknowledgement within 1 second of receiving each set of e-parameters.
- 2) When the MS originates a Multi-party call and hence receives Facility IEs containing CAI elements for each chargeable call the CCM shall record the sum of all the charges for the services currently being used and hence the ME shall insert the correct charge in the ACM field of the SIM.

Reference(s):

Conformance requirement 1: GSM 04.13.

Conformance requirement 2: GSM 02.24, GSM 04.83, GSM 04.84, GSM 04.86.

Related PICS/PIXIT Statement(s):

- Support of AoCC.
- Supported rates (full rate/half rate).

- Method of reading ACM from the SIM via the ME.
- Supported teleservices.
- Support for active state of the call control protocol (U10).

Initial Conditions:

System Simulator:

1 cell, default parameters, IMSI attach/detach disabled.

Mobile Station:

The MS is in MM-state "idle, updated".

Foreseen Final State of the MS:

The MS is in MM-state "idle, updated".

Method of Test:

The MS is made to initiate a call. The call is established with certain AoCC e-parameters sent in a Facility IE in the CONNECT message. The MS shall return the AoCC acknowledgement within 1 second of transmission of the CONNECT message.

The call (call B) is then put on hold by sending a HOLD message from the MS to the SS. The SS shall reply with a HOLD ACKNOWLEDGE. The traffic channel is now available to originate another call.

The MS is made to initiate a second call (call C). The call is established with certain AoCC e-parameters sent in a Facility IE in the CONNECT message. The MS shall return the AoCC acknowledgement within 1 second of transmission of the CONNECT message.

The MS invokes the multi-party service by sending a FACILITY message to the SS containing the BuildMPTY request.

The SS accepts the request and connects the MS with the other existing connections (active call C and held call B) and confirms with a FACILITY message.

The SS sends the DISCONNECT to the MS for call B x seconds after sending the call B CAI in the CONNECT message and the DISCONNECT for call C y seconds after sending the call C CAI in the CONNECT message. The MS shall have stored the correct amount on the SIM according to the two sets of e-parameters sent and call times x and y.

Maximum Duration of Test:

z minutes.

Expected Sequence:

Step	Direction	Message	Comments
0			At start of test only, read and note value of ACM on SIM
1	MS		The MS is made to initiate a call
2	MS -> SS	CHANNEL REQUEST	
3	SS -> MS	IMMEDIATE ASSIGNMENT	
4	MS -> SS	CM SERVICE REQUEST	
5	SS -> MS	CM SERVICE ACCEPT	
6	MS -> SS	SETUP	
7	SS -> MS	CALL PROCEEDING	
8	SS -> MS	ASSIGNMENT COMMAND	to a supported channel type
9	MS -> SS	ASSIGNMENT COMPLETE	
10	SS -> MS	ALERTING	
11	SS -> MS	CONNECT	As default message except contains Facility IE with contents as indicated in i below
			Either D or E branch is taken
D12	MS -> SS	CONNECT ACKNOWLEDGE	
D13	MS -> SS	FACILITY	As default message except contains Facility IE with contents as indicated in ii below
E12	MS -> SS	FACILITY	As default message except contains Facility IE with contents as indicated in ii below
E13	MS -> SS	CONNECT ACKNOWLEDGE	
14			The MS is made to initiate a second call and the first call (call B) is placed on hold . DTMF signalling may occur, when MMI keys are depressed
15	MS -> SS	HOLD	
16	SS -> MS	HOLD ACKNOWLEDGE	
17	MS -> SS	CM SERVICE REQUEST	
18	SS -> MS	CM SERVICE ACCEPT	
19	MS -> SS	SETUP	TI arbitrary but different from existing TI
20	SS -> MS	CALL PROCEEDING	
21	SS -> MS	ALERTING	
22	SS -> MS	CONNECT	As default message except contains Facility IE with contents as indicated in i below
			Either F or G branch is taken
F23	MS -> SS	CONNECT ACKNOWLEDGE	
F24	MS -> SS	FACILITY	As default message except contains Facility IE with contents as indicated in ii below
G23	MS -> SS	FACILITY	As default message except contains Facility IE with contents as indicated in ii below
G24	MS -> SS	CONNECT ACKNOWLEDGE	
25	MS -> SS	FACILITY (TI A-B/A-C)	The MS is made to build a multi-party call . DTMF signalling may occur, when MMI keys are depressed As default message except contains Facility IE with contents as indicated in iii below
26	SS -> MS	FACILITY (TI A-B/A-C)	As default message except contains Facility IE with contents as indicated in iv, below
27			Call durations x and y seconds after respective CAI information sent by SS
			Branch H and branch I are taken, the sequence depending on the durations x and y
H28	SS -> MS	DISCONNECT	For call C
H29	MS -> SS	RELEASE	y seconds after call C CAI sent
H30	SS -> MS	RELEASE COMPLETE	
I28	SS -> MS	DISCONNECT	For call B x seconds after call B CAI sent

I29	MS -> SS	RELEASE	
I30	SS -> MS	RELEASE COMPLETE	
31 32	SS -> MS MS	CHANNEL RELEASE	The main signalling link is released. SIM contents checked (either via MMI or by removing the SIM and using SIM reader) ACM shall have been incremented correctly.

NOTE: A-B/A-C indicates a choice. the transaction identifier (TI) used must be that of the active call or the held call (ref. GSM 04.84).

The values of x and y are given below.

The correct value of the ACM is found from the general AOC formula given in GSM 02.24 section 4 with CDUR = x,y seconds and e parameters as defined below.

Specific Message Contents:

i) FACILITY Information Element with Invoke = ForwardChargelInformation component type as defined in GSM 04.80 section 3.6.1 table 3.3.

For ASN.1 description see default message contents in section 31.6.4.

x set to 180 s, y set to 90 s.

The values of the e-parameters within the parameter part of the Facility Information Element shall be set to:

Call	e-parameter							CCM total at call end	Step 0 ACM value increased by
	1	2	3	4	5	6	7		
B(time x)	19	40	1	0	0	0	0	134	134
C(time y)	29	40	1	0	0	0	0		

Values shown in table are in the format and have units as in GSM 02.24 section 3.

ii) FACILITY Information Element with Return Result component type as defined in GSM 04.80 section 3.6.1 table 3.4.

For ASN.1 description see default message contents in section 31.6.4.

iii) FACILITY Information Element with Invoke = BuildMPTY component type as defined in GSM 04.80 section 3.6.1 table 3.4.

The following abbreviations are used in the descriptions below:

- U Universal tag class.
- CS Context Specific tag class.
- P Primitive tag form.
- C Constructed tag form.
- FIE Facility Information Element.

Contents	Value/remark	Coding
Facility IE Identifier	As GSM 04.80	00011100
Length of FIE contents	8	00001000
Component type tag	CS/C/tag=1	10100001
Component length	6	00000110
Invoke ID tag	U/P/tag=2	00000010
Invoke ID length	1	00000001
Invoke ID	Arbitrary (1 octet)	(00000000)
Op-Code tag	From GSM 04.80	00000010
Op-Code length	1	00000001
Op-Code	Build Multi-party operation (local value 124)	00000001

ii) FACILITY Information Element with Return Result component type as defined in GSM 04.80 section 3.6.1 table 3.4.

Contents	Value/remark	Coding
Facility IE Identifier	As GSM 04.80	00111100
Length of FIE contents	5	00001001
Component type tag	CS/C/tag=2	10100010
Component length	3	00000011
Invoke ID tag	U/P/Integer	00000010
Invoke ID length	1	00000001
Invoke ID	Same as used as	(00000000)
FIE		Invoke ID in Invoke

31.6.2 Charge Storage

31.6.2.1 Removal of SIM during an active call

Purpose:

- 1) To verify that when the SIM is removed from the ME during an active AoCC call the ME immediately terminates the call.
- 2) To verify that when the SIM is removed during an active AoCC call the ME has written the total charge up to that point in the call to the ACM field of the SIM.

Conformance Requirement(s):

- 1) When the SIM is removed from the ME during an active AoCC call the ME shall immediately terminate the call.
- 2) When the SIM is removed during an active AoCC call midway through an AOC charging time interval (e7 or e2) the ME shall have written the total charge up to the point in the call where the charging time interval last expired to the ACM field of the SIM.

Reference(s):

Conformance requirement 1: GSM 02.17.
Conformance requirement 1: GSM 02.24.

Related PICS/PIXIT Statement(s):

- Support of AoCC.
- Supported rates (full rate/half rate).
- Removal of the SIM is possible without disconnection of power supply.
- Supported teleservices.
- Support for active state of the call control protocol (U10).

Initial Conditions:

System Simulator:

1 cell, default parameters, IMSI attach/detach disabled.

Mobile Station:

The MS is in MM-state "idle, updated".

Foreseen Final State of the MS:

The MS is in MM-state "idle, updated".

Method of Test:

This test is only performed if it is possible to remove SIM without disconnecting the power supply. If the battery pack must be removed to get at the SIM see 31.6.2.2.

The MS is made to initiate a call. The call is established with certain AoCC e-parameters sent in a Facility IE in the CONNECT message. It is an implementation option whether the AoCC acknowledge is sent before or after the CONNECT ACKNOWLEDGE.

If possible, without removing the power supply, the SIM is removed from the ME y seconds after the SS sends the CAI in the CONNECT/FACILITY message. The call shall be terminated immediately by the MS and the MS shall have stored the correct amount on the SIM according to the e-parameters sent.

Maximum Duration of Test:

[z] minutes.

Expected Sequence:

Step	Direction	Message	Comments
0			At start of test only, read and note value of ACM on SIM
1	MS		The MS is made to initiate a call
2	MS -> SS	CHANNEL REQUEST	
3	SS -> MS	IMMEDIATE ASSIGNMENT	
4	MS -> SS	CM SERVICE REQUEST	
5	SS -> MS	CM SERVICE ACCEPT	
6	MS -> SS	SETUP	
7	SS -> MS	CALL PROCEEDING	
8	SS -> MS	ASSIGNMENT COMMAND	to a supported channel type
9	MS -> SS	ASSIGNMENT COMPLETE	
10	SS -> MS	ALERTING	
11	SS -> MS	CONNECT	As default message except contains Facility IE with contents as indicated in i below
			Either A or B branch is taken
A12	MS -> SS	CONNECT ACKNOWLEDGE	
A13	MS -> SS	FACILITY	As default message except contains Facility IE with contents as indicated in ii below
B12	MS -> SS	FACILITY	As default message except contains Facility IE with contents as indicated in ii below
B13	MS -> SS	CONNECT ACKNOWLEDGE	
14			SIM removed y seconds after CAI information sent by SS.
			Either C, D, E or F branch is taken
C15	MS -> SS	DISCONNECT	
C16	SS -> MS	RELEASE	
C17	MS -> SS	RELEASE COMPLETE	
C18	SS -> MS	CHANNEL RELEASE	The main signalling link is released.
D15	MS -> SS	RELEASE COMPLETE	
D16	SS -> MS	CHANNEL RELEASE	The main signalling link is released.
E15	MS -> SS	Layer 2 DISC	
E16	SS -> MS	UA	
F15			No further messages are sent
19			SIM contents checked (by removing the SIM and using SIM reader). ACM shall have been incremented correctly.

NOTE: The value of y is given below.

The correct value of the ACM is found from the general AOC formula given in GSM 02.24 section 4 with CDUR = y seconds and e parameters as defined below.

Specific Message Contents:

i) FACILITY Information Element with Invoke = ForwardChargelInformation component type as defined in GSM 04.80 section 3.6.1 table 3.3.

For ASN.1 description see default message contents in section 31.6.4.

The SIM is removed after approximately y=90 seconds.

The values of the e-parameters within the parameter part of the Facility Information Element shall be set to:

k-value e-parameter	CCM total							Step 0 ACM at call end	value increased by
	1	2	3	4	5	6	7		
	10	55	1	10	0	0	10	30	30

Values shown in table are in the format and have units as in GSM 02.24 section 3.

ii) FACILITY **Information Element with Return Result component type as defined in GSM 04.80 section 3.6.1 table 3.4.**

For ASN.1 description see default message contents in section 31.6.4.

31.6.2.2 **Interruption of power supply during an active call**

Purpose:

To verify that when the power supply of the MS is removed during an active AoCC call the ME has written the total charge up to that point in the call to the ACM field of the SIM.

Conformance Requirement(s):

When the power supply of the MS is removed during an active AoCC call midway through an AOC charging time interval (e7 or e2) the ME shall have written the total charge up to the point in the call where the charging time interval last expired to the ACM field of the SIM.

Reference(s):

Conformance requirement 1: GSM 02.24.

Related PICS/PIXIT Statement(s):

- Support of AoCC.
- Supported rates (full rate/half rate).
- Method of removing power supply.
- Supported teleservices.
- Support for active state of the call control protocol (U10).

Initial Conditions:

System Simulator:

1 cell, default parameters, IMSI attach/detach disabled.

Mobile Station:

The MS is in MM-state "idle, updated".

Foreseen Final State of the MS:

The MS is switched off.

Method of Test:

The MS is made to initiate a call. The call is established with certain AoCC e-parameters sent in a Facility IE in the CONNECT message. It is an implementation option whether the AoCC acknowledge is sent before or after the CONNECT ACKNOWLEDGE.

The ME power is switched off by pressing power button on MMI during the active call. The call shall be terminated immediately and the MS shall have stored the correct amount on the SIM according to the e-parameters sent.

The test is repeated for ME power being lost by removal of battery pack. The call shall be terminated immediately and the MS shall have stored the correct amount on the SIM according to the e-parameters sent.

Maximum Duration of Test:

[z] minutes.

Expected Sequence:

The sequence step 1-20 is executed for execution counter k = 1,2.

Step	Direction	Message	Comments
0			At start of test only, read and note value of ACM on SIM
1	MS		The MS is made to initiate a call
2	MS -> SS	CHANNEL REQUEST	
3	SS -> MS	IMMEDIATE ASSIGNMENT	
4	MS -> SS	CM SERVICE REQUEST	
5	SS -> MS	CM SERVICE ACCEPT	
6	MS -> SS	SETUP	
7	SS -> MS	CALL PROCEEDING	
8	SS -> MS	ASSIGNMENT COMMAND	to a supported channel type
9	MS -> SS	ASSIGNMENT COMPLETE	
10	SS -> MS	ALERTING	
11	SS -> MS	CONNECT	As default message except contains Facility IE with contents as indicated in i below
			Either A or B branch is taken
A12	MS -> SS	CONNECT ACKNOWLEDGE	
A13	MS -> SS	FACILITY	As default message except contains Facility IE with contents as indicated in ii below
B12	MS -> SS	FACILITY	As default message except contains Facility IE with contents as indicated in ii below
B13	MS -> SS	CONNECT ACKNOWLEDGE	
14			ME power interrupted y seconds after CAI information sent by SS by: MMI power switch (for k=1) Removing battery pack (for k=2) Depending on the value of k C or D branch is taken
15			SIM contents checked (by removing the SIM and using SIM reader). ACM shall have been incremented correctly.

NOTE: The value of y is given below.

The correct value of the ACM is found from the general AOC formula given in GSM 02.24 section 4 with CDUR = y seconds and e parameters as defined below.

Specific Message Contents:

i) FACILITY Information Element with Invoke = ForwardChargelInformation component type as defined in GSM 04.80 section 3.6.1 table 3.3.

For ASN.1 description see default message contents in section 31.6.4.

The ME power is removed after approximately y=90 seconds.

The values of the e-parameters within the parameter part of the Facility Information Element shall be set to:

k-value e-parameter	CCM total							Step 0 ACM at call end	value increased by
	1	2	3	4	5	6	7		
	10	55	1	10	0	0	10	30	30

Values shown in table are in the format and have units as in GSM 02.24 section 3.

ii) FACILITY Information Element with Return Result component type as defined in GSM 04.80 section 3.6.1 table 3.4.

For ASN.1 description see default message contents in section 31.6.4.

31.6.2.3 MS going out of coverage during an active AoCC call

NOTE: At present the core recommendations for AoCC in the case where the radio link is lost during an active call are vague. Does the mobile go on charging for a fixed period after radio link loss and continue as usual if radio link reestablishment occurs, or does charging stop? Input from people involved in charging for GSM is required.

Hence this test will be enhanced in the future when the requirements become clearer.

Purpose:

To verify that when the MS goes out of radio coverage area and an active call is dropped the ME has written the total charge up to that point in the call to the ACM field of the SIM.

Conformance Requirement(s):

When the MS goes out of radio coverage area during an active AoCC call midway through an AOC charging time interval (e7 or e2) and the call is dropped the ME shall have written the total charge up to the point in the call where the charging time interval last expired to the ACM field of the SIM.

Reference(s):

Conformance requirement 1: GSM 02.24.

Related PICS/PIXIT Statement(s):

- Support of AoCC.
- Supported rates (full rate/half rate).
- Method of reading ACM from the SIM via the ME.
- Supported teleservices.
- Support for active state of the call control protocol (U10).

Initial Conditions:

System Simulator:

1 cell, default parameters, IMSI attach/detach disabled.

Mobile Station:

The MS is in MM-state "idle, updated".

Foreseen Final State of the MS:

The MS is in MM-state "idle, updated".

Method of Test:

The MS is made to initiate a call. The call is established with certain AoCC e-parameters sent in a Facility IE in the CONNECT message. It is an implementation option whether the AoCC acknowledge is sent before or after the CONNECT ACKNOWLEDGE.

The cell simulated by the system simulator is then switched off to model the MS losing radio coverage. The MS shall have stored the correct amount on the SIM according to the e-parameters sent. [What happens on call reestablishment?]

Maximum Duration of Test:

[z] minutes.

Expected Sequence:

Step	Direction	Message	Comments
0			At start of test only, read and note value of ACM on SIM
1	MS		The MS is made to initiate a call
2	MS -> SS	CHANNEL REQUEST	
3	SS -> MS	IMMEDIATE ASSIGNMENT	
4	MS -> SS	CM SERVICE REQUEST	
5	SS -> MS	CM SERVICE ACCEPT	
6	MS -> SS	SETUP	
7	SS -> MS	CALL PROCEEDING	
8	SS -> MS	ASSIGNMENT COMMAND	to a supported channel type
9	MS -> SS	ASSIGNMENT COMPLETE	
10	SS -> MS	ALERTING	
11	SS -> MS	CONNECT	As default message except contains Facility IE with contents as indicated in i below
			Either A or B branch is taken
A12	MS -> SS	CONNECT ACKNOWLEDGE	
A13	MS -> SS	FACILITY	As default message except contains Facility IE with contents as indicated in ii below
B12	MS -> SS	FACILITY	As default message except contains Facility IE with contents as indicated in ii below
B13	MS -> SS	CONNECT ACKNOWLEDGE	
14			SS cell switched off y seconds after CAI information sent by SS Failure of radio path, end of call (CEND) occurs and MS stops charging (ref. GSM 02.24 sec 2)
15			SIM contents checked (either via MMI or by removing the SIM and using SIM reader). ACM shall have been incremented correctly.

NOTE: The value of y is given below.

The correct value of the ACM is found from the general AOC formula given in GSM 02.24 section 4 with CDUR = y seconds and e parameters as defined below.

Specific Message Contents:

i) FACILITY Information Element with Invoke = ForwardChargelInformation component type as defined in GSM 04.80 section 3.6.1 table 3.3.

For ASN.1 description see default message contents in section 31.6.4.

The cell being simulated by the SS is switched off after approximately y=90 seconds.

The values of the e-parameters within the parameter part of the Facility Information Element shall be set to:

k-value	e-parameter							CCM total	Step 0 ACM at call end	value increased by
	1	2	3	4	5	6	7			
	10	55	1	10	0	0	10	30	30	

Values shown in table are in the format and have units as in GSM 02.24 section 3.

ii) FACILITY Information Element with Return Result component type as defined in GSM 04.80 section 3.6.1 table 3.4.

For ASN.1 description see default message contents in section 31.6.4.

31.6.2.4 ACMmax operation / Mobile Originating

Purpose:

- 1) To verify that when the value stored in the ACM becomes equal to or exceeds its maximum value, the ACMmax, any outgoing calls in progress for which a non-zero CAI exists are terminated by the ME, once the chargeable interval determined by the CAI has elapsed, with an appropriate indication given to the user.
- 2) To verify that when the value stored in the ACM becomes equal to or exceeds its maximum limit, the ACMmax, the making of non-emergency calls is inhibited.
- 3) To verify that when the value stored in the ACM becomes equal to or exceeds its maximum limit, the ACMmax, the making of emergency calls is uninhibited.

Conformance Requirement(s):

- 1) When the value stored in the ACM becomes equal to or exceeds its maximum value, the ACMmax, any outgoing calls in progress for which a non-zero CAI exists shall be terminated by the ME, once the chargeable interval determined by the CAI has elapsed, with an appropriate indication given to the user.
- 2) When the value stored in the ACM becomes equal to or exceeds its maximum limit, the ACMmax, the making of further non-emergency calls shall be inhibited.
- 3) When the value stored in the ACM becomes equal to or exceeds its maximum limit, the ACMmax, the making of emergency calls shall be uninhibited.

Reference(s):

Conformance requirement 1: GSM 02.24.
 Conformance requirement 2: GSM 02.24.
 Conformance requirement 3: GSM 02.24.

Related PICS/PIXIT Statement(s):

- Support of AoCC.
- Supported rates (full rate/half rate).
- Method of reading ACM from the SIM via the ME.
- Type of user indication when ACMmax exceeded.
- Supported teleservices.
- Support for active state of the call control protocol (U10).

Initial Conditions:

System Simulator:

1 cell, default parameters, IMSI attach/detach disabled.

Mobile Station:

The MS is in MM-state "idle, updated".

PIN 2 is entered into the MS allowing modification of both the ACM and ACMmax fields on the SIM. The ACM is reset to zero and the ACMmax is set to 2 units.

Foreseen Final State of the MS:

The MS is in MM-state "idle, updated".

Method of Test:

The MS is made to initiate a call. The call is established with certain AoCC non-zero e-parameters sent in a Facility IE in the CONNECT message. It is an implementation option whether the AoCC acknowledge is sent before or after the CONNECT ACKNOWLEDGE.

After the ACM has been incremented to 2 units (60 s) the call shall be terminated by the MS once an additional chargeable interval of 30s has elapsed, and an indication given to the user. The call duration is recorded and the ACM is checked to ensure it has been incremented to 2 units.

The MS is then made to attempt to originate an ordinary call to the MS for which a non-zero CAI exists for the calling party and shall be unsuccessful. The MS shall not send a CHANNEL REQUEST for that call.

The MS is then made to attempt to originate an emergency call and shall be successful.

Maximum Duration of Test:

10 minutes.

Expected Sequence:

Step	Direction	Message	Comments
0			At start of test only, read and note value of ACM on SIM (it shall be zero)
A1	MS		For k= 1 The MS is made to initiate an ordinary call
A2	MS -> SS	CHANNEL REQUEST	
A3	SS -> MS	IMMEDIATE ASSIGNMENT	
A4	MS -> SS	CM SERVICE REQUEST	
A5	SS -> MS	CM SERVICE ACCEPT	
A6	MS -> SS	SETUP	
A7	SS -> MS	CALL PROCEEDING	
A8	SS -> MS	ASSIGNMENT COMMAND	to a supported channel type
A9	MS -> SS	ASSIGNMENT COMPLETE	
A10	SS -> MS	ALERTING	
A11	SS -> MS	CONNECT	As default message except contains Facility IE with contents as indicated in I below
B1	MS		For k = 3 The MS is made to initiate an emergency call (112 is entered)
B2	MS -> SS	CHANNEL REQUEST	Establishment cause is emergency call establishment
B3	SS -> MS	IMMEDIATE ASSIGNMENT	
B4	MS -> SS	CM SERVICE REQUEST	CM service type IE indicates "emergency call establishment"
B5	SS -> MS	CM SERVICE ACCEPT	
B6	MS -> SS	EMERGENCY SETUP	
B7	SS -> MS	CALL PROCEEDING	
B8	SS -> MS	ASSIGNMENT COMMAND	to a supported channel type
B9	MS -> SS	ASSIGNMENT COMPLETE	
B10	SS -> MS	ALERTING	
B11	SS -> MS	CONNECT	As default message except contains Facility IE with contents as indicated in i below For k=1 or 3 either branch C or D is taken
C12	MS -> SS	CONNECT ACKNOWLEDGE	
C13	MS -> SS	FACILITY	As default message except contains Facility IE with contents as indicated in ii below
D12	MS -> SS	FACILITY	As default message except contains Facility IE with contents as indicated in ii below
D13	MS -> SS	CONNECT ACKNOWLEDGE	
L14			For k=1 Record call duration, x seconds, after CAI information sent by SS until call is terminated by the ME
L15	MS -> SS	DISCONNECT	
L16	SS -> MS	RELEASE	
L17	MS -> SS	RELEASE COMPLETE	
L18	SS -> MS	CHANNEL RELEASE	The main signalling link is released.
L19			ACM checked (shall be 2 units)
M14			For k=3 Call duration y seconds after CAI information sent by SS
M15	MS -> SS	DISCONNECT	
M16	SS -> MS	RELEASE	
M17	MS -> SS	RELEASE COMPLETE	
M18	SS -> MS	CHANNEL RELEASE	The main signalling link is released.
M19			ACM checked (shall be 2 units)

k=1 - Non zero CAI call attempted by MS and should succeed.

k=2 - Non zero CAI call attempted by MS and should fail.

k=3 - Emergency call attempted by MS and should succeed.

NOTE: The values of x and y are given below.

The correct value of the ACM is found from the general AOC formula given in GSM 02.24 section 4 with CDUR = x,y seconds and e parameters as defined below.

Specific Message Contents:

i) FACILITY Information Element with Invoke = ForwardChargelInformation component type as defined in GSM 04.80 section 3.6.1 table 3.3.

For ASN.1 description see default message contents in section 31.6.4.

x shall be 90 ± 2 seconds.

y shall be set to 120 seconds.

The values of the e-parameters within the parameter part of the Facility Information Element shall be set to:

k-value	e-parameter							CCM total at call end	Step 0 ACM value increased by
	1	2	3	4	5	6	7		
1	1	30	1	0	0	0	0	2	2
2	1	30	1	0	0	0	0	0	2
3	0	0	0	0	0	0	0	0	2

Values shown in table are in the format and have units as in GSM 02.24 section 3.

ii) FACILITY Information Element with Return Result component type as defined in GSM 04.80 section 3.6.1 table 3.4.

For ASN.1 description see default message contents in section 31.6.4.

31.6.2.5 ACMmax operation / Mobile Terminating

Purpose:

- 1) To verify that when the value stored in the ACM becomes equal to or exceeds its maximum value, the ACMmax, any mobile terminating calls in progress for which a non-zero CAI exists are terminated by the ME, once the chargeable interval determined by the CAI has elapsed, with an appropriate indication given to the user.
- 2) To verify that when the value stored in the ACM becomes equal to or exceeds its maximum value, the ACMmax, and an incoming call is received for which subsequently a non-zero CAI is received, then the call is terminated by the ME with an appropriate indication given to the user.
- 3) To verify that when the value stored in the ACM becomes equal to or exceeds its maximum limit, the ACMmax, the receiving of calls for which the CAI is zero is uninhibited.

Conformance Requirement(s):

- 1) When the value stored in the ACM becomes equal to or exceeds its maximum value, the ACMmax, any mobile terminating calls in progress for which a non-zero CAI exists shall be terminated by the ME, once the chargeable interval determined by the CAI has elapsed, with an appropriate indication given to the user.
- 2) When the value stored in the ACM becomes equal to or exceeds its maximum value, the ACMmax, and an incoming call is received for which subsequently a non-zero CAI is received, the call shall be terminated by the ME with an appropriate indication given to the user.

- 3) When the value stored in the ACM becomes equal to or exceeds its maximum limit, the ACMmax, the receiving of calls for which the CAI is zero shall be uninhibited.

Reference(s):

Conformance requirement 1: GSM 02.24.
Conformance requirement 2: GSM 02.24.
Conformance requirement 2: GSM 02.24.

Related PICS/PIXIT Statement(s):

- Support of AoCC.
- Supported rates (full rate/half rate).
- Method of reading ACM from the SIM via the ME.
- Type of user indication when ACMmax exceeded.
- Supported teleservices.
- Support for active state of the call control protocol (U10).

Initial Conditions:

System Simulator:
1 cell, default parameters, IMSI attach/detach disabled.

Mobile Station:
The MS is in MM-state "idle, updated".

PIN 2 is entered into the MS allowing modification of both the ACM and ACMmax fields on the SIM.
The ACM is reset to zero and the ACMmax is set to 2 units.

Foreseen Final State of the MS:

The MS is in MM-state "idle, updated".

Method of Test:

The SS is made to initiate a call. The call is established with certain non-zero AoCC e-parameters sent in a Facility IE contained in a FACILITY message sent before the CONNECT message. It is an implementation option whether the AoCC e-parameters and AoCC acknowledge are sent before or after the CONNECT ACKNOWLEDGE.

After the ACM has been incremented to 2 units (60s) the call shall be terminated by the MS once an additional chargeable interval of 30s has elapsed and an indication given to the user. The ACM shall be checked to ensure that it has been incremented to 2 units.

The SS is then made to attempt to make an ordinary call to the MS for which a non-zero CAI exists for the called party and shall be unsuccessful. The MS shall terminate the call with a DISCONNECT message.

The SS is then made to attempt to make an ordinary call to the MS for which a zero CAI exists for the called party and shall be successful.

Maximum Duration of Test:

10 minutes.

Expected Sequence:The sequence step 1-20 is executed for execution counter $k = 1, \dots, 3$.

Step	Direction	Message	Comments
0			At start of test only, read and note value of ACM on SIM
1	SS		The SS is made to initiate a call
2	SS -> MS	PAGING REQUEST	
3	MS -> SS	CHANNEL REQUEST	
4	SS -> MS	IMMEDIATE ASSIGNMENT	
5	MS -> SS	PAGING RESPONSE	
6	SS -> MS	SETUP	
7	MS -> SS	CALL CONFIRMED	
8	SS -> MS	ASSIGNMENT COMMAND	to a supported channel type
9	MS -> SS	ASSIGNMENT COMPLETE	
10	MS -> SS	ALERTING	
11	MS -> SS	CONNECT	
12	SS -> MS	CONNECT ACKNOWLEDGE	
			For $k=1$ or 3 branch A is taken
A13	SS -> MS	FACILITY	As default message except contains Facility IE with contents as indicated in i below
A14	MS -> SS	FACILITY	As default message except contains Facility IE with contents as indicated in ii below
			For $k=2$ branch B, and then either branch C, D or E is taken
B13	SS -> MS	FACILITY	As default message except contains Facility IE with contents as indicated in i below
C13	MS -> SS	FACILITY	As default message except contains Facility IE with contents as indicated in ii below
C14	MS -> SS	DISCONNECT	MS terminates call
D13	MS -> SS	DISCONNECT	MS terminates call
D14	MS -> SS	FACILITY	As default message except contains Facility IE with contents as indicated in ii below
E13	MS -> SS	DISCONNECT	MS terminates call. DISCONNECT may or may not contain Facility IE with contents as indicated in ii below
			For $k= 1, 2$ and 3, F, G and branch shall be taken respectively
F15			For $k=1$ Record call duration, x seconds, after CAI information sent by SS until call is terminated by the ME
F16	MS -> SS	DISCONNECT	MS terminates call
F17	SS -> MS	RELEASE	
F18	MS -> SS	RELEASE COMPLETE	
F19	SS -> MS	CHANNEL RELEASE	The main signalling link is released.
			For $k=2$
G15	SS -> MS	RELEASE	
G16	MS -> SS	RELEASE COMPLETE	RELEASE COMPLETE may or may not contain Facility IE with contents as indicated in ii below
G17	SS -> MS	CHANNEL RELEASE	The main signalling link is released.
			For $k=3$
H15			Call duration y seconds after CAI information sent by SS
H16	MS -> SS	DISCONNECT	MS terminates call
H17	SS -> MS	RELEASE	
H18	MS -> SS	RELEASE COMPLETE	

H19	SS -> MS	CHANNEL RELEASE	The main signalling link is released.
20			ACM checked (should be 2 units)

k=1 - Non zero CAI call attempted to MS and should succeed.

k=2 - Non zero CAI call attempted to MS and should fail.

k=3 - Zero CAI call attempted to MS and should succeed.

NOTE: The values of x and y are given below.

The correct value of the ACM is found from the general AOC formula given in GSM 02.24 section 4 with CDUR = x,y seconds and e parameters as defined below.

Specific Message Contents:

i) FACILITY Information Element with Invoke = ForwardChargeInformation component type as defined in GSM 04.80 section 3.6.1 table 3.3.

For ASN.1 description see default message contents in section 31.6.4.

x shall be 90 ± 2 seconds.

y shall be set to 120 seconds.

The values of the e-parameters within the parameter part of the Facility Information Element shall be set to:

k-value	e-parameter							CCM total at call end	Step 0 ACM value increased by
	1	2	3	4	5	6	7		
1	1	30	1	0	0	0	0	2	2
2	1	30	1	0	0	0	0	0	2
3	0	0	0	0	0	0	0	0	2

Values shown in table are in the format and have units as in GSM 02.24 section 3.

ii) FACILITY Information Element with Return Result component type as defined in GSM 04.80 section 3.6.1 table 3.4.

For ASN.1 description see default message contents in section 31.6.4.

31.6.3 Advice of Charge Information

31.6.4 Default contents of messages

As default message contents in GSM 11.10 Section 26.8 "Tests related to circuit switched call control". These messages shall not contain SS version IEs.

Where indicated in specific tests CONNECT and FACILITY messages have Facility Information Elements as defined below.

Default contents of ForwardChargeAdvice Facility Information Elements

The following abbreviations are used in the descriptions below:

- U Universal tag class.
- CS Context Specific tag class.
- P Primitive tag form.
- C Constructed tag form.
- FIE Facility Information Element.

i) FACILITY

Information Element with Invoke = ForwardChargeInformation component type as defined in GSM 04.80 section 3.6.1 table 3.3.

Contents	Value/remark	Coding
Facility IE Identifier	As GSM 04.80	00011100
Length of FIE contents	43	00101011
Component type tag	CS/C/tag=1	10100001
Component length	41	00101001
Invoke ID tag	U/P/tag=2	00000010
Invoke ID length	1	00000001
Invoke ID	Arbitrary (1 octet)	(00000000)
Op-Code tag	From GSM 04.80	00000010
Op-Code length	1	00000001
Op-Code	Forward Charge Advice operation (local value 125)	01111101
Sequence Identifier	U/C/tag=16 from CCITT X.208	00110000
Length Indicator	33	00100001
SS-Code Identifier	CS/P/tag=0	10000000
Length Indicator	1	00000001
SS-Code	AoCC SS-Code	01110010
Charging Info. identifier	CS/C/tag=1	10100001
Length Indicator	28	00011100
e1 Identifier	CS/P/tag=1	10000001
Length Indicator	2	00000010
e1	(2 Octets)	See e-parameter table in relevant test
e2 Identifier	CS/P/tag=2	10000010
Length Indicator	2	00000010
e2	(2 Octets)	See e-parameter table in relevant test
.	.	.
.	.	.
.	.	.
e7 Identifier	CS/P/tag=7	10000111
Length Indicator	2	00000010
e7	(2 Octets)	See e-parameter table in relevant test

ii) FACILITY

Information Element with Return Result component type as defined in GSM 04.80 section 3.6.1 table 3.4.

Contents	Value/remark	Coding
Facility IE Identifier	As GSM 04.80	00111100
Length of FIE contents	5	00001001
Component type tag	CS/C/tag=2	10100010
Component length	3	00000011
Invoke ID tag	U/P/Integer	00000010
Invoke ID length	1	00000001
Invoke ID	Same as used as	(00000000)
		Invoke ID in Invoke FIE

31.7 Additional information transfer supplementary services

(Reserved).

31.8 Call restriction supplementary services

The following abbreviations are used:

BO:	Barring of Outgoing calls.
BAOC:	Barring of All Outgoing Calls.
BOIC:	Barring of Outgoing International Calls.
BOICExHC:	Barring of Outgoing International Call EXcept those directed to the Home PLMN country.
BI:	Barring of Incoming calls.
BAIC:	Barring of All Incoming calls.
BICRoam:	Barring of Incoming when Roaming outside the home PLMN country.
B:	Barring (common name for BAOc, BOIC, BOICExHC, BAIC and BICRoam).

These abbreviations are also used to represent the corresponding SS-Code; e.g. B is the SS-Code for all barring services.

NOTE: The password(s) to be used during tests of this section 31.8 may be randomly chosen - unless otherwise stated - in accordance with GSM 02.04 section 5.2.

31.8.1 Registration of a password

31.8.1.1 Registration accepted

31.8.1.1.1 Conformance requirements

- 1) For registration of a password for all barring services, the MS shall transmit successively
 - 1.1) a CHANNEL REQUEST with establishment cause set to "other services requested by the mobile user",
 - 1.2) a CM SERVICE REQUEST with CM service type indicating "supplementary service activation",
 - 1.3) and then the REGISTER message containing a facility IE that includes an invoke of the RegisterPassword operation with parameter values according to the user's request (MMI action).
- 2) When the mobile subscriber wants to register a new password, the old password, the new password and the repeat of the new password shall be entered into the MS. Then the MS sends to the network an invoke component of the operation "register password".
- 3) The MS shall be able to send a password by sending a FACILITY message in accordance to the user request (MMI actions).
- 4) Upon receipt of the result of the procedure, contained in RELEASE COMPLETE or FACILITY message, the MS shall provide the appropriate user indication (which is to be described by the manufacturer).

References

- 1.1) GSM 04.08 sections 3.3.1.2 and 9.1.9.
- 1.2) GSM 04.08 sections 4.5.1.1, 9.2.9 and 10.5.33.
- 1.3) GSM 04.88, GSM 04.80 sections 2.3 and 3.6.
- 2) GSM 04.10 section 4.2.
- 3) GSM 04.80.
- 4) GSM 02.30.

31.8.1.1.2 Test purpose

- 1) To check that the MS correctly requests a supplementary service transaction for registration of a password for all barring services in CHANNEL REQUEST message.
- 2) To check that the MS correctly requests a supplementary service transaction for registration of a password for all barring services in the subsequent CM SERVICE REQUEST.
- 3) To check that the MS sends a REGISTER message containing the invoke of the RegisterPassword operation with the expected parameter values for registration of a password for all barring services.

- 4) To check that when the mobile subscriber wants to register a new password, the old password, the new password and the repeat of the new password shall be entered into the MS before the MS sends to the network a CHANNEL REQUEST.
- 5) To check that the MS is able to send a password by sending a FACILITY message in accordance to the user request (MMI actions).
- 6) To check that upon receipt of the result of the procedure, contained in RELEASE COMPLETE or FACILITY message, the MS provides the appropriate user indication (as described by the manufacturer).

These checks are done for:

all barring services, the result of the operation being sent in a RELEASE COMPLETE message.

31.8.1.1.3 Method of test

Initial conditions

System Simulator:

1 cell, default parameters.

Mobile Station:

The MS is "idle updated".

Related PICS/PIXIT statement(s)

Description of the user's commands and of display of the answers from the network for call barring.

Foreseen final state of the MS

The MS is "idle updated".

Test procedure

By means of appropriate MMI functions (using either GSM 02.30 or manufacturer defined MMI), the user requests registration of a new password for all barring services by entering the old password, new password and a repeat of the old password.

Upon receipt of the operation (in a REGISTER message), the system simulator answers with the FACILITY message with the Facility information element containing an invoke of the GetPassword operation requiring the old password.

Upon receipt of the FACILITY message, the system simulator answers with the FACILITY message with the Facility information element containing an invoke of the GetPassword operation requiring a new password.

Upon receipt of the FACILITY message, the system simulator answers with the FACILITY message with the Facility information element containing an invoke of the GetPassword operation requiring again the new password.

Upon receipt of the FACILITY message, the system simulator answers with the RELEASE COMPLETE message with the Facility information element containing the return result of the RegisterPassword operation.

Maximum duration of test

3 minutes.

Expected sequence

Step	Direction	Message	Comments
1	MS		The MS is made to initiate a registration of a password for all call barring services. The old password, the new password and a repeat of the new password are entered.
2	MS -> SS	CHANNEL REQUEST	with establishment cause "Other procedures which can be completed with an SDCCH"
3	SS -> MS	IMMEDIATE ASSIGNMENT	
4	MS -> SS	CM SERVICE REQUEST	cause: "supplementary service activation"
5	SS -> MS	CM SERVICE ACCEPT	
6	MS -> SS	REGISTER	
7	SS -> MS	FACILITY	Invoke = GetPassword (password)
8	MS -> SS	FACILITY	GetPassword operation ReturnResult
9	SS -> MS	FACILITY	Invoke = GetPassword (new password)
10	MS -> SS	FACILITY	GetPassword operation ReturnResult
11	SS -> MS	FACILITY	Invoke = GetPassword (new password again)
12	MS -> SS	FACILITY	GetPassword operation ReturnResult
13	SS -> MS	RELEASE COMPLETE	RegisterPassword operation ReturnResult
14	SS -> MS	CHANNEL RELEASE	

Specific message content

step 6 -

- protocol discriminator: non call related SS message
- message type: REGISTER
- facility

invoke = RegisterPassword
Supplementary service code = B

steps 7, 9, and 11 -

- protocol discriminator: non call related SS message
- message type: FACILITY
- facility

invoke = GetPassword
Guidance info: Password (step 7), new password (step 9), new password again (step 11)

The linked ID must be the same as the invoke ID in the invoke of the RegisterPassword operation.

31.8.1.2 Registration rejected**31.8.1.2.1 Rejection after invoke of the RegisterPassword operation****31.8.1.2.1.1 Conformance requirements**

- 1) A transaction of any kind being already established, for registration of a password for all call restriction services, the MS shall establish a parallel MM transaction, sending a CM SERVICE REQUEST with CM service type indicating "supplementary service activation",
- 2) Then the MS shall send a REGISTER message related to the present SS transaction containing a facility IE that includes an invoke of the RegisterPassword operation with parameter values according to the user's request (MMI action).
- 3) Upon receipt of the RELEASE COMPLETE message related to the present SS transaction, the SS transaction shall be released but the first transaction shall remain unaffected.

- 4) Upon receipt of the RELEASE COMPLETE message, the MS shall provide the appropriate user indication (which is to be described by the Manufacturer).

References

- 1) GSM 04.08 sections 3.3.1.2 and 9.1.9.
- 2) GSM 04.08 sections 4.5.1.1, 9.2.9 and 10.5.33.
- 3) GSM 04.88, GSM 04.80 sections 2.3 and 3.6.
- 4) GSM 02.30 section 4.5.

31.8.1.2.1.2 Test purpose

- 1) To check that, when a call transaction is already established, the MS correctly requests the establishment of a parallel MM transaction for supplementary service transaction of registration of a password for all call restriction services, sending a CM SERVICE REQUEST.
- 2) To check that the MS sends a REGISTER message containing the invoke of the RegisterPassword operation with the expected parameter values for registration of a password for all call restriction services.
- 3) To check that upon receipt of the RELEASE COMPLETE message related to the present SS transaction, the first transaction remains unaffected.
- 4) To check that upon receipt of the RELEASE COMPLETE message, the MS provides the appropriate user indication (as described by the Manufacturer).

Those checks are performed with a call transaction already established for:

all call restriction services, the RELEASE COMPLETE message being sent at the beginning of the procedure with a facility IE containing a return_error(error) where error is "SS subscription violation".

31.8.1.2.1.3 Method of test

Initial conditions

System Simulator:
1 cell, default parameters.

Mobile Station:
The MS is in CC state U10.

Related PICS/PIXIT statement(s)

Description of the user's commands and of display of the answers from the network for call barring.

Foreseen final state of the MS

The MS is in CC state U10.

Test procedure

By means of appropriate MMI functions (using either GSM 02.30 or manufacturer defined MMI), the user requests registration of a new password for all call restriction services by entering the old password, the new password and a repeat of the new password.

Upon receipt of the operation (in a REGISTER message), the system simulator answers with the RELEASE COMPLETE (PD and TI of the SS transaction) message with the Facility information element containing a Return_error(error: SS subscription violation) of the RegisterPassword operation.

Upon receipt of the FACILITY message, the system simulator sends STATUS ENQUIRY, the MS responds with STATUS message indicating CC state U10.

Maximum duration of test

2 min.

Expected sequence

Step	Direction	Message	Comments
1	MS		The MS is made to initiate a registration of a new password for all call restriction services. The old password, the new password and a repeat of the new password are entered.
2	MS -> SS	CM SERVICE REQUEST	cause: "supplementary service activation"
3	SS -> MS	CM SERVICE ACCEPT	
4	MS -> SS	REGISTER	
5	SS -> MS	RELEASE COMPLETE	RegisterPassword operation Return_error
6	MS		provide correct MMI user indication
7	SS -> MS	STATUS ENQUIRY	
8	MS -> SS	STATUS	CC staTE U10

Specific message content

step 4 -

- protocol discriminator: non call related SS message
- message type: REGISTER
- facility

invoke = RegisterPassword

Supplementary service code = all call restrictions

step 5 -

- protocol discriminator: non call related SS message
- transaction identifier: same TI as previous REGISTER message
- message type: RELEASE COMPLETE
- facility:
 - return error code: SS subscription violation

For the return error the invoke ID must be the same as in the invoke of the RegisterPassword operation.

31.8.1.2.2 Rejection after password check with negative result**31.8.1.2.2.1 Conformance requirements**

- 1) A transaction of any kind being already established, for registration of a password for all call restriction services, the MS shall establish a parallel MM transaction, sending a CM SERVICE REQUEST with CM service type indicating "supplementary service activation",
- 2) Then the MS shall send a REGISTER message related to the present SS transaction containing a facility IE that includes an invoke of the RegisterPassword operation with parameter values according to the user's request (MMI action).
- 3) Upon receipt of the RELEASE COMPLETE message related to the present SS transaction, the SS transaction shall be released but the first transaction shall remain unaffected.
- 4) Upon receipt of the RELEASE COMPLETE message, the MS shall provide the appropriate user indication (which is to be described by the Manufacturer).

References

- 1) GSM 04.08 sections 3.3.1.2 and 9.1.9.
- 2) GSM 04.08 sections 4.5.1.1, 9.2.9 and 10.5.33.
- 3) GSM 04.88, GSM 04.80 sections 2.3 and 3.6, GSM 04.10 section 4.2.2, GSM 03.11 section 3.
- 4) GSM 02.30 section 4.5.

31.8.1.2.2 Test purpose

- 1) To check that, when a call transaction is already established, the MS correctly requests the establishment of a parallel MM transaction for supplementary service transaction of registration of a password for all call restriction services, sending a CM SERVICE REQUEST.
- 2) To check that the MS sends a REGISTER message containing the invoke of the RegisterPassword operation with the expected parameter values for registration of a password for all call restriction services.
- 3) To check that upon receipt of the RELEASE COMPLETE message related to the present SS transaction, the first transaction remains unaffected.
- 4) To check that upon receipt of the RELEASE COMPLETE message, the MS provides the appropriate user indication (as described by the Manufacturer).

Those checks are performed with a call transaction already established for:

all call restriction services, the RELEASE COMPLETE message being sent at the end of the procedure with a facility IE containing a return_error(error) where error is "NegativePasswordCheck".

31.8.1.2.3 Method of test

Initial conditions

System Simulator:

1 cell, default parameters.
WPA > 3

Mobile Station:

The MS is in CC state U10.

Related PICS/PIXIT statements

Description of the user's commands and of display of the answers from the network for call barring.

Foreseen final state of the MS

The MS is in CC state U10.

Test procedure

By means of appropriate MMI functions (using either GSM 02.30 or manufacturer defined MMI), the user requests registration of a new password for all call restriction services. By means of appropriate MMI functions the user enters the old and new passwords.

Upon receipt of the REGISTER message, the system simulator answers with the FACILITY message with the Facility information element containing an invoke of the GetPassword operation requiring the old password.

Upon receipt of the FACILITY message, the system simulator answers with the RELEASE COMPLETE message (PD and TI of the SS transaction) with the Facility information element containing a Return_error(error: NegativePasswordCheck) of the RegisterPassword operation.

The system simulator sends STATUS ENQUIRY, the MS responds with STATUS message indicating CC state U10.

Maximum duration of test

5 min.

Expected sequence

Step	Direction	Message	Comments
1	MS		The MS is made to initiate a registration of a new password for all call restriction services. The old and new passwords are entered. cause: "supplementary service activation"
2	MS -> SS	CM SERVICE REQUEST	
3	SS -> MS	CM SERVICE ACCEPT	
4	MS -> SS	REGISTER	
5	SS -> MS	FACILITY	Invoke = GetPassword (password) Register Password operation ReturnError provide correct MMI user indication
6	SS -> MS	RELEASE COMPLETE	
7	MS		
8	SS -> MS	STATUS ENQUIRY	
9	MS -> SS	STATUS	CC staTE U10

Specific message content

step 4 -

- protocol discriminator: non call related SS message
- message type: REGISTER
- facility

invoke = RegisterPassword
Supplementary service code = B

step 6 -

- protocol discriminator: non call related SS message
- transaction identifier: same TI as previous REGISTER message
- message type: RELEASE COMPLETE
- facility:
error code: NegativePasswordCheck

For the reject the invoke ID must be the same as in the invoke of the Registerpassword operation.

step 5 -

- protocol discriminator: non call related SS message
- transaction identifier: in FACILITY same as previous REGISTER message
- message type: FACILITY
- facility

invoke = GetPassword
Guidance info: Password (step 1)

31.8.1.2.3 Rejection after new password mismatch

31.8.1.2.3.1 Conformance requirements

- 1) A transaction of any kind being already established, for registration of a password for all call restriction services, the MS shall establish a parallel MM transaction, sending a CM SERVICE REQUEST with CM service type indicating "supplementary service activation",

- 2) Then the MS shall send a REGISTER message related to the present SS transaction containing a facility IE that includes an invoke of the RegisterPassword operation with parameter values according to the user's request (MMI action).
- 3) Upon receipt of the RELEASE COMPLETE message related to the present SS transaction, the SS transaction shall be released but the first transaction shall remain unaffected.
- 4) Upon receipt of the RELEASE COMPLETE message, the MS shall provide the appropriate user indication (which is to be described by the Manufacturer).

References

- 1) GSM 04.08 sections 3.3.1.2 and 9.1.9.
- 2) GSM 04.08 sections 4.5.1.1, 9.2.9 and 10.5.33.
- 3) GSM 04.88, GSM 04.80 sections 2.3 and 3.6.
- 4) GSM 02.30 section 4.5.
- 5) GSM 04.10 section 4.2.

31.8.1.2.3.2 Test purpose

- 1) To check that, when a call transaction is already established, the MS correctly requests the establishment of a parallel MM transaction for supplementary service transaction of registration of a password for all call restriction services, sending a CM SERVICE REQUEST.
- 2) To check that the MS sends a REGISTER message containing the invoke of the RegisterPassword operation with the expected parameter values for registration of a password for all call restriction services.
- 3) To check that upon receipt of the RELEASE COMPLETE message related to the present SS transaction, the first transaction remains unaffected.
- 4) To check that upon receipt of the RELEASE COMPLETE message, the MS provides the appropriate user indication (as described by the Manufacturer).

Those checks are performed with a call transaction already established for:

all call restriction services, the RELEASE COMPLETE message being sent at the end of the procedure with a facility IE containing a return_error(error) where error is "PasswordRegistrationFailure" with diagnostic "new password mismatch".

31.8.1.2.3.3 Method of test

Initial conditions

System Simulator:

1 cell, default parameters.

Mobile Station:

The MS is in CC state U10.

Related PICS/PIXIT statements

Description of the user's commands and of display of the answers from the network for call barring.

Foreseen final state of the MS

The MS is in CC state U10.

Test procedure

By means of appropriate MMI functions (using either GSM 02.30 or manufacturer defined MMI), the user requests registration of a new password for all call restriction services by entering the old password, the new password and a repeat of the new password.

Upon receipt of the REGISTER message, the system simulator answers with the FACILITY message with the Facility information element containing an invoke of the GetPassword operation requiring the old password.

Upon receipt of the FACILITY message, the system simulator answers with the FACILITY message with the Facility information element containing an invoke of the GetPassword operation requiring the new password.

Upon receipt of the FACILITY message, the system simulator answers with the FACILITY message with the Facility information element containing an invoke of the GetPassword operation requiring again the new password.

Upon receipt of the FACILITY message, the system simulator answers with the RELEASE COMPLETE message (PD and TI of the SS transaction) with the Facility information element containing a Return_error(error: PasswordRegistrationFailure, parameter: NewPasswordMismatch) of the RegisterPassword operation.

The system simulator sends STATUS ENQUIRY, the MS responds with STATUS message indicating CC state U10.

Maximum duration of test

3 min.

Expected sequence

Step	Direction	Message	Comments
1	MS		The MS is made to initiate a registration of a new password for all call restriction services. The old password, new password and a repeat of the new password are entered.
2	MS -> SS	CM SERVICE REQUEST	cause: "supplementary service activation"
3	SS -> MS	CM SERVICE ACCEPT	
4	MS -> SS	REGISTER	
5	SS -> MS	FACILITY	Invoke = GetPassword (password)
6	MS -> SS	FACILITY	GetPassword operation ReturnResult
7	SS -> MS	FACILITY	Invoke = GetPassword (new password)
8	MS -> SS	FACILITY	GetPassword operation ReturnResult
9	SS -> MS	FACILITY	Invoke = GetPassword (new password again)
10	MS -> SS	FACILITY	GetPassword operation ReturnResult
11	SS -> MS	RELEASE COMPLETE	Register Password operation ReturnError
12	MS		provide correct MMI user indication
13	SS -> MS	STATUS ENQUIRY	
14	MS -> SS	STATUS	CC staTE U10

Specific message content

step 4 -

- protocol discriminator: non call related SS message
- message type: REGISTER
- facility

invoke = RegisterPassword
Supplementary service code = B

step 11 -

- protocol discriminator: non call related SS message
- transaction identifier: same TI as previous REGISTER message
- message type: RELEASE COMPLETE
- facility:
 - error code: PasswordRegistrationFailure
 - parameter: NewPasswordMismatch

For the reject the invoke ID must be the same as in the invoke of the Registerpassword operation.

steps 5, 7, and 8 -

- protocol discriminator: non call related SS message
- transaction identifier: in FACILITY same as previous REGISTER message
- message type: FACILITY
- facility

invoke = GetPassword

Supplementary service code = B

Guidance info: Password (step 5), new password (step 7), new password again (step 8)

31.8.2 Erasure

Not applicable.

31.8.3 Activation

31.8.3.1 Activation accepted

31.8.3.1.1 Conformance requirements

- 1) For activation of any specific call restriction service with any parameters, the MS shall transmit successively
 - 1.1) a CHANNEL REQUEST with establishment cause set to "other services requested by the mobile user",
 - 1.2) a CM SERVICE REQUEST with CM service type indicating "supplementary service activation",
 - 1.3) and then the REGISTER message containing a facility IE that includes an invoke of the ActivateSS operation with parameter values according to the user's request (MMI action).
- 2) Upon receipt of FACILITY message requiring the password, the MS shall provide the appropriate user indication (which is to be described by the manufacturer).
- 3) The MS shall be able to send a password by sending a FACILITY message in accordance to the user request (MMI actions).
- 4) Upon receipt of the RELEASE COMPLETE message, the MS shall provide the appropriate user indication (which is to be described by the manufacturer).

References

- 1) GSM 04.08 sections 3.3.1.2 and 9.1.9.
- 2) GSM 04.08 sections 4.5.1.1, 9.2.9 and 10.5.33.
- 3) GSM 04.88, GSM 04.80 sections 2.3 and 3.6.
- 4) GSM 02.30 section 4.5.

31.8.3.1.2 Test purpose

- 1) To check that the MS correctly requests a supplementary service transaction for activation of a specific call restriction service in CHANNEL REQUEST message.

- 2) To check that the MS correctly requests a supplementary service transaction for activation of call restriction service in the subsequent CM SERVICE REQUEST.
- 3) To check that the MS sends a REGISTER message containing the invoke of the ActivateSS operation with the expected parameter values for activation of a specific call restriction service.
- 4) To check that upon receipt of FACILITY message requiring the password, the MS provides the appropriate user indication (as described by the manufacturer).
- 5) To check that the MS is able to send a password by sending a FACILITY message in accordance to the user request (MMI actions).
- 6) To check that upon receipt of the RELEASE COMPLETE message, the MS provides the appropriate user indication (which is to be described by the manufacturer).

These checks are done for:

- a) BAOC, for basic service group "all synchronous services".
- b) BICRoam, for all basic service groups.

31.8.3.1.3 Method of test

Initial conditions

System Simulator:
1 cell, default parameters.

Mobile Station:
The MS is "idle updated".

Related PICS/PIXIT statements

Description of the user's commands and of display of the answers from the network for call barring.

Foreseen final state of the MS

The MS is "idle updated".

Test procedure

By means of appropriate MMI functions (using either GSM 02.30 or manufacturer defined MMI), the user requests activation of BAOC, for basic service group "all synchronous services".

Upon receipt of the operation (in a REGISTER message), the system simulator answers with the FACILITY message with the Facility information element containing an invoke of the GetPassword operation requiring the current password.

Then, by means of appropriate MMI functions, the user gives a password.

Upon receipt of the FACILITY message, the system simulator answers with a RELEASE COMPLETE message with the Facility information element containing the Return_result of the ActivateSS operation.

The SS transaction and the dedicated channel are released.

Then again, by means of appropriate MMI functions, the user requests activation of BICRoam, for all basic service groups.

Upon receipt of the operation (in a REGISTER message), the system simulator answers with the FACILITY message with the Facility information element containing an invoke of the GetPassword operation requiring the current password.

Then, by means of appropriate MMI functions, the user gives a password.

Upon receipt of the FACILITY message, the system simulator answers with a RELEASE COMPLETE message with the Facility information element containing the Return_result of the ActivateSS operation.

The dedicated channel is released.

Maximum duration of test

3 min.

Expected sequence

Step	Direction	Message	Comments
1	MS		The MS is made to initiate a activation of BAOC(all synchronous services)
2	MS -> SS	CHANNEL REQUEST	with establishment cause "Other procedures which can be completed with an SDCCH"
3	SS -> MS	IMMEDIATE ASSIGNMENT	
4	MS -> SS	CM SERVICE REQUEST	cause: "supplementary service activation"
5	SS -> MS	CM SERVICE ACCEPT	
6	MS -> SS	REGISTER	
7	SS -> MS	FACILITY	GetPassword
8	MS		provide correct MMI user indication A password is entered.
9	MS -> SS	FACILITY	Getpassword operation Return Result
10	SS -> MS	RELEASE COMPLETE	ActivateSS operation Return_result
11	MS		provide user MMI indication
12	SS -> MS	CHANNEL RELEASE	
13	MS		The MS is made to initiate an activation of BICRoam(all basic service groups),
14	MS -> SS	CHANNEL REQUEST	with establishment cause "Other procedures which can be completed with an SDCCH"
15	SS -> MS	IMMEDIATE ASSIGNMENT	
16	MS -> SS	CM SERVICE REQUEST	cause: "supplementary service activation"
17	SS -> MS	CM SERVICE ACCEPT	
18	MS -> SS	REGISTER	
19	SS -> MS	FACILITY	GetPassword
20	MS		provide correct MMI user indication A password is entered.
21	MS -> SS	FACILITY	Getpassword operation Return Result
22	SS -> MS	RELEASE COMPLETE	ActivateSS operation Return result
23	MS		provide correct MMI user indication
24	SS -> MS	CHANNEL RELEASE	

Specific message contents

step 6 - BAOC

- protocol discriminator: non call related SS message
- message type: REGISTER
- facility

invoke = Activation

Supplementary service code = BAOC

Basic service code: Bearer Service (all synchronous services), no teleservice present.

step 18 -

- protocol discriminator: non call related SS message
- message type: REGISTER
- facility

invoke = Activation
Supplementary service code = BICRoam
Basic service code: no bearer service present, no teleservice present.

steps 7, 19 -

- protocol discriminator: non call related SS message
- transaction identifier: in FACILITY same as previous REGISTER message
- message type: FACILITY
- facility

invoke = GetPassword
Guidance info: Password

31.8.3.2 Activation rejected

31.8.3.2.1 Rejection after invoke of ActivateSS operation

31.8.3.2.1.1 Conformance requirements

- 1) A transaction of any kind being already established, for activation of one specific barring services, the MS shall establish a parallel MM transaction, sending a CM SERVICE REQUEST with CM service type indicating "supplementary service activation",
- 2) Then the MS shall send a REGISTER message related to the present SS transaction containing a facility IE that includes an invoke of the ActivateSS operation with parameter values according to the user's request (MMI action).
- 3) Upon receipt of the RELEASE COMPLETE message related to the present SS transaction, the SS transaction shall be released but the first transaction shall remain unaffected.
- 4) Upon receipt of the RELEASE COMPLETE message, the MS shall provide the appropriate user indication (which is to be described by the Manufacturer).

References

- 1) GSM 04.08 sections 3.3.1.2 and 9.1.9.
- 2) GSM 04.08 sections 4.5.1.1, 9.2.9 and 10.5.33.
- 3) GSM 04.88, GSM 04.80 sections 2.3 and 3.6.
- 4) GSM 02.30 section 4.5.

31.8.3.2.1.2 Test purpose

- 1) To check that, when a call transaction is already established, the MS correctly requests the establishment of a parallel MM transaction for supplementary service transaction of specific call barring service, sending a CM SERVICE REQUEST.
- 2) To check that the MS sends a REGISTER message containing the invoke of the ActivateSS operation with the expected parameter values for specific call barring service.
- 3) To check that upon receipt of the RELEASE COMPLETE message related to the present SS transaction, the first transaction remains unaffected.
- 4) To check that upon receipt of the RELEASE COMPLETE message, the MS provides the appropriate user indication (as described by the Manufacturer).

Those checks are performed with a call transaction already established for:

BOIC, the RELEASE COMPLETE message being sent at the beginning of the procedure with a facility IE containing a return_error(error) where error is "SS subscription violation".

31.8.3.2.1.3 Method of test**Initial conditions**

System Simulator:

1 cell, default parameters.

Mobile Station:

The MS is in CC state U10.

Related PICS/PIXIT statements

Description of the user's commands and of display of the answers from the network for call barring.

Foreseen final state of the MS

The MS is in CC state U10.

Test procedure

By means of appropriate MMI functions (using either GSM 02.30 or manufacturer defined MMI), the user requests activation of BOIC.

Upon receipt of the operation (in a REGISTER message), the system simulator answers with the RELEASE COMPLETE (PD and TI of the SS transaction) message with the Facility information element containing a Return_error(error: SS subscription violation) of the ActivateSS operation.

The system simulator then sends STATUS ENQUIRY, and the MS responds with STATUS message indicating CC state U10.

Maximum duration of test

2 min.

Expected sequence

Step	Direction	Message	Comments
1	MS		The MS is made to initiate a registration of a new password for BOIC
2	MS -> SS	CM SERVICE REQUEST	cause: "supplementary service activation"
3	SS -> MS	CM SERVICE ACCEPT	
4	MS -> SS	REGISTER	
5	SS -> MS	RELEASE COMPLETE	RegisterPassword operation Return_error
6	MS		provide correct MMI user indication
7	SS -> MS	STATUS ENQUIRY	
8	MS -> SS	STATUS	CC state U10

Specific message content

step 4 -

- protocol discriminator: non call related SS message
- message type: REGISTER
- facility

invoke = ActivateSS
Supplementary service code = BOIC

step 5 -

- protocol discriminator: non call related SS message
- transaction identifier: same TI as previous REGISTER message
- message type: RELEASE COMPLETE
- facility:
 - return error code: SS subscription violation

For the return error the invoke ID must be the same as in the invoke of the ActivateSS operation.

31.8.3.2.2 Rejection after use of password procedure

31.8.3.2.2.1 Conformance requirements

- 1) A transaction of any kind being already established, for activation of any specific call restriction services, the MS shall establish a parallel MM transaction, sending a CM SERVICE REQUEST with CM service type indicating "supplementary service activation",
- 2) Then the MS shall send a REGISTER message related to the present SS transaction containing a facility IE that includes an invoke of the ActivateSS operation with parameter values according to the user's request (MMI action).
- 3) Upon receipt of the RELEASE COMPLETE message related to the present SS transaction, the SS transaction shall be released but the first transaction shall remain unaffected.
- 4) Upon receipt of the RELEASE COMPLETE message, the MS shall provide the appropriate user indication (which is to be described by the Manufacturer).

References

- 1) GSM 04.08 sections 3.3.1.2 and 9.1.9.
- 2) GSM 04.08 sections 4.5.1.1, 9.2.9 and 10.5.33.
- 3) GSM 04.88, GSM 04.80 sections 2.3 and 3.6.
- 4) GSM 02.30 section 4.5.

31.8.3.2.2.2 Test purpose

- 1) To check that, when a call transaction is already established, the MS correctly requests the establishment of a parallel MM transaction for supplementary service transaction of activation of one specific call restriction service, sending a CM SERVICE REQUEST.
- 2) To check that the MS sends a REGISTER message containing the invoke of the ActivateSS operation with the expected parameter values for activation of one specific call restriction service.
- 3) To check that upon receipt of the RELEASE COMPLETE message related to the present SS transaction, the first transaction remains unaffected.
- 4) To check that upon receipt of the RELEASE COMPLETE message, the MS provides the appropriate user indication (as described by the Manufacturer).

Those checks are performed with a call transaction already established for:

BAIC, the RELEASE COMPLETE message being sent at the end of the procedure with a facility IE containing a return_error(error) where error is "NegativePasswordCheck".

31.8.3.2.2.3 Method of test

Initial conditions

System Simulator:
1 cell, default parameters.

Mobile Station:

The MS is in CC state U10.

Related PICS/PIXIT statements

Description of the user's commands and of display of the answers from the network for call barring.

Foreseen final state of the MS

The MS is in CC state U10.

Test procedure

By means of appropriate MMI functions (using either GSM 02.30 or manufacturer defined MMI), the user requests registration of a new password for all call restriction services.

Upon receipt of the REGISTER message, the system simulator answers with the FACILITY message with the Facility information element containing an invoke of the GetPassword operation requiring the current password.

Then, by means of appropriate MMI functions, the user gives a password.

Upon receipt of the FACILITY message, the system simulator sends RELEASE COMPLETE message (PD and TI of the SS transaction) with the Facility information element containing a Return_error(error: NegativePasswordCheck) of the GetPassword operation.

The system simulator sends STATUS ENQUIRY, the MS responds with STATUS message indicating CC state U10.

Maximum duration of test

3 min.

Expected sequence

Step	Direction	Message	Comments
1	MS		
2	MS -> SS	CM SERVICE REQUEST	The MS is made to initiate a registration of BAIC cause: "supplementary service activation"
3	SS -> MS	CM SERVICE ACCEPT	
4	MS -> SS	REGISTER	
5	SS -> MS	FACILITY	Invoke = GetPassword (password) provide correct MMI user indication A password is entered.
6	MS		
7	MS -> SS	FACILITY	GetPassword operation Return Result Register Password operation ReturnError provide correct MMI user indication
8	SS -> MS	RELEASE COMPLETE	
9	MS		
10	SS -> MS	STATUS ENQUIRY	CC state U10
11	MS -> SS	STATUS	

Specific message content

step 4 - BAIC

- protocol discriminator: non call related SS message
- message type: REGISTER
- facility

invoke = Activation
 Supplementary service code = BAIC

step 5 - All Barring services

- protocol discriminator: non call related SS message
- transaction identifier: in FACILITY same as previous REGISTER message
- message type: FACILITY
- facility

invoke = GetPassword

Guidance info: Password (step 5)

step 8 -

- protocol discriminator: non call related SS message
- transaction identifier: same TI as previous REGISTER message
- message type: RELEASE COMPLETE
- facility:

reject code: NegativePasswordCheck

For the reject the invoke ID must be the same as in the invoke of the GetPassword operation.

31.8.4 Deactivation

31.8.4.1 Deactivation accepted

31.8.4.1.1 Conformance requirements

- 1) For deactivation of any group of call restriction services with any parameters, the MS shall transmit successively
 - 1.1) a CHANNEL REQUEST with establishment cause set to "other services requested by the mobile user",
 - 1.2) a CM SERVICE REQUEST with CM service type indicating "supplementary service activation",
 - 1.3) and then the REGISTER message containing a facility IE that includes an invoke of the DeactivateSS operation with parameter values according to the user's request (MMI action).
- 2) Upon receipt of FACILITY message requiring the password, the MS shall provide the appropriate user indication (which is to be described by the manufacturer).
- 3) The MS shall be able to send a password by sending a FACILITY message in accordance to the user request (MMI actions).
- 3) Upon receipt of the RELEASE COMPLETE message, the MS shall provide the appropriate user indication (which is to be described by the manufacturer).

References

- 1) GSM 04.08 sections 3.3.1.2 and 9.1.9.
- 2) GSM 04.08 sections 4.5.1.1, 9.2.9 and 10.5.33.
- 3) GSM 04.88, GSM 04.80 sections 2.3 and 3.6.
- 4) GSM 02.30 section 4.5.

31.8.4.1.2 Test purpose

- 1) To check that the MS correctly requests a supplementary service transaction for deactivation of a group of call barring services in CHANNEL REQUEST message.
- 2) To check that the MS correctly requests a supplementary service transaction for deactivation of a group of call barring services in the subsequent CM SERVICE REQUEST.
- 3) To check that the MS sends a REGISTER message containing the invoke of the DeactivateSS operation with the expected parameter values for deactivation of a group of call restriction services.

- 4) To check that upon receipt of FACILITY message requiring the password, the MS provides the appropriate user indication (as described by the manufacturer).
- 5) To check that the MS is able to send a password by sending a FACILITY message in accordance to the user request (MMI actions).
- 6) To check that upon receipt of the RELEASE COMPLETE message, the MS provides the appropriate user indication (which is to be described by the manufacturer).

These checks are done for:

- a) all restrictions, for basic service group "speech".
- b) barring of outgoing calls, for all facsimile.

31.8.4.1.3 Method of test

Initial conditions

System Simulator:

1 cell, default parameters.

Mobile Station:

The MS is "idle updated".

Related PICS/PIXIT statements

Description of the user's commands and of display of the answers from the network for call barring.

Foreseen final state of the MS

The MS is "idle updated".

Test procedure

By means of appropriate MMI functions (using either GSM 02.30 or manufacturer defined MMI), the user requests deactivation of all restrictions, for speech.

Upon receipt of the operation (in a REGISTER message), the system simulator answers with the FACILITY message with the Facility information element containing an invoke of the GetPassword operation requiring the current password.

Then, by means of appropriate MMI functions, the user gives a password.

Upon receipt of the FACILITY message, the system simulator answers with the FACILITY message with the Facility information element containing the Return_result of the DeactivateSS operation.

The SS transaction and the dedicated channel are released.

Then again, by means of appropriate MMI functions, the user requests activation of barring of outgoing calls, for all facsimile.

Upon receipt of the operation (in a REGISTER message), the system simulator answers with the FACILITY message with the Facility information element containing an invoke of the GetPassword operation requiring the current password.

Then, by means of appropriate MMI functions, the user gives a password.

Upon receipt of the FACILITY message, the system simulator answers with a RELEASE COMPLETE message with the Facility information element containing the Return_result of the DeactivateSS operation.

The dedicated channel is released.

Maximum duration of test

5 min.

Expected sequence

Step	Direction	Message	Comments
1	MS		The MS is made to initiate a deactivation of all call restrictions(speech)
2	MS -> SS	CHANNEL REQUEST	with establishment cause "Other procedures which can be completed with an SDCCH"
3	SS -> MS	IMMEDIATE ASSIGNMENT	
4	MS -> SS	CM SERVICE REQUEST	cause: "supplementary service activation"
5	SS -> MS	CM SERVICE ACCEPT	
6	MS -> SS	REGISTER	
7	SS -> MS	FACILITY	GetPassword
8	MS		provide correct MMI user indication A password is entered.
9	MS -> SS	FACILITY	Getpassword operation Return Result
10	SS -> MS	RELEASE COMPLETE	DeactivateSS operation Return_result
11	SS -> MS	CHANNEL RELEASE	
12	MS		The MS is made to initiate a deactivation of barring of outgoing calls(all facsimile),
13	MS -> SS	CHANNEL REQUEST	with establishment cause "Other procedures which can be completed with an SDCCH"
14	SS -> MS	IMMEDIATE ASSIGNMENT	
15	MS -> SS	CM SERVICE REQUEST	cause: "supplementary service activation"
16	SS -> MS	CM SERVICE ACCEPT	
17	MS -> SS	REGISTER	
18	SS -> MS	FACILITY	GetPassword
19	MS		provide correct MMI user indication A password is entered.
20	MS -> SS	FACILITY	Getpassword operation Return Result
21	SS -> MS	RELEASE COMPLETE	DeactivateSS operation Return result
22	MS		provide correct MMI user indication
23	SS -> MS	CHANNEL RELEASE	

Specific message contents

step 6 - all call restrictions:

- protocol discriminator: non call related SS message
- message type: REGISTER
- facility

invoke = Deactivation

Supplementary service code = B

Basic service code: no Bearer Service present, teleservice: speech.

step 17 - barring of outgoing calls,

- protocol discriminator: non call related SS message
- message type: REGISTER
- facility

invoke = Deactivation

Basic service code: no bearer service present, teleservice: all facsimile.

steps 7, 18 -

- protocol discriminator: non call related SS message
- transaction identifier: in FACILITY same as previous REGISTER message
- message type: FACILITY
- facility

invoke = GetPassword
Guidance info: Password

31.8.4.2 Deactivation rejected

31.8.4.2.1 Rejection after invoke of DeactivateSS operation

31.8.4.2.1.1 Conformance requirements

- 1) A transaction of any kind being already established, for deactivation of a group of call restriction services, the MS shall establish a parallel MM transaction, sending a CM SERVICE REQUEST with CM service type indicating "supplementary service activation",
- 2) Then the MS shall send a REGISTER message related to the present SS transaction containing a facility IE that includes an invoke of the DeactivateSS operation with parameter values according to the user's request (MMI action).
- 3) Upon receipt of the RELEASE COMPLETE message related to the present SS transaction, the SS transaction shall be released but the first transaction shall remain unaffected.
- 4) Upon receipt of the RELEASE COMPLETE message, the MS shall provide the appropriate user indication (which is to be described by the Manufacturer).

References

- 1) GSM 04.08 sections 3.3.1.2 and 9.1.9.
- 2) GSM 04.08 sections 4.5.1.1, 9.2.9 and 10.5.33.
- 3) GSM 04.88, GSM 04.80 sections 2.3 and 3.6.
- 4) GSM 02.30 section 4.5.

31.8.4.2.1.2 Test purpose

- 1) To check that, when a call transaction is already established, the MS correctly requests the establishment of a parallel MM transaction for supplementary service transaction of a group of call barring services, sending a CM SERVICE REQUEST.
- 2) To check that the MS sends a REGISTER message containing the invoke of the DeactivateSS operation with the expected parameter values for a group of call barring services.
- 3) To check that upon receipt of the RELEASE COMPLETE message related to the present SS transaction, the first transaction remains unaffected.
- 4) To check that upon receipt of the RELEASE COMPLETE message, the MS provides the appropriate user indication (as described by the Manufacturer).

These checks are performed with a call transaction already established for:

BOIC, the RELEASE COMPLETE message being sent at the beginning of the procedure with a facility IE containing a return_error(error) where error is "SS subscription violation".

31.8.4.2.1.3 Method of test

Initial conditions

System Simulator:
1 cell, default parameters.

Mobile Station:

The MS is in CC state U10.

Related PICS/PIXIT statements

Description of the user's commands and of display of the answers from the network for call barring.

Foreseen final state of the MS

The MS is in CC state U10.

Test procedure

By means of appropriate MMI functions (using either GSM 02.30 or manufacturer defined MMI), the user requests deactivation of incoming calls.

Upon receipt of the operation (in a REGISTER message), the system simulator answers with the RELEASE COMPLETE (PD and TI of the SS transaction) message with the Facility information element containing a Return_error(error: SS subscription violation) of the DeactivateSS operation.

The system simulator then sends STATUS ENQUIRY, and the MS responds with STATUS message indicating CC state U10.

Maximum duration of test

30 s.

Expected sequence

Step	Direction	Message	Comments
1	MS		The MS is made to initiate a deactivation for bi cause: "supplementary service activation"
2	MS -> SS	CM SERVICE REQUEST	
3	SS -> MS	CM SERVICE ACCEPT	
4	MS -> SS	REGISTER	
5	SS -> MS	RELEASE COMPLETE	DeactivateSS operation Return_error provide correct MMI user indication
6	MS		
7	SS -> MS	STATUS ENQUIRY	CC state U10
8	MS -> SS	STATUS	

Specific message content

step 4 -

- protocol discriminator: non call related SS message
- message type: REGISTER
- facility

invoke = DeactivateSS
Supplementary service code = bi

step 5 -

- protocol discriminator: non call related SS message
- transaction identifier: same TI as previous REGISTER message
- message type: RELEASE COMPLETE
- facility:
return error code: SS subscription violation

For the return error the invoke ID must be the same as in the invoke of the DeactivateSS operation.

31.8.4.2.2 Rejection after use of password procedure**31.8.4.2.2.1 Conformance requirements**

- 1) A transaction of any kind being already established, for deactivation of a group of call restriction services, the MS shall establish a parallel MM transaction, sending a CM SERVICE REQUEST with CM service type indicating "supplementary service activation",
- 2) Then the MS shall send a REGISTER message related to the present SS transaction containing a facility IE that includes an invoke of the DeactivateSS operation with parameter values according to the user's request (MMI action).
- 3) Upon receipt of the RELEASE COMPLETE message related to the present SS transaction, the SS transaction shall be released but the first transaction shall remain unaffected.
- 4) Upon receipt of the RELEASE COMPLETE message, the MS shall provide the appropriate user indication (which is to be described by the Manufacturer).

References

- 1) GSM 04.08 sections 3.3.1.2 and 9.1.9.
- 2) GSM 04.08 sections 4.5.1.1, 9.2.9 and 10.5.33.
- 3) GSM 04.88, GSM 04.80 sections 2.3 and 3.6.
- 4) GSM 02.30 section 4.5.

31.8.4.2.2.2 Test purpose

- 1) To check that, when a call transaction is already established, the MS correctly requests the establishment of a parallel MM transaction for supplementary service transaction of deactivation of a group of call restriction services, sending a CM SERVICE REQUEST.
- 2) To check that the MS sends a REGISTER message containing the invoke of the DeactivateSS operation with the expected parameter values for deactivation of a group of call restriction service.
- 3) To check that upon receipt of the RELEASE COMPLETE message related to the present SS transaction, the first transaction remains unaffected.
- 4) To check that upon receipt of the RELEASE COMPLETE message, the MS provides the appropriate user indication (as described by the Manufacturer).

Those checks are performed with a call transaction already established for:

BOICExHC, the RELEASE COMPLETE message being sent at the end of the procedure with a facility IE containing a return_error(error) where error is "NegativePasswordCheck".

31.8.4.2.2.3 Method of test**Initial conditions**

System Simulator:
1 cell, default parameters.

Mobile Station:
The MS is in CC state U10.

Related PICS/PIXIT statements

Description of the user's commands and of display of the answers from the network for call barring.

Foreseen final state of the MS

The MS is in CC state U10.

Test procedure

By means of appropriate MMI functions (using either GSM 02.30 or manufacturer defined MMI), the user requests deactivation of a group of call restriction services.

Upon receipt of the REGISTER message, the system simulator answers with the FACILITY message with the Facility information element containing an invoke of the DeactivateSS operation requiring the current password.

Then, by means of appropriate MMI functions, the user gives a password.

Upon receipt of the FACILITY message, the system simulator sends RELEASE COMPLETE message (PD and TI of the SS transaction) with the Facility information element containing a Return_error(error: NegativePasswordCheck) of the GetPassword operation.

The system simulator sends STATUS ENQUIRY, the MS responds with STATUS message indicating CC state U10.

Maximum duration of test

3 min.

Expected sequence

Step	Direction	Message	Comments
1	MS		The MS is made to initiate a deactivation of BoicExHC cause: "supplementary service activation"
2	MS -> SS	CM SERVICE REQUEST	
3	SS -> MS	CM SERVICE ACCEPT	
4	MS -> SS	REGISTER	
5	SS -> MS	FACILITY	Invoke = GetPassword (password) provide correct MMI user indication A password is entered.
6	MS		
7	SS -> MS	RELEASE COMPLETE	Register Password operation ReturnError provide correct MMI user indication
8	MS		
9	SS -> MS	STATUS ENQUIRY	CC state U10
10	MS -> SS	STATUS	

Specific message content

step 4 -

- protocol discriminator: non call related SS message
- message type: REGISTER
- facility

invoke = DeactivateSS
Supplementary service code = BOICExHC

step 7 -

- protocol discriminator: non call related SS message
- transaction identifier: same TI as previous REGISTER message
- message type: RELEASE COMPLETE
- facility:
reject code: NegativePasswordCheck

For the reject the invoke ID must be the same as in the invoke of the DeactivateSS operation.

step 5 -

- protocol discriminator: non call related SS message
- transaction identifier: in FACILITY same as previous REGISTER message
- message type:FACILITY
- facility

invoke = GetPassword
Guidance info: Password (step 5)

31.8.5 Invocation

Invocation is not applicable.

31.8.6 Interrogation

31.8.6.1 Interrogation accepted

31.8.6.1.1 Conformance requirements

- 1) For interrogation of any specific call restriction service with any parameters, the MS shall transmit successively:
 - 1.1) a CHANNEL REQUEST with establishment cause set to "other services requested by the mobile user",
 - 1.2) a CM SERVICE REQUEST with CM service type indicating "supplementary service activation",
 - 1.3) and then the REGISTER message containing a facility IE that includes an invoke of the InterrogateSS operation with parameter values according to the user's request (MMI action).
- 2) Upon receipt of FACILITY message requiring the password, the MS shall provide the appropriate user indication (which is to be described by the manufacturer).
- 3) The MS shall be able to send a password by sending a FACILITY message in accordance to the user request (MMI actions).
- 4) Upon receipt of the RELEASE COMPLETE message, the MS shall provide the appropriate user indication (which is to be described by the manufacturer).

References

- 1) GSM 04.08 sections 3.3.1.2 and 9.1.9.
- 2) GSM 04.08 sections 4.5.1.1, 9.2.9 and 10.5.33.
- 3) GSM 04.88, GSM 04.80 sections 2.3 and 3.6.
- 4) GSM 02.30 section 4.5.

31.8.6.1.2 Test purpose

- 1) To check that the MS correctly requests a supplementary service transaction for interrogation of a specific call barring service in CHANNEL REQUEST message.
- 2) To check that the MS correctly requests a supplementary service transaction for interrogation of a call barring service in the subsequent CM SERVICE REQUEST.
- 3) To check that the MS sends a REGISTER message containing the invoke of the InterrogateSS operation with the expected parameter values for interrogation of one call restriction service.
- 4) To check that upon receipt of FACILITY message requiring the password, the MS provides the appropriate user indication (as described by the manufacturer).
- 5) To check that the MS is able to send a password by sending a FACILITY message in accordance to the user request (MMI actions).

- 6) To check that upon receipt of the RELEASE COMPLETE message, the MS provides the appropriate user indication (which is to be described by the manufacturer).

These checks are done for:

- a) BAIC, the result of the operation being a Basic Service code.
- b) BOICExHC, the result of the operation being a SS-status.

31.8.6.1.3 Method of test

Initial conditions

System Simulator:
1 cell, default parameters.

Mobile Station:
The MS is "idle updated".

Related PICS/PIXIT statements

Description of the user's commands and of display of the answers from the network for call barring.

Foreseen final state of the MS

The MS is "idle updated".

Test procedure

By means of appropriate MMI functions (using either GSM 02.30 or manufacturer defined MMI), the user requests interrogation of BAIC.

Upon receipt of the operation (in a REGISTER message), the system simulator answers with the FACILITY message with the Facility information element containing an invoke of the GetPassword operation requiring the current password.

Then, by means of appropriate MMI functions, the user gives a password.

Upon receipt of the FACILITY message, the system simulator answers with a RELEASE COMPLETE message with the Facility information element containing the Return_result (basic service) of the InterrogateSS operation.

The SS transaction and the dedicated channel are released.

Then again, by means of appropriate MMI functions, the user requests activation of BOICExHC.

Upon receipt of the operation (in a REGISTER message), the system simulator answers with the FACILITY message with the Facility information element containing an invoke of the GetPassword operation requiring the current password.

Then, by means of appropriate MMI functions, the user gives a password.

Upon receipt of the FACILITY message, the system simulator answers with a RELEASE COMPLETE message with the Facility information element containing the Return_result(SS-status) of the InterrogateSS operation.

The dedicated channel is released.

Maximum duration of test

3 min.

Expected sequence

Step	Direction	Message	Comments
1	MS		
2	MS -> SS	CHANNEL REQUEST	The MS is made to initiate a interrogation of BAIC with establishment cause "Other procedures which can be completed with an SDCCH" cause: "supplementary service activation"
3	SS -> MS	IMMEDIATE ASSIGNMENT	
4	MS -> SS	CM SERVICE REQUEST	
5	SS -> MS	CM SERVICE ACCEPT	
6	MS -> SS	REGISTER	
7	SS -> MS	FACILITY	GetPassword provide correct MMI user indication A password is entered. Getpassword operation Return Result InterrogateSS operation Return_result
8	MS		
9	MS -> SS	FACILITY	
10	SS -> MS	RELEASE COMPLETE	
11	SS -> MS	CHANNEL RELEASE	
12	MS		
13	MS -> SS	CHANNEL REQUEST	The MS is made to initiate a interrogation of call forwarding service for BOICExHC, with establishment cause "Other procedures which can be completed with an SDCCH" cause: "supplementary service activation"
14	SS -> MS	IMMEDIATE ASSIGNMENT	
15	MS -> SS	CM SERVICE REQUEST	
16	SS -> MS	CM SERVICE ACCEPT	
17	MS -> SS	REGISTER	
18	SS -> MS	FACILITY	GetPassword provide correct MMI user indication A password is entered. Getpassword operation Return Result InterrogateSS operation Return result provide correct MMI user indication
19	MS		
20	MS -> SS	FACILITY	
21	SS -> MS	RELEASE COMPLETE	
22	MS		
23	SS -> MS	CHANNEL RELEASE	

Specific message contents

step 6 - BOIC

- protocol discriminator: non call related SS message
- message type: REGISTER
- facility

invoke = Interrogation
Supplementary service code = BAIC

step 17 - BOICExHC

- protocol discriminator: non call related SS message
- message type: REGISTER
- facility

invoke = Interrogation
Supplementary service code = BOICExHC

steps 7, 18 -

- protocol discriminator: non call related SS message
- transaction identifier: in FACILITY same as previous REGISTER message
- message type: FACILITY
- facility

invoke = GetPassword
Guidance info: Password

31.8.6.2 Interrogation rejected

31.8.6.2.1 Conformance requirements

- 1) A transaction of any kind being already established, for interrogation of any specific call barring with any parameters, the MS shall establish a parallel MM transaction, sending a CM SERVICE REQUEST with CM service type indicating "supplementary service activation",
- 2) Then the MS shall send a REGISTER message related to the present SS transaction containing a facility IE that includes an invoke of the InterrogateSS operation with parameter values according to the user's request (MMI action).
- 3) Upon receipt of the RELEASE COMPLETE message related to the present SS transaction, the SS transaction shall be released but the first transaction shall remain unaffected.
- 4) Upon receipt of the RELEASE COMPLETE message, the MS shall provide the appropriate user indication (which is to be described by the Manufacturer).

References

- 1) GSM 04.08 sections 3.3.1.2 and 9.1.9.
- 2) GSM 04.08 sections 4.5.1.1, 9.2.9 and 10.5.33.
- 3) GSM 04.88, GSM 04.80 sections 2.3 and 3.6.
- 4) GSM 02.30 section 4.5.

31.8.6.2.2 Test purpose

- 1) To check that the MS correctly requests the establishment of a parallel MM transaction for supplementary service transaction of interrogation of a specific call barring service message, sending a CM SERVICE REQUEST.
- 2) To check that the MS sends a REGISTER message containing the invoke of the InterrogateSS operation with the expected parameter values for interrogation of call barring.
- 3) To check that upon receipt of the RELEASE COMPLETE message related to the present SS transaction, the first transaction remains unaffected.
- 4) To check that upon receipt of the RELEASE COMPLETE message, the MS provides the appropriate user indication (as described by the Manufacturer).

These checks are performed with a call transaction already established for:

- a) BICRoam, the RELEASE COMPLETE message being sent with a facility IE containing a return_error(error) where error is "SS not available".
- b) BOIC, the RELEASE COMPLETE message being sent with a facility IE containing a reject(involve_problem) where involve_problem is "resource limitation".

31.8.6.2.3 Method of test

Initial conditions

System Simulator:

1 cell, default parameters.

Mobile Station:

The MS is in CC state U10.

Related PICS/PIXIT statements

Description of the user's commands and of display of the answers from the network for call barring.

Foreseen final state of the MS

The MS is in CC state U10.

Test procedure

By means of appropriate MMI functions (using either GSM 02.30 or manufacturer defined MMI), the user requests interrogation of BICRoam.

Upon receipt of the operation (in a REGISTER message), the system simulator answers with a RELEASE COMPLETE message with the Facility information element containing a Return_error(error: SS not available) of the InterrogateSS operation.

The system simulator sends STATUS ENQUIRY, the MS responds with STATUS message indicating CC state U10.

Then again, by means of appropriate MMI functions, the user requests interrogation of BOIC.

Upon receipt of the REGISTER message, the system simulator answers with the RELEASE COMPLETE message (same PD and TI that in the REGISTER message) with the Facility information element containing a reject(invoke_problem: resource limitation) of the InterrogateSS operation.

The system simulator sends STATUS ENQUIRY, the MS responds with STATUS message indicating CC state U10.

Maximum duration of test

3 min.

Expected sequence

Step	Direction	Message	Comments
1	MS		The MS is made to initiate a interrogation of call barring service for BICRoam
2	MS -> SS	CM SERVICE REQUEST	cause: "supplementary service activation"
3	SS -> MS	CM SERVICE ACCEPT	
4	MS -> SS	REGISTER	
5	SS -> MS	RELEASE COMPLETE	InterrogateSS operation Return_error
6	SS -> MS	STATUS ENQUIRY	
7	MS -> SS	STATUS	CC state U10
8	MS		The MS is made to initiate a interrogation of call barring service for BOIC
9	MS -> SS	CM SERVICE REQUEST	cause: "supplementary service activation"
10	SS -> MS	CM SERVICE ACCEPT	
11	MS -> SS	REGISTER	
12	SS -> MS	RELEASE COMPLETE	(SS)
13	MS		provide correct MMI user indication
14	SS -> MS	STATUS ENQUIRY	
15	MS -> SS	STATUS	CC state U10

Specific message content

step 4 - BICRoam

- protocol discriminator: non call related SS message
- message type: REGISTER
- facility

invoke = Interrogation

Supplementary service code = BICRoam

step 5 -

- protocol discriminator: non call related SS message
- transaction identifier: same TI as previous REGISTER message
- message type: RELEASE COMPLETE
- facility:
 - return error code: SS not available

For the return error the invoke ID must be the same as in the invoke of the InterrogateSS operation.

step 11 - BOIC

- protocol discriminator: non call related SS message
- message type: REGISTER
- facility

invoke = Interrogation
Supplementary service code = BOIC

step 12 -

- protocol discriminator: non call related SS message
- transaction identifier: same TI as previous REGISTER message
- message type: RELEASE COMPLETE
- facility:
 - reject code: resource limitation

For the reject the invoke ID must be the same as in the invoke of the InterrogateSS operation.

31.8.7 Normal operation

In case of barring of outgoing call the calling mobile receives information about the activation of supplementary services subscribed.

In case of barring of incoming call the calling mobile receives information about the activation of supplementary services subscribed by the other party (the mobile called).

31.8.7.1 Conformance requirements

Upon receipt of the RELEASE COMPLETE message the MS shall provide the appropriate user indication (which is to be described by the manufacturer).

References

31.8.7.2 Test purpose

To check that upon receipt of the RELEASE COMPLETE message the MS provides the appropriate user indication (as described by the manufacturer).

This is tested in the case of an MS making a call to a mobile with incoming calls barred.

31.8.7.3 Method of test

Initial conditions

System Simulator:
1 cell, default parameters.

Mobile Station:
The MS is "idle updated".

Related PICS/PIXIT statements

Description of the user's commands and of display of the answers from the network for call barring.

Foreseen final state of the MS

The MS is "idle updated".

Test procedure

The MS is made to initiate a call.

Upon receipt of the SETUP message, the system simulator answers with the negative acknowledgement RELEASE COMPLETE (to simulate a case where call barring is activated).

Maximum duration of test

1 min.

Expected sequence

Step	Direction	Message	Comments
1	MS -> SS	CHANNEL REQUEST	
2	SS -> MS	IMMEDIATE ASSIGNMENT	
3	MS -> SS	CM SERVICE REQUEST	
4	SS -> MS	CM SERVICE ACCEPT	
5	MS -> SS	SETUP	
6	SS -> MS	RELEASE COMPLETE	provide correct MMI user indication
7	SS -> MS	CHANNEL RELEASE	

Specific message content

RELEASE COMPLETE

- protocol discriminator
- transaction identifier
- message type
- facility

invoke = notification

SS code = BI

SS status = activation indicator (indicating:
Provisioned, registered and active)

31.9 Handling of undefined (future) GSM supplementary services**31.9.1 Mobile station initiated Unstructured supplementary service data operation****31.9.1.1 ProcessUnstructuredSS-request/accepted****Conformance requirements**

- 1) The mobile station shall invoke an USSD request by sending a REGISTER message to the network containing a ProcessUnstructuredSS-Request invoke component. This message will contain the alphabet indicator set to "SMS default alphabet" and the language indicator set to "language unspecified". The ussd-string parameter shall contain the following digits and symbols depending on the operation initiated:

Activation

*NN(N)# (no supplementary information included)

*NN(N)*SI# (one field of supplementary infor. included)

*NN(N)*SIA*SIB# (two fields of supplementary infor. included)

Deactivation	#NN(N)# #NN(N)*SI# #NN(N)*SIA*SIB#
Interrogation	*#NN(N)# *#NN(N)*SI# *#NN(N)*SIA*SIB#
Registration	**NN(N)# **NN(N)*SI# **NN(N)*SIA*SIB#
Erasure	##NN(N)# ##NN(N)*SI# ##NN(N)*SIA*SIB#
Operations not yet defined in GSM 02.30	see conformance requirement 2)

NN(N) features a set of service codes which have not yet been allocated for GSM supplementary services (see GSM 02.30 for service codes already specified).

N is a digit within 1..9 and SI, SIA, SIB strings of characters.

- 2) Concerning operations which are not yet specified in GSM 02.30, the MS shall proceed as follows: The entry of 1 or 2 characters defined in the GSM 03.38 default alphabet followed by "SEND" shall be interpreted by the MS as an USSD request unless the MS is not engaged in a call and the first of the two character entry followed by "SEND" is a "1".
- 3) For supplementary service procedures independent of any call, the initiating side shall establish a MM-connection between the network and the mobile station according to the rules given in GSM 4.08.
- 4) Within a call, the MS shall transmit a USSD request from the user if any. See GSM 04.07 and GSM 04.08 for the handling of multiple MM connections.
- 5) Upon receipt of the RELEASE COMPLETE message, the MS shall display the information contained to the user in a way described by the manufacturer.

References

Conformance requirement 1: GSM 04.90 subclause 6.1, GSM 02.30 subclause 4.5.2, and GSM 02.90 subclause 4.1.1.

Conformance requirement 2: GSM 02.30 subclause 4.5.3.2.

Conformance requirement 3: GSM 04.10 subclause 3.2.1.

Conformance requirement 4: GSM 04.08 subclause 4.5.1.1.

Conformance requirement 5: GSM 03.90 subclause 6.2.1.

Test Purpose

- 1) To verify that the mobile station invokes an USSD request by sending a REGISTER message to the network containing a ProcessUnstructuredSS-Request invoke component. This message will contain the alphabet indicator set to "SMS default alphabet" and the language indicator set to "language unspecified". The ussd-string parameter shall contain the following digits and symbols depending on the operation initiated:

Activation	*NN(N)# (no supplementary information included) *NN(N)*SI# (one field of supplementary infor. included) *NN(N)*SIA*SIB# (two fields of supplementary infor. included)
Deactivation	#NN(N)# #NN(N)*SI# #NN(N)*SIA*SIB#

Interrogation	*#NN(N)# *#NN(N)*SI# *#NN(N)*SIA*SIB#
Registration	**NN(N)# **NN(N)*SI# **NN(N)*SIA*SIB#
Erase	##NN(N)# ##NN(N)*SI# ##NN(N)*SIA*SIB#
Operations not yet defined in GSM 02.30	see 2)

NN(N) features a set of service codes which have not yet been allocated for GSM supplementary services (see GSM 02.30 for service codes already specified).
N is a digit within 1..9 and SI, SIA, SIB strings of characters.

- 2) To check that the entry of 1 or 2 characters defined in the GSM 03.38 default alphabet followed by "SEND" shall be interpreted by the MS as an USSD request unless the MS is not engaged in a call and the first of the two character entry followed by "SEND" is a "1".
- 3) To verify that, for supplementary service procedures independent of any call, the initiating side must establish a MM-connection between the network and the mobile station according to the rules given in GSM 04.07 and GSM 04.08.
- 4) To verify that, within a call the MS shall transmit a USSD request if any. See GSM 04.07 and GSM 04.08 for the handling of multiple MM connections.
- 5) To check that upon receipt of the RELEASE COMPLETE message, the MS shall display the information contained to the user in a way described by the manufacturer.

Related PICS/PIXIT Statements

- support of USSD.
- Description of the user's commands and of display of USSD.
- Full rate supported.
- Supported teleservices.
- Support of active state of the call control protocol (U10).

Initial Conditions

System Simulator:

1 cell, default parameters.

Mobile Station:

The MS is in the MM-state "idle updated".

Foreseen final state of the MS

MM-state "idle updated".

Test Procedure

By means of appropriate MMI functions (using either GSM 02.30 or manufacturer defined MMI) the mobile is made to initiate an Unstructured SS data operation. The mobile first establishes a MM-connection with the SS. Then, a REGISTER message is sent to the SS. Upon receipt of this message, the system simulator answers with the RELEASE COMPLETE message. Then a CHANNEL RELEASE message is sent to the MS to release the main signalling link.

The mobile station is forced to originate a call. After the MS has received a CONNECT ACKNOWLEDGE, MMI keys are depressed on the mobile in order to initiate an Unstructured SS data operation. Then a REGISTER message is sent to the SS. Upon receipt of this message, the system simulator answers with

the RELEASE COMPLETE message. Finally, the main signalling link is released by transferring a CHANNEL RELEASE message to the MS.

Expected Sequence

The sequence is executed for execution counters $c=1, \dots, 17$.

Counter c determines the ussd-string selected by the user and sent by the MS (see specific message contents concerning the REGISTER message).

Step	Direction	Message	Comments
1	MS		The user presses appropriate MMI keys to initiate the desired unstructured SS data operation.
2	MS -> SS	CHANNEL REQUEST	with establishment cause set to "Other procedures which can be completed with an SDCCH".
3	SS -> MS	IMMEDIATE ASSIGNMENT	"Supplementary service activation". The SS checks that the content of this message matches specific message content i).
4	MS -> SS	CM SERVICE REQUEST	
5	SS -> MS	CM SERVICE ACCEPT	
6	MS -> SS	REGISTER	
7	SS -> MS	RELEASE COMPLETE	It terminates the transaction used to initiate the desired unstructured SS data operation. It is checked that the ussd string, if any, is displayed by the MS in a way described by the manufacturer. See ii).
8	SS -> MS	CHANNEL RELEASE	The main signalling link is released.
9	MS -> SS	CHANNEL REQUEST	with establishment cause related to mobile originating call.
10	SS -> MS	IMMEDIATE ASSIGNMENT	a TCH/F channel is assigned to the MS.
11	MS -> SS	CM SERVICE REQUEST	"mobile originating call"
12	SS -> MS	CM SERVICE ACCEPT	
13	MS -> SS	SETUP	
14	SS -> MS	CALL PROCEEDING	
15	SS -> MS	ALERTING	
16	SS -> MS	CONNECT	
17	MS -> SS	CONNECT ACKNOWLEDGE	
18			Specific MMI keys are depressed to initiate the desired undefined SS service operation. DTMF signalling may occur.
19	MS -> SS	CM SERVICE REQUEST	"Supplementary service activation". The MS starts the transaction on the radio interface. The SS checks that REGISTER matches i).
20	SS -> MS	CM SERVICE ACCEPT	
21	MS -> SS	REGISTER	
223	SS -> MS	RELEASE COMPLETE	It terminates the transaction used to activate the desired undefined SS data operation. See specific message contents ii).
23	SS -> MS	DISCONNECT	See message contents iii). The main signalling link is released.
24	MS -> SS	RELEASE	
25	SS -> MS	RELEASE COMPLETE	
26	SS -> MS	CHANNEL RELEASE	

Specific message contents.

i) **REGISTER** message.

Contents	Value/remark
Protocol Discriminator	set to "Supplementary service (call independent)"
Transaction identifier	
Register message type	As GSM 04.80
Facility Information Element	See below
SS version indicator	As specified in GSM 04.80

Facility Information Element with Invoke = ProcessUnstructuredSS-Request component type as defined in GSM 04.80 section 3.6.1 table 3.3.

Contents	Value/remark
Facility IE identifier	As GSM 04.08
Length of FIE contents	
Component type tag	Invoke from GSM 04.80
Component length	depending on the length of ussd-string
InvokeID tag	From GSM 04.80
Invoke ID length	1
Invoke ID	Arbitrary (1 octet)
Operation Code tag	From GSM 04.80
Operation Code length	1
Operation Code	ProcessUnstructuredSS-Request
ussd-dataCodingScheme	1 octet long. Alphabet indicator set to "default alphabet". Language indicator set to "undefined"
ussd-string	c=1, *60# (Activation with no supplementary information included) c=2, *201*35# (Activation with one field of supplementary information included) c=3, *70*635*562# (Activation with two fields of supplementary information included) c=4, #60# (Deactivation with no supplementary information included) c=5, #201*35# (Deactivation with one field of supplementary information included) c=6, #70*635*562# (Deactivation with two fields of supplementary information included) c=7, *#60# (Interrogation with no supplementary information included) c=8, *#201*35# (Interrogation with one field of supplementary information included) c=9, *#70*635*562# (Interrogation with two fields of supplementary information included) c=10, **60# (Registration with no supplementary information included) c=11, **201*35# (Registration with one field of supplementary information included) c=12, **70*635*562# (Registration with two fields of supplementary information included) c=13, ##60# (Erasure with no supplementary information included) c=14, ##201*35# (Erasure with one field of supplementary information included) c=15, ##70*635*562# (Erasure with two fields of supplementary information included) c=16,7 (related to conformance requirement 2) c=17, 26 (related to conformance requirement 2)

ii) RELEASE COMPLETE message.

Contents	Value/remark
Protocol Discriminator	set to "Supplementary service (call independent)"
Transaction identifier	the transaction value is the same as REGISTER transaction value but the transaction flag is different
Release Complete message type	As GSM 04.80
Cause	omitted.
Facility Information Element	See below

Facility information element with Return Result = ProcessUnstructuredSS-Request component type as defined in GSM 04.80 section 3.6.1 table 3.4.

Contents	Value/remark
Facility IE identifier	As GSM 04.08
Length of IE contents	
Component type tag	Invoke from GSM 04.80
Component length	depending on the length of the ussd-string
Invoke ID tag	From GSM 04.80
Invoke ID length	1
Invoke ID	The same as the invoke of the ProcessUnstructuredSS-Request
Sequence Identifier	From GSM 04.80
Operation Code tag	From GSM 04.80
Operation Code length	1
Operation Code	ProcessUnstructuredSS-Request
ussd-dataCodingScheme	1 octet long. Alphabet indicator set to "default alphabet" Language indicator set to "undefined"
ussd-string	chosen at random

iii) **RELEASE COMPLETE** message.

Contents	Value/remark
Protocol Discriminator	set to "Supplementary service (call control)"
Transaction identifier	same as current call.
Release Complete message type	As GSM 04.08

31.9.1.2 ProcessUnstructuredSS-request/cross phase compatibility and error handling

Conformance requirements

- 1) If a mobile initiated USSD request using protocol version 2 is rejected by the network, and the reason for the rejection is indicated either by the problem code "unrecognized operation" or a cause "facility rejected", the mobile station shall assume that the network only supports protocol version 1 of USSD operations. The mobile station shall re-attempt the request by using the appropriate protocol version 1 USSD operation without a SS version indicator if the unstructured data entered by the user can be coded as an IA5 string.
- 2) Upon receipt of the RELEASE COMPLETE message, the MS shall provide the appropriate user indication (which is to be described by the manufacturer). If ussd-String information is included this shall be given to the user (in a way described by the manufacturer).

References

Conformance requirement1:GSM 04.90 subclause 6.2.1.
Conformance requirement2:GSM 03.90 subclause.

Test Purpose

- 1) To verify that If a mobile initiated USSD request using protocol version 2 is rejected by the network, and the reason for the rejection is indicated either by the problem code "unrecognized operation" or a cause "facility rejected", the mobile station shall assume that the network only supports protocol version 1 of USSD operations. The mobile station shall re-attempt the request by using the appropriate protocol version 1 USSD operation without a SS version indicator if the unstructured data entered by the user can be coded as an IA5 string.
- 2) To check that, upon receipt of the RELEASE COMPLETE message, the MS shall provide the appropriate user indication (which is to be described by the manufacturer). If ussd-String information is included this shall be given to the user (in a way described by the manufacturer).

Related PICS/PIXIT Statements

- support of USSD.
- Full rate supported.
- Supported teleservices.
- Support of active state of the call control protocol (U10).

Initial Conditions

System Simulator:

1 cell, default parameters.

Mobile Station:

The MS is in the MM-state "idle updated".

Foreseen final state of the MS

MM-state "idle updated".

Test Procedure

Appropriate MMI keys are depressed on the mobile in order to activate an USSD service. The mobile first establishes a MM-connection with the SS. Then, a REGISTER message is sent to the SS. Upon receipt of this message, the system simulator answers with the RELEASE COMPLETE message with the cause element set to "Facility rejected" or the problem code set to "unrecognized operation". Then the SS checks that the MS re-attempts the request by using a REGISTER message containing an invoke of the ProcessUnstructuredData operation. The SS answers with a normal RELEASE COMPLETE to terminate the transaction. Finally the main signalling link is released by transferring to the MS a CHANNEL RELEASE.

Appropriate MMI keys are depressed on the mobile in order to activate an USSD service. The mobile first establishes a MM-connection with the SS. Then, a REGISTER message is sent to the SS. Upon receipt of this message, the system simulator answers with the RELEASE COMPLETE message with the cause element set to "Facility rejected", the main signalling link is release. Then the SS checks that the MS re-establishes a MM-connection and re-attempts the request by using a REGISTER message containing an invoke of the ProcessUnstructuredData operation. Then the SS answers with a normal RELEASE COMPLETE to terminate the transaction. Finally the main signalling link is released by transferring to the MS a CHANNEL RELEASE.

The mobile station is forced to originate a call. After the SS has sent a CONNECT ACKNOWLEDGE, MMI keys are depressed on the mobile in order to activate an USSD service. A REGISTER message is sent to the SS. Upon receipt of this message, the system simulator answers with the RELEASE COMPLETE message containing a return error with an error or a reject with a problem. Then the radio link is release by transferring to the MS a CHANNEL RELEASE message. This subtest is repeated with different errors and problems in the RELEASE COMPLETE message.

Expected Sequence

Step	Direction	Message	Comments
1	MS		The user presses appropriate MMI keys to initiate the desired undefined supplementary service operation.
2	MS -> SS	CHANNEL REQUEST	with establishment cause set to "Other procedures which can be completed with an SDCCH".
3	SS -> MS	IMMEDIATE ASSIGNMENT	"Supplementary service activation". See specific message contents i). Operation code set to "ProcessUnstructuredSS-Request"
4	MS -> SS	CM SERVICE REQUEST	
5	SS -> MS	CM SERVICE ACCEPT	
6	MS -> SS	REGISTER	
7	SS -> MS	RELEASE COMPLETE	
8	MS -> SS	CM SERVICE REQUEST	
9	SS -> MS	CM SERVICE ACCEPT	"Supplementary service activation".
10	MS -> SS	REGISTER	Operation code is set to "ProcessUnstructuredSS-Data". See specific message content i). normal release of the transaction. See iiiia).
11	MS -> SS	RELEASE COMPLETE	
12	SS -> MS	CHANNEL RELEASE	
13	MS		The user presses appropriate MMI keys to initiate the desired undefined supplementary service.
14	MS -> SS	CHANNEL REQUEST	with establishment cause set to "Other procedures which can be completed with an SDCCH".
15	SS -> MS	IMMEDIATE ASSIGNMENT	"Supplementary service activation". See specific message contents i). Operation code is set to "ProcessUnstructureSS- Request". See i). see iii).cause is set to "operation rejected"
16	MS -> SS	CM SERVICE REQUEST	
17	SS -> MS	CM SERVICE ACCEPT	
18	MS -> SS	REGISTER	
19	MS -> SS	RELEASE COMPLETE	
20	SS -> MS	CHANNEL RELEASE	
21	MS -> SS	CHANNEL REQUEST	with establishment cause set to "Other procedures which can be completed with an SDCCH".
22	SS -> MS	IMMEDIATE ASSIGNMENT	"Supplementary service activation". Operation code is "ProcessUnstructuredSSdata". See specific message contents i). normal release of the transaction. See iiiia).
23	MS -> SS	CM SERVICE REQUEST	
24	SS -> MS	CM SERVICE ACCEPT	
25	MS -> SS	REGISTER	
26	SS -> MS	RELEASE COMPLETE	
27	SS -> MS	CHANNEL RELEASE	
			For k=1 to 10, go through steps 28 to 45. Counter k deals with different kinds of general and invoke problems in step 41.
28	MS -> SS	CHANNEL REQUEST	with establishment cause related to mobile originating call.
29	SS -> MS	IMMEDIATE ASSIGNMENT	a TCH/F channel is assigned to the MS.
30	MS -> SS	CM SERVICE REQUEST	"mobile originating call"
31	SS -> MS	CM SERVICE ACCEPT	
32	MS -> SS	SETUP	
33	SS -> MS	CALL PROCEEDING	
34	SS -> MS	ALERTING	
35	SS -> MS	CONNECT	
36	MS -> SS	CONNECT ACKNOWLEDGE	
37			Specific MMI keys are depressed to initiate the desired undefined supplementary service. DTMF signalling may occur.
38	MS -> SS	CM SERVICE REQUEST	"supplementary service activation"
39	SS -> MS	CM SERVICE ACCEPT	The MS starts the transaction on the radio interface. See specific message contents i).The operation code is set to "ProcessUnstructuredSS-Request".
40	MS -> SS	REGISTER	
41	SS -> MS	RELEASE COMPLETE	different errors and problems are sent. See specific message contents iiib) and iiic).

42	SS -> MS	DISCONNECT	
43	MS -> SS	RELEASE	
44	SS -> MS	RELEASE COMPLETE	See message contents iv).
45	SS -> MS	CHANNEL RELEASE	The main signalling link is released.

Specific message contents.

i) **REGISTER** message.

Contents	Value/remark
Protocol Discriminator	set to "Supplementary service (call independent)"
Transaction identifier	
Register message type	As GSM 04.80
Facility Information Element	See below
SS version indicator	As specified in GSM 04.80 for version 2 protocol Always omitted for version 1 protocol

For steps 6, 18 and 40, Facility Information Element with Invoke = ProcessUnstructuredSS-Request (for version 2 protocol) component type as defined in GSM 04.80 section 3.6.1 table 3.3.

For steps 10 and 25, Facility Information Element with Invoke = ProcessUnstructuredSS-Data (for version 1 protocol) as defined in GSM 04.80 section 3.6.1 table 3.3.

Contents	Value/remark
Facility IE identifier	As GSM 04.08
Length of FIE contents	
Component type tag	Invoke from GSM 04.80
Component length	depending on the length of ussd-string
InvokeID tag	From GSM 04.80
Invoke ID length	1
Invoke ID	Arbitrary (1 octet)
Operation Code tag	From GSM 04.80
Operation Code length	1
Operation Code	ProcessUnstructuredSS-Request (for version 2 protocol) ProcessUnstructuredSS-Data (for version 1 protocol)
ussd-dataCodingScheme	1 octet long. Alphabet indicator set to "default alphabet". Language indicator set to "undefined"
ussd-string	*70*635*562#

ii) **RELEASE COMPLETE** message.

Contents	Value/remark
Protocol Discriminator	set to "Supplementary service (call independent)"
Transaction identifier	the transaction value is the same as the REGISTER transaction value but the transaction flag is different
Facility message type	As GSM 04.80
Facility Information Element	See below

Facility Information Element with Reject = ProcessUnstructuredSS-Request component type as defined in GSM 04.80 section 3.6.1 table 3.6.

Contents	Value/remark
Facility IE identifier	As GSM 04.08
Length of FIE contents	
Component type tag	Reject from GSM 04.80
Component length	depending on the length of ussd-string
InvokeID tag	From GSM 04.80
Invoke ID length	1
Invoke ID	The same as the invoke of the ProcessUnstructuredSS-Request
Problem Code tag	As GSM 04.80
Problem Code length	
General Problem code	Unrecognized operation

iii) **RELEASE COMPLETE** message.

Contents	Value/remark
Protocol Discriminator	set to "Supplementary service (call independent)"
Transaction identifier	the transaction value is the same as the REGISTER transaction value but the transaction flag is different
Release complete message type	As GSM 04.80
cause	for step 19, cause is set to "facility rejected" and FIE is omitted. for steps 11, 26, 41 this field is omitted.
Facility Information Element	for step 11 and 26 see iiiia). for step 41 see iiib) and iic). For step 19 this field is omitted.

iiiia) For steps 6, 18 and 40, Facility Information Element with Return Result = ProcessUnstructuredSS-Request component type as defined in GSM 04.80 section 3.6.1 table 3.4.

For steps 10 and 25, Facility Information Element with Return Result = ProcessUnstructuredSS-Data component type as defined in GSM 04.80 section 3.6.1 table 3.4.

Contents	Value/remark
Facility IE identifier	As GSM 04.08
Length of FIE contents	
Component type tag	Invoke from GSM 04.80
Component length	depending on the length of ussd-string
InvokeID tag	From GSM 04.80
Invoke ID length	1
Invoke ID	The same as the invoke of the ProcessUnstructuredSS-Request

iiib) Facility Information Element with Return Error = ProcessUnstructuredSS-Request component type as defined in GSM 04.80 section 3.6.1 table 3.5.

Contents	Value/remark
Facility IE identifier	As GSM 04.08
Length of FIE contents	
Component type tag	Return Error from GSM 04.80
Component length	depending on the length of ussd-string
InvokeID tag	From GSM 04.80
Invoke ID length	1
Invoke ID	The same as the invoke of the ProcessUnstructuredSS-Request
Error Code tag	As GSM 04.80
Error Code length	
Error Code	k=1, system failure k=2, data missing k=3, unknown alphabet k=4, unexpected data value

iiic) Facility Information Element with Reject = ProcessUnstructuredSS-Request component type as defined in GSM 04.80 section 3.6.1 table 3.6.

Contents	Value/remark
Facility IE identifier	As GSM 04.08
Length of FIE contents	
Component type tag	Reject from GSM 04.80
Component length	depending on the length of ussd-string
InvokeID tag	From GSM 04.80
Invoke ID length	1
Invoke ID	The same as the invoke of the ProcessUnstructuredSS-Request
Problem Code tag	As GSM 04.80
Problem Code length	
General Problem code	k=5, Unrecognized component k=6, Mistyped component k=7, Badly structured component
Invoke Problem code	k=8, Mistyped parameter k=9, Resource limitation k=10, Initiating release

iv) **RELEASE COMPLETE** message.

Contents	Value/remark
Protocol Discriminator	set to "Supplementary service (call control)"
Transaction identifier	same as current call.
Release Complete message type	As GSM 04.08

31.9.2 Network initiated unstructured supplementary service operations

31.9.2.1 UnstructuredSS-Notify/accepted

Conformance requirements

- 1) For a USSD notification, the MS shall display the text provided and await user input. The MS shall acknowledge the operation by sending a FACILITY message containing an empty result component to the network.

- 2) The MS shall include alphabet and language indicators in the response to the network. The alphabet indicator shall indicate "SMS default alphabet". The language indicator shall indicate "language unspecified".
- 3) At any stage while the MS is registered with a network, the network may send an unstructured string to the MS. So, the MS shall be able to process the operation during a call or out of a call.

References

conformance requirement 1: GSM 04.90 subclause 5.2.1.

conformance requirement 2: GSM 02.90 subclause 4.2.2.

conformance requirement 3: GSM 02.90 subclause 4.2.1.

Test Purpose

- 1) To verify that for a USSD notification, the MS shall display the text provided and await user input. If the user enters a response, the MS shall acknowledge the operation by sending a FACILITY message containing an empty result component to the network.
- 2) To verify that the MS shall include alphabet and language indicators in the response to the network. The alphabet indicator shall indicate "SMS default alphabet". The language indicator shall indicate "language unspecified".
- 3) To check that the MS shall be able to process the operation during a call or out of a call.

Related PICS/PIXIT Statements

- support of USSD.
- Full rate supported.
- Supported teleservices.
- Support of active state of the call control protocol (U10).

Initial Conditions

System Simulator:

1 cell, default parameters.

Mobile Station:

The MS is in the MM-state "idle updated".

Foreseen final state of the MS

MM-state "idle updated".

Test Procedure

- The MS is paged and a RR-connection is established. Then, the SS sends a REGISTER message containing a facility information element with operation code set to ProcessUnstructuredSS-Notify. The user checks that the ussd string sent by the SS is correctly displayed by the MS. The MS has to send a FACILITY message with an empty return result component.
- Then the SS originates a call to the MS. When the MS is in the U10 state, the SS releases the transaction identifier concerning USSD transaction by sending a RELEASE COMPLETE. The SS initiates a new ussd transaction by sending a REGISTER message containing a facility information element with operation code set to UnstructuredSS-Notify. The user checks that the ussd string sent by the SS is correctly displayed by the MS. The MS has to send a FACILITY message with an empty return result component. Finally the SS releases both MM connections and the radio link.

Step	Direction	Message	Comments
1	SS -> MS	PAGING REQUEST TYPE 1	
2	MS -> SS	CHANNEL REQUEST	
3	SS -> MS	IMMEDIATE ASSIGNMENT	a SDCCH is allocated to the MS.
4	MS -> SS	PAGING RESPONSE	
5	SS -> MS	REGISTER	initiation of the transaction concerning the USSD notification operation. See i).
6			The MS has to display the USSD string sent from the network.
7	MS -> SS	FACILITY	signalling message sent by the MS as the response. The SS checks that it matches ii).
8	SS -> MS	SETUP	incoming call.
9	MS -> SS	CALL CONFIRMED	
10	MS -> SS	ALERTING	
11	MS -> SS	CONNECT	
12	SS -> MS	ASSIGNMENT COMMAND	a TCH is allocated to the MS.
13	MS -> SS	ASSIGNMENT COMPLETE	
14	SS -> MS	CONNECT ACKNOWLEDGE	
15	SS -> MS	RELEASE COMPLETE	this message releases the transaction concerning the USSD operation. See iii).
16	SS -> MS	REGISTER	initiation of a USS request operation during a call. See specific message contents i).
17			The MS has to display the USSD string received from the SS.
18	MS -> SS	FACILITY	The SS checks that this message matches ii).
19	SS -> MS	RELEASE COMPLETE	It releases the transaction identifier concerning the ussd operation.
20	SS -> MS	DISCONNECT	call release initiation. see iv).
21	MS -> SS	RELEASE	
22	SS -> MS	RELEASE COMPLETE	
23	SS -> MS	CHANNEL RELEASE	

Specific message contents.

i) REGISTER message.

Contents	Value/remark
Protocol Discriminator	set to "Supplementary service (call independent)"
Transaction identifier	
Register message type	As GSM 04.80
Facility Information Element	See below

Facility Information Element with Invoke = UnstructuredSS-Notify component type as defined in GSM 04.90, clause 5.2.1.

Contents	Value/remark
Facility IE identifier	As GSM 04.08
Length of FIE contents	
Component type tag	Invoke from GSM 04.80
Component length	depending on the length of ussd-string
InvokeID tag	From GSM 04.80
Invoke ID length	1
Invoke ID	Arbitrary (1 octet)
Operation Code tag	From GSM 04.80
Operation Code length	1
Operation Code	UnstructuredSS-Notify
ussd-dataCodingScheme	1 octet long. Alphabet indicator set to "default alphabet". Language indicator set to "undefined"
ussd-string	arbitrary chosen by the SS

ii) Facility message.

Contents	Value/remark
Protocol Discriminator Transaction identifier	set to "Supplementary service (call independent)" the transaction value is the same as REGISTER transaction value but the transaction flag is different
Facility message type Facility Information Element	As GSM 04.80 See below

Facility Information Element with Return Result = empty result component according to GSM 04.90, clause 5.2.1, figure 5.3.

Contents	Value/remark
Facility IE identifier	As GSM 04.08
Length of FIE contents	
Component type tag	Return Result from GSM 04.80
Component length	
InvokeID tag	From GSM 04.80
Invoke ID length	1
Invoke ID	The same as the invoke of the UnstructuredSS-Notify

iii) RELEASE COMPLETE message.

Contents	Value/remark
Protocol Discriminator Transaction identifier	set to "Supplementary service (call independent)" the transaction value is the same as REGISTER transaction flag is different
Release Complete message type Facility Information Element	As GSM 04.80 omitted

iv) RELEASE COMPLETE message.

Contents	Value/remark
Protocol Discriminator Transaction identifier	set to "Supplementary service (call control)" same as current call.
Release Complete message type	As GSM 04.08

31.9.2.2 UnstructuredSS-Notify/rejected on user busy**Conformance requirements**

- 1) When the mobile station receives an USSD operation in parallel to any call independent supplementary transaction, it shall respond with a return error component in a RELEASE COMPLETE message, containing the "USSD-Busy" error.

References

conformance requirement 1: GSM 04.90 subclause 5.1.1.

Test Purpose

- 1) To verify that when the mobile station receives an USSD operation in parallel to any call independent supplementary transaction, it responds with a return error component in a RELEASE COMPLETE message, containing the "USSD-Busy" error.

Related PICS/PIXIT Statements

- support of USSD.
- Full rate supported.
- Supported teleservices.
- **Support of active state of the call control protocol (U10).**

Initial Conditions

System Simulator:

1 cell, default parameters.

Mobile Station:

The MS is in the MM-state "idle updated".

Foreseen final state of the MS

MM-state "idle updated".

Test Procedure

- The MS is paged and a RR-connection is established. Then, the SS sends a REGISTER message containing a facility information element with operation code set to UnstructuredSS-Notify. The SS initiates an other USSD transaction by sending a REGISTER message with transaction identifier different from the previous one. The SS checks that the MS answers with a RELEASE COMPLETE message with an error component set to "USSD busy". Then the SS releases the radio link.

Test Procedure

Step	Direction	Message	Comments
1	SS -> MS	PAGING REQUEST TYPE 1	
2	MS -> SS	CHANNEL REQUEST	
3	SS -> MS	IMMEDIATE ASSIGNMENT	a SDCCH is allocated to the MS.
4	MS -> SS	PAGING RESPONSE	
5	SS -> MS	REGISTER	initiation of the transaction concerning the USSD notification operation. See i).
6			The MS has to display the USSD string sent from the SS.
7	MS -> SS	FACILITY	See ii).
8	SS -> MS	REGISTER	initiation of an other USSD notification. The transaction identifier is different from that in step 5. See i).
9	MS -> SS	RELEASE COMPLETE	error set to "USSD busy". Transaction initiated in step 6 by the network is rejected by the MS. See iii).
10	SS -> MS	RELEASE COMPLETE	normal release of transaction initiated in step 5. See iii).
11	SS -> MS	CHANNEL RELEASE	release of the main signalling link.

Specific message contents.

i) **REGISTER** message.

See paragraph 31.9.2.1.

ii) **FACILITY** message.

See paragraph 31.9.2.1.

iii) **RELEASE COMPLETE** message.

Contents	Value/remark
Protocol Discriminator Transaction identifier	set to "Supplementary service (call independent)" for step 10, same as REGISTER transaction identifier for step 9, the transaction value is the same as REGISTER transaction value but the transaction flag is different.
Release complete message type Facility Information Element	As GSM 04.80 for step 9 see iiib). for step 10, see iia).

iiia) Facility Information Element with Return Result = UnstructuredSS-Notify component type as defined in GSM 04.80 section 3.6.1 table 3.4.

Contents	Value/remark
Facility IE identifier Length of FIE contents Component type tag Component length InvokeID tag Invoke ID length Invoke ID	As GSM 04.08 Return Result from GSM 04.80 From GSM 04.80 1 The same as the invoke of the UnstructuredSS-Notify in step 5

iiib) Facility Information Element with Return Error = UnstructuredSS-Notify component type as defined in GSM 04.80 section 3.6.1 table 3.5.

Contents	Value/remark
Facility IE identifier Length of FIE contents Component type tag Component length InvokeID tag Invoke ID length Invoke ID Error Code tag Error Code length Error Code	As GSM 04.08 Return Result from GSM 04.80 From GSM 04.80 1 The same as the invoke of the UnstructuredSS-Notify in step 8 As GSM 04.80 USSD Busy

31.9.2.3 UnstructuredSS-Request/accepted

Conformance requirements

- 1) For a USSD request, the MS shall display the text provided and await user input. if the user enters a response, the MS shall return the response to the network, maintaining the transaction.
- 2) The MS shall include alphabet and language indicators in the response to the network. The alphabet indicator shall indicate "SMS default alphabet". The language indicator shall indicate "language unspecified".

- 3) At any stage while the MS is registered with a network, the network may send an unstructured string to the MS. So, the MS shall be able to process the operation during a call or out of a call.

References

conformance requirement 1: GSM 03.90 subclause 5.2.5.

conformance requirement 2: GSM 02.90 subclause 4.2.2.

conformance requirement 3: GSM 02.90 subclause 4.2.1.

Test Purpose

- 1) To test that, for a USSD request, the MS shall display the text provided and await user input. If the user enters a response, the MS shall return the response to the network, maintaining the transaction.
- 2) To verify that the MS shall include alphabet and language indicators in the response to the network. The alphabet indicator shall indicate "SMS default alphabet". The language indicator shall indicate "language unspecified".
- 3) To check that the MS shall be able to process the operation during a call or out of a call.

Related PICS/PIXIT Statements

- support of USSD.
- Full rate supported.
- Supported teleservices.
- **Support of active state of the call control protocol (U10).**

Initial Conditions

System Simulator:

1 cell, default parameters.

Mobile Station:

The MS is in the MM-state "idle updated".

Foreseen final state of the MS

MM-state "idle updated".

Test Procedure

- The MS is paged and a RR-connection is established. Then, the SS sends a REGISTER message containing a facility information element with operation code set to ProcessUnstructuredSS-Request. The user checks that the ussd string sent by the SS is correctly displayed by the MS and answers the request by depressing MMI keys. Then the MS has to send a FACILITY message with ussd string exactly containing the digits and symbols expressed on the mobile equipment keypad.
- Then the SS originates a call to the MS. When the MS is in the U10 state, the SS releases the transaction identifier concerning USSD transaction by sending a RELEASE COMPLETE. The SS initiates a new ussd transaction by sending a REGISTER message containing a facility information element with operation code set to UnstructuredSS-Request. The user checks that the ussd string sent by the SS is correctly displayed by the MS and answers the request by depressing MMI keys. Then the MS has to send a FACILITY message with ussd string exactly containing the digits and symbols expressed on the mobile equipment keypad. Finally the SS releases both MM connections and the radio link.

Step	Direction	Message	Comments
1	SS -> MS	PAGING REQUEST TYPE 1	
2	MS -> SS	CHANNEL REQUEST	
3	SS -> MS	IMMEDIATE ASSIGNMENT	a SDCCH is allocated to the MS.
4	MS -> SS	PAGING RESPONSE	
5	SS -> MS	REGISTER	initiation of the transaction concerning the USSD Request operation. See i).
6			The MS has to display the USSD string sent from the network and waits for the user response. By depressing MMI keys followed by SEND the user answers
7	MS -> SS	FACILITY	signalling message sent by the MS as the response. See ii).
8	SS -> MS	SETUP	incoming call.
9	MS -> SS	CALL CONFIRMED	
10	MS -> SS	ALERTING	
11	MS -> SS	CONNECT	
12	SS -> MS	ASSIGNMENT COMMAND	a TCH is allocated to the MS.
13	MS -> SS	ASSIGNMENT COMPLETE	
14	SS -> MS	CONNECT ACKNOWLEDGE	
15	SS -> MS	RELEASE COMPLETE	this message releases the transaction concerning the USSD operation. See iii).
16	SS -> MS	REGISTER	initiation of a USS request operation during a call. See specific message contents i).
17			The MS has to display the USSD string received from the SS. By depressing MMI keys followed by SEND, the user answers. DTMF signalling may occur.
18	MS -> SS	FACILITY	See ii).
19	SS -> MS	RELEASE COMPLETE	It releases the transaction identifier concerning the ussd operation.
20	SS -> MS	DISCONNECT	
21	MS -> SS	RELEASE	
22	SS -> MS	RELEASE COMPLETE	call release initiation. see iv).
23	SS -> MS	CHANNEL RELEASE	

Specific message contents

i) REGISTER message.

Contents	Value/remark
Protocol Discriminator	set to "Supplementary service (call independent)"
Transaction identifier	
Register message type	As GSM 04.80
Facility Information Element	See below

Facility Information Element with Invoke = UnstructuredSS-Request component type as defined in GSM 04.80 section 3.6.1 table 3.3.

Contents	Value/remark
Facility IE identifier	As GSM 04.08
Length of FIE contents	
Component type tag	Invoke from GSM 04.80
Component length	depending on the length of ussd-string
InvokeID tag	From GSM 04.80
Invoke ID length	1
Invoke ID	Arbitrary (1 octet)
Operation Code tag	From GSM 04.80
Operation Code length	1
Operation Code	UnstructuredSS-Request
ussd-dataCodingScheme	1 octet long. Alphabet indicator set to "default alphabet". Language indicator set to "undefined"
ussd-string	arbitrary chosen by the SS

ii) Facility message.

Contents	Value/remark
Protocol Discriminator	set to "Supplementary service (call independent)"
Transaction identifier	the transaction identifier value is the same as REGISTER transaction value but the transaction flag is different.
Facility message type	As GSM 04.80
Facility Information Element	See below

Facility Information Element with Return Result = UnstructuredSS-Request component type as defined in GSM 04.80 section 3.6.1 table 3.4.

Contents	Value/remark
Facility IE identifier	As GSM 04.08
Length of FIE contents	
Component type tag	Return Result from GSM 04.80
Component length	depending on the length of ussd-string
InvokeID tag	From GSM 04.80
Invoke ID length	1
Invoke ID	The same as the invoke of the UnstructuredSS-Request
Sequence Identifier	
Sequence length	
Operation Code tag	1
Operation Code length	1
Operation Code	UnstructuredSS-Request
ussd-dataCodingScheme	1 octet long. Alphabet indicator set to "default alphabet". Language indicator set to "undefined"
ussd-string	contains exactly the digits and symbols expressed on the mobile equipment keypad.

iii) RELEASE COMPLETE message.

Contents	Value/remark
Protocol Discriminator	set to "Supplementary service (call independent)"
Transaction identifier	same as REGISTER transaction identifier
Release Complete message type	As GSM 04.80
Facility Information Element	omitted

iv) RELEASE COMPLETE message.

Contents	Value/remark
Protocol Discriminator	set to "Supplementary service (call control)"
Transaction identifier	same as current call.
Release Complete message type	As GSM 04.08

31.9.2.4 UnstructuredSS-Request/rejected on user busy**Conformance requirements**

- 1) When the mobile station receives an USSD operation in parallel to any call independent supplementary transaction, it shall respond with a return error component in a RELEASE COMPLETE message, containing the "USSD-Busy" error.

References

conformance requirement 1: GSM 04.90 subclause 5.1.1.

Test Purpose

- 1) To verify that when the mobile station receives an USSD operation in parallel to any call independent supplementary transaction, it responds with a return error component in a RELEASE COMPLETE message, containing the "USSD-Busy" error.

Related PICS/PIXIT Statements

- support of USSD.
- Full rate supported.
- Supported teleservices.
- Support of active state of the call control protocol (U10).

Initial Conditions

System Simulator:

1 cell, default parameters.

Mobile Station:

The MS is in the MM-state "idle updated".

Foreseen final state of the MS

MM-state "idle updated".

Test Procedure

- The MS is paged and a RR-connection is established. Then, the SS sends a REGISTER message containing a facility information element with operation code set to UnstructuredSS-Request . The SS initiates an other USSD transaction by sending a REGISTER message with transaction identifier different from the previous one. The SS checks that the MS answers with a RELEASE COMPLETE message with an error component set to "USSD busy". Then the SS releases the radio link.

Test Procedure

Step	Direction	Message	Comments
1	SS -> MS	PAGING REQUEST TYPE 1	
2	MS -> SS	CHANNEL REQUEST	
3	SS -> MS	IMMEDIATE ASSIGNMENT	a SDCCH is allocated to the MS.
4	MS -> SS	PAGING RESPONSE	
5	SS -> MS	REGISTER	initiation of the transaction concerning the USSD Request operation. See i).
6			The MS has to display the USSD string sent from the network and waits for the user response. By depressing MMI keys followed by SEND the user answers.
7	MS -> SS	FACILITY	signalling message sent by the MS as the response to the request. See ii).
8	SS -> MS	REGISTER	initiation of an other USSD request. The transaction identifier is different from that in step 5. See i).
9	MS -> SS	RELEASE COMPLETE	error set to "USSD busy". Transaction initiated in step 6 by the network is rejected by the MS. See iii).
10	SS -> MS	RELEASE COMPLETE	normal release of transaction initiated in step 5. See iii).
11	SS -> MS	CHANNEL RELEASE	release of the main signalling link.

Specific message contents

i) REGISTER message.

See paragraph 31.9.2.3.

ii) FACILITY message.

See paragraph 31.9.2.3.

iii) RELEASE COMPLETE message.

Contents	Value/remark
Protocol Discriminator	set to "Supplementary service (call independent)"
Transaction identifier	the transaction identifier value is the same as REGISTER transaction value but the transaction flag is different.
Release complete message type	As GSM 04.80
Facility Information Element	for step 9 see iiib). for step10 see iiia).

iiia) Facility Information Element with Return Result = UnstructuredSS-Request component type as defined in GSM 04.80 section 3.6.1 table 3.4.

Contents	Value/remark
Facility IE identifier	As GSM 04.08
Length of FIE contents	
Component type tag	Return Result from GSM 04.80
Component length	depending on the length of ussd-string
InvokeID tag	From GSM 04.80
Invoke ID length	1
Invoke ID	The same as the invoke of the UnstructuredSS-Request

iiib) Facility Information Element with Return Error = UnstructuredSS-Request component type as defined in GSM 04.80 section 3.6.1 table 3.5.

Contents	Value/remark
Facility IE identifier	As GSM 04.08
Length of FIE contents	
Component type tag	Return Error from GSM 04.80
Component length	depending on the length of ussd-string
InvokeID tag	From GSM 04.80
Invoke ID length	1
Invoke ID	The same as the invoke of the UnstructuredSS-Request
Error Code tag	As GSM 04.80
Error Code length	
Error Code	USSD Busy

31.10 MMI input for USSD

31.10.1 Conformance requirements

If the MS cannot interpret the MMI input as a defined GSM Supplementary Services, SIM control procedure or MS manufacturer-defined procedure, and if the MMI input is in the form:

"entry of any characters defined in the GSM 03.38 Default Alphabet (up to the maximum defined in GSM 04.80) followed by #SEND"

or

"entry of 1 or 2 characters defined in the GSM 03.38 Default Alphabet followed by SEND"

then it shall be interpreted by the MS as Unstructured SS Data and sent transparently towards the network, unless the MS is not engaged in a call and the first digit of the 2 character entry, followed by SEND, is a "1". In this case the MS shall transmit this as a call-setup request.

References

GSM 02.30 section 4.5.3.

31.10.2 Test purpose

To check that the entry of 2 digits in the form 1X (X in the set 0,...9) followed by SEND is accepted by the mobile station in idle mode as a normal call establishment for the 1X number. It is checked that the MS sends a CHANNEL REQUEST, sends CM SERVICE REQUEST message for mobile originated call (after having received an IMMEDIATE ASSIGNMENT), and then sends the SETUP message containing the 1X phone number as called number (after having received the CM SERVICE ACCEPT message).

31.10.3 Method of test

Initial conditions

System Simulator:

1 cell, default parameters.

Mobile Station

The MS is "idle updated";

Related PICS/PIXIT statement(s)

Foreseen final state of the MS:

The MS is "idle updated."

Test procedure

The user requests call establishment successively for every 2 digit phone number of the 1X form (X in the set 0,...9) allowing ten seconds between each attempts.

Maximum duration of test

3 min.

Expected Sequence

The following sequence is executed for execution counter k = 1 to 10.

Step	Direction	Message	Comments
1	MS		The MS is made to initiate call establishment for phone number 1X (where X = k-1)
2	MS -> SS	CHANNEL REQUEST	with establishment cause related to mobile originating call
3	SS -> MS	IMMEDIATE ASSIGNMENT	
4	MS -> SS	CM SERVICE REQUEST	"mobile originating call"
5	SS -> MS	CM SERVICE ACCEPT	
6	MS -> SS	SETUP	called BCD number is 1X
7	SS -> MS	RELEASE COMPLETE	
8			Wait for 10 seconds

Specific message contents.

None.

31.11 Specific message contents and ASN.1 codings**Introduction**

In this section a mixed form of ASN.1 coding has been used in ASN.1 components within the messages.

Some components use the indefinite form of coding, and some use the short definite form.

An example of a FACILITY message using indefinite form of coding is described below .

The same message using short definite form of coding is described in Test 31.2.1.1.1 Step 7 of this section.

Contents	Value/remark	Coding
Length of FIE contents	43	2B
Component type tag	Return Result	A2
Component length	indefinite	80
Invoke ID tag		02
Invoke ID length	1	01
Invoke ID	As received	--
Sequence tag		30
Sequence length	indefinite	80
Operation Code tag		02
Operation Code length	1	01
Operation Code	RegisterSS	0A
SS-Information		
Forwarding Info tag	Tag=A0	A0
Forwarding Info length	indefinite	80
SS-Code tag	Tag=4	04
SS-Code length	1	01
SS-Code	CFNRy	2A
Forwarding Feature List	Seq.	30
Length Indicator	indefinite	80
Forwarding Feature	Seq.	30
Forwarding Feature length	indefinite	80
Basic Service Code identifier	TeleserviceCode	83
Teleservice length	1	01
Teleservice code	AllSpeechTransmission	10
SS-Status	Tag=84	84
SS-Status length	1	01
SS-Status code	Prov., Registered, Active	07
Forwarded To Number identifier	Tag=85	85
ISDN-AddressString length	5	05
AddressString type	Unknown	81
AddressString	TBCD-String: 00431234	00 34 21 43
NoReplyConditionTime	Tag=87	87
Length Indicator	1	01
NoReplyConditionTime	5	05
End-Of-Content Tag	0	00
Length Indicator	0	00
End-Of-Content Tag	0	00
Length Indicator	0	00
End-Of-Content Tag	0	00
Length Indicator	0	00
End-Of-Content Tag	0	00
Length Indicator	0	00

Test 31.2.1.1.1. Registration accepted

MMI sequence: **61*00431234*11*5#

Step 6: MS -> SS REGISTER

Contents	Value/remark	Coding
Length of FIE contents	26	1A
Component type tag	Invoke	A1 (1)
Component length	24	18
Invoke ID tag		02
Invoke ID length	1	01
Invoke ID	Arbitrary	--
Operation Code tag		02
Operation Code length	1	01
Operation Code	RegisterSS	0A
RegisterSS-Arg	Seq.	30 (1)
RegisterSS-Arg length	16	20
SS-Code tag	Tag=4	04
SS-Code length	1	01
SS-Code	CFNRy	2A
Basic Service Code identifier	TeleserviceCode	83
Teleservice length	1	01
Teleservice code	AllSpeechTransmission	10
Forwarded To Number identifier	Tag=84	84
AddressString length	5	05
AddressString type	Unknown	81
AddressString	TBCD-String: 00431234	00 34 21 43
NoReplyConditionTime tag	Tag=85	85
NoReplyConditionTime length	1	01
NoReplyConditionTime	5	05

NOTE 1: This component may use the indefinite form.

Step 7: SS -> MS RELEASE COMPLETE

Contents	Value/remark	Coding
Length of FIE contents	35	23
Component type tag	Return Result	A2 (1)
Component length	33	21
Invoke ID tag		02
Invoke ID length	1	01
Invoke ID	As received	--
Sequence tag		30 (1)
Sequence length	28	1C
Operation Code tag		02
Operation Code length	1	01
Operation Code	RegisterSS	0A
SS-Information		
Forwarding Info tag	Tag=A0	A0 (1)
Forwarding Info length	23	17
SS-Code tag	Tag=4	04
SS-Code length	1	01
SS-Code	CFNRy	2A
Forwarding Feature List	Seq.	30 (1)
Length Indicator	18	12
Forwarding Feature	Seq.	30 (1)
Forwarding Feature length	16	20
Basic Service Code identifier	TeleserviceCode	83
Teleservice length	1	01
Teleservice code	AllSpeechTransmission	10
SS-Status	Tag=84	84
SS-Status length	1	01
SS-Status code	Prov., Registered, Active	07
Forwarded To Number identifier	Tag=85	85
ISDN-AddressString length	5	05
AddressString type	Unknown	81
AddressString	TBCD-String: 00431234	00 34 21 43
NoReplyConditionTime	Tag=87	87
Length Indicator	1	01
NoReplyConditionTime	5	05

MMI sequence: **21*00431234*13#

Step 15: MS -> SS REGISTER

Contents	Value/remark	Coding
Length of FIE contents	23	17
Component type tag	Invoke	A1 (1)
Component length	21	15
Invoke ID tag		02
Invoke ID length	1	01
Invoke ID	Arbitrary	--
Operation Code tag		02
Operation Code length	1	01
Operation Code	RegisterSS	0A
RegisterSS-Arg	Seq.	30 (1)
RegisterSS-Arg length	13	0D
SS-Code tag	Tag=4	04
SS-Code length	1	01
SS-Code	CFU	21
Basic Service Code identifier	TeleserviceCode	83
Teleservice length	1	01
Teleservice code	All Facsimile Services	60
Forwarded To Number identifier	Tag=84	84
AddressString length	5	05
AddressString type	Unknown	81
AddressString	TBCD-String: 00431234	00 34 21 43

Step 16: SS -> MS RELEASE COMPLETE

Contents	Value/remark	Coding
Length of FIE contents	42	2A
Component type tag	Return Result	A2 (1)
Component length	indefinite	80
Invoke ID tag		02
Invoke ID length	1	01
Invoke ID	As received	--
Sequence tag		30 (1)
Sequence length	indefinite	80
Operation Code tag		02
Operation Code length	1	01
Operation Code	RegisterSS	0A
SS-Information		
Forwarding Info tag	Tag=A0	A0 (1)
Forwarding Info length	indefinite	80
SS-Code tag	Tag=4	04
SS-Code length	1	01
SS-Code	CFU	21
Forwarding Feature List	Seq.	30 (1)
Length indicator	indefinite	80
Forwarding Feature	Seq.	30 (1)
Forwarding Feature length	indefinite	80
Basic Service Code identifier	TeleserviceCode	83
Teleservice length	1	01
Teleservice code	All Facsimile Services	60
SS-Status	Tag=84	84
SS-Status length	1	01
SS-Status code	Prov., Registered, Active	07
Forwarded To Number identifier	Tag=85	85
ISDN-AddressString length	5	05
AddressString type	Unknown	81
AddressString	TBCD-String: 00431234	00 34 21 43
End-Of-Content Tag	0	00
Length Indicator	0	00
End-Of-Content Tag	0	00
Length Indicator	0	00
End-Of-Content Tag	0	00
Length Indicator	0	00
End-Of-Content Tag	0	00
Length Indicator	0	00
End-Of-Content Tag	0	00
Length Indicator	0	00

Test 31.2.1.1.2. Registration rejected

MMI sequence: **67*00431234*21#

Step 4: MS -> SS REGISTER

Contents	Value/remark	Coding
Length of FIE contents	23	17
Component type tag	Invoke	A1 (1)
Component length	21	15
Invoke ID tag		02
Invoke ID length	1	01
Invoke ID	Arbitrary	--
Operation Code tag		02
Operation Code length	1	01
Operation Code	RegisterSS	0A
RegisterSS-Arg	Seq.	30 (1)
RegisterSS-Arg length	13	0D
SS-Code tag	Tag=4	04
SS-Code length	1	01
SS-Code	CFB	29
Basic Service Code identifier	BearerserviceCode	82
Bearerservice length	1	01
Bearerservice code	AllAsynchronousServices	60
Forwarded To Number identifier	Tag=84	84
AddressString length	5	05
AddressString type	Unknown	81
AddressString	TBCD-String: 00431234	00 34 21 43

Step 5: SS -> MS RELEASE COMPLETE

Contents	Value/remark	Coding
Length of FIE contents	8	08
Component type tag	Return Error	A3 (1)
Component length	6	06
Invoke ID tag		02
Invoke ID length	1	01
Invoke ID	As received	--
Error Code tag		02
Error Code length	1	01
Error Code	BearerServiceNot Provisioned	0A

MMI sequence: **002*00431234*13#

Step 11: MS -> SS REGISTER

Contents	Value/remark	Coding
Length of FIE contents	23	1715
Component type tag	Invoke	A1 (1)
Component length	21	15
Invoke ID tag		02
Invoke ID length	1	01
Invoke ID	Arbitrary	--
Operation Code tag		02
Operation Code length	1	01
Operation Code	RegisterSS	0A
RegisterSS-Arg		30 (1)
RegisterSS-Arg length	13	0D
SS-Code tag	Tag=4	04
SS-Code length	1	01
SS-Code	CF	20
Basic Service Code identifier	TeleserviceCode	83
Teleservice length	1	01
Teleservice code	All Facsimile Services	60
Forwarded To Number identifier	Tag=84	84
AddressString length	5	05
AddressString type	Unknown	81
AddressString	TBCD-String: 00431234	00 34 21 43

Step 12: SS -> MS RELEASE COMPLETE

Contents	Value/remark	Coding
Length of FIE contents	8	08
Component type tag	Reject	A4 (1)
Component length	6	06
Invoke ID tag		02
Invoke ID length	1	01
Invoke ID	As received	--
Invoke Problem tag	Tag=81	81
Invoke Problem length	1	01
Invoke Problem code	Resource limitation	03

Test 31.2.1.2.1. Erasure accepted

MMI sequence: ##004**13#

Step 6: MS -> SS REGISTER

Contents	Value/remark	Coding
Length of FIE contents	16	10
Component type tag	Invoke	A1 (1)
Component length	14	0E
Invoke ID tag		02
Invoke ID length	1	01
Invoke ID	Arbitrary	--
Operation Code tag		02
Operation Code length	1	01
Operation Code	EraseSS	0B
SS-ForBS	Seq.	30 (1)
SS-ForBS length	6	06
SS-Code tag	Tag=4	04
SS-Code length	1	01
SS-Code	CFC	28
Basic Service Code identifier	TeleserviceCode	83
Teleservice length	1	01
Teleservice code	All Facsimile Services	60

Step 7: SS -> MS RELEASE COMPLETE

Contents	Value/remark	Coding
Length of FIE contents	31	1F
Component type tag	Return Result	A2 (1)
Component length	29	1D
Invoke ID tag		02
Invoke ID length	1	01
Invoke ID	As received	--
Sequence tag		30 (1)
Sequence length	24	18
Operation Code tag		02
Operation Code length	1	01
Operation Code	EraseSS	0B
SS-Information		
Forwarding Info tag	Tag=A0	A0 (1)
Forwarding Info length	indefinite	80
SS-Code tag	Tag=4	04
SS-Code length	1	01
SS-Code	CFC	28
Forwarding Feature List	Seq.	30 (1)
Length Indicator	indefinite	80
Forwarding Feature	Seq.	30 (1)
Forwarding Feature length	indefinite	80
Basic Service Code identifier	TeleserviceCode	83
Teleservice length	1	01
Teleservice code	All Facsimile Services	60
SS-Status	Tag=84	84
SS-Status length	1	01
SS-Status code	Provisioned	04
End-Of-Content Tag	0	00
Length Indicator	0	00
End-Of-Content Tag	0	00
Length Indicator	0	00
End-Of-Content Tag	0	00
Length Indicator	0	00

MMI sequence: ##62#

Step 15: MS -> SS REGISTER

Contents	Value/remark	Coding
Length of FIE contents	13	0D
Component type tag	Invoke	A1 (1)
Component length	11	0B
Invoke ID tag		02
Invoke ID length	1	01
Invoke ID	Arbitrary	--
Operation Code tag		02
Operation Code length	1	01
Operation Code	EraseSS	0B
SS-ForBS	Seq.	30 (1)
SS-ForBS length	3	03
SS-Code tag	Tag=4	04
SS-Code length	1	01
SS-Code	CFNRc	2B

Step 16: SS -> MS RELEASE COMPLETE

Contents	Value/remark	Coding
Length of FIE contents	22	16
Component type tag	Return Result	A2 (1)
Component length	20	14
Invoke ID tag		02
Invoke ID length	1	01
Invoke ID	As received	--
Sequence tag		30 (1)
Sequence length	15	0F
Operation Code tag		02
Operation Code length	1	01
Operation Code	EraseSS	0B
SS-Information		
Forwarding Info tag	Tag=A0	A0 (1)
Forwarding Info length	10	0A
SS-Code tag	Tag=4	04
SS-Code length	1	01
SS-Code	CFNRc	2B
Forwarding Feature List	Seq.	30 (1)
Length Indicator	5	05
Forwarding Feature	Seq.	30 (1)
Forwarding Feature length	3	03
SS-Status	Tag=84	84
SS-Status length	1	01
SS-Status code	Provisioned	04

Test 31.2.1.2.2. Erasure rejected

MMI sequence: ##21**11#

Step 4: MS -> SS REGISTER

Contents	Value/remark	Coding
Length of FIE contents	16	10
Component type tag	Invoke	A1 (1)
Component length	14	0E
Invoke ID tag		02
Invoke ID length	1	01
Invoke ID	Arbitrary	--
Operation Code tag		02
Operation Code length	1	01
Operation Code	EraseSS	0B
SS-ForBS		30 (1)
SS-ForBS length	6	06
SS-Code tag	Tag=4	04
SS-Code length	1	01
SS-Code	CFU	21
Basic Service Code identifier	TeleserviceCode	83
Teleservice length	1	01
Teleservice code	AllSpeechTransmission	10

Step 5: SS -> MS RELEASE COMPLETE

Contents	Value/remark	Coding
Length of FIE contents	8	08
Component type tag	Return Error	A3 (1)
Component length	6	06
Invoke ID tag		02
Invoke ID length	1	01
Invoke ID	As received	--
Error Code tag	Tag=2	02
Error Code length	1	01
Error Code	TeleserviceNotProvisioned	0B

MMI sequence: ##61**13#

Step 11: MS -> SS REGISTER

Contents	Value/remark	Coding
Length of FIE contents	16	10
Component type tag	Invoke	A1 (1)
Component length	14	0E
Invoke ID tag		02
Invoke ID length	1	01
Invoke ID	Arbitrary	--
Operation Code tag		02
Operation Code length	1	01
Operation Code	EraseSS	0B
SS-ForBS		30 (1)
SS-ForBS length	6	06
SS-Code tag	Tag=4	04
SS-Code length	1	01
SS-Code	CFNRy	2A
Basic Service Code identifier	TeleserviceCode	83
Teleservice length	1	01
Teleservice code	All Facsimile Services	60

Step 12: SS -> MS RELEASE COMPLETE

Contents	Value/remark	Coding
Length of FIE contents	10	0A
Component type tag	Reject	A4 (1)
Component length	indefinite	80
Invoke ID tag		02
Invoke ID length	1	01
Invoke ID	As received	--
Invoke Problem tag		81
Invoke Problem length	1	01
Invoke Problem	Resource limitation	03
End-Of-Content Tag	0	00
Length Indicator	0	00

Test 31.2.1.3. Activation

MMI sequence: *002**22#

Step 6: MS -> SS REGISTER

Contents	Value/remark	Coding
Length of FIE contents	16	10
Component type tag	Invoke	A1 (1)
Component length	14	0E
Invoke ID tag		02
Invoke ID length	1	01
Invoke ID	Arbitrary	--
Operation Code tag		02
Operation Code length	1	01
Operation Code	ActivateSS	0C
SS-ForBS		30 (1)
SS-ForBS length	6	06
SS-Code tag	Tag=4	04
SS-Code length	1	01
SS-Code	CF	20
Basic Service Code identifier	BearerserviceCode	82
Bearerservice length	1	01
Bearerservice code	AllSynchronousServices	68

Step 7:SS -> MS RELEASE COMPLETE

Contents	Value/remark	Coding
Length of FIE contents	29	1D
Component type tag	Return Result	A2 (1)
Component length	indefinite	80
Invoke ID tag		02
Invoke ID length	1	01
Invoke ID	As received	--
Sequence tag		30 (1)
Sequence length	20	14
Operation Code tag		02
Operation Code length	1	01
Operation Code	ActivateSS	0C
SS-Information		
Forwarding Info tag	Tag=A0	A0 (1)
Forwarding Info length	indefinite	80
SS-Code tag	Tag=4	04
SS-Code length	1	01
SS-Code	CF	20
Forwarding Feature List	Seq.	30 (1)
Length Indicator	8	08
Forwarding Feature	Seq.	30 (1)
Forwarding Feature length	6	06
Basic Service Code identifier	BearerserviceCode	82
Bearerservice length	1	01
Bearerservice code	AllSynchronousServices	68
SS-Status	Tag=4	84
SS-Status length	1	01
SS-Status code	Prov., Registered, Active	07
End-Of-Content Tag	0	00
Length Indicator	0	00
End-Of-Content Tag	0	00
Length Indicator	0	00

MMI sequence: *21#

Step 15: MS -> SS REGISTER

Contents	Value/remark	Coding
Length of FIE contents	13	0D
Component type tag	Invoke	A1 (1)
Component length	11	0B
Invoke ID tag		02
Invoke ID length	1	01
Invoke ID	Arbitrary	--
Operation Code tag		02
Operation Code length	1	01
Operation Code	ActivateSS	0C
SS-ForBS	Seq.	30 (1)
SS-ForBS length	3	06
SS-Code tag	Tag=4	04
SS-Code length	1	01
SS-Code	CFU	21

Step 16: SS -> MS RELEASE COMPLETE

Contents	Value/remark	Coding
Length of FIE contents	26	1A
Component type tag	Return Result	A2 (1)
Component length	24	18
Invoke ID tag		02
Invoke ID length	1	01
Invoke ID	As received	--
Sequence tag		30 (1)
Sequence length	indefinite	80
Operation Code tag		02
Operation Code length	1	01
Operation Code	ActivateSS	0C
SS-Information		
Forwarding Info tag	Tag=A0	A0 (1)
Forwarding Info length	indefinite	80
SS-Code tag	Tag=4	04
SS-Code length	1	01
SS-Code	CFU	21
Forwarding Feature List	Seq.	30 (1)
Length Indicator	5	05
Forwarding Feature	Seq.	30 (1)
Forwarding Feature length	3	03
SS-Status	Tag=84	84
SS-Status length	1	01
SS-Status code	Prov. Registered, Active	07
End-Of-Content Tag	0	00
Length Indicator	0	00
End-Of-Content Tag	0	00
Length Indicator	0	00

Test 31.2.1.4. Deactivation

MMI sequence: #004**11#

Step 6: MS -> SS REGISTER

Contents	Value/remark	Coding
Length of FIE contents	16	10
Component type tag	Invoke	A1 (1)
Component length	14	0E
Invoke ID tag		02
Invoke ID length	1	01
Invoke ID	Arbitrary	--
Operation Code tag		02
Operation Code length	1	01
Operation Code	DeactivateSS	0D
SS-ForBS	Seq.	30 (1)
SS-ForBS length	6	06
SS-Code tag	Tag=4	04
SS-Code length	1	01
SS-Code	CFC	28
Basic Service Code identifier	TeleserviceCode	83
Teleservice length	1	01
Teleservice code	AllSpeechTransmission	10

Step 7: SS -> MS RELEASE COMPLETE

Contents	Value/remark	Coding
Length of FIE contents	29	1D
Component type tag	Return Result	A2 (1)
Component length	27	1B
Invoke ID tag		02
Invoke ID length	1	01
Invoke ID	As received	--
Sequence tag		30 (1)
Sequence length	22	16
Operation Code tag		02
Operation Code length	1	01
Operation Code	DeactivateSS	0D
SS-Information		
Forwarding Info tag	Tag=A0	A0 (1)
Forwarding Info length	indefinite	80
SS-Code tag	Tag=4	04
SS-Code length	1	01
SS-Code	CFC	28
Forwarding Feature List	Seq.	30 (1)
Length Indicator	indefinite	80
Forwarding Feature	Seq.	30 (1)
Forwarding Feature length	6	06
Basic Service Code identifier	TeleserviceCode	83
Teleservice length	1	01
Teleservice code	AllSpeechTransmission	10
SS-Status	Tag=84	84
SS-Status length	1	01
SS-Status code	Provisioned, Registered	06
End-Of-Content Tag	0	00
Length Indicator	0	00
End-Of-Content Tag	0	00
Length Indicator	0	00

MMI sequence: #62**13#

Step 15: MS -> SS REGISTER

Contents	Value/remark	Coding
Same header as Step 6		
SS-Code tag	Tag=4	04
SS-Code length	1	01
SS-Code	CFNRc	2B
Basic Service Code identifier	TeleserviceCode	83
Teleservice length	1	01
Teleservice code	All Facsimile Services	60

Step 16: SS -> MS RELEASE COMPLETE

Contents	Value/remark	Coding
Length of FIE contents	27	1B
Component type tag	Return Result	A2 (1)
Component length	25	19
Invoke ID tag		02
Invoke ID length	1	01
Invoke ID	As received	--
Sequence tag		30 (1)
Sequence length	20	14
Operation Code tag		02
Operation Code length	1	01
Operation Code	DeactivateSS	0D
SS-Information		
Forwarding Info tag	Tag=A0	A0 (1)
Forwarding Info length	15	0F
SS-Code tag	Tag=4	04
SS-Code length	1	01
SS-Code	CFNRc	2B
Forwarding Feature List	Seq.	30 (1)
Length Indicator	10	0A
Forwarding Feature	Seq.	30 (1)
Forwarding Feature length	indefinite	80
Basic Service Code identifier	TeleserviceCode	83
Teleservice length	1	01
Teleservice code	All Facsimile Services	60
SS-Status	Tag=4	84
SS-Status length	1	01
SS-Status code	Provisioned, Registered	06
End-Of-Content Tag	0	00
Length Indicator	0	00

Test 31.2.1.6.1. Interrogation accepted

MMI sequence: *#67#

Step 6: MS -> SS REGISTER

Contents	Value/remark	Coding
Length of FIE contents	13	0D
Component type tag	Invoke	A1 (1)
Component length	11	0B
Invoke ID tag		02
Invoke ID length	1	01
Invoke ID	Arbitrary	--
Operation Code tag		02
Operation Code length	1	01
Operation Code	InterrogateSS	0E
SS-ForBS		30 (1)
SS-ForBS length	3	03
SS-Code tag	Tag=4	04
SS-Code length	1	01
SS-Code	CFB	29

Step 7: SS -> MS RELEASE COMPLETE

Contents	Value/Remark	Coding
Length of FIE contents	13	0D
Component type tag	Return Result	A2 (1)
Component length	11	0B
Invoke ID tag	Tag=02	02
Invoke ID length	1	01
Invoke ID	As received	03
Sequence tag		30 (1)
Sequence length	6	06
Operation code tag	Tag=02	02
Operation code length	1	01
Operation code	InterrogateSS	0E
InterrogateSS-Res	Choice	
SS-Status	Tag=80	80
SS-Status length	1	01
SS-Status	Provisioned	04

MMI sequence: *#61**11#

Step 15: MS -> SS REGISTER

Contents	Value/Remark	Coding
Length of FIE contents	16	10
Component type tag	Invoke	A1 (1)
Component length	14	0E
Invoke ID tag		02
Invoke ID length	1	01
Invoke ID	Arbitrary	--
Operation code tag		02
Operation code length	1	01
Operation code	InterrogateSS	0E
SS-ForBS	Seq	30 (1)
SS-ForBS length	6	06
SS code tag	Tag=4	04
SS code length	1	01
SS code	CFNRy	28
Basic Service Code identifier	TeleserviceCode	83
Teleservice length	1	01
Teleservice code	AllSpeechTransmission	10

Step 16: SS -> MS RELEASE COMPLETE

Contents	Value/Remark	Coding
Length of FIE contents	26	1A
Component type tag	Return Result	A2 (1)
Component length	24	18
Invoke ID tag		02
Invoke ID length	1	01
Invoke ID	As received	03
Sequence tag		30 (1)
Sequence length	19	13
Operation code tag		02
Operation code length	1	01
Operation code	InterrogateSS	0E
InterrogateSS-Res	Choice	
Forwarding Feature List	Seq.	A3 (1)
length indicator	14	0E
Forwarding Feature tag	Seq.	30 (1)
Forwarding Feature length	12	0C
Basic Service Code identifier	TeleserviceCode	83
Teleservice length	1	01
Teleservice code	AllSpeechTransmission	10
SS-Status	Tag=84	84
SS-Status length	1	01
SS-Status code	Prov. Registered Active	07
Forwarded To Number Identifier	Tag=85	85
ISDN-AddressString length	4	04
AddressString type	International Number	91
AddressString	TBCD-String: 431234	34 21 43

Test 31.2.1.6.2. Interrogation rejectedMMI sequence: ***#62#****Step 4: MS -> SS REGISTER**

Contents	Value/remark	Coding
Length of FIE contents	13	0D
Component type tag	Invoke	A1 (1)
Component length	11	0B
Invoke ID tag		02
Invoke ID length	1	01
Invoke ID	Arbitrary	--
Operation Code tag		02
Operation Code length	1	01
Operation Code	InterrogateSS	0E
SS-ForBS		30 (1)
SS-ForBS length	3	03
SS-Code tag	Tag=4	04
SS-Code length	1	01
SS-Code	CFNRc	2B

Step 5: SS -> MS RELEASE COMPLETE

Contents	Value/remark	Coding
Length of FIE contents	8	08
Component type tag	Return Error	A3 (1)
Component length	6	06
Invoke ID tag		02
Invoke ID length	1	01
Invoke ID	As received	--
Error Code tag		02
Error Code length	1	01
Error Code	SS-NotAvailable	12

MMI sequence: *#67**13#

Step 11: MS -> SS REGISTER

Contents	Value/remark	Coding
Length of FIE contents	16	10
Component type tag	Invoke	A1 (1)
Component length	14	0E
Invoke ID tag		02
Invoke ID length	1	01
Invoke ID	Arbitrary	--
Operation code tag		02
Operation code length	1	01
Operation code	InterrogateSS	0E
SS-ForBS	Seq	30 (1)
SS-ForBS length	6	06
SS code tag	Tag=04	04
SS code length	1	01
SS code	CFB: CF on MS Busy	29
Basic Service Code identifier	TeleserviceCode	83
Teleservice length	1	01
Teleservice code	AllFacsimileServices	60

Step 12: SS -> MS RELEASE COMPLETE

Contents	Value/remark	Coding
Length of FIE contents	8	08
Component type tag	Reject	A4 (1)
Component length	indefinite	80
Invoke ID tag		02
Invoke ID length	1	01
Invoke ID	As received	--
Problem code tag	Tag=81	81
Problem code length	1	01
Invoke problem	Resource limitation	03
End-Of-Content Tag	0	00
Length Indicator	0	00

Test 31.2.1.7.1.1. Notification during an incoming call**Step 10 and 15: SS -> MS FACILITY**

Contents	Value/remark	Coding
Length of FIE contents	18	12
Component type tag	Invoke	A1 (1)
Component length	16	10
Invoke ID tag		02
Invoke ID length	1	01
Invoke ID	Arbitrary	--
Operation Code tag		02
Operation Code length	1	01
Operation Code	NotifySS	10
SS-ForBS		30 (1)
SS-ForBS length	indefinite	80
SS-Code tag	Tag=81	81
SS-Code length	1	01
SS-Code	CFB	29
SS-Notification tag	Tag=85	85
SS-Notification length	1	01
SS-Notification	Incoming call forwarded	02
End-Of-Content Tag	0	00
Length Indicator	0	00

Test 31.2.1.7.1.2. Notification during an outgoing call**Step 9 : SS -> MS ALERTING**

Contents	Value/remark	Coding
Length of FIE contents	18	12
Component type tag	Invoke	A1 (1)
Component length	indefinite	80
Invoke ID tag		02
Invoke ID length	1	01
Invoke ID	Arbitrary	00
Operation code tag		02
Operation code length	1	01
Operation code	NotifySS	10
NotifySS-Arg tag	Seq.	30 (1)
NotifyBS-Arg length	6	06
SS code tag	Tag=81	81
SS code length	1	01
SS code	CFU: Forw Unconditional	21
SS-Status	Tag=84	84
SS-Status length	1	01
SS-Status code	Prov. Registered Active	07
End-Of-Content Tag	0	00
Length Indicator	0	00

Step 10 : SS -> MS CONNECT

Contents	Value/remark	Coding
Length of FIE contents	18	12
Component type tag	Invoke	A1 (1)
Component length	16	10
Invoke ID tag		02
Invoke ID length	1	01
Invoke ID	Arbitrary	01
Operation code tag		02
Operation code length	1	01
Operation code	NotifySS	10
NotifySS-Arg tag	Seq.	30 (1)
NotifyBS-Arg length	indefinite	80
SS code tag	Tag=81	81
SS code length	1	01
SS code	CFC: Conditional Forw.	28
SS-Status	Tag=84	84
SS-Status length	1	01
SS-Status code	Prov. Registered Active	07
End-Of-Content Tag	0	00
Length Indicator	0	00

Test 31.2.1.7.2. Forwarded-to mobile subscriber side

Step 5 : SS -> MS SETUP

Contents	Value/remark	Coding
Length of FIE contents	18	12
Component type tag	Invoke	A1 (1)
Component length	indefinite	80
Invoke ID tag		02
Invoke ID length	1	01
Invoke ID	Arbitrary	00
Operation code tag		02
Operation code length	1	01
Operation code	NotifySS	10
NotifySS-Arg tag	Seq.	30 (1)
NotifyBS-Arg length	6	06
SS code tag	Tag=81	81
SS code length	1	01
SS code	CFNRc MS not reachable	2B
SS-Notification tag	Tag=85	85
SS-Notification length	1	01
SS-Notification	Forwarded call	01
End-Of-Content Tag	0	00
Length Indicator	0	00

Test 31.6.1.1. AOC time related charging/MS originated call

k=1 Step 11: SS -> MS CONNECT

Contents	Value/remark	Coding
Length of FIE contents	41	29
Component type tag	Invoke	A1 (1)
Component length	39	27
Invoke ID tag		02
Invoke ID length	1	01
Invoke ID	Arbitrary	--
Operation code tag		02
Operation code length	1	01
Operation code	ForwardChargeAdvice	7D
ForwardChargeAdviceArg	Seq.	30 (1)
ForwardChargeAdviceArg length	indefinite	80
SS code tag	Tag=80	80
SS code length	1	01
SS code	AoC-Charging	72
Charging Information	Tag=a1	A1 (1)
Charging Information length	24	18
e1 tag	Tag=81	81
e1 length	1	01
e1	Value = 6,0	3C
e2 tag	Tag=82	82
e2 length	2	02
e2	Value = 14,0	00 8C
e3 tag	Tag=83	83
e3 length	1	01
e3	Value = 1,0	64
e4 tag	Tag=84	84
e4 length	2	02
e4	Value = 25,0	00 FA
e5 tag	Tag=85	85
e5 length	1	01
e5	Value = 0,0	00
e6 tag	Tag=86	86
e6 length	1	01
e6	Value = 0,0	00
e7 tag	Tag=87	87
e7 length	2	02
e7	Value = 60,0	02 58
End-Of-Content Tag	0	00
Length Indicator	0	00

Step A13/B12: MS -> SS FACILITY

Contents	Value/remark	Coding
Length of FIE contents	5	05
Component type tag	Return Result	A2 (1)
Component length	3	03
Invoke ID tag		02
Invoke ID length	1	01
Invoke ID	As received	--

k=1...5: e-parameters

k-value	e-parameter values						
	e1	e2	e3	e4	e5	e6	e7
1	6	14	1	25	0	0	60
2	0	0	1	100	0	0	0
3	250	16	2	500	0	0	60
4	1	1	1	0	10	10	1
5	12,5	30	1	25	10	10	30

k-value	e-parameter coding						
	e1	e2	e3	e4	e5	e6	e7
1	3C	00 8C	64	00 FA	00	00	02 58
2	00	00	64	03 E8	00	00	00
3	09 C4	00 A0	00 C8	13 88	00	00	02 58
4	00 0A	00 0A	00 64	00 00	00 64	00 0A	00 0A
5	7D	01 2C	64	00 FA	64	0A	01 2C

Test 31.6.1.2. AOC time related charging/MS terminated call

k=1...5 Step 12: SS -> MS FACILITY e-parameters

k-value	e-parameter values						
	e1	e2	e3	e4	e5	e6	e7
1	0	0	0	0	0	0	0
2	0	0	1	100	0	0	0
3	6	14	1	25	0	0	60
4	1	1	1	0	0	0	1
5	12,5	30	1	25	0	0	30

k-value	e-parameter coding						
	e1	e2	e3	e4	e5	e6	e7
1	00	00	00	00	00	00	00
2	00	00	64	03 E8	00	00	00
3	3C	00 8C	64	00 FA	00	00	02 58
4	0A	0A	64	00	00	00	0A
5	7D	01 2C	00 64	FA	00	00	01 2C

Test 31.6.1.5. Change in charging information during a call

Step A12: SS -> MS FACILITY (initial CAI message)

Contents	Value/remark	Coding
CAI header element		
e1 tag	Tag=81	81
e1 length	1	01
e1	Value = 10,0	64
e2 tag	Tag=82	82
e2 length	2	02
e2	Value = 28,0	01 18
e3 tag	Tag=83	83
e3 length	1	01
e3	Value = 1,0	64
e4 tag	Tag=84	84
e4 length	1	01
e4	Value = 10,0	64
e5 tag	Tag=85	85
e5 length	1	01
e5	Value = 0,0	00
e6 tag	Tag=86	86
e6 length	1	01
e6	Value = 0,0	00
e7 tag	Tag=87	87
e7 length	2	02
e7	Value = 60,0	02 58

Step A12: SS -> MS FACILITY (subsequent CAI message)

Contents	Value/remark	Coding
CAI header element		
e1	Value = 10,0	64
e2	Value = 14,0	00 8C
e3	Value = 1,0	64
e4	Value = 5,0	32
e5	Value = 0,0	00
e6	Value = 0,0	00
e7	Value = 60,0	02 58

Test 31.6.1.6. Different formats of charging information

k=1 SS -> MS FACILITY

Contents	Value/remark	Coding
CAI header element		
e1	Value = 10,0	64
e2	Value = 40,0	01 90
e3	Value = 1,0	64
e4	Value = 0,0	00
e5	Value = 0,0	00
e6	Value = 0,0	00
e7	Value = 0,0	00 00

k=2 SS -> MS FACILITY

Contents	Value/remark	Coding
Length of FIE contents	27	1B
Component type tag	Invoke	A1 (1)
Component length	25	19
Invoke ID tag		02
Invoke ID length	1	01
Invoke ID	Arbitrary	--
Operation code tag		02
Operation code length	1	01
Operation code	forwardChargeAdvice	7D
ForwardChargeAdviceArg	Seq.	30 (1)
ForwardChargeAdviceArg length	17	11
SS code tag	Tag=80	80
SS code length	1	01
SS code	AoC-Charging	72
Charging Information	Tag=a1	A1 (1)
Charging Information length	indefinite	80
e1 tag	Tag=81	81
e1 length	1	01
e1	Value = 10,0	64
e2 tag	Tag=82	82
e2 length	2	02
e2	Value = 40,0	01 90
e3 tag	Tag=83	83
e3 length	1	01
e3	Value = 1,0	64
End-Of-Content Tag	0	00
Length Indicator	0	00

Test 31.6.1.7. AOC on a Call Hold call

Step 11: SS -> MS CONNECT

Contents	Value/remark	Coding
CAI header element		
e1	Value = 7,0	46
e2	Value = 40,0	01 90
e3	Value = 1,0	64
e4	Value = 0,0	00
e5	Value = 0,0	00
e6	Value = 0,0	00
e7	Value = 0,0	00

Step 20: SS -> MS CONNECT

Contents	Value/remark	Coding
CAI header element		
e1	Value = 13,0	00 82
e2	Value = 40,0	01 90
e3	Value = 1,0	64
e4	Value = 0,0	00
e5	Value = 0,0	00
e6	Value = 0,0	00
e7	Value = 0,0	00

Test 31.6.1.8. AOC on a Multi-party call

Step 11 & 20: SS -> MS CONNECT

k-value	e-parameter values						
	e1	e2	e3	e4	e5	e6	e7
1	19	40	1	0	0	0	0
2	29	40	1	0	0	0	0

k-value	e-parameter coding						
	e1	e2	e3	e4	e5	e6	e7
1	00 BE	01 90	64	00	00	00	00
2	01 22	01 90	64	00	00	00	00

Step 23: MS -> SS FACILITY

Contents	Value/remark	Coding
Length of FIE contents	8	08
Component type tag	Invoke	A1 (1)
Component length	6	06
Invoke ID tag		02
Invoke ID length	1	01
Invoke ID	Arbitrary	--
Operation code tag		02
Operation code length	1	01
Operation code	BuildMPTY	7C

Step 24: SS -> MS FACILITY

Contents	Value/remark	Coding
Length of FIE contents	7	07
Component type tag	Return Result	A2 (1)
Component length	indefinite	80
Invoke ID tag		02
Invoke ID length	1	01
Invoke ID	As received	--
End-Of-Content Tag	0	00
Length Indicator	0	00

Test 31.6.2. Charge Storage**31.6.2.1 Removal of SIM during an active call****and 31.6.2.2 Interruption of power supply during an active call****and 31.6.2.3 MS going out of coverage during an active AoCC call****Step A11: SS -> MS CONNECT**

Contents	Value/remark	Coding
Length of FIE contents	39	27
Component type tag	Invoke	A1 (1)
Component length	indefinite	80
Invoke ID tag		02
Invoke ID length	1	01
Invoke ID	Arbitrary	--
Operation code tag		02
Operation code length	1	01
Operation code	forwardChargeAdvice	7D
ForwardChargeAdviceArg	Seq.	30 (1)
ForwardChargeAdviceArg length	27	1B
SS code tag	Tag=80	80
SS code length	1	01
SS code	AoC-Charging	72
Charging Information	Tag=a1	A1 (1)
Charging Information length	22	16
e1 tag	Tag=81	81
e1 length	1	01
e1	Value = 10,0	64
e2 tag	Tag=82	82
e2 length	2	02
e2	Value = 55,0	02 26
e3 tag	Tag=83	83
e3 length	1	01
e3	Value = 1,0	64
e4 tag	Tag=84	84
e4 length	1	01
e4	Value = 10,0	64
e5 tag	Tag=85	85
e5 length	1	01
e5	Value = 0,0	00
e6 tag	Tag=86	86
e6 length	1	01
e6	Value = 0,0	00
e7 tag	Tag=87	87
e7 length	1	01
e7	Value = 10,0	64
End-Of-Content Tag	0	00
Length Indicator	0	00

Test 31.6.2.4. ACMmax operation/Mobile Originating

k=1 Step A11: SS -> MS FACILITY

Contents	Value/remark	Coding
Length of FIE contents	41	29
Component type tag	Invoke	A1 (1)
Component length	indefinite	80
Invoke ID tag		02
Invoke ID length	1	01
Invoke ID	Arbitrary	--
Operation code tag		02
Operation code length	1	01
Operation code	ForwardChargeAdvice	7D
ForwardChargeAdviceArg	Seq.	30 (1)
ForwardChargeAdviceArg length	27	1B
SS code tag	Tag=80	80
SS code length	1	01
SS code	AoC-Charging	72
Charging Information	Tag=a1	A1 (1)
Charging Information length	22	16
e1 tag	Tag=81	81
e1 length	1	01
e1	Value = 1,0	0A
e2 tag	Tag=82	82
e2 length	2	02
e2	Value = 30,0	01 2C
e3 tag	Tag=83	83
e3 length	1	01
e3	Value = 1,0	64
e4 tag	Tag=84	84
e4 length	1	01
e4	Value = 0,0	00
e5 tag	Tag=85	85
e5 length	1	01
e5	Value = 0,0	00
e6 tag	Tag=86	86
e6 length	1	01
e6	Value = 0,0	00
e7 tag	Tag=87	87
e7 length	1	01
e7	Value = 0,0	00
End-Of-Content Tag	0	00
Length Indicator	0	00

k=2 Step A11: SS -> MS FACILITY

Contents	Value/remark	Coding
Length of FIE contents	40	28
Component type tag	Invoke	A1 (1)
Component length	indefinite	80
Invoke ID tag		02
Invoke ID length	1	01
Invoke ID	Arbitrary	--
Operation code tag		02
Operation code length	1	01
Operation code	ForwardChargeAdvice	7D
ForwardChargeAdviceArg	Seq.	30 (1)
ForwardChargeAdviceArg length	26	1A
SS code tag	Tag=80	80
SS code length	1	01
SS code	AoC-Charging	72
Charging Information	Tag=a1	A1 (1)
Charging Information length	21	15
e1 tag	Tag=81	81
e1 length	1	01
e1	Value = 0,0	00
e2 tag	Tag=82	82
e2 length	1	01
e2	Value = 0,0	00
e3 tag	Tag=83	83
e3 length	1	01
e3	Value = 0,0	00
e4 tag	Tag=84	84
e4 length	1	01
e4	Value = 0,0	00
e5 tag	Tag=85	85
e5 length	1	01
e5	Value = 0,0	00
e6 tag	Tag=86	86
e6 length	1	01
e6	Value = 0,0	00
e7 tag	Tag=87	87
e7 length	1	01
e7	Value = 0,0	00
End-Of-Content Tag	0	00
Length Indicator	0	00

Test 31.6.2.5 ACMmax operation/Mobile Terminating

k=1 Step A13: SS -> MS FACILITY, k=2 Step B13: SS -> MS FACILITY

Contents	Value/remark	Coding
Length of FIE contents	41	29
Component type tag	Invoke	A1 (1)
Component length	indefinite	80
Invoke ID tag		02
Invoke ID length	1	01
Invoke ID	Arbitrary	--
Operation code tag		02
Operation code length	1	01
Operation code	ForwardChargeAdvice	7D
ForwardChargeAdviceArg	Seq.	30 (1)
ForwardChargeAdviceArg length	27	1B
SS code tag	Tag=80	80
SS code length	1	01
SS code	AoC-Charging	72
Charging Information	Tag=a1	A1 (1)
Charging Information length	28	1C
e1 tag	Tag=81	81
e1 length	1	01
e1	Value = 1,0	00 0A
e2 tag	Tag=82	82
e2 length	2	02
e2	Value = 30,0	01 2C
e3 tag	Tag=83	83
e3 length	1	01
e3	Value = 1,0	64
e4 tag	Tag=84	84
e4 length	1	01
e4	Value = 0,0	00
e5 tag	Tag=85	85
e5 length	1	01
e5	Value = 0,0	00
e6 tag	Tag=86	86
e6 length	1	01
e6	Value = 0,0	00
e7 tag	Tag=87	87
e7 length	1	01
e7	Value = 0,0	00
End-Of-Content Tag	0	00
Length Indicator	0	00

k=3 Step A13: SS -> MS FACILITY

Contents	Value/remark	Coding
Length of FIE contents	40	28
Component type tag	Invoke	A1 (1)
Component length	indefinite	80
Invoke ID tag		02
Invoke ID length	1	01
Invoke ID	Arbitrary	--
Operation code tag		02
Operation code length	1	01
Operation code	ForwardChargeAdvice	7D
ForwardChargeAdviceArg	Seq.	30 (1)
ForwardChargeAdviceArg length	26	1A
SS code tag	Tag=80	80
SS code length	1	01
SS code	AoC-Charging	72
Charging Information	Tag=a1	A1 (1)
Charging Information length	21	15
e1 tag	Tag=81	81
e1 length	1	01
e1	Value = 0,0	00
e2 tag	Tag=82	82
e2 length	1	01
e2	Value = 0,0	00
e3 tag	Tag=83	83
e3 length	1	01
e3	Value = 0,0	00
e4 tag	Tag=84	84
e4 length	1	01
e4	Value = 0,0	00
e5 tag	Tag=85	85
e5 length	1	01
e5	Value = 0,0	00
e6 tag	Tag=86	86
e6 length	1	01
e6	Value = 0,0	00
e7 tag	Tag=87	87
e7 length	1	01
e7	Value = 0,0	00
End-Of-Content Tag	0	00
Length Indicator	0	00

Test 31.8.1.1. Registration of a password accepted

MMI sequence:**03*330*1234*9876*9876#

Step 6: MS -> SS REGISTER

Contents	Value/remark	Coding
Length of FIE contents	11	0B
Component type tag	Invoke	A1 (1)
Component length	9	09
Invoke ID tag		02
Invoke ID length	1	01
Invoke ID	Arbitrary	--
Operation Code tag		02
Operation Code length	1	01
Operation Code	RegisterPasswordSS	11
SS-Code tag	Tag=4	04
SS-Code length	1	01
SS-Code	B: All barring services	90

Step 7: SS -> MS FACILITY

Contents	Value/remark	Coding
Length of FIE contents	14	0E
Component type tag	Invoke	A1 (1)
Component length	12	0C
Invoke ID tag		02
Invoke ID length	1	01
Invoke ID	Arbitrary	--
Linked ID tag		80
Linked ID length	1	01
Linked ID	As received	--
Operation Code tag		02
Operation Code length	1	01
Operation Code	GetPasswordSS	12
Guidance information	Enumerated	0A
Guidance length	1	01
Guidance	enter password	00

Step 9: MS -> SS FACILITY

Contents	Value/remark	Coding
Length of FIE contents	16	10
Component type tag	Return Result	A2 (1)
Component length	14	0E
Invoke ID tag		02
Invoke ID length	1	01
Invoke ID	As received	--

Sequence tag		30 (1)
Sequence length	9	09
Operation Code tag		02
Operation Code length	1	01
Operation Code	GetPasswordSS	12
Password tag	Numeric String	12
Password length	4	04
Password	Password = 1234	31 32 33 34

Step 10 & 12: FACILITY

Contents	Value/remark	Coding
Guidance	Enter New Password	01

Contents	Value/remark	Coding
Password	Password = 9876	39 38 37 36

Step 13 & 15: FACILITY

Contents	Value/remark	Coding
Guidance	EnterNewPasswordAgain	02

Contents	Value/remark	Coding
Password	Password = 9876	39 38 37 36

Step 16: SS -> MS RELEASE COMPLETE

Contents	Value/remark	Coding
Length of FIE contents	20	14
Component type tag	Return Result	A2 (1)
Component length	indefinite	80
Invoke ID tag		02
Invoke ID length	1	01
Invoke ID	As received	--
Sequence tag		30 (1)
Sequence length	indefinite	80
Operation Code tag		02
Operation Code length	1	01
Operation Code	RegisterPasswordSS	11
Password tag	Numeric String	12
Password length	4	04
Password	Password = 1234	31 32 33 34
End-Of-Content Tag	0	00
Length Indicator	0	00
End-Of-Content Tag	0	00
Length Indicator	0	00

Test 31.8.1.2. Registration of a password rejected**MMI sequence:**03*330*1234*9876*987X#****Test 31.8.1.2.1. Rejection after invoke of the RegisterPassword operation****Step 4: MS -> SS REGISTER**

Contents	Value/remark	Coding
Length of FIE contents	11	0B
Component type tag	Invoke	A1 (1)
Component length	9	09
Invoke ID tag		02
Invoke ID length	1	01
Invoke ID	Arbitrary	--
Operation Code tag		02
Operation Code length	1	01
Operation Code	RegisterPasswordSS	11
SS-Code tag	Tag=4	04
SS-Code length	1	01
SS-Code	B: All barring services	90

Step 5: SS -> MS RELEASE COMPLETE

Contents	Value/remark	Coding
Length of FIE contents	8	08
Component type tag	Return Error	A3 (1)
Component length	6	06
Invoke ID tag		02
Invoke ID length	1	01
Invoke ID	As received	--
Error Code tag	Tag=2	02
Error Code length	1	01
Error Code	SS subscription violation	13

Test 31.8.1.2.2. Rejection after password check with negative result**Step 6: SS -> MS RELEASE COMPLETE**

Contents	Value/remark	Coding
Length of FIE contents	10	0A
Component type tag	Return Error	A3 (1)
Component length	indefinite	80
Invoke ID tag		02
Invoke ID length	1	01
Invoke ID	As received	--
Error Code tag	Tag=2	02
Error Code length	1	01
Error Code	Negative Password Check	26
End-Of-Content Tag	0	00
Length Indicator	0	00

Test 31.8.1.2.3. Rejection after new password mismatch**Step 14: SS -> MS RELEASE COMPLETE**

Contents	Value/remark	Coding
Length of FIE contents	11	0B
Component type tag	Return Error	A3 (1)
Component length	9	09
Invoke ID tag		02
Invoke ID length	1	01
Invoke ID	As received	--
Error Code tag	Tag=2	02
Error Code length	1	01
Error Code	PW-Registration Failure	25
pw-Registration Failure cause	Tag=04	04 (2)
pw-Registration Failure length	1	01
pw-Registration Failure	New Password Mismatch	02

NOTE 2: This element is described in Rec. GSM 04.80 4.3.2.12, but there is no ASN.1 description in chapter 4.5. Description given in the informative annex A should be put at the end of chapter 4.5.

Test 31.8.3.1. Activation accepted

MMI sequence: *3322#**

Step 6: MS -> SS REGISTER

Contents	Value/remark	Coding
Length of FIE contents	16	10
Component type tag	Invoke	A1 (1)
Component length	14	0E
Invoke ID tag		02
Invoke ID length	1	01
Invoke ID	Arbitrary (01)	--
Operation code tag		02
Operation code length	1	01
Operation code	ActivateSS	0C
SS-ForBS	Seq.	30 (1)
SS-ForBS length	6	06
SS code tag	Tag=04	04
SS code length	1	01
SS code	BAOC	92
Basic Service Code identifier	BearerServiceCode	82
BearerService length	1	01
BearerService code	AllSynchronousServices	68

Step 7: SS -> MS FACILITY

Contents	Value/remark	Coding
Length of FIE contents	14	0E
Component type tag	Invoke	A1 (1)
Component length	12	0C
Invoke ID tag		02
Invoke ID length	1	01
Invoke ID	Arbitrary (02)	--
Linked ID tag		80
Linked ID length	1	01
Linked ID	As received (01)	--
Operation code tag		02
Operation code length	1	01
Operation code	Getpassword	12
Guidance tag	Enumerated	0a
Guidance length	1	01
Guidance	Enter Password	00

Step 9: MS -> SS FACILITY

Contents	Value/remark	Coding
Length of FIE contents	16	10
Component type tag	Return Result	A2 (1)
Component length	14	0E
Invoke ID tag		02
Invoke ID length	1	01
Invoke ID	As received (02)	--
Sequence tag		30 (1)
Sequence length	9	09
Operation code tag		02
Operation code length	1	01
Operation code	Getpassword	12
Password tag	NumericString	12
Password length	4	04
Password	Password = 1234	31 32 33 34

Step 10: SS -> MS RELEASE COMPLETE

This message is coded to give a complete answer to the MS request. Shorter message can also be used (see last paragraph).

Contents	Value/remark	Coding
Length of FIE contents	29	1D
Component type tag	Return Result	A2 (1)
Component length	27	1B
Invoke ID tag		02
Invoke ID length	1	01
Invoke ID	As received (01)	--
Sequence tag		30 (1)
Sequence length	indefinite	80
Operation code tag		02
Operation code length	1	01
Operation code	ActivateSS	0C
SS information		
CallBarringInfo	Tag=a1	A1 (1)
CallBarringInfo length	indefinite	80
SS code tag	Tag=04	04
SS code length	1	01
SS code	BAOC	92
CallBarringFeature List	Seq.	30 (1)
Length indicator	8	08
CallBarring Feature tag	Seq.	30 (1)
CallBarring Feature length	6	06
Basic Service Code identifier	BearerServiceCode	82
BearerService length	1	01
BearerService code	AllSynchronousServices	68
SS-Status	Tag=84	84
SS-Status length	1	01
SS-Status code	Prov. Registered Active	07
End-Of-Content Tag	0	00
Length Indicator	0	00
End-Of-Content Tag	0	00
Length Indicator	0	00

MMI sequence: *351#

Step 18: MS -> SS REGISTER

Contents	Value/remark	Coding
Length of FIE contents	13	0D
Component type tag	Invoke	A1 (1)
Component length	11	0B
Invoke ID tag		02
Invoke ID length	1	01
Invoke ID	Arbitrary	--
Operation code tag		02
Operation code length	1	01
Operation code	ActivateSS	0C
SS-ForBS	Seq	30 (1)
SS-ForBS length	3	03
SS code tag	Tag=04	04
SS code length	1	01
SS code	BICRoam	9B

Step 22: SS -> MS RELEASE COMPLETE

Contents	Value/remark	Coding
Length of FIE contents	26	1A
Component type tag	Return Result	A2 (1)
Component length	24	18
Invoke ID tag		02
Invoke ID length	1	01
Invoke ID	As received	--
Sequence identifier		30 (1)
Sequence length	19	13
Operation code tag		02
Operation code length	1	01
Operation code	ActivateSS	0C
SS-Information		
CallBarringInfo	Tag=a1	A1 (1)
CallBarringInfo length	14	0E
SS code tag	Tag=04	04
SS code length	1	01
SS code	BICRoam	9B
CallBarringFeature List	Seq.	30 (1)
Length indicator	indefinite	80
CallBarring Feature tag	Seq.	30 (1)
CallBarring Feature length	indefinite	80
SS-Status	Tag=84	84
SS-Status length	1	01
SS-Status code	Prov. Registered Active	07
End-Of-Content Tag	0	00
Length Indicator	0	00
End-Of-Content Tag	0	00
Length Indicator	0	00

Step 10 & 22: short messages

Step 11 and 24 messages can be coded using this shorter form:

Message containing only the "Return result"

Contents	Value/remark	Coding
Length of FIE contents	5	05
Component type tag	Return Result	A2 (1)
Component length	3	03
Invoke ID tag		02
Invoke ID length	1	01
Invoke ID	As received	--

Message containing the "Return result" and the "Operation Code"

Contents	Value/remark	Coding
Length of FIE contents	12	0C
Component type tag	Return Result	A2 (1)
Component length	indefinite	80
Invoke ID tag		02
Invoke ID length	1	01
Invoke ID	As received	--
Sequence identifier		30 (1)
Sequence length	3	03
Operation code tag		02
Operation code length	1	01
Operation code	ActivateSS	0C
End-Of-Content Tag	0	00
Length Indicator	0	00

Test 31.8.3.2.1. Rejection after invoke of ActivateSS operation

MMI sequence: *331#

Step 4: MS -> SS REGISTER

Contents	Value/remark	Coding
Length of FIE contents	13	0D
Component type tag	Invoke	A1 (1)
Component length	11	0B
Invoke ID tag		02
Invoke ID length	1	01
Invoke ID	Arbitrary	--
Operation code tag		02
Operation code length	1	01
Operation code	ActivateSS	0C
SS-ForBS	Seq	30 (1)
SS-ForBS length	3	03
SS code tag	Tag=04	04
SS code length	1	01
SS code	BOIC	93

Step 5: SS -> MS RELEASE COMPLETE

Contents	Value/remark	Coding
Length of FIE contents	8	08
Component type tag	Return Error	A3 (1)
Component length	6	06
Invoke ID tag		02
Invoke ID length	1	01
Invoke ID	As received	--
Error code tag		02
Error code length	1	01
Error code	SS Subscription Violation	13

Test 31.8.3.2.2. Rejection after use of password procedure

MMI sequence: *35#

Step 4: MS -> SS REGISTER

Contents	Value/remark	Coding
Length of FIE contents	13	0D
Component type tag	Invoke	A1 (1)
Component length	11	0B
Invoke ID tag		02
Invoke ID length	1	01
Invoke ID	Arbitrary	--
Operation code tag		02
Operation code length	1	01
Operation code	ActivateSS	0C
SS-ForBS	Seq	30 (1)
SS-ForBS length	3	03
SS code tag	Tag=04	04
SS code length	1	01
SS code	BAIC	9A

Step 8: SS -> MS RELEASE COMPLETE

Contents	Value/remark	Coding
Length of FIE contents	10	0A
Component type tag	Return Error	A3 (1)
Component length	indefinite	80
Invoke ID tag		02
Invoke ID length	1	01
Invoke ID	As received	--
Error code tag		02
Error code length	1	01
Error code	NegativePasswordCheck	26
End-Of-Content Tag	0	00
Length Indicator	0	00

Test 31.8.4.1. Deactivation accepted

MMI sequence: *330**11#

Step 6: MS -> SS REGISTER

Contents	Value/remark	Coding
Length of FIE contents	16	10
Component type tag	Invoke	A1 (1)
Component length	14	0D
Invoke ID tag		02
Invoke ID length	1	01
Invoke ID	Arbitrary	--
Operation code tag		02
Operation code length	1	01
Operation code	DeactivateSS	0D
SS-ForBS	Seq	30 (1)
SS-ForBS length	3	03
SS code tag	Tag=04	04
SS code length	1	01
SS code	B: All barring services	90
Basic Service Code identifier	TeleserviceCode	83
Teleservice length	1	01
Teleservice code	AllSpeechTransmission	10

Step 10: SS -> MS RELEASE COMPLETE

Contents	Value/remark	Coding
Length of FIE contents	21	15
Component type tag	Return Result	A2 (1)
Component length	indefinite	80
Invoke ID tag		02
Invoke ID length	1	01
Invoke ID	As received	--
Sequence identifier		30 (1)
Sequence length	12	0C
Operation code tag		02
Operation code length	1	01
Operation code	DeactivateSS	0D
SS-Information		
CallBarringInfo	Tag=a1	A1 (1)
CallBarringInfo length	7	07
CallBarringFeature List	Seq.	30 (1)
Length indicator	5	05
CallBarring Feature tag	Seq.	30 (1)
CallBarring Feature length	3	03
Basic Service Code Identifier	TeleserviceCode	83
Teleservice Length	1	01
Teleservice code	AllSpeechTransmission	10
End-Of-Content Tag	0	00
Length Indicator	0	00

MMI sequence: #333**13#

Step 17: MS -> SS REGISTER

Contents	Value/remark	Coding
Length of FIE contents	16	10
Component type tag	Invoke	A1 (1)
Component length	14	0E
Invoke ID tag		02
Invoke ID length	1	01
Invoke ID	Arbitrary	--
Operation code tag		02
Operation code length	1	01
Operation code	DeactivateSS	0D
SS-ForBS	Seq	30 (1)
SS-ForBS length	6	06
SS code tag	Tag=04	04
SS code length	1	01
SS code	BO	91
Basic Service Code identifier	TeleserviceCode	83
Teleservice length	1	01
Teleservice code	AllFacsimileServices	60

Step 21: MS -> SS RELEASE COMPLETE

Contents	Value/remark	Coding
Length of FIE contents	21	15
Component type tag	Return Result	A2 (1)
Component length	indefinite	80
Invoke ID tag		02
Invoke ID length	1	01
Invoke ID	As received	--
Sequence identifier		30 (1)
Sequence length	12	0C
Operation code tag		02
Operation code length	1	01
Operation code	DeactivateSS	0D
SS-Information		
CallBarringInfo	Tag=a1	A1 (1)
CallBarringInfo length	7	07
CallBarringFeature List	Seq.	30 (1)
Length indicator	5	05
CallBarring Feature tag	Seq.	30 (1)
CallBarring Feature length	3	03
Basic Service Code Identifier	TeleserviceCode	83
Teleservice Length	1	01
Teleservice code	AllFacsimileServices	60
End-Of-Content Tag	0	00
Length Indicator	0	00

Test 31.8.4.2.1. Deactivation rejected after invoke operation

MMI sequence: *#353#

Step 4: MS -> SS REGISTER

Contents	Value/remark	Coding
Length of FIE contents	13	0D
Component type tag	Invoke	A1 (1)
Component length	11	0B
Invoke ID tag		02
Invoke ID length	1	01
Invoke ID	Arbitrary	--
Operation code tag		02
Operation code length	1	01
Operation code	DeactivateSS	0D
SS-ForBS	Seq	30 (1)
SS-ForBS length	3	03
SS code tag	Tag=04	04
SS code length	1	01
SS code	BI	99

Step 5: SS -> MS RELEASE COMPLETE

Contents	Value/remark	Coding
Length of FIE contents	10	0A
Component type tag	Return Error	A3 (1)
Component length	indefinite	80
Invoke ID tag		02
Invoke ID length	1	01
Invoke ID	As received	--
Error code tag		02
Error code length	1	01
Error code	SS Subscription Violation	13
End-Of-Content Tag	0	00
Length Indicator	0	00

Test 31.8.4.2.2. Deactivation rejection after password operation

MMI sequence: *#332#

Step 4: MS -> SS REGISTER

Contents	Value/remark	Coding
Length of FIE contents	13	0D
Component type tag	Invoke	A1 (1)
Component length	11	0B
Invoke ID tag		02
Invoke ID length	1	01
Invoke ID	Arbitrary	--
Operation code tag		02
Operation code length	1	01
Operation code	DeactivateSS	0D
SS-ForBS	Seq	30 (1)
SS-ForBS length	3	03
SS code tag	Tag=04	04
SS code length	1	01
SS code	BOICExHome	94

Step 7: SS -> MS RELEASE COMPLETE

Contents	Value/remark	Coding
Length of FIE contents	8	08
Component type tag	Return Error	A3 (1)
Component length	6	06
Invoke ID tag		02
Invoke ID length	1	01
Invoke ID	As received	--
Error code tag		02
Error code length	1	01
Error code	NegativePasswordCheck	26

Test 31.8.6.1. Interrogation accepted

MMI sequence: *#35#

Step 6: MS -> SS REGISTER

Contents	Value/remark	Coding
Length of FIE contents	13	0D
Component type tag	Invoke	A1 (1)
Component length	11	0B
Invoke ID tag		02
Invoke ID length	1	01
Invoke ID	Arbitrary	--
Operation code tag		02
Operation code length	1	01
Operation code	InterrogateSS	0E
SS-ForBS	Seq	30 (1)
SS-ForBS length	3	03
SS code tag	Tag=04	04
SS code length	1	01
SS code	BAIC	9A

Step 10: SS -> MS RELEASE COMPLETE

Contents	Value/remark	Coding
Length of FIE Contents	15	0F
Component type tag	Return Result	A2
Component length	13	0D
Invoke ID tag		02
Invoke ID length	1	01
Invoke ID	As received	--
Sequence tag		30
Sequence length	8	08
Operation Code tag		02
Operation Code length	1	01
Operation Code	InterrogateSS	0E
InterrogateSS-Res	Choice	
BasicServiceGroupList tag	Seq.	A2
BasicServiceGroupList length	3	03
BasicService Code identifier	TeleserviceCode	83
Teleservice length	1	01
Teleservice code	Telephony	11

MMI sequence: *#332#

Step 17: MS -> SS REGISTER

Contents	Value/remark	Coding
Length of FIE Contents	13	0D
Component type tag	Invoke	A1
Component length	11	0B
Invoke ID tag		02
Invoke ID length	1	01
Invoke ID	Arbitrary	--
Operation Code tag		02
Operation Code length	1	01
Operation Code	InterrogateSS	0E
SS-ForBS	Seq	30
SS-ForBS length	3	03
SS-Code tag	Tag=4	04
SS-Code length	1	01
SS-Code	BOICExHome	94

Step 21: SS -> MS RELEASE COMPLETE

Contents	Value/remark	Coding
Length of FIE Contents	13	0D
Component type tag	Return Result	A2
Component length	11	0B
Invoke ID tag		02
Invoke ID length	1	01
Invoke ID	As received	--
Sequence tag		30
Sequence length	6	06
Operation Code tag		02
Operation Code length	1	01
Operation Code	InterrogateSS	0E
InterrogateSS-Res	Choice	
SS-Status	Tag=80	80
SS-Status length	1	01
SS-Status	Prov., Registered, Active	07

Test 31.8.6.2. Interrogation rejected

MMI sequence: *#351#

Step 4: MS -> SS REGISTER

Contents	Value/remark	Coding
Length of FIE Contents	13	0D
Component type tag	Invoke	A1
Component length	11	0B
Invoke ID tag		02
Invoke ID length	1	01
Invoke ID	Arbitrary	--
Operation Code tag		02
Operation Code length	1	01
Operation Code	InterrogateSS	0E
SS-ForBS	Seq	30
SS-ForBS length	3	03
SS-Code tag	Tag=4	04
SS-Code length	1	01
SS-Code	BICRoam	9B

Step 5: SS -> MS RELEASE COMPLETE

Contents	Value/remark	Coding
Length of FIE Contents	10	0A
Component type tag	Return Error	A3
Component length	indefinite	80
Invoke ID tag		02
Invoke ID length	1	01
Invoke ID	As received	--
Error code tag		02
Error code length	1	01
Error code	SS_NotAvailable	12
End-Of-Content Tag	0	00
Length Indicator	0	00

MMI sequence: *#331#

Step 11: MS -> SS REGISTER

Contents	Value/remark	Coding
Length of FIE Contents	13	0D
Component type tag	Invoke	A1
Component length	11	0B
Invoke ID tag		02
Invoke ID length	1	01
Invoke ID	Arbitrary	--
Operation Code tag		02
Operation Code length	1	01
Operation Code	InterrogateSS	0E
SS-ForBS	Seq	30
SS-ForBS length	3	03
SS-Code tag	Tag=4	04
SS-Code length	1	01
SS-Code	BOIC	93

Step 12: SS -> MS RELEASE COMPLETE

Contents	Value/remark	Coding
Length of FIE Contents	8	08
Component type tag	Reject	A4
Component length	6	06
Invoke ID tag		02
Invoke ID length	1	01
Invoke ID	As received	--
Problem code tag	Tag=81	81
Problem code length	1	01
Invoke problem code	Resource limitation	03

Test 31.8.7. Normal operation

Incoming call

Step 6: MS -> SS RELEASE COMPLETE

Contents	Value/remark	Coding
Length of FIE contents	16	10
Component type tag	Invoke	A1 (1)
Component length	14	0E
Invoke ID tag		02
Invoke ID length	1	01
Invoke ID	Arbitrary	--
Operation code tag		02
Operation code length	1	01
Operation code	NotifySS	10
NotifySS-Arg tag	Seq.	30 (1)
NotifySS-Arg length	6	06
SS code tag	Tag=81	81
SS code length	1	01
SS code	BI	99
SS-Status	Tag=84	84
SS-Status length	1	01
SS-Status code	Prov. Registered Active	07

Test 31.9. Registration accepted of a USSD

MMI sequence: **00#

Contents	Value/remark	Coding
Length of FIE contents	15	0F
Component type tag	Invoke	A1 (1)
Component length	13	0D
Invoke ID tag		02
Invoke ID length	1	01
Invoke ID	Arbitrary	--
Operation Code tag		02
Operation Code length	1	01
Operation Code	ProcessUSSDSS	0A
IA5 String tag	Tag=16	16
IA5 String length	5	05
Content	**00#	2A 2A 30 30 23

32 Testing of speech transcoding functions

The test sequences for speech transcoding and DTX tests, both for input and required output, are defined in GSM 06.10, section 5, and GSM 06.32, section 4 for the full rate speech codec. For the half rate speech codec the test sequences are defined in GSM 06.20, section 5 and GSM 06.42 section 7. They are available on floppy disks in IBM/AT MS-DOS format from ETSI publications department.

The Digital Audio Interface (DAI) is described in 36.4.

NOTE: For a definition of the term "traffic frame" used in this chapter, refer to GSM 06.32 and GSM 06.42.

32.1 Full Rate Downlink speech transcoding

32.1.1 Definition and applicability

Downlink speech transcoding transforms the 13 kbit/s net bit stream obtained by channel decoding the incoming bit stream from the air interface to 13 bit linear PCM.

The requirements and this test apply to all MS supporting TCH/FS.

32.1.2 Conformance requirement

The output bit stream from the speech transcoder shall be continuous and bit by bit exactly the same as the predefined output sequence (SEQ01.OUT, SEQ03.OUT, SEQ04.OUT and SEQ05.OUT).

GSM 06.01, 2; GSM 06.10, 5.2/5.2.2.

32.1.3 Test purpose

To verify that the speech transcoding of the MS can transform all predefined sequences (SEQ01.OUT, SEQ03.OUT, SEQ04.OUT and SEQ05.OUT) at 13 kbits/s level to 104 kbit/s (13 bit linear PCM at 8 kHz) level correctly.

32.1.4 Method of test

32.1.4.1 Initial conditions

DTX is off.

The DAI of the MS is connected to the SS and is set to the operating mode "Test of speech decoder/DTX functions (downlink)".

32.1.4.2 Procedure

- a) The SS resets the speech decoder of the MS via the DAI.
- b) The SS sends test sequence SEQ01.COD at 13 kbit/s to the MS via the air interface after passing it through the SS channel encoder.

NOTE: These test sequence files contain 16 bit words for all speech encoded parameters and are justified as described in GSM 06.10 table 5.1. 76 words are used as input in a period of 20 ms.

- c) The SS records the 104 kbit/s output bit stream from the MS on the digital audio interface.
- d) The test is repeated using the test sequences SEQ03.COD, SEQ04.COD and SEQ05.COD.

32.1.5 Test requirements

The bit stream output shall be continuous and bit by bit exactly the same as the sequence given in the files SEQ01.OUT, SEQ03.OUT, SEQ04.OUT and SEQ05.OUT.

NOTE: These files contain 16 bit words of 13 bit linear PCM left justified.

32.2 Full Rate Downlink receiver DTX functions

32.2.1 Definition and applicability

The DTX receiver functions consist of a SID frame detector, comfort noise generator functions and lost frame substitution and muting functions.

The requirements and this test apply to all MS supporting TCH/FS.

32.2.2 Conformance requirement

- 1) The output level of the decoder has to be constant for an input signal consisting of identical speech frames.

GSM 06.10.

- 2/3) When, after the first lost speech frame subsequent speech frames are lost, a muting technique shall be used that will gradually decrease the output level, resulting in the silencing of the output after a maximum of 320 ms. Speech frames with the FACCH flag set provoke a Bad Frame Indication (BFI = 1) and are hence regarded as lost speech frames.

GSM 06.01, 6; GSM 06.11, 2.1/2.2/3 for requirement 2 (first part).

GSM 06.01, 6; GSM 06.11, 2.1/2.2/3; GSM 06.31, 1.2.2/3.1.1 for requirement 3 (second part).

- 4/5) A valid SID-frame followed by a sequence of lost speech frames shall result in comfort noise generation with constant block amplitude parameters. Speech frames with the FACCH flag set provoke a Bad Frame Indication (BFI = 1) and are hence regarded as lost speech frames.

GSM 06.01, 3/5; GSM 06.12, 3/3.1;
GSM 06.31, 1.2.2/3.1/3.1.1/3.1.2 for requirement 4 (first part).

GSM 06.01, 3/5/6; GSM 06.11, 2.1/2.2; GSM 06.12, 3/3.1;
GSM 06.31, 1.2.2/3.1/3.1.1/3.1.2 for requirement 5 (second part).

- 6/7) An invalid SID-frame followed by a sequence of lost speech frames shall result in comfort noise generation, using the set of parameters from the last valid SID-frame. Speech frames with the FACCH flag set provoke a Bad Frame Indication (BFI = 1) and are hence regarded as lost speech frames.

GSM 06.01, 3/5; GSM 06.12, 3/3.1;
GSM 06.31, 1.2.2/3.1/3.1.1/3.1.2 for requirement 6 (first part).

GSM 06.01, 3/5/6; GSM 06.11, 2.1/2.2; GSM 06.12, 3/3.1;
GSM 06.31, 1.2.2/3.1/3.1.1/3.1.2 for requirement 7 (second part).

- 8) The energy of the output signal is controlled by the block amplitude parameter, x_{maxc} .

GSM 06.10, 3.1.20/3.1.21/3.2.1;

- 9/10) The first SID-frame that is expected and not received shall be substituted by the last valid SID-frame and the procedure for valid SID-frames shall be applied. For the second lost SID-frame, a muting technique shall be used that will gradually decrease the output level, resulting in silencing the output after a maximum of 320 ms. Speech frames with the FACCH flag set provoke a Bad Frame Indication (BFI = 1) and are hence regarded as lost speech frames.

GSM 05.08, 8.3; GSM 06.01, 6; GSM 06.11, 2.3/2.4;
GSM 06.31, 1.2.2/3.1.1/3.1.2.

32.2.3 Test purpose

- 1) To verify that the signal energy at the output of the decoder is constant with a tolerance of +/- 3 dB if a sequence of identical speech frames is applied at the receiver input.
- 2) To verify that the muting function of the receiver is within the required limits if a sequence of lost speech frames is applied at the receiver input.
- 3) To verify that the muting function of the receiver is within the required limits if a sequence of speech frames with the FACCH flag set is applied at the receiver input.
- 4) To verify the function of comfort noise generation when a valid SID-frame is received followed by a sequence of lost speech frames. The signal energy at the output of the decoder shall be constant with a tolerance of +/- 3 dB.
- 5) To verify the function of comfort noise generation when a valid SID-frame is received followed by a sequence of speech frames with the FACCH flag set. The signal energy at the output of the decoder shall be constant with a tolerance of +/- 3 dB.
- 6) To verify the function of comfort noise generation when an invalid SID-frame is received followed by a sequence of lost speech frames. The signal energy at the output of the decoder shall be constant with a tolerance of +/- 3 dB.
- 7) To verify the function of comfort noise generation when an invalid SID-frame is received followed by a sequence of speech frames with the FACCH flag set. The signal energy at the output of the decoder shall be constant with a tolerance of +/- 3 dB.
- 8) To verify that the signal energy at the output of the decoder depends on the block amplitude x_{maxc} of the input frames if a sequence of speech frames is applied to the decoder. The signal energy at the output of the decoder shall be constant with a tolerance of +/- 3 dB.
- 9) To verify the SID-frame substitution and muting functions on the comfort noise, if two consecutive expected SID-frames are lost with the other frames being lost speech frames.
- 10) To verify the SID-frame substitution and muting functions on the comfort noise, if two consecutive expected SID-frames are lost with the other frames being speech frames with the FACCH flag set.

32.2.4 Method of test

32.2.4.1 Initial conditions

Uplink DTX is off.

The DAI of the MS is connected to the SS and is set to the operating mode "Test of speech decoder/DTX functions (downlink)".

32.2.4.2 Procedure

- a) The SS transmits coded "speech" traffic frames on the air interface after passing them through the SS channel encoder. They contain a special test signal at 13 kbit/s as defined below. All traffic frames are identical with the exception of some frames which are SID frames as defined in GSM 06.32.
- b) The energy of the PCM signal is evaluated (as a mean square average) at the digital audio interface of the MS at 104 kbit/s level (13 bit, 8 kHz linear PCM) and recorded for each block of 20 ms synchronized to the 20 ms speech frame structure.
- c) The SS transmission of the TDMA frames of the TCH/FS on the air interface is ramped "on" and "off" on a traffic frame by traffic frame basis, taking into account the block diagonal interleaving scheme defined in GSM 05.03. The first traffic frame in step 1 occurs one frame after the window of the SACCH multiframe (TDMA frame 60 modulo 104), allocated for the SID frame (see GSM 05.02 and GSM 05.08). The SACCH will also be transmitted.

NOTE 1: 8 timeslots in 8 consecutive TCH/FS TDMA frames are seen as one traffic frame, and the next traffic frame starts in the middle of the previous one (i.e. after 4 TDMA frames of the previous one) due to the block diagonal interleaving scheme defined in GSM 05.03.

- d) The special test frame is an encoded "speech" traffic frame of 260 bits obtained from white Gaussian noise band limited to 300 - 3 400 Hz. When repeated, the special test frame results in a humming sound with a fairly constant level when decoded, and is defined in table 32-1.

Table 32-1: Table of special test traffic frame for receiver DTX tests

Encoded parameter:	Value:			
LARc(1)	38			
LARc(2)	42			
LARc(3)	24			
LARc(4)	20			
LARc(5)	10			
LARc(6)	9			
LARc(7)	5			
LARc(8)	3			
	Sub-block no:			
	0	1	2	3
Grid position (Mc)	1	3	2	0
Block amplitude (xmaxc)	40	40	40	40
LTP gain (Bc)	0	0	0	0
LTP lag (Nc)	40	120	40	120
RPE pulses (xmc)				
- pulse no 1	4	6	6	6
- pulse no 2	4	5	4	3
- pulse no 3	2	1	3	4
- pulse no 4	6	2	1	3
- pulse no 5	3	6	4	1
- pulse no 6	5	1	6	3
- pulse no 7	5	2	5	5
- pulse no 8	5	6	2	1
- pulse no 9	1	3	4	4
- pulse no 10	3	2	4	3
- pulse no 11	5	5	4	5
- pulse no 12	6	1	2	2
- pulse no 13	1	3	4	3

NOTE 2: The signal energy of the decoded special test frame is controlled with the block amplitude parameter (xmaxc). Reducing xmaxc from 40 to 32 reduces the signal energy by 6 dB, and reducing xmaxc from 40 to 24 reduces the signal energy by 12 dB.

- e) The sequence of traffic frames on the air interface is as follows:
- e.1) 23 test frames "on".
 - e.2) 20 frames "off".
 - e.3) 20 test frames "on".
 - e.4) 1 SID frame followed by 6 frames "off", another identical SID frame and 23 frames "off". Except for the SID codeword, the SID frames are identical to the test frame.
 - e.5) 1 different SID frame, however with 2 to 15 errors inserted in the SID codeword, followed by 23 frames "off".
 - e.6) 20 test frames "on", but with the block amplitude parameter xmaxc = 24.

- e.7) 1 SID frame followed by 50 frames "off". Except for the SID codeword, the SID frames are identical to the test frame.
- e.8) The whole test is repeated, but the frames "off" are replaced by frames "on" with the FACCH flag set.

32.2.5 Test requirements

- 1) In step e.1), the signal energy shall be fairly constant within +/- 3 dB.
- 2) In step e.2), the signal energy shall decrease to less than -60 dBm within 17 frames.
- 3) In step e.4), comfort noise shall be generated. The same requirements as in step e.1) apply.
- 4) In step e.5), the same requirements as in step e.4) apply.
- 5) In step e.6), the same requirements as in step e.1) apply. However, the signal energy shall be 12 dB lower.
- 6) In step e.7), the signal energy shall be fairly constant within +/- 3 dB for 28 frames. Then the signal energy shall decrease to less than -60 dBm within 16 frames.
- 7) In step e.8), the same requirements as in all previous steps apply.

32.3 Full Rate Uplink speech transcoding

32.3.1 Definition and applicability

Uplink speech transcoding transforms 13 bit linear PCM to the 13 kbit/s net bit stream. This net bit stream is to be channel encoded for transmission on the air interface.

The requirements and this test apply to all MS supporting TCH/FS.

32.3.2 Conformance requirement

The output bit stream from the speech transcoder shall be bit by bit exactly the same as the predefined output sequence (SEQ01.OUT, SEQ02.OUT, SEQ03.OUT and SEQ04.OUT).

GSM 06.01, 2; GSM 06.10, 5.2/5.2.1.

32.3.3 Test purpose

To verify that the speech transcoder on the MS can transform all predefined sequences (SEQ01.INP, SEQ02.INP, SEQ03.INP and SEQ04.INP) at 104 kbit/s (13 bit linear PCM at 8 kHz) level to 13 kbit/s level correctly.

32.3.4 Method of test

32.3.4.1 Initial conditions

Uplink DTX is off.

The DAI of the MS is connected to the SS and is set to the operating mode "Test of speech encoder/DTX functions (uplink)".

32.3.4.2 Procedure

- a) The SS resets the speech decoder on the MS (see 36.4).
- b) The SS sends a test sequence SEQ01.INP to the MS at 104 kbit/s level via the digital audio interface.

NOTE: These files contain 16 bit words for 13 bit linear PCM left justified. See also GSM 06.10 table 5.1.

- c) The SS records the 13 kbit/s output bit stream obtained by channel decoding the incoming bit stream from the air interface.
- d) The test is repeated using the test sequences SEQ02.INP, SEQ03.INP and SEQ04.INP.

32.3.5 Test requirements

The bit stream output shall be bit by bit exactly the same as the sequence given in the files SEQ01.COD, SEQ02.COD, SEQ03.COD and SEQ04.COD.

NOTE: These files contain 16 bit words of all the 76 parameters in a speech frame justified as in GSM 06.10 table 5.1. 76 codewords shall occur in a frame of 20 ms.

32.4 Full Rate Uplink transmitter DTX functions

32.4.1 Definition and applicability

The VAD/DTX transmitter functions consist of a Voice Activity Detector (VAD) and a surrounding Discontinuous Transmission (DTX) system introducing additional "speech" traffic frames on the air interface compared to those the VAD itself would classify as speech frames containing real speech. The additional traffic frames on the air are introduced due to:

- 1) A "hangover" period at the end of speech bursts in order to be certain that the traffic frames contain only noise and to evaluate the background acoustic noise characteristics when no real speech is present.
- 2) Special traffic frames (SID frames) added on the air at regular intervals containing only the evaluated background acoustic noise characteristics. These frames are used for generation of comfort noise in speaker silence periods on the receiving side.

The requirements and this test apply to all MS supporting TCH/FS.

32.4.2 Conformance requirement

The MS VAD and DTX function allows only those frames to be transmitted that are either marked with SP = 1 or that are properly positioned SID-frames.

GSM 05.08, 8.3; GSM 06.01, 3/4; GSM 06.31, 2.1/2.1.1/2.1.2; GSM 06.32, 1/2/2.1/2.2.8.

32.4.3 Test purpose

To verify that the combination of VAD and DTX operates correctly.

32.4.4 Method of test

32.4.4.1 Initial conditions

A call is set up on a TCH/FS according to the generic call set-up procedure.

Uplink DTX is on.

The DAI of the MS is connected to the SS and is set to the operating mode "Test of speech encoder/DTX functions (uplink)".

32.4.4.2 Procedure.

- a) The SS sends a test sequence SPEC_A1.INP of PCM samples, which are grouped into frames of 20 ms synchronized to the TDMA and traffic frame structure on the air interface, on the digital audio interface in the MS at 104 kbits/s (13 bit, 8 kHz linear PCM).

The start of the test sequences is synchronized with the radio transmission on the air interface so that the first traffic frame on the air occurs just after the traffic frame allocated for the SID frame (TDMA frame 56 modulo 104, see GSM 05.02 and GSM 05.08).

NOTE: 8 timeslots in 8 consecutive TCH/FS TDMA frames are seen as one traffic frame and the next traffic frame starts in the middle of the previous one (i.e. after 4 TDMA frames of the previous one) due to the block diagonal interleaving scheme defined in GSM 05.03.

- b) The SS detects whether or not there is any power transmitted over the radio path on a timeslot basis excluding SACCH frames. The speech frame by speech frame on/off transmission (on = 1) is recorded.
- c) The test is repeated for all test sequences *.INP described in GSM 06.32 section 4.

32.4.5 Test requirements

- 1) In step b), the traffic frame on/off sequence recorded shall be bit exact like the sequence of SP flags stored as bit 15 of LAR(2) on the respective reference files *.COD described in GSM 06.32, with the following exceptions:
 - 1.1) The occurrence of a SID frame in its allowed window within the SACCH multiframe as defined in GSM 05.08.
 - 1.2) The occurrence of a SID frame after 1 or more real speech frames consecutively transmitted on the air.

32.5 Full Rate Speech channel transmission delay

32.5.1 Definition and applicability

The total transmission delay within the various elements of a GSM system are specified as round trip delays. For the MS this would be equivalent to applying an RF equivalent of a speech signal to the MS receiver, closing an acoustic path from the ERP to the MRP, detecting the corresponding RF signal at the MS transmitter output and measuring the time interval between the signal originally fed to the MS receiver and that transmitted by the MS transmitter.

This simple approach cannot be demonstrated to be accurate due to the inherent non linear characteristic of the speech transcoder. The overall delay therefore is split into four identifiable and measurable delays. The delays are respectively:

- the downlink delay from RF input to DAI output,
- DAI output to ERP,
- MRP to DAI output, and
- DAI to uplink RF output.

Each delay is defined and its method of test described in the following sections.

The requirements and this test apply to all MS supporting TCH/FS.

32.5.2 Conformance requirement

The overall speech channel transmission delay shall be less than 143,9 ms.

GSM 03.50, section 3.3.6.1.

32.5.3 Test purpose

To verify that the round trip delay, of a speech channel for a MS, which consists of the sum of:

- the downlink delay from RF input to DAI output,
- DAI output to ERP,
- MRP to DAI output, and

- DAI to uplink RF output

meets the requirements when using the predefined test sequences SEQ01.COD, SEQ03.COD, SEQ04.COD and SEQ05.COD.

32.5.4 Downlink processing delay

32.5.4.1 Definition and applicability

The downlink processing delay is the delay from the first bit of a speech block transmitted from the RF output of the SS up to the last bit of the corresponding speech block received at the DAI on the output of the speech transcoder.

The requirements and this test apply to all MS supporting TCH/FS.

32.5.4.2 Method of test

32.5.4.2.1 Initial conditions

DTX is off.

The DAI of the MS is connected to the SS and is set to the operating mode "Test of speech decoder/DTX functions (downlink)".

32.5.4.2.2 Procedure

- a) The test set up is that described in 32.1 for downlink speech transcoding.
- b) The SS transmits one of the test patterns SEQ01.COD, SEQ03.COD, SEQ04.COD or SEQ05.COD to the MS.
- c) The SS measures for each speech block it transmits the time between the first bit at the air interface and the last bit of that speech block on the DAI. This difference is the delay measured.
- d) Step c) is repeated 20 times and the maximum delay measured in ms is the downlink processing delay TDP.

NOTE: This is to account for the fact that the processing time may not be constant.

32.5.5 Downlink coding delay

32.5.5.1 Definition and applicability

The downlink coding delay is defined as the delay between the digital representation of an acoustic signal on the DAI and the corresponding acoustic signal at the ERP.

The requirements and this test apply to all MS supporting TCH/FS.

32.5.5.2 Method of test

32.5.5.2.1 Initial conditions

The DAI of the MS is connected to the SS and is set to the operating mode "Test of acoustic devices and A/D & D/A".

The handset is mounted in the LRGP (see annex 1 of CCITT recommendation P.76) and the earpiece is sealed to the knife edge of the artificial ear conforming to CCITT recommendation P.51.

32.5.5.2.2 Procedure

- a) The SS generates on the DAI a digital representation of a sine wave with a frequency of 1 000 Hz.

- b) The SS measures the "phase shift" \varnothing_1 , in the range of 0 to 360 degrees, between the equivalent sine wave generated at the DAI and the sine wave at the input to the artificial ear.
- c) The frequency is increased to 1100 Hz and the resulting phase shift \varnothing_2 noted.
- d) The downlink coding delay TDC is calculated from either:

$$\text{TDC} = (\varnothing_2 - \varnothing_1)/36 \text{ ms} \quad \text{for } \varnothing_2 > \varnothing_1$$

or

$$\text{TDC} = (\varnothing_2 + 360 - \varnothing_1)/36 \text{ ms} \quad \text{for } \varnothing_2 < \varnothing_1$$

32.5.6 Uplink processing delay

32.5.6.1 Definition and applicability

The uplink processing delay is the delay from the first bit of a speech block on the DAI to the last bit of that speech block being transmitted on the air interface of the MS.

The requirements and this test apply to all MS supporting TCH/FS.

32.5.6.2 Method of test

32.5.6.2.1 Initial conditions

The DAI of the MS is connected to the SS and is set to the operating mode "Test of speech encoder/DTX functions (uplink)".

32.5.6.2.2 Procedure

- a) The test set up is that described in 32.3 for uplink speech transcoding.
- b) The SS sends one of the test patterns SEQ01.INP, SEQ03.INP, SEQ04.INP or SEQ05.INP to the DAI of the MS.
- c) The SS measures the time between the first bit on the DAI, and the last transmitted bit of the block at the air interface for each speech block the SS sends on the DAI. This time difference is the delay measured.
- d) Step c) is repeated 20 times. The maximum delay measured in ms is the uplink coding delay TUP.

NOTE: This is to account for the fact that the processing time may not be constant.

32.5.7 Uplink coding delay

32.5.7.1 Definition and applicability

The uplink coding delay is defined as the delay between an acoustic signal at the MRP and the digital representation of that signal on the DAI.

The requirements and this test apply to all MS supporting TCH/FS.

32.5.7.2 Method of test

32.5.7.2.1 Initial conditions

The DAI of the MS is connected to the SS and is set to the operating mode "Test of acoustic devices and A/D & D/A".

The handset is mounted in the LRGP (see annex 1 of CCITT recommendation P.76) and the earpiece is sealed to the knife edge of the artificial ear conforming to CCITT recommendation P.51.

32.5.7.2.2 Procedure

- a) The SS generates an acoustic signal at the artificial mouth of the LRGP, being a pure sine wave with a frequency of 1 000 Hz.
- b) The SS measures the "phase shift" \varnothing_1 , in the range of 0 to 360 degrees, between the signal at the MRP and its digital representation on the DAI.
- c) The SS set the generated frequency to 1 100 Hz and measures the resulting phase shift \varnothing_2 .
- d) The uplink coding delay TUC is calculated from either:

$$TUC = (\varnothing_2 - \varnothing_1)/36 \text{ ms} \quad \text{for } \varnothing_2 > \varnothing_1$$

or

$$TUC = (\varnothing_2 + 360 - \varnothing_1)/36 \text{ ms} \quad \text{for } \varnothing_2 < \varnothing_1$$

32.5.8 Test requirement

The sum of the delays {TDP + TDC + TUP + TUC} shall be less than 144,9 ms.

NOTE 1: This limit includes an allowance of 4*0,25 ms delay from the DAI to the MS transmission path.

NOTE 2: No allowances have been made for any delays within the measurement system. These must either be calibrated out or subtracted from the individual delays before performing the sum above.

32.6 Half Rate Downlink speech transcoding

32.6.1 Definition and applicability

Downlink speech transcoding transforms the 5,6 kbit/s net bit stream obtained by channel decoding the incoming bit stream from the air interface to 104 kbit/s (13 bit linear PCM at 8 kHz) level.

The requirements and this test apply to all MS supporting TCH/HS.

32.6.2 Conformance requirement:

The output bit stream from the speech transcoder shall be continuous and bit by bit exactly the same as the predefined output sequences contained in SEQ01.OUT, SEQ02.OUT, SEQ03.OUT and SEQ04.OUT.

GSM 06.02, 5; GSM 06.20.

32.6.3 Test purpose:

To verify that the speech transcoder of the MS can transform all the predefined sequences (SEQ01.DEC, SEQ02.DEC, SEQ03.DEC and SEQ04.DEC) at 5,6 kbit/s level to 104 kbit/s (13 bit linear PCM at 8 kHz) level correctly.

32.6.4 Method of test

32.6.4.1 Initial conditions

Uplink DTX is off.

The DAI of the MS is connected to the SS and is set to the operating mode "Test of speech decoder/DTX functions (downlink)".

Frequency hopping is on, where the BCCH carrier is part of the hopping sequence. Frequency hopping shall be performed over four carriers using random frequency hopping. Downlink power control shall be activated and a difference of 30 dB between the level of the BCCH carrier and the other carriers adjusted.

NOTE: Frequency hopping is used to ensure that the MS can cope with the reception of bursts (on the BCCH carrier) that have a power level that is different from the rest of the bursts.

32.6.4.2 Procedure

- a) The SS sends a reset pulse to the MS on the digital audio interface. This reset pulse will start the clock output of the MS at 104 kHz (pin 24 of the DAI).
- b) The SS sends test sequence SEQ01.DEC at 5,6 kbit/s to the MS via the air interface after passing it through the SS channel encoder. The speech decoder of the MS is reset by the special reset sequence which is at the beginning of the test sequence.
- c) The SS records the 104 kbit/s output bit stream from the MS on the digital audio interface. The recording shall be triggered by the reception of the encoder homing frame. The encoder homing frame itself shall not be recorded.
- d) The test is repeated using test sequences SEQ02.DEC, SEQ03.DEC and SEQ04.DEC.

32.6.5 Test requirement

The bit stream output shall be continuous and bit by bit exactly the same as the sequence describing the speech data contained in the files SEQ01.OUT, SEQ02.OUT, SEQ03.OUT and SEQ04.OUT. The two encoder homing frames at the beginning of each test sequence *.OUT shall be disregarded for this comparison.

32.7 Half Rate Downlink receiver DTX functions

32.7.1 Definition and applicability

The DTX receiver functions consist of a SID frame detector, comfort noise generator functions and lost frame substitution and muting functions.

The requirements and this test apply to all MS supporting TCH/HS.

32.7.2 Conformance requirement

The output bit stream from the speech transcoder shall be continuous and bit by bit exactly the same as the predefined output sequences contained in DTX*.OUT described in GSM 06.07 subclause 7.

GSM 06.02, 6/8; GSM 06.22; GSM 06.41.

32.7.3 Test purpose

To verify that the MS generates comfort noise correctly.

32.7.4 Method of test

32.7.4.1 Initial conditions

The DAI of the MS is connected to the SS and is set to the operating mode "Test of speech decoder/DTX functions (downlink)".

Frequency Hopping is on, where the BCCH carrier is part of the hopping sequence. Frequency Hopping shall be done over four carriers using random Frequency Hopping.

NOTE: Frequency Hopping is used to ensure that the MS can cope with the reception of dummy bursts (on the BCCH frequency) during DTX.

32.7.4.2 Procedure

- a) The SS sends a reset pulse to the MS on the digital audio interface. This reset pulse will start the clock output of the MS at 104 kHz (pin 24 of the DAI).
- b) The SS sends test sequence DTX01.DEC at 5,6 kbit/s to the MS via the air interface after passing it through the SS channel encoder. The speech decoder of the MS will be reset by the special reset sequence which is at the beginning of the test sequence.
- c) The SS transmission of the TDMA frames of the TCH/HS on the air interface is ramped "on" and "off" on a traffic frame by traffic frame basis, taking into account the block diagonal interleaving scheme defined in GSM 05.03. The first traffic frame in step b occurs one frame after the window of the SACCH multiframe (TDMA frame 0 or 52 modulo 104 for subchannel 0 and TDMA frame 1 or 53 modulo 104 for subchannel 1), allocated for the SID frame (see GSM 05.02 and GSM 05.08). The SACCH will also be transmitted.
- d) The information whether to ramp the transmitter of the SS "on" or "off" is derived from the sequence of SP-flags contained in the file DTX01.COD (see file format description in GSM 06.07 subclause 5 for the position of the SP-flag).
- e) The SS records the 104 kbit/s output bit stream from the MS on the digital audio interface. The recording shall be triggered by the reception of the encoder homing frame. The encoder homing frame itself is not recorded.
- f) The test is repeated using test sequences *.DEC described in GSM 06.07 subclause 7.

32.7.5 Test requirement

The bit stream output shall be continuous and bit by bit exactly the same as the sequence describing the speech data contained in the files DTX*.OUT described in GSM 06.07 subclause 7. The two encoder homing frames at the beginning of each test sequence *.OUT shall be disregarded for this comparison.

32.8 Half Rate Uplink speech transcoding

32.8.1 Definition and applicability

Uplink speech transcoding transforms 104 kbit/s (13 bit linear PCM at 8 kHz) level to the 5,6 kbit/s net bit stream. This net bit stream is to be channel encoded for transmission on the air interface.

The requirements and this test applies to all MS supporting TCH/HS.

32.8.2 Conformance requirement

The output bit stream from the speech transcoder shall be bit by bit exactly the same as the predefined sequences contained in SEQ01.COD, SEQ02.COD and SEQ03.COD described in GSM 06.07 subclause 6.

GSM 06.02, 5; GSM 06.20.

32.8.3 Test purpose

To verify that the speech transcoder of the MS can transform all the predefined sequences SEQ01.INP, SEQ02.INP and SEQ03.INP at 104 kbit/s (13 bit linear PCM at 8 kHz) level to 5,6 kbit/s level correctly.

32.8.4 Method of test

32.8.4.1 Initial conditions

Uplink DTX is off.

The DAI of the MS is connected to the SS and is set to the operating mode "Test of speech encoder/DTX functions (uplink)".

Frequency hopping is on.

32.8.4.2 Procedure

- a) The SS sends a reset pulse to the MS on the digital audio interface. This reset pulse will start the clock output of the MS at 104 kHz (pin 24 of the DAI).
- b) The SS synchronizes the input of the test sequences via the digital audio interface to the framing of the MS in the uplink. This can be done in two steps as follows:
 - b.1) The SS sends to the MS at 104 kbit/s level via the digital audio interface 13 triplets of input frames, each triplet consisting of 480 samples. The 480 samples of one triplet shall all be identical. The 13 bits of one sample shall all be set to "zero" except for one which is set to "one". The position of the bit within the 13 bits of a sample that is set to "one" shall vary in such a way, that all possible 13 positions are exercised within the 13 triplets of input frames. An example for such a sequence is given in test sequence BITSYNC.INP described in GSM 06.07 subclause 8. The SS records the 5,6 kbit/s output bit stream obtained by channel decoding the incoming bit stream from the air interface. As soon as the decoder homing frame is detected at the output, the framing of the MS with respect to the 13 bit long input words is known by looking at the corresponding input frame that has caused the decoder homing frame at the output.

NOTE: The encoder homing frame consists of 160 identical samples, each 13 bit long left justified, with the least significant bit set to "one" and all other bits set to "zero" (0008 hex). The speech encoder will go to its predefined home state at the end of the first received encoder homing frame. Consecutive encoder homing frames will produce the decoder homing frame at the output of the speech encoder.

- b.2) Synchronized to the 13 bit framing of the MS, the SS now sends test sequence SEQSYNC.INP described in GSM 06.07 subclause 8 to the MS at 104 kbit/s level via the digital audio interface. The SS records the 5,6 kbit/s output bit stream obtained by channel decoding the incoming bit stream from the air interface. The recording shall be triggered by the reception of the decoder homing frame. By comparing the first recorded frame that is not a decoder homing frame with the 160 possible output frames contained in sequences SYNC*.COD, the offset of the input to the 20 ms framing of the MS is known.
- c) Synchronized to the 20 ms framing of the MS, the SS sends a test sequence SEQ01.INP to the MS at 104 kbit/s level via the digital audio interface. The speech encoder of the MS is reset by the special homing sequence which is at the beginning of the test sequence.
- d) The SS records the 5,6 kbit/s output bit stream obtained by channel decoding the incoming bit stream from the air interface. The recording shall be triggered by the reception of the decoder homing frame. The decoder homing frame itself is not recorded.
- e) The test is repeated using test sequences SEQ02.INP and SEQ03.INP.

32.8.5 Test requirements

The bit stream output shall be bit by bit exactly the same as the sequences describing the speech parameters contained in the files SEQ01.COD, SEQ02.COD and SEQ03.COD. The two decoder homing frames at the beginning of each test sequence *.COD shall be disregarded for this comparison.

32.9 Half Rate Uplink transmitter DTX functions

32.9.1 Definition and applicability

The VAD/DTX transmitter functions consist of a Voice Activity Detector (VAD) that inhibits the transmitter during speech pauses, and a surrounding Discontinuous Transmission (DTX) system introducing Silence Descriptor (SID) frames on the air interface.

The requirements and this test apply to all MS supporting TCH/HS.

32.9.2 Conformance requirement

The MS VAD and DTX function allow only those frames to be transmitted that are either properly positioned SID-frames, SACCH-frames or frames marked with SP-flag = 1.

For the transmitted frames, the output bit stream from the speech transcoder shall be bit by bit exactly the same as the predefined sequences contained in DTX*.COD described in GSM 06.07 subclause 6.

GSM 05.08, 8.3; GSM 06.02, 6/7; GSM 06.41; GSM 06.42.

32.9.3 Test purpose

To verify that the combination of VAD and DTX operates correctly.

32.9.4 Method of test

32.9.4.1 Initial conditions

Uplink DTX is on.

The DAI of the MS is connected to the SS and is set to the operating mode "Test of speech encoder/DTX functions (uplink)".

Frequency Hopping is on.

32.9.4.2 Procedure

- a) The SS sends a reset pulse to the MS on the digital audio interface. This reset pulse will start the clock output of the MS at 104 kHz (pin 24 of the DAI).
- b) The SS synchronizes the input of the test sequences via the digital audio interface to the framing of the MS in the uplink. This can be done in two steps as follows:
 - b.1) The SS sends to the MS at 104 kbit/s level via the digital audio interface 13 triplets of input frames, each triplet consisting of 480 samples. The 480 samples of one triplet shall all be identical. The 13 bits of one sample shall all be set to "zero" except for one which is set to "one". The position of the bit within the 13 bits of a sample that is set to "one" shall vary in such a way, that all possible 13 positions are exercised within the 13 triplets of input frames. An example for such a sequence is given in test sequence BITSYNC.INP described in GSM 06.07 subclause 8. The SS records the 5,6 kbit/s output bit stream obtained by channel decoding the incoming bit stream from the air interface. As soon as the decoder homing frame is detected at the output, the framing of the MS with respect to the 13 bit long input words is known by looking at the corresponding input frame that has caused the decoder homing frame at the output.

NOTE: The encoder homing frame consists of 160 identical samples, each 13 bit long left justified, with the least significant bit set to "one" and all other bits set to "zero" (0008 hex). The speech encoder will go to its predefined home state at the end of the first received encoder homing frame. Consecutive encoder homing frames will produce the decoder homing frame at the output of the speech encoder.

- b.2) Synchronized to the 13 bit framing of the MS, the SS now sends test sequence SEQSYNC.INP described in GSM 06.07 subclause 8 to the MS at 104 kbit/s level via the digital audio interface. The SS records the 5,6 kbit/s output bit stream obtained by channel decoding the incoming bit stream from the air interface. The recording shall be triggered by the reception of the decoder homing frame. By comparing the first recorded frame that is not a decoder homing frame with the 160 possible output frames contained in sequences SYNC*.COD, the offset of the input to the 20 ms framing of the MS is known.
- c) The SS sends test sequence DTX01.INP of PCM samples described in GSM 06.07 subclause 7 on the digital audio interface in the MS at 104 kbit/s (13 bit linear PCM at 8 kHz). The speech encoder of the MS will be reset by the special homing sequence which is at the beginning of the test sequence.

- d) The start of the test sequence is synchronized with the radio transmission on the air interface so that the first traffic frame on the air caused by the first encoder homing frame in the test sequence occurs just after the traffic frame allocated for the SID frame (TDMA frame 0 or 52 modulo 104 for subchannel 0 and TDMA frame 1 or 53 modulo 104 for subchannel 1), allocated for the SID frame (see GSM 05.02 and GSM 05.08).
- e) The SS detects whether or not there is any power transmitted over the radio path on a time slot basis excluding SACCH frames. The speech frame by speech frame on/off transmission (on = 1) is calculated and recorded. The recording shall be triggered by the reception of the decoder homing frame. The flag marking the decoder homing frame itself is not recorded.
- f) The SS records the 5,6 kbit/s output bit stream obtained by channel decoding the incoming bit stream from the air interface. The recording shall be triggered by the reception of the decoder homing frame. The decoder homing frame itself is not recorded.
- g) The test is repeated for all test sequences DTX*.INP described in GSM 06.07 subclause 7.

32.9.5 Test requirements

- 1) The bit stream recorded in step e) shall be continuous and bit by bit exactly the same as the sequence of SP-flags contained in the files DTX*.COD (see file format description in GSM 06.07 subclause 5 for the position of the SP-flag), except for the bits marking those frames that are SID frames scheduled for transmission according to GSM 06.41. The first two frames in the reference files *.COD shall be disregarded for this comparison.
- 2) The bit stream recorded in step f) shall be continuous and bit by bit exactly the same as the sequence describing the speech parameters contained in the files *.COD described in GSM 06.07 subclause 7, except for the bits of the speech frames marked with SP-flag=0. The two decoder homing frames at the beginning of each test sequence *.COD shall be disregarded for this comparison.

32.10 Half Rate Speech channel transmission delay

32.10.1 Definition and applicability

The total transmission delay within the various elements of a GSM system are specified as round trip delays. For the MS this would be equivalent to applying an RF equivalent of a speech signal to the MS receiver, closing an acoustic path from the ERP to the MRP, detecting the corresponding RF signal at the MS transmitter output and measuring the time interval between the signal originally fed to the MS receiver and that transmitted by the MS transmitter.

This simple approach cannot be demonstrated to be accurate due to the inherent non linear characteristic of the speech transcoder. The overall delay therefore is split into four identifiable and measurable delays. The delays are respectively:

- the downlink delay from RF input to DAI output,
- DAI output to ERP,
- MRP to DAI output, and
- DAI to uplink RF output.

Each delay is defined and its method of test described in the following sections.

The requirements and this test applies to all MS supporting TCH/HS.

32.10.2 Conformance requirement

The overall speech channel transmission delay shall be less than 143,9 ms.

GSM 03.50 section 3.3.6.2.

32.10.3 Test purpose

To verify that the round trip delay of a speech channel for a MS which consists of the sum of:

- the downlink delay from RF input to DAI output,
- DAI output to ERP,
- MRP to DAI output, and
- DAI to uplink RF output

meets the requirements when using the predefined test sequences SEQ01.INP and SEQ01.DEC.

32.10.4 Downlink processing delay

32.10.4.1 Definition and applicability

The downlink processing delay is the delay from the first bit of a speech block transmitted from the RF output of the SS up to the last bit of the corresponding speech block received at the DAI on the output of the speech transcoder.

The requirements and this test apply to all MS supporting TCH/HS.

32.10.4.2 Method of test

32.10.4.2.1 Initial conditions

The DAI of the MS is connected to the SS and is set to the operating mode "Test of speech decoder/DTX functions (downlink)".

32.10.4.2.2 Procedure

- a) The test set up is that described in section 32.6.4.2 for downlink speech transcoding.
- b) The SS transmits the test pattern SEQ01.DEC described in GSM 06.07 subclause 6 to the MS.
- c) The SS measures for each speech block it transmits the time between the first bit at the air interface and the last bit of that speech block on the DAI. This time difference is the delay measured.
- d) Step c) is repeated 20 times and the maximum delay measured in ms is the downlink processing delay TDP.

NOTE: This is to account for the fact that the processing time may not be constant.

32.10.5 Downlink coding delay

32.10.5.1 Definition and applicability

The downlink coding delay is defined as the delay between the digital representation of an acoustic signal on the DAI and the corresponding acoustic signal at the ERP.

The requirements and this test applies to all MS supporting TCH/HS.

32.10.5.2 Method of test

32.10.5.2.1 Initial conditions

The DAI of the MS is connected to the SS and is set to the operating mode "Test of acoustic devices and A/D & D/A".

The handset is mounted in the LRGP (see annex 1 of CCITT recommendation P.76) and the earpiece is sealed to the knife edge of the artificial ear conforming to CCITT recommendation P.51.

32.10.5.2.2 Procedure

- a) The SS generates on the DAI a digital representation of a sine wave with a frequency of 1 000 Hz.

- b) The SS measures the "phase shift" \varnothing_1 , in the range of 0 to 360 degrees, between the equivalent sine wave generated at the DAI and the sine wave at the input to the artificial ear.
- c) The frequency is increased to 1 100 Hz and the resulting phase shift \varnothing_2 noted.
- d) The downlink coding delay TDC is calculated from either:

$$\text{TDC} = (\varnothing_2 - \varnothing_1) \text{ ms}/36 \text{ for } \varnothing_2 > \varnothing_1$$

or

$$\text{TDC} = (\varnothing_2 + 360 - \varnothing_1) \text{ ms}/36 \text{ for } \varnothing_2 < \varnothing_1$$

32.10.6 Uplink processing delay

32.10.6.1 Definition and applicability

The uplink processing delay is the delay from the first bit of a speech block on the DAI to the last bit of that speech block being transmitted on the air interface of the MS.

The requirements and this test apply to all MS supporting TCH/HS.

32.10.6.2 Method of test

32.10.6.2.1 Initial conditions

The DAI of the MS is connected to the SS and is set to the operating mode "Test of speech encoder/DTX functions (uplink)".

32.10.6.2.2 Procedure

- a) The test set up is that described in section 32.8.4.2 for uplink speech transcoding.
- b) The SS sends one of the test patterns SEQ01.INP described in GSM 06.07 subclause 6 to the DAI of the MS.
- c) The SS measures the time between the first bit on the DAI, and the last transmitted bit of the block at the air interface for each speech block the SS sends on the DAI. This time difference is the delay measured.
- d) Step c) is repeated 20 times. The maximum delay measured in ms is the uplink coding delay TUP.

NOTE: This is to account for the fact that the processing time may not be constant.

32.10.7 Uplink coding delay

32.10.7.1 Definition and applicability

The uplink coding delay is defined as the delay between an acoustic signal at the MRP and the digital representation of that signal on the DAI.

The requirements and this test applies to all MS supporting TCH/HS.

32.10.7.2 Method of test

32.10.7.2.1 Initial conditions

The handset is mounted in the LRGP (see annex 1 of CCITT recommendation P.76) and the earpiece is sealed to the knife edge of the artificial ear conforming to CCITT recommendation P.51.

32.10.7.2.2 Procedure

- a) The SS generates an acoustic signal at the artificial mouth of the LRGP, being a pure sine wave with a frequency of 1 000 Hz.
- b) The SS measures the "phase shift" \varnothing_1 , in the range of 0 to 360 degrees, between the signal at the MRP and its digital representation on the DAI.
- c) The SS sets the generated frequency to 1 100 Hz, and measures the resulting phase shift \varnothing_2 .
- d) The uplink coding delay TUC is calculated from either:

$$\text{TDC} = (\varnothing_2 - \varnothing_1) \text{ ms}/36 \text{ for } \varnothing_2 > \varnothing_1$$

or

$$\text{TDC} = (\varnothing_2 + 360 - \varnothing_1) \text{ ms}/36 \text{ for } \varnothing_2 < \varnothing_1$$

32.10.8 Test requirement

The sum of the delays TDP, TDC, TUP, and TUC shall be less than 144,9 ms.

NOTE: This limit includes an allowance of 4*0,25 ms delay from the DAI to the MS transmission path.

32.11 Intra cell channel change from a TCH/HS to a TCH/FS**32.11.1 Definition and applicability**

Dual rate MSs support an intra cell channel change from a TCH/HS to a TCH/FS by switching the Speech and channel codec used from HR to FR.

The requirements and this test apply to all MS supporting TCH/HS.

32.11.2 Conformance requirement:

- 1) When commanded to perform an intra cell channel change from a TCH/HS to a TCH/FS, the MS shall switch channels from HR to FR. The maximum time allowed for the MS to perform this switch in rates is 20 ms.

GSM 05.10, section 6.8.

- 2) For an intra cell channel change, the time between the end of the last complete speech frame sent on the old channel and the time the MS is ready to transmit on the new channel shall be less than 20 ms.

GSM 05.10, section 6.8.

32.11.3 Test purpose:

- 1) To verify that the MS encodes speech correctly after performing an intra cell channel change from a TCH/HS to a TCH/FS.
- 2) To verify that the MS, when commanded to perform an intracell channel change to a new ARFCN and/or timeslot number within the same cell, if the starting time is not used in the ASSIGNMENT COMMAND, is ready to transmit on the new channel within 20 ms of the last complete speech frame sent on the old channel.

32.11.4 Method of test**32.11.4.1 Initial conditions**

Uplink DTX is off.

The SS sets up a call according to the generic call set up procedure on a HR channel in the low ARFCN range on timeslot 1.

32.11.4.2 Procedure

- a) The SS records the sequence of BFI flags obtained by channel decoding the incoming bit stream from the uplink air interface using the HR channel decoder on the old channel and at the same time records the sequence of BFI flags obtained by channel decoding the incoming bit stream from the uplink air interface using the FR channel decoder on the channel to which the channel change will take place.
- b) The SS sends an ASSIGNMENT COMMAND to the MS allocating a FR channel in the high ARFCN range on timeslot 2, and with a power command of 7. These old and new carriers have a relative frequency tolerance of 0, and a relative timing tolerance of 1/4 bit.
- c) The time at which the sequence of BFI flags at the output of the HR channel decoder performs the first transition from 0 to 1 is registered (t_1).
- d) The time values at which the sequence of BFI flags at the output of the FR channel decoder performs transitions from 1 to 0 are registered. The time t_2 is defined as the time where the BFI flag at the output of the FR channel decoder toggles from 1 to 0 due to a correctly received speech traffic frame received at the channel decoder. Transitions due to the occurrence of an ASSIGNMENT COMPLETE frame or an SABM frame after the reception of good speech frames shall not be considered. If the first frame sent on the new traffic channel was an SABM frame, t_2 is defined as the time the BFI flag toggles from 1 to 0 due to a correctly received speech traffic frame after the reception of the SABM frame.

NOTE: There shall be an allowance of at maximum two transitions for this BFI flag from 0 to 1 and back to zero again after t_2 . These transitions are caused by the SABM frame if it was not the first frame to be sent on the new TCH, or the ASSIGNMENT COMPLETE frame, or both. Since both frames are FACCH frames, each would cause exactly one BFI=1 indications.

- e) The time difference $Dt = t_2 - t_1$ shall be calculated.

32.11.5 Test requirement

- 1) The last transition of the BFI flag at the output of the FR channel decoder from 1 to 0 shall be followed by a sequence of at least 50 zeroes, interrupted by at maximum two transitions to 1, each interruption containing exactly one BFI=1 flag, caused by the SABM or the ASSIGNMENT COMPLETE frames.
- 2) The calculated time difference Dt shall not exceed 13 TDMA frames. If the first frame sent on the new channel was an SABM frame, the calculated time difference Dt shall not exceed 17 TDMA frames.

NOTE: The BFI of the old channel will toggle from 0 to 1 only four frames after the reception of the last bit of the speech frame sent on the old channel. The time between the last bit of the last complete speech frame sent on the old channel and the time the MS is ready to transmit on the new channel shall be less than 20 ms (5.10, section 6.8). This time will expire 4 frames and 3 timeslots after the sending of the last bit of the last complete speech frame on the old channel, i.e. the MS may not be able to transmit in the corresponding timeslot in the current frame, but must wait approx. 4 frames until the next allowed frame (FN mod 13 = 0, 4 or 8) is reached. The next frame could be an idle frame, so the MS must wait for another frame. This equates to 5 frames, after which the MS is able to start transmission on the new channel. Additionally, 8 frames will be needed due to interleaving until the last bit of the first speech frame on the new channel is received and the BFI flag toggles from 1 to 0. This makes a total of 13 frames or 60 ms between the frame number when the BFI toggles from 0 to 1 on the old channel and the frame number when the BFI toggles from 1 to 0 on the new channel. See diagram below. If SABM is the first frame received on the new channel, 4 more frames are allowed, i.e. 17 frames or 78,5 ms.

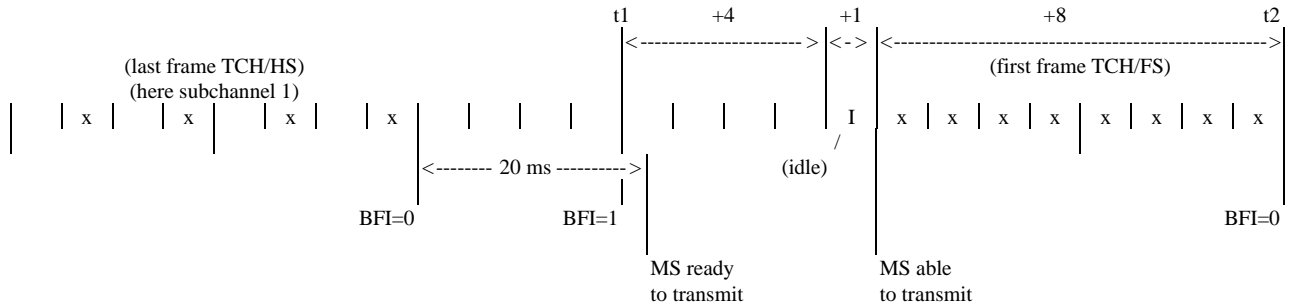

32.12 Intra cell channel change from a TCH/FS to a TCH/HS

32.12.1 Definition and applicability

Dual rate MSs support an intra cell channel change from a TCH/FS to a TCH/HS by switching the Speech and channel codec used from FR to HR.

The requirements and this test apply to all MS supporting TCH/HS.

32.12.2 Conformance requirement:

- 1) When commanded to perform an intra cell channel change from a TCH/FS to a TCH/HS, the MS shall switch channels from FR to HR.

GSM 05.10 section 6.8.

- 2) For an intra cell channel change, the time between the end of the last complete speech frame sent on the old channel and the time the MS is ready to transmit on the new channel shall be less than 20 ms.

GSM 05.10, section 6.8.

32.12.3 Test purpose:

- 1) To verify that the MS encodes speech correctly after performing an intra cell channel change from a TCH/FS to a TCH/HS.
- 2) To verify that the MS, when commanded to perform an intra cell channel change to a new ARFCN and/or new timeslot number within the same cell, if the starting time is not used in the ASSIGNMENT COMMAND, is ready to transmit on the new channel within 20 ms of the last complete speech frame sent on an old channel.

32.12.4 Method of test**32.12.4.1 Initial conditions**

Uplink DTX is off.

The SS sets up a call according to the generic call set up procedure on a FR channel in the low ARFCN range on timeslot 1.

32.12.4.2 Procedure

- a) The SS records the sequence of BFI flags obtained by channel decoding the incoming bit stream from the uplink air interface using the FR channel decoder on the old channel and at the same time the sequence of BFI flags obtained by channel decoding the incoming bit stream from the uplink air interface using the HR channel decoder on the channel to which the channel change will take place.
- b) The SS sends an ASSIGNMENT COMMAND to the MS allocating a HR channel in the high ARFCN range on timeslot 2, and with a power command of 7. These old and new carriers have a relative frequency tolerance of 0, and a relative timing tolerance of 1/4 bit.
- c) The time at which the sequence of BFI flags at the output of the FR channel decoder performs the first transition from 0 to 1 is registered (t_1).
- d) The time values at which the sequence of BFI flags at the output of the HR channel decoder performs transitions from 1 to 0 are registered. The time t_2 is defined as the time where the BFI flag at the output of the FR channel decoder toggles from 1 to 0 due to a correctly encoded speech traffic frame received at the channel decoder. Transitions due to the occurrence of an ASSIGNMENT COMPLETE frame or and SABM frame after the reception of good speech frames shall not be considered. If the first frame sent on the new traffic channel was an SABM frame, t_2 is defined as the time the BFI flag toggles from 1 to 0 due to a correctly received speech traffic frame after the reception of the SABM frame.

NOTE: There shall be an allowance of at maximum two transitions for this BFI flag from 0 to 1 and back to zero again after t_2 . These transitions are caused by the SABM frame if it was not the first frame to be sent on the new TCH, or the ASSIGNMENT COMPLETE frame, or both. Since both frames are FACCH frames, each would cause exactly two BFI=1 indications.

- e) The time difference $Dt = t_2 - t_1$ shall be calculated.

32.12.5 Test requirement

- 1) The last transition of the BFI flag at the output of the HR channel decoder from 1 to 0 shall be followed by a sequence of at least 50 zeroes, interrupted by at maximum two transitions to 1, each interruption containing exactly two BFI=1 flags, caused by the SABM or the ASSIGNMENT COMPLETE frames.
- 2) The calculated time difference Dt shall not exceed 12 TDMA frames. if the first frame sent on the new channel was an SABM frame, the calculated time difference Dt shall not exceed 20 TDMA frames.

NOTE: The BFI of the old channel will toggle from 0 to 1 only 4 frames after the reception of the last bit of the last speech frame sent on the old channel. The BFI on the old channel will toggle from 0 to 1 only four frames after the reception of the last bit of the last complete speech frame sent on the old channel.

The time between the last bit of the last complete speech frame sent on the old channel and the time the MS is ready to transmit on the new channel shall be less than 20 ms (5.10, section 6.8). This time will expire 4 frames and 3 timeslots after the sending of the last bit of the last complete speech frame on the old channel, i.e. the MS may not be able to transmit in the corresponding new timeslot in its current frame, but must wait approx. 4 frames until the next allowed frame ($FN \bmod 13 = 0, 4 \text{ or } 8$) is reached.

The next frame could be an idle frame, so the MS must wait for another frame. This equates to 5 frames, after which the MS is able to start transmission on the new channel.

Additionally, 7 frames will be needed due to interleaving until the last bit of the first speech frame on the new channel is received and the BFI flag toggles from 1 to 0.

This makes a total of 12 frames or 55,4 ms between the frame number when the BFI toggles from 0 to 1 on the old channel and the frame number when the BFI toggles from 1 to 0 on the new channel. See diagram below.

If SABM is the first frame received on the new channel, 8 more frames are allowed, i.e. 20 frames or 92,3 ms.

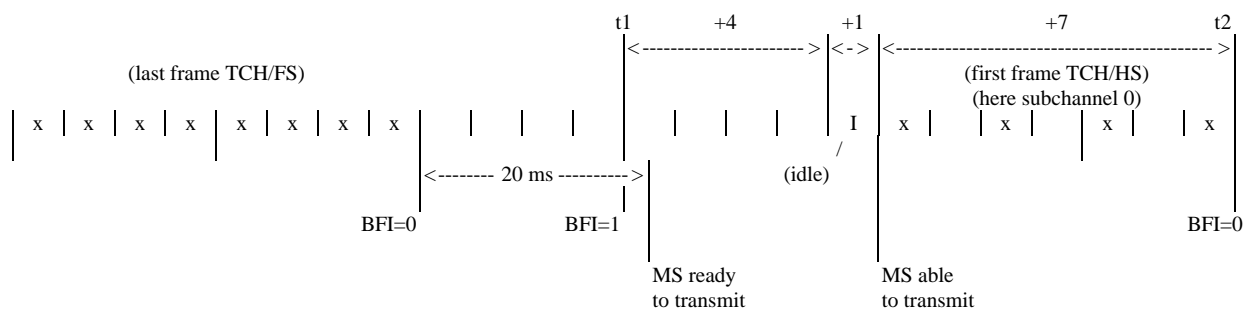

33 Mobile station features

GSM 02.07 defines mandatory and optional MS features. Their presence and appropriate functioning are verified by the following tests.

33.1 Entry and display of called number

33.1.1 Definition and applicability

The entry and display of a called number is the ability of a MS to correctly display and signal to the network the user required number.

The requirements and this test apply to all MS.

33.1.2 Conformance requirement

- 1) The number of the called subscriber is included in the Called party BCD number Information element of the SETUP message for an outgoing call.

The "Display of Called number" shall be implemented in an MS where a human interface is provided.

- 2) The "Numbering plan identification" is included in the Called party BCD number Information element of the SETUP message for an outgoing call.

An MS with MMI shall as default use the Numbering Plan Identification CCITT E164, unless otherwise indicated by the user.

- 3) The "Type of number" is included in the Called party BCD number Information element of the SETUP message for an outgoing call.

An MS with MMI shall, if the "+" is not entered, and a number is entered, set the Type of Number to "unknown".

- 4) The "Type of number" is included in the Called party BCD number Information element of the SETUP message for an outgoing call.

An MS with MMI shall, if the "+" is entered, and a number is entered, set the Type of Number to "International".

33.1.3 Test purpose

- 1) To verify that an MS with human interface, in a SETUP message sent to originate a call, includes the same "Number digits" in the "Called party BCD number" of the SETUP message as displayed.
- 2) To verify that an MS with MMI, when made to establish a call sends a SETUP message, which includes the "Numbering plan identification" in the "Called party BCD number" of the SETUP message for an outgoing call with the value "ISDN/telephony numbering plan (E.164/E.163)".
- 3) To verify that an MS with MMI, when made to establish a call without use of the "+-key" function, sends a SETUP message, which includes the "Type of number" in the "Called party BCD number" of the SETUP message for an outgoing call with the value "unknown".
- 4) To verify that an MS with MMI, implementing the "+-key" function, when made to establish a call with use of the "+-key" function, sends a SETUP message, which includes the "Type of number" in the "Called party BCD number" of the SETUP message for an outgoing call with the value "international number".

33.1.4 Method of test**33.1.4.1 Initial conditions**

The MS is registered in a cell of the SS.

33.1.4.2 Procedure

- a) A number (not including "+ function") is entered and then a call is set up.
- b) After the SS has accepted the call the number displayed on the MS and the number received in the SS are compared.
- c) The NPI and TON are examined in the SS.
- d) Steps a) to c) are repeated, but in a), the number entered starts with the "+ function".

NOTE 1: This test may also be performed automatically using the EMMI.

33.1.5 Test requirements

- 1) In step b), both numbers shall be identical.
- 2) In step c), the NPI shall be "E164" and the TON shall be "unknown".
- 3) In step d), the NPI shall be "E164" and the TON shall be "international".

33.2 Indication of call progress signals**33.2.1 Definition and applicability****33.2.2 Conformance requirement****33.2.3 Test purpose****33.2.4 Ringing tone****33.2.4.1 Method of test**

- a) According to section "Structured procedures, Mobile originating call, early assignment, Method of test", paragraphs a) to j).

33.2.4.2 Requirements

- 1) According to section "Structured procedures, Mobile originating call, early assignment, Requirements", paragraphs 1) to 7).
- 2) The ringing tone characteristics shall be as follows:

Tone	Frequency	Tolerance	Type
Ringing tone	425 Hz	15 Hz	Periodic tone on 1 s, silence 4 s

33.2.5 Busy tone**33.2.5.1 Method of test**

- a) According to section "Structured procedures, Mobile originating call, early assignment, Method of test", paragraphs a) to h).

- b) The SS then sends message DISCONNECT with cause number 17.

Message: DISCONNECT	(GSM 04.08, 9.3.7) to the MS:
<u>Information element</u>	<u>Comment</u>
Protocol discriminator	CM
Transaction identifier	MS orig.
Message type	
Cause	
- Coding standard	GSM
- Location	User
- Cause value	#17 "user busy"

33.2.5.2 Requirements

- 1) According to section "Structured procedures, Mobile originating call, early assignment, Requirements", paragraphs 1) to 5).
- 2) After the reception of DISCONNECT a busy tone shall be generated. The busy tone characteristics shall be as follows:

Tone	Frequency	Tolerance	Type
Busy tone	425 Hz	15 Hz	Periodic tone on 500 ms, silence 500 ms

33.2.6 Congestion tone

33.2.6.1 Method of test

- a) According to section "Structured procedures, Mobile originating call, early assignment, Method of test", paragraphs a) to h).
- b) The SS then sends message DISCONNECT with cause number 42.

DISCONNECT message: As in 33.2.3.1 with cause value #42 "Switching equipment congestion" (0101010).

33.2.6.2 Requirements

- 1) According to section "Structured procedures, Mobile originating call, early assignment, Requirements", paragraphs 1) to 5).
- 2) After the reception of DISCONNECT a congestion tone shall be generated.
- 3) The congestion tone characteristics shall be as follows:

Tone	Frequency	Tolerance	Type
Congestion tone	425 Hz	15 Hz	Periodic tone on 200 ms, silence 200 ms

33.2.7 Authentication failure tone

33.2.7.1 Method of test

- a) According to section "Structured procedures, Mobile originating call, early assignment, Method of test", paragraphs a) to e).
- b) After reception of message AUTHENTICATION RESPONSE the SS sends message AUTHENTICATION REJECT.

Message: AUTHENTICATION REJECT	(GSM 04.08, 9.2.1) to the MS:
<u>Information element</u>	<u>Comment</u>
Protocol discriminator	MM
Transaction identifier	not relevant
Message type	

33.2.7.2 Requirements

- 1) According to section "Structured procedures, Mobile originating call, early assignment, Requirements", paragraphs 1) to 4).
- 2) After reception of AUTHENTICATION REJECT a tone shall be generated indicating authentication failure.
- 3) The authentication failure tone is the error/special information tone with characteristics as follows:

Tone	Frequency	Tolerance	Type
Error/Special	950 Hz	50 Hz	Triple tone
Information tone	1400 Hz	50 Hz	tones on 330 ms
	1800 Hz	50 Hz	silence 1,0 s

33.2.8 Number unobtainable tone

33.2.8.1 Method of test

- a) According to section "Structured procedures, Mobile originating call, early assignment, Method of test", paragraphs a) to h).
- b) The SS then sends message DISCONNECT with cause number 1.

DISCONNECT message: As in 33.2.3.1 with cause value #1 "Unassigned (unallocated) number" (0000001).

33.2.8.2 Requirements

- 1) According to section "Structured procedures, Mobile originating call, early assignment, Requirements", paragraphs 1) to 5).
- 2) After reception of DISCONNECT a tone shall be generated indicating that the called number is unobtainable.

The number unobtainable tone is the error/special information tone with characteristics as in 33.2.5.2.

33.2.9 Call dropped tone

33.2.9.1 Method of test

- a) According to section "Structured procedures, Mobile originating call, early assignment, Method of test", paragraphs a) to l). However, it shall be indicated in the system information messages that call re-establishment shall not be attempted (RACH control parameters).
- b) When the call has been established the SS stops transmitting on the TCH/SACCH.

33.2.9.2 Requirements

- 1) According to section "Structured procedures, Mobile originating call, early assignment, Requirements", paragraphs 1) to 8).
- 2) After the radio link time-out period has expired a tone shall be generated indicating that the call has been dropped.

The call dropped tone characteristics shall be as follows:

Tone	Frequency	Tolerance	Type
Call dropped tone	425 Hz	15 Hz	Tone on 200 ms, silence 200 ms 3 bursts of on/off

33.3 Network selection / indication

33.3.1 Definition and applicability

Network selection and indication is the ability of the MS to correctly select a network and display to the user in accordance with GSM 02.11 and GSM 03.22.

The requirements and this test apply to all MS.

Tests concerning the MS behaviour after having received a location updating reject message with specific causes are included in section 26.7.4.2.

Tests concerning the MS handling of the forbidden PLMN list are also included in section 26.7.4.

33.3.2 Conformance requirement

- 1) Upon switching on, when an IMSI is available and there is no registered PLMN on the SIM, the MS shall select its Home PLMN and perform the cell selection procedure.
- 2) If the MS loses radio coverage for its registered PLMN, and the MS is in automatic PLMN selection mode, it shall attempt to select its Home PLMN.
- 3) If the Registered PLMN is unavailable due to the loss of radio coverage and the MS is in automatic PLMN selection mode and the HPLMN is also unavailable, it shall attempt to select a suitable cell and access the PLMNs in turn, in the order of priority as stored in the SIM,.
- 4) If there is no registered PLMN in the SIM or the registered PLMN is unavailable and If the Home PLMN is unavailable and the MS is in automatic PLMN selection mode, it shall attempt to select a suitable cell and accesses the PLMNs in turn, in the order of priority as stored in the SIM, upon switching on and when the IMSI is available.
- 5) An MS, roaming in a VPLMN whose MCC is the same as the MCC of the IMSI, shall periodically attempt to obtain service on its Home PLMN in automatic mode. For this purpose, a value T minutes, which is the HPLMN search period, may be stored in the SIM; T is either in the range 6 minutes to 8 hours in 6 minutes step or it indicates that no periodic attempt shall be made. If no HPLMN search value is available on the SIM the mobile equipment shall use a default value of 30 minutes.
- 6) At switch on, the MS selects and attempts to perform a Location Update on the Registered PLMN if it exists. If the registered PLMN is a VPLMN of the SIM's home country, the MS shall wait at least 2 minutes before attempting to obtain service on its home PLMN.

33.3.3 Test purpose

- 1) To verify that the MS with SIM containing in the PLMN selector field at least one PLMN different from the Home PLMN and containing no registered PLMN, when in automatic PLMN selection mode, selects its Home PLMN, if available, upon switching on and when the IMSI is available. (This is verified by observation of the location updating procedure).(Steps 1.1 through 1.5).
- 2) To verify that if the MS loses radio coverage for its registered PLMN, and the MS is in automatic PLMN selection mode, it shall attempt to select its Home PLMN. (Steps 1.14C through 1.16C).
- 3) To verify that the MS, when it loses radio coverage for its selected PLMN (i.e. Registered PLMN) and in automatic PLMN selection mode, selects the PLMN with the highest priority among the PLMNs stored on the SIM, if the Home PLMN is unavailable. (Steps 1.10 through 1.12).

- 4) If there is no registered PLMN in the SIM or the registered PLMN is unavailable and If the Home PLMN is unavailable and the MS is in automatic PLMN selection mode, it shall attempt to select a suitable cell and accesses the PLMNs in turn, in the order of priority as stored in the SIM, upon switching on and when the IMSI is available. (Steps 1.22 through 1.25).
- 5) To verify that an MS, roaming in a VPLMN whose MCC is the same as the MCC of the IMSI, shall attempt to obtain service on its Home PLMN in automatic mode with a period of T. To verify that the MS shall not attempt to obtain service on its home PLMN in automatic mode when T is set to "no periodic attempts shall be made". To verify that a default value of 30 min is used when no HPLMN search timer value is available on the SIM. (Steps 1.13 A through 1.15A, 1.13B through 1.15B and 1.13C.)
- 6) To verify that, at switch on, the MS selects and attempts to perform a Location Update on the registered PLMN if it exists. If the registered PLMN is a VPLMN of the SIM's home country, the MS shall wait at least 2 minutes before attempting to obtain service on its home PLMN. (Steps 1.25 through 1.28).

Reference

Requirements 1, 2, 3: see GSM 03.22 section 4.4.3.1.

Requirements 4: see GSM 03.22 section 3.1.

Requirement 5, 6: see GSM 03.22 section 4.4.3.3.

33.3.4 Method of Test

Procedure 1: This procedure applies to both automatic and manual mode for PLMN selection. This procedure is run for each of the following cases:

case A) Timer T is set to 6 min in the SIM.

case B) No HPLMN search timer value is available on the SIM.

case C) Timer T is set to "no periodic attempt to obtain service on the HPLMN shall be made" in the SIM.

Procedure 2: This procedure applies to the manual mode for PLMN selection.

33.3.4.1 Procedure 1

- 1.1) The MS is set up with a SIM which contains, in the "PLMN selector" data field, a list of 3 PLMN in the priority order PLMN2 (highest priority), PLMN3, PLMN4 (lowest priority). PLMN1 is the Home PLMN of the MS as defined in the IMSI. The "Forbidden PLMN" data field shall contain NULL values. "registered PLMN" data field shall contain Null values.

case A) Timer T is set to 6 min in the SIM.

case B) No HPLMN search timer value is available on the SIM.

case C) Timer T is set to "no periodic attempt to obtain service on the HPLMN shall be made" in the SIM.

- 1.2) The SS transmits 4 BCCH carriers with the following parameters:

	<u>PLMN</u>	<u>Level dBμVemf()</u>
Carrier 1	PLMN1 any value for MCC	28
Carrier 2	PLMN2 any value for MCC	33
Carrier 3	PLMN3 with the same MCC as PLMN1	38
Carrier 4	PLMN4 any value for MCC	43

Each carrier has the "IMSI attach" (ATT) flag set in the BCCH data. (The purpose of this is to force the MS to do location updating whenever it is switched on, so that the SS can determine which PLMN has been selected).

The other system information parameters are as in table 33-1.

- 1.3) The MS is brought into the "on" condition with automatic selection mode active.
- 1.4) The SS checks that the MS sends a "location updating request" on carrier 1.
- 1.5) The SS sends a "location updating accept" message to the MS on carrier 1. After 5 s, the MS "selected PLMN indicator" is checked.
- 1.6) The SS switches off carriers 1.
- 1.7) The SS checks that the MS sends a "location updating request" on carrier2.
- 1.8) The SS sends a "location updating accept" message to the MS on carrier 2. After 5 s, the MS "selected PLMN indicator" is checked.
- 1.9) Carrier 2 is turned off.
- 1.10) The SS checks that the MS sends a "location updating request" on carrier 3.
- 1.11) The SS sends a "location updating accept" message on carrier 3. After 5 s, the MS "selected PLMN indicator" is checked.
- 1.12) Carriers 1 and 2 are turned on with the same parameters as in step 1.2) above.

In case A for which T is set to 6 min, take branch A.

In case B for which default value for T is applied take branch B.

In case C for which T is set to "no periodic attempt shall be made", take branch C.

Branch A

- 1.13A) The SS checks that the MS does not send a "location updating request" on either carrier 1 or 2 during 6 minutes after step 1.11 is completed.
- 1.14A) The SS checks that the MS sends a "location updating request" on channel 1 between 6 and 12 min after step 1.11 is completed.
- 1.15A) The SS sends a "location updating accept" message on carrier 1. After 5 s, the MS "selected PLMN indicator" is checked.

Branch B

- 1.13B) The SS checks that the MS does not send a "location updating request" on either carrier 1 or 2 during 30 minutes after step 1.11 is completed.
- 1.14B) The SS checks that the MS sends a "location updating request" on channel 1 between 30 and 60 min after step 1.11 is completed.
- 1.15B) The SS sends a "location updating accept" message on carrier 1. After 5 s, the MS "selected PLMN indicator" is checked.

Branch C

- 1.13C) The SS checks that the MS does not send a "location updating request" on either carrier 1 or 2 during 40 min.
- 1.14C) The SS switches off carrier 3.

- 1.15C) The SS checks that the MS sends a "location updating request" on channel 1.
- 1.16C) The SS sends a "location updating accept" message on carrier 1. After 5 s, the MS "selected PLMN indicator" is checked.
- 1.17) The SS switches off carrier 1 and switches on carrier 3.
- 1.18) The SS checks that the MS sends a "location updating request" on carrier 2.
- 1.19) The SS sends a "location updating accept" message on carrier 2. After 5 s, the MS "selected PLMN indicator" is checked.
- 1.20) The mobile station is switched off.
- 1.21) The SS switches off carrier 2.
- 1.22) The mobile station is switched on.
- 1.23) The SS checks that the MS sends a "location updating request" on carrier 3.
- 1.24) The SS sends a "location updating accept" message on carrier 3. After 5 s, the MS "selected PLMN indicator" is checked.
- 1.25) The MS is switched off.
- 1.26) The SS switches on carrier 1.
- 1.27) The mobile station is switched on.
- 1.28) The SS checks that the MS does not send a "location updating request" on carrier 1. After 2 min, the MS "selected PLMN indicator" is checked.

33.3.4.2 Requirements 1

Requirement 1.1) is mandatory for all MS. Requirements 1.2) and 1.3) only apply to MS with a human interface.

- 1.1) The MS shall make a response as indicated in steps 1.4, 1.7, 1.10, 1.13A, 1.13B, 1.14A, 1.14B, 1.15C, 1.18, 1.23 above. In cases 1.4, 1.7, 1.10, 1.15C, 1.18 and 1.23, the MS shall respond within 30 s.
- 1.2) The selected PLMN shall be indicated:

End of Step	1.5	1.8	1.11	1.15A/B	1.16C
PLMN indicated:	PLMN1	PLMN2	PLMN3	PLMN1	PLMN1
End of Step	1.19	1.24	1.28		
PLMN indicated:	PLMN2	PLMN3	PLMN3		

33.3.4.3 Procedure 2

- 2a) The MS is set up with a SIM which contains NULL values in the "PLMN selector" data field. PLMN1 is the Home PLMN of the MS as defined in the IMSI. The "forbidden PLMN" data field shall contain PLMN3. the "registered PLMN" field is set to PLMN2.

2b) The SS transmits 4 BCCH carriers with the following parameters:

	<u>PLMN</u>	<u>Level dBμVemf()</u>
Carrier 1	PLMN1	28
Carrier 2	PLMN2	33
Carrier 3	PLMN3	38
Carrier 4	PLMN4	43

Each carrier has the "IMSI attach" (ATT) flag set in the BCCH data. (The purpose of this is to force the MS to do location updating whenever it is switched on, so that the SS can determine which PLMN has been selected.)

The other system information parameters are as in table 33-1.

2c) The MS is brought into the "on" condition with manual selection mode active.

2d) The SS checks that the MS sends a "location updating request" on carrier 2.

33.3.4.4 Requirements 2

2.1) The MS shall make a response as indicated in step 2d). The MS shall respond within 30 s.

Table 33-1: Normal system information fields

Parameter	Reference in GSM 04.08	Abbreviation	Normal setting
Cell Channel Description	10.5.2.1	-	Any values
Max retrans	10.5.2.17	-	1
Tx-integer	10.5.2.17	-	Any value
CELL_BAR_ACCESS	10.5.2.17	CBA	0 (i.e. no barred)
AC CN	10.5.2.17	AC	All 0
RE	10.5.2.17	RE	0 (i.e. re-establishment allowed)
BA ARFCN	10.5.2.13	BA	One entry equal to the ARFCN of the carrier
NCC	10.5.2.15	NCC	Any value
Cell Identity	10.5.1.1	-	Any value
MCC, MNC	10.5.1.3	PLMN	Ref. 33.3.2, 1b) and 33.3.2, 2b)
LAC	10.5.1.3	LAC	1111 (Hex)
ATT, B_AG_BLK_RES,T3212,	10.5.2.8	-	ATT = "1"
CCCH_CONF			Other parameters any values.
BS_PA_MFRMS	10.5.2.8	BPM	5 frames
Cell Options	10.5.2.3	-	Any values
CELL_RESELECT_HYSTERESIS	10.5.2.4	CRH	10 dB
MS_TXPWR_MAX_CCH	10.5.2.4	MTMC	Maximum RF output power of MS.
RXLEV_ACCESS_MIN	10.5.2.4	RAM	-95 dBm

33.4 Invalid and blocked PIN indicators

33.4.1 Definition and applicability

The requirements and this test apply to all MS.

33.4.2 Conformance requirement

33.4.3 Test purpose

33.4.4 Method of test

33.4.4.1 Initial conditions

The MS contains a SIM with the PIN enabled, and the SIM unblocking counter set to zero by previous presentation of the personal unblocking key.

33.4.4.2 Procedure

- a) The MS is switched on.
- b) Three wrong PIN are entered.

Activation may be either manual or via the EMMI.

33.4.5 Test requirements

For the first and second incorrect PIN the MS shall indicate that the PIN code has been rejected

For the third incorrect PIN the MS shall indicate that the PIN is blocked.

33.5 Service indicator

33.5.1 Definition and applicability

The requirements and this test apply to all MS.

33.5.2 Conformance requirement

33.5.3 Test purpose

33.5.4 Method of test

33.5.4.1 Initial conditions

- a) The MS is in idle mode, unregistered.
- b) The SS shall emulate perfect radio conditions so that the MS is able to register and to set up or receive a call.

33.5.4.2 Procedure

- a) The MS is brought in an active state by either switching it on or by inserting a SIM.

33.5.5 Test requirements

- 1) The successful registration and the good condition shall be indicated by the MS indicator and by the SS.

33.6 Subscription identity management

33.6.1 Definition and applicability

Subscription identity management is the ability of the MS to prevent the establishment of MO (except MO emergency calls) and MT calls without a valid subscription.

The requirements and this test apply to all MS.

33.6.2 Conformance requirement

An MS can only be operated, if a valid IMSI is present.

33.6.3 Test purpose

- 1) To verify that during an established call:
 - either
 - 1.1) on removal of the SIM from an MS, the MS will perform an IMSI detach;
 - or
 - 1.2) after removing the power source from the MS, removing the SIM, and restoring the power source to the MS, the MS may perform an IMSI detach.
- 2) To verify that an MS without SIM card will not establish a MO call which is not an emergency call.
- 3) To verify that an MS without SIM card will not accept an incoming call.

33.6.4 Method of test**33.6.4.1 Initial conditions****33.6.4.2 Procedure**

- a) A call is set up.
- b) (Reserved).
- c) Either
 - (i) the SIM is removed;
 - or
 - (ii) where this is not possible, the power source is removed from the MS, the SIM is removed and the power source is restored to the MS.

The SS observes whether or not the MS performs IMSI detach.
- d) An attempt to establish a MO call is made (not an emergency call).
- e) An attempt to establish a MT call is made.

33.6.5 Test requirements

- 1) Either
 - in step c(i), the MS shall perform an IMSI detach;
 - or
 - in step c(ii), the MS may perform an IMSI detach.
- 2) In step d) the MS shall not attempt to set up a new call via the Um interface.
- 3) In step e), the MS shall not respond to the attempt to set up a new call via the Um interface.

33.7 Barring of outgoing calls**33.7.1 Definition and applicability**

The barring of outgoing calls is an optional feature. It is the ability of the MS to prevent all MO calls except emergency calls.

The requirements and this test apply to all MS supporting this feature.

33.7.2 Conformance requirement

An MS may have an optional facility to bar outgoing calls. Such barring facility shall not prevent the transmission on emergency calls.

33.7.3 Test purpose

To verify that an MS for which a local facility to bar outgoing calls has been declared as being implemented, is able to establish an emergency call if this facility is activated.

33.7.4 Method of test

33.7.4.1 Initial conditions

33.7.4.2 Procedure

- a) The local facility to bar outgoing calls is activated.
- b) Via MMI, the MS is actioned to establish an emergency call.

33.7.5 Test requirements

- 1) The MS shall establish an emergency call.

33.8 Prevention of unauthorized calls

33.8.1 Definition and applicability

The prevention of unauthorized calls is an optional feature in the MS. It is the ability of the MS to prevent unauthorized use by using a key or keyword protection facility. When activated the MS does not prevent the establishment of except emergency calls.

The requirements and this test apply to all MS supporting this feature.

33.8.2 Conformance requirement

An MS may have an optional facility to prevent unauthorized use. Such facility shall not prevent the transmission on emergency calls.

33.8.3 Test purpose

To verify that an MS for which a local facility to prevent unauthorized use has been declared to be implemented, is able to establish an emergency call, if this facility is activated.

33.8.4 Method of test

33.8.4.1 Initial conditions

33.8.4.2 Procedure

- a) The local facility to restrict operation such that the MS can only be operated by using a key or a keyword is activated. The most restrictive situation is created.
- b) Via MMI, the MS is actioned to establish an emergency call.

33.8.5 Test requirements

- 1) The MS shall establish an emergency call.

34 Short message service (SMS)

Ref.: GSM 03.40, GSM 04.11 (point to point)
GSM 03.41, GSM 04.12 (cell broadcast)

34.1 General

The purpose of these tests is to verify that the MS can handle GSM functions when submitting or receiving Short Messages (SM) between MS and a short message service centre as described in GSM 03.40.

The procedures are based upon services provided by the Mobility Management (MM) sublayer which is not tested in this case.

The SMS comprises three basic services. The SMS point to point services shall work in an active MS at any time independent of whether or not there is a speech or data call in progress. The SMS cell broadcast service only works when the MS is in idle mode.

Since the timer TC1M currently is not standardized, the value of TC1M shall be declared by the manufacturer (to be used in 34.2.1 and 34.2.2).

The manufacturer shall declare whether SMS messages are stored in the SIM and/or the ME. This shall be referred to as the SMS message store in the following tests.

Unless otherwise stated default message contents from section 26.6.14 applies for GSM 900 and default message contents from section 26.6.15 applies for DCS 1 800.

34.2 Short message service point to point

34.2.1 SMS mobile terminated

34.2.1.1 Conformance requirements

An active MS shall be able to receive short message TPDU (SMS-DELIVER) at any time, independently of whether or not there is a speech or data call in progress. A report will always be returned to the SC, confirming that the MS has received the short message.

Reference

GSM 03.40; 3.1.

34.2.1.2 Test purpose

To verify the ability of a MS to receive and decode the SMS where provided for the point to point service.

34.2.1.3 Method of test

Initial Conditions

System simulator:

1 cell, default parameters.

Mobile Station:

The MS shall be in "Idle, updated" state.

The SMS message storage shall be empty.

Related PICS/PIXIT Statements

Support for Short message MT/PP.

Description of the basic procedures to display a mobile terminated short message.

The value of timer TC1M.

Whether SMS messages are stored in the SIM and/or the ME.

Support for call control state U10.

Foreseen Final State of MS

Idle, updated.

Test Procedure

- a) The SS initiates the transmission of a short message using a paging request. Upon response of the MS to the paging the SS assigns an SDCCH, authenticates the MS and activates ciphering. Then the SS establishes SAPI 3 by sending a SABM frame with SAPI 3 on the SDCCH. When a UA frame (SAPI 3) is received in response, the SS sends a CP-DATA message. The information element of the CP-DATA message will be RP-DATA RPDU (SMS DELIVER TPDU).
- b) The SS waits a maximum of 25 seconds for the CP-ACK message and then a maximum of 60 seconds for the CP-DATA message containing the RP-ACK RPDU.
- c) The SS sends a CP-ACK to the MS within TC1M with no further CP-DATA messages and the SS initiates channel release.
- d) Steps a), b) and c) are repeated but the first CP-DATA message from the MS is not acknowledged. The second CP-DATA message from the MS is acknowledged by a CP-ACK within a time TC1M.
- e) Steps a) and b) are repeated. The SS is configured not to send CP-ACK. Then maximum 3 CP-DATA retransmissions may occur. After a duration of TC1M + 5 seconds after the last CP-DATA retransmission the SS then initiates the channel release. The 5 seconds is the appropriate time to wait to verify that the MS does not send more than the maximum allowed (3) CP-DATA retransmissions.
- f) The SMS message store shall be cleared manually by the operator.
- g) A data or speech call is established on a TCH with the SS and the state U10 of call control is entered. The SS sends a SABM frame with SAPI-3 on the SACCH associated to the TCH. When a UA frame (SAPI-3) is received in response, the SS sends a CP-DATA message. The information element of the CP-DATA message will be RP-DATA RPDU (SMS DELIVER TPDU). The SS waits a maximum of 25 seconds for the CP-ACK message and then a maximum of 60 seconds for the CP-DATA message containing the RP-ACK RPDU.
- h) The SS sends a CP-ACK to the MS within TC1M with no further CP-DATA messages and the SS initiates channel release. The SMS message store shall be cleared manually by the operator.
- i) Steps g) and h) are repeated but the first CP-DATA message from the MS is not acknowledged. The second CP-DATA message from the MS is acknowledged by a CP-ACK within a time TC1M.
- j) Step g) is repeated. The SS is configured not to send CP-ACK. Then maximum 3 CP-DATA retransmissions may occur. After a duration of TC1M + 15 seconds after the last CP-DATA retransmission the SS initiates the channel release. The 15 seconds is the appropriate time to wait to verify that the MS does not send more than the maximum allowed (3) CP-DATA retransmissions (during a call in progress).
- k) A data or speech call is established on a TCH with the SS and the state U10 of call control shall be entered. The SS sends a SABM frame with SAPI-3 on the SACCH associated to the TCH. After the UA response on SAPI-3, the speech call is cleared by the SS with a disconnect message. (The call clearing is continued on the FACCH in parallel to the following exchange of messages related to SMS).
The SS sends a CP-DATA RPDU (SMS DELIVER TPDU) message. The information element of the CP-DATA message is RP-DATA.

The SS waits a maximum of 25 seconds for the CP-ACK message and then a maximum of 60 seconds for the CP-DATA message containing the RP-ACK RPDU.

The SS sends a CP-ACK to the MS within TC1M with no further CP-DATA messages and the SS initiates channel release.

The SMS message store shall be cleared manually by the operator.

- l) A data or speech call is established on a TCH with the SS and the state U10 of call control is entered. The SS sends a SABM frame with SAPI-3 on the SACCH associated to the TCH. After the UA response on SAPI-3, the speech call shall be cleared from the MS. (The call clearing is continued on the FACCH in parallel to the following exchange of messages related to SMS).

The SS sends a CP-DATA message. The information element of the CP-DATA message is RP-DATA RPDU (SMS DELIVER TPDU).

The SS waits a maximum of 25 seconds for the CP-ACK message and then a maximum of 60 seconds for the CP-DATA message containing the RP-ACK RPDU.

The SS sends a CP-ACK to the MS within TC1M with no further CP-DATA messages and the SS initiates channel release.

The SMS message store shall be cleared manually by the operator.

Maximum Duration of Test

20 minutes

Expected Sequence

Step	Direction	Message	Comments
1	SS -> MS	PAGING REQUEST	
2	MS -> SS	CHANNEL REQUEST	Establishment cause is "Answer to paging"
3	SS -> MS	IMMEDIATE ASSIGNMENT	SS assigns an SDCCH
4	MS -> SS	PAGING RESPONSE	Message is contained in SABM.
5	SS -> MS	AUTHENTICATION REQUEST	
6	MS -> SS	AUTHENTICATION RESPONSE	SRES specifies correct value.
7	SS -> MS	CIPHERING MODE COMMAND	SS starts deciphering after sending the message.
8	MS -> SS	CIPHERING MODE COMPLETE	Shall be sent enciphered. All following messages shall be sent enciphered.
9	SS		SS starts ciphering.
10	SS -> MS	SABM (SAPI=3)	SS establishes SAPI 3
11	MS -> SS	UA (SAPI=3)	MS shall respond to SABM in step 10
12	SS -> MS	CP-DATA	Contains RP-DATA RPDU (SMS DELIVER TPDU)
13	SS		Waits max 25 seconds for CP-ACK
14	MS -> SS	CP-ACK	
15	SS		Waits max 60 seconds for RP-ACK RPDU
16	MS -> SS	CP-DATA	Contains RP-ACK RPDU
17	SS -> MS	CP-ACK	Within TC1M after step 16, no further CP-DATA messages
18	SS -> MS	CHANNEL RELEASE	The main signalling link is released.
19	MS		The MS shall indicate that an SM has arrived. If the MS provides the functionality to display MT messages, it is checked that the correct message is displayed
20	SS -> MS	PAGING REQUEST	
21	MS -> SS	CHANNEL REQUEST	Establishment cause is "Answer to paging"
22	SS -> MS	IMMEDIATE ASSIGNMENT	SS assigns an SDCCH
23	MS -> SS	PAGING RESPONSE	Message is contained in SABM.
24	SS -> MS	AUTHENTICATION REQUEST	
25	MS -> SS	AUTHENTICATION RESPONSE	SRES specifies correct value.
26	SS -> MS	CIPHERING MODE COMMAND	SS starts deciphering after sending the message.
27	MS -> SS	CIPHERING MODE COMPLETE	Shall be sent enciphered. All following messages shall be sent enciphered.
28	SS		SS starts ciphering.
29	SS -> MS	SABM (SAPI=3)	SS establishes SAPI 3
30	MS -> SS	UA (SAPI=3)	The MS shall respond to the SABM
31	SS -> MS	CP-DATA	Contains RP-DATA RPDU (SMS DELIVER TPDU)
32	SS		Waits max 25 seconds for CP-ACK
33	MS -> SS	CP-ACK	
34	SS		Waits max 60 seconds for RP-ACK RPDU
35	MS -> SS	CP-DATA	First CP-DATA from MS, contains RP-ACK RPDU
36	SS		First CP-DATA message not acknowledged by SS
37	MS -> SS	CP-DATA	Retransmitted CP-DATA from MS within twice TC1M, after step 35, contains RP-ACK RPDU
38	SS -> MS	CP-ACK	Second CP-DATA message is acknowledged within TC1M after step 37, no further CP-DATA messages
39	SS -> MS	CHANNEL RELEASE	The main signalling link is released.
40	MS		The MS shall indicate that an SM has arrived. If the MS provides the functionality to display MT messages, it is checked that the correct message is displayed
41	SS -> MS	PAGING REQUEST	
42	MS -> SS	CHANNEL REQUEST	Establishment cause is "Answer to paging"
43	SS -> MS	IMMEDIATE ASSIGNMENT	SS assigns an SDCCH
44	MS -> SS	PAGING RESPONSE	Message is contained in SABM.
45	SS -> MS	AUTHENTICATION REQUEST	

46	MS -> SS	AUTHENTICATION RESPONSE	SRES specifies correct value.
47	SS -> MS	CIPHERING MODE COMMAND	SS starts deciphering after sending the message.
48	MS -> SS	CIPHERING MODE COMPLETE	Shall be sent enciphered. All following messages shall be sent enciphered.
49	SS		SS starts ciphering.
50	SS -> MS	SABM (SAPI=3)	SS establishes SAPI 3
51	MS -> SS	UA (SAPI=3)	The MS shall respond to the SABM
52	SS -> MS	CP-DATA	Contains RP-DATA RPDU (SMS DELIVER TPDU)
53	SS		Waits max 25 seconds for CP-ACK
54	MS -> SS	CP-ACK	
55	SS		Waits max 60 seconds for RP-ACK RPDU
56	MS -> SS	CP-DATA	Contains RP-ACK RPDU
57	SS		First CP-DATA message not acknowledged by SS
58	MS -> SS	CP-DATA	Retransmitted CP-DATA from MS within twice TC1M after step 56, contains RP-ACK RPDU
59	SS		Retransmitted CP-DATA message not acknowledged by SS
60	MS		Depending upon the maximum number of CP-DATA retransmissions implemented, step 58 and 59 may be repeated.
61	SS -> MS	CHANNEL RELEASE	The main signalling link is released after a duration of TC1M + 5 seconds after the last CP-DATA retransmission..
62	MS		The MS shall indicate that an SM has arrived. If the MS provides the functionality to display MT messages, it is checked that the correct message is displayed
63	SS		A data or speech call is established on a TCH and the state U10 of call control is entered.
64	SS -> MS	SABM (SAPI=3)	Sent on SACCH associated with the TCH
65	MS -> SS	UA (SAPI=3)	The MS shall respond to the SABM
66	SS -> MS	CP-DATA	Contains RP-DATA RPDU (SMS DELIVER TPDU)
67	SS		Waits max 25 seconds for CP-ACK
68	MS -> SS	CP-ACK	
69	SS		Waits max 60 seconds for RP-ACK RPDU
70	MS -> SS	CP-DATA	Contains RP-ACK RPDU
71	SS -> MS	CP-ACK	Within TC1M after step 70, no further CP-DATA messages
72	SS -> MS	CHANNEL RELEASE	The main signalling link is released.
73	MS		The MS shall indicate that an SM has arrived. If the MS provides the functionality to display MT messages, it is checked that the correct message is displayed
74	MS		Clear the SMS message store
75	SS		A data or speech call is established on a TCH and the state U10 of call control is entered.
76	SS -> MS	SABM (SAPI=3)	Sent on SACCH associated with the TCH
77	MS -> SS	UA (SAPI=3)	The MS shall respond to the SABM
78	SS -> MS	CP-DATA	Contains RP-DATA RPDU (SMS DELIVER TPDU)
79	SS		Waits max 25 seconds for CP-ACK
80	MS -> SS	CP-ACK	
81	SS		Waits max 60 seconds for RP-ACK RPDU
82	MS -> SS	CP-DATA	First CP-DATA from MS, contains RP-ACK RPDU
83	SS		First CP-DATA message not acknowledged by SS
84	MS -> SS	CP-DATA	Retransmitted CP-DATA message within twice TC1M after step 82, contains RP-ACK RPDU
85	SS -> MS	CP-ACK	Second CP-DATA message is acknowledged within TC1M after step 84, no further CP-DATA messages
86	SS -> MS	CHANNEL RELEASE	The main signalling link is released.

87	MS		The MS shall indicate that an SM has arrived. If the MS provides the functionality to display MT messages, it is checked that the correct message is displayed
88	MS		Clear the SMS message store
89	SS		A data or speech call is established on a TCH and the state U10 of call control is entered.
90	SS -> MS	SABM (SAPI=3)	Sent on SACCH associated with the TCH
91	MS -> SS	UA (SAPI=3)	The MS shall respond to the SABM
92	SS -> MS	CP-DATA	Contains RP-DATA RPDU (SMS DELIVER TPDU)
93	SS		Waits max 25 seconds for CP-ACK
94	MS -> SS	CP-ACK	
95	SS		Waits max 60 seconds for RP-ACK RPDU
96	MS -> SS	CP-DATA	First CP-DATA from MS, contains RP-ACK RPDU
97	SS		First CP-DATA message not acknowledged by SS
98	MS -> SS	CP-DATA	Transmitted CP-DATA message within twice TC1M after step 96, contains RP-ACK RPDU
99	SS		Retransmitted CP-DATA message not acknowledged by SS
100	MS		Depending on the maximum number of CP-DATA retransmissions implemented, step 98-99 may be repeated. The maximum number of retransmissions may however not exceed three.
101	SS -> MS	CHANNEL RELEASE	The main signalling link is released after a duration of TC1M + 15 seconds after the last CP-DATA retransmission.
102	MS		The MS shall indicate that an SM has arrived. If the MS provides the functionality to display MT messages, it is checked that the correct message is displayed
103	MS		Clear the SMS message store
104	SS		A data or speech call is established on a TCH and the state U10 of call control is entered.
105	SS -> MS	SABM (SAPI=3)	Sent on SACCH associated with the TCH
106	MS -> SS	UA (SAPI=3)	The MS shall respond to the SABM
107	SS -> MS	DISCONNECT	The speech call is cleared by the SS. The call clearing is continued on the FACCH in parallel to the following exchange of messages related to SMS.
108	SS -> MS	CP-DATA	Contains RP-DATA RPDU (SMS DELIVER TPDU)
109	SS		Waits max 25 seconds for CP-ACK
110	MS -> SS	CP-ACK	
111	SS		Waits max 60 seconds for RP-ACK RPDU
112	MS -> SS	CP-DATA	Contains RP-ACK RPDU
113	SS -> MS	CP-ACK	Within TC1M after step 112, no further CP-DATA
114	SS -> MS	CHANNEL RELEASE	The main signalling link is released.
115	MS		The MS shall indicate that an SM has arrived. If the MS provides the functionality to display MT messages, it is checked that the correct message is displayed
116	MS		Clear the SMS message store
117	SS		A data or speech call is established on a TCH and the state U10 of call control is entered.
118	SS -> MS	SABM (SAPI=3)	Sent on SACCH associated with the TCH
119	MS -> SS	UA (SAPI=3)	The MS shall respond to the SABM
120	MS -> SS	DISCONNECT	The speech call is cleared from the MS.
121	SS -> MS	CP-DATA	Contains RP-DATA RPDU (SMS DELIVER TPDU)
122	SS -> MS	RELEASE	This message is likely to be sent on the FACCH before all of the CP-DATA message has been sent on the SACCH.
123	MS -> SS	RELEASE COMPLETE	

124	MS -> SS	CP-ACK	shall be sent before 25 seconds after the start of step 121
125	SS		Waits max 60 seconds for RP-ACK RPDU
126	MS -> SS	CP-DATA	Contains RP-ACK RPDU
127	SS -> MS	CP-ACK	Within TC1M after step 126, no further CP-DATA
128	SS -> MS	CHANNEL RELEASE	The main signalling link is released.
129	MS		The MS shall indicate that an SM has arrived. If the MS provides the functionality to display MT messages, it is checked that the correct message is displayed
130	MS		Clear the SMS message store

NOTE: Time values for SS wait time are chosen sufficiently high to be sure that the MS has enough time to respond to the different messages.

Specific Message Contents:

SMS DELIVER TPDU

Information element	Comment	Value
TP-MTI	SMS DELIVER	"00"B
TP-MMS	more messages are waiting in SC	"0"B
TP-RP	no reply path	"0"B
TP-UDHI	TP-UD contains only the SM	"0"B
TP-SRI	no status report returned	"0"B
TP-OA	an international number coded E.164	
TP-PID	default	"00000000"B
TP-DCS	default alphabet	"00000000"B
TP-SCTS	any legal value (cf. GSM 03.40)	
TP-UDL		160
TP-UD (140 octets)	text of message (160 characters)	

NOTE: The 160 characters shall include at least one occurrence of each character in the default alphabet (see GSM 03.40 annex 2).

34.2.2 SMS mobile originated

34.2.2.1 Conformance requirements

An active MS shall be able to submit short message TPDU (SMS-SUBMIT) at any time, independently of whether or not there is a speech or data call in progress.

Reference

GSM 03.40; 3.1.

34.2.2.2 Test purpose

To verify that the MS is able to correctly send a short message where the SMS is provided for the point to point service. The test also verifies that the MS is capable of simultaneously receive a network originated SM whilst sending a mobile originated SM.

34.2.2.3 Method of test

Initial Conditions

System simulator:

1 cell, default parameters.

Mobile Station:

The MS shall be in "Idle, updated" state.
The SMS message storage shall be empty.

Related PICS/PIXIT Statements

Support for Short message MO/PP.

Description of the basic procedures to display a mobile originated short message.

Support for state U10 of call control.

The value of timer TC1M.

Whether SMS messages are stored in the SIM and/or the ME.

Maximum length (characters) of a mobile originated short message.

Foreseen Final State of MS

Idle, updated.

Test Procedure

- a) The MS shall be set up to send a SM to the SS. The SS responds to the channel request message by allocating an SDCCH. The SS answers correctly to the SABM on SAPI 0 and then performs the authentication and ciphering procedures.
- b) The SS responds with a UA frame SAPI-3 to the MS.
- c) The SS responds to the CP-DATA containing RP-DATA RPDU (SMS SUBMIT TPDU) from the MS with a CP-ACK message within TC1M followed by a CP-DATA message containing the correct RP-ACK RPDU. The SS waits a maximum of 25 seconds for the CP-ACK message.
- d) The SS sends a channel release message to the MS.
- e) Steps a) and b) are repeated. The SS is configured not to send the CP-ACK message. Then maximum 3 CP-DATA retransmissions may occur. After a duration of TC1M + 5 seconds after the last CP-DATA retransmission the SS initiates channel release. The 5 seconds is the appropriate time to wait to verify that the MS does not send more than the maximum CP-DATA retransmissions.
- f) Steps a) and b) are repeated. On receipt of the CP-DATA from the MS the SS sends a CP-ERROR message within TC1M containing a "Network Failure" cause. Then the SS initiates channel release.
- g) A data or speech call is established on a TCH with the SS and the state U10 of call control is entered. The MS is setup to send an SM to the SS. After the reception of the CM SERVICE REQUEST, the SS sends a CM SERVICE ACCEPT message. The SS responds with a UA frame SAPI-3 to the SABM with SAPI-3 received from the MS.
- h) The SS responds to the CP-DATA containing RP-DATA RPDU (SMS SUBMIT TPDU) from the MS with a CP-ACK message within TC1M followed by a CP-DATA message containing the correct RP-ACK RPDU. The SS waits a maximum of 25 seconds for the CP-ACK message. Then the SS sends a channel release message to the MS.
- i) Step g) is repeated. The SS is configured not to send the CP-ACK message. Then maximum 3 CP-DATA retransmissions may occur. After a duration of TC1M + 15 seconds after the last CP-DATA retransmission the SS initiates channel release. The 15 seconds is the appropriate time to wait to verify that the MS does not send more than the maximum CP-DATA retransmissions (during a call in progress).
- j) The SS is configured to receive a mobile originated SM. Steps a) and b) are repeated and, using the end of the CP-DATA message from the MS as a trigger, the SS sends a SM to the MS. In this case a new transaction identifier shall be used in the CP messages of SMS mobile terminated.

- k) The MS is set up to send an SM to the SS. On receipt of the CM SERVICE REQUEST the SS sends a CM SERVICE REJECT message with the reject cause set to "Service Option not supported" or "Service Option temporarily out of order". After 5 seconds the SS initiates channel release.

Maximum Duration of Test

20 minutes

Expected Sequence

Step	Direction	Message	Comments
1	MS -> SS	CHANNEL REQUEST	Establishment cause is "Other procedures which can be completed with an SDDCH" NECI = 0
2	SS -> MS	IMMEDIATE ASSIGNMENT	SS assigns an SDCCH
3	MS -> SS	CM SERVICE REQUEST	Message is contained in SABM on SAPI 0. CM service type set to "Short message transfer"
4	SS -> MS	AUTHENTICATION REQUEST	
5	MS -> SS	AUTHENTICATION RESPONSE	SRES specifies correct value.
6	SS -> MS	CIPHERING MODE COMMAND	SS starts deciphering after sending the message.
7	MS -> SS	CIPHERING MODE COMPLETE	Shall be sent enciphered. All following messages shall be sent enciphered.
8	SS		SS starts ciphering.
9	MS -> SS	SABM (SAPI=3)	MS establishes SAPI 3
10	SS -> MS	UA (SAPI=3)	
11	MS -> SS	CP-DATA	Contains RP-DATA RPDU (SMS SUBMIT TPDU)
12	SS -> MS	CP-ACK	Sent within TC1M after step 11
13	SS -> MS	CP-DATA	Contains RP-ACK RPDU
14	SS		Waits max 25 seconds for CP-ACK
15	MS -> SS	CP-ACK	
16	SS -> MS	CHANNEL RELEASE	The main signalling link is released.
17	MS -> SS	DISC (SAPI=0)	MS shall respond to channel release with a layer 2 DISC frame with SAPI 0
18	MS -> SS	CHANNEL REQUEST	Establishment cause is "Other procedures which can be completed with an SDDCH" (NECI=0)
19	SS -> MS	IMMEDIATE ASSIGNMENT	SS assigns an SDCCH
20	MS -> SS	CM SERVICE REQUEST	Message is contained in SABM on SAPI 0.
21	SS -> MS	AUTHENTICATION REQUEST	
22	MS -> SS	AUTHENTICATION RESPONSE	SRES specifies correct value.
23	SS -> MS	CIPHERING MODE COMMAND	SS starts deciphering after sending the message.
24	MS -> SS	CIPHERING MODE COMPLETE	Shall be sent enciphered. All following messages shall be sent enciphered.
25	SS		SS starts ciphering.
26	MS -> SS	SABM (SAPI=3)	MS establishes SAPI 3
27	SS -> MS	UA (SAPI=3)	
28	MS -> SS	CP-DATA	Contains RP-DATA RPDU (SMS SUBMIT TPDU)
29	SS		SS configured not to send CP-ACK
30	MS -> SS	CP-DATA	Retransmitted CP-DATA message within twice TC1M after step 28
31	MS		Depending on the maximum number of CP-DATA retransmissions implemented, step 30 may be repeated. The maximum number of retransmissions may however not exceed three.
32	SS -> MS	CHANNEL RELEASE	The main signalling link is released after a duration of TC1M + 5 seconds after the last CP-DATA retransmission.
32a	MS -> SS	DISC (SAPI = 0)	MS shall respond to channel release with a layer 2 DISC frame with SAPI 0.
33	MS -> SS	CHANNEL REQUEST	Establishment cause is "Other procedures which can be completed with an SDDCH" (NECI=0)
34	SS -> MS	IMMEDIATE ASSIGNMENT	SS assigns an SDCCH
35	MS -> SS	CM SERVICE REQUEST	Message is contained in SABM. CM service type set to "short message transfer"
36	SS -> MS	AUTHENTICATION REQUEST	
37	MS -> SS	AUTHENTICATION RESPONSE	SRES specifies correct value.
38	SS -> MS	CIPHERING MODE COMMAND	SS starts deciphering after sending the message.

39	MS -> SS	CIPHERING MODE COMPLETE	Shall be sent enciphered. All following messages shall be sent enciphered.
40	SS		SS starts ciphering.
41	MS -> SS	SABM (SAPI=3)	MS establishes SAPI 3
42	SS -> MS	UA (SAPI=3)	
43	MS -> SS	CP-DATA	Contains RP-DATA RPDU (SMS SUBMIT TPDU)
44	SS -> MS	CP-ERROR	Sent within TC1M containing "Network Failure" cause.
45	SS -> MS	CHANNEL RELEASE	The main signalling link is released.
45a	MS -> SS	DISC (SAPI = 0)	MS shall respond to channel release with a layer 2 DISC frame with SAPI 0.
46	SS		A data or speech call is established on a TCH and the state U10 of call control is entered.
47	MS		The MS is set up to send an SM
48	MS -> SS	CM SERVICE REQUEST	Sent in a layer 2 frame on the FACCH. CM service type set to "short message transfer"
49	SS -> MS	CM SERVICE ACCEPT	
50	MS -> SS	SABM (SAPI=3)	Sent on SACCH associated with the TCH
51	SS -> MS	UA (SAPI=3)	
52	MS -> SS	CP-DATA	Contains RP-DATA RPDU (SMS SUBMIT TPDU)
53	SS -> MS	CP-ACK	Sent within TC1M after step 52
54	SS -> MS	CP-DATA	Contains RP-ACK RPDU
55	SS		Waits max 25 seconds for CP-ACK
56	MS -> SS	CP-ACK	
57	SS -> MS	CHANNEL RELEASE	The main signalling link is released.
58	MS -> SS	DISC (SAPI =0)	The MS shall respond to channel release with a layer 2 DISC frame with SAPI 0.
59	SS		A data or speech call is established on a TCH and the state U10 of call control is entered.
60	MS -> SS	CM SERVICE REQUEST	Sent in a layer 2 frame on the FACCH. CM service type set to "short message transfer"
61	SS -> MS	CM SERVICE ACCEPT	
62	MS -> SS	SABM (SAPI=3)	Sent on SACCH associated with the TCH
63	SS -> MS	UA (SAPI=3)	
64	MS -> SS	CP-DATA	Contains RP-DATA RPDU (SMS SUBMIT TPDU)
65	SS		SS configured not to send CP-ACK
66	MS -> SS	CP-DATA	Transmitted CP-DATA message within twice TC1M after step 64
67	MS		Depending on the maximum number of CP-DATA retransmissions implemented, step 66 may be repeated. The maximum number of retransmissions may however not exceed three.
68	SS -> MS	CHANNEL RELEASE	The main signalling link is released after a duration of TC1m + 15 seconds after the last CP-DATA retransmission.
69	MS -> SS	DISC (SAPI =0)	The MS shall respond to channel release
70	MS -> SS	CHANNEL REQUEST	Establishment cause is "Other procedures which can be completed with an SDDCH" (NECI=0)
71	SS -> MS	IMMEDIATE ASSIGNMENT	SS assigns an SDCCH
72	MS -> SS	CM SERVICE REQUEST	Message is contained in SABM. CM service type set to "short message transfer"
73	SS -> MS	AUTHENTICATION REQUEST	
74	MS -> SS	AUTHENTICATION RESPONSE	SRES specifies correct value.
75	SS -> MS	CIPHERING MODE COMMAND	SS starts deciphering after sending the message.
76	MS -> SS	CIPHERING MODE COMPLETE	Shall be sent enciphered. All following messages shall be sent enciphered.
77	SS		SS starts ciphering.
78	MS -> SS	SABM (SAPI=3)	MS establishes SAPI 3
79	SS -> MS	UA (SAPI=3)	
80	MS -> SS	CP-DATA	Contains RP-DATA RPDU (SMS SUBMIT TPDU)

81	SS		The SS sends an SM to the MS triggered by the end of the CP-DATA message from the MS Contains RP-DATA RPDU (SMS DELIVER TPDU) The MS shall correctly receive the SM and indicate that a message has arrived. If the MS provides the functionality to display MT messages, it is checked that the correct message is displayed. In the MO case the MS shall send the CP-ACK message with transaction identifier assigned to this transfer. In the MT case the MS shall send a CP-ACK message and a CP-DATA message containing the RP-ACK RPDU. The transaction identifier shall be the same as chosen by the SS for the MT transfer.
82	SS -> MS	CP-DATA	
83	MS		
84	MS -> SS	CHANNEL REQUEST	Establishment cause is "Other procedures which can be completed with an SDDCH" (NECI=0)
85	SS -> MS	IMMEDIATE ASSIGNMENT	SS assigns an SDCCH
86	MS -> SS	CM SERVICE REQUEST	Message is contained in SABM. CM service type set to "short message transfer"
87	SS -> MS	CM SERVICE REJ	Reject cause set to "Service Option not supported" or "Service Option temporarily out of order"
88	MS		The MS shall not establish SAPI-3
89	SS -> MS	CHANNEL RELEASE	Sent 5 seconds after CM SERVICE REJ

NOTE: Time values for SS wait times are chosen sufficiently high to be sure that the MS has enough time to respond to the different messages.

Specific Message Contents:

SMS SUBMIT TPDU

Information element	Comment	Value
TP-MTI	SMS SUBMIT	"01"B
TP-VPF	not checked	
TP-RP	no reply path	"0"B
TP-UDHI	not checked	
TP-SRR	not checked	
TP-MR	not checked	
TP-RD	not checked	
TP-DA	not checked (an E164 number)	
TP-PID	default	"00000000"B
TP-DCS	default alphabet	"00000000"B
TP-VP	not checked	
TP-UDL	as applicable	
TP-UD (140 octets max)	maximum number of characters (text of message)	as defined by the manufacturer (see PICS/PIXIT)

34.2.3 Test of memory full condition and memory available notification:

The Memory Available Notification provides a means for the MS to notify the network that it has memory available to receive one or more short messages. The SMS status field in the SIM contains status information on the "memory available" notification flag.

34.2.3.1 Conformance requirement

- When a mobile terminated message is Class 2, the MS shall ensure that the message has been transferred to the SMS data field in the SIM before sending an acknowledgement to the SC. The MS shall return a protocol error message if the short message cannot be stored in the SIM and there is other short message storage available in the MS. If all the short message storage in the MS is already in use, the MS shall return "memory capability exceeded".
- When the MS rejects a short message due to lack of available memory capability the need to transfer notification shall be stored in the SIM.

3. If the memory capability becomes available because memory is cleared, the value of the memory capability exceeded notification flag in the SIM is read. If the flag is set, the MS notifies the network that memory capability is now available. After a positive acknowledgement from the network, the ME unsets the memory capability exceeded notification flag in the SIM.

References

GSM 03.40, 9.2.3.10, GSM 03.38, 4.
 GSM 03.40, 10.3 (operation 14).
 GSM 03.40, 10.3 (operation 14).

34.2.3.2 Test purpose

1. To verify that the MS sends the correct acknowledgement when its memory in the SIM becomes full.
2. To verify that the MS sends the correct acknowledgement when its memory in the ME and the SIM becomes full, and sets the "memory exceeded" notification flag in the SIM.
3. To verify that the MS performs the "memory available" procedure when its message store becomes available for receiving short messages, and only at this moment.

34.2.3.3 Method of test

Initial conditions

System Simulator:

1 cell, default parameters

Mobile Station:

The MS shall be in the idle updated state.

The SMS message storage shall be empty.

The MS shall be connected to the SIM simulator. The following shall be present in the SIM simulator:

- EF_{SMS} with at least one record;
- $EF_{SMSstatus}$, with SMS "Memory Cap. Exceed" notification flag set to "memory available";
- Service no. 4 (SMS) in EF_{SST} set to allocated and activated.

For storing of Class 1 Short Messages the MS shall be set up to store Short Messages in the ME memory (by way of MMI, as described in PICS/PIXIT statement).

Related PICS/PIXIT Statements

Support for Short message MT/PP.

Description of the basic procedures to display a mobile terminated short message.

Whether SMS messages are stored in the SIM and/or the ME.

The value of timer TC1M.

Foreseen Final State of MS

Idle, updated.

Test Procedure

- a) step a) of 34.2.5.3 (test of Class 2 Short Messages) is repeated until the MS sends a negative acknowledgement (RP-ERROR). The SIM simulator shall indicate if the "memory capability exceeded" notification flag has been set on the SIM.
- b) a Class 1 Short Message is sent to the MS.
- c) step b) is repeated until the MS sends a negative acknowledgement (RP-ERROR). The SIM simulator shall indicate if the "memory capability exceeded" notification flag has been set on the SIM.
- d) a Short Message is sent to the MS with the DCS field of the SMS-DELIVER TPDU set to 0.
- e) the SS prompts the operator to read a short message and to remove it from the message store of the MS.
- f) the SS waits for a CHANNEL REQUEST from the MS, and sends an IMMEDIATE ASSIGNMENT allocating an SDCCH.
- g) the SS answers correctly to the SABM on SAPI 0.
- h) the SS answers correctly to the SABM on SAPI 3.
- i) the SS answers to the RP-SMMA from the MS with a CP-DATA containing a RP-ACK RPDU.
- j) after the MS has acknowledged the CP-DATA with a CP-ACK, the SS releases the channel with a CHANNEL RELEASE message. The SIM simulator shall indicate if the "memory capability exceeded" notification flag has been unset on the SIM.
- k) step e) is repeated.

Maximum Duration of Test

-

Expected Sequence

Step	Direction	Message	Comments
1	SS -> MS	PAGING REQUEST	
2	MS -> SS	CHANNEL REQUEST	Establishment cause is "Answer to paging"
3	SS -> MS	IMMEDIATE ASSIGNMENT	SS assigns an SDCCH
4	MS -> SS	PAGING RESPONSE	Message is contained in SABM.
5	SS -> MS	AUTHENTICATION REQUEST	
6	MS -> SS	AUTHENTICATION RESPONSE	SRES specifies correct value.
7	SS -> MS	CIPHERING MODE COMMAND	SS starts deciphering after sending the message.
8	MS -> SS	CIPHERING MODE COMPLETE	Shall be sent enciphered. All following messages shall be sent enciphered.
9	SS		SS starts ciphering.
10	SS -> MS	SABM (SAPI=3)	SS establishes SAPI 3
11	MS -> SS	UA (SAPI=3)	
12	SS -> MS	CP-DATA	Contains RP-DATA RPDU (SMS DELIVER TPDU), Class 2 Short Message
13	SS		Waits max 25 seconds for CP-ACK
14	MS -> SS	CP-ACK	
15	SS		Waits max 60 seconds for RP-ACK RPDU
16	MS -> SS	CP-DATA	Contains RP-ACK RPDU
17	SS -> MS	CP-ACK	Within TC1M after step 16
18	SS -> MS	CHANNEL RELEASE	The main signalling link is released. Step 1-18 is repeated until MS sends a negative acknowledgement (RP-ERROR) in step 16. The RP-ERROR RPDU cause field shall be "Protocol error, unspecified" if there is message capability in the ME, or "Memory capability exceeded" if there is no message capability in the ME. If the total memory store of the MS is full, the ME shall set the "memory capability exceeded" notification flag on the SIM.
19	SS -> MS	PAGING REQUEST	
20	MS -> SS	CHANNEL REQUEST	Establishment cause is "Answer to paging"
21	SS -> MS	IMMEDIATE ASSIGNMENT	SS assigns an SDCCH
22	MS -> SS	PAGING RESPONSE	Message is contained in SABM.
23	SS -> MS	AUTHENTICATION REQUEST	
24	MS -> SS	AUTHENTICATION RESPONSE	SRES specifies correct value.
25	SS -> MS	CIPHERING MODE COMMAND	SS starts deciphering after sending the message.
26	MS -> SS	CIPHERING MODE COMPLETE	Shall be sent enciphered. All following messages shall be sent enciphered.
27	SS		SS starts ciphering.
28	SS -> MS	SABM (SAPI=3)	SS establishes SAPI 3
29	MS -> SS	UA (SAPI=3)	
30	SS -> MS	CP-DATA	Contains RP-DATA RPDU (SMS DELIVER TPDU), Class 1 Short Message
31	SS		Waits max 25 seconds for CP-ACK
32	MS -> SS	CP-ACK	
33	SS		Waits max 60 seconds for RP-ACK RPDU
34	MS -> SS	CP-DATA	Shall contain RP-ACK RPDU if there is memory capability in the ME. If not it shall contain RP-ERROR RPDU which cause field shall be "memory capability exceeded". If the total memory store of the MS now becomes full at this step, the ME shall set the "memory cap. exceed" notification flag on the SIM.
35	SS -> MS	CP-ACK	Within TC1M after step 34

36	SS -> MS	CHANNEL RELEASE	The main signalling link is released. Step 19-36 is repeated until the MS sends an RP-ERROR. The SIM simulator shall indicate if the "memory capability exceeded" notification flag has been set on the SIM.
37	SS -> MS	PAGING REQUEST	Establishment cause is "Answer to paging" SS assigns an SDCCH Message is contained in SABM.
38	MS -> SS	CHANNEL REQUEST	
39	SS -> MS	IMMEDIATE ASSIGNMENT	SRES specifies correct value.
40	MS -> SS	PAGING RESPONSE	
41	SS -> MS	AUTHENTICATION REQUEST	SS starts deciphering after sending the message.
42	MS -> SS	AUTHENTICATION RESPONSE	
43	SS -> MS	CIPHERING MODE COMMAND	Shall be sent enciphered. All following messages shall be sent enciphered. SS starts ciphering. SS establishes SAPI 3
44	MS -> SS	CIPHERING MODE COMPLETE	
45	SS		Contains RP-DATA RPDU (SMS DELIVER TPDU) with TP-DCS set to 0 Waits max 25 seconds for CP-ACK
46	SS -> MS	SABM (SAPI=3)	
47	MS -> SS	UA (SAPI=3)	Waits max 60 seconds for RP-ACK RPDU Shall contain RP-ERROR RPDU with error cause "memory capability exceeded". Within TC1M after step 52
48	SS -> MS	CP-DATA	
49	SS		The main signalling link is released. Prompts the operator to remove one of the short messages from the message store of the MS.
50	MS -> SS	CP-ACK	
51	SS		Establishment cause "Other services which can be completed with an SDCCH" (NECI=0). SS allocates an SDCCH
52	MS -> SS	CP-DATA	
53	SS -> MS	CP-ACK	Message is contained in SABM. CM service type information element is set to "Short message transfer". SAPI 0
54	SS -> MS	CHANNEL RELEASE	
55	SS		MS shall establish SAPI 3
57	MS -> SS	CHANNEL REQUEST	
58	SS -> MS	IMMEDIATE ASSIGNMENT	Contains RP-SMMA RPDU
59	MS -> SS	CM SERVICE REQUEST	
60	SS -> MS	CM SERVICE ACCEPT (UA)	Contains RP-ACK RPDU Acknowledge of CP-DATA containing the RP-ACK RPDU. The ME shall unset the "memory capability exceeded" notification flag on the SIM.
61	MS -> SS	SABM (SAPI=3)	
62	SS -> MS	UA (SAPI=3)	The main signalling link is released. The SIM simulator shall indicate if the "memory capability exceeded" notification flag has been unset on the SIM.
63	MS -> SS	CP-DATA	
64	SS -> MS	CP-ACK	Prompts the operator to remove one of the short messages from the message store of the MS.
65	SS -> MS	CP-DATA	
66	MS -> SS	CP-ACK	Shall not attempt to send a RP-SMMA RPDU. This is verified by checking that the MS does not send a CHANNEL REQUEST message with the establishment cause "Other services which can be completed with an SDCCH"
67	SS -> MS	CHANNEL RELEASE	
68	SS		
69	MS		

NOTE: Time values for SS wait time are chosen sufficiently high to be sure that the MS has enough time to respond to the different messages.

Specific Message Contents:**SMS-DELIVER TPDU in step 12**

Information element	Comment	Value
TP-MTI	SMS DELIVER	"00"B
TP-MMS	more messages are waiting in SC	"0"B
TP-RP	no reply path	"0"B
TP-UDHI	TP-UD contains only the SM	"0"B
TP-SRI	no status report returned	"0"B
TP-OA	an international number coded E.164	
TP-PID	default	"00000000"B
TP-DCS	default alphabet, class 2	"11110010"B
TP-SCTS	any legal value (cf. GSM 03.40)	
TP-UDL		160
TP-UD (140 octets)	text of message	(160 characters)

SMS-DELIVER TPDU in step 30

same as in step 12 except:

TP-DCS	default alphabet, class 1	"11110001"B
--------	---------------------------	-------------

SMS-DELIVER TPDU in step 48

same as in step 12 except:

TP-DCS	default alphabet	"00000000"B
--------	------------------	-------------

34.2.4 Test of the status report capabilities and of SMS-COMMAND:

This test applies to MSs which support the status report capabilities.

34.2.4.1 Conformance requirement

The SMS offers the SC the capabilities of informing the MS of the status of a previously sent mobile originated short message. This is achieved by the SC returning a status report TPDU (SMS-STATUS-REPORT) to the originating MS.

SMS-COMMAND enables an MS to invoke an operation at the SC.

The MS shall increment TP-MR by 1 for each SMS-SUBMIT or SMS-COMMAND being submitted.

References

GSM 03.40; 3.2.9.

GSM 03.40; 9.2.3.6.

34.2.4.2 Test purpose

- 1) To verify that the MS is able to accept a SMS-STATUS-REPORT TPDU.
- 2) To verify that the MS is able to use the SMS-COMMAND functionality correctly and sends an SMS-COMMAND TPDU with the correct TP-Message-Reference.

34.2.4.3 Method of test

Initial conditions

System Simulator:

1 cell, default parameters.

Mobile Station:

The MS shall be in the idle updated state.

Related PICS/PIXIT Statements

Support of SMS MO/PP and MT/PP.

Foreseen Final State of MS

Idle, updated.

Test Procedure

- a) The MS is made to send a Mobile Originated short message as in steps a) to d) of test 34.2.2 (SMS Mobile originated).
- b) The SS establishes a data link on SAPI-3 with the MS, then sends a CP-DATA message containing a RP-DATA RPDU itself containing an SMS-STATUS-REPORT TPDU.
- c) The SS sends a CHANNEL RELEASE message.
- d) The MS is made to send an SMS-COMMAND message enquiring about the previously submitted short message.
- e) The SS responds to the MS so as to enable it to establish a data link on SAPI-3 on an SDCCH.
- f) The SS acknowledges the CP-DATA message from the MS with a CP-ACK followed by a CP-DATA message containing an RP-ACK RPDU
- g) After receiving the CP-ACK from the MS, the SS releases the channel by using a CHANNEL RELEASE message.
- h) The MS is made to send an SMS-COMMAND message requiring to delete the previously submitted short message.
- i) steps e) to g) are repeated.

Maximum Duration of Test

-

Expected Sequence

Step	Direction	Message	Comments
1	MS -> SS	CHANNEL REQUEST	Establishment cause is "Other procedures which can be completed with an SDCCH " (NECI=0)
2	SS -> MS	IMMEDIATE ASSIGNMENT	SS assigns an SDCCH
3	MS -> SS	CM SERVICE REQUEST	Message is contained in SABM.
4	SS -> MS	AUTHENTICATION REQUEST	
5	MS -> SS	AUTHENTICATION RESPONSE	SRES specifies correct value.
6	SS -> MS	CIPHERING MODE COMMAND	SS starts deciphering after sending the message.
7	MS -> SS	CIPHERING MODE COMPLETE	Shall be sent enciphered. All following messages shall be sent enciphered.
8	SS		SS starts ciphering.
9	MS -> SS	SABM (SAPI=3)	MS establishes SAPI 3
10	SS -> MS	UA (SAPI=3)	
11	MS -> SS	CP-DATA	Contains RP-DATA RPDU (SMS SUBMIT TPDU)
12	SS -> MS	CP-ACK	Sent within TC1M after step 11
13	SS -> MS	CP-DATA	Contains RP-ACK RPDU
14	SS		Waits max 25 seconds for CP-ACK
15	MS -> SS	CP-ACK	
16	SS -> MS	CHANNEL RELEASE	The main signalling link is released.
17	SS -> MS	PAGING REQUEST	
18	MS -> SS	CHANNEL REQUEST	Establishment cause is "Answer to paging"
19	SS -> MS	IMMEDIATE ASSIGNMENT	SS assigns an SDCCH
20	MS -> SS	PAGING RESPONSE	Message is contained in SABM.
22	SS -> MS	AUTHENTICATION REQUEST	
23	MS -> SS	AUTHENTICATION RESPONSE	SRES specifies correct value.
24	SS -> MS	CIPHERING MODE COMMAND	SS starts deciphering after sending the message.
25	MS -> SS	CIPHERING MODE COMPLETE	Shall be sent enciphered. All following messages shall be sent enciphered.
26	SS		SS starts ciphering.
27	SS -> MS	SABM (SAPI=3)	SS establishes SAPI 3
28	MS -> SS	UA (SAPI=3)	
29	SS -> MS	CP-DATA	Contains RP-DATA RPDU (SMS-STATUS-REPORT TPDU)
30	MS -> SS	CP-ACK	
31	MS -> SS	CP-DATA	Contains RP-ACK RPDU
32	SS -> MS	CP-ACK	
33	SS -> MS	CHANNEL RELEASE	
34	MS		The MS is made to send an SMS-COMMAND message enquiring about the previously submitted SM
35	MS -> SS	CHANNEL REQUEST	Establishment cause "Other services which can be completed with an SDCCH".
36	SS -> MS	IMMEDIATE ASSIGNMENT	SS assigns an SDCCH
37	MS -> SS	CM SERVICE REQUEST	Message is contained in SABM.
38	SS -> MS	AUTHENTICATION REQUEST	
39	MS -> SS	AUTHENTICATION RESPONSE	SRES specifies correct value.
40	SS -> MS	CIPHERING MODE COMMAND	SS starts deciphering after sending the message.
41	MS -> SS	CIPHERING MODE COMPLETE	Shall be sent enciphered. All following messages shall be sent enciphered.
42	SS		SS starts ciphering.
43	MS -> SS	SABM (SAPI=3)	MS establishes SAPI 3
44	SS -> MS	UA (SAPI=3)	
45	MS -> SS	CP-DATA	Contains RP-DATA RPDU (SMS-COMMAND TPDU) which shall contain the correct TP-MR
46	SS -> MS	CP-ACK	

47	SS -> MS	CP-DATA	Contains RP-ACK RPDU
48	MS -> SS	CP-ACK	
49	SS -> MS	CHANNEL RELEASE	
50	MS	The MS is made to send an SMS-COMMAND	message requiring to delete the previously submitted SM.
51	MS -> SS	CHANNEL REQUEST	Establishment cause "Other services which can be completed with an SDCCH".
52	SS -> MS	IMMEDIATE ASSIGNMENT	SS assigns an SDCCH
53	MS -> SS	CM SERVICE REQUEST	Message is contained in SABM.
54	SS -> MS	AUTHENTICATION REQUEST	
55	MS -> SS	AUTHENTICATION RESPONSE	SRES specifies correct value.
56	SS -> MS	CIPHERING MODE COMMAND	SS starts deciphering after sending the message.
57	MS -> SS	CIPHERING MODE COMPLETE	Shall be sent enciphered. All following messages shall be sent enciphered.
58	SS		SS starts ciphering.
59	MS -> SS	SABM (SAPI=3)	MS establishes SAPI 3
60	SS -> MS	UA (SAPI=3)	
61	MS -> SS	CP-DATA	Contains RP-DATA RPDU (SMS-COMMAND TPDU) which shall contain the correct TP-MR
62	SS -> MS	CP-ACK	
63	SS -> MS	CP-DATA	Contains RP-ACK RPDU
64	MS -> SS	CP-ACK	
65	SS -> MS	CHANNEL RELEASE	

Specific Message Contents:**SMS SUBMIT TPDU**

Information element	Comment	Value
TP-MTI	SMS SUBMIT	"01"B
TP-VPF	not checked	
TP-RP	no reply path	"0"B
TP-UDHI	not checked	
TP-SRR	status report is requested	"1"B
TP-MR	not checked	
TP-RD	not checked	
TP-DA	not checked (an E164 number)	
TP-PID	default	"00000000"B
TP-DCS	default alphabet	"00000000"B
TP-VP	not checked	
TP-UDL	as applicable	
TP-UD (140 octets max)	maximum number of characters	

SMS-STATUS-REPORT TPDU (SS to MS in step 29):

Information element	Comment	Value
TP-MTI	SMS-STATUS-REPORT	"10"B
TP-MR	same as previous SMS-SUBMIT	
TP-MMS	no more messages	"1"B
TP-SRQ	result of SMS-SUBMIT	"0"B
TP-RA	same as the Destination address of the SMS-SUBMIT	
TP-SCTS	any legal value (cf. GSM 03.40)	
TP-DT	any legal value (cf. GSM 03.40)	
TP-ST	SM received	"00000000"B

first SMS-COMMAND TPDU (MS to SS in step 44)

Information element	Comment Value
TP-MTI	SMS-COMMAND "10"B
TP-MR	TP-MR in previous SMS-SUBMIT plus "1"
TP-SRR	status report requested (GSM 03.40 9.2.3.19) "1"B
TP-PID	default "00000000"B
TP-CT	Enquiry relating to previously submitted short message "00000000"B
TP-MN	not checked (TP-MR in previous SMS-SUBMIT)
TP-DA	not checked (an E164 number)
TP-CDL	not checked
TP-CD	not checked

second SMS-COMMAND TPDU (MS to SS in step 60)

Information element	Comment Value
TP-MTI	SMS-COMMAND "10"B
TP-MR	TP-MR in previous SMS-COMMAND plus "1"
TP-SRR	status report not requested "0"B
TP-PID	default "00000000"B
TP-CT	Delete previously submitted short message "00000010"B
TP-MN	not checked (TP-MR in previous SMS-SUBMIT)
TP-DA	not checked (an E164 number)
TP-CDL	not checked
TP-CD	not checked

34.2.5 Test of message class 0 to 3

The tests under this section only apply to a MS capable of displaying short messages (see PICS/PIXIT).

34.2.5.1 Short message class 0**34.2.5.1.1 Conformance requirement**

When a mobile terminated message is class 0 and the MS has the capability of displaying short messages, the MS shall display the message immediately and send an acknowledgement to the SC when the message has successfully reached the MS irrespective of whether there is memory available in the SIM or ME. The message shall not be automatically stored in the SIM or ME.

References

GSM 03.38, 4.

34.2.5.1.2 Test purpose

To verify that the MS will accept and display but not store a class 0 message, and that it will accept and display a class 0 message if its message store is full.

NOTE: failure of this test in a mobile could cause it to reject a class 0 message when its SMS memory becomes full. This could lead to unwanted repetitions between the MS and the service centre.

34.2.5.1.3 Method of test**Initial conditions**

System Simulator:

1 cell, default parameters.

Mobile Station:

The MS shall be in the idle updated state.

The MS message store shall be empty.

Related PICS/PIXIT Statements

Support for Short message MT/PP.

Description of the basic procedures to display a mobile terminated short message.

The value of timer TC1M.

Whether SMS messages are stored in the SIM and/or the ME.

Foreseen Final State of MS

Idle, updated.

Test Procedure

- a) The SS sends a class 0 message by using the method described in step a) of section 34.2.1 but with the TPDU described in this section.
- b) The MS message store shall be filled (for example by using the method of 34.2.3 test of the memory available notification) with the same SMS-DELIVER TPDU except that TP-DCS is set to class 1.
- c) The SS sends a class 0 message as in step a).

Maximum Duration of Test

-

Expected Sequence

Step	Direction	Message	Comments
1	SS -> MS	PAGING REQUEST	
2	MS -> SS	CHANNEL REQUEST	Establishment cause is "Answer to paging"
3	SS -> MS	IMMEDIATE ASSIGNMENT	SS assigns an SDCCH
4	MS -> SS	PAGING RESPONSE	Message is contained in SABM.
5	SS -> MS	AUTHENTICATION REQUEST	
6	MS -> SS	AUTHENTICATION RESPONSE	SRES specifies correct value.
7	SS -> MS	CIPHERING MODE COMMAND	SS starts deciphering after sending the message.
8	MS -> SS	CIPHERING MODE COMPLETE	Shall be sent enciphered. All following messages shall be sent enciphered.
9	SS		SS starts ciphering.
10	SS -> MS	SABM (SAPI=3)	SS establishes SAPI 3
11	MS -> SS	UA (SAPI=3)	
12	SS -> MS	CP-DATA	Contains RP-DATA RPDU (SMS DELIVER TPDU), Class 0 Short Message
13	MS -> SS	CP-ACK	
14	MS -> SS	CP-DATA	Contains RP-ACK RPDU.
15	SS -> MS	CP-ACK	
16	SS -> MS	CHANNEL RELEASE	
17	MS		The content of the short message shall be displayed by the ME. The MS shall not store the message. This can be checked by verifying that it is impossible to retrieve any short messages from the MS message store.
18	SS		The MS message store shall be filled (for example by using the method of 34.2.3) with Class 1 SMS-DELIVER TPDU.
19	SS -> MS	PAGING REQUEST	
20	MS -> SS	CHANNEL REQUEST	Establishment cause is "Answer to paging"
21	SS -> MS	IMMEDIATE ASSIGNMENT	SS assigns an SDCCH
22	MS -> SS	PAGING RESPONSE	Message is contained in SABM.
23	SS -> MS	AUTHENTICATION REQUEST	
24	MS -> SS	AUTHENTICATION RESPONSE	SRES specifies correct value.
25	SS -> MS	CIPHERING MODE COMMAND	SS starts deciphering after sending the message.
26	MS -> SS	CIPHERING MODE COMPLETE	Shall be sent enciphered. All following messages shall be sent enciphered.
27	SS		SS starts ciphering.
28	SS -> MS	SABM (SAPI=3)	SS establishes SAPI 3
29	MS -> SS	UA (SAPI=3)	
30	SS -> MS	CP-DATA	Contains RP-DATA RPDU (SMS DELIVER TPDU), Class 0 Short Message
31	MS -> SS	CP-ACK	
32	MS -> SS	CP-DATA	Contains RP-ACK RPDU.
33	SS -> MS	CP-ACK	
34	SS -> MS	CHANNEL RELEASE	
35	MS		The content of the short message shall be displayed by the ME.

Specific Message Contents:**SMS-DELIVER TPDU (containing a class 0 message) (SS to MS):**

Information element	Comment	Value
TP-MTI	SMS-DELIVER	"00"B
TP-MMS	more messages are waiting in SC	"0"B
TP-RP	no reply path	"0"B
TP-UDHI	TP-UD contains only the SM	"0"B
TP-SRI	no status report returned	0
TP-OA	an international number coded E.164	
TP-PID	default	"00000000"B
TP-DCS	default alphabet, class 0	"1111 0000"B
TP-SCTS	any legal value (cf. GSM 03.40)	
TP-UDL		160
TP-UD (140 octets)	text of message	(160 characters)

SMS-DELIVER TPDU (containing a class 1 message to fill the MS message store) (SS to MS):

Information element	Comment	Value
TP-MTI	SMS-DELIVER	"00"B
TP-MMS	more messages are waiting in SC	"0"B
TP-RP	no reply path	"0"B
TP-UDHI	TP-UD contains only the SM	"0"B
TP-SRI	no status report returned	0
TP-OA	an international number coded E.164	
TP-PID	default	"00000000"B
TP-DCS	default alphabet, class 1	"1111 0001"B
TP-SCTS	any legal value (cf. GSM 03.40)	
TP-UDL		160
TP-UD (140 octets)	text of message	(160 characters)

34.2.5.2 Test of class 1 short messages

This test shall apply to MSs which support:

- storing of received Class 1 Short Messages and
- displaying of stored Short Messages.

34.2.5.2.1 Conformance requirement

When a mobile terminated message is class 1, the MS shall send an acknowledgement to the SC when the message has successfully reached the MS and can be stored, either in the ME or in the SIM.

References

GSM 03.38, 4.

34.2.5.2.2 Test purpose

This procedure verifies that the MS acts correctly on receiving a class 1 message, i.e. that it stores the message in the ME or SIM and sends an acknowledgement (at RP and CP-Layer).

34.2.5.2.3 Method of test**Initial conditions**

System Simulator:

1 cell, default parameters.

Mobile Station:

The MS shall be in the idle updated state.

The MS message store shall be empty.

For storing of class 1 Short Messages, the MS shall be set up to store Short Messages in the ME memory (by way of MMI, as described in PICS/PIXIT statement).

Related PICS/PIXIT Statements

Support for Short message MT/PP.

Description of the basic procedures to display a mobile terminated short message.

The value of timer TC1M.

Whether SMS messages are stored in the SIM and/or the ME.

Foreseen Final State of MS

Idle, updated.

Test Procedure

- a) the SS delivers a Short Message of class 1 to the MS as specified in section 34.2.1, step a).
- b) the Short Message is recalled (e.g. by means of the MMI).

Maximum Duration of Test

-

Expected Sequence

Step	Direction	Message	Comments
1	SS -> MS	PAGING REQUEST	
2	MS -> SS	CHANNEL REQUEST	Establishment cause is "Answer to paging"
3	SS -> MS	IMMEDIATE ASSIGNMENT	SS assigns an SDCCH
4	MS -> SS	PAGING RESPONSE	Message is contained in SABM.
5	SS -> MS	AUTHENTICATION REQUEST	
6	MS -> SS	AUTHENTICATION RESPONSE	SRES specifies correct value.
7	SS -> MS	CIPHERING MODE COMMAND	SS starts deciphering after sending the message.
8	MS -> SS	CIPHERING MODE COMPLETE	Shall be sent enciphered. All following messages shall be sent enciphered.
9	SS		SS starts ciphering.
10	SS -> MS	SABM (SAPI=3)	SS establishes SAPI 3
11	MS -> SS	UA (SAPI=3)	
12	SS -> MS	CP-DATA	Contains RP-DATA RPDU (SMS DELIVER TPDU), Class 1 Short Message
13	MS -> SS	CP-ACK	
14	MS -> SS	CP-DATA	Contains RP-ACK RPDU.
15	SS -> MS	CP-ACK	
16	SS -> MS	CHANNEL RELEASE	
17	MS		The short message shall be recalled and displayed at the MS.

Specific Message Contents:**SMS-DELIVER TPDU (containing a class 1 message) (SS to MS):**

Information element	Comment	Value
TP-MTI	SMS-DELIVER	"00"B
TP-MMS	more messages are waiting in SC	"0"B
TP-RP	no reply path	"0"B
TP-UDHI	TP-UD contains only the SM	"0"B
TP-SRI	no status report returned	0
TP-OA	an international number coded E.164	
TP-PID	default	"00000000"B
TP-DCS	default alphabet, class 1	"1111 0001"B
TP-SCTS	any legal value (cf. GSM 03.40)	
TP-UDL		160
TP-UD (140 octets)	text of message	(160 characters)

34.2.5.3 Test of class 2 short messages**34.2.5.3.1 Definition and applicability**

Class 2 Short Messages are defined as SIM specific, and the MS shall ensure that a message of this class is stored on the SIM.

This test shall apply to MSs which support:

- storing of received Class 2 Short Messages in the SIM.

34.2.5.3.2 Conformance requirement

When a mobile terminated message is Class 2, the MS shall ensure that the message has been correctly transferred to the SMS data field in the SIM before sending an acknowledgement to the SC. The MS shall return a "protocol error, unspecified" error message if the short message cannot be stored in the SIM and

there is other short message storage available at the MS. If all the short message storage at the MS is already in use, the MS shall return "memory capacity exceeded".

Reference(s)

GSM 03.40, 9.2.3.10; GSM 03.38, 4. GSM 11.11, 10.3.3.

34.2.5.3.3 Test purpose

This procedure verifies that the MS acts correctly on receiving a class 2 message, i.e. that it stores the message correctly in the SIM, and if this is not possible, returns a protocol error message, with the correct error cause, to the network.

There are 2 cases:

- 1) If the MS supports storing of short messages in the SIM and in the ME, and storage in the ME is not full, and the short message cannot be stored in the SIM, the error cause shall be "protocol error, unspecified".
- 2) If the MS supports storing of short messages in the SIM and not in the ME, and storage in the ME is not full, and the short message cannot be stored in the SIM, the error cause shall be "memory capacity exceeded".

NOTE: If the MS supports storing of short messages in the SIM and the ME, and storage in the ME is full, and the short message cannot be stored in the SIM, the error cause shall be "memory capacity exceeded". This case is not tested in this test.

34.2.5.3.4 Test method

Initial conditions

System Simulator:

1 cell, default parameters.

Mobile Station:

The MS shall be in the idle updated state.

The ME message store shall be empty.

The ME shall be connected to the SIM simulator. The following shall be present in the SIM simulator:

- EF_{SMS} with at least two free records and one full record;
- EF_{SMSstatus}, with SMS "Memory Cap. Exceed" notification flag set to "memory available";
- Service no. 4 (SMS) in EF_{SST} set to allocated and activated;

For storing of Class 1 Short Messages the MS shall be set up to store Short Messages in the ME memory (by way of MMI, as described in PICS/PIXIT statement).

Related PICS/PIXIT Statements

Support for Short message MT/PP.

The value of timer TC1M.

Whether SMS messages are stored in the SIM and/or the ME.

Foreseen Final State of MS

Idle, updated.

Test Procedure

- a) the SS delivers a Short Message of class 2 to the MS as specified in section 34.2.1, step b).
- b) following an attempt by the ME to store the short message in a free record of EF_{SMS} in the SIM, the SIM simulator returns the status response "OK" ("90 00").
- c) step a) is repeated.
- d) following an attempt by the ME to store the short message in a free record of EF_{SMS} in the SIM, the SIM simulator returns the status response "memory problem" ("92 40").
- e) the SIM simulator indicates if an attempt was made in steps a) and c) to store the messages and if the messages are stored according to the requirement.

Maximum Duration of Test

-

Expected Sequence

Step	Direction	Message	Comments
1	SS -> MS	PAGING REQUEST	
2	MS -> SS	CHANNEL REQUEST	Establishment cause is "Answer to paging"
3	SS -> MS	IMMEDIATE ASSIGNMENT	SS assigns an SDCCH
4	MS -> SS	PAGING RESPONSE	Message is contained in SABM.
5	SS -> MS	AUTHENTICATION REQUEST	
6	MS -> SS	AUTHENTICATION RESPONSE	SRES specifies correct value.
7	SS -> MS	CIPHERING MODE COMMAND	SS starts deciphering after sending the message.
8	MS -> SS	CIPHERING MODE COMPLETE	Shall be sent enciphered. All following messages shall be sent enciphered.
9	SS		SS starts ciphering.
10	SS -> MS	SABM (SAPI=3)	SS establishes SAPI 3
11	MS -> SS	UA (SAPI=3)	
12	SS -> MS	CP-DATA	Contains RP-DATA RPDU (SMS DELIVER TPDU), Class 2 Short Message
13	MS -> SS	CP-ACK	
14	ME		The ME shall correctly store the short message in a free record of EFSMS in the SIM, i.e. -the ME shall use a free record - the first byte of the record shall indicate "message received by MS from network"
15	SIM		- the TS-Service-Centre-Address shall be correctly stored - the TPDU shall be identical to that sent by the SS - bytes following the TPDU shall be set to "FF" The SIM simulator returns the status response "OK" ("90 00"). The SIM simulator shall indicate if an attempt was made by the ME to store the short message in the SIM.
16	MS -> SS	CP-DATA	Contains RP-ACK RPDU.
16A	SS -> MS	CP-ACK	
17	SS -> MS	CHANNEL RELEASE	
18	SS -> MS	PAGING REQUEST	
19	MS -> SS	CHANNEL REQUEST	Establishment cause is "Answer to paging"
20	SS -> MS	IMMEDIATE ASSIGNMENT	SS assigns an SDCCH
21	MS -> SS	PAGING RESPONSE	Message is contained in SABM.
22	SS -> MS	AUTHENTICATION REQUEST	
23	MS -> SS	AUTHENTICATION RESPONSE	SRES specifies correct value.
24	SS -> MS	CIPHERING MODE COMMAND	SS starts deciphering after sending the message.
25	MS -> SS	CIPHERING MODE COMPLETE	Shall be sent enciphered. All following messages shall be sent enciphered.
26	SS		SS starts ciphering.
27	SS -> MS	SABM (SAPI=3)	SS establishes SAPI 3
28	MS -> SS	UA (SAPI=3)	
29	SS -> MS	CP-DATA	Contains RP-DATA RPDU (SMS DELIVER TPDU), Class 2 Short Message
30	MS -> SS	CP-ACK	
31	ME		The ME shall attempt to store the short message in a free record of EFSMS in the SIM.
32	SIM		The SIM simulator returns the status response "memory problem" ("92 40"). The SIM simulator shall indicate if an attempt was made by the ME to store the short message in the SIM.
33	MS -> SS	CP-DATA	Contains RP-ERROR RPDU with error cause "protocol error, unspecified" if the MS supports storing of short messages in the ME, or error cause "memory capacity exceeded" if not.

33A	SS -> MS	CP-ACK	
34	SS -> MS	CHANNEL RELEASE	

Specific Message Contents:**SMS-DELIVER TPDU (containing a class 2 message) (SS to MS):**

Information element	Comment	Value
TP-MTI	SMS-DELIVER	"00"B
TP-MMS	more messages are waiting in SC	"0"B
TP-RP	no reply path	"0"B
TP-UDHI	TP-UD contains only the SM	"0"B
TP-SRI	no status report returned	0
TP-OA	an international number coded E.164	
TP-PID	default	"00000000"B
TP-DCS	default alphabet, class 2	"1111 0010"B
TP-SCTS	any legal value (cf. GSM 03.40)	
TP-UDL		160
TP-UD (140 octets)	text of message	(160 characters)

34.2.5.4 Test of class 3 short messages

For further study.

34.2.6 Test of short message type 0

For further study.

34.2.7 Test of the replace mechanism for SM type 1-7**34.2.7.1 Definition and applicability**

This test shall apply to MSs which support:

- Replace Short Messages and
- display of received Short Messages.

34.2.7.2 Conformance requirement

On receipt of a short message, the MS shall check to see if the associated Protocol Identifier contains a Replace Short Message Type code. If such a code is present, then the MS will check the associated SC address (RP-OA) and originating address (TP-OA) and replace any existing stored message having the same Protocol Identifier code, SC address and originating address with the new short message.

Reference(s)

GSM 03.40; 9.2.3.9.

34.2.7.3 Test purpose

This procedure verifies the correct implementation of the replace mechanism for Replace Short Messages.

34.2.7.4 Test method**Initial conditions**

System Simulator:

1 cell, default parameters.

Mobile Station:

The MS shall be in the idle updated state.

The MS message store shall be empty.

Related PICS/PIXIT Statements

Support for Short message MT/PP.

Description of the basic procedures to display a mobile terminated short message.

The value of timer TC1M.

Foreseen Final State of MS

Idle, updated.

Test Procedure

- a) two different numbers n and m are drawn randomly between 1 and 7. Two different addresses for TP-Originating-Address (TPOA1 and TPOA2) are drawn. Two different addresses for RP-Originating-Address (RPOA1 and RPOA2) are drawn.
- b) the SS delivers a short message to the MS as specified in section 34.2.1 step a). In the SMS-DELIVER TPDU, the TP-Protocol-Identifier parameter is "Replace Short Message Type n", the TP-Originating-Address is TPOA1, and the RP-Originating-Address is RPOA1.
- c) step b) is repeated but with a different TP-Originating-Address (TPOA2), and different contents of TP-User-Data in the SMS-DELIVER TPDU. The other parameters are the same as in step b).
- d) step c) is repeated but with RPOA2 in the RP-Originating-Address, and contents of TP-User-Data different from the former two messages. The other parameters are the same as in step c).
- e) step d) is repeated but with the TP-Protocol-Identifier equal to "Replace Short Message Type m", and contents of TP-User-Data different from the former three messages. The other parameters are the same as in step d).
- f) step e) is repeated but the contents of TP-User-Data are different from that used in step e).
- g) the SS prompts the operator to display the Short Messages stored in the MS.

Maximum Duration of Test

-

Expected Sequence

Step	Direction	Message	Comments
1	SS -> MS	PAGING REQUEST	
2	MS -> SS	CHANNEL REQUEST	Establishment cause is "Answer to paging"
3	SS -> MS	IMMEDIATE ASSIGNMENT	SS assigns an SDCCH
4	MS -> SS	PAGING RESPONSE	Message is contained in SABM.
5	SS -> MS	AUTHENTICATION REQUEST	
6	MS -> SS	AUTHENTICATION RESPONSE	SRES specifies correct value.
7	SS -> MS	CIPHERING MODE COMMAND	SS starts deciphering after sending the message.
8	MS -> SS	CIPHERING MODE COMPLETE	Shall be sent enciphered. All following messages shall be sent enciphered.
9	SS		SS starts ciphering.
10	SS -> MS	SABM (SAPI=3)	SS establishes SAPI 3
11	MS -> SS	UA (SAPI=3)	
12	SS -> MS	CP-DATA	Contains RP-DATA RPDU (SMS DELIVER TPDU) TP-PID is "Replace Short Message Type n", TP-OA is TPOA1 and RP-OA is RPOA1
13	MS -> SS	CP-ACK	
14	MS -> SS	CP-DATA	Contains RP-ACK RPDU.
14A	SS -> MS	CP-ACK	
15	SS -> MS	CHANNEL RELEASE	
16	SS -> MS	PAGING REQUEST	
17	MS -> SS	CHANNEL REQUEST	Establishment cause is "Answer to paging"
18	SS -> MS	IMMEDIATE ASSIGNMENT	SS assigns an SDCCH
19	MS -> SS	PAGING RESPONSE	Message is contained in SABM.
20	SS -> MS	AUTHENTICATION REQUEST	
21	MS -> SS	AUTHENTICATION RESPONSE	SRES specifies correct value.
22	SS -> MS	CIPHERING MODE COMMAND	SS starts deciphering after sending the message.
23	MS -> SS	CIPHERING MODE COMPLETE	Shall be sent enciphered. All following messages shall be sent enciphered.
24	SS		SS starts ciphering.
25	SS -> MS	SABM (SAPI=3)	SS establishes SAPI 3
26	MS -> SS	UA (SAPI=3)	
27	SS -> MS	CP-DATA	Contains RP-DATA RPDU (SMS DELIVER TPDU) TP-PID is "Replace Short Message Type n", TP-OA is TPOA2 and RP-OA is RPOA1, TP-UD different from step 12
28	MS -> SS	CP-ACK	
29	MS -> SS	CP-DATA	Contains RP-ACK RPDU.
29A	SS -> MS	CP-ACK	
30	SS -> MS	CHANNEL RELEASE	
31	SS -> MS	PAGING REQUEST	
32	MS -> SS	CHANNEL REQUEST	Establishment cause is "Answer to paging"
33	SS -> MS	IMMEDIATE ASSIGNMENT	SS assigns an SDCCH
34	MS -> SS	PAGING RESPONSE	Message is contained in SABM.
35	SS -> MS	AUTHENTICATION REQUEST	
36	MS -> SS	AUTHENTICATION RESPONSE	SRES specifies correct value.
37	SS -> MS	CIPHERING MODE COMMAND	SS starts deciphering after sending the message.
38	MS -> SS	CIPHERING MODE COMPLETE	Shall be sent enciphered. All following messages shall be sent enciphered.
39	SS		SS starts ciphering.
40	SS -> MS	SABM (SAPI=3)	SS establishes SAPI 3
41	MS -> SS	UA (SAPI=3)	

42	SS -> MS	CP-DATA	Contains RP-DATA RPDU (SMS DELIVER TPDU) TP-PID is "Replace Short Message Type n", TP-OA is TPOA2 and RP-OA is RPOA2, TP-UD different from step 12 and 27
43	MS -> SS	CP-ACK	
44	MS -> SS	CP-DATA	Contains RP-ACK RPDU.
44A	SS -> MS	CP-ACK	
45	SS -> MS	CHANNEL RELEASE	
46	SS -> MS	PAGING REQUEST	
47	MS -> SS	CHANNEL REQUEST	Establishment cause is "Answer to paging"
48	SS -> MS	IMMEDIATE ASSIGNMENT	SS assigns an SDCCH
49	MS -> SS	PAGING RESPONSE	Message is contained in SABM.
50	SS -> MS	AUTHENTICATION REQUEST	
51	MS -> SS	AUTHENTICATION RESPONSE	SRES specifies correct value.
52	SS -> MS	CIPHERING MODE COMMAND	SS starts deciphering after sending the message.
53	MS -> SS	CIPHERING MODE COMPLETE	Shall be sent enciphered. All following messages shall be sent enciphered.
54	SS		SS starts ciphering.
55	SS -> MS	SABM (SAPI=3)	SS establishes SAPI 3
56	MS -> SS	UA (SAPI=3)	
57	SS -> MS	CP-DATA	Contains RP-DATA RPDU (SMS DELIVER TPDU) TP-PID is "Replace Short Message Type m", TP-OA is TPOA2 and RP-OA is RPOA2, TP-UD different from step 12, 27 and 42
58	MS -> SS	CP-ACK	
59	MS -> SS	CP-DATA	Contains RP-ACK RPDU.
59A	SS -> MS	CP-ACK	
60	SS -> MS	CHANNEL RELEASE	
61	SS -> MS	PAGING REQUEST	
62	MS -> SS	CHANNEL REQUEST	Establishment cause is "Answer to paging"
63	SS -> MS	IMMEDIATE ASSIGNMENT	SS assigns an SDCCH
64	MS -> SS	PAGING RESPONSE	Message is contained in SABM.
65	SS -> MS	AUTHENTICATION REQUEST	
66	MS -> SS	AUTHENTICATION RESPONSE	SRES specifies correct value.
67	SS -> MS	CIPHERING MODE COMMAND	SS starts deciphering after sending the message.
68	MS -> SS	CIPHERING MODE COMPLETE	Shall be sent enciphered. All following messages shall be sent enciphered.
69	SS		SS starts ciphering.
70	SS -> MS	SABM (SAPI=3)	SS establishes SAPI 3
71	MS -> SS	UA (SAPI=3)	
72	SS -> MS	CP-DATA	Contains RP-DATA RPDU (SMS DELIVER TPDU) TP-PID is "Replace Short Message Type m", TP-OA is TPOA2 and RP-OA is RPOA2, TP-UD different from step 57
73	MS -> SS	CP-ACK	
74	MS -> SS	CP-DATA	Contains RP-ACK RPDU.
74A	SS -> MS	CP-ACK	
75	SS -> MS	CHANNEL RELEASE	
76	SS		Prompts the operator to display the Short Messages stored in the MS. Only the Short Messages delivered in step 12, 27, 42 and 72 shall be retrievable and displayed

Specific Message Contents:**SMS-DELIVER TPDU**

Information element	Comment Value
TP-MTI	SMS-DELIVER "00"B
TP-MMS	no more messages are waiting in SC "1"B
TP-RP	no Reply Path "0"B
TP-UDHI	TP-UD contains only the SM "0"B
TP-SRI	no Status Report returned "0"B
TP-OA	an international number coded E.164 (see test method description)
TP-PID	binary 01000xxx, xxx represents n resp. m (see test method description)
TP-DCS	default alphabet "00000000"B
TP-SCTS	the time when the message was submitted according to GSM 03.40
TP-UDL	160
TP-UD (140 octets)	text of message (160 characters) (see test method description)

34.2.8 Test of the reply path scheme**34.2.8.1 Definition and applicability**

This test applies to MSs which support

- reply procedures (the class of MSs for which this is mandatory is described in GSM 03.40, annex 4)
- displaying of received Short Messages and
- submitting Short Messages.

Steps b) and d) are only executed for MSs which support storing of Short messages.

34.2.8.2 Conformance requirement

When a replying MS receives an original mobile terminated short message it has:

originating SME = TP-Originating Address in the SMS-DELIVER TPDU;

original SC = RP-Originating Address in the RP-MT-DATA.

When submitting the reply mobile originated short message, the replying MS should use parameters as follows:

TP-Destination Address in SMS-SUBMIT TPDU = originating SME;

RP-Destination Address in RP-MO-DATA = original SC.

Reference(s)

GSM 03.40 annex 4, sect. 5, 6.

34.2.8.3 Test purpose

This procedure verifies that the MS is able to send a Reply Short Message back to the correct originating SME even if in the meantime it receives another Short Message.

34.2.8.4 Test method

Initial conditions

System Simulator:

1 cell, default parameters.

Mobile Station:

The MS shall be in the idle updated state.

The MS message store shall be empty.

Related PICS/PIXIT Statements

Support for Short message MT/PP.

Support for Short message MO/PP.

Description of the basic procedures to display a mobile terminated short message.

Description of the basic procedures to send a mobile originated short message.

The value of timer TC1M.

Foreseen Final State of MS

Idle, updated.

Test Procedure

- a) the SS delivers a Short Message as specified in section 34.2.1, step b) with TP-Reply-Path set to 1.
- b) step a) is repeated but with:
 - different TP-Originating-Address for the originating SME;
 - different RP-Originating-Address for the original SC and
 - different message contents TP-User-Data.
- c) one of the two Short Messages is displayed (e.g. by means of the MMI) and the Reply Short Message is submitted (e.g. by means of the MMI).
- d) step c) is repeated for the other Short Message.

Maximum Duration of Test

-

Expected Sequence

Step	Direction	Message	Comments
1	SS -> MS	PAGING REQUEST	
2	MS -> SS	CHANNEL REQUEST	Establishment cause is "Answer to paging"
3	SS -> MS	IMMEDIATE ASSIGNMENT	SS assigns an SDCCH
4	MS -> SS	PAGING RESPONSE	Message is contained in SABM.
5	SS -> MS	AUTHENTICATION REQUEST	
6	MS -> SS	AUTHENTICATION RESPONSE	SRES specifies correct value.
7	SS -> MS	CIPHERING MODE COMMAND	SS starts deciphering after sending the message.
8	MS -> SS	CIPHERING MODE COMPLETE	Shall be sent enciphered. All following messages shall be sent enciphered.
9	SS		SS starts ciphering.
10	SS -> MS	SABM (SAPI=3)	SS establishes SAPI 3
11	MS -> SS	UA (SAPI=3)	
12	SS -> MS	CP-DATA	Contains RP-DATA RPDU (SMS DELIVER TPDU) TP-RP set to 1
13	MS -> SS	CP-ACK	Sent within TC1M after step 12
14	MS -> SS	CP-DATA	Contains RP-ACK RPDU.
14A	SS -> MS	CP-ACK	
15	SS -> MS	CHANNEL RELEASE	
16	SS -> MS	PAGING REQUEST	
17	MS -> SS	CHANNEL REQUEST	Establishment cause is "Answer to paging"
18	SS -> MS	IMMEDIATE ASSIGNMENT	SS assigns an SDCCH
19	MS -> SS	PAGING RESPONSE	Message is contained in SABM.
20	SS -> MS	AUTHENTICATION REQUEST	
21	MS -> SS	AUTHENTICATION RESPONSE	SRES specifies correct value.
22	SS -> MS	CIPHERING MODE COMMAND	SS starts deciphering after sending the message.
23	MS -> SS	CIPHERING MODE COMPLETE	Shall be sent enciphered. All following messages shall be sent enciphered.
24	SS		SS starts ciphering.
25	SS -> MS	SABM (SAPI=3)	SS establishes SAPI 3
26	MS -> SS	UA (SAPI=3)	
27	SS -> MS	CP-DATA	Contains RP-DATA RPDU (SMS DELIVER TPDU) TP-OA, RP-OA and TP-UD different from step 12
28	MS -> SS	CP-ACK	Sent within TC1M after step 12
29	MS -> SS	CP-DATA	Contains RP-ACK RPDU.
29A	SS -> MS	CP-ACK	
30	SS -> MS	CHANNEL RELEASE	
31	MS		One of the two Short Messages is displayed and the Reply Short Message is submitted.
32	MS -> SS	CHANNEL REQUEST	
33	SS -> MS	IMMEDIATE ASSIGNMENT	SS assigns an SDCCH
34	MS -> SS	CM SERVICE REQUEST	Message is contained in SABM.
35	SS -> MS	AUTHENTICATION REQUEST	
36	MS -> SS	AUTHENTICATION RESPONSE	SRES specifies correct value.
37	SS -> MS	CIPHERING MODE COMMAND	SS starts deciphering after sending the message.
38	MS -> SS	CIPHERING MODE COMPLETE	Shall be sent enciphered. All following messages shall be sent enciphered.
39	SS		SS starts ciphering.
40	MS -> SS	SABM (SAPI=3)	MS establishes SAPI 3
41	SS -> MS	UA (SAPI=3)	
42	MS -> SS	CP-DATA	Contains RP-DATA RPDU (SMS SUBMIT TPDU) RP-DA = RP-OA corresponding to the message displayed TP-DA = TP-OA corresponding to the message displayed
43	SS -> MS	CP-ACK	Sent within TC1M after step 42

44	SS -> MS	CP-DATA	Contains RP-ACK RPDU
45	SS		Waits max 25 seconds for CP-ACK
46	MS -> SS	CP-ACK	
47	SS -> MS	CHANNEL RELEASE	The main signalling link is released.
48	MS		The other Short Message is displayed and the Reply Short Message is submitted.
49	MS -> SS	CHANNEL REQUEST	
50	SS -> MS	IMMEDIATE ASSIGNMENT	SS assigns an SDCCH
51	MS -> SS	CM SERVICE REQUEST	Message is contained in SABM.
52	SS -> MS	AUTHENTICATION REQUEST	
53	MS -> SS	AUTHENTICATION RESPONSE	SRES specifies correct value.
54	SS -> MS	CIPHERING MODE COMMAND	SS starts deciphering after sending the message.
55	MS -> SS	CIPHERING MODE COMPLETE	Shall be sent enciphered. All following messages shall be sent enciphered.
56	SS		SS starts ciphering.
57	MS -> SS	SABM (SAPI=3)	MS establishes SAPI 3
58	SS -> MS	UA (SAPI=3)	
59	MS -> SS	CP-DATA	Contains RP-DATA RPDU (SMS SUBMIT TPDU) RP-DA = RP-OA corresponding to the Message displayed TP-DA = TP-OA corresponding to the message displayed
60	SS -> MS	CP-ACK	Sent within TC1M after step 59
61	SS -> MS	CP-DATA	Contains RP-ACK RPDU
62	SS		Waits max 25 seconds for CP-ACK
63	MS -> SS	CP-ACK	
64	SS -> MS	CHANNEL RELEASE	The main signalling link is released.

Specific Message Contents:

SMS-DELIVER TPDU

Information element	Comment Value
TP-MTI	SMS-DELIVER "00"B
TP-MMS	no more messages are waiting in SC "1"B
TP-RP	Reply Path exists "1"B
TP-UDHI	TP-UD contains only the SM "0"B
TP-SRI	no Status Report returned "0"B
TP-OA	an international number coded E.164 (see test method description)
TP-PID	default "00000000"B
TP-DCS	default alphabet "00000000"B
TP-SCTS	the time when the message was submitted according to GSM 03.40
TP-UDL	160
TP-UD (140 octets)	text of message (160 characters) (see test method description)

34.2.9 Multiple SMS mobile originated

34.2.9.1 MS in idle mode

This test applies to MS supporting the ability of sending multiple short messages on the same RR connection when there is no call in progress.

34.2.9.1.1 Conformance requirements

When the MS chooses to use the same RR connection to send another short message or a memory available notification, then:

- the MS shall transmit a CM SERVICE REQUEST for the new CM connection before the final CP-ACK (e.g. the one that acknowledges the CP-DATA that carried the RP-ACK) for the old MM connection is transmitted;
- before transmission of the first CP-DATA on the new MM connection, the MS shall transmit the CP-ACK for the old MM connection;
- the Transaction Identifier used on the new MM connection shall be different to that used on the old MM connection; and
- the MS shall not initiate establishment of the new MM connection before the final CP-DATA (e.g. the one carrying the RP-ACK) has been received.

Reference

GSM 03.40; 3.1
GSM 04.11; 5.4
GSM 04.13; 5.6

34.2.9.1.2 Test purpose

To verify that the MS is able to correctly send multiple short messages on the same RR connection when using an SDCCH.

34.2.9.1.3 Method of test

Initial conditions

System simulator:

1 cell, default parameters.

Mobile Station:

The MS shall be in "Idle, updated" state.

The SMS message storage shall be empty.

Related PICS/PIXIT statements

Support for multiple short message MO/PP on the same RR connection
Description of how to enter multiple SMS
Description of the basic procedures to display a mobile originated short message
Whether SMS messages are stored in the SIM and/or the ME.

Foreseen final state of MS

Idle, updated

Test procedure

- a) The MS shall be set up to send 3 short messages as multiple SM to the SS. The SS responds to the channel request message by allocating an SDCCH. The SS answers correctly to the SABM on SAPI 0 and then performs the authentication and ciphering procedures.
- b) The SS responds with a UA frame SAPI-3 to the MS.
- c) The SS responds to the CP-DATA containing RP-DATA RPDU (SMS SUBMIT TPDU) from the MS with a CP-ACK message followed by a CP-DATA message containing the correct RP-ACK RPDU. The Transaction Identifier used on this MM connection is 'x'.

- d) the MS shall transmit a CM SERVICE REQUEST for the new CM connection (for the second short message) before the final CP-ACK (the one that acknowledges the CP-DATA that carried the RP-ACK before) for the old MM connection is transmitted. The MS shall not initiate establishment of the new MM connection before the final CP-DATA (i.e. the one carrying the RP-ACK for the first short message) has been received. Before transmission of the first CP-DATA on the new MM connection, the MS shall transmit the CP-ACK for the old MM connection. The Transaction Identifier used on the new MM connection shall be y , where $y < x$ (see procedure c)).
- e) The SS waits a maximum of 5 seconds after receiving the CM SERVICE REQUEST for the CP-ACK message from the MS.
- f) The SS responds to the CP-DATA containing RP-DATA RPDU (SMS SUBMIT TPDU) from the MS with a CP-ACK message followed by a CP-DATA message containing the correct RP-ACK RPDU.
- g) the MS shall transmit a CM SERVICE REQUEST for the new CM connection (for the third short message) before the final CP-ACK (the one that acknowledges the CP-DATA that carried the RP-ACK before) for the old MM connection is transmitted. Before transmission of the first CP-DATA on the new MM connection, the MS shall transmit the CP-ACK for the old MM connection. The Transaction Identifier used on the new MM connection shall be z , where $z < y$ (see procedure d)). The MS shall not initiate establishment of the new MM connection before the final CP-DATA (i.e. the one carrying the RP-ACK for the second short message) has been received.
- h) The SS waits a maximum of 5 seconds after receiving the CM SERVICE REQUEST for the CP-ACK message from the MS.
- i) The SS responds to the CP-DATA containing RP-DATA RPDU (SMS SUBMIT TPDU) from the MS with a CP-ACK message followed by a CP-DATA message containing the correct RP-ACK RPDU.
- j) The SS waits a maximum of 5 seconds after sending CP-DATA for the CP-ACK message from the MS.
- k) The SS sends a Channel Release message to the MS.

Maximum duration of test

5 min.

Expected sequence

Step	Direction	Message	Comments
1	MS -> SS	CHANNEL REQUEST	Establishment cause is "Other procedures which can be completed with an SDCCH" NECI = 0
2	SS -> MS	IMMEDIATE ASSIGNMENT	SS assigns an SDCCH
3	MS -> SS	CM SERVICE REQUEST	Message is contained in SABM on SAPI 0. CM service type set to "Short message transfer"
4	SS -> MS	AUTHENTICATION REQUEST	
5	MS -> SS	AUTHENTICATION RESPONSE	SRES specifies correct value.
6	SS -> MS	CIPHERING MODE COMMAND	SS starts deciphering after sending the message.
7	MS -> SS	CIPHERING MODE COMPLETE	Shall be sent enciphered. All following messages shall be sent enciphered.
8	SS		SS starts ciphering.
9	MS -> SS	SABM (SAPI=3)	MS establishes SAPI 3 on DCCH
10	SS -> MS	UA (SAPI=3)	
11	MS -> SS	CP-DATA	Contains RP-DATA RPDU (SMS SUBMIT TPDU). The Transaction Identifier used in steps 11, 12, 13 and 15 shall be x.
12	SS -> MS	CP-ACK	
13	SS -> MS	CP-DATA	Contains RP-ACK RPDU
14	MS -> SS	CM SERVICE REQUEST	CM service type set to "Short message transfer".
15	MS -> SS	CP-ACK	Shall be sent within 5 seconds of step 14
16	SS -> MS	CM SERVICE ACCEPT	
17	MS -> SS	CP-DATA	Contains RP-DATA RPDU (SMS SUBMIT TPDU). The Transaction Identifier used in steps 17, 18, 19 and 21 shall be y where $y <> x$ (see step 11).
18	SS -> MS	CP-ACK	
19	SS -> MS	CP-DATA	Contains RP-ACK RPDU
20	MS -> SS	CM SERVICE REQUEST	CM service type set to "Short message transfer".
21	MS -> SS	CP-ACK	Shall be sent within 5 seconds of step 20
22	SS -> MS	CM SERVICE ACCEPT	
23	MS -> SS	CP-DATA	Contains RP-DATA RPDU (SMS SUBMIT TPDU). The Transaction Identifier used in steps 23, 24, 25 and 26 shall be z, where $z <> y$ (see step 17).
24	SS -> MS	CP-ACK	
25	SS -> MS	CP-DATA	Contains RP-ACK RPDU
26	MS -> SS	CP-ACK	Shall be sent within 5 seconds of step 25
27	SS -> MS	CHANNEL RELEASE	The main signalling link is released.
28	MS -> SS	DISC (SAPI=0)	MS shall respond to channel release with a layer 2 DISC frame with SAPI 0

Specific message contents:**SMS SUBMIT TPDU**

Information element	Comment	Value
TP-MTI	SMS SUBMIT	'01'B
TP-VPF	not checked	
TP-RP	no reply path	'0'B
TP-UDHI	not checked	
TP-SRR	not checked	
TP-MR	not checked	
TP-RD	not checked	
TP-DA	not checked (an E164 number)	
TP-PID	default	'00000000'B
TP-DCS	default alphabet	'00000000'B
TP-VP	not checked	
TP-UDL	as applicable	
TP-UD (140 octets max.)	maximum number of characters (text of message)	as defined by the manufacturer (see PICS/PIXIT)

34.2.9.2 MS in active mode

This test applies to MS supporting the ability of sending concatenated multiple short messages when there is a call in progress.

34.2.9.2.1 Conformance requirements

When the MS chooses to use the same RR connection to send another short message or a memory available notification, then:

- the MS shall transmit a CM SERVICE REQUEST for the new CM connection before the final CP-ACK (e.g. the one that acknowledges the CP-DATA that carried the RP-ACK) for the old MM connection is transmitted;
- before transmission of the first CP-DATA on the new MM connection, the MS shall transmit the CP-ACK for the old MM connection;
- the Transaction Identifier used on the new MM connection shall be different to that used on the old MM connection; and
- the MS shall not initiate establishment of the new MM connection before the final CP-DATA (e.g. the one carrying the RP-ACK) has been received.

Reference

GSM 03.40; 3.1
GSM 04.11; 5.4
GSM 04.13; 5.6

34.2.9.2.2 Test purpose

To verify that the MS is able to correctly concatenate multiple short messages on the same RR connection when sent parallel to a call.

34.2.9.2.3 Method of test**Initial conditions**

System simulator:

1 cell, default parameters.

Mobile Station:

The MS shall be in "Idle, updated" state.

The SMS message storage shall be empty.

Related PICS/PIXIT statements

Support for multiple short message MO/PP on the same RR connection

Description of how to enter multiple SMS

Description of the basic procedures to display a mobile originated short message

Support for state U10 of call control

Whether SMS messages are stored in the SIM and/or the ME.

Foreseen final state of MS

Idle, updated

Test procedure

- a) A data or speech call is established on a TCH with the SS and the state U10 of call control is entered. The MS is set up to send 3 short messages as multiple SM to the SS. After the reception of the CM SERVICE REQUEST, the SS sends a CM SERVICE ACCEPT message. The SS responds with a UA frame SAPI-3 to the SABM with SAPI-3 received from the MS.
- b) Steps c) to k) of the test procedure in section 34.2.9.1.3 are repeated.

Maximum duration of test

5 min.

Expected Sequence

Step	Direction	Message	Comments
1	SS		A data or speech call is established on a TCH and the state U10 of call control is entered.
2	MS		The MS is set up to send 3 short messages as multiple SM
3	MS -> SS	CM SERVICE REQUEST	Sent in a layer 2 frame on the FACCH. CM service type set to "short message transfer"
4	SS -> MS	CM SERVICE ACCEPT	
5	MS -> SS	SABM (SAPI=3)	Sent on SACCH associated with the TCH
6	SS -> MS	UA (SAPI=3)	
7	MS -> SS	CP-DATA	Contains RP-DATA RPDU (SMS SUBMIT TPDU). The Transaction Identifier used in steps 7, 8, 9 and 11 shall be x.
8	SS -> MS	CP-ACK	
9	SS -> MS	CP-DATA	Contains RP-ACK RPDU
10	MS -> SS	CM SERVICE REQUEST	Sent in a layer 2 frame on the FACCH. CM service type set to "short message transfer"
11	MS -> SS	CP-ACK	Shall be sent within 5 seconds of step 10
12	SS -> MS	CM SERVICE ACCEPT	
13	MS -> SS	CP-DATA	Contains RP-DATA RPDU (SMS SUBMIT TPDU). The Transaction Identifier used in steps 13, 14, 15 and 17 shall be y where y <> x (see step 7).
14	SS -> MS	CP-ACK	
15	SS -> MS	CP-DATA	Contains RP-ACK RPDU
16	MS -> SS	CM SERVICE REQUEST	Sent in a layer 2 frame on the FACCH. CM service type set to "short message transfer"
17	MS -> SS	CP-ACK	Shall be sent within 5 seconds of step 16
18	SS -> MS	CM SERVICE ACCEPT	
19	MS -> SS	CP-DATA	Contains RP-DATA RPDU (SMS SUBMIT TPDU). The Transaction Identifier used in steps 19, 20, 21 and 22 shall be z, where z <> y (see step 13).
20	SS -> MS	CP-ACK	
21	SS -> MS	CP-DATA	Contains RP-ACK RPDU
22	MS -> SS	CP-ACK	Shall be sent within 5 seconds of step 21
23	SS -> MS	CHANNEL RELEASE	The main signalling link is released.
24	MS -> SS	DISC (SAPI = 0)	MS shall respond to channel release with a layer 2 DISC frame with SAPI 0.

Specific Message Contents:

SMS SUBMIT TPDU

Information element	Comment	Value
TP-MTI	SMS SUBMIT	'01'B
TP-VPF	not checked	
TP-RP	no reply path	'0'B
TP-UDHI	not checked	
TP-SRR	not checked	
TP-MR	not checked	
TP-RD	not checked	
TP-DA	not checked (an E164 number)	
TP-PID	default	'00000000'B
TP-DCS	default alphabet	'00000000'B
TP-VP	not checked	
TP-UDL	as applicable	
TP-UD (140 octets max.)	maximum number of characters (text of message)	as defined by the manufacturer (see PICS/PIXIT)

34.3 Short message service cell broadcast

This test applies to all MSs.

34.3.1 Conformance requirements

If the MS supports SMS-CB, it is responsible for recombination of the four blocks received via the radio path into a single block which constitutes the cell broadcast short message.

In idle mode, the MS listens to the BCCH and to the paging sub-channel for the paging group it belongs to. The MS is required to receive and analyse the paging messages and immediate assignment messages sent on the paging subchannel corresponding to its paging subgroup.

Reference

GSM 03.41; 8.

GSM 04.08; 3.2.1, 3.3.2.1.

34.3.2 Test purpose

This test verifies that an MS supporting SMS-CB is able to receive SMS-CB messages.

This test verifies that an MS is able to respond to a paging requested during the transmission of a cell broadcast short message.

34.3.3 Test method

Initial conditions

System Simulator:

1 cell, default parameters, except BS_PA_MFRMS = 2.

The SS provides a BCCH/CCCH to support the MS in idle mode.

Periodic location updating is disabled.

Mobile Station:

The MS shall be in the idle updated state.

Related PICS/PIXIT Statements

Support for short message transmission cell broadcast.

Description of the basic procedures to display a cell broadcasted short message.

Foreseen Final State of MS

Idle, updated.

Test Procedure

- a) Three Cell Broadcast (CB) messages are sent by the SS on the CBCH with serial numbers 0,1,1.
- b) Step a) is repeated, but the SS pages the MS during the transmission of the second CB message. This shall be achieved by paging the MS immediately after the first block of the CB message has been sent. The SS shall ensure that the page is transmitted on the radio interface prior to the transmission of the 4th block of the CB message.

NOTE: The use of BS_PA_MFRMS = 2 ensures that this can be achieved irrespective of the IMSI.

The MS shall respond to the page.

Maximum Duration of Test

-

Expected Sequence

Since the SMS-CB messages are sent continuously, a table is not applicable in this test.

Specific Message Contents:

Cell broadcast test message content

Information element	Comment Value
Serial Number - Geographical scope - Message code - Update number Message identifier Data Coding Scheme Page parameter Contents of message	"00"B see test procedure "0000000000"B or "0000000001"B as applicable "0"B Default alphabet, English "00000000"B "0001 0001"B 93 user characters using 93 different characters of default 7 bit coded alphabet

SYSTEM INFORMATION TYPE 4

As default except:

Information element	Value/remark
CBCH Channel Description - Channel type and TDMA offset - Timeslot number - Training sequence code - Hopping channel -Channel selector	SDDCH/4 + SACCH/C4 or CBCH (SDDCH/4) time slot zero 5 (same as BCC) Single RF channel Channel number 20 (for GSM 900 MS) Channel number 590 (for DCS 1 800 MS)
CBCH Mobile Allocation	Not included

34.4 Default message contents:

CP-DATA (including RP-DATA SS->MS)

Protocol Discriminator	SMS messages ("1001"B)
Transaction Identifier	
TI value	any value from the set {0,, 6}
TI flag	0
Message type	00000001
CP-User data	
length indicator	
RP-DATA	max 248 octets
RP-Message Type	001 (RP-DATA SS->MS)
RP-Message Reference	see GSM 04.11 8.2.3
RP-Originator Address	see GSM 04.11 8.2.5.1
RP-Destination Address	length indicator set to 0
RP-User Data	
length indicator	
TP-DATA	max 233 octets

CP-DATA (including RP-DATA MS->SS)

Protocol Discriminator	SMS messages ("1001"B)
Transaction Identifier	
TI value	any value from the set {0,, 6}
TI flag	0
Message type	00000001
CP-User data	
length indicator	
RP-DATA	max 248 octets
RP-Message Type	000 (RP-DATA MS->SS)
RP-Message Reference	see GSM 04.11 8.2.3
RP-Originator Address	length indicator set to 0
RP-Destination Address	see GSM 04.11 8.2.5.2
RP-User Data	
length indicator	
TP-DATA	max 233 octets

CP-DATA (including RP-ACK MS->SS)

Protocol Discriminator	SMS messages ("1001"B)
Transaction Identifier	
TI value	
TI flag	
Message type	00000001
CP-User data	
length indicator	
RP-ACK	
RP-Message Type	010 (RP-ACK MS->SS)
RP-Message Reference	see GSM 04.11 8.2.3

CP-DATA (including RP-ACK SS->MS)

Protocol Discriminator	SMS messages ("1001"B)
Transaction Identifier	
TI value	
TI flag	
Message type	00000001
CP-User data	
length indicator	
RP-ACK	
RP-Message Type	011 (RP-ACK SS->MS)
RP-Message Reference	see GSM 04.11 8.2.3

CP-DATA (including RP-ERROR MS->SS)

Protocol Discriminator	SMS messages ("1001"B)
Transaction Identifier	
TI value	
TI flag	
Message type	00000001
CP-User data	
length indicator	
RP-ERROR	
RP-Message Type	100 (RP-ERROR MS->SS)
RP-Message Reference	see GSM 04.11 8.2.3
RP-Cause	see GSM 04.11 8.2.5.4
RP_User Data	see GSM 04.11 8.2.5.3 : optional, may be present or not
Length indicator	
TP-Data	max 233 octets

CP-DATA (including RP-ERROR SS->MS)

Protocol Discriminator	SMS messages ("1001"B)
Transaction Identifier	
TI value	
TI flag	
Message type	00000001
CP-User data	
length indicator	
RP-ERROR	
RP-Message Type	101 (RP-ERROR SS->MS)
RP-Message Reference	see GSM 04.11 8.2.3
RP Cause	see GSM 04.11 8.2.5.4
RP User Data	see GSM 04.11 8.2.5.3 : optional, may be present or not
Length indicator	
TP-Data	max 233 octets

CP-DATA (including RP-SMMA MS->SS)

Protocol Discriminator	SMS messages ("1001"B)
Transaction Identifier	
TI value	
TI flag	
Message type	00000001
CP-User data	
length indicator	
RP-SMMA	
RP-Message Type	110 (RP-SMMA MS->SS)
RP-Message Reference	see GSM 04.11 8.2.3

CP-ACK

Protocol Discriminator	SMS messages ("1001"B)
Transaction Identifier	
TI value	
TI flag	
Message type	00000100

CP-ERROR

Protocol Discriminator	SMS messages ("1001"B)
Transaction Identifier	
TI value	
TI flag	
Message type	00010000
CP-Cause	
Cause value	see GSM 04.11 8.1.4.2

35 Low battery voltage detection

35.1 Definition and applicability

Low battery or shutdown voltage detection is used to trigger inhibition of all RF transmission before the MS supply voltage reaches a level where effective use of the radio frequency spectrum is no longer guaranteed.

The requirements and this test apply to all types of GSM 900 and DCS 1 800 MS.

35.2 Conformance requirement

1. The MS shall not make ineffective use of the radio frequency spectrum. In no case shall the MS exceed the transmitted levels as defined in GSM 05.05 for extreme operation.
GSM 05.05, annex D.2.2.
2. The MS shall inhibit all RF transmission when the power supply voltage is below the manufacturer declared approximate shutdown voltage.
GSM 05.05, annex D.2.2.

35.3 Test purpose

1. To verify that the MS does not make ineffective use of the RF spectrum.
2. To verify that the MS inhibits all RF transmission when the battery voltage falls below the manufacturer declared shutdown level.

35.4 Method of test

35.4.1 Initial conditions

The SS transmits a BCCH with a location updating time set to 0,1 hours.

The SS sends a paging request message to the MS.

The MS responds with a channel request message.

The SS sends an immediate assignment message establishing an SDCCH.

35.4.2 Procedure

- a) The SS gradually reduces the power supply voltage until the MS ceases the production of RF output.

The RF output spectrum shall be monitored for any anomalies while the supply voltage is being reduced.

NOTE 1: The declared approximate shutdown voltage gives an indication of the voltage where the MS will cease RF output.

NOTE 2: If any anomalies occur, then additional testing using the transmitter tests at the voltage where the anomaly occurred is performed to determine in an objective manner, whether or not the conformance requirement is met.

- c) After 7 minutes, the SS sends a paging message to the MS.
- d) The SS observes whether or not the MS produces any RF output.

This measurement is performed over the relevant transmit band.

The spectrum analyser is set to:

Bandwidth: 3 MHz

Peak Hold

- e) The SS modifies the location area of the BCCH.
- f) For 7 minutes, the SS observes whether or not the MS produces any RF output.

NOTE 3: It is anticipated that the MS might attempt location updating.

- g) The MS is switched off and on.
- h) The SS pages the MS.
- i) The SS observes whether or not the MS produces any RF output.

35.5 Test requirement

1. In step a) no anomalies shall occur.
2. In step a), the MS shall cease the production of RF output.
3. In steps d), f) and i), the MS shall not produce any RF output above -30 dBm.

36 Individual equipment type requirements and interworking - special conformance testing functions

36.1 General

This chapter specifies those ME functions which are required for conformance testing purposes only. However, except for the Electrical Man Machine Interface (EMMI), they are required for every mobile station.

For conformance tests, functions are activated via the radio interface, test SIM or dedicated pins. These functions must be capable of being activated when a test SIM is present but must not function with any other (e.g. network) SIM present. In this state, the MS must be able to perform all functions specified in this MS conformity specification; in addition however, the special conformance testing functions must be operational.

The special conformance testing functions of the ME are enabled by use of a dedicated Subscriber Identity Module (test SIM, see annex 4). SIM, in general, is described in GSM 11.11. The ME recognizes the test SIM by the Administrative Data Field.

36.2 Activation and deactivation of special test functions in the MS

These functions can be activated and deactivated from a SS by sending appropriate layer 3 commands to the MS. The protocol discriminator to be used is defined in GSM 04.08, section 10.2.

The layer 3 commands are sent on the DCCH. On layer 2, SAPI 0 is used in acknowledged mode.

Apart from sending the appropriate deactivation command to the MS the functions can be deactivated by switching off the MS or removing the test SIM.

The following test functions can be activated (and deactivated):

- TCH Loop,
- TCH Burst-by-Burst Loop,
- Electrical MMI,
- Test via DAI.

The TCH loops and the test via DAI are test functions which are mutually exclusive.

36.2.1 Internal test loops

A number of internal test loops are required providing access to isolated functions of the MS without introducing new physical interfaces just for the reason of type approval testing. Fig 36-1 shows a functional block diagram of a reference MS containing the different test loops.

NOTE: It should be emphasized that these test loops only describe the functional behaviour of the MS with respect to its external interfaces; physical implementation of the loops is completely left open to the manufacturer.

A particular loop is activated in an MS by transmitting the appropriate command message to the MS.

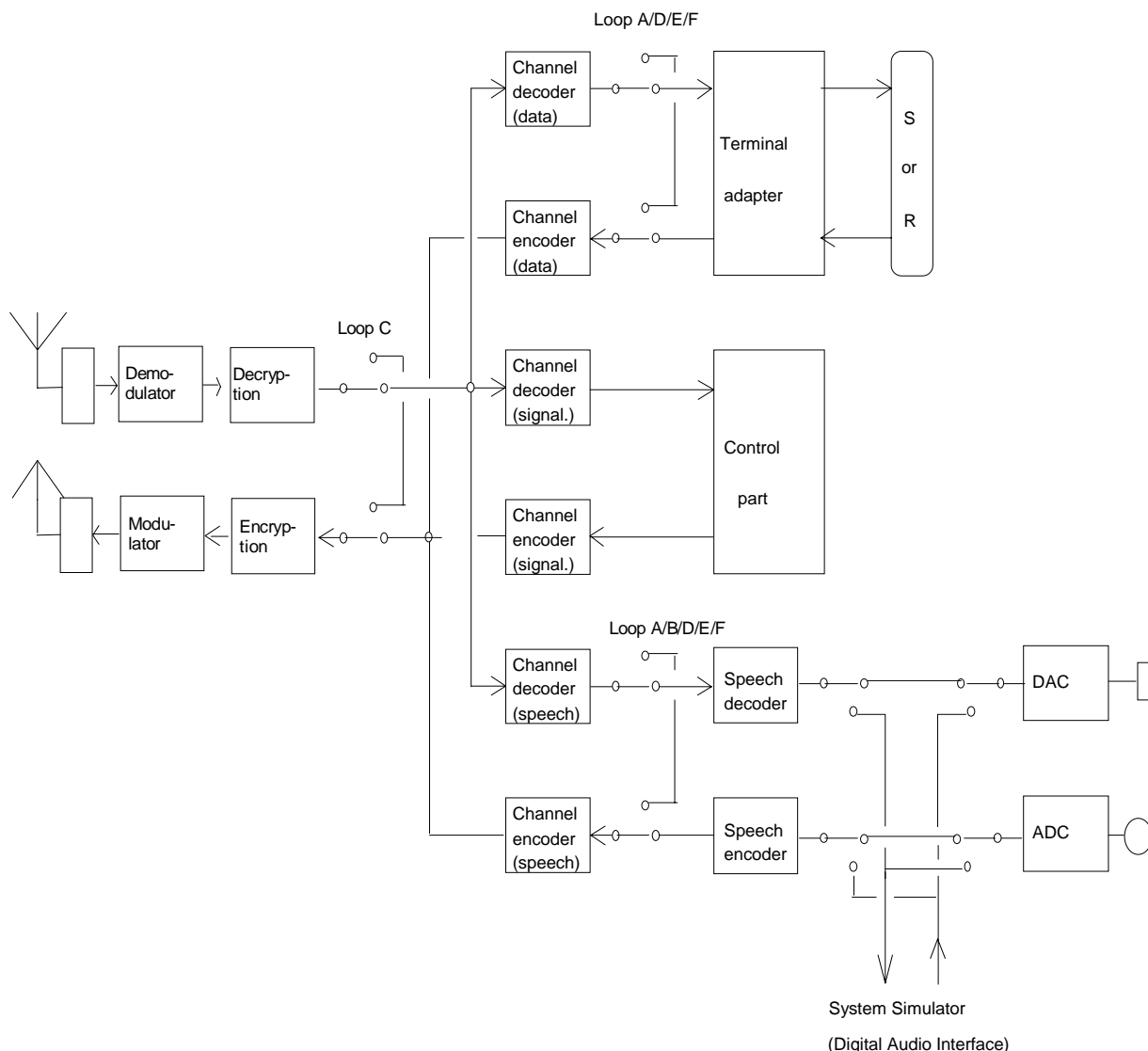

Figure 36-1: Test loops in the MS

36.2.1.1 TCH loop

Purpose:

To establish a transparent loop for TCH blocks. A TCH must be active between SS and MS. The TCH may be full or half rate, speech or data of any rate specified in the GSM system.

Six types of TCH loop back are defined.

The first (A) includes the signalling of erased frames and is used to determine Frame Erasure Ratio (FER) and Residual Bit Error Ratio (RBER) for speech TCH and Bit Error Ratio (BER) for any data TCH.

The second type (B) is required to determine Class II bit error ratio for the speech TCH.

With the third loop (C) the 114 information bits of each TCH burst (excluding stealing flags) prior to applying benefit of the channel decoder, but after decryption, shall be transmitted in an uplink burst. (Equivalent error rate to TCH/FS Class II). All that is received shall be re-transmitted regardless of the state of the received midamble. The midamble in the uplink bursts shall be the normal midamble used by the MS. SACCH and idle bursts are not looped back.

The fourth loop (D) includes the signalling of erased frames and unreliable frames and is used to determine Unreliable Frame Ratio (UFR) and Residual Bit Error Ratio (RBER) for TCH/HS.

The fifth loop (E) includes the signalling of erased SID frames and is used to determine Erased SID Frame Rate (ESIDR) and Residual Bit Error Ratio (RBER) for TCH/HS.

The sixth loop (F) includes the signalling of erased valid SID frames and is used to determine Erased Valid SID Frame Rate (EVSIDR) and Residual Bit Error Ratio (RBER) for TCH/HS.

NOTE: Measurement of TCH/FS chip BER is approximately five times faster using loop C rather than loop B.

36.2.1.1.1 TCH loop including signalling of erased frames (A)

Procedure:

The SS orders the MS to close its TCH loop by transmitting a CLOSE_TCH_LOOP_CMD message, specifying the TCH to be looped and that erased frames are to be signalled by the MS. The SS then starts timer TT01.

If no TCH is active, or any test loop is already closed, the MS shall ignore any CLOSE_TCH_LOOP_CMD message.

If a TCH is active, the MS shall close its TCH loop for the TCH specified and send back to the SS a CLOSE_TCH_LOOP_ACK message. Upon reception of that message the SS stops timer TT01.

After the MS has closed its TCH loop, every good speech frame or any user data frame received by the MS on the specified TCH (downlink) shall be taken from the output of the channel decoder, input to the channel encoder and transmitted on the same TCH (uplink).

If the channel decoder detects a bad speech frame, then this shall be signalled to the SS by setting the input frame to the channel encoder to zero's, and transmitting on the TCH (uplink).

If the MS decodes stealing flags as indicating an FACCH frame, then there is no defined response for the MS to the channel encoder for transmission on the TCH (uplink). The FACCH channel shall operate as normal.

36.2.1.1.2 Speech TCH loop without signalling of erased frames (B)

Procedure

The SS orders the MS to close its TCH loop by transmitting a CLOSE_TCH_LOOP_CMD message, specifying the TCH to be looped. The SS then starts timer TT01.

If no TCH is active or any test loop is already closed, the MS shall ignore any CLOSE_TCH_LOOP_CMD message.

If a TCH is active, the MS shall close its TCH loop for the TCH specified and send back to the SS a CLOSE_TCH_LOOP_ACK message. Upon reception of that message the SS stops timer TT01.

After the MS has closed its TCH loop, any speech frame received by the MS on the specified TCH (downlink) shall be taken from the output of the channel decoder, input to the channel encoder, and transmitted on the same TCH (uplink).

The SS should avoid using the FACCH downlink in this situation until the test is complete.

36.2.1.1.3 TCH burst-by-burst loop (C)

Applicability: The test loop shall be implemented by all ME, supporting any TCH.

Procedure

Establishment and clearing of the loop is performed at ideal radio conditions.

Establishment:

- The establishment shall be commanded by transmitting a CLOSE_TCH_LOOP_CMD message. The SS then starts timer TT01. This command shall be acknowledged by the MS with a CLOSE_TCH_LOOP_ACK message. Upon receipt of that message the SS stops timer TT01. The MS shall establish the loop within one reporting period [SACCH-block = 104 frames] from the sending of the CLOSE_TCH_LOOP_ACK.
- If no TCH is active or any test loop is already closed, the MS shall ignore any CLOSE_TCH_LOOP_CMD message.

Operation:

- The round trip delay (RTD), which is the number of TCH frames between the reception of one burst at the MS, and the transmission of the same burst (on the uplink) shall be less than 26 TDMA frames. The actual value shall be declared for the implementation to be tested.

NOTE 1: The RTD can be as long as required to receive the number of interleaved burst for the relevant TCH.

NOTE 2: Example of RTD = 5.

TDMA	1	2	3	4	5	6	7	8	9	10	11	12	13	14	15	16	17	18
Frame No.																		
Downlink	T1	T2	T3	T4	T5	T6	T7	T8	T9	T10	T11	T12	Sd	...				
Uplink					...	T1	T2	T3	T4	T5	T6	T7	Su	T8	T9	T10	T11	T12

Sd = Downlink SACCH frame, Su = Uplink SACCH frame, Tn = TCH frame

Note from the above that TCH frames looped back prior to the uplink SACCH (or Idle) frame are delayed on the air interface by 5 TDMA frames, but the TCN frames following the SACCH frame are delayed by 6 TDMA frames. The RTD is therefore not to be confused with the TDMA frame delay for a TCH burst, which varies depending on whether the TCH burst is before or after the uplink SACCH frame. The reason for the variable TDMA time delay is to preserve the uplink SACCH frame position in the multi-frame. Note also that the uplink SACCH data is not a looped back version of the downlink SACCH data.

36.2.1.1.4 TCH loop including signalling of erased frames and unreliable frames (D)**Procedure:**

The SS orders the MS to close its TCH loop by transmitting a CLOSE_TCH_LOOP_CMD message, specifying the TCH to be looped and that erased frames and unreliable frames are to be signalled by the MS. The SS then starts timer TT01.

If no TCH is active, or any test loop is already closed, the MS shall ignore any CLOSE_TCH_LOOP_CMD message.

If a TCH is active, the MS shall close its TCH loop for the TCH specified and send back to the SS a CLOSE_TCH_LOOP_ACK message. Upon reception of that message the SS stops timer TT01.

After the MS has closed its TCH loop, every reliable speech frame (UFI = 0) received by the MS on the specified TCH/HS (downlink) shall be taken from the output of the channel decoder, input to the channel encoder and transmitted on the same TCH (uplink).

If the channel decoder detects a bad speech frame or an unreliable frame (BFI = 1 or UFI = 1) or if the MS decodes the stealing flags as indicating an FACCH frame, then this shall be signalled to the SS by setting the input frame to the channel encoder to zero's, and transmitting on the TCH/HS (uplink). The FACCH channel shall operate normally.

36.2.1.1.5 TCH loop including signalling of erased SID frames (E)

Procedure:

The SS orders the MS to close its TCH loop by transmitting a CLOSE_TCH_LOOP_CMD message, specifying the TCH to be looped and that erased SID frames are to be signalled by the MS. The SS then starts timer TT01.

If no TCH is active, or any test loop is already closed, the MS shall ignore any CLOSE_TCH_LOOP_CMD message.

If a TCH is active, the MS shall close its TCH loop for the TCH specified and send back to the SS a CLOSE_TCH_LOOP_ACK message. Upon reception of that message the SS stops timer TT01.

After the MS has closed its TCH loop, every valid SID frame (SID = 2) or invalid SID frame (SID = 1) received by the MS on the specified TCH/HS (downlink), shall be taken from the output of the channel decoder, input to the channel encoder and transmitted on the same TCH/HS (uplink).

If the channel decoder detects an erased SID frame (SID = 0), then this shall be signalled to the SS, by setting the input frame to the channel encoder to zero's, and transmitting on the TCH/HS (uplink).

If the MS decodes the stealing flags as indicating an FACCH frame, then this shall be signalled to the SS by setting the input frame to the channel encoder to zero's, and transmitting on the TCH/HS (uplink). The FACCH channel shall operate normally.

36.2.1.1.6 TCH loop including signalling of erased valid SID frames (F)

Procedure:

The SS orders the MS to close its TCH loop by transmitting a CLOSE_TCH_LOOP_CMD message, specifying the TCH to be looped and that erased valid SID frames are to be signalled by the MS. The SS then starts timer TT01.

If no TCH is active, or any test loop is already closed, the MS shall ignore any CLOSE_TCH_LOOP_CMD message.

If a TCH is active, the MS shall close its TCH loop for the TCH specified and send back to the SS a CLOSE_TCH_LOOP_ACK message. Upon reception of that message the SS stops timer TT01.

After the MS has closed its TCH loop, every valid SID frame (SID = 2 and BFI = 0) received by the MS on the specified TCH/HS (downlink), shall be taken from the output of the channel decoder, input to the channel encoder and transmitted on the same TCH/HS (uplink).

If the channel decoder detects an erased valid SID frame (SID = 1) or (SID = 0) or ((BFI or UFI) = 1), then this shall be signalled to the SS by setting the input frame to the channel encoder to zero's, and transmitting on the TCH/HS (uplink).

If the MS decodes the stealing flags as indicating an FACCH frame, then this shall be signalled to the SS by setting the input frame to the channel encoder to zero's, and transmitting on the TCH/HS (uplink). The FACCH channel shall operate normally.

36.2.1.1.7 Deactivating TCH loops

The SS orders the MS to open any TCH loop by transmitting an OPEN_LOOP_CMD message.

If no loop is closed the MS shall ignore any OPEN_LOOP_CMD message.

If a TCH is looped, the MS shall open the loop.

If the loop opened was type C, the MS shall send an OPEN_LOOP_CMD message to the SS with bit 0 of the optional acknowledgement element set to 1.

All channels shall be open for normal use again.

36.2.1.1.8 Additional non-mandatory operating characteristics

In order to optimize the speed and flexibility of mobile manufacturing and repair, the following non-mandatory characteristics of the test loops are suggested:

The normal FACCH downlink and uplink functions should ideally be maintained when the test loop is closed. In particular, channel assignments or handovers, and call termination from either the mobile or the base station simulator.

Following an assignment or handover, the loop should not open if it was closed prior to the handover.

Following call dropping or deliberate call termination, the loop should be re-opened.

The loopback functions should ideally operate with or without (i.e. no SIM) the test SIM present, but should not operate with a network SIM present.

Audio muting should be enabled when the loop is closed.

36.2.2 Activating and deactivating EMMI

Activating EMMI requires the presence of a test SIM. EMMI shall be activated by any of the following:

- switching on the MS;
- inserting a test SIM;
- layer 3 message on the radio interface (ACT_EMMI_CMD).

When the MS is ready to receive frames, it shall send one XON message.

EMMI shall be deactivated by any of the following:

- switching off the MS;
- removing the test SIM;
- layer 3 message on the radio interface (DEACT_EMMI).

NOTE: No XOF shall be sent after deactivation.

The L3 message used on the radio interface to activate the EMMI is the activation command ACT_EMMI_CMD (see 36.2.4.4). This message has to be acknowledged by the message ACT_EMMI_ACK on the radio interface sent by the MS (see 36.2.4.5).

For deactivation of the EMMI in the MS through the radio interface, the message DEACT_EMMI is defined in 36.2.4.6. An acknowledgement of this message is not required.

36.2.3 Activating and deactivating DAI tests

Purpose: to determine the routing of speech data (DAI or internal, i.e. normal mode) and which device is being tested (speech transcoder / DTX functions or A/D & D/A).

Prerequisites: a dedicated channel must be established if the manufacturer has stated that the DAI is activated by means of the layer 3 message.

Procedure: the SS sends a TEST_INTERFACE message if the manufacturer has stated that the DAI is activated by means of the layer 3 message or applies the appropriate control signal on the DAI if the manufacturer has declared that the DAI is activated this way.

When the test mode is established i.e. speech data comes from test interface, each new test function overrides the previous one.

36.2.4 Message definitions and contents

NOTE 1: A message received with skip indicator different from 0 will be ignored.

NOTE 2: For definition of "Presence" and "Format", see GSM 04.07 sections 11.4 and 11.1.1.

36.2.4.1 CLOSE_TCH_LOOP_CMD

Information element	Reference	Type	Length
Protocol discriminator	GSM 04.07 sect. 11.2.1	MF	
Skip indicator	GSM 04.07 sect. 11.2.2	MF	2
Message type		MF	
Sub-channel		MF	1

where message type is:

8	7	6	5	4	3	2	1	bit no.
0	0	0	0	0	0	0	0	octet 1

and Sub-channel is:

8	7	6	5	4	3	2	1	bit no.
0	0	0	B	A	Z	Y	X	octet 1

X = 0 If there is only one TCH active (so there is no choice) or if sub-channel 0 of two half rate channels is to be looped.

X = 1 If sub-channel 1 of two half rate channels is to be used.

Y = 0 If the looped TCH is a speech channel then the frame erasure is to be signalled, type A.

Y = 1 If the looped TCH is a speech channel then frame erasure is not signalled, type B.

Z = 0 The type of the loop is determined by the value Y.

Z = 1 The Burst-by-Burst loop is activated, type C. The value of Y is disregarded.

A = 0 and B = 0 The loop is determined by the values Z, Y and X.

A = 1 and B = 0 If the looped TCH is a half rate speech channel then frame erasure and unreliable frames have to be signalled, type D. The values of Y and Z are disregarded.

A = 0 and B = 1 If the looped TCH is a half rate channel sending SID frames then SID frame erasure is to be signalled, type E. The values of Y and Z are disregarded.

A = 1 and B = 1 If the looped TCH is a half rate channel sending SID frames then valid SID frame erasure is to be signalled, type F. The values of Y and Z are disregarded.

36.2.4.2 CLOSE_TCH_LOOP_ACK

Information Element	Reference	Presence	Format	Length
Protocol discriminator	GSM 04.07 sect. 11.2.1	M	V	1/2
Skip indicator	GSM 04.07 sect. 11.2.2	M	V	1/2
Message type		M	V	1

where message type is:

8	7	6	5	4	3	2	1	bit no.
0	0	0	0	0	0	0	1	octet 1

36.2.4.3 OPEN_LOOP_CMD

Information Element	Reference	Presence	Format	Length
Protocol discriminator	GSM 04.07 sect. 11.2.1	M	V	1/2
Skip indicator	GSM 04.07 sect. 11.2.2	M	V	1/2
Message type		M	V	1
Acknowledge		O	TV	1

where message type is:

8	7	6	5	4	3	2	1	bit no.
0	0	0	0	0	1	1	0	octet 1

where Acknowledge Information Element Identifier is:

8	7	6	5	4	3	2	1	bit no.
1	0	0	0					octet 1

and the Acknowledge Information Element contents are:

				4	3	2	1	bit no.
				0	0	0	1	octet 1
				Spare	Spare	Spare		

36.2.4.4 Command for the activation of the EMMI, ACT_EMMI_CMD

Information Element	Reference	Presence	Format	Length
Protocol discriminator	GSM 04.07 sect. 11.2.1	M	V	1/2
Transaction identifier	GSM 04.07 sect. 11.2.2	M	V	1/2
Message type		M	V	1

where message type is:

8	7	6	5	4	3	2	1	bit no.
0	0	0	0	1	1	0	0	octet 1

36.2.4.5 Acknowledge of the activation of the EMMI, ACT_EMMI_ACK

Information Element	Reference	Presence	Format	Length
Protocol discriminator	GSM 04.07 sect. 11.2.1	M	V	1/2
Skip indicator	GSM 04.07 sect. 11.2.2	M	V	1/2
Message type		M	V	1

where message type is:

8	7	6	5	4	3	2	1	bit no.
0	0	0	0	1	1	0	1	octet 1

36.2.4.6 Deactivation of the EMMI, DEACT_EMMI

Information Element	Reference	Presence	Format	Length
Protocol discriminator	GSM 04.07 sect. 11.2.1	M	V	1/2
Skip indicator	GSM 04.07 sect. 11.2.2	M	V	1/2
Message type		M	V	1

where message type is:

8	7	6	5	4	3	2	1	bit no.
0	0	0	1	0	0	0	0	octet 1

36.2.4.7 Test_Interface

Information Element	Reference	Presence	Format	Length
Protocol discriminator	GSM 04.07 sect. 11.2.1	M	V	1/2
Skip indicator	GSM 04.07 sect. 11.2.2	M	V	1/2
Message type		M	V	1
Tested device		M	V	1

Where message type is:

8	7	6	5	4	3	2	1	bit no.
0	0	0	1	0	1	0	0	octet 1

and Tested device is:

8	7	6	5	4	3	2	1	bit no.
0	0	0	0	0	X	X	X	octet 1

Tested devices:

- 000 = normal operation (no tested device via DAI)
- 001 = test of speech decoder / DTX functions (downlink)
- 010 = test of speech encoder / DTX functions (uplink)
- 100 = test of acoustic devices and A/D & D/A.

All other values are reserved.

36.2.5 Timer values

TT01: To be started when a CLOSE_TCH_LOOP_CMD is sent. To be stopped when the corresponding CLOSE_TCH_LOOP_ACK is received.

Recommended value: [2,5 seconds].

36.3 Electrical Man Machine Interface (EMMI)**36.3.1 Use of the EMMI**

Conformity tests of mobile stations are made using the system simulator specified in annex 4.

Test signals are sent on the Um interface, and actions of the MS are registered. The Electrical Man Machine Interface (EMMI) is a half duplex communication link between the SS and the MS by which it is possible to automatically register the status, indications and performance of the MS.

It is also possible to simulate actions normally made by the user on the keyboard of the MS.

36.3.2 Formal aspects

- i) The EMMI is optional for the ME.
- ii) The EMMI is mandatory for the SS.
- iii) If the EMMI is to be used in conformance testing of an MS, it shall be possible to connect the SS to a connector on the MS, or to an adapter connected to the same MS. If an adapter is to be used, it shall be provided by the manufacturer.
- iv) If the MS fulfils the requirements performed with the use of an EMMI, the MS is regarded as having passed that test.
- v) If the MS is rejected in a test performed with EMMI, the test shall be repeated on the same mobile with the device carrying the EMMI to the MS removed. The MS shall be regarded as fulfilling the requirements, if it then passes the test.
- vi) When using the EMMI, the MS does not necessarily conform to the RF requirements. Therefore, tests concerning Rx and Tx parameters on MS with integral antenna and cabinet radiation tests for all types of MS will never be performed with the use of the EMMI.

36.3.3 Layered structure of the interface

The definition of the EMMI is divided into three different layers. On layer 1 the use of a 25-pole socket with standard electrical characteristics for serial communication is defined. On layer 2, an extremely simple frame oriented protocol is defined. On layer 3, messages for control and verification of functions and indications are defined. Each layer is defined independently of surrounding layers, and is therefore easy to replace.

The EMMI protocol structure takes into account that the SS only sends and receives layer 3 frames when the corresponding step within a test case is to be performed.

36.3.4 Terminology

EMMI	Electrical Man Machine Interface
MI	Message Identifier
ME	Mobile Equipment
MS	Mobile Station
SS	System Simulator
Frame	Used on layer 2 to transfer messages to and from layer 3
Message	Information on layer 3

36.3.5 Description of the EMMI**36.3.5.1 EMMI, Layer 1****36.3.5.1.1 Mechanical and electrical characteristics**

If implemented, the EMMI interface shall use the same connector as the Digital Audio Interface (DAI), described in section 36.4.3.

The pin assignments for the EMMI shall be as follows:

Pin	Function	Source
2	Transmitted data	SS
3	Received data	MS
7	EMMI signal ground	

The electrical characteristics of the interface shall be as given in section 36.4.3.2.

36.3.5.1.2 Transmission and reception characteristics

The EMMI uses asynchronous serial data transmission with 1 start bit (S), 8 data bits (D1 to D8), no parity and 1 stop bit (E).

S	D1	D2	D3	D4	D5	D6	D7	D8	E
---	----	----	----	----	----	----	----	----	---

Table 36-1: Use of start and stop bits

The conditions on start and stop characters are defined in REC CCITT V.1.

The transmission rates are: 600, 1200, 2400, 4800, 9600 bits per second. The ME shall support at least one of these speeds.

The SS will adapt its rate (manually or by MMI) to this ME rate.

36.3.5.2 EMMI, layer 2**36.3.5.2.1 General structure**

On layer 2, frames are used to carry data from higher layers. Frames consist of one or several octets. One frame with variable length is used to carry data from higher layers, and four other frames with the length of one character is used to control the flow of frames.

36.3.5.2.2 Control frames

Special frames have been assigned to control the flow of frames on layer 2. They are only one octet long.

Abbr.	Meaning	Dec.value	Bit pattern
ACK	Acknowledge	06	0000 0110
NAK	Not Acknowledge	21	0001 0101
XON	Resume sending data	17	0001 0001
XOF	Stop sending data	19	0001 0011

Table 4: Characters for flow control**36.3.5.2.3 Frame structure**

Two octets, called characters, indicate start and stop of I-frames.

Abbr.	Meaning	Dec.value	Bit pattern
STX	Start of data	02	0000 0010
ETX	End of data	03	0000 0011

Table 5: Start and stop characters

Information from higher layers are transferred in I-frames with the following structure.

Field name	No of octet	Value	Start at octet no	Note
Start	1	Character STX	1	-
Length	1	Length of data	2	a1)
Data	0-255	Content of data	3	a2)
Check	1	Error detection	Length+2	a3)
End	1	Character ETX	Length+3	

NOTES:

- a1) Length: The total number of data octets in the data field of the frame is calculated. The value shall be in the range of (0..255 decimal). The corresponding binary value is put into the length field.
- a2) Data: Data to and from higher layers are in the form of octets (groups of 8 digital bits).

- a3) Check: Longitudinal checksum is created by exclusive OR on all characters starting with the Start field and ending with the last octet before the Check field. The value, one octet, is mapped into the Check field.

36.3.5.2.4 Flow of I-frames on layer 2

36.3.5.2.4.1 Transmission of frames

A multiple frame starts with the first octet being the character STX and stops with the last octet with content ETX. The time between the start bits of two consecutive octets shall not be longer than T22.



The time between two frames is measured from the start bit of the last octet of the nth frame to the start bit of the first octet of the n+1st frame. The time between two consecutive frames shall not be less than T23.

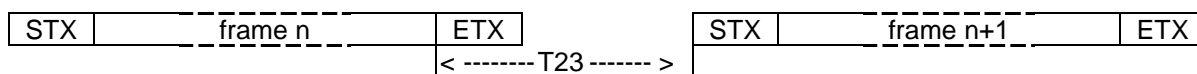

36.3.5.2.4.2 Reception of frames

Start of a frame is defined as (more than $T22 \cdot 2$ since previous reception of octet) AND (reception of STX).

End of a frame is defined as (reception of ETX in octet number (length+2)) OR (more than $T22 \cdot 2$ since last reception of octet).

36.3.5.2.4.3 Use of ACK and NAK on receiving side

ACK is used by the MS to acknowledge a frame on receiving side if all the following conditions are fulfilled. Otherwise NAK is used.

- 1) The content of Start field is STX.
- 2) The content of Check field corresponds to the exclusive OR sum of previous octets in the frame.
- 3) The content of the last octet is ETX.

NAK is used by the SS to request retransmission of a frame. Otherwise ACK is used.

NOTE: NAK shall not be used for layer 3 errors, if the layer 2 frame is correct. If the meaning of a layer 3 message is undefined or not performable, then the problem is solved with layer 3 messages.

36.3.5.2.4.4 Use of XON and XOF

XON and XOF are used for flow control of layer 2.

XOF is sent if the unit (MS or SS) due to internal processing is not capable of receiving a following frame when a frame is being received.

XON is sent if XOF has been sent previously, but the reason for that XOF-transmission no longer exists.

36.3.5.2.4.5 Parameters on layer 2

Bit rate	Value of T22	Value of T23
600	25,0 ms	58,3 ms
1200	12,5 ms	29,2 ms
2400	6,3 ms	14,6 ms
4800	3,1 ms	7,3 ms
9600	1,6 ms	3,6 ms

Table 7: Timer values on layer 2**36.3.5.3 EMMI, layer 3****36.3.5.3.1 Message structure**

Messages are used on layer 3. They are defined by Message Identifiers (MI) in the range of (0..255). The message identifier is always the first, and often the only, octet of the message.

MI	Use
0-49	Not used.
50-179	General messages. All undefined values reserved for further evolution of the EMMI.
180-209	ME-type dependent blocks, may be used by the SS as a sender or receiver, if so requested by the manufacturer. Undefined values available for the manufacturer.
210-239	ME-type dependent blocks, never to be used by the SS in conformance testing. Undefined values available for the manufacturer.
240-255	Reserved for L3 error handling. All undefined values reserved for further evolution of the EMMI.

NOTE: Layer 2 is transparent, but to avoid unnecessary interference from layer 3, MI with the same value as control frames on layer 2 are not used.

Table 8: Use of message identifiers

Most of the messages, especially in the direction SS - MS contain only one octet, the message indicator. Some of the messages, especially in the direction MS - SS are quite long.

NOTE 1: If the interface is limited only to the minimum required for automatic conformity testing with the electrical man machine interface, then the included L3 messages should be RQTI, KEYS, BEL1, BEL0, HOK1, HOK0, BCAP and RSTI.

Table 9: Block types

MI value	Abbr.	Meaning	Source	
			MS	SS
051	VOL1	Increase volume (***)		X
052	VOL0	Decrease volume (***)		X
053	RQTS	Request for table, status		X
054	RQTI	Request for table, indication		X
055	RQPL	Request for power level		X
056	RQBE	Request for bell status		X
057	RQSM	Request for short message		X
058	KEYS	Perform keystroke sequence		X
060	BEL1	Indication user alert on	X	
061	BEL0	Indication user alert off	X	
064	HOK1	Hook on		X
065	HOK0	Hook off		X
070	BCAP	Selection of bearer capability		X
080	STPO	Set power level		X
091	RSTS	Response table, status	X	
092	RSTI	Response table, indication	X	
093	RSPO	Response, power level	X	
101	RXSM	Received short message	X	
102	RXSN	No short message received	X	
240	ER00	Internal malfunction detected	X	
241	ER01	L3 message not recognized	X	X
242	ER02	L3 message not performable	X	
255	RESE	Perform hardware and software reset		X

NOTE 2: Functioning of this should be verified, as the volume control in the ME might be of another type (non-incremental).

36.3.5.3.2 Definition of messages

Messages are defined in the order of the value of the message identifier.

051 VOL1 Increase volume
052 VOL0 Decrease volume

Increase/decrease volume in the loudspeaker by one step.

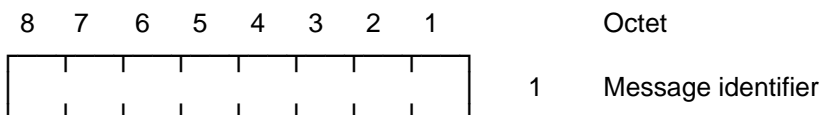

053 RQTS Request for table, status
054 RQTI Request for table, indication
055 RQPL Request for power level

On receiving a request message RQxy, the corresponding table RSxy shall be sent.

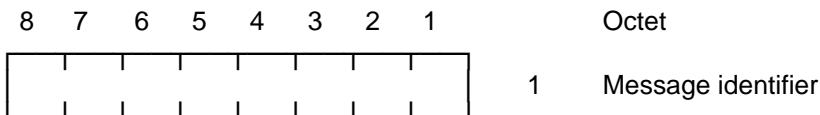

056 RQBE Request for bell status

On receiving a request message RQBE, the internal user alert status (BEL1 or BEL0) shall be sent. BEL1 and BEL0 will indicate whether the ringing or alert procedure has been activated or not. (See also the definition of BEL1 and BEL0).

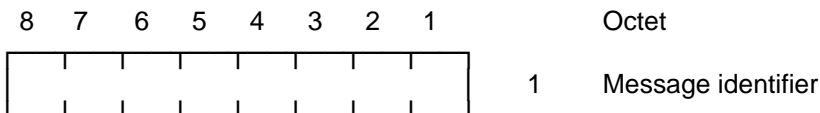

057 RQSM Request for short message

In response to the RQSM request the MS shall send either the short message type using the message RXSM or, in case of no short message received, the message RXSN.

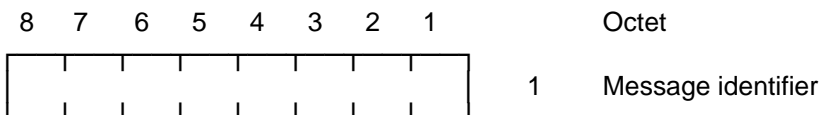

058 KEYS Perform keystroke sequence

Perform the MS function related to the received keystroke sequence.

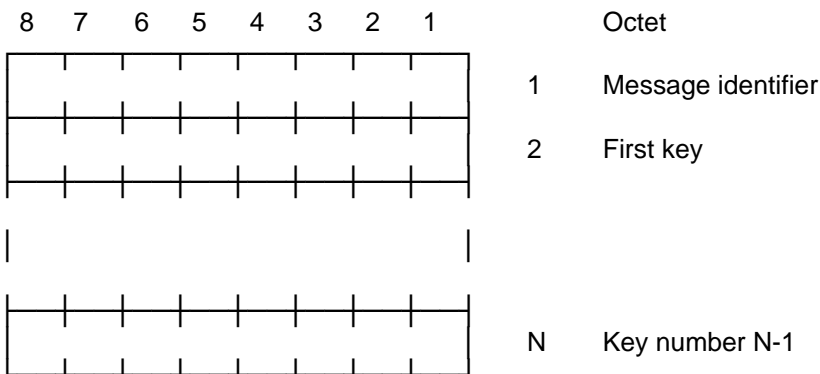

The possible keystroke sequences are based on the basic public man machine interface as defined in GSM 02.30. There exists a minimum set of key characters.

The codes associated with these characters are defined as follows:

<u>Key</u>	<u>Code (decimal)</u>
#	35
*	42
+	43
0	48
1	49
2	50
3	51
4	52
5	53
6	54
7	55
8	56
9	57
END (function)	18
SEND (function)	20

- 060 BEL1 Indication user alert on**
- 061 BEL0 Indication user alert off**

Indication user alert shall indicate, on request of the SS, the internal status of the alert or ringing procedure. For this purpose, the SS shall send the RQBE (request for bell status) message to the MS.

BEL1 shall indicate that the alert procedure is active.

BEL0 shall indicate that the alert procedure is not active.

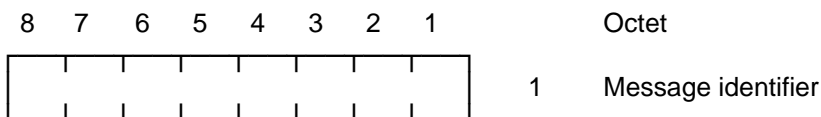

- 064 HOK1 Hook on**
- 065 HOK0 Hook off**

Control of the hook. The hook on/off command shall action the normal procedure associated with physically lifting the handset and replacing it whatever that maybe.

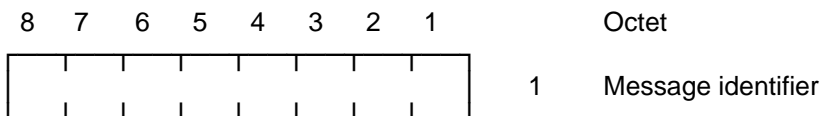

070 BCAP Selection of bearer capability

The EMMI BCAP message shall change the default bearer capability on all future calls made via the EMMI "perform keystroke sequence" message. The new default bearer capability shall be in effect until the ME is switched off or until the ME receives another EMMI BCAP message.

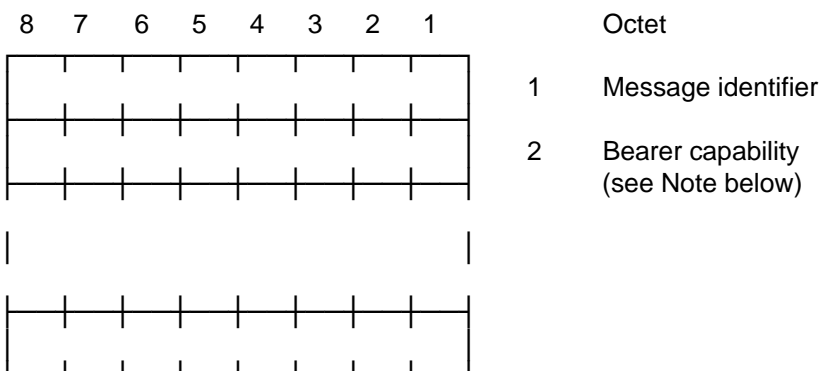

NOTE 1: The field "bearer capability" in the BCAP message is mandatory and is coded bit for bit exactly as the "bearer capability" information element as described in GSM 04.08 section 10.5.4.4, beginning with octet 2 (length of the bearer capability contents). Because the "bearer capability" is mandatory, the first byte of the field shall be the length of the bearer capability content and not the bearer capability information element identifier.

080 STPO Set power level

Used to control the Tx power level of the ME.

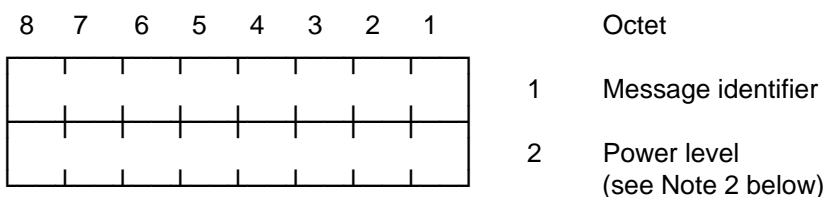

NOTE 2: The power level is defined as the 2nd octet of the power command information element in GSM 04.08.

091 RSTS Response table, status

Response table status is sent as an answer to the corresponding request.

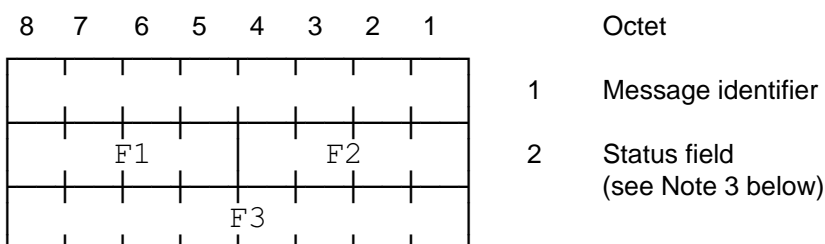

NOTE 3:

- F1
0 0 0 0 Spare
- F2 (1=yes, 0=no)
- Bit 4 L2 link on SACCH established
- Bit 3 Speech connection on TCH establ
- Bit 2 Listening to BCCH
- Bit 1 SDCCH established
- F3
- Bit 8 Frequency hopping (yes/no)
- Bit 7-1 ARFCN of BCCH of serving cell

092 RSTI Response table, indication

Response table indication send as an answer to the corresponding request.

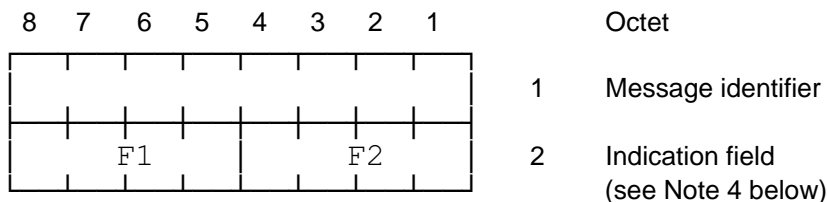

NOTE 4:

- F1
0000000 Spare
- F2 (yes=1, no=0)
- Bit 1 Service indication On (yes/no)

093 RSPO Response, power level

Response power level is sent as an answer to the corresponding request.

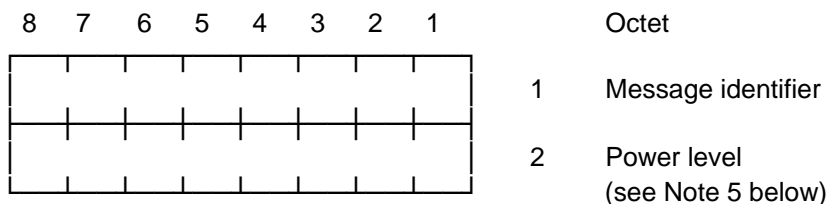

NOTE 5: The power level is defined as the 2nd octet of the power command information element in GSM 04.08.

101 RXSM Received short message

The message RXSM has to be sent by the MS in response to the RQSM request if a short message has been received.

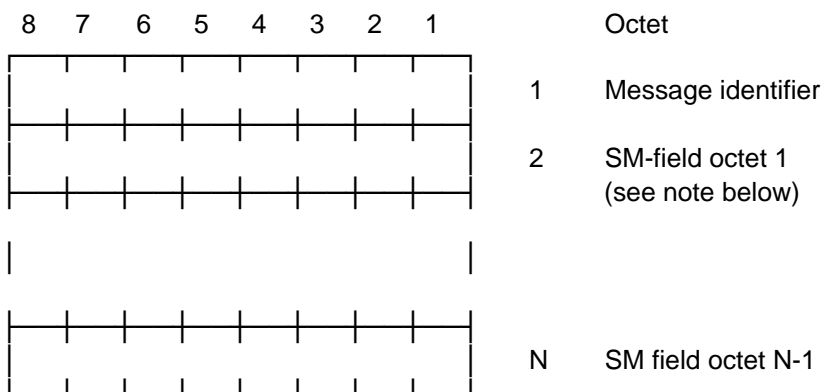

NOTE 6: The SM field is defined as the content of the data field short message storage defined in GSM 11.11 paragraph 3.5.1, excluding byte 1, as follows:

- 1 byte NULL value
- 12 bytes TP Originating Address
- 12 bytes TS Service Centre Address
- 1 byte TP Protocol Identifier
- 1 byte TP Data Coding Scheme
- 7 bytes TP Service Centre Time Stamp
- 1 byte TP User Data Length
- up to 140 bytes TP User Data.

If the length of the address for TP and for TS service centre is less than 12 bytes, the remaining bytes are filled with null values.

102 RXSN No short message received

The message RXSN has to be sent by the MS in response to the RQSM request if no short message has been received.

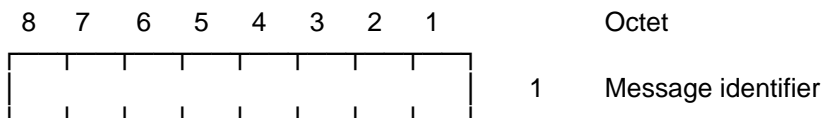

240 ER00 Internal malfunction detected

Used to indicate to the SS that the MS has discovered an internal error. This error message is to be handled in the same manner as the layer 3 error messages (only to be sent to the SS in response to a Layer 3 message received at the MS).

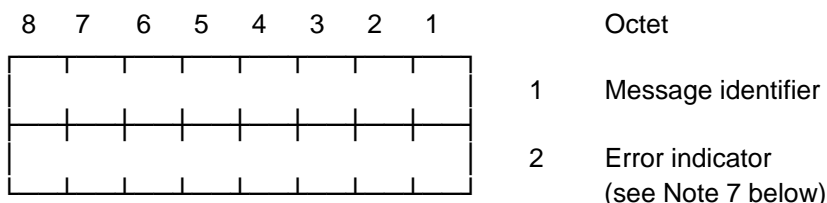

NOTE 7: The error indicator is defined by the manufacturer of the ME.

241 ER01 L3 message not recognized

Used by the receiver to indicate to the sender that the message was correctly received, but ignored due to the fact that it was not understandable (e.g. a KEYS message with one or many values which are not part of the standard set of keys for the MSE). The message to the MS implies a request for re-sending the latest message sent.



242 ER02 L3 message not performable

Used by the receiver to indicate to the sender that the message was understood, but not performable due to intentional lack of functionality in the MS (e.g. as answer to a CALL message containing a type of service which the MS is not able to use) or to a message requesting a change to a state already existent.

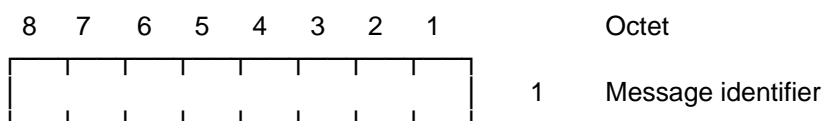

255 RESE Perform HW and SW reset

The MS shall perform a total reset. The MS shall behave as if it has been switched "off" and "on".

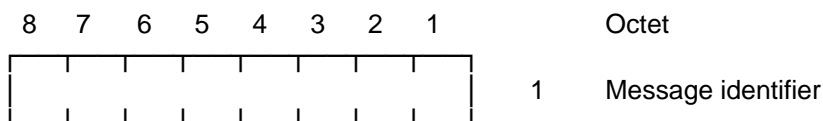

36.4 Digital audio interface

36.4.1 General

A special interface is required in order to perform the bit exact test of the speech coder/decoder and to test the SLR/RLR performance of the analogue and acoustic devices. It shall be possible to insert and extract speech data in both the transmit and receive directions. The interruption of the normal speech data paths can be commanded either by a layer 3 message over the air interface or by special control lines in the test interface. The MS need react to only one of these command methods. The manufacturer shall state which method is to be used.

36.4.2 Formal aspects

It shall be possible to connect the SS to the ME or to an adapter connected to the ME. If an adapter is to be used, it shall be provided by the manufacturer of the ME.

When using the DAI, the MS does not necessarily conform to all RF requirements.

When the DAI is connected the MS shall be able to correctly send and receive on a TCH and associated channels under ideal radio conditions.

NOTE: Prior to tests of the speech coder, other functional entities involved in the tests, such as the channel codec or RF units must have been verified successfully.

36.4.3 Hardware aspect of the interface

The data exchanged on the interface are 13 bit linear PCM at 8 000 samples per second, which, in order to keep the pin count low, are transferred on a duplex set of serial lines at 104 kbit/s.

One additional line resets the speech transcoder and the speech A/D and D/A functions. Two lines control the data flow direction and working mode of the interface, one mode being normal operation of the MS. These lines are controlled by the SS. Another line, controlled by the MS, clocks the data as required or available.

This is described in detail below.

36.4.3.1 Mechanical characteristics of the interface

The interface shall use a 25-pin DSUB socket, detailed in the ISO 2110 document. The ME shall use a female part.

The manufacturer may provide this interface on an external test "adapter".

The pin assignment of the connector shall be as follows:

Pin	Use	Function	Source
1		Chassis ground	ME
2-3	EMMI	signals	
4-6	Not used		
7	EMMI	Signal ground	
8-10	Not used		
11	DAI	Test control 1	SS
12	DAI	Signal ground	
13	DAI	Test control 2	SS
14-21	Not used		
22	DAI	Reset	SS
23	DAI	Data	ME
24	DAI	Data clock (104 kHz)	ME
25	DAI	Data	SS

NOTE: The EMMI interface is optional and is described in section 36.3.

36.4.3.2 Electrical characteristics of the interface

The state of a signal pin is defined by the voltage (V) between the pin and its associated ground as follows:

Logical state	Voltage v
0 or "LOW" or "ON"	$0\text{ V} < v < +0,8\text{ V}$
1 or "HIGH" or "OFF"	$+3,5\text{ V} < v < +5\text{ V}$
undefined	$+0,8\text{ V} < v < +3,5\text{ V}$
forbidden	$v < 0\text{ V}, \quad v > +5\text{ V}$

36.4.3.3 Timing characteristics of the interface

The following timing applies:

Parameter	Value
Clock frequency	104 kHz +/- 20 ppm
Duty cycle	40 to 60 %
Clock rising edge time	< 1 microsecond
Clock falling edge time	< 1 microsecond
Reset pulse duration	>= 4 millisecond

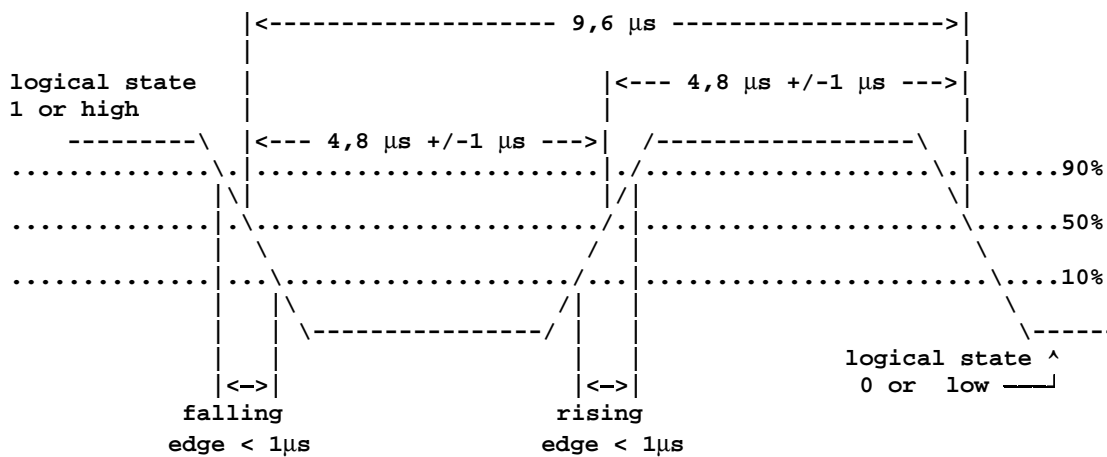

Data shall be stable during the period between 3 microseconds before and 1 microsecond after the rising edge of the clock (50 % level).

36.4.4 Logical interface

The reset signal is active low.

The data consists of 13 bit words in two's complement format, with the most significant bit transmitted first.

Data are read in by the MS or SS at the rising edge and are output by the SS or MS at the falling edge of the clock, as defined in figure 36-2.

The clock signal is high when inactive.

The two test control lines determine the routing of the speech data (DAI or internal, i.e. normal mode) and which device is being tested (speech transcoder/DTX functions or A/D & D/A) as follows:

Test control line 1	Test control line 2	Function
Low	Low	Normal operation
Low	High	Test of speech decoder / DTX functions (downlink)
High	Low	Test of speech encoder / DTX functions (uplink)
High	High	Test of acoustic devices and A/D & D/A

The same test setup may be achieved by the layer 3 TEST_INTERFACE message (see 36.2.3 and 36.2.4.7).

36.4.5 Functionality of the DAI

To initiate a test, the SS shall apply the appropriate test control signals or send the appropriate layer 3 messages and then, more than 1 second later, apply a reset pulse.

Upon release of the reset pulse, the MS subsequently starts the test by issuing clock pulses when data are required or are ready.

When testing uplink speech transcoding or DTX functions, the first falling clock edge shall request from the SS the first bit of the speech samples to be encoded, the transmission of which shall start at the next earliest possible interleaved block TDMA frame (as defined in GSM 05.02) after the release of the reset pulse.

When testing downlink speech transcoding or DTX functions, the first falling clock edge shall output to the SS the first bit of the speech samples decoded from the first interleaved block TDMA frames, the reception of which is completed subsequently to the release of the reset pulse.

The MS speech transcoders shall be reset by the end of the reset pulse, whenever it occurs, whilst the DAI is in one of the active states (Test of speech decoder / DTX functions (downlink), Test of speech encoder / DTX functions (uplink), Test of acoustic devices and A/D and D/A).

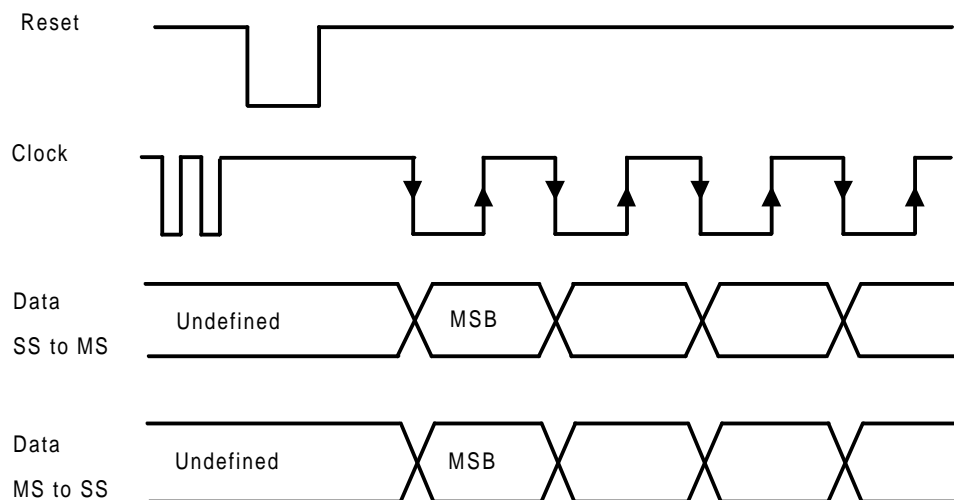

Figure 36-2 / GSM 11.10: DAI Timing

36.5 SIM/ME test interface

36.5.1 General

A special interface is required in order to perform the tests of the SIM/ME interface.

36.5.2 Formal aspects

It shall be possible to connect the SIM simulator to the ME. If an adapter is to be used, it shall be provided by the manufacturer of the ME.

When using the SIM simulator, the ME does not necessarily conform to all RF requirements.

When the SIM simulator is connected the ME shall be able to correctly send and receive on a TCH and associated channels under ideal radio conditions (according to GC3 of annex 1).

36.5.3 Hardware and logical aspects of the interface

The signals on this interface are specified in GSM 11.11.

36.5.4 Mechanical characteristics of the interface

The interface of the SIM-simulator offers two connection types:

- i) a paddle which is inserted into the ME under test in place of an IC card SIM, and connects with wires to the measuring equipment. The dimensions of the paddle are shown in figure 36-3.
- ii) a connector with leads of length 12cm, terminated directly at the contacting elements inside the ME under test.

For ME which use the plug in SIM, or when the paddle cannot be inserted due to constraints imposed by the ME design, then the ME manufacturer shall, for the purpose of testing the SIM/ME interface only, provide the ME with the connector of type ii) and the leads attached directly to the contacting elements. This connector with the flying leads shall be delivered by the test house.

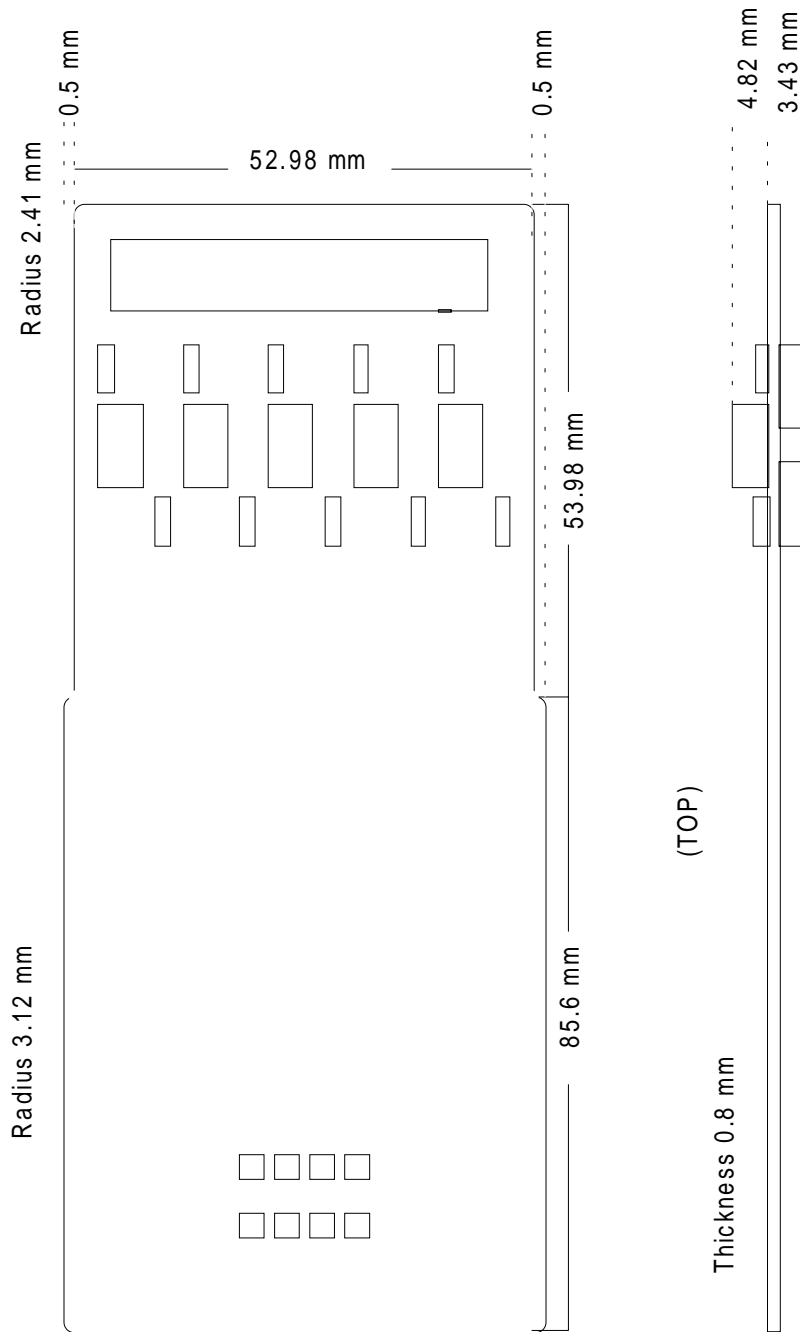

Figure 36-3 / GSM 11.10: Dimensions of full size paddle

Annex 1 (Normative): Reference test methods

A1.1 General Conditions (GC)

A1.1.1 Outdoor test site and general arrangements for measurements involving the use of radiated fields (GC4)

The outdoor test site shall be on a reasonably level surface or ground. At one point on the site a ground plane of at least 5 metres diameter shall be provided. In the middle of this ground plane a non-conducting support capable of rotation through 360 degrees in the horizontal plane shall be used to support the test sample at 1,5 metres above the ground plane.

The test site shall be large enough to allow the erection of a measuring or transmitting antenna at a distance of half a wavelength or at least 3 metres whichever is the greater. Sufficient precautions shall be taken to ensure that reflections from extraneous objects adjacent to the site and ground reflections do not degrade the measurement results.

The test antenna is used to detect the radiation from both the test sample and the substitution antenna, when the site is used for radiation measurements. Where necessary the substitution antenna is used as a transmitting antenna, when the site is used for the measurement of receiver characteristics. This antenna is mounted on a support such as to allow the antenna to be used in either the horizontal or vertical polarization and for the height of its centre above ground to be varied over the range 1 to 4 metres. Preferably test antennas with pronounced directivity should be used. The size of the test antenna along the measurement axis shall not exceed 20 % of the measuring distance.

For radiation measurements the test antenna is connected to a test receiver capable of being tuned to any frequency under investigation and of measuring accurately the relative levels of signals at its input. When necessary (for receiver measurements) the test receiver is replaced by a signal source.

The substitution antenna shall be a half wave dipole, resonant at the frequency under consideration, or a shortened dipole, or (in the range 1 to 4 GHz) a horn radiator. Antennas other than a half wave dipole shall have been calibrated to the half wave dipole. The centre of this antenna shall coincide with the reference point of the test sample it has replaced. This reference point shall be the volume centre of the sample when its antenna is mounted inside the cabinet, or the point where an external antenna is connected to the cabinet. The distance between the lower extremity of the dipole and the ground shall be at least 30 cm.

The substitution antenna shall be connected to a calibrated signal generator when the site is used for radiation measurements and to a calibrated measuring receiver when the site is used for measurements of receiver characteristics. The signal generator and the receiver shall be operating at the frequencies under investigation and shall be connected to the antenna through suitable matching and balancing network.

A1.1.2 Anechoic shielded chamber (GC5)

As an alternative to the above mentioned outdoor test site an indoor test site, being a well shielded anechoic chamber simulating free space environment may be used. If such a chamber is used, this shall be recorded in the test report.

NOTE: The anechoic shielded chamber is the preferred test site for testing to this specification.

The measurement site may be an electrically shielded anechoic chamber being 10 m long, 5 m broad and 5 m high. Walls and ceiling should be coated with RF absorbers of 1 m height. The ground should be covered with absorbing material 1 m thick able to carry test equipment and operators. A measuring distance of 3 to 5 m in the long middle axis of the chamber can be used for measurements up to at least 10 GHz.

The test antenna, test receiver, substitution antenna and calibrated signal generator are used in a way similar to that of the outdoor test site method with the exception that, because the floor absorbers reject floor reflections, the antenna height need not be changed and shall be at the same height as the test sample. In the range between 30 MHz and 100 MHz some additional calibration may be necessary.

A1.1.3 Temporary antenna connector (GC7)

If the MS to be tested does not normally have a permanent external 50 ohm connector then for test purposes only it may be modified to fit a temporary 50 ohm antenna connector.

The permanent integral antenna shall be used for measurement of:

- Transmitter effective radiated power (section 13.3).
- Radiated spurious emissions (section 12).

For tests in the MS Receive band (925-960 MHz):- The temporary antenna coupling factor is determined using the procedure defined in annex 1, 1.1.5. When using the temporary antenna connector, the temporary antenna coupling factor needs to be taken into consideration when determining a stimulus or measured level in the receive band.

For tests in the MS Transmit band (880-915 MHz):- The temporary antenna coupling factor is determined using the procedure defined in 13.3.4.2 When using the temporary antenna connector, the temporary antenna coupling factor needs to be taken into consideration when determining a stimulus or measured level in the transmit band.

For frequencies outside the GSM bands (880-915 MHz and 925-960 MHz) the temporary antenna coupling factor is assumed to be 0 dB.

NOTE 1: The uncertainty in the determined value of the temporary antenna coupling factor is directly related to the uncertainty of the field strength value measured in 13.3.4.2 step n) and annex 1, 1.1.5.2 (approximately +/- [3dB]). By mutual agreement, between the MS manufacturer and the testing authority, a value of 0 dB for the temporary antenna coupling factor could be used.

NOTE 2: The accommodation of the uncertainty in the temporary antenna coupling factor in the MS receive band (925-960 MHz) for the tests in section 14 is for further study.

NOTE 3: The uncertainty in the temporary antenna coupling factor in the MS transmit band (880-915 MHz) can be accommodated with appropriate adjustment of the measured levels by the uncertainty.

Testing must be performed in the following order to ensure that all the free field measurements are performed before the MS is modified.

- Section 12.1.2.
- Sections annex 1, 1.1.5.1 and annex 1, 1.1.5.2.
- Section 13.3.4.2 (during this step the MS is modified).
- Section annex 1, 1.1.5.3.
- All remaining tests of sections 12, 13, 14, 15, 16, 17, 18, 19, 20, 21 and 22.

A1.1.4 Temporary antenna connector characteristics

The method of connection of the temporary connector shall allow secure and repeatable connections to be made to the device under test.

The antenna connector shall present a nominal 50 ohm impedance over the GSM receive and transmit frequency ranges. The maximum loss within the frequency range 100 kHz to 12,75 GHz shall be less than 1 dB.

The connection circuitry shall be maximally broadband and shall contain no non-linear or active devices.

The characteristics of the connector shall not be significantly affected by temperatures in the range -25 to +60 degrees Celsius.

A1.1.5 Calibration of the temporary antenna connector

For equipments fitted with an integral antenna and not provided with a permanent means for connection to an external antenna a calibration procedure is required to allow subsequent measurements to be performed on the temporary antenna connector.

Once calibrated this temporary antenna connector enables all receiver test procedures to be identical for equipments with an integral antenna and for equipments with an antenna connector.

The calibration procedure shall be carried out at three frequencies, namely an ARFCN in the low mid and high ARFCN ranges. The procedure consists of three distinct stages as follows:

- 1) Establish the MS antenna radiation pattern for the three selected frequencies.
- 2) Calibrate the test range (or anechoic shielded chamber) for the conditions needed in 1).
- 3) Determine the temporary antenna connector coupling factor.

A1.1.5.1 Antenna radiation pattern

- a) The MS shall be in the anechoic shielded chamber, or on an outdoor test site, on an isolated support in a vertical position at an orientation specified by the manufacturer. This position is the 0 degree position.

A test antenna, connected to the SS shall be in the anechoic shielded chamber, or on the outdoor test site, at a distance of at least 3 metres from the MS.

- b) A call shall be originated by the SS to the MS on a frequency in the low ARFCN range. The MS shall be made to answer the call. The SS shall command the MS to maximum transmit power.
- c) The SS shall, using estimated parameters for the outdoor test site or anechoic shielded chamber, set its output level "E" [see figure A1-1 to give an MS receiver input level of approximately 32 dB μ Vemf. This corresponds to a field strength of 55,5 dB μ V/m at the MS position. The signal shall be the Standard Test Signal C1.

NOTE 1: The absolute value of the received signal level is not critical. The value suggested however will ensure that the MS receiver is operating essentially error free, yet is low enough to avoid any non linear effects in the receiver.

- d) The SS shall use the RXLEV message from the MS to determine a measure of the received field strength. The procedure detailed in the flow chart of figure A1-1 shall now be followed.

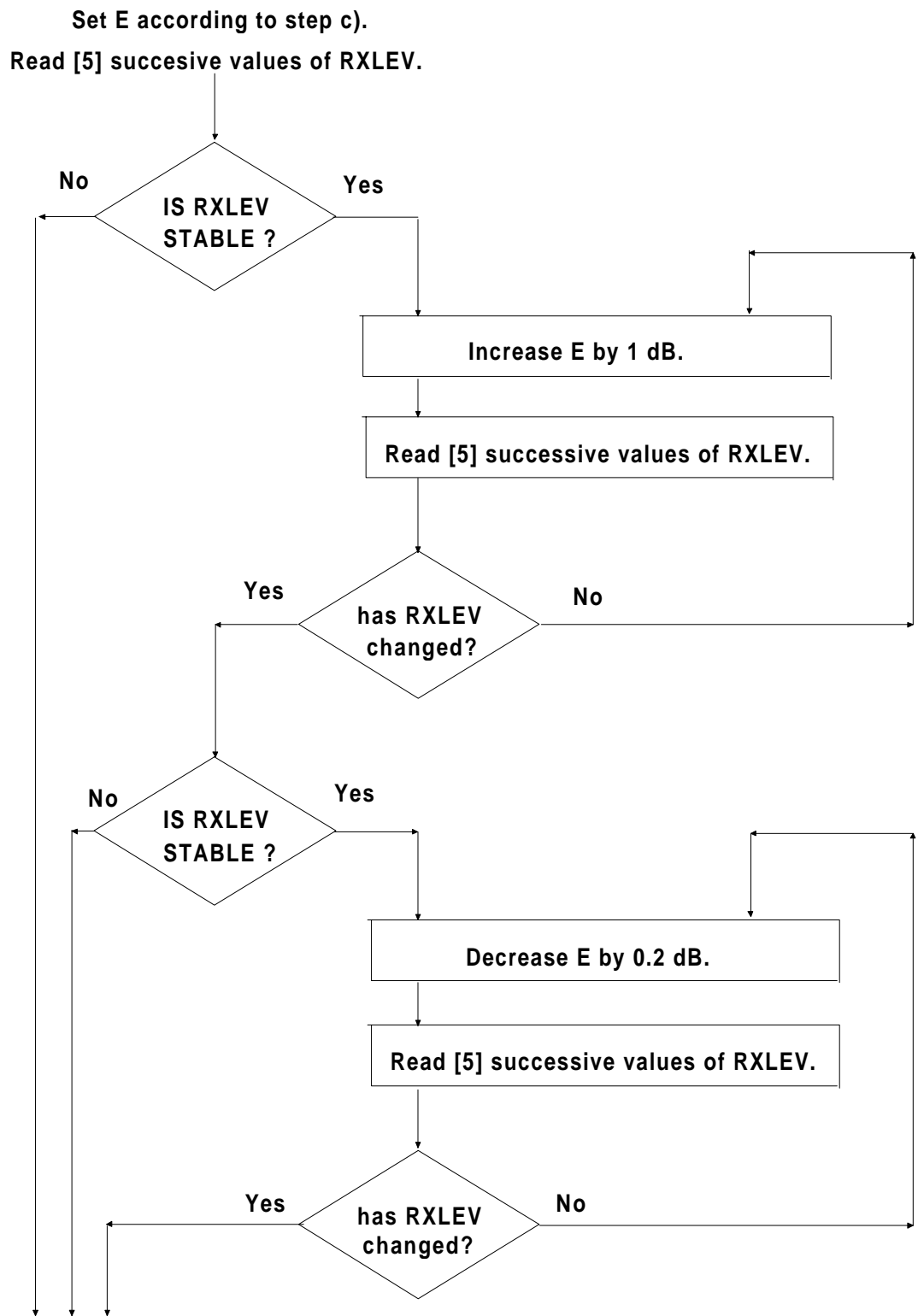

Record the signal level E from SS.

Figure A1-1

The signal level from the SS that just results in the transition from $RXLEV_a$ to $RXLEV_b$ shall be recorded as E_i .

NOTE 2: The actual values of $RXLEV_a$ and $RXLEV_b$ will need to be recorded, because this transition will be used as the reference point for all further stages of the calibration procedure.

- e) Step d) shall be repeated after the MS has been rotated by $n * 45$ degrees in the horizontal plane. Ensuring that the same RXLEV transition is used, the signal levels from the SS shall be recorded as E_{in} .
- f) Calculate the effective mean signal level from the RMS value of the eight signal levels obtained in d) and e) above by using the following formula:

$$E_1 = \left[\frac{8}{\sum_{n=0}^{n=7} \frac{1}{E_{in}}} \right]^{1/2}$$

- g) Repeat steps b) to f), except in step b) use an ARFCN in the mid ARFCN range to obtain a mean signal level E_2 . Ensure the same RXLEV transition is used.
- h) Repeat steps b) to f), except in step b) use an ARFCN in the high ARFCN range to obtain a mean signal level E_3 .

Ensure the same RXLEV transition is used.

A1.1.5.2 Test range calibration

The objective of this step is to determine the actual field strength at the MS corresponding to the three signal levels E_1 , E_2 and E_3 established in annex 1, 1.1.5.1. The following procedure shall be used:

- a) Replace the MS by a calibrated reception antenna connected to a measuring receiver.
- b) For each frequency used in annex 1, 1.1.5.1 measure the field strength E_r corresponding to the respective signal levels E_r determined in steps f), g) and h) of annex 1, 1.1.5.1 record these values as E_{f1} , E_{f2} , E_{f3} .

A1.1.5.3 Temporary antenna connector coupling factor

The coupling factor of the temporary antenna connector is the relationship expressed in dB, between the output signal of the SS and the effective receiver input signal for the MS.

The test sample MS is modified to fit a temporary antenna connector in accordance with annex 1, 1.1.3. Or alternatively a second MS shall be provided, fitted with such a temporary antenna connector.

NOTE: If only one MS is supplied for testing, the tests of radiated spurious emissions (transmit and receive) and receiver sensitivity shall be performed before the MS is modified to accept a temporary antenna connector.

The calibration procedure shall be as follows:

- a) The MS temporary connector is connected to the output of the SS.
- b) A call shall be originated by the SS to the MS using a frequency in the low ARFCN range. The MS shall be made to answer the call. The SS shall command the MS to maximum transmit power, non hopping encrypted mode.
- c) The SS shall, using the procedures of annex 1, 1.1.5.1, adjust its output signal level to determine the $RXLEV_a$ to $RXLEV_b$ transition. This signal level shall be recorded as E_{c1} .
- d) Repeat steps b) and c) for frequencies in the mid ARFCN range and the high ARFCN range. Record the RXLEV transitions as E_{c2} and E_{c3} respectively.

- e) The temporary antenna connector coupling factor F is then calculated from:

$$F_n = 20 \log_{10} \left[\frac{E_{cn}}{E_{fn} * K_n} \right]$$

where K_n = conversion factor of an isotropic antenna expressed as μV at the frequency $\mu V/m$ corresponding to the ARCFN used.

- f) The mean antenna coupling factor F_m to be used for measurements requiring hopping shall be calculated from the RMS value of all parameters in e) as follows:

$$E_{cm} = \left[\frac{3}{1/E_{c1} + 1/E_{c2} + 1/E_{c3}} \right]^{1/2}$$

$$E_{fm} = \left[\frac{3}{1/E_{f1} + 1/E_{f2} + 1/E_{f3}} \right]^{1/2}$$

$$k_m = \left[\frac{k_1 + k_2 + k_3}{3} \right]^{1/2}$$

$$F_m = 20 \log_{10} \left[\frac{E_{cm}}{E_{fm} + k_m} \right]$$

- g) In all tests in which a MS with integral antenna is the unit under test, the signal level at the temporary antenna connector is determined from:

$$E_{in} = E_{req} + F$$

where: E_{in} = signal level at coupling device (dB μ Vemf)
 E_{req} = signal level required by the test (dB μ Vemf)
 F = coupling factor at the respective ARCFN (dB)

This is indicated in the test procedures as E_{req} , dB μ Vemf(), where the empty parenthesis is to be read as E_{in} .

For frequencies not in the receive band or the transmit band, 0dBi antenna gain shall be assumed.]

A1.2 Normal and extreme Test Conditions (TC)

A1.2.1 Power sources and ambient temperatures (TC2)

During type approval tests the power source of the equipment shall be replaced by a test power source, capable of producing normal and extreme test voltages as specified in sections 1.2.2 and 1.2.3. The internal impedance of the test power source shall be low enough for its effect on the test results to be negligible. For the purpose of tests, the voltage of the power source shall be measured at the input terminals of the equipment. If the equipment is provided with a permanently connected power cable, the test voltage shall be that measured at the point of connection of the power cable to the equipment. In equipment with incorporated batteries the test power source shall be applied as close to the battery terminals as practicable.

During tests the power source voltages shall be maintained within a tolerance of +/-3 % relative to the voltage at the beginning of each test.

A1.2.2 Normal test conditions (TC2.1)

The normal temperature and humidity conditions for tests shall be any convenient combination of temperature and humidity within the following ranges:

Temperature: +15 °C to +35 °C (degrees Celsius)

Relative humidity: 20 % to 75 %

NOTE: When it is impracticable to carry out the tests under the conditions stated above, the actual temperature and relative humidity during the tests shall be recorded in the test report.

The normal test voltage for equipment to be connected to the mains shall be the nominal mains voltage. For the purpose of these specifications, the nominal voltage shall be the declared voltage or any of the declared voltages for which the equipment was designed. The frequency of the test power source corresponding to the mains shall be within 1 Hz of the nominal mains frequency.

When the radio equipment is intended for operation from the usual types of regulated lead-acid battery power source of vehicles, the normal test voltage shall be 1,1 times the nominal voltage of the battery (6 volts, 12 volts etc.).

For operation from other power sources or types of battery (primary or secondary) the normal test voltage shall be that declared by the equipment manufacturer.

A1.2.3 Extreme test conditions (TC2.2)

For tests under extreme test conditions the 4 combinations of extreme voltages and extreme temperatures in table A1.1 shall be applied.

Table A1.1

	1	2	3	4
Temperature	High	High	Low	Low
Voltage	High	Low	High	Low

For tests at extreme ambient temperatures measurements shall be made at the temperatures given in table A1.2, following the testing procedures given in IEC publications 68-2-1 and 68-2-2 for the low and high temperature tests.

For tests at the high temperature, after thermal balance has been achieved, the MS is switched on in the transmit condition (non DTX) for a period of one minute followed by 4 minutes in the idle mode (non DRX) after which the MS shall meet the specified requirements.

For tests at the low temperature, after thermal balance has been achieved, the MS is switched to the idle mode (non DRX) for a period of one minute after which the MS shall meet the specified requirements.

Table A1.2

	Temperature (degrees Celsius)	
	Low	High
Handheld	-10	+55
Vehicular or Portable	-20	+55

For tests at extreme voltages measurements shall be made at the lower and higher extreme voltages as declared by the MS manufacturer. For MS that can be operated from one or more of the power sources listed below, the lower extreme voltage shall not be higher, and the higher extreme voltage shall not be lower than that specified in table A1.3.

Table A1.3

Power source:	Voltage (relative to nominal)		
	Lower extreme	Higher extreme	Normal cond.
AC mains	0,9	1,1	1,0
Regulated lead acid battery	0,9	1,3	1,1
Non regulated batteries:			
Leclanché/ lithium	0,85	1,0	1,0
mercury/ nickel cadmium	0,9	1,0	1,0

A1.2.4 Vibration requirements (TC4)

When the MS is to be tested under vibration, then random vibration is used, where the acceleration spectral densities (ASD) and the frequency ranges of GSM 05.05 [annex D.2.3] apply. These are given in table A1.4.

Table A1.4

frequency in Hz	ASD in m^2/s^3
5- 20	0,96
20 - 500	0,96 at 20 Hz, thereafter -3 dB / octave

The test shall be performed as described in IEC publication 68-2-36.

Annex 2: Not used

Text deleted.

Annex 3: Protocol implementation information

General

The list of PICS and PIXIT gives all the information needed to perform the tests described in GSM 11.10.

A3.1 Protocol Implementation Conformance Statement (PICS)

For the points listed the manufacturer has the choice between different solutions in implementation. The manufacturer has to describe his choice if there is any consequence for the tests.

A3.1.1 LAPDm protocol (GSM 04.05 and 04.06)

A3.1.1.1 Simplified protocol - GSM 04.06 section 6

Statement about the choice made by the manufacturer.

A3.1.1.2 Management of SAPI = 3 - GSM 04.11 section 2.3

Statement about the handling of SAPI = 3 on the data link layer chosen by the manufacturer.

A3.1.2 Mobility management

A3.1.2.1 IMSI detach initiation by the MS - GSM 04.08 section 4.3.4.1

During a location updating, if an IMSI detach has to be performed (SIM or power off), the IMSI detach can be delayed until the location updating is finished, or can be omitted.

A3.1.2.2 IMSI detach completion by the MS - GSM 04.08 section 4.3.4.3

The MS should delay the local release of the channel to allow a normal release from the network after a detach by power off command, if possible.

If not possible the RR sub-layer on the MS side should be aborted without waiting for something from the network.

A3.1.2.3 MM specific procedures - GSM 04.08 section 4.4 and 4.5.1.1

During the lifetime of an MM specific procedure, if an MM connection establishment is required by a CM-entity, this request will either be rejected or delayed until the running MM specific procedure is terminated and, provided that the network has not sent a "follow-on proceed" indication, the RR connection is released.

If the LOCATION UPDATING REQUEST message has not been sent, the mobile station may include a "follow-on request" indicator in the message. The mobile station shall then delay the request until the MM specific procedure is completed, when it may be given the opportunity by the network to use the RR connection.

A3.1.2.4 Receiving an MM STATUS message - GSM 04.08 section 4.6

If the MM-entity of the Mobile Station receives a MM-STATUS message no state transition and no specific action shall be taken as seen from the radio interface, i.e. local actions are possible.

A3.1.3 Call control

A3.1.3.1 Status enquiry procedures - GSM 04.08 section 5.5.3.1

The MS may send a STATUS ENQUIRY and take the appropriate actions based on the answer (STATUS) of the network.

A3.1.3.2 Receiving a STATUS message by a CC entity - GSM 04.08 section 5.5.3.2

The determination of which CC states are incompatible between the MS and the network is left as an implementation decision except in some particular cases.

A3.1.3.3 Called side compatibility checking - GSM 04.08 annex B.3

Compatibility checking can be performed in various ways from the viewpoint of execution order and information to be checked, e.g. first DDI number, sub-address and then compatibility or vice versa.

A3.1.3.4 Disconnect on incoming call

The mobile equipment may or may not offer the possibility to disconnect an incoming call:

- a) after having confirmed an incoming call, but before alerting.
- b) after alerting, but before connecting.

GSM 02.30 (5.2.3) allows the combination of SEND and END function in one key.

A3.1.4 Layer 1

A3.1.4.1 Optional storage of BCCH carrier information - GSM 05.08 section 6.3

The MS may include optional storage of BCCH carrier information. For instance, the MS may store the BCCH carriers in use by the PLMN accessed when it was last active in the GSM network, or it may store BCCH carriers for more than one PLMN.

A3.1.5 Autocalling - (ref.: GSM 02.07, annex 1)

Cause number 27 implemented in:

- category 2 (preferred);
- category 3.

A3.1.6 Transient states

The following call control states may be transient in the mobile station:

State U6

State U6 may be transient if the mobile station is not configured to support explicit refusal of an incoming call by the (human or non-human) user (e.g. via a terminal interface) before call confirmation.

If U6 is transient, there is an internal transition

CALL CONFIRMED

U6 > U9

or an internal transition

RELEASE COMPLETE

U6 > U0.

State U7

State U7 is transient if the implementation allows for automatic connect after an implementation specific time T.

If U7 is transient, there is an internal transition:

after T, CONNECT

U7 > U8.

State U9

State U9 is not transient if:

- the implementation does not support immediate connect
- an appropriate TCH is not yet assigned
- the signalling element has not been present in the SETUP

If the implementation supports immediate connect, there is an internal transition:

CONNECT

U9 > U8.

If the appropriate TCH is available or the signalling element was present in SETUP, there is an internal transition:

ALERTING

U9 > U7.

State U12

U12 is a stable state, if an appropriate speech traffic channel is connected and progress indicator #8 was present in the DISCONNECT message. Otherwise U12 is transient, and there is an internal transition:

A3.2 Protocol Implementation Extra Information for Testing (PIXIT)

A3.2.0 Introduction

Some of the features listed below are mandatory, others are not ; but in any case for each feature implemented the manufacturer must provide information to enable regulatory testing to be conducted.

A3.2.1 Basic characteristics

A3.2.1.1 Type of antenna

- Integrated without a connector.
- Position for normal use (if integrated without a connector).
- With a connector allowing the connection of an external antenna.
If with a connector, declare in band impedence.

A3.2.1.2 Power supply

- Type of battery (if any).
- Type of power supply.
- Nominal voltage(s).
- End-point voltage(s) of battery(s) (if any).
- Details of MS shut-down voltage.

A3.2.1.3 Power class of the MS

- Different class declared.
- Class mark change: description of the means to change the RF power capabilities.

A3.2.1.4 Channel modes supported

Speech full rate
 Speech half rate
 Data 12 kbit/s full rate T/NT
 Data 6 kbit/s full rate T/NT
 Data 6 kbit/s half rate T/NT
 Data 3,6 kbit/s full rate T
 Data 3,6 kbit/s half rate T

A3.2.1.5 Teleservices supported

- 11) Telephony
- 12) Emergency calls
- 21) Short message MT/PP
- 22) Short message MO/PP
- 23) Short message transmission cell broadcast
- 61) Alternate speech and facsimile group 3 T/NT
- 62) Automatic facsimile group 3 T/NT

A3.2.1.6 Supplementary services supported

Call forwarding.
 Call restriction.
 Handling of undefined GSM Supplementary Services.

A3.2.1.7 Bearer services supported

- | | | | |
|------|----------------------------------|---------------|------|
| 21) | Data circuit Duplex asynchronous | 300 bit/s | T/NT |
| 22) | Data circuit Duplex asynchronous | 1200 bit/s | T/NT |
| 23) | Data circuit Duplex asynchronous | 1200/75 bit/s | T/NT |
| 24) | Data circuit Duplex asynchronous | 2400 bit/s | T/NT |
| 25) | Data circuit Duplex asynchronous | 4800 bit/s | T/NT |
| 26) | Data circuit Duplex asynchronous | 9600 bit/s | T/NT |
| 31) | Data circuit Duplex synchronous | 1200 bit/s | T |
| 32) | Data circuit Duplex synchronous | 2400 bit/s | T/NT |
| 33) | Data circuit Duplex synchronous | 4800 bit/s | T/NT |
| 34) | Data circuit Duplex synchronous | 9600 bit/s | T/NT |
| 41) | PAD Access circuit asynchronous | 300 bit/s | T/NT |
| 42) | PAD Access circuit asynchronous | 1200 bit/s | T/NT |
| 43) | PAD Access circuit asynchronous | 1200/75 bit/s | T/NT |
| 44) | PAD Access circuit asynchronous | 2400 bit/s | T/NT |
| 45) | PAD Access circuit asynchronous | 4800 bit/s | T/NT |
| 46) | PAD Access circuit asynchronous | 9600 bit/s | T/NT |
| 51) | Data Packet Duplex synchronous | 2400 bit/s | NT |
| 52) | Data Packet Duplex synchronous | 4800 bit/s | NT |
| 53) | Data Packet Duplex synchronous | 9600 bit/s | NT |
| 61) | Alternate Speech/Data | | |
- (here Data offers the same service as bearer services 21-34 with "3,1kHz" information transfer capability)

- 81) Speech followed by Data
(here Data offers the same service
as bearer services 21-34 with "3,1kHz" information transfer capability)

A3.2.1.8 SIM removal

- Removal of the SIM is possible without disconnection of the power supply (Y/N).

A3.2.1.9 Classmark

The coding of Mobile station classmark 1, 2, and 3 and the fact whether and under which conditions the classmark 3 information element is included in a CLASSMARK CHANGE message, has to be declared by the manufacturer. The declaration has to fulfil the following requirements:

- Mobile station classmark 1: Bits 4, 5, and 8 of the first (and only) octet of the value part of the information element shall be coded as "0". The "Revision level" and "RF power capability" field shall specify the value that is correct for the MS.
- Mobile station classmark 2: Bits 4, 5, and 8 of the first octet, bits 2, 3, and 8 of the second octet, bits 3 to 7 of the third octet of the value part of the information element shall be coded as "0". The "Revision level" field, "RF power capability" field, "PS capability" field, "SS Screening indicator" field, "SM capability" field, "Frequency capability" field, "Classmark 3" field, "A5/2 algorithm supported" field, and "A5/3 algorithm supported" field shall specify the value that is correct for the MS.
- Mobile station classmark 3: Bits 5 to 8 of the first octet of the value part of the information element shall be coded as "0". If the value part contains more octets, they shall be coded as "0000 0000". The "A5/4 algorithm supported" field, "A5/5 algorithm supported" field "A5/6 algorithm supported" field, and "A5/7 algorithm supported" field shall specify the value that is correct for the MS (that is, they shall be set to "0").

NOTE: The requirements to the classmark may be subject to changes. That is why test cases are expected to verify the manufacturer's declaration, whereas the correctness of the manufacturer's declaration is to be verified "off line".

A3.2.1.10 Type of SIM/ME interface (ref. GSM 11.11 and GSM 11.12)

- 5V SIM/ME interface (5V only ME)
- 3V SIM/ME interface (3V only ME)
- 5V/3V SIM/ME interface (3V technology ME)

A3.2.2 Man machine interface

A3.2.2.1 Mobile station features

- Description of manual entry and display of a called number.
- Description of the basic way to send a call manually.
- Description of the basic way to take a call manually.
- Description of the basic way to end a call manually.
- Description of the basic way to send an emergency call manually.
- Description of the basic way to send DTMF manually.
- Description of the manual PLMN selector.
- Description of the automatic PLMN selector.
- Description of the indication of the country.
- Description of the indication of the available PLMN.

- Description of the indication of the automatic registration to a PLMN.
- Description of the service indicator.
- Description of the management of the SIM by the user:
 - . keying PIN and changing PIN,
 - . indication of acceptance or rejection of keyed PIN,
 - . indication of blocked SIM,
 - . indication of successful unblocking of the SIM,
 - . storing an abbreviated number,
 - . displaying an abbreviated number.
- Description of the selection of the hands free.
- Description of the volume control.
- Description of local barring of outgoing calls.
- Description of prevention of unauthorized calls.
- Description of the auto calling management:
 - . selection of the auto calling,
 - . indication that the call failed and a re-try is attempted,
 - . indication that the call finally failed.
- Description of the way in which the MS generates an MS originated NOTIFY, if possible. This feature may or may not be supported by the MS.

NOTE: All the above description could be extracted from the user's manual.

A3.2.2.2 Short message service

- Description of the basic procedures to send a mobile originated short message.
- Description of the basic procedures to display a mobile terminated short message.
- Description of the basic procedures to display a cell broadcasted short message.
- The value of the timer TC1M.
- Whether SMS messages are stored in the SIM and/or the ME.
- Maximum length (characters) of a mobile originated short message.

A3.2.2.3 Supplementary services

A3.2.2.3.1 Call forwarding

- Description of the user's commands and of the display of the answers from the network for:
 - registration,
 - erasure,
 - activation,
 - deactivation,
 - interrogation,
 - specific data request.
- Description of the display of:
 - . notification of an incoming call to the "served" mobile or the "forwarded to" mobile,
 - . notification during out-going call,
 - . information to the calling mobile.

A3.2.2.3.2 Call restriction

- Description of the user's commands and the display of the answers from the network for:
 - registration,
 - change of the password,
 - activation,
 - deactivation,
 - interrogation.
- Description of the display of the indication of call barring.

A3.2.2.3.3 Handling of (undefined) GSM supplementary services

- Description of the user's commands and the display of the answer from the network.

A3.2.3 Electrical Man Machine Interface (EMMI)**A3.2.3.1 Methods supported for activation/deactivation of EMMI**

- all possibilities specified in GSM 11.10, section 36.2.2;
- all possibilities specified in GSM 11.10, section 36.2.2, except activation by inserting a test SIM (when the ME is already switched on);
- activation/deactivation only via layer 3 messages on the radio interface according to GSM 11.10, section 36.2.2.

A3.2.3.2 Transmission rate supported by the ME on the EMMI**A3.2.3.3 Layer 3 messages supported on the EMMI**

- Layer 3 messages as specified in GSM 11.10, section 36.3.5.3.2, except: (followed by the list of messages not supported);
- others than defined in GSM 11.10 section 36.3.5.3.1 table 9.

A3.2.3.4 Keystroke sequence messages

Non standard keystroke sequences to be used on the EMMI (in line with GSM 11.10, 36.3.5.3.2):

- related to tests of the mobile station features (GSM 11.10, section 33);
- related to testing of the ME/SIM interface (GSM 11.10, section 27);
- related to tests of autocalling restrictions (GSM 11.10, section 28);
- related to tests of supplementary services (GSM 11.10, section 31);
- related to tests of data services (GSM 11.10, section 29);
- related to tests of short message service (GSM 11.10, section 34);
- related to other tests.

A3.2.3.5 Internal malfunction detected messages

List of the error indicators provided.

A3.2.4 Digital Audio Interface (DAI)

Description of the speech data routing:

- via the control lines;
- or via the test interface message.

A3.2.5 Characteristics related to bearer services or teleservices

A3.2.5.1 Access interface

Description of the access interface to connect the DTE (e.g. V series (V.24, V.28), X series, two wire analogue interface for use with fax group 3, I.420 (S-reference point).

In case of a proprietary interface to a DTE (non standard), description of this interface (hardware and software).

In case of a non standard connector provide a mechanical adapter.

A3.2.5.2 Configuration of the MT

Description of the configuration information to be selected in the MT to connect a terminal equipment to the mobile termination.

Description of the (different) configuration(s) of the MT for each bearer service and each teleservice supported, with the range or value for the parameters and the configuration procedure.

For the purpose of test of MOC, the manufacturer shall describe precisely how it is possible to put the MT in the different configurations to generate the capability information of the Mobile according to section 3.2.5.3, and described as supported by the MS.

For the purpose of test of MTC, the manufacturer shall describe how to verify the correct selection by the MT of the required function with regard to the capability information as described below, especially using the messages at the Um interface if there is no R or S interface available (case MTO). The description shall be made for every combination of the parameter value valid for the MT.

A3.2.5.3 Capability information

Description of the capability information, related to supported bearer services:

- bearer capabilities,
- higher layer capabilities,
- lower layer capabilities,

The manufacturer shall describe for every capability the associated terminal functions and their characteristics.

A3.2.5.4 Subaddress or DDI number

Subaddress or a DDI number of the MT.

Procedure to allocate or change DDI number or subaddress, if possible.

A3.2.5.5 User to user signalling

Description of the function and the user's access to it.

A3.2.5.6 Data call set-up and data call clearing

For each implemented transparent and non-transparent data service:

- Description of the data call establishment mechanism:
 - Terminal initiated (CT108) (if possible),

- MT (MMI/EMMI) initiated.
 - Description of DCE provided information (MT to TE), if any.
 - Declaration of optimal function and procedure, services supported by the MT.
- Description of the data call clearing mechanism:
 - Terminal initiated (CT109) (if possible),
 - MT (MMI/EMMI) initiated.
 - Description of DCE provided information (MT to TE) related to a mobile or network initiated call clearing, if any.

A3.2.5.7 Characteristics of non-transparent data services

Description of Radio Link Protocol (RLP) features supported.

Description of flow control mechanism:

- INBAND (XON/XOFF);
- OUTBAND COPnoFICt (CT105 and CT106).

A3.2.5.8 Possible ways of setting-up a call from either an external interface or internally

Describe in detail all possible ways a call can be initiated from the MS or a connected terminal.

A3.2.5.9 Application layer causing automatic call termination.

State whether the call termination facility can be disabled and if so, describe in detail how.

A3.2.5.10 Call re-establishment for MS not supporting speech

Applicability of call re-establishment.

A3.2.6 International mobile station equipment identity

IMEI of the MS.

A3.2.7 Receiver intermediate frequencies

F_{lo} - Local Oscillator frequency applied to first receiver mixer.

$IF_1 \dots IF_n$ - intermediate frequencies.

A.3.2.8 Artificial ear

The manufacturer shall declare which type of artificial ear (type 1 or type 3.2) is used for teleservices speech testing.

Annex 4: Test SIM Parameters

A4.1 Introduction

This section defines default parameters for programming the elementary files of the test SIM. The requirements of this annex do not apply to the SIM/ME tests of section 27.

A4.1.1 Definitions

"Test SIM card":

A SIM card supporting the test algorithm for authentication, programmed with the parameters defined in this section. The electrical, mechanical and environmental requirements of the test SIM card are specified in GSM 11.11.

"Test SIM":

Either a test SIM card or the SIM simulator programmed with the parameters defined in this section.

A4.1.2 Definition of the test algorithm for authentication

The following procedure employs bit wise modulo 2 addition ("XOR")

The following convention applies:

In all data transfer the most significant byte is the first byte to be sent; data is represented so that the left most bit is the most significant bit of the most significant byte.

Step 1:

XOR to the challenge RAND, a predefined number Ki, having the same bit length (128 bits) as RAND. The result RES1 of this is

$$\text{RES1} = \text{RAND XOR Ki}$$

Step 2:

The most significant 32 bits of RES1 form SRES. The next 64 bits of RES1 form Kc. The remaining 32 bits are not used.

A4.2 Default Parameters for the test SIM

Ki:

The authentication key "Ki" will be chosen by the test house and will be non zero. The "Ki" value used by the SS will align with this value.

PIN Disabling

The PIN enabled / disabled flag will be set to "PIN Disabled". This ensures that when the Test SIM is inserted into a MS the user will not be prompted for PIN entry. This requires a specific card capability defined by the SIM service table (see section 2.9).

A4.3. Default settings for the Elementary Files (EFs).

The format and coding of elementary files of the SIM are defined in GSM 11.11. The following sections define the default parameters to be programmed into each elementary file. Some files may be updated by the MS based on information received from the SS. These are identified in the following sections.

A4.3.1 EF_{ICCID} (ICC Identification)

The programming of this EF is a test house option.

A4.3.2 EF_{LP} (Language preference)

The programming of this EF is a test house option.

A4.3.3 EF_{IMSI} (IMSI)

The IMSI value will be chosen by the test house. The IMSI used by the SS will align this value.

File size: 9 bytes
 Default values: Byte 1 (DEC): 8
 Bytes 2-9 (HEX): 09 10 10 ** * * * * * *

**" indicates any number between 0 and 9 subject to the restriction that IMSI mod 1000 (i.e. bytes 7, 8 and 9) lies in one of the following ranges:

063-125, 189-251, 315-377, 441-503, 567-629, 693-755, 819-881 or 945-999

NOTE: This ensures that the MS can listen to the second CCCH when more than one basic physical channel is configured for the CCCH. This is necessary for the test of "paging re-organization".

A4.3.4 EF_{Kc} (Ciphering key Kc)

File size: 9 Bytes
 Default values (HEX): Bytes 1-8: Align with Kc used by SS
 Byte 9: 07

Byte 9 is set to 07 to indicate that there is no key available at the start of a test.

The bytes within this elementary file may be updated by the MS as a result of a successful authentication attempt.

A4.3.5 EF_{PLMNsel} (PLMN selector)

File size: 102 bytes
 Default values (HEX): Bytes 1-3: 32 F4 10 (MCC, MNC) - Translates to 234, 01
 Bytes 4-6: 32 F4 20 (MCC, MNC)
 Bytes 7-9: 32 F4 30 (MCC, MNC)

 Bytes 94-96: 32 F4 23 (MCC, MNC)
 Bytes 97-99: 32 F4 33 (MCC, MNC)
 Bytes 100-102: 32 F4 43 (MCC, MNC)

34 PLMNs are shown coded above since this is the largest number required for a test - see section 27.9.4.1. It is necessary to take this into account since the SIM cards must be dimensioned to cope with this number of records.

A4.3.6 EF_{HPLMN} (HPLMN search period)

File size: 1 byte
 Default value (HEX): 00 (no HPLMN search attempts)

A4.3.7 EF_{ACMmax} (ACM maximum value)

File size: 3 bytes
 Default: Byte 1: 00
 Byte 2: 00
 Byte 3: 00

The above translates to: "Not valid".

A4.3.8 EF_{SST} (SIM service table)

Services will be allocated and activated as follows:

Service	Allocated	Activated
No. 1: CHV1 disable function	Yes	Yes
No. 2: Abbreviated Dialling numbers (ADN)	Yes	Yes
No. 3: Fixed dialling numbers (FDN)	Yes	Optional
No. 4: Short Message Storage (SMS)	Yes	Yes
No. 5: Advice of Charge (AoC)	Yes	Yes
No. 6: Capability Configuration Parameters (CCP)	Yes	Yes
No. 7: PLMN Selector	Yes	Yes
No. 8: Reserved for future use	No	No
No. 9: MSISDN	Optional	Optional
No. 10: Extension 1	Yes	Optional
No. 11: Extension 2	Yes	Optional
No. 12: SMS Parameters	Yes	Yes
No. 13: Last Dialed Number (LND)	Yes	Yes
No. 14: Cell Broadcast Message Identifier	Yes	Yes
No. 15: Group identifier Level 1	Yes	Optional
No. 16: Group identifier Level 2	Yes	Optional

A4.3.9 EF_{ACM} (Accumulated call meter)

File size: 3 bytes
 Default: Byte 1: 00
 Byte 2: 00
 Byte 3: 00

The above translates to: "Not yet implemented".

A4.3.10 EF_{PUCT} (Price per unit and currency table)

File size: 5 bytes
 Default: Byte 1-3: FF
 Byte 4-5: 00

A4.3.11 EF_{CBMI} (Cell broadcast Message Identifier Selection)

The programming of this EF is a test house option.

The file size is 2n bytes, where n is the number of Cell broadcast message identifier records - each record defining a type of Cell Broadcast message which may be accessed by the MS. Care should be taken when dimensioning the SIM to take into account the number of Cell Broadcast message identifier records required.

A4.3.12 EF_{BCCH} (Broadcast control channels)

File size:	16 Bytes	
Default values (BIN):	Bytes 1-2:	11111111 11111111
	Bytes 3-4:	11111111 11111111
	Bytes 5-6:	11111111 11111111
	Bytes 7-8:	11111111 11111111
	Bytes 9-10:	11111111 11111111
	Bytes 11-12:	11111111 11111111
	Bytes 13-14:	11111111 11111111
	Bytes 15-16:	11111111 11111111

This field may be updated dependent on the MS implementation.

A4.3.13 EF_{ACC} (Access control class)

File size:	2 Bytes	
Default values (BIN):	Byte 1:	00000000
	Byte 2:	*****

The test house may set any single bit of byte 2 to "1". All remaining bits of byte 2 will be set to "0". This determines the access control class of the SIM.

A4.3.14 EF_{FPLMN} (Forbidden PLMNs)

Length:	12 Bytes	
Format (HEX):	Bytes 1-3:	FF FF FF
	Bytes 4-6:	FF FF FF
	Bytes 7-9:	FF FF FF
	Bytes 10-12:	FF FF FF

This coding corresponds to an empty "forbidden PLMN list". The bytes within this file may be updated if a LOCATION UPDATE REJECT message is received by the MS with cause, "PLMN not allowed".

A4.3.15 EF_{LocI} (Location information)

File size:	11 Bytes	
Default values:	Bytes 1-4 (HEX):	FF FF FF FF (TMSI)
	Bytes 5-9 (HEX):	42 F6 18 FF FE (LAI)
	Byte 10 (HEX):	FF (Periodic LU Time = "the timer is not running")
	Byte 11 (BIN):	00000001 (Location Update Status = "not updated")

Bytes 5-9: LAI-MCC = 246 (bytes 5-6) and LAI-MNC = 81 (byte 7) are frequently used in section 27. The LAC (bytes 8-9) is set to "FF FE" since this, in conjunction with byte 11 setting of "01", is used to ensure that the MS performs a location update at the beginning of a test.

Bytes in this file (e.g. TMSI in bytes 1-4) may be updated as a result of a location update attempt by the MS.

A4.3.16 EF_{AD} (Administrative data)

File size:	3 bytes	
Default values	Byte 1:	10000000 - (type approval operations)
	Byte 2:	11111111
	Byte 3:	11111111

A4.3.17 EF_{Phase} (Phase identification)

File size:	1 byte	
Default value (HEX):	02	Phase 2

A4.3.18 EF_{ADN} (Abbreviated dialling numbers)

The programming of this EF is a test house option. It should be noted that sufficient space should be provided on the SIM card for 101 records - see section 27.15.4.1.

A4.3.19 EF_{FDN} (Fixed dialling numbers)

Optional.

A4.3.20 EF_{SMS} (Short messages)

Default: Records 1-5	Byte 1:	00
	Byte 2:	FF
	Bytes 3-14:	FF FF FF FF FF FF FF FF FF FF FF FF
	Bytes 15-26:	FF FF FF FF FF FF FF FF FF FF FF FF
	Byte 27:	FF
	Byte 28:	FF
	Bytes 29-35:	FF FF FF FF FF FF FF
	Byte 36:	FF
	Bytes 37-176:	All Bytes set to FF

A4.3.21 EF_{CCP} (Capability configuration parameters)

File size:	14 bytes
Default values	Byte 1: 04
	Byte 2: 01
	Byte 3: A0
	Bytes 4-14: FF

The above translates to: "Full rate, GSM Standardized coding, circuit mode and speech".

A4.3.22 EF_{MSISDN} (MSISDN)

Optional.

A4.3.23 EF_{SMSP} (Short message service parameters)

The programming of this EF is a test house option.

Each record size is 28+Y bytes, where Y is the number of bytes in the Alpha Identifier. Care should be taken when dimensioning the SIM to take into account the number of Short message service parameter records required.

A4.3.24 EF_{SMSS} (SMS status)

File size: 2 bytes	Byte 1:	00
	Byte 2 (BIN):	11111111

The above translates to:

- (a) Last Mobile Originated Short Message had a TP Message Reference parameter of "00".
- (b) SMS Memory Capacity Exceeded, Notification Flag unset: memory capacity available.

A4.3.25 EF_{EXT1} (Extension 1)

Optional.

A4.3.26 EF_{EXT2} (Extension 2)

Optional.

Annex 5: Test equipment

A5.1 Introduction

A5.1.1 General

The test equipment is either an equipment or assembly of equipments which enables the tests described in this specification to be conducted.

This annex describes requirements for the test equipment which cannot be derived from and which are assumed in, the conformance test descriptions described in this specification.

Specifically stimulus setting and measurement uncertainties are defined.

A5.1.2 Test equipment terms

The term "System Simulator" (SS) is used to describe the complete suite of test equipment required to perform the tests in this specification when interacting with the following MS interfaces:

- Antenna (Connector or radiated);
- Acoustic;
- Data Port(s);
- Power supply;
- DAI.

NOTE: To perform a sub-set of tests, the SS may be simplified accordingly.

The term "SIM simulator" is used to describe the test equipment required to interact with the SIM/ME interface.

A "test SIM" has the physical characteristics of a standard SIM card, (see GSM 11.11) with specific parameters defined in annex 3.

A5.1.3 Confidence level

All uncertainty values stated in this annex are quoted for a Confidence Level of 95 %.

A5.2 Standard test signals

The Cx signals represent the wanted signals and the Ix signals represent the unwanted signals.

Signal C0	Unmodulated continuous carrier;
Signal C1	A standard GSM signal with the modulation derived by applying a data reversals signal to the input of a channel coder. The channel coder will depend on the test and the cipher mode shall be selectable by the test method. When using this signal in the non hopping mode, the unused seven time slots shall also contain dummy bursts, with power levels variable with respect to the used timeslot, see also 2.3.1.3.
Signal I0	Unmodulated continuous carrier;
Signal I1	A GMSK modulated carrier following the structure of the GSM signals, but with all modulating bits (including the midamble period) derived directly from a random or pseudo random data stream.
Signal I2	A standard GSM signal with valid midamble, different from C1. The data bits (including bits 58 and 59) shall be derived from a random or pseudo random data stream.

A5.3 SS functional requirements

A5.3.1 Level setting range

It is assumed that the SS is capable of setting stimulus levels, at the MS interface, to those required in the test specification extended by the measurement uncertainty defined in this annex.

NOTE: This ensures that the SS is able adequately to stimulate the MS performance at and just beyond the limit requirement under all conditions.

A5.3.2 Level Measurement / operation range

It is assumed that the SS is capable of performing measurements, within the uncertainty defined in this annex, over a level range, at the MS interface, as required in the test specification extended by the SS measurement uncertainty defined in this annex and extended by a further 3dB on the MS conformity requirement.

NOTE: This ensures that the SS is able adequately to measure the MS performance at and just beyond the limit requirement under all conditions.

A5.3.3 MS power supply interface

Test DC power supply for MS:

Voltage setting uncertainty < 1 %.
Ripple < 10 mV RMS, 50 mV peak to peak.

Test AC power supply for MS:

Voltage setting uncertainty: < 1 %.

A5.3.4 MS antenna interface

The SS is assumed to offer a nominal 50 ohm impedance to the MS.

VSWR	GSM/DCS bands <= 1,3	< 4 GHz <= 2,0	< 10 GHz <= 3,0	< 12,75 GHz <= 3,5
------	-------------------------	-------------------	--------------------	-----------------------

A5.3.4.1 Uplink receiver error

The SS receiver should be capable of performing the tests as specified in GSM 11.10 without the addition of bit errors in excess of 1 in 10E7 due to the receiver performance when operated with a MS which meets the transmitter requirements of GSM 05.05.

NOTE: This requirement is based on a minimum BER measurement of 1 in 10E5.

A5.3.4.2 Power versus time measurements

Measurement uncertainty of peak transmitter carrier power: +/- 1 dB

Measurement uncertainty of power level (relative to peak transmitter carrier power):

Power level	Measurement uncertainty
+ 6 dB to - 7 dB	+/-0,25 dB
- 7 dB to -20 dB	+/-1,0 dB
-20 dB to -32 dB	+/-2,0 dB
-32 dB to -45 dB	+/-5,0 dB
-45 dB to -71 dB	+/-1,0 dB
<-71 dB	+/-2,0 dB

NOTE: Due to the method of measurement (downconversion to I/Q baseband / filtering / A/D conversion / postprocessing) several uncertainties occur. The sources are:

- a) absolute level uncertainty;
- b) filter ripple,
I/Q gain imbalance,
I/Q imperfect quadrature;
- c) A/D conversion (resolution),
I/Q offset.

Items under b) and c) affect the individual samples and can be observed as a "ripple" in the horizontal part of the power time mask.

Items under b) are uncertainties which are proportional to the signal measured.

Items under c) are constant amounts of uncertainty, independent of the signal measured.

The item a) moves the entire power time template up or down.

The uncertainties b) and c) are added to the measured signal as an uncorrelated interferer.

The above mentioned absolute measurement uncertainty refers to a). The table covers uncertainties b) and c).

Uncertainty of time measurement

The relative timing uncertainty of the transition point:

- bit 13 to 14 in the midamble (normal burst);
- end of the sync sequence (access burst);

is +/- 1/8 bit.

Timing uncertainty of the measurement samples in the vertical part of the power time mask are displayed as marked fields in the figure A5.3-1

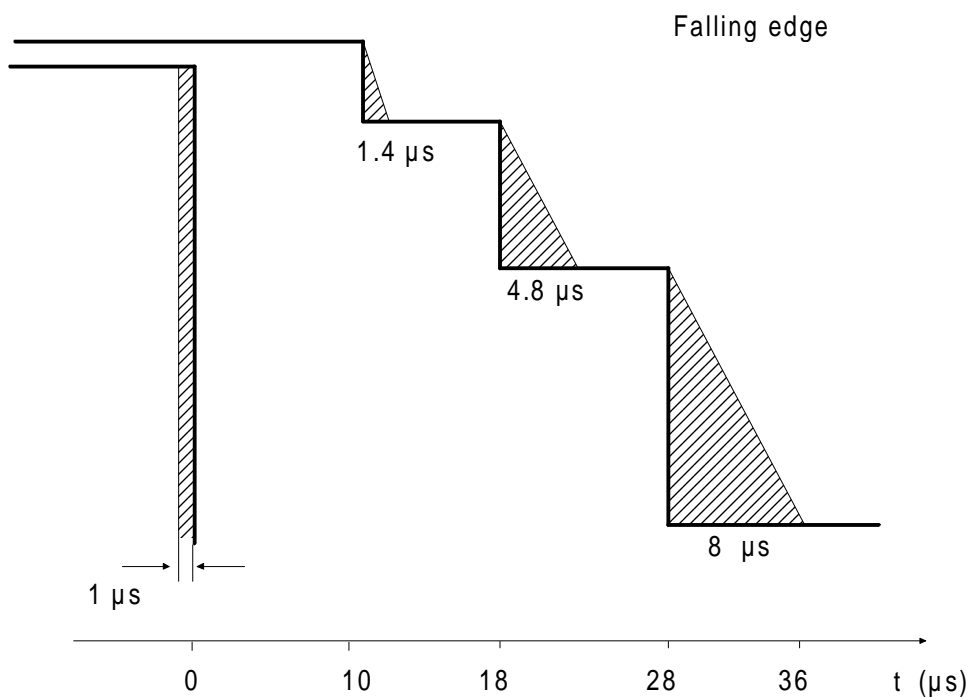
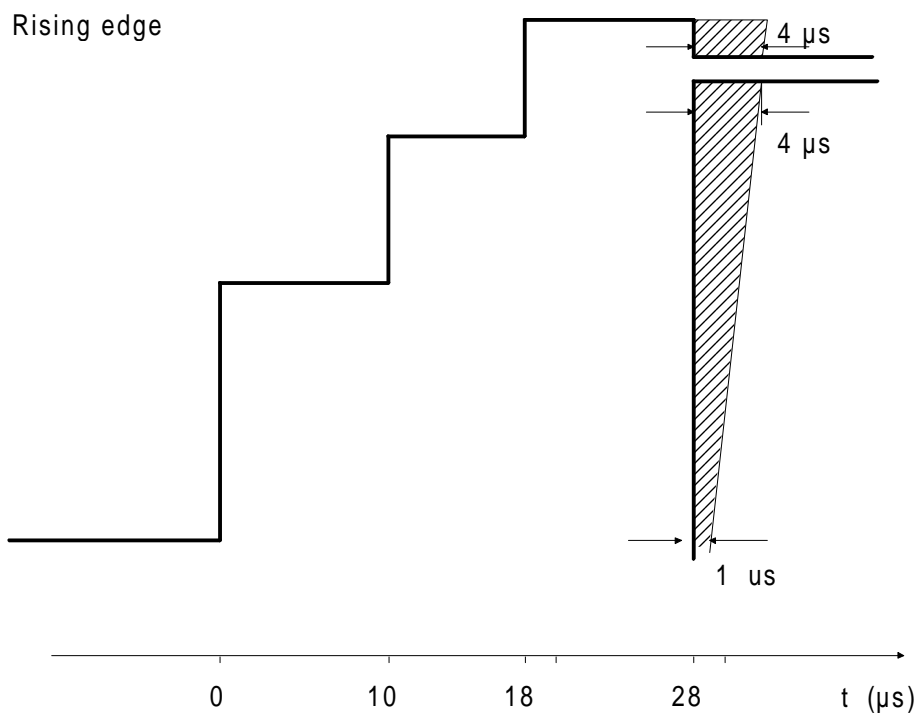

Figure A5.3-1 Time Measurement Uncertainty for the Power Time Mask

NOTE: With a real method of measurement one has to reckon on systematic measurement uncertainties in the vertical part of the power time template (figures 13-2 & 13-3). The reason for this is that the measurement is conducted through a filter which has to fulfil different requirements simultaneously, requirements in the frequency domain and in the time domain as well. The time behaviour of the filter causes the above mentioned measurement uncertainty. It occurs clearly when measuring the falling edge of the power burst. The measurement uncertainty, which in principle delays the actual performance, depends on the filter characteristics and on the signal shape. At favourable signal shapes the uncertainty is negligible, however, at unfavourable signal shapes it consumes the marked area in figure A5.3-1 (falling edge).

The underlying filter is:

type	inverse Chebycheff
passband	$\leq \pm 200$ kHz
stopband (40 dB stop att.)	$\geq \pm 541,67$ kHz.

To avoid aliasing with this filter the RF output spectrum must meet the requirements of section 13.4.

If the lowest limit line in the power time template is replaced by a -54 dBm line, measuring lower carrier powers, the area of measurement uncertainty is reduced equivalently.

The marked area in figure A5.3-1 describes the systematic measurement uncertainty of the test equipment and does not widen the design requirements.

Uncertainties associated with 13.3.5 requirement b) (power control levels, adjacent steps):

Repeatability	$\pm 0,3$ dB
Linearity	$\pm 0,03$ dB/dB
Combined uncertainty is:	$\pm (0,3 + 0,03 \text{ dB/dB})$ dB

E.g. where the indicated value of the step size is 2,0 dB, the uncertainty is:
 $\pm (0,3 + 0,06)$ dB = $\pm 0,36$ dB.

A5.3.4.3 Wideband selective power measurement

Power is to be measured selectively for spurious emissions without frequency hopping (ref.: section 12).

Uncertainty conducted	100 kHz to 1GHz	$\pm 1,5$ dB
	1 GHz to 12,75 GHz	$\pm 3,0$ dB
Uncertainty radiated	30 MHz to 4 GHz	± 6 dB

NOTE: The uncertainties include the effect of a worst case reflection from the MS of 0,7 for out of band signals.

It is acceptable to use a band stop filter in spurious emission measurements of the transceiver in order to fulfil the above requirements.

A5.3.4.4 Inband selective power measurements

Power is to be measured selectively for output RF spectrum.

The measurement is performed on a single frequency while the MS is frequency hopping (ref.: section 13.3)

Uncertainty	$< \pm 1,6$ dB
-------------	----------------

NOTE: The video signal of the spectrum analyser is "gated" such that the spectrum generated by at least 40 of the bits 87 to 132 of the burst is the only spectrum measured. This gating may be analogue or numerical, dependent upon the design of the spectrum analyser.

A5.3.4.5 Phase trajectory and frequency error measurements

Ref.: Sections 13.1 & 13.2 for definitions and methods of measurement.

Phase measurement uncertainty	± 1 degree RMS
	± 4 degrees for individual phase measurement samples

The phase measurement uncertainties above apply during the useful bits.

Frequency measurement uncertainty: +/- 5 Hz.

A5.3.4.6 RF delay measurements relative to nominal times

Range	-140 to +140 bit periods
Resolution	1/4 bit period
Uncertainty	+/- 1/8 bit period

A5.3.4.7 The wanted signal or traffic channel of serving cell

The Wanted signal is used in most of the specified RF measurements. The traffic channel of the serving cell is used in most of the signalling tests.

FREQUENCY:

Uncertainty: < +/- 5*10E-9

PHASE:

Uncertainty: < +/- 1 degree RMS and
< +/- 4 degrees peak(as defined in GSM 05.05)

LEVEL:

Uncertainty: < +/- 1 dB in section 13, 14 except:-
< +/- 3 dB for test 14.2 radiated
< +/- 1,2 dB for test 14.6
< +/- 2,5 dB for all other tests.

Settling time: < 10 us

DYNAMIC LEVEL SETTING:

The SS shall be able to switch from any power level to any other power level within the range of 30 dB on a timeslot per timeslot basis. This dynamic switching requirement only applicable for a single channel for a limited number of tests.

MODULATION: GMSK (as specified in GSM 05.04)

SPURIOUS:

inchannel: Covered by phase error

outchannel:

Noise Power, 1 Hz bandwidth:
<-100 dBc for >100kHz carrier offset,
<-110 dBc for >300kHz carrier offset,
<-121 dBc for >1500kHz carrier offset.

Non harmonics: < -55 dBc for > 100kHz carrier offset,
< -68 dBc for >1500kHz carrier offset

FREQUENCY HOPPING:

The signal shall be capable of hopping according to the criteria of GSM 05.02. The timing of the frequency change shall be such that frequency transitions do not occur during the active timeslot of the MS.

A5.3.4.8 The first interfering signal or traffic channel of the first adjacent cell

The First interfering signal is used in measurements of co-channel rejection, adjacent channel rejection and intermodulation rejection. The Traffic channel of the first adjacent cell is used in handover tests.

FREQUENCY:

Uncertainty: < +/- 5*10E-9

PHASE:

Uncertainty: < +/- 1 degree RMS and
< +/- 4 degrees peak(as defined in GSM 05.05)

LEVEL:

Uncertainty < +/- 1 dB relative to the wanted signal for test 13.2 and 14.5
 < +/- 0,3 dB relative to the wanted signal for test 14.4
 < +/- 1 dB for test 14.6
 < +/- 2,5 dB for all other tests

MODULATION: GMSK (as specified in GSM 05.04)

The total relative single sideband power (noise + harmonics) in the frequency range 1,5 to 1,7 MHz offset from the nominal carrier frequency shall be less than -72 dBc.

SPURIOUS:

Inchannel: Covered by phase error

Outchannel:

Noise Power, 1 Hz bandwidth:

<-100 dBc for > 100kHz carrier offset

<-110 dBc for > 300kHz carrier offset

<-127 dBc for >1500kHz carrier offset

non harmonics < -55 dBc for > 100kHz carrier offset

< -68 dBc for >1500kHz carrier offset

FREQUENCY HOPPING:

The signal shall be capable of hopping according to the criteria of GSM 05.02. The timing of the frequency change shall be such that frequency transitions do not occur during the active timeslot of the MS.

A5.3.4.9 The second interfering signal

The second interfering signal is used in the measurements of intermodulation rejection and blocking.

FREQUENCY:

Uncertainty: < +/- 5*10E-9

LEVEL:

Uncertainty: < +/- 1 dB for test 14.6
 < +/- 1,5 dB relative to the wanted signal for all other tests.

MODULATION: Unmodulated

SPURIOUS:

Inchannel: No requirements

Outchannel:

Noise Power, 1 Hz bandwidth:

<-135 dBc for > 500kHz carrier offset,

<-140 dBc for > 700kHz carrier offset,

<-150 dBc for >1500kHz carrier offset.

Non harmonics < -79 dBc for > 500kHz carrier offset,

< -84 dBc for > 700kHz carrier offset,

< -94 dBc for >1500kHz carrier offset

Harmonically related spuri <-40 dBc

A5.3.4.10 BCCH carriers of serving and adjacent cells

The BCCH of the serving cell is used for synchronizing the MS and to send network information to the MS under test. The BCCH signals of the adjacent cells are used in the handover tests. The MS measures the RF-levels of the BCCHs of adjacent cells.

FREQUENCY:

Uncertainty: < +/- 5*10E-9

PHASE:

Uncertainty: < +/- 1 degree RMS and
< +/- 4 degrees peak(as defined in GSM 05.05)

LEVEL:

Uncertainty: < 1 dB for tests 13.2 and 20
< 2,5 dB for all other tests
< 0,6 dB relative to each other and to TCH
for test 21 over the range 65 dBmicroVoltemf
to 3 dBmicroVoltemf
< 1,2 dB relative to each other and to TCH for test 26.3

MODULATION: GMSK (as specified in GSM 05.04)

SPURIOUS:

Inchannel: Covered by phase error

Outchannel:

Noise Power, 1Hz bandwidth:

<-100 dBc for > 100kHz carrier offset
<-125 dBc for >1500kHz carrier offset

Non harmonics < -55 dBc for > 100kHz carrier offset
< -72 dBc for >1500kHz carrier offset

A5.3.4.11 The wide frequency range signal

The wide frequency range signal is used in the measurements of spurious response.

FREQUENCY

Uncertainty: < +/- 5*10E-9

LEVEL

Uncertainty: < +/- 1,5 dB relative to the wanted signal for test 14.7
< +/- 1 dB error of substituted "wanted signal"

MODULATION: unmodulated

SPURIOUS in the MS receiving range

non harmonics: < -94 dBc

Harmonically related spurii: < -40 dBc

Noise: < -4 dBuVemf equivalent at the MS receiver input
when measured in a 200 kHz bandwidth.

A5.3.4.12 The multipath fading function

The multipath fading function simulates the fading effects of a broadband radio channel in mobile radio communication

The propagation conditions are specified in GSM 05.05, annex 3.

The multipath fading function shall be performed only within a 5 MHz bandwidth during one test case.

A5.3.5 MS audio interface and DAI**A5.3.5.1 General uncertainties**

Unless otherwise specified, the following uncertainties apply to the audio interface:--

Signal level measurement uncertainty: +/- 0,2 dB
Sound pressure measurement uncertainty: +/- 0,6 dB
Frequency Measurement uncertainty: +/- 0,1 %

Stimulus frequency setting uncertainty:

Frequency settings are taken from ISO 3, R10 series or R40 series or from table 2 of Rec. CCITT P.79. A departure from the nominal frequencies of +/- 5 % below 240 Hz and +/- 2 % at 240 Hz and above is accepted.

In the case of 4 kHz the departure is restricted to -2 %.

A5.3.5.2 Analogue single test tone

Total distortion: < 0,5 %

A5.3.5.3 Delay measurement between Um and DAI

The delay measurement between the Um interface of the MS and its DAI in both directions is described in section 32.5.

Uncertainty: < +/- 0,1 ms

A5.4 SIM simulator functional requirements

A5.4.1 General

The SIM simulator shall implement the functions of a SIM as described in GSM 02.17 and 11.11.

The Test Algorithm for authentication incorporated in the SIM Simulator shall operate as described in annex 3

A5.4.2 Contacts C1, C2, C6, C7

A5.4.2.1 Default measurement / setting uncertainties

Unless stated otherwise below, the following uncertainties apply:

Voltage measurement uncertainty:	< +/- 50 mV
Voltage setting uncertainty:	< +/- 20 mV
Time measurement uncertainty:	< +/- 100 ns

A5.4.2.2 Contact C1

Continuous Spikes

Voltage measurement uncertainty:	< +/- 100 mV
----------------------------------	--------------

Current Load Amplitude	0 mA - 20 mA
Adjustable Step Size	1 mA
Uncertainty	< +/- 1 mA

Additional Current Offset	0 mA - 5 mA
Adjustable Step Size	1 mA
Uncertainty	< +/- 1 mA

Pulse Width	100 ns - 500 ns
Adjustable Step Size	50 ns
Uncertainty	< +/- 25 ns
Rise and Fall Time	<= 50 ns

Pause Width	100 ns - 500 ns
Adjustable Step Size	50 ns
Uncertainty	< +/- 25 ns

Random Spikes

Voltage measurement uncertainty:	< +/- 100 mV
Current Load Amplitude	50 mA - 200 mA
Adjustable Step Size	1 mA
Uncertainty	< +/- 1 mA
Additional Current Offset	0 mA - 5 mA
Adjustable Step Size	1 mA
Uncertainty	< +/- 0,1 mA
Pulse Width	100 ns - 500 ns
Adjustable Step Size	50 ns
Uncertainty	< +/- 25 ns
Rise and Fall Time	<= 50 ns
Pause Width	0,1 ms - 500 ms, randomly varied
Adjustable Step Size	0,1 ms
Uncertainty	< +/- 0,1 ms

A5.4.2.3 Contact C7

The Elementary Time Unit (etu) used in the sections below refer to the nominal bit duration on the I/O line, as defined in ISO 7816-3.

Rise & fall Time setting uncertainty:	< +/- 100 ns
Jitter measurement uncertainty:	< +/- 5*10E-3 etu
Jitter setting uncertainty:	< +/- 5*10E-3 etu

A5.4.3 Contact C3

Frequency measurement uncertainty:	< +/- 0,5 %
Voltage Measurement uncertainty:	< +/- 50 mV
Rise & fall time measurement uncertainty:	< +/- 5 ns
Duty cycle measurement uncertainty:	< +/- 2,5 %

A5.4.4 Definition of timing

It shall be possible to define all timings relative to the clock. The SIM simulator shall be able to calculate and to use the absolute values automatically, even if the ME changes the frequency during the communication.

History

Document history			
November 1994	Public Enquiry (I-ETS 300 607)	PE 73:	1994-11-07 to 1995-03-03
November 1995	Vote	V 94:	1995-12-27 to 1996-02-16
March 1996	First Edition		
May 1996	Unified Approval Procedure (Second Edition)	UAP 47:	1996-05-20 to 1996-09-13
August 1996	Unified Approval Procedure (Third Edition)	UAP 51:	1996-08-19 to 1996-12-03
October 1996	Second Edition		
November 1996	Unified Approval Procedure (Fourth Edition)	UAP 58:	1996-11-18 to 1997-03-14
January 1997	Third Edition		
March 1997	One-step Approval Procedure (Fifth Edition)	OAP 9731:	1997-04-04 to 1997-08-01
May 1997	Fourth Edition		
August 1997	One-step Approval Procedure (Sixth Edition)	OAP 9850:	1998-08-14 to 1998-12-11
September 1997	Fifth Edition		
November 1997	One-step Approval Procedure (Seventh Edition)	OAP 9813:	1997-11-28 to 1998-03-27
January 1998	Sixth Edition		
March 1998	One-step Approval Procedure (Eighth Edition)	OAP 9829:	1998-03-20 to 1998-07-17
April 1998	Seventh Edition		
May 1998	One-step Approval Procedure (Ninth Edition)	OAP 9841:	1998-05-20 to 1998-10-16
August 1998	One-step Approval Procedure (Tenth Edition)	OAP 9850:	1998-08-14 to 1998-12-11