



**E**UROPEAN  
**T**ELECOMMUNICATION  
**S**TANDARD

**ETS 300 601**

September 1994

---

Source: ETSI TC-SMG

Reference: GSM 09.04

ICS: 33.060.30

**Key words:** European digital cellular telecommunications system, Global System for Mobile communications (GSM)

**European digital cellular telecommunications system (Phase 2);  
Interworking between the Public Land Mobile Network (PLMN)  
and the Circuit Switched Public Data Network (CSPDN)  
(GSM 09.04)**

**ETSI**

European Telecommunications Standards Institute

**ETSI Secretariat**

**Postal address:** F-06921 Sophia Antipolis CEDEX - FRANCE

**Office address:** 650 Route des Lucioles - Sophia Antipolis - Valbonne - FRANCE

**X.400:** c=fr, a=atlas, p=etsi, s=secretariat - **Internet:** secretariat@etsi.fr

Tel.: +33 92 94 42 00 - Fax: +33 93 65 47 16

---

**Copyright Notification:** No part may be reproduced except as authorized by written permission. The copyright and the foregoing restriction extend to reproduction in all media.

© European Telecommunications Standards Institute 1994. All rights reserved.



## Contents

Foreword .....	5
1 Scope .....	7
2 Normative references .....	7
3 Definitions and abbreviations .....	8
4 Introduction.....	9
5 Network Characteristics.....	9
5.1 Key Characteristics of Network Concerned .....	9
6 Interworking classification .....	10
6.1 Service interworking .....	10
6.2 Network interworking.....	10
6.3 Signalling interworking .....	10
6.3.1 Connection CSPDN .....	10
6.3.2 Multiplexing schemes, CCITT X.51 .....	10
6.3.3 Allocation of channels, X.54 .....	10
6.4 Numbering .....	10
6.5 Supplementary service interworking.....	10
7 Network interworking.....	11
7.1 Checking bearer capabilities .....	11
7.1.1 Network interworking mobile originated .....	11
7.1.1.1 Home IWF access .....	12
7.1.1.2 Visited IWF access.....	13
7.1.2 Network interworking mobile terminated.....	14
7.2 Transparent service support.....	14
7.2.1 MSC to IWF rate adaptation scheme.....	14
7.2.2 Rate adaptation in the IWF .....	14
7.2.3 Mapping of signalling MS/IWF to CSPDN signalling.....	14
7.2.4 Establishment of end-to-end terminal synchronisation.....	15
History .....	16

Blank page

## Foreword

This European Telecommunication Standard (ETS) has been produced by the Special Mobile Group (SMG) Technical Committee (TC) of the European Telecommunications Standards Institute (ETSI).

This ETS identifies the Interworking Functions (IWFs) and requirements to support interworking between Public Land Mobile Network (PLMN) and Circuit Switched Public Data Network (CSPDN). This ETS corresponds to GSM technical specification GSM 09.04 version 4.0.2.

The specification from which this ETS has been derived was originally based on CEPT documentation, hence the presentation of this ETS may not be entirely in accordance with the ETSI/PNE rules.

Reference is made within this ETS to GSM-TSs (NOTE).

NOTE: TC-SMG has produced documents which give the technical specifications for the implementation of the European digital cellular telecommunications system. Historically, these documents have been identified as GSM Technical Specifications (GSM-TSs). These TSs may have subsequently become I-ETSs (Phase 1), or ETSs (Phase 2), whilst others may become ETSI Technical Reports (ETRs). GSM-TSs are, for editorial reasons, still referred to in current GSM ETSs.

Blank page

## 1 Scope

The purpose of this specification is to identify the IWFs and requirements to support interworking between PLMN and CSPDN.

## 2 Normative references

This ETS incorporates by dated and undated reference, provisions from other publications. These normative references are cited at the appropriate places in the text and the publications are listed hereafter. For dated references, subsequent amendments to or revisions of any of these publications apply to this ETS only when incorporated in it by amendment or revision. For undated references, the latest edition of the publication referred to applies.

- [1] GSM 01.04 (ETR 100): "European digital cellular telecommunication system (Phase 2); Definitions, abbreviations and acronyms".
- [2] CCITT Recommendation V.110: "Support of data terminal equipments (DTEs) with V-Series interfaces by an integrated services digital network".
- [3] CCITT Recommendation X.51: "Fundamental parameters of multiplexing scheme for international interface between synchronous data networks using 10 bit envelope structure".
- [4] CCITT Recommendation X.54: "Allocation of channels on international multiplex links at 64 kbps".
- [5] CCITT Recommendation X.121: "International numbering plan for public data networks".
- [6] CCITT Recommendation X.300: "General principles and arrangements for interworking between public data networks, and between public data networks and other networks".
- [7] CCITT Recommendation X.21: "Interface between Data Terminal Equipment (DTE) and Data Circuit Terminating Equipment (DCE) for synchronous operations in public data networks".
- [8] CCITT Recommendation X.30: "Support of X.21, X.21 bis and X.20 bis based terminal equipments (DTEs) by integrated services digital network (ISDN)".
- [9] CCITT Recommendation X.71: "Decentralized terminal and transit control signalling system on international circuits between synchronous data networks".
- [10] CCITT Recommendation Q.931: "Integrated services digital network.(ISDN) User-Network interface layer 3 specification for basic control".
- [11] CCITT Recommendation Q.921: "Integrated services digital network.(ISDN) user-network interface - Data link layer specification".
- [12] CCITT Recommendation I.461: "Support of X.21, X.21bis and X.20bis based data terminal equipment (DTEs) by integrated services digital network (ISDN)".
- [13] GSM 02.01 (ETS 300 500): "European digital cellular telecommunication system (Phase 2); Principles of telecommunication services supported by a GSM Public Land Mobile Network (PLMN)".
- [14] GSM 02.02 (ETS 300 501): "European digital cellular telecommunication system (Phase 2); Bearer Services (BS) supported by a GSM Public Land Mobile Network (PLMN)".

- [15] GSM 02.03 (ETS 300 502): "European digital cellular telecommunication system (Phase 2); Teleservices supported by a GSM Public Land Mobile Network (PLMN)".
- [16] GSM 02.04 (ETS 300 503): "European digital cellular telecommunication system (Phase 2); General on supplementary services".
- [17] GSM 03.70 (ETS 300 541): "European digital cellular telecommunication system (Phase 2); Routing of calls to/from Public Data Networks (PDN)".
- [18] GSM 04.21 (ETS 300 562): "European digital cellular telecommunication system (Phase 2); Rate adaption on the Mobile Station - Base Station System (MS - BSS) interface".
- [19] GSM 04.22 (ETS 300 563): "European digital cellular telecommunication system (Phase 2); Radio Link Protocol (RLP) for data and telematic services on the Mobile Station - Base Station System (MS - BSS) interface and the Base Station System - Mobile-services Switching Centre (BSS - MSC) interface".
- [20] GSM 08.20 (ETS 300 591): "European digital cellular telecommunication system (Phase 2); Rate adaption on the Base Station System - Mobile-services Switching Centre (BSS - MSC) interface".
- [21] GSM 09.07 (ETS 300 604): "European digital cellular telecommunication system (Phase 2); General requirements on interworking between the Public Land Mobile Network (PLMN) and the Intergrated Services Digital Network (ISDN) or Public Switched Telephone Network (PSTN)".
- [22] GSM 04.08 (ETS 300 557): "European digital cellular telecommunication system (Phase 2); Mobile radio interface layer 3 specification".
- [23] GSM 07.03 (ETS 300 584): "European digital cellular telecommunication system (Phase 2); Terminal Adaptation Functions (TAF) for services using synchronous bearer capabilities".

### 3 Definitions and abbreviations

Use is made of the following terms within this specification. These terms refer to information requirements necessary to support interworking functions, some of these terms will be identifiable with their use in other specifications.

- Bearer capability information  
Specific information defining the lower layer characteristics required within the network.
- Lower layer capability information  
Information defining the lower layer characteristics of the terminal.
- Higher layer compatibility information  
Information defining the higher layer characteristics of a teleservice in accordance with GSM 02.03 used by the terminal.
- Protocol identifier  
Information defining the specific protocols utilised for the support of data transfer by a terminal.
- Progress indicator  
Information supplied to indicate to the terminal that the network interworking has taken place.
- Out of band parameter exchange  
Information exchanged via an associated or non-associated signalling link e.g. SS No7.



Abbreviations used in this specification are listed in GSM 01.04.

## 4 Introduction

There are two ways to interwork with the CSPDN, directly or via the ISDN.

Direct interworking:

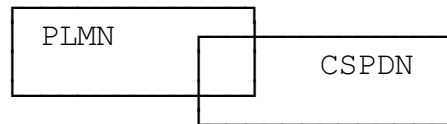

Interworking via ISDN:

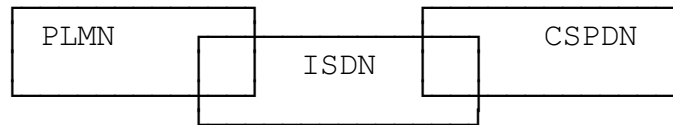

Only synchronous interworking with the speeds 2400, 4800 and 9600 shall be possible. Depending on the fact that it is impossible to flowcontrol the terminals connected to the CSPDN only transparent services in PLMN are used.

No particular functionality is needed in a VPLMN without a connected CSPDN for support of CSPDN access for roaming subscribers.

## 5 Network Characteristics

### 5.1 Key Characteristics of Network Concerned

Characteristics	GSM PLMN	CSPDN	ISDN
Subscriber Interface	Digital	Digital	Digital
User-network signalling	GSM 04.08	X.21, X.21bis	Q.931, Q.921
User-terminal equipment supported	See GSM 07.03	X.21,X21.bis-terminals	
Inter-exchange signalling	SS No.7 ISUP,TUP+,MAP	X.71	ISUP, TUP+
Transmission facilities	Digital	Digital	Digital
Exchange types	Digital	Digital	Digital
Information transfer mode	Circuit	Circuit	Circuit
Information transfer capability	Digital unrestricted	Circuit switched data transmission services	Digital unrestricted

## 6 Interworking classification

### 6.1 Service interworking

No service interworking has been identified as a requirement of the GSM system.

### 6.2 Network interworking

Network interworking is required whenever a PLMN and a non-PLMN together are involved to provide an end to end connection and may be required in instances of PLMN to PLMN connections.

The concept of Bearer Services was developed for the ISDN and has been extended to GSM in accordance with GSM 02.02. A bearer service is defined as:

A type of telecommunication service that provides the capability for the transmission of signals between user-network interfaces.

Access at mobile station	Connection Type	Data transmission service in CSPDN	Bearer Service in ISDN
Data cct duplex synchronous 2.4 kbit/s	Circuit mode unstructured (8 kbit/s) with unrestricted digital capability	circuit switched user class 4	cct mode structured 64kbit/s unrestricted
Data cct duplex synchronous 4.8 kbit/s	Circuit mode unstructured (8 kbit/s) with unrestricted digital capability	circuit switched user class 5	
Data cct duplex synchronous 9.6 kbit/s	Circuit mode unstructured (16 kbit/s) with unrestricted digital capability	circuit switched user class 6	

The network interworking is described in section 7.

### 6.3 Signalling interworking

#### 6.3.1 Connection CSPDN

PLMN is connected to CSPDN using an interworking function according to CCITT X.300.

The interface between IWF and CSPDN is in accordance to CCITT X.71 (Direct interworking). If PLMN is connected to CSPDN via ISDN the interface to ISDN shall be according to GSM 09.07 and the information rate adapted according to CCITT X.30.

#### 6.3.2 Multiplexing schemes, CCITT X.51

The multiplexing schemes for the X.71 connections shall be in accordance with CCITT X.51. Housekeeping bits shall be allocated in the same way as for DSE to DSE in CSPDN.

#### 6.3.3 Allocation of channels, X.54

The allocation of channels on the X.71 connection shall be according to CCITT recommendation X.54.

### 6.4 Numbering

Numbering shall be in line with GSM 03.70.

### 6.5 Supplementary service interworking

Supplementary service interworking between GSM PLMN and CSPDN is described in GSM 02.04, GSM 02.8x and 02.9x-series, GSM 03.11, GSM 03.8x and 03.9x-series, if applicable.

## 7 Network interworking

### 7.1 Checking bearer capabilities

The table shows bearer capability elements and the values. Just the element user rate is optionally.

**Table 3: Shows parameters which have to be considered by the IWF.**

Parameter name	In band	Out of band SETUP or CALL CONF
ITC, Info transfer capability		UDI
UR, User rate		2400,4800,9600
SA, Sync/Async		Sync
CE, Connection		T
RCR, Radio Channel Requirement		HR,FR,dualFR,dualHR

#### 7.1.1 Network interworking mobile originated

Bearer capability compatibility checking of the mobile originated call is carried out by the IWF to determine the appropriate data transmission service class in the CSPDN. If it is not possible for the IWF to provide a bearer service match, then the IWF shall fail the call and indicate the reason to the user.

As well as compatibility checking, the network shall check the subscribers subscription parameters, see GSM 02.01, to ensure that the calling mobile does subscribe to the requested service.

7.1.1.1 Home IWF access

Home IWF access would be available to a mobile subscriber if the home PLMN has a CSPDN IWF. Figure 09.04/1 illustrates both the case when the mobile subscriber is present in the home PLMN and when present in a visited PLMN that does not support a CSPDN IWF.

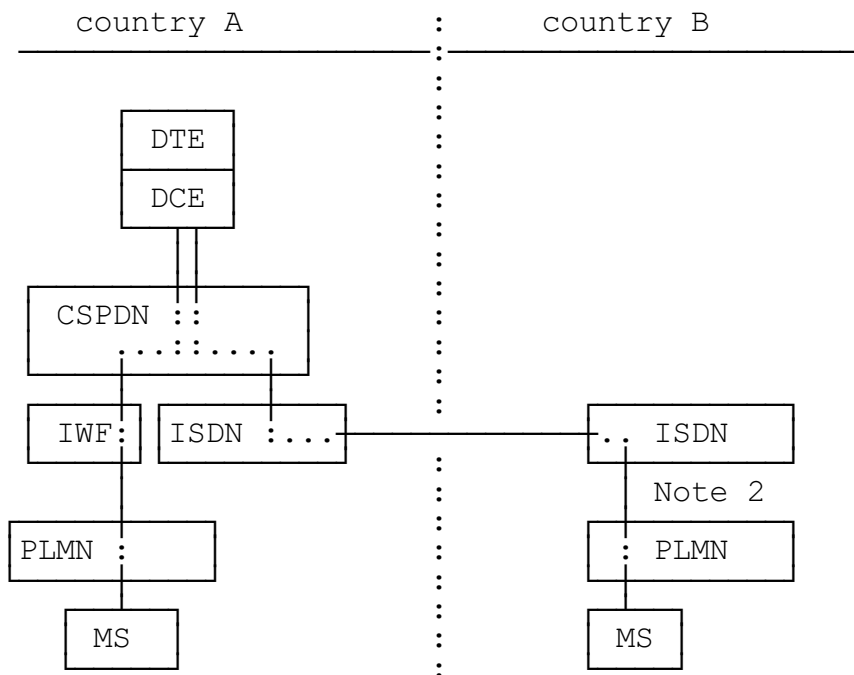

Note 1: Home IWF Access via home PLMN for a mobile in VPLMN may not be possible (HPLMN as transit network).

Note 2: IWF for ISDN must be provided in VPLMN. This connection presumes E.164 addressing capability and two step dialing.

Figure 09.04/1 Home IWF access

7.1.1.2 Visited IWF access

A visited IWF access would be available to a mobile subscriber if the visited PLMN has a CSPDN IWF. This is shown in figure 09.04/2.

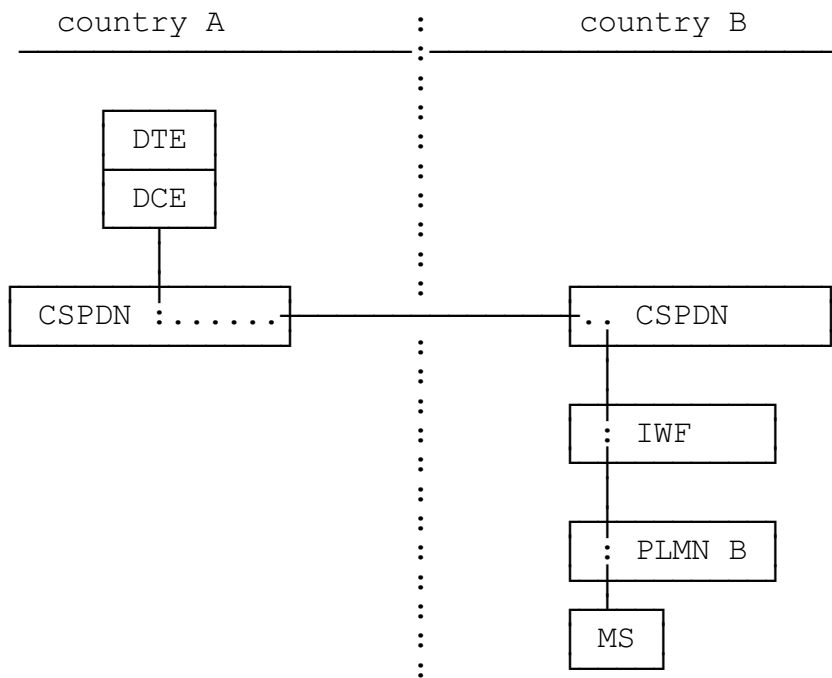
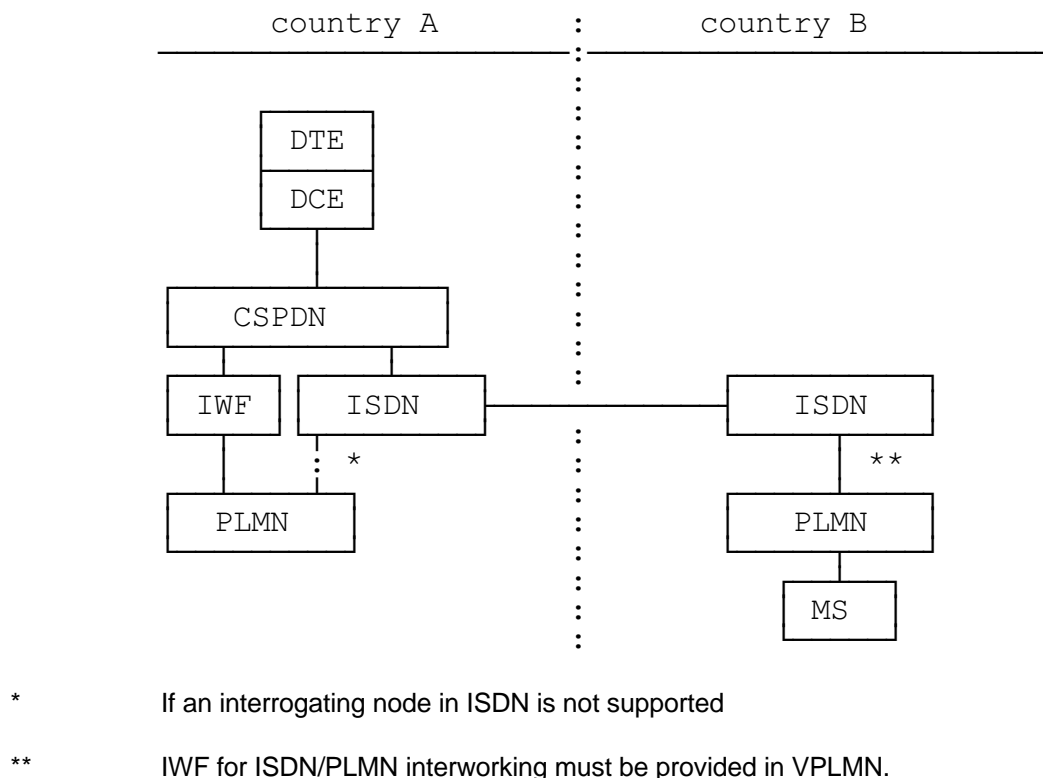

Figure 09.04/2 Visited IWF access

**7.1.2 Network interworking mobile terminated**

Bearer capability compatibility checking of the CSPDN originated call is carried out by the IWF to determine the appropriate bearer service selection in the PLMN. If it is not possible for the IWF to provide a bearer service match, then the IWF shall fail the call and indicate the reason for the user (if possible).

As well as compatibility checking, the network shall check the subscribers subscription parameters, see GSM 02.01, to ensure that the called mobile does subscribe to the requested service.



**Figure 09.04/3 Terminating call**

**7.2 Transparent service support**

**7.2.1 MSC to IWF rate adaptation scheme**

This link consists of a 64 kbit/s channel with the information, both user data and in band parameter information rate adapted in conformance to GSM 08.20.

**7.2.2 Rate adaptation in the IWF**

This process is a reverse of that provided in the Terminal Adaptation Function of the MS. Specification GSM 04.21 refers to the rate adaptation mechanism to be provided.

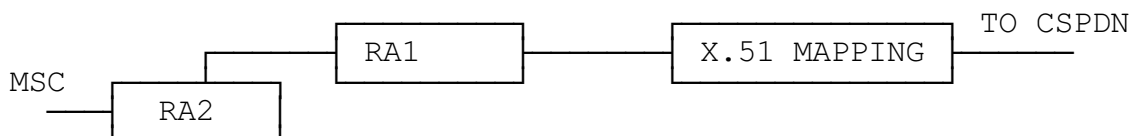

**7.2.3 Mapping of signalling MS/IWF to CSPDN signalling**

In GSM SS no7 is used for signalling. Towards CSPDN channel associated signalling defined in CCITT X.71 is used. Therefore the interworking function has to map between those two signalling systems.

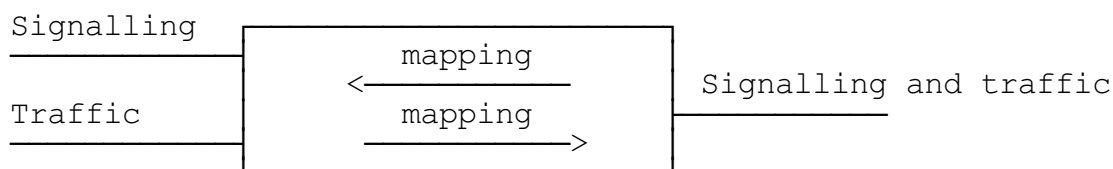

#### 7.2.4 Establishment of end-to-end terminal synchronisation

Prior to exposing the traffic channel of a PLMN connection to transmission of user data, the controlling entities of the connection have to assure of the availability of the traffic channel. This is done by a so called synchronisation process

- starting on the indication of "physical connection established" resulting from the PLMN-inherent outband signalling procedure. This indication is given on sending message CONNECT in case of MOC, CONNECT ACKNOWLEDGEMENT in case of MTC.
- ending by indicating the successful execution of this process to the controlling entity, which then takes care of the further use of the inband information (data,status).

Network interworking within an IWF is concerned with the terminating side (to the MS) and the transit side (to the fixed network) of a connection. Both sides have to be treated individually related to the synchronisation process.

With respect to the terminating side the procedure is as follows:

- sending of synchronisation pattern 1/OFF (all D bits "1", all S bits "1", all E bits "1") to the MS using the RA1/RA2 rate adaption function
- searching for detection of the synchronisation pattern 1/OFF from the MS within valid V.110 frames. This implies that the E1, E2 and E3 bits for each V.110 frame shall be checked for legal user rate in order to distinguish TCh synchronisation pattern from BSS Idle bit pattern.

When the 1/OFF from the MS has been recognised as a steady state, the IWF continues sending the synchronisation pattern 1/OFF to the MS unless a timer T expires. From this time the information on the receiving lines from the MS and from the fixed network are directly mapped to the respective sending lines.

During the synchronisation process described above, i.e. while the synchronisation pattern is being sent by the IWF, the IWF will not send X.51-frame structure to the CSPDN transit network. Once timer "T" expires the synchronisation pattern will continue to be transmitted from the IWF to the MS, however, the IWF will start mapping the information received from the MS into X.51 frames to the CSPDN transit network. The IWF will start looking for the CSPDN frame alignment to be received from the CSPDN. On recognising frame alignment the IWF will cease sending its synchroniation pattern to the MS and connect the CSPDN through to the MS.

## History

<b>Document history</b>	
September 1994	First Edition
November 1995	Converted into Adobe Acrobat Portable Document Format (PDF)