



**E**UROPEAN  
**T**ELECOMMUNICATION  
**S**TANDARD

**ETS 300 585**

May 1996

Second Edition

---

Source: ETSI TC-SMG

Reference: RE/SMG-040705PR2

ICS: 33.060.50

**Key words:** Digital cellular telecommunications system, Global System for Mobile communications (GSM)

**GSM**

GLOBAL SYSTEM FOR  
MOBILE COMMUNICATIONS

**Digital cellular telecommunications system (Phase 2);  
Use of Data Terminal Equipment - Data Circuit terminating;  
Equipment (DTE - DCE) interface for  
Short Message Service (SMS) and Cell Broadcast Service (CBS)  
(GSM 07.05)**

**ETSI**

European Telecommunications Standards Institute

**ETSI Secretariat**

**Postal address:** F-06921 Sophia Antipolis CEDEX - FRANCE

**Office address:** 650 Route des Lucioles - Sophia Antipolis - Valbonne - FRANCE

**X.400:** c=fr, a=atlas, p=etsi, s=secretariat - **Internet:** secretariat@etsi.fr

Tel.: +33 92 94 42 00 - Fax: +33 93 65 47 16

\*

---

**Copyright Notification:** No part may be reproduced except as authorized by written permission. The copyright and the foregoing restriction extend to reproduction in all media.

© European Telecommunications Standards Institute 1996. All rights reserved.



## Contents

Foreword	.....	5
0	Scope	7
	0.1 Normative references	7
	0.2 Definitions and abbreviations	8
1	Reference configuration	9
	1.1 V.24 Interface Circuits	9
2	SMS Block Mode	10
	2.1 Beginning and ending of SMS/CBS Block Mode	10
	2.1.1 Beginning SMS/CBS Block Mode	10
	2.1.2 Returning from SMS/CBS Block Mode To Default Mode	10
	2.2 Protocol description	11
	2.3 Requesting messages already held in the Mobile Termination	12
	2.3.1 Requesting List Of Messages	12
	2.3.2 Requesting Transfer Of Messages	13
	2.3.2.1 Requesting Transfer Of A Specific Message	13
	2.3.2.2 Requesting Transfer Of All Messages	13
	2.3.3 Requesting Diversion Of Incoming Messages	13
	2.3.3.1 Requesting SMS Messages	14
	2.3.3.2 Requesting CBS Messages	14
	2.3.3.3 Requesting indication of message arrival	14
	2.3.4 Requesting Transfer Into Mobile Termination	15
	2.3.5 Requesting Deletion Of Messages	16
	2.4 Message functional definitions and contents	17
	2.4.1 Commands Issued By The Terminal Equipment	17
	2.4.1.1 List Request	18
	2.4.1.2 Get Message	18
	2.4.1.3 Get First Message	18
	2.4.1.4 Get Next Message	18
	2.4.1.5 Transfer Inc SMS	18
	2.4.1.6 Indicate Inc SMS	19
	2.4.1.7 Transfer Inc CBS	19
	2.4.1.8 Insert SMS	19
	2.4.1.9 Delete message	19
	2.4.1.10 Unable to process	20
	2.4.1.11 End SMS Mode	20
	2.4.1.12 Acknowledge Message	20
	2.4.2 Responses/Indications Issued By The MT	20
	2.4.2.1 Message List	21
	2.4.2.2 Message	21
	2.4.2.3 Get Message Failure	21
	2.4.2.4 Inc Message	22
	2.4.2.5 Message Arrived	22
	2.4.2.6 Insert SMS Complete	22
	2.4.2.7 Insert SMS Failure	22
	2.4.2.8 Delete Message Complete	23
	2.4.2.9 Delete Message Failure	23
	2.4.2.10 Unable To Process	23
	2.4.2.11 End SMS Mode	23
	2.4.2.12 Request Confirmed	24
2.5	General message format and information elements coding	25
	2.5.1 Message Type	25

2.5.2	Other Information Elements.....	26
2.5.2.1	Short Message Reference.....	26
2.5.2.2	SMS Transfer Type .....	27
2.5.2.3	Indication Type .....	28
2.5.2.4	Insert Type.....	29
2.5.2.5	Short Message Index .....	30
2.5.2.6	Short Message Data .....	32
2.5.2.7	Cause .....	33
2.5.2.8	Index Count.....	34
2.5.2.9	CBS Transfer Type.....	35
2.5.2.10	Page Index.....	36
2.5.2.11	Last Short Message.....	36
2.5.2.12	TP-Failure Cause.....	38
3.	Text Mode .....	39
3.1	Parameter Definitions .....	39
3.2	General Configuration Commands .....	41
3.2.1	Select Message Service +CSMS.....	41
3.2.2	Preferred Message Storage +CPMS .....	42
3.2.3	Message Format +CMGF .....	43
3.2.4	Enter SMS Block Mode Protocol +CESP.....	43
3.2.5	Message Service Failure Result Code +CMS ERROR.....	44
3.2.6	Informative Examples.....	45
3.3	Message Configuration Commands.....	45
3.3.1	Service Centre Address +CSCA .....	45
3.3.2	Set Text Mode Parameters +CSMP.....	46
3.3.3	Show Text Mode Parameters +CSDH.....	46
3.3.4	Select Cell Broadcast Message Types +CSCB.....	47
3.3.5	Save Settings +CSAS .....	48
3.3.6	Restore Settings +CRES .....	48
3.3.7	Informative Examples.....	49
3.4	Message Receiving and Reading Commands .....	50
3.4.1	New Message Indications to TE +CNMI .....	50
3.4.2	List Messages +CMGL.....	54
3.4.3	Read Message +CMGR .....	55
3.4.4	Informative Examples.....	56
3.5	Message Sending and Writing Commands.....	58
3.5.1	Send Message +CMGS.....	58
3.5.2	Send Message from Storage +CMSS .....	60
3.5.3	Write Message to Memory +CMGW.....	60
3.5.4	Delete Message +CMGD.....	61
3.5.5	Send Command +CMGC .....	61
3.5.6	Informative Examples.....	62
4	PDU Mode.....	64
4.1	List Messages +CMGL.....	64
4.1.1	Read Message +CMGR .....	65
4.1.2	Send Message +CMGS.....	65
4.1.3	Write Message to Memory +CMGW.....	66
4.1.4	Send Command +CMGC .....	67
Annex A (Normative):	Character Set Conversions for SMS Text Mode .....	68
Annex B (Informative):	Example of processing a data block .....	71
B.1	Example state diagrams for the block receiver.....	71
B.2	Example of coding and decoding a data block.....	71
History	.....	75

## Foreword

This second edition European Telecommunication Standard (ETS) was produced by the Special Mobile Group (SMG) Technical Committee (TC) of the European Telecommunications Standards Institute (ETSI).

This ETS defines a protocol for use of the V series DTE/DCE interface over the R reference point for SMS and CBS procedures within the European digital cellular telecommunications system (Phase 2).

This ETS correspond to GSM 07.05 version 4.5.0.

The specification from which this ETS has been derived was originally based on CEPT documentation, hence the presentation of this ETS may not be entirely in accordance with the ETSI/PNE rules.

Reference is made within this ETS to GSM Technical Specifications (GSM-TS) (note).

NOTE: TC-SMG has produced documents which give the technical specifications for the implementation of the European digital cellular telecommunications system. Historically, these documents have been identified as GSM Technical Specifications (GSM-TSs). These TSs may have subsequently become I-ETTs (Phase 1), or ETSS (Phase 2), whilst others may become ETSI Technical Reports (ETRs). GSM-TSs are, for editorial reasons, still referred to in current GSM ETSS.

<b>Transposition dates</b>	
Date of adoption of this ETS:	30 April 1996
Date of latest announcement of this ETS (doa):	20 August 1996
Date of latest publication of new National Standard or endorsement of this ETS (dop/e):	18 February 1997
Date of withdrawal of any conflicting National Standard (dow):	18 February 1997

Blank page

## 0 Scope

This European Telecommunication Standard (ETS) defines three interface protocols for control of SMS functions within a GSM mobile telephone from a remote terminal via an asynchronous interface.

Section 2 defines a binary protocol ("Block Mode"). The protocol includes error protection and is suitable for use where the link may not be completely reliable. It will be of particular use where control of remote devices is required. Efficient transfer of binary encoded user data is possible.

Section 3 defines a character-based interfaced based on "AT" commands ("Text Mode"). This mode is suitable for unintelligent terminals or terminal emulators, and for application software built on command structures like those defined in V.25ter. Some of the commands defined in Section 3 will also be useful for implementations of Section 2 and/or Section 4, for example enabling an indication of incoming SMS messages.

Section 4 defines a character-based interface with hex-encoded binary transfer of message blocks ("PDU Mode"). This mode is suitable for software drivers based on AT command structures which do not understand the content of the message blocks and can only pass them between the MT and "upper level" software resident in the TE.

In all three modes, the terminal is considered to be in control for SMS/CBS transactions.

This specification considers the mobile termination to be a single entity. Other GSM Technical Specifications describe the split of functionality between the mobile equipment and SIM.

### 0.1 Normative references

This ETS incorporates by dated and undated reference, provisions from other publications. These normative references are cited at the appropriate places in the text and the publications are listed hereafter. For dated references, subsequent amendments to or revisions of any of these publications apply to this ETS only when incorporated in it by amendment or revision. For undated references, the latest edition of the publication referred to applies.

- [1] GSM 01.04 (ETR 100): "European digital cellular telecommunication system (Phase 2); Abbreviations and acronyms".
- [2] GSM 03.38 (ETS 300 628): "European digital cellular telecommunication system (Phase 2); Alphabet and language specific information".
- [3] GSM 03.40 (ETS 300 536): "European digital cellular telecommunication system (Phase 2); Technical realization of the Short Message Service (SMS) Point to Point (PP)".
- [4] GSM 03.41 (ETS 300 537): "European digital cellular telecommunication system (Phase 2); Technical realization of Short Message Service Cell Broadcast (SMSCB)".
- [5] GSM 04.08 (ETS 300 557): "European digital cellular telecommunication system (Phase 2); Mobile radio interface layer 3 specification".
- [6] GSM 04.11 (ETS 300 559): "European digital cellular telecommunication system (Phase 2); Point-to-Point (PP) Short Message Service (SMS) support on mobile radio interface".
- [7] GSM 04.12 (ETS 300 560): "European digital cellular telecommunication system (Phase 2); Short Message Service Cell Broadcast (SMSCB) support on the mobile radio interface".

- [8] GSM 07.01 (ETS 300 582): "European digital cellular telecommunication system (Phase 2); General on Terminal Adaptation Functions (TAF) for Mobile Stations (MS)".
- [9] GSM 07.07 (ETS 300 642): "European digital cellular telecommunication system (Phase 2); AT command set for GSM Mobile Equipment (ME)".
- [10] GSM 11.11 (ETS 300 608): "European digital cellular telecommunication system (Phase 2); Specification of the Subscriber Identity Module - Mobile Equipment (SIM - ME) interface".
- [11] CCITT Recommendation V.25ter: "Serial Asynchronous Automatic Dialling And Control"
- [12] CCITT Recommendation V.24: "List of definitions for interchange circuits between data terminal equipment (DTE) and data circuit-terminating equipment".
- [13] CCITT Recommendation E.164: "Numbering plan for the ISDN era".
- [14] CCITT Recommendation E.163: "Numbering plan for the international telephone service".

## 0.2 Definitions and abbreviations

Abbreviations used in this specification are listed in GSM 01.04 [1].



## 1 Reference configuration

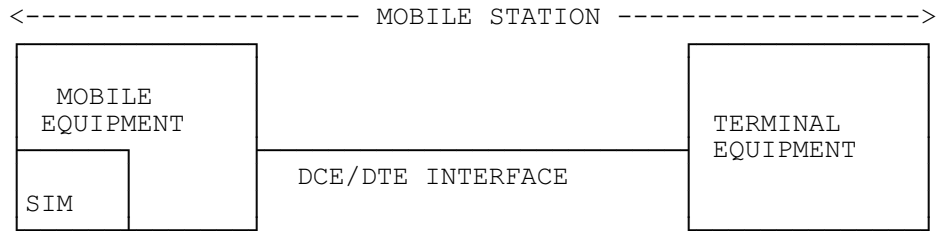

MOBILE TERMINATION (MT2)

**Figure 1: Reference configuration**

The mobile termination consists of the mobile equipment (ME) and the SIM. Messages may be stored in either, but this specification does not distinguish between messages stored in the SIM or in the ME. The management of message storage in the two parts of the mobile termination is a matter for the mobile termination implementation.

### 1.1 V.24 Interface Circuits

The operation of the CCITT V.24 blue book interface circuits for SMS is shown in table 1.1/GSM 07.05.

**Table 1.1/GSM 07.05:: Use of V.24 interface circuits**

V.24 CIRCUIT	DESCRIPTION	TE to MT	MT to TE
CT102	signal ground	x	x
CT103	TXD	x	
CT104	RXD		x
CT105	RTS	x	
CT106	CTS		x
CT107	DSR		x
CT108.2	DTR	x	
CT109	DCD		x

NOTE: CT105 at the TE is connected to CT133 at the MT

#### CT103

All commands from the TE to the MT are transferred across this circuit. Inband flow control is not permitted during Block Mode.

#### CT104

All responses/indications from the MT to the TE are transferred across this circuit. Inband flow control is not permitted during Block Mode.

**CT105**

This circuit allows the TE to flow control the MT when in the Block Mode and at other times if hardware flow control is enabled.

**CT106**

This circuit allows the MT to flow control the TE when in the Block Mode and at other times if hardware flow control is enabled.

**CT107**

This circuit shall be set to the ON condition before entry into the Block Mode, and shall remain in the ON condition during Block Mode. If the TE detects that this circuit returns to the OFF condition during the block mode then the TE shall return CT108.2 to the OFF condition and exit the Block Mode.

**CT108.2**

This circuit shall be set in the ON condition before the AT+CESP command is sent from the TE to begin the Block Mode, and shall be maintained in the ON condition during the Block Mode. It shall be returned to the OFF condition after the command 'END SMS MODE' has been accepted and acknowledged by the MT. If the MT detects that this circuit returns to the OFF condition during the Block Mode then the MT shall exit the Block Mode.

**CT109**

This circuit shall be set to the ON condition before entry into the Block Mode and remain in the ON condition during the Block Mode. If the TE detects that this circuit returns to the OFF condition during the Block Mode then the TE shall return CT108.2 to the OFF condition and shall exit the Block Mode.

## **2 SMS Block Mode**

### **2.1 Beginning and ending of SMS/CBS Block Mode**

#### **2.1.1 Beginning SMS/CBS Block Mode**

As described in TS GSM 07.01, the DTE/DCE interface is normally associated with the terminal adaptation function (TAF), if such a function is available. When no data connection is in progress, and the terminal equipment wishes to enter SMS/CBS mode, the command 'AT+CESP' shall be issued by the TE through the DTE/DCE interface requesting that the Block mode protocol described in this specification is to be used. The syntax of this command is further described in section 3.2.4 later. The syntax for these commands is derived from V.25ter, i.e. the command is encoded as an IA5 character string together with delimiters as described in V.25ter.

Upon receipt of this command, the mobile termination shall respond as follows:

If the mobile termination supports SMS/CBS block mode commands, responses and indications as described in this technical specification, it shall respond with 'OK' and enter the SMS/CBS mode.

If the mobile termination does not support SMS/CBS block mode commands, responses and indications as described in this technical specification, it shall respond with 'ERROR' and remain in the current mode..

If the SMS/CBS block mode command is accepted by the mobile termination, then all further commands, responses and indications shall be as defined in section 2 of this technical specification. These SMS/CBS mode commands, responses and indications use 8-bit encoded data and not IA5 characters.

#### **2.1.2 Returning from SMS/CBS Block Mode To Default Mode**

When the terminal equipment wishes to return to default mode from SMS/CBS mode, it shall issue the command 'END SMS MODE', described in section 2.4.1.11. The mobile termination shall respond with 'OK' to indicate that the DTE/DCE interface has returned to default mode. The TE shall change back to default mode whether or not such a response is received.

The TE may also indicate that it has exit from the SMS/CBS mode through the use of CT 108/2 (see section 1.1)

If an incoming data call arrives while the DTE/DCE interface is set to SMS/CBS mode, then the mobile termination may autonomously issue the 'END SMS MODE' indication (section 2.4.2.11) and revert to default mode in order to connect the data call through the TAF.

The MT may exit from SMS/CBS mode autonomously if the power to the MT is switched off and then on again. In addition, the MT manufacturer may provide MMI to change the mode back to the default mode. In the latter case, the MT shall issue the 'END SMS MODE' indication (section 2.4.2.11) and exit the SMS/CBS mode immediately.

The MT may also indicate that it has exit from the SMS/CBS mode through the use of CT 107 and CT 109 (see section 1.1).

A BREAK condition in either direction at the DTE/DCE interface shall cause the TE and the MT to exit from the SMS/CBS block mode and return to the default mode.

In the event where the TE or the MT find themselves unable to recover from a protocol error then either entity may exit the SMS/CBS mode using any of the mechanisms described above. Confirmation of default mode operation will be achieved through the use of AT commands and responses.

## 2.2 Protocol description

The communication path between the MT and the TE across the DTE/DCE interface should be quite reliable if it uses a short wire link. However, to ensure that the low error rate does not cause malfunction, the following error protection scheme is provided.

Each message sent from the MT to the TE or vice-versa consists of a data block (DATA) and block check sum (BCS, see figure 2.2.1). In the following description the notation DLE, STX, NUL and ETX refer to control characters having the values 10 02 00 and 03 hexadecimal respectively.

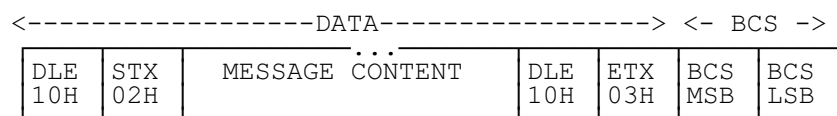

**Figure 2.2.1/GSM 07.05: Format of DTE/DCE interface messages**

The data block consists of a start transmission sequence, set to 00010000 00000010 (10 02 hex), the message content as defined below and an end transmission sequence, set to 00010000 00000011 (10 03 hex). The least significant bit of each octet is always transmitted first.

The block check sum is calculated at the transmitter by adding all of the octets in the message content modulo 65536. Each bit of the 16-bit result is then inverted, and 1 is added to the answer.

During transmission of the message content and the BCS octets, any occurrence of the value 10 hex (DLE) shall result in an additional 'stuffing' octet of value 00 hex (NUL) being transmitted immediately following the octet containing 10 hex. This is to ensure that the start and end markers are unambiguous. The receiver shall remove stuffing octets by discarding any octet of value 00 hex (NUL) which immediately follows an octet of value 10 hex (DLE).

After removal of any stuffing octets, the receiver can check the BCS by adding all of the octets in the message content and the 16-bit BCS modulo 65536. The correct result is 0000 hex. If any message is received with an incorrect BCS, then the message is discarded. No response is sent over the DTE/DCE interface, but an indication may be provided to higher layers within the receiving entity.

The transmitter shall only send DLE when it is followed by STX, NUL or ETX. Therefore, if the receiver sees a DLE followed by anything else then the receiver shall assume that some data has been lost, and shall start to search for the start marker. An unexpected end marker at the receiver shall also result in a search for a start marker. A start marker shall always be treated as the start of a new block, regardless of which state the receiver is in.

Examples of state diagrams for a block receiver to implement this procedure are given in Annex B, together with an example of coding and decoding a message.

Only one Command/Response transaction shall be permitted at any one time from any sending or receiving entity. It shall however be possible for a Command/Response transaction from one entity to be initiated even if there is a Command/Response transaction in progress from the other entity.

If an immediate response is expected to a message sent over the DTE/DCE interface, then the sending entity shall wait 10 seconds. If no response is received within this time, the sending entity shall repeat the message. The message shall be repeated a maximum of 3 times, after which the sending entity shall exit from the SMS/CBS mode and provide an error indication to the user.

If a message cannot be understood by the receiving entity even though it has a correct BCS, then it shall return an UNABLE TO PROCESS message with cause value 'Command not understood'. The receipt of an UNABLE TO PROCESS message should not in itself initiate re-transmission although re-transmission may take place due to the timeout mechanism described earlier since an UNABLE TO PROCESS is deemed to be an invalid response. The 'Cause' may however be referred to a higher layer. An UNABLE TO PROCESS shall not be sent as the result of an incorrect BCS.

### 2.3 Requesting messages already held in the Mobile Termination

The TE may request the MT to provide SMS or CBS messages already stored. The TE will either request all messages, or request a list of messages and subsequently ask for specific messages.

At the start of the SMS/CBS mode session, the MT shall number all messages contiguously, starting with message number 1. These "Short Message References" are only valid for a single SMS/CBS MODE session and should not be confused with the GSM 03.40 TP-Message-Reference. Each message retains its Short Message Reference for the duration of the SMS/CBS mode session. New messages will normally be given the lowest previously-unused Short Message Reference. However, if all Short Message References have been used then the MT may reallocate Short Message References previously allocated to now-deleted messages.

Short Message Reference 0 signifies that there are no messages in the MT. The value of 0 is used under the following conditions:

- When an INSERT SMS command is used to transfer an SM over the air interface and not store it in the MT then the MT will return a Short Message Reference of 0 in the REQUEST CONFIRMED response and the ensuing INSERT SMS COMPLETE / INSERT SMS FAILURE indications.
- For Class 0 SM's which are not stored in the MT
- For TE specific SM's which are not stored in the MT

If Message number 0 is requested by the TE, the MT will always return an error cause, but will also include the highest valid Short Message Reference (see section 2.3.2.1 below).

#### 2.3.1 Requesting List Of Messages

The TE may request the MT to provide a list of SMS and CBS messages currently stored in the mobile termination. This is achieved by the LIST REQUEST command (section 2.4.1.1). The MT divides the messages stored into groups of 5 (called pages) and transfers the first 5 in a MESSAGE LIST response (section 2.4.2.1) containing message references allocated by the MT, plus the relevant header information described in GSM 03.40/04.11 and GSM 03.41/04.12.

If there are no messages stored in the MT, then the MESSAGE LIST response shall be empty.

The TE may then request further groups of up to 5 messages by repeating the LIST REQUEST command for pages 2,3, and so on. The MT will indicate that there are no more pages by responding with an empty MESSAGE LIST response.

## **2.3.2 Requesting Transfer Of Messages**

The TE may request the transfer of one or more messages by means of the commands described below. The MT does not delete messages which have been transferred. Messages can only be deleted by the DELETE MESSAGE command (section 2.4.1.9).

### **2.3.2.1 Requesting Transfer Of A Specific Message**

The TE may request the MT to transfer a specific message by sending the GET MESSAGE command (section 2.4.1.2), including the appropriate message reference. The MT will provide the full message including header in a MESSAGE response (section 2.4.2.2). If the message reference is unallocated, then the GET MESSAGE FAILURE response is returned with cause 'No such message' and the highest valid Message Reference (section 2.4.2.3).

### **2.3.2.2 Requesting Transfer Of All Messages**

The TE may request the MT to transfer all messages by sending the GET FIRST MESSAGE command (section 2.4.1.3), followed by the appropriate number of GET NEXT MESSAGE commands (section 2.4.1.4).

The MT shall be able to transfer all messages one-by-one, starting with the 'first' and continuing with the 'next'. The precise ordering of the messages is left to the MT implementation.

If the MT exits from SMS/CBS mode for any reason, then this information need not be retained.

On receipt of the GET FIRST MESSAGE command, the MT shall set a pointer to the first message, and transfer this message using the MESSAGE response as described in section 2.3.2.1.

On receipt of the GET NEXT MESSAGE command, the MT shall move the pointer to the first available message after the last message transferred (using either GET FIRST MESSAGE, GET MESSAGE or GET NEXT MESSAGE), and transfer this message using the MESSAGE response as described in section 2.3.2.1.

If the MT receives a GET NEXT MESSAGE command when all messages have been transferred to the TE, or there are no messages stored in the MT, then the GET MESSAGE FAILURE response shall be provided with the cause 'No such message' (see section 2.4.2.3).

If the TE receives an out of sequence message then it shall attempt to transfer the missing message using the GET MESSAGE command before continuing with GET NEXT MESSAGE. If this attempt fails with the cause 'no such message', it means that the message has been deleted, or it has been lost due to a failure at the MT.

The MT includes a LAST SHORT MESSAGE REFERENCE in the GET MESSAGE FAILURE response. This is so that the TE can detect whether or not the last short message was received in error.

If the MT receives a GET NEXT MESSAGE command prior to receiving a GET FIRST MESSAGE or GET MESSAGE command, then it shall continue as if the command had been GET FIRST MESSAGE (ie. provide the 'first' message and continue with the 'next' on receipt of the subsequent GET NEXT MESSAGE command).

## **2.3.3 Requesting Diversion Of Incoming Messages**

The TE may request the MT to transfer SMS or CBS messages directly from the air interface to the DTE/DCE interface, by the following procedures. If messages are diverted then they are not stored in the MT. If messages are diverted and there is no communication path to the TE (eg because it has been disconnected), the diversion shall be cancelled.

### 2.3.3.1 Requesting SMS Messages

The TE may request an indication of arrival of incoming SMS messages, or the direct transfer of incoming SMS messages.

The TE requests new SMS messages by the TRANSFER INC SMS command (section 2.4.1.5). This command will be sent with parameters indicating whether all incoming SMS messages are to be transferred, or only those indicated as being for the TE.

The MT shall confirm receipt of this command with a REQUEST CONFIRMED message provided there is memory available to store SM's in the ME or the SIM. If there is no memory available, the MT shall respond with 'unable to process' with a cause value No memory.

The MT shall transfer incoming messages by the INC MESSAGE indication (section 2.4.2.4).

For an INC MESSAGE which contains a Short Message (SMS) info element id, the TE shall acknowledge receipt of the INC MESSAGE with an ACKNOWLEDGE MESSAGE (section 2.4.1.12). The MT should not send another INC MESSAGE which contains a Short Message (SMS) info element id to the TE whilst it is waiting for an ACKNOWLEDGE MESSAGE.

In the event of the MT not receiving an ACKNOWLEDGE MESSAGE within a time specified by the MT manufacturer the MT shall exit the SMS mode automatically after 'n' attempts to send the INC MESSAGE (where n is a number specified by the MT manufacturer). The MT should attempt to store the unacknowledged SM or Status Report (contained in the INC MESSAGE) in the MT or on the SIM as appropriate.

The MT must not delay sending the RP-ACK defined in GSM TS 03.40 (to the SC) for longer than the RP-ACK timeout specified in GSM TS 04.08. It may therefore be impractical for the MT to wait for ACKNOWLEDGE MESSAGE from the TE before sending RP-ACK.

The TE requests the cessation of incoming message transfer by the same command, indicating no incoming messages. The transfer of messages will automatically cease on exit of the SMS/CBS mode. Transfer shall not recommence until a new request is issued by the TE.

### 2.3.3.2 Requesting CBS Messages

The TE may request the transfer of all cell broadcast messages directly from the air interface to the DTE/DCE interface. This is achieved by the use of the TRANSFER INC CBS message (section 2.4.1.7).

The MT shall confirm receipt of this command with a REQUEST CONFIRMED message.

After receipt of this command, the MT shall transfer all CBS pages as they arrive on the air interface, using the INC MESSAGE indication (section 2.4.2.4).

While the CBS pages are being transferred, any other indication or response required to be sent to the TE will take precedence over the CBS pages. However, the MT shall not interrupt the transfer of a page to send other information within the SMS/CBS mode (ie. the MT shall wait until a page boundary).

The transfer of messages will automatically cease on exit of the SMS/CBS mode. Transfer shall not recommence until a new request is issued by the TE.

### 2.3.3.3 Requesting indication of message arrival

If the TE requires an indication of incoming message arrival, the INDICATE INC SMS command (section 2.4.1.6) shall be used.

The MT shall confirm receipt of this command with a REQUEST CONFIRMED message.

After receipt of this command, the MT shall indicate all incoming messages in the specified categories (unless they are directly transferred) with the MESSAGE ARRIVED indication (section 2.4.2.5). This indication shall be of the same format as the MESSAGE LIST response described in section 2.3.1.

The TE shall acknowledge receipt of the MESSAGE ARRIVED with an ACKNOWLEDGE MESSAGE (section 2.4.1.12). The MT should not send another MESSAGE ARRIVED to the TE whilst it is waiting for an ACKNOWLEDGE MESSAGE.

In the event of the MT not receiving an ACKNOWLEDGE MESSAGE within a time specified by the MT manufacturer the MT shall exit the SMS mode automatically after 'n' attempts to send the MESSAGE ARRIVED (where n is a number specified by the MT manufacturer). The MT should attempt to store the unacknowledged SM or Status Report in the MT or on the SIM as appropriate.

The MT must not delay sending the RP-ACK defined in GSM TS 03.40 (to the SC) for longer than the RP-ACK timeout specified in the GSM TS 04.08. It may therefore be impractical for the MT to wait for ACKNOWLEDGE MESSAGE from the TE before sending RP-ACK.

The TE requests the cessation of incoming message indication by the INDICATE INC SMS command, with the 'no incoming messages' parameter.

### **2.3.4 Requesting Transfer Into Mobile Termination**

The TE may request transfer of SMS messages into the mobile termination. Cell broadcast messages cannot be transferred in this direction.

The TE shall use the INSERT SMS command (section 2.4.1.8) to transfer the message. This command shall indicate whether the message is to be stored in the MT, sent over the air interface or both. The command shall include the full SMS message and header as described in GSM 03.40, except for the message reference and message type indication (which are allocated by the MT).

Only one INSERT SMS command may be outstanding at any given instant. An INSERT SMS is deemed complete when an INSERT SMS COMPLETE or an INSERT SMS FAILURE indication has been received irrespective of whether an intermediate REQUEST CONFIRMED has been received.

Upon receipt of an INSERT SMS command, the MT shall act in the following way:

If the TE requested the MT to store the message, the MT shall attempt to store the message. If the attempt is successful, the MT shall return an INSERT SMS COMPLETE indication (section 2.4.2.6), including the message reference allocated by the MT. If the attempt fails (eg. due to lack of memory), the MT shall return an INSERT SMS FAILURE indication (section 2.4.2.7), providing a cause for the failure.

If the TE requested the MT to send the message, the MT shall respond immediately with a REQUEST CONFIRMED message, and attempt to send the message. If the send attempt subsequently succeeds, the MT shall send an INSERT SMS COMPLETE indication, including the message references allocated by the MT. If the send attempt subsequently fails, the MT shall return an INSERT SMS FAILURE indication, providing a cause for the failure.

If the TE requested the MT to store and send the message, the MT shall first attempt to store the message. If no storage is available, the MT shall return an INSERT SMS FAILURE indication (section 2.4.2.7) and shall not attempt to send the message. If storage is available, the MT shall store the message and then respond with a REQUEST CONFIRMED message. If the send attempt is successful, the MT shall return an INSERT SMS COMPLETE indication (section 2.4.2.6), including the message references allocated by the MT. If the transmission of the message fails, then the MT shall return an INSERT SMS FAILURE indication (section 2.4.2.7). This will show that the send attempt failed and provide a cause. After that the MT shall delete the stored message.

### 2.3.5 Requesting Deletion Of Messages

The TE may request deletion of SMS or CBS messages from the store in the MT. This is achieved by the DELETE MESSAGE command (section 2.4.1.9). The command will include a message reference, as defined by the MT and provided in the message list.

Upon receipt of this command, the MT shall attempt to delete the message. If successful, the MT shall return a DELETE MESSAGE COMPLETE indication (section 2.4.2.8). If not successful, the MT shall return a DELETE MESSAGE FAILURE indication (section 2.4.2.9).

On successful deletion of an SM or CBS message the Page Index (see 2.5.2.10) and the Index Count (see 2.5.2.8) shall be re-assigned so that their values are contiguous (i.e. there are no gaps in either parameter). The original short message Reference values remain unchanged.



## 2.4 Message functional definitions and contents

This section provides an overview of the message structure to be used over the DTE/DCE interface in SMS/CBS block mode. Each message definition includes a brief description of the use of the message, and a table showing all the information elements which may be included in the message. For each information element the following data are provided:

Reference - this indicates where the detailed description of each element can be found.

Presence:

M	Mandatory	must always be present receiver: If not present, consider message erroneous
C	Conditional	presence depending on e.g. a) value of other element b) presence of optional element receiver: If not present when condition met, consider message erroneous
O	Optional	presence is a choice of the sender receiver: present or not, accept message

Format:

T	Type only, fixed length, only IEI
V	Value only, fixed length, no IEI included
TV	Type and value, fixed length, IEI included
LV	Length and value, variable length, no IEI included and Length indicator included
TLV	Type, Length and Value, variable length, IEI and length indicator included

Length - this indicates the length of the information element in octets.

### 2.4.1 Commands Issued By The Terminal Equipment

Table 2.4.1/GSM 07.05 summarises the commands which may be issued by the TE.

**Table 2.4.1/GSM 07.05: Commands which may be issued by the TE**

	Reference
LIST REQUEST	2.4.1.1
GET MESSAGE	2.4.1.2
GET FIRST MESSAGE	2.4.1.3
GET NEXT MESSAGE	2.4.1.4
TRANSFER INC SMS	2.4.1.5
INDICATE INC SMS	2.4.1.6
TRANSFER INC CBS	2.4.1.7
INSERT SMS	2.4.1.8
DELETE MESSAGE	2.4.1.9
UNABLE TO PROCESS	2.4.1.10
END SMS MODE	2.4.1.11
ACKNOWLEDGE MESSAGE	2.4.1.12

#### 2.4.1.1 List Request

This message is sent by the TE to the MT to request a list of messages stored in the MT.

Information element	Reference	Presence	Format	Length
Message Type	2.5.1	M	V	1
Page Index	2.5.2.10	M	V	1

#### 2.4.1.2 Get Message

This message is sent by the TE to the MT to request transfer of a specific SMS or CBS message stored in the MT.

Information element	Reference	Presence	Format	Length
Message Type	2.5.1	M	V	1
Short Message Reference	2.5.2.1	M	V	1

#### 2.4.1.3 Get First Message

This message is sent by the TE to the MT to request transfer of the first available SMS or CBS message stored in the MT.

Information element	Reference	Presence	Format	Length
Message Type	2.5.1	M	V	1

#### 2.4.1.4 Get Next Message

This message is sent by the TE to the MT to request transfer of the next available SMS or CBS message stored in the MT.

Information element	Reference	Presence	Format	Length
Message Type	2.5.1	M	V	1

#### 2.4.1.5 Transfer Inc SMS

This message is sent by the TE to the MT to request the direct transfer of incoming messages from the air interface to the TE.

Information element	Reference	Presence	Format	Length
Message Type	2.5.1	M	V	1
SMS Transfer Type	2.5.2.2	M	V	1

#### 2.4.1.6 Indicate Inc SMS

This message is sent by the TE to the MT to request that the MT indicates when an incoming message arrives.

Information element	Reference	Presence	Format	Length
Message Type	2.5.1	M	V	1
Indication Type	2.5.2.3	M	V	1

#### 2.4.1.7 Transfer Inc CBS

This message is sent by the TE to the MT to request transfer of all cell broadcast messages directly from the air interface to the DTE/DCE interface.

Information element	Reference	Presence	Format	Length
Message Type	2.5.1	M	V	1
CBS Transfer Type	2.5.2.9	M	V	1

#### 2.4.1.8 Insert SMS

This message is sent by the TE to the MT to request the transfer of an SMS TPU to the MT memory or across the air interface. The TPDU is formatted in exactly the same way as described in TS 03.40. Where the TPDU includes a TP-Message-Reference which is to be incremented by the MS for every outgoing message, the TP-Message-Reference provided by the TE will be overwritten by the MT before transmission of the message.

Information element	Reference	Presence	Format	Length
Message Type	2.5.1	M	V	1
Insert Type	2.5.2.4	M	V	1
RP-Destination-Address	GSM 04.11	M	LV	1-12 a)
SMS-TPDU	GSM 03.40	M	V	max 164

- a) If no RP-Destination-Address is to be transferred then the length is set to 0. In this case, the MT inserts the default SC address.

#### 2.4.1.9 Delete message

This message is sent from the TE to the MT to request deletion of a specific SMS or CBS message held in the MT.

Information element	Reference	Presence	Format	Length
Message Type	2.5.1	M	V	1
Short Message Reference	2.5.2.1	M	V	1

**2.4.1.10 Unable to process**

This response is sent from the TE to the MT to indicate that the MT's message could not be processed.

Information element	Reference	Presence	Format	Length
Message Type	2.5.1	M	V	1
Cause	2.5.2.7	M	V	1

**2.4.1.11 End SMS Mode**

This message is sent from the TE to the MT to terminate the SMS/CBS mode of the DTE/DCE interface.

Information element	Reference	Presence	Format	Length
Message Type	2.5.1	M	V	1

**2.4.1.12 Acknowledge Message**

This message is sent from the TE to the MT to acknowledge receipt of a INC MESSAGE or MESSAGE ARRIVED which contains a Short Message (SMS) info element id, (e.g. a Short Message or a Status Report but not a CBS message).

Information element	Reference	Presence	Format	Length
Message Type	2.5.1	M	V	1

**2.4.2 Responses/Indications Issued By The MT**

Table 2.4.2/GSM 07.05 summarises the responses/indications which may be issued by the MT.

**Table 2.4.2/GSM 07.05: Responses/Indications which may be issued by the MT**

	Reference
MESSAGE LIST	2.4.2.1
MESSAGE	2.4.2.2
GET MESSAGE FAILURE	2.4.2.3
INC MESSAGE	2.4.2.4
MESSAGE ARRIVED	2.4.2.5
INSERT SMS COMPLETE	2.4.2.6
INSERT SMS FAILURE	2.4.2.7
DELETE MESSAGE COMPLETE	2.4.2.8
DELETE MESSAGE FAILURE	2.4.2.9
UNABLE TO PROCESS	2.4.2.10
END SMS MODE	2.4.2.11
REQUEST CONFIRMED	2.4.2.12

### 2.4.2.1 Message List

This response is sent from the MT to the TE on receipt of a LIST REQUEST from the TE.

Information element	Reference	Presence	Format	Length
Message Type	2.5.1	M	V	1
Page Index	2.5.2.10	M	V	1
Index Count	2.5.2.8	M	V	1
Short Message Index (1)	2.5.2.5	O	TLV	8-48
Short Message Index (2)	2.5.2.5	O	TLV	8-48
:	:	:	:	:
Short Message Index (n)	2.5.2.5	O	TLV	8-48

The number of Short Message Indices included in the message may be 0, 1, 2, 3, 4 or 5.

### 2.4.2.2 Message

This response is sent from the MT to the TE when a short message has been requested.

Information element	Reference	Presence	Format	Length
Message Type	2.5.1	M	V	1
Short Message Data	2.5.2.6	M	TLV	28-181

### 2.4.2.3 Get Message Failure

This response is sent from the MT to the TE when a request for a short message cannot be fulfilled.

Information element	Reference	Presence	Format	Length
Message Type	2.5.1	M	V	1
Last Short Message	2.5.2.11	M	V	1
Cause	2.5.2.7	M	V	1

#### 2.4.2.4 Inc Message

This indication is sent from the MT to the TE after the MT has been requested to transfer messages of certain categories immediately upon receipt.

Information element	Reference	Presence	Format	Length
Message Type	2.5.1	M	V	1
Short Message Data	2.5.2.6	M	TLV	28-181

#### 2.4.2.5 Message Arrived

This indication is sent from the MT to the TE after the MT has been requested to provide an indication of the receipt of certain categories of incoming message.

Information element	Reference	Presence	Format	Length
Message Type	2.5.1	M	V	1
Short Message Index	2.5.2.5	M	TLV	8-48

#### 2.4.2.6 Insert SMS Complete

This response is sent by the MT to the TE to indicate that the TE's request to insert a message has been completed.

Information element	Reference	Presence	Format	Length
Message Type	2.5.1	M	V	1
Short Message Reference	2.5.2.1	M	V	1
TP-Message Reference	GSM 03.40	C a)	V	1

- a) The TP-Message Reference is only included if the message had been requested to be transferred over the air interface.

#### 2.4.2.7 Insert SMS Failure

This response is sent from the MT to the TE to indicate that the attempt to insert an SMS message failed.

Information element	Reference	Presence	Format	Length
Message Type	2.5.1	M	V	1
Cause	2.5.2.7	M	V	1-2
TP-Failure Cause	2.5.2.13	O	TLV	4
Short Message Reference	2.5.2.1	O	TV	2

#### 2.4.2.8 Delete Message Complete

This response is sent from the MT to the TE to indicate that the request to delete a message from the MT store has been completed.

Information element	Reference	Presence	Format	Length
Message Type	2.5.1	M	V	1
Short Message Reference	2.5.2.1	M	V	1

#### 2.4.2.9 Delete Message Failure

This response is sent from the MT to the TE to indicate that the request to delete a message from the MT store failed.

Information element	Reference	Presence	Format	Length
Message Type	2.5.1	M	V	1
Short Message Reference	2.5.2.1	M	V	1
Cause	2.5.2.7	M	V	1

#### 2.4.2.10 Unable To Process

This response is sent from the MT to the TE to indicate that the TE's request could not be processed.

Information element	Reference	Presence	Format	Length
Message Type	2.5.1	M	V	1
Cause	2.5.2.7	M	V	1

#### 2.4.2.11 End SMS Mode

This indication is sent from the MT to the TE when the MT autonomously exits from SMS/CBS mode.

Information element	Reference	Presence	Format	Length
Message Type	2.5.1	M	V	1
Cause	2.5.2.7	M	V	1

**2.4.2.12 Request Confirmed**

This indication is sent from the MT to the TE to indicate that the MT has received the request from the TE and will perform the requested function.

Information element	Reference	Presence	Format	Length
Message Type	2.5.1	M	V	1
Confirm Type	2.5.2.12	M	V	1
Short Message Reference	2.5.2.1	O	TV	2



**2.5 General message format and information elements coding**

This section describes the content of messages for the SMS/CBS mode of the DTE/DCE interface. Within the figures in this section, the bit designated "bit 1" is transmitted first, followed by bits 2,3,4 etc. Similarly, the octet shown at the top of each figure is sent first.

**2.5.1 Message Type**

The purpose of the message type is to identify the function of the message being sent. The message type is coded as shown in figure 2.5.1/GSM 07.05 and table 2.5.1/GSM 07.05.

Bit 8 is reserved for possible future use as an extension bit.

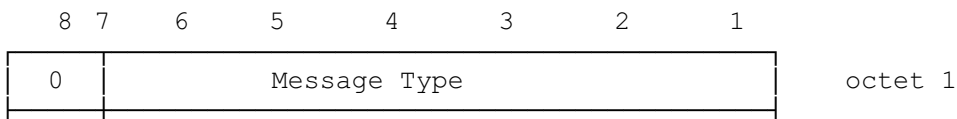

**Figure 2.5.1/GSM 07.05: Message Type**

**Table 2.5.1/GSM 07.05: Message Types**

8	7	6	5	4	3	2	1		
0	0	0	-	-	-	-	-	Commands/ Responses issued by TE	
0	0	0	0	0	0	0	0	LIST REQUEST	
0	0	0	0	0	0	0	1	GET MESSAGE	
0	0	0	0	0	0	0	1	0	GET FIRST MESSAGE
0	0	0	0	0	0	0	1	1	GET NEXT MESSAGE
0	0	0	0	0	0	1	0	0	TRANSFER INC SMS
0	0	0	0	0	0	1	0	1	INDICATE INC SMS
0	0	0	0	0	0	1	1	0	TRANSFER INC CBS
0	0	0	0	0	0	1	1	1	INSERT SMS
0	0	0	0	1	0	0	0	0	DELETE MESSAGE
0	0	0	0	1	0	0	1		UNABLE TO PROCESS
0	0	0	1	1	1	1	0		END SMS MODE
0	0	0	1	1	1	1	1		ACKNOWLEDGE MESSAGE
0	0	1	-	-	-	-	-	Responses/Indications issued by MT	
0	0	1	0	0	0	0	0	MESSAGE LIST	
0	0	1	0	0	0	0	1	MESSAGE	
0	0	1	0	0	0	1	0	GET MESSAGE FAILURE	
0	0	1	0	0	0	1	1	INC MESSAGE	
0	0	1	0	0	1	0	0	MESSAGE ARRIVED	
0	0	1	0	0	1	0	1	INSERT SMS COMPLETE	
0	0	1	0	0	1	1	0	INSERT SMS FAILURE	
0	0	1	0	0	1	1	1	DELETE MESSAGE COMPLETE	
0	0	1	0	1	0	0	0	DELETE MESSAGE FAILURE	
0	0	1	0	1	0	0	1	UNABLE TO PROCESS	
0	0	1	0	1	0	1	0	REQUEST CONFIRMED	
0	0	1	1	1	1	1	1	END SMS MODE	
All other values are reserved									

**2.5.2 Other Information Elements**

Other information elements follow the general coding principles specified in GSM 04.08, and are described in the following sections.

**2.5.2.1 Short Message Reference**

The Short Message Reference uniquely identifies a short message stored in the MT. It is an 8 bit number and is allocated by the MT.

The Short Message Reference information element is coded as shown in figure 2.5.2/GSM 07.05 and table 2.5.2/GSM 07.05.

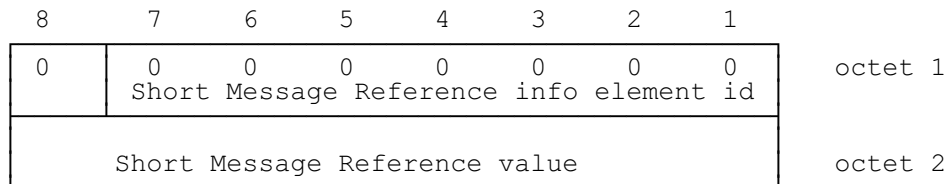

**Figure 2.5.2/GSM 07.05: Short Message Reference information element**

**Table 2.5.2/GSM 07.05: Short Message Reference information element**

Short Message Reference value (octet 2).
In the Short Message Reference value field bit 8 of octet 2 is the most significant bit and bit 1 of octet 2 is the least significant bit.
Short Message Reference values are allocated by the MT.

**2.5.2.2 SMS Transfer Type**

The SMS Transfer Type indicates to the MT which SMS messages are required to be transferred to the TE.

The SMS Transfer Type information element is coded as shown in figure 2.5.3/GSM 07.05 and table 2.5.3/GSM 07.05.

8	7	6	5	4	3	2	1	
0	0	0	0	0	0	0	1	octet 1
SMS Transfer Type info element ident								
0	0	0	0	0	SMS Txfr Type value			octet 2
Reserved								

**Figure 2.5.3/GSM 07.05: SMS Transfer Type information element**

**Table 2.5.3/GSM 07.05: SMS Transfer Type information element**

SMS Txfr Type value (octet 2).	
The SMS txfr type is coded as follows:	
bit 2	bit 1
0	0 Transfer no SMS messages
0	1 Transfer SMS messages marked as TE-specific
1	0 Reserved
1	1 Transfer all SMS messages
Bit 3 shows whether to transfer SMS-STATUS-REPORTS	
Bit 3	
0	Do not transfer SMS-STATUS-REPORTS
1	Transfer SMS-STATUS-REPORTS

2.5.2.3 Indication Type

The Indication Type tells the MT when to notify the TE that an incoming message has been received.

The Indication Type information element is coded as shown in figure 2.5.4/GSM 07.05 and table 2.5.4/GSM 07.05.

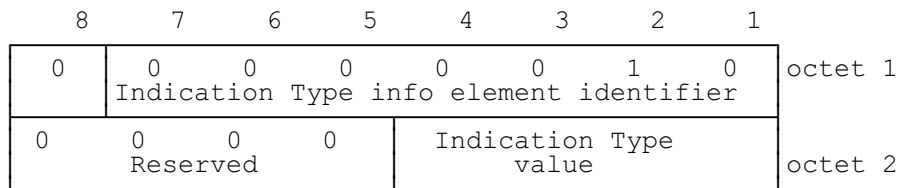

Figure 2.5.4/GSM 07.05: Indication Type information element

Table 2.5.4/GSM 07.05: Indication Type information element

Indication Type value (octet 2).			
The indication type is coded as follows:			
bit 3	bit 2	bit 1	
0	0	0	Indicate no messages
0	0	1	Reserved
0	1	0	Indicate all SMS messages
0	1	1	Indicate SMS messages marked as TE-specific
1	0	0	Indicate all CBS messages
1	0	1	Indicate CBS messages marked as TE-specific
1	1	0	Indicate all CBS and SMS messages
1	1	1	Indicate SMS and CBS messages marked as TE-specific
Bit 4 shows whether or not to indicate SMS reports:			
bit 4			
0	Do not indicate SMS reports		
1	Indicate SMS reports		

**2.5.2.4 Insert Type**

The Insert Type tells the MT what to do with the short message arriving from the TE.

The Insert Type information element is coded as shown in figure 2.5.5/GSM 07.05 and table 2.5.5/GSM 07.05

8	7	6	5	4	3	2	1	
0	0	0	0	0	0	1	1	octet 1
Insert Type info element identifier								
0	0	0	0	0	0	Insert Type value		octet 2
Reserved								

**Figure 2.5.5/GSM 07.05: Insert Type information element**

**Table 2.5.5/GSM 07.05: Insert Type information element**

Insert Type value (octet 2).		
The insert type is coded as follows:		
bit 2	bit 1	
0	0	Reserved
0	1	Store the short message in the MT
1	0	Send the short message over the air
1	1	Store the short message in the MT and send it over the air

**2.5.2.5 Short Message Index**

The Short Message Index provides information about each individual short message currently stored in the MT. Two types of Short Message index are provided; one for SMS and one for CBS.

The Short Message Index (SMS) information element is coded as shown in figure 2.5.6/GSM 07.05 and table 2.5.6/GSM 07.05. A Short Message Index may be an SMS-SUBMIT, an SMS-DELIVER or an SMS-STATUS-REPORT.

The Short Message Index (CBS) information element is coded as shown in figure 2.5.7/GSM 07.05 and table 2.5.7/GSM 07.05.

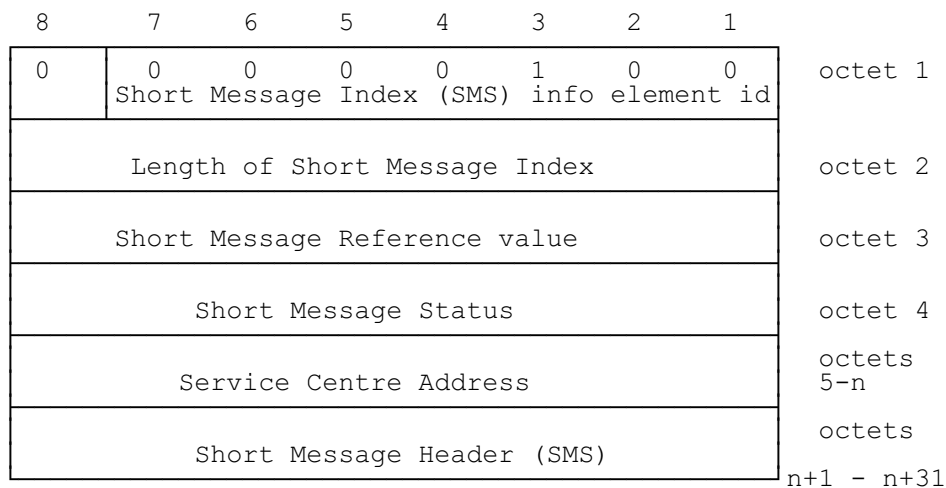

**Figure 2.5.6/GSM 07.05: Short Message Index (SMS) information element**

n can take a value between 5 and 18 (inclusive)

**Table 2.5.6/GSM 07.05: Short Message Index (SMS) information element**

Short Message Reference value (octet 3).

The Short Message Reference value is coded as specified in table 2.5.2/GSM 07.05.

Short Message Status (octet 4).

The Short Message Status is coded as follows:

8	7	6	5	4	3	2	1	
0	0	0	0	0	0	0	0	Not read/not sent
0	0	0	0	0	0	0	1	Read/Sent

All other values are reserved.

If the message is mobile originated then bit 1 indicates whether the message has been sent to the network. If the message is mobile terminated then bit 1 indicates whether the message has been read.

Service Centre Address (Octets 5-n).

The Service Centre Address is coded as the RP-Origination or RP-Destination address specified in TS GSM 04.11. If the short message is mobile originated, the address will be the RP-Destination address. If the short message is mobile terminated, the address will be the RP-Origination address. The address is of variable length, 1-12 octets.

Short Message Header (SMS) (Octets n+1 - n+31).

The Short Message Header (SMS) is coded as a TPDU as described in TS GSM 03.40. In the case of SMS-DELIVER or SMS-SUBMIT, the TP-User-Data is not included, but the TP-User-Data-Length is included. The Short Message Header is of variable length, 6-31 octets.

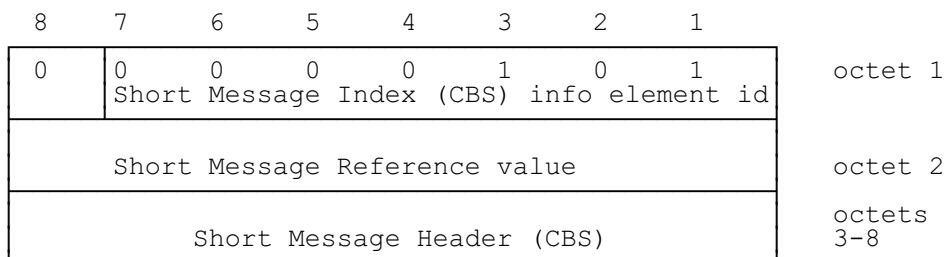

**Figure 2.5.7/GSM 07.05: Short Message Index (CBS) information element**

**Table 2.5.7/GSM 07.05: Short Message Index (CBS) information element**

Short Message Reference value (octet 2).

The Short Message Reference value is coded as specified in table 2.5.2/GSM 07.05.

Short Message Header (CBS) (Octets 3-8).

The Short Message Header (CBS) is coded as described in TS GSM 03.41, including SEQUENCE NUMBER, MESSAGE IDENTIFIER, ALPHABET IDENTIFIER and PAGE PARAMETER, but excluding the characters of the message.

**2.5.2.6 Short Message Data**

The Short Message Data information element is a copy of a short message currently stored in the MT. Two types of Short Message Data information element are provided; one for SMS and one for CBS.

The Short Message Data (SMS) information element is coded as shown in figure 2.5.8/GSM 07.05 and table 2.5.8/GSM 07.05. Short Message Data may be an SMS-SUBMIT, an SMS-DELIVER or an SMS-STATUS-REPORT.

The Short Message Data (CBS) information element is coded as shown in figure 2.5.9/GSM 07.05 and table 2.5.9/GSM 07.05.

8	7	6	5	4	3	2	1	
0	0	0	0	0	1	1	0	octet 1
Short Message Data (SMS) info element id								
Length of Short Message Data								octet 2
Short Message Reference value								octet 3
Short Message Status								octet 4
Service Centre Address								octets 5-n
Short Message (SMS)								octets n+1-n+164

**Figure 2.5.8/GSM 07.05: Short Message Data (SMS) information element**

n can take a value between 5 and 18 (inclusive)



**Table 2.5.8/GSM 07.05: Short Message (SMS) information element**

Short Message Reference value (octet 3).

The Short Message Reference value is coded as specified in table 2.5.2/GSM 07.05.

Short Message Status (octet 4).

The Short Message Status is coded as follows:

8	7	6	5	4	3	2	1	
0	0	0	0	0	0	0	0	Not read/not sent
0	0	0	0	0	0	0	1	Read/Sent

All other values are reserved.

If the message is mobile originated then bit 1 indicates whether the message has been sent to the network. If the message is mobile terminated then bit 1 indicates whether the message has been read.

Service Centre Address (Octets 5-n).

The Service Centre Address is coded as the RP-Origination-Address or RP-Destination Address specified in TS GSM 03.40.

If the short message is mobile originated, the address will be the RP-Destination address. If the short message is mobile terminated, the address will be the RP-Origination Address. The address is of variable length, 1-12 octets.

Short Message (SMS) (Octets n+1 - n+164).

The Short Message (SMS) is coded as a TPDU as described in GSM 03.40.

The Short Message is of variable length, 6-164 octets.

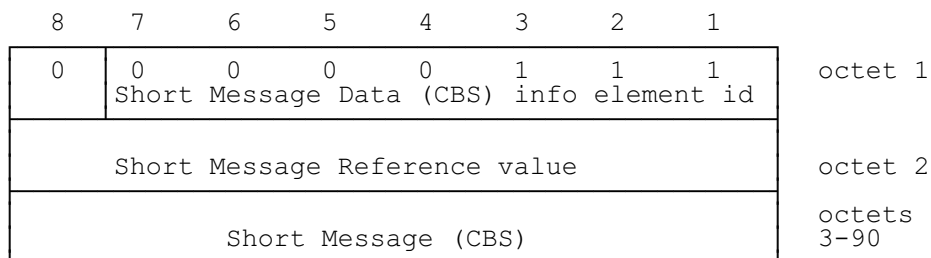

**Figure 2.5.9/GSM 07.05: Short Message Data (CBS) information element**

**Table 2.5.9/GSM 07.05: Short Message Data (CBS) information element**

Short Message Reference value (octet 2).

The Short Message Reference value is coded as specified in table 2.5.2/GSM 07.05.

Short Message (CBS) (Octets 3-90).

The Short Message (CBS) is coded as described in TS GSM 03.41, including SEQUENCE NUMBER, MESSAGE IDENTIFIER, ALPHABET IDENTIFIER, PAGE PARAMETER and CHARACTERS OF THE MESSAGE.

**2.5.2.7 Cause**

The Cause information element provides more detail as to why an error has occurred. The Cause information element is coded as shown in figure 2.5.10/GSM 07.05 and table 2.5.10/GSM 07.05.

8	7	6	5	4	3	2	1	
0	0	0	0	1	0	0	0	octet 1
Cause information element identifier								
0								octet 2
ext	Cause value							
04.11 RP-Cause value								octet 3

Figure 2.5.10/GSM 07.05: Cause information element

Table 2.5.10/GSM 07.05: Cause information element

Cause value (octet 2).								
The cause is coded as follows:								
8	7	6	5	4	3	2	1	
0	0	0	0	0	0	0	0	No such message -- no short message exists with the provided shortmessage reference
0	0	0	0	0	0	0	1	No memory -- the short message cannot be stored due to lack of memory
0	0	0	0	0	0	1	0	No air interface -- submission of the short message cannot be attempted because the mobile is out of coverage
0	0	0	0	0	0	1	1	Receiving entity busy -- the request was notfulfilled because the Receiving entity is busy on another task
0	0	0	0	0	1	0	0	Command not understood -- error in the coding of the command, or command belongs to higher version of protocol of protocol than that implemented
0	0	0	0	0	1	0	1	Incoming data call -- Incoming data call forces MT to exit from SMS mode
0	0	0	0	0	1	1	0	User-invoked exit -- User has taken MT out of SMS by MMI
1	0	0	0	0	1	1	1	Message Transfer failed -- The SMS transfer to the SC failed and the 04.11 error cause is provided in octet 3
All other values are reserved.								
04.11 RP-Cause value (octet 3)								
If this element is included then bit 8 of octet 2 is set to '1'. The error cause included in the RP-Cause over the air interface is directly mapped into this element. This element is only included if the MT attempts to send a short message to the network and that send attempt fails.								

2.5.2.8 Index Count

The Index Count identifies the number of short message indices contained in a MESSAGE LIST response from the MT to the TE. It is an 8 bit number.

The Index Count information element is coded as shown in figure 2.5.11/GSM 07.05 and table 2.5.11/GSM 07.05.

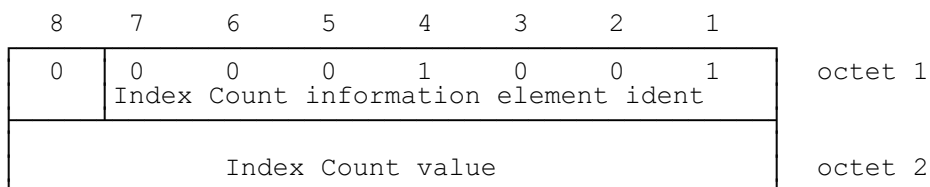

Figure 2.5.11/GSM 07.05: Index Count information element

Table 2.5.11/GSM 07.05: Index Count information element

Index Count value (octet 2).

In the Index Count field bit 8 of octet 2 is the most significant bit and bit 1 of octet 2 is the least significant bit.

### 2.5.2.9 CBS Transfer Type

The CBS Transfer Type indicates to the MT which CBS messages are required to be transferred to the TE.

The CBS Transfer Type information element is coded as shown in figure 2.5.12/GSM 07.05 and table 2.5.12/GSM 07.05.

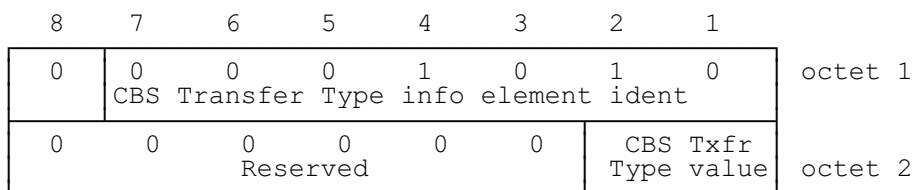

Figure 2.5.12/GSM 07.05: CBS Transfer Type information element

Table 2.5.12/GSM 07.05: CBS Transfer Type information element

CBS Txfr Type value (octet 2).

The CBS txfr type is coded as follows:

bit 2	bit 1	
0	0	Transfer no CBS messages
0	1	Transfer CBS messages marked as TE-specific
1	0	Reserved
1	1	Transfer all CBS messages

**2.5.2.10 Page Index**

The Page Index indicates to the MT which Page of SMS Indices is required to be transferred. It also indicates to the TE which Page of SMS Indices is being transferred.

The Page Index information element is coded as shown in figure 2.5.13/GSM 07.05 and table 2.5.13/GSM 07.05.

8	7	6	5	4	3	2	1	
0	0	0	0	1	0	1	1	octet 1
Page Index info element ident								
0	0	Page Index value						octet 2
Reserved								

**Figure 2.5.13/GSM 07.05: Page Index information element**

**Table 2.5.13/GSM 07.05: Page Index information element**

Page Index value (octet 2).

In the Page Index field bit 6 of octet 2 is the most significant bit and bit 1 of octet 2 is the least significant bit. The Page Index can have a value from 1 to 51.

**2.5.2.11 Last Short Message**

The Last Short Message field indicates to the TE the highest value of Short Message Reference which points to a valid message stored in the MT. The value 0 signifies that there are no short messages stored in the MT.

The Last Short Message information element is coded as shown in figure 2.5.14/GSM 07.05 and table 2.5.14/GSM 07.05.

8	7	6	5	4	3	2	1	
0	0	0	0	1	1	0	0	octet 1
Last Short Message info element ident								
Last Short Message value								octet 2

Figure 2.5.14/GSM 07.05: Last Short Message information element

Table 2.5.14/GSM 07.05: Last Short Message information element

Last Short Message value (octet 2).

In the Last Short Message field bit 8 of octet 2 is the most significant bit and bit 1 of octet 2 is the least significant bit. The Last Short Message can have a value from 0 to 255.

2.5.2.12 Confirm Type

The Confirm Type field indicates the message to which the REQUEST CONFIRM is a response.

The Confirm Type information element is coded as shown in figure 2.5.15/GSM 07.05 and table 2.5.15/GSM 07.05.

8	7	6	5	4	3	2	1	
0	0	0	0	1	1	0	1	octet 1
Confirm Type info element ident								
Confirm Type value								octet 2

Figure 2.5.15/GSM 07.05: Confirm Type information element

Table 2.5.15/GSM 07.05: Confirm Type information element

Confirm Type value (octet 2).

The Confirm Type is coded as follows:

8	7	6	5	4	3	2	1	
0	0	0	0	0	0	0	0	Reserved
0	0	0	0	0	0	0	1	Confirm request to transfer incoming SMS messages
0	0	0	0	0	0	1	0	Confirm request to transfer incoming CBS messages
0	0	0	0	0	0	1	1	Confirm request to indicate arrival of messages in MT
0	0	0	0	0	1	0	0	Confirm request to attempt to send short message (actual send is confirmed later: see section 3.3)

All other values are reserved.

2.5.2.12 TP-Failure Cause

This optional field is present if provided by the Relay Layer. The TP-Failure Cause is provided from the Service Centre and indicates to the TE the reason why the delivery of the message was unsuccessful. The TP-Failure cause information element is coded as shown in figure 2.5.16/GSM 07.05 and table 2.5.16/GSM 07.05.

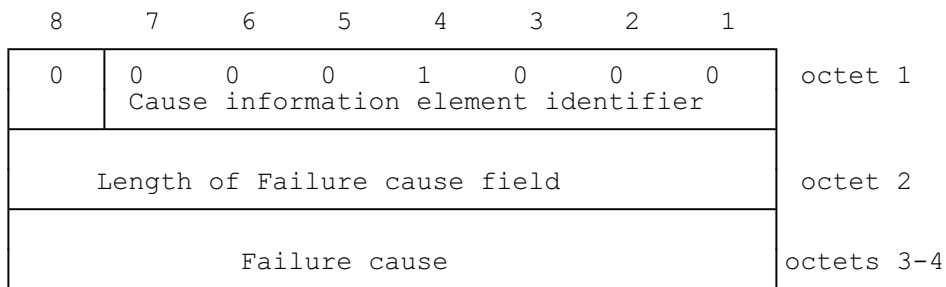

Figure 2.5.16/GSM 07.05: TP-Failure Cause information element

Table 2.5.16/GSM 07.05: TP-Failure Cause information element

Failure cause (octet 3-4)

The failure cause contained in this field is directly mapped from the TP-Failure Cause (TP-FCS) field of the SMS-SUBMIT-REPORT message defined in GSM 03.40.

### 3. Text Mode

#### 3.1 Parameter Definitions

The following parameters are used in the subsequent sections which describe all commands. The formats of integer and string types referenced here are defined in V.25ter. The default values are for command parameters, not for result code parameters.

##### Message Storage Parameters

- <index> integer type; value in the range of location numbers supported by the associated memory
- <mem1> string type; memory from which messages are read and deleted (commands List Messages +CMGL, Read Message +CMGR and Delete Message +CMGD); defined values (others are manufacturer specific):
- "BM" broadcast message storage
  - "ME" ME message storage
  - "MT" any of the storages associated with ME
  - "SM" SIM message storage
  - "TA" TA message storage
- <mem2> string type; memory to which writing and sending operations are made (commands Send Message from Storage +CMSS and Write Message to Memory +CMGW), and to which received SMs are preferred to be stored (unless forwarded directly to TE; refer command New Message Indications +CNMI); refer <mem1> for defined values; received CBMs are always stored in "BM" (or some manufacturer specific storage) unless directly forwarded to TE
- <stat> integer type in PDU mode (default 0), or string type in text mode (default "REC UNREAD"); indicates the status of message in memory; defined values:
- 0 "REC UNREAD" received unread message (i.e. new message)
  - 1 "REC READ" received read message
  - 2 "STO UNSENT" stored unsent message (only applicable to SMs)
  - 3 "STO SENT" stored sent message (only applicable to SMs)
  - 4 "ALL" all messages (only applicable to +CMGL command)
- <total1> integer type; total number of message locations in <mem1>
- <total2> integer type; total number of message locations in <mem2>
- <used1> integer type; number of messages currently in <mem1>
- <used2> integer type; number of messages currently in <mem2>

## Message Data Parameters

- <alpha> string type alphanumeric representation of <da> or <oa> corresponding to the entry found in MT phonebook; implementation of this feature is manufacturer specific; used character set should be the one selected with command Select TE Character Set +CSCS (see definition of this command in TS 07.07)
- <ct> GSM 03.40 TP-Command-Type in integer format (default 0)
- <da> GSM 03.40 TP-Destination-Address Address-Value field in string format; BCD numbers (or GSM default alphabet characters) are converted to characters of the currently selected TE character set (refer command +CSCS in TS 07.07); type of address given by <tda>
- <data> GSM 03.40 TP-User-Data in text mode responses; format:
- if <dcs> indicates that GSM 03.38 default alphabet is used and <fo> indicates that GSM 03.40 TP-User-Data-Header-Indication is not set:
    - if TE character set other than "HEX" (refer command Select TE Character Set +CSCS in TS 07.07): ME/TA converts GSM alphabet into current TE character set according to rules of Annex A
    - if TE character set is "HEX": ME/TA converts each 7-bit character of GSM alphabet into two IRA character long hexadecimal number (e.g. character II (GSM 23) is presented as 17 (IRA 49 and 55))
  - if <dcs> indicates that 8-bit data coding scheme is used or <fo> indicates that GSM 03.40 TP-User-Data-Header-Indication is set: ME/TA converts each 8-bit octet into two IRA character long hexadecimal number (e.g. octet with integer value 42 is presented to TE as two characters 2A (IRA 50 and 65))
- <dcs> depending on the command or result code: GSM 03.38 SMS Data Coding Scheme (default 0), or Cell Broadcast Data Coding Scheme in integer format
- <dt> GSM 03.40 TP-Discharge-Time in time-string format: "yy/MM/dd,hh:mm:ss±zz", where characters indicate year (two last digits), month, day, hour, minutes, seconds and time zone. E.g. 6th of May 1994, 22:10:00 GMT+2 hours equals to "94/05/06,22:10:00+08"
- <fo> depending on the command or result code: first octet of GSM 03.40 SMS-DELIVER, SMS-SUBMIT (default 17), SMS-STATUS-REPORT, or SMS-COMMAND (default 2) in integer format
- <length> integer type value indicating in the text mode (+CMGF=1) the length of the message body <data> in characters; or in PDU mode (+CMGF=0), the length of the actual TP data unit in octets
- <mid> GSM 03.41 CBM Message Identifier in integer format
- <mn> GSM 03.40 TP-Message-Number in integer format
- <mr> GSM 03.40 TP-Message-Reference in integer format
- <oa> GSM 03.40 TP-Originating-Address Address-Value field in string format; BCD numbers (or GSM default alphabet characters) are converted to characters of the currently selected TE character set (refer command +CSCS in TS 07.07); type of address given by <tooa>
- <page> GSM 03.41 CBM Page Parameter bits 4-7 in integer format



- <pages> GSM 03.41 CBM Page Parameter bits 0-3 in integer format
- <pdu> GSM 03.40 SMS-DELIVER or SMS-STATUS-REPORT, or GSM 03.41 CBM in hexadecimal format: ME/TA converts each octet of TP data unit into two IRA character long hexadecimal number (e.g. octet with integer value 42 is presented to TE as two characters 2A (IRA 50 and 65))
- <pid> GSM 03.40 TP-Protocol-Identifier in integer format (default 0)
- <ra> GSM 03.40 TP-Recipient-Address Address-Value field in string format; BCD numbers (or GSM default alphabet characters) are converted to characters of the currently selected TE character set (refer command +CSCS in TS 07.07); type of address given by <tora>
- <sca> GSM 04.11 RP SC address Address-Value field in string format; BCD numbers (or GSM default alphabet characters) are converted to characters of the currently selected TE character set (refer command +CSCS in TS 07.07); type of address given by <tosca>
- <scts> GSM 03.40 TP-Service-Centre-Time-Stamp in time-string format (refer <dt>)
- <sn> GSM 03.41 CBM Serial Number in integer format
- <st> GSM 03.40 TP-Status in integer format
- <toda> GSM 04.11 TP-Destination-Address Type-of-Address octet in integer format (when first character of <da> is + (IRA 43) default is 145, otherwise default is 129)
- <tooa> GSM 04.11 TP-Originating-Address Type-of-Address octet in integer format (default refer <toda>)
- <tora> GSM 04.11 TP-Recipient-Address Type-of-Address octet in integer format (default refer <toda>)
- <tosca> GSM 04.11 RP SC address Type-of-Address octet in integer format (default refer <toda>)
- <vp> depending on SMS-SUBMIT <fo> setting: GSM 03.40 TP-Validity-Period either in integer format (default 167) or in time-string format (refer <dt>)

## 3.2 General Configuration Commands

### 3.2.1 Select Message Service +CSMS

#### Parameter Command Syntax

Command	Possible response(s)
+CSMS=<service>	+CSMS: <mt>, <mo>, <bm>  +CMS ERROR: <err>
+CSMS?	+CSMS: <service>, <mt>, <mo>, <bm>
+CSMS=?	+CSMS: (list of supported <service>s)

### Description

Set command selects messaging service <service>. It returns the types of messages supported by the ME: <mt> for mobile terminated messages, <mo> for mobile originated messages and <bm> for broadcast type messages. If chosen service is not supported by the ME (but is supported by the TA), final result code +CMS ERROR: <err> shall be returned. See chapter Message Service Failure Result Code for a list of <err> values.

Also read command returns supported message types along the current service setting.

Test command returns a list of all services supported by the TA.

### Defined Values

<service>:

0 GSM 03.40 and 03.41

1...127 reserved

128... manufacturer specific

<mt>, <mo>, <bm>:

0 type not supported

1 type supported

### Implementation

Mandatory.

### 3.2.2 Preferred Message Storage +CPMS

#### Parameter Command Syntax

Command	Possible response(s)
+CPMS=<mem1>[,<mem2>]	+CPMS: <used1>,<total1>,<used2>,<total2>  +CMS ERROR: <err>
+CPMS?	+CPMS: <mem1>,<used1>,<total1>,<mem2>,<used2>,<total2>
+CPMS=?	+CPMS: (list of supported <mem1>s), (list of supported <mem2>s)

### Description

Set command selects memory storages <mem1> and <mem2> to be used for reading, writing, etc. If chosen storage is not appropriate for the ME (but is supported by the TA), final result code +CMS ERROR: <err> shall be returned. See chapter Message Service Failure Result Code for a list of possible <err> values.

Test command returns lists of memory storages supported by the TA.

### Implementation

Mandatory.

### 3.2.3 Message Format +CMGF

#### Parameter Command Syntax

Command	Possible response(s)
+CMGF= [ <mode> ]	
+CMGF?	+CMGF: <mode>
+CMGF=?	+CMGF: (list of supported <mode>s)

#### Description

Set command tells the TA, which input and output format of messages to use. <mode> indicates the format of messages used with send, list, read and write commands and unsolicited result codes resulting from received messages. Mode can be either PDU mode (entire TP data units used) or text mode (headers and body of the messages given as separate parameters). Text mode uses the value of parameter <chset> specified by command Select TE Character Set +CSCS to inform the character set to be used in the message body in the TA-TE interface.

Test command returns supported modes as a compound value.

#### Defined Values

<mode>:

0 PDU mode (default when implemented)

1 text mode

#### Implementation

Mandatory also when only one mode implemented.

### 3.2.4 Enter SMS Block Mode Protocol +CESP

#### Action Command Syntax

Command	Possible response(s)
+CESP	
+CESP=?	

## Description

Execution command sets the TA in SMS block protocol mode. Final result code OK (or 0) shall not be returned until block mode is exited.

## Implementation

Mandatory when block mode implemented.

### 3.2.5 Message Service Failure Result Code +CMS ERROR

Final result code +CMS ERROR: <err> indicates an error related to mobile equipment or network. The operation is similar to ERROR result code. None of the following commands in the same command line is executed. Neither ERROR nor OK result code shall be returned. ERROR is returned normally when error is related to syntax or invalid parameters.

## Defined Values

<err> values used by common messaging commands:

0...127	GSM 04.11 Annex E-2 values
128...255	GSM 03.40 section 9.2.3.22 values
300	ME failure
301	SMS service of ME reserved
302	operation not allowed
303	operation not supported
304	invalid PDU mode parameter
305	invalid text mode parameter
310	SIM not inserted
311	SIM PIN necessary
312	PH-SIM PIN necessary
313	SIM failure
314	SIM busy
315	SIM wrong
320	memory failure
321	invalid memory index
322	memory full
330	SMSC address unknown
331	no network service
332	network timeout

500	unknown error
...511	other values in range 256...511 are reserved
512...	manufacturer specific

## Implementation

Mandatory.

### 3.2.6 Informative Examples

Setting up a TA supporting GSM SMS:

```

AT+CSMS=?                (inquiry of available services in TA)

+CSMS: ( 0 )            (only GSM SMS implemented)

OK

AT+CSMS=0 ; +CPMS=?     (set GSM SMS; query available memories)

+CSMS: 1 , 1 , 1       (all MT, MO and CBM supported)

+CPMS: ( "BM" , "ME" , "SM" ) , ( "ME" , "SM" )    (CBM, ME and SIM memories for reading,
OK                                                                ME and SIM memories for writing)

AT+CPMS="ME" , "ME" ; +CMGF=?    (set ME memory; query available message formats)

+CPMS: "ME" , 5 , 99 , "ME" , 5 , 99    (five messages in ME, 99 total space)

+CMGF: ( 0 , 1 )            (both text and PDU mode implemented)

OK

AT+CMGF=1 ; +CSCS=?     (select text mode; query available TE character sets)

+CSCS: ( "IRA" , "PCCP437" , "8859-1" )

OK

AT+CSCS="PCCP437"      (select PC code page 437)

OK

```

## 3.3 Message Configuration Commands

### 3.3.1 Service Centre Address +CSCA

#### Parameter Command Syntax

Command	Possible response(s)
+CSCA=<sca>[ ,<tosca> ]	
+CSCA?	+CSCA: <sca> , <tosca>
+CSCA=?	

**Description**

Set command updates the SMSC address, through which mobile originated SMs are transmitted. Setting is used in both PDU and text mode.

**Implementation**

Mandatory.

**3.3.2 Set Text Mode Parameters +CSMP**

**Parameter Command Syntax**

Command	Possible response(s)
+CSMP=[ <fo> [ , <vp> [ , <pid> [ , <dc> ] ] ] ]	
+CSMP?	+CSMP : <fo> , <vp> , <pid> , <dc>
+CSMP=?	

**Description**

Set command is used to select values for additional parameters needed when SM is sent to the network or placed in a storage when text format message mode is selected. It is possible to set the validity period starting from when the SM is received by the SMSC (<vp> is in range 0... 255) or define the absolute time of the validity period termination (<vp> is a string). The format of <vp> is given by <fo>.

NOTE: When storing a SMS-DELIVER from the TE to the preferred memory storage in text mode (refer command Write Message to Memory +CMGW), <vp> field can be used for <sc>.

**Implementation**

Mandatory when text mode implemented.

**3.3.3 Show Text Mode Parameters +CSDH**

**Parameter Command Syntax**

Command	Possible response(s)
+CSDH=[ <show> ]	
+CSDH?	+CSDH: <show>
+CSDH=?	+CSDH: (list of supported <show>S)

**Description**

Set command controls whether detailed header information is shown in text mode result codes.

Test command returns supported values as a compound value.

### Defined Values

<show>:

- 0 do not show header values defined in commands +CSCA and +CSMP (<sca>, <tosca>, <fo>, <vp>, <pid> and <dcs>) nor <length>, <toda> or <tooa> in +CMT, +CMGL, +CMGR result codes for SMSPP text mode
- 1 show the values in result codes

### Implementation

Mandatory when text mode implemented.

## 3.3.4 Select Cell Broadcast Message Types +CSCB

### Parameter Command Syntax

Command	Possible response(s)
+CSCB=[ <mode>[ , <mids>[ , <dcss> ] ] ]	
+CSCB?	+CSCB: <mode> , <mids> , <dcss>
+CSCB=?	+CSCB: (list of supported <mode>s)

### Description

Set command selects which types of CBMs are to be received by the ME.

Test command returns supported modes as a compound value.

### Defined Values

<mode>:

- 0 message types specified in <mids> and <dcss> are accepted
- 1 message types specified in <mids> and <dcss> are not accepted

<mids>:

string type; all different possible combinations of CBM message identifiers (refer <mid>) (default is empty string); e.g. "0,1,5,320-478,922"

<dcss>:

string type; all different possible combinations of CBM data coding schemes (refer <dc>) (default is empty string); e.g. "0-3,5"

**Implementation**

Optional.

**3.3.5 Save Settings +CSAS**

**Action Command Syntax**

Command	Possible response(s)
+CSAS[=<profile> ]	+CMS ERROR: <err>
+CSAS=?	+CSAS: (list of supported <profile>s)

**Description**

Execution command saves active message service settings to a non-volatile memory. A TA can contain several profiles of settings. All settings specified in commands Service Centre Address +CSCA, Set Message Parameters +CSMP and Select Cell Broadcast Message Types +CSCB (if implemented) are saved. See chapter Message Service Failure Result Code for <err> values.

Test command shall display the supported profile numbers for reading and writing of settings.

**Defined Values**

<profile>:

0...255 manufacturer specific profile number where settings are to be stored

**Implementation**

Optional.

**3.3.6 Restore Settings +CRES**

**Action Command Syntax**

Command	Possible response(s)
+CRES[=<profile> ]	+CMS ERROR: <err>
+CRES=?	+CRES: (list of supported <profile>s)



**Description**

Execution command restores message service settings from non-volatile memory to active memory. A TA can contain several profiles of settings. All settings specified in commands Service Centre Address +CSCA, Set Message Parameters +CSMP and Select Cell Broadcast Message Types +CSCB (if implemented) are restored. See chapter Message Service Failure Result Code for <err> values.

Test command shall display the supported profile numbers for reading and writing of settings.

**Defined Values**

<profile>:

0...255 manufacturer specific profile number from where settings are to be restored

**Implementation**

Optional.

**3.3.7 Informative Examples**

Figure 1 illustrates an example setup of a TE-TA-ME system for GSM SMS. Location of volatile and non-volatile parameter memories, and the operations to change the parameter values are shown. +CSMP is used to set the text mode header values of SMS-SUBMIT (or SMS-DELIVER when received message is written from TE to a storage). The volatile memory may as well be in the ME, or when no volatile memory is used, +CSMP, +CSCA and +CSCB settings are stored directly to non-volatile memory of ME.

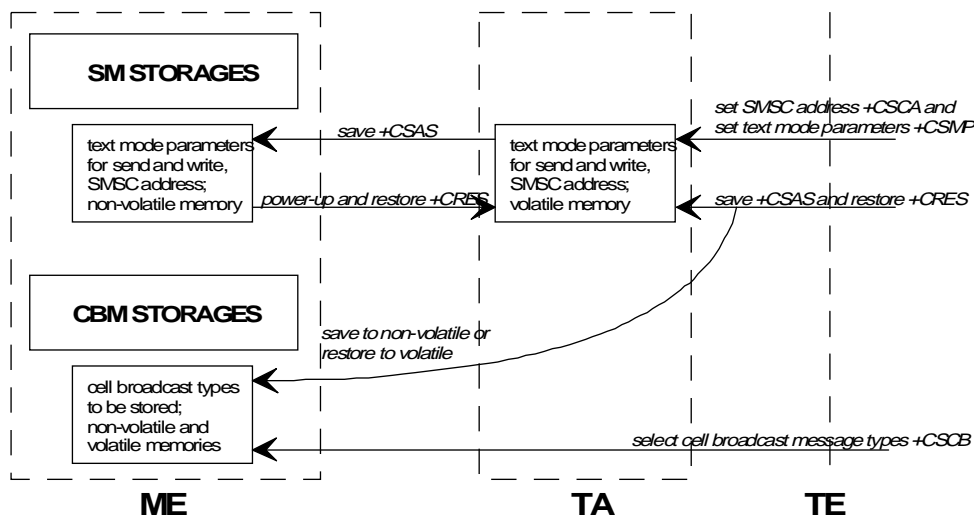

**Figure 1: Message service parameter procedures**

In this example, the volatile parameter settings of TA are used to construct messages in text mode. SMSC address setting is used also in PDU mode. The next example illustrates a session to restore the message parameters from the ME to the TA, and to set up the CBM identifiers (and languages) which are wanted to be received:



## Defined Values

<mode> (refer figure 2;

NOTE: The buffering mechanism may as well be located in the ME; the setting affects only to unsolicited result codes specified within this command):

- 0 buffer unsolicited result codes in the TA; if TA result code buffer is full, indications can be buffered in some other place or the oldest indications may be discarded and replaced with the new received indications.
- 1 discard indication and reject new received message unsolicited result codes when TA-TE link is reserved (e.g. in on-line data mode); otherwise forward them directly to the TE
- 2 buffer unsolicited result codes in the TA when TA-TE link is reserved (e.g. in on-line data mode) and flush them to the TE after reservation; otherwise forward them directly to the TE
- 3 forward unsolicited result codes directly to the TE; TA-TE link specific inband technique used to embed result codes and data when TA is in on-line data mode

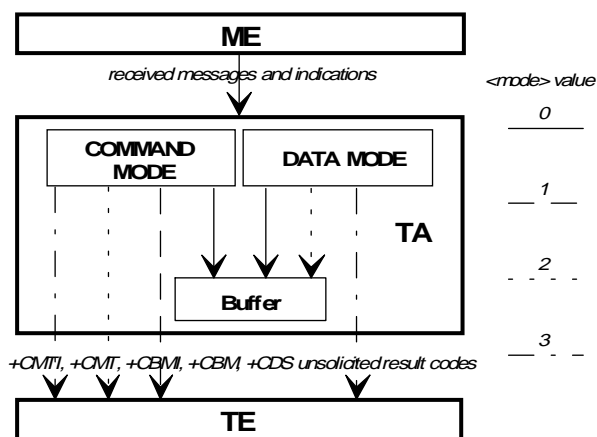

Figure 2: <mode> parameter

<mt> (the rules for storing received SMs depend on its message class, preferred memory storage (+CPMS) setting and this value; refer table 1):

- 0 no SMS-DELIVER indications are routed to the TE
- 1 indication of SMS-DELIVER is routed to the TE using unsolicited result code +CMTI: <mem>, <index>
- 2 SMS-DELIVERS (except class 2 messages) are routed directly to the TE using unsolicited result code +CMT: <pdu> (PDU mode enabled) or +CMT: <oa>, [<alpha>], <scts>[, <toa>, <fo>, <pid>, <dc>, <sca>, <tosca>, <length>]<CR><LF><data> (text mode enabled; about parameters in italics, refer command Show Text Mode Parameters +CSDH); class 2 messages result in indication as defined in <mt>=1
- 3 class 3 SMS-DELIVERS are routed directly to TE using unsolicited result codes defined in <mt>=2; messages of other classes result in indication as defined in <mt>=1

Table 1: <mt> parameter

<mt>	Receiving procedure for different message classes (GSM 03.38 SM Data Coding Scheme)
0	class 0: as in GSM 03.38, but use <mem2> as preferred memory if message is tried be stored  class 1: as in GSM 03.38, but use <mem2> as preferred memory  class 2: as in GSM 03.38  class 3: as class 1
1	as <mt>=0 but send indication if message stored successfully
2	class 0: as in GSM 03.38, but always route message to TE and do not try to store it in memory  class 1: route message to TE  class 2: as in GSM 03.38, but also send indication if message stored successfully  class 3: route message to TE
3	class 0, 1, 2: as <mt>=1  class 3: route message to TE

<bm> (the rules for storing received CBMs depend on its message class, the setting of Select CBM Types (+CSCB) and this value; refer table 2):

- 0 no CBM indications are routed to the TE
- 1 indication of new CBM is routed to the TE using unsolicited result code +CBMI: <mem>, <index>
- 2 new CBMs are routed directly to the TE using unsolicited result code +CBM: <pdu> (PDU mode enabled) or +CBM: <sn>, <mid>, <dcs>, <page>, <pages><CR><LF><data> (text mode enabled)
- 3 class 3 CBMs are routed directly to TE using unsolicited result codes defined in <bm>=2; messages of other classes result in indication as defined in <bm>=1

Table 2: &lt;bm&gt; parameter

<bm>	Receiving procedure for different message classes (GSM 03.38 CBM Data Coding Scheme)
0	store message to "BM" (or some manufacturer specific memory)
1	as <bm>=0 but send indication if message stored successfully
2	route message to TE
3	no class, class 1 and 2: as <bm>=1 class 3: route message to TE

<ds>:

- 0 no SMS-STATUS-REPORTs are routed to the TE
- 1 SMS-STATUS-REPORTs are routed to the TE using unsolicited result code +CDS: <pdu> (PDU mode enabled) or +CDS: <fo>, <mr>, [<ra>], [<tora>], <scts>, <dt>, <st> (text mode enabled)

<bfr>:

- 0 TA buffer of unsolicited result codes defined within this command is flushed to the TE when <mode> 1...3 is entered (OK response shall be given before flushing the codes)
- 1 TA buffer of unsolicited result codes defined within this command is cleared when <mode> 1...3 is entered

### Implementation

Mandatory when any of the new message indications implemented.

3.4.2 List Messages +CMGL

Action Command Syntax

Command	Possible response(s)
+CMGL[=<stat> ]	<p><b>if text mode (+CMGF=1), command successful and SM storage:</b></p> <p>+CMGL:                      &lt;index&gt;,&lt;stat&gt;,&lt;oa/da&gt;,[&lt;alpha&gt;],[&lt;scts&gt;][,&lt;tooa/toda&gt;,&lt;length&gt;]&lt;CR&gt;&lt;LF&gt;&lt;data&gt;[&lt;CR&gt;&lt;LF&gt;</p> <p>+CMGL:                      &lt;index&gt;,&lt;stat&gt;,&lt;da/oa&gt;,[&lt;alpha&gt;],[&lt;scts&gt;][,&lt;tooa/toda&gt;,&lt;length&gt;]&lt;CR&gt;&lt;LF&gt;&lt;data&gt;[...]</p> <p><b>if text mode (+CMGF=1), command successful and CBM storage:</b></p> <p>+CMGL: &lt;index&gt;,&lt;stat&gt;,&lt;sn&gt;,&lt;mid&gt;,&lt;page&gt;,&lt;pages&gt;</p> <p>&lt;CR&gt;&lt;LF&gt;&lt;data&gt;[&lt;CR&gt;&lt;LF&gt;</p> <p>+CMGL: &lt;index&gt;,&lt;stat&gt;,&lt;sn&gt;,&lt;mid&gt;,&lt;page&gt;,&lt;pages&gt;</p> <p>&lt;CR&gt;&lt;LF&gt;&lt;data&gt;[...]</p> <p><b>otherwise:</b></p> <p>+CMS ERROR: &lt;err&gt;</p>
+CMGL=?	+CMGL: (list of supported <stat>s)

## Description

Execution command returns messages with status value *<stat>* from preferred message storage *<mem1>* to the TE. About text mode parameters in italics, refer command Show Text Mode Parameters +CSDH. If status of the message is 'received unread', status in the storage changes to 'received read'. If listing fails, final result code +CMS ERROR: *<err>* is returned. See chapter Message Service Failure Result Code for *<err>* values.

Test command shall give a list of all status values supported by the TA.

## Implementation

Optional.

### 3.4.3 Read Message +CMGR

#### Action Command Syntax

Command	Possible response(s)
+CMGR=<index>	<p><b>if text mode (+CMGF=1), command successful and SMS-DELIVER:</b></p> <p>+CMGR:  <i>&lt;stat&gt;</i>, <i>&lt;oa&gt;</i>, [<i>&lt;alpha&gt;</i>], <i>&lt;scts&gt;</i> [, <i>&lt;toa&gt;</i>, <i>&lt;fo&gt;</i>, <i>&lt;pid&gt;</i>, <i>&lt;dcs&gt;</i>, <i>&lt;sca&gt;</i>, <i>&lt;tosca&gt;</i>, <i>&lt;length&gt;</i>] &lt;CR&gt; &lt;LF&gt; <i>&lt;data&gt;</i></p> <p><b>if text mode (+CMGF=1), command successful and SMS-SUBMIT:</b></p> <p>+CMGR:  <i>&lt;stat&gt;</i>, <i>&lt;da&gt;</i>, [<i>&lt;alpha&gt;</i>] [, <i>&lt;toda&gt;</i>, <i>&lt;fo&gt;</i>, <i>&lt;pid&gt;</i>, <i>&lt;dcs&gt;</i>, [<i>&lt;vp&gt;</i>], <i>&lt;sca&gt;</i>, <i>&lt;tosca&gt;</i>, <i>&lt;length&gt;</i>] &lt;CR&gt; &lt;LF&gt; <i>&lt;data&gt;</i></p> <p><b>if text mode (+CMGF=1), command successful and CBM storage:</b></p> <p>+CMGR:  <i>&lt;stat&gt;</i>, <i>&lt;sn&gt;</i>, <i>&lt;mid&gt;</i>, <i>&lt;dcs&gt;</i>, <i>&lt;page&gt;</i>, <i>&lt;pages&gt;</i> &lt;CR&gt; &lt;LF&gt; <i>&lt;data&gt;</i></p> <p><b>otherwise:</b></p> <p>+CMS ERROR: <i>&lt;err&gt;</i></p>
+CMGR=?	

## Description

Execution command returns message with location value *<index>* from preferred message storage *<mem1>* to the TE. About text mode parameters in italics, refer command Show Text Mode Parameters +CSDH. If status of the message is 'received unread', status in the storage changes to 'received read'. If reading fails, final result code +CMS ERROR: *<err>* is returned. See chapter Message Service Failure Result Code for *<err>* values.

## Implementation

Optional.

3.4.4 Informative Examples

Message forwarding is done as illustrated in figure 3. In this example, there is no TA memory for messages and result code buffer is situated in TA.

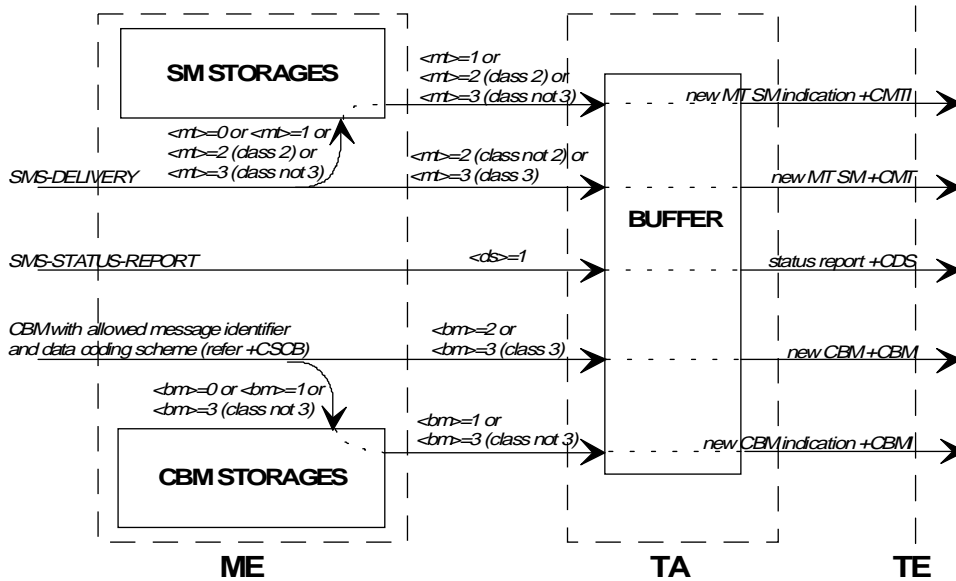

Figure 3: Message receiving procedures

Setting new message indications:

```

AT+CNMI=?           (query new message unsolicited result code modes)

+CNMI: (0-2),(0-3),(0-3),(0,1),(0,1)

OK

AT+CNMI=2,1,0,1,0  (send SM and status report indications to TE)

OK                 when TA in command mode, otherwise buffer)
    
```

In this example, the TA is set so that it should send an unsolicited result code +CMTI:  $\langle mem \rangle, \langle index \rangle$  to the TE when a new SMS-DELIVER is received from the network and stored successfully to storage  $\langle mem \rangle$ , and an unsolicited result code +CDS: ... when a SMS-STATUS-REPORT is received. These result codes are routed to the TE when TA is in command mode, but buffered when in on-line data mode. Now, if new SM is received, it can be read as follows (text mode with no detailed header information; GSM default alphabet used in message body):

```

+CMTI: "ME", 2      (new message received in index 2)

AT+CMGR=2           (read the message)
    
```



+CMGR: "REC UNREAD", "+358507654321", "Mr. Jones", "95/07/03,17:38:15+04"

This is the Mr. Jones testing

OK

In the next example all messages of storage <mem1> are listed (text mode with no detailed header information; GSM default alphabet used in message bodies):

AT+CMGL="ALL" (read all SMs)

+CMGL: 1, "REC READ", "+358501234567", "Mr. Smith", "95/07/03,17:45:03+04"

This is the body of the message.

+CMGL: 2, "STO UNSENT", "+358501234567", "Mr. Smith",

This is the body of the reply.

OK

The next example shows a method to read new CBMs received from the network (text mode; GSM default alphabet used in message bodies):

AT+CNMI=2,,2,,0 (CBMs will be sent to the TE)

OK

AT+CPMS="BM";+CMGL (select CBM memory for reading; list all unread CBMs)

+CMGL: 1, "REC UNREAD", 100,40,1,3 (first page of three page weather information)

Weather in Finland 3rd of July 1995

+CMGL: 2, "REC UNREAD", 100,40,2,3 (second page of three page weather information)

Helsinki: cloudy, snow storms, -20 degrees Celcius, wind -14 m/s NE

+CMGL: 3, "REC UNREAD", 100,40,3,3 (third page of three page weather information)

Tampere: sunny, 40 degrees Celcius, wind 1 m/s SW

OK

### 3.5 Message Sending and Writing Commands

#### 3.5.1 Send Message +CMGS

##### Action Command Syntax

Command	Possible response(s)
<b>if text mode (+CMGF=1):</b>  +CMGS=<da>[ , <tda>] <CR> <i>text is entered</i> <ctrl-Z/ESC>	<b>if sending successful:</b>  +CMGS: <mr>  <b>if sending fails:</b>  +CMS ERROR: <err>
+CMGS=?	

##### Description

Execution command sends message from a TE to the network (SMS-SUBMIT). Message reference value <mr> is returned to the TE on successful message delivery. Value can be used to identify message upon unsolicited delivery status report result code. If sending fails in a network or an ME error, final result code +CMS ERROR: <err> is returned. See chapter Message Service Failure Result Code for a list of <err> values. This command should be abortable.

- entered text (GSM 03.40 TP-Data-Unit) is sent to address <da> and all current settings (refer Set Text Mode Parameters +CSMP and Service Centre Address +CSCA) are used to construct the actual PDU in ME/TA
- the TA shall send a four character sequence <CR><LF><greater\_than><space> (IRA 13, 10, 62, 32) after command line is terminated with <CR>; after that text can be entered from TE to ME/TA
- the DCD signal shall be in ON state while text is entered
- the echoing of entered characters back from the TA is controlled by V.25ter echo command E
- the entered text should be formatted as follows:
  - if <dc> (set with +CSMP) indicates that GSM 03.38 default alphabet is used and <fo> indicates that GSM 03.40 TP-User-Data-Header-Indication is not set:
    - if TE character set other than "HEX" (refer command Select TE Character Set +CSCS in TS 07.07): ME/TA converts the entered text into GSM alphabet according to rules of Annex A; backspace can be used to delete last character and carriage returns can be used (previously mentioned four character sequence shall be sent to the TE after every carriage return entered by the user)
    - if TE character set is "HEX": the entered text should consist of two IRA character long hexadecimal numbers which ME/TA converts to 7-bit characters of GSM alphabet (e.g. 17 (IRA 49 and 55) will be converted to character II (GSM 23))
  - if <dc> indicates that 8-bit data coding scheme is used or <fo> indicates that GSM 03.40 TP-User-Data-Header-Indication is set: the entered text should consist of two IRA character long hexadecimal numbers which ME/TA converts into 8-bit octet (e.g. two characters 2A (IRA 50 and 65) will be converted to an octet with integer value 42)

- sending can be cancelled by giving <ESC> character (IRA 27)
- <ctrl-z> (IRA 26) must be used to indicate the ending of the message body

**Implementation**

Optional.

### 3.5.2 Send Message from Storage +CMSS

#### Action Command Syntax

Command	Possible response(s)
+CMSS=<index>[ ,<da>[ ,<toda> ] ]	<p><b>if sending successful:</b></p> <p>+CMSS: &lt;mr&gt;</p> <p><b>if sending fails:</b></p> <p>+CMS ERROR: &lt;err&gt;</p>
+CMSS=?	

#### Description

Execution command sends message with location value <index> from preferred message storage <mem2> to the network (SMS-SUBMIT). If new recipient address <da> is given, it shall be used instead of the one stored with the message. Reference value <mr> is returned to the TE on successful message delivery. Value can be used to identify message upon unsolicited delivery status report result code. If sending fails in a network or an ME error, final result code +CMS ERROR: <err> is returned. See chapter Message Service Failure Result Code for a list of <err> values. This command should be abortable.

#### Implementation

Optional.

### 3.5.3 Write Message to Memory +CMGW

#### Action Command Syntax

Command	Possible response(s)
<p><b>if text mode (+CMGF=1):</b></p> <p>+CMGW=&lt;oa/da&gt;[ ,&lt;tooa/toda&gt;[ ,&lt;stat&gt; ] ]&lt;CR&gt;</p> <p><i>text is entered</i>&lt;ctrl-Z/ESC&gt;</p>	<p>+CMGW: &lt;index&gt;</p> <p>+CMS ERROR: &lt;err&gt;</p>
+CMGW=?	

#### Description

Execution command stores message (either SMS-DELIVER or SMS-SUBMIT) to preferred memory storage <mem2>. Memory location <index> of the stored message is returned. By default message status will be set to 'stored unsent', but parameter <stat> allows also other status values to be given. The entering of text is done similarly as specified in command Send Message +CMGS. If writing fails, final result code +CMS ERROR: <err> is returned. See chapter Message Service Failure Result Code for <err> values.

## Implementation

Optional.

### 3.5.4 Delete Message +CMGD

#### Action Command Syntax

Command	Possible response(s)
+CMGD=<index>	+CMS ERROR: <err>
+CMGD=?	

#### Description

Execution command deletes message from preferred message storage <mem1> location <index>. If deleting fails, final result code +CMS ERROR: <err> is returned. See chapter Message Service Failure Result Code for <err> values.

## Implementation

Optional.

### 3.5.5 Send Command +CMGC

#### Action Command Syntax

Command	Possible response(s)
<b>if text mode (+CMGF=1):</b> +CMGC=<fo>,<ct>[,<pid>[,<mn>[,<da>[,<toda>]]] ]<CR> <i>text is entered</i> <ctrl-Z/ESC>	<b>if sending successful:</b> +CMGC: <mr>  <b>if sending fails:</b> +CMS ERROR: <err>
+CMGC=?	

#### Description

Execution command sends a command message from a TE to the network (SMS-COMMAND). The entering of text (GSM 03.40 TP-Command-Data) is done similarly as specified in command Send Message +CMGS, but the format is fixed to be a sequence of two IRA character long hexadecimal numbers which ME/TA converts into 8-bit octets (refer +CMGS). Message reference value <mr> is returned to the TE on successful message delivery. Value can be used to identify message upon unsolicited delivery status report result code. If sending fails in a network or an ME error, final result code +CMS ERROR: <err> is returned. See chapter Message Service Failure Result Code for a list of <err> values. This command should be abortable.

## Implementation

Optional.

3.5.6 Informative Examples

Figure 4 is an example of a TE-TA-ME setup when messages are sent to network or stored to ME. The volatile memory may as well be in the ME, or a non-volatile memory may be used instead when constructing messages.

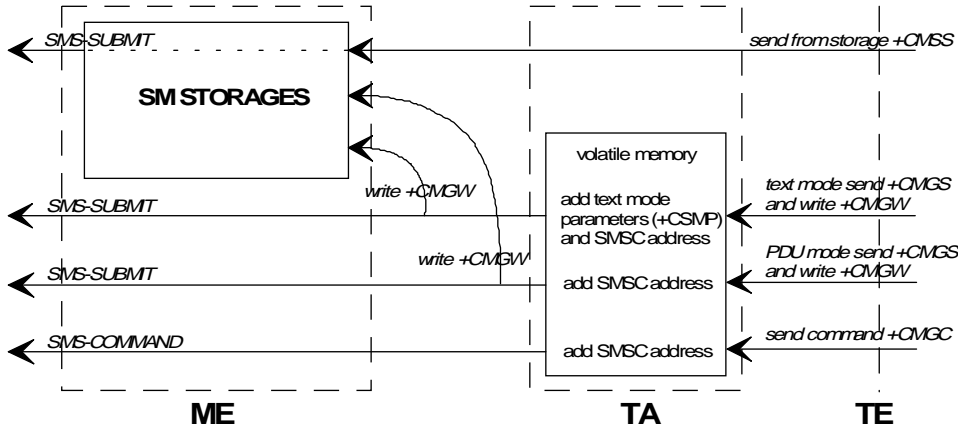

Figure 4: Message service send and write procedures

An example of sending a default alphabet message in text mode and a SMS-STATUS-REPORT is wanted:

```

AT+CNMI?           (check that status reports are routed to TE)

+CNMI: 2,1,0,1,0

OK

AT+CSMP=32,167,0,0   (status report wanted; otherwise default settings)

OK

AT+CMGS="+358501234567" (start editing a message)

> This the first line. (edit first line and press carriage return)

> This is the last line.^Z (edit second line and send message by pressing control-Z)

+CMGS: 10           (success: message reference 10 returned from SMSC)

OK

+CDS: 2,10,"+358501234567",145,"95/07/04/13:12:14+04",

"95/07/04/13:12:20+04",0 (status report report of successful message delivery received)
    
```

Storing an unsent message in memory, sending it from there, and deleting it:

```
AT+CPMS?                (check memory settings)

+CPMS: "ME",4,10,"ME",4,10

OK

AT+CMGW="9501231234"    (write message)

> This is the message body^Z

+CMGW: 7                (index number in storage returned)

OK

AT+CMSS=7                (send from storage)

+CMSS: 12                (success: reference value 12 sent from SC)

OK

AT+CMGD=7                (delete message)

OK
```

## 4 PDU Mode

The PDU mode uses the same commands and responses as the Text Mode described in Section 3. However, the following commands and responses have a different format. In the PDU mode, a complete SMS Message including all header information is passed as a binary string. This binary string is composed of hexadecimal IA5 characters as defined in section 3 above under "Message Data Parameters".

### 4.1 List Messages +CMGL

#### Action Command Syntax

Command	Possible response(s)
+CMGL[=<stat>] ]	<p><b>if PDU mode (+CMGF=0) and command successful:</b></p> <p>+CMGL: &lt;index&gt;,&lt;stat&gt;,&lt;length&gt;&lt;CR&gt;&lt;LF&gt;&lt;pdu&gt;</p> <p>[&lt;CR&gt;&lt;LF&gt;+CMGL: &lt;index&gt;,&lt;stat&gt;,&lt;length&gt;&lt;CR&gt;&lt;LF&gt;&lt;pdu&gt;</p> <p>[...]]</p> <p><b>otherwise:</b></p> <p>+CMS ERROR: &lt;err&gt;</p>
+CMGL=?	+CMGL: (list of supported <stat>s)

#### Description

Execution command returns messages with status value <stat> from preferred message storage <mem1> to the TE. Entire data units <pdu> are returned. If status of the message is 'received unread', status in the storage changes to 'received read'. If listing fails, final result code +CMS ERROR: <err> is returned. See chapter Message Service Failure Result Code for <err> values.

Test command shall give a list of all status values supported by the TA.

#### Implementation

Optional.



#### 4.1.1 Read Message +CMGR

##### Action Command Syntax

Command	Possible response(s)
+CMGR=<index> >	<p><b>if PDU mode (+CMGF=0) and command successful:</b></p> <p>+CMGR: &lt;stat&gt;,&lt;length&gt;&lt;CR&gt;&lt;LF&gt;&lt;pdu&gt;</p> <p><b>otherwise:</b></p> <p>+CMS ERROR: &lt;err&gt;</p>
+CMGR=?	

##### Description

Execution command returns message with location value <index> from preferred message storage <mem1> to the TE. Status of the message and entire message data unit <pdu> is returned. If status of the message is 'received unread', status in the storage changes to 'received read'. If reading fails, final result code +CMS ERROR: <err> is returned. See chapter Message Service Failure Result Code for <err> values.

##### Implementation

Optional.

#### 4.1.2 Send Message +CMGS

##### Action Command Syntax

Command	Possible response(s)
<p><b>if PDU mode (+CMGF=0):</b></p> <p>+CMGS=&lt;length&gt;&lt;CR&gt;<i>PDU is given</i>&lt;ctrl-Z/ESC&gt;</p>	<p><b>if sending successful:</b></p> <p>+CMGS: &lt;mr&gt;</p> <p><b>if sending fails:</b></p> <p>+CMS ERROR: &lt;err&gt;</p>
+CMGS=?	

##### Description

Execution command sends message from a TE to the network (SMS-SUBMIT). Message reference value <mr> is returned to the TE on successful message delivery. Value can be used to identify message upon unsolicited delivery status report result code. If sending fails in a network or an ME error, final result code +CMS ERROR: <err> is returned. See chapter Message Service Failure Result Code for a list of <err> values. This command should be abortable.

- <length> must indicate the number of octets coded in the TP layer data unit to be given

- SMSC address set with command Service Centre Address +CSCA is used in RP layer data unit
- the TA shall send a four character sequence <CR><LF><greater\_than><space> (IRA 13, 10, 62, 32) after command line is terminated with <CR>; after that PDU can be given from TE to ME/TA
- the DCD signal shall be in ON state while PDU is given
- the echoing of given characters back from the TA is controlled by V.25ter echo command E
- the PDU shall be hexadecimal format (similarly as specified for <pdu>) and given in one line; ME/TA converts this coding into the actual octets of PDU
- sending can be cancelled by giving <ESC> character (IRA 27)
- <ctrl-z> (IRA 26) must be used to indicate the ending of PDU

**Implementation**

Optional.

**4.1.3 Write Message to Memory +CMGW**

**Action Command Syntax**

Command	Possible response(s)
<b>if PDU mode (+CMGF=0):</b> +CMGW=<length>[,<stat>]<CR> <i>PDU is given</i> <ctrl-Z/ESC>	+CMGW: <index> +CMS ERROR: <err>
+CMGW=?	

**Description**

Execution command stores message (either SMS-DELIVER or SMS-SUBMIT) to preferred memory storage <mem2>. Memory location <index> of the stored message is returned. By default message status will be set to 'stored unsent', but parameter <stat> allows also other status values to be given. The entering of PDU is done similarly as specified in command Send Message +CMGS. If writing fails, final result code +CMS ERROR: <err> is returned. See chapter Message Service Failure Result Code for <err> values.

**Implementation**

Optional.

## 4.1.4 Send Command +CMGC

## Action Command Syntax

Command	Possible response(s)
<b>if PDU mode (+CMGF=0):</b> +CMGC=<length><CR> <i>PDU is given</i> <ctrl-Z/ESC>	<b>if sending successful:</b> +CMGC: <mr>  <b>if sending fails:</b> +CMS ERROR: <err>
+CMGC=?	

## Description

Execution command sends a command message from a TE to the network (SMS-COMMAND). The entering of PDU is done similarly as specified in command Send Message +CMGS. Message reference value <mr> is returned to the TE on successful message delivery. Value can be used to identify message upon unsolicited delivery status report result code. If sending fails in a network or an ME error, final result code +CMS ERROR: <err> is returned. See chapter Message Service Failure Result Code for a list of <err> values. This command should be abortable.

## Implementation

Optional.

## Annex A (Normative): Character Set Conversions for SMS Text Mode

The following conversions to and from GSM 03.38 default alphabet are defined:

TE char set	bits/char	Commands
PC Code Page 437	8	+CMGF=1 ; +CSCS="PCCP437"
PC Danish/Norwegian	8	+CMGF=1 ; +CSCS="PCDN"
ISO 8859 Latin 1	8	+CMGF=1 ; +CSCS="8859-1"
IRA	7	+CMGF=1 ; +CSCS="IRA"
GSM default alphabet	7	+CMGF=1 ; +CSCS="GSM"

The tables below show which 7 bit GSM value corresponds to the 7 or 8 bit value of external character set. The TE character set value is computed by adding column value, 00H through F0H (70H for 7 bits/char), with the row value (00H through 0FH). All values are in hexadecimal, but the H suffix is not used. When text mode is implemented, it is mandatory for a TA to have at least one conversion which include the conversion table of IRA (e.g. PC Code Page 437 does). Additional conversions can be defined by manufacturers. It is manufacturer specific if the TE set is actually converted to GSM set in the TA or in the ME, and if the TE set is converted to a ME specific set in the TA before converting it to GSM set when message is sent to the network. It is recommended that characters which cannot be converted to GSM set are deleted.

Conversion from IRA to GSM:

	00	10	20	30	40	50	60	70
00	-	-	20	30	00	50	-	70
01	-	-	21	31	41	51	61	71
02	-	-	22	32	42	52	62	72
03	-	-	23	33	43	53	63	73
04	-	-	02	34	44	54	64	74
05	-	-	25	35	45	55	65	75
06	-	-	26	36	46	56	66	76
07	-	-	27	37	47	57	67	77
08	-	-	28	38	48	58	68	78
09	-	-	29	39	49	59	69	79
0A	LF	-	2A	3A	4A	5A	6A	7A
0B	-	-	2B	3B	4B	-	6B	-
0C	-	-	2C	3C	4C	-	6C	-
0D	CR	-	2D	3D	4D	-	6D	-
0E	-	-	2E	3E	4E	-	6E	-
0F	-	-	2F	3F	4F	-	6F	-

Conversion from PCCP437 (PC-8 Code Page 437) to GSM:

	00	10	20	30	40	50	60	70	80	90	A0	B0	C0	D0	E0	F0
00	-	-	20	30	00	50	-	70	09	45 <sup>7</sup>	61 <sup>11</sup>	-	-	-	-	-
01	-	-	21	31	41	51	61	71	7E	1D	69 <sup>12</sup>	-	-	-	1E	-
02	-	-	22	32	42	52	62	72	05	1C	6F <sup>13</sup>	-	-	-	13	-
03	-	-	23	33	43	53	63	73	61	6F <sup>8</sup>	75 <sup>14</sup>	-	-	-	-	-
04	-	-	02	34	44	54	64	74	7B	7C	7D	-	-	-	18	-
05	-	5F	25	35	45	55	65	75	7F	08	5D	-	-	-	-	-
06	-	-	26	36	46	56	66	76	0F	75 <sup>9</sup>	-	-	-	-	-	-
07	-	-	27	37	47	57	67	77	09	06	-	-	-	-	-	-
08	-	-	28	38	48	58	68	78	65	79 <sup>10</sup>	60	-	-	-	12	-
09	-	-	29	39	49	59	69	79	65	5C	-	-	-	-	19	-
0A	LF	-	2A	3A	4A	5A	6A	7A	04	5E	-	-	-	-	15	-
0B	-	-	2B	3B	4B	-	6B	-	69	-	-	-	-	-	-	-
0C	-	-	2C	3C	4C	-	6C	-	69	01	-	-	-	-	-	-
0D	CR	-	2D	3D	4D	-	6D	-	07	03	40	-	-	-	-	-
0E	-	-	2E	3E	4E	-	6E	-	5B	-	-	-	-	-	-	-
0F	-	-	2F	3F	4F	-	6F	-	0E	-	-	-	-	-	-	-

1 : â ⇒ a      2 : ç ⇒ Ç      3 : ê ⇒ e      4 : ë ⇒ e      5 : ï ⇒ i  
 6 : î ⇒ i      7 : É ⇒ E      8 : ô ⇒ o      9 : û ⇒ u      10 : ÿ ⇒ y  
 11 : á ⇒ a      12 : í ⇒ i      13 : ó ⇒ o      14 : ú ⇒ u

Conversion from PCDN (PC-8 Danish/ Norwegian) to GSM:

	00	10	20	30	40	50	60	70	80	90	A0	B0	C0	D0	E0	F0
00	-	-	20	30	00	50	-	70	09	45 <sup>7</sup>	61 <sup>11</sup>	-	-	-	-	-
01	-	-	21	31	41	51	61	71	7E	1D	69 <sup>12</sup>	-	-	-	1E	-
02	-	-	22	32	42	52	62	72	05	1C	6F <sup>13</sup>	-	-	-	13	-
03	-	-	23	33	43	53	63	73	61	6F <sup>8</sup>	75 <sup>14</sup>	-	-	-	-	-
04	-	-	02	34	44	54	64	74	7B	7C	7D	-	-	-	18	-
05	-	5F	25	35	45	55	65	75	7F	08	5D	-	-	-	-	-
06	-	-	26	36	46	56	66	76	0F	75 <sup>9</sup>	-	-	-	-	-	-
07	-	-	27	37	47	57	67	77	09	06	-	-	-	-	-	-
08	-	-	28	38	48	58	68	78	65	79 <sup>10</sup>	60	-	-	-	12	-
09	-	-	29	39	49	59	69	79	65	5C	-	-	-	-	19	-
0A	LF	-	2A	3A	4A	5A	6A	7A	04	5E	-	-	-	-	15	-
0B	-	-	2B	3B	4B	-	6B	-	69	0C	-	-	-	-	-	-
0C	-	-	2C	3C	4C	-	6C	-	69	01	-	-	-	-	-	-
0D	CR	-	2D	3D	4D	-	6D	-	07	0B	40	-	-	-	-	-
0E	-	-	2E	3E	4E	-	6E	-	5B	-	-	-	-	-	-	-
0F	-	-	2F	3F	4F	-	6F	-	0E	-	-	-	-	-	-	-

1 : â ⇒ a      2 : ç ⇒ Ç      3 : ê ⇒ e      4 : ë ⇒ e      5 : ï ⇒ i  
 6 : î ⇒ i      7 : É ⇒ E      8 : ô ⇒ o      9 : û ⇒ u      10 : ÿ ⇒ y  
 11 : á ⇒ a      12 : í ⇒ i      13 : ó ⇒ o      14 : ú ⇒ u

Conversion from 8859-1 (ISO 8859 Latin 1) to GSM:

	00	10	20	30	40	50	60	70	80	90	A0	B0	C0	D0	E0	F0
00	-	-	20	30	00	50	-	70	-	-	-	-	41 <sup>1</sup>	-	7F	-
01	-	-	21	31	41	51	61	71	-	-	40	-	41 <sup>2</sup>	5D	61 <sup>21</sup>	7D
02	-	-	22	32	42	52	62	72	-	-	-	-	41 <sup>3</sup>	4F <sup>1</sup>	61 <sup>22</sup>	08
03	-	-	23	33	43	53	63	73	-	-	01	-	41 <sup>4</sup>	4F <sup>1</sup>	61 <sup>23</sup>	6F <sup>3</sup>
04	-	-	02	34	44	54	64	74	-	-	24	-	5B	4F <sup>1</sup>	7B	6F <sup>3</sup>
05	-	-	25	35	45	55	65	75	-	-	03	-	0E	4F <sup>1</sup>	0F	6F <sup>3</sup>
06	-	-	26	36	46	56	66	76	-	-	-	-	1C	5C	1D	7C
07	-	-	27	37	47	57	67	77	-	-	5F	-	09	-	09 <sup>24</sup>	-
08	-	-	28	38	48	58	68	78	-	-	-	-	45 <sup>5</sup>	0B	04	0C
09	-	-	29	39	49	59	69	79	-	-	-	-	45 <sup>6</sup>	55 <sup>17</sup>	05	06
0A	LF	-	2A	3A	4A	5A	6A	7A	-	-	-	-	45 <sup>7</sup>	55 <sup>18</sup>	65 <sup>25</sup>	75 <sup>33</sup>
0B	-	-	2B	3B	4B	-	6B	-	-	-	-	-	45 <sup>8</sup>	55 <sup>19</sup>	65 <sup>26</sup>	75 <sup>34</sup>
0C	-	-	2C	3C	4C	-	6C	-	-	-	-	-	49 <sup>9</sup>	5E	07	7E
0D	CR	-	2D	3D	4D	-	6D	-	-	-	-	-	49 <sup>1</sup>	59 <sup>20</sup>	69 <sup>27</sup>	79 <sup>35</sup>
0E	-	-	2E	3E	4E	-	6E	-	-	-	-	-	49 <sup>1</sup>	-	69 <sup>28</sup>	-
0F	-	-	2F	3F	4F	-	6F	-	-	-	-	60	49 <sup>1</sup>	1E	69 <sup>29</sup>	79 <sup>36</sup>

- 1 : À ⇒ A      2 : Á ⇒ A      3 : Â ⇒ A      4 : Ã ⇒ A      5 : È ⇒ E
- 6 : É ⇒ E      7 : Ê ⇒ E      8 : Ë ⇒ E      9 : Ì ⇒ I      10 : Í ⇒ I
- 11 : Î ⇒ I      12 : Ï ⇒ I      13 : Ò ⇒ O      14 : Ó ⇒ O      15 : Ô ⇒ O
- 16 : Õ ⇒ O      17 : Ù ⇒ U      18 : Ú ⇒ U      19 : Û ⇒ U      20 : Ý ⇒ Y
- 21 : á ⇒ a      22 : â ⇒ a      23 : ã ⇒ a      24 : ç ⇒ Ç      25 : ê ⇒ e
- 26 : ë ⇒ e      27 : í ⇒ i      28 : î ⇒ i      29 : ï ⇒ i      30 : ó ⇒ o
- 31 : ô ⇒ o      32 : õ ⇒ o      33 : ú ⇒ u      34 : û ⇒ u      35 : ý ⇒ y
- 36 : ÿ ⇒ y

Conversions from GSM default alphabet to above character sets are otherwise straightforward, but no conversions of the characters listed below tables are applied.

## **Annex B (Informative): Example of processing a data block**

### **B.1 Example state diagrams for the block receiver**

The state diagrams on the following two pages show how the receiver component at the block level could work. In this example the received octets are processed in two stages.

Stage 1 is a low level function which detects the unique start and end markers, and removes any stuffing octets. The results of this stage are passed to stage 2. Any unexpected octet value after a DLE will be indicated as 'abort'.

Stage 2 assembles the message content and the BCS octets, using octets passed from stage 1 and the 'start' and 'end' indications. A 'start' will always reset the process to state 1 from any state. An 'abort' will always cause a return to state 0 where a 'start' will be awaited. When an 'end' is received in state 1, the following two octets are checked as the BCS. If the BCS is correct, the message content is passed to another stage of the receiver for processing of the message content.

### **B.2 Example of coding and decoding a data block**

The last page of this annex shows the coding of an example message at a transmitter, and the decoding stages at a receiver which has the two stages of processing as described above.

In this example, the message content and the BCS both contain an octet with a value of 10 hex. Therefore the message as transmitted over the interface has additional stuffing octets (00 hex) inserted after these octets. The receiver first detects the start and end markers, and removes the stuffing octets. Finally the BCS is checked.

### EXAMPLE STATE DIAGRAMS FOR THE BLOCK RECEIVER

The block receiver can be considered as two stages. Stage 1 detects start and end markers, and removes stuffing characters. Stage 2 assembles the received message and checks the BCS.

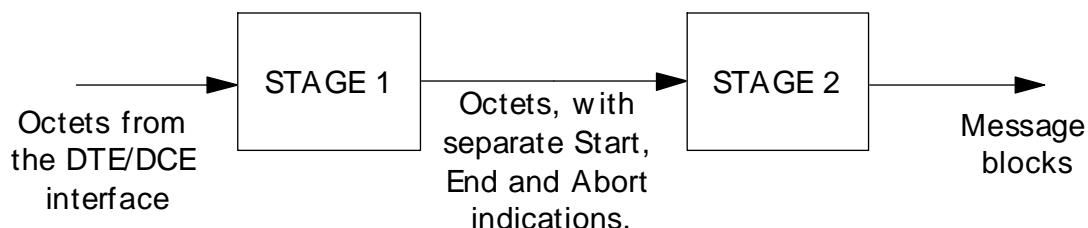

### STATE TRANSITIONS IN STAGE 1

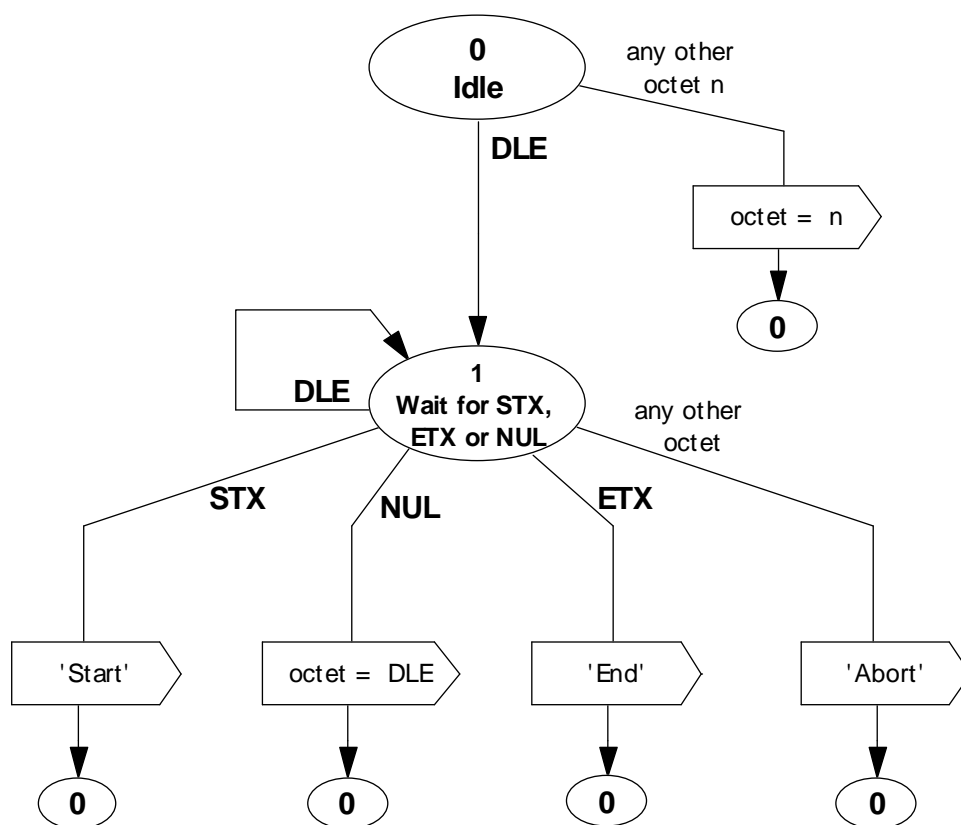



STATE TRANSITIONS IN STAGE 2

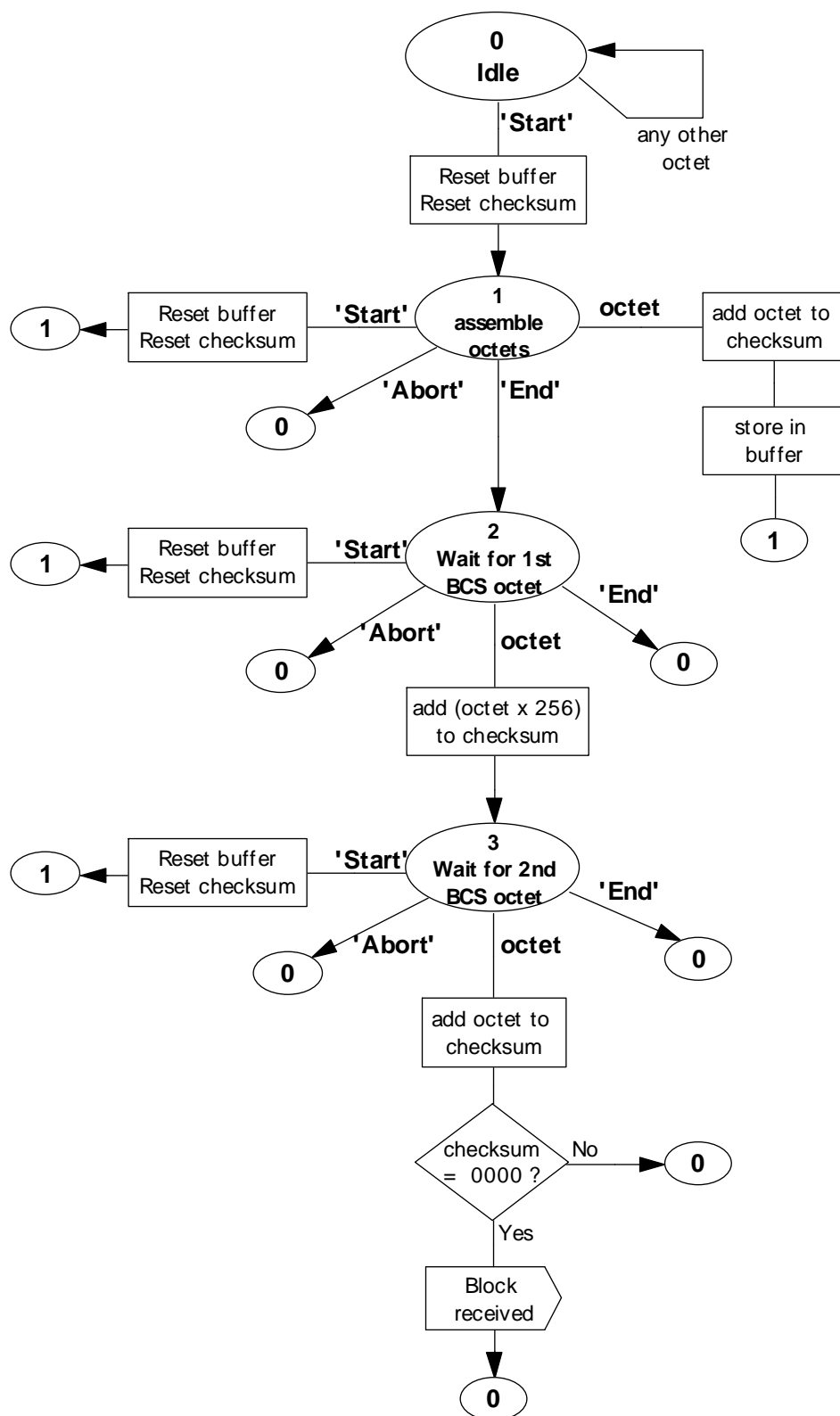

### Example of coding / decoding a message at the DTE/DCE interface

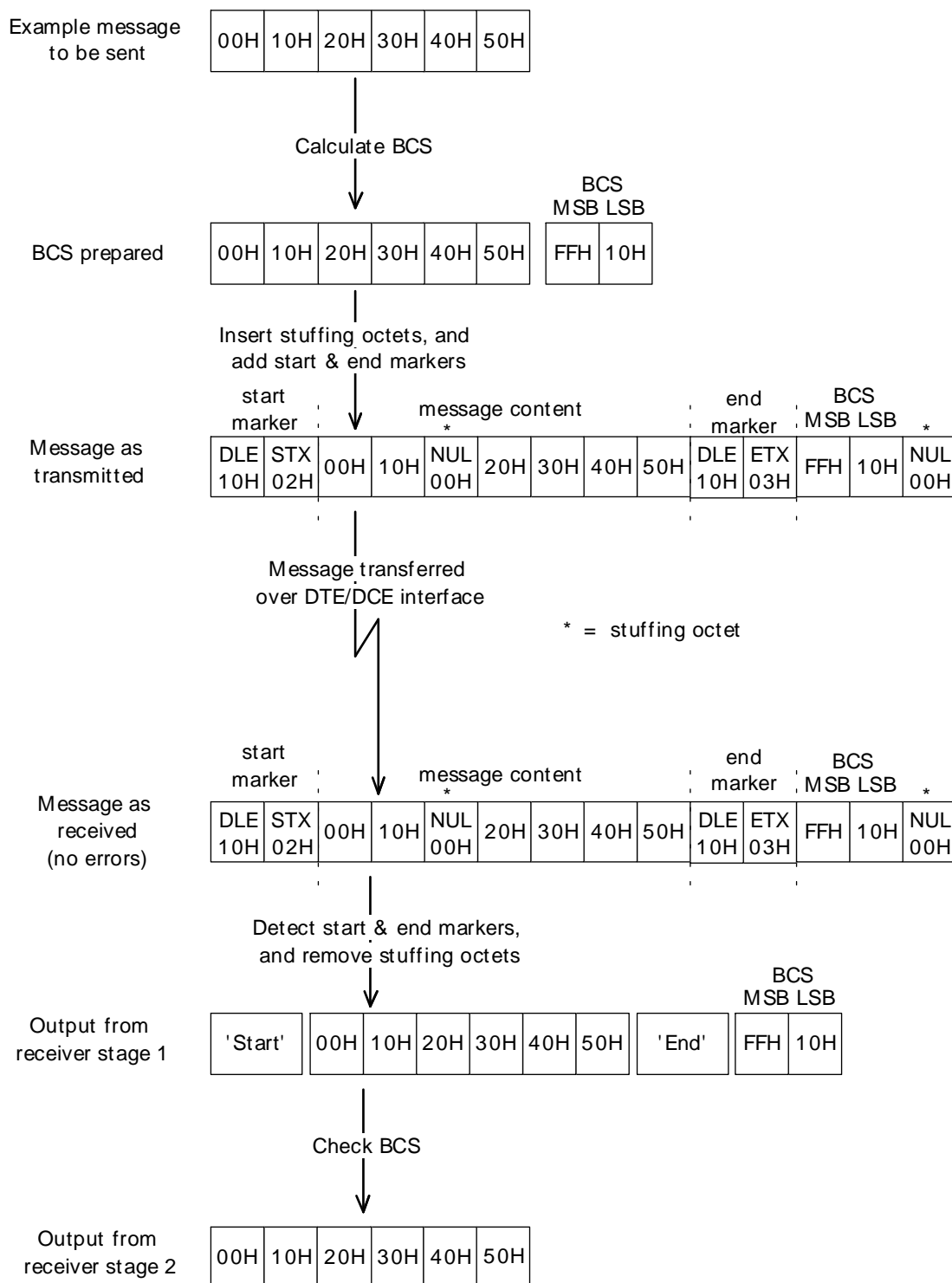

## History

Document history	
September 1994	First Edition
March 1995	Amendment 1 to Edition 1 of ETS 300 585
December 1995	Unified Approval Procedure (Second Edition) UAP 40: 1994-12-04 to 1996-04-12
May 1996	Second Edition