



EUROPEAN
TELECOMMUNICATION
STANDARD

ETS 300 574

January 1998

Sixth Edition

Source: SMG

Reference: RE/SMG-020502PR5

ICS: 33.020

Key words: Digital cellular telecommunications system, Global System for Mobile communications (GSM)



**Digital cellular telecommunications system (Phase 2);
Multiplexing and multiple access on the radio path
(GSM 05.02 version 4.9.1)**

ETSI

European Telecommunications Standards Institute

ETSI Secretariat

Postal address: F-06921 Sophia Antipolis CEDEX - FRANCE

Office address: 650 Route des Lucioles - Sophia Antipolis - Valbonne - FRANCE

X.400: c=fr, a=atlas, p=etsi, s=secretariat - **Internet:** secretariat@etsi.fr

Tel.: +33 4 92 94 42 00 - Fax: +33 4 93 65 47 16

Copyright Notification: No part may be reproduced except as authorized by written permission. The copyright and the foregoing restriction extend to reproduction in all media.

© European Telecommunications Standards Institute 1998. All rights reserved.

Contents

Foreword	5
1 Scope	7
1.1 Normative references	7
1.2 Abbreviations	7
2 General.....	7
3 Logical channels.....	8
3.1 General	8
3.2 Traffic channels	8
3.2.1 General.....	8
3.2.2 Speech traffic channels	8
3.2.3 Data traffic channels.....	8
3.3 Control channels.....	8
3.3.1 General.....	8
3.3.2 Broadcast channels.....	9
3.3.2.1 Frequency correction channel (FCCH).....	9
3.3.2.2 Synchronization channel (SCH).....	9
3.3.2.3 Broadcast control channel (BCCH)	9
3.3.3 Common control type channels, known when combined as a common control channel (CCCH)	10
3.3.4 Dedicated control channels.....	10
3.3.5 Cell Broadcast Channel (CBCH)	10
3.4 Combination of channels	10
4 The physical resource	10
4.1 General	10
4.2 Radio frequency channels	10
4.2.1 Cell allocation and mobile allocation	10
4.2.2 Downlink and uplink	10
4.3 Timeslots and TDMA frames.....	11
4.3.1 General.....	11
4.3.2 Timeslot number	11
4.3.3 TDMA frame number.....	11
5 Physical channels.....	11
5.1 General	11
5.2 Bursts.....	12
5.2.1 General.....	12
5.2.2 Types of burst and burst timing	12
5.2.3 Normal burst (NB)	12
5.2.4 Frequency correction burst (FB).....	13
5.2.5 Synchronization burst (SB).....	13
5.2.6 Dummy burst	13
5.2.7 Access burst (AB).....	14
5.2.8 Guard period	14
5.3 Physical channels and bursts	14
5.4 Radio frequency channel sequence.....	15
5.5 Timeslot and TDMA frame sequence	15
5.6 Parameters for channel definition and assignment	15
5.6.1 General.....	15
5.6.2 General parameters	15
5.6.3 Specific parameters	15
6 Mapping of logical channels onto physical channels.....	16
6.1 General	16

6.2	Mapping in frequency of logical channels onto physical channels	16
6.2.1	General	16
6.2.2	Parameters	16
6.2.3	Hopping sequence generation	16
6.2.4	Specific cases	18
6.2.5	Change in the frequency allocation of a base transceiver station	18
6.3	Mapping in time of logical channels onto physical channels	18
6.3.1	General	18
6.3.2	Key to the mapping table of section 7	18
6.3.3	Mapping of TCH/F9.6, TCH/F4.8, TCH/H4.8 and TCH/H2.4	19
6.3.4	Mapping of BCCH data	19
6.3.5	Mapping of SID Frames	19
6.4	Permitted channel combinations	19
6.5	Operation of channels and channel combinations	20
6.5.1	General	20
6.5.2	Determination of CCCH_GROUP and PAGING_GROUP	21
6.5.3	Determination of specific paging multiframe and paging block index	21
6.5.4	Short Message Service Cell Broadcast (SMSCB)	22
Annex A (normative): Phase 2 mobiles in a phase 1 infrastructure		36
A.1	Scope	36
A.2	Implementation options for TCH channels	36
A.2.1	C0 filling on the TCH	36
A.2.2	Half burst filling	36
A.2.3	Dummy burst Stealing flag	37
A.2.4	Half burst Filling Stealing flag	37
A.2.5	Allowed combinations	37
A.3	Idle Channels	37
History		38

Foreword

This European Telecommunication Standard (ETS) has been produced by the Special Mobile Group (SMG) of the European Telecommunications Standards Institute (ETSI).

This ETS defines the physical channels of the radio sub-system required to support the logical channels used within the Digital cellular telecommunications system (Phase 2).

The specification from which this ETS has been derived was originally based on CEPT documentation, hence the presentation of this ETS may not be entirely in accordance with the ETSI/PNE Rules.

Transposition dates	
Date of adoption of this ETS:	5 December 1997
Date of latest announcement of this ETS (doa):	30 April 1998
Date of latest publication of new National Standard or endorsement of this ETS (dop/e):	31 October 1998
Date of withdrawal of any conflicting National Standard (dow):	31 October 1998

Blank page

1 Scope

This European Telecommunication Standard (ETS) defines the physical channels of the radio sub-system required to support the logical channels. It includes a description of the logical channels and the definition of frequency hopping, TDMA frames, timeslots and bursts.

1.1 Normative references

This ETS incorporates by dated and undated reference, provisions from other publications. These normative references are cited at the appropriate places in the text and the publications are listed hereafter. For dated references, subsequent amendments to or revisions of any of these publications apply to this ETS only when incorporated in it by amendment or revision. For undated references, the latest edition of the publication referred to applies.

- [1] GSM 01.04 (ETR 100): "Digital cellular telecommunications system (Phase 2); Abbreviations and acronyms".
- [2] GSM 03.03 (ETS 300 523): "Digital cellular telecommunications system (Phase 2); Numbering, addressing and identification".
- [3] GSM 04.03 (ETS 300 552): "Digital cellular telecommunications system (Phase 2); Mobile Station - Base Station System (MS - BSS) interface Channel structures and access capabilities".
- [4] GSM 04.06 (ETS 300 555): "Digital cellular telecommunications system (Phase 2); Mobile Station - Base Station System (MS - BSS) interface Data Link (DL) layer specification".
- [5] GSM 04.08 (ETS 300 557): "Digital cellular telecommunications system (Phase 2); Mobile radio interface layer 3 specification".
- [6] GSM 05.03 (ETS 300 575): "Digital cellular telecommunications system (Phase 2); Channel coding".
- [7] GSM 05.04 (ETS 300 576): "Digital cellular telecommunications system (Phase 2); Modulation".
- [8] GSM 05.05 (ETS 300 577): "Digital cellular telecommunications system (Phase 2); Radio transmission and reception".
- [9] GSM 05.08 (ETS 300 578): "Digital cellular telecommunications system (Phase 2); Radio subsystem link control".
- [10] GSM 05.10 (ETS 300 579): "Digital cellular telecommunications system (Phase 2); Radio subsystem synchronization".

1.2 Abbreviations

Definitions and abbreviations used in this ETS are listed in GSM 01.04 [1].

2 General

The radio subsystem is required to support a certain number of logical channels that can be separated into two overall categories as defined in GSM 04.03:

- i) The traffic channels (TCH's).
- ii) The control channels.

More information is given about these logical channels in section 3 which also defines a number of special channels used by the radio sub-system.

Section 4 of this document describes the physical resource available to the radio sub-system, section 5 defines physical channels based on that resource and section 6 specifies how the logical channels shall be mapped onto physical channels. Figure 1 depicts this process.

3 Logical channels

3.1 General

This section describes the logical channels that are supported by the radio subsystem.

3.2 Traffic channels

3.2.1 General

Traffic channels (TCH's) are intended to carry either encoded speech or user data. Two general forms of traffic channel are defined:

- i) Full rate traffic channel (TCH/F). This channel carries information at a gross rate of 22.8 kbits/s.
- ii) Half rate traffic channel (TCH/H). This channel carries information at a gross rate of 11.4 kbit/s.

The specific traffic channels available in the categories of speech and user data are defined in the sections following.

3.2.2 Speech traffic channels

The following traffic channels are defined to carry encoded speech:

- i) Full rate traffic channel for speech (TCH/FS).
- ii) Half rate traffic channel for speech (TCH/HS).

3.2.3 Data traffic channels

The following traffic channels are defined to carry user data:

- i) Full rate traffic channel for 9.6 kbit/s user data (TCH/F9.6).
- ii) Full rate traffic channel for 4.8 kbit/s user data (TCH/F4.8).
- iii) Half rate traffic channel for 4.8 kbit/s user data (TCH/H4.8).
- iv) Half rate traffic channel for ≤ 2.4 kbit/s user data (TCH/H2.4).
- v) Full rate traffic channel for ≤ 2.4 kbit/s user data (TCH/F2.4).

3.3 Control channels

3.3.1 General

Control channels are intended to carry signalling or synchronization data. Three categories of control channel are defined: broadcast, common and dedicated. Specific channels within these categories are defined in the sections following.

3.3.2 Broadcast channels

3.3.2.1 Frequency correction channel (FCCH)

The frequency correction channel carries information for frequency correction of the mobile station. It is required only for the operation of the radio sub-system.

3.3.2.2 Synchronization channel (SCH)

The synchronization channel carries information for frame synchronization of the mobile station and identification of a base transceiver station. It is required only for the operation of the radio sub-system. Specifically the synchronization channel shall contain two encoded parameters:

- a) Base transceiver station identity code (BSIC): 6 bits (before channel coding) consists of 3 bits of PLMN colour code with range 0 to 7 and 3 bits of BS colour code with range 0 to 7 as defined in GSM 03.03.
- b) Reduced TDMA frame number (RFN): 19 bits (before channel coding) =

T1	(11 bits)	range 0 to 2047	= FN div (26 x 51)
T2	(5 bits)	range 0 to 25	= FN mod 26
T3'	(3 bits)	range 0 to 4	= (T3 - 1) div 10

where

T3	(6 bits)	range 0 to 50	= FN mod 51
----	----------	---------------	-------------

and

FN = TDMA frame number as defined in section 4.3.3.

GSM 04.06 and GSM 04.08 specify the precise bit ordering, GSM 05.03 the channel coding of the above parameters and GSM 05.10 defines how the TDMA frame number can be calculated from T1, T2, and T3'.

3.3.2.3 Broadcast control channel (BCCH)

The broadcast control channel broadcasts general information on a base transceiver station per base transceiver station basis. Of the many parameters contained in the BCCH, the use of the following parameters, as defined in GSM 04.08 are referred to in section 6.5:

- a) CCCH_CONF which indicates the organization of the common control channels:

From this parameter, the number of common control channels (BS_CC_CHANS) and whether or not CCCH or SDCCH are combined (BS_CCCH_SDCCH_COMB = true or false) are derived as follows:

CCCH_CONF	BS_CC_CHANS	BS_CCCH_SDCCH_COMB
000	1	false
001	1	true
010	2	false
100	3	false
110	4	false

- b) BS_AG_BLK_RES which indicates the number of blocks on each common control channel reserved for access grant messages:
3 bits (before channel coding) range 0 to 7.

- c) BS_PA_MFRMS which indicates the number of 51 TDMA frame multiframe between transmission of paging messages to mobiles of the same paging group: 3 bits (before channel coding) range 2 to 9.

3.3.3 Common control type channels, known when combined as a common control channel (CCCH)

- i) Paging channel (PCH): Downlink only, used to page mobiles.
- ii) Random access channel (RACH): Uplink only, used to request allocation of a SDCCH.
- iii) Access grant channel (AGCH): Downlink only, used to allocate a SDCCH or directly a TCH.

3.3.4 Dedicated control channels

- i) Slow, TCH/F associated, control channel (SACCH/TF).
- ii) Fast, TCH/F associated, control channel (FACCH/F).
- iii) Slow, TCH/H associated, control channel (SACCH/TH).
- iv) Fast, TCH/H associated, control channel (FACCH/H).
- v) Stand alone dedicated control channel (SDCCH/8).
- vi) Slow, SDCCH/8 associated, control channel (SACCH/C8).
- vii) Stand alone dedicated control channel, combined with CCCH (SDCCH/4).
- viii) Slow, SDCCH/4 associated, control channel (SACCH/C4).

3.3.5 Cell Broadcast Channel (CBCH)

The CBCH, downlink only, is used to carry the short message service cell broadcast (SMSCB). The CBCH uses the same physical channel as the SDCCH.

3.4 Combination of channels

Only certain combinations of channels are allowed as defined in GSM 04.03. Section 6.4 lists the combinations in relation to basic physical channels.

4 The physical resource

4.1 General

The physical resource available to the radio sub-system is an allocation of part of the radio spectrum. This resource is partitioned both in frequency and time. Frequency is partitioned by radio frequency channels (RFCHs) divided into bands as defined in GSM 05.05. Time is partitioned by timeslots and TDMA frames as defined in section 4.3 of this ETS.

4.2 Radio frequency channels

4.2.1 Cell allocation and mobile allocation

GSM 05.05 defines radio frequency channels (RFCHs), and allocates numbers to all the radio frequency channels available to the system. Each cell is allocated a subset of these channels, defined as the cell allocation (CA). One radio frequency channel of the cell allocation shall be used to carry synchronization information and the BCCH, this shall be known as BCCH carrier. The subset of the cell allocation, allocated to a particular mobile, shall be known as the mobile allocation (MA).

4.2.2 Downlink and uplink

The downlink comprises radio frequency channels used in the base transceiver station to mobile station direction.

The uplink comprises radio frequency channels used in the mobile station to base transceiver station direction.

4.3 Timeslots and TDMA frames

4.3.1 General

A timeslot shall have a duration of $\frac{3}{5} 200$ seconds ($\approx 577 \mu\text{s}$). Eight timeslots shall form a TDMA frame ($\approx 4,62$ ms in duration).

At the base transceiver station the TDMA frames on all of the radio frequency channels in the downlink shall be aligned. The same shall apply to the uplink (see GSM 05.10).

At the base transceiver station the start of a TDMA frame on the uplink is delayed by the fixed period of 3 timeslots from the start of the TDMA frame on the downlink (see figure 2).

At the mobile station this delay will be variable to allow adjustment for signal propagation delay. The process of adjusting this advance is known as adaptive frame alignment and is detailed in GSM 05.10.

The staggering of TDMA frames used in the downlink and uplink is in order to allow the same timeslot number to be used in the downlink and uplink whilst avoiding the requirement for the mobile station to transmit and receive simultaneously. The period includes time for adaptive frame alignment, transceiver tuning and receive/transmit switching (see figure 4).

4.3.2 Timeslot number

The timeslots within a TDMA frame shall be numbered from 0 to 7 and a particular timeslot shall be referred to by its timeslot number (TN).

4.3.3 TDMA frame number

TDMA frames shall be numbered by a frame number (FN). The frame number shall be cyclic and shall have a range of 0 to FN_MAX where $\text{FN_MAX} = (26 \times 51 \times 2048) - 1 = 2715647$ as defined in GSM 05.10. The frame number shall be incremented at the end of each TDMA frame.

The complete cycle of TDMA frame numbers from 0 to FN_MAX is defined as a hyperframe. A hyperframe consists of 2048 superframes where a superframe is defined as 26×51 TDMA frames. A 26 TDMA frame multiframe is used to support traffic and associated control channels and a 51 TDMA frame multiframe is used to support broadcast, common control and stand alone dedicated control (and their associated control) channels. Hence a superframe may be considered as 51 traffic/associated control multiframes or 26 broadcast/common control multiframes.

The need for a hyperframe of a substantially longer period than a superframe arises from the requirements of the encryption process which uses FN as an input parameter.

5 Physical channels

5.1 General

A physical channel uses a combination of frequency and time division multiplexing and is defined as a sequence of radio frequency channels and time slots. The complete definition of a particular physical channel consists of a description in the frequency domain, and a description in the time domain.

The description in the frequency domain is addressed in section 5.4, the description in the time domain is addressed in section 5.5.

5.2 Bursts

5.2.1 General

A burst is a period of R.F. carrier which is modulated by a data stream. A burst therefore represents the physical content of a timeslot.

5.2.2 Types of burst and burst timing

A timeslot is divided into 156.25 bit periods. A particular bit period within a timeslot is referenced by a bit number (BN), with the first bit period being numbered 0, and the last (1/4) bit period being numbered 156. In the sections following the transmission timing of a burst within a timeslot is defined in terms of bit number. The bit with the lowest bit number is transmitted first.

Different types of burst exist in the system. One characteristic of a burst is its useful duration. This document, in the sections following, defines four full bursts of 147 bits useful duration, and one short burst of 87 bits useful duration. The useful part of a burst is defined as beginning from half way through bit number 0. The definition of the useful part of a burst needs to be considered in conjunction with the requirements placed on the phase and amplitude characteristics of a burst as specified in GSM 05.04 and 05.05.

The period between bursts appearing in successive timeslots is termed the guard period. Section 5.2.8 details constraints which relate to the guard period.

5.2.3 Normal burst (NB)

Bit Number (BN)	Length of field	Contents of field	Definition
0 - 2	3	tail bits	(below)
3 - 60	58	encrypted bits (e0 .. e57)	05.03
61 - 86	26	training sequence bits	(below)
87 - 144	58	encrypted bits (e58 .. e115)	05.03
145 - 147	3	tail bits	(below)
(148 - 156)	8,25	guard period (bits)	section 5.2.8)

- where the "tail bits" are defined as modulating bits with states as follows:

(BN0, BN1, BN2) = (0, 0, 0) and
 (BN145, BN146, BN147) = (0, 0, 0)

- where the "training sequence bits" are defined as modulating bits with states as given in the following table according to the training sequence code, TSC. For broadcast and common control channels, the TSC must be equal to the BCC, as defined in GSM 03.03 and as described in this technical specification in section 3.3.2.

Training Sequence Code (TSC)	Training sequence bits (BN61, BN62 ... BN86)
0	(0,0,1,0,0,1,0,1,1,1,0,0,0,0,1,0,0,0,1,0,0,1,0,0,1,0,1,1,1)
1	(0,0,1,0,1,1,0,1,1,1,0,1,1,1,1,0,0,0,1,0,1,1,0,1,1,1,1)
2	(0,1,0,0,0,0,1,1,1,0,1,1,1,0,1,0,0,1,0,0,0,0,1,1,1,0)
3	(0,1,0,0,0,1,1,1,1,0,1,1,0,1,0,0,0,1,0,0,0,1,1,1,1,0)
4	(0,0,0,1,1,0,1,0,1,1,1,0,0,1,0,0,0,0,0,1,1,0,1,0,1,1)
5	(0,1,0,0,1,1,1,0,1,0,1,1,0,0,0,0,0,1,0,0,1,1,1,0,1,0)
6	(1,0,1,0,0,1,1,1,1,0,1,1,0,0,0,1,0,1,0,0,1,1,1,1,1,1)
7	(1,1,1,0,1,1,1,1,0,0,0,1,0,0,1,0,1,1,1,0,1,1,1,1,0,0)

Under certain circumstances only half the encrypted bits present in a normal burst will contain complete information. For downlink DTX operation on TCH-FS and TCH-HS, when a traffic frame (as defined in GSM 06.31) is scheduled for transmission and one of its adjacent traffic frames is not scheduled for

transmission, the other half of the encrypted bits in the normal bursts associated with the scheduled traffic frame shall contain partial SID information from any associated SID frame, with the appropriate stealing flags BN60 or BN87 set to 0. In other cases the binary state of the remaining bits is not specified.

5.2.4 Frequency correction burst (FB)

Bit Number (BN)	length of field	Contents of field	Definition
0 - 2	3	tail bits	(below)
3 - 144	142	fixed bits	(below)
145 - 147	3	tail bits	(below)
(148 - 156)	8,25	guard period (bits)	section 5.2.8)

- where the "tail bits" are defined as modulating bits with states as follows:

$$(BN0, BN1, BN2) = (0, 0, 0) \quad \text{and} \\ (BN145, BN146, BN147) = (0, 0, 0)$$

- where the "fixed bits" are defined as modulating bits with states as follows:

$$(BN3, BN4 \dots BN144) = (0, 0 \dots 0)$$

NOTE: This burst is equivalent to unmodulated carrier with a +1 625/24 kHz frequency offset, above the nominal carrier frequency.

5.2.5 Synchronization burst (SB)

Bit Number (BN)	Length of field	Contents of field	Definition
0 - 2	3	tail bits	(below)
3 - 41	39	encrypted bits (e0 .. e38)	05.03
42 - 105	64	extended training sequence bits	(below)
106 - 144	39	encrypted bits (e39 ... e77)	05.03
145 - 147	3	tail bits	(below)
(148 - 156)	8,25	guard period (bits)	section 5.2.8)

- where the "tail bits" are defined as modulating bits with states as follows:

$$(BN0, BN1, BN2) = (0, 0, 0) \quad \text{and} \\ (BN145, BN146, BN147) = (0, 0, 0)$$

- where the "extended training sequence bits" are defined as modulating bits with states as follows:

$$(BN42, BN43 \dots BN105) = (1, 0, 1, 1, 1, 0, 0, 1, 0, 1, 1, 0, 0, 0, 1, 0, 0, 0, 0, 0, 0, 1, 0, \\ 0, 0, 0, 0, 0, 1, 1, 1, 1, 0, 0, 1, 0, 1, 1, 0, 1, 0, 1, 0, 0, 0, \\ 1, 0, 1, 0, 1, 1, 1, 0, 1, 1, 0, 0, 0, 0, 1, 1, 0, 1, 1)$$

5.2.6 Dummy burst

Bit Number (BN)	Length of field	Contents of field	Definition
0 - 2	3	tail bits	(below)
3 - 144	142	mixed bits	(below)
145 - 147	3	tail bits	(below)
(148 - 156)	8,25	guard period (bits)	section 5.2.8)

- where the "tail bits" are defined as modulating bits with states as follows:

$$(BN0, BN1, BN2) = (0, 0, 0) \quad \text{and} \\ (BN145, BN146, BN147) = (0, 0, 0)$$

- where the "mixed bits" are defined as modulating bits with states as follows:

$$\begin{aligned}
 (\text{BN3, BN4 ... BN144}) &= (1, 1, 1, 1, 1, 0, 1, 1, 0, 1, 1, 1, 0, 1, 1, 0, 0, 0, 0, 0, 1, 0, 1, \\
 &\quad 0, 0, 1, 0, 0, 1, 1, 1, 0, 0, 0, 0, 0, 1, 0, 0, 1, 0, 0, 0, 1, 0, \\
 &\quad 0, 0, 0, 0, 0, 0, 1, 1, 1, 1, 1, 0, 0, 0, 1, 1, 1, 0, 0, 0, 1, 0, 1, 1, 1, 0, \\
 &\quad 0, 0, 1, 0, 1, 1, 1, 0, 0, 0, 1, 0, 1, 0, 1, 1, 1, 0, 1, 0, 0, 1, 0, 1, 0, 0, \\
 &\quad 0, 1, 1, 0, 0, 1, 1, 0, 0, 1, 1, 1, 0, 0, 1, 1, 1, 1, 0, 0, 1, 1, 1, 1, \\
 &\quad 1, 0, 0, 0, 1, 0, 0, 1, 0, 1, 1, 1, 1, 1, 0, 1, 0, 1, 0)
 \end{aligned}$$

5.2.7 Access burst (AB)

Bit Number (BN)	Length of field	Contents of field	Definition
0 - 7	8	extended tail bits	(below)
8 - 48	41	synch. sequence bits	(below)
49 - 84	36	encrypted bits (e0...e35)	05.03
85 - 87	3	tail bits	(below)
(88 - 156)	68,25	extended guard period (bits)	section 5.2.8)

- where the "extended tail bits" are defined as modulating bits with the following states:

$$(\text{BN0, BN1, BN2 ... BN7}) = (0, 0, 1, 1, 1, 0, 1, 0)$$

- where the "tail bits" are defined as modulating bits with the following states:

$$(\text{BN85, BN86, BN87}) = (0, 0, 0)$$

- where the "sync. sequence bits" are defined as modulating bits with the following states:

$$\begin{aligned}
 (\text{BN8, BN9 ... BN48}) &= (0, 1, 0, 0, 1, 0, 1, 1, 0, 1, 1, 1, 1, 1, 1, 1, 1, 1, 0, 0, 1, 1, 0, 0, \\
 &\quad 1, 1, 0, 1, 0, 1, 0, 1, 0, 0, 0, 1, 1, 1, 1, 0, 0, 0)
 \end{aligned}$$

5.2.8 Guard period

The guard period is provided because it is required for the MSs that transmission be attenuated for the period between bursts with the necessary ramp up and down occurring during the guard periods as defined in GSM 05.05. A base transceiver station is not required to have a capability to ramp down and up between adjacent bursts, but is required to have a capability to ramp down and up for non-used time-slots, as defined in GSM 05.05. In any case where the amplitude of transmission is ramped up and down, then by applying an appropriate modulation bit stream interference to other RF channels can be minimized.

5.3 Physical channels and bursts

The description of a physical channel will be made in terms of timeslots and TDMA frames and not in terms of bursts. This is because there is not a one to one mapping between a particular physical channel, and the use of a particular burst.

5.4 Radio frequency channel sequence

The radio frequency channel sequence is determined by a function that, in a given cell, with a given set of general parameters, (see section 5.6.2), with a given timeslot number (TN), a given mobile radio frequency channel allocation (MA) and a given mobile allocation index offset (MAIO), maps the TDMA frame number (FN) to a radio frequency channel.

In a given cell there is therefore, for a physical channel assigned to a particular mobile, a unique correspondence between radio frequency channel and TDMA frame number.

The detailed hopping generation algorithm is given in section 6.2.

5.5 Timeslot and TDMA frame sequence

A given physical channel shall always use the same timeslot number in every TDMA frame. Therefore a timeslot sequence is defined by:

- i) a timeslot number (TN); and
- ii) a TDMA frame number sequence.

The detailed definitions of TDMA frame number sequences are given in section 7.

The physical channels where the TDMA frame number sequence is 0,1, .. FN_MAX (where FN_MAX is defined in section 4.3.3) are called "basic physical channels".

5.6 Parameters for channel definition and assignment

5.6.1 General

This section describes the set of parameters necessary to describe fully the mapping of any logical channel onto a physical channel. These parameters may be divided into general parameters, that are characteristic of a particular base transceiver station, and specific parameters, that are characteristic of a given physical channel.

5.6.2 General parameters

These are:

- i) the set of radio frequency channels used in the cell (CA), together with the identification of the BCCH carrier.
- ii) the TDMA frame number (FN), which can be derived from the reduced TDMA frame number (RFN) which is in the form T1,T2,T3', see section 3.3.2.

These parameters are broadcast (or derived from parameters broadcast) in the BCCH and SCH.

5.6.3 Specific parameters

These parameters define a particular physical channel in a base transceiver station. They are:

- o) the training sequence Code (TSC);
- i) the timeslot number (TN);
- ii) the mobile radio frequency channel allocation (MA);
- iii) the mobile allocation index offset (MAIO);
- iv) the hopping sequence number (HSN);
- v) the type of logical channel;
- vi) the sub-channel number (SCN).

The last two parameters allow the determination of the frame sequence.

6 Mapping of logical channels onto physical channels

6.1 General

The detailed mapping of logical channels onto physical channels is defined in the following sections. Section 6.2 defines the mapping from TDMA frame number (FN) to radio frequency channel (RFCH). Section 6.3 defines the mapping of the physical channel onto TDMA frame number. Section 6.4 lists the permitted channel combinations and section 6.5 defines the operation of channels and channel combinations.

6.2 Mapping in frequency of logical channels onto physical channels

6.2.1 General

The parameters used in the function which maps TDMA frame number onto radio frequency channel are defined in section 6.2.2. The definition of the actual mapping function, or as it is termed, hopping sequence generation is given in 6.2.3.

6.2.2 Parameters

The following parameters are required in the mapping from TDMA frame number to radio frequency channel for a given assigned channel.

General parameters of the BTS, specific to one BTS, and broadcast in the BCCH and SCH:

- i) CA: Cell allocation of radio frequency channels.
- ii) FN: TDMA frame number, broadcast in the SCH, in form T1,T2,T3' (see section 3.3.2).

Specific parameters of the channel, defined in the channel assignment message:

- i) MA: Mobile allocation of radio frequency channels, defines the set of radio frequency channels to be used in the mobiles hopping sequence. The MA contains N radio frequency channels, where $1 \leq N \leq 64$.
- ii) MAIO: Mobile allocation index offset.(0 to N-1, 6 bits).
- iii) HSN: Hopping sequence (generator) number (0 to 63, 6 bits).

6.2.3 Hopping sequence generation

For a given set of parameters, the index to absolute radio frequency channel number (ARFCN) within the mobile allocation (MAI from 0 to N-1, where MAI=0 represents the lowest absolute radio frequency channel number (ARFCN) in the mobile allocation ARFCN is in the range 0 to 7 023 and the frequency value can be determined according to GSM 05.05 sec 2 with $n = \text{ARFCN}$), is obtained with the following algorithm:

if HSN = 0 (cyclic hopping) then:

MAI, integer (0 ... N-1) : MAI = (FN + MAIO) modulo N

else:

M, integer (0 ... 152) : M = T2 + RNTABLE((HSN xor T1R) + T3)

S, integer (0 ... N-1) : M' = M modulo (2 ^ NBIN)
T' = T3 modulo (2 ^ NBIN)

if M' < N then:

S = M'

else:

S = (M'+T') modulo N

MAI, integer (0 ... N-1) : MAI = (S + MAIO) modulo N

NOTE: Due to the procedure used by the mobile for measurement reporting when DTX is used, the use of cyclic hopping where (N)mod 13 = 0 should be avoided.

where:

T1R: time parameter T1, reduced modulo 64 (6 bits)

T3: time parameter, from 0 to 50 (6 bits)

T2: time parameter, from 0 to 25 (5 bits)

NBIN: number of bits required to represent N = INTEGER(log₂(N)+1)

^: raised to the power of

xor: bit-wise exclusive or of 8 bit binary operands

RNTABLE: Table of 114 integer numbers, defined below:

Address	Contents									
000...009:	48,	98,	63,	1,	36,	95,	78,	102,	94,	73,
010...019:	0,	64,	25,	81,	76,	59,	124,	23,	104,	100,
020...029:	101,	47,	118,	85,	18,	56,	96,	86,	54,	2,
030...039:	80,	34,	127,	13,	6,	89,	57,	103,	12,	74,
040...049:	55,	111,	75,	38,	109,	71,	112,	29,	11,	88,
050...059:	87,	19,	3,	68,	110,	26,	33,	31,	8,	45,
060...069:	82,	58,	40,	107,	32,	5,	106,	92,	62,	67,
070...079:	77,	108,	122,	37,	60,	66,	121,	42,	51,	126,
080...089:	117,	114,	4,	90,	43,	52,	53,	113,	120,	72,
090...099:	16,	49,	7,	79,	119,	61,	22,	84,	9,	97,
100...109:	91,	15,	21,	24,	46,	39,	93,	105,	65,	70,
110...113:	125,	99,	17,	123,						

The hopping sequence generation algorithm is represented diagrammatically in figure 6.

6.2.4 Specific cases

On the RFCH carrying a BCCH (C0), frequency hopping is not permitted on any timeslot supporting a BCCH according to table 3 of section 7. A non-hopping radio frequency channel sequence is characterized by a mobile allocation consisting of only one radio frequency channel, i.e. with $N=1$, $MAIO=0$. In this instance sequence generation is unaffected by the value of the value HSN.

6.2.5 Change in the frequency allocation of a base transceiver station

The consequence of adding or removing a number of radio frequency channels in a base transceiver station is a modification of the cell allocation (CA) and the mobile allocation (MA). In order to achieve this without disruption to mobile stations with currently assigned channels it is necessary to send a message to all mobiles with assigned channels. The message, as defined in 04.08, will contain a new cell allocation (if necessary), mobile allocation and a time (in the form of a TDMA frame number) at which the change is to occur. A new cell allocation may not be necessary if channels are only being removed, and not added.

6.3 Mapping in time of logical channels onto physical channels

6.3.1 General

The mapping in time of logical channels is defined in the tables of section 7, which also defines the relationship of the air interface frames to the multiframe.

6.3.2 Key to the mapping table of section 7

The following relates to the tables of section 7. The columns headed:

- i) "Channel designation" gives the precise acronym for the channel to which the mapping applies.
- ii) "Sub-channel number" identifies the particular sub-channel being defined where a basic physical channel supports more than one channel of this type.
- iii) "Direction" defines whether the mapping given applies identically to downlink and uplink (D&U), or to downlink (D) or uplink (U) only.
- iv) "Allowable timeslots assignments" defines whether the channel can be supported on, or assigned to, any of the timeslots, or only on specific timeslots.
- v) "Allowable RF channel assignments" defines whether the channel can use any or all of the radio frequency channels in the cell allocation (CA), or only the BCCH carrier (C0). It should be noted that any allocated channel C_x within CA could be any radio frequency channel, and that no ordering of radio frequency channel number is implied. For example, allocated channel C0 need not have the lowest radio frequency channel number of the allocation.
- vi) "Burst type" defines which type of burst as defined in section 5.2 is to be used for the physical channel.
- vii) "Repeat length in TDMA frames" defines how many TDMA frames occur before the mapping for the interleaved blocks repeats itself e.g. 51.
- viii) "Interleaved block TDMA frame mapping" defines, within the parentheses, the TDMA frames used by each interleaved block (e.g. 0...3). The numbers given equate to the TDMA frame number (FN) modulo the number of TDMA frames per repeat length; Therefore, the frame is utilized when:

$$\text{TDMA frame mapping number} = (\text{FN}) \bmod \text{repeat length given}$$

Where there is more than one block shown, each block is given a separate designation e.g. B0, B1. Where diagonal interleaving is employed then all of the TDMA frames included in the block are given, and hence the same TDMA frame number can appear more than once (see GSM 05.03). It should be noted that the frame mapping for the SACCH/T channel differs according to the timeslot allocated in order to lower the peak processing requirements of the BSS.

6.3.3 Mapping of TCH/F9.6, TCH/F4.8, TCH/H4.8 and TCH/H2.4

This paragraph has been deleted.

6.3.4 Mapping of BCCH data

In order to facilitate the MS operation, it is necessary to transmit some System Information messages in defined multiframes and defined blocks within one multiframe, as follows (where $TC = (FN \text{ DIV } 51) \text{ mod } (8)$):

System Information Message	Sent when TC =	Allocation
Type 1	0	BCCH Norm
Type 2	1	BCCH Norm
Type 2 bis	5	BCCH Norm
Type 2 ter	5 or 4	BCCH Norm
Type 3	2 and 6	BCCH Norm
Type 4	3 and 7	BCCH Norm
Type 7	7	BCCH Ext
Type 8	3	BCCH Ext

This subclause defines requirements on minimum scheduling: the network may send any System Information message when sending of a specific System Information message is not required. The following rules apply:

- i) BCCH Ext may share the resource with PCH and AGCH (see section 6.5.1).
- ii) System Information Type 1 need only be sent if frequency hopping is in use. If the MS finds another message when $TC = 0$, it can assume that System Information Type 1 is not in use.
- iii) System Information Type 2 bis or 2 ter messages are sent if needed. If only one of them is needed, it is sent when $TC=5$. If both are needed, 2bis is sent when $TC=5$ and 2ter at least in every 4th occurrence of $TC=4$. A System Information 2 message shall be sent at least every time $TC=1$.
- iv) The definitions of BCCH Norm and BCCH Ext are given in section 7, table 3 of 5.
- v) Use of System Information type 7 and 8 is not always necessary. It is necessary if System Information type 4 does not contain all information needed for cell selection.

All the allowable timeslot assignments in a frame (see table 3 of 5 in section 7) shall contain the same information.

6.3.5 Mapping of SID Frames

When the DTX mode of operation is active, it is required to transmit Silence Descriptor (SID) information, or equivalent dummy information, during the SACCH/T block period (104 TDMA frames). As the SID frames do not constitute a logical channel and their use is specific to DTX operation, the mapping of SID frames onto the TDMA frames is specified in GSM 05.08.

6.4 Permitted channel combinations

The following are the permitted ways, as defined by GSM 04.03, in which channels can be combined onto basic physical channels (numbers appearing in parenthesis after channel designations indicate sub-channel numbers; channels and sub-channels need not necessarily be assigned):

- i) TCH/F + FACCH/F + SACCH/TF
- ii) TCH/H(0,1) + FACCH/H(0,1) + SACCH/TH(0,1)
- iii) TCH/H(0,0) + FACCH/H(0,1) + SACCH/TH(0,1) + TCH/H(1,1)
- iv) FCCH + SCH + BCCH + CCCH
- v) FCCH + SCH + BCCH + CCCH + SDCCH/4(0...3) + SACCH/C4(0...3)
- vi) BCCH + CCCH
- vii) SDCCH/8(0 ..7) + SACCH/C8(0 .. 7)
where CCCH = PCH + RACH + AGCH

NOTE 1: Where the SMSCB is supported, the CBCH replaces SDCCH number 2 in cases v) and vii) above.

NOTE 2: A combined CCCH/SDCCH allocation (case v) above) may only be used when no other CCCH channel is allocated.

6.5 Operation of channels and channel combinations

6.5.1 General

- i) A base transceiver station must transmit a burst in every timeslot of every TDMA frame in the downlink of radio frequency channel C0 of the cell allocation (to allow mobiles to make power measurements of the radio frequency channels supporting the BCCH, see GSM 05.08). In order to achieve this requirement a dummy burst is defined in section 5.2.6 which shall be transmitted by the base transceiver station on all timeslots of all TDMA frames of radio frequency channel C0 for which no other channel requires a burst to be transmitted.
- ii) Timeslot number 0 of radio frequency channel C0 of the cell allocation must support either channel combinations iv) or v) in section 6.4. No other timeslot or allocated channel from the cell allocation is allowed to support channel combinations iv) or v) in section 6.4.
- iii) The parameter BS_CC_CHANS in the BCCH defines the number of basic physical channels supporting common control channels (CCCHs). All shall use timeslots on radio frequency channel C0 of the cell allocation. The first CCCH shall use timeslot number 0, the second timeslot number 2, the third timeslot number 4 and the fourth timeslot number 6. Each CCCH carries its own CCCH_GROUP of mobiles in idle mode. Mobiles in a specific CCCH_GROUP will listen for paging messages and make random accesses only on the specific CCCH to which the CCCH_GROUP belongs. The method by which a mobile determines the CCCH_GROUP to which it belongs is defined in section 6.5.2.
- iv) The parameter BS_CCCH_SDCCH_COMB in the BCCH (see section 3.3.2) defines whether the common control channels defined are combined with SDCCH/4(0..3) + SACCH/C4(0..3) onto the same basic physical channel. If they are combined then the number of available random access channel blocks (access grant channel blocks and paging channel blocks; see following), are reduced as defined in table 5 of section 7.
- v) The PCH, AGCH and BCCH Ext may share the same TDMA frame mapping (considered modulo 51) when combined onto a basic physical channel. The channels are shared on a block by block basis, and information within each block, when de-interleaved and decoded allows a mobile to determine whether the block contains paging messages, system information messages or access grants. However, to ensure a mobile satisfactory access to the system a variable number of the available blocks in each 51 multiframe can be reserved for access grants and system information messages, only. The number of blocks not used for paging (BS_AG_BLK_RES) starting from, and including block number 0 is broadcast in the BCCH (see section 3.3.2). As above the number of paging blocks per 51 TDMA frame multiframe considered to be "available" shall be reduced by the number of blocks reserved for access grant messages.

If system information messages are sent on BCCH Ext, BS_AG_BLK_RES shall be set to a value greater than zero.

Table 5 of section 7 defines the access grant blocks and paging blocks available per 51 TDMA frame multiframe.

- vi) Another parameter in the BCCH, BS_PA_MFRMS indicates the number of 51 TDMA frame multiframe between transmissions of paging messages to mobiles of the same paging group. The "available" paging blocks per CCCH are then those "available" per 51 TDMA frame multiframe on that CCCH (determined by the two above parameters) multiplied by BS_PA_MFRMS. Mobiles are normally only required to monitor every Nth block of their paging channel, where N equals the number of "available" blocks in total (determined by the above BCCH parameters) on the paging channel of the specific CCCH which their CCCH_GROUP is required to monitor. Other paging modes (e.g. page reorganize or paging overload conditions described in GSM 04.08) may require the mobile to monitor paging blocks more frequently than this. All the mobiles listening to a particular paging block are defined as being in the same PAGING_GROUP. The method by which a particular mobile determines to which particular PAGING_GROUP it belongs and hence which particular block of the available blocks on the paging channel is to be monitored is defined in section 6.5.2.

6.5.2 Determination of CCCH_GROUP and PAGING_GROUP

$$\text{CCCH_GROUP } (0 \dots \text{BS_CC_CHANS}-1) = ((\text{IMSI mod } 1000) \text{ mod } (\text{BS_CC_CHANS} \times N)) \text{ div } N$$

$$\text{PAGING_GROUP } (0 \dots N-1) = ((\text{IMSI mod } 1000) \text{ mod } (\text{BS_CC_CHANS} \times N)) \text{ mod } N$$

where

N = number of paging blocks "available" on one CCCH = (number of paging blocks "available" in a 51 frame TDMA multiframe on one CCCH) x BS_PA_MFRMS.

IMSI = International Mobile Subscriber Identity, as defined in GSM 03.03.

mod = Modulo

div = Integer division

6.5.3 Determination of specific paging multiframe and paging block index

The required 51 TDMA frame multiframe occurs when:

$$\text{PAGING_GROUP div } (N \text{ div } \text{BS_PA_MFRMS}) = (\text{FN div } 51) \text{ mod } (\text{BS_PA_MFRMS})$$

The index to the required paging block of the "available" blocks in the 51 TDMA frame multiframe:

$$\text{Paging block index} = \text{PAGING_GROUP mod } (N \text{ div } \text{BS_PA_MFRMS})$$

where the index is then used with the look-up table 5 of section 7 to determine the actual paging channel interleaved block to be monitored.

6.5.4 Short Message Service Cell Broadcast (SMSCB)

When a short message service cell broadcast (SMSCB) message is to be sent, the message shall be sent on the cell broadcast channel (CBCH) in four consecutive multiframes using the block defined in table 3 of Section 7. The multiframes used shall be those in which $TB=0,1,2$ and 3 (multiframes with $TB = 4, 5, 6$ or 7 shall not contain any SMSCB message) where:

$$TB = (FN \text{ DIV } 51) \bmod(8)$$

The SMSCB header shall be sent in the multiframe in which $TB=0$. When SMSCB is in use, this is indicated within the BCCH data (see GSM 04.08), and the parameter `BS_AG_BLKS_RES` shall be set to one or greater. When the CBCH is mapped onto a `CCCH+SDCCH/4` channel, use of SMSCB does not place any constraint on the value of `BS_AG_BLKS_RES`.

Section 7 Table 1 of 5: Mapping of logical channels onto physical channels (see sections 6.3, 6.4, 6.5)

Channel designation	Sub-channel number	Direction	Allowable timeslot assignments	Allowable RF channel assignments	Burst type	Repeat length in TDMA frames	Interleaved block TDMA frame mapping
TCH/FS TCH/F2.4		D&U	0 ... 7	C0 ... Cn	NB ¹	13	B0(0...7),B1(4...11),B2(8...11,0...3)
TCH/HS	0 1	D&U	0 ... 7	C0 ... Cn	NB ¹	13	B0(0,2,4,6),B1(4,6,8,10),B2(8,10,0,2) B0(1,3,5,7),B1(5,7,9,11),B2(9,11,1,3)
FACCH/F		D&U	0 ... 7	C0 ... Cn	NB ¹	13	B0(0...7),B1(4...11),B2(8...11,0...3)
FACCH/H	0	U	0 ... 7	C0 ... Cn	NB ¹	26	B0(0,2,4,6,8,10),B1(8,10,13, 15,17,19),B2(17,19,21,23,0,2)
FACCH/H	0	D	0 ... 7	C0 ... Cn	NB ¹	26	B0(4,6,8,10,13,15),B1(13,15,17, 19,21,23),B2(21,23,0,2,4,6)
FACCH/H	1	U	0 ... 7	C0 ... Cn	NB ¹	26	B0(1,3,5,7,9,11),B1(9,11,14, 16,18,20),B2(18,20,22,24,1,3)
FACCH/H	1	D	0 ... 7	C0 ... Cn	NB ¹	26	B0(5,7,9,11,14,16),B1(14,16,18, 20,22,24),B2(22,24,1,3,5,7)
SACCH/TF		D&U	0	C0 ... Cn	NB ¹	104	B(12, 38, 64, 90)
SACCH/TF		D&U	1	C0 ... Cn	NB ¹	104	B(25, 51, 77, 103)
SACCH/TF		D&U	2	C0 ... Cn	NB ¹	104	B(38, 64, 90, 12)
SACCH/TF		D&U	3	C0 ... Cn	NB ¹	104	B(51, 77, 103, 25)
SACCH/TF		D&U	4	C0 ... Cn	NB ¹	104	B(64, 90, 12, 38)
SACCH/TF		D&U	5	C0 ... Cn	NB ¹	104	B(77, 103, 25, 51)
SACCH/TF		D&U	6	C0 ... Cn	NB ¹	104	B(90, 12, 38, 64)
SACCH/TF		D&U	7	C0 ... Cn	NB ¹	104	B(103, 25, 51, 77)
SACCH/TH	0 1	D&U	0	C0 ... Cn	NB ¹	104	B(12, 38, 64, 90) B(25, 51, 77, 103)
SACCH/TH	0 1	D&U	1	C0 ... Cn	NB ¹	104	B(12, 38, 64, 90) B(25, 51, 77, 103)
SACCH/TH	0 1	D&U	2	C0 ... Cn	NB ¹	104	B(38, 64, 90, 12) B(51, 77, 103, 25)
SACCH/TH	0 1	D&U	3	C0 ... Cn	NB ¹	104	B(38, 64, 90, 12) B(51, 77, 103, 25)
SACCH/TH	0 1	D&U	4	C0 ... Cn	NB ¹	104	B(64, 90, 12, 38) B(77, 103, 25, 51)
SACCH/TH	0 1	D&U	5	C0 ... Cn	NB ¹	104	B(64, 90, 12, 38) B(77, 103, 25, 51)
SACCH/TH	0 1	D&U	6	C0 ... Cn	NB ¹	104	B(90, 12, 38, 64) B(103, 25, 51, 77)
SACCH/TH	0 1	D&U	7	C0 ... Cn	NB ¹	104	B(90, 12, 38, 64) B(103, 25, 51, 77)

NOTE 1: An Access Burst (AB) is used on the uplink during handover.

Section 7 Table 2 of 5: Mapping of logical channels onto physical channels (see sections 6.3, 6.4, 6.5)

Channel designation	Sub-channel number	Direction	Allowable timeslot assignments	Allowable RF channel assignments	Burst type	Repeat length in TDMA frames	Interleaved block TDMA frame mapping
TCH/F4.8 TCH/F9.6		D&U	0 ... 7	C0 ... Cn	NB ¹	26	B0(0 ... 11, 13 ... 22) B1(4 ... 11, 13 ... 24, 0, 1) B2(8 ... 11, 13 ... 24, 0 ... 5) B3(13 ... 24, 0 ... 9) B4(17 ... 24, 0 ... 11, 13, 14) B5(21 ... 24, 0 ... 11, 13 ... 18)
TCH/H2.4 TCH/H4.8	0	D&U	0 ... 7	C0 ... Cn	NB ¹	26	B0(0,2,4,6,8,10,13,15,17,19,21,23,0,2,4,6,8,10,13,15,17,19) B1(8,10,13,15,17,19,21,23,0,2,4,6,8,10,13,15,17,19,21,23,0,2), B2(17,19,21,23,0,2,4,6,8,10,13,15,17,19,21,23,0,2,4,6,8,10)
	1						B0(1,3,5,7,9,11,14,16,18,20,22,24,1,3,5,7,9,11,14,16,18,20), B1(9,11,14,16,18,20,22,24,1,3,5,7,9,11,14,16,18,20,22,24,1,3), B2(18,20,22,24,1,3,5,7,9,11,14,16,18,20,22,24,1,3,5,7,9,11)

NOTE 1: An Access Burst (AB) is used on the uplink during handover.

Section 7 Table 3 of 5: Mapping of logical channels onto physical channels (see sections 6.3, 6.4, 6.5)

Channel designation	Sub-channel number	Direction	Allowable timeslot assignments	Allowable RF channel assignments	Burst type	Repeat length in TDMA frames	Interleaved block TDMA frame mapping
FCCH		D	0	C0	FB	51	B0(0),B1(10),B2(20),B3(30),B4(40)
SCH		D	0	C0	SB	51	B0(1),B1(11),B2(21),B3(31),B4(41)
BCCH Norm		D	0,2,4,6	C0	NB	51	B(2..5)
BCCH Ext		D	0,2,4,6	C0	NB	51	B(6..9)
PCH AGCH		D	0,2,4,6	C0	NB	51	B0(6..9),B1(12..15),B2(16..19), B3(22..25),B4(26..29),B5(32..35), B6(36..39),B7(42..45),B8(46..49)
RACH		U	0,2,4,6	C0	AB	51	B0(0),B1(1)..B50(50)
CBCH(SDCCH/4)		D	0	C0	NB	51	B(32..35)
CBCH(SDCCH/8)		D	0 ... 3	C0 ... Cn	NB	51	B(8..11)
SDCCH/4	0	D	0	C0	NB ¹	51	B(22..25)
	1	U					B(37..40)
	2	D					B(26..29)
	3	U					B(41..44)
		D					B(32..35)
		U					B(47..50)
		D					B(36..39)
		U					B(0..3)
SACCH/C4	0	D	0	C0	NB	102	B(42..45)
	1	U					B(57..60)
	2	D					B(46..49)
	3	U					B(61..64)
		D					B(93..96)
		U					B(6..9)
		D					B(97..100)
		U					B(10..13)

NOTE 1: An Access Burst (AB) is used on the uplink during handover.

Section 7 Table 4 of 5: Mapping of logical channels onto physical channels (see sections 6.3, 6.4, 6.5)

Channel designation	Sub-channel number	Direction	Allowable timeslot assignments	Allowable RF channel assignments	Burst type	Repeat length in TDMA frames	Interleaved block TDMA frame mapping
SDCCH/8	0	D	0 ... 7	C0 ... Cn	NB ¹	51	B (0 ... 3)
	1	U					B (15 ... 18)
		D					B (4 ... 7)
	2	U					B (19 ... 22)
		D					B (8 ... 11)
	3	U					B (23 ... 26)
		D					B (12 ... 15)
	4	U					B (27 ... 30)
D		B (16 ... 19)					
5	U	B (31 ... 34)					
	D	B (20 ... 23)					
6	U	B (35 ... 38)					
	D	B (24 ... 27)					
7	U	B (39 ... 42)					
	D	B (28 ... 31)					
SACCH/C8	0	D	0 ... 7	C0 ... Cn	NB	102	B (32 ... 35)
	1	U					B (47 ... 50)
		D					B (36 ... 39)
	2	U					B (51 ... 54)
		D					B (40 ... 43)
	3	U					B (55 ... 58)
		D					B (44 ... 47)
	4	U					B (59 ... 62)
D		B (83 ... 86)					
5	U	B (98 ... 101)					
	D	B (87 ... 90)					
6	U	B (0 ... 3)					
	D	B (91 ... 94)					
7	U	B (4 ... 7)					
	D	B (95 ... 98)					
		U					B (8 ... 11)

NOTE 1: An Access Burst (AB) is used on the uplink during handover.

Section 7 Table 5 of 5: Mapping of logical channels onto physical channels (see sections 6.3, 6.4, 6.5)

BS_CCCH_SDCCH_COMB	Random access channel blocks available	Access grant blocks available	BS_AG_BLK_RES		Paging channel blocks available (Paging block index = 0, 1, 2, 3, 4, 5, 6, 7, 8)
			Number of paging blocks available per 51 multiframe		
False	B0, B1 ... B50	B0, B1 ... B8	0	9	B0, B1, B2, B3, B4, B5, B6, B7, B8
False			1	8	B1, B2, B3, B4, B5, B6, B7, B8
False			2	7	B2, B3, B4, B5, B6, B7, B8
False			3	6	B3, B4, B5, B6, B7, B8
False			4	5	B4, B5, B6, B7, B8
False			5	4	B5, B6, B7, B8
False			6	3	B6, B7, B8
False			7	2	B7, B8
True	B4, B5, B14, B15 ... B36, B45, B46	B0, B1, B2	0	3	B0, B1, B2
True			1	2	B1, B2
True			2	1	B2

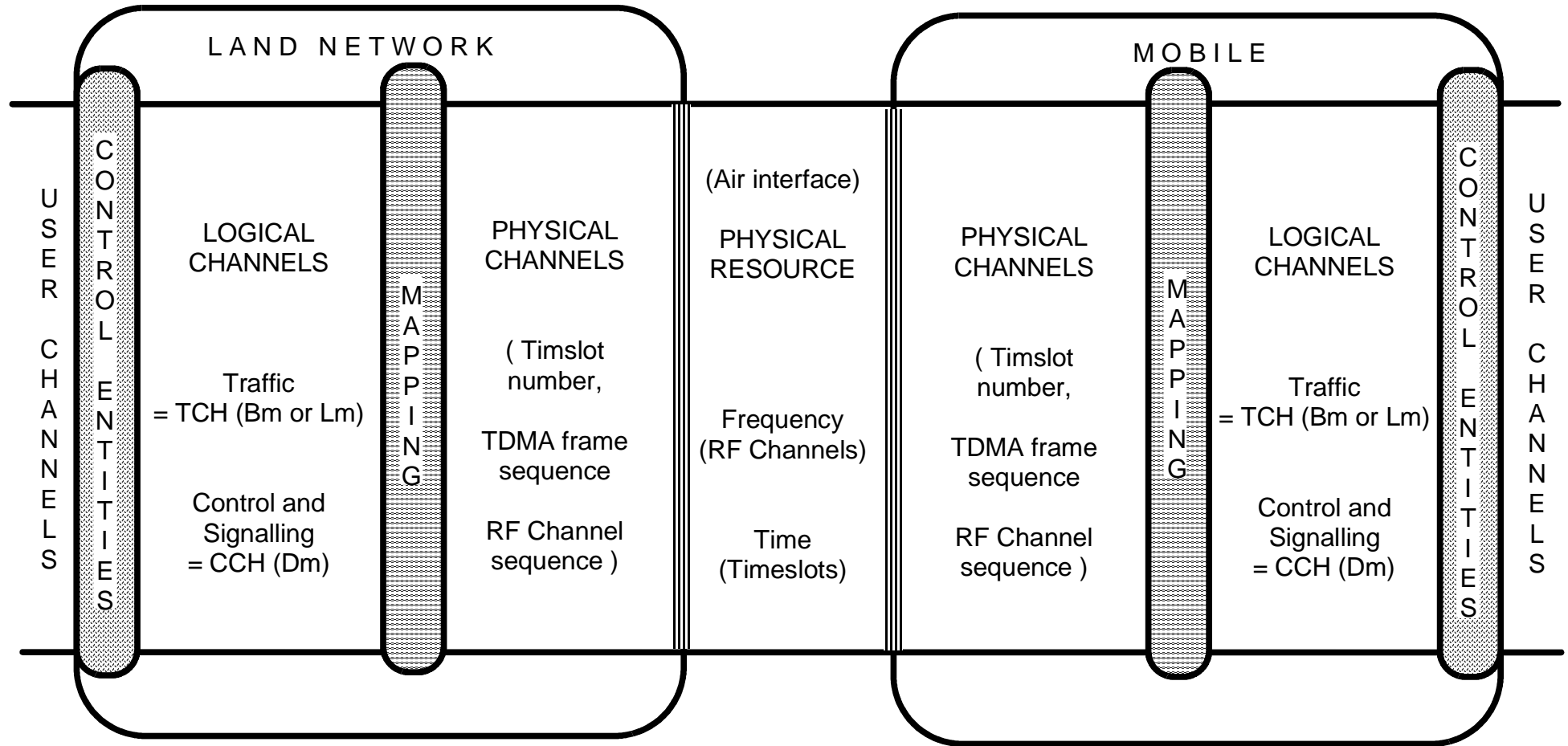

Figure 1: Mapping of logical channels onto physical channels based on the physical resource

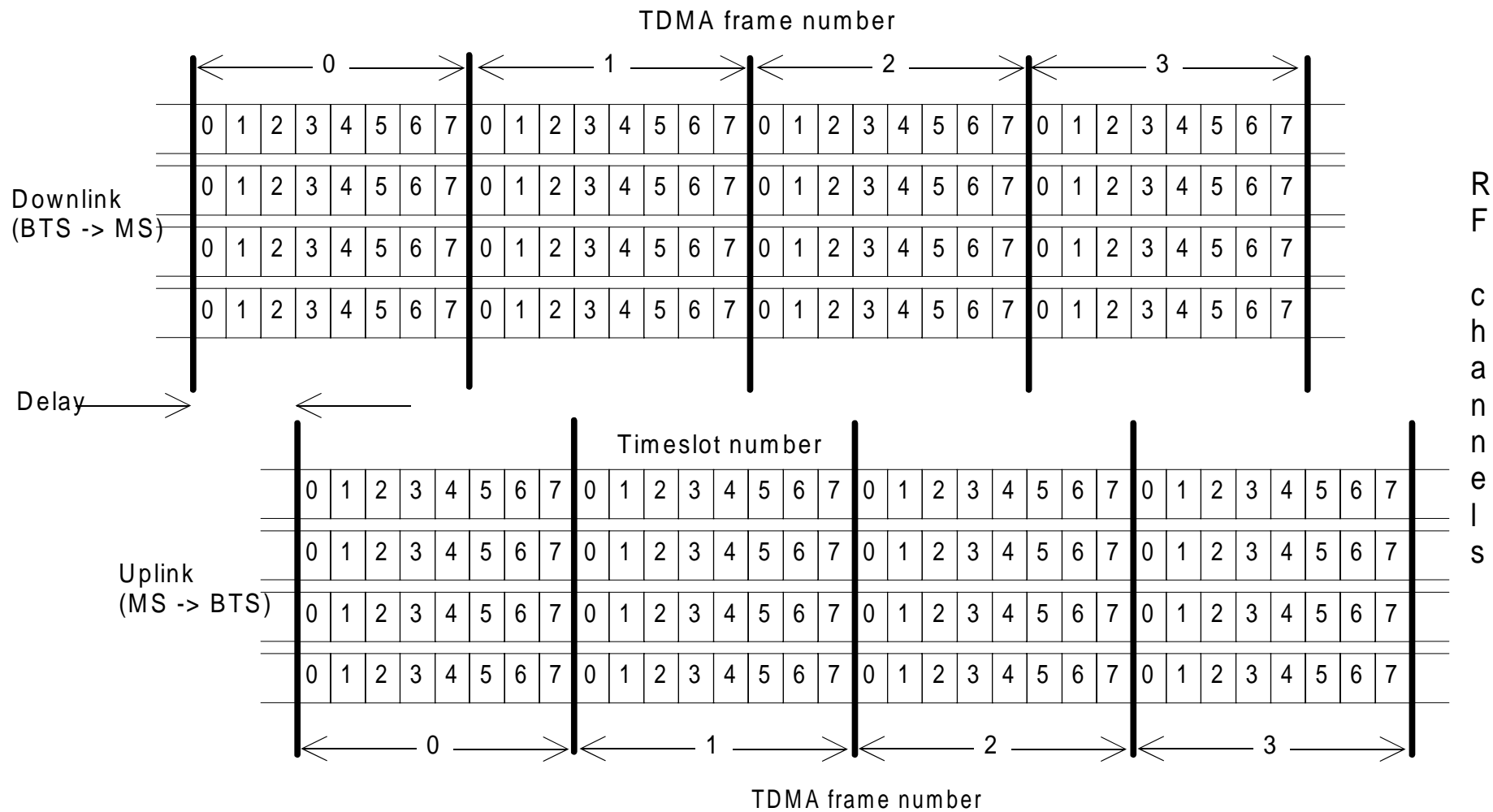

Figure 2: The structure imposed on the physical resource: Timeslots, TDMA Frames and Radio Frequency channels (in this example the cell has an allocation of 4 RF Channel pairs)

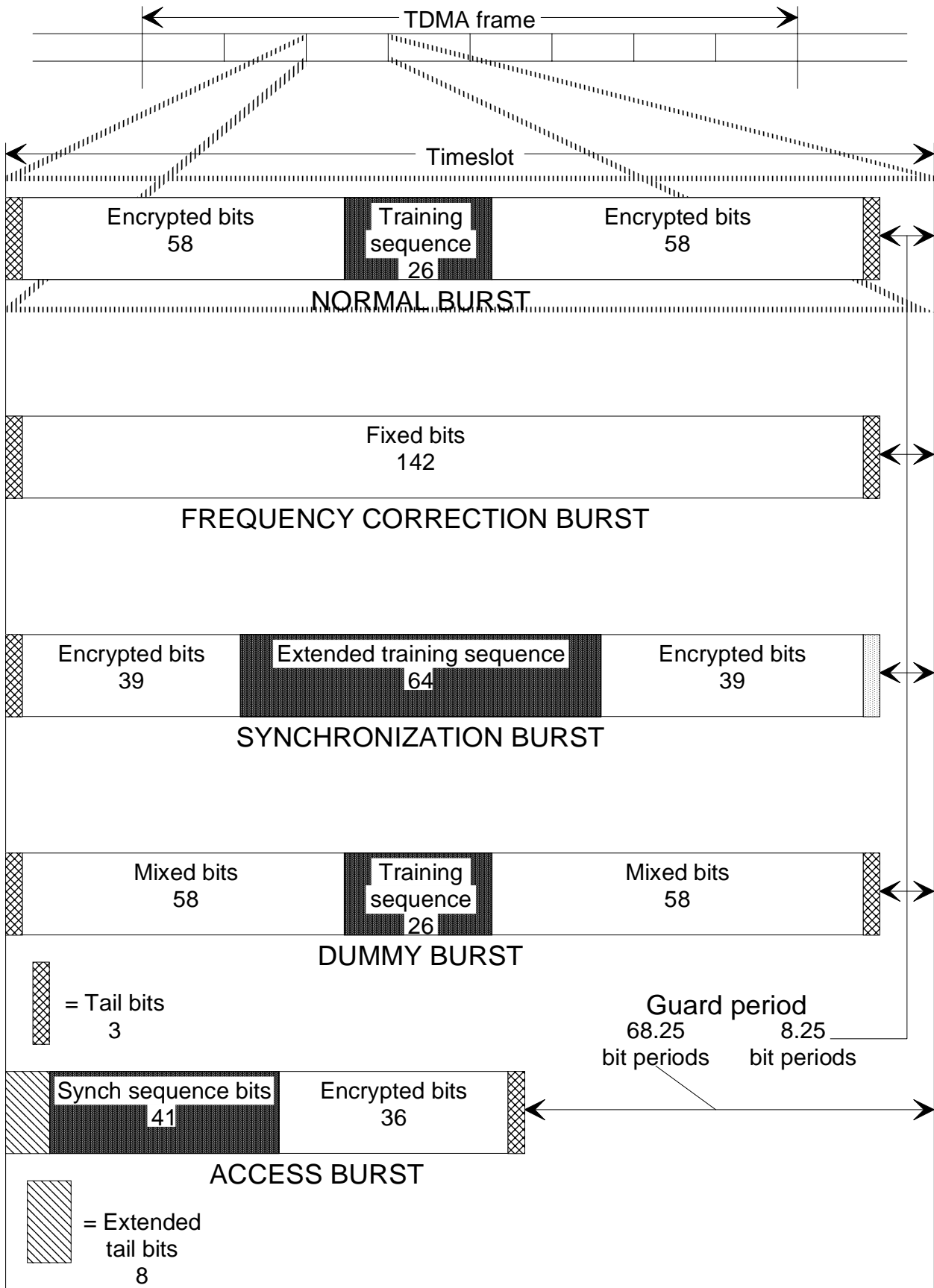

Figure 3: Timeslot and format of bursts

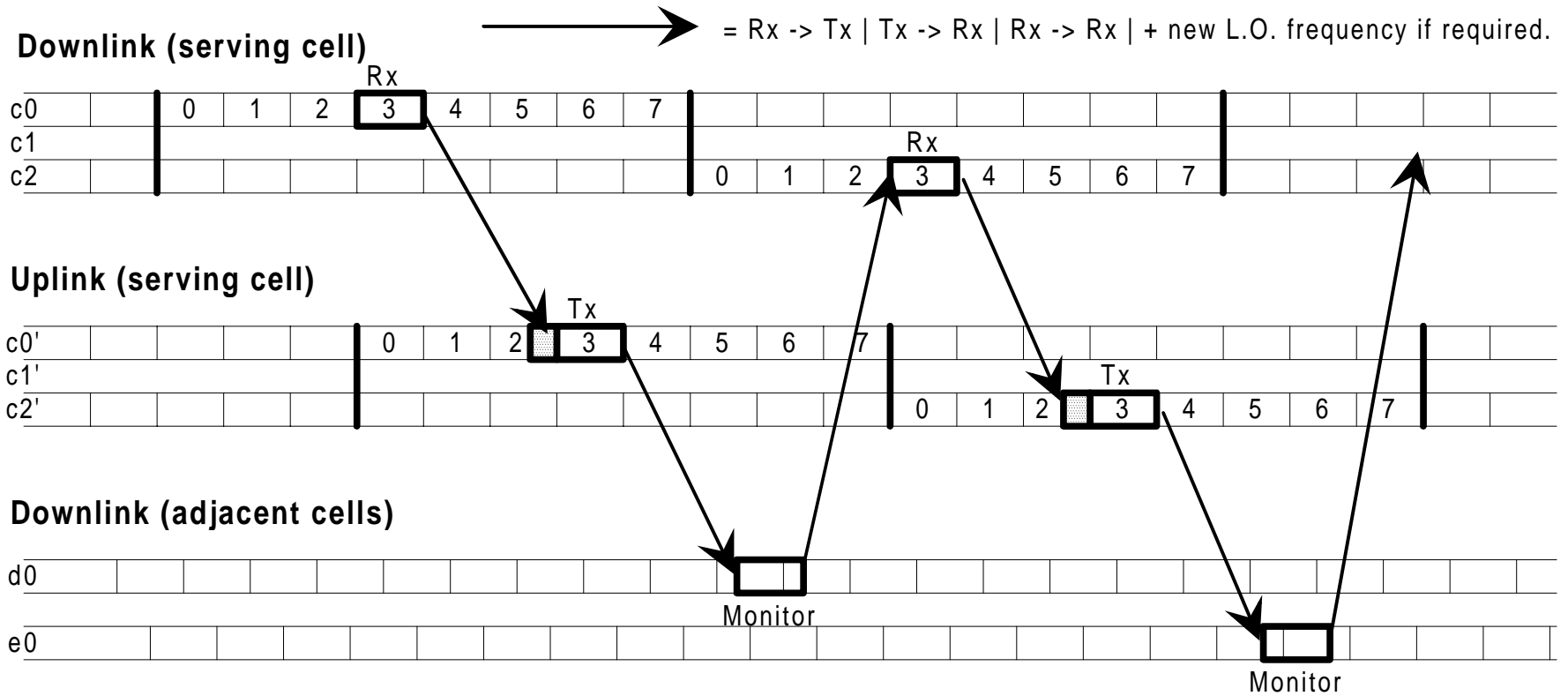
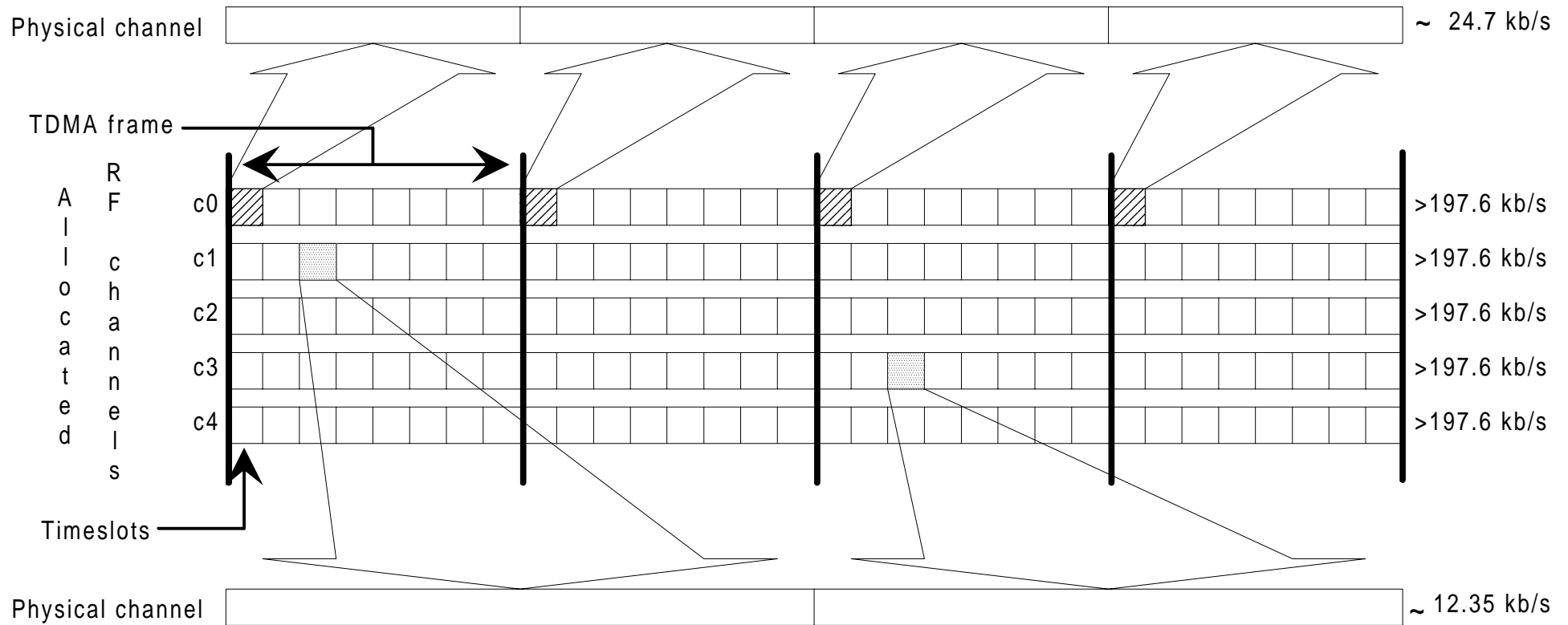

Figure 4: Mobile station usage of physical channel timeslots (for a full-rate hopping traffic channel assigned timeslot 3)

(This example of a physical channel is non-hopping using timeslot 0 of every TDMA frame)



(This example of a physical channel is hopping using 3 of every other TDMA frame)

Figure 5: Example of two different physical channels

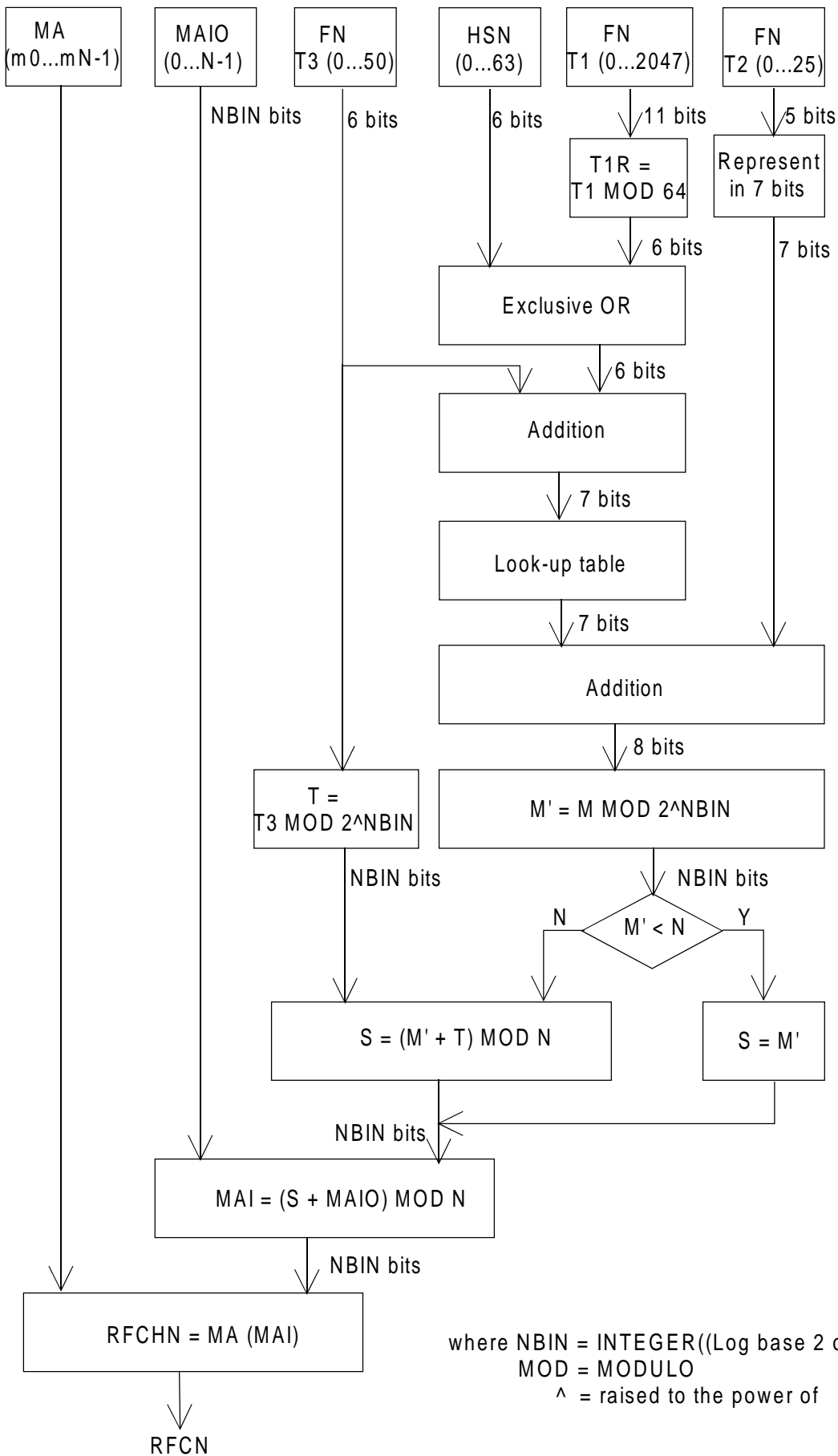

Figure 6: Block diagram of the frequency hopping algorithm when HSN ≠ 0

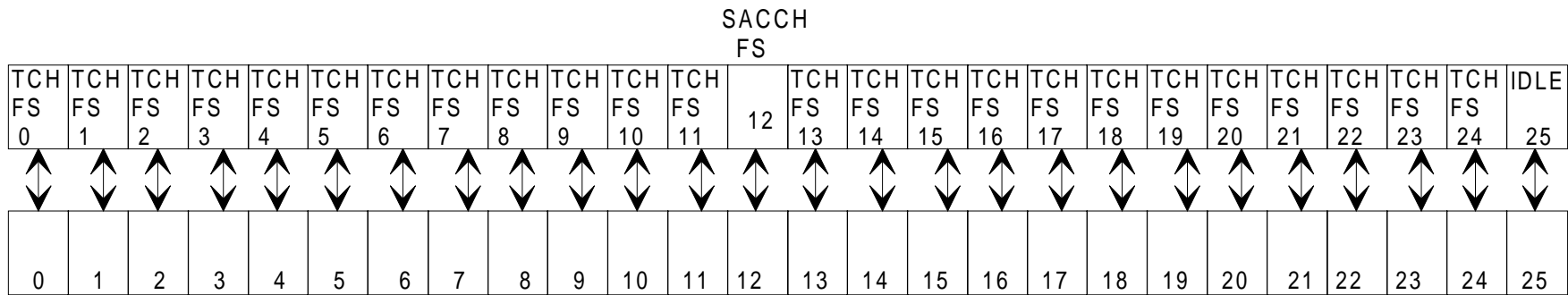

Figure 7a: TDMA frame mapping for TCH/FS + SACCH/FS

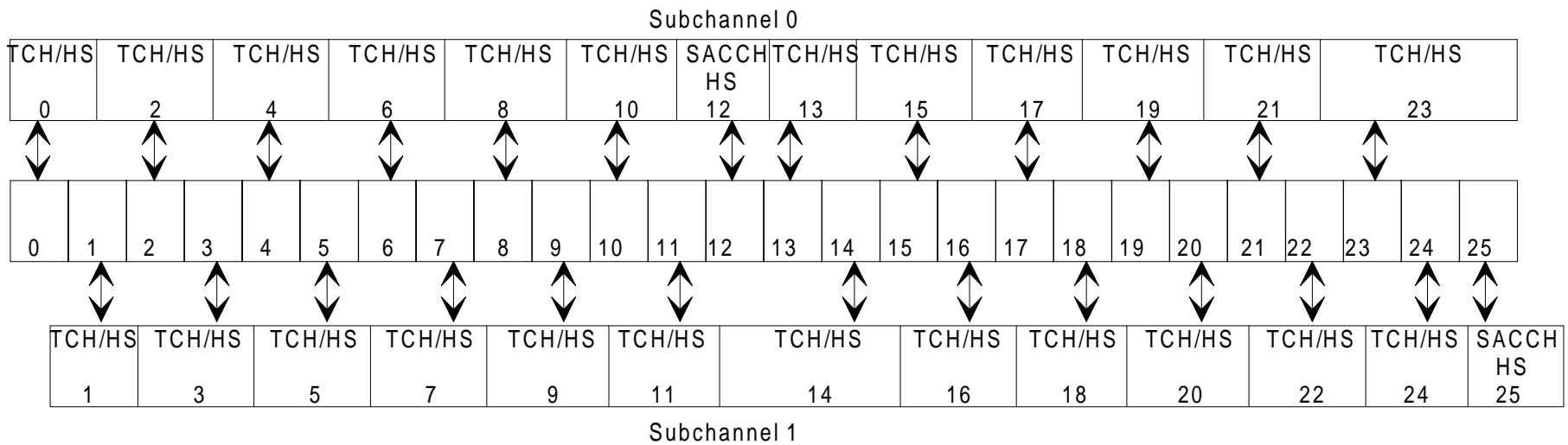

Figure 7b: TDMA frame mapping for TCH/HS + SACCH/HS sub-channels 0 and 1

Figure 7: Example of a TDMA frame mapping for traffic channels

Figure 8b: TDMA frame mapping for FCCCH + SCH + BCCH + CCCH + SDCCH/4(0...3) + SACCH/4(0...3)

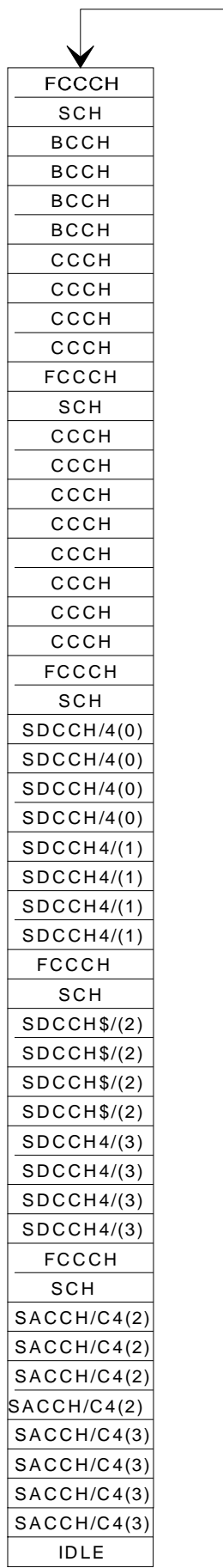

Figure 8a: TDMA frame mapping for FCCCH + SCH + BCCH + CCCH

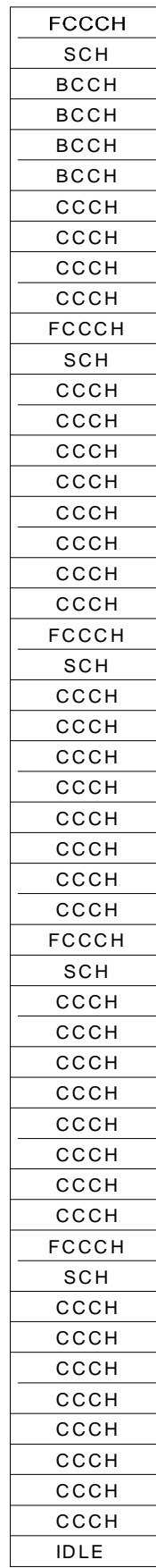
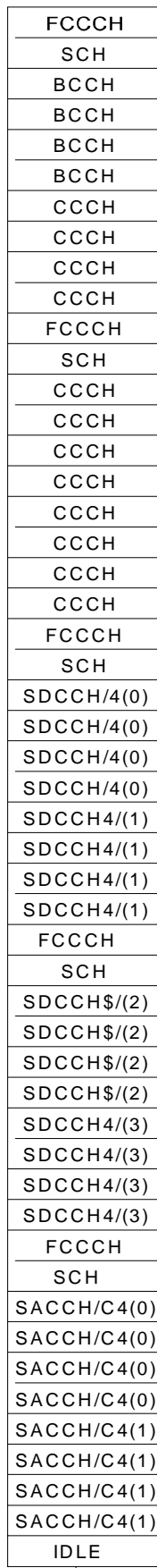

Figure 8: Example of TDMA frame mapping for control channels

Annex A (normative): Phase 2 mobiles in a phase 1 infrastructure

A.1 Scope

Phase 2 mobiles are required to behave properly in a Phase 1 networks, when downlink DTX is used in conjunction with frequency hopping.

A.2 Implementation options for TCH channels

A.2.1 C0 filling on the TCH

When the TCH is active, and no associated traffic frame is scheduled for transmission, the following options apply for filling the burst on the C0 radio frequency channel.

A.2.1.1 A dummy burst with (BN61, BN62, BN86) = training sequence bits of normal bursts.

A.2.1.2 A dummy burst with the "C0 filling training sequence":

(BN61, BN62, BN86) = (0,1,1,1,0,0,0,1,0,1,1,1,0,0,0,1,0,1,1,1,0,0,0,1,0,1)

A.2.1.3 A dummy burst with (BN61, BN62, BN86) mapped from the TSC bits of normal bursts according to the table below.

TSC for other bursts on TCH	Dummy bursts (BN61, BN62 BN86)	Corresponding TSC
0	(0,1,0,0,0,0,1,1,1,0,1,1,1,0,1,0,0,1,0,0,0,0,1,1,1,0)	2
1	(0,1,0,0,1,1,1,0,1,0,1,1,0,0,0,0,0,1,0,0,1,1,1,0,1,0)	5
2	(0,0,1,0,0,1,0,1,1,1,0,0,0,0,1,0,0,0,1,0,0,1,0,1,1,1)	0
3	(0,0,0,1,1,0,1,0,1,1,1,0,0,1,0,0,0,0,0,1,1,0,1,0,1,1)	4
4	(0,1,0,0,1,1,1,0,1,0,1,1,0,0,0,0,0,1,0,0,1,1,1,0,1,0)	5
5	(0,1,0,0,0,0,1,1,1,0,1,1,1,0,1,0,0,1,0,0,0,0,1,1,1,0)	2
6	(0,1,0,0,0,1,1,1,1,0,1,1,0,1,0,0,0,1,0,0,0,1,1,1,1,0)	3
7	(0,1,0,0,1,1,1,0,1,0,1,1,0,0,0,0,0,1,0,0,1,1,1,0,1,0)	5

A.2.1.4 Partial SID information

The BTS transmits bursts containing parts of the SID frames provided by the speech encoder. The bits transmitted in such bursts on C0 carrier contain the same bits that would have been transmitted in those bursts in those if the associated traffic frames were scheduled for transmission.

A.2.2 Half burst filling

For downlink DTX, when a given traffic frame is scheduled for transmission and one of its adjacent traffic frames is not scheduled for transmission, half of the "encrypted bits" belonging to the normal bursts associated with the scheduled traffic frame need to be filled. These bits are referred to as "half burst filling bits". These half bursts filling bits contain either:

A.2.2.1 Partial SID information from any associated SID frame; or

A.2.2.2 The mixed bits of the dummy bursts (encrypted or not encrypted).

A.2.3 Dummy burst Stealing flag

The dummy burst stealing flag are set to either 1 or 0.

A.2.4 Half burst Filling Stealing flag

BN60 or BN87 corresponding to the "encrypted bits" of a filled half burst, defined as the "half burst filling stealing flag", are jointly set to a value of either 1 or 0.

A.2.5 Allowed combinations

Table A 2.5.1 below provides the allowed combinations for phase 1 networks supporting downlink DTX in conjunction with frequency hopping.

Table A 2.5.1: Possible combinations for networks supporting downlink DTX in conjunction with frequency hopping

Combination	C0 filling on the TCH	Half Burst filling	Dummy Bursts Stealing Flag	Half Burst Filling Stealing Flag
1	Dummy bursts with (BN61-BN86) equal to the bits of the TSC of the other normal bursts (A.2.1.1)	not defined	0	0
2	Dummy burst with "C0 filling training sequence" (A.2.1.2)	Partial SID information (A.2.2.1)	0	0
3	Dummy burst with (BN61, BN62....BN86) mapped from the TSC bits of normal bursts (A.2.1.3)	Partial SID information (A.2.2.1)	0	0
4	Partial SID information (A.2.1.4)	Partial SID information (A.2.2.1)	1	1
5	Dummy burst with "C0 filling training sequence" (A.2.1.2)	Dummy burst mixed bits (A.2.2.2)	1	1
6 (for DCS 1 800 only)	Partial SID information (A.2.1.4)	Partial SID information (A.2.2.1)	0	0

A.3 Idle Channels

When a channel is idle, a dummy burst may be transmitted on C0 frequency channel with any options described in sections A.2.1.1, A.2.1.2, A.2.1.3.

History

Document history			
September 1995	First Edition		
August 1995	Unified Approval Procedure (Second Edition)	UAP 34:	1995-08-21 to 1995-12-15
December 1995	Unified Approval Procedure (Third Edition)	UAP 40:	1995-12-04 to 1996-04-12
January 1996	Second Edition		
March 1996	Unified Approval Procedure (Fourth Edition)	UAP 44:	1996-03-04 to 1996-06-28
August 1996	Third Edition		
August 1996	Fourth Edition		
November 1996	Unified Approval Procedure (Fifth Edition)	UAP 58:	1996-11-18 to 1997-03-14
April 1997	Fifth Edition		
July 1997	One-step Approval Procedure (Sixth Edition)	OAP 9747:	1997-07-21 to 1997-11-28
January 1998	Sixth Edition		