



**E**UROPEAN  
**T**ELECOMMUNICATION  
**S**TANDARD

**ETS 300 559**

October 1995

Second Edition

---

Source: ETSI TC-SMG

Reference: RE/SMG-030411P

ICS: 33.060.30

**Key words:** European digital cellular telecommunications system, Global System for Mobile communications (GSM)

**European digital cellular telecommunications system (Phase 2);  
Point-to-Point (PP) Short Message Service (SMS)  
support on mobile radio interface  
(GSM 04.11)**

**ETSI**

European Telecommunications Standards Institute

**ETSI Secretariat**

**Postal address:** F-06921 Sophia Antipolis CEDEX - FRANCE

**Office address:** 650 Route des Lucioles - Sophia Antipolis - Valbonne - FRANCE

**X.400:** c=fr, a=atlas, p=etsi, s=secretariat - **Internet:** secretariat@etsi.fr

Tel.: +33 92 94 42 00 - Fax: +33 93 65 47 16

---

**Copyright Notification:** No part may be reproduced except as authorized by written permission. The copyright and the foregoing restriction extend to reproduction in all media.

© European Telecommunications Standards Institute 1995. All rights reserved.



## Contents

Foreword.....	7
1 General.....	9
1.1 Scope.....	9
1.2 Normative references.....	9
1.3 Definitions and abbreviations.....	9
2 Overview of Short Message Service (SMS) support.....	9
2.1 Protocols and protocol architecture.....	10
2.2 Use of channels.....	11
2.3 Layer 2 SAPI 3 handling.....	11
3 Service definition.....	12
3.1 General.....	12
3.2 Service provided by the CM-sublayer.....	12
3.2.1 Definition of primitives on the MS side.....	13
3.2.1.1 MNSMS-ABORT-REQest.....	13
3.2.1.2 MNSMS-DATA-REQest.....	13
3.2.1.3 MNSMS-DATA-INDication.....	14
3.2.1.4 MNSMS-ESTablish-REQest.....	14
3.2.1.5 MNSMS-ESTablish-INDication.....	14
3.2.1.6 MNSMS-ERROR-INDication.....	14
3.2.1.7 MNSMS-RELease-REQest.....	14
3.2.2 Definition of primitives on the network side.....	15
3.2.2.1 MNSMS-ABORT-REQest.....	15
3.2.2.2 MNSMS-DATA-REQest.....	15
3.2.2.3 MNSMS-DATA-INDication.....	16
3.2.2.4 MNSMS-ESTablish-REQest.....	16
3.2.2.5 MNSMS-ESTablish-INDication.....	16
3.2.2.6 MNSMS-ERROR-INDication.....	16
3.2.2.7 MNSMS-RELease-REQest.....	16
3.3 Service provided by SM-RL.....	17
3.3.1 Definition of primitives on the MS side.....	17
3.3.1.1 SM-RL-DATA-REQest.....	18
3.3.1.2 SM-RL-DATA-INDication.....	18
3.3.1.3 SM-RL-MEMORY-AVAILABLE-REQest.....	18
3.3.1.4 SM-RL-REPORT-REQest.....	18
3.3.1.5 SM-RL-REPORT-INDication.....	18
3.3.2 Definition of primitives on the network side.....	19
3.3.2.1 SM-RL-DATA-REQest.....	19
3.3.2.2 SM-RL-DATA-INDication.....	19
3.3.2.3 SM-RL-MEMORY-AVAILABLE-INDication.....	19
3.3.2.4 SM-RL-REPORT-REQest.....	20
3.3.2.5 SM-RL-REPORT-INDication.....	20
4 [Spare].....	20
5 CM-procedures.....	21
5.1 General.....	21
5.2 Short Message Control states.....	21
5.2.1 SMC states at the MS side of the radio interface.....	21
5.2.1.1 Mobile Originating Case.....	21
5.2.1.1.1 MO-Idle (State 0).....	21
5.2.1.1.2 MO-MM-connection pending (State 1).....	21

	5.2.1.1.3	MO-Wait for CP-ACK (State 2) .....	21
	5.2.1.1.4	MO-MM-connection established (State 3).....	22
	5.2.1.2	Mobile Terminating case.....	22
	5.2.1.2.1	MT-Idle (State 0).....	22
	5.2.1.2.2	MT-Wait for CP-ACK (State 2).....	22
	5.2.1.2.3	MT-MM-connection established (State 3).....	22
5.2.2		SMC states at the network side of the radio interface .....	23
	5.2.2.1	Mobile Originating Case .....	23
	5.2.2.1.1	MO-Idle (State 0).....	23
	5.2.2.1.2	MO-Wait for CP-ACK (State 2) .....	23
	5.2.2.1.3	MO-MM-connection established (State 3).....	23
	5.2.2.2	Mobile Terminating Case .....	23
	5.2.2.2.1	MT-Idle (State 0).....	23
	5.2.2.2.2	MT-MM-connection pending (State 1) ..	23
	5.2.2.2.3	MT-Wait for CP-ACK (State 2).....	23
	5.2.2.2.4	MT-MM-connection established (State 3).....	24
5.3		Short message control procedures .....	24
	5.3.1	MM-connection establishment.....	24
	5.3.2	RPDU transfer.....	24
	5.3.3	Release of MM and CM connections.....	25
	5.3.4	Abnormal cases .....	25
5.4		Concatenating short message or notification transfers.....	26
6		SM-RL-procedures .....	28
	6.1	General .....	28
	6.2	Transition states of SMR entity.....	28
	6.2.1	SMR-states at the MS-side of the radio interface.....	28
	6.2.1.1	Idle (State 0).....	28
	6.2.1.2	Wait for RP-ACK (State 1) .....	28
	6.2.1.3	Wait for RETRANS TIMER (State 4).....	28
	6.2.2	SMR-states at the network side of the radio interface .....	29
	6.2.2.1	Idle (State 0).....	29
	6.2.2.2	Wait for RP-ACK (State 1) .....	29
	6.2.2.3	Wait to send RP-ACK (State 3) .....	29
	6.3	Short Message Relay procedures.....	29
	6.3.1	TPDU relaying .....	29
	6.3.2	[spare].....	30
	6.3.3	Notification relaying.....	30
	6.3.3.1	MS side .....	30
	6.3.3.1.1	Idle state .....	30
	6.3.3.1.2	Wait for RP-ACK state.....	30
	6.3.3.1.3	Wait for RETRANS Timer state .....	31
	6.3.3.2	Network side .....	31
	6.3.3.2.1	Idle state .....	31
	6.3.3.2.2	Wait to Send RP-ACK state .....	31
	6.3.4	Abnormal cases .....	31
7		Message functional definitions and content .....	32
	7.1	General .....	32
	7.2	Messages for short message or notification transfer on CM .....	32
	7.2.1	CP-DATA.....	32
	7.2.2	CP-ACK.....	33
	7.2.3	CP-ERROR .....	33
	7.3	Messages for short message and notification transfer on SM-RL.....	34
	7.3.1	RP-DATA.....	34
	7.3.1.1	RP-DATA (Network to Mobile Station).....	34

	7.3.1.2	RP-DATA (Mobile Station to Network).....	34
	7.3.2	RP-SMMA .....	35
	7.3.3	RP-ACK .....	35
	7.3.4	RP-ERROR .....	35
8		Message format and information elements coding.....	36
	8.1	CP-messages .....	36
		8.1.1 General .....	36
		8.1.2 Protocol Discriminator and Transaction Identifier.....	36
		8.1.3 Message type .....	36
		8.1.4 Other required information elements .....	37
		8.1.4.1 CP-User data element.....	37
		8.1.4.2 CP-Cause element.....	37
	8.2	RP-messages .....	38
		8.2.1 General .....	38
		8.2.2 Message type indicator (MTI) .....	38
		8.2.3 Message reference .....	39
		8.2.4 [Spare].....	39
		8.2.5 Other required information elements .....	39
		8.2.5.1 Originator address element .....	39
		8.2.5.2 Destination address element.....	40
		8.2.5.3 RP-User data element.....	41
		8.2.5.4 RP-Cause element.....	41
9		Handling of unknown, unforeseen, and erroneous protocol data .....	44
	9.1	General .....	44
	9.2	CP Error Handling .....	44
		9.2.1 Message too short .....	44
		9.2.2 Unknown or unforeseen transaction identifier .....	44
		9.2.3 Unknown or unforeseen message type.....	45
		9.2.4 Non-semantic mandatory information element errors.....	45
		9.2.5 Messages with semantically incorrect contents.....	45
	9.3	RP Error Handling .....	46
		9.3.1 Message too short .....	46
		9.3.2 Unknown or unforeseen Message Reference.....	46
		9.3.3 Unknown or unforeseen message type.....	47
		9.3.4 Non-semantic mandatory information element errors.....	47
		9.3.5 Messages with semantically incorrect contents.....	47
10		Timers.....	48
	Annex A (informative):	Arrow diagrams .....	49
	Annex B (normative):	SDL-description of the CM-layer .....	54
	Annex C (informative):	Arrow diagrams .....	71
	Annex D (normative):	SDL-description of the short message relay layer.....	77
	D.1	Introduction.....	77
	Annex E (informative):	Cause definition .....	85
	Annex F (informative):	LAPDm SAPI 3 handling for short message service.....	92
	History .....		99

Blank page

## Foreword

This European Telecommunication Standard (ETS) has been produced by the Special Mobile Group (SMG) Technical Committee (TC) of the European Telecommunications Standards Institute (ETSI).

This ETS defines the Short Message Service (SMS) support on mobile radio interface within the European digital cellular telecommunications system (Phase 2).

This second edition ETS has been produced as a result of further work carried out by TC-SMG and correspond to GSM technical specification, GSM 04.11 version 4.8.0.

The specification from which this ETS has been derived was originally based on CEPT documentation, hence the presentation of this ETS is not in accordance with the ETSI/PNE rules.

Reference is made within this ETS to GSM Technical Specifications (GSM-TS) (NOTE).

NOTE: TC-SMG has produced documents which give the technical specifications for the implementation of the European digital cellular telecommunications system. Historically, these documents have been identified as GSM Technical Specifications (GSM-TS). These TSs may have subsequently become I-ETSs (Phase 1), or ETSs (Phase 2), whilst others may become ETSI Technical Reports (ETRs). GSM-TSs are, for editorial reasons, still referred to in current GSM ETSs.

<b>Transposition dates</b>	
Date of adoption of this ETS:	31 October 1995
Date of latest announcement of this ETS (doa):	31 January 1996
Date of latest publication of new National Standard or endorsement of this ETS (dop/e):	31 July 1996
Date of withdrawal of any conflicting National Standard (dow):	31 July 1996

Blank page



## 1 General

### 1.1 Scope

This European Telecommunications Standard (ETS) specifies the procedures used across the mobile radio interface by the signalling layer 3 function Short Message Control (SMC) and Short Message Relay function (SM-RL).

### 1.2 Normative references

This ETS incorporates by dated and undated reference, provisions from other publications. These normative references are cited at the appropriate places in the text and the publications are listed hereafter. For dated references, subsequent amendments to or revisions of any of these publications apply to this ETS only when incorporated in it by amendment or revision. For undated references, the latest edition of the publication referred to applies.

- [1] GSM 01.04 (ETR 100): "European digital cellular telecommunication system (Phase 2); Abbreviations and acronyms".
- [2] GSM 03.40 (ETS 300 536): "European digital cellular telecommunication system (Phase 2); Technical realization of the Short Message Service (SMS) Point to Point (PP)".
- [3] GSM 04.06 (ETS 300 555): "European digital cellular telecommunication system (Phase 2); Mobile Station - Base Station System (MS - BSS) interface Data Link (DL) layer specification".
- [4] GSM 04.07 (ETS 300 556): "European digital cellular telecommunication system (Phase 2); Mobile radio interface signalling layer 3 General aspects".
- [5] GSM 04.08 (ETS 300 557): "European digital cellular telecommunication system (Phase 2); Mobile radio interface layer 3 specification".
- [6] ISO 7498: "Information processing systems - Open Systems Interconnection - Basic Reference Model".

### 1.3 Definitions and abbreviations

Abbreviations used in this specification are listed in GSM 01.04.

## 2 Overview of Short Message Service (SMS) support

The purpose of the Short Message Service is to provide the means to transfer messages between a GSM PLMN Mobile Station and a Short Message Entity via a Service Centre, as described in TS GSM 03.40. The terms "MO" - Mobile Originating - and "MT" - Mobile Terminating - are used to indicate the direction in which the short message is sent.

This Technical Specification describes the procedures necessary to support the Short Message Service between the MS and the MSC and vice versa, as described in TS GSM 03.40.

The procedures are based on services provided by the Mobility Management sublayer as described in TS GSM 04.07/04.08.

## 2.1 Protocols and protocol architecture

The hierarchical model shows the layer structure of the MSC and the MS.

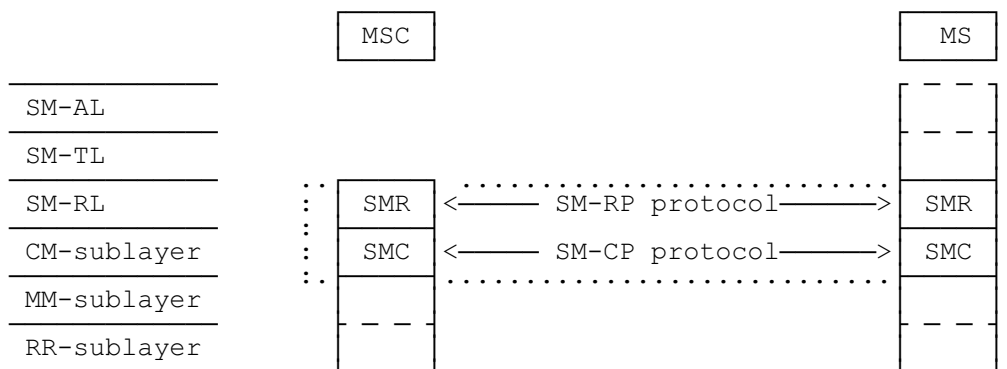

**Figure 2.1/GSM 04.11: Protocol hierarchy**

The CM-sublayer, in terms of the Short Message Service Support, provides services to the Short Message Relay Layer.

On the MS-side the Short Message Relay Layer provides services to the Short Message Transfer Layer. The Short Message Relay Layer is the upper layer on the network side (MSC), and the SM-user information elements are mapped to TCAP/MAP.

The peer protocol between two SMC entities is denoted SM-CP, and between two SMR entities, SM-RP.

### Abbreviations:

SM-AL	Short Message Application Layer
SM-TL	Short Message Transfer Layer
SM-RL	Short Message Relay Layer
SM-RP	Short Message Relay Protocol
SMR	Short Message Relay (entity)
CM-sub	Connection Management sublayer
SM-CP	Short Message Control Protocol
SMC	Short Message Control (entity)
MM-sub :	Mobility Management sublayer
RR-sub :	Radio Resource Management sublayer

## 2.2 Use of channels

The short message service will be supported by an SDCCH or SACCH, depending on the use of a TCH;

- When a TCH is not allocated, the short message service will use an SDCCH;
- If a TCH is allocated during a short message transaction on an SDCCH, the short message transaction will stop and continue on the SACCH associated with the TCH;
- If a TCH is allocated for the short message service, the short message service will use the associated SACCH;
- When an entity using a TCH finishes its transaction, the RR-sublayer may choose to continue an ongoing short message transfer on the SACCH, or optionally transfer it to an SDCCH.

Table 2.1/GSM 04.11 summarizes the use of channels for the short message service. Arrows indicate changes of channel.

Channel dependency	Channel used
TCH not allocated	SDCCH
TCH not allocated -> TCH allocated	SDCCH -> SACCH
TCH allocated	SACCH
TCH allocated -> TCH not allocated	SACCH -> SACCH opt. SDCCH

**Table 2.1/GSM 04.11:  
Channels used for short message transfer**

## 2.3 Layer 2 SAPI 3 handling

General rule:

The Radio Resource Management (RR ref TS. GSM 04.08) in the Mobile Station and on the network side (i.e. in the BSC) shall establish the acknowledged mode of operation on SAPI 3 whenever needed, i.e. when a message requiring SAPI 3 transfer shall be transmitted.

RR shall control the layer 2 also for SAPI 3, and keep knowledge of the mode.

The network side may initiate release of the acknowledged mode for SAPI 3 either explicitly (by the use of DISC- and UA-frames, ref., TS GSM 04.06) or indirectly by channel release (ref. TS GSM 04.08).

This means:

- the Mobile Station side will initiate establishment of SAPI 3 acknowledged mode in the case of mobile originating short message transfer;
- the network side will initiate establishment of SAPI 3 acknowledged mode in the case of mobile terminating short message transfer;
- the network side may choose to keep the channel and the acknowledged mode of operation to facilitate transfer of several short messages for or from the same Mobile Station. The queuing and scheduling function for this should reside in the MSC.

### **3 Service definition**

#### **3.1 General**

The layer service is described as a set of service primitives. These service primitives are abstractions and attempt to capture only those details of the interaction between the entities that are aspects of the layer service itself. A service primitive neither specifies nor constrains the implementation of entities or the interface between them.

The general syntax of a primitive and the initials of them are in line with the 04-series of GSM Technical Specifications.

NOTE: In order to limit the number of primitives and state definitions to a reasonable amount, a description method has been chosen which does not claim to be totally in line with the formal description method of the layered ISO reference model (ISO 7498) for Open Systems Interconnection.

#### **3.2 Service provided by the CM-sublayer**

In order to support the Short Message Service, the CM-sublayer provides services to the Short Message Relay Layer.

The CM-sublayer services are provided using layer specific functions and lower layer services offered to the CM-sublayer, controlled by short message service control entities called SMCs.

An SMC entity in the MS communicates with an SMC entity in the MSC by means of a peer protocol, SM-CP (Short Message Service Control Protocol). The arrow diagrams in annex A give an overview of the messaging on the CM-sublayer during a short message transfer.

A mobile station supporting the short message service shall have a minimum of two SMC entities. This enables the MS to receive MT messages during an MO message transfer.

To ensure that an MS having the minimum of two SMC entities is able to receive MT messages during an MO message transfer, and to send MO messages during MT message transfer, parallel message transfer in the same direction is prohibited. This means that the SMC entities shall not simultaneously perform messaging in the same direction. The rules for concatenation of message transfers are described in section 5.4.

The MSC shall have a minimum of two SMC entities available during an MT message transfer to a mobile station, one being reserved for MO message transfer. In an MO message transfer, the MSC shall have one SMC entity reserved for handling of an MT message.

### 3.2.1 Definition of primitives on the MS side

This section defines the service primitives used on the MS side. Table 3.1/GSM 04.11 gives an overview of the service primitives and main parameter linked to the primitives. All necessary control parameters to be used in the short message service are defined in section 7. All MNSMS service primitives defined in this section are passed to an SMC-entity.

SERVICE PRIMITIVES		PARAMETER
NAME	TYPE	
MNSMS-ABORT-	Req	Cause
MNSMS-DATA-	Req	MT RPDU
	Ind	MO RPDU
MNSMS-EST-	Req	MO RPDU
	Ind	MT RPDU
MNSMS-ERROR-	Ind	Cause
MNSMS-REL-	Req	Cause

**Table 3.1/GSM 04.11:  
MNSMS service primitives on the MS-side**

#### 3.2.1.1 MNSMS-ABORT-REQuest

A request from an SMR entity to release a CM-connection in abnormal cases.

When the CM-sublayer receives this request, and if the MM connection exists, it shall form and send the CP-ERROR message. Irrespective of whether or not the CP-ERROR message was sent, the CM-sublayer shall then release the lower layer services.

#### 3.2.1.2 MNSMS-DATA-REQuest

A request from an SMR entity to send a RPDU on the established CM-connection.

The SMC entity forms the CP-DATA message, the user information element being the RPDU, and transfers the message by means of the lower layer services.

NOTE: After reception of an incoming RP-DATA, the SMR entity typically returns the acknowledgement RP-ACK, or an error indication, RP-ERROR, to the Service Centre.

### **3.2.1.3 MNSMS-DATA-INDication**

An indication used by the SMC entity to pass the user information element (RPDU) of a received CP-DATA message to SM-RL.

NOTE: The RPDU is typically an RP-ACK or an RP-ERROR. Normally this service is used to report the outcome of either a MO message transfer attempt or a mobile station memory available notification attempt.

### **3.2.1.4 MNSMS-ESTablish-REQuest**

A request from an SMR entity to establish a CM-connection. The request contains a RP-DATA UNIT as a parameter. It implies the:

- establishment of a CM-connection for this SMR entity;
- forming of the CP-DATA message containing the RPDU; and
- passing of CP-DATA to the MM-sublayer.

### **3.2.1.5 MNSMS-ESTablish-INDication**

An indication used by the SMC entity to pass the SM-user information (RPDU) of a received CP-DATA message to SM-RL. It implies completion of the establishment of the CM-connection for this SMR entity.

### **3.2.1.6 MNSMS-ERROR-INDication**

An indication used by the SMC entity to pass error information to SM-RL. The error information may be local or relayed by the CP-ERROR message.

Use of this service primitive implies release of both CM and MM-connection.

### **3.2.1.7 MNSMS-RELease-REQuest**

A request to release the CM-connection (if it still exists).

Use of this service primitive implies release of the associated CM and MM-connections.

### 3.2.2 Definition of primitives on the network side

This section defines the service primitives used on the network side.

Table 3.2/GSM 04.11 gives an overview of the service primitives and linked main parameter. All MNSMS service primitives defined in this section are passed to an SMC-entity.

SERVICE PRIMITIVES		PARAMETER
NAME	TYPE	
MNSMS-ABORT-	Req	Cause
MNSMS-DATA-	Req	MO RPDU
	Ind	MT RPDU
MNSMS-EST-	Req	MT RPDU
	Ind	MO RPDU
MNSMS-ERROR-	Ind	Cause
MNSMS-REL-	Req	Cause

**Table 3.2/GSM 04.11:  
MNSMS service primitives on the network side**

#### 3.2.2.1 MNSMS-ABORT-REQuest

A request from an SMR entity to release a CM-connection in abnormal cases.

When the CM-sublayer receives this request, it may form and send the CP-ERROR message to release the connection. Irrespective of whether or not the CP-ERROR message was sent, the CM-sublayer shall then release the lower layer services.

#### 3.2.2.2 MNSMS-DATA-REQuest

A request from an SMR entity to send a RPDU on the established CM-connection.

The SMC entity forms the CP-DATA message, the user information element being the RPDU, and transfers the message by means of the lower layer services.

NOTE: After reception of an incoming RP-DATA or RP-SMMA the RPDU typically returns the acknowledgement, RP-ACK, or an error indication RP-ERROR, to the Mobile Station.

### **3.2.2.3 MNSMS-DATA-INDication**

An indication used by the SMC entity to pass the user information element (RPDU) of a received CP-DATA message to SM-RL.

NOTE: The RPDU is typically an RP-ACK or an RP-ERROR. Normally this is used to report the outcome of a MT messaging attempt.

### **3.2.2.4 MNSMS-ESTablish-REQuest**

A request from an SMR entity to transmit a RPDU, containing the SM-user information element; it implies the:

- establishment of a CM-connection for this SMR entity;
- forming of the CP-DATA message containing the RPDU; and
- passing of CP-DATA to the MM-sublayer.

### **3.2.2.5 MNSMS-ESTablish-INDication**

An indication used by the SMC entity to pass the SM-user information (RPDU) of a received CP-DATA message to SM-RL; it implies completion of the establishment of the CM-connection for this SMR entity.

### **3.2.2.6 MNSMS-ERROR-INDication**

An indication used by the SMC entity to pass error information to SM-RL. The error information may be local or relayed by the CP-ERROR message.

Use of the service primitive implies release of both CM and MM-connection.

### **3.2.2.7 MNSMS-RELease-REQuest**

A request to release the CM-connection (if it still exists).

Use of this service implies release of the associated CM and MM-connections.



### 3.3 Service provided by SM-RL

In order to support the Short Message Service, the Short Message Relay Layer provides services to the Short Message Transfer Layer.

The Short Message Relay Layer services are provided using layer specific functions and lower layer services offered to the Short Message Relay Layer, controlled by short message control entities called SMRs.

An SMR entity in the MS communicates with an SMR entity in the MSC by means of a peer protocol, SM-RP (Short Message Relay Protocol). The arrow diagrams in annex C give an overview of the messaging on the Short Message Relay Layer used for the short message service. The diagrams in annex C indicate a layer RL. This is not a layer, but the functional interface to the fixed network. The SM-RL is the upper layer in the MSC. Consequently the service primitives passed between SM-RL and RL indicate the interworking function.

The requirements on the SM-RL are the same as for the CM-sublayer. This means that there is exactly one SMR entity for each SMC entity, operating as described in section 3.2.

#### 3.3.1 Definition of primitives on the MS side

This section defines the service primitives used on the MS side. Table 3.3/GSM 04.11 gives an overview of the service primitives and linked main parameters. All SM-RL service primitives defined in this section are passed on an SM-RL-connection.

SERVICE PRIMITIVES		PARAMETER
NAME	TYPE	
SM-RL-DATA-	Req	MO SMS-TPDU
	Ind	MT SMS-TPDU
SM-RL-MEMORY AVAILABLE	Req	See section 3.3.1
SM-RL-REPORT-	Req	See section 3.3.1.4
	Ind	See section 3.3.1.5

**Table 3.3/GSM 04.11:  
SM-RL service primitives on the mobile station side**

### **3.3.1.1 SM-RL-DATA-REQuest**

A request from the SM-TL entity to pass the SMS-TPDU and necessary control information to SM-RL; it implies:

- establishment of an SM-RL connection for MO message transfer;
- forming of the RP-DATA message, containing the SMS-TPDU;
- transfer of the RP-DATA message as an RPDU in an MNSMS-EST-Req.

The purpose of this service is to relay the SMS-TPDU from the mobile station to the peer entity in the MSC.

### **3.3.1.2 SM-RL-DATA-INDication**

An indication used by the SMR entity to pass the SMS-TPDU and necessary control information of a received RP-DATA message to SM-TL.

### **3.3.1.3 SM-RL-MEMORY-AVAILABLE-REQuest**

When received without a parameter, this is a request from the SM-TL entity to pass the necessary control information to SM-RL; it implies:

- Establishment of an SM-RL-connection for transfer of the notification to the network that the mobile has memory available to receive one or more short messages;
- forming the RP-SM-MEMORY-AVAILABLE message; and
- transfer of the RP-SM-MEMORY-AVAILABLE message as an RPDU in an MNSMS-EST-Req.

The SM-TL entity may abort the transmission of an RP-SM-MEMORY-AVAILABLE message by use of a SM-RL-MEMORY-AVAILABLE-REQuest with the added parameter, SMS-MEM-NOTIF-ABORT, being present. This parameter is, of course, defined only on the interface between the SM-TL and SMR entities within the mobile station. Use of this request with the added parameter will have no effect on messages already given to the lower layers for transmission, but will only abort retransmission of the RP-SM-MEMORY-AVAILABLE message by the SMR entity.

### **3.3.1.4 SM-RL-REPORT-REQuest**

A request used by the SM-TL to relay the RP-ACK or RP-ERROR message from the mobile station to the network. This implies transfer of the RP-ACK or RP-ERROR message as an RPDU in an MNSMS-DATA-Req.

### **3.3.1.5 SM-RL-REPORT-INDication**

An indication used by the SMR entity to pass an acknowledgement (RP-ACK) or error information to SM-TL. The error information may be local or relayed by the RP-ERROR message; it consists of an appropriate cause and optionally extended diagnostic information.

### 3.3.2 Definition of primitives on the network side

This section defines the service primitives used on the network side.

Table 3.4/GSM 04.11 gives an overview of the service primitives and linked main parameter. All SM-RL service primitives defined in this section are passed on an SM-RL-connection.

SERVICE PRIMITIVES		PARAMETER
NAME	TYPE	
SM-RL-DATA-	Req	MT SMS-TPDU
	Ind	MO SMS-TPDU
SM-RL-MEMORY AVAILABLE	Ind	None
SM-RL-REPORT-	Req	See section 3.3.2.4
	Ind	See section 3.3.2.5

**Table 3.4/GSM 04.11:  
SM-RL service primitives on the network side**

#### 3.3.2.1 SM-RL-DATA-REQuest

A request from RL to pass the SMS-TPDU to SM-RL; it implies:

- establishment of a SM-RL-connection for MT message transfer;
- forming of the RP-DATA message, containing the SMS-TPDU; and
- transfer of the RP-DATA message as an RPDU in an MNSMS-EST-Req.

The purpose of this service is to relay the SMS-TPDU from the MSC to the peer entity in the mobile station.

#### 3.3.2.2 SM-RL-DATA-INDication

An indication used by the SMR entity to pass the SMS-TPDU of a received RP-DATA message to RL.

#### 3.3.2.3 SM-RL-MEMORY-AVAILABLE-INDication

An indication used by the SMR entity to pass to RL the notification to the network that the mobile has memory available to receive one or more short messages.

#### **3.3.2.4 SM-RL-REPORT-REQuest**

A request used by RL (the network interworking function) to relay the RP-ACK or RP-ERROR message from the network to the mobile station. This implies transfer of the RP-ACK or RP-ERROR message as an RPDU in an MNSMS-DATA-Req.

#### **3.3.2.5 SM-RL-REPORT-INDication**

An indication used by the SMR entity to pass an acknowledgement (RP-ACK) or error information to RL. The error information may be local or relayed by the RP-ERROR message.

#### **4 [Spare]**

## **5 CM-procedures**

### **5.1 General**

This section describes the procedures used by the SMC entity on the Connection Management sublayer. An SMC entity communicates with a corresponding peer entity using an MM-connection.

Multiple MM-connections may be established at the same time, allowing parallel transactions. The description of the procedures is related to one single transaction.

The CM-procedures described in this section can only be performed if an MM-connection has been established between the mobile station and the network. Detailed SDL diagrams for SMC entities are contained in Annex B.

### **5.2 Short Message Control states**

The state transition diagrams for the MO and MT SMC entities on both the MS side and network side are contained in Annex B.

#### **5.2.1 SMC states at the MS side of the radio interface**

##### **5.2.1.1 Mobile Originating Case**

The states described in this section are for an SMC entity in an MS handling mobile originating short message transfer and notification to the network that the mobile has memory available to receive one or more short messages (referred to below as 'notification').

###### **5.2.1.1.1 MO-Idle (State 0)**

This state exists when the MO-SMC entity is in idle mode, or when an MO short message transfer or notification ends in a normal or abnormal way.

###### **5.2.1.1.2 MO-MM-connection pending (State 1)**

This state exists when the MO-SMC has requested the establishment of an MM-connection.

###### **5.2.1.1.3 MO-Wait for CP-ACK (State 2)**

This state exists after the MO-SMC has initiated the transfer of a CP-DATA message.

**5.2.1.1.4 MO-MM-connection established (State 3)**

This state exists when the MO-SMC has:

- received the acknowledgement, CP-ACK; or
- received the message CP-DATA (including sending of the associated CP-ACK).

**5.2.1.2 Mobile Terminating case**

The states described in this section are for an SMC entity in an MS handling mobile terminating short message transfer.

**5.2.1.2.1 MT-Idle (State 0)**

This state exists when the MT-SMC entity is in idle mode, or when a short message transfer ends in a normal or abnormal way.

**5.2.1.2.2 MT-Wait for CP-ACK (State 2)**

This state exists after the MT-SMC has initiated the transfer of a CP-DATA message.

**5.2.1.2.3 MT-MM-connection established (State 3)**

This state exists when the MT-SMC has:

- received the acknowledgement, CP-ACK; or
- received the message CP-DATA (including sending of the associated CP-ACK).

## **5.2.2 SMC states at the network side of the radio interface**

### **5.2.2.1 Mobile Originating Case**

The states described in this section are for an SMC entity in an MSC handling both mobile originating short message transfer and notification to the network that the mobile has memory available to receive one or more short messages (referred to below as 'notification').

#### **5.2.2.1.1 MO-Idle (State 0)**

This state exists when the MO-SMC entity is in idle mode, or when a short message transfer or notification ends in a normal or abnormal way.

#### **5.2.2.1.2 MO-Wait for CP-ACK (State 2)**

This state exists after the MO-SMC has initiated the transfer of a CP-DATA message.

#### **5.2.2.1.3 MO-MM-connection established (State 3)**

This state exists when the SMC has:

- received the acknowledgement, CP-ACK; or
- received the message CP-DATA (including sending of the associated CP-ACK).

### **5.2.2.2 Mobile Terminating Case**

The states described in this section are for an SMC entity in an MSC handling mobile terminating short message transfer.

#### **5.2.2.2.1 MT-Idle (State 0)**

This state exists when the MT-SMC entity is in idle mode, or when a short message transfer ends in a normal or abnormal way.

#### **5.2.2.2.2 MT-MM-connection pending (State 1)**

This state exists when the MT-SMC has requested an MM-connection for mobile terminating short message transfer.

#### **5.2.2.2.3 MT-Wait for CP-ACK (State 2)**

This state exists after the SMC has initiated the transfer of a CP-DATA message.

#### 5.2.2.2.4 MT-MM-connection established (State 3)

This state exists when the SMC has:

- received the acknowledgement, CP-ACK; or
- received the message CP-DATA (including sending of the associated CP-ACK).

### 5.3 Short message control procedures

The procedures needed for short message control are:

- connection establishment procedures;
- RP Data Unit (RPDU) transfer procedures;
- connection release procedures; and
- procedures for abnormal cases.

The procedures of section 5.3 are described with respect to one particular instance of an SMC entity. Different SMC entities are identified by their Transaction Identifier. Messages with Transaction Identifiers that do not correspond to this particular instance of the SMC entity are not treated by it.

#### 5.3.1 MM-connection establishment

When an SMC entity is in the Idle state and transfer of an RPDU is requested, the peer to peer connection between the MM-sublayers in the MS and the network (MSC) has to be established.

The SMC entity on the originating side requests the MM-sublayer to establish an MM-connection, and enters the MM-Connection Pending state.

After completion of the MM-connection establishment, a confirmation is given to the originating side to indicate that the MM sublayer is ready for RPDU transfer.

The MM-connection establishment is indicated to the SMC entity at the destination side when the CP-DATA message has been received by the MM-sublayer (in line with TS GSM 04.08). The destination side SMC entity then sends a CP-ACK and enters the MM-Connection Established state.

#### 5.3.2 RPDU transfer

When an SMC entity in the MM-Connection Pending state is informed that an MM-connection has been established, the SMC entity forwards the CP-DATA message containing the RPDU, sets the timer TC1\* and enters the Wait for CP-ACK state.

The value of TC1\* may vary with the length of the CP-DATA message and the channel type that is being used for its transmission. However, the value of TC1\* shall be sufficiently great to allow the lower layers to transmit the CP-DATA and CP-ACK messages and to allow for some retransmissions of layer 2 frames,

If an SMC entity in the Wait for CP-ACK state gets an indication that the CP-DATA message has probably been lost (eg. due to dedicated channel assignment, handover, assignment failure, handover failure, or a SAPI 3 data link failure) then, as an implementation option, that SMC entity may reduce the time until expiry of TC1\*.



If the timer TC1\* expires in the Wait for CP-ACK state, the CP-DATA message is retransmitted and the state Wait for CP-ACK is reentered. The maximum number of CP-DATA message retransmissions is an implementation option but shall be either 1, 2 or 3. If the timer TC1\* expires after the maximum number of retransmission attempts, an error indication is passed to SM-RL and an MM-connection release request is passed to the MM-sublayer. The Idle state is then entered.

On receipt of the CP-ACK message in the Wait for CP-ACK state, the SMC resets the timer TC1\* and enters the MM-Connection Established state.

When receiving a CP-DATA message in the MM-Connection Established state, the SMC entity checks the parameters relevant to the CP protocol. If these are valid, the RPDU is passed to the SM-RL, the CP-ACK message is sent and the state MM-Connection Established is reentered.

If an SMC entity in the Idle state is unable to accept a CP-DATA message, it sends a CP-ERROR message followed by an MM-connection release request and then enters the Idle state.

When receiving a MNSMS-DATA-Req primitive in the MM-Connection Established state, the SMC entity forwards a CP-DATA message containing the RPDU to the MM-sublayer, sets the timer TC1\* and enters the Wait for CP-ACK state.

### 5.3.3 Release of MM and CM connections

With the exception of error situations, release of the MM and CM connection is controlled by the SM-RL.

When an SMC entity in the Wait for CP-ACK state receives a release request from SM-RL, this request is stored until the next state (either MM Connection Established or Idle) is entered. If the Idle state is entered, the request is discarded. If the MM Connection Established state is entered, or if the SMC entity receives a release request from SM-RL in this state, an MM-connection release request is sent to the MM-sublayer and the SMC entity enters the Idle state.

### 5.3.4 Abnormal cases

Abnormal cases that shall be handled by the SMC entity in any state can be classified into five cases:

- Upper Layer Abort: Errors occurring in the SM-RL may cause the SM-RL to send an MNSMS-ABORT Request to the SMC entity.
- CP-Layer Abort: Errors occurring within the SMC entity itself may require termination of all activities related to that transaction identifier.
- Lower Layer Abort: Errors occurring within the layers beneath the CP-layer may cause an MMSM-ERROR Indication to be sent to the SMC entity.
- CP-Layer Protocol Errors: Errors occurring within the protocol exchange between the SMC entities may result in the sending of a CP-ERROR message between the entities.
- Lower Layer Release: Events occurring within the layers beneath the CP layer may cause an MMSM-REL Indication to be sent to the SMC entity.

When the CM-sublayer in the network receives an Upper Layer Abort, it may form and send the CP-ERROR message to to release the connection. Irrespective of whether or not the CP-ERROR message was sent, an MM-connection release request, without indication of release cause, is passed to the MM-sublayer. The SMC entity in the network then enters the Idle state.

When the CM-sublayer in the MS receives an Upper Layer Abort and if the MM connection exists, it shall form and send the CP-ERROR message. Irrespective of whether or not the CP-ERROR message was sent, an MM-connection release request, without indication of release cause, is passed to the MM-sublayer. The SMC entity in the mobile station then enters the Idle state.

In the case of a CP-Layer Abort, an error indication is passed to SM-RL. If possible, a CP-ERROR message is sent to the partner SMC entity to indicate the error situation. Then the SMC entity enters the Idle state.

In the case of a Lower Layer Abort, the SMC entity passes an error indication to SM-RL, an MM-connection release request is passed to the MM-sublayer, and the SMC entity immediately enters the Idle state.

In the case of the reception of a CP-ERROR message from the partner SMC entity, an error indication is passed to SM-RL, an MM-connection release request, without indication of release cause, is passed to the MM-sublayer, and the SMC entity enters the Idle state.

In the case of a lower layer release, the SMC entity passes an MNSMS-ERROR Indication to SM-RL and then enters the Idle state.

In all cases, if the timer TC1\* is running, it is reset.

Due to structure of message flow on SAPI 0 and 3 it is possible that the CP-ACK of a short message transfer might not be received (e.g. due to handover). If the first CP-ACK (acknowledging the CP-DATA that carried the first RPDU) is not received the reception of CP-DATA may be interpreted as the reception of the awaited CP-ACK and CP-DATA message.

#### 5.4 Concatenating short message or notification transfers

If an entity has more than one short message or notification to send then it is useful to maintain the Radio Resource (RR) connection in between transfers. For mobile terminated short messages this is simple because the network decides when, and whether, to release the RR connection. However, for mobile originated transfers, the network does not know whether or not the mobile has more messages to transfer.

If another short message or a memory available notification is to be sent, an originating SMR entity in the MS may choose to continue to use the same RR connection. When the MS chooses to use the same RR connection, then:

- the MS shall transmit a CM SERVICE REQUEST for the new CM connection before the final CP-ACK (eg. the one that acknowledges the CP-DATA that carried the RP-ACK) for the old MM connection is transmitted;
- before transmission of the first CP-DATA on the new MM connection, the MS shall transmit the CP-ACK for the old MM connection;
- the Transaction Identifier used on the new MM connection shall be different to that used on the old MM connection; and
- the MS shall not initiate establishment of the new MM connection before the final CP-DATA (eg. the one carrying the RP-ACK) has been received.

NOTE: When an MS sends successive memory available notifications and/or mobile originated short messages on different RR connections, the MS is strongly recommended to use different Transaction Identifiers for the old and new MM connections.

Due to the structure of message flow on SAPIs 0 and 3 it is possible that the final CP-ACK of a short message transfer may not be received (eg. due to transmission errors and/or handovers). For mobile terminated transfers, if the CP-ACK is lost, the reception of a CP-DATA with a different transaction identifier and carrying an RPDU shall be interpreted as the implicit reception of the awaited CP-ACK followed by the reception of the new CP-DATA message. For mobile originated transfers, if the CP-ACK is lost, the reception of a CM SERVICE REQUEST followed by a CP-DATA with a different transaction identifier and carrying an RPDU shall be interpreted as the implicit reception of the awaited CP-ACK followed by the reception of the new CP-DATA message.

## **6 SM-RL-procedures**

### **6.1 General**

This section describes the procedures used by the SMR entity for short message and notification support on the Short Message Relay Layer. An SMR entity communicates with a corresponding peer entity using a CM-connection.

Multiple CM-connections may be established at the same time, allowing parallel transactions. There is a functional one to one relation between the SMR entity and the SMC entity of the CM-sublayer. The descriptions of the procedures are related to one single transaction.

The RL-procedures described in this section can only be performed if a CM-connection has been established between the mobile station and the network. Detailed SDL-diagrams for short message control on SM-RL are contained in annex D.

### **6.2 Transition states of SMR entity**

The state transition diagram for the SMR entities on both MS-side and network side are contained in Annex D.

#### **6.2.1 SMR-states at the MS-side of the radio interface**

The states described in this section are for a SMR entity in a MS, handling mobile originating- and mobile terminating short messages and notification transfer.

##### **6.2.1.1 Idle (State 0)**

This state exists when the SMR entity is in idle mode, or when a short message or notification transfer ends in a normal or abnormal way.

##### **6.2.1.2 Wait for RP-ACK (State 1)**

This state exists for mobile originating short message or notification transfer when the SMR has passed the RP-DATA or RP-SMMA to the SMC entity and set the timer TR1M.

##### **6.2.1.3 Wait for RETRANS TIMER (State 4)**

This state exists for memory available notification when the SMR is waiting to retransmit the RP-SMMA message. Timer TRAM has been set. The possibility of an abort of the sending of the memory available notification by the SM-TL exists. No underlying connection exists.

## 6.2.2 SMR-states at the network side of the radio interface

The states described in this section are for a SMR entity in a MSC, handling mobile originating- and mobile terminating short message and notification transfer.

### 6.2.2.1 Idle (State 0)

This state exists when the SMR entity is in idle mode, or when a short message transfer or notification end in a normal or abnormal way.

### 6.2.2.2 Wait for RP-ACK (State 1)

This state exists for a mobile terminating short message transfer when the SMR has passed the RP-DATA message to the SMC entity and set the timer TR1N.

### 6.2.2.3 Wait to send RP-ACK (State 3)

The SMR entity will enter this state after passing a received RP-DATA or RP-SMMA message to RL and setting the timer TR2N.

## 6.3 Short Message Relay procedures

The procedures needed for short message and notification relaying are:

- TP Data Unit (TPDU) relay procedures;
- notification relay procedures;
- procedures for abnormal cases.

### 6.3.1 TPDU relaying

When the SMR entity is in the Idle state and receives a request from SM-TL to relay a TPDU, it forms and transfers the RP-DATA message (containing the TPDU), sets the timer TR1\* and enters the state Wait for RP-ACK.

Retransmission of RP data units by the CM-sublayer is described in section 5.

When the SMR entity is in the "Wait for RP-ACK" state, the following situations may occur:

- a) reception of an RP-ACK or RP-ERROR message (containing the same reference number as the transmitted RP-DATA message);
- b) reception of an error indication from the CM-sublayer;
- c) the timer TR1\* expires.

In case a) or b), the timer TR1\* is reset, a report indication is passed to SM-TL, a request to release the CM-connection is passed to CM-sublayer, and the SMR entity enters the Idle state.

In case c), a request to abort the CM-connection is passed to the CM-sublayer, a report indication is passed to SM-TL, and the SMR entity enters the Idle state.

When the SMR entity is in the Idle state and receives an MNSMS-EST-Ind containing a valid RP-DATA message, it passes the SMS-TPDU to the SM-TL, starts timer TR2\*, and enters the state "Wait to Send RP-ACK".

When the SMR entity is in the state "Wait to Send RP-ACK" and the SMR entity receives the SM-RL-Report-Request, the timer TR2\* is reset, the RP-message (RP-ACK or RP-ERROR) is generated and relayed to the peer entity, a CM-connection release request is passed to the CM-sublayer, and the SMR entity enters the Idle state.

When the SMR entity is in the state "Wait to Send RP-ACK" and the SMR entity receives an error indication from the CM-sublayer, the timer TR2\* is reset, a report indication is passed to the SM-TL and the SMR entity enters the Idle state.

When the SMR entity is in the state "Wait to send RP-ACK" and the timer TR2\* expires, the SMR entity passes a CM-connection abort request to the CM-sublayer, a report indication is passed to the SM-TL, and the SMR entity enters the Idle state.

### 6.3.2 [spare]

### 6.3.3 Notification relaying

#### 6.3.3.1 MS side

##### 6.3.3.1.1 Idle state

When the SMR entity in the MS in the Idle state receives a request from the SM-TL to relay a notification to the network, it forms and transfers the RP-SMMA message, starts timer TR1M, and enters the state Wait for RP-ACK.

##### 6.3.3.1.2 Wait for RP-ACK state

When the SMR entity in the MS is in the Wait for RP-ACK state and it receives either:

- an RP-ACK (containing the same reference number as the last transmitted RP-SMMA message); or
- an RP-ERROR (containing the same reference number as the last transmitted RP-SMMA message) with a permanent failure indication; or
- an error indication from the CP-sublayer;

then the MS shall reset timer TR1M, pass a report indication to SM-TL, give a CM-connection release request to the CM-sublayer, and enter the Idle state. If set, timer TRAM and the RETRANS flag are also reset.

When the SMR entity in the MS is in the Wait for RP-ACK state and either:

- it receives an RP-ERROR (containing the same reference number as the last transmitted RP-SMMA message) with a temporary failure indication; or
- timer TR1M expires;

then the MS shall examine the RETRANS flag:

- if the RETRANS flag is set (ie. no more transmissions of the RP-SMMA message are permitted) then,
  - the MS shall pass a report indication to SM-TL, give a CM-connection release request to the CM-sublayer, reset the RETRANS flag, reset TR1M, and enter the Idle state.

- If the RETRANS flag is not set (ie. at least another transmission of the RP-SMMA message is currently permitted) then,
  - the MS shall give a CM-connection release request to the CM-sublayer, set the RETRANS flag, reset TR1M, start timer TRAM and enter the Wait for Retrans Timer state.

When the SMR entity in the MS is in the Wait for RP-ACK state and it receives an SM-RL-MEMORY-AVAILABLE-Req (SMS-MEM-NOTIF-ABORT) primitive, then the MS shall set the RETRANS flag and reenter the Wait for RP-ACK state.

#### **6.3.3.1.3 Wait for RETRANS Timer state**

When the SMR entity in the MS is in the Wait for Retrans Timer state and timer TRAM expires then, the MS shall form and transfer an RP-SMMA message, start timer TR1M, and enter the state Wait for RP-ACK. The RP-Message Reference in this RP-SMMA message shall be different from that in the previous RP-SMMA message.

When the SMR entity in the MS is in the Wait for Retrans Timer state and it receives an SM-RL-MEMORY-AVAILABLE-Req (SMS-MEM-NOTIF-ABORT) primitive, then the MS shall reset the RETRANS flag, reset timer TRAM, pass a report indication to SM-TL, and enter the Idle state.

#### **6.3.3.2 Network side**

##### **6.3.3.2.1 Idle state**

When the SMR entity in the network is in the Idle state and receives an MNSMS-EST-Ind containing a valid RP-SMMA message, it passes the SMS-TPDU to the SM-TL, starts timer TR2N, and enters the state "Wait to send RP-ACK".

##### **6.3.3.2.2 Wait to Send RP-ACK state**

When the SMR entity in the network is in the state "Wait to Send RP-ACK" and the SMR entity receives the SM-RL-Report-Request, timer TR2N is reset, the RP-message (RP-ACK or RP-ERROR) is generated and relayed to the MS, a CM-connection release request is passed to the CM-sublayer, and the SMR entity enters the Idle state.

When the SMR entity in the network is in the state "Wait to Send RP-ACK" and the SMR entity receives an error indication from the CM-sublayer, timer TR2N is reset, a report indication is passed to the SM-TL and the SMR entity enters the Idle state.

When the SMR entity in the network is in the state "Wait to Send RP-ACK" and the timer TR2N expires, the SMR entity passes a CM-connection abort request to the CM-sublayer, a report indication is passed to the SM-TL, and the SMR entity enters the Idle state.

#### **6.3.4 Abnormal cases**

Format errors etc:

If the SMR entity upon receipt of an RP-DATA or RP-SMMA message detects an erroneous condition which it can act on, (e.g. format errors, invalid parameters etc.) it shall return an RP-ERROR message with an appropriate cause value and possibly extended diagnostic information, release or abort the CM-connection, and enter the Idle state.

## 7 Message functional definitions and content

### 7.1 General

The notation used is as used in TS GSM 04.08/section 9, and each definition includes:

- a) A brief description of the message direction and use.
- b) A table listing the information elements in the order of their appearance in the message. For each information element the table indicates:
  - 1) A reference to the section/Technical Specification describing the information element.
  - 2) The presence requirement indication (M, C, or O) for the IE as defined in TS GSM 04.07.
  - 3) The format of the information element (T, V, TV, LV, TLV) as defined in TS GSM 04.07
  - 4) The length of the information element (or permissible range of lengths), in octets, in the messages.

### 7.2 Messages for short message or notification transfer on CM

This section describes the functional definition and content of the messages sent between two SMC entities.

There are three messages defined: CP-DATA, CP-ACK and CP-ERROR.

#### 7.2.1 CP-DATA

The CP-DATA message is sent between an MSC and an MS, in both directions. The message contains the user data to be relayed between the CM-users, and associated parameters. See table 7.1/ GSM 04.11.

Information element	Reference	Presence	Format	Length
Protocol discriminator	TS GSM 04.07	M	V	1/2 octet
Transaction identifier	TS GSM 04.07	M	V	1/2 octet
Message type	Section 8.1.3	M	V	1 octet
CP-User data	Section 8.1.4.1	M	LV	≤256 octets

**Table 7.1/GSM 04.11:  
CP-DATA message content**



### 7.2.2 CP-ACK

The CP-ACK message is sent between an MSC and an MS, in both directions, and is used to acknowledge the reception of a CP-DATA message.

See table 7.2/GSM 04.11.

	Information element	Reference	Presence	Format	Length
	Protocol discriminator	TS GSM 04.07	M	V	1/2 octet
	Transaction identifier	TS GSM 04.07	M	V	1/2 octet
	Message type	Section 8.1.3	M	V	1 octet

**Table 7.2/GSM 04.11:  
CP-ACK message content**

### 7.2.3 CP-ERROR

The CP-ERROR message is sent between an MSC and an MS, in both directions, and used to convey error information. See table 7.3/GSM 04.11.

	Information element	Reference	Presence	Format	Length
	Protocol discriminator	TS GSM 04.07	M	V	1/2 octet
	Transaction identifier	TS GSM 04.07	M	V	1/2 octet
	Message type	Section 8.1.3	M	V	1 octet
	CP-Cause	Section 8.1.4.2	M	V	1 octet

**Table 7.3/GSM 04.11:  
CP-ERROR message content**

### 7.3 Messages for short message and notification transfer on SM-RL

This section describes the functional definition and content of the messages sent between two SMR entities.

There are 4 messages defined: RP-DATA, RP-SMMA, RP-ACK and RP-ERROR.

#### 7.3.1 RP-DATA

A phase 2 entity shall not reject a RP-DATA message where both address elements have a length greater than 0.

##### 7.3.1.1 RP-DATA (Network to Mobile Station)

This message is sent in MSC -> MS direction. The message is used to relay the TPDUs. The information elements are in line with TS GSM 03.40. See table 7.4/GSM 04.11.

Information element	Reference	Presence	Format	Length
RP-Message Type	Section 8.2.2	M	V	3 bits
RP-Message Reference	Section 8.2.3	M	V	1 octet
RP-Originator Address	Section 8.2.5.1	M	LV	1-12 octets
RP-Destination Address	Section 8.2.5.2	M	LV	1 octet
RP-User Data	Section 8.2.5.3	M	LV	≤239 octets

**Table 7.4/GSM 04.11:  
RP-DATA message content**

##### 7.3.1.2 RP-DATA (Mobile Station to Network)

This message is sent in MS -> MSC direction. The message is used to relay the TPDUs. The information elements are in line with TS GSM 03.40. See table 7.5/GSM 04.11.

Information element	Reference	Presence	Format	Length
RP-Message Type	Section 8.2.2	M	V	3 bits
RP-Message Reference	Section 8.2.3	M	V	1 octet
RP-Originator Address	Section 8.2.5.1	M	LV	1 octet
RP-Destination Address	Section 8.2.5.2	M	LV	1-12 octets
RP-User Data	Section 8.2.5.3	M	LV	≤239 octets

**Table 7.5/GSM 04.11:  
RP-DATA message content**

### 7.3.2 RP-SMMA

This message is sent by the mobile station to relay a notification to the network that the mobile has memory available to receive one or more short messages. The information elements are in line with TS GSM 03.40. See table 7.6/GSM 04.11

	Information element	Reference	Presence	Format	Length
	RP-Message Type	Section 8.2.2	M	V	3 bits
	RP-Message Reference	Section 8.2.3	M	V	1 octet

**Table 7.6/GSM 04.11:  
RP-SMMA message content**

### 7.3.3 RP-ACK

This message is sent between the MSC and the mobile station in both directions and used to relay the acknowledgement of a RP-DATA or RP-SMMA message reception. The information elements are in line with TS GSM 03.40. See table 7.7/GSM 04.11.

	Information element	Reference	Presence	Format	Length
	RP-Message Type	Section 8.2.2	M	V	3 bits
	RP-Message Reference	Section 8.2.3	M	V	1 octet

**Table 7.7/GSM 04.11:  
RP-ACK message content**

### 7.3.4 RP-ERROR

This message is sent between the MSC and the mobile station in both directions and used to relay an error cause from an erroneous short message or notification transfer attempt. The information elements are in line with TS GSM 03.40. See table 7.8/GSM 04.11.

The contents of the cause field are given in Section 8.2.5.4.

	Information element	Reference	Presence	Format	Length
	RP-Message Type	Section 8.2.2	M	V	3 bits
	RP-Message Reference	Section 8.2.3	M	V	1 octet
	RP-Cause	Section 8.2.5.4	M	LV	2-3 octets
	RP-User Data	Section 8.2.5.3	O	TLV	≤240 octets

**Table 7.8/GSM 04.11:  
RP-ERROR message content**

## 8 Message format and information elements coding

### 8.1 CP-messages

#### 8.1.1 General

The message format and information elements coding is in line with TS GSM 04.07 and TS GSM 04.08.

The message shall consist of the following parts:

- a) protocol discriminator;
- b) transaction identifier;
- c) message type;
- d) other required information elements.

This organization is illustrated in the example shown in Figure 8.1/04.11

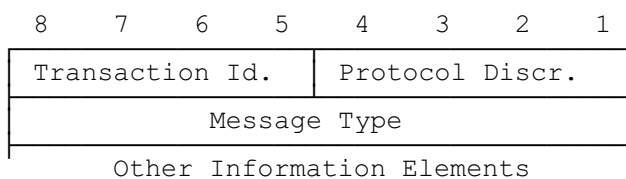

**Figure 8.1/GSM 04.11.**

#### 8.1.2 Protocol Discriminator and Transaction Identifier

The Protocol Discriminator and Transaction Identifier is described in TS GSM 04.07.

#### 8.1.3 Message type

The purpose of the message type, together with the protocol discriminator, is to identify the function of the message being sent. The coding of message types is shown in table 8.1/GSM 04.11.

8	7	6	5	4	3	2	1	
0	0	0	0	0	0	0	1	CP-DATA
0	0	0	0	0	1	0	0	CP-ACK
0	0	0	1	0	0	0	0	CP-ERROR

**Table 8.1/GSM 04.11:  
 Message types for short message and notification transfer on CM**

### 8.1.4 Other required information elements

#### 8.1.4.1 CP-User data element

The CP-User data element is used to carry the RPDU. It has an information element identifier, a length indicator and a data field. The data field will contain the RPDUs. The maximum length of the data field is 255 octets. The layout is indicated in figure 8.2/GSM 04.11.

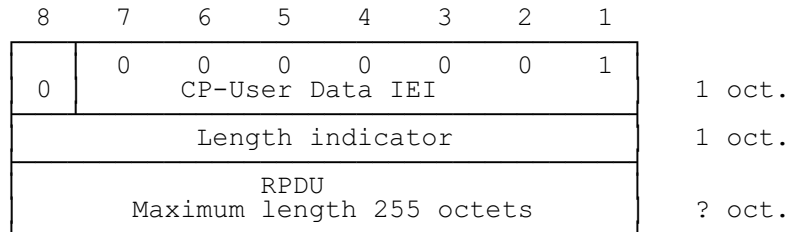

Figure 8.2/GSM 04.11: CP-User data element layout.

#### 8.1.4.2 CP-Cause element

This element is included in the CP-ERROR message, the layout is given in figure 8.3/GSM 04.11. The error causes are listed in table 8.2/GSM 04.11.

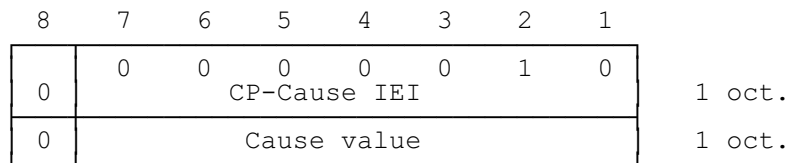

Figure 8.3/GSM 04.11: CP-Cause element layout.

---

Cause value Cause nr. Cause

7 6 5 4 3 2 1	#	
0 0 1 0 0 0 1	17	Network failure
0 0 1 0 1 1 0	22	Congestion
1 0 1 0 0 0 1	81	Invalid Transaction Identifier value
1 0 1 1 1 1 1	95	Semantically incorrect message
1 1 0 0 0 0 0	96	Invalid mandatory information
1 1 0 0 0 0 1	97	Message type non-existent or not implemented
1 1 0 0 0 1 0	98	Message not compatible with the short message protocol state
1 1 0 0 0 1 1	99	Information element non-existent or not implemented
1 1 0 1 1 1 1	111	Protocol error, unspecified

All other cause values shall be treated as cause number 111.

---

Table 8.2/GSM 04.11:  
Content and coding of CP-Cause

## 8.2 RP-messages

### 8.2.1 General

The message shall consist of the following parts:

- a) message type indicator;
- b) message reference;
- c) other required information elements.

This organization is illustrated in the example shown in figure 8.4/04.11

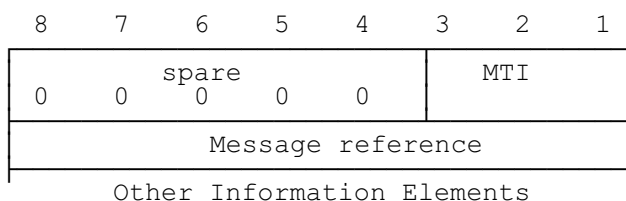

**Figure 8.4/GSM 04.11.**

### 8.2.2 Message type indicator (MTI)

The message type indicator, MTI, is a 3-bit field, located in the first octet of all RP-messages. The coding of the MTI is defined by table 8.3/GSM 04.11.

Bit value 3 2 1	Direction	RP-Message
0 0 0	ms -> n	RP-DATA
0 0 0	n -> ms	Reserved
0 0 1	ms -> n	Reserved
0 0 1	n -> ms	RP-DATA
0 1 0	ms -> n	RP-ACK
0 1 0	n -> ms	Reserved
0 1 1	ms -> n	Reserved
0 1 1	n -> ms	RP-ACK
1 0 0	ms -> n	RP-ERROR
1 0 0	n -> ms	Reserved
1 0 1	ms -> n	Reserved
1 0 1	n -> ms	RP-ERROR
1 1 0	ms -> n	RP-SMMA
1 1 0	n -> ms	Reserved
1 1 1	ms -> n	Reserved
1 1 1	n -> ms	Reserved

**Table 8.3/GSM 04.11:  
 Coding of Message Type Indicator**

**8.2.3 Message reference**

The message reference field contains a sequence number in the range 0 through 255, and is used to link an RP-ACK message or RP-ERROR message to the associated (preceding) RP-DATA or RP-SMMA message transfer attempt.

**8.2.4 [Spare]**

**8.2.5 Other required information elements**

**8.2.5.1 Originator address element**

In the case of MT transfer this element contains the originating Service Centre address.

The RP-Originator Address information element is coded as shown in figure 8.5/GSM 04.11.

The RP-Originator Address is a type 4 information element. In the network to mobile station direction the minimum value of the length octet is 2 and the maximum value is 11. In the mobile station to network direction the value of the length octet of the element is set to 0.

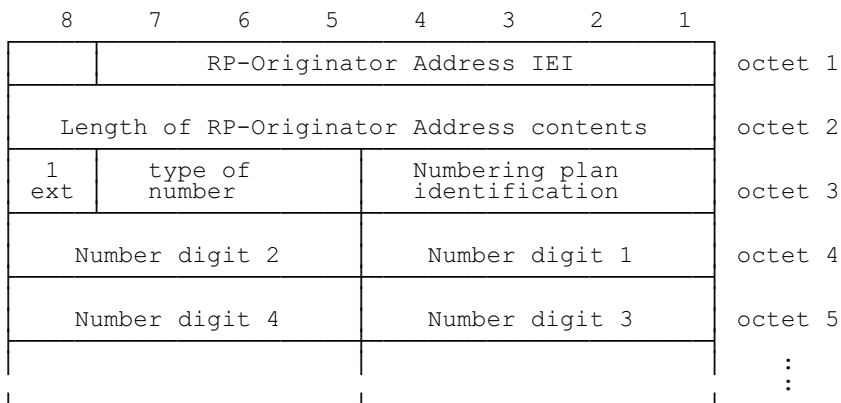

**Figure 8.5/GSM 04.11:  
RP-Originator Address information element**

If the RP-Originator Address contains an odd number of digits, bits 5 to 8 of the last octet shall be filled with an end mark coded as "1111".

The contents of octets 3, 4, etc. are the same as those defined for the Called Party BCD Number IE defined in TS GSM 04.08.

**8.2.5.2 Destination address element**

In the case of MO transfer, this element contains the destination Service Centre address.

The RP-Destination Address information element is coded as shown in figure 8.6/GSM 04.11.

The RP-Destination Address is a type 4 information element. In the mobile station to network direction the minimum value of the length octet is 2 and the maximum value is 11. In the network to mobile station direction, the value of the length octet of the element is set to 0.

8	7	6	5	4	3	2	1	
RP-Destination Address number IEI								octet 1
Length of RP-Destination Address contents								octet 2
1 ext	type of number			Numbering plan identification				octet 3
Number digit 2				Number digit 1				octet 4
Number digit 4				Number digit 3				octet 5
								:
								:

**Figure 8.6/GSM 04.11:  
RP-Destination Address information element**

The number digit(s) in octet 4 precede the digit(s) in octet 5 etc. The number digit which would be entered first is located in octet 4, bits 1 to 4.

If the RP-Destination Address contains an odd number of digits, bits 5 to 8 of the last octet shall be filled with an end mark coded as "1111".

Since the information element contains the complete RP-Destination Address there is no need for an additional complete indication.

The contents of octets 3, 4, etc. are the same as those defined for the Called Party BCD Number IE defined in TS GSM 04.08.



### 8.2.5.3 RP-User data element

The RP-User data field contains the TPDU and is mandatory in a RP-DATA message. RP-User data is also optionally carried in an RP-Error message. The element has a variable length, up to 239 octets, the first octet sent being a length indicator.

RP-User data in an RP-Error message is conveyed as diagnostic information within the 'SM-DeliveryFailureCause' response to a MAP Forward-Short-Message procedure (see TS GSM 09.02). The diagnostic information may be sent in both directions, and shall always be forwarded by the MSC if it is received.

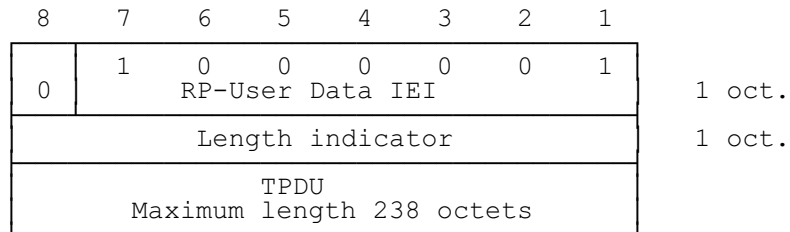

Figure 8.7/GSM 04.11: RP-User data element layout.

### 8.2.5.4 RP-Cause element

This element is a variable length element always included in the RP-ERROR message, conveying a negative result of a RP-DATA message transfer attempt or RP-SMMA notification attempt. The element contains a cause value and optionally a diagnostic field giving further details of the error cause.

The coding of the cause value is given in table 8.4/GSM 04.11. The mapping between error causes in TS GSM 04.11 and TS GSM 09.02 (MAP) is specified in TS GSM 03.40. Parameters included in the return error from MAP (e.g. System Failure) are mapped directly into the diagnostic field.

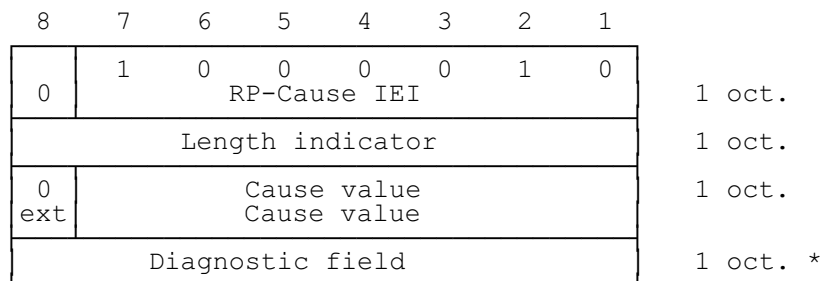

Figure 8.8/GSM 04.11: RP-Cause element layout.

Cause value Class value	Cause number	Cause
7 6 5 4 3 2 1	#	
0 0 0   0 0 0 1	1	Unassigned (unallocated) number
0 0 0   1 0 0 0	8	Operator determined barring
0 0 0   1 0 1 0	10	Call barred
0 0 0   1 0 1 1	11	Reserved
0 0 1   0 1 0 1	21	Short message transfer rejected
0 0 1   1 0 1 1	27	Destination out of order
0 0 1   1 1 0 0	28	Unidentified subscriber
0 0 1   1 1 0 1	29	Facility rejected
0 0 1   1 1 1 0	30	Unknown subscriber
0 1 0   0 1 1 0	38	Network out of order
0 1 0   1 0 0 1	41	Temporary failure
0 1 0   1 0 1 0	42	Congestion
0 1 0   1 1 1 1	47	Resources unavailable, unspecified
0 1 1   0 0 1 0	50	Requested facility not subscribed
1 0 0   0 1 0 1	69	Requested facility not implemented
1 0 1   0 0 0 1	81	Invalid short message transfer reference value
1 0 1   1 1 1 1	95	Semantically incorrect message
1 1 0   0 0 0 0	96	Invalid mandatory information
1 1 0   0 0 0 1	97	Message type non-existent or not implemented
1 1 0   0 0 1 0	98	Message not compatible with short message protocol state
1 1 0   0 0 1 1	99	Information element non-existent or not implemented
1 1 0   1 1 1 1	111	Protocol error, unspecified
1 1 1   1 1 1 1	127	Interworking, unspecified

All other cause values shall be treated as cause number 41, "Temporary Failure"

**Table 8.4/GSM 04.11 (part 1):  
Cause values that may be contained in an RP-ERROR message  
in a mobile originating SM-transfer attempt**

Cause value Class value	Cause number	Cause
7 6 5 4 3 2 1	#	
0 0 1   0 1 1 0	22	Memory capacity exceeded
1 0 1   0 0 0 1	81	Invalid short message transfer reference value
1 0 1   1 1 1 1	95	Semantically incorrect message
1 1 0   0 0 0 0	96	Invalid mandatory information
1 1 0   0 0 0 1	97	Message type non-existent or not implemented
1 1 0   0 0 1 0	98	Message not compatible with short message protocol state
1 1 0   0 0 1 1	99	Information element non-existent or not implemented
1 1 0   1 1 1 1	111	Protocol error, unspecified

All other cause values shall be treated as cause number 111, "Protocol error, unspecified"

**Table 8.4/GSM 04.11 (part 2):  
Cause values that may be contained in an RP-ERROR message  
in a mobile terminating SM-transfer attempt**

---

Cause value Class value	Cause number	Cause type	Cause
7 6 5 4 3 2 1	#		
0 0 1   1 1 1 0	30	P	Unknown Subscriber
0 1 0   0 1 1 0	38	T	Network out of order
0 1 0   1 0 0 1	41	T	Temporary failure
0 1 0   1 0 1 0	42	T	Congestion
0 1 0   1 1 1 1	47	T	Resources unavailable, unspecified
1 0 0   0 1 0 1	69	P	Requested facility not implemented
1 0 1   1 1 1 1	95	P	Semantically incorrect message
1 1 0   0 0 0 0	96	P	Invalid mandatory information
1 1 0   0 0 0 1	97	P	Message type non-existent or not implemented
1 1 0   0 0 1 0	98	P	Message not compatible with short message protocol state
1 1 0   0 0 1 1	99	P	Information element non-existent or not implemented
1 1 0   1 1 1 1	111	P	Protocol error, unspecified
1 1 1   1 1 1 1	127	P	Interworking, unspecified

All other cause values are treated as cause number 41, "Temporary failure"

Each cause is classified as 'Temporary' or 'Permanent', as indicated by T and P respectively in the cause type column.

---

**Table 8.4/GSM 04.11 (part 3):  
 Cause values that may be contained in an RP-ERROR message  
 in a memory available notification attempt**

## **9 Handling of unknown, unforeseen, and erroneous protocol data**

### **9.1 General**

This section specifies procedures for handling of unknown, unforeseen, and erroneous protocol data by the receiving entity. These procedures are called "error handling procedures", but in addition to providing recovery mechanisms for error situations they define a compatibility mechanism for future extensions of the protocols.

Most error handling procedures are mandatory for the MS but optional for the network. Detailed error handling procedures in the network are implementation dependent and may vary from PLMN to PLMN.

In this section the following terminology is used:

- An IE is defined to be syntactically incorrect in a message if it contains at least one value defined as "reserved", or if its value part violates rules. However it is not a syntactical error that a type 4 IE specifies in its length indicator a greater length than defined.
- A message is defined to have semantically incorrect contents if it contains information which, possibly dependant on the state of the receiver, is in contradiction to the resources of the receiver and/or to the procedural part of TS GSM 04.11.

### **9.2 CP Error Handling**

Upon receiving a CP-ERROR message the SMC entity (in any state) shall pass an error indication to SM-RL, pass an MM-connection release request to the MM-sublayer, and enter the Idle State.

After sending a CP-ERROR message the SMC entity (in any state) shall pass an MM-connection release request to the MM sublayer and then enter the Idle State.

#### **9.2.1 Message too short**

When a message is received that is too short to contain a complete message type information element, that message shall be ignored, cf. TS GSM 04.07.

#### **9.2.2 Unknown or unforeseen transaction identifier**

The Mobile Station shall ignore a CP message (CP-DATA, CP-ACK, CP-ERROR) received with TI value "111". Whenever a CP-ACK message is received specifying a Transaction Identifier which is not associated with an active SM transfer, the mobile station shall discard the message and return a CP-ERROR message with cause #81, "Invalid Transaction Identifier" using the received Transaction Identifier, if an appropriate connection exists. The Mobile Station shall ignore a CP-ERROR message that is received specifying a Transaction Identifier which is not associated with an active SM transfer.

The same procedures may apply to the network.

### 9.2.3 Unknown or unforeseen message type

If the Mobile Station receives a message with message type not defined for the PD or not implemented by the receiver, it shall ignore the message and return a CP-ERROR message with cause # 97 "message type non-existent or not implemented", if an appropriate connection exists.

NOTE: A message type not defined for the PD in the given direction is regarded by the receiver as a message type not defined for the PD, see TS GSM 04.07.

If the Mobile Station receives a message not consistent with the protocol state, the Mobile Station shall ignore the message and return a CP-ERROR message with cause #98 "Message type not compatible with the short message protocol state", if an appropriate connection exists.

The network may follow the same procedures.

### 9.2.4 Non-semantic mandatory information element errors

When on receipt of a message

- an "imperative message part" error; or
- a "missing mandatory IE" error.

is diagnosed or when a message containing a syntactically incorrect mandatory IE is received, the mobile station shall proceed as follows:

When the corresponding SM transfer is not seen as successfully transferred, i.e. the transaction is not completed, the mobile station shall ignore the message and return a CP-ERROR message with cause # 96 "invalid mandatory information", if an appropriate connection exists.

When the SM transfer is seen as successfully transferred, the mobile station shall ignore the message and enter the Idle State.

In the case that the message received is a CP-ERROR message, the mobile station shall ignore the message and enter the Idle State.

The network may follow the applicable procedures defined in this section.

### 9.2.5 Messages with semantically incorrect contents

When a message with semantically incorrect contents is received, the foreseen reactions of the procedural part of TS GSM 04.11 are performed. If however no such reactions are specified, the mobile station shall proceed as follows:

- When the corresponding SM transfer is not seen as successfully transferred, the mobile station shall ignore the message and return a CP-ERROR message with cause value # 95 "semantically incorrect message", if an appropriate connection exists.;
- When the SM transfer is seen as successfully transferred, the mobile station shall ignore the message and enter the Idle State;
- in the case that the message received is a CP-ERROR message, the mobile station shall ignore the message and enter the Idle State.

The network may follow the same procedure.

### **9.3 RP Error Handling**

Upon receiving or sending an RP-ERROR message the SMR entity shall behave as described in the procedural description in section 6.

#### **9.3.1 Message too short**

When a message is received that is too short to contain a complete message type information element and Message Reference, that message shall be ignored.

#### **9.3.2 Unknown or unforeseen Message Reference**

Whenever any RP-ACK message is received specifying a Message Reference which is not associated with an active SM transfer, the mobile station shall discard the message and return an RP-ERROR message with cause #81, "Invalid short message transfer reference value" using the received Message Reference, if an appropriate connection exists.

When an RP-ERROR message is received specifying a Message Reference which is not associated with an active SM transfer, the mobile station shall discard the message.

When the mobile station's SMR entity is not in the Idle state, and it receives an RP-DATA message specifying a Message Reference which is not associated with the active SM transfer, then it shall either:

- send an RP-ERROR message with cause #81, "Invalid short message transfer reference value" using the received Message Reference, if an appropriate connection exists; or
- behave as described below for the receipt of an message not consistent with the protocol state.

The same procedures may apply to the network.

### 9.3.3 Unknown or unforeseen message type

If the Mobile Station receives an RP-message with an undefined message type, it shall ignore the message and return an RP-ERROR message with cause # 97 "message type non-existent or not implemented", if an appropriate connection exists.

If the Mobile Station receives a message (except RP-ERROR) not consistent with the protocol state, the Mobile Station shall ignore the message and return a RP-ERROR message with cause #98 "Message type not compatible with Short Message protocol state", if an appropriate connection exists.

If the Mobile Station receives an RP-ERROR message not consistent with the protocol state, the Mobile Station shall ignore the message.

The network may follow the same procedures.

### 9.3.4 Non-semantic mandatory information element errors

When on receipt of a message

- an "imperative message part" error; or
- a "missing mandatory IE" error.

is diagnosed or when a message containing a syntactically incorrect mandatory IE is received, the mobile station shall proceed as follows:

- when the message is an RP-DATA or RP-ACK, the mobile station shall ignore the message and return an RP-ERROR message with cause # 96 "invalid mandatory information", if an appropriate connection exists;
- when the message is an RP-ERROR, the mobile station shall treat the message as an RP-ERROR message carrying RP-Cause value 111 without any diagnostic field, and with no RP-User Data.

The network may follow the applicable procedures defined in this section.

### 9.3.5 Messages with semantically incorrect contents

When a message with semantically incorrect contents is received, the foreseen reactions of the procedural part of TS GSM 04.11 are performed. If however no such reactions are specified then:

- if the message was not an RP-ERROR message, the MS shall ignore the message and return an RP-ERROR message with cause value # 95 "semantically incorrect message", if an appropriate connection exists; while
- if the message was an RP-ERROR message, the mobile station shall treat the message as an RP-ERROR message carrying RP-Cause value # 111 without any diagnostic field, and with no RP-User Data.

The network may follow the same procedure.

## 10 Timers

This technical specification places the following requirements on the timers described in this technical specification:

- timer TR1M shall be greater than 35 seconds and less than 45 seconds;
- the value of timer TRAM shall be greater than 25 seconds and less than 35 seconds.

Constraints on the value of TR2M are imposed by TS GSM 04.13.



**Annex A (informative): Arrow diagrams**

## Arrow diagram A1:

The diagram shows MO-message transfer by means of interlayer service primitives and the actual messages being transferred between the layer entities.

- MNSMS-primitives indicate services provided by CM to SM-RL.
- MMSMS-primitives indicate services provided by MM to CM.
- CP-DATA is the CM-message carrying SM-RP data units.
- CP-ACK acknowledge CP-DATA reception on CM.

## Arrow diagram A2:

The diagram shows MT-messaging by means of interlayer service primitives and the actual messages being transferred between the layer entities.

- MNSMS-primitives indicate services provided by CM to SM-RL.
- MMSMS-primitives indicate services provided by MM to CM.
- CP-DATA is the CM-message carrying SM-RP data units.
- CP-ACK acknowledge CP-DATA reception on CM.

## Arrow diagram A3 and A4:

These diagrams are repetitions of diagrams A1 and A2 with the modifications being the request for the subsequent MM-Connection prior to the sending of the second CP-ACK.

# Mobile Originated Messaging on CM-sublayer

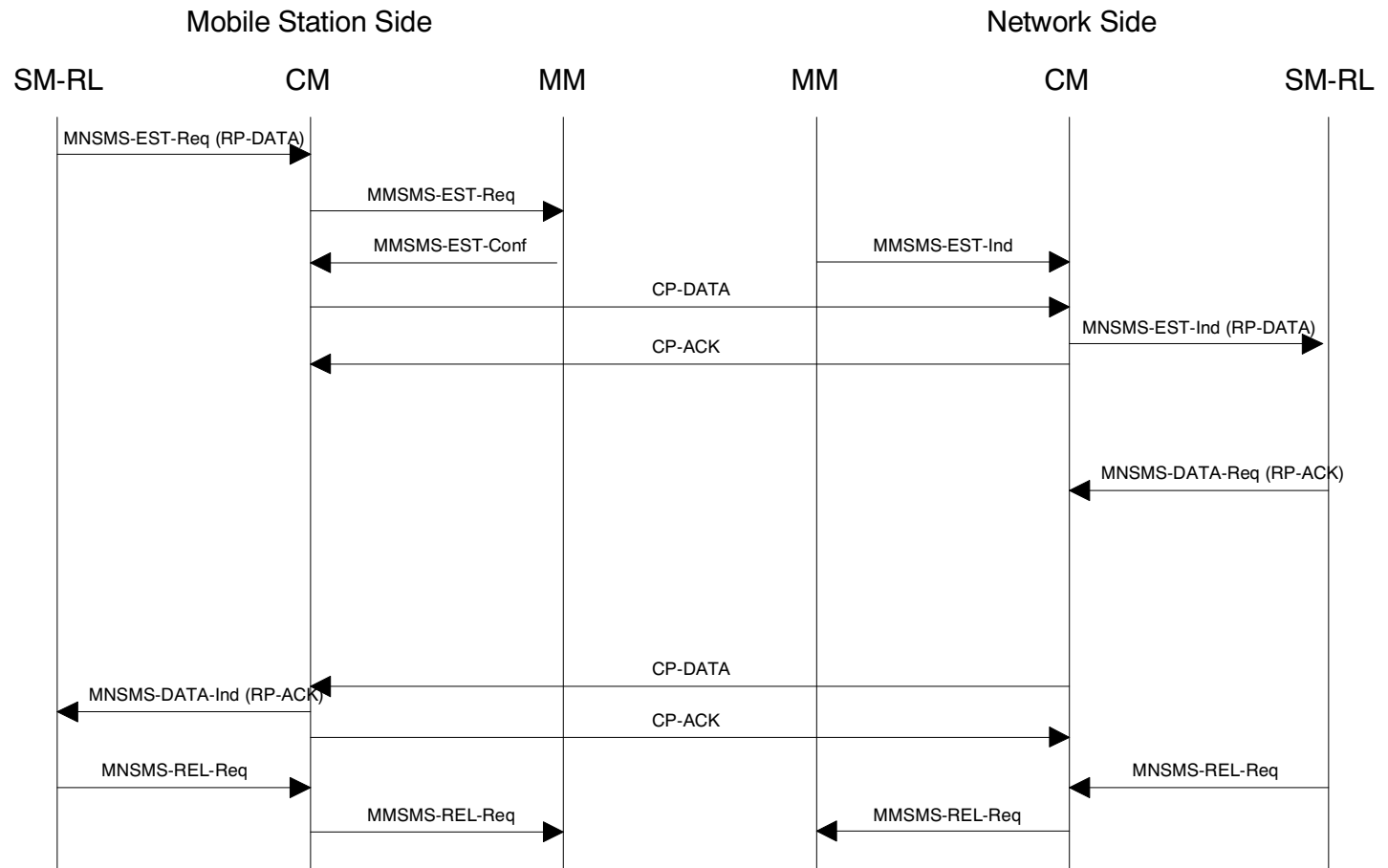

Arrow diagram A1

# Mobile Terminated Messaging on CM-sublayer

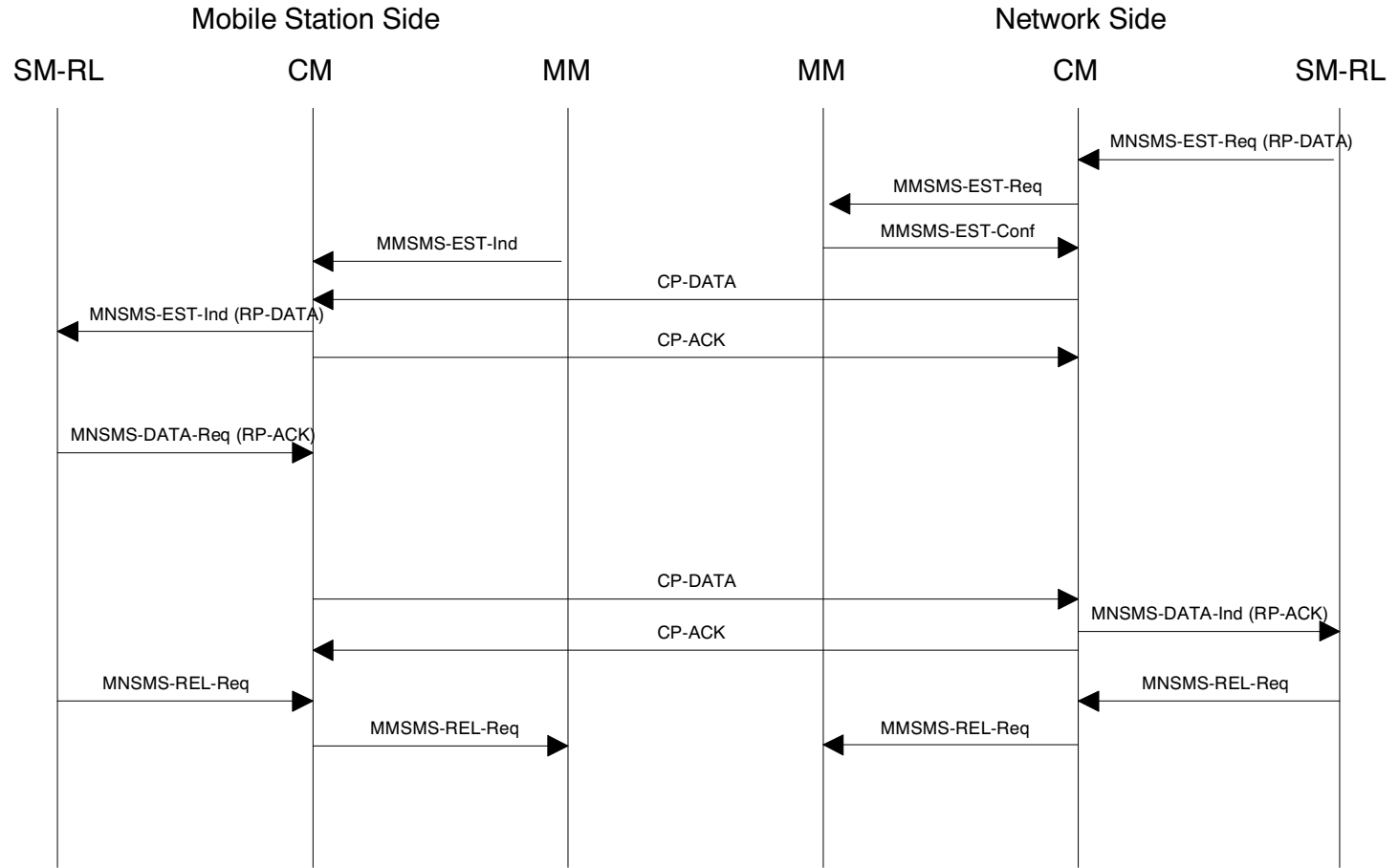

Arrow diagram A2

# Mobile Originated Messaging on CM-sublayer

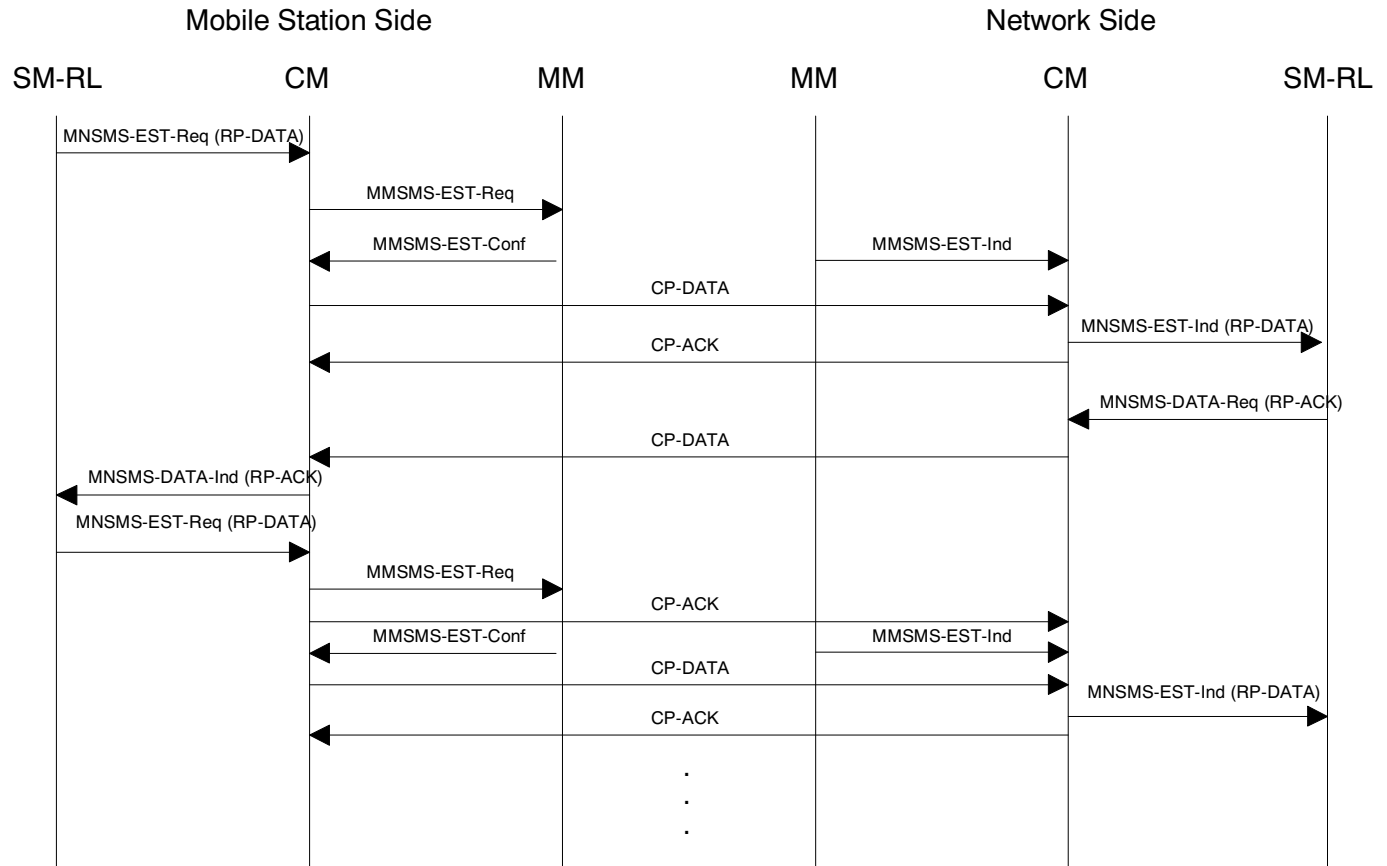

Arrow diagram A3

# Mobile Terminated Messaging on CM-sublayer

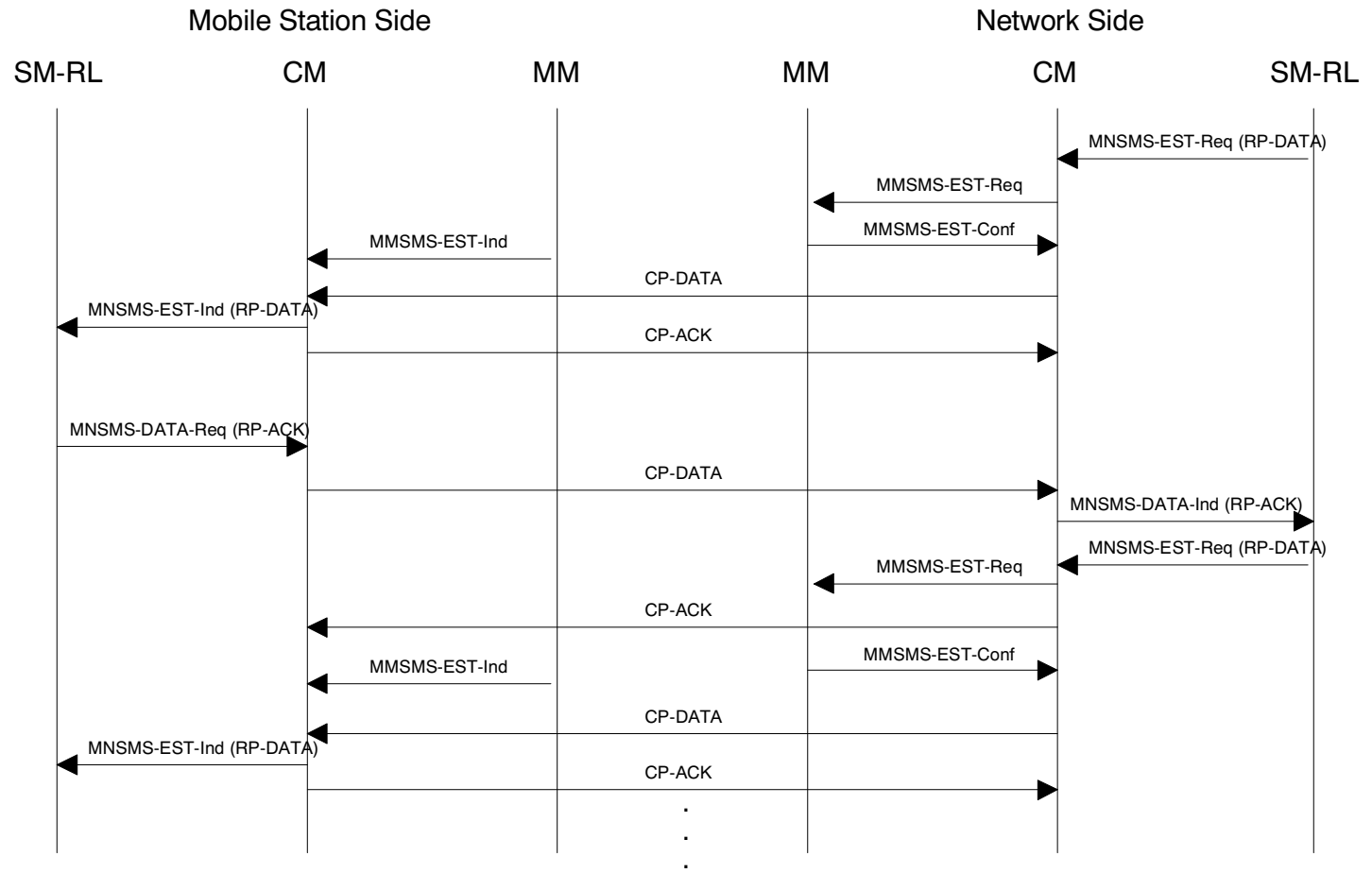

Arrow diagram A4

## **Annex B (normative):      SDL-description of the CM-layer**

### B1. Introduction

This annex contains an SDL-description of the Connection Management Sublayer in terms of the Short Message Service Support. The CM- sublayer provides services to Short Message Relay Layer.

The SDLs contain a mixture of peer to peer messages and conceptual primitives between the layers SM-RL, CM and MM, as viewed by the SMC entities. SDL-1/2/3 show the SMC entity on MS-side for Mobile Originated (MO) short message transfer, SDL-4/5/6 show the SMC entity on MS-side for Mobile Terminated (MT) short message transfer, SDL-7/8/9 show the SMC entity on the network side for Mobile Originated (MO) short message transfer, and SDL-10/11/12 show the SMC entity on the network side for Mobile Terminated (MT) short message transfer.

The lower layers (below MM) are transparent to an SMC entity.

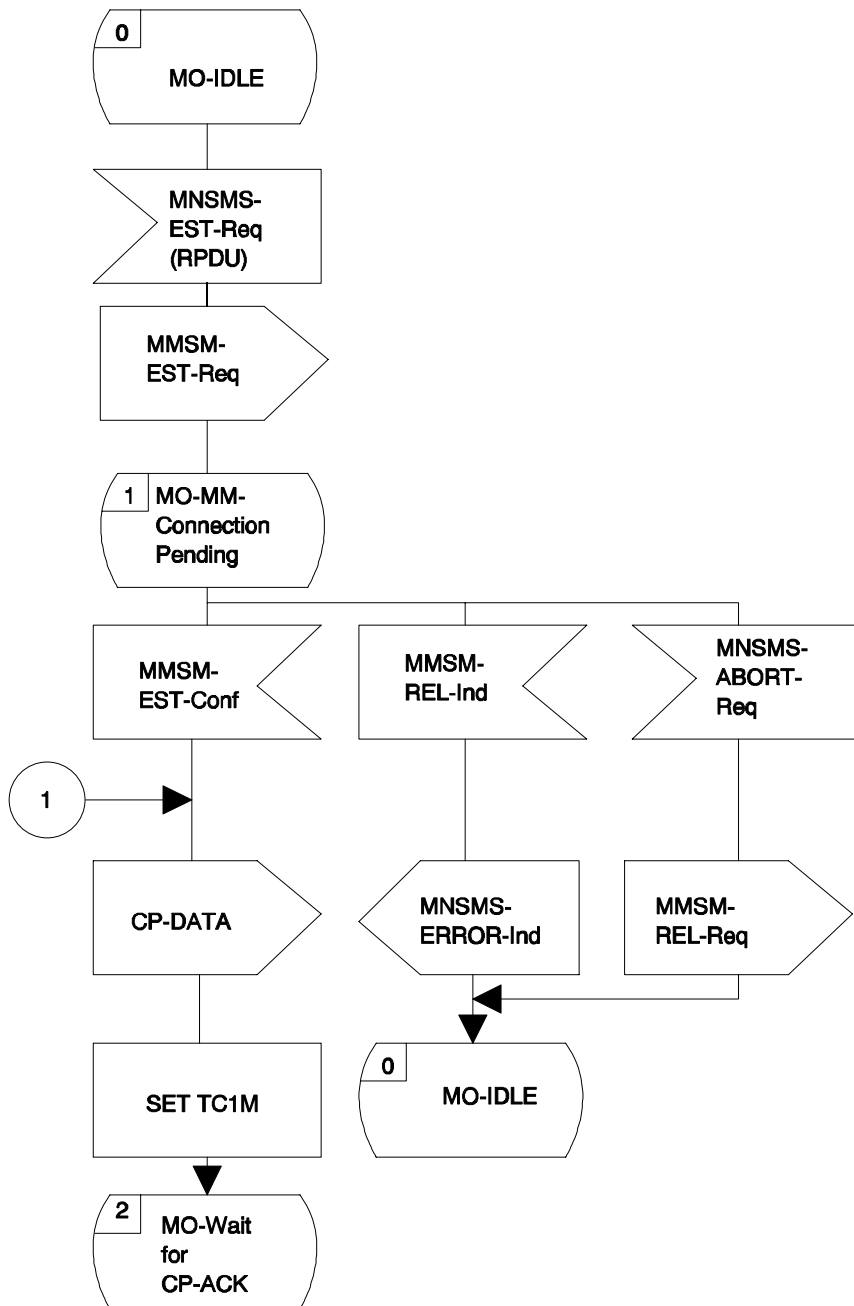

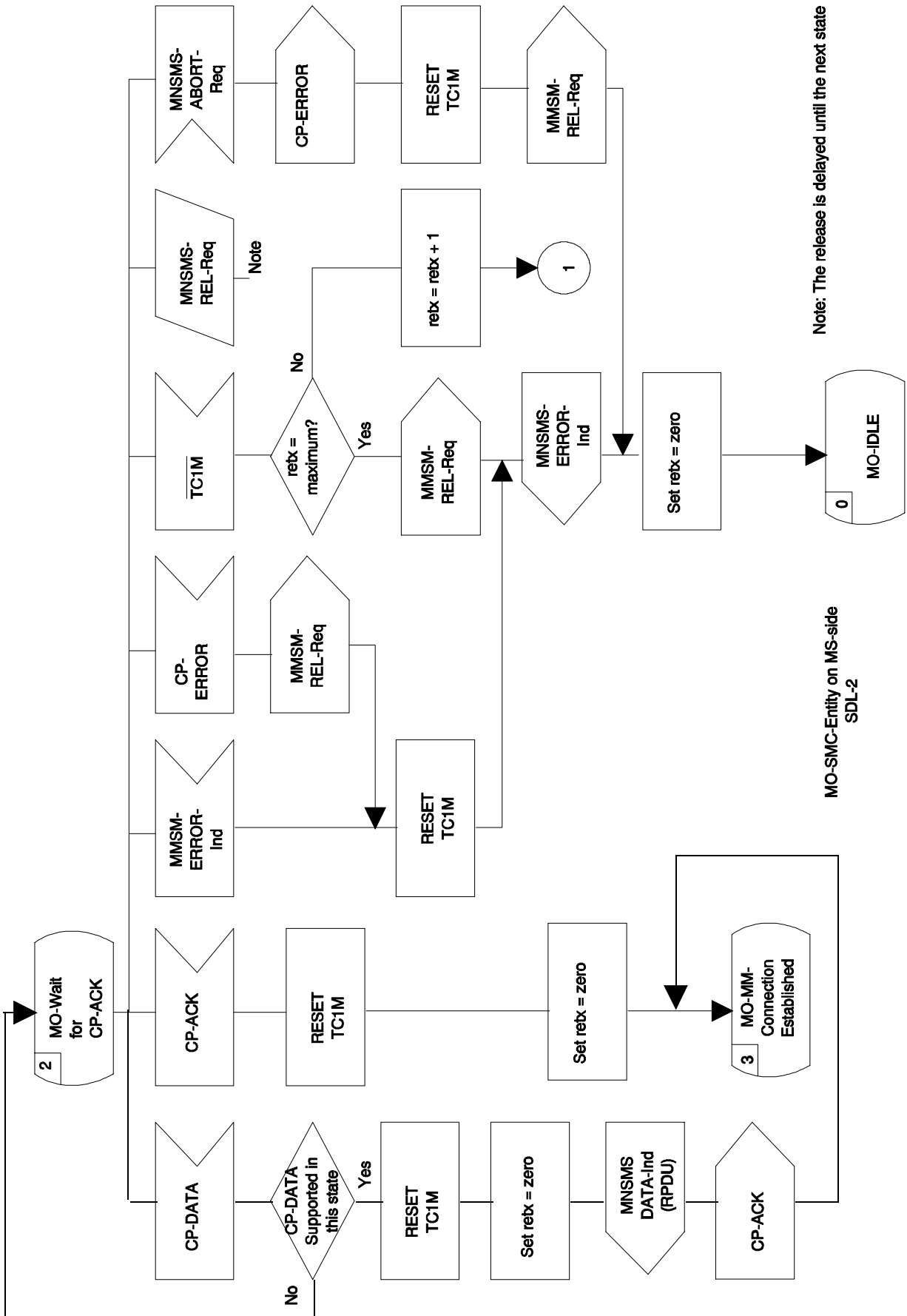



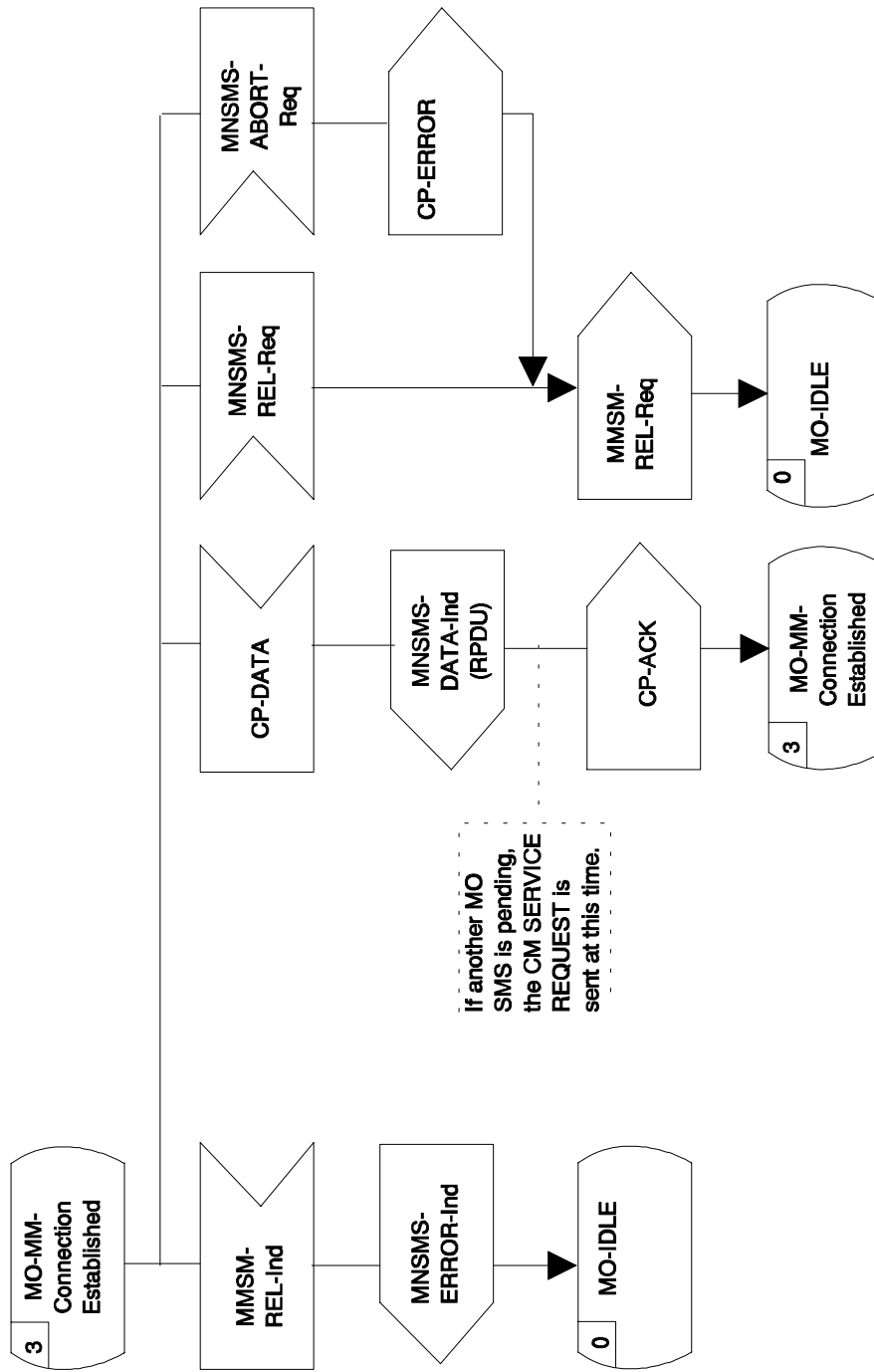

MO-SMC-entity on MS-side  
 SDL-3

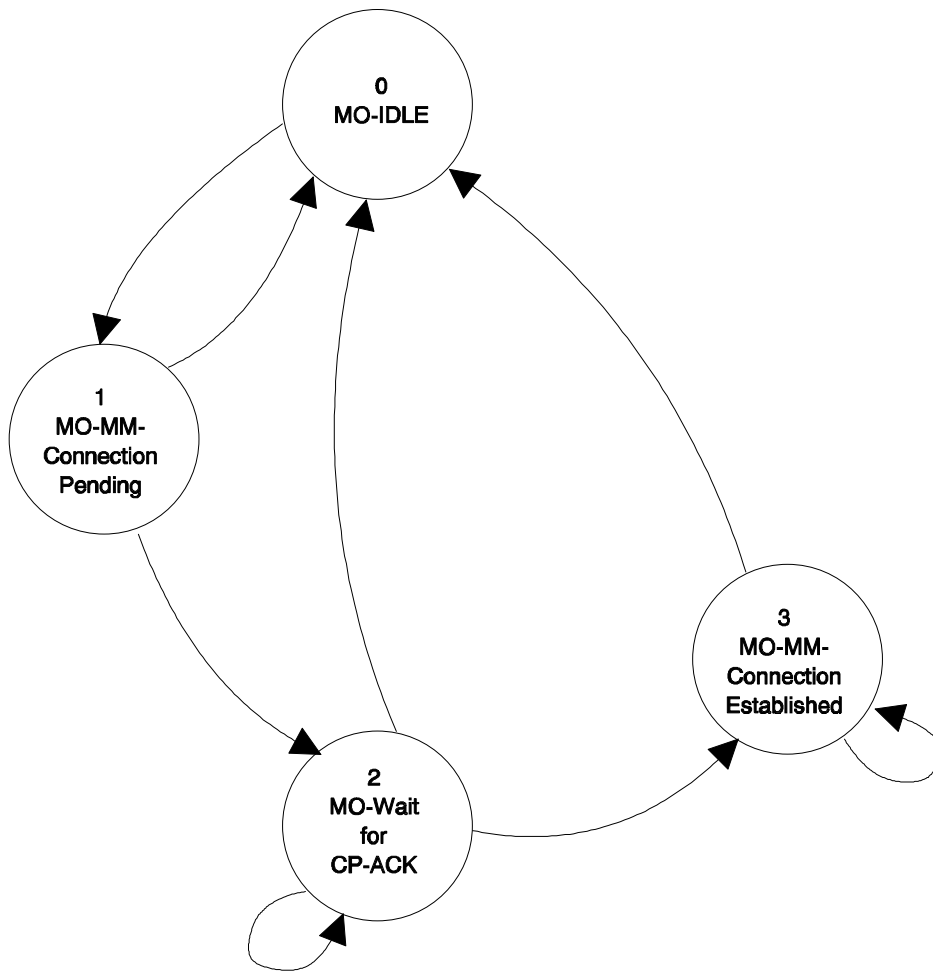

MO-SMC-entity on MS-side  
State transition diagram

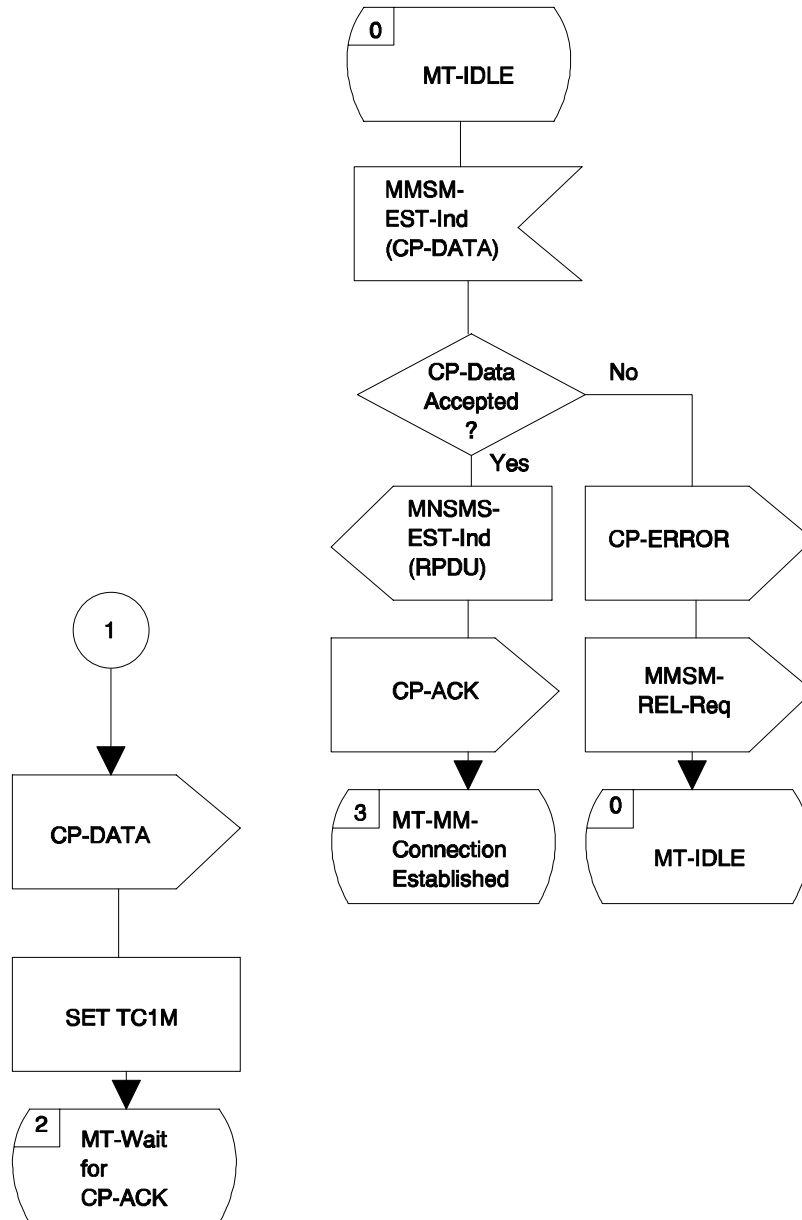

MT-SMC-entity on MS-side  
 Initiating message transfer  
 SDL-4

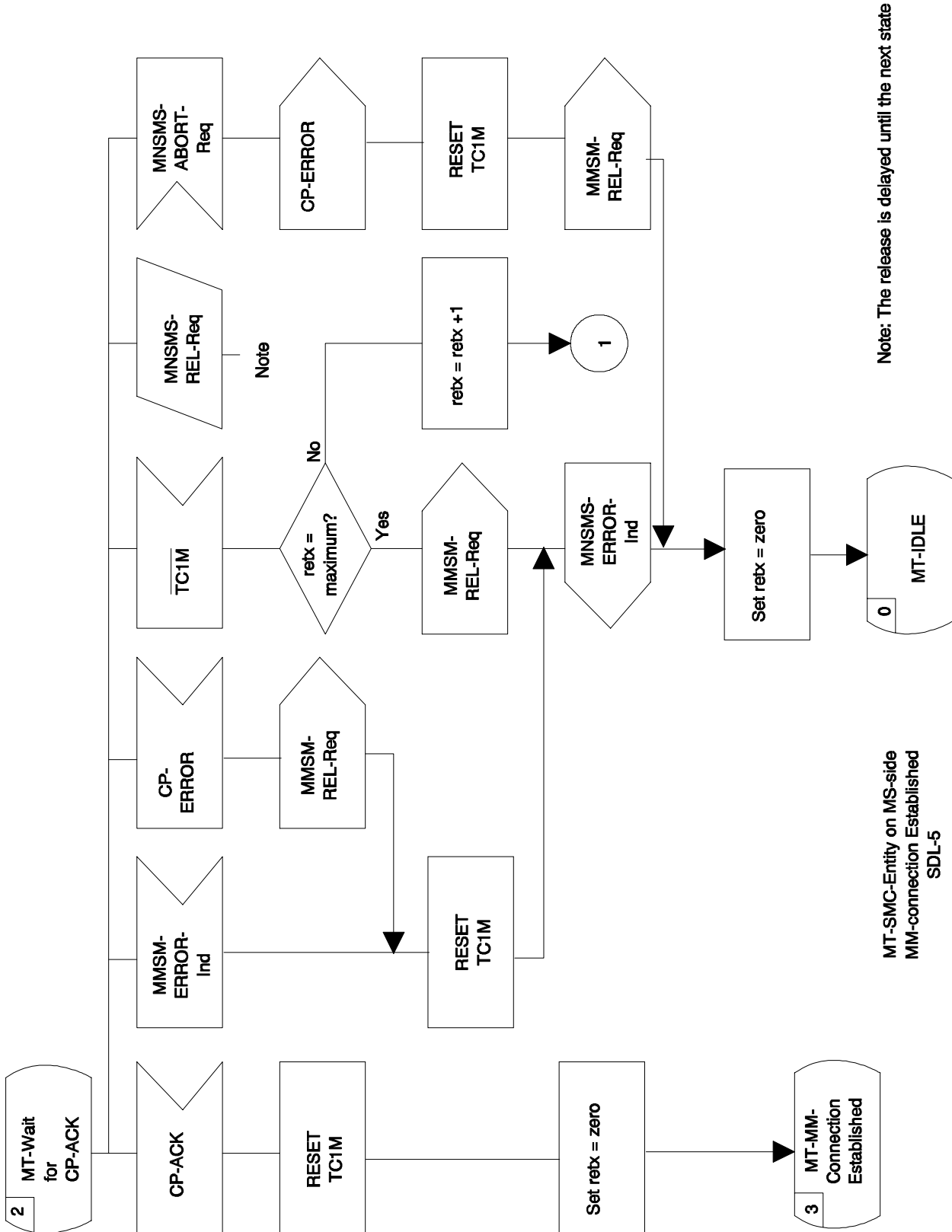

Note: The release is delayed until the next state

MT-SMC-Entity on MS-side  
 MM-connection Established  
 SDL-5

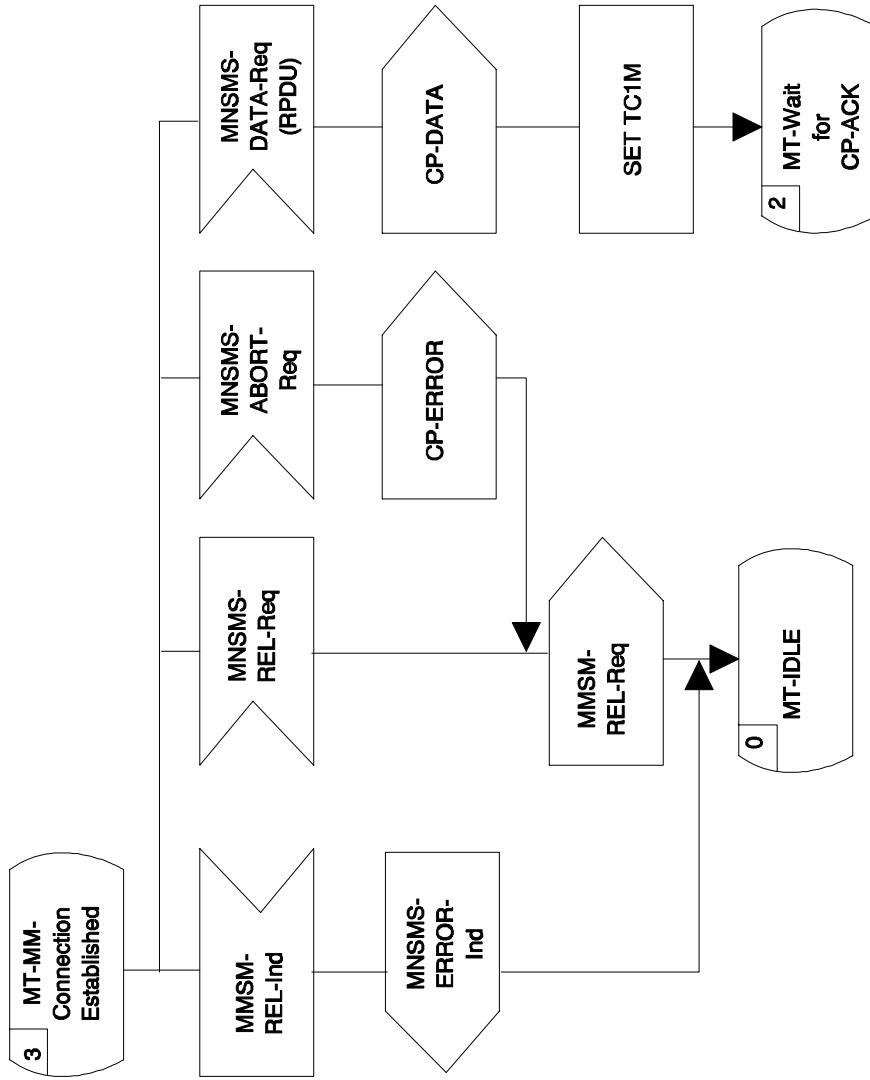

MT-SMC-entity on MS-side  
 MM-Connection released  
 SDL-6

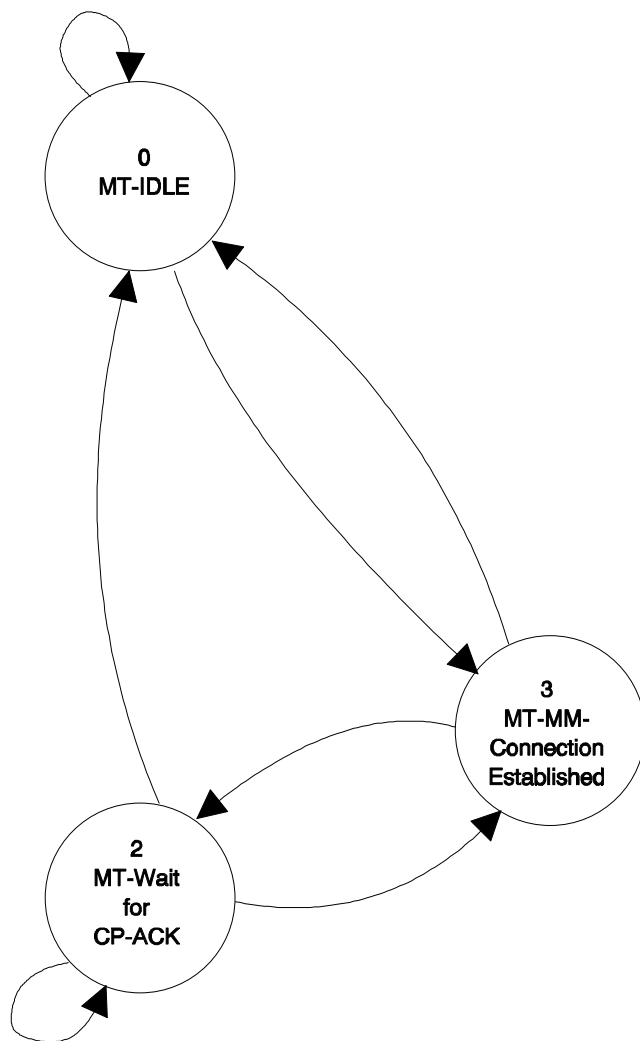

MT-SMC-entity on MS-side  
State transition diagram

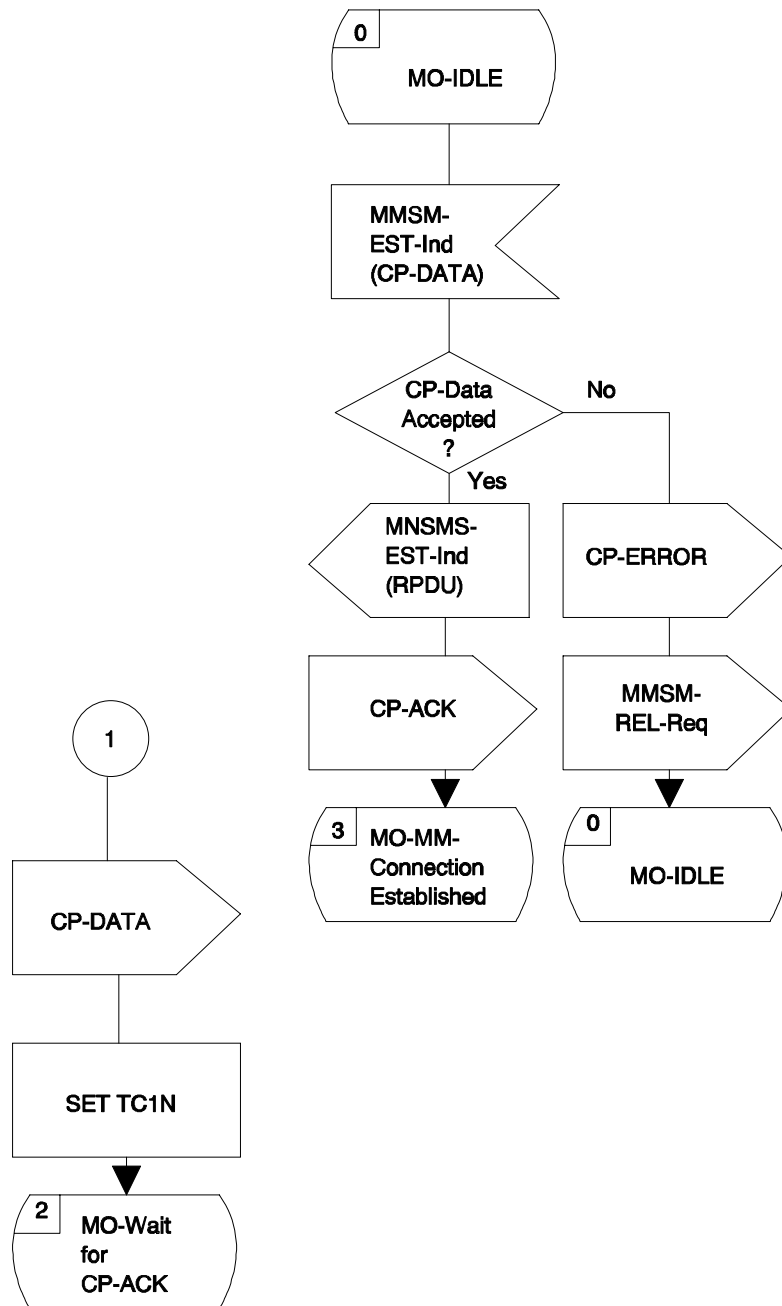

MO-SMC-entity on Network-side  
 SDL-7

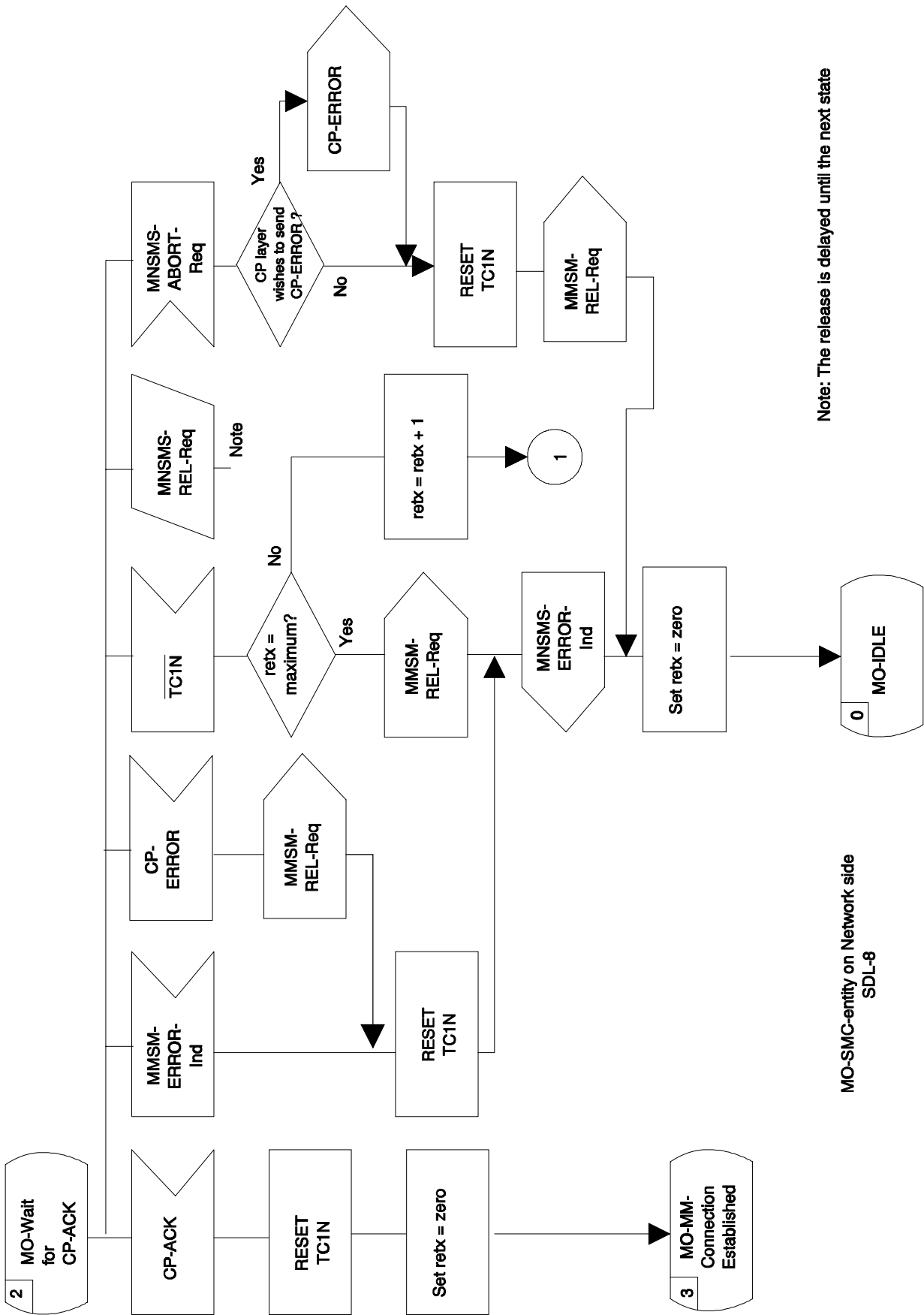



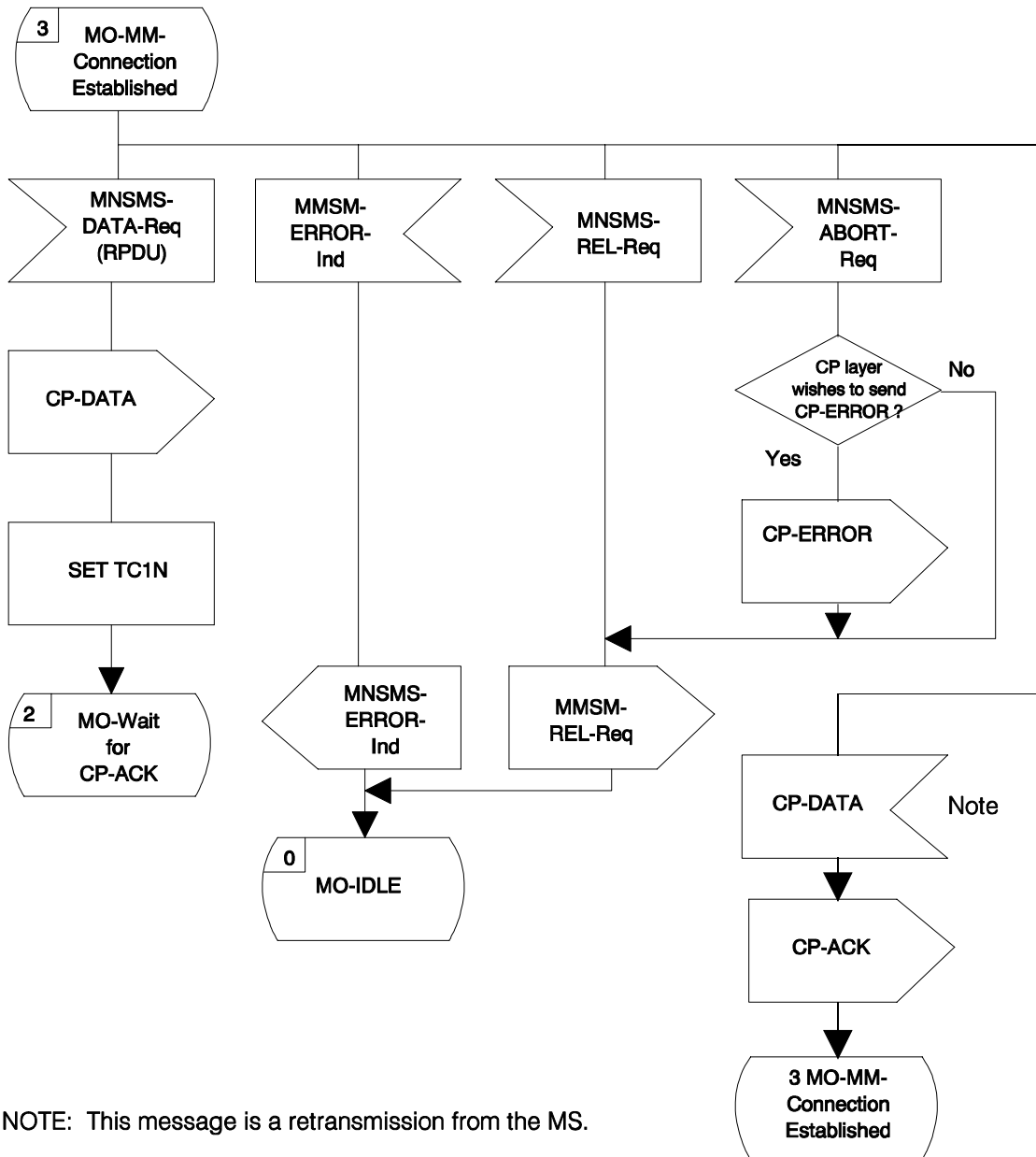

NOTE: This message is a retransmission from the MS.

MO-SMC-entity on Network side  
 SDL-9

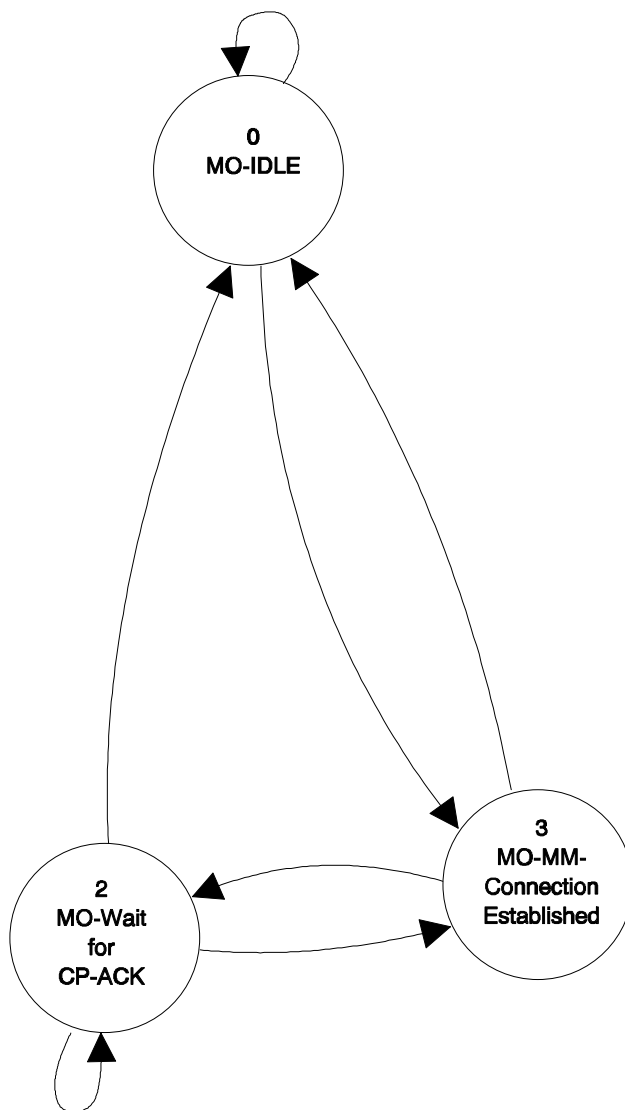

MO-SMC-entity on Network side  
State transition diagram

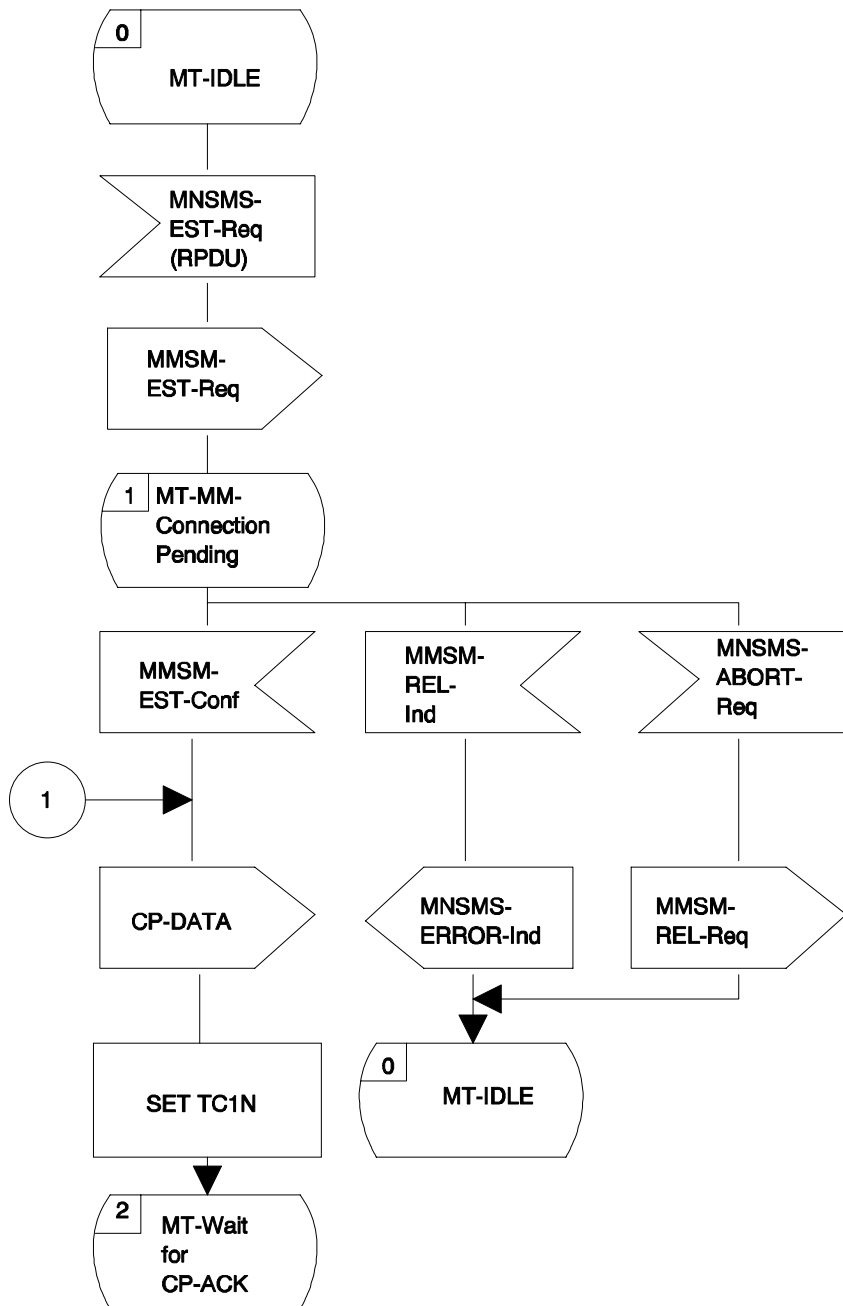

MT-SMC-entity on Network-side  
 SDL-10

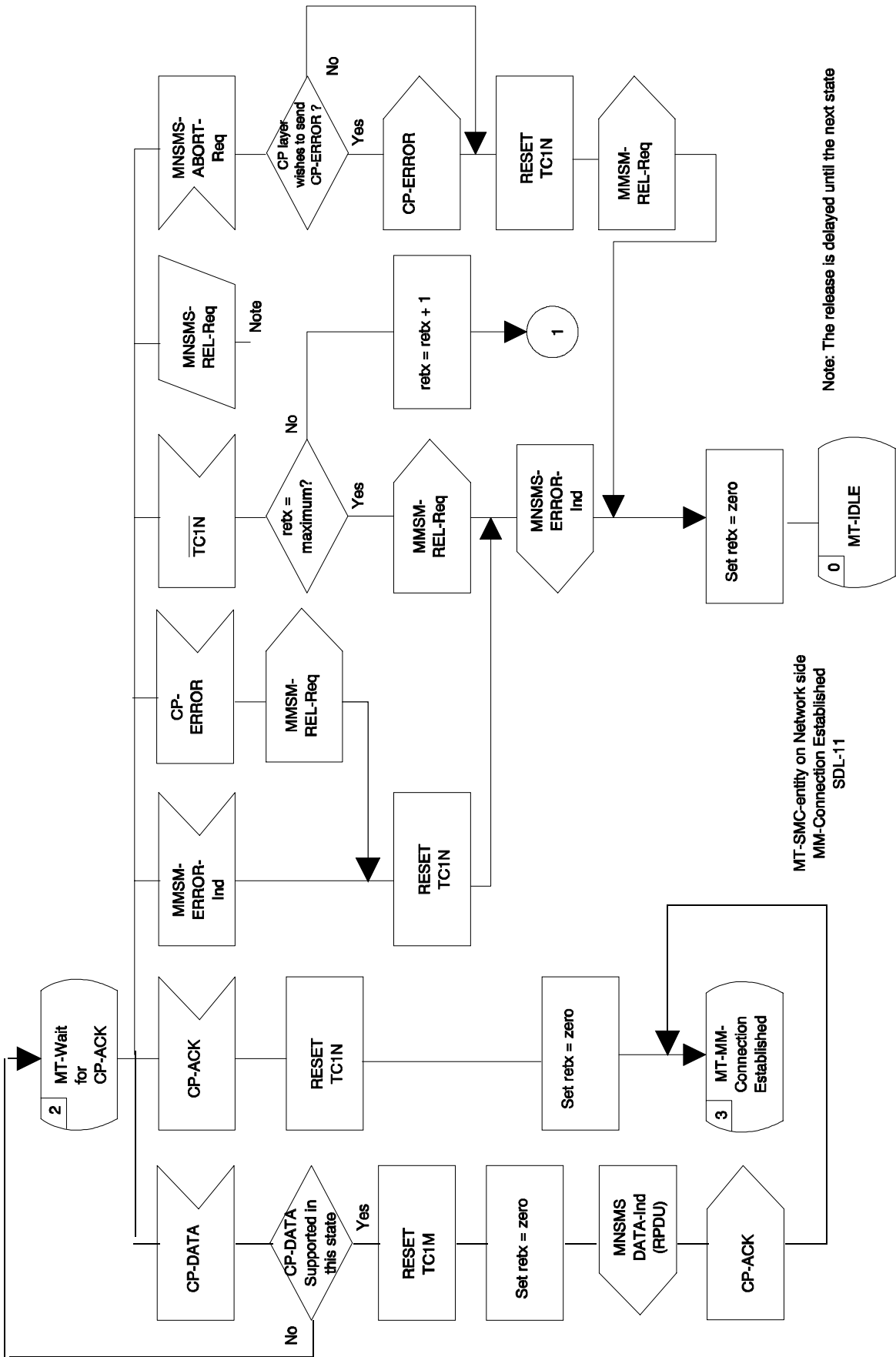

MT-SMC-entity on Network side  
 MM-Connection Established  
 SDL-11

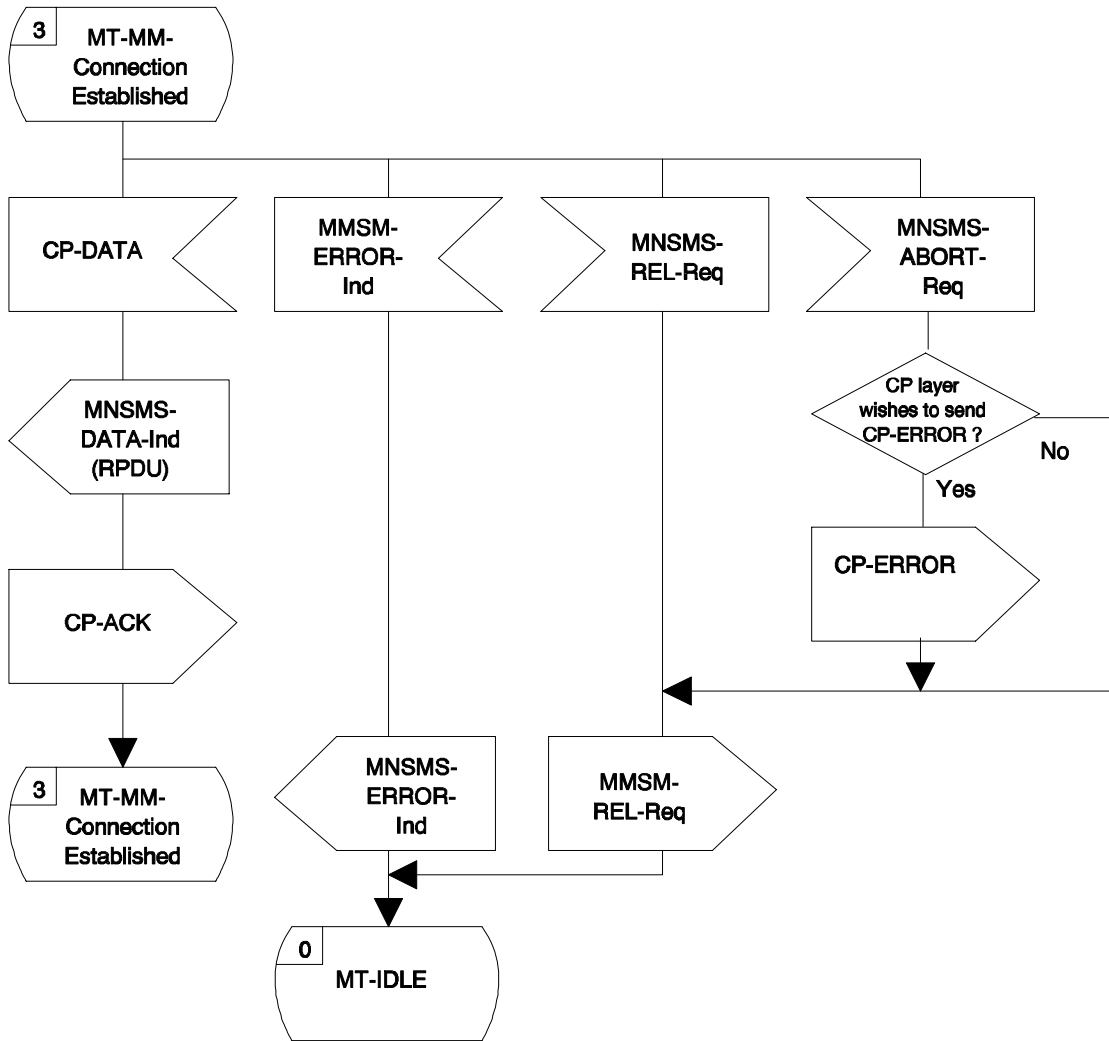

MT-SMC-entity on Network side  
 Message transfer active  
 SDL-12

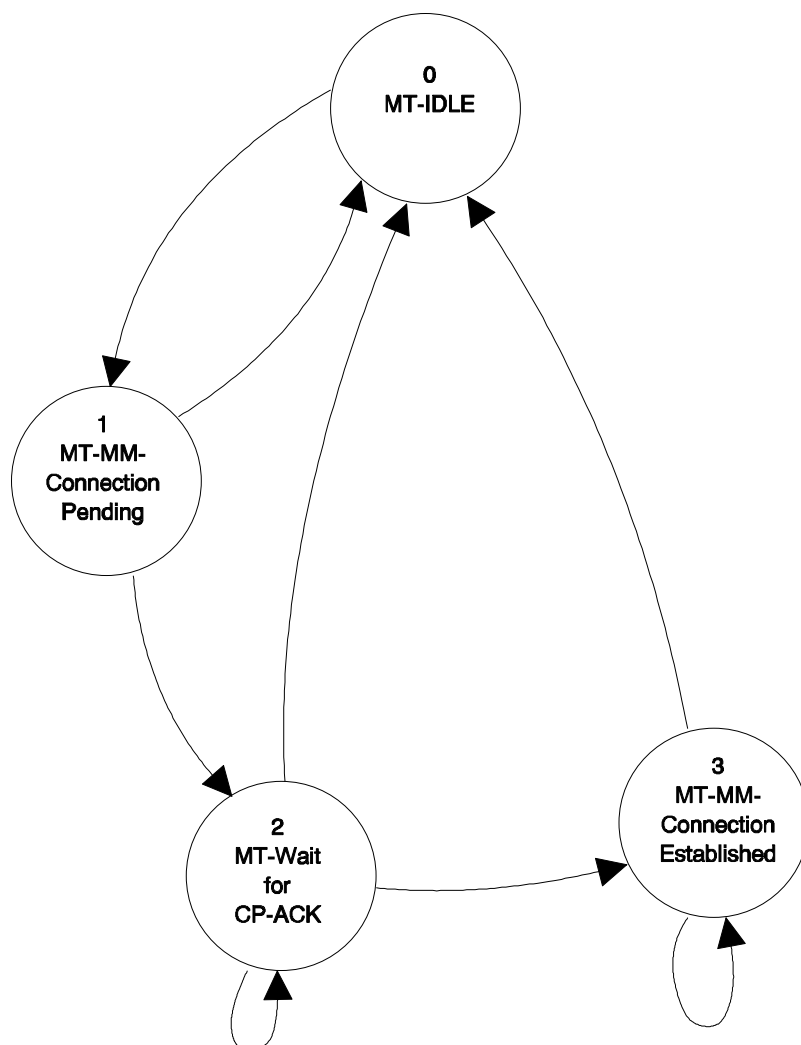

MT-SMC-entity on Network side  
State transition diagram

**Annex C (informative): Arrow diagrams**

## Arrow diagram C1:

The diagram reflects MO-message transfer by means of interlayer service primitives and the actual messages being transferred between the layer entities.

- SM-RL-primitives indicate services provided by SM-RL to SM-TL and RL (\* see the note on the next page).
- MNSMS-primitives indicate services provided by CM to SM-RL.
- RP-DATA is the SM-RL message carrying SM-TP data units
- RP-ACK acknowledges RP-DATA reception on SM-RL

## Arrow diagram C2:

The diagram reflects MT-messaging by means of interlayer service primitives and the actual messages being transferred between the layer entities.

- SM-RL-primitives indicate services provided by SM-RL to SM-TL and RL (\* see the note on the next page).
- MNSMS-primitives indicate services provided by CM to SM-RL.
- RP-DATA is the SM-RL message carrying SM-TP data units
- RP-ACK acknowledges RP-DATA reception on SM-RL

## Arrow diagram C3:

The diagram reflects memory available notification transfer by means of interlayer service primitives and the actual messages being transferred between the layer entities.

- SM-RL-primitives indicate services provided by SM-RL to SM-TL and RL (\* see the note on the next page).
- MNSMS-primitives indicate services provided by CM to SM-RL.
- RP-SMMA is the SM-RL message indicating that the mobile has memory available to receive one or more short messages.
- RP-ACK acknowledges RP-SMMA reception on SM-RL.
- RP-ERROR reports a failure in the notification procedure on the network side.

Arrow diagram C4:

The diagram reflects the abort of any retransmission of a memory available notification by SM-RL by means of the SM-RL-MEMORY-AVAILABLE interlayer service primitive request with the SM-MEM-NOTIF-ABORT parameter present. The use of this primitive and the associated parameter are, of course, local to the mobile station.

- SM-RL-primitives indicate services provided by SM-RL to SM-TL and RL (note).
- MNSMS-primitives indicate services provided by CM to SM-RL.
- RP-SMMA is the SM-RL message indicating that the mobile has memory available to receive one or more short messages.
- RP-ACK acknowledges RP-SMMA reception on SM-RL
- RP-ERROR reports a failure in the notification procedure on the network side.

NOTE: The SM-RL being the upper layer in the MSC, an interworking function between SM-RL-procedures and MAP-procedure is necessary. The term "RL" is used in the diagrams to indicate this function (see figure).

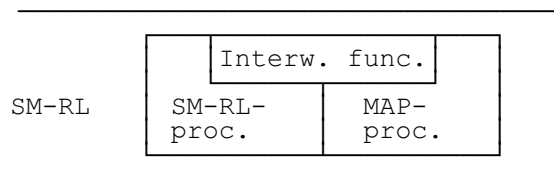



# Mobile Originated Messaging on SM-RL

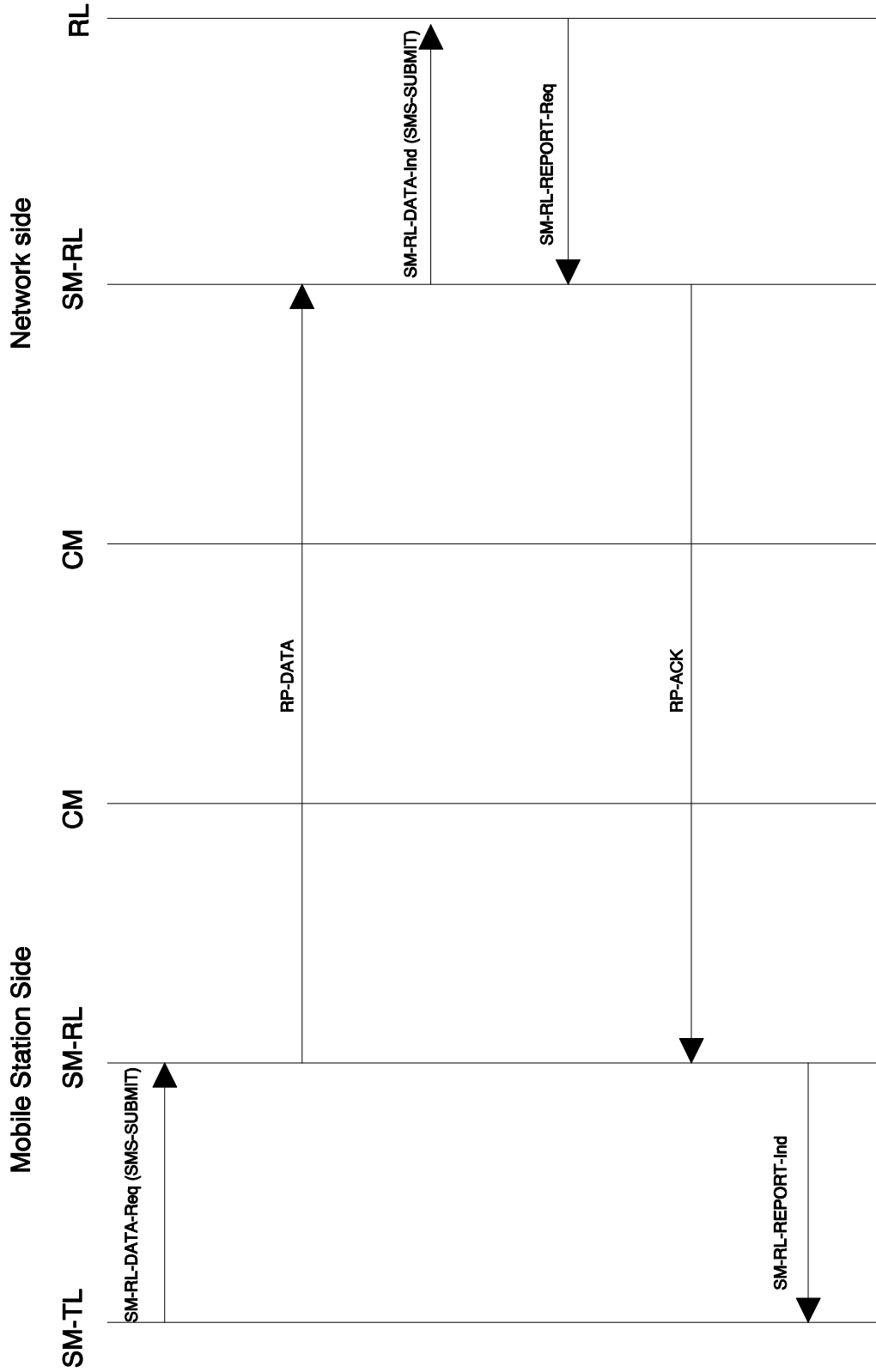

Arrow diagram C1

# Mobile Terminated Messaging on SM-RL

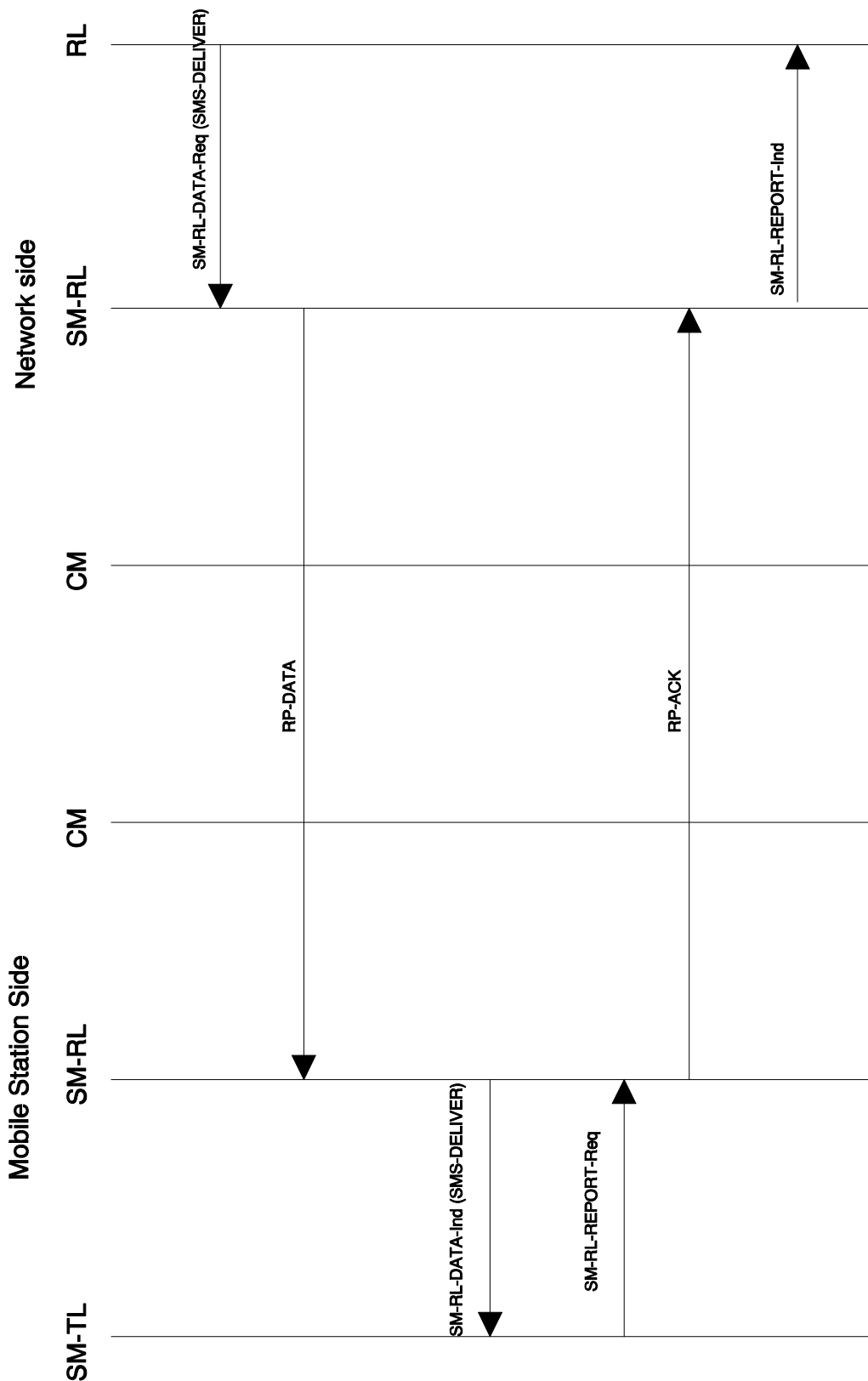

Arrow diagram C2

# Memory Available Notification on SM-RL

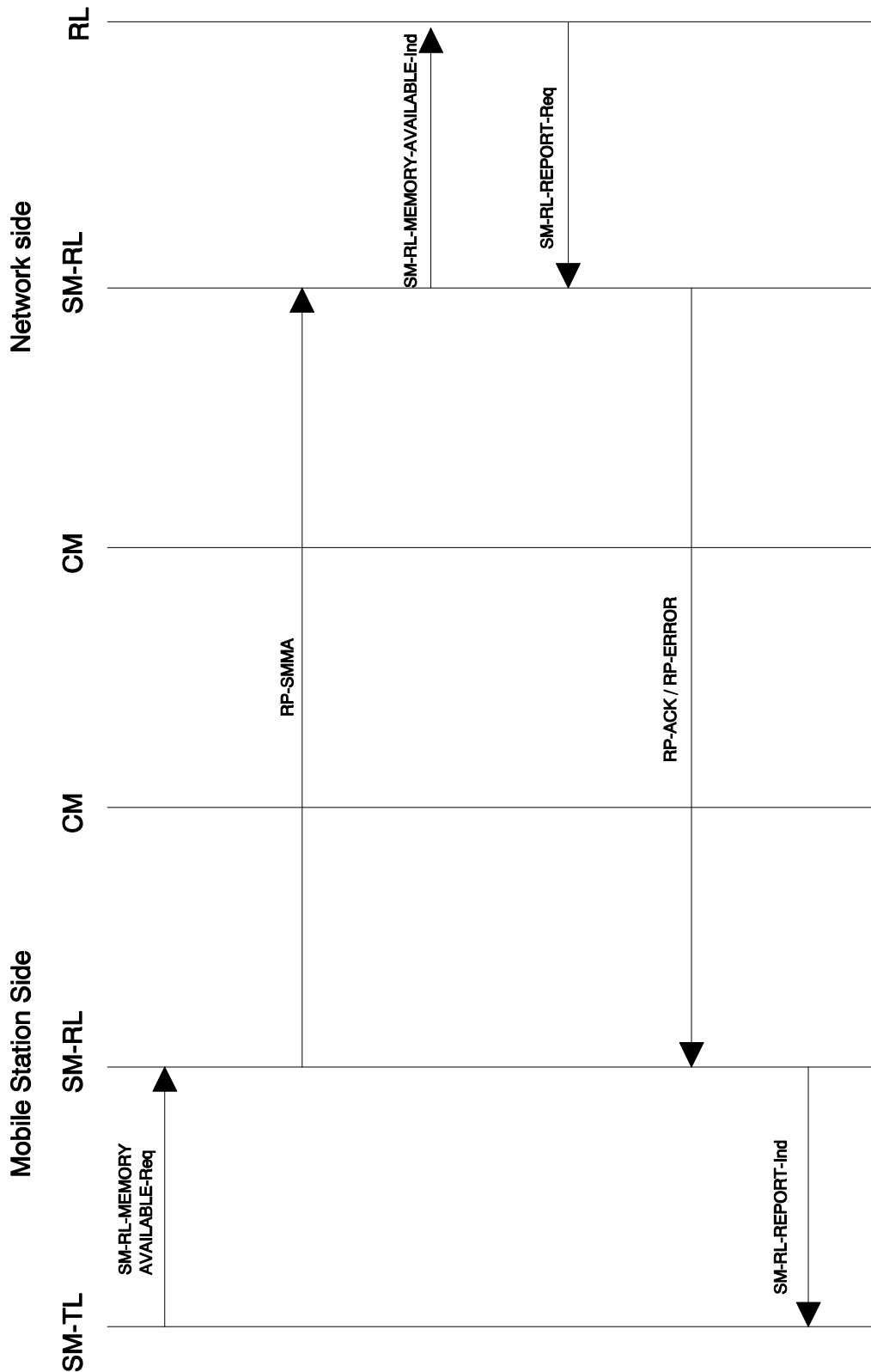

Arrow diagram C3

# Memory Available Notification Abort on SM-RL

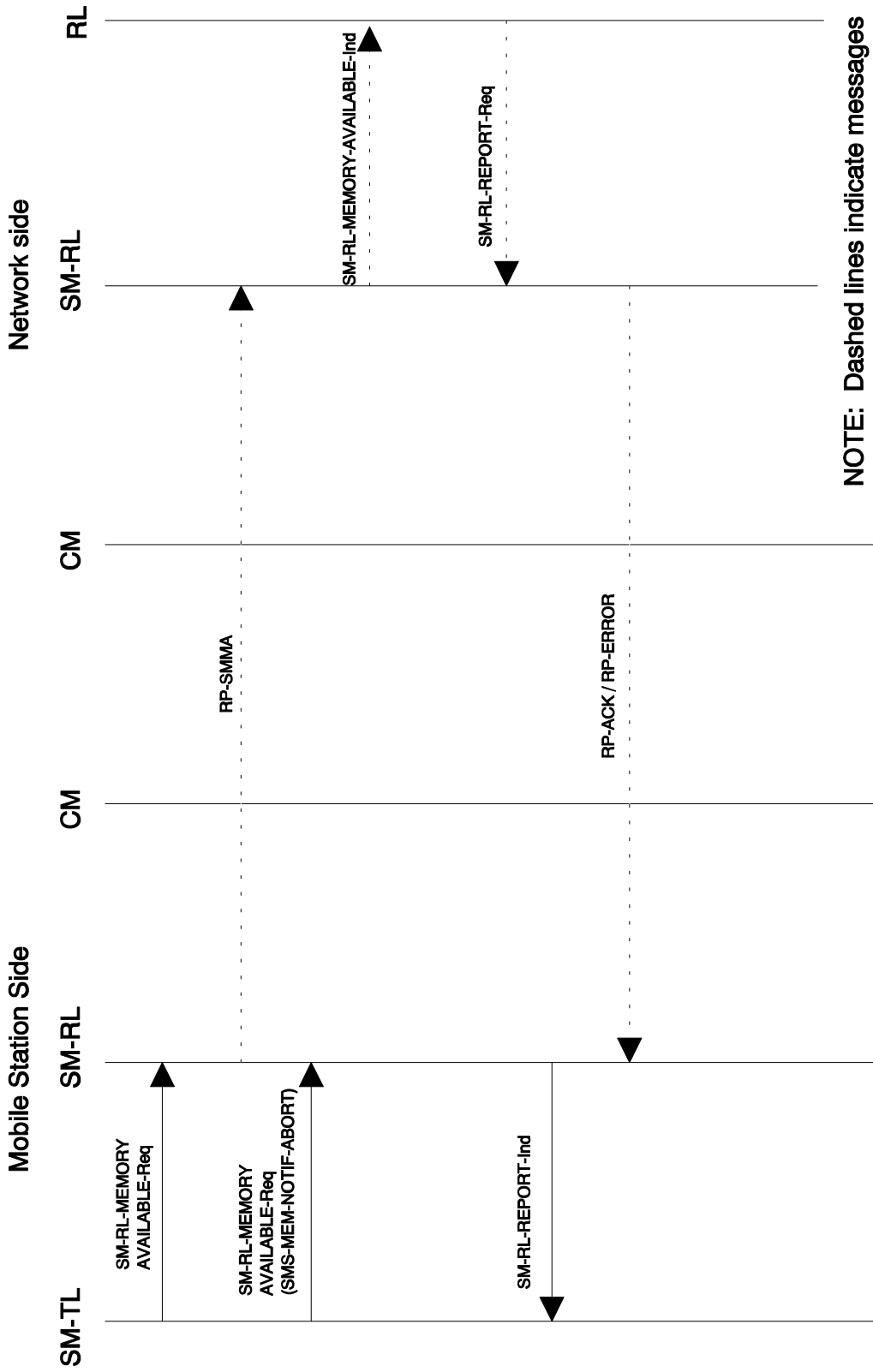

**NOTE:** Dashed lines indicate messages that may be sent, even though an abort request was given.

Arrow diagram C4

**Annex D (normative): SDL-description of the short message relay layer****D.1 Introduction**

This annex contains an SDL-description of the Short Message Relay Layer in terms of the Short Message Service Support. The Short Message Relay Layer provides services to Short Message Transfer Layer.

The SDLs contain a mixture of peer to peer messages and conceptual primitives between the layers SM-TL, SM-RL and CM, as viewed by the SMR entities. SDL-1/2/3 show the SMR entity on MS-side, and SDL-4/5 on the network side.

The lower layers (below CM) are transparent to an SMR entity.

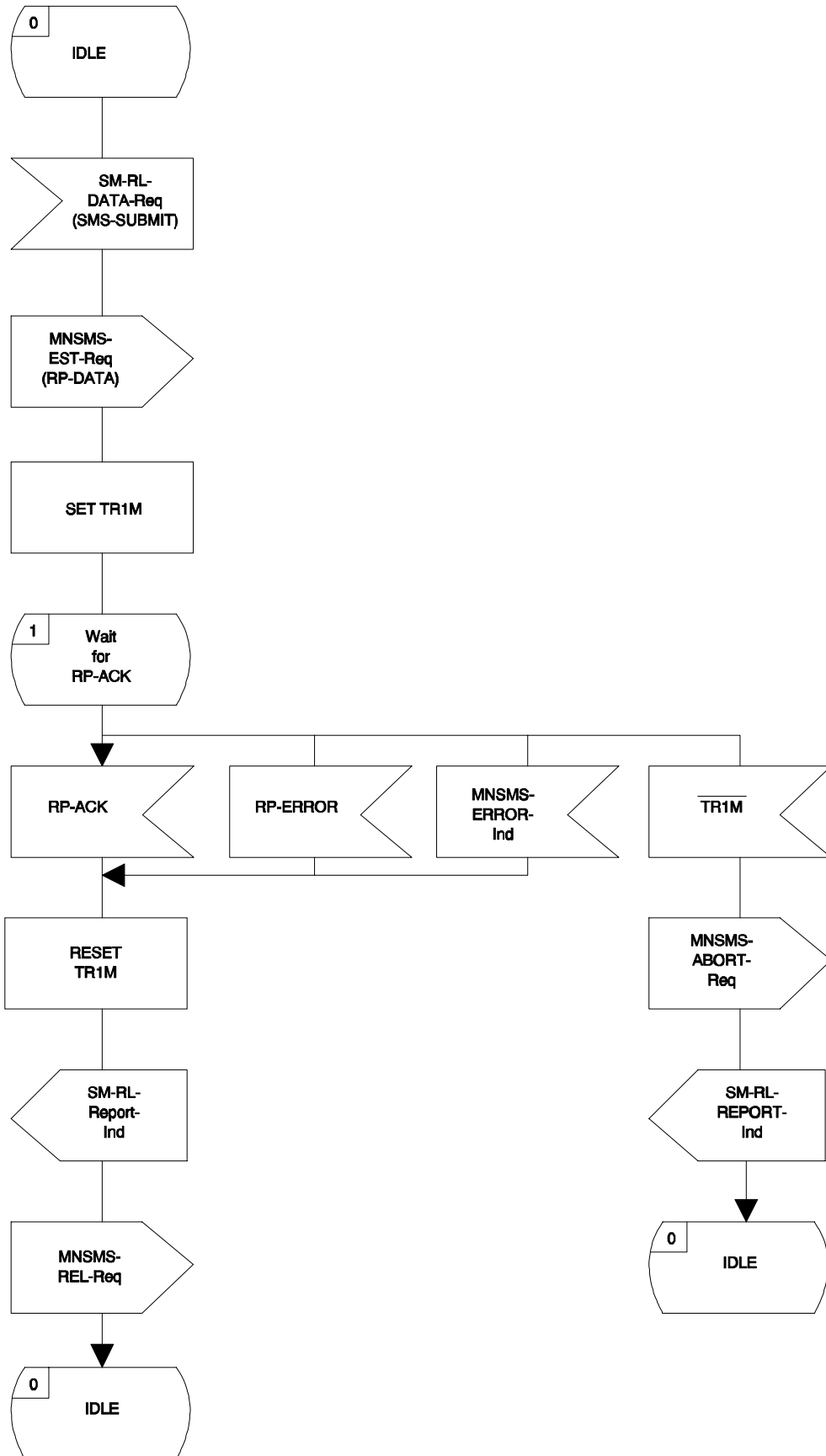

SMR-entity on MS-side  
 MO Short Message transfer  
 SDL-1

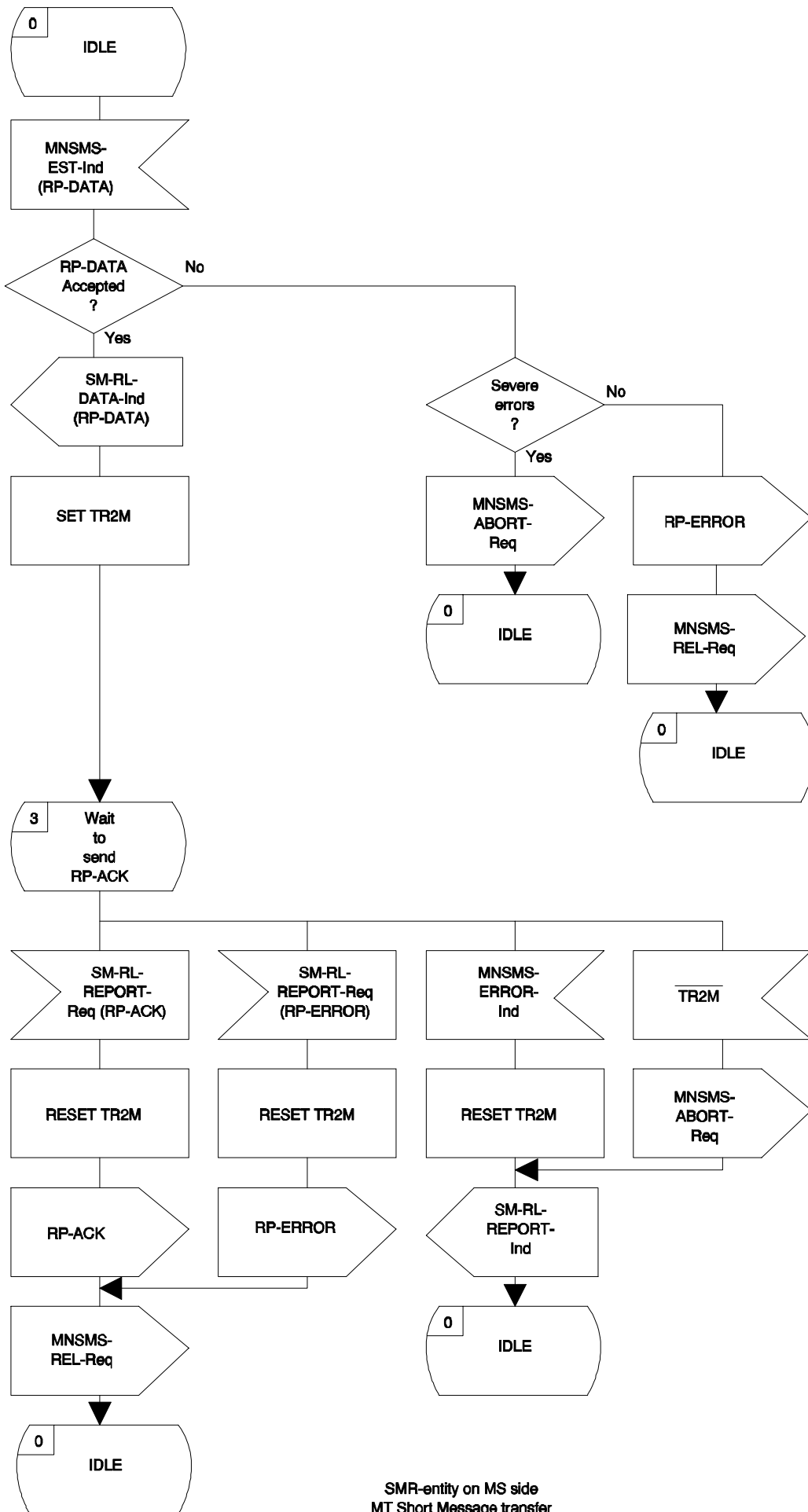

SMR-entity on MS side  
 MT Short Message transfer  
 SDL-2

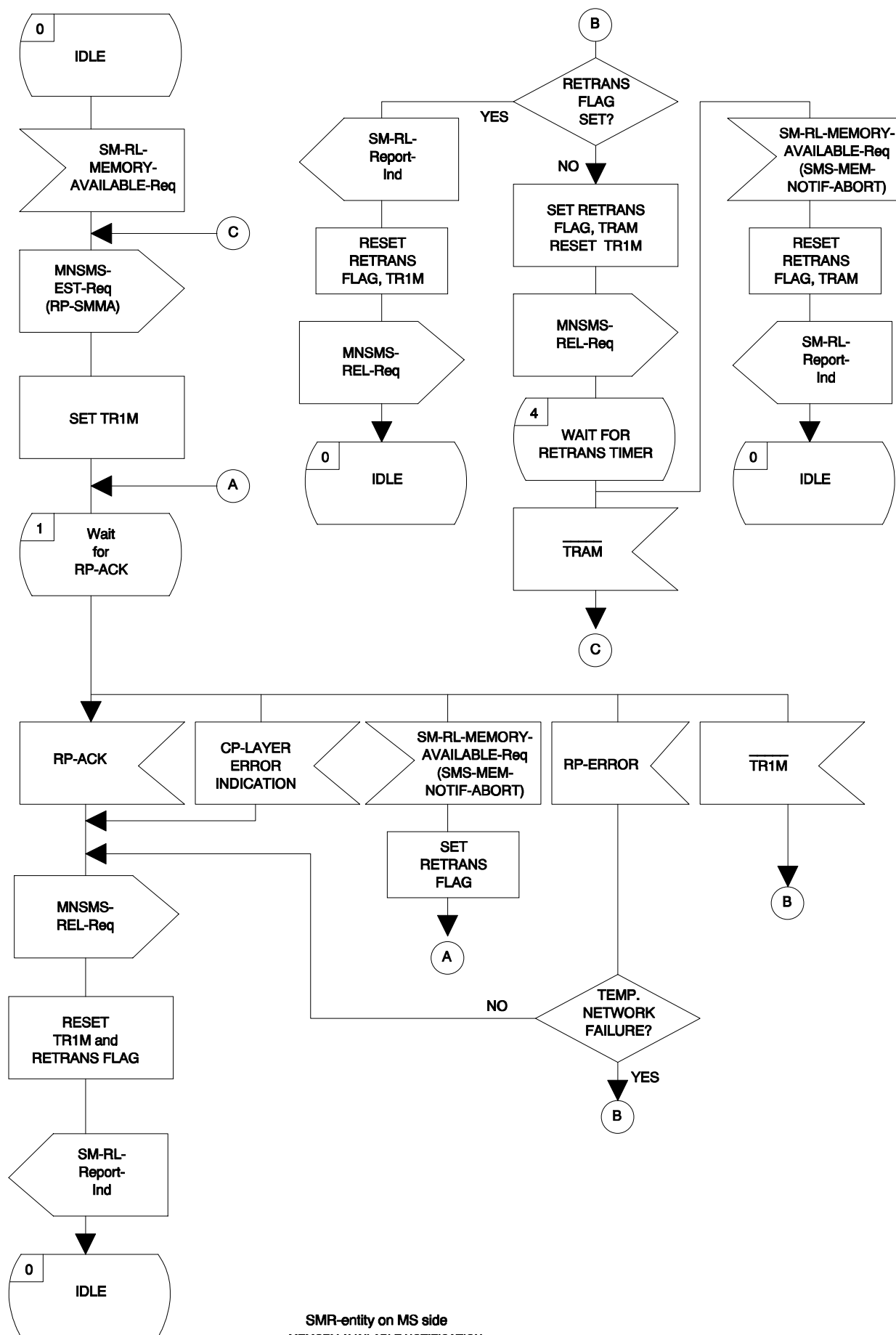



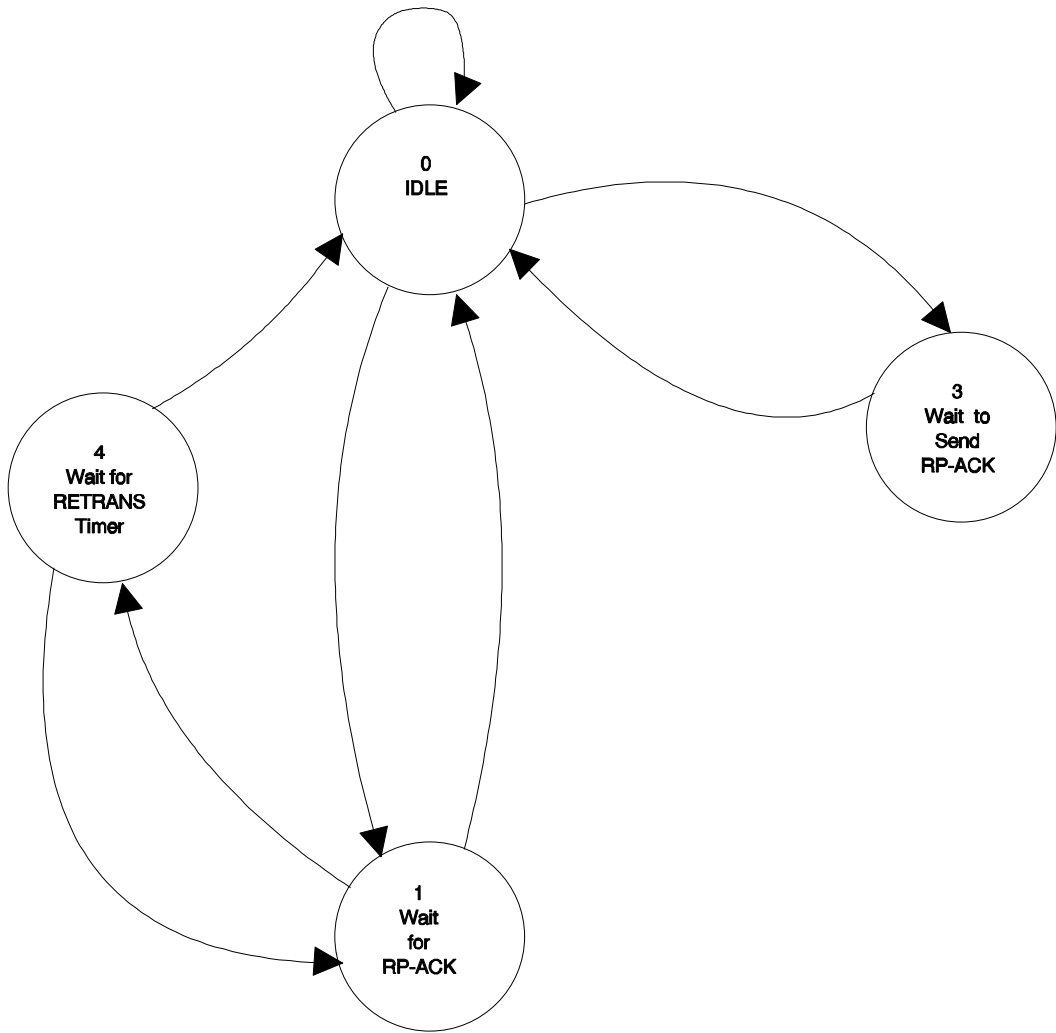

SMR-entity on MS-side  
State transition diagram

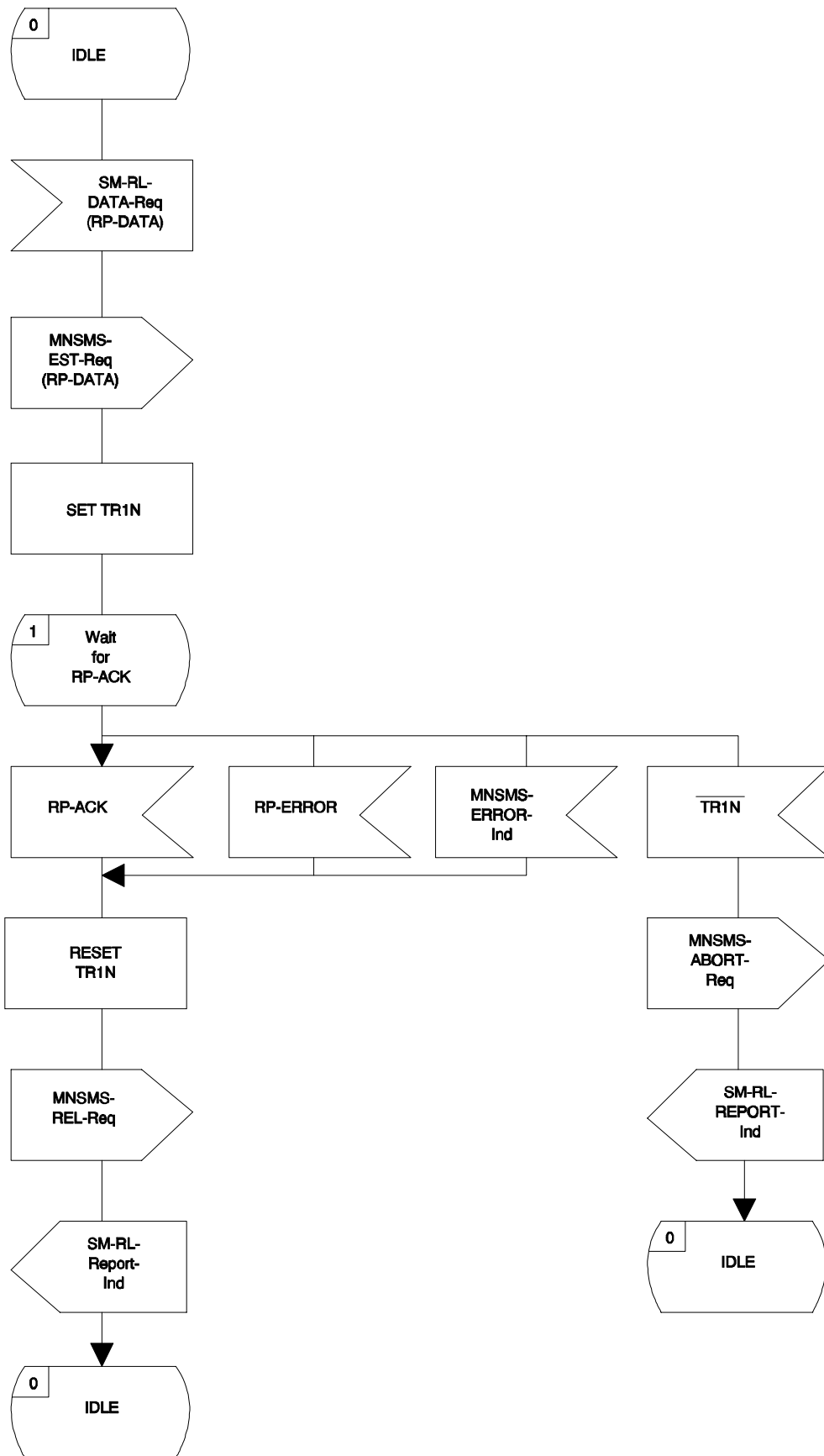

SMR-entity on Network-side  
 MT Short Message transfer  
 SDL-4

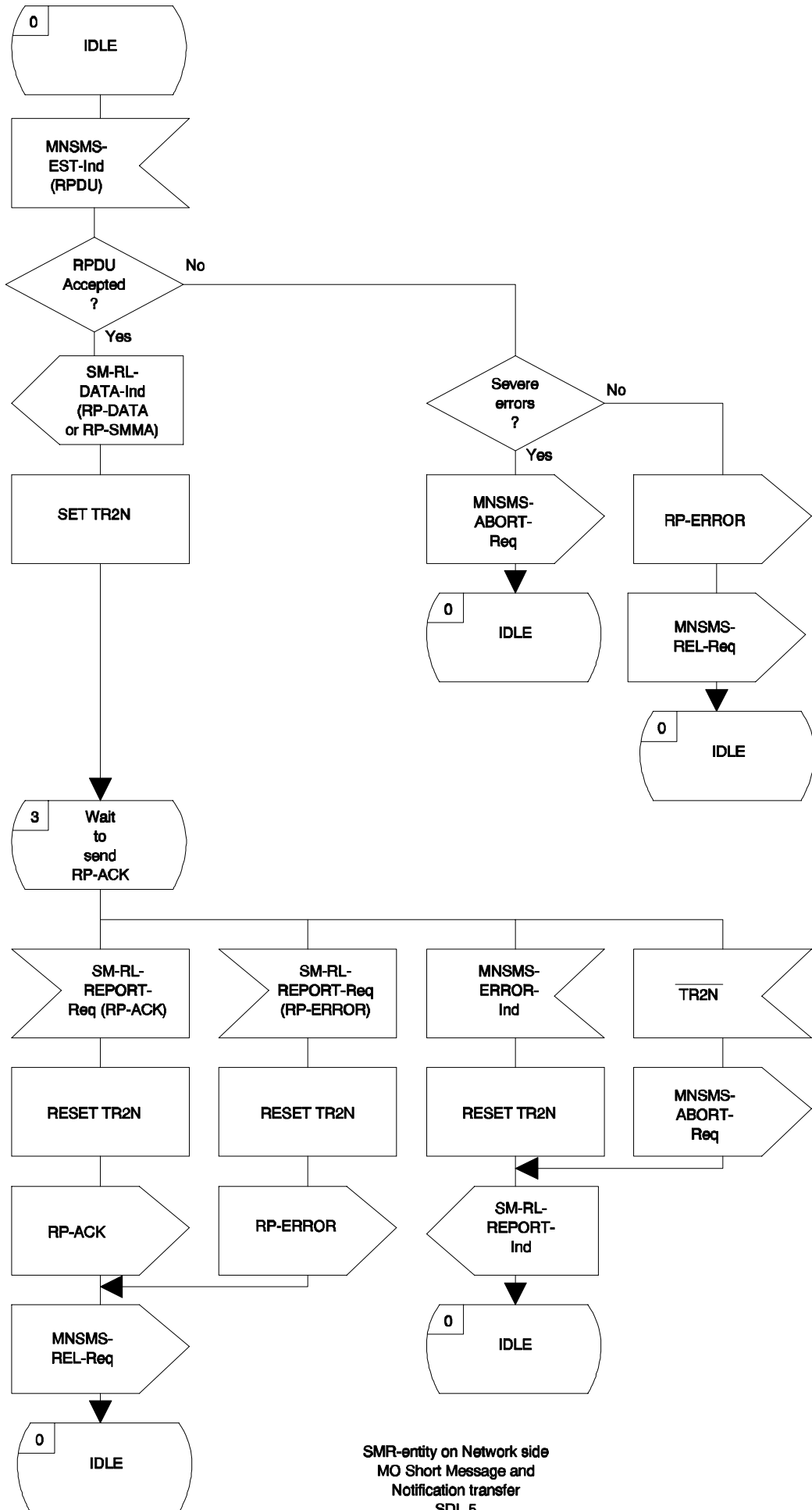

SMR-entity on Network side  
 MO Short Message and  
 Notification transfer  
 SDL 5

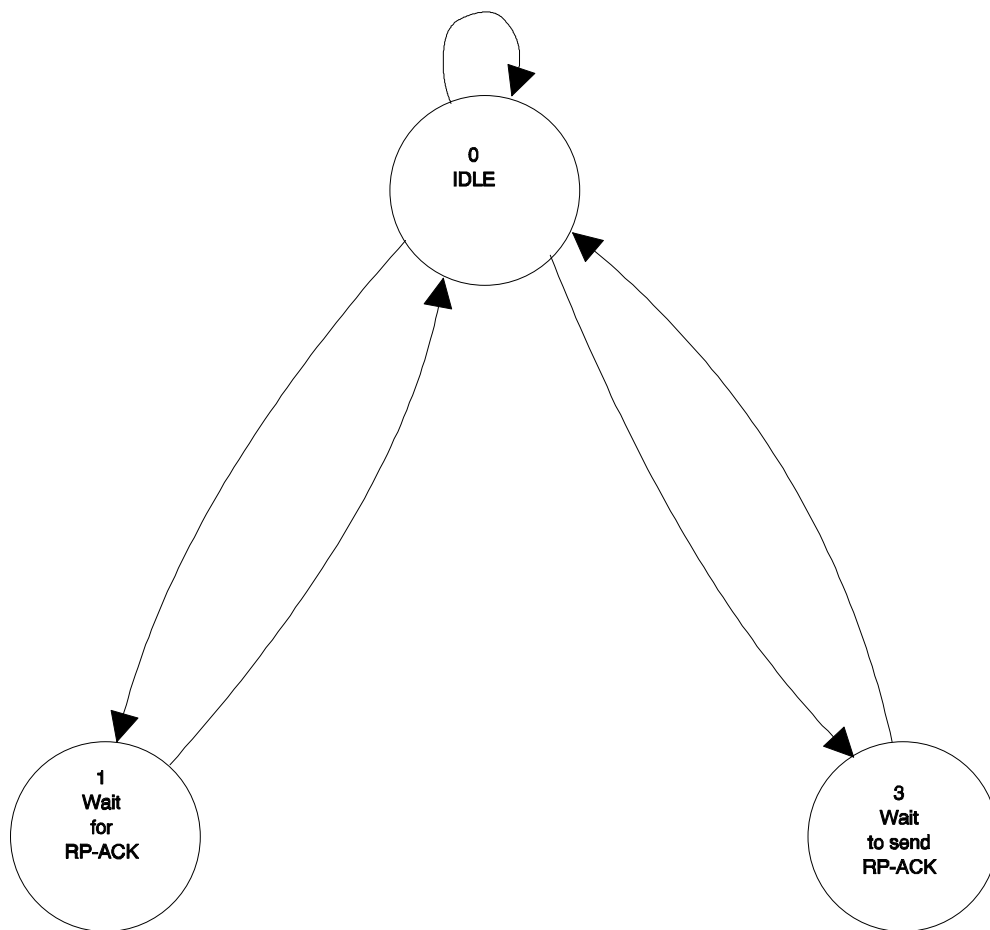

SMR-entity on Network side  
State transition diagram

**Annex E (informative): Cause definition**

## E-1: CP-cause definition

## Cause no 17: "Network failure"

This cause is sent to the MS if the MSC cannot service an MS generated request because of PLMN failures, e.g. problems in MAP.

## Cause no 22: "Congestion"

This cause is sent if the service request cannot be actioned because of congestion (e.g. no channel, facility busy/congested etc.).

## Cause no 81: "Invalid Transaction Identifier"

This cause indicates that the equipment sending this cause has received a message with a Transaction Identifier which is currently not use on the MS - network interface.

## Cause no 95: "Semantically incorrect message"

This cause is used to report the receipt of a message with semantically incorrect content.

## Cause no 96: "Invalid mandatory information"

This cause indicates that the equipment sending this cause has received a message with non-semantical mandatory information element errors.

## Cause no 97: "Message type non-existent or not implemented"

This cause indicates that the equipment sending this cause has received a message with a message type it does not recognize either because this is a message not defined or defined but not implemented by the equipment sending this cause.

## Cause no 98: "Message not compatible with short message protocol state"

This cause indicates that the equipment sending this cause has received a message not compatible with the Short Message protocol state.

## Cause no 99: "Information element non-existent or not implemented"

This cause indicates that the equipment sending this cause has received a message which includes information elements not recognized because the information element identifier is not defined or it is defined but not implemented by the equipment sending the cause. However, the information element is not required to be present in the message in order for the equipment sending the cause to process the message.

Cause no 111: "Protocol error, unspecified"

This cause is used to report a protocol error event only when no other cause applies.

E-2: RP-cause definition mobile originating SM-transfer

Cause no 1: "Unassigned (unallocated) number"

This cause indicates that the destination requested by the Mobile Station cannot be reached because, although the number is in a valid format, it is not currently assigned (allocated).

Cause no 8: "Operator determined barring"

This cause indicates that the MS has tried to send a mobile originating short message when the MS's network operator or service provider has forbidden such transactions.

Cause no 10: "Call barred"

This cause indicates that the outgoing call barred service applies to the short message service for the called destination.

Cause no 21: "Short message transfer rejected"

This cause indicates that the equipment sending this cause does not wish to accept this short message, although it could have accepted the short message since the equipment sending this cause is neither busy nor incompatible.

Cause no 27: "Destination out of service"

This cause indicates that the destination indicated by the Mobile Station cannot be reached because the interface to the destination is not functioning correctly. The term "not functioning correctly" indicates that a signalling message was unable to be delivered to the remote user; e.g., a physical layer or data link layer failure at the remote user, user equipment off-line, etc.

Cause no 28: "Unidentified subscriber"

This cause indicates that the subscriber is not registered in the PLMN (i.e. IMSI not known)

Cause no 29: "Facility rejected"

This cause indicates that the facility requested by the Mobile Station is not supported by the PLMN.

Cause no 30: "Unknown subscriber"

This cause indicates that the subscriber is not registered in the HLR (i.e. IMSI or directory number is not allocated to a subscriber).

## Cause no 38: "Network out of order"

This cause indicates that the network is not functioning correctly and that the condition is likely to last a relatively long period of time; e.g., immediately reattempting the short message transfer is not likely to be successful.

## Cause no 41: "Temporary failure"

This cause indicates that the network is not functioning correctly and that the condition is not likely to last a long period of time; e.g., the Mobile Station may wish to try another short message transfer attempt almost immediately.

## Cause no 42: "Congestion"

This cause indicates that the short message service cannot be serviced because of high traffic.

## Cause no 47: "Resources unavailable, unspecified"

This cause is used to report a resource unavailable event only when no other cause applies.

## Cause no 50: "Requested facility not subscribed"

This cause indicates that the requested short message service could not be provided by the network because the user has not completed the necessary administrative arrangements with its supporting networks.

## Cause no 69: "Requested facility not implemented"

This cause indicates that the network is unable to provide the requested short message service.

## Cause no 81: "Invalid short message transfer reference value"

This cause indicates that the equipment sending this cause has received a message with a short message reference which is not currently in use on the MS-network interface.

## Cause no 95: "Invalid message, unspecified"

This cause is used to report an invalid message event only when no other cause in the invalid message class applies.

Cause no 96: "Invalid mandatory information"

This cause indicates that the equipment sending this cause has received a message where a mandatory information element is missing and/or has a content error (the two cases are undistinguishable).

Cause no 97: "Message type non-existent or not implemented"

This cause indicates that the equipment sending this cause has received a message with a message type it does not recognize either because this is a message not defined or defined but not implemented by the equipment sending this cause.

Cause no 98: "Message not compatible with short message protocol state"

This cause indicates that the equipment sending this cause has received a message such that the procedures do not indicate that this is a permissible message to receive while in the short message transfer state.

Cause no 99: "Information element non-existent or not implemented"

This cause indicates that the equipment sending this cause has received a message which includes information elements not recognized because the information element identifier is not defined or it is defined but not implemented by the equipment sending the cause.

However, the information element is not required to be present in the message in order for the equipment sending the cause to process the message.

Cause no 111: "Protocol error, unspecified"

This cause is used to report a protocol error event only when no other cause applies.

Cause no 127: "Interworking, unspecified"

This cause indicates that there has been interworking with a network which does not provide causes for actions it takes; thus, the precise cause for a message which is being send cannot be ascertained.



## E-3: RP-cause definition mobile terminating SM-transfer

## Cause no 22: "Memory capacity exceeded"

This cause indicates that the mobile station cannot store the incoming short message due to lack of storage capacity.

## Cause no 81: "Invalid short message reference value"

This cause indicates that the equipment sending this cause has received a message with a short message reference which is not currently in use on the MS-network interface.

## Cause no 95: "Invalid message, unspecified"

This cause is used to report an invalid message event only when no other cause in the invalid message class applies.

## Cause no 96: "Invalid mandatory information"

This cause indicates that the equipment sending this cause has received a message where a mandatory information element is missing and/or has a content error (the two cases are undistinguishable).

## Cause no 97: "Message type non-existent or not implemented"

This cause indicates that the equipment sending this cause has received a message with a message type it does not recognize either because this is a message not defined or defined but not implemented by the equipment sending this cause.

## Cause no 98: "Message not compatible with short message protocol state"

This cause indicates that the equipment sending this cause has received a message such that the procedures do not indicate that this is a permissible message to receive while in the short message transfer state.

## Cause no 99: "Information element non-existent or not implemented"

This cause indicates that the equipment sending this cause has received a message which includes information elements not recognized because the information element identifier is not defined or it is defined but not implemented by the equipment sending the cause. However, the information element is not required to be present in the message in order for the equipment sending the cause to process the message.

## Cause no 111: "Protocol error, unspecified"

This cause is used to report a protocol error event only when no other cause applies.

E-4: RP-Cause definition memory available notification

Cause no 30: "Unknown Subscriber"

This cause indicates that the subscriber is not registered in the HLR (i.e. IMSI or directory number is not allocated to a subscriber).

Cause no 38: "Network out of order"

This cause indicates that the network is not functioning correctly and that the condition is likely to last a relatively long period of time; e.g., immediately reattempting the short message transfer is not likely to be successful.

Cause no 41: "Temporary failure"

This cause indicates that the network is not functioning correctly and that the condition is not likely to last a long period of time; e.g., the Mobile Station may wish to try another short message transfer attempt almost immediately.

Cause no 42: "Congestion"

This cause indicates that the short message service cannot be serviced because of high traffic.

Cause no 47: "Resources unavailable, unspecified"

This cause is used to report a resource unavailable event only when no other cause applies.

Cause no 69: "Requested facility not implemented"

This cause indicates that the network is unable to provide the requested memory available notification service.

Cause no 95: "Invalid message, unspecified"

This cause is used to report an invalid message event only when no other cause in the invalid message class applies.

Cause no 96: "Invalid mandatory information"

This cause indicates that the equipment sending this cause has received a message where a mandatory information element is missing and/or has a content error (the two cases are undistinguishable).

Cause no 97: "Message type non-existent or not implemented"

This cause indicates that the equipment sending this cause has received a message with a message type it does not recognize either because this is a message not defined or defined but not implemented by the equipment sending this cause.

Cause no 98: "Message not compatible with short message protocol state"

This cause indicates that the equipment sending this cause has received a message such that the procedures do not indicate that this is a permissible message to receive while in the short message transfer state.

Cause no 99: "Information element non-existent or not implemented"

This cause indicates that the equipment sending this cause has received a message which includes information elements not recognized because the information element identifier is not defined or it is defined but not implemented by the equipment sending the cause.

However, the information element is not required to be present in the message in order for the equipment sending the cause to process the message.

Cause no 111: "Protocol error, unspecified"

This cause is used to report a protocol error event only when no other cause applies.

Cause no 127: "Interworking, unspecified"

This cause indicates that there has been interworking with a network which does not provide causes for actions it takes; thus, the precise cause for a message which is being send cannot be ascertained.

## **Annex F (informative): LAPDm SAPI 3 handling for short message service**

This annex describes several typical SMS message transfer scenarios.

Case A: Mobile originating short message transfer, no parallel call.

The mobile station side will initiate SAPI 3 establishment by a SABM command on the SDCCH after the cipher mode has been set. If no handover occurs, the SAPI 3 link will stay up until the last CP-ACK is received by the MSC, and the clearing procedure is invoked.

Case B: Mobile terminating short message transfer, no parallel call.

The network side, i.e. the BSS will initiate SAPI3 establishment by a SABM command on the SDCCH when the first CP-Data message is received from the MSC. If no handover occurs, the link will stay up until the MSC has given the last CP-ack and invokes the clearing procedure.

Case C: Mobile originating short message transfer, parallel call.

The mobile station will send a SABM command on the SACCH when a CM\_SERV\_ACC message has been received from the network, allowing the short message transfer to start. If no handover occurs the link will stay up until the MSC orders an explicit release, or the clearing procedure is invoked. If the parallel call is cleared before the short message transfer is finalised, the MSC will delay the clearing procedure toward the BSS, i.e. the channel release procedure is delayed.

Case D: Mobile terminating short message transfer, parallel call.

The network side, i.e. the BSS will initiate SAPI3 establishment by a SABM command on the SACCH when the first CP-DATA message is received from the MSC. The further handling is exactly as described for case C.

Case E: Mobile terminating short message transfer together with Inter-MSC handover, parallel call.

The MAP procedures "Forward access signalling" and "Process access signalling" will be used between the two MSCs to transfer the CP-DATA, CP-ACK and CP-ERROR messages.

Case F: Mobile terminating short message transfer on SDCCH channel together with Inter-MSC handover.

The MAP procedures "Forward access signalling" and "Process access signalling" will be used between the two MSC's to transfer the CP-DATA, CP-ACK and CP-ERROR messages.

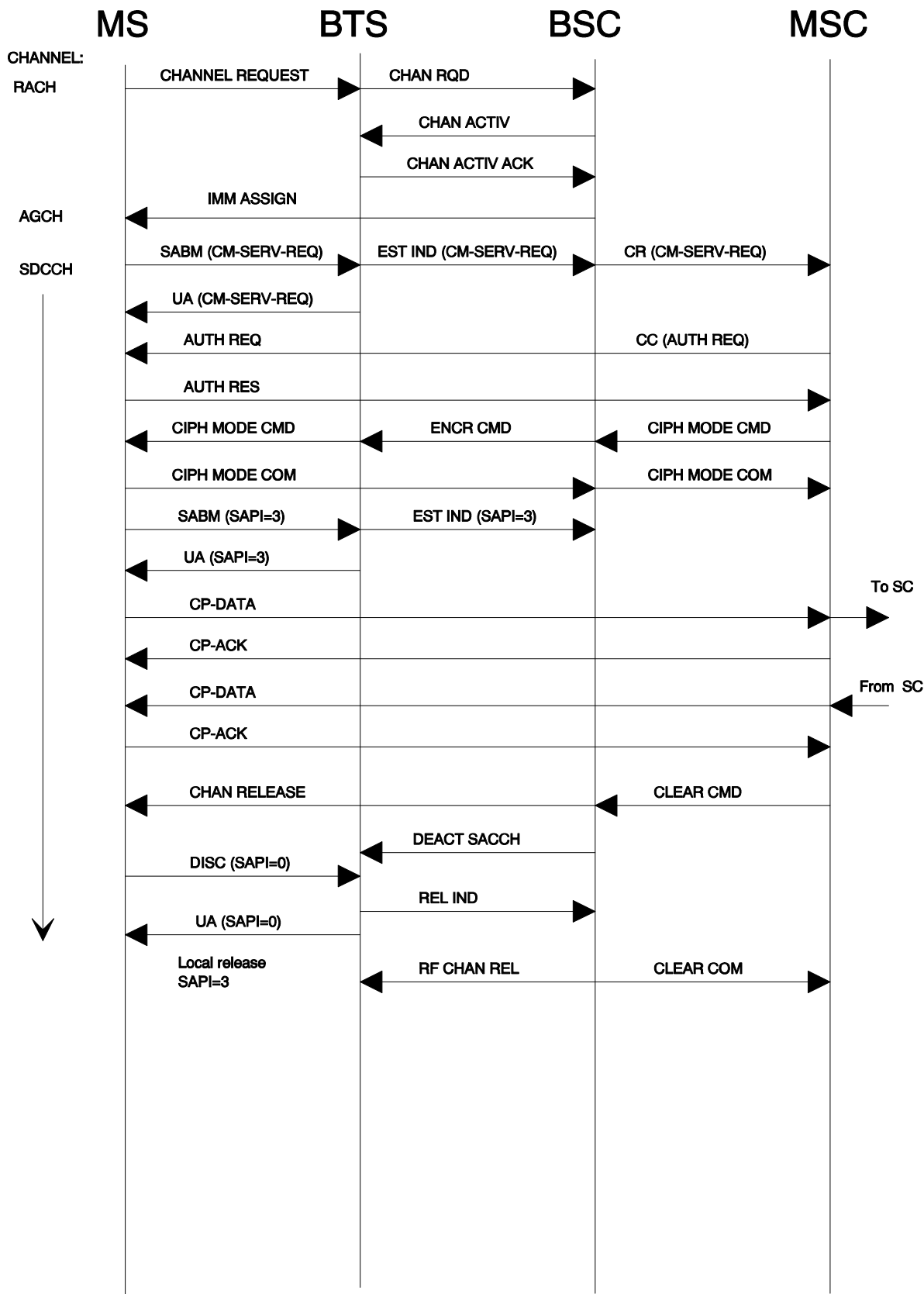

Figure F1/GSM 04.11  
Mobile originated Short Message on SDCCH

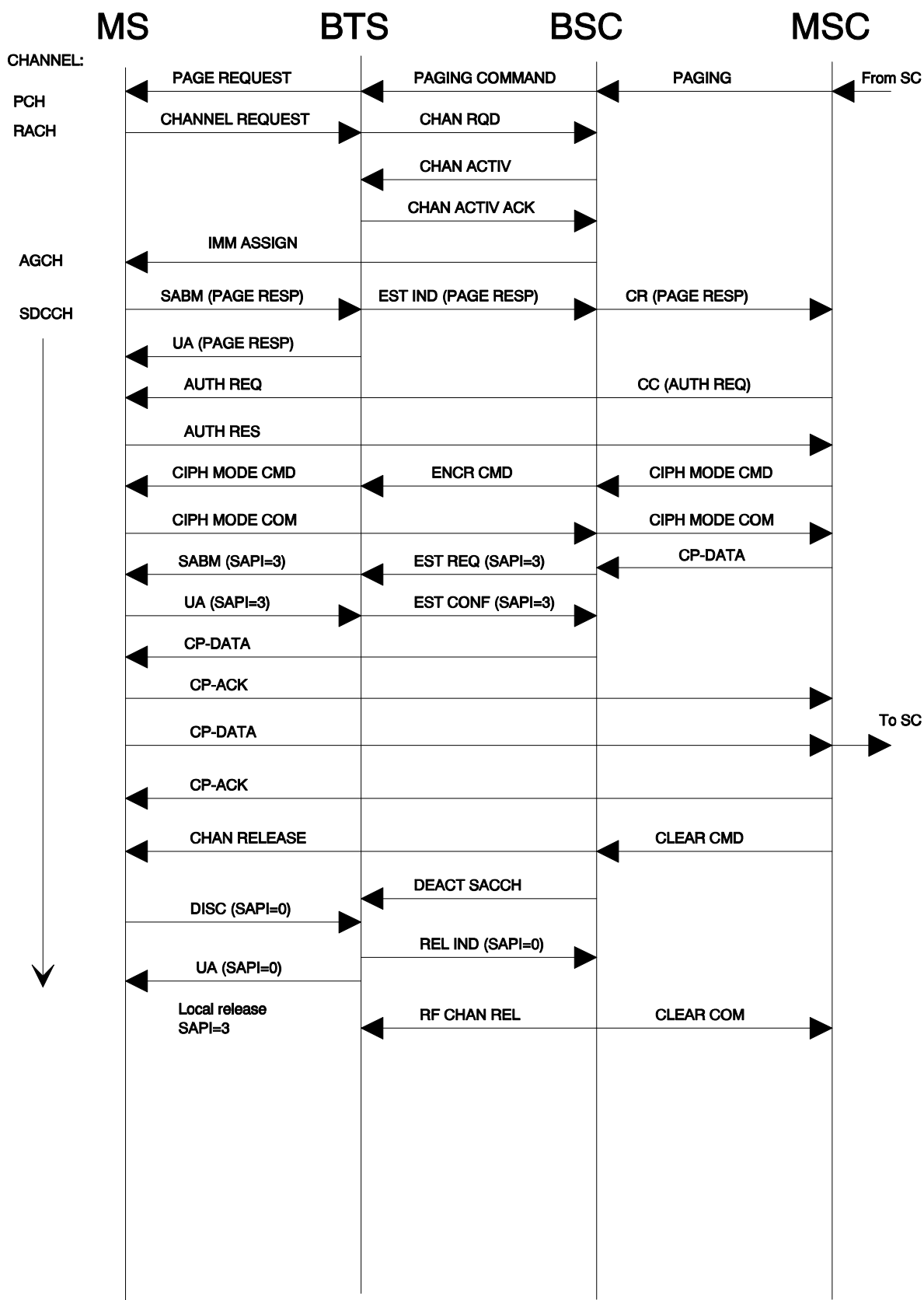

Figure F2/GSM 04.11  
 Mobile terminated Short Message on SDCCH

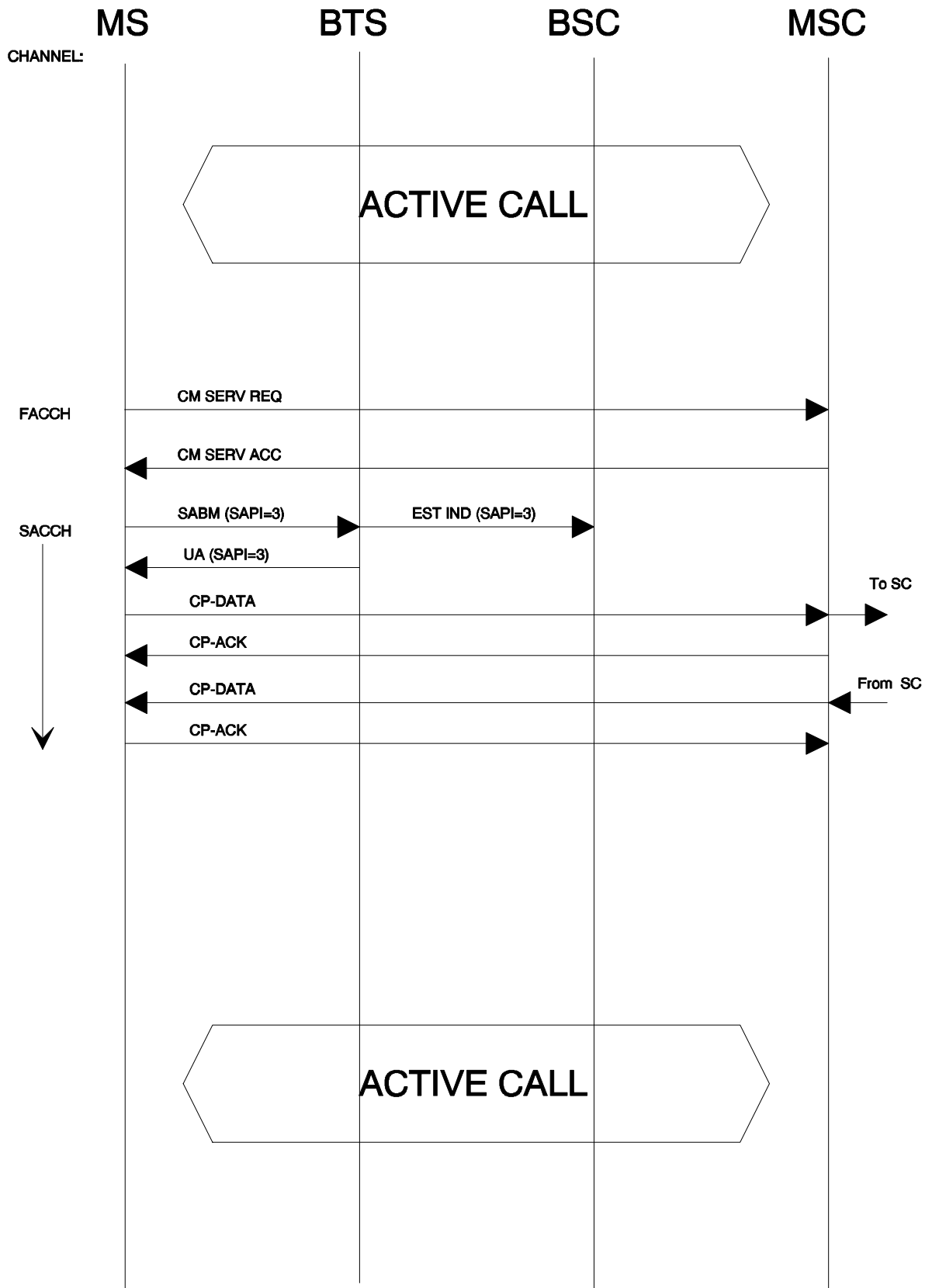

Figure F3/GSM 04.11  
 Mobile originated Short Message on SACCH

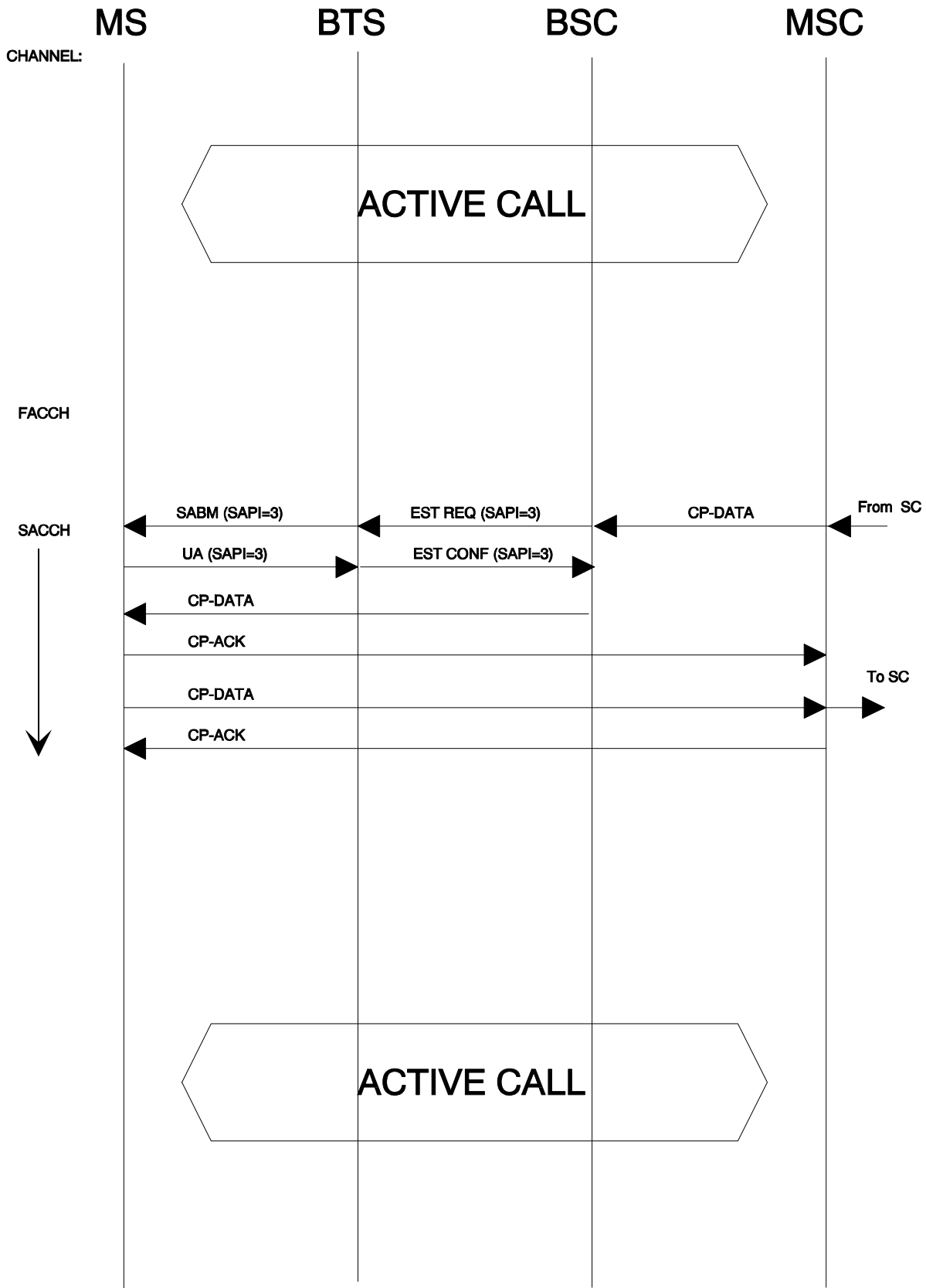

Figure F4/GSM 04.11  
 Mobile terminated Short Message on SACCH



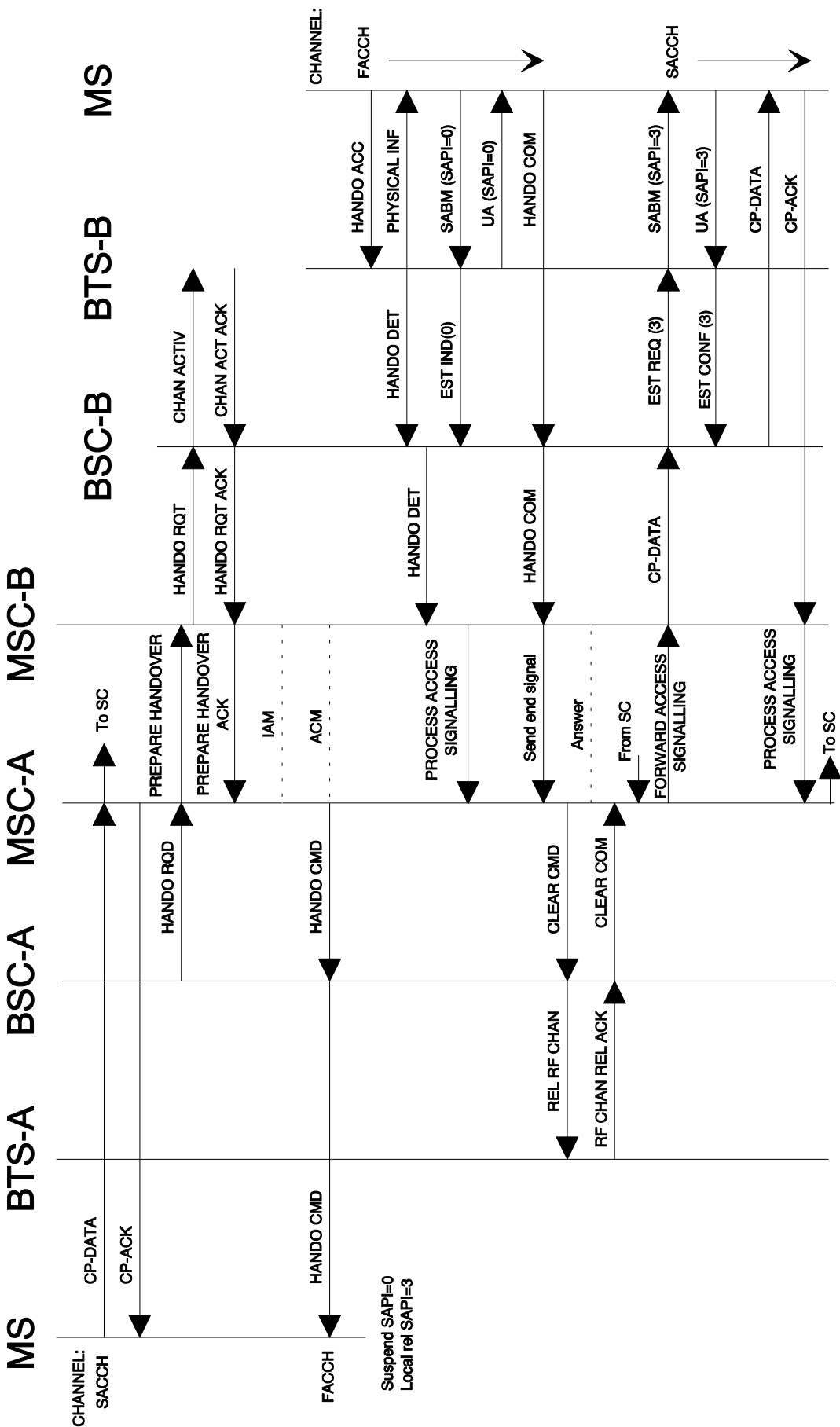

Figure F5/GSM 04.11 Inter/MS handover during Short Message transfer on SACCH

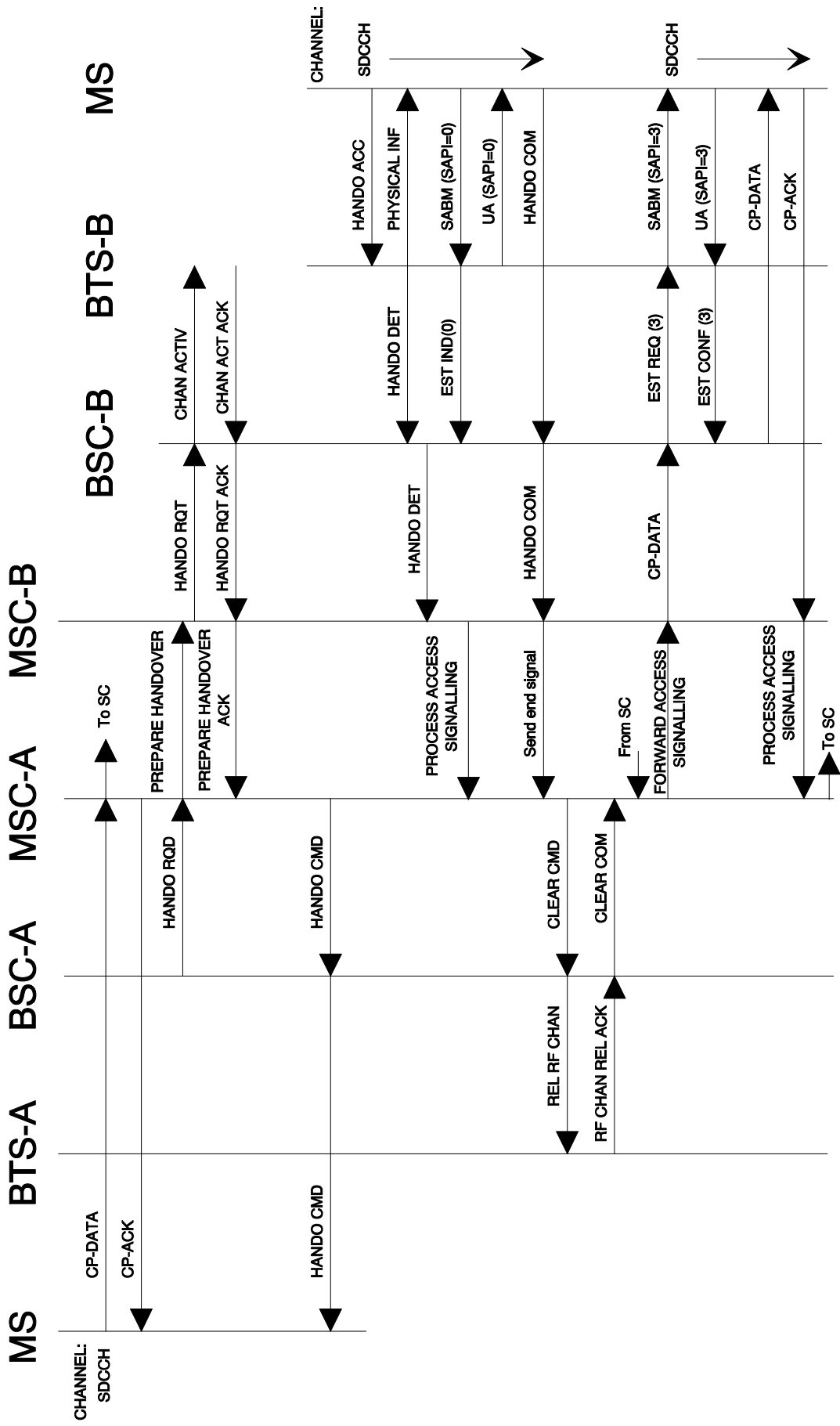

Figure F6/GSM 04.11  
 Inter/MS handover during Short Message transfer on SDCCH

## History

Document history	
February 1995	First Edition
May 1995	Unified Approval Procedure UAP 29: 1995-05-22 to 1995-09-15
October 1995	Second Edition
January 1996	Converted into Adobe Acrobat Portable Document Format (PDF)