



EUROPEAN
TELECOMMUNICATION
STANDARD

ETS 300 540

March 1999

Fifth Edition

Source: SMG

Reference: RE/SMG-110350PR3

ICS: 33.020

Key words: Digital cellular telecommunications system, Global System Mobile communications (GSM)



**Digital cellular telecommunications system (Phase 2);
Transmission planning aspects of the speech service in the GSM
Public Land Mobile Network (PLMN) system
(GSM 03.50 version 4.5.1)**

ETSI

European Telecommunications Standards Institute

ETSI Secretariat

Postal address: F-06921 Sophia Antipolis CEDEX - FRANCE

Office address: 650 Route des Lucioles - Sophia Antipolis - Valbonne - FRANCE

Internet: secretariat@etsi.fr - <http://www.etsi.org>

Tel.: +33 4 92 94 42 00 - Fax: +33 4 93 65 47 16

Copyright Notification: No part may be reproduced except as authorized by written permission. The copyright and the foregoing restriction extend to reproduction in all media.

© European Telecommunications Standards Institute 1999. All rights reserved.

Contents

Foreword		7
1	Scope	9
1.1	Normative references	9
1.2	Definitions and abbreviations	11
1.3	Introduction	11
2	Network configurations	12
2.1	General	12
2.2	Model of the PLMN	12
2.3	Interfaces	13
2.4	Configurations of Connections	13
2.4.1	General Configurations of Connections	13
2.4.2	Reference configurations to illustrate delay and echo control issues	14
2.5	4-wire circuits in the PLMN	14
3	Transmission performance	14
3.1	Overall Loss/Loudness ratings	15
3.1.1	Connections with handset MSs	15
3.1.2	Connections with handsfree MSs using loudspeakers	16
3.1.3	Connections with headset MSs	16
3.2	Stability Loss	16
3.3	Delay	17
3.3.1	General	17
3.3.2	Sources of delay	17
3.3.2.1	Elements of the PLMN that cause delay	17
3.3.2.2	Elements of the PSTN that cause delay	17
3.3.3	Effects of delay	18
3.3.4	Allocation of delay to the PLMN	18
3.3.4.1	Allocation of delay to the PLMN when using a full rate system	18
3.3.4.2	Allocation of delay to the PLMN when using a half rate system	18
3.3.5	Delay of various network configurations	18
3.3.5.1	National and international connections with no echo control in the PSTN (reference configurations A)	18
3.3.5.2	National and international connections with echo control in the PSTN (reference configurations B)	19
3.3.5.3	Connections where re-routing leads to a significant increase in transmission path length (reference configurations C)	19
3.3.6	Delay related requirements on the MS	19
3.3.6.1	Full rate MS	19
3.3.6.2	Half rate MS	19
3.4	Echo	19
3.4.1	General	19
3.4.2	Electrical echo control in the PLMN (Reference configurations A)	20
3.4.3	Acoustic echo control in the PLMN	20
3.4.3.1	Acoustic echo control in a handsfree MS	20
3.4.3.2	Acoustic echo control in a handset MS	20
3.4.3.3	Acoustic echo control in a headset MS	20
3.4.4	Interaction between tandem echo control devices (reference configurations B & C)	21
3.5	Clipping	21
3.5.1	General	21
3.5.2	Properties of voice switches in the PLMN	21
3.5.3	Problems of tandem voice switching	21

3.6	Idle channel noise	22
3.6.1	Sending.....	22
3.6.2	Receiving	22
3.7	Noise contrast	22
3.7.1	General	22
3.7.2	Elements of a PLMN which can cause noise contrast impairment.....	23
3.7.3	Reduction of noise contrast	23
3.7.3.1	Reduction of noise contrast by limiting the noise received by the microphone.....	23
3.7.3.1.1	Headset MS.....	23
3.7.3.1.2	Handset MS.....	23
3.7.3.1.3	Handsfree MS	24
3.7.3.2	Reduction of noise contrast by insertion of comfort noise ..	24
3.7.4	Consequence of the introduction of high comfort noise levels on other voice-operated devices	24
3.8	Sensitivity/frequency characteristics	24
3.8.1	Headset and Handset MSs.....	24
3.8.1.1	Sending	24
3.8.1.2	Receiving	25
3.8.2	Handsfree MS.....	25
3.9	Distortion	25
3.9.1	Sending.....	25
3.9.2	Receiving	26
3.10	Sidetone	27
3.10.1	Sidetone loss	27
3.10.2	Sidetone distortion	27
3.11	Out-of-band signals.....	27
3.11.1	Discrimination against out-of-band input signals	27
3.11.2	Spurious out-of-band signals	28
3.12	Requirements for information tones.....	28
3.13	Crosstalk	28
3.13.1	Near and far end crosstalk	28
3.13.2	Go/return crosstalk	28
Annex A (informative): Considerations on the Acoustic Interface of the Mobile Station		38
A.1	Handsfree MS.....	38
A.2	Handset MS	38
A.3	Headset MS	38
A.4	Inter-reaction with DTX.....	38
Annex B (normative): Transmission requirements testing.....		39
B.1	Loudness ratings	39
B.1.1	Sending Loudness Rating (SLR).....	39
B.1.2	Receiving Loudness Rating (RLR).....	39
B.2	Idle Channel Noise	39
B.2.1	Sending	39
B.2.2	Receiving.....	40
B.3	Sensitivity/frequency Characteristics	40
B.3.1	Sending	40
B.3.2	Receiving.....	40
B.4	Distortion.....	40
B.4.1	Sending	40
B.4.2	Receiving.....	41
B.5	Variation of gain with input level	41

B.5.1	Sending.....	41
B.5.2	Receiving.....	41
B.6	Sidetone.....	41
B.6.1	Talker sidetone (STMR).....	41
B.6.2	Listener sidetone (LSTR).....	42
B.7	Sidetone distortion.....	42
B.8	Out-of-band signals.....	42
B.8.1	Discrimination against out-of-band input signal.....	42
B.8.2	Spurious out-of-band signals.....	42
B.9	Acoustic echo loss.....	43
Annex C (normative):	MS delay requirement definition.....	44
C.1	Full rate MS delay requirement definition.....	44
C.2	Half rate MS delay requirement definition.....	45
Annex D (informative):	Document change history.....	46
History.....		47

Blank page

Foreword

This European Telecommunication Standard (ETS) has been produced by the Special Mobile Group (SMG) of the European Telecommunications Standards Institute (ETSI).

This ETS describes the transmission planning aspects pertaining to the speech service within the digital cellular telecommunications system (Phase 2).

The contents of this ETS is subject to continuing work within SMG and may change following formal SMG approval. Should SMG modify the contents of this ETS, it will be resubmitted for OAP by ETSI with an identifying change of release date and an increase in version number as follows:

Version 4.x.y

where:

- 4 indicates GSM Phase 2
- x the second digit is incremented for changes of substance, i.e. technical enhancements, corrections, updates, etc.
- y the third digit is incremented when editorial only changes have been incorporated in the specification;

Transposition dates	
Date of adoption of this ETS:	12 March 1999
Date of latest announcement of this ETS (doa):	30 June 1999
Date of latest publication of new National Standard or endorsement of this ETS (dop/e):	31 December 1999
Date of withdrawal of any conflicting National Standard (dow):	31 December 1999

Blank page

1 Scope

This European Telecommunication Standard (ETS) is concerned with the transmission planning aspects pertaining to the speech service in the pan-European PLMN system. Due to technical and economic factors, there cannot be full compliance with the general characteristics of international telephone connections and circuits recommended by CCITT.

This ETS gives guidance as to the precautions, measures and minimum requirements needed for successful interworking of the PLMN with the national and international PSTN. The Recommendation identifies a number of routing and network configurations. The objective is to reach a quality as close as possible to CCITT standards in order to safeguard the performance seen by PSTN customers.

1.1 Normative references

This ETS incorporates by dated and undated reference, provisions from other publications. These normative references are cited at the appropriate places in the text and the publications are listed hereafter. For dated references, subsequent amendments to or revisions of any of these publications apply to this ETS only when incorporated in it by amendment or revision. For undated references, the latest edition of the publication referred to applies. Unless otherwise stated, all references to CCITT Recommendations are from the Blue Book (1989).

- [1] GSM 01.04 (ETR 100): "Digital cellular telecommunication system (Phase 2); Abbreviations and acronyms".
- [2] GSM 03.04 (ETS 300 524): "Digital cellular telecommunication system (Phase 2); Signalling requirements relating to routing of calls to mobile subscribers".
- [3] GSM 06.01 (ETS 300 580-1): "Digital cellular telecommunication system (Phase 2); Full rate speech processing functions".
- [4] GSM 06.10 (ETS 300 580-2): "Digital cellular telecommunication system (Phase 2); Full rate speech transcoding".
- [5] GSM 06.11 (ETS 300 580-3): "Digital cellular telecommunication system (Phase 2); Substitution and muting of lost frames for full rate speech channels".
- [6] GSM 06.12 (ETS 300 580-4): "Digital cellular telecommunication system (Phase 2); Comfort noise aspect for full rate speech traffic channels".
- [7] GSM 06.31 (ETS 300 580-5): "Digital cellular telecommunication system (Phase 2); Discontinuous Transmission (DTX) for full rate speech traffic channel".
- [8] GSM 06.32 (ETS 300 580-6): "Digital cellular telecommunication system (Phase 2); Voice Activity Detection (VAD)".
- [9] GSM 06.02 (ETS 300 581-1): "Digital cellular telecommunication system (Phase 2); Half rate speech processing functions".
- [10] GSM 06.20 (ETS 300 581-2): "Digital cellular telecommunication system (Phase 2); Half rate speech transcoding".
- [11] GSM 06.21 (ETS 300 581-3): "Digital cellular telecommunication system (Phase 2); Substitution and muting of lost frames for half rate speech traffic channels".
- [12] GSM 06.22 (ETS 300 581-4): "Digital cellular telecommunication system (Phase 2); Comfort noise aspects for half rate speech traffic channels".

- [13] GSM 06.41 (ETS 300 581-5): "Digital cellular telecommunication system (Phase 2); Discontinuous Transmission (DTX) for half rate speech traffic channels".
- [14] GSM 06.42 (ETS 300 581-6): "Digital cellular telecommunication system (Phase 2); Voice Activity Detection (VAD) for half rate speech traffic channels".
- [15] ETS 300 085 (1990): "Integrated Services Digital Network (ISDN); 3,1 kHz telephony teleservice; Attachment requirements for handset terminals".
- [16] CCITT Recommendation G.103: "Hypothetical reference connections".
- [17] CCITT recommendation G.111: "Loudness ratings (LRs) in an international connections".
- [18] CCITT Recommendation G.113: "Transmission impairments".
- [19] CCITT Recommendation G.114: "Mean one-way propagation time".
- [20] CCITT Recommendation G.121: "Loudness ratings (LRs) of national systems".
- [21] CCITT Recommendation G.122: "Influence of national systems on stability, talker echo, and listener echo in international connections".
- [22] CCITT Recommendation G.131: "Stability and echo".
- [23] CCITT Recommendation G.165: "Echo cancellers".
- [24] CCITT Recommendation G.223: "Assumptions for the calculation of noise on hypothetical reference circuits for telephony".
- [25] CCITT Recommendation G.703: "Physical/electrical characteristics of hierarchical digital interfaces".
- [26] CCITT Recommendation G.711: "Pulse code modulation (PCM) of voice frequencies".
- [27] CCITT Recommendations G.712: "Transmission performance characteristics of pulse code modulation".
- [28] CCITT Recommendations G.714: "Separate performance characteristics for the send and receive sides of PCM channels applicable to 4-wire voice frequency interfaces".
- [29] CCITT Recommendations M.1020: "Characteristics of special quality".
- [30] CCITT Recommendations M.1025: "Characteristics of special quality international leased circuits with basic bandwidth conditioning".
- [31] CCITT Recommendations M.1030: "Characteristics of ordinary quality international leased circuits forming part of private switched telephone networks".
- [32] CCITT Recommendations M.1040: "Characteristics of ordinary quality international leased circuits".
- [33] CCITT Recommendation O.132 (1988), "Specification for a quantizing distortion measuring apparatus using a sinusoidal test signal."
- [34] CCITT Recommendation P.11: "Effect of transmission impairments".

- [35] CCITT Recommendation P.34: "Transmission characteristics of hands-free telephones".
- [36] CCITT Recommendation P.38: "Transmission characteristics of operator telephone systems (OTS)".
- [37] CCITT Recommendation P.50: "Artificial voices".
- [38] CCITT Recommendation P.51 (1988), "Artificial mouths and artificial ears."
- [39] CCITT Recommendation P.64 (1988), "Determination of sensitivity/frequency characteristics of local telephone systems to permit calculation of their loudness ratings."
- [40] CCITT Recommendation P.76 (1988), "Determination of loudness ratings; fundamental principles."
- [41] CCITT Recommendation P.79 (1988), "Calculation of loudness ratings."
- [42] CCITT Recommendation Q.35: "Technical characteristics of tones for the telephone service".
- [43] CCITT Recommendation Q.551: "Transmission characteristics of digital exchanges".
- [44] CCITT Blue Book (1988), Volume V, Supplement 13, "Noise spectra."
- [45] ISO 3 - 1973, "Preferred numbers - series of preferred numbers."
- [46] ITU-T Recommendation P.57 (1996), "Artificial ears."

1.2 Definitions and abbreviations

In addition to those below the definitions and abbreviations used in this specification are listed in GSM 01.04.

ADC	Analogue to Digital Converter
ADPCM	Adaptive Differential Pulse Code Modulation
AEC	Acoustic Echo Control
BSC'	Base Station Controller (excluding transmission systems)
BTS'	Base Transceiver Station (excluding transmission systems)
DAC	Digital to Analogue Converter
DMR	Digital Mobile Radio
DSI	Digital Speech Interpolation
EEC	Electric Echo Control
EL	Echo Loss
ERP	Ear Reference Point
FDM	Frequency Division Multiplex
LSTR	Listener Sidetone Rating
MRP	Mouth Reference Point
OLR	Overall Loudness Rating
PCM	Pulse Code Modulation
POI	Point of Interconnection (with PSTN)
RLR	Receiver Loudness Rating
SLR	Send Loudness Rating
STMR	Sidetone Masking Rating
UPCMI	13-bit Uniform PCM Interface

1.3 Introduction

Since the transmission quality and the conversational quality of the PLMN will in general be lower than the quality of the PSTN connection due to coding distortion, delay, etc, only some transmission aspects can

be brought in line with CCITT Recommendations. It is therefore necessary to improve the overall quality as much as possible by implementing proper routing and network configurations.

It should be recognised that the transmission plan for the pan-European PLMN cannot lead to major changes in the PSTN. However, it is important to use the improvements in the evolving PSTN (e.g. digitalization, introduction of echo cancellers) in an effective way.

The transmission requirements are in the first place based on international connections. When the quality is sufficient for international connections, it can be assumed that the national connections will have the same or better quality.

In order to obtain a sufficient quality in the connection, it is preferable to have digital connectivity between the Base Station System (BSS) and the international exchange. The PLMN requirements are based on this assumption. When this situation cannot be provided, a lower quality must temporarily be accepted.

This Recommendation consists of two parts: one will deal with network configurations, the other with transmission performance.

The part about network configurations gives information about the reference connections, on which the transmission plan is based. Furthermore, some guidelines are presented for improvement of the transmission quality in the evolving (digital) PSTN.

The part about transmission performance gives mainly characteristics of the transmission between MS acoustic interface (MRP/ERP) and the interface between the PLMN and the PSTN (POI). For transmission aspects where it is impossible to give overall characteristics, it is in some cases necessary to make recommendations for individual parts of the equipment.

Unless otherwise stated, all references to CCITT Recommendations are from the Blue Book (1989).

Annex A considers the effects of the type of acoustic interfaces of the MS.

2 Network configurations

2.1 General

The basic configuration for the interworking with the PSTN is shown in figure 1.

2.2 Model of the PLMN

A more detailed model of the PLMN used for the consideration of transmission planning issues for speech is shown in figure 2. This model represents the main functions required and does not necessarily imply any particular physical realisation. Routing of calls is given in Recommendation GSM 03.04.

Any acoustic echo control is not specifically shown as it will be provided by analogue processing of digital processing or a combination of both techniques.

2.3 Interfaces

The main interfaces identified within the GSM Recommendations are shown in figure 1. For the purposes of this Recommendation, the Air Interface and the Point of Interconnect (POI) are identified along with two other interfaces, Interface Z and a 13-bit Uniform PCM Interface (UPCMI). These interfaces are needed to define the PLMN transmission characteristics and the overall system requirements.

The Air Interface is specified by GSM 05 series Recommendations and is required to achieve MS transportability. Analogue measurements can be made at this point by using the appropriate radio terminal equipment and speech transcoder. The losses and gains introduced by the test speech transcoder will need to be specified.

The POI with the PSTN will generally be at the 2048 kbits/s level at an interface, in accordance with CCITT Recommendation G.703. At the point, which is considered to have a relative level of 0 dBr, the analogue signals will be represented by 8-bit A-law, according to CCITT Recommendation G.711. Analogue measurements may be made at this point using a standard send and receive side, as defined in CCITT Recommendations G.714 and G.712.

Interface Z might be used in the case of direct MSC to MSC connections. Interface Z is of the same nature as the POI.

The UPCMI is introduced for design purposes in order to separate the speech transcoder impairments from the basic audio impairments of the MS.

2.4 Configurations of Connections

2.4.1 General Configurations of Connections

Figure 3 shows a variety of configurations of connections. There are a number of PSTN features which should be avoided from such connections. These include:

- echo control devices in the international network. If present, and not disabled, these devices will be in tandem with PLMN echo cancellers and may introduce degradation;
- satellite routeings. The delay inherent in the connections when added to the PLMN delay, may result in conversational difficulties. Double satellite links are likely to cause severe difficulties and special precautions should be taken to avoid this situation under call forwarding arrangements;
- digital speech interpolation systems (DSI). There is likely to be an adverse interaction between DSI and DTX;
- ADPCM. The distortion introduced by ADPCM on routes where PSTN echo control is not provided is likely to reduce the echo cancellation provided by the PLMN electric echo canceller;
- significant differences in clock rates on non-synchronised digital network components. The resulting phase roll and slips are likely to degrade the performance of the PLMN echo canceller;
- those analogue FDM routeings which exhibit phase roll. Any phase roll due to the absence of synchronisation between the carrier frequencies on the two directions of transmission is likely to degrade the performance of the PLMN echo canceller;
- tandem connections of sources of quantisation distortion. The PLMN speech transcoder is estimated to be equivalent to 7 QDUs between uniform PCM interfaces (see CCITT Recommendation G.113).

It is recognised that on some connections it may not be feasible to avoid these features, but in many cases, especially if taken into account at the planning stage, this should be possible.

2.4.2 Reference configurations to illustrate delay and echo control issues

Three basic reference configuration types shown in Figures 4 to 6 are defined to illustrate delay and echo control issues. Intermediate echo control devices as shown in the figures are disabled by appropriate signalling between the MSC and ISC or MSC and MSC.

Reference configurations A (see figure 4) represent national or international connections where there is no echo control device in the PSTN. These reference configurations include re-routeing configurations where the overall delay of the transmission path has not been extended.

Reference configurations B (see figure 5) represent national or international connections where echo control is provided in the PSTN. These reference configurations include re-routeing configurations where the overall delay of the transmission path has not been extended.

Reference configurations C (see figure 6) represent national or international connections where re-routeing has lead to an increase in the overall delay of the transmission path beyond recommended limits.

2.5 4-wire circuits in the PLMN

As shown in figure 2, the PLMN will usually contain transmission systems. Where present, they should provide 4-wire circuits.

In the case of digital circuits which do not include any speech processing devices, the overall system requirements of the PLMN will not be affected by the presence of the link.

In the case of analogue links, the transmission characteristics (e.g. attenuation, attenuation distortion, noise) will affect the overall system requirements of the PLMN. CCITT Recommendations M.1020, M.1025, M.1030 and M.1040 describe several transmission characteristics for leased circuits. In cases where the analogue link introduces loss, provision will have to be made at the interface to restore the loss.

3 Transmission performance

The overall transmission performance of connections in alternate conversation mode can be considered as a summation of the effects of:

- the audio part between the MRP/ERP and the UPCMI interface;
- the speech transcoder part including the effects of radio transmission, and speech processing between the UPCMI and the POI;
- the overall characteristics of the connection between POI and the other user.

There is not only a linear addition of these effects but there is also an influence from different parts of the connection on the performance of the speech transcoder and other speech processing devices.

Where possible, the transmission performance is specified between the MRP/ERP and the POI. Where this is not possible, the transmission aspects of the audio part mentioned above have been specified. The transmission aspects of the speech transcoder are specified in GSM 06 series Recommendations. In the following subclauses, requirements are specified for the UPCMI, the Air Interface or the POI as appropriate.

The following subclauses are applicable to handset MSs. In some places, reference is made to headset and handsfree MSs, but further study is needed to fully extend this Recommendation to these types of acoustic interface (see Annex A).

The transmission requirements of the MS have been derived from the requirements of digital telephones stated in ETS 300 085 (December 1990).

MSs will have to work in a variety of environments ranging from quiet office locations to very noisy environments as found in moving cars. In noisy conditions, different values for SLR, STMR and low frequency response may be required. These different values may be achieved by introducing some switch-over function (manual or automatic). This point needs further study.

The overall transmission performance in full duplex conversation mode will also greatly depend on the performance of the echo control devices which may be included in the connection.

3.1 Overall Loss/Loudness ratings

The overall international connection involving PLMNs and the PSTN should meet the overall loudness rating (OLR) limits in CCITT Recommendation G.111. The national parts of the connection should therefore meet the send and receive loudness rating (SLR, RLR) limits in CCITT Recommendation G.121.

For the case where digital routings are used to connect the PLMN to the international chain of circuits, the SLR and RLR of the national extension will be largely determined by the SLR and RLR of the PLMN. The limits given below are consistent with the national extension limits and long term objectives in CCITT Recommendation G.121.

The SLR and RLR values for the PLMN apply up to the POI. However, the main determining factors are the characteristics of the MS, including the analogue to digital conversion (ADC) and digital to analogue conversion (DAC). Hence, in practice, it will be convenient to specify loudness ratings to the Air Interface. For the normal case, where the PLMN introduces no additional loss between the Air Interface and the POI, the loudness ratings to the PSTN boundary (POI) will be the same as the loudness ratings measured at the Air Interface. However, in some cases loss adjustment may be needed for interworking situations in individual countries.

These values are directly applicable to the case of an MS operating in a conventional non-mobile noise environment. Studies have shown that under the PLMN noise environment, speech levels are likely to be higher. Hence, in order to avoid clipping in the speech transcoder, the value of SLR may need to be increased.

NOTE: Measurement of SLR and RLR using sinusoidal test frequencies may not be sufficiently accurate because of the adaptive characteristics of the PLMN full-rate speech transcoder. A possible method is to use the artificial voice described in CCITT Recommendation P.50 to measure send and receive sensitivities. A method used by one administration uses the artificial voice to measure the loudness rating according to the Zwicker algorithm.

3.1.1 Connections with handset MSs

The nominal values of SLR/RLR to the POI shall be:

SLR = 8 +/- 3 dB;

RLR = 2 +/- 3 dB.

Where a user-controlled receiving volume control is provided, the RLR shall meet the selected nominal value for at least one setting of the control. When the control is set to maximum, the RLR shall not be less than (louder than) - 13 dB.

With the volume control set to the minimum position the RLR shall not be greater than (quieter than) 18 dB.

Compliance shall be checked by the tests described in Annex B, subclauses B.1.1 and B.1.2.

NOTE: The mechanical design of some MSs may make it impossible to seal the earpiece to the knife edge of the CCITT artificial ear. Minimal additional methods may be used to provide the seal provided that they do not affect the mounting position of the MS with respect to the Mouth Reference Point and the Ear Reference Point.

3.1.2 Connections with handsfree MSs using loudspeakers

The SLR and RLR should be measured and computed using the methods given in CCITT Recommendation P.34 section 6 with an artificial voice satisfying CCITT Recommendation P.50.

The values of SLR/RLR to/from the POI should be:

SLR = 13 +/- 3 dB (note 1);
RLR = 2 +/- 3 dB with the volume control set to the mid position.

A receive volume control should be provided with a range of between +/- 7.5 dB and +/- 15 dB.

The use of values towards the most sensitive end of the range may result in problems with amplifying crosstalk from other channels (note 2).

NOTE 1: This values takes into account the CCITT Recommendation P.34; the SLR of a handsfree telephone should be 5 dB higher than the corresponding value for a handset instrument. The tolerance of +/- 3 dB is provisional.

NOTE 2: This procedure assumes no automatic gain control in the mobile terminal. The use of such techniques is not recommended for mobile applications.

NOTE 3: Further work is required to develop a practical test method using CCITT Recommendation P.50.

3.1.3 Connections with headset MSs

The SLR and RLR should be measured and computed using methods given in CCITT Recommendation P.38. This Recommendation currently gives a measuring technique for supra-aural earphone and insert-type receivers. Study is continuing on other types of earpieces in CCITT SGXII.

The nominal values of SLR/RLR to/from the POI should be:

SLR = 8 +/- 3 dB;
RLR = 2 +/- 3 dB with any volume control set to mid position.

Where a user-controlled receiving volume control is provided, the RLR shall meet the selected nominal value for at least one setting of the control. When the control is set to maximum, the RLR shall not be less than (louder than) - 13 dB.

With the volume control set to the minimum position the RLR shall not be greater than (quieter than) 18 dB.

3.2 Stability Loss

The stability loss presented to the PSTN by the PLMN at the POI should meet the principles of the requirements in Sections 2 and 3 of CCITT Recommendation G.122. These requirements will be met if the attenuation between the digital input and digital output at the POI is at least 6 dB at all frequencies in the range 200 Hz to 4 kHz under the worst-case acoustic conditions at the MS (any acoustic echo control should be enabled).

For the normal case of digital connection between the Air Interface and the POI, the stability requirement can be applied at the Air Interface. The worst-case acoustic conditions will be as follows (with any volume control set to maximum):

Handset MS: the handset lying on, and the transducers facing, a hard surface with the earpiece uncapped.

Handsfree MS: a representative worst-case position of microphone and loudspeaker (for further study).

Headset MS: for further study.

NOTE: The test procedure will need to take into account the switching effects of echo control and DTX.

3.3 Delay

3.3.1 General

A significant propagation time between the two ends of a connection causes difficulties in conversation over the connection. This arises from two causes. Firstly, the signal is reflected back from the distant end causing an echo to the talker (this is considered in subclause 3.4). Secondly, even if ideal echo control were achieved, the delay between a user talking and receiving a reply from the user at the distant end of the connection could cause conversational difficulty.

PLMNs will be connected to the PSTN at a point where present planning rules allow for a delay of less than 12 ms (see CCITT Recommendation G.114 subclause 2.2a). The delay within the PLMN will greatly exceed this. If unacceptable circuit delays are not to be experienced by users, action will have to be taken when planning routes or during call set-up.

3.3.2 Sources of delay

3.3.2.1 Elements of the PLMN that cause delay

The delay of the PLMN is made up of the following elements:

- speech transcoding delay;
- radio channel coding delay;
- PLMN network delay (i.e. fixed elements such as multiplexing, propagation, switching, echo control).

3.3.2.2 Elements of the PSTN that cause delay

CCITT recommendation G.114 identifies various elements present in some PSTN connections which cause delay. These include:

- coaxial, radio and optical fibre terrestrial transmission systems;
- geostationary satellites;
- digital speech interpolators;
- digital exchanges (see also CCITT recommendation Q.551);
- echo cancellers.

3.3.3 Effects of delay

Some recent studies have suggested that under ideal conditions, i.e.:

- effective control of all echoes without clipping by the use of good echo cancellers;
- low background noise leading to an absence of perceptible noise contrast;
- low distortion of transmitted signals;
- ideal loudness ratings;

users can tolerate a circuit delay well in excess of 400 ms (currently the maximum delay recommended in CCITT Recommendation G.114). Other studies indicate that the difficulty caused by circuit delay increases when impairments, such as imperfect echo control caused by echo suppressers, clipping and noise contrast, are present.

However, the mobile environment is very harsh, with high background noise levels and distortion from the speech transcoder. In particular, the use of acoustic echo suppression could give rise to severe speech clipping and noise contrast. Also the operation of the voice switching used with DTX will give impairments similar to those caused by echo suppression. All subjective tests performed with echo suppressors indicate that, because of the increased effect of clipping with increased delay, the difficulty experienced by users increases rapidly with delay. According to curve 2 of figure A.1 of CCITT Recommendation G.114, the percentage of users experiencing difficulties with echo suppressors reaches 20% with a delay of 150 ms rising to 40% with a delay of 300 ms. CCITT Recommendation G.114 Annex A details the test conditions under which this curve was derived and it concludes that connections with more than 300 ms can only be used by very disciplined users who are aware of the problems involved in such a connection. However, recent work has indicated that delays of up to 500 ms can be used satisfactorily, provided that effective echo cancellation is incorporated in the link.

3.3.4 Allocation of delay to the PLMN

3.3.4.1 Allocation of delay to the PLMN when using a full rate system

Taking account of Recommendations on the separate factors described in subclause 3.3.2.1, the maximum both-way in the PLMN between the MRP/ERP and the Point of Interconnection (see figure 1) will be 180 ms. In the case that the transcoder is positioned outside the BTS, the maximum distance between the POI and the furthest border of the cell controlled by the BTS is limited by a one-way propagation delay of 1.5 ms (approximately 300 km). If the transcoder is positioned at the BTS, the limit is 6.5 ms (approximately 1300 km). These limits may be subject to increase resulting from savings made in the overall network.

3.3.4.2 Allocation of delay to the PLMN when using a half rate system

If it is assumed that the speech quality associated with the half rate system is the same as the full rate system (considering both the speech transcoder and the radio sub-system), then in order to achieve the same overall transmission quality, the maximum delay within the PLMN should be maintained at 180 ms.

3.3.5 Delay of various network configurations

3.3.5.1 National and international connections with no echo control in the PSTN (reference configurations A)

Reference configurations A (see figure 4) contain no echo control in the PSTN because present planning rules require the use of echo control devices only when the PSTN delay between two fixed PSTN users exceeds 25 ms. This leads to a maximum PSTN delay of 22 ms from the point of interconnection to the PLMN (see subclause 3.4.2).

3.3.5.2 National and international connections with echo control in the PSTN (reference configurations B)

Reference configurations B (see figure 5) contain echo control in the PSTN because present planning rules require their use when the PSTN delay between PSTN users exceeds 25 ms. However, action may have to be taken by administrations when planning routes or at call set-up to limit the maximum delay.

Subclause 3.3.3 describes how the impairments from the harsh mobile environment when coupled with delay can give rise to difficulty. If very good cancellation of both electrical and acoustic echo can be achieved and there are no sources of speech clipping or noise contrast either in the PLMN or the PSTN part of the connection, the circuit delay should be kept below 400 ms. This means that every attempt should be made to avoid mobile to mobile calls via satellite (expected delay > 440 ms).

If acoustic echo suppression is used or DTX is enabled, or there is any other source of clipping or noise contrast present in the PSTN, the additional distortion introduced makes it desirable to avoid any satellite routing whenever possible in order to keep the delay below 300 ms.

3.3.5.3 Connections where re-routeing leads to a significant increase in transmission path length (reference configurations C)

A number of possible combinations of re-routeing are described by reference configurations C (see figure 6), all of which increase the path length and hence the delay and some of which increase the number of impairments in the network.

These routings are likely to cause severe degradation to the quality of the connection and may result in significant difficulty, particularly when the connection contains one or maybe more satellite links.

These connections should be avoided in network planning and, if this is not possible, then the facilities of Signalling System No. 7 should be used to control the routing of the call at call set-up to minimise the effects.

3.3.6 Delay related requirements on the MS

3.3.6.1 Full rate MS

In accordance with the outline of transmission delay in various GSM system elements contained in GSM 03.50 the trip delay in the MS shall not exceed 143.9 ms as defined in Annex C.

3.3.6.2 Half rate MS

The round trip delay in the MS shall not exceed 143.9 ms as defined in Annex C.

3.4 Echo

3.4.1 General

There are two main sources of echo:

- acoustic echo caused by the acoustic path between receive and transmit transducers;
- electrical echo caused by coupling between the transmit and receive directions of transmission. The primary source of this form of echo is a two-to-four wire converter.

Electrical echo can be eliminated by the use of end-to-end four-wire transmission. Acoustic echo will be generated in all telephone instruments with the exception of carefully designed headsets.

In general, electrical echo is characterised by a short reverberation time and low dispersion while acoustic echo is likely to have a longer reverberation time and greater dispersion. The case of the acoustic echo may be further complicated by the time variant nature of acoustic echo which may be more severe in the mobile environment.

Curves showing the tolerance to echo, taking account of the relationship between the delay and the level of the echo, are given in CCITT Recommendation G.131 figure 2/G.131. In practice, it has been found that for any connection with a delay of greater than 25 ms, some form of echo control will be required to reduce the level of the echo (CCITT Recommendation G.131 Rule M).

With the expected maximum one-way delay in the PLMN of 90 ms, acoustic echo control will be required in the MS to reduce the echo returned to the distant end and electrical echo control will be required at the POI to reduce the echo returned to the PLMN user from the PSTN. The design of these echo control devices should be such as to provide operation in full duplex mode (as opposed to alternate mode).

The echo loss (EL) presented by the PLMN at the POI should be at least 46 dB during single talk. This value takes into account the fact that a MS is likely to be used in a wide range of noise environments. This requirement should be met for both handset and handportable MSs. The requirement for handsfree MSs is for further study. The test method is defined in Annex B, clause B.9.

3.4.2 Electrical echo control in the PLMN (Reference configurations A)

The electrical echo control device at the interface with the PSTN should meet the requirements given in CCITT Recommendation G.165, but with an end delay of 60 ms. This refers to t_d in subclause 3.2 of CCITT Recommendation G.165. The 60 ms is calculated as follows. CCITT Recommendation G.131 states that the maximum length of connection which need not have echo control has a mean one-way propagation time of 25 ms. However, this figure is the sum of the delays of the international connection and the maximum national delays at each end of the connection. Since the interconnection of the PLMN to the PSTN is unlikely to be at a point where the PSTN delay is > 22 ms, and the dispersion may be up to 8 ms, the maximum expected end delay which the echo canceller in the MSC should expect is:

$$(22 + 8) \times 2 = 60 \text{ ms} \quad (\text{see figure 7}).$$

Certain countries on the geographical limits of a continent may need to increase this limit as there may be a proportion of connections which do not comply with CCITT Recommendation G.131 having a mean one-way delay of greater than 25 ms and yet are not provided with echo control.

3.4.3 Acoustic echo control in the PLMN

Acoustic echo control provided in the MS should provide an EL of 46 dB at the POI (see subclause 3.4.1) over the likely range of acoustic end delays. If acoustic echo control is provided by voice switching, comfort noise should be injected. This comfort noise shall operate in the same way to that used in Discontinuous Transmission system (DTX). Effectively, the acoustic echo loss is provided by MS as the GSM network is zero loss from the air interface to the POI and hence the 46dB requirement shall be applied to the MS.

3.4.3.1 Acoustic echo control in a handsfree MS

The telephone transmission parameters for handsfree MS are for further study. However, the basic requirement of 46 dB echo loss should apply to handsfree terminals, also. If acoustic echo control is provided using some form of echo cancellation technique, the cancellation algorithm should be designed to cope with the expected reverberation and dispersion. In the case of the handsfree MS, this reverberation and dispersion may be time variant. The expected values of dispersion are under study.

3.4.3.2 Acoustic echo control in a handset MS

The echo loss requirement for the handset MS shall be 46 dB. Careful acoustic design of the handset body and selection of the mouth and ear piece transducers may facilitate the required acoustic echo loss without the need for active echo control techniques. However, should echo cancellation be employed the echo canceller should be capable of dealing with the variations in handset positions when in normal use. The implications of this are under study.

3.4.3.3 Acoustic echo control in a headset MS

The echo loss requirement for a headset shall be 46 dB. Due to the obstacle effect of the head in this type of terminal, careful design might mean that no active echo control is necessary.

3.4.4 Interaction between tandem echo control devices (reference configurations B & C)

On long international routes or routes containing a satellite path, network echo control devices will be present in accordance with CCITT Recommendation G.131 Rule M. These devices will be echo suppressors or echo cancellers generally with centre clippers. The tandem connection of such devices can lead to increased clipping and, if echo suppressors are used, additional loss. It is recommended that signalling or routing means be used to avoid the tandem connections of echo control devices whenever possible (see figure 7).

3.5 Clipping

3.5.1 General

The loss of the start or the end of a speech burst is known as clipping, the main cause of which is voice switching controlled by voice activity detection. Voice switching occurs in devices within the network or within terminal devices. The following devices employ voice switching:

- echo suppressors. These are generally located at an ISC at either end of a long international connection or connections using satellites.
- echo cancellers with centre clippers. These are located as for the echo suppressors above. In addition, it is recommended that they be used in the MSC at the interface with the PSTN. Clipping in these devices arises from the action of the centre clipper only.
- digital speech interpolators (DSI). These devices are used in circuit multiplication equipments which are often employed on international connections.
- discontinuous transmission (DTX) devices. These are located in the PLMN.
- loudspeaking telephones. These are used in the PSTN and in the PLMN. It should be noted that regulations in certain countries prohibit the use of handheld MSs by drivers of moving vehicles.

3.5.2 Properties of voice switches in the PLMN

Recommendation GSM 06.32 specifies the requirements for the voice activity detector used for DTX and the total clipping allowed in the MS. Any voice switching used for acoustic echo control should not exceed these limits. Information on recommended characteristics of handsfree telephones is given in section 5 of CCITT Recommendation P.34.

3.5.3 Problems of tandem voice switching

The effect of tandem voice switches which are not under one common control will be an increase in clipping. Moreover, under conditions of high or rapidly changing ambient noise, false detection of speech is likely to occur in the voice activity detectors in DSI equipment or network echo control devices. These devices are generally designed for constant and low levels of noise.

In order to minimise clipping, the following action should be taken:

- intermediate tandem voice switching devices in the network should be either disabled by signalling means or avoided by routing means;
- the voice switching for the MS for acoustic control and for DTX should be under one common control.

However, it should be noted that, in many cases, it will not be possible to exclude DSI equipment or loudspeaking telephones from the connection.

3.6 Idle channel noise

3.6.1 Sending

The maximum noise level produced by the apparatus at the UPCMI under silent conditions in the sending direction shall not exceed - 64 dBm_{0p}.

NOTE 1: This level includes the eventual noise contribution of an acoustic echo canceller under the condition that no signal is received.

NOTE 2 This figure applies to the wideband noise signal. It is recommended that the level of single frequency disturbances should be 10 dB lower (CCITT Recommendation P.11).

Compliance shall be checked by the test described in Annex B, subclause B.2.1.

3.6.2 Receiving

The maximum (acoustic) noise level at the handset MS when no signal (O-level) is received from the speech transcoder shall be as follows:

If no user-controlled receiving volume control is provided, or, if it is provided, at the setting of the user-controlled receiving volume control at which the RLR is equal to the nominal value, the noise measured in the artificial ear contributed by the receiving equipment alone shall not exceed - 57 dBPa(A) when driven by a PCM signal corresponding to the decoder output value number 1.

Where a volume control is provided, the measured noise shall also not exceed - 54 dBPa(A) at the maximum setting of the volume control.

NOTE: In a connection with the PSTN, noise conditions as described in CCITT Recommendation G.103 can be expected at the input (POI) of the PLMN. The characteristics of this noise may be influenced by the speech transcoding process (for further study).

Compliance shall be checked by the test described in Annex B, subclause B.2.2.

3.7 Noise contrast

3.7.1 General

On any PLMN call there is likely to be continuous background noise which is present regardless of whether the users are talking or not. There may also be one or more voice-operated devices; these effectively break the circuit when there is no speech on it.

Noise contrast problems are caused by the background noise being interrupted when the circuit is broken so that the user listening on the circuit hears the background noise being continually switched on and off. This is particularly disturbing for a user talking to a PLMN user in a moving vehicle because the background noise being modulated in this way is at a very high level. In this situation, it has been found that speech intelligibility can be impaired.

The main sources of background noise are:

- background acoustic noise picked up by the microphone. For a loudspeaking telephone in a moving vehicle the speech/noise ratio can be as low as 0 dB;
- idle channel noise. This includes noise generated in the transmission system (thermal noise and crosstalk) the switching system and in speech transcoders.

3.7.2 Elements of a PLMN which can cause noise contrast impairment

The following elements can cause noise contrast impairments:

- the acoustic echo control device in the MS. A moving vehicle presents a very difficult environment for an echo canceller, so an echo suppressor is likely to be used (possibly in conjunction with an echo canceller). Echo suppressors contain voice-operated switches;
- DTX. The transmitter switching will cause a PSTN user talking to a PLMN user to hear modulation of the mobile background noise. It will also cause the PLMN user to hear modulation of the PSTN noise. The PSTN noise will vary from connection to connection and should decrease in the future with increasing network digitalisation;
- the electric echo control devices protecting the PLMN user against echo returned from the PSTN. The centre clipper in this echo canceller will cause some noise modulation.

3.7.3 Reduction of noise contrast

A reduction in noise contrast:

- reduces conversational difficulty, particularly for long conversations;
- allows a greater tolerance on the matching of the level and spectrum of the comfort noise to the ambient noise.

NOTE: Preliminary tests in vehicles indicate that, in a constant noise environment with a handsfree MS and a signal-to-noise ratio of approximately 10 dB, a maximum level mismatch of 2 dB can be tolerated. The comfort noise spectrum was a reconstruction of the averaged medium term ambient noise spectrum.

3.7.3.1 Reduction of noise contrast by limiting the noise received by the microphone

The characteristics of the ambient noise (spectrum and level) depend on the environment in which the MS is used. As a microphone is characterised by its sensitivity and directivity, only part of this noise will enter the microphone.

A general principle for reducing noise contrast is to maximise the signal-to-noise ratio at the microphone input. This can be achieved by simultaneously increasing directivity, reducing sensitivity, and placing the microphone close to the mouth of the talker. Consequently, the implementation of the acoustic terminal will significantly affect the dynamic range of the noise contrast.

3.7.3.1.1 Headset MS

In the case of a headset and if DTX is disabled, then noise contrast will not be present since acoustic echo control (with centre clipping) is not required. If DTX is enabled, then only a small amount of noise contrast might result since the microphone would be close to the talker's mouth and would follow the movement of the talker's head, thus fulfilling the general principle described above. In the worst case, the headset is likely to give a minimum of 15 dB signal-to-noise ratio. (This value is for further study).

3.7.3.1.2 Handset MS

In the case of a handset, and if DTX is disabled, then noise contrast will not be present if optimised echo cancelling techniques (without residual echo clipping) are used to control the acoustic echo (providing 46 dB EL). If DTX is enabled or acoustic echo control with centre clipping is used, then only a small amount of noise contrast might result since the microphone would be close to the talker's mouth and would follow the movement of the talker's head, thus fulfilling the general principle described above. In the worst case, the handset is likely to give a minimum of 15 dB signal-to-noise ratio. (This value is for further study).

3.7.3.1.3 Handsfree MS

In the case of a handsfree telephone and even if DTX is disabled, noise contrast will be introduced unless 46 dB EL can be provided without the use of centre clipping. This is unlikely to be achievable. As the microphone is distant from the talker's mouth, and as the talker may be moving during the conversation, the sensitivity of the microphone has to be high and directivity low. This could result in a worse case signal-to-noise ratio of 0 dB. (This value is for further study).

The following is given as interim guidelines. In the case of a vehicle mounted handsfree MS, the characteristics of the microphone should be such as to limit the change in speech level to 5 dB for all positions of the talker while sitting.

3.7.3.2 Reduction of noise contrast by insertion of comfort noise

GSM Recommendation 06.12 specifies comfort noise to be used both for acoustic echo control with centre clipping and DTX.

3.7.4 Consequence of the introduction of high comfort noise levels on other voice-operated devices

Two problems associated with other voice switching devices (e.g. DSI) may result from the introduction of high levels of comfort noise:

- the high comfort noise level may be interpreted as a voice signal;
- if the high level of comfort noise is detected as noise, then another source of comfort noise at a different level may be introduced downstream, thus increasing the noise contrast.

3.8 Sensitivity/frequency characteristics

3.8.1 Headset and Handset MSs

3.8.1.1 Sending

The sensitivity/frequency characteristics from MRP to the UPCMI shall be as follows:

The sending sensitivity - frequency response (from MRP to digital interface) shall be within a mask which can be drawn between the points given in table 1. The mask is drawn with straight lines between the breaking points in table 1 on a logarithmic (frequency) - linear (dB sensitivity) scale.

Table 1: Sending sensitivity/frequency mask

Frequency (Hz)	Upper limit	Lower limit
100	- 12	-
200	0	-
300	0	- 12
1000	0	- 6
2000	4	- 6
3000	4	- 6
3400	4	- 9
4000	0	-

All sensitivity values are dB on an arbitrary scale.

Compliance shall be checked by the test described in Annex B, subclause B.3.1.

3.8.1.2 Receiving

The sensitivity/frequency characteristics from the UPCMI to the ERP shall be as follows:

The receiving sensitivity - frequency response (from the digital interface to the ERP) shall be within the mask which can be drawn with straight lines between the breaking points in table 2 on a logarithmic (frequency) - linear (dB sensitivity) scale.

Table 2: Receiving sensitivity/frequency mask

Frequency (Hz)	Upper limit	Lower limit
100	- 12	-
200	0	-
300	2	- 7
500	*	- 5
1000	0	- 5
3000	2	- 5
3400	2	- 10
4000	2	-

All sensitivities are dB on an arbitrary scale.

* = The limit at intermediate frequencies lies on a straight line drawn between the given values on a log (frequency) - linear (dB) scale.

Compliance shall be checked by the test described in Annex B, subclause B.3.2.

3.8.2 Handsfree MS

Recommended sensitivity/frequency characteristics curves for handsfree terminals are given in section 4 of CCITT Recommendation P.34.

3.9 Distortion

3.9.1 Sending

The sending part between MRP and the UPCMI shall meet the following distortion requirements:

NOTE: Digital signal processing other than the transcoder itself is included in this requirement (e.g. echo cancelling).

The ratio of signal-to-total distortion power measured with the proper noise weighting (see table 3 of CCITT Recommendation G.223) shall be above the limits given in table 3 unless the sound pressure at MRP exceeds +10 dBPa.

Table 3: Limits for signal-to-total distortion ratio

SENDING level dB relative to ARL	Sending Ratio (dB)
- 35	17,5
- 30	22,5
- 20	30,7
- 10	33,3
0	33,7
+ 7	31,7
+ 10	25,5

Limits for intermediate levels are found by drawing straight lines between the breaking points in the table on a linear (dB signal level) - linear (dB ratio) scale.

Compliance of the sending distortion shall be checked by the test described in Annex B, subclause B.4.1.

The gain variation relative to the gain for ARL shall remain within the limits given in table 4. For intermediate levels, the same limits for gain variation apply.

Table 4: Variation of gain with input level, sending:

SENDING level dB relative to ARL	Upper limit (dB)	Lower limit (dB)
13	0,5	- 0,5
0	0,5	- 0,5
- 20	0,5	- 0,5
- 20	0,5	- 2
- 30	0,5	- 2
- 30	1	-
- 40	1	-
- 40	2	-
- 45	2	-

Compliance of the gain variation in the sending direction shall be checked by the test described in Annex B, subclause B.5.1.

3.9.2 Receiving

The receiving part between the UPCMI and ERP shall meet the requirements in this section at the nominal setting of the volume control:

The ratio of signal-to-total distortion power measured with the proper noise weighting (see table 4 of CCITT Recommendation G.223) shall be above the limits given in table 5 when the sound pressure at ERP is up to +10 dBPa. For sound pressures exceeding + 10 dBPa at the ERP there is no distortion requirement.

Table 5: Limits for signal-to-total distortion ratio

RECEIVING level at the digital interface (dBm0)	Receiving Ratio (dB)
- 45	17,5
- 40	22,5
- 30	30,5
- 20	33,0
- 10	33,5
- 3	31,2
0	25,5

Limits for intermediate levels are found by drawing straight lines between the breaking points in the table on a linear (dB signal level) - linear (dB ratio) scale.

Compliance of the receiving distortion shall be checked by the test described in Annex B, subclause B.4.2.

The gain variation relative to the gain at an input level of -10 dBm0, shall be within the limits given in table 6. For intermediate levels, the same limits for gain variation apply. The requirement is valid for sound pressures up to + 10 dBPa. For sound pressures exceeding + 10 dBPa at the ERP there is no lower limit requirement.

Table 6: Variation of gain with input level, receiving

RECEIVING level at the digital interface (dBm0)	Upper limit (dB)	Lower limit (dB)
+ 3	0,5	- 0,5
- 10	0,5	- 0,5
- 40	0,5	- 0,5
- 40	1	- 1
- 50	1	- 1
- 50	2	- 2

Compliance of the gain variation in the receiving direction shall be checked by the test described in Annex B, subclause B.5.2.

3.10 Sidetone

3.10.1 Sidetone loss

A sidetone requirement is appropriate for MSs using handsets and headsets. There are separate requirements for listenersidetone (LSTR) and talker sidetone (STMR). The listener sidetone performance is considered as the major parameter affecting the user perception of the system. Though talker sidetone is important to give the user some comfort in using the equipment. A value for D is recommended which is the discrimination of the sending section of speech over noise.

The value of the Listener Sidetone Rating (LSTR) shall not be less than 15 dB. Where a user-controlled receiving volume control is provided, the LSTR shall meet the requirement given above at the setting where the RLR is equal to the nominal value.

Compliance of the LSTR requirement shall be checked by the test described in Annex B, subclause B.6.2.

The nominal value of the Sidetone Masking Rating (STMR) shall be 13 dB +/- 5 dB. Where a user-controlled receiving volume control is provided, the STMR shall meet the requirement given above at the setting where the RLR is equal to the nominal value.

Compliance of STMR requirement shall be checked by the test described in Annex B, subclause B.6.1.

It is recommended that the STMR is independent of the volume control.

It is recommended, but not required, that the sending path is designed so that the value of D, defined in CCITT recommendation G.111, should not be less than 2 dB, where $LSTR = STMR + D$.

3.10.2 Sidetone distortion

The third harmonic distortion generated by the terminal equipment shall not be greater than 10%.

Compliance shall be checked by the test described in Annex B, clause B.7.

3.11 Out-of-band signals

3.11.1 Discrimination against out-of-band input signals

When out-of-band signals are applied at the MRP, a range of frequencies will be transmitted to the UPCMI. For these signals, the following requirements shall apply.

With any sine-wave signal above 4.6 kHz and up to 8 kHz applied at the MRP at a level of - 4,7 dBPa, the level of any image frequency produced at the digital interface shall be below a reference level obtained at 1 kHz (- 4,7 dBPa at MRP) by at least the amount (in dB) specified in table 7.

Table 7: Discrimination levels

Applied sine-wave frequency	Limit (minimum) *
4,6 kHz	30 dB
8 kHz	40 dB

* The limit at intermediate frequencies lies on a straight line drawn between the given values on a log (frequency) - linear (dB) scale.

Compliance shall be checked by the test described in Annex B, subclause B.8.1.

3.11.2 Spurious out-of-band signals

The level of out-of-band signals at the ERP shall meet the following requirements when the relevant input signals are simulated at the UPCMI.

With a digitally-simulated sine-wave signal in the frequency range of 300 Hz to 3,4 kHz and at a level of 0 dBm applied at the digital interface, the level of spurious out-of-band image signals in the frequency range of 4,6 to 8 kHz measured selectively in the artificial ear shall be lower than the in-band acoustic level produced by a digital signal at 1 kHz set at the level specified in table 8.

Table 8: Discrimination levels

Image Signal frequency	Equivalent Input Signal Level *
4,6 kHz	- 35 dBm0
8 kHz	- 45 dBm0

* The limit at intermediate frequencies lies on a straight line drawn between the given values on a log (frequency) - linear (dB) scale.

Compliance shall be checked by the test described in Annex B, subclause B.8.2.

3.12 Requirements for information tones

The PLMN should be capable of transmitting information tones generated by the PSTN in the range 300-1800 Hz conforming to CCITT Recommendation Q.35 (Reference 3).

3.13 Crosstalk

3.13.1 Near and far end crosstalk

The near end or far end crosstalk ratio between two complete PLMN connections should not be less than 65 dB.

3.13.2 Go/return crosstalk

The crosstalk ratio between the go and return channels of a single PLMN connection should not be less than 55 dB. This is to avoid nullifying the effect of the electrical echo canceller at the MSC. The requirement applies for an acoustic input signal at the MRP with a measurement being made at the UPCMI in the opposite direction of transmission.

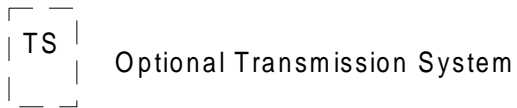
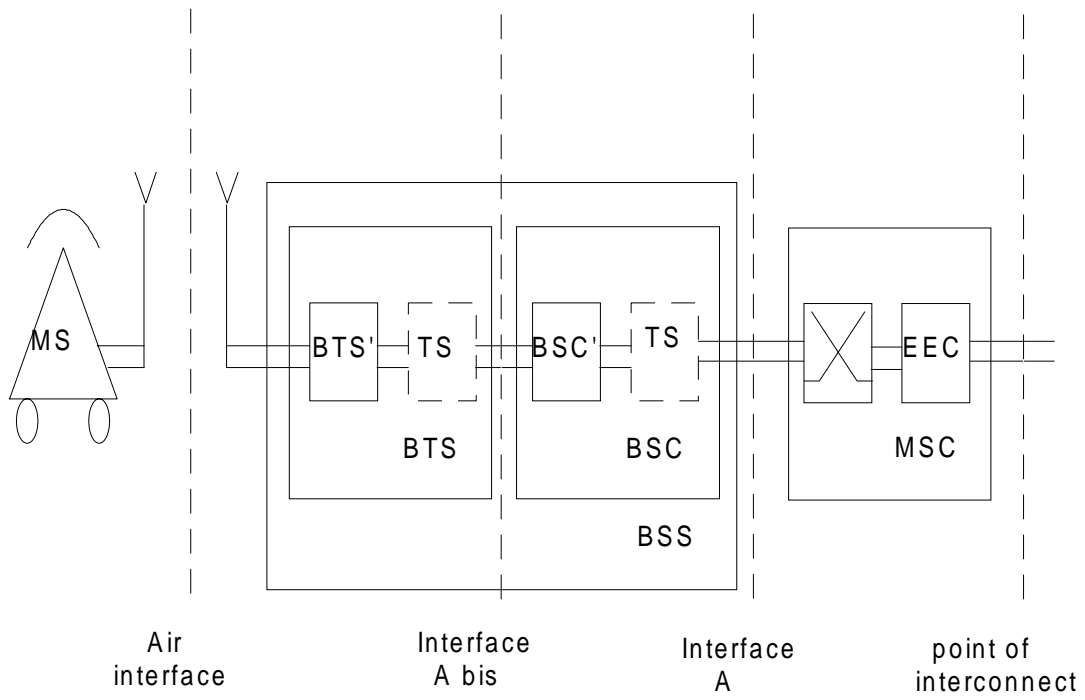

Notes to figure 1

- NOTE 1: For transmission planning purposes. Interfaces A and A bis are not required.
- NOTE 2: The speech transcoder may be at either the BTS or the BSC.

Figure 1: Basic Configuration for Interworking with the PSTN

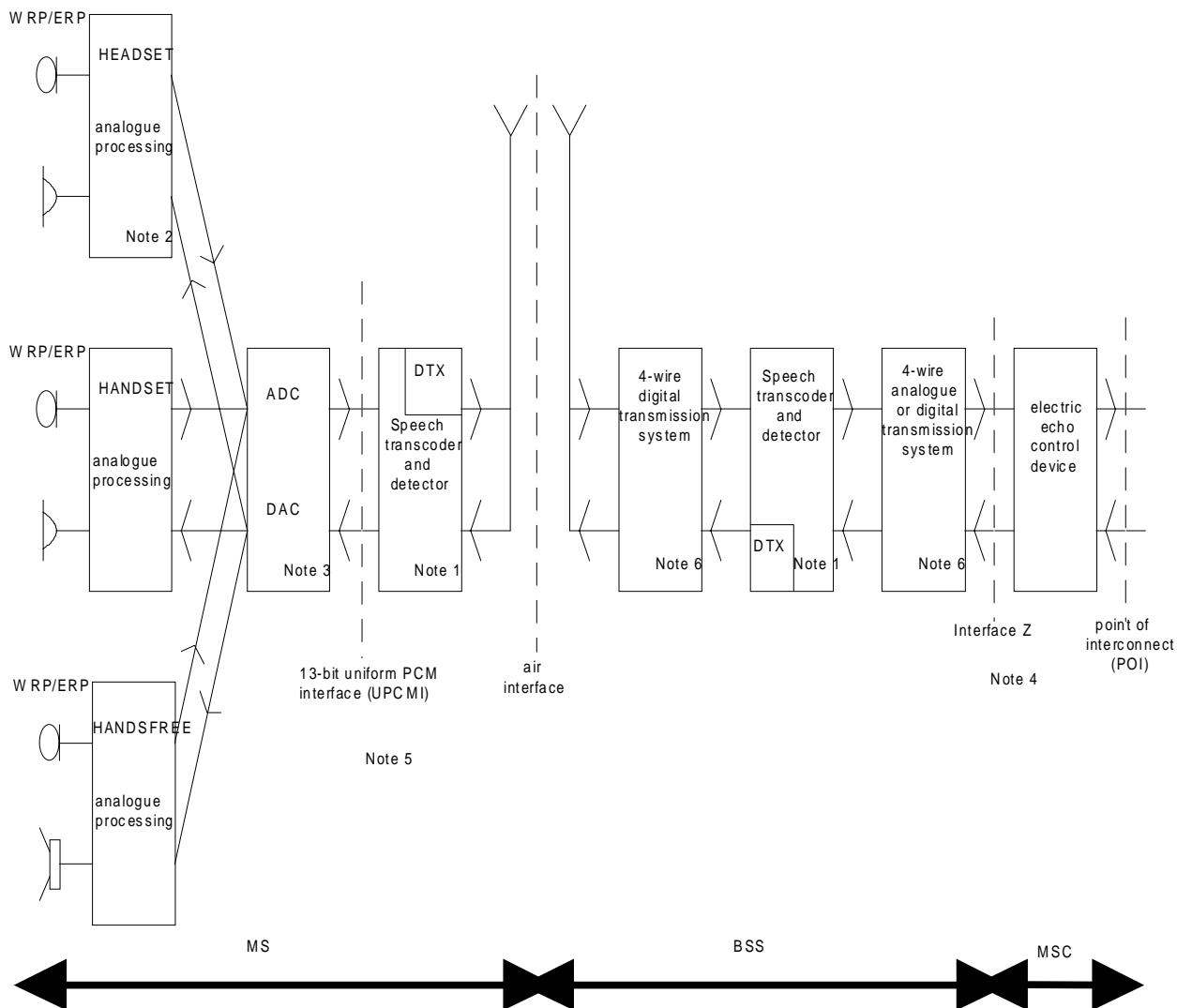

Notes to figure 2

- NOTE 1: Speech detection is incorporated in the speech transcoder. Speech detection is needed to provide the function of DTX and, if required, acoustic echo control (see note 2 below).
- NOTE 2: Acoustic echo control may not be provided in the case of the headset.
- NOTE 3: Includes filtering.
- NOTE 4: In the case of direct MSC to MSC connections, the EEC function should not be active. The EEC device should be either disabled or not inserted in the circuit.
- NOTE 5: In simple talk and in double talk, when no centre clipper is used, and in double talk only if a centre clipper is used, the level of quantising noise introduced by the speech transcoding will effect the level of residual acoustic echo when echo cancellation techniques are used for AEC.
- NOTE 6: The transmission system need not be present.

Figure 2: PLMN System Model Used for Consideration of Transmission Planning Issues

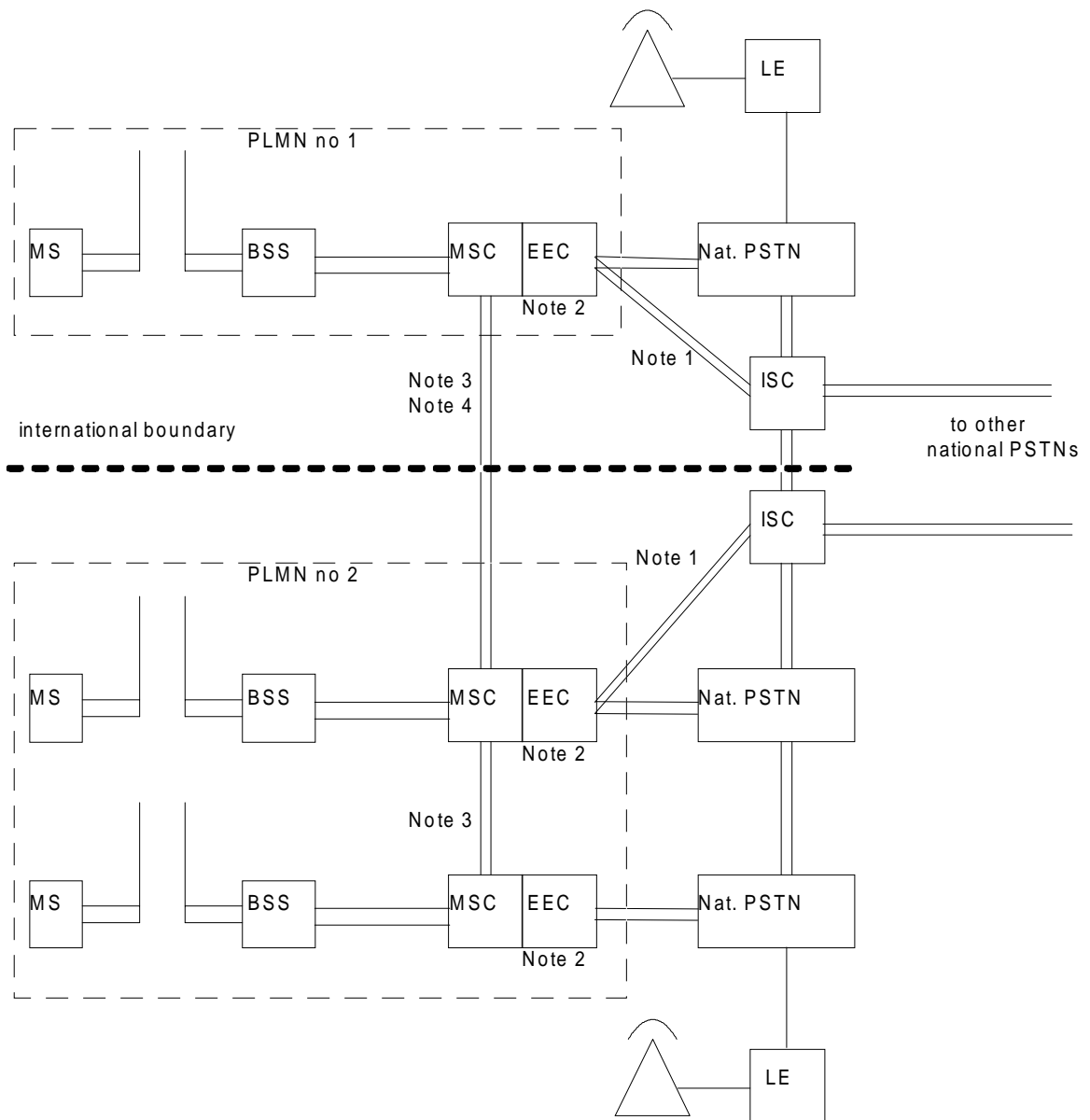

Notes to figure 3

- NOTE 1: A direct link between MSC and ISC may be used in cases where Signalling System No. 7 is not provided in the PSTN or where a link via the PSTN would have excessive delay.
- NOTE 2: An echo canceller should be provided at every POI to cancel any echo returning to the PLMN from the PSTN. This is necessary because the one-way echo path back to the MS greatly exceeds 25 ms (see CCITT Recommendation G.131).
- NOTE 3: A direct link between MSCs reduces the number of echo control devices that need to be provided and avoids the tandem connection of such devices. These direct links may be expected to have less delay than PSTN connections.
- NOTE 4: This arrangement may be provided.

Figure 3: PLMN to PSTN Interconnection Configurations

Direct routing and re-routing where the overall delay of the transmission path has not been extended and no echo control in the PSTN.

Normal configurations

Call from PSTN to PLMN

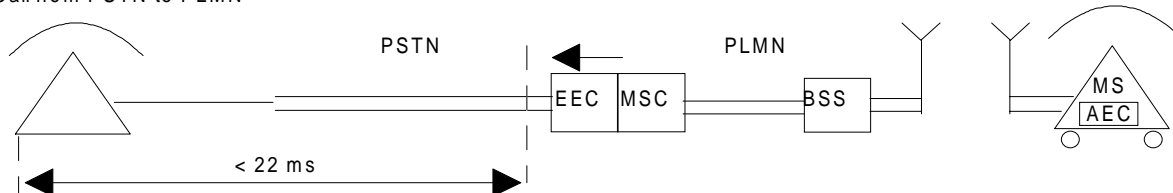

Call from PLMN to PSTN

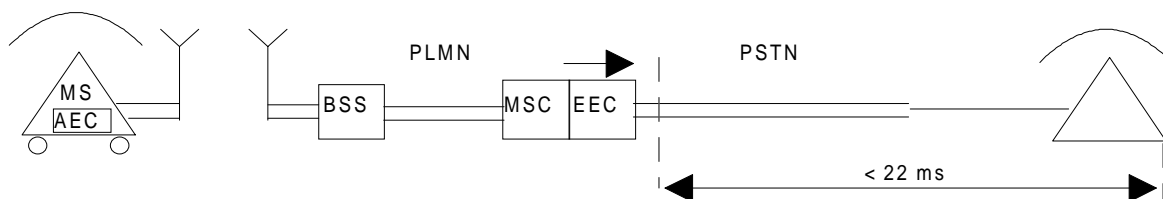

Call from PLMN to PLMN

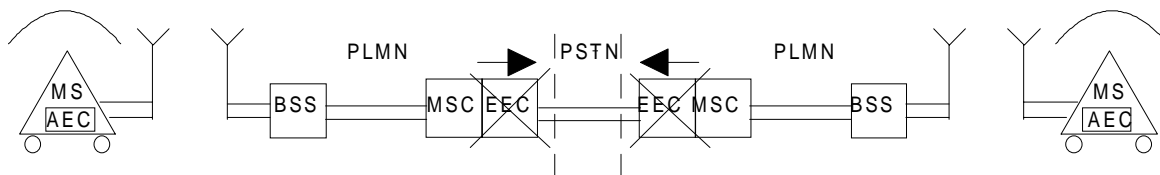

Call from PSTN to PLMN with re-route at MSC and via PSTN

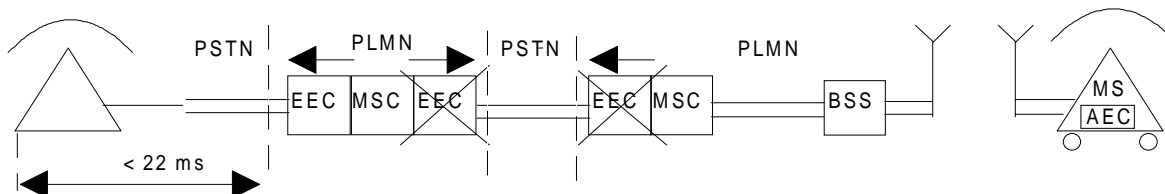

Direction of signalling is left to right

 echo control disabled

 direction of arrow indicates the echo loop

 Other configurations may exist if a call from PLMN to PLMN is re-routed at an MSC via the PSTN

Figure 4: Reference Configurations A

Where direct MSC-MSC connections exist, these configurations may apply.

Call from PSTN to PLMN with re-route via PLMN

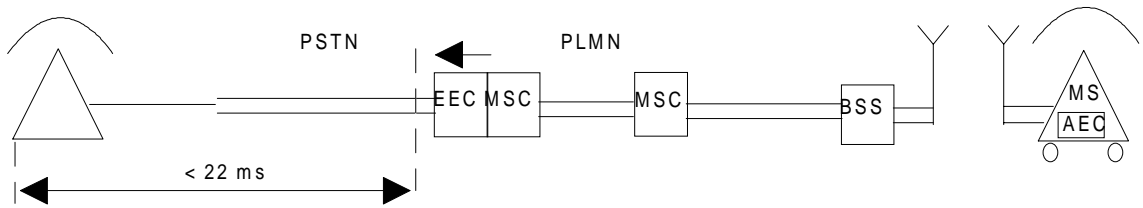

Call from PLMN to PSTN with long routing in PLMN

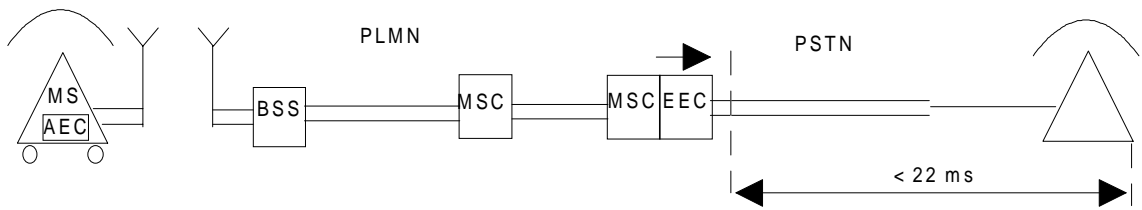

Call from PLMN to PLMN not involving PSTN

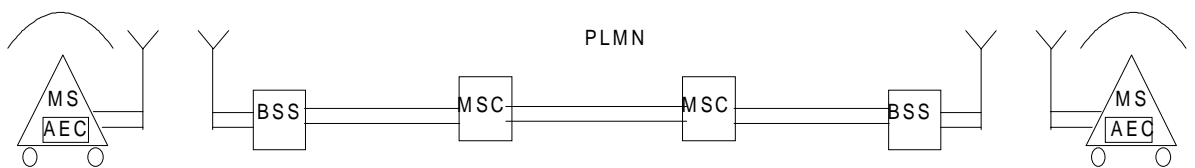

Direction of signalling is left to right

direction of arrow indicates the echo loop



|
|

Figure 4 Continued

Direct routing and re-routings where the overall delay of the transmission path has not been extended and with echo control in the PSTN.

Normal Configurations

Call from PSTN to PLMN

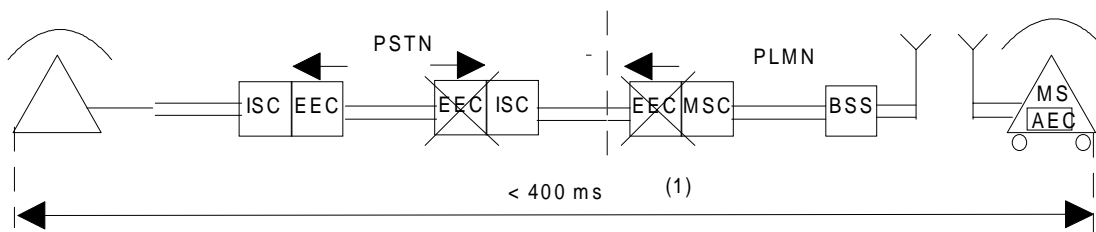

Call from PLMN to PSTN

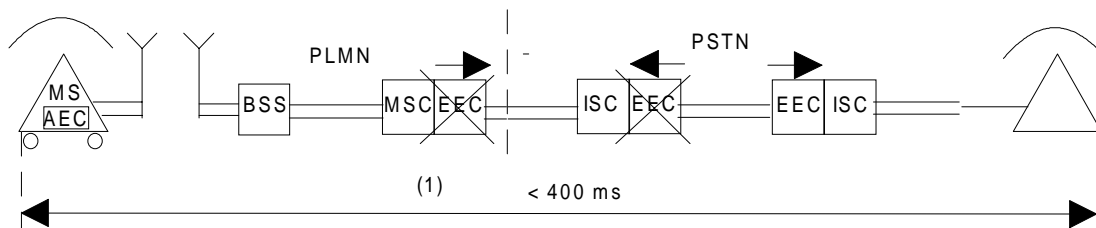

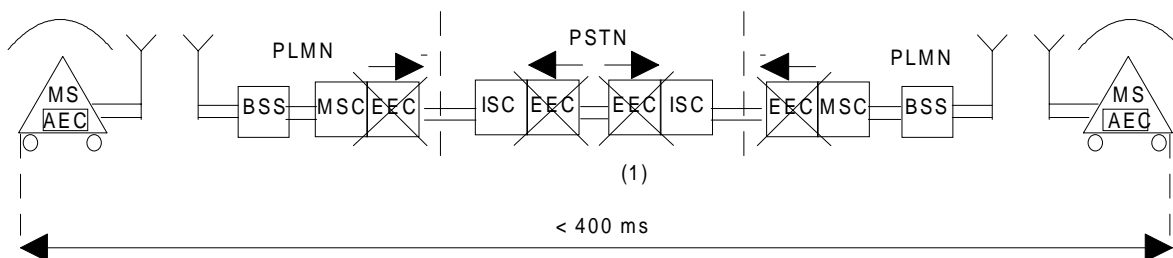

Call from PLMN to PLMN



(1) see paragraph 3.3.5.2

Direction of signalling is left to right

-  echo control disabled
-  direction of arrow indicates the echo loop

Other configurations may exist if a call from PLMN to PLMN is re-routed at an MSC via the PSTN

Figure 5: Reference Configurations B

Where direct MSC - MSC connections exist, these configurations may apply.

Call from PSTN to PLMN with re-route via PLMN

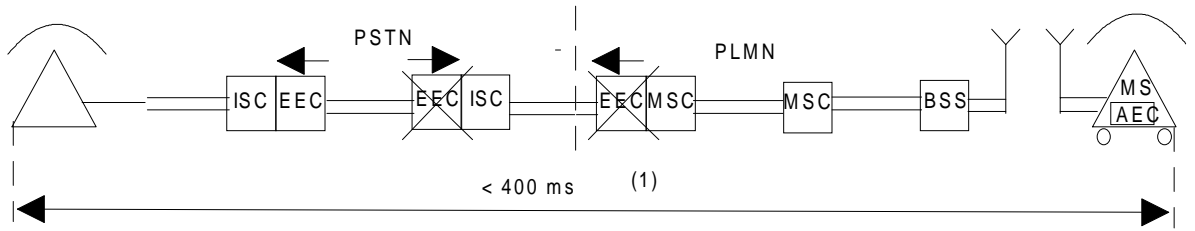

Call from PLMN to PSTN with long routing in PLMN

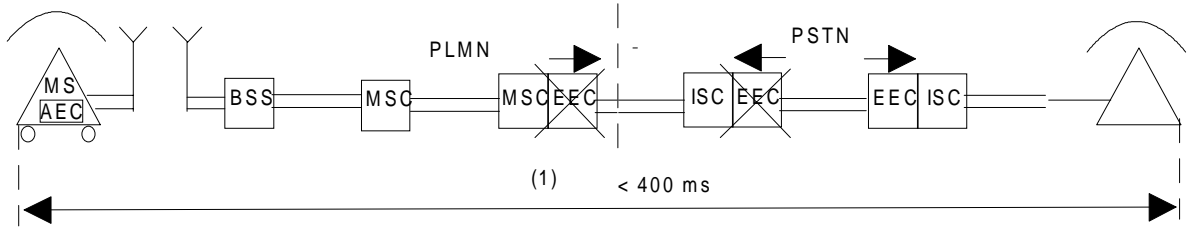

(1) see paragraph 3.3.5.2

Direction of signalling is left to right



-  echo control disabled
-  direction of arrow indicates the echo loop



Figure 5 Continued

Re-routings where the overall delay of the transmission path has been extended beyond transmission planning limits.

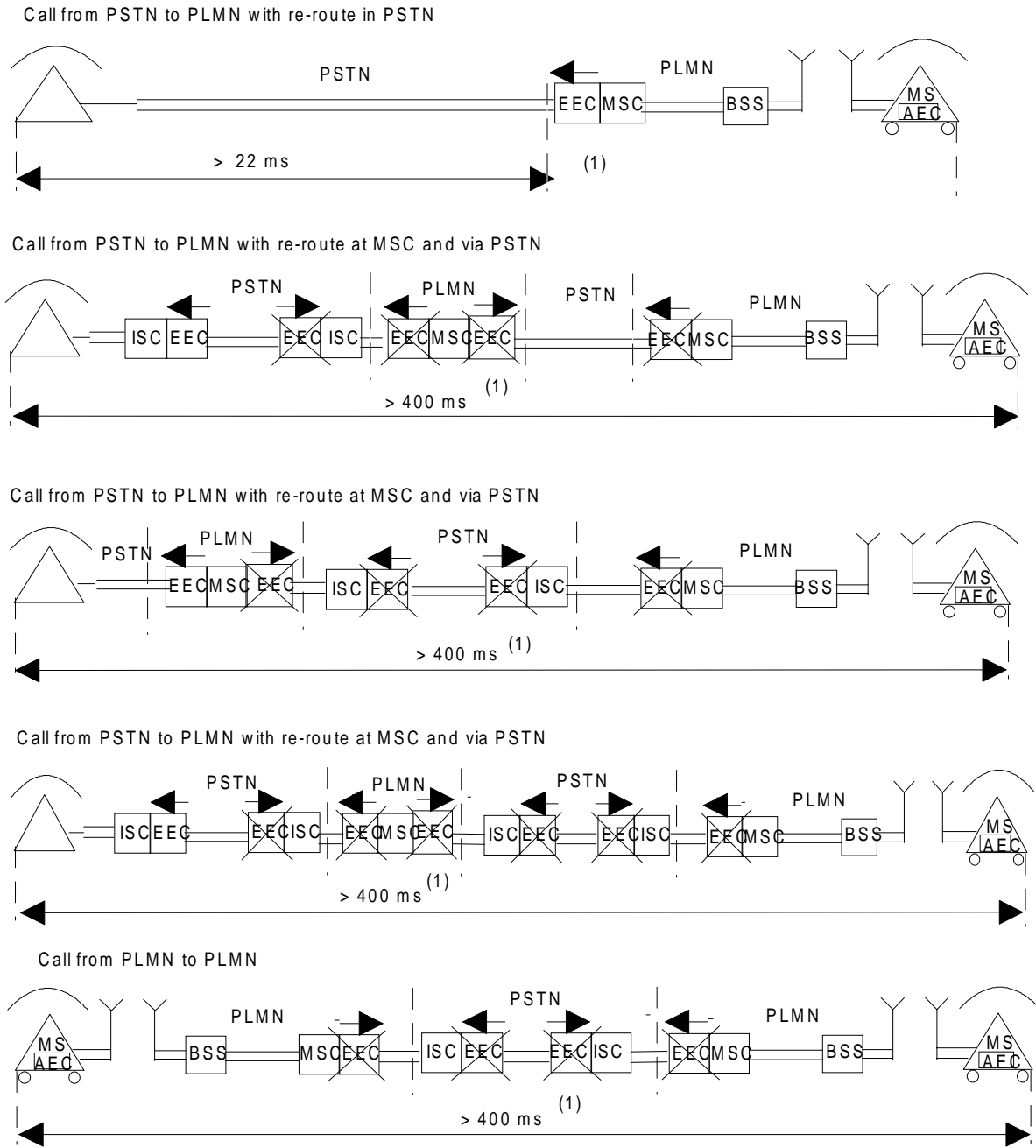

(1) see paragraph 3.3.5.2

Direction of signalling is left to right

-  echo control disabled
-  direction of arrow indicates the echo loop

Other configurations may exist if a call from PLMN to PLMN is re-routed at an MSC via the PSTN

Figure 6: Reference Configuration C

No echo control in PSTN

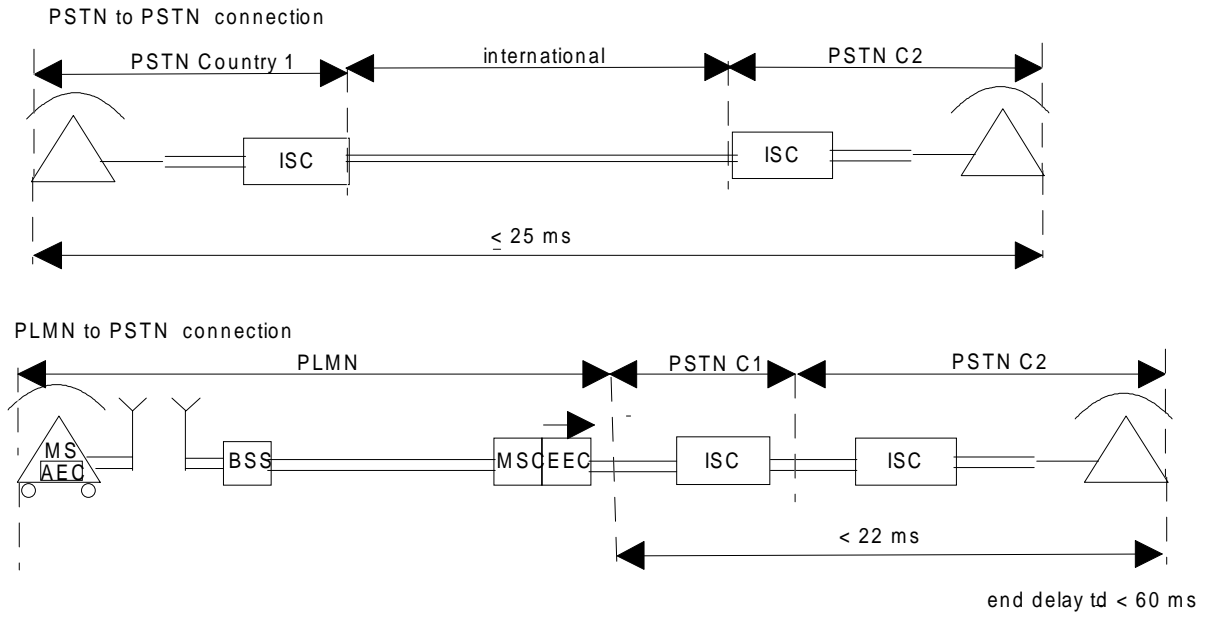

Echo control in PSTN.

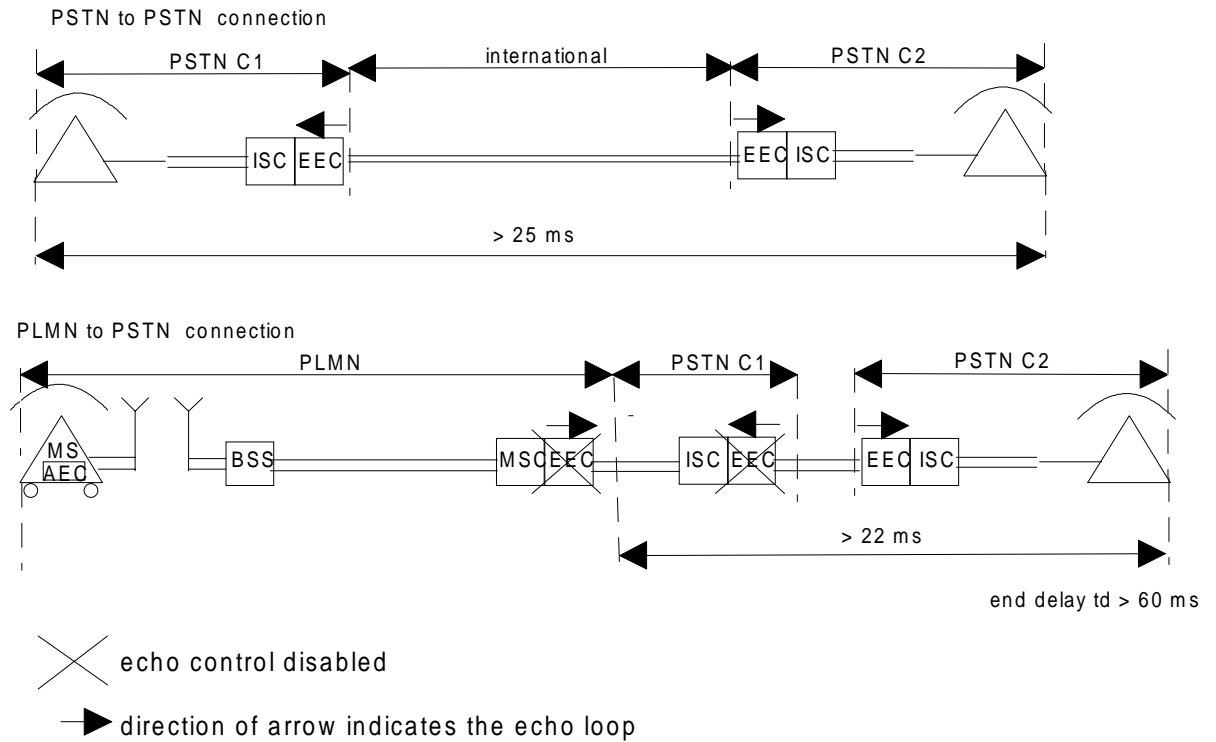

Figure 7: End Delay Requirements for PLMN EEC

Annex A (informative): Considerations on the Acoustic Interface of the Mobile Station

A.1 Handsfree MS

The handsfree MS will almost certainly require the use of non-linear processing for the acoustic echo control, the extraction of the speech from high levels of ambient noise. The implementation of these functions may well cause degradation to the overall transmission quality and cause difficulty to the distant end user especially during duplex conversation.

A.2 Handset MS

The handset MS, depending on the detailed implementation, might not require the use of non-linear processing for the acoustic echo control. Also, the position of the microphone should give a significantly improved signal-to-noise ratio, compared with a handsfree MS especially in noisy environments. This is likely to result in significantly improved transmission quality compared with the handsfree MS and easier duplex conversation.

A.3 Headset MS

The headset MS is likely to be the simplest, since with careful design, it might not require acoustic echo control. As with the handset case, the signal-to-noise ratio should be significantly improved compared with the handsfree MS especially in noisy environments. Consequently, the headset MS is likely to give the best transmission quality and easiest duplex conversation.

A.4 Inter-reaction with DTX

Because of the improved signal-to-noise ratio, both the headset MS and the handset MS are likely to give better transmission quality when DTX is enabled than that of handsfree MS.

Annex B (normative): Transmission requirements testing

When an artificial ear is required, the ITU-T Recommendation P.57 [46] Type 1 artificial ear shall be used.

If requested by the terminal supplier, the ITU-T Recommendation P.57 [46] Type 3.2 artificial ear shall be used for all tests. In this case the following apply:

- The low leakage option of Type 3.2 artificial ear shall be adopted;
- The force against the ear shall be as specified in ITU-T Recommendation P.57 [46].
- Sound pressure measurements shall be referred to the ERP as specified in ITU-T Recommendation P.57 [46].
- No leakage correction shall be made in the calculation of RLR (i.e. $L_E=0$).

The test report shall indicate the type of artificial ear used for the receive tests.

B.1 Loudness ratings

B.1.1 Sending Loudness Rating (SLR)

- a) The sending sensitivity shall be measured at each of the 14 frequencies given in table 2 of CCITT Recommendation P.79, bands 4 - 17.
- b) The sensitivity is expressed in terms of dBV/Pa and the SLR shall be calculated according to CCITT Recommendation P.79 formula 4.19b, over bands 4 to 17, and using the sending weighting factors from CCITT Recommendation P.79 table 2, adjusted according to table 3 of this Recommendation.

B.1.2 Receiving Loudness Rating (RLR)

- a) The receiving sensitivity shall be measured at each of the 14 frequencies listed in Table 2 of CCITT Recommendation P.79, bands 4 - 17.
- b) The sensitivity is expressed in terms of dBPa/V and the RLR shall be calculated according to CCITT Recommendation P.79 formula 4.19c, over bands 4 to 17, using the receiving weighting factors from table 2 of this Recommendation, adjusted according to table 3 of this Recommendation.
- c) The artificial ear sensitivity shall be corrected using the real ear correction of table 4 of CCITT Recommendation P.79.

NOTE: The value of real ear correction of CCITT Recommendation P.79 table 4 were derived for one type of handset conforming to the shape defined in CCITT Recommendation P.35.

These values are used in this standard because there is no measurement method agreed for the real ear correction. If a method of measurement is agreed, it is intended to change this standard to use the values appropriate to each handset.

B.2 Idle Channel Noise

B.2.1 Sending

With the handset mounted at LRGP and the earpiece sealed to the knife-edge of the artificial ear in a quiet environment (ambient noise less than 30 dBA), the noise level at the digital output is measured with apparatus including psophometric weighting according to CCITT Recommendation G.223, table 4.

NOTE: The ambient noise criterion should be met if the ambient noise does not exceed NR20.

B.2.2 Receiving

The handset is mounted at LRGP and the earpiece is sealed to the knife-edge of the artificial ear. A signal corresponding to decoder output value number 1 shall be applied at the digital interface. The level of the noise shall be measured in the artificial ear.

The ambient noise for this measurement shall not exceed 30 dBA.

B.3 Sensitivity/frequency Characteristics

B.3.1 Sending

- a) The handset is mounted in the LRGP (see Annex A of CCITT Recommendation P.76). The earpiece is sealed to the knife-edge of an artificial ear.
- b) A pure tone signal with a sound level of -4,7 dBPa (in accordance with CCITT Recommendation P.64 shall be applied at the MRP as described in CCITT Recommendation P.64, using an artificial mouth conforming to CCITT Recommendation P.51.
- c) A digital measuring instrument, or high quality digital decoder followed by an analogue level measuring set, shall be connected at the interface.
- d) Measurements shall be made at one twelfth-octave intervals as given by the R.40 series of preferred numbers in ISO 3 for frequencies from 100 Hz to 4 kHz inclusive.

At each frequency, the output level for a sound pressure of -4,7 dBPa shall be measured.

B.3.2 Receiving

- a) The handset is mounted in the LRGP and the earpiece is sealed to the knife-edge of the artificial ear.
- b) A digital signal generator shall be connected at the digital interface delivering a signal equivalent to a pure tone level of -16 dBm₀, see CCITT Recommendation P.64.
- c) Measurements shall be made at one twelfth-octave intervals as given by the R.40 series of preferred numbers in ISO 3 for frequencies from 100 Hz to 4 kHz inclusive.

At each frequency, the sound pressure in the artificial ear shall be measured by connecting a suitable measuring set to the artificial ear.

B.4 Distortion

B.4.1 Sending

The handset is mounted at LRGP and the earpiece is sealed to the knife-edge of the artificial ear.

A sine-wave signal with a frequency in the range 1004 Hz to 1025 Hz is applied at the MRP.

The level of this signal is adjusted until the output of the terminal is - 10 dBm₀. The level of the signal at the MRP is then the ARL.

The test signal shall be applied at the following levels: - 35, - 30, - 25, - 20, - 15, - 10, - 5, 0, 5, 10 dB relative to ARL.

The ratio of the signal to total distortion power of the digital signal output shall be measured with the psophometric noise weighting (see CCITT Recommendations G.714 and 0.132).

B.4.2 Receiving

The handset is mounted at LRGP and the earpiece is sealed to the knife-edge of the artificial ear.

A digitally simulated sine-wave signal with a frequency in the range 1004 Hz to 1025 Hz shall be applied at the digital interface at the following levels: - 45, - 40, - 35, - 30, - 25, - 20, - 15, - 10, - 5, 0 dBm0.

The ratio of the signal-to-total distortion power shall be measured with the psophometric noise weighting in the artificial ear (see CCITT Recommendations G.714 and 0.132).

B.5 Variation of gain with input level

B.5.1 Sending

The handset is mounted at LRGP and the earpiece is sealed to the knife-edge of the artificial ear.

A sine-wave signal with a frequency in the range 1004 Hz to 1025 Hz is applied at the MRP. The level of this signal is adjusted until the output of the terminal is - 10 dBm0. The level of the signal at the MRP is then the ARL.

The test signal shall be applied at the following levels: - 45, - 40, - 35, - 30, - 25, - 20, - 15, - 10, - 5, 0, 5, 10, 13 dB relative to ARL.

The variation of gain relative to the gain for ARL is measured.

NOTE: Selective measurement may be used to avoid the effects of ambient noise.

B.5.2 Receiving

The handset is mounted at LRGP and the earpiece is sealed to the knife-edge of the artificial ear.

A digitally simulated sine-wave signal with a frequency in the range 1004 Hz to 1025 Hz shall be applied at the digital interface at the following levels: - 50, - 45, - 40, - 35, - 30, - 25, - 20, - 15, - 10, - 5, 0, 3 dBm0.

The variation of gain relative to the gain at an input level of - 10 dBm0 shall be measured in the artificial ear.

NOTE: Selective measurement may be used to avoid the effects of ambient noise.

B.6 Sidetone

For the tests described in subclauses B.6.1 and B.6.2, the digital input of the terminal shall be driven by a PCM signal corresponding to decoder value number 1.

B.6.1 Talker sidetone (STMR)

- a) The handset is mounted in the LRGP and the earpiece is sealed to the knife-edge of the artificial ear. A pure tone signal of - 4.7 dBPa shall be applied at the mouth reference point. For each frequency given in CCITT Recommendation P.79 table 2, bands 4 to 17, the sound pressure in the artificial ear shall be measured.
- b) The sidetone path loss L_{meST} as expressed in dB and the STMR (in dB) shall be calculated from the formula 8-4 of CCITT Recommendation P.79, using the weighting factors of column (3) in table 6 of this Recommendation (unsealed), and values of LE in accordance with table 4 of CCITT Recommendation P.79.

B.6.2 Listener sidetone (LSTR)

- a) The sound field is calibrated in the absence of any local obstacles. The averaged field shall be uniform to within +4 dB/-2 dB within a radius of 0,15 m of the MRP, when measured in one-third octave bands from 100 Hz to 8 kHz (bands 1 to 20).
- b) A calibrated half-inch microphone is mounted at MRP. The sound field is measured in one-third octave bands. The spectrum shall be "Pink noise" as described in CCITT recommendation P.64 Annex B to within +/- 1 dB and the level shall be adjusted to 70 dBA (- 24 dBP(A)). The tolerance on this level is +/- 1 dB.
- c) The artificial mouth and ear are placed in the correct position relative to MRP, the handset is mounted at LRGP and the earpiece is sealed to the knife-edge of the artificial ear.
- d) Measurements are made in one-third octave bands for the 14 bands centered at 200 Hz to 4 kHz (bands 4 to 17). For each band the sound pressure in the artificial ear shall be measured by connecting a suitable measuring set to the artificial ear.
- e) The listener sidetone path loss is expressed in dB and the LSTR shall be calculated from the CCITT Recommendation P.79 formula 8-4, using the weighting factors in column (3) in table 6 of the Recommendation, and the values of LE; in accordance with table 4 of the Recommendation.

B.7 Sidetone distortion

The handset is mounted at LRGP and the earpiece is sealed to the knife-edge of the artificial ear. An instrument capable of measuring the third harmonic distortion of signals with fundamental frequencies in the range of 315 Hz to 1 kHz is connected to the artificial ear.

A pure-tone signal of - 4,7 dBP(A) is applied at the mouth reference point at frequencies of 315 Hz, 500 Hz, and 1 kHz. For each frequency, the third harmonic distortion shall be measured in the artificial ear.

B.8 Out-of-band signals

B.8.1 Discrimination against out-of-band input signal

The handset is mounted at LRGP and the earpiece is sealed to the knife-edge of the artificial ear.

For input signals at frequencies of 4,65 kHz, 5 kHz, 6 kHz, 6.5 kHz, 7 kHz and 7.5 kHz at the level specified in subclause 3.11.1, the level of any image frequencies at the digital interface shall be measured.

B.8.2 Spurious out-of-band signals

The handset is mounted at LRGP and the earpiece is sealed to the knife-edge of the artificial ear.

For input signals at the frequencies 500, 1000, 2000, and 3150 Hz applied at the level specified in subclause 3.11.2, the level of spurious out-of-band image signals at frequencies of up to 8 kHz shall be measured selectively in the artificial ear.

B.9 Acoustic echo loss

The MS is mounted at the Loudness Rating Guardring Position (LRGP), (see annex 1 of CCITT recommendation P.76), with the earpiece sealed to the knife edge of the artificial ear, conforming to CCITT recommendation P.51.

A call is set up between the MS and the SS.

Where a user controlled volume control is provided it shall be set to maximum.

An implementation of the CCITT P.50 artificial speech shall be connected to the analogue or digital input of the reference speech encoder of the SS. This implementation could be a real time algorithm producing the artificial speech or a pre-recorded tape of the artificial speech. Both 'male' and 'female' artificial speech is required.

A ten second segment of the 'male' artificial speech is applied to the analogue or digital input of the reference speech encoder of the SS. The third octave power of the input signal shall be measured. The echo loss signal is not measured at this stage as the first ten second segment is used to allow any acoustic echo cancellation devices within the MS to adapt to the echo path.

Immediately afterwards a second ten second segment of the 'male' artificial speech is applied to the analogue or digital input of the reference speech encoder of the SS. The third octave power of the echo signal is measured at the digital output of the reference speech decoder of the SS.

The difference between the third octave input power and the third octave output power is entered into the CCITT G.122 TCL algorithm and the acoustic echo loss calculated.

The test shall be repeated with the 'female' artificial speech and the results of both 'male' and 'female' averaged to give the final result.

Annex C (normative): MS delay requirement definition

C.1 Full rate MS delay requirement definition

The symbol definitions for the calculations in this section are:

Trftx:	The time required for transmission of a TCH radio interface frame over the air interface due to the interleaving and de-interleaving (given in table 4/2) (system dependent).
Ttransc:	The speech encoder processing time, from input of the last PCM sample to output of the final encoded bit (implementation dependent).
Tsample:	The duration of the segment of PCM speech operated on by the speech transcoder.
Tencode:	The time required for the channel encoder to perform channel encoding (implementation dependent).
Trxproc:	The time required after reception over the radio interface to perform equalization, channel decoding and SID-frame detection (implementation dependent).
Tproc:	The time required after reception of the first RPE-sample to process the speech encoded data for the full-rate speech decoder and to produce the first PCM output sample (implementation dependent).
Ta/d	Delay in the analogue to digital converter in the downlink.
Tmargin	an allowance for system entities that are implementation dependant.
Td/a	Delay in the digital to analogue converter in the uplink.
Tpcm	The duration of a segment of PCM speech for the downlink processing delay.

The full rate MS speech delay in the uplink direction is the delay between an acoustic event at the MRP to the last bit of the corresponding speech frame at the antenna connector and shall not exceed:

$$\begin{aligned}\text{MS uplink delay} &= T_{a/d} + T_{\text{margin}} + T_{\text{sample}} + T_{\text{transc}} + T_{\text{encode}} + T_{\text{rftx}} \\ &= 2.0 + 3.0 + 20.0 + 8.0 + 1.6 + 37.5 \text{ ms} \\ &= 72.1 \text{ ms}\end{aligned}$$

The full rate MS speech delay in the downlink direction is the delay between the first bit of a speech frame at the antenna connector and the last acoustic event at the ERP corresponding to that speech frame and shall not exceed:

$$\begin{aligned}\text{MS downlink delay} &= T_{\text{pcm}} + T_{\text{rftx}} + T_{\text{rxproc}} + T_{\text{proc}} + T_{\text{margin}} + T_{d/a} \\ &= 20 + 37.5 + 8.8 + 1.5 + 3.0 + 1.0 \\ &= 71.8 \text{ ms}\end{aligned}$$

The round trip delay shall therefore not exceed:

$$71.8\text{ms} + 72.1\text{ms} = 143.9\text{ms}.$$

C.2 Half rate MS delay requirement definition

The symbol definitions for the calculations in this section are:

Trftx:	The time required for transmission of a TCH radio interface frame over the air interface due to the interleaving and de-interleaving (given in table 4/2) (system dependent).
Ttransc:	The speech encoder processing time, from input of the last PCM sample to output of the final encoded bit (implementation dependent).
Tsample:	The duration of the segment of PCM speech operated on by the speech transcoder.
Tencode:	The time required for the channel encoder to perform channel encoding (implementation dependent).
Trxproc:	The time required after reception over the radio interface to perform equalization, channel decoding and SID-frame detection (implementation dependent).
Tproc:	The time required after reception of the first gain vector (GSP0) to process the speech encoded data for the half-rate speech decoder and to produce the first PCM output sample (implementation dependent).
Ta/d	Delay in the analogue to digital converter in the downlink.
Tmargin	an allowance for system entities that are implementation dependant.
Td/a	Delay in the digital to analogue converter in the uplink.
Tpcm	The duration of a segment of PCM speech for the downlink processing delay.

The half rate MS speech delay in the uplink direction is the delay between an acoustic event at the MRP to the last bit of the corresponding speech frame at the antenna connector and shall not exceed:

$$\begin{aligned}
 \text{MS uplink delay} &= T_{a/d} + T_{\text{margin}} + T_{\text{sample}} + T_{\text{trans}} + T_{\text{encode}} + T_{\text{rftx}} \\
 &= 1.0 + 1.9 + 24.4 + 12.1 + 1.2 + 32.9 \\
 &= 73.5 \text{ ms}
 \end{aligned}$$

The half rate MS speech delay in the downlink direction is the delay between the first bit of a speech frame at the antenna connector and the last acoustic event at the ERP corresponding to that speech frame and shall not exceed:

$$\begin{aligned}
 \text{MS downlink delay} &= T_{\text{pcm}} + T_{\text{ftx}} + T_{\text{rxproc}} + T_{\text{proc}} + T_{\text{margin}} + T_{d/a} \\
 &= 24.4 + 32.9 + 24.4 + 1.9 + 1.9 + 32.9 \\
 &= 70.4 \text{ ms}
 \end{aligned}$$

The half rate round trip delay shall therefore not exceed:

143 ms (see subclause 3.3.6.2).

Annex D (informative): Document change history

SMG	SPEC	CR	PHA	VERS	NEW_VE	SUBJECT
S09	03.50	011	2	4.0.0	4.1.0	Acoustic noise performance
S09	03.50	012	2	4.0.0	4.1.0	Gain control linearity
S09	03.50	013	2	4.0.0	4.1.0	Distortion of the receiving part
S09	03.50	014	2	4.0.0	4.1.0	Changes to annex B
S09	03.50	015	2	4.0.0	4.1.0	Echo loss measurement
S11	03.50	017	2	4.1.0	---	Phase 2 MS RLR requirement for Minimum
S13	03.50	A001			4.2.0	Speech Channel transmission delay
S13	03.50	A002				Clarification to GSM 03.50
S13	03.50	A003				Half rate speech traffic channel delay figures
S15	03.50	A004			4.2.0	Half Rate speech delay
s24	03.50	A009	2	4.2.0	4.3.0	CR to GSM 03.50 Allow use of artificial ear Type 3.2
s25	03.50	A012	2	4.3.0	4.4.0	Removal of inconsistency in RLR for Handsetand
s27	03.50	A015		4.4.0	4.5.0	Correction of reference in Section 1.1
				4.5.0	4.5.1	Version update for publication

History

Document history	
February 1995	First Edition
January 1996	Second Edition
June 1998	Third Edition
October 1998	Fourth Edition
November 1998	One-step Approval Procedure (Fifth Edition) OAP 9910: 1998-11-06 to 1999-03-05
March 1999	Fifth Edition