



EUROPEAN
TELECOMMUNICATION
STANDARD

ETS 300 478-1

February 1998

Source: NA

Reference: DE/NA-053205

ICS: 33.020

Key words: Access, ATM, Broadband, CBDS, CL, Network, UNI

**Network Aspects (NA);
Connectionless Broadband Data Service (CBDS)
over Asynchronous Transfer Mode (ATM);
Framework and protocol specification at the
User-Network Interface (UNI);
Part 1: Specification**

ETSI

European Telecommunications Standards Institute

ETSI Secretariat

Postal address: F-06921 Sophia Antipolis CEDEX - FRANCE

Office address: 650 Route des Lucioles - Sophia Antipolis - Valbonne - FRANCE

X.400: c=fr, a=atlas, p=etsi, s=secretariat - **Internet:** secretariat@etsi.fr

Tel.: +33 4 92 94 42 00 - Fax: +33 4 93 65 47 16

Copyright Notification: No part may be reproduced except as authorized by written permission. The copyright and the foregoing restriction extend to reproduction in all media.

© European Telecommunications Standards Institute 1998. All rights reserved.

Contents

Foreword	5
1 Scope	7
2 Normative references	7
3 Abbreviations.....	8
4 Framework for the provision of CBDS.....	9
4.1 Group addressing	9
4.2 Functional architecture.....	10
4.3 Connectionless server functional description	11
4.4 Interfaces	13
4.4.1 CLAI	13
4.4.1.1 Access Termination Functions (ATF)	15
4.4.1.1.1 ATM Access Termination Functions (AATF)	15
4.4.1.1.2 CL Access Termination Functions (CLATF)	15
4.4.2 Connectionless Network Interface (CLNI).....	16
4.4.2.1 Network Termination Functions (NTF)	17
4.4.2.1.1 ATM Network Termination Functions (ANTF)	18
4.4.2.1.2 CL Network Termination Functions (CLNTF).....	18
4.5 Connections	18
4.6 Protocols	19
4.7 Numbering and addressing.....	19
4.7.1 Individual Address (IA)	19
4.7.2 Group Address (GA).....	19
4.7.3 Nested Group Address (NGA)	19
4.8 Traffic aspects: access class enforcement.....	20
4.8.1 Maximum Information Rate (MIR)	20
4.8.2 Sustained Information Rate (SIR) and PDUs Per Time Unit (PPTU).....	21
4.9 Operations and maintenance.....	21
4.9.1 Identification of OAM information flow.....	21
4.9.2 OAM supported functions.....	21
5 Layer service and functions provided by the connectionless layer.....	21
5.1 Layer service provided by the connectionless layer.....	22
5.1.1 Description of primitives	22
5.1.1.1 CLL-UNITDATA.request.....	22
5.1.1.2 CLL-UNITDATA.indication.....	22
5.1.1.3 MCL-UNITDATA.request.....	22
5.1.1.4 MCL-UNITDATA.indication.....	23
5.1.2 Definition of parameters	23
5.1.2.1 source_address	23
5.1.2.2 destination_address.....	23
5.1.2.3 QoS.....	23
5.1.2.4 Data	23
5.2 Connectionless layer functions for user data transport.....	23
5.3 Transit operator selection	23
6 Protocol for the support of the CBDS on B-ISDN at the UNI	24
6.1 Protocol stack	24
6.2 Layer service expected from the AAL	24
6.3 CLNAP protocol data unit structure and encoding.....	25
6.3.1 Destination-Address	25
6.3.2 Source-Address.....	25
6.3.3 Higher-Layer-Protocol-Identifier (HLPI).....	26
6.3.4 PAD-length	26

6.3.5	QoS.....	26
6.3.6	CRC Indication Bit (CIB).....	26
6.3.7	Header Extension Length (HEL).....	26
6.3.8	Reserved	26
6.3.9	Header extension.....	26
6.3.10	User-information	27
6.3.11	PAD	27
6.3.12	CRC	27
6.4	Procedures.....	27
6.4.1	Interaction between CLNAP entity and CLLR&R entity	27
6.4.2	Primitives between CLNAP & CLLR&R entities.....	27
Annex A (normative):	Encodings of the destination address field and source address field.....	29
Annex B (informative):	CRC32 generation and checking.....	30
Annex C (informative):	Interworking conditions with Switched Multi-megabit Data Service (SMDS)	31
C.1	Destination and source addresses	31
C.2	Header Extension Length (HEL).....	31
C.3	Header Extension (HE) field	31
C.4	HLPI.....	31
Annex D (informative):	Additional requirements in case of address screening supplementary service .	32
Annex E (informative):	Procedures.....	33
E.1	Receiving procedures.....	33
E.1.1	PDU checks	33
E.1.2	Ingress error conditions.....	33
E.2	Sending procedures.....	34
E.2.1	PDU checks	34
E.2.2	Egress error conditions	34
Annex F (informative):	Bibliography	35
History		36

Foreword

This European Telecommunication Standard (ETS) has been produced by the Network Aspects (NA) Technical Committee of the European Telecommunications Standards Institute (ETSI).

The present document is part 1 of a multi-part ETS covering the framework and protocol specification at the User-Network Interface (UNI) for the Connectionless Broadband Data Service (CBDS) over Asynchronous Transfer Mode (ATM), as identified below:

Part 1: "**Specification**";

Part 2: "Connectionless Network Access Protocol (CLNAP); Protocol Implementation Conformance Statement (PICS) proforma specification".

Transposition dates	
Date of adoption of this ETS:	6 February 1998
Date of latest announcement of this ETS (doa):	31 May 1998
Date of latest publication of new National Standard or endorsement of this ETS (dop/e):	30 November 1998
Date of withdrawal of any conflicting National Standard (dow):	30 November 1998

Blank page

1 Scope

This first part of ETS 300 478 describes the support of connectionless data service on Broadband Integrated Services Digital Network (B-ISDN) in accordance with:

- ETS 300 217 [2], which details the stage 1 aspects for the Connectionless Broadband Data Service (CBDS);
- ITU-T Recommendation I.113 [5], which defines **connectionless service** (vocabulary);
- CCITT Recommendation F.812 [4], which provides a service description of a CBDS. CCITT Recommendation F.812 [4] generally describes the service to include:
 - source address validation;
 - addresses based on CCITT Recommendation E.164 [3] numbering;
 - point-to-point and multicast information transfer;
 - address screening for point-to-point and multicast information transfer;
 - network capabilities for charging;
 - interworking with other ConnectionLess and Connection oriented data services;
 - Quality of Service (QoS) parameters.
- ITU-T Recommendation I.211 [6], which describes connectionless data service aspects. ITU-T Recommendation I.211 [6] identifies two configurations, type (i) and type (ii) to support connectionless data service. In type (i), a Connectionless Service Function (CLSF) is installed outside the B-ISDN. In type (ii), a CLSF, which handles routing of data to be transferred based on connectionless techniques, is installed within the B-ISDN;
- ITU-T Recommendation I.327 [8], which describes "high layer capabilities" for the support of services (e.g. connectionless service) and gives functional architectural models for the cases mentioned in F.812 Recommendation [4];
- ITU-T Recommendation I.362 [9], which specifies the use of ATM Adaptation Layer (AAL) type 3/4 for connectionless data services (although I.362 recognizes that the use of other AAL types is for further study) and identifies that routing and addressing are provided by the layer located above AAL type 3/4;
- ETS 300 349 [10], which specifies AAL type 3/4;
- ITU-T Recommendation I.364 [1], which specifies the support of Broadband Connectionless Data Bearer Service (BCDBS) on B-ISDN.

This ETS relates to type (ii) (direct) provision of connectionless service, using B-ISDN connectionless service. However, aspects of this ETS may be applied to some type (i) provision of connectionless service. This ETS describes the framework for network support of CBDS and the protocol used to support CBDS at the User Network Interface (UNI). The protocol used to support CBDS at the Network Node Interface (NNI) is described in 300 479-1 [14].

2 Normative references

This ETS incorporates by dated and undated reference, provisions from other publications. These normative references are cited at the appropriate places in the text and the publications are listed hereafter. For dated references, subsequent amendments to or revisions of any of these publications apply to this ETS only when incorporated in it by amendment or revision. For undated references the latest edition of the publication referred to applies.

- [1] ITU-T Recommendation I.364 (1993): "Support of broadband connectionless data service on B-ISDN".

- [2] ETS 300 217-2 (1992): "Network Aspects (NA); Connectionless Broadband Data Service (CBDS) Part 2: Basic bearer service definition".
- [3] CCITT Recommendation E.164 (1991): "Numbering plan for the ISDN era".
- [4] CCITT Recommendation F.812 (1992): "Broadband connectionless data bearer service".
- [5] ITU-T Recommendation I.113 (1988): "Vocabulary of terms for broadband aspects of ISDN".
- [6] ITU-T Recommendation I.211 (1993): "B-ISDN Service Aspects".
- [7] ITU-T Recommendation I.324 (1988): "ISDN network architecture".
- [8] ITU-T Recommendation I.327 (1993): "B-ISDN Functional Architecture".
- [9] ITU-T Recommendation I.362 (1993): "B-ISDN ATM Adaptation Layer (AAL) Functional Description".
- [10] ETS 300 349: "Broadband Integrated Services Digital Network (B-ISDN); Asynchronous Transfer Mode (ATM) Adaptation Layer (AAL) specification - type 3/4".
- [11] ISO/IEC IS 8802-6: "Information processing systems - Local Area Networks (LAN) - Part 6: Distributed Queue Dual Bus (DQDB) Subnetwork of a Metropolitan Area Network (MAN)".
- [12] ITU-T Recommendation I.371: "Traffic Control and Congestion Control in B-ISDN".
- [13] ISO/IEC IS 10039: "LAN MAC service definition".
- [14] ETS 300 479-1: "Network Aspects (NA); Connectionless Broadband Data Service (CBDS) over Asynchronous Transfer Mode (ATM); Protocol specification at the Network Node Interface (NNI); Part 1: Specification".

3 Abbreviations

For the purposes of this ETS, the following abbreviations apply:

AAL	ATM Adaptation Layer
AATF	ATM Access Termination Functions
ANTF	ATM Network Termination Functions
ATF	Access Termination Functions
ATM	Asynchronous Transfer Mode
BAsize	Buffer Allocation Size
BCD	Binary Coded Decimal
BCDBS	Broadband Connectionless Data Bearer Service
B-ISDN	Broadband Integrated Services Digital Network
BOM	Beginning Of Message
CBDS	Connectionless Broadband Data Service
CF	Connection Functions
CIB	CRC Indication Bit
CL	Connectionless
CLAI	Connectionless Access Interface
CLATF	CL Access Termination Functions
CLHF	Connectionless service Handling Functions
CLL	Connectionless Layer
CLLR&R	Connectionless Layer Routeing & Relaying
CLMF	Connectionless Mapping Functions
CLNAP	Connectionless Network Access Protocol

CLNI	Connectionless Network Interface
CLNIP	Connectionless Network Interface Protocol
CLNTF	CL Network Termination Functions
CLS	Connectionless Server
CLSF	Connectionless Service Function
CPCS	Common Part Convergence Sublayer
CPE	Customer Premises Equipment
CRC	Cyclic Redundancy Check
CTF	Control Functions
DA	Destination Address
DQDB	Distributed Queue Dual Bus
EI	Encapsulating Indicator
EOM	End Of Message
GA	Group Address
GAHF	Group Address Handling Functions
GAP	Group Addressed PDU
HE	Header Extension
HEL	Header Extension Length
IA	Individual Address
IEC	International Electrotechnical Commission
IM	Initial MAC
IS	International Standard
ISDN	Integrated Services Digital Network
ISO	International Organization for Standardization
LAN	Local Area Network
MAC	Media Access Control
MAN	Metropolitan Area Network
MCL	Connectionless Layer Management
MID	Multiplexing Identification
MIR	Maximum Information Rate
NA	Network Aspects
NGA	Nested Group Address
NNI	Network Node Interface
NPC	Network Parameter Control
NTF	Network Termination Functions
OAM	Operation And Maintenance
PCF	Protocol Conversion Functions
PDU	Protocol Data Unit
PPTU	PDUs per Time Unit
QoS	Quality of Service
SA	Source Address
SAP	Service Access Point
SAR	Segmentation And Reassembly
SDU	Service Data Unit
SIR	Sustained Information Rate
SMDS	Switched Multi-megabit Data Service
SSCS	Service Specific Convergence Sublayer
SSM	Single Segment Message
UNI	User Network Interface
UPC	Usage Parameter Control
VCI	Virtual Channel Identifier
VPI	Virtual Path Identifier

4 Framework for the provision of CBDS

This definition of CBDS is provided by ETS 300 217 [2] in conjunction with this ETS.

4.1 Group addressing

Group addressing is a mechanism used for multicast communication (CCITT Recommendation F.812 [4], paragraph 2).

Multicast information transfer allows a subscriber to send an Connectionless Network Access Protocol-Protocol Data Unit (CLNAP-PDU) to the network which delivers the same CLNAP-PDU to several intended recipients. The network shall deliver one and only one copy of the Group Addressed CLNAP-PDU (GAP) across each of the Connectionless Access Interface (CLAI) associated with the individual addresses represented by the group address (i.e. each CLAI associated with multiple destination addresses will receive a single copy from the network). The GAP shall not be copied back to the originating CLAI. Any recipient of a GAP may make use of the destination Group Address carried by that GAP to multicast to the other recipients of the GAP. Non members of a group identified by a group address (GA) may send GAPs to that group.

As a result of address screening, it is possible that some of the copies of the GAP will not be delivered, all other copies are delivered according to the QoS.

The service provider is responsible for assigning group addresses and ensuring that each GA identifies uniquely only one set of individual addresses. GA can be distinguished from individual addresses by the address type.

4.2 Functional architecture

The provision of the connectionless data service in B-ISDNs is realized by means of ATM switched capabilities and Connectionless Service Functions (CLSF). The ATM switched capabilities support the transport of connectionless data units in B-ISDNs between specific functional groups CLSF able to handle the connectionless protocol and to realize the adaptation of the connectionless data units into ATM cells to be transferred in a connection-oriented environment. The CLSF functional groups may be located outside a B-ISDN, in a private connectionless network or in a specialized service provider, or inside a B-ISDN. The relevant reference configuration for the provision of the connectionless data service in a B-ISDN is depicted in figure 1.

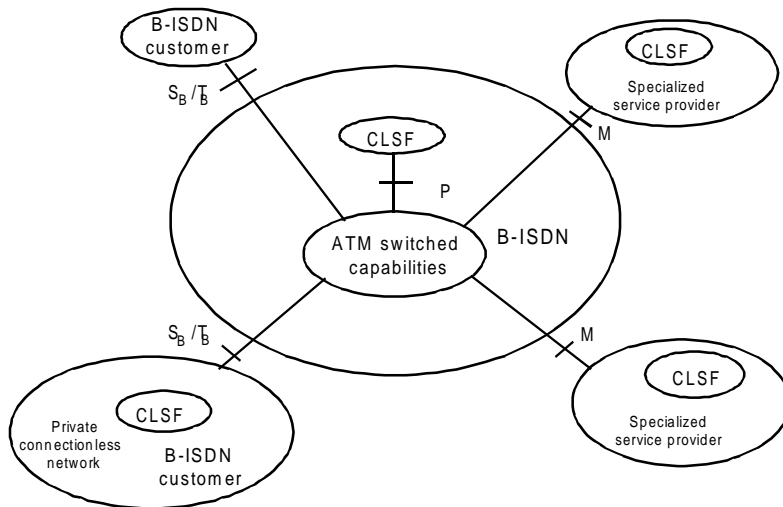

CLSF: Connectionless Service Function.

M, P, S_B, T_B: Reference points.

Figure 1: Reference configuration for the provision of the CL data service in B-ISDN

The ATM switched capabilities are performed by the ATM nodes (ATM switch/cross-connect) which realize the ATM transport network. The CLSF functional group terminates the B-ISDN connectionless protocol and includes functions for the adaptation of the connectionless protocol to the intrinsically connection-oriented ATM layer protocol and functions for the adaptation of the CL protocols using up to 9 2766 octets (9 188 user information plus protocol control information), variable size PDUs to the fixed size, 48 octet ATM-SDUs and to the specific error characteristics (possible cell loss, possible burst cell loss) of the ATM networks. These latter functions are those performed by the ATM Adaptation layer type 3/4 (AAL 3/4), while the former ones are those related to the layer directly above the AAL denoted Connectionless Layer (CLL) and performed by the Connectionless Network Access Protocol (CLNAP), Connectionless Network Interface Protocol (CLNIP) and related Connectionless Layer Routing & Relaying (CLLR&R) functions, respectively.

The CLL protocols include functions such as routing, addressing, QoS selection. In order to perform the routing of CL data units, the CLSF has to interact with the control/management planes of the underlying ATM network.

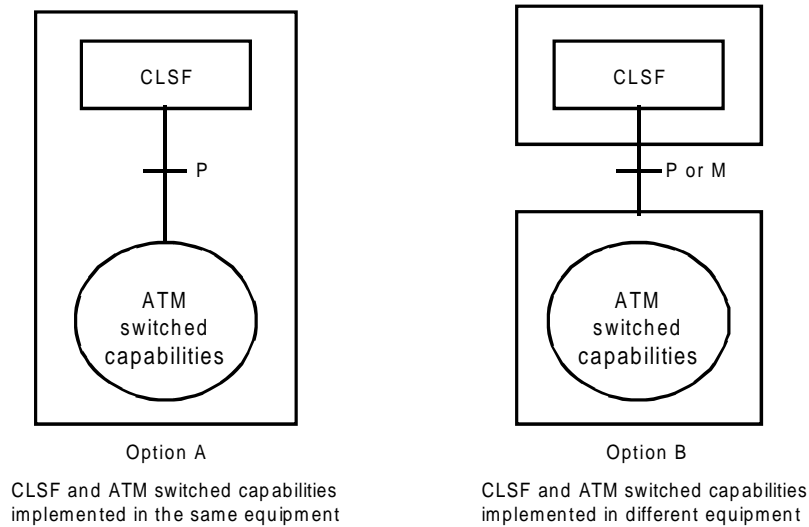
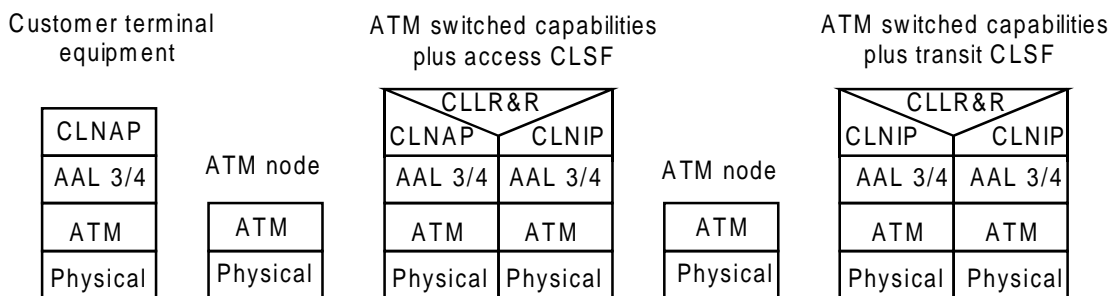

Figure 2: Implementation of CLSF and ATM switched capabilities

The general protocol structure for the provision of ConnectionLess (CL) data service in B-ISDN is shown in figure 3.



NOTE: A null (empty) Service Specific Convergence Sublayer (SSCS) is used.

Figure 3: General protocol structure for provision of CBDS in B-ISDN

The CLSF functional group can be considered implemented in the same equipment together with the ATM switched capabilities as depicted in figure 2 (option A). In this case there is no need to define the interface at the P reference point. CLSF functional group and ATM switched capabilities can be implemented also in separate equipment (figure 2, option B). In this case interfaces shall be defined at the M or P Reference Points (refer to ITU-T Recommendations I.324 [7] and I.327 [8]) depending on whether the CLSF is located outside or inside the B-ISDN.

4.3 Connectionless server functional description

A Connectionless Server (CLS) is a network element which includes the CLSF. It interfaces ATM nodes or other CLSs at the P/M reference points and B-ISDN customer equipment at S_B/T_B reference points. The CLS may perform among others the following functions (see also figure 4):

- Connection Functions (CF), which include all port-related functionalities for the termination of ATM connections;
- Connectionless Handling Functions (CLHF), which include all the service-specific functions required for the support of connectionless service provision in B-ISDN. In general they are related to the network integrity issues (e.g. address validation/screening, access class enforcement) and to relaying issues (e.g. routing, group address handling);

- Control Functions (CTF) are related to connection/resource handling and service processing; the information necessary to effect control over the communication resources in the server can be exchanged with other network elements through signalling or management protocols;
- Operation And Maintenance (OAM) functions.

NOTE: Transit CLSs do not contain access termination functions and access connection control functions.

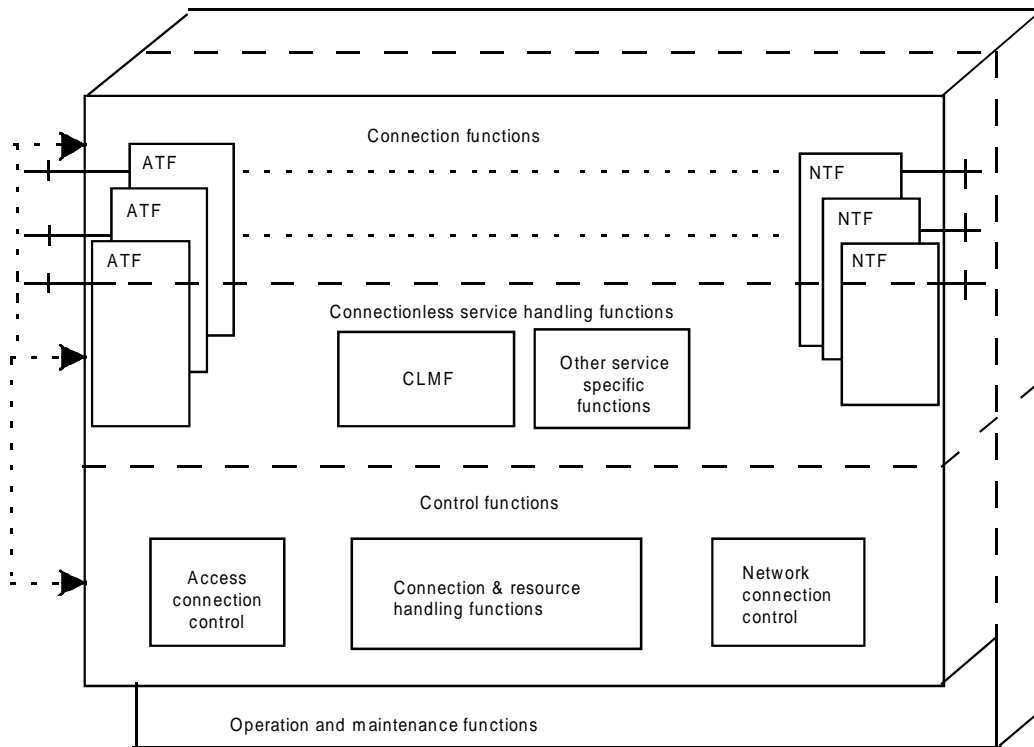

Figure 4: Connectionless server functional model

The Access Termination Functions (ATF) blocks contain the functions required to receive/transmit information from/to a B-ISDN user possibly through an ATM node. The block performs protocol functionalities corresponding to physical, ATM, AAL type 3/4 protocols and CLNAP.

The Network Termination Functions (NTF) blocks include the functions required to receive/transmit information from/to a CLS possibly through an ATM node. The block performs protocol functionalities corresponding to physical, ATM, AAL type 3/4 protocols and CLNIP.

Both ATF and NTF blocks include functions for terminating ATM connections and some CL services specific functions. The description of the functional architecture of the ATF and NTF blocks relevant to the specification of CLAI and Connectionless Network Interface (CLNI), respectively, is given in subclause 4.4.

The Connectionless Handling Functions (CLHF) are located partly in the ATF/NTF blocks and partly in the Connectionless Mapping Functions (CLMF) block.

The CLMF block (see figure 5) performs routing, protocol conversion between access and network terminations and group address handling functions, i.e. CLLR&R functions. The CLMF block (as shown in figure 5) is composed of the following functional blocks:

- Group Address Handling Functions (GAHF);
- Protocol Conversion Functions (PCF); and
- Routing functions.

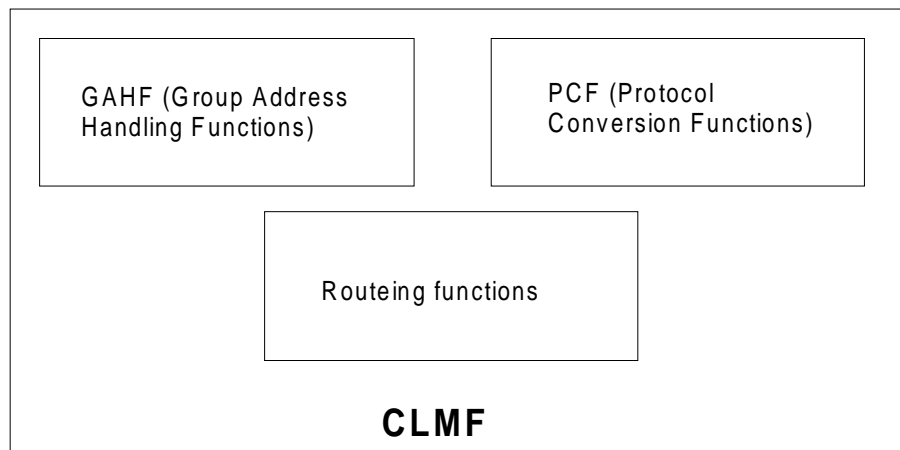

Figure 5: CLMF Block

The GAHF block handles both group-addressed CLNAP-PDUs and group-addressed CLNIP-PDUs whose resolution is requested by this CLS. This functional block performs group-addressed data units handling, resolving the group address into its associated individual addresses. The resolved individual addresses may identify end users served either by this CLS or by a remote CLS.

The PCF block performs protocol conversion between the Access Termination Functions (ATF) and the Network Termination Functions (NTF). In particular, it provides all the relevant information necessary to properly create a CLNIP-PDU from a CLNAP-PDU or to recover a CLNAP-PDU from the received CLNIP-PDU.

The functions denoted as routeing, on the basis of the destination address of the data unit to be forwarded across a User Network Interface (UNI) or Network Node Interface (NNI), select the proper outgoing physical link and Virtual Path Identifier/Virtual Channel Identifier (VPI/VCI) to reach that destination.

The Control Functions (CTF) include the following functional blocks: access connection control, network connection control, connection/resource handling functions. These blocks perform functions related to internal resource allocation (e.g. associated with CL message multiplexing, QoS preservation), connection establishment/release, etc. In particular, if the CL service is provided on the basis of switched ATM connections between the terminal equipment and the CLS or between CLSs, the access and network connection control functions support user access and network signalling systems, respectively. The access and network connection control functions are, instead, related to the management plane if the CL service is provided on the basis of semi-permanent ATM connections between the terminal equipment and the CLS or between CLSs.

The block in figure 5, labelled "Other service specific functions" includes in particular usage information measurement, traffic observations.

The functions described in this clause do not imply any particular implementation.

4.4 Interfaces

In the following subclauses, the access and network interfaces for the support of the CBDS on B-ISDN are described for the user plane. The description of the control and management planes for these interfaces is out of the scope of this ETS.

4.4.1 CLAI

The CLAI supports user access to the CBDS as defined in ETS 300 217 [2] on an ATM network.

User access to the ATM network is provided at the S_B/T_B reference points.

Direct service provision is performed through the use of specialized network elements (CL servers, CLS); user equipment may have direct access to the CLS at the S_B/T_B reference points. The protocol stack includes the UNI physical and ATM layers both in the user equipment on one side of the CLAI and in the CL Server on the other side. Policing functions, as foreseen for ATM user access, are performed on the server side of the CLAI.

a) direct access

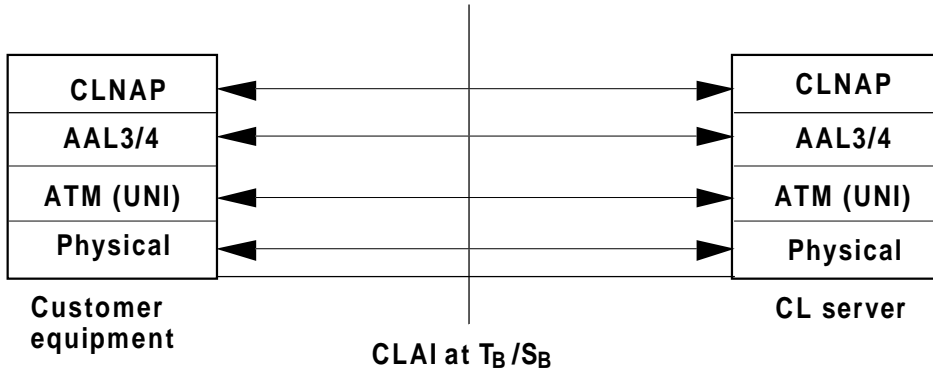

NOTE: A null (empty) SSSS is used.

b) access via ATM nodes

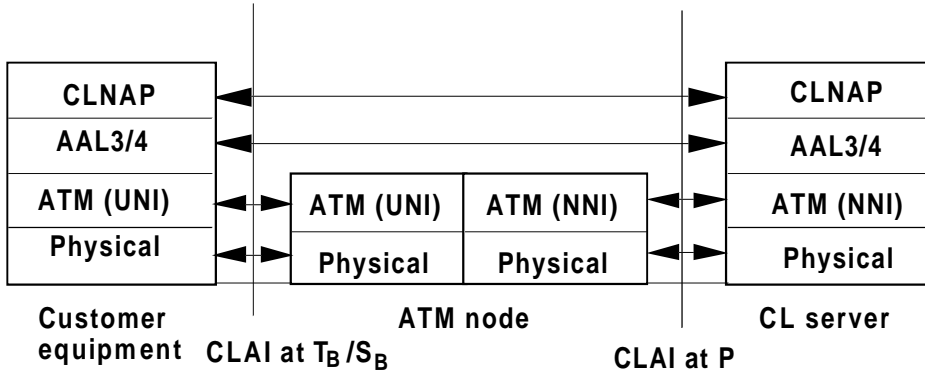

NOTE: A null (empty) SSSS is used.

Figure 6: Protocol stack at the U-plane for CLAI

Indirect user access to the server through one or more ATM nodes is also possible. In this case the interface between the user equipment and the adjacent ATM node is defined at the S_B/T_B reference points, while that between the server and the adjacent ATM node(s) is defined at the P/M reference points.

At the S_B/T_B reference points, the physical and ATM layers of the CLAI protocol stack are terminated in the user equipment and the ATM node(s). They are based on the ATM UNI. Usage Parameter Control (UPC) functions as foreseen for ATM user access are performed by the ATM network elements at the network side of the UNI.

At the P reference point, the physical and ATM layers of the CLAI stack are terminated in the server and the ATM node(s) and are based on the ATM NNI.

The functions performed by the CL specific protocols (AAL type 3/4 and CLNAP) are the same both in the direct and indirect access cases. The CLAI protocol stack for the "direct" and "indirect" access is shown in figure 6. The CLNAP protocol functions and elements are defined in clause 6 of this ETS.

4.4.1.1 Access Termination Functions (ATF)

The ATF functional block performs all termination functions associated with the CLAI protocol stack and some service support functions. Figure 7 gives a functional decomposition of the ATF block.

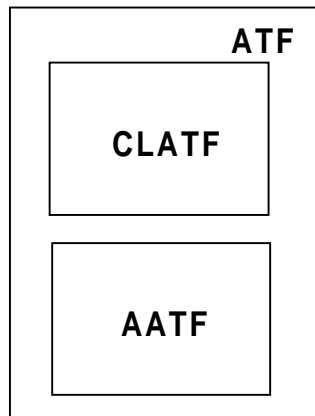

Figure 7: ATF Functional Decomposition

The description given in the following does not imply any particular implementation.

4.4.1.1.1 ATM Access Termination Functions (AATF)

The AATF perform the protocol functionalities of the physical and ATM layers of the B-ISDN protocol reference model.

Moreover the AATF perform some of the functions needed for connection establishment and release to support communication between the server and the users served by it.

Traffic monitoring and control functions based on UPC and/or Network Parameter Control (NPC), as specification by ITU-T Recommendation I.371 [12], may also be performed by the AATF according to the type of access.

4.4.1.1.2 CL Access Termination Functions (CLATF)

This subclause only describes the CL termination functions performed in the CLS. CL termination functions that are performed in the customer equipment are out of the scope of this ETS.

The CLATF of the CLS perform the protocol functionalities of the AAL type 3/4 Segmentation And Reassembly (SAR), Common Part Convergence Sublayer (CPCS) and the CLNAP.

Other functions performed include:

- **Source address validation.**
The source address of each CLNAP-PDU is checked by the CLNAP entity at the server side of the CLAI to support the source address validation feature as specified in ETS 300 217 [2];
- **Local traffic filtering.**
The destination address of each CLNAP-PDU is checked by the CLNAP entity at the server side of the CLAI to screen out non-OAM communications destined to the same CLAI (internal to the Customer Premises Equipment (CPE));
- **Destination address screening.**
If the address screening supplementary service as defined in ETS 300 217 [2] is provided, destination address screening is performed by the CLNAP entity at the server side of the CLAI on both individual and group addresses, in accordance to the service specifications;

- **Source address screening.**
If the source address screening supplementary service as defined in ETS 300 217 [2] is provided, source address screening is performed by the CLNAP entity of the server before delivering a CLNAP-PDU at the destination CLAI;
- **Access class enforcement.**
If the network offers access classes, the CLNAP entity on the server side of the CLAI performs access class enforcement (see subclause 4.8);
- **Control of the maximum number of concurrent PDUs.**
PDUs in excess of this value are discarded in the user-to-network direction and stored up to a pre-subscribed limit in the network-to-user direction (see note).

NOTE: In case the number of the maximum allowed concurrent PDUs corresponds to the number of maximum allowed Multiplexing Identification (MID) in the AAL 3/4 entity, the AAL 3/4 entity discards the PDUs exceeding the limit.

4.4.2 Connectionless Network Interface (CLNI)

The CLNI supports connectionless service provision, allowing for transparent transfer of connectionless service data units between CL servers using the ATM switched capabilities of the B-ISDN.

The CLNI protocol stack is terminated in CL servers and is based on the ATM Network Node Interface (NNI) protocols.

Servers may be interconnected directly. Indirect interconnection through one or more ATM nodes is also possible. In both cases the AAL type 3/4 protocol and the CLNIP of the CLNI protocol stack are terminated in CL servers.

The physical and ATM layers are terminated in adjacent servers or between servers and adjacent ATM node(s). They are in both cases based on the ATM Network Node Interface (NNI) when servers are attached at the P reference point.

The protocol stack for the CLNI is shown in figure 8.

a) direct connection between servers

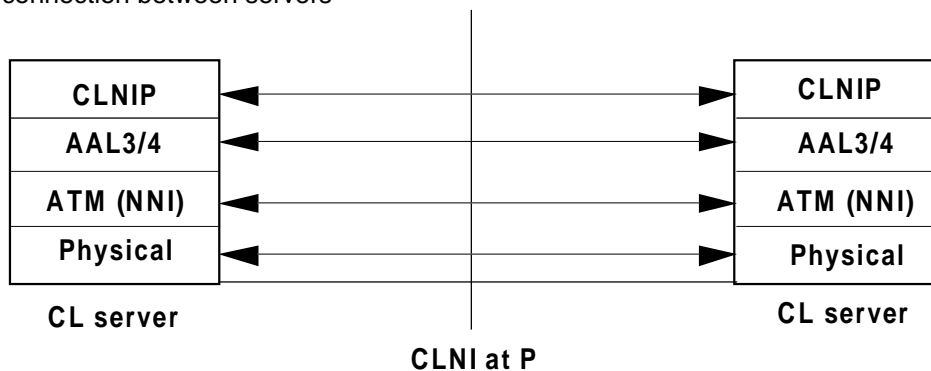

NOTE 1: A null (empty) SSSS is used.

b) servers connected via ATM nodes

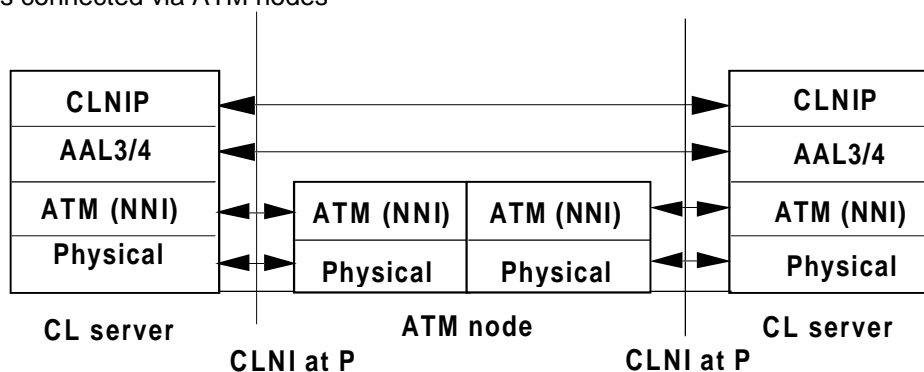

NOTE 2: A null (empty) SSSS is used.

Figure 8: Protocol stack at the U-plane for CLNI

The protocol stack for the CLNI includes, on the user plane, the physical, ATM, AAL type 3/4 and Connectionless Network Interface Protocol (CLNIP).

This protocol stack for the user plane applies both when the connected network elements belong to the same network operator/service provider and when the network elements belong to different operators/service providers.

The CLNIP protocol functions and elements are defined in 300 479-1 [14].

4.4.2.1 Network Termination Functions (NTF)

The NTF functional block performs all termination functions associated with the CLNI protocol stack. Figure 9 gives a functional decomposition of the NTF block.

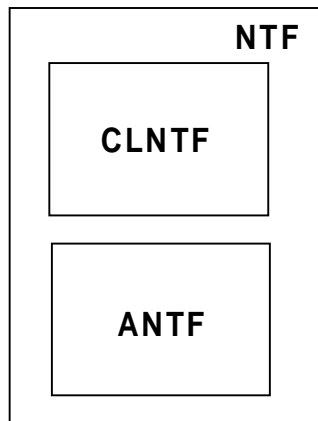

Figure 9: NTF functional decomposition

The description given in the following does not imply any particular implementation.

4.4.2.1.1 ATM Network Termination Functions (ANTF)

The ANTF perform the protocol functionalities of the physical and ATM layers of the B-ISDN protocol reference model.

Moreover the ANTF perform some of the functions needed for connection establishment and release to support communication between servers.

Traffic monitoring and control functions based on NPC, according to the specification of ITU-T Recommendation I.371 [12], are also performed by the ANTF when required.

4.4.2.1.2 CL Network Termination Functions (CLNTF)

The CLNTF perform the protocol functionalities of the AAL type 3/4 (SAR and CPCS sublayers, using a null SSCS) and the CLNIP.

4.5 Connections

CBDS over ATM networks will be supported by ATM connections provisioned on either permanent, semi-permanent, or switched basis. The CL and AAL type 3/4 functions will be realized by the CL server(s).

Assignment of the VCI/VPI values is a local matter at each CLAI; a VPC/VCC at a given CLAI supports all the overall end to end CL communication that a subscriber needs.

Connectionless communications take place at the CLL. For simultaneous transmission of multiple CLNAP/CLNIP-PDUs each of them is associated with one AAL type 3/4 connection. Multiple AAL type 3/4 connections each associated with one MID value can be mapped on a single ATM connection.

The maximum number of concurrent PDUs is agreed at subscription time.

For a given pair of source and individually addressed destination, at the CL layer the PDU sequence integrity shall be preserved or, in other words, no PDU should be mis-sequenced (see note).

NOTE: Mis-sequencing occurs at a given receiving interface when the order of reception of two PDUs issued from the same source interface is different from the sending order. A PDU is considered as received when the EOM (End of Message) cell/SAR segment of the PDU has been received. Similarly, a PDU is considered as having been sent when its EOM (End of Message) has been sent. In the case of interleaving on a ATM connection of CLNAP/CLNIP-PDUs with the same source and destination address the AAL type 3/4 may not guarantee the order in which the PDUs are delivered to the CLL.

4.6 Protocols

The protocol for the support of CBDS on B-ISDN at the UNI is described in clause 6.

The protocol for the support of CBDS at the NNI is described in 300 479-1 [14].

4.7 Numbering and addressing

The number structure of CCITT Recommendation E.164 [3] shall be supported. One or more CCITT Recommendation E.164 [3] number(s) is (are) assigned to the individual interface at the T_B reference point. The same number is used in the CLL protocol address fields to identify the CLL entity.

The subscriber, to which the service is offered by a given network operator, accesses the service via a single CLAI. One or more of the numbers assigned to the T_B reference point are associated to the CLAI through which the subscriber accesses the service offered to him. The association of CCITT Recommendation E.164 [3] numbers with S_B reference point is outside the scope of this ETS.

Further information concerning Numbering and addressing for CBDS can be found in annex F, reference 4).

4.7.1 Individual Address (IA)

An individual address represents the address of a particular interface at the T_B reference point. More than one number may be assigned to a T_B reference point (and could be used as an address in a PDU).

An IA can be used either as a source or a destination address.

One or more of the CCITT Recommendation E.164 [3] numbers assigned to the T_B reference point are associated with the CLAI through which the customer accesses the service.

4.7.2 Group Address (GA)

A group address is used as a destination address where a number of recipients is intended, each recipient being accessed through the use of the "unique" group identity. Each GA identifies uniquely a set of individual addresses.

The intended recipients of a GA may be served by more than one network.

A GA can only be used as a destination address.

More than one Group Address (GA) may be associated with a CLAI at the T_B reference point. An interface at the T_B reference point is identified by a group address if one or more of the individual addresses assigned to the interface at the T_B reference point is identified by the group address.

4.7.3 Nested Group Address (NGA)

A Nested Group Address (NGA) is related to a GA and identifies a subset of individual addresses pertaining to that GA. The NGA represents a set of individual addresses of members of a GA that are located inside a given network; this network can be different from the network where the GAP originated and from the network resolving the GA. (The resolution function provides, for a given GA or NGA, the list of addresses of all the members and/or NGAs in the case of a GA using NGAs). The type of address used for a NGA is the same as the one defined for a GA.

A NGA is globally unique. A given NGA associated with a GA cannot be reused for another GA in order to allow independent evolution of the two GAs. A NGA is not intended to be used in a CLNAP-PDU.

4.8 Traffic aspects: access class enforcement

The access class enforcement applies between the CPE and the connectionless server (i.e. at the CLAI) it is connected to in the direction from the user to the network. An access class is defined as a subscription condition based on the maximum allowed sustained information rate (see note 1) across the CLAI. An access class mechanism is defined as a set of functions limiting the information rate (see note 1) across the CLAI at the T_B reference point to enforce the access class and it is based on the following three parameters:

NOTE 1: In this subclause the term "information rate" identifies the bit rate available to the CLL users at the CLAI at the T_B reference point excluding the overhead.

MIR: Maximum Information Rate: this parameter is defined in ETS 300 217 [2]. As the MIR is defined under the assumption of maximum length Service Data Unit (SDU) and maximum header extension in the Protocol Data Unit (PDU), it is possible to directly deduce the required bandwidth (peak cell rate) of the underlying ATM connection by the following formula.

ATM peak cell rate = $MIR \times (\text{maximum number of user data octets} + \text{length of CLNAP header in octets} + \text{length of CPCS header and trailer in octets}) / (\text{maximum number of user data octets} \times \text{SAR-PDU payload length in octets} \times \text{bits/octet})$, i.e. ATM peak cell rate = $MIR \times (9\ 188 + 44 + 8) / (9\ 188 \times 44 \times 8)$ given in cell/s.

SIR: Sustained Information Rate: this SIR is defined in ETS 300 217 [2].

PPTU: PDUs Per Time Unit: it is the long term average PDU rate for bursty traffic.

NOTE 2: The PPTU parameter can be set to a value such that no enforcement results from it.

The user sending only messages shorter than the length L defined by the formula $L = SIR / (8 \times PPTU)$ is not able to utilize the SIR declared at subscription time.

For connectionless service, AAL type 3/4 can operate in two different modes: message mode and streaming mode. In the case of message mode operation, the BAsize field is equal to the length of the CPCS-PDU payload and the user credit will be correctly decremented for access class enforcement. In the case of streaming mode, the AAL type 3/4 specifies that the BAsize is equal to or greater than the CPCS-PDU length, which is derived from the maximum length indication given in the CPCS-UNITDATA-invoke primitive. The parameter in this primitive represents the maximum length of the CPCS-SDU, i.e. the CLNAP-PDU.

NOTE 3: If the access class enforcement is based on the BAsize value and if the maximum length is for example 9 188 octets, too much credit could be consumed with regard to the actual length of the CLNAP-SDU. This could lead to the network's discarding of CPCS-PDUs carrying CLNAP-PDUs which could have been accepted otherwise.

In order to control the parameters related to an access class, the following algorithms are defined.

4.8.1 Maximum Information Rate (MIR)

Due to the direct relationships between the MIR and the ATM peak cell rate, it is sufficient to rely on the UPC at the ingress to the ATM network, to check this parameter.

NOTE: It is important to notice that the UPC is enforcing the ATM peak cell rate regardless of the PDU structure and that therefore the impact of violation of the MIR may lead to a high degradation of the QoS.

4.8.2 Sustained Information Rate (SIR) and PDUs Per Time Unit (PPTU)

For each user the access class enforcement is to be applied to, the following set of variables shall be maintained by the ingress CLS:

- C: represents the current number of octets that is allowed to be accepted by the network;
- P: represents the current number of Beginning Of Message (BOM) or Single Segment Message (SSM) SAR-PDUs that is allowed to be accepted by the network;
- Dt: represents the time period after which the C variable is incremented;
- dt: represents the time period after which the P variable is incremented;
- DC: represents the number of octets by which C shall be incremented every Dt period of time;
- DP: represents the number of CLNAP-PDUs by which P shall be incremented every dt period of time;
- CMAX: represents the maximum value that the variable C may reach;
- PMAX: represents the maximum value that the variable P may reach.

The following algorithm shall be applied:

every Dt : $C = C + DC$ up to CMAX;

every dt : $P = P + DP$ up to PMAX;

Whenever a BOM or SSM SAR-PDU arrives in the ingress CLS:

if ($C \geq BAsize - 20$ (see see note 1)) and ($P \geq 1$)
then {CPCS-PDU is transmitted
and $C = C - BAsize + 20$
and $P = P - 1$ }
else {CPCS-PDU is discarded}.

NOTE 1: It has been assumed that the header extension field length is zero since no standard use has been defined for the header extension field.

NOTE 2: $SIR = 8 \times DC / Dt$. SIR corresponds to the user information , i.e. the CLL-SDU.

4.9 Operations and maintenance

4.9.1 Identification of OAM information flow

The CLNAP provides the means by which an OAM related information flow can be identified in each CLNAP entity. The OAM information flow is transported in particular CLNAP-PDUs: CL-OAM-PDU.

4.9.2 OAM supported functions

- Accessibility test of the network by the user.
- Accessibility test of the user by the network.

5 Layer service and functions provided by the connectionless layer

The Connectionless Layer Service (CLL Service) and the functions of the CLL are provided by appropriate interactions of CLNAP, CLNIP and CLLR&R entities. They are accessed by a CLL user via an interface to a CLNAP entity.

5.1 Layer service provided by the connectionless layer

The CLL provides for the transparent transfer of variable size CLL Service Data Units from a source to one or more destination CLL user(s) in a manner such that lost or corrupted data units are not retransmitted. This transfer is performed using a connectionless technique, including embedding of destination and source CLL user addresses in each corresponding CLL Protocol Data Unit.

The information exchanged between a CLNAP entity and a CLL user entity across a CLL SAP (see figure 12) uses the following primitives:

- a) CLL-UNITDATA.request (source_address, destination_address, data, QoS);
- b) CLL-UNITDATA.indication (source_address, destination_address, data, QoS).

The information exchanged between a CLNAP entity and the associated management entity uses the following primitives:

- 1) MCL-UNITDATA.request (source_address, destination_address, data);
- 2) MCL-UNITDATA.indication (source_address, destination_address, data).

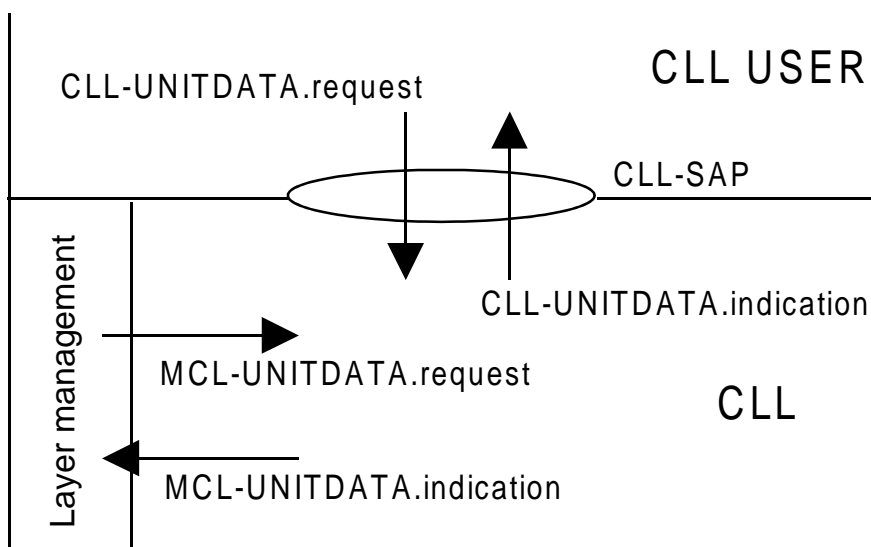

Figure 10: CLL block

5.1.1 Description of primitives

5.1.1.1 CLL-UNITDATA.request

This primitive is issued by the CLL user to request the transfer of a CLL-SDU to its peer CLL user entity if an individual destination addresses is used, or peer entities if a group destination address is used. This CLL-SDU is not retransmitted in case of loss or corruption.

5.1.1.2 CLL-UNITDATA.indication

This primitive is issued to a CLL user to indicate the arrival of a CLL-SDU. In the absence of errors, the contents of the CLL-SDU are complete and unchanged relative to the data parameter in the associated CLL-UNITDATA.request.

5.1.1.3 MCL-UNITDATA.request

This primitive is issued by the management entity to request the transfer of CL-OAM data to a peer management entity. This CL-OAM data is always transmitted in a manner such that lost or corrupted data units are not retransmitted.

NOTE: The use of GA in this primitive is not foreseen.

5.1.1.4 MCL-UNITDATA.indication

This primitive is issued to the management entity to indicate the arrival of CL-OAM data. In the absence of errors, the CL-OAM data is complete and unchanged relative to the data parameter in the associated MCL-UNITDATA.request.

5.1.2 Definition of parameters

5.1.2.1 source_address

The source_address parameter identifies the individual source CLL user/OAM entity.

5.1.2.2 destination_address

The destination_address parameter identifies either an individual CLL destination user/OAM entity or a group of CLL destination users.

5.1.2.3 QoS

The QoS parameter specifies the QoS desired for the CLL-SDU transfer.

5.1.2.4 Data

The data parameter is the CLL-SDU/CL-OAM data to be transferred.

5.2 Connectionless layer functions for user data transport

The functions provided by the Connectionless Layer include source address validation, local traffic filtering, destination address screening, source address screening, access class enforcement, control of maximum number of concurrent PDUs (see subclause 4.4.1.2).

In addition the following functions are provided:

- Preservation of CLL-SDUs
This function provides for the delineation and transfer of CLL-SDUs.
- Addressing
This function provides the ability to a CLL user entity to select, on a per CLL-SDU basis, to which destination CLL user entity or entities the CLL-SDU is to be delivered and provides the ability to indicate to the destination CLL user(s) the source of the CLL-SDU.
- PDU sequence preservation
This function assures the utilization of the same route for a given combination Source Address (SA) and Destination Address (DA) under no fault condition in the network. The function is applied to each CLNAP-PDU received.
- Routeing
The routeing shall be done at least on the basis of the Destination Address.
- Group address resolution
This function provides, for a given GA known, a list of some members of the group and their individual addresses and the list of NGAs, when any in use for the given GA, for the other members (not in the first list). See subclause 4.7.3 and clause 8 of 300 479-1 [14].
- QoS selection
The QoS function provides selection of the QoS desired for the CLL-SDU transfer. As a network operator's option only one QoS class is supported. A network which supports only one class shall ignore any QoS selection.

5.3 Transit operator selection

This function provides the ability to a CLL user entity to explicitly select, either on a permanent or a per CLL SDU basis, the source CLL user's preferred transit operator(s). The mechanism for selection of the transit operator is outside the scope of this ETS. The provision of this function is a service provider option.

NOTE: The word carrier may alternatively be used instead of transit operator in some environment.

6 Protocol for the support of the CBDS on B-ISDN at the UNI

The clause describes a protocol for supporting a connectionless data service across the B-ISDN UNI. The protocol provides a Layer Service similar to the Media Access Control (MAC) sub-layer service described in the ISO/IEC IS 10039 [13], with enhanced capabilities.

The protocol elements defined at the CLL and CPCS sublayer of the AAL type 3/4 protocol allow correspondence with the elements defined for the Initial MAC (IM) sublayer defined in ISO/IEC IS 8802-6 [11]. This alignment is considered highly desirable in order to facilitate ease of interworking between the two protocols for supporting connectionless service.

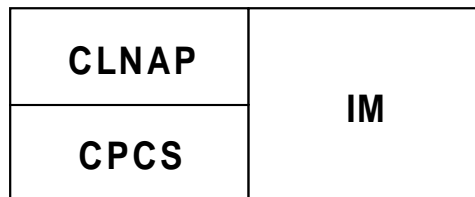

NOTE: A null (empty) SSSS is used.

Figure 11: Correspondence between IM and CPCS/CLNAP

6.1 Protocol stack

Figure 12 illustrates the protocol stack for supporting CBDS at the UNI. The CLNAP uses the AAL type 3/4 unassured service (using null SSSS) and includes the necessary functionality to provide the CLL Service. The CLL provides its Layer Service to the CLL user(s).

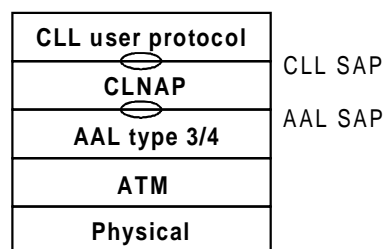

NOTE: A null (empty) SSSS is used.

Figure 12: Protocol stack for supporting the CBDS

6.2 Layer service expected from the AAL

The CLL expects the AAL to provide for the transparent and sequence-preserving transfer of CLNAP-PDUs between two CLNAP entities when accessing a point-to-point AAL connection (see ETS 300 349 [10] for the definition of AAL connections). This transfer is provided in a manner such that lost or corrupted data units are not retransmitted (Unassured Operation).

The information transfer between the CLNAP entity and the AAL entity can be performed in Message Mode or Streaming Mode.

The information exchange between the AAL entities and the CLNAP entities across the AAL-SAP uses the following primitives:

- a) AAL-UNITDATA.request (Interface Data, More (see note), Maximum Length (see note));
- b) AAL-UNITDATA.indication (Interface Data, More (see note), Maximum Length (see note), Reception Status);
- c) AAL-U-Abort.request (see note);
- d) AAL-U-Abort.indication (see note);
- e) AAL-P-Abort.indication (see note).

NOTE: These primitives/parameters are used in streaming mode only.

The CLNAP entities shall not make use of the Corrupted Data Delivery option which may be supported by the AAL type 3/4 protocol i.e. the optional Reception Status parameter in the AAL-UNITDATA.indication primitive is not used.

A detailed description of the primitives and parameters is provided in ETS 300 349 [10].

6.3 CLNAP protocol data unit structure and encoding

The detailed structure of the CLNAP-PDU is illustrated in figure 13.

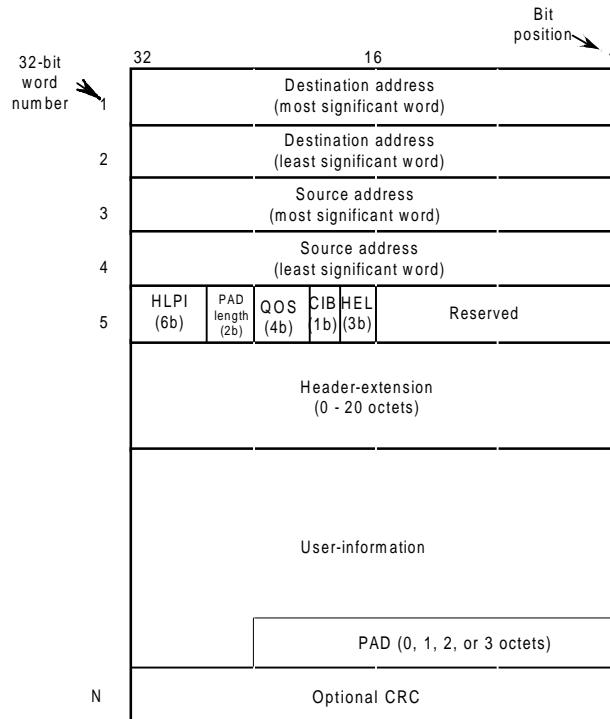

(nb) - length of field (n) in bits

NOTE: The order of transmission is from left to right and from top to bottom.

Figure13: Structure of the CLNAP-PDU

It contains the following fields:

6.3.1 Destination-Address

This 8-octet field contains a 4 bit "address-type" subfield, followed by the 60-bit "address" subfield. The "address-type" subfield indicates whether the "address" subfield contains a publicly administered 60-bit individual address or a publicly administered 60-bit group address. The "address" subfield indicates to which CLNAP-entity(ies) the CLNAP-PDU is destined. The encoding of this "address-type" subfield is described in annex A. This "address" subfield is structured according to CCITT Recommendation E.164 [3]. The encoding of the 60-bit "address" subfield is described in annex A.

6.3.2 Source-Address

This 8-octet field contains a 4 bit "address-type" subfield, followed by the 60-bit "address" subfield. The "address-type" subfield indicates that the "address" subfield contains a publicly administered 60-bit individual address. The "address" subfield indicates the CLNAP-entity that sourced the CLNAP-PDU. The encoding of this "address-type" subfield is described in annex A. This "address" subfield is structured according to CCITT Recommendation E.164 [3]. The encoding of the 60-bit "address" subfield is described in annex A.

6.3.3 Higher-Layer-Protocol-Identifier (HLPI)

This 6-bit field is used to identify the CLNAP user/OAM entity which the CLL-SDU is to be passed to at the destination node.

The means by which the originating CLL user entity indicates the destination CLL user entity is out of the scope of this specification (i.e. specific to implementation).

Table 1: Coding table of the HLPI field

HLPI range	Protocol Entity
1	Reserved for logical link control (see notes 1 and 2)
2	Reserved for Metropolitan Area Network (MAN) layer management (see notes 1 and 2)
43	Reserved for identification of CL-OAM-PDU
44-47	Reserved for indication of encapsulation inside the network. These values shall never be set by a CLL user entity. Any CLNAP-PDU having the HLPI set to any of these values shall be discarded by the network.
48-63	Reserved for end-to-end user application. This range of values is not subject to standardization (see notes 1 and 2)
Other values	Reserved for future standardization
NOTE 1:	This value has to be transparently transported by the network.
NOTE 2:	The network shall not discard CLNAP-PDUs on the basis of this value.

NOTE: The mapping of higher layer protocols to/from CLNAP is outside the scope of this ETS. Further information may be found in ETR 156 and ISO TR 9577 as listed in annex F.

6.3.4 PAD-length

This 2-bit field indicates the length of the PAD field (0–3 octets). The number of PAD octets is such that the total length of the User-Information field and the PAD field together is an integral multiple of four octets.

6.3.5 QoS

This 4-bit field is used to indicate the QoS requested for the CLNAP-PDU. The default value of this field is "0".

A network which supports only one QoS class shall ignore this field.

6.3.6 CRC Indication Bit (CIB)

This 1-bit field indicates the presence (if CIB=1) or absence (if CIB=0) of a 32-bit Cyclic Redundancy Check (CRC) field.

6.3.7 Header Extension Length (HEL)

This 3-bit field shall be set in the range [0-5] and indicates the number of 32-bit words in the header extension field.

6.3.8 Reserved

This 16-bit field is reserved for future use. Its default value is 0.

6.3.9 Header extension

This variable-length field is in the range [0-20] octets, its length is indicated by the value of the Header Extension Length field (see subclause 6.3.7).

In cases where the header extension length (HEL) is unequal to zero, all unused octets in the header extension are set to zero. The information carried in the header extension is structured into information entities. An information entity (element) consists (in this order) of element length, element type, and element payload.

Element length: This is a one octet field and contains the combined lengths of the element length, element type, and element payload in octets.

Element type: This is also a one octet field and contains a binary encoded value which indicates the type of information found in the element payload field.

Element payload: This is a variable length field and contains the information indicated by the element type field.

6.3.10 User-information

This field is of variable length up to 9 188 octets and is used to carry the CLL-SDU.

6.3.11 PAD

This field is 0, 1, 2 or 3 octets in length and coded as all zeroes. Within each CLNAP-PDU the length of this field is chosen such that the length of the resulting CLNAP-PDU is aligned on a 32-bit boundary.

6.3.12 CRC

The CRC is a 32-bit field optionally generated by the originating CPE and carried end to end, whose presence or absence is indicated by the CIB field. The field contains the result of a standard CRC32 calculation performed over the CLNAP-PDU with the "Reserved" field always treated as if it were coded as all zeros.

The CRC32 is calculated using the following generator polynomial:

$$G(x) = x^{32} + x^{26} + x^{23} + x^{22} + x^{16} + x^{12} + x^{11} + x^{10} + x^8 + x^7 + x^5 + x^4 + x^2 + x + 1$$

Annex B provides the details on the encoding and checking of this field. By default the network does not process this field.

6.4 Procedures

6.4.1 Interaction between CLNAP entity and CLLR&R entity

A receiving CLNAP entity forwards each CLNAP-PDU with the EI parameter to the CLLR&R entity. The EI (Encapsulating Indicator) is set to FALSE, indicating that the CLNAP-PDU is not an encapsulating one.

A transmitting CLNAP entity receives from the CLLR&R entity the CLNAP-PDU to be transmitted.

6.4.2 Primitives between CLNAP & CLLR&R entities

The use of primitives does not imply any implementation.

The description of the interaction is made in terms of primitives between the CLLR&R entity and the protocol entity but these primitives are named invoke (when initiated by the CLLR&R) and signal (when initiated by the protocol entity) to differentiate from layer interface primitives.

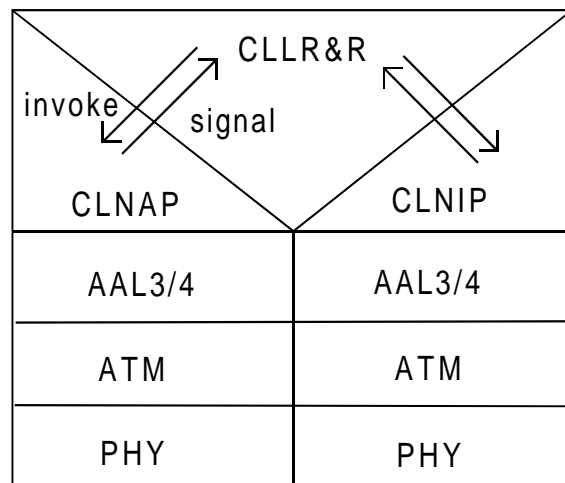

NOTE: A null (empty) SSSCS is used.

Figure 14: Primitives between CLNAP and CLLR&R

The function of the CLLR&R entity is described in subclauses 4.3 and 4.4.

It is assumed that the protocol entity (CLNAP) checks the validity of any CLNAP-PDU it receives over a CLAI. The PDU received by the CLLR&R is then assumed to be correct in relation to encapsulation/non-encapsulation.

It is assumed as well that the CLNAP functions belonging to the functional blocks ATF and NTF (see subclause 4.3) perform formatting of the PDUs i.e. encapsulation or decapsulation.

Signals to/from CLNAP:

- CLNAP-UNITDATA.invoke (data):
 - data = CLNAP-PDU to be forwarded;
- CLNAP-UNITDATA.signal (data, EI):
 - data = CLNAP-PDU received;
 - EI = false.

EI (Encapsulating indicator) indicates whether the data is an encapsulating PDU (EI=TRUE) or a non-encapsulating PDU (EI=FALSE).

Annex A (normative): Encodings of the destination address field and source address field

Table A.1: Encodings of the Destination Address Field

Address type	Address structure / meaning
0100	Reserved (see note)
1000	Reserved (see note)
1100	CCITT Recommendation E.164 [3] publicly administered individual address
1101	Reserved (see note)
1110	CCITT Recommendation E.164 [3] publicly administered group address
1111	Reserved (see note)
All other codes	Reserved for future standardization
NOTE:	The use of these values are defined for MAN's application (see ISO/IEC IS 8802-6 [11]).

Table A.2: Encoding of the Source Address Field

Address type	Address structure / meaning
0100	Reserved (see note)
1000	Reserved (see note)
1100	CCITT Recommendation E.164 [3] publicly administered individual address
1101	Reserved (see note)
All other codes	Reserved for future standardization
NOTE:	The use of these values are defined for MAN's application (see ISO/IEC IS 8802-6 [11]).

The CCITT Recommendation E.164 [3] number carried in the 60-bit address subfield is the international ISDN number. The international ISDN number can be up to 15 decimal digits. When numbers are less than 15 decimal digits, the number is placed in the most significant bits of the address subfield. The remaining part of the address subfield is coded to all binary 1's.

The CCITT Recommendation E.164 [3] numbers are coded using Binary Coded Decimal (BCD).

Annex B (informative): CRC32 generation and checking

For the purpose of CRC calculation the CLNAP-PDU "Reserved" field is assumed to be zeros. The CRC32 is calculated using the following generator polynomial:

$$G(x) = x^{32} + x^{26} + x^{23} + x^{22} + x^{16} + x^{12} + x^{11} + x^{10} + x^8 + x^7 + x^5 + x^4 + x^2 + x + 1.$$

The CRC32 is the one's complement of the sum (modulo 2) of the following:

- a) the remainder of $x^k (x^{31} + x^{30} + x^{29} + \dots + x^2 + x + 1)$ divided (modulo 2) by $G(x)$, where k is the number of bits in the calculation fields; with
- b) the remainder after multiplication of the contents (treated as a polynomial) of the calculation fields by x^{32} and then division (modulo 2) by $G(x)$.

The CRC field contains the coefficient of the highest term in the most significant bit position.

As an example implementation, at a transmitter, the initial remainder of the division is preset to all ones and is then modified by division of the calculation fields by the generator polynomial, $G(x)$. The one's complement of this remainder is inserted in the CRC field.

As an example implementation, at a receiver, the initial remainder is preset to all one's. The division of the received calculation field by the generator polynomial, $G(x)$, results, in the absence of errors, in a unique remainder value which is represented by the polynomial:

$$C(x) = x^{31} + x^{30} + x^{26} + x^{25} + x^{24} + x^{18} + x^{15} + x^{14} + x^{12} + x^{11} + x^{10} + x^8 + x^6 + x^5 + x^4 + x^3 + x + 1.$$

Annex C (informative): Interworking conditions with Switched Multi-megabit Data Service (SMDS)

For interworking of the CBDS and the SMDS over ATM the following issues have to be considered.

NOTE: The terminology used in the case of SMDS can be found in the bibliography references TR-TSV-000772 and in TR-TSV-001060.

C.1 Destination and source addresses

SMDS networks will provide DA and SA of users in their domain, structured as required by CCITT Recommendation E.164 [3]; the national number will be in accordance with the SMDS network's own numbering plan e.g. for the USA it is a number restricted to 10 digits in addition to the country code equal to 1. The SMDS networks will use international addresses to send PDUs to users outside their domains.

No specific function is identified for interworking in relation with addressing.

C.2 Header Extension Length (HEL)

- SMDS requires a fixed length of the header extension field of 12 octets. L3-PDUs with other Header Extension Length (HEL) values are to be discarded by the network.
- CBDS however allows a variable HEL of 0 up to 20 octets and will forward a corresponding CLNAP-PDU to the end user.

No interworking function is identified. In the direction SMDS to CBDS, CBDS network accepts HEL of 3. In the direction CBDS to SMDS, it is the user responsibility to adapt the HEL to a fixed value of 3.

C.3 Header Extension (HE) field

In the direction SMDS to CBDS, the meaning of HE (national carrier, protocol version) is irrelevant to the CBDS network which will carry the field transparently.

In the direction CBDS to SMDS, it is the responsibility of the user to provide at least a version element. Failure to do so will lead SMDS networks to discard the PDU. Until the functionality of the HE is defined, this field is carried transparently through the CBDS network.

C.4 HLPI

This field is transparent to an SMDS network, but some values are not transparent for a CBDS network. In the direction SMDS to CBDS, it is not required from a CBDS network to check the content of the encapsulated CLNAP-PDU before delivery to a CBDS user. In the direction CBDS to SMDS, CLNAP-PDUs with values of HLPI in the range 43 to 47 will not be transported to an SMDS network. It is the user responsibility to use values transparently transported by a CBDS network which are meaningful to the destination in a SMDS network.

Annex D (informative): Additional requirements in case of address screening supplementary service

A CLAI is identified by the physical UNI and the virtual circuit dedicated to CDBS traffic from/to that user.

The network enforces a limit on the number of CCITT Recommendation E.164 [3] numbers assigned to a CLAI. For IAs, the default value is 16. Lower values are allowed, higher figures are for further study.

A GA identifies members of a group possibly connected to different CLAI. A CLAI can be identified by more than one GA. For GAs identifying a given CLAI, the network enforces a limit. The default value is 48.

The sets of addresses used for screening are designated respectively by individual address screen and group address screen.

If a user specifies one individual address screen and one group address screen, then the individual address screen must be used for

a) source address screening and;

b) for destination address screening if the destination address is an individual address:

the group address screen must be used for destination address screening in case the destination address is a group address. If more than one CCITT Recommendation E.164 [3] address is assigned to a user, and only in that case, the user can specify more than one individual address screen and more than one group address screen. If so then:

- each address assigned to the CLAI shall be associated with one individual address screen, which is used for destination address screening of individually addressed CLNAP-PDUs sent from that CLAI and having that address as source address, and which is also used for source address screening of CLNAP-PDUs intended for delivery to that CLAI and having that address as destination address;
- each address assigned to the CLAI (if group addressing is applied) shall be associated with one group address screen, which is used for destination address screening of group addressed CLNAP-PDUs sent from that CLAI and having that address as source address;
- each group address that identifies the CLAI shall be associated with one individual address screen, which is used for source address screening of group addressed CLNAP-PDUs intended for delivery to that CLAI and having that address as destination address.

The number of IA screens and of GA screens respectively is 1 to 4 per CLAI. The maximum number of addresses contained in these screens per CLAI is 128. Higher numbers could be considered in a later edition of the ETS.

Annex E (informative): Procedures

E.1 Receiving procedures

E.1.1 PDU checks

Functions performed on the CLNAP-PDU assume that the underlying CPCS-PDU is correct. To avoid complete PDU assembly at the CLL, checks on the CPCS-PDU can take place on a cell by cell basis. This enables most of the service checks required at the CLL to be performed on the BOM/SSM of the CLNAP-PDU which contains the complete CLNAP header as described in subclause 6.3.

The following ingress checks are required at the CLL:

- number of concurrent PDUs according to the subscription of the user;
- DA address type according to the values allowed (e.g. individual, group);
- PDU length class according to the subscription of the user;
- Access Class violation according to subclause 4.8;
- CLNAP-PDU format (SA type and format, HLPI, HE and HEL);
- SA validation and then DA screening (if the address screening supplementary service is subscribed).

Some logical ordering of the above-mentioned checks is possible. However, to avoid influencing potential implementation, only the following sequence is suggested:

- a) PDU length class according to the user's subscription and then Access Class violation according to subclause 4.8;
- b) SA validation and then DA screening (if the address screening supplementary service is subscribed).

Failures in ingress checks lead to the discard of the CLNAP-PDU except when by operator option the CLNAP-PDU is not discarded but the violation is recorded (excess in the number of concurrent PDUs, Access Class Violation).

E.1.2 Ingress error conditions

Ingress CLNAP-PDU errors:

- invalid HLPI: if the HLPI is invalid according to subclause 6.3.3 the CLNAP-PDU shall be discarded by the CLNAP entity;
- invalid SA and/or DA type: if the Source or Destination Address type is invalid according to subclauses 6.3.1 or 6.3.2 the CLNAP-PDU shall be discarded by the CLNAP entity;
- invalid SA and/or DA format: if the Source or Destination Address format is invalid according to subclauses 6.3.1 or 6.3.2 the CLNAP-PDU shall be discarded by the CLNAP entity;
- invalid PAD and/or PAD length: if the PAD length or PAD content is invalid according to subclauses 6.3.4 and 6.3.11 the CLNAP-PDU shall be discarded by the CLNAP entity;
- invalid HEL: if the HEL is invalid according to subclause 6.3.7 the CLNAP-PDU shall be discarded by the CLNAP entity;
- invalid HE: if the HE field is invalid according to subclause 6.3.9 the CLNAP-PDU shall be discarded by the CLNAP entity (see note);
- invalid payload length class: if the payload field exceeds the payload class subscribed by the user, the CLNAP-PDU shall be discarded by the CLNAP entity.

NOTE: When new elements are defined, other error condition will exist for this field.

E.2 Sending procedures

When it receives a CLNAP-UNITDATA.invoke (see subclause 6.4.2.1), the CLNAP entity shall generate a CLNAP-PDU according to subclause 6.3.

E.2.1 PDU checks

The following checks shall be performed before emitting the CLNAP-PDU across a CLAI:

- destination not available;
- SA screening (if the address screening supplementary service is subscribed);
- number of maximum concurrent PDUs according to the subscription of the user;
- PDU length class according to the subscription of the user.

When a CLNAP-PDU to be sent across a CLAI fails one of the above-mentioned checks, it is discarded. However, in the case of maximum concurrent PDUs, the sending procedures shall conform to ETS 300 217-2 [2], subclause 9.2.3 which may require buffering of a limit number of PDUs according to the subscription option of the user.

E.2.2 Egress error conditions

Invalid payload length class: if the payload field exceeds the payload class subscribed by the user, the CLNAP-PDU shall be discarded by the CLNAP entity.

Annex F (informative): Bibliography

- 1) TR-TSV-000772 (1991): "Generic System Requirements in Support of Switched Multi-Megabit Data Service".
- 2) TR-TSV-001060 (1991): "Switched Multi-megabit Data Service Generic Requirements for Exchange Access and Intercompany Serving Arrangement".
- 3) ETR 156: "Asynchronous Transfer Mode (ATM); Multiprotocol interconnect over ATM based subnetworks".
- 4) DTR/NA-021206: "Network Aspects (NA); Connectionless Broadband Data Service (CBDS); Addressing principles and related aspects for the CBDS".
- 5) ITU-T Recommendation I.361 (1993): "B-ISDN ATM Layer Specification".
- 6) ISO TR 9577: "Protocol identification in the network layer".

History

Document history			
April 1995	Public Enquiry	PE 82:	1995-04-10 to 1995-09-01
December 1997	Vote	V 9805:	1997-12-02 to 1998-01-30
February 1998	First Edition		