



**E**UROPEAN  
**T**ELECOMMUNICATION  
**S**TANDARD

**DRAFT**  
pr **ETS 300 452**

September 1994

---

Source: ETSI TC-BTC

Reference: DE/BTC-02033

ICS: 33.020, 33.040.40

**Key words:** ONP leased lines

**Business TelecommuniCations (BTC);  
Special quality voice bandwidth  
4-wire analogue leased line (A4S)  
Connection characteristics and network interface presentation**

**ETSI**

European Telecommunications Standards Institute

**ETSI Secretariat**

**Postal address:** F-06921 Sophia Antipolis CEDEX - FRANCE

**Office address:** 650 Route des Lucioles - Sophia Antipolis - Valbonne - FRANCE

**X.400:** c=fr, a=atlas, p=etsi, s=secretariat - **Internet:** secretariat@etsi.fr

Tel.: +33 92 94 42 00 - Fax: +33 93 65 47 16

---

**Copyright Notification:** No part may be reproduced except as authorized by written permission. The copyright and the foregoing restriction extend to reproduction in all media.

© European Telecommunications Standards Institute 1994. All rights reserved.



## Contents

Foreword .....	5
Introduction .....	5
1 Scope .....	7
2 Normative references .....	7
3 Definitions and abbreviations .....	8
3.1 Definitions .....	8
3.2 Abbreviations .....	8
4 Requirements and tests .....	9
4.1 Connection characteristics .....	9
4.1.1 Tabulation of connection characteristics .....	9
4.1.2 Overall loss .....	9
4.1.3 Loss/frequency distortion .....	10
4.1.4 Transmission signals .....	11
4.1.4.1 Maximum mean input power .....	11
4.1.4.2 Maximum instantaneous power .....	11
4.1.4.3 Maximum signal power at 10 Hz bandwidth .....	11
4.1.4.4 Maximum input power outside the voice band .....	11
4.1.5 Transmission delay .....	11
4.1.6 Group-delay distortion .....	12
4.1.7 Variation of overall loss with time .....	13
4.1.7.1 Amplitude hits .....	13
4.1.7.2 Other variations .....	13
4.1.8 Random circuit noise .....	13
4.1.9 Impulsive noise .....	14
4.1.10 Phase jitter .....	14
4.1.11 Distortion .....	14
4.1.11.1 Quantizing distortion .....	14
4.1.11.2 Total distortion .....	14
4.1.12 Single tone interference .....	14
4.1.13 Frequency error .....	14
4.1.14 Harmonic distortion .....	15
4.2 Interface presentation .....	15
4.2.1 Connector specification .....	15
4.2.2 Hardwired presentation .....	15
4.2.3 Return loss .....	16
4.2.4 Power feeding .....	16
4.3 Safety .....	16
4.4 Overvoltage protection .....	16
4.5 Electro-magnetic compatibility .....	17
Annex A (normative): Test methods .....	18
A.1 General .....	18
A.1.1 Equipment connection .....	18
A.1.2 Reference impedance .....	18
A.1.3 Measurement frequency .....	18
A.2 Test Methods .....	18
A.2.1 Tests of connection characteristics .....	18
A.2.1.1 Overall loss .....	18
A.2.1.2 Loss/frequency distortion and maximum mean input power .....	19

A.2.1.3	Transmission delay.....	20
A.2.1.4	Group delay distortion.....	20
A.2.1.5	Amplitude hits .....	21
A.2.1.6	Random circuit noise .....	22
A.2.1.7	Impulsive noise .....	22
A.2.1.8	Phase jitter.....	23
A.2.1.9	Total distortion .....	24
A.2.1.10	Single tone interference.....	24
A.2.1.11	Frequency error .....	25
A.2.1.12	Harmonic distortion.....	25
A.2.1.13	Maximum instantaneous power .....	26
A.2.2	Tests for interface presentation.....	27
A.2.2.1	Return loss.....	27
A.2.2.2	Power feeding.....	28
Annex B (informative):	Weighted return loss measurements.....	29
B.1	Introduction .....	29
B.2	Weighting function .....	29
B.2.1	Calculation (trapezoidal rule).....	29
B.2.2	Calculation (tabulated data) .....	30
Annex C (informative):	Bibliography .....	31
History .....		32

## Foreword

This draft European Telecommunication Standard (ETS) has been produced by the Business Telecommunications (BTC) Technical Committee of the European Telecommunications Standards Institute (ETSI), and is now submitted for the Public Enquiry phase of the ETSI standards approval procedure.

This ETS resulted from a mandate from the Commission of the European Community (CEC) to provide harmonized standards for support of the Directive on Open Network Provision (ONP) of leased lines (92/44/EEC).

There is another standard directly related to this ETS:

ETS 300 453: "Business Telecommunications (BTC); Ordinary and Special quality voice bandwidth 4-wire analogue leased lines (A4O and A4S); Terminal equipment interface".

This ETS is based on information from CCITT Recommendations and ETSI publications and the relevant documents are quoted where appropriate.

<b>Proposed transposition dates</b>	
Date of latest announcement of this ETS (doa):	3 months after ETSI publication
Date of latest publication of new National Standard or endorsement of this ETS (dop/e):	6 months after doa
Date of withdrawal of any conflicting National Standard (dow):	6 months after doa

## Introduction

The Council Directive on the application of Open Network Provision to leased lines (92/44/EEC), concerns the harmonization of conditions for open and efficient access to, and use of, the leased lines provided over public telecommunications networks and the availability throughout the Community (EEC) of a minimum set of leased lines with harmonized technical characteristics.

The consequence of the Directive is that Telecommunications Organizations within the EEC shall make available a set of leased lines within and between points in these countries with specified connection characteristics and specified interfaces. Under the Second Phase Directive (91/263/EEC) terminal equipment for connection to these leased lines will be required to fulfil certain essential requirements.

CCITT Recommendation M.1020 (1988) is used as the basis for the connection characteristics.

Blank page

## 1 Scope

This European Telecommunication Standard (ETS) specifies the technical requirements and test principles for the connection characteristics and the physical and electrical characteristics of the network interface presentation of special quality, voice bandwidth, 4-wire, analogue leased lines, provided as part of the minimum set under the Council Directive on the application of Open Network Provision (ONP) to leased lines (92/94/EEC).

A connection is presented via interfaces at Network Termination Points (NTP) and includes any equipment that may provide the NTP. Signals between terminal equipments are subject to impairments during their transfer over the connection. The limits to these impairments are stated in this ETS. This ETS describes the service offered.

The leased line provides access to the voice bandwidth (300 Hz to 3 400 Hz) with no restrictions on the use of the frequencies.

This ETS is applicable for leased lines, including part time leased lines, for which the establishment or release does not require any protocol exchange or other intervention at the NTP.

The tests specified in this ETS cannot be carried out, nor can performance be monitored by the leased line provider, while the leased line is in service, i.e. carrying user's traffic. Thus the tests are designed for bringing into and returning into service although there is no obligation to perform these tests each time the leased line is brought into or returned into service.

This ETS covers the physical, mechanical and electrical characteristics of the network interface and specifies the conformance tests for the connection characteristics and network interface. Some of the tests described in this ETS are not designed to be applied to the interface of an installed leased line; such tests may be applied to equipment of the kind used to provide the interface.

This ETS does not include details concerning the implementation of the tests nor does it include information on any regulations concerning testing.

## 2 Normative references

This ETS incorporates by dated and undated reference, provisions from other publications. These normative references are cited at the appropriate places in the text and the publications are listed hereafter. For dated references, subsequent amendments to or revisions of any of these publications apply to this ETS only when incorporated in it by amendment or revision. For undated references the latest edition of the publication referred to applies.

- [1] CCITT Recommendation O.41 (1988): "Psophometer for use on telephone-type circuits".
- [2] CCITT Recommendation O.71 (1988): "Impulsive noise measuring equipment for telephone-type circuits".
- [3] CCITT Recommendation O.81 (1988): "Group-delay measuring equipment for telephone-type circuits".
- [4] CCITT Recommendation O.91 (1988): "Phase jitter measuring equipment for telephone-type circuits".
- [5] CCITT Recommendation O.95 (1988): "Phase and amplitude hit counters for telephone-type circuits".
- [6] CCITT Recommendation O.132 (1988): "Quantizing distortion measuring equipment using a sinusoidal test signal".
- [7] EN 28877 (1989): "Information processing systems - Interface connector and contact assignments for ISDN basic access interface located at reference points S and T".

[8] EN 60950 (1992): "Safety of information technology equipment including electrical business equipment".

NOTE: This ETS also contains a number of informative references which have been included to indicate the sources from which material has been derived, hence they do not have an associated normative reference number. Details of these publications are given in Annex C. In some cases the same publication may have been referenced in both a normative and an informative manner.

### 3 Definitions and abbreviations

#### 3.1 Definitions

For the purposes of this ETS, the following definitions apply:

**Group delay:** a measure of the propagation time through the leased line. For a given frequency it is equal to the first derivative of the phase shift through the leased line, measured in radians, with respect to the angular frequency measured in radians per second.

**Group delay distortion:** the difference between group delay at a given frequency and minimum group delay, in the frequency band of interest.

**Leased lines:** the telecommunications facilities provided by a public telecommunication network that provide defined transmission characteristics between network termination points and that do not include switching functions that the user can control, (e.g. on-demand switching).

**Network Termination Point (NTP):** all physical connections and their technical access specifications which form part of the public telecommunications network and are necessary for access to and efficient communication through that public network.

**Reference impedance  $Z_R$ :** this is 600  $\Omega$ . See also Annex A, subclause A.1.2.

**Terminal Equipment (TE):** equipment intended to be connected to the public telecommunication network; i.e.:

- a) to be connected directly to the termination of a public telecommunication network; or
- b) to interwork with a public telecommunication network being connected directly or indirectly to the termination of a public telecommunication network,

in order to send, process, or receive information.

**Voice bandwidth:** the band of frequencies over which the communication of voice signals takes place. For the purpose of this ETS, this is defined to be the range 300 Hz to 3 400 Hz.

#### 3.2 Abbreviations

For the purposes of this ETS, the following abbreviations apply:

$a$	Return loss in dB
$a(f)$	Return loss at frequency $f$ in dB
$a_w$	Weighted return loss in dB
$A(f)$	Return loss at frequency $f$ expressed as a ratio
A4S	Special quality voice bandwidth 4-wire analogue leased line
ADPCM	Adaptive Differential Pulse Coded Modulation
EMC	Electro-Magnetic Compatibility
$f$	frequency
NTP	Network Termination Point
ONP	Open Network Provision
QDU	Quantizing Distortion Unit
rms	root mean square



RX	Receive is a signal input at either the leased line interface or the test equipment
TE	Terminal Equipment
TNV	Telecommunication Network Voltage (see EN 60950 [8], subclause 3.4.)
TX	Transmit is a signal output at either the leased line interface or the test equipment
$Z_R$	Reference impedance

## 4 Requirements and tests

### 4.1 Connection characteristics

The special quality voice bandwidth 4-wire analogue leased line is a bidirectional line, configured point-to-point, nominally covering the voice bandwidth. The connection is, in general, symmetrical, i.e. each direction of transmission has the same nominal characteristics, although the actual values are independent.

#### 4.1.1 Tabulation of connection characteristics

The parameters defining the characteristics of the connection are given in table 1. These characteristics define the service offered.

**Table 1: Network performance characteristics**

Description	Nature	Reference subclause
Overall loss	$0 \leq \text{Overall loss} \leq 13 \text{ dB}$	4.1.2
Loss/frequency distortion	Table 2, figure 1	4.1.3
Transmission signals		4.1.4
- maximum mean input power	-13 dBm	4.1.4.1
- maximum instantaneous power	0 dBm	4.1.4.2
- signal power in a 10 Hz bandwidth	no requirement	4.1.4.3
- maximum input power outside voice band	no requirement	4.1.4.4
Transmission delay		4.1.5
- terrestrial (for distance G in kilometres)	$< (15 + 0,01 G) \text{ ms}$	
- via satellite	$< 350 \text{ ms}$	
Group delay distortion	Table 3, figure 2	4.1.6
Variation of overall loss with time		4.1.7
- amplitude hits	$\leq 10$ in a 15 minute period	4.1.7.1
- other variations	$\pm 4 \text{ dB}$ of that at 1 020 Hz	4.1.7.2
Random circuit noise	$< -41 \text{ dBm0p}$ (see NOTE)	4.1.8
Impulsive noise	$\leq 18$ peaks $\geq -21 \text{ dBm0}$ in a 15 minute period (see NOTE)	4.1.9
Phase jitter	$\leq 10^\circ$ peak to peak	4.1.10
Total distortion		4.1.11
- quantizing distortion	$\leq 5 \text{ QDU}$ ; no ADPCM	4.1.11.1
- total distortion	$> 28 \text{ dB}$ signal to distortion ratio	4.1.11.2
Single tone interference	$\leq -44 \text{ dBm0}$ (see NOTE)	4.1.12
Frequency error	$\leq \pm 5 \text{ Hz}$	4.1.13
Harmonic distortion	$\geq 25 \text{ dB}$ below fundamental	4.1.14
NOTE:	Where the output relative level is not defined, an alternative value is specified in the reference subclause.	

#### 4.1.2 Overall loss

**Requirement:** The overall loss, including long term variations, presented to a signal frequency of 1 020 Hz sent at a power level of -13 dBm in each direction of transmission with the line terminated in 600  $\Omega$  at each end shall be in the range:

$$0 \leq \text{Overall loss} \leq 13 \text{ dB.}$$

NOTE: The overall loss in each direction can be different.

Test: The test shall be conducted according to Annex A, subclause A.2.1.1.

4.1.3 Loss/frequency distortion

Requirement: The overall loss relative to that defined in subclause 4.1.2 above for the connection, presented to a signal sent at a power level of -13 dBm with the line terminated in 600 Ω at each end shall lie between the limits given in table 2 and figure 1.

Below 300 Hz and above 3 600 Hz the loss shall not be less than 0 dB, but is otherwise unspecified.

Table 2: Limits for loss of the circuit relative to that at 1 020 Hz

Upper limit			Lower limit		
Point	Frequency Hz	Relative loss dB	Point	Frequency Hz	Relative loss dB
A	300	6	G	300	0
B	500	6	H	300	-2
C	500	3	I	500	-2
D	2 800	3	J	500	-1
E	2 800	6	K	2 800	-1
F	3 000	6	L	2 800	-2
			M	3 600	-2
			N	3 600	0

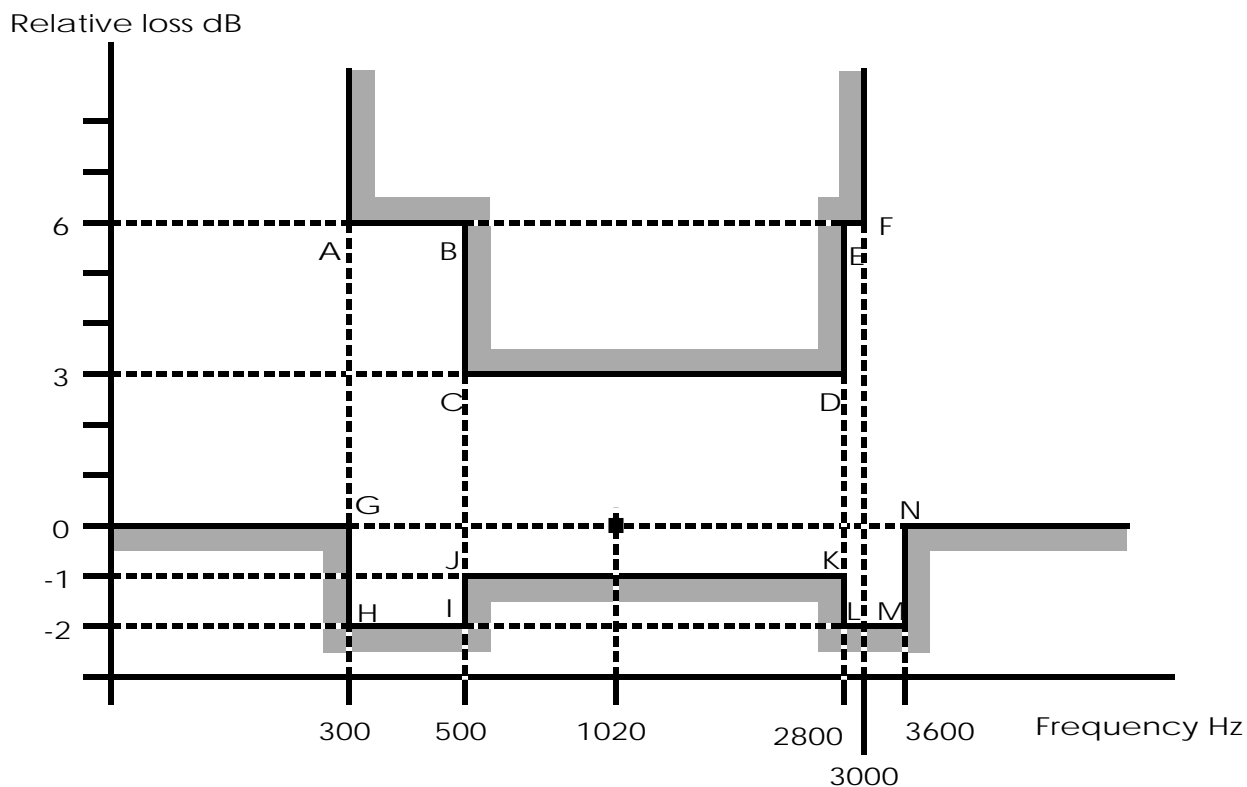

Figure 1: Limits for overall loss of the circuit relative to that at 1 020 Hz

NOTE: Figure 1 is based on figure 1/M.1020.

Test: The test shall be conducted according to Annex A, subclause A.2.1.2.

#### 4.1.4 Transmission signals

##### 4.1.4.1 Maximum mean input power

**Requirement:** The leased line shall be capable of carrying any signal presented at the input with a one minute mean power level of -13 dBm within a voice bandwidth of 300 Hz to 3 400 Hz with the line terminated in 600  $\Omega$  at each end.

**Test:** The test shall be conducted according to Annex A, subclause A.2.1.2.

##### 4.1.4.2 Maximum instantaneous power

**Requirement:** The leased line shall be capable of carrying a signal at the input having a maximum value equal to an instantaneous power which is 13 dB above the mean value of -13 dBm (i.e. 0 dBm).

NOTE: This value is based upon a provisional CCITT value. See CCITT Recommendation V.2.

**Test:** The test shall be conducted according to Annex A, subclause A.2.1.13.

##### 4.1.4.3 Maximum signal power at 10 Hz bandwidth

There is no requirement for maximum power in a 10 Hz bandwidth.

NOTE: However, there is a corresponding requirement on the terminal equipment specified in ETS 300 453.

##### 4.1.4.4 Maximum input power outside the voice band

NOTE: The leased line interface is not suitable for the handling of signals below 300 Hz and above 3 400 Hz. Out of band signals from the terminal equipment are limited to avoid trouble in the network (see terminal equipment interface requirement ETS 300 453).

#### 4.1.5 Transmission delay

**Requirement:** The requirement depends upon whether satellite transmission is involved in the connection or not:

- a) for connections where satellite transmission is not involved the one way end-to-end delay shall be less than  $(15 + 0,01 G)$  ms, where G is the geographical distance in kilometres, as shown in figure 2; or

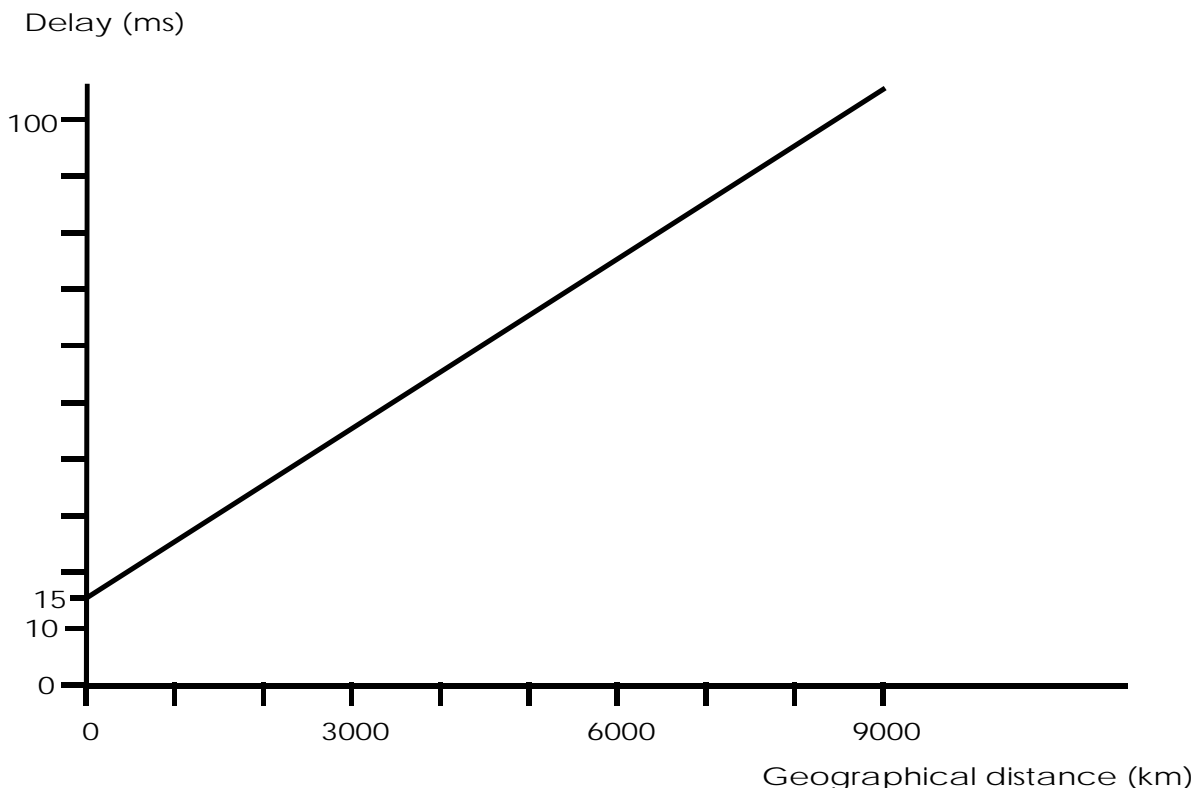

**Figure 2: Upper limit of delay**

- b) for connections where satellite transmission is involved the one way end-to-end delay shall be less than 350 ms.

NOTE: Requirements a) and b) are based on CCITT Recommendation G.114, §§ 2.2 and 2.3 with suitable adjustment to requirement a) to allow for the possible use of loaded cable.

**Test:** The test shall be conducted according to Annex A, subclause A.2.1.3.

**4.1.6 Group-delay distortion**

**Requirement:** The connection shall conform to the limits for group delay distortion given in table 3 and figure 3 in which the limiting values over the frequency band are expressed as values relative to the minimum measured group delay in the 500 Hz to 2 800 Hz frequency band.

NOTE: Figure 3 is based on figure 2/M.1020

**Table 3: Limits for group delay relative to the minimum measured group delay in the 500 Hz to 2 800 Hz band**

Upper limit		
Point	Frequency Hz	Group delay distortion ms
A	500	3,0
B	600	3,0
C	600	1,5
D	1 000	1,5
E	1 000	0,5
F	2 600	0,5
G	2 600	3,0
H	2 800	3,0

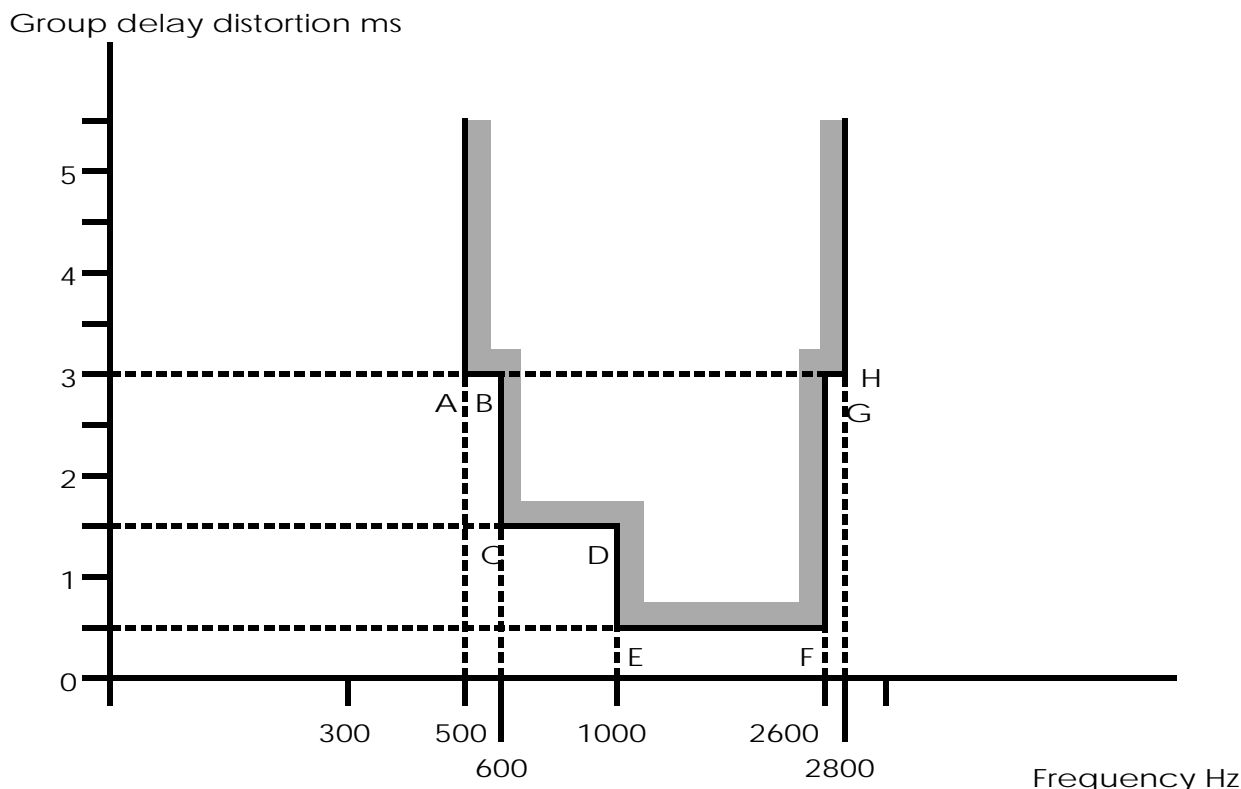

Figure 3: Limits for group delay relative to the minimum measured group delay in the 500 Hz to 2 800 Hz band

**Test:** The test shall be conducted according to Annex A, subclause A.2.1.4.

#### 4.1.7 Variation of overall loss with time

##### 4.1.7.1 Amplitude hits

**Requirement:** When measurements are made using an instrument complying with CCITT Recommendation O.95 [5] with the send level set at -13 dBm at a frequency of 1 020 Hz, the number of amplitude hits greater than  $\pm 2$  dB shall not exceed 10 in any 15 minute measuring period.

**NOTE:** Phase or amplitude hits are defined as sudden positive or negative changes in phase or amplitude of an observed test signal which exceed a specified threshold and persist for a period of time greater than a specified duration.

**Test:** The test shall be conducted according to Annex A, subclause A.2.1.5.

##### 4.1.7.2 Other variations

**Requirement:** For a particular implementation variations with time of the overall loss at 1 020 Hz (including daily and seasonal variations but excluding amplitude hits) shall not exceed  $\pm 4$  dB variation from the value established by the test for overall loss, see subclause 4.1.2. Any such variation shall not result in an overall loss greater than the maximum specified in subclause 4.1.2.

**Test:** There is no test for this but the record of the results of successive tests of overall loss may be used to check compliance. The test shall be conducted according to Annex A, subclause A.2.1.1.

#### 4.1.8 Random circuit noise

**Requirement:** The level of the psophometric noise power at the output of the leased line shall be less than -41 dBm<sub>0p</sub>. In order that this parameter can be tested, the leased line provider should declare the planned value of the output relative level of the leased line.

Where the output relative level either is not, or cannot be, declared by the leased line provider, the psophometrically weighted random circuit noise level shall be 28 dB below a received test signal which is sent at a level of -13 dBm at a frequency of 1 020 Hz into the far end of the leased line.

**Test:** The test shall be conducted according to Annex A, subclause A.2.1.6.

#### 4.1.9 Impulsive noise

**Requirement:** With an input signal level of -13 dBm applied at a frequency of 1 020 Hz to the input of the leased line, there shall not be more than 18 impulsive noise peaks exceeding a threshold level of -21 dBm<sub>0</sub> within a period of 15 minutes. In order that this parameter can be tested, the leased line provider should declare the planned value of the output relative level of the leased line.

Where the output relative level either is not, or cannot be, declared by the leased line provider, the threshold level shall be 8 dB below the received signal level. Thus, if a signal level of -13 dBm is applied at the input and the line loss is 13 dB then the received signal level will be -26 dBm and the threshold for impulsive noise peaks will be -34 dBm.

**Test:** The test shall be conducted according to Annex A, subclause A.2.1.7.

#### 4.1.10 Phase jitter

**Requirement:** The phase jitter shall be less than or equal to 10° peak-to-peak when measured at a frequency of 1 020 Hz.

**Test:** The test shall be conducted according to Annex A, subclause A.2.1.8.

#### 4.1.11 Distortion

##### 4.1.11.1 Quantizing distortion

**Requirement:** The quantizing distortion shall not exceed 5 QDU. ADPCM systems shall not be used.

**Test:** There is no test. This requirement shall be checked by calculation using information from the network plans.

##### 4.1.11.2 Total distortion

**Requirement:** With a power level of -13 dBm applied at a frequency of 1 020 Hz to the input of the leased line, the signal to total distortion ratio shall be greater than 28 dB.

**Test:** The test shall be conducted according to Annex A, subclause A.2.1.9.

#### 4.1.12 Single tone interference

**Requirement:** The power level of single tone interference in the band 300 Hz to 3 400 Hz shall not exceed -44 dBm<sub>0</sub>, that is 3 dB less than the permitted noise power level (see subclause 4.1.8). In order that this parameter can be tested, the leased line provider should declare the planned value of the output relative level of the leased line.

Where the output relative level either is not, or cannot be, declared by the leased line provider, the power level of any single tone shall be 31 dB below a received test signal which is sent at a level of -13 dBm at a frequency of 1 020 Hz into the far end of the leased line.

**Test:** The test shall be conducted according to Annex A, subclause A.2.1.10.

#### 4.1.13 Frequency error

**Requirement:** The frequency error introduced by the connection shall be less than or equal to ± 5 Hz when measured at a frequency of 1 020 Hz.

**Test:** The test shall be conducted according to Annex A, subclause A.2.1.11.

#### 4.1.14 Harmonic distortion

**Requirement:** When a 700 Hz test frequency of -13 dBm is injected at the input of the leased line, the level of any individual harmonic frequency at the output shall be at least 25 dB below the received level of the fundamental frequency.

**Test:** The test shall be conducted according to Annex A, subclause A.2.1.12.

#### 4.2 Interface presentation

The physical connection arrangements shall be by a socket; however at the request of the user, and with agreement of the leased line provider, an alternative means of connection may be provided, which shall consist of a hardwired connection using insulation displacement connectors.

##### 4.2.1 Connector specification

**Requirement:** Where a connector is specified as the means of termination of the leased line, the network interface shall provide an 8-contact socket of the type specified in EN 28877 [7] and with contact assignments as specified in table 4.

**Table 4: Contact assignment**

Contact	Network interface
1	Unused
2	Unused
3 & 6	Receive pair
4 & 5	Transmit pair
7	Unused
8	Unused

NOTE: The transmit pair is the output from the network interface. The receive pair is the input to the network interface as shown in figure 4. Where the terms "output" and "input" are used without qualification in this ETS, they refer to the network interface.

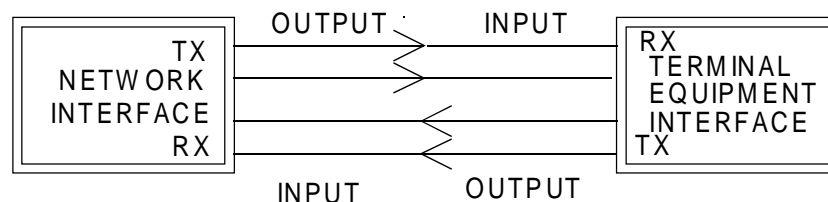

**Figure 4: Leased line configuration conventions**

**Test:** There shall be a visual inspection that the socket is of the correct type. The contact assignments are tested indirectly through the tests in Annex A.

##### 4.2.2 Hardwired presentation

**Requirement:** Where one or more leased lines are being terminated as hardwired connections, these connections shall be via an insulation displacement terminal block, suitable for terminating solid conductors having diameters in the range 0,4 to 0,6 mm, and provided by the leased line provider. The leased line provider shall provide information on the configuration of the insulation displacement terminals used for each leased line interface.

**Test:** There shall be a visual inspection that both an insulation displacement connector is provided suitable for taking solid conductors as defined in the requirement and that information on the configuration is provided.

NOTE: All subsequent tests are carried out via the appropriate connection method.

#### 4.2.3 Return loss

**Requirement:** The return loss presented by the network interface against the reference impedance, when the far end interface of the connection is terminated by the reference impedance, shall either be:

- a) greater than 6 dB over the frequency range 300 Hz to 3 400 Hz when measured with a voltage equivalent to a signal power level at the input to the leased line of -13 dBm at 1 020 Hz; or
- b) if the return loss is not greater than 6 dB at all frequencies, then the weighted return loss against the reference impedance, when the far end of the leased line connection is terminated with the reference impedance, shall be greater than 6 dB over the frequency range 300 Hz to 3 400 Hz, when measured with a voltage equivalent to a signal power at the input to the leased line of -13 dBm at 1 020 Hz.

The weighted return loss  $a_w$ , shall be given by:

$$a_w = 3,85 - 10 \log \left[ \int_{300}^{3400} \frac{A(f)}{f} df \right] \text{dB}$$

where  $A(f) = 10^{-a(f)/10}$

and  $a(f)$  is the measured return loss at frequency  $f$  expressed in dB.

**Test:** The test shall be conducted according to Annex A, subclause 2.2.1.

#### 4.2.4 Power feeding

**Requirement:** The network interface shall not be designed to support power feeding capabilities to or from the attached terminal equipment.

**Test:** The test for power output from the network interface shall be conducted according to Annex A, subclause A.2.2.2. The test for the requirement not to support power feeding from the terminal interface is tested indirectly through the various tests of Annex A since no power is supplied over the network interface from the test equipment.

#### 4.3 Safety

**Requirement:** The leased line interface presentation shall comply with the requirements for TNV circuits and protection against electric shock given in subclause 6.2 of EN 60950 [8].

**Test:** The test shall be conducted according to subclause 6.2 of EN 60950 [8].

NOTE: The tests associated with the requirements in this subclause are not suitable for use on installed leased lines. Such tests may be applied to equipment of the kind used to provide the interface.

#### 4.4 Overvoltage protection

**Requirement:** The leased line provider shall provide primary protection in accordance with the general practice adopted in the country in which the leased line is terminated.

NOTE: Secondary protection at the terminal equipment may be necessary to protect the terminal equipment from damage caused by overvoltages.

**Test:** The test provisions of the applicable national requirements shall apply.



#### 4.5 Electro-magnetic compatibility

There are no EMC requirements under this ETS.

NOTE: EMC requirements are imposed under the EMC Directive (89/336/EEC). Requirements for conducted emissions and immunity to continuous conducted signals may be added to this ETS when appropriate specifications become available if these requirements are not imposed under the EMC directive.

## Annex A (normative): Test methods

### A.1 General

This annex describes the test principles to be used to determine the compliance of a leased line connection and network interface presentation against the requirements of this ETS.

It is outside the scope of this annex to identify the specific details of the implementation of the tests.

Details of test equipment accuracy and the specification tolerance of the test devices are not included in all cases. Where such details are provided, they shall be complied with, but the way they are expressed shall not constrain the method of implementing the test.

NOTE: Attention is drawn to the issue of measurement uncertainty which may be addressed in future documents. Not all the required test results make allowance for spurious events during testing (e.g. errors due to EMC effects), which may make it necessary to repeat a test.

The test configurations given do not imply a specific realization of the test equipment or test arrangement, or the use of specific test devices. However any test configuration used shall provide those test conditions specified under "interface state", "stimulus" and "monitor" for each individual test.

The test equipment shall be a device, or group of devices, that is capable of generating a stimulus signal conforming to this ETS and capable of monitoring the receive signal from the interface.

#### A.1.1 Equipment connection

The leased line interface may be supplied with either a socket or an insulation displacement connector. Testing shall be performed at the socket or connector as this is the point at which compliance with this ETS is required.

#### A.1.2 Reference impedance

Where the test defines the use of the reference impedance then this shall be as follows:

**Reference impedance  $Z_R$ :** The characteristic test impedance for the line. This shall be a non-reactive resistance of  $600 \Omega \pm 0,25 \%$ .

#### A.1.3 Measurement frequency

Many of the requirements specify a test signal frequency of 1 020 Hz. Where this is the case, the specified reference frequency tolerance shall be -7 Hz to +2 Hz (range 1 013 Hz to 1 022 Hz).

### A.2 Test Methods

#### A.2.1 Tests of connection characteristics

##### A.2.1.1 Overall loss

Requirement: Subclauses 4.1.2 and 4.1.7.2.

Purpose: To determine the overall loss of the leased line.

Test configuration: A test sender is connected to one interface of the leased line. A level meter is connected to the far end interface of the leased line which is terminated in the reference impedance. See figure A.1.

The test is repeated in the other direction.

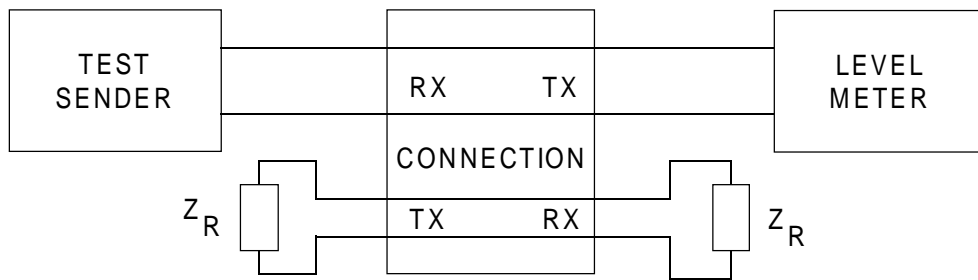

**Figure A.1: Overall loss**

Connection state: Available.

Stimulus: The test sender, with an impedance of  $600 \Omega$ , is set to send a signal frequency of 1 020 Hz into a load impedance consisting of the reference impedance at a power level of -13 dBm. The load impedance is then disconnected and the signal applied to one interface of the leased line.

Monitor: The power level is measured at the far end of the leased line with a terminating impedance of  $600 \Omega$ .

Result: The overall loss, which is the difference between -13 dBm and the measured output power, shall be as defined in subclause 4.1.2.

NOTE: For the purposes of checking the requirement of subclause 4.1.7.2 the test result may be recorded every time the test is performed during the lifetime of the leased line and the record checked for deviation from the limits set in subclause 4.1.7.2.

#### **A.2.1.2 Loss/frequency distortion and maximum mean input power**

Requirement: Subclauses 4.1.3 and 4.1.4.1.

Purpose: To check the loss/frequency distortion of the leased line over the bandwidth 300 Hz to 3 600 Hz. This test also serves to check the requirement for maximum mean input power handling capacity of the leased line interface over the bandwidth 300 Hz to 3 400 Hz.

Test configuration: A test sender, with an impedance of  $600 \Omega$ , is connected to one interface of the leased line. A level meter is connected to the far end interface of the leased line which is terminated in  $600 \Omega$ . See figure A.2.

The test is repeated in the other direction.

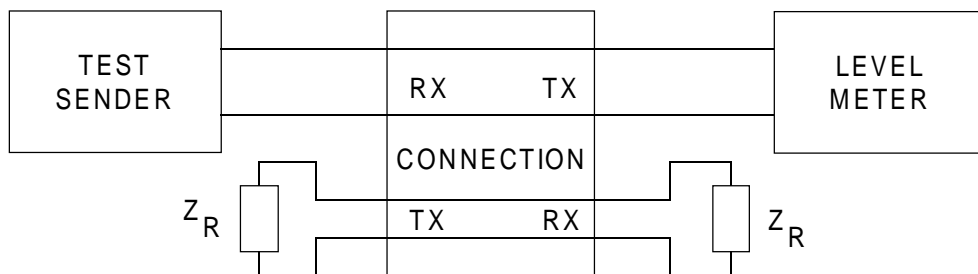

**Figure A.2: Loss/frequency distortion and maximum mean input power**

Connection state: Available.

Stimulus: The test sender, with an impedance of 600  $\Omega$ , is set to send a signal at a number of frequencies within the range 300 Hz to 3 600 Hz into a load impedance of 600  $\Omega$  at a power level of -13 dBm. At each frequency in turn the load impedance is disconnected and the signal applied to one interface of the leased line.

Monitor: The power level is measured at the far end of the leased line with a terminating impedance of 600  $\Omega$ .

Result: Relative to the received level measured in subclause A.2.1.1 the received levels at other frequencies shall be within the limits defined by table 2 and figure 1.

### A.2.1.3 Transmission delay

Requirement: Subclause 4.1.5.

Purpose: To check the transmission delay of the leased line.

NOTE: This test describes general principles only. Test equipment for the performance of the test may not be readily available and therefore special implementations may be needed.

Test configuration: See figure A.3.

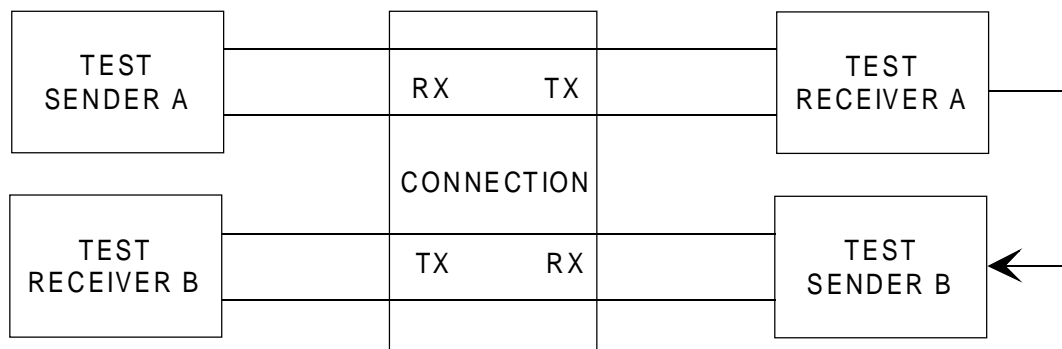

Figure A.3: Measurement of transmission delay

Connection state: Available.

Stimulus: Test sender A shall send a distinctive signal within the bandwidth of the leased line. Test sender B shall commence transmission of a distinctive signal at a known time after the receipt of the test signal from test sender A.

Monitor: The delay between test sender A commencing transmission of the signal and the receipt of the signal returned to test receiver B.

Result: The transmission delay of the leased line calculated from the measurements shall be less than the limits specified in subclause 4.1.5.

### A.2.1.4 Group delay distortion

Requirement: Subclause 4.1.6.

Purpose: To check the group delay distortion of the leased line.

Test configuration: A measuring set, to the specification of CCITT Recommendation O.81 [3], is connected with the transmitter at one end of the connection to be measured, which may include the return connection, and the receiver is connected to the other end of the connection. Figure A.4 illustrates the case where the test is performed on one direction of transmission.

The test is repeated in the other direction.

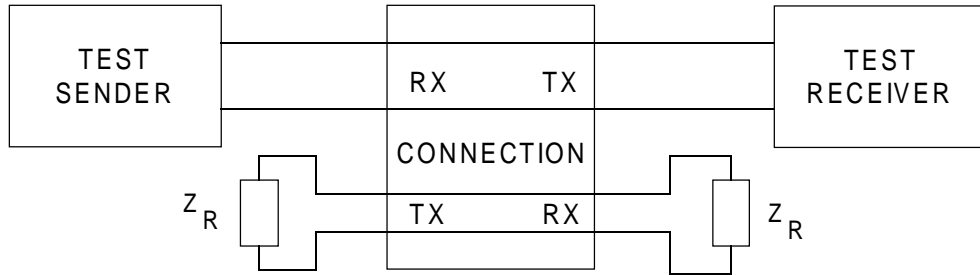

**Figure A.4: Group delay distortion**

- Connection state: Available.
- Stimulus: Modulated, identified, reference and measurement frequency signal, as described in CCITT Recommendation O.81 [3].
- Monitor: The group delay.
- Result: The group delay shall be within the range specified in subclause 4.1.6.

**A.2.1.5 Amplitude hits**

- Requirement: Subclause 4.1.7.1.
- Purpose: To check the leased line for amplitude hits.
- Test configuration: Performed using an instrument complying with CCITT Recommendation O.95 [5].

The transmitter (test sender) is connected to one interface of the circuit under test, which may include a return connection, and the receiver is connected to the other interface. See figure A.5.

The test is repeated in the other direction.

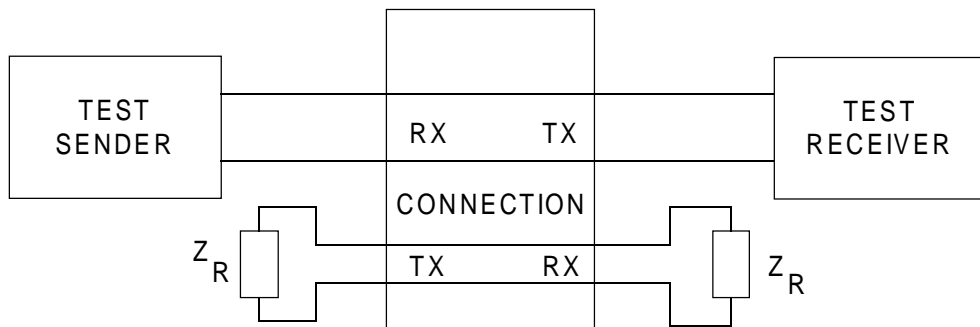

**Figure A.5: Variation of loss with time, amplitude hits**

- Connection state: Available.
- Stimulus: The transmitter, with an impedance of 600 Ω, is set to send at a power level of -13 dBm at a frequency of 1 020 Hz.
- Monitor: The number of amplitude hits greater than ± 2 dB with a duration of 4 ms or greater for a period of 15 minutes. Slow amplitude changes, as defined in CCITT Recommendation O.95, shall not be counted.

Result: The number of amplitude hits shall be within the limits specified in subclause 4.1.7.1.

#### A.2.1.6 Random circuit noise

Requirement: Subclause 4.1.8.

Purpose: To measure the random circuit noise of the leased line connection.

Test configuration: Performed using a psophometer complying with CCITT Recommendation O.41 [1].

With the far end interface of the leased line terminated with the reference impedance the psophometer is connected to the near interface. See figure A.6.

The test is repeated in the other direction.

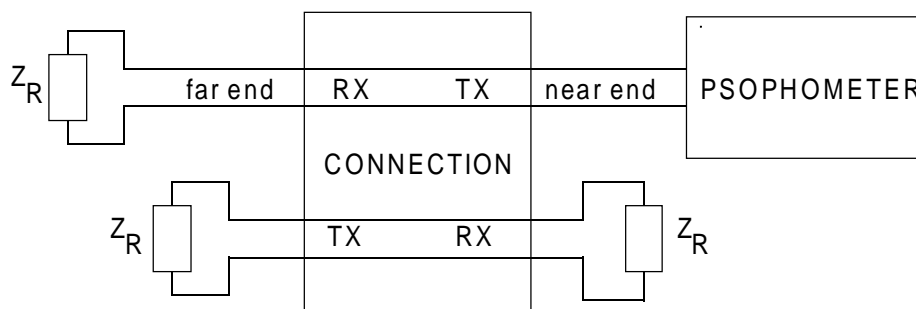

Figure A.6: Random circuit noise

Connection state: Available.

Stimulus: None.

Monitor: The psophometrically weighted noise signal across the  $600 \Omega$  termination at the near end interface of the leased line.

NOTE: The psophometer terminates the near end of the line with its own internal  $600 \Omega$  termination.

Result: The readings obtained shall be within the limits specified in subclause 4.1.8.

#### A.2.1.7 Impulsive noise

Requirement: Subclause 4.1.9.

Purpose: To check the impulsive noise performance of the leased line connection.

Test configuration: Performed using an instrument complying with CCITT Recommendation O.71 [2].

With the far end of the leased line connected to the impulsive noise measuring equipment and the threshold of the measuring equipment adjusted to  $-21 \text{ dBm}_0$  or, where the output relative level is not declared, 8 dB below the received signal level. The test sender is connected to the near end of the leased line. See figure A.7.

The test is repeated in the other direction.

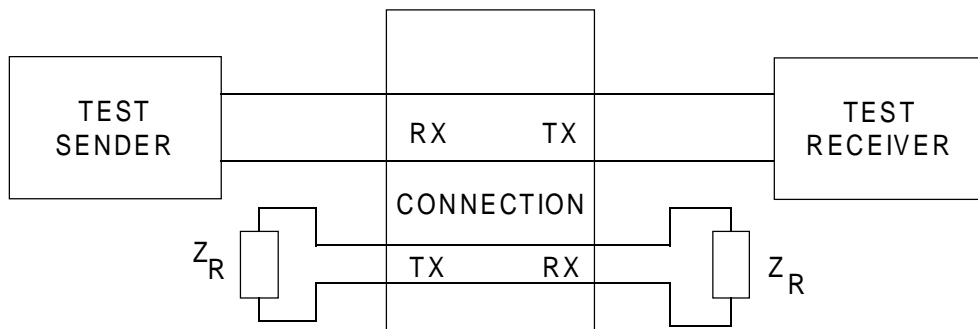

**Figure A.7: Impulsive noise**

- Connection state: Available.
- Stimulus: The test sender is set to send a signal at 1 020 Hz at a power level of -13 dBm.
- Monitor: The number of impulsive noise peaks exceeding the threshold in a 15 minute measurement period.
- Result: The number of impulsive noise peaks exceeding the threshold shall be less than the limit specified in subclause 4.1.9.

**A.2.1.8 Phase jitter**

- Requirement: Subclause 4.1.10.
- Purpose: To check the phase jitter performance of the leased line.
- Test configuration: Performed with an instrument complying with CCITT Recommendation O.91 [4].  
The phase jitter measuring equipment is connected to the leased line interfaces as shown in figure A.8.

The test is repeated in the other direction.

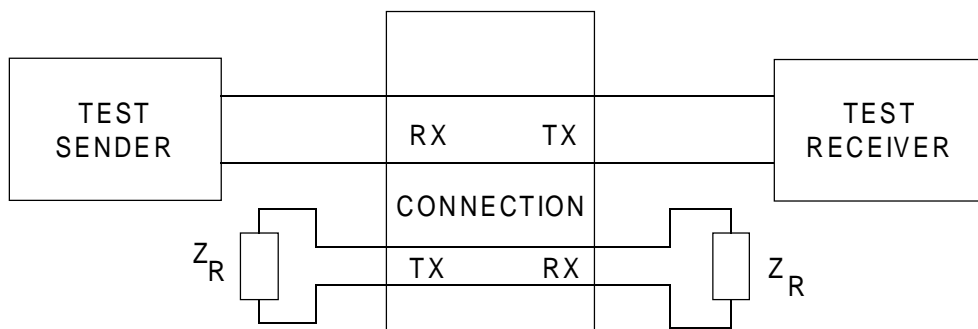

**Figure A.8: Phase jitter**

- Connection state: Available.
- Stimulus: A test signal as specified in CCITT Recommendation O.91 [4].
- Monitor: The jitter in degrees peak-to-peak.
- Result: The jitter shall not exceed the limit specified in subclause 4.1.10.

**A.2.1.9 Total distortion**

Requirement: Subclause 4.1.11.2.  
 Purpose: To check the total distortion of the leased line.  
 Test configuration: Performed using a distortion measuring equipment using a sinusoidal test signal complying with CCITT Recommendation O.132 [6]. See figure A.9.

The test is repeated in the other direction.

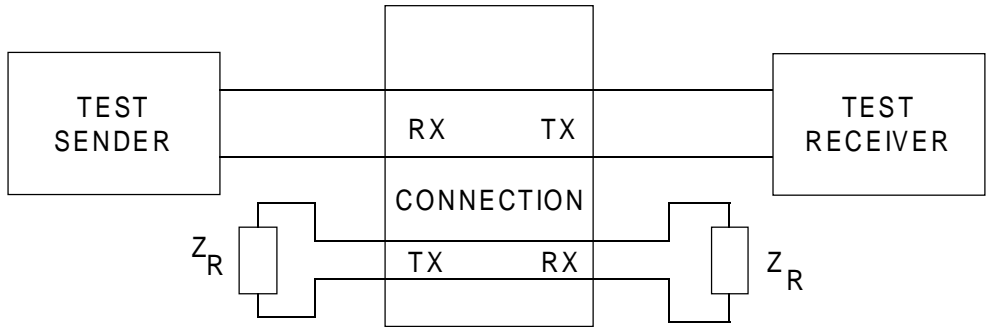

**Figure A.9: Total distortion**

Connection state: Available.  
 Stimulus: A test signal complying with CCITT Recommendation O.132 [6] is applied to one interface of the circuit under test at a level of -13 dBm and a frequency of 1 020 Hz.  
 Monitor: The signal to distortion ratio when measured with the 1 000 Hz to 1 020 Hz test signal reject filter.  
 Result: The measuring equipment receiver shall indicate a total distortion power level below the power level of the received signal as specified in subclause 4.1.11.2.

**A.2.1.10 Single tone interference**

Requirement: Subclause 4.1.12.  
 Purpose: To check the single tone interference performance of the leased line.  
 Test configuration: With the far end interface terminated in the reference impedance, a selective level meter with an input impedance of 600 Ω is connected to the near end interface. See figure A.10.

The test is repeated in the other direction.

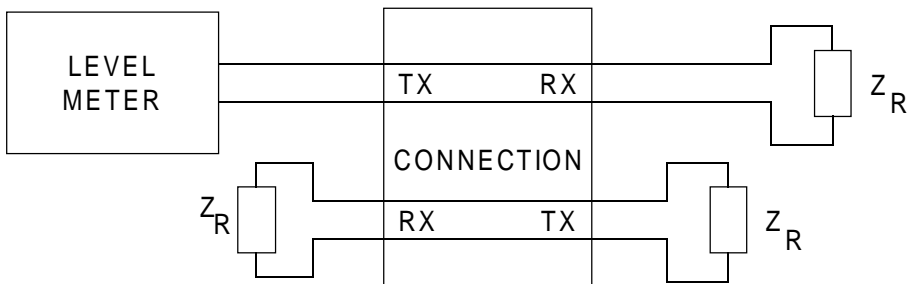

**Figure A.10: Single tone interference**

Connection state: Available.



Stimulus: None.

Monitor: The frequency band 300 Hz to 3 400 Hz is scanned with a bandwidth of 30 Hz upwards and downwards at a rate of 1 octave per minute.

Result: No single tone shall exceed the limits specified in subclause 4.1.12.

#### A.2.1.11 Frequency error

Requirement: Subclause 4.1.13.

Purpose: To check the frequency error performance of the leased line.

Test configuration: A test sender is connected to one interface of the leased line. A frequency counter is connected to the other interface of the leased line with the line terminated in  $600 \Omega$ . See figure A.11.

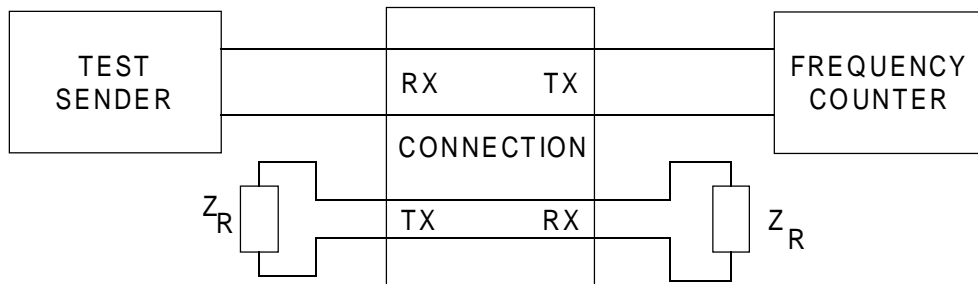

Figure A.11: Frequency error

Connection state: Available.

Stimulus: The test sender, with an impedance of  $600 \Omega$ , is set to send a signal at a frequency of 1 020 Hz into a load impedance of  $600 \Omega$ , at a level of -13 dBm. The load impedance is then disconnected and the signal applied to one interface of the leased line.

Monitor: The signal frequency at the output of the leased line.

Result: The difference between the measured signal frequency and the input frequency shall be within the limits of  $\pm 5$  Hz.

#### A.2.1.12 Harmonic distortion

Requirement: Subclause 4.1.14.

Purpose: To measure the harmonic distortion performance of the leased line. The test uses a test signal frequency of 700 Hz.

NOTE: The frequency of 700 Hz is chosen because it gives the fundamental and the first three harmonics conveniently spaced within the voice bandwidth.

Test configuration: A test sender is connected to one interface of the leased line. A selective level meter or suitable equivalent is connected to the other interface of the leased line. See figure A.12.

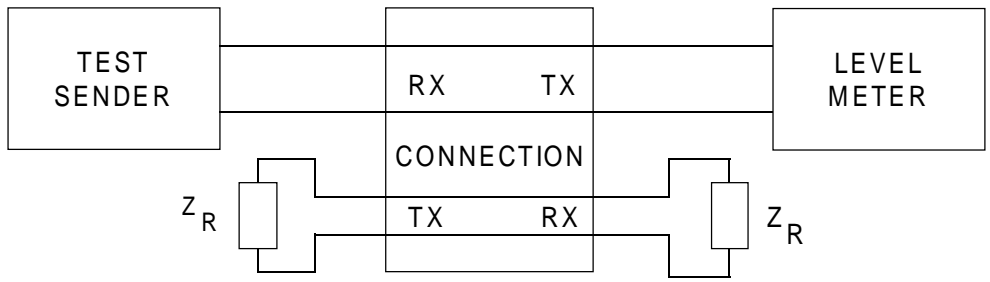

**Figure A.12: Harmonic distortion**

Connection state: Available.

Stimulus: The test sender, with an impedance of 600 Ω, is set to send a signal at a frequency of 700 Hz into an impedance of 600 Ω at a level of -13 dBm. The impedance is then disconnected and the signal applied to one interface of the line.

Monitor: The received power in 600 Ω measured by the level meter at the far end of the line at the fundamental frequency of 700 Hz and at the three harmonic frequencies of 1 400 Hz, 2 100 Hz and 2 800 Hz.

Result: The received power level of the harmonics of the test signal shall be at least 25 dB below the received level of the test signal.

**A.2.1.13 Maximum instantaneous power**

Requirement: Subclause 4.1.4.2.

Purpose: To verify that the leased line can carry a signal corresponding to the peak value of a +0 dBm signal at the input. A single cycle of a sine wave of 1 020 Hz, equivalent to 0 dBm, is transmitted into the leased line, there should be no clipping at the output. By requiring > 50 ms between cycles, the one minute mean signal level should not be exceeded.

Test configuration: See figure A.13.

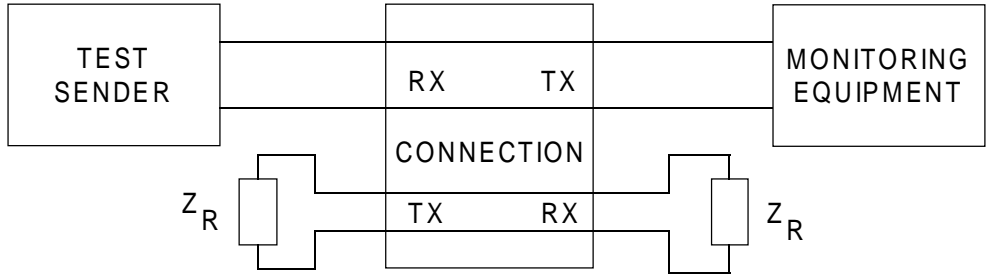

**Figure A.13: Maximum instantaneous power**

Connection state: Available.

Stimulus: To verify that the leased line can carry a signal corresponding to the peak value of a +0 dBm signal at the input. A single cycle of a sine wave of 1 020 Hz, equivalent to -1 dBm, is transmitted into the leased line, there should be no clipping at the output. By using a duty cycle of < 5 %, the one minute mean signal level should not be exceeded.

Monitor: The signal across a termination impedance of 600 Ω at the far end of the leased line.

Result: There shall be no clipping of the signal at the output of the leased line.

## A.2.2 Tests for interface presentation

### A.2.2.1 Return loss

Requirement: Subclause 4.2.3.

Purpose: To measure the return loss of both the input and output ports of the leased line with respect to the reference impedance  $Z_R$ .

Test configuration: The leased line interface is connected as shown in figure A.14.

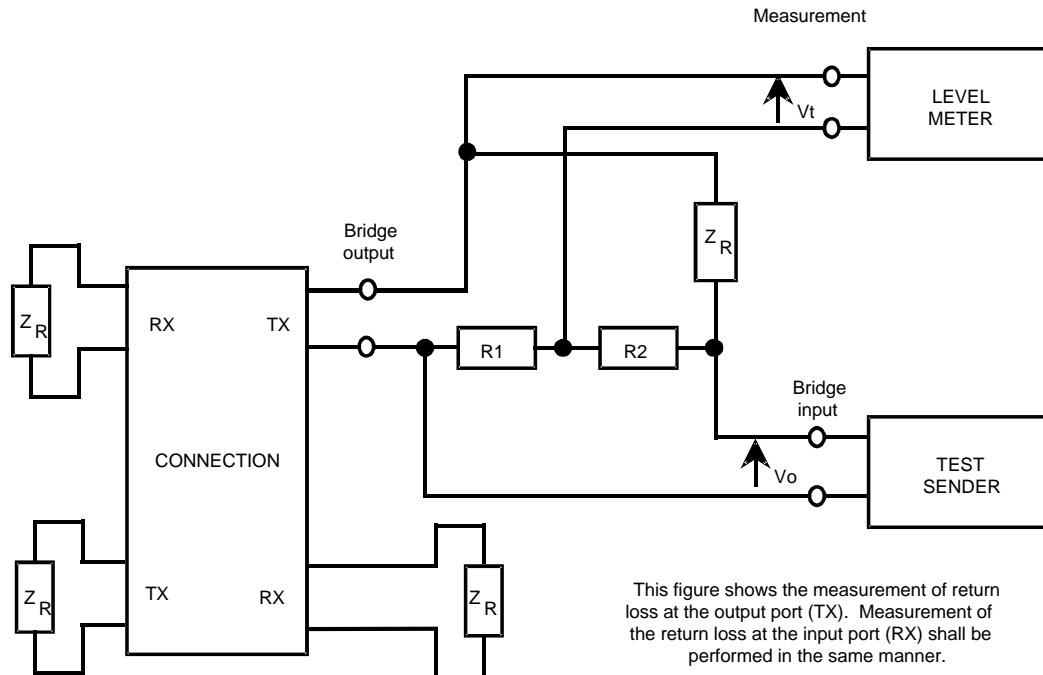

$R1 = R2$ ; between  $100 \Omega$  and  $800 \Omega$ , preferably  $600 \Omega$ , matched to better than 0,2 %  
 Test sender output impedance  $< 10 \Omega$   
 Level meter input impedance  $> 1 \text{ M}\Omega$

**Figure A.14: Return loss**

Connection state: Available.

Stimulus: A sinusoidal signal with a constant voltage is applied to the input of the bridge at various frequencies between 300 Hz and 3 400 Hz. The constant voltage is that required to give a power level of -13 dBm at 1 020 Hz into a reference impedance connected to the output of the bridge. Each measurement frequency shall be spaced by not more than one third of an octave from the next frequency of measurement.

Monitor: The level of voltages  $V_o$  and  $V_t$  with, in turn, both the leased line input and output connected to the output of the bridge, as shown in figure A.14.

Result: For both the input and output ports of the leased line, either the return loss  $a(f)$  or the weighted return loss  $a_w$  shall meet the requirement of subclause 4.2.3 across the frequency range; where:

$$a(f) = 20 \log \left| \frac{V_o}{2V_t} \right| \text{ is the measured return loss at frequency } f,$$

$$\alpha_w = 3,85 - 10 \log \left[ \int_{300}^{3400} \frac{A(f)}{f} df \right] \text{dB, and}$$

$$A(f) = 10^{-a(f)/10}$$

where  $V_o$  is the test signal level

and  $V_t$  is the level measured across the bridge.

Information on the application of the weighting function is given in Annex B.

### A.2.2.2 Power feeding

Requirement: Subclause 4.2.4.

Purpose: To verify that the leased line is not designed for power feeding by measuring the output current from the leased line into an impedance of 300 Ω.

Test configuration: See figure A.15. The termination at the far end of the leased line is undefined.

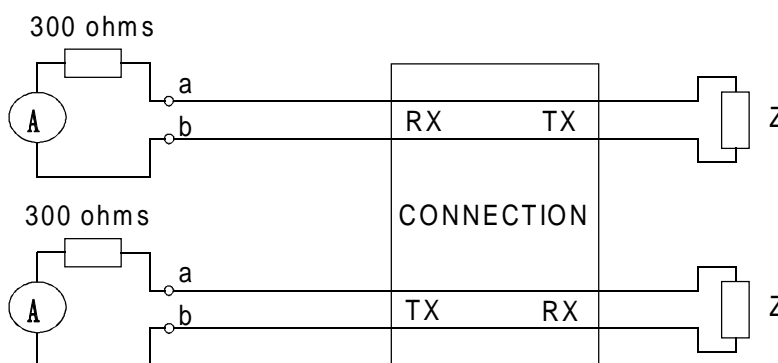

Figure A.15: Power feeding

Connection state: Available.

Stimulus: None.

Monitor: The current through each resistance of 300 Ω.

Result: The current through each resistance shall be less than 1 mA.

## Annex B (informative): Weighted return loss measurements

### B.1 Introduction

The use of a weighted return loss measurement is allowed within this ETS because a fixed return loss is difficult to meet in some situations. Such situations include long local ends to leased lines and short local ends to leased lines in tandem with loaded cable. The definition of a complex reference impedance solves the problem for long local ends but in the case of lines containing loaded cable the situation is worse. The problem results from the behaviour of the impedance of loaded cable near to the cut-off frequency and it is for this reason that the weighting function has been introduced into the requirement to give more weight to the lower frequencies.

### B.2 Weighting function

Limitations are placed on the impedance of the leased line interface in order to control trans-hybrid loss in the terminal equipment. A weighting function which relates to trans-hybrid loss and which is relatively convenient to use is provided for the determination of echo loss in CCITT Recommendation G.122; this weighting function can also be used for the determination of the weighted return loss.

The weighted return loss  $a_w$  is derived from the integral of the power transfer characteristic,  $A(f)$ , weighted by a negative slope of 3 dB per octave, starting at 300 Hz and extending to 3 400 Hz as follows:

$$a_w = 3,85 - 10 \log \left[ \int_{300}^{3400} \frac{A(f)}{f} df \right] \text{dB} \quad (1)$$

where

$$A(f) = 10^{-a(f)/10}$$

and

$a(f)$  is the measured return loss at frequency  $f$  expressed in dB.

#### B.2.1 Calculation (trapezoidal rule)

In order to calculate the weighted return loss, the weighting function can be approximated by choosing measurement frequencies that are equidistant on a log-frequency scale and using the trapezoidal rule, as described in Annex B of CCITT Recommendation G.122. Thus if equidistant measurement frequencies are chosen on a log-frequency scale and the measurement frequencies are spaced by no more than one third of an octave, then the weighted return loss  $a_w$  can be represented by:

$$a_w = -10 \log \left[ \frac{1}{N} \left( \frac{A_0}{2} + A_1 + A_2 + A_3 + \dots + A_{N-1} + \frac{A_N}{2} \right) \right] \quad (2)$$

where

$N+1$  is the number of measurement frequencies

$$A_n = 10^{-a(f_n)/10}, \text{ for } n \text{ from } 0 \text{ to } N$$

and

$a(f_n)$  is the measured return loss at frequency  $f_n$  expressed in dB.

**B.2.2 Calculation (tabulated data)**

Where the loss/frequency data are only available at N+1 discrete frequencies, which are non-uniformly spaced on a log-frequency scale, an approximation to the formula for weighted return loss  $a_w$  can be given by:

$$a_w = 3,24 - 10\log \sum_{n=1}^N (A_n + A_{n-1})(\log f_n - \log f_{n-1}) \quad (3)$$

where N+1 is the number of measurement frequencies

$$A_n = 10^{-a(f_n)/10}, \text{ for } n \text{ from } 0 \text{ to } N$$

and  $a(f_n)$  is the measured return loss at frequency  $f_n$  expressed in dB.

NOTE 1: The approximation involved is to assume that within the sub-band  $f_{n-1}$  to  $f_n$ , the power ratio is constant and has the value  $A(f) = (A_n + A_{n-1}) / 2$ .

NOTE 2: The constant 3,24 in the approximate formula arises from a combination of the constant 3,85 in the definition and other constants produced by the approximation.

The sum of product terms may be conveniently calculated as illustrated by the following example.

EXAMPLE: Weighted return loss = 3,24 - 10log(0,5050) = 6,21 dB

**Table B.1: Example of calculation of weighted return loss**

n	f (Hz)	log f <sub>n</sub>	log f <sub>n</sub> - log f <sub>n-1</sub>	measured return loss	A <sub>n</sub>	A <sub>n</sub> + A <sub>n-1</sub>	(3) x (6)
	(1)	(2)	(3)	(4)	(5)	(6)	(7)
0	300	2,477		5,00	0,316		
1	500	2,699	0,222	6,00	0,251	0,567	0,1259
2	800	2,903	0,204	8,00	0,158	0,410	0,0836
3	1 000	3,000	0,097	7,00	0,200	0,358	0,0347
4	1 500	3,176	0,176	6,00	0,251	0,451	0,0794
5	2 000	3,301	0,125	6,00	0,251	0,502	0,0628
6	2 500	3,398	0,097	6,00	0,251	0,502	0,0487
7	3 000	3,477	0,079	5,80	0,263	0,514	0,0407
8	3 400	3,531	0,054	5,60	0,275	0,538	0,0293
						Total	0,5050

## Annex C (informative): Bibliography

- 1) 89/336/EEC: "Council Directive of 3 May 1989 on the approximation of the laws of Member States relating to electromagnetic compatibility".
- 2) 91/263/EEC: "Council Directive of 29 April 1991 on the approximation of the laws of Member States concerning telecommunications terminal equipment, including the mutual recognition of their conformity".
- 3) 92/44/EEC: "Council Directive of 5 June 1992 on the application of Open Network Provision to leased lines".
- 4) CCITT Recommendation G.114 (1988): "Mean one-way propagation time".
- 5) CCITT Recommendation G.122 (1988): "Influence of national systems on stability, talker echo, and listener echo in international connections".
- 6) CCITT Recommendation M.1020 (1988): "Characteristics of Special Quality International Leased Circuits with Special Bandwidth Conditioning".
- 7) CCITT Recommendation V.2 (1988): "Power levels for data transmission over telephone lines".
- 8) prETS 300 453: "Business TeleCommunications (BTC); Ordinary and Special quality voice bandwidth 4-wire leased lines (A4O and A4S); Terminal equipment interface".

## History

<b>Document history</b>	
September 1994	Public Enquiry PE 70: 1994-09-05 to 1994-12-30
October 1995	Converted into Adobe Acrobat Portable Document Format (PDF)